

"I am extraordinarily impressed. To my knowledge, you are the first expert in Germany who has addressed this particular topic in a scholarly impeccable and well-founded way. It is not for me to attribute an ice-breaker function to your expert report. It is easy to see which political-historical effects will originate from it, though its entire dimension cannot yet be estimated."

Prof. Dr. Hellmut Diwald, Historian, January 22, 1992

"I read it with great interest. [...] My impression is, however, that this expert report is an important contribution to a very important question which, since the 'Leuchter Report,' needs to be answered urgently. [...] One can only very much hope that the well-known tactics of hushing up is not applied to your expert report, but that critical responses and comments will be made."

Prof. Dr. Ernst Nolte, Historian, January 28, 1992

"For me, the significance of receiving your report rests on the fact that it substantially contributes to our stock of knowledge. With many of my colleagues active in the field of contemporary history, I am overjoyed and thankful for you having initiated this research activity. Of course, I am even more delighted regarding the results of your accurate scientific investigation."

Prof. Dr. Werner Georg Haverbeck, Historian, January 31, 1992

"I calmly read your report! It gives me hope to realize that a representative of the younger generation courageously sets out, with scientific thoroughness, noticeable great expertise, and corresponding investigative curiosity, to get to the bottom of a controversial question that is of worldwide significance! The result is clear and unequivocal! True facts cannot be suppressed forever! I wish that your work will make the breakthrough!"

Prof. Emil Schlee, Historian, April 1, 1992

"[...] I sincerely hope that all statements about this topic would obviously be based on long and intensive work such as yours. Most of it is certainly unverifiable for the layman, but the photographs are already quite informative. [...]"

Prof. Dr. Ernst Nolte, Historian, January 6, 1993

"Rudolf is a young scientist who tried to prove in an excellently layed-out work with tables, graphics, and so on, that the gas chambers were technically impossible. [...] These scientific analyses are perfect."

Hans Westra, Anne-Frank-Foundation, BRT 1 TV (Belgium), Panorama, April 27, 1995

"All in all, he relies on literature which was written long before this report was completed, and the report must be described as scientifically acceptable."

Prof. Dr. Henri Ramuz, Chemist, interrogated as expert witness about the Rudolf Report by the Swiss Court at Châtel-St.-Denis, May 18, 1997

Germar Rudolf • The Rudolf Report



Germar Rudolf

The Rudolf Report

Expert Report on Chemical and Technical Aspects
of the 'Gas Chambers' of Auschwitz



HOLOCAUST Handbooks Series
Volume Two
Theses & Dissertations Press
PO Box 257768
Chicago, IL 60625, USA



Color Image 1: Inside of the ruins of morgue 1 ('gas chamber') of crematorium II. The arrow points to the photograph taking location (see chapter 8.3.3.). Note: Not the slightest trace of blue discoloration can be found on the walls.

Color pictures 1-4: © Karl Philipp



Color Image 2: Exterior southwest wall of the Zyklon B disinfestation wing of BW 5b in the Auschwitz-Birkenau camp: a deep blue discoloration, caused by cyanide compounds which penetrated the entire wall over the decades since WWII and formed the blue pigment with iron compounds contained in cement and bricks. This pigment is unaffected by 55 years of weathering.



Color Image 3: Northwest room of the Zyklon B disinfestation wing of BW 5a in the Auschwitz-Birkenau camp. The external walls (background and to the right) show an intensive blue discoloration caused by the application of Zyklon B (HCN). The internal wall to the left was added later and is therefore free of cyanide residues. **Color Image 4 (inset):** Exterior of a wall of the same part of BW 5a. Cyanide penetrated the wall and caused blue stains.



Color Image 5: Blue discoloration of the exterior wall of disinfestation installation barrack 41 in Majdanek camp (Bad und Desinfektion I), caused by the application of Zyklon B. © C. Mattogno



Color Image 6: Blue discoloration of the ceiling of the large Zyklon B disinfestation chamber, barrack 41 in Majdanek camp (Bad und Desinfektion I), caused by the application of Zyklon B. © C. Mattogno



Color Image 7: Blue discoloration of the interior of the walls of chamber III, disinfestation installation barrack 41 (Bad und Desinfektion I) in Majdanek camp, caused by the application of Zyklon B. **Color Image 8** (inset): East wall of this chamber. © C. Mattogno



Color Image 9: Blue discoloration of the interior walls of the Zyklon B disinfestation installation in the Stutthof camp. © C. Mattogno



Color Image 10 (left): Blue discoloration of the east exterior wall of the Zyklon B disinfestation installation in the Stutthof camp. **Color Image 11 (right):** section enlargement. © C. Mattogno

THE RUDOLF REPORT

Expert Report on Chemical and Technical Aspects
of the 'Gas Chambers' of Auschwitz

**Dedicated to the unknown thousands of Germans
now suffering political persecution in their own country**

All readers are reminded that all income from sales of this book and similar publications is intended for revisionists, who are, for the most part, subject to governmental terror and have frequently been financially ruined as a result of that terror. Persons wishing to support revisionism are kindly requested to refrain from illegal copying, and to buy and distribute the book in the proper manner.

The Publishers

Germar Rudolf
Certified Chemist

**THE
RUDOLF
REPORT**

Expert Report on
Chemical and
Technical Aspects
of the 'Gas Chambers'
of Auschwitz

HOLOCAUST Handbooks Series, vol. 2:

Germar Rudolf:

The Rudolf Report.

*Expert Report on Chemical and Technical Aspects
of the 'Gas Chambers' of Auschwitz.*

Translated by Carlos Porter, Michael Humphrey,
James Damon, and the author.

Theses & Dissertations Press, Imprint of Castle Hill Publishers,
Chicago (Illinois), March 2003.

Paperback: ISBN 0-9679856-5-X

Hardcover: ISBN 0-9679856-6-8

ISSN 1529-7748

First German edition:

Rüdiger Kammerer, Armin Solms (ed.):

Das Rudolf Gutachten.

*Gutachten über die Bildung und Nachweisbarkeit von
Cyanidverbindungen in den "Gaskammern" von Auschwitz.*

Cromwell Press, London, July 1993 (ISBN 1-898419-00-0)

Second German edition:

Germar Rudolf:

Das Rudolf Gutachten.

Gutachten über die "Gaskammern" von Auschwitz

Castle Hill Publishers, Hastings, April 2001 (ISBN 1-902619-03-X)

Distribution Australia/Asia: Peace Books, PO Box 3300,
Norwood, 5067, Australia

Distribution Rest of World: Castle Hill Publishers
UK: PO Box 118, Hastings TN34 3ZQ
USA: PO Box 257768, Chicago, IL 60625

Set in Times New Roman

Table of Contents

	Page
1. Prelude.....	11
1.1. Slow Death in U.S. Gas Chambers	11
1.2. Hydrogen Cyanide—a Dangerous Poison.....	15
1.3. The Acid that Causes Blue Stains	20
2. The Coup.....	23
2.1. Fred Leuchter on Auschwitz and Majdanek.....	23
2.2. Damage Control	26
3. The Origins	29
3.1. On the Problem	32
3.2. On Politics.....	36
4. A Brief History of Forensic Examinations of Auschwitz.....	39
4.1. Introduction	39
4.2. The Moral Obligation of Forensic Examination	39
4.3. A Definition of Forensic Science	41
4.4. Forensic Science and Auschwitz.....	42
4.4.1. Forensics in the Courts.....	42
4.4.1.1. The 1946 Cracow Auschwitz Trial.....	42
4.4.1.2. The 1964-1966 Frankfurt Auschwitz Trial	44
4.4.1.3. The 1972 Vienna Auschwitz Trial.....	45
4.4.2. Forensics Outside the Courts.....	46
4.4.2.1. In Search of Mass Graves	46
4.4.2.2. Faurisson and the Consequences	46
5. Auschwitz.....	49
5.1. Introduction	49
5.1.1. <i>“Opera During the Holocaust”</i>	49
5.1.2. On the History of the Camp	51
5.2. Epidemics and the Defense Against them.....	59
5.2.1. Danger of Epidemics.....	59
5.2.2. Epidemic Control with Zyklon B	60
5.2.3. Epidemic Control in Auschwitz	65

5.2.3.1. Terminology Used and Responsibilities	65
5.2.3.2. Procedures Used	67
5.2.3.3. Results	68
5.2.3.4. Basic Policy Decisions	69
5.2.3.5. The Army Medical Officer	70
5.2.3.6. Short-Wave Delousing Facility	73
5.2.4. Disinfestation Installations BW 5a und 5b	73
5.3. ‘Gas Chamber’ in the Auschwitz I Main Camp	78
5.4. ‘Gas Chambers’ in Birkenau Camp	88
5.4.1. Crematoria II and III	88
5.4.1.1. Starting Situation	88
5.4.1.2. The Obsessive Search for “ <i>Criminal Traces</i> ”	94
5.4.1.2.1. New Cellars Stairways	95
5.4.1.2.2. Gassing Cellar, Undressing Room, and Showers	96
5.4.1.2.3. “ <i>Gas-tight Doors</i> ” for Crematorium II	103
5.4.1.2.4. Ventilation Installations	107
5.4.1.2.5. Pre-heated Morgues	108
5.4.1.2.6. “ <i>Cremation with Simultaneous Special Treatment</i> ”	109
5.4.1.2.7. “ <i>Gas Testers</i> ” and “ <i>Indicator Devices for HCN Residues</i> ”	111
5.4.1.2.8. Zyklon B Introduction Holes and Columns	113
5.4.1.2.9. Conclusions	133
5.4.2. Crematoria IV and V	135
5.4.3. Farmhouses 1 and 2	139
5.4.4. The Drainage System in Birkenau	141
5.4.4.1. Background: Eyewitness Accounts	141
5.4.4.2. The Ground Water Table in Birkenau	141
5.4.4.3. Open-Air Incineration in Pits	143
5.5. Construction Conclusions	145
6. Formation and Stability of Iron Blue	151
6.1. Introduction	151
6.2. Instances of Damages to Buildings	152
6.3. Properties of Hydrogen Cyanide, HCN	155
6.4. Composition of Iron Blue	158
6.4.1. Overview	158
6.4.2. Excursus	158
6.5. Formation of Iron Blue	159

6.5.1. Overview	159
6.5.2. Water Content	161
6.5.2.1. Overview	161
6.5.2.2. Excursus.....	161
6.5.3. Reactivity of Trivalent Iron.....	163
6.5.3.1. Overview	163
6.5.3.2. Excursus.....	163
6.5.4. Temperature	164
6.5.4.1. Overview	164
6.5.4.2. Excursus.....	167
6.5.5. pH Value	168
6.6. Stability of Iron Blue.....	170
6.6.1. pH Sensitivity.....	170
6.6.2. Solubility.....	171
6.6.2.1. Overview	171
6.6.2.2. Excursus.....	172
6.6.3. Excursus: Competing Ligands	175
6.6.4. Effects of Light	176
6.6.4.1. Overview	176
6.6.4.2. Excursus.....	176
6.6.5. Long-Term Test	177
6.7. Influence of Various Building Materials.....	180
6.7.1. Brick.....	180
6.7.1.1. Overview	180
6.7.1.2. Excursus.....	181
6.7.2. Cement Mortar and Concrete	181
6.7.2.1. Overview	181
6.7.2.2. Excursus.....	182
6.7.3. Lime Mortar	185
6.7.4. Effects upon the Formation of Iron Blue.....	185
7. Zyklon B for the Killing of Human Beings	191
7.1. Toxicological Effect of HCN	191
7.2. Evaporation Characteristics of Zyklon B.....	194
7.3. The Gassing of Human Beings.....	196
7.3.1. Eyewitness Testimonies	196
7.3.1.1. Boundary Conditions.....	196

7.3.1.2. Eyewitness Fantasies	199
7.3.1.3. Quantities of Poison Gas	208
7.3.1.3.1. Overview	208
7.3.1.3.2. Excursus 1: Poisoning or Suffocation?	211
7.3.1.3.3. Excursus 2: HCN Loss due to Adsorption	216
7.3.2. Critique of the Eyewitness Descriptions	218
7.3.2.1. Theatre of the Absurd	218
7.3.2.1.1. Necessity of Co-Operation	218
7.3.2.1.2. Failure to Separate the Sexes	219
7.3.2.1.3. Towel and Soap	220
7.3.2.2. Speed of Ventilation of the ‘Gas Chambers’	220
7.3.2.2.1. Introduction	220
7.3.2.2.2. Excursus	220
7.3.2.2.3. Ventilation of the Morgues of Crematorium II & III	223
7.3.2.3. Simulation Calculations	227
7.3.2.4. Excursus: Capacity of Protective Filters	230
7.3.3. Evaluation of Eyewitnesses	233
7.3.4. An Expert on Cyanide Speaks Out	238
7.3.5. Why Precisely Zyklon B?	241
8. Evaluation of Chemical Analyses	245
8.1. Test Sample Taking and Description	245
8.2. Analytical Methods	246
8.3. Evaluation of Analytical Results	247
8.3.1. F.A. Leuchter/Alpha Analytic Laboratories	247
8.3.2. Institute for Forensic Research, Cracow	250
8.3.3. G. Rudolf/Fresenius Institute	252
8.3.3.1. Samples 1-4: Crematorium II, Morgue 1	253
8.3.3.2. Samples 5 to 8 and 23, 24: Inmate Barracks	258
8.3.3.3. Samples 9 to 22: Disinfestation Building	258
8.3.3.4. Samples 25-30: Tests	265
8.3.4. John C. Ball	268
8.4. Discussion of the Analysis Results	269
8.4.1. Blue Wall Paint?	269
8.4.2. False Method of Analysis	270
8.4.3. The Memory Hole	273
8.4.4. The Moon is Made of Pizza	276
8.4.5. Anticipated Values	279

8.4.6. Limits of the Chemical Method.....	283
9. Conclusions	287
10. Acknowledgements.....	293
11. Hunting Germar Rudolf	297
11.1. What Makes Revisionists?	297
11.2. The Naiveté of a Young Revisionist	316
11.3. Flaws of a State Under the Rule of Law	330
11.4. Rudolf’s Thought ‘Crimes’	345
11.5. The Media and the Case of Germar Rudolf	383
11.6. Outlawed in the Federal Republic of Germany.....	404
11.7. Biographical Notes on the Author.....	421
12. Bibliography	423
12.1. Monographs.....	423
12.2. Periodical Articles	428
12.3. Archival Documents.....	434
12.4. Internet Documents	434
12.5. Courts Files, Governmental Documents	436
12.6. Video, Audio, and Unpublished Documents.....	437
13. Lists.....	439
13.1. List of Tables.....	439
13.2. List of Illustrations	440
13.3. List of Graphs.....	444
13.4. List of Abbreviations.....	445
14. Index	447

1. Prelude

1.1. Slow Death in U.S. Gas Chambers

On June 15, 1994, dramatic events unfolded during the execution of capital punishment. David Lawson, sentenced to death for a capital felony, was scheduled to be killed by hydrogen cyanide in the gas chamber located in the state prison of Raleigh, North Carolina—but the prisoner refused to assist his executioners.¹ Lawson repeatedly held his breath for as long as possible and took only short breaths in between.² Lawson exhibited enormous willpower, calling out to both executioners and witnesses throughout his execution:

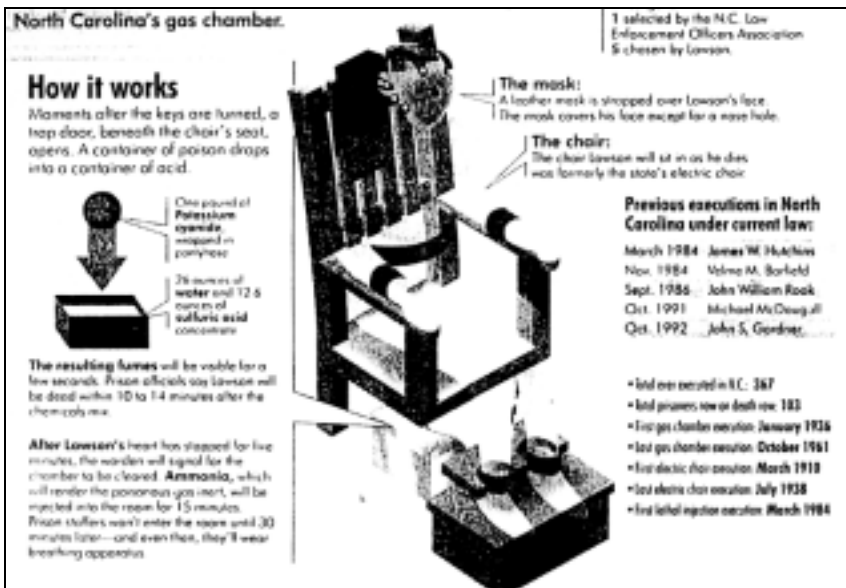

Fig. 1: Schematic drawing of the US execution gas chamber in North Carolina.⁴

¹ A detailed description of this execution can be found at: Bill Krueger, "Lawson's Final Moments", *The News & Observer*, Raleigh, North Carolina, June 19, 1994, p. A1.

² *Newsweek*, November 8, 1993, p. 75; *The New York Times*, October 6, 1994, p. A20; *ibid.*,

“I am human.”

At first his cry was clearly audible but as the minutes went by he became less and less understandable and finally, more than ten minutes into the execution, there was just a mutter. He was declared dead only after eighteen minutes. The witnesses to the execution were horrified. The warden of the prison who had also supervised the execution was so shaken that he resigned. Because of this execution fiasco, executions with poison gas have been abandoned for a short period of time in the USA and replaced with lethal injections.

In early March 1999, however, this horror had already been forgotten. This time, the victim was a German national. Despite intervention by the German government, Walter LaGrand was executed in the state prison at Florence, Arizona. LaGrand’s death struggle against lethal cyanide gas lasted eighteen minutes. Thirty witnesses peered through a bulletproof window as the confessed, convicted murderer died horribly behind an armor-reinforced door.³

It is now clear to the experts, and especially to those still waiting on death row, that a quick and painless execution by gas requires the cooperation of the intended victim. Prisoners about to be gassed were usually encouraged to inhale deeply as soon as the cyanide was released in order to make their deaths come easily. However, if an intended victim was uncooperative, the execution could easily become a fiasco. By simply refusing to take the deep breaths needed to quickly ingest a lethal dose of cyanide, the agony could last for more than eighteen minutes, even under ideal conditions. Publications in the United States reveal that executions lasting from 10 to 14 minutes are the rule, rather than the exception. Amnesty International calls them “*botched executions*”.⁴⁻⁷

June 16, 1994, p. A23.

³ Bettina Freitag, “*Henker warten nicht*”, *New Yorker Staats-Zeitung*, March 13-19, 1999, p. 3.

⁴ *The News & Observer*, Raleigh (NC), June 11, 1994, p. 14A (according to the prison warden, normally 10-14 min.).

⁵ C.T. Duffy, *88 Men and 2 Women*, Doubleday, New York 1962, p. 101 (13-15 min.); C.T. Duffy was warden of San Quentin Prison for almost 12 years, during which time he ordered the execution of 88 men and 2 women, many of them executed in the local gas chamber.

⁶ Stephen Trombley, *The Execution Protocol*, Crown Publishers, New York 1992, p. 13 (approximately 10 minutes or more.); Amnesty International, *Botched Executions*, Fact Sheet December 1996, distributed by Amnesty International USA, 322 Eighth Avenue, New York, NY 10001-4808 (more than 7 min).

⁷ These paragraphs are based on an article by Conrad Grieb, “*The Self-assisted Holocaust Hoax*” (available online only: <http://www.codoh.com/gcgv/gcgvself.html>); Ger.: “*Der*

The method used in American execution gas chambers was introduced in 1924, and has since been improved to technical perfection. The expense to kill just one single person is tremendously high, since neither the witnesses, nor the prison personnel or the environment may be endangered by the poison gas released for such an execution. Reinforced-glass windows, massive, heavy, hermetically-sealed steel doors, powerful ventilation systems with a device to burn the evacuated poisonous gases, and a chemical treatment of the chamber interior to neutralize all remaining traces of the poison make this execution method the most a cumbersome of all.⁸

During the last two decades of the 20th century, the only technical expert in the United States able to build and maintain this equipment was Frederick A. Leuchter Jr., sometimes referred to in the media as “*Mr. Death*”,⁹ since his profession was the design, construction and maintenance of various kinds of execution devices.¹⁰

A feature article in *The Atlantic Monthly* (Feb. 1990), for example, factually described Leuchter as

“*the nation’s only commercial supplier of execution equipment. [...] A trained and accomplished engineer, he is versed in all types of execution equipment. He makes lethal-injection machines, gas chambers, and gallows, as well as electrocution systems [...]*”

Similarly, a lengthy *New York Times* article (October 13, 1990), complete with a front-page photo of Leuchter, called him

“*The nation’s leading adviser on capital punishment.*”

In his book about “*America’s Capital Punishment Industry*”, Ste-

selbstassistierte Holocaust-Schwindel”, *Vierteljahreshefte für freie Geschichtsforschung*, 1(1) (1997), pp. 6ff. (online: www.vho.org/VffG/1997/1/Grieb1.html) (subsequently abbreviated as *VffG*).

⁸ Re. the technical proceedings cf.: F. A. Leuchter, *The Third Leuchter Report*, Samisdad Publishers Ltd., Toronto 1989 (online: www.zundelsite.org/english/leuchter/report3/leuchter3.toc.html).

⁹ Such is the title of a documentary movie directed by Errol Morris about Fred Leuchter, shown at the Sundance Film Festivals in Park City (Utah, USA) in late January 1999: “*Mr. Death: The Rise and Fall of Fred A. Leuchter, Jr.*” There are actually several versions of this movie, the one offered as a VHS video for retail being massively reworked.

¹⁰ The following paragraphs were taken from Mark Weber, “*Probing Look at ‘Capital Punishment Industry’ Affirms Expertise of Auschwitz Investigator Leuchter*”, *The Journal of Historical Review* 17(2) (1998), pp. 34ff. (subsequently abbreviated as *JHR*); Ger.: “*Ein prüfender Blick in Amerikas’ Todesstrafen-Industrie’ bestätigt das Leuchter-Gutachten*”, *VffG*, 2(3) (1998), pp. 226ff. (online: www.vho.org/VffG/1998/3/Buecher3.html)

phen Trombley confirms that Leuchter is, in fact,¹¹

“America’s first and foremost supplier of execution hardware. His products include electric chairs, gas chambers, gallows, and lethal injection machines. He offers design, construction, installation, staff training and maintenance.”

Killing someone in a gas chamber is very dangerous for those who carry out the execution, above all because the body of the dead prisoner is saturated with lethal gas. After the execution, explains Leuchter:¹²

“You go in. The inmate has to be completely washed down with chlorine bleach or with ammonia. The poison exudes right out through his skin. And if you gave the body to an undertaker, you’d kill the undertaker. You’ve got to go in, you’ve got to completely wash the body.”

Bill Armontrout, warden of the Missouri State Penitentiary in Jefferson City, confirms the danger:¹³

“One of the things that cyanide gas does, it goes in the pores of your skin. You hose the body down, see. You have to use rubber gloves, and you hose the body down to decontaminate it before you do anything [else]”

In Leuchter’s opinion, gas chamber use should be discontinued, not just because of the cruelty of this method of execution, but because of his beliefs relating to gas chambers as such.¹⁴

“They’re dangerous. They’re dangerous to the people who have to use them, and they’re dangerous for the witnesses. They ought to take all of them and cut them in half with a chain saw and get rid of them.”

With a career built on the motto “*Capital punishment, not capital torture*”, Leuchter takes pride in his work. He is glad to be able to ensure that condemned prisoners die painlessly, that the personnel who carry out executions are not endangered, and that taxpayer dollars are saved.

¹¹ Stephen Trombley, *op. cit.* (note 6), p. 8.

¹² *Ibid.*, p. 98.

¹³ *Ibid.*, p. 102

¹⁴ *Ibid.*, p. 13.

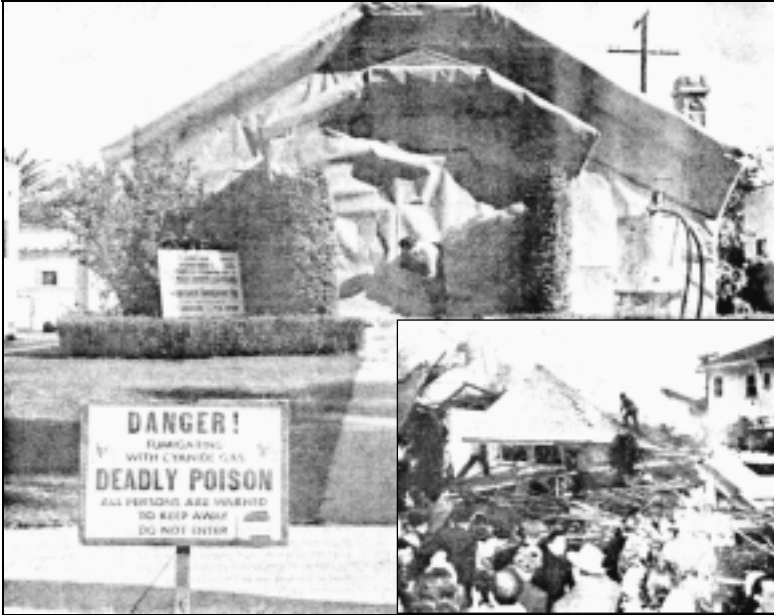

Fig. 2: How to get rid of termites: Larger photo: Before. Smaller photo: After.

1.2. Hydrogen Cyanide—a Dangerous Poison

Hydrogen cyanide, is not, of course, utilized solely for the purpose of executions in American gas chambers, but for much more constructive purposes as well. Since approximately the end of WWI, hydrogen cyanide, or HCN, has been used to exterminate vermin such as bed-bugs, lice, corn weevils, termites, cockroaches, and other pests. It is, of course, important to be extremely cautious while applying hydrogen cyanide in order to avoid disaster, because it is in many ways a highly dangerous poison.

The residents of a house in Los Angeles, California, had to learn this in a quite painful way shortly before Christmas 1947. They had hired the Guarantee Fumigation Company to destroy the termites which threatened to eat up the wooden structure. The pest controllers, however, were apparently not very competent, because when using a container of pressurized HCN to fill the house, which had been wrapped up like a Christmas present, they exceeded safe limits and

pumped in too much gas. (Fig. 2).¹⁵ Due to unknown reasons, the mixture of air and HCN, which can be highly explosive under certain circumstances, ignited during the fumigation. The resulting explosion destroyed the entire dwelling.¹⁶

However, hydrogen cyanide has yet another insidious characteristic: it is highly mobile. This mobility is highly welcome when it comes to killing vermin: Wherever fleas and bugs try to hide, the gas will still reach them! Unfortunately, hydrogen cyanide does not restrict itself to attack vermin. Rather, it indiscriminately seeps into the smallest cracks and even penetrates porous substances such as felt sealing materials and thin walls, thereby leaking into areas where it is not welcome. The failure on the part of disinfestors to ensure that all places to be fumigated are adequately sealed off have been described in toxicological literature:¹⁷

“Example: J.M., a 21 year old female home decorator, was working in the cellar of the house, the second floor of which was being treated for vermin with cyanide gas. Due to insufficient sealing during fumigation, the gas penetrated the corridors, where it poisoned the disinfestor, and reached the cellar through air shafts. Mrs. M. suddenly experienced an intense itching sensation in her throat followed by headache and dizziness. Her two fellow workers noticed the same symptoms and they all left the cellar. After half an hour, Mrs. M. returned to the cellar whereupon she suddenly collapsed and fell unconscious. Mrs. M. was taken to a hospital together with the unconscious exterminator. Mrs. M. recovered and was released. The exterminator, by contrast, was pronounced dead on arrival.”

But the dangers of this type of poison gas are not merely restricted to persons in the same house in which fumigation is taking place. Large quantities of gas may penetrate the open air and endanger the entire neighborhood, as shown by an accident in the fall of 1995 in a Croatian holiday resort:¹⁸

¹⁵ A gassing requires 1-2% by volume, while an explosion requires 6% by volume or more; see, in this regard, chapter 6.3.

¹⁶ “How to get rid of termites”, *Life*, Dec. 22, 1947, p. 31; see also *Liberty Bell*, 12/1994, pp. 36f.

¹⁷ S. Moeschlin, *Klinik und Therapie der Vergiftung*, Georg Thieme Verlag, Stuttgart 1986, p. 300.

¹⁸ dpa, “Dilettantische Kammerjäger”, *Kreiszeitung, Böblinger Bote*, Nov. 16, 1995, p. 7. Research has failed to determine which toxic gas was involved. Since hydrogen cyanide is one of the most poisonous and most rapidly diffusing of all gases used in disinfestation, the reported damage would have been at least as great if caused by hydrogen cyanide, even if hydrogen cyanide was not in fact involved in this accident. A number of additional examples are de-

“That failed profoundly. Three local residents suffering from symptoms of poisoning and a number of surviving woodworms were the results of the botched action against vermin in a church in the Croatian holiday resort Lovran, close to Rijeka. The exterminator’s clumsy work necessitated the evacuation of several hundred residents of the locality.

The exterminators tried to treat the Church of the Holy Juraj for woodworm during the night, using the highly toxic gas. But since they failed to seal off the church appropriately, the gas seeped into surrounding houses in which people were already asleep. ‘Fortunately, the people woke up immediately because of sudden attacks of nausea—that’s what saved them from certain death,’ wrote the newspaper, ‘Vecernji List’. Three residents nevertheless suffered severe intoxication. The mayor decided to evacuate the center of the town. The exterminators were arrested. The woodworms survived. dpa”

But that is still not all: on top of this, hydrogen cyanide is also a tenacious poison. It adheres wherever it is utilized, especially in a moist environment. Deadly cyanide gas continues to evaporate slowly from moist objects for hours and days, involving a permanent environmental hazard where sufficient ventilation cannot be assured. This is emphasized by an especially dramatic and simultaneously macabre accident in the United States in the fall of 1998:



Oct. 10, 1998

Suicide fumes sicken nine Iowa students

GRINNELL, Iowa (CPX) A student at Grinnell College committed suicide by swallowing so much potassium cyanide that the fumes from his body sickened nine people.

Two college staff members, three students and four paramedics were weakened and nauseated by the fumes after encountering the student’s body Monday. They were treated and

scribed by K. Naumann: “Die Blausäurevergiftung bei der Schädlingsbekämpfung”,
Zeitschrift für hygienische Zoologie und Schädlingsbekämpfung, 1941, pp. 36-45.

released from a local hospital.

Carl T. Grimm, 20, a sophomore from Placentia, Calif., swallowed a crystalline form of potassium cyanide, which prevents oxygen from entering cells. He immediately asked his roommate to call for help but not before the chemical reacted with water in his body and began to produce cyanide gas, a spokesman for the college said.

Grimm's residence hall at the private liberal arts college located about 50 miles east of Des Moines was evacuated because of the fumes. Grinnell Regional Medical Center, where Grimm's body was taken, also had to be aired out.

College officials are still trying to determine how Grimm got the potassium cyanide and why he wanted to kill himself.^{19]}

Another case, which occurred somewhat differently, nevertheless led to an accident which was no less tragic. Salts of cyanide, which release cyanide gas in the presence of moisture, are used for the separation of gold and silver during the processing of precious metals. In the case in question, a company was engaged in the processing of the cyanide-rich residues of such chemical reactions contained in large tanks, which is not without risk. The employer directed the workers, who were not equipped with gas masks or protective clothing, to go into the tanks which were still releasing cyanide gas. The consequences were tragic.



Department of Justice

Department of Justice National News Release

MONDAY, MAY 10, 1999

On May 7, the jury in Pocatello, ID, found that Allan Elias ordered employees of Evergreen Resources, a fertilizer manufacturing company he owned, to enter and clean out a 25,000-gallon storage tank containing cyanide without taking required precautions to protect his employees. Occupational Safety and Health Administration inspectors repeatedly had warned Elias

¹⁹ www.mankato.msus.edu/depts/reporter/reparchive/10_15_98/campuscope.html

about the dangers of cyanide and explained the precautions he must take before sending his employees into the tank, such as testing for hazardous materials and giving workers protective gear.

Scott Dominguez, an Evergreen Resources employee, was overcome by hydrogen cyanide gas while cleaning the tank and sustained permanent brain damage as a result of cyanide poisoning.[...]

Over a period of two days in August 1996, Elias directed his employees—wearing only jeans and T-shirts—to enter an 11-foot-high, 36-foot-long storage tank and clean out cyanide waste from a mining operation he owned. Elias did not first test the material inside the tank for its toxicity, nor did he determine the amount of toxic gases present. After the first day of working inside the tank, several employees met with Elias and told him that working in the tank was giving them sore throats, which is an early symptom of exposure to hydrogen cyanide gas.

The employees asked Elias to test the air in the tank for toxic gases and bring them protective gear—which is required by OSHA and which was available to the defendant free of charge in this case. Elias did not provide the protective gear, and he ordered the employees to go back into the tank, falsely assuring them that he would get them the equipment they sought. Later that morning, Dominguez collapsed inside the tank. And he could not be rescued for nearly an hour because Elias also had not given employees the required rescue equipment.^[20]

Even this example fails to convey the full scope of the insidious nature of cyanide gas, since it does not just kill by means of inhalation; even a gas mask may prove insufficient, especially if a person is sweating heavily. Hydrogen cyanide is dissolved most readily on moist sur-

²⁰ www.osha.gov/media/oshnews/may99/national-19990510.html; see also *The Plain Dealer*, Dec. 19, 1999, p. 30A; *Nation—The Orange County Register*, Jan. 9, 2000, News 11; Allan Elias was sentenced to 17 years imprisonment on April 28, 2000, APBnews.com, April 29, 2000, www.apbnews.com/safetycenter/business/2000/04/29/safetycrime0429_01.html and .../safetycrime0429_doc.html: The cyanide-contaminated sludge in the tank also contained phosphoric acid, resulting in the release of cyanide gas.

faces, and it easily penetrates the skin. This was proven by a dramatic accident in 1995 in a cave in the French city of Montérolier:²¹

“The death of nine persons on June 21, 1995, in the cave of Montérolier (Seine-Maritime) was said to have been caused by the re-leasé of cyanide gas originating from the poison gas used during First World War, the so-called Vincennite. This was announced Wednesday by former Professor of Physical Chemistry, Louis Soulié. [...] At a press conference in Buchy, he said that ‘neither the children nor the firemen rushing to the rescue—one of whom wore a gas mask—died of carbon monoxide poisoning.’

[...] ‘Even six days after their deaths, a cyanide concentration twice as high as the fatal dose was still observed in the victims’ blood.’

According to the professor’s remarks, the three children lit a fire in the cave and threw a Vincennite bomb found in the cave into the fire. The bomb exploded. The gas caused the deaths of three children, four firemen, the father of one of the children and an amateur spelunker.

According to Prof. Soulié, the deaths of the firemen looking for the children in the cave, including the fireman wearing a gas mask, were due to the fact that hydrogen cyanide dissolves in the sweat and penetrates the body through the skin, where it causes poisoning.”

1.3. The Acid that Causes Blue Stains

Great excitement was caused by a strange occurrence in a Protestant church at Wiesenfeld, Lower Bavaria, Germany, in the spring and summer of 1977. The congregation had renovated the deteriorating church at great expense during the previous year, but now they faced a disaster. Huge blue stains were found to have formed in all parts of the plastered inte-

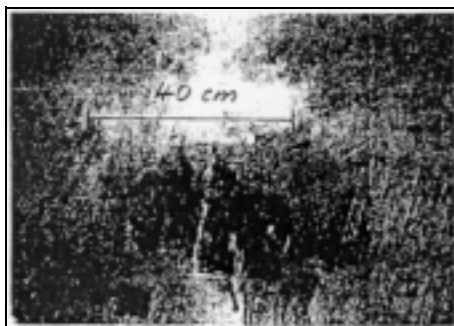

Fig. 3: Inky blue stains on the plaster of a church fumigated with hydrogen cyanide.

²¹ “Un expert évoque la présence de gaz mortel dans la grotte”, *Le Quotidien de la Réunion*, June 25, 1998.

rior of the church. The experts having renovated the church were now called in for consultation, and found themselves confronted by a riddle which was only solved by a chemical analysis of the stained portions of the walls. The entire interior surface of the church was impregnated by Iron Blue. No explanation could be found for this in the literature. It nevertheless proved possible to reconstruct the sequence of events.

A few weeks after the replastering of the church with a water-resistant cement mortar, the entire church had been fumigated with Zyklon B (hydrogen cyanide) to exterminate woodworm in the choir stalls. The hydrogen cyanide, released by the Zyklon B, did not just kill woodworm: it



Fig. 4: In August 1976, the Protestant church at D-96484 Meeder-Wiesefeld was fumigated with Zyklon B.

Subsequently, blue-colored stains appeared all over the plaster (see Fig. 3).

also reacted chemically with the plaster. The hydrogen cyanide contained in the Zyklon reacted with the iron oxides contained in quantities of 1-2% in all plasters, thus forming Iron Blue, a highly stable compound well-known for centuries.²²

Reports of blue pigmentation of walls resulting from fumigation with hydrogen cyanide for the destruction of vermin in areas with

²² G. Zimmermann (ed.), *Bauschäden Sammlung*, volume 4, Forum-Verlag, Stuttgart 1981, pp. 120f., relating to the case of building damage occurring in August 1976 in the Protestant church at D-96484 Meeder-Wiesefeld. We wish to thank Mr. W. Lüftl, Vienna, for discovering this information, as well as Mr. K. Fischer, Hochstadt am Main, who was held liable for damages as responsible architect, and who supplied me with further details. Reproduced from: E. Gauss (alias Germar Rudolf), "Wood Preservation through Fumigation with Hydrogen Cyanide: Blue Discoloration of Lime- and Cement-Based Interior Plaster", in: E. Gauss (ed.), *Dissecting the Holocaust*, Theses & Dissertations Press, Capshaw, AL, 2000, pp. 555-559 (online: www.vho.org/GB/Books/dth/findwood.html).

moist, ferrous plaster are well-known in technical literature, as shown by a recent survey.²³ The necessary prerequisite for this reaction appears to be that the fumigated plaster must be new and must exhibit high humidity. In other cases, there was also damage to the structure and interior installations, but no blue stains, perhaps because the plaster was old and had already set.²⁴

²³ E. Emmerling, in: M. Petzet (ed.), *Holzschädlingsbekämpfung durch Begasung*, Arbeitshefte des Bayerischen Landesamtes für Denkmalpflege (Working Notebooks of the Bavarian State Office for Monument Maintenance), vol. 75, Lipp-Verlag, Munich 1995, pp. 43-56. Whether the examples cited in the paper may perhaps refer to the above mentioned case only in a roundabout way, must remain open for the time being. Carl Hermann Christmann reports the case of a farm building belonging to an 18th century monastery; the farm building was sold to a farmer following secularization, and the farmer then used it as a barn. Approximately 20 years ago, an investor converted the beautiful Baroque building into a luxury holiday restaurant. The existing interior plaster was repaired and painted white. After some time, blue stains appeared in the white paint; the stains were identified by a consulting expert as Iron Blue. The expert assumed that the former owner must have fumigated the building with hydrogen cyanide between 1920 and 1940, which then caused the stains 40-50 years later. Personal communication from C.H. Christmann according to his recollection on July 13, 1999; Mr. Christmann was unfortunately unable to find the source of the information. I would be extremely grateful for any references to passages in the literature in relation to this case.

²⁴ In one case, the fumigation of a church freshly painted with iron-free lime paint led to dark stains caused by the polymerization of hydrogen cyanide: D. Grosser, E. Roßmann, "*Blausäuregas als bekämpfendes Holzschutzmittel für Kunstobjekte*", *Holz als Roh- und Werkstoff*, 32 (1974), pp. 108-114.

2. The Coup

2.1. Fred Leuchter on Auschwitz and Majdanek

On February 3, 1988, Fred Leuchter received an unexpected visitor at his home in Boston, Massachusetts. A professor of French, Greek, Latin, as well as critic of testimonies, texts and documents from the University of Lyon II—Dr. Robert Faurisson—had an unusual assignment in mind: He wanted to persuade Leuchter, in his capacity as an expert in execution technology, to prepare a professional opinion to be used in a criminal trial then taking place in Toronto, Canada.²⁵ More precisely, Dr. Faurisson wanted to convince Leuchter to determine whether or not the generally alleged mass exterminations with hydrogen cyanide gas in the concentration camps of the Third Reich were technically possible. Until that time, Leuchter had never questioned the existence of German homicidal gas chambers. When Prof. Faurisson showed him some mostly technical documents, however, Leuchter began to have doubts about the technical feasibility of the alleged homicidal gassings and agreed to come to Toronto to view additional documentation.

After this meeting and on the assignment of defense counsel, he then traveled to Poland with his wife who was also his secretary, his draftsman, a video cameraman and a translator, to make a technical examination of the concentration camps at Auschwitz, Auschwitz-Birkenau and Majdanek for the above trial. He returned to the United States and wrote a 192-page report (incl. appendices). He also brought 32 test samples taken from the masonry in the crematoria at Auschwitz and Birkenau, the locations where the alleged gassings are said to have taken place, as well as from a delousing gas chamber. The background of these samples is as follows:

²⁵ Re. background and course of the criminal proceedings cf.: R. Lenski, *The Holocaust on Trial*, Reporter Press, Decatur, Alabama 1990, abridged transcript of the trial against Ernst Zündel in Toronto 1988; Ger.: *Der Holocaust vor Gericht*, Samisdat Publishers Ltd., Toronto 1996 (online: www.zundelsite.org/german/lenski/lenskitoc.html); a lengthy compilation of the entire trial: Barbara Kulaszka (ed.), *Did Six Million Really Die? Report on the Evidence in the Canadian "False News" Trial of Ernst Zündel—1988*, Samisdat Publishers Ltd., Toronto 1992 (online: www.zundelsite.org/english/dsmrd/dsmrdtoc.html).

Almost all the concentration camps of the Third Reich contained facilities for the disinfestation of lice carried by inmate clothing. Various methods were used to accomplish this objective: hot air, hot steam, several different poison gases, and towards the end of the war even microwaves. Delousing was urgently needed in particular because lice carry epidemic typhus, a disease with a history of repeated outbreaks in eastern and central Europe. Epidemic typhus appeared again during WWII where it claimed hundreds of thousands of victims, not only in the concentration camps and prisoner-of-war camps, but among soldiers at the front. Since WWI, the most effective and the most widely used means for the extermination of lice and other pests, was hydrogen cyanide, marketed under the trade-name *Zyklon B*.

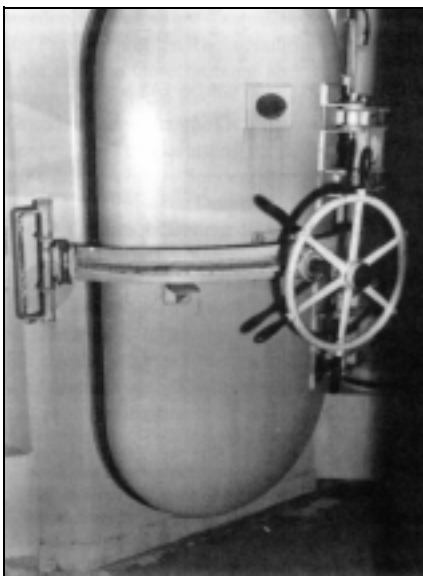

Fig. 5: Single door to an execution gas chamber for one single person per gassing procedure (Baltimore, USA, 1954, technology from the 1930s). The execution of a single person with hydrogen cyanide is inevitably far more complicated and dangerous to the environment than the fumigation of clothing (even in a DEGESCH circulation chamber).



Fig. 6: One of three doors from an alleged National Socialist gas chamber for the execution of hundreds of persons simultaneously, using Zyklon B (hydrogen cyanide) (crematorium I, Auschwitz, Poland, early 1940s). This door is neither of sturdy construction, nor is it air-tight (note the keyhole). It is partly glazed and opens inwards i.e., into the room, where corpses were allegedly piling up.

It has been known for decades that the walls within the buildings in which Zyklon B is proved to have been used to delouse inmate clothing exhibit massive, blotchy, bluish discoloration. This blue discoloration is due to a chemical substance known as *Iron Blue* which, under the right conditions, is formed in a chemical reaction by hydrogen cyanide with certain components of masonry. This substance can still be observed in surviving delousing facilities today. It is obviously a very stable compound. Professor Faurisson was the first person to point out that this blue discoloration is absent from the supposed homicidal gas chambers at Auschwitz. Faurisson's idea was to analyze samples from the masonry in the alleged homicidal gas chambers for traces of poison gas or its compounds (cyanides) and compare them with samples taken from the delousing chambers. Fred Leuchter followed this suggestion when doing his on-site investigations in Auschwitz in 1988.

On April 20 and 21, 1988, Leuchter took the stand as an expert witness in the courtroom in Toronto. He reported about his research and developed his conclusions. The atmosphere in the courtroom was tense. Leuchter's testimony was straightforward and at the same time sensational: According to Leuchter, there had never been any possibility of mass extermination of human beings by gassing in Auschwitz, nor in Birkenau, nor in Majdanek.²⁶



Fig. 7: Frederick A. Leuchter, the world's first, and possibly only, cyanide gas chamber expert, during a talk at the conference of the Institute for Historical Review in 1992

"It is the best engineering opinion of this author that the alleged gas chambers at the inspected sites could not have then been, or now, be utilized or seriously considered to function as

²⁶ F. A. Leuchter, *An Engineering Report on the alleged Execution Gas Chambers at Auschwitz, Birkenau and Majdanek, Poland*, Samisdat Publishers Ltd., Toronto 1988, 195 pp.; Ger.: *Der erste Leuchter Report*, *ibid.*, 1988 (online: ihr.org/books/leuchter/leuchter.toc.html).

execution gas chambers.”

Shortly before Leuchter, another witness was questioned: Bill Armontrout, Warden of the Maximum Security Prison in Jefferson City, Missouri. It was Armontrout who, on request of defense attorney Barbara Kulaszka, pointed out that no one in the United States understood the operation of gas chambers better than Fred A. Leuchter. Armontrout himself confirmed in Court the great difficulties involved in killing people with poison gas, as Robert Faurisson had done before him.

Following Leuchter, Prof. James Roth, director of a chemical laboratory in Massachusetts, also took the witness stand to describe the results of his analysis of the 32 masonry samples, the origins of which had been unknown to him: All samples taken from the gas chambers supposedly used for mass human extermination exhibited either no or only negligible traces of cyanide, while the sample from the delousing chambers taken for use as control purposes exhibited enormously high cyanide concentrations.²⁷

Leuchter’s report and subsequent testimony shook the foundations of Holocaust history, the story of the ‘Nazi gas chambers’. Considering the tens of thousands of copies of this “*Leuchter Report*” that have been distributed in all major languages all over the world and the many speeches Leuchter held, the impact of the work of this one man was enormous.

2.2. Damage Control

Alarmed by this development, the ‘Never Forget, Never Forget’ brigade wasted no time in taking counter-measures. Self-styled ‘Nazi hunter’ Beate Klarsfeld announced that Fred Leuchter “*has to understand that in denying the Holocaust, he cannot remain unpunished.*”²⁸

Jewish organizations launched a vicious smear campaign to destroy not only his reputation, but his ability to make a living. Leading the charge was Shelly Shapiro and her group, “*Holocaust Survivors*

²⁷ Partially derived from Prof. Faurisson’s description in: “*Zum Zündel-Prozeß in Toronto, Teil 2. Vorgeschichte—Ablauf—Folgen*”, *Deutschland in Geschichte und Gegenwart* 36(4) (1988), pp. 4-10 (online: http://www.vho.org/D/DGG/Faurisson36_4.html) (hereafter abbreviated as *DGG*).

²⁸ This paragraph is again quoted acc. to Mark Weber, who gives no reference for this alleged quote of Beate Klarsfeld in his article *op. cit.* (note 10),.

and Friends in Pursuit of Justice". Calling Leuchter a fraud and impostor, this group claimed, despite better knowledge, that he lacked qualifications as an execution equipment specialist and had asserted the possession of professional qualifications which he had never earned.²⁹

Although these accusations were entirely unfounded and failed to survive any legal verification, the 'get Leuchter' campaign, with the co-operation of mainstream journalists and editors, was successful. Leuchter's contracts with state authorities for the manufacture, installation, and servicing of execution hardware were cancelled. He was financially forced out of his home in Massachusetts and had to find private work elsewhere. No American has suffered more for his defiance of the Holocaust lobby.

²⁹ Cf. *JHR*, 12(4) (1992), pp. 421-492 (online: www.vho.org/GB/Journals/JHR/12/index.html#4).

3. The Origins

Before the publication of the *Leuchter Report*, discussion relating to the reliability of eyewitness testimony of National Socialist mass murder was confined to groups describing themselves as ‘revisionists’, usually termed ‘Neo-Nazis’ or ‘right-wing extremists’ by the media. But in fact, the labels used by the media were wide off the mark, as can be seen in the case of four of the most well-known revisionists: Paul Rassinier, French Socialist and former member of the French Resistance, who was an inmate of the concentration camps Buchenwald and Dora-Mittelbau;³⁰ German Jew, Josef Ginsburg, who suffered from anti-Jewish measures taken during WWII by other countries as well as Germany.³¹ The two most notable revisionists, Professors Arthur R. Butz, USA,³² and retired Prof. Robert Faurisson, of France, can certainly not be accused of being political extremists, and nobody ever seriously tried to do this.³³

The discussion on the technical problems of the National Socialist mass-murder of the Jews was begun in the late 1970s

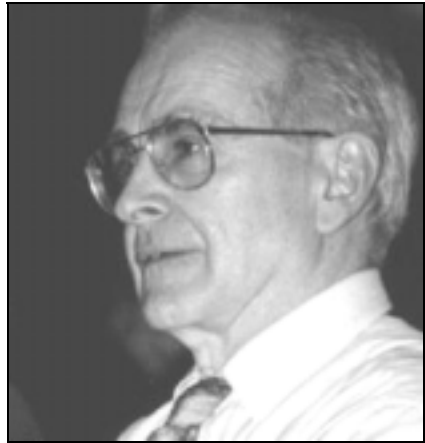

Fig. 8: Prof. Dr. Robert Faurisson

³⁰ Cf. his four most-important works: *Die Lüge des Odysseus*, K.-H. Priester, Wiesbaden 1959; *Was nun, Odysseus?*, *ibid.* 1960; *Das Drama der Juden Europas*, H. Pfeiffer, Hannover 1965; *Was ist Wahrheit?*, Druffel, Leoni ⁸1982; Engl.: *Debunking the Genocide Myth*, The Noontide Press, Los Angeles, 1978 (online: abbc.com/aaargh/engl/PRdebunk1.html).

³¹ Cf. his most import works: *Schuld und Schicksal*, Damm-Verlag, Munich 1962 (online: www.vho.org/D/sus); *Sündenböcke*, Verlag G. Fischer, Munich 1967; *NS-Verbrechen— Prozesse des schlechten Gewissens*, *ibid.* 1968; *Verschwörung des Verschweigens*, Ederer, Munich 1979; *Majdanek in alle Ewigkeit?*, *ibid.* 1979 (online: www.vho.org/D/miae); *Zionazi-Zensur in der BRD*, *ibid.* 1980.

³² Cf. *The Hoax of the Twentieth Century*, Institute for Historical Review, Newport Beach, California, ⁷1985 (online: www.vho.org/GB/Books/thottc); “Context and perspective in the ‘Holocaust’ controversy”, *JHR*, 3(4) (1982), pp. 371-405. (online: www.vho.org/GB/Journals/JHR/3/4/Butz371-405.html).

³³ Cf. *Mémoire en défense*, La Vieille Taupe, Paris 1980; Serge Thion (ed.), *Vérité historique ou vérité politique?*; La Vieille Taupe, Paris 1980 (online: abbc.com/aaargh/fran/histo/SF1.html); R. Faurisson, *Écrits révisionnistes*, 4 vols., published by author, Vichy 1999.

by Robert Faurisson, then Professor of French, Greek and Latin, and an analyst of documents, texts, and witness statements at the University of Lyon II. He began to question the standard historical version of the Holocaust after he had made numerous critical studies concerning witness testimony and on documents that supposedly supported the claims of mass-murder. In 1978 for the first time, he advanced the argument that “*there had not been one single gas chamber under Adolf Hitler*”.³⁴ Later he supported this claim with physical, chemical, topographic, architectural, documentary, and historical arguments. He described the existence of the homicidal gas chambers as “*radically impossible*”.³⁵ At the end of 1979, the largest French daily newspaper, *Le Monde*, decided to publish Professor Faurisson’s provocative thesis, so he was given the opportunity to summarize it in an article.³⁶ The establishment historians reaction was characteristic³⁷ and is best illustrated by a passage from a declaration signed by Pierre Vidal Naquet and 33 other researchers:³⁸

“*One may not ask how such a mass-murder [of Jews] was possible. It was technically possible, because it happened. This is the obligatory starting-point of every historical investigation of this subject. We simply want to call into memory this truth: There is no debate over the existence of the gas chambers, and there must not be one.*”

Such a dogmatic explanation is equivalent to a capitulation, which was well understood. Hence, they reconsidered their standpoint and went back to the drawing board.

Over the years that followed, establishment historians took up the questions raised by Robert Faurisson and others, at least to some ex-

³⁴ Cf. in addition to arguments in the works in note 33 also R. Faurisson, “*Es gab keine Gaskammern*”, Deutscher Arbeitskreis Witten, Witten 1978.

³⁵ R. Faurisson, “*Le camere a gas non sono mai esistite*”, *Storia illustrata*, 261 (1979), pp. 15-35 (online: abbc.com/aaargh/fran/archFaur/Rf7908xx2.html); Engl.: “*The Gas Chambers: Truth or Lie?*” *The Journal of Historical Review*, 2(4) (1981), pp. 319-373 (online: www.vho.org/GB/Journals/JHR/2/4/Faurisson319-373.html); cf. Faurisson, “*The Mechanics of Gassing*”, *JHR*, 1(1) (1980) pp. 23ff. (online: abbc.com/aaargh/engl/FaurisArch/Rf80spring.html); Faurisson, “*The Gas Chambers of Auschwitz Appear to be Physically Inconceivable*”, *ibid.*, 2(4) (1981), pp. 311ff. (online: www.vho.org/GB/Journals/JHR/2/4/Faurisson312-317.html)

³⁶ “*‘Le problème des chambres à gaz’ ou ‘la rumeur d’Auschwitz’*”, *Le Monde*, Dec. 29, 1978, p. 8; see also “*The ‘problem of the gas chambers’*”, *JHR*, 1(2) (1980), pp. 103-114 (online: ihr.org/jhr/v01/v01p103_Faurisson.html).

³⁷ Cf. the documentation on numerous articles and letters in R. Faurisson, *Mémoire...*, *op. cit.* (note 33), pp. 71-101.

³⁸ *Le Monde*, Feb 21, 1979.

tent, although they doggedly refused to permit him, or any one else who even remotely voiced similar thoughts, to participate in any academic activities. In the early 1980s, two large Holocaust conferences were held in the cities of Paris³⁹ and Stuttgart.⁴⁰ One of the more important reasons for these conferences certainly were the works of Faurisson, Butz, and others.⁴¹

In 1983, as a counter-measure against the ongoing successes of revisionists, a compilation was published, principally the work of French and German establishment historians.⁴² While this book ridiculed and insulted revisionists and cast political aspersions against them, and at the same time was intended to refute their claims, it does neither address any particular revisionist argument, nor are any revisionist publications quoted or authors named, so that it is impossible to the reader of this book to verify the polemic accusations made against the revisionists. This book also repeats the mistake often emphasized by revisionists: quotations from ‘eye-witness’ testimony and passages from documents were taken out of context and pasted uncritically into a pre-determined historical schema.

The publication of the *Leuchter Report* at the end of the 1980s gave a significant boost to revisionism. From that time onward, there has been an unending stream of publications.⁴³ The number of persons

³⁹ At the Sorbonne from Jun 29.—July 2., 1982, entitled “*Le national-socialisme et les Juifs*”; cf. Ecole des hautes études en sciences sociales (ed.), *L’Allemagne nazie et le génocide juif*, Gallimard/Le Seuil, Paris 1985; on December 11-13, 1987, there was a second Colloquium held at the Sorbonne, cf. R. Faurisson, *Écrits révisionnistes, op. cit.* (note 33), vol. 2, pp. 733-750 (online: abbc.com/aaargh/fran/archFaur/RF871210.html).

⁴⁰ For a transcript of the conference, cf.: Jäckel, E., J. Rohwer, *Der Mord an den Juden im Zweiten Weltkrieg*, Deutsche Verlags-Anstalt, Stuttgart 1985.

⁴¹ Most importantly, Wilhelm Stäglich’s *Der Auschwitz-Mythos*, published in 1979, (Grabert, Tübingen, online: www.vho.org/D/dam; Engl.: *The Auschwitz Myth*, Institute for Historical Review, Torrance, CA, 1986) as well as Walter N. Sanning’s papers and book on Jewish population statistics: “*Die europäischen Juden. Eine technische Studie zur zahlenmäßigen Entwicklung im Zweiten Weltkrieg, Teil 1-4*”, DGG 28(1-4) (1980), pp. 12-15; 17-21; 17-21; 25-31; Sanning, *Die Auflösung des osteuropäischen Judentums*, Grabert, Tübingen 1983 (online: www.vho.org/D/DGG/Sanning28_1.html and www.vho.org/D/da); English: *The Dissolution of Eastern European Jewry*, Institute for Historical Review, Torrance, CA, 1983.

⁴² E. Kogon, H. Langbein, A. Rückerl et al. (eds.), *Nationalsozialistische Massentötungen durch Giftgas*, S. Fischer Verlag, Frankfurt 1983; Engl.: *Nazi Mass Murder*, Yale University Press, New Haven 1993; French: Henry Rollet, *Les chambres à gaz secret d’Etat*, Les Editions de Minuit, Paris 1984.

⁴³ The most important: J. Ball, *Air Photo Evidence, Auschwitz, Treblinka, Majdanek, Sobibor, Bergen Belsen, Belzec, Babi Yar, Katyn Forest*, Ball Resource Service Ltd., Delta, B.C., Canada 1992 (permanently updated and enhanced online: www.air-photo.com); Ernst Gauss (alias G. Rudolf), *Vorlesungen über Zeitgeschichte*, Grabert, Tübingen 1993 (online:

involved in ‘revisionism’ increases steadily; although in France and in German-speaking countries, this development has been curtailed by the enactment of laws threatening heavy penalties.⁴⁴

3.1. On the Problem

A fact-oriented discussion of the technical arguments brought into the public by the *Leuchter Report* was started in France by an attempt

www.vho.org/D/vuez); Gauss. (ed.), *Grundlagen zur Zeitgeschichte*, *ibid.* 1994 (online: co-doh.com/inter/intgrundex.html); Engl.: *Dissecting the Holocaust*, note 22; Jürgen Graf, *Der Holocaust auf dem Prüfstand*, Guideon Burg, Basel 1992 (online: www.zundelsite.org/german/graf/Prueftoc.html); Graf, *Der Holocaust-Schwindel*, *ibid.* 1993; Graf, *Auschwitz. Tätergeständnisse und Augenzeugen des Holocaust*, Verlag Neue Visionen, Würenlos 1994 (online: www.vho.org/D/atuadh); Graf, *Todesursache Zeitgeschichtsforschung*, *ibid.* 1995 (online: www.zundelsite.org/ezundel/german/graf/Graf_TOC.html); Graf and Carlo Mattogno, *KL Majdanek*, Castle Hill Publishers, Hastings 1998 (online: www.vho.org/D/Majdanek/MR.html); Graf, Mattogno, *Das KL Stutthof*, Castle Hill Publishers, Hastings 1999 (online: www.vho.org/D/Stutthof); Jürgen Graf, *Riese auf tönernen Füßen*, *ibid.* 1999 (online: www.vho.org/D/Riese); Engl: *The Giant With Feet of Clay*, Theses & Dissertations Press, Capshaw, AL, 2001 (online: www.vho.org/GB/Books/Giant); Gerd Honsik, *Freispruch für Hitler*, Burgenländischer Kulturverband, Vienna 1988 (online: www.vho.org/D/ffh); Honsik, *Schelm und Scheusal*, Bright Rainbow, Madrid n.d. [1994]; Rüdiger Kammerer, Armin Solms (ed.), *Das Rudolf-Gutachten*, Cromwell, London 1993 (online: www.vho.org/D/rga); Carlo Mattogno, *La soluzione finale. Problemi e polemiche*, Edizioni di Ar, Padua 1991; *Auschwitz. La prima gasazione*, Edizioni di Ar, Padua 1992; Mattogno, *Auschwitz: The End of a Legend*, Institute for Historical Review, Costa Mesa 1994 (online: www.vho.org/GB/Books/anf/Mattogno.html); Herbert Verbeke (ed.), *Auschwitz: Nackte Fakten*, Vrij Historisch Onderzoek, Berchem 1995 (online: www.vho.org/D/anf). Before the *Leuchter Report*, there were really only three revisionist periodicals (*JHR*, *Annales d'Histoire Révisionniste*, *Historische Tatsache*, online cf. www.vho.org/Archive.html#Journals), there are now eight—apart from various information services and newsletters: *JHR* (PO Box 2739, Newport Beach, CA 92659, USA; online: ihr.org/jhr), *VffG* (PO Box 118, Hastings TN34 3ZQ, UK; online: www.vho.org/VffG), *The Barnes Review* (130 Third Street SE, Washington, D.C. 20003, USA; online: www.barnesreview.org), *Révision* (11 rue d'Alembert, F-92130 Issy-les-Moulineaux), *L'Autre Histoire* (BP 3, F-35134 Coësmes), *Revisionist History* (PO Box 849, Coeur d'Alene, Idaho 83816, USA; online: hoffman-info.com), *Akribea* (45/3 route de Vourles, F-69230 Saint-Genis-Laval; online: www.vho.org/F/j/Akribeia), *Le Révisionniste* (VHO, BP 46, B-2600 Berchem 1, Belgium); *The Revisionist* (PO Box 257768, Chicago, IL 60625, online: www.vho.org/tr).

⁴⁴ The Fabius-Gayssot Law was passed in France in 1990, rendering punishable the ‘denial of the facts’ of the National Socialist war crimes ‘ascertained’ at the Nuremberg Trials of 1946 convened by the Allied powers. In 1993, Austria followed suit (sec. 3h Criminal Law); in 1994, Germany (sec. 130 Criminal Code, new version), in 1995, Switzerland (sec. 216^{bis} Criminal Code) and in 1996, Spain enacted similar laws. A similar law passed in Belgium in 1997 has not yet been enforced. Poland adopted a similar law in 2000, Hungary is currently preparing to introduce one. Canada and Australia have created ‘Human Rights Commissions’ which persecute revisionists although there is no legal framework for this.

at refutation by the pharmacist Jean-Claude Pressac in the periodical *Jour Juif*.⁴⁵ His work could hardly qualify as an expert discussion in view of the absence of any references to his sources and any exact scientific argumentation. Though he did point out several deficiencies in the *Leuchter Report*, he made several errors himself in chemical and engineering questions due to his lack of expertise.⁴⁶

The first response from Germany came from the *Institut für Zeitgeschichte* (IfZ, Institute for Contemporary History).⁴⁷ It was based on Pressac's work and was hardly useful due to the lack of technical expertise in the same.⁴⁸

A little later, a contribution on the *Leuchter Report* appeared in an anthology on the Third Reich, authored by retired social worker Werner Wegner, who had no qualifications in chemistry or civil engineering either.⁴⁹ Instead of seeking the advice of qualified people on these matters, he drew his own conclusions—to his own massive embarrassment.⁵⁰ One may question why Dr. Rainer Zitelmann, the responsible editor of this anthology, included this ridiculous piece in his otherwise well-researched compilation.⁵¹

At the end of 1991, chemist Dr. J. Bailer critiqued the *Leuchter Report* in a little booklet published in Austria.⁵² This work is notable

⁴⁵ J.-C. Pressac, *Jour J*, December 12, 1988, pp. I-X. See also the related discussion in the undated translation, without references; see also Pressac in: S. Shapiro (Ed.), *Truth Prevails: Demolishing Holocaust Denial: The End of the Leuchter Report*, Beate Klarsfeld Foundation, New York 1990.

⁴⁶ On this cf. W. Schuster, "Technische Unmöglichkeiten bei Pressac", *DGG*, 39(2) (1991), pp. 9-13 (online: vho.org/D/DGG/Schuster39_2); also Paul Grubach, "The Leuchter Report Vindicated: A Response to Jean-Claude Pressac's Critique", *JHR*, 12(2) (1992), pp. 248ff. (online: codoh.com/gcgv/gc426v12.html)

⁴⁷ H. Auerbach, Institut für Zeitgeschichte, letter to Bundesprüfstelle, Munich, Oct. 10, 1989; Auerbach, November 1989 (no day given), both published in U. Walendy, *Historische Tatsache* no. 42, Verlag für Volkstum und Zeitgeschichtsforschung, Vlotho 1990, pp. 32 and 34.

⁴⁸ In this regard, see my technical appraisal, reprinted in Henri Roques, Günter Anthon, *Der Fall Günter Deckert*, DAGD/Germania Verlag, Weinheim 1995, pp. 431-435 (online: www.vho.org/D/Deckert/C2.html).

⁴⁹ W. Wegner, "Keine Massenvergasungen in Auschwitz? Zur Kritik des Leuchter-Gutachtens", in U. Backes, E. Jesse, R. Zitelmann (ed.), *Die Schatten der Vergangenheit*, Propyläen, Frankfurt 1990, pp. 450-476 (online: www.vho.org/D/dsdv/Wegner.html, with interpolated critique by the present writer).

⁵⁰ On this cf. W. Häberle, "Zu Wegners Kritik am Leuchter-Gutachten", *DGG*, 39(2) (1991), pp. 13-17 (online: www.vho.org/D/DGG/Haerberle39_2.html).

⁵¹ In a personal communication to me, he confessed that he had been forced to include the paper to avoid opposition to his book due to the fact that the other papers were 'revisionist' in tone.

⁵² J. Bailer, "Der Leuchter-Bericht aus der Sicht eines Chemikers", in: *Amoklauf gegen die Wirklichkeit*, Dokumentationszentrum des österreichischen Widerstandes, Bundesministerium

for largely ignoring the witness testimony on the procedures supposedly used during the gassings at Auschwitz and for the author's lack of understanding of the process by which hydrogen cyanide reacts with masonry. Despite criticism directed at his study,⁵³ Bailer repeated his unsustainable objections in a later publication, without responding to his critics.⁵⁴

At approximately the same time as Bailer's first publication, G. Wellers also published a study of the *Leuchter Report*. Wellers' position was superficial, and is characterized by lack of technical and scientific knowledge.⁵⁵

Finally, the Auschwitz State Museum itself ordered an expert report to be compiled. The Institute for Forensic Research, Toxicology Division, of Cracow, Poland, named after Prof. Dr. Jan Sehn, prepared this report under Prof. Dr. J. Markiewicz on September 24, 1990, which confined itself to the analysis of masonry samples.⁵⁶ The report concluded that the reason why Leuchter's samples from the homicidal gas chambers were mostly negative with respect to traces of cyanide was because the cyanide compounds had been exposed for more than 40 years to weathering, which these compounds allegedly could not have withstood. Three of these authors from the Jan Sehn Institute later published additional findings,⁵⁷ which were, however, based on a verifiably incorrect analytical method—as was the first series of analy-

für Unterricht und Kultur (eds.), Vienna 1991, pp. 47-52. With respect to the cyanide content of human hair: Expert Opinion of the Cracow Institute, 1945, on the cyanide content of human hair, hair pins and a ventilation lid, B. Bailer-Galanda, *ibid.*, pp. 36-40; the original is in the custody of the Auschwitz State Museum.

⁵³ Cf. E. Gauss (alias G. Rudolf), *Vorlesungen...*, *op. cit.* (note 43), pp. 290-293; Gauss, "Chemische Wissenschaft zur Gaskammerfrage", *DGG*, 41(2) (1993), pp. 16-24 (online: vho.org/D/DGG/Gauss41_2).

⁵⁴ J. Bailer, in B. Bailer-Galanda, W. Benz, W. Neugebauer (ed.), *Wahrheit und Auschwitzlüge*, Deuticke, Vienna 1995, pp. 112-118; cf. my critique "Zur Kritik an 'Wahrheit und Auschwitzlüge'", in Herbert Verbeke (ed.), *Kardinalfragen zur Zeitgeschichte*, Vrij Historisch Onderzoek, Berchem, 1996, pp. 91-108 (online: www.vho.org/D/Kardinal/Wahrheit.html); Engl.: "Critique of Truth and the Auschwitz-Lie" (online: www.vho.org/GB/Books/cq/critique.html).

⁵⁵ G. Wellers, "Der Leuchter-Bericht über die Gaskammern von Auschwitz", *Dachauer Hefte*, 7(7) (November 1991), pp. 230-241.

⁵⁶ J. Markiewicz, W. Gubala, J. Labeledz, B. Trzcinska, Expert Opinion, Prof. Dr. Jan Sehn Institute for Forensic Research, department for toxicology, Cracow, Sept. 24, 1990; partially published, e.g. in: "An official Polish report on the Auschwitz 'gas chambers'", *JHR*, 11(2) (1991), pp. 207-216 (online: www.vho.org/GB/Journals/JHR/11/2/IHR207-216.html)

⁵⁷ J. Markiewicz, W. Gubala, J. Labeledz, *Z Zagadnien Nauk Sadowych*, Z XXX (1994) pp. 17-27 (online: www2.ca.nizkor.org/ftp.cgi/orgs/polish/institute-for-forensic-research/post-leuchter.report).

ses—so that their results were flawed.⁵⁸ Correspondence with the authors failed to elucidate the reasons for the deliberate use of an incorrect method.⁵⁹

In 1997 in France, distribution of the French edition of the present report produced two notable reactions, only one of which addressed factual arguments,⁶⁰ but which nevertheless failed to discuss the technical problems in a scientific manner.⁶¹ The Chemical Department of the French Academy of Sciences chose not to make a comment publicly on factual arguments, but rather to resort to polemic phraseology and personal attacks.⁶²

In 1998, in the United States, in answer to the present report, a paper appeared on the Internet, consisting partly of discussion of technical issues and partly of political name-calling.⁶³ In related correspondence,⁶⁴ however, the author of the paper avoided any discussion of the central issues.⁶⁵

In 1999, cultural historian Prof. Robert Jan van Pelt produced an expert report on Auschwitz for the defense in the libel case of British

⁵⁸ G. Rudolf, “*Leuchter-Gegengutachten: Ein Wissenschaftlicher Betrug?*”, in DGG 43(1) (1995) pp. 22-26 (online: www.vho.org/D/Kardinal/Leuchter.html); Engl.: “*Counter-Leuchter Expert Report: Scientific Trickery?*” (online: www.vho.org/GB/Books/cq/leuchter.html); summarized in Rudolf, “*A Fraudulent Attempt to Refute Mr. Death*”, online: www.vho.org/GB/c/GR/Fraudulent.html.

⁵⁹ G. Rudolf and J. Markiewicz, W. Gubala, J. Labedz, “*Briefwechsel*”, in: *Sleipnir*, 1(3) (1995) pp. 29-33; reprinted in Herbert Verbeke (ed.), *op. cit.* (note 54), pp. 86-90 (online Engl.: as note 58).

⁶⁰ B. Clair, “*Revisionistische Gutachten*”, *VffG*, 1(2) (1997), pp. 102-104 (online: www.vho.org/VffG/1997/2/Clair2.html).

⁶¹ G. Rudolf, “*Zur Kritik am Rudolf Gutachten*”, *ibid.*, pp. 104-108 (online: www.vho.org/VffG/1997/2/RudGut2.html).

⁶² La Vielle Taupe/Pierre Guillaume, “*Rudolf Gutachten: 'psychopathologisch und gefährlich'. Über die Psychopathologie einer Erklärung*”, *VffG*, 1(4) (1997), pp. 224f. (online: www.vho.org/VffG/1997/4/Guillaume4.html).

⁶³ Richard J. Green, “*The Chemistry of Auschwitz*”, May 10, 1998, online: holocaust-history.org/auschwitz/chemistry/, and “*Leuchter, Rudolf and the Iron Blues*”, March 25, 1998, online: holocaust-history.org/auschwitz/chemistry/blue/, with considerable proselytizing ‘anti-fascist’ bias.

⁶⁴ A detailed description of the deficiencies of the paper appeared in “*Das Rudolf Gutachten in der Kritik, Teil 2*”, *VffG* 3(1) (1999), pp. 77-82 (online: www.vho.org/VffG/1999/1/RudDas3.html); Engl.: “*Some considerations about the 'Gas Chambers' of Auschwitz and Birkenau*”, online: www.vho.org/GB/c/GR/Green.html.

⁶⁵ Richard J. Green, Jamie McCarthy, “*Chemistry is Not the Science*”, May 2, 1999, online: holocaust-history.org/auschwitz/chemistry/not-the-science/. About 50% of the article consists of political accusations and vilification. For a response, see G. Rudolf, “*Character Assassins*”, online: www.vho.org/GB/c/GR/CharacterAssassins.html.

Historian David Irving against American writer Deborah Lipstadt.⁶⁶ This report represents a retreat to the argumentative situation *before* Jean-Claude Pressac's first book, published in 1989,⁶⁷ ignoring almost all arguments brought forward by revisionists since that year.⁶⁸ In 2002, however, Prof. van Pelt published a summary of the evidence presented at said trial and his interpretation of it.⁶⁹ This book is the first in English to intensively discuss various revisionist arguments, for which he mainly relies on the works of J.-C. Pressac.⁷⁰ It is a pity, though, that the cultural historian van Pelt tries to address many chemical, toxicological, engineering and architectural questions for which he simply lacks both expertise and experience.

Most of the above-mentioned attempted refutations of the *Leuchter Report*, and subsequent discussion with other revisionists, are marred by personal insinuations about the motivations of persons making use of revisionist arguments, or by polemical excursions, neither of which contribute to the scientific discussion.

3.2. On Politics

The question of whether or not systematic mass-killings of Jews in homicidal gas chambers specifically constructed for the purpose of accomplishing their extermination took place under the National Socialist regime is apparently viewed as a political issue. Whether or not a moral appraisal of the National Socialist regime depends on the existence or non-existence of gas chambers is disputable. A political evaluation of the Third Reich is not significantly dependent upon this

⁶⁶ *Pelt Report*, introduced in evidence during the libel case before the Queen's Bench Division, Royal Courts of Justice, Strand, London, David John Cawdell Irving vs. (1) Penguin Books Limited, (2) Deborah E. Lipstadt, ref. 1996 I. No. 113.

⁶⁷ Jean-Claude Pressac, *Auschwitz: Technique and operation of the gas chambers*, Beate-Klarsfeld-Foundation, New York 1989.

⁶⁸ Cf. G. Rudolf, "Gutachter und Urteilsschelte", *VffG* 4(1) (2000), pp. 33-50 (online: www.vho.org/VffG/2000/1/Rudolf33-50.html); more exhaustively, in English, online: www.vho.org/GB/c/GR/RudolfOnVanPelt.html and [.../CritiqueGray.html](http://www.vho.org/CritiqueGray.html).

⁶⁹ Robert J. van Pelt, *The Case for Auschwitz. Evidence from the Irving Trial*, Indiana University Press, Bloomington/Indianapolis 2002; cf. Robert H. Countess, "Van Pelts Plädoyer gegen den gesunden Menschenverstand", *VffG*, 6(3) 2002), pp. 349-354; Paul Grubach, "Greuel-propaganda des Ersten Weltkriegs und der Holocaust", *ibid.*, pp. 354-359 (online: www.vho.org/VffG/2002/3/Countess349-354.html and [.../Grubach354-359.html](http://www.vho.org/Grubach354-359.html)).

⁷⁰ When he addresses chemical questions, he also refers to some degree to the work of R. Green, *op.cit.* (notes 63, 65).

moral evaluation. Since the present discussion contains neither a moral, nor political, evaluation of a long-dead regime, I shall make no moral or political statements. Personally, I am inclined to judge a politician, or political system, on the basis of what he, or it, was able to leave behind for their respective population—everything else follows. That must suffice at this point.

To everyone who has ever suspected that revisionists are motivated by a desire to whitewash National Socialism, or restore the acceptability of right-wing political systems, or assist in a breakthrough of Nationalism, I would like to say the following:

While researching, our highest goal must at all times be to discover how historical events actually occurred—as the 19th century German historian Leopold Ranke maintained. Historians should not place research in the service of making criminal accusations against, for example, Genghis Khan and the Mongol hordes, nor to whitewash any of their wrong-doings. Anybody insisting that research be barred from exonerating Genghis Khan of criminal accusations would be the object of ridicule and would be subject to the suspicion that he was, in fact, acting out of political motives. If this were not so, why would anyone insist that our historical view of Genghis Khan forever be defined solely by Khan's victims and enemies?

The same reasoning applies to Hitler and the Third Reich. Both revisionists and their adversaries are entitled to their political views. The accusation that revisionists are only interested in exonerating National Socialism and that such an effort is reprehensible or even criminal, is a boomerang: This accusation implies that it is deemed unacceptable to partially exonerate National Socialism historically, and by



Fig. 9: *People who run out of arguments turn to violence. Prof. Faurisson after an attack by Jewish thugs, Sept. 16, 1989.⁷¹*

⁷¹ *The Globe and Mail*, Sept. 18, 1989, *Le Monde*, Sept. 19, 1989, *Sunday Telegraph*, Sept. 24, 1989; see also “Revisionist Historian Suffers Savage Beating” (cdoh.com/thoughtcrimes/8909FAUR.HTML).

so doing, always also morally. But by declaring any hypothetical exoneration based on possible facts as unacceptable, one admits openly not to be interested in the quest for the truth, but in incriminating National Socialism historically and morally under any circumstances and at all costs. And the motivation behind this can *only* be political. Hence, those accusing revisionists of misusing their research for political ends have themselves been proven guilty of exactly this offense. It is therefore not necessarily the revisionists who are guided by political motives—though quite a few of them certainly are—but with absolute certainty all those who accuse others of attempting to somehow historically exonerate a political system which has long since disappeared.

As a consequence, our research must never be concerned with the possible ‘moral’ spin-off effects of our findings in relation to politicians or regimes of the past, but solely with the facts. Anyone who argues the opposite does not understand scientific research and should not presume to condemn others on the basis of authentic research.

4. A Brief History of Forensic Examinations of Auschwitz

4.1. Introduction

In late spring 1993, the Max-Planck-Institute for Solid State Research in Stuttgart issued an internal memorandum informing its employees that a doctoral candidate there—the author of this book—had been dismissed because of private research he had done on Auschwitz. The institute explained that in view of the horror of the National Socialists' crimes against the Jews, it was morally repugnant to discuss the specific manner, in which the victims had been killed, or to try to determine the precise number of the dead. That one of the world's leading scientific research institutes stated to its personnel that to determine accurate quantities is not only unethical, but reprehensible, and cause for dismissal, is not without its own irony. However, many people are deeply moved by the question whether or not the monstrous crime alleged should be subject to careful scrutiny by means of thorough forensic analysis. The following attempts to answer this question and offers a brief overview on forensic examinations of the purported crimes scenes at Auschwitz which have been conducted thus far.

4.2. The Moral Obligation of Forensic Examination

Does it really matter how many Jews lost their lives in the German sphere of influence during the Second World War? Is it so important, after so many years, to attempt painstakingly to investigate just how they died? After all, it is surely morally correct that even one victim is one too many; and nobody seriously denies that many Jews died.

To affirm these things, however, is not to raise a valid objection—moral or otherwise—to the scientific investigation of a crime held to be unique and unparalleled in the history of mankind. Even a crime that is alleged to be uniquely reprehensible must be open to a procedure that is standard for any other crime: namely, that it can be—must be—subject to a detailed material investigation. Further: whoever pos-

tulates that a crime, alleged or actual, is unique must be prepared for a uniquely thorough investigation of the alleged crime before its uniqueness is accepted as fact.

If, on the other hand, someone sought to shield so allegedly unparalleled a crime from investigation by erecting a taboo of moral outrage, the creators of that taboo would, at least morally, themselves commit a singular offense: imputing unparalleled guilt, beyond any critique and defense, in this case to an entire people, the Germans.

To demonstrate just what kind of double standard is being applied to 'the Holocaust' (generally defined as the purposeful annihilation, chiefly by gassing, of millions of Jews by the National Socialists), let us note the international reaction to several recent examples of mass murder or 'crimes against humanity.'

In 1949, a trial started in southwest France which caused as much attention in France as did the Nuremberg War Crimes Trial: Mdm. Marie Besnard was accused of having murdered twelve people with arsenic. During this extraordinary court battle, 15 experts on medical, chemical, geological and analytical forensic experts made exhaustive analyses and long-lasting, extensive experiments with the aim to verify whether the arsenic traces found in the buried victims stemmed from poison or are the result of yet unknown concentration processes in buried corpses. Finally, after twelve years of research and arguing of the fifteen experts, of which eight were professors and one even a Nobel Prize laureate, Mdm. Besnard was acquitted due to lack of evidence.⁷²

After the collapse of the Soviet Union in 1991, numerous mass graves, containing altogether hundreds of thousands of bodies of victims of the Soviets, were discovered, excavated, and investigated. Not only was the number of victims determined, but in many cases the specific cause of death as well. In the same regions where many of these mass graves were found, one million Jews are said to have been shot by the *Einsatzgruppen*: yet no such grave has ever been reported found, let alone dug and investigated, in the more than half a century during which these areas have been controlled by the USSR and its successor states.

During the conflict in Kosovo in 1999, rumors about mass killings by Serbs spread around the world. After the fighting was over, an in-

⁷² Michael D. Kelleher, C. L. Kelleher, *Murder Most Rare: The Female Serial Killer*, Praeger, Westport, Conn., 1998.

ternational forensic commission arrived in Kosovo, searching, excavating, and forensically investigating mass graves. These graves proved to be not only fewer than the Serbs' Albanian opponents had alleged, but to contain small fractions of the number of victims claimed.

Did the Allies attempt, during the Second World War and in the years immediately following, to find and to investigate mass graves of persons said to have been victims of the Germans? So far as is known, only once: at Katyn. But the findings of the Soviet forensic commission, which blamed the mass murder of several thousand Polish officers buried there on the Germans, are today generally considered a fabrication. The report of the international forensic commission invited by the Germans in 1943, on the other hand, which found that the Soviets had carried out this mass murder, is today considered accurate even by the Russian government.⁷³

4.3. A Definition of Forensic Science

Forensic science is generally regarded as a supporting science of criminology. Its aim is to collect and to identify physical remnants of a crime, and from these to draw conclusions about the victim(s), the perpetrator(s), the weapon(s), time and location of the crime as well as how it was committed, if at all. This science is relatively new and entered the court rooms only in 1902, when fingerprint evidence was accepted, in an English court, for the first time. The 1998 CD-ROM *Encyclopedia Britannica* writes about forensic science:

“A broad range of scientific techniques is available to law enforcement agencies attempting to identify suspects or to establish beyond doubt the connection between a suspect and the crime in question. Examples include the analysis of bloodstains and traces of other body fluids (such as semen or spittle) that may indicate some of the characteristics of the offender. Fibres can be analyzed by microscopy or chemical analysis to show, for instance, that fibres found on the victim or at the scene of the crime are similar to those in the clothing of the suspect. Hair samples, and particularly skin cells attached to hair roots, can be compared chemically and genetically to those of the suspect. Many inorganic substances, such as glass, paper, and paint, can yield considerable information under microscopic or chemical analysis. Examination of a document

⁷³ Cf. F. Kadell, *Die Katyn Lüge*, Herbig, Munich 1991.

in question may reveal it to be a forgery, on the evidence that the paper on which it is written was manufactured by a technique not available at the time to which it allegedly dates. The refractive index of even small particles of glass may be measured to show that a given item or fragment of glass was part of a particular batch manufactured at a particular time and place.”

Hence, forensic research is exactly what revisionists, starting with Robert Faurisson, have called the search for material evidence. The revisionists’ demand for such material evidence is entirely consistent with the normal practice of modern law enforcement. Also, as is generally acknowledged, forensic evidence is more conclusive than eye-witness testimony or documentary evidence.

Even though forensic methods have hardly been applied with regards to Auschwitz, there are a few examples which I shall discuss briefly in the following chapter.

4.4. Forensic Science and Auschwitz

4.4.1. Forensics in the Courts

4.4.1.1. The 1946 Cracow Auschwitz Trial

The 1946 Cracow Auschwitz Trial. In 1945, the Jan Sehn Institute for Forensic Research (Instytut Ekspertyz Sadowych) prepared a report on a forensic investigation of Auschwitz that was submitted in evidence in the 1946 Auschwitz trial in Cracow, Poland.⁷⁴ This expert report should be treated with caution, because forensic examinations and judicial procedures under the Communists have been anything but trustworthy, and in 1945, Poland was a Stalinist satellite. One need only point to the example of Katyn, the Soviet account of which was fully endorsed by Poland’s Communist regime.⁷³

The Cracow forensic investigators took hair, presumably cut from inmates, and hair clasps from bags found by the Soviets in Auschwitz. Tested for cyanide residues, both hair and clasps showed positive results. Additionally, a zinc-plated metal cover was tested for cyanide and found to have a positive result as well. The Cracow Institute claims that this metal cover once shielded the exhaust duct of a sup-

⁷⁴ Published in German, *op. cit.* (note 52), pp. 36-40; the original is in the Auschwitz State Museum.

posed homicidal gas chamber at Birkenau.

The tests conducted by the institute were qualitative, not quantitative, analyses. In other words, they could only determine whether or not cyanide was present, not how much of it was there. As to whether or not homicidal gassing with hydrogen cyanide took place in Auschwitz, these analyses are worthless, for three reasons:

1. There is no way of determining the origin and history of the hair and hair clasps obtained from bags in Auschwitz. Assuming that the analytic results are correct, from a chemical point of view the following can be noted: A positive test for cyanide in human hair proves only that the hair has been exposed to HCN (hydrogen cyanide). But that result does not suffice to establish that the persons from whom the hair came were killed by cyanide. It is a good deal more likely that the hair had already been cut when it was exposed to the gas: in German as well as in Allied camps, it was standard to cut off prisoners' hair for hygienic reasons. When hair over a certain length was later reused,⁷⁵ it had to be deloused beforehand (often with Zyklon B, the active ingredient of which is hydrogen cyanide). Hence, positive cyanide results from loose hair do not prove human gassings.
2. We face a similar problem with the zinc-plated covers allegedly used to cover the ventilation ducts of the supposed gas chambers: their exact origin and history is unknown. It would have been much preferable for the Cracow Institute to have analyzed samples from the walls of the alleged gas chambers instead of obtaining samples from pieces of metal:
 - a. Whereas the origin and history of these metal covers was uncertain, the origin and (at least partly) the history of the walls of the morgues allegedly used as gas chambers was known.
 - b. In contrast to cement and concrete, zinc-plated metal covers prevent the formation of stable iron cyanide compounds.⁷⁶ The developing zinc cyanide compounds are relatively unstable and must be expected to vanish in a short period of time.⁷⁷

⁷⁵ Letter from the SS-Wirtschafts- und Verwaltungshauptamt, Oranienburg, to concentration camp commanders, August 6, 1942, IMT Document 511-USSR, cited in: *Der Prozeß gegen die Hauptkriegsverbrecher vor dem Internationalen Militärgerichtshof* (Nuremberg, 1949), pp. 553f. The letter ordered the recycling of prisoners' hair twenty centimeters or more in length.

⁷⁶ Zinc prevents the formation of rust, which is required to form long-term stable iron cyanides.

⁷⁷ Like earth alkaline cyanides, zinc cyanides are slowly decomposed by humidity.

- c. The tendency of porous wall material in moist underground rooms to accumulate and to bind hydrogen cyanide, physically as well as chemically, is hundreds of times higher than that of sheet metal.⁷⁸
 - d. As a matter of fact, the letter accompanying the samples sent to the Cracow Institute actually mentions that a mortar sample allegedly taken from a so-called gas chamber is enclosed as well and should also be tested for cyanide. However, for unknown reasons, the Cracow Institute did not mention this mortar sample in its report, perhaps because it did not show any positive result.
3. It is unknown where those zinc-plated metal covers are today. It is furthermore impossible to identify them, since the Cracow report does not include a description or photo of them. Therefore, this analysis cannot be reproduced.

4.4.1.2. The 1964-1966 Frankfurt Auschwitz Trial

Several expert reports were prepared during the Frankfurt Auschwitz trial, the best known being those of the Munich *Institut für Zeitgeschichte* (Institute for Contemporary History).⁷⁹ However, none of these reports was forensic in nature. They addressed legal, historical, or psychological topics. Throughout this mammoth trial, the court, the prosecution,⁸⁰ and the defense⁸¹ never suggested that material traces of the alleged crime be secured and investigated. The prosecution had at its disposal numerous statements by eyewitnesses and confessions by perpetrators, and it considered this material entirely sufficient to estab-

⁷⁸ For this, see chapter 6.7.

⁷⁹ H. Buchheim *et al.*, *Anatomie des SS-Staates*, Walter, Freiburg 1964.

⁸⁰ Throughout his writings, Adalbert Rückerl, one of the most prominent German prosecutors in 'Holocaust cases', dispenses with any mention of material evidence. Instead, he declares documentary evidence the best and most important form of evidence, even in the absence of material evidence for the authenticity and correctness of the documents themselves (in J. Weber, P. Steinbach (eds.), *Vergangenheitsbewältigung durch Strafverfahren?*, Olzog, Munich 1984, p. 77). Rückerl reports that it is practically impossible to find a suspect guilty solely on documentary evidence, so that, especially given the increasing time span separating alleged crimes from trial, it is almost always necessary to fall back on eyewitness testimony, even though its unreliability is clear, particularly in trials of so-called 'National Socialist violent crimes' (A. Rückerl, *NS-Verbrechen vor Gericht*, C. F. Müller, Heidelberg 1984, p. 249; Rückerl, *Nationalsozialistische Vernichtungslager im Spiegel deutscher Strafprozesse*, dtv, Munich 1978, p. 34; Rückerl, *NS-Prozesse*, C. F. Müller, Karlsruhe 1972, pp. 27, 29, 31).

⁸¹ Such total naiveté, combined with legal incompetence, on behalf of the defense is best exemplified in Hans Laternser, *Die andere Seite im Auschwitzprozeß 1963/65*, Seewald, Stuttgart 1966.

lish beyond reasonable doubt the existence of a program to exterminate Jews in Auschwitz and elsewhere during the Third Reich.⁸² The abundance of such evidence has since been used to argue that the lack of documentary and material evidence was irrelevant.⁸³ That no material evidence was presented during the Frankfurt Auschwitz Trial was freely conceded by the court in its ruling.⁸³

“The court lacked almost all possibilities of discovery available in a normal murder trial to create a true picture of the actual event at the time of the murder. It lacked the bodies of the victims, autopsy records, expert reports on the cause of death and the time of death; it lacked any trace of the murderers, murder weapons, etc. An examination of the eyewitness testimony was only possible in rare cases. Where the slightest doubt existed or the possibility of a confusion could not be excluded with certainty, the court did not evaluate the testimony of witnesses [...]”

4.4.1.3. The 1972 Vienna Auschwitz Trial

Between January 18 and March 10, 1972, two architects responsible for the design and construction of the crematoria in Auschwitz-Birkenau, Walter Dejaco and Fritz Ertl, were put on trial in Vienna, Austria.⁸⁴ During the trial, an expert report on the possible interpretation of the blueprints of the alleged gas chambers of the Auschwitz and Birkenau crematoria was presented to the court. The report concluded that the rooms in question could not have been gas chambers, nor could they have been converted into gas chambers.⁸⁵ Thanks to this first methodologically sound expert report on Auschwitz, the defendants were acquitted.

⁸² One of the most prominent German advocates of this thesis is Professor Ernst Nolte in his book *Streitpunkte*, Propyläen, Berlin 1993, pp. 290, 293, 297.

⁸³ Ref. 50/4 Ks 2/63; cf. I. Sagel-Grande, H. H. Fuchs, C. F. Rüter (eds.), *Justiz und NS-Verbrechen*, vol. 21, University Press, Amsterdam 1979, p. 434.

⁸⁴ Ref. 20 Vr 6575/72 (Hv56/72), Jan. 18-March 10, 1972; this reference number is different from the one Robert Van Pelt quotes in his report: *The Pelt Report*, *op. cit.* (note 66), p. 135 n. 59: 20 Vr 3806/64 and 27 C Vr 3806/64).

⁸⁵ Personal communication from the expert, who must, for the time being, remain anonymous for fear of persecution and prosecution. See Michael Gärtner, “Vor 25 Jahren: Ein anderer Auschwitzprozess,” *VffG*, 1(1) (1997), pp. 24f. (online: www.vho.org/VffG/1997/1/Gaertner1.html)

4.4.2. Forensics Outside the Courts

4.4.2.1. In Search of Mass Graves

In 1966, the Auschwitz State Museum commissioned the Polish company Hydrokop to drill into the soil of the Auschwitz-Birkenau camp and to analyze the samples. It is not known whether this research was done in the context of the Frankfurt Auschwitz trial. The results, however, vanished into the museum's archives: they have never been released, which by itself is revealing enough. Years later, however, several pages from this report were photocopied and sent to the German revisionist publisher Udo Walendy, who published them with commentary in an issue of his periodical.⁸⁶ Traces of bones and hair allegedly found at several places might indicate mass graves. The few pages published by Walendy, however, do not reveal whether these findings led to an excavation or a subsequent forensic study of the traces. It is not even evident whether the bone and hair samples collected are human or animal remains.

4.4.2.2. Faurisson and the Consequences

As a result of Prof. Faurisson's activities as described in chapter 3., forensic research on Auschwitz boomed since 1988. Each time a researcher came to a conclusion contradicting the widely held views, he was socially ostracized and persecuted, like Prof. Faurisson, Fred Leuchter, and Germar Rudolf, but when the results confirmed the reigning paradigms, the researchers were darlings of the media and politicians, like Jean-Claude Pressac, the researchers from the Jan-Sehn-Institute in Cracow, and more recently Prof. Robert van Pelt.⁶⁹

It must therefore be stated that forensic research on Auschwitz is not at all reprehensible, as stated by the Max-Planck-Institute in Stuttgart. Such research was always done, more or less intensively. What is often considered to be reprehensible, however, is a research result that is unwanted by the public. This is an unfortunate bias, because science can prosper only where any result is openly and freely published and discussed without researchers fearing punitive measures.

The present book is an attempt to give the reader an update about the results of the ongoing forensic research on the two major camps of

⁸⁶ Udo Walendy, *Historische Tatsachen*, no. 60, Verlag für Volkstum und Zeitgeschichtsforschung, Vlotho 1993, pp. 7-10.

Auschwitz, the *Stammlager* or main camp close to the town of Auschwitz itself, and the *Birkenau* camp some 3 km to the northwest of the town. May it *not* lead to more persecution and ostracism of its author than he already has experienced.⁸⁷

⁸⁷ For this, see the appendix at the end of this book.

5. Auschwitz

5.1. Introduction

5.1.1. “Opera During the Holocaust

We are all familiar with the name Auschwitz. Most people could identify Auschwitz as a ‘death camp’ for the Jews. Many people might be capable of recalling that it was located in Poland. Many would be uncertain of details, but would be at least familiar with the name. In any case, it is a part of modern culture.

Auschwitz is usually depicted as the place of incessant, methodical and centrally-planned extermination of the Jews (not the Jewish race, as there is none.)

There are many accounts and descriptions about the total horror, the pervasive atmosphere of suffering and the impending assembly line of death. Could such a place possibly have had a swimming pool for the prisoners? Could it have been equipped with a social-educational centre, organized discussion groups, concerts, theatre, a children’s choir, opera performances—all run by, and for, the internees? Impossible! That wouldn’t fit in with the image with which we are all familiar.

Anyone prepared to search books, papers, and videos presenting the non-establishment evidence and opinions—material which, significantly, is never available in mainstream book shops—will become familiar with this information.

The swimming pool has appeared in published reproductions of various wartime aerial photographs. Of course, these photos could be fakes; but the prisoner’s pool—now seen close-up—appears in a video filmed in modern-day Auschwitz. This video includes a rather surprising interview with the head tour guide and the director of the modern-day camp, Dr. Franciszek Piper. The film was made by David Cole.

Mr. Cole is an American Jew. Perhaps the video is a forgery. But if the other facilities did, in fact, exist, then the swimming pool is quite plausible.

For evidence of the reality of the other facilities, let’s turn to no less a source than the Jerusalem Post (domestic edition), January, 25,

1995, (Features), page 7.

This present writer has the original copy, it was sent to him from Israel. One half-page article is entitled 'Amidst the Killing, Children Sang of Brotherly Love'. 'In 1943, 10-year-old Daniel K. arrived in Auschwitz. Now a university professor, he looks back at a different face of the death camp', runs the introduction. Professor K. writes: 'The Chorale from [Beethoven's Ninth Symphony] was... performed by a Jewish children's choir at Auschwitz-Birkenau in 1943... I was a member of that choir... I... remember my first engagement with culture, with history, and with music—in the camp...'

'In March 1944, I was severely ill with diphtheria and was sent to the camp hospital barracks. My mother had asked to be transferred to stay with me in the hospital. [Response not stated]... Nurses, doctors, and patients survived...'

Why nurses, doctors, even hospitals, for people who were sent there to be killed? Why was the boy fed, clothed, and housed for between two and three years? Daniel K continues:

'One of the youth leaders of our group... asked to establish an education centre for children. He was given permission, and in a short time the education centre became a spiritual and social centre for the family camp. [The family camp!] It was the soul of the camp.

'Musical and theatrical performances, including a children's opera, were held at the centre. There were discussions of various ideologies—Zionism, Socialism, Czech nationalism... There was a conductor named Imre... (who) organized the children's choir. Rehearsals were held in a huge lavatory barracks where the acoustics were good...

'(In) the fall 1944... huge masses of inmates fit for labour were being sent to Germany.' (End quote.)

Ah, so 'huge masses' of them were kept fit to work! I have deliberately ignored the many usual references to extermination, gas ovens, and so on; they are available ad nauseam all around us.

My purpose is to bring to attention the admitted existence of these leisure facilities. Their existence can no longer be doubted. Their existence throws a new and thought-provoking light on those familiar stories we all know: Could it be that Auschwitz was not quite the type of place usually described?"

The above article by Dan McSweeney was published on May 1, 1997, in the Australian newspaper *Killoy Sentinel* (New South Wales).

David Cole's eye-opening video, described in the article, can still be purchased today.⁸⁸ The leisure facilities described in the article above are in no way as unknown to the usual literature as represented here. Rather, the literature of concentration camp experiences and the secondary literature dealing with the same subject is saturated with similar references to stays in hospital, expensive health care treatments of seriously ill 'unfit' persons, dental clinics, kindergartens, concerts, sports events (Birkenau had its own soccer field), access to the city of Auschwitz, etc.). These descriptions are, of course, not the dominant theme. They are mentioned in passing, alongside the well-known horror stories and atrocities. It is only when one deliberately looks for such things and compiles them that one becomes aware of what a paradoxical image these contemporary witnesses of Auschwitz actually portray—and not just of Auschwitz, by any means. That should be sufficient 'food for thought' for any of us. A consistent analysis of the eyewitness accounts which have, in the meantime, multiplied to sheer infinity, from this point of view, remains to be compiled. Who dares to perform this thankless task?

5.1.2. On the History of the Camp

Although the name of Auschwitz, a town in Polish Upper Silesia, is utilized as a synonym for the alleged National Socialist crime of an assembly-line extermination of Jews—frequently described as 'unique'—thus far, worldwide, there has never been any balanced description of this concentration camp. Generally, only three books, from the thousands on the subject, are worth selecting for discussion here.

Danuta Czech's *Kalendarium*, a work of post-war Polish-Communist propaganda, resembles a sort of catalogue of chronological listing of actual and invented individual events, without any attempt to draw up a theoretically definitive and critical view of the existing material on the history of the camp.⁸⁹

Jean-Claude Pressac's works concentrate almost exclusively on

⁸⁸ "David Cole Interviews Dr. Franciszek Piper, Director, Auschwitz State Museum", VHS Video, distributed by CODOH, P.O. Box 439016, San Diego, CA 92143, USA (online: codoh.com/cole.ra (includes audio)); for the abridged text-only version, see: David Cole, "A Jewish Revisionist's Visit to Auschwitz", *JHR* 13(2) (1993), pp. 11-13 (online: codoh.com/gcgv/gcgvcole.html (excerpt))

⁸⁹ *Kalendarium der Ereignisse im Konzentrationslager Auschwitz-Birkenau 1939-1945*, Rowohlt Verlag GmbH, Reinbek bei Hamburg, 1989.

only five buildings in the camp, the crematoria,^{67,90} but due to his lack of technical and architectural expertise, nevertheless fails miserably in his self-appointed task of explaining the technique and manner of functioning of these buildings.⁹¹

Robert van Pelt and Deborah Dwork, in their history of the city of Auschwitz, deal only superficially with the subject of the concentration camp,⁹² and van Pelt's more recent book is perhaps a bit too narrowly focused on homicidal gassings and does not really go beyond what Pressac already presented.⁶⁹

Books available on bookstore shelves are—for the most part—a compendium of eyewitness reports, scattered amongst serious attempts at documentation and literary pretensions.⁹³

Only in the very early 1990s, *i.e.*, since the collapse of the Communist regime in Eastern Europe, did the files of those agencies of the Third Reich become available to us which allow a reliable history of Auschwitz camp to be written. The files of the *Zentralbauleitung der Waffen SS und Polizei Auschwitz* (Central Construction Office of the

⁹⁰ J.-C. Pressac, *Les crématoires d'Auschwitz. La machinerie du meurtre de masse*, CNSR, Paris 1993; German: *Die Krematorien von Auschwitz. Die Technik des Massenmordes*, Piper, Munich 1994; if not mentioned otherwise, back references to this footnote refer to the French original.

⁹¹ For a criticism of Pressac's first book, see R. Faurisson, *JHR*, 11(1) (1991), pp. 25ff.; *ibid.*, 11(2) (1991), pp. 133ff. (online French.: www.vho.org/F/j/RHR/3/Faurisson65-154.html); F. A. Leuchter, *The Fourth Leuchter Report*, Samisdat Publishers Ltd., Toronto 1991 (online: www.zundelsite.org/english/leuchter/report4/leuchter4.toc.html); for critique of Pressac's second book see: Herbert Verbeke (ed.), *op. cit.* (note 43); for a criticism of the principles underlying Pressac's methodology, see G. Rudolf, "Gutachten über die Frage der Wissenschaftlichkeit der Bücher Auschwitz: Technique and operation of the gas chambers und Les Crématoires d'Auschwitz, la Machinerie du meurtre de masse von Jean-Claude Pressac", in: W. Schlesiger, *Der Fall Rudolf*, Cromwell, London 1994 (Engl. online: www.vho.org/GB/Books/trc/index.html#expert-report); Pressac has since been the target of massive, quite unscientific, attacks from Jewish quarters as well; see also *Rivarol*, March 22, 1996, p. 8 (online: abbc.com/aaargh/fran/archFaur/RF960322.html); *ibid.*, April 12, 1996, p. 4; see also Pierre Guillaume's criticism, *De la misère intellectuelle en milieu universitaire*, B.p. 9805, 75224 Paris cedex 05, 1995 (online: abbc.com/aaargh/fran/archVT/vt9309xx1.html).

⁹² Robert van Pelt, Deborah Dwork, *Auschwitz: 1270 to the Present*, Yale University Press, New Haven and London 1996; see also Carlo Mattogno's criticism "Architektonische Stümpereien zweier Plagiatoren", *VffG*, 4(1) (2000), pp. 25-33 (online: www.vho.org/VffG/2000/1/Mattogno25-33.html); Engl.: "Auschwitz 1270 to the Present" (online: <http://www.codoh.com/granata/irving-eng.html>).

⁹³ See, in this regard, Norman G. Finkelstein's condemnation in Norman G. Finkelstein, Ruth Bettina Birn, *A Nation on Trial: The Goldhagen Thesis and Historical Truth*, Metropolitan Books, New York 1998; see also Richard Widmann's criticism, "Holocaust-Literatur versus Holocaust-Wissenschaft", *VffG* 2(4) (1998), pp. 311 ff. (online: www.vho.org/VffG/1998/4/Buecher4.html).

Waffen SS and Police at Auschwitz),⁹⁴ which are located in Moscow, the files of the *Kriegsarchiv der Waffen SS* (War Archive of the Waffen SS) in the Military-Historical Archives in Prague, and the files of Auschwitz concentration camp, which are located at the Auschwitz Museum, are especially important in this regard. Since there are more than one hundred thousand documents in these archives, it will be necessary to wait for several years for the appearance of a seriously documented work on the topic. It must be considered certain that such research, which is only just beginning, will lead to a further massive revision of our image of Auschwitz concentration camp.

In the absence of better documentation, in the following—as far as the brief survey of the history of Auschwitz is concerned—I will rely upon the statements of Jean-Claude Pressac,^{67,90} where his statements are undisputed, since Pressac is continued to be praised as *the* expert regarding the technique of Auschwitz.⁹⁵

The installations of the Auschwitz I camp, also known as the *Stammlager* (main camp) and located on the outskirts of the city of Auschwitz, originally formed part of the barracks of the Austrian-Hungarian Monarchy (later Poland), and were transformed into a concentration camp after the German invasion of Poland in September 1939. Camp II, located in the vicinity of the city of Birkenau (known as Auschwitz-Birkenau), was rebuilt after the start of the Russian campaign, officially as a Waffen SS prisoner of war camp for the reception of Russian POWs. Both camps belonged to the same complex, with over 30 additional smaller camps in Upper Silesia, intended to supply manpower, etc., for the chemical works recently built by the Germans on a large scale at Auschwitz, in particular the BUNA works of the German industrial giant *I.G. Farbenindustrie AG* for coal refining (liquefaction and gasification plants for artificial rubber and fuel production), located close to the settlement Monowitz east of Auschwitz, see Fig. 10. Birkenau camp was used, among other things, for the reception of unfit prisoners. The intended camp capacity of 200,000 to 300,000 inmates, according to the final planning situation, was unique among the concentration camps of the Third Reich. This capacity was

⁹⁴ Tsentr Chranenija Istoriko-dokumental'nic Kollektsii (hereafter *TCIDK*); see also the documents in the Gosudarstvennyy Archiv Rossiskoy Federatsii.

⁹⁵ Cf. Manfred Köhler, “*Pressac und die deutsche Öffentlichkeit*”, in: Herbert Verbeke, *op. cit.* (note. 43), pp. 19-30 (online: www.vho.org/D/anf/Koehler.html); Engl.: “*Pressac and the German Public*”, online: www.vho.org/GB/Books/anf/Koehler.html

however never even approximately achieved.

The cramming together of large number of people in the most restricted areas of the camp, the sanitary infrastructure of which was just being developed, caused serious health problems in all camps of the Third Reich. Both inmates and hundreds of civilians working in the camps could introduce all sorts of parasitic insects into the camp, in particular lice and fleas. Lice are the chief carriers of epidemic typhus which was a widespread disease in Eastern Europe. Therefore, the camps were equipped with hygienic installations, including extensive disinfestation installations, in which the clothing and personal effects of newly arriving inmates were disinfested, for instance with the insecticide Zyklon B (a porous carrier material soaked with liquid hydrogen cyanide), a product frequently used for this purpose. The inmates themselves were given a haircut⁹⁶ and were made to shower thoroughly. Since the camp was at times insufficiently equipped with disinfestation installations and materials, also aided by the carelessness during disinfestation on the part of civilians working in the camp, typhus epidemics broke out repeatedly killing large numbers of inmates as well as guards.

Due to the high mortality rate, these camps were equipped with cremation facilities. After a devastating typhus epidemic during the summer of 1942, during which more than 300 people died per day in peak times, plans were made to build four cremation facilities at Birkenau in the hope of being able to cope with the amount of corpses. Of these four crematoria, however, two were severely damaged shortly after they were put into operation. Since it turned out that the capacity of the four Birkenau crematoria was much higher than needed, the two damaged crematoria were not repaired but were allowed to remain idle. The main camp in Auschwitz possessed only one crematorium installation which was put out of operation with the opening of the installations at Birkenau.

Historians today usually assume that the above mentioned cremation installations were not only used for the purpose initially planned, *i.e.*, the incineration of inmates having died of natural causes, but were later misused for the mass extermination of the Jews, among others. According to these historians, the term “*arbeitsunfähig*” (unfit for la-

⁹⁶ In the Third Reich, hair cut to a certain length is alleged to have been collected for industrial purposes, after previous delousing, see note 75.

bor), used in relation to prisoners, was equivalent in meaning to ‘undeserving of life’. This implies that any arriving inmates who were unable to work were killed immediately. For this purpose, human beings are said to have been killed (‘gassed’), after a few structural modifications, in a few rooms in the particular cremation installations, using Zyklon B—actually intended for vermin control. Allegedly, the victims were then burnt, some of them in the cremation ovens and some in open ditches.

According to eyewitness accounts, a homicidal gas chamber is supposed to have existed in the crematorium of Auschwitz I; this location still exists today, intact, but has been the object of serious manipulation, as we shall see. Additional homicidal gas chambers are said to have existed in the Birkenau camp, Auschwitz II, located approximately three kilometers away. These gas chambers were allegedly located in the four crematoria of that camp, as well as in two farmhouses outside the actual camp itself, modified for homicidal gassing purposes.

Of the installations used for disinfestation in the Birkenau camp using *Zyklon B*, only buildings 5a and b (BW 5a/b) in construction sections 1a/b (*Bauabschnitt* 1a/b) remain intact. In these buildings, one wing each is said to have been temporarily used for the disinfestation of personal effects with hydrogen cyanide. The following is an architectural and structural description of the individual structures of the Auschwitz main camp and Birkenau, Figs. 11 and 12.

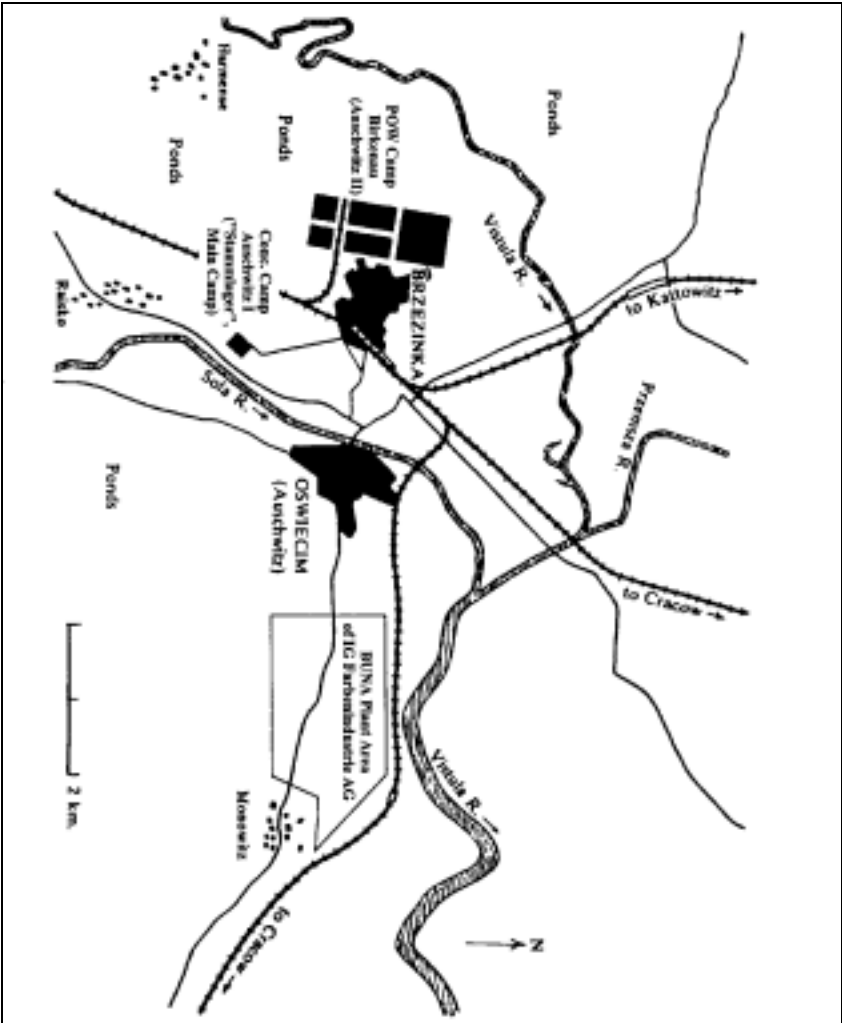

Fig. 10: Map of the surrounding vicinity of Auschwitz during the Second World War. The boundary lines of the terrain of the IG Farbenindustrie factories were entered later, and are only an approximate indication of the factory terrain. The terrain of Birkenau concentration camp corresponds to the planning situation of 1945, which was, in fact, never completed.

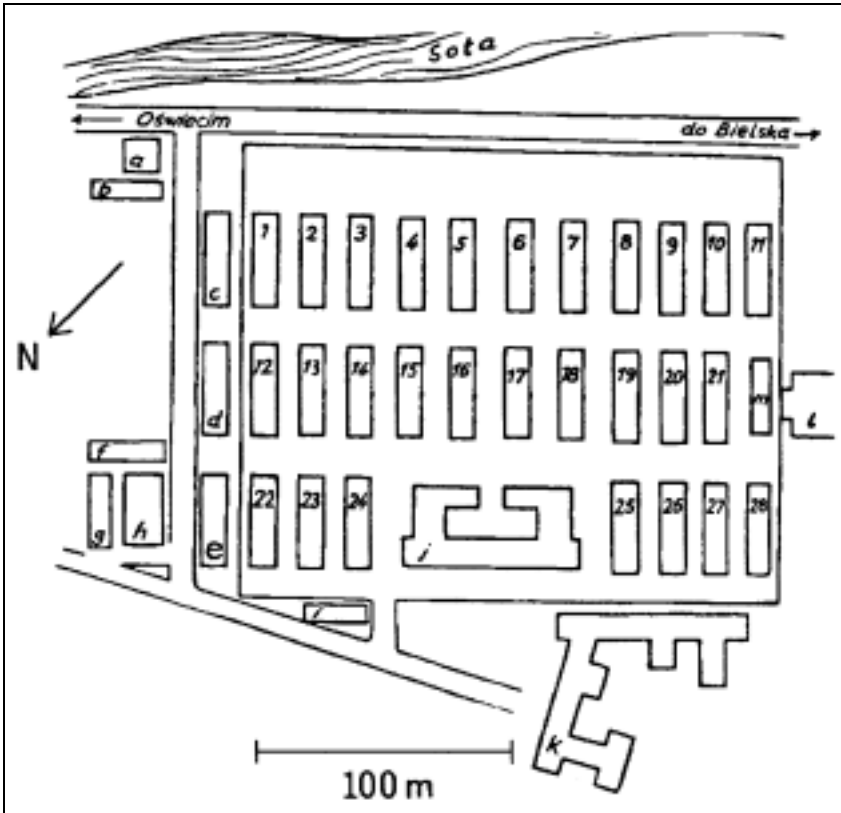

Fig. 11: Map of Auschwitz I/Main Camp (concentration camp), according to the information brochure of the Auschwitz State Museum in 1991.

Block 1—28: inmate barracks

- a: commandant's house
- b: main guard station
- c: camp commandant's office
- d: administration building
- e: SS hospital
- f,g: political division

- h: crematorium I with 'gas chamber'
- i: guard station near camp entrance gate
(block leader room)
- j: camp kitchen
- k: inmate registration building
- l: camp warehouse, theatre building
- m: new laundry

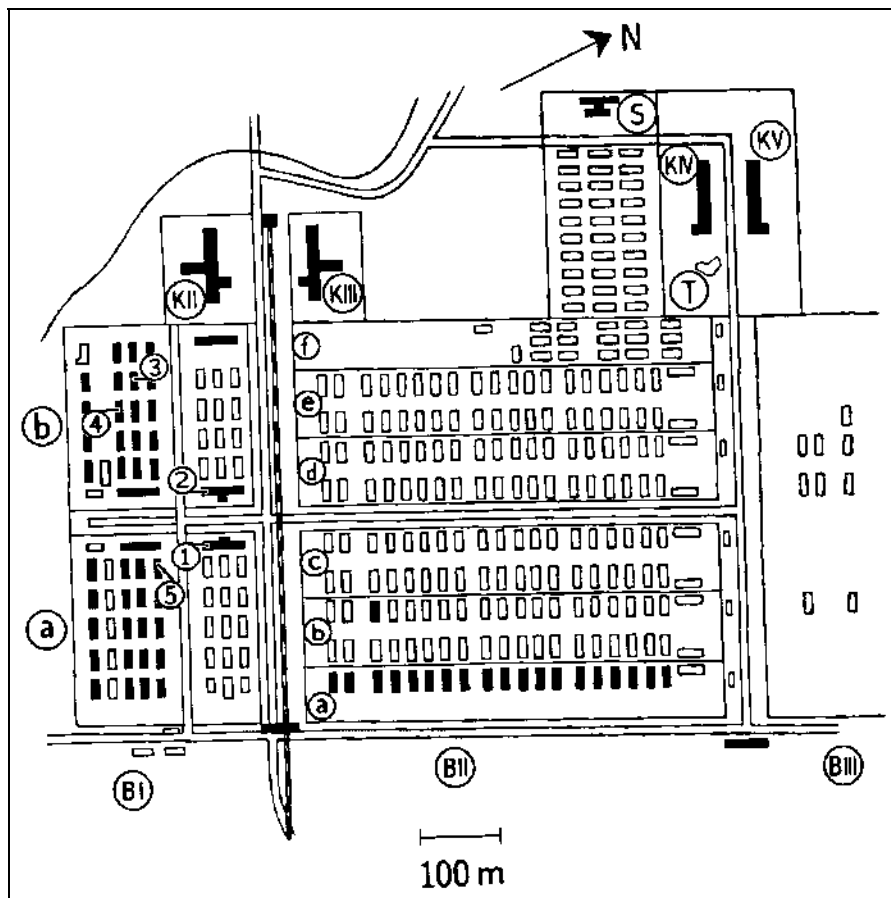

Fig. 12: Map of POW camp Auschwitz II/Birkenau, approximately 2 km north-west of the main camp, construction situation as of the end of 1944. The shaded buildings still exist, some of them, however, only in the form of ruins or foundations (crematoria II-V), the rest having been torn down by Polish civilians for building materials after the war. According to the information brochure of the Auschwitz State Museum, 1991.

BI-III: building sector I to III

Bla/b: women's camp

BIIa: quarantine camp

BIIb: family camp

BIIc: Hungarian camp

BIIId: men's camp

BIIe: gypsy camp

BIIIf: inmate hospital

K II: crematorium II with 'gas chamber'

K III: crematorium III with 'gas chamber'

K IV: crematorium IV with 'gas chamber'

K V: crematorium V with 'gas chamber'

S: 'Zentralsauna', hot-air/steam disinfestation

T: pond

1: building sector 5a—Zyklon B disinfestation

2: building sector 5b—Zyklon B disinfestation

3: inmate barracks no. 13

4: inmate barracks no. 20

5: inmate barracks no. 3

5.2. Epidemics and the Defense Against them

5.2.1. Danger of Epidemics⁹⁷

Before the era of modern warfare, it has always been taken for granted that during a war epidemic disease caused more deaths among the soldiers and civilians than the use of weapons. It took the atomic bomb, deployed in a ruthless and criminal manner by the United States against unarmed people and in contravention of international law, to change this assumption.

The epidemic most feared in World War I at the eastern front was typhus.⁹⁸ Typhus epidemics claimed uncounted thousands of lives among German soldiers at the Russian front and could be prevented from spreading into German territory after the end of the war only by the most rigorous of measures. Since that time, the danger of epidemics has been taken seriously by medical and military offices and personnel.⁹⁹

For example, the German encyclopedia *Der große Brockhaus*, vol. VI of the 1930 Leipzig edition, contains a comprehensive article on epidemic typhus. This acute infectious disease is spread only by the body louse.¹⁰⁰

“The disease is caused by Rickettsia prowazeki (discovered in 1910 by Ricketts and in 1913 by Prowazek), a micro-organism found in the intestines and salivary glands of infected lice. [...]

Epidemic typhus occurs chiefly where unfavorable social and sanitary conditions prevail: in dank overcrowded living quarters, hospitals,

⁹⁷ The following remarks are largely based on H.J. Nowak’s study, “Shortwave Delousing Facilities in Auschwitz”, in: E. Gauss (ed.), *op. cit.* (note 43), pp. 312-324 (online: www.vho.org/GB/Books/dth/fndNowak.html).

⁹⁸ Epidemic Typhus, which is also called European, Classic, or Louse-Borne Typhus, or Jail Fever, is a louse-borne disease caused by bacteria belonging to the Rickettsia group. Whereas Typhus is the term used in English to refer to all diseases caused by various Rickettsia bacteria, the German term is “Fleckfieber”, which, in English, is used only for one type of typhus, the so-called Rocky Mountain Spotted Fever that is transferred by ticks; see <http://www.merck.com/pubs/mmanual/section13/chapter159/159a.htm>

⁹⁹ O. von Schjerning, *Handbuch der Ärztlichen Erfahrungen im Weltkrieg 1914/1918*, volume VII Hygiene, J. A. Barth Verlag, Leipzig 1922, in particular, pp. 266ff: “Sanierungsanstalten an der Reichsgrenze”.

¹⁰⁰ The *Brockhaus Encyclopedia* refers to the article by A. Schittenhelm, “Flecktyphus” in *Handbuch der Inneren Medizin*, 2nd ed., 1925.

prisons, emigration ships, caused by crop failures and price increases, thus also known as starvation, hospital, prison, ship or war typhus. Typhus is endemic in Russia, the Balkans, northern Africa, Asia Minor, and Mexico. According to Tarrassevich, 25-30 million people suffered from epidemic typhus in Russia in 1918-1921, which amounts to 20-23% of the population. [...]

Successful control and prevention of epidemic typhus consists of enforcing all measures available to destroy the body louse.”

The experiences of German physicians during WWII were no different.^{101,102} The topic of epidemics can be found in countless publications. Practical experiments were also conducted which increased the knowledge about fighting the causes of this disease.

Professor Dr. F. Konrich was completely justified in stating, in his publication “*About sanitation facilities of German POW camps*”¹⁰³ that epidemics such as those in question “[...] had long been extinct here [in Germany].” However, it also becomes quite understandable why all of the offices and institutions involved over-reacted when epidemic typhus broke out in the Auschwitz concentration camp in early July 1942.¹⁰⁴ The outbreak was traced to the civilian laborers brought in to work in the camp, rather than to inmates deported to Auschwitz. Also, due to drastic measures taken to isolate and eradicate this epidemic, its spreading to the camp’s nearby civilian population could be prevented.

5.2.2. Epidemic Control with Zyklon B

One of the most efficient methods to fight lice and thereby to contain and eliminate typhus—but also to kill other vermin like grain beetles, bugs, cockroaches, termites, mice, rats and many more—is their poisoning with highly volatile hydrogen cyanide.

Liquid hydrogen cyanide has a short shelf life and is extremely dangerous with incorrect handling. At the end of the First World War, hydrogen cyanide was introduced onto the market in an easier to han-

¹⁰¹ R. Wohrlab, “*Fleckt看phusbekämpfung im Generalgouvernement*”, *Münchner Medizinische Wochenschrift*, 89(22) (1942), pp. 483-488.

¹⁰² W. Hagen, “*Krieg, Hunger und Pestilenz in Warschau 1939-1943*”, *Gesundheitswesen und Desinfektion*, 65(8) (1973), pp. 115-127; *ibid.*, 65(9) (1973), pp. 129-143.

¹⁰³ Friedrich Konrich, “*Über die Sanierungsanstalten der deutschen Kriegsgefangenenlager*”, *Gesundheits-Ingenieur*, July 19, 1941, pp. 399-404.

¹⁰⁴ Cf. Wilhelm Stromberger, “*Was war die ‘Sonderbehandlung’ in Auschwitz?*”, *Deutschland in Geschichte und Gegenwart*, 44(2) (1996), pp. 24f. (online: www.vho.org/D/DGG/Strom44_2.html).

dle and safer form: porous materials soaked with hydrogen cyanide with the addition of a stabilizer and an irritant warning material, intended to warn people of low concentrations of hydrogen cyanide, which in lower concentrations has only a slight odor and that many people cannot even smell at all. This product, called Zyklon B, was then packed in tin cans, which can only be opened with a special tool. The number of patents filed for the additives to Zyklon B shows that there was no simple, clear solution to the problems relating to the stabilizers and irritant warning materials.¹⁰⁵ Legally, there was a great difference between the stabilizer for Zyklon B and the irritant warning material. A stabilizer for Zyklon B was required by German law,¹⁰⁶ while an irritant warning material, by contrast, was not legally required.¹⁰⁷

Zyklon B was licensed and produced by the DEGESCH¹⁰⁸ corporation residing in Frankfurt.¹⁰⁹ Until the end of the Second World War, it played an extraordinarily important role in the struggle against insect pests and rodents^{110,111} in food warehouses, large-scale means of trans-

¹⁰⁵ See also, in this regard, Wolfgang Lambrecht, Otto Karl, *Das Handelsprodukt Zyklon B*, soon to be published on the internet at www.vho.org/D/Beitraege/Zyklon.html.

¹⁰⁶ Deutsche Reichsbahn Eisenbahnverkehrsordnung (EVO, German Reich railway regulations), annex C to §54 EVO, *Vorschriften über die nur bedingt zur Beförderung zugelassenen Gegenstände vom 1. Okt. 1938* (Regulations on Objects Permissible for Restricted Transport Only, dated 1 October 1938), p. 50:

“Die Blausäure muß durch einen von der Chemisch-Technischen Reichsanstalt nach Art und Menge anerkannten Zusatz, der zugleich ein Warnstoff sein kann, beständig gemacht sein.” (The hydrogen cyanide must be stabilized by an additive, which may also be an irritant, in the manner and quantity recognized by the Chemical-Technical Reichs Foundation.)

¹⁰⁷ L. Gaßner, “Die gesetzlichen Bestimmungen der Anwendung hochgiftiger gasförmiger Stoffe zur Schädlingsbekämpfung in Deutschland” (The legal provisions relating to the use of highly poisonous gaseous materials for pest control in Germany) in Karl Greimer, *Handbuch des praktischen Desinfektors*, Th. Steinkopf, Dresden 1937, pp. 185f. The fact that Auschwitz concentration camp received Zyklon B without an irritant is therefore not so unusual as sometimes represented in the literature, i.e., as a ‘criminal trace’. The well-known exceptional regulations for the Waffen SS are no exception; they merely referred to the applicable Reichs regulations and implementation provisions regulating the use of Zyklon B; see Deutsches Reich, “Anwendung von hochgiftigen Stoffen zur Schädlingsbekämpfung durch die Waffen-SS”, Rund-Erlaß des Reichministers für Ernährung und Landwirtschaft vom April 3, 1941, quoted acc. to *Zeitschrift für hygienische Zoologie und Schädlingsbekämpfung*, 33 (1941), p. 126.

¹⁰⁸ Deutsche Gesellschaft für Schädlingsbekämpfung (German Society for Pest Control), a subsidiary of the I.G. Farbenindustrie AG.

¹⁰⁹ On the history of the firm, mixed with Holocaust story telling, see Jürgen Kalthoff, Martin Werber, *Die Händler des Zyklon B*, VSA-Verlag, Hamburg 1998; much more factual and technically correct is the work by Wolfgang Lambrecht, Otto Karl, *op. cit.* (note 105).

¹¹⁰ O. Hecht, “Blausäuredurchgasungen zur Schädlingsbekämpfung”, *Die Naturwissenschaften*, 16(2) (1928), pp. 17-23.

port like trains, ships, both in Europe and in America.¹¹² For example, Dr. G. Peters reports in his work *Blausäure zur Schädlingsbekämpfung* (Hydrogen Cyanide for Pest Control)¹¹³ about the fumigation of ships with hydrogen cyanide, which happened in the United States as early as 1910, and about tunnel facilities, in which entire railway trains could be driven into in order to be disinfested (see Fig. 13).



Fig. 13: A lice-ridden train enters a railway gassing tunnel in Budapest.¹¹²

The use of Zyklon B in public buildings, barracks, prisoner of war camps, concentration camps was also featured in the literature of that time.¹¹⁴⁻¹¹⁷ Of course, there were several other gaseous pest control agents in addition to Zyklon B.^{118,119} Zyklon B continued to play an important role even after the war, until it was largely replaced by DDT and its successors.^{120,121}

A large number of publications are available from both the war-time and pre-war periods, to which reference is made.^{113,114,117,122-126}

¹¹¹ G. Peters, W. Ganter, "Zur Frage der Abtötung des Kornkäfers mit Blausäure", *Zeitschrift für angewandte Entomologie*, 21(4) (1935), pp. 547-559.

¹¹² G. Peters, "Eine moderne Eisenbahn-Entwesungsanlage", *Anzeiger für Schädlingskunde*, 14(8) (1938) pp. 98f.; cf. F.P. Berg, *op. cit.* (note. 131).

¹¹³ Gerhard Peters, *Blausäure zur Schädlingsbekämpfung*, Ferdinand Enke Verlag, Stuttgart 1933.

¹¹⁴ Walter Dötzer, "Entkeimung, Entseuchung und Entwesung", in J. Mrugowsky (ed.), *Arbeitsanweisungen für Klinik und Laboratorium des Hygiene-Instituts der Waffen-SS*, 2nd ed., Urban & Schwarzenberg, Berlin and Vienna 1943.

¹¹⁵ F.E. Haag, *Lagerhygiene, Taschenbuch des Truppenarztes*, vol. VI, F. Lehmanns Verlag, Munich 1943.

¹¹⁶ F. Puntigam, "Die Durchgangslager der Arbeitseinsatzverwaltung als Einrichtungen der Gesundheitsvorsorge", *Gesundheits-Ingenieur*, 67(2) (1944), pp. 47-56.

¹¹⁷ For a more recent treatment of the topic, see: F.P. Berg, *op. cit.* (note. 131).

¹¹⁸ G. Peters, *Die hochwirksamen Gase und Dämpfe in der Schädlingsbekämpfung*, F. Enke Verlag, Stuttgart 1942.

¹¹⁹ DEGESCH, *Acht Vorträge aus dem Arbeitsgebiet der DEGESCH*, 1942, p. 47; Document NI-9098 from the Nuremberg Trials, table of properties of the gaseous insecticide/pest control product used by DEGESCH.

¹²⁰ H. Kruse, *Leitfaden für die Ausbildung in der Desinfektion und Schädlingsbekämpfung*, Muster-Schmidt, Göttingen 1948.

¹²¹ H. Kliewe, *Leitfaden der Entseuchung und Entwesung*, F. Enke Verlag, Stuttgart 1951.

¹²² F. Puntigam, H. Breymesser, E. Bernfus, *Blausäuregaskammern zur Fleckfieberabwehr*, Sonderveröffentlichung des Reichsarbeitsblattes, Berlin 1943.

There are also guidelines on the fumigation of property and rooms, describing the procedures in detail, both before and afterwards.^{127,128} These do not considerably differ from the regulations in application today.¹²⁹ Based upon this, the following is a brief discussion of the technology and method of procedure employed.

Initially, for the disinfestation of personal effects, ordinary rooms (10 to 30 m² surface area) were temporarily modified, by making the windows and doors as gas-tight as possible by means of felt sealant material and paper strips, while providing for proper heating and ventilation of the rooms. Workers wearing gas masks spread Zyklon B evenly on the floor of the room containing the property to be disinfested. This procedure was similar to what was then the regular fumigation of ordinary rooms for the destruction of vermin. Such converted rooms may be seen even today in the main camp of Auschwitz I. The use of temporarily sealed rooms for fumigation purposes is not without risk since the sealing is never perfect.

Later, special gas-tight installations without windows were built, equipped with efficient heating and ventilation systems, and later also with circulating air systems for a more rapid circulation of the gas inside the room (so-called “*DEGESCH-Kreislaufverfahren*,” DEGESCH circulation procedure, see Fig. 14). Cans of Zyklon B were opened by means of an exterior mechanism, so that the workers were no longer exposed to danger. The bottom of the can was automatically punctured and the preparation fell into a basket, into which a fan blew hot-air, thus quickly evaporating the hydrogen cyanide and carrying the fumes

¹²³ G. Peters, “*Gefahrlose Anwendung der hochgiftigen Blausäure in Entlausungskammern*”, *Arbeitsschutz*, 5(III) (1942), pp. 167f.

¹²⁴ F. Puntigam, “*Raumlösungen von Entlausungsanlagen*”, *Gesundheits-Ingenieur*, 67(6) (1944), pp. 139-180.

¹²⁵ E. Wüstinger, “*Vermehrter Einsatz von Blausäure-Entlausungskammern*”, *Gesundheits-Ingenieur*, 67(7) (1944), p. 179.

¹²⁶ A more recent summary of this topic was prepared by Friedrich P. Berg, “*The German De-lousing Chambers*”, *JHR*, 7(1) (1986), pp. 73-94 (online: codoh.com/gcgv/gcdelouse.html); cf. also Berg, *op. cit.* (note 131).

¹²⁷ *Entseuchungs- und Entwesungsvorschrift für die Wehrmacht*, H. Dv. 194, M. Dv. Nr. 277, L. Dv. 416, Reichsdruckerei, Berlin 1939.

¹²⁸ *Richtlinien für die Anwendung von Blausäure (Zyklon) zur Ungeziefervertilgung (Entwesung)*, Gesundheitsanstalt des Protektorats Böhmen und Mähren, Prag o.J.; Dokument NI-9912(1) at the International Military Tribunal, reproduced by Herbert Verbeke (ed.), *op. cit.* (note 43), pp. 94-99.

¹²⁹ *Technische Regeln für Gefahrstoffe*, TRGS 512, Begasungen, BArbBl. no. 10/1989, p. 72, in: Robert Kühn, Karl Birett, *Merkblätter Gefährlicher Arbeitsstoffe*, ecomed, Landsberg 1990.

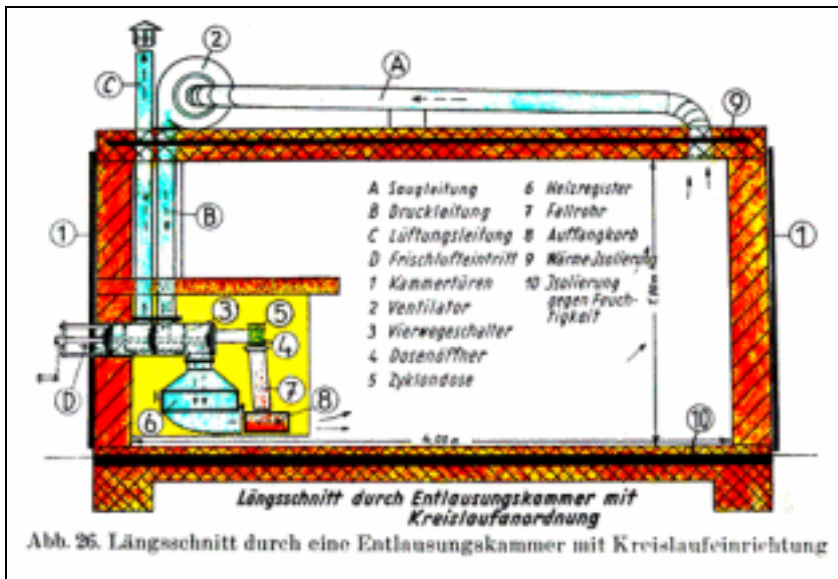

Fig. 14: DEGESCH delousing chamber with circulation feature.¹³⁰

away. These installations, with the so-called circulation procedure, were relatively small in size, a few m³, to economize on the highly-expensive vermin destruction product.

These professional installations were often part of an entire hygienic complex. As a rule, this building complex was organized approximately as follows in terms of purpose (see Fig. 15):¹⁰³

- Undressing room, ‘dirty side’. People to be deloused removed their soiled clothing and handed them over for disinfection/disinfection.
- Shower. Prisoners washed themselves after undressing, plus sometimes other procedures, such as haircuts, medical examinations, including a sauna.
- Dressing room, ‘clean side’. Their own cleaned and sanitized clothing was given back to the prisoners or substitute clothing was issued to them since the cleaning may have lasted many hours.
- Disinfection/Disinfection room. An area to clean and process the clothing combined with a laundry.

¹³⁰ Ludwig Gaßner, “Verkehrshygiene und Schädlingsbekämpfung”, *Gesundheits-Ingenieur*, 66(15) (1943), S. 174ff.; cf. F.P. Berg, *op. cit.* (note 131).

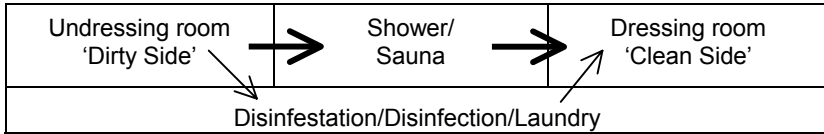

Fig. 15: Schematic organization of a hygiene complex
 → Clothing pathway; → Inmate pathway

It was not uncommon for a crematorium to be installed in the same building complex, as may still be seen at Dachau concentration camp today (near Munich), in which the new hygienic installation possesses a series of DEGESCH circulating air installations for the disinfestation of clothing, with an undressing and redressing room to the right and left of the inmate showers, as well as a crematorium. (The room described as a “*gas chamber*” at Dachau today is actually the inmate shower, which is indispensable in the above schema, and which has been intentionally mislabeled by the Museum.)

The applicable concentrations during the disinfestation of clothing might be very different according to the type of vermin and exterior conditions, and usually ranged from 5 to 30 g of hydrogen cyanide per m³ of air. The application time varied just as greatly, from under two hours up to ten hours and more. In the more modern installations with heating (higher than 25°C) and circulating air/ventilation installations, good results could be attained with concentrations of 20 g per m³, already after 1 to 2 hours. Disinfestation in ordinary rooms, on the other hand, could last up to 24 hours or more.

5.2.3. Epidemic Control in Auschwitz

5.2.3.1. Terminology Used and Responsibilities

We shall use the technical terms established in the 1939 German Army Regulations (*Heeresdienstvorschrift* 194),¹²⁷ since these determined how the personnel, *i.e.*, the physicians and those who disinfected the camps, were to proceed:

“Disinfection

Disinfection means [...]: destroying the disease-(epidemic-)causing agents on objects, in rooms, in excretions and on the bodies of infectious persons.



Fig. 16: Typical advertisement of the firm DEGESCH about the broad variety of applications of gassing methods offered: Flour mills, ships, grain storages, houses, railroad cars, trucks.¹³¹

Disinfestation

Disinfestation means: ridding rooms, objects and people of vermin (small life forms) that can transmit pathogens, cause economic damage or annoy man."

The regulation quoted lists all known physical and chemical means of disinfection and disinfestation. Similarly, a “work guideline” was released in 1943 by the Sanitation Institute of the Waffen-SS: “*Entkeimung, Entseuchung und Entwesung*”¹¹⁴ (Sterilization, Disinfection and Disinfestation).

The authority in charge of sanitation in the Waffen-SS as well as in the concentration camps was the “*Hygieneinstitut der Waffen-SS*”¹³² (Sanitation Institute of the Waffen-SS), established in 1942 in Berlin, which set up a branch office in 1943 in Rajsko near Auschwitz, with its “*Hygienisch-bakteriologischen Untersuchungsstelle Südost d. W-SS*” (Sanitary and Bacteriological Testing Station Southeast of Waffen-SS). The files from this testing station have survived (151 volumes dating from 1943 to 1945).¹³³

¹³¹ *Der praktische Desinfektor*, Heft 2, Verlag Erich Deleiter, Berlin 1941, inside cover; cf. F.P. Berg, “Typhus and the Jews”, *JHR*, 8(4) (1988), pp. 433-481 (online:

The garrison physician (army medical officer) and the medical personnel were in charge of implementing all sanitary measures. This physician—and this was the case at Auschwitz as well—was to be consulted as subject expert in all relevant matters of construction planning and other things. Where hydrogen cyanide was to be used, requirements called for specially trained expert personnel. In Auschwitz, this role was filled by the “*disinfectors*”.

5.2.3.2. Procedures Used

Generally, four procedures were used at Auschwitz for disinfestation and disinfection:

- hot air
- hot steam
- hydrogen cyanide
- microwaves

Data on the disinfestation and disinfection installations in operation in Auschwitz camp may be taken from a listing dated January 9, 1943: “*Hygienische Einrichtungen im KL und KGL Auschwitz*”¹³⁴ (Sanitary Facilities in the POW and Concentration Camp Auschwitz) directed to the Amtsgruppenchef C (Berlin), and an “*Aufstellung über die im KL und KGL Auschwitz eingebauten Entwesungsanlagen Bäder und Desinfektionsapparate*”¹³⁵ (List of Disinfestation Facilities, Baths and Disinfection Systems Installed in the POW and Concentration Camp Auschwitz), dated July 30, 1943.

The following capacities, taken from the last-mentioned document, relate to a 24-hour a day operation period.

a) In the concentration camp (protective custody camp):

Block 1: One hot air disinfestation installation, manufactured by the Klein corporation for 1,800 people and approximately 3,600 blankets since the fall of 1940.

Block 3: One hydrogen cyanide gas disinfestation installation

www.vho.org/GB/Journals/JHR/8/4/Berg433-481.html).

¹³² *TCIDK* 502-1-26-117.

¹³³ Heinz Bobrach *et al.*, *Inventar archivalischer Quellen des NS-Staates*, K. G. Saur, Munich 1995, volumes 3/1, 1991. So far, we are aware of approximately 110,000 laboratory examinations. Many probative and highly informative facsimiles are to be found in *Hefte von Auschwitz*, nos. 1 through 19, special editions, Auschwitz State Museum Publishers, Auschwitz Museum, since 1959.

¹³⁴ *TCIDK* 502-1-332-46/46a.

¹³⁵ *TCIDK* 502-1-332-9/10.

(i.e., Zyklon B), for 1,400 people and approximately 20,000 pieces of laundry.¹³⁶

Block 26: One hot air installation for 2,000 people.

Disinfestation building at *Deutsche Ausrüstungs-Werke* (German Equipment Works, i.e., Canada I): 1 hydrogen cyanide gas disinfestation installation (BW 28) for approximately 30,000 pieces of laundry, blankets, etc. (in operation since the summer of 1942).

Civilian worker disinfestation barracks: One hot air disinfestation installation, manufactured by the *Hochheim* corporation, with a daily capacity for 2,000 people, with large shower bath installation and disinfection apparatus, permanently installed.

b) In the POW camp (K.G.L., Birkenau):

BW 5a in B Ia: One disinfestation apparatus (manufactured by *Werner*) and one hot air apparatus (manufactured by *Hochheim*) in operation since November 1942 for 2,000 people.

One chamber for hydrogen cyanide fumigation has been built for 8,000 blankets and has been in operation since the fall of 1942.

BW 5b in B Ib: Installation as in BW 5a.

All the facilities listed therein were subject to modifications. The number of sanitary facilities increased with the number of inmates, as the two aforementioned documents already show. Pressac mentions 25 chambers operated with Zyklon B, without providing a verifiable source.¹³⁷

5.2.3.3. Results

The results could only be compiled if one knew the number of persons disinfested by means of the installation. These numbers have thus far remained unclear. Although Danuta Czech claims in her book⁸⁹ that such documents on large time periods are available in the Auschwitz archive, we have so far been unable to examine them. As of the present writing, it is still impossible to make a reliable statement as to whether

¹³⁶ According to Pressac, in operation since 1941/42, *op. cit.* (note 67), p. 25.

¹³⁷ *Ibid.*, p. 550.

or not the existing disinfection installations were consistently reliable for the indicated number of persons. Pressac, in the conclusions to his second book,¹³⁸ indicates the peak of the first epidemic between “7./11. September” 1942 with “375 deaths per day”, which clearly indicates that the capacity of the facilities available did not suffice.

5.2.3.4. Basic Policy Decisions

Two policy decisions made by the *SS-Hauptamt Haushalt und Bauten* (SS Main Office Budget and Construction) in the Reich Administration of the SS and its successor no doubt also influenced the measures taken in the camp. The first decision of June 5, 1940,¹³⁹ stated that HCN would no longer be used, and replaced instead with a hot-air method. The reason for this was probably that the use of HCN in makeshift delousing chambers was not reliable and had caused many accidents and was thus deemed too dangerous. The second decision, issued on March 11, 1942,¹⁴⁰ 21 months later, seems to have reversed that first decision by calling for the “[...] *conversion of all delousing facilities to operation with HCN*”, in which regard it was noted:

“Deviations therefrom—delousing by means of hot air or hot steam—is only permissible insofar as they involve temporary installations, in which the necessary safety for the handling of HCN is not assured.”

A further letter from the Office C VI of February 11, 1943,¹⁴¹ to the Commandant again expressly states, probably with reference to the letter of June 5, 1940: “[...] *as per the prohibition against the use of HCN for disinfection* [...]”. This means that all efforts were to be made to convert all facilities to be operated with the only really reliable method available—HCN—but that the use of HCN was allowed only where and if the necessary safety and reliability of the method was assured, *i.e.*, makeshift delousing chambers were not allowed to be operated with HCN.

Men in positions of authority, accustomed to decision-making, and faced with a dangerous epidemic capable of spreading to the civilian population with incalculable consequences, will always take suitable

¹³⁸ J.-C. Pressac, *op. cit.* (note 90), p. 157

¹³⁹ *TCIDK* 502-1-333-145

¹⁴⁰ *TCIDK* 502-1-336-94

¹⁴¹ *TCIDK* 502-1-332-37

measures and act accordingly. Hydrogen cyanide (= Zyklon B) was the most reliable disinfestation agent of its time (for details, please see “*Blausäure als Entlausungsmittel in Begasungskammern*”,¹⁴² or “*Entlausung mit Zyklon-Blausäure in Kreislauf-Begasungskammern*”).¹⁴³ The only problem was in finding a safe location for such facilities, perhaps outside the actual camp (see chapter 5.4.3.).

5.2.3.5. The Army Medical Officer

On September 9, 1942, Dr. E. Wirths was stationed in Auschwitz as garrison physician. From the records we may say that he performed his duties correctly; in this context, reference is made, in particular, to his massive criticism of the highest echelons.

As time went by, the number of inmates increased steadily, and unfortunately there were more than just one epidemic. We shall therefore briefly summarize, by means of examples, the conclusions reached by this physician and the steps he took in consequence.

On December 4, 1942, Dr. Wirths reported to headquarters about a discussion held in the administrative council of Bielitz District. The subject was epidemic typhus. A considerable number and range of persons had participated in the discussion, including the medical officer, the Wehrmacht, and representatives of the government. This illustrates how seriously the epidemic was taken to be:¹⁴⁴

“He reports that at present three large disinfestation, shower, and sauna facilities could be put into operation, specifically two facilities for the inmates and one for the members of the SS troops. The capacity of these facilities is some 3,000 to 4,000 persons per 24 hours. Zyklon B disinfestation has been discontinued entirely, since it has been found that success is not 100% certain with this procedure.”

Buildings BW5a and 5b were intended for the inmates. The capacity of these disinfestation facilities was probably adequate for the number of inmates at this time. One must consider, however, that at this same time the structural shell for another 19 DEGESCH circulation

¹⁴² Gerhard Peters and W. Rasch, “*Die Blausäure als Entlausungsmittel in Begasungskammern*”, *Der praktische Desinfektor*, September 1941, pp. 93-96.

¹⁴³ Gerhard Peters, Emit Wüstinger, “*Entlausung mit Zyklon-Blausäure in Kreislauf-Begasungskammern. Sach-Entlausung in Blausäure-Kammern*”, *Zeitschrift für hygienische Zoologie und Schädlingsbekämpfung*, issue 10/11 (1940), special printing. TCIDK 502-1-332-86/90; it arrived at the Auschwitz construction office on July 3, 1941.

¹⁴⁴ TCIDK 502-1-332-117/119

fumigation chambers was being completed in Building BW160 of the Main Camp (Admissions building). Another paragraph of the above letter states that the garrison physician of Kattowitz had provided the loan of two mobile boiler installations.

On April 18, 1943, Wirths reports to the Commandant, with warning reference to the sewer system in Birkenau, and concludes that “[...] *great danger of epidemics is inevitable.*”¹⁴⁵

On May 7, 1943, in a discussion with the chief of Amtsgruppe C, SS Brigadier General and Major General of the Waffen-SS engineer Dr. Kammler, and others, the garrison physician set out in chapter “*II. Bauten in Zuständigkeit des Standortarztes*” (II. Buildings Under the Charge of the Garrison Physician).¹⁴⁶

“[...] *that the continued health of the inmates for the major tasks is not guaranteed, due to the poor toilet conditions, an inadequate sewer system, the lack of hospital barracks, and separate latrines for the sick, and the lack of washing, bathing, and disinfection facilities.*”

Dr. Wirths clearly pointed out the inadequacies and also how to rectify them.

At this point we must warn the reader, who may perhaps not be sufficiently aware of the historical context, not to jump to false conclusions. The reader may well lack an understanding of all the problems that were involved in obtaining materials as well as all the other necessities required to build these facilities in wartime. Figuratively speaking, a written permission was required to purchase every brick.

We must also point out that, in those days in eastern Europe, a sewer system of any kind at all was exemplary to start with, and that this is all the more true for sewage treatment facilities, which were built for both camps at great expenditure in resources and according to high technical standards.

The above quoted document continues:

“The Brigadier General acknowledges the foremost urgency of these matters and promises to do everything possible to ensure rectification of the shortcomings. He is somewhat surprised, however, that the medical side presents him with reports giving a very favorable account of the sanitary and hygienic conditions on the one hand; while he is then immediately confronted with reports to the exact opposite effect on the

¹⁴⁵ TCIDK 502-1-332-219

¹⁴⁶ TCIDK 502-1-233-33/38

other hand. The Chief of the Zentralbauleitung is hereby instructed to present suggestions for rectification by May 15, 1943." (Emphasis added.)

It began with the toilet facilities, with regards to which he enforced changes that he considered necessary. For example: lids on the toilets, because otherwise "[...] a great danger of epidemics is inevitable."¹⁴⁷ These lids were ordered by the Head of Department C of the WVHA (*Wirtschafts-Verwaltungshauptamt*, Economic Administrative Main Office) on May 10, 1943.¹⁴⁸ It ended with roofing matters related to the gypsy kindergarten.¹⁴⁹

"For the damaged roofs of kindergarten blocks 29 and 31 in the Gypsy Camp I request 100 rolls of roofing felt (very urgent.)"

In between, on May 28, 1943,¹⁵⁰ he selected six circulating air delousing facilities which—as was noted down in handwriting—were ordered on May 29, 1943, by the Building Administration's expert on heating matters, Jährling. Then there is an account of a water quality test on June 1, 1943,¹⁵¹ etc. This extensive correspondence resulted in separate subject files in the filing system of the *Zentralbauleitung*, such as "*Sanitary Conditions*".¹⁵²

The physician's field of work was great and varied and deserved its own monograph. He was even responsible for ensuring that the inmates' kitchen personnel were frequently examined—including laboratory tests of their stool, etc. That Dr. Wirths truly saw to absolutely everything is obvious from the documents.

The garrison physician's reminders and admonitions increased over time. On balance, one must conclude that, just as today, while there were opportunists and careerists in those days, there were also—as our example shows—SS-men with backbone and a sense of duty, professional ethics and the courage to stand up for their beliefs.

At the end of the comments section of the Memorandum of May 9, 1943, we find:

"As stop-gap measure until that time, the Brigadier General provides the loan of a new short-wave delousing platoon." (Emph. added.)

¹⁴⁷ TCIDK 502-1-322-219

¹⁴⁸ TCIDK 502-1-322-31

¹⁴⁹ Taken from a letter of March 23, 1944 to the Zentralbauleitung (Central Construction Office) in Auschwitz, TCIDK 502-1-332-175.

¹⁵⁰ TCIDK 502-1-332-28

¹⁵¹ TCIDK 502-1-332-212

¹⁵² TCIDK 502-1-149-135

5.2.3.6. Short-Wave Delousing Facility

Perhaps one of the most fascinating aspects of Auschwitz concentration camp is the installation of a stationary short-wave installation, the world's first technological predecessor to the microwave ovens in common use today. This technology was invented by Siemens in the late 1930s and developed to mass-production readiness during the war. This was a by-product of the powerful radio tubes built for the television transmission of the Berlin Olympics in 1936, the energy-rich radio waves which killed the insects in the vicinity of the antenna. The development took place with financial assistance from the Wehrmacht, which hoped to achieve a perceptible improvement in the struggle against the epidemics raging in the east. Since the inmates assigned to the armaments industries in the concentration camps were particularly valuable towards the end of the war, the Reich leadership decided not to put the first installation into operation at the front for the disinfection of soldiers' clothing, but rather, in the largest Labor complex in the Reich, in Auschwitz. Due to Allied bombing attacks, however, there was a one-year delay in the completion of this installation, which probably cost the lives of tens of thousands of inmates. The Auschwitz camp administration had anticipated its installation as early as 1943 and had therefore postponed other delousing projects. This facility, put into operation during the summer of 1944, proved in fact to be of revolutionary effectiveness, both quick and cheap: personal effects were moistened and placed on one end of a conveyor belt and emerged at the other end a few minutes later, completely free of vermin and sterile.¹⁵³

5.2.4. Disinfection Installations BW 5a und 5b

The only buildings remaining intact in Auschwitz-Birkenau today, possessing a wing for the disinfection of personal effects with Zyklon B, are buildings (*Bauwerk*, BW) 5a and 5b in building sections B1a and B1b, respectively. Both buildings were planned as mirror images of each other. The west (resp. east) wing of these buildings were used,

¹⁵³ See also, in this regard, H.-J. Nowak, *op. cit.* (note 97); H. Lamker, "Die Kurzwellen-Entlausungsanlagen in Auschwitz, Teil 2", *VffG* 2(4) (1998), pp. 261-272 (online: <http://www.vffg.de/1998/4/Lamker4.html>); an English summary appeared by Mark Weber, "High Frequency Delousing Facilities at Auschwitz", *JHR*, 18(3) (1999), p. 4. (www.ihr.org/JHR/v18/v18n3p-4_Weber.html)

at least temporarily, for disinfection with Zyklon B. These rooms were expressly labeled “*Gaskammer*” (gas chamber) in the building plans, see Fig. 17.

This is no triviality: rather, it is important proof that the term ‘gas chamber’, at that time, referred exclusively to installations for the disinfection of personal effects, both by architects during the planning of such buildings, and by disinfection experts. The title of one of the most important contemporary publications on the subject of cyanide disinfection by F. Puntigam, H. Breymesser, E. Bernfus: *BlausäureGASKAMMERN* [sic!!!] *zur Fleckfieberabwehr* [hydrogen cyanide GAS CHAMBERS for the prevention of epidemic typhus], or the term used in an advertisement of the firm DEGESCH: “*gas chambers*”, see Fig. 16, p. 66. This was simply the ordinary designation for rooms used for the disinfection of personal effects.

Therefore, we must always assume, in the absence of proof to the contrary, that use of the word ‘gas chamber’ in a German

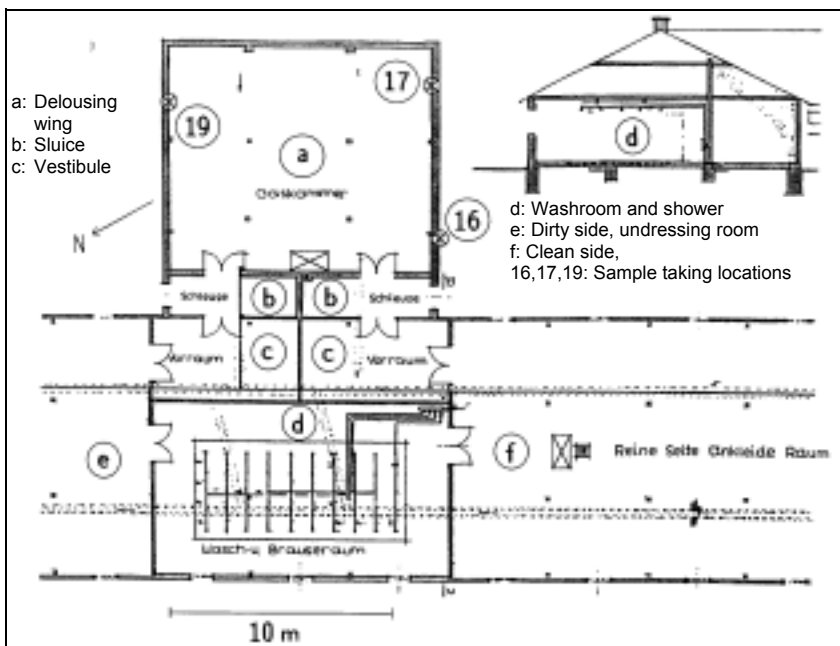

Fig. 17: Ground plan of the HCN disinfection wing of building 5a before building alterations (mirror image) and BW 5b today. BW 5b Sample taking locations drawn in.¹⁵⁴

document from this period refers to a room for the disinfestation of personal effects!

For this reason, *in the following*, the term gas chamber will be placed in single quotation marks at all times ('gas chamber'), whenever the word refers to chambers for the execution of human beings. There are two reasons for this:

1. The German technical term *Gaskammer* originally pointed exclusively to disinfestation chambers operated with toxic gas. To apply the same term to chambers intended for the execution of human beings is an incorrect use of the term at that time.
2. Simply for the purpose of avoiding confusion as to the meaning of the word 'gas chamber' in each case, a distinction must be made in writing.

Fig. 17 shows the ground plan of the two disinfestation gas chambers of building 5a and 5b approximately in their original condition. The chamber in building 5a was transformed in the summer of 1943

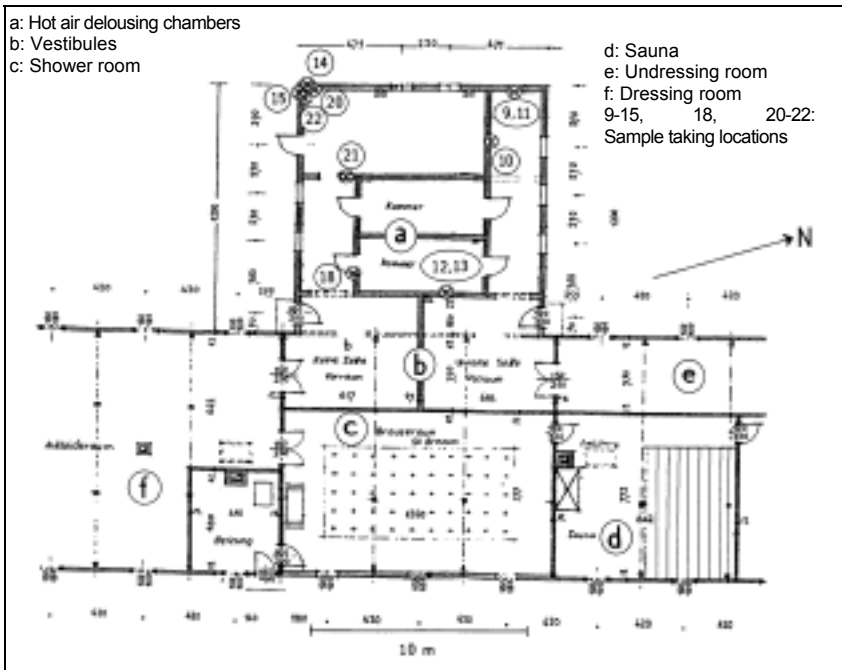

Fig. 18: Ground plan of the hot air disinfestation wing of building 5a after building alterations in 1943. BW 5a sample taking locations drawn in.¹⁵⁴



Fig. 19: Ventilation outlets from the disinfestation wing of building BW 5b, without equipment today. The ends of the water pipes are visible inside; see also Fig. 20.

and received two small hot air chambers, visible in Fig. 18.¹⁵⁴ The buildings have ordinary brick walls and a concrete foundation built level with the ground, plastered and whitewashed on the interior with chalk-based mortar. The room in building 5b has no separate ceiling, the roof's framework is covered from underneath with boards of an unknown material (perhaps Heraclite). Originally without windows, like building BW 5b today, the disinfestation wing of BW 5a was equipped, during the building alterations, with windows firmly walled in which cannot be opened.

In the gable wall of the disinfestation room in BW 5b are two circular openings, approximately 50 cm in diameter, corresponding to the former ventilation exhaust and air intake channels, Fig. 19. The roof has three ventilation chimneys; there must have been three ovens in this room during the time of operation.¹⁵⁵ The double doors, opening inwards and drawn onto the plans, have been replaced with single doors, also opening inwards. For the time being, one can only specu-

¹⁵⁴ J.-C. Pressac, *op. cit.* (note 67), pp. 55-58, Plans of Buildings 5a/b, pp. 59f. exterior photos. Building alteration plan no. 2540 for conversion to hot air delousing installation, dated July 5, 1943.

¹⁵⁵ *Ibid.*, p. 53.

late on any equipment of the disinfestation chambers.

The room has a surface area of approximately 130 m², is open to the framework of the roof, and therefore has a volume of at least 400 m³. However, the space above 2 m in height must probably be considered to have been unusable dead space, resulting in the waste of huge amounts of HCN/Zyklon B, since a quantity of Zyklon B of at least 4 to 5 kg (10 g per m³) cyanide content was necessary for just one gassing,¹⁵⁶ regardless of whether the room contained only a few personal effects or whether the available area was filled. For example, with 100 fumigation cycles per year (one every 3 or 4 days) approximately 0.8 tons of Zyklon B would have been consumed by this installation alone and by building 5a, corresponding to 10% of the entire Zyklon B deliveries to Auschwitz in 1942, with a total delivery of 7.5 tons.¹⁵⁷

When one considers that there were other HCN disinfestation installations in Birkenau in addition to this one; that the deliveries to Birkenau camp also supplied the related labor camps (more than 30 in number); and the fact that inmate barracks were also occasionally fumigated with this insecticide,¹⁵⁸ it will be seen that the quantities of Zyklon B delivered to Auschwitz camp can actually be explained by normal delousing activities.

The annual delivery quantities were too low to ensure successful disinfestation of all personal effects and buildings in all camps in the Auschwitz complex, since typhus epidemics were never entirely eliminated.

How frequently the delousing chambers of BW 5a and 5b were actually used for HCN disinfestation has to remain open for the time being, since no documentation about this has been found yet, and also because the document cited above states that the use of Zyklon B had to be abandoned as early as December 1942 (at least in unsafe installa-

¹⁵⁶ The gross mass given on the label of a Zyklon B can always refer to the net HCN content of the can, *i.e.*, excluding the mass of the carrier material. That means for instance that a 1 kg Zyklon B can consisted of 1 kg HCN *plus* some 2 kg of carrier material, *i.e.*, a 1 kg can had a total mass of some 3 kg.

¹⁵⁷ Office of Chief of Counsel for War Crimes, British Military Tribunal, Case against B. Tesch *et al.*, here, the sworn statement of A. Zaun, Hamburg Oct. 24, 1945, Document No. NI-11 396; quoted according to U. Walendy, *Auschwitz im IG-Farben-Prozess*, Verlag für Volkstum und Zeitgeschichtsforschung, Vlotho 1981, p. 62.

¹⁵⁸ See also the Höß order relating to the avoidance of accidental poisoning during the disinfestation of barracks, reproduced by J.-C. Pressac, *op. cit.* (note 67), p. 201. For each barracks with a volume of approximately 40m×12m×3.5m > 1,500 m³, this means a requirement of 15 kg Zyklon B; the 100 barracks in Birkenau camp alone would require 1.5 tons!

tions), *i.e.*, just a few weeks after this installation was put into operation (see p. 70).

A remarkable feature of this room in building BW 5b is the intricate construction of the water pipes, laid in the hooks fastened to the diagonal roof girders, visible in Fig. 20. A few of the pipe endings are equipped with shower heads. The water pipes have no connection. Paradoxically, they end in the above mentioned ventilation outlets, and can only have been installed after the removal of the ventilators installed there. There are, of course, shower rooms in these buildings, but in a very different location (see Fig. 17). The shower installations once in existence there, however, have been entirely dismantled. Since the doors to these rooms are open, any visitor may examine this peculiar construction. The original German drawings and documents of this building do not indicate that these pipes were installed during the German occupation, which means that they were probably installed after the war for an unknown reason.



Fig. 20: Water pipe system with shower heads in the disinfestation wing of building BW 5b. These water pipes have no connection; they terminate in the ventilation outlets. See Fig. 19.

5.3. ‘Gas Chamber’ in the Auschwitz I Main Camp

According to Pressac, no material or documentary evidence of the ‘gas chamber’ in the crematorium in the main camp exists, but there are many eyewitness accounts:¹⁵⁹

“As evidence to establish the reality of homicidal gassings there remain only the testimonies of participants,[...]”

¹⁵⁹ J.-C. Pressac, *op. cit.* (note 67), p. 123.

These accounts, according to Pressac, are characterized by many contradictions, technical impossibilities, and general incredibility. He observes a “*general tendency to exaggerate*”, and explains the gross errors and technical impossibilities in the eyewitness accounts and writings of camp commandant Höß by stating:

“He was present, without seeing.”

That is, Pressac alleges that Höß had no idea of the methods, risks and dangers involved in the handling of Zyklon B. But this is in contradiction to an order issued by commandant Höß calling for caution during the fumigation of barracks with Zyklon B¹⁵⁸—caution which had become necessary in view of several cases of poisoning. This special order of the commandant warning of accidents involving Zyklon B gas, an order which was distributed throughout the camp, indicates a duty of care with regards to those inmates who were, allegedly and nevertheless, doomed to die from the effects of that same gas sooner or later. We will have occasion to speak of Höß’s testimony at a later time.

Pressac, moreover, explains the form and basic tone of the testimony of SS man Pery Broad as incorrect because this testimony is soaked in Polish patriotism, to say nothing of the transparent Polish hatred against SS men, although Broad was an SS man himself and had no links to Poland, and because Pressac found out that this ‘testimony’ has been slightly reworked by the Poles, the original of which is missing. In other words, this ‘document’, obviously patched together by the Poles, is quite worthless insofar as a critical examination of its source is concerned. Nevertheless, Pressac considers the basic testimonies with regards to homicidal gassings to be correct.¹⁶⁰

The ‘gas chamber’ in the main camp is a room in a ground level building, which replaced a former kitchen building of the former Austro-Hungarian barracks located at the same spot.¹⁶¹ The floor and ceiling of crematorium I are of reinforced concrete while the exterior walls are of brick masonry, insulated on the exterior by a coating of tar. Except for the access ways, the building is practically underground due to the fact that dirt has been piled up against the walls. The interior walls are plastered and whitewashed.

¹⁶⁰ *Ibid.*, pp. 126-128.

¹⁶¹ *Ibid.*, p. 129.

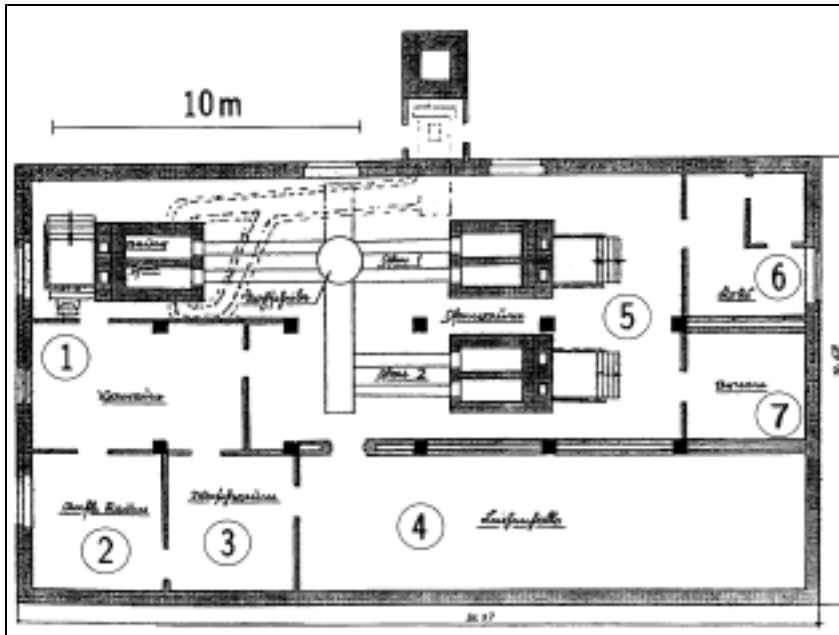

Fig. 21: Ground plan of crematorium I in Auschwitz I/main camp in its original condition. The morgue was later alleged to have been used as a 'gas chamber'.¹⁶²

- 1: Vestibule; 2: Laying-out room; 3: Wash room; 4: Morgue;
5: Oven room; 6: Coke; 7: Urns

Fig. 21 shows the building plan of the building at the beginning of the war, planned and constructed as a normal crematorium, with a morgue.¹⁶² This also explains the piles of dirt, which were intended to ensure an even, cool temperature. For the same reason, the partition between the morgue and the oven room is double-walled with a heat-insulating air-barrier in between.

As far as I know, no documents exist concerning the installation of a ventilation system into this morgue, though it appears inconceivable to operate a morgue without windows, exterior doors, and any kind of forced ventilation.

The morgue was later alleged to have been 'converted' into a 'gas chamber'. Three to four hatches are later said to have been pierced through the roof for the introduction of the Zyklon B for homicidal

¹⁶² *Ibid.*, pp. 151/153.

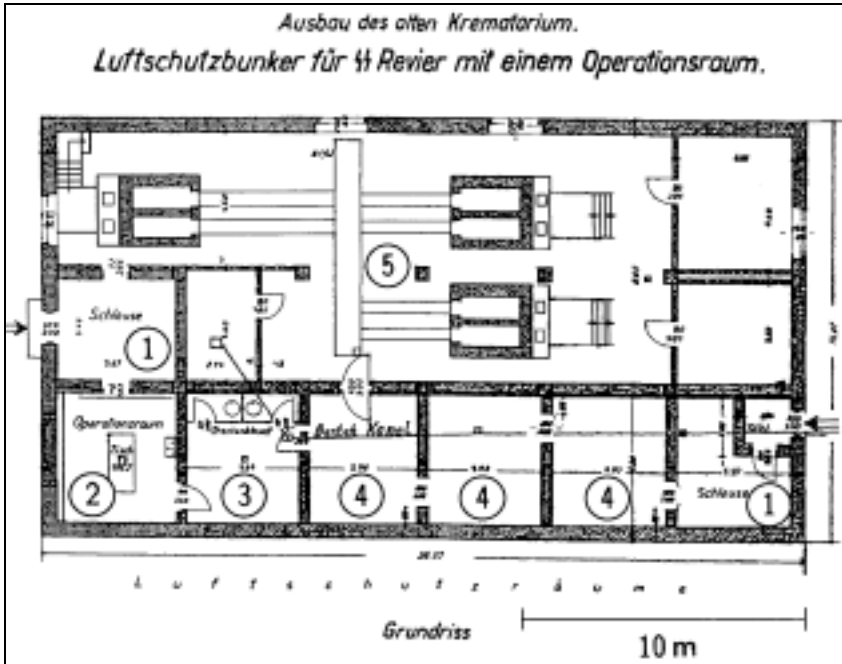

Fig. 22: Ground plan of crematorium I Auschwitz I Main Camp after conversion to air raid shelter, 1944.¹⁶⁶

1: Sluice; 2: Operating room; 3: Former washroom, now air raid shelter with toilet; 4: Air raid shelter; 5: Former oven room.

gassings, as well as two hatches for the incorporation of heavy ventilators.¹⁶³ The head of the Auschwitz Museum, Franciszek Piper, however is of the opinion that:¹⁶⁴

“In the case of Crema I there were no ventilators. The doors were opened and the gas was allowed to ventilate by convection.”

Pressac reproduces a photo of the roof of the crematorium, taken by the Soviets shortly after the liberation, in which three dark spots on the roofing felt are alleged to be troughs of former Zyklon B introduction holes, allegedly now covered up.^{163,165} The photograph reproduced in his book is, however, too poor in quality to permit anything to be

¹⁶³ *Ibid.*, pp. 131f.

¹⁶⁴ D.D. Desjardin, “My Visit to Auschwitz-Birkenau, May 30-31, 1996”, Interview mit F. Piper, online: codoh.com/newvoices/nddd/ndddausch.html.

¹⁶⁵ J.-C. Pressac, *op. cit.* (note 67), p. 149; photograph of the roof of crematorium I immediately after the liberation.

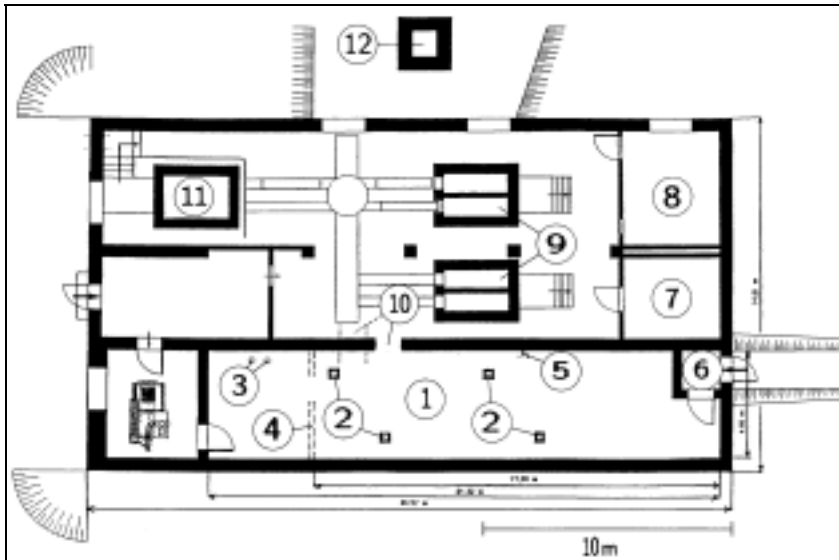

Fig. 23: Ground plan of crematorium I in Auschwitz I/Main Camp today, after subsequent fakery.¹⁶⁸

1: 'Gas chamber'; 2: Fake Zyklon B introduction holes; 3: Toilet drains; 4: former partition morgue-washroom; 5: Ventilation chimney from air raid shelter; 6: Air raid chute, today referred to as victim entryway; 7: Urns; 8: Coke; 9: Reconstructed ovens; 10: Newly pierced entry to oven room; painted: old entryway; 11: Remains of the old oven; 12: Fake chimney.

seen with clarity, much less permitting any conclusion as to the construction or engineering. Pressac's speculation must therefore be viewed as groundless.

In the autumn of 1944, the crematorium was converted into an air raid shelter. The building alterations, especially the replacement of the thin partition by thick walls, can be seen in Fig. 22.¹⁶⁶ The alleged Zyklon B introduction holes as well as the ventilation holes are alleged to have been sealed at that time—assuming that they ever existed.

The building work undertaken for this conversion is described in a document into the smallest detail.¹⁶⁷ There is no mention of any filling in of any old existing holes pierced in the roof but rather of the incorporation of gas-tight windows and doors as well as the piercing of new holes:

¹⁶⁶ *Ibid.*, p. 156.

¹⁶⁷ "Herstellung der für die Beheizungsöfen, sowie für die Ent- und Belüftung erforderlichen Mauerdurchbrüche und Schläuche", letter from the Auschwitz Air Raid Warden, Aug. 26, 1944, TCIDK 502-1-401.

*“Installation of gas-tight doors, window shutters, and windows,
 Manufacture of the openings in the masonry necessary for the heating ovens, as well as for the ventilation outlets and intakes and pipes.”*

This is a strong indication that before this time there were neither gas-tight doors and windows nor any other openings for ventilation installations or for any other purpose (Zyklon introduction holes); otherwise such old openings would have been used for this purpose, or their filling would have been mentioned.

Direct access to the air raid shelters, which evolved from the multiple division of the morgue/‘gas chamber’, was possible through a newly added entrance with sluice, which today is represented as the entryway taken by the victims, although the ‘gas chamber’ had no entrance in that location—as a matter of fact, it had no direct entrance from the outside at all.¹⁶³ Toilets were likewise built into the former washroom at this time.

Fig. 23 shows the ground plan of the crematorium in its present condition.¹⁶⁸ According to Pressac, the access from the morgue/‘gas chamber’ to the present cremation room was newly placed after the war—not quite at the original location. The partitions in the air-raid shelter, including the wall to the washroom, which was, however, never part of the morgue (the later ‘gas chamber’), were torn down. Accordingly, the irritated visitor sees two discharge pipes from two toilets inside the alleged ‘gas chamber’. According to Pressac, who gives no source for this statement, the roof was newly covered with tarpaper during which the traces of the Zyklon B holes and ventilation holes of the ‘gas chamber’ were allegedly covered over. The renewed incorporation of four staggered Zyklon B introduction stacks by the Polish Museum after the war is therefore not alleged to have taken place in the same location. This argument, on Pressac’s part, must cause astonishment, since from the inside, the roof/ceiling is of unplastered bare concrete. It should have been quite possible to determine the location of the original openings—now allegedly sealed—from the interior and it would also have been quite possible to make openings in the same place.

As confirmed to visitors by the Museum administration upon inquiry, the two chimney openings in the cremation room, as well as the

¹⁶⁸ J.-C. Pressac, *op. cit.* (note 67), p. 159.

chimney itself, which is without any functional connection outside the building, were built after the war as a “*reconstruction for Museum purposes*” on the location of the alleged original installations.¹⁶⁹

The French journalist and well-known anti-revisionist, Eric Conan, writes:¹⁷⁰

*“Another delicate subject: What to do with the **falsifications** left behind by the communist administration? In the 50s and 60s, several buildings which had disappeared or had been misappropriated were rebuilt with gross errors and displayed as authentic. Some, which were ‘too new’, have been closed for the public. Not to mention the delousing gas chambers which were sometimes presented as homicidal gas chambers. Those aberrations have helped the deniers a lot, which took the essence for their legends out of it. The example of the Crematory I is typical. In its morgue, the first gas chamber was installed. It operated for a short period of time in early 1942. The blocking of this area, which was essential for the gassings, disturbed the operation of the camp. End of April 1942, it was therefore decided to move the deadly gassings to Birkenau, where it was conducted on an industrial scale mainly with Jewish victims. The Crematory I was subsequently converted into an air raid shelter with a surgery room. In 1948, when the Museum was created, Crematory I was reconstructed in a supposed original state. **Everything in it is false.**^[171] the dimensions of the gas chamber, the locations of the doors, the openings for pouring in Zyklon B, the ovens, rebuilt according to the recollections of some survivors, the height of the chimney. At the end of the 70s, Robert Faurisson exploited those **falsifications** all the better because at that time the Museum officials balked at admitting*

¹⁶⁹ *Ibid.*, p. 133; see also the confirmation of changes in the partial recreation of the installation in the letter from the Auschwitz State Museum to Joel P. Hayward, ref. I-8523/26/2120/ 91, dated May 7, 1991; B. Bailer-Galanda, *Informationen der Gesellschaft für politische Aufklärung*, Innsbruck, June 1991, no. 29, p. 1, relating to Leuchter’s statement relating to crematorium I: “*Er verwechselt museale Rekonstruktionen der Gaskammern, die dem Betrachter einen Eindruck der damaligen Geschehnisse vermitteln sollen, mit real funktionierenden Gaskammern.*” (He confuses a museum reconstruction of the gas chambers, intended to provide the observer with the impression of the events at that time, with authentically functioning gas chambers.); Letter from Dr. Scheel, Bonn, German Foreign Office, Jan. 8, 1979, ref. 214-E-Stuparek: “*Auch mir ist bekannt, daß es im Lager Auschwitz keine Gaskammern gegeben hat. Die Gaskammern befanden sich im ca. 3 km davon entfernten KZ Auschwitz-Birkenau.*” (I know as well that there were no gas chambers in Auschwitz camp. The gas chambers were located in the Auschwitz-Birkenau camp, located approximately 3 km away.)

¹⁷⁰ “*Auschwitz: la mémoire du mal*”, *L'Express*, 19.-25. January 1995; see also, in this regard, Robert Faurisson’s remarks: “*Sur Auschwitz, lentement, la vérité reprend ses droits*” (The truth about Auschwitz is slowly reclaiming its rights), Feb. 4, 1995 (online: abc.com/aaargh/fran/archFaur/RF950204.html).

¹⁷¹ In the original: “*Tout y est faux: [...]*”

them.^[172] *An American revisionist*^[88] *has shot a video in the gas chamber, still presented as authentic: one may see him questioning the visitors with his ‘revelations’. [...] For the moment, things remain as they are, and **the visitors are not told anything**. This is too complicated. One shall see later what to do.” (Emphases added.)*

According to the inflection: they were lying, they are lying, they will be lying...

In view of this unrealistic ‘reconstructions’ carried out after the war, the Jewish-American professor of architecture Robert van Pelt, who actually is only a professor for cultural history, in co-operation with the Jewish-Canadian Holocaust historian Deborah Dwork, arrives at the following, no less unequivocal conclusions:¹⁷³

“The architecture designed to enact the metamorphosis from Mensch to Untermensch was intact when the Soviets liberated the camp in 1945. All traces of it were removed subsequently. The guidebook for sale in the bookstore does not mention the building [crematorium I] at all. Perhaps the men and women who created the museum could not reconcile its implications with their ideology of a resistance: an ideology that denied total victimization. Perhaps it was simply a question of resources and the need for tourist services. Whether for doctrinal or practical reasons, the destruction of the original arrangement within the present visitor reception center is a postwar obfuscation and a loss.

There have been additions to the camp the Russians found in 1945 as well as deletions, and the suppression of the prisoner reception site is matched by the reconstruction of crematorium I just outside the north-east perimeter of the present museum camp. With its chimney and its gas chamber, the crematorium functions as the solemn conclusion for tours through the camp. Visitors are not told that the crematorium they see is largely a postwar reconstruction.

When Auschwitz was transformed into a museum after the war, the decision was taken to concentrate the history of the whole complex into one of its component parts. The infamous crematoria where the mass murders had taken place lay in ruins in Birkenau, two miles away. The committee felt that a crematorium was required at the end of the memorial journey, and crematorium I was reconstructed to speak for the history of the incinerators at Birkenau. This program usurpation was rather detailed. A chimney, the ultimate symbol of Birkenau, was re-created;

¹⁷² See Serge Thion (ed.), *op. cit.* (note 33), pp. 316f.; R. Faurisson, “*The Gas Chambers...*”, *op. cit.* (note 35), p. 335.

¹⁷³ *Op. cit.* (note 92), pp. 363f.

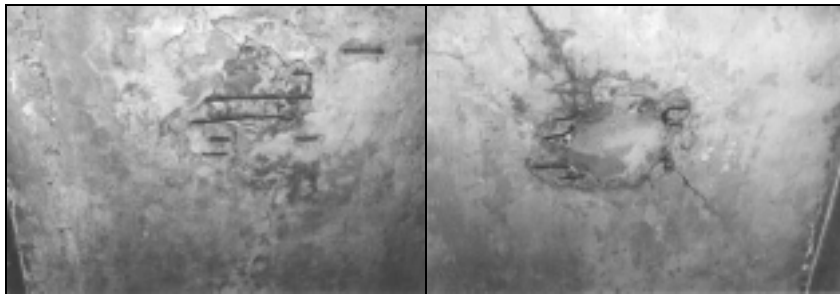

Figs. 24 and 25: Symptoms of decay visible on the interior ceiling of the morgue of crematorium I in Auschwitz Main Camp. After more than 50 years, the rusting of the steel reinforcement rods near the surface has begun cracking the concrete. The provisional attempts of the Museum administration to plaster these holes (right) will prove useless.

four hatched openings in the roof, as if for pouring Zyklon B into the gas chamber below, were installed, and two of the three furnaces were rebuilt using original parts. There are no signs to explain these restitutions, they were not marked at the time, and the guides remain silent about it when they take visitors through this building that is presumed by the tourist to be the place where it happened.”

This argument of the “*usurpation*” is packed with dynamite, because it suggests that the events alleged to have taken place in crematorium I, events described by eyewitnesses Rudolf Höß, Pery Broad and a few others actually never took place at this location. But this undermines the credibility of all other eyewitnesses from the very outset, including those from Birkenau. We wonder if the authors are aware of this?

It may at least be stated without fear of contradiction that the ceiling, exterior walls and pillars as well as the foundation of the building are in their original condition. If Zyklon B introduction stacks and ventilation openings had existed in the reinforced concrete roof, breaks in the reinforced concrete structure would be visible from the interior in the corresponding places, since these cannot have been made to disappear without leaving visible traces. In addition to today’s Zyklon B introduction stacks there are, however, no indications of any former openings in the roof. The holes allegedly made in another location therefore never existed!

The openings in the concrete visible today are neither plastered, nor have the remains of the cut steel reinforcement rods been removed in a professional manner. The holes have been planked with wood and

sealed with tar. Such poor workmanship reflects neither the care required in handling a poisonous gas, nor standard German craftsmanship.

If the SS had put these holes in the concrete during the war, one must assume that they would have taken care to evenly distributed these holes in the ceiling of the original(!) morgue in order to ensure an even distribution of the Zyklon B inside the room. The stacks today, however, are only evenly distributed in the ceiling of this room if one considers the washing room, which was only incorporated after the war(!), as an integral part of the morgue ('gas chamber'.) (See Figs. 21 and 23). Thus, the arrangement of today's introduction holes only make sense if they were created especially for its present status as a falsely dimensioned "*reconstruction for Museum purposes*" (B. Bailer-Galanda)¹⁶⁹ *after* the war. This by itself is strong circumstantial evidence that those holes were chiseled in after the interior walls of the former air raid shelter—one too many of them—had been torn down by the Soviets or the Poles. This is also supported by the fact that it has been generally assumed until the present day—without contradiction by any side—that the introduction holes visible today were indeed created *after* the war *without* recourse to the alleged remains of old, walled-up holes.¹⁷⁴

The flat roof of the crematorium, like all flat roofs, is not watertight. Due to decades of erosion by rain water and the steel reinforcement rods, lying near the surface, rusting over time and splitting the concrete,¹⁷⁵ the interior of the room exhibits clear signs of decay; see Figs. 24f. The Museum administration has, of course, attempted to plaster these places, but the plaster is immediately destroyed by the crumbling of rust from the steel reinforcement rods. Janitors from the Museum are compelled to sweep away falling pieces of crumbling mortar and concrete. It would be entirely incorrect to explain these signs of deterioration as the remains of former introduction holes

¹⁷⁴ See, in this regard, the interview with D. Cole, *op. cit.* (note 88).

¹⁷⁵ Steel reinforcement rods in concrete are only practicable when the iron is deeply embedded in the concrete and therefore protected for decades against corrosion by the very durable alkaline environment of the concrete, since concrete is only slowly carbonated by the carbon dioxide (CO₂) in the environment, resulting in a neutralization of its pH value. The reinforcement rods in the ceiling of the morgue in question lie directly on the surface, where the pH value would fall very quickly (*i.e.*, would become less alkaline), particularly when rain water containing CO₂ penetrated the concrete; see the crack in Fig. 25 which would quickly allow the entry of rain water.

through the roof. Such a claim is refuted by four facts:

1. The steel reinforcement rods would have had to have been removed during the opening of any holes.
2. A border between the old concrete of the ceiling and the filling material added later would also be visible. The corrosion locations all indicate a homogenous structure of the concrete.
3. These locations would have to be evenly distributed over the ceiling of the *original* morgue.
4. These locations would have to exhibit an even, regular form (round, square or rectangular).

Based on all these arguments, it can be concluded with certainty that at the time of the alleged use of this rooms as a ‘gas chamber’, there were no openings for the introduction of Zyklon B. There is no indication of a former device to ventilate the room either. Furthermore, there was no direct access to the ‘gas chamber’ from the outside. The victims would have had to enter through the corpse room (laying out room), or through the oven room. They would, therefore, have had to file past the corpses of their already-murdered companions in misery—truly a macabre spectacle. There could be no successful deception of the victims and camouflage nor could there be any hope of willing cooperation or acquiescence on the part of the inmates under such circumstances. Or, to put the lack of direct access doors to the ‘gas chamber’ in Robert Faurisson’s words:

“No doors, no destruction.”

5.4. ‘Gas Chambers’ in Birkenau Camp

5.4.1. Crematoria II and III

5.4.1.1. Starting Situation

These crematoria are entirely comparable in size, equipment, and manner of construction to other similar installations built in the Third Reich at that time, as well as with those built today.¹⁷⁶ In this connec-

¹⁷⁶ The present writer has before him a sketch of the ground plan of the crematorium, built in 1939, in the Sachsenhausen concentration camp, which is similar in design and dimensions with crematoria II and III at Auschwitz, yet no mass murders are alleged to have occurred at Sachsenhausen. Reference should also be made to the construction design of modern crematoria: H.-K. Boehlke, *Friedhofsbauten*, Callwey Verlag, Munich 1974, in particular, the crematorium diagram on p. 117, including a doctor’s office; E. Neufert, *Bauentwurfslehre*, Ullstein

tion, reference is made to the trial of the builder of the cremation installations in Birkenau camp. In 1972, the court acquitted the two defendants, master builder W. Dejaco and master builder F. Ertl, since suspicion of aiding and abetting in mass murder could not be corroborated.¹⁷⁷ An expert report drawn up during this trial on the surviving plans and documents on the construction of the crematoria led to the conclusion that these buildings could not have been used or modified so as to serve as instruments of mass murder.⁸⁵ In an eyewitness statement made recently, one of the master builders at Auschwitz, Walter Schreiber, stated as follows on the planning of these crematoria:¹⁷⁸

Question: *In which positions were you active?*

Answer: *As supervising engineer, I inspected the Huta Corporation and dealt with the Zentralbauleitung of the SS. I also audited the invoices of our firm.*

Q.: *Did you enter the camp? How did that happen?*

A.: *Yes. One could walk everywhere without hindrance on the streets of the camp and was only stopped by the guards upon entering and leaving the camp.*

Q.: *Did you see or hear anything about killings or mistreatment of inmates?*

A.: *No. But lines of inmates in a relatively poor general condition could be seen on the streets of the camp.*

Q.: *What did the Corporation build?*

A.: *Among other things, crematoria II and III with the large morgues.*

Q.: *The prevalent opinion is that these large morgues were gas chambers for mass killings.*

A.: *Nothing of the sort could be deduced from the plans made available to us. The detailed plans and provisional invoices drawn up by us refer to these rooms as ordinary cellars.*

Q.: *Do you know anything about introduction hatches in the reinforced concrete ceilings?*

A.: *No, nothing more from memory. But since these cellars were*

Fachverlag, Frankfurt 1962, pp. 423f.

¹⁷⁷ Proceedings against master builders W. Dejaco and F. Ertl (note 84).

¹⁷⁸ Schreiber was the Supervising Engineer at the Kattowitz agency of the Huta corporation, which built the crematoria at Birkenau. See also Werner Rademacher, "In memoriam Dipl.-Ing. Dr. techn. Walter Schreiber", *VffG* 4(1) (2000), pp. 104f. (online: www.vho.org/VffG/2000/1/Rademacher104f.html). He died in 1999.

also intended to serve the auxiliary purpose of air raid shelters, introduction holes would have been counter-productive. I would certainly have expressed an objection to such an arrangement.

Q.: Why were such large cellars built, when the water table in Birkenau was so extremely high?

A.: I don't know. Originally, however, above-ground morgues were to be built. The construction of the cellars caused great problems in retention and sealing.

Q.: Would it be conceivable that you were deceived and that the SS nevertheless had gas chambers to be built by your firm without your knowledge?

A.: Anyone who knows anything about what happens on a building site knows that that is impossible.

Q.: Do you know any gas chambers?

A.: Naturally. Everyone in the east knew about disinfection chambers. We also built disinfection chambers, which look quite different. We built such installations and knew what they looked like, even after the necessary installations. As a building firm, we often had work to do after installation of the machinery...

Q.: When did you learn that your firm was supposed to have built gas chambers for industrial mass killing?

A.: Only after the end of the war.

Q.: Weren't you quite amazed about it?

A.: Yes! After the war I made contact with my former boss in Germany and asked him about it.

Q.: What did you learn?

A.: He also only learned about it after the war, but he assured me that the Huta Corporation certainly did not build the cellars in question as gas chambers.

Q.: Would building alterations be conceivable after the withdrawal of the Huta Corporation?

A.: Conceivable, sure, but I would rule that out on the basis of time factors. After all, they would have needed corporations again, the SS couldn't do that on their own, even with inmates. Based on the technical requirements for the operation of a gas chamber, which only became known to me later, the building erected by us would have been entirely unsuited for the purpose in regard to the necessary machinery and practicable operation.

Q.: Why didn't you publish that?

A.: *After the war, first, I had other problems. And now it is no longer permitted.*

Q.: *Have you been interrogated as a witness in this matter?*

A.: *No Allied, German, or Austrian agency has ever taken an interest in my knowledge of the construction of crematoria II and III, I or my other activity in the former general government. I was never interrogated in this matter, although my services for the Huta Corporation were known. I mentioned them in all my later CVs and recruitment applications. Since knowledge of the facts is dangerous, however, I never felt any urge to disseminate it. But now, when the lies are getting increasingly bolder and contemporary witnesses like myself are slowly but surely dying off, I am glad that someone is willing to listen and set down the way it really was. I have serious heart trouble and can die at any moment, it's time now.*

Prof. van Pelt has stated as follows on crematorium II:¹⁷⁹

“Auschwitz is like the Holy of Holies. I’ve prepared for years to go there. And to have a fool [Leuchter] come in, coming completely unprepared, it’s sacrilege! Somebody who walks into the Holy of Holies and doesn’t give a damn.” [00:44:30]

“Crematorium II is the most [word indistinct: notorious?] of Auschwitz. In the twenty-five hundred square feet of this one room more people lost their lives than in any other place on this planet. Five hundred thousand people were killed. If you would draw a map of human suffering, if you create a geography of atrocities, this would be the absolute center.” [01:00:00]

“If the Holocaust revisionists would be shown to be right we would lose our sense about the Second World War, we would lose our sense about what democracy was. The Second World War was a moral war; it was a war between good and evil. And so if we take the core of this war, which is in fact Auschwitz, out of the picture, then everything else becomes unintelligible to us. We collectively end up in a madhouse.” [01:23:30]

We will not allow ourselves to be distracted by the notion that Prof. van Pelt considers internment in a madhouse the only alternative

¹⁷⁹ Van Pelt’s testimony in Errol Morris’ documentary movie *Mr Death*, *op. cit.* (note 9), time given in [min:sec:frame].

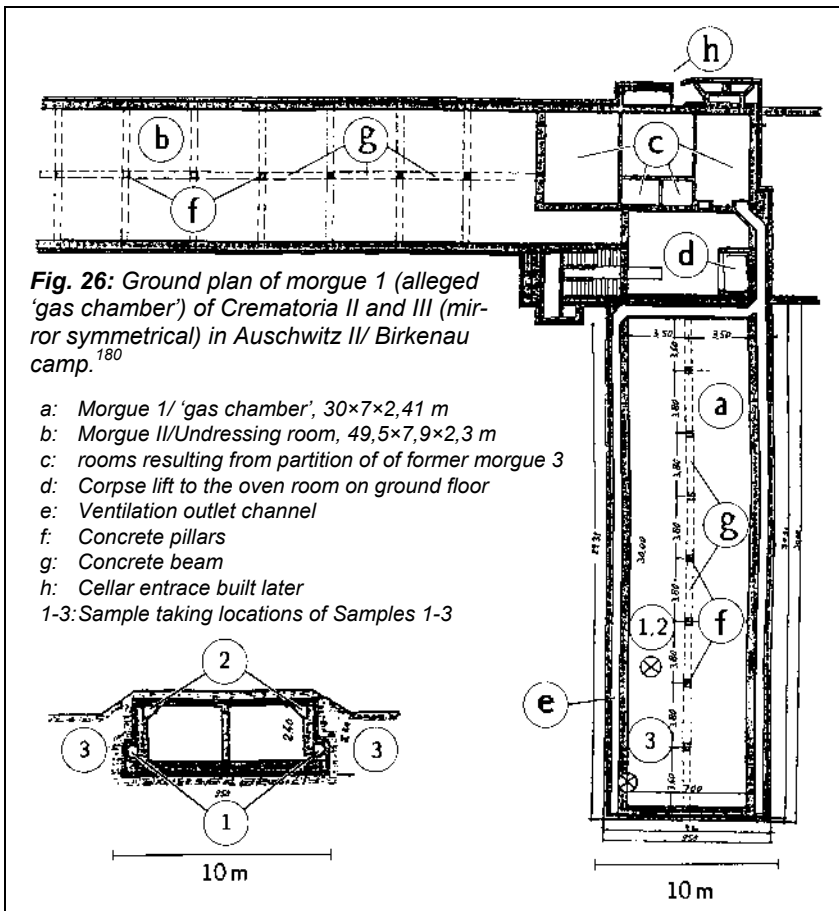

to believe in the Holocaust. Van Pelt's testimony does, however, emphasize the importance of crematorium II (and crematorium III, built as a mirror image of crematorium II, although allegedly not used quite so intensively), which will be discussed in the following.

A special, separate morgue with better ventilation was then used, as is usual today, as a laying out room for the victims of possible epi-

demics. This cellar is designated as an “*Infektionsleichenkeller*” (infection corpse morgue) in the technical literature. Fig. 26 is the ground plan of morgue 1 (alleged ‘gas chamber’) of crematorium II, which was designed mirror symmetrically to crematorium III. Fig. 27 shows the cross section through morgue 1.¹⁸⁰ As may be seen from the cross-section, these morgues, for the most part, are located below ground. The long and slender type of construction, the underground location, as well as the lack of contact with the cremation rooms result in an even, cool temperature in these areas. This corresponds to their having been planned as morgues, which is how they are designated in the building plans.

The planning of such large cellars is not astonishing, furthermore, when one considers that several hundred corpses a day had arrived during the worst periods of the epidemics raging in Auschwitz, and that these corpses had to be stored somewhere. The compelling interpretation of the non-criminal planning of these rooms as harmless morgues is shared even by Pressac.

The documentation reproduced by Pressac shows that this installation was derived from an earlier 1941 plan for a new crematorium in the main camp.¹⁸¹ The access street to the crematoria in Birkenau was located on the side of the chimney wing (see Fig. 29). The original plan for the main camp, however, provided for an access street on the other side of the building. Moreover, the high water table of the terrain in Birkenau did not permit location of the morgue quite underground.¹⁸² The cellars were therefore raised so as not to swim on top of the ground water. Together with the layer of earth on top of the cellars, these were insurmountable for vehicles and carts. Direct access to the cellars from the outside was therefore blocked. For this reason, an additional flight of stairs was incorporated to the offices of morgue 3 as well as a flight of stairs at the end of morgue 2 (see Fig. 29).

Possibly as a result of the dramatically altered military situation after the German defeat of Stalingrad in the winter of 1942-43, all construction plans were reduced in costs and required manpower wherever

¹⁸⁰ J.-C. Pressac, *op. cit.* (note 67), pp. 319-329. Plans for crematoria II and III.

¹⁸¹ *Ibid.*, p. 183, on the non-criminal planning of crematoria II and III, see, in particular, p. 264.

¹⁸² See also Michael Gärtner, Werner Rademacher, “*Grundwasser im Gelände des KGL Birkenau (Auschwitz)*”, *VffG* 2(1) (1998), pp. 2-12 (online: www.vho.org/VffG/1998/1/GaeRad1.html); Engl.: “*Ground Water in the Area of the POW camp Birkenau*”, *The Revisionist*, 1(1) (2003), pp. 3-12 (www.vho.org/tr/2003/1/GaertnerRademacher3-12.html).

possible. Hence, the new stairways did not have corpse chutes as the old stairway. Several other cost-reducing changes were made on crematorium III.¹⁸³ Defects in the quality of the cheap material used for crematoria IV and V must have led to their early breakdown (see next chapter).

The original basement stairways with corpse chutes of crematoria II and III had already been finished by then, although they could only be accessed with difficulty. That these stairs were built at all, indicates an over-hasty transmission of the old plans for the main camp to the new situation in Birkenau.

The walls of the morgue consist of double brick masonry with a layer of tar in between for insulation.¹⁸³ The interior walls are plastered with a hard, cement-rich material, the ceiling and support pillars of reinforced concrete show the marks of wooden planking and are therefore not plastered. The roof, made of reinforced concrete, is isolated by a layer of tar, which is protected from environmental and mechanical damage by a rather thin layer of cement covering it. The layers of tar both on top of the roof as well as between the two brick walls was indispensable as a water barrier due to the high ground water in the swampy region of Birkenau. Both morgues had several drains.

5.4.1.2. The Obsessive Search for “*Criminal Traces*”

Jean-Claude Pressac was the first researcher to dig through the mountains of documentation at the Auschwitz Museum and later through the documentation of the *Zentralbauleitung* stored in Moscow. He was also the first one to create the now-widely used term “*criminal trace*”. Based on the total absence of documents proving the erection of homicidal ‘gas chambers’, Pressac resorted to a semantic trick by attributing a criminal significance to harmless documents, which were said to constitute a clue that something was not quite right about the crematoria at Auschwitz. Based on the progress in research, however, all these ‘criminal traces’ compiled by Pressac and others and accompanied by sometimes fantastic cerebral acrobatics have collapsed. The most notable of them are listed and briefly refuted in the following.

¹⁸³ J.-C. Pressac, *op. cit.* (note 67), p. 187, costs and survey of construction design of crematoria II and III.

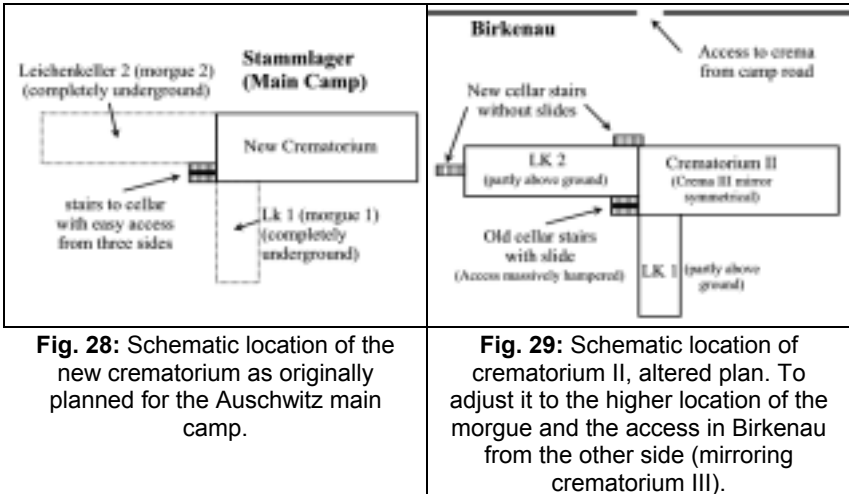

5.4.1.2.1. New Cellars Stairways

Fact 1: Additional access ways via stairways from the outside were later incorporated into the cellars of crematoria II and III.

Incorrect additional allegation: The corpse chute at the old, original stairway entrance was demolished.¹⁸⁴

Incorrect conclusion: The construction of new stairways *without* corpse chutes with the simultaneous demolition in the original stairway access way could mean only one thing: no more corpses were to go sliding into the cellars but rather people who were still able to walk down a few steps. Hence they had to be alive while entering, and were killed *after* they had entered the building.¹⁸⁵

Correct conclusion: The new stairways were necessary based on the alteration in the plans, see the chapter above. This is supported by the heading of the plan for the new stairways: “*Change of cellar access to street side*”.¹⁸⁶ The corpse chute, furthermore, was not even demolished. In fact, it appears in all following plans as shown by Carlo Mattogno:¹⁸⁷

¹⁸⁴ Judgment of Judge Gray, D. Irving vs. D.E. Lipstadt, *op. cit.* (note 66), §7.61, 13.76, 13.84.

¹⁸⁵ On Gray, see preceding footnote; J.-C. Pressac, *op. cit.* (note 67), pp. 213, 218.

¹⁸⁶ J.-C. Pressac, *op. cit.* (note 67), pp. 183f., 302f.; with regards to the original plans by Walter Dejaco, see J.-C. Pressac, *op. cit.* (note 90), Document 9.

¹⁸⁷ The following list was taken from Carlo Mattogno’s “*Architektonische Stümpereien...*”, *op. cit.* (note 92), p. 29.

- “Plan 2136 of the Zentralbauleitung of 22 February 1943 for crematorium III;¹⁸⁸
- Plan 2197 of the Zentralbauleitung of 18 March 1943 for crematorium II;¹⁸⁹
- Plan 109/15 of the firm Huta of 24 September 1943 for crematoria II and III;¹⁹⁰
- Plan 109/16A of the firm Huta of 9 October 1943 for crematoria II and III.¹⁹¹

Moreover, the ‘chute’ is mentioned as existing in ordinances 200 and 204 of the Zentralbauleitung to the Häftlingsschlosserei of 18 March 1943 respecting crematorium II.¹⁹²“

Furthermore, crematoria II and III were undoubtedly used during their entire period of operation for the temporary storage of the bodies of persons having died of ‘natural’ causes (epidemics, exhaustion, age, etc.), awaiting cremation, which amounted at least to thousands of bodies. If it were true that stairways without chutes could only be used by living persons still capable of climbing stairs on their own, then one might be permitted to ask: how did the corpses of persons having died of ‘natural causes’ get into the morgue (or wherever they were stored)? Did they walk by themselves? Of course not. They were carried, and sometimes certainly even a few steps up and down—and not only inside the crematorium. Was it therefore impossible to get corpses into a building not having a chute? Certainly not. Would missing chutes therefore prove that only living people could enter? Of course not. So why did the SS not build a new corpse chute by the new stairway? Perhaps simply because the costs of the crematorium were running out of control due to the constant changes in plans, and because it was desired or necessary to keep the costs down? Would that not be a much simpler and more logical explanation?

5.4.1.2.2. Gassing Cellar, Undressing Room, and Showers

Fact 1: There are documents of SS *Zentralbauleitung* which mention an “*Auskleidekeller*” (undressing room) in crematorium II.¹⁹³

¹⁸⁸ J.-C. Pressac, *op. cit.* (note 67), p. 305.

¹⁸⁹ *Ibid.*, p. 307.

¹⁹⁰ *Ibid.*, p. 327.

¹⁹¹ *Ibid.*, p. 328.

¹⁹² *The Trial of Höß*, volume 11a, p. 88.

¹⁹³ J.-C. Pressac, *op. cit.* (note 67), pp. 433ff.

Fact 2: There is a document which mentions a “*Vergasungskeller*” (gassing cellar,) in crematorium II.¹⁹⁴

Fact 3: There is a document which lists “*14 Brausen*” (14 showers) for crematorium III.¹⁹⁵

Fact 4: Pieces of wooden planking left in the underside of the ceiling of morgue 1 in crematorium II are visible even today.¹⁹⁶

Incorrect conclusion: Morgue 1 of crematoria II & III was built as homicidal ‘gas chamber’, equipped with “*false*” shower heads, which were fastened to the pieces of wood left in the concrete and used to deceive the victims; morgue 2 was used as the undressing room for the victims.¹⁹⁷

Correct conclusion: It is not known which room is being referred to by means of the term “*Vergasungskeller*” in the above mentioned document. Since there were still no proper means to drill holes in concrete ceilings and no neat plastic rawl plugs in the 1940s, there was only one way to fasten installations to bare concrete walls: conical pieces of wood were cast in the concrete onto which the electrical lines, water pipes, and other installations were screwed tightly. The existence of such pieces of wood in the ceiling of morgue 1 does not prove that shower heads were fastened there. It is more probable that lamps or electrical lines were fastened there. Nor is there any proof that the “*showers*” mentioned in the document were “*false*”, as stated by Pressac. In actual fact, the *Zentralbauleitung* temporarily considered expanding the Birkenau crematoria into hygiene centers equipped with disinfestation installations, inmate showers and undressing rooms but nevertheless later abandoned these plans. Carlo Mattogno has produced extensive documentation in support of this argument.¹⁹⁸

Now in an ‘Aufstellung’ (itemization) by the Topf company dated 13 April, 1943, concerning requested metals to be used in the construction of certain machinery for crematorium II at Auschwitz, the following

¹⁹⁴ *Ibid.*, p. 432.

¹⁹⁵ *Ibid.*, p. 430.

¹⁹⁶ *Ibid.*, p. 488.

¹⁹⁷ See also four Pressac footnotes above; see also Gray, judgment, *op. cit.* (note 66), §13.69, 13.82.

¹⁹⁸ C. Mattogno, “*Leichenkeller von Birkenau: Luftschutzräume oder Entwesungskammern?*” *VffG* 4(2) (2000), pp. 152-158 (online: www.vho.org/VffG/2000/2/Mattogno152-158.html); Engl.: “*Morgue Cellars of Birkenau: Gas Shelters or Disinfesting Chambers?*” (online: <http://www.codoh.com/granata/leichen.html>).

piece of information appears.^[199]

‘2 Topf disinfection heaters for crematorium II in the prisoner of war camp Auschwitz.’

On 14 May, Bischoff sent Topf the following ‘urgent telegram’.^[200]

‘On Monday bring the overdue warm water project for approximately 100 showers. Installation of water heater or boiler in the still under construction trash incinerator crematorium III or flue for the purpose of utilizing the high emission temperature. Contingently higher walling of the oven for the purpose of accommodating a large reserve container is possible. It is being requested to send along the appropriate designs with Herrn Prüfer on Monday, May 17.’

On June 5, 1942, Topf sent Drawing D60446 to the Zentralbauleitung ‘regarding the installation of the boilers in the rubbish incinerator’. This project involved the installations intended for crematorium II.^[201]

In an undated ‘questionnaire’ apparently written in June 1943 regarding the Birkenau crematoria, in answer to the question, ‘Are the exhaust gases utilized?’, the head of the Zentralbauleitung, Bischoff, responded: ‘planned but not carried out’, and in response to the following question: ‘If yes, to what purpose?’, Bischoff answered: ‘for bath facilities in crematorium II and III’.^[202]

Finally, there is an invoice from the firm VEDAG Vereinigte Dachpappen-Fabriken Aktiengesellschaft (United Roofing-Felt Factories, Incorporated) dated July 28, 1943, with the subject ‘Auschwitz-crematorium’ referring to ‘completed sealing work for the disinfection facility’ (emphasis added) which was carried out between May 21 and July 16, 1943, cf. Fig. 30.^[203]

Before drawing any conclusions, a few explanations are required. While both Topf disinfection heaters were then installed in the Zentralsauna, the document cited above refers them to crematorium II. The project for the installation of 100 showers in crematorium III (and in crematorium II) could not have been for the prisoners of the ‘Sonderkommando’ of the crematoria, since only 50 showers were installed in the shower room of the Zentralsauna, which had been designed for the in-

¹⁹⁹ Archiwum Panstwowego Muzeum w Oswiecimiu (hereafter APMO), BW 30/34, p. 47.

²⁰⁰ APMO, BW 30/34, p. 40.

²⁰¹ TCIDK, 502-1-336 (page number illegible).

²⁰² TCIDK, 502-1-312, p. 8.

²⁰³ TCIDK, 502-1-316, p. 431, “Zweitschrift” in 502-1-323, p. 137.

mates of the entire camp,^[204] therefore it is clear that the ‘bath facilities in crematorium II and III’ in the ‘questionnaire’ quoted above, were intended for the prisoners of the entire camp as well. This means that it was planned to convert the crematoria II and III into hygienic centers.

The purpose of such centers was to cleanse the inmates and their clothing, i.e., to free them from dirt and disease-carrying parasites. But this necessarily included a disinfection or disinfestation installation. The expansion of the crematoria was not however completed because work had already begun in the meantime on the central sauna which was better suited for this purpose. The documents cited here nevertheless prove a temporary intent on the part of the Zentralbauleitung to perform cremation, inmate cleaning and the disinfestation of clothing in the same building.

Now I think that it is not irrelevant to note here that in this project the water heating system for the showers was connected to the garbage incinerator and not to the crematorium oven, as for example in the five-muffle oven of the Lublin KL. In my opinion, the reason for that decision was the fact that the crematorium ovens did not ensure a continuity of use to be able to provide sufficient hot water throughout the entire day; in other words, the crematorium ovens were not used enough to ensure efficient operation of the water heating system.

That the VEDAG-Invoice^[203] indeed refers to the hot-air disinfecting chambers installed in the Zentralsauna, is definitely proven by a VEDAG single invoice which has the same date and the same contents as the first invoice noted above, but it refers to the ‘BW 32 = disinfestation facility’, that is to say, precisely in the Zentralsauna. [cf. Fig. 31,²⁰⁵] But for what reason does the invoice have as its subject: ‘Auschwitz-crematorium’? This heading has an obvious relationship to the aforesaid Topf ‘itemization’ of April 13, 1943, concerning ‘2 Topf disinfestation heaters for Crema II’ which were then installed in the Zentralsauna. In any case, the two documents establish the correlation crematorium–disinfestation and portray the expression of a plan or at least of a Zentralbauleitung intention to combine cremation and disinfestation within the same edifice.”

Since, as shown in chapter 5.2.2., the installation of hygiene centers with showers, disinfestation, undressing and dressing rooms and adjacent crematoria is not at all unusual, the “traces” adduced by Presac and van Pelt may be seen to have been incorrectly interpreted.

²⁰⁴ Inventory of the delivery negotiations relating to the “Desinfektions- und Entwesungsanlage” (Zentralsauna) of 22. January 1944. TCIDK, 502-1-335, p. 3.

²⁰⁵ TCIDK, 502-1-316, S. 430.

Zweitschrift 37

VEDAG

VEHRENDIGER GRUPPENFABRIK
KUNSTSTOFFWERKE

BETRIEBE SCHLESIE

STAMMHAUS 1846 GEGRÜNDET

Fachabteilung für Grundwasserabdichtungen, Isolierungen u. Asphaltierungen

Post- und Drahtanschrift: Vedag Breslau Fernruf: 324 31 Bank-Konto: Deutsche Bank, Filiale Breslau Postfach-Konto: Breslau 2416

Centralbauleitung
der Waffen- und Polizei

Auschwitz Ost-08

13. VII. 43
[Signature]

Ihre Zeichen: Ihre Bezeichnung von: Unsere Zeichen: 4.163 (73) Ergabnis 1. Übersicht in: 20. Juli 1943

RECHNUNG Nr. 102: Auschwitz-Krematorium

1943	Bezeichnung der Leistung	Stimmen z.B.	Gesamtbetrag z.B.
21. Mai - 16. Juli	Über: ausgeführte Abdichtungsarbeiten für die <u>Desinfestationsanlage</u> Lt. beabsichtigter Tagelohnliste wurden geleistet und verarbeitet:		
170	300 Stunden Klebeabdichter	30	2.100,00
150	100 Überstunden = 25,4 Zuschlag	30	440,00
	600 Zuschlag	30	180,00
	24 Tage Auslösung	30	108,00
	2.040 Zuschlag	30	2,20
2	460 200 Litonenpappe 500er	30	787,20
4	500 200 Litonen	30	762,30
100	kg Voranstrich	30	54,00
4	Stahl-Teerbürsten	30	16,00
6	gewöhnliche Teerbürsten	30	9,00
15%	Zuschlag auf Material (Bsk. 1020,50)	30	244,28
	Für Abnutzung der Schneidknocher und sonstigen Veräte 15% von Lohn (Bsk. 270,-)		14,77
			40,50
			Bsk. 2450,15

Nachgerechnet am 22. VII.

[Signature]

Netto-Gehalt 1

H. Goleg Dr. 1

Zielgruppenrechnung und Zielgruppen-CC - Zielgruppen-Größe
Zielgruppenrechnung und Zielgruppen-CC - Zielgruppen-Größe
Ergebnis-Ziele Geschäftsziele

Regional: Rudolf Eberhard - Hans C. Frenz - Carl Deitzgen - Alfred Frenz - Hans J. Frenz - Carl Müller

Fig. 30: "Re.: Auschwitz crematorium [...] Caulking work performed for the disinfestation installation"

TCIDK, 502-1-316, p. 431, "Zweitschrift" in 502-1-323, p. 137.

229

430

Beschrieb. K.G.L.

Bausatz Waffen-ll 1943. Rep 2475 II (Pas) 65

Genehmigungsvorladung vom _____

Zofen/einrichtung vom _____

Waffengr. Nr. 194 vom 25.5.43

Vertrag Nr. _____ vom _____ mit _____

Geräte (EW): 32

Zeichnungsblatt Gdz Nr. 20

Titel der Vergütung:
(Waffenfabrikation)

(zeitlich)
beidehändige Handhabung
einseitige Handhabung

488

Einzel-/Teil-/Schluß-Rednung Nr. _____

(Hauptrechnung für den Bau)

der Firma **VEBAG, Verp. Dachpappen-Fabriken, A.G.**
Breslau 1, Elferplatz 1 a
betr. Abdichtungsarbeiten

Siehe beigeführte Originalrechnung

Bankkonto der Firma: **Deutsche Bank Breslau**

Breslau 28. Juli 1943.

Feldpost-Adresse der Firma: **Breslau Nr. 2416**

Zu- sammen Gdz.	Anzahl der Stücke	Einheit	Beschreibung des Arbeits gegenstandes	in Gulden	
				in Gdz.	in Gulden
			Re: 32 = Entlüftungsvorlage		
	1943		Ausgeführte Arbeit für die Entlüftungsvorlage		240,00
	21.5.		11. besond. Arbeit für den geleisteten Aufwand	0,83	12,24
	20		Stunden Lohn	0,21	42,24
			Überstunden		22,24
			24 Tage Zuschlag	4,50	108,00
			24 Tage Zuschlag		2,20
	2 450		an Mittenplatte 300 Gradstb.	0,32	767,20
	2 200		an Mittenplatte	0,50	762,30
	100		Vorhandstrich		54,-
	1		Stab. Stahl-Fest-Büchsen		16,-
	1		gewebliche Beschützung		9,-
	1		24 % Zuschlag auf Material	1,50	244,20
			für Abmätzung der Schweißnähte und sonstigen Geräte 15 % vom Lohn		38,45
			(= 240,-)		2 442,19

Fachtechnik richtig!
Rechnung Nr. 18/1943
J. G. Gabel

Festgestellt auf am 20.9.43
J. G. Gabel

Rechnungsbetrag 2 442,19

Nachgerechnet am 20.9.43

2 442,19

H-Formblatt - Das - 15 - Staatliche - (Einzel-/Teil-/Schluß-Rednung) - K. G. L. - (1943)

502-1-316-471

Fig. 31: "Re: BW: 32 = Disinfestation installation [...] Caulking work performed for the disinfestation installation" TCIDK, 502-1-316, p. 430.



Fig. 32: "2 Topf disinfection ovens for crematorium II in the Prisoner of War Camp, Auschwitz." *Archiwum Panstwowego Muzeum w Oswiecimiu, BW 30/34, p. 47.*

5.4.1.2.3. “Gas-tight Doors” for Crematorium II

Fact 1: Morgue 1 in crematorium II was equipped with gas-tight doors with a peephole.²⁰⁶

Fact 2: An initially planned double door opening to the inside of morgue 1 was replaced by a double door opening to the outside.²⁰⁷

Incorrect conclusion 1: Morgue 1 in crematorium II was converted into a homicidal ‘gas chamber’, equipped with gas-tight doors.²⁰⁸

Incorrect conclusion 2: Doors opening to the inside of morgue 1 would have been blocked by gassing victims piling up in front of it so that the doors could not have been opened. Realizing this, the SS changed the doors to open to the outside.

Correct conclusions 1: Even if a peephole was not entirely necessary for a disinfestation chamber, it has nevertheless been proved that the disin-



Fig. 33: Wooden disinfestation chamber door at Auschwitz, rendered provisionally gas-tight with peephole and metal protection grid. This is what the gas-tight doors for the homicidal ‘gas chambers’ are supposed to have looked like. Note the extremely flimsy lock.

²⁰⁶ J.-C. Pressac, *op. cit.* (note 67), pp. 434-436.

²⁰⁷ *Ibid.*, pp. 285, 302.

²⁰⁸ See also Pressac footnote above; see also Gray, judgment, *op. cit.* (note 66), §13.84.

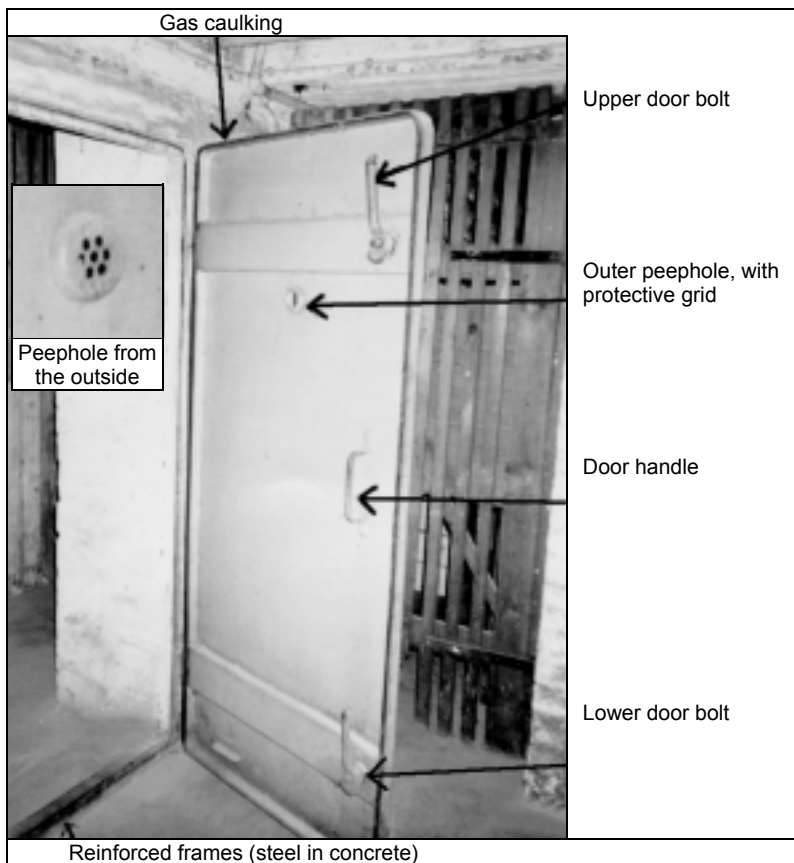

Fig. 34: German air-raid shelter door from 1939 in the cellar of a private house in Karlsruhe © Photo: R. Faurisson, 1991

festation chamber doors installed in Auschwitz were also equipped with exactly such peepholes, as shown in the photograph reproduced here (Fig. 33).²⁰⁹ One document indicates that gas-tight doors measuring 100 cm × 192 cm were ordered for morgue 1 (the ‘gas chamber’) of crematoria II and III.²¹⁰

On the delivery plan, *i.e.*, the final plan for crematorium II, the size of the doors is nevertheless drawn in as 190 cm × 200 cm, as on all previous plans, so that these gas-tight doors would not have fit-

²⁰⁹ J.-C. Pressac, *op. cit.* (note 67), p. 49.

²¹⁰ *Ibid.*, p. 436. In the inventory list on p. 430, a handwritten entry mentioning a gas-tight door only appears in crematorium II.

ted.²¹¹ Based on the ruins, it must be possible even today, to establish whether the door was possibly walled in to make it narrower and whether there are any traces of door frames. Excavations would be necessary to determine this.

The engineers Nowak and Rademacher have shown that the ‘gas-tight’ doors manufactured at Auschwitz by inmates from wooden planks could not have been gas-tight in a technical sense, the planks did not close hermetically, the fittings were simply fastened through the wood by means of bolts, and the seals consisted of felt strips.²¹²

One has to consider that a hypothetical homicidal ‘gas chamber’ door would have to open outwards—a door opening inwards would be blocked by inmate bodies lying in front of the door. Such doors would require an especially stable arrangement as the locks and hinges would have to be capable of resisting the pressure of hundreds of panicking people. The pressure exerted by such masses of people becomes apparent when one recalls the photographs of panicky spectators at football/soccer matches. Separating fences and partitions between individual spectator blocks are commonly trampled down like mere blades of grass in such situations. In any case, a simple wooden door, rendered provisionally gas-tight, as has been found in Auschwitz, a photograph of which is reproduced by Pressac in his book (see Fig. 33),²¹³ could never have resisted such pressure.

The camp administration could actually have ordered solid, technically gas-tight steel doors (air-raid shelter doors, Fig. 34) since they were offered such doors but it can be proven that they did not order them. One must assume that they had no serious need for them.²¹²

In this context, a comparison of the flimsy wooden doors as found in Auschwitz (used for delousing purposes only) with technically gas tight, massive iron doors as used for executions in U.S. homicidal gas chambers is revealing, compare Fig. 33 with Fig. 5 (page 24).

The installation of a door with felt seals in crematorium II may have been temporarily considered either in connection with the temporarily considered expansion into a hygiene center or because it was

²¹¹ *Ibid.*, pp. 227, 311, 312.

²¹² H.J. Nowak, W. Rademacher, “‘Gasdichte’ Türen in Auschwitz”, *VffG* 2(4) (1998), pp. 248-261 (online: www.vho.org/VffG/1998/4/NowRad4.html); Engl.: “‘Gas-Tight’ Doors in Auschwitz”, in: E. Gauss (ed.), *op. cit.* (note 43), pp. 324-336 (online: www.vho.org/GB/Books/dth/fndNowak.html).

²¹³ J.-C. Pressac, *op. cit.* (note 67), pp. 46-49, 425-428, 486, 500.

desired to use the only solid reinforced concrete cellar in Birkenau camp as an air-raid shelter, as remarked by senior engineer Schreiber. This cellar was actually used as an air-raid shelter for inmates as suggested by a few eyewitness testimonies.²¹⁴ This would also explain other more minor ‘traces’ which cannot be discussed here. Samuel Crowell has shown in several articles the extent to which the SS actually built air-raid shelter installations not only for themselves but also for the camp inmates.²¹⁵

Correct conclusions 2: The change in orientation of the doors was probably caused by the design of this morgue’s ventilation system. Since the air inlet of this system had a higher resistance than the outlet (see next chapter), a considerable subpressure was caused in morgue 1, constantly sucking air in from the rest of the building. This is a desired effect for a morgue where many corpses had to be stored, so that unpleasant smells would not reach other parts of the building. A double door opening to the side with a lower pressure (inside morgue 1) would open automatically, whereas a door opening to the side of higher pressure closes automatically.

²¹⁴ Miklos Nyiszli’s book *Auschwitz: A Doctor’s Eyewitness Account*, Arcade Publishing, New York 1993, alleges, on p. 128, that the inmates took refuge in the gas chamber during air raids. Martin Gilbert’s *Auschwitz and the Allies* (Henry Holt & Co., New York 1981), p. 309, contains the testimony of a female survivor, according to which she, together with many other female arriving inmates, was led to a darkened room to remain there during an air raid. What is most interesting about this testimony is the description of the manner in which some of the women became hysterical during the air raid and believed that they were inhaling poison gas. Another conclusion which could be drawn from this testimony is that the SS were concerned with protecting their inmates from air raids, and that there must have existed several such air raid shelters at Birkenau, which must have been gas-tight, that however remained entirely unnoticed and unstudied (from: S. Crowell, “*Technik und Arbeitsweise deutscher Gasschutz-bunker im Zweiten Weltkrieg*”, *VffG* 1(4) (1997), p. 242, fn. 4 online:

www.vho.org/VffG/1997/4/Crowell4.html; Engl.: “*Technique and Operation of German Anti-Gas Shelters in WWII: A Refutation of J.C. Pressac’s Criminal Traces*”, online:

www.codoh.com/incon/incompressac.html). Another survivor reports that the inmates were regularly led into an air raid shelter during Allied air raids in 1944: Colin Rushton, *Spectator in Hell. A British Soldier’s Extraordinary Story*, Pharaoh Press, Springhill (Berkshire) 1998.

²¹⁵ Samuel Crowell, *ibid.*; see also “*Defending Against the Allied Bombing Campaign: Air Raid Shelters and Gas Protection in Germany, 1939-1945*”, online: www.codoh.com/incon/inconabr.html; “*The Gas Chamber of Sherlock Holmes: An Attempt at a Literary Analysis of the Holocaust Gassing Claim*”, online: www.codoh.com/incon/inconshr123.html; “*New Documents on Air Raid Shelters at Auschwitz Camp*”, online: www.fpp.co.uk/Auschwitz/documents/LSKeller/MoscowDocs.html; “*Comments on Mattogno’s critique of the bomb shelter thesis*”, online: www.codoh.com/incon/inconscrmtgno.html; “*Bombenschutzeinrichtungen in Birkenau: Eine Neubewertung*”, *VffG* 4(3&4) (2000), pp. 284-330; Engl. “*Bomb Shelters in Birkenau: A Re-appraisal*”, online: www.codoh.com/incon/inconbsinbirk.html.

5.4.1.2.4. Ventilation Installations

Fact: All rooms in crematoria II and III were equipped with efficient ventilation installations.²¹⁶

Incorrect conclusion: Morgues 1 of crematoria II and III were converted into homicidal ‘gas chambers’ equipped with installations for the intended purpose of evacuating poison gases.²¹⁷

Correct conclusion: It is in fact inconceivable that a large morgue without windows and with only one door filled with innumerable bodies of the victims of epidemic disease would *not* be equipped with a ventilation installation. The efficiency of the ventilation, however, proves that these installations were designed for typical morgues.²¹⁸ The efficiency of the blowers may be seen from the invoices sent to the *Zentralbauleitung* by the Topf corporation after installation of the systems.²¹⁹ According to the invoices, both morgues #1, *i.e.*, the alleged ‘gas chambers’ (in the invoice designated as the “*B-room*”), were each equipped with a 4,800 m³/h intake and outlet blower,²²⁰ while for the “*L-room*” (the so-called “*undressing room*”) only one outlet blower was installed, with a capacity of 10,000 m³/h.²²¹

²¹⁶ The ventilation ducts of morgue 1 are visible in the plans published by J.-C. Pressac, *op. cit.* (note 67), pp. 224, 289; chapter on the ventilation installations of crematoria II and III: *ibid.*, pp. 355ff.; engine power of the ventilation installations for all rooms in crematoria II and III: *ibid.*, p. 374 and 377; size of the ventilation outlets: *ibid.*, p. 234; Fig. of an outlet cover in the ventilation outlets.

²¹⁷ For Pressac see footnote above; a similar opinion has been expressed by Van Pelt, *Pelt Report, op. cit.* (note 66), p. 208, as well as by Judge Gray in the Irving vs. Lipstadt trial, *op. cit.* (note 66), §7.62.

²¹⁸ See also, in this regard, Carlo Mattogno, “*Auschwitz. das Ende einer Legende*”, in: Herbert Verbeke (ed.), *op. cit.* (note 43, also the English version), pp. 134f. (online: Ger.: www.vho.org/D/anf/Mattogno.html; Engl.: www.vho.org/GB/Books/anf/Mattogno.html). The following remarks are closely patterned after Mattogno; for further details, see Mattogno.

²¹⁹ Invoice no. 729 dated May 27, 1943. *APMO*, D-Z/Bau, nr. inw. 1967, pp. 246f.; *ibid.*, 231f.: invoice no. 171 dated 22. February 1943 for crematorium II.

²²⁰ The engines had a nominal output of 2 HP (approximately 1.5 KW). The output data relate to a back-pressure of 40 mm water column. The increment calculations for estimating the ventilation shaft resistances in crematoria II & III according to engineering handbooks have shown that the back pressure to be expected would probably have been higher (in the region of 50-60 mm water columns), due, particularly, to the primitive lids with many small holes covering the ventilation slit. Two blowers were probably used for this reason. Personal communication from Hans Lamker, a certified engineer.

²²¹ J.-C. Pressac gives the output of these blowers at 8,000 m³/h, but without proving it (together with Robert van Pelt in: Yisrael Gutman, Michael Berenbaum (ed.), *Anatomy of the Auschwitz Death Camp*, Indiana University Press, Bloomington 1994, pp. 210, 232). Perhaps he simply crudely added the output of the two blowers together, which is impermissible, since the blowers did not work in parallel, but rather, in series (behind each other).

When considering the volume of the two morgues (morgue 1÷504 m³; morgue 2÷900 m³), the results for the alleged, planned ‘gas chambers’ (4,800/504 =) are approximately 9.5 air exchanges per hour and for the undressing room (10,000/900 =) approximately 11 air exchanges per hour. Does anybody seriously believe that, at the end of May 1943, *i.e.*, two months after the beginning of the alleged mass murders, it was assumed that the ‘gas chambers’ would need less ventilation than the undressing rooms, or even less than the dissecting rooms, laying out rooms and wash rooms, the ventilation efficiency of which were even greater—approximately 13¹/₃ air exchanges per hour?

Wilhem Heepke’s classic work on the construction of crematoria states that a morgue requires a minimum of 5 air exchanges per hour and 10 during intensive use.²²² Thus it is clear that the ventilation installations provided for the morgues were designed, in terms of orders of magnitude, for morgues in intensive use or for morgues containing the bodies of epidemic disease victims. For comparison: Zyklon B disinfestation chambers with circulating air systems were equipped with 72 air exchanges per hour.²²³ Furthermore, it should be mentioned that the *original* plans for a new crematorium in the main camp from 1941—a time when even Pressac admits that the SS had no criminal intentions—provided for 17(!) air exchanges per hour for the dissecting room(!) and the morgues.²²⁴ This exchange rate is considerably higher than what was later realized for all rooms of crematoria II and III, including the alleged ‘gas chambers’. Thus, on the way from beneficial planning to (allegedly sinister) construction, the air exchange rates had been drastically reduced (probably in order to reduce costs). Does anybody seriously believe, the SS would have lowered the ventilation capacity when changing the designation of a morgue from a beneficial use to a homicidal ‘gas chamber’, instead of increasing it? This is thus the final refutation of any argument on the alleged criminal characteristics of the ventilation installations in these crematoria.

5.4.1.2.5. Pre-heated Morgues

Fact: The morgues of crematoria II and III were never heated, although a heating system was temporarily considered; water pipes in

²²² W. Heepke, *Die Leichenverbrennungs-Anstalten*, C. Marhold, Halle 1905, p. 104.

²²³ Gerhard Peters, Emil Wüstiger “*Sach-Entlausung in Blausäure-Kammern*”, *Zeitschrift für hygienische Zoologie und Schädlingsbekämpfung*, 10/11 (1940), pp. 191-196, here p. 195.

²²⁴ J.-C. Pressac, *Les crématoires d'Auschwitz*, *op. cit.* (note 90) p. 18.

morgue 1 were removed.²²⁵

Incorrect conclusion: Morgues need no heating for normal operational functioning. Crematoria II and III were converted into homicidal ‘gas chambers’, (intended to be) equipped with a heating system so that ‘the gas would work more rapidly’. It was necessary to eliminate the plumbing system in the morgue because panic-stricken inmates would have damaged the pipes.²²⁶

Correct conclusion: According to expert literature, morgues do indeed need some kind of heating equipment, because corpses must be protected from the effects of frost and freezing temperatures in winter.²²⁷ Hence, under normal operation, morgues would have been equipped with heating devices, but the initial plans to equip the morgues in Auschwitz with heaters were cancelled,²²⁸ rendering the argument irrelevant. Regarding the removal of the water pipes, a ‘non-criminal’ explanation follows logically: Since no heating was ever installed in these morgues, there was a danger that the water pipes would have burst in freezing temperatures due to the lack of any heating. In order to prevent burst pipes and a subsequent flooding of the morgues, the pipes had to be removed.

5.4.1.2.6. “Cremation with Simultaneous Special Treatment”

Fact: With regards to the “*Electrical supply and installation of the concentration camp and prisoner of war camp*” the documentary note (“*Aktenvermerk*”) of the Auschwitz *Zentralbauleitung* of January 29, 1943, states:²²⁹

“This putting into operation [of crematorium II] can however only extend to restricted use of the available machines (in which case cremation with simultaneous special treatment [original: “Sonderbehandlung”] will be made possible) since the [electrical] supply leading to the crema-

²²⁵ Pre-heating: J.-C. Pressac, *op. cit.* (note 67), pp. 221, 223. Demolition of the water pipes: *ibid.*, p. 286; for further details in this discussion, which is just as fruitless, since they are based on the “*criminal traces*” dreamed up by Pressac, see also, generally, H. Verbeke, *op. cit.* (note 43).

²²⁶ See also the above footnotes referring to Pressac, in particular, relating to the water pipes; a similar opinion expressed by Van Pelt, *Pelt Report, op. cit.* (note 66), p. 296, as well as by Judge Gray in the Irving vs. Lipstadt trial, *op. cit.* (note 66), §7.68.

²²⁷ E. Neufert, *op. cit.* (note 176).

²²⁸ J.-C. Pressac, *op. cit.* (note 67), p. 230. The waste heat of the forced draught blowers was to be used, but since these burned out and were removed, the entire pre-heating project for morgue 1 was cancelled.

²²⁹ *TCIDK 502-1-26-21*, Jan. 29, 1943.

torium is too weak for its output consumption.”

Incorrect conclusion: Since the “*special treatment*” mentioned apparently required electricity and because the homicidal ‘gas chamber’ possessed an electrical ventilation, R.J. van Pelt concludes that “*Sonderbehandlung*” referred to homicidal gassings, which was made possible by operating the ventilation despite a reduced power supply.²³⁰

Correct conclusion: First, it is not apparent from this document whether or not electricity is required for “*special treatment*”. Furthermore, on January 29, 1943, the ventilation installation for the morgue had not yet even been delivered, let alone installed and put into operation. Commencement of construction was not anticipated before February 10.²³¹ Installation was only charged to the account on February 22, 1943.²³² Therefore, the “*available machines*” on January 1, 1943, in no way included the morgue ventilation installations. Actually, the concept “*special treatment*” in this connection has no ‘criminal’ significance at all, as W. Stromberger¹⁰⁴ and recently C. Mattogno have pointed out.²³³

“By considering the historical context—a typhus epidemic increase so dangerous in 1942 as to induce [...] Major General of the Waffen SS Glücks to command on February 8, 1943, the complete quarantine of the camp^[234]—the meaning of the term ‘special treatment’ in the memorandum of January 29, 1943, could only be an extension of its hygienic-sanitary meaning which emerges from other documents.²³⁵ That is, from the hygienic-sanitary point of view, the ‘existing machines’ would have guaranteed proper cremation with limited capacity.

This is confirmed by a document going back a few weeks. On January 13, 1943, Bischoff wrote a letter to the firm Deutsche Ausrüstungswerke in Auschwitz with the subject ‘Fulfillment of carpentry jobs for the building planning room.’ In this document, Bischoff complained about the delay in receiving doors ‘for crematorium I in the KGL’, ex-

²³⁰ Robert van Pelt, Deborah Dwork, *op. cit.* (note 92), p. 330.

²³¹ Memorandum from Kirschnek dated 29 January 1943. *APMO*, BW 30/34, p. 105.

²³² Topf, invoice no. 171 dated 22. February 1943 relating to the installation for the ventilation of crematorium II. *TCIDK*, 502-1-327, pp. 25-25a. See also C. Mattogno, *op. cit.* (note 218), pp. 136-139.

²³³ See also C. Mattogno, “*Architektonische Stümpereien...*”, *op. cit.* (note 92), p. 31.

²³⁴ *APMO*, Standort-Befehl, D-AuI-1, p. 46.

²³⁵ For this, see Carlo Mattogno, „*Sonderbehandlung*“ *ad Auschwitz. Genesi e Significato*, Edizioni di Ar, Padua 2001.

*plaining in detail.*²³⁶

‘Above all, the ordered doors of Bftgb. No. 17010/42/Ky/Pa of order letter dated 26.10.42 for crematorium I of the concentration camp is urgently needed for carrying out special measures.’

The expression ‘carrying out special measures’ had no criminal significance at all. On the contrary, it denoted the construction of hygienic-sanitary installations, including the hospital for the prisoners (Häftlings-lazarett) projected for the BIII sector of Birkenau. Therefore, if the crematorium was made for ‘carrying out special measures,’ it means that it was a part of these installations and its hygienic-sanitary function was exclusively the cremation of dead bodies of deceased camp prisoners.”

5.4.1.2.7. “Gas Testers” and “Indicator Devices for HCN Residues”

Fact 1: There is a telegram of February 26, 1943, by means of which heating technician Jährling of the Topf & Söhne oven construction firm orders “10 Gas testers” for crematorium II.

Fact 2: There is a letter from the Topf corporation of March 2, 1943, which, referring to the above telegram, mentions “Anzeigergeräte für Blausäure-Reste” (indicator devices for HCN residues).

Incorrect conclusion: The SS ordered the indicator devices in order to verify whether the ventilation of the ‘gas chamber’ was successful after completion of mass murder with hydrogen cyanide in crematorium II.²³⁷

Correct conclusion: According to the technical literature, “Gas testers” are flue gas analyzers intended to determine the exhaust gas composition of oven gases.²³⁸ Such devices were standard equipment in crematoria. That the above mentioned order referred to such devices is clear from the fact that they were ordered by a heating technician from an oven construction firm. The letter in reply from the Topf corporation dated March 2, 1943, stating that one must first find out who marketed these devices, has been revealed on several occasions to be an absurdity.²³⁹

²³⁶ *APMO*, BW 30/34, p. 78.

²³⁷ See the two footnotes above, with relation to Pressac; van Pelt, *Pelt Report*, *op. cit.* (note 66), pp. 200, 254.

²³⁸ Akademischer Verein Hütte (ed.), *Hütte*, Ernst und Sohn, Berlin ²⁷1942, p. 1087

²³⁹ Werner Rademacher, “*The Case of Walter Lüftl*”, in Ernst Gauss (ed.), *op. cit.* (note 22), pp. 78ff. (online: www.vho.org/D/gzz/3.html); C. Mattogno, “*Die ‘Gasprüfer’ von Auschwitz*”,

- According to contemporary literature, devices for the detection of HCN residues were called “*Blausäurerestnachweisgeräte*” (HCN residue detection devices) or “*Gasrestnachweisgeräte für Zyklon*” (Gas residue detection devices for Zyklon).¹²⁸ Since the Topf & Söhne corporation according to the letter had already received information on the possibility of procurement of such devices from three firms, the correct name of these devices must in the meantime have penetrated even to Topf & Söhne.
- Furthermore, these detection devices are based on a wet chemical method which possessed no “*indicator*” and could not, therefore, be designated as indicator devices. On the other hand, the gas testers mentioned in the telegram had a physico-chemical sensor connected to a dial (see Fig. 35).
- According to contemporary prescriptions, testing with HCN residue testing devices was obligatory in every disinfection action using hydrogen cyanide in order to test whether the ventilation of a fumigated room had been successful before it could be entered without a gas mask. Since disinfection had been performed on a large scale in Birkenau since 1941, it is absolutely incredible that no one should have concerned himself with the possibility of or-

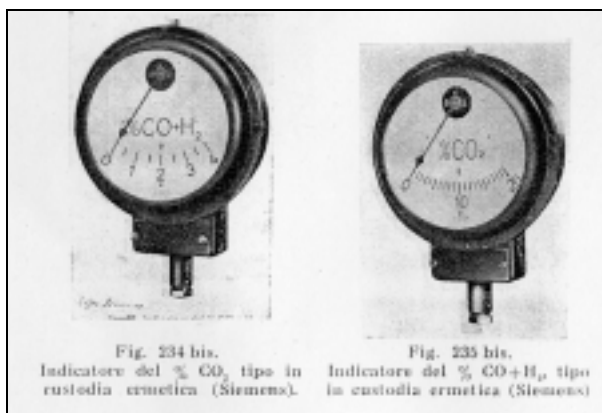

Fig. 35: Photograph of two indicator devices from the Siemens corporation for the CO₂ and/or CO+H₂- gas content in %. Component of a gas tester.²⁴⁰

VffG 2(1) (1998), pp. 13-22 (online: www.vho.org/VffG/1998/1/Mattogno1.html).

²⁴⁰ Alberto Cantagalli, *Nozioni teorico-pratiche per i conduttori di caldaie e generatori di vapore*, G. Lavagnolo Editore, Turin 1940, p. 308; taken from C. Mattogno, *op. cit.* (note 239),

dering such devices before early 1943!

- Since the creation of Birkenau camp in 1941, the SS garrison doctor for Auschwitz camp was responsible, among other things, for the ordering, administration, and use of Zyklon B and all materials for its handling (disinfestation installations, gas masks, HCN residue detection devices, etc.). He therefore had three years experience in this business. Why then should the *Zentralbauleitung*, which was not competent in this matter, in addition to being unauthorized, have issued the order for the procurement of HCN residue detection devices in 1943?
- In addition to crematorium ovens, the Topf corporation also produced hot air disinfestation ovens, as well as silo fumigation installations which were, however, not operated with HCN.²⁴¹ Why then should the heating technician Jährling, a civilian engineer, order devices of which he had no knowledge from a firm which obviously did not even know the supplier of the devices when the health service of Auschwitz camp had already been regularly supplied with these devices by the Tesch und Stabenow corporations for two years and therefore knew the supplier? There was very probably a supply of them in storage at the camp.

It is therefore the conviction of W. Rademacher, C. Mattogno, and myself that this reply from the Topf corporation is a forgery, in which a word such as “*Anzeigegeräte für Rauchgasanalyse*” was perhaps replaced by the word “*Anzeigegeräte für Blausäure-Reste*” (Indicator Device for Smoke Analysis by Indicator Device for HCN Residues).

5.4.1.2.8. Zyklon B Introduction Holes and Columns

Fact 1: There are eyewitness testimonies claiming that there were three or four square holes measuring 70 cm in the roofs of both morgues 1 of crematoria II and III. According to some witnesses, columns fabricated of mesh metal ran from the floor of the morgues through the holes in the ceiling and protruded over the roof. Zyklon B is alleged to have been thrown into these columns for the purpose of

p. 19.

²⁴¹ Hydrogen cyanide would form poisonous residues with moist food. The gases Areginal and Cartox were used; see also G. Kunike, *Das ABC der Vorrats- und Hausschädlinge und ihre Bekämpfung*, Theodor Weicher, Berlin 1941, pp. 53f.



Fig. 36: Photograph of crematorium II of Birkenau taken in February 1943.²⁴⁴

mass killings.²⁴²

Fact 2: There are two photographs showing objects on the roof (see further below).

Fact 3: There is a document mentioning “*Drahtnetzeinschubvorrichtungen*” (wire mesh push-in devices).

Incorrect conclusion: The eyewitnesses are right.

Correct conclusion: Pressac reproduced a photo of crematorium II showing square objects located on the roof of morgue 1 (the fourth object obviously lies behind the cellar).²⁴³ The same photograph also appears in Danuta Czech’s book.²⁴⁴ It was taken in early February 1943, see Fig. 36, the decisive detail of which being magnified in Fig. 37. If these objects are really Zyklon B introduction holes, as Pressac believes, then one must assume that the objects are:

- a) of equal size
- b) regularly aligned

²⁴² Henryk Tauber: J.-C. Pressac, *op. cit.* (note 67) p. 484; Filip Müller, *Sonderbehandlung*, Steinhausen, Munich 1979, p. 95; Charles Sigismund Bendel: E. Kogon *et al.*, *op. cit.* (note 42), p. 227; Michal Kula: E. Kogon *et al.*, *op. cit.* (note 42), p. 231; for a summary and critique of these and other witness accounts on these alleged openings and introduction devices, see G. Rudolf, *op. cit.* (note 68), pp. 34-37.

²⁴³ *Op. cit.* (note 67), crematorium II, p. 340, taken ca. between Feb. 9 and 11, 1943.

²⁴⁴ D. Czech, *op. cit.* (note 89), p. 454.

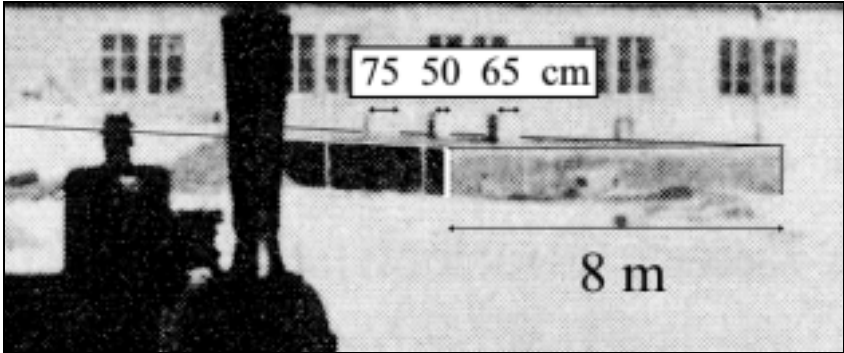

Fig. 37: Magnification of detail from Fig. 36 with outlines of the morgue and scale of measurements drawn in. The width of the three objects in Fig. 36 shows strong variation between ca. 50 and 75 cm. Furthermore, it is notable that the shady side of the first object, seen from the left, is considerably weaker than those of the others.

- c) regularly distributed along the roof
- d) nearly the same color and
- e) casting approximately the same shadows.

Fig. 37 points out the outlines of the cellar, indicating its width as well as the approximate width of the three objects. Despite the mediocre resolution of the photograph, it may be concluded that these objects are of unequal width, not evenly distributed over the roof, but stand, on the contrary, close together. It also seems peculiar that the shady side of the first object seen from the left, compared with those of the other two objects, is remarkably light in color. Fig. 38 shows the alignment of perspective, viewed from above, on which these objects can possi-

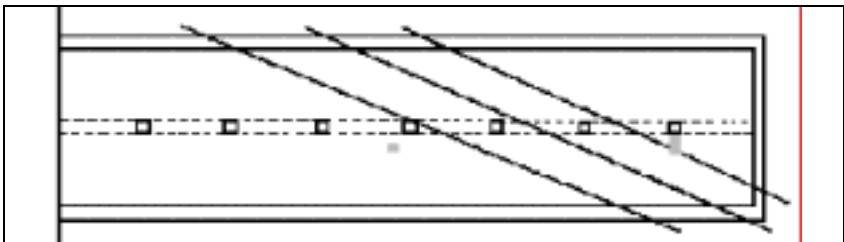

Fig. 38: Schematic drawing of a view onto morgue 1 of crematorium II. Longitudinally painted: the concrete longitudinal beam with the 7 supporting pillars. Drawn in as intersecting lines: base-lines, upon which the middle of the three objects located on the roof must have been located.²⁴⁵ Obviously, they were not evenly distributed along the roof. Grey rectangle: actual location of the two openings in existence today.

bly be located.²⁴⁵ As none of the requirements set forth above is met, the argument that these objects are above-roof parts of Zyklon B introduction stacks must be abandoned.



Fig. 39: Photograph of crematorium II from Jan. 20, 1943, similar in perspective as Fig. 36, but without objects on the roof of morgue 1.

It should be mentioned in passing that these objects are not to be seen in other photographs of the morgue, see Fig. 39 taken on January 20, 1943,²⁴⁶ as well as another photograph reproduced by Pressac and taken in the summer of 1943.²⁴⁷ It will therefore be necessary to find another explanation for the objects in the photograph taken in February 1943, such as, for example, that some sort of objects had been placed on the roof—perhaps in the course of constructing the building, undertakings which were obviously still underway—or *horribile dictu*, but less likely, that the picture has been retouched at a later date.

Fig. 40 shows an enlargement of an Allied air photo of Birkenau camp taken on August 25, 1944.²⁴⁸ Darkened areas (arrow) are clearly visible on the lateral wing, the roof of morgue 1 (‘the gas chamber’) of crematorium II. A stereoscopic evaluation of this air photo shows that these darkened areas on Fig. 40 cannot have possessed any height.²⁴⁹

²⁴⁵ Taken from Jean-Marie Boisdefeu, *La controvers sur l’extermination des Juifs par les Allemands*, volume 1, Vrij Historisch Onderzoek, Berchem 1994, p. 168.

²⁴⁶ From D. Czech, *op. cit.* (note 89), p. 398, and J.-C. Pressac, *op. cit.* (note 67), p. 335.

²⁴⁷ J.-C. Pressac, *op. cit.* (note 67), p. 341. Pressac, of course, alleges the existence of Zyklon B introduction apertures; in actual fact, however, nothing of the sort is to be seen.

²⁴⁸ Allied aerial photographs, National Archives Air Photo Library, Washington, D.C., RG 373 Can F 5367, exp. 3185, published by CIA employees D.A. Brugioni and R.G. Poirier, *Le Monde Juif*, no. 97, January-March 1980, p. 2, allegedly on their own, private, responsibility.

²⁴⁹ R. Lenski, *op. cit.* (note 25), pp. 356ff., testimony of aerial photographic appraiser Kenneth R. Wilson, pp. 8 927-8 941e of the trial transcript; see also B. Kulaszka (ed.), *op. cit.* (note 25), pp. 353f. According to Wilson, the spots on the photos dated Sept. 13, 1944, cannot be seen.

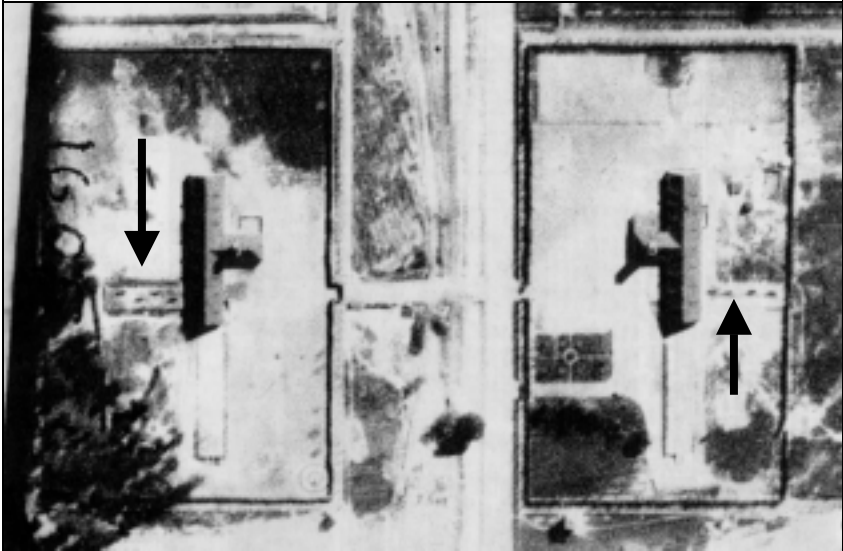

Fig. 40: Enlargement of Allied air photo RG 373 Can F 5367, exp. 3185 of Birkenau camp, taken on August 25, 1944. An interesting feature is the dark spots on morgue 1 ('gas chambers') of both crematoria (arrow), of which it is known today that there are no introduction stacks for Zyklon B.

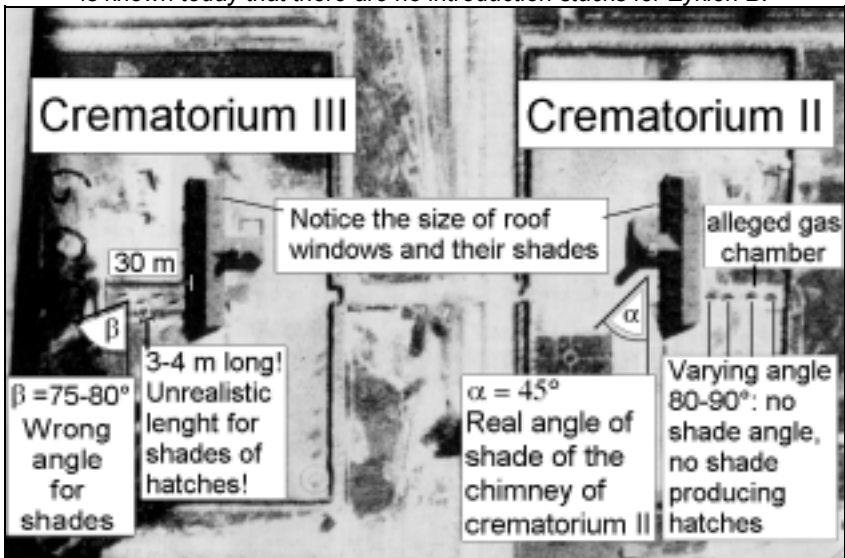

Fig. 41: Schematic drawing of the air photo in Fig. 40. It is immediately apparent that the spots on the roofs of morgues 1 cannot be introduction stacks: too large, too irregular, wrong direction for 'shadows'.

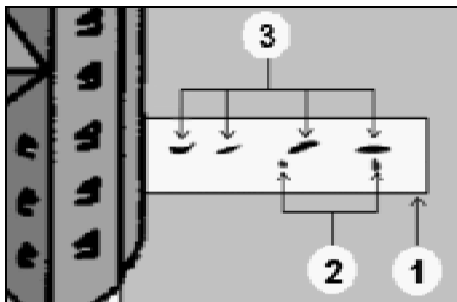

Fig. 42: Schematic drawing of the location and size of the spots (3) on the roof of morgue 1 (the 'gas chamber') of crematorium II (1) visible on the air photos, as well as the location (2) of the only holes to be found today.²⁵⁰

If the Zyklon B introduction stacks really possessed the dimensions of 70 cm ($2\frac{1}{3}$ ft) on each side as described by the eyewitnesses, this cannot be reconciled with the spots on the air photo, which are approximately 2 to 3 m² in area (20-23 ft²). It must be noted that the chimneys of the inmate barracks as well as the large crematorium chimneys are rich in contrast, symmetrical, and straight. The spots on morgue 1 of both crematoria, by contrast, form an angle of approximately 75-80° (crematorium III) or 80-90° (crematorium II, irregular) to the arrangement of the main wing of crematorium II (see schematic drawing Fig. 41). If these spots were objects of any kind, they would have to exhibit the same alignment as the shadows of the crematorium chimney of crematorium II, the chimney of an inmate barracks, and other sharply conspicuous parts of the picture. The actual shadows, in contrast to the spots above, form a 45° angle to the main direction of crematoria II and III (see Fig. 41).

We know that the crematorium chimney of crematorium II was 15 m high.¹⁸⁰ It throws a shadow on the picture which is five times as long as the spots on the roof of morgue 1 ('gas chamber') of crematorium III (length of shadow of chimney: 20 m, that is, the angle of the sun was approximately 37°, length of the spots on morgue 1 ('gas chamber') of crematorium III: approximately 4 m). This means simply that the alleged Zyklon B introduction stack must have projected 3 m above the roof of morgue 1 ('gas chambers') of crematorium III in order to cast such long shadows, which may be ruled out as impossible.

Absence of spatial height, irregular shape, incorrect size (length and width), and wrong, irregular direction of the spots therefore prove definitively that these spots are not the shadows of any objects, nor can

²⁵⁰ Figure 42 was taken from the Air Photo Evidence website (air-photo.com/altered/altered.html) with John C. Ball's kind permission.



Fig. 43: Interior photograph taken from the ruins of morgue 1 ('gas chamber') of crematorium II. The arrow points to the photograph taking location (see chapter 8.3.3.).

they be the legendary Zyklon B introduction stacks. The irregular, vague nature of these spots, as well as the fact that they are missing on at least one air photo,²⁵¹ gives rise to the conclusion that they are the retouching of a forger, added at a later time. An expert study prepared in late 1992 by John Clive Ball, a professional air photo interpreter in Canada, has since proven that the air photos were faked while they were in the possession of the CIA— surprise, surprise!²⁵²

As a result of the long-lasting wrong interpretation of these spots on this air photo, the otherwise unfounded allegation was made that the alleged Zyklon B introduction stacks were aligned linearly on the middle of the roof in case of morgue 1 ('gas chamber') of crematorium II, and aligned alternating to the left and to the right of the middle of the

²⁵¹ J. Ball, *op. cit.* (note 43), p. 48, morgue 1 of crematorium II, photograph dated 13 September 1944, RG 373 Can B 8413, exp. 6V2.

²⁵² The manipulations on this picture are overly plentiful, such as, for example, an interpolated drawing of a group of inmates allegedly marching over the roof of a barracks! See also J.C. Ball, *ibid.*, p. 42; Ball, "Air Photo Evidence" in: Ernst Gauss (ed.), *op. cit.* (note 22), pp. 271-284 (online: www.vho.org/GB/Books/dth/fndaerial.html). On the alleged original photographs, it may furthermore be seen that the spots on morgues 1 of both crematoria (II + III) are pointing in different directions; *ibid.* private communication by J.C. Ball.



Fig. 44: *Alleged Zyklon B introduction hole in the ceiling of morgue 1 ('gas chamber') of crematorium II, entry to the still passable part of the cellar.*

roof in case of morgue 1 of crematorium III, according to the location of the spots on this air photo. The alternating alignment, however, would contradict the argument that the Zyklon B introduction columns were aligned behind the concrete support pillars in order to conceal them so that the entering victims would not become suspicious. As a matter of fact, no introduction column could have been hidden behind a concrete pillar, because this would have necessitated the opening of a hole not only through the reinforced concrete roof, but also through the massive longitudinal support beam, see Fig. 26, which would have compromised the stability of the entire morgue. Hence, an alignment to the left and/or right of the support pillars would have been unavoidable.

After the building was destroyed towards the end of the war—by whom does not matter—one occasionally encounters the attitude that the remaining ruins are fakes, and that the original installations have disappeared without a trace. This would mean that the Poles rebuilt the crematoria true to the original for many millions of Zlotys after the war, only in order to blow them up. A grotesque idea. Thus the author of the present book was rejected as an expert witness by a court on De-



Fig. 45: Ceiling of morgue 1 ('gas chamber') of crematorium II. Sample taking location of samples 1 and 2.

ember 6, 1991, and May 5, 1992, on the grounds that his research on the 'gas chambers' was fully irrelevant since, as it was allegedly well known, the structures in Auschwitz were only fakes, the authentic 'gas chambers' having disappeared without a trace.²⁵³

Such allegations are, of course, absurd, and only testify to the technical incompetence of the judges entrusted with these matters. It is a shame that such individuals are given the power to decide the fate of others in these disputes.²⁵⁴

The roofs of morgue 1 ('gas chambers') of both crematoria today are broken in pieces and have collapsed, but the ceiling of morgue 1 ('gas chamber') of crematorium II is still relatively intact. The next to the last of the seven pillars of morgue 1 ('gas chamber') of crematorium II, seen from the south, still bears a piece of the ceiling. There, one can still climb down into the interior of the cellar through a hole in the ceiling (Fig. 44, p. 120) (see also Figs. 43 and 45), in which the ground water stands on the floor even in summer during a fairly

²⁵³ County Court Munich, ref. 451 Cs 112 Js 3326/90 and ref. 432 Cs 113 Js 3619/90.

²⁵⁴ See, in this regard, the letter from the semi-official German Institut für Zeitgeschichte, in which, with relation to the Auschwitz State Museum, the reconstruction of the installations in crematorium I is described and the condition of the original ruins of the crematoria in Birkenau are briefly mentioned: H. Auerbach, Institut für Zeitgeschichte, Munich, letter dated March 20, 1992.



Fig. 46: Alleged Zyklon B introduction hole in the roof of morgue 1 ('gas chamber') of crematorium II in December 1991. It is clearly visible that it was not cleared from the steel reinforcement rods. These were simply bent backwards.

lengthy dry season. Large parts of the masonry work and concrete ceiling accessible there are in original condition, protected from wind and weather. There are no visible signs of erosion or corrosion. In his book, Pressac shows illustrations of the circular, intact ventilation pipe openings through the ceiling of morgue 2 of crematorium II as well as through the concrete ceiling of the oven room of crematorium III.²⁵⁵

Figs. 49-53 (p. 126) show the five openings in the ceiling of the oven room of crematorium III as of December 1991. They were used to withdraw radiant heat from the crematorium ovens. The ceiling collapsed during the demolition of the oven room and most of the five holes were partially destroyed during the process.

If the Zyklon B introduction holes described by eyewitnesses really existed, with the wire mesh columns installed inside them, then what else is to be expected?

1. According to eyewitness Henryk Tauber, the victims would have demolished all the equipment in this room:²⁵⁶

²⁵⁵ J.-C. Pressac, *op. cit.* (note 67), pp. 365f.

²⁵⁶ *Ibid.*, pp. 483f.; *Pelt Report, op. cit.* (note 66), p. 106.

“The people going to be gassed and those in the gas chamber damaged the electrical installations, tearing the cables out and damaging the ventilation equipment.”

2. Several hundred people, locked into a cellar with a very small surface area, anticipating death, would panic and attempt to escape, damaging everything that stood in their way. So what would the victims locked into the cellar have done to the wire mesh columns described by the eyewitnesses? If these columns actually existed, their outer framework would have to have been of solid steel, but certainly not of fragile wire mesh construction.

3. These columns would, in addition, have had to have been solidly anchored in the concrete ceiling, the floor, and the concrete pillars. But since solid anchoring dowels did not yet exist at that time, hoop irons would have been cast into the concrete during the construction of the cellar, spread out to a ‘dovetail’ inside the concrete.²⁵⁷ If carried out after completion of the building, holes would have been chiseled into the concrete, and the hoop irons would have been cast in cement filling these holes, see Fig. 47. In both cases, a removal of such cast-in hoop irons would have been impossible. All one could do is cut them off with a saw or a welding torch.²⁵⁸ Hence, if any introduction device was ever installed in these morgues, traces of such hoop irons must still be present.

4. Furthermore, the steel reinforcement rods in the reinforced concrete would have to run wreath-like around the hole, and would be capable of verification by means of induction devices, even today.

5. Since, in addition, the morgues’ roofs were covered with a layer of soil approximately one half meter thick, the entire construction would have to be protected against the intrusion of soil and rain water, and in so doing it would have been indispensable to raise the edges of the holes above the surface

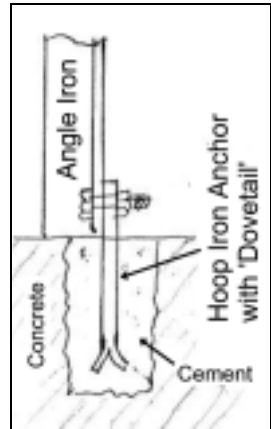

Fig. 47: Hoop iron with dovetail, cast in cement in a hole in concrete.

²⁵⁷ I am grateful to Carl Hermann Christmann, a certified building engineer, for this information.

²⁵⁸ I am grateful to R. Faßbender, a certified building engineer, for this information, who also provided the drawings.



Fig. 48: Notch (fatigue) effect resulting at inserted openings from the application of force. The only crack running through the wall proceeds, naturally enough, from the corner of the window.²⁶⁰

of the roof like miniature chimneys.

Nothing of the kind can be found on the roof of morgue 1 of crematorium II which has remained largely intact. The only two holes which can be found today of anything approaching the diameter involved were obviously crudely pierced at a later time, as may be seen in Figs. 46 and 44 (p. 120). Even Pressac admits that these are the only holes visible today.²⁵⁹ Nevertheless his richly illustrated book includes not one clear photograph of the two existing holes.

All other smaller breakthroughs, cracks, and openings in the roofs of morgues 1 ('gas chamber') of crematoria II and III visible today are breaks in the reinforced concrete effected at a later time with the iron reinforcing rods sticking out. Nowhere does one find cleanly poured concrete edges or rough, chiseled out edges with some remaining plaster work; there are no remains of ascending concrete or brick/mortar stacks; no steel reinforcement rods running other than would be expected for an ordinary flat roof without holes; and there are no traces of any hoop irons, dovetails, or any other means of anchoring any device to the morgue's floor, ceiling, or concrete pillars.

²⁵⁹ J.-C. Pressac, *op. cit.* (note 67), p. 354.

If any of these holes were used as Zyklon B introduction holes, they would have to have been broken through following completion of the roof, *i.e.*, shortly before the commencement of the alleged mass murders.²⁶¹ Such holes with no plasterwork to polish off their rough edges, however, could neither have been sealed against escaping poison gas, nor against intruding soil and water, nor would it have been possible to safely install any panic-proof introduction devices in them. Using such crude holes would truly be an incredibly stupid piece of bungling.

But there is more. In the opening shown in Fig. 46 the reinforcement rods were only separated and bent back. They possess their full length even today. One could bend them back again and weld them back together with their stumps, which are also visible to the left of the photograph (covered with snow).²⁶² Nor is there any trace of reinforcement rods running in a wreath-like pattern around the hole. This hole, therefore, can never have been used as an introduction hole; it was never finished. And what makes matters worse: this is still the ‘best’ of all holes and cracks in this roof in existence today. All others are even more irregular and filled with reinforcement rods.

No apparatus, using the technology available at that time, could be anchored in such crudely pierced, unplastered holes, from which the reinforcement rods were not even removed; therefore, no gas introduction device could ever have been firmly installed, let alone sealed from the exterior. This means that the entire environment including the supposed perpetrators would have been endangered by the gas streaming out of the opening. The supposed victims could furthermore only have been prevented by force from escaping through these holes, or even throwing the Zyklon B back out through the hole, since these holes were obviously incapable of closing.

We might even go much further in this direction: we can tell from

²⁶⁰ *Kurier*, Aug. 30, 1992, p. 20: “*Wenn Felsen fallen*”.

²⁶¹ The ceiling was finished towards the winter of 1942/43, while the mass exterminations allegedly began in March 1943; see also J.-C. Pressac, *op. cit.* (note 67), pp. 338f.

²⁶² Please do not attempt to bend them back again! More recent photographs show that individuals have obviously broken off two of the three reinforcement rods during similar such attempts. One of these persons who unintentionally broke off one rod was Dr. Fredrick Töben in February 1997, as he advised me personally after his visit to Auschwitz. Another rod was broken off later by unknown person(s), see. Carlo Mattogno, “*Keine Löcher, keine Gaskammer(n)*” *VffG* 6(3) (2002), pp. 284-304 (online: www.vho.org/VffG/2002/3/Mattogno284-304.html).

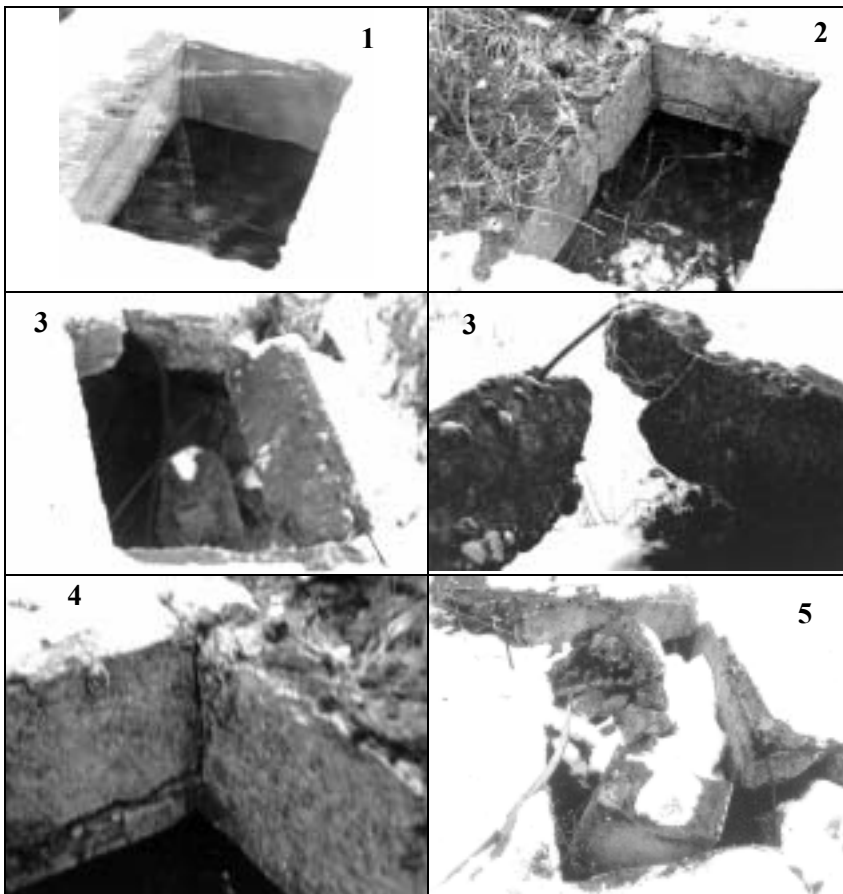

Figs. 49-53: The five properly constructed ventilation holes in the ceiling of the oven room to the upper story, crematorium III; condition: December 1991. Note the cracks caused by the explosion.

the concrete when at least one of the two large holes was pierced. An opening pierced through the concrete in the roof of either morgue 1 ('gas chamber') in consideration at a later time would inevitably have had the consequence, when the building was blown up, that the breaks and fissures caused to the roof by the explosion would have run preferentially through these holes.

The reason for this is that explosions exert extraordinarily great forces, and that the formation of cracks is favored by any weakness in the structure, since the tension peaks attain very high values in the vicinity of acute angles (notch effect, see Fig. 48). Such holes, in particu-

lar, which would already have damaged the structure of the concrete due to their incorporation following completion of the structure, represent not only points of likely fracture, but points of inevitable fracture. This is made more obvious by Figs. 49-53 (p. 126). Although the explosion pressure in the oven room, on an even level with the ground, could turn aside in all directions, and the roof remains relatively intact to the attic, three of the five oven room ventilation holes, cleanly cast and reinforced in the concrete roof, were completely destroyed. In the case of two of the other holes, clearly visible cracks formed at the corners, visible in the photos reproduced by Pressac.²⁵⁵

In the morgues of crematoria II and III, the explosion pressure could only turn upwards, causing their roofs to be much more seriously damaged than the roof of the oven room. The alleged Zyklon B introduction holes in the roof of morgue 1 ('gas chamber') of crematorium II however are conspicuous for having remained relatively intact; in the case of the hole in Fig. 46 all the cracks and fissures run around this hole! On the spot, one furthermore recognizes the arbitrary arrangement of this hole in a location at which the roof of the morgue is undamaged. This alone proves with building engineering certainty that this hole was broken through after the destruction of the roof!

The chisel marks on the edge of the hole in Fig. 44 are so similar to those in Fig. 46 that it must be assumed that both holes have the same history.²⁶³

There were therefore no holes in the ceilings of these rooms through which the poison gas preparation could be introduced by means of *wire mesh pillars*" or otherwise, as described by eyewitnesses.

Prof. van Pelt remarked accurately in this regard.²⁶⁴

"Today, these four small holes that connected the wire-mesh columns and the chimneys [on the roof of morgue 1, crematorium II] cannot be observed in the ruined remains of the concrete slab. Yet does this mean they were never there?"

An interesting question, which the professor of architectural history answers as follows:

²⁶³ Carlo Mattogno, *op. cit.* (note 262), has shown that the size of this hole actually increased over the years, probably because the Auschwitz Museum wants to give it a more regular, rectangular shape.

²⁶⁴ *Pelt Report, op. cit.* (note 66), p. 295.

“While there is no certainty in this particular matter, it would have been logical to attach at the location where the columns had been some framework at the bottom of the gas chamber ceiling, and pour some concrete in the holes, and thus restore the slab.”

Van Pelt’s claim that the camp administration could have filled the holes in the ceiling with concrete in the fall of 1944 in order to restore the ceiling, is without proof. But at least Prof. van Pelt believes that the SS administration acted logically, in that they allegedly attempted to wipe away all trace of their alleged crime. But does van Pelt really believe that it would have made more sense to fill up the holes with concrete instead of removing the entire roof of the ‘gas chamber’, as was done with the roofs of morgues 2, the “undressing room”? An Allied air photo taken on December 21, 1944, shows that the roof of the other morgue, which is not alleged to have been used to commit any murders, was completely removed.²⁶⁵ Obviously the whole matter makes no sense. To believe van Pelt, we must believe, that the SS arbitrarily created architectural relics to confuse later tourists and Holocaust researchers instead of destroying the roof entirely, as in the case of the undressing room. This seems too absurd to be taken seriously.

But if van Pelt had the most rudimentary knowledge of architecture, he would know that it is impossible to remove holes measuring 70 × 70 cm (that is almost half a square meter!) from a concrete roof *without leaving clearly visible traces*. Actually, however, there are no traces of openings in the roof later closed with concrete.

In addition, concrete patches filled in later would have flown out of these holes like corks out of a shaken champagne bottle during an explosion, thus making the holes just as visible as they were before. On closer inspection, Prof. van Pelt’s allegation turns out to be not only demonstrably wrong, but utterly absurd.

But at least Prof. van Pelt agrees with the revisionists that there are no remains of these alleged holes. In remarking that there are no such traces, van Pelt has in fact proven that there were never any holes in the ceiling of this room, and, consequently, no Zyklon B introduction holes of any nature whatever, and, consequently, no introduction of any poisonous substances whatever in the manner described by the ‘eyewitnesses’. He has proven that his ‘eyewitnesses’ were lying. He

²⁶⁵ Dino A. Brugioni, Robert G. Poirier, *op. cit.* (note 248), p. 15; see also G. Rudolf, *op. cit.* (note 68), p. 39. I am grateful to Fritz P. Berg for this argument.

has proven that there is no proof for the mass murders in Auschwitz. Actually, he has proven that there is no proof for the Holocaust. “*No holes, no ‘Holocaust’*” (Robert Faurisson). It is beautiful to see the great Professor of Architecture Robert Jan van Pelt in the year 2000 come to the same conclusion as myself in the year 1991, when I investigated the ceiling of the alleged ‘gas chamber’ of crematorium II of Birkenau. Only our conclusions are somewhat divergent.

At this point, I would like to introduce a witness who contacted David Irving by e-mail after conclusion of Mr. Irving’s legal proceedings against Deborah Lipstadt in May 2000. He is an engineer named Barford; his colleagues are assisting in the conservation and restoration of the camp for the Auschwitz Museum administration. He informed David Irving that, during his trial, investigations were made in complete secrecy at Auschwitz with regards to the mystery of the holes, and then remarked:

“[W]hat happened to their [the Auschwitz Museum’s] tests on the roof of Crema II mentioned in the attachment. Did they find the Zyklon B holes or not? Did they report those results to Lipstadt’s lawyers, and when! [...]

As you can guess, despite my belief that you and the Revisionists are wrong, and despite spending half an hour examining the collapsed roof of the underground gas chamber of crematorium II from different angles, I found no evidence of the four holes that the eye-witnesses say were there [...].

Secondly several areas of the slabs are covered in small rubble from an outer layer of concrete which was fractured by the blast. Now I would have expected these fragments to have fallen through the holes, if they were there, into the void beneath. [...]

I remain puzzled by the lack of physical evidence for these holes.”

In early 2000, Charles D. Provan distributed a paper claiming he had located the missing holes in the roof of morgue 1 of crematorium II.²⁶⁶ What Provan did, however, was simply to declare those cracks as ‘holes’, which were caused by the concrete support pillars piercing through the collapsing roof and cracks caused by the roof bending over the longitudinal beam. All holes described by Provan are full of rein-

²⁶⁶ “*No Holes? No Holocaust? A Study of the Holes in the Roof of Leichenkeller 1 of Krematorium II at Birkenau*” published by author in early 2000; online: <http://www.revisingrevisionism.com>.

forcement bars, they lack regular shape, have no straight edges and corners (as is to be expected for regular, planned-in holes), no traces of plaster (as is to be expected if holes were chiseled in later), no traces of chimney extensions to lead these stacks through the soil, no traces of anchoring devices (rawl plugs, hoop irons, dovetails...). In his schematic drawing of the roof, Provan even possesses the boldness to display these cracks as holes with regular shapes.²⁶⁷ C. Mattogno has pointed out in detail how unfounded and distorted Provan's claims really are.²⁶⁸

Finally, I want to focus on those legendary “Zyklon B introduction columns” for which Michal Kula is the most frequently quoted ‘eye witness’. He gives a detailed description of these columns which he claimed he had built.²⁶⁹ J.-C. Pressac²⁷⁰ (see Fig. 54) and Prof. van Pelt²⁷¹ have prepared drawings of these columns based on Kula's description. Firstly, there neither exists material nor documentary evidence that these columns existed.²⁶⁸ All we

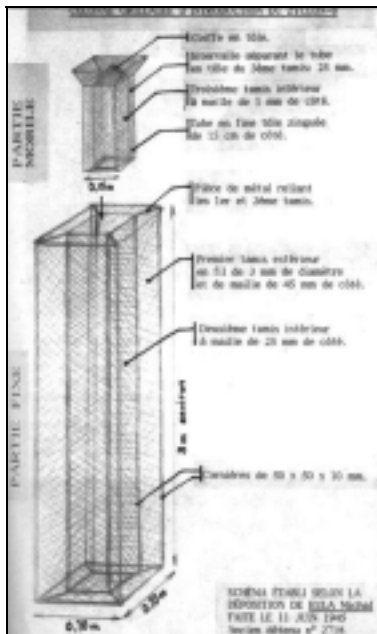

Fig. 54: J.-C. Pressac's drawing of the legendary “Zyklon B introduction columns” as described by Michal Kula.²⁷⁰

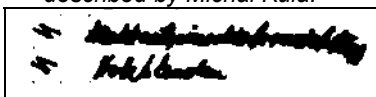

Fig. 55: Handwritten entries in an inventory list of crematorium II for morgue 2. The lower one reads “Holzblenden” (wooden blinds). Can anybody guess what the upper one means?¹⁹⁵

²⁶⁷ *Ibid.*, p. 36.

²⁶⁸ Carlo Mattogno, *op. cit.* (note 262).

²⁶⁹ Höß trial, vol. 2, pp. 99-100.

²⁷⁰ J.-C. Pressac, *op. cit.* (note 67), p. 487; on p. 287, Pressac shows a rather primitive drawing with French inscriptions, probably prepared by a former French inmate on request of the Soviet investigation commission right after the war.

²⁷¹ R. van Pelt, *op. cit.* (note 69), pp. 194, 208; *caveat emptor*: Though van Pelt's translation of Kula's testimony is erroneous, and though the data supplied in Kula's testimony is rather meager, van Pelt uses it to make five different, very detailed drawings—some of it necessarily based on van Pelt's fantasy, and the rest based on Kula's fantasy.

actually have in this regard is a handwritten entry in an inventory list for crematorium II,¹⁹⁵ of which some people claim it means “4 *Draht-netzeinschubvorrichtungen*”, which, literally translated means something like ‘wire mesh push-in device’. I have reproduced this handwritten entry in Fig. 55. The following points deserve to be taken notice of:

- this entry is basically illegible and could also mean something else;
- it is unknown, by whom and when this handwritten entry was made;
- this entry is made for morgue no. 2, the alleged undressing cellar, not(!) for morgue 1, the alleged ‘gas chamber’;
- if Kula’s introduction columns would be included in this inventory list, they would appear with an appropriate name describing the whole thing, not just a ‘push-in device,’ which could only be the inner part of Kula’s device;
- in German, *schub* describes horizontal (pushing) movements,²⁷² whereas for vertically lowering an object, the word *laß* is used, i.e., *Einlaßvorrichtung* instead of *Einschubvorrichtung*.

Whatever this handwritten entry really refers to, one thing is clear: it does not support Kula’s claim of the existence of complex Zyklon B introduction devices(!) in morgue 1(!) of the crematoria II and III.

Furthermore, M. Kula’s credibility as a witness must be considered very low, since he claims for example that he saw how corpses of gassing victims were carried away:

“I saw then that they [the corpses] were greenish. The nurses told me that the corpses were cracked, and the skin came off.”

As will be shown in chapter 7., victims of Zyklon B gasings aren’t greenish (they are pinkish-reddish), and there is no reason for the corpses to crack and for their skin to come off. This is nothing but atrocity propaganda.

But let us assume for a moment, the SS would have faced the problem of introducing HCN into the morgues 1 of crematoria II and III after their roofs had been finished. I offer two options to solve the problem, and every reader might pick the solution that seems more likely:

- a) Pierce (2×4=) eight holes through the reinforced concrete roofs – a

²⁷² E.g., a cabinet’s drawer is a *Schublade*.

laborious and expensive task, leading to massive, irreparable damage to the roofs' layer of tar and upper cement layer; add (2×4=) eight brick or concrete chimneys of at least 1 m height to lead the holes through the layer of soil on top of the roofs, and attempting to repair the damage done to the roof by the violent hole piercing process – another laborious, material consuming, and expensive task; design and construct (2×4) eight wire mesh columns 3 m high, consisting of three parts: a panic-proof, outer column made of massive steel, a middle wire mesh column (with no purpose at all but to hinder the HCN from spreading out), and a removable inner wire mesh column, another laborious, material as well as time consuming, and expensive task; finding a way to anchor these eight devices panic-proof in the concrete floor, ceiling and pillars, another laborious and expensive task; all these works had to be planned, approved, tested, and material had to be allotted, leaving a thick and long 'paper trail' of documents (which, by the way, doesn't exist); but finally, all one would possess at the end would be a primitive device allowing for the simple introduction of Zyklon B by pouring it into the inner column; one had to sit and wait for a long time until a lethal amount of HCN had evaporated from the Zyklon B carrier and had spread into the morgue, or alternatively, one had to apply an excessive amount of Zyklon B to ensure high evaporation rates for quick execution success, and remove and destroy the Zyklon B after the gassing, though only a fraction of the HCN had been released by then.²⁷³

But there was a second, much simpler option:

- b) Installing a simple basket – to hold Zyklon B – in the air intake shaft of morgue 1 right after the easily accessible intake ventilator, which then would blow the HCN vapors right into the 'gas chamber', similar to the DEGESCH circulation procedure; thus reducing the gassing time and the amount of Zyklon B required to a fraction compared to any scenario where Zyklon B is simply kept closely together on heaps without any moving air.²⁷⁴

²⁷³ For evaporation rates of Zyklon B, see chapter 7.2. and 7.3.1.3.

²⁷⁴ The brick-built air intake duct was easily accessible from the attic, where the fans were installed, and the ground floor; see J.-C. Pressac, *op. cit.* (note 67), pp. 276, 291, 329, 369. The use of the air intake fan to introduce HCN would have led to some HCN losses through the air exhaust chimney already during the gassing, thus endangering anybody close to those crematoria, but certainly not more than would have been the case when all the HCN had to be removed after the end of a hypothetical gassing, so this would not be an argument against this

Also, one could have drastically increased the evaporation rate of the Zyklon B in this basket even further, hence accelerating the execution procedure. All that would have been required was to alter an idea the Topf engineers had in early March 1943. When facing cooling problems of the cremation furnaces' forced draught blowers, the Topf engineers suggested to use the excess heat produced by these engines to pre-heat the morgue. The only constructional change needed for this was to redirect this excess heat into the morgue's air intake duct.²⁷⁵ Though the forced draught blowers overheated and were damaged shortly thereafter,²²⁸ it would have been easy to construct a short air duct from the furnace chimney to the air intake duct of morgue 1 instead. In this way, warm air coming from the crematory ovens would have been redirected over the Zyklon B basket into morgue 1, supplying this room with warm air enriched with HCN.

I assume the point I am making is clear: there were all sorts of cheaper and less complicated solutions available than suggested by Michal Kula. His solution is simply impracticable and is an insult to every engineer's and architect's intelligence—naturally bearing in mind the fact that the ruins of crematorium II clearly prove that no such columns were ever installed anyway.

5.4.1.2.9. Conclusions

Pressac's "*criminal traces*" have been refuted on structural engineering grounds. So, too, have all the 'eyewitnesses', who have been discredited without exception. The alleged homicidal 'gas chambers' are therefore refuted upon the grounds of building engineering. Or, in Robert Faurisson's words:

"No Holes, No 'Holocaust'"

In summary, the arguments relating to the introduction columns may be listed as follows:

technique. Also, such a loss of HCN is minimal compared to the loss following Kula's scenario. For more on this, see chapter 7.3.1.3.

²⁷⁵ See chapter 5.4.1.2.5.

Table 1: Arguments relating to the Zyklon B introduction columns

ALLEGATION	FACT
Zyklon B introduction stacks are visible on morgue 1 ('gas chamber') crematoria II and III on an air photo.	An analysis of this air photo proves that the spots visible have no spatial height, have an irregular shape, an incorrect size (much too long and wide), and irregular directions different from real shadows; these spots can therefore neither be shadows of any objects, nor can they be the legendary Zyklon B introduction stacks.
The filling stacks are visible on a ground photo of crematorium II.	These three objects are only visible on one photograph; on others they are missing. They stand closely together, have different dimensions and irregular alignment. Introduction stacks would have the same size, a regular alignment and evenly distributed over the roof. The objects do not accord with the holes actually found, either in location or in number.
For planned introduction holes, cleanly cast and reinforced holes with concrete/brick stacks protruding over the layer of soil laying on this roof would have to be expected.	The only two holes deserving this name clearly show chisel marks; the concrete structure was destroyed at a later time; there are no smooth, cast concrete edges and surfaces, no stack-like elevation to prevent the entry of rain water and soil into the hole. All other cracks and openings are highly irregular, filled with reinforcements rods, and obviously caused by the collapsing roof being pierced by pillars and bent over the longitudinal beam.
For holes chiseled in, the reinforcement rods would have to be removed, the edges polished off, and a protruding stack built. Such holes would be severely damaged by an explosion.	In all cases the reinforcement rods still project into the holes; in one case, these were only cut through and bent back. The edges of all holes and cracks were not plastered; the tar insulation is openly visible; there is no trace of any stacks added. The 'best' of these holes is in an area unaffected by the explosion that blew up this morgue, proving that this hole was chiseled in after the war.
The installation of introduction devices running from the ceiling to the floor requires panic-proof fixtures, like massive rawl-plugs and hoop irons with dovetails	No trace of such fixtures can be found anywhere, hence no such devices were ever installed.

5.4.2. Crematoria IV and V

Figure 56 shows the ground plan of crematorium IV and mirror-symmetrically that of crematorium V.²⁷⁶ Based on cost considerations, these buildings, planned and begun later, were constructed in a simpler manner than crematoria II and III. Due to low quality materials, the crematorium ovens of both crematoria broke down shortly after the putting into operation of the installation. They were not repaired due to crematorium over-capacity. There are few documents as well as contradictory and, to some extent, incredible eyewitness testimonies relating to these installations, which, according to Pressac, must be considered the least well-known:²⁷⁷

“[...] the least known of the instruments of extermination [...] a comparison of such testimonies reveals inconsistencies.”

These crematoria were planned starting in the summer of 1942, built until early 1943. According to Pressac, in addition to the two western rooms, which bear no designation in the plans, the vestibules are also supposed to have been used as homicidal ‘gas chambers’. All

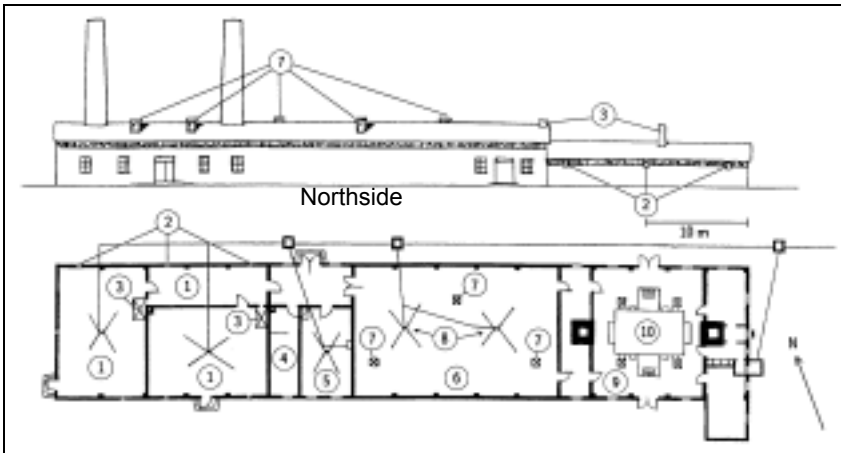

Fig. 56: North lateral view (above) and ground plan (below) of crematorium IV and/or V (mirror image) in Auschwitz II/Birkenau camp.²⁷⁶

1: Alleged ‘gas chambers’; 2: Alleged Zyklon B introduction hatches; 3: Heating ovens; 4: Coke room; 5: Doctor’s office; 6: Morgue; 7: Ventilation chimneys; 8: Gullies; 9: Oven room; 10: Crematorium ovens

²⁷⁶ Plan received from R. Faurisson. The same plan is found in J.-C. Pressac, *op. cit.* (note 67), p. 401, but of very poor quality.

these rooms allegedly possessed gas-tight hatches with wooden shutters approximately 1.50 m from the floor and measuring 30×40 cm, in the exterior walls, for the introduction of Zyklon B,²⁷⁸ which are later supposed to have been widened to 40×50 cm.²⁷⁹

Both rooms had heating furnaces that needed to be fired from the vestibule, which, according to Pressac, was allegedly also used as a ‘gas chamber’ (for the heating, see Fig. 56). No ventilation installation is known to have existed. Pressac assumes ventilation by natural convection.²⁷⁹ Franciszek Piper, Director of the Auschwitz Museum agrees:¹⁶⁴

“There were plans for mechanical ventilation of the Zyklon B, but these were not put into effect. Evacuation of the gas was instead achieved by convection, that is, by merely opening the doors.”

Pressac alleges the later incorporation of a door in the corridor for natural ventilation support, but without proving it.²⁸⁰ Since it would hardly have been any more expensive for the SS to provide for mechanical ventilation in these rooms, and since this solution would have been considerably more effective, Pressac’s argument of the installation of a door for ventilation can be rejected as unrealistic. It is also obvious that the morgue and oven room possessed ventilation chimneys. The rooms which purportedly served as ‘gas chambers,’ however, are the only rooms which, apart from the coke room and doctor’s office,²⁸¹ possessed *no* ventilation chimney!

According to an older Pressac publication,²⁸² these ‘gas chambers’ were not planned and built as such either, which he bases, among other things, on the fact that the absence of a ventilation installation would have led to a need to evacuate the entire building for many hours during a gassing.²⁸³ It is, in fact, inconceivable for a gas chamber *not* to

²⁷⁷ J.-C. Pressac, *op. cit.* (note 67), pp. 379ff., chapter on crematoria IV and V.

²⁷⁸ *Ibid.*, p. 384. For an illustration of the gas-tight door and hatches, see pp. 46-49, 425-428, 486, 500.

²⁷⁹ *Ibid.*, p. 386.

²⁸⁰ Pressac points to a photo of crematorium IV, *ibid.*, p. 417, as proof of his hypothesis. But since the photograph was taken from the south side while the corridor lies on the north side of the building, the door shown in the plan is the access, drawn on the plan, to one of the undesignated rooms. If he means to refer to crematorium V, hidden in the forest in the background, then it is impossible to claim seriously that anything can be recognized on this photo.

²⁸¹ A doctor’s office in crematoria, by the way, is quite normal, even today; see also E. Neufert, *op. cit.* (note 176).

²⁸² J.-C. Pressac, *Le Monde Juif*, no. 107, Juli-September 1982, pp. 91-131.

²⁸³ Pressacs argues this way in his new book as well, *op. cit.* (note 90), pp. 67, 89.

possess a ventilation system, regardless of the purpose for which it was designed.

In his new book, Pressac leaves these arguments unchanged.²⁸⁴ Since the mass extermination of the Jews was supposed to have been already fully underway—particularly, in farmhouses I and II—when crematoria IV and V were being planned, it is, of course, absurd to believe that these installations could have been incorrectly designed and built. Today, therefore, Pressac assumes a “*criminal planning*” of the crematoria.²⁸⁵ Proof of such criminality is alleged to have been supplied by various documents, mentioning the “*installation of gas-tight [sic] windows*”, “*pouring concrete floor in gas chamber*”, and repeated mentions of gas-tight doors in various connections.²⁸⁶

As already shown in the chapter on the disinfestation of personal effects, the German word “*Gaskammer*” (gas chamber) was the designation commonly used at that time for the disinfestation of personal effects. The combination of crematoria and disinfestation installations in one and the same building was very common practice at that time.²⁸⁷ Indications have since been found leading to the inference that it was initially planned to use the rooms referred to in some documents as “*gas chambers*” for disinfestation purposes. One factor in favor of this hypothesis, for example, is that the ovens for the heating of these rooms had to be heated from the hallway, and that the lamps planned for installation in these rooms had to be explosion-proof, and installed in a recess.²⁸⁸

In the case of crematoria IV and V, one must assume that the rooms in question here were intended for disinfestation purposes, but never completed for this purpose, let alone used. In any case, there is no evidence that ventilation systems absolutely necessary for the use of HCN were ever installed.²⁸⁹ The reason for this may lie in the fact that

²⁸⁴ J.-C. Pressac, *op. cit.* (note 67), p. 386.

²⁸⁵ *Ibid.*, p. 447.

²⁸⁶ *Ibid.*, pp. 406, 442-455.

²⁸⁷ For a prominent example, one need only consider Dachau concentration camp, the crematorium building of which contained a series of DEGESCH circulation delousing chambers, see p. 65.

²⁸⁸ A point which suggests that a fundamental danger of explosion must be reckoned with during fumigations with hydrogen cyanide; see also chapter 6.3.

²⁸⁹ J.-C. Pressac, *op. cit.* (note 90), pp. 89f., alleges, in this regard, that a ventilation installation was built into crematorium IV only in late May 1944, but his remarks are untenable in this regard; see also Germar Rudolf, “*Some Technical and Chemical Considerations about the ‘Gas Chambers’ of Auschwitz and Birkenau*”, in: Ernst Gauss (ed.), *op. cit.* (note 22), pp. 347f.

starting in early 1943, the Germans were working on the completion of a large hygienic complex with a large hot air disinfestation installation (the so-called ‘*Zentralsauna*’) in the immediate vicinity of these crematoria, and were also anticipating the early use of microwave disinfestation installations as promised by Berlin (see chapter 5.2.3.6.).

W. Rademacher has remarked that Pressac personally quotes a document by means of which “*210 Gas door anchorings*” were ordered in Auschwitz. This document indicates that the term gas-tight (“*gasdicht*”) does not necessarily constitute a reference to execution of disinfestation chambers, since it has never been claimed that there was a need for roughly one hundred doors for homicidal ‘gas chambers’ at Auschwitz.²⁹⁰ It is entirely possible that all doors and windows were designated as ‘gas tight’ if they were equipped with felt insulation and were, therefore, sealed off against air currents, a characteristic not at all common in windows for inmate barracks in a concentration camp.²⁹¹

Pressac himself provides yet another item of proof that the term ‘gas chamber’ has no criminal significance in Auschwitz documents. One document states: “*1 key for gas chamber*”. Since all ‘gas tight’ doors found at Auschwitz, as well as all surviving photographs of such doors, show that these doors had no locks, this document must refer to a door for another type of room, such as a room for the storage of Zyklon B, which truly required storage under lock and key.²⁹²

The walls of crematoria IV and V, which were built entirely above ground, were of simple brick masonry. After they were blown up, both buildings were demolished to their foundation walls and concrete foundations. The foundation wall of crematorium V, which is approximately 1 m high, is supposed to have been rebuilt.²⁹³ The foundation wall of crematorium IV, which is approximately 50 cm high, is also supposed to have been rebuilt out of other rubble at a later time.⁵⁶

Even these ruins can still speak to us, even if, in this case, only the concrete foundations are authentic, since everything else is probably not authentic. Another technical precondition for the use of the rooms alleged to have been homicidal ‘gas chambers’ would be that it would

(online: www.vho.org/GB/Books/dth/fndgcger.html).

²⁹⁰ W. Rademacher, *op. cit.* (note 239), p. 80; J.-C. Pressac, *op. cit.* (note 67), p. 451.

²⁹¹ At least the windows of those inmate barracks still accessible today in Birkenau have been installed in a very sloppy way, so that the wind blows intensely through the gaps. It is, however, questionable whether these barracks are authentic or were rebuilt after the war.

²⁹² J.-C. Pressac, *op. cit.* (note 67), p. 456.

²⁹³ *Ibid.*, p. 390.

have to have been rendered impossible for the victims on the inside to get anywhere near the introduction hatches, since otherwise they could have simply pushed the SS man off the ladder while he was throwing the Zyklon B into the chamber; they could then have attempted to escape. A U-shaped, solid steel grid construction anchored in the floor and in the masonry of the walls with steel hoop anchors spread out into dovetails would have been necessary to keep the victims on the inside at arm's length from the hatches. The concrete floors of these rooms surviving today, however, make it clear that nothing of the sort was ever anchored in the floor.

5.4.3. Farmhouses 1 and 2

According to eyewitness accounts, there are supposed to have been two farmhouses (sometimes referred to as bunkers 1 and 2), located west-north west of the Birkenau camp, which were converted into homicidal 'gas chambers'. Their location and construction are not, however, exactly described. Pressac mentions contradictory eyewitness reports in this regard.²⁹⁴ Relating to the testimony of P. Broad, for example, he writes: "[...] *not exploitable* [...], *since it has been rewritten by and for the Poles* [...]", and: "*It is impossible to make a synthesis of all these accounts*". Höß's report relating to the characteristics and location of these buildings is only superficial.²⁹⁵ According to remarks in the judgment to the Frankfurt Auschwitz trial,²⁹⁶ the homicidal mass gassings are supposed to have taken place in a manner similar to those in the chambers of crematoria IV and V, described above. This procedure is clarified by the testimony of Richard Böck,²⁹⁷ and, to a certain extent, by Milton Buki,²⁹⁸ Rudolf Höß, Szlama Dragon, Maurice Benroubi, Moshe Maurice Garbarz, Johann Paul Kremer (at the Frankfurt Auschwitz trial), and André Lettich.²⁹⁹

Pressac has published a photograph of what are alleged to be the

²⁹⁴ *Ibid.*, pp. 161ff.

²⁹⁵ R. Höß, in: M. Broszat (ed.), *Kommandant in Auschwitz*, Deutsche Verlags-Anstalt, Stuttgart 1958.

²⁹⁶ Judgment of the so-called Frankfurt Auschwitz Trial, ref. 50/4 Ks 2/63, p. 99; see note 83.

²⁹⁷ Interrogation of the eyewitness R. Böck during pre-trial investigations for the so-called Frankfurt Auschwitz Trial: Staatsanwaltschaft beim LG Frankfurt (Main), Strafsache beim Schwurgericht Frankfurt (Main) gegen Baer und Andere wegen Mordes, ref. 4 Js 444/59, sheets 6878ff. Quoted: sheet 6881f.

²⁹⁸ J.-C. Pressac, *op. cit.* (note 67), p. 163.

²⁹⁹ See also J. Graf, *Auschwitz. Tätergeständnisse und Augenzeugen*, *op. cit.* (note 43).

remains of the foundation walls of farmhouse 2.³⁰⁰ According to analyses of Allied air photographs, there was only temporarily a building in the vicinity of the location ascribed to farmhouse 2; there is no trace of farmhouse 1.^{252,301} The extermination of the Hungarian Jews is supposed to have been underway when the air photos were taken, with many thousands of victims per day and strongly smoking cremations in large open ditches precisely in the area analyzed.³⁰² There is no trace of large cremation ditches, large fires giving off copious smoke, or large stockpiles of fuel. Only on air photos made during the winter of 1944/1945, a few mass graves can be seen west of crematorium III—probably for the victims of the chaotic circumstances in the camp after the Germans started to shut down and dismantle the equipment in fall of 1944 during their withdrawal.³⁰³

Recently discovered documents prove that one of these farmhouses actually existed—and was used for disinfestation. The SS, in particular, was prohibited from carrying on the disinfestation of personal effects with Zyklon B inside the camp whenever there was a safety risk. The conversion of a farmhouse, which was located outside the camp, and whose utilization as provisional HCN disinfestation installations would not have involved any safety risk for the camp itself, could have resulted from this difficult situation. Several documents are now available which refer to an “*existing building*” outside of construction section B III, in which a bath installation and sauna were to be installed.³⁰⁴

In late 2001, several European newspapers reported that an Italian scholar had discovered the ‘bunker 1’ in Birkenau.³⁰⁵ As C. Mattogno has shown, however, this is nothing but a hoax. The farmhouse allegedly identified as the old bunker is at a totally different location than the alleged bunker 1 supposedly was, and it was never anything else but a farmhouse.³⁰⁶

³⁰⁰ J.-C. Pressac, *op. cit.* (note 67), p. 176.

³⁰¹ Pfeiffer, Hansa Luftbild GmbH, aerial photographic analysis of Allied photograph dated Aug. 25, 1944 (note 248), letter dated July 17, 1991; J. Konieczny, *The Soviets, But Not the Western Allies, Should Have Bombed the Auschwitz Camp*, Polish Historical Society, unpublished paper.

³⁰² J.-C. Pressac, *op. cit.* (note 67), p. 253.

³⁰³ See J.C. Ball, in E. Gauss, *op. cit.* (note 252), p. 283.

³⁰⁴ *TCIDK* 502-1-24-77, Nov. 30, 1942; 502-1-24-33, Dec. 3, 1942; 502-1-332-46a, Jan. 9, 1943; 502-1-26-66, April 9, 1943; 502-1-238-10, Sept. 30, 1943.

³⁰⁵ *Le Monde*, Nov. 20, 2001; *Bild*, Nov. 20, 2001; *Corriere della Sera*, Nov. 21, 2001, p. 35.

³⁰⁶ C. Mattogno, “*Die ‘Entdeckung’ des ‘Bunkers 1’ von Birkenau: alte und neue Betrügereien*”,

5.4.4. The Drainage System in Birkenau

5.4.4.1. Background: Eyewitness Accounts

J.-C. Pressac quotes various eyewitnesses claiming that due to the restricted capacity of the Auschwitz crematoria, a large portion of the bodies of the victims of homicidal mass gassing were cremated in open-air pits. These pits were allegedly located north of crematorium V as well as close to the farmhouses (bunkers) 1 and 2. The size of these pits is described as roughly 20-60 m long, 3-7 m wide, and 1.5 to 3 m deep.³⁰⁷

5.4.4.2. The Ground Water Table in Birkenau

In his expert report, Fredrick Leuchter pointed out that due to the high ground water table he found in Birkenau in 1988, it would have been impossible to dig deep pits and to light and maintain a fire in them.²⁶ The reason for the high ground water table is that the Birkenau camp lies in the immediate vicinity of the confluence of the Sola river into the Vistula river. A few hundred meters away from the camp one finds today swampy meadows.

Leuchter, however, did not investigate the important question of whether the ground water table was similarly high in 1942-1944, when the events attested to by the witnesses took place. It has been pointed out that the Birkenau camp had a sophisticated grid work of drainage canals which lowered the ground water table.³⁰⁸ This drainage system is still functioning fairly well to this day. Whereas the ground water table around the camp is basically right at the surface, it is today lowered to 60 to 70 cm under the surface within the camp, obvious, for example, from Figure 57. The photo was taken on August 15, 1991, during a long period of drought. It shows a construction trench in front of the *Zentralsauna* located in the western part of the camp.

But how effective was this drainage system in 1942-1944, and most importantly, how effective was it in the area north of crematorium V and in the vicinity of the alleged farmhouses, which were lo-

VffG 6(2) (2002), pp. 139-145 (online: www.vho.org/VffG/2002/2/Mattogno139-145.html); Engl. see the presentation of Russ Granata, "The 'Discovery' of 'Bunker 1' of Birkenau", www.vho.org/~granata/Discovery.html

³⁰⁷ J.-C. Pressac, *op. cit.* (note 67), p. 162-164, 171, 177

³⁰⁸ J.-C. Pressac, *op. cit.* (note 67), p. 209, drainage plan POW camp Birkenau.

cated *outside* of the camp's drainage system?

There are two pieces of circumstantial evidence indicating that the water table was not much different then than it is today. The first evidence is the well known small pond in the vicinity of crematorium IV, which is supposed to have existed the same way during the war. If the drainage system had lowered the water table by several meters, the pond next to crematorium IV, contrary to many witness statements, would have dried up. This proves the unchanged water table from then until now. The second evidence is the subterranean location of the morgues of crematoriums II and III, as well as some of the building sections of the *Zentralsauna*. They all were constructed by insulating the buildings' basements from intruding water with a waterproof layer of tar, which indicates that there was a need to protect against such water in the first place. Also, since the drainage ditches in the camp are only 1 to 1.5 meters deep, they could not have lowered the water table to less than one meter. This maximum value, though, can only be achieved in the immediate vicinity of the ditches.

In complementary studies, Michael Gärtner and Werner Rade-



Fig. 57: Then and today—the unchanged ground water state in the Birkenau camp, here in midsummer 1991, in a construction trench in front of the *Zentralsauna*, approximately 70 cm. Incinerations of corpses in pits many meters deep, in accordance with witness testimony, were not possible.

macher on the one hand¹⁸² and Carlo Mattogno on the other hand³⁰⁹ have shown, with a vast amount of contemporary German documents dealing with the camp authorities' problems caused by the high water table, that between the end of 1941 and middle of 1944, the water table in Birkenau in general and outside the camp perimeter in particular was very high, coming close or even reaching the surface and turning the entire area into a swampy region. All three authors showed that construction on buildings with basements was possible only by permanently pumping off ground water, and Mattogno even found documents expressively *forbidding* the digging of pits for outhouse latrines, because this would contaminate the drinking water of the entire Auschwitz region. Mass incinerations of corpses in deep pits, of course, would have contaminated the drinking water as well, hence would never have been permitted.

5.4.4.3. Open-Air Incineration in Pits

In general, it is of course possible to burn corpses in open-air pits, though it certainly takes more time and fuel than any cremation in a crematorium, and it also leaves many more traces due to incomplete combustion. In 1999, Dr. Myrosław Dragan conducted an experimental incineration of an 80 lb. deer in a pit roughly 1 m deep, 70 cm wide, and 1.2 m long. This incineration with a relatively small amount of wood lasted some 4-5 hours and was almost completely successful.³¹⁰ Dr. Dragan found out that for open-air incinerations, small, narrow holes are advantageous over large, wide holes or, even worse, cremations on ground level, since the soil walls of a pit act like the walls of a crematorium oven, storing and reflecting a great deal of the heat produced by the fire—provided that the soil has a considerable amount of clay stabilizing the wall of the pit, and, of course, that no ground water flows into the pit and extinguishes the fire.

The situation in Birkenau, however, was drastically different from that. Not only did the witnesses claim that those pits were very wide,

³⁰⁹ “‘Verbrennungsgruben’ und Grundwasserstand in Birkenau”, *VffG* 6(4) (2002), pp. 421-424 (online: www.vho.org/VffG/2002/4/Mattogno421-424.html); Engl.: “‘Incineration Pits’ and Ground Water Level in Birkenau”, *The Revisionist*, 1(1) (2003), pp. 13-16 (online: www.vho.org/tr/2003/1/Mattogno13-16.html).

³¹⁰ Only small pieces of the skull were left over which were located in a corner of the pit. Communications of Dr. M. Dragan, whom I helped to investigate the carcass’ remains in June 1999.

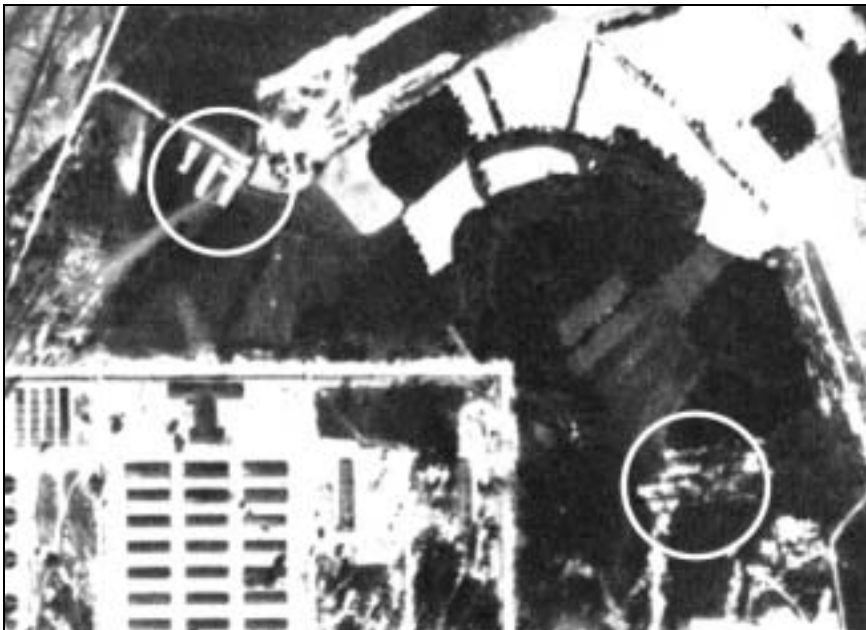

Fig. 58: *White circles: possible sites of old mass graves of typhus victims in Auschwitz.*

but as Gärtner, Rademacher, and Carlo Mattogno have shown, the extremely high ground water table in the areas around the alleged location of those cremation pits was so high that it would have been impossible to dig such deep pits, arrange hundreds of corpses and fuel in them, and maintain a fire for many hours without these pits quickly filling with water. These findings show clearly that the attested burning of corpses in pits many meters deep was impossible under such conditions, since these pits would have filled up with ground water rather quickly.

It is known that in Birkenau the corpses which had accumulated during the typhus epidemic of the summer of 1942 were first buried in mass graves. Due to the danger of the contamination of the ground water, however, they had to be exhumed in the spring of 1943. Since the new cremation facilities still were not capable of functioning at that time, it is possible that at least a portion of the corpses were burned on funeral pyres. For this purpose, as a rule, one removes the turf and the upper layer of topsoil in order to preserve them from damage and to absorb the ashes of the wood and the corpses. But holes many meters

deep are not dug.

Indeed, one can unearth in excavations west of the Birkenau camp ashes and bone splinters (whether from humans or cattle remains open) to the depth of several decimeters, intensively mixed with all kinds of refuse (glass and porcelain shards, slag, bits of iron, etc.). Apparently this place served as a rubbish heap for the camp under German administration and/or after the war under Polish administration.

In his detailed study of aerial photos of the Birkenau camp made by the allied surveillance planes, J.C. Ball has revealed that at no point in time in the summer and autumn of 1944 in the camp or in its environs were large incineration pits—and fuel stockpiles necessary for that—to be seen, let alone flames and smoke, as they are repeatedly attested to.³¹¹ He did, however, locate the places where mass graves had existed (see Fig. 58).³⁰³

5.5. Construction Conclusions

Even the most primitive temporary disinfestation installations—whether in the initial period of the life of Auschwitz camp or elsewhere—were always equipped with a ventilation and heating system, the last being, of course, useful but not absolutely necessary. But no room possessing no ventilation system need even be seriously considered as a room for fumigation with poisonous gases, whether for lice or human beings. Homicidal ‘gas chambers’ must furthermore be equipped, apart from the entry doors, with an opening for the introduction of the poison gas material from the outside; this is not absolutely necessary for disinfestation installations, but is nevertheless useful. It must be concluded, therefore, that no installation possessing neither a poison gas introduction device from the outside, nor any possibility of ventilation, can be taken seriously as a homicidal ‘gas chamber’. If one considers the rooms discussed above in a summary manner, the results are shown in Table 2.

Not taken into consideration in the above, among other things, is the fact that hypothetical homicidal ‘gas chambers’ would have to be escape-proof, that their equipment had to be panic-proof, that their ventilation would have to be efficient enough for homicidal purposes,

³¹¹ J.C. Ball, *op. cit.* (note 43).

Table 2: Equipment and suitability of actual or alleged ‘gas chambers’

Building \ Equipment/ Suitability	Poison gas introduction	Heating	Ventilation	Suitability as disinfestation chamber	Suitability as execution chamber
Disinfestation cham- bers	○	●	●	yes	if with means of introduction
Crematorium I	×	×	○	hardly/perhaps	no
Crematoria II and III	×	×	●	perhaps	no
Crematoria IV and V	●	●	×	hardly	hardly
Farmhouses I and II	○	× / ○	× / ○	hardly/perhaps	no

● = present or possible; ○ = possibly present; × = not present

which, in view of the above, was not the case, and finally that the evacuation of the poison gas into the environment after the execution required special measures in order to avoid that people close to the ‘gas chambers’—both inside the building as well as in its vicinity—get hurt or even killed.

Although the literature is generally unanimous as to the equipment of the rooms in crematoria IV and V, the information is, to a certain extent, speculative, due to the lack of documents and material evidence. The same is true for the information relating to the farmhouses, on which there are practically no documents available.

Fortunately, it is precisely the one ‘gas chamber’ in which the largest number of people was allegedly killed by poison gas during the Third Reich which has remained almost entirely intact: morgue 1 of crematorium II. Contrary to all eyewitness testimony, this cellar, during the period of its operation, possessed no Zyklon B introduction holes in the roof. It is only logical and consequent to transfer these conclusions also to the mirror-symmetrically built, but otherwise identical crematorium III, even though we do not possess any physical evidence for this due to the almost complete destruction of the roof of its morgue 1. If this is so, those rooms cannot have been used as locations for mass homicide using poison gas, as alleged by witnesses.

When one considers the technical circumstances prevailing in and around Auschwitz, in the broadest sense, one becomes aware of the absurdity of the entire claim of homicidal mass gassings. The camp management was fully aware of the methods and technical preconditions for Zyklon B disinfestation, and was even informed as to the latest developments in the related technology.¹⁴³ But instead of using these methods, it allegedly had recourse, for mass gassing purposes, to extremely crude methods, particularly where bunkers I and II, and,

later, crematoria IV and V, were concerned:

Allegedly, hundreds or thousands of people were killed with highly poisonous gas in rooms,

- which had walls and ceilings made of a material absorbing huge amounts of the poison gas and letting it penetrate;
- which did not have escape-proof doors and windows;
- which did not have panic-proof equipment;
- which did not have technically gas tight doors and shutters;
- which had no provision to quickly release and distribute the poison gas;
- which had no effective device to ventilate or otherwise render ineffective the poison gas after the end of the execution.

At the same time, the most modern disinfestation installations were being built all over German-occupied Europe,

- which had walls and ceilings covered with gastight coatings;
- which were equipped with escape-proof doors and had *no* windows;
- which had technically gas tight doors;
- which had devices to quickly release and distribute the poison gas;
- which had effective devices to ventilate or otherwise render ineffective the poison gas after the end of the gassing procedure.

There were never any perceptible delivery problems for these installations. In the Auschwitz main camp, the latest technology for disinfestation using HCN was even incorporated (cf. chapter 5.2.3.5.), while the *Zentralsauna* at Birkenau was even equipped with the most modern hot air disinfestation technology! And to top it all: the Germans even invented the microwave technology, which is so well-known today, *to kill lice!* They erected these installations, which were still very expensive at that time, in Auschwitz camp, *to save inmate lives!* And we are supposed to believe that the Germans were incapable of installing adequate technical equipment for Zyklon B gassings in at least one of their alleged homicidal ‘gas chambers’! Can anything be more insulting to the human mind?

So much for the claim that homicidal ‘gas chambers’ existed at Auschwitz. We have also proven that the largest room, the one allegedly most-often used as a homicidal ‘gas chamber’, could not have been used for that purpose as stated by alleged eyewitnesses. Together with the untruthful witnesses to a homicidal ‘gas chamber’ in the Main

Camp (see chapter 5.3.), and in view of the fact that there is no documentary indication of a criminal use of these rooms, we must conclude that there is no credible proof, and no “*criminal trace*”, in support of the claimed existence of homicidal ‘gas chambers’ in Auschwitz.

Considering these facts, it can not really come as a surprise that finally even the mainstream historians and media are taking notice of them: In May 2002, Fritjof Meyer, a senior editor at Germany’s largest, left-wing weekly magazine *Der Spiegel*, stated in an article that documents and witness statements regarding the alleged gas chambers in the crematoria II and III of Birkenau

*“rather indicate that attempts were made in March and April of 1943 to use the mortuary cellars for mass murder in the early summer of 1943. Apparently, the tests were not successful [...] The actually committed genocide probably took place mainly in the two converted farmhouses outside of the camp.”*³¹²

In other words: there is a tendency to abandon those locations which Prof. Dr. R. van Pelt called “*the absolute center*” in the “*geography of atrocities*” (see page 91), or even the Birkenau crematoria altogether, since, according to Meyer the genocide is now supposed to have taken place mainly in those ominous farmhouses or bunkers of which we possess hardly any documentary evidence.

Following Meyer, the final destruction of the corpses of the alleged victims of mass murder is now supposed to have happened almost exclusively by means of open-air incinerations in deep pits. However, all claims made regarding the alleged open-air incineration of corpses in deep pits are obviously untrue because no traces of such incinerations can be found on contemporary air-photos, and because the high water table in Birkenau would have prevented the maintenance of fires in deep pits.

Those readers who take no interest in the chemical problems relating to the alleged ‘gas chambers’ in Auschwitz may skip the following chapter 6. Prior to a solution to the problem of how the poisonous preparation was introduced into the presumed ‘gas chambers’, further speculation as to the manner and method of the murders, and their pos-

³¹² F. Meyer, “*Die Zahl der Opfer von Auschwitz*”, *Osteuropa*, 52(5) (2002), pp. 631-641, here p. 632; for critical reviews of these articles, see Germar Rudolf, “*Cautious Mainstream Revisionism*”, *The Revisionist*, 1(1) (2003), pp. 23-30 (online: www.vho.org/tr/2003/Rudolf23-30.html); Carlo Mattogno, “*Auschwitz. The new Revisions by Fritjof Meyer*”, *The Revisionist*, 1(1) (2003), pp. 30-37 (online: www.vho.org/tr/2003/Mattogno30-37.html).

sible chemical traces, remains a mere academic exercise, with no basis in reality. Our study of Auschwitz could, therefore, conclude here.

However, because the chemical questions involved attracted so much attention, caused the hottest controversies, and stirred the most intensive debates, detailed remarks are nevertheless in order, below, about the chemical questions, raised by Faurisson and Leuchter, relating to the formation of residues (Iron Blue) caused by the reactivity of hydrogen cyanide.

6. Formation and Stability of Iron Blue

6.1. Introduction

Hundreds of thousands of people are claimed to have been killed in the alleged Auschwitz ‘gas chambers’ by hydrogen cyanide in the form of the product *Zyklon B*[®]. The question which now arises is the following: could this poisonous gas leave chemical traces, which could perhaps be detected in these alleged chemical slaughterhouses?

If hydrogen cyanide (HCN), the reactive compound in *Zyklon B*, were only bound to the walls by adsorption (adhesion),³¹³ there would not be any detectable residues today anymore, due to the volatility of hydrogen cyanide (boiling point: 25.7°C); all the hydrogen cyanide involved would long since have evaporated.

But if one assumes that the hydrogen cyanide, during fumigation, would combine with certain materials in the masonry to create other, considerably more stable compounds, then one might anticipate the possible existence of chemical residues even today.

The reaction products of interest to us in this respect are the salts of hydrogen cyanide, called cyanides,³¹⁴ in particular, the iron cyanide group, formed by a compound of iron and cyanide. Iron occurs universally in nature. It is iron which gives brick its red color, sand its ochre color, and clay its color ranging from yellowish to reddish-brown. More precisely, we are speaking of iron oxide, popularly known as ‘rust’. Basically, all walls consist of at least 1% rust, as a result of sand, gravel, clay, and cement, of which the wall is constructed.

The iron cyanides have long been known for their extraordinary stability, one of them having achieved particular fame as one of the most commonly used blue pigments during the last three centuries:

³¹³ *Absorption* and *Adsorption* are not the same! *Absorption* is the incorporation (sometimes even consumption) of a matter into a medium (light is absorbed/consumed by a pigment, gas is absorbed/dissolves into a liquid), whereas *Adsorption* is the adhesion of matter onto a—usually solid—surface (dust on furniture, steam on windscreen, vapours on any solid surface...); *Adsorption* is further subdivided in *chemisorption*, in which the matter is bound to a surface by chemical bonds, and *physisorption*, in which the bonding is only a physical effect. The transition between both is fluent.

³¹⁴ For simplicity’s sake, ‘cyanide’ is frequently understood to mean only the anionic part of the cyanide salts, the cyanide ion, CN⁻.

Iron Blue, also often referred to as Prussian Blue.³¹⁵

6.2. Instances of Damages to Buildings

Chapter 1.3. contained a discussion of an instance of damage to a church which occurred in 1976 in Bavaria, Germany. In the many hundreds of thousands of fumigations which have been carried out since 1920, there cannot, as a rule, have been any complications, otherwise the procedure would have been very rapidly abandoned. The case in question was, therefore, an exception. But what exactly was it that made this church an exception?

Different scenery. 1939-1945. In the camps of the Third Reich, hundreds of thousands of people—Jews, political prisoners, criminals, ‘anti-socials,’ and prisoners of war—were crammed together. To stem the raging epidemics, attempts were made, not always with great success, to kill the carriers of disease, particularly head lice. This was done in particular with hydrogen cyanide, Zyklon B. This was sometimes done in chambers professionally designed for such purposes, sometimes ordinary rooms were equipped for such purposes in an auxiliary manner, and provisionally used for disinfestation. Many of the camps in the Third Reich were leveled at the end of the war or afterwards; in other camps the existing buildings were torn down and the buildings materials used for the reconstruction of the ruined cities. A few buildings, however, remain intact today. The interiors of these buildings look as in Fig. 59-66 (see also the color picture section in the middle of this book).

From the remarks of a Polish research team having conducted investigations on behalf of the Auschwitz Museum, we also know that the disinfestation chamber in the Auschwitz main camp is colored a spotty blue.^{56,57} To my knowledge, only the Zyklon B disinfestation chambers of Dachau camp (DEGESCH circulation chambers) exhibit no blue pigmentation, because the walls were professionally coated with a paint impermeable to gas and water.

³¹⁵ Iron Blue is the ISO designation (ISO 2495) for iron cyanide blue pigments of various composition, which are also known as Berlin Blue, Turnbull’s Blue, Prussian Blue, Vossen Blue[®], Milori Blue, Paris Blue, French Blue, China Blue, Bronze Blue, Steel Blue, Ink Blue, among others.



Fig. 59: Interior northwest room in the Zyklon B disinfestation wing of BW 5a in the Birkenau camp. (© Karl Philipp)



Fig. 60: Exterior southwest wall of the Zyklon B disinfestation wing of BW 5b in the Birkenau camp. (© Karl Philipp)



Fig. 61: Zyklon B disinfestation installation, chamber III, of barrack 41 in Majdanek camp. (© C. Mattogno³¹⁶)



Fig. 62: Zyklon B disinfestation installation, east wall of chamber III of barrack 41 in Majdanek camp. (© C. Mattogno³¹⁶)



Fig. 63: Large Zyklon B disinfestation chamber, ceiling, barrack 41 in Majdanek camp. (© C. Mattogno³¹⁶)



Fig. 64: Zyklon B disinfestation installation, chambers II and III (exterior wall), of barrack 41 in Majdanek camp. (© Carlo Mattogno³¹⁷)

³¹⁶ Taken from the book by Jürgen Graf, Carlo Mattogno, *KL Majdanek*, *op. cit.* (note 43), photos XIII, XIV, XIX (online: www.vho.org/D/Majdanek/MR.html); see also the photo in Michael Berenbaum, *The World Must Know*, Little, Brown & Co., Boston 1993, p. 138.

³¹⁷ Taken from the book by Ernst Gauss (Ed., alias G. Rudolf), *Dissecting the Holocaust*, *op. cit.* (note 22), color page, with kind permission by Carlo Mattogno.



Fig. 65: Zyklon B disinfestation chamber in Stutthof camp, interior view taken from the south door. (© Carlo Mattogno³¹⁸)



Fig. 66: Zyklon B disinfestation chamber in Stutthof camp, east side, exterior. (© Carlo Mattogno³¹⁸)

It seems therefore that a blue pigmentation of masonry is no exception, but rather a rule, particularly where unprotected masonry is repeatedly exposed to hydrogen cyanide over long periods. The large-scale, long-term use of hydrogen cyanide for vermin control in disinfestation chambers only began, in practice, with the onset of the Second World War. And with the dissolution of the National Socialist prisoner camps, the confiscation of the corporation having manufactured and marketed Zyklon B (the *I.G. Farbenindustrie AG*), and the invention of DDT at the end of World War II, this large-scale use of hydrogen cyanide ended just as abruptly. No one cared about any ‘instances of building damage’ having occurred in the former National Socialist disinfestation chambers in this period. The question never arose in the literature... until Frederick A. Leuchter came along.

The following is an attempt to demonstrate the manner in which these blue pigments, referred to as Iron Blue, came to be formed in the masonry during fumigation with HCN, and the conditions favorable to their formation.

There have been many publications on this chemical compound in the last five decades, which were perused and will be summarized in the following in relation to our topic. In so doing, attention was directed at:

- 1) the circumstances which lead to the formation of Iron Blue, and
- 2) the long-term stability of Iron Blue under the existing circumstances.

³¹⁸ Taken from the book by Carlo Mattogno, Jürgen Graf, *Das KL Stutthof*, op. cit. (note 43), photos 13 & 14 (online: www.vho.org/D/Stutthof).

When writing the initial versions of this expert report intended to be presented at German courts of law, I was extremely anxious not to make any errors, because I knew that the topic was extremely controversial. As a consequence, I over-examined several chemical aspects involved, some of which can be understood only by chemical experts. Others aspects are not really necessary for an understanding of the core issue. In order to have a complete English version of my expert report, I nevertheless decided to include all the material I accumulated over the years. Those sections, however, which are considered of marginal interest or of interest to experts only, I have given headlines always starting with “*Excursus*”. For some readers it might be advisable to skip these chapters. They will most likely not miss anything.³¹⁹

But first a short description of the starting substance, hydrogen cyanide.

6.3. Properties of Hydrogen Cyanide, HCN

Hydrogen cyanide, a colorless liquid, is similar, in many of its physical properties, to water.³²⁰ This similarity also explains the limitless solubility of HCN in water and its strong tendency towards absorption (dissolution) in water. The equilibrium concentration³²¹ of hydrogen cyanide in water is investigated in more detail in chapter 6.5.3.

The opinion is often expressed that, because gaseous hydrogen cyanide is approximately 5% lighter than air, it must separate from air and rise. Hydrogen cyanide gas is, however, only slightly lighter than air and does not separate, because of the thermal movement of every gas particle. To clarify this, reference must be made to the principal components of air: The main component of air, nitrogen, 78% by volume, is 8% heavier than hydrogen cyanide gas. If a separation took place between hydrogen cyanide gas and nitrogen, it would all the more occur between the two main components of air, since oxygen (21% of air by volume) is 15% heavier than nitrogen. This would have

³¹⁹ I also want to point out that I did not include all this academic, self-serving ivory tower chatter in order to impress people. I was simply advised by many friends, supporters, and adversaries to include all my material since back-references to my German original is no help to most English language speakers, of whom only a tiny fraction can read German.

³²⁰ High polarity, low molecular mass, possibility of formation of hydrogen bonds.

³²¹ Concentration is the number of parts per volume.

Table 3: Physical Properties of HCN³²²

Molecular weight	27.026 g mol ⁻¹
Boiling point (1 atm)	25.7°C
Melting point	-13.24°C
Specific density of the gas at 31°C (air = 1)	0.947
Explosion limits in air	6-41 Vol.% ³²³

as a result that all the oxygen of the earth's atmosphere would settle in the lower fifth of the atmosphere, as a consequence of which the entire surface of the earth would get oxidized, *i.e.*, burn. This obviously does not happen. Thus, a spontaneous separation of hydrogen cyanide gas would never take place in air.

The 5% lesser density of pure hydrogen cyanide gas compared to air (this corresponds to a density difference of 35°C warm air as compared to 20°C warm air) can however very well lead to a density convection, when pure gaseous hydrogen cyanide is released in a location with the same temperature as the ambient air. The gas would then rise slowly, but gradually mix with the ambient air. But to conclude from this that hydrogen cyanide vapors always rise, would be an incorrect conclusion. At 15°C, for example, on physicochemical grounds, no concentrations higher than 65% of hydrogen cyanide can occur in air (see Graph 1); the density of such a mixture lies only approximately 3% below that of air. Furthermore, a great deal of energy is withdrawn from the ambient air by the evaporating hydrogen cyanide. Consequently, the ambient temperature sinks until exactly as much energy is transported to the liquid (adsorbed) HCN as needed for the decelerated evaporation at the corresponding lower temperature. It is therefore theoretically possible for hydrogen cyanide vapors containing little HCN, but which are cold, to be denser, that is, heavier than the ambient air.

Graph 1 shows the equilibrium percentage of hydrogen cyanide in air as a function of temperature. Even at 0°C, the percentage still lies at

³²² W. Braker, A.L. Mossman, *Matheson Gas Data Book*, Matheson Gas Products, East Rutherford 1971, p. 301. I have left out some of the less interesting dimensions in this connection: heat capacity (20.9°C): 2.625 J g⁻¹ K⁻¹ (Water=4.187 J g⁻¹ K⁻¹); dielectricity constant (20°C): 114 (Water=78.5); evaporation heat: 28 kJ mol⁻¹; evaporation entropy: 190 J mol⁻¹ K⁻¹; spontaneous combustion temperature: 538°C; flash point: -17.8°C; regarding dielectricity constants, see: R.C. Weast (ed.), *Handbook of Chemistry and Physics*, 66th Ed., CRC Press, Boca Raton, Florida 1986, E 40. However, under normal conditions (1 atm, 25°C), hydrogen cyanide is not a gas.

³²³ 1 vol.% is 10,000 ppm (for HCN, roughly 12 g/m³)

approximately 36% by volume. Condensation of HCN on surrounding objects would occur only if the percentage rose over the equilibrium percentage (the so-called dew point). Since in all cases here under consideration, a maximum concentra-

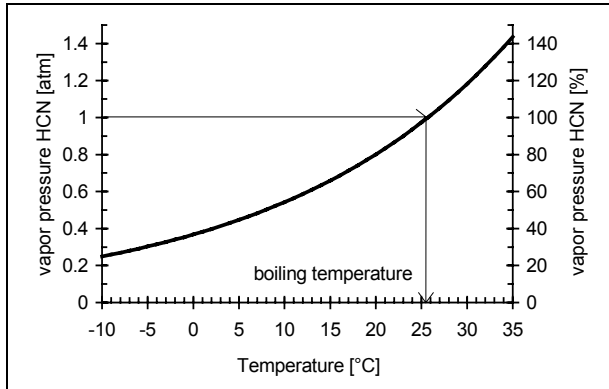

Graph 1: Vapor pressure of hydrogen cyanide in percentage of air pressure as a function of temperature.

tion of 10% HCN in air would only be reached for a short period of time close to the source of HCN (the Zyklon B carrier), no condensation of HCN on walls can be expected. An exception is, however, the so-called capillary condensation, which can occur in finely porous materials such as cement mortar.³²⁴

Hydrogen cyanide forms explosive mixtures with air in the range of 6 to 41% by volume. With strong initial ignition, its explosive effects can be compared with nitro-glycerin.³²⁵ In the applications under discussion here, a proportion of 6% by volume and more can be reached in the immediate vicinity of the source, which suffices for local blow ups at the most. Hence, only inappropriately high concentrations can lead to explosive mixtures, as shown by a corresponding accident in 1947.¹⁶ With correct application quantities and concentrations, the technical literature indicates that there is practically no danger of explosion.³²⁶

³²⁴ The lowered vapor pressure caused by adsorption effects in a narrow hollow space leads to early condensation.

³²⁵ The usual explosive in dynamite. Cf. Wilhelm Foerst (ed.), *Ullmanns Encyklopädie der technischen Chemie*, vol. 5, Urban und Schwarzenberg, Munich ³1954, p. 629.

³²⁶ Willibald Schütz, "Explosionsgefährlichkeit gasförmiger Entwesungsmittel", *Reichsarbeitsblatt*, Teil III (Arbeitsschutz no. 6), no. 17/18 (1943), pp. 198-207, here p. 201.

6.4. Composition of Iron Blue

6.4.1. Overview

The stoichiometric composition of an ideal Iron Blue crystal is:

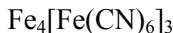

It is characteristic that the iron in this compound is present in two different oxidation states: Fe^{2+} (here in square brackets) and Fe^{3+} (here on the outer left). The interaction between these two different iron ions also gives rise to the blue color of this compound (Charge-Transfer-Complex). The actual composition can be quite variable, depending on the stoichiometry on formation and the presence of impurities, in which case the color varies between dark blue and greenish-blue tones.

6.4.2. Excursus

It was with support of the Mössbauer spectroscopy³²⁷ that a long-lasting argument could be decided:^{328,329} Turnbull's Blue, $\text{Fe}_3[\text{Fe}(\text{CN})_6]_2$, is actually the same as Berlin Blue, $\text{Fe}_4[\text{Fe}(\text{CN})_6]_3$, even if the summation formulas suggest they are different. As a matter of fact, the summation formula of Berlin Blue is closest to the reality: In the ideal Iron Blue crystal, 16 molecules of coordination water are included:

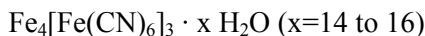

Today it is known that the 'soluble' Iron Blue which frequently is referred to in older literature, is mainly a substance with the composition $\text{MeFe}^{\text{III}}[\text{Fe}^{\text{II}}(\text{CN})_6] \cdot x \text{H}_2\text{O}$, where Me is the counter ion to the opposite cyanoferrate, $[\text{Fe}(\text{CN})_6]^{3-/4-}$, mostly potassium (K^+) or ammonium (NH_4^+).

According to Buser,³²⁹ 'soluble' Iron Blue is formed mainly during quick formation and precipitation of the pigments, leading to the inclusion of large amounts of water and potassium or ammonium ions

³²⁷ Impulseless resonance absorption of γ -quants (gamma radiation) from a radioactive isotope, here Cobalt: $^{57}\text{Co} \rightarrow ^{57}\text{Fe} + \gamma$ (main quant: 122 keV; quant used for spectroscopy has a different energy)

³²⁸ E. Fluck, W. Kerler, W. Neuwirth, *Z. anorg. allg. Chem.* 333 (1964), pp. 235-247; J.F. Duncan, *J. Chem. Soc.* 1963, pp. 1120-1125.

³²⁹ H.J. Buser, D. Schwarzenbach, W. Peter, A. Ludi, *Inorg. Chem.* 16 (1977), pp. 2704-2710. Iron Blue single crystals of high purity and homogeneity were obtained by slow oxidation of a solution of $\text{Fe}^{\text{II}}[\text{Fe}^{\text{II}}(\text{CN})_6]$ in concentrated (!) HCl_{aq} in air. If in the presence of molar amounts of Kalium only some 2% inclusions were observed.

in the extremely voluminous precipitate. The resulting crystal is therefore very faulty and more appropriately called a polymer.³³⁰ By filtration, drying and intensive grinding, however, this very inhomogeneous, polluted Iron Blue can be transformed into a pigment which is only hardly colloidal dispersible.³³¹ This ‘soluble’ Iron Blue is not soluble in the original sense of the word, but can more easily be colloidally dispersed than the ‘insoluble’ Iron Blue, which is very important for its application as a pigment.^{332,333}

However, these colloids are very instable and precipitate easily when salts are added.³³⁴ According to Buser,³²⁹ even in presence of high concentrations of potassium ions, almost pure ‘insoluble’ Iron Blue can be obtained, if the formation process is proceeding slowly enough. In case of deeper interest about the structure one might consult the following literature.^{329,335}

6.5. Formation of Iron Blue

6.5.1. Overview

We are only concerned, in this connection, with how Iron Blue arises from hydrogen cyanide and iron compounds in building materials. In building materials, the iron is generally present in trivalent form (Fe^{3+}), in the form of ‘rust’.

³³⁰ Originally, this term was used only in organic chemistry for chainlike connected, sometimes also branched attachments of equal segments.

³³¹ *Dispersion* (lat.: dispersere, distribute) are distribution of two different phases within each other. They are called *colloids* (gr.: gluelike) if the particles are between 10^{-8} and 10^{-7} m small. Such a mixture in liquids scatters the light (Tyndall effect), is thus not clear. But due to electrostatic repulsion (equally charged particles), colloids do not tend to coagulate and precipitate.

Suspension: (lat.: to float) are coarsely dispersed system with particle sizes bigger than 10^{-6} m.

³³² R.E. Kirk, D.F. Othmer, *Encyclopedia of Chemical Technology*, Vol. 13, 3. ed., Wiley & Sons, New York 1979, pp. 765-771; J.A. Sistino, in: Peter A. Lewis (ed.), *Pigment Handbook*, Vol. 1, Wiley and Sons, New York 1974, pp. 401-407; A.F. Holleman, N. Wiberg, *Lehrbuch der Anorganischen Chemie*, de Gruyter, Berlin¹⁰⁰1985, p. 1143

³³³ H. Ferch, H. Schäfer, *Schriftenreihe Pigmente Nr. 77*, Degussa AG, Frankfurt 1990.

³³⁴ K.A. Hofmann, *Anorganische Chemie*, Vieweg, Braunschweig²¹1973, p. 677; B.N. Gosh, K.C. Ray, *Trans. Far. Soc.* 53 (1957), pp. 1659-1661; E.F. Zhel'vis, Y.M. Glazman, *Ukrainskii Khim. Zh.* 35 (1969), pp. 766ff.; *East European Sci. Abs.* 5 (1969), pp. 84f.

³³⁵ M.B. Robin, *Inorg. Chem.* 1 (1962), pp. 337-342; *Gmelins Handbuch der Anorganischen Chemie*, 59 (Fe), B4, Verlag Chemie, Weinheim 1932, pp. 670-732; R.E. Wilde, S.N. Ghosh, B.J. Marshall, *Inorg. Chem.* 9 (1970), pp. 2512-2516; R.S. Saxena, *J. Ind. Chem. Soc.* 28 (1951), pp. 703-709; A.K. Bhattacharya, *J. Ind. Chem. Soc.* 28 (1951), pp. 221-224.

For the formation of Iron Blue, therefore, a part of this iron must be reduced to bivalent form (Fe^{2+}). The subsequent combination of these different iron ions with CN^- to Iron Blue occurs spontaneously and completely.³³⁶ The most probable mechanism³³⁷ is one in which the cyanide ion itself acts as a reducing agent. The starting point in so doing is an Fe^{3+} ion, largely surrounded (complexed) by CN^- ions: $[\text{Fe}(\text{CN})_{4-6}]^{(1-3)-}$. A slightly alkaline environment is favorable to the final reduction of the iron(III)-ion to iron(II).³³⁸

The pigment formation in the case under consideration here is then organized in 5 steps:

- a) Ad-/absorption of hydrogen cyanide (HCN),³¹³
- b) Ionic splitting (electrolytic dissociation)³³⁹ of hydrogen cyanide in water to the cyanide ion, which alone can form complexes

³³⁶ F. Krleza, M. Avlijas, G. Dokovic, *Glav. Hem. Tehnol. Bosne Hercegovine*, 23-24 (1977, Vol. Date 1976), pp. 7-13.

³³⁷ Photolytic decomposition of the $[\text{Fe}^{\text{III}}(\text{CN})_6]^{3-}$ by means of UV radiation is also conceivable as an alternative. Since the interior walls of the rooms in question are not exposed to any UV radiation, this mechanism is ignored here. See also G. Stochel, Z. Stasicka, *Polyhedron* 4(11) (1985), pp. 1887-1890; T. Ozeki, K. Matsumoto, S. Hikime, *Anal. Chem.* 56 (14) (1984), pp. 2819-2822; L. Moggi, F. Bolletta, V. Balzani, F. Scandola, *J. Inorg. Nucl. Chem.* 28 (1966), pp. 2589-2598.

³³⁸ pH value of 9-10 according to M.A. Alich, D.T. Haworth, M.F. Johnson, *J. Inorg. Nucl. Chem.* 29 (1967), pp. 1637-1642. Spectroscopic studies of the reaction of hexacyanoferrate(III) in water and ethanol. 3.3×10^{-4} M $\text{Fe}(\text{NO}_3)_3$ were exposed with a cyanide excess of likewise 3.3×10^{-4} mol l⁻¹. With pH values of approximately 10, all the $\text{Fe}_2[\text{Fe}(\text{CN})_6]$ was converted into Iron Blue within 48 hours. Cyanate, the anticipated product of the oxidation of the CN^- , could not, however, be proven. Perhaps this is further oxidized directly into CO_2 . If this mechanism is assumed, the result, purely stoichiometrically, is that an alkaline environment must be favorable. This finding is supported by the known fact that hexacyanoferrate(III) is a strong oxidation agent in alkaline medium and is even able to oxidize trivalent chrome to hexavalent, therefore, that is, CN^- ions must have oxidized very quickly: J.C. Bailar, *Comprehensive Inorganic Chemistry*, Vol. 3, Pergamon Press, Oxford 1973, p. 1047. An overly alkaline environment would, however, disturb the complexing of the Fe^{3+} -ion by cyanide, which is then displaced by OH^- ($\text{Fe}(\text{OH})_3$ then occurs as a by-product) and/or the latter can hardly be displaced from the iron.

The driving force in the reduction of the Fe^{3+} is the considerably more favorable energetical situation of the hexacyanoferrate(II) as compared to hexacyanoferrate(III); see, in this regard, R.M. Izatt, G.D. Watt, C.H. Bartholomew, J.J. Christensen, *Inorg. Chem.* 9 (1970), pp. 2019ff. Calorimetric measurements relating to the formation enthalpies of Iron Blue from respective educts (in brackets) were as follows:

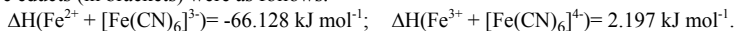

For this reason, a direct reduction of uncomplexed Fe^{3+} , i.e., not surrounded by cyanide, has an energy disadvantage and is therefore negligible.

³³⁹ *Dissociation*: is the splitting of a compound, in this case into two differently charged ions (heterolytic) in aqueous medium (electrolysis):

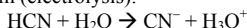

- with iron;
- c) Complexing of trivalent iron (Fe^{3+}) to the complex iron(III)-cyanide,³⁴⁰ that is, the displacement of oxygen and/or OH^- ions in rust by cyanide ions;
 - b) Reduction of iron(III)-cyanide to iron(II)-cyanide;
 - e) Precipitation of iron(II)-cyanide with trivalent iron as Iron Blue.

The velocity of formation of the pigment can be influenced by various factors, which will be considered:

1. Water content of the reaction medium;
2. Reactivity of the iron;
3. Temperature;
4. Acid content.

6.5.2. Water Content

6.5.2.1. Overview

The formation of cyanide through absorption and subsequent dissociation of hydrogen cyanide in water is the necessary precondition for a reaction with iron compounds, since the hydrogen cyanide itself exhibits only a low reactivity. All reactions listed in chapter 6.5.1. under a)-e) occur almost exclusively in water. Water furthermore ensures that the reaction partners—all salts capable of being dissolved in water—come together in the first place. Finally, the moisture contained in the building material also acts as a hydrogen cyanide trap, since hydrogen cyanide dissolves eagerly in water. A relatively high water content in the masonry will therefore considerably increase the speed of reaction.

6.5.2.2. Excursus

The reason for the low reactivity of HCN compared to the free cyanide ion is because HCN is less nucleophilic than the free ion.³⁴¹ Aside from the dissociation of hydrogen cyanide in water, the process

³⁴⁰ Correct: hexacyanoferrate(III).

³⁴¹ *nucleophilic* (gr.: core/nucleus loving) is the tendency of a particle to react with positively charged particles. For this, at least a partial negative charge of the nucleophilic particle is required. In this case, cyanide is, due to its negative charge (CN^-), much more nucleophilic towards the positively charged iron (Fe^{3+}) than the formally uncharged (though polar) hydrogen cyanide.

of chemisorption³¹³ on solid surfaces deserves being mentioned, where the hydrogen cyanide releases its proton (H^+) to an alkaline oxide and is itself attached to a metal ion.

Absorption and dissociation of the superbly soluble hydrogen cyanide (see chapter 6.5.4.) is clearly superior to chemisorption. Furthermore, the aqueous solution (as solvent) is indispensable for the complex formation and redox reactions of the cyanide with Fe^{3+} . Additionally, the aqueous medium makes the reacting agents mobile, which do not always form at the same location. And finally, the moisture contained in the solid material works as a trap for hydrogen cyanide, because it intensely binds the hydrogen cyanide. Or the other way around: the drier a solid material is, the easier hydrogen cyanide, which was ad-/absorbed before, will be released back into the environment. Therefore, a relatively high water content of the solid material will accelerate the reaction.

Experiments with reactions of hydrogen cyanide (some 4 g per m^3 in air, $15^\circ C$, 75% rel. humidity) with mixtures of $Fe(OH)_2$ - $Fe(OH)_3$ attached to wet paper strips showed that a blue discoloration occurred after 30 min at a pH value³⁴² of 2 to 3, since at such low values almost no hydrogen cyanide dissociates to the reactive cyanide (see chapter 6.5.5.). At pH values of 7 to 9, a visible blue discoloration occurred after a few minutes of inserting the sample. At higher pH values, this time span grew again, because the initially absorbed hydrogen cyanide had to lower the pH value first, before it could form the pigment (see chapter 6.6.1., pH Sensitivity).

These experiments show clearly that undissociated, gaseous HCN or HCN dissolved as gas shows no reactivity. An addition of small amounts of KCN to an aqueous sulfuric acid solution of Fe^{2+}/Fe^{3+} , however, results in the immediate precipitation of the pigment. The cyanide obviously reacts faster with the iron salts than it is protonated by sulfuric acid, *i.e.*, converted into hydrogen cyanide.

³⁴² *pH* (pondus hydrogenii) is a measure for the acid content of aqueous solutions (negative, decadic logarithm of H_3O^+ concentration: $-\lg_{10}(c(H_3O^+))$):
pH < 7: acid
pH = 7: neutral
pH > 7: alkaline

6.5.3. Reactivity of Trivalent Iron

6.5.3.1. Overview

The solubility of trivalent iron diminishes rapidly with increasing alkalinity (rising pH value). Even in a pH neutral environment, almost all iron is bound as rust.³⁴³ The reaction between iron compounds and cyanide resulting in the formation of the intermediate product iron(III)-cyanide, $[\text{Fe}(\text{CN})_6]^{3-}$, is therefore largely a reaction on the solid-liquid interface, that is, between the iron adhering to the solid body and the cyanide ion in solution. This reaction occurs considerably more slowly than the same reaction in an aqueous solution. The fastest possible reaction requires a large surface area on the solid-fluid phase boundary, that is, a large, interior, microscopically rough surface and a fine, highly porous solid body, since in such cases, a lot of the iron compounds lie on the surface and are therefore less solidly bound and can quickly combine with cyanide.

In an increasingly alkaline environment, only decreasingly small amounts of ‘rust’ can slowly be converted into iron(II)-cyanide, but cannot react with iron(III)-ions to form Iron Blue.

6.5.3.2. Excursus

Even in an alkaline environment, it must be expected that rust, in the presence of perceptible cyanide concentrations, will be quite slowly transformed into iron(III)-cyanide and finally into iron(II)-cyanide.³⁴⁴ The last step required for the formation of Iron Blue, however, the combination of iron(II)-cyanide with iron(III), will not occur due to the lack of dissolved iron(III)-ions. In a strongly alkaline environment, an increasing concentration of iron(II)-cyanide, which is chemically stable, can slowly accumulate. It remains in a stand-by position, waiting for the pH value to drop.

Iron salts generally tend to incorporate water, and Iron Blue is no exception to this. A higher water content in the solid body results in

³⁴³ $\text{Fe}_2\text{O}_{(3-x)}(\text{OH})_{2x} \cdot x \text{H}_2\text{O}$

³⁴⁴ Naturally, the equilibrium of the reaction $\text{Fe}(\text{OH})_3 + 6 \text{CN}^- \rightleftharpoons [\text{Fe}(\text{CN})_6]^{3-} + 3 \text{OH}^-$ under such conditions is strongly on the left hand side. However, this does not mean, as is well known, that a minute quantity of iron(III)-cyanide will not be formed. The latter, however, is withdrawn from the equilibrium in alkaline medium in the presence of excess cyanide, by being reduced by the latter to iron(II)-cyanide, which is considerably more stable in alkaline medium than iron(III)-cyanide; for further details, see also chapter 6.6.1.

increased water accumulation in rust, too. The rust expands, so to speak, and thus becomes more reactive towards competing ligands³⁴⁵ like cyanide. Freshly precipitated, extremely moist and non-homogenous iron hydroxide precipitations possess extreme reactivity, and together with hydrogen cyanide, as shown in chapter 6.5.2.2., they form the pigment in visible quantities in minutes.

For the formation of colloiddally dispersible Iron Blue, the quick formation in aqueous solution with high concentrations of the agents is required (see chapter 6.4.2.), since this leads to heterogeneous crystallites (tiny crystals) with many inclusions (ions, solvent molecules) and a high degree of disorder. These crystallites have only a small tendency to coagulate.

The slow interface reaction on the phase-boundary layer liquid-solid with quite low concentrations of the reacting agents will suppress the formation of colloiddally dispersible Iron Blue. The process described here, occurring in walls exposed to hydrogen cyanide, strongly resembles the formation of monocrystals as described by Buser,³²⁹ since in this case also, one reagent (Fe^{2+}) had to be formed through slow reduction by excess cyanide. Thus, except from the inhomogeneous material, the conditions here under consideration are suitable for a slow crystal growth of insoluble Iron Blue without large amounts of inclusions and formation of crystal defects.

6.5.4. Temperature

6.5.4.1. Overview

The environmental temperature influences larger magnitudes in quite a different manner:

- A) Accumulation of hydrogen cyanide in the moisture of the masonry;
- B) Water content of the solid body;
- C) Velocity of reaction.

A: Graph 2 shows the maximum solubility of HCN in water at various temperatures with a hydrogen cyanide content of 1 mol% in

³⁴⁵ In complex chemistry, *ligands* refer to in most cases negatively charged particles (anions) surrounding in most cases a positively charged central particle (cation, in general a metal ion). In this case, the central atom iron ($\text{Fe}^{2+/3+}$) is surrounded by the ligand cyanide (CN^-).

air,³⁴⁶ which corresponds to approximately 13 g hydrogen cyanide per m³ air.³⁴⁷ It increases, as with any gas, with decreasing temperature and lies between 0.065 mol per l at 30°C and 0.2 mol per l at 0°C.

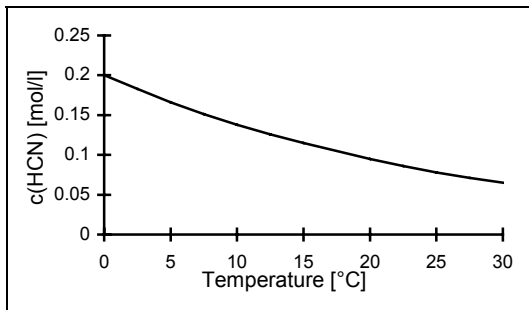

Graph 2: Saturation concentration of hydrogen cyanide in water as a function of temperature at 1 mol% HCN in the air (partial pressure³⁴⁸ of $p(\text{HCN})=0.01$, e.g., 10 mbar HCN at 1,000 mbar total pressure).

These high concentrations prove the extreme solubility of hydrogen cyanide in water.³²⁰ It decreases by approximately half every 20°C. It is therefore approximately 10,000 times more soluble in water than oxygen (O₂) and approximately 250 times more soluble than carbon dioxide (CO₂). The latter is not without importance, since the opinion is sometimes expressed in the literature that the carbon dioxide content of air could have an influence on the amount of hydrogen cyanide soluble in water.⁵⁷ But since hydrogen cyanide is considerably more soluble in water than CO₂, and since CO₂, furthermore, is hardly converted into carbonic acid in water at all, this influence may be disregarded.³⁴⁹

B: The moisture content of masonry is very strongly dependent on the relative humidity of air and the temperature. Since the tendency of water to evaporate (water vapor pressure) increases with rising tem-

³⁴⁶ mol is a standard amount of particles: 1 mol = 6.023×10^{23} particles, according to the definition, the number of atoms contained in 12 g Carbon.

³⁴⁷ Landolt-Börnstein, *Eigenschaften der Materie in ihren Aggregatzuständen*, part 2, volume b, *Lösungsmittelgleichgewichte I*, Springer, Berlin 1962, pp. 1-158.

³⁴⁸ The partial pressure of a gas is its fraction of the total gas content.

³⁴⁹ The influence is supposed to be based on the fact that carbonic acid (H₂CO₃, pK_A= 6.37) displaces the cyanide ion (CN⁻) from the equilibrium: 1. CO₂ + H₂O ⇌ H₂CO₃; 2. CN⁻ + H₂CO₃ ⇌ HCN + HCO₃⁻. Since, however, CO₂ is only soluble in water with difficulty and since, in addition, the equilibrium of the reaction CO₂ + H₂O ⇌ H₂CO₃ (carbonic acid) lies almost completely on the left side, the concentration of carbonic acid in the moisture of masonry itself is several orders of magnitude lower than that of the hydrogen cyanide, even if the content of carbon dioxide in the room under consideration, exposed to hydrogen cyanide, is similar to the hydrogen cyanide content. HCO₃⁻ (pK_A=10.25), finally, is a weaker acid than HCN (pK_A=9.31) and would therefore be displaced by the latter: HCN + HCO₃⁻ ⇌ CN⁻ + CO₂ + H₂O. Therefore, even a higher carbon dioxide content in air can hardly influence the absorption of hydrogen cyanide in masonry.

perature, and since, as a rule, the relative humidity of the air decreases, and since both lead to a drop in the water content, any increase in the temperature has a cumulative effect. Drops in water content by a power of ten at temperature increases of 10°C have been proven in the temperature ranges of 10-30°C under consideration (see chapter 6.7.).

C: Only an acceleration in the slowest of the five steps described in chapter 6.5.1. can be responsible for a change in the velocity of the entire reaction. In neutral or alkaline medium, this is the displacement of the oxygen or OH⁻-ion in rust by the cyanide ion (point c). Although the iron(III)-cyanide [Fe(CN)₆]³⁻ itself is stable in a moderately alkaline medium³⁵⁰—that is, the iron(III)-cyanide is more stable than the rust—the displacement of the OH⁻-ions in rust is inhibited by the cyanide, since the rust is not dissolved in water. An increase in temperature by 20°C usually doubles the velocity of reaction, if the other parameters remain unchanged.

This is, however, not so in extreme cases, since, as shown above, the velocity of reaction is very strongly negatively influenced by the massively decreased water content at higher temperatures (see above): decreased mobility of the reaction partner, decreased reactivity of iron, increased evaporation of ad-/absorbed hydrogen cyanide etc. (see chapters 6.5.2. and 6.5.3.). A strong reduction in pigment formation must therefore be expected at increased temperatures.

A decisively higher water content of the solid material and the considerably better absorption and solubility properties of hydrogen cyanide in water are the reasons for the tendency of solid materials to accumulate more cyanides with lower temperatures. An increase in the reactivity of iron oxide (rust) in the solid body with relation to hydrogen cyanide with a higher water content of the solid material at lower temperatures must be anticipated, as well as with a general increase in the reactivity of all agents. A cooler, and thus moister, solid material is therefore better suited to the formation of Iron Blue than a warm, dry body.³⁵¹

³⁵⁰ See also J.C. Bailar's remarks on the massive reduction force of Fe(CN)₆³⁻ in the *alkaline* environment, *op. cit.* (note 338).

³⁵¹ In the immediate vicinity and beyond the freezing point of water, however, the reactivity drops of course.

6.5.4.2. Excursus

There are two more steps in the observed reaction which could, theoretically, have an influence on the reaction under consideration:

- A) Adsorption on the solid material;
- B) Dissociation of hydrogen cyanide.

A: The adsorption of hydrogen cyanide on solid surfaces decreases with rising temperature, according to Langmuire (see Graph 3).³⁵²

$$\Theta = \frac{\frac{K}{\sqrt{T}} \cdot p \cdot e^{-\Delta H/RT}}{1 - \frac{K}{\sqrt{T}} \cdot p \cdot e^{-\Delta H/RT}} \quad (1)$$

Θ = Degree of adsorption ΔH = adsorption enthalpy (negative)
 K = variable R = universal gas constant
 T = temperature e = Euler's number (2.71828...)
 p = gas pressure

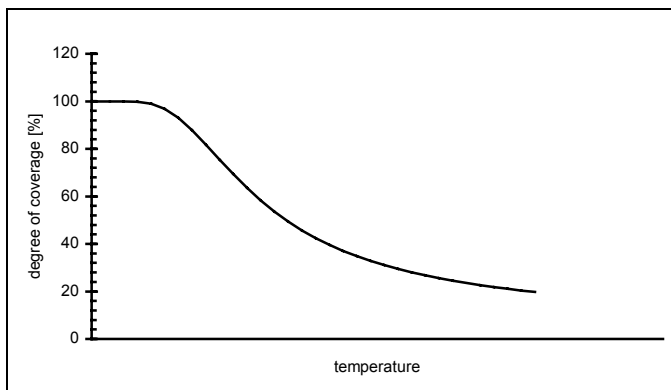

Graph 3: Degree of coverage of the surface of a solid material with an adsorbed gas as a function of temperature (schematic)

The intensity of the decrease of the equilibrium degree of adsorption (coverage) with rising temperature as well as the point of approximate saturation, however, are unknown for the problem at hand. But since, as discussed before, all reactions under consideration require aqueous solutions anyway, adsorptions on solid, *i.e.*, dry surfaces are

³⁵² J. Oudar, *Physics and Chemistry of Surfaces*, Blackie & Son, Glasgow 1975, pp. 26ff.

of no importance to our investigation.

B: According to the literature, the dissociation behavior of acids as a function of temperature is not unanimous.³⁵³ Although there is a tendency of increasing protolysis³⁵⁴ with rising temperature, this tendency turns upside down at higher temperatures for some acids, others show generally falling values. Since the changes are generally in the range of low percentages only, and because speed of protolysis is generally very high, hence never a restricting factor, this can be neglected here.

6.5.5. pH Value

The pH value (acidity) influences the formation in various ways. In chapter 6.5.1., reference has already been made to the higher reduction power of cyanide and iron(III)-cyanide in alkaline environment. The pH value also influences the reactivity of iron compounds in the solid body (chapter 6.5.3.).

As remarked above, dissolved hydrogen cyanide hardly exhibits reactivity. The formation of cyanide ions by absorption and dissociation of hydrogen cyanide only starts in sufficient degree at neutral pH values and above, see Graph 4.³⁵⁵ The data leading to Graph 4, together with the data that enabled us to plot Graph 2 (saturation concentration of HCN as a function of temperature), leads to a graph revealing the relationship between temperature, pH value (acid content), and CN^- saturation concentration, see Graph 5 (at a concentration of 1 mol% HCN in air, which is approximately 1% by weight, the usual disinfection

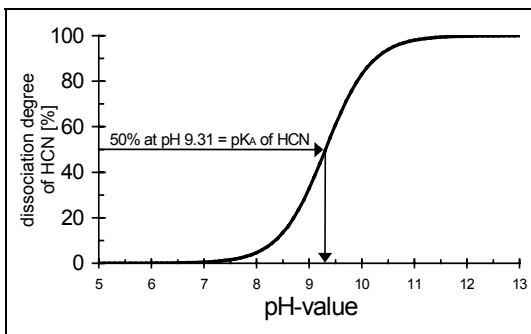

Graph 4: Degree of disassociation of hydrogen cyanide as a function of the pH value at room temperature.

³⁵³ R.C. Weast (ed.), *op. cit.*, (note 322), p. D 163.

³⁵⁴ Protolysis is the splitting of acids (HAc) into their corresponding acid anion (base, Ac^-) and proton (H^+ , or with water to H_3O^+):
 $\text{HAc} + \text{H}_2\text{O} \rightarrow \text{Ac}^- + \text{H}_3\text{O}^+$
 here $\text{HCN} + \text{H}_2\text{O} \rightarrow \text{CN}^- + \text{H}_3\text{O}^+$.

³⁵⁵ pK_A values of HCN: 9.31; R.C. Weast (ed.), *op. cit.* (note 353).

concentration).³⁵⁶

At neutral pH values, equilibrium concentrations of CN^- are within the range of 3×10^{-4} to 1×10^{-3} mol per liter, depending on the temperature. An increase in the pH value by one point results in a ten-fold increase in the cyanide equilibrium concentration.

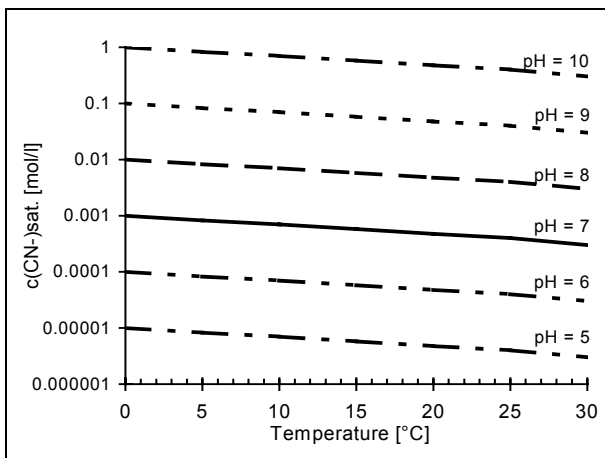

Graph 5: Cyanide equilibrium concentration in water as a function of the temperature and pH value at 1 mol-% HCN in the air.

The actual cyanide concentration in masonry is determined by the velocity of absorption of the gas, adsorption effects within the solid material, and possible reactions of the cyanide.

The result of all these factors is that slightly alkaline pH values are favorable to the formation of the pigment.

The individual parameters and their influence on the formation of Iron Blue are summarized in the following table:

Table 4: Formation of Iron Blue

Parameter	Effect
Water content	Increase in water content results in the following: increased absorption of hydrogen cyanide; long-term retention of ad-/absorbed hydrogen cyanide; increased mobility of reaction partners; increased reactivity of iron oxide; water is the basic precondition for disassociation and redox reactions; generally positive influence with increasing water content. The water content is dependent above all upon the temperature.
Reactivity of the iron	Factor determining reaction velocity, apart from the type of material and pH value (see below), positively influenced by increasing water content.

³⁵⁶ Valid for ideal solutions.

Parameter	Effect
Temperature	Increased ad-/absorption of hydrogen cyanide as well as—under otherwise identical conditions—decreased velocity of individual reactions with falling temperature; strong increase on water content, and therefore a strongly positive net influence upon all other factors with a falling temperature.
pH value	Increased iron reactivity with falling pH, as well as a massive reduction in cyanide accumulation and redox reactivity of iron(III)-cyanide; compromise between iron reactivity and cyanide formation/Fe ³⁺ reduction: A weakly alkaline pH value is favorable to absorption of hydrogen cyanide and accumulation of cyanide as well as for the reduction in iron(III)-cyanide, which determines the velocity of the reaction. Although more strongly alkaline media can accumulate iron(II)-cyanide over longer periods of time, no Iron Blue can form under such circumstances.

6.6. Stability of Iron Blue

6.6.1. pH Sensitivity

Iron Blue is an extremely acid-resistant, but base-decomposing pigment.³⁵⁷ Hydrogen cyanide is only released by warm, diluted sulfuric acid, while hydrochloric acid, by contrast, has no effect.³⁵⁸ In a clearly alkaline environment, *i.e.*, in the presence of high concentrations of OH⁻ ions, these displace the cyanide ion from the iron(III)-ion. Fe(OH)₃ is then precipitated ('rust sludge'), and the Iron Blue is destroyed.³⁵⁹

³⁵⁷ The hexacyanoferrate acids are very strong acids: J. Jordan, G.J. Ewing, *Inorg. Chem.* 1 (1962), pp. 587-591. The findings of analyses of disassociation constants show, for hexacyanoferrate(III): $K_1^{III} > K_2^{III} > K_3^{III} > 0.1$; hexacyanoferrate(II): $K_1^{II} > K_2^{II} > 0.1$; $K_3^{II} = 6 \times 10^{-3}$; $K_4^{II} = 6.7 \times 10^{-5}$. Thus, hexacyanoferrate(III) is still almost completely disassociated at pH=1, hexacyanoferrate(II) doubly, from pH=3 triply, from pH=5 complete.

³⁵⁸ G.-O. Müller, *Lehrbuch der angewandten Chemie*, vol. I, Hirzel, Leipzig 1986, p. 108; the pigment is, however, reversibly soluble in concentrated hydrochloric acid, *i.e.*, the pigment is not decomposed, but merely physically brought into solution; there is therefore no release of hydrogen cyanide; see also H.J. Buser *et al.*, *op. cit.* (note 329); see also chapter 8.2.: analytical method for total cyanide content according to DIN: the pigment is destroyed by boiling HCl_{aq.}. Iron Blue suspensions (see note 331) have an acid pH value of approximately 4. At this slightly acid *eigen* pH, as is formed, for example, by acid rain in surface waters, Iron Blue is at its most stable: H. Ferch, H. Schäfer, *op. cit.* (note 333). In technical applications, the alkaline resistance is increased by adding nickel, cf. R.E. Kirk, D.F. Othmer, *op. cit.* (note 332); J.A. Sistino, *op. cit.* (note 332); E. Elsermann, *Deutsche Farben-Z.* 5 (1951), pp. 419ff.; R. Beck, *Deutsche Farben-Z.* 6 (1952), p. 231.

³⁵⁹ Iron(III)-hydroxide is even less soluble in this range than Iron Blue; on the solubility of Fe(OH)₃ see chapter 6.6.3.; to be exact, Iron Blue is not totally destroyed at a high pH; rather,

The literature contains authenticated cases of studies with iron at pH values of 9 and 10, in which it is still stable.³⁶⁰ The pH range around 10 to 11 can be considered the critical limit for the stability of Iron Blue. Based on the alkaline behavior of fresh mortar and concrete (in this regard, see also chapter 6.7.2), Iron Blue is only used to paint these surfaces to a limited extent.³⁶¹

6.6.2. Solubility

6.6.2.1. Overview

Iron Blue is considered one of the least soluble cyanide compounds, which is the precondition for its widely-varied application as a pigment.³⁶² The literature flatly refers to Iron Blue as “*insoluble*”.³⁶³

Concrete, reliable values on the solubility of Iron Blue are not recorded in the scientific literature. Based on comparative calculations between the known solubility of $\text{Fe}(\text{OH})_3$ on the one hand, and the limit value of the pH stability of Iron Blue on the other hand (pH 10), the approximate solubility of Iron Blue in water can, however, be calculated (see chapter 6.6.2.2.). It amounts to approximately 10^{-24} g Iron Blue per liter of water, this means that 0.000000000000000000000001 g Iron Blue dissolve in 1,000 g of water.

In addition to a compound's solubility in water, its condition (crudely or finely crystalline, superficially adherent or adsorbed by capillary effects) as well as, in particular, the condition and quantity of

the Fe^{3+} is, initially, merely withdrawn; the base-resistant $[\text{Fe}(\text{CN})_6]^{4-}$ remains intact; see note 344.

³⁶⁰ See the studies by M.A. Alich *et al.*, *op. cit.* (note 338).

³⁶¹ J.A. Sistino, *op. cit.* (note 332); H. Beakes, *Paint Ind. Mag.* 69(11) (1954), pp. 33f. Mixtures of Iron Blue and phthalocyanine blue generally find application, since both, alone, lack sufficient long-term stability; Degussa describes the lime fastness of Iron Blue as “*not good*” (H. Ferch, H. Schäfer, *op. cit.* (note 333)); however, Degussa is referring to its fastness on still uncarbonated, alkaline plasters and concretes: H. Winkler, Degussa AG, letter to this author, June 18, 1991. My own experiments with the dissolution of fresh Iron Blue precipitations resulted in a limit value of pH 10-11 for the stability of Iron Blue.

³⁶² This property is used in Russian industry, for example, for the passivation of steel pipes against aggressive waste waters, since CN^- contained in waste waters coats the interior of pipes with an insoluble protective layer of Iron Blue: N.G. Chen, *J. Appl. Chem. USSR*, 74(1)(1974), pp. 139-142. But it should be noted that this borders on criminal negligence, since toxic cyanides simply do not belong in waste waters.

³⁶³ DIN Safety Data Sheet VOSSEN-Blau[®], in: *Schriftenreihe Pigmente Nr. 50*, Degussa AG, Frankfurt 1985; see also H. Ferch, H. Schäfer, *op. cit.* (note 333). Last but not least, pigments, by definition, are coloring agents practically insoluble in dissolvents and binding agents (DIN 55,943 and 55,945).

the water supplied are decisive in determining the actual velocity of dissolution of a substance. Iron Blue formed in masonry will be present in a finely crystalline form and adsorbed by capillary effects, in which case the former favors dissolution, while the latter is extremely detrimental to dissolution. Water almost or entirely saturated with iron(III)-ions is no longer capable of dissolving further iron. Furthermore, water permeation through finely porous solid material like masonry is extremely low even at high water tables; the iron saturation concentration is quickly attained, which, in addition, as remarked above, is generated by the slightly more soluble iron oxides of the solid body rather than by the Iron Blue having once arisen. It is furthermore very well known that mortar and concrete permeated with paints practically cannot be rendered colorless.³⁶⁴ It cannot, therefore, be anticipated that the Iron Blue content once having arisen in walls can be perceptibly reduced by dissolution in water. Water running down the exterior surfaces is considerably more aggressive, exerting, in particular, an erosive effect, *i.e.*, damaging the masonry as such.

6.6.2.2. Excursus

Tananaev *et al.*³⁶⁵ examined the solubility of metal hexacyanoferrate(II) and discovered a solubility product³⁶⁶ of $3 \cdot 10^{-41}$ ($pK_S = 40.5$) for the solubility product of Iron Blue, without mentioning the unit used.

Assuming they used the summation formula of $Fe_4[Fe(CN)_6]_3$ (unit being $mol^7 l^{-7}$), one attains a solubility of 0.5 mg per liter water. Thus, it would be 14 times less soluble than the nearly insoluble calcium carbonate ($CaCO_3$, 7.1 mg per liter water, $K_S = 4.95 \cdot 10^{-10} mol^2 l^{-2}$).³⁶⁷ Later publications support these findings,³³⁶ although attention must be paid to deviations in the stoichiometry (composition) of Iron Blue with impurities, leading to an increased solubility.

Tananaev *et al.* precipitated the complex metal cyanoferrate from

³⁶⁴ See also, in this regard, the remarks of a company dealing in colored cements and concretes: Davis Colors, 3700 East Olympics Blvd., Los Angeles, CA 90023, www.coloredeconcrete.com/davis/Tech/03470.html.

³⁶⁵ I.V. Tananaev, M.A. Glushkova, G.B. Seifer, *J. Inorg. Chem. USSR*, 1 (1956), pp. 72ff.

³⁶⁶ The *solubility product* of a compound is defined as the product of the entire ionic concentration of the totally dissociated compound: $Fe_4[Fe(CN)_6]_3 \rightarrow 4 Fe^{3+} + 3 [Fe(CN)_6]^{4-}$;
 $K_L(Fe_4[Fe(CN)_6]_3) = c(Fe^{3+}) \cdot c(Fe^{3+}) \cdot c(Fe^{3+}) \cdot c(Fe^{3+}) \cdot c([Fe(CN)_6]^{4-}) \cdot c([Fe(CN)_6]^{4-}) \cdot c([Fe(CN)_6]^{4-}) \cdot c([Fe(CN)_6]^{4-})$
 $= c^4(Fe^{3+}) \cdot c^3([Fe(CN)_6]^{4-})$.

The pK_S value correlates to the negative decimal logarithm of the product of solubility.

³⁶⁷ R.C. Weast (ed.), *op. cit.*, (note 322), p. B 222.

an appropriate metal salt solution with $\text{Li}_4[\text{Fe}(\text{CN})_6]$, probably acquiring a high rate of inclusions (lithium, water) as well. Thus, in spite of the four hour-long accumulation of the precipitation, the filtrate would certainly still have contained colloiddally dispersed Iron Blue. Since they finally determined the amount of free Fe^{3+} in the filtrate by precipitating it with ammonia as $\text{Fe}(\text{OH})_3$, they will undoubtedly also have precipitated the Fe^{3+} of the colloiddally dispersed Iron Blue, as ammonia raises the pH value so much that Iron Blue is no longer stable (see chapter 6.6.1.).

Therefore, they did not determine the solubility of Iron Blue, but the measure of stability of the dispersion of fresh precipitations of the pigment.

The solubility product of $\text{Pb}_2[\text{Fe}(\text{CN})_6]$ given by Krleza *et al.*,³³⁶ which they used as a reference to determine the solubility products, is much lower than the one used by Tananaev *et al.*. If applied to Tananaev's calculations, this produces a solubility of Iron Blue of only 0.05 mg per liter. Krleza *et al.*, however, find similar results for the solubility of most of the metal cyanides analyzed, including Iron Blue. Since conventional methods of analysis, such as gravimetry and titration, tend to be unreliable when facing minute traces, one must but wonder about these similar results.

However, one can escape this dilemma by thoughtful reasoning.

It is safe to say that Iron Blue is stable at a pH value of 7, *i.e.*, in a neutral aqueous medium, so we take this as a minimum value. As mentioned earlier, a pH value of about 10 can be considered the upper limit of stability for Iron Blue, so we take this as maximum value for the following calculations. At pH=7, and even more so at pH=10, the free iron concentration is extremely low, since $\text{Fe}(\text{OH})_3$ is nearly insoluble (see Table 5).

At pH 7 and 10, respectively, a saturated $\text{Fe}(\text{OH})_3$ solution has the following free Fe^{3+} concentration:

$$c(\text{Fe}^{3+}) = \frac{K_1(\text{Fe}(\text{OH})_3)}{c^3(\text{OH}^-)} \quad (2)$$

$$\text{pH}=7: = \frac{2.67 \times 10^{-39} \text{ mol}^4 \text{ l}^{-4}}{10^{-21} \text{ mol}^3 \text{ l}^{-3}} = 2.67 \times 10^{-18} \text{ mol l}^{-1} \quad (3)$$

$$\text{pH}=10: = \frac{2.67 \times 10^{-39} \text{ mol}^4 \text{ l}^{-4}}{10^{-12} \text{ mol}^3 \text{ l}^{-3}} = 2.67 \times 10^{-27} \text{ mol l}^{-1} \quad (4)$$

Should the free Fe^{3+} concentration surpass this value due to a better solubility of Iron Blue, then Fe^{3+} would precipitate as hydroxide and would be increasingly removed from the pigment, thereby destroying it in the end. Since this does not happen at $\text{pH}=7$ at all, and $\text{pH}=10$ can be considered the point where it just starts to happen, the concentration of the Fe^{3+} ion in a saturated Iron Blue solution must lie well below 10^{-18} mol/liter, *i.e.*, in the area of 10^{-27} mol/liter. Thus, the solubility of Iron Blue must also have a value around 10^{-27} mol per liter (actually: $\frac{1}{4}$ of the free Fe^{3+} concentration, K_S less than $4.1 \cdot 10^{-187}$ mol⁷ l⁻⁷, $\text{p}K_S$ larger than 186.6) which, at a mol mass of $1,110 \text{ g mol}^{-1}$ ($(\text{Fe}_4[\text{Fe}(\text{CN})_6]_3 \cdot 14 \text{ H}_2\text{O})$) would correlate to 10^{-24} g.

With this, the complex iron pigment does indeed deserve to be called insoluble, as only one part of dissolved Iron Blue can statistically be found in 100,000,000,000,000,000,000,000,000 parts of water (10^{29}). The actual solubility would therefore be less by a factor of 10^{20} as determined by Tananaev *et al.*, which would come pretty close to values calculated for other so-called ‘insoluble’ compounds, like mercury sulfide (HgS). However, one must consider that the chemistry of Fe^{3+} in aqueous solutions doesn’t justify the terms ‘dissolved’ or ‘precipitated’, since a multitude of complexes do exist in the

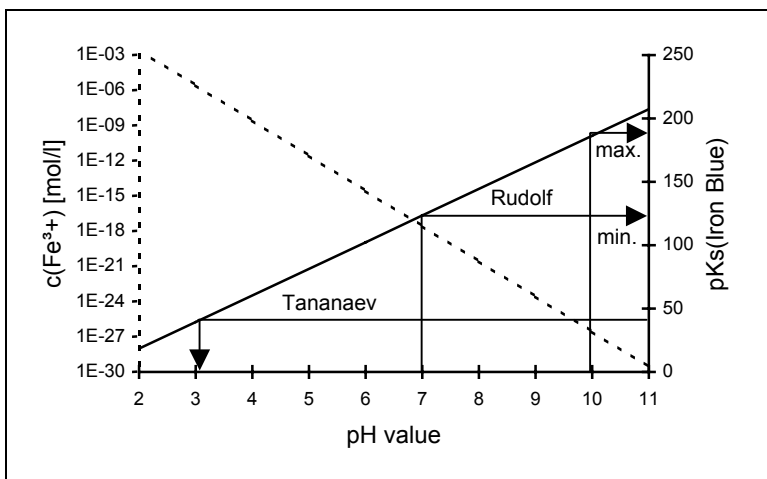

Graph 6: Free Fe^{3+} concentration as a function of pH value and the resulting minimal $\text{p}K_S$ value of Iron Blue, depending on its stability at the corresponding pH value. $\text{p}K_S$ value acc. to Tananaev *et al.* : 40.5; according to reflections made here: greater than 123, smaller than 186.

broad pH-spectrum, partly as polymer hydroxo-aquo-complexes (compare chapter 6.5.3.).

Graph 6 shows the correlation between the pH value of the free Fe^{3+} -concentration in a hypothetical saturated solution of Iron Blue and the respectively resulting minimal pK_S values possible for Iron Blue, which it must possess, should stability prevail at the given pH-reading. Tananaev's pK_S value given, it is obvious that the pigment would remain stable only up to pH 3. Accordingly, it would dissociate itself by its *eigen* pH value of 4 (see chapter 6.6.1., note 358), which is formed in its own dispersion. Thus the magnitude of error in the results of Tananaev *et al.* and Krleza *et al.* is apparent.

These reflections show that iron, bound as hydroxides or oxides in solid materials, tends to dissolve in a neutral medium more readily than Iron Blue, since its equilibrium concentration must be higher than that of Iron Blue.

6.6.3. Excursus: Competing Ligands

As shown, OH^- -ions may, due to the low solubility of $\text{Fe}(\text{OH})_3$, noticeably precipitate the Fe^{3+} of Iron Blue in pH media above 9 to 10. The residual hexacyanoferrate(II), on the other hand, would only decompose in strongly alkaline media, because $\text{Fe}(\text{OH})_2$ is simply more soluble (compare Table 5).³⁶⁹

Tartrate³⁷⁰ has, in contrast to oxalate, hardly any effects so that

Table 5: Dissociation constants and solubility products of iron compounds

Compound	Constant	Source
$\text{K}_S(\text{Fe}_4[\text{Fe}(\text{CN})_6]_3)$	$4.1 \cdot 10^{-187} \text{ mol}^7 \text{ l}^{-7}$	
$\text{K}_{D(6)}([\text{Fe}(\text{CN})_6]^{4-})$	$10^{-24} \text{ mol l}^{-1}$	368
$\text{K}_{D(6)}([\text{Fe}(\text{CN})_6]^{3-})$	$10^{-31} \text{ mol l}^{-1}$	368
$\text{K}_S(\text{Fe}(\text{OH})_2)$	$4.79 \times 10^{-17} \text{ mol}^3 \text{ l}^{-3}$	367
$\text{K}_S(\text{Fe}(\text{OH})_3)$	$2.67 \times 10^{-39} \text{ mol}^4 \text{ l}^{-4}$	367
$\text{K}_S(\text{FeCO}_3)$	$3.13 \times 10^{-11} \text{ mol}^2 \text{ l}^{-2}$	367

³⁶⁸ C. Wilson, *Wilson & Wilson's Comprehensive Inorganic Chemistry*, Vol. 1B, Elsevier, Amsterdam 1960, p. 162.

³⁶⁹ In absence of free cyanide ions, the pH stability limit of hexacyanoferrate(II) (total dissociation) is at 11.8, but already very small amounts of free cyanide ($10^{-10} \text{ mol l}^{-1}$) push the limit up to pH=13.

³⁷⁰ *Tartrate*, corresponding base of tartaric acid. The mixed potassium-sodium-salt is the famous tartrate (potassium bitartrate), which crystallizes on the cork of wine bottles (Seignette salt).

Fe^{3+} can be quantitatively removed from sour wine with $[\text{Fe}(\text{CN})_6]^{4-}$, a usual procedure to remove iron ions from wine.³⁷¹ Concentrated alkali carbonate solutions will precipitate the Fe^{2+} of Iron Blue as FeCO_3 , so that they destroy the entire pigment by precipitating Fe^{3+} as $\text{Fe}(\text{OH})_3$ (due to alkalinity) and the hexacyanoferrate(II) salt $[\text{Fe}(\text{CN})_6]^{4-}$.³⁷² Calcium carbonate solutions, however, would not be sufficient due to their marginal saturation solubility. Besides that, Kohn examined the supportive effect of most of the organic ligands to disperse Iron Blue.³⁷³

Thus, apart from OH^- (alkaline medium), there are no other ligands to be considered competing in the formation or dissolution of Iron Blue in the cases here under consideration.

6.6.4. Effects of Light

6.6.4.1. Overview

Iron Blue itself is generally considered a light-resistant pigment, which is only slowly decomposed by the effects of UV radiation.³⁷⁴ Thus, there are even patents utilizing Iron Blue as a UV-absorbing pigment, which is only meaningful with sufficient resistance to UV radiation.³⁷⁵ Since the walls of interest to us here are protected from UV radiation and because UV radiation can only exert a superficial effect on the walls, while the Iron Blue would form and remain within the walls, a possible process of decomposition by UV radiation can have no influence upon our investigation.

6.6.4.2. Excursus

Certain wave lengths of ultraviolet radiation may set free CN^- from hexacyanoferrate(II) and -(III), the preliminary stages of Iron Blue. As far as hexacyanoferrate(III) is concerned, this leads to the formation of

³⁷¹ C. Lapp, C. Wehrer, P. Laugel, *Analisis*, 13 (4) (1985), pp. 185-190.

³⁷² G.-O. Müller, *op. cit.* (note 358).

³⁷³ M. Kohn, *Anal. Chim. Acta* 3 (1949), pp. 558ff.; *ibid.*, 5 (1951), pp. 525-528; *ibid.*, 11 (1954), pp. 18-27.

³⁷⁴ See also Winnacker-Küchler, *Chemische Technologie*, volume 2, Carl Hanser Verlag, Munich 1982, p. 197; H. Ferch, H. Schäfer, *op. cit.* (note 333); Wilhelm Foerst (ed.), *Ullmanns Encyclopädie der technischen Chemie*, volume 13, Urban und Schwarzenberg, Munich ³1962, p. 794; *ibid.*, volume 18, Verlag Chemie, Weinheim 1979, pp. 623ff.; H. Watanabe, *J. Jap. Soc. Col. Mat.*, 34 (1961), pp. 5-8; L. Müller-Focken, *Farbe und Lack*, 84 (1987), pp. 489-492.

³⁷⁵ H. Tada, M. Kumio, H. Kawahara, *Jpn. Kokai Tokkyo Koho*, 1990, 3 p. Source only available as abstract.

Iron Blue.³³⁷ As far as hexacyanoferrate(II) is concerned, quantum efficiencies³⁷⁶ of 0.1 to 0.4 are reported for wave lengths of 365 nm.³⁷⁷

Lately, it has been discussed whether complex cyanides can be removed from industrial waste waters by ultraviolet radiation. The unbound cyanide will be oxidized and destroyed by hydroxyl radicals originating from the parallelly occurring photolysis of water.³⁷⁸ However, results are not unequivocal.³⁷⁹

As for Iron Blue, one knows of the bleaching effect under strong, perpetual sun radiation and the ensuing re-darkening during the night.³⁸⁰ Here also, the liberation of CN^- is responsible, which reduces parts of the Fe^{3+} ions to Fe^{2+} ions. The latter process, however, will reverse during the night under the influence of oxygen and moisture. The Iron Blue concentration will eventually be reduced by the loss of the released CN^- , either by evaporation of hydrogen cyanide, by washing out as CN^- , or by oxidation through Fe^{3+} /atmospheric oxygen or from hydroxyl radicals from the natural photolysis of water. The latter process is minute and can therefore be omitted. At any rate, most of the cyanide released by photolysis will again be complex bound to iron.

6.6.5. Long-Term Test

The best long-term test available to us consists of disinfestation buildings BW 5a and 5b in Birkenau, which have defied the wind and weather of the strongly corrosive climate in the industrial region of Upper Silesia for over 50 years, and which are still colored blue, both inside and out, exhibiting a high cyanide content. These findings are also supported by two other long-term tests.

The color durability of Iron Blue, in addition to other pigments,

³⁷⁶ *Quantum efficiency* is that part of the absorbed light quants which leads to photo reactions under scrutiny, here from 10 to 40%.

³⁷⁷ L. Moggi, *et al.*, *op. cit.* (note 337); V. Carassiti, V. Balzani, *Ann. Chim.* 50 (1960), pp. 782-789.

³⁷⁸ *Photolysis* of water leads to the splitting of water into uncharged parts with unpaired electrons (formation of radicals through homolytic splitting (homolysis); see also dissociation, note 339):

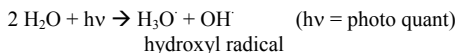

³⁷⁹ M.D. Gurol, J.H. Woodman, *Hazard. Ind. Waste* 21 (1989), pp. 282-290; S.A. Zaidi, J. Carey, in: *Proceedings of the Conference on Cyanide and the Environment*, Colorado State University, 1984, pp. 363-377.

³⁸⁰ Deutsche Chemische Gesellschaft (ed.), *Gmelins Handbuch*, *op. cit.* (note 335); *Ullmanns Encyklopädie*, *op. cit.* (note 374); L. Müller-Focken, *op. cit.* (note 374).

was tested during an environmental resistance test lasting 21 years in the industrial district of Slough, west of London.³⁸¹ In so doing, pieces of aluminium sheet metal were alternatively dipped in an iron(III)-cyanide and then in an iron(III)-salt solution,³⁸² by which the resulting pigment was adsorbed on the aluminium sheet metal. The test sheets were then exposed to the environment on the roof of a building in a vertical 45° angle facing south-west.

During the 21 years lasting test, in which eight Iron Blue samples were tested among other pigments, the Iron Blue, in particular, followed by iron ochre (Fe₂O₃, rust), exhibited only minimal alterations after this period of time. One sample of Iron Blue and iron ochre was removed only after 10 to 11 years in each case.³⁸³ All other samples still exhibited an intense blue color. Half of the seven remaining Iron Blue samples received the value 4 out of a maximum of 5 points for the best retention of quality, on the grey scale used there in the determination of color changes. Only minor alterations were detected.

The exhibits were therefore exposed to the environmental conditions of a strongly industrialized area, with full effects of precipitation, direct sunshine, and wind erosion for more than 21 years. Under intense summer sunshine and in the absence of wind, the temperature of the dark-blue colored aluminium metal sheets rose steeply (Iron Blue is only stable up to approximately 140°C.³⁸⁴). Snow, frost, hail, storms, and the finest, driving acid drizzle had obviously just as little an effect on the pigment as the UV radiation of direct sunlight. What is remarkable is that in determining the degree of destruction of the pigment no unexposed samples were used since these had been lost over the 21-year period; rather, places on the surface of the exhibits which had been relatively well protected from direct environmental influences by the frames and by rubber rings on the screw joints were used as control samples. These exhibited almost no alterations.

In comparison to the environmental conditions which are of inter-

³⁸¹ J.M. Kape, E.C. Mills, *Tranp. Inst. Met. Finish.*, 35 (1958), pp. 353-384; *ibid.*, 59 (1981), pp. 35-39.

³⁸² K₄[Fe(CN)₆]₃ or Fe(NO₃)₃.

³⁸³ The literature does not, however, mention this Iron Blue sample as “*Prussian Blue*”, like the others, since it was, at that time, considered to be of another type, *i.e.*, “*Turnbull’s Blue*” or “*ferrous ferricyanide*”.

³⁸⁴ Compare Ferch, H. Schäfer, *op. cit.* (note 333); S. Barbezat, *J. Réch. Cent. Nat. Réch. Sci.* 4 (1952), pp. 184ff.; E. Gratzfeld, *Färg och Lack*, 3 (1957), pp. 85-108; E. Herrmann, *Farbe und Lack*, 64 (1958), pp. 130-135.

est here, this long-term test involved considerably more severe conditions, since in this case, the externally formed Iron Blue was only superficially adsorbed upon the aluminium sheets. The pigment nevertheless resisted extremely well.

Another event proves the extraordinary long-term stability of Iron Blue. For many decades at the end of the 19th and the early decades of the 20th century, Iron Blue was a by-product in the generation of city gas, because the hydrogen cyanide contained in coke gas had to be eliminated for security reasons by washing it with iron hydroxide prior to introduction into the city gas network. Iron Blue is the end product of this washing process. City gas works frequently disposed of this product by distributing some of it over their factory terrain with the intend to kill weeds—in vain, though, since Iron Blue has no effect as an herbicide. Today, the grounds of former German city gas works still contain high quantities of Iron Blue, many decades after the works were put out of operation. It was neither decomposed, nor dissolved or washed away by rain water, since it is insoluble. In particular, terrain with a high Iron Blue content is not considered polluted, since it is physiologically unobjectionable due to its stability.³⁸⁵

In summary, it may be stated that Iron Blue having formed in the interior of a wall as a component of the wall itself, possesses a longevity comparable to the iron oxide from which it has formed. This means simply that Iron Blue possesses a degree of stability which is comparable to that of the masonry itself: the Iron Blue will remain contained in the wall for as long as the wall itself remains in existence.³⁸⁶

Once perceptible quantities of cyanide have accumulated within a wall, therefore, and once conditions permit the conversion of the cyanide into Iron Blue, no perceptible reduction in the Iron Blue content can be anticipated, even after fifty years or more.

A typical example of the manner in which the media deal with these facts is a press report issued by the German Press Agency (*Deutsche Presseagentur*, dpa) on March 29, 1994, and which was then published in many German newspapers and even broadcast on radio. The report

³⁸⁵ D. Maier, K. Czurda, G. Gudehus, *Das Gas- und Wasserfach*, in: *Gas • Erdgas*, 130 (1989), pp. 474-484.

³⁸⁶ An interesting study has been conducted in this connection about the reduction of soluble components in concrete standing in water, providing support to the statements made here: not even the concentration of alkali ions, which are the most soluble components of concrete, was massively reduced: H.A. El-Sayed, *Cement and Concrete Research*, 11 (1981), pp. 351-362.

flatly claimed that, according to unnamed experts:

*“Cyanide compounds decompose very quickly. In the ground, this occurs even after six to eight weeks; in masonry, these compounds could only be preserved under ‘absolute conditions of conservation including complete exclusion of air and bacteria.’”*³⁸⁷

Inquiries with the dpa press office in Stuttgart which published the report revealed that the writer responsible for the report, Albert Meinecke, had simply invented this expert opinion.³⁸⁸ This obvious lie continues to be further disseminated, even by German government agencies such as, for example, the Bavarian Ministry of the Interior.³⁸⁹

6.7. Influence of Various Building Materials

6.7.1. Brick

6.7.1.1. Overview

Bricks are well-known to acquire their hardness and stability during their baking process. This causes an intensive binding of the components in bricks (sintering). One result of this is that the reactivity of the iron oxide occurring in bricks (2 to 4%) is strongly reduced, so that a perceptible inclination to form iron cyanide is hardly to be anticipated. The immediate surface of bricks slightly attacked by atmospheric influences (weathering) nevertheless constitutes an exception to this rule, so that the superficially adherent iron oxide is available for conversion into Iron Blue.

³⁸⁷ German daily newspapers, for instance: *Süddeutsche Zeitung*, *Stuttgarter Zeitung*, *Südwestpresse-Verbund* (March 29, 1994), *taz*, *Frankfurter Rundschau* (March 30, 1994).

³⁸⁸ See also W. Schlesiger, *op. cit.* (note 91), pp. 21-24; G. Rudolf, “Über die frei erfundene Expertenmeinung der ‘dpa’”, *DGG 42(2)* (1994), pp. 25f. (online: www.vho.org/D/DGG/Rudolf42_2.html); Engl. in the appendix to this book, chapter 11.5.

³⁸⁹ See the Bavarian State Ministry for the Interior, *Verfassungsschutzbericht 1997*, Munich 1998, p. 64. A corresponding reference to the factual incorrectness of the remarks made in this regard by the *Arbeitskreis Zeitgeschichte und Politik* (in a letter by president Hans-Jürgen Witzsch, dated Oct. 8, 1998, Fürth) was countered by the Ministry as follows: “Your efforts to deny and/or relativize the crimes of the National Socialists have been known to the security authorities for years. [...] We see no occasion for a discussion of gas chambers.” The letter, from Dr. Weber of the Bavarian State Ministry of the Interior dated Oct. 13, 1998, ref. IF1-1335.31-1, probably established a new world record for stupidity.

6.7.1.2. Excursus

The chemical composition of bricks varies massively due to the different sorts of mar and loam used as initial material. The content of clay (included in this are 20 to 60% Kaolinite, consisting roughly of 47% SiO₂, 40% Al₂O₃, 13% H₂O) may lie between 20 and 70%, the rest being carbonate, finest sand and iron oxides.³⁹⁰ According to my own analyses, the latter content may vary between 2 and 4%.

The porosity values of bricks lie between 20 and 30 vol.%,³⁹¹ according to other sources up to 50%.³⁹² According to my own mercury penetration tests, the pore size of bricks lies heavily concentrated around 1 μm.³⁹³

Due to the decreased specific surface (0.5 to 1 m² per g, BET,³⁹⁴ own tests), the reactivity of the iron oxide is strongly reduced. However, partly dissolved iron at brick surfaces immediately exposed to weathering can be set free for reactions in bigger amounts.

The normal free, *i.e.*, not chemically bound water content of bricks in dry rooms (20°C) is in the area of one volume percent, but it can rise up to 4% at a relative humidity of over 90%.³⁹⁵

6.7.2. Cement Mortar and Concrete

6.7.2.1. Overview

The rust content (Fe₂O₃) of Portland cement, of particular interest to us here, the cement most frequently used for concrete and cement mortars, is usually between 1 and 5%.³⁹⁶ The sand added to the mortar can also exhibit a high iron content (up to 4%). As mentioned in chapter 6.5.3., a large surface area at the solid-liquid phase limit (iron oxide-cyanide solution) is favorable to the formation of Iron Blue. This is extraordinarily large in cement and concrete mortars (microscopic inte-

³⁹⁰ O. Hähnle, *Baustoff-Lexikon*, Deutsche Verlagsanstalt, Stuttgart 1961, p. 384.

³⁹¹ Landolt-Börnstein, *Zahlen und Funktionen aus Physik, Chemie, Astronomie, Technik*, volume IV *Technik*, part 4b *Wärmetechnik*, Springer, Berlin 1972, pp. 433-452.

³⁹² S. Rößert (ed.), *Systematische Baustofflehre*, volume 1, VEB Verlag für Bauwesen, Berlin 1983, p. 120.

³⁹³ These mercury penetration tests were performed at the research institute of the VARTA Batterie AG in Kelkheim, Germany, in late 1991.

³⁹⁴ Method to determine the specific surface with nitrogen adsorption following Brunauer, Emmet, Teller.

³⁹⁵ K. Wesche, *Baustoffe für tragende Bauteile*, volume 1, Bauverlag, Wiesbaden 1977, p. 37.

³⁹⁶ W.H. Duda, *Cement-Data-Book*, Bauverlag, Wiesbaden 1976, pp. 4ff., as well as my own analysis.

rior surfaces of approximately 200 m² per gram).³⁹⁷

Fresh concrete and cement mortars—which are identical from a chemical point of view—are relatively strongly alkaline (pH approximately 12.5). It later falls, however, due to the binding of carbon dioxide from the air. Depending on the special chemistry of the cement mortar, this process proceeds very slowly in the depth of the material. According to the composition of the cement mortar, this may last from a few months to many decades, until the pH value of such a mortar or concrete becomes neutral, even in the deepest layers.³⁹⁶⁻³⁹⁸ This chemical behavior explains the entire secret of the stability of reinforced concrete, which prevents the embedded steel from rusting further in the environment within the concrete, which remains alkaline for lengthy periods of time.³⁹⁹

The water content of concrete and cement mortars depends on the temperature and relative humidity of the air and fluctuates between 1% and less at 20°C and 60% relative humidity up to 10% in air saturated with humidity.³⁹⁵ In case of permanently high humidity, penetrating wetness from outside, a huge part of the pore system can be filled with water.⁴⁰⁰

Poorly insulated rooms built underground always have cool and humid walls due to their great exchange surface area with the ground: partly because of their absorption of humidity from the ground, and partly because of the condensation of humidity in the air on the cool walls when the temperature falls below the dew point. The water content of these walls therefore lies around 10%, *i.e.*, a factor of approximately 10 or more above that of dry walls of heated rooms built above ground.

6.7.2.2. Excursus

The chemical composition of Portland cement, the most frequently used cement for concrete and water mortar, can be seen in Table 6.

³⁹⁷ W. Czernin, *Zementchemie für Bauingenieure*, Bauverlag, Wiesbaden 1977, pp. 49f.

³⁹⁸ N.V. Waubke, *Transportphänomene in Betonporen*, Dissertation, Braunschweig 1966.

³⁹⁹ In the strongly alkaline environment, iron is passivated by a passive layer of Fe(OH)₃. ‘Botch work’ on building sites, *i.e.*, rusting reinforcement rods and cracking concrete after only a few years or decades, due to overly low pH value in the vicinity of the embedded reinforcement rods, is caused by a) an incorrect composition of the concrete (too little cement—it’s cheaper this way—and/or too much or too little water—incompetence), or b) by installing the reinforcement rods too close to the surface of the concrete, where the pH value falls strongly after a few years or decades; see notes 396f.

⁴⁰⁰ K. Wesche, *Baustoffe für tragende Bauteile*, volume 2, Bauverlag, Wiesbaden 1981, pp. 51f.

Table 6: Composition of Portland cement⁴⁰²

Al ₂ O ₃ : 5 to 10 %	K ₂ O: 0.2 to 0.6 %
SiO ₂ : 20 %	Na ₂ O: 0.5 to 3 %
CaO : 60 %	Fe ₂ O ₃ : < 5 %

The specific surface of the cement powder is in the order of 3,000 cm² per g. Concrete and cement mortar get their stability by hydration of the cement compounds calcium oxide CaO (burnt lime), silicium dioxide SiO₂ (Quartz), iron and aluminium oxide Fe₂O₃/Al₂O₃ to mixed, microfibrinous calcium aluminosilicate-hydrates with a chemically bound water content of some 25 mass %.⁴⁰¹ It then has a specific surface of up to 200 m² per g when measured with water adsorption, which is an extremely high value. Other methods (e.g. BET-measuring with nitrogen) yield a value of only 1/3 of this or less.³⁹⁷ The porosity of mortar and concrete heavily depends on the amount of water added during preparation and lies at a minimum of 27% according to the literature,⁴⁰⁰ in which case the volume of the microcapillary pores between the silicate fibers is included as well, which cannot be determined with mercury penetration measurements.

Aside from the absolute porosity, the pore size distribution is deci-

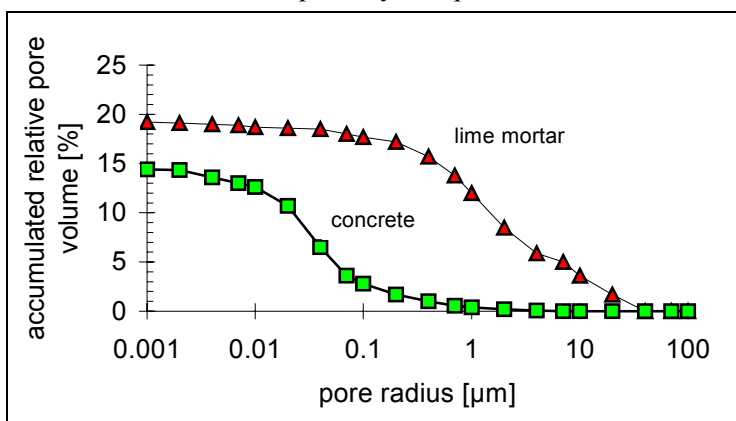

Graph 7: Accumulated pore volume distribution of concrete, according to "Forschungs- und Materialprüfungsanstalt, Abteilung 1: Baustoffe" (Research and Material Testing Agency, Department 1: Building Materials), Stuttgart, and of wall mortar, own analysis. In each case determined by Hg penetration.

⁴⁰¹ Verein Deutscher Zementwerke, *Zement Taschenbuch 1972/73*, Bauverlag, Wiesbaden 1972, pp. 19ff.

⁴⁰² W.H. Duda, *op. cit.* (note 396).

sive for the reactivity towards gases. If the main pore volume is formed by micropores, then the gas diffusion into the material is more inhibited than if the main pore volume is formed by larger pores. Graph 7 shows the accumulated pore volume distribution of concrete and one wall mortar (exact composition unknown, since taken from an old wall, but according to its brittle consistency probably a lime mortar).

Having a similar total pore volume like the wall mortar (here only 14% due to the test method), the concrete's largest portion of pore volume lies between a pore radius of 0.01 and 0.1 μm , whereas the wall mortar's largest portion lies between 0.1 and 10 μm . Hence, if compared with the wall mortar, the gas diffusion into the concrete will be disadvantaged. In general, the average pore size of cement building materials changes to larger values when increasing the content of sand and lime.

Fresh concrete is relatively strongly alkaline, caused by the high content of calcium hydroxide, which, however, gets bound as calcium aluminosilicates rather quickly. However, depending on the type of cement, a certain amount of it is released as time goes by. The pH value of non-carbonated concrete is around 12.5. It later falls, however, due to the binding of carbon dioxide from the air.

The speed of carbonation into the depth of the concrete depends strongly on the consistency and porosity of the material and follows a square root relation.⁴⁰³

$$D = c \cdot \sqrt{t} \tag{5}$$

d = depth of carbonation

c = constant

t = time

In water tight concretes, it takes many years for the limit of carbonation to advance only a few centimeters due to the inhibition of diffusion in this highly compact material.

In the area of carbonation, the pH value decreases to roughly 7, the equilibrium value of saturated calcium carbonate solutions. But if the wall is wet, this results in a proton exchange and therefore no sharp pH border is formed. If a large portion of the air pores (size in the order of a tenth of a millimeter) flooded with water poor in carbon dioxide, the carbonation advances more slowly, because compared to the

⁴⁰³ W. Czernin, *op. cit.* (note 397); Verein Deutscher Zementwerke, *op. cit.* (note 401); N.V. Waubke, *op. cit.* (note 398).

gaseous phase, diffusion in aqueous phases is much slower, by some orders of magnitude. In case of waters rich in carbon dioxide, however, this can accelerate the carbonation.

6.7.3. Lime Mortar

The iron content of lime mortars is based, in particular, on the admixed sand (up to 4 % Fe_2O_3). Lime mortar is manufactured using only burnt lime (CaO), sand, and water and acquires its solidity through the binding of slaked lime (Ca(OH)_2) with atmospheric carbon dioxide to lime (CaCO_3). This procedure takes only days or weeks (depending on the thickness of the particular layers), due to the cruder porous system which facilitates the diffusion of gas. For fresh lime mortar, an extreme high water content can be damaging, as the carbon dioxide necessary for the binding process can no longer penetrate into the wall.

The final pH value of this material lies within the neutral range. Since this medium no longer provides sufficient protection for steel reinforcement rods and offers only slight environmental resistance, it is usually used for the plastering of interior walls and for interior brick walls only, in the latter case often mixed with cement.⁴⁰⁰ The specific surface of lime mortar lies considerably beneath that of cement mortar (up to one order of magnitude).⁴⁰⁴ The water content is similar to cement mortar.

6.7.4. Effects upon the Formation of Iron Blue

The first step in the formation of Iron Blue in masonry is the absorption of gaseous hydrogen cyanide. A cool (10°C) wall in a cellar with atmospheric humidity near the saturation point, due to its higher water content (by a factor of at least 10), has an increased ability (by a factor of 10) to absorb hydrogen cyanide compared to warm walls in a heated room built above ground with lower atmospheric humidity (20°C , 50% rel.).

The second step in the formation of Iron Blue is the ionic split (disassociation) of the hydrogen cyanide, that is, its conversion into simple cyanide.⁴⁰⁵ This procedure requires an alkaline environment,

⁴⁰⁴ The reason: no formation of very finely crystalline aluminosilicate with higher surface area.

⁴⁰⁵ In masonry, this largely corresponds to the neutralization of the hydrogen cyanide by calcium hydroxide Ca(OH)_2 into calcium cyanide Ca(CN)_2 .

which, in lime mortars, lasts only for a few days or weeks, but which are present for months or years in cement mortar and concrete.

The next step is the formation of iron(III)-cyanide, a process that hardly occurs in a strongly alkaline environment and which occurs slowly in slightly alkaline environments. In the neutral range, this reaction is once again slowed down because the cyanide converts into non-reactive, volatile hydrogen cyanide by the humidity in the wall. The environment around the carbonation limit of concrete and mortar (which is slightly alkaline), can therefore be addressed as the area in which iron(III)-cyanide can form easily. In a strongly alkaline area of the masonry, it only arrives at this prior stage of Iron Blue formation through the slow detour of the reduction of slight traces of iron(III)-cyanide to iron(II)-cyanide. A large surface area, as found in cement mortars and concrete, is especially favorable to the solid-liquid interface reaction between solid rust and cyanide in a liquid solution. These generally have the advantage of retaining an alkaline medium for longer periods of time, so that the cyanide accumulated in the masonry is not lost and has enough time to react with rust. Once again, a high water content, which broadens the range of moderately alkaline acid values, is advantageous.⁴⁰⁶ The reduction of a part of the iron(III)-ions to iron(II)-ions finally, the next to last step in Iron Blue formation, requires a moderately alkaline acid value, but also occurs in the strongly alkaline range. A distinction can be made between three areas of different reactivity in masonry:

1. Larger quantities of cyanide ions can accumulate in the non-carbonated portion, due to the alkaline medium, further favored by the increased absorption of hydrogen cyanide by the still-humid material. The cyanide is only bound as iron(III)-cyanide to a slight extent. This is converted quite rapidly into the more stable iron(II)-cyanide due to its strong oxidation behavior in the alkaline medium. An accumulation of iron(III)-cyanide will therefore take place over a longer time period.
2. In the zone of carbonation, the tendency to accumulate cyanide is reduced, since the disassociation equilibrium lies increasingly on the side of the hydrogen cyanide. The oxidation strength of the iron(III)-cyanide is also diminished. On the other hand, the pig-

⁴⁰⁶ Very humid mortars and concretes, due to proton diffusion, exhibit no sharp carbonation, *i.e.*, pH limit.

ment itself now becomes stable, so that increased quantities of iron(II)-cyanide will be converted into Iron Blue, intimately mixed with the lime which is now also forming in this area, with the now somewhat more easily soluble iron(III)-ion at the carbonation limit.⁴⁰⁷

3. In the pH-neutral, carbonated part of the masonry, the formation is considerably dependent on the available cyanide concentration, which is strongly reduced there. Already formed iron(II)-cyanide is gradually converted into Iron Blue in the presence of humidity.

Table 7 shows the adsorption values of hydrogen cyanide in various building materials.⁴⁰⁹ They confirm the assumption of considerably higher reactivity of cements compared to brick, as well as the greater tendency of fresh cement compared to older and generally more humid building materials toward accumulation of hydrogen cyanide. The hydrogen cyanide accumulation in concrete masonry, the age of which is unfortunately not indicated, is astonishingly high. Since by definition there is no considerable difference between the composition of cement mortar and concrete, it is furthermore not clear how the differing analytical results are to be interpreted. These data are therefore not without their difficulties.⁴¹⁰ But at least the tendency of humid masonry to absorb higher

Table 7: Absorption of hydrogen cyanide by various building materials under the effect of 2% HCN by volume over 24 hours.⁴⁰⁹

MATERIAL	HCN [mg m ⁻²]
Terracotta.....	55.2
Brick.....	73.0
Lime sandstone, naturally humid.....	22,740.0
Lime sandstone, briefly dried.....	4,360.0
Lime sandstone, dried approx. ½ year at 20°C.....	2,941.0
Concrete block, dried for 3 days.....	8,148.0
Lime mortar blocks, a few days old*.....	4,800.0
Cement mortar blocks, a few days old*.....	540.0
Cement mortar blocks, a month old*.....	140.0
Cement blocks, pure, a few days old*.....	1,550.0

* 2.5 to 3.3% HCN by volume.⁴⁰⁸ The vol. % data, according to the authors, represent theoretical nominal values, which, in practice, however, are only reached up to 50% or less, through adsorption onto walls and fumigation materials.

⁴⁰⁷ From the CO₂ in the air and the Ca(OH)₂ in the mortar.

⁴⁰⁸ F. Puntigam, *et al.*, *op. cit.* (note 122), pp. 35ff.

⁴⁰⁹ L. Schwarz, W. Deckert, *Z. Hygiene und Infektionskrankheiten*, 107 (1927), pp. 798-813; *ibid.*, 109 (1929), pp. 201-212.

⁴¹⁰ The method cannot establish any possible chemical binding of hydrogen cyanide, since only that fraction of hydrogen cyanide was measured which evaporated from the samples.

quantities of hydrogen cyanide is confirmed (compare lime sandstone: factor 8 at equal temperature and relative atmospheric humidity, but different prior history). W.A. Uglow showed in a detailed series of tests that concrete absorbs approximately four to six times as much hydrogen cyanide as lime mortar. He also found a strong tendency of humid building materials towards increased adsorption of hydrogen cyanide. He also noted a dark blue pigmentation running through the entire concrete sample and did not therefore exclude the possibility of a chemical reaction of the hydrogen cyanide with the material.⁴¹¹

The durability of very high concentrations of hydrogen cyanide over longer periods of time even in dry, chemically bound cement may be seen from Graph 8. Concentrations do not fall below $\frac{1}{4}$ of the initial values even after three days. With daily fumigation lasting several hours, this resulted, in this example, in average HCN concentration in the wall swinging around approximately 100 to 200 mg hydrogen cyanide per m^2 of masonry.

The measurement values in Graph 8 were approximated by a function consisting of two terms:

$$c(t) = 100 \cdot e^{-(t/0.3)} + 100 \cdot e^{-(t/4)} \quad (6)$$

$c(t)$ = HCN concentration at time t
 t = time in days

The first term in the above can be interpreted as desorption from the surface material with a τ ⁴¹² of 0.3 days. The second term describes a slower desorption of hydrogen cyanide with a τ of four days, perhaps caused by the much slower diffusion through the pore water of the samples. Larger errors relating to the drop in concentration described here will be made over longer periods of time because the release of hydrogen cyanide is increasingly inhibited by physical and chemical effects (forming of stable compounds).

An analogous function is assumed by the absorption of hydrogen cyanide:

$$c(t) = 100 \cdot (2 \cdot e^{-(t/0.3)} - e^{-(t/4)}) \quad (7)$$

⁴¹¹ W.A. Uglow, *Z. Hygiene und Infektionskrankheiten*, 108 (1928), pp. 108-123.

⁴¹² τ is the time after which the value has fallen to the $1/e$ -multiple (0.368...) of the initial value.

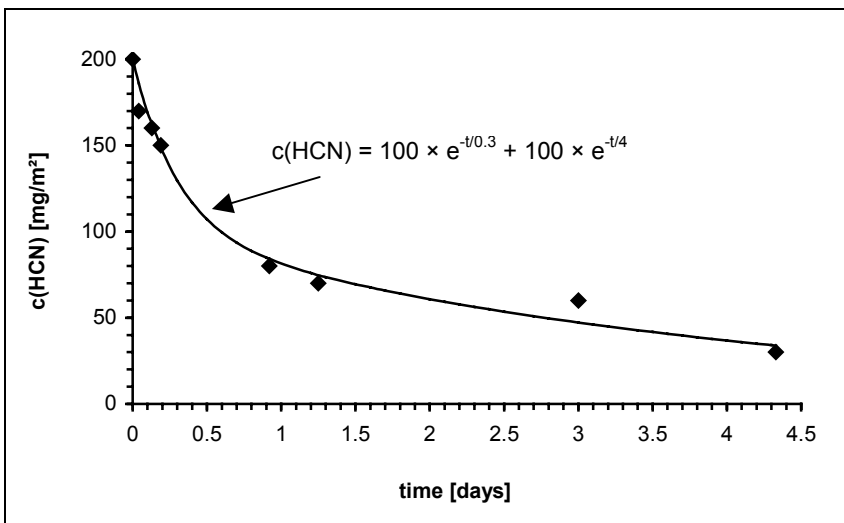

Graph 8: Drop in the hydrogen cyanide concentration in old, dry, cement blocks, after 24-hour fumigation with 2.5% HCN by volume⁴⁰⁹ (see footnote in Table 7, S. 187).

This is only a correct description of the process when the concentration of hydrogen cyanide in air in the room remains constant. The function then reaches its maximum saturation after approximately 20 days. In order to allow for such an approximation, one must reduce the gassing time involved in such a way as to equal real conditions with variable concentrations. In case of a series of consecutive gassings and airings of masonry, a quasi-constant concentration will be reached after 20 cycles as well.

7. Zyklon B for the Killing of Human Beings

7.1. Toxicological Effect of HCN

The effect of hydrogen cyanide is based on the fact that it paralyzes the respiration of every individual cell in the body. Oxygen can no longer be transported from the blood through the cell walls into the cells.⁴¹³ As the vital cell functions are thereby starved of oxygen, the animal or human being suffocates.

Insects and, in particular, insect eggs, are considerably less sensitive to hydrogen cyanide than warm-blooded animals. On the one hand, this is due to their greater resistance (slower metabolism). On the other hand, this is due to the fact that lethal concentrations of the gas must penetrate every crack and fissure, no matter how tiny. Every hem and seam of all the garment in the property to be fumigated must be filled with the poison in order to kill, for example, every concealed louse. Warm-blooded animals, by contrast, are rapidly exposed to high concentrations of the gas, not only because of their size, but above all due to their breathing through lungs.

Lethal doses of cyanide can be ingested orally, inhaled, or absorbed through the skin. Oral poisoning (for example, with potassium cyanide KCN) is very painful due to muscular convulsions caused by cell suffocation. Even though victims of poisoning by inhalation of high concentrations of hydrogen cyanide become more rapidly unconscious than with oral ingestion, painful convulsions caused by muscular suffocation appear in these cases as well. For this reason, execution by use of hydrogen cyanide gas, as performed in some U.S. states, has recently been a topic of much controversy; see chapter 1. A dose of 1 mg cyanide per kg body weight is generally considered lethal. Non-lethal doses of cyanide are quickly decomposed and excreted by the body.⁴¹⁴

⁴¹³ Reversible attachment of the cyanide onto the Fe^{3+} of the cell-specific enzyme of respiration, cytochromoxidase, thereby interrupting the supply of oxygen to the cells, rendering impossible the processes of respiration which are essential for the life of the cell.

⁴¹⁴ Binding onto sulfur (to form rhodanide).

The bright red coloration of the blood and bruised spots, caused by over-saturation of the blood with oxygen, since the blood can no longer give off its oxygen to the cells, are generally considered, among other things, symptomatic of hydrogen cyanide poisoning in fatal cases.^{17,415-}

⁴¹⁷ Testimonies describing a blue or green coloration of the victims are therefore false.⁴¹⁸

Absorption through the skin is especially likely when the skin has become moist, for example, as a result of sweating at work. It is generally advised to avoid sweating during the handling of hydrogen cyanide. In this regard, concentrations from 6,000 ppm⁴¹⁹ (0.6 % by volume) constitute a health hazard, while 10,000 ppm (1% by volume) can cause death in just a few minutes.⁴²⁰

Table 8 shows the effects of various concentrations of hydrogen cyanide, found in the literature.⁴²¹

Table 8: Effect of various concentrations of hydrogen cyanide in air upon human beings

2 to 5 ppm:	Perceptible odor
10 ppm:	Maximum permissible work site concentration, acc. to German law
20 to 40 ppm:	Slight symptoms after a few hours
45 to 54 ppm:	Tolerable for ½ to 1 hour without significant or delayed effect
100 to 200 ppm:	Lethal within ½ to 1 hour
300 ppm:	Rapidly fatal

F. Flury and F. Zernik indicate that 200 ppm can be fatal within five to ten minutes, while 270 ppm are immediately fatal.⁴²⁰ These are not, of course, the results of experiments on human beings, but rather extrapolations, in which lower risk thresholds have been determined on

⁴¹⁵ W. Wirth, C. Gloxhuber, *Toxikologie*, Georg Thieme Verlag, Stuttgart 1985, pp. 159f.

⁴¹⁶ W. Forth, D. Henschler, W. Rummel, *Allgemeine und spezielle Pharmakologie und Toxikologie*, Wissenschaftsverlag, Mannheim 1987, pp. 751f.

⁴¹⁷ H.-H. Wellhöner, *Allgemeine und systematische Pharmakologie und Toxikologie*, Springer Verlag, Berlin 1988, pp. 445f.

⁴¹⁸ This is why Michal Kula's statement about the color of gassing victims—"I saw then that they were greenish", proves that he never saw what he claims he did, see p. 131.

⁴¹⁹ ppm stands for 'parts per million'; here, 1 ppm HCN corresponds to 1 ml HCN per m³ (1,000,000 ml) of air.

⁴²⁰ F. Flury, F. Zernik, *Schädliche Gase, Dämpfe, Nebel, Rauch- und Staubarten*, Berlin 1931, p. 405; see also M. Daunderer, *Klinische Toxikologie*, 30th suppl. delivery 10/87, ecomed, Landsberg 1987, pp. 4ff.; considering the age of the first source as well as the vast amount of literature quoted in chapter 5.2.2., Pressac's claim on page 147 of his first book (note 67) that the lethal dose was not known is completely false. It was also already a known fact in those days that HCN could be absorbed via the skin.

⁴²¹ DuPont, *Hydrogen Cyanide*, Wilmington, Delaware 7/83, pp. 5f.

the grounds of safety. This will be demonstrated in the following. To kill an average person with a body weight of 100 kg, the victim must therefore ingest approximately 100 mg hydrogen cyanide (1 mg per kilo body weight). The respiration of a human being at rest amounts to approximately 15 liters of air per minute.⁴²² With a hydrogen cyanide content of 0.02% (approximately 0.24 mg per liter) the victim must inhale approximately 416 liters of air before ingesting the fatal quantity of hydrogen cyanide. At 15 liters per minute, this will take about half an hour. A very strong person can survive even this period of time. By contrast, a sensitive person weighing 50 kg breathing at an accelerated rate as a result of physical effort or excitement will inhale 40 liters per minute, ingesting a fatal dose of 208 liters of air in five minutes. It is obvious from these calculations, that the data in safety instructions are always intended to protect smaller, weaker people from accidents under the most unfavorable circumstances. The data given in the literature as “*immediately*” or “*rapidly fatal*” doses are furthermore so indefinite as to be unable to satisfy our purposes. In addition, they only refer to the time when a victim has ingested a fatal dose, but not when death occurs, which can sometimes take a very long time.⁴²³

The threshold values will be different if we require even the strongest individual, out of all conceivable individual victims, to die in just a few minutes.⁴²⁴ The concentrations necessary for this purpose will, by its very nature of the thing, be several times higher than the values indicated above. They could only be determined by a series of experiments, which is naturally impossible with human beings. The only data available to us are those gathered during executions with hydrogen cyanide carried out in the United States. Leuchter speaks of concentrations of hydrogen cyanide used in executions in the USA in the order of magnitude of 3,200 ppm. In these cases, death occurs after 4 to 10 minutes, depending on the physical constitution of the victim.⁴²⁵ Press reports from the USA indicate that executions lasting from 10 to 17 minutes are the rule rather than the exception (see chapter 1.1.).

In relation to the quantities used, the US execution gas chamber in

⁴²² Robert F. Schmidt, *Biommaschine Mensch*, Piper, Munich 1979, p. 124.

⁴²³ M. Daunderer, *op. cit.* (note 420), p. 15.

⁴²⁴ Among toxicologists known as the lethal dose for 100% of all victims, LD₁₀₀.

⁴²⁵ F. A. Leuchter, Boston, FAX to H. Herrmann dated April, 20, 1992, as well as private communication from Mr. Leuchter.

Raleigh (North Carolina), for example, is said to use 454 g KCN in half concentrated sulfuric acid, leading to instant formation of hydrogen cyanide vapor, which is even visible for a short period to the witnesses in the witness room and which reaches the victim in seconds.¹ As a matter of pure calculation, this generates approximately 180 g of hydrogen cyanide, corresponding to 150 liters of gas. However, since a considerable part of it remains dissolved in the half concentrated sulfuric acid (approximately 50%, see chapter 8.3.3.4.), we assume in the following that approximately 90 g or 75 liters hydrogen cyanide are released as gas. In North Carolina, this gas arises immediately beneath the victim, so that the victim must be exposed, immediately after the beginning of the execution process, to a concentration which probably exceeds 10% by volume for a short period, but then falls steadily as a result of diffusion of the hydrogen cyanide throughout the chamber.⁴²⁶

At a normal respiration volume of approximately 15 to 20 liter per minute and assuming an average concentration during the execution of only 0.75% by volume, approximately 1.35 to 1.8 grams of HCN will be ingested in 10 minutes (150-200 liters of inhaled air), which corresponds to ten to twenty times the fatal dose. In the following calculations, we will assume a ten-fold overdose only, in order to kill all the people in the chamber, with certainty, in ten minutes.

7.2. Evaporation Characteristics of Zyklon B

Zyklon B does not release its poison gas instantaneously, but rather over an extended period of time. Since this period of time can be decisive for the evaluation both of eyewitness accounts as well as of chemical analyses, it will be investigated more thoroughly in this chapter.

R. Imscher of DEGESCH reported in a paper written in 1942 that, at that time, the use of cardboard discs and gypsum (Ercco) were the most commonly used carrier material.⁴²⁷ The gypsum version was

⁴²⁶ Assuming a volume of 10 m³ in the chamber, 75 Liter HCN corresponds to 0.75% by volume, i.e., somewhat more than double the end values taken by Leuchter.

⁴²⁷ R. Imscher, "Nochmals: 'Die Einsatzfähigkeit der Blausäure bei tiefen Temperaturen'", *Zeitschrift für hygienische Zoologie und Schädlingsbekämpfung*, 1942, pp. 35f.; on the history of the development of Zyklon B, see Wolfgang Lambrecht, "Zyklon B—eine Ergänzung", *VffG* 1(1) (1997), pp. 2-5 (online: www.vho.org/VffG/1997/1/Lambrecht1.html) as well as W. Lambrecht, O. Karl, *op. cit.* (note 105).

used—even according to eyewitness testimony—in the concentration camps.

The evaporation characteristics of this product at various temperatures, low relative humidity of the air, and a fine distribution of the carrier material are reproduced in Graph 9 as given by Irmscher. The evaporation is “seriously delayed” at high atmospheric humidity, because the evaporating hydrogen cyanide withdraws considerable quantities of energy from the liquid HCN, the carrier material, and the ambient air. As a consequence, the temperature of the product and the ambient air drops. If the temperature of the air reaches the dew point, atmospheric humidity condenses out of the air onto the carrier material, which binds the hydrogen cyanide and slows down the evaporation process.

For later references, we want to keep in mind that, at 15°C and in the presence of lower atmospheric humidity, approximately 10% of the hydrogen cyanide used at Auschwitz have left the carrier material during the first five minutes, and approximately 50% after half an hour. In cool cellar areas with a relative humidity of approximately 100%, the evaporation times would have been “seriously delayed”.

The question of how Zyklon B would have behaved if spread on the floor in a room filled with human beings, is somewhat more difficult. The radiant heat of the bodies would have a slightly accelerating effect upon the evaporation by increasing the temperature in the vicinity of the floor. Further acceleration of evaporation may occur due to a possible reduction in size of the carrier granules as a result of being

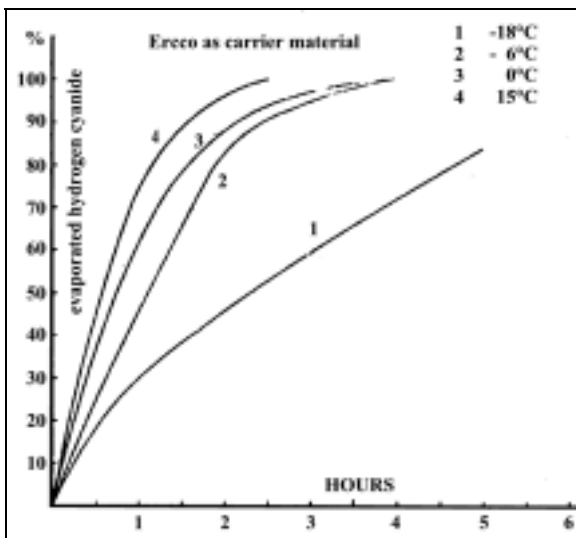

Graph 9: Evaporation rate of hydrogen cyanide from the Ercco carrier material (gypsum with some starch) at various temperatures and fine distribution, according to R. Irmscher/DEGESCH 1942.⁴²⁷

trampled upon or crushed by falling human bodies, as well as direct bodily contact.

The relative atmospheric humidity in the cellars of crematoria II and III, which must certainly have approached 100%, would have “*seriously delayed*” evaporation,⁴²⁸ as well as the possible fluid secretions caused by panic on the part of victims lying on the floor, which could very well have occurred as soon as the door was closed, that is, prior to release of the Zyklon B. Under such conditions, a serious delay in the discharge of the hydrogen cyanide from the carrier material would have to be anticipated.

If assuming that Zyklon B introduction devices were installed in some of the Auschwitz ‘gas chambers’ as attested to by Michal Kula,⁴²⁹ such a device would have had the following effects: a) the Zyklon B granules would not have been spread out, but rather would have been kept together by the inner wire mesh, reducing the evaporation rate considerably; b) all three wire mesh columns would have drastically reduced any air convection within them, reducing both evaporation rate as well as the speed with which the gas spreads out into the chamber; c) due to high humidity in the air and the lack of air convection, moisture would have condensed intensively on the Zyklon B carrier, reducing the evaporation rate of HCN “*seriously.*”

The present study regarding homicidal mass gassings will be based on the conservative assumption that the Zyklon B would at best have behave in the manner described by Irmscher at 15°C (see above).

7.3. The Gassing of Human Beings

7.3.1. Eyewitness Testimonies

7.3.1.1. Boundary Conditions

This chapter will examine a few related eyewitness testimonies for a determination of the chemical, physical, and technical boundary conditions of the alleged homicidal gassings. A complete and detailed analysis of the many eyewitness testimonies in the individual trials and

⁴²⁸ Unheated cellar rooms by their very nature, have very high relative atmospheric humidity. As a result of the large numbers of human beings crammed into the cellar, the atmospheric humidity would certainly approach 100%, resulting in the condensation of water on cold objects.

⁴²⁹ See chapter 5.4.1.2.8., p. 130, for this.

in the literature would be too voluminous to include here.⁴³⁰ The following survey is therefore not complete.

For a clarification of the evidence problems, an extract from the judgment of the Frankfurt Auschwitz Trial may be quoted here.⁸³

“The court lacked almost all possibilities of discovery available in a normal murder trial to create a true picture of the actual event at the time of the murder. It lacked the bodies of the victims, autopsy records, expert reports on the cause of death and the time of death; it lacked any trace of the murderers, murder weapons, etc. An examination of the eye-witness testimony was only possible in rare cases. Where the slightest doubt existed or the possibility of a confusion could not be excluded with certainty, the court did not evaluate the testimony of witnesses [...]

The general findings [...] are based on [...] the credible testimony of witnesses [...] Böck, in addition to the written notes of the first camp commandant Höß.”

In the opinion of the court, many of the witness testimonies possessed insufficient credibility. But it nevertheless succeeded in obtaining testimonies from a few allegedly credible witnesses that sounded sufficiently credible to the court.

Before we analyze some of these testimonies more closely, a few remarks are necessary about the circumstances and the atmosphere in which these testimonies and confessions of alleged victims and perpetrators came about in the first couple of years after the end of World War II. It was in those years that the story of the conveyor-belt like extermination of human beings in Auschwitz and elsewhere was elevated to ‘common knowledge.’ Challenging this story led to a severe increase in legal penalty for any defendant, as it still does to this day in many countries in Europe.

According to reports by Bernard Clarke, who arrested Höß at that time, Höß was tortured after his arrest.⁴³¹ In his autobiography, Höß also reports this and mentioned similar procedures during his Polish

⁴³⁰ See, in this regard, the excellent analysis of J. Graf, *Auschwitz. Tätergeständnisse und Augenzeugen*, *op. cit.* (note 43).

⁴³¹ R. Butler, *Legions of Death*, Arrows Books Ltd., London 1986, pp. 236f.; see: R. Faurisson, “*Comment les Britanniques ont obtenu les aveux de Rudolf Hoess*”, *Annales d’Histoire Révisionniste* 1 (1987) pp. 137-152 (online: aaargh.vho.org/fran/archFaur/1986-1990/RF8703xx1.html); Engl.: “*How the British obtained the confessions of Rudolf Hoess*”, *JHR*, 7(4) (1986), pp. 389 ff. (online: www.vho.org/GB/Journals/JHR/7/4/Faurisson389-403.html); D. Irving, *Nuremberg. The Last Battle*, Focal Point, London 1996, pp. 241-246.

imprisonment.²⁹⁵ According to a report by a US Senator drawn up at that time, mistreatment of German prisoners by Allied personnel was a frequent occurrence.⁴³²

- Burning of the skin;
- Beds of the nails destroyed by ramming matches under the nails;
- Torn-out fingernails;
- Broken teeth;
- Broken jaws;
- Crushed testicles;
- All kinds of wounding by beating with truncheons, brass knuckles, and kicks;
- Confinement while naked in cold, damp, and dark rooms;
- Imprisonment for days in hot rooms without water;
- Mock trials;
- Mock judgments;
- Mock executions;
- Mock priests, and many other methods.

A few voices were raised at that time in the USA clearly stating that the Nuremberg Tribunal was a case of revenge, not justice.⁴³³

These voices spoke of:

- Forced testimony under the threat of punishment;
- Compelled production of all documents to the prosecution;
- Refusal to provide documents or examination of documents for the defense;
- Travel and currency prohibitions against the defense.

A glance at the London Agreement, which established the legal framework for the Nuremberg Trials, reveals two remarkable articles, which are clearly incompatible with the procedures of a state under the

⁴³² Reference is made here to the mock trials held at Dachau by the Americans; see the speech by Senator J. McCarthy, sent to Dachau as an observer on behalf of the U.S. Senate, Congressional Record-Senate No. 134, Sept. 26, 1949, pp. 10397ff., reproduced in full in R. Tiemann, *Der Malmedy-Prozeß*, Munin, Osnabrück 1990, pp. 269ff.; see also F. Oscar, *Über Galgen wächst kein Gras*, Erasmus-Verlag, Braunschweig 1950, pp. 38ff.; R. Aschenauer, *Macht gegen Recht*, Arbeitsgemeinschaft für Recht und Wirtschaft, Munich 1952, pp. 13ff.; Freda Uitley, *Kostspielige Rache*, H.H. Nölke-Verlag, Hamburg ⁷1952, esp. pp. 216ff.; Engl.: Freda Uitley, *The High Cost of Vengeance*, Regnery, Chicago 1949.

⁴³³ See, in this regard in particular, the article in: *New York Times*, Feb. 23, 25, 29; March 6; July 30; Oct. 7, 1948; Jan. 7, March 2, 5; May 5, 1949; *Chicago Daily Tribune*, Feb. 23-26, 28, 29, 1948; March 12; Sept. 13, 1949; *Our Sunday Visitor*, USA, June 14, 1959, 15; *Daily News*, Washington, Jan. 9, 1949; *Sunday Pictorial*, Great Britain, Jan. 23, 1949.

rule of law. Article 19 states:⁴³⁴

“The Tribunal shall not be bound by technical rules of evidence. It shall adopt and apply to the greatest possible extent expeditious and non-technical procedure, and shall admit any evidence which it deems to have probative value.”

while Article 21 states:

“The Tribunal shall not require proof of facts of common knowledge but shall take judicial notice thereof [...]”

For a correct evaluation of Holocaust testimony of the witnesses and the confessions of the defendants, it is essential to pay attention to the boundary conditions under which the so-called NSG trials were held⁴³⁵ and continue to be held.⁴³⁶

7.3.1.2. Eyewitness Fantasies

What is the credibility of the eyewitness testimonies as to content? Reference should be made at this point to a few detailed works on this problem.⁴³⁷ The following is a closer examination of three of the more frequently quoted eyewitnesses: Rudolf Höß, former camp commandant at Auschwitz, Richard Böck, a camp SS man of subordinate rank, as well as Henryk Tauber, former inmate and member of the “*Sonderkommando*” in crematorium II in Birkenau.

The Höß statements may be consulted in the Broszat edition and read as follows:²⁹⁵

“Maintaining the fire at the ditches, pouring the collected fat [over the burning bodies ...] They ate and smoked while dragging corpses [...]” (p. 126)

“The bodies were doused first with oil residues, and later with methanol [...] He also attempted to destroy the bodies with explosives, [...]” (p. 157ff.)

⁴³⁴ Reprinted in its entirety in T. Taylor, *The Anatomy of the Nuremberg Trials*, Little, Boston 1992, pp. 645ff.; probably the best analysis of the trial itself was written by Alexander von Knieriem, *Nürnberg. Rechtliche und menschliche Probleme*, Klett, Stuttgart 1953.

⁴³⁵ NSG = National-Sozialistische Gewaltverbrechen; National Socialist violent crimes.

⁴³⁶ See, in this regard, Manfred Köhler (alias G. Rudolf), “*The Value of Testimony and Confessions Concerning the Holocaust*”, in: E. Gauss (ed.), *op. cit.* (note 22), pp. 85-131 (online: www.vho.org/GB/Books/dth/fndvalue.html).

⁴³⁷ E. Kern, *Meineid gegen Deutschland*, Schütz, Pr. Oldendorf, ²1971; E. Gauss, *Vorlesungen...*, *op. cit.* (note 43); Jürgen Graf, *Auschwitz...*, *op. cit.* (note 43); also: M. Köhler, *op. cit.* (note 436).

“Half an hour after the introduction of the gas, the door was opened and the ventilation installation was turned on. Removal of the bodies began immediately [...]” (p. 166.)

and elsewhere:⁴³⁸

“[...]”

Q But was not it [sic] quite dangerous work for these inmates to go into these chambers and work among the bodies and among the gas fumes?

A No.

Q Did they carry gas masks?

A They had some, but they did not need them, as nothing ever happened. [...]”

Anyone who has ever grilled meat knows that fat cannot be scooped up from burning flesh. Fat ignites at approximately 184°C.⁴³⁹ It is therefore the first thing that burns on a corpse located in a fire. Hence, it is impossible to collect the easily combustible fat during the incineration of a corpse. After all, the bodies were burnt—not grilled.

The incineration of corpses in the open air with combustible fluids is impracticable because fluids have the property of flowing down or away and/or evaporating. When corpses, which consist of more than 60% water, are burnt, this must take place with the expenditure of quite large quantities of fuel and great heat. In particular, open oil or methane combustion would be insufficient.

The alleged attempt to destroy bodies by means of explosives requires no further comment. In reading such testimonies, one must inevitably wonder as to Höß’s mental condition in writing them, as well as that of anyone who takes such claims seriously. Unfortunately, such testimonies are the rule rather than the exception.⁴⁴⁰

Entering the ‘gas chamber’ without a protective filter, eating and smoking in the ‘gas chamber’, as well as the commencement of the corpse dragging operation immediately after the opening of the doors, would only be conceivable if there were no longer any dangerous

⁴³⁸ Henry Friedländer, *The Holocaust*, Vol. 12: *“The ‘finale solution’ in the extermination camps and the aftermath”*, Garland, New York 1982, p. 113, Testimony of R. Höß, taken at Nuremberg, April 2, 1946.

⁴³⁹ J.H. Perry, *Chemical Engineer’s Handbook*, Wilmington Delaware 1949, p. 1584.

⁴⁴⁰ For a more detailed study in this regard, see Arnulf Neumaier, *“The Treblinka-Holocaust”*, in E. Gauss (ed.), *op. cit.* (note 22), pp. 467-495 (online: www.vho.org/GB/Books/dth/fndtreb.html).

quantity of gas in the chamber. The question of whether this was possible will be the subject of chapter 7.3.2.2.

It is interesting to note that M. Broszat deleted the last pages of Rudolf Höß's testimony from his edition, since they contain "*completely erroneous data on the numerical strength of these Jews*", as Broszat himself stated in a footnote. In these pages, Höß speaks of three million Jews in Hungary, four million in Romania, two million in Bulgaria. The actual figures were lower by a factor of approximately ten.⁴⁴¹ In addition, the same pages contain the following, which is also incredible:⁴⁴²

"Although well-cared for and plentifully provided with bonus payments, one often saw them [the Jewish Sonderkommandos] dragging corpses with one hand, and holding and gnawing on something to eat with the other hand.

Even during the horrid work of digging up and burning the mass graves, they did not allow themselves to be disturbed while eating. Even the burning of their closest relatives could not shake them. [...]"

This is really a bit hard to digest.

Another commonly quoted witness is Henryk Tauber. Tauber was, according to his own testimony, a member of the inmate Sonderkommando of crematorium II during the war. J.-C. Pressac writes that this eyewitness testimony is the best in relation to the crematoria, which he considers to be 95% reliable. This testimony contains the following:⁴⁴³

"During the incineration of such [not emaciated] corpses, we used the coke only to light the fire of the furnace initially, for fatty corpses burned of their own accord thanks to the combustion of the body fat. On occasion, when coke was in short supply, we would put some straw and wood in the ash bins under the muffles, and once the fat of the corpse began to burn the other corpses would catch light themselves. [...]"

Later on, as cremations succeeded one another, the furnaces burned

⁴⁴¹ Intensive statistical studies in this regard were undertaken by W.N. Sanning, *op. cit.* (note 41); W. Benz, *Dimension des Völkermords*, Oldenbourg, Munich 1991; see also G. Rudolf, "*Holocaust Victims: A Statistical Analysis* · W. Benz and W. N. Sanning – *A Comparison*", in: E. Gauss (ed.), *op. cit.* (note 22), pp. 183-216 (online: www.vho.org/GB/Books/dth/fndstats.html).

⁴⁴² J. Bezwinska, *KL Auschwitz in den Augen der SS*, Verlag des Staatlichen Auschwitz-Museums, Auschwitz 1973, pp. 135f.

⁴⁴³ Interrogation of Henryk Tauber dated May 25, 1945, annex 18, volume 11 of the Höß trial, quoted acc. to J.-C. Pressac, *op. cit.* (note 67), pp. 489f.; this testimony is not untypical; see also A. Neumaier, *op. cit.* (note 440).

thanks to the embers produced by the combustion of the corpses. So, during the incineration of fat bodies, the fires were generally extinguished. [...]

Another time, the SS chased a prisoner who was not working fast enough into a pit near the crematorium that was full of boiling human fat. At that time [summer 1944], the corpses were incinerated in open-air pits, from which the fat flowed into a separate reservoir, dug in the ground. This fat was poured over the corpses to accelerate their combustion. [...]"

Tauber's claims as to self-igniting, self-combustible corpses are completely absurd, and in contradiction to all the laws of physical and technical sciences.⁴⁴⁴ He also confuses grilling with burning with relation to the allegedly boiling fat from the corpses. What is more, fat cannot boil at all. It simply begins to ignite at temperatures of approximately 180-190°C.

Tauber also proves himself a liar in the technical details related by him. The combustion gases in a crematorium oven stream from the combustion chamber⁴⁴⁵ through the cremation chamber containing the corpse (muffle), through the ash chamber into the flue, which conducts the exhaust gases to the chimney.⁴⁴⁶ If a fire had been ignited in the ash chamber to burn the bodies located above, this would have reversed the flow of gas: fresh air would have been sucked in through the chimney, while the exhaust gases would have flowed through the muffle into the combustion chamber, from which they would have found their way out into the oven room. Starting the fire in the ash chamber, as described by Tauber, would have been disastrous.

On top of this, Tauber also claims that the *Sonderkommandos* shoved extraordinarily many corpses into each oven (up to eight) when they heard Allied planes approaching. Tauber claims that by so doing, huge flames would have come out of the crematorium's chimney, which they hoped would make the Allied bomber pilots aware of them. But as is common knowledge and has been pointed out many times, no

⁴⁴⁴ On the energy requirements in general and in the crematoria of Auschwitz in particular, see C. Mattogno and F. Deana, "*The Crematoria Ovens of Auschwitz and Birkenau*", in: E. Gauss (ed.), *op. cit.* (note 22), pp. 373-412 (online: www.vho.org/GB/Books/dth/fndcrema.html).

⁴⁴⁵ This is the so-called coke gas generator, where coke is burned with reduced oxygen supply, producing a combustible mixture of CO and H₂ (and some CO₂ and H₂O), which burned in the muffle under addition of air.

⁴⁴⁶ J.-C. Pressac, *op. cit.* (note 67), pp. 93ff., chapter on the design and functioning of crematorium ovens built in the German concentration camps at that time.

flames ever come out of crematorium chimneys. It is also impossible to push eight corpses in an cremation muffle whose door is just two feet wide and high.⁴⁴⁷ And apart from that, before Tauber and his co-inmates would have been able to push eight corpses into each oven and get a huge blaze going, any plane they claim to have heard approaching would have long flown far, far away. Such testimonies are, to use Pressac's words, nothing but downright lies and pure invention.⁴⁴⁸

Now to the testimony of the witness Richard Böck as quoted during the Frankfurt tribunal:²⁹⁷

"One day, it was during the winter of 1942/43, H. asked me, whether I wanted to drive with him to a gassing action. [...]"

The transport train, which had already arrived, stood on the free stretch of track. [...]"

They were all loaded, and driven to a former farmhouse. [...]"

After the entire transport—there must have been approximately 1,000 people—was in the building, the door was closed. Finally, an SS man came, I believe it was a Rottenführer, to our ambulance and got out a gas canister. He then went to a ladder with this gas canister. [...] At the same time, I noticed that he had a gas mask on while climbing the ladder. [...] he shook [...] the contents of the canister into the opening. [...] When he had closed the little door again, an indescribable crying began in the chamber. [...] That lasted approximately 8-10 minutes, and then all was silent. A short time afterwards, the door was opened by inmates and one could see a bluish cloud floating over a gigantic pile of corpses. [...] At any rate, I was surprised that the inmate commando which was assigned to remove the bodies, entered the chamber without gas masks, although this blue vapor floated over the corpses, from which I assumed that it was a gas. [...]"

In winter of 1942/1943, no crematorium was operable in Birkenau (the first became operable in spring 1943). For this reason, the alleged victims of homicidal mass gassings in a farmhouse as attested to by Böck are supposed to have been cremated in open-air pits close to this farmhouse.

In view of our previous study of the subject, we can establish:

- According to professional air photo analyses of the decisive loca-

⁴⁴⁷ On cremation technology, see C. Mattogno and F. Deana, *op. cit.* (note 444).

⁴⁴⁸ *Ibid.*, pp. 469ff., on several claims made by the witnesses C.S. Bendel, M. Nyzsli, and H. Tauber.

tions, there were no large cremation ditches, no fuel stockpile, no development of smoke or flames.⁴⁴⁹ Accordingly, the scenario of destruction is obviously false in this regard.

- One thousand people occupy a surface area of at least 200 m². According to eyewitness testimonies, the farmhouses had only half this much surface area, at the most.⁴⁵⁰
- Chapter 7.1.: Hydrogen cyanide is a colorless, invisible gas. Therefore, no “*blue vapor floating over the corpses*” could be seen. This passage is a sign of pure fantasy, obviously suggested by the German name of HCN, “*Blausäure*” (blue acid), which only relates, however, to the formation of the pigment Iron Blue.
- Chapter 7.2.: Since the events described are alleged to have taken place in winter, the rapidity of the procedure is incredible, since Zyklon B only releases gas slowly at frost temperatures.
- The described entry into chambers with a high concentration of toxic gas without a protective filter is impossible; such a manner of procedure would obviously sooner or later be fatal.

German public prosecutor Willy Dreßen had the following to say about Böck’s testimony.⁴⁵¹

“Dear Mr. [...],

I enclose a copy of the eyewitness testimonies of former members of the SS on the gassing of inmates at Auschwitz [...] for your information. They are only a selection—there are numerous other such testimonies. In contrast to yourself, I am of the opinion that these eyewitness testimonies relating to the fact of the occurrence of gassings of human beings, are entirely suitable to refute the denial of this fact.

Faithfully, (Dreßen), Public Prosecutor”

And yet again: “Dear Mr. [...],

[...] Furthermore, the testimony of B ö c k is only one of numerous similar statements [...]

Faithfully, (Dreßen), Public Prosecutor”

⁴⁴⁹ See also J.C. Ball, *op. cit.* (note 43).

⁴⁵⁰ J.-C. Pressac, *op. cit.* (note 67), pp. 161ff.

⁴⁵¹ Letter from public prosecutor Willy Dreßen, Zentrale Stelle der Landesjustizverwaltung Baden-Württemberg, Ludwigsburg, ref. 110 AR 916/89, July 26, 1989, and Oct. 11, 1989, respectively; see also the book by Ernst Klee, Willy Dreßen, *Schöne Zeiten*, S. Fischer, Frankfurt 1988; Engl.: *The Good Old Days*, Free Press, New York 1991.

Böck's testimony was one of the few which the Frankfurt tribunal considered credible after careful examination, that is, the inconsistencies would not be so easily recognized by the layman, in contrast to the many other testimonies. And yet it is entirely incredible.

Pressac himself becomes very critical in quite a few of his passages relating to the reliability and credibility of eyewitness testimonies;⁴⁵² yet it is upon these eyewitness testimonies that all the descriptions of the 'gas chamber' killings are based. He lists the untruths, impossibilities, and exaggerations of the witnesses and explains how they presumably materialized. Finally, in an interview, he said:⁴⁵³

"No, no. One cannot write serious history based only upon eyewitness testimonies."

At the same time, however, he bases all of his remarks on the alleged existence of homicidal 'gas chambers' exclusively on these eyewitness testimonies! And elsewhere, he states, with a naiveté which can hardly be surpassed:⁴⁵⁴

"Witnesses never lie, but they can be mistaken."

Pressac seems to be the only person of the establishment who takes notice of the progress of revisionist research. He knows that traditional historiography of the Holocaust is reduced to absurdity by the facts revealed by this research. Consequently, he keeps changing his attitude when making public statements. The most vehement attack of the media darling Pressac on the dominating historiography occurred during an interview published as an appendix to a PhD thesis analyzing the history of Holocaust revisionism in France. In it, Pressac described the established historiography of the Holocaust as "rotten" and stated:⁴⁵⁵

"Can we alter the course? It is too late. A general correction is factually and humanely impossible [...]. New documents will unavoidably turn up and will overthrow the official certainties more and more. The current view of the world of the [National Socialist] camps, though tri-

⁴⁵² J.-C. Pressac, *op. cit.* (note 67), pp. 124-128, 162, 174, 176f., 181, 229, 239, 379f., 459-502.

For additional eyewitness testimonies, see also note 442 and E. Kogon *et al.*, *op. cit.* (note 42), pp. 194-239.

⁴⁵³ *Focus* no. 17/1994, pp. 118, 120.

⁴⁵⁴ *Die Woche*, Oct. 7, 1993, p. 8

⁴⁵⁵ In: Valérie Igounet, *Histoire du négationnisme en France*, Editions du Seuil, Paris 2000, p. 652. I thank R. Faurisson, who made me aware of this interview.

umphant, is doomed. What of it can be salvaged? Only little.”

In his first and so far most comprehensive book, Pressac is compelled to correct the statements of witnesses in many cases in order to eliminate errors and, in his opinion, technical impossibilities. But when so doing, he never reveals the basis upon which he undertakes these corrections. In actual fact, he merely replaces the capriciousness of ‘eyewitnesses’ with his own. Thus, the numbers of victims per gassing procedure, as estimated by Pressac, for example, are considerably lower than those estimated in the eyewitness statements, which often speak of several thousand victims per gassing operation per day for crematoria II and III. One thousand people could only have been made to enter a cellar with a surface area of 210 m² under the maintenance of extraordinary discipline accompanied by a readiness to co-operate(!) on the part of the victims (see chapter 7.3.2.1.1.). The numbers of people reported in places by witnesses, on the other hand (2,000 and more⁴⁵⁶) could not have been contained by morgue 1. To arrive at the number of victims of Auschwitz-Birkenau, as spread by sensationalist media and literature until the late 1980s—four million—one is in fact compelled to resort to technically impossible figures of ‘gas chamber’ occupancy, as the witnesses do. At the moment, the official estimates range from approximately 1 to 1½ million victims,⁴⁵⁷ though in his second book, Pressac downgraded the ‘gas chamber’ victims to 630,000⁴⁵⁸ and later even further down to 470,000-550,000,⁴⁵⁹ and in an article published in a small German periodical in early 2002, a German mainstream journalist attempted to reduce the death toll of the Auschwitz ‘gas chambers’ down to as little as 356,000.⁴⁶⁰ But as long as this revolutionary development is not accepted by most scholars, we will stick to the number of one million ‘gas chamber’ victims for all further considerations.

⁴⁵⁶ 2,000 according to R. Höß (H. Friedländer, *op. cit.* (note 438), S. 112), as well as C.S. Bendel, 3,000 according to M. Niyzli, see note 448.

⁴⁵⁷ On the correction to the number of victims in 1990, see also Werner Rademacher, “Die Wandlungen der Totenzahl von Auschwitz”, *VffG* 3(3) (1999), pp. 256-267 (online: www.vho.org/VffG/1999/3/Rademacher256-267.html); Robert Faurisson: “Wieviele Tote gab es in Auschwitz?” *VffG* 3(3) (1999), pp. 268-272 (online: www.vho.org/VffG/1999/3/Faurisson268-272.html).

⁴⁵⁸ J.-C. Pressac, *Les crématoires d’Auschwitz*, *op. cit.* (note 90), p. 147.

⁴⁵⁹ J.-C. Pressac, *Die Krematorien von Auschwitz*, *op. cit.* (note 90), p. 202.

⁴⁶⁰ F. Meyer, *op. cit.* (note 312). For an overview of the wide range and development of claims about the Auschwitz death toll, see Robert Faurisson, “How many deaths at Auschwitz?”, *The Revisionist*, 1(1) (2003), pp. 17-23 (www.vho.org/tr/2003/Faurisson17-23.html).

The following is a description of the homicidal gassing procedures for the individual installations, if one were to assume that one million human beings were actually gassed:

- Crematorium I: Blocking the crematorium environs to third parties; 500-700 victims undressing in open air (what a spectacle for all other inmates!); entry into 'gas chamber' (morgue) near oven room; on their way to the 'gas chamber,' victims march past piles of corpses of earlier victims; introduction of Zyklon B through pillars with utilization of gas masks after closure of doors; turning on of ventilators (if available) and opening of doors after death of victims (approximately five min.); evacuation of chambers without gas masks; removal and cremation of victims.⁴⁶¹ According to Pressac only a few gassings, with a total of only 10,000 victims.⁴⁶²
- Crematoria II/III: Entry of 800 to 1,200 victims into western entrance stairway into crematorium II; undressing in undressing cellar; travel through stairwell into morgue 1 ('gas chamber'); introduction of Zyklon B through pillars with utilization of gas masks; turning on ventilators after death of victims (approximately five min.); opening of doors after approximately 20 minutes; hosing down of corpses, soiled with blood, vomit, and excrement; removal of bodies without utilization of gas masks; cutting of hair and removal of gold teeth while bodies are still in cellar; transport with lift (payload 1.5 tons) to ground floor; there, transport through water-filled channels to ovens; cremation.³⁰² Approximately 400,000 victims for crematorium II, 350,000 for crematorium III according to Pressac.⁴⁶³
- Crematorium IV/V: Undressing of a few hundred victims in open air (again: what a spectacle for all other inmates!),

⁴⁶¹ J.-C. Pressac, *op. cit.* (note 67), p. 125.

⁴⁶² *Ibid.*, pp. 131f.

⁴⁶³ *Ibid.*, p. 187.

otherwise in morgue, some of them next to corpses of last gassing victims awaiting cremation; entry into ‘gas chambers’ past coal room and doctor’s office; evacuation of the entire building; introduction of Zyklon B through hatches from a ladder after closure of door(s); opening of doors after 15 to 20 minutes; removal of corpses to morgue or to cremation ditches behind crematorium V by the Sonderkommando, some of them wearing gas masks, some not. According to Pressac, the number of victims can only be estimated with difficulty, probably approximately 100,000.⁴⁶⁴ A similar scenario applies to farmhouses I and II (see chapter 5.4.3.).

7.3.1.3. Quantities of Poison Gas

7.3.1.3.1. Overview

Opinions differ as to the concentration of poison gas alleged to have been used in the presumed executions (see next chapter). The only indirect source available to us are the alleged execution times reported by the eyewitnesses, which in turn permit a crude estimate of the concentrations used. These reported execution times all allege a gassing time of only a few minutes.⁴⁶⁵

⁴⁶⁴ *Ibid.*, pp. 384-390.

⁴⁶⁵ With relation to the killing times, see in, for example: Schwurgericht Hagen, verdict from July 24, 1970, ref. 11 Ks 1/70, p. 97 (5 min.); Final Trial Brief of the Prosecution, quoted acc. to U. Walendy, *Auschwitz im IG-Farben-Prozeß*, *op. cit.* (note 157), pp. 47-50 (3 to 15 minutes in extreme cases); E. Kogon *et al.*, *op. cit.* (note 42), ubiquitous (immediately up to 10 min., more rarely, up to 20 min.); J. Buszko (ed.), *Auschwitz, Nazi Extermination Camp*, Interpress Publishers, Warschau ²1985, in cooperation with the Auschwitz State Museum, pp. 114 + 118 (a few minutes); H.G. Adler, H. Langbein, E. Lingens-Reiner (ed.), *Auschwitz*, Europäische Verlagsanstalt, Cologne ³1984, pp. 66, 80 + 200 (a few minutes, up to 10 minutes); Hamburger Institut für Sozialforschung (ed.), *Die Auschwitz-Hefte*, vol. 1, Beltz Verlag, Weinheim 1987, pp. 261ff. +294 (instantly, up to 10 min.); C. Vaillant-Couturier, in: *Der Prozeß gegen die Hauptkriegsverbrecher vor dem Internationalen Militärgerichtshof Nürnberg (IMT)*, vol. VI, p. 242 (5 to 7 min.); M. Nyzsli in: G. Schoenberner (ed.), *Wir haben es gesehen*, Fourier, Wiesbaden 1981, p. 250 (5 min.); C.P. Bendel in: H. Langbein, *Menschen in Auschwitz*, Europaverlag, Vienna 1987, p. 221 (end of screaming of victims after 2 min.); P. Broad in: B. Naumann, *Auschwitz*, Athenäum, Frankfurt/Main 1968, p. 217 (4 min.), opening of doors after 10-15 minutes: A. Rückerl, *NS-Verbrechen vor Gericht*, C.F. Müller, Heidelberg, ²1984, pp. 58f.; K. Höltinger in: H. Langbein, *Der Auschwitz-Prozeß*, Europäische Verlagsanstalt, Frankfurt/Main 1965, p. 73 (1 min.); R. Böck, *ibid.*, p. 74 (screaming victims for 10 minutes following closure of doors, followed by opening of doors, cf. note 297); H. Stark, *ibid.*, p. 439

Assuming an execution time approximately corresponding to those in US execution gas chambers (ten minutes and more at 3,200 ppm HCN, see chapter 7.1.), a concentration of at least 3,000 ppm (3.6g/m³) would have had to have reached even the remotest corner of the chamber after only half this time (five minutes). With a free volume of 430 m³ in morgue 1 of crematoria II and III,⁴⁶⁶ this corresponds to a quantity of hydrogen cyanide of approximately 1.5 kg released and spread out after five minutes. Since the carrier material only releases approximately 10% of its hydrogen cyanide content after five minutes (see chapter 7.2.), at least ten times that amount would have been required in order to kill in only a few minutes, *i.e.*, this would mean the utilization of at least 15 kg of Zyklon B.⁴⁶⁷ This, of course, only applies on the condition that the hydrogen cyanide released reached the victims immediately, which cannot be expected in large, overcrowded

(screaming victims for 10-15 minutes); F. Müller, *ibid.*, p. 463 (8-10 min.); E. Pyš, *ibid.*, p. 748 (ventilators switched on after only a few minutes); K. Lill, *ibid.*, p. 750 (a scream a few seconds after the introduction of Zyklon B, pall of thick smoke exiting the chimney a few minutes later); transcript of the expert opinion of Prof. Dr. G. Jagschitz, 3rd-5th hearing days of criminal proceedings against Gerd Honsik, April 4., April 30, May 4, 1992, ref. 20e Vr 14184 and Hv 5720/90, District Court Vienna, p. 443 (2-3 min); Dokument 3868-PS, IMT volume 33, pp. 275ff., quoted according to L. Rosenthal, "Endlösung der Judenfrage", *Massenmord oder "Gaskammerlüge"?*, Verlag Darmstädter Blätter, Darmstadt 1979 (2 to 15 minutes in exceptional cases); R. Höß, *op. cit.* (note 295: 30 minutes for the entire procedure, including ventilation); Hans Münch, in G. Rudolf, "Auschwitz-Kronzeuge Dr. Hans Münch im Gespräch", *VffG*, 1(3) (1997), pp. 139-190 (2 to 5 min. in winter) (online: www.vho.org/VffG/1997/3/RudMue3.html); Salmen Lewenthal, *Hefte von Auschwitz*, Sonderheft 1, *Handschriften von Mitgliedern des Sonderkommandos*, Verlag Staatliches Museum Auschwitz, 1972, p. 155 (sudden silence); Dov Paisikovic, in: Léon Poliakov, *Auschwitz*, René Julliard, 1964, pp. 159ff. (3-4 minute), Franke-Gricksch Report, in: J.-C. Pressac, *op. cit.* (note 67), p. 238 (one minute to kill the victims, another until the doors were opened); Rudolf Vrba alias Walter Rosenberg, Alfred Wetzler, ref. M 20/153, Yad Vashem (acc. to War Refugee Board, "German Extermination Camps—Auschwitz and Birkenau", in David S. Wyman (ed.), *America and the Holocaust*, volume 12, Garland, New York/London 1990, p. 20 (evening in the room was dead after three minutes); Jerzy Tabeau, in: *The Extermination Camps of Auschwitz (Oswiecim) and Birkenau in Upper Silesia* (10 minutes, quoted according to Enrique Aynat, *Los protocolos de Auschwitz. i Una fuente historica?* Verlag Garcia Hispan, Alicante 1990); André Lettich, *Trente-quatre mois dans les Camps de Concentration*, Imprimerie Union Coopérative, Tours, 1946 (a few moments). Janda Weiss, in David E. Hackett, (ed.), *The Buchenwald Report*, Beck, Munich 1997, p. 394 (3 min.). If longer killing times appear in the eyewitness testimonies, they refer, not to crematoria II and III, but, rather, to crematoria IV/V, bunkers 1-2, or crematorium I in the Main Camp. The killings in crematoria II and III are therefore alleged to have been committed very quickly.

⁴⁶⁶ 504 m³ empty volume of the cellar minus 75 m³ occupied by 1,000 persons.

⁴⁶⁷ At least because the initial evaporation of the hydrogen cyanide would have led to an immediate condensation of the environmental humidity onto the carrier, more or less interrupting the further evaporation of hydrogen cyanide; see also chapter 7.2.

cellars. It must therefore be considered established that quantities of at least 20 kg of Zyklon B per gassing (ten 2 kg cans or twenty 1 kg cans) would probably have had to have been used for the gassing procedures described.

Let us state that the scenarios described by the witnesses would require a quick increase in the concentration of hydrogen cyanide *everywhere* in the chamber. At the same time, logically, there cannot have been a simultaneous drop in the hydrogen cyanide in the chamber—such as through the respiration of the victims. Such a loss in hydrogen cyanide would have had to have been overcompensated for through an even more rapid evaporation of fresh hydrogen cyanide, because the hydrogen cyanide concentration would have *had* to increase for rapid executions. After the end of respiration due to increasing numbers of dead victims, who died in a matter of minutes, this most important cause of a loss in hydrogen cyanide would have ceased to exist as a factor. But since Zyklon B continues to give off large amounts of hydrogen cyanide for many more minutes, it must be assumed that the hydrogen cyanide content in such chambers would continue to increase constantly, and very rapidly, during the first quarter hour at least. Since deadly concentrations (3,200 ppm) would have had to have been reached even in the remotest corner of the chamber even after a few minutes, this means that the hydrogen cyanide concentration inside the chamber after approximately one quarter hour would have exceeded 10,000 ppm and would have continued to rise thereafter—slowly, of course, but nevertheless constantly at all times.

To assume that the respiration of the victims locked in the chambers would have been capable of perceptibly reducing the concentration of hydrogen cyanide in the air is therefore entirely in contradiction to the eyewitness statements.⁴⁶⁸ In particular, this would have to assume that the victims, confined in the chamber, could have acted as quasi-living filters for the greater proportion of the time during which the Zyklon B was releasing hydrogen cyanide (at least one hour). But one thousand people locked in a hermetically sealed cellar would have died in an hour from lack of oxygen alone.

These considerations show that a concentration of hydrogen cya-

⁴⁶⁸ Such is, for example, the hypothesis brought forth by G. Wellers, *op. cit.* (note 55), which is similarly incorrect in its findings, due to the incorrect hypothesis that lower quantities of Zyklon B were used: J. Bailer, *op. cit.* (note 52); W. Wegner, *op. cit.* (note 49).

nide in morgue 1 of crematoria II and III during the alleged gassings would have had an effect on the masonry which would have been at least as great as that occurring during disinfestation. High rates of hydrogen cyanide absorption would have to be expected during these periods, particularly on the cool and moist masonry of cellars in crematoria II and III. The duration of the gassing period would have depended above all on the subsequent ventilation, which will be examined below.

7.3.1.3.2. Excursus 1: Poisoning or Suffocation?

Because eyewitness statements about the amount of Zyklon B are rare, and since humans are more sensitive to HCN than insects (see chapter 7.1.), some scholars opine that only small amounts of Zyklon B were used for the alleged mass murders in Auschwitz, for example J. Bailer,⁵⁴ W. Wegner,⁴⁹ and G. Wellers,⁵⁵ who assume an applied concentration of 1 g per m³ (0.083 Vol.%) or less.

The few witnesses statements we have, however, claim that several kilograms of Zyklon B were used.⁴⁶⁹ In his book, Pressac frequently refers to a HCN concentration of 12 g per m³ or 1 vol.% used for executions.⁴⁷⁰ He backs this up with many witness accounts, according to which four to six 1-kg cans of Zyklon B were allegedly poured into the ‘gas chambers’ (morgues) of crematorium II and III, which indeed corresponds to a concentration of 1 vol.%.³⁰²

Pressac, on the other hand, assumes that 95 to 98% of the entire Zyklon B delivered to the camp were used for the original purpose, *i.e.*, for delousing clothes and rooms,⁴⁷¹ for which he relies on statements from the Nuremberg tribunal.⁴⁷² Pressac justifies this with the fact that, in relation to other concentration camps, where doubtlessly no exter-

⁴⁶⁹ J. Buszko (ed.), *op. cit.* (note 465), p. 118: 6 to 12 kg; Léon Poliakov, *Harvest of Hate*, Greenwood Press, Westport, Conn., 1971, p. 205: 5-7 kg; an analysis of the eyewitness statements has been undertaken by D. D. Desjardin: “*Kenneth Stern’s Critique of The Leuchter Report: A Critical Analysis*”, online: codoh.com/newvoices/nddd/ndddstern.html. The analysis does not, however, take account of the slow release of hydrogen cyanide by the carrier material. See also Desjardin’s interview with F. Piper, *op. cit.* (note 164), where Piper talks about 6 kg per 1,400 victims.

⁴⁷⁰ J.-C. Pressac, *op. cit.*, p. 18.

⁴⁷¹ J.-C. Pressac, *op. cit.*, pp. 15 and 188.

⁴⁷² Office of Chief of Counsel for War Crimes, British Military Tribunal, trial against B. Tesch *et al.*, Hamburg March 1-8, 1946, Document No. NI-12 207, quoted acc. to: U. Walendy, *op. cit.* (note 157), p. 83. Note: No staff member of the former Zyklon B producers was ever convicted, because there was no evidence linking them to a crime: Degussa AG (ed.), *Im Zeichen von Sonne und Mond*, Degussa AG, Frankfurt/Main 1993, pp. 148f.

mination took place, the Auschwitz camp did not receive higher amounts of Zyklon B deliveries, if seen in relation to the number of inmates and in relation to the material delousing facilities that doubtlessly operated there.

The supply figures of the Auschwitz camp can be found in the protocols of the International Military Tribunal Nuremberg. In total, they reached some 19,000 kg during the years 1942 and 1943.¹⁵⁷ The total supplied amount during the entire existence of the camp from late 1940 to early 1945 will hardly have exceeded 40 tons. According to Pressac's statement that not 2-5% of this was used for killings, 800 to 2,000 kg of the total delivery was used for extermination of humans.

But when dividing up this amount of Zyklon B for one million people allegedly killed with it, with 1,000 victims per gassing—the 'gas chambers' (morgues I) of crematorium II and III could hardly hold 1,000 persons per execution—only roughly 0.8 to 2 kg HCN was available for each gassing. With the morgues' free volume of roughly 430 m³,⁴⁶⁶ and after all hydrogen cyanide had evaporated from the carrier (after more than an hour), 800 to 2,000 g of hydrogen cyanide would result in a theoretical end concentration of 1.86 to 4.65 g per m³, which means that the concentration during the first five or ten minutes was much lower.

If, on the other hand, one million victims were killed according to the eyewitness statements, *i.e.*, with high concentrations in a few minutes, those 1,000 gassing would have required 1,000×20 kg = 20 tons of Zyklon B, or at least 50% of the entire Zyklon B delivery to the camp.

This shows an obvious inconsistency in Pressac's statements. One cannot have both high concentrations during homicidal gassings and a low percentage of the entire Zyklon B delivery to Auschwitz used for these gassings.

Let us now have a closer look at the theory endorsed by J. Bailer,⁵⁴ W. Wegner,⁴⁹ and G. Wellers,⁵⁵ that only a small amount of HCN was used for the killings. In such a case, the concentration reduction due to the respiration of the victims is no longer a negligible quantity.

Per capita, the respiration of HCN is the higher, the higher the applied concentration is. The reason for this is that although the victim incorporates lethal amounts of hydrogen cyanide in short periods of time in case of high concentrations, their organism's reaction is delayed. During this delay, the victim incorporates more overdoses of

hydrogen cyanide.

Graph 10 shows the behavior of the breathing volume per minute of persons dying of suffocation or poisoning (biochemical suffocations). Respiratory arrest occurs at the end of this period of time (at 5). Death occurs only several minutes after respiratory arrest. If one assumes a time period of 5 minutes until respiratory arrest, the assumed breathing volume during each single minute is: 1.: 20 l; 2.: 30 l; 3.: 50 l; 4.: 80 l; 5.: 30 l.⁴⁷² In total, this yields a breathing volume of ca. 210 l. Furthermore, we assume that the function is independent of the length of time until respiratory arrest. This means that the double amount of air is inhaled if the time period would be doubled.

Regarding morgue 1 ('gas chamber') of crematorium II, we have the following data: Volume: 504 m³; volume of 1,000 persons: ca. 75 m³; resulting free air volume: ca. 430 m³. First, the oxygen content in the room may be studied. In Table 9, the total inhaled volume of 1,000 victims is given in m³ and multiples of the free air volume as a function of time. The average oxygen content is reduced by 20-30% per inhalation. This results in the remaining oxygen content in the chamber as given in the last two columns. Oxygen contents below 6% are lethal.⁴⁷³ So, even without adding any toxic gas, we have to reckon with the victims being suffocated in an airtight chamber already after some 45-60 minutes.

If one increases the number of locked-up persons, this process is accelerated accordingly. However, if there were Zyklon B holes in the morgues I of crematorium II and III during wartime, contrary to the results achieved before, these rooms could not be sealed off in an air tight

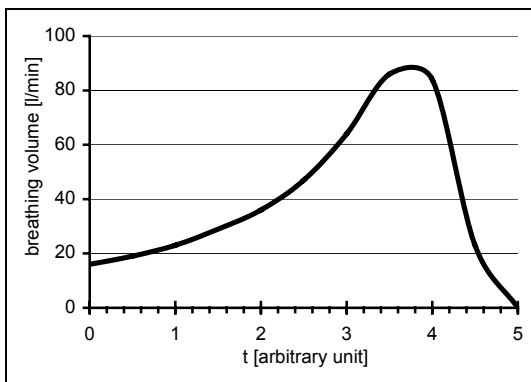

Graph 10: Schematic representation of the breathing volume behavior relative to time in case of suffocation/poisoning.

⁴⁷³ Y. Henderson, H.W. Haggard, *Noxious Gases*, Reinhold Publishing, New York 1943, pp. 144f.; J.S. Haldane, J.G. Priestley, *Respiration*, Yale University Press, New Haven 1935, pp. 223f.

Table 9: Reduction of O₂ content
in air-tight morgue 1 as a function of time

Time until respiratory arrest [min]	Inhaled volume of 1,000 victims [m ³]	in free volumes of the room	Reduction of O ₂ content (30% per Inhalation)	Reduction of O ₂ content (20% per inhalation)
5	210	0.5	17.9	18.9
10	420	1	15	16.8
20	840	2	10.5	13.4
30	1,260	3	7.4	10.8
45	1,890	4.5	4.2 (lethal)	7.8
60	2,520	6		5.5 (lethal)
120	5,040	12		

manner. Also, small amounts of air would have seeped into the interior through the ventilation shafts.

Due to the extremely high capability of the lungs to absorb HCN, the human lung acts like a perfect filter which absorbs all hydrogen cyanide out of the air. Taking the experiences of US execution ‘gas chamber’ as a base, death occurs after some 10 minutes at the earliest in case of an application of ca. 4 g HCN per m³. In assuming a total inhaled volume of ca. 210 l, this corresponds to an incorporated amount of HCN of ca. 800 mg, which is a tenfold overdose of the lethal dose (80 mg/person). In the following, it is assumed that an execution lasting several hours, no overdoses of HCN are incorporated. Using these benchmark figures, a relation between incorporated overdose and execution time results as shown in Graph 11.

The HCN content in the air of a room decreases similarly by breathing as by ventilation (exponential behavior, see chapter 7.3.2.2.2.). If the victims have inhaled the entire room volume

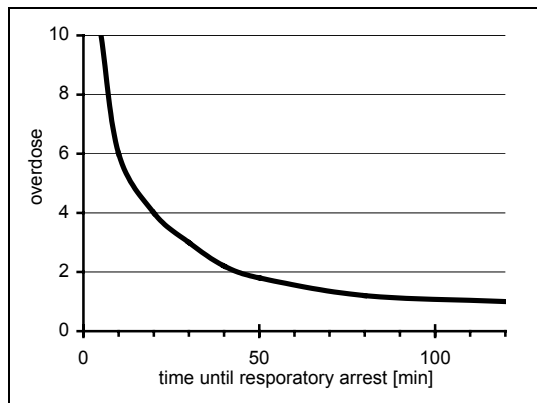

Graph 11: Incorporated amount of HCN as function of time until respiratory arrest in overdoses of lethal dose (ca. 80 mg).

Table 10: Amount of hydrogen cyanide as a function of execution time

(lethal dose = 80 mg/person = 80 g/1,000 persons)

Time until respiratory arrest [min]	Over-dose	Inhaled Amount of HCN [g]	Portion of released HCN [%]	released amount of HCN from carrier [g]	Applied Zyklon B (15°C) [g]	HCN _{inhaled} /HCN _{applied} [%]
5	10	800	40	2,030	28,600	3
10	6	480	63	760	5,000	10
20	4	320	86	370	1,230	26
30	3	240	95	252	625	38
45	2	160	99	161	320	50
60	1.5	120	100	120	200	60
120	1	80	100	80	100	80

once, the HCN content will be reduced to ca. 37% of the initial value. As a function of time passed until respiratory arrest occurs, Table 10 shows, how much HCN was incorporated by the victims in total (column 3), which portion of the total content of HCN in the air this is (column 4), how much HCN had been released in total (column 5), and how much Zyklon B at a carrier temperature of 15°C had to have been applied to release that much HCN as is required in this period of time. The last column shows the ratio of the inhaled amount of HCN and the applied amount. In so doing, it was assumed that the HCN concentration was available to every victim right from the start. In reality, the applied amount of hydrogen cyanide had to be a bit higher than assumed here (delay due to release and distribution of hydrogen cyanide).

According to testimonies, the execution times until all victims were dead were shorter than 10 minutes.⁴⁶⁵ When considering the delays caused by the release of the gas and its distribution, as well as the fact that death occurs only several minutes after respiratory arrest, the first two lines of Table 10, corresponding to execution times of ca. 10 and 15 minutes, respectively, are at the upper limit of witness accounts. This means that an execution within a few moments or minutes would have required enormous amounts of Zyklon B. Such witness accounts are therefore unrealistic. Furthermore, it must be assumed that, with the execution times attested to, only a fraction of the applied (<10%) and at the execution time released amount of hydrogen cyanide (<60%) actually could have been incorporated by the victims. The rest

was available to react with the walls, among other things. Therefore, one has to reckon with high adsorption rates of hydrogen cyanide especially at the cool and wet walls of the cellars of crematorium II and III, contrary to Weller's hypothesis, according to which this is not supposed to happen.⁵⁵ According to his opinion, the little amounts of hydrogen cyanide applied were supposedly inhaled entirely. This contradicts the witness accounts of the quick 'gas chamber' death which required large amounts of hydrogen cyanide.

Finally, the application of small amounts of hydrogen cyanide of an end concentration of only $1\text{g}/\text{m}^3$, *i.e.*, the use of only some 400 g Zyklon B per gassing, would have been senseless, if the facilities were indeed air-tight, which would have been imperative for their use as a mass 'gas chamber'. This is, because the victims would have died in a similar period of time due to lack of oxygen anyway (cf. Table 9).

7.3.1.3.3. Excursus 2: HCN Loss due to Adsorption

It is worth taking a look into the HCN losses caused during disinfestations due to adsorption on walls and clothes, as well as due to leaks. Puntigam *et al.*¹²² describe the hydrogen cyanide concentration behavior at different locations of a delousing chamber with and without air circulation ("Kreislaufverfahren"). Puntigam neither gives measures and loading of the chamber, nor the type of carrier material and its distribution, nor the temperature. Since the different measuring

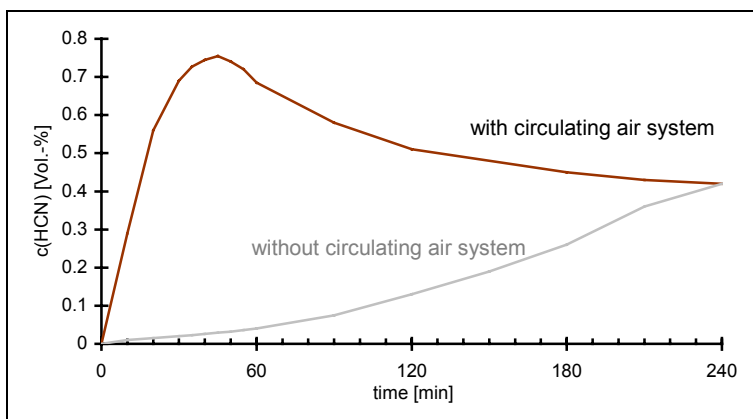

Graph 12: Hydrogen cyanide concentration behavior in delousing chamber with and without circulating air systems, measuring points always in center of room (intern. correspondence of DEGESCH; values at various points differed greatly).¹²²

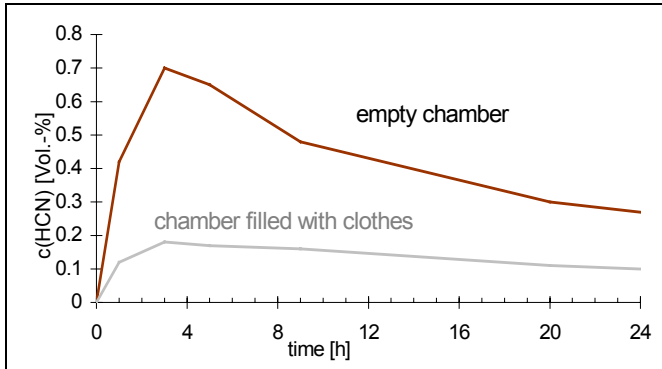

Graph 13: Hydrogen cyanide concentration behavior in disinfestation chamber with and without clothes at room temperature.⁴⁰⁹

points show different concentrations peaks, this indicates a non-even distribution of the products in the chamber. For the sake of clarity, only the concentration behavior in the center of the room is reproduced in Graph 12.

The loss of hydrogen cyanide as a function of temperature in a disinfestation chamber can be seen in Graph 14. The higher losses at lower temperatures is caused by a higher moisture content in the gassed material and in the walls of the observed room.¹²³

According to the already quoted publication by Schwarz *et al.*,⁴⁰⁹ their measurements were made in the range of room temperature. Although the interesting part of Graph 13 is only poorly resolved, it is nevertheless clear that under these circumstances the maximum concentration is reached as late as 4 to 5 hours after the start. In these

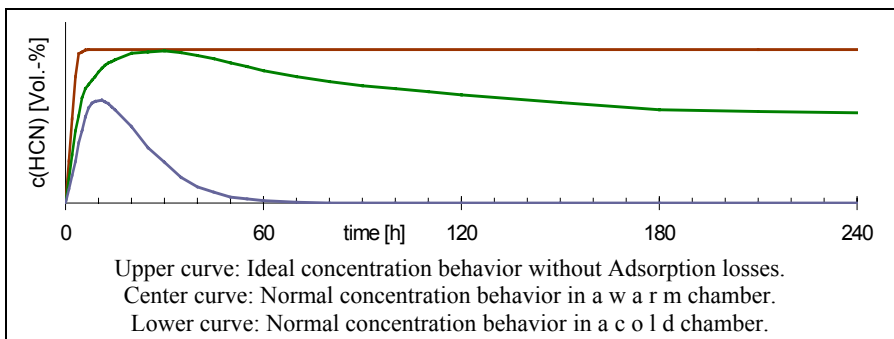

Graph 14: Relation between hydrogen cyanide adsorption on clothing and temperature in a delousing chamber with circulating air system (schematic).¹²³

years, circulating air systems did not yet exist, so that only the natural air convection was responsible for distributing the gas. Remarkable is the strong concentration reduction due to adsorption on the load, here lifeless material to be deloused. Due to the slow increase towards the maximum concentration, it must be assumed that Puntigam's values without circulating air system (Graph 12, lower curve) were achieved at similar temperatures.

In case of hypothetical homicidal gassings, the sweat produced by the frightened, crowded people and their HCN absorption through skin and lungs will cause similar losses, and in case of the underground morgues of crematorium II and III, additional losses will occur due to the cold and moist walls.

In order to kill all victims quickly, as attested to by the 'eyewitnesses', such losses would have to be compensated by introducing even more HCN than calculated before (chapter 7.3.1.3.1. and 7.3.1.3.3.) in order to quickly reach *and maintain* high HCN concentrations everywhere in the 'gas chamber.'

7.3.2. Critique of the Eyewitness Descriptions

7.3.2.1. Theatre of the Absurd

First, a few critical remarks on three topics of eyewitness statements relating to homicidal mass gassings should be made at this point.

7.3.2.1.1. Necessity of Co-Operation

Just imagine the following scene: 1,000 people of both sexes plus children enter the undressing room with a surface area of 390 m² (4,200 ft²). Each one would therefore have a area of only 60 cm × 60 cm (2×2 ft) in which to undress. Experience shows that people do not pack themselves tightly to the very edge of an enclosed area, unless, of course, they are quite willing to do so.⁴⁷⁴ In order to get people to do this, the procedure must be rehearsed; they must be aware of what is happening and what steps they must follow—and they must be willing to co-operate.

Alternatively, few people could be made to undress at a time, but this assumes that the people who have already undressed are in the 'gas

⁴⁷⁴ Just think of street cars or buses, where everyone remains near the door, even though there is plenty of room at the rear.

chamber' and waiting patiently for the next arrival of naked inmates. Once inside the 'gas chamber', the same problem occurs again. Here each individual has only an area of 45 cm × 45 cm (1.5×1.5 ft) in which to stand. The people must press themselves tightly together; the first people entering the room must proceed to the end of the room in a disciplined manner and line up against the wall. The next lot will form the line directly in front, and so on, until the entire chamber is full, which must have taken approximately half an hour, even with perfect choreography.

How did they get these 1,000 people to pack themselves tightly together, as one can expect it from soldiers who have exercised this for weeks on a parade ground? The only solution is that this must have been exercised just as intensively and disciplined as soldiers do it. And of course, at some point in this alleged scenario, people had to realize that they were *not* gathering for a shower, thus resulting in panic and lack of orderly cooperation with their murderers' procedures.

7.3.2.1.2. Failure to Separate the Sexes

All eyewitness accounts known to the author are unanimous in claiming that the victims were not separated by sex before being sent into the 'gas chambers'. The eyewitness accounts of the failure to separate the sexes are incredible for the following four reasons:

1. This procedure is in contradiction to the procedures followed during disinfestation, where, according to the same witnesses, the sexes were carefully separated.⁴⁷⁵

2. Since there were always two alleged 'gas chambers' of each type available in Birkenau (in crematorium II and III, or IV and V, or bunker I and II), there is no apparent reason why the victims could not have been separated by sex.

3. The claims were repeatedly made that the victims were made to believe that they were going to shower or undergo disinfestation. These procedures would have necessarily separated the populace on the basis of sex, if only because of the need for deception.

4. Particularly in the 1940s of last century, large numbers of people could only have been made to disrobe completely with others

⁴⁷⁵ See, for example, the pictures taken by the SS before and after delousing new arriving inmates, neatly separated by sex, as published in the Serge Klarsfeld (ed.), *The Auschwitz Album. Lilly Jacob's Album*, New York 1980.

of the opposite sex if they had been threatened with force and violence. But this would have nullified all the other measures of concealment.

7.3.2.1.3. Towel and Soap

According to a few eyewitnesses, the victims were handed towels and bars of soap to make them believe that they were going to take a shower.⁴⁷⁶ (Who, by the way, would go with a towel under a shower?) This statement becomes incredible given the chaos in the ‘gas chamber’: 1,000 corpses, 1,000 towels, and 1,000 bars of soap, plus vomit, urine, and blood from 1,000 victims! How was it possible to recycle those 1,000 bars of soap? How did they clean 1,000 towels? Did they waste 1,000 towels and 1,000 soap bars for every gassing? It can therefore be concluded that such accounts are untrue, and witnesses testify about it are not trustworthy.⁴⁷⁷

7.3.2.2. Speed of Ventilation of the ‘Gas Chambers’

7.3.2.2.1. Introduction

An imaginary experiment may perhaps assist in clarifying a somewhat complicated mathematical relationship: you have a bucket filled to the brim with sea water in front of you. You now take a second bucket filled with fresh water and pour it very carefully into the first bucket, allowing the excess flow over the edge. Now the question: when you have emptied the second bucket of fresh water into the first, containing sea water, what is the composition of the water in the first bucket? Pure fresh water? Of course not. It will be a mixture of salt and fresh water.

7.3.2.2.2. Excursus

In mathematics, the equation related to this problem is called a linear, homogenous differential equation.

In general, the following time behavior applies for the concentration change of a substance i with time, dc_i/dt , in case of air exchange,

⁴⁷⁶ Cf. the testimony of André Lettich, Thèse Fac. Med., *Trent-quatre mois dans les camp de concentration*, Ed. Tours, impr. dl’Union cooperative, Paris 1946; quoted acc. to E. Kogon *et al. op. cit.* (note 42), p. 210.

⁴⁷⁷ See also, in this regard, the detailed analysis of the testimony of SS Man Dr. Hans W. Münch: G. Rudolf, “*Auschwitz-Kronzeuge...*”, *op. cit.* (note 465).

provided that the newly added gas (free of i) is ideally mixed with the old gas:

$$\frac{dc_i}{dt} = -a \cdot c_i(t) \quad (8)$$

i.e., that the concentration change of substance i is proportional to the concentration $c_i(t)$ at time t . The modification of the equation yields:

$$\int \frac{1}{c_i(t)} dc_i = \int -a \cdot dt \quad (9)$$

After integration over dc and dt , resp., this yields:

$$\ln(c_i(t)) = a' - a \cdot t \quad (10)$$

or

$$c_i(t) = a'' \cdot e^{-at} \quad (11)$$

For $t = 0$, $e^{-at} = 1$ and thus

$$a'' = c_i(t=0) = c_0 \quad (12)$$

with c_0 as initial concentration (when the ventilation is started). This leads to:

$$c_i(t) = c_0 \cdot e^{-at} \quad (13)$$

From equation (8) results the initial concentration change $dc_i(t=0)/dt$:

$$\frac{dc_i(t=0)}{dt} = -a \cdot c_0 \quad (14)$$

Hence, we get for the constant a :

$$-a = \frac{dc_i(t=0)}{(dt \cdot c_0)} \quad (15)$$

In case of a sufficiently low exchange volume dv per time interval dt , the ratio of total volume V to the exchange volume dv can be introduced as initial concentration change (in case of infinitesimal transition ($dt \rightarrow 0$) this is mathematically correct). For example, if the air exchange per time unit is $1/1,000$ of the total, the concentration change per time unit is $1/1,000$, too.

This turns (15) into

$$-a = \frac{dv}{(dt \cdot dV)} \quad (16)$$

After the time $t = \frac{V \cdot dt}{dV}$, the complete volume is exchanged one time.

Therefore, a is the reciprocal of the air exchange time:

$$a = \frac{1}{\text{exchange time}} \quad (17)$$

After a single air exchange, the concentration is:

$$c_i(t) = c_o \cdot e^{-1} \approx 0.37 \cdot c_o \quad (18)$$

For the $1/x$ -value period (time period in which the concentration drops to $1/x$) the following applies accordingly:

$$t_{1/x}^1 = \frac{\ln(1/x)}{-a} \quad (19)$$

Example: If it is required to lower the value down to 1% of the initial value (12 g per m³, 1 Vol.%, down to 120 mg hydrogen cyanide per m³, 0.01 Vol.%), i.e., down to 1/100 of the initial value, this results to:

$$t_{1/100}^1 = \frac{\ln(1/100)}{-a} \approx 4.6 \times \text{air exchange time} \quad (20)$$

The half-value period is:

$$t_{1/2} \approx \frac{0.693}{-a} \quad (21)$$

Therefore, the concentration has dropped down to half after roughly 2/3 of a complete air exchange. This is true, if the fresh and the old air are mixed perfectly. However, this is not necessarily the case, as there are two other possible scenarios:

1. Exchange of old gas only (linear, laminar flow along the entire cross-section of the room): air exchange time roughly identical with ventilation time: Technically not given in the facilities under consideration.
2. Exchange of mainly fresh gas (exhaust close to intake), areas of old gas partly not involved: ventilation time is a multiple of what

is described above. In our case, this is certainly given for the areas between the corpses, since here almost no mixing of the gases takes place. Additionally, the unfavorable location of the air intakes to the exhausts leads to a partial exchange of fresh gas (air short circuit). This increases the ventilation time by a factor two to four or more.

The following chapter will determine, which scenario was given in the alleged 'gas chambers'.

7.3.2.2.3. Ventilation of the Morgues of Crematorium II and III

As shown above, when fresh air and stale air mix together, the concentration of the latter falls to only approximately 37% of the initial value after one complete air exchange, and to approximately 14% after a second exchange.

Data are only available on the ventilation installations in crematoria II and III, so that at this point we have to ignore all other 'gas chambers' in this regard.⁴⁷⁸ In chapter 5.4.1.2.4., the ventilation capacity of morgues 1 of crematoria II and III was shown to have been 4,800 m³ per hour. With a volume of free air in the morgue 1 of 430 m³, the volume of the room would be exchanged once in approximately 5-6 minutes.⁴⁶⁶

For morgues 1 of crematoria II and III under consideration at this point, however, a further problem arises. In particular, the ventilation intake has been installed only approximately 2 m away from the ventilation outlet in the same wall. The distance to the ventilation outlet on the opposite wall, however, is 7.3 m, *i.e.*, 3.5 times as far. The result, in these cellars, is a 'ventilation short circuit', especially if we assume that the victims of the alleged mass extermination are all tightly crammed together, especially in the middle of the room, which would further lengthen the fresh air pathway from one side of the cellar to the other. The air blown into the ventilation intake openings would therefore, for the most part, be immediately sucked out through the ventilation outlet openings located nearby.⁴⁷⁹ Therefore, it must be expected that the actual ventilation time would be greatly increased in comparison to a perfect mixing of fresh air and stale air as a result of this poor design.

⁴⁷⁸ Crematorium I is deliberately left out of the discussion, since the mass murders allegedly committed there have, in the meantime, after all, been generally questioned.

⁴⁷⁹ A reasonable regulation would have been to install the ventilation inlets on one side of the room, and the ventilation outlets on the other side.

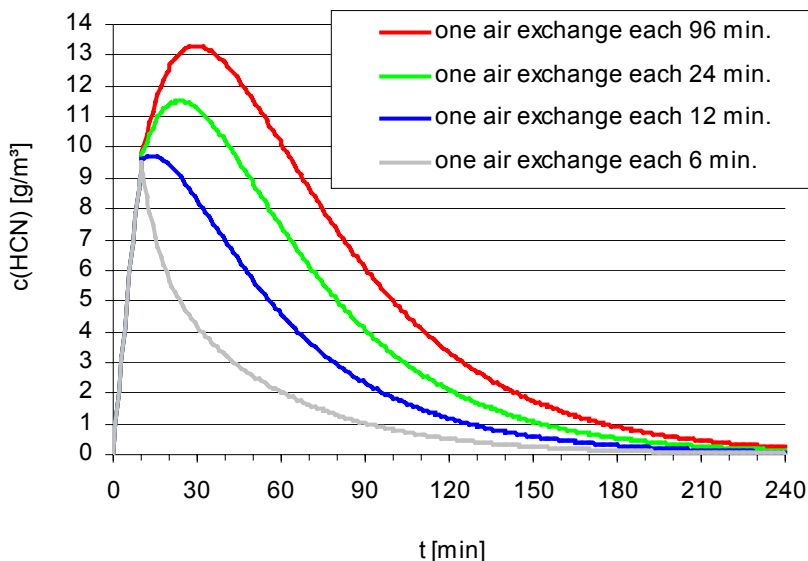

Graph 15: Simulation of the concentration of hydrogen cyanide in a hypothetical homicidal 'gas chamber' of the type of morgue 1 of crematorium II in Auschwitz-Birkenau, see text.

In addition, the following problem would also arise: the Zyklon B granules, which in the meantime would certainly have become moist, would lie trapped underneath the bodies in at least some places. To understand how this would effect the ventilation, we have carried out a simulation calculation based on the following assumption:

1. At 15°C, the moist Zyklon B releases hydrogen cyanide in the dry environment in the manner described by R. Irmscher (see chapter 7.2.).
2. Reaching an *average* concentration of hydrogen cyanide throughout the entire chamber of approximately 5-6 g/m³ after 5 minutes and/or approximately 10-12 g/m³ after 10 minutes (0.5 or 1 Vol.-%)—necessary for the rapid killing of all victims according to the eyewitnesses—requires the use of approximately 20 kg of Zyklon B (see chapter 7.3.1.3.).
3. The ventilation is turned on after 10 minutes, reducing the concentration of hydrogen cyanide according to the well-known formula (see chapter 7.3.2.2.2.)

The results may be taken from the Graph 15 for four air exchanges

differing in efficiency: one air exchange every 6, 12, 24 and 96 minutes.⁴⁸⁰ A few average values are listed in Table 11, taken from the individual scenarios. The value for 5g/m³ indicates, when the HCN concentration falls below a value at which it is possible to enter the chamber with a gas mask, but without protective garment and without performing physical work. The value for 2g/m³ should lie in the vicinity of a value permitting light physical work with a gas mask, but without protective garment. The value for 0.1g/m³ indicates when the HCN concentration falls below a concentration permitting entry of the chamber without a gas mask and without any health hazard. The column with the heading “[c(t) dt/10g/m³]” finally corresponds to a tenth of the surface area under the particular curve. The value corresponds to the duration of a hypothetical gassing of a chamber with a constant 10g/m³ HCN, when the hydrogen cyanide suddenly rises at the beginning of this period of time and then suddenly disappears at the end of this period. These values can now be used for simulation calculations; see next chapter.

The 6 min/air exchange applies in the absence of a short circuit of the air in the chamber. The 12 min/air exchange corresponds to this necessary correction. Both cases assume an empty chamber. In fact, the ventilation of the intermediate area between the hundreds of bodies

⁴⁸⁰ For those who wish to see it written out:

- a. Equation for release of HCN from the carrier material (in fractions):

$$A(t) = e^{-t/a}$$

- in which t = time after the initial release of HCN in minutes
- in which a = 43.5/minutes (so as to attain the velocity and low atmospheric humidity at 15°C alleged by Irmscher, note 427)

- b. Equation for the reduction of the HCN content through ventilation:

$$B(t) = e^{-t/b}$$

- in which b = necessary time for a single air exchange of the room in question.

- c. Equation for the actual HCN content:

- i. For the first 10 minutes (no ventilation, only release of HCN):

$$C1(t) = (1 - A(t)) \times D$$

- in which D = e/f
- in which e = mass of Zyklon B introduced in grams)
- in which f = volume of the chambers = 430 m³ (net volume, without the volume taken up by the victims)
- e has been selected so as to attain a concentration of approximately 10g/m³ after 10 minutes. For the sake of simplicity, I have used 20 kg = 20,000 g .

- ii. Differential equation for the actual HCN content for times after 10 minutes, *i.e.*, with ventilation, iteratively resolved into one minute steps:

$$C2(t+1) = C2(t) \times e^{-1/b} + (A(t) - A(t+1)) \times D$$

- in which (A(t)) - A(t+1)) × D is the quantity of HCN evaporating from the carrier with each new minute.

Table 11: Some values of the ventilation efficiency of a hypothetical homicidal 'gas chamber', with Zyklon B remaining in the chamber, see text. Data in minutes.

Air exchange duration	t (5g/m ³)	t (2g/m ³)	t (0.1g/m ³)	∫c(t) dt/10g/m ³
6	24	61	192	35
12	56	97	228	63
24	81	123	254	90
96	100	144	278	118

allegedly lying around on the floor, and the Zyklon B trapped underneath, will further slow the procedure to a considerable extent, so that, in relation to a hazard-free entry of the chamber, the truth will rather lie somewhere between cases two and four or beyond them.

It may be considered established that under no circumstances could these cellars be entered without a gas mask in less than 3-4 hours after the beginning of the gassing. Hard physical work with gas masks, but without protective clothes, *i.e.*, the alleged removal of the bodies, would not have been possible in less than 1½ to 2 hours.

If assuming the existence of Zyklon B introduction devices which allowed the removal of Zyklon after the end of the gassing, the resulting data would, of course, look dramatically different, see Table 12. Under such circumstances, it might have been possible to enter the 'gas chamber' with a gas mask for hard labor already after 30 to 45 minutes, and without a gas mask within one to two hours. This would then lie at least within the range of some less extravagant eyewitness accounts. That explains also, why Pressac and van Pelt insist on the existence of these introduction columns, contrary to all physical evidence and despite the lack of any documentary proof and reliable witness testimony. Without those introduction columns, however, the scenarios described by eyewitnesses regarding a swift removal of the corpses from the 'gas chamber' after the gassing are simply impossible.

These are, of course, only calculated guesses; if one were to ask

Table 12: Some values of the ventilation efficiency of a hypothetical homicidal 'gas chamber', with Zyklon B removed from chamber, see text. Data in minutes.

Air exchange duration	t (5g/m ³)	t (2g/m ³)	t (0.1g/m ³)	∫c(t) dt/10g/m ³
6	14	20	37	11
12	18	29	65	16
24	22	38	92	22
96	26	47	119	28

me whether I would rely upon these values and enter such a ‘gas chamber’ without a gas mask, I would reply that I preferred to insist upon the performance of a traditional chemical test beforehand. The simple reason for this is that all reliable calculation would be rendered impossible by the Zyklon B trapped beneath the bodies, as well as by the wet bodies moistened with hydrogen cyanide.

The rooms in crematoria IV and V which purportedly served as ‘gas chambers,’ like farmhouses I and II, allegedly had no ventilation installation and only slight ventilation possibilities by means of a few doors. The use of a room *without* efficient ventilation installations for mass murder at a time and in a place, where even dissecting rooms, wash rooms, and laying-out rooms could be and were equipped with ventilation installations, and where many ventilation fans were supplying lots of fresh air in disinfestation rooms right next door, is so absurd that any rational human being ought to refuse to take such stories seriously.

7.3.2.3. Simulation Calculations

The following are the results a series of simulation calculations for the determination of the relative saturation of the masonry with hydrogen cyanide based on the assumption that similar concentrations of hydrogen cyanide are used in all cases. In so doing, a distinction is made between two sets of circumstances:

1. Disinfestation chamber. The constant concentration assumed for the calculation amounts to 10 g/m^3 . A constant concentration cannot, however, be assumed, particularly for the existing epidemic disinfestation installations BW 5a und 5b existing in Birkenau, since great quantities of hydrogen cyanide would escape through the non-airtight roof on the one hand, and since both the masonry and the clothing would have absorbed considerable quantities of hydrogen cyanide over time (see chapter 7.3.1.3.3.). We therefore assume two models, as follows: a) one gassing daily with a constant concentration over 6 hours, and b) one gassing daily with 12 hours of constant concentration.⁴⁸¹ This

⁴⁸¹ In order to keep the HCN concentration in those make-shift delousing chambers of BW 5a and BW 5b constant over 12 hours, this would have required the application of an initial concentration at least twice or thrice as high as 10 g/m^3 , but this would have been impossible due to lack of sufficient Zyklon B. The quantities of Zyklon B necessary for such use would have corresponded to 24 to 30 kg per day, or approximately 9 to 11 tons per year, which is roughly the total quantity delivered to the camp, leaving no HCN for homicidal gasings. Hence, this

would mean that the chamber was used around the clock, *i.e.*, more or less 24 hours a day, seven days a week, which must be viewed as the extreme upper value.

2. Homicidal ‘gas chamber.’ Here as well, our calculation assumes a constant concentration of 10 g/m³. I have selected two different gassing times here: 1/20 day (72 min) and 1/100 of a day (14.4 min). The first value corresponds to the average constant exposure time of ‘gas chamber’ walls to HCN if assuming no Zyklon B introduction columns and a fairly good ventilation after the gassing (see 5th column in Table 11), the second value corresponds to the same scenario, but this time with Zyklon B columns and a close to perfect ventilation after the gassing (see 5th column in Table 12).

In former editions of this expert report, I have used the equations determined in chapter 6.7.4. to calculate the relative saturation of masonry cyclically exposed to hydrogen cyanide. However, after using several approaches on exactly how to do it, which lead to sometimes quite different results,⁴⁸² I decided to refer to this equation only in order to establish the time it takes for masonry to reach its maximum saturation or a quasi-constant concentration (20 days and 20 daily cycles, respectively). In this edition, the quasi-stationary concentration in masonry were calculated iteratively using Fick’s law of diffusion.⁴⁸³

One wall model used was considered to be insulated at one end that corresponds to the situation as given in morgues I of crematoria II and III, which were built of two layers of brick wall with a insulating layer of tar in between.⁴⁸⁴ The other wall model had no such insulation, *i.e.*, it lost HCN on its ‘outside,’ leading to an average concentration within the entire wall which is roughly half as high as in the insulated case. This was the situation as it was given in the Zyklon B disinfection rooms of BW 5a and BW 5b.

Table 13 shows the results of these calculations. Whereas the av-

scenario is unrealistic for our purposes, because our scenario requires homicidal gasings; see also chapter 7.3.1.3.

⁴⁸² The equations determined in chapter 6.7.4. consist of two terms, which can be handled individually or both together, and it is not at all clear, which time value is to be used when switching over from gassing to airing, which all influences the result.

⁴⁸³ I am not going to explain basic statistical laws of diffusion here. This law is so commonly known that anybody interested in it might look it up in any physics book. Maybe the iterative steps I used where a bit too big, so there is an error margin in my calculations, but if so, it affects all series, so it should not make a difference regarding my comparisons.

⁴⁸⁴ See chapter 5.4.1.1. and footnote 183. Though tar is not gas-tight, it still prevents most of the water and HCN to penetrate it.

Table 13: Quasi-stationary concentrations of HCN in masonry in percent of saturation, as a function of daily exposure time to HCN

time	insulated	not insulated, average	not insulated, on surface
14.4 min	1.6%	0.8%	1.6%
72 min	7.9%	4.2%	7.8%
6 h	30.9%	16.2%	30.6%
12 h	56.1%	29.8%	56.2%

erage concentration profiles of the insulated wall model is constant, it is linearly decreasing in the non-insulated walls from the inside out. The maximum average values close to the inner, HCN-exposed surface are quite comparable to the respective constant average concentrations in the insulated cases.

I have emphasized the values of particular interest: In case of homicidal gasings in the morgues I of crematoria II and III (without Zyklon B introduction columns), the walls will reach a quasi-stationary concentration of 8% of their saturation concentration. In case of disinfestation chambers, the value given for 6 hours of exposure to a constant HCN concentration—corresponding to a round-the-clock operation—leads to ca. 16% for the average value of the entire wall, and some 30% for the surface.

The values under consideration here are percent values of the saturation concentration of a wall, *i.e.*, *relative* values. The cases of the disinfestation and homicidal ‘gas chamber’ are only correctly comparable when one considers the *absolute* hydrogen cyanide concentrations in the masonry. If, for example, one considers that, in particular, the interior walls of the disinfestation chambers intended for personal effects were warm, dry walls, while the alleged homicidal ‘gas chambers’ in crematoria II and III were cool and very moist, then, with equal gassing concentrations, one must multiply the relative concentrations of the homicidal ‘gas chamber’ by the factor of the increased hydrogen cyanide absorption capability of cool, moist walls. If one assumes the value of 8 determined in this regard on page 187, then the absolute average hydrogen cyanide content of the homicidal ‘gas chamber’ would be a value lying around 64% of the saturation concentration of a warm, dry wall in a disinfestation chamber, *i.e.*, four times higher than the average hydrogen cyanide content of the disinfestation chamber wall (ca. 16%), and more than twice as high as its maximum content at the surface (ca. 30%). Even when assuming the existence of

Zyklon B introduction columns and a close to perfect success of the subsequent ventilation, the moist and cool homicidal ‘gas chamber’ walls would still have accumulated HCN corresponding to 13% of the average saturation of dry disinfestation walls, which is close to what would accumulate in those disinfestation walls (16%).

As a result of the high moisture content of those underground morgues, one can see that even with such short gassing times, the walls of a homicidal ‘gas chamber’ accumulate a hydrogen cyanide content which would be quite comparable to that of a disinfestation chamber. Much less hydrogen cyanide in the quasi-stationary condition of the hypothetical homicidal ‘gas chambers’ could only be expected, if one were to assume absurdly short, but technically unfeasible gassing times, the application of very little Zyklon B, or only very few gas-gings at all.

7.3.2.4. Excursus: Capacity of Protective Filters

Filter devices to protect against hazardous and/or lethal gases and vapors are divided a) into types according to the kind of gas to be filtered and b) into classes according to their capacity. Filters of class 3 with a large capacity are stored externally, usually in a container to be carried at one’s side, since they are too heavy to be carried on the mask. They are connected to the mask with a hose. Filters of class 2 are screwed into the mask and form the majority of all used filter types. Filters of class 1 are plug-in filters.

The service life of gas filters depends on:

- Type and concentration of the harmful compound;
- Air demand of the carrier, as a function of the intensity of work performed and the personal constitution;

Table 14: Maximally admissible concentration of harmful compound for protection filters⁴⁸⁵

Gas filter class	Maximally admissible concentration of harmful compound	
1	0.1 Vol.%;	1,000 ml m ⁻³ (ppm)
2	0.5 Vol.%;	5,000 ml m ⁻³ (ppm)
3	1.0 Vol.%;	10,000 ml m ⁻³ (ppm)
Short-term excess up to twice of the table value is permissible		

⁴⁸⁵ Hauptverband der gewerblichen Berufsgenossenschaften, *Atenschutz-Merkblatt*, Carl Heymanns Verlag, Cologne Oct. 1981.

- Humidity and temperature of the air.

Needless to say that the *Deutsche Institut für Normung* (DIN, German Institute for Standardization) has determined the minimum values of break-through times of filters under standard testing conditions. These conditions are:

- 20°C;
- 70 % relative humidity of air;
- 30 liters flow-through of air per minute.

In Table 15 the values of different filter types are given with their respective harmful gas.

Hydrogen cyanide filters used by the allies during that time belonged to class 3 with filters to be carried externally. The service life of such filters at hard physical labor and 0.05 vol.% of hydrogen cyanide is given with 3 to 5 hours. At a concentration of over 1 vol.%, the gas quickly breaks through even these devices.⁴⁸⁷

R. Queisner wrote a report about his experiences with German filter devices used during the Second World War for delousing procedures with hydrogen cyanide.⁴⁸⁸ The filter inserts “J” and “G” used at that time were especially developed for being applied in air containing hydrogen cyanide and had a service life of 30 min. with a peak load of

Table 15: Minimum break through times for filters according to DIN 3181 part 1 in minutes⁴⁸⁶

type	test gas	break through criterion (ppm)	class 1 test concentration	class 2 test concentration	class 3 test concentration
A	CCl ₄	10	80	40	60
B	Cl ₂	1	20	20	30
	H ₂ S	10	40	40	60
	HCN	10*	25	25	35
E	SO ₂	5	20	20	30
K	NH ₃	25	50	40	60

* relating to HCN + (CN)₂

⁴⁸⁶ DIN 3181 part 1, draft, *Atemfilter für Atemschutzgeräte. Gas- und Kombinationsfilter der Gasfilter-Typen A,B,E und K. Sicherheitstechnische Anforderungen, Prüfung, Kennzeichnung*, Beuth Verlag GmbH, Berlin, May 1987.

⁴⁸⁷ War Department, *Hydrocyanic-Acid-Gas Mask*, US Government Printing Office, Washington 1932; War Department, *Technical Manual No. 3-205*, US Government Printing Office, Washington 1941.

⁴⁸⁸ R. Queisner, “*Erfahrungen mit Filtereinsätzen und Gasmasken für hochgiftige Gase zur Schädlingsbekämpfung*”, *Zeitschrift für hygienische Zoologie und Schädlingsbekämpfung*, 1943, pp. 190-194.

1 vol.%. Since the mask carrier is only exposed to small amounts of hydrogen cyanide during delousing activities (during distribution of the product and at the end of the gassing, the hydrogen cyanide concentration is rather low), experience showed that it is possible to use the mask several hours.

According to Schmidt,⁴²² relaxed humans inhale some 14 liters of air per minute. This can increase up to 50 to 60 liters per minute in case of heavy physical work, in extreme cases even up to 100 to 120 liters.

If, according to Pressac and in agreement with the witness accounts, a concentration of 1 vol.% was used during the gassings, the inmates of the special commands ('Sonderkommandos'), who carried away the corpses out of the 'gas chambers' of the crematorium IV and V as well as out of the farmhouses I/II, which did not have a ventilation system, had to wear gas masks. Equipped with gas filters of class 2 and doing heavy physical work, they would have been exposed to a high concentration of toxic gas. Since hydrogen cyanide is particularly well absorbed through sweat-wet skin, this would certainly have led to signs of poisoning.

The minimum break-through times of corresponding modern gas filters of class 2, type B (for hydrogen cyanide) lies at 25 min. for 0.5 vol.% at an air flow-through of 30 liters per min. In case of a sufficiently hard physical labor, this time will be quickly cut to half or a quarter. Therefore, a modern filter of class 2 can offer only several minutes of safety under the circumstances under consideration. Breathing would have been seriously hindered by these filters (max. 5.6 mbar pressure difference at 95 l per min. according to the current DIN), hence the working speed would have been slow and the demand for resting times and forced pauses due to gas poisonings would have been huge. Since they were especially designed for hydrogen cyanide, the filters of that time had a higher capacity, and consequently their durability might have been correspondingly higher, which, in turn, increased their service time.

Pressac writes⁴⁸⁹ that a hydrogen cyanide concentration of 1 vol.% is not tolerable even with filter mask, and that an exposure time of up to one minute is granted only in emergency cases, and this without any heavy physical work!

⁴⁸⁹ J.-C. Pressac, *op. cit.*, (note 67), p. 16.

Finally, a poisoning through the sweat-wet skin would have been avoidable under these circumstances only if the workers would have worked with protective garments in the ‘gas chamber’, which was not reported by any witness and which would have reduced the working performance even more. The accounts of some witnesses regarding the applied concentrations *and* the quick clearing of the chamber after the execution *without* protective garments and masks, on which even Pres-sac relies, exclude each other and thus can certainly not be correct.

It should not be forgotten here that hydrogen cyanide is a contact poison. Transporting corpses, on whose skin huge, possible lethal amounts of hydrogen cyanide are absorbed, had required that the special commands dealing with these corpses had to wear protective clothes. Finally, when considering the applied concentrations attested to, the guards, like the special commands, would have risked their health. This is true for all ‘gas chambers’.

7.3.3. Evaluation of Eyewitnesses

It is possible to provide a satisfactory answer to the problem of the Zyklon B introduction holes in the roofs of morgue 1 (the ‘gas chambers’) of crematoria II and III through the interpretation of air photos and structural considerations. One must therefore conclude that the holes and cracks visible today were only put in during or after the destruction of the building during the winter of 1944-45. This means that the poison gas could not have been introduced into the alleged ‘gas chambers’ in the manner described by the eyewitnesses.

The rapidity of the executions as described by the eyewitnesses, in their extreme values (“*a few moments*”, “*a few minutes*”, “*two minutes*”, etc.) cannot, once again, be attained with Zyklon B under the given technical conditions, and can only be attained through the use of very high quantities of Zyklon B.

Entering the ‘gas chambers’ without protective measures, the performance of heavy physical work in the chambers, sometimes with a naked torso, while eating and smoking, along with testimony relating to large quantities of toxic gas, reveals the perjury of these eyewitnesses.⁴⁹⁰

Equally false are the statements relating to the duration of ventilation of morgue 1 (the ‘gas chamber’) of crematoria II and III, since the

⁴⁹⁰ There are, of course, witnesses who allege that gas masks were worn. Protective garment, however, is never mentioned.

ventilation would be greatly influenced by various factors (hindrance of circulation by the bodies, the short circuit in the ventilation pathway, the release of hydrogen cyanide by Zyklon B). In fact, safe entry into the ‘gas chamber’ without protective measures can hardly have been possible in less than three to four hours. Finally, heavy physical work could only have been conceivable before the expiration of at least another one and a half hours, even with gas masks.

The eyewitness testimonies relating to the alleged cremation of the bodies, finally, are riddled with fantasy: cremation in deep ditches; cremation with liquid fuels; entirely without—or with ridiculously little—fuel; the destruction of corpses with explosives; the collection of human fat. These have nothing in common with technical reality or possibility, and are largely refuted by the Allied aerial photographic evidence: no huge ditches, no smoke, no fire, no fuel storage areas.

The illogical and ridiculous—in Pressac’s words—gassing scenarios in the ‘gas chambers’ of crematoria IV and V as well as the comparable ones in farmhouses I and II, would have been extremely dangerous for the Sonderkommandos (see chapter 5.4.2. and 5.4.3.). Yet these ‘gas chambers’ must have been planned and built as instruments of mass murder,⁴⁹¹ if mass gassings were already underway elsewhere in the camp during their period of construction. All of this must compel people accustomed to thinking in terms of technology and the natural sciences to conclude that the Germans must have decided to choose absolutely the most expensive, laborious, most dangerous and difficult way possible in which to kill people *en masse*.

It would have been logical, for propaganda purposes, to have described the installations such as the disinfestation chambers intended for personal effects located in buildings 5a and 5b as homicidal ‘gas chambers’. But this was never attempted, nor are there any eyewitness testimonies as to such a utilization of these premises. Furthermore, the doors drawn in the plans of the disinfestation chambers of buildings 5b—as well as the doors located there today—open inwards, which would have rendered it impossible to remove bodies lying in front of the doors after the mass gassings. These rooms were, therefore, certainly never used as homicidal ‘gas chambers’. It is nevertheless possible that an attempt was made to represent the disinfestation chamber in

⁴⁹¹ J.-C. Pressac, *op. cit.* (note 67), p. 447

building 5b as a (fake) homicidal ‘gas chamber’. The water pipes visible there hang freely in space inside the room, without any connection; only a few of them are equipped with shower heads, while they terminate in the ventilation openings in the exterior wall, *i.e.*, they were installed after the removal of the disinfestation devices (ovens, ventilators, and so on), very probably after the German withdrawal (see Fig. 20). Remarkably, all pipes and fittings have been removed from the real shower room in the same wing (see Fig. 17). In case this is not an attempted falsification, it is still possible that this wing was clumsily converted into a shower room after the end of the war, when Birkenau was used as prisoner camp for Germans. But this is not likely, since this building had proper showers already, so why dismantle them first, and then construct a makeshift shower in a room unsuitable for it?

Brief mention should be made at this point of the widespread notion that the toxic gas streamed into the alleged homicidal ‘gas chamber’ through shower heads, especially as there are even a few such eyewitness statements. Zyklon B consists of the active ingredient, hydrogen cyanide, adsorbed on a solid carrier material (gypsum) and only released gradually. Since it was neither a liquid nor a gas under pressure, the hydrogen cyanide from this product could never have traveled through narrow water pipes and shower heads. Possible showers, or fake shower heads, could therefore only have been used to deceive the victims; they could never have been used for the introduction of this poison gas. There is general unanimity as to this point, no matter what else might be in dispute.

Table 16: Evaluation of eyewitnesses

EYEWITNESS CLAIM	EVALUATION
Death of all victims after 0 (instantaneously) to 15 minutes.	If high concentrations of hydrogen cyanide are used, as in American execution chambers, death occurs in a period of 10 minutes or even later. During the process, the victim is therefore exposed to a high overdose concentration of hydrogen cyanide. Technically this is not possible with Zyklon B, since the Zyklon B carrier base releases the gas slowly (50% in 30 to 90 minutes, according to the temperature and relative humidity). The distribution of the gas throughout the chamber from a few sources of hydrogen cyanide only, and the absorption of the gas by the moist walls and the nearby victims would further delay the process. Killing all the victims in a few (less than five) minutes would be impossible. Even during the use of very large quantities of Zyklon B (much more than 10g per m ³).
Opening of the doors to the 'gas chamber' after the execution (and sometimes a short ventilation time) and immediate commencement of transport of the bodies without gas masks and protective clothing.	The ventilation system, if it existed, did not have the performance to clear the chambers in the time frame attested to. Assuming that the victims died quickly from the high concentrations of toxic gas, then the workers in the Sonderkommando would also have been killed by the gas. Working without gas masks equipped with a filter is totally inconceivable; at high concentrations of poison gas, even these are very unsafe. Heavy respiratory devices must be worn at concentrations of over 0.5 Vol.%, which would render the removal of the bodies much more difficult. Contamination through the skin must be expected during heavy work, involving perspiration, and due to the high concentrations of hydrogen cyanide on the skin of the victims. At the same time, such concentrations are sufficient to put a stop to the workers' ability to work (dizziness, nausea, etc.). Protective clothing is therefore required.
Blue vapor over the victims.	Hydrogen cyanide is a colorless liquid and/or an invisible gas. The name " <i>Blausäure</i> " (blue acid) is due to the reaction of hydrogen cyanide with iron, forming the iron-blue pigment. There cannot, therefore, have been any blue vapor.
Bluish/greenish coloration of the skin of the victims.	Hydrogen cyanide blocks the oxygen supply to the cells. The blood can no longer give off oxygen to the cells. Saturation of the blood with oxygen therefore occurs; the skin of the victim therefore has a reddish, not bluish, appearance, especially on the mucous membranes and during post-mortem lividity. On the other hand, if the victims had slowly suffocated, this could explain bluish coloration of skin.
Attempted destruction of the bodies by means of explosives.	Totally unsuited and dangerous.

EYEWITNESS CLAIM	EVALUATION
Cremation of bodies in crematorium ovens without fuel.	This testimony is quite absurd. Cadavers never burn due to their own fat content alone. Additional fuel is always required.
Commencement of body transport from the chamber of crematoria II and III 20 minutes after commencement of ventilation, without gas masks.	The unheated morgues 1 of crematoria II and III, filled with bodies, would have been incompletely ventilated in 15 to 20 minutes using the allegedly built-in ventilation installation. Hydrogen cyanide released for hours from the Zyklon B distributed among the bodies, release of hydrogen cyanide absorbed by the skin and walls and the absence of air exchanges between the bodies would have led to ventilation times amounting to several hours, before the cellar could have been entered without gas masks equipped with filters.
Cremation of the corpses in pits 1.5 to 3 meters deep.	Due to the high water table in Birkenau in 1942-1994, deep pits would have quickly filled with water. The maintenance of fires in such pits was not possible.
Cremation of the corpses with methanol and/or old oil.	The complete cremation of corpses requires a high temperature. Liquid fuels always burn only near and on the corpse, so that the heat is lost upwards; in addition, they trickle down into the subsoil in open air. Methanol evaporates very easily and therefore has a very low flame temperature. Experiments with cremations in the open air show that corpses can be carbonized on the outside, but not however entirely cremated with these fuels.
Pouring escaping human fat over the bodies.	This is an entirely absurd testimony. If anything burns in the flesh at all, it is the fat. Since the bodies would have been lying in the fire, the fat cannot possibly have been collected outside the fire by means of channels.
Flames shooting out of heavily smoking crematorium chimneys.	Coke fires are very short-flamed and develop only little smoke, and this smoke usually burns within the muffle. Even carbonized, burning corpses do not generate any flame and do smoke only slightly if the muffle is working inefficiently. That flames could penetrate through a 10 meter long flue and a 15 ft high chimney to the outside, is technically impossible. Even the fire's reflections disappear in the flue.

7.3.4. An Expert on Cyanide Speaks Out

“Gérard Roubeix
51 Av. de la Coquetterie
44000 Nantes

Nantes, the 2nd Nov. 1997
to M. Michel Adam
c/o ANEC
PO Box 21
44530 St. Gildas-des-Bois

Sir,

Having learned about the odious persecution of which you are a victim in the name of ‘freedom of expression’, let me express all of my sympathy and my total solidarity to you.

I have spent 20 years of my career as an engineer in the hydrogen cyanide industry in the service of the groups Pechiney-Ugine-Kuhlmann and Charbonnages de France. In particular, I have been the director of the St. Avold plant, which in 1970, with its production of 40 tons of cyanides per day, was the most important plant world-wide; theoretically, this production would have allowed the lethal poisoning of 500 million human beings on a single day. This shows how I am aware of the problems regarding the handling of HCN. Well, I affirm that all the ‘testimonies’ I have read or heard of concerning these gas chambers, in which 2 to 3,000 people were crammed, are nothing but total fantasy.

I congratulate you for your admirable battle against the hoax. The truth is on its way.

[signed Roubeix]

P.S: You may use this testimony, if necessary.”

Michel Adam was a teacher of history and geography in the West of France. At the beginning of July 1997, as a former lady deportee to the concentration camp of Ravensbrück was giving a conference at his school telling about her ‘memories,’ he opposed the lady several times by using solid revisionist arguments. Michel Adam was immediately suspended and, after one year of troubles of all sorts, he was dismissed

by French Minister for the Arts Claude Allègre on account of the three following official reasons:

- showing his revisionist views in front of his pupils;
- disturbing a meeting of his pupils with a former deportee;
- showing doubts about the credibility of a deportee's testimony.

Already in 1998, Gérard Roubeix wrote a similar letter which has been published elsewhere.⁴⁹² He died in 2001.

ANEC stands for *Association normande pour l'éveil du citoyen*, (Norman Association for the Warning of Citizens), which was an association created by the Normandy teacher Vincent Reynouard, who, just as Michel Adams before him, lost his job because of his revisionist views and was sentenced to fines and a three months prison term.⁴⁹³ ANEC published 36 issues of the revisionist periodical *Nouvelle Vision*.

⁴⁹² *Annales d'Histoire Révisionniste* 7 (1989), pp. 212f.

⁴⁹³ Cf. Vincent Reynouard, "Deutsch-Französische Völker-Freundschaft", *VffG*, 4(3&4) (2000), pp. 410-415 (online: www.vho.org/VffG/2000/3/Reynouard410-415.html)

GÉRARD ROUBEIX

Spécialiste de la chimie

51 Av. de la Coquette

44000 Nantes

Nantes le 2 Nov 97

87

à M^{rs} Michel Arlaud

% ANEC
BP 21

44530 St Gilles des Bois

Monsieur,

Ayant appris l'odieux persécution dont vous êtes la victime au nom de la "liberté d'expression" je tiens à vous féliciter, toute ma sympathie et ma totale solidarité.

J'ai passé 20 ans de ma carrière d'ingénieur dans l'industrie de l'acide cyanhydrique au sein des groupes Raschig - Uzin - Kuhlmann et Charbonnages de France. J'ai été notamment directeur de l'usine de St-Amand que, avec sa production de 40T par jour et forte du monde; cette production aurait permis théoriquement d'intoxiquer moyennement 500 millions d'êtres humains en une seule journée. C'est dire que je connais les problèmes concernant la manipulation de l'HCN. Et bien j'affirme que tous les "émissions" que j'ai lus ou entendues concernant ces chambres à gaz dans lesquelles on fournait à 2000 personnes relevant de la phase totale fantaisie -

Je vous félicite pour votre admirable combat et impopulaire. La vérité est en marche

si nécessaire utilisons ce té-

7.3.5. Why Precisely Zyklon B?

One might naturally wonder why the SS are supposed to have decided to use Zyklon B as an instrument of mass murder. The Soviets, at any rate, killed countless millions of human beings either simply by shooting them in the back of the neck or allowing them to die in camps under miserable conditions. Surely it would have been simpler to leave the people deported to Auschwitz to their fate; they would have perished from hunger and epidemics within a very short time anyway. That is how the Americans murdered approximately 1 million German civilian internees after the end of the Second World War.⁴⁹⁴ Instead, the SS at Auschwitz spent almost one billion dollars, in today's values, to bring the epidemics raging there under control, incurring huge expenditures on medical facilities, to cure the internees from the typhus epidemics, which were very often fatal.⁴⁹⁵ This alone speaks volumes about the credibility of the conventional wisdom.

The academic question, therefore, of whether or not some other poison gas would have been better suited for the mass murders instead of hydrogen cyanide in the form of Zyklon B cannot, in the last analysis, be answered, since there are no scientifically documented experimental values for mass murder by poison gas.

Theoretically, one could, at that time, have chosen between nitrogen (N₂), carbon dioxide (CO₂), carbon monoxide (CO), phosgene (COCl₂), chlorine (Cl₂), hydrogen cyanide (HCN), nerve gases such as Tabun and Sarin, Diesel engine exhaust, internal combustion engine exhaust, producer gas, coke or city gas, process gas, and, possibly, still other, entirely different, instruments of mass murder, suitable even under completely different circumstances (shooting in the back of the neck, hunger, epidemics). But if one really wished to take the trouble to commit mass killings with poison gas, it is most probable that one would have used carbon monoxide, which is definitely lethal to human

⁴⁹⁴ James Bacques, *Other Losses*, Stoddart, Toronto 1989; Bacque, *Crimes and Mercies*, Little, Brown & Co., Toronto 1996.

⁴⁹⁵ Hans Jürgen Nowak, *op. cit.* (note 97), pp. 323f.; Manfred Gerner, Michael Gärtner, Hans Jürgen Nowak, "Die Kosten von Auschwitz" *VffG*, 6(2) (2002), pp. 146-158; (online: www.vho.org/VffG/2002/2/GernerGaertnerNowak146-158.html); on the medical care, see the unpublished studies by the late C. Jordan on the G. Weise case; see also *ibid.*, "The German Justice System: A Case Study", in E. Gauss (ed.), *op. cit.* (note 22), pp. 147-181 (online: www.vho.org/GB/Books/dth/fndpoljust.html).

beings above 0.1%, for the following reasons:

1. The poison gas CO was available in limitless quantities and in lethal concentrations at giveaway prices, substantially cheaper than Zyklon B, on almost every street corner in the Third Reich:
 - a) Internal combustion engines easily attain a CO content of 7% by volume, so that it would have been suitable for mass murder. Nevertheless only a very small minority of eyewitnesses speak of the use of internal combustion engines in only one German concentration camp (Sobibor).⁴⁹⁶
 - b) Producer gas generators generate a gaseous mixture with a proportion of CO of up to 35% by volume, using only wood or coke, air and water. These generators were installed in hundreds of thousands of vehicles all over German-occupied Europe during the Second World War, since it was necessary to convert to alternate fuels due to the Allied oil blockade. As F.P. Berg has shown, every member of the German Reich Government was familiar with these extraordinarily economical and easily operated installations with their quickly lethal toxic gas, especially the transport experts, whose duty it was to gradually replace all Diesel and internal combustion engines with generator gas installations. These were, in some cases, exactly the same people who were entrusted with the deportation and allegedly with the killing of Jews—such as Adolf Eichmann, for example.⁴⁹⁶ But it has never been claimed that these installations were used for purposes of homicide.
 - c) Toxic city gas with a CO portion of up to 30% by volume was available in every major city for a ridiculously low price. Consideration would obviously have been given to committing murder with it.
 - d) Process gas: The German corporate giant *I.G. Farbenindustrie AG* had already built a coal gasification/liquidification plant only a few kilometers away from Auschwitz concentration camp in the early 1940s. Here, by means of various conversion processes, coal was converted into chemical end products, from which oils, fats, fuels, and synthetic rubbers could be processed. The first step in this process is the generation of process gas,

⁴⁹⁶ See Friedrich P. Berg, “*The Diesel Gas Chambers: Ideal for Torture—Absurd for Murder*”, in: Ernst Gauss (ed.), *op. cit.* (note 22), pp. 435-465 (online: www.vho.org/GB/Books/dth/fndieselgc.html).

which has a similar composition to coke gas or city gas. The *I.G. Farbenindustrie AG* factory had a concentration camp in its immediate vicinity by the name of Monowitz, which was connected to the extensive system of more than 30 different Auschwitz concentration camps more than 30 kilometers in Upper Silesia and Western Poland. If the SS had looked for a simpler way to kill millions of Jews, the center of extermination certainly would have been built in the vicinity of Monowitz, with a direct process gas pipeline from the *I.G. Farbenindustrie AG* factory.

2. It would not have been necessary to order and store CO and pay attention to the use-by date, as was necessary in the case of Zyklon B; carbon monoxide would have been available at all times, as soon as the economical installations were completed.
3. The handling of CO would have been considerably simpler for the executioners. Almost the only thing to pay attention to would have been the opening and closing of the CO valve. The handling of Zyklon B, on the other hand, would have demanded a remarkable number of safety precautions on the part of the executioners. The wearing of gas masks, and, when possible, additional protective clothing (gloves), the careful opening of the cans with a suitable tool, the careful introduction of the carrier through the openings, the careful disposal of the Zyklon B residues.
4. CO can be introduced simply and quickly through pressure pipes or through a blower, while Zyklon B, on the other hand, releases its toxic fumes only slowly.
5. In the case of CO, there would not have been so many problems with ventilating the air in the mass execution areas as with hydrogen cyanide/Zyklon B, since the introduction of CO could be stopped simply by closing a valve, and because CO does not adhere to surfaces and is almost insoluble in water—in extreme contrast to hydrogen cyanide.
6. Zyklon B was scarce and expensive, and was needed everywhere to combat epidemics such as typhus, including in the army and German-allied armed forces, so that any avoidable squandering of it for other purposes would have been avoided—even, and especially, at Auschwitz, where typhus threatened not only the lives of the inmates, but also the guards and civilians entering the camp or who lived in the vicinity. In plain English, this means that the typhus epidemic in Auschwitz concentration camp threatened the extremely important production of the war industries located in

Upper Silesia, the second-greatest industrial region in Germany after the Ruhr at that time. The struggle against epidemics, for which Zyklon B was undoubtedly needed, was therefore of the greatest importance, in larger quantities than the manufacturer, DEGESCH, was able to deliver at that time.

Naturally, CO would not necessarily speed up the execution procedure in comparison to hydrogen cyanide, but it would have been safer, more easily available nearby, less complicated, and cheaper.⁴⁹⁷

Certainly,

“the bottleneck in the extermination process [...would have been] the incineration of the bodies, not the gassing itself. [An appropriate equipment provided,] A thousand people could be killed in a matter of minutes, or an hour or two at most, counting the entire operation from arrival at the camp to the final ventilation of the gas chamber.

Yet to burn the bodies of those thousand people [...would have taken] quite a long while.”⁴⁹⁸

As C. Mattogno and F. Deana have shown, the cremation installations at Auschwitz were never able to cremate the bodies of the dead from the various epidemics and other unhygienic conditions of Auschwitz camp which occurred anyway, not to mention the bodies allegedly occurring as the result of mass murders,⁴⁴⁴ this is a further proof that there was never a program of mass homicide at Auschwitz.

⁴⁹⁷ If for no other reason because, according to the establishment literature, CO was also already used in connection with the euthanasia action.

⁴⁹⁸ According to a part of the answer from “Nizkor” (www2.ca.nizkor.org/features/qar/qar29.html) to question no. 2: “*Why did they use this instead of a gas more suitable for mass extermination?*” (www.zundelsite.org/english/debate/debatetoc.html) of a flyer distributed by the Institute for Historical Review: *66 Questions and Answers on the Holocaust*, IHR, Costa Mesa, undated.

8. Evaluation of Chemical Analyses

8.1. Test Sample Taking and Description

As far as I am aware, test samples from buildings at Auschwitz have been analyzed by four persons or groups so far.⁴⁹⁹

1. Fred A. Leuchter, Consulting Engineers, Boston, MA, on behalf of the defense of E. Zündel, Toronto. F.A. Leuchter marked the locations where he took samples from crematoria in maps of these buildings drawn by himself and reproduced in his expert report. Only Leuchter's samples taken from morgue 1 ('gas chamber') of crematorium II are reproduced in the sketch below (Fig. 67). There is also a video establishing Leuchter's sample taking locations.⁵⁰⁰ J.-C. Pressac has subjected the sample taking to criticism.⁴⁵ Leuchter failed to indicate a more exact specification of the sample material; the designation is "*brick*" in all cases. The sample taking was done without regard for depth. From the traces left by Leuchter in the corresponding places in the masonry, one must calculate sample taking depths of up to 3 cm and more.

2. Prof. Dr. Jan Markiewicz, Jan Sehn Institute for Forensic Research, Toxicology Department, Cracow, on behalf of the Auschwitz State Museum. J. Markiewicz provides more exact data on the sample taking locations, the type of material, and the depth taken in a sample taking records. The control samples were taken from a disinfection chamber in the Auschwitz main camp, the interior walls of which, according to the report, were painted during the war, so that only a pale blue tint is visible in places. This is not, therefore, unaltered masonry material; thus, in case the samples were taken from the upper layer of the wall only, one has to expect lower results in comparison to an untreated wall.^{56,57}

3. Dipl.-Chem. Germar Rudolf, Stuttgart, Germany, on behalf of

⁴⁹⁹ C. Mattogno (Rome) has also taken samples from some of the installations ('gas chambers') at Birkenau and has had them analyzed; the findings concur with those of F.A. Leuchter and G. Rudolf. C. Mattogno, letter to the author, Rome, May 26, 1992.

⁵⁰⁰ The video documentation on Leuchter's investigations at Auschwitz can be ordered from: Samisdad Publishers Ltd., 206 Carlton Street, Toronto Canada, M5A 2L1 (E-mail: ezundel@cts.com).

the defense of the late Major General O. E. Remer. The samples were taken in the presence of witnesses by hammer and chisel and immediately sealed in a plastic bag. The subsequent numbering of the bags was recorded by hand, including the measured sample taking location and type of sample. Table 19 shows buildings, sample taking locations and depths, as well as a brief description of the wall material. The exact locations are shown in the sketch of the corresponding buildings in chapter 5 of this book.

4. John C. Ball, Ball Resource Services Ltd., Delta, BC, Canada. John C. Ball has not given any details about where exactly he took his samples, nor what kind of material it was. According to his own description, at least the samples from the delousing rooms of BW 5a and BW 5b consist of a mixture of material taken at various places of these rooms, both inside and outside. Hence, the same might be true for his other samples. For this reason, we will only briefly list Ball's analyses results here without going into too many details about how they are to be interpreted.

8.2. Analytical Methods

The analyses were performed in each case respectively by:

1. Prof. Dr. J. Roth, Alpha Analytic Laboratories, Ashland, Massachusetts. For the cyanide analysis, this laboratory used a procedure carried out analogously to the German standard (see 3.).⁵⁰¹ Control analyses were prepared for some test samples near the detectable threshold of 1 mg cyanide per kg test material. The results fluctuated up to 40%.

2. Jan Sehn Institute for Forensic Research, Toxicology Department, Cracow, Poland, under Jan Markiewicz. The Polish Scientist used the micro-diffusion chamber procedure, which does not permit the detection of Iron Blue.⁵⁰² The detection threshold for other cyanides lies at 10 µg per kg sample material.

3. Fresenius Institute, Taunusstein, Hessen, Germany, with no

⁵⁰¹ The iron content was also determined by means of ICP spectrometer. The values lay between 6 and 7.5 g per kg.

⁵⁰² In this procedure, the sample is to semi-concentrated sulfuric acid for 24 hours. The gases released are only collected by means of diffusion in a KOH collector.

knowledge of the origins of the samples. Proof of the presence of cyanide was produced in conformity with DIN 38 405, section D 13. The detection threshold lies nominally in the range from 0.5 to 0.1 mg per kg.⁵⁰³ All values below 0.5 mg per kg are uncertain, and are commonly marked as “*not proven*”. Control analyses were performed by the *Institut für Umweltanalytik Stuttgart*, IUS (Institute for Environmental Analytics) (Table 20).

4. Unknown. However, the results indicate that the method used was similar to the one used by Leuchter/Roth and Rudolf/Fresenius.

8.3. Evaluation of Analytical Results

8.3.1. F.A. Leuchter/Alpha Analytic Laboratories

All of Leuchter’s positive findings from the alleged homicidal ‘gas chamber’ lie in the vicinity of the ‘official’ detection threshold (1 mg per kg) and must be expected to exhibit very high fluctuations. Control sample no. 32 is from the disinfestation wing of Building 5a (which Leuchter calls “*disinfestation chamber I*”). The foundations of crematoria IV and V are alleged to have been rebuilt from the rubble of other buildings (see chapter 5.4.2). Thus, the analyses of samples originating from these walls are nevertheless interesting, due to their positive findings in places.

That the analytical values of samples from areas protected from environmental influences are just as low as results from exposed locations, or not detectable at all, led Leuchter to the conclusion that the environmental influences could not have considerably reduced the cyanide content of the exposed buildings,⁵⁰⁴ which would be in accordance with the findings in chapter 6.6. According to Leuchter, low cyanide traces may have resulted from an isolated fumigation of the morgues for pest control, since interior disinfestations were carried out in many camp buildings at that time. The positive result (1.3 mg per kg) of Sample 28, which Leuchter took from the partition of the former washroom to the dissecting room of crematorium I, a wall which never

⁵⁰³ Driving out the hydrogen cyanide by boiling the sample for one hour in aqueous HCl in a slightly reductive medium (SnCl₂), Driving out in the continuous stream of air, collection in the aqueous KOH collector. Finally, photometric or titrimetric testing depending on the concentration in each case. Proof of iron was achieved here by the ICP spectrometer.

⁵⁰⁴ F.A. Leuchter, press release, Boston, 13. February 1990.

formed part of the alleged ‘gas chamber’ and moreover was probably newly erected during the conversion to an air raid shelter, is remarkable. This result, approximately as high as the rest of the samples (including those from the foundation walls of crematorium IV and V, built of unknown material) may largely be explained by three factors:

1. Cyanide traces of this minimal order of magnitude may be present anywhere, which is, however, improbable.
2. This air raid shelter, like all rooms in Auschwitz-Birkenau, was occasionally fumigated with Zyklon B for disinfection purposes.
3. Analytical values in this order of magnitude (near the detectable threshold) are not reproducible and therefore cannot be interpreted due to the limited efficiency of the method. They are equivalent to zero values. In view of the results to be discussed below, this reason appears the most probable.

According to Bailer, the high cyanide content of the control samples taken by Leuchter in the disinfection wing is to be attributed either to an artifact, an error in the sample taking, or an analytical error. He understands an artifact to mean that the wall of the disinfection wing was painted with blue paint, precisely, an Iron Blue paint, at an earlier time. Bailer further expresses the opinion that no Iron Blue could form in the masonry material due to the alkaline environment. In addition, the high cyanide content of 1,050 mg per kg is said to mean that the walls consist 0.1% of pigment, which in his opinion could not possibly be true.⁵⁰⁵

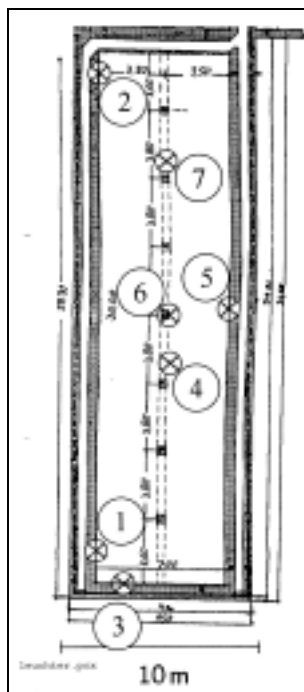

Fig. 67: Sketch of morgue 1 ('gas chamber') of crematorium II in Birkenau with test sample taking locations by F.A. Leuchter.²⁶

- Samples 1, 2, 3, 5 from Masonry;
- Sample 4 from the ceiling;
- Sample 6 from the pillars;
- Sample 7 from the debris on the ground.

⁵⁰⁵ J. Bailer, *op. cit.* (note 52); similar to *ibid.*, in B. Bailer-Galanda, *et al.* (ed.), *op. cit.* (note 54),

Table 17: Cyanide concentrations in the masonry of 'gas chambers'/disinfestation chambers		
According to F.A. Leuchter/Alpha Analytic Laboratories, Ashland, Massachusetts, USA		
Test sample no.	Sample taking location	CN ⁻ [mg per kg]
1-7	Crematorium II, morgue 1	0.0
8	Crematorium III, morgue 1	1.9
9	Crematorium III, morgue 1	6.7
10,11	Crematorium III, morgue 1	0.0
12	Door sealing	0.0
13,14	Crematorium IV	0.0
15	Crematorium IV	2.3
16	Crematorium IV	1.4
17-19	Crematorium IV	0.0
20	Crematorium IV	1.4
21	Crematorium V	4.4
22	Crematorium V	1.7
23,24	Crematorium V	0.0
25	Crematorium I, morgue	3.8
26	Crematorium I, morgue	1.3
27	Crematorium I, morgue	1.4
28	Crematorium I, wash room	1.3
29	Crematorium I, morgue	7.9
30	Crematorium I, morgue	1.1
31	Crematorium I, morgue	0.0
32	Disinfestation chamber 1	1,050.0

The morgue of crematorium I and morgue 1 of crematorium II are alleged to have been homicidal 'gas chambers'.

As shown in chapter 6.5., the environment is only alkaline in the non-carbonated masonry. It was also established that an alkaline environment even supports the accumulation of cyanide and certain other steps in the reaction towards the formation of Iron Blue. If one assumes, as an extreme case, a complete conversion of all iron compounds contained in the masonry into pigment (1 to 2% iron content), the values found by Leuchter are even rather low. Whether the walls of the disinfestation wing were painted blue, *i.e.*, whether a high cyanide content can only be found on the upper, *i.e.*, the paint layer of the wall, will be discussed at a later time.

Pressac opines that the low cyanide traces in the masonry of the crematoria are the final proof of the existence of the 'gas chambers,' since they are still detectable today after what was, in his opinion, a

short exposition time and low reactivity of hydrogen cyanide on cool masonry and despite corrosion and erosion.⁵⁰⁶ He furthermore expresses the opinion that warm walls would be necessary for the formation of the pigment.⁵⁰⁷ Just how unrealistic this opinion really is, has already been shown: Firstly, the pigment formed is durable (chapter 6.6.); secondly, cool and moist walls have a higher reactivity to pigment formation than dry and warm walls (chapter 6.5.); thirdly, Leuchter's Sample no. 28 proves that the cyanide traces are not caused by homicidal gassings.

8.3.2. Institute for Forensic Research, Cracow

The analytical values shown in Table 18 were never published by the Jan Sehn Institute. They only became public knowledge due to an act of indiscretion. The results appear to suggest that the alleged 'gas chambers' exhibit either no cyanide residues at all or values which are clearly lower than those found in samples taken from the disinfestation chambers. The scientist responsible, Prof. Markiewicz, writes about the chemistry involved:⁵⁶

"Hydrogen cyanide is a weak acid, which has the result that its salts decompose slightly in the presence of stronger acids. One of these stronger acids is carbonic acid, which arises from the reaction between carbon dioxide and water. [Even] stronger acids, such as, for example, sulfuric acid, decompose cyanide even more easily. Complex compounds with cyanide ions with heavy metals are more durable. Among such compounds is the already mentioned 'Prussian Blue' [=Iron Blue], but even this decomposes slowly in an acid environment.

One could hardly expect, therefore, that building materials (plaster, brick) exposed to environmental influences (precipitation, acid oxides, especially sulfuric and nitric monoxide) would contain derivative compounds of cyanides after a period of 45 years."

This contradicts the facts established above, and so to repeat:

- a) Carbon dioxide is only slightly soluble in water and hardly forms carbonic acid in water at all, and therefore the cyanide salts cannot "decompose" (see chapter 6.5.4.1. and note 349; actually, the water is responsible for the decomposition);
- b) Iron Blue (Prussian Blue) is extraordinarily stable in acids and is

⁵⁰⁶ *Op. cit.*(note 45); *ibid.*, *op. cit.* (note 67), p. 133.

⁵⁰⁷ J.-C. Pressac, *op. cit.* (note 67), p. 53.

Table 18: Cyanide concentrations in the masonry of 'gas chambers'/ disinfestation chambers				
According to the Jan Sehn Institute for Forensic Research, Department for Toxicology, Cracow, Poland, data in mg per kg				
No.	Building	Sample taking location and -depth	Material	CN ⁻
1	Disinfestation Block 3	Room 4, around the ventilator opening, 2 mm	Plaster	0.068
2	Disinfestation Block 3	Room 4, next to doors to Room 3, 2 mm	Plaster	0.036
7	Disinfestation Block 3	Room 3, below window, opposite, 2 mm	Plaster	0.076
8	Disinfestation Block 3	Door opening between Room 2 and 1, 2 mm upper left	Plaster	0.140
9	Disinfestation Block 3	Like Nr. 8, lower left	Plaster	0.404
10	Disinfestation Block 3	Room 1, Ventilator opening, 2 mm	Plaster	0.528
11	Disinfestation Block 3	Like 10, light blue	Plaster	0.588
15	Crematorium II, morgue 1	Concrete support columns	Plaster (?)	0.024

4 additional samples from crematorium II, 1 from crematorium I, 1 from crematorium V, in each case an alleged 'gas chamber', and 2 control samples contained demonstrable traces of CN⁻.

not destroyed by the influences of weathering, even over decades (chapter 6.6.).

In a private exchange of correspondence with Werner Wegner, Prof. Markiewicz displayed his ignorance once again.⁵⁰⁸

“VIII. Water activates many chemical processes. The chambers were certainly moist. What kind of influence this exerts upon the binding of HCN by cement (wall plaster)—is unknown to us. [...]

IX. The blue stains on the exterior walls of Building 5a are not easily explained. Above all, we must examine whether or not it is actual Berlin Blue [=Iron Blue...]”

In a later study, these authors published additional analysis results of samples taken later, using the same analytic method. According to these analyses, the cyanide concentration of samples taken in a disinfestation chamber and in alleged homicidal 'gas chambers' were in the range of 0.0 to 0.8 and 0.0 to 0.6 mg/kg, respectively. This study also

⁵⁰⁸ Letter from the Prof. Dr. Jan Sehn Institute for Forensic Expert Opinions, Department for Forensic Toxicology, Cracow, to W. Wegner, undated (winter 91/92), (illegible signature) unpublished.

discussed the selection of the analytical method.⁵⁷ This was said to have been selected because the authors could not imagine how blue iron cyanide compounds could form in the masonry:

“It is hard to imagine the chemical reactions and physicochemical processes that could have led to the formation of Prussian blue in that place.”

They furthermore assume, together with J. Bailer,^{52,54} that the blue pigmentation of the disinfestation chamber walls could be due to a coat of paint. To exclude this pigmentation from the analysis, they decided to apply a method which is insensitive to iron cyanides.

An exchange of correspondence with myself in 1995 once again revealed the general incompetence with which the Polish researchers approached this set of problems.^{58,59}

A more detailed discussion of the Polish findings appears in chapter 8.4.2.

8.3.3. G. Rudolf/Fresenius Institute

Only a few samples were taken from the alleged homicidal ‘gas chambers.’ Care was taken to ensure that samples were only taken from material not exposed to weathering. Only a few places in morgue 1 (the alleged ‘gas chamber’) in crematorium II at Birkenau, where a pillar supports the roof even today and has therefore visibly protected both the underside of the roof and parts of the wall from all influence of weathering, exemplified by the deposition of spider webs many years old and the absence of any trace of lime precipitation on the concrete or mortar, which would be caused by rain water.

Many samples have already been taken from the alleged ‘gas chambers’ by the Cracow team and Leuchter, all with at least nearly negative results. Since it was above all a matter of clarifying the question of which circumstances favor the formation of pigment and since clearly positive findings were not to be expected according to the analyses performed in the alleged ‘gas chambers’ thus far, the sample gathering took place chiefly in the disinfestation chambers of Buildings 5a and 5b in construction section Ia and/or Ib. It is known that their walls not only contain large quantities of pigment, but that their age also corresponds approximately to that of the crematoria on the same location, which cannot be said of the buildings in the main camp. The age can, but need not, have an influence on the chemistry of the wall

materials. Furthermore, these buildings are not so much in the spotlight of the museum activity as those in the main camp, and therefore rather permit hope of an absence of subsequent building alterations.

Finally, samples were taken from a few inmate barracks to examine Leuchter's argument that low cyanide traces could also result from a few fumigations for pest control. The numbering of the barracks corresponds to those found on the barracks today.⁵⁰⁹ See also, in this regard, Fig. 12.

8.3.3.1. Samples 1-4: Crematorium II, Morgue 1

On the taking of samples 1 to 3, see Figure 26 (page 92). An extremely high concentration of cyanide on the surface of the material must generally be expected. To investigate this, sample 1 contains, principally, concrete prongs from the ceiling/underside of the roof (caused by wooden planking), that is, the most exposed part of the concrete, as well as material from the uppermost layer of concrete, 1 to 2 cm thick, including a piece up to a depth of approximately 3 mm.

Sample 2 contains concrete to a depth of 5 mm, taken from the place at which the piece extending inward up to a depth of 3 mm was obtained in sample 1.

Separation between material from the topmost layer (Sample 1) and lower layers (Sample 2) was not entirely possible due to the extreme hardness of the concrete.

Sample 3 is a harder plaster, obviously rich in cement, extending to the first row of bricks.

Sample 4 originates from the plaster of the concrete beam in the chimney wing (rubbish incineration) of crematorium II. It is only interesting as a blind sample in addition to the others.

The results lie in the same order of magnitude as Leuchter's positive findings from other alleged 'gas chambers', although Leuchter had no positive results in samples from morgue 1 ('gas chamber') of crematorium II. The difference between Samples 1 and 2 may indicate that a depth profile is actually prevalent in the concrete. Table 20 shows a list of control analyses. Sample 3 mentioned above with a low positive result of 6.7 mg/kg now has a value below the detectable threshold (0.5 mg per kg). This confirms the statement made in chapter 8.2. that values near the detectable threshold are not reproducible.

⁵⁰⁹ J.-C. Pressac, *op. cit.* (note 67), p. 514, plan of Birkenau camp with barracks numbering.

Table 19: Cyanide concentrations in masonry of 'gas chambers' / delousing chambers According to G. Rudolf/Institut Fresenius, Tausnusstein, Hessen, Germany						
Concentration values in mg per kg: %Fe: Portion of total iron content converted to Iron Blue, assuming that all detected cyanide was present as Iron Blue.						
No	Building	Sampling location and depth	Material	c[CN ⁻]	c[Fe]	%Fe
1	Crema II	Morgue 1, ceiling, between 2. and 3. supporting pillar from the south, removal of material from a broad area, concrete drips incl. a small piece of deeper material, 0-3 mm.	Concrete	7.2	13,000	-
2	Crema II	as 1, 1-5 mm.	Concrete	0.6	20,000	-
3	Crema II	Inner side of western wall of morgue 1, 0-1.5 cm, see Figure 43 (page 119).	Plaster	6.7	10,000	-
4	Crema II	Inner side of the northern wall of the chimney wing, garbage	Plaster	0.1	11,000	-
5	B1b Barrack 20	Wall separating berth, underneath the crossing beam of one bed in the large room, 2 nd row of berths from the entrance, first berth to the right (separating wall), ca. 5 · 5 · 5 cm ³ big.	Plaster	0.6	9,400	-
6	B1b Barrack 20	Separate room in the west, interior wall, mortar between bricks, 0-1 cm.	Mortar	<0.1	4,400	-
7	B1b Barrack 20	as 6, at the entrance directly to the right, 0-1 cm.	Plaster	0.3	19,000	-
8	B1b Barrack 13	as 5, behind beam rest.	Plaster	2.7	11,000	-
9	B1a BW 5a	Inside of external wall (West), 120 cm from northern wall, 155 cm from the floor, 0-2 mm.	Plaster	11,000.0	12,000	75
10	B1a BW 5a	Internal wall (south), 240 cm from western wall, 170 cm from the floor, 0-2 mm.	Plaster	3.6	10,000	-
11	B1a BW 5a	as 9, 1-10 mm.	Plaster	2,640.0	6,000	36
12	B1a BW 5a	Eastern wall (inside), 170 cm from northern wall, 170 cm from floor, (eastern hot air chamber), 0-2 mm.	Plaster	2,900.0	8,500	28
13	B1a BW 5a	as 12, 2-10 mm.	Plaster	3,000.0	9,000	27
14	B1a BW 5a	Outside western wall, 40 cm from southern wall, 160 cm from the ground, 0-5 mm.	Brick	1,035.0	25,000	3.5

Table 19 continued: Analyses results Rudolf/Fresenius						
No	Building	Sampling location and depth	Material	c[CN]	cj[Fe]	%Fe
15a	B1a BW 5a	Outside southern wall, 40 cm from western wall, 210 cm from the ground, 0-3 mm.	Mortar	1,560.0	10,000	13
15b	B1a BW 5a	as a, > 0-5 mm, with pigment layer removed.	Brick	56.0	n.b.	-
15c	B1a BW 5a	as b, removed pigment layer, < 1 mm.	Brick	2,400.0	n.b.	-
16	B1b BW 5b	Outside southern wall, 2 m from entrance door, 1 m from the ground, 0-7 mm.	Brick	10,000.0	47,000	17
17	B1b BW 5b	Inside southern wall, 130 cm from eastern wall, 130 cm from the floor, 4-10 mm.	Plaster	13,500.0	15,000	74
18	B1a BW 5a	Floor area of door post of hot air delousing chamber, eastern chamber, pointing to the main wing, 0-5 mm.	Wood	7,150.0	n.b.	-
19a	B1b BW 5b	Inside northern wall, 230 cm from eastern wall, 90 cm from the floor, 0-4 mm.	Plaster	1,860.0	4,300	35
19b	B1b BW 5b	as 19a, 4-8 mm.	Plaster	3,880.0	9,500	33
20	B1a BW 5a	Inside exterior wall (west), 40 cm from southern wall, 210 cm from the floor, 0-3 mm.	Plaster	7,850.0	11,000	59
21	B1a BW 5a	Interior wall (east) from western wall, 30 cm from door, 190 cm from the floor, 10-50 mm.	Mortar	0.3	18,000	-
22	B1a BW 5a	Inside of exterior wall (south), 40 cm from western wall 155 cm from the floor, 3-10 mm.	Plaster	4,530.0	11,000	34
23	B1a Barrack 3	Special room northwest, inside exterior wall (north), 0-5 mm.	Plaster	0.3	8,100	-
24	B1a Barrack 3	Main room inside exterior wall, (north), 0-5 mm.	Mortar	0.1	13,000	-
25	Experiment	Untreated brick, 0-5 mm.	Brick	9.6	35,000*	-
26	Experiment	16 h in 0.3 vol.% HCN, 0-5 mm, see text.	Brick	0.1	35,000*	-
27	Experiment	24 $\frac{3}{4}$ h in 2 vol.% HCN, +1 g H ₂ O, 20 mm, 100 g.	Cement Mortar	109**	8,800*	1.0
28	Experiment	as 27, without added H ₂ O, 108 g.	Cement Mortar	94**	8,800*	0.9
29	Experiment	as 28, 94 g.	Lime Mortar	53**	4,500*	1.0
30	Experiment	as 28, + 2g H ₂ O, 96 g.	Lime Mortar	58**	4,500*	1.1

CN* values between 0.1 and 0.5 mg/kg are considered uncertain (NN); n.d.=not determined; *=own analyses; **= Institut für Umweltanalytik, Stuttgart (IUS).



**Institut
Fresenius**

Chemische und Bakteriologische
Laboratorien GmbH

6204 Tarusstein-Neuhof
Telefon 06128/744-0
Telefax 06128/925 blaud
Telefax 06128/744890

Dipl.-Chem. Gernar Rudolf

Pr.Nr. 91TA065282-65310
Unsere Auftrags-Nr. 91/13946-00

09. September 1991
Herr E. Gorbauch/Wa
06128 / 744-337

Untersuchung von Baumaterial auf die Gehalte an Eisen und Cyaniden
Ihr Schreiben vom 22.08.91

Eingang der Proben: 23.08.91 (überbracht)

Untersuchungsergebnisse:

Pr.Nr.	Probenbezeichnung	Eisen, gesamt (Fe) %	Cyanide, gesamt (CN) mg/kg
91TA065282	Probe Nr. 1	1,3	7,2
91TA065283	Probe Nr. 2	2,0	0,6
91TA065284	Probe Nr. 3	1,0	6,7
91TA065285	Probe Nr. 4	1,1	0,1
91TA065286	Probe Nr. 5	0,94	0,6
91TA065287	Probe Nr. 6	0,44	<0,1
91TA065288	Probe Nr. 7	1,9	0,3
91TA065289	Probe Nr. 8	1,1	2,7
91TA065290	Probe Nr. 9	1,2	11.000
91TA065291	Probe Nr. 10	1,0	3,6
91TA065292	Probe Nr. 11	0,60	2.640
91TA065293	Probe Nr. 12	0,85	2.900
91TA065294	Probe Nr. 13	0,90	3.000
91TA065295	Probe Nr. 14	2,5	1.035

...



**Institut
Fresenius**

Chemische und Biologische
Laboratorien GmbH

6204 Taunusstein-Neuhof

Telefon 06128/744-0

Telex 6128 925 biosd

Telefax 06128/744000

Blatt 2 zum Schreiben vom 09. September 1991

an:

Dipl.-Chem. Gernar Rudolf

Fr.-Nr. 91TA065282-65310

Fr.-Nr.	Probenbezeichnung	Eisen, gesamt (Fe) %	Cyanide, gesamt (CN) mg/kg
91TA065296	Probe Nr. 15a	1,0	1.560
91TA065297	Probe Nr. 15b	n.b.	56
91TA065298	Probe Nr. 15c	n.b.	2.400
91TA065299	Probe Nr. 16	4,7	10.000
91TA065300	Probe Nr. 17	1,5	13.500
91TA065301	Probe Nr. 18	n.b.	7.150
91TA065302	Probe Nr. 19a	0,43	1.060
91TA065303	Probe Nr. 19b	0,95	3.080
91TA065304	Probe Nr. 20	1,1	7.850
91TA065305	Probe Nr. 21	1,8	0,3
91TA065306	Probe Nr. 22	1,1	4.530
91TA065307	Probe Nr. 23	0,81	0,3
91TA065308	Probe Nr. 24	1,3	0,1
91TA065309	Probe Nr. 25	n.b.	9,6
91TA065310	Probe Nr. 26	n.b.	0,1

* = Werte für Cyanide (gesamt) zwischen 0,1 und 0,5 mg/kg unsicher

n.b. = nicht bestimmt

INSTITUT FRESENIUS GMBH

Table 20: Analysis results from the Institut Fresenius and the Institut für Umweltanalytik, Stuttgart (IUS)			
In both cases the cyanide demonstration took place according to DIN 38405/D13. Data in mg CN ⁻ per kg.			
Sample	Sample taking location	Fresenius	IUS
3	Morgue 1 ('gas chamber'), crematorium II, wall plaster 0-1.5 cm	6.7	< NG
8	1b barracks 13, partition wall of berth, 3-5 cm	2.7	< NG
11	B1a, building 5a, interior side of exterior wall (west), 1-10 mm	2,640.0	1,430*
25	Untreated brick	9.6	9.6
26	3 additional samples of fumigated brick	-	<NG*

* This sample was examined according to DIN 35 405/D14. Here in contrast to D13 no cadmium salt was added. Nothing is known as to the effects on the results. Demonstrable threshold (NG) in each case 0.5 mg per kg.

8.3.3.2. Samples 5 to 8 and 23, 24: Inmate Barracks

Samples 5 and 8 are from a large lump of plaster a few centimeters thick taken from the large room of the respective barracks (see Table 19, p. 254). A depth profile was not drawn up; the values must therefore be viewed as average values. Samples 6 and 7 are from the special room located at the west end of these barracks. Samples 23 and 24 are from the exterior wall of the large room of a third barrack.

Quantities of cyanide on the order of magnitude of those found by Leuchter in the alleged 'gas chambers' can apparently also be found in the wall material of the inmate barracks. This is indicated by the results of Sample 8. All others are also positive, but notably lower. In this case as well, the control analysis (Table 20, p. 258) failed to yield reproducible results.

8.3.3.3. Samples 9 to 22: Disinfestation Building

With regards to the sample taking locations of the individual samples, see Figs. 17f. Judging from the consistency, the material used to build the brick walls of buildings 5a and 5b is a mortar rich in sand but extremely poor in cement (extremely crumbly), covered with a lime mortar plaster.

Building 5a: What is remarkable about the outside of the exterior walls of the disinfestation chamber of BW 5a is that, in places, it ex-



Fig. 68: The outside of the external wall of hydrogen cyanide delousing wing of building 5a in August 1991. Small amounts of cyanide which diffused through the walls are discoloring them at places still today. 50 years of the most detrimental environmental influences did not change this fact.

hibits blue bricks and mortar joints (see 68, above). Sample 14 is a loose fragment of brick which is clearly dark blue at all points facing outwards and therefore exposed to weathering. Sample 15a is mortar from the south wall, only the topmost layer of which was blue to a depth of approximately 1 mm. The cyanide value at this point must have been above the average value of the first approximately 3 mm. Sample 15b is a fragment of brick, the blue layer of which was separated with a spatula (Sample 15c). The mass of the remaining fragment amounted to approximately twenty times the layer scratched off; only slight cyanide concentrations are detectable here. The average concentration here must have been around 120 mg/kg. On the brick as well, the pigment has only formed in perceptible quantities on the outermost side, that which is exposed to weathering (in this regard, see the exterior wall of the disinfestation chamber in Stutthof concentration camp, Fig. 65).

Very important is the confirmation of the fact that the pigment actually possesses an enormous environmental resistance, since Samples 14 to 15c were exposed to intensive sunshine, wind, rain, etc. for more



Fig. 69: *Picture of a room located in the northwest of the disinfestation wing of building 5a (see Figure 18). The exterior walls are located in the background and to the right, showing intensive blue discolorations caused by iron Blue. Taking locations of samples 9 and 11 are visible. On the left in the picture is the interior wall, erected during the conversion to a hot air disinfestation chamber. Sample 10, with a slightly positive cyanide content, was taken from this wall.*

than 40 years. But how did the pigment arise in such high concentrations at this precise location, although the outside of the exterior walls were not exposed to any direct fumigation? The low quantities of cyanide which diffused through the masonry are apparently sufficient to enable the formation of pigment on the outside of the wall, which was moist, especially during rainy weather, and its iron compounds were certainly massively activated by environmental influences.

The inside of the exterior walls of the disinfestation wing of Building 5a are almost completely blue, even dark blue (see Fig. 69, below). Interestingly, the pattern of the brick structure located below the plaster has made an imprint on the intensity of Iron Blue formation in the upper layer of the plaster. Such a phenomenon is similar to, *e.g.*, the well known condensation of excessive atmospheric humidity on cool walls (for example, in large groups of sweating human beings, such as at rock concerts, in discotheques, or, generally, in poorly heated rooms), which also leads to the formation of patterns exhibiting the



Fig. 70: Picture of the door frame in disinfestation wing of building 5a. the lower, rusty hinge has developed Iron Blue under the influence of hydrogen cyanide. Sample taking location of sample no. 18.

underlying brick structure of such walls. Differently-baked bricks have a different tendency towards accumulation through condensation due to their differing heat conductivity. Differing reactivity to the formation of cyanides due to differing moisture contents and temperatures may therefore be the cause of this effect, but also differing transport capacities for migrating cyanide salts due to differing moisture contents.

Underneath the first layer of wall plaster, only approximately 1 mm thick, the material appears, by contrast, pale blue, just like the entire east wall of the wing, which is an interior wall of the original disinfestation chamber and whose discoloration is much less intensive (samples 12 and 13).

The interior walls of the same room, which were incorporated at a later time, *i.e.*, those belonging to the hot air disinfestation chamber (see Fig. 18), exhibit, as expected, no trace of blue.

The results of samples 9 and 11, and 20 and 22, resp., confirm the first impression. The topmost layer of plaster on the inside of the exterior walls has a very high cyanide concentration; underneath, the concentration decreases. The high cyanide concentration of Sample 11 could not, however, be exactly reproduced. The results of the control analysis lies at only 54% of the first value. The slightly different ana-



Fig. 71: *In contrast to building 5a (see Fig. 68), the disinfestation wing of building 5b was used as a hydrogen cyanide delousing chamber for a longer period of time. Subsequently, the outside of its walls are covered with blue spots, unimpressed by 50 years of weathering here as well.*

lytical procedure may be responsible for (see footnote in Table 20).

In pure Iron Blue, 1 g of cyanide contains approximately 0.82 g iron. The iron analysis, assuming that the cyanide is present completely in the form of Iron Blue, shows that, in Sample 9, approximately $\frac{3}{4}$ of all iron was converted to pigment. If one considers that not all iron can be reached by the hydrogen cyanide, then one can speak of a near-saturation of the upper layer of material with the pigment. The drop in the concentration from the topmost layer to the lower layers is explained, for one thing, by the linear gradient which must be expected in not isolated walls (see chapter 7.3.2.3.). Furthermore, as with the blue pigmentation of the exterior of the walls, the effect of accumulation of cyanides on the surface through evaporation of water carrying soluble cyanide compounds must be considered, even though this effect was certainly smaller on inside walls than on outside walls due to lack of air exchange in these rooms after the war (high relative humidity of the air, no wind), and due to the lack of sun activity in the room equipped with windows facing northwards only, see in Fig. 69.

Samples 12 and 13 correspond to Samples 9 and 11, taken from the interior wall only, from the east wall, near one of the hot air chambers. The surface concentration is considerably lower than on the in-

side of the exterior walls, there is no recognizable concentration profile. The reason for this may be that the dry walls allow the hydrogen cyanide to diffuse more easily into the masonry, while the hydrogen cyanide more readily reacts superficially on the moist exterior walls. It is more probable, however, that no migration of soluble cyanide salts to the surface took place in the interior wall due to dryness. These samples are also interesting insofar as they prove that high quantities of cyanide compounds, highly-resistant for long periods of time, can form on warm and dry interior walls. Due to the high ground water table in Birkenau, as well as due to the lack of an effective heat insulation, the exterior walls must be expected to have been quite cool and moist even when the interior was heated, particularly during the cool seasons.

The samples from the walls added during the conversion to hot air disinfection should exhibit no cyanide residues. Accordingly, sample no. 10 from the interior wall incorporated at a later time exhibits only a very low cyanide concentration near the detectable threshold. Sample 21 was taken from the mortar between the bricks of the wall installed later, at a depth of 1 cm to 5 cm into the masonry. There is a crack in the masonry of the interior wall at this location. The analysis shows minimal but hardly interpretable traces of cyanide below the detectable threshold in this interior wall as well. This finding may indicate disinfection of these rooms after the conversion to hot disinfection, if the slight quantities have not in any case lost all probative value, like the control analysis of the other samples have shown.

Sample 18, finally, was taken from the door frame which was only incorporated after the conversion to hot air disinfection. Below the lower hinge, the wood exhibits a visibly blue pigmentation (see Fig. 70, p. 261). The pigment was able to form here due to the moisture in the floor, in connection with the rusting iron. This is assuming that the rooms were either charged with hydrogen cyanide after the conversion of the installation or that the floor of the installation continued to give off cyanide over longer periods of time. In the first case, the cyanide traces in the walls added later (Samples 10 and 21) could actually be explained by fumigation of the rooms. However, during the conversion of this wing to a hot air disinfection facility, this gas-tight door may have been removed from the access way to this wing and re-used here, so that the cyanide would result from earlier fumigations. The analytical results should only be conditionally considered as qualitative, since

organic material can be a disturbing factor during analysis. In any case, the high reactivity of moist iron oxide mixtures (rust) is confirmed.

Building 5b: The exterior walls of disinfestation wing BW 5b are not only blue in places, as in the case of BW 5a, but rather, almost completely so, even below the ground (see Fig. 71, below). An exception here is the east wall, which hardly exhibits any blue pigmentation (see Fig. 19, p. 76). The analysis of a fragment of brick from the south side (Sample 16) therefore shows an extremely high value. Here, the pigment extends further into the masonry. Here as well, weathering has had no visible or measurable effect on the pigment concentration. Approximately 17% of the iron in the fragment of brick has been transformed into pigment, despite the only slight concentration in cyanides able to reach the exterior of the masonry wall here as well. The conspicuous difference between Building BW 5b and 5a, which is only blue in places, is explained by the longer period of use of the 5b wing as a Zyklon B disinfestation chamber. The reason for the perceptibly lesser blue pigmentation of the east side of the exterior wall of this wing can be explained by the lesser influence of weathering on this side (east winds are mostly accompanied by dry weather in eastern Europe).

When examining the interior of this wing, one is surprised by the walls which are mostly white. Pale green stains are visible only in a few places. The analysis of the green-colored plaster underneath the upper layer, Sample 17, however, shows the highest value found anywhere, despite the thick layer of plaster consisting of a compact, very hard material, 3 to 4 mm thick. With relation to the transformation of the iron, what was said of the upper layer of plaster in BW 5a only, is true here: near saturation. The color of the material, here only greenish, is apparently not directly meaningful with regards to the cyanide concentration. Because even in the presence of maximum values, the proportion of pigment in the plaster only amounts to 1.5 %, the intense blue color in places on the surface of the inside of exterior walls of BW 5a cannot moreover be explained in this manner. Rather, the dark blue colors result from a still higher concentration of pigment in the uppermost layers in the micro-meter range of magnitude caused by the accumulation processes of migrating, soluble cyanide salts as described above.

That these accumulation processes did not occur on the surface of the inside of Building 5b may be explained by the different type of ma-

terial and its preparation. The hard, iron-poor interior plaster of lime mortar adheres very poorly to the wall and is already falling off in some places. The contact between plaster and wall is so poor in places, that when one knocks on the wall, one hears that there is a hollow space beneath. Such weak contact between wall and plaster, however, prevents moisture in the wall from diffusing through to the surface plaster and carrying soluble cyanide compounds (for example, iron(II)-cyanide) with it.

Sample 19 was divided in two, since the upper layer of plaster in this room is visibly different from the layer lying beneath: The first 4 mm of plaster consists of a white, brittle, hard material (sand-poor lime plaster), while the layer underneath consists of an ochre-colored, sand-rich lime plaster. The separation was not completely successful; parts of the sand-rich mortar remain in Sample 19a. The analysis for iron, which might possibly have been even lower in the presence of complete separation, confirms the assumption that the upper layer is an iron-poor lime plaster. This explains the deficient formation of blue spots of pigment on the surface of the plaster in this room, since there is too little iron available for the formation of pigment. Nevertheless, even the upper layer of plaster exhibits quite high cyanide values. This shows that the layer of plaster was not applied after termination of the disinfection actions.

8.3.3.4. Samples 25-30: Tests

For an evaluation of the reactivity of hydrogen cyanide with building materials, a series of tests was undertaken; during the first series, only brick was fumigated with hydrogen cyanide, generated from a defined quantity of $\text{KCN} + \text{H}_2\text{SO}_4$ in a gas-tight container. Over the course of the tests, it became apparent by means of sensitive differential pressure measurements that only a part of the hydrogen cyanide added to 16% sulfuric acid was released as gas. Hydrogen cyanide is so easily soluble, even in this acid, that only a portion of it is actually released into the gas room. The actual quantity of gas in the reaction container therefore lay far below the mathematically calculated 3.7% by volume, while the pressure measurements consequently lay around 2 % by volume.

On the construction of a reaction container from a glass cylinder, sealed above and below by PVC plates with gas qualities and O-rings,

see Fig. 72. 16% H_2SO_4 was placed in a crucible, KCN was added by means of a magnetic lever mechanism with the container sealed. The mixing was performed by means of a magnetic stirrer.

The samples listed in Table 21 were analyzed. The following parameters were kept constant:

- 11°C air and sample temperature;
- 90% relative atmospheric humidity;
- Storage of the samples for approximately five weeks under these conditions prior to initiation of the tests;
- Sealing of the samples on all sides, except for one frontal surface, with paraffin 52/54 (thus fumigation on one side only)
- Fumigation with 2% by volume hydrogen cyanide;
- 24.75 hours fumigation time;
- Storage of the samples after fumigation at room temperature and low atmospheric humidity for 71 days.

Exceptions from these conditions are listed in the right column of Table 21 (p. 267). Following fumigation, the topmost layers of the sealed surfaces of samples 27 to 30 were removed, and hence the sealing layer of paraffin. The additionally moistened samples 27 and 30 made themselves perceptible by an intense odor of hydrogen cyanide during storage at room temperature, in contrast to samples 28 and 29 which were only moist by nature. The odor of hydrogen cyanide disappeared suddenly upon additional moistening. In the case of the

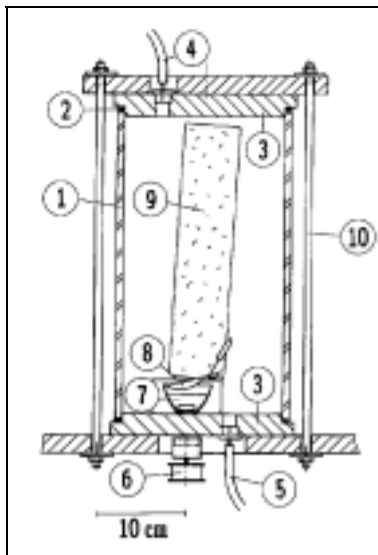

Fig. 72: Construction drawing of the experimental container for the fumigation of material samples with hydrogen cyanide.

- 1: Glass cylinder
- 2: O-sealing ring
- 3: PVC lid and floor plate
- 4: Gas outlet and pressure gauge
- 5: Gas ventilation outlet
- 6: Magnet mixer motor
- 7: Porcelain dish with 16 Vol.% H_2SO_4 and magnet mixer
- 8: Spoon with KCN fixed axle, capable of tipping over magnet from exterior
- 9: Sample material (here brick)
- 10: Bolts

Table 21: Test sample preparation and fumigation

Nr.	Material	Conditions
25/26	Brick from demolished building from Bavaria; only sample 26 was fumigated!	16 h fumigation with 0.3 Vol.%, Storage after fumigation for 120 days at room temperature. No sealing with paraffin
27	Cement mortar: 1 part sand, 1 part Portland cement, ½ part lime. Sample measurements: 55×60×20 mm, 100 g (ca. 1.5 g/cm ³)	addition of 1 g water
28	Cement mortar: 1 part sand, 1 part Portland cement, ½ part chalk. Sample measurements: 55×60×20 mm, 108 g (approx. 1.6 g/cm ³)	
29	Lime mortar: 2 ½ parts sand, 1 part lime. Sample measurements: 55×60×20 mm, 94 g (ca. 1.4 g/cm ³)	
30	Lime mortar: 2 ½ parts sand, 1 part lime. Sample measurements: 52×58×20 mm, 96 g (ca. 1.6 g/cm ³)	addition of 2 g water

cement mortar sample, the odor was no longer perceptible after a week, while in the case of the lime mortar sample, it was no longer perceptible after two weeks. Storage of the samples for more than two months at room temperature therefore perceptibly reduced the hydrogen cyanide content, while the drying of the samples strongly hindered the conversion to iron cyanide.

The analytical results relating to the brick samples (Table 19, p. 254, Sample no. 25 and 26) are surprising for their values, which appear paradoxical: the fumigated sample, in contrast to the unfumigated sample, exhibited no traces of cyanide. The value of the unfumigated sample could be exactly reproduced (Table 20). Further analyses of the fumigated brick likewise resulted in no demonstrable cyanide concentrations. These findings prove that cyanide values up to 10 mg per kg have only very limited probative value, since these can be attributed to traces which occur everywhere.⁵¹⁰

The interpretation of the analytical results of samples 27 to 30 resulted in the following data:

- In total, 30 mg of cyanide were found in the samples during the analysis. Since 300 mg cyanide were used during this test, 10% of

⁵¹⁰ It is also conceivable that the unfumigated samples were contaminated during preparation for analysis, perhaps through an improperly cleaned ball mill, in which samples with a high cyanide content had previously been crushed. The reason for the good reproducibility may be that there is hardly any carbonate in brick, since it acts as a disturbance ion.

this quantity was found durably bound to the samples.

- The cement mortar samples, in contrast to the lime mortar samples, exhibit a higher cyanide concentration by a factor of two. The higher iron content of the cement mortar samples may be the reason for this, since the cyanide content increases proportionally to the iron content (see the last column of Table 19). In addition, hydrogen cyanide adsorption was certainly favored by the higher inner surface area of the cement mortar as compared to lime mortar.
- The increased hydrogen cyanide absorption caused by the addition of moisture was only slightly perceptible in the analytical results, since the samples were all very moist anyway, and because the material dried out during the final storage phase and therefore the hydrogen cyanide was only able to bind partially.
- Blue pigmentation of the samples was not to be expected, since even if all the bound cyanide were present in the form of Iron Blue, only 0.005-0.01% of the total material would consist of the blue pigment, which would cause hardly any perceptible coloration to the naked eye. An accumulation of cyanides on the surface of the sample, finally, could not occur due to the absence of water in diffusion. In addition, the dry storage of the samples probably blocked the conversion process.

8.3.4. John C. Ball

All samples taken from alleged homicidal ‘gas chambers’ are around or well under the detection threshold and must therefore be considered zero. Ball’s samples from the delousing wings of buildings 5a and 5b do represent a fairly good average of my own and confirm my results.

Table 22: Cyanide concentrations in the masonry of ‘gas chambers’/disinfestation chambers according to John C. Ball⁵¹¹

No.	Location	c(CN ⁻) [mg/kg]
1	Delousing Room B1b BW 5b, inside and outside	3,170.0
2	Delousing Room B1b BW 5a, inside and outside	2,780.0
3	Crematorium II, morgue 1 (‘gas chamber’)	0.4
4	Crematorium III, morgue 1 (‘gas chamber’)	1.2
5	White Farm House, remnants of foundation	0.07
6	Crematorium V, remnants of foundation wall	0.1

⁵¹¹ John Clive Ball, *The Ball Report*, Ball Resource Services Ltd., Delta, BC, Canada, 1993.

8.4. Discussion of the Analysis Results

8.4.1. Blue Wall Paint?

The hypothesis expressed by J. Bailer,^{52,54} that blue paint could be responsible for the high cyanide values in the disinfestation chambers, does not correspond to the facts:

1. Iron Blue is not sold as wall paint at all, since it lacks sufficiently high lime fastness (see chapter 6.6.1.).

2. If this argument were correct, it would be remarkable that the SS, of all the rooms in the Third Reich, would apply blue paint only to their disinfestation chambers where no one could admire it; and, strangely, always the same blue. All other rooms were whitewashed. Were the SS practitioners of 'blue magic'?

3. The disinfestation chambers themselves already had a coat of lime paint. Why would they cover this coat of lime paint with another paint which, in addition, is not even lime fast? They would therefore have had to wait until the lime paint and plaster had set before one could paint the walls. And then it would have been by no means certain that the paint would not furthermore have become stained as a result of chemical reactions.

4. A coat of paint on the interior of the room would not explain the patchy pattern of the blue stains on the interior of the exterior walls of the disinfestation wing of Building 5a.

5. Neither would a coat of paint on the interior of the room explain the absence of blue coloration on the interior walls added to the disinfestation wing at a later time. Or are the SS supposed to have painted only certain walls, and then, not evenly, with paint brushes, but, perhaps, soiling the wall statistically by throwing and spattering?

6. Bailer's argument is refuted by the fact that none of the colored walls shows any pattern of brush marks, and no identifiable coat of paint, since wall paint consists not only of pigment, but also of a not inconsiderable proportion of binding agents and other chemicals. The blue pigment is, however, simply one component of the lime paint and plaster.

7. Bailer's argument furthermore fails to explain how the artistic skills of the painters could have succeeded in imitating the brick structure lying beneath the plaster. Or did they not only practice 'blue magic,' but were equipped with X-ray eyes as well?

8. Bailer's argument does not explain the only pale blue tint of the interior south walls of the original disinfestation wing of Building 5a.

9. Neither does Bailer's argument explain the high cyanide concentration in the superficially white, iron-poor material of the walls of the disinfestation wing of Building 5b. Or is it his opinion that these rooms were, perhaps, painted with an 'iron white,' a paint color that does not even exist?

10. Bailer's argument furthermore fails to explain the still higher cyanide concentration of deeper, greenish-bluish coats of material in the walls of the disinfestation wing of Building 5b; or does he perhaps intend to argue that the SS even applied iron-blue paint to wall plaster and wall mortar where no one could ever admire it? There, it would in addition have certainly have been decomposed into its component parts due to the alkaline pH value of fresh mortar and would have lost its color at least temporarily.

11. Finally, Bailer's argument cannot explain why even the exterior walls of the disinfestation rooms, exposed to weathering, have a notable cyanide content and are discolored with blue stains. Or did the SS employ the technique of statistically throwing and splashing paint about here as well, paying particular attention to the structure of the brick, resisting at all times the temptation to apply the coats of paint which are so typical of ordinary painting, simply because blotchy blue-stained brick is so sexy? Or was the Iron Blue applied to the bricks upon manufacture, resisting the baking process of the brick in a magical fashion known only to the blue-magic SS?

The Polish scientists, as indicated above, adopted Bailer's argument and therefore preferred simply not to prove the presence of Iron Blue at all. *Honni soit qui mal y pense...* (a rogue who thinks evil about it)

8.4.2. False Method of Analysis

Many people, both experts and laymen, rely good-naturedly upon the findings of the Jan Sehn Institute for Forensic Research in Cracow, *i.e.*, the study published in 1994 by Prof. Markiewicz and colleagues. These Polish scientists, however, tested their samples with analytical methods that were unable to detect stable iron cyanide compounds. They did this because they could not imagine how such stable iron cyanide compounds could form. It is, of course, no shame to fail to

understand something initially. Anyone, however, who makes a claim to scientific reliability must, before making statements upon the subject, at least attempt to investigate and understand. But not so the Polish scientists. They assert their lack of understanding as a justification for their failure to act. Has anyone ever heard that failure to understand a phenomenon was any reason for scientists *not* to study it? To the Polish scientists, this was obviously the case. It would only be permissible to exclude Iron Blue from the study if it were possible to *exclude*, with practical certainty, that the effects of hydrogen cyanide on masonry could result in the formation of iron cyanide, and, consequently, Iron Blue, and if there were at least some indication that these rooms had been painted with Iron Blue. The Polish scientists completely neglected to do this. And even worse: they did not even attempt to refute my arguments on the formation of stable iron cyanide compounds which I published in early 1993.⁵¹² They were familiar with this publication, because they quoted it, but not, for example, in order to discuss my arguments, but simply to condemn it flatly as an example of the allegedly diabolical deeds of the ‘deniers’ and the ‘whitewashers’ of Hitler, who Prof. Markiewicz and his colleagues intended to refute—so their own words. This should suffice to show that the Polish actions were ideologically motivated, to a high degree. If they had been neutral scientists, they would have applied the correct and interpretable method of analysis and would have discussed my publications in a scholarly manner instead of worrying about Hitler’s dirty laundry.

Prof. Markiewicz and his colleagues did not even attempt to find any explanation for the high iron cyanide concentration in the walls of the disinfestation chambers and their blotchy-blue surfaces.

Although they had sought out an analytical method able to produce the results desired by them, the results of their first series of tests were obviously so disturbing that they decided to suppress them and never published them. These data only became public knowledge through an act of indiscretion in 1991 (see chapter 8.3.2.).⁵¹³

The Polish scientists therefore rejected the undesired results of

⁵¹² E. Gauss, *Vorlesungen...*, *op. cit.* (note 43), pp. 163-170; 290-294.

⁵¹³ The first series of studies, undertaken by J. Markiewicz, W. Gubala, J. Labeledz, and B. Trzcinska, were never published by the authors of the studies. Only the revisionists have published their findings, after the article was smuggled out of the Jan Sehn Institute by unknown persons in 1991; see also note 56; for further remarks on this example of ‘political science’, see G. Rudolf, *op. cit.* (note 58).

Table 23: Orders of magnitude of analytical results of various samples, in mg CN/kg

Author:	Markiewicz <i>et al.</i>	Leuchter	Rudolf	Ball
Results from:	Cyanide without iron cyanide	———— Total cyanide ————		
delousing chambers:	0-0.8	1,025	1,000-13,000	2,780-3,170
'gas chambers':	0-0.6	0-8	0-7	0-1.2

their first series of tests and took even more samples, until they finally produced the results that fitted in with their preconception: this time, both the samples from the disinfestation chamber and the alleged 'gas chambers' showed cyanide residues on the same order of magnitude.⁵⁷

But even Prof. Markiewicz and his colleagues, during the test fumigations performed by them, at least confirmed that moist cement mortar (as was used in the morgues of crematoria II and III) absorbs at least ten times more hydrogen cyanide than dry lime mortar (as used in the disinfestation chambers), as I had assumed for my calculations in this work.

Table 24 shows the analysis results of Prof. Markiewicz and his colleagues compared to those of Fred Leuchter, John C. Ball, and mine.

I will spare myself further analysis since analysis results obtained in a methodically incorrect manner cannot be corrected even by correct interpretation. Any attempt at interpretation is therefore a waste of time.⁵¹⁴

Even a direct comparison with my arguments and the open expression of suspected fraud could not move Prof. Markiewicz and his colleagues to justify or correct their unscientific manner of behavior.^{58,59} The director of this group, Dr. Jan Markiewicz, who is not a chemist, but rather, a "*Technical Testing Specialist*", died in 1997. Both the other authors have remained silent.

One can after all understand that these Polish authors made their careers in Communist Poland, and, as Polish patriots, can under no circumstances permit the undermining of 'Auschwitz' as a moral justification for the Polish ethnic cleansing of the East Prussians, East Pomeranians, and Silesians after the end of World War Two, as a result

⁵¹⁴ A word on the HCN-CO₂ mixture used by the Poles for their fumigation experiments. In their view, CO₂ has a negative influence on the adsorption of HCN in the masonry. Their own test results are, however, in contradiction to this view; they are also incorrect in assuming that CO₂ could have a negative influence on the absorption of HCN; see also note 349, p. 165.

of which some three million Germans lost their lives, as well as it being the greatest land robbery of modern history. Many Poles fear in their hearts that the post-war state of Poland stands and falls with Auschwitz. This may explain Prof. Markiewicz's and his colleagues' scientific contortions, but it fails to be a justification for them. Even the possible circumstance that the scientists assigned to the topic were not and are not chemists and that their laboratory was perhaps not equipped up to Western standards, cannot explain this, since an analysis of the total cyanide concentration is not expensive in terms of laboratory equipment and the chemistry involved is anything but complicated.

The manner with which the Polish scientists approached the problem, however, gives rise to serious suspicion that this was an attempt at scientific fraud, a suspicion which is also supported by the fact that they were unable to justify their incorrect methods of measurement except through their incompetence and ignorance.

The conclusions to be drawn from the above is clear: the only 'scientific' attempt to refute Fredrick A. Leuchter's sensational argument proves, upon closer examination, to be one of the greatest scientific falsifications of the 20th century.

How desperate must one really be, if it is believed necessary to stoop to such methods in an attempt to defend the established version of the Holocaust, *i.e.*, the alleged systematic extermination of the Jews in homicidal 'gas chambers'?

8.4.3. The Memory Hole

At the end of chapter 6.6.5., I already referred to the bold lies of Albert Meinecke from the German press agency dpa regarding the alleged short life term of hydrogen cyanide in masonry. A new corny joke was recently added to this debate by Prof. James Roth from the Alpha Analytic Laboratories, Ashland, Massachusetts. I discuss this event here because Prof. Roth's allegations were widely publicized by the international media in connection with the libel case of British historian David Irving against Deborah E. Lipstadt.⁵¹⁵

For his documentary movie *Mr. Death* on Fredrick A. Leuchter, Errol Morris also interviewed Prof. Dr. James Roth. In 1988, Roth's

⁵¹⁵ This claim played a role in the verdict which should not be underestimated, cf. judgment Gray, *op. cit.* (note 66), §13.79; cf. note 68.

laboratory had analyzed the masonry samples from the alleged ‘gas chambers’ taken by Leuchter in Auschwitz for their cyanide content. During the trial against Ernst Zündel in Toronto that same year, for which the Leuchter report had been produced, Prof. Dr. Roth himself was interrogated as an expert witness. Ten years later, Errol Morris interviewed Roth about this event. During this interview, Prof. Roth did all he possibly could to distance himself from the possible consequences of the analyses performed by his company. His interview gained importance only due to the fact that the Dutch architectural Historian Prof. Robert van Pelt quoted Roth in his 1999 expert report prepared for the Irving trial. In it, van Pelt wrote about Roth’s statements in Morris’ movie:⁵¹⁶

“Roth explained that cyanide will react on the surface of brick or plaster, penetrating the material not more than 10 microns, or 0.01 mm, or one tenth the thickness of a human hair [...]. In other words, if one wants to analyze the cyanide concentration in a brick sample, one should take a representative sample of the surface, 10 microns thick, and no more.”

It can be shown that Prof. Dr. James Roth is wrong for the following reasons:

1. It is a fact that the walls of the disinfestation chambers in Auschwitz, Birkenau, Stutthof, and Majdanek are saturated with cyanide compounds, and this not only superficially, but into the depth of the masonry, as I have proved by taking samples from different depths of the wall, compare in this regard especially my samples no. 11, 13, 17, 19b, and 23 in Table 19. They prove that hydrogen cyanide can rather easily reach deep layers of plaster and mortar. But even the other samples taken from the surface prove that Prof. Roth’s allegation is wrong: Provided that most of the cyanide detectable today is present in the form of iron cyanide (Iron Blue and other cyanoferrates), as Prof. Roth assumes himself, his thesis would mean that 10% to 75% of the iron content of these samples are located in the upper 10 micrometer of my samples (0.010 mm), *i.e.*, they are located in less than 1% of the entire sample mass, and the rest of the sample would have been massively deprived of iron. How this migration of a major portion of iron to a thin surface layer would have happened is inexplicable to me.

⁵¹⁶ Pelt Report, *op. cit.* (note 66), p. 307.

2. Furthermore, expert literature is detailed in that
 - a. hydrogen cyanide is a extremely mobile chemical compound with physical properties comparable to water,³²²
 - b. which can quite easily penetrate through thick, porous layers like walls.⁴⁰⁹
3. In addition, it is generally known that cement and lime mortar are highly porous materials, comparable for instance with sponges.⁵¹⁷ In such materials, there does not exist something like a defined layer of 0.01 mm beyond which hydrogen cyanide could not diffuse, as there can also be no reason, why water could not penetrate a sponge deeper than a millimeter. Steam, for example, which behaves physically comparable to hydrogen cyanide, can very easily penetrate walls.
4. Finally, the massive discolorations of the *outside* walls of the disinfestation chambers in Birkenau and Stutthof, as shown in this expert report, are clearly visible and conclusive evidence for the fact how easily hydrogen cyanide and its soluble derivatives can penetrate such walls.

As a professor of analytical chemistry, Prof. Roth must know this, so one can only wonder why he spreads such outrageous nonsense. That Prof. Roth is indeed a competent chemist can be seen from what he said during his testimony under oath as an expert witness during the above mentioned Zündel trial:⁵¹⁸

“In porous materials such as brick or mortar, the Prussian blue [recte: hydrogen cyanide] could go fairly deep as long as the surface stayed open, but as the Prussian blue formed, it was possible that it would seal the porous material and stop the penetration.”

⁵¹⁷ DIN 4108, part 3 to 5, deals with diffusion of steam into building materials. The most important coefficient for building materials is the so-called coefficient of diffusion resistance; this is a dimensionless number indicating, how much longer the diffusion of steam takes to penetrate a layer of certain materials compared to the time it takes to diffuse through the same layer of still air. This coefficient is valid not only for water vapor, but also for gaseous hydrogen cyanide as well as for any other gas. In the list of 100 different building materials compiled in DIN 4108 part 4, one can find lime and cement mortar with diffusion resistances from 15 to 35, in which case the resistance grows with increasing cement content, for gypsum plaster, the coefficient is 10, for brick walls 5 to 10, for glass wool mats it is 1. That means, if a gas diffuses through a layer of still air with a speed of 1 cm per second, it does take 15 to 35 seconds to diffuse through a 1 cm thick layer of lime or cement mortar and 5 to 10 seconds to diffuse just as deep into a brick wall. (I am grateful to Mr. C.H. Christmann for this reference.) In this regard, compare also the analysis about the porosity of masonry, graph 7, p. 183.

⁵¹⁸ B. Kulaszka (ed.), *op. cit.* (note 25), p. 363 (protocol p. 93-9291).

Prof. Roth might have felt obligated to attack Leuchter in order to avoid becoming himself a target of certain lobby groups who already managed to destroy Leuchter's career. That would explain why the truth temporarily dropped into a hole in Prof. Roth's memory while being interviewed by Errol Morris. It is also revealing that Prof. Roth mentioned during this interview, if he had known where Leuchter's samples originated from, his analytical results would have been different. Does that mean that Prof. Roth manipulates his result according to whether or not he likes the origin of certain samples? Such an attitude is exactly the reason why one should never tell an 'independent' laboratory about the origin of the samples to be analyzed, simply because 'independence' is a very flexible term when it comes to controversial topics. What Prof. Dr. Roth has demonstrated here is only his lack of professional honesty.

8.4.4. The Moon is Made of Pizza

Another strange story is that of Richard Green, a PhD Chemist with quite similar educational background as I have.⁶³⁻⁶⁵ The layman would expect two experts, with similar educational background, to come to similar conclusions in questions relating to their expert knowledge. But this is only partly the case. The reason for this is that Dr. Green ignores many facts that are either supported by documentary evidence—like the performance of the ventilation installed in crematoria II and III, or the speed of executions in U.S. execution chambers—or by expert literature—like the higher tendency of cold, moist walls to adsorb HCN, and the longer lasting alkalinity of cement mortar compared to lime mortar.

However, Dr. Green makes some concessions which are important to note:

a) He agrees that basically all witnesses attest to very short execution times, indicating a rather high concentration of HCN used.

b) He also agrees "*that Rudolf is correct or nearly correct regarding the formation of blue staining in the delousing chambers.*"

What he does challenge, though, is the possibility of formation of any noticeable quantities of Iron Blue in the homicidal 'gas chambers.' One of his flawed and deficient arguments to support his thesis is that in his view, no noticeable amounts of cyanide could have accumulated in the walls of the morgues ('gas chambers'). According to Dr. Green,

one major factor for this is supposed to be the fact that masonry has a neutral pH value which does not allow the protolysis of hydrogen cyanide and thus the formation of cyanide salts. But if that were true, how come huge amounts of cyanides did accumulate in the walls of the disinfestation chambers?

My argument in this regard is that particularly cement plasters and concretes, as used in morgues 1 of crematoria II and III, are noticeably alkaline for many weeks, months, or even years, which I documented thoroughly with expert literature on the chemistry of building materials (see chapter 6.7.2.). Hence, I concluded that these walls would have been very much inclined to accumulate cyanide salts and to form Iron Blue, even more so than the lime plaster of the disinfestation chambers, which in turn provoked the following answer by Dr. Green:

“[In 1993] *The IFRC* [Institute for Forensic Research, Cracow], *on the other hand measured the pH* [of mortar samples from the alleged gas chambers] *to be between 6 and 7* [i.e. neutral].”

Dr. Green obviously did not consult any literature on the chemistry of building materials, as he quotes none. He solely relies on the findings of the Cracow institute. In order to make the reader see how flawed Dr. Green’s way of arguing is, let me say it in a parable:

By referring to a couple of Italian expert pizza baking instructions, I showed that a pizza, when taken out of the oven, is hot or warm for quite a while (one hour). Now, Dr. Green comes along claiming that I am wrong because a Polish friend of his has just now measured the temperature of a pizza which was baked a week ago, and which has been lying around somewhere since. And the Polish scientists found out that this pizza is indeed cold right now. Surprise, surprise!

Of course, samples taken from the surface of walls erected 50 years ago or more are now pH neutral! Even this I have proved by showing how the front of neutralization slowly migrates into concrete and mortar (see chapter 6.7.2.2.). But what does the pH value of samples taken 50 years after the erection of these building prove regarding their pH value shortly after they were built? Dr. Green’s way of arguing is childish to the highest degree.

When it comes to intellectual honesty, Dr. Green reveals some other very strange behavioral patterns, one of which I want to address here.

Dr. Green agrees with me that the Iron Blue found in delousing

chambers is the result of gassings with hydrogen cyanide. Hence he disagrees with the opinion of Markiewicz and others that this Iron Blue has its origin for different reasons, like residual paint. Consequently, Dr. Green should refuse the approach of the Cracow team to exclude Iron Blue from the analysis, because this would most likely exclude the major parts of the cyanide residues formed by gassings with HCN in general (not just in case of delousing chambers). Subsequently, Dr. Green should furthermore criticize Markiewicz for having chosen a method of analysis which must lead to faulty and misleading result, as I did. Additionally and more generally, he should say that the Polish scientists neither tried to understand what they claimed not to have understood, nor discussed the attempts to understand as made by others, which were known to them. No matter which results the Polish scientists produced and what their scientific opinion might have been: their behavior is extremely unscientific, as **the most important task of a scientist is to try to understand what has not been understood so far, and to discuss the attempts of others to make understandable.** The Polish scientists did just the opposite: they decided to ignore and exclude what they did not understand. Finally, in their article as well as in a letter to me, the Polish scientists themselves stated that the purpose of their paper was to refute the “*Holocaust Deniers*” and to prevent Hitler and National Socialism from being whitewashed, *i.e.*, their purpose was *not* to find out the truth! Thus, by their own confession, they used unscientific methods in order to produce desired results for the purpose of achieving certain political goals.

Let me quote Prof. A.R. Butz in this connection, who stated another appropriate metaphor to emphasize the degree of intellectual dishonesty revealed by Markiewicz and his colleagues:⁵¹⁹

“The argument [of Markiewicz et al. for excluding Iron Blue from their analyses], to the extent that it was intelligible enough to be summarized at all, was that they did not understand how the iron-cyanide compounds got to be there, so they decided to ignore them in reaching their conclusions. I don’t understand how the moon got there, so I will ignore all effects associated with it, such as tides. I hope I don’t drown.”

And the amazing thing about Dr. Green is that he—and with him Prof. van Pelt, who relies on Green⁶⁹—does not only defend Prof.

⁵¹⁹ Arthur R. Butz, “*Historical Past vs. Political Present*”, *JHR*, 19(6) (2000), pp. 12ff. (online: www.ihr.org/jhr/v19/v19n6p12_Butz.html).

Markiewicz's behavior in every regard, but he attacks me for my critique against the Polish scientists, while omitting *all the reasons* I gave for doing so. To crown this, Dr. Green even defends the fact that Prof. Markiewicz never even bothered to address any of my critique, even though addressing critiques is paramount for scientists. Dr. Green argues:

"Rudolf complains that Markiewicz et al. have not responded to his queries. Why should they do so? What credibility does Rudolf have, that demands they answer his every objection no matter how ill-founded?"

However, since Dr. Green agrees that the Iron Blue detectable in disinfestation walls *is* the result of gassings with Zyklon B, he himself has indirectly admitted that all my objections against Markiewicz's method of analysis are well-founded, *i.e.*, just the opposite of "*ill-founded*".

And why does Dr. Green think I bear no credibility demanding a discussion of any of my arguments? Not because I lack scientific qualifications. No, he thinks I am an abomination because of my views, and because I have been subject to social persecution and political prosecution, leading to the total destruction of my social existence, my reputation, and finally my freedom. Dr. Green even resorts to calling me a "*liar*," "*obfuscator*," and "*hater*" because of my different well-founded opinions.

The scheme is as follows: first, people like Dr. Green attempt to do everything to destroy my reputation by name-calling, persecution, and prosecution, and when they succeed, they claim that there is no need to discuss anything with me anymore, since I do not have any reputation and credibility anyway. This way they can nicely ignore any argument refuting their flawed thesis. And they have the chutzpah to call themselves righteous scientists and to call me a pseudo-scientific liar and obfuscator of the truth.

Dr. Green unconditionally defends the scientific frauds from the Cracow institute, and both get away with it, because in the eyes of the public, both have the 'politically correct' 'scientific' opinion about Auschwitz. Birds of the same feather flock together.

8.4.5. Anticipated Values

The only case of the formation of Iron Blue through fumigation with hydrogen cyanide, which is fairly well documented, is the case of

damage to a church in Lower Bavaria as cited above.²² Even today, buildings are fumigated with hydrogen cyanide, yet Iron Blue is rarely formed. The reason for this, however, is quite obvious. Fumigation with hydrogen cyanide is used to kill vermin, such as woodworm, meal moths, corn beetles, or lice. However, a massive case of vermin infestation requiring the use of hydrogen cyanide occurs, in practice, only in buildings which have already been in use for relatively long periods of time, *i.e.*, many years. It is therefore to be expected that the interior plaster of such buildings has long since become thoroughly carbonized. Furthermore, the rooms to be fumigated are, as a rule, heated in order to enhance the effectiveness of the hydrogen cyanide (faster evaporation, slower adsorption losses, stimulated metabolism of vermin). Since it is not to be expected, according to the findings presented here, that a perceptible accumulation of cyanides, let alone the formation of Iron Blue, would occur after only one fumigation in warm, dry, and chemically set wall materials, one cannot be surprised that such building damage is the exception rather than the rule.

The damage to the building in Bavaria is a typical exception here, since the unheated church, notorious for its humid walls, had been plastered with cement mortar, which is known to remain alkaline for many months, only a few weeks before. These are exactly the conditions which in my view were favorable to the formation of Iron Blue. With increasing setting of the cement plaster over the course of months, the pH value of the masonry in the church finally dropped, so that the final reaction led to the formation of Iron Blue, which is stable for long periods of time. This final reaction of the adsorbed cyanide into Iron Blue was only completed after approximately two years. The prior stage of this reaction, the formation of considerably paler iron cyanides, could already have been completed or well progressed prior to this.⁵²⁰

A comparison with the probable conditions of the disinfestation chambers and alleged homicidal ‘gas chambers’ of the Third Reich is quite informative (see Table 24). The following assumes that both installations (tacitly assuming the existence of the homicidal ‘gas chambers’) were put into use more or less immediately after their construc-

⁵²⁰ Incidentally, all the plaster in the church had to be knocked off the walls and replaced, since there was no other way to get rid of the Iron Blue. Communication from Konrad Fischer, head architect during the renovation of the church at that time.

Table 24: Comparison between cases of building damage, morgue and disinfestation chamber

LOCATION PROPERTY	PLASTERING OF CHURCH	CREMATORIUM II/III MORGUE I	DISINFESTATION BW 5A/B
Iron Content	> 1 Weight.-%	1-2 Weight.-%	0.5-5 Weight.-%
Type of plaster	Lime + Cement	Cement (+lime?)	Lime
Alkalinity	Medium-term high	Medium-to-long-term high	Short-term high
Moisture	Moderately high (hydrophobic plaster, cool, moist church)	High (unheated cellar below ground water table, condensing sweat*)	Moderate (exterior wall) to low (interior room) (heated room)
Time elapsed between plastering and fumigation	A few weeks	Between a few weeks and three months*	(a few weeks?)
Number of fumigations	1	Allegedly $\geq 400^*$, in each case at least one hour	Probably < 400 , in each case many hours
Proof of cyanide	Clear	Negative	Clear (0.1-1 weight-%)

* = assuming the correctness of the alleged mass gassing scenarios

tion, *i.e.*, at a time when the concrete, mortar, and plaster was still not entirely set. In addition, they were in near-constant use for one to two years.

That the entire plaster job on the wall of the church referred to above turned blue even after only one fumigation is explained by the especially (un)favorable circumstances. The alleged 'gas chambers' of crematoria II and III in Birkenau show a striking similarity to this case. These cool and moist cellar rooms were only completed shortly before they were put into service and are then said to have been exposed to hydrogen cyanide on a constant basis in contrast to the church mentioned above, which was only fumigated once.

Finally, the interesting question of which analytical values were really to be expected, if the reported mass gassings with Zyklon B really occurred in the 'gas chambers' at Auschwitz, must now be examined.

First, consideration will be restricted to the morgues 1 of crematoria II and III, since sufficient data are only available for these buildings and because it is only here that meaningful samples can be taken, since it is certain that the material is in its original condition.

As a comparative value, let us take two of the samples taken by myself from the interior wall of Building 5a: Samples no. 12 and 13, with a total cyanide concentration of 2,900 and 3,000 mg/kg, respec-

tively.

The following is a list of individual properties which exert an influence upon the formation of Iron Blue.

1. Properties, which were approximately the same in both installations:
 - the (alleged) operating time (approximately 1 year)⁵²¹
 - the (alleged) frequency of use (a few hundred times),⁵²² even if a document quoted in chapter 5.2.3.5. states that shortly after the putting into operation of these hydrogen cyanide disinfestation chambers, a decision was made to stop using them, see. p. 70. It may therefore well be that the cyanide residues to be found in these disinfestation chambers today result from considerably fewer fumigations.
 - the (necessary) application concentration.⁵²³
 - both installations were (allegedly) put into operation more or less immediately after completion.⁵²⁴
2. Properties that were advantageous to the formation of Iron Blue in the disinfestation chamber:
 - the duration of the fumigation times led, in the disinfestation chamber, to a concentration of cyanide in the masonry between 16% and 30% of saturation; in the case of the homicidal ‘gas chambers’, however, only to values of between 1.6% and 8% could be reached (factor 2-19).⁵²⁵
3. Properties which were advantageous to the formation of Iron Blue in the homicidal ‘gas chambers’:
 - the morgues possessed cool, moist walls, which have a higher ten-

⁵²¹ With regards to the homicidal ‘gas chambers’, the period between March 1943 and the fall of 1944 is ‘attested to’. Building 5a was completed in the fall of 1942 (*TCIDK*, 502-1-214; acc. to 502-1-22-19, it was completed already by June 20, 1942), but converted to operate with hot air in the summer of 1943 (J.-C. Pressac, *op. cit.* (note 67), pp. 55-58; acc. to *TCIDK*, 502-1-24, equipment of BW 5a and 5b with hot air disinfestation facility started on Nov. 1, 1942).

⁵²² For the homicidal ‘gas chambers’, this follows from the alleged victim totals of several hundred thousand victims per chamber; for the delousing installations, this follows from the maximum number of days available in $\frac{3}{4}$ of a year (approximately 270 days).

⁵²³ See also chapters 7.1. and 7.3.1.3.

⁵²⁴ Crematorium II was completed in February/March, after which the gassings are alleged to have begun in mid-March or the end of March. With relation to the delousing installations, we have no data, but one may assume that the building was used as soon as it was completed, even if it must be expected that the delousing chambers could not be used for a while, since, for delousing, it was necessary first to install all the equipment after completion of the building, *i.e.*, undressing rooms, showers, saunas, heating, etc. The same applies, of course, to the crematoria/morgues.

⁵²⁵ See also chapters 7.3.2.2.f.

dency, higher by a factor of 8, to adsorb hydrocyanic than the warm, dry interior walls of the disinfestation chamber under consideration (factor 8).⁵²⁶

- Ceilings and walls of the morgue consisted of cement mortar and/or concrete, which, due to their longer-lasting alkaline properties and due to their greater specific inner surface area, are able to adsorb and bind hydrogen cyanide for a longer time and more strongly than the cement-poor mortar and plaster of the disinfestation wing under consideration. Quantification in this regard is difficult, but a factor in excess of two must be anticipated (factor 2).⁵²⁷

According to these considerations, the factors indicating that rather more iron cyanide would have had to form in the homicidal ‘gas chambers’ than on the interior walls of the disinfestation chamber in question ($\frac{8 \times 2}{2 \text{ to } 19} \approx 0.4\text{-}8$) weigh more heavily. In actual fact, however, the homicidal ‘gas chambers’ contain such low cyanide concentrations that they are neither capable of reproducible detection nor of adequate interpretation, but in any case at least some 150 to 10,000 times lower than those detectable in the walls of the disinfestation chambers.

Or in plain English: When analyzing wall samples from the alleged ‘gas chambers’ of crematoria II and III, we ought to expect results which are in the same order of magnitude as the results of samples taken from the walls of the delousing chambers of BW 5a and 5b. What we do find in those ‘gas chamber’ samples, however, is practically nothing.

8.4.6. Limits of the Chemical Method

The most recent development in the official school of thought tends to modify the marginal conditions for the homicidal mass gasings, even when this stands in shattering contradiction to the statements of eyewitnesses or the technical data.

Whereas it was still the rule, until a few years ago, for the eyewitness testimonies to allege daily, or even continuous, gasings,⁵²⁸ today it is occasionally assumed, as a result of the drastic reduction in the

⁵²⁶ See also chapters 6.5.1., 6.5.3., 6.7.2.f.

⁵²⁷ See also chapters 6.5.2., 6.7.2.f.

⁵²⁸ According, for example to the testimony of M. Buki in the Frankfurt Auschwitz Trial; see H. Langbein, *Der Auschwitz-Prozeß, op. cit.* (note 465), p. 96.

number of victims to a maximum of 630,000,⁴⁵⁸ 470,000 to 550,000,⁴⁵⁹ or even 356,000 gassing victims,⁴⁶⁰ that there were considerably fewer homicidal gassings per ‘gas chamber’ than hitherto believed.

There is furthermore a tendency towards a strong reduction in the alleged quantity of hydrogen cyanide utilized as compared, for example, to the quantities alleged by the eyewitnesses.^{49,54,55}

There is much unfounded fantasizing as to the existence of any ominous Zyklon B introduction devices, which would have permitted the toxic gas to be released through holes in the ceiling into the chamber—holes which, unfortunately, did not and do not exist—and to be removed again following conclusion of the gassings.⁵²⁹

Furthermore, the opinion is occasionally expressed that the homicidal ‘gas chamber’ was sprayed with a water hose after every gassing. This assertion forgets that it would have lasted many hours until the ‘gas chamber’ could have been cleared of bodies (they had to be cremated, which is time-consuming, after all) that the hydrogen cyanide does not merely sit on the surface of the wall, but rather, due to its extremely high diffusion capacity, penetrates deeply into the wall within a few hours, and that a water hose would be of no assistance in this regard, quite apart from the fact that such an action would have had the effect of causing the consequently extremely damp walls to adsorb even more hydrogen cyanide during the next hypothetical gassing. In addition, the samples taken from the ceiling, which was certainly not hosed down, likewise show no reproducible cyanide concentrations.

Yet there are also physical-chemical boundary conditions which can influence the analytical results. It is, for example, not inconceivable that, for whatever reason remaining unknown until the present time, the masonry of the alleged ‘gas chambers’ was not, or more slightly, inclined to the formation of Iron Blue, or that possible residues were destroyed for unknown reasons.

The assumptions made in relation to the boundary conditions relating to hypothetical homicidal gassings were naturally subject to particular reserves, since no empirical data were available in this regard. Thus the question of how quickly the hydrogen cyanide contained in Zyklon B could diffuse in hypothetical ‘gas chambers’ and how

⁵²⁹ Pressac (note 67) and van Pelt (note 69) are true masters in the composition of such inventions. The court historians either fail to notice or deliberately ignore the fact that these fairy tales are not based upon documents or physical reality.

quickly it could have resulted in death for all the victims, cannot be answered with absolute certainty. The assumptions made here are, of course, generally well-founded, but are not infallible.

All of the above makes prediction with *certainty* of the quantities of cyanide which one might have expected to find in the masonry of the alleged 'gas chambers' impossible. The anticipated cyanide values indicated above and the subsequently following, summarized conclusions are therefore only the well-founded conclusions of an expert; under no circumstances do they constitute dogmatic truth. An extensive series of tests, for which neither the time, nor the equipment, nor the money are available to me, would have been necessary under the most varied conditions for a better prediction of the expected values. In view of the importance of the topic, it would perhaps have been proper, after 55 years, for some renowned institute to begin with such investigations at long last.

Matters are different, however, when coming to conclusions based upon architectural and engineering questions. Because the structural fabric of some of the buildings under discussion has remained in its original condition, and due to the extensive documentation available about them, we are able to arrive at concrete statements, especially regarding the absence of alleged Zyklon B introduction holes in crematoria I, II, and III.

9. Conclusions

- ❑ Even according to the statements of pharmacist J.-C. Pressac, who, in the late 80s and early 90s, was promoted as *the* technical Holocaust expert, eyewitness testimonies relating to the engineering of the installations and their capacity are, almost without exception, untenable. But even the corrections to the testimonies considered by Pressac to be necessary do not go far enough to make them credible. In particular, the testimonies relating to the duration of executions in the ‘gas chambers’ (morgue 1) of crematoria II and III, as well as the ventilation times after the executions go completely awry. This is because of the over-estimation of the evaporation rate of hydrogen cyanide from the carrier of Zyklon B, as well as the incorrect concept of the effectiveness of the ventilation of the rooms. If the eyewitness testimonies relating to the quantities of Zyklon B used, and at least approximately relating to the rapidity of the execution procedure are to be accepted, then they are incompatible with testimonies, sometimes of the same witnesses, that the victims’ corpses were removed from the ‘gas chambers’ immediately after the executions and without gas masks and protective garments. This is particularly true for those alleged ‘gas chambers’ without ventilation installations (crematoria IV and V and farmhouses I and II), since working in poorly ventilated ‘gas chambers’ with high concentrations of poison gas is impossible without gas masks. The extreme danger to the sweating workers of the Sonderkommando, who are supposed to have worked without protective garments, makes the witnesses untrustworthy. The eyewitness accounts are therefore completely contradictory, illogical, contrary to the laws of nature, and therefore incredible. The witnesses engage in particular contortions when it comes to the cremations (amount and kind of fuel used, speed of cremation, development of flames and smoke), which furthermore fail to accord with the analyses of aerial photography.
- ❑ The alleged installations for the mass murder of human beings are, in Pressac’s judgment, impractical for their purpose, but were, on the contrary, illogically constructed in parts, so that they would not have been suitable as instruments of mass extermination. Once one

considers the actual technical requirements, the impression remains of the total inadequacy of the installations in question—which were deficient to the point of uselessness—in gross contradiction to the technically advanced disinfestation chambers in the immediate vicinity. The facts set forth here with relation to Zyklon B introduction pillars in the ceilings of the ‘gas chambers’ (morgue 1) of crematoria I to III strengthen the suspicion of a subsequent manipulation almost to a certainty. These installations would have been even less suitable than crematoria IV and V. It would have been impossible to introduce the gas into them.

- Due to the proven, enormous environmental resistance of Iron Blue pigment, the slight cyanide traces in alleged homicidal ‘gas chambers’, which are demonstrable in places, but are not reproducible, cannot be explained on the basis of remaining residues of a disintegration process, since even on the weathered exterior side of the disinfestation wing large quantities of cyanide can be found even today. Towards the end of the operating period of the installations, therefore, the cyanide content must have been present in the same order of magnitude as it is today, as well as in the areas which were never exposed to weathering. But the cyanide values of protected areas in the alleged homicidal ‘gas chambers’ are just as low as in places exposed to weathering. Weathering has, therefore, not actually diminished these slight traces. The low cyanide values cannot be explained by fumigation of the premises for vermin, as postulated by Leuchter, since such fumigation would probably have left greater quantities of cyanide in the moist cellars of crematoria II and III. The cyanide values of the alleged homicidal ‘gas chambers’ lie in the same order of magnitude as the results, among others, of the samples taken by myself from parts of other buildings (hot air disinfestation Building 5a, inmates barracks, the washroom of crematorium I). These values, however, lie so near the detectable threshold that no clear significance can be attributed to them, most importantly due to their lack of reproducibility. From the above, one can safely conclude that *no* cyanide residues capable of interpretation can be found in the walls of the alleged homicidal ‘gas chambers’.

It was further possible to show that, under the conditions of the mass gassings as reported by eyewitnesses in the alleged ‘gas chambers’ of crematorium II to V, cyanide residues would have

been found in similar quantities, coloring the walls blue, as they can be found in the disinfestation wings of building 5a/b. Since no significant quantities of cyanide were found in the alleged homicidal 'gas chamber', one must conclude that these installations were exposed to similar conditions as the above mentioned other installations (hot air disinfestation, inmate barracks, washroom of crematorium I), *i.e.*, that they most likely were never exposed to any hydrogen cyanide.

Final Conclusions

A. On chemistry

A: The investigation of the formation and stability of cyanide traces in masonry of the indicated structures as well as interpretation of the analytic results of samples of building material from these structures in Auschwitz show:

1. Cyanide reacting in masonry to produce Iron Blue is stable over periods of many centuries. It disintegrates on the same time scale as the masonry itself. Therefore, traces of cyanide should be detectable today in almost undiminished concentrations, regardless of the effects of weather. The outer walls of the delousing chambers BW 5a/b in Birkenau, which are deep blue and contain high concentrations of cyanide, are evidence of this.
2. Under the physically possible conditions of the mass-gassing of humans with hydrogen cyanide, traces of cyanide must be found in the same range of concentration in the rooms in question as they are found in the disinfestation structures, and the resulting blue discoloration of the walls should likewise be present.
3. In the walls of the supposed 'gas chambers' the concentrations of cyanide remnants are no higher than in any other building taken at random.

Conclusion to A:

On physical-chemical grounds, the mass gassings with hydrogen cyanide (Zyklon B) in the supposed 'gas chambers' of Auschwitz claimed by witnesses did not take place.

B: On building technology

The investigation of the events of alleged mass gassings in the indicated rooms claimed by witnesses, from a technical and practical standpoint, including physical-chemical analysis, showed:

1. The extensive documentation on the Auschwitz camp does not contain a single reference to execution ‘gas chambers’; rather it refutes such suspicions.
2. The supposed main gas chambers of Auschwitz, the morgue hall of the crematorium in the main camp and the morgue cellars I (‘gas chambers’) of crematories II and III, did not have any means for the introduction of poison gas mixtures. Holes in the roofs visible today were made after the war, and all other cracks are the result of the building’s destruction at the end of the war.
3. The release of lethal quantities of hydrogen cyanide from the Zyklon B carrier requires many multiples of the time asserted; the actual duration runs to several hours.
4. To provide the necessary ventilation for the supposed ‘gas chambers’ of crematories II and III would have taken many hours, contrary to all witness testimony.
5. It would have been impossible to provide an effective ventilation of the supposed ‘gas chambers’ of crematories IV or V or of farmhouses I and II. The corpses could not have been removed from the rooms and carried away by the Sonderkommando without protective garments and the use of gas masks with special filters.

Conclusion to B:

The procedures of mass-gassing as attested to by witnesses during their interrogation before various courts of law, as cited in judicial rulings, and as described in scientific and literary publications, in any building of Auschwitz whatever, are inconsistent with documentary evidence, technical necessities, and natural scientific law.



Germar Rudolf, Certified Chemist, in exile, on September 13, 2002.

DECLARATION

The author of this report can refer only to the *existing* eyewitness testimonies and documents, which *alone* are the basis for the widespread historical viewpoint in the matters dealt with here.

If the conviction should nevertheless become prevalent that the eyewitnesses erred in their corresponding testimonies, then an expert can only confirm that there is no longer any basis upon which to draw up an expert opinion, and, in the opinion of this author, there will no longer be any basis upon which court judgments, a method of historiography established by criminal law, or criminal prosecution of certain statements could be based.

10. Acknowledgements

Not everybody who was directly or indirectly involved in creating this expert report or who expressed their support, can be thanked here. Also on behalf of those who cannot be mentioned, I am expressing my gratitude to the following individuals and institutions for their support:

- ✿ to the *Forschungs- und Materialprüfungsanstalt* (Research and Material Testing Agency) Baden-Württemberg, Otto Graf Institut, Department 1: Building Materials, Stuttgart, for informative discussions and their permission to use their rich literature;
- ✿ to the *Forschungsinstitut für Pigmente und Lacke e.V.* (Research Institute for Pigments and Varnishes), Stuttgart, for permission to use their library;
- ✿ to the research center of the *VARTA Batterie AG*, Kelkheim, for performing mercury penetration tests of building materials;
- ✿ to the *Bundesarchiv-Militärarchiv* (Federal Archive-Military Archive) in Freiburg for their information about Soviet tank engines during World War two;
- ✿ to the *Degussa AG* for sending information material on Iron Blue (trade name Vossen-Blau[®]);
- ✿ to the *Detia Freyberg GmbH* and *ARED GmbH* for their information on Zyklon B;
- ✿ to the *Institut Fresenius*, Taunusstein, for giving me insights into their working and analysis methods and for their informative discussions about analytic problems;
- ✿ to the *Institut für Umweltanalytik* (Institute for Environmental Analytics), Stuttgart, for their co-operation with the control and experimental analyses;
- ✿ to retired Major General Otto Ernst Remer, whose martial public statements were the reasons why this expert report became necessary in the first place;
- ✿ to Mr. Karl Philipp, whose initiative on behalf of O.E. Remer and whose logistic support enabled me to prepare this report;
- ✿ to Mr. Prof. Dr. Robert Faurisson for critically reading the first manuscript in late 1991, and for supplying me with an abundance of documentary material;
- ✿ to Dipl.-Ing. Winfried Zwerenz for offering me his rooms and

- equipment to conduct experiments and for his sub-expert statements regarding ventilation and cremation techniques;
- ⊗ to the certified engineers Dipl.-Ing. Gerhard Förster, Ing. Emil Lachout, Dipl.-Ing. Arnulf Neumaier, Dipl.-Ing. Michael Gärtner, Dipl.-Ing. Harald Reich, Dipl.-Ing. Carl Hermann Christmann, Dipl.-Ing. R. Faßbender, and Dipl.-Ing. Konrad Fischer for their various support and research contributions;
 - ⊗ in particular to Dipl.-Ing. Baurat h.c. Walter Lüftl for all kinds of comments and suggestions on various questions of engineering;
 - ⊗ to Dr. Horst Leipprand and Otto Karl for their indispensable research on the properties of Zyklon B;
 - ⊗ to John C. Ball for his broader investigations of Allied air photos of Auschwitz;
 - ⊗ to Carlo Mattogno for his extremely detailed and productive critique and for his excellent archival studies which he allowed me to use and quote extensively;
 - ⊗ to Friedrich Paul Berg for his very valuable research on executions with hydrogen cyanide in the USA;
 - ⊗ to Werner Wegner, and Jan Markiewicz for their friendly correspondence in this matter;
 - ⊗ to Dr. Myroslaw Dragan for his productive critique regarding the ingestion of hydrogen cyanide by the victims and his instructive cremation experiments;
 - ⊗ to Charles D. Provan for his fruitful, though unfortunately still unpublished, critique regarding the Zyklon B introduction holes;
 - ⊗ to attorneys at law Hajo Herrmann, Dr. Günther Herzogenrath-Amelung, Dr. Klaus Göbel, Jürgen Rieger and Dr. Herbert Schaller for their support in legal matters;
 - ⊗ to Dr. Heinz Knödler, Linda M. Faith, Andrew Fuetterer, and Dr. Fredrick Töben for proofreading various versions of this report;
 - ⊗ to Carlos Porter, Michael Humphrey, and James M. Damon for various contributions to get this work translated from German into English;
 - ⊗ to the historians Dr. Rainer Zitelmann, Prof. Dr. Werner Georg Haverbeck, Prof. Dr. Hellmuth Diwald and Prof. Dr. Emil Schlee, Prof. Dr. Robert Hepp, Prof. Dr. Ernst Nolte, Dr. Walter Post, and Dr. Joachim Hoffmann for their encouragement;
 - ⊗ to my good friends Elda and Robert H. Countess, PhD, who were there for me when I became a refugee and needed friends, who

helped me to build up this fine publishing house *Theses & Dissertations Press*, and particularly to Bob who discussed many details with me and did the final proofreading (blame any typos on him ☺);

- ✿ to the *Zentralrat der Juden in Deutschland* (Central Council of Jews in Germany), who, by their highly inappropriate intervention, encouraged my dismissal from finishing my doctoral dissertation, from the prospect of pursuing a post-doctoral degree, and from all duties of a professional career, so that I can dedicate 24 hours a day to revisionism;
- ✿ to the University of Stuttgart and the Max-Planck-Institute for Solid State Research in Stuttgart, who successfully prevented that I waste my life in the ivory towers of science by denying me my PhD degree and dismissing me without notice;
- ✿ to the District Court Stuttgart, the County Court Tübingen, the County Court Böblingen, the County Court Weinheim, the County Court Berlin-Tiergarten, the County Court Munich, as well as the *Bundesprüfstelle für jugendgefährdende Medien* (German Federal Review Office for Youth-Endangering Media) for trying to drown me in uncounted criminal prosecutions, which had as a consequence that I can now follow my revisionist publishing activities in exile, undisturbed by the terror of the German authorities;
- ✿ and finally to the German and British media for their uncounted inflammatory articles and footages against me, forcing me into inner emigration and giving me even more time to dedicate for revisionism.

11. Hunting Germar Rudolf

11.1. What Makes Revisionists?

Bavarian Nostalgia

During the early 1980s, in my last three years at high school, I developed a passion for everything Bavarian: the soccer team *Bayern München*, Lederhosen, the dialect, and, of course, the Bavarian Party, the CSU,⁵³⁰ which exists in Bavaria only. I also became a fan of Franz-Josef Strauß, who for many decades was chairman of this party and became kind of a symbol for everything Bavarian. I surely would have joined the CSU, also because of its strong conservative views, but unfortunately this party was open only to those residing in Bavaria, where I never lived.

At that time, I also joined the youth organization of Germany's semi-conservative party CDU,⁵³¹ but was active only a short time, because when my university studies took me to Bonn in 1983, I abandoned all political commitments for the time being.

When I started to study chemistry at University of Bonn in the fall of 1983, Bonn, then capital of West Germany, was a hotbed of anti-government demonstrations mainly by leftist students. The German federal government, lead by CDU and CSU, had agreed to the stationing of Pershing middle range nuclear weapons in Germany by the US. Armed Forces and also planned a census of the German population. Both infuriated the German left, who was strongly opposed to any foreign military presence in Germany and to any governmental intrusion into the privacy of German citizens.⁵³² I, on the other hand, took the position held by the German Federal government led by CDU/CSU,

⁵³⁰ *Christlich Soziale Union*, Christian Social Union.

⁵³¹ *Christlich Demokratische Union*, Christian Democratic Union. They actually refused to be called conservative, and rightly so, since only a minority of their members has conservative views, the majority having quite liberal views. The CDU has no section in Bavaria, where the CSU plays its role, though the Bavarian CSU is more conservative than the 'Prussian' CDU.

⁵³² Today, the German government consists of those who demonstrated against such politics in the 70s and 80s, and as was to be expected, they do even worse in politics: They wage war in Serbia and Afghanistan, and they are increasingly dismantling the Germans' civil rights.

arguing *for* the census and *for* the stationing of U.S. nuclear weapons to deter the Soviets.

However, my involvement was abruptly curbed when CSU chairman Strauß engineered a one billion Deutschmark loan to communist East Germany, a deal that contradicted everything Strauß stood for, in particular, the principle that one should never do business with the totalitarian powers of the East, unless some reciprocal benefit was forthcoming. The reciprocal benefit here, however, was only imaginary in that East Germany's communist government promised to remove the 'robot' machine guns on the inner-German border, which automatically killed or maimed every German trying to pass from totalitarian East Germany to 'Golden' West Germany. Subsequently, these atrocious weapons were indeed removed, but this was accompanied by the construction of a second border fence further inland. As a result, the inner-German border became even more impenetrable. Hence, Strauß' deal did not lead to any humane relief for the East Germans, but instead stabilized East Germany's economy, thus delaying its—as we know today—unavoidable final collapse for a few more years. From today's perspective, my criticism at the time was entirely justified. But at that time, it was the opinion of a separate minority only, a minority subject to ridicule—it was a 'peculiar view'.

First jail experience

In October 1983, I had joined a Catholic student fraternity, founded in Königsberg (East Prussia) in the late 1800s, but relocated to Bonn after WWII. At the end of WWII, almost the entire German population of East Prussia either fled or was murdered and expelled by the invading Soviets who divided this old German province in two parts, annexed the northern part and gave the southern part to Poland. In 1984, a 'brother' of this fraternity persuaded me to accompany him on a trip to Czechoslovakia in February of that same year. This fraternity brother was a student of Catholic theology and had adopted the cause of the suppressed Catholic Church in the then still Stalinist Czechoslovakia. Also, he had acquaintances there, and his parents were from the *Sudetenland*, a once purely German border region of Czechia, from where most *Sudeten*-Germans had been expelled or murdered after WWII by the Czechs. This fraternity brother of mine believed and fought for the rights both of the small *Sudeten*-German

minority still living in Czechoslovakia and for the expelled *Sudeten-Germans*, most of whom had resettled in Bavaria and Austria after WWII.

With the knowledge and support of the Catholic Church, we attempted to smuggle theological and political books, as well as a photocopier, to a Catholic congregation in Prague. Our political literature included, for example, a Czech edition of George Orwell's *1984*, which was forbidden in the then Czechoslovakian Socialist Soviet Republic. Although the books arrived at their destination, the photocopier was discovered at the border and my fraternity brother, another person traveling with us and myself were immediately confined to prison at Pilsen in the west of Czechoslovakia. After two weeks of nervous waiting, without any contact to the outside world, during which I was interrogated twice, I was told I could leave. My fraternity brother, however, was later sentenced to a year's imprisonment. He was forced to remain in jail for ten months until Christmas time 1984, when German Foreign Minister Hans-Dietrich Genscher intervened and managed to get him released early.

Justice, not brute force

For many others, this experience might possibly have convinced them to leave controversial topics well enough alone. For me, it was the opposite. Because when I find that I have been the victim of injustice, my reaction is to fight until amends are made.

It was at this time that I became familiar with the dark side of the Communist dictatorship. I swore to myself in prison, once I was set free, I would combat the evil of Communism.

During the following year and a half, I became more involved with those who had been the victim of expulsions: firstly, because my father had been expelled from the east German province Silesia, together with millions of German compatriots (after WWII, Silesia was annexed by Poland and is now its southwestern part); secondly, probably as a result of memories of the fraternity brother mentioned above; and thirdly, from a conviction that the expulsion and persecution of East Germans by the communist dictatorships of Czechoslovakia, Yugoslavia, Poland, and the USSR was one of the greatest crimes in history, a crime which ought never be forgotten, trivialized or minimized, approved or justified. Parallels with the arguments invariably

made in regards to the persecution of the Jews inevitably come to mind.

First political thoughts

The year 1985 was marked by two events:

First, the so-called Engelhard⁵³³ Law was discussed and finally enacted, according to which the offense to dispute, diminish, or justify the crimes of the National Socialist regime, or any other tyrannical regime, will be prosecuted automatically, without anybody needing to file a complaint. The original intention of those who started this discussion—the leftist Social-Democrats—was to make it easier for the legal system to prosecute ‘Holocaust deniers’, without the necessity of a complaint by some Jewish individual or organization. Certain segments of Germany’s semi-conservative party—especially those lobbying for the German expellees—demanded that this law should also apply to anyone minimizing or justifying the crimes of other dictatorships, for example, those who minimized or justified the criminal post-war expulsion of Germans from east Germany and eastern Europe.

In this discussion, I vigorously took sides on the wing of the conservatives often disparagingly referred to as the ‘steel helmet fraction’. By then, I had frequently experienced that those working and arguing on behalf of the German expellees are confronted with the argument that the Germans in general and the German expellees in particular have no right to insist on their claims, even if they were supported by international law.

After all, since Germany under Hitler had wanted war and started war, and since so much guilt had accumulated as a result of the ‘extermination’ or ‘intended extermination’ of the Jews and Slavs, any subsequent crimes committed against Germans by the peoples of Eastern Europe must be viewed as mere recompense. One had to take this view for the sake of a peaceful life. But by so doing, crimes, when committed against Germans by non-Germans, are considered to constitute a counterbalance to German crimes against other nationals, and are thus accepted as ‘fair punishment’. This is common practice, it is a matter of good conduct in Germany to see it this way. But you will be sorry, should it ever enter your mind to turn this argument around and compare and counterbalance German crimes, actual or alleged, with those

⁵³³ Named after the then German Secretary of Justice.

of other nationalities. This is, of course, *verboten!* In fact, continual reminders of German crimes, whether true or not, were and are still used to suppress any memory of crimes committed against my own people, the Germans, or to discuss justified claims resulting from the allied crimes.

No doubts about the indisputable

Certainly, it would have been possible to try and dispute these German crimes, actual or alleged, as a means of overcoming the obstacles of discussing the crimes committed against Germans. But this course of action was not open to me, since I could neither argue nor act against my strongly held convictions. I was a firm believer in the standard historical account of the extermination of the Jews. This approach was therefore closed to me—it did not even occur to me as a theoretical possibility. The only available way was to take the position that two wrongs do not make a right, and no good could ever come of a wrong. This applies to the National Socialist persecution of the Jews as well as to the expulsion of the Germans.

Tackling the *Zeitgeist*

The second significant event of 1985 was my joining a political party called *Republikaner* (not to be confused with the US Republicans). I made contact with this party through my involvement with the youth branch of an organization of Silesian Germans. At that time, these *Republikaner* were relatively unknown and their members were thought of as conservative patriots, but not as right-wing radicals. I discovered that this party had originated from a split with Bavaria's conservative party CSU. The reason for some members of the CSU to leave this party and form their own was dissatisfaction with the mediation of the billion deutschmark loan to communist East Germany by CSU chairman Franz-Josef Strauß, as already mentioned. The party appeared to me as a kind of nation-wide CSU—minus the fear and trembling in the face of the Eastern bloc, and minus the marked patronage of offices and blatant corruption which was noticeable already then.

At first, I thought that this was just the party I had long been looking for, at least with respect to German national politics. However, their handling of the subject of immigrants repelled me, because as a Catholic I was very sensitive to programs or ideas that appeared to be

motivated by hostility to foreigners.

An anti-fascist climb-down

The year 1986 was again marked by two events:

First, I came to realize that the *Republikaner*, at least in the Bonn-Siegburg districts, were mostly a collection of hard-core right-wingers who had been expelled from East Germany after WWII. At the only membership meeting that I attended, it was obvious to me that they could not find anything more important to talk about than the question of whether and to what extent West Prussia was German, and whether territorial claims to it could be asserted. This complete withdrawal from political reality accompanied by a failure to recognize that which was politically necessary at the time the world was debating the reunion of West and East Germany, contributed to my decision to leave the Party.

The most compelling reason for my decision was a recognition that the party included more than a few former members of the right-wing radical party NPD,⁵³⁴ with whom I wanted no contact. After a membership of half a year, I left the party in early or middle 1986.

The second event that I wish to discuss here took place in January 1986, at a convention to celebrate the 115th anniversary of the founding of the German Reich in 1871, organized by the student fraternity *Ver-ein Deutscher Studenten* (VDSt, Association of German Students), and held in Frankfurt. It was at this convention that I first learned that the VDSt Frankfurt was a nationalistically oriented student organization. And it was after this celebration that I had a long argument with a student member of this organization who claimed to be a member of the nationalist party NPD. The subject of our argument was the extermination of the Jews. He maintained that the established description did not fit the facts, and that there were not, in reality, six million victims, but three million at most. I was appalled by this manner of argument, and will explain why.

Repulsive numbers juggling

First, there was the natural repugnance aroused by a line of argument which tended merely to diminish a few numbers, although the

⁵³⁴ *Nationaldemokratische Partei Deutschlands*, National Democratic Party of Germany.

issue is not really the actual numbers, but the intention behind the deed. My belief at that time was that Hitler had planned to exterminate the Jews, and had done whatever had been necessary to accomplish this goal. The actual 'how' and 'how many' were of secondary importance.

From the student's style of argument, it was clear that he had strong political motives for his way of thinking. He spoke of the use of the 'Auschwitz bludgeon' against the political right, and in particular, against his party. His mixture of political objectives and scientific argumentation made me skeptical. I could not take his arguments at face value, because I was unable to trust him. I silently reproached him for his political involvement, believing that he was no longer willing or able to distinguish between truth and falsehood, between the justified and the unjustified.

I have forgotten his exact arguments and conclusions. Perhaps I do him an injustice, but I still retain a bitter taste of his unbending, politically-motivated way of thinking. It is possible that this is merely an impression I had, because at the time, I thought of all NPD members as extremists with dishonest intentions. It is therefore possible that it wasn't the NPD member who had a distorted view of things, but rather, that I saw him distortedly by my own prejudices. That question will never be answered.

Politics prevents doubt

What can one say today about that event? Although I had dealt with this Holocaust 'denier' and was well aware of the reality of the political misuse of the 'Auschwitz bludgeon' against the political right or right-wing oriented people, this did not lead to my doubting the truth of the usual historical version of the National Socialist persecution of the Jews. The reason was that I could not, and cannot, take seriously any position maintained for obviously political reasons.

In the years that followed, I devoted myself chiefly to my studies; in 1986, I had entered the demanding graduate phase of my studies with subsequent preparation for the *Diplom* examination.⁵³⁵ During this period, I abandoned all political activity and withdrew from my work with German refugee organizations and with my student fraternity. This was due not only to my academic work load, but also because I

⁵³⁵ Regarding its difficulty, the German *Diplom* is almost an equivalent to an Anglo-Saxon PhD.

had had my fill of nonsense and no longer cared about activities which were partially unrealistic and mostly useless.

Turks into the ‘gas chamber’?

The pressure let up in the year 1989, as I had just completed my *Diplom* examinations and therefore enjoyed some free time for different intellectual pursuits. The same year was also marked by two significant events.

The first event was the elections for the Berlin Chamber of Deputies, during which the *Republikaner* gained their famous (or infamous) entry into the city’s parliament. Like most people, I was completely surprised by this outcome, since I had lost almost all contact with this party. But, in contrast to most other people, I had some idea of what the *Republikaner* were, and were not. The horrifying media witch-hunt against this party immediately following the electoral success infuriated me. Characteristic of this witch-hunt was the question posed by a journalist on election eve to Bernhard Andres, then party chairman in Berlin, as to whether the *Republikaner* wished to do to the Turks what Hitler had done to the Jews. That was when things turned sour. It was clear to me in the flash of a moment’s insight that I would rejoin the *Republikaner* out of pure defiance and democratic solidarity, even if I was displeased by some things about this party. One could take or leave a few isolated party positions as one wished. As long as the party was in compliance with the German constitution, it was entitled to treatment on the basis of equality.

Of course, nothing that has happened since then bears any resemblance to democracy. Party meetings were regularly harassed or prohibited, although Germans were guaranteed the freedom of assembly as a ‘basic right’. The print and electronic news media were instructed to report nothing but negative information about this party, a fact not in conformity with the standards of ethics and the legal duty of the publicly-funded news media to report the news with objectivity.

The establishment parties placed the *Republikaner* beyond the pale of democracy and constitutional politics. It was therefore those establishment parties who had violated the constitutional right of the *Republikaner* to equal treatment, as well as to the freedoms of expression and assembly.

Professional disbarment due to loyalty to the constitution

One of my close friends, a long-time member of Germany's semi-conservative party CDU, had recently completed his studies in civil administration and was assigned to the city government of a large city in Saxony during his period of practical training. He then received orders from his supervisor, a CDU member, to prohibit the planned regional party convention of the *Republikaner*. Since it was his specific duty as a civil servant to respect the provisions of the German constitution, he refused to obey these orders on the grounds that the *Republikaner* were a legally constituted party, the unconstitutionality or undemocratic nature of which has remained unproven. Therefore, in accordance with the principle of equal treatment for political parties, as well as with the rights of free assembly and a respect for the duty of democratic parties to hold regular meetings of their members, their party convention could not lawfully be prohibited.

The consequence of this disobedience was that my friend was told that he would not be able to complete his period of practical training. To avoid forced termination during this period, my friend agreed to a termination agreement to become effective subsequent to this training. His concomitant attempt to fight the agreement in the Labor Court naturally failed. In Germany, those who defend the constitution are dumped on the street, while those who continually violate the constitution enjoy offices and power while the media cheer them on.

'Reprehensible' German unity

I need to discuss another reason for my rejoining the *Republikaner* in 1989. My belief that one should hold fast to the unity of the German Fatherland has never changed. The left-wing German party SPD⁵³⁶ had abandoned the goal of reunification in the mid-70s, while the left-wing radical GRÜNE (Greens) had always supported the division of Germany into two independent states. The small liberal party FDP⁵³⁷ followed in the mid-80s in their support for two independent German states, and towards the end of the 80s, even within the semi-conservative CDU calls to put off the German reunification forever became louder and louder. In this connection (I believe it was in 1987),

⁵³⁶ *Sozialdemokratische Partei Deutschlands*, Socialdemocratic Party of Germany.

⁵³⁷ *Freie Demokratische Partei*, Free Democratic Party.

I remember the commentary of Dr. Helmut Kohl, then leader of the CDU and German chancellor, on a position paper of a certain CDU Member of Parliament, Bernhard Friedmann, concerning German reunification, which Dr. Kohl described as “*blooming nonsense*”. After the political sea-change of 1983, when the semi-conservative/liberal CDU/FDP coalition replaced that of the socialist/liberal SPD/FDP government of the decade before, the new government dissolved all governmental departments in charge of administrative preparations for a German reunification. The left wing of the CDU, under Rita Süßmuth, Heiner Geißler and Norbert Blüm, campaigned openly for dual statehood. In the summer of 1989, the Federal Council of the CDU youth organization *Junge Union* (Young Union) took the initiative to recommend the deletion of the political goal of German reunification from the party program of the CDU— just a few months before the Berlin Wall fell and Germany actually was reunified!

Now that Germany is reunited, a devastating judgment must be passed upon all the established political parties with regards to their political competence. From the standpoint of the present, the *Republikaner* were the only party, of those involved at the time, with a correct estimation of the historical and political forces, even if they were subsequently booted out by the turncoats of reunification. I was in the party because all the other parties had abandoned, or were about to abandon in an absolutely unconstitutional manner, the principle of reunification, a principle laid down in the preamble to the German constitution.

It is significant also that my membership in the *Republikaner*, which ended in the summer of 1991, was later used by the District Court Stuttgart as an indicator of my political mania— in full knowledge of what I have just described. Nowadays, support for the maintenance of constitutional political principles is deemed reprehensible, if not outright illegal. Further comments are superfluous.

Ready to go into a new era...

The young people that streamed into the *Republikaner* party at that time wanted to do something for German reunification, since this was impossible in almost any other political party. Former members of the CDU, the SPD and the FDP joined, as well as people from right-wing splinter parties and many people who had never been in any party at

all. It was a motley group resulting in an unholy chaos. But among us students in Frankfurt, where I completed work for my diploma thesis and later performed my compulsory military service,⁵³⁸ this plate of mixed vegetables was intellectually very fruitful. In the newly founded *Republikaner* university organization, we had one former member of the liberal party FDP, one from the socialist party SPD, one from the conservative ecologist party ÖDP,⁵³⁹ three from the semi-conservative CDU, and many who were active for the first time. During this time, we were flooded with new ideas and discussed controversial issues as never before.

In this Frankfurt period, which ended in late 1990, I read nearly 200 books, mostly during my ‘loafer-service’ in the *Bundeswehr*: I read right-wing and left-wing books, books from the middle-of-the-road, and books without any political viewpoint. It was one of the best times I have ever experienced. It was like preparing for an intellectual break-out.

...but instead into the offside

Our interest in involvement with the *Republikaner* party disappeared due to the fact that it was extremely anti-academic, both in its ranks and leadership. We had to let ourselves be mocked and called greenhorns and academic egg-heads by other members, and the work of our high-school organization was torpedoed by the *Republikaner* leadership which led to our resignation. From 1990 onwards, the *Republikaner* party has concerned itself mostly with internal conflicts; since every initiative for constructive work was received with malicious criticism, I resigned in the summer of 1991, about nine months after my relocation to Stuttgart in order to start my PhD studies.

A concentration camp inmate...

Now back to the question of how I became a revisionist. Certainly in the beginning of my second involvement with the *Republikaner*, I was repeatedly confronted with the use of the ‘Auschwitz bludgeon’ used against both ‘my’ party and myself. I have mentioned above the scandalous question of the journalist after the Berlin election, a question which was used continually to suggest that the *Republikaner*—

⁵³⁸ In Germany, military service is compulsory for all men physically fit to do so.

⁵³⁹ *Ökologisch Demokratische Partei*, Ecological Democratic Party.

after they had seized power—intended to ‘gas’ the Turkish immigrants residing in Germany. Wouldn’t it have been easy to have introduced the idea of disputing the Holocaust at such a time?

I had a chance to do this in the spring of 1989, when one of my friends, who had left the ‘liberal’ FDP shortly before to join the *Republikaner*, addressed the Holocaust issue in one of our discussions. He recommended that I read the book *Was ist Wahrheit*, (What is Truth) by the socialist Frenchman, Professor Paul Rassinier.⁵⁴⁰ This may be regarded as the first fully revisionist book ever published. It deals with the supposed extermination of the Jews from the point of view of a former member of the French Resistance who had been incarcerated by the Germans in several concentration camps during WWII.

The remarkable thing about the book is its author. Since he was interned in several concentration camps as a member of the Resistance and was a pronounced left-winger—before and after WWII, he was a French member of parliament for the leftist socialists—he could not be accused of wanting to whitewash anything or of having any kind of political agenda. Written in a factual and balanced style, the book was easy to read; we discussed it, and that was all. I felt no need to devote myself further to the subject, either through the examination of further revisionist or establishment literature or through undertaking my own investigations. If there had ever been a political reason for an involvement with Holocaust revisionism, it would have been when I was throwing myself intensively into debating on behalf of the *Republikaner*.

...a neutral Swiss...

The cause of my interest in the Holocaust problem, beginning in the fall of 1989, came from quite another source, one that was only secondarily political and which had nothing to do with the *Republikaner*. In the fall of 1989, I bought the book *Der Nasenring. Im Dickicht der Vergangenheitsbewältigung* (The Nose Ring—In the Thicket of Coming to Terms with the Past) by the Swiss political scientist Dr. Armin Mohler.⁵⁴⁰ I had already received an earlier edition of this book as a gift from my mother in the mid-1980s. This earlier edition was the result of an assignment given to Mohler by a semi-official institute of West Germany. Mohler was asked to study how and when

⁵⁴⁰ Heitz & Höffkes, Essen 1989.

German attempts to come to terms with their past—originally a purely moral impetus—had become a weapon in day-to-day political discussion and intrigues.

That ‘coming to terms with the past’ could lend itself to misuse for dirty schemes is obvious. From my own experience, I can think of three notable cases, where prominent German figures were driven out of office and their reputation destroyed by political and media smear campaigns. In such cases, the media and/or competing colleagues either use (allegedly) ‘brown spots’ in the CV of the attacked individuals’ WWII history, or they distort and/or instrumentalize ‘politically incorrect’ statements certain individuals made in public or private about Germany’s WWII past.⁵⁴¹ Whatever the CV or the statements about the past of the victims of these campaigns are; the treatment which they receive by colleagues and the media must arouse the suspicion that the German past is being used today as a weapon of political intrigue against undesirables in one’s own political party, in other parties, or in general against any unwelcome professional competitor.

The question of how true the historical picture is that hides behind the ‘coming to terms with the past’ Mohler handled only peripherally in this early edition of his book. His new book, which I read in the fall of 1989, goes into this question very thoroughly and thereby naturally brings up the question of the validity of historical revisionism—something which first became clear to me while reading the book.

That I got hold of this book was due not so much to its contents, which I previously knew nothing about, but more to my interest in the analyses of a Swiss political scientist, someone writing from what I considered to be a neutral position.

...and an apolitical American...

This Swiss author also reported about a study on the alleged ‘gas chambers’ at the Auschwitz concentration camp. This study, so Mohler, had been prepared by an American expert for execution technologies, who had come to the conclusion that there had never been any gassings with poison gas in Auschwitz. One of his main arguments was the absence of traces of the poison gas supposedly used in the walls of those locations identified as homicidal ‘gas chambers’. Since this was a quite intriguing argument, I decided to order a copy of this

⁵⁴¹ The names of those persons are: Hans Filbinger, Philipp Jenninger, and Werner Höfer.

study, for which Dr. Mohler even provided an address in his book. Thus were the factors brought together that I needed to compel me to get to the bottom of the problem: the report of an author I held to be politically neutral of a study by an apolitical non-partisan American on a discipline in which I had recently completed my diploma examination: Chemistry.

...enabled me to doubt

At that point, I was ready to put to the test my hitherto held opinion on the correctness of the established Holocaust dogma, because I had been presented with arguments from politically neutral persons that I could examine by means of my technical skill.

In late summer 1989, I received an English copy of the so-called *Leuchter Report*, which I have just mentioned, and I read and translated it into German immediately, but the report did not convince me entirely, because it was inexact at points and contained sloppy errors, as I described extensively in a letter to the editor published in the small right-wing monthly newspaper *Junge Freiheit* in 1990. But the *Leuchter Report* had embedded the thorn of doubt in my heart. I must now explain what that meant, since therein lies the real reason for my involvement.

Would only morons doubt?

It is generally known that none of the world's religions reproaches its adherents for doubting the faith. Religion teaches us that to doubt is human, and therefore acceptable. One who doubts is not guilty as a result.

After reading the *Leuchter Report*, I began to doubt whether the historically accepted view of the events of the Holocaust was correct. I nevertheless felt guilty, because in western societies we are imbued with our mother's milk that the history of the Holocaust is the purest truth, and those who doubt or deny this are evil or insane: extremists, National Socialists, Jew-haters, ethnic persecutors, weak-minded, morons, idiots, fruitcakes, cranks, crooks, anti-Semites, and so forth.

Yet, through a purely chemical argument, the thorn of doubt had been deeply embedded and I could only get rid of it by plucking it out or trying to forget it. I doubted, and felt guilty for doubting; yet I knew that it is not right to feel guilty for doubting.

From pole star to shooting star

Religions expect their adherents to believe in certain dogmas, but they do not demand doubters to feel guilty. At least the same must apply to science, where doubters should not be expected to feel guilty either. Here I was confronted with chemical-historical questions, and ideally speaking, science knows no dogmas, knows no compulsion to obedience, and no punishments for those who contradict the prevalent paradigm.

I therefore asked myself, why do western societies guard the Holocaust dogma closer than any religion does its own dogmas? The reason is certainly that western societies, and in particular German society, regards the Holocaust as one of their moral foundations. This I have explained elsewhere, in the book *Dissecting the Holocaust*.⁵⁴² The German elites almost uniformly maintain that the health and wealth of the German Republic depends on the observance of current description of the Holocaust. In the German Republic, we are raised with the conviction that the Holocaust is the moral pole star of our world-view, with respect to which everything else must be oriented.

That was my own unconscious belief until I began to question the standard historical version of the Holocaust. When these doubts surfaced, I was confronted with the possibility that the pole star might turn out to be only a meteor, that everything which had been held as fundamental truth may in reality be false.

Motivations

Here then are the reasons I have dedicated myself to revisionism:

1. Because of my upbringing, I felt bad merely for doubting. I knew something was wrong with a society when it instills guilt-feelings in its members simply because they dissent. The Holocaust is the one area, and almost the only area, where one is admonished to accept facts blindly; not to think critically. We are taught to question practically everything else, even that which is kept in high regard, such as the reality of God, or sexual intimacy. We are primed to be docile subjects and kept fearful of any transgressions with respect to the Holocaust. That angered me then and it angers me still.

⁵⁴² 2nd edition, Theses & Dissertations Press, Chicago, IL, 2003, pp. 49-53.

2. Because of my doubts, my entire outlook on life became unstable. I was no longer certain what was correct or incorrect, who lied and who told the truth. The eternal conflict of good and evil was revived in me. The question where the truth could be found concerning the Holocaust was so important, that I knew I could only recover my peace of mind by finding out for myself, personally, where the truth lay. I wanted to rid myself of uncertainty one way or the other.
3. There is no scientific area in which those who hold dissident opinions are persecuted more mercilessly by the 'ruling order' than that of revisionism. That is probably why most people don't want to touch it, and most avoid it by convincing themselves that the subject is not relevant to current problems. But for me, this draconian persecution is the best proof there is that this is a crucial subject, because the powers that be regard it as most important that nobody touches this taboo. Comprehensive and critical research in this area is therefore very important for scientific, political and social reasons.⁵⁴³
4. The treatment of revisionism and its proponents in areas of science, journalism, politics and law is a scandal worldwide—it demands redress.

Almost stopped...

Up to the beginning of my PhD studies in the fall of 1990, I had read only two books on the subject: Wilhelm Stäglich's *Der Auschwitz Mythos*⁴¹ and the book by Kogon and others entitled *Nationalsozialistische Massentötungen durch Giftgas*.⁴²

After reading these books I collected information on the so-called Zündel trial in order to find out what arguments had been made there. I had discovered in winter 1989/1990 that Zündel, who had commissioned the *Leuchter Report*, was an admirer of Adolf Hitler. This revelation had the equivalent effect of a kick in the stomach, because now I had to deal with the possibility that the *Leuchter Report* was not the independent report of an apolitical American technician, but merely the instrument of a German-Canadian Neo-Nazi. But such considerations could not remove the points made by Leuchter and therefore could not

⁵⁴³ See also my paper "Wissenschaft und ethische Verantwortung", in Andreas Molau (ed.), *Op-
position für Deutschland*, Druffel-Verlag, Berg am Starnberger See 1995, pp. 260-288.

remove my doubts about the historical picture.

In other words, I fully realized that a fact-oriented argument remains a fact-oriented argument—and needs to be treated as such by the examining scientist—even if it came from somebody who stated them for political reasons.

...but then getting into gears

I began my own research into this area at the beginning of 1991, at first out of pure personal curiosity regarding the question whether the pigment Iron Blue that developed in the walls of the buildings, where gassings with hydrogen cyanide from Zyklon B allegedly had taken place, were sufficiently stable to still be there today. After that had been proved, I concentrated on the question if, when, how, and under what circumstances this pigment could develop in walls of different compositions.

A revisionist had read my letter to the editor of *Junge Freiheit* in 1990, mentioned above, and after a phone conversation, he sent me a list of addresses of persons and organizations—almost all of them unknown to me.

After I had sent out my first research results in spring 1991 to this list, I was contacted by one person on that list, a friend of ret. Major General Otto Ernst Remer, a retired Wehrmacht officer. At that time, Remer was engaged in publishing political pamphlets, some of which made quite blunt revisionist statements, which had led to several criminal prosecutions against him. Because of this, his friend and the Düsseldorf lawyer Hajo Herrmann, a well-known former *Luftwaffe* fighter pilot who was now Remer's defense attorney, were looking for an expert to support Remer's revisionist claims.

At that time, it even appeared to be possible for me to work jointly with the *Institut für Zeitgeschichte* (Institute for Contemporary History), an official German left-wing historical institute, whose address was on that list as well. However, they never responded to my letters, apparently because they were not interested in the technical-scientific side of the problem.

In summer 1991, I decided to leave the *Republikaner* party. I have already given the reasons for my decision. An additional and decisive motivation was that I did not want my involvement with revisionism to be interpreted politically because of my membership of a party or that

my scientific activity in this controversial area would conflict with the political goals or principles of any party.

Sheer horror...

I should mention another reason that may be helpful toward understanding my involvement. Until my first trip to Auschwitz-Birkenau, I had had no exact idea of the condition of the camp's former crematoria, in which the alleged 'gas chambers' were located, so I had no idea whether it would actually be useful to undertake technical or chemical research. Before my first trip, I had thoroughly prepared myself as to what I might expect with respect to the material remains at, for example, 'gas chambers', if the generally accepted reports of the mass gassings in Birkenau were correct. It was clear to me, for example, if one was to believe the eye-witnesses, that the roofs of the morgues of crematoria II and III should show three or four holes through which Zyklon B was to have been thrown into the room.

On August 16, 1991, as I stood on the roof of morgue 1 of crematoria II at Birkenau, which was usually designated as the 'gas chamber' where the most mass-murders of the Third Reich were said to have taken place, a roof which was in various stages of collapse and yet still held together and partially rested on supporting columns; a roof in which I could find neither breath nor trace of these holes, so that I asked myself whether I lived in a world of madmen. I found myself horribly duped by a judiciary which had never thought it necessary to make any special technical examinations of the alleged crime scene. I had been lied to by all the politicians of the world who to date had failed to assemble even the most minuscule investigation commission. I had been deceived by the innumerable 'Holocaust historians' who to date had not deemed it necessary to make any investigation of the camps of Auschwitz or elsewhere, examinations which paleontologists and historians of antiquity have undertaken on the sites of ruins and other remains of ancient settlements. And I felt betrayed by the natural scientists and engineers world-over who swallowed any and every story whatsoever from the 'eye-witnesses' without so much as a murmur that the material remains, the supposed crime scenes, and the eye-witness testimony itself should be subjected to some rudimentary scrutiny.

...leads to the collapse of a world-view

On this 16th of August, 1991, my world-view collapsed and I swore to do whatever necessary to advance clarification to this complex of questions. I will only abandon my position when my doubts are confirmed or rejected through convincing scientific arguments in a fair scientific discourse. Use of force will never change this position. On the contrary: it fortifies my conviction that I am right, because only he who lacks arguments must use force. And since I have been chased all over the world ever since by all sorts of government with brute force, I now know that I must be right.

The Eros of Cognition

In time, a further motivation was added to those mentioned above, namely what I call the 'Eros of Cognition.' Whoever calls himself a scientist and has not experienced this, is not, in my opinion, a real scientist. The excitement of taking part in decisive scientific research and discoveries, to push things forward which one knows are new and even revolutionary, the consciousness of standing at the forefront and helping direct 'whither the ship of discovery goest'— those are things that one must know first-hand, in order to understand what is 'Eros of cognition'.

11.2. The Naiveté of a Young Revisionist

A Fleeting Acquaintance

In February 1991, I attended a seminar in Bad Kissingen put on by a *Sudeten*-German youth organization—I was not a member but had been invited. Toward the end of the seminar, I got to know another participant of about my age. He suggested that before we departed we pay a visit to Wehrmacht Generalmajor Otto Ernst Remer, who lived in that town.

Remer, I was told, was the person who had suppressed the Putsch of July 20, 1944, against Hitler, and I was told he held fast to his views of that time. Our intended visit would be a little bit like a visit to a museum containing a living political fossil. I was curious, so I agreed and off we went.

To a young man from a bourgeois home who had been fed a steady diet of anti-fascism, the living room of General and Frau Remer was creepy—Hitler busts, military decorations and all kinds of propaganda hand-outs caused a shiver to run down my back. We were given a tour of the house by Frau Remer and then treated to a showing of a video-film that portrayed the events of July 20, 1944, from Remer's viewpoint. Thus 'enlightened', after an hour we left for home.⁵⁴⁴

Freedom to Witness

In summer 1991, when I was requested by Remer's attorney to prepare an expert opinion on the 'gas chambers' of Auschwitz for a

⁵⁴⁴ Moreover, the Remer couple could remember as little from this chance meeting as from the two subsequent occasions on which I met them, when I appeared as an unknown, unimportant person among a crowd. (Summer 1991: On the return from my first Auschwitz trip, I accompanied Karl Philipp on a brief visit during a reception on Remer's 80th birthday. Philipp was Remer's friend who had initially contacted me, who had driven me to Auschwitz and helped me there, and who later helped me with all kinds of technical and infrastructural/logistical support. Autumn 1992: Dinner of the defense team during the trial against Remer, after the court had refused to accept me as an expert witness.) The Remers came to know me personally only in January 1995, when the Stuttgart District Court went to Spain to interrogate the Remer couple as part of the trial against me on account of the commentary that Remer had added to the report without asking me. Even then in Spain they needed to ask who I was. They got to know me fairly well only after I had fled to Spain in early 1996, where I resided for four months some 50 miles west of Remer's residence in exile.

criminal trial against his client, I well knew the client for whom I would be acting. It was clear to me that there was a danger that Remer's political opinions and activities could rub off on 'his expert witness', if the witness came to a 'politically incorrect' conclusion. Why I nevertheless decided to proceed is as follows.

In a state under the rule of law, a witness, including an expert witness, can not be punished for what he says before the court or for what he presents in writing to the court, in good conscience and to his best understanding.

Also, in civil law an expert witness is only liable if it can be proven that he violated the rules and accepted practices of his profession in producing his report and in so doing caused someone bodily or mental harm.

Therefore, when an expert witness through painstaking effort evaluates all available sources and interprets them in a technically sound manner, in good conscience and to his best understanding, then even if the conclusions of the expert report were wrong he could not be made liable for any gross negligence.

Consequently, he could defend himself at law against any civil disadvantages that resulted from the presentation of a possibly politically incorrect expert report because a witness—here an expert witness—may not be made to suffer for having testified in good conscience and to his best understanding.

Though I could see there were storms threatening to come my way, I looked on them placidly since I believed that having the law on my side gave me the upper hand.

May one publish expert opinions?

It was intended from the beginning that the expert report arising from this request of Remer's attorney would be published. It is unusual to publish expert reports from judicial proceedings, but it does happen when the subject is of public interest. Expert reports drawn up for several trials against supposed National Socialist war criminals, for example, were later made available to a wide public for educational purposes. The Frankfurt Auschwitz Trial is a prime example of this. The expert reports produced during this trial by scientists at the *Institut für Zeitgeschichte* were later published as a collection.⁵⁴⁵

⁵⁴⁵ H. Buchheim *et al.*, *Anatomie des SS-Staates*, Walter, Freiburg 1964.

My report was ready for publication in spring 1992. The original document prepared for the court was enlarged by numerous substantial additions and the layout was improved. In summer 1992, the German publishing houses Ullstein-Langen Müller and von Hase & Köhler showed active interest in the project. Dr. Fleißner, head of the Ullstein-Langen Müller publishers, quickly got cold feet due to the controversial nature of the theme, despite initial agreement, but von Hase & Köhler wasted no time presenting me with a signed contract. The problem with this contract was that it did not contain any specification as to when the book should appear. This meant publication could have been put off indefinitely while my hands were tied by my contractual agreement. When I pressed them to fix this they lost interest.

Waiting for the Doctor

Social and legal repression was a hint that the theme was a hot one, even when it was handled in a dry, scientific manner. On the advice of various people, I decided to postpone the publication of the document by a politically right-leaning publisher until after I had received my PhD degree.

In the European right-wing scene, the appearance of my report was awaited with increasing impatience throughout 1992; it was expected that my report would contribute decisively to a breakthrough of historical revisionism.

Various people began to prepare openly for the coming publication. I regarded these activities with mixed feelings and often needed to point out that my doctorate would not be properly completed until many months hence.

At the beginning of 1992, I reckoned that I could be in possession of the much-desired degree in the fall. Because of the workload of my doctoral supervisor Prof. von Schnering, however, I extended this period several times. I ended waiting five more months to February, 1993, until Prof. von Schnering began to proofread my dissertation.

Various Distributions Activities

I came into conflict with German-Canadian revisionist Ernst Zündel in this time, because in summer 1992, without my knowledge, he gave out copies of the report as prepared for the court in February, 1992. In November, again without my knowledge, he went so far as to

translate this outdated version of my report into English. Later he let it be known that he would like to be reimbursed for his translation costs to the amount of \$10,000.

I had a more pleasant experience with an attorney in Austria, Dr. Herbert Schaller. In February, 1993, he asked me if he could have 100 copies of the report to distribute discreetly in Austrian high society. Up to that point, I had made a total of 50 copies of the report by photocopier and glued in color photos by hand, which was an enormous labor. I told the attorney that since my doctoral supervisor had begun to work on my dissertation, I had no time to make 100 copies for him. However, I agreed that he could make copies from the copy he had and could distribute those—on the condition that he do so as discreetly as I myself had done already without accompanying commentary and without public propaganda.

As far as I know, Dr. Schaller did make and distribute 100 copies in February or March, 1993. To this day, there has been no public report of his action.

Remer Acts

As fate would have it, the Austrian attorney Dr. Schaller was also one of Otto Ernst Remer's defense attorneys. Remer must have heard about the distribution of my report in Austria. Shortly thereafter, I was informed by one of Remer's friends, and without Remer's knowledge, as I found out later, concerning Remer's intention to do in Germany what his lawyer had done in Austria. According to what I was told, Remer intended to do exactly as the Austrian had done. But because Germany is more than ten times larger than Austria, Remer and his friends intended to do their distribution activity more professionally by having my expert report printed instead of photocopied. Though I knew this could put my PhD degree in jeopardy, I saw no reason to intervene. Naively I thought that Remer would stick to the rules the Austrian had followed, which were perhaps too natural to me to be pointed out specifically: the report must remain unaltered, no additional text, no public propaganda is to be made. As we shall see, these rules were not considered natural by Remer and his friends.

The Bull in the China Shop

In March, 1993, with a furious publicity campaign, Remer announced as a measure of self-defense that he was going to publish and distribute that piece of exculpatory evidence that he was not permitted to present to the court, because the Holocaust is assumed to be self-evident.⁵⁴⁶ Thereby Remer broke the first unconditional rule for the protection of my doctoral title, namely that there be no accompanying public propaganda. Thinking that this writing would only circulate in Remer's circle of supporters, I paid little attention. When I received a phone call from a journalist of a west German radio station, informing me that some of those advertising sheets had surfaced at the University of Cologne, the situation changed. Soon the management of the Fresenius Institute was on the telephone asking me what was in the report—the Fresenius Institute had analyzed the masonry samples from Auschwitz for me. They hinted that they might consider joining me in taking legal action against Remer. An hour later the Institute's attorney was threatening me with legal action. Remer had become a bull in the china shop.

Between a Rock and a Rock

My situation was precarious. At the request of an attorney, I had prepared an expert opinion to be used in the defense of his client. The conclusion of the report was potentially capable of reducing the culpability of said client with respect to the criminality of some of his factual assertions. I intended to publish the report a few months after completing my doctoral work anyway. Now the client took the step of publishing the report at a time that was uncomfortably early and, what was worse and unexpected, with an unhealthy press campaign. Should I now take him to court after having helped him in court? Should I take him to court for doing what I intended to do myself in a few months, though with a smaller or different press campaign?⁵⁴⁷ After all, I had

⁵⁴⁶ Chapter 244 of the German Criminal Code provides that the court may reject evidence on the grounds of 'common knowledge' or complete unsuitability. This happens mostly in 'Holocaust' cases, and, indeed, without examination of the submitted evidence, to determine whether it is actually unsuitable or whether it may be able to defeat 'common knowledge', which it might do if it were superior to evidence previously submitted. In trials against revisionists and also against supposed 'National Socialist criminals,' exculpatory evidence is de facto *verboten*, a classic indication of a show trial.

⁵⁴⁷ My hesitation in taking legal measures against Remer was later used by the court as an indica-

been informed in advance and did not intervene then. The only thing that had changed were Remer's public relation activities.

The Industrious Additions

As if Remer's industrious publicity campaign were not enough, in April 1993, as my expert report was handed out for the first time, I learned that a one-page foreword and a five-page appendix consisting of a description of Remer's criminal trial had been added to my report.⁵⁴⁸ I was not the least bit interested in whether or not the added commentary was criminally relevant. I only glanced at the forward and took no notice of the trial description added after the end of my report. I was aggravated in that Remer had expanded and thus altered the text without authorization. Never mind what was in the commentary—it did not have my approval and that was aggravating enough. But now that this report of mine had been printed, what could I do about it? I thought that it was obvious that I could not be held responsible for something whose addition to my report I had had no knowledge of, not to mention that I had neither given my agreement to it nor had participated in its preparation. So why should I care whether the content of Remer's commentary was criminal? As a matter of fact, I basically ignored Remer's comments. So it happened that I perused Remer's commentary for the first time at the end of 1994, fully one and three quarters of a year afterward, after my own criminal indictment because of that commentary.

The Hot Potato

In any case, in early 1993, I was concerned only about my doctoral work. This also was due to a passage in Remer's appendix, which my doctoral supervisor held under my nose shortly after he—as all professors of chemistry in Germany—had received his copy. In the above-mentioned report on Remer's criminal trial, I had been mentioned in connection with the Max-Planck-Institute for Solid State Research in Stuttgart. Though I was preparing my PhD thesis in theoretical crystallography at this institute, my research about the 'gas chambers' of Auschwitz and my subsequent activities as an expert witness

tion of my complicity with him.

⁵⁴⁸ See chapter 11.4.1. for the text Remer had added. Reprinted in German in: Herbert Verbeke (ed.), *op. cit.* (note 54), pp. 109-115 (online: www.vho.org/D/Kardinal/Remer.html).

had nothing to do with this governmental research institute. It was my private activity. However, the fact that I was referred to in Remer's appendix as an "*expert from the Max-Planck-Institute*" had the consequence that the German news media and scientific, legal, and political circles unleashed a storm over the Max-Planck-Institute and demanded to have my head. At the insistence of the Institute, I consulted an attorney specializing in copyright law. He, however, made it clear to me that no 'serious' attorney would touch such a hot potato, both from conviction and for the sake of his reputation. Also, it was not clear whether I had any ground of action against Remer, since the copyright had probably gone to him because he had ordered and paid for the report as I had admitted.⁵⁴⁹

The question of the copyright to the report has never been cleared up. The Remers always held the position that they have the copyright to the report because they paid for it, and that they can do with it as they please. There was a contractual agreement set to paper, but unfortunately I lost my copy as a result of house searches and changes of abode, and the Remers could not find their copy after their flight to Spain, so that the actual contents of the document cannot be determined. I remember only that I was promised to be reimbursed for expenses that I incurred through the production of the report, and that in turn I was supposed to publish my expert report, but no time limit was given for that. The copyright was not discussed.

Also, the Remers have silently accepted that since June 1993, without consulting them, I have on my own determined where, when, and how my report is to appear in each of several languages—German, English, French and Dutch.

Thousands of Dollars—for Nothing

Left out in the rain, as it were, in mid-April 1993, I tried to divert Herr Remer. At the start of May, I finally succeeded in persuading him to curtail his distribution activities because of the reprisals I was experiencing.

Aside from any legal aspect of Remer's commentary, I would like to make a few observations. First, Remer's remarks were composed in a style that would insult any average anti-fascist citizen—and that would be about 95% of the population. One could well assume for that

⁵⁴⁹ I was only paid expenses.

reason alone that most recipients of this version of the report would toss it into the wastebasket unread.

Not only that, but Remer had done something that would cause nearly all his recipients who possessed a spark of pride to consign the piece to the fire. In his foreword on the inside front cover, he attacked our leading politicians, media people, and jurists with the words, “*These Liars need to be driven from their spoils fortresses*”.

At the same time, Remer sent this version of my report to exactly these leading politicians, media people, and jurists, and apparently believed he could achieve some success thereby. It is certain that to send a piece of writing to someone in which he is criticized and threatened is a useless exercise. Remer’s defense action must have cost him thousands of Dollars—all for nothing.

In the Talons of Justice

After I had stopped Remer’s defense action, the legal process ran its course. It was my thinking that no one could touch me for something I had not done. But the State’s Attorney had to investigate, since many of those to whom Remer had sent his copies had filed criminal complaints against him and against me: the German Society of Chemists, many State Attorneys and Chief State Attorneys, Judges and Presidents of District Courts and Federal Courts, left-wing party representatives from various parliaments, professors of various disciplines from universities throughout Germany, and on and on and on. Not to mention that there were continual inquiries from Tel Aviv that persist even today.

Strangely, the State Attorneys were active only against me. They made inquiries about Remer, but saw no need to search his house. With respect to Remer, they were satisfied to push papers around. With respect to me, over the following years they searched my house three times and took away everything that was not nailed down. Apparently, German justice did not consider Remer to be dangerous. The Remer problem, they probably thought, would solve itself biologically. My case, however, they decided, needed extra effort.

The End of Illusions

The trial, which lasted from the end of 1994 to the middle of 1995, destroyed what remained of my illusions about the rule of law in Ger-

many. I have described this in chapter 11.3. “*Flaws of the State Under the Rule of Law*”.⁵⁵⁰ On January 19, 1996, the Federal General State Attorney determined that I was to spend 14 months behind bars, not for my report but for Remer’s commentary. The Federal Supreme Court concurred with this sentence in a decision on March 7, 1996 (Ref. 1 StR 18/96). On Remer’s commentary, the District Court of Stuttgart stated in passing sentence (Ref. 17 KLS 83/94, S. 115):

“Although the foreword and afterward did not explicitly accuse the Jews of fabricating the descriptions of the Holocaust for political and material benefits, in the view of the court the Remer version of the Report had the purpose of suggesting this and thereby arousing hostility toward the Jews. This follows from the fact that the reader, believing the claims of the Report to be correct and influenced by the tendentious comments and rhetoric, would come to the conclusion that the surviving Jews as the most important witnesses of events, surviving relatives as directly affected and Jewish researchers must have intentionally concocted false reports on the Holocaust.”

According to the court, then, Remer’s remarks were not punishable by themselves; only together with my report a reader so inclined could ‘read between the lines’ and would supposedly be led to hostility toward the Jews, and that is morally indefensible because it must be clear to everyone that one ought to be ‘a friend of the Jews’.

Therefore, not only was I punished for a crime I had not committed, but for one which no one had committed.

This would have made some sense, at least, if Remer had foregone his commentary and I had been sentenced for my report and not for somebody else’s commentary, but that was not the case.

In Exile

On May 7, 1996, the criminal trial against me and others for the publication of the book *Grundlagen zur Zeitgeschichte*⁵⁵¹ (for this, see chapter 11.4.2.) began before the County Court of Tübingen. The sentence that could be imposed by such a court was one to four years imprisonment. Since I had already been sentenced to 14 months of imprisonment without probation, the sentence for me this time would

⁵⁵⁰ Published in German in Herbert Verbeke (ed.), *op. cit.* (note 54), pp. 59-63 (online: www.vho.org/D/Kardinal/Webfehler.html).

⁵⁵¹ See the English translation *Dissecting the Holocaust*, *op. cit.* (note 22).

probably not be less than two years—also without probation. Also, the public prosecutor of Tübingen was answerable to the General Prosecutor’s Office in Stuttgart, and who knows to whom they are answerable. From the beginning, the following dicta overshadowed the trial:

“*The moral foundation of this Republic is at stake.*”⁵⁵²

“*All democracies have a basis, a cornerstone. For France it is 1789, for Germany it is Auschwitz.*”⁵⁵³

In its sentence, the Tübingen County Court decided the book *Grundlagen zur Zeitgeschichte* should be withdrawn from circulation, effectively annihilated and that the author and publisher should be punished. This, after prominent German historians had submitted to the court expert opinions to the effect that the book held to scientific standards and that therefore the authors, editor, publisher, sellers, printer and purchasers were owed the right of freedom of science and the right of freedom of expression (see chapter 11.4.2.).⁵⁵⁴ It did not help:

“*The Non-Jew Must Burn!*”

Since I was the editor of the book, *Grundlagen zur Zeitgeschichte*, a warrant for my arrest was issued and I fled the country. In view of all this I hope one may forgive and understand my reasons that I took my family and went into exile. A busy young father had better things to do than breathe jail-house air.⁵⁵⁵

Hindsight is Insight

Today, nine years after these events, I know that it is precisely the serious, scientific revisionist work that the establishment considers threatening, since one cannot fight a professionally written work with cat-calls and jeers. Unlike shallow pamphlets, it must be taken seriously. Patrick Bahners stated the establishment view in the highly respected German daily *Frankfurter Allgemeine Zeitung*.⁵⁵⁶

“*The state protects the freedom of science. It recognizes the scien-*

⁵⁵² *Die Zeit*, Dec. 31, 1993, p. 51.

⁵⁵³ German Federal Foreign Minister Joschka Fischer in *Süddeutschen Zeitung*, acc. to *Rheinischer Merkur*, April 16, 1999.

⁵⁵⁴ Ref. 4 Ls 15 Js 1535/95.

⁵⁵⁵ Unfortunately, my wife took my two children and left me in January 1999, initiating divorce proceedings in early 2000.

⁵⁵⁶ “*Objektive Selbsterstörung*”, *Frankfurter Allgemeine Zeitung*, August 15, 1994, p. 21.

tist not by the result, but by correct form. [...] But it can be seen that the intention to agitate can be recognized not only by errors of form that separate beer hall talk from scientific undertaking. On the contrary agitation that is perfect in form is the most perfidious. [...] But for those who survived Auschwitz it can hardly be a slighting insult when an expert using phony reasoning tells him there never was a mortal danger.

Also the state is mocked here. If Deckert's [a German revisionist] 'Views about the Holocaust' were correct, the Federal Republic was founded on a lie. Every Presidential address, every minute of silence, every history book would be a lie. When he denies the murder of Jews, he repudiates the legitimacy of the Federal Republic."

However, Bahnert proceeds from false premises.

First, Bahnert does not make clear how an intention to agitate can be recognized, if not by errors of form. It is stated in the German constitution that science is free without restriction. Decisions of the German Federal Constitutional Court have stated that science is defined by formal rules alone and not by content. These decisions are in agreement with fundamental theoretical works on the nature of scientific knowledge. If Bahnert thinks differently, he is anti-constitutional, anti-scientific, and anti-human rights.

Secondly, there are no experts who assert that the survivors of Auschwitz were "*never in mortal danger*". Bahnert warms up the calculated lie that revisionists would present Auschwitz as a vacation resort without danger to life or limb and generally characterize the National Socialist persecution of the Jews as harmless to the Jews. Either Bahnert doesn't know what he's talking about—in which case he should stay away from the keyboard—or he himself is agitating against others with different opinions, in which case the *Frankfurter Allgemeine Zeitung* should not allow Bahnert to soil its reputation.

Thirdly, Bahnert's conception that the legitimacy of the Federal Republic of Germany is based on the unconditional recognition of the established version of the National Socialist persecution and extermination of the Jews is absurd and utterly false. If the Federal Republic of Germany were actually founded on this historical detail, it would be a dire weakness, because every state that bases its existence on a version of history enforced under pains and penalties must sooner or later come to grief.

Certainly, the formal foundations of the legitimacy of the German Republic are very different—human rights, civil right, acceptance by

the people of the state, international recognition, political, historical and cultural identity and continuity with preceding German states—and there is no need to accept the harsh judgment of Bahners and some of his colleagues.

Pseudo-legal Contortions

However, it was recently made clear by the Ministry of Justice of Baden-Württemberg that in future, Germany's judicial system will adopt Bahners' viewpoint that revisionist works of a scientific nature constitute incitement to hatred and must therefore be burned. In its answer to a question relating to the seizure of scientific revisionist books of Grabert Verlag it stated:⁵⁵⁷

“Legal intervention is not constitutionally excluded even when it is clear that the case involves a work of science or research. Article 5, Para. 3, Cl. 1 of the Fundamental Law contains no expressed prohibition of limits. In constitutional law it is recognized that even freedoms that are granted without expressed conditions have limits. Such limits might come from the fundamental rights of third parties or from other constitutionally-protected goods. In these cases there must be a comparison of the competing claims of the equally constitutionally-protected interests with the purpose of optimizing these claims. There must be a particular examination of the case making use of the method of proportionality. (Decisions of the Federal Constitutional Court (BVerfGE) 67, 213, 228; 77, 240, 253; 81, 278, 292ff.; 83, 130, 143) When these constitutional requirements are met, in special cases use of appropriate measures is consistent with freedom of science or of research”

The assertion of the Minister of Justice that even a scientific work can be seized when the fundamental rights of others are involved is completely false, and the decisions of the German Federal Constitutional Court cited here are misleading. It is true that no fundamental right can be guaranteed unconditionally and when there is a conflict with other fundamental rights that an optimal compromise of interests must be found by means of the principle of proportionality. However, this limitation of fundamental rights pertaining to the freedom of science can never extend to the determination of what theses may be stud-

⁵⁵⁷ Dr. Ulrich Goll, ref. 4104—III/185, Sept. 23, 1996; cf. IDN, “‘Appell der 500’ vor Landtag”, *DGG* 44(4) (1996), pp. 9f. (online: www.vho.org/D/DGG/IDN44_4.html); VHO, “Zur Wissenschaftsfreiheit in Deutschland”, *VffG* 1(1) (1997), pp. 34-37 (online: www.vho.org/VffG/1997/1/VHOWiss1.html).

ied and to which conclusions one may come.

Only the means by which research is conducted is subject to limitations, since research may not employ methods that compromise the rights of others—such as experiments on humans or endangering the environment. If it is forbidden to science to formulate new theses or to attempt to refute existing theories, however controversial these attempts and their conclusions might be, or if it is forbidden to science to use certain arguments or to come to certain conclusions, or to publish scientific conclusions in order to subject them to indispensable public scrutiny and scientific criticism, then one throws the fundamental right to freedom of scientific research out the window entirely, because the critical examination of standing theories and paradigms through serious attempts to refute them, and the publication thereof, is the heart of science, or even of human knowledge in general.⁵⁵⁸

The Consequences

The declaration of the Ministry of Justice given above is clearly unconstitutional and one may hope that the German Federal Constitutional Court will say so at some point in the case of *Grundlagen zur Zeitgeschichte*. Of course, it is not likely to do so under present conditions, since in a similar case of Federal book-burning in the early 1980s, the German Federal Constitutional Court itself made a statement in the sense of the Ministry of Justice's statement above.⁵⁵⁹

Therefore one cannot avoid the conclusion that the present situation in Germany is as follows:

1. With respect to the core of the Holocaust claim—gas chambers, the National Socialist's intention to annihilate the Jews, and the carrying out of such a program—there can be only one predetermined conclusion under penalty of law.
2. The most important condition to the free pursuit of science would then be suspended, that which states: Every thesis must be subjected to the strictest attempts at refutation and must be refutable in theory and in practice. Neither may any conclusion of scientific research be prescribed nor proscribed (cf. Article 3(3) of German

⁵⁵⁸ Cf. Karl R. Popper, *Objektive Erkenntnis*, Hoffmann & Campe, Hamburg ⁴1984.

⁵⁵⁹ On Wilhelm Stäglich, *op. cit.* (note 41): German Federal Constitutional Court, ref., ref. 1 BvR 408f./83, reprinted in Wigbert Grabert, *Geschichtsbetrachtung als Wagnis*, Grabert, Tübingen 1984, pp. 287ff.

Basic Law).

3. The fundamental dignity of humans that sets us apart from animals lies in the fact that we do not take our sensual impressions as being identical to objective reality, but that we doubt and can resolve our doubts through intellectual activity—research. This factor of human dignity is suspended in Germany in this particular field. (cf. Article 1, of German Basic Law).

It remains an open question what one is to do with Article 20(4) of the German Basic Law which states:

“All Germans have the right of resistance to anyone who attempts to overthrow this provision if no other means avail.”

11.3. Flaws of a State Under the Rule of Law

Introduction

Where politics and the *Zeitgeist* exert heavy pressure on justice, one must expect that unjust judgments will be handed down on purpose. For this there is no need either for a state with a constitution which is openly contrary to the rule of law or a condition similar to civil war.¹ With respect to normal prosecutions of criminals, the legal procedures of nations observing the rule of law and those not observing the rule of law are similar. Only in politically motivated prosecutions will it show whether or not judges follow the rule of law, that is, whether they can be forced by trial procedures not to deviate from them. For some time there has been a discussion as to how far the character of the Federal Republic of Germany as a nation observing the rule of law has been endangered by certain phenomena of the *Zeitgeist*.

One case in particular caused severe accusations from many sides of the German society so that the political distortions within the German legal system have indeed reached such a degree that even legal experts are seriously troubled: In 1991, Günter Deckert, then leader of the German nationalistic party NPD (Nationaldemokratische Partei Deutschlands), organized a convention where Fred. A. Leuchter, a U.S. expert for execution technologies, lectured about his technical and chemical research regarding the alleged ‘gas chambers’ of Auschwitz. Deckert translated his speech for the audience into German. He was subsequently prosecuted for this and eventually sentenced to 12 months on probation. Following a huge media-outcry and massive intervention of national as well as international politicians, Deckert was put on trial again—at a different court with different judges—and sentenced to two years without probation. His first judge Dr. Rainer Orlet was threatened to be prosecuted for violating the law—his sentence was considered to have been too mild—but was eventually only forced to retire.⁵⁶⁰ Deckert’s publication about this affair,⁵⁶¹ together with

⁵⁶⁰ See G. Herzogenrath-Amelung: “*Gutachten im Asylverfahren von Gernar Rudolf*”, *VffG*, 6(2) (2002), pp. 176-190, here pp. 180-182 (online: www.vho.org/VffG/2002/2/Amelung176-190.html).

⁵⁶¹ Günther Anntohn, Henri Roques, *Der Fall Günter Deckert*, DAGD/Germania Verlag, Wein-

other ‘thought’ crimes like writing naughty letters to Jewish representatives and selling prohibited revisionist literature—were prosecuted as well and, together with his first conviction, led to an accumulated prison term of more than five years. Eventually, even his defense lawyer Ludwig Bock was prosecuted and sentenced for too vigorously defending Deckert by asking for permission to introduce revisionist evidence. This was considered criminal behavior because Bock allegedly indicated with this that he identifies himself with revisionist thoughts.⁵⁶² In a similar case, the well-know German right-wing defense lawyer Jürgen Rieger was put on trial in 2000, because during the proceedings against one of his clients in summer 1996, he had filed a motion to introduce me as an expert witness as evidence for the fact that his client’s revisionist claims were well founded. Though Jürgen Rieger was initially acquitted by the Hamburg District Court,⁵⁶³ the German Federal Supreme Court subsequently overturned this verdict, demanding the sentencing and punishment of every lawyer who dares to ask for, or introduce, evidence challenging the common ‘knowledge’ about the Holocaust.⁵⁶⁴ Thus, it is clear that every judge, who dares to hand out lenient sentences to revisionist, at least risks an abrupt end of his career, and defense lawyers trying to defend their clients effectively may themselves be prosecuted for that.

In what follows, I shall show by my own experience which indicates that the rule of law in the German state has many flaws that make it easy for the judicial system in general and the judges in particular to deliberately make bad decisions uncorrectable, because they have the appearance of being decided according to the rule of law.

Again and again in various sorts of company I encounter the same disbelieving astonishment as to the state of the German criminal justice system that overcame me at the beginning of the prosecution avalanche

heim 1995 (District Court Mannheim, ref. (13) 5 Ns 67/96) online: www.vho.org/D/Deckert

⁵⁶² *VffG* 3(2) (1999), p. 208; online: www.vho.org/VffG/1999/2/Zornig208.html. As a consequence of his prosecution, Bock subsequently changed his defense strategy, and when assigned to defend the Australian revisionist Dr. Fredrick Töben in November 1999, he remained completely silent in order to prevent further prosecutions, hence rendering any defense of Dr. Töben impossible.

⁵⁶³ *Hamburger Morgenpost*, Nov. 14, 2000; see “*Verteidiger Rieger siegt in Verfahren wegen ‘unzulässiger Verteidigung’*”, *VffG* 4(3&4) (2000), p. 457 (online: www.vho.org/News/D/News3_00.html#n7)

⁵⁶⁴ German Federal Supreme Court, BGH, ref. 5 StR 485/01; see German daily press from April 11, 2002 (*taz*, *Bild*, *Frankfurter Rundschau*, *Stuttgarter Zeitung*, *Frankfurter Allgemeine Zeitung*, all on page 21).

against me. Despite my lack of legal qualification I believe I have been called upon to raise my voice on this subject, since the numerous formal defects of the German legal system have apparently not been dealt with by those with the professional competence to do so.

Since I am no legal expert but only one who has been self-educated on the subject through painful experience, I hope readers will excuse my ineptness of expression. If I make frequent reference here to my trial before the District Court of Stuttgart (ref. 17 KLS 83/94), it is because these examples serve to indicate major problems in the German system of government and its judicial system.

No Word-For-Word Record

Until the end 70s, a record of the proceedings was kept during German criminal trials, in which the statements of witnesses and responses of the accused were set down. The contents of this record were never relevant for an appeal or revision. For example, if in the record it said ‘The witness said A’, but in the decision the court stated ‘The witness said B’, the assertion in the decision would be taken as the fact and that in the record would be considered meaningless.

In the course of a change in the German criminal law at the end of the 70s, the duty to make entries in the record of the proceedings was removed for reasons of economy for all courts higher than the County Courts. What appears now in German trial records is something like ‘The witness made statements on the subject’ or ‘The accused made a declaration’. The substance of what was said cannot be found there and it can no longer be proven by documentation when the court uses statements incorrectly.⁵⁶⁵

In other nations observing the rule of law, such as the United States, Canada, Australia, or Austria, word-by-word transcripts of the

⁵⁶⁵ There is always the possibility that the defense can hire its own stenographer to record the proceedings and type them up later. Then there would have to be a motion to insert this record into the record of the proceedings. Motions of this sort are always denied because the German Code of Criminal Procedures does not provide any rules for such records. In order to defeat the usual refusal of the court to accept such a motion on the grounds that the transcript is factually incorrect, the motion would have to be made either before the dismissal of the witness or immediately after the response of the accused or the defense attorney. Thereby the doubts of the court could be allayed through questioning of the witnesses or the accused. Although the record of the statements can be entered into the record of the proceedings with the (denied) motion in this way, they will still be irrelevant in appeals and revision procedures. Considering the expense to the accused in time and money of such an effort over the course of, say, a thirty-day trial with twenty witnesses, it should be clear how impractical this scenario is.

proceedings are prepared.

The anti-justice consequences of the present German system can easily be imagined, and I will briefly illustrate it with three examples from my own trial.

1. The issue in this trial was whether or not I had participated in the distribution of a version of my expert report with added commentary by Generalmajor O.E. Remer in April 1993. The court was interested in, among other things, how Remer had come into possession of that particular version of my report which he used for producing his printed version. In the trial I had stated that Remer had probably received it from his attorney Hajo Herrmann. The court was more than eager to nail me as a liar, so they were trying to make Hajo Herrmann concede that he never sent a copy of this particular version to his client. Remer had reproduced the “*second version of the 3rd edition*” of my report, which the court called version “F2”.⁵⁶⁶ In the trial report made by an observer, the questioning of Herrmann on December 6, 1994, ran somewhat as follows:

“Then the witness Hajo Herrmann, year-of-birth 1913, was questioned. He confirmed that in the summer of 1991 he had assigned the preparation of the expert report to the defendant (Germar Rudolf). The witness states that he had received every version of the expert report from the defendant and had sent a copy of each to his client Remer. Later the witness stated that he did not know whether he had received another expert report in November or December 1992. When the judge inquired about it further he said that he could almost exclude this. He also did not believe that he had provided Remer with a new version of the expert report during the appeal to the Federal Supreme Court. Later, Herrmann said that the first version of the 3rd edition sent in November 1992 was the last that he had received. When the defendant (Germar Rudolf) interrogated Herrmann (which the judge at first objected to) whether the witness thought that the arrangement of the chapters of the first version of the 3rd edition was correct, the witness remembered that he had requested a change by telephone. At that point the witness decided that he must have received the second version of the 3rd edition that had been changed due to his request [this was the version called “F2” by the court, which Remer used to produce his published version]. Herrmann could also not exclude that Remer might have obtained documentation with

⁵⁶⁶ The first edition was mailed out in some 15 copies in January 1992, the second in February 1992, the first version of the third edition in November 1992, and a slightly revised version of this edition (second version) in December 1992.

new versions of the expert report during the appeal to the Federal Supreme Court. He said he had submitted the expert report both during the appeal to the District Court and during the appeal to the Federal Supreme Court. At this moment, the Presiding Judge interjected that the expert report was not to be found in the records of either of these proceedings. Made aware of the error of his statement, the witness said that due to the voluminous material in the numerous trials in which he was involved he was not able to pay such particular attention to any one document, hence he could not remember every single one. In the course of time he had been involved in 12 to 15 trials in which he used Rudolf's expert report, in addition to all his other trials. For him, the witness, the expert report of the accused was just one document among many others and so he was not able to remember details."

What can be seen from this is that the witness Herrmann was basically confused and could not remember details about which version he had sent to whom and when. But at least Herrmann remembered clearly that he had requested changes to the expert report, so he concluded logically that I must have sent him copies of this rearranged version; after all, I had prepared this version on his request. The court, however, described the statements of the witness on page 199 as follows:

"The taking of evidence has shown on the other hand that attorney Herrmann never, and in any case not during 1992 nor in the first quarter of 1993, had come into possession of draft 'F2' and that he did not send it to Remer. The witness Herrmann affirmed that the draft 'F1' was the last version of the 'expert report' that had come to him, and in addition he could not say when he came into possession of this version. In the rest, he believably reported that he had had no further contact with Remer after the trial in Schweinfurt on Oct. 22, 1992, due to the 'expert report'. He could not remember having sent a copy of the 'expert report' to Remer in December 1992."

The difference between the two texts is obvious: The independent observer reported that Herrmann did revise his initial statement after I made him remember that it was Herrmann himself who made me prepare this particular version "F2", which leads to the logical conclusion that he did, of course, receive at least one copy of this version he had specifically demanded. But the court simply 'forgot' about this detail. From its own faulty reasoning, the court concluded on page 202f.:

"The fact that the accused knowingly spread an untrue account of

how the Remer operation came about is a particularly clear indication that he was involved in the Remer operation.”

2. The Court was also eager to try to prove that I did tell my sister about Remer’s commentary before Remer had even started to distribute my report, which would have been possible only if I had been involved in the production of said commentary. The first copies of my report mailed out by Remer arrived at their destinations briefly after Easter 1993. Did I tell my sister already before Easter about these comments, then this would put a ‘nail into my coffin’. According to the above-mentioned independent observer, the sister of the accused made the following statement on January 24, 1995:

“The sister of the accused states that she learned from her brother during a visit shortly before Easter 1993 (April 10-12, 1993), that Remer had joined a racist and anti-Semitic commentary to the expert report, which he had obtained from his attorney, and distributed it against his will. In this connection there was talk [between my sister and me] of a measure against Remer at one time. The inquiry, whether her brother described the Remer operation as a threatening event or as a completed happening, she could not answer because she could not remember. It was possible that the operation had already happened. Actually she had spoken with her brother on this subject numerous times since there had been telephone communications between them once a fortnight. Under intensive questioning by the court about details of content and chronology of the events at that time, the witness appeared stressed and appreciably abashed. On inquiry of her brother she said she could no longer remember exactly when she had heard what news from her brother on this subject. She could only describe her overall impression.”

The court described this witness statement as follows (p. 210):

“Moreover the sister of the accused said he had expressed to her already in Easter 1993 (April 11/12, 1993) the intention to follow the Remer version with an ‘authorized’ version. The reason he had given was that Remer had scattered racist expressions through the ‘expert report’. But in his testimony the accused says he saw the Remer version first from his doctoral supervisor on 16th April 1993 and first knew of the Remer additions at that time. The fact that he referred to Remer’s ‘racist expressions’ previous to this is a further indication that the accused had knowledge of the Remer operation beforehand.”

However, according to the independent observer, my sister thought “*it was possible*” that Remer’s mailout had already taken place

before Easter 1993, which is clearly incorrect—all copies of Remer's version were mailed to their recipients only after April 15, 1993. This proves that my sister's memory was wrong regarding the chronology, which is also supported by her own statements under intensive inquiry both by the judges and by me that she simply could not remember when she had heard what from me. The fact that the witness could no longer remember the exact chronology was duly omitted by the court for obvious reasons. Who of us can remember, down to the exact day, what we heard from our siblings two years ago? But for the court, this was a major stepping stone to its verdict.

3. Another way to prove me a liar was the court's attempt to prove that my statements regarding contacts with the Remer couple were a lie. By showing that I was hiding my contacts to Remers, they sought to prove that I was in fact involved in their plot to hide the truth from the court. On my contacts with O.E. Remer, the independent observer wrote the following on the trial day November 11, 1994:

“At that point he [the accused] mentioned among other things his four meetings with O. E. Remer, of which the last took place at the beginning of May 1993. At this time, he had negotiated a declaration of injunction with Remer through an intermediary. The intermediary had re-phrased it and given it to him, the accused. Shortly thereafter, Remer had signed it in the presence of the intermediary and himself. When asked, why he had not handled the declaration of injunction himself, the accused explained he had not had any contact with Remer and did not desire to do so.”

For January 24, 1995, one reads there:

“Next was introduced an application form to participate at a revisionist gathering in Roding in summer 1991, organized by O. E. Remer, which had been filled out by the accused but not sent in. The accused said he had been interested in the proceedings because of the announced participants Prof. R. Faurisson and Dr. W. Stäglich. In any case, he was not there, which is also proved by the fact that he had not sent in the application form. He had not noticed at the time that Remer directed the proceedings.

The defense attorney said that he had himself participated in this gathering but could not remember that he had seen his present client there.”

But the court portrayed both happenings, which it interpreted as

evidence of my lack of credibility, as follows (p. 148ff.):

“For one thing he [the accused] took part in the closed revisionist proceedings called by Remer on 29.6.1991 [in Roding], in which Remer gave the welcoming address (p. 49). The copy of the filled out application form that was found at his house shows that. The accused has not contested this. [...]

In addition, he finally admitted to have stopped by Remer’s place in Bad Kissingen on May 2, 1993, together with Philipp in connection with the completion of the declaration of injunction (p. 124). The accused at first attempted to disguise this contact. In his first response during the trial, when talking about how this declaration evolved, he said he had communicated with Remer ‘through an intermediary’ after the latter had not responded to his written warnings. This intermediary had worked out the text of the declaration with Remer and had given it to him. As reason for having made use of an intermediary he said he did not want to have direct contact with Remer.

The accused attempted to deliberately misrepresent his attitude to Remer in other cases as well. The above-mentioned letter of the accused to attorney Herrmann on Dec. 20, 1993, shows this. [...] At the same time the accused described [in this letter] the supposedly only three meetings with Remer. [...]

*It is noteworthy that his letter to attorney Herrmann deliberately describes his relation to Remer incompletely by leaving out both of these events [revisionist gathering in Roding and arranging publication of the brochure *Die Zeit lügt!*,⁵⁶⁷]. The chamber is convinced from this that it does not reflect the true relations and the actual opinion of the accused on Remer, but was written expressly for the purpose of misleading the investigation process.”*

Since the original of the application form to the revisionist gathering in Roding had been introduced as evidence during the trial and not a copy, as the court falsely claims in its written verdict, it is easy to see that I was not present at the gathering in Roding. In a later publication, my defense lawyer confirmed the report of the independent observer and criticized the court harshly for this rather odd mistake.⁵⁶⁸ One can see even further that the report of the independent observer is correct with respect to my responses. If one considers that Remer was abso-

⁵⁶⁷ (The (German weekly) Time lies!), edited by O.E. Remer, Verlag Remer Heipke, Bad Kissingen 1992 (online: www.vho.org/D/Beitraege/Zeit.html).

⁵⁶⁸ G. Herzogenrath-Amelung, *op. cit.* (note 560), pp. 186f.

lutely not involved in arranging the publication of the brochure *Die Zeit lügt!*, i.e., that it did not lead to any correspondence or meetings between Remer and me (not even the Court claimed that), that it was not me who decided to put Remer's name and publishing house on the imprint of the brochure,⁵⁶⁹ and that in the letters and statements quoted

⁵⁶⁹ This brochure was mainly written by me (under four pen names), but made fit for publication by Karl Philipp, who made some changes to it and chose Remer as editor and publisher to protect me legally (which worked). As far as I know, Remer was not involved in the actual production of the brochure, and I was never involved in its distribution. Therefore, no link ever existed between my writing the brochure—without any intention to do it *for* Remer—and the fact that Philipp put Remer's name on it (probably even without Remer knowing it) *after* I had finished my writings. True, I never complained about it, but there was, realistically seen, no other way than Philipp's way to have this brochure published swiftly—which was necessary since it was a reaction to a series of articles in a weekly newspaper—, and I did not intend to reveal my pen names to anybody anyway, so why bother?

It should be mentioned in this context that this brochure still causes me some trouble in that my use of four pen names for it (Dipl.-Ing. Hans Karl Westphal, engineer; Dr. Werner Kretschmer, barrister, Dr. Christian Konrad, historian, Dr. Dr. Rainer Scholz, chemist and pharmacologist), all of them pretending to have a different academic degree, led to the accusation of dishonesty and attempted confidence trickery (see, e.g., www.holocaust-history.org/auschwitz/chemistry/not-the-science/). The background of these pen names was not the attempt to impress people with phony doctorates, though I must admit that it can have this effect. I therefore wish to set the record straight by repeating what I stated already elsewhere (www.who.org/GB/c/GR/CharacterAssassins.html):

The first revisionist publication I was involved in was a brochure with the title *Die Zeit lügt!*, published in October 1992. It was a reply to two lengthy articles of a certain Till Bastian published in summer 1991 in the German weekly *Die Zeit* (no. 39, Sept. 18, 1992, p. 104, and no. 40, Sept. 25, 1992, p. 90). This brochure is the fairest writing about the Holocaust controversy that ever appeared, simply for the reason that both articles of Bastian were reprinted *in their entirety*, and discussed afterwards. The reader always has the means to check both points of view. Nobody else has ever done that before or since—on either side of this discussion.

Nowhere in that brochure is reference made to the special expertise and qualifications of the authors given—simply because these names were added after the brochure was written—nor would the claims and arguments brought forward in this brochure require the qualifications of these experts. Though it was certainly incorrect to do this, I would like to explain why it was done, as it was certainly not done in order to claim qualifications that are actually not present. Let me therefore be a bit more detailed.

In spring and summer 1992, I was called by several defense lawyers as an expert witness in several trials imposed on revisionists in Germany (Udo Walendy, District Court Bielefeld, February 1992; Gerd Honsik, Upper District Court Munich, March 1992; David Irving, County Court Munich, May 1992; Detscher, County Court Munich, July 1992; Max Wahl, District Court Munich, July 1992). In these trials—as in all trials against revisionists—the judges rejected any evidence presented by the defense, including all expert witnesses. In one case, I had to learn that a chemist (me) was rejected because he was neither a toxicologist nor a historian, an engineer (Leuchter) was rejected because he was neither a chemist nor a historian, and a historian (Prof. Haverbeck) was rejected because he was neither a chemist nor an engineer. My conclusions were that one obviously had to be at the same time an engineer, a chemist, a toxicologist, a historian and perhaps even a barrister to be accepted as an expert witness at a German court of law. The legal process being so perverted in Germany, I decided to mock it with a parody by inventing a person with all these features, but then Karl Philipp

by the Court I was always writing and speaking about actual dealings with Remer—there was none in connection with the brochure *Die Zeit lügt!*—it must be asked: who lacks credibility here?

A large number of similar cases could be shown in which the court made observations on the statements of mine or of witnesses that differ from the trial report. Since the differing interpretation of the court were always disadvantageous for me, the question must be raised whether we are supposed to believe that these errors were made unintentionally.

Hiding the Purpose of Evidence

It appears possible that in German courts, the written judgment will suddenly present evidence as the main proof of guilt which had remained in the background during the proceedings of the trial, in that the court reinterprets it in a way that had not been mentioned during the proceedings. In this way, it is impossible for the defense to bring in evidence to refute evidence which at first appears to be harmless since no one can tell what evidence the court will use as proof of what fact.

When the defense attorney wants to introduce a piece of evidence, he must always provide a reason for it so that the court can decide on the request. On the other hand, this rule does not seem to apply to the court itself.

Here is one example of that. The court interpreted certain publication details of the original version of the Rudolf expert report used by Remer in his version as well as of the version without comments published by me a few months later as proof that Remer's distribution activities of his version and the subsequent publication of my authorized version were one single operation planned in advance. As one of the main proofs for this the court pointed to the fact that in the draft of my expert report produced in November 1992 (version F2), Prof. R. Faurisson had not been mentioned in the acknowledgements at the end of the report. He had first been expressly thanked in the authorized version of my expert report published in July 1993 on the inner cover. According to the Court, this allegedly proves that the authorized version was planned already in November 1992 (decision, pp. 93, 208ff.

and I realized that this would be a bit unrealistic, so we split that person into many. That is the background. I think it is both tragic—for the victims of those German kangaroo trials—as well as funny—for the neutral observer to see the desperate attempts of German judges to keep any evidence out—, but the reader does, of course, not have to agree with me on that.

Don't try to find logic in it. There is none.). It did not enter the judges' minds that I had deleted the acknowledgement to Faurisson from the November 1992 version simply because I feared to be rejected as an expert witness, should any court recognize that I had been in contact and on good terms with the world's leading revisionist, and not because I already planned to thank Faurisson later in a prominent place in the authorized version. The whole argument spun around this point about the acknowledgement, which first surfaced in the decision and was based on different versions of the expert report that had been introduced as evidence, had never been mentioned even peripherally in the 29 days of the trial proceedings, so that the defense was unable to bring in any evidence to counter this supposed evidence proving the guilt of the accused.

Introduction of Evidence After the Verbal Decision

It is doubtful whether the introduction of evidence following the trial is admissible. Nevertheless, the District Court of Stuttgart used exactly this method in order to portray me as untrustworthy. As supposed proof that I had manipulated witnesses, on page 170f. of its decision the court stated:

“Further, during a search of his living quarters on March 27, 1995, which took place in the context of an investigation conducted by the State Attorney of Tübingen on the book “Grundlagen zur Zeitgeschichte”, another computer belonging to the accused was found on which there was an answer list that concerned the interrogation of the witness Dill by the court, as the accused himself declared in the trial.”

First, the description of the court is misleading, since I had only declared that my computer had been seized, but not that an answer list had been found on it. This document had been mentioned by the court in the trial but it had not been introduced as evidence in the trial. For this reason, the defense attorney did not think it necessary to produce evidence to oppose this imputation, which might have explained that the item was not an answer list intended for use in an upcoming questioning of a witness. In fact, it was a detailed record I had prepared about what Dill was asked and what he answered when he appeared for the first time in front of the court, and this list was prepared *after* this interrogation, hence could not be used to manipulate this witness at all.

Refusal of Foreign Witnesses Without Reason

In the middle of the 1980s, the German criminal justice system was altered so that motions could effectively be denied to hear the testimony of foreign witnesses in their own country. In the course of the trial concerning Remer's distribution of my report, it became obvious that several foreign revisionists had participated in the operation indirectly or directly. Since these revisionists faced the possibility of arrest if they traveled to Germany, due to their revisionist activity, they would have had to give their testimony outside the country. Because of the reformulation of the German law, however, it was possible for the court in the final phase of the trial to deny numerous motions of the defense that were intended to hear the testimony of foreign witnesses outside the country on key questions. The effect this can have on the judgment is obvious.

Prevention of Appeal

In criminal proceedings caused by crimes that are considered by the German authorities to have caused major violations of law and order, the trial is held immediately on the District Court level, *i.e.*, on what normally is supposed to be the appeal level (the first level is the County Court). In such cases, the accused has only one trial during which evidence can be presented, that is, there is no appeal possible to the verdict of this court! Only a so-called application for a revision of the verdict with the German Federal Supreme Court is possible, but such an application can only criticize errors of form (matters of law). The factual assertions of the deciding court, *i.e.*, description and evaluation of evidence (matters of fact), will not be discussed anymore. Furthermore, it is usually the case that applications for a revision will be denied by the German Federal Supreme Court, if the defense is the only party to request it.

Whoever determines, and on whatever basis, whether or not law and order have been seriously violated by an offender, must remain open. But such a serious violation seems to be always given, if the offence massively attacked political taboos. In such cases—where the accused's entire existence is at stake—he has no possibility of reopening the taking of evidence in an appeal.

The fact that recent attempts were made in Germany to deny an appeal even for trials of minor misdemeanors held before County

Courts for the sake of relieving the workload of the court, shows how little room for maneuver is left to him who gets caught up in the wheels of justice.

The Arbitrary Evaluation of Evidence

Even if a court has introduced evidence in the course of a trial that made its delicately constructed bridge of circumstantial evidence to collapse by refuting it, this is no reason not to impose a sentence. Here is an example.

In my case, the court had come up with the idea that, already in October 1992, I had planned Remer's distribution activities of his version and the subsequent publication of my authorized version as one single operation planned in advance (decision pp. 207ff.).

At the same time, on Feb. 16, 1995, the court introduced a letter of mine to Mark Weber, dated May 22, 1993, from which it was clear that up to the end of May 1993, a month after the end of Remer's distribution operation, I still did not know where I could publish my authorized version of the expert report, which indisputably contradicted the court's thesis that I was already planning to publish the authorized version at the same time as I was allegedly helping to plan the Remer operation.

Here is a discussion of a second example of the court's logic-free evaluation of the evidence. In its written verdict, the court conceded that I intended to get the attention of the lay public for my expert report (decision pp. 23f., 108f., 210), so that I had paid attention that there was no reason for the general public to suspect any lack of technical merit and reputation, *e.g.*, by including political comments (decision pp. 17ff., 196f., 218). This was supported by the evidence as a whole and in particular by the documents introduced on June 13, 1995, which was a series of letters that I wrote to various persons between 1991 and 1993, all clearly stating that I did not want any political or polemic comments included in or associated with my expert report. However, if one was to follow this logic, one has to assume that I would have sent out—or agreed to the distribution of—a version of my expert report which confined itself to technical discussion but would *never* have sent out one such as the Remer version with its polemical/political commentary. In the decision the court can escape this logical contradiction only by claiming that I had miscalculated the effect of Remer's commentary (p. 228).

Incriminating Mitigating Evidence

Having arrived at a verdict in this way, the tens of pieces of exonerating evidence—documents and witnesses—that my lawyer had introduced served the court as evidence of my “*criminal energy*”, since, according to the court, this exonerating evidence was all partly made up (decision pp. 13, 22, 65, 118-126, 131, 175, 192) and served only to deceive the court:

“The culpability of the accused is even greater when one takes note of the high criminal energy with which the crime was committed. The accused acted on the basis of a calculated and highly refined strategy carried out in a hidden manner that was chosen beforehand with great deliberation, involved numerous deceits and manipulations and was therefore very difficult to penetrate.” (decision p. 237)

Which leads to the Court’s conclusion:

“The sentence of imprisonment is not subject to probation, by sec. 56 of the Criminal Code (StGB).” (decision p. 238)

since:

“On the contrary, [the crime of the accused] as described, because of the calculated and refined and clandestine manner in which it was carried out, should be seen as particularly grave.” (decision p. 240)

Conclusions

Given the present circumstances of the criminal justice system in the Federal Republic of Germany, when a judge or a panel of judges intend to render an unjust verdict, they will have no difficulty in doing so as long as they are assured there is no organized public resistance from the media, academia, the police, or the churches.

The statements of witnesses and accused may be manipulated at will. Evidence may be interpreted any which way in the decision or may be brought in after the process is over. Submitted evidence may be passed over without mention and use of foreign witnesses may be denied arbitrarily.

Exculpatory evidence may be discredited as a deceptive maneuver of the accused and serve as evidence that the accused is particularly deserving of punishment. A second trial instance to try to correct these measures can be denied in case of public necessity. The evaluation of evidence is bound neither by the evidence introduced nor by logic.

The question, how these conditions can be overcome so that further misuse can be reduced as much as possible, needs to be answered by honest jurists and politicians.

Closing Remarks

The court based its refusal to allow for a probation of the sentence of imprisonment not only on my supposedly high “*criminal energy*,” but also on the fact that I did not seem to have a favorable social prognosis, since I had not only not repudiated my revisionist views, but defended them even more vehemently and kept propagandizing them. As proof for this the court pointed to the book *Grundlagen zur Zeitgeschichte*,⁵⁷⁰ edited by me under a pen name, which had come onto the market just at the beginning of this trial, as well as to the almost-complete book *Auschwitz: Nackte Fakten*⁵⁷¹ found on my computer during a house search conducted in March 1995, *i.e.*, right in the middle of the ongoing proceedings.

With this, a fact was used to harden my punishment that had not even been determined to be a criminal offense in a legally binding decision by a German court in the first place, as was a work which had not yet been published and which therefore could not even theoretically have been a crime. By German law, it is admissible for a German criminal court to take account of the opinions of the accused—here my historical revisionist opinions—in the weighing of punishment. Through this back-door, the trial against me was turned into a political trial.⁵⁷²

⁵⁷⁰ E. Gauss (ed.), *Grundlagen zur Zeitgeschichte*, *op. cit.* (note 43); Engl.: *Dissecting the Holocaust*, *op. cit.* (note 22).

⁵⁷¹ Herbert Verbeke (ed.), *Auschwitz: Nackte Fakten*, *op. cit.* (note 43).

⁵⁷² This article was completed after the house search of the small Berlin publishing house *Verlag der Freunde* at the end of November 1995 (triggered by a revisionist article of mine they had published), when it had become clear that the documentation of my trial intended to be published by this publisher could not appear; taken from *Staatsbriefe* 1/1996, Verlag Castel del Monte, Postfach 14 06 28, 80456 Munich, pp. 4-8.

11.4. Rudolf's Thought 'Crimes'

11.4.1. The First Crime: Remer's Commentary

Reprinted below is the commentary of retired Major General Otto Ernst Remer, which he included in his version of the Rudolf expert report, as it was printed on pages 109a to 114 of the court decision against Germar Rudolf.⁵⁷³ After reading this chapter 11 so far, readers should be in a position to judge whether this commentary was sufficient cause to sentence expert witness Germar Rudolf to 14 months' loss of freedom, had he been the author of the commentary, which he was not, though the Great State Security Chamber of the District Court of Stuttgart disregarded the evidence and said he was the author.

On Jan. 19, 1996, the German Attorney General demanded that Germar Rudolf should spend 14 months behind bars for nothing other than this commentary. The German Federal Supreme Court concurred with this demand in a decision on March 7, 1996 (ref.: 1 StR 18/96).

In addition to these judicial issues, there were other problems with Remer's commentary. In his preface printed on the inside front cover, under the caption "*To all friends, countrymen ...*" he attacked our leading politicians, media people and jurists harshly with the words, "*These liars need to be driven from their spoils fortresses*". At the same time, Remer mailed this version to exactly these leading politicians, media people and jurists. It is certain that to send such a piece of writing to these leading politicians, media people and jurists was entirely useless—though it must have cost many thousand DM.

Remer attached a comprehensive five-page article on the October 1992 trial, in which Remer himself had been sentenced to a 22 months prison term for denying the Holocaust and other things. This article was written by a close friend of Remer who had attended Remer's trial. It basically summarizes the major events of this trials, like a description of various pieces of evidence presented by the two defense lawyers, their rejection by the court, and the final pleadings of the public prosecutor and Remer's defence attorneys. The Rudolf Report had

⁵⁷³ For this version, the text of Remer's comments were retyped, trying to keep the layout as close to the original as possible. The original German version of this is available online at www.vho.org/D/Kardinal/Remer.html.

been prepared for this and for other trials.

In the trial against expert witness Rudolf, the District Court of Stuttgart took exception against this article, which had been entitled “*Justice in Germany 1992*”. For example, they criticized that the quotation from the Foreign Office saying that it was known that there were no gas chambers in Auschwitz (p. I) was incomplete, as the ellipses showed. The quoted German official Dr. Scheel had stated later in his letter that the gas chambers had been located in the Birkenau camp which was 3 km to the west. Thus he had not denied the existence of gas chambers in the complex Auschwitz-Birkenau, as the quotation suggested, but only with respect the main camp Auschwitz. This determination of the court is correct and demonstrates that Remer’s friend misconstrued documents to mislead the public. However, it should be pointed out that the statement of the Foreign Office that there had been no gas chambers in Auschwitz contradicts many witnesses, such as Pery S. Broad or Rudolf Höß. If these witnesses were wrong with their statements about the main camp Auschwitz, how can we be certain that other witnesses to other camps were not just as wrong? How can it be that under such circumstances to doubt the existence of gas chambers in other camps, or even to dispute their existence, is a criminal offense?

The District Court of Stuttgart also commented that the “*Comparison of official figures on the number of those killed in the gas chambers in Auschwitz*” (p. II) was insulting and constituted incitement to racial hatred. But in the meantime, quite official and well reputed sources have added even lower figures to this list of massively differing numbers: in 1993 and 1994, the French pharmacist Jean-Claude Pressac claims between 630,000 and 470,000 ‘gas chamber’ victims, and in 2002, a German mainstream journalist reduced the death toll of the Auschwitz ‘gas chambers’ down to as little as 356,000.⁵⁷⁴ One could certainly agree to the view that any number of victims which is too high or too low can have an insulting effect on some people or can incite to hatred against others. However, it was not Remer who had put these widely differing figures into the world, among which only one can be correct at best—and all others potentially inciting to racial hatred.

Also, Remer’s statement that the Frankfurt Auschwitz trial had de-

⁵⁷⁴ See notes 458-460.

terminated that there were only 45,510 deaths in the gas chambers was not strictly true. In 1965, the Frankfurt Jury Court had sentenced some of the former camp staff on grounds of murder of a certain number of people by poison gas, and for other reasons. All told, it repaid 45,510 gas chamber murders in that it found some defendants guilty of having killed or contributed to the murder of a certain number of inmates. As to the question, how many prisoners had been killed by poison gas in Auschwitz all in all, the court had given no answer and did not have the duty to do so. The determination of the total count of victims is properly a scientific question. That having been said, this would also mean that the Stuttgart Court did not have the duty nor the competence either to make a judgment about the total death toll of Auschwitz, that is, it should not have criticized others for asking questions and having different views in this regard.

It remains true that German justice has judicially determined a figure of 45,510 gas chamber deaths, no more, no less, and that anything more is a scientific question and not a question of criminal justice. It must be asked then, why one should proceed against people with threats of criminal penalty and use of the magic formula ‘common knowledge,’ who do nothing else but to assert that counts of victims as high as several hundred thousand or even several millions are greatly exaggerated, particularly since several well-known mainstream authors do make similar statements. Only that can be judicially claimed to be ‘common knowledge’ which has been determined to be so in court on examination of evidence. With respect to the number of victims of the gas chambers of Auschwitz, that has not been done.

In the written basis for the decision, as proof of their assertion that the epilogue of the Remer version had deliberately created the impression that the Holocaust was used by Jews to exploit Germany, the Court gave this one example (decision, p. 235):

“This applies especially to the reprinting of a letter claimed to have been written by a Jew on May 2, 1991 (p. IV of the epilogue, p. 113 above). Together with the assertion that the Holocaust was an invention of the Jews, this deliberately inflames hatred against the Jews.”

In the epilogue in a display box one sees that Remer has quoted a letter with a sender’s address in Israel, in which the writer inquires about financial reparations based on the claim that his uncle was allegedly gassed in the concentration camp at Dachau. That this letter was

written by a Jew is not mentioned anywhere, nor is there any reference to the religious affiliation of this person in this article. There is also no assertion in Remer's (or his friend's) comments "*that the Holocaust was an invention of the Jews,*" quite contrary to what the court claims. All that Remer's friend did was to juxtapose the letter from Israel with a letter from the City of Dachau, in which the latter clarifies that there had never been any homicidal gassings in the concentration camp at Dachau.

The court had not examined whether or not this letter existed, therefore, on the principle "*In dubio pro reo,*" it had to assume that it did exist. In fact, not just Remer but also many other activists had photocopies of the letter which Remer's friend had reproduced in the appendix to Remer's version. It is a fact that there is a large number of statements from witnesses attesting to homicidal gassing in Dachau, but it is also well known that both the official Dachau Concentration Camp Museum as well as the City of Dachau clearly state that there were never any homicidal gassings of humans in this concentration camp.⁵⁷⁵

These well-recognized facts were given with the documents published or quoted by Remer (or his friend), which cannot be a crime. In his commentary on this letter, Remer points out that false witness statements like the one quoted here, attesting to his uncle's death in a Dachau gas chamber, serve as a basis for 'common knowledge' in Germany. Nowhere did he make the claim that anybody had lied for purposes of material enrichment. It is the court that is to blame for the charge that the reader would get the impression from these two reproduced documents, Remer wanted to impute, Jews had invented a lie for the purpose of exploiting Germany.

That even Jews sometimes make false statements about the period between 1945 and 1993 cannot be disputed. This was particularly clear in the criminal trial of John Demjanjuk in Jerusalem. The trial ended with an acquittal for the accused, since even the Israeli court could not shut its eyes to the flood of false documents and false witness testimony.⁵⁷⁶ Fortunately, in this case also, Jewish personalities turned

⁵⁷⁵ There are, of course, other sources contradicting this, see Reinhold Schwertfeger, "*Gab es Gaskammern im Altreich?*", *VffG*, 5(4) (2001), pp. 446-449 (online: www.vho.org/VffG/2001/4/Schwertfeger446-449.html).

⁵⁷⁶ Cf. the summarizing article of Arnulf Neumaier, *op. cit.* (note 440).

against the flood of untruths that appeared in this trial.⁵⁷⁷

That the same untrustworthy witnesses who appeared in this Jerusalem trial had made similar (incredible) statements in trials in Germany and elsewhere, did not affect their credibility in the eyes of the German court, of course.

In addition, the advertising blitz of the Jews Aze Brauner and his friends on May 6, 1995, in the German daily newspapers *Frankfurt Allgemeine Zeitung* and *Süddeutschen Zeitung*, which rehashed the old lies about soap made of the fat of Jews and lampshades made of human skin which have been repudiated even by the Holocaust Institute Yad-Vashem of Jerusalem,⁵⁷⁸ did not serve to make our jurists consider that not everything a Jew says about the years from 1933 to 1945 is necessarily true.

Even the recently reconfirmed information that the Jew Ilya Ehrenburg, who was Stalin's chief propagandist, was one of the worst deceivers and liars in questions of the supposed National Socialist annihilation of the Jews⁵⁷⁹ does not appear to impress anyone in Germany. On the contrary, the Federal German justice system seems to opine that a Jew always tells the truth and that a non-Jew who accuses a Jew of reporting falsehoods or even lying belongs in jail.⁵⁸⁰

In the decision of the 17th Criminal Chamber of the District Court Stuttgart, there is this discussion on Remer's preface and epilogue (p. 115):

“Although preface and epilogue do not expressly accuse the Jews of having invented the accounts on the Holocaust particularly to gain political and material advantages,”

—read: although the crime of which Germar Rudolf was accused of had not been committed...

⁵⁷⁷ Asides from note 576 compare the book of Demjanjuk's defense lawyer: Yoram Sheftel, *The Demjanjuk Affair. The Rise and Fall of the Show Trial*, Victor Gollancz, London 1994; cf. *Frankfurter Allgemeine Zeitung*, March 11, 1995, p. 8.

⁵⁷⁸ Shmuel Krakowski, archives director of Yad Vashem, and Professor Yehuda Bauer finally admitted in 1990 that “the Nazis never made soap from human fat”, *The Jerusalem Post International Edition*, May 5, 1990; see M. Weber, *JHR* 11(2) (1991) pp. 217-227 (online: www.vho.org/GB/Journals/JHR/11/2/Weber217-227.html).

⁵⁷⁹ Joachim Hoffmann, *Stalins Vernichtungskrieg*, Verlag für Wehrwissenschaften, Munich 1995; Engl.: *Stalin's War of Extermination 1941-1945*, Theses & Dissertations Press, Capshaw, AL, 2001.

⁵⁸⁰ As such Helge Grabitz, *NS-Prozesse – Psychogramme der Beteiligten*, 2nd ed., C.F. Müller, Heidelberg 1986, pp. 64-90; cf. Manfred Köhler, *op. cit.* (note 436).

“in the eyes of this court the purpose of the Remer-Version of the ‘Expert Report’ is nevertheless to suggest this”

—read: the judges can read the mind and intention of the accused...

“and hence to stir up hostile emotions against the Jews. Provided that the claims of the ‘Expert Report’ are correct,”

—the court did nothing to find out whether or not Rudolf’s Expert Report is correct, so it had to assume that it indeed is correct...

“this arises already from the fact that the reader, among others due to the tendentious statements and attitude, must and had to come to the conclusion that the [...] Jews must have consciously forged the accounts on the Holocaust.”

—read: even if the Expert Report is correct, the publisher has to make sure that his readers don’t think wrongly, or he will be punished for that, and the judges know the effect of this publication on the reader without even having any evidence for it.

This meant the expert witness was not only punished for a crime that he had not committed, but also for one that no one had committed in the first place. The crime was invented by the court—they ignored the facts and fantasized about what may be written between the lines!

Even though this was Rudolf’s first conviction, this sentence could, according to the court, not be suspended, (p. 239):

*“if only because no positive social prognosis can be made for the accused (§56 para. 1. Penal Code), who is to be categorized as a **fanatical, politically motivated criminal**. During and despite of the current trial, the accused did publish more ‘revisionist’ works or prepared them, **which once again proves his views**. These, too, use the same strategy of apparent **objectivity** to deny the Holocaust. For example, in fall 1994 the book ‘Grundlagen zur Zeitgeschichte’ [=Dissecting the Holocaust, August 2000] appeared, and the book against Pressac was prepared. The Court has therefore no doubt that, in regard of the laws mentioned, the accused is not willing to be a law abiding citizen.” (emphasis added)*

Here the court openly admits that it sentenced Rudolf to a prison term because of his scholarly convictions which allegedly render him an incorrigible criminal. No more proof is needed to show that Rudolf is politically persecuted in Germany.

Furthermore, the court uses publications, which it had called “scholarly” at the beginning of the verdict and which at that time had

not yet finally been declared illegal by any court decision, to justify a prison term without probation.

By the time the judges handed down their verdict in June 1995, Rudolf had published three books. About the first, Rudolf's Expert Report on chemical and technical details of the alleged gas chambers of Auschwitz, the verdict states at page 23:

"This work, the basis of his publishing activities, is essentially written in a scholarly style. It addresses a chemical detail (the problem of hydrocyanic acid) and does not make any general political conclusions."

In general, the verdict says about Rudolf's three main works (*Expert Report*, *Vorlesungen zur Zeitgeschichte*, *Grundlagen zur Zeitgeschichte*):

"They are characterized by a scholarly attitude with reference to his expertise as a scientifically trained chemist. Tone and form are generally held in a way, as if they were interested only in the matter. Additionally, intensive discussions of details, tables and graphs as well as voluminous references to literature are meant to give the impression of an unbiased and open-minded scholarship. This is primarily true for the three large publications of the accused" (p. 23 of verdict)

About *Grundlagen zur Zeitgeschichte*—now published in English under *Dissecting the Holocaust*—the verdict says, it includes "*a maximum appearance of objectivity*" (p. 26), which later was confirmed by two German mainstream historians in expert reports they wrote in support of Rudolf's scholarly work. Of course, the court had to insert the word "*appearance*", to cast doubt on the quality of these works, because otherwise it could not possibly have sentenced Rudolf.

Considering the contempt and hate this verdict shows against Gernar Rudolf, such words of open endorsement cannot be underestimated. Since the court had to admit that Rudolf's main works are formally scientific and scholarly (form, *i.e.*, appearance, not content, is the only criterion for scholarly works!), the accused could not possibly have committed any crime by publishing them, since the German constitution guarantees the freedom of science without restriction in article 5.3 of the German Basic Law (Germany's unofficial constitution). So Remer's additions were used instead to tie the rope around Rudolf's neck.

With this finding, the court turned the historical dissident (revisionist) Gernar Rudolf into a "*thought criminal*".

It should be pointed out here that in May 2002, Fritjof Meyer, an editor of Germany's largest, left-wing weekly magazine *Der Spiegel*, stated in a scholarly article addressing the alleged death toll of Auschwitz that the evidence indicates only some failed test gassings for the Birkenau crematoria, but no mass murder on a genocidal scale.⁵⁸¹ This sensational statement is close to the claim Rudolf has been making since 1992, *i.e.*, that "the mass gassings [...] did not take place [as] claimed by witnesses". Hence, Meyer's article is nothing short of a partial but timely rehabilitation of Rudolf, and it might take only one or two more revisions of the official historiography of Auschwitz to reach the point where it agrees totally with what Rudolf is stating in his expert report.

I pondered a long time over the question whether or not to reprint Remer's comments, since they caused me an awful lot of distress. But I think he had a perfect right to say what he had to say, and it was really a scandal how the German legal system persecuted this old man. Though I do not agree with everything Remer and his friend wrote, and much less with their style, I decided to reprint these comments in full, so that the reader can understand, how easy one can get imprisoned in Germany for making, endorsing, or—as in my case—simply being associated with hot-headed, but perfectly legal and harmless statements.

————— Remer's commentary —————

[Preface]

Otto Ernst Remer, General-major, retired, Winkelser Str. 11E,
8730 Bad Kissingen, Tel: 0971-63741, Fax: 69634

**To all friends, countrymen and people who love the truth: I
am in distress!**

On October 22, 1992, the District Court of Schweinfurt, Judge

⁵⁸¹ F. Meyer, "Die Zahl der Opfer von Auschwitz", *Osteuropa*, 52(5) (2002), pp. 631-641, here p. 632; for critical reviews of these articles, see Gernar Rudolf, "Cautious Mainstream Revisionism", *The Revisionist*, 1(1) (2003), pp. 23-30 (online: www.vho.org/tr/2003/Rudolf23-30.html); Carlo Mattogno, "Auschwitz. The new Revisions by Fritjof Meyer", *The Revisionist*, 1(1) (2003), pp. 30-37 (online: www.vho.org/tr/2003/Mattogno30-37.html).

Siebenbürger presiding, sentenced me to 22 months prison without probation. This is the equivalent of a death sentence for me.

The trial against me was not a real trial. The main session of the trial ended in a deadlock. The sentence was equivalent to the destruction of an 80-year old man. I was not permitted to defend myself against charges consisting of lies, harassment, and attacks on my honor. The court denied me the possibility of defense by means of sec. 186 of the German Penal Code. It refused to put my assertions to the test of examination.

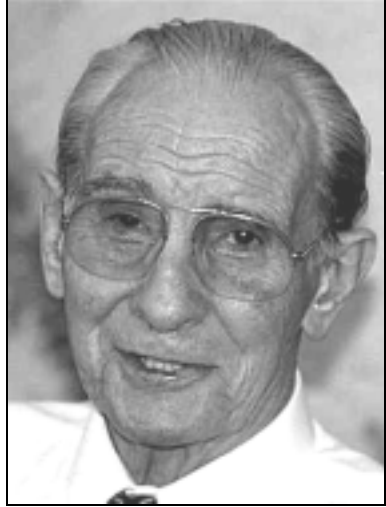

ret. Major General Otto Ernst Remer in 1992

My defense attorney had asked the expert witness Rudolf to appear. This expert witness was in the courtroom, his expert report had already been submitted along with other official records. However, the expert witness was not allowed to speak and the expert report was not allowed to be read. The expert report and irrefutable scientific facts were denied by presiding judge Siebenbürger.

Earlier, Diplom-Chemist Rudolf had been assigned by my defense attorney, retired Colonel Hajo Herrmann, as expert witness to investigate testimony concerning alleged homicidal gassings at Auschwitz. Rudolf used modern scientific, precise measurement techniques to establish the presence of cyanic residue.

No physical evidence has ever been presented in court to support claims of homicidal gassings: no document, no photo, and no orders from military or civil authorities. Can you imagine that a group of people as large as the population of Munich could be annihilated without leaving any traces of the crime? The only proofs of mass homicidal gassings are absurd witness statements. In the great Frankfurt Auschwitz trial (50/4 Ks 2/63) the court 'proved' the existence of homicidal gas chambers with the testimony of a single eye-witness, named Böck, who reported having seen thousands of Jews killed with Zyklon B. He testified that he "*saw with my own eyes*" how the prisoners' commando worked without any protective garment in the midst of this Zyklon B

gas, still hovering in blue clouds over the corpses, without suffering ill effects. What is the difference between Böck's testimony and that of eye-witnesses who confirmed under oath that they saw witches riding brooms on their way to the Blocksberg?



The masonry samples taken by Rudolf were analyzed by the renowned Institut Fresenius.

In a powerful and irrefutable scientific work, my expert witness made a shattering discovery. The buildings in Auschwitz which are pointed out to tourists as homicidal gas chambers, in which millions of Jews were allegedly killed, never came in contact with Zyklon B. The analyses were carried out by no less an organization than the renowned Fresenius Institute. Notable historians agree that this research will revise world history.

This expert report has been in the hands of the Federal Chancellor, the *Zentralrat der Juden in Deutschland* (Central Council of Jews in Germany), the Federal Attorney General, the Ministry of Justice, and notable scientists and personalities for more than a year. Every one of them remained as quiet as a mouse.

The condition under which my expert witness agreed to testify was that his report should be presented only to the court. He specifically forbade me to make his report available to the public. However, since the Auschwitz Lie has become an instrument which threatens the existence of all Germans, I can no longer allow myself to be bound by this condition.

I myself shall die in prison for publishing scientific facts. By means of an unbelievably satanic twisting of history our people will be held defenseless and “*subject to extortion*”, as the Association of German Veterans wrote in its journal *Soldat im Volk* no. 7/8 in 1992. In this condition of eternal abject surrender we shall be destroyed by means of a horrifying ‘multiculturalism.’ This has forced me to a desperate defensive measure, which takes the form of unauthorized publication of Rudolf's Expert Report on the alleged gas chambers of Auschwitz.

Since 1945, generations of German politicians have not only acquiesced in these ghastly lies against the German nation, they have participated in manufacturing them. The same applies to the mass me-

dia. These elements are doing everything they can to propagate the most vicious lies in the history of mankind through the German criminal justice system. When the truth comes to light, these corrupt and venal politicians know that they will be scorned by the public. The media brotherhood know they will be reviled as liars and driven from their posh editorial offices.

This whole pack of liars should be scorned and despised, deprived of position and driven from their spoils fortresses for what they have done to our people. I would like to contribute to this.

You too can help distribute this Expert Report. In the first phase of this operation, I myself will send copies to 1,000 leading Germans. Among them will be leaders of the military, business, scientific, and university communities, in particular members of chemistry and history faculties. I shall send a copy to every representative in parliament as well as media personalities.

In the second and third phases, I shall send another 1,000 copies of this scientific report. No person of prominence will be able to say that he did not know the truth.

These operations will be very expensive since postage alone costs 4 Marks per copy. Therefore I need your support. By ordering a copy of the Expert Report, you will be helping help me to distribute this irrefutable scientific document. Additional contributions will enable additional distribution. I am counting on your help.

Faithfully yours, Otto Ernst Remer

25th October 1992

I have added Sections I-V of the report of my trial in Schweinfurt. After reading this report, you will understand the desperation of my defense effort.

[Appendix]

Justice in Germany 1992: “Death Sentence for General Remer”

This trial report by E. Haller is taken from REMER DEPESCHE no. 6/1992



Kahlenbergdorf

(Austria), the 2.6.1988,

Source: Honsik, *Acquittal for Hitler?*

As a Roman Catholic priest I say to you ... question the existence of gas chambers in the Third Reich. It is the right of those who seek the truth to be allowed to doubt, investigate and evaluate. Wherever this doubting and evaluating is forbidden, wherever someone demands that he must be believed, an arrogance arises that is a blasphemy to God. This is why. If those whom you doubt have the truth on their side, they will accept any questions gracefully and answer them patiently. They will no longer hide their proofs and their records. If these are lying, they will cry for the judge. That is how you will recognize them. The truth is always graceful, while lies cry out for earthly judges.

Respectfully,
with best regards,

/s/ Pastor Viktor Robert Knirsch

Schweinfurt (EH) - On October 22, 1992, the First Great Criminal Chamber of the District Court of Schweinfurt, Judge Siebenbürger presiding, sentenced General Remer for publication of a scientific expert report. The main point of the expert report Remer had published was: there were no mass killings in Auschwitz with Zyklon B. The court called this publication 'incitement to racial hatred,' and Siebenbürger imposed on General Remer a sentence of 22 months imprisonment without probation. State Attorney Baumann demanded a 30 months prison term and moved for the immediate arrest of the 80-year old defendant in the courtroom. Observers of the trial began to suspect that the sentence had been decided before the trial began. At 9:00 hours on October 20, 1992, the day the trial opened, radio BAYERN 1 had announced: "*This time it will cost Remer. [...] this time the punishment will be harder.*" How did the announcer from B1 know that General Remer would be punished more severely than in previous trials? Why was an acquittal not conceivable?

This document is one of many that were presented to the court as evidence.

Answer: "*Denied on grounds of common knowledge.*"

FOREIGN OFFICE

214-E-Stuparek

Bonn , 8th Jan. 1979

Dear Mr. Stuparek!

Federal Minister Genscher has asked me to respond to your letter of December 21, 1978.

As far as I know, there were no gas chambers in the camp of Auschwitz ...

Best regards,

For the Federal Minister,

/s/ Dr. Scheel

What had Remer done? As editor of the periodical *Remer Depe-sche*, the highly-decorated front-line officer had published the results of a number of scientific expert reports. One of them was the *Leuchter Report*, which former Minister of Justice Engelhard described as “*scientific research*”. Fred Leuchter is a constructor of execution gas chambers that use hydrogen cyanide in the USA. Later, the Director of the Auschwitz Museum, Dr. F. Piper, assigned the Jan Sehn Institut in Cracow to make a similar expert report. A technical expert report in German in conjunction with the renowned Institute Fresenius followed in February 1992. The discussion that the General had opened up with his publications was desired even by the Federal President. A letter from the Presidential Office on October 23, 1989, states that von Weizsäcker “*will follow the discussion [on the Leuchter Report] closely*”. Had the Federal President lured General Remer into a trap with this letter? Remer naturally felt that ex-Minister of Justice Engelhard and the Federal President had encouraged him to publish his facts.

Homicidal gas chambers that never came in contact with gas

All three expert reports came to the same conclusion: The gas chambers of Auschwitz and Birkenau testified to by witnesses never came in contact with Zyklon B. In legal terms: the weapon was not loaded. For better understanding: When hydrogen cyanide (Zyklon B) comes into contact with concrete or stones, it forms permanent compounds with traces of iron in such building material. The compound that develops is blue (hence the German name Blue Acid (*Blausäure*) for hydrogen cyanide, although the gas itself is colorless) and occurs on the surface and within the walls exposed to gas. Today, one can easily see a massive blue dyeing on both inner and outer walls in the delousing buildings. There is no such dyeing in the alleged homicidal gas chambers. Chemical analyses of samples from the delousing buildings show very high concentrations of cyanide, while no traces can be found in samples from the alleged gas chambers. Scientific expert reports were never produced for any of the numerous National Socialist trials. No physical proof was ever offered.

In Nuremberg, the propaganda lies of the victors were given reference numbers. Since then they have become ‘facts.’

All courts have continually prevented all gas chamber skeptics from use of any evidence for their scientific investigations. The courts have taken the point of view that the homicidal gas chambers should be regarded as commonly known ‘facts’. ‘Commonly known’ means that the existence of homicidal gas chambers is as certain a fact as that the day has 24 hours. The Nuremberg Military Tribunal introduced the use of ‘common knowledge’ into judicial practice. Pure war horror propaganda items from the Second World War were turned into ‘facts’ (IMT-Statutes 19 and 21) which had to be accepted without question by the accused. Defense attorneys who attempted to prove the opposite were threatened with the death penalty. The Stalinist massacre at Katyn was one of the charges, as well as homicidal gassings in the former concentration camp Dachau (IMT Document 2430-PS). In Document 3311-PS, the Polish government “*put the victors’ tribunal on notice*” that hundreds of thousands of Jews had been “*steamed*” at Treblinka. Note: “*steamed*”, not ‘gassed’. Today, the Holocausters look down shamefully when they are confronted with this nonsense. In the great National Socialist trial before the District and Chamber Court of Berlin (ref. PKs 3-50) it was determined: “*There were no gas chamber structures in the concentration camp Majdanek*”. But in Schweinfurt, General Remer was sentenced to imprisonment because he had published in his *Depeschen* the court’s determination on the absence of gas chambers in Majdanek.

To destroy the German people, only these words are necessary: ‘common knowledge.’

Concerning the alleged gas chambers, no one can speak of the kind of common knowledge such as that which underlies the fact that the day has 24 hours. Only such assertions, as that the day has 24 hours, require no proof. In all other cases there must be proof.

Remer’s proofs are new and far superior

The defense attorneys, Hajo Herrmann and Dr. Herbert Schaller, had prepared comprehensive evidence. They prepared their evidence to conform with a decision of the Upper District Court of Düsseldorf. In a ‘gas chamber denial’ case, this court held that evidence must be admitted when it was superior to the ‘proofs’ in the former National Socialist

<p>Herr Judge Siebenbürger, Herr State Attorney Baumann, please tell me which of the following figures is ‘common knowledge’. Why have you not told the General during the trial which number he should believe in? For which number should Remer now die in prison?</p>	
<p>Comparison of official figures on the number of those killed in the gas chambers of Auschwitz:</p>	
Jul. 26, 1990: <i>Allgemeine Jüdische Wochenzeitung</i> 4,000,000	June 11, 1992: <i>Allgemeine Jüdische Wochenzeitung</i> 1,500,000
Apr. 20, 1978: French newspaper <i>Le Monde</i> 5,000,000	Sept. 1., 1989: French newspaper <i>Le Monde</i> 1,472,000
1945: International Military Tribunal in Nuremberg 4,000,000	1985: Raul Hilberg: <i>Die Vernichtung der europäischen Juden</i> 1,250,000
1979: The Pope during his visit to Auschwitz 4,000,000	July 1990: The left-wing TAZ and other newspapers 960,000
April 1990: Chief State Attorney Majorowsky/Wuppertal 4,000,000	1974: G. Reitlinger: <i>Die Endlösung</i> 850,000
1945: French War Crimes Investigations Office 8,000,000	1989: USSR releases death-books. Total deaths 66,000
1989: Eugen Kogon: <i>Der SS-Staat</i> 4,500,000	1965: Auschwitz decision 50/4 Ks 2/63. including claimed gassing deaths 45,510
1989: Lie-memorial tablet in Birkenau removed, with number 4,000,000	1965: Auschwitz decision 50/4 Ks 2/63, without claimed gassing deaths 619

trials. New, superior evidence trumps ‘common knowledge’, according to the Düsseldorf court. The evidence submitted by the defense is new and far superior to that from the National Socialist trials, since there was no physical evidence presented there.

Auschwitz: ‘Annihilation camp’ with a brothel, legal advice, sauna and soccer ...

Before the examination of the evidence that had been submitted, attorney Herrmann addressed the State Attorney and judge: “*It must be proven, whether there were gas chambers or not, before there can be a decision on common knowledge. The court must determine facts.*” Attorney Herrmann then presented evidence taken from anti-fascist literature and from court documents that showed that Auschwitz was no an-

nihilation camp. The attorney read how there had been a brothel for prisoners in Lager Auschwitz, that there had been weekly soccer games between SS staff and camp inmates, that there was a central sauna, that legal advice was available to the inmates, that in case of non-natural death the camp administration had to notify the appropriate State Attorney with over 30 signatures, that prisoners could be released, that SS-men were not allowed to hit prisoners, that 4,800 sick persons were under medical care (although in the usual version, they landed in the ‘gas chambers’ right away), and that, when the camp was abandoned, the prisoners preferred evacuation by the SS over Soviet ‘liberation’...

The State Attorney roars

This piece of evidence made the State Attorney roar. *“This piece of evidence is an insult to the victims”*, he yelled into the courtroom with a red face. Herrmann replied, *“Then your victims were insulted by the decision in the Auschwitz trial in Frankfurt, Herr State Attorney. Most of what I have just read are observations of the court in the great Auschwitz trial in Frankfurt. You can read them in the decision.”* At this the State Attorney was speechless. It is peculiar, how a State Attorney can free himself from almost any evidentiary difficulty with only two magical words: ‘common knowledge’. He knew nothing about the decision in the National Socialist trials and he knew next to nothing about historical connections or physical facts. All a state attorney needs in such a case is to be able to pronounce the words, *“denied on account of common knowledge.”*

The court refused to accept this evidence. That is, it refused to accept whole passages from the decision in the Auschwitz trial in Frankfurt as well as passages from the writings of ‘survivors’ such as Langbein. Naturally, on account of *“common knowledge”*.

The English crown: no gassings

As part of the evidence he submitted, Dr. Schaller presented the book of Jewish Princeton Professor Arno J. Mayer. In his book, Mayer concludes that the majority of Auschwitz prisoners died of natural causes and that there was no *“Hitler order”* for the ‘gassing’ of the Jews. Mayer confirms that *“proofs”* for the gas chambers are *“rare and unreliable”*. As evidence against the ‘common knowledge of gas

chambers', the attorney submitted a book by British history professor F. H. Hinsley. Hinsley is the official historian of the English crown. His book *British Intelligence in the Second World War* can be obtained from the royal stationer's office. There was a new edition in 1989. On page 673, Hinsley states that from 1942 the English were able to break the coded messages from the German concentration camps. The English found that the main cause of death in the camps was illness. Hinsley reports that there were also shootings and hangings. The official historical scientist of the English royal house states: "*There was no mention of gassings in the decoded messages.*"

The State Attorney moved that this evidence, too, be refused on account of 'common knowledge'. One more time, the court agreed with the State Attorney. At this point, the trial was suspended. It resumed on October 22, 1992. Every time General Remer reentered the courtroom after a pause in the proceedings, the public stood respectfully. Many remained sitting when the court entered, however.

An expert witness is kept out

The defense surprised the court with an evidence physically present in the court room, the technical expert Diplom-Chemist G. Rudolf. By the court's rules of procedure, evidence that is physically present can not be refused, even on account of 'common knowledge'. The technical expert sat in the courtroom. He had researched the alleged gas chambers in Auschwitz from a physico-chemical point of view. He had taken samples of mortar and had them analyzed by the Institute Fresenius. Also he had conducted his own laboratory experiments in which he had gassed masonry with hydrogen cyanide. The expert witness could present scientific proof that the alleged gas chambers never came in contact with Zyklon B. The expert report prepared by the expert witness was submitted to the court with the rest of the evidence. The expert witness could also prove that prisoner commandos could not have "*gone into blue clouds of Zyklon B still hovering over the corpses*", without having been killed themselves. This nonsensical testimony on work in the midst of clouds of Zyklon B had been given by Richard Böck, the principal witness in the Auschwitz trial in Frankfurt. Thus Böck was asserting that the commando had been immune to Zyklon B. Yet the judge in the Auschwitz trial in Frankfurt believed that he had proved the existence of gas chambers in Auschwitz with Böck's

statement. Böck had witnessed the gassings in two farm-houses which never existed, according to a technical report of HANSA LUFTBILD, which analyzed Allied air-reconnaissance photos. The expert witness could also prove that hydrogen cyanide is a colorless poison. The expert witness was sitting in the courtroom. He could provide clarification. What did the State Attorney have to say about that?

“I move that the expert witness be refused, since the gas chambers are common knowledge fact”, was State Attorney’s monotonous refrain. He demanded that the expert witness be refused without his technical qualifications having been examined. The court agreed with the motion of the State Attorney and refused the expert witness, without having heard a word he had to say, as *“completely unsuitable evidence”*. In addition, the court refused to read the expert report, because of ‘common knowledge.’

No one can see the Auschwitz death-books

Attorney Herrmann next submitted a large selection from the official death books of Auschwitz. In 1989, these death books had been released by the Soviet Union. These official papers documented 66,000 cases of death in minute detail. All of them are under seal at the special effects office in Arolsen. No one is allowed to look at them. A ten country commission, including Israel, prevents any inspection of these documents. Recently, the journalist W. Kempkens succeeded in photocopying these documents in the Moscow archive. Herrmann submitted a representative sample to the court. The defense attorney moved that Kempkens be allowed to testify. The Holocausters keep talking about how the old and unfit-for-work Jews were sorted out on the ‘ramp’ and ‘gassed’ immediately, so they could not have been entered in the camp register. The death books prove the opposite. Most of the entries were elderly men and most were Jews. The State Attorney moved that the documents should not be admitted as evidence, since the gas chambers are ‘common knowledge’ fact. The court agreed with the motion of the State Attorney.

The State Attorney’s pleading

At that point, the taking of evidence was ended and the State Attorney began his pleading. He did not need any evidence, since for him the ‘gas chambers’ are ‘common knowledge.’ He described Remer as

Mephisto (the devil) for “*denying*” what is “*common knowledge*.” For such a “*devil*”, he argued, the absolute minimum sentence should be imprisonment for two years and six months. He moved that the imprisonment begin immediately.

Defense Attorney Herrmann’s pleading

The attorney protested, “*We have submitted evidence in many areas, but the court has never undertaken to examine whether the accused had a valid claim.*” Once more Herrmann discussed the denial of



*Defense Attorney ret. Colonel
Hajo Herrmann*

evidence in connection with the ‘confession’ of the former camp commander of Auschwitz, Rudolf Höß. “*The court had refused to allow the reading of Höß’s torture with the comment that it had not been proven that Höß had made a false confession because of torture. But Höß’s confession is false*”, thundered the retired colonel, a former inspector of Germany’s WWII night fighters, in the courtroom. “*Höß confessed 3 million murdered Jews. Today Holocaust historians say the number killed is 1.5 million*”, he flung at the State Attorney and judge. Then Herrmann read the record of the capture of Höß. It is described there how the former commandant was thrown on a butcher bench and how his face was smashed for hours. The Jewish sergeant shoved a guide-lamp staff deep in his throat and dumped a whole bottle of whiskey into his victim. His handcuffs were left on for three weeks. “*That’s what you don’t want to hear, Herr State Attorney*”, the defense attorney’s words rang out. Then Herrmann read relevant paragraphs from the transfer treaty of the occupying powers. In these paragraphs, Germany was forced to recognize forever the historical ‘facts’ that were the basis of the Nuremberg trials. And so German courts still say ‘common knowledge’ to the four million Auschwitz lie, to the lie about gassings in Dachau and the lie about “*mass steamings*” in Treblinka. Nonsense and oppression know no limit.

“*I note*”, said the attorney, “*that the accused was denied his right.*”

Judge Siebenbürger and State Attorney Baumann justified themselves with this kind of witness when they yell, “Evidence denied on account of common knowledge.”



Holon, Israel

I once had an uncle in Karlsruhe B/Baden that was gast in Dchau. I can get some damajes frm this?? Much thank in advans! [misspellings in source]

This text is taken from a letter that was mailed on May 2, 1991, from Holon/Israel to a German acquaintance with the request for help with an application for compensation. The writer’s uncle was “gast” in Dachau and he wanted “damajes”. For Judge Siebenbürger and State Attorney Baumann, this served to prove that the gas chambers are ‘common knowledge’.

Response of the City of Dachau:

**City of
DACHAU**

District capital
(coat of arms)

Our Ref.: 4.2/Ra/Sa

Artists' town for 1200 years

Date: 14.11.88

Dear Herr Geller!

With reference to your question, I must inform you that there were no gassings in the former concentration camp Dachau ...

Best regards - Rahm; Director of Administration

Not only the State Attorney is bound politically. This is about an obligation imposed on the state by the transfer treaty of the victorious powers. But this treaty has no place in this court of law.”

Then he continued, “*I have never before seen the public stand when an accused enters the courtroom. Yes, the general is no turncoat,*

and that is basically what you are accusing him of.” Herrmann pinpointed the State Attorney’s error: “*The State Attorney refuses to accept as evidence the decision of the Auschwitz trial in Frankfurt, which counted 45,510 dead.*” Herrmann hammered on the conscience of the State Attorney, which does not exist. Then he continued, “*But, according to the State Attorney, the accused must know that 6 million Jews were gassed.*” Herrmann turned to the judge’s bench and shouts: “*The court intends to prove that the defendant acted with criminal intent, that ‘he knows it.’*”

The public realized that this great man had lived through times where just dealing, dignity, honor, and decency were still common. A trial like the present was very difficult for him. Once again, Herrmann counted the denied pieces of evidence and asked, “*Who in this courtroom was not well served by the defense?*” Then he confronted the State Attorney and said, “*The State Attorney will try to convince the accused that he knew that what he said was not true. Herr State Attorney, you do not sit in the back of the accused’s head.*”

Then the attorney said what he thought was behind the court’s—in many people’s opinion—scandalous handling of the trial: “*I believe that there is another power that hangs over our legal system that gives you your orders. I know that if you were to acquit, there would be a great howling—not just here, but mostly in other countries. If you fear this, you should decline to conduct the trial. How can you designate even one piece of evidence as superfluous when the issue is life or death, as it is here? You should recollect that the chief prosecutor at Nuremberg described the victorious powers’ tribunal as a continuation of the war against Germany. One cannot so totally destroy and plunder a civilized people such as the Germans without an ostensible reason or pretext. Auschwitz was that pretext.*

If ‘common knowledge’ does not endure forever, at what limit of common knowledge do we find ourselves now? Yes, this ‘common knowledge’ will collapse, but will the accused die in his prison cell beforehand?” With that, Attorney Herrmann ended his pleading.

Dr. Schaller’s pleading

“*This is a political trial of a very peculiar nature*”, the courageous Viennese attorney threw at the judge and State Attorney. “*For the reason that it deals with a crime of opinion, where there was no violence.*

The defenders of democracy sit on the accuser's bench. When a democratic state takes upon itself the power to determine what the truth is, it is no longer a democracy", the attorney admonished the State Attorney and court.

Dr. Schaller told of a case in Frankfurt of an African drug dealer with a criminal history who stuck a 17 centimeter long knife into the abdomen of a young German because the latter did not want to buy drugs. The attorney quoted the *Frankfurter Allgemeine Zeitung* newspaper, as to how the judge in this case would not regard the assault as attempted murder or even as attempted manslaughter. She regarded it as a case of the African's



Defense Attorney Dr. Herbert Schaller

merely wanting to “*teach the German a lesson.*” This example of justice in modern day Germany that Dr. Schaller so graphically portrayed is reminiscent of the case of two Turks who stabbed an 18-year old German in Berlin because the latter had blond hair. Both Turks had already been convicted of manslaughter, yet they received probation. For the 80-year old General Remer who published scientific papers, the State Attorney wants the ‘death sentence’. In the waiting room, people passed around articles from large German newspapers relating how foreign murderers, robbers and mankillers are set free because indictments cannot be prepared in time due to ‘shortage of staff’. Every spectator was outraged that there was no shortage of judges to handle the prosecution and indictment of an acknowledged national hero because of his publication of the truth. Dr. Schaller said further: “*To prosecute assertions of fact in the same way that murderers should be prosecuted—but today no longer are—will lead to social collapse.*”

The state should take care that arguments are expressed in words. The truth does not need criminal justice. The truth will prevail of its own power”, the attorney scolded the State Attorney. The attorney further said: “*Doesn't the State Attorney's demand for a two and a half year sentence for the publication of scientific knowledge smell of*

[communist east German] *GDR justice? And such a thing for an 80-year old man? Is this Bautzen?* [a prison for political prisoners in former communist east Germany]” demanded Dr. Schaller. “*This defense team has introduced a plethora of evidence that supports the claims of the accused. A plethora of proofs and expert reports that has never been presented to any court of the victorious wartime Allies. And yet, the Allies’ magic words from Nuremberg, ‘common knowledge’ should still apply here?*” Facing the State Attorney, Schaller asked, “*Suppose that we had a new government in Germany and this government were to examine the manner in which you servants of the state are proceeding, keeping in mind paragraphs 56 and 62 through 65 of the Basic Law. Do you think you would escape harm from the hands of the German people?*” Then, facing the public: “*Suppose the State Attorney had to justify his charges against the General. Suppose a judge should ask him, what proof do you have of the existence of homicidal gas chambers? He would have nothing to show. But as of today, no state attorney needs to produce evidence. We have not arrived at that point yet.*”

Next he quoted the Jewish revisionist, Rabbi Immanuel Jakobovits, who says: “*Today, there is a whole spectrum of business relating to the Holocaust Industry, with authors, researchers, museum curators and politicians.*” To the judges’ bench, Dr. Schaller hollered, “*The real threat to public order begins when one demands of the German people that they should assume guilt for gas chamber murders.*”

These are dangerous perversions which construe publication of scientific investigation of alleged gas chambers as defamation and incitement to racial hatred. How does the State Attorney dispute this scientific evidence which the accused has published? He merely tells us that we Germans should and must remain guilty as charged at the Nuremberg trials following World War II. That is all.

On the other hand, defense counsel have an expert witness here in the chamber who has produced an expert report that leaves no question unanswered. The expert witness has come to the indisputable scientific conclusion that the so-called gas chambers never came in contact with Zyklon B gas. Never!”

Schaller continued, “*There sits the technical expert, who is not allowed to say a word. A scientist from the world renowned Max-Planck-Institute is not allowed to testify in a German court! And you want to send General Remer to prison? Are you willing to accept responsibility for that?*”

Then, raising his voice: *“The accused has the right to expect that the court will fulfill its duty. that is, to inquire into the innocence of the accused. This kowtowing to the victorious Allies of World War II cannot go on forever!”* With the following words tears came to his eyes: *“Why should a man be put to the sword to keep alive this mythology of wartime propaganda? Mr. State Attorney, you should not continue believing novels that become ever more lurid with the passage of time. It cannot go on like this, to leave one’s own people standing out in the cold. Please allow the introduction of evidence once more.”* Thus the defense attorney closed his pleading.

The General’s closing words

“To this kangaroo court that has denied me the introduction of scientific evidence I have only one thing to say.” General Remer pointed at the state attorney and the judge. *“Germany will one day hold you responsible for what you have done in this courtroom.”*

Resume

General Remer seems to be dangerous to the former victorious powers because he has brought about a discussion of Auschwitz with his scientific publications. If Remer can prove his case, the Allies will lose their justification for having butchered and looted the German people. The Jews will lose, as Prof. Wolffsohn says, *“their only remaining identity-forming myth.”* For these reasons, General Remer is condemned to die in jail. This death sentence is reminiscent of other cases of unsolved deaths such as those of Franz Josef Strauß and his wife Marianne. First Marianne died of unexplained causes in a traffic accident, then the fit, healthy former Minister President of Bavaria passed away under unusual circumstances which are not medically explicable.

The *Allgemeing Jüdische Wochenzeitung* (German Jewish weekly newspaper) of October 29, 1992, recalled Strauß’ goals: *“The declaration of Franz J. Strauß on February 1, 1987, that the Federal Republic should come out from under the shadow of the Nazi past and begin a new chapter in the book of history...”*

The transfer treaty of the victorious powers forbids Germany to *“come out from under the shadow of the Nazi past and begin a new chapter in the book of history”*. The Allies would lose forever their

justification for the horrendous crimes and ethnic cleansing which they committed against Germany, and the Jews would lose their identity-forming principle. This might endanger the existence of the state of Israel. Are there parallels between Remer's 'death sentence' and the death of Marianne and F. J. Strauß?

11.4.2. The Second Crime: A Scientific Anthology

German Court Order: Scientific Work Must Burn!

Since the 7th of May 1995, Judge Burkhardt Stein of the County Court of Tübingen held court on the fates of the publisher, editor, and some of the authors of the fundamental revisionist work *Grundlagen zur Zeitgeschichte* (ref. 4 Gs 173/95).⁵⁷⁰ First, the proceedings against the authors were separated on various grounds. Next, the trial against the editor Ernst Gauss alias Germar Rudolf was separated since the accused was not present at the proceedings. For that reason, Judge Stein issued an arrest warrant against Rudolf.

During the trial, the public attorney and the judge accused the publisher Wigbert Grabert that the incriminated book would meet the test for the crime of inciting to racial hatred in that it used a number of Holocaust denying adjectives such as "*supposed*", "*presumed*" and "*so-called*". In order to show that the book had scientific merits, the defense attorney insisted that while reading certain passages from the book, one needed to consult the comprehensive and detailed footnotes that it contained, which made reference mostly to books of establishment sources. The judge merely turned toward Susanne Teschner, the public attorney, and answered that the court would not think out loud during the trial. The court denied numerous motions of the defense for recourse to relevant expert reports or for access to court records that might show that the words "*supposed*", and so forth, did not *per se* constitute an intentional denying.

The court also denied two motions of the defense to suspend the trial on grounds that in this trial there was theoretically no possibility that the judge would acquit the accused, because in such a case the judge himself might encounter social harassment or even criminal reprisal from the judicial system, as the case of Judge Orlet in the trial

against the revisionist Günter Deckert had shown.

Several days after the beginning of the trial, the expert witness Dr. Joachim Hoffmann was interrogated as to whether the book *Grundlagen zur Zeitgeschichte* was scientific. Dr. Hoffmann, for decades a historian in the *Militärgeschichtliche Forschungsamt* (Military History Research Department) of the German *Bundeswehr* in Freiburg, wrote an expert report on request of the defendant Gernar Rudolf (see below).

During his interrogation, the expert witness stated that terms such as “*presumed*” or “*supposed*” did not please him, yet he did not consider that they put the scientific merit of the book in question.

The public attorney’s pleading was next. The phrases in the book that offended her most—“*supposed annihilation camp*”, “*Auschwitz bludgeon*”, “*Holocaust religion*”, “*identity-forming group fantasies*”, “*supposed genocide*”, “*established Holocaust scene*”, “*lead ad absurdum*”—although taken partly from established publications, deny the National Socialist murder of Jews and therefore qualify as incitement to racial hatred. According to the public attorney, the expert witness Dr. Hoffmann was no more competent to judge whether the book was scientific than a judge or a state attorney is, and his expert report should therefore be disregarded. The publisher Grabert should be sentenced to 9 months prison on probation.

On the last day of the trial, held on a Saturday(!),⁵⁸² June 15, 1996, in his pleading the defense attorney referred to the denunciations of the public attorney, whereby the book was allegedly a pseudoscientific hack-job of the vilest sort, saying that this sort of speech was “*pseudo-legal browbeating*” without content or definition. The defense pointed to the high degree of scientific expertise that had been necessary to produce the book and also to the fact that the expert witness had unreservedly confirmed the book’s scientific quality. He also pointed out that sec. 130 para. 3 of the German Penal Code (StGB, incitement to racial hatred) was unconstitutional when it served to deliver proven scientific publications up to book-burning.

The judge sentenced the publisher Grabert to pay a fine of DM 30,000 (\$15,000) and ordered the seizure—in effect, the burning—of all copies of *Grundlagen zur Zeitgeschichte* as well as all materials needed to produce it. In the written verdict, he stated that although

⁵⁸² In Germany, courts of law do not hold sessions on Saturdays—with this exception.

parts of the book had scientific merit, phrases such as “supposed”, “presumed”, “burnt sacrifice of the Jews”, “imputed systematic nature”, “furious fantasies”, although partly drawn from citations of established personages, denied the Holocaust and therefore qualified as the crime of incitement to racial hatred.

A Historian’s Expert Report

Joachim Hoffmann was born on December 1, 1930, in Königsberg, East Prussia. Since 1951, he initially studied natural sciences, but later changed to study modern history, eastern European history, and comparative ethnology at the University of Hamburg and the Free University of Berlin. He ended his studies with a PhD degree in 1959/1960. In the same year, he became Academic Director at the *Militärgeschichtliche Forschungsamt*, the official historical research institute of the German Armed Forces. He stayed in this position until he retired in 1995, more and more specializing on the German-Soviet war of 1941-1945. He has published numerous articles and books and won several cultural awards. Dr. Hoffmann died in February 2002. The following is the text of his expert report written in defence of Germar Rudolf and his anthology *Grundlagen zur Zeitgeschichte (Dissecting the Holocaust)*.⁵⁸³

Preamble

Accredited chemist Germar Rudolf has written me to request an expert statement regarding an anthology titled *Grundlagen zur Zeitgeschichte: Ein Handbuch über strittige Fragen des 20. Jahrhunderts* (Foundations on Contemporary History. A Handbook of Points at Issue of the 20th Century), edited by Ernst Gauss and published in 1994 by Grabert-Verlag in Tübingen, Germany. The foremost issue was to be the question of the work’s scientific, *i.e.*, academic nature, rather than the content *per se*.

As a historian specializing in recent and East European history, and on the basis of my decades of professional experience and practice in the academic service of the Federal Republic of Germany, I am qualified and entitled to give an expert opinion on the matter in question.

⁵⁸³ Also published in E. Gauss (ed.), *op. cit.* (note 22), pp. 561-564.

Regarding my personal qualifications, I wish to state that I was a member of the *Militärgeschichtliche Forschungsamt* (Military History Research Department) in Freiburg from 1960 to 1995. For almost three decades, my work has focused exclusively on matters related to the German-Soviet war. Through the publication of academic books and periodical articles on this topic I am well established as an expert in my field, both at home and abroad. Accredited chemist Rudolf and the co-authors of the anthology at issue are not personally known to me.

The Formal Aspect

As pointed out in the anthology in question, the book does not offer a comprehensive overview of the course of the National Socialist persecution of the Jews during World War Two. Rather, the focus is on specific individual topics regarding disputed and controversial aspects of killings of the Jews. The various contributions to the book are expertly written in a predominantly investigative style. Where detail and completeness are concerned, the body of supporting and documenting references leaves little to be desired and is extremely helpful to a reader seeking further information, not least of all since sources from the opposing subject literature are also cited without reservation. It appears, therefore, that this anthology is part of the large-scale academic dispute over a serious contemporary issue which reaches far beyond its actual academic scope and into the political realm.

The individual contributions to this anthology are logically consistent and objectively descriptive in structure, even though at times a polemical note does become evident—as is perhaps inevitable in such emotionally charged topics, and as is also quite common in political and historical controversies. In any case, a striving for new understanding is tangibly apparent throughout the book. From this perspective, therefore, the anthology cannot be denied an academic character, particularly if one compares it with many a publication from its opposing side, whose academic nature is also never questioned. There is much in the various contributions that strikes one as thoroughly convincing. Much else may be merely noted with objective interest. Elsewhere, doubts and criticisms also come to mind. The issue may perhaps be simplified by pointing out that what we are dealing with in this great controversy is a rather more accusatory style of literature on the one hand, and a rather more apologetic one on the other. This is to suggest

that in the heat of controversy, both sides may be overly inclined to overshoot the mark and to leave the solid ground of provable facts behind. One might perhaps summarize by saying that the time for conclusive declarations regarding the great persecution of the Jews has not yet come.

The Problem of Self-Evidentness

There can be no doubt about the fact that genocide was committed against the Jewish people by the *Einsatzgruppen* of the Security Police and the SD and by the SS personnel in charge in the concentration camps in the former General Government of Poland. Hitler, Himmler and Dr. Goebbels clearly admitted these misdeeds on several occasions. The anthology's editor, Ernst Gauss, also considers this as given in his chapter. And in fact, the genocide provides an unspoken backdrop for the anthology at issue. To rule out any misunderstanding, it would perhaps have been better to spell these things out unambiguously and to clarify that an academic controversy today can no longer dispute the mass killings per se, but rather only the numbers of victims and the methods of murder. In this respect, we admittedly may expect to see far-reaching modifications as yet. In this context as well, the rather overused concept of self-evidentness is in need of limitation, or at least of a more precise definition.

Two Important Examples

We shall give two especially significant examples of this.

1) From 1945 to 1990, the figure of 4 million victims in Auschwitz was considered self-evident and was accorded judicial notice in the Federal German courts. But where did this figure come from? It originated with Soviet war propaganda. On March 1, 1945, an official Soviet announcement stated for the first time that “*at least five million people were exterminated*” in Auschwitz. This figure was then reduced to four million in the official Soviet communiqué of May 7, 1945. This number of 4 million victims—put about by Soviet war propaganda, in other words by the NKVD, and in no way proven by any evidence whatsoever—was adopted by the public in western countries, and persisted unchanged until 1990, when it was officially reduced to 1.5 million virtually overnight. Currently the number of Auschwitz victims is set at a remaining 631,000 to 711,000, and a further reduction has not

been ruled out.

2) To this day the total number of Jewish victims is generally given as 6 million. According to the current opinion of the German experts on contemporary history, this figure was first provided to the Americans by SS Sturmbannführer Dr. Hoettl in spring 1945, and repeated at the IMT in Nuremberg on November 26, 1945. It must be noted, however, that this selfsame figure was demonstrably first put forth in the foreign press as early as January 4, 1945, several weeks prior to the January 27, 1945 liberation of the Auschwitz concentration camp (with its alleged 4 million victims)—put about by none other than the infamous Soviet Minister of Propaganda, Ilya Ehrenburg. Thus it was Ehrenburg who came up with the figure of six million. [cf. Joachim Hoffmann, *Stalins Vernichtungskrieg 1941-1945*, 5th ed., Herbig, Munich 1999, pp. 182ff.; Engl.: *Stalin's War of Extermination 1941-1945*, Theses & Dissertations Press, Capshaw, AL, 2001, pp. 189f.]

Regarding Ehrenburg himself, it must be mentioned that in 1941 Stalin had given him the general order to incite a boundless national and racial hatred against all Germans. Ehrenburg's years-long unbridled frenzies of hatred culminated in his call to "*put an end to Germany*" and in an effort which he described as "*modest and honorable*", namely "*to reduce the population of Germany*", towards which end the only thing left to decide was whether it would be better "*to kill the Germans with axes or with clubs*".

Both examples show that new evidence can immediately overthrow something that is allegedly self-evident, and, accordingly, it is the duty of any contemporary historian to call allegedly conclusive findings into question. Even in matters involving grave charges, the principle of self-evidentness has been known to become invalidated. As an example one need only

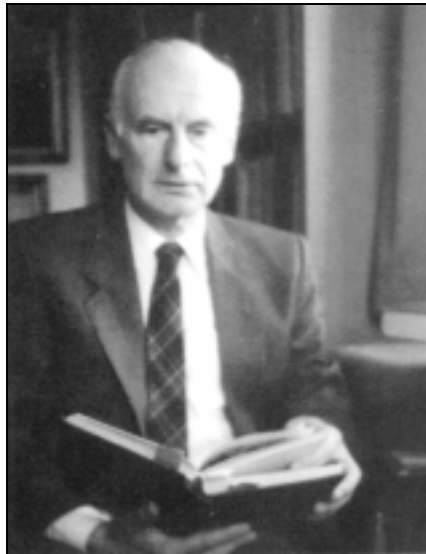

Dr. Joachim Hoffmann

consider the claim (widely accepted in Germany in particular, but now denied by Yad Vashem itself) that the Germans had manufactured soap from the bodies of murdered Jews—a fabrication that also goes back to Soviet war propaganda. Therefore, the anthology at issue here does not commit anything unlawful, but rather engages in a justified and necessary pursuit in its attempt to critically examine allegedly self-evident issues on the basis of new evidence or findings, as it is in fact the natural task of historiography to do.

The Problem of Eyewitness Testimony

Several contributions to this anthology point out, and rightly so, that the testimony of eyewitnesses is unreliable; these contributions back their claims with numerous examples, some of which are indeed truly grotesque. Such experiences certainly agree with those of other historians of the Second World War. This is not to say that eyewitness statements are entirely superfluous, but practical experience definitely has shown that they must always be examined and corroborated with authentic documents. My personal experience has been that as early as 1970 eyewitness testimony about details of the events of the war was so unreliable that it would have been a breach of professional duties to base a historical treatise on them alone.

Benz's Anthology

On the whole, the contributions to the anthology here at issue frequently manifest a profound understanding of the subject and its associated literature, even though some suggestions made do appear questionable at times. However, the Establishment literature about the Holocaust also often contains factual errors. One example in this context is Benz's 1991 anthology *Dimension des Völkermords*, which displays a downright disarming ignorance of the state of affairs on the Soviet side. The authors of the Gauss anthology object, and correctly so, that Benz bases his studies uncritically on the announcements made by Soviet war propaganda and on the publications about Soviet show trials. The anthology edited by Benz attempts, by means of elaborate statistical minutiae, to prove the correctness of the six-million figure. Anyone who has worked with demographic statistics knows what serious errors can enter into such complex analyses even under a strictly objective agenda. Benz is entirely unaware that Ehrenburg had already

introduced the six-million figure into the annals of war propaganda on January 4, 1945. Thus, he will have to accept the charge that, though unwittingly, he has really only worked to confirm a propaganda figure of Ehrenburg's. From this perspective, his and his co-authors' research findings offer a foothold for fundamental criticism.

Babi Yar

The mass execution of Jewish inhabitants of Kyiv, known as the massacre of Babi Yar, is also subjected to justified and necessary criticism in the anthology here at issue. Over time, the actions of *Einsatzkommando* 4a of the Security Police and the SD under Blobel have experienced propagandistic inflation to the point where restoring the actual facts to their real dimensions is an obligation for anyone striving for historical veracity. Of course this does not impinge on the fact that thousands of Jews were killed in Kyiv.

Overall Impression

The overall impression evoked by this anthology edited by Gauss is that its contents must be acknowledged—with critical common sense, of course—no less than is always undisputedly and unrestrictedly done with the 'official' literature about the Holocaust. The principle of *audiatur et altera pars* [let the other side be heard] must apply in this case as well! A suppression of this carefully documented work would represent a forcible obstruction of the legitimate striving for scientific and academic understanding. The state of knowledge is never static. Experience has shown that exaggerations and errors always grind themselves down in the course of a normal academic controversy. One must not deny a mature and free researcher and reader his ability to exercise his critical faculties. It would then be only a small step from suppressing unpopular books, to burning them; and then, though with different motivations, we would be right back where the entire misfortune began.

Conclusion

As historian officially commissioned by the Militärgeschichtliche Forschungsamt I have spent two-and-a-half decades studying the Soviet military literature about the history of the Red Army and the Second World War in its original documentary texts—an endless chain of

misrepresentations, fabrications, distortions and slander. But even this historical literature turned up the occasional truths. I could not have carried out my academic duties if I had rejected the Soviet publications out-of-hand as being unacademic. The same goes infinitely more for the anthology here at issue, which is on a respectable academic level and which doubtless contributes much to our understanding of aspects of the war, despite any reservations one may have.

[sgd.] Dr. J. Hoffmann, Acad. Director (retired)

[written on September 28, 1995]

On June 15, 1996, judge Burkhardt Stein from Tübingen County Court ordered the confiscation and incineration of all books *Grundlagen zur Zeitgeschichte* and all means for its manufacturing (Ref. 4 Gs 173/95). The expert reports presented by the defense were ignored.

11.4.3. More Thought Crimes...

Since I fled my home country in early 1996, many more criminal prosecutions were started for publications I authored, edited, published, or distributed, and keep authoring, editing, publishing, and distributing. The following list contains cases where such proceedings came to my knowledge. Since distributing literature banned by the German Federal Review Office for Youth-Endangering Publications (*Bundesprüfstelle für jugendgefährdende Schriften*) is a criminal offense in Germany, and each confiscation of literature by a German court is accompanied automatically by criminal prosecution against those who authored, edited, published, distributed, printed, imported, exported, stored or otherwise made available the confiscated literature, each of the following cases is considered to be a crime under the tough German thought crime legislation. One must therefore assume that each of the following cases may result in at least one criminal proceeding against me. Finally, I have added a list of works published by me for which it is unknown if any criminal proceedings were started. Since the content of these publications is comparable to the other publications listed here, it must be expected that in any of these cases criminal investigations have been or will be started.

1. In 1994, the State Prosecution Office of Böblingen confiscated the following books written by Gernar Rudolf. It is likely that Rudolf's ongoing distribution of these publications since 1994—both in printed form as well as online—led to further criminal proceedings against him (County Court Böblingen, 9 Gs 521/94):
 - Rüdiger Kammerer, Armin Solms (ed.), *Wissenschaftlicher Erd-rutsch durch das Rudolf Gutachten*, Cromwell Press, London 1993.
 - Manfred Köhler, *Prof. Dr. Ernst Nolte: Auch Holocaust-Lügen haben kurze Beine*, Cromwell Press, London 1994.⁵⁸⁴
 - Wilhelm Schlesiger, *Der Fall Rudolf*, Cromwell Press, Brighton 1994.⁵⁸⁵
2. In 1996, the County Court Munich ordered the confiscation and destruction of the issue 6/1995 of the periodical *Staatsbriefe*, (Castel del Monte, Munich), because of an article authored by Gernar Rudolf (County Court Munich, 8440 Ds 112 Js 10161/96)⁵⁸⁶
3. In 1996, the County Court Berlin Tiergarten ordered the confiscation and destruction of the issues 2 and 3/1995 of the periodical *Sleipnir*, (Castel del Monte, Munich), because of an article authored by Gernar Rudolf (County Court Berlin-Tiergarten, 271 Ds 155/96)⁵⁸⁷
4. During a search of his property in March 1997, the Judge Dr. Payer of County Court Böblingen orders the search of a German PO Box used by Gernar Rudolf, and its formal owner, because of a prosecution launched against Gernar Rudolf for disseminating revisionist literature via the Internet address www.codoh.com, where this PO Box is given as a contact address (County Court Böblingen, ref. 9(8) Gs 228/97).
5. In 1997, the County Court Weinheim ordered the confiscation and

⁵⁸⁴ Online: www.vho.org/D/Nolte; no Engl. version available.

⁵⁸⁵ Online: www.vho.org/D/dfr; Engl.: www.vho.org/GB/Books/trc

⁵⁸⁶ “*Naht ein deutscher Bürgerkrieg?*”, *Staatsbriefe* 6(6) (1995), pp. 6-8, online German only: www.vho.org/D/Staatsbriefe/Rudolf6_6.html.

⁵⁸⁷ G. Rudolf and J. Markiewicz, W. Gubala, J. Labedz, “*Briefwechsel?*”, *Sleipnir*, 1(3) (1995) pp. 29-33; online: www.vho.org/D/Kardinal/LeuchterR.html; Engl.: www.vho.org/GB/Books/cq/leuchter.html; G. Rudolf, “*Kein Brief ins Gefängnis?*”, *Sleipnir* 1(2) (1995), not online. The criminal investigation against me in that case, Public Attorney's Office I in the District Court of Berlin, ref. 81 Js 1385/95, was dropped on March 21, 1996, under sec. 154 German Penal Procedure Rules (StPO), because the expected punishment “*would not carry much weight*” in comparison to the one expected from the District Court of Stuttgart in my first “*thought crime*” trial.

- destruction of the book formally edited by Herbert Verbeke, but factually written and published by Gernar Rudolf, *Kardinalfragen zur Zeitgeschichte* (Cardinal Questions of Contemporary History), Vrij Historisch Onderzoek, Berchem 1996 (County Court Weinheim, ref. 2 Ds 11 Js 5428/97)⁵⁸⁸
6. In 1997, the County Court Böblingen ordered the confiscation and destruction of the book edited by Rüdiger Kammerer, Armin Solms, and authored by Gernar Rudolf, *Das Rudolf Gutachten*, Cromwell Press, London 1993 (County Court Böblingen, ref. 9(8) Gs 228/97)⁵⁸⁹
 7. In 1997, the County Court Böblingen ordered the confiscation and destruction of the book formally edited by Herbert Verbeke, but factually edited and co-authored by Gernar Rudolf under the pen names Ernst Gauss and Manfred Köhler, *Auschwitz: Nackte Fakten*, Vrij Historisch Onderzoek, Berchem 1996 (County Court Böblingen, ref. 9(8) Gs 228/97).⁵⁹⁰ On April 8, 1999, the German Federal Review Office for Youth-Endangering Publications put this book on its list of prohibited literature (*Bundesanzeiger* No. 81, April 30, 1999)
 8. On December 2, 1997, the German Federal Review Office for Youth-Endangering Publications informs the publisher of the journal *Vierteljahreshefte für freie Geschichtsforschung* (Quarterly for free Historical Research), formally Herbert Verbeke, but factually Gernar Rudolf, that it is going to put the issues one and two of the year 1997 on its list of prohibited literature.⁵⁹¹
 9. On May 12, 1998, the German Federal Review Office for Youth-Endangering Publications informs the formally responsible persons of the website www.vho.org, Herbert Verbeke, but factually and since summer 1998 even formally Gernar Rudolf, that it is going to put the entire content of this website on its list of prohibited literature. (Ref. No. BPjS, Pr. 273/98 UK/Schm)⁵⁹²
 10. On August 25, 1998, the Office of State Prosecution in Munich I informs the publisher of the journal *Vierteljahreshefte für freie*

⁵⁸⁸ Online: www.vho.org/D/Kardinal; Engl.: www.vho.org/GB/Books/cq

⁵⁸⁹ Online: www.vho.org/D/rga; Engl.: to be posted soon at www.vho.org/GB/Books/trr.

⁵⁹⁰ Online: www.vho.org/D/anf; Engl.: www.vho.org/GB/Books/anf

⁵⁹¹ Online: www.vho.org/VffG/1997/1/1_97.html and www.vho.org/VffG/1997/2/2_97.html (German).

⁵⁹² See the transcript of this document at www.vho.org/censor/BPjS_vho.html (German).

Geschichtsforschung (Quarterly for free Historical Research), formally Herbert Verbeke, but factually Germar Rudolf, that criminal proceedings have been started against them for an article published in the issue 1/1998 of this journal, dealing with the ground water table in the region of the former concentration camp Auschwitz-Birkenau (Staatsanwaltschaft Munich I, ref. 112 Js 11282/98)⁵⁹³

11. On January 12, 1999, the German Federal Review Office for Youth-Endangering Publications informs the publisher of the journal *Vierteljahreshefte für freie Geschichtsforschung* (Quarterly for free Historical Research), formally Herbert Verbeke, but factually Germar Rudolf, that it put the issues three and four of the year 1997 on its list of prohibited literature (Ref. No. 5490 (V)).⁵⁹⁴
12. On March 30, 1999, the County Court Munich ordered the confiscation and destruction of the issue 2/1998 of the journal *Vierteljahreshefte für freie Geschichtsforschung* (Quarterly for free Historical Research), published by Germar Rudolf, and informs him that criminal proceedings were initiated against him.⁵⁹⁵ Reason for this were mainly two articles dealing with the concentration camp Majdanek⁵⁹⁶ and with microwave delousing facilities in the concentration camp Auschwitz⁵⁹⁷ (County Court Munich, ref. 812 Gs 16/98).
13. On January 5, 2000, the German Federal Review Office for Youth-Endangering Publications informs the publisher of the book *KL Majdanek. Eine historische und technische Studie (Concentration Camp Majdanek. A Historical and Technical Study)*, Germar Rudolf, that it put this book on its list of prohibited literature. (Ref. 5715(V), *Bundesanzeiger* No. 20, Jan. 29, 2000)⁵⁹⁸

⁵⁹³ Online: www.vho.org/VffG/1998/1/GaeRad1.html; Engl.: www.vho.org/GB/c/WW/GroundWater.html.

⁵⁹⁴ Online: www.vho.org/VffG/1997/3/3_97.html and www.vho.org/VffG/1997/4/4_97.html (German).

⁵⁹⁵ Online: www.vho.org/VffG/1998/2/2_98.html (German).

⁵⁹⁶ A review of the later confiscated book on the same topic, see next.

⁵⁹⁷ Hans Jürgen Nowak, "Kurzwellen-Entlausungsanlagen in Auschwitz", *Vierteljahreshefte für freie Geschichtsforschung* 2(2) (1998), pp. 87-105; online: www.vho.org/VffG/1998/2/Nowak2.html; Engl.: in E. Gauss (ed.), *Dissecting the Holocaust*, Theses & Dissertations Press, Capshaw, AL, 2000, pp. 331-324 (online: www.codoh.com/found/found.html).

⁵⁹⁸ Authored by Jürgen Graf, Carlo Mattogno, Castle Hill Publishers, Hastings 1998; online: www.vho.org/D/Majdanek; English to follow soon.

14. On April 19, 2000, the police of Baden-Württemberg confiscated and destroyed all copies available of the book *Vorlesungen über Zeitgeschichte* (Lectures on Contemporary History), authored by Germar Rudolf under the pen name Ernst Gauss, as ordered by the County Court Tübingen (County Court Tübingen, ref. 4 Gs 312/2000).⁵⁹⁹
15. Criminal investigation so far unknown, but most likely: J. Graf, C. Mattogno, *Das Konzentrationslager Stutthof und seine Funktion in der nationalsozialistischen Judenpolitik*, Castle Hill Publishers, Hastings 1999.⁶⁰⁰
16. Criminal investigation so far unknown, but most likely: J. Graf, *Riese auf tönernen Füßen. Raul Hilberg und sein Standardwerk über den "Holocaust"*, Castle Hill Publishers, Hastings 1999.⁶⁰¹
17. Criminal investigation so far unknown, but most likely: *Vierteljahreshefte für freie Geschichtsforschung* (Quarterly for free Historical Research), all issues since 3/1998 (four each year).⁶⁰²
18. Criminal investigation so far unknown, but most likely: Ernst Gauss (ed.) (i.e., Germar Rudolf), *Dissecting the Holocaust. The Growing Critique of 'Truth' and 'Memory'*, Theses & Dissertations Press, Capshaw 2000.⁵⁹⁷
19. In August 2002, a customer of mine made me aware of the fact that criminal proceedings were started against him because he had ordered ten copies of the German version of this book, *Das Rudolf Gutachten*, Castle Hill Publishers, Hastings 2001.⁶⁰³ This means that distributing this book in Germany is considered a crime, so a criminal investigation must have been started against me because of this book.
20. Criminal investigation so far unknown, but most likely: C. Mattogno, J. Graf, *Treblinka. Durchgangslager oder Vernichtungslager?* (Treblinka. Transit Camp or Extermination Camp?), Castle Hill Publishers, Hastings 2002.⁶⁰⁴

Each of these crimes, which are doubtlessly covered by the First Amendment of the US Constitution, can be punished with up to five

⁵⁹⁹ Online: www.vho.org/D/vuez (German only).

⁶⁰⁰ Online: www.vho.org/D/Stutthof/index.html.

⁶⁰¹ Online: www.vho.org/D/Riese/index.html.

⁶⁰² Cf. online: www.vho.org/VffG/index.html.

⁶⁰³ Online: www.vho.org/D/rga2/index.html.

⁶⁰⁴ Online: www.vho.org/D/Treblinka/index.html.

years in prison in Germany. Would I surrender to the German authorities, I might well face some 10 years in prison for my entirely and acknowledged scientific writings and for my internet fight against German censorship, to which I have devoted parts of my website www.vho.org, which offers all the literature banned and confiscated by German authorities, as long as it does not promote pornography or violence.⁶⁰⁵

⁶⁰⁵ See online: www.vho.org/censor.

11.5. The Media and the Case of Germar Rudolf

The Object of Zeal⁶⁰⁶

When in spring 1992 Germar Rudolf sent out the first draft of his “*Expert Report on the Formation and Detectability of Cyanide Compounds in the ‘Gas Chambers’ of Auschwitz*” to a narrow circle of recipients in science and politics, several historians responded with interest. The media, however, received no notice of the existence of the report. Only in spring 1993, when retired Major General Otto Ernst Remer took a later draft of the expert report, provided it with a peppery political preface, and then sent some 1,000 to 2,000 copies to the media, public attorneys, politicians, and scientists, did a certain circle of the Establishment learn of the existence of this report.

The press was quiet, except for two short articles that appeared on May 8/9 and 13, 1993, in the *Wiesbadener Kurier* reporting on the embarrassment the expert report had caused to the chemical analysis Institute Fresenius hired by Rudolf, located in Taunusstein near Wiesbaden, and an announcement in the *Märkische Allgemeinen* of May 14, 1993, that a certain Prof. L. Bisky had filed a criminal complaint. Finally, in spring 1994, when the Labor Court heard the case between Rudolf and his former employer, the Max-Planck-Institute for Solid State Research at Stuttgart, which ended with a compromise, the *dpa* (German Press Agency) issued a press release that appeared in many newspapers and even on the radio. That prompted the ARD (German Public Broadcasting) television program *Report* to make a witch-hunt broadcast.

In the regional press of the Stuttgart area, where Rudolf resided at that time, there appeared mostly factual police notices, reporting that the State Security Department of the Criminal Police of Baden-Württemberg⁶⁰⁷ for various reasons had ordered house-searches (Sep-

⁶⁰⁶ Appeared in *Staatsbriefe* 2-3/1996, Verlag Castel del Monte, Postfach 14 06 28, 80456 Munich, pp. 23-30.

⁶⁰⁷ The uninitiated reader may be unaware that in Germany there is a division of the Criminal Police called the State Security Department which prosecutes politically motivated crimes. This department, by far the largest of the criminal offices, has separate areas for right-wing extremist, left-wing extremist, and foreign-influenced political crimes, respectively. Those employed in one department tend to have a political opinion hostile to their target group. For example, those in the right-wing extremist department tend to have left-wing, anti-fascist ori-

tember 30, 1993,⁶⁰⁸ August 18, 1994,⁶⁰⁹ and March 27, 1995⁶¹⁰). However, the headlines were occasionally ridiculous. For example, the headline “*Nazi book depot in Steinenbronn*” appeared in the *Böblinger Boten* of March 29, 1995. In fact, there were neither Nazis, Nazi material nor a book depot in Rudolf’s home.

The authorized version of the expert report was published in summer 1993 in Great Britain with the title *Das Rudolf Gutachten* and has been distributed and sold in Germany since then.⁶¹¹ There has been no echo about this version in the media.

The media showed increased interest, when the 17th State Security Chamber of the Stuttgart District Court began the criminal investigation against me on account of suspicion of participation in the preparation and distribution of Remer’s commented version of my report. However, they were not interested in the Expert Report nor in me, but merely in the question, whether there should be made an example “*to punish the right-wing*” for reasons of public instruction.

The trial proceedings did not center upon the actual contents of my expert report, but on Remer’s political commentary and my (alleged) political views. This was despite the fact that prosecutions for dissenting political views are forbidden according to the German constitution (cf. article 3.3. of the German Basic law). They have a strong tendency to turn into show-trials, and this is exactly what happened in this case.

Later on, several of the media reports that were published in the course of the hubbub over the Rudolf expert report and its author attempted to critically evaluate how true—or rather how false—this expert report was.

On March 28, 1994, the Max-Planck-Gesellschaft (MPG, M.-P.-Corporation), umbrella organization of some 200 Max-Planck-Institutes all over Germany and Austria—I had been a PhD student at one

entations. In addition, the German Federal court system includes State Security Chambers whose only work is to punish politically motivated crimes. The prosecutors who work in these courts were politically trained to deal with such crimes.

⁶⁰⁸ This house search concerned the commented version of my expert report distributed by Remer.

⁶⁰⁹ This house search was due to suspicion of participation in the production and distribution of the newsletters *Remer Depesche* and *Deutschland Report*. (See <http://www.nationaljournal.org>)

⁶¹⁰ This house search concerned the revisionist anthology edited by me under the pseudonym Ernst Gauss entitled *Grundlagen zur Zeitgeschichte*. *op. cit.* (note 43); Engl.: *Dissecting the Holocaust*, *op. cit.* (note 22).

⁶¹¹ R. Kammerer, A. Solms (ed.), *op. cit.* (note 43).

of them—issued a press release on my expert report. They reported on internal measures taken by my former employer, the Max-Planck-Institute for Solid State Research in Stuttgart, against me. The MPG made it clear that since they agreed with the German Federal Constitutional Court and the Federal Supreme Court as to the commonly known fact of the Holocaust, they would not involve themselves in the discussion of the issues raised by my expert report.

The Expert Opinion of the *dpa* – Invented from Whole Cloth

The news release of the *dpa* Press Bureau Stuttgart which appeared the following day in almost all German newspapers and also on the radio contained the following passage:⁶¹²

“According to their spokesman, the Max-Planck-Corporation has no proof that the samples are really from Auschwitz. Even if they are from there, according to expert opinion, it is certainly no wonder that no traces of hydrogen cyanide were found, because cyanide compounds disintegrate quickly. In earth this takes six to eight weeks and in stone they can only be preserved by “absolute conservation conditions, including complete exclusion of air and bacteria”.

Of course, the Max-Planck-Corporation had no evidence about the origin of the samples, since they did not ask me for any and I had no reason to give them any without having been asked. This is nothing else but a clumsy diversion from the main question. And by the way: if this topic is important to anybody, no one is prevented from verifying the results of my expert report and the test results of others as discussed in chapter 8.

On inquiry about the supposed expert opinion about the instability of cyanide compounds, Albert Meinecke, the person at *dpa* apparently responsible for the notice, referred first to the press statement from the MPG.⁶¹³ After it was shown to Meinecke that the statement contained no comment on the factual content of the expert report, nor any comment on the stability or presence of cyanide compounds,⁶¹² he made various claims, depending on the caller and the time of the call:

⁶¹² Daily newspapers, such as *Süddeutsche Zeitung*, *Stuttgarter Zeitung*, *Südwestpresse-Verbund* (March 29, 1994), *taz*, *Frankfurter Rundschau* (March 30, 1994).

⁶¹³ Telephone conversation of K. Philipp, Frankfurt/Main, March 30, 1994.

- a) He did not have the source for the expert opinion at hand.^{612,614}
- b) He did not know who was responsible for the press notice.⁶¹³
- c) The person responsible for the notice was out of the office.⁶¹³
- d) The person responsible for the notice was possibly on vacation.⁶¹³
- e) Since Meinecke had said both b) and c) in the same conversation, he was confronted with the fact that he had contradicted himself and that he must know very well who the responsible party was if he could say the person was not in the office. When asked if he had not made a great pile of goat-dung with his press notice, he opined that no one was without fault.⁶¹³
- f) He would call Rudolf when he knew more about who was responsible and what the source was.⁶¹³ As of January 2003, this has still not happened.

The connection between the MPG and the unnamed expert opinion created by the phraseology of the *dpa* notice would suggest to the reader that the expert opinion was that of the MPG. The latter declared by fax on April 12, 1994, that this was not the case and that the claim in the *dpa* notice was mistaken.

After two weeks of silence, on April 13, 1994, *dpa* Editor-in-Chief D. Ebeling of Hamburg, speaking for the agency, announced in a fax message to me that the unnamed expert would remain unnamed to protect his privacy. Two days later, in an unsigned faxed notice, A. Meinecke denied my accusation of falsehood⁶¹⁵ and referred me to the Editor-in-Chief in Hamburg.

The Technical Issues

Among others, the *dpa* notice contained the following assertion:

“Even if they [the samples] are from there [Auschwitz], according to expert opinion, it is certainly no wonder that no traces of hydrogen cyanide were found, because cyanide compounds disintegrate quickly.”

Evidently the writer of these lines does not know the difference between hydrogen cyanide and cyanide compounds. If he should wish to subsume cyanide compounds under hydrogen cyanide, which might make it easier for the layman to understand, then it is clear: This sentence and the following one discuss the stability of cyanide com-

⁶¹⁴ Telephone conversation of G. Rudolf, Jettingen, March 30, 1994.

⁶¹⁵ Press release, G. Rudolf on April 8, 1994.

pounds, the only thing that makes sense with respect to the Rudolf Report. The question as to the stability of hydrogen cyanide itself, as raised by Ebeling in his fax to me, is of no concern to anyone⁶¹⁶—the question is a useless diversion from the subject.

The supposed statements of the unknown expert assert that cyanide compounds disintegrate quickly. This blanket claim is and will always be untenable and shameful for any expert to make. As proof for this, the reader may simply go back to chapter 6.6. of this book, and there in particular to chapter 6.6.5. (page 177).

Ebeling's assertions that stable compounds may form but do not necessarily form⁶¹⁵ needs no confirmation from competent authority, since the fact that every acid in the world forms stable as well as unstable compounds is as trivial as an 'Amen' in church.

In the *dpa* notice it was stated that cyanide compounds will last in stone only under "*absolute conservation conditions*", but in contrast to that, in the masonry of the cases of interest here and investigated in detail in this report, the disinfestation chambers of Auschwitz, hydrogen cyanide formed extremely long-lasting iron cyanide compounds of the Iron Blue type. See the arguments given above for proof of this.

Wrong is therefore not only the claim of the *dpa* press release that this statement stemmed from an expert, but the actual content of this release is absolutely untenable. No expert would have endorsed such an embarrassingly absurd statement. It is not hard to see why the person responsible for having released this article did not want to be named, as Herr Ebeling said.

Report Portrait: Incitement to Hatred

One of the main incidents of the witch-hunt against Germar Rudolf was the left-wing *Report* broadcast of the German public TV station ARD on April 11, 1994. In the footage by Stefan Rocker, everyone from Conservative to neo-Nazi personalities, including Germar Rudolf, were thrown all together into one pot. By this sort of undifferentiated reporting, one can produce in certain sectors of the German population a pogrom mood against everything which is or might be right-wing. *Report* showed pictures of a synagogue in Lübeck which had been fire-bombed just a few months before, using the words, that as soon as Auschwitz denial would boom again, synagogues would be

⁶¹⁶ D. Ebeling's response to numerous queries to the Stuttgarter *dpa* bureau, April 13, 1994.

burning. The next picture shown in this footage was that of Germar Rudolf on his way to the Labor Court in Stuttgart. Thereby, Herr Rudolf was made into a sort of paper accomplice of the Lübeck arson. This was strengthened by the commentator's choice of words, when he mentioned the title of the well-known play *Biedermann und die Brandstifter* (Everyman and the Arsonist).⁶¹⁷

If that does not constitute criminal incitement of the German television-viewing audience against Germar Rudolf, what would? It goes without saying that reports of this kind are loaded with pictures of concentration camps, deported Jews, and a sea of corpses in order to ridicule the supposed denial claim of a Germar Rudolf. This is the way the left-wing *Report* works.

But which viewer would know that Rudolf had not only not denied, but had actually denounced the frequent injustices that *did* occurred at that time?⁶¹⁸ And who would notice that the pictures proved nothing except that thousands in the concentration camps died from sickness and malnutrition? Who noticed that no TV program ever showed a film or a picture of a 'gas chamber' either in operation or capable of being put into operation—the only point in which Germar Rudolf holds a different viewpoint from media outfits such as *Report*?

Report spewed falsehoods and lies into the world. One of them was seized upon by Franziska Hundseher in her book *Rechte machen Kasse* (Right-wingers Cash In) and will be dealt with in the next section. Here I will discuss another.⁶¹⁹

In the appendix of his expert report under the heading *Danksgangung* (Acknowledgements), Rudolf had thanked a number of persons and institutions who had helped him in many ways in the collection of data or sources, the recovery and analysis of samples, or for any assistance in the production of the report. Among these were the firms DEGUSSA AG and Institute Fresenius, since the first had supplied important technical data on the stability of Iron Blue and the second had analyzed most of the samples in Rudolf's presence and initially with his help. Such acknowledgements are usual in scientific publica-

⁶¹⁷ In the referenced book by Max Frisch, Herr Biedermann played just the opposite role of a paper criminal, he was the victim of a criminal (and his own gullibility). But this fact was not made clear to the viewer.

⁶¹⁸ Cf. E. Gauss (ed.), *Dissecting the Holocaust*, *op. cit.* (note 22), pp. 31-34.

⁶¹⁹ There is a detailed discussion of this broadcast in: W. Schlesiger, *Der Fall Rudolf*, *op. cit.* (note 91); there Rudolf disputes that he hid behind the pseudonym Ernst Gauss. He had admitted that in the trial in the District Court of Stuttgart, ref. 17 KLS 83/94.

tions—also they are polite.

In their commentary, *Report* reproached Rudolf that he had used the names of well-known institutes and firms to give his report the appearance of competence. In view of the facts just given, this reproach is both malevolent and ridiculous. *Report's* additional assertion that a criminal complaint for fraud had been filed against Rudolf due to this misuse of well-known names, was pure invention. Up to today, January 2003, there have been no criminal complaints from any of the persons or institutions directly or indirectly involved in the production of the report. *Report's* false accusation was a direct smear.

Stefan Rocker also participated in an *ARD-Tagesthemen* news broadcast on June 6, 1996, covering the book-burning trial of the book *Grundlagen zur Zeitgeschichte*,⁶²⁰ edited by Rudolf, then before the County Court of Tübingen. A written version of this piece appeared in *FAZ (Frankfurter Allgemeine Zeitung)* of June 10, 1996, p. 14. It began with the following sentence:

“Everyman and the Arsonist: diplom chemist German^[621] Rudolf, 31, was sentenced to 14 months imprisonment by the Stuttgart District Court a year ago for incitement to racial hatred and denial of the holocaust.”

Rudolf was also accused of having published a “*pseudo-scientific*” “*hack-job*” titled *Grundlagen zur Zeitgeschichte*, whereby he had proven himself a repetitious right-wing extremist offender. It was stated he had left the country and was sought by the police.

The fact that 100 academics had placed an advertisement in the *Frankfurter Allgemeine Zeitung* during the book-burning trial⁶²² which criticized the use of censorship and the violation of civil rights by German courts was termed a “*frontal assault on the Federal German justice system*” in this commentary. Throughout that piece, the authors threw everyone who was politically right-of-center into one big brown bucket.

Ripple Effects

In mid-May 1995, the left-wing political TV show *Panorama* (again from the German public station ARD) reported on several me-

⁶²⁰ Cf. chapter 11.4.2. in this volume.

⁶²¹ Should be: Germar. Error in Original.

⁶²² Cf. “*About true and false Perceptions*” (www.vho.org/GB/Books/cq/percept.html).

dium-size businesses that had become known as supporters of right-wing circles.⁶²³ This broadcast was a cinematic presentation of the book *Rechte machen Kasse*,⁶²⁴ (Right-Wingers Cash In) written by the journalist who produced the broadcast, Franziska Hundseher. In the book, the author discusses Gernar Rudolf or his expert report twice. Both times her discussion is full of errors and falsehoods.

For example, in referring to the invented *dpa* press release about the alleged instability of cyanide compounds, Frau Hundseher concludes:

“Therefore, this so-called expert report of Herr Rudolf—like the expert report of Frederick A. Leuchter, which similarly found no traces of cyanide in the walls of Auschwitz-Birkenau crematoria 1 and 2—contains no proof of anything other than the methods by which right-wing extremists conduct historical research.”

Though notified in writing about the falsity of the *dpa* press release she was relying upon, Frau Hundseher never changed her position on this. The same is true for a passage on page 212 of her book, where she claims I had tried to collect several tens of thousands of deutschmarks in order to buy copies of the death books of the Auschwitz camp. She gives the impression that I was trying to get the money. But this is not true. The letter quoted by her had already been distortedly quoted by the above mentioned *Report* journalists who must have illegally received a complete copy of this letter from the trial record. However, if read completely, the letter reveals that I did not want any money, but was asking several personalities to donate money to a third person I had no personal connection with.

The Verdict a Foregone Conclusion

As the trial against Gernar Rudolf in the State Security Chamber of the District Court of Stuttgart began at the end of November 1994, there were several media individuals who distinguished themselves by their painful ignorance of the subject matter of the trial. The cause for this seemed to be that no journalist deemed it necessary to ask for in-

⁶²³ Cf. *Die Welt*, May 15, 1995: “Unterstützen Unternehmer die rechtsextremen Szene?” (Do Businesses Support the Right-wing Extremist Scene?). As a result of this broadcast, Gernar Rudolf’s employer was placed under such pressure from his customers, suppliers, competitors, and employees that he terminated Herr Rudolf’s employment contract.

⁶²⁴ Knaur, Munich, May 1995.

formation from anyone involved in the trial. So it happened that repeatedly items were misunderstood or misreported. One might not attribute purposeful distortion to the journalists if it were not for the fact that these misunderstandings were always decidedly unfavorable to Rudolf.

The partisan orientation of the *Süddeutscher Rundfunk*, *SDR*, another public broadcasting station (almost all German public broadcasting stations are left-wing oriented) was exposed when it decided to report only one side of the story, namely that of the investigating police officer.

Since his statements were apparently not critical enough for the *SDR*, soon items were invented. The *SDR* took the only two statements from the several hundred pages of correspondence in which Rudolf had mentioned two Jewish personalities in a disapproving way, which were cited by the police officer. *SDR* then asserted falsely, the officer had characterized the rest of my correspondence “*as the vilest incitement and defamation*”. The *SDR* also attributed to the police officer that he had understood Rudolf to have said he wanted to “*rewrite the history of Germany from 1871 onward, without the Holocaust or World War II*”, which in view of the absurdity of the statement may cause doubt about the sanity of the journalists involved. And of course, the *SDR* was silent on the substantial mitigating evidence presented by the defense in the following months.⁶²⁵

With a few exceptions, the entire media was silent until the end of the trial. It could be seen from the behavior of the journalists present that they were not looking for the real story, but were intent on bringing in a sacrifice for the *Zeitgeist*: all but one of them—a new person from *Südwestfunk* radio—resorted only to the prosecuting attorneys and judges in their search for information.

The *Stuttgarter Zeitung* (*StZ*) provides a clear example of the tendentious method of reporting used by the media. Since not enough incriminating material turned up in the several thousand pages of Rudolf’s correspondence that were found in the first house search in September 1993, on January 27, 1995, the *StZ* conjured up “*writing in the hand of the accused with indisputable [...] xenophobic content*”. However, in the whole trial there was never any talk of xenophobia or racism, because there was never any basis for same. At the end of a piece

⁶²⁵ *Süddeutscher Rundfunk*, in all four afternoon radio programs on Nov. 25, 1994.

of the *Landesschau* of *Südwest 3* TV station on December 27, 1994, the Christian-Conservative Rudolf mutated into a neo-Nazi: the trial against Rudolf was characterized as another case of a neo-Nazi in the Stuttgart District Court, following a real trial against several National Socialists that had taken place in the same court a short time before.⁶²⁶

That the verdict was assumed to have been decided before the fact became more and more noticeable as the question was raised whether there would be difficulties in convicting Rudolf of the crime he was accused of, as if it were not the task of the court to determine the truth without respect to party, but rather that it should find guilt whether or not the crime had been committed.

The *Böblinger Kreiszeitung* reported in this vein on May 10, 1995, as the trial was nearing its end. There, on page 13 under the headline “*Sentence Before Pentecost*”, one found:

“He [the presiding judge] believes that the prosecuting attorney will conclude her case at the next session on May 18 of this year, and that the sentence against the chemist will be handed down before Pentecost unless something unforeseen happens.”

How can it be that, according to this press report, the presiding judge can announce before the end of the trial (it ended on June 23, 1995) that the expected judgment will be *against* the accused, that it will be decided to his disadvantage? It would have made sense to state that the judgment will be given *in* a case or *about* the accused. If the journalist here reported the presiding judge’s words correctly, the choice of words shows the partisanship of the judge; otherwise it shows that of the journalist.

It is worthwhile to note the relative emphasis the media gave to the pleadings of the prosecution as opposed to that of the defense. On June 13, 1995, the *StZ* reported the arguments of the public attorney in a detailed 3-column story on page 2, while the defense appearance was covered the following day in a small single-column story which merely recapitulated the events of the trial and did not report any of the arguments of the accused.

To be fair, it should be mentioned that after the sentence came down on June 24, 1995, Sonnhild Maier, the journalist for the *StZ*, mentioned some of the defense arguments:

⁶²⁶ The video of this program distributed by the Süddeutscher Rundfunk was correspondingly labeled with the caption “*Neo-Nazi*”.

“The court ruled that the expert report and the preface were a single work and were to be seen as a ‘common production’ of Rudolf and Remer.

This is what the accused chemist vehemently disputed. He is a practicing Catholic, believes in the political order of the Federal Republic and would never have entered into an association with Remer, whom he took to be a ‘living political fossil’. In the chemist’s words: ‘I would not have been so stupid—this would have undermined me in the final phase of my doctoral program’.^[627] At the time he was preparing his doctoral thesis at the Max-Planck-Institute in Stuttgart. When his expert report became publicly known, he lost his job.”

In a 3-column story on June 14, 1995, the *Stuttgarter Nachrichten* summarized the prosecution case. The story gave the defense’s claims responding to the prosecution’s points, but not a single argument supporting these claims. Instead of this, the defense arguments were superficially refuted by the journalist Frank Schwaibold using somewhat erroneous counterarguments.

Against the assertion of the prosecution that Rudolf had revealed himself as a politically motivated criminal by his work under the pseudonym Ernst Gauss and therefore deserved no probation, the defense objected that the Gauss case could not be applied. It was hidden from the reader that in a state under the rule of law an accused can not be disadvantaged through a court case that had not even started. In response to the defense counterargument to the prosecution charge that Rudolf cooperated with Remer, journalist Frank Schwaibold asserted falsely that Rudolf had met and talked with Remer three times. The truth is that Rudolf and Remer met only by chance in the course of Rudolf’s work as expert witness for Remer’s defense attorney. During these accidental encounters, there was no conversation between them, which even the court acknowledged.⁶²⁸

Against the defense assertion that the accused was no neo-Nazi, the journalist cited a letter absurdly out of context in which Rudolf *“referred to the ‘Jew Republic Germany’ in context with the person Ignatz Bubis”*. In that letter,⁶²⁹ Rudolf criticized a proposal made in spring

⁶²⁷ Because of the Remer’s commented version, the University of Stuttgart refused to give Rudolf an appointment to take the *rigorosum*, the final examination for his PhD title.

⁶²⁸ Confidential letter of G. Rudolf to H. Herrmann, Dec. 20, 1992, Computer Data File 2, sheet 222, in records of the District Court Stuttgart, ref. 17 KLS 83/94, introduced Dec. 6, 1994.

⁶²⁹ Letter to K. Philipp on March 1, 1993, Investigation File 1, sheet 351, in records of the Dis-

1993 that Ignatz Bubis be elected Federal German President. Taking into consideration that Bubis had almost no political experience at that time but had a criminal past, Rudolf commented that the proposal reflected the immense importance that was given to him as the leader of a diminishing minority in the German state (the late Ignatz Bubis was head of the *Zentralrat der Juden in Deutschland*, Central Council of Jews in Germany, at that time). For that reason, Rudolf stated that it was appropriate to rename the name of the German nation, using this minority as a prefix: *Judenrepublik Deutschland* (Jew Republic of Germany).⁶³⁰ The Jewish witness Horst Lummert, who testified on behalf of Germar Rudolf, confirmed before the court on January 9, 1995, that this reasoning was justified.⁶³¹

Given these facts, it remains for Frank Schwaibold to explain to us where neo-Nazism is hidden in Rudolf's remarks.

Execution by Media

Naturally, after the announcement of the sentence of the District Court of Stuttgart, according to which Rudolf was to be punished with 14 months imprisonment without probation, the media found it easy to drag Germar Rudolf through the mud. The first was the *Süddeutscher Rundfunk*. Following the imperative of the *Zeitgeist*, without making use of the decision of the court or any other evidence, it labeled Rudolf a “neo-Nazi”. It also attempted to make the Rudolf expert report ridiculous by resurrecting the *dpa* notice from a year before. *SDR 3* simply claimed that it was known to competent chemists that cyanide compounds disintegrate within a few weeks in rocks.⁶³²

The program *Landesschau* of the regional television station *Südwest 3* made comments similar to those of *SDR 3*, but piled even further on the defamation by misrepresenting an article that appeared in the *Stuttgarter Nachrichten* the week before. This article of June 14,

trict Court Stuttgart, ref. 17 KLS 83/94, introduced on Dec. 17, 1994.

⁶³⁰ Response of G. Rudolf to accusation May 1994, introduced in trial before District Court Stuttgart, ref. 17 KLS 83/94, on March 17, 1995 in chambers, in records.

⁶³¹ H. Lummert thinks that one should stay with the abbreviation for BRD: “*Bubisrepublik Deutschland*” (Bubis Republic Germany). Approximately 30 witnesses testified that they had never heard Germar Rudolf make anti-Semitic remarks and that he had even protested against their use. There was no contrary testimony. The media likewise ignored a speech at an academic fraternity by Rudolf to students which was clearly pro-Jewish. On May 9, 1995, the court verified that the speech had taken place.

⁶³² *SDR 3*, June 23, 1995, 13:30 hours.

1995, was entitled “*Only a Victim of the ‘Father-figure of Neo-Nazism’?*”. Under the Word “*Neo-Nazism*,” a picture of the accused was shown. The question raised by this newspaper headline was whether Rudolf had been a victim of O. E. Remer, who was identified as the “*Father-figure of Neo-Nazism*”.

In filming a copy of this article, the *Südwestfunk* bent the paper so that the viewer would see only the words “*Father-figure of Neo-Nazism*” over the photograph of Rudolf. The viewer would unavoidably receive the impression that the harsh sentence on Rudolf was a judicial determination that with Rudolf one was dealing with the father-figure of Neo-Nazism. It is difficult to imagine how media distortion could get any worse.

Many media sources considered the sentence handed down by the court as an insufficient condemnation of Rudolf, as can be seen from several examples. On June 24, 1995, the *Böblinger Bote* wrote that Rudolf could be linked to National Socialist race doctrine. This complete fabrication is so absurd and so far from any reality that it was never an issue during the course of the trial, nor was it mentioned in the court’s spoken opinion giving the basis for the written verdict. Unfortunately, this did not hinder the court from inserting this unfounded assertion into the written verdict for the sentence.⁶³³

On the same day, and despite Rudolf’s personal appeal, Frank Schwaibold of the *Stuttgarter Nachrichten* could not help but once again misconstrue the contacts between Rudolf and Remer, in that he wrote, Rudolf had been “*provably in personal contact with Remer three times*”, where the word “*personal*” imputed a relationship between the two that had never existed.

On June 24, 1995, the *Süddeutsche Zeitung* outdid itself in manipulating the news. It wrote that Rudolf had occasionally been a member of the right-wing extremist Republican Party. But, in fact, Rudolf had been a member of the party at a time when it was not considered “*right-wing extremist*” and even important members of the semi-conservative Christian Democrats (CDU/CSU) maintained contacts with members of the party. Whatever opinion the media and the Ger-

⁶³³ Verdict of the District Court Stuttgart, ref. 17 KLS 83/94, pp. 15, 156ff. As evidence the court used an unpublished writing of the accused. In it, Rudolf commented how the confirmation of revisionist theses might embarrass Jews. Records of the District Court Stuttgart, ref. 17 KLS 83/94, Computer Data File 3, introduced on Jan. 26, 1995. Where there is racism in these speculative remarks is unclear.

man internal secret service, the Office for the Defense of the Constitution (*Verfassungsschutz*) had after Rudolf left the party in summer 1991 cannot be taken as a criterion for the evaluation of Rudolf's political views. Also, Rudolf was not on trial for his political beliefs, which, according to Article 3, Para. 3 of the German Basic Law can never be cause for deprivation of rights. Finally, it is absurd to try to associate the patriotic-conservative views of the Republicans with the National Socialist views of Remer, which was clearly the intention of the *Süddeutsche Zeitung*.

The *Süddeutsche Zeitung* also was the only one of Germany's bigger daily newspapers that again trotted out the fable of the supposedly long-ago refuted Rudolf expert report, based on the *dpa* notice:

"According to information from competent chemists, hydrogen cyanide compounds disintegrate within a few months from the effects of weather and are no longer detectable."

With this perpetual falsehood, the point was made to every uninitiated reader that the Rudolf expert report was the technically worthless hack-job of an incompetent chemist. At the beginning of the trial on November 23, 1994, the *Böblinger Bote* had spread the same nonsense:

"According to expert opinion, no traces of cyanide can be found after 50 years since they disintegrate quickly."

In their report of 1997, p. 64, even the Bavarian Office for the Protection of the Constitution (*Bayerisches Amt für Verfassungsschutz*) has the nerve to repeat that nonsense.

In view of the supposedly proven pseudo-science in the Rudolf expert report, the newspapers avoided the words "*expert report*" or printed them in quotation marks and also characterized it as a "*hack-job*" (*StZ*, November 23, 1994). However, on that date, November 23, 1994, the court declared that it did not consider itself competent to decide to what extent the expert report satisfied scientific criteria. It avoided the issue of scientific evidence by attributing to Rudolf the preface and epilogue written by Remer's friend in Remer's version and sentenced Rudolf on that basis.

In a wider context, Hans Westra, Director of the Anne Frank Foundation in the Netherlands, has commented on the technical correctness of the Rudolf expert report. The Anne Frank Foundation is one of the most well-known of the institutions world-wide that occupy themselves with uncovering and documenting proofs of the Holocaust.

In response to the question of a journalist as to whether the scientific conclusions of the Rudolf expert report were correct, Hans Westra replied:⁶³⁴

“These scientific analyses are perfect. What one cannot determine is how this Rudolf got them, how he obtained the samples.”

Certainly Mr. Westra could not restrain himself from casting doubt on the authenticity of the samples, since established researchers seem to be able to find no other loop-hole in the scheme of arguments in the Rudolf expert report.

News for Public Instruction

The day of the announcement of the sentence in the case of Germar Rudolf may be the only one in which the media outside the local region reported on it. As mentioned above, the *Süddeutsche Zeitung* devoted an extensive story to the sentence.

Also, on June 23, 1995, the nationwide TV news show *heute* of the ZDF (German public Television 2) felt called on to write a short story reporting that the diplom chemist Germar Rudolf had been sentenced to 14 months imprisonment without probation on account of an expert report on the gas chambers of Auschwitz. Since as the media outside the local region had reported almost nothing on the case previous to this, the normal television viewer would hardly know what to do with this very brief piece of information. Therefore, the report can have had only one purpose: It should be made clear to every potential technical witness Republic-wide that those who voice views about the Holocaust complex that deviate from those officially allowed—however factually correct, reputable, scientific and perhaps even professionally correct—will be thrown in jail without probation.

The news reports of the local press on May 6, 1996, ran in the same direction after my application for a revision of the verdict was turned down by the German Federal Supreme Court. They hinted to the reader that the scientist Rudolf had been sentenced because of his expert report, which had come to an incorrect conclusion and thereby denied the Holocaust. It apparently did not interest anyone that the expert report had not been an issue at the trial. Naturally, the *Böblinger*

⁶³⁴ BRT 1 (Belgian Television), *Panorama*, April 27, 1995.

Bote could not restrain itself from digging up the *dpa* lie again.⁶³⁵

“In opposition to competent scientific authorities, the Jettingen chemist asserted that mass-killing of humans with hydrogen cyanide would leave traces of cyanide in the masonry of the remaining buildings in the camp, but no such traces can be found.”

That the extremely harsh sentence against Rudolf was due to reasons of public instruction, and thus for the purpose of frightening any scientist who might play with the idea of publishing a deviating opinion (general prevention), was also the opinion of the *Böblinger Bote* on June 27, 1996:

“No probation was granted for the sentence of 14 months imprisonment handed down in June last year on grounds of general prevention.”

Hunted Abroad

In March of 1996, Gernar Rudolf went into exile. The press initially lost track of him and for the time being, lost interest as well. This changed in the fall of 1999, when British journalist Chris Hastings (34) set about tracking him down in England. Since Rudolf had registered, as required by law, and residency records are open to the public, it was not difficult to establish that Rudolf was residing in England. In addition, Rudolf had listed his post office address on his website (PO Box 118, Hastings TN34 3ZQ.) Chris Hastings succeeded in locating the apartment in which Rudolf was registered. He left a note requesting an interview. Rudolf granted his request by allowing him a two hour interview at Victoria station in London. The content of this interview concerned primarily the present state of human rights in Germany as well as the official persecution of Rudolf. But as Rudolf suspected, Hastings was not interested in the present state of human rights in Germany. In Hastings’ article in the *Sunday Telegraph* of Oct. 17, 1999, the subject was not even mentioned. Instead, under a subtitle demagogically slandering Rudolf as a “*neo-nazi*”, Hastings wrote:⁶³⁶

“He [Rudolf] confirms that, during his stay in Britain, he has forged links with far-Right extremists including members of the National Front

⁶³⁵ *Kreiszeitung Böblinger Bote* and *Gäubote/Südwestpresse-Verbund*, May 6, 1996.

⁶³⁶ Jessica Berry and Chris Hastings, “*German neo-Nazi fugitive is found hiding in Britain*”, *The Sunday Telegraph*, Oct. 17, 1999; repeated on Oct. 18, 1999 in the *Independent*.

and the British National Party.[...]

'In Britain I work as an Holocaust revisionist 24 hours a day. My work has brought me into contact with people on the far Right. I have met leading members of the National Front and the British National Party while I have been in England.'"

In the worst tradition of yellow journalism, Hastings took individual words and phrases totally out of context and rearranged them to suit his sensationalistic purposes. Rudolf never uttered such sentences, with the exception of the sentence about working 24 hours a day for revisionism. It is a fact that, in the spring of 1999, Rudolf met with Nick Griffin and discussed Griffin's experiences with the British justice system. The year before, Griffin was, among other things, accused of having published an article with revisionist statements in a small right-wing periodical edited by himself, but he had been acquitted. Because of Rudolf's own exposed position, and because he had extensively reported on official censorship in his publication *Vierteljahreshefte für freie Geschichtsforschung (VffG)* before, Rudolf was naturally very interested in Griffin's story, but he was not interested in Griffin's organizational memberships or functions. Before this meeting, Rudolf was not aware that Griffin held a leading position in the nationalist British National Party. However, during the meeting, Griffin informed him that he aspired to chairmanship of the party, to which position he was subsequently elected. When asked by Hastings whether he was in contact with members of the political right, Rudolf straightforwardly told him of the conversation with Griffin. Hastings used this to suggest to his readers that Rudolf had forged contacts with the organizational leadership of the leading rightwing extremist parties of England. But to the best of his knowledge, Rudolf has never made contact with any member of the National Front.

Hastings went so far as to interview Rudolf's former landlady, whom he absurdly quoted as follows:

"Sheila Evans, Rudolf's former landlady, said: 'I remember he said he was a writer working for journals in Germany. I was struck by how clean he left the house when he left. He stripped it bare. I think he was trying to cover his tracks.'"

In fact, when he negotiated the tenancy contract in July 1996, Rudolf had told his landlady that he will write for a German periodical. (*VffG* first appeared in spring of 1997, published by the Flemish or-

ganization Vrij Historisch Onderzoek⁶³⁷). Mrs. Evans was the most ferocious house-dragon that Rudolf ever met. When Rudolf moved out, he had to repair and repaint every little scratch on the skirting boards, every bit of chipped enamel on door frames and heaters, every tiny dent in the walls before she would return his deposit. Surely it was normal behavior for Rudolf to take his belongings with him when he moved out. It seems that when people read about their neighbors in the newspapers, they see ghosts and goblins everywhere.

Chris Hastings continued to make Rudolf's presence and activities known to a very large number of nosy and peculiar people. He prompted them to agree that England needs a law to protect holocaust lore against scientific examination. And he prompted them to agree that Rudolf should be extradited to Germany immediately.

The results were not long in coming. The established media in Germany ground out another sensationalistic story. "*Indicted Neo-nazi in Great Britain*", blared the *dpa* (German Press Agency) on October 18, 1999 (it was printed on the 19th in *Rheinpfalz* and other places.) "*Holocaust denier hiding out in England*" announced the leftwing *Stuttgarter Nachrichten* on October 21, page 4. On October 31, Chris Hastings jubilantly announced in the *Sunday Telegraph* that Germany would now seriously pursue Rudolf's extradition. He predicted that England would comply because Rudolf had not been convicted for holocaust denial, but for incitement to racial hatred, which is a violation of English law, too.⁶³⁸ On October 22, the local press in Hastings, where Rudolf resided, chimed in with "*Fleeing neo-nazi uses base in Hastings*" (*The Hastings and St. Leonards Observer*). The monthly English manhunter tabloid *Searchlight* joined the hunt in December with "*Auschwitz liar hides out in Britain*" on page 13.⁶³⁹ Chris Hastings added more wood to the flames in his update of January 16, 2000: "*Neo-nazi accused of 'racial hatred' goes on the run [...] Germany has issued an international arrest warrant for Germar Rudolf, who fled to England to escape a prison sentence for inciting racial hatred.*"

The manhunt turned completely into hysteria with a BBC report about Rudolf on March 28, 2000, which was repeated the day after by

⁶³⁷ Address: Castle Hill Publishers, PO Box 118, Hastings TN34 3ZQ, UK; online: <http://vho.org/VffG>

⁶³⁸ This was echoed, e.g., by the *Australian Jewish News*, Nov. 5, 1999.

⁶³⁹ The German matching piece to this periodical, *blick nach rechts*, started its campaign as late as June 2000 with a contribution by Thomas Pfeiffer in the same style, of course.

the south English regional TV station ITV. Six or seven photographs of Rudolf were shown during the report which had been taken from Rudolf's website www.vho.org. The public was warned to beware of this "nazi sympathizer". The audience must have gained the impression that Rudolf was so dangerous that he was running around murdering people. Mr. Michael Whine of the British Jewish Board of Deputies was pleased to appear before the cameras and announce that regarding Rudolf, England was dealing with a "new breed of dangerous nazis". The local press chimed in once more with "Escaped Neo-nazi still hiding in Hastings [...] he [...] was still being hunted." (*The Hastings and St. Leonards Observer*, March 31, 2000). Obviously, the powers that be are striving to familiarize the local populace with Rudolf's likeness and condition them to be afraid of him. It wants them to complain to the police about the desperado in their midst.

On May 27, 2000, Günther Hoerbst of the *Hamburger Abendblatt* reported on a report of the Israeli university of Tel Aviv entitled "Anti-Semitism Worldwide 1998/99":

"Twelve pages of the report are dedicated to Germany. The report complains about the growing acceptance of the holocaust lie, primarily by means of the internet and rightwing extremist groups. The report acknowledges that present German legislation provides the most 'advanced and effective attempts at combating the holocaust lie', but 'it nevertheless is a growing phenomenon'. For instance, the leading German holocaust liar Rudolf continues to disseminate his writings over the internet from foreign countries, even though he has been convicted and sentenced in Germany."

What a pity that is!

So far, the only more or less impartial article about Rudolf has appeared on January 7, 2000, in the *Los Angeles Times*, in connection with the Irving vs. Lipstadt trial. It was written by Kim Murphy.⁶⁴⁰

Freedom of the Press = A Truthful Press?

Against several of the above-mentioned media pieces, namely those where the person of Germar Rudolf himself had been attacked, it would have been possible to demand a right of reply in the press. However, with respect to factually false assertions such as the fabricated *dpa* notice which did not touch Rudolf personally, there can be

⁶⁴⁰ Online at: <http://www.codoh.com/newsdesk/000107.html>.

no recourse under current law.

The District Court of Stuttgart sentenced Gernar Rudolf to 14 months imprisonment without probation for the reasons that Rudolf was deeply marked with anti-Semitism, that he was entangled in a revisionist and right-wing extremist environment, and that he was obviously a fanatical, politically motivated criminal. In that moment, the court gave the media license to vilify and malign Gernar Rudolf without let or hindrance, since in the Federal Republic of Germany, anyone labeled as an anti-Semite or right-wing extremist is a de facto outlaw. That the court did not find that Rudolf was a right-wing extremist, merely that he had had dealings with supposedly “*right-wing extremist*” persons, was of secondary importance and in view of the media practice of imputing guilt by association no cause to hold back. Rudolf’s applications for rebuttal in the press were denied out-of-hand, since in the meantime the version of the story spread by the press had been confirmed by the courts.

In a democracy, the people are the sovereign. Should the voice of the people become the voice of God not only with respect to power, but also partly with respect to infallibility, care must be taken that the people are comprehensively and truthfully informed. In this modern information age, the media play the central role in forming the public will. For this reason, it must be guaranteed that the people are comprehensively and truthfully informed.

The intentional presentation of false and one-sided information to the public must automatically lead to false conceptions of reality and thence to unwise political decisions. The intentional presentation of disinformation through suppression of news or spreading of false news should be considered one of the most serious crimes of a political nature that can be committed in a democracy.

The question of the executive and judicial means by which the people can be guaranteed to be kept comprehensively and truthfully informed is bound to be a difficult one in view of the fundamental freedoms of press and speech. It would be necessary to require, for example, that the media be subject to democratic control in that the formation of political or economic monopolies would be prevented. One proposal would be to allow access to the media in their area of operations to political parties proportional to the vote they received or to socially-concerned organizations (such as religions) proportional to their membership, without a limiting minimum percent.

Also the right of reply in the press should be expanded such that it should apply not only when a person's reputation is harmed, but also when it can be shown that a news item is grossly one-sided or wrong, and that the truth itself has been harmed.

The criminal prosecution of persons of whom it can be proven that they deliberately composed and distributed false information is problematic, since the proof of the assertion that a journalist deliberately spread false news—that he lied—could only rarely succeed. The simple assertion that the journalist must have known that his report was not true since all others knew it should never suffice.⁶⁴¹

After all, I think we do not need laws to censor liars, but laws that punish censors. That alone can be a remedy for the escalating censorship in modern Europe.

⁶⁴¹ This is the trick used to send revisionists to jail: Since everyone knows that the Holocaust happened, revisionists must know it also. When they still assert the opposite, they must do so wittingly and therefore they lie. Whoever lies has evil intentions and therefore belongs behind bars. Such is the logic of terror.

“Thank heaven, we live under the rule of law. But unfortunately, that does not apply to the territory of the Federal Republic of Germany.”

Johannes Gross, *Capital*, Germany, Nov. 1994, p. 3

11.6. Outlawed in the Federal Republic of Germany The Disfranchisement of Unwelcome Citizens⁶⁴²

In antiquity and in the Middle Ages, many European nations possessed the legal power to disfranchise citizens for gross misdeeds. With the rise of secularized constitutional nations, the use of this power disappeared until it resurfaced in the 3rd Reich as Thought-crime Laws. In the Federal Republic of Germany, the possibility of far-reaching revocations of civil rights was built right into the constitution in Article 18 of the Basic Law, but until recently no use was made of it. Jochen Lober has shown that the equivalent curtailment of the civil rights of citizens has been achieved by extra-constitutional regulation.⁶⁴³ We will examine here Lober’s question, whether a form of *de facto* outlawry was introduced with the revision of section 130 of the German Penal Code, which made any kind of Holocaust denial—or revisionism—and opposition to multi-culturalism a potential criminal offense punishable by up to five years in prison. This will be done by studying the fate of Auschwitz researcher Diplom-Chemist Germar Rudolf. What happened to him will be examined phenomenologically, not chronologically, in order to focus on the effects of German criminal law on the civil rights of German citizens.

First Step: Denunciation

From September 20 to 22, 1991, a seminar took place in Nuremberg (Bavaria) on Holocaust revisionism, sponsored by the libertarian Bavarian Thomas Dehler Foundation.

Among the participants, besides Germar Rudolf, there was a certain Diplom-Physicist Hermann Körber from Bünde, north Germany. His behavior during the seminar was highly unpleasant. During a dis-

⁶⁴² Written after reading the article by J. Lober in *Staatsbriefe* 7/95 mentioned in the beginning; taken from *Staatsbriefe* 12/95, Verlag Castel del Monte, Postfach 14 06 28, 80456 Munich, pp. 10-15.

⁶⁴³ *Staatsbriefe* 7/95

cussion period, for example, he stated that the German people should not only be considered as murderers, but as plunderers as well. He also suggested that the Germans themselves were to blame for the many deaths among old people, women and children that were caused by the Allied aerial bombardment, because they had started the bombing (which is not true) and had knowingly failed to evacuate the civil population (which was also not true, since many children were sent to the country). During the Sunday dinner, Körber threatened a fellow participant sitting at his table with a dinner knife because the person did not share his opinion on the Holocaust, and at the close on Sunday afternoon, he loudly called the participants Germar Rudolf and Winfried Zwerenz pigs, because they had disagreed with him on scientific grounds.

On November 5, 1992, this Hermann Körber filed a criminal complaint with State Attorney Baumann in Schweinfurt against Germar Rudolf for instigating Otto Ernst Remer to incitement to racial hatred.⁶⁴⁴ He claimed that it was Rudolf and his expert report that had caused Remer to begin publishing material on the Holocaust in his *Remer Depesche (Remer Dispatches)*.⁶⁴⁵ Subsequently, the state attorney of Schweinfurt initiated a criminal investigation against Rudolf on grounds of incitement to racial hatred, and others, in which O. E. Remer was also named.⁶⁴⁶ Both accused denied the accusations.

Then, on April, 19, 1993, at the state attorney's office in Bielefeld, Körber filed a witness affidavit in which he stated:⁶⁴⁷

"As a Diplom Chemist, Rudolf knows and must know that his theses are scientifically untenable.

It can be proven that that which Rudolf convinced Remer of is trickery."

On April 27, 1993, as proof of his assertion that Rudolf was knowingly deceitful, Körber filed another affidavit in which he interpreted Rudolf's technical arguments made in an exchange of correspondence with Werner Wegner, as incitement to racial hatred, and characterized

⁶⁴⁴ Investigation File 1 in the trial against Germar Rudolf, District Court of Stuttgart, ref. 17 KLs 83/94, sheet 15.

⁶⁴⁵ The *Remer Depesche* had already appeared in Spring 1991, before Rudolf had begun his research as expert witness.

⁶⁴⁶ Ref. 8 Js 13182/92, Investigation File 1 (District Court Stuttgart, ref. 17 KLs 83/94), sheet 17ff.

⁶⁴⁷ *Ibid.*, sheet 58.

Rudolf's assertion that unambiguous technical evidence was superior to ambiguous documentary evidence as "*unscientific and unprofessional procedure*".⁶⁴⁸

In another affidavit made on April 30, 1993, Körber asserted falsely that Rudolf supported

"the Leuchter thesis that there was a danger of explosion throughout the Auschwitz compound, at least for structures, whenever gassing operations with Zyklon B were going on."

Rudolf had in fact stated that the use of high concentrations of Zyklon B to reduce execution periods to minutes or seconds, as the witnesses had reported, would mean that there would be safety problems due to explosive concentrations of hydrogen cyanide.⁶⁴⁹ He had never spoken nor written of a general danger of explosion.

The busy witness Körber was at it again on May 26, 1993, this time to assert that the references to the Rudolf Report in various editions of the *Remer Depesche* proved that the author Rudolf was the cause. Körber also claimed that Rudolf's attempt to testify as an expert witness, which was refused by the court, constituted conspiracy to commit perjury.⁶⁵⁰ On June 7, 1993, he repeated his accusations that Rudolf had instigated Remer to his misdeeds in the *Remer Depesche*, and offered evidence that would defer the possible termination of the investigation.⁶⁵¹

It should be pointed out that there is no mention among Körber's statements of the fact that Gernar Rudolf had written him a lengthy letter in January 1993, in which Rudolf presented detailed arguments supporting the conclusions of his report.⁶⁵² Körber had never answered the letter. His only response had been to make false accusations about Rudolf to the police.

In mid-April 1993, the state attorney of Stuttgart set in motion another prosecution against Gernar Rudolf in addition to the ongoing prosecution concerning incitement. This one was initiated by retired Generalmajor O. E. Remer's distribution of a commented version of

⁶⁴⁸ Ibid., sheet 63

⁶⁴⁹ See chapter 6.3. for this.

⁶⁵⁰ Investigation File 1 (District Court Stuttgart, ref. 17 KLs 83/94), sheet 84f.

⁶⁵¹ Ibid., sheet 86.

⁶⁵² In the exhibits of the trial against Rudolf (District Court Stuttgart, ref. 17 KLs 83/94), Correspondence File K. Rudolf had added thanks for Körber's Christmas present – his criminal complaint.

the Rudolf Report.

The first copies of Remer's version were sent to various notable personalities in politics, justice, and science on April 16, 1993.⁶⁵³ On the same day, Prof. Dr. Hanns F. Zacher, President of the Max-Planck-Corporation (MPG), received a call from the Chairman of the Directorate of the *Zentralrat der Juden in Deutschland* (Central Council of Jews in Germany), Ignatz Bubis, in which Herr Bubis told Prof. Zacher of his concern about the effect of the Rudolf Report by Diplom-Chemist Germar Rudolf, at that time an MPG employee.⁶⁵⁴ It is not known what Prof. Zacher did in response to the call. In any case there was no attempt by the MPG administration to terminate Rudolf's employment at that time.

In mid-May 1993, Rudolf received at his office two calls from journalists (the German weekly magazine *stern* and the private TV station *SAT 1*) dealing with the distribution of the Remer version. During one of these calls, a colleague of Rudolf was in the room. The colleague later told another colleague, Jörg Sassmannshausen, who immediately reported the event to the executive Director of the Max-Planck-Institute, Prof. Arndt Simon.⁶⁵⁵ Subsequently, Germar Rudolf was asked not to appear at the Institute anymore unless at the explicit request of his doctoral supervisor, Prof. Dr. H. G. von Schnering, in order to make sure that there might be no further contact with journalists during work hours. His employment contract had not been mentioned.

This request was subsequently repeated in writing. Nine days afterwards, Rudolf entered the Max-Planck-Institute in order to copy some documents and to discuss the reproduction of his doctoral thesis with his doctoral supervisor. He deliberately avoided his office in order

⁶⁵³ Germar Rudolf's doctoral supervisor, Prof. Dr. Dr. h. c. H. G. von Schnering, as well as several other professors at the Max-Planck-Institute for Solid State Research received the pirated version on this day: decision, District Court Stuttgart, ref. 17 KLs 83/94, p. 126.

⁶⁵⁴ A later letter of the Central Council of Jews to the President of the MPG on June 22, 1993, refers to this telephone call. Facsimile published in Wilhelm Schlesiger, *Der Fall Rudolf*, *op. cit.* (note 91); from the records of the Labor Court Stuttgart in the case *Rudolf v. Max-Planck-Institute for Solid State Research*, ref. 14 Ca 6663/93.

⁶⁵⁵ According to information from his secretary, Prof. Simon knew what role he was being forced to play, but for opportunistic reasons he put his career and the reputation of the Max-Planck-Institute ahead of upholding the principles of scientific research; information received from my former wife who still works at this institute. On this affair, cf. also Prof. Simon's revealing statements and the discussion on the social taboo that must be observed by German scientists in: W. Schlesiger, *Der Fall Rudolf*, (note 91).

to avoid being confronted with questions from the media. Rudolf was seen by Institute workers, however, and they reported his presence to the executive director.

Second Step: Professional Ruin

Rudolf had neglected to ask his doctoral supervisor for permission to enter the Institute. The following day he was asked to accept termination of his employment contract without notice.⁶⁵⁶ The justification for this was primarily that Rudolf had sent letters on stationary with the Max-Planck-Institute letterhead while working on the Report. Rudolf had privately engaged the Fresenius Institute to analyze the wall samples from Auschwitz for traces of cyanide. But when the Fresenius Institute was already working on his samples in Rudolf's presence, he handed in a letter typed on a letter head of his employer with a detailed specification of the work to be conducted by the Fresenius Institute and a detailed description of the samples. Though the unauthorized use of official letterheads for private purposes was widespread at the Max-Planck-Institute at the time, in Rudolf's case it became a no-no. It was this use of Institute letterhead, about which the management of the Institute first became aware through news reports,⁶⁵⁷ that established the connection of the Institute with the Rudolf Report.

Apparently because of the failure of the MPG to respond to the intercession of I. Bubis (see above), on June 22, 1993, the *Zentralrat der Juden in Deutschland* (Central Council of Jews in Germany) felt it necessary to notify the President of the MPG that he was expected to take appropriate measures to restrict the activities of Report researcher Gernar Rudolf. On July 14, 1993, the President of the MPG informed the Central Council that the MPG had no further responsibility for the activities of Herr Rudolf, since he had been fired.

The subsequent labor court proceeding instituted by Rudolf against the Max-Planck-Institute with respect to his termination without notice turned on the question, whether the generally-practiced and in his case already known infraction "*private use of official letterhead*" could be used as grounds for dismissal without notice when the Auschwitz issue was mixed in. Labor court judge Stolz made it clear

⁶⁵⁶ This description is based on the transcript of Rudolf's testimony from memory from this time, Computer Data File 2, (District Court Stuttgart, ref. 17 KLS 83/94), 175-220.

⁶⁵⁷ *Wiesbadener Kurier* on 8./9. and 13. May 1993.

that an employer could dismiss an employee anytime who held such views as the plaintiff Germar Rudolf. This amounts to the principle that Rudolf and others who think like him are outlaws with respect to the labor law. For reasons of social concern, the Max-Planck-Institute offered to make an agreement with the plaintiff out of court, by which the termination without notice would be revoked and at the same time replaced by a mutual agreement that the employment contract would be terminated, barring further recourse.⁶⁵⁸

Despite this dispute between Rudolf and his now former employer, his doctoral supervisor Prof. H. G. von Schnering continued to support his doctoral candidate and in July 1993 certified that Rudolf possessed the necessary professional and ethical qualification to take the next step, the final examination called the Rigorosum. In that month, Rudolf submitted to the University of Stuttgart his doctoral thesis with all necessary supporting documents and applied for admission to the Rigorosum. By fall 1993, however, permission for the promotion had still not been granted. On inquiry at the University, Rudolf was told that his application had been put on hold because of the criminal investigation initiated against Rudolf for incitement to racial hatred as well as that against O. E. Remer for distribution of Remer's version of the Rudolf Report. The University of Stuttgart maintained that it was questionable whether the candidate possessed the necessary ethical qualification.

The grounds for this decision was section 4 of the Law On Academic Degrees, enacted by Adolf Hitler in 1939 and still in force in Germany today. By this provision, an academic degree can be revoked or withheld, if one does not possess the necessary ethical qualification. According to a decision of the Administrative Court of Baden-Württemberg, an academic title can only be withheld when there has been a judicial sentence for a serious crime that has been entered on the person's police record of conduct.⁶⁵⁹

⁶⁵⁸ Labor Court of Stuttgart, ref. 14 Ca 6663/93. A detailed description of the events in the Max-Planck-Institute and elsewhere about the Rudolf report during the year 1993, with a series of reproduced documents, can be found in the brochure W. Schlesiger, *The Rudolf Case, op. cit.* (note 91).

⁶⁵⁹ Ref. IX 1496/79, decision on March 18, 1981. At that time, a person who had been convicted to five years imprisonment for a drug offense which was entered in his police record, was certified as *having* the necessary ethical qualification, and the University was ordered to admit him to the Rigorosum. In this decision, it was held that this Hitler law is still in effect because it does not contain National Socialist thinking and should be considered as having been legally

Since at the time of his application for admission to the Rigorosum 1) Rudolf had not been judicially sentenced and 2) such a decision was not expected by him, Rudolf filed a complaint against the University of Stuttgart in the County Court of Stuttgart for failure to act. At the behest of the University of Stuttgart, the County Court Stuttgart stalled on grounds that the ongoing criminal proceeding against Rudolf would have to be concluded before it could be decided whether Rudolf possessed the necessary qualifications for promotion.⁶⁶⁰

After the sentence against Rudolf was handed down in March 1996, the University of Stuttgart advised him that it was in his best interest to withdraw his application for promotion, since otherwise the University most likely would refuse his application because of Rudolf's conviction for a severe crime. Rudolf complied, because he might otherwise have to reckon with the problem that his doctoral work might be unacceptable everywhere else in the world.⁶⁶¹

By good fortune, in fall 1994 Rudolf obtained a position as a field representative with a firm dealing in corrosion inhibiting products. During her research into 'right-wing businesses', left-wing journalist F. Hundseder stumbled onto the fact that Rudolf was employed at one of them. In the ARD broadcast *Panorama* in mid-May 1995, this discovery was described as a scandal, and both the company and their employee Rudolf as heinous Neo-Nazis. The company came immediately under such heavy pressure from customers, suppliers, employees and competitors that by mutual agreement they and Rudolf terminated his employment contract in order to prevent further loss to the company. Due to this denunciation by the media, Rudolf lost his job within a few days.

In the current state of German labor law, if in future applications for employment Rudolf were not to mention his revisionist activities and this were to become known to his employer, it would be considered grounds for dismissal. If he duly mentioned these activities, however, he could expect not to find any ordinary employment anywhere

enacted.

⁶⁶⁰ Ref. 13 K 1329/94. After the prison sentence against Rudolf was announced, Rudolf's doctoral supervisor commented that he would have to sit out his punishment before he could complete his doctoral program. Prof. von Schnering was apparently always ready to stand behind his candidate.

⁶⁶¹ See the letter of the University as well as Rudolf's reaction (in German only online: vho.org/Authors/UniStgt.html and vho.org/Authors/RudolfUniStgt.html).

in Germany.⁶⁶²

Third Step: Persecution through Prosecution

A more complete analysis of the prosecution against Rudolf will be left to other works. Rudolf was accused not only because of Remer's political commentary, which was falsely attributed to Rudolf, but also because of the purely technical conclusions in his Report.⁶⁶³ In the principal hearing Presiding Judge Dr. Dietmar Mayer stated that the competence of the court did not extend to the evaluation of the scientific validity of the expert report. Because of this, the contents of the expert report were not addressed in the proceeding, but only the question whether the defendant was responsible for Remer's commentary.

In its decision, the court made no secret of the fact that it held revisionist thinking itself to be reprehensible and punishable by increasing the severity of the sentence.⁶⁶⁴ However, the sentence against Rudolf to 14 months prison without probation was based on the false contention that Rudolf had at least knowingly contributed to the political commentary contained in Remer's version of his expert report. The court justified its sentence with a tiresomely assembled chain of proofs amounting to 240 pages which in decisive points departed from the actual evidence and which completely ignored the contradictory evidence on the main point of the defense.

The chemical and construction problems of the buildings at Auschwitz dealt with in the Rudolf Report were characterized by the court as "*hardly clarifiable details of the National Socialist mass-crimes*", thus, under no circumstance a matter of 'common knowledge'.⁶⁶⁵

Rudolf's trial on account of the business with Remer's version ended in summer 1995. Under which star this trial was held was made blindingly clear by a document from the trial records: Rudolf's judges in the District Court of Stuttgart wanted to prevent that they themselves should come under the wheels of denunciation and inquisition, as had the judges of the District Court of Mannheim in the Günter Deckert Case, who were massively criticized by media and politicians,

⁶⁶² There remained the non-ordinary way that he has followed successfully.

⁶⁶³ Criminal indictment by the States Attorney of Stuttgart on 19. April 1994, ref. 4 Js 34417/93.

⁶⁶⁴ Trial District Court Stuttgart, ref. 17 KLS 83/94, decision p. 239.

⁶⁶⁵ Trial District Court Stuttgart, ref. 17 KLS 83/94, decision p. 15.

threatened with prosecution, and eventually send to early retirement because they had dared to call a leading revisionist a man of good character and sentence him only to one year imprisonment *with* probation. Before the opening of the trial against Rudolf, Rudolf's judges therefore carefully inquired with the German Federal Supreme Court with respect to its decision against Günter Deckert and receive an immediate reply.⁶⁶⁶ Since the German Federal Supreme Court revised the Deckert decision so many times until a sentence of imprisonment without probation was certain, it is obvious that in the Rudolf Case the same sentence of imprisonment without probation was the only option if the judges wanted to stay out of trouble.

At the same time as the above-mentioned prosecution, there were three other prosecutions underway against Germar Rudolf. In the first case, he was accused of being mainly or at least partially responsible for the publication of the journals *Remer Depesche* and *Deutschland Report*.⁶⁶⁷ The second involved his publication of the work *Grundlagen zur Zeitgeschichte*.⁶⁶⁸ The third was directed against an exchange of correspondence between Rudolf and the Cracow Institute for Forensic Research on chemical questions concerning the gas chambers of Auschwitz that was published in *Sleipnir*, issue 3, 1995.⁵⁸⁷

It was clear already then that these would not be the last measures taken against Rudolf, especially since he intended to defend himself in print. In view of the fact that the District Court of Stuttgart was able to find the defendant guilty contrary to the evidence, one could justifiably fear that in each outstanding trial, the innocent defendant would be found just as guilty, and that he would find himself incarcerated under the terms of several sentences of increasing severity.

In the meantime, Rudolf's home had been searched three times, and each time books, archives, correspondence, technical data and his computer equipment were seized. The principal loss was not that of physical items, but the intellectual loss of data and archive material. The result was that Rudolf could no longer work as a scientist and also could not defend himself unrestrictedly in court, since his resources to

⁶⁶⁶ Trial District Court Stuttgart, ref. 17 KLS 83/94, Letter of the 17th Criminal Justice Chamber of the District Court of Stuttgart to the Federal High Court (BGH) on April 21, 1994. Investigation File 2, sheet 768. Answer of the Federal High Court on April 26, 1994 with enclosure: decision on March 15, 1994 re: G. A. Deckert, ref. 1 StR 179/93.

⁶⁶⁷ County Court of Böblingen, ref. 9 Gs 521/94. This case was later dropped due to lack of evidence.

⁶⁶⁸ See chapter 11.4.2.

do so were continually taken away. Even the standard literature on the Holocaust was confiscated.

Only those who have themselves undergone the same thing can judge the psychological stress caused to an innocent person through undergoing years-long criminal prosecutions. In addition to these psychic burdens, there are the legal expenses to consider. Currently, they can be calculated only with difficulty but, loosely estimated, they must run into a few hundred thousand Dollars. It is clear that at the close of the trial against him, Rudolf was financially ruined for the foreseeable future—quite apart from the fact that for the foreseeable future he would be given no chance to meet these burdens through employment in his profession, at least not within Germany.

Fourth Step: Defamation

At the close of the labor court hearing of the case against the Max-Planck-Institute, the *Deutsche Presse-Agentur* (*dpa*) published its already mentioned false announcement on the Rudolf Report.

Rudolf not only proved that the expert opinion cited in this announcement by the *dpa* was wholly fabricated – the MPG distanced itself from the announcement – but also that the report based on the phantom opinion is so false that no expert in the world would embrace it. But this does not hinder the media to spread the announcement far and wide and to use it as proof of the obvious falseness of the Rudolf Report.⁶⁶⁹ In the meantime, this false press release even appeared in the media in foreign countries.⁶⁷⁰ Since then, Rudolf has been defamed as a right-wing radical,⁶⁷¹ a right-wing extremist,⁶⁷² a Neo-Nazi⁶⁷³ and a brown doctoral candidate.⁶⁷⁴ His Report is always named in quotation-marks, and characterized as hack-work⁶⁷⁵ or merely as a “*false report*”.⁶⁷⁶ Unfounded accusations of xenophobia⁶⁷⁷ are accompanied by

⁶⁶⁹ See chapter 11.5.

Cf. also the article “*The Role of the Press in the Case of Germar Rudolf*” in this collection.

⁶⁷⁰ For example, in the South African newspaper *The Citizen*, June 24, 1995, p. 8.

⁶⁷¹ *dpa* news release on March 28, 1994, published in the German daily newspapers on March 29, 30, 31, 1994.

⁶⁷² *Die Welt*, April 5, 1995.

⁶⁷³ *Landesschau*, Südwest 3, Dec. 27, 1994; *Kreiszeitung – Böblinger Bote*, March 29, 1995.

⁶⁷⁴ *Die Zeit*, April 15, 1993, p. 44.

⁶⁷⁵ *Stuttgarter Zeitung*, Nov. 23, 1994

⁶⁷⁶ *Die Welt*, March 29, 1994.

⁶⁷⁷ *Stuttgarter Zeitung*, Jan. 27, 1995

the false assertion of Judge Dr. Mayer that Rudolf was deeply marked by anti-Semitism, which, since it is wrong, is all the more ferociously maintained.

By 1994, Rudolf had had no success with his attempts to defend himself against the effects of hostile descriptions, but this was due more to financial difficulties than to judicial defeats.⁶⁷⁸ But once Rudolf was sentenced for his supposed crime, the media declared open season on him.

Fifth Step: Destruction of the Personal World

When the ARD smeared Rudolf in the most vicious way in its spring 1994 broadcast *Report*,⁶⁷⁹ Rudolf's parents distanced themselves from him and refused to come to his wedding, scheduled for several weeks later. All his relatives joined them in this, except for his siblings.⁶⁸⁰ His godmother Hannelore Dörschler distanced herself expressly from the views of the people with whom Rudolf surrounded himself, without knowing with which persons Rudolf actually surrounded himself or what views they held.⁶⁸¹

Since November 2, 1983, Gernar Rudolf had belonged to the Catholic German Student Fraternity AV Tuisconia Königsberg in Bonn. This fraternity is a member of an umbrella organization that claims to be the largest academic organization of Europe, and to which famous personalities belong(ed): Josef Cardinal Höffner, Joseph Cardinal Ratzinger, Friedrich Cardinal Wetter, Archbishop Johannes Dyba, Franz-Josef Strauß (former Ministerpresident of Bavaria, Federal Defense Minister), Philipp Jenninger (former President of the German Parliament), Matthias Wissmann (former Minister for Science and Technology), Alexander von Stahl (former Federal General State Attorney), Herbert Hupka, Rainer Barzel, Otto von Habsburg, Friedrich Wilhelm, Prince von Hohenzollern, Prof. Peter Berglar, Prof. Josef Stingl, Thomas Gottschalk and others.⁶⁸²

⁶⁷⁸ A complaint against the *Süddeutsche Zeitung* was denied on account of errors of form, but the fee of ca. DM 5,000 (ca. \$2,500) had to be paid anyway.

⁶⁷⁹ A detailed critique of this broadcast can be found in: W. Schlesiger (note 91).

⁶⁸⁰ Statement of witness Ursula Rudolf on March 24, 1995 in Trial District Court Stuttgart, ref. 17 KLs 83/94.

⁶⁸¹ Letter of the accused to his godmother on April 30, 1994, introduced in the main trial proceeding on Feb. 23, 1995 in Trial District Court Stuttgart, ref. 17 KLs 83/94.

⁶⁸² Cartell-Verband der katholischen deutschen Studentenverbindungen (Cartel-Union of Catholic German Student Fraternities) (CV), with approximately 35,000 members.

When Rudolf's revisionist activity became known in spring 1994, the umbrella organization exerted pressure on Rudolf's organization to expel him. Because of this, his organization convened a session of various of its members that spring, without the knowledge or participation of Rudolf, at which his revisionist activity was discussed. An expulsion process followed that held a hearing on August 20, 1994, and ended by expelling him in the fall.

This expulsion was by reason that:⁶⁸³

“The Holocaust and the acknowledgement thereof is the normative foundation of our [German] Constitution. The legitimacy—in the sense of worthiness of acceptance—of the Basic Law is based on the recognition of the fact of National Socialist criminal measures by which Jews were subject to a systematic technical mass murder. Inasmuch as Fraternity Brother Rudolf raises doubts about the deliberate annihilation of the Jews, he also raises doubts about the normative consensus on which the Basic Law is based.

Content (normative consensus) and form (institutional order) of the Basic Law are inextricably interwoven and their substance cannot be altered.

Thereby, Fraternity Brother Rudolf violates our Patria Principle.”

The Patria Principle is one of the four principles of the semi-conservative umbrella organization.⁶⁸⁴ Today, the principle is primarily understood as meaning constitutional patriotism. It is left to the reader to judge the mental health of the lawyers that composed these pronouncements. The fact is that the decision to expel Rudolf because of the pressure from the superior organization was inescapable, and it was admitted that the decision would have been otherwise, had there been no outside pressure.⁶⁸⁵

Sixth Step: Homelessness

When the police searched Rudolf's home a second time on August 18, 1994, the local media described him as a well-known right-wing extremist personality. In the small village of Jettingen, where Rudolf lived at the time, it was thought necessary to do something to rid the

⁶⁸³ Written decision of the Conduct Court, e. v. AV Tuisconia Königsberg zu Bonn on Aug. 20, 1995, written by constitutional attorney Herbert Stomper. Rudolf's appeal was rejected.

⁶⁸⁴ The other three are: religio, scientia, amicitia.

⁶⁸⁵ Testimony of union brother Dr. Markus Kiefer in the trial in the Conduct Court.

town of this unwelcome citizen. It was made clear to Rudolf's landlord that the community did not wish him to lease a dwelling to Rudolf. It was also made clear to Rudolf's landlord that he should have an interest in getting rid of his lessee, too, since otherwise he would have to deal with such things as that his son could no longer bring his friends home, because their parents would not allow them to enter a house in which Neo-Nazis lived.⁶⁸⁶ Therefore, Rudolf's occupancy of the dwelling was terminated as soon as the lease allowed, at a time when his wife expected the birth of their first child within four weeks.⁶⁸⁷

When the landlords of the dwelling that Rudolf had rented thereafter, the couple Sedlatschek of Steinenbronn, learned from the news on June 23, 1995, about the fact that Rudolf had been sentenced to 14 months imprisonment, they had their lawyers communicate the following to him:⁶⁸⁸

"In the name of and on behalf of our clients we hereby terminate immediately the lease under the lease contract executed October 26, 1994, between you and them.

Our clients became aware through the press, by radio, and television that you, Herr Rudolf, were sentenced to 14 months imprisonment by the District Court of Stuttgart for the crime of incitement to racial hatred. Our clients therefore no longer desire to continue the lease.

I am required to demand of you to depart from the dwelling no later than

July 31, 1995

and to surrender the premises to our clients in the agreed-upon condition.

If you fail to comply with this demand, we are authorized to file a complaint without delay."

When Rudolf requested his landlord to withdraw the termination, threatening otherwise he would file a counter-complaint, the landlord threatened eviction. For private reasons, among them that his wife was expecting her second child, he submitted, found a new residence and

⁶⁸⁶ So the statement of the landlord at the time, Karlheinz Bühler, to G. Rudolf in later Summer 1994.

⁶⁸⁷ It was not necessary to give a reason, because by the German Civil Code (BGB) no reason for termination is necessary with respect to a two-family house in which the landlord himself lives.

⁶⁸⁸ Facsimile reproduction of this document in *Sleipnir* 4/95, insider back cover.

settled with his landlord out of court.

Seventh Step: Special Treatment

On May 5, 1995, the GRÜNE/Alternative Liste (a radical-left environmental splinter party) of the parliament of Hamburg demanded access to court records in the Rudolf case. Though denied at first, a subsequent request for records access on July 3, 1995, apparently succeeded,⁶⁸⁹ although it is not legal to grant access to the court records to outside persons who have no direct interest in a case. It is reasonable to fear that the records may have come into the hands of radical anti-fascist groups, where data on witnesses could be collected and compared.

The dot on the 'i' was the request on October 16, 1994, of the Project for Study of Anti-Semitism, Faculty of Humanities of the University of Tel Aviv, in which a certain Sarah Rembiszewski requested information on the state of Rudolf's prosecution.⁶⁹⁰ The judges also were aware of the world-wide attention on the case. Tel Aviv also pressed for records access. Is it possible to hope that records access will remain denied despite the ever more strident pleas out of Tel Aviv, inasmuch as the research institute has no legal claim to such access? Under current law, access to court records cannot normally be granted to outside persons with no interest in a case. If it should turn out that Tel Aviv got access to the records without legal ground, that therefore Jews in Germany still receive *Sonderbehandlung* (special treatment),⁶⁹¹ presumably a copy of the records will soon appear in the offices of a university that probably would like to have intimate details of the revisionist scene in Germany. It is even likely the records will find their way to other offices where a more active use might be made of them.

Eighth Step: Destruction of the Family

After his 14 months prison sentence was confirmed in March 1996 by the German Federal Supreme Court, and considering the prospect of perhaps even more severe convictions in several other pending crimi-

⁶⁸⁹ Sheet 1411 of the Records in Trial District Court Stuttgart, ref. 17 KLs 83/94, with the handwritten note by Dr. Mayer that access to the records should be granted after records had been returned by the defense.

⁶⁹⁰ Investigation File 2, Sheet 876, in trial of District Court Stuttgart, ref. 17 KLs 83/94.

⁶⁹¹ From the letter of the defense attorney Dr. G. Herzogenrath-Amelung to the District Court of Stuttgart on this subject on Nov. 16, 1995, in Trial District Court Stuttgart, ref. 17 KLs 83/94.

nal investigations, probably ending with a summary sentence of up to four years in prison, Rudolf decided to leave Germany with his family and to settle in England, where he thought freedom of speech is more than mere lip service. Having built up a revisionist publishing company abroad, his wife decided at the end of 1998 that she could not bear the life in exile, permanently fearing the extradition of her husband, being separated from all her old friends and relatives, having difficulties to find new friends and acquaintances, and thus heavily suffering from homesickness. Hence, in early 1999, she and their two children returned to Germany and later started the divorce procedure from her husband, leaving him alone in exile.

In fall 1999, when the British media started a smear campaign against Rudolf, the nightmare of his wife became true: Rudolf became fair game of British politics, media and the justice system.⁶⁹² Had it been possible for his wife and his children until then to visit Rudolf frequently, this turned out to be extremely difficult ever after, since Rudolf left Europe in late 1999 and entered the USA, where he applied for Political Asylum in October 2000. Especially the abandoned father and his two children suffer terribly under this situation of being almost totally isolated from each other.

In February 2000, Rudolf's father urged him to get sterilized, since it would be irresponsible both for his first family as well as in general—considering the conditions he has to live in—to father any more children.⁶⁹³

“Hallo *Germar,*
[...] If you want to avoid such difficulties in future [...], and you should do this, regarding getting children, I mean, you should do something about it. Don't leave it up to the women. You surely know how easy vasoligature is for a man. Except you want to have more children. But to be honest, you cannot do this to your first family. And especially not in your situation. A chat with the urologist, and it already happened. You are upset about me? So be it. Just see it objectively. [...]
Father”

Formerly, the persecution of the Jews by some Germans led to consideration to get certain Jews sterilized. Today, the persecution of Germans, mainly promoted by some Jewish lobbies, leads to consid-

⁶⁹² See chapter 11.5.

⁶⁹³ Email from Georg Hermann Rudolf from February 19, 2000.

erations to get Germans sterilized.

In August 2000, a week before he was legally divorced from his wife, Germar Rudolf was told by his mother that his parents had disinherited him and entered his children in their last will instead.

11.7. Biographical Notes on the Author

Germar Rudolf, a certified chemist, was born on October 29, 1964, in Limburg/Lahn, Germany. Elite High School Diploma (*Gymnasium Abitur*) in 1983 in Remscheid, followed by study for a certified chemist's degree at the University of Bonn, graduation *summa cum laude* in September 1989. Completion of compulsory military service with the German *Luftwaffe* (Air Force). Between October 1990 and June 1993, Mr. Rudolf worked on the preparation of a doctoral thesis at the Max-Planck-Institute for Solid State Research in Stuttgart. Despite the highest recommendations, he was forced to withdraw his dissertation, because the University of Stuttgart threatened to reject it on political grounds (due to his involvement in revisionism).

Since early 1993, he has been the defendant in several criminal prosecutions resulting from the publication of scientific texts; in March 1996, he left his native Germany and went into exile, first England, then, in late 1999, the United States. In late 1996, Mr. Rudolf founded the publishing house Castle Hill Publishers and, simultaneously, a quarterly historical periodical of German language, the aim of which is to deal with critical aspects of contemporary history currently suppressed in all German speaking countries. In 2000, he started publishing English language books on revisionist topics under the imprint of Theses & Dis-

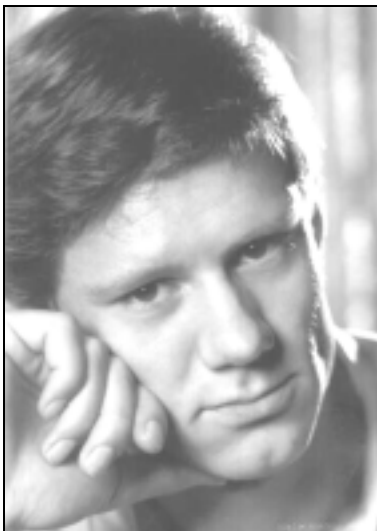

*The Author in summer 1991,
while doing the main work
for this expert report*



The author in late 2002

sertations Press, a firm originally established by Robert H. Countess and purchased by Rudolf in summer 2002. Since 2003, he also publishes a quarterly historical language of English language, which focuses on the same topics as his the German periodical.

Books and brochures published: *Vorlesungen über Zeitgeschichte* (1993, 2nd edition due for 2003), *Das Rudolf Gutachten* (1993, 2nd edition 2001; a Dutch translation was published in 1994, a French translation appeared in 1996, for an English translation see this work); *Wissenschaftlicher Erdrutsch durch das Rudolf Gutachten*, (brochure, 1993; an English translation appeared in 1994), *Prof. Dr. Ernst Nolte: Auch Holocaust-Lügen haben kurze Beine* (brochure, 1994), *Der Fall Rudolf* (brochure, 1994), *Grundlagen zur Zeitgeschichte* (1994; English under the title *Dissecting the Holocaust 2000*, 2nd edition due for 2003); *Auschwitz: Nackte Fakten* (1995); *Kardinalfragen zur Zeitgeschichte* (1996).

Since early 1997, Mr. Rudolf is the publisher and responsible editor of the German quarterly journal *Vierteljahreshefte für freie Geschichtsforschung*, and since early 2003, he is also the publisher and responsible editor of the English quarterly journal *The Revisionist. Journal for Critical Historical Inquiry* (UK address: Castle Hill Publishers, PO Box 118, Hastings TN34 3ZQ; US address: PO Box 257768, Chicago, IL 60625; email: chp@vho.org), both including many articles by Mr. Rudolf (see online: vho.org/i/a.html).

12. Bibliography

12.1. Monographs

- Hans G. Adler, Hermann Langbein, Ella Lingens-Reiner (ed.), *Auschwitz*, Europäische Verlagsanstalt, Cologne ³1984
- Akademischer Verein Hütte (ed.), *Hütte*, Ernst und Sohn, Berlin ²⁷1942
- Günther Anntohn, Henri Roques, *Der Fall Günter Deckert*, DAGD/Germania Verlag, Weinheim 1995
- Rudolf Aschenauer, *Macht gegen Recht*, Arbeitsgemeinschaft für Recht und Wirtschaft, Munich 1952
- Enrique Aynat, *Los protocolos de Auschwitz. i Una fuente historica?* Verlag Garcia Hispan, Alicante 1990
- Uwe Backes, Eckhart Jesse, Rainer Zitelmann (ed.), *Die Schatten der Vergangenheit*, Propyläen, Frankfurt 1990
- James Bacque, *Crimes and Mercies*, Little, Brown & Co., Toronto 1996.
- James Bacques, *Other Losses*, Stoddart, Toronto 1989
- John C. Bailar, *Comprehensive Inorganic Chemistry*, Vol. 3, Pergamon Press, Oxford 1973
- Brigitte Bailer-Galanda, W. Benz, W. Neugebauer (ed.), *Wahrheit und Auschwitzlüge*, Deuticke, Vienna 1995
- John Clive Ball, *Air Photo Evidence, Auschwitz, Treblinka, Majdanek, Sobibor, Bergen Belsen, Belzec, Babi Yar, Katyn Forest*, Ball Resource Service Ltd., Delta, B.C., Canada 1992
- John Clive Ball, *The Ball Report*, Ball Resource Services Ltd., Delta, BC, Canada, 1993
- Bayerischer Staatsminister des Inneren (ed.), *Verfassungsschutzbericht 1997*, Munich 1998
- Wolfgang Benz, *Dimension des Völkermords*, Oldenbourg, Munich 1991
- Michael Berenbaum, *The World Must Know*, Little, Brown & Co., Boston 1993
- Jadwiga Bezwinska, *KL Auschwitz in den Augen der SS*, Verlag des Staatlichen Auschwitz-Museums, Auschwitz 1973
- Heinz Bobrach *et al.*, *Inventar archivalischer Quellen des NS-Staates*, K. G. Saur, Munich 1995, volumes 3/1, 1991
- Hans-Kurt Boehlke, *Friedhofsbauten*, Callwey Verlag, Munich 1974
- Jean-Marie Boisdefeu, *La controversie sur l'extermination des Juifs par les Allemands*, volume 1, Vrij Historisch Onderzoek, Berchem 1994
- William Braker, Allen L. Mossman, *Matheson Gas Data Book*, Matheson Gas Products, East Rutherford 1971
- Martin Broszat (ed.), *Kommandant in Auschwitz*, Deutsche Verlags-Anstalt, Stuttgart 1958
- Hans Buchheim, Martin Broszat, Hans-Adolf Jacobsen, Helmut Krausnick, *Anatomie des SS-Staates*, Walter, Freiburg 1964
- Josef G. Burg, *Schuld und Schicksal*, Damm-Verlag, Munich 1962
- Josef G. Burg, *Sündenböcke*, Verlag G. Fischer, Munich 1967
- Josef G. Burg, *NS-Verbrechen—Prozesse des schlechten Gewissens, ibid.* 1968
- Josef G. Burg, *Verschönerung des Verschweigens*, Ederer, Munich 1979
- Josef G. Burg, *Majdanek in alle Ewigkeit?*, *ibid.* 1979
- Josef G. Burg, *Zionazi-Zensur in der BRD, ibid.* 1980.
- Jozef Buszko (ed.), *Auschwitz, Nazi Extermination Camp*, Interpress Publishers, Warschau ²1985
- Rupert Butler, *Legions of Death*, Arrows Books Ltd., London 1986
- Arthur R. Butz, *The Hoax of the Twentieth Century*, Institute for Historical Review, Newport

- Beach, California, 71985
- Alberto Cantagalli, *Nozioni teorico-pratiche per i conduttori di caldaie e generatori di vapore*, G. Lavagnolo Editore, Turin 1940
 - Danuta Czech, *Kalendarium der Ereignisse im Konzentrationslager Auschwitz-Birkenau 1939-1945*, Rowohlt Verlag GmbH, Reinbek bei Hamburg, 1989
 - Wolfgang Czernin, *Zementchemie für Bauingenieure*, Bauverlag, Wiesbaden 1977
 - Max Daunderer, *Klinische Toxikologie*, 30th suppl. delivery 10/87, ecomed, Landsberg 1987
 - Degussa AG (ed.), *Im Zeichen von Sonne und Mond*, Degussa AG, Frankfurt/Main 1993
 - *Der praktische Desinfektor*, Heft 2, Verlag Erich Deleiter, Berlin 1941
 - Der Prozeß gegen die Hauptkriegsverbrecher vor dem Internationalen Militärgerichtshof, Nürnberg 1949
 - Deutsche Chemische Gesellschaft (ed.), *Gmelins Handbuch der Anorganischen Chemie*, 59 (Fe), B4, Verlag Chemie, Weinheim 1932
 - Dokumentationszentrum des österreichischen Widerstandes, Bundesministerium für Unterricht und Kultur (eds.), *Amoklauf gegen die Wirklichkeit*, Vienna 1991, pp. 47-52
 - W.H. Duda, *Cement-Data-Book*, Bauverlag, Wiesbaden 1976
 - C.T. Duffy, *88 Men and 2 Women*, Doubleday, New York 1962
 - DuPont, *Hydrogen Cyanide*, Wilmington, Delaware 7/83
 - Ecole des hautes études en sciences sociales (ed.), *L'Allemagne nazie et le génocide juif*, Gallimard/Le Seuil, Paris 1985
 - *Encyclopaedia Britannica*, 1998 edition on CD-ROM
 - E. Emmerling, in: M. Petzet (ed.), *Holzschädlingsbekämpfung durch Begasung*, Arbeitshefte des Bayerischen Landesamtes für Denkmalpflege, vol. 75, Lipp-Verlag, Munich 1995
 - Robert Faurisson, *Mémoire en défense*, La Vieille Taupe, Paris 1980
 - Robert Faurisson, *Écrits révisionnistes*, 4 vols., published by author, Vichy 1999.
 - Robert Faurisson, “*Es gab keine Gaskammern*”, Deutscher Arbeitskreis Witten, Witten 1978
 - H. Ferch, H. Schäfer, *Schriftenreihe Pigmente Nr. 77*, Degussa AG, Frankfurt 1990
 - Norman G. Finkelstein, Ruth Bettina Birn, *A Nation on Trial: The Goldhagen Thesis and Historical Truth*, Metropolitan Books, New York 1998
 - Ferdinand Flury, Franz Zernik, *Schädliche Gase, Dämpfe, Nebel, Rauch- und Staubarten*, Berlin 1931
 - Wilhelm Foerst (ed.), *Ullmanns Encyklopädie der technischen Chemie*, vol. 5, Urban und Schwarzenberg, Munich ³1954; volume 13, *ibid.* ³1962; volume 18, Verlag Chemie, Weinheim 1979.
 - Wolfgang Forth, Dietrich Henschler, Werner Rummel, *Allgemeine und spezielle Pharmakologie und Toxikologie*, Wissenschaftsverlag, Mannheim 1987
 - Henry Friedländer, *The Holocaust*, Vol. 12: “*The ‘finale solution’ in the extermination camps and the aftermath*”, Garland, New York 1982
 - Ernst Gauss, *Vorlesungen über Zeitgeschichte*, Grabert, Tübingen 1993
 - Ernst Gauss (ed.), *Dissecting the Holocaust*, Theses & Dissertations Press, Capshaw, AL, 2000
 - Ernst Gauss (ed.), *Grundlagen zur Zeitgeschichte*, *ibid.* 1994
 - Ernst Gauss (ed.), *Dissecting the Holocaust*, 2nd edition, Theses & Dissertations Press, Capshaw, AL, 2003
 - Martin Gilbert, *Auschwitz and the Allies*, Henry Holt & Co., New York 1981
 - Wigbert Grabert, *Geschichtsbetrachtung als Wagnis*, Grabert, Tübingen 1984
 - Helge Grabitz, *NS-Prozesse – Psychogramme der Beteiligten*, 2nd ed., C.F. Müller, Heidelberg 1986
 - Jürgen Graf, *Der Holocaust auf dem Prüfstand*, Guideon Burg, Basel 1992
 - Jürgen Graf, *Der Holocaust-Schwindel*, *ibid.* 1993
 - Jürgen Graf, *Auschwitz. Tätergeständnisse und Augenzeugen des Holocaust*, Verlag Neue Visionen, Würenlos 1994
 - Jürgen Graf, *Todesursache Zeitgeschichtsforschung*, *ibid.* 1995
 - Jürgen Graf, Carlo Mattogno, *KL Majdanek*, Castle Hill Publishers, Hastings 1998

- Jürgen Graf, *Mattogno, Das KL Stutthof*, Castle Hill Publishers, Hastings 1999
- Jürgen Graf, *Riese auf tönernen Füßen*, *ibid.* 1999
- Jürgen Graf, *The Giant With Feet of Clay*, Theses & Dissertations Press, Capshaw, AL, 2001
- Karl Greimer, *Handbuch des praktischen Desinfektors*, Th. Steinkopf, Dresden 1937
- Pierre Guillaume, *De la misère intellectuelle en milieu universitaire*, B.P. 9805, 75224 Paris cedex 05, 1995
- Yisrael Gutman, Michael Berenbaum (ed.), *Anatomy of the Auschwitz Death Camp*, Indiana University Press, Bloomington 1994
- Friedrich E. Haag, *Lagerhygiene, Taschenbuch des Truppenarztes*, vol. VI, F. Lehmanns Verlag, Munich 1943
- David E. Hackett, (ed.), *The Buchenwald Report*, Beck, Munich 1997
- O. Hähnle, *Baustoff-Lexikon*, Deutsche Verlagsanstalt, Stuttgart 1961
- Joseph S. Haldane, J.G. Priestley, *Respiration*, Yale University Press, New Haven 1935
- Hamburger Institut für Sozialforschung (ed.), *Die Auschwitz-Hefte*, vol. 1, Beltz Verlag, Weinheim 1987
- *Handbuch der Inneren Medizin*, 2nd ed., 1925.
- Wilhelm Heepke, *Die Leichenverbrennungs-Anstalten*, C. Marhold, Halle 1905
- Yandell Henderson, Howard W. Haggard, *Noxious Gases*, Reinhold Publishing, New York 1943
- Joachim Hoffmann, *Stalins Vernichtungskrieg*, Verlag für Wehrwissenschaften, Munich 1995
- Joachim Hoffmann, *Stalin's War of Extermination 1941-1945*, Theses & Dissertations Press, Capshaw, AL, 2001
- K.A. Hofmann, *Anorganische Chemie*, Vieweg, Braunschweig ²¹1973
- A.F. Holleman, N. Wiberg, *Lehrbuch der Anorganischen Chemie*, de Gruyter, Berlin ¹⁰⁰1985
- Gerd Honsik, *Freispruch für Hitler*, Burgenländischer Kulturverband, Vienna 1988
- Gerd Honsik, *Schelm und Scheusal*, Bright Rainbow, Madrid n.d. [1994]
- Franziska Hunseder, *Rechte machen Kasse*, Knauer, Munich, May 1995
- Valérie Igounet, *Histoire du négationnisme en France*, Editions du Seuil, Paris 2000
- David Irving, *Nuremberg. The Last Battle*, Focal Point, London 1996
- Eberhard Jäckel, Jürgen Rohwer, *Der Mord an den Juden im Zweiten Weltkrieg*, Deutsche Verlags-Anstalt, Stuttgart 1985
- Franz Kadell, *Die Katyn Lüge*, Herbig, Munich 1991
- Jürgen Kalthoff, Martin Werber, *Die Händler des Zyklon B*, VSA-Verlag, Hamburg 1998
- Rüdiger Kammerer, Armin Solms (ed.), *Das Rudolf-Gutachten*, Cromwell, London 1993
- Michael D. Kelleher, C. L. Kelleher, *Murder Most Rare: The Female Serial Killer*, Praeger, Westport, Conn., 1998
- Erich Kern, *Meineid gegen Deutschland*, Schütz, Pr. Oldendorf, ²1971
- R.E. Kirk, D.F. Othmer, *Encyclopedia of Chemical Technology*, Vol. 13, 3. ed., Wiley & Sons, New York 1979
- Serge Klarsfeld (ed.), *The Auschwitz Album. Lilly Jacob's Album*, New York 1980
- Ernst Klee, Willy Dreßen, *Schöne Zeiten*, S. Fischer, Frankfurt 1988
- Ernst Klee, Willy Dreßen, *The Good Old Days*, Free Press, New York 1991
- Heinrich Kliewe, *Leitfaden der Entseuchung und Entwesung*, F. Enke Verlag, Stuttgart 1951
- Alexander von Knieriem, *Nürnberg. Rechtliche und menschliche Probleme*, Klett, Stuttgart 1953
- Eugen Kogon, Hermann Langbein, Adalbert Rückerl *et al.* (eds.), *Nationalsozialistische Massentötungen durch Giftgas*, S. Fischer Verlag, Frankfurt 1983
- Eugen Kogon, Hermann Langbein, Adalbert Rückerl *et al.* (eds.), *Nazi Mass Murder*, Yale University Press, New Haven 1993
- Herinrich Kruse, *Leitfaden für die Ausbildung in der Desinfektion und Schädlingsbekämpfung*, Muster-Schmidt, Göttingen 1948
- Barbara Kulaszka (ed.), *Did Six Million Really Die? Report on the Evidence in the Canadian "False News" Trial of Ernst Zündel—1988*, Samisdat Publishers Ltd., Toronto 1992

- Georg Kunike, *Das ABC der Vorrats- und Hausschädlinge und ihre Bekämpfung*, Theodor Weicher, Berlin 1941
- Landolt-Börnstein, *Eigenschaften der Materie in ihren Aggregatzuständen*, part 2, volume b, *Lösungsmittelgleichgewichte I*, Springer, Berlin 1962
- Landolt-Börnstein, *Zahlen und Funktionen aus Physik, Chemie, Astronomie, Technik*, volume IV *Technik*, part 4b *Wärmetechnik*, Springer, Berlin 1972
- Hermann Langbein, *Menschen in Auschwitz*, Europaverlag, Vienna 1987
- Hermann Langbein, *Der Auschwitz-Prozeß*, Europäische Verlagsanstalt, Frankfurt/Main 1965
- Hans Laternser, *Die andere Seite im Auschwitzprozeß 1963/65*, Seewald, Stuttgart 1966
- Robert Lenski, *The Holocaust on Trial*, Reporter Press, Decatur, Alabama 1990
- Robert Lenski, *Der Holocaust vor Gericht*, Samisdat Publishers Ltd., Toronto 1996
- André Lettich, *Trente-quatre mois dans les Camps de Concentration*, Imprimerie Union Coopérative, Tours, 1946
- Fredrick A. Leuchter, *The Third Leuchter Report*, Samisdat Publishers Ltd., Toronto 1989
- Fredrick A. Leuchter, *An Engineering Report on the alleged Execution Gas Chambers at Auschwitz, Birkenau and Majdanek, Poland*, Samisdat Publishers Ltd., Toronto 1988
- Fredrick A. Leuchter, *The Fourth Leuchter Report*, Samisdat Publishers Ltd., Toronto 1991
- Salmen Lewenthal, *Hefte von Auschwitz*, Sonderheft 1, *Handschriften von Mitgliedern des Sonderkommandos*, Verlag Staatliches Museum Auschwitz, 1972
- Peter A. Lewis (ed.), *Pigment Handbook*, Vol. 1, Wiley and Sons, New York 1974
- Carlo Mattogno, *La soluzione finale. Problemi e polemiche*, Edizioni di Ar, Padua 1991; *Auschwitz. La prima gasazione*, Edizioni di Ar, Padua 1992
- Carlo Mattogno, *Auschwitz: The End of a Legend*, Institute for Historical Review, Costa Mesa 1994
- Carlo Mattogno, „Sonderbehandlung“ *ad Auschwitz. Genesi e Significato*, Edizioni di Ar, Padua 2001
- S. Moeschlin, *Klinik und Therapie der Vergiftung*, Georg Thieme Verlag, Stuttgart 1986
- Andreas Molau (ed.), *Opposition für Deutschland*, Druffel-Verlag, Berg am Starnberger See 1995
- Joachim Mrugowsky (ed.), *Arbeitsanweisungen für Klinik und Laboratorium des Hygiene-Instituts der Waffen-SS*, 2nd ed., Urban & Schwarzenberg, Berlin and Vienna 1943.
- G.-O. Müller, *Lehrbuch der angewandten Chemie*, vol. I, Hirzel, Leipzig 1986
- Bernd Naumann, *Auschwitz*, Athenäum, Frankfurt/Main 1968
- Ernst Neufert, *Bauentwurfslehre*, Ullstein Fachverlag, Frankfurt 1962
- Ernst Nolte, in his book *Streitpunkte*, Propyläen, Berlin 1993
- Miklos Nyiszli, *Auschwitz: A Doctor's Eyewitness Account*, Arcade Publishing, New York 1993
- Friedrich Oscar, *Über Galgen wächst kein Gras*, Erasmus-Verlag, Braunschweig 1950
- J. Oudar, *Physics and Chemistry of Surfaces*, Blackie & Son, Glasgow 1975
- Robert J. van Pelt, *The Case for Auschwitz. Evidence from the Irving Trial*, Indiana University Press, Bloomington/Indianapolis 2002
- Robert van Pelt, Deborah Dwork, *Auschwitz: 1270 to the Present*, Yale University Press, New Haven and London 1996
- J.H. Perry, *Chemical Engineer's Handbook*, Wilmington Delaware 1949
- Gerhard Peters, *Blausäure zur Schädlingsbekämpfung*, Ferdinand Enke Verlag, Stuttgart 1933
- Gerhard Peters, *Die hochwirksamen Gase und Dämpfe in der Schädlingsbekämpfung*, F. Enke Verlag, Stuttgart 1942
- Léon Poliakov, *Auschwitz*, René Julliard, 1964
- Léon Poliakov, *Harvest of Hate*, Greenwood Press, Westport, Conn., 1971
- Karl R. Popper, *Objektive Erkenntnis*, Hoffmann & Campe, Hamburg 1984
- Jean-Claude Pressac, *Auschwitz: Technique and Operation of the Gaschambers*, Beate-Klarsfeld-Foundation, New York 1989
- Jean-Claude Pressac, *Les crématoires d'Auschwitz. La machinerie du meurtre de masse*,

- CNSR, Paris 1993
- Jean-Claude Pressac, *Die Krematorien von Auschwitz. Die Technik des Massenmordes*, Piper, Munich 1994
 - *Proceedings of the Conference on Cyanide and the Environment*, Colorado State University, 1984
 - Franz Puntigam, Hermann Breymesser, Erich Bernfus, *Blausäuregaskammern zur Fleckfieberabwehr*, Sonderveröffentlichung des Reichsarbeitsblattes, Berlin 1943
 - Paul Rassiner, *Die Lüge des Odysseus*, K.-H. Priester, Wiesbaden 1959
 - Paul Rassiner, *Was nun, Odysseus?*, *ibid.* 1960
 - Paul Rassiner, *Das Drama der Juden Europas*, H. Pfeiffer, Hannover 1965
 - Paul Rassiner, *Was ist Wahrheit?*, Druffel, Leoni ⁸1982
 - Paul Rassiner, *Debunking the Genocide Myth*, The Noontide Press, Los Angeles, 1978
 - Otto Ernst Remer (ed.), *Die Zeit lügt!*, Verlag Remer Heipke, Bad Kissingen 1992
 - S. Röbert (ed.), *Systematische Baustofflehre*, volume 1, VEB Verlag für Bauwesen, Berlin ⁴1983
 - Henry Rollet, *Les chambres à gaz secret d'Etat*, Les Editions de Minuit, Paris 1984
 - Henri Roques, Günter Anthon, *Der Fall Günter Deckert*, DAGD/Germania Verlag, Weinheim 1995
 - Ludwig Rosenthal, “*Endlösung der Judenfrage*”, *Massenmord oder “Gaskammerlüge”?*, Verlag Darmstädter Blätter, Darmstadt 1979
 - Adalbert Rückerl, *NS-Verbrechen vor Gericht*, C. F. Müller, Heidelberg 1984, p. 249
 - Adalbert Rückerl, *Nationalsozialistische Vernichtungslager im Spiegel deutscher Strafprozesse*, dtv, Munich 1978
 - Adalbert Rückerl, *NS-Prozesse*, C. F. Müller, Karlsruhe 1972
 - Adalbert Rückerl, *NS-Verbrechen vor Gericht*, C.F. Müller, Heidelberg, ²1984
 - Colin Rushton, *Spectator in Hell. A British Soldier's Extraordinary Story*, Pharaoh Press, Springhill (Berkshire) 1998
 - Ingrid Sagel-Grande, H. H. Fuchs, Christiaan F. Rüter (eds.), *Justiz und NS-Verbrechen*, vol. 21, University Press, Amsterdam 1979
 - Walter N. Sanning, *Die Auflösung des osteuropäischen Judentums*, Grabert, Tübingen 1983
 - Walter N. Sanning, *The Dissolution of Eastern European Jewry*, Institute for Historical Review, Torrance, CA, 1983
 - Otto von Schjerning, *Handbuch der Ärztlichen Erfahrungen im Weltkrieg 1914/1918*, volume VII Hygiene, J. A. Barth Verlag, Leipzig 1922
 - Wilhelm Schlesiger, *Der Fall Rudolf*, Cromwell, London 1994
 - Robert F. Schmidt, *Biomaschine Mensch*, Piper, Munich 1979
 - Gerhard Schoenberger (ed.), *Wir haben es gesehen*, Fourier, Wiesbaden 1981
 - Shelly Shapiro (Ed.), *Truth Prevails: Demolishing Holocaust Denial: The End of the Leuchter Report*, Beate Klarsfeld Foundation, New York 1990
 - Yoram Sheftel, *The Demjanjuk Affair. The Rise and Fall of the Show Trial*, Victor Gollancz, London 1994
 - Wilhelm Stäglich, *Der Auschwitz-Mythos*, Grabert Verlag, Tübingen 1979
 - Wilhelm Stäglich, *The Auschwitz Myth*, Institute for Historical Review, Torrance, CA, 1986
 - Telford Taylor, *The Anatomy of the Nuremberg Trials*, Little, Boston 1992
 - Serge Thion (ed.), *Vérité historique ou vérité politique?*, La Vielle Taupe, Paris 1980
 - Ralf Tiemann, *Der Malmedy-Prozeß*, Munin, Osnabrück 1990
 - Stephen Trombley, *The Execution Protocol*, Crown Publishers, New York 1992
 - Freda Utley, *Kostspielige Rache*, H.H. Nölke-Verlag, Hamburg ⁷1952
 - Freda Utley, *The High Cost of Vengeance*, Regnery, Chicago 1949
 - Herbert Verbeke (ed.), *Auschwitz: Nackte Fakten*, Vrij Historisch Onderzoek, Berchem 1995
 - Herbert Verbeke (ed.), *Kardinalfragen zur Zeitgeschichte*, Vrij Historisch Onderzoek, Berchem, 1996
 - Verein Deutscher Zementwerke, *Zement Taschenbuch 1972/73*, Bauverlag, Wiesbaden 1972

- Udo Walendy, *Auschwitz im IG-Farben-Prozeß*, Verlag für Volkstum und Zeitgeschichtsforschung, Vlotho 1981
- N.V. Waubke, *Transportphänomene in Betonporen*, Dissertation, Braunschweig 1966
- R.C. Weast (ed.), *Handbook of Chemistry and Physics*, 66th Ed., CRC Press, Boca Raton, Florida 1986
- Jürgen Weber, Peter Steinbach (eds.), *Vergangenheitsbewältigung durch Strafverfahren?*, Olzog, Munich 1984
- H.-H. Wellhöner, *Allgemeine und systematische Pharmakologie und Toxikologie*, Springer Verlag, Berlin 1988
- Karlhans Wesche, *Baustoffe für tragende Bauteile*, volume 1, Bauverlag, Wiesbaden 1977; volume 2, Bauverlag, Wiesbaden 1981
- C. Wilson, *Wilson & Wilson's Comprehensive Inorganic Chemistry*, Vol. 1B, Elsevier, Amsterdam 1960
- Winnacker-Küchler, *Chemische Technologie*, volume 2, Carl Hanser Verlag, Munich 1982
- Wolfgang Wirth, Christian Gloxhuber, *Toxikologie*, Georg Thieme Verlag, Stuttgart 1985
- David S. Wyman (ed.), *America and the Holocaust*, volume 12, Garland, New York/London 1990
- G. Zimmermann (ed.), *Bauschäden Sammlung*, volume 4, Forum-Verlag, Stuttgart 1981

12.2. Periodical Articles

- *Anal. Chem.* 56 (14) (1984), pp. 2819-2822: T. Ozeki, K. Matsumoto, S. Hikime
- *Anal. Chim. Acta* 3 (1949), pp. 558ff.
 - 5 (1951), pp. 525-528
 - 11 (1954), pp. 18-27: M. Kohn
- *Analisis*, 13 (4) (1985), pp. 185-190: C. Lapp, C. Wehrer, P. Laugel
- *Ann. Chim.* 50 (1960), pp. 782-789: V. Carassiti, V. Balzani
- *Annales d'Histoire Révisionniste* 1 (1987) pp. 137-152: Robert Faurisson, "Comment les Britanniques ont obtenu les aveux de Rudolf Hoess"
 - 7 (1989), pp. 212f.: Gérard Roubeix, Letter to the Editor
- *Anzeiger für Schädlingskunde*, 14(8) (1938) pp. 98f.: Gerhard Peters, "Eine moderne Eisenbahn-Entwesungsanlage"
- *Arbeitsschutz*, 5(III) (1942), pp. 167f.: Gerhard Peters, "Gefahrlose Anwendung der hochgiftigen Blausäure in Entlausungskammern"
- *Bild*, Nov. 20, 2001; ; April 11, 2002, p. 2
- *blick nach rechts*, June 2000: Thomas Pfeiffer
- *Cement and Concrete Research*, 11 (1981), pp. 351-362: H.A. El-Sayed
- *Chicago Daily Tribune*, Feb. 23-26, 28, 29, 1948; March 12; Sept. 13, 1949
- *Corriere della Sera*, Nov. 21, 2001, p. 35.
- *Dachauer Hefte*, 7(7) (November 1991), pp. 230-241: Georges Wellers, "Der Leuchter-Bericht über die Gaskammern von Auschwitz"
- *Daily News*, Washington, Jan. 9, 1949
- *Das Gas- und Wasserfach*, in: *Gas • Erdgas*, 130 (1989), pp. 474-484: D. Maier, K. Czurda, G. Gudehus
- *Der praktische Desinfektor*, September 1941, pp. 93-96: Gerhard Peters and W. Rasch, "Die Blausäure als Entlausungsmittel in Begasungskammern"
- *Deutsche Farben-Z.* 5 (1951), pp. 419ff.: E. Elsermann
 - 6 (1952), p. 231.: R. Beck

- *Deutschland in Geschichte und Gegenwart* 28(1-4) (1980), pp. 12-15; 17-21; 17-21; 25-31: Walter N. Sanning, “Die europäischen Juden. Eine technische Studie zur zahlenmäßigen Entwicklung im Zweiten Weltkrieg, Teil 1-4”
- 36(4) (1988), pp. 4-10: Robert Faurisson, “Zum Zündel-Prozeß in Toronto, Teil 2. Vorgeschichte—Ablauf—Folgen”
- 39(2) (1991), pp. 13-17: Wolfgang Häberle, “Zu Wegners Kritik am Leuchter-Gutachten”
- 39(2) (1991), pp. 9-13: Wolfgang Schuster, “Technische Unmöglichkeiten bei Pressac”
- 41(2) (1993), pp. 16-24: Ernst Gauss, “Chemische Wissenschaft zur Gaskammerfrage”
- 42(2) (1994), pp. 25f.: Germar Rudolf, “Über die frei erfundene Expertenmeinung der ‘dpa’”
- 43(1) (1995) pp. 22-26: Germar Rudolf, “Leuchter-Gegengutachten: Ein Wissenschaftlicher Betrug?”
- 44(2) (1996), pp. 24f.: Wilhelm Stromberger, “Was war die ‘Sonderbehandlung’ in Auschwitz?”
- 44(4) (1996), pp. 9f.: IDN, “‘Appell der 500’ vor Landtag”
- *Die Naturwissenschaften*, 16(2) (1928), pp. 17-23: O. Hecht, “Blausäuredurchgasungen zur Schädlingsbekämpfung”
- *Die Welt*, March 29, 1994; April 5, 1995; May 15, 1995: “Unterstützen Unternehmer die rechtsextremen Szene?”
- *Die Woche*, Oct. 7, 1993, p. 8
- *Die Zeit*, no. 39, Sept. 18, 1992, p. 104; no. 40, Sept. 25, 1992, p. 90: Till Bastian; April 15, 1993, p. 44; Dec. 31, 1993, p. 51
- *dpa* news release on March 28, 1994, published in the German daily newspapers on March 29, 30, 31, 1994.
- *East European Sci. Abs.* 5 (1969), pp. 84f.: E.F. Zhel’vis, Y.M. Glazman
- *Farbe und Lack*, 64 (1958), pp. 130-135: E. Herrmann
- *Färg och Lack*, 3 (1957), pp. 85-108: E. Gratzfeld
- *Focus* no. 17/1994, pp. 118, 120
- *Frankfurter Allgemeine Zeitung*, August 15, 1994, p. 21: Patrick Bahners, “Objektive Selbsterstörung”; March 11, 1995, p. 8; May 6, 1995; June 10, 1996, p. 14; April 11, 2002, p. 2
- *Frankfurter Rundschau*, March 30, 1994; April 11, 2002, p. 2
- *Gäubote/Südwestpresse-Verband*, May 6, 1996
- *Gesundheits-Ingenieur*, July 19, 1941, pp. 399-404: Friedrich Konrich, “Über die Sanierungsanstalten der deutschen Kriegsgefangenenlager”
- 66(15) (1943), S. 174ff.: Ludwig Gaßner, “Verkehrshygiene und Schädlingsbekämpfung”
- 67(2) (1944), pp. 47-56: Franz Puntigam, “Die Durchgangslager der Arbeitseinsatzverwaltung als Einrichtungen der Gesundheitsvorsorge”
- 67(6) (1944), pp. 139-180: Franz Puntigam, “Raumlösungen von Entlausungsanlagen”
- 67(7) (1944), p. 179: Emil Wüstinger, “Vermehrter Einsatz von Blausäure-Entlausungskammern”
- *Gesundheitswesen und Desinfektion*, 65(8) (1973), pp. 115-127; 65(9) (1973), pp. 129-143: W. Hagen, “Krieg, Hunger und Pestilenz in Warschau 1939-1943”
- *Glav. Hem. Tehnol. Bosne Hercegovine*, 23-24 (1977, Vol. Date 1976), pp. 7-13: F. Krleza, M. Avlijas, G. Dokovic
- *Hamburger Abendblatt*, May 27, 2000: Günther Hoerbst “Anti-Semitism Worldwide 1998/99”
- *Hamburger Morgenpost*, Nov. 14, 2000
- *Hazard. Ind. Waste* 21 (1989), pp. 282-290: M.D. Gurol, J.H. Woodman

- *Historische Tatsache* no. 42, Verlag für Volkstum und Zeitgeschichtsforschung, Vlotho 1990: U. Walendy
- no. 60, Verlag für Volkstum und Zeitgeschichtsforschung, Vlotho 1993: Udo Walendy
- *Holz als Roh- und Werkstoff*, 32 (1974), pp. 108-114: D. Grosser, E. Roßmann, “*Blausäuregas als bekämpfendes Holzschutzmittel für Kunstobjekte*”
- *Informationen der Gesellschaft für politische Aufklärung*, Innsbruck, June 1991, no. 29: Brigitte Bailer-Galanda
- *Inorg. Chem.* 1 (1962), pp. 337-342: M.B. Robin
- 1 (1962), pp. 587-591: J. Jordan, G.J. Ewing
- 9 (1970), pp. 2019ff.: R.M. Izatt, G.D. Watt, C.H. Bartholomew, J.J. Christensen
- 9 (1970), pp. 2512-2516: R.E. Wilde, S.N. Ghosh, B.J. Marshall
- 16 (1977), pp. 2704-2710: H.J. Buser, D. Schwarzenbach, W. Peter, A. Ludi
- *J. Appl. Chem. USSR*, 74(1)(1974), pp. 139-142: N.G. Chen
- *J. Chem. Soc.* 1963, pp. 1120-1125: J.F. Duncan
- *J. Ind. Chem. Soc.* 28 (1951), pp. 221-224: A.K. Bhattacharya
- 28 (1951), pp. 703-709: R.S. Saxena
- *J. Inorg. Chem. USSR*, 1 (1956), pp. 72ff.: I.V. Tananaev, M.A. Glushkova, G.B. Seifer
- *J. Inorg. Nucl. Chem.* 28 (1966), pp. 2589-2598: L. Moggi, F. Bolletta, V. Balzani, F. Scandola
- 29 (1967), pp. 1637-1642: M. Andrew Alich, D.T. Haworth, M.F. Johnson
- *J. Jap. Soc. Col. Mat.*, 34 (1961), pp. 5-8; L. Müller-Focken, *Farbe und Lack*, 84 (1987), pp. 489-492: H. Watanabe
- *J. Réch. Cent. Nat. Réch. Sci.* 4 (1952), pp. 184ff.: S. Barbezat
- *Jour J*, December 12, 1988, pp. I-X: Jean-Claude Pressac
- *Jpn. Kokai Tokkyo Koho*, 1990, 3 p.: H. Tada, M. Kunio, H. Kawahara
- *Killoy Sentinel* (New South Wales, Australia), May 1, 1997
- *Kreiszeitung – Böblinger Bote*, November 23, 1994; March 29, 1995; May 10, 1995; June 24, 1995; Nov. 16, 1995: dpa, “*Dilettantische Kammerjäger*”; May 6, 1996; June 27, 1996
- *Kurier*, Aug. 30, 1992, p. 20: “*Wenn Felsen fallen*”
- *L'Express*, 19.-25. January 1995: Eric Conan, “*Auschwitz: la mémoire du mal*”
- *Le Monde Juif*, no. 97, January-March 1980, p. 2: Dino A. Brugioni, Robert G. Poirier; no. 107, Juli-September 1982, pp. 91-131: Jean-Claude Pressac
- *Le Monde*, Dec. 29, 1978, p. 8: Robert Faurisson, “*Le problème des chambres à gaz 'ou 'la rumeur d'Auschwitz*””; Feb 21, 1979: Robert Faurisson; Sept. 19, 1989; Nov. 20, 2001
- *Le Quotidien de la Réunion*, June 25, 1998: “*Un expert évoque la illustration de gaz mortel dans la grotte*”
- *Liberty Bell*, 12/1994, pp. 36f.
- *Life*, Dec. 22, 1947, p. 31: “*How to get rid of termites*”
- *Los Angeles Times*, Jan. 7, 2000: Kim Murphy, “*Danger in Denying Holocaust?*”
- *Märkische Allgemeinen*, May 14, 1993
- *Münchener Medizinische Wochenschrift*, 89(22) (1942), pp. 483-488: R. Wohlrab, “*Flecktyphusbekämpfung im Generalgouvernement*”
- *Nation—The Orange County Register*, Jan. 9, 2000, News 11
- *New Yorker Staats-Zeitung*, March 13-19, 1999, p. 3: Bettina Freitag, “*Henker warten nicht*”,
- *Newsweek*, November 8, 1993, p. 75
- *Osteuropa*, 52(5) (2002), pp. 631-641: Fritjof Meyer, “*Die Zahl der Opfer von Auschwitz*”
- *Our Sunday Visitor*, USA, June 14, 1959, 15

- *Paint Ind. Mag.* 69(11) (1954), pp. 33f.: H. Beakes
- *Polyhedron* 4(11) (1985), pp. 1887-1890: G. Stochel, Z. Stasicka
- *Rheinpfalz* Oct. 18, 1999: “*Gesuchter deutscher Neonazi offenbar in Großbritannien*”
- *Revue d’Histoire Révisionniste*, 3 (1990/91), pp 65-154: Robert Faurisson, “*Auschwitz : Technique and Operation of the Gas Chambers (1989) ou bricolage et ‘gazouillages’ à Auschwitz et Birkenau selon J.-C. Pressac (1989)*”
- *Rheinischer Merkur*, April 16, 1999
- *Rivarol*, March 22, 1996, p. 8; April 12, 1996, p. 4
- *Schriftenreihe Pigmente Nr. 50*, Degussa AG, Frankfurt 1985
- *Searchlight*, Dec. 1999, p. 13: Graeme Atkinson, “*Auschwitz liar hides out in Britain*”
- *Sleipnir* 1(2) (1995): Germar Rudolf, “*Kein Brief ins Gefängnis?*”
 - 1(3) (1995) pp. 29-33: Germar Rudolf and J. Markiewicz, W. Gubala, J. Labedz, “*Briefwechsel*”
 - 4/95, insider back cover
- *Staatsbriefe*, 6(6) (1995), pp. 6-8: Germar Rudolf, “*Naht ein deutscher Bürgerkrieg?*”
 - 6(7) (1995): Jochen Lober
 - 6(12) (1995), pp. 10-15: Germar Rudolf, “*In der Bundesacht*”
 - 7(1) (1996), Verlag Castel del Monte, Munich, pp. 4-8: Germar Rudolf, “*Webfehler im Rechtsstaat*”
 - 7(2-3) (1996), pp. 23-30: Germar Rudolf, “*Die Rolle der Presse im Fall Germar Rudolf*”
- *Storia illustrata*, 261 (1979), pp. 15-35: Robert Faurisson, “*Le camere a gas non sono mai esistite*”
- *Stuttgarter Nachrichten*, June 14, 1995; Oct. 21, 1999, p. 4: “*Holocaust-Leugner im englischen Versteck*”
- *Stuttgarter Zeitung*, March 29, 1994; Nov. 23, 1994; Jan. 27, 1995; June 13, 1995. p. 2; June 24, 1995: Sonnhild Maier; April 11, 2002, p. 2
- *Süddeutsche Zeitung*, March 29, 1994; May 6, 1995; June 24, 1995
- *Südwestpresse-Verbund*, March 29, 1994
- *Sunday Pictorial*, Great Britain, Jan. 23, 1949.
- *Sunday Telegraph*, Sept. 24, 1989; Oct. 17, 1999: Jessica Berry, Chris Hastings, “*German neo-Nazi fugitive is found hiding in Britain*”; October 31, 1999: Berry, Hastings, “*Germany pursues Rudolf extradition*”; Jan. 16, 2000: Berry, Hastings, “*Neo-nazi accused of ‘racial hatred’ goes on the run*”
- *Sydney Jewish News*, Nov. 5, 1999
- *tageszeitung*, March 30, 1994; April 11, 2002, p. 2
- *The Atlantic Monthly*, Feb. 1990
- *The Citizen*, South Africa, June 24, 1995, p. 8
- *The Globe and Mail*, Sept. 18, 1989
- *The Hastings and St. Leonards Observer*, Oct. 22, 1999: James Clarke, “*Fleeing neo-nazi uses base in Hastings*”; March 31, 2000: Clarke, “*Escaped Neo-nazi still hiding in Hastings*”
- *The Independent*, Oct. 18, 1999: Jessica Berry and Chris Hastings, “*German neo-Nazi fugitive is found hiding in Britain*”
- *The Jerusalem Post International Edition*, May 5, 1990
- *The Journal of Historical Review* 1(1) (1980) pp. 23ff.: Robert Faurisson, “*The Mechanics of Gassing*”
 - 1(2) (1980), pp. 103-114: Robert Faurisson, “*The ‘problem of the gas chambers’*”

- 2(4) (1981), pp. 311ff.: Robert Faurisson, “*The Gas Chambers of Auschwitz Appear to be Physically Inconceivable*”
- 2(4) (1981), pp. 319-373: Robert Faurisson, “*The Gas Chambers: Truth or Lie?*”
- 3(4) (1982), pp. 371-405: Arthur R. Butz, “*Context and perspective in the ‘Holocaust’ controversy*”
- 7(1) (1986), pp. 73-94: Friedrich P. Berg, “*The German Delousing Chambers*”
- 7(4) (1986), pp. 389 ff.: Robert Faurisson, “*How the British obtained the confessions of Rudolf Hoess*”
- 8(4) (1988), pp. 433-481: Friedrich Paul Berg, “*Typhus and the Jews*”
- 11(1) (1991), pp. 25ff.: Robert Faurisson, “*Pressac, Jean-Claude. Auschwitz: Technique and operation of the gas chambers. (part 1).*”
- 11(2) (1991) pp. 217-227: Mark Weber, “*Jewish soap*”
- 11(2) (1991), pp. 133ff.: Robert Faurisson, “*Pressac, Jean-Claude. Auschwitz: Technique and operation of the gas chambers. (part 2).*”
- 11(2) (1991), pp. 207-216: “*An official Polish report on the Auschwitz ‘gas chambers’*”
- 12(2) (1992), pp. 248ff.: Paul Grubach, “*The Leuchter Report Vindicated: A Response to Jean-Claude Pressac’s Critique*”
- 12(4) (1992), pp. 421-492 (various articles)
- 13(2) (1993), pp. 11-13: David Cole, “*A Jewish Revisionist’s Visit to Auschwitz*”
- 17(2) (1998), pp. 34ff.: Mark Weber, “*Probing Look at ‘Capital Punishment Industry’ Affirms Expertise of Auschwitz Investigator Leuchter*”
- 18(3) (1999), p. 4: Mark Weber, “*High Frequency Delousing Facilities at Auschwitz*”
- 19(6) (2000), pp. 12ff.: Arthur R. Butz, “*Historical Past vs. Political Present*”
- *The New York Times*, Feb. 23, 25, 29; March 6; July 30; Oct. 7, 1948; Jan. 7, March 2, 5; May 5, 1949; Oct. 13, 1990; June 16, 1994, p. A23; October 6, 1994, p. A20
- *The News & Observer*, Raleigh, North Carolina, June 11, 1994, p. 14A; June 19, 1994, p. A1: Bill Krueger, “*Lawson’s Final Moments*”
- *The Plain Dealer*, Dec. 19, 1999, p. 30A
- *The Revisionist*, 1(1) (2003), pp. 3-12: Michael Gärtner, Werner Rademacher, “*Ground Water in the Area of the POW camp Birkenau*”
- 1(1) (2003), pp. 13-16: Carlo Mattogno: “*‘Incineration Pits’ and Ground Water Level in Birkenau*”
- 1(1) (2003), pp. 17-23: Robert Faurisson, “*How many deaths at Auschwitz?*”
- 1(1) (2003), pp. 23-30: Gernar Rudolf, “*Cautious Mainstream Revisionism*”
- 1(1) (2003), pp. 30-37: Carlo Mattogno, “*Auschwitz. The new Revisions by Fritjof Meyer*”
- *The Sunday Telegraph*, Oct. 17, 1999: Jessica Berry and Chris Hastings, “*German neo-Nazi fugitive is found hiding in Britain*”
- *Tranp. Inst. Met. Finish.*, 35 (1958), pp. 353-384; 59 (1981), pp. 35-39: J.M. Kape, E.C. Mills
- *Trans. Far. Soc.* 53 (1957), pp. 1659-1661: B.N. Gosh, K.C. Ray
- *Ukrainskii Khim. Zh.* 35 (1969), pp. 766ff.: E.F. Zhel’vis, Y.M. Glazman
- *Vierteljahreshefte für freie Geschichtsforschung* 1(1) (1997), pp. 2-5: Wolfgang Lambrecht, “*Zyklon B – eine Ergänzung*”
- 1(1) (1997), pp. 34-37: VHO, “*Zur Wissenschaftsfreiheit in Deutschland*”
- 1(1) (1997), pp. 6ff.: Conrad Grieb, “*Der selbstassistierte Holocaust-Schwindel*”
- 1(1) (1997), pp. 24f.: Michael Gärtner, “*Vor 25 Jahren: Ein anderer Auschwitzprozess*”
- 1(2) (1997), pp. 102-104: Bertrand Clair, “*Revisionistische Gutachten*”

- 1(2) (1997), pp. 104-108: Germar Rudolf, “Zur Kritik am Rudolf Gutachten”
- 1(3) (1997), pp. 139-190: Germar Rudolf, “Auschwitz-Kronzeuge Dr. Hans Münch im Gespräch”
- 1(4) (1997), p. 226-243: Samuel Crowell, “Technik und Arbeitsweise deutscher Gasschutzbunker im Zweiten Weltkrieg”
- 1(4) (1997), pp. 224f.: La Vielle Taupe/Pierre Guillaume, “Rudolf Gutachten: ‘psychopathologisch und gefährlich’. Über die Psychopathologie einer Erklärung”
- 2(1) (1998), pp. 2-12: Michael Gärtner, Werner Rademacher, “Grundwasser im Gelände des KGL Birkenau (Auschwitz)”
- 2(1) (1998), pp. 13-22: Carlo Mattogno, “Die ‘Gasprüfer’ von Auschwitz”
- 2(2) (1998), pp. 87-105: Hans Jürgen Nowak, “Kurzwellen-Entlausungsanlagen in Auschwitz”
- 2(3) (1998), pp. 226ff.: Mark Weber, “Ein prüfender Blick in Amerikas ‘Todesstrafen-Industrie’ bestätigt das Leuchter-Gutachten”
- 2(4) (1998), pp. 311ff.: Richard Widmann, “Holocaust-Literatur versus Holocaust-Wissenschaft”
- 2(4) (1998), pp. 261-272: Hans Lamker, “Die Kurzwellen-Entlausungsanlagen in Auschwitz, Teil 2”
- 2(4) (1998), pp. 248-261: Hans Jürgen Nowak, W. Rademacher, “‘Gasdichte’ Türen in Auschwitz”
- 3(1) (1999), pp. 77-82: Germar Rudolf, “Das Rudolf Gutachten in der Kritik, Teil 2”
- 3(2) (1999), p. 208: Rudi Zornig, “Rechtsanwalt wegen Stellung von Beweisantrag verurteilt”
- 3(3) (1999), pp. 256-267: Werner Rademacher, “Die Wandlungen der Totenzahl von Auschwitz”
- 3(3) (1999), pp. 268-272: Robert Faurisson: “Wieviele Tote gab es in Auschwitz?”
- 4(1) (2000), pp. 104f.: Werner Rademacher, “In memoriam Dipl.-Ing. Dr. techn. Walter Schreiber”
- 4(1) (2000), pp. 33-50: Germar Rudolf, “Gutachter und Urteilsschelte”
- 4(1) (2000), pp. 25-33: Carlo Mattogno, “Architektonische Stümpereien zweier Plagiatoren”
- 4(2) (2000), pp. 152-158: Carlo Mattogno, “Leichenkeller von Birkenau: Luftschutzräume oder Entwesungskammern?”
- 4(3&4) (2000), pp. 284-330: Samuel Crowell, “Bombenschutzeinrichtungen in Birkenau: Eine Neubewertung”
- 4(3&4) (2000), pp. 410-415: Vincent Reynouard, “Deutsch-Französische Völker-Freundschaft”
- 4(3&4) (2000), p. 457: “Verteidiger Rieger siegt in Verfahren wegen ‘unzulässiger Verteidigung’”
- 5(4) (2001), pp. 446-449: Reinhold Schwertfeger, “Gab es Gaskammern im Altreich?”
- 6(2) (2002), pp. 139-145: Carlo Mattogno, “Die ‘Entdeckung’ des ‘Bunkers 1’ von Birkenau: alte und neue Betrügereien”
- 6(2) (2002), pp. 146-158: Manfred Gerner, Michael Gärtner, Hans Jürgen Nowak, “Die Kosten von Auschwitz”
- 6(2) (2002), pp. 176-190: Günther Herzogenrath-Amelung: “Gutachten im Asylverfahren von Germar Rudolf”
- 6(3) (2002), pp. 284-304: Carlo Mattogno, “Keine Löcher, keine Gaskammer(n)”
- 6(3) (2002), pp. 349-354: Robert H. Countess, “Van Pelt’s Plädoyer gegen den gesunden Menschenverstand”

- 6(3) 2002), pp. 354-359: Paul Grubach, “*Greuelpropaganda des Ersten Weltkriegs und der Holocaust*”
- 6(4) (2002), pp. 421-424: Carlo Mattogno, “*‘Verbrennungsgruben’ und Grundwasserstand in Birkenau*”
- *Wiesbadener Kurier*, 8./9. and 13. May 1993
- *Z Zagadnien Nauk Sadowych*, Z XXX (1994), pp. 17-27: Jan Markiewicz, Wojciech Gubala, Jerzy Labedz
- *Z. anorg. allg. Chem.* 333 (1964), pp. 235-247: E. Fluck, W. Kerler, W. Neuwirth
- *Z. Hygiene und Infektionskrankheiten*, 107 (1927), pp. 798-813; *ibid.*, 109 (1929), pp. 201-212: L. Schwarz, Walter Deckert
 - 108 (1928), pp. 108-123: W.A. Uglow
- *Zeitschrift für angewandte Entomologie*, 21(4) (1935), pp. 547-559: Gerhard Peters, W. Ganter, “*Zur Frage der Abtötung des Kornkäfers mit Blausäure*”
- *Zeitschrift für hygienische Zoologie und Schädlingsbekämpfung*, 10/11 (1940), pp. 191-196: Gerhard Peters, Emil Wüstinger, “*Entlausung mit Zyklon-Blausäure in Kreislauf-Begasungskammern. Sach-Entlausung in Blausäure-Kammern*”
 - (1941), pp. 36-45: K. Naumann: “*Die Blausäurevergiftung bei der Schädlingsbekämpfung*”
 - 33 (1941), p. 126.
 - (1942), pp. 35f.: Richard Irmscher, “*Nochmals: ‘Die Einsatzfähigkeit der Blausäure bei tiefen Temperaturen*”
 - (1943), pp. 190-194: R. Queisner, “*Erfahrungen mit Filtereinsätzen und Gasmasken für hochgiftige Gase zur Schädlingsbekämpfung*”

12.3. Archival Documents

- Allied aerial photographs, National Archives Air Photo Library, Washington, D.C., RG 373 Can F 5367, exp. 3185; RG 373 Can B 8413, exp. 6V2
- APMO, BW 30/34, p. 40, 47, 78, 105; D-Z/Bau, nr. inw. 1967, pp. 231f., 246f.; Standort-Befehl, D-Aul-1, p. 46
- Tsentr Chranenija Istoriko-dokumental’nich Kollektzii (TCIDK, recently renamed to Rossiskii Gosudarstvennii Vojennii Archiv, RGVA): 502-1: 26-117; 332-46/46a; 332-9/10; 333-145; 336-94; 332-37; 332-86/90; 332-117/119; 332-219; 233-33/38; 322-219; 322-31; 332-175; 332-28; 332-212; 149-135; 401; 336; 312-8; 316-431; 323-137; 335-3; 316-430; 26-21; 327-25/25a; 24-77; 24-33; 1-332-46a; 1-26-66; 238-10; 214; 22-19; 24

12.4. Internet Documents

- APBnews.com, April 29, 2000
(www.apbnews.com/safetycenter/business/2000/04/29/safetycrime0429_01.html;
www.apbnews.com/safetycenter/business/2000/04/29/safetycrime0429_doc.html)
- Codoh, “*Revisionist Historian Suffers Savage Beating*”
(www.codoh.com/thoughtcrimes/8909FAUR.HTML)
- Samuel Crowell, “*Technique and Operation of German Anti-Gas Shelters in WWII: A Refutation of J.C. Pressac’s Criminal Traces*” (www.codoh.com/incon/inconpressac.html)
- Samuel Crowell, “*Defending Against the Allied Bombing Campaign: Air Raid Shelters and Gas Protection in Germany, 1939-1945*” (www.codoh.com/incon/inconabr.html)

- Samuel Crowell, “*The Gas Chamber of Sherlock Holmes: An Attempt at a Literary Analysis of the Holocaust Gassing Claim*” (www.codoh.com/incon/inconshr123.html)
- Samuel Crowell, “*New Documents on Air Raid Shelters at Auschwitz Camp*” (www.fpp.co.uk/Auschwitz/documents/LSKeller/MoscowDocs.html)
- Samuel Crowell, “*Comments on Mattogno’s critique of the bomb shelter thesis*” (www.codoh.com/incon/inconscrmtgno.html)
- Samuel Crowell, “*Bomb Shelters in Birkenau: A Reappraisal*”, (www.codoh.com/incon/inconbsinbirk.html)
- Davis Colors (www.coloredconcrete.com/davis/Tech/03470.html)
- D.D. Desjardin: “*Kenneth Stern’s Critique of The Leuchter Report: A Critical Analysis*” (www.codoh.com/newrevoices/nddd/ndddstern.html)
- D.D. Desjardin, “*My Visit to Auschwitz-Birkenau, May 30-31, 1996*”, Interview mit F. Piper (www.codoh.com/newrevoices/nddd/ndddtausch.html)
- Department of Justice National News Release, May 10, 1999 (www.osha.gov/media/oshnews/may99/national-19990510.html)
- Robert Faurisson, “*Sur Auschwitz, lentement, la vérité reprend ses droits*” (www.abbc.com/aaargh/fran/archFaur/RF950204.html)
- Michael Gärtner, Werner Rademacher, “*Ground Water in the Area of the POW camp Birkenau*” (www.vho.org/GB/c/WW/GroundWater.html)
- Richard J. Green, “*The Chemistry of Auschwitz*”, May 10, 1998 (www.holocaust-history.org/auschwitz/chemistry)
- Richard J. Green, “*Leuchter, Rudolf and the Iron Blues*”, March 25, 1998 (www.holocaust-history.org/auschwitz/chemistry/blue)
- Richard J. Green, Jamie McCarthy, “*Chemistry is Not the Science*”, May 2, 1999 (www.holocaust-history.org/auschwitz/chemistry/not-the-science)
- Conrad Grieb, “*The Self-assisted Holocaust Hoax*” (www.codoh.com/gcgv/gcgvself.html)
- Manfred Köhler, “*Pressac and the German Public*” (www.vho.org/GB/Books/anf/Koehler.html)
- Carlo Mattogno, “*Auschwitz 1270 to the Present*” (www.codoh.com/granata/irving-eng.html)
- Carlo Mattogno, “*Morgue Cellars of Birkenau: Gas Shelters or Disinfesting Chambers?*” (www.codoh.com/granata/leichen.html)
- Merck, “*The Merck Manual of Diagnosis and Therapy. Section 13. Infectious Diseases. Chapter 159. Rickettsial Diseases*” (www.merck.com/pubs/mmanual/section13/chapter159/159a.htm)
- Nizkor (www2.ca.nizkor.org/features/qar/qar29.html)
- Charles Provan, “*No Holes? No Holocaust? A Study of the Holes in the Roof of Leichenkeller 1 of Krematorium II at Birkenau*” (www.revisingrevisionism.com)
- Report, Minnesota State University, “*Suicide fumes sicken nine Iowa students*”, Oct. 10, 1998 (www.mankato.msus.edu/depts/reporter/reparchive/10_15_98/campuscope.html)
- Germar Rudolf, “*A Fraudulent Attempt to Refute Mr. Death*” (www.vho.org/GB/c/GR/Fraudulent.html)
- Germar Rudolf, “*About true and false Perceptions*” (www.vho.org/GB/Books/cq/percept.html)
- Germar Rudolf, “*Cardinal Questions about Contemporary History*” (www.vho.org/GB/Books/cq)
- Germar Rudolf, “*Character Assassins*” (www.vho.org/GB/c/GR/CharacterAssassins.html)
- Germar Rudolf, “*Counter-Leuchter Expert Report: Scientific Trickery?*” (www.vho.org/GB/Books/cq/leuchter.html)
- Germar Rudolf, “*Critique of Claims Made by Robert Jan Van Pelt*” (www.vho.org/GB/c/GR/RudolfOnVanPelt.html)

- Germar Rudolf, “*Critique of the ‘Findings on Justification’ by Judge Gray*” (www.vho.org/GB/c/GR/CritiqueGray.html)
- Germar Rudolf, “*Critique of Truth and the Auschwitz-Lie*” (www.vho.org/GB/Books/cq/critique.html)
- Germar Rudolf, “*Some considerations about the ‘Gas Chambers’ of Auschwitz and Birkenau*” (www.vho.org/GB/c/GR/Green.html)
- Germar Rudolf, *The Rudolf Case* (www.vho.org/GB/Books/trc)
- Herbert Verbeke (ed.), “*Auschwitz: Plain Facts*” (www.vho.org/GB/Books/anf)

12.5. Courts Files, Governmental Documents

- Baden-Württemberg, Administrative Court, ref. IX 1496/79, decision on March 18, 1981
- Berlin, Public Attorney’s Office I in the District Court, ref. 81 Js 1385/95
- Böblingen, County Court, ref. 9 Gs 521/94; ref. 9(8) Gs 228/97
- Bonn, Bundesprüfstelle, letter to Vrij Historisch Onderzoek, May 12, 1998, ref. Pr. 273/98 UK/Schm (www.vho.org/censor/BPjS_vho.html); ref. No. 5490 (V); Ref. 5715(V)
- Cracow, *The Trial of Höß*, volume 11a.
- Federal Constitutional Court, Germany, ref. 1 BvR 408f./83
- Federal Supreme Court, Germany, ref. 1 StR 18/96; ref. 5 StR 485/01
- Frankfurt (Main), Public Prosecutor at the District Court, “*Strafsache beim Schwurgericht Frankfurt (Main) gegen Baer und Andere wegen Mordes*”, ref. 4 Js 444/59
- Frankfurt, Jury Court, ref. 50/4 Ks 2/63 (Auschwitz trial)
- Frankfurt, City of, Letter to the Bundesprüfstelle, April 27, 1998, ref. 51.16 schu
- Hagen, Jury Court, verdict from July 24, 1970, ref. 11 Ks 1/70, p. 97
- London, Queen’s Bench Division, Royal Courts of Justice, Strand, David John Cawdell Irving vs. (1) Penguin Books Limited, (2) Deborah E. Lipstadt, ref. 1996 I. No. 113: Robert Jan van Pelt, Pelt Report, introduced as evidence; Judgment of Judge Gray
- Mannheim, District Court, ref. (13) 5 Ns 67/96
- Munich, County Court, ref. 451 Cs 112 Js 3326/90; ref. 432 Cs 113 Js 3619/90; ref. 812 Gs 16/98
- Munich, Public Prosecution I, ref. 112 Js 11282/98
- Nuremberg Documents: NI-9098 (DEGESCH, *Acht Vorträge aus dem Arbeitsgebiet der DEGESCH*, 1942); 511-USSR; NI-9912(1) (*Richtlinien für die Anwendung von Blausäure (Zyklon) zur Ungeziefervertilgung (Entwesung)*, Gesundheitsanstalt des Protektorats Böhmen und Mähren, Prag o.J.); NI-11 396; 3868-PS (IMT volume 33, pp. 275ff.)
- Stuttgart, County Court, ref. 13 K 1329/94
- Stuttgart, District Court, ref. 17 KLs 83/94, Verdict and investigative files
- Stuttgart, Labor Court, Rudolf v. Max- Planck- Institute for Solid State Research, ref. 14 Ca 6663/93
- Stuttgart, Public Prosecutor, Criminal indictment, 19. April 1994, ref. 4 Js 34417/93
- Tübingen, County Court, ref. 4 Gs 173/95; ref. 4 Ls 15 Js 1535/95; ref. 4 Gs 312/2000
- U.S. Senate, Congressional Record-Senate No. 134, Sept. 26, 1949, pp. 10397ff.
- Vienna, District Court, trial against Gerd Honsik, April 4., April 30, May 4, 1992, ref. 20e Vr 14184 and Hv 5720/90; transcript of the expert opinion of Prof. Dr. G. Jagschitz, 3.-5. hearing days
- Vienna, District Court, trial against Walter Dejaco and Fritz Ertl, ref. 20 Vr 6575/72 (Hv56/72)

- Weinheim, County Court, ref. 2 Ds 11 Js 5428/97
- Deutsches Reich, “Anwendung von hochgiftigen Stoffen zur Schädlingsbekämpfung durch die Waffen-SS”, Rund-Erlaß des Reichsministers für Ernährung und Landwirtschaft vom April 3, 1941
- Deutsche Reichsbahn Eisenbahnverkehrsordnung (EVO, German Reich railway regulations), annex C to §54 EVO, Vorschriften über die nur bedingt zur Beförderung zugelassenen Gegenstände vom 1. Okt. 1938
- DIN: 3181 part 1 (draft); DIN 4108, part 3 to 5; 38 405, section D 13 & 14; 55,943, 55,945
- *Entseuchungs- und Entwesungsvorschrift für die Wehrmacht*, H. Dv. 194, M. Dv. Nr. 277, L. Dv. 416, Reichsdruckerei, Berlin 1939.
- Hauptverband der gewerblichen Berufsgenossenschaften, *Atenschutz-Merkblatt*, Carl Heymanns Verlag, Cologne Oct. 1981
- Robert Kühn, Karl Birett, *Merkblätter Gefährlicher Arbeitsstoffe*, ecomed, Landsberg 1990: *Technische Regeln für Gefahrstoffe, TRGS 512, Begasungen*, BARbBl. Nr. 10/1989
- Franz Puntigam, Hermann Breymesser, Erich Bernfus, *Blausäuregaskammern zur Fleckfleberabwehr*, Sonderveröffentlichung des Reichsarbeitsblattes, Berlin 1943
- Willibald Schütz, “Explosionsgefährlichkeit gasförmiger Entwesungsmittel”, *Reichsarbeitsblatt*, Teil III (Arbeitsschutz no. 6), no. 17/18 (1943), pp. 198-207
- War Department, *Hydrocyanic-Acid-Gas Mask*, US Government Printing Office, Washington 1932
- War Department, *Technical Manual No. 3-205*, US Government Printing Office, Washington 1941

12.6. Video, Audio, and Unpublished Documents

- Amnesty International, *Botched Executions*, Fact Sheet December 1996, Amnesty International USA, 322 Eighth Avenue, New York, NY 10001-4808.
- Hellmuth Auerbach, Institut für Zeitgeschichte, letter to Bundesprüfstelle, Munich, Oct. 10, 1989
- Hellmuth Auerbach, Institut für Zeitgeschichte, letter to Bundesprüfstelle, Munich, November 1989
- Hellmuth Auerbach, Institut für Zeitgeschichte, letter, Munich, March 20, 1992
- Auschwitz State Museum, letter to Joel P. Hayward, ref. I-8523/26/2120/ 91, dated May 7, 1991
- Willy Dreßen, Zentrale Stelle der Landesjustizverwaltung Baden-Württemberg, Ludwigsburg, letters to Karl Philipp, ref. 110 AR 916/89, July 26, 1989, and Oct. 11, 1989
- Dieter Ebeling’s response to numerous queries to the Stuttgarter dpa bureau, April 13, 1994
- Dr. Ulrich Goll, Ministry of Justice of Baden-Württemberg, letter to Parliament Baden-Württemberg, ref. 4104—III/185, Sept. 23, 1996
- IHR, *66 Questions and Answers on the Holocaust*, flyer, Institute for Historical Review, Costa Mesa, undated.
- Jan Konieczny, *The Soviets, But Not the Western Allies, Should Have Bombed the Auschwitz Camp*, Polish Historical Society, unpublished paper.
- Wolfgang Lambrecht, Otto Karl, *Das Handelsprodukt Zyklon B*, unpublished manuscript
- Fredrick A. Leuchter, Boston, FAX to H. Herrmann dated April, 20, 1992
- Jan Markiewicz, Wojciech Gubala, Jerzy Labedz, B. Trzcinska, *Expert Opinion*, Prof. Dr. Jan

- Sehn Institute for Forensic Reserach, department for toxicology, Cracow, Sept. 24, 1990
- Errol Morris “*Mr. Death: The Rise and Fall of Fred A. Leuchter, Jr.*” documentary, VHS video.
- Pfeiffer, Hansa Luftbild GmbH, aerial photographic analysis of Allied photograph dated Aug. 25, 1944, letter dated July 17, 1991
- Germar Rudolf, press release, April 8, 1994
- Dr. Scheel, Bonn, German Foreign Office, letter to Mr. Stuparek, Jan. 8, 1979, ref. 214-E-Stuparek
- Prof. Dr. Jan Sehn Institute for Forensic Expert Opinions, Department for Forensic Toxicology, Cracow, letter to W. Wegner, undated (winter 91/92)
- AV Tuisconia Königsberg zu Bonn, written decision of the Conduct Court against Germar Rudolf, Aug. 20, 1995
- University of Stuttgart, letter exchange between with Germar Rudolf (vho.org/Authors/UniStgt.html and vho.org/Authors/RudolfUniStgt.html)
- Dr. Weber of the Bavarian State Ministry of the Interior, Letter to Hans-Jürgen Witzsch, Oct. 13, 1998, ref. IF1-1335.31-1
- H. Winkler, Degussa AG, letter to this author, June 18, 1991.

- ARD *Panorama*, May 1995
- ARD *Report*, April 11, 1994
- ARD *Tagesthemen*, June 6, 1996
- BBC, March 28, 2000, news report about G. Rudolf
- BRT 1 (Belgian Television), *Panorama*, April 27, 1995
- David Cole, “*David Cole Interviews Dr. Franciszek Piper, Director, Auschwitz State Museum*” , VHS Video, distributed by CODOH, P.O. Box 439016, San Diego, CA 92143, USA
- ITV (southeast England), March 29, 2000, news report about G. Rudolf
- Süddeutscher Rundfunk, news reports on G. Rudolf in all four afternoon radio programs on Nov. 25, 1994
- Süddeutscher Rundfunk 3, June 23, 1995, 13:30 hours
- Südwest 3 TV station, *Landesschau*, December 27, 1994, report on Germar Rudolf, available as VHS entitled “*Neo-Nazi*” distributed by the Süddeutscher Rundfunk
- ZDF *heute*, June 23, 1995

13. Lists

13.1. List of Tables

	Page
Table 1: Arguments relating to the Zyklon B introduction columns.....	134
Table 2: Equipment and suitability of actual or alleged ‘gas chambers’.....	146
Table 3: Physical Properties of HCN.....	156
Table 4: Formation of Iron Blue.....	169
Table 5: Dissociation constants and solubility products of iron compounds.....	175
Table 6: Composition of Portland cement.....	183
Table 7: Absorption of hydrogen cyanide by various building materials.....	187
Table 8: Effect of various concentrations of hydrogen cyanide in air upon human beings.....	192
Table 9: Reduction of O ₂ content in air-tight morgue 1 as a function of time.....	214
Table 10: Amount of hydrogen cyanide as a function of execution time.....	215
Table 11: Some values of the ventilation efficiency of a hypothetical homicidal ‘gas chamber’, with Zyklon B remaining in the chamber.....	226
Table 12: Some values of the ventilation efficiency of a hypothetical homicidal ‘gas chamber’, with Zyklon B removed from chamber.....	226
Table 13: Quasi-stationary concentrations of HCN in masonry in percent of saturation, as a function of daily exposure time to HCN.....	229
Table 14: Maximally admissible concentration of harmful compound for protection filters.....	230
Table 15: Minimum break through times for filters.....	231
Table 16: Evaluation of eyewitnesses.....	236
Table 17: Cyanide concentrations in the masonry of ‘gas cham-	

bers'/disinfestation chambers according to F.A. Leuchter	249
Table 18: Cyanide concentrations in the masonry of 'gas chambers'/disinfestation chambers according to the Jan Sehn Institute for Forensic Research.....	251
Table 19: Cyanide concentrations in the masonry of 'gas chambers'/disinfestation chambers according to G. Rudolf.....	254
Table 20: Analysis results from the Institut Fresenius and the Institut für Umweltanalytik.....	258
Table 21: Test sample preparation and fumigation.....	267
Table 22: Cyanide concentrations in the masonry of 'gas chambers'/ disinfestation chambers according to J.C. Ball	268
Table 23: Orders of magnitude of analytical results of various samples.....	272
Table 24: Comparison between cases of building damage, morgue and disinfestation chamber	281

13.2. List of Illustrations

	Page
Figure 1: Schematic drawing of the US execution gas chamber in North Carolina	11
Figure 2: How to get rid of termites	15
Figure 3: Inky blue stains on the plaster of a church fumigated with hydrogen cyanide.....	20
Figure 4: The Protestant church at Meeder-Wiesefeld.....	21
Figure 5: Single door to an execution gas chamber for one single person per gassing procedure (Baltimore, USA).....	24
Figure 6: Door of an alleged National Socialist gas chamber for the execution of hundreds of persons simultaneously (crematorium I, Auschwitz)	24
Figure 7: Frederick A. Leuchter	25
Figure 8: Prof. Dr. Robert Faurisson	29
Figure 9: Prof. Faurisson after an attack by Jewish thugs.....	37
Figure 10: Map of the surrounding vicinity of Auschwitz during the Second World War.....	56
Figure 11: Map of Auschwitz I/Main Camp (concentration	

camp)	57
Figure 12: Map of POW camp Auschwitz II/Birkenau.....	58
Figure 13: A lice-ridden train enters a railway gassing tunnel in Budapest	62
Figure 14: DEGESCH delousing chamber with circulation fea- ture.....	64
Figure 15: Schematic organization of a hygiene complex	65
Figure 16: Typical advertisement of the firm DEGESCH	66
Figure 17: Ground plan of the HCN disinfestation wing of building 5a before building alterations (mirror im- age) and BW 5b today	74
Figure 18: Ground plan of the hot air disinfestation wing of building 5a after building alterations in 1943	75
Figure 19: Ventilation outlets from the disinfestation wing of building BW 5b.....	76
Figure 20: Water pipe system with shower heads in the disin- festation wing of building BW 5b.....	78
Figure 21: Ground plan of crematorium I in Auschwitz I/main camp in its original planning condition	80
Figure 22: Ground plan of crematorium I Auschwitz I Main Camp after conversion to air raid shelter.....	81
Figure 23: Ground plan of crematorium I in Auschwitz I/Main Camp today.....	82
Figure 24f.: Symptoms of decay visible on the interior ceiling of the morgue of crematorium I in Auschwitz Main Camp.....	86
Figure 26: Ground plan of morgue 1 (alleged ‘gas chamber’) of Crematoria II and III (mirror symmetrical) in Auschwitz II/Birkenau	92
Figure 27: Cross-section of morgue 1 (alleged ‘gas chamber’) of crematoria II and III (mirror symmetrical) in Auschwitz II/Birkenau	92
Figure 28: Schematic location of the new crematorium as originally planned for the Auschwitz main camp.....	95
Figure 29: Schematic location of crematorium II, altered plan for Birkenau	95
Figure 30: “Re.: Auschwitz crematorium [...] Caulking work performed for the disinfestation installation”	100
Figure 31: “Re: BW: 32 = Disinfestation installation [...]”	

	Caulking work performed for the disinfestation installation”	101
Figure 32:	“2 Topf disinfestation ovens for crematorium II in the Prisoner of War Camp, Auschwitz.”	102
Figure 33:	Wooden disinfestation chamber door at Auschwitz.....	103
Figure 34:	German air-raid shelter door.....	104
Figure 35:	Photograph of two indicator devices from the Siemens; component of a gas tester	112
Figure 36:	Photograph of crematorium II of Birkenau taken in February 1943	114
Figure 37:	Magnification of detail from Fig. 36 with outlines of the morgue and scale of measurements drawn in	115
Figure 38:	Schematic drawing of a view onto morgue 1 of crematorium II	115
Figure 39:	Photograph of crematorium II from Jan. 20, 1943.....	116
Figure 40:	Enlargement of Allied air photo RG 373 Can F 5367, exp. 3185 of Birkenau camp, taken on August 25, 1944	117
Figure 41:	Schematic drawing of the air photo in Fig. 40.....	117
Figure 42:	Schematic drawing of the location and size of the spots on the roof of morgue 1 (the ‘gas chamber’) of crematorium II	118
Figure 43:	Interior photograph taken from the ruins of morgue 1 (‘gas chamber’) of crematorium II.....	119
Figure 44:	Alleged Zyklon B introduction hole in the ceiling of morgue 1 (‘gas chamber’) of crematorium II, entry to the still passable part of the cellar.....	120
Figure 45:	Ceiling of morgue 1 (‘gas chamber’) of crematorium II ...	121
Figure 46:	Alleged Zyklon B introduction hole in the roof of morgue 1 (‘gas chamber’) of crematorium II in December 1991.....	122
Figure 47:	Hoop iron with dovetail, cast in cement in a hole in concrete.....	123
Figure 48:	Notch (fatigue) effect resulting at inserted openings from the application of force.....	124
Figs. 49-53:	The five properly constructed ventilation holes in the ceiling of the oven room to the upper story, crematorium III.....	126
Figure 54:	J.-C. Pressac’s drawing of the legendary “Zyklon B	

	introduction columns”	130
Figure 55:	Handwritten entries in an inventory list of crematorium II for morgue 2	130
Figure 56:	North view and ground plan of crematorium IV and/or V (mirror image) in Auschwitz II/Birkenau	135
Figure 57:	Then and today—the unchanged ground water state in the Birkenau camp, here in midsummer 1991	142
Figure 58:	White circles: possible sites of old mass graves of typhus victims in Auschwitz.....	144
Figure 59:	Interior room in the Zyklon B disinfestation wing of BW 5a in the Birkenau camp.....	color section, 153
Figure 60:	Exterior wall of the Zyklon B disinfestation wing of BW 5b in the Birkenau camp.....	color section, 153
Figure 61:	Zyklon B disinfestation installation, chamber III of barrack 41 in Majdanek camp	color section, 153
Figure 62:	Zyklon B disinfestation installation, east wall of chamber III, barrack 41, Majdanek.....	color section, 153
Figure 63:	Large Zyklon B disinfestation chamber, ceiling, barrack 41 in Majdanek camp.....	color section, 153
Figure 64:	Zyklon B disinfestation installation, exterior wall of barrack 41 in Majdanek camp.....	color section, 153
Figure 65:	Zyklon B disinfestation chamber in Stutthof camp, interior.....	color section, 154
Figure 66:	Zyklon B disinfestation chamber in Stutthof camp, east side, exterior	color section, 154
Figure 67:	Sketch of morgue 1 (‘gas chamber’) of crematorium II in Birkenau with test sample taking locations by F.A. Leuchter	248
Figure 68:	The outside of the external wall of hydrogen cyanide delousing wing of building 5a in August 1991	259
Figure 69:	Interior room in the Zyklon B disinfestation wing of BW 5a in the Birkenau camp (same as Fig. 59)	260
Figure 70:	Picture of the door frame in disinfestation wing of building 5a	261
Figure 71:	Exterior wall of the Zyklon B disinfestation wing of BW 5b in the Birkenau camp (same as Fig. 60)	262
Figure 72:	Construction drawing of the experimental container for the fumigation of material samples with hydrogen cyanide	266

Unnumbered:

Letter by Michel Adam Nov. 2, 1997.....	240
Results of analyses by Institut Fresenius.....	256
Otto Ernst Remer.....	353
Building of Institut Fresenius.....	354
Viktor Robert Knirsch.....	356
Hajo Herrmann.....	363
Letter Moritz Rotberg, Holon, Israel.....	364
Dr. Herbert Schaller.....	366
Dr. Joachim Hoffmann.....	374
Germar Rudolf.....	421

13.3. List of Graphs

	Page
Graph 1: Vapor pressure of hydrogen cyanide in percentage of air pressure as a function of temperature.....	157
Graph 2: Saturation concentration of hydrogen cyanide in water as a function of temperature at 1 mol% HCN in the air.....	165
Graph 3: Degree of coverage of the surface of a solid material with an adsorbed gas as a function of temperature.....	167
Graph 4: Degree of disassociation of hydrogen cyanide as a function of the pH value at room temperature.....	168
Graph 5: Cyanide equilibrium concentration in water as a function of the temperature and pH value.....	169
Graph 6: Free Fe ³⁺ concentration as a function of pH value and the resulting minimal pKS value of Iron Blue.....	174
Graph 7: Accumulated pore volume distribution of concrete and of wall mortar.....	183
Graph 8: Drop in the hydrogen cyanide concentration in old, dry, cement blocks, after 24-hour fumigation.....	189
Graph 9: Evaporation rate of hydrogen cyanide from the Ercco carrier material.....	195
Graph 10: Schematic representation of the breathing volume behavior relative to time in case of suffocation/poisoning.....	213

Graph 11: Incorporated amount of HCN as function of time until respiratory arrest.....	214
Graph 12: Hydrogen cyanide concentration behavior in delousing chamber with and without circulating air systems.....	216
Graph 13: Hydrogen cyanide concentration behavior in disinfection chamber with and without clothes.....	217
Graph 14: Relation between hydrogen cyanide adsorption on clothing and temperature in a delousing chamber	217
Graph 15: Simulation of the concentration of hydrogen cyanide in a hypothetical homicidal 'gas chamber'	224

13.4. List of Abbreviations

APMO	Archiwum Panstwowego Muzeum w Oswiecimiu
DIN	Deutsches Institut für Normung
DGG	Deutschland in Geschichte und Gegenwart
IMT	International Military Tribunal/Internationaler Militärgerichtshof
JHR	The Journal of Historical Review
TCIDK	Tsentr Chranenija Istoriko-dokumental'nich Kollektzii (recently renamed to Rossiskii Gosudarstvennii Vojennii Archiv)
VffG	Vierteljahreshefte für freie Geschichtsforschung

14. Index

Names, locations, topics. Entries in footnotes in italics. Topics covered by certain chapters are not included. Names and locations in source references, in the bibliography and in lists are not included.

— A —

absorption: *151*
 Academy of Sciences, French: 35
 Adam, Michel: 238
 Administrative Court, Baden-Württemberg: 409
 adsorption: *151*
 Afghanistan: 297
 Allègre, Claude: 239
 Allgemeine Jüdische Wochenzeitung: 359, 368
 Alpha Analytic Laboratories: 246, 247, 249, 273
 Amnesty International: 12
 Andres, Bernhard: 304
 ANEC: 238
 ARD
 Panorama: 389, 410
 Report: 383, 387, 388, 389, 390
 Tagesthemen: 389
 ARED GmbH: 293
 Armontrout, Bill: 14, 26
 Arolsen: 362
 Ashland, MA: 246, 249, 273
 Asia Minor: 60
 Auschwitz: *passim*.
 Auschwitz State Museum: 34, 46, 53, 57, 58, 94, *121*, *127*, 129, 136, 152, 245, 357
 Auschwitz Trial
 Cracow: 42
 Frankfurt: 44, 45, 46, 139, 317, 346, 353, 359, 360, 361, 365
 Vienna: 45, 89
 Australia: 32, 332
 Austria: 32, 33, 45, 299, 319, 332, 356, 384
 Austro-Hungarian Monarchy: 53, 79

— B —

Babi Yar: 376
 Bad Kissingen, Germany: 316, 337, 352
 Bahners, Patrick: 325, 326, 327
 Bailer, Josef: 33, 34, 211, 212, 248, 252, 269, 270
 Balkan: 60
 Ball, John Clive: 119, 145, 246, 268, 272, 294
 Baltimore: 24
 Barford, engineer: 129
 Barzel, Rainer: 414
 Bastian, Till: 338
 Baumann, prosecutor: 356, 359, 364, 405
 Bautzen: 367
 Bavarian Ministry of the Interior: 180
 Bayern 1 radio: 356
 Beethoven, Ludwig van: 50
 Belgium: 32
 Bendel, Charles S.: *203*, *206*
 Benroubi, Maurice: 139
 Benz, Wolfgang: 375
 Berg, Friedrich Paul: *128*, 242, 294
 Berglar, Peter: 414
 Berlin: 66, 67, 138, 304, 307, 366
 Olympics: 73
 Wall: 306
 Berlin Blue: 158, 251
 Besnard, Marie: 40
 BET: 181
 Bielefeld: 405
 Birkenau: *passim*.
 family camp: 50, 58
 gypsy camp: 58
 Hungarian camp: 58
 pond: 142
 Bischoff, Karl: 98, 110
 Blobel, Paul: 376
 blue cloud in 'gas chamber': 203, 204, 236

Blüm, Norbert: 306
Bock, Ludwig: 331
Böck, Richard: 139, 197, 199, 203, 204,
205, 353, 354, 361, 362
bones: 46, 145
Boston, MA: 23, 245
Brauner, Aze: 349
British National Party: 399
Broad, Pery S.: 79, 86, 139, 346
Broszat, Martin: 199, 201
Bubis, Ignatz: 393, 394, 407, 408
Buchenwald: 29
Buchy, France: 20
Bühler, Karlheinz: 416
Buki, Milton: 139
Bulgaria: 201
Bünde, north Germany: 404
Bundesarchiv-Militärarchiv: 293
Bundesprüfstelle für jugendgefährdende
Schriften: 295, 377, 379, 380
Bundeswehr: 307, 370
Buser, H.J.: 159, 164
Butz, Arthur R.: 29, 31, 278

— C —

Canada: 23, 32, 119, 332
Canada I: 68
capillary condensation: 157
carbon monoxide: 20, 241, 243
Cartell-Verband der katholischen
deutschen Studentenverbindungen:
414
CDU: 297, 305, 306, 307, 395
Charbonnages de France: 238
chemisorption: 151
Christmann, Carl Hermann: 22, 123, 275,
294
Church of the Holy Juraj, Croatia: 17
CIA: 119
city gas: 179, 241, 242, 243
Clarke, Bernard: 197
coke gas: 241
Cole, David: 49, 51
common knowledge: 197, 199, 202, 331,
347, 348, 356, 358, 359, 360, 361,
362, 363, 364, 365, 367, 411
Conan, Eric: 84

concentration: 155
Countess, Elda: 294
Countess, Robert H.: 294, 422
County Court
Berlin Tiergarten: 295, 378
Böblingen: 295, 378, 379
Munich: 295, 338, 378, 380
Stuttgart: 410
Tübingen: 295, 324, 325, 369, 377,
381, 389
Weinheim: 295, 378
Court Toronto: 25, 26
Cracow, Poland: 34, 46
crematoria II/III: chapter 5.4.1., and
passim.
crematoria IV/V: chapter 5.4.2., and
passim.
crematorium I: chapter 5.3., and passim.
Croatia: 16
Crowell, Samuel: 106
CSU: 297, 298, 301, 395
Czech, Danuta: 51, 68, 114
Czechoslovakia: 298, 299

— D —

Dachau: 65, 152, 347, 348, 358, 363, 364
Damon, James M.: 294
Deana, Franco: 244
Deckert, Günter: 326, 330, 370, 411, 412
Degesch: 24, 61, 63, 64, 65, 66, 74, 194,
195, 216, 244
Kreislaufverfahren: 63, 64, 65, 70, 72,
108, 132, 137, 152, 216, 217, 218
Degussa AG: 171, 293, 388
Dejaco, Walter: 45, 89
Delta, B.C.: 246
Demjanjuk, John: 348
Der Spiegel: 148, 206, 352
Detia Freyberg GmbH: 293
Detscher: 338
Deutsche Ausrüstungs-Werke: 68, 110
Deutsche Presseagentur: 17, 179, 180,
273, 383, 385, 386, 387, 390, 394,
396, 398, 400, 401, 413
Deutschland Report: 384, 412
Diesel engine exhaust: 241, 242
dispersion: 159

- dissociation: 160
 District and Chamber Court of Berlin: 358
 District Court
 Bielefeld: 338
 Hamburg: 331
 Mannheim: 411
 Munich: 338
 Schweinfurt: 334, 352, 356
 Stuttgart: 295, 306, 316, 324, 332,
 340, 345, 346, 349, 384, 389, 390,
 392, 394, 402, 411, 412, 416
 Diwald, Hellmut: 294
 Dominguez, Scott: 18
 doors, gas-tight: 24, 63, 82, 83, 103, 104,
 105, 137, 263
 Dora-Mittelbau: 29
 Dragan, Myrosław: 143, 294
 Dragon, Szlama: 139
 Drahtnetzeinschubvorrichtungen = wire
 mesh push-in devices: 114, 131
 Dreßen, Willy: 204
 Dwork, Deborah: 52, 85
 Dyba, Archbishop Johannes: 414
 dynamite: 157
- E —
- East Prussia: 272, 298, 371
 Ebeling, Dieter: 386, 387
 Ehrenburg, Ilya: 349, 374, 375, 376
 Eichmann, Adolf: 242
 Einsatzgruppen: 40, 373
 Einsatzkommando: 376
 Elias, Allan: 18
 Engelhard, Hans. A: 300, 357
 England: 398, 399, 400, 401, 418, 421
 Ercco, Zyklon B: 194, 195
 Ertl, Fritz: 45, 89
 Evans, Sheila: 399, 400
 Evergreen Resources: 18
 experimental gas chamber: 265, 266
- F —
- Fabius-Gayssot, law: 32
 Faith, Linda M.: 294
 farmhouses: 1, 55, 137, 139, 140, 141,
 146, 204, 208, 227, 232, 234, 287, 290
 Faßbender, R.: 123, 294
- fat, human
 for cremation: 199, 200, 201, 202, 237
 for soap: 349
 Faurisson, Robert: 23, 25, 26, 29, 30, 31,
 37, 42, 46, 84, 88, 104, 129, 133, 149,
 293, 336, 339, 340
 FDP: 305, 306, 307, 308
 Federal Constitutional Court, German:
 326, 327, 328, 385
 Federal Supreme Court, German: 324,
 331, 333, 334, 341, 345, 385, 397, 412
 Fick's law of diffusion: 228
 Filbinger, Hans: 309
 Fischer, Konrad: 21, 280, 294
 flames
 cremation pits: 145, 204, 234, 287
 crematorium chimney: 202, 203, 237
 Fleckfieber: 59
 Fleißner, Herbert: 318
 Florence, AZ: 12
 Flury, Ferdinand: 192
 Forschungs- und Materialprüfungsanstalt,
 Stuttgart: 183, 293
 Forschungsinstitut für Pigmente und
 Lacke e.V.: 293
 Förster, Gerhard: 294
 France: 238
 Franciszek Piper: 49, 81, 136, 357
 Frankfurt Auschwitz Trial: 197
 Frankfurt, Germany: 302, 307, 366
 Free University of Berlin: 371
 Freiburg, Germany: 293, 370, 372
 Friedmann, Bernhard: 306
 Friedrich Wilhelm, Prince von
 Hohenzollern: 414
 Fuetterer, Andrew: 294
- G —
- Garbarz, Moshe Maurice: 139
 Gärtner, Michael: 142, 144, 294
 gas chamber: passim.
 Gassing Cellar: 96, 97
 Gaus, Ernst: 369, 371, 373, 375, 376,
 379, 381, 393
 Geißler, Heiner: 306
 Genscher, Hans-Dietrich: 299, 356
 German Democratic Republic: 367

Germany: 32
Ginsburg, Josef: 29
Glücks, Richard: 110
Göbel, Klaus: 294
Goebbels, Joseph: 373
Gottschalk, Thomas: 414
Grabert Verlag: 327, 371
Grabert, Wigbert: 369, 370
Graf, Jürgen: 381
Green, Richard J.: 276, 277, 278, 279
Griffin, Nick: 399
Grimm, Carl T.: 17
Grinnell College: 17
Grinnell Regional Medical Center: 17
Gross, Johannes: 404
GRÜNE: 305, 417
Guarantee Fumigation Company: 15

— H —

Habsburg, Otto von: 414
hair: 41, 42, 43, 46, 274
hair clasps: 42, 43
hair cut: 54, 64, 207
Haller, E.: 355
Hamburg: 386, 417
Hansa Luftbild: 362
Hastings, Chris: 398, 399, 400
Hastings, East Sussex: 398, 400, 401
hatches, gas-tight: 136
Haverbeck, Werner Georg: 294, 338
Heepke, Wilhem: 108
Hepp, Robert: 294
Herrmann, Hajo: 294, 313, 333, 334, 337,
353, 358, 359, 360, 362, 363, 365
Herzogenrath-Amelung, Günther: 294,
417
Hilberg, Raul: 359, 381
Himmler, Heinrich: 373
Hinsley, Francis H.: 361
Hitler, Adolf: 30, 37, 271, 278, 300, 303,
304, 312, 316, 360, 373, 409
Hoerbst, Günther: 401
Höfer, Werner: 309
Hoffmann, Joachim: 294, 370, 371, 374,
377
Höffner, Josef Cardinal: 414
Holocaust Survivors and Friends in

Pursuit of Justice: 27
Holon, Israel: 364
Honsik, Gerd: 338, 356
Höb, Rudolf: 79, 86, 139, 197, 199, 200,
201, 206, 346, 363
Höttl, Wilhelm: 374
Humphrey, Michael: 294
Hundseder, Franziska: 388, 390, 410
Hungarian Jews: 140
Hungary: 32, 201
Hupka, Herbert: 414
Huta: 89, 90, 91, 96
Hydrokop: 46
Hygieneinstitut der Waffen-SS: 66

— I —

I.G. Farbenindustrie AG: 53, 56, 154, 242,
243
Institut Fresenius: 246, 247, 252, 254,
255, 258, 293, 320, 354, 357, 361,
383, 388, 408
Institut für Umweltanalytik: 293
Institut für Zeitgeschichte: 33, 44, 121,
313, 317
Institute for Historical Review: 25
Irmscher, Richard: 194, 195, 196, 224
Iron Blue: *passim*
Irving, David: 36, 129, 273, 274, 338, 401
Israel: 50, 347, 348, 362, 364, 369

— J —

Jährling, Rudolf: 72, 113
Jail fever: 59
Jakobovits, Immanuel: 367
Jan Sehn Institute, Cracow: 34, 42, 43, 44,
46, 245, 246, 250, 251, 270, 277, 279,
357, 412
Jefferson City: 14, 26
Jenninger, Philipp: 309, 414
Jerusalem: 348, 349
Jerusalem Post: 49
Jettingen: 398, 415
Junge Union: 306
Jungen Freiheit: 310, 313
Jury Court, Frankfurt: see

— K —

Kahlenbergedorf, Autria: 356
 Kammerer, Rüdiger: 379
 Kammler, Hans: 71
 Karl, Otto: 294
 Karlsruhe: 104
 Katyn: 41, 42, 358
 Kelkheim, Germany: 181, 293
 Khan, Genghis: 37
 Kiefer, Markus: 415
 Klarsfeld, Beate: 26
 Knirsch, Viktor Robert: 356
 Knödler, Heinz: 294
 Kogon, Eugen: 312, 359
 Kohl, Helmut: 306
 Köhler, Manfred: 379
 Kohn, M.: 176
 Königsberg, East Prussia: 298, 371
 Konrad, Christian: 338
 Konrich, Friedrich: 60
 Körber, Hermann: 404, 405, 406
 Kosovo: 40, 41
 Kremer, Johann Paul: 139
 Kretschmer, Werner: 338
 Krleza, F.: 173, 175
 Kula, Michal: 130, 131, 133, 192, 196
 Kulaszka, Barbara: 26
 Kyiv, Ukrain: 376

— L —

Labor Court Stuttgart: 388
 Lachout, Emil: 294
 LaGrand, Walter: 12
 lampshades made of human skin: 349
 Langbein, Hermann: 360
 Langmuire: 167
 Lawson, David: 11
 LD₁₀₀: 193
 Le Monde: 30, 359
 Leipprand, Horst: 294
 Lettich, André: 139
 Leuchter Report: 26, 29, 31, 32, 33, 34,
 36, 310, 312, 357
 Leuchter, Frederick A.: 13, 14, 23, 25, 26,
 27, 34, 46, 91, 141, 149, 154, 193,
 245, 247, 248, 249, 250, 252, 253,
 258, 272, 273, 274, 276, 288, 312,

330, 338, 357, 390, 406
 ligand: 164
 Limburg, Germany: 421
 Lipstadt, Deborah E.: 36, 129, 273, 401
 Lober, Jochen: 404
 London Agreement: 198
 London, England: 178, 398
 Los Angeles: 15
 Lovran, Croatia: 17
 Lübeck, Germany: 387, 388
 Lublin: see Majdanek
 Lüftl, Walter: 21, 294
 Luftwaffe: 313, 421
 Lummert, Horst: 394

— M —

Maier, Sonnhild: 392
 Majdanek: 23, 25, 99, 153, 274, 358, 380
 Markiewicz, Jan: 34, 245, 246, 250, 251,
 270, 271, 272, 273, 278, 279, 294
 Mattogno, Carlo: 95, 97, 110, 113, 125,
 130, 140, 143, 144, 153, 154, 244,
 245, 294, 381
 Max-Planck-Corporation, Munich: 384,
 385, 386, 407, 408, 413
 Max-Planck-Institute for Solid State
 Research, Stuttgart: 39, 46, 295, 321,
 322, 367, 383, 385, 393, 407, 408,
 409, 413, 421
 Mayer, Arno J.: 360
 Mayer, Dietmar: 411, 414, 417
 Meinecke, Albert: 180, 273, 385, 386
 Mexico: 60
 Meyer, Fritjof: 148, 352
 Militärgeschichtliche Forschungsamt: 370,
 371, 372, 376
 Ministry of Justice, Baden-Württemberg:
 327
 Mohler, Armin: 308, 309, 310
 mol: 165
 Monowitz: 53, 243
 Montérolier: 20
 Mösbauer, Rudolf: 158
 Moscow: 53, 94, 362
 Munich: 44, 353, 379
 Murphy, Kim: 401

— N —

Nantes: 238
National Front: 398, 399
Neumaier, Arnulf: 294
New South Wales, Australia: 50
Niyszli, Milkos: 203, 206
NKVD: 373
Nolte, Ernst: 294
northern Africa: 60
Nowak, Hans Jürgen: 105
NPD: 302, 303, 330
nucleophilic: 161
Nuremberg: 404
Nuremberg Tribunal: 40, 198, 199, 211,
212, 358, 359, 363, 365, 367, 374

— O —

ÖDP: 307
Orlet, Rainer: 330, 369

— P —

Paris: 31
partial pressure: 165
Payer, judge Dr.: 378
Pechiney-Ugine-Kuhlmann: 238
Pelt, Robert Jan van: 35, 36, 46, 52, 85,
91, 99, 110, 127, 128, 129, 130, 226,
274, 278
Peters, Gerhard: 62
pH: 162
Philipp, Karl: 153, 293, 316, 337, 338
phosgene: 241
photolysis: 177
physisorption: 151
Pilsen: 299
pK_s: 172
Placentia, CA: 17
Pocatello, ID: 18
Poland: 23, 32, 34, 42, 49, 53, 79, 243,
246, 272, 273, 298, 299, 373
Political Asylum: 418
Pomerania: 272
Porter, Carlos: 294
Post, Walter: 294
Prague, Czechia: 53
Pressac, Jean-Claude: 33, 36, 46, 51, 52,
53, 68, 69, 78, 79, 81, 82, 83, 93, 94,

97, 99, 105, 108, 114, 116, 122, 124,
127, 130, 133, 135, 136, 137, 138,
139, 141, 201, 203, 205, 206, 207,
208, 211, 212, 226, 232, 233, 234,
245, 249, 287, 346, 350
process gas: 241, 242, 243
producer gas: 241, 242
protolysis: 168
Provan, Charles D.: 129, 130, 294
Prowazek, scientist: 59
Prüfer, Kurt: 98
Prussian Blue: 152, 178. = Iron Blue

— Q —

quantum efficiency: 177

— R —

Rademacher, Werner: 105, 113, 138, 143,
144
Rahm, Director: 364
Rajsko: 66
Raleigh, NC: 11, 194
Ranke, Leopold: 37
Rassinier, Paul: 29, 308
Ratzinger, Joseph Cardinal: 414
Ravensbrück: 238
Reich, Harald: 294
Reitlinger, Gerald: 359
Rembiszewski, Sarah: 417
Remer Depesche: 355, 357, 358, 384, 405,
406, 412
Remer, Anneliese: 316, 322
Remer, Otto Ernst: 246, 293, 313, 316,
317, 319, 320, 321, 322, 323, 324,
333, 334, 335, 336, 337, 338, 339,
341, 342, 345, 346, 347, 348, 349,
351, 352, 353, 355, 356, 357, 358,
359, 361, 362, 366, 367, 368, 369,
383, 384, 393, 395, 396, 405, 406,
407, 409, 411
Republikaner: 301, 302, 304, 305, 306,
307, 308, 313
Resistance, French: 29, 308
Reynouard, Vincent: 239
Ricketts, scientist: 59
Rickettsia: 59
Rieger, Jürgen: 294, 331

- Rijeka, Croatia: 17
 Rocker, Stefan: 387, 389
 Roding, Germany: 336, 337
 Romania: 201
 Roth, James: 246, 247, 273, 274, 275, 276
 Roubeix, Gérard: 238, 239
 Rückerl, Adalbert: 44
 Rudolf, Georg Hermann: 418
 Rudolf, Germar: 46, 245, 247, 252, 254, 255, 272, 276, 279, 290, 371, 372.
 chapter 11
 Rudolf, Ursula: 414
 Russia: 60
 campaign WWI: 59
 campaign WWII: 53
 government: 41
- S —
- Sachsenhausen: 88
 Sarin: 241
 Sassmannshausen, Jörg: 407
 SAT 1 TV: 407
 Saxony: 305
 Schaller, Herbert: 294, 319, 358, 360, 365, 366, 367
 Scheel, Dr.: 346, 356
 Schlee, Emil: 294
 Schmidt, Robert F.: 232
 Schnering, Hans Georg von: 318, 407, 409, 410
 Scholz, Rainer: 338
 Schreiber, Walter: 89, 106
 Schwaibold, Frank: 393, 394, 395
 Schweinfurt, Germany: 358, 405
 Sedlatschek: 416
 Seine-Maritime: 20
 Self-Evidentness: 373, 374, 375
 Serbia: 297
 Shapiro, Shelly: 26
 shower heads: 97, 235
 showers: 96, 97, 98, 99, 219, 220, 235
 Siebenbürger, judge: 353, 356, 359, 364
 Siemens: 112
 Silesia: 272, 299
 Simon, Arndt: 407
 skin
 green/blue of gassing victims: 131, 192, 236
 lampshades made of human: 349
 poisoning through: 14, 20, 191, 192, 218, 232, 233, 236
 Sleipnir: 378, 412
 Slough, England: 178
 smoke
 from cremation pits: 140, 145, 204, 234, 287
 from crematorium chimney: 237
 smoking in ‘gas chamber’: 199
 soap
 from Jewish fat: 349, 375
 in ‘gas chamber’: 220
 Sobibor: 242
 Sola river: 141
 Soldat im Volk: 354
 Solms, Armin: 379
 solubility product: 172
 Sonderbehandlung: 109, 110, 417
 Sonderkommando: 98, 199, 201, 202, 208, 232, 234, 236, 287, 290
 Sorbonne: 31
 Soulié, Louis: 20
 Spain: 32, 316
 SPD: 305, 306, 307
 Special Treatment: 109, 110, 417
 Spotted Fever: 59
 St. Avold: 238
 Stäglich, Wilhelm: 312, 328, 336
 Stahl, Alexander von: 414
 Stalin, Joseph: 42, 349, 358, 374
 Stalingrad: 93
 State Security Department, German: 383
 Stein, Burkhardt: 369, 377
 Steinenbronn, Germany: 384, 416
 stern magazine: 407
 Stingl, Josef: 414
 Stomper, Herbert: 415
 Strauß, Franz-Josef: 297, 298, 301, 368, 369, 414
 Strauß, Marianne: 368
 Stromberger, Wilhelm: 110
 Stuparek: 356
 Stuttgart: 31, 39, 180, 183, 245, 247, 258, 293, 325, 383, 385
 Süddeutscher Rundfunk: 391, 394

Sudeten: 298, 299, 316
Südwestfunk: 391, 392, 394, 395
suspension: 159
Süssmuth, Rita: 306
Switzerland: 32
synagogue: 387

— T —

Tabun: 241
tageszeitung: 359
Tananaev, I.V.: 172, 173, 174, 175
Tarrassevich: 60
tartrate: 175
Tauber, Henryk: 122, 199, 201, 202, 203
Taunusstein: 246, 254, 293, 383
Tel Aviv: 323, 401, 417
Tesch und Stabenow: 113
Teschner, Susanne: 369
Thomas Dehler Stiftung: 404
thought criminal: 351
Töben, Fredrick: 125, 294, 331
Topf & Söhne: 97, 98, 99, 102, 107, 111,
112, 113, 133
Toronto: 23, 245, 274
towels
in 'gas chamber': 220
Treblinka: 358, 363, 381
Trombley, Stephen: 14
Tübingen, Germany: 325, 340, 371
Tuisconia Königsberg, fraternity: 414
Turnbull's Blue: 152, 178. = Iron Blue
typhus: 24, 54, 59, 60, 70, 74, 77, 110,
144, 241, 243
epidemic: 59
louse-borne: 59

— U —

Ugnow, W.A.: 188
Ullstein-Langen Müller: 318
Undressing Room: 64, 65, 96
University of Bonn: 297, 421
University of Cologne: 320
University of Hamburg: 371
University of Lyon II: 23, 30
University of Stuttgart: 295, 393, 409,
410, 421
University of Tel Aviv: 417

Upper District Court
Düsseldorf: 358, 359
Munich: 338
Upper Silesia: 51, 53, 177, 243, 244
USSR: 40, 299, 359, 362

— V —

VARTA Batterie AG: 181, 293
Vecernji List: 17
VEDAG Vereinigte Dachpappen-
Fabriken Aktiengesellschaft: 98, 99
Ventilation: 107, 145, 146, 221, 222, 223,
234, 237, 294
accident: 17
crematorium I: 80, 82, 83, 86, 200
crematorium II/III: 92, 106, 107, 108,
110, 111, 214, 223, 224, 225, 226,
227, 234, 276, 287, 290
crematorium IV/V: 136, 137, 232,
287, 290
disinfestation: 63, 78, 112, 145, 227,
235
farmhouses: 232, 287, 290
homicidal chamber: 145, 211, 227,
228, 230, 236, 237, 244
homicidal chambers: 220
short circuit: 223, 234
US execution chamber: 13
Verbeke, Herbert: 379, 380
Verein Deutscher Studenten: 302
Verlag der Freunde: 344
Vidal Naquet, Pierre: 30
Vienna: 45
Vincennite: 20
Vistula river: 141
vol. %: 156
von Hase & Köhler: 318
Vrij Historisch Onderzoek: 400

— W —

Wahl, Max: 338
Walendy, Udo: 338
Weber, Mark: 26, 342
Wegner, Werner: 33, 211, 212, 251, 294,
405
Weizsäcker, Richard von: 357
Wellers, Georges: 34, 211, 212

Westphal, Hans Karl: 338
 Wetter, Friedrich Cardinal: 414
 Wiesbaden, Germany: 383
 Wiesenfeld, Bavaria: 20, 21
 windows, gas-tight: 137
 wire mesh push-in devices: see
 Drahtnetzeinschubvorrichtungen
 Wirths, Eduard: 70, 71, 72
 Wissmann, Matthias: 414
 Witzsch, Hans-Jürgen: 180
 Wolffsohn, Michael: 368

— Y —

Yugoslavia: 299

— Z —

Zacher, Hanns F.: 407
 ZDF, heute: 397
 Zentralbauleitung der Waffen SS und
 Polizei, Auschwitz: 52, 72, 89, 94, 96,
 97, 98, 99, 107, 109, 113
 Zentralrat der Juden in Deutschland: 295,
 354, 394, 407, 408
 Zentralsauna: 58, 98, 99, 138, 141, 142,
 147
 Zernik, Franz: 192
 Zitelmann, Rainer: 33, 294
 Zündel, Ernst: 245, 274, 275, 312, 318
 Zwerenz, Winfried: 293, 405
 Zyklon B: chapter 7.2., and passim.