

DESIGN OF THE UNIVERSE
THE HEAVENS AND THE EARTH

DESIGN
OF THE
UNIVERSE

THE HEAVENS AND THE EARTH

By

FRITZ KAHN

CROWN PUBLISHERS, INC.

NEW YORK

Copyright, 1954, by Fritz Kahn

Library of Congress Catalog Card Number: 54-6641

Manufactured in the U.S.A.

American Book-Stratford Press, Inc., New York

To

PAUL V. STEINER

without whose enthusiasm for the idea of presenting the achievements of modern science the author would never have ventured on an enterprise so daring, and whose never-failing resourcefulness helped to overcome the adversities of the stormy nineteen-forties.

ACKNOWLEDGMENTS

I want to express my thanks to the artists who worked with me for years: Matthew Kalmenoff, who cooperated with me in planning the layouts and supervised the teamwork of the studio; Dmitri Alexandroff; Martin Kallman; Harold Felber; and Fred Knorr (Switzerland).

Contents

PART ONE: THE WORLD OF MODERN PHYSICS

1. SPACE AND TIME IN CLASSICAL PHYSICS	3
The Four Eras of Natural Science	3
Natural Science in Antiquity	3
Natural Science in the Middle Ages	7
The Medieval Newton: Alchemist and Mystic	11
The Modern Newton, Creator of Classical Physics	14
2. SPACE AND TIME IN MODERN PHYSICS	20
Relativity I: A Straight Line Is Not Straight	20
Relativity II: Motions Are Not Determinable	22
Relativity III: Time Does Not Flow Equally	25
3. MATTER AND ENERGY IN CLASSICAL PHYSICS	31
Matter in the Asian Religious Philosophies: Brahma and Tao	31
The Medieval Concept of Matter: Ether	33
4. MATTER IN MODERN PHYSICS	35
The First Dynamic Concept of Matter: The "Ether Vortex" of Descartes	35
The Pycnotic Substance: Forerunner of the Wave Theory of Matter	36
Einstein's Concept of Mass-Energy	38
The Relativistic Variation in Mass, Measure and Time	40
The Replacement of Newton's Concept of Gravity by Einstein's Concept of the Field	42
Einstein's Field Theory. A New Design of the Universe	44

PART TWO: THE ATOM

1. THE "PLANETS" OF THE ATOMIC SYSTEM: THE ELECTRONS	51
The Atomic Theory of Democritus	51
Numbers in Science	52
The Numbers of Atoms	54
The Atom: A Microcosmic Solar System	54
The Electron	56

The Emptiness of the Atom and the Origin of "Heavy Substances"	59
The Electrons in Their Courses	63
The 100 Elements of the Periodic Table	66
2. RADIATION	72
Waves	72
Electromagnetic Waves	74
Heat: Long Waves Created by the Oscillation of Atoms and Molecules	75
Light: Medium Waves Created by the Jumping Electrons of the Atom's Outer Shells	78
X-Rays: Waves Created by the Jumping Electrons between the Inner Orbits of Large Atoms	81
Gamma Rays: Waves Emitted by the Atom Nucleus	82
The Double Nature of Light: Wave and Corpuscle	84
3. THE NUCLEUS OF THE ATOM	87
The Discovery of the Nucleus	87
The Constituents of the Nucleus, the Nucleons	90
Cosmic Radiation	93
The Packing Loss	96
Isotopes	98
4. NUCLEAR FISSION	102
Bombarding Atoms	102
Radioactive Isotopes	107
The Uranium Clock and the Carbon Calendar	111
Uranium	112
Plutonium	116
The Atomic Age	119
Physics at the Crossroads	123
PART THREE: THE HEAVENS	
1. INSTRUMENTS AND METHODS OF MODERN ASTRONOMY	131
Microcosm and Macrocsm	131
Telescope and Camera	133
Astronomical Calculation	138
Spectrum Analysis	143
Radio-Astronomy	151
Astronomy of Tomorrow	154
2. THE GALAXY	156
Man's Home in the Universe: The "Milky Way"	156
The Galaxy's Companions: The Magellanic Clouds and the Globular Clusters	161

3. THE "UNIVERSE"	164
A Hundred Million Galaxies	164
The Hypothesis of the Exploding Universe	167
The Hypothesis of the Pulsating Universe	171
The Hypothesis of the Continuous Creation of the "Balanced Universe"	173
4. THE STARS OF THE GALAXIES: SUNS	174
The Theory of Gaseous Spheres	174
The Theory of Helium Synthesis As the Source of the Sun's Energy	176
The Hectic Life of the Sun	179
5. STARS: SPHERES OF GLOWING GASES	184
Physical and Chemical Properties of the Stars	184
The Spatial Distribution of the Stars: Single Stars, Double Stars, Star Groups and Star Clusters	188
Variable Stars	192
New Stars: Novae	195
Super-Novae	196
The Motion of the Stars	200
The Life-Cycle of a Star	201
6. THE PLANETARY SYSTEM	207
The Origin of the Planetary System	207
The Structure of the Planetary System	212
The Four Inner Dwarf Planets	215
The Ring of Asteroids	221
The Two Giant Planets: Jupiter and Saturn	224
The Three Outer Planets: Uranus, Neptune and Pluto	229
The Comets	235
Meteorites	239
7. THE EARTH AND ITS MOON	243
The Earth: An Irregularly Rotating Sphere	243
The Moon and Its Complex Orbit	250
The World of the Moon	253
The Impact of Astronomy on the Mind of Modern Man	260

PART FOUR: EARTH

1. THE STRUCTURE OF THE GLOBE	265
The Slow-Moving Clock of Earth's History	265
The Age of the Earth	267
The Size and Mass of the Globe	268
The Interior of the Globe: We Walk on an Eggshell	268

2. THE STONY BOOK OF EARTH'S HISTORY	273
The Chapters in Earth's History: The Geological Periods	273
The Pages in the Book of Earth's History: Rocks	276
Text and Pictures in the Book of Earth's History: Strata and Fossils	280
Cracks and Wrinkles in the Book of Earth's History: Mountains and Grabens	283
3. THE THEORY OF THE FLOATING CONTINENTS	290
The Birth of a Theory	290
The Dismembered Continents	293
The Battle between Laurasia and Gondwana	296
Current Continental Movements	299
4. THE AIR	303
The Lower Atmosphere, Troposphere and Stratosphere	303
The Upper Atmosphere	304
The Circulatory System of the Atmosphere	307
5. THE WATER	312
Clouds	312
Cyclones	314
The Weather Map	320
The Subsoil Water	322
The Oceans	325
The Ocean Currents	329
Tides	332
6. THE LAND	335
The Landscape in a Humid Climate	335
The Landscape in a Dry Climate	344
Erosion	348
Deserts	353
Geology, a Stepping Stone	358
Index	363

In accordance with the growing trend in international science, measurements are expressed in metric units. Lengths and heights are given in millimeter, centimeter, meter and kilometer; weights in gram and kilogram; temperatures in centigrades. American measurements have been used in some places for very familiar distances and for setting up comparisons with everyday experiences.

PART ONE

The World of Modern Physics
Space and Time, Energy and Matter

Ens unum infinitum et eternum.
*The one being, boundless and
eternal.*

—SPINOZA

This is the universe: infinity. Space without beginning, without end, dark, empty, cold. Through the silent darkness of this space move gleaming spheres, separated from each other by inconceivable distances. Around them, again inconceivably far away, like bits of dust lost in immensity, circle smaller dark spheres, receiving light and life from their "mother suns." One of these little spheres, in the light of one of the countless suns in endless space, is our earth. This is man's home in the universe.

Space and Time in Classical Physics

The Four Eras of Natural Science

NATURAL SCIENCE has passed through four eras in the course of its history. The first, the science of antiquity, came to an end with the rise of Christianity. The second era, medieval science, extended to the Renaissance, when, after the long night of the Middle Ages, free research began again. The third era, classical science, began with the inductive reasoning of Copernicus, Kepler, Galileo, Huygens and Newton and came to a close around 1900, when several discoveries invalidated the concepts of the classical period. Radium was discovered and unveiled the structure of the atom, Max Planck introduced the concept, quantum, and the prevailing theories of light and radiation had to be altered; Einstein's equations of relativity created new concepts of matter, space and time. In California, giant reflecting telescopes were erected on the peaks of dust-free mountains; their wide eyes penetrated outer-galactic space to hundreds of millions of light-years and revealed innumerable galaxies, sister worlds of our Milky Way. Genes, the carriers of heredity, and their mutations; viruses, the half-living structures, the "missing link" between the dead and the living world, were found. Discoveries like those of the hormones, the vitamins, the anti-biotics changed our ideas of organic life. Under the impact of these achievements the world of classical science crumbled like an outdated fortress under the fire of modern artillery. A new design of the universe arose—modern science.

Natural Science in Antiquity

The era of antiquity, which had its origins in the early civilizations of China, Babylonia and Egypt, reached its pinnacle in classical Greece. The Greek scientists were equal in stature to those of our time, but almost all of their works have been lost. Most of them had to live far from their homeland on the dispersed islands of the Aegean Sea because they had been banished as "dangerous free thinkers." In those early times between 600 and 400 B.C. ideas were rarely developed into systems or preserved in books. They were

mostly discussed in "inner circles," such as academies where they were transferred from teacher to pupil. Only the basic fundamentals of a philosophy or theory survived. For example, Thales said that the universal element of the world is water. The details of his reasoning are lost.

Books, if written at all, were written by hand and the number of copies was limited. Most of the copies disappeared in the course of the perpetual wars among the quarreling city-states. Even those which were collected in the great library at Alexandria and guarded there as the supreme treasure of antiquity perished in later and greater wars. A few years before the birth of Christ, the library was accidentally burned when Octavian, later the Emperor Augustus, defeated Mark Antony in Egypt. The manuscripts were, as far as possible, restored, but in 640 A.D., when the Roman Empire was reeling, the victorious Mohammedans stood before the library, and, according to legend, the Islamic leader Amr said: "If these books agree with the Koran they are useless; if they disagree, they are pernicious. Burn them!" So the priceless heritage of the science of antiquity went up in flames.

Hellenic science was a period of brilliant beginnings. Pythagoras, born shortly after 600 B.C., created algebra, recognized that the character of music is directly related to numbers, and, it seems, even used the calculus, the mathematical method which was introduced into natural science 2,200 years later by Leibniz and Newton. He taught that nature follows mathematical laws from which it cannot deviate, that the earth is a globe born of a central sun and that there were antipodes on the other side of the sphere. (*Figs. 1 and 2*)

Two hundred years later, Eudoxus invented geometry and his papers were collected by Euclid around 300 B.C. King Ptolemy, one of the Greek rulers of Egypt after the death of Alexander the Great, admired the new science but found it too abstract and asked whether there were not an easier way to master the discipline. Euclid's reply is still valid for those of us who are perplexed today by relativity and quantum mechanics: "There is no royal road."

Especially interesting for us today is the creation of the atom theory. Democritus and his pupils taught that all things were composed of small invisible units which they called atoms. They tried to reduce natural phenomena to atomic interactions.

In the next century Aristarchus, who lived on the island of Samos, found that the axis of the earth is inclined to the plane of its orbit and came to the conclusion that the earth revolves around the sun, but his friends urged him to keep quiet lest he endanger his life.

His contemporary, Eratosthenes, went so far as to calculate the size of the globe. He performed this remarkable feat by comparing the length of the shadow cast at noon by a staff in Alexandria, in Lower Egypt, with the shadow cast by an equally long staff in Luxor, in Upper Egypt, about 625 miles nearer the equator. He arrived at the astonishingly close figure of 46,000 kilometers for the circumference of the globe. The mistake of 15 per cent is not to be blamed on his computations but rather on the fact that



Fig. 1. DESIGN OF THE UNIVERSE, 300 B.C.

The Greek philosophers were the first to recognize the design of the universe. Archimedes coined the famous sentence: "Give me a point on which to stand and I will move the earth."

the actual distance between Alexandria and Luxor is 1 kilometer greater than was officially accepted at the time.

The last outstanding representative of the science of antiquity was Aris-

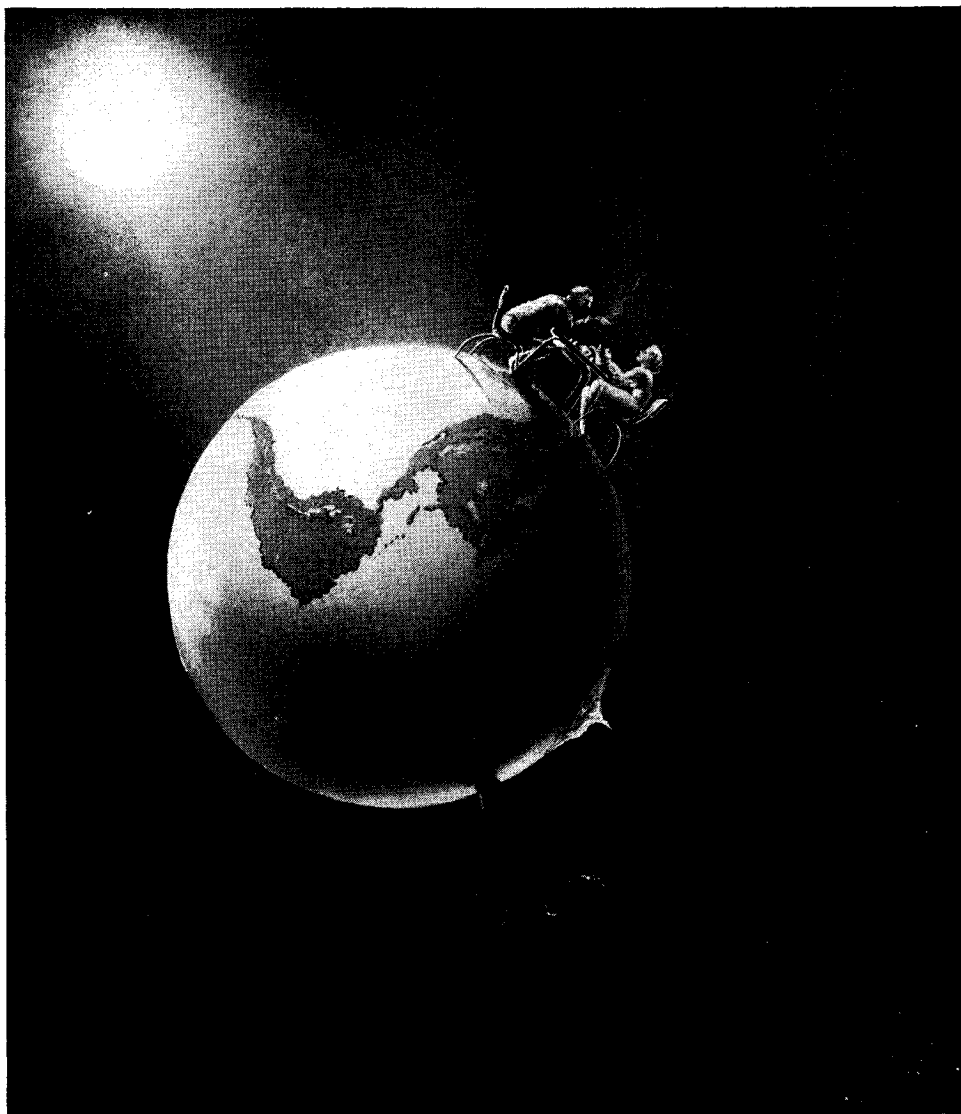

Fig. 2. DESIGN OF THE UNIVERSE, 1600

The invention of the telescope proved that the planets are globes floating freely in empty space.

totle, pupil of Plato and tutor of Alexander the Great. Aristotle became one of the most influential figures in the history of science. Driven by a limitless curiosity, his scope included the phenomena of nature as well as philosophical and social problems. A keen observer, he was not satisfied to describe plants and animals, but performed autopsies and vivisections. His teachings on logic established an accepted standard for research and discussion for almost 2,000 years.

Oral discussion in medieval times played a major role in science because

books were not generally available, and the debater who handled the weapons of Aristotelian methodology with the greatest skill was proclaimed the victor. So the "Stagirite," as he was called after the name of his birthplace, became the father of European science and remained the infallible pope of the *ecclesia scientiarum* throughout the Middle Ages. His writings were the main source of scientific information left to the impoverished Western world after the collapse of the antique civilizations. In the last sentence of the Pentateuch, the stature of Moses is brought forth in the monumental coda: "And there arose not a prophet since in Israel like unto Moses, whom the Lord knew face to face." After Aristotle there arose no naturalist of equal rank.

The Romans, whose interests and talents were directed toward military and political goals, added little that is basic to the natural sciences. The barbarians who brought the overgrown Roman Empire to its downfall added nothing. On the contrary. Illiterate and without the slightest understanding of the values of the classics, they burned parchments and from the stones of deserted academies they built their crude fortresses. When, later on, the Christian sectarians baptized the pagans, they erected basilicas over the ruins of the classical temples.

Natural Science in the Middle Ages

With the rise of Christianity a new epoch in the history of mankind began. Science was frozen, glacial-like. The great masses were illiterate and remained so. For the medieval men of wars and weapons the phenomenon "nature" did not exist. Intellectualism even in its most modest form was despised. The only ones who read and wrote—also modestly—were the priests and monks who became the guardians of the spiritual heritage of antiquity. The cultural relics were by no means venerated or studied but regarded with suspicion and pity as the works of a still unenlightened humanity. They served only as sources for information about geography, astronomy, the calendar, language and dialectic. The most respected author was Aristotle, whose writings provided directives for expression of ideas and methods of discussion. So the dialectics of Aristotle became the standard of all methodical expression of ideas in writing and speaking.

One single book was venerated as the source of all truths: the Bible. In those times it acquired its proud name: *Biblos*, Bible, *The Book*. It was also the authentic "encyclopedia" for all natural sciences, and since it stated that the world was created in six days, criticism or disagreement with this notion was considered heresy.

Science independent of the Bible slept for a thousand years. Then came the slow, slow awakening, called the Renaissance, the Age of Rebirth.

The first "modern" naturalist was the English friar Roger Bacon who lived

around 1250 and should not be confused with Francis Bacon, the contemporary of Shakespeare. We know almost nothing about his life. Yet one thing is sure: he must have been a scientific genius. Although it contradicts all probability, it seems that he used a microscope and a telescope as well because he mentions "spermatazoa" and "spiral nebulae." He recognized the character of science when he insisted that statements must be based on observation and verified by mathematics, which he called "the gate and key to science." He revolted against discussions of pure theology or Aristotelian dialectics. "Without experience nothing can be known sufficiently. . . . Argumentation does not suffice but experience does."

Roger Bacon's ideal was not realized in his time. Even the term "science" did not exist; the old Greek word "philosophy" was used. Newton's famous work is entitled *Philosophiae Naturalis Principia Mathematica*, although it deals with problems which today we would call scientific, not philosophical.

Medieval science differed fundamentally from our present approach. Research was based on accepted "truths," some of which were revealed in the Bible, and some established by the infallible Aristotle. The aim of science was not to find new facts and to verify hypotheses but to confirm the revelations of Scripture and the doctrines of Aristotle. Medieval science could be termed "totalitarian"; it was designed to corroborate the credo of the regime—an approach, incidentally, which was contrary to Aristotle's own.

According to Scripture, the world was created in six days and the year of creation determinable through the genealogies in the Old Testament. A contemporary of Newton, Bishop Ussher of Arlet in Ireland, worked out the exact day and hour. The creation of the world, he stated, occurred at nine o'clock on October 26, 4004 B.C., a date which even Newton accepted.

The earth was supposed to be flat. The sun, as the first chapter of the Bible described it, was placed in the sky to illuminate the days of man. The firmament was firm, as its name indicated, and supported the cupola of heaven. The stars were holes in heaven's dome through which the angels could peer at the hustle and bustle of Adam's sinful progeny. After death, the sinner went to hell while the blessed soul was carried up to heaven by angels.

There was no question about the veracity of these doctrines. Science was permitted to operate only within this framework of orthodox tradition. If anyone were to arrive at contradictory conclusions, it was he who was wrong. To proclaim anti-biblical findings was considered a crime; he was summoned before a clerical tribunal. If he persisted in his error, he was charged with being allied with Satan to destroy the work of God and had to be punished as a heretic, a fate which befell almost all the precursors of modern science. Roger Bacon, as could be expected, was imprisoned in 1277.

When Copernicus, who was canon of the cathedral of Frauenburg in East Prussia, became convinced that the earth was not the fixed center of the universe but revolved around the sun, he was reluctant to make his findings

known. Although he received permission from a liberal-minded pope to publish them, he hid his calculations for ten years and had them printed only when he was on his deathbed in 1543. Actually, he died a few days after the first copies were brought from the printer. When, fifty years later, Galileo expounded the theories of Copernicus, he was summoned to Rome and thrown into prison. Legend says that on the rack he uttered his famous cry, "*Eppur si muove!*" (And yet it does move!) Because of his great reputation and because he had powerful friends among the princes, he was released, but only on the condition that he remain silent. Giordano Bruno, who at the same time proclaimed the modern concept of the boundless universe in hymnal dialogues, was publicly burned at the stake in Rome during the first weeks of 1600. (*Fig. 3*)

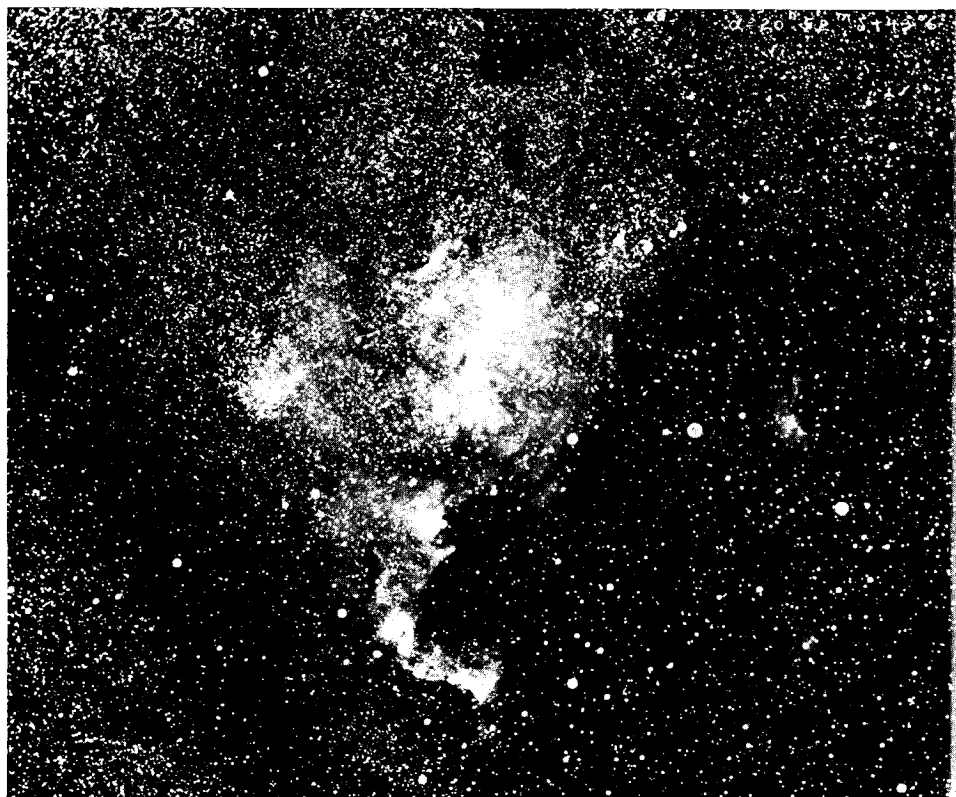

Fig. 3. THE INFINITY OF THE UNIVERSE IS RECOGNIZED

"Prisoned and bound in vain, 'tis time to rise
Through sparkling fields of air to pierce the skies."

—*Giordano Bruno*

These events were a macabre prelude to a century of bloody battle between the defenders of the "sacred truths" and the *avant-garde* of modern science. Innumerable "unknown soldiers" fell in this "war of independence." It was more than a revolt against thought-control by church and state and

against suspicious and spying neighbors: it was man's struggle to liberate himself from the chains of traditional thinking and the all-pervading atmosphere of superstition. This emancipation was not as easily achieved as we imagine today. It was not simply a matter of gazing through a telescope to see "the light of truth." When Galileo asked the dean of the University of Pisa to look through the telescope and convince himself of the existence of Jupiter's moons, the dean refused. Aristotle had made no mention of them; therefore they could not exist. When the Jesuit friar Joseph Scheiner, one of the first specialists in solar research, announced in 1611 that there were spots on the sun, the astronomers declared that he must have misinterpreted stains on the lenses of his telescope—the beacon God had placed in the sky could not possibly have spots! Yet Scheiner himself refused to acknowledge the findings of Copernicus and Kepler but persisted in the medieval error that the sun circled around the earth, which remained the center of the universe for him.

In his endeavor for "auto-emancipation," man was thwarted by another obstacle. Science during medieval times was interwoven with mystical symbolism. Everything in nature had a symbolical meaning which concealed an esoteric secret. Kepler heralded the theory of Copernicus like a gospel: "I have attested it as true in my deepest soul and I contemplate its beauty with incredible and ravishing delight." Yet he clung to the medieval notion that the sun was the image of the Mother of God; that the stars were the manifestation of the Son of God; and that the ether driving the planets was an emanation of the Holy Ghost. Newton, too, identified space with God's omnipotence.

Characteristic of the intellectual atmosphere in the days of science's rebirth was an event which occurred while Newton was lecturing on optics at Trinity College in Cambridge. For months the university was in turmoil, not about Newton's theory of light, but about a "miracle": a fish had been found with a Bible in its stomach. Naturalists and theologians discussed the wonder; perhaps God wished to convey a message to mankind, and had chosen Cambridge as He had once chosen Mount Sinai. Or was it a blasphemous trick of the devil to mock the Holy Book? No one considered the simple possibility that the fish had swallowed the book which may have drifted in the sea after a shipwreck.

Theses by which students had to prove themselves worthy of being called doctor (a "learned man") bore titles such as "What Are the Measurements of Hell?", "Is the Fire of Purgatory Hotter Than Ordinary Fire?", "Did Adam and Eve Possess Navels?" or, "At the Resurrection, Will Adam Appear with Eleven or Twelve Ribs?" Fossils found in the ground were considered the devil's handiwork, placed there to confuse mankind about the order of the world. Freaks were considered proof that the mother had fornicated with the devil. When, as happened in most cases, the *Collegium Doctorum* furnished "overwhelming evidence," such hapless women were burned at the stake. No one regarded such cruel verdicts objectionable. It was the

sacred office of science to protect the divine order of creation against the plots of the devil and against those who had succumbed to his temptations.

This was the mental and moral setting of the stage when the founders of modern science opened the fourth act of the great spectacle, SCIENCE, with discussions on space and time, gravitation and radiation—the problems of *our* age!

The Medieval Newton: Alchemist and Mystic

The head of the Roman god Janus is two-faced; one of the faces looks back, the other looks ahead. Isaac Newton was just such a double-faced half-god—half of his outlook was medieval while the other half projected into the future. We should not be surprised if a man born in 1642 (the year of Galileo's death) grew up as a Saul, steeped in medieval mysticism, who would later become the Paul of modern science. Strangely enough, this did not happen. Newton lived in both ages simultaneously and there does not seem to have been an open conflict in his life between the two incompatible worlds. Yet the modern psychologist might find in this dual existence the cause for his abnormal attitude toward science and life: he was gifted with the greatest talents for scientific accomplishment, but was an almost unique phenomenon in the history of science—apathetic toward humanity, progress, science and even his own genius.

In striking contrast to the prominence of Newton as a scientist, very little authentic material survives concerning the private life and the real character of this recluse. "We might," said one of his modern biographers, L. T. More (1934), "almost accuse his contemporaries of having entered into a conspiracy to destroy all the evidences of his humanity in order that he should be thought of as a pure 'ideal of intellectual genius.'"

Newton was born at a time when the religious struggles of the declining Middle Ages raged in their last full furor. On the European continent the Thirty Years' War between Catholicism and Protestantism was nearing its end; in England a similar conflict of spiritual and political creeds had torn the nation into discordant factions and plunged it into the turmoil of a civil war. The house where Newton grew up was invaded in turn by the soldiers of the two warring parties. Very early in life this unhappy orphan learned to be suspicious of everyone. His youth was somber. His father had died before he was born. A premature baby, he was so puny he could have been "put into a quarter mug," and was not expected to survive the day. His mother remarried and left home, and the unfortunate boy was raised by his grandmother. For years he was so feeble that he had to wear special collars to support his "weak" head—a head destined to house one of the master-brains of all time.

Out of this hapless infancy, lacking the love of a mother and the guidance and comradeship of a father, a hypersensitive, misanthropic youth emerged. A psychologist would find it easy to deduce the behavior of the later Newton from his abnormal childhood. His "second life," actually his main one, with its persistent pursuit of gold, was a retarded longing for the happiness, the wonders, the surprises which as a child he did not enjoy. Newton was not the typical scientist—devoted to research, forgetting all else and laboring for decades to find a solution for universal problems. He wasted at least three-quarters of his time and his energy in occupations outside his real vocation. During his early years he was obsessed by the alchemistic dream of manufacturing gold. This dream having faded, he sought an economic sinecure and became Master of the Royal Mint. In his later years he devoted so much attention to religious problems that the philosopher John Locke called him one of the greatest theologians of his time. The fact that Newton nevertheless achieved such tremendous success in physics, mathematics, astronomy and optics was not the result of interest and effort but must be attributed to his unique ingenuity.

It has been said correctly that there was no problem in mathematics he could not solve immediately if it was at all solvable in his day. In June, 1696, the Swiss John Bernoulli challenged the mathematicians of the world to solve two problems. He allowed six months for the solution. At the request of the leading German mathematician Leibniz, who solved one of the problems, he extended the time of the competition by a year. On the 29th of January, 1697, the challenge was received by Newton. On the next day he sent the solution of both problems to the President of the Royal Society. They were published anonymously. When Bernoulli saw the publication, he exclaimed: *Tanquam ungue leonem*—the lion is known by his claw.

Some years later, Leibniz sent an extremely difficult problem directly to Newton. Newton received it at five o'clock in the afternoon, as he was returning from the Mint. Despite his fatigue he began to calculate, finished it the same night and sent the solution back to Leibniz the next day. His voluminous *Principia* was completed in less than eighteen months. Newton poured out geometrical constructions and mathematical equations the same way Mozart composed his symphonies and operas—as quickly as the ink flowed from the pen and with no sign of effort.

Almost nothing is known about Newton's alchemistic studies. It is said that he gave up his frustrated quest only with great reluctance and demolished the furnaces, the retorts and all his papers. It seems that after his death others destroyed even the last remnants in order to clear the gigantic monument of every stain—as if truth, even bitter, were not many times more appealing than the deceptive picture of a superhuman idol who never lived.

After his long and futile attempts, he adopted a more realistic approach to satisfy *auri sacra fames*. His friend Lord Halifax, founder of the Bank of England, procured for him, against the long resistance of the king, the

lucrative position of Master of the Royal Mint. Although thus made financially secure, he now began to speculate on the stock market. He became an extraordinarily wealthy man, who could afford to lose a fortune in a crash.

Alchemy, which had captivated Newton's interest for so many years, was not only medieval chemistry, but a mystical system. Sulphur and mercury, the two elements of the Philosopher's Stone, were also regarded as the opposing symbols of the sun and moon, the ruling principles of masculine and feminine, represented in mythology as Osiris and Isis, and in nature as the toad, the denizen of the ground, and as the eagle, the denizen of the air. Sun, stars, planets, and chemical elements, plants, animals and men—all were regarded as actors in the one great miracle-play of God's creation, whose secret is hinted at in the events of the early days of mythology. God laid

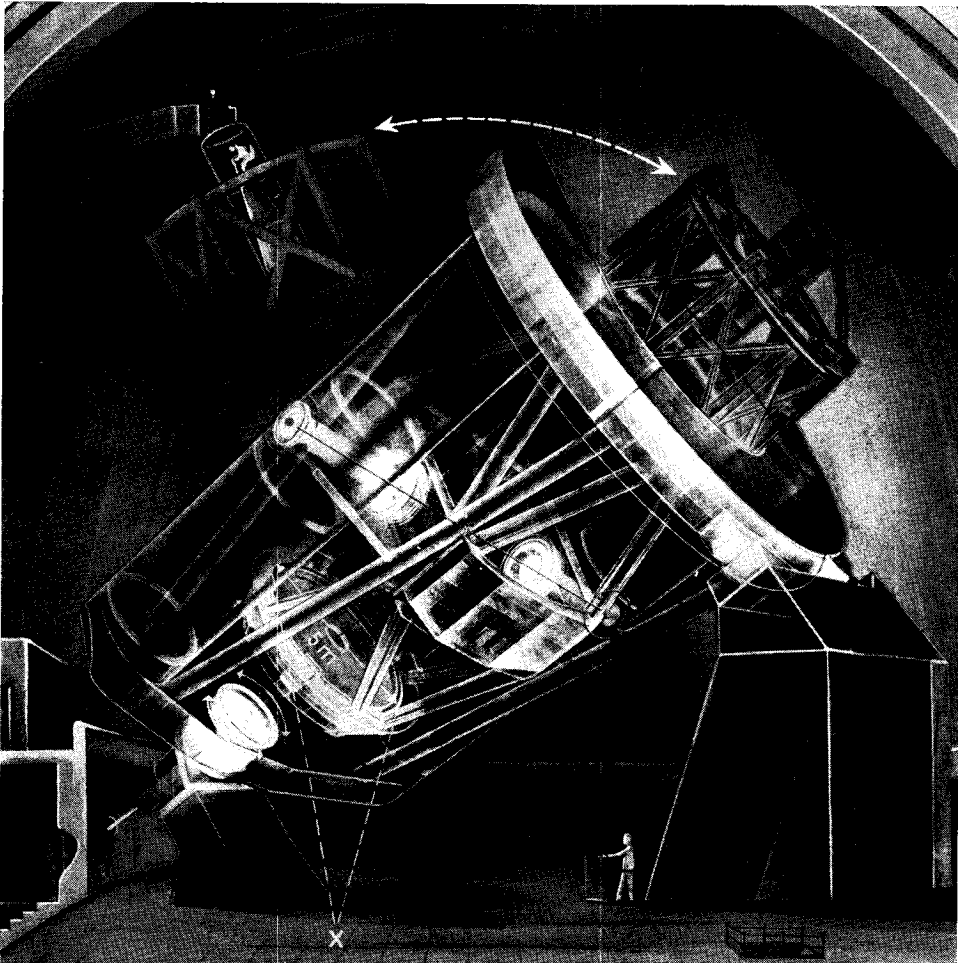

Adapted from Porter's design of Palomar Mirror

Fig. 4. THE MIRROR TELESCOPE

The mirror telescope was introduced by Cassegrain, Gregory, and Newton during the seventeenth century. The latest and most magnificent mirror telescope is the Hale Mirror of Mt. Palomar.

out the world before mankind like a rebus to be solved piece by piece—this was the Design of the Universe in medieval times. The pious Newton felt that he had been endowed by God with his great mathematical talent to cope with the divine riddle.

Every attempt to enter into the mentality of a medieval man is vain; the past is, as Goethe said, a book sealed with seven seals. We can do nothing but report the strange fact that Newton took literally every date and every figure of the old traditions in Greek and Egyptian mythology and in the chronology of the Bible. He had not the slightest doubt that the world was created in the year 4004 B.C. The same hand that wrote those admirable equations on the precession of the equinoxes which points to a celestial mechanism of billions of years scribbled calculations to correlate the life of Isis with the expulsion from Paradise and the expedition of the Argonauts with the Exodus from Egypt. The man who had computed the shape of the globe with an exactitude never before achieved squandered time and talent to determine the displacement of Noah's Ark at 18,231 tons, not one ton more or less. So engrossed was he in these manipulations that his secretary wrote: "He very rarely went to bed before two or three of the clock, sometimes not till five or six." Often he took his meals hastily, gulping a few bites without even sitting down.

Most of his papers were destroyed. Several times he himself burned piles of notes, and once a paper-crammed cabinet went up in flames because he left a candle burning when he went to church. Despite this repeated decimation, the amount of still-existing notes is said to comprise over one and a half million words and figures. A part of his prehistoric pseudo-science was published under the title *Chronology of Ancient Kingdoms Amended*. He was so convinced of the validity of his calculations that he wrote: "I do not pretend to be exact to a year; there may be errors of five or ten years and sometimes twenty, but not much above." He who in astronomical calculations achieved results of the highest accuracy was never aware that he had missed the mark by millions of years.

The Modern Newton, Creator of Classical Physics

Newton was a child prodigy. As a schoolboy he constructed a water clock which is said to have run accurately for years. In the year 1665, when Newton was in his early twenties, the Great Plague swept through England. All public institutions were closed, people fled to the open country, and twice Newton had to spend eight months on his mother's farm. In later years he referred to these months by the words: "In those days I was in the prime of my age for invention and minded mathematics and philosophy [*i.e.*, science]

more than at any time since." He brought with him a collection of lenses, prisms and mirrors, and began his experimentation and calculations.

He quickly recognized that, for telescopic purposes, mirrors were superior to the lenses which in those times were almost exclusively used as magnifiers. Newton is not, as is so often said, the inventor of the mirror telescope. Two mirror telescopes had been constructed previously. But Newton proved the superiority of mirrors by calculation and experiment and demonstrated his findings by constructing an instrument of his own.

It was Newton's method to base scientific problems on mathematical calculation, to prove them by experiment and to perform every experiment with utmost exactitude. He ground and polished the mirrors with the unflinching patience characteristic of him and took the finished instrument to Cambridge. Here it was admired as a masterpiece of optical engineering. The Royal Society, founded a few years before, invited Newton to demonstrate his instrument, but Newton had already dismantled the precious instrument to use the parts for new experiments.

Newton was one of those not-so-rare scientists whose interest in science is strictly theoretical. Once a problem was solved and his curiosity was satisfied, he stopped. He was not concerned with practical applications. Astronomical discoveries did not tempt him. The telescope no longer existed, but for Newton it was no problem to construct a second model, which is said to have been even better than the first. Shortly after he demonstrated it, the extraordinary young physicist was invited to become a member of the Society. And thus Newton began his sixty-year affiliation with the Royal Society in London.

At the time Newton worked on his telescope, he saw that now immortal apple falling from a tree. It is often said that he discovered gravitation at that moment. This is incorrect, because gravity was already known. Neither did he discover the law of gravitation, for this, too, had been formulated previously. No less than four contemporaries of Newton—Christian Huygens in the Netherlands, Robert Hooke, Halley and Wren in England—aimed at the "Newtonian Law of Gravitation." However, their conceptions of the nature of gravity were nebulous and conflicting because many basic ideas about the relation of the bodies to each other were not yet clear.

Aristotle had implanted in the minds of men the idea that heavenly bodies were subject to laws different from those which governed bodies on earth. Concepts of space and force were not yet fixed. The physicists discussed the question of the extent of the force of gravitation. The law of gravitation was formulated but the mathematical proof was still to be demonstrated. This proof could not be given because the algebraic tools were lacking. Newton, twenty-two, transformed this chaos into order.

The problem was twofold. The term "body" had not yet been mathematically defined and the measurement of distances between bodies was still inexact. Scientists were vague about the points from which to start in meas-

uring distances. Which point of the moon should be chosen in defining the distance of the moon from the earth? The contemporaries of Newton measured distances from the surfaces of bodies. Newton grasped the key idea "that gravity operates not according to the quantity of the surfaces . . . but according to the quantity of the solid matter which they contain and penetrates to the very centers of the sun and planets, without suffering the least diminution of its forces." Thus Newton created the concept of "center of gravity," and was the first to determine with mathematical correctness the distances of bodies.

The center of a body is not a point concretely existing in nature but a concept. The moon, a tree or an ant exists; a "center" is an abstraction of the human mind. The theoretical sciences such as physics do not work with facts but with concepts. Lines, circles, degrees, the equator, the poles, temperature, climate do not exist, but are mental concepts created to attack specific problems, just as a mechanic needs special tools to open and to repair a specific machine like a watch or the engine of an automobile.

"Physics," Einstein says, "really began with the invention of mass, force and an inertial system. These concepts are all free inventions. They led to the formulation of the mechanical points of view. . . . Science is compelled to invent ideas corresponding to the reality of our world. . . . Science is not just a collection of laws, a catalogue of unrelated facts. It is a creation of the human mind, with its freely invented ideas and concepts."

The invention of the concept of "center" was not sufficient to solve the problem of gravitation. The free bodies which attract each other move with changing speed. A stone, thrown into the air, diminishes its speed as long as it flies upward. After reaching its highest point and standing still at speed "zero," it returns to earth with increasing velocity. In Newton's time there was no mathematical method to calculate exactly this change in speed. Newton was confronted by a "vacuum." He invented a method by dividing the course of the moving stone into an infinite number of different sections and by integrating the individual results into an entity. This method of calculation by first differentiating and thereafter integrating is called the differential and integral calculus. (*Fig. 5*)

With the help of the two intellectual tools—the concept of "center" and the calculus—Newton succeeded in determining and predicting the courses of earth, moon, planets and comets with unprecedented precision. He furnished proof that gravitation acts from center to center, and that all bodies, whether they be apples falling toward the earth or comets flying toward the sun, attract each other in proportion to their masses and in the inverse ratio to the squares of their distances.

One would expect that a young man who had succeeded in formulating a fundamental law, invented calculus, discovered the color-composition of sunlight and built a sensational mirror telescope would be impatient for the

$$\begin{aligned}
& + \left\{ \begin{aligned} & \left(\frac{5}{4} + \frac{23}{16} m^2 - \frac{1485}{128} m^3 - \frac{5597}{64} m^4 - \frac{12036265}{24576} m^5 \right) \\ & - \left(\frac{11}{24} + \frac{47503}{1536} m^2 \right) e^2 - \frac{389}{32} m^2 e'^2 \\ & - \left(\frac{5}{16} - \frac{135}{128} m \right) \gamma^2 + \frac{17}{192} e^4 \end{aligned} \right\} e^2 \sin 2\varphi \\
& + \left(\frac{13}{12} + \frac{41}{24} m^2 - \frac{43}{64} e^2 - \frac{5}{8} \gamma^2 \right) e^3 \sin 3\varphi \\
& + \frac{103}{96} e^4 \sin 4\varphi + \frac{1097}{960} e^5 \sin 5\varphi \\
& + \left\{ \begin{aligned} & -3m + \frac{735}{16} m^3 + \frac{1261}{4} m^4 + \frac{142817}{96} m^5 + \frac{3257665}{576} m^6 \\ & + \frac{964471235}{55296} m^7 \\ & - \left(\frac{27}{8} m + \frac{2925}{32} m^2 + \frac{454735}{512} m^3 + \frac{39522017}{6144} m^4 \right) e^2 \\ & + \frac{638335067}{16384} m^5 \\ & - \frac{27}{8} m e'^2 + \left(\frac{27}{8} m - \frac{117}{32} m^2 - \frac{6785}{512} m^3 \right) \gamma^2 \\ & + \left(-\frac{9}{4} m + \frac{5751}{128} m^3 + \frac{13871}{32} m^4 \right) e'^2 \sin 2\varphi' \\ & - \frac{81}{32} m e^2 - \frac{7}{4} m e'^2 + \frac{81}{32} m \gamma^2 \end{aligned} \right\} e' \sin \varphi' \\
& - \frac{53}{24} m e'^3 \sin 3\varphi' \\
& + \left\{ \begin{aligned} & \frac{21}{4} m + \frac{1233}{32} m^2 + \frac{15165}{64} m^3 + \frac{2844993}{2048} m^4 \\ & + \frac{307187071}{36864} m^5 + \frac{91720676239}{1769472} m^6 \\ & + \frac{51}{32} m e^2 + \frac{189}{32} m e'^2 - \frac{63}{8} m \gamma^2 \end{aligned} \right\} e e' \sin(\varphi - \varphi') \\
& + \left\{ \begin{aligned} & -\frac{21}{4} m - \frac{717}{32} m^2 - \frac{3215}{32} m^3 - \frac{2806183}{6144} m^4 \\ & - \frac{19962409}{2216} m^5 - \frac{18084760319}{1769472} m^6 \\ & - \frac{51}{32} m e^2 - \frac{189}{32} m e'^2 + \frac{63}{8} m \gamma^2 \end{aligned} \right\} e e' \sin(\varphi + \varphi')
\end{aligned}$$

Fig. 5. MODERN FORMULAS

The introduction of calculus by Leibniz and Newton led to formulas like this one of the moon's motion computed by the French astronomer Pontécoulant. The above is but 1/23 of the whole formula.

plague to subside so that he might acquaint the world with his achievements. But not Newton; he kept his results to himself.

As one might have predicted, this secretiveness did not fail to land Newton in almost perpetual trouble. In periods of scientific progress there is always simultaneity of ideas and discoveries. While Newton's calculus was gathering dust in his desk, the German philosopher Leibniz, with whom Newton was in continuous contact, published the same method of calculation. Newton was by no means the wise sage idolized by posterity, but an exceedingly sensitive and jealous person. A modern psychologist might say that he suffered from a persecution complex. Infuriated, he claimed that Leibniz had usurped his idea, just as he accused Robert Hooke of having stolen his formulas of gravitation, and the great and famous John Locke of plotting against him.

This was the beginning of the longest and most bitter controversy in the history of science, raging for decades, becoming more acrimonious with the years. It ended, like the fight against Robert Hooke, an unhappy and chronically ill dwarf, with the defeat of Newton. The final decision stated that Leibniz invented the calculus independently of and prior to Newton.

Even the publication of Leibniz' integral calculus did not prompt Newton to come out of his scientific hiding and it seems doubtful whether posterity would have had any publication of Newton's if the famous comet of 1682 had not appeared in the sky. Its discoverer, Edmund Halley, found himself unable to calculate the course of the comet with satisfying exactness. He asked Newton to undertake the calculation and was so impressed by his ingenuity in solving the problem that he urged him to publish the many papers which lay idle in the drawers of his desk. He did not succeed until he offered to prepare the manuscripts, to take care of the printing—and to contribute toward the expenses. Finally, almost twenty years too late, Newton went to work, and two years later, in 1687, the *Philosophiæ Naturalis Principia Mathematica* was published—"perhaps the greatest work in the history of science."

The *Principia* is not a homogeneous unit. It is a 550-page collection of different papers, each dealing with a different topic. The first section, about 50 pages long, treats the movements of the planets according to Newton's laws of motion and gravitation and improving the results of Copernicus and Kepler. The main part is devoted to the motion of bodies in resistant media and to the dynamics of waves. Interspersed in the other parts are the concepts of mass, inertia, center and motion and Newton's famous laws. The last part deals with astronomical questions such as the path of the moon, the relation of moon, earth, sun and planets, the tides and so on.

Despite its fragmentary character, the *Principia* discusses all the fundamental problems of physics. It defines the basic concepts of physics in the simplest words and with such mathematical clarity that the *Principia* has been rightly compared to Euclid's *Elements*. As a few samples we quote:

Absolute space in its own nature, without relation to anything external, remains always similar and immovable.

Absolute, true and mathematical time, of itself and from its own nature, flows equably without relation to anything external. The flowing of absolute time is not liable to any change.

Physical bodies are built of atoms, solid, massive, hard, impenetrable particles which God created indivisible. [The masses composed of these atoms are] inert and continue in their state of rest or of uniform motion in a straight line, unless they are compelled to change that state by forces impressed upon them.

In several dozen sentences like these Newton gave the classical definitions of space, time, force, gravitation, inertia, action and counter-action, distance, undulation, etc., all proved by his incomparable experiments and calculations.

He demonstrated that, by using these concepts, science could be purified of all medieval pseudo-agents, spirits, essences and scholastic subtleties that haunted the researcher in those times. Nature could be described as one mechanical unit, all bodies following the same simple rules. The dominant law of the universe was the law of causality: nothing happened without a cause; every effect of an action can be determined as a reaction and can be predicted with mathematical precision. The curve of a stone falling to earth can be described in advance as can the eclipses of the sun, or the path of a comet even if this comet disappears into space seemingly forever—but to return and its return can be foretold to the very day. Hasn't this been proved with Halley's Comet?

Newton's exposition of the universe made a profound impression on his contemporaries. The time was ripe for a change and it was Newton who brought it. The mathematicians were awed by his masterworks of calculation. Leibniz said: "Taking mathematics from the beginning of the world to the time when Newton lived, what he had done was much the better half." Pierre Laplace, who became the most eminent of Newton's successors and who solved many of the problems Newton posed, called him not only "the greatest genius that ever existed, but also the most fortunate, for there is but one universe, and it can happen to but one man in the world's history to be the interpreter of its laws." The *Principia* became a scientific best seller. The stock of books was quickly exhausted, and copies were sought throughout Europe. Yet, characteristically, it was twenty-five years before Newton prepared a second edition.

Newton, psychologically inhibited, confined himself to laying the foundations. In vain we search in his books for the "Newtonian universe." He could not erect the edifice because it would have become the "Temple of Reason." Normally, the genius grows with his mental awakening and widens his childhood piety into a pantheistic philosophy, as Plato, Spinoza, Shakespeare, Goethe and Einstein have done. But Newton was one of those "who, though moving others, remain themselves like stone." He who opened the eyes of others to the immensity of the heavens did not open his own. He who found the "universal law" never became a universalist. He was horrified to find himself praised by men like Voltaire as a patron of the modernists, whom he hated, and quickly assured the world that "it is not to be conceived that mere mechanical causes could give birth to so many regular motions."

He entrenched himself behind a wall of yellowed scriptures to prove that the world was created in 4004 B.C.—despite a certain Isaac Newton who had constructed, a couple of decades earlier, the "Frame of the System of the World." As a recluse in his theological cabinet-cloister, the aging Newton did penance for the intellectual sins the youthful rebel had committed.

So the double-faced Janus, Newton, stands at the bar of history: one-half a modern scientist, one-half a medieval mystic and pietist. Towering above all others, he personifies mankind at the crossroads of medieval tradition and modern thinking.

Space and Time in Modern Physics

THIS LINE OF type we are reading is “unquestionably” a straight line. Let us assume that the text does not end but that the letters are printed in one continuous line. Where would it lead us? Over the edge of the desk, through the window to the other side of the street. Then the line would continue through the house opposite ours, through the city limits, and into the next town. But any geographer knows that the next town is not on the same plane as ours. It lies somewhat lower because of the curvature of the earth. A reader who persisted in reading straight on would move all the way around the globe and return from the opposite direction. The “straight lines” of type we are reading are not straight at all; they are parts of those great curves that, like the equator, circle the globe. All our straight lines are segments of geodesic curves. (*Fig. 6*)

Relativity I: A Straight Line Is Not Straight

An architect who would have to erect “straight” buildings on the earth’s curved surface would find himself in a dilemma. If he insisted on making the walls mathematically parallel, they would not be at right angles to the ground. If he were to set them exactly vertical to the ground they would be farther apart at the top than at the bottom, since they are extensions of the earth’s radii. Of course, these deviations are infinitesimal. A water level will not reveal them. But for a scientist two lines are parallel, or they are not; if at the end of 60,000 miles they are one inch farther apart than at the beginning, they are *not* parallel.

A yardstick should be straight; but curved lines cannot be measured with a straight stick. The deviation is negligible. But even a section of the earth’s surface only 50 yards long is not straight: it is roughly one-millionth of a great circle, the earth’s circumference. A modern physicist cannot calculate a curved line with a straight linear measure.

Since we live on the rounded surface of the earth, Euclid’s axioms do not apply to our world, as Einstein has proved. They are the “truth” only for the saucer-flat world as it was conceived by the Greeks. The shortest connecting line between two points should be a straight line—but connecting lines on the surface of the earth are curves. The sum of the three angles of

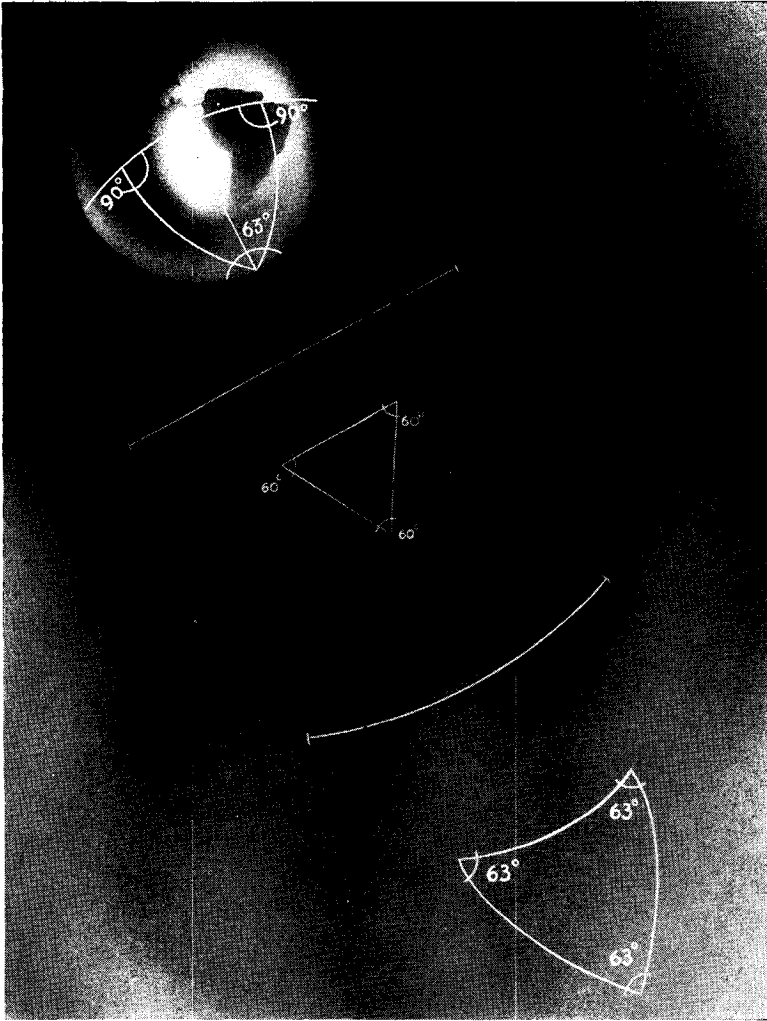

Fig. 6. THE CURVATURE OF SPACE

According to modern physicists, space is curved. All straight lines are in fact curved. Theorems such as those of Euclid, long venerated as axioms, would thus be true only conditionally.

a triangle should total two right angles, but you need only look at a globe to see that on the surface of a globe they do not. The lines of longitude intersect the equator at right angles and meet at the pole to form an additional third angle which has to be counted. Every triangle on the earth's surface is a "small brother" to this one. (*Fig. 6*)

If we try to separate geometry from the earth's surface and project it into empty space, we will again be disappointed. Euclid's geometry would be valid in space if there were such a thing as Newton's absolute space, unalterable and eternal, without qualities of its own and independent of its components. But there is no such space. According to the calculations of modern mathematicians, crowned by Einstein's formulas, space is not without qualities, but is formed by masses and alters with events. Every space has a geometry of its own.

Relativity II: Motions Are Not Determinable

An electric light bulb falls from the ceiling of a moving railway coach and hits a passenger on the head. In court, a witness who was in the same car testifies: "The bulb fell perpendicularly from the ceiling." When questioned about the distance, he says: "About four and a half feet." A railroad attendant, whose gate the train was passing when the incident occurred, disputes the testimony. "The bulb did not fall perpendicularly, but at an angle. It started to fall just as the car window appeared at the left end of my gate. As it reached the right end, the bulb struck the passenger's head. It fell diagonally, and the distance it traveled was at least fifteen feet." (*Fig. 7*)

A photographer who happened to photograph the event from outside the earth's atmosphere offers still other evidence. "The train was moving from north to south. During the time the bulb traveled from the ceiling to the passenger's skull, the train moved eastward with the globe. As you can see from this strip of film, the bulb moved in an arc from northwest to southeast. The arc is twenty-one feet long in a north-south direction and ends one hundred and fifty feet west of the starting point." (*Fig. 7*)

Let us assume that this incident took place in the age of interplanetary telephone service. An observer on a neighboring planet might be called as a further witness. He reports that he watched the event by television and saw the bulb flying in a loop about twelve miles long and, as can easily be demonstrated, the line of its fall was a segment of a para-hyper-diabolic curve. (*Fig. 7*) Since he is a man of higher civilization, he begins a long explanation, citing tables and curves: his planet was traveling at speed x and the earth at speed y ; his planet, during the time of observation, turned through angle α , the earth through angle β , and consequently . . .

The judge could go on indefinitely summoning witnesses to the court. An observer from the system of Sirius would testify that the bulb had moved



Fig. 7. RELATIVITY OF LENGTHS

Measurements are valid only in relation to their system of reference. The course of a falling bulb inside a moving train is interpreted as a short vertical line only by the passenger. Observers from other systems of reference (street, plane, other planets, other galaxies) record different courses.

178 miles in a highly complex path, because the sun and Sirius move in different paths. An observer from the opposite side of the Milky Way would see the line drawn out to more than 300 or 400 miles, because all the stars

move in streams through the spirals of our Milky Way at 200 miles a second. An observer from the nebula in the constellation Andromeda would describe the path of motion in terms completely beyond our comprehension, because all the nebulae rush at enormous speeds through "infinite space," whereas, according to Galileo and Newton, a body once set in motion will move in a straight line forever, provided no outside force interferes, and does so according to definite formulas of "initial force" and "initial velocity" neither of which exists. (*Fig. 1*)

To the seeker of truth, the disturbing fact about these proceedings is that each witness is correct. The passenger who shared the compartment saw a straight line; the railroad attendant, a diagonal one; the man from another planet, a loop. To each the length was different. It all depends on the observer's point of view. But "points of view" are not really points. In this universe, where everything is in motion, a point of view is a curve of motion. There is no measure for motion, because there is no fixed point from which to calculate it. The straight line of Galileo and Newton along which a body moves into infinity throughout eternity is nonexistent.

We encounter the same dilemma in measuring speeds. When an aviator and a shell are flying toward each other "at the same speed," they are approaching each other at twice that speed. If the aviator flies alongside the shell, it does not move at all as far as he is concerned. If his plane were to fly faster than the shell he would say, "the shell is moving backward." And it would be, to him.

None of us can determine how fast a body in the universe really moves. The earth moves around the sun at twenty miles a second, the sun five times as fast, our whole Milky Way even more swiftly than that. *All* bodies move, some faster, some more slowly, one to the right, another to the left, now forward, now backward, in straight lines or in curved lines, steadily or at a changing speed. Who can say how or where or how fast anything moves in the universe? We can only say how fast a body is moving in relation to its environment, that is, "relatively."

Galileo, Newton and many other scientists pondered the relativity of speed in their day. John Locke, a contemporary of Newton, used the simile of a chessboard being carried from one room to another: the board has been moved but the pieces remain in their relative positions. They have moved "absolutely" but have stayed put "relatively." Newton said that a man on a ship during a calm crossing cannot tell whether the ship is moving at all, and still less in what direction it is progressing. The same, he explained, was true about mankind on the moving globe. As we are unable to determine absolute motion, he concluded, we should accept as truth what our perceptions and instruments tell us about the relative change of position inside a restricted system.

We do just this, of course, in our daily lives. We say an automobile has a speed of 60 m.p.h. when it moves with that speed over the highway, which is

its frame of reference. We can ignore absolute motion because, as Newton pointed out, the physical laws of nature remain unaltered within a uniformly moving system such as our globe traveling through space. A cup drops aboard a uniformly moving ship the same way it would in a house on the shore, or aboard an airplane moving at ten times the speed of the ship.

This was the point reached by classical physics. Then came Einstein, who computed mathematically the way in which movement influences bodies, observers and the flow of events. His calculations led to the revolutionary laws of relativity. Movement, he stated, changes everything: bodies change their mass; distances, their lengths; objects, their diameters. These changes can not be perceived by an observer who is a member of the moving system because he and his instruments as well as the observed objects change their mass, their dimensions and other properties all in the same ratio.

At the speed of a cruising ship, the changes, even if measured by an "outsider," are imperceptible, but the greater the speed, the greater the change. When the velocities approach the speed of light, changes become not only apparent but catastrophic. Masses increase to the value of infinity, the diameter in the plane of movement diminishes to zero and action comes to a standstill. Existence ceases. Therefore, Newton's principles, which were based on the assumption that space, time, masses, distance, observers and instruments remain unchanged, are not true cosmic laws. They are "laws," valid only in specific systems of reference and for events of moderate speeds, but by no means intrinsic, unalterable, absolute laws of nature.

Relativity III: Time Does Not Flow Equally

In order to approach the problem of dimensions we look at models of one-, two-, three- and four-dimensional systems.

A railroad track may be regarded as a one-dimensional structure: we need only read the milestones to see at what point along the track a train happens to be. In a one-dimensional system of reference only *one* statement is needed to determine a specific point.

The surface of an ocean is two-dimensional. To determine the position of a ship, two statements are required. The ship's log reads: Position 30° North (from the reference line of the equator), 12° West (from the reference line of Greenwich).

In an airplane we pass through three-dimensional space, so we need three statements to determine our position; in addition to latitude and longitude, we must state our altitude. Now let us imagine that an accident occurs: a passenger jumps from the airplane. To describe this event, the reporter has to add a fourth statement, the time: "At 2.30 p.m. (1), 30 miles west (2) of Chicago (3), at an altitude of 6,000 feet (4), a passenger opened the door and

jumped out. . . ." The physicist calls this time-statement the time-coordinate or the fourth dimension and says: All events take place in a four-dimensional space-time-continuum. This fourth dimension is nothing mystic and has nothing to do with the fourth dimension of the spiritists. It is nothing more than the addition of the time-element to the three geometrical dimensions of space.

Suppose we are having breakfast in Washington at 9 A.M. The mail has brought an urgent message for a friend who went to San Francisco two days ago. We call him at his office but there no one answers, for it is still night in San Francisco. If we ring someone still farther west, in Tokyo, it is "yesterday" in that city, and people there are just entering the theater for the evening performance. It is impossible to decide whether their night is past, "yesterday night," or the coming of today. There is no universally valid "present" on earth. Let us imagine that two commentators on radio stations, one in England, the other in East Asia, describe the appearance of the sun at the same moment. The first praises the youthful rise of the sun out of its nightly sleep, the other speaks of a melancholic sun-setting. Both are right because of their different points of observation. Similarly the date, December 24, evokes contrasting associations in the minds of people whether they live in the north, celebrating Christmas in midst of snow and darkness as the feast of returning light, or in the southern hemisphere where they enjoy the climax of summer at their beaches.

Though these examples do not apply directly to the relativity of time in modern physics, they are, in effect, valuable means of proceeding from our acceptance of everyday statements into the world of scientific nonacceptance and skepticism.

Until modern times, people seldom realized the relativity of time because their everyday activities and travels were restricted to small areas where the time differences were not so apparent; but today radio listeners in London after lunch hear morning U. N. debates from New York. The wristwatches of airplane passengers who take off from Paris in the morning (a "Paris morning") will read four o'clock when they arrive in Quebec (4 P.M., Paris time), but it is noon at the Quebec airport. In this truly global life we now realize that there is no Newtonian "equable flow of time."

Our clocks and watches do not show an absolute time, but only the relative time of the locality to which they are adjusted. When pilots fly rockets at the speed of the rotating earth, normal watches will be of no use to them; they will need watches coordinated to the speed and direction of their flight. If they were to fly at the speed of the earth's rotation from west to east, the sun would remain at the same place in the sky, as it did over Gibeon in the days of Joshua. Their time would indeed stand still. No matter how long they were to fly, it would always be sunset or midnight. If the plane were to fly faster than the earth revolves, the pilot would need a watch the hands of which moved backward. A pilot might start from New York on February 1, and arrive in Honolulu on January 31. With the increasing speed of air

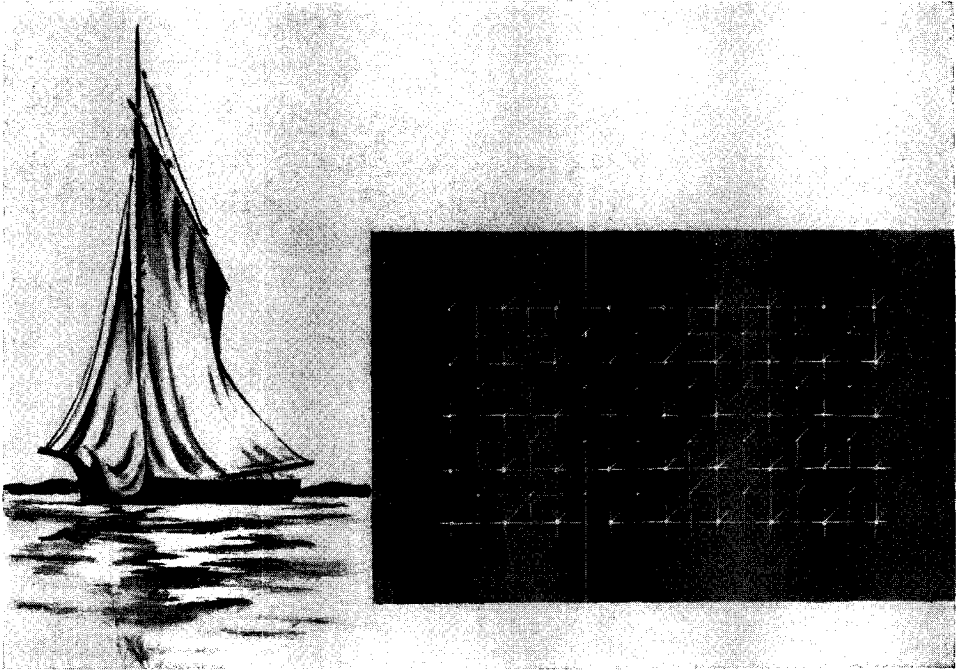

Space

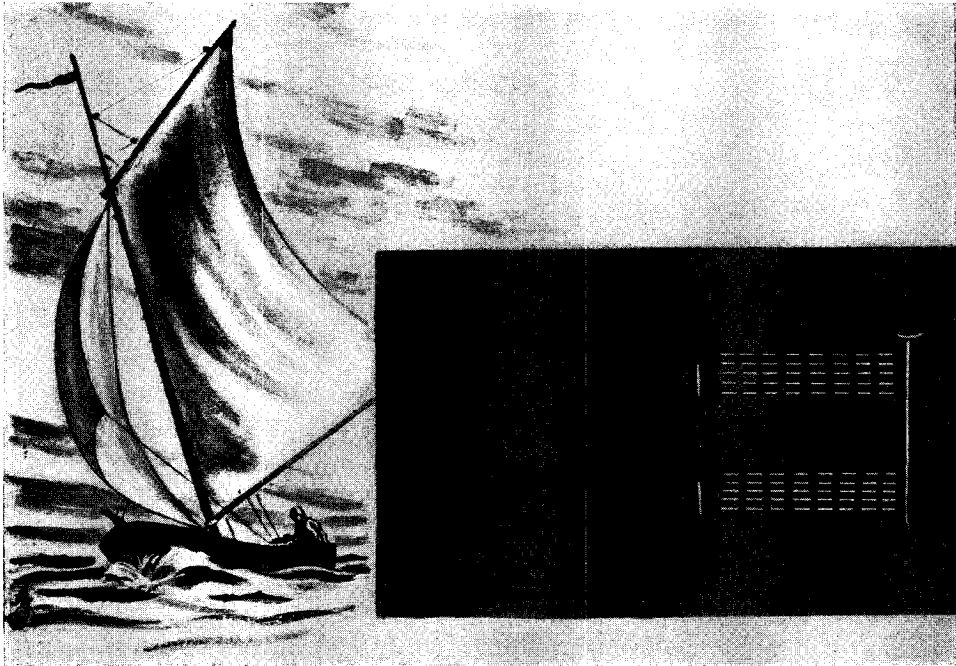

Force

Fig. 8. SYMBOLS OF PHYSICS I

travel, our system of timing will have to be revised. The watches in use today will seem as outmoded to our descendants as the hourglass does to us.

We can travel into space and time by visiting an observatory. The astronomer assures us that his chart of the stars is accurate, with each of the 50,000 dots exactly in place. He points his telescope at any star we choose. Yet not a single star is where the chart places it and the telescope shows it. How far away is our star? We might be told that the one we have chosen is 220 light-years away, which means that its light, which travels 186,000 miles per second (just under 300,000 km/sec), takes 220 years to reach our earth.

Obviously the star is not in the position where we see it. It was there 220 years and perhaps 7 months, 6 days, 14 hours and 32 minutes ago. We cannot tell where it actually is; we do not even know if it still exists. It may have exploded 118 years ago. The Andromeda nebula, our "sister system" among the cosmic islands in space, is supposedly 1,500,000 light-years away. Perhaps it no longer exists; it may have exploded 300,000 years ago. History on earth will have to march 450,000 years farther before the man of the future can know what happened to it 1,000,000 years before our time.

A look into space is a look into the past. What we see as tonight's sky is, in fact, an accumulation of views from different times, and has no more reality than a picture album of history with portraits of Hammurabi and Aristotle, Caesar, Newton and Lincoln together on one page. But the picture of the universe is alive: if four spectators from four other solar systems looked at the earth at this moment, an observer on a planet around Algol might see Lincoln making his address at Gettysburg; an observer on Mizar might see Columbus stepping from his ship on the shore of San Salvador; an observer on Alcyone might see Nero declaiming over burning Rome; and another in the world of the Orion nebula might see the wailing Jeremiah in the ruins of Jerusalem. The same happens to us. When we look at the sky, we do not see "the present," but a thousand different periods of the history of the universe. Our concept of the universe is an inextricable mixture of space and time.

Even in our earthly notions we interchange expressions of time and space. "Noon" is an expression of space as well as of time. It is the moment at which the sun passes a special point in the sky, the zenith of its course over our city. A date on a calendar is not actually a determination of time but of space; days are specific points on the earth's orbit around the sun.

Einstein used an example to demonstrate our arbitrary concept of time. A fork of lightning strikes a railroad track just ahead of and just behind a moving train. An observer beside the track sees both flashes simultaneously. A passenger watching the event on a screen in the center of the train will observe the flashes at different times. The flash in the front of the train appears earlier than that in the rear, because the train is moving toward the first flash and away from the second. The faster the train travels, the greater will be the interval between the appearance of the flashes. If the train is traveling at the speed of light, the passenger will see only the first flash, be-

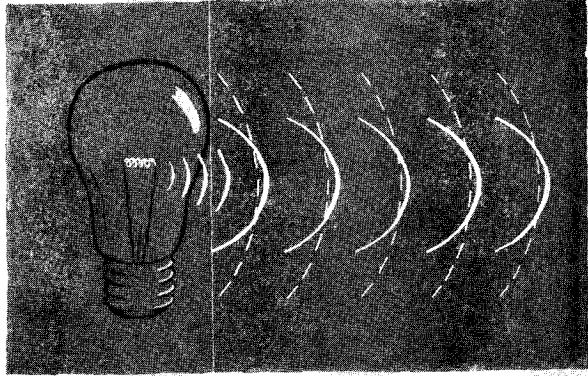

Waves

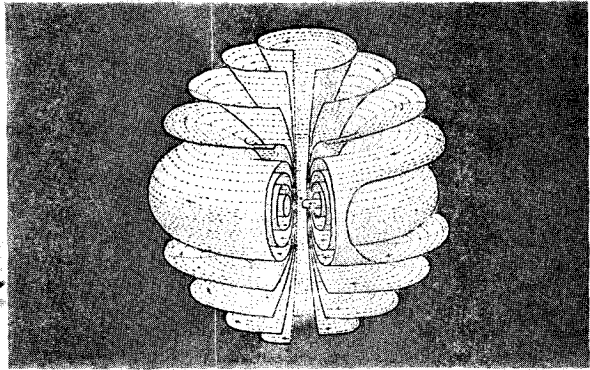
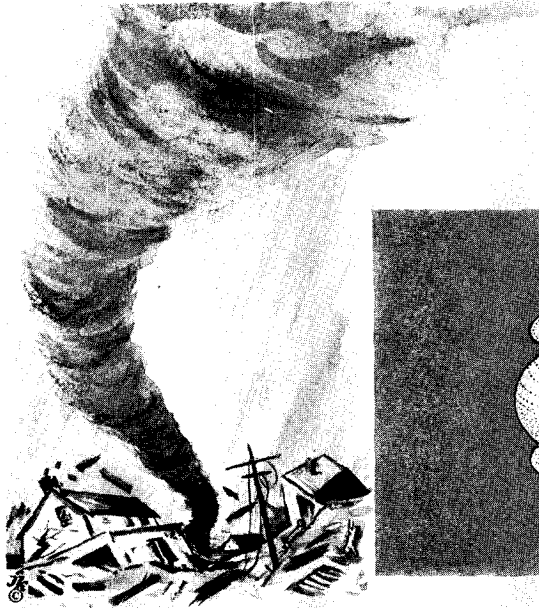

Bodies

Fig. 9. SYMBOLS OF PHYSICS II

cause the light from the rear, traveling at the same speed, can never catch up with the train. If the train were to stop after an hour, the rear flash would arrive just after the train had come to halt, and the observer would say: "Look, a flash of lightning behind us! An hour ago there was another flash in front of our train." It would not occur to him that the two flashes were the two arms of the same stroke.

We may make a similar mistake in recording events in the sky. Two "new stars" flash at the same hour, "tonight." Actually one might be an explosion that occurred eighty-two years ago; the other may have occurred in Plato's time.

Thus time and space, past and future are interwoven into a deceptive fabric. Reality is, as the Hindus symbolized it, a "Veil of Maya," a veil of delusion; we cannot report events in different systems of reference with our popular expressions "now" or "today" or "before." Our picture of the universe is not purely fictional but neither is it "objective." There is no such thing as truth in human science. That is why Alfred Whitehead said: "Exactness is fake."

Matter and Energy in Classical Physics

*Matter in the Asian Religious Philosophies:
Brahma and Tao*

SPACE CANNOT BE really empty, a “nothing.” Either space must be something in itself, or, if space itself is nothing, it must be filled with something. We live in the light and warmth of the sun, which is 150,000,000 kilometers away. The moon makes the oceans heave, even though it is separated from the earth by almost 400,000 kilometers, so there must be a “medium” which serves as a conductor.

The peoples of India and China were the first to develop a coherent theory about the relationship of space, time, matter and events. It is surprising how much their early philosophies, first conceived some 5,000 years ago, resemble our modern concepts. The German philosopher Schopenhauer called the translation of the *Upanishads* in 1840 “the greatest intellectual event of the century.” And just one hundred years later Aldous Huxley presented them to modern readers under the title *The Perennial Philosophy*.

In Brahmanic thinking, as in modern physics, matter and energy are identical. There is one universal “mass-energy” which plays as dominant a role in ancient Hindu philosophy as does God in the Bible. Named Brahma, it is regarded as the one universal divine agent. Brahma is the same pantheistic concept of god and nature as the One and All of the Greek philosophers, the *Ens Unum Eternum et Infinitum* of Spinoza, and Goethe’s concept of the all-embracing God-Nature.

The following excerpts deserve to be read with care because through them one becomes acquainted with a beautiful interpretation of our mysterious world:

In the beginning was not non-existence, nor existence: there was no realm of air, no sky beyond it: no water, no height, no depth. Death was not then, nor was there aught immortal; no light was there, the day’s and night’s divider. Darkness was there, and darkness concealed the beginning of creation. But One Thing *was* there, and apart from it, was nothing whatsoever: Brahma. But he had no form as yet and no motion. The Gods were not yet there, for the Gods came later into the world.

Who verily knows whence it was born and whence comes this creation? Not the Gods, but sages who searched with their heart's thought discovered the existent's kinship in the non-existent.

Again and again Brahma is praised by the Hindus in hymns and parables, just as praise of God runs through the Bible.

Invisible yet omnipresent; the hand cannot grasp him, yet he embraces all; he cannot be seen, yet light comes from him. He cannot be felt, yet all feeling proceeds from him. From him comes everything that happens, but he himself remains the same. He is never surprised and never speaks. He sees everything and causes everything to happen. Everything in him is unquiet, yet he himself remains quiet. As all things have proceeded from him, all return to him, as if they had never been. Therefore he is patient and still.

Brahma himself is without qualities. Qualities are only peremptory states of unrest in the ever-changing but never-disappearing Brahma. The man who liberates himself from this unrest loses these qualities, and, with them, all suffering; he becomes identical with Brahma. Identification with Brahma is the desired goal of those who seek liberation from human anguish. The guiding principle is: strive for nothing and you will gain everything.

Representing the heroes of the western world are Ulysses, who strives to reach home through all obstacles; Don Quixote, who chases windmills; Hamlet, who seeks revenge for the murder of his father; and Faust, who thirsts for the pleasures of life and longs to solve the riddles of nature. The hero of the Hindus is Buddha, who contemplates with resignation the chaos of life, but remains unmoved himself.

With all due respect for its spiritual loftiness and moral nobility, this philosophy contradicts the sense of life. No doubt the living are born to live. The meaning of life cannot be to deny it. India's philosophy has become the bane of the Hindus. In no other country has there been so much suffering by the poor and so much tyranny by the rich as in India; nowhere have passions been so highly pitched as here where men have tried to stifle their passions and desires.

The Chinese also venerate the universal mass-energy as divinity, calling it Tao, "The Not Yet Perfected." Yet from this same basic concept they have derived a different philosophy of life. The Seven Steps of Buddha lead through "renunciation" to "deliverance." But Tao strives toward fulfillment, and it is the part of man not to disturb this quest for perfection, but to support it. The same doctrine was held by the medieval mystics of Europe: man should not hinder God as He goes about His work of perfecting His incompleted work of creation.

Tao, the way to perfection, must be traveled by every individual; he must discipline himself and aid others, instruct the ignorant and assist the young, avoid all discord and remain at peace with his neighbors and with nature in

general. The teaching of Tao encouraged the creative impulses of the Chinese people, whose science and technology attained astonishing heights thousands of years ago. They knew about electricity and steam power, used compasses for traveling, invented paper and printing and created a beautiful calligraphy. At the peak of their culture, their language included more than 80,000 ideograms, or word pictures.

The well-known characteristics of the Chinese—their devotion to work and duty, the strict regulation of family life, the children's respect for their parents, their neighborliness, their resigned acceptance of the blows of fate, their cheerful affirmation of life, their zeal in the arts, their love of flowers and animals and their familiarity with the intimacies of nature—all these virtues have grown in the sunlight of the teaching of Tao. The Hindus and the Chinese, neighbors in geography and brothers in philosophy, provide an illuminating example of the effect of philosophy and science on the attitude and thereby on the historical fate of nations.

The Medieval Concept of Matter: Ether

The Western term for cosmic matter, "ether," was introduced by Aristotle. He said: "The earth is surrounded by water, the water by air, the air by the ether. Beyond the ether, there is nothing more." This was a remarkable statement for a man who, living in 350 B.C., had no instruments of research other than his five senses.

In the first half of the seventeenth century, the Dutch physicist Christian Huygens made two fundamental discoveries. He found that light travels through a vacuum and that a ray of light passing through a crystal of Iceland spar splits into two rays. Each of these two rays now radiates only in its separate plane. This splitting and undulating of light in specific planes is called polarization.

These two observations led Huygens to the conclusion that the so-called vacuum is not actually empty, but that the "empty" space is filled with that fine matter Aristotle had imagined as "ether." Light is an undulation of this ether, vibrating in transversal waves. All phenomena of light—propagation, reflection, polarization—seemed explainable. Thus Huygens' "undulation theory" competed with Newton's theory, which stated that light is an emission of fine corpuscles ejected from a glowing source.

In 1881 and 1887, A. A. Michelson in Cleveland performed his famous experiment to prove the existence of the ether. He started with the idea that if the earth travels through a sea of ether, light should arrive at the "bow" at a speed about 20 miles per second faster than at the "stern." He constructed an instrument known as an "interferometer." Mirrors deflect the rays of a bundle of light in different directions, so that the rays from the same

bundle return to a special point from opposite directions, some from the front of the traveling earth, and others from the rear. If the earth traveled through a sea of ether, the light from the front should travel at a speed 20 miles higher than the light from the rear. Michelson's interferometer was sensitive enough to detect differences in the speed of light as small as two miles per second. But he could detect no disparities; the light arrived at the two points simultaneously.

The negative result of Michelson's experiment caused a great sensation among physicists. There had always been some physicists who doubted the existence of the ether. The first was Newton; the second, Faraday. And now after Michelson's negative experiment came Einstein. He pointed out that a substance like the assumed ether, which transmits a vibration at the speed of 300,000 km/sec, would have to be finer than any gas but nevertheless more elastic than the hardest steel. These two qualities would seem to be irreconcilable. Einstein proposed to abandon the theory of the ether. He said:

All our attempts to make the ether real failed. Nothing remained of all the properties of ether except that for which it was invented, *i.e.*, its ability to transmit electro-magnetic waves. . . . After such unsatisfactory experiences, this is the moment to forget ether completely and to try never to mention its name. We shall say: our space has the physical property of transmitting waves, and so omit the use of a word we have decided to avoid. The omission of a word from our vocabulary is, of course, no remedy. Our troubles are indeed much too profound to be solved in this way!

Our only way out seems to be to take for granted that space has the physical property of transmitting electro-magnetic waves, and not to bother too much about the meaning of this statement. We may still use the word "ether," but only to express some physical properties of space. This word "ether" has changed its meaning many times in the development of science. At the moment it no longer stands for a medium built of particles.

As Einstein said, to eliminate the word "ether" from our vocabulary and to substitute the expression "space having physical properties" is no solution. Space that is empty but nevertheless serves as a transmitter is not a satisfactory concept. Ether might have been an impostor but he was a fairly good ruler. Now, King Ether being dethroned, we live in an interregnum.

This is only one of the numerous paradoxes that plague the modern physicist. We will encounter many more, one by one.

Matter in Modern Physics

*The First Dynamic Concept of Matter:
The "Ether Vortex" of Descartes*

THE FIRST SERIOUS attempt to explain the origin of matter by means of an evolutionary principle was made by the French mathematician and philosopher René Descartes. He is the father of the concept "vortex." (*Fig. 9*)

If we fill a washbasin with water and then pull out the stopper, we see the formation of a vortex. Since only a small portion of the water can enter the narrow drainpipe at one time, the higher levels of the water push the lower ones into a moving spiral, a vortex. By spiraling, the water creates two phenomena: a form and a force. The force is called attraction; the form, a vortex. Vortices, said Descartes, were the beginning of all things. Modern theoreticians have drawn pictures of these vortices; one is used in *Fig. 9* to symbolize energy and matter. Descartes speculated that vortices appeared in the ocean of ether. The creation of the universe was a storm in the ocean of ether, a sort of cosmic typhoon. This storm is still whirling in the microcosm as "ether atoms"; in the macrocosm, as spiral nebulae. Creation—Tao—is not yet finished. At creation, God said: "*Jehi!* Let there be whirling!" If He should be disappointed with the result and decide to annihilate His creation, He would have only to revoke that *Jehi*, and with the slowing down of the whirling, the forms would fade, the forces diminish and everything would sink again into the void from whence it whirled—back to Brahma.

The final fate of Descartes is characteristic of Renaissance times. He was a contemporary of the persecuted Galileo and of Giordano Bruno, who died at the stake. His mechanical concept of creation could not go unpunished. The disloyal pupil of the Jesuits, who had taken for his motto the anti-authoritarian maxim, "Whoever begins in certainty will end in doubt, but whoever begins in doubt will arrive at certainty," fled from France to Holland. From there he went to Sweden at the invitation of the young Queen Christina, daughter of the champion of Protestantism, Gustavus Adolphus.

This very young queen was an eccentric teen-ager; she wore boys' clothing, lived more on horseback than on the ground, never combed her hair and,

as her biographers say, "never washed her face." Her capital was a semi-barbaric outpost of civilization where even generals and ministers could not write their names but signed documents with a cross. Yet, as the daughter of the Great Protestant, she felt it her mission to make his palace an athenaeum of persecuted thinkers, and Descartes was one of the first caught by this unwashed Nordic Circe. When, long after midnight, she tired of the coarse entertainment at her court, she would awaken the philosopher from his sleep for endless intellectual discussion—hadn't she hired him for this purpose? The refugee could not flee the madhouse-palace. Three months after his arrival, the founder of analytic geometry—the algebraic calculation of geometric figures—was dead, the first celebrated victim of the bizarre girl who should have lived on a ranch but reigned on a throne.

*The Pycnotic Substance: Forerunner
of the Wave Theory of Matter*

Many years ago a young student, thumbing through library file cards, came across a book entitled *The Rise and Fall of the Universe as a Cosmic Cyclical Process, Based on the Pycnotic Concept of Matter*. He could not have been true to his calling as a student had he not felt compelled to take out the book. His curiosity was repaid by one of his most remarkable experiences as a reader.

The author of the book, J. G. Vogt, born in 1843, had taken up Descartes' ideas. *Pycnos* is Greek for dense. Matter, said Vogt, is a modulation of the ether, a disturbance resembling a vortex. When matter is formed, it is not created in the shape of atoms, as Newton had thought, but, said Vogt, the ether forms vortices. All bodies are composed of minute ether vortices whirling with enormous speed. When a body moves through space, it is not a "solid body" that moves through "empty space" like a cannon ball. The ether—the "substance"—remains in place while the vortex moves through the ether just as a whirlwind travels through the atmosphere. When a hurricane moves northward from the Gulf of Mexico, the air of the Gulf does not flow toward Canada; it is only the disturbance which moves. When the storm reaches a city, no outside air arrives. The air of the city itself is caught up in the disturbance. When the hurricane has passed, the same air as before is above the city. Similarly, moving objects are moving *disturbances*, typhoons in the ethereal atmosphere of space.

Let a spool roll across the table, and imagine that it is an enlarged model of the Cartesian ether vortex. The rolling spool is not only a model because of its form, but the spool is actually composed of ether vortices knit together in the shape of a reel. According to the theory of pycnosis, the vortices at the front of the rolling spool involve the ether in the disturbance of which they consist, while those at the back release the ether again. When the reel



Fig. 10. PYCNOSIS

The old theory of pycnosis, conceived on purely theoretical grounds, has been revived by modern physics in the form of the theory of matter waves. Electrons are both bodies and waves according to the approach of the observer. The figure of the electron is fictional.

passes, "ethereal calmness" returns, superseding the disturbance we call "spool."

Move your finger through the air. It is a localized disturbance in the shape of a finger that moves past your eyes. Watch a ball flying over a field, a racing automobile, a galloping horse, a walking man—they are disturbances, forming as they move, and dissolving. It is a fascinating theory that J. G. Vogt presented. Yet such an audacious and imaginative concept could reap nothing but scorn from the contemporary scientists. But the young student who found the book, dusty and unread, on the library shelves, was so fascinated that for months he thought and dreamed of nothing but pycnosis. He saw all objects and events as pycnosis and tried in vain to make his friends share his enthusiasm. He tried to convert his physics professor to that hypothesis, but the latter lectured him as a parson would preach to a drunkard to abstain from the alcohol and to return to his family.

The student never forgot his pycnosis hero, and it was a joyful, an unexpected justification of Vogt, ridiculed as a Don Quixote of physics, when the modern concept of mass-energy appeared for the first time. In 1922, Prince de Broglie published his calculations on the matter-waves, and the modern term "wavicle," a shortened form of "wave particle," was coined. The Viennese physicist, Erwin Schrödinger, expressed this idea: "The electron revolving in the atom is a disturbance proceeding along the electron orbit in the form of a wave." (*Fig. 10*) Einstein said: "A moving stone is a changing field where the state of greatest intensity travels through space with the velocity of the stone." J. C. Vogt—substantiated!

Einstein's Concept of Mass-Energy

A vortex is neither a body nor a force; it is both. A force cannot make itself felt unless there is matter to act upon. A vortex needs air in which to appear as a hurricane, or water in which to form a whirlpool. Matter and energy are inseparably connected in a vortex. The greater the energy of a whirling vortex, the more it assumes the qualities of a body. The faster a fan revolves, the more the air vortex around it solidifies. A rubber ball flung at the fan will rebound from the air vortex as if it had been thrown against a wall. If the rate of the fan's revolutions were increased a hundredfold, even a stone could not pierce the vortex.

Modern physicists speak of matter as a special state of energy. Nobody knows what energy is, and the physicist who is in search of the laws of the universe does not ask for the why but only for the what. When energy travels with the speed of light, it is called radiation. When it concentrates at specific points, let us say, as a vortex, it assumes the properties of "mass"; it becomes impenetrable, disputes its place with other vortices, and repels them. Mass is concentrated energy; energy is deconcentrated mass. Einstein created the term "mass-energy" to embody this interchangeability. Mass and energy

are not strictly identical but equivalent; mass can be changed into energy, and energy into mass. The process which turns mass into energy is radiation. All radiations travel with the speed of light. Since the speed of light is always the same, it is called a universal constant and is used as the measuring rod of cosmic distances. The light-times—light-seconds, light-hours, light-years—mean the distance in space over which light travels in a given period of time. The distance to the moon is 1.2 light-seconds, the distance to the nearest star outside the solar system is 4.4 light-years.

Einstein has succeeded in expressing the relationship between energy and mass in his formula: $E = m \times c^2$. "E" stands for energy expressed in ergs; one erg is approximately the energy required for a blink of the eye; "m" stands for mass in grams, and "c" (the Latin *celeritas*, speed) represents the speed of light in centimeters per second, amounting to 30,000,000,000, or 3×10^{10} . The square of c, c^2 , is $9 \times 10^{20} = 900,000,000,000,000,000,000$. Mass is convertible to 900,000,000,000 times 1,000,000,000 times as much energy as its own weight, the weight expressed in grams and the energy in ergs.

The amount of energy concentrated in mass is, according to this formula, tremendous. Out of one single shotgun pellet we could extract as much energy as all the power stations of the world could produce during twenty-four hours, or, conversely, if all the power stations of the world were to convert their energy production into mass, we would see after a day no more than a shotgun pellet.

No wonder that, when Einstein published his formula for mass-energy, the physicists shook their heads. This new concept of matter and energy seemed fantastic. But when, on July 16, 1945, the atom bomb exploded, Einstein was at last proved right.

The importance of a scientific formula can be determined, like that of an art work, by its range of influence. A formula like Ohm's law, which bears only upon the action of electric current, is essential solely for those engaged in the study of electricity. Kepler's formulas concerning the courses of the planets are more highly valued than Ohm's law because they relate to the earth and our solar system and are of interest to every inhabitant of this journeying globe. Newton's laws are held in even higher esteem because they govern the behavior of all bodies in space. Einstein's equation formulates the relationship between energy and matter, the most fundamental fact in nature, and it is difficult to imagine that there could emerge one day a formula which would eclipse this one in importance.

Simplicity is another criterion in evaluating a work of art or thought. The greatest achievements in architecture, in sculpture, in painting, literature and in the formulation of mathematical truths are astonishingly simple. The classical Greek temple, the famous sculpture of Michelangelo or paintings like the Madonnas of Raphael, the Sermon on the Mount or the tale of Genesis—all are so simple that everyone is impressed at first sight and a child can understand their meaning. The great sentences of philosophy are often no longer

than three or five words. The Newtonian laws are short and simple. A formula cannot be simpler than the statement of the fundamental relation between matter and energy: $E = m \times c^2$.

*The Relativistic Variation in Mass, Measure
and Time*

Energy is equivalent to mass. If we add energy to a body, we add mass to it—infinitesimal traces but real mass. A heated iron, richer in energy, weighs more than a cold one. An automobile in motion weighs a small but definite amount more than when it stands in its garage. The increase in mass is proportionate to the speed. When a body travels at half the speed of light, its mass increases by 15 per cent over the mass at rest. At 85 per cent of the speed of light its mass is doubled; at 99 per cent of the speed of light its mass is seven times what it was at rest. From then on its mass mounts in a steep curve. At the speed of light its mass reaches mathematical infinity. A body of infinite mass would offer infinite resistance and would no longer move at all. That is the reason why no body can ever attain the speed of light.

The increase in mass is accompanied by a decrease in diameter in the direction in which the body is moving. Since the earth travels around the sun at 30 km/sec, its axis in the direction of its course is 10 centimeters shorter than it would be if the earth stood still. The automobile on the highway shortens its length with increasing speed. If human beings could travel in a space-rocket at a speed of 1,000 miles a second, they would become flattened. Near the speed of light they would be as flat as gingerbread men. The travelers themselves would not notice the flattening, for their spaceship and all its contents would shrink in the same proportion. A yardstick used on the earth, which travels at the speed of 30 km/sec around the sun, is about 0.000,000,005 centimeter shorter than it would be if it were resting in Euclidean space. The exact shortening of all things around us and of ourselves is not determinable because we do not know how fast our galaxy is flying through the universe. We believe that other galaxies fly at enormous speeds, up to half the speed of light, and it may be that observers from other galaxies would say the same of us. If the cosmic pinwheel were to come to a sudden halt, our yardsticks might stretch out like the ladders of a fire engine, the pencils in our hands might lengthen into flagpoles; but we would not be aware of these extensions, for we ourselves would grow into giants rising to the clouds. Our heads would not touch the clouds, because the clouds themselves would have risen into stratospheric heights.

It is not only the spatial yardstick that diminishes in length, but the yardstick of time as well. Time does not flow equally, as Newton stated. The flow of time is geared to the energy of a system. With the increase of energy the flow of time decreases. Since the force of gravity is greater on the sun than

on earth, a watch there would run 0.000,000,5 per cent less quickly. Watches on a moving train run more slowly, and if the train could accelerate to the velocity of light, the watches would come to a stop. When a man climbs to the top of the Empire State Building, his watch runs 0.000,000,000,000,05 per cent faster as a result of the lessening of gravity. We cannot travel to the sun to compare watches; we cannot stand on top of the Empire State Building for 70,000 years until our watches are a few seconds fast. But Einstein suggested the use of atoms as timepieces.

Each line of color in a spectrum corresponds to a specific energy of the electrons jumping between the orbits of the atoms. If the energy increases, the line shifts toward the violet side of the spectrum; if it diminishes, the line is displaced toward the red end of the spectrum. The color lines of the sun's spectrum are, compared to the color lines of glowing gases on earth, displaced toward the red because the mass of the sun is so much greater than that of the earth and the stronger gravitation slows down the electrons. Every star shows a similar displacement of the spectral lines. From the extent of the displacement, known as the "Einstein Effect," the astronomer can estimate the mass of the star. (See p. 86.)

The electrons inside an organism revolve more slowly when a body enters a strong gravitational field or moves at high speeds. Life runs slowly in heavy worlds and quickly in light ones. An organism may be compared to the clockwork of a toy that can make only a given number of revolutions. The more slowly the clockwork moves, the longer the toy will keep going. If a man were set down in the extremely massive world of the Sirius satellite, the tempo of his life would be sluggish and he would live longer. If a group of persons were to travel into cosmic space at a speed approaching the velocity of light, not only would their clocks and calendars slow down, but their metabolism rate as well. Their hearts might beat only ten times a minute, but they would be unaware of this decrease because everything around them would be retarded. Their pulses would still beat seventy times a minute, checked on their watches; and their calendars would not fail them, because they would keep tearing off the pages at intervals of weeks. If they returned as they intended at the end of five years, according to their time measurements, they would not recognize their families at the landing-field. During the "five years" of their absence, their wives would have lived seven times five years, and would look like their mothers; their children would be old enough to pass as their brothers and sisters. For them Hamlet's cry would ring true—"The time is out of joint!" But it is not likely that men who had undergone such a journey could still quote Shakespeare. With the passage of time and the flow of blood, thinking, too, becomes retarded. Scientists departed—morons returned.

Had the space travelers achieved the speed of light, the flow of time would have slowed down to zero, and their lives would have come to a standstill. Their minds would have been inactive, quasi-frozen. Their masses

having reached the value of infinity and their diameters having been shortened to zero, they would have disappeared. Would they come back into existence as they were before? The formula speaks in mathematical symbols; it says nothing about the mystery of reincarnation.

The Replacement of Newton's Concept of Gravity by Einstein's Concept of the Field

A well-known professor of physics in Leipzig used to begin his lectures with a simple demonstration. A metal ball was suspended on a string near his desk. He would cut the string, and when the ball had fallen to the floor, he would say: "This is the greatest miracle I can show you in all my lectures." There is, of course, no "greatest miracle" in nature, just as there is no "greatest work" in art or "greatest drama" in literature. There is only *one* all-embracing miracle, nature itself.

The effects of gravity are so common that only two people are amazed by it: the child and the philosopher. A baby is surprised when his rattle suddenly disappears over the side of his crib. A year later he is shocked when his cup of milk tumbles from the edge of his highchair and shatters on the floor. Later, when he tries to walk, he is puzzled at the force that makes him fall and looks around to find out who the culprit may be. But gradually, after many painful experiences, he learns to accept gravity as an inherent factor of nature and to brace himself against it. By the time he is grown-up, he finds it quite natural that an apple should fall from a tree, and, unless he has the genius of a Newton, he never stops to think about something that everyone takes for granted.

Newton recognized gravitation as a basic force acting between all bodies and formulated its laws. A law is a mathematical description of the relationship of events; it does not describe the nature of the forces involved. Science describes phenomena, but does not speculate about the so-called nature of things, which is basically unrecognizable. Nevertheless, no scientist can repress man's urge to speculate on the deeper, the "metaphysical" meanings of the objects he deals with.

Newton believed that gravitation was a "force" acting without delay over unlimited distances through empty space. Einstein, who has often been called "The Rebel," distrusted the existence of the ether. The concept of a force acting without delay over unlimited distances contradicts the relativistic axiom that no action can proceed more quickly than the speed of light. Actually, the modern quantum calculations lead to the assumption that gravitation, like light, travels in waves and forms fields. In strong gravitational fields the gravitational waves materialize, as light waves do in becoming photons. The resulting particles are called gravitons. Since our globe is a relatively light

body, its gravitational field is weak and we never experience gravitons as particles.

Einstein, explaining gravitational phenomena without resorting to a mysterious force, hypothesized an example: A group of physicists is locked in an elevator so as to be unable to make any statement about their relation to the external world. At first the elevator falls freely down the shaft of an immensely high building. Unaware of their situation, the physicists perform experiments. One of them takes a pen from his pocket and lets go of it. Since all bodies, according to Galileo's laws, drop with equal speed, the pen, falling like the scientists, remains in mid-air. If the physicist pushed his pen to one side, it will continue to move in that direction according to Newton's law of inertia. He jumps from the floor and floats toward the ceiling with a speed proportional to the energy of his leap. The physicists come to the conclusion that there is no force of gravity acting on their "system"; they are suspended in empty space. Einstein concludes: we are liable to deny the existence of a force if we cannot observe its action.

Einstein suggests another scene: the elevator is in empty space, no longer subject to any power of attraction. But someone pulls it up, not with uniform, but with increasing, velocity. As the occupants and objects in the elevator, according to the law of inertia, tend to remain in their initial state, they are pressed against the floor. "Quite normal," they say. "We are within the gravitational field of the earth, being attracted by its mass." Thus the physicists assume the presence of gravitation where there is none.

Now the elevator is swung in a circle at the end of a rope, and the physicists are pressed against the outer wall of their cage. They assume that the wall is "bottom" and put their feet against it. If we could see them from our point of view, they would appear to be standing straight out from the wall, horizontal to the floor, not unlike stunt motorcyclists racing in a "loop." The physicists, however, conclude that their position is quite normal with gravitation pressing them against the "bottom." Again they fall prey to the fallacy of assuming a nonexistent force, where only movement and inertia are at work.

Einstein concludes that gravitation is an invention of the human mind, not a force acting through empty space. He believes it is more reasonable to regard it as a phenomenon of motion. He gives the example: an observer, looking out of a window, sees beneath him some boys playing with marbles in a yard. The ground is uneven and the marbles follow certain contours of the ground. The observer cannot see the unevenness of the ground; to him it looks as though the marbles were deflected by unknown forces. He assumes that a force is acting. Einstein inclines to the assumption that bodies in space follow certain tracks because space is not uniform. Space is not independent of masses and events, but consists of a sum total of fields with physical qualities.

The concept of the "field" was introduced by Michael Faraday, born in 1791, the son of an English blacksmith, and later apprenticed to a bookbinder. He had no normal education but he had an insatiable interest in physical prob-

lems. He seems to have been one of those bookbinders, not so rare in those times, who made the customers desperate because they did not get their books back before the binder finished reading them. His master, impressed by the lad's interest in physics, gave him tickets for Humphry Davy's lectures. Davy soon recognized Faraday's outstanding capacities and gave him a job as an assistant in his laboratory. Thus began his phenomenal career as a physicist. His most famous discovery was induction, the transmission of electrical or magnetic properties from one body to another without direct contact. Induction is the basic principle on which many of our electrical devices, especially dynamos and electric motors, function.

In order to explain this tele-effect, Faraday introduced the concept of the electric field, "an audacious mental creation," as Einstein said, "which we owe chiefly to the fact that Faraday never went to school, and therefore preserved the rare gift of thinking freely." If we want to visualize a "field," we can hold a magnet under a piece of paper covered with iron filings and shake the paper gently; the field forces exerted by the magnet will cause the filings to arrange themselves in curved lines. These lines represent a cross-section of the magnetic field.

In 1873 the Scottish physicist James Clerk Maxwell formulated his famous field equations concerning the interaction of electricity and magnetism. The equations made possible the calculation of events in electromagnetic fields on the purely spatial relations of acting energies. Einstein took up Maxwell's theory, and after many years of effort arrived at his own boldly conceived field theory of gravitation.

*Einstein's Field Theory:
A New Design of the Universe*

Newton considered the universe an empty space in which celestial bodies are subjected to a number of forces, one of them being gravitation. Einstein visualizes the universe differently: the underlying principle of the universe is mass-energy. Space is identical with the realm of this mass-energy. Mass-energy is the common basis for all phenomena. Energy can be concentrated into mass; mass can be dispersed into energy. Where mass-energy concentrates on specific points, it forms "mass"; where it spreads out with the speed of light, we call it radiation. The universe with its masses and energies is a unit, the *ens unum* of Spinoza.

Mass, born of energy, is the center of a field of energy. When a body moves, a field of energy moves. "A moving stone," says Einstein, "is a changing field where the state of greatest intensity travels through space with the velocity of the stone." When a body creates a field of energy, this field expands with the speed of light, just as an electromagnetic field around the oscillator of a

radio station does. This expanding field of energy is identical with space. Mass, space and energy do not exist separately; they form a trinity. If there were no energy, there would be no matter; if there were no matter, there would be no space. Time, too, would cease to exist. Space is the relation of masses; time is the sequence of events. Where nothing exists, nothing happens; if there is nothing to count, there is no time. When Einstein first arrived in the United States in the twenties, reporters swarmed onto the approaching ship like pirates and pressed the scientist to explain his theory of relativity during the noisy confusion of passport inspection. Striving for the greatest possible simplification, he said: "If you will not take my answer too seriously, but regard it only as a kind of joke, I can explain it as follows: It was formerly believed that, if all material things disappeared from the universe, time and space would still remain. According to the theory of relativity, however, time and space would disappear along with the things."

If there were a single electron in the universe, its field would expand in all directions without any hindrance, like a blown-up soap bubble. When we blow a bubble of soap, we are watching an expanding "field" created by a grain of substance. Not only is its surface curved, but also its content, because the bubble is not empty but is a ball of vapor. Similarly, the space fields around bodies are curved. The universe does not consist of one electron but of innumerable quantities of electrons. Each body creates its own field, forming its "private" space. The space of the universe is divided into fields, like soap bubbles in a bowl pushing against each other.

The heavier a mass, the greater its force and the more marked the curvature of its space. Einstein says that very dense masses are enveloped by their space as if they were "wrapped in paper." The sun, in the middle of the planetary system, is surrounded by a strong and therefore sharply curved gravitational field. The planets generate weaker fields, each according to its mass. The moons have even smaller fields. All these fields are, as Einstein puts it, interlocked like cogwheels.

The cogwheels are revolving. The axis of the "space machinery" is the sun; at different distances the smaller gears of the planets revolve and they in turn are circled by the still smaller gears of the moons. If space could be made visible, the planetary system would seem to us like a celestial clock inside of which we were living.

The movements of the planets and their moons can be calculated with the formulas of Newton's physics without detectable deviation. Mercury, which is the smallest of the planets and the nearest to the sun, is the one exception. Leverrier discovered an irregularity which he called the "abnormal revolution of the perihelion of Mercury." The perihelion is the point at which a planet in its elliptic orbit is nearest to the sun. The perihelion of Mercury swings around the sun once during a cycle of several million years. (*Fig. 11*) No matter how diligently the scientists worked on this problem, using Newton's formulas, they were unable to calculate this cycle accurately.

Einstein attacked the problem with his new concepts. Mercury, he speculated, was near the sun, and as the space around the sun is markedly curved, Mercury is deflected from its orbit. Planets follow the curvature of space—

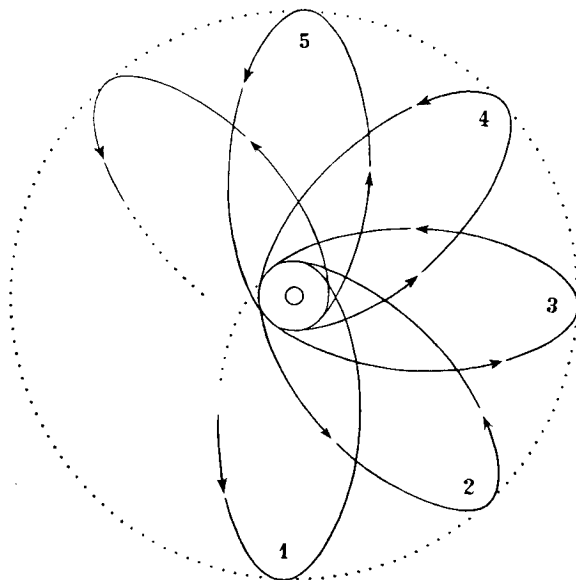

Fig. 11.
FIRST PROOF OF THE
CURVATURE OF
SPACE

The elliptic orbit of Mercury revolves around the sun completing a circle in about 220,000 years (1, 2, 3, 4, 5, etc.). The exact calculation of this movement defied all endeavors as long as Newtonian concepts were used. Einstein succeeded by attacking the problem with his new concepts.

the curvatures of spaces. They take the path of least resistance, traveling along the grooves between the bubbles just as railroad tracks follow the contours of the landscape. With his new concepts, Einstein arrived at an accurate result. His success caused great excitement—not because the riddle of Mercury's perihelion had been solved, but because a problem that had defied the formulas of Newton had been solved by new concepts of space, mass and gravitation. For the first time, a doubt about the infallibility of Newton's "eternal laws of nature" assailed the scientists. The "Frame of the System of the World"—which Laplace had said could be erected only once in the history of mankind with Newton as its Michelangelo—had begun to sway.

As was to be expected, a phalanx of classical-minded physicists arose to defend the venerated Newton. Every imaginable objection was raised, questioning the validity of the new concepts. Einstein, no lover of discussion, challenged his adversaries with a purely impersonal proposition: light is radiation; radiation is a special form of energy. Energy has mass; masses are influenced by gravitation or, as the new theory put it, by the curvature of space. The path of whatever crosses the solar system is affected by the furrows and humps of space. "A light ray passes through the planetary system just as a planet would if it moved with the speed of light." If the light of a star on its way to the earth passes close to the sun, it will be bent, thus demonstrating that the energy of light has mass.

Under normal conditions stars in the vicinity of the sun are invisible, but during the minutes of a total eclipse, they can be discerned in the darkened

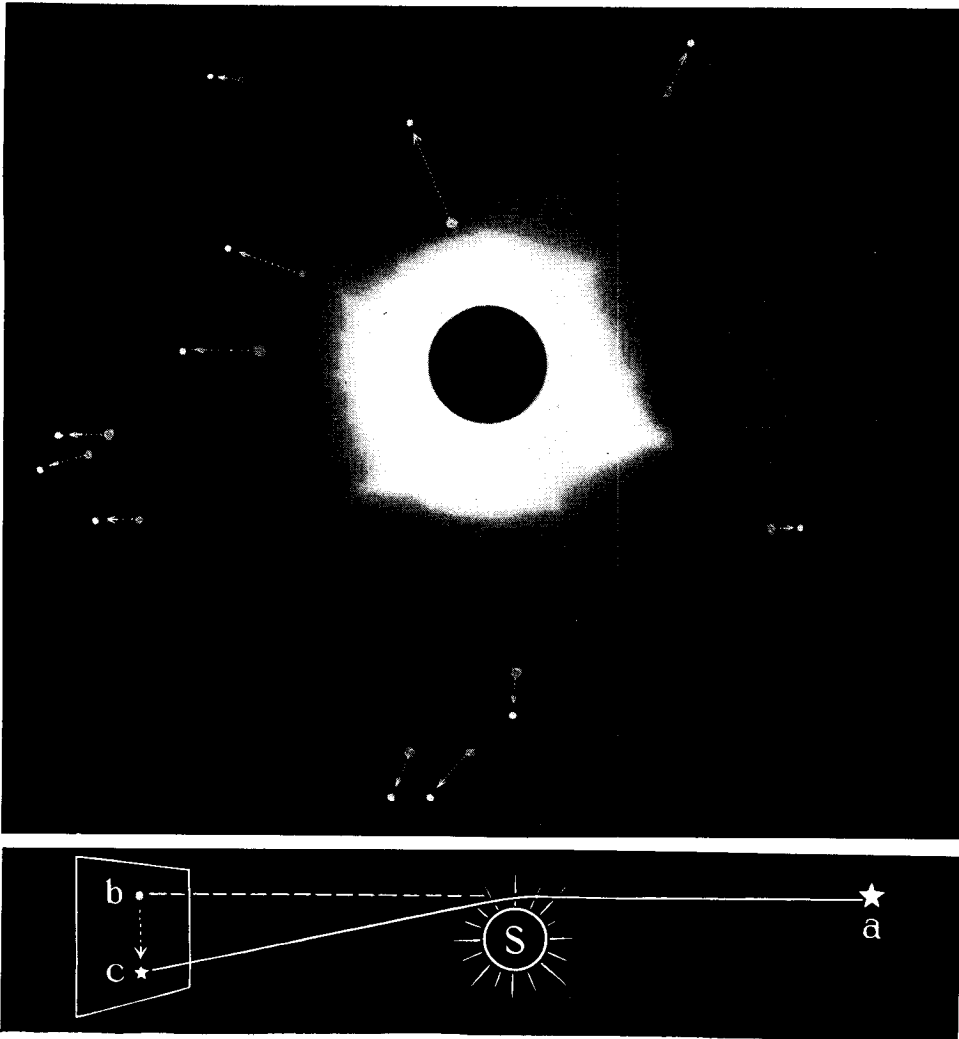

Fig. 12. THE VICTORY OF THE MODERN DESIGN
OF THE UNIVERSE

The solar eclipse of 1919 provided an opportunity to prove the theories of the curvature of space and the bending of light rays by gravitation. The stars around the sun appeared to be displaced according to the calculations and predictions made by Einstein.

sky around the obscured disc. Since their normal places are known, any deviation of their rays can be observed. Einstein proposed the following test: a solar eclipse expected in May, 1919, would occur when the sun was in the center of the constellation Taurus in the midst of the Hyades, one of the most thickly star-populated regions of the sun's yearly path. If photographs of these stars were made during the eclipse, they should show a dislocation of their normal position.

The first World War was barely over and Einstein was a physicist in enemy

territory. Nevertheless, the Royal Society in London took up the challenge and sent two expeditions to Brazil and to New Guinea, where the eclipse could be observed in its totality.

The world of science awaited the outcome of this scientific match with an excitement comparable to that in the sporting world on the eve of a heavy-weight championship bout. Never in doubt about the result, Einstein himself remained unperturbed. The decision could not be expected for at least six months because two sets of photographs had to be compared: the first set taken during the solar eclipse, and the second taken from the same position six months later with the sun in the opposite part of the sky and the stars of Taurus clearly visible as night stars. When the photographs were compared, the displacement was clearly recognizable, but not exactly as Einstein had predicted. Einstein's comment was characteristic of him: "If they take better pictures next time, the stars will be in the proper places." (*Fig. 12*)

He was right, of course. The experiment has been repeated several times. In every case the displacement was revealed, but never exactly. Finally, in 1952, when a total solar eclipse was visible in Upper Egypt, an astronomer performed the test with the accuracy astronomical measurements require. The continually dry climate of this region enabled him to leave his instruments on the spot. After six months he returned and made a second set of exposures under exactly the same conditions. This time the displacement verified the formula.

Even though in 1919 the results were not yet entirely satisfactory, the Royal Society was impressed and convinced that Einstein's new concepts of a relativistic universe were superior to the mechanical ones of Newton. They regarded him as Newton's successor, and at a solemn assembly they bestowed on him the highest tribute English science could offer. As the climax of the ceremony, the portrait of Einstein was hung under the picture of Newton. The British mathematician and philosopher Alfred North Whitehead compared the unforgettable atmosphere of the meeting with that of a Greek drama. By chance the gathering coincided with the first anniversary of the Armistice. It was an act of rare magnanimity which did as much credit to British science as to the guest of honor. On this day Newton's rigid "Frame of the System of the World" was torn down, and the elastic Frame of Relativity erected in its place. The era of modern physics had begun.

PART TWO

The Atom

Student: *“Why are you crying?”*

Professor (peering into the microscope):

“The atoms are so small.”

The “Planets” of the Atomic System: The Electrons

The Atomic Theory of Democritus

TOMOS is a Greek word meaning cut. Atom means the non-cuttable, the indivisible. The word was coined about 400 B.C., when Democritus and his pupils advanced the atomic theory. All visible things, they thought, are composed of small invisible particles which cannot be divided. When a new object appears in the world, it is not really new; instead, the invisible atoms, which are everlasting, fly together like doves at feeding time. And just as doves fly apart after they have fed, nothing really perishes; instead, the atoms disperse. When a cloud gathers in the blue sky, it is a flocking together of groups of atoms, called molecules. Though they were invisible as they moved separately through the atmosphere, they are now aggregated into visible mist. Later, when the rain evaporates from the wet ground, the groups of molecules fly apart again. As a child grows, atoms are being added to his body. When a dead man rots in his grave, the atoms that were given him for a brief time, for weal or for woe, return to the cycle of nature.

If we consider the normal conditions on the earth, we can rightly say atoms are indestructible. The atoms floating in the air today are the same ones which have been there since the earth began. Among the atoms that you are inhaling at this moment there may be one that passed through the nostrils of a dinosaur; later it may have been exhaled by Democritus himself. If the carbon atoms that make up the printer's ink on this page could speak, they could tell far more of natural history than any author. They were spewed forth in the glowing smoke of primordial volcanoes. They floated with the shells of primitive cuttlefish in the warm seas of the Devonian geologic era. They were part of the fern trees of the Coal Age forests. They smudged the hearthstone of Ice Age man, when he painted bison on the walls of his cave. And they whirled upward with the smoke from the flames of burning Troy, when Hecuba lamented the sons of Priam. Now, for a brief period, they are captured here in printer's ink. But they will still exist when we are no longer here, and when this book has crumbled to dust.

Democritus and his fellow-worker Leukippus expounded many other excellent ideas about the atom. They recognized that atoms are governed by powers of attraction and repulsion, and said that "the love and hate of atoms" is the cause of unrest in the world. We would say today that their interactions provide the incentive for evolution. They recognized also that what we learn about things is not what they actually are, but only what their atoms tell us about them. We smell a particular odor when certain groups of molecules strike against the sensory apparatus of our noses. Taste is the drum-fire of molecules against the nerves in our tongues. Nature is not only a universe built up by atoms; even the impressions which we receive of nature, such as heat and cold, light and taste are transmitted by atoms, either singly or grouped together as molecules.

Democritus' atomic theory has survived for more than 2,000 years. In our own day it has experienced a glorious rebirth in an improved form, as the modern atomic theory. But in one respect Democritus was wrong: atoms are not a-toms, indivisible, but tomics, divisible.

Numbers in Science

In the world of atoms as well as later in the realm of the stars, we will have to deal with figures which are beyond all numbers we use in our daily life, even the billions of our national budgets. To understand as far as possible the meaning of these gargantuan figures, it is necessary to become aware of the nature of human figures and of the means the scientists use to express excessive values.

The human numerical system is based on ten because we have ten fingers. In order to exceed the figure of ten and reach higher stages in the art of counting, a symbol has been introduced increasing a given basic quantity ten times. This "operator" is the symbol zero. It is an ingenious invention which only highly civilized peoples have achieved. The fact that the pre-Columbian Mayas used the zero would be sufficient evidence of their high level of civilization even if all other evidence were lacking.

One zero placed after a number means that a certain amount has to be multiplied ten times. If we write "one" and attach a zero, we multiply the one by ten. If we add a second zero, we must count from one to ten ten times over. If we attach a third zero, we arrive at 1,000. Suppose someone asked you to count aloud to a thousand, number by number. You would not be happy but you might still comply. But when asked to count to the fourth zero, 10,000, you would have to give up because you would be hoarse. You realize what a devilish invention the zero is. When we progress from the fourth to the fifth zero, not only does counting become impossible but the imagination of man reaches the limit of its capacity. The leap from 1,000,000

to 10,000,000 is literally “transcendental.” With each additional zero, a number or mass or a distance becomes ten times as great as it was.

Scientists must work with numbers so large that it is difficult to read and even to print them. Therefore, instead of writing out the zeros, we indicate them by a figure above the line, the “power” to which the ten is to be raised:

$$\begin{aligned} 10^1 &= 1 \text{ with } 1 \text{ zero} = 10 \\ 10^2 &= 1 \text{ with } 2 \text{ zeros} = 100 \\ 10^6 &= 1 \text{ with } 6 \text{ zeros} = 1,000,000 \end{aligned}$$

We use the same system for decimals, to save writing too many zeros after the decimal point:

$$\begin{aligned} 10^{-1} &= 0.1 \\ 10^{-2} &= 0.01 \\ 10^{-6} &= 0.000,001 \end{aligned}$$

To indicate numbers which do not begin or end with 1, the number in question is set as a factor before the 10, thus:

$$\begin{aligned} 7 \times 10^6 &= 7,000,000 \\ 7 \times 10^{-6} &= 0.000,007 \end{aligned}$$

It is easy to remember: in all numbers, there are just as many zeros as the number of the power; the decimal starts with the zero before the decimal point.

$$\begin{aligned} 10^{31} &\text{ is a } 1 \text{ with } 31 \text{ zeros, or} \\ &10,000,000,000,000,000,000,000,000,000 \end{aligned}$$

What does this number mean? Suppose we take a small electric motor which rotates 33 times a second. This would mean roughly 2,000 times every minute and almost 3,000,000 times a day. Let us combine the motor with a comptometer which counts these rotations. The comptometer will stop the motor when the number 10^{31} is reached. We watch the numbers mount: 100, 200, 300 . . . 2,600, 2,700, 2,800 . . . 16,400, 16,500, 16,700. We are confident. The electric current needed to run the tiny gadget is negligible. But we are curious whether the number 10^{31} will be reached before Christmas or after Easter. We take a sheet of paper and calculate. We are appalled! The motor has to rotate for about ten years to reach 10^{10} . To reach the number 10^{12} it will have to run for 1,000 years. A million years will pass before we arrive at 10^{15} ! And our whole universe may not exist long enough to give our motor a chance to reach the number 10^{31} . We have fallen victim to the magic of the zero.

The Numbers of Atoms

It is well to understand that all physicists up to our day came to the erroneous conclusion that atoms are, as Newton said, "solid, hard, impenetrable and unbreakable," for atoms are so minute that it seems only natural to think of them as the basic immortal units of the universe.

When you are sitting at the breakfast table tomorrow, dip out a spoonful of coffee. In these few drops of liquid there are about 50,000,000,000,000,000,000 atoms. Let us try to understand the meaning of such a number, as far as man's mind is able to grasp it at all. Imagine pouring the coffee from the spoon atom by atom. You tilt the spoon so that three atoms drip down every second. Since you will get tired of holding the spoon, you fasten it inside a hermetically sealed glass tube. Twenty-four hours later nearly 300,000 atoms will have dripped from the spoon. At the end of a year the 100,000,000 mark is almost reached. Nevertheless you do not see any diminution in the size of the tiny coffee lake. You calculate how long it will take until you become aware of the loss or how long it will take until the last atoms drop. Fifty billion years, or just about ten times longer than the universe is thought to have been in existence!

The artificially created element, No. 96, curium, named in honor of Pierre and Marie Curie, is a radioactive element. The atoms of a radioactive substance are overcharged and sooner or later they explode. The speed at which they do so differs. It may be a few seconds or millions of years may elapse before half the atoms disintegrate. In curium it happens in about half a year. Imagine that a piece of curium is before you, the size of a sugar lump. Now look at your watch. While the second hand moves from one small point to the next, 100,000,000,000 atomic particles fly out of the little cube! This radiation will continue, decreasing imperceptibly, for weeks and months. When half a year has passed, look again at your cube of curium, and you will find that half of it is still left—and 50,000,000,000 particles are being emitted every second!

The human body is made up of 10^{28} atoms. The earth contains 10^{52} . In the visible world of stars, there are—so say the calculators— 10^{87} .

"It is as easy to count atoms as to resolve the proposition of a lover"—according to Shakespeare.

The Atom: A Microcosmic Solar System

In spite of their infinitesimal size, atoms are not solid, massy, hard and impenetrable. On the contrary, every atom is comparatively as spacious and as empty as our solar system. Amazingly enough, it is also similar in its struc-

ture and its mechanism. The atom consists of a “central sun,” the nucleus, surrounded by revolving planets, the electrons. The similarity can hardly be interpreted as accidental. The “solar system” is the basic unit of the universe. The macrocosm of galaxies is composed of solar systems; the microcosm of “matter,” the elements and compounds of gases, liquids, solids, is built of atoms. The solar system is the atom of the macrocosm, and the atom is the solar system of the microcosm. (*Fig. 13*)

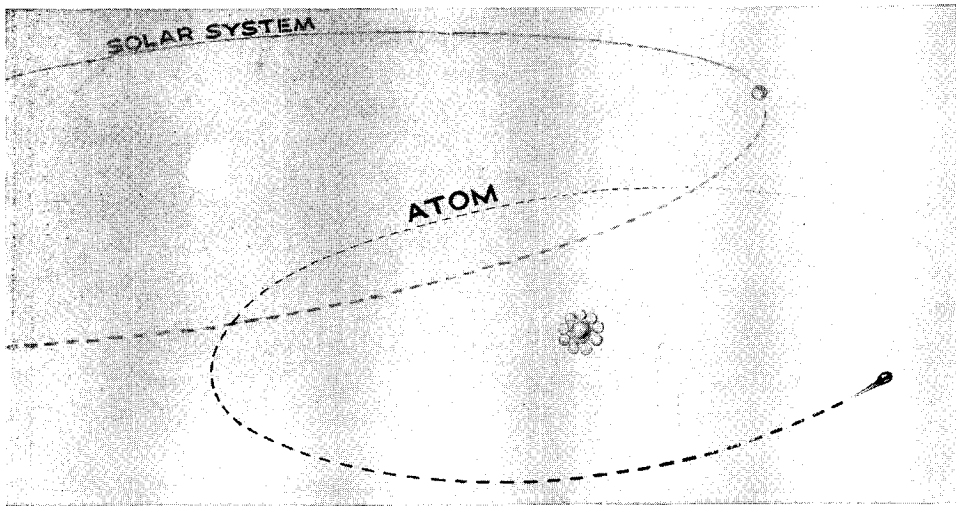

Fig. 13. THE ATOM

The atom is generally compared to the solar system. Like planets, electrons revolve around a central nucleus in which energy is concentrated.

Yet there are differences. The solar system is a gravitational system; the force that chains the planets to the sun is the force of gravity. The atom is an electrical system. Events within the solar system are mechanical and follow the laws of Newton; events within the atom are electrical processes. Since the electrical field is incomparably stronger and acts more vehemently, we will meet in the world of atoms energies and speeds which surpass those in the solar system millions of times and which cannot be calculated with classical mathematics but only with the methods of quantum mechanics.

A second difference: In the solar system the sun is larger than the planets. The nucleus of the atom differs little in size from its planets, the electrons.

A third difference: In the solar system the planets are of various sizes; in the atom the planets are all the same size.

A fourth difference: In contrast to the planets, which revolve around the sun in one plane, the ecliptic, the electrons of the atom circulate around the nucleus in different planes, forming a globular structure. The solar system is a disc, like a merry-go-round; the atom could be compared to an onion, with its concentric skins. (*Fig. 10*) However, since an onion is compact and an atom is open and empty, an even better comparison would be a swarm of flies

buzzing around the head of a trotting horse. The horse's head is the nucleus, the electrons are flies, attracted by the horse's smell. While the horse moves along the road the flies buzz around it.

A fifth difference: In the solar system the planets move relatively slowly. The outer planets take dozens of years to revolve around the sun. But the electrons in the atomic system race along at hundreds or even thousands of kilometers every second. The single electron in the orbit of the atom of hydrogen is supposed to fly at an average speed of 700 km/sec. If electrons were to fly in a straight line, they could cross the North American continent in less than ten seconds. Since their orbits are so small, they whirl around the nucleus an average of 6×10^{15} times every second.

Both the solar system and the atom are spacious. They are empty to a degree that we might almost call uncanny. When men in the future travel through the solar system, they will be gripped by a shattering sensation of being lost in boundless space. If the substance in the solar system, the matter of sun, planets, moons and asteroids, were distributed evenly, the solar system would be vaporized into a gas 230 million times as thin as air!

The atom is even more empty than the solar system. Imagine that the nucleus of an atom is a cherry, and that the electrons flying around it are mosquitoes. The nucleus hangs as it would on a cherry tree right here before you. Where are the electron-mosquitoes? We glance about but do not see them. We pick up a telescope and search the landscape. Yes, over there, more than half a mile away, something rushes across our field of vision. We cannot really tell whether it is a mosquito, because it is moving too fast. We say, "It is nothing, a mere shadow," and that is true. A flying electron is no more than a touch-and-go. And a few ghostlike naughts buzzing around a cherry a half-mile away—that is the structure of the atom. It is more a phantom than a thing. Yet this phantom is the building stone of the universe.

The Electron

During the nineteenth century electricity was regarded as a force. But after the discovery of the electron in 1897, it became more and more evident that electricity is a force only in the sense that rain could be called a force. Rain can act as a force, splitting leaves, washing out gullies, even breaking windowpanes; but actually rain is a substance just as the driving air we call wind is a flowing substance.

Electricity is composed of electrons as rain is composed of water drops. The electron is not a definite corpuscle but is something like a vortex. The electronic vortex is made of that indescribable all-pervading something the old physicists called world-ether, and the present physicists call mass-energy or space or do not name at all.

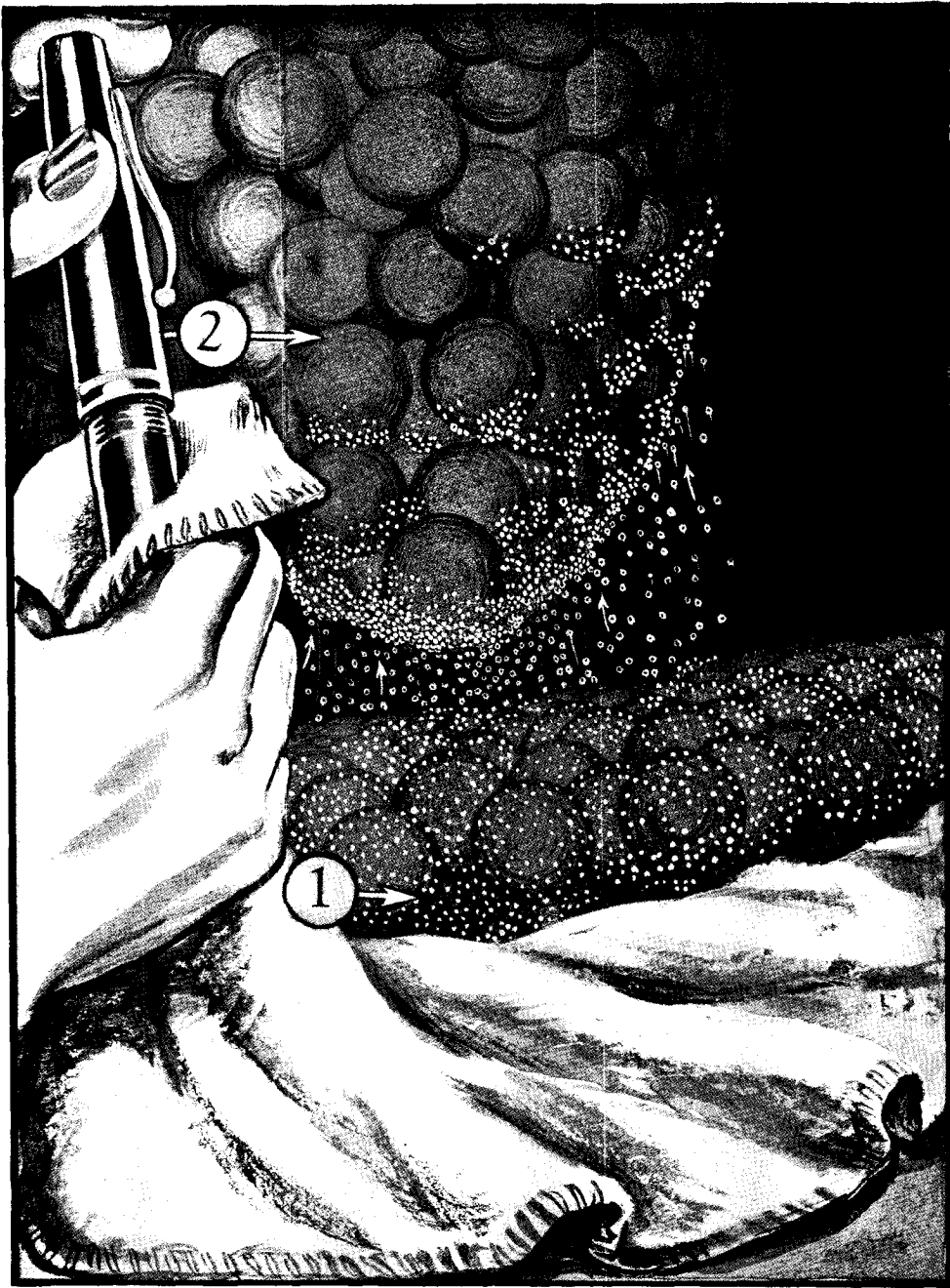

Fig. 14. ELECTRONS

The simplest way to demonstrate the ubiquitous existence of electrons is to rub the shaft of a fountain pen (2) with a woolen cloth (1). The electrons inside the open spaces of the wool are attracted by the pen and gather here as an "electrical charge."

Like all vortices, the electrons spin in one direction or another. We could say: some are cyclones whirling from the periphery to the center and others are anti-cyclones rotating from the center to the periphery. Or we could say that some are positive and others negative electricity. Actually, we know only that there are two kinds of electrons; some have a positive charge and are called positrons; the others represent a negative charge and are called electrons. A more logical name would be negatrons. In the early years of research in electricity, Benjamin Franklin termed the electrical pole, which sends out the then unknown electrons, the negative pole and the other, which accepts the stream of electrons, the positive pole. So the two terms positive and negative electricity came into use just contrary to the facts. The carriers of electricity, the electrons, are called negatively charged, or negative electricity.

As a basic unit of the universe the electron is very small. It weighs 9.1×10^{-28} grams. The weight of an electron compares to the weight of a pea, as the weight of a pea compares to that of the earth. Compared with a man, the electron has the same mass as a man compared to the largest of all known stars.

As a vortex the electron has no definite size. The radius of the resting electron is fixed at 2.8×10^{-13} centimeters. This, too, is so minute that it can be comprehended only by a metaphor. If, after the great flood, Noah had begun to line up electrons like the beads of a necklace at the rate of ten electrons per minute, working eight hours per day, and if his descendants had continued through the ages up to the present, the naked eye still could not see the result of their labor.

The electron, being smaller than the shortest light wave, cannot emit light, just as a bacillus cannot utter a cry. Occasionally photographs are printed with the misleading caption, "Photograph of an Electron," but actually it is not an electron that is photographed but only the effect caused by an electron. When electrons are shot through a "Wilson chamber," a vessel filled with super-cooled vapor, they strike floating molecules of the vapor. The shaken molecules condense into drops of mist and the path of the electron becomes visible as a chain of droplets. The electrons themselves remain invisible just as do the bullets the hunter shoots into a flock of birds. But the birds, as they fall, reveal the path of the bullets. (*Fig. 15*)

Similarly the name "electron microscope" misleads the reader. It is not a microscope which shows electrons. Rather it uses beams of electrons, instead of light, to make visible objects which are too small to scatter light waves.

It does not seem probable that electrons can ever be made visible, but in science and technology one should never say never. Man, the Master of the Electronic Brain, who speaks over oceans with wireless and pierces the veil of clouds with his radar-eye, may yet invent a device to make electrons visible as he has done with bacteria, viruses and even molecules.

*The Emptiness of the Atom and the Origin of
“Heavy Substances”*

The solar system is so poor in matter that we can almost say it is a void. No human being can imagine the vastness of the spaces between the planets. But these distances shrivel into nothingness when we compare them to the

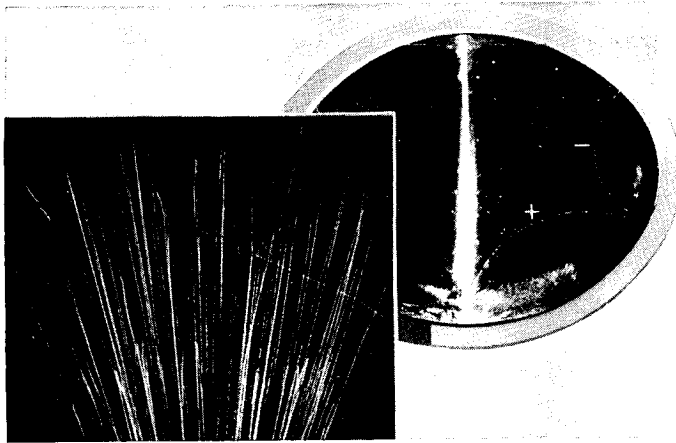

Fig. 15.
PHOTOGRAPHY
OF FLYING PAR-
TICLES OF THE
ATOM

The particles themselves are invisible, but their paths become visible in the Wilson chamber since they disturb the molecules of water vapor and cause them to condense.

isolation of our solar system from the other suns in our galaxy. It takes light eight minutes to travel from sun to earth and eight hours to reach the outermost planet. It takes it eight years to reach Sirius, the nearest of the large stars; and the next “nearest” large stars are three, five and ten times as far away. Ten light-years is an average distance between members of the “starry host.”

The distances between the atoms of a substance, even between those in solid substances, are similar. The atom itself is enormously spacious. We compared it to a cherry and a few mosquitoes half a mile or so distant. Where will you find the nearest cherry? On a tree nearby? No. We must start on a journey. The trees are as distant from each other as are the great cities on the continent of North America. The atoms of gases are ten times farther apart. On the whole continent we would find only three or four “neighboring trees,” one in Vancouver perhaps, the second in Philadelphia and the third in New Orleans. If there were a creature living on the electron of an iron atom in the middle of a steel girder, it would peer out into its universe and compose poems on the “awesome vastness of cosmic space.” Now we are no longer surprised that heat waves pass through iron plates, light through windowpanes, electric current through copper wires, and that radio and television waves penetrate through walls as though nothing stood in their way. There *is* really nothing in their way. Only a billionth of the seemingly solid wall consists of matter; the rest is space.

Despite the vastness of the atom, it is extremely difficult to press one atom against another or to compress the orbits of the electrons. Electrons re-

volve 6×10^{15} times a second around a nucleus. A system with such a quotient of rotation is harder than steel, no matter how small the mass or how great the distances. An atom behaves like a propeller which makes a million revolutions per second.

Until recent times it had proved impossible to compress the molecules of water to any noticeable degree. "Liquids cannot be compressed" is one of the propositions of classical physics. Recently water has been compressed to 60 per cent of its volume. Ice made of this compressed water does not float like ordinary ice but sinks like lead.

To overcome the resistance of the revolving electrons, a pressure of 100,000,000 kilograms per square centimeter must be exerted. Then the electrons are driven from their orbits and after the disappearance of the electrons, the atoms form a mass consisting of nuclei only, the "nuclear liquid," which is the densest possible condensation of matter. A human body whose atoms were thus compressed would shrink to the size of a bacillus without losing any weight. The whole of humanity could be packed into a thimble, and not one iota of matter would be lacking! Only space, the space between and inside the atoms, would have been taken away.

It has been estimated that the annual production of all the steel mills in the world could be collected in one egg, if the output were condensed into nuclear liquid. But such an egg would become so heavy that it would sink before our eyes into the ground, like a stone in water, and down into the depths of the magma below the earth's crust.

The pressure increases the farther down you go into the earth's interior. In the center it reaches one-fifth of the amount needed to break down atoms. In the interior of Jupiter, which is a thousand times larger than the earth, the pressure comes dangerously close to the critical point. Jupiter is about as large as a cold celestial body can be. The increasing mass makes it impossible for a star to concentrate unlimited amounts of matter in its interior. If too many atoms are concentrated in its core, those in the center of the mass break, the star collapses and becomes a dwarf star. One such dwarf star revolves around Sirius, our neighbor in the universe. It is not much larger than the earth, but its mass is 200,000 times as dense. If we would put the Empire State Building on the companion of Sirius, it would contract to the size of a needle—without losing a gram of weight. If this "needle" were to fall on one of our steel bridges, it would pierce the heavy-duty construction as if the whole skyscraper had struck it. (*Fig. 16*)

Compressed atoms have a tendency to spring back to their original size, like the spring released from a jack-in-the-box. If the needle from the companion of Sirius were to fall upon the earth, it would explode because of the decreased pressure. It would expand until it was once more the size of a skyscraper. (*Fig. 17*) Such "atomic explosions" happen in the universe. The exploding star flares up and is seen as a "super-nova." Scientists regard Sirius' satellite with suspicion. It is like an atomic bomb hovering over our

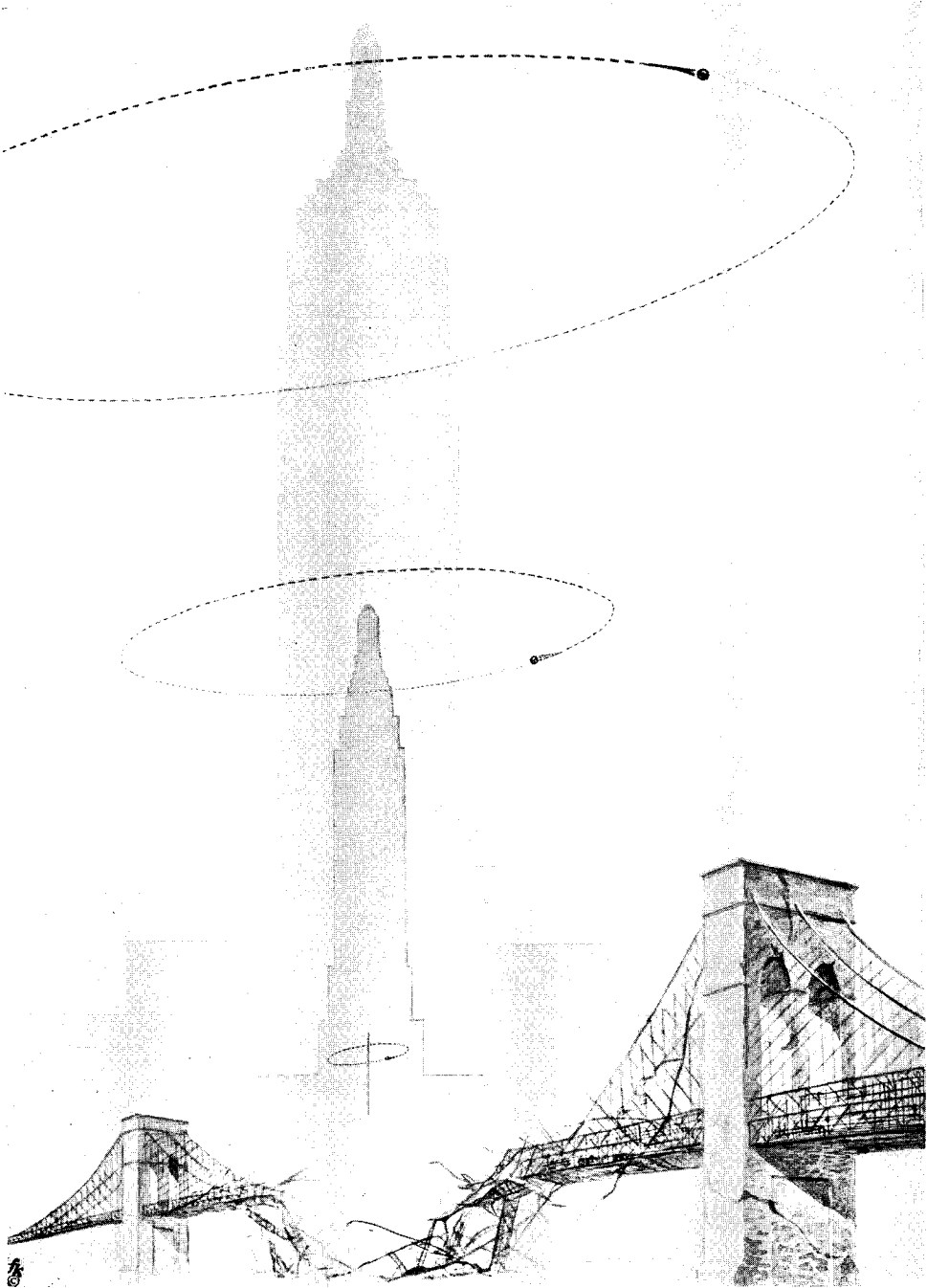

Fig. 16. THE EMPTINESS OF MASS

Since atoms contain space and are widely separated it is theoretically possible to consolidate them. A structure like the Empire State Building could be compressed to the size of a needle without losing weight. The million-ton needle would pierce any steel bridge.

heads, ready to explode at any moment. "Over our heads," in the universe, means 86,000,000,000,000 kilometers away; "any moment," in the cosmos, means 60,000,000 or 600,000,000 years from now. So we can sleep as peacefully as our grandparents did who knew nothing about the "impending danger."

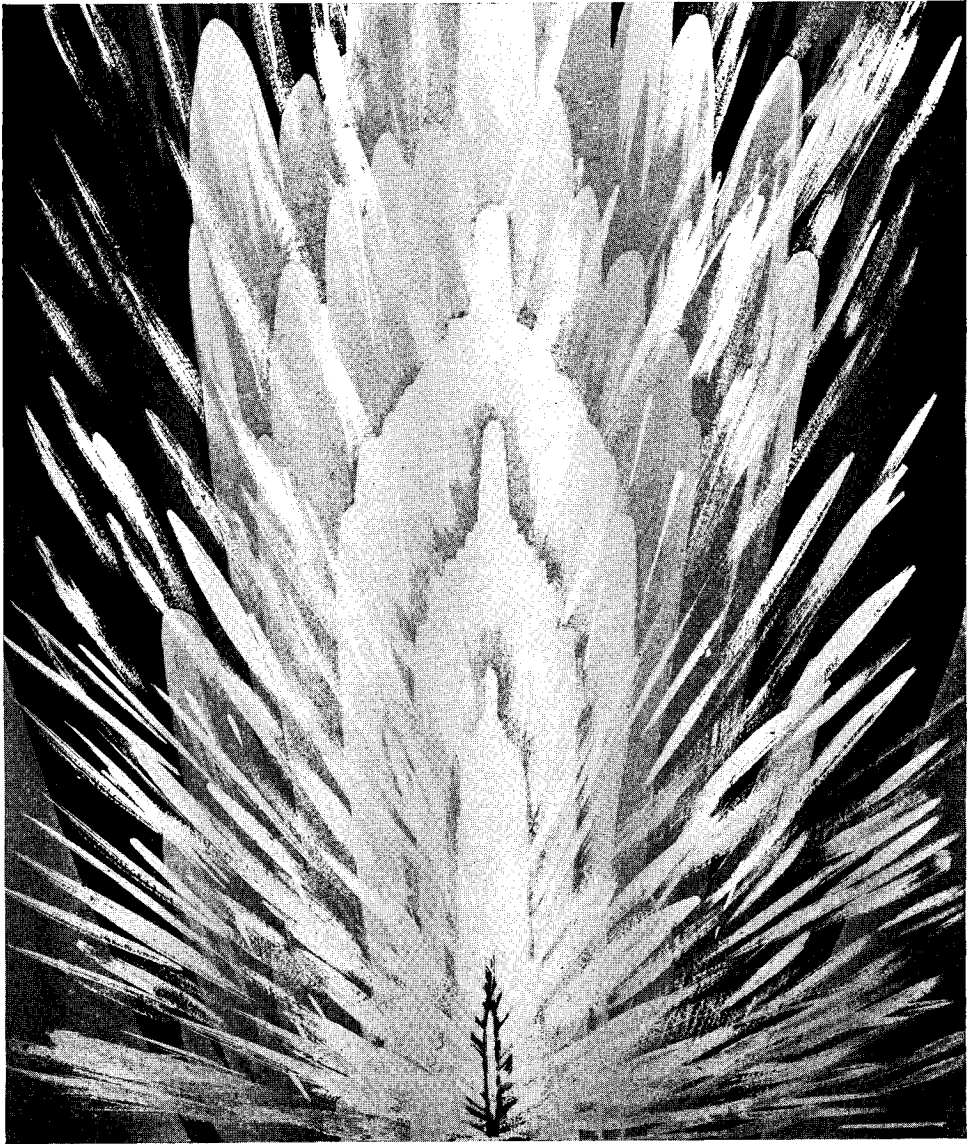

Fig. 17. THE EXPLOSION OF A NUCLEAR NEEDLE

Released from pressure, a needle of "nuclear mass" would bounce back with high energy and—theoretically—the Empire State Building would reappear.

The Electrons in Their Courses

The number of electrons revolving around the nucleus of an atom ranges from one to about 100. We call the various kinds of atoms elements, and number them according to the number of electrons they contain. The smallest atom, with only one electron, we call hydrogen, which means water-builder, because it forms water by combining with oxygen. The next element is helium, the "sun-substance," which has two electrons. The third, lithium, has three, and so the series continues, on up to the largest atom found in a natural state on the earth, uranium, with 92 electrons.

The names of the elements are mostly medieval and mostly senseless, a burden for the student as well as for the public. If at least the first ten were named logically—protonium, secundium, tertium—atomic physics would be considerably facilitated.

It is customary to use the first letter or letters of the element as a symbol. The abbreviation is usually clear: He for helium, Li for lithium, U for uranium. Some of the symbols have been taken from the old Latin and Greek names for the elements. Na (natrium) is the abbreviation for sodium; K (kalium) is used for potassium; Fe (ferrum) denotes iron; Pb (plumbum, the element of the plumber) is lead. The number of electrons revolving around the nucleus of an atom is written in front of the chemical symbol: 1 H, 26 Fe, 92 U.

The electrons revolve around the nucleus in orbits or "shells." Their number varies from one to seven, depending on the number of circulating electrons. They are either numbered from one to seven or labeled K, L, M, N, O, P, Q in spectroscopic research. Like the orbits of the planets in the solar system the orbits of the electrons do not really exist but are only the paths of the atomic "planets."

As in the solar system, the orbits become larger the farther we move toward the outer part of the system. On the innermost shell there is room for only two electrons. If the atom acquires a third electron, this third electron must find a place in a second shell. The second shell has room for 8 electrons, electrons 3–10. (*Fig. 19*) If an eleventh electron joins the system, it must revolve in the third shell, which has room for as many as 18 electrons.

But the shells generally do not fill to capacity. When the third shell has accepted 8 electrons, and the total number of electrons has reached 18, the nineteenth electron must revolve in the next, or fourth, shell, which generally fills up with 18 electrons yet is capable of accepting 32. The fifth shell accepts 18 as a rule but is able to offer space for more. Generally an orbit does not fill up to capacity; instead, the electrons distribute themselves in a flexible arrangement following the scheme 2, 8, 18, 18, 18, 18. This makes a total of 82 electrons, which is the maximum a stable atom can hold together. If the number of electrons exceeds 83, the atom becomes unstable.

Electrons and other parts of the atom do not follow the laws of classical mechanics; they are subject to the laws of quantum mechanics. An electron cannot move as freely as a planet; it can perform only specific "quantum leaps." An electron may alter its distance from the center of an atom. It

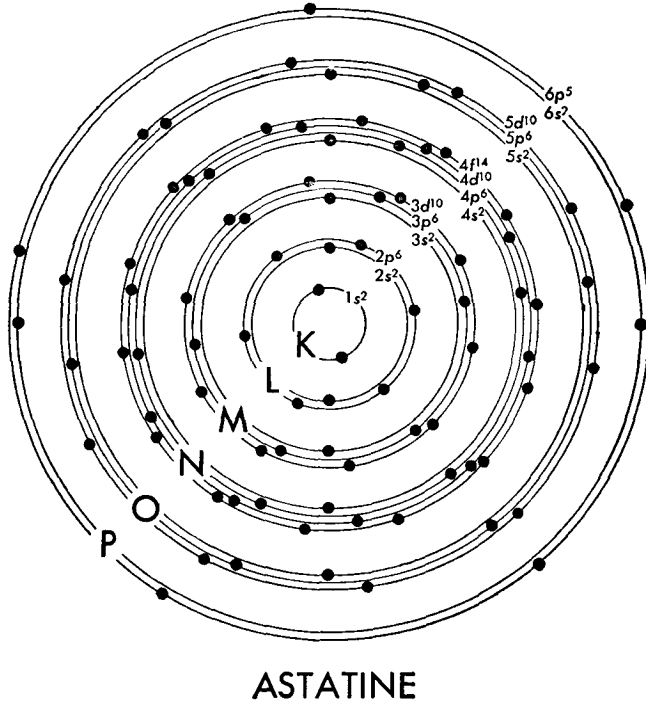

Fig. 18.
**THE SHELLS OF
THE ATOM**

The shells of atoms are subdivided into subshells. In the atom, Astatine, the electrons are distributed in 6 shells: 2, 8, 18, 32, 18, 7, whose subshells are shown.

may make a great quantum leap and jump from one shell to another. Or it can jump slightly from its main track to a side track, just as a horse running on a racetrack can take a step to the side and run a yard farther away from the center of the track. By stepping to such side tracks, the electron adds a subshell to the main shell. (*Fig. 18*) The electrons, especially those newly added, revolve in such subshells, which are designated by the letters s, p, d, f. $6p^5$ means that on subshell p of shell 6 five electrons are circling.

These subshells would not have to be mentioned if they had not become so significant after the introduction of radio astronomy. Atoms, mostly hydrogen atoms with one electron revolving around the nucleus, fly erratically in cosmic space. These electrons jump from time to time from the main shell to a subshell, releasing some quanta of energy which radiate through space as a wave 21.1 centimeters long. This wave, just inside the range of our radio band, is audible by sensitive receivers. (*Page 151*)

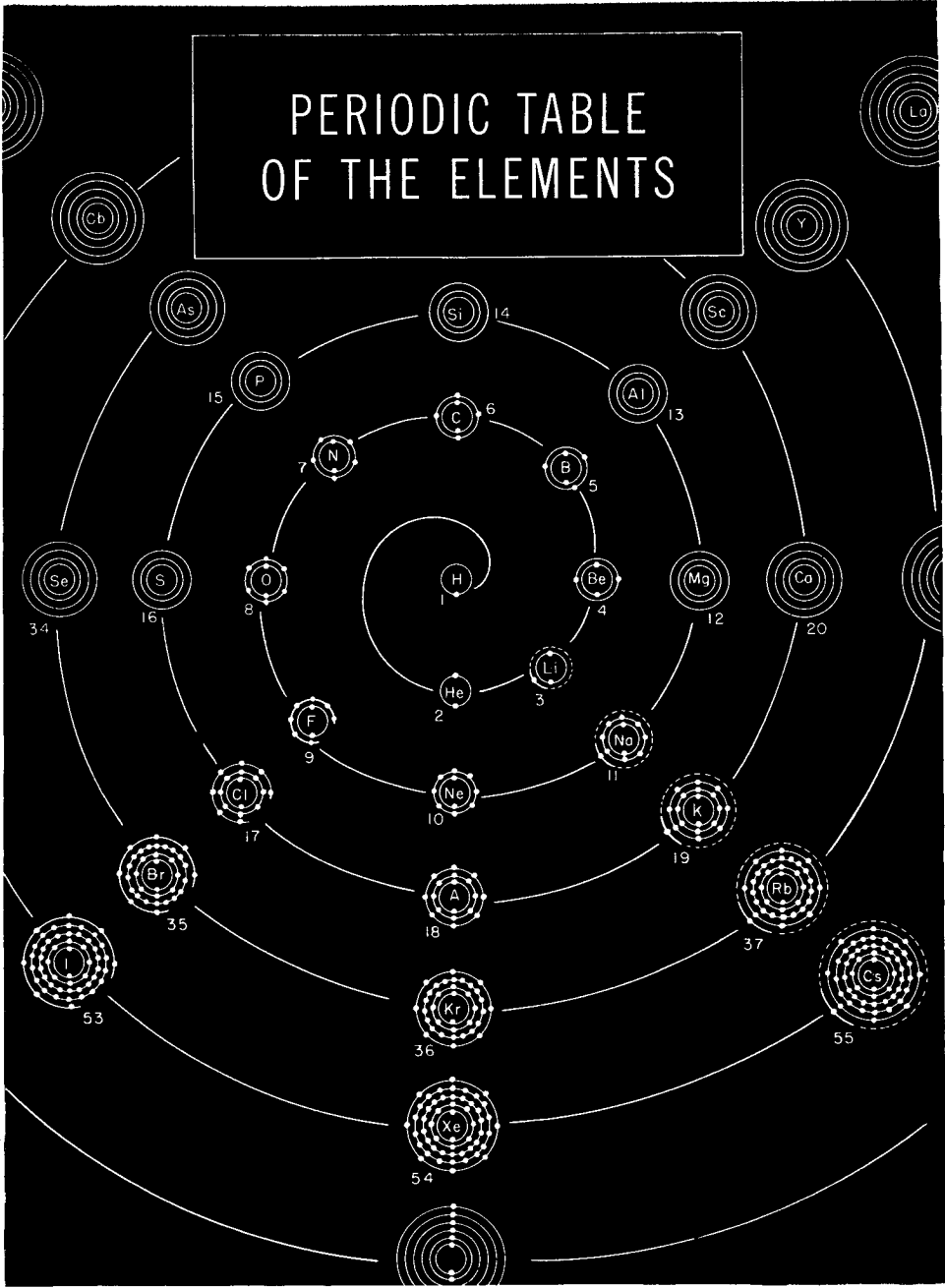

Fig. 19. THE PERIODIC TABLE OF THE ELEMENTS
 The chemical properties of the elements are determined by the number of the electrons in the outer orbit of the atom. Elements having the same number of electrons or gaps in the outer orbit resemble each other in chemical properties and form "families," such as the atoms 2, 10, 18, 36, 54, which are filled to capacity and known as the rare gases.

The 100 Elements of the Periodic Table

The chemical character of an element is determined by the number of its electrons. The hydrogen atom has certain properties because it has a single electron. If a second electron is added, the properties of helium appear, and, with the third electron, those of lithium. Ions, the exception to this rule, are discussed on page 76.

If we go through the series of elements, we are struck by the fact that these properties reappear at certain intervals. Elements 1 to 9 are different from one another. But the tenth element is similar to the second, the eleventh to the third, the twelfth to the fourth. The repetition of qualities appears in the first 26 elements at intervals of 8, and later in the system, at intervals of 18. This periodic repetition of properties was discovered around 1860, almost simultaneously by the Russian chemist Dimitri I. Mendeleev and by Lothar Meyer in Germany. The discovery led to the construction of a table of the elements called the Periodic Table of the Elements. (*Fig. 19*)

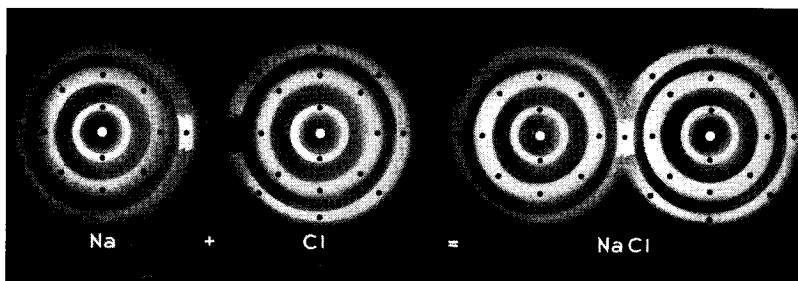

Fig. 20. CHEMICAL AFFINITY

Atoms combine in order to fill vacancies in their outer orbits. Sodium, Na, combines with chlorine, Cl, and becomes common table salt, NaCl, because the sodium atom has in its outer orbit one electron, and the atom of chlorine has on its outer shell one gap to admit this electron.

As so often happens, the generation which made the discovery could not grasp "the fact behind the fact" because the structure of the atom was not yet known. Modern atomic theory has unveiled the secret.

When two electrons revolve—at different angles—on the first shell, the shell is "satisfied" because at this distance from the nucleus no more than two electrons can circle. An atom with a "satisfied" shell does not enter into compounds with other atoms; it is called a rare or, better, an inert gas. Atoms with completely occupied outer shells are never found in any natural compound but only as isolated gases. In respect to their "splendid isolation," they are termed "Noble Gases."

The atom with the satisfied first shell is helium. When the second shell is

filled to capacity, the element is another “inert” gas, neon, the second in the periodic recurrence of rare gases. When the third shell is occupied to capacity by electrons, the element is the third inert gas, argon. So the family of inert gases continues—krypton, xenon, radon. They form one spoke in the diagrammatic spiral of the Periodic Table. (*Fig. 19*)

Elements are similar chemically if they correspond in the number of electrons in their outermost shell. Elements 2, 10, 18, 36 and 54 form the series of inert gases because they have the largest possible number of electrons in their outermost shells. The elements immediately preceding them in the system, 9,



Fig. 21. COMBUSTION

Combustion is oxidation, the combining of oxygen O either with hydrogen into H_2O water (*left*) or with carbon C into CO_2 carbon dioxide (*right*).

17, 35 and 53, are similar because each has one less than the number of electrons which could revolve in its outer shell. Their outer shell is characterized by a gap for a single electron.

These elements—9, 17, 35 and 53—are fluorine, chlorine, bromine and iodine. They form the family of halogens, or salt-formers, because they combine easily with corresponding elements to form salts. The “corresponding” elements are the elements 3, 11, 19, 37, which follow the inert gases in the Periodic Table, having one single electron on their outside shell, natrium (sodium), kalium (potassium), etc. Ordinary salt (sodium chloride) is common in nature because the sodium atom possesses the one electron, revolving alone in its third orbit, which the chlorine atom needs to fill the gap in its third electron shell. (*Fig. 20*) All atoms follow this pattern in their chemical behavior: they combine most readily with those atoms which have the complementary number of electrons or gaps on the corresponding outer shell.

Combustion—the combining of carboniferous matter with oxygen—is one of the most common processes in nature. Today we know why. Both the carbon atom and the oxygen atom have an incomplete outer shell. The outer shell of the oxygen atom needs two electrons to be complete; the outer shell of the carbon atom needs four electrons. Carbon fills its four gaps by combining with two oxygen atoms: $2 + 2 = 4$. The result is a molecule of carbon dioxide. The oxygen atom may fill its outer-orbit gaps by combining with two of the ubiquitous hydrogen atoms. The result of this combination is water. Carbon dioxide and water are thus the two most common end-products of combustion. (*Fig. 21*)

Until our own day, chemistry was a gamble. Chemists tried out combinations and hoped, among hundreds of attempts, to hit upon a useful one. With the discovery of electrons and electron vacancies, chemistry is in the process of changing from a gamble, in which atoms were used as stakes, to an exact science with predictable results. Yesterday, alchemy; today, chemistry; tomorrow, electron-dynamics.

THE SERIES OF ELEMENTS

First Electron Shell: 1–2 Electrons

1	H	Hydrogen
2	He	Helium

Second Electron Shell: 3–10 Electrons

3	Li	Lithium
4	Be	Beryllium
5	B	Boron

6	C	Carbon
7	N	Nitrogen
8	O	Oxygen
9	F	Fluorine
10	Ne	Neon

Third Electron Shell: 11–18 Electrons

11	Na	Natrium (sodium)
12	Mg	Magnesium
13	Al	Aluminum
14	Si	Silicon
15	P	Phosphorus
16	S	Sulphur
17	Cl	Chlorine
18	A	Argon

Fourth Electron Shell: 19–36 Electrons

19	K	Kalium (potassium)
20	Ca	Calcium
21	Sc	Scandium
22	Ti	Titanium
23	V	Vanadium
24	Cr	Chromium
25	Mn	Manganese
26	Fe	Ferrum (iron)
27	Co	Cobalt
28	Ni	Nickel
29	Cu	Copper
30	Zn	Zinc
31	Ga	Gallium
32	Ge	Germanium
33	As	Arsenic
34	Se	Selenium
35	Br	Bromine
36	Kr	Krypton

Fifth Electron Shell: 37–54 Electrons

37	Rb	Rubidium
38	Sr	Strontium
39	Y	Yttrium
40	Zr	Zirconium
41	Cb	Columbium (niobium)
42	Mo	Molybdenum

43	Ma	Technetium
44	Ru	Ruthenium
45	Rh	Rhodium
46	Pd	Palladium
47	Ag	Argentum (silver)
48	Cd	Cadmium
49	In	Indium
50	Sn	Tin
51	Sb	Antimony
52	Te	Tellurium
53	I	Iodine
54	Xe	Xenon

Sixth Electron Shell: 55–86 Electrons

55	Cs	Cesium
56	Ba	Barium
57–71		Rare minerals, from lanthanum to lutecium
72	Hf	Hafnium
73	Ta	Tantalum
74	W	Wolfram (tungsten)
75	Re	Rhenium
76	Os	Osmium
77	Ir	Iridium
78	Pt	Platinum
79	Au	Aurum (gold)
80	Hg	Mercury
81	Tl	Thallium
82	Pb	Plumbum (lead)
83	Bi	Bismuth
84	Po	Polonium
85	Ab	Alabamine
86	Rn	Radon (formerly Em, Emanation)

Seventh Electron Shell: 87 to (theoretically) 118 Electrons

87	Ack	Actinium K
88	Ra	Radium
89	Ac	Actinium
90	Th	Thorium
91	Pa	Protoactinium
92	U	Uranium
93	Np	Neptunium
94	Pu	Plutonium
95	Am	Americium

- 96 Cm Curium
- 97 Berkelium
- 98 Californium
- 99 detected in 1954, not yet named
- 100 detected in 1954, not yet named
- 101 } expected but
- 102 } not yet detected
- 103 }

Radiation

Waves

LET US CAUSE a "disturbance." We will throw a stone into a pond. The disturbance spreads out in all directions in what we call "waves." (Figs. 22, 23) Waves appear not only in water but also in air, metal, rock or in "empty space." Waves in solid masses are usually called shock waves; those in air, sound waves; those in empty space, electromagnetic waves or radiation.

All waves in a specific medium travel at a specific speed. Sound waves travel at about 330 m/sec, light waves at about 300,000 km/sec or 186,000 miles/sec. The unvarying speed of electromagnetic or light waves is a uni-

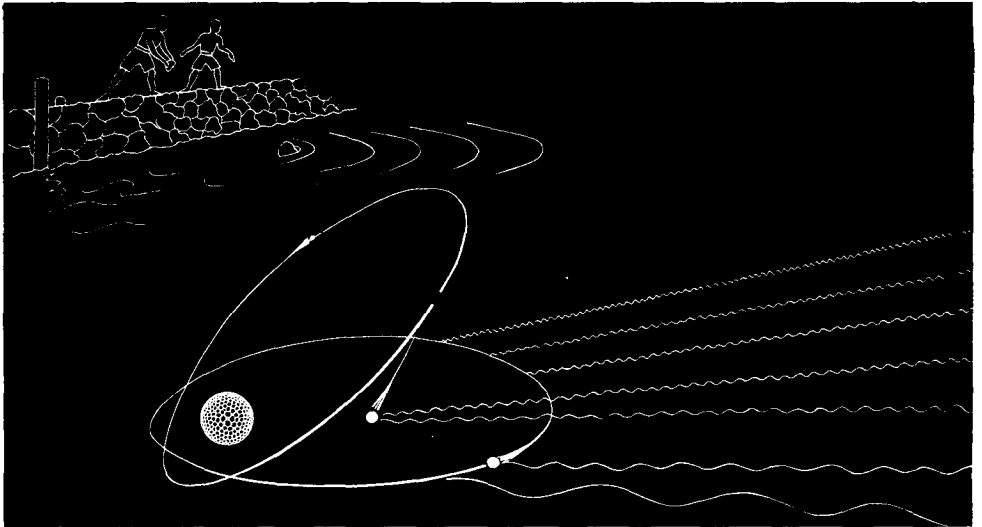

Fig. 22. WAVES

When we throw stones into a pond, rhythmical disturbances spread out in all directions.

versal constant and appears in the mathematical formulas of modern physics as the letter c , as in Einstein's formula $E = m \times c^2$.

Waves may vary in length. When we throw a big stone into water, the waves created are long waves. If we fling a small stone, the waves are short. If we play a bass viol, we produce long waves which we perceive as deep tones; a violin produces small waves which we hear as high sounds. Since

the speed is a constant, long waves follow each other at longer intervals than short ones, just as the dog who trots alongside his master must, with his shorter legs, take more steps than the longer-legged man. (Fig. 24) The wave-length is normally measured in centimeters. By counting the number of these waves which arrive at a specific point per second, we obtain the "frequency."

The energy of an electromagnetic wave is in inverse proportion to its wave-length. Long waves are low in energy; short waves, high in energy. Therefore, the shortest waves, those of cosmic radiation, are the waves with the highest energy. The law of inverse proportion is known to every amateur photographer. He learns that red light is least effective on film, because the long red waves are weak in energy and in ordinary film the light-sensitive grains are affected very slowly. Thereafter he learns from experience that red objects appear on photographs as dark, while blue and violet objects reproduce as white. The waves of ordinary sunlight tan the skin slowly; the hundred thousand times shorter x-rays burn the skin quickly; the gamma rays, ten thousand times shorter than the x-rays, are deadly because they

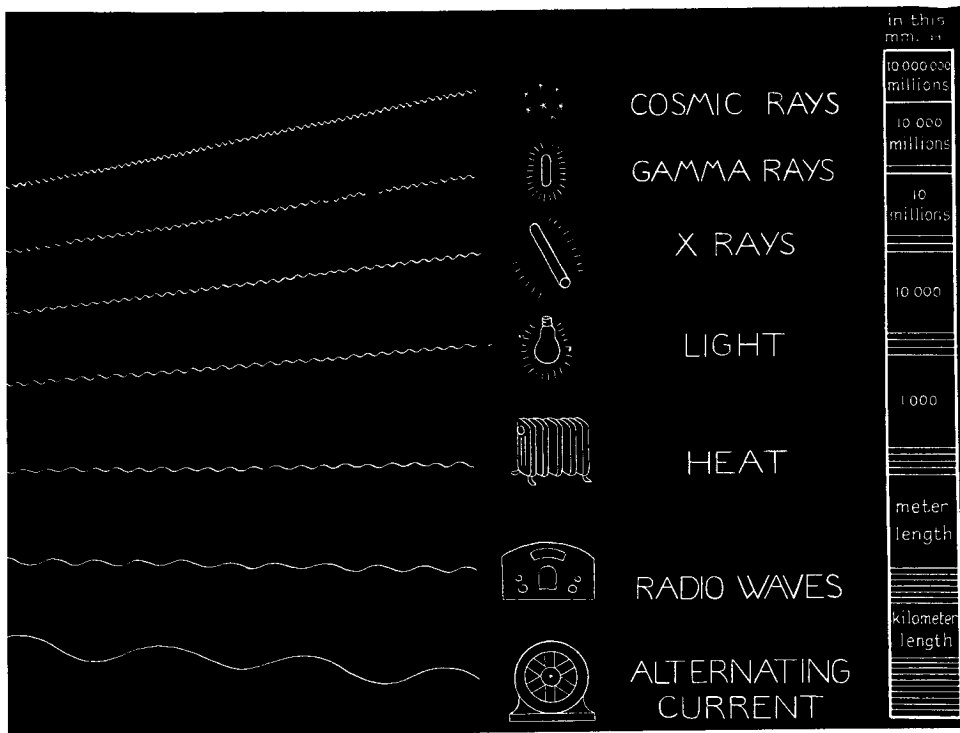

Fig. 23. THE GAMUT OF ELECTROMAGNETIC WAVES
 Electromagnetic waves are rhythmical disturbances of the electromagnetic field. Their length varies from cosmic rays to the waves of alternating current.

penetrate to and burn the inner organs of the body. Cosmic rays are even more destructive. One of the problems of the space-traveler will be protection from the effect of the short waves above the level of the filtering atmosphere.

If we arrange the waves according to their length, starting with the longest and ascending to ever shorter ones, we build up a "keyboard." We can compose a keyboard with any waves we choose. The most familiar keyboard is the scale of the sound waves presented by the piano. The physicists also arrange the waves of the atoms in a scale as the keyboard of radiation.

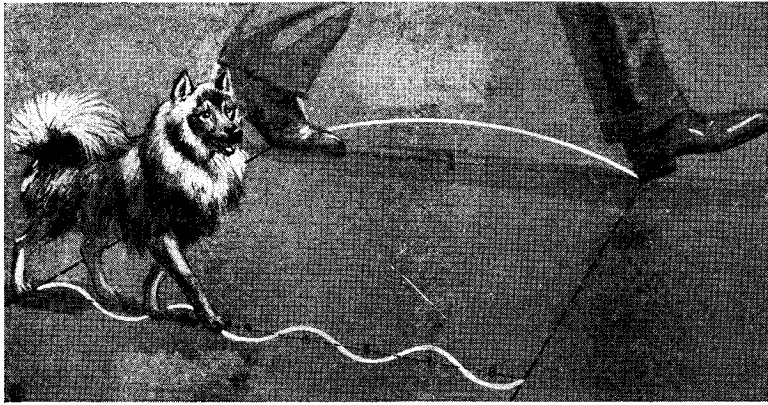

Fig. 24. WAVE-LENGTH AND FREQUENCY

The length of a wave varies inversely with its frequency. The man's footsteps correspond to a frequency of 1 in relation to a frequency of 8 for the dog's.

Electromagnetic Waves

Radiation is the rhythmic disturbance of the electromagnetic field around a rhythmically vibrating disturber which is called a transmitter. All electromagnetic waves travel through space at a speed of 300,000 km/sec. The term "wave" is pictorial. We say wave because the disturbances expand as waves do. They behave like waves when they are reflected or squeezed through narrow slits. But the real nature of these waves is still unknown. We know only that they move as a transversal vibration, as water does when it undulates up and down transversally to the wave's progression.

The prevailing transmitter of electromagnetic waves in nature is the atom, but the man of the machine age has constructed apparatus emitting electromagnetic waves of all conceivable lengths. Among the longest of these artificial electromagnetic waves are those of alternating current, which flow through the wires of our homes or bring us radio or television broadcasts.

The generator of these waves, the dynamo, produces an electric current, or, what is practically the same, an electromagnetic field spreading out in all directions at a speed of 300,000 km/sec. The current does not flow evenly as "direct current" does. The poles of the dynamo are rhythmically reversed, the negative pole becoming positive and the positive pole becoming negative. With the reversal of the poles the current changes its direction; it "alternates." The frequency of this alternation can be geared *ad libitum*, 10, 100 or 100,000 times a second. The alternating current of our homes alternates with a frequency of either 25 or 60 cycles/sec. Since electromagnetic waves travel at a speed of 300,000 km/sec, a single wave of alternating current with a frequency of 60 cycles/sec is 5,000 kilometers long.

Heat: Long Waves Created by the Oscillation of Atoms and Molecules

One of a child's first experiences is his awareness of hot and cold. When a baby burns his mouth with hot food or protests against too hot or too cold bath water it is performing its first painful "experiments" in physics. After ten years of repeated experiences the boy of school age is firmly convinced that he knows what hot and cold are—fire is hot and ice is cold, very simple. When he begins to study physics, he finds that he does *not* know, and the more he studies the problem the more he becomes aware that studying nature "consists of knowing less and less about more and more."

Our present meager knowledge about temperature can be summarized in a few sentences. The temperature of a gas like air results from the motion of the molecules. At room temperature the molecules of the air fly at a speed of 500 m/sec. When they fly at double this velocity, the temperature is 890°. Atoms flying 100,000 km/sec produce a heat of about 20,000,000°. When radiation is directed against atoms or atom compounds (molecules), they begin to oscillate. This oscillation, or more precisely, the effect of this oscillation, we call the temperature of the heated body. If there is no oscillation of the atoms, there is no temperature. In this case, we say the temperature is zero, not the zero of our thermometers but absolute zero, or 273° below the freezing point of water.

Previously it was assumed that the temperature of cosmic space was absolute zero, because if there were nothing there, there could be no oscillation. Actually, cosmic space is not empty; atoms, mostly of hydrogen, fly around, a few in each cubic centimeter of space. They emit waves 21.1 centimeters in length. The energy of this emission corresponds to a temperature of about 70° on the absolute scale, or around 203° below the freezing point of water. The atoms receive their energy from the stars, the galaxies and the radiating dark clouds in cosmic space. All these radiations combine, with the result

that the electromagnetic field of empty space is not calm but undulates, and cosmic space is not absolute zero but about 70° above this point.

The influence of temperature on the behavior of atoms and molecules is familiar to us from our experiences with water. We find water in nature in different stages, as invisible humidity, as condensed vapor visible as mist, fog or clouds, as liquid in the form of raindrops, pools, rivers, lakes and oceans, and finally in solid form as snowflakes, hailstones and ice.

When the temperature is low, the molecules of water arrange themselves to form crystals, best seen in snowflakes and ice-ferns on a windowpane. The atoms and molecules of the frozen water are by no means calm. They oscillate more or less according to the temperature, but as long as the temperature is below the melting point, the oscillations are weaker than the electrical forces which bind the molecules. With rising temperature the oscillations become more and more violent, finally surpassing the binding forces between molecules and breaking their bonds. The ice melts.

Above the freezing point, water is liquid. In this state, too, the molecules still cling to each other and form chains (liquid crystals), but with a further rise in temperature, the oscillations become so violent that the last bonds between the molecules are broken and the water now forms an ideal liquid, each molecule separate from the others.

With a further rise in temperature, the force of the oscillations prevails over the force of cohesion. The molecules fly into the atmosphere due to buoyancy and the water evaporates. Even snow and ice disappear slowly by evaporation but the evaporation becomes perceivable only near 100° , the boiling point at which the molecules escape in a catastrophic uproar.

The escaped matter is no longer visible because the molecules are dispersed. The water forms a gas. The three physical states of matter are solid, fluid, gaseous. The ring-manager of the whole spectacle is the temperature.

Water vapor, too, can be heated to higher degrees. By doing so, the oscillations increase and become so vehement that the atoms which are combined into the compound, water, break their bonds and the molecule H_2O dissociates into hydrogen H and oxygen O.

At higher temperatures the atoms, too, dissociate. The electrons escape from their orbits and the atoms become atoms with a diminished number of electrons. (*Fig. 25*) Atoms which have lost electrons are ions. The process of losing electrons is called ionization. When all electrons have escaped, the naked nuclei remain and all further processes occur between the nuclei as nuclear reactions. In the interior of stars such as our sun, the atoms are ionized to this ultimate degree and no further chemical processes or interplay between the electrons of the outer shell take place, only nuclear reactions between nuclei. Under extreme heat and pressure even the nuclei disintegrate into their constituent protons, neutrons and mesons, which are regarded as the "last particles of matter." Only some of them are stable, the others are short-lived and dissolve sooner or later into mass-energy, undulating mass-

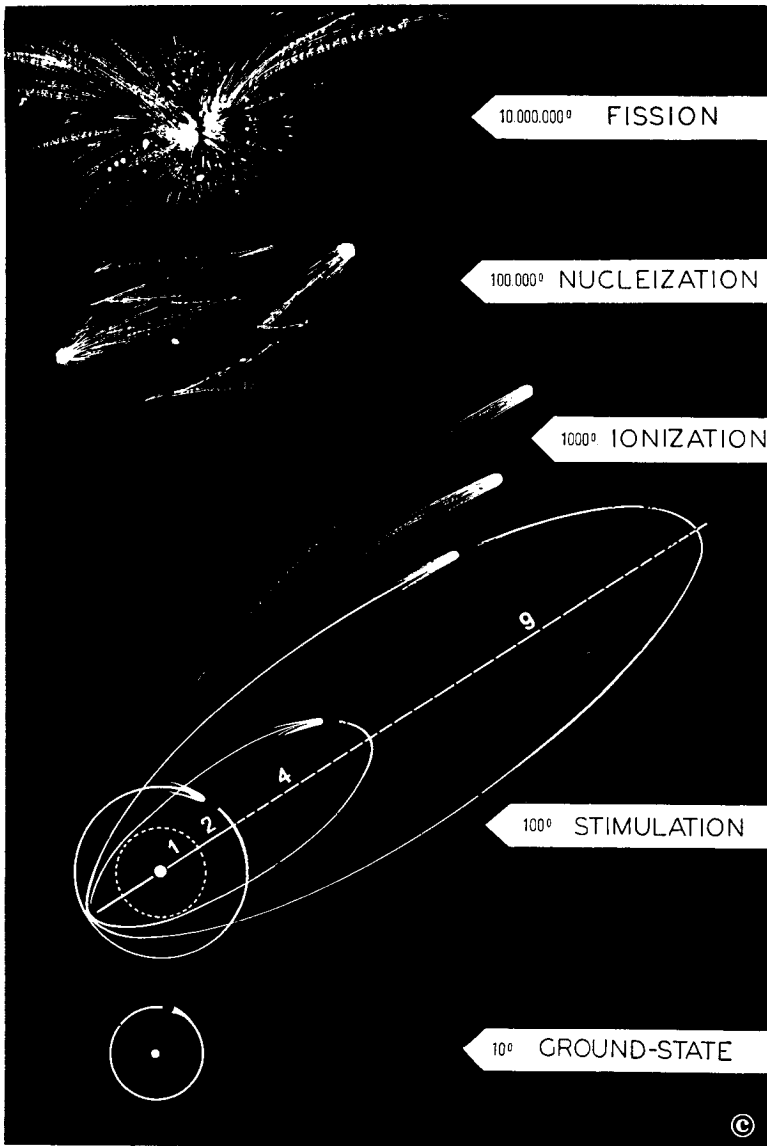

Fig. 25. STIMULATION OF THE ATOM

1. Atom and electron are at rest.
2. Heat causes the electrons to revolve more quickly and to increase their distance from the nucleus in definite "jumps."
3. Strongly stimulated electrons leave their orbits (ionization).
4. After total ionization only the nuclei remain.
5. All reactions become nuclear reactions.

energy, radiation. Thus the energy which built up the universe returns into the empty space from which it emerged and the cycle of existence is repeated again and again.

All elements and compounds behave like water and wander through the different stages of solid, liquid, gaseous, dissociation, ionization, nucleization and fission according to the temperature, which make the atoms and their constituents oscillate. Each compound or element has its specific point of melting, boiling, dissociation. Iron is found on the surface of the earth only in a solid state because its melting point is high in the hundreds; helium we find only as a gas because its melting point is extremely low, not far from absolute zero. These variations help us to determine the temperature of heavenly bodies. Clouds of ammonia in the atmosphere of Saturn reveal that the temperature of the atmosphere must be very low; the presence of ionized iron vapor in the corona of the sun indicates a temperature of a million degrees. The knowledge of the relation between temperature and behavior of the elements provides us with a kind of tele-thermometer which can reach not only to the sun and stars but to all the visible galaxies of the universe.

*Light: Medium Waves Created by the
Jumping Electrons of the Atom's Outer Shells*

When an atom is "at rest," its electrons circle at a certain speed. (*Fig. 25*) If it is stimulated (heat waves are generally used as a stimulant), the electrons revolve more quickly. After the electron attains a certain velocity, it can no longer hold the track of its orbit but jumps to a wider one. The physicist says: "It is raised to a higher energy level."

Planets, which are ruled by mechanical laws, would, in a corresponding case, recede from the sun in spirals. Electrons and other particles of the atom are subjected to the rules of quantum mechanics. They remain in their orbits or they jump, but when they do so they can jump only over specific distances. At its first leap, an electron increases its distance from the nucleus by 2^2 or 4; at its second, by 3^2 or 9; at its third by 4^2 or 16; thereafter its distance becomes 25, 36 or 49 times the original distance from the nucleus. Finally, the electron jumps from the outermost shell into free space and the atom becomes ionized. (*Fig. 25*)

A ball that is thrown up in the air has a tendency to return to the earth. In the same way, the electron tends to return from its higher stage of energy to its original orbit. But since the electron is governed by the rules of quantum mechanics—"quantum" means a *specific* amount—the electron cannot return in one long curve like the ball but has to perform "quantum leaps." It returns to its initial shell in specific jumps, like a ball tumbling down a staircase. (*Fig. 26*)

The energy invested to toss the ball reappears as heat, when the falling ball strikes the earth. The electron returns the energy which pushed it to higher orbits in the form of electromagnetic waves or radiation.

The first electrons to leave their orbits in a stimulated atom are, naturally, those that are farthest away from the nucleus and less subject to its pull. The outer orbits of an atom, like the outer orbits of a planet, are far apart. Consequently, the electrons must jump long distances, and the vibrations occur at relatively long intervals. Long red waves appear, the bass waves of the

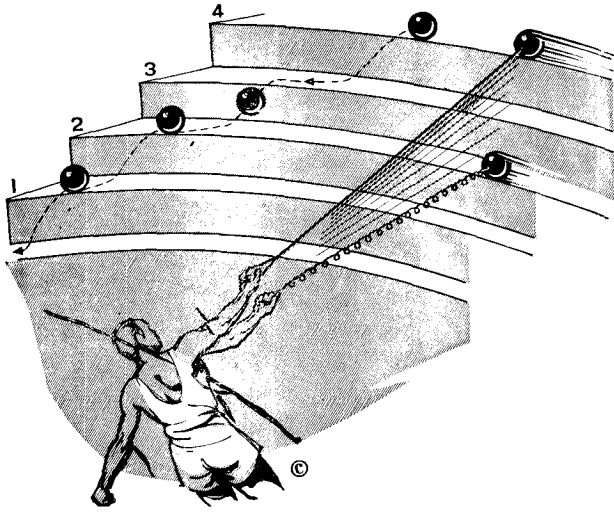

Fig. 26.
**THE QUANTUM
LEAP**

Unlike the swinging weight, which recedes in a gradually extending spiral from the arm of the athlete, the electron of the atom is governed by the laws of quantum mechanics and can jump only in specific leaps like a ball rolling down a staircase.

keyboard of light. If a greater amount of energy is applied to the atom, the electrons nearer the nucleus also leap out of their orbits. Their jumps are shorter, and the vibrations follow in more rapid succession. After red appears orange, then yellow, green, blue and violet light. The violet vibrations are only half as long as those of red light. The waves of red light arrive at the rate of about 400 trillion, violet at about 800 trillion per second. (*Fig. 27*)

Of the long scale of electromagnetic waves, the human eye perceives only those between red and violet light, the band of the rainbow, or of the spectrum, as the artificial rainbow is called. Compared to the whole scale ranging from the longest waves, those of alternating current, to the shortest waves, those of cosmic radiation, the visible part consists of less than the tone of one single key on the keyboard of our piano.

Let us imagine a man of the future who would be able to see the whole gamut of electromagnetic waves from the bass of alternating current to the treble of cosmic radiation. This superman might look at us with the same pity we feel for a man who sits beside us in a concert hall, listening carefully to a symphony of Beethoven but deaf to all tones with the exception of one tone, let us say, that of the A-string of the violin. Yet this radiation-deaf man perceives enough, nevertheless, to be exalted about the "beauty of the world."

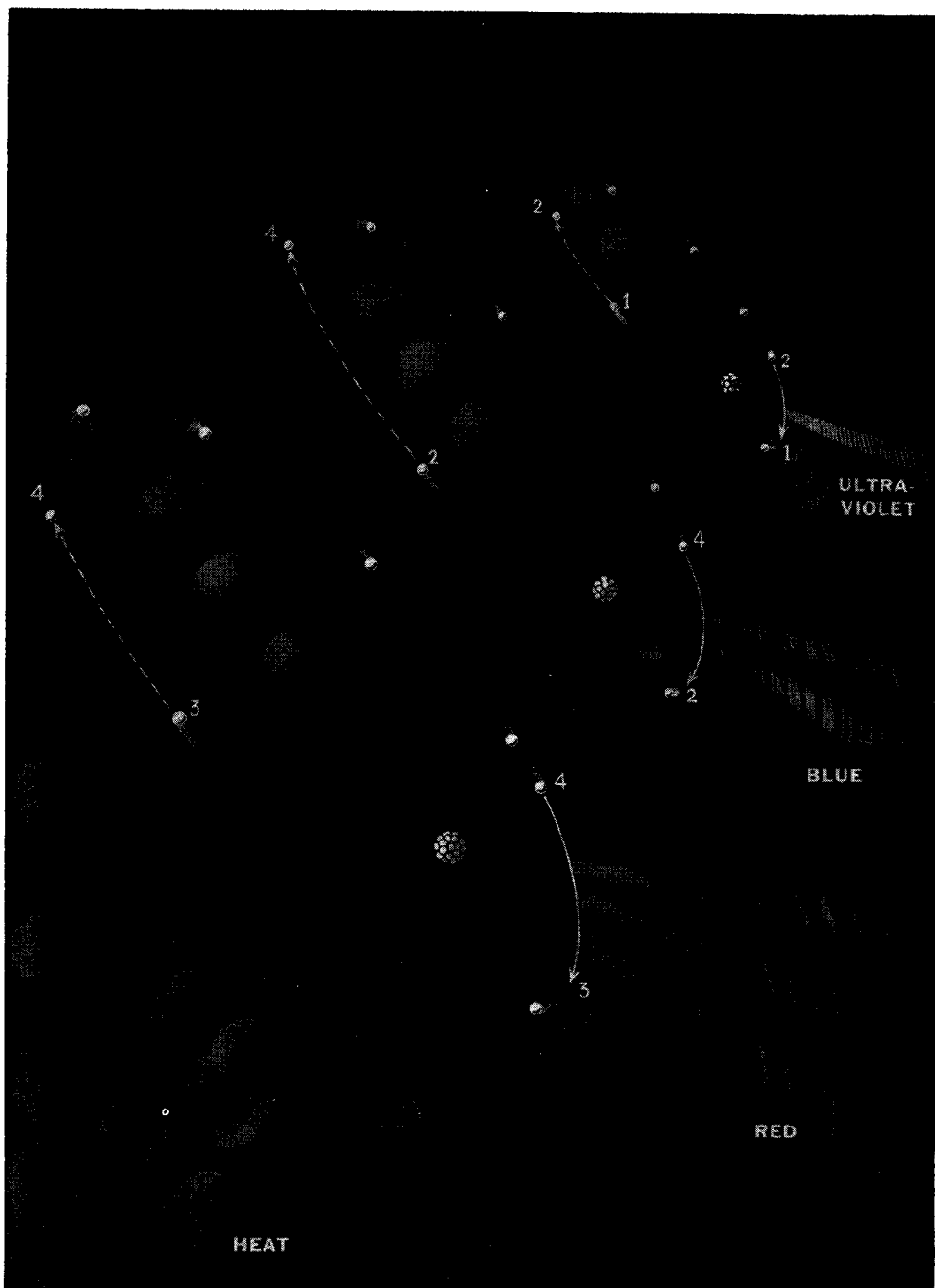

Fig. 27. THE ORIGIN OF COLORS

When electrons are stimulated by heat (*bottom*), they leap from inner to outer shells (*broken lines*). First the electrons of the outer shells jump (3 to 4); later the electrons leave the inner shells (2 to 4, 1 to 2). The electrons tend to leap back (*white lines*). Herewith they return the invested energy as rays. In approaching the nucleus, the wave-lengths decrease and the colors change from red to blue to violet to ultraviolet.

*X-Rays: Waves Created by the Jumping
Electrons between the Inner Orbits of
Large Atoms*

The nuclei of small atoms must hold only a few electrons in their orbits. Consequently, the nuclei are small and their attractive force is relatively weak. The nuclei of great atoms must hold large numbers of electrons in their orbits. Therefore they harbor a greater number of constituents, called "nucleons," and exert a correspondingly greater force of attraction. The electrons on the innermost orbit of the aluminum atom, 13 Al, are held with a force which is about 13 times as great as that which holds the single electron on the orbit of the hydrogen atom. The electrons on the innermost orbit of iron, 26 Fe, are held with a force 26 times as great. The force that holds the inner electrons of tungsten (wolfram), 74 W, or platinum, 78 Pt, is correspondingly greater. Tremendous energies must be fired at the electrons to dislodge them from their orbits. When the electrons, striving to return to their former position, jump back into their orbits, waves of equally high energy are produced. They are about ten thousand times shorter than the shortest visible light rays and are called x-rays. (*Fig. 28*)

As with radio, heat and light waves, the range of x-rays extends over several octaves of the radiation scale. The long x-rays are called soft because their penetrating power is relatively weak. Shorter x-rays are high in energy and penetrate soft tissue such as wood and flesh which are composed of small atoms. Metals and hard tissue such as bone, which contain large and heavy atoms like phosphorus and calcium in considerable percentage, forbid the passage of the x-rays. Because of this differential screening of the x-rays, a coin lodged within a windpipe shows up as a dark shadow inside the otherwise half-transparent silhouette of the soft lungs and their air-filled windpipes.

X-rays of specific length correspond to the distances between the molecules and atoms in crystals. When crystals are pierced by x-rays of specific lengths, lattice-like figures called "diffraction patterns" appear. They are similar to the patterns we see when we look at a bright light through the cloth of an umbrella. If the molecules in the material under consideration are regularly spaced, the pattern is regular. If they are jumbled, the pattern is chaotic. X-ray examination can reveal not only gallstones in the human body, but also flaws in an airplane propeller. They show up a "latent caries" in a piston as well as in a human molar, and warn of the beginning of a "cataract" in a telescope as well as in a human eye.

Aside from their medical and industrial uses, x-rays have proved an important tool in the exploration of the atom. A visible light is produced by electrons which jump between outer orbits. Spectroscopic examination of this light has failed to provide dependable values for mathematical calculation

because stray electrons from the outer world and other influences interfere, thereby deviating the course of the electrons. The electrons on the inner orbits of large atoms, like tungsten or platinum, however, are held firmly in their courses by the strong attracting power of their large nucleus and protected from any disturbing influences by the four or five outer orbits. The spectroscopic study of x-rays emitted from the interior of large atoms has provided a reliable foundation for the exact mathematical description of the structure and the dynamics of the atom.

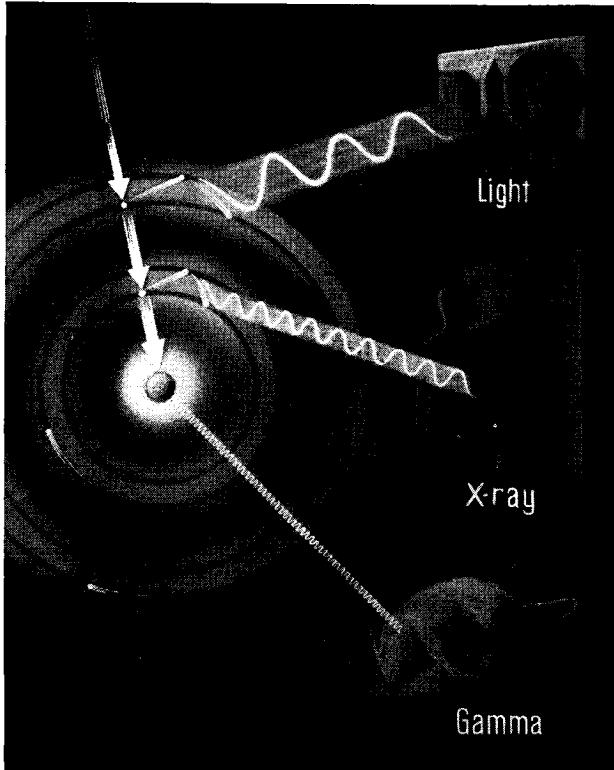

Fig. 28.
THE THREE MAJOR
EMISSIONS OF THE
ATOM

The electrons on the outer orbits of the atom emit visible radiation, or "light." The inner electrons of large atoms emit invisible x-rays. The nucleus emits gamma rays.

*Gamma Rays: Waves Emitted by the
Atom Nucleus*

The shortest waves an atom can emit are those which the nucleus of the atom sends out, since these rays are produced not by electron jumps but by oscillations of the tiny nucleus or the even smaller stimulated constituents of the nucleus. When, at the beginning of the century, the emissions of the radioactive atoms were studied, they were provisionally labeled with the first letters of the Greek alphabet, alpha, beta, gamma. These meaningless names survived the era of early research. The waves emitted by atom nuclei are thus called gamma rays. A suitable name would be nuclear rays.

The emitter "nucleus" is minute, so the nuclear waves are short and have a high frequency: 3×10^{18} to 6×10^{20} per sec. As with light waves and x-rays, gamma rays do not have one specific length but have a range of a whole series of octaves.

Since the energy of radiation is in inverse proportion to the length of the waves, gamma rays have enormous penetrating power. They pierce not only the finer tissues of the human body or the wood of a jewelry chest, as do x-rays, but they also penetrate everything with the exception of thick walls of lead or four-foot barriers of concrete. They radiate through the walls of an ordinary house as though nothing stood in their path. They radiate for hundreds of yards around, and as far as they spread out nothing stays alive. (*Fig. 28*)

At the beginning of radium research, when the dangers of gamma rays were not yet recognized, many physicists became the victims of x-ray and gamma rays, the first martyrs of the dawning atomic age. One scientist carried a radium preparation, for "reasons of security," in his breast pocket; he might just as well have put a cobra in his coat. Others found their fingers rotting away, like those of lepers in the Middle Ages; some became blind, because the lens of the eye is especially sensitive to radiation. The buildings where radium preparations were kept without the precautionary measures known today became charnel-houses. Workers in the laboratories grew anemic. The physicist's dog could no longer climb steps. Trees in a nearby park shed their leaves. Cows in a stable a hundred yards away lost their calves prematurely. On rocky slopes where ashes from the furnace were deposited, no weeds grew. At the edge of the woods, ants abandoned their nests, leaving their larvae behind, for the young in them had died.

Specific laws govern the relation between waves and their mechanical effect on bodies. Water waves affect most strongly ships which are about the same length as the waves. An ocean liner, while not affected by small waves, begins to pitch and roll when a long ocean swell passes under it. A small sailboat rides the long waves but may even be capsized by short choppy waves which do not affect the liner. The effect of electromagnetic waves on the atom is greatest when the length of the wave is about one-thousandth the diameter of the atom. Gamma rays are so destructive to organic tissues because their wave length is in the order of one-thousandth of the diameter of the small atoms, such as carbon, hydrogen and oxygen, which make up the organic tissues.

In destroying an atom inside or outside a living organism, the gamma ray loses the main part of its energy. The rest radiates through the surrounding tissue in long waves of devastating heat. This secondary heat burns the tissue by coagulating the protoplasm, just as the yolk of an egg is hardened in boiling water.

Gamma rays compel physicists to handle all radioactive material with the utmost care. Uranium piles are shielded by thick walls of lead, concrete or

water. All operations are performed by tele-action from the outside. Gigantic arms are thrust into the hellish fire and electrically controlled hands perform the manipulation and do it as delicately as the fingers of a Swiss watch-maker.

"Dangerous" is a relative term. Water is a horror for the man who does not swim but a delight for the swimmer. For thousands of years lightning was feared as the heaven-sent scourge of mankind. Today the lightning in wires boils milk for the child and brightens the night for families in their homes and for strollers on the street. Gamma rays are dreaded today; tamed, they may perform the "wonders of tomorrow."

The Double Nature of Light: Wave and Corpuscle

In the seventeenth century two great physicists, Christian Huygens in the Netherlands and Isaac Newton in England, offered contradictory theories of radiation. The term radiation, however, was not used because at that time, of all radiations, only light was subject to investigation. Both men agreed on the basic laws of the behavior of light, but they held different ideas on the nature of light.

The refraction and reflection of light rays indicated that light behaved as if the rays were waves. Huygens' undulation theory was so called because he believed light to be an undulation of a fine fluid called "world-ether." Newton came to the conclusion that light was composed of minute corpuscles emitted by the source of light. A century-long scientific controversy raged between their defenders.

The undulation theory of Huygens attained a decisive victory when Maxwell presented his famous Maxwell Equations which were based on the concept that light is a part of the electromagnetic wave scale. Fifteen years later Heinrich Hertz sent the first artificial electromagnetic waves through air without the use of wires and concluded that "the wave theory of light is, from the point of view of human beings, a certainty."

It then seemed as if the hundred-year war between the undulation theory and the corpuscular theory had ended with a victory for Huygens. But history has no mercy. Shortly after the victory of the undulation theory had been pompously celebrated, contradictory phenomena came to light.

When Max Planck in Berlin made calculations about the radiation of heated bodies, he found himself faced with a dilemma: according to the classic concept of light as an undulation, the heated body should return the invested energy in a specific curve. Yet the emission of energy did not follow the formulas. Especially in the octaves of ultraviolet, the discrepancy between fact and formula was so striking that it was called the "violet catas-

trophe." Planck recalculated the facts with new formulas. His result harmonized with the radiation in the range of ultraviolet but not with the radiation in the range of the lower frequencies. It must have been a not too comfortable situation for the perspiring physicist when he saw two different formulas on his paper, each one right in its own range of the light scale, each one wrong in relation to the octaves outside this range, and no general formula which would cover the whole gamut of radiation.

Planck invented a new concept—the quantum. Just as Newton by inventing the calculus separated the smooth uninterrupted motion of a flying body into innumerable small portions, so Planck introduced the concept of a quantum, a small unit of measure for radiation. Radiation, said Planck, moves through space not in even waves but in discrete, indivisible units or bundles of energy, quanta. We might call the quantum the "penny of energy," since it is a basic unit that can no longer be divided. The quantum, like the electron, has a certain "charge" of energy, called the energy constant, which is represented by the symbol h . h is equal to 0.000,000,000,000,000,000,000,000,006,55 erg-seconds, written 6.55×10^{-27} . One erg-second is approximately the energy needed to blink your eyelid once.

Einstein was even more audacious than Planck. He concluded that light not only travels in quanta but is identical with these quanta. Light, he said, is composed of quanta just as electricity is composed of electrons. Using the analogy of such words as electron, proton, etc., he named the quantum of light, photon. The photon is a discrete quantity of light energy, having no mass, but having the properties of particles.

To substantiate his photon theory, Einstein investigated critically the phenomenon of photoelectricity. If light is directed against certain metals such as beryllium or selenium, which are prone to give up their electrons easily, the radiation pushes the electrons out of their atoms. They issue forth in a stream, which we call "photoelectricity." If light were propagated in waves, the atoms would not give up electrons immediately. The electrons would be expected to leave the metal only after an interval and thereafter in increasing numbers and speeds. Yet this is not the case. The metal, exposed to light, emits electrons at once and the first electrons fly off as speedily as the later ones.

A second disturbing phenomenon becomes evident when a beam of light is sent through a narrow light-scattering slit and two photoelectric cells are placed on corresponding points of the scatter-field. If light spreads out in waves, the two devices should signal the arrival of the waves in the same rhythm. Yet they do not; they signal independently, like targets on a rifle range when hit by bullets. These two observations would seem to be two catastrophic defeats for the "victorious" exponents of the undulation theory.

Einstein lists some other phenomena and ideas in favor of his photon theory. A ray of light moving through the gravitational field of the sun, says Einstein, acts as a planet would if it were traveling at the speed of light. When

light leaves the surface of a star, it loses energy in proportion to the force of the gravitational field of the star. Loss of energy means a lengthening of the wave. The position of the lines in the spectrum shifts toward the red side. From the amount of this red shift, called the Einstein Effect, the mass of the star can be estimated.

Radiation exerts pressure. At the beginning of the twentieth century the Swedish astronomer Svante Arrhenius promulgated the theory that the radiation pressure of sunlight is powerful enough to propel living germs throughout the solar system. The Russian Lebedew performed experiments demonstrating this light pressure. These ideas were dismissed as fantasy. Today, radiation pressure has been given a high rank as one of the great forces of the universe. It is one of the energies which may cause a star to explode.

Normal light, as we receive it on earth from the sun, exerts only a minimal radiation pressure. But as the radiation increases, the pressure rises according to the fourth power. Thus, when radiation is doubled, the pressure increases by 2^4 , or 16 times; and when radiation increases a hundred times, its pressure increases by 100^4 , or 100,000,000 times. A heat of $50,000^\circ$ exerts a force of 100 grams on every square centimeter; at $1,000,000^\circ$, the pressure rises to 10,000 kilograms; at $40,000,000^\circ$ of heat, which might be the average central temperature of the hotter stars, the radiation force should be about 25,000,000,000 kilograms against every square centimeter. Thus pressure of radiation from the center outward equals the gravitational force acting in the opposite direction. On the scales the pointer trembles, deciding the further fate of the star. If gravity prevails, the atoms collapse and the star becomes a "heavy dwarf star." If the pressure of radiation is stronger, the star explodes.

Einstein's photon theory did not entirely solve the riddle. We are confronted with contradictory observations. When light is directed against mirrors or sent through lenses and prisms, it behaves as if it traveled in waves. The perfect construction of telescopes and spectroscopes demonstrates the validity of Huygens' undulation theory. Yet photoelectricity, the pressure of radiation, the expansion of radiation in the form of single quanta, would indicate that light is composed of Newton's "corpuscles." Newton foresaw this duality when he wrote: "The interchangeability of bodies and light conforms with the essence of nature which seems delighted with transmutations." The physicist of today cannot see his way out of this dilemma. He has to undergo the intellectual humiliation to which the English physicist William Bragg, Jr., submits himself: "Monday, Wednesday and Friday, I lecture on the wave theory; Tuesday, Thursday and Saturday, on quantum mechanics."

The Nucleus of the Atom

The Discovery of the Nucleus

THE NUCLEUS, meaning “kernel,” hovers in the center of the atom as does the sun in the planetary system. In contrast to the sun, which is a thousand times the size of the largest planet, the nucleus is not prominent in comparison to the dimensions of the atom. On the contrary, it is so inconspicuous that even in the midst of the unimaginably tiny atom it is as lost as a mosquito in a cathedral. If we were to close the gap between the two pillars of the letter U by a fence composed of a million sticks, the gaps would be very small. Yet if we were to close the space between two of these sticks with another fence of a million laths, the gaps of this second fence would still be wide enough to let an atom-nucleus pass. If an atomic bullet shoots through the interior of a lithium atom, the chances of its hitting the nucleus are no more than one in 100,000,000.

It would, therefore, seem to be an almost impossible task to shoot the nucleus of an atom with a projectile. The probability, as Einstein had said, is no greater than the chance of a hunter’s hitting a duck if he went out at night in a region where ducks are rare and shot at random into the sky in the hope of bringing one down. Yet, in one of the most admirable triumphs of modern science, man has succeeded. Of course, the physicist does not aim at a specific nucleus; rather, he shoots volleys of “bullets” into the shooting gallery, hoping that one of them will hit the mark.

The size of the nucleus varies in accordance with the number of electrons in the atom; the smallest nuclei are found in the first elements and the largest in those atoms with 80 and more electrons. In contrast to its small size, the nucleus is incredibly heavy. If a drop of dew were made entirely of nuclear mass, it would be 130,000,000,000,000 times heavier than it is now, composed of water molecules. A solid lump of nuclei the size of a lump of sugar would weigh 24,000,000,000 kilograms.

Despite its enormous density the nucleus is not compact but has a differentiated structure. There is room enough inside the nucleus for its parts to move and to change their positions. The nucleus, like a peach, has a hard core which is surrounded by a softer middle section. Both are covered by a skin



Fig. 29. IMAGINARY PORTRAIT OF AN ATOM NUCLEUS

The atom nucleus is regarded as a "halo of vibrating mass-energy" (Schrödinger). Physicists speak often of the "boiling" nucleus. The black and white balls represent the interchanging protons and neutrons.

which is as fluffy as the velvet of a peach. (*Fig. 29*) How do we know? If a nucleus is hit, the bullets rebound in varying angles which, when measured, enable the physicist to calculate the different densities in the different levels of the nuclear globe.

The fact that the infinitesimal nucleus of the atom must be composed of several constituents came to light when radium was extracted from uranium. The behavior of this new element was so exceptional that it was displayed at the Paris Exhibition in 1900 amid the other marvels of the time. Its activity was so contradictory to all classical concepts that the American physicist S. P. Langley of the Smithsonian Institution stamped it as a "Gallic trick." His blunder is pardonable. It seemed incredible and still does even today. (*Fig. 30*)

One gram of radium emits tens of thousands of particles every second. But despite this intensity, the fireworks last more than a thousand years before its display diminishes, and only after another millennium would its brilliance have faded to half of its original intensity.

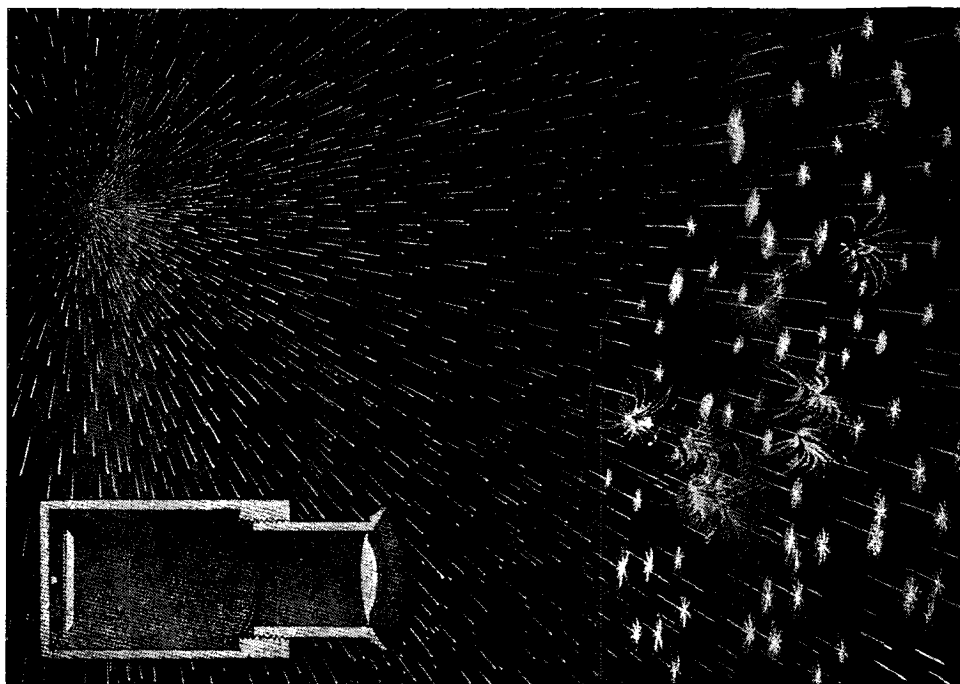

Fig. 30. RADIOACTIVITY SEEN IN A SPINTHARISCOPE

One grain of radioactive substance emits millions of particles per second from the exploding atom nuclei.

The duration of radioactivity is measured in “half-life.” Half-life in atomics is the time which has elapsed when half of the unstable radiating atoms have ceased to radiate and have been transformed into stable atoms. This rather inexact radio-clock is the only practical one, because in the world of atoms and especially atom nuclei many of the laws of classical physics no longer apply. Instead of the “infallible” mathematical calculations of classical physics, the rules of probability govern atomic events. It is impossible, with our present knowledge, to calculate the moment when a single radium atom will explode. It may happen in a second or in 5,000 years. The atoms behave like the shells of a burning munitions depot. Now one shell explodes, a few minutes later another, then two at the same moment, then ten minutes may elapse before the next shell explodes, and so on. Just as we can predict fairly well the length of time it will take for the entire depot to be destroyed, so can we ascertain the rate of transformation of quintillions of

atoms. The fairly determinable moment when half the mass is burned out we use as our unit of measurement.

Radium emits two kinds of particles and two kinds of waves. Alpha particles equal nuclei of helium, and beta particles equal electrons. The waves are a mixture of long waves, heat, and very short waves, gamma rays.

The "Gallic trick" was tricky but not in the sense that Langley had suspected. The fact that a grain of radium emits both an enormous number of particles and powerful radiation was indisputable. The discovery required a drastic revision of the concept, atom. Atoms could neither be the basic units of the universe nor unbreakable. They were composed of more elementary parts. Ernest Rutherford and Niels Bohr designed models of the atom in which a positively charged nucleus was circled by negatively charged electrons. Since it is possible for the atom to emit radiation as well as fast flying "shells," it must be packed with energy. The physicists concluded that this energy was to be found inside the nucleus. If it could be harnessed, man would have tapped an unlimited source of energy. The stampede for the bright new world began. Nuclear physics was born.

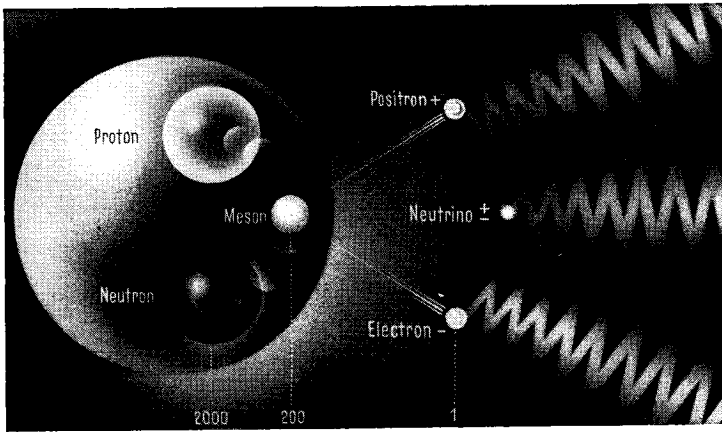

Fig. 31.
THE SIX BASIC
CONSTITU-
ENTS OF THE
NUCLEUS

Nucleons are protons, neutrons, mesons, positrons, electrons and neutrinos. They are not stable, but transmute into each other.

The Constituents of the Nucleus, the Nucleons

The particles inside the nucleus are called "nucleons" and the science of the nucleus and its constituents is termed "nucleonics." We know so little about the nucleons that there is not much use in describing them with words. Our present conceptions, and therefore also our vocabulary, limp far behind the mathematical calculations. Let us say that they are vortices, because, like the electrons, they are spinning.

Since the planets of the atoms are the negatively charged electrons and the nucleus has to hold them, the nucleus must carry a positive charge of just the same strength as the total of the charges of the electrons. The nucleus contains as many positively charged bodies as there are electrons. These positively

charged "holders of the electrons" are called protons, the "first ones," because they were believed to be the primordial units of the universe. Hydrogen, the smallest atom, has only one electron on its shell; consequently, the hydrogen nucleus contains only one proton. Protons and hydrogen nuclei are identical. The nucleus of uranium, surrounded by 92 electrons, contains 92 protons. The mass of the proton is 1,840 times the mass of an electron.

Since the protons are all equally charged, they strongly repel each other. If the twenty-six protons inside the nucleus of the iron atom were liberated from their bonds, they would fly apart with a pressure of 7×10^{18} atmospheres, an "atmosphere" being the average air pressure at sea level, or about fifteen pounds per square inch. The released energy corresponds to a temperature of more than a 100,000,000°. Vehemence of action and million-degree heat are the "nuclear energy" we gain by fissioning the nuclei of atoms or, as it is generally expressed, nuclear reactions.

Despite their strong tendency to repel each other, the protons stay together because their charges are neutralized by bodies beside them called neutralizers, or neutrons. We do not know what neutrons are or how they act. Since they are heavier than protons and the difference coincides with the mass of an electron it is assumed that a neutron is a proton combined with an electron. This assumption seems justified because neutrons are not stable. Free neutrons live only twenty minutes, disintegrating into protons, electrons and hypothetical neutral particles which have no mass and are called neutrinos.

Long before the discovery of the nucleus, the Dutch physicist Van der Waals calculated that the molecules of liquids, let us say of a drop of water, cling together by exchanging electrons of the outer shells of their atoms. Since the electrons have to shuttle back and forth between atoms, the "exchange force" acts only over very short atomic distances.

At first it sounds strange that a third body shuttling back and forth should have the force to hold together two other bodies much larger than itself. But it is not so odd; we experience in daily life everywhere the effect of exchange forces. Two card players sit for hours at a table, almost inseparably bound together by the force of the exchanged cards. Two chess players are spell-bound by the little chessmen on their board. The exchange forces holding protons and neutrons together inside the nucleus are a million times stronger than those between the molecules of water which Van der Waals studied. Since these binding forces act only over very small distances, a nucleus explodes as soon as the distance between its parts is widened. If a "bullet" is shot into a nucleus, the distances between the nucleons are widened, the binding forces weaken and the repelling forces of the identically charged protons become dominant. The nucleus explodes.

After the exchange forces were recognized as the power which binds the particles of the nucleus together, it was assumed that an electron might also act as an intermediary between proton and neutron. But the Japanese physicist Hideki Yukawa calculated that this intermediary must be a particle

heavier than an electron but lighter than a proton or neutron. He called this hypothetical courier a meson, "the body in between." Just as a hundred years ago astronomers looked for the companion of Sirius whom Bessel had "discovered" on paper, so in our times physicists all over the world hunted the as yet undetected meson. Several years after Yukawa's prediction it was found on photographic plates exposed to cosmic radiation, and fifteen years later the young Brazilian Giulio Lattes, working as a physicist in England, came to California and demonstrated that mesons could be produced by the great cyclotrons at Berkeley.

The atom is an electrical system. All atomic reactions take place with immense speed, sometimes approaching the speed of light. The particles inside the nucleus are unimaginably close to each other. The messenger meson runs, according to the calculations, 5×10^{17} times per second between proton and neutron. Let us imagine that proton and neutron were tennis players and that they started their match when the earth was born and have played day and night since then. Even so, their ball has not yet traversed the net as often as the meson shuttles between proton and neutron in a single second.

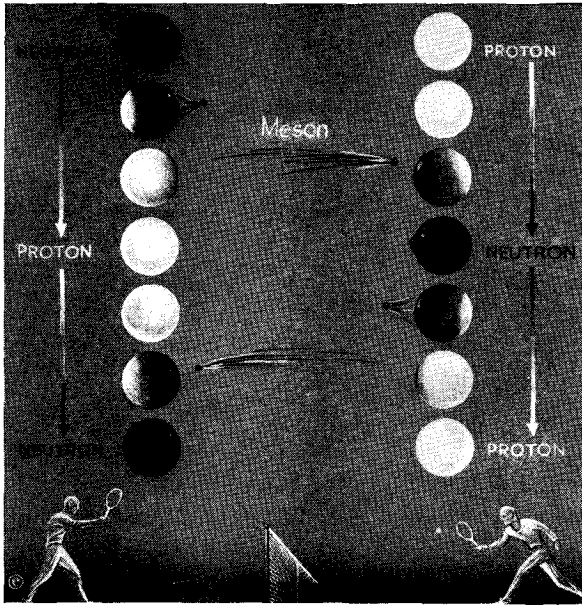

Fig. 32.
THE TENNIS BALL
THEORY

Neutrons and protons are not basically different but oppositely charged particles of the same kind. They exchange their charges as tennis players volley a tennis ball, the ball being a meson. The one which has the ball is the neutron; the one without the ball, the proton. They exchange the ball millions of times per second.

Every time the meson leaves it, the proton becomes a neutron; every time it enters the neutron, the neutron is transformed into a proton. Like neutrons, mesons do not last when they are freed. They disintegrate in less than a second, dissolving into secondary mesons. These secondary mesons have less mass than the original ones and are therefore called the medium mesons in contrast to the heavy mesons; they also dissolve, forming the "light mesons." Besides their difference in mass, the mesons differ also in their electric charge, some being negatively charged, others positively, and still others neutral.

Altogether ten different mesons appear—or should appear according to calculations—but some of them are not yet identified.

The Italian physicist Enrico Fermi, who calculated the known and unknown particles of the atom nucleus, concluded that there should be a total of about 23 particles inside the atom nucleus. Not all of them are bodies such as protons. They may not exist simultaneously. Some of them appear only as intermediary stages, comparable to lightning during a thunderstorm. Enrico Fermi and other physicists have absolute confidence in the validity of mathematical calculations. They are convinced that, besides the known units which can be thought of as positive castings, their counterparts should exist as negative “molds” of mesons and protons. They are not easily found because they appear under specific conditions only, and then but for parts of a trillionth of a second or so. Fermi describes these “anti-protons” and “anti-mesons” as voids or holes in space. Like eddies they attract the corresponding protons, mesons or electrons. When the positive particles unite with their negative counterparts, they disappear. Mass cannot disappear from the cosmos into nothing. The disappearing mass transforms into energy according to the formula $E = m \times c^2$. The amount of energy released during the union is enormous, millions of times greater than the energies liberated by other nuclear reactions. Since some strange—and not yet sufficiently explained—signs of such events are observed in the field of cosmic radiation, it is suspected that in remote regions of the universe there may be stars built of “reversed matter.” In these strange worlds the atoms would have nuclei with negative anti-protons and the electrons revolving in the orbits of these anti-atoms would be positively charged, positrons. These ideas are still highly speculative but they demonstrate how far modern physics has extended the frontiers of atomic research and how it is reorienting our basic concepts of the universe.

Cosmic Radiation

After the discovery of radium, when the physicists began to search for radiating substances in nature, they found signs of radioactivity everywhere in water, soil and air. The radiation seemed to be strongest near the ground and to diminish with the altitude. At the beginning of the century the German specialist in atmospheric physics, Albert Gockel, ascended in a balloon to determine how far up the radiation could be traced. He expected to arrive at a zero point but was startled to find that the radiation diminished only up to a certain altitude. A few hundred meters further it began to increase and the higher the balloon rose the stronger the radiation grew. He evolved the theory that an unknown radiation from cosmic space bombards the earth, and thereby became the discoverer of cosmic radiation.

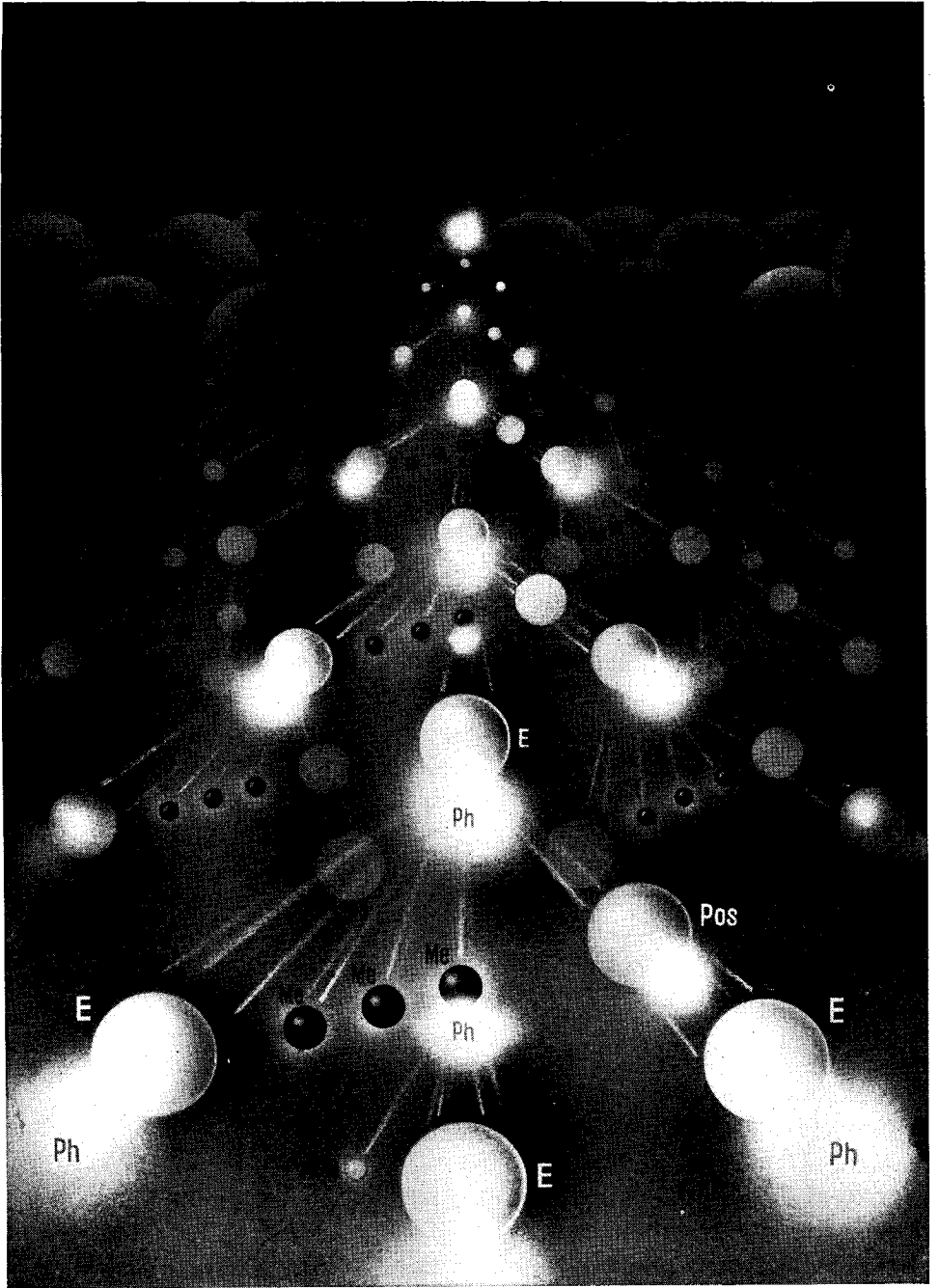

Fig. 33. COSMIC RADIATION
One atmospheric atom hit by a cosmic proton (*above*) touches off the chain reaction of cosmic radiation (*below*). E, electron; Ph, photon; Me, meson; Pos, positron; Neu, neutrino.

He was not, however, greeted like a returning Columbus. His contemporaries called his observations fake, his theory nonsense, and after a long and exhausting controversy, Gockel died. Subsequently one of his pupils proved the veracity of his findings and cosmic radiation became celebrated "as one of the greatest discoveries of the century."

The term cosmic radiation is slightly inaccurate. It is not a radiation which streams against the earth; instead the earth is bombarded by an incessant barrage of atomic particles. The exact composition of these projectiles is still unknown. Supposedly they are a mixture: 80 per cent protons and 20 per cent a combination of two protons and two neutrons, nuclei of helium. They fly at three-quarters the speed of light. Since the energy of a flying body increases as the square of its velocity, the energy of these cosmic bullets is tremendous. According to the accounts of physicists, the energy of a cosmic particle exceeds 10^{16} electron volts—one electron volt being the amount of energy acquired by an electron in passing from the negative to the positive pole of a one-volt battery, which corresponds to a speed of about 360 miles per second. A photographic plate, which was sent in a balloon to a height of 30 kilometers was struck by a cosmic missile which split an atom nucleus into no less than 72 parts. This cosmic projectile must have had an energy of trillions of electron volts.

We know of no cosmic "cannon" which could send such missiles through space with this enormous energy. The sun is much too cold, and even the hottest stars known are not able to supply a projectile with such tremendous speed. Only exploding stars like the super-novae release energies on this scale at the moment of their explosion. Some theorists went so far as to speculate that the cruising protons might be leftovers of the primordial nuclear cloud which, in the days of Genesis, exploded and brought forth the dissipating galaxies of our cosmos.

The arriving protons shatter the nuclei of the air atoms and initiate a sequence of reactions which is shown in *Fig. 33*. The parts of the pierced nuclei, mostly mesons, electrons and positrons, fly around for the inconceivably short time of a trillionth of a second and then disintegrate into radiation of extremely high frequencies, 2.47×10^{20} per second—"cosmic radiation." Photons of this high radiation frequency are transformed back into mesons, electrons and positrons of different masses and charges. Since, in the sequence of these transformations, some of the energy is unaccounted for, it is believed that a not yet established particle called the neutrino is created, too.

After the process of transformation from bodies into radiation and from radiation back into bodies has been repeated about fifteen times, the progeny of one proton rains as a shower of about 75 per cent mesons and 25 per cent electrons over an area of 100 square meters. Despite the considerable loss in momentum the particles striking the ground are still so rich in energy that they can pass through a skyscraper and still have enough energy to penetrate

a mine beneath the ground. A man sitting in his home can be pierced, too. In the time it has taken you to read this page, hundreds or even thousands of mesons and electrons have darted through your skull into your brain, down into your chest and blood and have finally left your body through the soles of your feet. The uninterrupted bombardment is, of course, harmless; otherwise you would not be sitting here reading. The whole evolution of life took place in the uninterrupted rain of cosmic radiation.

When one of the traveling mesons hits an atom nucleus in our body, this nucleus, too, is shattered. It has been calculated that about a thousand nuclear explosions caused by cosmic radiation occur every second in our body. Each of us is a walking atomic pile with a "capacity" of 1,000 fissions per second. But since our body is composed of 10^{28} atoms and continually replaces its loss of atoms by intake of oxygen and consumption of food—50,000,000,000,000,000,000 in one coffee spoon—1,000 atomic explosions per second have no more damaging effect than the impact of a tiny crab against the hull of an ocean liner.

Cosmic radiation is the richest source of energy known to man, dwarfing the energy sent us by the sun. Perhaps the man of the next century will not use oil, electricity or atomic power; instead, he may drive his machines with cosmic rays. Perhaps his generators will float high above the earth as "artificial moons," transforming cosmic radiation into human happiness.

The Packing Loss

Since energy is liberated when an atom nucleus is split, energy must have been invested in the nucleus. We do not know how nuclei originated. The nucleus of the iron atom contains 26 protons. To combine 26 positively charged protons into a unit requires an energy of billions of degrees of heat and a pressure of more than 7×10^{18} atmospheres. Even in its fieriest days the earth could never have furnished such power. Nor could the sun have endowed the earth with such a heritage. More potent progenitors must have sired our iron and other metals.

Since energy is equivalent to mass, some mass must have been lost in the process of manufacturing nuclei. Actually, the 26 protons inside the nucleus of an iron atom weigh less than 26 single protons. This packing effect is one of the most startling discoveries of modern physics. Imagine that you were to buy four apples, each weighing a quarter of a pound. The merchant weighs them one by one before your eyes and puts them in a bag. At home, you place the bag with the four apples on a scale and find that the fruit weighs less than a pound. Indignantly you run back. The grocer takes the apples out and shows you that each apple weighs a quarter of a pound. Embarrassed, you look at him and at the scale, but he is a modern, well-informed grocer. He smiles and says: "Packing loss."

Atoms are weighed not by grams but by an atomic mass unit, MU. A mass unit is the sixteenth part of the mass of an oxygen atom. The figure 16 has been chosen because it is the only one which can be divided into even numbers down to 2. Expressed in grams, a mass unit equals 1.685×10^{-24} grams.

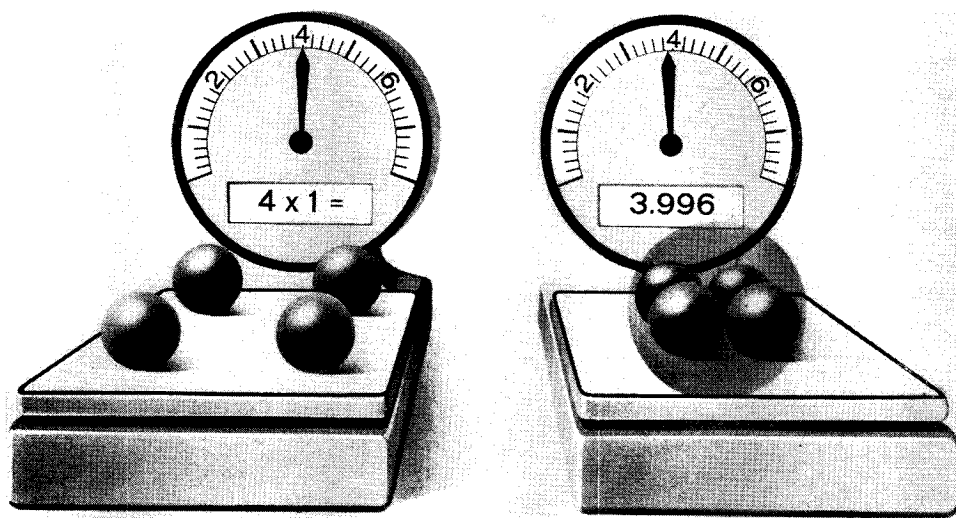

Fig. 34. THE PACKING LOSS

In some atoms the nucleus weighs less than the sum of its constituents. The "nuclear fusion" caused a loss in mass which radiated away as "atomic energy."

A proton weighs 1.00756 MU. A neutron, which probably is a proton plus a negative charge, weighs somewhat more—1.00893 MU. The smallest of all complex nuclei, that of helium, contains 2 protons and 2 neutrons. The nucleus of helium should weigh:

$$\begin{array}{r} 2 \text{ protons } 2 \times 1.00758 = 2.01516 \text{ MU} \\ 2 \text{ neutrons } 2 \times 1.00893 = 2.01786 \text{ MU} \end{array}$$

$$= 4.03302 \text{ MU}$$

Yet it weighs only 4.00280 MU

By packing the 4 particles together, 0.03022 MU have been lost. (Fig. 34) According to the equation $E = m \times c^2$, 0.03022 MU are equivalent to about 30,000,000 electron volts. This amount of energy must have been lost when the helium nucleus was built of two protons and two neutrons. It must have been dissipated as radiation. If man could repeat this process artificially, he should be able to gain this energy. He succeeded by imitating a celestial model of a gigantic nuclear reactor, the sun.

The sun gains its heat by forming the nuclei of helium from four protons. (Page 176 and Fig. 67) It can do so because its internal heat is about 20,000,-

000°. In a heat so “hellish” the atoms are stripped of all their electrons; the bare nuclei hurtle back and forth with such speed that they collide a million times every second and fuse. Since a high temperature is needed, the fusion of protons is called a thermo-nuclear reaction. Man, too, must heat his atomic furnace to a very high temperature. A temperature of millions of degrees can be attained by setting off an atomic explosion. By exploding an atom bomb, man provides the thermal milieu needed to forge helium atoms from protons. The hydrogen bomb, the first device which provided atomic energy by fusion, was given its name because protons are identical with the nuclei of hydrogen atoms.

The hydrogen bomb is composed of two bombs. The first is a conventional uranium bomb. As it explodes, it creates atomic heat of 20,000,000°. This heat is used to bring about the thermo-nuclear reaction which fuses the protons into helium. The energy liberated by thermo-nuclear fusion is, compared atom to atom, only about two and a half times the amount released by the fission of uranium or plutonium. What is really gained by using fusion is the *unlimited* amount of explosive material that can be amassed in a hydrogen bomb compared to the always limited dimension of a plutonium bomb. If a hydrogen bomb is manufactured in the size of a “block-buster,” its destructive force is almost “cosmic.”

Isotopes

The number of protons in the atom nucleus is fixed; the nucleus contains as many protons as there are electrons on the shells. Each proton has a

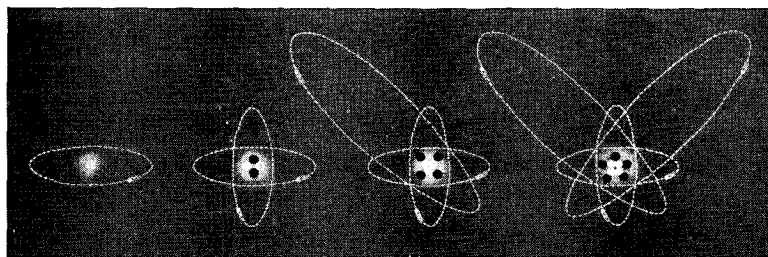

Fig. 35. THE LAW OF PROTONS AND THE RULE OF NEUTRONS
 The law of protons: the nucleus of the atom contains as many protons as there are electrons in the shells.
 The rule of neutrons: the higher the number of protons, the greater the excess of neutrons.

positive charge which is strong enough to counterbalance one negatively charged electron. If the nucleus loses a proton, an electron breaks away from the system. If the nucleus gains a proton, a “free” electron from the outside

world joins the "planets" of the atom. When an atom nucleus is bombarded with protons and the number of protons in the nucleus increases, correspondingly more electrons are attracted and the element changes.

In contrast to the protons, the number of neutrons is not in proportion to the electrons. The nucleus of the first atom, hydrogen, carries a proton but no neutron. (*Fig. 35*) (1) The nucleus of helium contains two protons and two neutrons. (2) The nucleus of the third atom, lithium, has three protons, but four rather than three neutrons. (3) The 50 protons in the nucleus of tin are accompanied by 70 neutrons, and the 92 protons of uranium by 146 neutrons. The rule establishing the relationship between protons and neutrons is: the more protons a nucleus contains, the more neutrons are needed to neutralize the opposing charges of the protons. The nucleus of lithium has a surplus of one neutron; that of tin, a surplus of 20; the nucleus of uranium, a surplus of 54. This excess of neutrons is the source of free neutrons, which are used as projectiles to bombard other nuclei.

As a carry-over from the past century, when protons and neutrons were as yet unknown and scientists could measure only the weight of the whole atom, it is customary to write Uranium 238 or U^{238} . Generally the number of protons is added in the following form: $U^{\frac{238}{92}}$. Better than this presently-used formula is the form 92 U 146, because this symbol makes unnecessary the annoying subtraction $238 - 92 = 146$; we see at a glance that we are dealing with a nucleus composed of 92 protons and 146 neutrons whereas the value 238 has no specific interest for us.

The chemical qualities of an atom depend on the number of its electrons, especially those on the outer shell. An atom with six protons in its nucleus and six electrons in its orbit is always carbon. If one proton is added to the nucleus and one electron consequently attaches itself to the outer shell, the atom is no longer carbon, 6 C, but nitrogen, 7 N. If an additional proton invades the nucleus, 7 N, it becomes 8 O, oxygen. Transformations like these take place in atomic plants, where 3 lithium becomes 4 beryllium or 92 uranium becomes 93 neptunium and 93 neptunium becomes 94 plutonium.

A change solely in the number of neutrons does not alter the character of the element. The nucleus of the lithium atom generally contains four neutrons, but occasionally it may have one more or one less. (*Fig. 36*) The more frequent combination is called the "normal" atom; the uncommon combination is called an isotope, *isos* meaning equal, and *topos* place, because they stand at the same place in the Periodic Table of Elements. An isotope, containing more neutrons and consequently weighing more than a normal atom, is called a heavy isotope; an isotope with fewer neutrons is a light isotope.

All elements have several isotopes. The atom of the first element, hydrogen, contains a single proton in its nucleus. Yet this nucleus can accept an unnecessary neutron. Nuclei of hydrogen carrying a neutron beside the proton are called deuterons (the seconds). The atoms with these supercharged nuclei are called deuterium. If the compound H_2O , water, contains one or

two H-atoms with neutrons in their nuclei, the water molecule is somewhat heavier than the ordinary water molecule and is called "heavy water." Since deuterons dispose of their superfluous neutron easily, they were highly valued by physicists, especially in the early stages of nuclear research. The "Story of Heavy Water" is one of the most dramatic chapters of World War II. Joliot-Curie, fleeing from Paris, saved his precious stock of a few bottles of heavy water. Later, the Allies sabotaged and finally bombed the Norwegian factory making heavy water for German nuclear experiments.

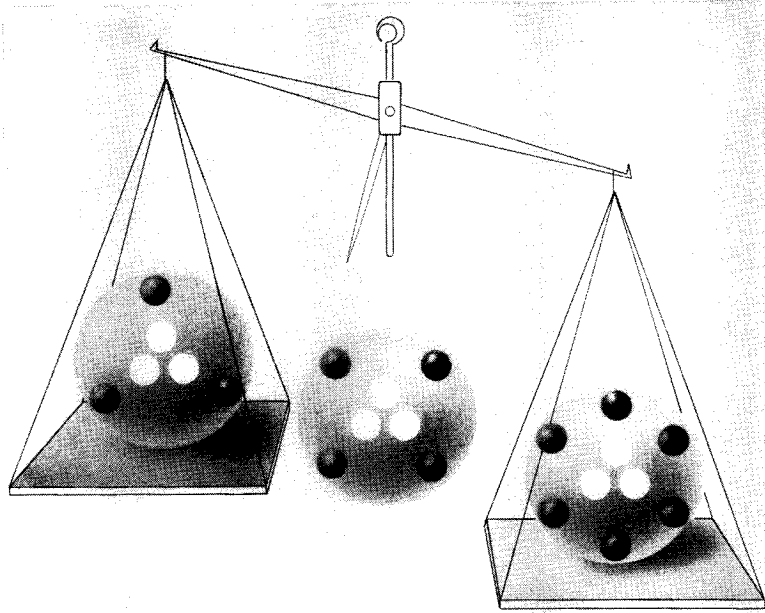

Fig. 36. ISOTOPES

The atom in the center is the "normal" lithium atom, ${}^7_3\text{Li}$. The one at the left, ${}^6_3\text{Li}$, has one neutron missing; the one at the right, ${}^9_3\text{Li}$, has two neutrons too many. The one to the left is called the light isotope, the one to the right the heavy isotope.

When the atom nuclei of nitrogen are split by the bombarding cosmic particles in the upper layers of the atmosphere, some of the fragments are units composed of one proton and two neutrons, called tritium (the thirds). Deuterium is the heavy, tritium is the super-heavy isotope of hydrogen. Tritium rains down to earth with the snowflakes and the raindrops. Every organism contains some deuterium and some tritium. Since tritium is not stable, but decays with a half-life of twelve and a half years, the proportion of intact tritium atoms gives a hint about the age of water, fruits, canned food and all other materials containing water.

The elements with the greatest number of isotopes are tin (stannum) with

13, ranging from $^{50}\text{Sn} 62$ to $^{50}\text{Sn} 74$, and xenon with 17, from $^{54}\text{Xe} 70$ to $^{54}\text{Xe} 86$.

Besides the 300 isotopes found in nature, almost a thousand artificial isotopes have been produced by bombarding nuclei with neutrons or by splitting nuclei. The term isotope, formerly an almost esoteric word hidden in fine print at the bottom of scientific folios of the last century, has risen like a Cinderella in our day to newspaper headlines.

Nuclear Fission

Bombarding Atoms

THE FIRST bombardment of atom nuclei was accomplished by Ernest Rutherford at the beginning of the century. As artillery he used the newly discovered radium, which ejects helium nuclei with a speed of about 15,000 km/sec. The penetrating power of these atomic bullets, although not overwhelming, is sufficient to enter the nuclei of small atoms. Rutherford aimed his "atomic cannon" against nitrogen. The helium nuclei entered the nitrogen nuclei and the nitrogen was transformed into oxygen: $7\text{N}7 + 2\text{He}2 = 8\text{O}9 + 1\text{H}0$. A small amount of lost mass transformed into kinetic energy. Rutherford's historic experiment thus brought about the first artificial transformation of an element. The medieval dream of making gold out of lead— $82\text{Pb} \text{ minus } 3 = 79\text{Aurum}$ —seemed near. But the nucleus of an atom which has 82 electrons is not so easy to attack as the nuclei of smaller atoms. The nucleus of an atom is the densest structure in the universe. Compared to it the hardest steel in the world is as soft as butter. The nucleus has the properties of a drop, but the surface tension of this drop is 10^{18} times stronger than the surface tension of a drop of water. Finally, the binding forces in the nucleus resist every attempt to disperse the closely coherent particles.

Bombardment of atomic nuclei seems an almost hopeless undertaking, especially since the atomic bullets must be smaller than the nuclei themselves, and small bullets have little striking power. Yet there is a redeeming law of physics: the penetrating power grows with the square of the speed of the projectile. If a car doubles its speed, the energy of its moving mass does not double but quadruples. If a car is driven three times faster, the braking power required to stop it must be nine times as great. The physicists based their experiments on this law. The American physicist Ernest Lawrence constructed an atomic cannon, the cyclotron, which whips nuclear bullets to speeds of 100,000 km/sec or more.

As the name indicates, a cyclotron has a circular shape. Its basic part is an empty tube which serves as a racetrack for the flying bullet. The force propelling the bullet is a high-voltage alternating current which alternates up to several or even a hundred million times every second compared to the 25 or 60 alternations in our home current. To exploit the alternating current, the "circus" is cut into halves and at the gaps the electrodes end as poles. The current is synchronized to the speed of the flying particle so that the

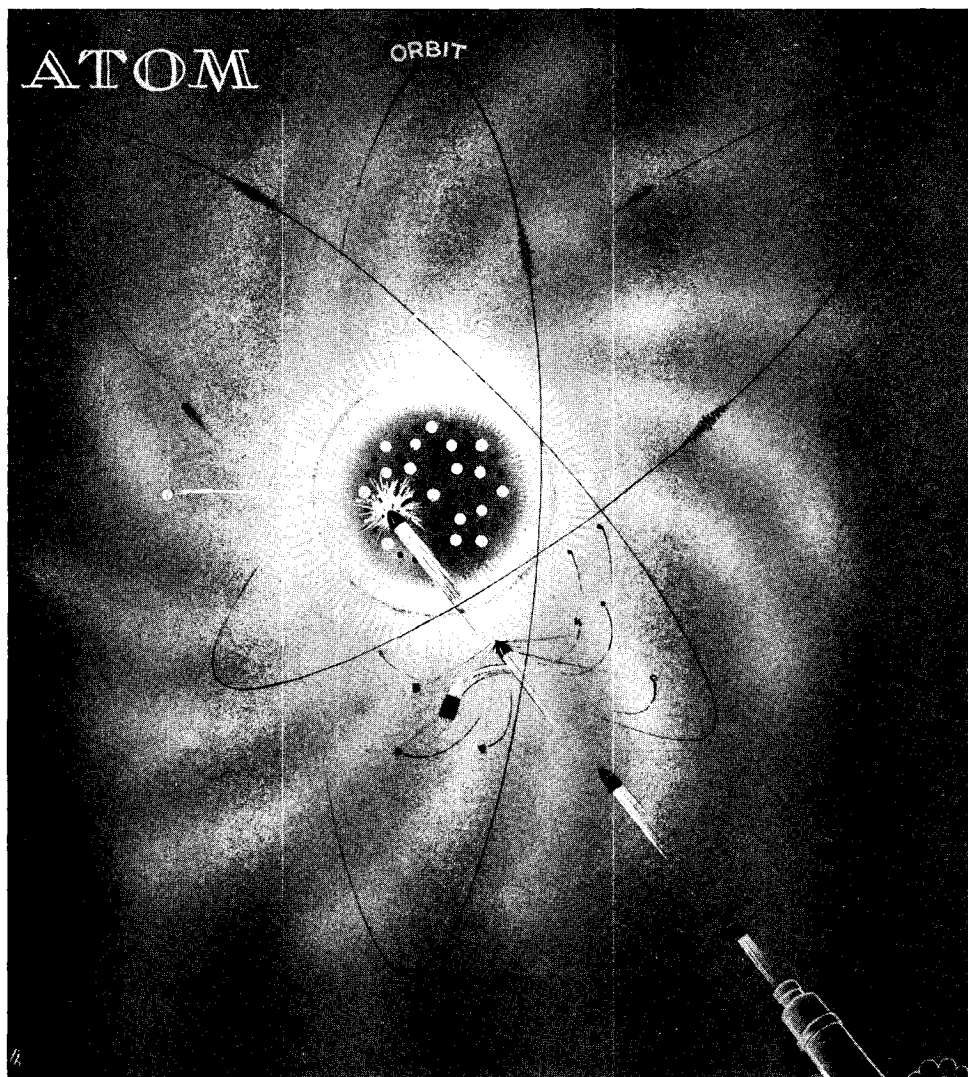

Fig. 37. ONE OF THE FIRST BOMBARDMENTS OF THE ATOM NUCLEUS

One of the first bombardments of the atom nucleus was performed with the nuclei of heavy hydrogen which contain one proton combined with one neutron. The positively charged proton (rectangular) is repulsed by the identically charged nucleus; the neutron, electrically neutral, enters the nucleus.

electric pole in front of the flying bullet attracts it, since it always has a charge opposite to that of the flying particle. In this way the flying particle receives after each half-circle "a touch of the whip" until its velocity approaches the speed of light.

The "flying horse" is held on its circular track by an invisible but strong bridle—huge electromagnets, weighing up to several thousand tons, circled

by thick copper wires more than ten miles in length. The magnets force the particle to fly in their path, but with increasing speed the particle flies in ever wider circles, describing a spiral. After about 1,000 turns the missile leaves the track through a gate and shoots against its target. Thus the cannon that fires the tiniest bullet against the most minute target in the world has become the largest, the most powerful and the most costly machine modern man has erected.

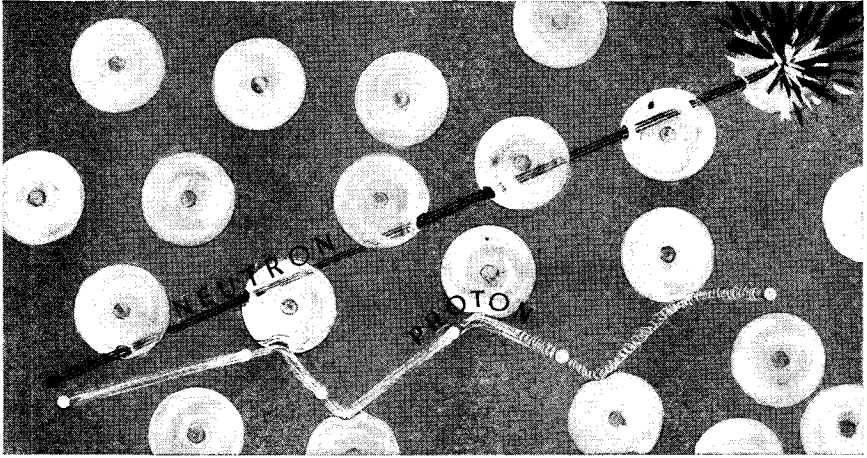

Fig. 38. WHY ARE NEUTRONS THE IDEAL BULLETS FOR BOMBARDING NUCLEI?

The positively charged proton is repulsed by the positively charged nuclei and therefore zig-zags among the atoms. The neutron, electrically neutral, shoots, unaffected, straight through the atoms until it hits a nucleus.

Several cyclotron models have been constructed but the principle is always the same. The first bullets used for atomic bombardments were the nuclei of helium or the hydrogen nuclei of heavy water because they are relatively massy and therefore penetrate more easily. The bombardment of an atom with the nuclei of heavy hydrogen (deuterium) is illustrated in *Fig. 37*. When the proton-neutron projectile approaches the nucleus, the proton—shown as a rectangle—is repulsed, for it carries a positive electrical charge just as the bombarded nucleus does. The neutron—shown as a triangle—carries no charge and therefore does not feel the electrical charge of the nucleus. The neutron pierces the barriers of the nucleus as if they did not exist. This immunity to all positive or negative charges makes the neutron an ideal missile for nuclear artillery. It crosses thousands of atomic systems in a straight line because neither negatively charged electrons nor positively charged nuclei deflect it from its course or slow down its velocity. (*Fig. 38*)

Yet the dominant role of the neutron as a nuclear bullet is somewhat outdated. Modern atom smashers are so powerful that they accelerate bullets to

almost the speed of light. Flying at such speeds, any projectile, even if it carries a charge, pierces the strong defense lines of the nuclear fortress.

In *Figs. 39 to 41* several methods and consequences of bombarding atoms are illustrated. The bullet may be a proton Pr, a neutron N or a nucleus of helium He.

- a. If the bullet is a neutron, the element stays the same but the number of neutrons is increased and the atoms become a heavy isotope.
- b. If the nucleus is not able to absorb the newcomer but strives to get rid of the excess mass and energy, the heavy isotope emits energy and becomes an artificial radioactive isotope.
- c. If the bullet is a proton, the nucleus will contain an increased number of protons, will attract a corresponding number of additional elec-

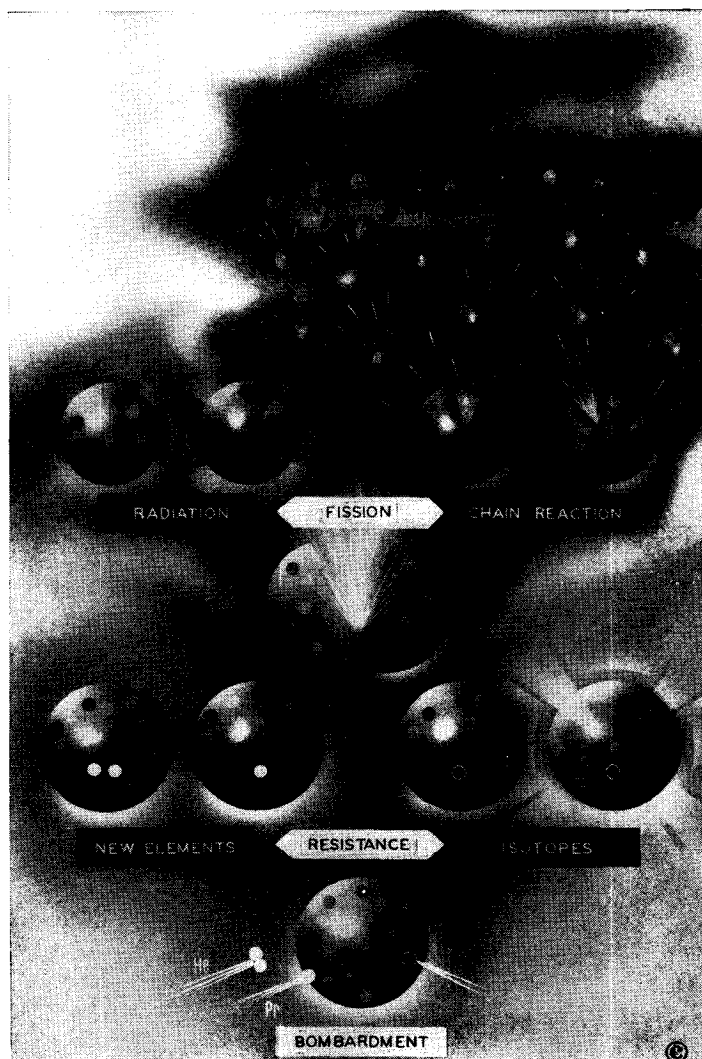

Fig. 39.
SEVERAL POSSIBLE CONSEQUENCES OF BOMBARDING ATOMS

Depending on the bullet—N, neutron; Pr, proton, He, helium nucleus—the effect of a hit differs.

trons and the atom will be transformed into an atom of a higher element (transmutation of elements).

- d. The bullet may pierce the nucleus, and the split nucleus will disintegrate into fragments (nuclear fission).

In *Fig. 40* a proton is shown flying into the nucleus of an atom of lithium. The nucleus of the lithium atom is composed of 3 protons and 4 neutrons. The added proton transforms ${}^3\text{Li}^4$, lithium, into ${}^4\text{Be}^4$, beryllium. The nucleus thus produced is not the nucleus of ordinary beryllium because normal beryllium carries 5 neutrons, and has the symbol ${}^4\text{Be}^5$. Since four neutrons cannot balance the four protons, the nucleus explodes and disintegrates into two nuclei of helium having less mass than the nucleus of beryllium. The excess of mass radiates out into space.

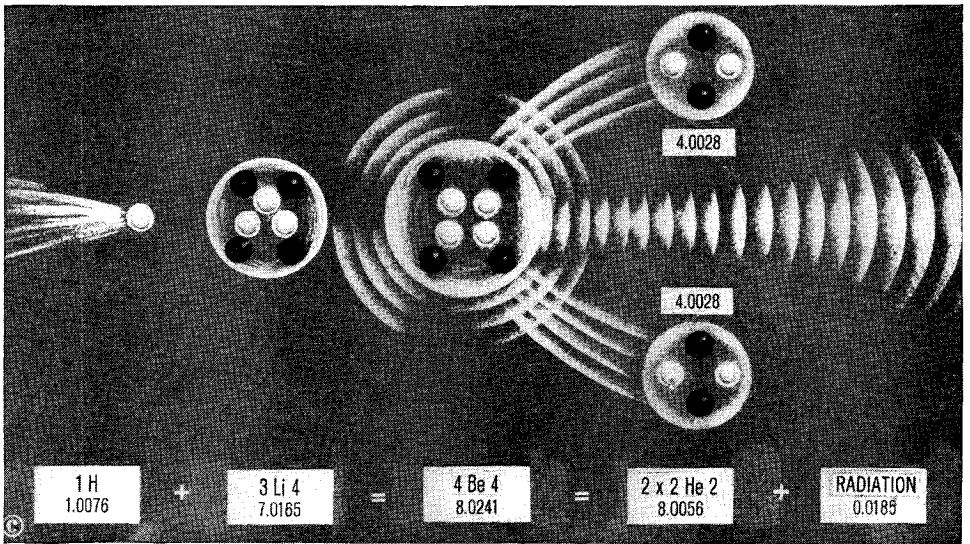
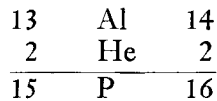

Fig. 40. GAIN IN ATOMIC ENERGY BY FISSION

The intruding nucleus of hydrogen, H, transforms the nucleus of lithium, Li, into an overcharged nucleus of beryllium, Be, which splits into two halves, each half a nucleus of helium, He. As the mass units reveal, 0.0185 MU remains as surplus and radiates away as the energy gained.

Fig. 41 shows Frederic Joliot-Curie's experiment in the early thirties in which he produced the first artificial radioactive isotope by bombarding aluminum with helium. Since the nucleus of helium contains two protons, aluminum with its 13 protons is transformed into 15 phosphorus by the simple addition:



The impact of the intruding projectile is so strong that one neutron flies on ahead and is lost to the nucleus which thus becomes ${}^{15}\text{P}^{15}$. This nucleus is

not stable. It strives to regain its balance by transforming one proton into a neutron. The bombarded mass radiates for about two weeks. With the transformation of a proton into a neutron, $^{15}\text{P} 15$ becomes $^{14}\text{Si} 16$, or silicon.

The time which radiating substances require to transform from unstable to stable varies over a wide range. The half-lives of some of the most often mentioned radioactive elements and isotopes are, in round numbers:

90 Thorium C	2×10^{-7} seconds
88 Radium C	0.000,15 seconds
90 Thorium A	0.16 seconds
88 Radium C	19.7 minutes
93 Neptunium	32 hours
15 Phosphor 17	14 days
86 Radon	3.8 days
16 Radio-sulphur	12 weeks
84 Polonium	20 weeks
88 Radium D	25 years
94 Plutonium 144	50 years
88 Radium A	1,570 years
6 Radio-carbon	5,700 years
94 Plutonium 145	24,000 years
92 Uranium 146	4,600,000,000 years

Radioactive Isotopes

Ever since physicists have been able to shoot nuclear particles into nuclei, artificial isotopes have been created in ever-increasing numbers. Up to now, almost a thousand artificial isotopes have been manufactured. Since they carry more particles than normal atoms, many of them are not stable. They radiate and are called artificial radioactive isotopes.

The presence of radiating atoms can be detected by an instrument called a Geiger counter, consisting of a tube filled with an inert gas. This gas does not conduct electricity as long as its atoms are intact. But when an atomic particle passes through the gas, it will tear apart some atoms, or "ionize" them. In contrast to the untouched atoms the ionized ones do conduct electricity. A battery is connected to the ends of the tube but its weak current cannot pass through the gas until there are ionized atoms. The passing current when amplified will make a bulb light up, will trigger a radio signal or oscillate a needle.

The Geiger counter and the radioactive isotope are a pair of magic tools no scientist of previous centuries would ever have dreamed of. Their applications are so varied that it is difficult to select specific samples as "typical." Let us imagine that the water of a rain puddle is "infected" with a few drops of a radioactive solution. By using a Geiger counter this water can be traced

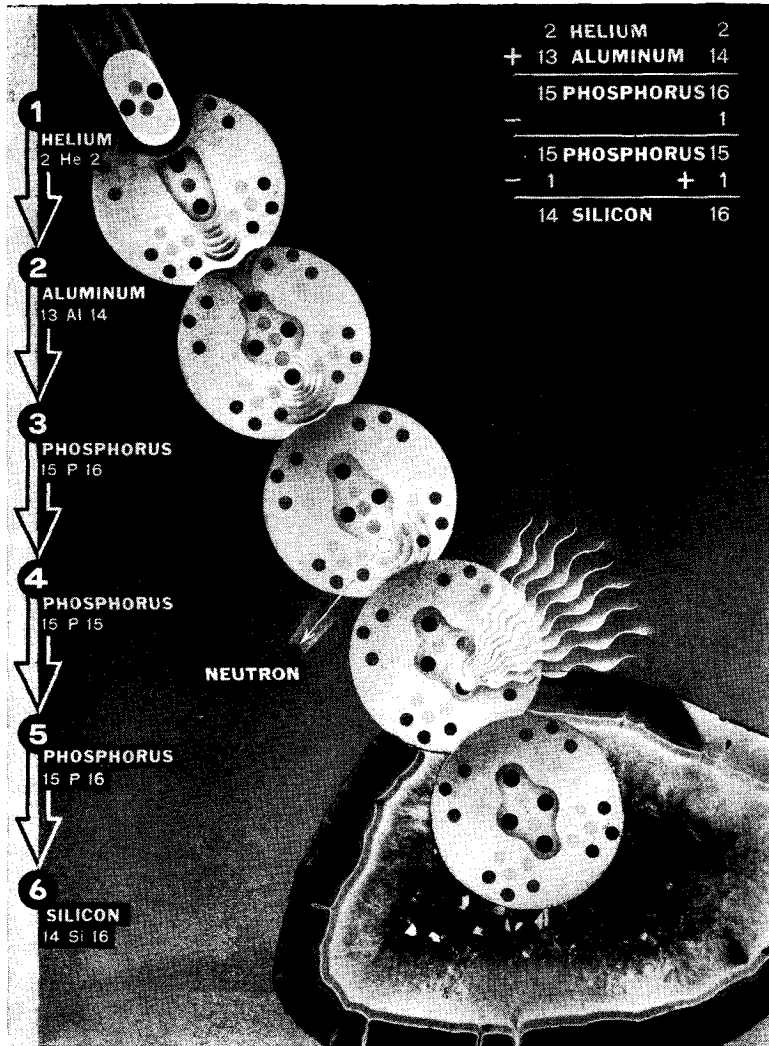

Fig. 41. THE PRODUCTION OF A RADIOACTIVE ISOTOPE

A helium nucleus (1) enters the nucleus of an aluminum atom (2) and transforms it into a heavy isotope of phosphorus, ^{15}P (3). The overcharged nucleus radiates and is therefore called the radioactive isotope of phosphorus (4). Through loss of a charge, a proton becomes a neutron (5) and ^{15}P is transformed into ^{14}Si , silicon (6).

through the subsoil, because the Geiger counter is so sensitive that it signals the intrusion of a single atomic particle.

Our electronic detective tells us that at first the water trickles ten yards downward. Thereafter it wanders half a mile away into a spring and reappears after many hours in a remote place. After its return to the topsoil it enters

the roots of plants. The ascent of the water can be followed from roots to stem, to buds, to leaves. Only a small part of the water remains within the plant; most of it is evaporated through the leaves. The remaining atoms combine with other atoms to form carbohydrates or acids. The new compounds pass into the buds, the blossoms, the leaves and the roots. A few radiating atoms participate in the forming of nectar. A bee comes and sucks the nectar. The bee, with the radiating atoms inside its body, can be traced to its hive, where the atoms enter into the honey which is consumed by man. Now the adventures of these same atoms can be followed through all the metabolic processes inside the body. Two days after the honey-sweet breakfast the atoms are radiating from the man's brain. If a "brain storm" occurs, they wander quickly through the bloodstream and are deposited, let us say, in an arteriosclerotic patch in the arteries of the kidney or on the wall of the gall bladder where a gallstone may be in the making.

Like bees, insects, molds, bacilli and viruses can be traced when they contain radioactive atoms, and this leads the scientist to various paths of investigation. The modern pathologist can follow the labyrinthine path of a bacillus or a virus from the manure of a field, through soil, grass, cow and milk into an intestine and perhaps into a lung where it may cause an infection or may be expectorated.

One of the most revealing tracer-atoms is that of radioactive phosphorus. It invites the scientist to make an almost endless number of trips into the unexplored world of biological chemistry. Phosphorus plays a vital part in all phases of life from the very first moment of fertilization. Without the assistance of phosphorus atoms life cannot begin. During the embryonic development it participates in the construction of all cells, but predominantly those of bone marrow and the nervous system. Its activity does not lessen during the infant's years of growth to puberty and maturity. It is the spark in the plasmatic motor of the muscles of the athlete and in the brain of the intellectual.

By tracing radioactive phosphorus added to fertilizers of the soil, it was proved that a particular fertilizer, mono-ammonium-phosphate, was absorbed by plants more quickly and in greater amounts than any other. Young plants which have not yet developed sufficient roots are more dependent on artificial fertilizer than older ones which prefer the natural ingredients of the soil. Clover, a quick-growing plant, absorbs fertilizer so rapidly that phosphorus atoms radiate from the young leaves two hours after the soil is watered with a solution containing phosphorus. The absorbed phosphorus is stored in those parts of the plants from which new growth will appear. Later, when the plant has matured, the major part of the phosphorus is passed along to the fruit, to build up those giant molecules, the phosphatides, which are the carriers of the basic functions of life.

One of the problems brought within a closer range of attack by the discovery of radioactive isotopes is how a plant manufactures sugar and starch

in its leaves from water and carbon dioxide. A new industrial era may begin with the unlimited production of artificial food, independent of soil and labor. One more dream will be realized on man's road to the "Paradise of the Future."

Out of a thousand experiments and applications of radioactive isotopes we quote a few at random to demonstrate the wide range of actual investigations under way. In the course of an hour, a goldfish exchanges all its water molecules with the molecules of the water in which it swims. Man replaces his water molecules every day. All water molecules in your body right now will be gone tomorrow night, a third exhaled with the breath, a third evaporated from the skin and the last third excreted by kidneys and bowels. When we drink water containing radioactive sodium and hold our hand against a Geiger counter, after three minutes the amplifying device connected with the counter will begin to tick. If we drink water containing potassium it would take twice as long.

When rats are fed sugar, 88 per cent of the sugar molecules are burned as fuel and most of the tracer atoms appear in the breath exhaled from the lungs; but within twenty-four hours 2 per cent is deposited inside the liver as fat, while 10 per cent is distributed as fat throughout other tissues.

One of the most powerful radioactive isotopes is radio-cobalt. It emits a thousand times as many of the deadly gamma rays as does radium and consequently it radiates only briefly. It has been proposed that radio-cobalt be mixed in the food given hogs shortly before they are slaughtered. The radiating cobalt atoms would kill any larvae of trichina in the muscles of the hog. Before the pork chops reached the butcher's scales the radiation would have faded away and they would be safe for human consumption. Radio-cobalt may prove to be an effective germicide. We might be able to place some of the radiating substance inside a room, a cellar, a ship, a barrel, and thus sterilize, within a few hours, the whole area in the range of the radiation. The "quarantine," which means forty (days), could be compressed to forty minutes. Potatoes exposed to radio-cobalt become sterile, remaining fresh for more than a year, while unirradiated potatoes shrink about 20 per cent.

By adding radiating isotopes to rubber, steel or grease, the quality of these materials can be determined and defects or leaks easily detected. A radioactive substance may be added to the outer layer of a tire. When the surface of the tire has been worn off, the radiation ceases. Thus in a comparison of two tires, the better tire would be the one which would radiate longer. To test the cleansing quality of a detergent, butter can be mixed with radiating material and rubbed on a cloth. If the detergent has removed all the butter, the cloth will no longer radiate.

Radioactive isotopes can also be dangerous. When nuclear laboratories ship artificial radioactive isotopes for scientific research, they are enclosed in cases ten thousand times heavier than their contents and often more costly

than the "merchandise" itself. The isotope is liquefied, exactly measured and diluted. It is poured into a small tube; the tube is enclosed in a cylinder of metal; the metal cylinder is put into a case of lead; the case of lead is embedded in insulating material and finally encased in a heavy wooden chest.

Since radioactive isotopes may be deadly in their effect, and can be disseminated without any restraint, they are among the most dangerous of modern weapons. An atom bomb is loud and acts quickly; a radioactive isotope acts silently, slowly, treacherously like a lethal potion. Radioactive isotopes can be blown into the winds, to be wafted across whole provinces, turning a breeze into a deadly gas. They can be poured into springs, to trickle with creeks and rivers across the countryside, turning every sip of water into a cup of hemlock. Clothing washed in this water could become a cloak of Nessus, burning into the skin like the garment which the jealous Dejanira gave to Hercules. Clouds that have been seeded with radioactive isotopes would rain down a vitriol that would consume leaves and burn roots. In a few weeks the countryside could become a graveyard where not even a worm creeps and the corpses do not rot because no bacteria can thrive on the radiating tissue.

When the volcanic island of Krakatoa exploded in the Sunda Strait in 1883, volcanic dust floated down several weeks later over the roofs of Stockholm. When Mount Pelée on Martinique erupted in 1902, the sky over the cities of Europe glowed after sundown, lighted up by volcanic dust in the stratosphere. Alas for the human race, when radioactive isotopes glow in its sky!

The Uranium Clock and the Carbon Calendar

Uranium $^{92}\text{U} 146$ is a slowly disintegrating element, or more correctly, a radioactive isotope with a half-life of 4,600,000,000 years. Since uranium is found among the ores, the earth cannot be an unlimited number of years old. The age of a uranium deposit can be determined. Uranium disintegrates, after it has passed through a dozen intermediary products, into a stable isotope of lead $^{82}\text{Pb} 124$, which is produced exclusively by uranium. If the uranium had been deposited 4,600,000,000 years ago, we would find half uranium and half uranium-lead; but no such relationship has ever been found. Uranium always predominates in mass, indicating that uranium has not lain in its resting-place for this length of time. The oldest deposits of uranium are a maximum of 4,000,000,000 years old. Other indications, in addition to this "uranium clock," point to the earth's age as about 3,000,000,000 years.

Uranium, which disintegrates over billions of years, is a clock for measuring geological times. Radium, with a half-life of slightly less than two thousand years, is a clock for measuring centuries. One of the most useful atomic

clocks is the radioactive carbon of the atmosphere, which has a half-life of 5,568 years.

Eighty per cent of the atmosphere is nitrogen. When the protons of cosmic radiation strike the atoms of the atmosphere, they shatter the nuclei of the nitrogen atoms. Several interesting substances are found among the fragments: helium (1 per cent of the atmosphere), tritium, a heavy isotope of hydrogen with one proton plus two neutrons, and radio-carbon.

Radio-carbon is formed when one of the liberated neutrons enters the nucleus of a nitrogen atom. The neutron pushes out a proton and increases the number of neutrons. ${}^7\text{N}7$ becomes ${}^6\text{C}8$, radio-carbon. The oxygen combines with the carbon atom to form carbon dioxide. Carbon dioxide is inhaled by plants. Thus, radiating carbon becomes an integral part of the living protoplasm of plants as well as animals. In each trillion carbon atoms, one is radioactive; a piece of tissue containing one gram of carbon emits 10 to 11 electrons per second.

The moment a living being dies and ceases to inhale and to feed, the intake of radioactive atoms of carbon stops. From now on the number of radiating atoms decreases. The number will be halved after 5,568 years; after the next 5,568 years their number will have decreased to one-quarter the original amount.

By the careful use of a sensitive Geiger counter, which is immersed with the specimen in a hermetically sealed mercury bath, it is possible to date organic relics backwards in time for 40,000 years with an error of less than 1 per cent. Every carbon-containing product created in the last 40,000 years can be dated by the percentage of its radiating carbon atoms.

The paintings on the walls of the Ice Age caves have been found to be 16,000 years old as the carbonic ingredients record. The temples of the Mayas were built around 300 B.C., only a hundred years after the Acropolis was erected in Athens. The oldest homes in the Middle East, where wheat was first cultivated, are 7,000 years old; the oldest Indian camps on Manhattan are, as the radiation of their organic remains reveals, just half that old. Glacial ice covered the state of Michigan about 12,000 years ago. The giant sloths of Nevada deposited their excrement 10,500 years ago. No sciences seemed more remote from one another than did nuclear physics and history. And yet nuclear physics has presented historians with a stylus with which to insert the correct dates in the chronicles of the past.

Uranium

Three reasons combine to make uranium the choice of the nuclear physicists as preferred material for the performance of nuclear fission.

The first reason: The nucleus of the uranium atom is the largest of all stable

nuclei: 92 protons plus 146 neutrons. Actually the nucleus is not stable, but since it lasts billions of years before half the nuclei will have exploded, to man, who lives only a few dozen years, uranium appears to be stable. Since the nucleus of uranium stands on the borderline between stability and non-stability, it is relatively easy to split it, just as a large drop of liquid is easily disintegrated. The addition of a minute amount of fluid or a slight shock is sufficient to break the drop into droplets.

A further reason for the choice of uranium: A nucleus so rich in particles yields a great amount of energy when the binding forces are liberated.

The final reason: The nucleus of the uranium atom carries an excess of 54 neutrons which are liberated when the nucleus is split: A more or less greater part of them spreads out and enters neighboring nuclei. The nuclei thus afflicted split again, spread out their excess of neutrons and in this manner a chain reaction results. (*Fig. 39*)

When the first uranium nucleus was split in the laboratory of Otto Hahn in Germany in 1939 the nucleus divided into two fragments. One was the nucleus of 56 Barium 82 and the other of 36 Krypton 47. (*Fig. 42*)

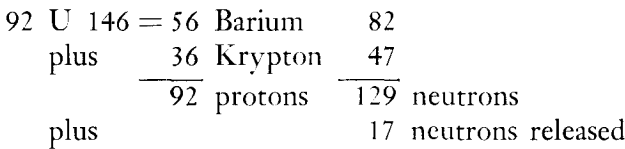

The liberated neutrons were hurled away at a speed of about 1,000 km/sec. If each one of them were to split a neighboring uranium nucleus, the chain reaction would spread out with the factor 17: 17, 17 × 17, 17 × 17 × 17.

Yet the factor 17 is only theory. In practice not every neutron will hit a nucleus nor will every nucleus explode after being struck. Even if the nucleus explodes, it will not always divide into barium and krypton; this happens in only about 6 per cent of the fissions. Dozens of other fragmentations are possible. The diagram in *Fig. 42* is worth studying because it explains principles basic to an understanding of nuclear fission.

Nuclei of atoms are not "dead," like the clay pigeons of a shooting gallery; they are dynamic structures, we could almost say living organisms. They behave like the colored pieces of glass neatly composed inside a kaleidoscope, which when disarranged always rearrange themselves in a perfectly symmetric figure. The first two fragments in the fission illustrated in *Fig. 42* are nuclei of xenon and strontium, but neither nucleus has the normal number of neutrons; both are overcharged with neutrons and convert neutrons into protons. They eject superfluous electrons and descend the ladder of elements until they finally reach a state of balance. The fission of an atom nucleus is not comparable to the bursting of a shell; it is an "organic" decomposition like the metabolic combustion of a food molecule inside the body. If someone were to have the patience to depict the two dozen variations in the decomposition of a uranium nucleus in a great mural, one hundred times the size of

Fig. 42, the human mind might then become aware of the multitude of the fissional processes inside the uranium reactor.

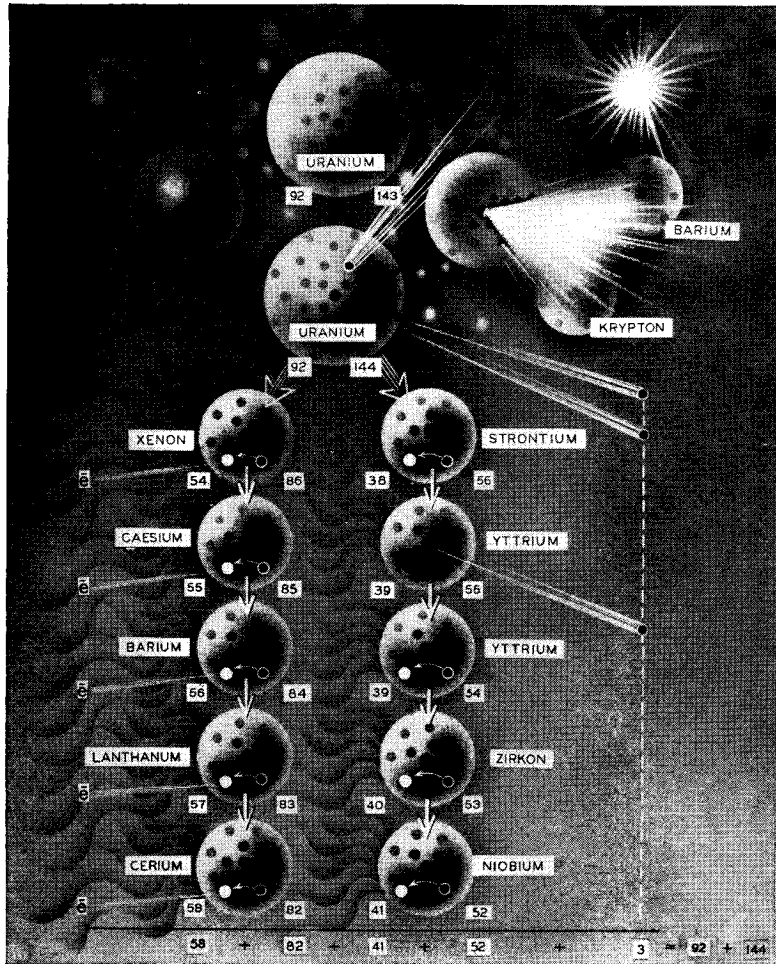

Fig. 42. THE FISSION OF THE NUCLEUS OF URANIUM

Fission is not a simple process. The nucleus can disintegrate in a dozen different ways. The fragments are mostly not stable nuclei but over-charged radiating isotopes which disintegrate more or less quickly until they reach a stable "end-product." This figure illustrates the splitting of uranium into xenon and strontium and the transformation of these isotopes, through several unstable stages, into stable cerium and niobium.

By splitting into xenon and strontium the nucleus of uranium releases only two neutrons. Later the intermediary element yttrium emits one neutron more. The average number of neutrons liberated during the fission of the uranium nucleus is not 17 but 2.3. Practically, there is no difference between 2 and 17 or even 77. The ejected neutrons have an average life-span of a millionth part of a millionth part of a second. They fly with a speed that would carry them around the globe in two seconds; the distances between

the nuclei are but one millionth of the diameter of the point over this i. Whether so quick a reaction is multiplied by the factor 2.3 or 17 is inconsequential. Any atomic chain reaction spreads out with a speed a million times greater than that of a dynamite explosion.

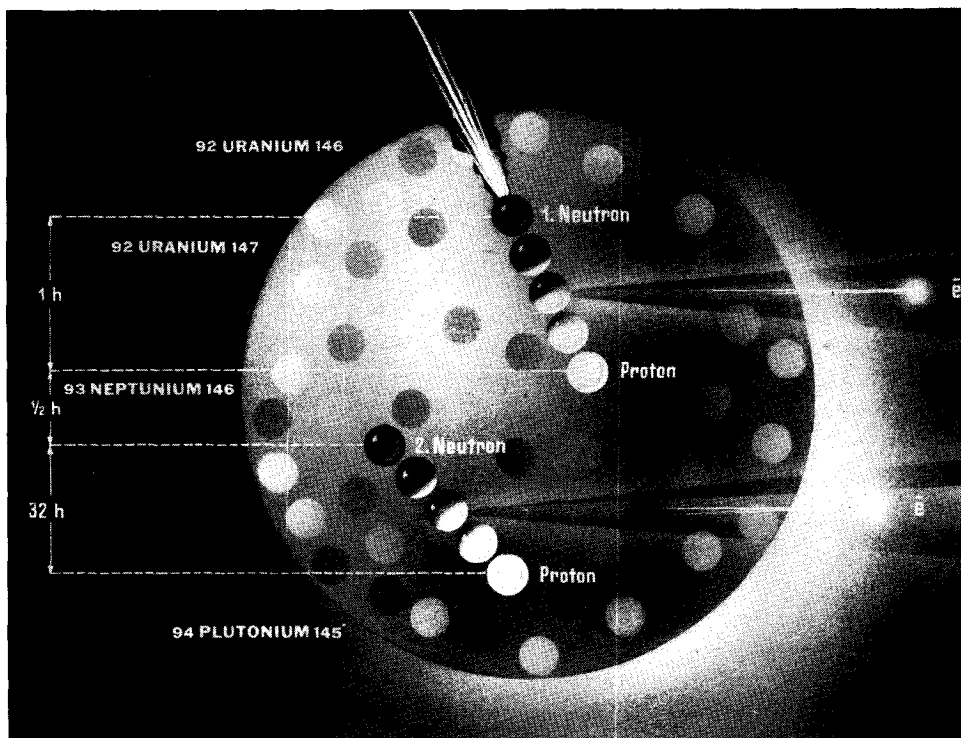

Fig. 43. THE TRANSFORMATION OF URANIUM INTO PLUTONIUM

When uranium 146 is hit by a neutron it is transformed, within about 34 hours, into plutonium. Twice a (*black*) neutron transforms into a (*white*) proton, each time shifting the atom to the next higher element.

In dynamite, molecules, not nuclei, explode. The chain reaction in dynamite springs from molecule to molecule as a chemical reaction and proceeds so slowly that we could say: a dynamite explosion, compared to an atomic explosion, is like the history of a whole century in contrast to one flash of lightning. The energy of the uranium nuclei is released in a millionth of a second. It is this high speed of reaction that renders an atomic explosion so disastrous, for the energy of an explosion is related to its speed. The air pressure is so great that it alone knocks people down over a radius of miles. After dynamite explosions, there is debris; after atomic bombs, nothing. Everything is blown up into dust. The speed of the atomic reaction also accounts for the tremendous heat. In the center of the explosion the heat rises to millions of degrees. The flash is so brilliant that in the moment of

the blaze the sun pales to a gray disc in the bright noonday sky. Man, "nothing as terrible as man," as the Greek chorus says in a drama by Sophocles, has finally succeeded in darkening the sun at noon.

Plutonium

Uranium in its natural state does not explode. It is not even fissionable. Uranium ore is so innocent that a man could sleep on it and dream of eternal life. In order to initiate and, more important, to maintain an effective chain reaction, atomic fuel must be absolutely pure. Even slight traces of foreign substances slow down the neutrons so much that the chain reaction comes to an end sooner or later.

Aside from its impurities, the uranium found in nature is a mixture of three isotopes: U 92 with 142, with 143 and with 146 neutrons. The most prevalent is 92 U 146. Among 140 atoms of U 146 there is one of U 143; and among 17,000 atoms of U 146 and U 143 one atom of U 142 can be found. Not only must the impurities be removed but the three isotopes must also be separated, since they react differently. This separation, however, is a formidable task, because isotopes do not differ in chemical behavior and, therefore, cannot be separated by chemical means. They differ in atomic weight because their nuclei contain different numbers of neutrons.

U 143 weighs 0.000,000,000,000,000,000,000,039,249 gram

U 146 weighs 0,000,000,000,000,000,000,000,039,446 gram

The difference is surely not impressive but it makes the Herculean task of separation possible. The isotopes can be separated by sending them through an electromagnetic field; the light atoms will be more strongly diverted than the heavy. This method, however, yields in a day, with strong currents and high costs, not more than a few millionths of a gram. A somewhat more efficient procedure is the use of centrifuges. But a whole battery of centrifuges will yield no more than a fraction of a gram in one day.

The most profitable method is diffusion. The uranium is combined with fluorine to form the gaseous compound uranium hexa-fluoride. This gas is then forced through filters which have extremely fine pores just wide enough to let the molecules pass. It is tedious work. In the original gas, among a million atoms of U 146 float 7,100 atoms of U 143. During the first diffusion this number rises to 7,130. The diffusion must be repeated several thousand times before a gas composed of approximately equal portions of the two isotopes is obtained. To produce one pound of U 143 per day requires the efforts of more than 20,000 people. Nevertheless, this diffusion method was chosen as the most "practical" one and great plants with thousands of diffusion chambers have been built. The monotonous exterior

of these fortress-like plants mirrors the monotony of the process that goes on in their interiors.

The two isotopes must be separated because they react differently to the flying neutrons which are used as bullets. U 146 will rarely split when struck by a flying neutron; it will do so only occasionally if the neutron arrives at a specific speed. Usually the nucleus simply absorbs the neutron and $^{92}\text{U} 146$ transforms into $^{92}\text{U} 147$. (Fig. 43) This isotope is not stable. During the next hour the neutron emits an electron and becomes a proton and $^{92}\text{U} 147$ is transformed into $^{93}\text{Np} 146$, neptunium.

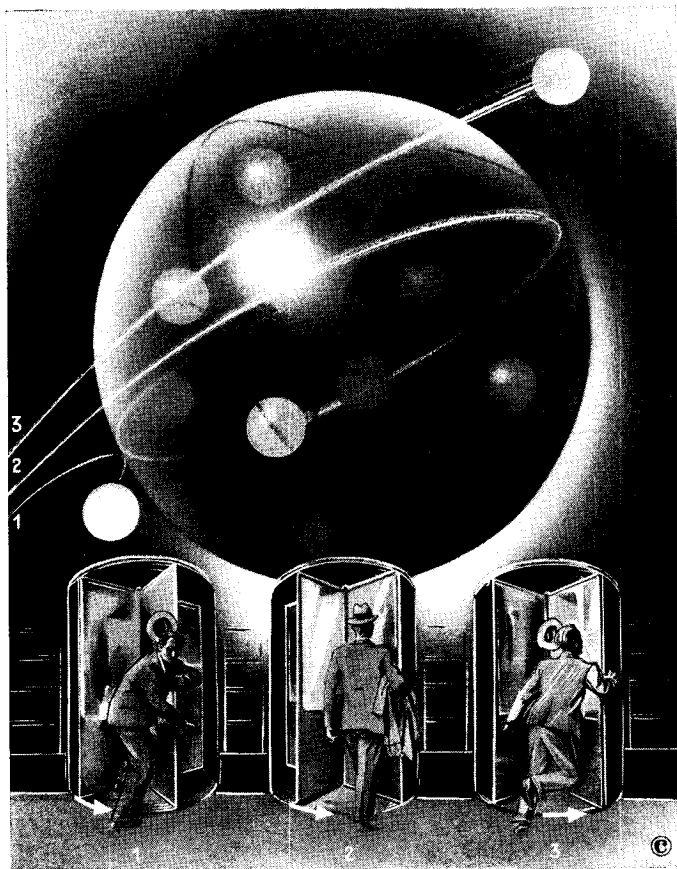

Fig. 44.

RESONANCE

The atomic bullet enters the dynamic system of the nucleus best when its speed is "in resonance" with the vibrations of the nucleus. If the neutron moves too slowly (1), it will be repulsed; if it moves too quickly (3), it pierces the nucleus.

Neptunium itself is not stable, but in the course of 25 to 50 hours one more neutron becomes a proton in order to stabilize the unbalanced nucleus, and $^{94}\text{Pu} 145$, plutonium, is formed. Plutonium is fairly stable because it takes 24,000 years before half of its nuclei have exploded. As a result of protracted disintegration the radiation is moderate and the material itself is harmless—as long as it is not exposed to flying neutrons. If a flying neutron hits a nucleus of U 143 or of plutonium, the nucleus splits, emits two to three neutrons and the chain reaction starts.

Substances which begin to explode one-thousandth of a second after the

first neutron hits a nucleus are highly dangerous. Neutrons fly around in the atmosphere; they come partly from atoms split by the protons of cosmic radiation in the heights of the atmosphere, partly from radioactive substances in soil, rocks or water. No one can be sure at what moment a neutron will come whizzing along. Uranium 143 and plutonium are, therefore, handled with the most elaborate precautionary measures. They are stored and transported under water and shielded from the open air by thick walls of protective materials. Not every piece of uranium 143 or plutonium is at the point of explosion. The neutrons must arrive at a speed not too high and not too low. If they fly too fast, they pass through the nucleus just as an arrow, flying at a great speed, will pass through a football. The arrow will stick inside the ball only if its speed is in accordance with the resistance of the material of the football.

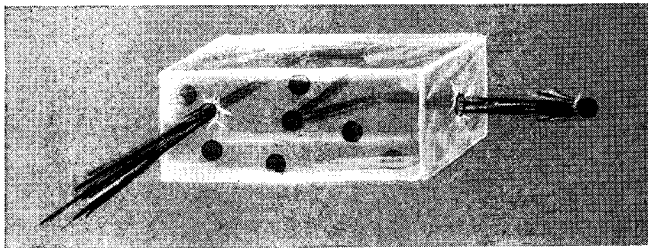

Fig. 45a.

THE NONCRITICAL MASS

A noncritical mass of a fissionable material is an amount too small to retard the speed of an intruding neutron to the proper "resonance speed." A block of uranium must have a diameter of at least 10 cm in order to reduce the speed of the neutrons to the critical point.

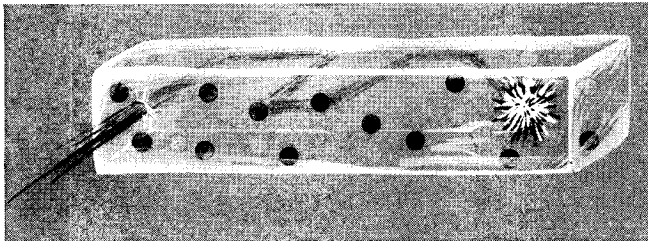

Fig. 45b. THE CRITICAL MASS

The critical mass of a fissionable material is a mass large enough to retard the speed of the intruding neutrons to such a velocity that they do not pierce the nuclei but remain inside and overcharge them.

Neutrons spread out from the interior of the exploding nuclei at speeds averaging 1,000 km/sec. To enter other nuclei and to remain there, the neutrons must be slowed down to less than 100 km/sec. Since the nucleus is a whirling system, it is said that the speed of the neutron must be in "resonance" with the frequency of the nucleus. (*Fig. 44*) If the diameters of pieces of uranium or plutonium are shorter than 10 centimeters, the neutrons have no opportunity to slow down by collision with other nuclei to the medium velocity, but escape instead. Small pieces the size of a lump of sugar are therefore harmless. The minimum size of a piece of plutonium or uranium

necessary to maintain chain reaction is called the critical mass. (*Fig. 45b*) One way to avoid accumulation of critical masses is to distribute the explosive material in thin sheets. These are not "critical" because the probability is zero that great numbers of neutrons, which are indispensable for a chain reaction, would travel in the thin plane of these sheets. The sheets are separated by neutron-capturing covers of boron or cadmium and are immersed in water, which is also an effective barrier against vagrant neutrons.

When an explosion is desired, the noncritical masses must be combined so that they become critical. This must be done in a fraction of a thousandth of a second. Otherwise the masses would explode before they are really united, the overlapping ends would be blasted away and the explosive effect would be only partial.

By shooting protons into the nuclei of plutonium at the proper speed, higher elements have been created: 95, americium; 96, curium; 97, berkelium; 98, californium. All are unstable. Americium has a half-life of more than a year, so that it is possible to amass a visible amount of it. The other "artificial elements" are so short-lived that they vanish quickly.

Among the fragments of the fissioned atoms were found those few elements which were still missing from the Periodic Table. One of them, element 43, appearing in no less than 23 isotopes, was christened technetium because it was created by technology. In the time a nuclear reactor yields 40 kilograms of plutonium, one kilogram of technetium is produced as a by-product. The last gap in the Periodic Table was filled when element 61 was detected. It was baptized promethium, in honor of that legendary hero of the Greeks who dared to steal the lightning of Jupiter and to bring it down, as fire, into the home of man. As punishment, he was chained to a rock and attacked each day by an eagle from Olympus. Modern man has stretched his hand even higher into the sky. He has stretched his hand to the sun and the stars. What will be *his* fate?

The Atomic Age

If we were to toss a lighted match into an open tank of gasoline the combustion energy would be released in one vehement flash or explosion. To exploit this energy productively we must learn to tame the explosive energy. We must reduce the fiery liquid into a million drops and bring the single drops to explosion in an orderly sequence. Thus tamed, the explosive material drives a car. Similarly, the chain reaction of uranium, which, in an atom bomb, takes place in a millionth part of a second, can be stretched out for years. The resultant heat, tuned to workable temperatures, can be exploited for any technical purpose whatsoever, from propelling ocean liners to driving cars or heating whole cities with a single furnace, model "nuclear reactor."

The technical apparatus now used to slow down the chain reaction of uranium is called the "uranium pile" or "nuclear reactor." The outdated word "pile" came into use when, in 1942 in a Chicago laboratory, thin sheets of uranium were cautiously piled up until the rising temperature revealed that the first atomic engine was in gear. That day, rather than July 16, 1945, when the first atomic bomb exploded at Los Alamos, was the "New Year's Day" of the atomic age.

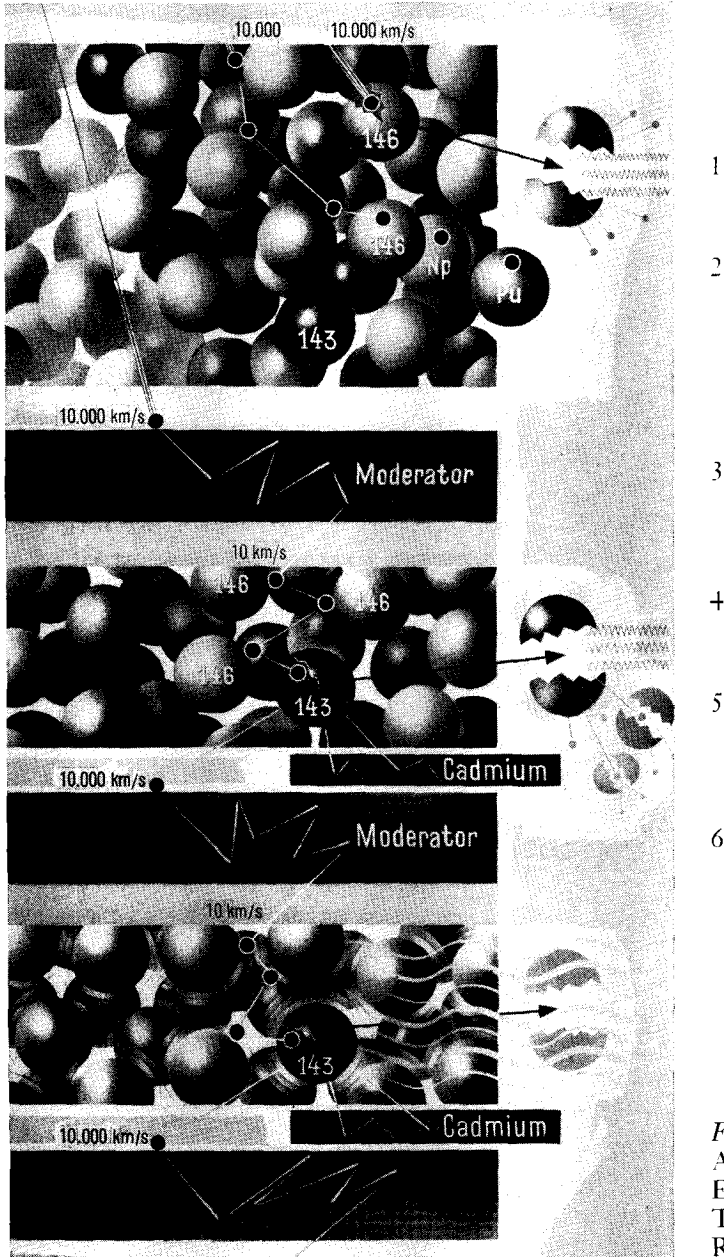

Fig. 46.
ATOMIC PROCESSES INSIDE THE URANIUM REACTOR

In *Fig. 46* the sequence of events which take place inside a nuclear reactor is diagrammed. The sketch may not be comprehensible at first glance. But if we will take a few minutes to follow the processes from top to bottom, we shall be rewarded for the effort.

Since a simultaneous general reaction is not desired, the reactor is not filled with a highly purified isotope such as uranium 143 or pure plutonium as in the atom bomb but with a mixture of the three isotopes U 142, U 143, and U 146. Reactions begin as soon as an intruding neutron hits a nucleus, and after the splitting of this first nucleus a volley of liberated neutrons shoots into neighboring nuclei. Since U 146 is predominant, the neutrons will hit mostly these nuclei. Occasionally one will explode, but this happens rarely and not regularly enough to start a chain reaction (1). Most of the neutrons will be slowed down; when their speed is in resonance with that of the nuclei of U 146, they will be captured quietly and will transform the nuclei into the short-lived neptunium and thereafter into the more stable plutonium (2).

If all the neutrons were allowed to zig-zag among the atoms of U 146 they would all be captured by the overwhelming mass of U 146. No neutrons would be left to enter the nuclei of U 143—at 10 km/sec—and to initiate and maintain the chain reaction. The neutrons must be slowed down from 1,000 km/sec to 10 km/sec without having the opportunity to encounter atoms of U 146. For this purpose the uranium is distributed in small tubes and these are immersed in certain substances such as heavy water or graphite, called “moderators” because they moderate the speed of flying neutrons without absorbing them (3).

After the neutrons have been slowed down inside these moderators to about 10 km/sec, they are allowed to re-enter the uranium-filled tubes. Now they dart among the atoms of uranium 146 without being captured by them (4). Yet if they hit one of the rather rare nuclei of U 143, they enter it. The nucleus explodes and emits, besides other particles, two or three high-speed neutrons (5). Some of these enter nuclei of U 146, transforming them into plutonium; some escape into the moderator and are slowed down to become new bullets for U 143 (6). In this fashion the chain reaction continues.

Movable strips of cadmium or boron (which are impassable for neutrons) are inserted between the different sections of the reactor and regulate the number of neutrons which are allowed to stray from one tube to the next. Thus the nuclear explosions are held to a desired number.

A reactor of medium size produces a few grams of plutonium a day. After a certain amount of plutonium has been manufactured, it must be removed because the nuclei of plutonium are too vulnerable to neutrons and the plutonium will, in due course, disappear under the attack of the same neutrons which have created it. The uranium of the reactor is distributed in about thirty tubes and each tube is withdrawn after a month of operation. After re-

removal of the plutonium, the tube is returned to the reactor.

In addition to plutonium, radioactive isotopes appear as inevitable by-products of the fissions. Some are fragments of split nuclei, some are produced by the flying neutrons which pierce the nuclei and transform them into overcharged heavy isotopes. The isotopes adulterate the uranium which must be kept pure to maintain a steady chain reaction. Not only the uranium but all parts of the machinery are contaminated and begin to radiate.

The uranium tubes are transported from one section of the plant to another through water-filled canyons. Monastically stringent rules restrict the daily ritual of anyone who is admitted to this latest order of mankind, "the keepers of the pile." It is not the danger of an explosion of the nuclear reactor that is feared, but the contamination of the whole environment. The atoms of the machinery, the air, water, dust, clothing and even human tissue become radioactive. Defense against this all-permeating peril requires massive shielding and remote control.

If we ignore the high costs of a nuclear reactor and consider only the output in energy, the nuclear reactor overshadows all "classical" power-producing devices. One gram of coal yields about 8,000 gram-calories; one gram of uranium, theoretically 3.95×10^{12} ! An average nuclear reactor, 1953 model, using one kilogram of uranium as fuel, produces as much energy as almost 3,000,000 kilograms of coal or 600,000 gallons of high-grade gasoline. Five hundred nuclear reactors of the 1953 type would have been sufficient to provide the world with its energy requirement for that year.

We, contemporaries of the first nuclear reactors, stand in awe before this magic engine, just as our grandfathers gazed in disbelief at the miraculous "iron horse" that pulled six carriages through the grasslands—"One horse pulling six carriages!" Yet the nuclear reactor is only the initial model of atomic technique. The fuel of the future will not be the costly, difficult-to-handle uranium. We already know of two still unexploited and inexhaustible sources of energy—cosmic radiation and radioactive isotopes. Cosmic radiation might be collected by generators floating weightless beyond the atmosphere. A matchbox of radioactive material could drive a luxury liner for years on all the seven seas.

The first model of a radioactive battery has been demonstrated. It is a simple device: the bottom of a tiny box is covered with a paper-thin layer of radiating material. The emission is directed at a transistor which amplifies the energy. From the top a wire conducts as "current" the electrons which the disintegrating atoms emit. The battery generates a very weak current, indeed, and our grandchildren will joke about this first atomic "tin can," but it will be exhibited in the memorial hall of technical progress beside Edison's electric bulb. It is the realization of one of man's most extravagant dreams, the philosopher's stone of the medieval alchemists, the *perpetuum mobile* of the modern utopian.

Physics at the Crossroads

Only now after we have become acquainted with the world of atoms and the phenomenon of radioactivity are we able to understand the paradoxical situation in which the modern physicist sees himself after half a century of revolutionary discoveries. He finds his situation like that of a mountain climber who has succeeded in ascending at record speed but whose path has suddenly ended. Gaps, insurmountable gaps, yawn around him. The physicist of today has arrived—for the time being at least—at a dead end, with his experiments as well as with his mathematical calculations.

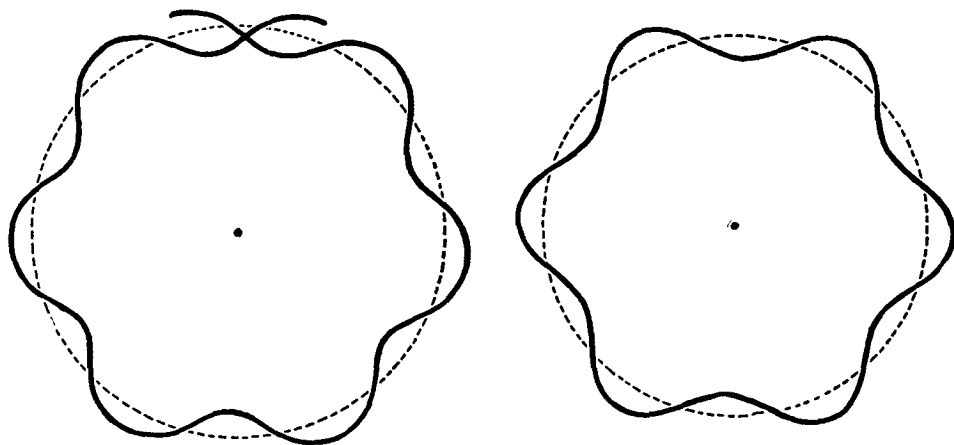

Fig. 47. THE MODERN CONCEPT OF THE ATOM

The electrons swing along their orbits in “waves.” The orbit of the electron can remain stable only if the oscillation of the wave corresponds to the length of the orbit. The pattern at the left is unstable.

The experiments cannot be further advanced because the objects are no longer within his range. Particles like electrons or mesons cannot be made visible because they are too small to emit light waves. If shorter waves, like gamma rays, are used, a new problem interferes with the magnification. The smaller an object the stronger the light beam must be to make it perceivable.

Let us suppose that an imaginary microscope could magnify an electron to the size of a brandy snifter. The light that would have to be used in this process would be so high in energy that its photons would smash against the delicate goblet like ivory billiard balls. We would not dare to make the shot. Suppose someone assured us that the brandy snifter is shatterproof, so we “shoot the ball.” But it is of no avail; the photon knocks the glass aside. Werner Heissenberg proved mathematically that it is impossible in the world of nuclear dimensions to arrive at clear-cut results with our present methods of observation and calculation and proclaimed the “principle of indeterminability.”

Thus the physicists came to the dismaying conclusion: in the atomic world the objects of research are altered by the approach of the researcher. By investigation, man intervenes in the course of events. Even when the astronomer observes a large and slowly moving body like the moon, he cannot avoid some "falsification." It takes the observer a fraction of a second to react to an optical impression or to push a button. It takes the shutter of the camera a part of a second to open and then to close again. During this moment the position of the moon changes so little that the variance is not visible on the plate—but a discrepancy does exist! There is no such thing as an "exact" and "objective" registration of events in nature. In the world of electrons and mesons the margin of error becomes so wide that the result is practically worthless. James Jeans said: "It is probably as meaningless to discuss how much room an electron takes up as it is to discuss how much room a fear, an anxiety or an uncertainty takes up."

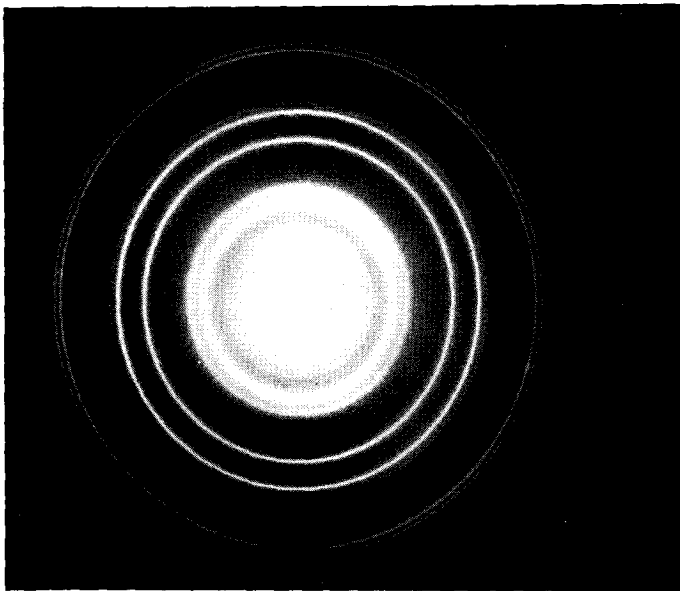

Fig. 48.
THE WAVE-
CHARACTER OF
THE ELECTRON

When a beam of electrons is shot through a crystal or a thin film of metal, an interference pattern appears which can be produced only by interfering waves and not by particles.

Courtesy Laboratories of Radio Corporation of America.

An electron which revolves at a speed of several hundred kilometers a second on an atom orbit races through its course like a glowing sparkler swung in a circle. We cannot even say in which direction it is whirling. Descriptive physics has reached its limit. (Fig. 47)

We are shocked. But then comes the next blow. Electrons and all other particles have a dual nature. When electrons are shot through a crystal, they seem to disappear; instead, a wave pattern comes forth. (Fig. 48) Electrons are not particles, they are waves; in fact, they are both! Protons and neutrons also behave in this way. Protons, the most massy material of the universe—waves! Erwin Schrödinger, one of the leading contemporary physicists, says: "Both the particle picture and the wave picture have truth value and we cannot give up either one or the other. . . . Everything

has the continuous structure with which we are so familiar in fields, as well as the discrete structure with which we are equally familiar in particles. . . . The difficulty of combining these two so very different character traits in one mental picture is the main stumbling block that causes our conception of matter to be so uncertain." Asked how he could explain this paradox, he recalled Cervantes' tale of Sancho Panza, who loses his donkey in one chapter but, a few chapters later, thanks to the forgetfulness of the author, is "riding the dear little animal again." Our logic of today is unable to bring the two incompatible notions into one concept.

Atomic research led from "The atom—a microcosmic solar system" to "The atom, a cloud of vibration," as Schrödinger calls it. Seen in terms of the wave theory, the atom is a high-tension field of energy. The center of the field is a whirl of waves, called a nucleus; the space around the nucleus vibrates like the air in a concert hall. At the points where the sound waves cross each other, nodes—electrons—appear. Like the nodes in a vibration system, they have no "individuality." They cannot be called by name as if they were planets in the solar system. We cannot say: electron No. 1 has jumped from point *a* to point *b*. We can only state: there was a node at *a*, now there is a node at *b*. "One never observes the same particle a second time." Einstein says about the motion of photons: we can only say *that* a photon will appear, but we cannot say where it will appear. It cannot appear at random, but only at one of several points along the path of the vibration. Certainty has been replaced by probability.

Classical physicists observed individual acts. Galileo followed the path of the balls he dropped from the "Leaning Tower" of Pisa. Newton calculated the course of Halley's comet. The modern physicist experiments with mass phenomena. He looks with awe at the quintillions of particles sent out by a gram of radium; he listens to the drumfire of electrons and mesons in the chain reaction of a cosmic ray; he bombards atom nuclei in his cyclotron with cannonades of a billion projectiles. On the stage of science there is no longer a hero delivering ringing speeches; instead masses of "unknown soldiers" march to the battlefields of modern experiments. The aristocratic law of causality is voted down by the anonymous majority.

The behavior of a star as a whole can be calculated by the laws of classical physics; yet the paths of its atoms cannot be determined. On the rim of the star the force of gravity becomes so weak that it is no longer greater than the expansive tendency of the gas. No mathematics can calculate whether a particular atom will move toward the center or escape into space. A modern physicist is like a man who watches a storm of snowflakes. He cannot predict where and when flake No. 6,784,644,839 will touch the ground. He has become the colleague of the actuary in an insurance company. He cannot say on what day the owner of policy No. 167483 will die but he can calculate the average life expectancy of the 200,000 people insured so accurately that directors of insurance companies can sleep more peacefully than those

they have insured. Physics, too, has become a question of statistics. The modern physicist no longer stands amid an imposing array of glittering apparatus; he sits hunched over sheets of paper covered with hieroglyphics and searches for the magic formula of the universe.

The formulas are right; the formulas are wrong! The calculating physicist experiences the unhappiest fate a scientist can suffer. He sees himself confronted with two results, each one correct but contradicting the other. Light *is* an undulation; light is *not* undulation. The proton *is* a particle; the proton is *not* a particle but a field with far-stretching continuity. Nothing can move at the speed of light, but photons travel at this "impossible" speed.

Faced with insoluble contradictions, most physicists are ridden with despair. Modern physics, which started so triumphantly, has come, like young Hercules, to a dividing of the ways. The one leads to the unification of the physical phenomena as in Einstein's fascinating formulas of mass, energy, space and time. Yet the other way, equally correct, leads to contrary results. The world is built up of particles, more than twenty different kinds of them, and they are not constant but "fields," short-lived, short-ranged, ever changing, permanently annihilated and reborn fields. The universe has been dissolved into a collection of fields. Behaving lawlessly and unpredictably, they can no more be caught by a physicist than a man can catch eels with his bare hands.

Einstein, a valiant fighter, is one of the few who refuse to capitulate. Over decades he has labored to find formulas that might bring the disconcerting fields into a harmonious chorus. As his first step he tried to find uniting formulas for the two "classical" and best-known fields, the gravitational and the electromagnetic fields, which are both governed by laws and act with the speed of light over unlimited distances. Wrestling over long years—like Jacob with the angel of darkness: "I will not let thee go, except thou bless me"—he succeeded in finding common formulas valid for both. The experimental proof for his results cannot be expected for decades.

An even greater task is a unified field theory for the unpredictable, "lawless," short-lived "quantum fields." Einstein objects to the defeatist assumption that these quantum fields could not have a common denominator, that they are not subject to certainty and determinability. He regards the present chaos and traffic jam in physics as only transitory. "I cannot believe that God plays dice with the world." He is convinced that a "universal field theory" can be developed, even though the mathematical difficulties are enormous and surpass the capacity of our present mathematical methods. He thinks he has found the formulas of this unified field theory but he cannot prove them. He compares his situation with that of Newton, who, having found the law of gravitation, had to create the calculus to prove it mathematically. He does not agree that the world is dualistic, that protons are bodies which follow classical laws and are at the same time waves which do not follow classical laws but the rules of quantum mechanics. He does not abandon the scientific

approach as hopeless. Like all great thinkers he believes that the universe is essentially what the word uni-verse means: a One; and that a formula will be found which embraces all events in the universe. Asked for evidence to support his conviction, he replied: "I put my trust in my intuition."

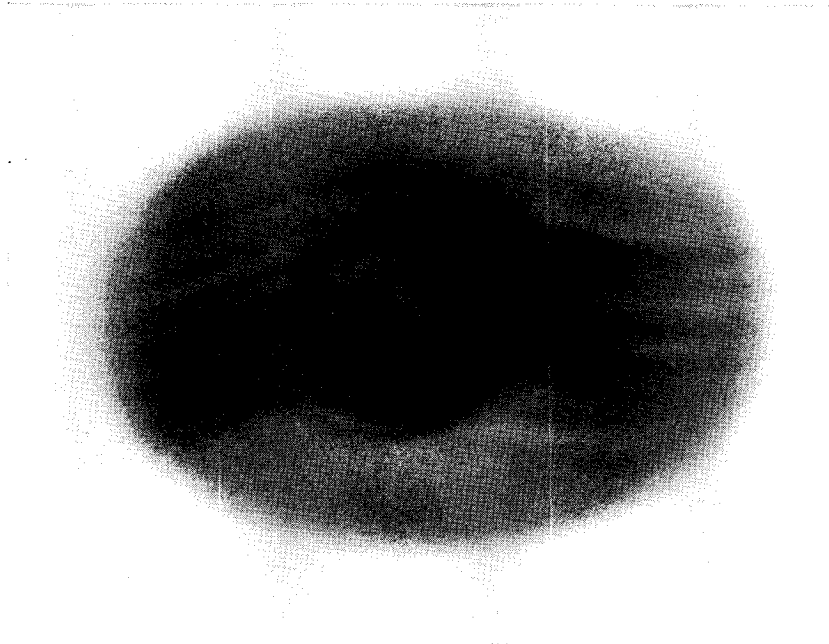

MATTER OR WAVE?

PART THREE

The Heavens

"This scandal to human thought!"

—H. E. BARNES

Instruments and Methods of Modern Astronomy

W

Microcosm and Macrocosm

WE PRICK OUR FINGERTIP with a needle, and squeeze out a drop of blood. We dilute the drop and look at it, magnified 150 times, under a microscope: the drop has become many tiny discs, or cells, which are the suns of the microcosm of the human body. We try to count them but do not get very far; there are too many. In the drop of blood from our fingertip there are approximately five million cells. There are about a million drops in a quart. Since the human body contains about five quarts of blood, there are a total of twenty-five trillion blood cells drifting in the bloodstream. How much is 25,000,000,000,000? If a single blood cell were to drip from the prick in our finger every second, it would take a million years for the body to bleed dry. If such an experiment had been begun by a man who listened to Christ's Sermon on the Mount, the man would by now have lost far less blood than the pint a blood-donor gives for a transfusion. All the blood cells in the average human body, if laid side by side like a string of beads, would encircle the earth.

Now let us increase the magnifying powers of our microscope a thousand-fold and dye one of the cells. The dye reveals it as a delicate and elaborate structure with porous walls, its interior a fine network. If we use an electron microscope, every thread in this network is resolved into a string of beads. In every bead we find a pattern like that of the mosaics on the walls of old Byzantine churches. As seen through an even more powerful instrument than our present ones, each mosaic stone appears as one of the giant molecules of which blood pigment and the other elements of protoplasm are composed. In each of these molecules there are more than 1,000 atoms joined together: C636 H1025 N164 O187 S3 Fe in one molecule of hemoglobin. If we increase the magnification several million times, the atoms inside the molecules would appear as points. And if we could further enlarge the image another thousand times, we would see these points as solar systems—electrons revolving like planets around a central solar nucleus.

A creature living on one of these electrons would find his world as rich in "heavenly bodies" and as vast in dimension as we find our world of stars. The distance between electrons would impress him as much as the distance

between our planets does us. The depths of space yawning between atom and atom would be as awe-inspiring for the "man on the electron" as the distances between the solar systems of the universe are for us. The molecules would look like star clusters to him. And the blood cell in which he found himself would seem to be a lens-shaped system of 100,000,000,000 suns, an "island universe" like our Milky Way. Each cell in the blood is a Milky Way, four and a half million of them in one drop of blood! Like the galaxies in cosmic space, 25,000,000,000,000 atomic island universes moving in the blood of every human body—this is the microcosm!

Overpowered, we fall asleep and dream. We are standing on a pier. A gleaming white liner is about to leave for a cruise around the world. The last passengers hurry up the gangplank. We board it and off we go. We come to Gibraltar and then to Suez. We arrive at Bombay and visit Bali. We land in Canton and finally in Honolulu. And one day the snowy peak of Mt. Rainier greets us from afar, announcing that we have circled the globe. If we were to repeat this long journey seven times, we would have covered the distance a ray of light spans in one second, known as a light-second.

We remember having heard that the distance between the earth and the moon is somewhat more than a light-second. So in our dream we swing into the seat of a jet-plane, ready to shoot off into space at the speed of sound. But even at this rate it would take us two weeks to reach the moon. To get to the sun we would have to fly for fourteen years. If we started out at the age of twenty, we would be almost fifty by the time we got back. Yet even if our rocket-plane were to travel three times faster, we could not visit the outer planets of our solar system. It would take more than a hundred years to get to Saturn or Neptune and back.

So we will have to build an entirely new type of ship which can travel at the speed of light—186,000 miles a second! This ship really moves! Instead of fourteen years, it would take us only eight minutes to reach the sun. In a half-hour we would arrive at Jupiter, in one hour at Saturn, and at the end of five hours we would pass the outermost planet Pluto, which, like a lighted buoy, marks the beginning of the outer ocean of space.

We are off to the stars. Our spaceship is comfortably equipped for a long journey, with cabins, lounge and library. We relax, eat and sleep, just as if we were on an ocean liner, reconciled to the idea of an extended trip. We spend the first evening discussing the photographs we have taken of the sun and moon, Mars and Saturn. Finally, our eyes weary and our minds filled with impressions, we go to bed. The next morning we look out the window. There is no "morning"; it is pitch-black night. The sun behind us has shrunk to a small faint disc. We look around for the nearest star, which will become our next sun, Alpha Centauri. There it is before us, directly in front of the nose of our ship. A star like all the others. Are we moving? We look at the

speedometer. Yes, we are still traveling 186,000 miles a second. "Just be patient," says the purser.

We settle down, unpack our books, open our typewriter and begin a report on the solar system. We have dinner, we play cards, we grow tired at our usual bedtime and go to sleep. The next "morning" we look out the window again. Alpha Centauri is not a bit brighter. We begin to worry. "How long will it take us to reach Alpha Centauri?" "Four and a half years" is the reply. Four and a half years—traveling at a speed of 186,000 miles a second—will bring us only to the nearest star! "And when do we get to Sirius, the brightest of our neighbors?" "Eight and a half years from now." "And Aldebaran?" "Fifty-five years." We cannot believe our ears. Fifty-five years! No hope of arriving there and coming back to tell about it.

But Rigel is much brighter and seems to be closer. So we question him about Rigel. The man with the timetable in his hand answers sternly: "Rigel? You won't get there. *We* will get there in five hundred and forty-three years." We look into his eyes, and realize that it is no mortal who faces us. We are aware that the ship in which we are moving was not built by human hands. We are in a world of fantasy. A spaceship which can take human beings to the stars is still a utopian dream. Light circles the globe seven times every second. Even so, it would take four and a half years to reach the nearest star, eight years to Sirius, four hundred and seven years to Deneb, five hundred and forty-three to Rigel. And still we would not have left the immediate neighborhood of our own "village." We would have to pass millions of suns, each separated from its "neighbor" by many light-years, merely to cross our own island universe, called the galaxy. This galaxy is by no means the universe. It is only our home in the universe, one of millions of similar units scattered all about us in the infinities of space. Each galaxy is separated from the others by a distance of about a million light-years.

An ant who creeps out of its anthill on the Pacific Coast, determined to crawl on its tiny scabbling feet from San Francisco to New York, has more chance of reaching her goal than man, who dreams of traversing the universe. We can count stars and weigh them, just as we can count and weigh atoms. But both are beyond our comprehension.

So, forewarned and forearmed, we climb from the microcosmic world of the atoms to the macrocosm of the heavens.

Telescope and Camera

The tremendous dimensions ascribed to the universe seem incredible. It is a blow to our ego, to all our concepts of human dignity. Our beautiful earth, humming with life in every corner, degraded to a mote of dust! Can it

be that Schopenhauer was right in calling civilization a coating of mold on the shrinking skin of a decaying apple? Only convincing proof can persuade us to submit to the so-called facts of modern astronomy.

All primitive people believe that all of nature is given to man for his comfort; that the earth is man's kingdom in this world, and that the sun, moon and stars ride across the blue dome of the sky to illuminate the day and festoon the night. When the apex of urban civilizations is reached, however, a more realistic *Weltanschauung* replaces this mythological naïveté. So the priests in Babylon and Egypt and, a thousand years later, the Greek philosophers recognized the true nature and relation of earth, moon and sun.

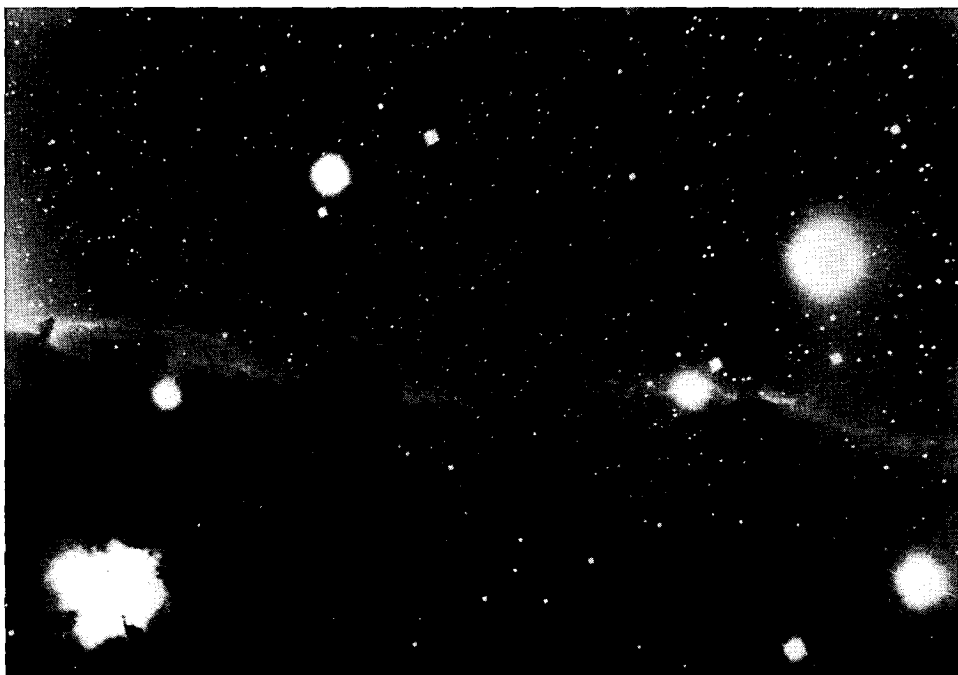

Mount Wilson Observatory

Fig. 49. PROGRESS IN ASTRONOMICAL PHOTOGRAPHY I

Part of the cloud in Orion, known as the "Horse-head," photographed by the Mount Wilson 100-inch telescope around 1930.

Thales of Miletus, a town on the Asian shore of the Aegean Sea, correctly predicted an eclipse of the sun on May 28, 585 B.C. He was able to do this because he knew that "the earth is a globe and inhabited on all sides. We have antipodeans; for them, above is what we consider below." He said: "The moon is a dark body and an eclipse occurs when the moon crosses the line between the earth and the sun." The astronomers of the Pythagorean school of the following century knew that the sun rises and sets because the globe of the earth turns from west to east. The most prominent, Aristarchus (circa 280 B.C.) of the island of Samos, had a really modern insight into the nature

of the universe. He recognized that our earth "is no more than a spot and our mountains are no more than dust on a ball." "The stars," he said, "are so far away that even the earth's orbit, which has a diameter of more than one hundred million stadia, must be called a trifle when compared to the distance to the stars" (one stadium is about 600 feet).

This magnificent knowledge about the heavens was entirely lost during the time of the Romans, who were interested only in secular problems. The sleep of science lasted until the fifteenth century, when men arose in protest against the naïve geocentric picture of the world that was proclaimed as indisputable fact. More than a thousand years entirely lost for progress!



Mount Palomar Observatory

Fig. 50. PROGRESS IN ASTRONOMICAL PHOTOGRAPHY II

The Horse-head photographed with the Mount Palomar 200-inch telescope around 1950.

The first man who picked up the lost thread to the heavens was Copernicus. The publication of Copernicus' *De Revolutionibus Orbium Coelestium* touched off real "revolution" in an entirely different sense.

A few decades later the telescope was invented. Galileo was the first mortal to study the sky through a telescope. Its magnifying power was only thirty times, but it was enough to see that the moon was a sphere, a world like ours with plains, mountains and craters, and that the planet Jupiter was also a

sphere with moons revolving around it. Copernicus had been right! The planets moved around the sun. Galileo became an ardent promoter of the Copernican theory, but was persecuted for his "revolutionary" ideas. His telescope was a combination of lenses. Some decades later, Newton constructed his famous mirror telescope, enabling astronomers to make even more exact measurements. But not one of these men suspected anything about the real dimensions of the stellar world.

A half-century after Newton's death, Wilhelm Herschel, a poor musician who had emigrated from Germany to England where he subsequently became Director of the Royal Observatory, built the first giant telescope. He hoped to see the fixed stars as "suns." He was disappointed. They did not appear as discs, but remained points of light. Herschel realized that they must be very far away. Thus the idea of the immensity of the universe entered the mind of man and became one of the basic concepts of modern science.

As Herschel pointed his giant instrument at the mist of the Milky Way, he recognized that it consisted of innumerable stars too far away to be seen as points, just as the lights of a distant city appear from afar to be a diffused glow. Since the Milky Way encircles the sky in the form of a small band, Herschel rightly supposed that the stars are arranged like a coral island—each tiny coral a sun. He drew the first picture of the Milky Way as an island of suns in empty space. What Copernicus had done for the earth 200 years earlier, Herschel now accomplished for the sun. He removed it from its false position as the center of the world and placed it properly as a sun among the suns in an island of stars.

Nothing basically new has been added to the technique of telescope building in the almost 200 years since Herschel set up the first large mirror telescope, except that the mirrors became wider and the instrument more complicated. The latest mirror telescope, set up in 1948 at Mt. Palomar in Southern California, has a mirror 200 inches in diameter. It is the largest "eye" on earth. (*Fig. 4*) The astronomer who operates it must ride up in an elevator through six floors of framework. There he is suspended in the aperture of the artificial eye, a spider in an architectural web, catching galactic flies. Like the spider with its alarm thread, through telephone lines he directs the assistants and engineers below who drive the motors, the steerings and the gears that keep the mirror's focus fixed on any point despite the double motion of the earth—its daily rotation on its own axis and its yearly revolution around the sun. Today—and this is decided progress since Herschel's time—for most observation the human eye is replaced by a mechanical eye a hundred times more efficient: the photographic camera.

The photographic camera is built on the principle of the eye, but, unlike the human retina, film does not tire. Hour after hour, today, tomorrow, and the next day, the gigantic eye is fixed at an invisible faint point in the night of the universe. Photon after photon hammers in weak, very weak, blows against the microscopic light-sensitive grain of the photographic plate, and finally the molecular structure of the silver grain cracks and blackens, and what is eter-

nally invisible to the human eye appears on the photographic plate.

The astronomical camera has become a mirror instrument as did the telescope. Our ordinary cameras are refractors which concentrate light rays through lenses. The Swedish-German optician Bernhardt Schmidt, who as a boy lost an arm by experimenting with a new mixture of explosives, blue-printed a new type of photographic apparatus, the "Schmidt camera."

Schmidt was not spared the tragic fight against the resistance of his contemporaries, which is the monotonous theme in the history of science. The experts testified that it would be an impossible task to produce a mirror-camera and after years of battles and defeats he emigrated to California which had developed into the most progressive center of astronomical optics. The enterprising Americans accepted his ideas enthusiastically and the first large-sized Schmidt camera was built. He, like his contemporary Gockel, died before he was vindicated.

The Schmidt camera differs from the traditional camera by having a concave mirror at the back where the film is usually found. (*Fig. 51*) This mirror (3) receives the image and projects it into the middle of the camera where the film is set. (4) Mirrors, as well as lenses, have certain optical drawbacks, so, to avoid distortions, a delicately ground correction plate is installed at the place where ordinarily the light-collecting lens is inserted. (2)

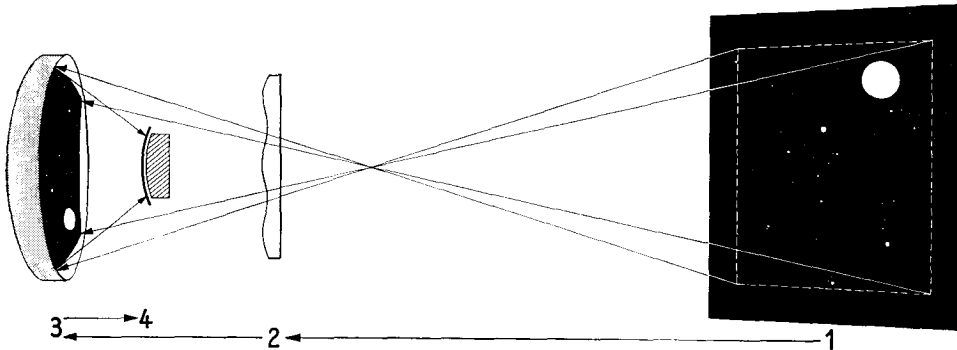

Fig. 51. DIAGRAM OF SCHMIDT CAMERA

The most efficient camera for astro-photography was invented by the Swedish-German optician Bernhardt Schmidt. A wide area of the sky (1) is reflected by a concave mirror (3) and projected onto a curved film (4). The inevitable distortions are eliminated by a correcting plate (2).

The Schmidt camera, also called the Schmidt telescope, is the most efficient photographic instrument built up to now. Its advantage is a hitherto unknown combination of performances. In *one* single exposure it photographs an area as wide as the whole constellation of Orion, with detail as clear, sharp and rich as if the picture were a composite of more than a dozen ordinary shots. The Schmidt "super-camera" at Mt. Palomar is an instrument 10 yards long with a mirror 4 feet in diameter. The picture it produces is 30,000,000 times brighter than that which the human lens projects upon the retina.

The stars in the sky are catalogued according to their luminosity; the brightest stars are known as stars of the first magnitude; the dimmest stars the naked eye can discern on a clear night are those of the sixth magnitude. The 100-inch telescopic mirror at Mt. Wilson extends our range of vision to the twenty-first magnitude, the luminosity of a candle 10,880 kilometers away. The 200-inch mirror at Mt. Palomar photographs stars up to a magnitude of 22.4. It is powerful enough to break down the picture of a cosmic nebula 20,000,000 light-years away into individual stars. The farthest objects which show up on photographic plates made by the Palomar camera are estimated to be 1,600,000,000 light-years away, a range that is expected to be extended to 2,000,000,000 light-years, when accessory instruments, such as corrective lenses and photoelectric cells, are improved. If we could mount the Palomar mirror on the top of the Empire State Building and if we could look over the surface of the globe as far as the power of the instrument allows, we would see from our platform in New York the flashes of the fireflies buzzing in the garden of the Imperial Palace in Tokyo.

There is not much point in building larger instruments. The night sky is not an absolute black but emits a dim glow which fogs the photographic plates before they have caught the image of such faint objects as distant nebulae. Other ways must be sought. It is hoped that the same electrons which made visible such tiny objects as viruses and molecules may also enable us to multiply the magnifying power of our present telescopes by a factor of from ten to fifty. The photons which arrive as the picture of a distant galaxy might be stored on specific metals, later released, scanned and projected on sensitive plates or screens. This idea sounds promising, and it may be that with the introduction of this electronic "tele-vision," new vistas will be opened into the depths of the universe.

Astronomical Calculation

We respect highly an instrument which photographs sparks half the globe away. Yet man's mightiest instrument is neither the telescope nor the camera, but the brain in his head. And even for astronomical research, the most important field is not the sky but a simple sheet of paper.

In the eighteen thirties, three astronomers sat at their desks trying to calculate the distance to a fixed star. None knew of the others. One carried out his calculations in Königsberg in eastern Prussia, the second in Dorpat on the Russian Baltic, and the third in Capetown. When a scientific problem is ripe, a whole field of "thoroughbreds" races for the grand prize of discovery. They speed along, neck and neck, with no marked difference between them. At the end of the race, the victor is ahead perhaps only by a nose-length, or just the tip of a nose. But the prize goes only to the first. Mendeleev, not

Lothar Meyer, is recognized as the discoverer of the Periodic Table. Leverrier, and not Adams, is celebrated as the discoverer of the planet Neptune. Bell, not Philipp Reis, is honored as the inventor of the telephone. So Friedrich Wilhelm Bessel in Königsberg won the honor of being the first to calculate the distance to a fixed star, while F. G. Wilhelm Struve and Thomas Henderson, just as deserving, are recorded as having been "in the running."

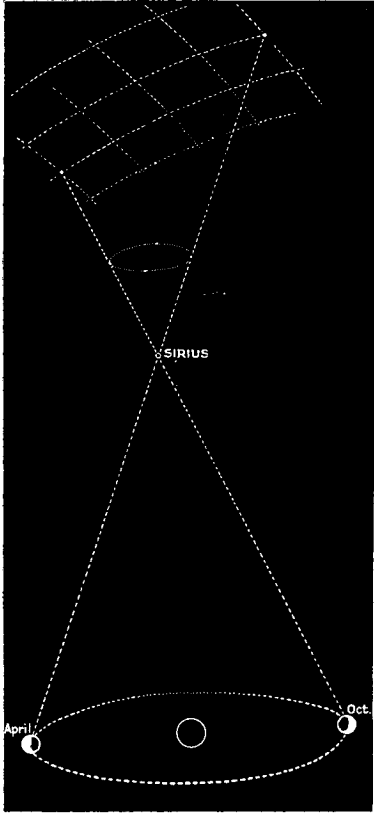

Fig. 52. TRIANGULATION

Triangulation is used to measure the distances between the stars and earth. The earth (*bottom*) changes its position by 300,000 km in the course of the seasons. A not-too-far star like Sirius appears dislocated against the background of the sky just as does a pencil which we observe alternately with the right and the left eye against a wall. The dislocation permits the calculation of the distance of the star.

The principle each of the three astronomers used in his calculations was the same: it is called parallax, or triangulation. Parallax is the optical shifting of a body against its background when it is observed from two different points of view. Hold your index finger in front of your nose and shut each eye alternately. The way your finger seems to jump to the right and to the left against the background is caused by the effect of parallax. If you know the distance between your eyes, you can figure out how far your finger is from them by the degree of shifting. If you hold the finger close to your eyes, it appears to make a large jump. As you stretch out your arm, the size of the jump becomes smaller. If you photograph the moon at the same moment in London and in Rome, its position differs in relation to the background of stars. If the distance between the two observatories is known, the distance to the moon can be calculated.

The base-line between London and Rome, while sufficient for measuring the distance of the moon which is only a little more than one light-second away, is not long enough for stars which are many light-years distant. In the time of Newton, the French astronomer Richet used the distance between Paris and Cayenne in French Guiana as a base-line for the triangulation of planets. The longest distance at our disposal as inhabitants of the earth is the line between two opposite points on the earth's orbit. The triangulation proceeds in this way: The position of a star is determined accurately. Six months later, when the globe is 300,000,000 kilometers from the former location, the star's position is again determined. With such a long line as base, a shifting of the star's apparent position becomes evident. (*Fig. 52*)

Although each of the three astronomers was concerned with a different star, their calculation in each case came to a tremendous figure, confirming the old suspicion that stars are far, far away. The star 61 Cygni in the constellation of the Swan, studied by Bessel in Königsberg, is about 100,000,000 times a million kilometers away. Light, which travels around the earth more than seven times in one second and races across the 150,000,000 kilometers between earth and sun in eight and one-half minutes, takes more than eleven years to get from 61 Cygni to us. Henderson, working in the Southern Hemisphere, investigated Alpha Centauri, the nearest of the fixed stars, and found that it was four and a quarter light-years away, 250,000 times farther away from us than the sun. These are the stars we call our "neighbors"!

From the days when scientists told mankind that the earth was not flat and firm but a rotating sphere and that there were "antipodeans" walking on the opposite side of the globe without falling off, no such intellectual demand had been made of humans. Man would find it difficult to digest facts that proclaimed the sun's nearest neighbor to be a quarter of a million times more distant than the sun, which itself, they announced, was 150,000,000 kilometers away.

Could the figures be trusted? The proof was not long in coming. If the earth describes an ellipse around the sun, a star's parallactic displacement must also be an ellipse. (*Figs. 52, 53*) With the scrupulousness of an astronomer Bessel followed the motion of Sirius along its ellipse. He found that Sirius did not move at a steady pace. Instead, like the hand of a defective clock, it sometimes moved too fast, sometimes too slowly. This was not in accordance with Bessel's calculations. But no one has as much confidence in the infallibility of his equations as a mathematician. The idea never occurred to Bessel that his results might be wrong. His attitude was similar to that of the philosopher Hegel at whom a heckler once shouted: "Your statements do not agree with the facts!" And Hegel returned: "So much the worse for the facts." Bessel's conclusion was: "Sirius, not I, must be wrong." He suspected that Sirius has a companion which pulls it forward, sideways or backwards, depending on its position. This companion could not be seen, as the telescopic instruments of those times were too weak. Consequently, Bessel died without actually having

seen it. But so firm was he in his conviction, that had one of his assistants burst into his home shouting, "The companion of Sirius is discovered!" Bessel probably would not even have stirred from his supper table.

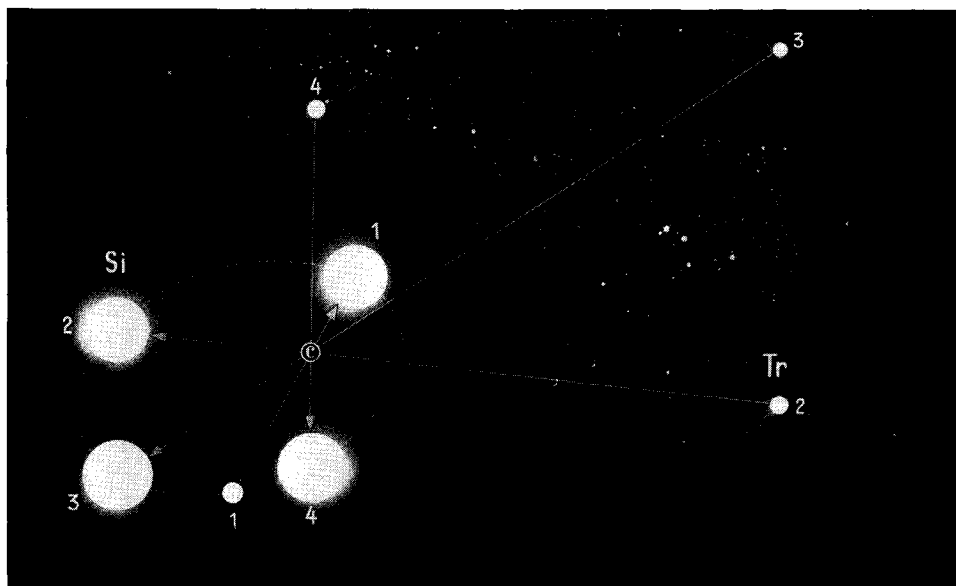

Fig. 53. TRIUMPH OF TRIANGULATION

Soon after his first triangulation in 1843, the German astronomer Bessel found that Sirius changes its position periodically. He assumed the existence of a then invisible companion star which was detected 20 years later. Sirius, Si, and its trabant, Tr, circle around a common center of gravity, c .

Twenty years after Bessel's death, the two famous American astronomers and lens-makers, the Alvan Clarks, father and son, constructed the famous refractor of the Yerkes Observatory in Wisconsin. As they tried the instrument, young Clark saw a faint star near Sirius. Brought up in the spirit of science, he betrayed no excitement, but said dryly to his father: "There it is."

To follow the parallactic movement of a star and to determine deviations in this motion—a difficult task demanding skill and patience—a telescope must be focused at the sky with the utmost precision, and must be able to maintain this position. The great modern telescopes are masterpieces not only in optical efficiency, but also in their mounting. They do not stand upon what we call the "ground." Instead, as a preventive measure against displacement and jarring, they are mounted on pillars which reach deep into the earth and are insulated on all sides.

Nonetheless, discrepancies occasionally appear between the calculations and the recordings. The astronomer, convinced that these differences are not due to his calculations, proceeds like a physician diagnosing an illness. He observes the disturbance over a certain period, studying the symptoms, watch-

ing for clues. Certain observatories noticed strange and unsuspected influences of climate and weather on their instruments. When the sun shines in the morning on the eastern side of an observatory, the building expands in that direction and pulls the telescope eastward. During the day the building moves with the sun. Not only a building, but a whole mountain may be distorted. In winter with the freezing of the northern side, the expanding ice shifts whole parts of the mountain and the instruments change their position. In astronomy a quarter of an inch counts and is labeled as "catastrophic."

At the end of the last century, the astronomers at the observatory at Heidelberg found that something had gone amiss with the positions of the stars; they no longer agreed with the tabulations. Since the discrepancy was the same for all stars in all telescopes, they concluded that the observatory itself must have shifted. When they carefully checked the observatory's position, it turned out that the whole town had apparently shifted 7.2 inches! Similar disturbances induced the astronomers in Leipzig and Rome to recheck the distance of their observatories from each other. They found they had drawn closer by the width of a hand. Here we face two impressive facts: first, that whole cities shift their positions; second, that science has reached such a high degree of perfection that it is able to detect a change of three inches in a distance of a thousand miles.

Newton found that the globe is not a perfect sphere. The deviation is so minute that if a billiard ball were modeled on the earth, not even a champion player would complain about its shape. Three times during the nineteenth century astronomers set out to determine the degree of this deviation. Each used his own method. Bessel, the first, followed this train of thought: What we call the "dome of the sky" is actually a projection of the earth's globe upon empty space. Therefore deformities in the earth's shape must cause corresponding deformities in the dome of the sky and these, in turn, must show up as deflections in the courses of the stars. He calculated that the radius from the center of the earth to the North Pole was several miles shorter than it should be, and determined its length as 6,950,344 yards.

Five years later, Laplace attacked the same problem from a different angle. He started with disturbances in the moon's orbit and arrived at a figure which differed from Bessel's by not more than 500 yards. Fifty years later a third astronomer approached the problem from still another point. If the distance from the earth's surface to its center varies at different parts of the globe—let us say Quebec is nearer the center than Lima—the length of the pendulum stroke should vary correspondingly. He came to a figure differing from Bessel's by no more than 150 yards.

One would think the astronomers would be proud. But no. They feel the discrepancies are far too great to be attributed to their calculations. They say: "The blame cannot be placed on us. There can be little doubt that the earth changes its shape from decade to decade."

Spectrum Analysis

Sunlight is a mixture of light-waves of various lengths and, therefore, has no specific color. When sunlight passes through a prism, the bundled rays are deflected to a greater or lesser degree depending on their wave-length. The disentangled waves then appear on the other side of the prism as a multi-colored band called the spectrum. (Fig. 54) The seemingly simple rainbow thus created is astonishingly informative and a whole science has developed to analyze the spectra of the stars—spectrum analysis.

Analysis of the sun's spectrum shows that the various broad bands of color

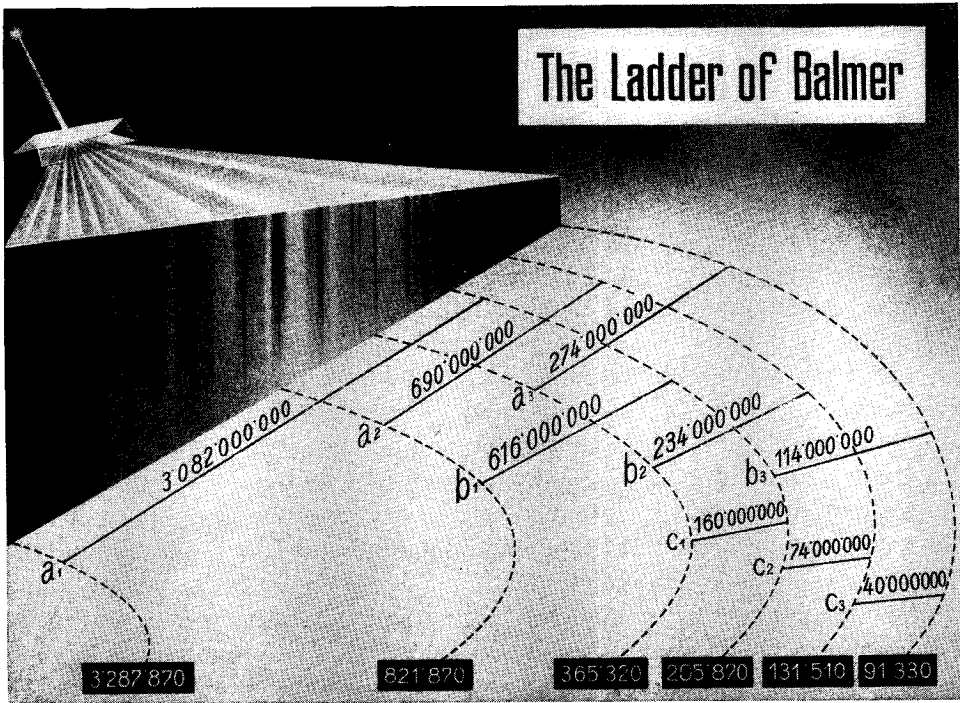

Fig. 54. THE SPECTROGRAM

In 1885 the Swiss mathematician, J. J. Balmer, attempted to arrive at a formula to account for the specific frequencies emitted by the hydrogen atom (a_1 , a_2 , etc.). His calculations produced a number, 3,287,870, which, divided by 1^2 , 2^2 , 3^2 , 4^2 , 5^2 , 6^2 resulted in the distances between the frequencies (the numbers in the black rectangles). The diagram representing these conclusions became famous as the "Ladder of Balmer." About 40 years later Niels Bohr proved that the distances between the rungs correspond to the distances between the shells within the atom.

The diagram represents the ladder shaped to the curves of atomic orbits and emanating from the spectrum. The numbers represent billions.

are composed of fine single color lines and that interspersed among these are small dark lines. (*Fig. 54*) There are so many color lines that they coalesce. Their great number results from the simultaneous glowing of the numerous elements in the sun. This is the first message the light telegram of the spectrum transmits: our sun is not a homogeneous ball, comprised of one or two elements, but a mixture of many elements.

Most stars emit spectra identical with or similar to the sun's spectrum. The second message we receive from the spectrum reads: the elements glowing in the sun and stars are the same as we find on earth. The universe is chemically uniform. Stars are brothers and sisters and the earth is formed from their substance.

Finer analysis of the color lines enabled astronomers to determine the different elements and their state. Our eye sees colors when electromagnetic waves of specific length strike our retina. Four hundred trillion waves per second are registered as red, 600 trillion as green, 800 trillion as violet. The frequency of the waves depends on the leaps of the electrons between the orbits of stimulated atoms. At the time that the single electron which circles around the nucleus of the hydrogen atom is stimulated, it performs nine different leaps. Consequently the glowing hydrogen atom produces a spectrum composed of nine specific lines. (*Fig. 54*) If these lines are found in a spectrum we know that hydrogen is among the glowing elements. This is the third message from the spectrum: the position of the lines tells us, just as the dots and lines of the Morse-telegram do, who is the sender of the light message.

When the single electron of the first and simplest atom performs nine different leaps, cabled as lines, we are not surprised that other elements with a dozen or several dozens of electrons send telegrams signed with dozens and hundreds of lines. Since the chemist has isolated pure elements, it was not too difficult a task to compose an atlas of spectrograms which serves as a code for deciphering the spectra of stars. The deciphering itself is not easy, because the lines of the elements are intermingled and densely crowded—hundreds and thousands of lines bundled together in a typical stellar spectrum, comparable to the thousand different sound waves which vibrate against our eardrums when a great orchestra plays a symphony, sym-phonie meaning a collection of sounds.

If, in the spectrum of a star, the lines of iron are found, the star must have at least the temperature of molten iron. The exact temperature can be judged by the wave-lengths sent out by the glowing iron. If only long red waves appear, the temperature is low. If short violet and ultraviolet waves arrive, the star must be hot, for only the strong energies of high temperatures are able to lift electrons from the inner orbits of large atoms such as iron and so produce the short waves of violet. Thus, the fourth message of the spectrogram tells us the temperature of the star.

In solid bodies and in fluids, atoms are crowded together. Because their movements interfere with each other, their wave-lengths are not clearly sepa-

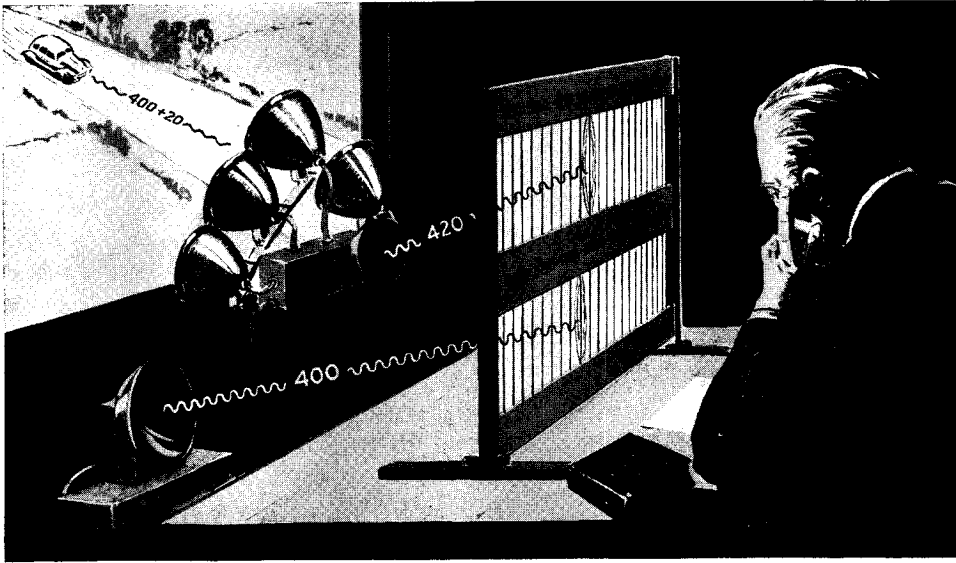

Fig. 55a. ACOUSTICAL METHOD OF MEASURING MOTION

The number of sound waves from the horn of an approaching car increases in proportion to the speed of the vehicle. The difference of frequency between the sound of the stationary and that of the approaching horn is the basis for the calculation of the speed.

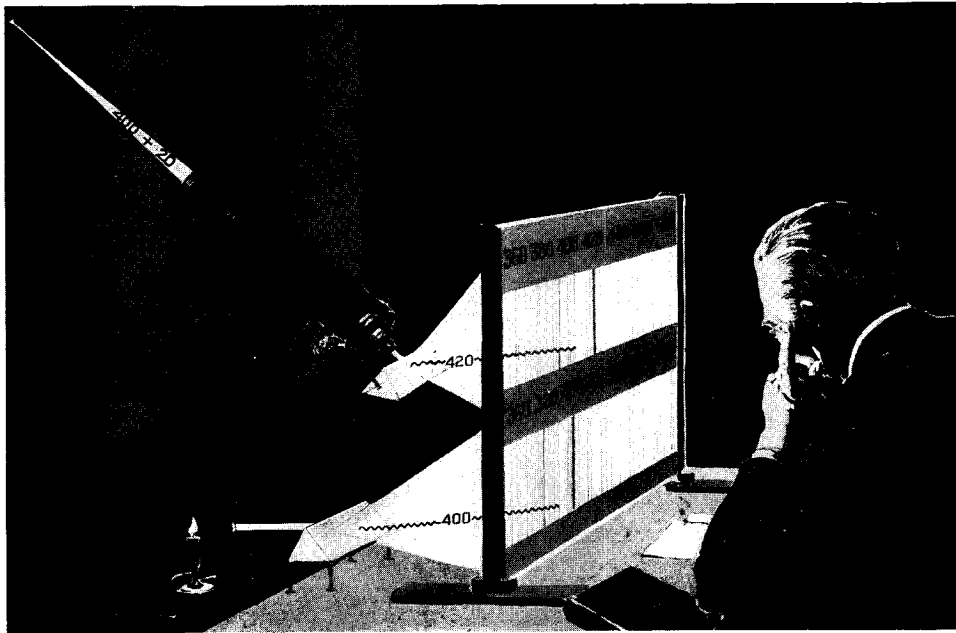

Fig. 55b. OPTICAL METHOD OF MEASURING MOTION

The frequency of light waves increases or decreases when the observed source moves. By comparing the arriving light waves with those of a stationary spectrum the shift of the spectrum lines can be measured and the speed of the light source computed.

rated. The colors of the spectrum appear as broad bands which coalesce like the colors of the rainbow. However, if the incandescent mass is a gas, the atoms are separated by relatively large distances. They do not disturb each other, and the spectroscope produces sharply separated lines. The fifth message of the light-telegraph spectrum informs us whether the light rays are transmitted by solids or gases.

To understand the sixth message, we set up four tuning forks, pitched to the tonic chord of C major: C, E, G and C. We place four similar tuning forks in the next room. Then we ask someone in the next room to strike the E-fork. Of the four forks in front of us, the one tuned to E begins to vibrate, indicating that it is the E-fork that is vibrating in the next room. This is called sympathetic vibration or resonance. Now we close the door almost all the way, leaving it only slightly ajar, and place a third E-fork in this small opening between the two rooms. When the E-fork in the next room is struck, the fork in the opening vibrates, but the E-fork before us remains silent because the energy of the wave has been captured en route by the fork in the crack. If all four forks are struck in the next room, only three of the forks before us vibrate. The E-fork remains silent. From the tone that is missing, we can tell that the chord has passed an E-fork on the way.

Similarly, stellar spectra show color gaps which appear as black lines, called absorption lines or Fraunhofer lines. Joseph Fraunhofer, who discovered these gaps, was a poor glass-polisher's apprentice who later became famous as an optician and mathematician. His early death at the age of thirty-eight was a great loss for science. The Fraunhofer lines show that light, on its way from its source to us, has passed a gas which has absorbed the missing wave-lengths. If the nine lines of hydrogen are missing among 100 colored lines in a spectrum of a star, we know that the light has passed through an atmosphere containing hydrogen. Thus, the sixth message of the spectrum reveals that the traveling light rays passed layers of invisible gases which absorbed the missing wave-lengths. The nature of the passed gas can be determined by the array of missing lines.

The seventh message: when we say the sound of an automobile horn has a frequency of 400, we mean that 400 sound waves reach our ears every second. (*Fig. 55a*) But this is true only when the car is standing still. If it is approaching, a greater number of waves arrive and the pitch ascends. If the car is moving away from us, the frequency diminishes and the tone falls. From the increase or decrease in wave-frequency, we can figure out the speed of the car. All of us are familiar with this phenomenon, discovered by Doppler and called the "Doppler effect."

The number of vibrations sent out by the automobile's headlights rises or falls in the same manner. When a car is approaching us, a greater number of light vibrations per second reach our eyes, and the lights appear more violet. When the car is moving away, fewer light waves per second reach our eyes, and the lights grow redder. (*Fig. 55b*) Indeed, the speeds of our vehicles

are far too low for the human eye to perceive this minute change of wavelength. But in the case of stars, which approach or recede at the rate of many miles a second, we can readily see a displacement of the spectral lines, when compared to the spectrum from a source of light that is not moving. If the star approaches us, the number of arriving light waves per second is higher and the lines are shifted to the violet side of the spectrum (violet shift); if the star recedes, the lines show a shift to the red (red shift). (*Fig. 63*) Under favorable conditions the speed of the motion can be determined with admirable exactness, up to half-a-mile accuracy. When we consider that the star is 20 or 120 light-years away this determination deserves indeed the awe awarded a miracle. It is without doubt one of the highest achievements of science. Yet it is not the acme of success: modern spectroscopes are so efficient that it is possible to compare the spectra of the left and the right rim of luminous stars and to find that the stars rotate like our sun. Even the velocity of their rotation can be calculated.

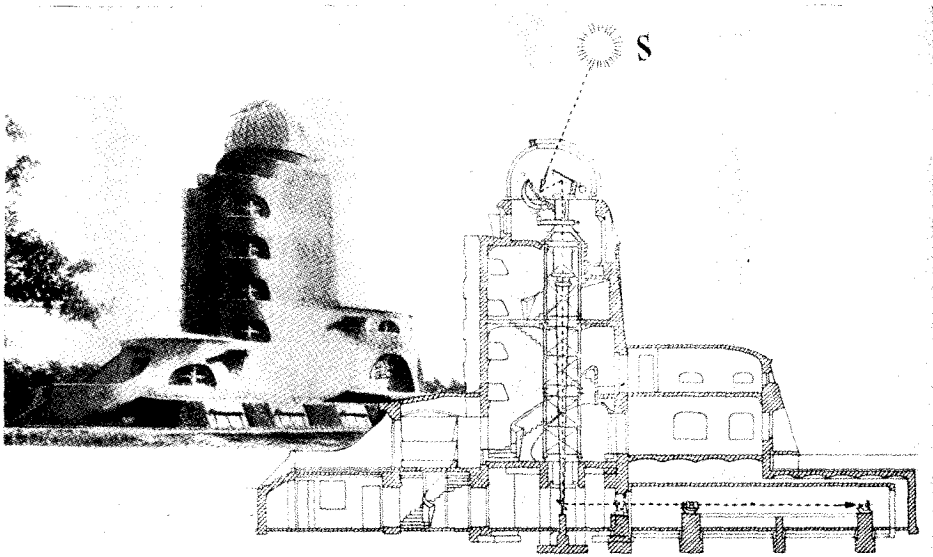

Einstein Tower Near Potsdam

Fig. 56. MODERN SPECTROSCOPY

The modern spectroscope is mounted on firm foundations and set deeply in the ground to protect the sensitive instrument against shock, change of temperature, etc. Light from sun or stars is collected by a huge mirror on the top of a tower. A series of prisms widens the spectrum to more than a mile and displays up to 100,000 discernible lines.

Naturally, to obtain such detailed results, the astronomer must work with precision instruments, protected against any possible contingency. So-called sun towers were, therefore, built for spectroscopic observations. They are the modern version of the Egyptian pyramids which were not only the tombs of kings but also astronomical observatories. Egypt's New Year was pro-

claimed when the arc of the daily path of Sirius rose high enough in the sky to cross the slit cut in the southern wall of a pyramid.

The sun's image is caught by a mirror at the top of the modern sun tower, and conveyed by a system of mirrors to a depth of almost 100 feet underground. (*Fig. 56*) There it appears on a mirror as a disc half a yard in diameter, so bright that no mortal eye can look upon it without being blinded. The rays are then sent through a series of prisms. Each successive prism widens the spectrum of the preceding one, so that the band of color expands until each line is broadened to the width of a sidewalk. If the entire spectrum were spread out, it would be a huge fan, and we would have to blast out an underground hall more than a mile wide to catch the whole projection. But only small sections of the spectrum are projected at a time. In this way more than 100,000 lines and gaps have been registered, and whole treatises written about a single line or gap.

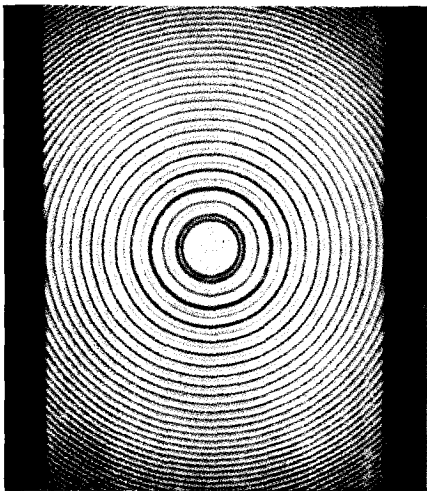

Fig. 57. THE ULTIMATE IN
SPECTROSCOPIC
RESEARCH

The small lines of the spectrum are passed through the interferometer which transforms each line into a scatter circle to reveal finer details.

One might think that the modern astronomer would be satisfied with instruments so marvelous that Newton or Huygens would be in ecstasy. But not at all. He longs to dissect the lines of the secret message from other worlds into slices as fine as those which the anatomist produces with his microtome, a mounted knife that slices tissues so fine that a beam of light can pass through them. As his "microtome" he uses the interferometer, mentioned on page 33. Just as a drop of water or oil can be pressed between two plates of glass and flattened into a thin pancake of fluid, this precision instrument transforms the spectrum lines into scatter circles. (*Fig. 57*) Just as a minimal change in pressure distorts the scatter lines of the drop of water, flattened between the glass plates, the scatter circles of the spectrum lines record the slightest change in the length of light waves by blurring the interferometric arabesque. The performance of an interferometer borders on the incredible. If a telescope combined with an interferometer were trained on a coin two miles away

and the eagle on the coin were to flap his wings one-tenth of an inch, the interferometer would record the displacement.

All these instruments, admirable as their performance is, are overshadowed by the finest of all instruments—mathematical calculation. The Indian physicist Megh Nad Saha, using the methods of quantum mechanics, analyzed the lines and especially the gaps between them and was able to determine position and structure of the gaps so accurately that his calculations surpassed all results of direct observation. He proved once again that the real hero of science is not the field commander with all his blundering artillery of instruments but the quiet strategist who sits inconspicuously at a table scribbling his apocryphal symbols on a simple piece of paper.

The prism is not the most sensitive instrument for dispersing light. An even finer diffraction is achieved with ruled gratings made of glass with an aluminum coating. These gratings can have more than 30,000 parallel, equidistant grooves to the inch—that is, thousands in the diameter of this letter o.

The spectra thus produced can be investigated with photoelectric devices. These reveal that each line is composed of a central area and various lateral zones. The gaps in the spectrum are not “empty,” but are rather regions of fainter radiation, their centers deep dark, their “wings” graduated. These dark areas of the spectrum do not radiate light but invisible heat waves. The investigator uses a bolometer, which registers the influence of heat waves on an electric current. It is sensitive enough to indicate a million different temperature levels between two gradations on a thermometer. The physicist who works with a bolometer cannot have a cigarette between his lips; the needle would jump like a seismograph during an earthquake. He must leave his dog home, too. If the dog were to appear in the doorway, the needle would tremble. A warm-blooded body radiates against a bolometer like the morning sun against the walls of a house.

We are now prepared to take part in a nightly “seance” under the cupola of an observatory. An astronomer invites us to look through a telescope while he launches on a running commentary: “Here you see a point of light. We call the point a star. Actually, it is a sun about 86 light-years away. It has a temperature on its surface of 14,000°. Since it shines from this distance with such brightness, it must be a sun disc with a diameter of at least 15,000,000 miles. The spectrogram reveals that it is a gaseous sphere. In a globe of gas this size, the pressure in its interior is equal to 8,000,000 atmospheres. This pressure corresponds to a temperature of about 32,000,000° in the center of the sphere. As the spectrum indicates, about twenty-three elements are glowing in this ball of gas. The following are predominant. . . .” He lists them, and then continues his lecture.

“There are gaps in the spectrum. Therefore, the globe is surrounded by an atmosphere. The number and position of the gaps reveal that this atmosphere is composed predominantly of hydrogen, helium and calcium, in the

ratio of 60:20:12. But the gaps are not in the expected places; they are displaced. The star is moving toward us at a speed of 20 to 22 miles a second. The movement is not steady. For 88 hours the lines of the spectrum wander

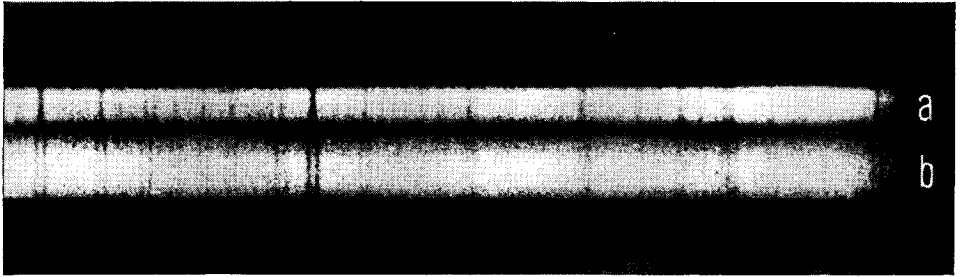

Fig. 58. SPECTROGRAM OF A DOUBLE STAR

Most double stars are too far away to be recognizable even on telescopic photographs. The duality of the star is uncovered by the periodic appearance of a second spectrum beside the original one.

slowly toward the red; then they stand still, reverse, and for the next 88 hours they move toward the violet. (*Fig. 58*) The star describes spirals as it approaches us. This indicates that the star is accompanied by a second star, or 'companion,' which is not visible. In order to deflect a sun of this size from its orbit in this particular way, the companion must be three-fifths the mass of the star itself and must be 120,000,000 miles away from the main star. To complete one revolution at this distance, the companion must move at 75 miles a second.

"At specific intervals the companion obscures the star, an occurrence which provides us with a series of important clues. Certain lines of the spectrum disappear, among them those of iron. This tells us that the atmosphere of the companion contains considerable amounts of gaseous iron. To hold iron in a gaseous state the atmosphere must have a temperature of several thousand degrees. From the length of time during which the gaps are present, we can ascertain that the atmosphere of the invisible star has an altitude of about 120,000 miles. While the dark star is eclipsing the shining star, its brightness decreases, but not in a simple curve. This indicates that the companion does not cross the star in our line of vision, but that its orbit is inclined at an angle of 30° .

"A periodic disturbance indicates there is a third star, about 165,000,000 miles away from the gravitational center of the system. It is easy . . ."

Easy? We jump up from our half-dream. Here stands a man who calls himself an astronomer, from "astro," star, and "nomos," law. He speaks glibly of the laws governing the paths of the stars. He has shown us a point in the telescope which he says is a triple world, 435 trillion miles away. Easy? We—who have now learned about mirror telescopes and mile-wide spectra, Fraunhofer gaps with centers and wings, interferometers and parallactic computation—can understand. But what of the uninformed person? Might he

not think he was listening to the raving of a madman? Yet there is "method in this madness." Method, thy name is Science!

Radio-Astronomy

The trio of telescope, spectroscope and camera has been transformed into a quartet by the unsuspected addition of the radio. An American radio engineer, K. G. Janski, was assigned by two radio corporations to investigate the noises interfering with short-wave broadcasts, especially during the day, but also often at night. He focused his attention on the sun and arrived at the not-so-surprising conclusion that the sun was actually the source of the disturbances which stutter stridently in the morning from the east and during the afternoon from the west, to fade out when the sun has set. He built a wide paraboloid antenna to collect the disturbing waves and connected the antenna with a sensitive receiver, thereby constructing the first model of a radio telescope. It did not enter the mind of the purely radio-minded engineer that he had performed a historic deed, that he had opened the sky for a new era of research.

Man, living on the floor of the atmosphere like a starfish on the bottom of the sea, can perceive only those celestial radiations which reach the ground. Two sectors of the wave scale are intercepted by the atmosphere. The short waves—gamma rays, x-rays and ultraviolet rays—are absorbed because they ionize the atoms of the atmosphere and thereby consume their energy. When the waves become longer than those of ultra-violet, they are too long to influence the atoms; they bypass them and arrive at the bottom of the air-sea as light. When they reach the length of 10^{-4} centimeters, they set the molecules of the air to swinging, thereby losing their energy, and are thus also missing in the scale of the perceptible waves. Yet waves longer than a centimeter affect neither atoms nor molecules and can be received over the radio.

The sun emits radio waves in salvos. Since the salvos are composed of waves of different lengths, the reception is not pleasant. But just as the prism in the spectroscope can separate the different wave-lengths of sunlight, the ear-splitting noise can be disentangled by receivers which are tuned to specific wave-lengths. By assorting them we produce the "spectrum of the sun's radio radiation." Just as the different sets of wave-lengths in the optical spectrum are produced by specific atoms, allowing us to say, "here is iron, or sodium, glowing," so the bundles of radio waves inform us about the atoms which emit the waves and moreover about some of their physical properties, such as their number, density and temperature. The analysis of the sun's broadcasting has added considerably to our still sparse knowledge of the sun's structure and activity.

From the beginning it was evident that the sun could not be the only source

of disturbances. Some noises did not coincide with the rising and setting of the sun, but followed the time-clock of the stars which rise four minutes earlier each day than the day before because of the progression of the earth on its course around the sun (24 hours divided by 365 equals 4 minutes per day).

The sender of the astral music was found to be the Milky Way, and the loudest fanfares in the circular "band" were the galactic clouds, in the constellation of Sagittarius, which are suspected to be the center of the galaxy. Judging from the chaotic noise, the diffuse masses of gases, mostly of hydrogen, seem to whirl in a state of vehement turbulence.

These findings produced a sensation among astronomers. Countries such as England and the Netherlands, which are considerably handicapped in astronomical research by their unfavorable climate, installed radio-observatories and began a systematic survey of the sky. Improved instruments and methods revealed that not only the shiny clouds of the Milky Way but also dark areas were broadcasting. Some of them have been known since as "dark clouds," yet with the help of radio-scopy—perhaps we should say radio-phony—it became possible to determine the extent of these clouds with far greater accuracy than before.

Much more than the simple existence and extent of dark clouds became evident. The prevailing tone of the astral broadcast comes on a wave-length of 21.1049 centimeters. It is the acoustical spectral line of the hydrogen atom, long since considered the building stone of the universe. The Dutch astronomer H. C. van de Hulst predicted in 1944 that it would be possible to pick up a radio signal on wave-length 21.1 centimeters from cosmic space if hydrogen atoms actually were present and if there were a sufficient amount of energy to push the electrons of the hydrogen atoms from their orbits.

Electromagnetic waves are emitted from an atom when the circling electrons are stimulated so that they leap from an inner shell to an outer one. (*Fig. 27*) Falling back to their original shell, they return the energy which pushed them to the outer shell as radiation, just as the falling stone returns the energy that threw it upwards as "impact." The stronger the energy that pushed the electron, the shorter the wave produced. Waves of highest energy are the ultra-short gamma rays which appear in nuclear processes. Gradually lessening in energy follow x-rays, light and heat waves. If the pushing energy is so weak that the electrons do not jump from one shell to another but only to a subshell, the atom emits long waves, many of them in the range of the radio-band.

The atoms of the dark clouds are not stimulated enough to emit the short waves of light; but they receive from stars and shiny clouds in their cosmic neighborhood enough energy and are themselves turbulent enough to emit the long waves of the radio band. The energy we receive from these radio signals is very small. All the radiations from dark clouds which are intercepted

by our planet add up to no more than one or two watts—barely enough to operate a flashlight.

The emission, mostly but not exclusively sent out by hydrogen atoms, does not arrive from all clouds with the same frequency. From some clouds the tone is a bit higher or a little lower—with a difference of about 170 kilocycles (a kilocycle being the frequency of 1,000 waves per second). The acoustic spectral lines follow the same rules as the optical. If the source of the sound approaches, the pitch rises; if it recedes, the pitch falls. (*Fig. 55a*) The broadcasting clouds move. Their velocity averages 5 km/sec. Some clouds send a mixture of high and low frequencies, indicating that their parts move in different directions as do the parts of our atmospheric clouds, or that the cloud is rotating.

Today, like the shiny parts, the dark sections of the sky are mapped. In some places dark points radiate with an angle not wider than that of a star. They have been named radio stars although the existence of actual stars has not been established. Two kinds of “radio stars” have been classified: strong ones which are found along the spirals of the Milky Way and are almost surely objects of our galaxy; and weaker ones which are evenly distributed over the sky and seem to be extragalactic. The strongest of these extragalactic objects is found in the constellation of Cygnus. Its distance must be around 2,000,000 light-years, one and a quarter times the distance of our neighboring galaxy, the nebula in Andromeda. The dislocations of the wave-lengths indicate that here two spirals are rotating, one alongside the other, with rotational speeds of more than 1,000 km/sec. Nothing is to be seen in this entirely dark region, not even with the best telescopes and cameras.

With the use of radio receivers, it became evident that the galaxies are even larger than they appear. The shiny arms of the Milky Way could be traced outward into the dark and also the radio waves of spirals of other galactic nebulae could be detected beyond the boundaries of their visibility. In the wake of the spirals ten times as many hydrogen atoms emit signals as they do in empty space.

It has been found that “empty space,” too, is humming on the wave-length of 21.1 centimeters. This confirms the old calculation that space is not really empty, but is populated, if thinly, by hydrogen atoms: one hydrogen atom in every cubic centimeter of space against 60,000,000,000,000,000,000 in a cubic centimeter of our air. According to recent calculations, a hydrogen atom in such thinly populated space will encounter another hydrogen atom every fifty years. If the electrons of the colliding atoms do not really collide but approach each other while spinning in the same direction, the effect will not be tumultuous enough so that the emission would be perceivable. But if the electrons spin in opposite directions, they shuttle back and forth and the chances are even that after the encounter one atom may depart with an electron from the other atom. The statistics of quantum mechanics

say that it will happen three times out of eight or, on an average, every 133 years. Yet the probability that an electron will leap and emit a radio wave is 1:11,000,000 years. It sounds desperately rare, but space is infinite and scattered with hydrogen atoms.

Since radiation is identical with "temperature," empty space should have a temperature a few degrees above absolute zero (-273° centigrade), and the dark clouds a temperature of about 50° to 75° above absolute zero or 200° below zero C.

Thus the first page in the story of the humming atoms in space is being written. The "dark" secrets of the heavens are unveiled. Radio-astronomy maps the empty areas of the sky where even the most powerful telescopes and the most sensitive photographic plates register "nothing." It is really a "ful-fillment"; the three-quarters-empty sky fills up. The vision of the Pythagoreans has come true: man listens to the music of the spheres.

Astronomy of Tomorrow

When a cosmic body shoots into our atmosphere, it rips electrons from the atoms of the air, and since it is heated by friction, it loses electrons from its own mass. The liberated electrons cause electrostatic fluctuations which can be recorded by electronic devices such as sensitive radio receivers. It makes no difference whether it is day or night, clear or cloudy, or whether the astronomer is "on deck" or sitting at his dinner table. The apparatus registers the objects automatically on a rolling strip of film. The curve thus recorded makes it possible for the astronomer to compute the size, path and speed of the stranger.

The astronomer of old, who while the world slept beneath him sat in his domed tower at night staring and staring until his eyes grew tired, has become as much a figure of the past as the village blacksmith. Today a photographic solar telescope, a heliograph, snaps a picture of the sun automatically every twenty seconds. When the film is run off, the scientist can watch volcanic eruptions on the face of the sun grow and vanish. The hitherto tedious work of weeks is now condensed into a movie that lasts a few minutes. Furthermore, the scientist can bring the film to a standstill at any point for any length of time, permitting research and discussion whenever and as often as desired. The spectrum can also be surveyed in this way. An automatic spectro-helio-motion-picture camera takes snapshots of the sun's spectrum at intervals of twenty minutes. Thus the sun's daily life is recorded in a spectroscopic diary.

Heretofore mathematicians sat poring over endless calculations in astronomical institutes. No one outside their inner circle had the remotest idea how much computation was involved, how protracted these calculations

were or how often they had to be repeated because of possible error. Sometimes astronomers had to work half their lives on a single problem. (*Fig. 5*) A great part of their problems had to remain unsolved because of lack of money, time and assistance. This situation is now radically altered by the introduction of the electronic computers whose "electronic brains" multiply, divide, raise to any desired power, find any desired root, discover mistakes and correct themselves with incredible speed. A multiplication such as $346,593,787,163 \times 868,937,544,619$ is no small matter. Even an experienced calculator needs time to do it and to check the result. The calculating robot gives the answer in—a fraction of a second. In the course of one morning it can carry out a computation which had been called "transcendental" fifty years ago. It has a magnetic memory which can retain thousands of figures and juggle them in all imaginable combinations. The introduction of the electronic brain marks the beginning of an age of unlimited possibilities in astronomical calculations.

The rocket, the astronomer's newest instrument, stands in the hangar ready to start out. Theoretically, the technical problems of rocket flight above the limits of the atmosphere are solved. It is only a question of money and public support before the first space-rocket ascends and circles the earth like an "artificial moon." Equipped with photographic and recording instruments, and operated by remote control, it will send back its reports as television and radio to the scientists on the ground.

In the not-too-distant future, it may be possible to send rockets to the moon, perhaps even to neighboring planets. When this happens, man may be drunk at first with pride at his great achievements. Before long, though, he will find himself confronted by problems which will reduce his pride to humility. He will find that the distances to planets such as Jupiter and Saturn are far too great for even the fastest imaginable vehicles. A round trip to Saturn is an enterprise of years. To reach the outer planet Pluto will remain a dream, for man's life is too short for the round-trip journey. The nearest star is about 100,000 times farther away. It will take several hundred thousand years to set foot on our closest "sister world." But man, confined for all time to his planetary prison, may find consolation: a visit to the stars will never solve the riddles of the universe. It will enrich our store of facts. But facts do not provide solutions. The mystery remains.

The Galaxy

*Man's Home in the Universe:
The "Milky Way"*

OUR HOME in the universe is a spiral of 200,000,000,000 stars, a unit of suns whirling through space like a fiery pinwheel. Our own sun, this lantern of our day, is but one of 200,000,000,000 and not a great one but a "dwarf" among giants and supergiants. On clear nights the spiral of stars can be seen with the naked eye. Two distinct phenomena are visible: first, stars, large and small, in all parts of the sky; second, a blurry strip with irregular outlines, crossing the sky from horizon to horizon as a faint "milky" band. In ancient times the Greeks named it the Galaxy, the "Milky Way." Jupiter, although the first of the gods, was not a faithful husband. To make his natural son Hercules immortal, he put the child at the breast of his wife Juno while she slept. Awakened, she hurled the bastard from her and her milk spilled across the sky.

Actually the Milky Way is an inside view of the great spiral of stars in which we live. Imagine that you are riding in a skywriting plane. It has just traced the letter C in the air. The people on the street below can read the C. But in the plane you merely see a ring of white smoke around you, a "Milky Way." If we could get outside the galaxy, we would see it for what it is: a flat lens-shaped spiral of stars similar to the great nebula in Andromeda or the huge galaxy in the Triangle, which are "Milky Ways" in "extragalactic" outer space. (*Fig. 59*)

The beginner is confused by the fact that he sees stars in all directions of the sky but at the same time is expected to believe that he lives inside this small band crossing his zenith. Let us imagine that we are on a ship approaching a harbor at night. The distant lights of the harbor look like a band of light, a Milky Way. Yet the lights of your own ship, since you are in their midst, are all around you—in front, behind, to the right and left, below and above at the top of the masts. But your friends on the pier see the lights of your ship close on one plane. An hour later your ship arrives in the harbor and disappears into the small band of the coastal "Milky Way."

Our galaxy is an elliptical or roughly circular spiral—about 100,000 to 200,000 light-years in diameter, and 10,000 to 20,000 light-years thick at the center. A system of such dimensions implies certain mathematical conditions. The galaxy we behold could not have been born yesterday. It must have

existed for billions of years. It must have a certain amount of mass to be stable, and the mass must have a considerable rotary speed to maintain the form of the spiral. According to mathematical reasoning, the total mass of our



Fig. 59. THE VARYING APPEARANCE OF THE GALAXIES

Most galaxies are spirals with shining central clouds. We see these spirals from different angles.

Milky Way should be 250,000,000,000 stars. Yet statistical calculations based on photographs of different parts of the galaxy point to the fact that not more than 200,000,000,000 radiant stars are gathered in our galactic system. About one-fifth of the total mass must, therefore, exist in invisible form as dark clouds or dark stars, as planets of these stars, as moons of these planets, or as planetoids, meteors, cosmic dust or thinly distributed gases.

When we look toward the constellation of the Swan on a clear night, we see "holes" in the gray of the Milky Way, with no stars in them. These are called the "Coal Sacks." By comparing these dark spots with the other parts of the sky, we note with surprise that our sky is not really black but gray. Only the Coal Sacks are truly black. These Coal Sacks are dark clouds producing partial blackouts of the Milky Way. Also, our solar system happens to be in a cosmic region interspersed with dark clouds—an unfortunate circumstance for science because considerable parts of the Milky Way are obscured.

Yet not only is our own stellar neighborhood shrouded by clouds but the whole galaxy seems to be rimmed by dark masses, so that all extragalactic objects in the equatorial plane of our galaxy are also obscured. In *Fig. 59 (3)*, a photograph of a galaxy seen in its equatorial plane, circumgalactic clouds are clearly discernible. It seems as if an equatorial rim of cosmic dust is an intrinsic part of rotating galaxies. Generally, the dark masses cannot be observed optically but occasionally bright stars glow in the midst of the clouds. Just as we can see the fog of a November night in the light of a street lamp, so we get a glimpse of the clouds in the neighborhood of these stars. One of the clouds thus illuminated is the great nebula in Orion, which can be seen with the naked eye under the Belt, a favorite object of stargazers. The nebula is about 1,000 light-years distant and about 100 light-years in diameter. Undoubtedly a cosmic storm is raging there, and from the presence of many young hot stars we may assume that a new star-cluster is in the making. The commotion is not apparent to the human eye, just as the clouds that swirl wildly forth from Vesuvius seem to be still when looked at from 50 miles away. If we could take a thousand pictures of this cosmic nebula, one every hundred years, and then run off the 1,000 exposures like a motion picture, we would see chaos in action. (*Figs. 49, 50*)

A second famous nebula is the North America nebula, so called because it duplicates in the sky, with surprising faithfulness, the outlines of the continent of North America. (*Fig. 3*) To understand this picture one should look not at the white "continent" but at the dark "gulf" in the lower right. The "nebula" is not a gleaming nebula at all but an ordinary portion of the Milky Way vignettted by two dark clouds so that it appears to have the shape of the American continent. One of the clouds is about 700 light-years away from us; the other, 3,000 light-years. Up to now about 1,000 such dark clouds have been mapped, and the new survey of the sky by radio will

undoubtedly enrich our knowledge of the dark masses to an unforeseeable extent.

To explore the visible parts of the Milky Way, the astronomer combines telescope and camera into a powerful twin-instrument. (*Fig. 60*) A telescopic photograph of the Milky Way looks as if granulated sugar had been dusted over a black plate—each grain a sun as big, as bright and as hot as ours. No! Bigger, brighter, hotter. Our sun is much too small and too dim to show up on photographs like that of the North America nebula whose stars are 10,000 light-years away. The enormous distance of the galactic host also accounts for the crowding, which is an illusion. Points which appear separate over

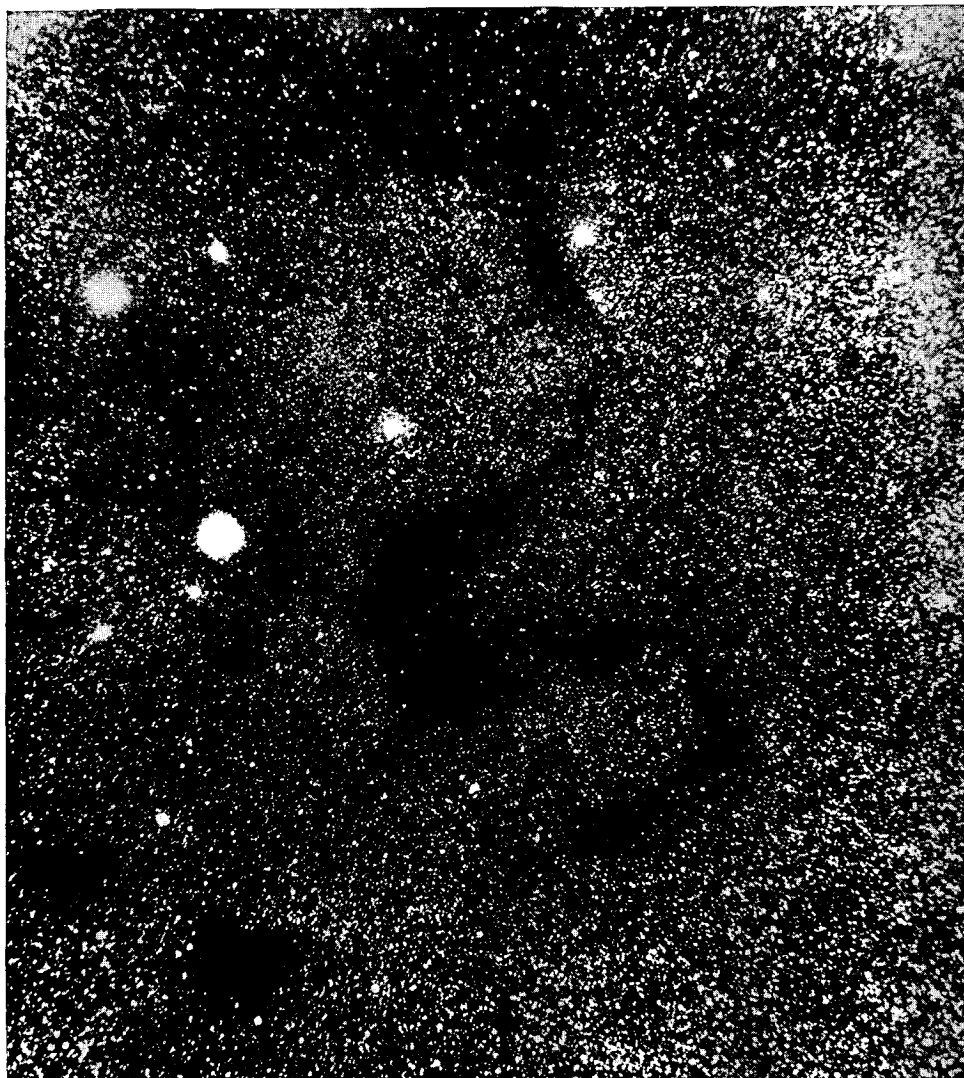

Fig. 60. THE COAL SACKS IN THE MILKY WAY

distances of light-years must be billions of miles apart. From another solar system we could never see our earth, 150,000,000 kilometers away from the sun, as a separate point. Furthermore, on photographic plates the stars seem to be on one plane. Yet two stars appearing side by side may be 500 and 1,200 light-years away respectively. It is like viewing a city at night from the top of a hill. The lights seem crammed together, yet actually between those twinkling points people are strolling and cars are riding along freely on streets.

Not only are stars *not* crowded, they are terrifyingly isolated in space. The Milky Way could encompass a million times as many stars without being "filled up." The chances of one star colliding with another, even in the densest sections of our Milky Way, are only one in 500,000,000,000,000 years. No star could live that long, no galaxy, probably not even the universe itself.

Since the galaxies are open spirals, the stars in them must revolve to retain the stability of their formation. In our galaxy the stars travel along the loops of the spiral at an average speed of 200 to 300 km/sec. Our sun is supposed to be about 33,000 to 50,000 light-years from the center, and to travel with a speed of 219 (± 15) km/sec. It takes a star about 250,000,000 years to make one revolution. When dinosaurs inhabited the earth, our solar system was on the other side of the galaxy.

The center of our galaxy is seen in the constellation Sagittarius (Archer) where the density and brightness of the Milky Way reach their maximum. The Archer gives us a direction in which to look; we see the distant center framed by this constellation as we see the moon in the frame of our window.

The photographic, spectroscopic and radio-phonic survey of the space beyond the galaxy has revealed that the Milky Way does not end where the visible arms of the spiral fade away in the darkness. Wide arcs of dark masses enwrap the whole system like a "corona" of cosmic dust, comparable to the fine cloud of dust which enfolds the sun and is sometimes seen as the Zodiac Light. The star-populated spiral rotates, yet this outer disc seems to be still. Few stars are dispersed over its vast remoteness.

Fig. 61 illustrates our present conception of "Man's Home in the Milky Way." The symbol *T* represents Tellus, the Latin name for our earth. The circle around *T* has a radius of 5,000 light-years. This is the area with which we are fairly well acquainted—a depressingly small district when compared with the whole system. Beyond this circle, the recordings of our instruments are more and more vague, our calculations more and more problematical. The rim of this circle is the limit of certainty. For everything beyond it we can rely only on the conviction that the same matter is strewn all over space and that the same laws govern the behavior of mass and energy everywhere in the cosmos. Distances of hundreds of millions of light-years do not change the basic rules as much as an iota and a billion years of time will not make the immortal laws of nature senile.

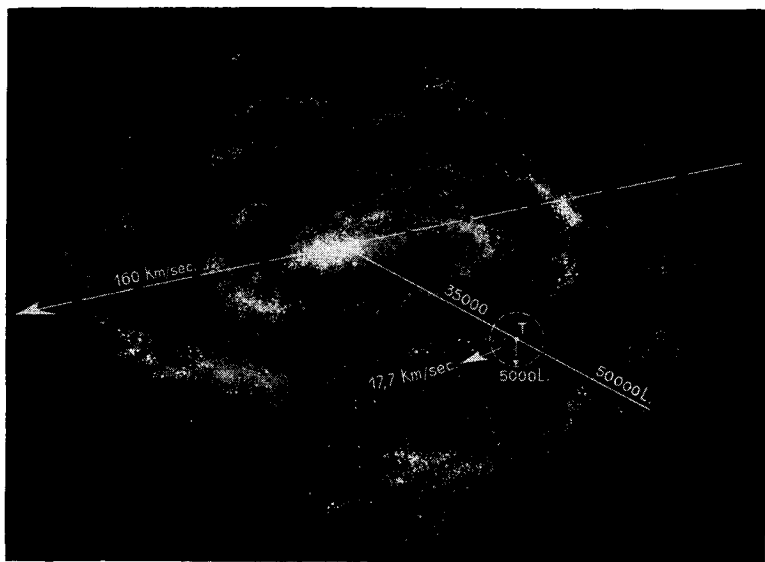

Fig. 61. THE GALAXY, MAN'S HOME IN THE UNIVERSE

"Tellus," the earth, exists as a member of the solar system supposedly 35,000 light-years from the center of a spiral of 200,000,000 stars. Presumably the solar system travels around the center of the galaxy at somewhat less than 20 km/sec. The circle around Tellus (with a radius of 5,000 light-years) defines the area of the Milky Way which is explorable with our present instruments. Everything outside this circle is—with few exceptions—still unexplored, presently unexplorable and all our conclusions are more or less hypothetical.

*The Galaxy's Companions:
The Magellanic Clouds and the
Globular Clusters*

When Magellan sailed around South America—the first white man to do so—he saw in the night sky two stellar clouds near the constellation of the Southern Cross. The larger one glowed so brightly that it could be seen even at full moon. As we know today, these Magellanic clouds are two small and still chaotic young galaxies at a distance of about 150,000 light-years. The larger cloud is approximately 20,000 light-years long and contains more than 100,000 brightly shining stars. The smaller is only half as large, but it is more densely populated by stars. If they were ordinary stars, like ours, it would not be possible to resolve the shiny nebula into single points. Our sun is much too faint to be perceived at a distance of 150,000 light-years.

The stars of the Magellanic clouds are extraordinarily hot and bright. One of them, S Doradus, 500,000 times more luminous than our sun, radiates more

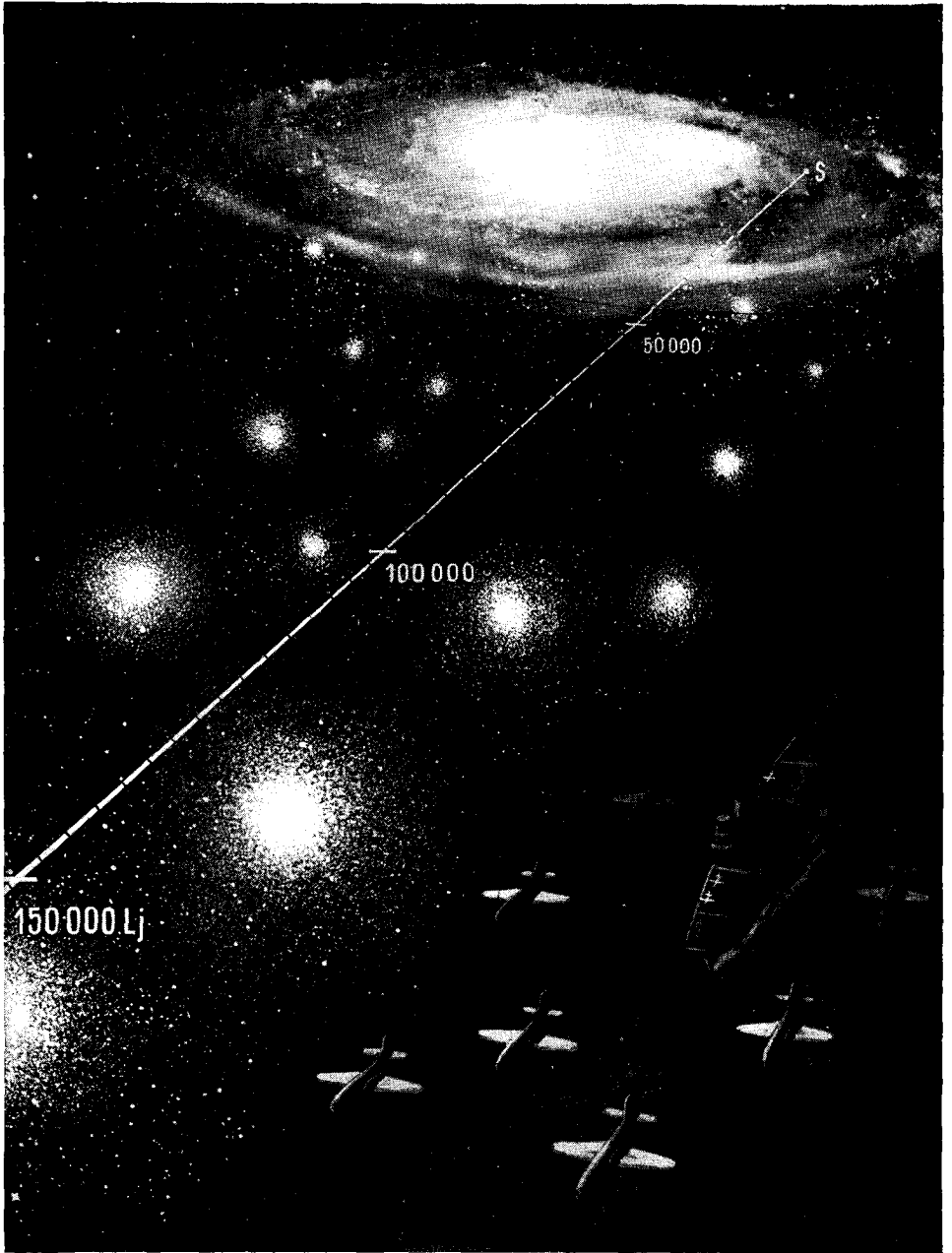

Fig. 62. THE GLOBULAR CLUSTERS

The globular clusters are globes of extremely hot stars. One hypothesis assumes that they accompany the galaxies just as a protective canopy of airplanes escorts a carrier. The American specialist in cluster research, Shapley, arrived at a new concept—that they are near the center of the galaxy.

strongly than any other known star. They are so luminous that many of them can be seen on telescopic photographs as single points. Most of the recognizable stars are "blue supergiants," brilliant and presumably young stars. They are considered young because they are intimately connected with the cloudy material we believe to be the building stuff of stars. The energy they send out must be 1,000 times greater than the energy radiated by the stars in our region of the galaxy. The galaxy marked as *1* in *Fig. 59* gives some idea of the relation of the Magellanic clouds to our galaxy. It, too, is accompanied by a still amorphous piece of galactic material.

In addition to the Magellanic clouds, a great flock of ball-shaped clusters of stars flies through space with our galaxy, like squadrons of airplanes escorting a ship. Their spherical form is responsible for the name "globular clusters." They are all about the same size, 100 or 200 light-years in diameter, and each contains several tens of thousands of suns, many of them hot bright stars of the Rigel type. Again, if they were suns like ours, we would be unable to see them at their distances—40,000 to 400,000 light-years away. The brilliance of a globular cluster, the ordered grouping of thousands of stars around a center, like the jewels in a diadem, is the most impressive view the sky has to offer.

The star clusters have absorbed the attention of astronomers, but no satisfactory explanation has yet been found. One current theory is illustrated in *Fig. 62*. It holds that the clusters—altogether about a hundred—are dispersed over a space twice as large as that occupied by the galaxy. No clusters are seen in the equatorial plane of the galaxy or up to 20° latitude on both sides of the galaxy's equator. Yet this may be only an optical illusion caused by the dark clouds surrounding the system. Most of the star clusters, as seen from our point of view, are concentrated in the region of Centaurus, Ophiuchus and Sagittarius, the direction in which the center of our galaxy is thought to be. Harlow Shapley, who studied the globular clusters with concentrated interest, has expressed the opinion that they may really be located there. Within each globular cluster the distribution of stars is also remarkable. They seem to be arranged in accordance with the ideal distribution of masses so that the globular clusters may be called celestial crystals, each stellar atom represented by a brightly shining star.

The similarity of globular clusters and crystals gives us a feeling of the unity of the universe, but we are completely at a loss to explain why stars form mathematically perfect globular groups, why these groups are found around galaxies everywhere, all of the same size and the same brilliance. Only on the wings of imagination can we fly toward these solitary worlds to learn how a man on a planet in the center of a globular cluster feels, beneath a sky filled with thousands of suns, one as bright as the other, sparkling like diamonds. The human eye would surely be blinded; the first glimpse would be the last.

The "Universe"

T *A Hundred Million Galaxies*

THE MILKY WAY, the "island-universe" which is our home in space, is but one of innumerable galaxies drifting like snowflakes through the void of the universe. The nearest of the "outergalactic systems" is seen on clear nights by the naked eye as a tiny glimmer in the constellation Andromeda and is therefore called the nebula in Andromeda. Photographed with a telescopic camera the "nebula" reveals its true nature and thereby we learn how inappropriate the term nebula is. It is like calling Chicago a "mist" just because at night and from a distance we see it as a glimmering haze.

The Andromeda system is a spiral of stars very much like our own galaxy. If there were intelligent beings gazing into the sky from the nebula in Andromeda, they would see our Milky Way as a tiny spot as inconspicuous as the nebula in Andromeda is in our sky.

It seems as if the Andromeda nebula is a sister system of our own. It is almost identical in size, mass and structure. Its spiral arms rotate around the center; the spectra of its stars are similar to the spectra of our stars; the distribution of the stars seems to be the same. Even the two Magellanic clouds and the flocks of globular clusters are there. When we gaze at the nebula in Andromeda, we are gazing at our twin sister born five billion years ago of an unknown mother.

We have learned more about galactic structure from the nebula in Andromeda than from our own Milky Way, because it affords us the opportunity to study a galactic system from the outside. Powerful telescopes in combination with photographic cameras, spectroscopes, bolometer and other devices have furnished us with basic information about the general structure of spiral galaxies. (*Fig. 59*)

A typical spiral galaxy is composed of 200 to 400 billion stars and its diameter is between 25,000 and 250,000 light-years. The spiral rotates around a central mass, the nucleus, which is composed predominantly of glowing gases. The nucleus is featureless and does not participate in the rotation of the spirals. The spirals themselves are not simple bands of stars; they twist and fork and intertwine in a rather complex pattern. They seem to be not only separated by dark masses but interwoven with plumes of cosmic dust bordered by blue-white "giants." These young stars are not distributed at random but are as neatly aligned as the beads on a necklace.

We do not know how many stars are obscured by the dark masses of a galaxy. The mapping of the sky by radio will perhaps pierce the obscuring clouds and unravel their secrets. Photoelectric measurements of radiation reveal that the nebula in Andromeda, like our Milky Way, is wrapped in a pall of cosmic dust, which is the fundamental reason that our knowledge of the structure of our galaxy is so limited.

The detectable stars are not evenly distributed over the systems. The young and strongly radiating "blue giants" are found mostly in the spirals. The central nucleus of the galaxy harbors the majority of older and less luminous stars, the "red giants." Yet we must remember that over distances of millions of light-years our present telescopes and cameras register only stars which are hundreds or thousands of times more luminescent than our sun. A yellow dwarf star is too insignificant to be noted even as a dot. The spectrogram is more eloquent than direct photography. It reveals that yellow suns are intermingled with the strongly radiating visible stars.

Not all galaxies have a spiral structure. Some are amorphous, like the Magellanic clouds; these are thought to be galaxies in the making, since most of their stars are "blue giants." Yellow or red glowing stars are rare or altogether missing in these embryonic galaxies. The Magellanic clouds also show the first signs of a future arrangement of their masses into spirals. The spiral seems to be the median state of a galaxy. Later on, the spirals fade while the nucleus remains and the spiral galaxy shape is transmuted into an elliptic disc. Chaos, spiral, disc are probably the three stages in the life story of a galactic system—a thesis which seems to be justified by the fact that the chaotic galaxies consist predominantly of gas and cosmic dust in the form of clouds; the spiral galaxy is rich in stars of high temperature and the space between the stars is pervaded by dust and gases floating between the stars. The elliptic galaxies have no dust at all; their stars are mostly stars of lower temperature and it seems as if these elliptic galaxies represent a rather stable and final stage.

The distances between the galaxies are 1,000,000 light-years or more. According to present estimate the nebula in Andromeda is about 1,500,000 light-years away.

If a man on one of its planets were to look at our earth, he would see the earth as it was 1,500,000 years ago. With a super-telescope he might at this very instant gaze at our landscapes and insert in his log book: "No sign of civilized beings at all"—true for him.

We, too, see the Andromeda galaxy not as it is today but as it was 1,500,000 years ago. We do not see it where it is now but where it was then. We do not know where it is today. Our instruments inform us only that 1,500,000 years ago the Andromeda system was approaching us at a speed of 300 km/sec. Man on earth has not the slightest reason to be frightened. Who knows whether the system exists at all today or whether it is traveling at the same speed? Even if it is, the *light* from the Andromeda system that we receive today took 1,500,000 years to get here. The system itself moves only one-

thousandth as fast. During the time the light took to reach us, the galaxy at most could have moved only one-thousandth of the distance nearer, or 1,500 light-years. It is as if two ships 3,000 miles apart had moved a mere 3 miles closer to each other. Even if the Andromeda galaxy flew constantly toward us, it would take 1,500,000,000 years to get "here." In the meantime, we ourselves would have been traveling for 1,500,000,000 years. But it is highly improbable that the Andromeda nebula approaches us in a straight line. Heavenly bodies fly in curves. At times they come nearer, only to recede later on, as the planets around us do. There is more reason to fear being hit by a stone catapulted from a volcano in Mexico while you are sitting in Boston or Chicago, than to lose sleep over danger from the Andromeda nebula.

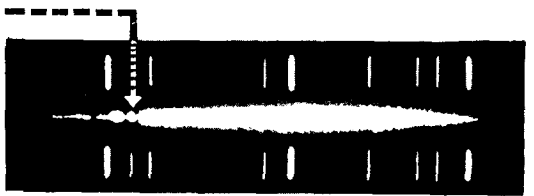

VIOLET **RED**
Spectrum of galaxy in the constellation Virgo; distance 10,000,000 light years; the red shift indicates a recession of 1,000 km/sec.

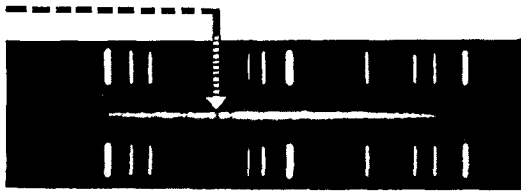

Galaxy in Corona borealis; distance 150,000,000 light years; recession 20,000 km/sec.

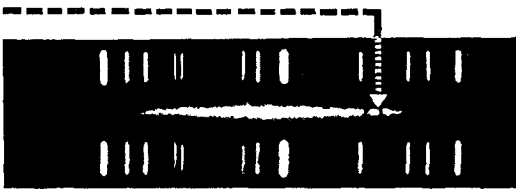

Galaxy in Hydra; distance 350,000,000 light years; recession 60,000 km/sec.

Fig. 63.

THE THEORY OF THE RECEDING GALAXIES

The lines in the galaxies' spectra shift to the red side as the galaxies recede from the earth. The strong vertical lines of the three photographs are the lines of glowing helium. The dark lines in the faint horizontal spectra of the galaxies (*arrows*) are the lines H and K of calcium.

The Milky Way, the Magellanic clouds, the nebula in Andromeda, a spiral of stars in the Triangle and about ten smaller systems, among them the Sculptor and the Fornax systems, form a group that is concentrated in a relatively small cube whose sides are 3,000,000 light-years long. Outside of "our" group a distance of more than 3,000,000 light-years must be crossed before the next group is reached. Up to now, about fifteen such groups have been discovered. The largest is 120,000,000 light-years away and is composed

of more than 1,000 galaxies crowded together in a cube whose sides are 20,000,000 light-years long.

The great mirrors set up on top of the mountains in the clear air of Southern California proved veritable deep-sea nets in exploring cosmic space. Just as the Challenger Expedition in the nineteenth century brought amazing creatures out of the depths of tropical seas, so in California, miracle eyes found more and more unsuspected galaxies, the deeper they penetrated into space—each galaxy thousands of light-years in diameter, each a cosmic system of billions of stars. If we divide the sky into windows the size of the moon, the telescope can find 1,000 galaxies in each windowpane. Photographs with more than 10,000 such galaxies on one plate have been made.

The giant telescope at Palomar cannot reach far beyond a distance of 2,000,000,000 light-years, because sensitive film cannot be exposed for an unlimited time without turning gray. However, Einstein's computations on the relationship of mass and space lead to the assumption that our universe should have a diameter of 7,000,000,000 to 8,000,000,000 light-years. If we assume that the island universes are distributed equally, we arrive at a figure of 1,000,000,000 galaxies, each composed of 200 to 500 billions of stars, each star a sun 1,000,000 times as large as our earth. And on the earth—you and I.

The Hypothesis of the Exploding Universe

Edwin Powell Hubble was the fortunate man whom fate placed on the captain's bridge of the great Californian optical spaceship which opened the offensive against the galactic islands in the vast ocean of cosmic space.

Mustering the spectra of the extragalactic nebulae, he noticed that 80 per cent of them showed a displacement of their lines toward red. By "classic" interpretation, this would mean that the universe-islands are moving away. When he compared the degree of shifting with the distances of the galaxies, it became apparent that the farther away the galaxy, the greater the shifting of the spectral lines, meaning that the farther away the galaxy, the faster it is receding into space. (*Fig. 63*)

The speed increases about 180 km/sec with every million light-years of distance. The nearest galaxies, 1,500,000 to 2,000,000 light-years distant, travel mostly at 125 km/sec; those 4,000,000 light-years away, at about 500 km/sec; those at a distance of 6,000,000 to 8,000,000 light-years, at about 1,000 km/sec. At a distance of 50,000,000 light-years, the rate is 10,000 km/sec. The most remote objects of which a spectrogram can be made is a group of galaxies estimated to be 360,000,000 light-years away, and the displacement of their lines implies a speed of more than 60,000 maybe even 100,000 km/sec.

Science advances by two stages: first, a fact is discovered; thereafter, it

must be explained. The second task is by far more difficult and more hazardous. After the discovery that the universe is populated by a billion galaxies and that these galaxies are spreading out in space, scientists began to speculate about their origin and their goal and the forces which cause them to speed through space. More and more hypotheses have been promulgated. None of them, however, is regarded as definitive.

The first theory to explain the red shift was the theory of the fatigued light ray. The farther light travels, the more energy it loses; its waves become longer and the lines of the spectrum shift toward red. Cosmic space is not empty; about 20 per cent of the universe's mass is scattered throughout space as "interstellar matter." One cubic meter of cosmic space is thought to contain, on the average, from 1,000,000 to 5,000,000 atoms of hydrogen, 1,000 of oxygen, 2 of sodium, 2 of potassium. A light ray in cosmic space, according to the law of probability, must travel five minutes before it collides with an atom. However, ten or even ten hundred million years is a long time. It is conceivable that vibrations traveling for such a long period would be slowed down. Consequently, the farther away an object is, the more its spectral lines will be shifted toward red.

The theory of the fatigued light ray has lost popularity among the scientists. More and more they became convinced that galaxies move as the spectrograms indicated. The first who was audacious enough to take the motion of the galaxies for granted and to use their movement as the basis for a dynamic theory of the universe was the Belgian astronomer Abbé Georges Lemaître. He started with the statement that the galaxies must move, because a galaxy cannot hang motionless in space just as a stone cannot stay motionless in mid-air over billions of years. They must either strive toward a center by gravitation or expand by a force counteracting and surpassing gravity. Since they disperse, Lemaître proposed the theory of a primordial explosion of a highly compressed and overheated cloud which contained all the mass we see today spreading out in the form of galaxies through the universal space. The creation of the universe, then, was an explosion.

As in every explosion, the parts dispersed at varying speeds. Those that traveled fastest are farthest from the original point of explosion. The slower ones are still near the center. Our galaxy is a fragment that is traveling slowly. The Andromeda system may not necessarily be traveling toward us; we may be flying side by side, with the distance between diminishing every second by 300 kilometers. The question, of course, arises as to how two fragments flying from the center of an explosion can approach one another instead of becoming more and more remote. Yet we have reason to suppose that the movements of the galactic bodies are not straight-lined but are curved segments of spirals. The primordial nuclear cloud could also have been a spiral, swirling around itself at the moment of explosion. (*Fig. 64*)

Judging by the speeds and distances of the fragments, the original explosion must have occurred about 5,000,000,000 or, at the most, 8,000,000,000

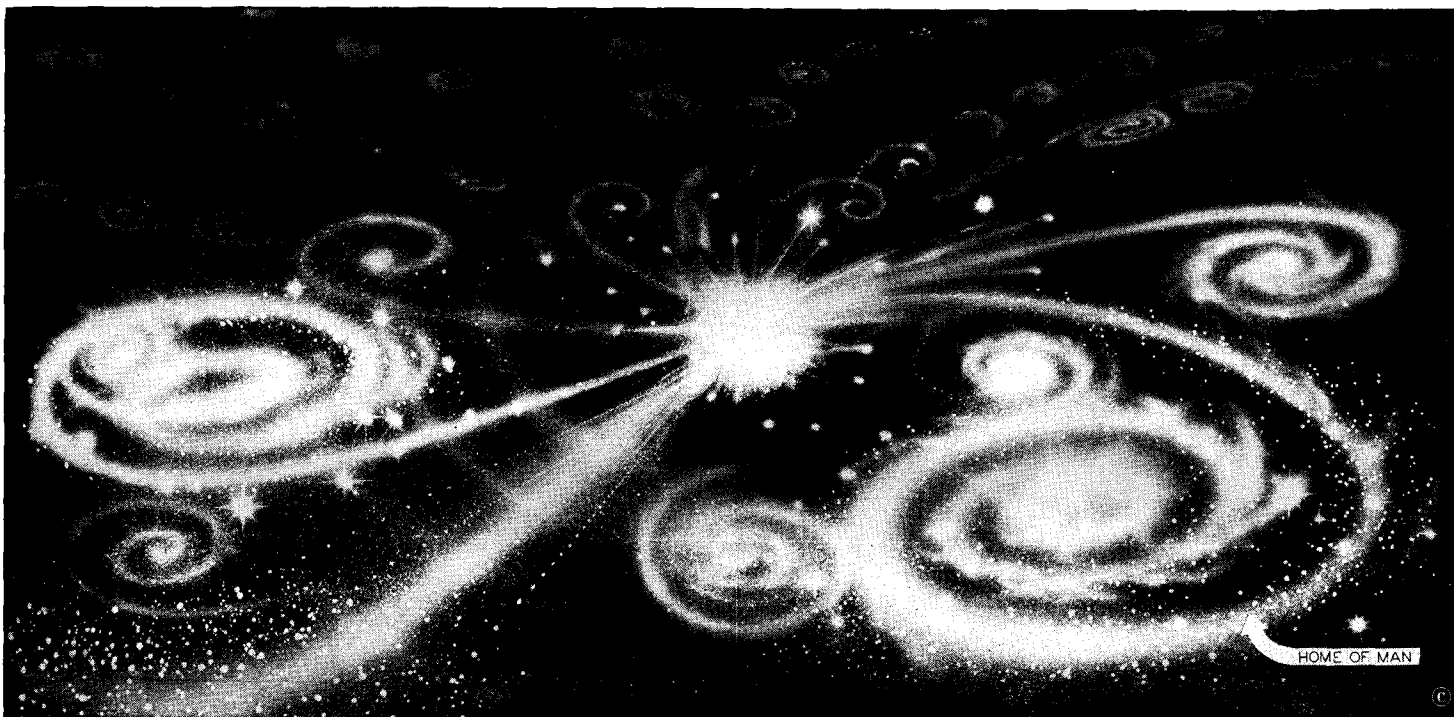

Fig. 64. THE EXPLODING UNIVERSE

The Belgian Abbé Lemaitre expounded the hypothesis that the universe is an exploding mass,

each fragment a galaxy. This idea occurred to him because the galaxies seem to whirl away from a common center.

years ago. From the size of the fragments, we can determine the size the "bomb of creation" must have been. Measured by astronomical concepts, it was not impressively large—a few light-hours in diameter, a cloud of about the size of our solar system.

One might ask: "Where did this cloud come from?" In one of his essays about the origin of the universe the nuclear physicist George Gamow quotes Saint Augustine, who wrote in his *Confessions*: "Some people say that before He made Heaven and Earth, God prepared Gehenna (the Hell) for those who have the hardihood to inquire into such high matters." We must be content that science has led us so far into the past.

Basing his theory on the established fact that matter can be transformed into radiation and radiation into matter, Gamow speculates that in the primordial state of the universe, radiation exceeded matter. There were more photons than mesons or protons. The primordial cloud was a cloud of photons. Its temperature reached into the billions. According to the Scottish physicist Paul Adrien Dirac, at zero hour the temperature of the cosmic cloud was one trillion degrees. Then came the hypothetical explosion. Just as the explosion of an atom bomb creates, in a split second, by fusion and fission radioactive isotopes which did not exist before, so the primordial cloud of photons created in minutes, by a chain reaction, the elements of the present universe. From photons came mesons; mesons combined in an unknown way with other elementary particles, forming protons; protons combined with electrons to form neutrons; they combined into larger groups, forming first protonium or, as we say today, hydrogen; thereafter they became deuterium, then tritium, helium, etc., and the whole row of elements arose up to uranium and the trans-uranian elements—the universe was created.

The physicists give us an exact timetable of the size and the temperature of the growing universe. At the end of ten seconds, says Dirac, the universe had the size of the sun with the mass of our moon. The temperature fell rapidly. According to Gamow, at the age of five minutes the universe had a mean temperature of $1,000,000,000^{\circ}$; after a day it was $40,000,000^{\circ}$, equal to the temperature at the center of the sun or of an atomic bomb; at the age of 300,000 years the mean temperature of the universe was $6,000^{\circ}$ (the temperature of the surface of the sun), and at 10,000,000 years the temperature had sunk to a temperature comparable to that on the surface of our earth today.

The exploding mass spread out and dispersed into different clouds, the proto-galaxies, each one with a diameter of about 40,000 light-years and a mass of about 200,000,000 times our sun. The matter of these clouds condensed into stars and the clouds became galaxies.

Mass, volume, age and temperature of the universe are interwoven. The mass of the universe, says Dirac, is the square of universal time. Dirac uses as a universal time unit the time a light ray needs to traverse the diameter of an electron (10^{-23} second). The temperature of the universe, says Gamow, is

equal to $15,000,000,000^\circ$ absolute temperature divided by the square root of its age expressed in seconds. It sounds like cabala but it is modern science, the science of the mathematical formula. And the idea that the universe (our galactic universe, which may be an insignificant part of a greater one) may have been born by the explosion of a cosmic atom bomb is so strange that the physicists themselves wonder. But they cannot escape their equations.

The late Arthur Eddington, in his time the leading English astrophysicist, trained to think clearly, to reckon coolly, made this admission: "The theory of the exploding universe is in some respects so preposterous that we naturally hesitate to commit ourselves to it. It contains elements apparently so incredible that I feel almost an indignation that anyone should believe it—except myself."

The Hypothesis of the Pulsating Universe

When a mass is formed, a field of gravitation extends outward at the speed of light. This field is called the gravitational field and may be identified with "space." Space is curved. Curves can be either positive or negative. A positive curve comes full circle and completes itself like a ring. A negative curve is similar to a hairpin with the ends spreading out. The space of the solar system has a positive curve, but no conclusion has yet been reached about the curve of cosmic space. If the space of the universe has a positive curve, a ray of light traveling straight ahead would "turn around" after some 20,000,000,000 years and come back from the opposite side, like an aviator who flies "straight ahead" around the earth. A man with the optical power and endurance to look to the "ends of the world" would, in 22,000,000,000 years, see the back of his head. (*Fig. 65*) This is only metaphorical; the "view into infinity" is neither a straight nor a simple curved line. Since everything moves, the space-gazer would no longer be on the same spot after 22,000,000,000 years. Space is subdivided into innumerable curved fields, and his line of vision would be so twisted that its ends would never meet.

In space with a positive curve, objects move closer together optically the farther they are from the observer. Imagine yourself standing under a dome ornamented with evenly distributed stars. The farther away these stars are from your eyes, the closer together they seem. The opposite is true of negatively curved space. The physicist George Gamow draws the following picture. If you stand in a valley and look up at a slope on which trees are evenly planted, the higher they stand, the farther apart from each other they appear to be. The theory that cosmic space may be negatively curved is supported by the fact that the distances between the island-universes apparently become greater the farther away they are from the supposed center of the galactic universe.

Since space is identical with extending gravitational fields around masses, new space appears with new masses. When, during the explosion of the primordial cloud, matter was formed, space, too, was formed. When in a

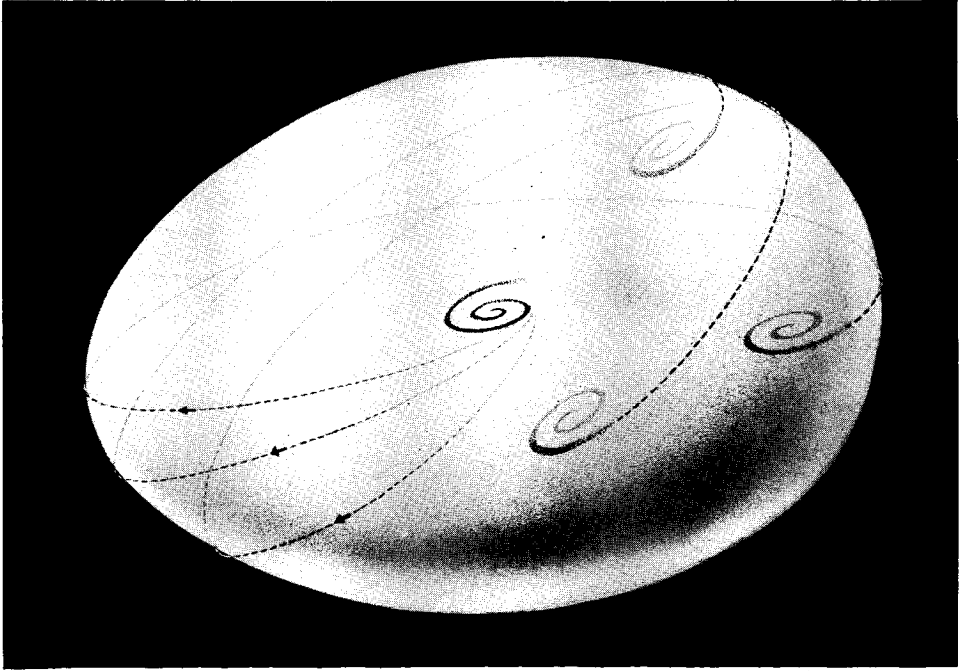

Fig. 65. IS THE UNIVERSE AN ILLUSION?

Since space is said to be curved, the question has been raised whether the light rays may travel "around the universe" and one actual galaxy (*center*) may appear at different points. This idea stems from the fact that some extra-galactic objects are so similar as to seem identical.

later stage the suns started to lose mass by radiation, the fields around them grew weaker, and space diminished. The space of our universe increases or decreases in proportion to the matter in it. There are times when the masses increase and the universe expands. Then come epochs when the masses dwindle, and space does, too. The universe is a sort of organism: it breathes. Each breath takes billions of years. At present the universe is "inhaling" and the space in which the galaxies travel is increasing about 0.000,000,001 per cent every year, *i.e.*, 25,000,000 km/sec.

The increase in mass and space cannot continue indefinitely. Like an oak tree, the universe may some day attain the peak of its growth and the limit of its life-span, which Dirac calls the universal age. As long as the universe is young, more mass is formed than is lost, and it is growing. But there may come a time when the process will be reversed. The galaxies now flying apart will move closer together. An observer who sets up a spectroscope at that time will find a violet shift instead of a red one. The galaxies will re-

turn and crowd together, the temperatures which are at present diminishing will rise, and finally the concentrating masses may condense into a nuclear cloud. When the cloud becomes charged to the point of explosion, the drama will be re-enacted. In the light of this hypothesis, the universe pulsates like a heart. And just as the heart sends 10^{13} blood cells circulating through the body, so the universe propels 10^{20} stars out into cosmic space, sucks them back and once again discharges them outward.

*The Hypothesis of the Continuous
Creation of the "Balanced Universe"*

Two young British cosmogonists, Hermann Bondi and Thomas Gold, later joined by others, have tackled the problem of the receding galaxies from another angle, coming up with an equally attractive theory. Like Lemaître, they begin with the premise that the red shift of the spectral lines is caused by an actual recession of the galaxies, and that the speed beyond the borderline of our present observation is steadily accelerating. However, Einstein's theory maintains that no body can reach the speed of light, since at this point the mass of the moving body reaches the value of infinity. These British cosmogonists believe that after having reached the speed of light the galaxies disappear. They use the metaphor of a pail filled with water, which overflows when the water reaches the brim. They do not try to explain what happens after that. They say only: in losing galaxies, the universe loses mass, and since the universe has a tendency to remain stable, it forms new masses in the same proportion that galaxies disappear over its rim. To maintain stability, each quart of space must produce one electron in a period of 500,000 years. New masses produce their own fields of energy, space. This newly formed space provides the stimulus for the galaxies to move, just as a gushing fountain carries the leaves floating on its surface to the rim of the basin.

So the English version of the universe holds that it loses its galaxies at the outer rim of space, continually rejuvenating itself in the center with new mass. It lives like a tree which sheds its withered leaves from the twigs, regaining new substance and energy from roots and stem.

Present estimates say our galaxy may not fly faster than several hundred miles per second. This is a rather modest pace compared to the mass-destroying speed of light. We are, therefore, still far from the vanishing point. While the hypothesis of the "exploding universe" is rather chilling, the new hypothesis of the English cosmogonists quiets our fears somewhat. We can relax—until the next hypothesis about this uneasy universe rises on the horizon of science.

The Stars of the Galaxies: Suns

T

The Theory of Gaseous Spheres

THE STAR NEAREST US is the sun. It is typical of the average star in our galaxy. Most of them would look like suns if we could see them as close up as we do "our" sun. "Close up" is a relative phrase. There are 150,000,000 kilometers, or 93,000,000 miles, between us and the sun. It would take a fast plane twenty-five years to cover the distance, and 6,000,000 years to get to the nearest neighboring sun.

Knowing the sun's distance from the earth, we are able to figure out the sun's diameter. It is more than one hundred times the diameter of the earth, and three times as long as the distance between the earth and moon, so that the moon's orbit would easily fit inside the sun. (*Fig. 66*)

The sun looks like a disc, but it is actually a sphere which rotates, like the earth, from west to east. The sun spots appear at the eastern edge, move across the sun to the western edge in about twelve days, and if they return at all, reappear about twelve days later on the eastern edge. The "sun-day" is equal to twenty-five days on earth.

The sharp lines of the solar spectrum disclose that the sun is a gaseous sphere. Gaseous spheres are ideal objects for scientific study because they are subject to laws as simple and inexorable as those of atomic physics. Eddington and his co-worker Emden found that the stars follow in detail the laws of gases, a discovery which revolutionized stellar science. The theory of the gaseous spheres, coupled with the simultaneous rise of atomic physics, formed the basis for the new science of astrophysics. The discovery of the atom was as revolutionary for astronomy as that of the cell sixty years earlier had been for biology and medicine. It was no small surprise to the world of 1920 when it received the wedding announcement of "star and atom." Since then the unequal partners have become a familiar couple.

A sphere of gas, according to the theory of the gaseous spheres, must contain a certain number of atoms. Small gaseous spheres do not exist because, lacking sufficient mass, their gravitational force is too feeble to hold the atoms together. Gaseous spheres produce heat as a result of the collision of their atoms or molecules, constantly moving toward the center of gravity. The energy of impeded motion is transformed to heat. (*Page 75*) Small gaseous spheres cannot maintain their temperature. They lose more warmth than they

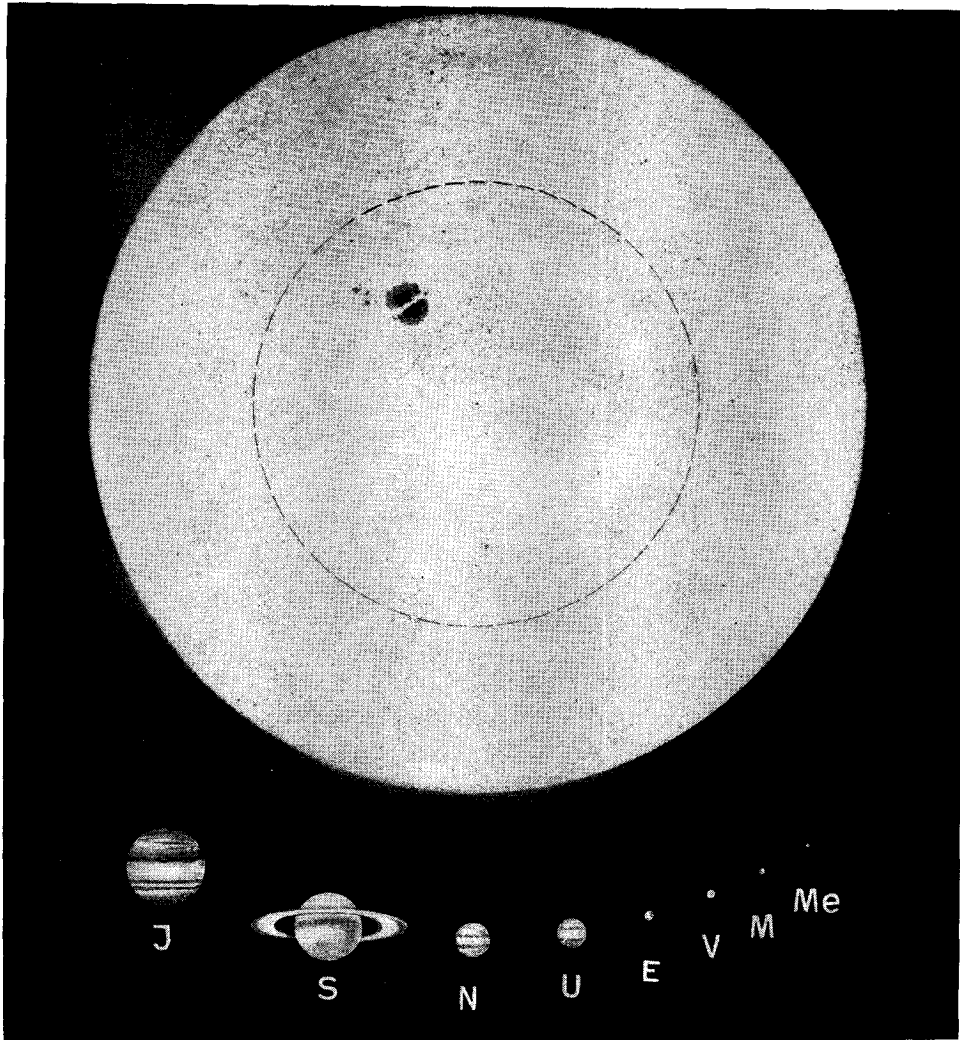

Fig. 66. RELATIVE SIZE OF SUN AND PLANETS

Although our sun is among the smaller stars (*Fig. 69*), it is gigantic in comparison with the planets. The circle inside the sun is the orbit of the moon.

are able to produce. A big gaseous sphere loses comparatively little heat because the radiation from the core cannot easily penetrate the enormous number of overlying strata. On their way to the periphery, the heat waves encounter innumerable atoms. These start to move and, in turn, send out secondary waves in all directions, thus heating up the solar mass. The trip to the surface is believed to take about 10,000 years. How paradoxical! The wave of sunlight arriving on earth took but eight minutes to reach us over a distance of 150,000,000 kilometers; its ascent, however, from the center to the surface of the sun took 10,000 years!

There is a limit to the mass of a gaseous sphere. If the resistance to the heat waves becomes too great to let them escape, the temperature inside the ball rises to a catastrophic degree because radiation exerts pressure. The pressure of radiation mounts to the fourth power in proportion to that of the temperature. When the temperature doubles, the pressure of radiation is 2^4 or 16 times greater. At 1,000,000° of heat the radiation presses against each square inch with a force of 150,000 pounds. At the point where the pressure of radiation (which pushes outward) becomes stronger than the force of gravitation (which pushes inward) the star explodes. Therefore, while from time to time we see a star exploding in the universe, we never find one with a mass greater than 1,000 times the mass of our sun. Like organisms, stars have a limit, we could almost say a biological limit to their growth.

*The Theory of Helium Synthesis
As the Source of the Sun's Energy*

The volume of the sun is 1,300,000 times that of the earth, but its mass is only 333,000 times as much, and is therefore only one-fourth as dense. On the surface the atoms are thinly spread out. About halfway to the center the density reaches that of water. In the center itself the matter is 76 times as dense as water, the gas pressure that of 100,000,000,000 atmospheres, and the temperature approximately 25,000,000°.

The earth is 150,000,000 kilometers away from the sun. Since we know the surface area of the two bodies, we can calculate that not more than 0.000,000,000,000,5 per cent of the sun's radiation falls on the terrestrial globe. Every square yard of the sun's surface radiates approximately 1,000 kilowatts of energy per second.

The gravitational movement of atoms toward the center is not enough to produce this energy. Other sources of heat, such as cosmic bodies falling into the sun, must contribute. But even an enormous influx of them would contribute only a negligible percentage of fuel for the solar furnace. Unable to arrive at a satisfactory explanation, the scientists of the nineteenth century prognosticated an ominous finale. The sun was cooling off, and the "inevitable" day would come when its radiation would no longer melt winter ice or run the great chlorophyll machinery of plant life through the seasons. The dire "end of the world" was circled in black on the last page of humanity's calendar.

Then along came the Atomic Age and one of its early fruits was the theory of the energy-providing synthesis of helium in the interior of the sun. The theory, created by the two physicists Weizsäcker and Bethe, is one of the masterpieces of modern astrophysics. (*Fig. 67*)

The temperature in the interior of the sun is presumably around 20,000,-

000°. At so high a temperature all atoms are ionized and reduced to nuclei. The nuclei found in the sun are those of the first simple elements: hydrogen H, carbon C, oxygen O, nitrogen N. The nuclei of the first element, hydrogen, are predominant, being identical with protons. According to the law of probability, at a temperature of 20,000,000°, a flying proton will invade the nucleus of the carbon atom C about every 2,500,000 years. The

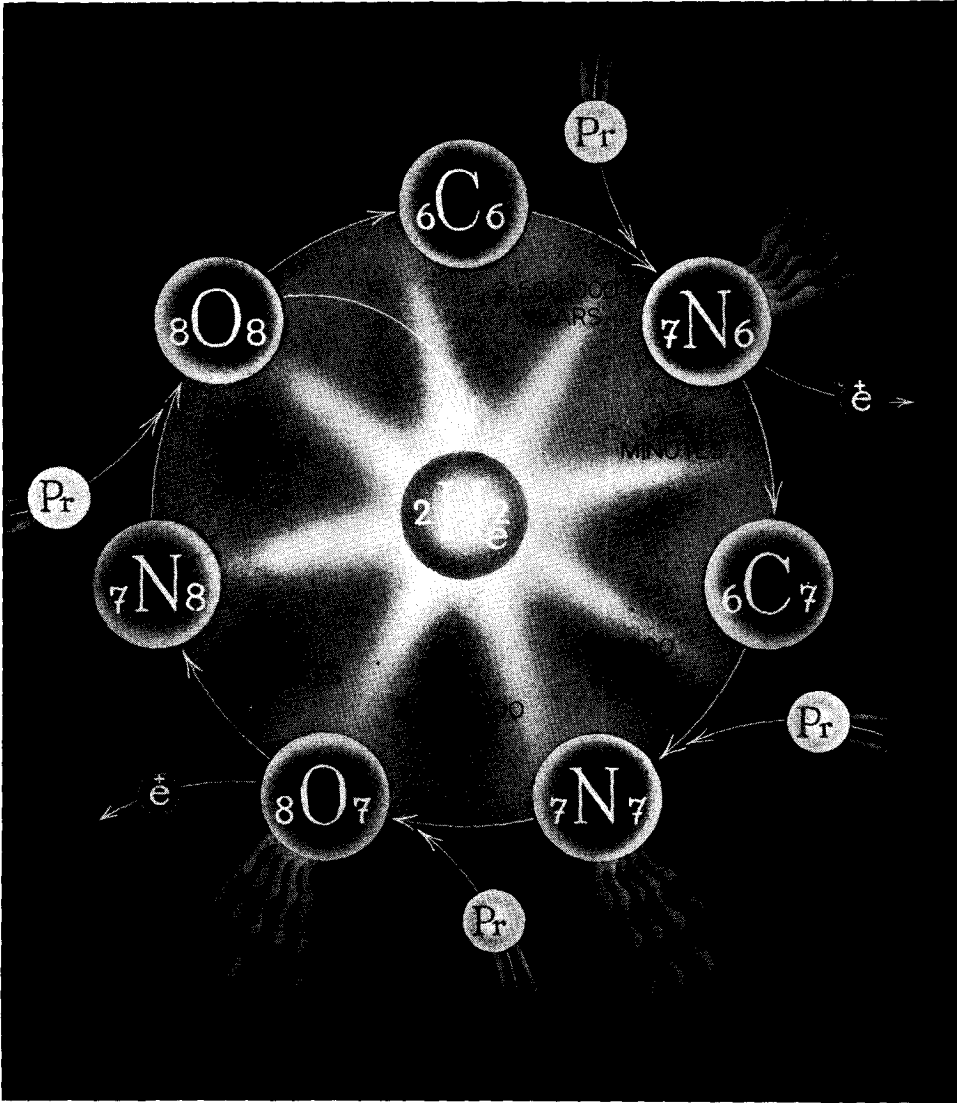

Fig. 67. PRESENT THEORY ABOUT THE ORIGIN OF SOLAR ENERGY

In the interior of the sun, protons, Pr, enter nuclei of carbon, C, and start a chain reaction. Carbon is transformed into nitrogen, N, and later into oxygen, O, finally a nucleus of helium is released. Each chain reaction lasts about seven million years.

carbon nucleus contains 6 protons and 6 neutrons expressed by the formula ${}^6_6\text{C}$. If one proton is added, ${}^6_6\text{C}$ turns into ${}^7_6\text{N}$, nitrogen. ${}^7_6\text{N}$ is not normal nitrogen, ${}^7_7\text{N}$, but an unstable light isotope. The 6 neutrons are unable to hold 7 protons together. One proton gives up its electrical charge and changes into a neutron. One proton less and one neutron more results in:

$$\begin{array}{r} {}^7_6\text{N} \\ -1 \quad +1 \\ \hline {}^6_7\text{C} \end{array}$$

The nitrogen has thus been transformed, not into normal carbon, ${}^6_6\text{C}$, but into a "heavy isotope" of carbon, ${}^6_7\text{C}$.

According to the rule of probability, 50,000 years will now pass before this carbon nucleus is struck by another of the protons shooting around and is transformed into nitrogen:

$$\begin{array}{r} {}^6_7\text{C} \\ +1 \\ \hline {}^7_7\text{N} \end{array}$$

After another 4,000,000 years or so, the next proton comes along and lodges in the nucleus of ${}^7_7\text{N}$:

$$\begin{array}{r} {}^7_7\text{N} \\ +1 \\ \hline {}^8_7\text{O} \end{array}$$

The result is oxygen, but not in its normal form. Therefore, one proton changes into a neutron, emitting an electrical charge and radiation:

$$\begin{array}{r} {}^8_7\text{O} \\ -1 \quad +1 \\ \hline {}^7_8\text{N} \end{array}$$

${}^7_8\text{N}$, the heavy isotope of nitrogen, accepts a flying proton fairly easily. In the course of the next twenty years, it becomes:

$$\begin{array}{r} {}^7_8\text{N} \\ +1 \\ \hline {}^8_8\text{O} \end{array}$$

Under the powerful impact of the flying proton, this nucleus of normal oxygen expels a group of four particles: 2He , helium.

$$\begin{array}{r} {}^8_8\text{O} \\ -2\text{He} \\ \hline {}^6_6\text{C} \end{array}$$

Through the loss of 2He the initial nucleus of the carbon atom is restored, and the process begins again.

This is only the framework of the story. If we balance the above accounting, we discover that these transformations are accompanied by minute but

important "binding losses." The four separate protons which have flown into the nucleus weigh four times 1.008, or 4.032 mass units. But the helium nucleus that has been built out of them weighs only 4.003 mass units. During the process 0.029 mass unit has been lost in the form of radiation.

According to the formula $E = m \times c^2$, this amount of matter, lost by the formation of a single helium atom, corresponds to 600,000,000 calories of energy—enough energy to bring 6,000,000 quarts of water to the boiling point. If solar radiation were produced solely by helium synthesis, the sun would suffer a loss of 240,000,000 tons every minute—a figure that may well strike terror into the heart of the man who carries home his one-pound loaf of daily bread. But the sun contains two times 10^{30} kilograms of mass. During a whole century of manufacturing helium it would lose only 0.000,000,001 per cent of its mass. Thirty billion years would have to elapse before the inhabitants of earth could notice a lessening of solar radiation—and the whole universe is only 7 or 8 billion years old.

Helium as one of the "rare gases" does not participate in chemical processes and, therefore, it does not absorb radiation. As the content of helium in and around the sun increases, the heat under the blanket of this inert gas rises proportionately. With the rise in temperature the nuclear processes become more energetic, new kinds of nuclear transformations are started and add to the heating of the sun.

Scarcely has the ghost of "death in ice" faded behind the horizon of man's hypochondria, when a new nightmare appears of an earth parched by the pitiless rays of a scorching sun. So the pendulum of science swings to and fro between the theory of yesterday and the theory of tomorrow.

The Hectic Life of the Sun

The chief instrument of solar research at the present time is the spectroscope. No one who is not familiar with this special field can realize the vast amount of intellectual energy expended on the study of the seven colors of the rainbow's band. When the Englishman Wollaston brought out the first treatise on the solar spectrum in 1802, he listed seven lines. Twelve years later, when Fraunhofer traced the sun's spectrum with his improved instruments, he described more than 500. Today more than 25,000 visible lines have been classified and, in addition, more than 3,000 invisible ones.

The composition of the sun's "atmosphere" is very similar to that of the earth as far as the ratio of the gases goes. Yet while the earth's atmosphere is composed of about 79 per cent nitrogen and 20 per cent oxygen with 1 per cent helium and 0.03 per cent carbon dioxide, the sun's atmosphere contains about 79 per cent hydrogen, somewhat less than 20 per cent helium and 0.03 per cent oxygen. Beside them are traces of metals like iron, aluminum

and nickel and elements like carbon, silicon, sodium, potassium, calcium. The large radioactive atoms are lacking. In addition to free atoms, there are simple compounds, some of which are no longer found on earth: CN, CH, NH, OH, CaH, MgH, SiH, FeO, but they number only 1 among 10,000 atoms.

The principal source of solar radiation is a layer called the photosphere, from *photos*, the Greek word for light. Its depth is estimated to be 300 kilometers. (Fig. 68) The photosphere is the only layer visible to us. The 700,000 kilometers below the photosphere are too dense to be recognized; the 15,000-kilometer-high chromosphere above is too transparent and the same is true of the corona, which extends to a height of several million kilometers.

The photosphere appears granulated on photographs (Gr.). Though these grains have a diameter up to 700 miles, they are short-lived, lasting but a few minutes. For this reason the papal astronomer Secchi, one of the outstanding figures in solar research in the middle of the last century, compared them to "grains of rice bubbling in a milky fluid." It is assumed that hot gases rise from deeper layers, cool off and then fall back, like the waters of a fountain, and the "grains" are the crests of these gaseous fountains. Despite the photosphere's strong radiation, its bottom or innermost layer, the so-called reversing layer, is 200 times thinner than our atmosphere at sea level.

Above the photosphere is the chromosphere, so termed because it appears colored during a solar eclipse. The pressure of the gases decreases with the distance from the sun's core, and at the outer edge the chromosphere is 10^{13} times finer than our atmosphere at sea level.

But this is still not the end. The outer part, called the corona, changing in visibility with the fluctuation of the sunspots, extends from time to time to a height of several times the diameter of the sunball itself. The height of an atmosphere depends on three factors: the weight of its atoms, the gravitational force which draws the atoms downward, and the temperature which drives them against the force of gravity. These factors reveal that the corona must have a very high temperature, more than a hundred times higher than the surface of the "well-tempered" sun. One is at first inclined toward disbelief, but facts are stubborn. The atoms in the corona move at speeds of 9,600 km/sec, corresponding to a temperature believed to be more than 1,000,000°. The discovery of this supra-solar heat has solved the long-disputed question of the red and green lines spoken of as "corona lines." They were unmasked by Swedish astronomers as lines originating from strongly ionized atoms, specifically atoms of calcium, iron and nickel, lacking 13, 14 and 15 electrons respectively. Without the infernal heat of the corona, it would be impossible to lift more than a dozen electrons from the orbits of the nuclei of iron and nickel atoms. The presence of these heavy atoms confronts us with the next riddle: what forces bring these heavy atoms of iron and nickel out of the sun's interior?

Corona

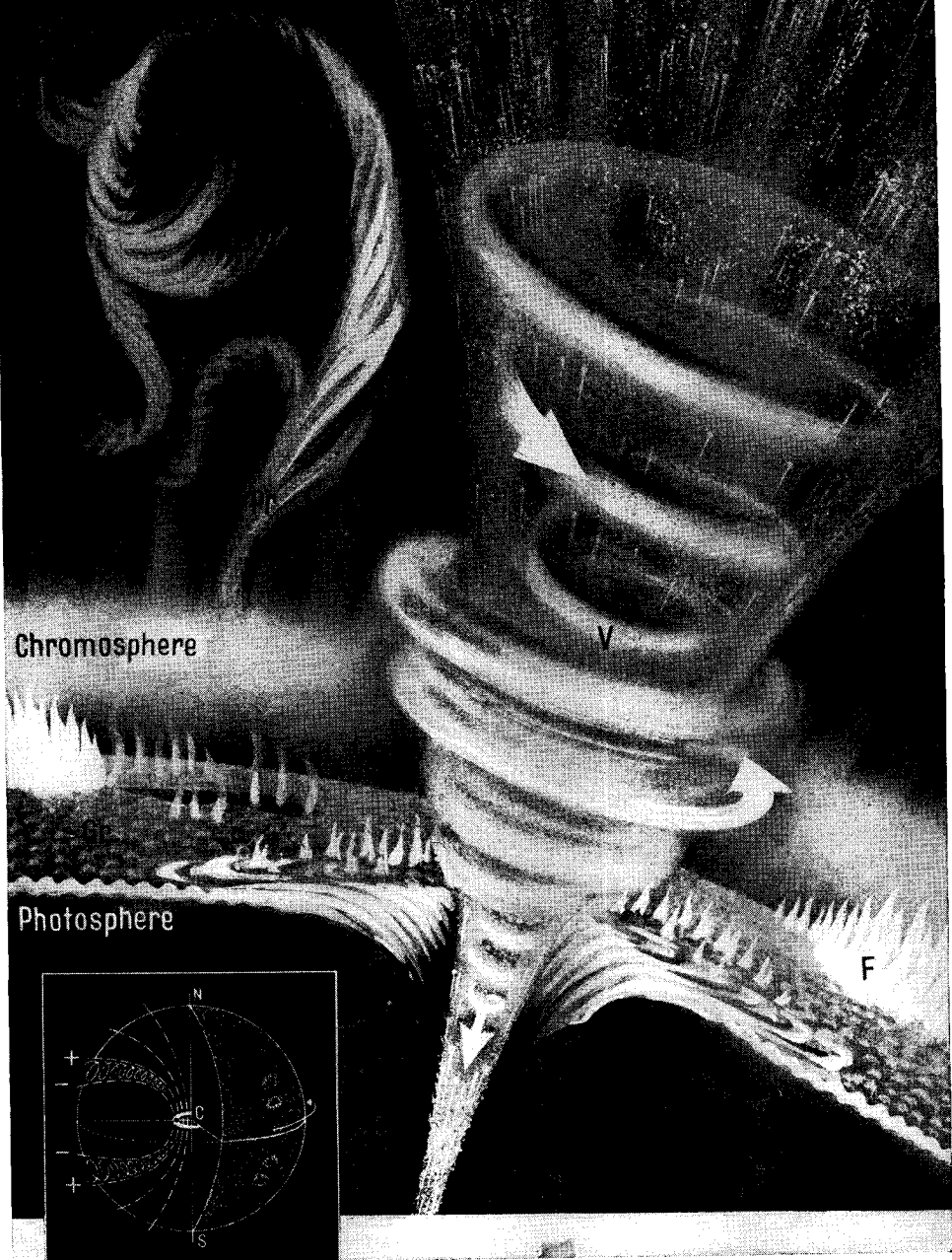

Fig. 68. SURFACE OF THE SUN

The surface of the sun is a sea of fire (F). Grains bubble up (Gr), fiery fountains rise (Pr), vortices erupt (V). Seen on earth, they appear as sunspots. The diagram at the lower left illustrates a theory of Swedish astronomers about the origin of sunspots.

The only conceivable answer seems to lie with the sunspots. Their rising gases may transport the heavy atoms from the inner layers of the sun. The magnetic fields generated by the sunspots may function like the cyclotrons in our laboratories and carry the atoms up into the heights of the corona.

Sunspots are manifestations of "volcanic eruptions," yet far different from volcanoes on earth. They look like spots because the craters are less radiant than the surrounding areas. (*Fig. 68*) Their temperature is about $1,000^{\circ}$ lower than the unbroken surface. Glowing gases rise in them at speeds of half a mile per second, and are dispersed sideways in spirals. In the vacuum thus formed along the axis of the vortex, gases travel downward from the higher layers, moving about twice as fast as the rising gases. These rising gases, mixed with heavy metals such as iron, are probably the gaseous elevators which carry the heavy atoms up to the "top of the sun." The gases sucked downward consist of light elements such as hydrogen.

Sunspots are not simple eruptions. They are the result of complex processes originating deep within the sun's interior (*see small diagram in Fig. 68*). All theories on the sunspots have to consider the following facts: The spots do not appear haphazardly; they are never seen at the poles or at the equator, but always break out at approximately the 30th degree of latitude on both sides of the equator (where the signs + and - are found on the diagram). From here they move slowly toward the equator, but do not reach it. They develop as they move, attaining full growth when they are in about the middle of their course. When they reach the 5th degree of latitude, they vanish. The spots appear first in pairs, a few degrees apart in longitude, and often on either side of the equator. One spot is positively charged (+), the other negatively (-).

Working with these facts, Swedish astronomers have presented this latest theory: A magnetic disturbance develops in the center of the sun (C). It divides into two eddies which repel each other and move toward the surface in the form of a horseshoe magnet, one pole on each side of the equator. This journey to the surface can be seen on the left side of the diagram. When the horseshoe magnet reaches the surface, it pierces the sun's gaseous cover, and two corresponding sunspots appear at 30° latitude, north and south of the equator.

The spots do not appear without premonitory signs. Days in advance, their coming is heralded by unusually hot radiation at the place where the eruption will later occur. The radiation is accompanied by the outbreak of flame-like incandescent projections, the prominences (*Pr*). These are glowing gases of calcium rising up a million kilometers and remaining afloat for weeks. Then huge upheavals of glowing masses spring up from the fiery ocean of gases and die down after several minutes or hours. The surface bursts; after which we look through the open crater *V* (vortex) and the area of the eruption manifests itself to us as a dark spot on the face of the sun.

A few spots are almost always visible, but their number increases in

intervals of about eleven years. The climax lasts two to three years, and then the solar activity returns to normal. Hence we speak of an eleven-year period. More accurately, we should speak of a twenty-three-year period, for the magnetic charge of the sunspots alternates from one eleven-and-a-half-year period to the other. If, in one period, the spots on the northern hemisphere of the sun are positively charged and those on the southern hemisphere negatively charged, the reverse will be true in the next period.

The solar eruptions are accompanied by magnetic fields which manifest themselves as splitting of the spectral lines. Disturbed by the agitated area, the entire magnetic field around the sun, the field in which the planets float, vibrates. Sympathetically, magnetic needles on the earth begin to tremble, and magnetic storms disrupt telegraph communication and radio reception. This is because the ionosphere, which reflects radio waves as a mirror reflects light, becomes distorted, thus distorting the "tone-images." Migrating birds lose their way, seemingly confused by magnetic sensations; hailstorms and thunderstorms play havoc with the atmosphere.

Whole cannonades of electrons shoot out from the depths of the solar crater. Their trip to the earth takes about thirty hours. As they approach the terrestrial globe, they head for the poles, along the magnetic lines. There they disturb the atoms of the atmosphere, rob them of electrons and light up the gases like neon lamps. When the Northern Lights glow on the horizon, you will know the sun is shooting electrons at us with the machine-guns of her sunspots.

Not only do the electrons penetrate the atmosphere, they pierce our skulls as well. The claim has been repeated again and again that they cause magnetic storms in the brain; that people become irascible and quarrelsome; that the numbers of suicides, crimes and divorces go up and down with the number of sunspots. In spite of endless discussions and entire volumes crowded with "careful" statistics, no unanimity of opinion about such a relationship has been attained. It is still an open field for romantic ideas as well as sober calculations.

Stars: Spheres of Glowing Gases

Physical and Chemical Properties of the Stars

IN VIEWING the panorama of the sky, the beginner almost inevitably falls into two errors. First, he believes he is seeing "countless" stars; in reality he sees only from 3,000 to 6,000. Second, he identifies the bright ones as "great stars" and the weaker ones as small. This, too, is an illusion. Sirius seems so brilliant only because it is one of the stars nearest us. Actually, Sirius is a bright star, shining thirty times stronger than the sun. But Deneb in the Swan, which is far more luminescent than Sirius, seems to our eyes much weaker, for it is fifty times farther away.

In order to compare the stars on an equal basis, the astronomer theoretically moves all stars to an identical distance of $32\frac{1}{2}$ light-years from the earth. From this hypothetical place Sirius would appear as faint as Deneb does now; Deneb would shine brighter than any star now in our sky; the sun would dwindle to a point as faint as the "Little Rider" above Mizar in the Great Bear.

The chemical composition of all stars is so similar that there can be no doubt as to their common origin and close relationship. Since the first two elements, hydrogen and helium, are predominant, we may define stars as spheres of glowing gases composed 80 per cent of hydrogen and 15 per cent of helium. $H + He$ is the simple formula of a star.

When an atom is heated, its electrons widen their orbits and leave the atom in increasing numbers. Thus the structure of the atoms becomes simplified, the leaps of the electrons decrease in number and the lines in the spectrum decrease too. The number of spectral lines varies in inverse proportion to the temperature of the star.

The first attempt to classify stellar spectra was undertaken by the American astronomer Henry Draper, who divided them into twenty-seven types, and labeled the most important with the letters of the alphabet from A to Q. This arrangement, called the "Harvard Classification" for the observatory which brought it out, has been generally accepted. It has been shortened for daily use, errors have been corrected and the sequence changed. At present the sequence is: O, B, A, F, G, K, M, R, N, S.

Every class is subdivided into ten types: $B_0, B_1, B_2, \dots, B_9$. Thus there are 100 compartments into which every spectrum of a star can be filed, just as in a card index. When a star is labeled spectral class M_6 , an astronomer can

visualize it as clearly as a zoologist does a particular animal on reading the words *Hydra viridis*.

Starting with the hot stars, which are about $40,000^\circ$ on the surface, the classification runs the gamut down to the coolest visible stars, those with a temperature of about $2,000^\circ$. The Harvard Classification begins with the spectra of the hottest stars which show only the simple lines of the first two elements, hydrogen and helium. As the temperature decreases, more and more electrons are added to the atoms, and more and more lines appear. When the temperature is down to $7,000^\circ$, the photosphere contains ten different atoms up to calcium. At $6,000^\circ$ the multicolored solar spectrum appears and the number of gaps (Fraunhofer lines) increases, for the atmosphere of the star becomes so rich in various atoms that a considerable portion of the light waves is absorbed and gaps replace the color lines.

The temperature of a star, in addition to being investigated spectroscopically, can be estimated by the color of its light. Red stars are cool, averaging $2,000^\circ$ to $4,000^\circ$ on their surfaces; yellow stars like our sun have a moderate temperature of about $6,000^\circ$; white and blue-white stars are two or three times as hot. If two stars show similar spectra but dissimilar brightness, they differ either in size or distance. If the distance is known, the size can be figured out, and vice versa.

From the four factors of temperature, distance, brightness and size, the mass can be determined. In gaseous spheres the mass is limited to a relatively narrow range. Ninety per cent of all stars have a mass not smaller than one-tenth and not larger than ten times the mass of our sun.

If a cosmic cloud contains too few atoms, it cannot form a stable sphere. If the number of atoms rises above a crucial limit, the gravitational pressure becomes intolerable and the atoms in the central part of the sphere are crushed. Then nuclear reactions start and produce radiations so strong that their pressure overwhelms the gravitational forces and the star explodes. With 10^{56} atoms, our sun is average in mass. A star several hundred times as massive as our sun could not exist. At one time the astronomers found a star which seemed to have this impossible mass. Promptly they announced it could not be a simple star. Sure enough, this unusual object, on closer investigation, turned out to be a group of four stars revolving around each other.

In contrast to the narrow limitations of mass and temperature, the density of gaseous spheres may differ over a wide range. Density is mass per unit of volume. The relation between mass and volume is well illustrated by the drop of soapy water which can be blown up into a balloon-size soap bubble, or by the smoke of one cigarette which can permeate a whole room. In each case it is not the mass but the density that has changed. There are giant stars inflated to diameters of 1,000,000,000 miles, like one in our neighborhood, Epsilon Aurigae, so that our planetary system from sun to Saturn could be placed in one of them. (*Fig. 69*) Other "giants" not quite as gigantic but half this size are Rigel, Aldebaran, Betelgeuse, Antares and Capella. The gas

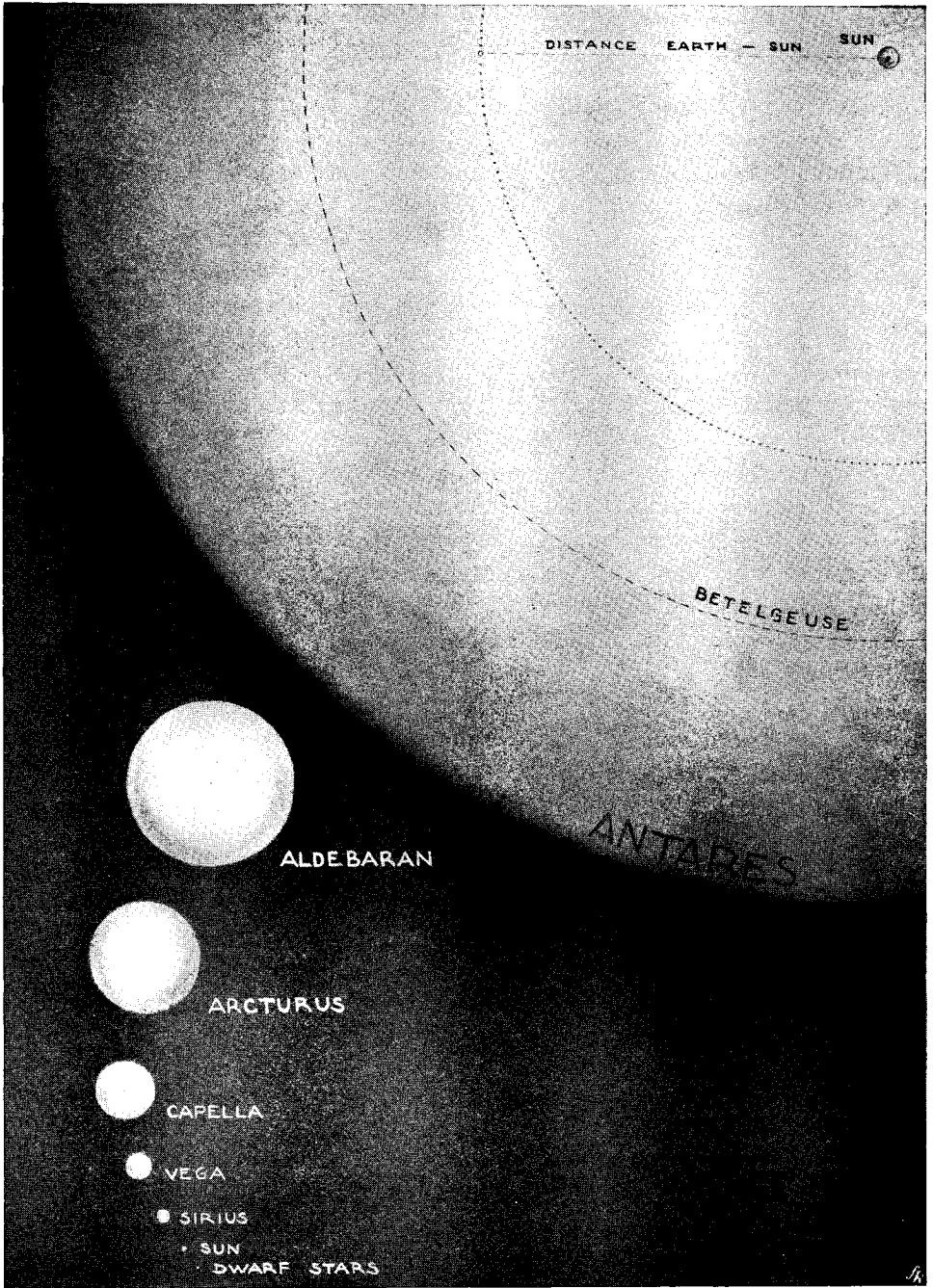

Fig. 69. THE SIZE OF STARS

Our sun, a million times larger than the earth, is almost a dwarf among the stars. Giant stars such as Betelgeuse and Antares are so large that the inner half of the solar system from the sun to Mars could be placed inside them.

of these giant stars is spread out so thinly that a visiting space traveler could fly right into one of them without being aware that he was deep inside a star.

If, on the contrary, the mass of a star is condensed to the utmost, the star becomes a "dwarf." The smallest of the dwarf stars are not much larger than our moon. The companion of Sirius has a diameter only $3\frac{1}{2}$ times that of the earth, yet its mass is 330,000 times more; its density is 50,000 times that of water. Another dwarf even denser is the Van Maanen star at a distance of 13 light-years. The smallest found to date is a star discovered by William J. Luyten. This dwarf, 25 light-years away, is only a trifle larger than our moon and has a volume only $1/30$ of the earth's. It is assumed that a star so small in size must have a very dense mass and that its gravitational force should be correspondingly strong.

Since these stars are dwarfs, we can see only the nearest of them. Although Luyten's star is only 25 light-years away, it shines with no more brightness than that of the 16th magnitude. We can only guess how many of them are dispersed over the wider fields of the sky. Of the fifty stars closest to us, six are dwarfs. If this proportion is typical, an enormous number of dwarfs populate the spirals of the Milky Way.

Small stars are not young, not cosmic "seeds" of stars. On the contrary, they seem to be old. How the transition from youthful normalcy to dwarfed senility comes about we do not yet know, but atom physics gives us clues. Normal atoms consist mainly of empty space. Only when the pressure becomes extreme and the electrons are stripped from their nuclei and the nuclei draw close to each other, does matter become dense. When electrons combine with the protons their negative charge neutralizes the positive charge of the protons and transforms them into neutrons. Since the neutrons do not repel each other, they sink unhindered downward to the center of the star. Thus the star becomes compact with no empty space in and between its atoms—a heavy dwarf. (*Fig. 74, 18*) The friction between the gathering atoms and compressed nuclei generates heat. The temperature rises and, hence, the radiation, too. The star shines brightly as a white dwarf. (*Fig. 74, 21*) Radiation exerts pressure. When radiation pressure surpasses the gravitational forces that hold the star's masses together, the white dwarf will explode. The—hypothetical—neutron-star is an atom bomb of stellar size, a fearful menace to all heavenly bodies near it, especially to its planets and their moons—if any such unfortunate "earth" should rotate in the light of this treacherous sun.

One would expect that the beams of a star which glowed so hotly would cast their light far. But not at all. Gravitational force causes rays of light to deviate. (*Fig. 12*) When gravitation becomes as strong as it does around the compact dwarf, the light rays are bent to such a degree that they cannot leave the star. The rays circle around the star like horses on a carousel and the star becomes invisible.

Not only the dwarf's own light rays but also those arriving from other stars

are bent so strongly by the gravitational field of the heavy star that the dwarf becomes a "collector of light rays" and is wrapped in light. The astrophysicist Fritz Zwicky calls this light-bending star a "gravitational lens." He is so sure of his speculations that he is screening the sky with a spectroscope to detect a gravitational lens floating in cosmic space. His chances are not great, because a bundle of rays which do not leave their nest can only be faint and could be seen only within close range—if it exists at all. Up to now it has appeared on paper only, yet an astronomer looking for a gravitational lens in space is the newest type of explorer of unknown frontiers. Not even a Leverrier or an astronomer as imaginative as Percival Lowell could have dreamed of a seeker of cosmic lenses among his successors.

*The Spatial Distribution of the Stars:
Single Stars, Double Stars, Star Groups and
Star Clusters*

To get an idea of the spatial distribution of the stars, we must look back at *Fig. 61*. The spiral is our galaxy; the circle around our earth, T (Tellus), has a diameter of 10,000 light-years. The white dot represents the earth but it contains much more. It contains the sun, which is almost 100,000,000 miles distant. Then the nearest star, Alpha Centauri, 250,000 times farther away. To reach it we would have to travel with the speed of light for four and a half years. At twice this distance we find Sirius. Altair is double the distance of Sirius, and Aldebaran twice that of Altair. Ten light-years later we arrive at Capella. But we are still far from the rim of the tiny white dot. We would have to travel 800 years at the speed of light, 300,000 km/sec, in order to traverse the smallest unit of this drawing, a point!

The distances between stars are so unimaginable, the abyss of cosmic space so depressingly wide and deep and dark and cold, that there is not the slightest hope that the human mind could bridge it, even in imagination. Stick a pin with a little colored head into the ground. Get into your car and drive straight ahead, let us say 10 miles. Step out. Look around. A second pin should be somewhere. They said: "Ten miles." But perhaps it is in another direction. Or in a third or fourth. How can you hope to find a pin 10 miles away? A third pin is said to be 80 miles from the second. How could anyone find it? This is the superhuman task that confronts a man who would travel through space to find the stars. The first one, then the second, a third, a seventh, a seventy-seventh—billions, trillions.—*Lasciate ogni speranza che voi entrate.*

One-third of the stars live in pairs as "twins," or in triple systems, such as our nearest neighbors, the three stars of Alpha Centauri. The principal star of this triple system is similar to our sun; the second star is somewhat cooler.

Although they are 23 times farther apart than the sun and the earth, so that a man on a planet of the one would see the other only as a star, they revolve around each other rather rapidly—once every 80 years. They are encircled by the orbit of a third star which is 9,000 times as far from the other two as the earth is from the sun! Since this third star is not larger than our sun but only half as hot on its surface, it should appear to a person living in the world of the other two as an inconspicuous starlet in the sky. Yet for us on earth this forlorn starlet is one of the most impressive objects in the universe. During its revolution it comes nearer to us than any other star outside our solar system, and therefore became famous as “Proxima.”

Stars which are seen very close together are called double stars. Some are easily seen with the naked eye and are well known, such as the middle star in the handle of the Big Dipper, Mizar, and Alcor, the “Little Rider,” just above it. There is a Hungarian tale, written by Maurice Jokai, about Alcor. Before going off to battle, the warriors were ordered to look up at Mizar. Those who could not see the rider above it were doomed never to return.

Most double stars can be seen only with the aid of instruments. In the star-cluster around Aldebaran, the Hyades, anyone with a field-glass can find several pairs of double stars. But the majority can be seen only through a telescope and are therefore called telescopic double-stars, like the companion of Sirius which was not discovered until the famous refractor of the Yerkes Observatory in Wisconsin was installed.

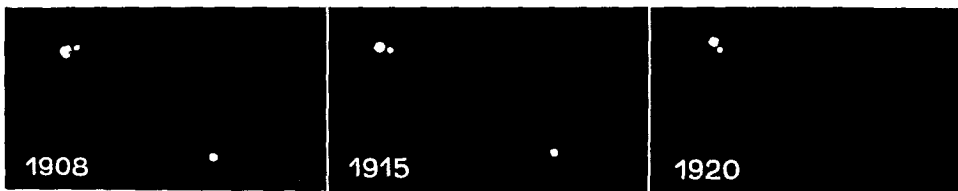

Fig. 70. DOUBLE STARS

The star Krüger 60 is one of the rare double stars where the rotation of the companion star around the main star can be observed.

Double stars may be a mere optical phenomenon. Two stars may appear side by side in the same way we see an airplane “near” the moon. Or, they really may be neighbors revolving around a common center of gravity. These real double stars are called binaries, from “bini,” a Latin word meaning two by two. Binaries in our stellar neighborhood are Sirius (*Fig. 53*), Krüger 60 at a distance of twelve light-years (*Fig. 70*) and 61 Cygni, the star which Bessel used as the first object of triangulation. 61 Cygni is specifically interesting because the two main suns revolve around each other once in 720 years in an orbit with a diameter about 120 times the distance between sun and earth. These are accompanied by a third body which is only sixteen times as massive as Jupiter.

Even in telescopes many binaries cannot be recognized as such because

they are too far away or too near each other to be separated optically. But man is sagacious. When, in 1889, Pickering undertook spectroscopic research on Mizar, the star below the Rider, he made an astonishing discovery: while its spectrum is usually clear, it occasionally grows indistinct. On further analysis, he found that the lines are hazy because they are split. (*Fig. 58*) For five days series of lines move toward red. Then the runaways stand still, and move back. Soon after, the same lines move to the opposite side toward violet, and again return. Pickering promptly came to the right conclusion: Mizar is a double star; two stars revolve in a twenty-day rhythm. Stars recognizable as double stars only by spectroscopic analysis are now called "spectroscopic binaries."

As the two stars move, they are sometimes side by side in our line of vision, and at other times one disappears behind the other. When they are side by side, their light is doubled; when one is behind the other, their brilliance is diminished. (*Fig. 71*) Stars which change their apparent brightness are called variables. The most striking example of a variable is Algol in Perseus. Algol, an Arabic name, means the demon (*Al—the, gol—demon*). The Arabs seemed aware of Algol's variability. For two days, twenty hours, forty-nine minutes, the "demon" is a star of the second magnitude. In the course of five hours, its intensity begins to diminish, and fades to a magnitude of 3.5. The process is then reversed over an equal period of time. The successful unraveling of this light curve is one of the most impressive achievements of modern astronomy.

Algol is 100 light-years away. Since it appears as a star of 2.3 magnitude from this distance, its brilliance must be 60 times that of our sun. The principal star has a surface temperature of 12,000°. This means that it is a gaseous sphere about 4,000,000 kilometers in diameter, or three times the diameter of our sun. The companion must have a diameter one-fifth longer than that of the principal star. Because its surface temperature is only 6,000°, it appears darker than the principal star. The combined masses of the two stars are less than that of the sun, the chief star weighing half, and the companion a quarter as much. They revolve around a common center of gravity with a distance of 5,000,000 kilometers between them, the large star at 40 km/sec, and the smaller at 90 km/sec.

Certain variations in the light curve lead us to believe that the smaller star passes through "phases" just as our moon does. The system itself describes a periodical circle, pointing to the presence of a third body which is assumed to be 25,000,000 to 35,000,000 kilometers from the two known twins.

Near Capella is a red giant, Zeta Aurigae, which is 15,000,000 times larger than the sun. (*Fig. 71*) Like the sun, it rotates; around it revolves a smaller star which is only half its weight but is as dense as our earth. This heavy companion revolves around the giant star at the same distance as Saturn from our sun. One revolution takes almost a thousand days. During this time it disappears from our view for 39 days behind the large gaseous sphere. But

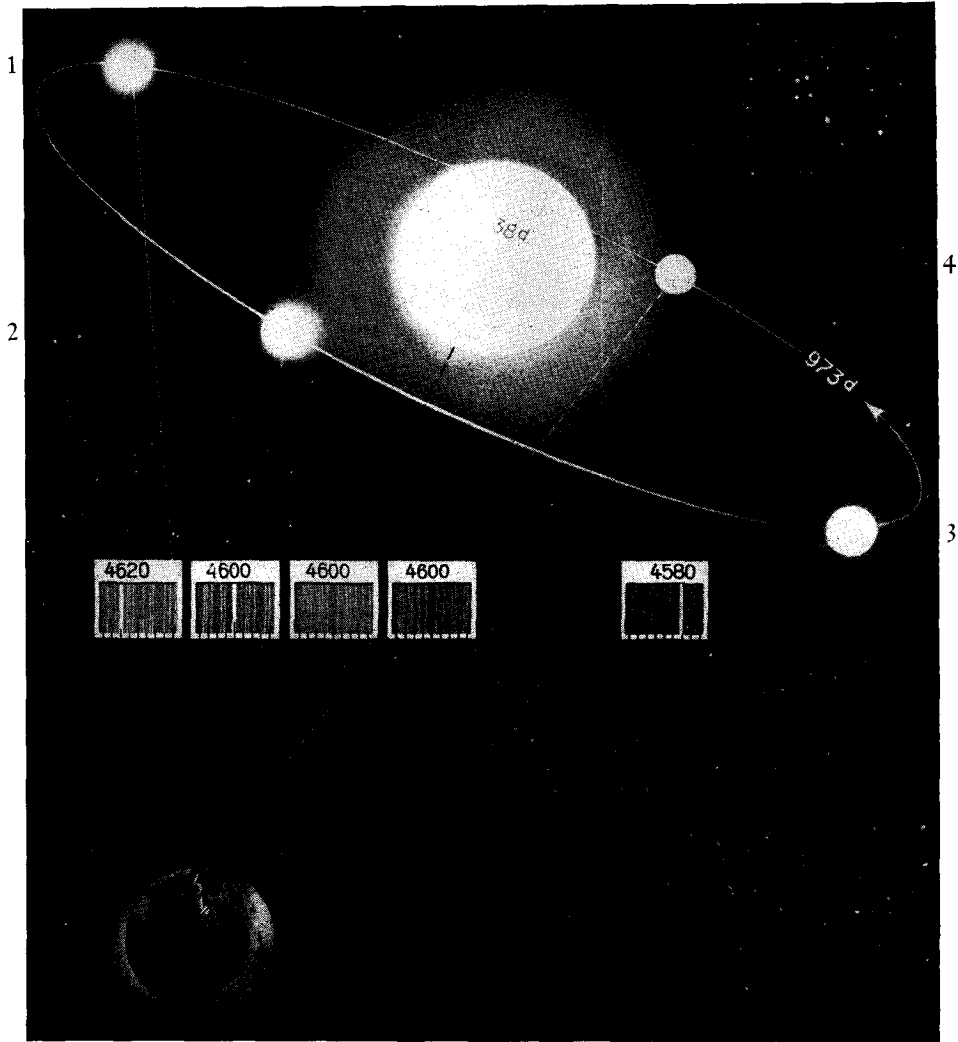

Fig. 71. SPECTROSCOPIC DOUBLE STAR

Most double stars cannot be recognized as such by telescope but only by spectroscope (spectroscopic double stars). The periodic appearance and disappearance of the lines in the spectrum and the periodic shifting of the lines provide the basis for scientists' far-reaching conclusions about structure and dynamics.

since the giant star is very thin and has a broad transparent atmosphere, we can follow the path of the companion star through the veil of the atmosphere. The Fraunhofer gaps which appear in its spectrum disclose that the atmosphere of the central star is rich in calcium.

With this data in hand, it is easy to follow the phases in *Fig. 71*. When the companion star is seen at *1*, it is moving toward us, and the lines of the spectrum are displaced toward the violet. When the star is seen at *2*, it is

in front of the calcium atmosphere. From 2 to 3 the distance between star and earth is not changing, and the displacement of the spectral lines ceases. As the companion moves from 3 to 4, the spectral lines shift toward red. When the star has reached 4, the calcium lines disappear, for the wave-lengths of calcium are absorbed by the atmosphere. When the wandering companion has reached the maximum of its recession, it disappears for 38 days behind the eclipsing central star. When it reappears, the spectral lines begin to shift toward violet.

Capella, the main star of Auriga, 52 light-years away, is also a spectroscopic binary. The two stars revolve around a common center of gravity at a radius of 125,000,000 kilometers, taking 104 days to complete the circle. Since they send out 127 times as much light as the sun, though their temperature is only $5,000^{\circ}$, they must appear to us as broad discs. The atmospheres of the two stars, large and close together, intermingle from time to time, and in certain positions form a quasi-double sun shaped like a dumbbell.

We do not know how double stars come into being. In our youth we were taught that after "journeys of trillions of years" the stars converge in the center of our galaxy; they approach each other and form double stars; later they collide, and out of the ashes of their fiery death the phoenix arises to begin the flight anew on its flaming wings. But stars do not travel for "trillions of years"; they never meet each other; and collisions, even in the center of the galaxy, are such rare exceptions that they could never account for the millions of binaries that populate the sky.

Of the twelve hot suns in the nebula in Orion, no fewer than eleven are pairs and groups of three. They hang in the threads of the nebula like dew-drops in the web of a spider.

The binaries are neither old couples nor twins. Most of them differ from each other fundamentally. A light blue aquamarine is paired with a dark red garnet. A sparkling diamond is accompanied by a tired yellow topaz. One star is hot, the other cool; one may be an ethereal giant, the other a dwarf. The old-time metaphors of Castor and Pollux or Philemon and Baucis are outmoded. We are entirely at a loss to explain the origin of binaries. We are once more reminded, as Harlow Shapley says, after a lifelong study of the problems of the Milky Way: "Obviously the most interesting feature of this science, astronomy, is our eager ignorance."

Variable Stars

The binary Algol, with its regularly undulating light curve, is the archetype of countless variable stars which populate the sky. In the dawn of modern science at the turn of the year 1600, a Frisian pastor named Fabricius discovered that one of the stars in the constellation of the Whale (Cetus), a star

normally as bright as those in the Great Bear, became so faint for certain periods that it could no longer be seen. After an absence of several months, it reappeared as bright as ever. He was so astonished at this phenomenon that he called it the miracle-star in the Whale, *Mira Ceti*.

So many variable stars have since been discovered that we no longer think of them as miracles. But to this day no satisfactory explanation has been found for the majority of the variables. Some of them become periodically brighter, others fainter. Stars of the *Mira* type are observed only among the large cool red giants. The change of luminosity of the *Mira*-stars follows strange curves, up to now not clearly understood. Their light diminishes and stays dim for months. Then they begin to brighten in a steep upward curve and flare for several weeks. The intensity of their light increases at least 100 times, frequently 1,000 times, and in some cases as much as 10,000 times. Nothing about these periods is definite, neither the length of the intervals nor the duration and degree of light-increase. The spectroscope reveals that glowing gases are moving rapidly toward us. We suspect that they gush out from the interior to the surface. Consequently these stars are called "pulsating stars."

Another type of variable is called a cepheid, named after its best-known representative in the constellation of Cepheus. Its intervals are short and almost mathematically constant. There are cepheids which flare up at intervals of 10 hours, others of 10 days, and still others of 100 days. The fluctuations are as regular as the flashing of a lighthouse beam.

Yet the time element is only one of several laws peculiar to cepheids. There is a relation between the length of the intervals and the degree of increase in brightness: the longer the interval, the greater the increase in luminosity. Cepheids with periods of one day become 100 times brighter when they flare up; those with periods of 10 days, 1,000 times brighter; and those with intervals of 100 days, 10,000 times more brilliant than before. It is like kindling a signal fire on a mountain: the longer it takes to collect the brushwood, the brighter the beacon.

Another law is that the denser the star, the shorter the period. If you are not dismayed by the intricacies of a mathematical formulation, you might pause here for a moment to admire the following masterpiece in the gallery of science. The cepheid equation reads: "The square of the period, multiplied by the average density, is a constant." If you put the corresponding figures in place of the words of this equation, you will arrive at the same value for all cepheids.

In 1912 a woman astronomer at Harvard, Henrietta Leavitt, enriched astronomy by a two-fold discovery. She found cepheids in the Magellanic clouds and from this drew her first conclusion: the cepheids must be very bright; otherwise they could not be seen from the tremendous distance of, as she assumed, 86,000 light-years. Today we estimate all extragalactic distances to be twice as great as was believed in pre-Palomaric times. Since the

days of Miss Leavitt, cepheids have been detected in the Andromeda nebula, and with the Palomar mirror cepheids as far as 6,000,000 light-years away have been photographed.

Miss Leavitt then embarked on a truly remarkable intellectual excursion. The distances of the Magellanic clouds are known. When a cepheid flares up at intervals of twelve days, becoming 1,600 times brighter than normal, and appearing at its maximum as a star of the fourteenth magnitude, we can compute its absolute luminosity. If we compare the brightness of this cepheid with that of another, which has the same period and therefore emits the same amount of light, we can figure out the distance of the latter.

This reasoning of Miss Leavitt's became an important aid in determining the distances of cepheids. Parallaxic triangulation is limited to stars in our galactic neighborhood, up to distances of a few hundred light-years. But the distances of cepheids can be determined as far as their light reaches. Thus cepheids became the milestones of the universe.

Nobody knows what cepheids are. Some astronomers describe their pulsations so vividly one would think they had observed their breathing and felt their pulses with their own fingers. They speak of cepheids as "geysers" of gushing lava and fiery steam.

Others say the force of gravity inside the cepheids grapples with the force of radiation. Gravity causes the atoms to converge. The conglomeration creates heat. Heat causes radiation. Then the pressure of radiation explodes the star. The mass is dispersed, again collected, and the cycle begins anew.

A third theory maintains that the cepheids build up an atmosphere which becomes increasingly dense and obscures the light of the star. At a certain point, the atmosphere explodes and exposes the white-hot core for a time.

A fourth hypothesis states that the cepheids are rotating stars shaped like dumbbells. When we see the dumbbell from its broad side, the star appears bright. When one head of the dumbbell is behind the other, the star is small and faint.

A fifth theory holds that the cepheids are surrounded by rings like that of Saturn. They, too, sometimes show the edge of their rings, and at other times the broad side. This last theory has the advantage of offering an explanation for the mathematical precision of the periods as well as the curve of changing luminosity.

These "theories on parade" are presented here neither for acceptance nor rejection; we should not commit ourselves to any one hypothesis. Instead we are content to admire this extraordinary phenomenon in the sky and the array of theories about an object that, even with the use of a powerful telescope, appears only as an unsteady point among points on a photographic plate.

An entirely different type of variable star is presented by Eta Carinae which is not listed in the otherwise reliable catalog of Ptolemy (made around 140 A.D.), although the other stars in its surroundings are registered

there. It is not referred to in the annals of astronomy until 1677 when Edmund Halley, a contemporary of Newton's, mentioned Eta Carinae as a star of the fourth magnitude. In 1834 John Herschel, the son of William Herschel, found it as bright as Polaris, the North Star. Ten years later it was almost as bright as Sirius, but after fifteen glorious years it faded rapidly. By 1870 it was again as inconspicuous as the polar star, at the turn of the century visible only through a telescope as a star of the eighth magnitude, and twenty-five years later it disappeared altogether. But the star has begun to brighten again in our time. Naturally, this phenomenon has attracted the interest of the astronomers, and photoelectric equipment has been brought to the observatory of Canberra in Australia so that coming events on Eta Carinae can be kept under steady supervision.

New Stars: Novae

The term "new stars" is misleading. We do not know of new stars and have never seen a star in the making. New stars are stars that, previously inconspicuous, suddenly flare up. A star formerly of the nineteenth magnitude and recognizable only on photographic plates may brighten to the ninth magnitude. Since the introduction of telescopic photography, novae are observed frequently. A point, one point in the midst of sixteen thousand on a plate, changes its brightness. Often only a trained eye can see the difference. This inconspicuous change is recorded as a nova. Today, by international collaboration, astronomers in observatories all over the world photograph a section of the sky assigned to them every second night. The plates are checked electronically and a nova is discovered on an average every ten days. Novae so bright that the naked eye can see them as new stars appear only once or twice in a decade. They remain visible only for a brief time.

Many novae flare up periodically at irregular intervals. One of these is classified as the U-Geminorum, after their best-known representative in Gemini, the Twins. At intervals of months they flare up to a hundred times their normal luminosity and return after a short time to their original faintness. One of them has flared up not less than four hundred times.

We do not know what causes stars to flare up as novae. The old mechanistic concept of catastrophes comparable to traffic accidents has been abandoned. Novae are definitely not the victims of collisions. Even in the most densely "crowded" areas, stars are so sparsely distributed that collisions could be only exceptional events. The region over which a single star holds sway could be filled with a million stars and even then there would be no crowding. The old theory that stars flare up when they fly into cosmic clouds sounds plausible but has been considerably devaluated since it has been recognized that cosmic clouds are generally no denser than the vacuum in an electric bulb.

It seems as if internal processes cause some stars to burst, boil over, erupt like volcanoes, blast through a cover of clouds and set off a stellar fireworks.

Some novae reveal a few identifiable events. Spectrography discloses that gases fly apart at speeds of thousands of miles a second. The spectral lines shift, some toward red, some toward violet. The confused spectrum contrasts sharply with the clear lines of the calmly glowing normal star. The atoms of the gases are flung forth so violently that the electrons are hurled from their orbits, and the atoms become ionized. This ionization is typical of a nova. A spectrum with blurred lines and the signature "ionization" are the code message that means "nova."

If the nova is not too far away, the dissipated gases become visible on telescopic photographs after a while. The clouds of the nova of June, 1918, could be seen on photographs taken six months later. The nova of 1934 emitted two diverging clouds which in 1940 were three arc-seconds apart.

In some cases a nova is kindled by a veritable explosion. We do not know what circumstances lead to such a disaster. We have only some faint notions. Explosions of stars cannot be too rare, for in 1948 one of our nearest neighbors, only six light-years away, exploded. Stars of the sun type can be regarded as fairly stable, but a star that had been catalogued as belonging to the same class as our sun flared up recently and must have brought instant destruction to any planet that might have been circling around it. A blasting neighbor, an exploding sun—these are not encouraging prospects. Yet around us hover innumerable suns, all of them billions of years old, well established in their orbits. Our earth has been circling around its sun for probably 3,000,000,000 years, undisturbed through the whole history of evolution. There is little reason to add cosmic anxiety to our earth-bound worries.

Super-Novae

A nova is not a harmless event; yet it is surpassed by far in destructiveness by that rare catastrophe the human eye experiences as a super-nova. It is a celestial spectacle observed only once or twice in a millennium. In several thousand years of astronomical observation not more than half a dozen supernovae have been reported. The first record of a super-nova in historical times might be the Star of Bethlehem, but no ancient observer except the Gospel writer mentions it. The first authentic information about a super-nova is found in Chinese and Japanese records in which a blazing star is mentioned as appearing in the year 1054. The cloud of this explosion can still be seen today as the luminescent Crab nebula, pictured in *Fig. 72*. The first report on a super-nova in the western world is the vivid description of a flaring star by the Danish astronomer Tycho Brahe. As he left his house on a November evening in 1572, a hitherto unseen star brighter than Sirius glittered over

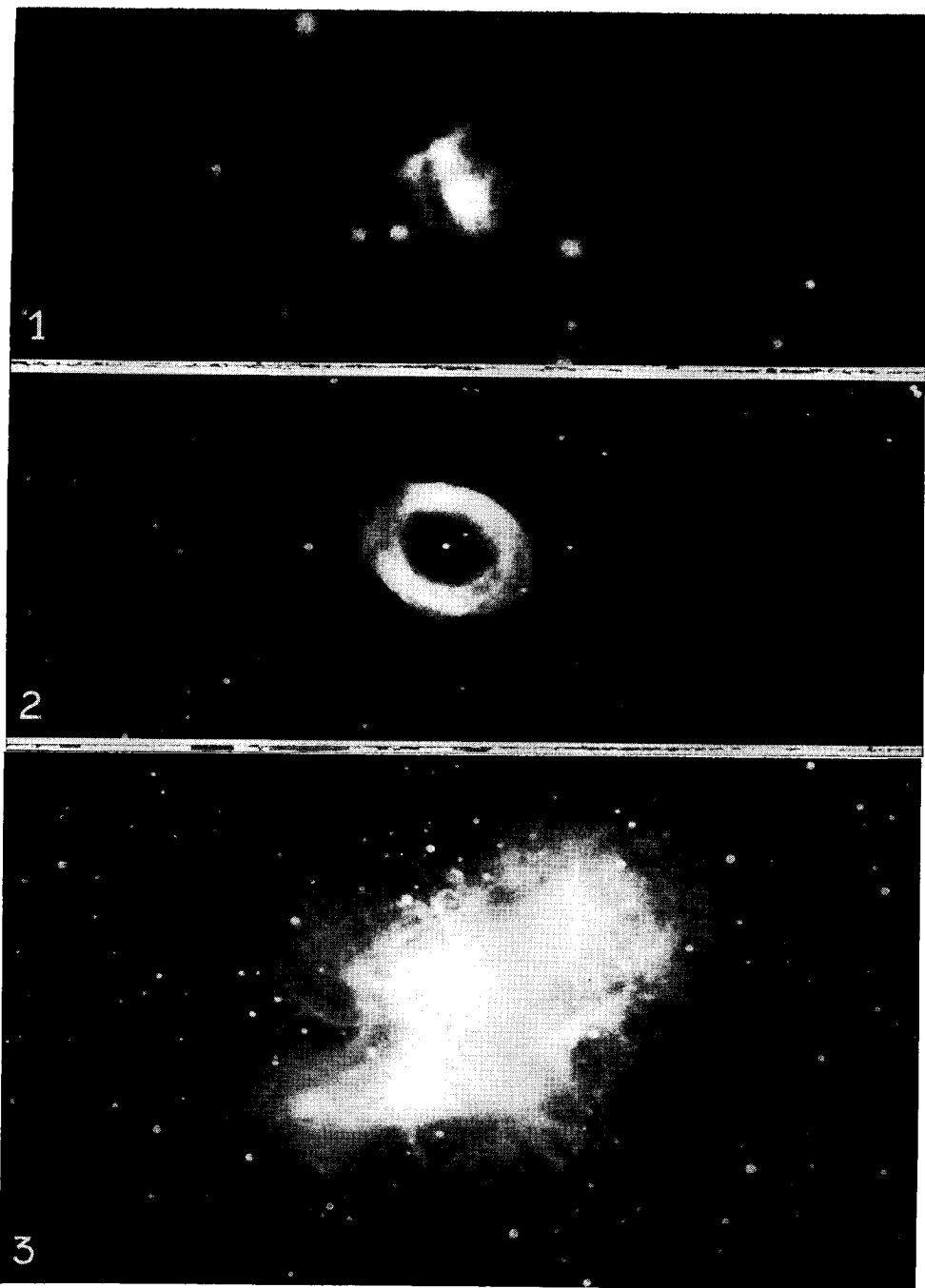

Fig. 72. THE FATE OF AN EXPLODED STAR

Photographs of three stellar phenomena which may be hypothesized as three stages of an exploded star.

1. The gases of an exploded star spread out.
2. Fifteen thousand years later they form a ring around the focus of the explosion.
3. Finally, the gases disperse into a diffuse nebula.

his head. The next night the new star was even brighter and surpassed Venus at her most brilliant. In the following days he could see it even while the sun shone. But from that time on it dimmed and by September the jewel that had once crowned the sky had faded into a starlet. Today this super-nova of 1572 is no longer visible but a strong radio emission is received from the point where it once gleamed.

Strangely enough, a second one followed not so long after the first. In 1604 Johannes Kepler, a pupil of Tycho Brahe, also saw a super-nova. Since then none has been observed except on photographic plates, and most of these have been recorded in other galaxies, millions of light-years away.

Although a super-nova is an extremely rare event and science has had no opportunity to investigate one with modern methods, we know more about the super-novae than about the novae because a super-nova follows a simple pattern. A super-nova is an atomic explosion of a sun. The radiation is, like that of an exploding atom bomb, enormous. The curve of luminosity rises almost vertically. In a few hours the super-nova radiates as much energy as our sun does in a million years. The gases shoot out with speeds of 160,000 km/sec and more. The lines of the spectrum shift so considerably that the colors blend into a haze. After a few dozen hours, the star fades and after about 55 days, the luminosity diminishes to half. The celestial blaze continues for some months, but after two years or so only a glowing cloud remains at the site of the catastrophe.

Why does a super-nova lose half its initial luminosity in 55 days? Fifty-five days is the half-life of radiating beryllium 7, a radioactive isotope that disintegrates to form lithium. The sequence of elements in the Periodic Table is hydrogen, helium, lithium, beryllium. As we have seen, hydrogen nuclei, identical with protons, combine inside the stars to form helium. This synthesis of helium is the source of solar and stellar energy. When the supply of hydrogen is used up, the star begins to contract and the helium nuclei fuse to become beryllium, which is composed of two helium nuclei. Shrinking globes have the tendency to rotate faster and faster until the centrifugal force of the rapidly rotating sphere becomes stronger than the gravitational hold: the star explodes. One of the main products of the nuclear explosion is the strongly radiating isotope of beryllium, ${}^7_4\text{Be}$, which accounts for the luminosity of the super-nova.

This new theory of the super-nova is the child of our atomic age. A hypothesis like this could not have been conceived in the times of Tycho Brahe or even Pickering. Yet whether it corresponds to the facts is not sure. New ages will bring forth new concepts and new concepts are the progenitors of new theories.

The atomic flash of the exploding star accounts for the almost incredible fact that, as early as 1885, a super-nova was photographed in the Andromeda nebula which is 1,500,000 light-years away. In March, 1950, a super-nova

was photographed in a galaxy seven times farther away! This means the event took place 10,000,000 years ago.

After the explosion, the gases, propelled in all directions, form a sphere. Since the sphere is transparent, it is visible only along its periphery, and appears to us as a ring. Such a gaseous sphere is the ring nebula in the Lyre, which is about 1,500 light-years away. In the center of the ring glows a star which was probably the focal point of the explosion. The surface temperature of this central star is $75,000^{\circ}$, as against the $6,000^{\circ}$ of our sun. (*Fig. 72, 2*) The Crab nebula in Taurus, the Bull (*3*), is 4,100 light-years away, and is spreading out at the rate of 1,300 km/sec. The dissemination must, therefore, have started between the years 1050 and 1150. Basing our deduction on these facts, we can be quite sure that the Crab nebula is the residue of the super-nova of 1054.

Extending nebulae like those of the super-novae should remain visible for about 30,000 years. If a "super-explosion" occurs every 200 years, as it does at present in our region of the galaxy, we should find 200 to 300 such nebulae in the sky—and we do. They are labeled with the misleading name "planetary nebulae."

If a super-nova explodes within a range of 1,000 light-years of us, the earth is subjected for decades, perhaps centuries, to powerful radiation. Short-wave radiation influences the "genes," those bearers of inheritance in the cells of organisms. As paleontological documents testify, evolution has not progressed at an even pace; at certain periods new species suddenly sprang up. It is not impossible that the spasmodic course of evolution has been due to occasional strong bombardments of the earth by a hail of short-wave photons from a super-nova.

But whether this is true or not is less important than the fact that such an idea can be fostered by the human mind. Genes and super-novae—remember the wedding of atom and star?—are a modern combination of which Darwin could not have conceived a hundred years ago. Seeking the incentive for evolution, he introduced the concepts of the "struggle for life" and the "survival of the fittest" and on these bases constructed the ladder of evolution. Today we are sure that Darwin's ladder does not contain all the rungs to explain the rise of new species. They can account for neither a butterfly nor a dinosaur, very impracticable creations, misfits. We have to look for new agents. One of them is mutation, the occasional rearrangement of atomic groups inside the molecules of the genes, the hereditary factors of our sex cells. They are very sensitive to radiation. The idea that radiation from super-novae may play an active role in the history of evolution puts an interesting new face on an old problem. As far back as records show, men have attributed their fate to the position of the stars. Stars may be responsible, but in a quite different sense than anyone would have imagined before learning about super-novae.

The Motion of the Stars

A whirlpool can exist only as long as the water continues to eddy. In the same way, a spiral of stars, like the Milky Way, can exist only as long as the stars are whirling. A spiral can be a cyclone with the masses moving from the edges toward the center, or an anti-cyclone, moving in the opposite direction. It has not yet been ascertained which way the stars in the galaxies swirl. As far as we are informed—our measurements do not surpass the small circle on *Fig. 61*—some stars move toward the center and others away from the center. Yet our extremely meager information does not permit definite conclusions about the general dynamics of our galaxy.

It is nearly impossible to determine almost instantaneously the motion of a flying body at a distance. If we can follow for just a few seconds a child's balloon drifting far away, it is very difficult to determine whether it is rising or falling, approaching or receding, flying in a straight line or in a curve. Yet such is the situation of a man who looks at the stars. They are thousands of light-years away; their journey goes on for billions of years and we humans can accompany them on only a tiny fraction of their immense trek.

It is, therefore, not surprising that our knowledge of the motion of the stars is still depressingly poor. The photograph registers the position of the stars and their lateral displacement called the "proper motion"; the spectrogram tells us whether a star is moving toward us or receding, termed "radial motion." The real motion of a star is a combination of the two. Yet even knowledge of these factors is not sufficient to determine the star's path, whether it is straight or curved, a fragment of a circle or of a spiral. And now we are confronted not with a dozen stars but with millions, and most of them so far away that we can hardly hope to succeed at all. As a final contribution to this discouraging spate of problems we have to consider that we, too, are moving.

Even the most optimistic enthusiast among the pioneers of heaven will be stricken with despair. Up to the present we know the motions of stars only in our nearest galactic neighborhood. We know that Sirius, Vega, Altair, Deneb and Arcturus are approaching and that Rigel, Betelgeuse and Aldebaran are receding. This does not imply that they are traveling in straight lines. Like the planets which on their course around the sun approach us at times and then recede, they, too, may circle. The swiftest movement of a star was detected by Edward E. Barnard, who, at the turn of the century, discovered a small star at a distance of six light-years. It became famous as "Barnard's Runner." In the short space of 200 years, it will change its position by more than the width of the moon. (*Fig. 73*) Alpha Centauri, the star nearest us, at a distance of four and a half light-years takes 500 years to move as far; Arcturus, 800; Procyon, 1,550. Since all stars change their positions, the

aspect of the constellations alters over the course of millennia. In 25,000 years the stocky Great Bear will have turned into a lanky Giraffe. Orion will have lost his belt and Sagittarius will have emptied his quiver.

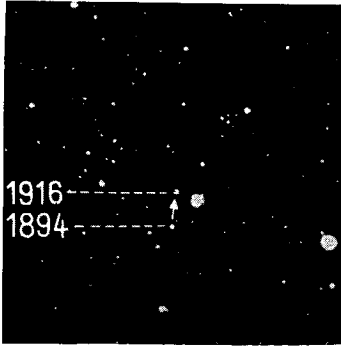

Fig. 73. FIXED STARS ARE NOT FIXED
They all change their positions, but none so quickly as "Barnard's Runner."

Groups of stars like the Pleiades or the Hyades have a special significance because they are ostensibly of common origin and of the same age. The present arrangement of the stars, the speed and the direction in which they move supply clues as to the age of the group and the original pattern of the formation. No constellation is older than 3,000,000,000 to 5,000,000,000 years—the age of our universe. Since the galactic system is a kind of organism with a design, we are entitled to expect that the different types of stars are distributed in a pattern. The various types are intermingled, but not chaotically. In the inner spirals cool red giants, dim dwarfs, variables and global clusters predominate; in the outer spirals most of the hot blue giants, white dwarfs and stars of the type of our sun are found. Cepheids with short periods are encountered more frequently in the central spirals; those with long periods, in the outskirts. But their separation is not categorical. Every look at our sky discloses that our very neighborhood, comprising only a tiny area of the galaxy, is populated by stars of all types: the blue Rigel beside the red Arcturus, van Maanen's heavy dwarf near the ethereal super-giant Betelgeuse.

The famous Lick Observatory in California completed a new photographic survey of the northern sky. More than a thousand large photographs have been taken, each one exposed for two hours. It is planned to repeat this photographic survey fifty years hence. The comparison between the two sets of photographs is expected to give evidence of the motion of so many stars that the great galactic pinwheel will reveal more of its secrets.

The Life-Cycle of a Star

As a kind of farewell to the stars, we cannot resist the temptation to undertake a task which, though pardonable, is doomed to failure in principle. We

will try to write the biography of a star. First of all, too little is known as anyone who has read the previous sections is aware. Second, it is doubtful whether our current methods of thinking can cope with the subject.

Only rarely can a human being transcend the thought patterns of his time. We are today under the spell of the evolutionary thinking begun 150 years ago by Kant and Laplace in astronomy, by Thomas Buckle and Herder in history, by Buffon, Lamarck and Darwin in biology. This way of reasoning solved so many problems and cleared the aspect of nature so brilliantly, that a whole century was quasi-hypnotized. We children of these generations automatically think in terms of evolution, assume that everything had a beginning, and that this beginning was "chaos." Higher forms, we believe, evolve from embryonic condition: larvae develop into insects, savages into civilized people, oxcarts into automobiles.

The question now arises as to whether astronomical problems can be solved by evolutionary trains of thought. A method of reasoning must fit the problem. A violin bow is a fine implement, but it is not suitable for opening safes. We speak of stars as if they were ferns or salamanders. We give life-histories to the lifeless. In reality, stars are gaseous spheres, subject to physical laws, not biological. Life in the sky is similar to life in the atmosphere: clouds appear without "parents," large drops do not grow from small ones. Big stars do not grow out of small ones, and cool stars are not necessarily the withering old age of once hot-blooded youths. Though the pictures in *Fig. 74* follow the evolutionary conceptions of modern astronomy, they should be regarded as random snapshots in a family album rather than the consecutive record of a biography.

In the center, a super-nova explodes. The gases disperse in space, furnishing the substance for the formation of new stars. (1) Sooner or later, the force of gravitation gathers the scattered atoms. When about 4 times 10^{34} atoms have collected, they form a sphere of extremely tenuous gases, a "Giant Star," which then leads a life of its own, in accordance with certain physical laws. (2) As the atoms converge toward the center, they interfere with each other, and the hindered movement is transformed into heat. (3) When the sphere has condensed to a millionth of its original extent, the central heat reaches $1,000,000^{\circ}$. (4)

At this temperature, the atoms have lost all their electrons and the naked nuclei collide with such force that nuclear reactions start. If one proton, $1\text{ H }0$, collides with another proton, one of them changes into a neutron and becomes the heavy isotope of hydrogen called deuterium ($1\text{ D }1$). The energy liberated by this process adds to the rise in temperature. The higher temperature again accelerates the movements of the nuclei. They collide even more violently, and $1\text{ H }0$ and $1\text{ D }1$ combine into $2\text{ He }1$, the light isotope of helium. (5) Once again energy is liberated, the temperature mounts, and at $3,000,000^{\circ}$, three protons combine into lithium, $3\text{ Li }3$. (6) At $5,000,000^{\circ}$,

the next proton intrudes and transforms lithium into its heavy isotope, ${}^3\text{Li}4$. (7) At $6,000,000^\circ$, beryllium is built up. (8) At $8,000,000^\circ$, boron, ${}^5\text{B}6$. (9) At $12,000,000^\circ$, carbon, ${}^6\text{C}5$. (10) With the appearance of carbon, the "helium-synthesis" which heats our sun begins. (11)

According to present theories the sun is growing hotter and may some day become as bright as Sirius (12), perhaps even as hot as U Ophiuchi (13) and S Doradus (14), which radiates 500,000 times more light than our sun does today. But no star can radiate this strongly for long without losing considerable mass. The star shrinks and its decrease in size is accompanied by an increase in the tempo of rotation. Driven by centrifugal force, the gases float toward the equator, and form a huge collar which eventually breaks up, exposing the naked core of the star in its unscreened brilliance. The change in the position of this hypothetical ring, and its occasional disruption, may account for the variability of some stars, or the flaring up of novae.

A star which has reached its pinnacle of radiation must inevitably cool off and descend the ladder of temperature from S Doradus to U Ophiuchi (15) to Sirius (16) to the sun. (17) Eventually it contracts into a solid ball (18), but this contraction also has its limit. The pressure in the center reaches a degree where it surpasses the ability of the atoms to resist it. In the center of the earth, the pressure may reach about 1,500,000 atmospheres. In the center of Jupiter, which is about 1,000 times larger, the pressure presumably reaches 10,000,000 atmospheres, probably the maximum. If the pressure exceeds this limit, the electrons are pressed from their orbits, protons converted into neutrons and these are smashed into an inert pulp (19). Now the star shrinks rapidly (20) into a dwarf (21).

The fate of a dwarf may take several turns. The shrinking may proceed so rapidly that a terrific heat is unleashed and the star explodes. Or, the star may go through the process of shrinking without exploding, and finally form a "heavy star." Some of these, like the companion of Sirius, may shine brightly and be visible as white dwarfs (21). In radiating strongly, they lose mass on the surface, and the outer shell becomes so thin that it can no longer hold the atoms in the unnatural state of compression. One day the atoms recoil violently, and the star explodes (22).

There is still another way for a star to leave the stage of existence. As small atoms are transformed into larger ones, a great deal of energy is consumed. The temperature of the star, especially inside the core, decreases rapidly. The gases condense and produce a vacuum where the compact core had been. Into this internal emptiness the gases of the outer layers rush downward like "Niagaras." The unhampered descent causes friction, generating enormous heat. Now the star flares up again as a nova, or explodes as a supernova (23).

So each star follows its own life cycle. As in the fate of man, only two things are certain: birth and death. Everything in between is unpredictable.

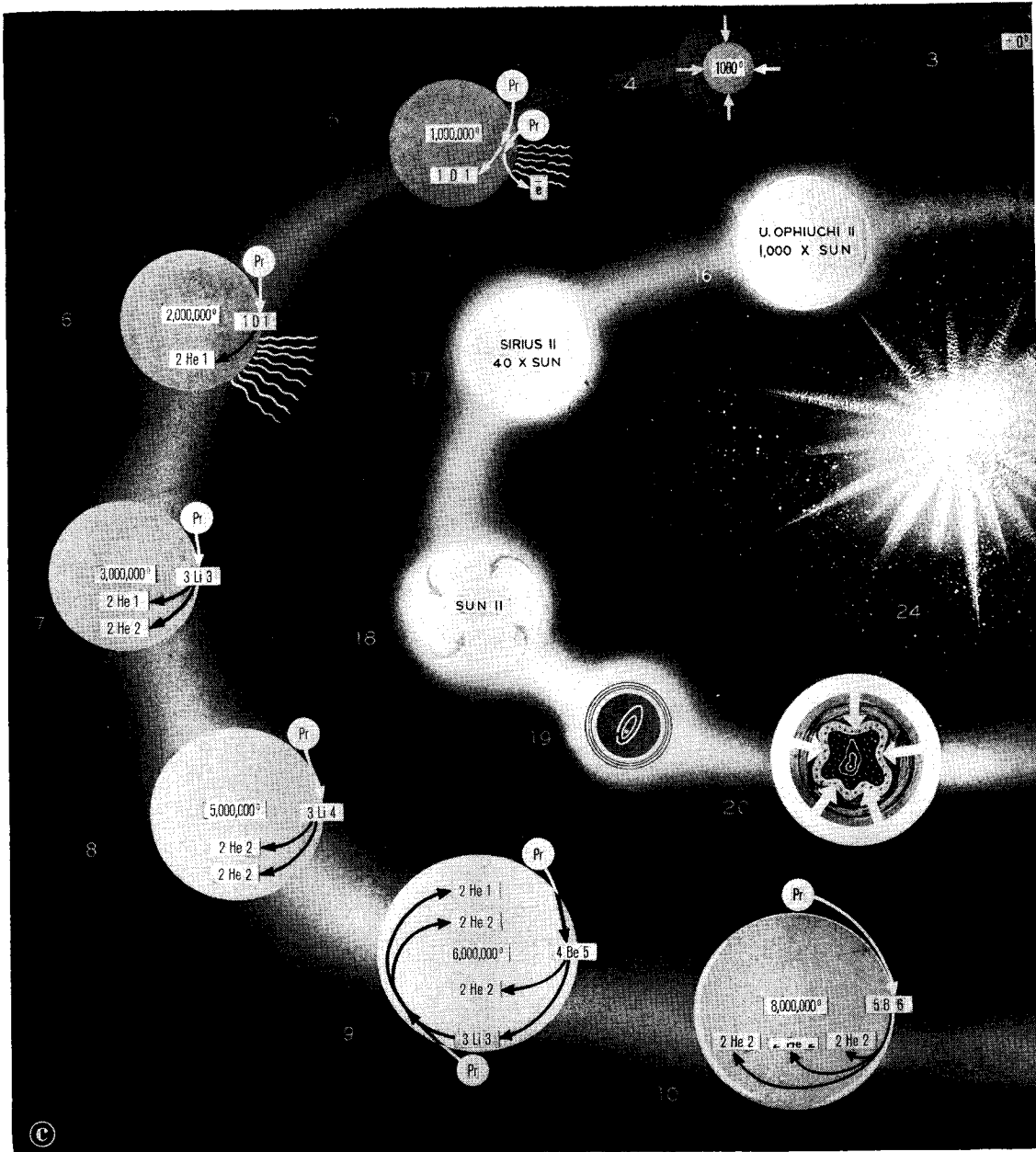
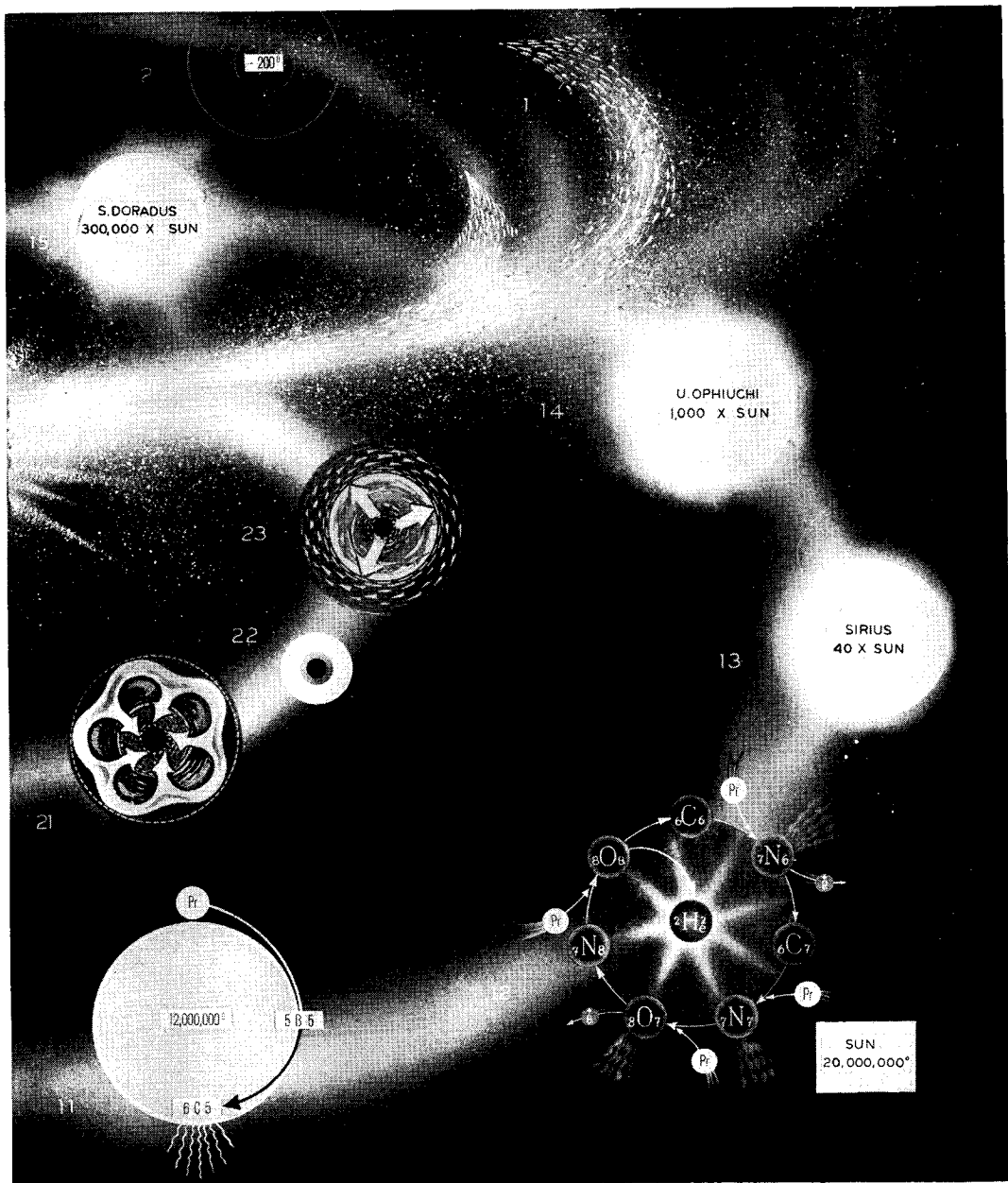

Fig. 74. LIFE STORY OF A STAR



The life story of a star is highly hypothetical. This diagram combines some of the present hypotheses about the birth, growth and death of stars.

A star may have a short life, or a long one. It may be cut off in youth by a catastrophe, or mellow into gentle old age. It may live in anonymous obscurity, or play a triumphant role as a super-nova on the blue stage of the sky.

The Planetary System

W

The Origin of the Planetary System

WE INHABITANTS of the earth live inside an astronomical unit called the solar or planetary system. The two names are opposite sides of the same coin: solar system, because the sun is in the center; planetary system, because nine spheres called the planets revolve around the sun. We live on the third planet.

Factually, we know nothing about the origin of the planets. More than a dozen theories have been advanced, but none has proved satisfactory. The best known of the earlier ones were those of Kant and Laplace. Commonly linked as the Kant-Laplacian theory of the solar system, they are really two independent theories. When, in the middle of the eighteenth century, Kant wrote his pamphlet, Laplace was still in his cradle. Kant's *Natural History of the Heavens* was the imaginative thesis of a young philosopher who lived in Königsberg on the German-Russian frontier. Laplace was a mathematician in Paris who continued the work of Newton by treating the main problems of the solar system mathematically. In his famous *Traité de Mécanique Céleste* he included a cosmogony of the planetary system based on mathematical calculations. It is unlikely that he had ever heard of the small pamphlet by a philosopher published in the German language decades before. But even if he had, he would probably not have deigned to read such "amateurish" speculation, let alone be influenced by it.

Both theories are based on the idea that the planets originated from the sun, and that before the birth of the planets, the sun filled the space of the present solar system as a fiery gaseous ball. Cooling off, the sun contracted, and the planets disengaged themselves from the contracting and rotating mass. In the times of Kant and Laplace the laws of gaseous spheres, so brilliantly developed at the end of the nineteenth century, were as yet unknown. A whole array of objections based on these new laws has been posed to these early cosmogonies:

1. The solar system does not contain enough atoms to have formed a gaseous sphere extending from the sun to the orbits of the outer planets.
2. More than 90 per cent of the system's mass is concentrated in the sun. It is highly improbable that so small an amount as the remainder could have detached itself from the gravitational pull of the supposed primordial central sun.

3. The small planets such as Venus, the earth and Mars could never have been gaseous balls, because spheres of gas cannot exist with so little mass.

4. It seems unlikely that planets like the earth, with a high content of heavy atoms such as those of silicon or iron, could have sprung from the sun which consists predominantly of light atoms like those of hydrogen and helium.

5. It is difficult to see how the large planets Jupiter and Saturn, rotating 50 times as rapidly as the sun, could have derived their motion from a "mother star," the sun, which rotates so much more slowly.

The theories of Kant and Laplace seem to be outmoded. We can do no more than place respectful wreaths on their graves. New cosmogonies followed. The term "cosmogony" is misleading, for these hypotheses do not deal with the creation of the cosmos, as do the theories of the exploding universe, but only with the origin of the solar system. In relation to the real cosmogony, the birth of the solar system is an event as trifling as the hatching of a sparrow is to the history of mankind.

In the days of Kant, another "amateur," the French naturalist Buffon, founder of modern zoology, promoted his own theory of the origin of the planetary system. A heavenly body wandered past the sun, stirred up a tidal wave of solar mass and drew a string of planets away from it. This theory has been revived several times, most recently by Eddington and Jeans, and is, therefore, reprinted in almost every astronomy book. Yet it seems contrary to all probabilities that stars, separated by distances of light-years, should meet like people in the street, exchange masses and then depart.

At the turn of the twentieth century, the French astronomer Emile B elot offered a theory, which also encountered serious objections and has also been discarded. But the Frenchman's mental creation is worth recalling. B elot attacked the problem in typical modern fashion—marching from paper to stars, not from stars to paper. Like Bessel, Leverrier and Adams, the modern physicist or astrophysicist begins by calculating and arriving at certain formulas. Then, paper in hand, he enters the observatory, where the telescope is mounted, and says to the skygazer: "Focus your telescope at point X and you will find a star; focus it at point Y—there must be a planet there."

B elot based his cosmogony on the theory of vibrations, which have become so important in our decade of waves and aeronautics. He assumed that the galaxy is a whirling vortex, interspersed with clouds of cosmic gases. In primordial days our solar system was also a galactic cloud. During its journey, traveling 24 km/sec, it encountered a second cloud and began to vibrate. At the nodal points of the vibration, the planets were formed. (*Fig. 75*)

Depending on their increasing distance from the sun, the size of the planets, as well as the speed of their rotation, should increase from Mercury to Jupiter and decrease from Saturn to Uranus. The planets should be tilted against the plane of the system at various angles. Uranus, at the "pivot" of the vortex, should be especially far inclined. All these factors—distance, size,

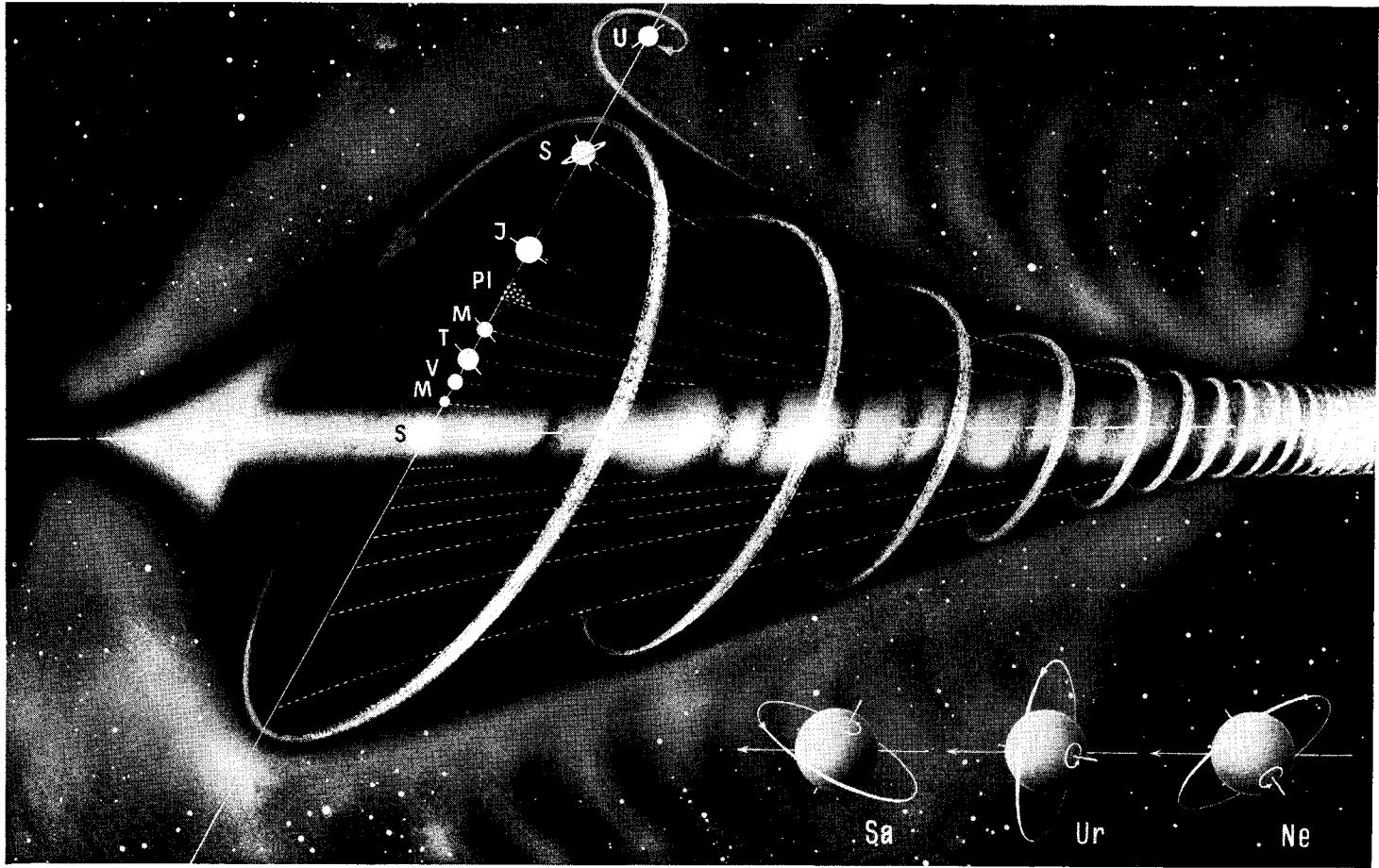

Fig. 75. ORIGIN OF THE SOLAR SYSTEM
 The vortex theory of the French astronomer Emile B elot illustrated here is one of many cosmogonic

hypotheses. It is chosen as representative of the modern trend of thinking in terms of dynamics.

rotational speed and inclination—as well as the numbers and orbits of the moons conform to B elot's calculations but on the other hand so many discrepancies remained that this product of astronomical speculation is also stored in the museum of science.

One of the contemporary theories on the origin of the solar system is that of the British cosmologists who base their reasoning on the fact that almost half the stars are binaries. They assume that in earlier stages of evolution in our galaxy even more binaries existed, but in many cases one of the partners disappeared, and out of the dispersed mass, planets were formed. Double stars are not twins, but stars of different types and temperatures. The hotter of the two builds up larger atoms and becomes a heavy star. Its internal heat creates a radiation so strong that the pressure ruptures the shell. Gases are blown out and envelop the companion, which sucks these gases into the plane of its equator. Here they rotate as a "ring" and later as planets and moons.

This audacious theory clears up a lot of discomfiting problems. It explains how the planets can rotate more quickly than the sun, and how they are able to contain heavier atoms than their "mother." The sun is not the mother, but rather the aunt of the earth. The mother died in giving birth to the earth and other planets, all of whom are the offspring of a deceased companion star of the sun.

Almost simultaneously with the British cosmologists, Harold Urey looked at the problem from the point of view of the chemist. At the turn of the century, E. E. Barnard of the Yerkes Observatory, famous for his masterpieces of galactic photography, had discovered on his photographs of diffuse nebulae black spots that are thought to be opaque globes of gas and dust. Shaped like lenses, they have a diameter of a few light-years and a mass about that of our solar system; they are, according to the theory, the nuclei of future solar systems. The dusty and gaseous particles of the lens-shaped cloud tend to gather around a center. First they are driven inward by the pressure that the neighboring stars exert through their radiation. Then, as the gathering particles crowd closer together, the gravitational force they exert on each other becomes stronger and stronger. Since the cloud does not hover quietly in space but, as a part of the spiraling galaxy, spins along on one of the outer arms, the cloud itself rotates. The turbulence causes the dust particles to arrange themselves in a pattern hypothesized by the German astrophysicist C. F. von Weizs acker. (Fig. 76) Each of the outer eddies is the nucleus of a future planet; the central mass will become the "sun."

The agglomerations of gas and dust are called protoplanets; the particles of dust pressed together into rather substantial bodies are called planetesimals.

The hypothesis of the planetesimals was suggested by the face of the moon, whose surface is dotted with "mares," like the Mare Imbrium, Mare Lacrimarum and others. While the Latin word *mare* means "sea," these seas contain no water—there is none on the moon—nor are they the beds of vanished oceans. They are regarded as areas where planetesimals hit the moon.

The impact of the collision heated the surface to the melting point, and a sea of molten lava was formed, the solidified residue of which appears today as a mare. The shores of the lava sea were pushed up to the bordering heights of the lunar "Alps" and "Apennines." Planetesimals that arrived later left as their mark the smaller "volcanoes" seen amidst the mares. Those with low trajectories plowed through the mountains and cut trenches that groove the surface of the moon.

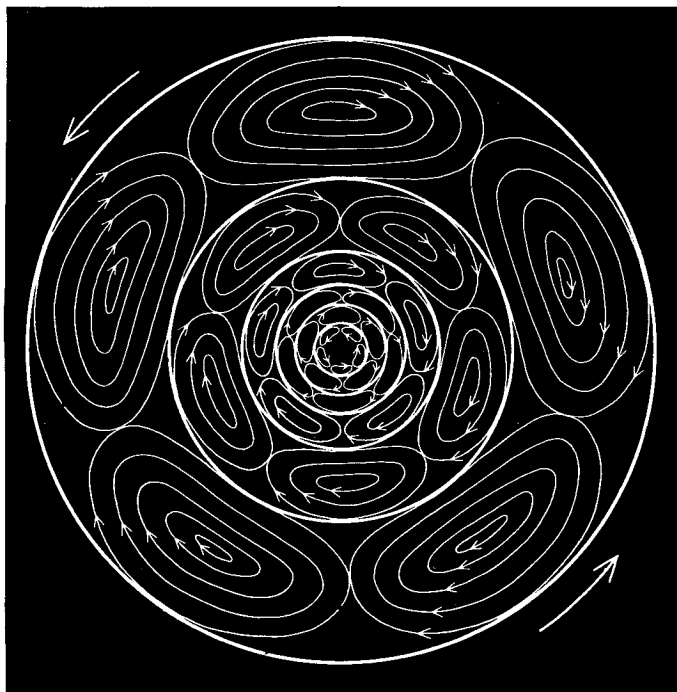

Fig. 76.
THE THEORY OF
THE PLANETESI-
MALS

The solar system evolved from a rotating cloud of cosmic dust. The dust particles gathered into eddies which are the pre-planetary or planetesimal stage of the final planets. (C. F. von Weizsäcker)

Urey, by focusing his interest on the chemistry of the solar system, has made a valuable contribution to cosmogony, since most astronomers view cosmogonic questions mathematically or mechanically. Finally, a chemist entered the fray. Urey hypothesizes that the primordial cloud was similar in composition to the sun and the interstellar gases of today. Hydrogen, nitrogen, oxygen and the rare gases helium and neon were its fundamentals. The cloud, extending five or ten times as far as the present limits of the solar system, cooled from the outer rim and contracted slowly. While it cooled, the simple compounds—methane, water, ammonia—formed, one after the other. Methane, the first, condensed outside the present-day orbit of Pluto. One might suspect that the comets, so conspicuously rich in methane, also formed in those days far beyond the orbits of the planets. Water and ammonia condensed later when the contracting cloud reached as far as the orbits of Saturn and Jupiter, which, formed at this stage, are overrich in just these compounds. They surpass in size all other planets because these primordial substances were so abundant in mass.

The atmosphere of the earth, too, was originally saturated with these gases, but it was also rich in hydrogen, and hydrogen, being very volatile, escaped easily and early; ammonia, NH_3 , became nitrogen, and methane, CH_4 , oxidized into carbon dioxide, CO_2 .

The dust hypothesis is as highly speculative as all previous cosmogonies. A cosmogony can be nothing but speculative, and cosmogonic endeavor will always have "the smell of the lamp."

The Structure of the Planetary System

The masses and dimensions of the planetary system, like all astronomical values, are incomprehensible to the human mind. The mass of all the planets and moons combined is less than two-thousandths that of the sun. If all planetary bodies were snatched away, the sun would not, like Niobe, plead with the gods to let her die because she lost her children. The sun would feel her loss no more than an oak when the autumn wind shakes off a few acorns.

To get an idea of interplanetary distances we can put a beach ball on the ground to represent the sun. About 118 feet from the ball we stick one of those pins with a colored glass head into the ground; that is Mercury, the planet closest to the sun. About 50 feet farther, we put down a pea—Venus. Earth, a pea like Venus, is 60 feet farther. Mars, smaller than the earth but somewhat larger than Mercury, is over 150 feet from the earth. These four planets form the "inner group" and are considered "very near to the sun."

Going on to the second part of the system, we enter a world of entirely different dimensions. Here the planets are on a gigantic scale, in size as well as in distance from one another and from the sun. Instead of pins and peas, we will use cherries and plums. The first is Jupiter, a plum 5 times the distance of the earth from the sun. Saturn, a smaller plum, is almost twice as far as Jupiter. Uranus and Neptune, the next two planets, are 20 and 30 times the distance of the earth from the sun. In size they are cherries. This, however, is by no means the end of our planetary system. There is an outer planet, Pluto, not larger than the earth, yet 5 times Saturn's distance from the sun—we would have to drive 2 miles from the beach ball to find this pea, the outermost member of the system.

Our images and diagrams are adapted to our visual and mental capacities; a picture printed in a book could not represent the solar system without distortion. If Mercury were printed as a pin-prick, the sun would have to be represented by a disc too large for the page. If Mercury were shown as small as the period at the end of this sentence, Jupiter would have to be placed far beyond the margin of this page. Any representation of the solar system has to be divided into two pictures, one showing the proportionate sizes of the planets (*Fig. 77*), the other their relative distances. (*Fig. 78*)

The solar system, rarely understood in its real proportions, is composed of

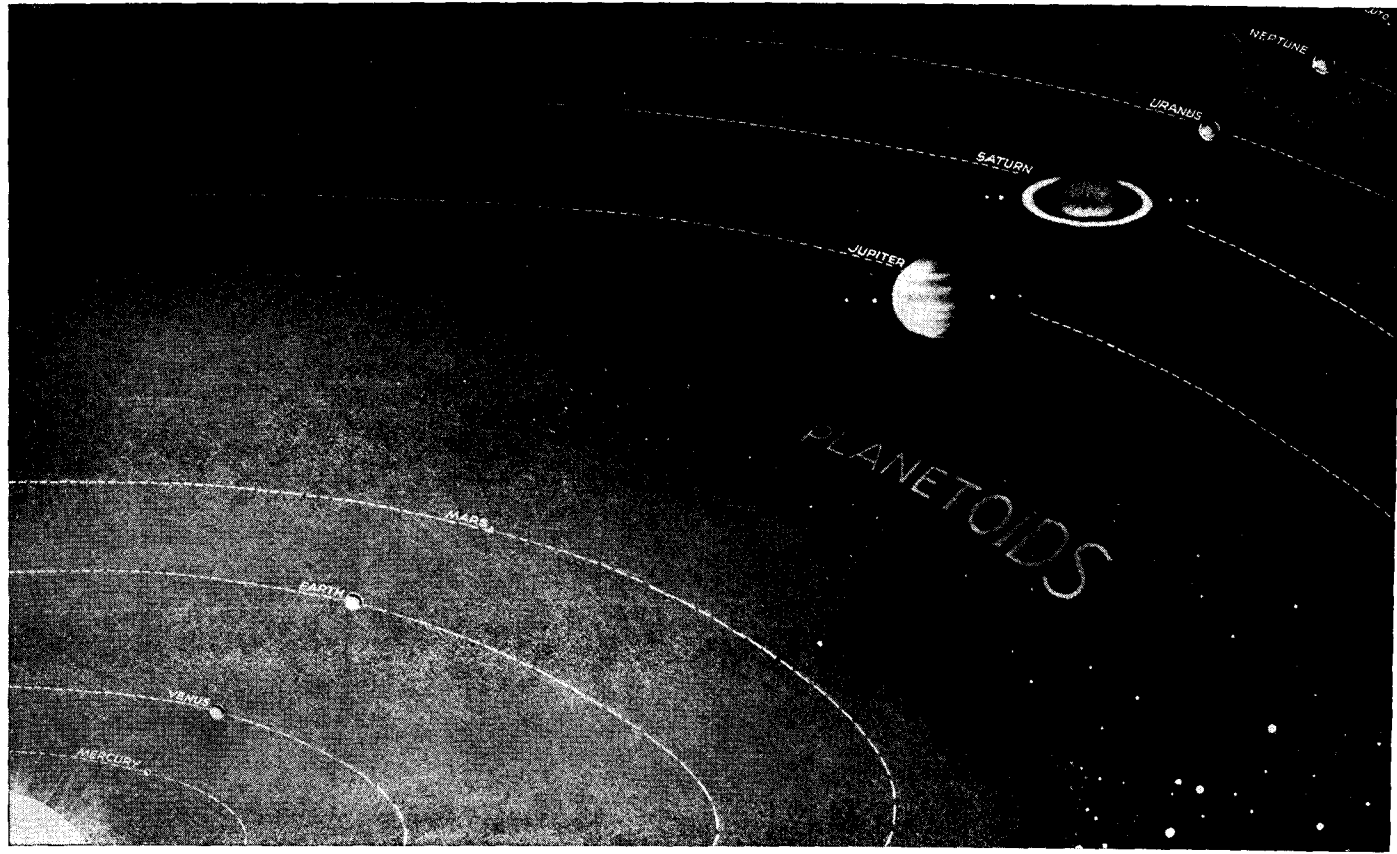

Fig. 77. THE BASIC STRUCTURE OF THE SOLAR SYSTEM

The solar system is composed of two fundamentally different halves. The inner half comprises the four small,

neighboring planets; the outer half the widely dispersed "giant planets."

two basically different parts: the four inner dwarf planets which are "crowded" around the sun; and the four outer giant planets which are far-flung and separated by vast distances from the sun as well as from each other. Between the two parts of the solar system is a broad girdle harboring several thousand very small bodies called minor planets or asteroids. Besides the two groups of four there is a ninth planet, Pluto. A tenth is suspected.

The giants differ so greatly from the dwarfs that we cannot even say for sure whether these two groups are genetically related. There is a faint possibility that our present system is the result of the combining of two planetary groups whose origin was different. The contrasts between the two groups become apparent when we set down their sizes and distances in numbers. Expressed in units of 1,000 miles, the dwarfs have roughly the following diameters: 3, 8, 8, 4. The giants: 90, 75, 30, 30 (Pluto: 4). Taking 100 as the earth's distance from the sun, the approximate distances from the sun of the dwarfs are: 40, 70, 100, 150. Those of the giants: 500, 1,000, 2,000, 3,000, 4,000. We ought not even speak of the two groups in the same breath, but should get into the habit of thinking and speaking of "the four inner dwarf planets" and "the four outer giant planets."

In spite of the immense distances separating them, the intervals between the planets reveal an underlying principle reminding us of the harmonies in music. To grasp the celestial harmony we will put down a series of numbers beginning with 0, followed by 1, and then double each successive number, thus:

0 1 2 4 8 16 32 64 128

We then multiply each number by 3, and get:

0 3 6 12 24 48 96 192 384

Finally, we add 4 to each number in the latter series:

4 7 10 16 28 52 100 196 388

This last row of numbers has a conspicuous congruity with the relative distances of the planets from the sun, using the distance from earth to sun as 10:

3.9 7.2 10.0 15.2 26.5 52 95.4 192 307

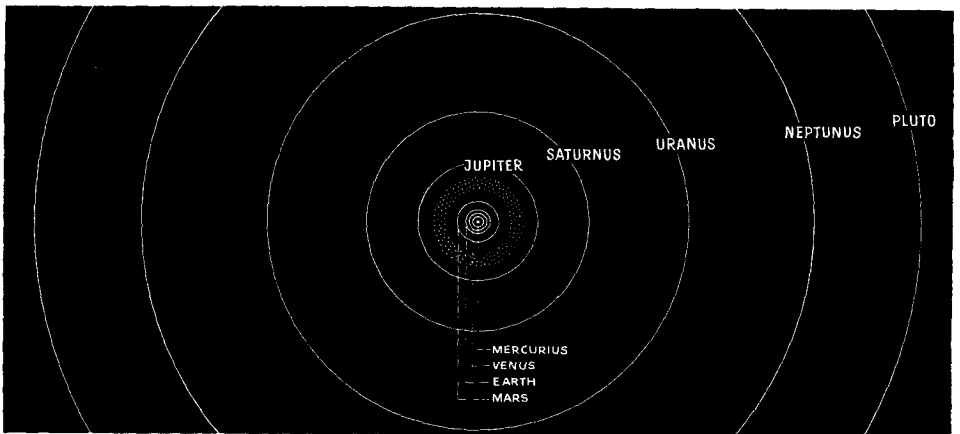

Fig. 78. SOLAR SYSTEM IN ITS REAL PROPORTIONS

The above progression, discovered by Titius in 1766 and published six years later by Bode, is known as Bode's law, and it is difficult to see how it could be ascribed to chance. To think of it as an accident, as many astronomers do, is much like believing that a stuffed and properly labeled cockatoo in the British Museum flew there from Africa, hopped in through the window of the Tropical Birds Hall and alighted on the branch where the plaque had already been placed.

The Four Inner Dwarf Planets

The atom is three-dimensional; the electrons revolve around the nucleus at all possible angles. The solar system is, not in a mathematical sense but practically, two-dimensional, for the planets revolve around the sun in a common plane. The fact that the comets and meteors travel in all planes of space can be disregarded because these tiny bodies, like dust particles in our atmosphere, are relatively unaffected by the general dynamics of the solar system. The plane of planetary revolution is called the ecliptic because eclipses occur when sun, earth and moon are in line in this common plane.

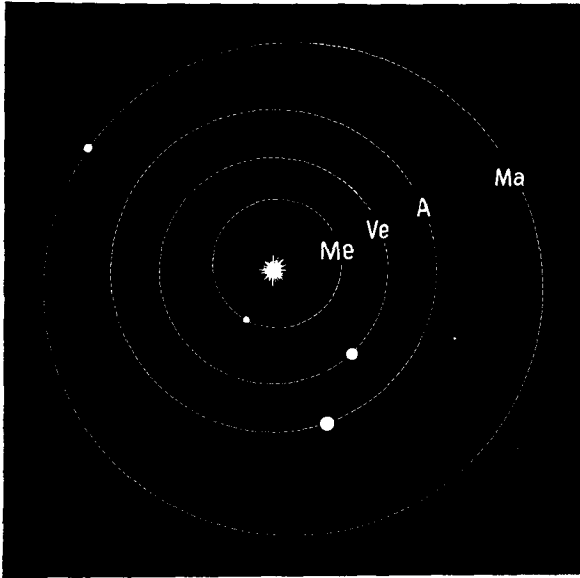

Fig. 79.

THE ORBITS OF THE FOUR INNER PLANETS

The statement that the planets revolve around the sun in ellipses creates an erroneous conception in the layman's mind. It is better to think of the planets as revolving in circles, with the sun slightly off center. (*After Fath*)

The orbits of the planets are not circles but neither are they the long ellipses that are usually drawn to represent them. These diagrammatic ellipses implant erroneous images in our minds. It is better to think of the orbits as circles with the sun standing somewhat off center, as presented in *Fig. 79*.

As we have seen, the four inner planets are Mercury, Venus, the earth and Mars. Seen from the earth, Mercury and Venus are "inner," and Mars, one

of the “outer” planets. Since Mercury and Venus revolve around the sun in smaller circles than the earth does, they constantly appear to be near the sun, either preceding it and seen on the eastern horizon as morning stars, or following it and shining in the western sky as evening stars. Because Mercury is so close to the sun that city-dwellers rarely get a chance to see it, it is Venus that is honored with the title “Morning or Evening Star.” During some periods Venus cannot be seen at all, because it disappears in the sun’s rays or is even eclipsed. Occasionally Mercury or Venus will pass directly in front of the sun’s disc, an event called the “transit” of Venus or Mercury. Like our moon, the two inner planets have “phases,” depending on their position in relation to the sun. Their brightness varies according to the phase. (*Fig. 81*) In certain favorable positions Mercury shines as a bright yellow-red

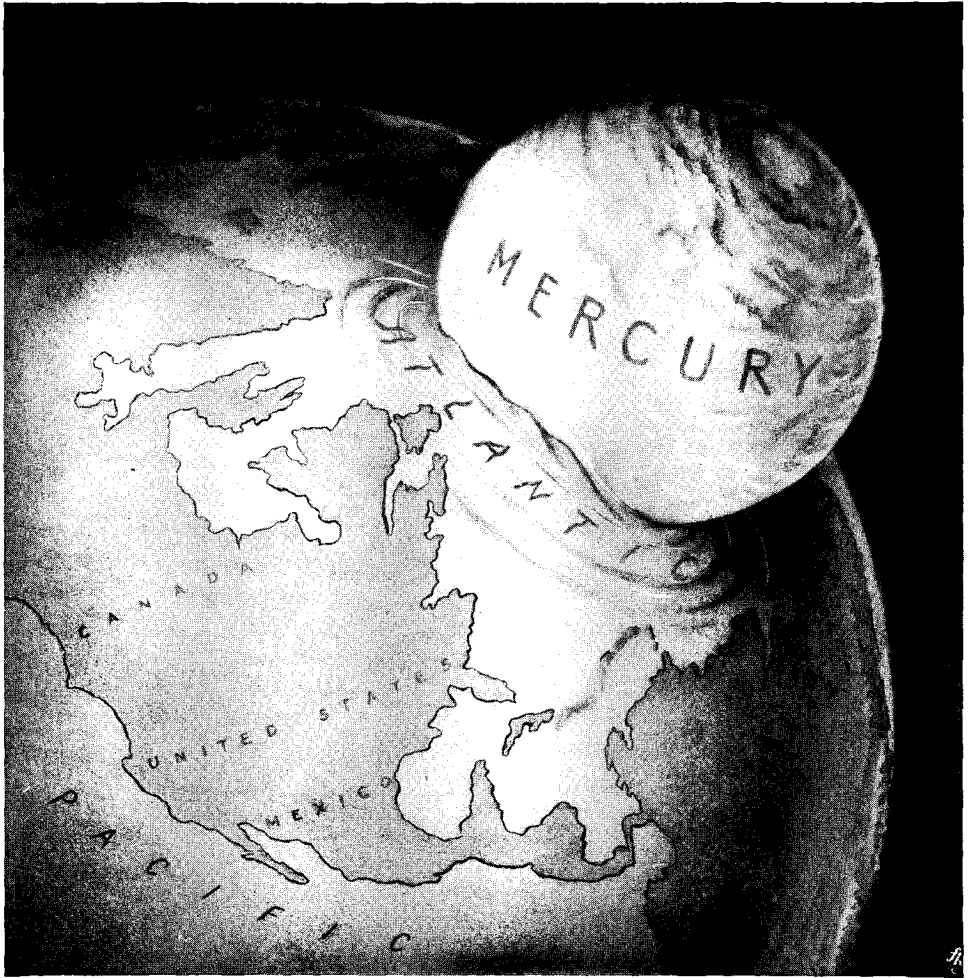

Fig. 80. MERCURY, THE INNERMOST PLANET

Mercury is so small that it could plunge into the Atlantic Ocean between Canada and the British Isles without touching the continents.

star, while Venus at its most brilliant may appear 13 times as bright as Sirius and even casts shadows on the earth. At such times it is possible to follow its path across the sky even during the daytime. The tiny point gleams like a sliver of gold coursing through the blue heavens.

We know astonishingly little about the planets. The era of planetary research is still to come when missiles, equipped with cameras, television apparatus, Geiger counters and all other recording instruments, will rise into space and look, unhampered by atmosphere and distance, at our brother and sister worlds "eye to eye" for the first time. Mankind, impatient but still earth-bound, will watch on television sets or other devices, and a new era of astronomy will begin, the era of planetary reconnaissance.

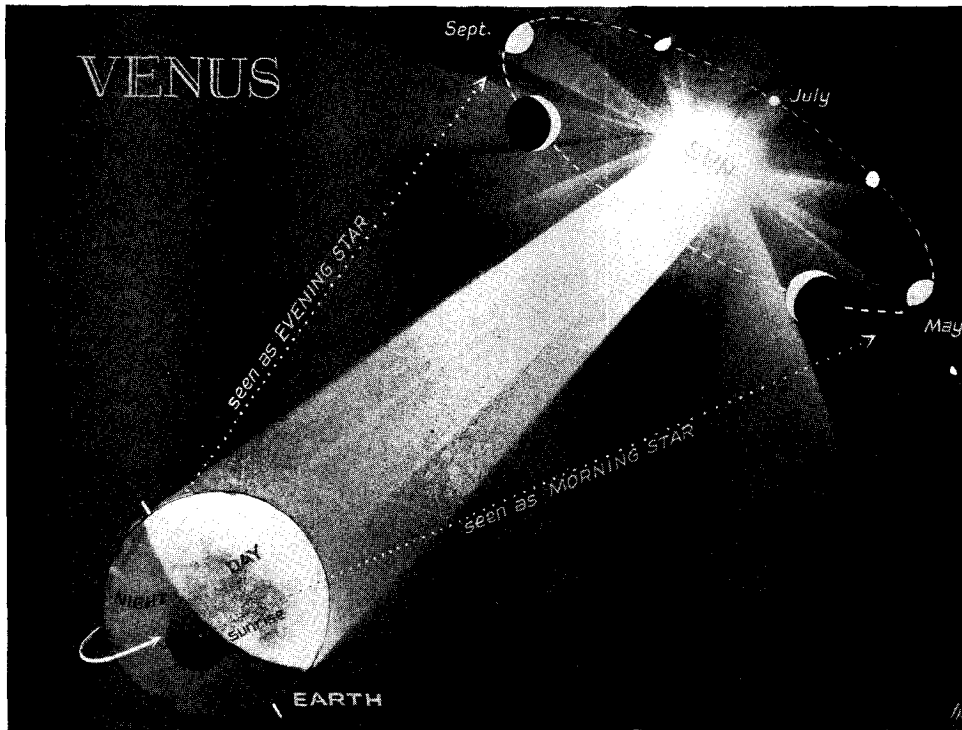

Fig. 81. VENUS

Venus circles around the sun in a relatively small circle and is therefore always seen near the sun, sometimes as the "morning star," sometimes as the "evening star." Its brightness changes considerably with its position. The dates September and February have only didactic value.

Mercury is small—only one-twentieth the size of our planet. If it fell to earth it could sink into the Atlantic without grazing a continent. (Fig. 80) Its surface reflects so little light that it is probably covered by a dark substance like granite or lava. A planet of Mercury's size does not exert enough gravitational force to hold the atoms of an atmosphere, especially when a body as large and as hot as the sun is so near that it attracts the atoms and

excites them to motion. Mercury seems always to turn the same side toward the sun, as the moon does toward the earth. It takes only 88 days to circle along its orbit, that eccentric orbit which gave Einstein an opportunity to prove that space is curved. (*See page 45 and Fig. 11*)

Venus is about the same size as the earth. In contrast to Mercury, it reflects the light of the sun so strongly that it is the most brilliant of all heavenly bodies. A dense, cloudy atmosphere rich in carbon dioxide but poor in oxygen and water perpetually veils the planet. On the side that faces the sun, its temperature is presumably high. (*Fig. 81*)

We are considerably better informed about Mars: first, because it is our closest neighbor on the side away from the sun and consequently we can see it under optically ideal conditions, with the sun behind us; and second, because the atmosphere of Mars is thin and conceals little. No wonder that no other heavenly body has stirred man's imagination so deeply! (*Fig. 82*)

Mars is nearly twice as far from the sun as the earth, and therefore receives a good deal less light and heat. Its orbit is decidedly eccentric, so that the distance between Mars and the sun varies 50,000,000 kilometers during one revolution with the result that the difference between its winters and summers is sharply marked. Since Mars takes almost twice as long as the earth to revolve around the sun—687 days—its seasons are consequently longer, the cold, dimly lit winter lasting twelve months.

Mars is small, about half as large in diameter as the earth, and a pound on Mars weighs less than two-fifths as much as it does here. On the ground the atmospheric pressure is less than a tenth of ours. The air is tenuous and, since Mars' weak gravitational force cannot hold the atoms of light gases, contains almost no hydrogen and oxygen and therefore almost no water, which is a compound of these two. The main component of Mars' atmosphere is nitrogen; it also has some carbon dioxide. Occasionally fine cirrus-like white clouds appear 20 miles up, composed of fine crystals of carbon dioxide or water. They drift westward, as the clouds on earth do, with winds ranging up to 60 miles an hour, near hurricane speed. When the high and low pressure areas of the Martian atmosphere are traced we note a striking similarity to the pressure and wind distribution on earth.

Far from the sun, protected only by a thin, dry atmosphere, Mars has low temperatures. At the height of summer in the tropics, the temperature climbs to 20° C. But in general the daytime temperature rarely rises above the freezing point; at night it falls to -85° C. If there were as much water on Mars as on earth, it would be an ice-covered globe with a landscape like that of our polar regions. But if there is any water at all, it is only very little, and it is doubtful whether the two caps that cover the poles of Mars are ice and snow but rather white masses of other chemicals. The caps, which advance and retreat in a seasonal rhythm, cover no less than some 6,400,000 square kilometers at each pole by the end of the Martian winter. In the middle of spring, dark rifts start to split the caps into fragments which

disintegrate rapidly. During the summer the caps are only a tenth of their winter size and sometimes may vanish entirely. In the final weeks of the summer, white clouds appear over the poles and veil more and more of the arctic sections throughout fall and winter. When the cloud cover breaks up at the end of the long winter season, the polar caps become visible at their full extension. But not for long; with springtime approaching, the caps break up again into fragments that "melt" or, more probably, vanish by evaporation into the cold dryness of the atmosphere.

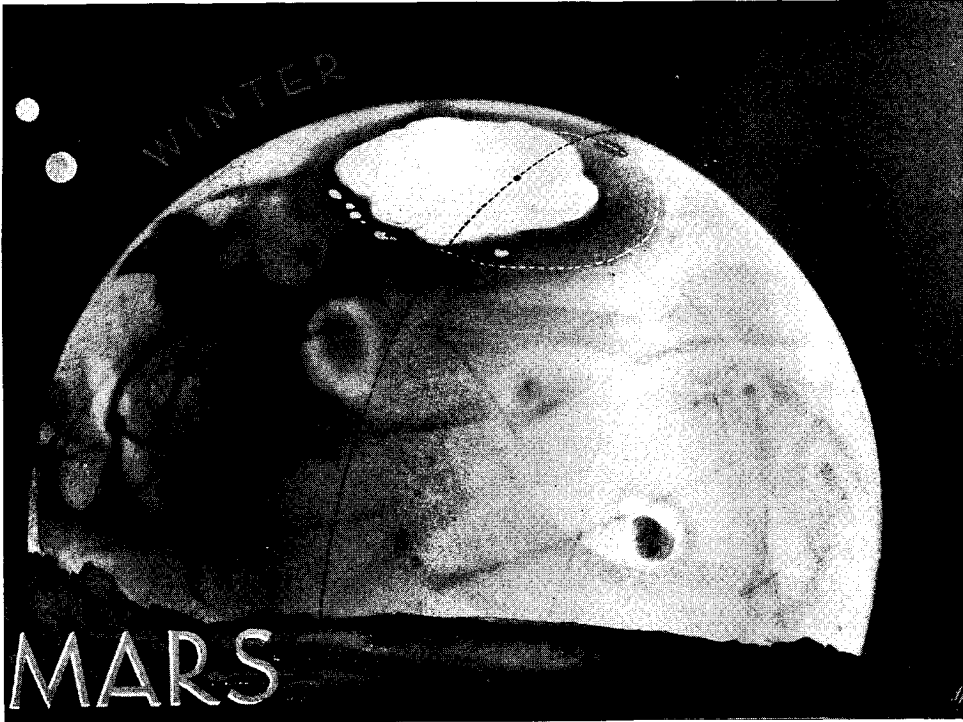

Fig. 82. MARS

This half diagrammatic picture is fictional. It combines the winter and summer aspects of the planet, separated by a dotted line, to display the typical differences such as the melting of the ice caps and the darkening of the plains and canals.

While the caps are shrinking, dark masses migrate to the equatorial zones. They follow specific lines which are considered rifts in a mountainous landscape because the caps break up every year in the same spots and the dark masses flow through the same arteries. The dark masses travel like a flood at a speed of 17.5 kilometers a day; a second, more diffuse mass, which is thought to be a mist, advances 45 kilometers a day. The flowing masses can hardly be water, since water is sparse and would evaporate quickly into the dry atmosphere or freeze on the below-zero ground.

Basically, the Martian landscape has an unchanging face. Because there is

no water on Mars, there are no seas, and consequently none of the flashing mirrors that oceans would create. Most areas are reddish in color and are thought to be deserts. The light they reflect reveals that the ground is covered with ferrous oxide. From time to time dust clouds—"sandstorms"—arise and our spectometric instruments disclose that the ferrous dust is mixed with silicates of aluminum and potassium.

The colors of the landscape change with the seasons. Areas hitherto bright darken and stay dark for some months or even years. In winter they are grayish or greenish; in summer they turn brown and violet. The stream of the polar masses, too, changes in detail and color. The surface of Mars was mapped carefully by the indefatigable and enthusiastic Italian astronomer Giovanni Schiaparelli in the seventies of the last century. He projected the antique world of Biblical and Hellenic geographical names onto its surface.

If Mars had a temperature ranging as much above zero as it does below, if the arctic winter did not last almost twelve months according to our calendar, if the temperature did not change so abruptly from day to night, if there were an atmosphere with oxygen and water vapor, and if there were as many seas as there are deserts, and thunderstorms instead of dust tempests—if, in short, everything were just the opposite of the way it is, we could speak of our brother world in the cosmos and make haste to speed the day when our first spaceship landed on the Martian shores and the Columbus from earth was embraced by the man of Mars. But, alas, there is no reason for optimism or hope for adventure. The future traveler to Mars can expect only a cold, desiccated planet with deserts and lifeless mountains. No people who might understand the Pythagorean message of a tellurian civilization will give the arrivals a ticker-tape parade.

Plenty of discussion within scientific circles and without has been expended on the problem of life on Mars. But the high expectations have sunk down to the level of stunted lichens and mosses thriving miserably on an icy tundra. Even this seems overoptimistic. Schiaparelli's "canals" built by a highly skilled nation are phantoms of illusion. There is only one spark left in the burned-down ashes of the Martian dream: perhaps in bygone times conditions on Mars were more favorable; life progressed through the same evolution as on earth and a race similar to ours in physique and intellect developed. As we are trying to do, Martian man emancipated himself from nature and built up a kind of "underground" civilization. Independent of the favors and assaults of nature he lives still on this doomed world, in a planetary mausoleum. And upon our arrival he may crawl out of his hiding place—his subterranean metropolis. This is a very faint spark in the ashes of our dreams of a Martian world.

The Ring of Asteroids

The computations of the distances between planets indicate that there should be another planet revolving between the inner dwarfs and the outer giants. Kepler had already sought it early in the seventeenth century. In the eighteenth century an international scientific hunt for the missing planet was started. But to no avail. Yet if a planet cannot be found where the formulas would have it, we may be sure that it *was* there once. At last, on the first night of the year 1801, the astronomer Piazzi in Palermo tracked down the long-hunted "middle planet." He followed it for six weeks, but illness interrupted his observations. When he looked for it again, it was no longer to be found.

At the same time there lived at Göttingen, the famous nineteenth century stronghold of mathematics, a child prodigy named Karl Friedrich Gauss, a veritable Mozart of numbers, who at the age of three astonished his family by his mathematical acrobatics. At the age of twenty-three he sat down and re-constructed, from the meager data Piazzi had gathered, the orbit of the lost planet and the points where it could be expected to reappear. At the end of the year the planet was rediscovered where Gauss had predicted it would be. It turned out to be a small body, 800 kilometers in diameter, a piece of rock about the size of England flying through space.

Scientists were both relieved and disappointed—happy that the theory was confirmed and a planet had been located according to calculations, but disappointed in its small size. They were convinced that there must be others. A new celestial hunt was begun and in the course of a few years three additional planets were traced. They were, however, so tiny that they hardly deserved the title of planet. As one might expect of men who sat up with their telescopes at night, the scientists expressed their scorn of the disappointingly minute planets by naming them after the female deities of Olympus: Ceres, Pallas, Vesta and Juno.

When at the end of the nineteenth century photography was introduced as a method of astronomical research, many more "minor planets" were easily discovered. On plates, exposed for hours, the fixed stars showed up as points, but the planets, traveling through their orbits, appeared as small stripes among the sharp points. In this convenient manner about 2,000 minor planets or asteroids have been found. It is assumed that tens of thousands more exist. All of them travel in the same direction as the planets, following the "rule of the road." With few exceptions they swing in the plane of the ecliptic with deviations of not more than 34° . They are very small, most of them having a diameter of only a few miles, and their mass is light, their density much like the moon's, only three and one-half times that of water.

We are not sure what asteroids really are. Earlier theories assumed that

they were fragments of the vanished "middle planet," but all the asteroids together contain no more mass than our moon. If a middle planet once existed its fragments have dissipated almost completely. If we adhere to the theory of the planetesimals, the asteroids may be regarded as the residual masses left over when the primordial planetesimal masses gathered into planets and moons. The area in which they fly around is the very one in which free-roving masses are supposed to be found according to the nodal theory of "vibration."

In view of their small size, lightness and large number, it is not surprising that their planetary neighbors, Mars on the inner side and Jupiter on the outer, deflect and occasionally even "capture" asteroids and turn them into "moons."

A misleading term in astronomy is "moon." Any bodies which revolve around planets are indiscriminately called moons and we thereby lose the distinction between large spherical bodies, like our moon, which revolve in a definite orbit for millions of years, and bodies which accidentally join a planet for a transitory period. Such bodies as these latter might fly into the range of a planet at any time and revolve around it for a relatively short period. They should be called "satellites." Mars would have no moons in the sense that the earth and Jupiter have. It is accompanied by two satellites so small that they did not come to the attention of observers until the great modern telescopes discovered them at the end of the last century. Only six to seven miles in diameter, they are nothing but two flying rocks, probably not spherical. They are closer to the planet than real moons can ever be, according to the equations of Roche. Whereas our moon is about 400,000 kilometers away from us, one of Mars' satellites is only 10,000 kilometers from the planet's center; the other, 22,000 kilometers.

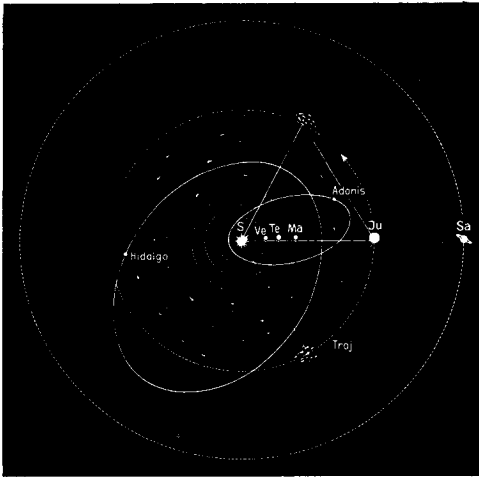

Fig. 83. THE TROJANS

The Trojans are two groups of asteroids which fly in the orbit of Jupiter as distant from Jupiter as the sun is. Adonis and Hidalgo are two asteroids with strongly eccentric orbits.

The outer of the two satellites revolves around Mars at nearly the same speed as the planet itself and, therefore, stands almost still in the planet's sky. The inner one, Phobos, moves so rapidly that it rises in the west, travels eastward, and traverses the distance from the horizon to the zenith in about two

hours. If there are Martians, they have no need for clocks. Phobos moves like a sidereal hand across the constellations of their sky in four hours. Since Mars wanders along the inner rim of the asteroid belt, it seems highly probable that these two bodies are captured asteroids.

Jupiter, revolving on the outer rim of the asteroid belt, is several thousand times as large as Mars, and has, therefore, drawn many more asteroids into its orbit, sucking them up like a voracious polyp. We do not know how many asteroids Jupiter has captured through the eons. The number may well be in the hundreds. The minor planets still revolving today may well be regarded as the survivors of ten thousand times as many which once filled the sky like migrating birds.

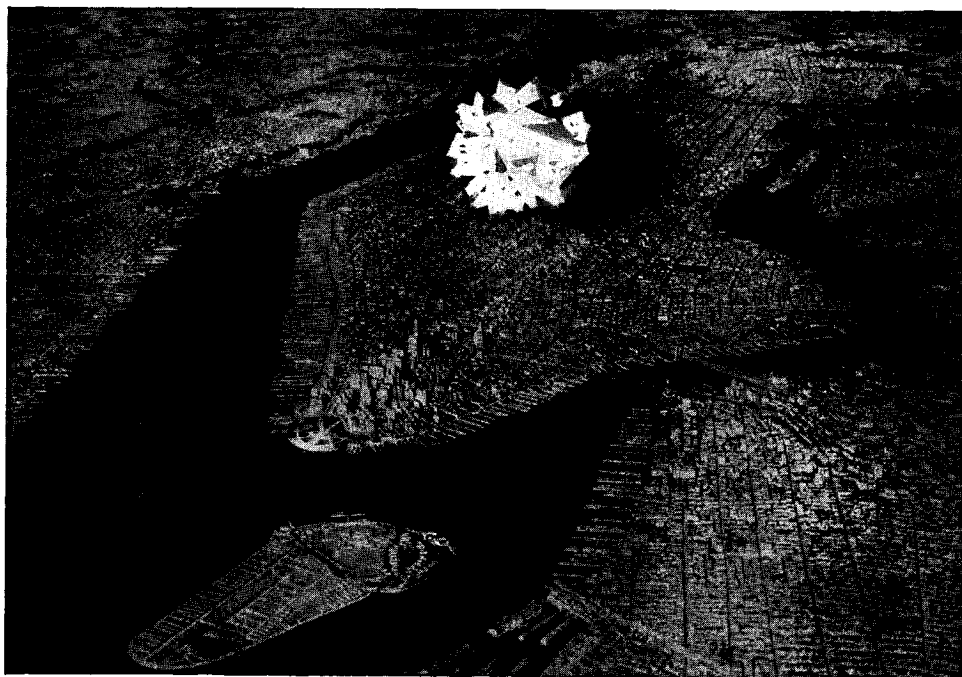

Fig. 84. THE ASTEROID HERMES OVER MANHATTAN

Asteroids are often no larger than city blocks. (Adapted from a model at the New York World's Fair, 1939.)

At present Jupiter is encircled by about a dozen "satellites" in addition to its four moons. It also has about a dozen other companions, called Trojans, flying in two groups—one preceding, the other following the planet. Each group is as far from Jupiter as Jupiter is from the sun, so that the sun, Jupiter and each group of Trojans form an equilateral triangle. (*Fig. 83*) The French physicist Fresnel once calculated the possible positions in which three bodies moving through space could maintain a stable relationship to each other. He came to the conclusion that one of the possibilities is the distribution of the masses on the corners of an equilateral triangle. The arrange-

ment of sun, Jupiter and Trojans at the corners of such a triangle is a substantiation of Fresnel's theorem drawn on the blackboard of the nocturnal sky.

In *Fig. 83* two eccentric orbits of asteroids have been added: the orbit of Hidalgo, which is a long ellipse and takes the asteroid into the vicinity of Saturn's orbit; and Adonis, which crosses the orbits of all the inner planets. In 1936 it came within 1,920,000 kilometers of the earth. In October, 1937, a small body, Hermes, came within 480,000 kilometers of earth, almost as close as our moon. It was the size of a city block, and it could have been shot to pieces by a space rocket (*Fig. 84*) but our cosmic artillery was not yet mounted. Another body, Eros, came within 10,000,000 miles of the earth in 1917. It was shaped like a dumbbell and rotated on its axis once every 5 hours and 17 minutes. It seems to be a rule that celestial bodies assume a dumbbell shape before they break up.

There need be no fear of an asteroid's endangering the earth. The steady course maintained by the earth indicates that no large body has disturbed our globe in its planetary orbit for at least several hundred million years. The French mathematician Roche calculated that, whenever a small heavenly body approaches a bigger one within two and a half times the radius of the larger body, the force of attraction shatters the intruder. The "Roche limit" is a protective mine field. So the next time you see a newspaper headline reading, "Comet Approaches Earth! Worlds in Collision?" just sit back and smile. Extraterrestrial catastrophes are not the ones that threaten the history of life.

The Two Giant Planets: Jupiter and Saturn

If we were traveling in a rocket ship from the region of the inner planets through the belt of asteroids into the realm of the outer planets, we would soon notice that we had entered a world of entirely different dimensions. In size, Mars or the earth cannot compare with Jupiter or Saturn. If the volume of the earth is taken as 1, Jupiter's would be 1,000 and the sun's 1,000,000. It would take 1,330 earths to fill the globe of Jupiter. Jupiter's mass, however, is so light it would take only 318 earths to equal its mass. The fact that Jupiter is considerably flattened suggests that it is a gaseous sphere. Yet there is reason to suppose that under its cloudy cover of ammonia and methane Jupiter, as well as Saturn, consists of a rocky metallic core encased in a thick coating of ice, and that this combined solid mass is surrounded by an atmosphere of hydrogen.

During the nineteenth century it was assumed that Jupiter was a sphere of still hot and radiant gases, a conclusion mistakenly deduced from the great red spot which appeared on it in 1857, spread out over an area of more than 24,000 square kilometers, reached its maximum in 1887 and then gradually faded,

though it is still visible. When modern thermoelectric heat-measuring instruments were brought into use, they revealed that the temperature on the surface of Jupiter is far below zero.

At a temperature as low as that, the methane should still be gaseous but the ammonia mostly frozen—hence the supposition that beneath the methane-ammonia clouds the planet may be covered with a high layer of ammonia ice.

The rocky-metallic core may be in a state of volcanism and the red spot and other similar spots appearing on the surface from time to time may be clouds of metallic dust.

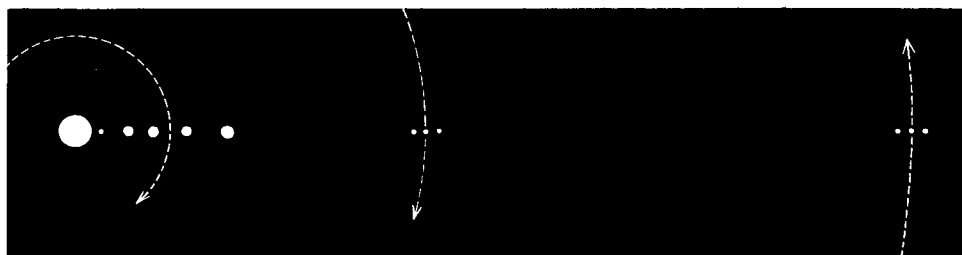

Fig. 85. THE MOONS OF JUPITER

Only four of the so-called twelve moons of Jupiter (the twelfth would be far off the page) are real moons. All others seem to be asteroids attracted by the gigantic planet.

The most perplexing riddle of the colossus among the planets is its rapid rate of rotation; Jupiter spins at a tremendous speed, 60 times faster than the sun, making a full turn in 10 hours. This “suprasolar” velocity is one of the strongest arguments against theories like those of Kant and Laplace. It is impossible to see how a sphere spinning so rapidly could have been derived from the lazily rotating sun.

The immense planet is accompanied by about a dozen satellites, four of them actual moons. (*Fig. 85*) They were the first hitherto unknown bodies in the sky to be discovered by telescope. Independently of each other, Galileo and Simeon Marius saw Jupiter’s satellites with their simple prototypes of all later telescopic instruments. Since those renaissance days when intellectual life was truly reborn, it has remained a favorite pastime of stargazers to follow the kaleidoscopic interplay of these four revolving moons and to watch the specks of their shadows wander over the white screen of the clouded atmosphere beneath them. No less interesting is the fact that primitive races had knowledge of their existence, although it seems highly improbable that even sharp eyes could have seen them without the help of a magnifying device. We will be confronted with this oddity soon again.

The first, second and fourth of the Galilean satellites are similar to our moon in size, mass and density, but in contrast to our moon, which has a dark surface, they reflect the sunlight strongly. The third cannot be rocky, since its density is only a little more than half that of water; it must be a globe of

matter similar to the outer layers of Jupiter, perhaps a sphere composed of hydrogen, methane and frozen ammonia.

The other eight or more satellites of Jupiter are not true moons but much smaller bodies, the outer ones being only a few miles in diameter. With the exception of one, which rushes close to the Jovian clouds at enormous speed, they form two almost equal groups. The inner group is approximately 160,000 to 1,600,000 kilometers away from Jupiter, and the outer group is about 20,000,000 to 22,000,000 kilometers distant. The three outermost satellites move in a direction opposite to that of Jupiter and its moons. Some future mathematician may find formulas to prove that the system of Jupiter is dynamically a vortex, and that a zone of counter-suction forces bodies at a certain distance to whirl in this retrograde direction.

Saturn seems in every respect like a brother of Jupiter's. It is also a giant of a planet, 750 times larger than the earth, but even lighter than Jupiter. Despite its immense size its mass is only a hundred times that of the earth. It, too, rotates rapidly and is veiled by a blanket of methane and ammonia clouds. The surface of the clouds is somewhat colder than the surface of Jupiter's clouds, which might be accounted for by Saturn's greater distance from the sun. But they are still about 50° warmer than the calculations lead us to expect, suggesting that the planet's core radiates heat. Occasionally visible disturbances hint at volcanic action and violent turbulence. Despite the enormous distance between Jupiter and Saturn, they attract each other, the two orbits swaying in a rhythm of about 900 years.

Saturn holds the record in moons. No less than eight *veritable* moons revolve around the curious globe. From the planet outward, they become progressively larger, then smaller. The largest is somewhat bigger than our moon; its atmosphere contains methane. Four times as far from the planet as the outermost moon, at a distance of 12,800,000 kilometers, circles a satellite that takes a year and a half to describe one revolution.

Among the most remarkable phenomena in the solar system are the rings around Saturn. (*Fig. 86*) There are, in fact, not several rings, but one broad ring, divided into three parts. If this ring were not plainly visible, every earnest scholar would ridicule the idea of a ring around a planet as a figment of science-fiction. Yet the equations of Roche justify its existence: a satellite cannot maintain itself if it comes closer to a planet than about two and a half times the planet's radius. Phobos, the satellite of Mars, circles around at a distance of 2.79 times the radius of the planet; Jupiter's innermost moon is 2.54 times the radius away from it, and Saturn's innermost moon is at 3.11 times the radius. Putting our trust in the omnipotence of mathematical formulas, we are certain that if we explored a thousand solar systems we would never find a satellite nearer its planet than two and a half times the planet's radius.

Saturn's ring is presumed to be the remains of moons that disintegrated into stony fragments when they reached the Roche limit. The ring, 250,000 kilo-

meters in diameter, is 72,000 kilometers broad but only 16 kilometers thick. It is so thin because the stones remain suspended in space only as long as they stay in the plane of the planet's equator where centrifugal force and gravity are holding them in balance.

The stony fragments are thought to become progressively larger going toward the outer rim of the ring, but all seem to be relatively small. The closer the stony fragments are to the planet, the more rapidly they move, following Kepler's law. Those inside revolve more rapidly than the planet itself rotates, and consequently "rise" in the west.

According to astronomical computations there must be a zone between the second and third sections of the ring, about 3,500 kilometers wide, in which the stony particles cannot stay in balance. In point of fact there is a gap,



Fig. 86. SATURN

Saturn is the most fantastic of heavenly bodies. A wide ring rotates around the great planet. This mysterious ring is probably the residue of disintegrated moons.

which was discovered in 1675 by Cassini, the first director of the Paris Observatory, and named the Cassini division. We do not know what really takes place within the ring of Saturn and everything said about it is purely hypothetical. Since the planet's moons attract the stony fragments, we may assume that the ring is subject to tides. These tides might pull the fragments out of the planet's equatorial plane. As they rushed through the "atmosphere," they could tear atoms apart, so that "arctic lights" and electrical storms might occur on a gigantic scale. There is probably no place in our entire planetary system where it would be more exciting to stand than under this rolling belt of trillions of fragments—if a human being could stand amidst this rain of stones. However, no one could live in an environment so different from our planet's, with such strong gravitation, such violent centrifugal force, so low a temperature and an atmosphere suffused with a deadly gas like ammonia. Who knows how many pioneering space travelers of the future will lose their lives under the thundering ring of Saturn?

Of late, the suspicion has arisen that the "rocks" of the ring may be chunks of ice, for the spectroscope indicates the presence of water, sunlight is strongly reflected and the inner moons of Saturn have the density of water. At the beginning of the century a German cosmologist advanced the hypothesis that water plays as prominent a role in the building of the universe as it does on earth. Why, he asked, should we ignore the simple fact that in the world of the other planets water may be one of the common compounds, since hydrogen, the "water-builder," is the all-pervading gas of the universe. Because the temperature of space is so low, the water would have to be rock-hard ice; with no air and no wind, the ice must be stable as stone.

The ideas of this "world-ice" hypothesis were enthusiastically promoted by ardent followers, and discussions flared up between the adherents of the new cosmic idea and the holders of the "old, well-established facts." The ardor of the dispute contrasted almost comically with the coldness of the subject. It is, in fact, exacting to demand of a mind, educated in "classic" concepts, that it conceive of a comet as a chunk of ice which melts when it approaches the glowing sun. Yet since we know so little about the universe, we should listen even to as strange a hypothesis as this one, as long as it does not clash with fundamental laws and calculations. As Oliver Wendell Holmes once said, "No one can swallow the universe."

An amazing sidelight on the mystery of the ring of Saturn is that it was known to the ancient Maoris of New Zealand. Since it is biologically impossible for naked eyes, no matter how sharp, to perceive the ring, we are led to wonder how these aborigines received their strange knowledge.

To attack this puzzle, we must first rid ourselves of any prejudice that only the so-called literate peoples are intelligent or productive. The difference between literate and non-literate races is not one of intelligence, but rather of a way of life. Civilization is associated with urban existence. All great civilizations are the products of countries centered around big cities: Babylon, Peking, Thebes in Egypt, Troy or Athens, Rome, Baghdad, Constantinople,

Toledo. Citizens of great cities accumulate their learning, their literary and artistic achievements, and bequeath them to future generations. So today we stand in admiration before monuments like the pyramids or documents like the Ebers Papyrus with its medical wisdom. We read with awe the tragedies of Sophocles which were played in Athens, and pay respect to the Roman Law, written in the "Eternal City" by the men who proudly said: *Civis romanus sum*.

Less documented, but not necessarily inferior, was the way of life of those races who preferred an uninhibited existence in a natural habitat to the maelstrom of great cities. Their unrecorded achievements—myths, songs and rituals—are drowned in the stream of time. But the fragmentary residue of their poetry and the relics of their handicraft prove that they possessed poetic and artistic gifts as great as ours.

So it was with the Maoris. Little is known about their vanished culture, but Saturn's ring is mentioned in their legends! How could they have come by this knowledge? Perhaps once upon a time an artisan, polishing metal mirrors, casually discovered that concave mirrors magnify the images caught in them. He may even have combined several mirrors into a homemade telescope. And so it may have been that he saw the moons of Jupiter and the ring of Saturn.

Perhaps he pointed them out to his fellows, who looked on for a while in amusement. For them it was not a revelation as it was for Galileo. They knew nothing about the worlds in the sky and did not care to know. Sun, moon, stars, Magellanic clouds, moons around Jupiter and a ring around Saturn—these were not things to bother a Maori. Off to the woods they went to hunt, back to the shore to fish. The accidental telescope of the Maori "astronomer" fell apart, and Maori science died in the hour it was born, a stillbirth in the chronicle of science.

Who can decide which man is wiser? He who sees an eclipse of the sun and shudders as the wolf of hell threatens to devour the golden-haired daughter of the gods . . . who stands by night on a hill enraptured by the stars, those sparkling diamonds on the robe of the queen of heaven? Or he who labors in an observatory measuring to a gram the weight of the gaseous sphere and its pressure to the millibar until eyes are too weary to behold the wonders of the world and ears too dulled to hear more than the ticking of the chronometer? Who knows whom the Lord of the Universe will welcome with greater delight: those who come to his throne, bearing in their hands dissertations on the periodicity of the cepheids, or those who offer only a garland of myths about the milky band in the night sky.

The Three Outer Planets: Uranus, Neptune and Pluto

Beyond Saturn one enters the fourth ring of the solar system. The dwarf planets, Mercury, Venus, earth and Mars, form the first ring; the asteroids, the second; Jupiter and Saturn, the third. Properly speaking, the outermost

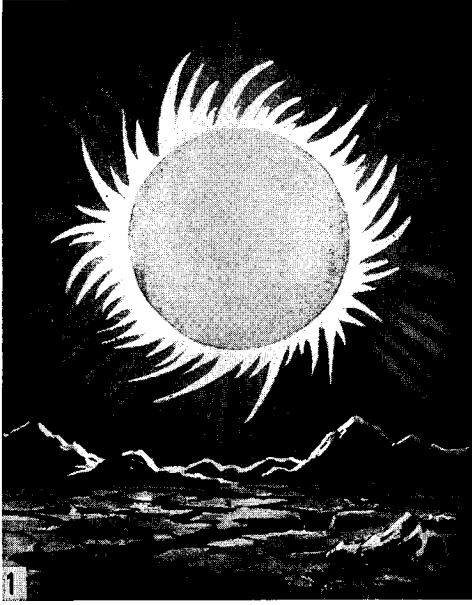

MERCURY



VENUS



EARTH



MARS

Fig. 87. THE SUN SEEN FROM THE PLANETS



JUPITER

SATURN

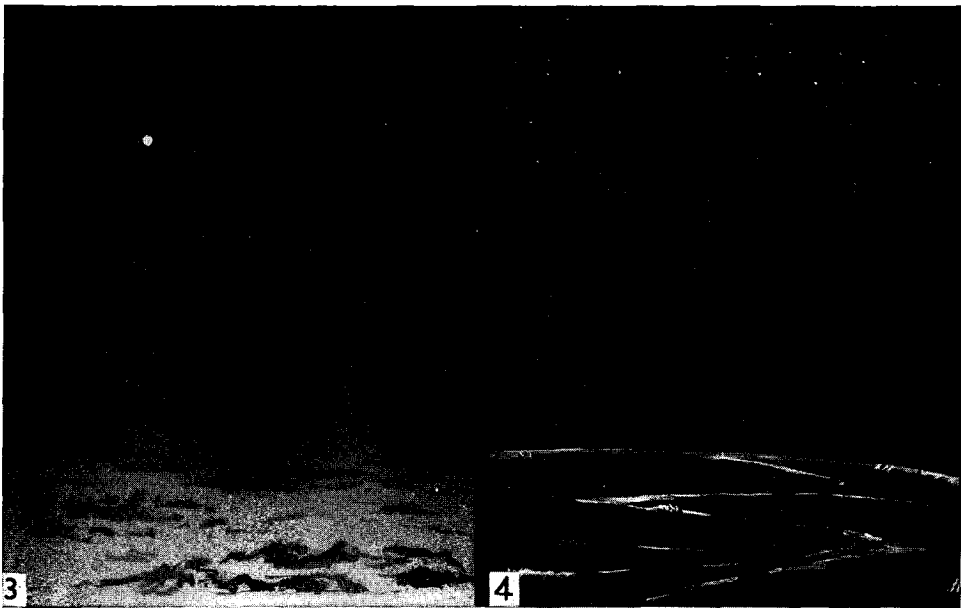

URANUS

NEPTUNE

These pictures illustrate how the sun would appear from the different planets if each had an atmosphere similar to that of the earth.

area of the solar system is divided into a fourth and fifth ring: Uranus and Neptune, which are similar in size and matter and about half as large as Jupiter and Saturn, compose the first of these, and beyond them is a ring consisting of an unknown number of borderline bodies.

In these outer spheres of the solar system, the distances of the planets from the sun and from each other are tremendous. Uranus is 20 times as far from the sun as the earth is; Neptune, 30 times; Pluto, 40 times. From these planets the sun is scarcely distinguishable from the other stars. (*Fig. 87*) Uranus may still receive some faint illumination resembling our moonlight, but the other two planets revolve in eternal night. Radiation from the sun does not heat the surface of Uranus to more than -170° nor that of Neptune to more than -220° . We assume that life does not exist at such low temperatures in pitch darkness, but we cannot be certain. The clouds enveloping the planets may be icy cold, but it is possible that beneath them volcanoes, hot springs or radioactivity furnish a climate like that of a hothouse. There may be inhabitants who live comfortably in an artificially heated and illuminated world. We cannot speak too glibly of these outer planets as "icy spheres of rock" or "dead-frozen worlds."

Though the three outer planets are so distant that they show up as mere pin-points on photographic plates, they are far from uninteresting. Each of them presents challenging riddles.

Uranus is barely visible to the naked eye. Even in its closest position to the earth, it appears as a star of only the sixth magnitude. Far away from the sun, therefore traveling slowly, Uranus takes 84 years to complete one journey through its orbit. It is a large planet, half the size of Saturn, and, like all the large planets, its mass is light. The question of why the big planets are light is one of the puzzles of the planetary system. One reason may be that they hold all their original elements because their gravitational force is strong. Small planets, with less gravity, lose their light elements in the early stages of development, and consequently later on have a heavier specific weight. The atmosphere of Uranus is even richer in methane than that of Jupiter and Saturn. There seems to be a rule that the quantity of methane in the atmosphere of a planet increases with the planet's distance from the sun.

The most unusual thing about Uranus is its position on the plane of the planetary system. All other planets spin like tops—the north pole above, the south pole below the ecliptic. Yet Uranus spins on its orbit like a top that has fallen over. It inclines to almost 100° , so that instead of looking at its equator we see its pole. Its five moons, small but genuine, are between 128,000 and 576,000 kilometers from the planet and revolve at a steep, almost perpendicular angle to the ecliptic. (*Fig. 75, bottom*)

Uranus was discovered not once but twenty times before it was recognized as a planet. The French astronomer Pierre Lemonnier repeatedly missed his chance at immortality. He saw Uranus no fewer than eight times during the year 1768, but did not realize what kind of body it was. Nineteen years later

Herschel arrived theoretically at the conclusion that Uranus was a planet, thus making it the first new planet to be discovered since ancient times, and the first to be disclosed by calculations. But Herschel's computations concerning the movement of the planet proved inaccurate. Twenty years later, the planet was found to be one-thirtieth the breadth of a full moon away from the point predicted by his equations.

A yearly deviation of $1/600$ of a full moon's diameter will never be accepted by astronomers. The French mathematician Alexis Bouvard set out to find the flaw. He struggled for twenty years with the persistence of the devoted scientist, only to be disappointed by finding Uranus' position discordant with his equations too. Now everyone was convinced that it was not the calculations that were wrong—but Uranus!

Two young students, one in England and the other in France, and unknown to one another, attacked the problem with new calculations. Each arrived at the same conclusion: a planet must be revolving beyond Uranus, causing Uranus to waver in its course. John Couch Adams, the first to arrive at this conclusion, wrote the director of the Greenwich Observatory in 1845, informing him that a trans-Uranian planet of a given size, weight and orbit should be at a certain point in the sky, and requesting him to look for it. But the director of a Royal Observatory can hardly be expected to pay much attention to directives from unknown students. Adams' paper was shelved.

The French student Urbain Leverrier was more fortunate. A periodical published his treatise. Upon reading it, the Greenwich director remembered the similar study he had received. He compared the two and, without bothering to look for the stray, simply referred the matter to the observatory at Cambridge "for further investigation." There, too, the policy of "wait and see" prevailed. Though the planet was sighted on two occasions as a "star" no one took the trouble to identify it as a planet.

Then the news burst from the Continent—a new planet had been discovered beyond Uranus! Leverrier had written to Johann Encke, director of the Berlin Observatory which was known to be using the best stellar charts then available. Encke handed the letter to his assistant Johann Galle, and on the night of September 23, 1846, Galle located, very close to the point indicated by Leverrier, a star not recorded in Argelander's catalogue, the most complete of its time. The following night, when he found that it had changed its position, Galle immediately realized that he had located Leverrier's planet. So it was that Leverrier, not Adams—who justly deserved the honor—won immortal fame for having calculated the existence of a previously unknown planet, which was christened Neptune. With characteristic French esprit, the inscription on Leverrier's statue in Paris reads: *To the genius who discovered a planet with the point of his pen.* Poor Adams!

As far as we now know, Neptune is accompanied by two bodies. The first is large, a real moon of considerable size, about as large as the planet Mercury.

This moon, Triton, revolves in a retrograde direction. A second satellite of Neptune was discovered through photographs. It is a small body, 320 kilometers in diameter, and was given the poetic name Nereid because the merman Triton is pictured by classical painters as being surrounded by his daughters, the Nereids. The unusual size and the retrograde motion of Triton aroused the suspicions of scientists and, as was later proved, not without reason.

Neptune moves very slowly along its orbit, so that not for fifty years did it become evident that this planet, too, does not adhere to its calculated path. Convinced that there must be a "trans-Neptunian" planet, the planet-hunters began a search for it—not in the sky but on paper by calculation. The leader of these heaven-rangers was Percival Lowell, a wealthy Bostonian and a gifted amateur astronomer. A man whose great imagination was paired with flaming enthusiasm, Lowell worked for years on his computations and organized an international quest for the undetected planet. Though he did not live to see it discovered (the search lasted twenty-five years after his death), an astronomer at the Lowell Observatory finally identified a star of the fifteenth magnitude as the long-hunted planet. Far from the sun, and therefore moving extremely slowly, it has traveled since its discovery only from the constellation Gemini (the Twins) to Leo (the Lion). To immortalize the contribution of Percival Lowell the name Pluto, beginning with his initials, was chosen for the new planet.

As often happens in science, the discovery of Pluto did not solve the riddle but made it more complex. Pluto could not be the sole cause of the disturbance in Neptune's orbit; it is too small. Pluto is no larger than Mars. Its orbit is unusually eccentric. The solution of the problem may be at hand: since Pluto is about the same size as Neptune's unusually large moon, Triton, it is possible that Pluto and Triton are twins. Either Pluto is not a planet, but a brother-moon of Triton, one which escaped from Neptune and now revolves around the sun as a "planet"; or Triton, the "moon" of Neptune, is not a moon, but a small planet, Pluto's twin. Off in the outskirts of the solar system where the attractive force of the sun is weak, this small planet may have wandered into Neptune's sphere, and the prisoner may now be forced to revolve around Neptune.

Whatever Pluto may be, it is surely not large enough to deflect Neptune from its orbit. There must be other bodies beside or beyond Pluto. It is hard to say whether the missing body would register on even the most sensitive film. It might be so far from the sun that it could not reflect any light. But the astronomer of tomorrow will say: "There must be a body of mass x at a distance y from the sun, at point z in its orbit. No telescope can see it. Take a radio-gun, aim it at this point, and fire. Wait the eleven hours it will take the radio signal to reach the body and eleven hours for the echo to return. Tomorrow at four-thirty we will know the answer. . . ." In this way or in another, the secret of the trans-plutonic planet will be solved.

The Comets

There are two groups of heavenly bodies in the planetary system, each group represented by three kinds of members. The members of the first group are the sun, the planets and the moons. These are bodies whose form and mass are constant; they stay in their orbits and are always found where they are supposed to be. The second group consists of occasional passers-by: comets, meteorites and meteors. The question of whether comets and meteorites are genuine members of the solar system or tourists from the outer world of stars has yet to be decided. At the moment, astronomers are inclined to regard them as the residue of the hypothetical cloud whose dust conglomerated into the primordial planetesimals.

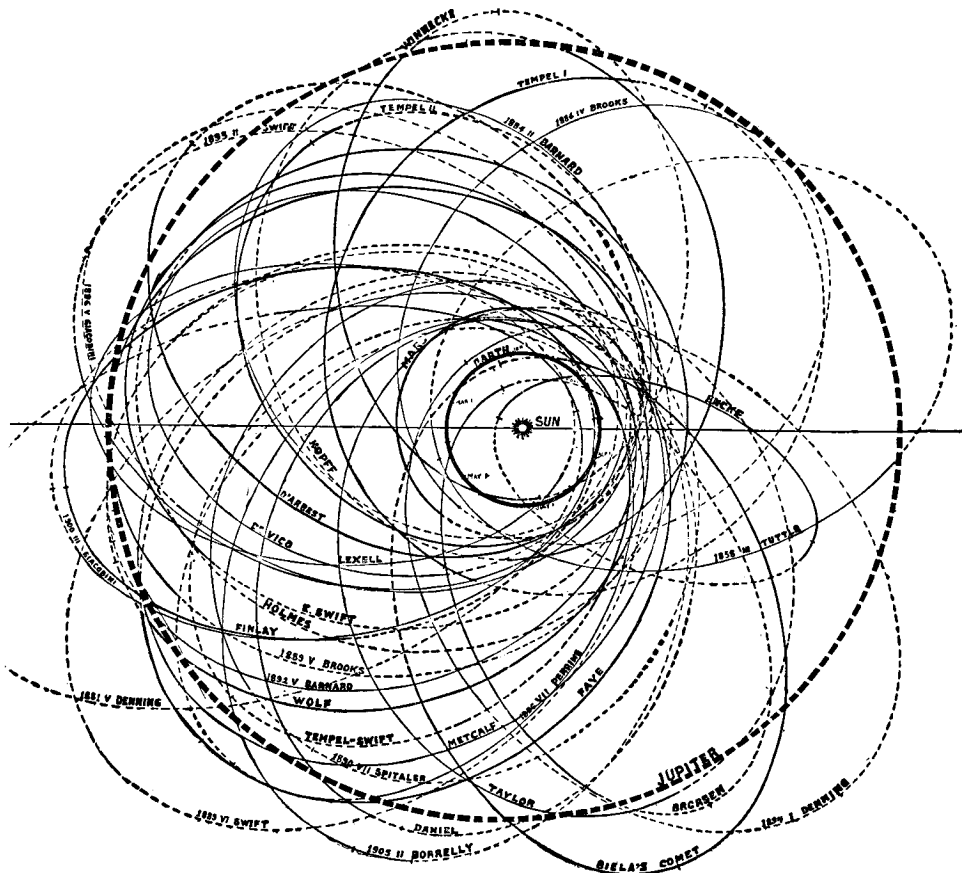

Fig. 88. THE "COMET-FAMILY" OF JUPITER
Huge Jupiter has "captured" several dozen comets which shuttle between Jupiter and the sun in elliptic and parabolic orbits. The small black circle is the orbit of the earth, the large broken circle is the orbit of Jupiter.

Comets are small cosmic bodies traveling around the sun in elongated ellipses, parabolas or hyperbolas. Most of the known comets circle in orbits extending from the sun to the orbit of Jupiter. (*Fig. 88*) The ellipses may be so elongated that the comets swing out into cosmic space as much as ten times farther than the orbit of Neptune. Since the speed of a body revolving around the sun increases as it approaches the sun and decreases when it withdraws, comets, unlike planets and moons, travel with changing velocity. At its maximum distance from the sun, a comet moves no faster than a man on a bicycle. But as it comes closer, its velocity accelerates progressively and finally it races around the sun with terrific speed. Thus, while a comet may take as long as a thousand years to pass—unseen by us—the outer arc of its orbit, it flashes through the inner part of the solar system in a few weeks and around the sun itself in a few hours. (*Fig. 89*)

With the aid of telescopes and cameras, comets are discovered every few weeks, but these cosmic vagabonds present a spectacle on our heavenly proscenium only when, once in a thousand times, one of them crosses the path of the earth at a crucial angle. A human being can consider himself lucky if once in a lifetime he witnesses the passage of a great comet.

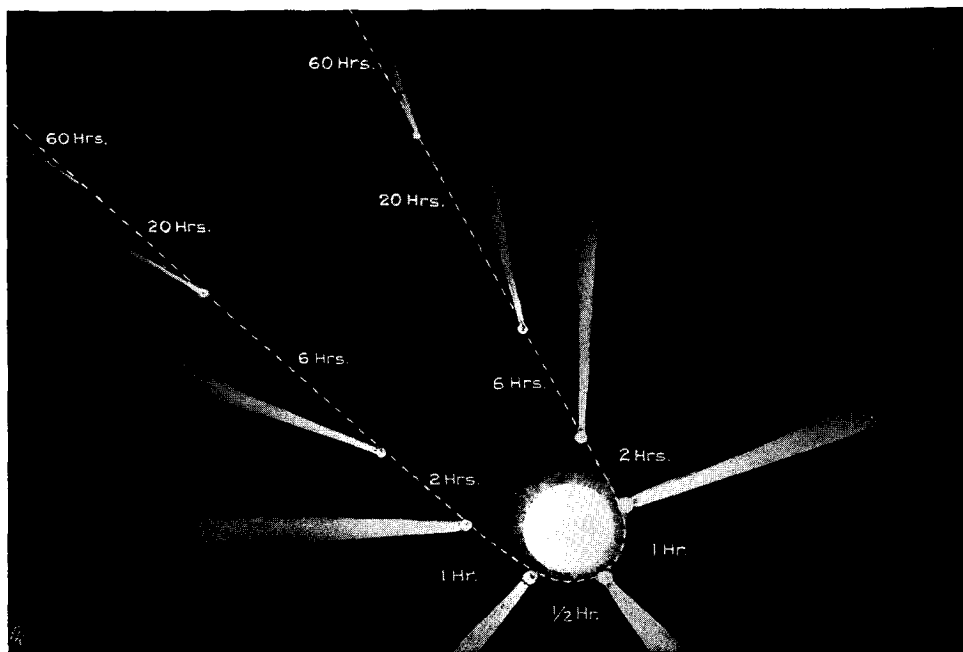

Fig. 89. ORBIT OF A COMET

The comet flies through its far-flung course with progressively increasing speed as it approaches the sun and correspondingly diminishing speed as it recedes.

At a long distance from the sun a comet is inconspicuous. Yet as it approaches the sun it begins to shine and to display three distinct parts: a burn-

ing mass as a nucleus; around the nucleus a halo of glowing gases; and behind the head, like two long tresses of hair, a forked tail, fading out into the darkness of space. The head may become as large as three full moons and so bright that it is visible in the middle of the day. The tail, as a rule, points away from the sun and may be described as a comet's "luminescent shadow." A comet's tail is by far the most extended object in the solar system, spreading out up to as much as 300,000,000 kilometers. Yet it is not an "object"; it is luminescent gas, like that of the Northern Lights. The spectroscope reveals that the luminescent atoms are those of ionized carbon monoxide, CO, and cyanogen, CNO. This is puzzling, because to produce these carbon-compounds and to ionize them requires considerable energy; we have not yet been able to divine this hidden source of energy.

Since early times comets have been regarded as "omens from heaven." When a comet appeared in the sky in the year 1456, the churches ordered this prayer to be offered up: "Protect us, O Lord, from Satan, the Turks and the Comet." Today, people no longer impart such religious significance to comets. But the old dismay returned anew in our times and, naturally, in accordance with the spirit of the age, in scientific guise: cyanogen, the gas in the comet's tail, said the prophets of doom, is a deadly poison. When the earth passed through the tail of Halley's Comet in 1910, an end-of-the-world panic took hold. Newspapers published sensational articles predicting the "execution of mankind" by "the most frightful of all poisons." Thousands gravely prepared themselves for death. Repentant sinners waited in line at confessionals. When the appointed night came, tens of thousands lay trembling in their beds, eyes on the clock, sniffing for the dread odor of cyanogen. Of course they smelled nothing. Not only is cyanogen odorless, but a comet's tail is less substantial than the vacuum in an x-ray tube. Even if the tail were composed of pure cyanogen, the whole earth, in passing through it, would be showered with less cyanogen than there is in an almond cake.

Mankind was not "executed" by Halley's Comet. The next day people went about their business, forgetting the comet as well as their embarrassing reaction to it. But the comedy will doubtless be re-enacted when another comet "threatens the earth." Superstition and fear of death are too deeply ingrained in man's soul to be uprooted by experience and enlightenment.

In the year 1770 a comet crossed the path of the earth at a distance of less than 2,000,000 kilometers. If its mass had been only one-millionth that of the earth's, its gravitational pull would have deflected the earth from its orbit. On another occasion a bright comet was seen to travel straight through the world of Jupiter's moons without having the slightest mechanical effect on these relatively small and light satellites.

In 1826 an Austrian army officer named Biela discovered a comet whose revolution was very short, taking less than seven years. After three return trips, Biela's comet broke into two parts in 1845 right before the eyes of the astronomers. In a few months these parts were well separated, and when the

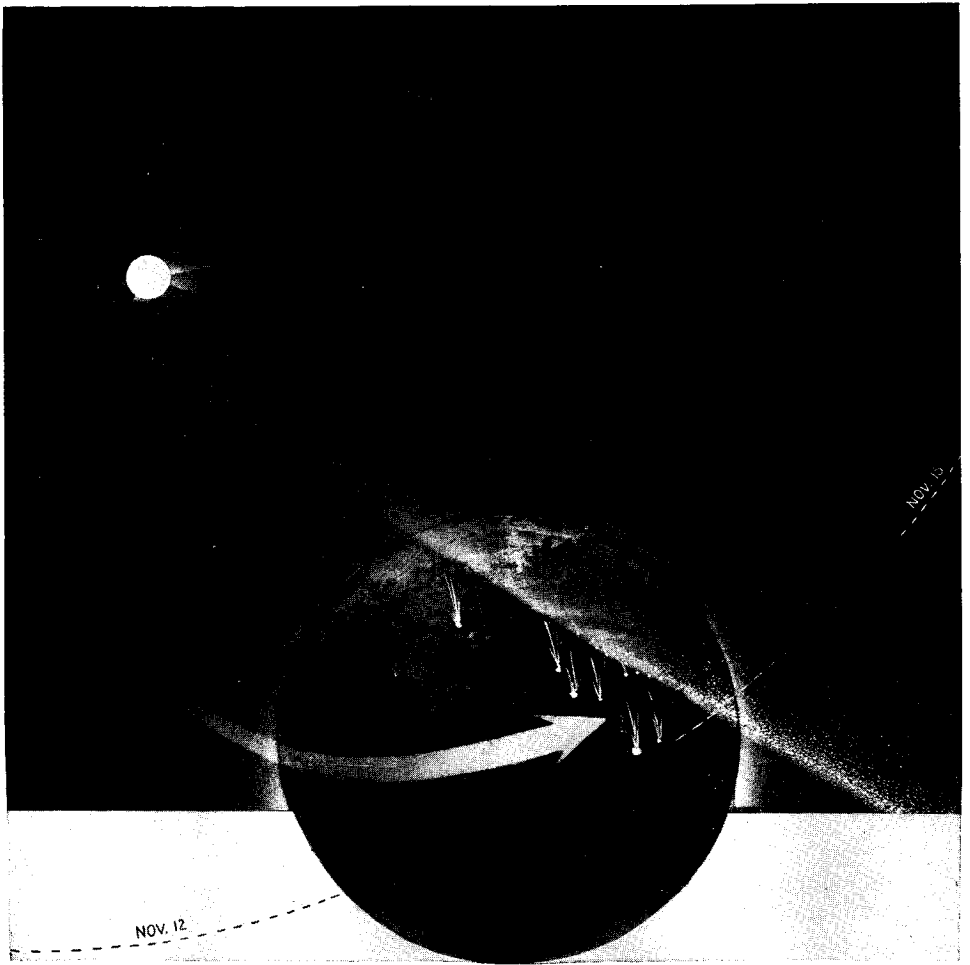

Fig. 90. SHOOTING STARS

Shooting stars are small particles which glow when they enter the atmosphere of the earth. Periodic swarms of shooting stars are supposed to be the residue of comets whose orbits the earth crosses.

comet returned in 1852 the fragments were more than 1,500,000 miles apart. They were never seen again, but in 1885, the year when the comet, if it had been on schedule, would have crossed the orbit of the earth for the fifth time, a shower of shooting stars—meteors—splattered down.

Meteors are the embers of comets. (*Fig. 90*) They are created when minute particles from cosmic space flare up while crossing the dense atmosphere of the earth and emit sparks, as the wheels of an abruptly braked train do. The particles themselves are much too small to be seen over distances of more than 80 kilometers. What we do see are the atoms of air ionized by the hurtling particles, comparable to the famous “photographs of electrons” in a physicist’s Wilson chamber, in which we see not the shooting electrons them-

selves, but rather the molecules of vapor struck by the invisible flying particles and condensed into visible droplets. It is estimated that about 100,000,000 meteors rain down daily into the earth's atmosphere.

By ionizing a layer of the atmosphere, the meteors produce an "ionosphere" just as the sun's rays do. (*Fig. 117*) And just as the solar ionosphere is exploited by us to reflect the short radio waves, so this layer, too, furnishes us with a mirror to broadcast over long distances and even around the globe. Since the channels for short-wave transmission are overcrowded, this meteoric mirror is a welcome addition to the first.

When the earth passes through the tail of a faded comet, the number of meteors may increase and create brilliant fireworks like those Alexander von Humboldt saw when he crossed the Andes in 1833 or the one visible in the northern sections of the United States and in Canada in the fall of 1946. Regularly reappearing, but now rather weak, showers of meteors are the Perseids in August and the Leonids in November, so called because their focal points are the constellations of Perseus and Leo. At these times the earth crosses the paths of bygone comets. Showers of meteors are reminiscences and like all reminiscences they gradually fade. "Once upon a time there was a comet . . ."

Meteorites

One day early in the nineteenth century, a shower of stones fell out of a clear sky onto a quiet village in Gascony, in southern France. A report of the event, bearing the signatures of three hundred witnesses, was sent to the Academy of Science in Paris. The "Supreme Court of Continental Science" replied: "The Academy regrets to note that in our enlightened age there can still be people so superstitious as to believe that stones fall from the sky." When, in 1807, a stone fell in Connecticut, and two professors asked the government for permission to excavate it, President Jefferson, himself an ardent and enlightened naturalist, declined their request with the comment: "It is more likely that two Yankee professors are lying than that a stone fell from the sky."

Of course, stones *do* fall from the sky, every day, every hour. In the course of the earth's history millions must have hailed down upon it. They are called meteorites. The difference between meteor and meteorite is easily understood. A meteor—the shorter word—becomes a meteorite—the longer word—when it survives its longer passage through the atmosphere to arrive at the ground.

Meteorites are found in museum collections by the thousands and innumerable more must lie scattered around but still undetected. Yet those that are found are only a few of the many more that have vanished. When

the falling body approaches the ground, the resistance of the air becomes so great that the meteor disintegrates and the fragments vaporize. The great meteorite which, in 1947, roared over Vladivostok, glowed so brilliantly that it outshone the light of the sun in the middle of the day. Its roar was heard over an area of 200 miles. The Siberian meteorite of 1908 mowed down several miles of forest, not by hitting the trees directly, but by compressing the air over them. By contrast, small meteorites survive because their small surface provides less resistance to the atmosphere.

The largest meteorites found up to now have a mass of about 30 tons. One exceptionally heavy meteorite of 36.5 tons survived the crash against the ground because it fell on a slope which is covered most of the year by snow and it came down just as a skier approaches and skims over the surface of the snow. Two-thirds of all meteorites plunge into the oceans. Yet even those which reach the ground are not necessarily found. Made up mostly of iron, all meteorites in humid countries rust away and, like the skeletons of dinosaurs or of primitive man, meteorites and meteorite craters are almost exclusively found in arid zones. It is no accident that of the two great meteoritic

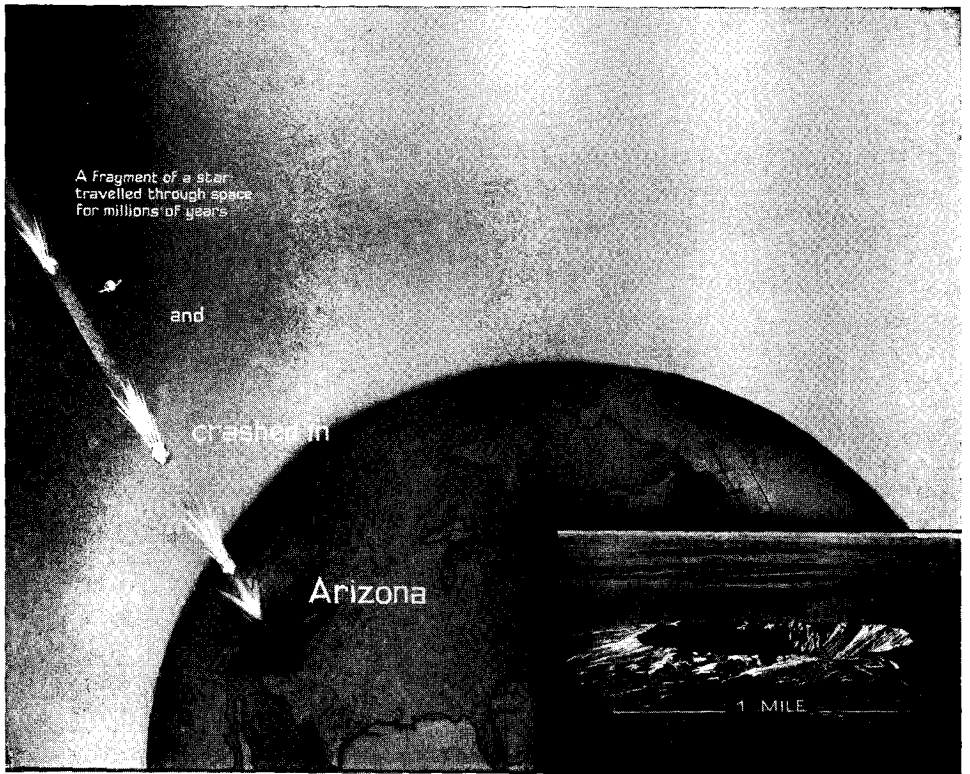

Fig. 91. METEORITES

Meteorites are cosmic bodies which reach the surface of the earth without disintegrating as meteors do. The mile-long crater in Arizona and an even larger one in northern Canada are burial-places of meteorites.

monuments on the North American continent, one stands in the dry landscape of Arizona and the other in northern Canada as the frozen Ungava Crater Lake. Large meteorites are reported to lie in the Sahara Desert and in the Gobi Desert in central China, where a great cemetery of dinosaurs also awaits excavation.

The famous meteorite crater in Arizona, 1,270 meters in diameter and 175 meters deep, is the product not of a single meteorite but a swarm of meteorites. One relatively large body was accompanied by a smaller "moon" and a swarm of even smaller bodies followed at a distance of some hundred meters. The residue points to four different types of meteorites which traveled as a "system" through space. Most of the masses vaporized and vanished and only small fragments and kernels of the charred masses remained.

Those countries afflicted by the ice age are devoid of meteorites. The meteorites, covered by snow for millennia, rusted away. Later the migrating ice sheet rolled over their remains, grinding them into tiny fragments.

Adding up the facts, we conclude that the number of meteorites in relation to the surface of the globe must be considerable. Yet the precision of the earth's orbit indicates that despite the steady rain of meteorites the globe has not gained noticeably in weight or size during the past 2,000,000,000 years. The daily addition of cosmic material is seemingly counter-balanced by the earth's loss of mass in the form of atmospheric gases, volcanic dust and vapor from the oceans that escapes through the heights of the atmosphere into cosmic space.

Meteorites glow as they fall, but this is only a surface display. They travel through interstellar space for millions, perhaps billions of years, and they must have a temperature not far above the absolute freezing point. The few seconds it takes the meteorites to pass through the atmosphere are not sufficient to warm an "absolutely cold" mass more than superficially. On the contrary, so swiftly does the cosmic cold of the meteorite's core counteract the surface warmth caused by atmospheric friction, that a meteorite can be picked up and handled immediately after it has landed. A meteorite which fell into a hot, damp jungle in India was immediately enveloped in ice, which condensed on its surface. Another cosmic stone landed on a dry haystack without setting the hay on fire.

After all we have learned about the universe, we are not surprised to find that meteorites are in substance no different from the ores or stones of the earth. Some are actually stones, aerolites, consisting of hardened magma or basalt. Others are composed of a mixture of iron and nickel. When the cut surface of an iron meteorite is polished, a network like the pattern of woven cloth appears. This network, called the Widmannstätten figures, is a test of the authenticity of meteorites.

Spectroscopic examination has revealed traces of about fifty elements in meteorites. One special type contains a considerable percentage of a glassy mass. It has not been decided whether this glassy mass comes from cosmic

space, or whether it is formed by the meteorite's burrowing into sandy soil and fusing with the silicon in the sand.

The age of a meteorite can be estimated from the relationship between its content of radioactive uranium and the end products of the disintegrated uranium, helium and uranium-lead. (*See page 111*) Since there are several possibilities for error in so complex a computation, the results obtained by physicists differ; but all of the physicists agree that no meteorite is less than 3,000,000,000 or more than 5,000,000,000 years old.

We have learned that different facts and calculations point to the age of the universe as several billion years, ranging between 5 to 8 billions for the universe and somewhat less for the solar system. The meteorites confirm this. Hurling from cosmic space, they press their signet into the earth. The astronomer picks them up and reads their seal: "Born four billion years ago."

The Earth and Its Moon

The Earth: An Irregularly Rotating Sphere

THE FIRST AND most essential fact to know about the earth is that it is a sphere. All the larger heavenly bodies are spheres, not because they are "gaseous balls that have cooled off" but because their substance is flexible. If one could somehow square up the earth into a cube, the corners would slowly round off again under the influence of the force of gravity. For the same reason, heavenly globes cannot be shattered. If a mountain were shot up at the moon, its sphere would not break apart; instead the moon would swallow the mountain as a dog gulps down a morsel thrown his way.

The earth is not, however, a perfect sphere. Due to the centrifugal force created by its rotation and the attraction exerted by the sun and the moon, this elastic ball bulges at the equator, so that here we are almost thirteen miles farther from the center of the earth than we are at the poles. If you travel from one of the poles to the equator, you will weigh almost a pound less, because you are getting farther away from the earth's center and because you are subject to stronger centrifugal forces, which tend to lift you up. When the sun and moon are on the same side of the earth and therefore pulling in the same direction as happens at the time of the new moon, the loss in weight is even greater, and the tides of the oceans are higher than usual. You cannot, however, measure your loss, since not only you, but everything around you, including the weights on the scale, is subject to an equal decrease in weight.

In the time it takes you to read this page, you will have traveled dozens of miles with the surface of this rotating sphere. You can become aware of this movement when you observe how rapidly the sun rises or sets on the horizon.

A cannon shell shot on a north-south line will not land due north or south of the cannon. During its flight, it will move from west to east at the speed of the point from which it was fired. The point where it lands will have rotated more rapidly if it is nearer to the equator and less rapidly if it is nearer the poles. Hence, if the ball is shot toward the pole, it will land not only north but slightly east of the calculated line of flight; if shot toward the equator it will land not only south but slightly west of it.

The rotation of the earth affects everything on its surface. Centrifugal force pushes the waters toward the equator and raises the level of the seas

(*Fig. 108*); and the continents, too, floating on the underground sea of magma, will strive toward the equator. The ocean currents are shifted, the tides distracted and the trade winds flow at an angle toward the equator.

The rotation of the earth on its axis constitutes our twenty-four-hour day. The length of the day is scientifically determined from the moment when the sun or a star passes the vertical crosshair in a telescope oriented exactly on a north-south meridian line.

Over a century ago, it was discovered that for astronomical purposes the earth is by no means a reliable clock. Sometimes the globe rotates more rapidly, sometimes more slowly. In 1878 the earth-clock began to slow down and the days became three-thousandths of a second longer. During the gay nineties, perhaps trying to live up to the mood of the era, the earth began to rotate more quickly again. At the turn of the century, the earth-clock was twelve seconds fast. But during the following decade this error was compensated for, and the earth ran correctly for a while. Between 1912 and 1918, it slowed down, and by December 31, 1918, it was twenty-five seconds slow—small wonder that it should have been thrown off balance at a time when all mankind went mad and the reverberations of 10,000 cannon shook the world day and night.

We are still baffled by the irregularities of the global clock. One theory maintains that the floating continents slide back and forth during the earth's rotation, and with them slide the time-measuring observatories. (*Fig. 109*)

To get a really accurate clock, we must dispense with the unreliable earth. At present the best clock we have is the so-called atomic clock, which despite its name has little to do with atoms. Actually, it is a quartz oscillator whose plates vibrate exactly 23,870,100 times a second. This frequency is regulated by the resonance of ammonia gas whose atoms oscillate with "atomic" exactness. This clock runs so accurately that even under the most unfavorable circumstances it would take 317 years for it to be a single second off. A Rip Van Winkle could lie down for a thousand-year nap, set the alarm of this ammonia clock for 8:30 A.M. on May 1, 2900, and be awakened within four seconds of the right time.

The orbit of the earth is an ellipse, and so the length of the radius from the earth to the sun varies. There is a difference of about 5,000,000 kilometers between the longest and the shortest radii; the 93,000,000 miles that we speak of as the distance between sun and earth is an average. The change in distance affects both the force of gravitation and the speed with which the earth moves. When it is winter in the northern hemisphere, the earth is closer to the sun and moves somewhat faster. Therefore, the winter half of the year is seven days shorter than the summer half, 179 as against 186 days. In the southern hemisphere, conversely, winter is longer than summer.

The changes in the earth's speed during the several seasons make exact computation difficult. Since the fluctuations tend to cancel out during the

course of the year, astronomers work with a "fictional earth," one which is assumed to be traveling at an average speed throughout the year.

Fig. 92 is a diagrammatic representation of the earth's orbit around the sun. The revolution of the earth around the sun constitutes a year. The revolution of the moon around the earth roughly constitutes a month, which is divided into weeks by the phases of the moon. One rotation of the earth on its axis forms a day.

Thus year, month and day are read from three different clocks: the sun, the moon and the earth. Because it is an insoluble problem to coordinate these three movements with mathematical exactness, our calendar is a rather make-shift timetable. The days do not fit into the year because the earth does not turn exactly 365 times during its revolution around the sun, and the new moon does not reappear after exactly 28 days but closer to 29. No railroad could operate on a timetable as lacking in precision as our calendar. In an attempt to make the calendar more accurate, every civilization has created a new one of its own; the calendar we currently use, which was introduced shortly before 1600 by Pope Gregory XIII, is so full of faults that the problem of calendar reform never ceases to occupy progressive minds, and there are countless proposals for improved calendars. Hampered most by the inaccuracy of our tripartite calendar are the astronomers, who constantly have to coordinate the dials of sun, moon and earth.

Our problems with the calendar are further complicated by the fact that the axis of the globe does not run perpendicular to its orbit, but is inclined at an angle of $23\frac{1}{2}^{\circ}$. If the axis were perpendicular to the orbit, every part of the globe would have twelve hours of sunlight and twelve of darkness the year round. Air movements would be regular, and there would be neither seasons nor great changes in weather. The inclination of the earth's axis produces both the seasons, and the alternation of seasons on the northern and southern halves of the globe. When the North Pole is tilted toward the sun, the arctic landscape is in sunlight during all twenty-four hours of the day, and summer prevails in the northern hemisphere. (*Fig. 92, right side*) When it is tilted away from the sun and stands in the nocturnal shadow for all twenty-four hours, it is the season of "polar night," and winter holds sways. (*Fig. 92, left side*)

On March 21 and September 22, when the sun crosses the celestial equator, the earth's axis is perpendicular to the ecliptic. (*Fig. 92, above and below*) On those days the sun is exactly on the plane of the equator, and all points on the earth's surface have twelve hours of light and twelve hours of darkness. We call this the time of the equinox, which means the night (nox) is equal to the day. Much has been written about the inclination of the earth's axis, and its relation to the earth's fate. If the axis were tilted 5° more or less, the climate of the globe would be quite different, and the history of the earth would have taken a different course. There are scientists who maintain that life could

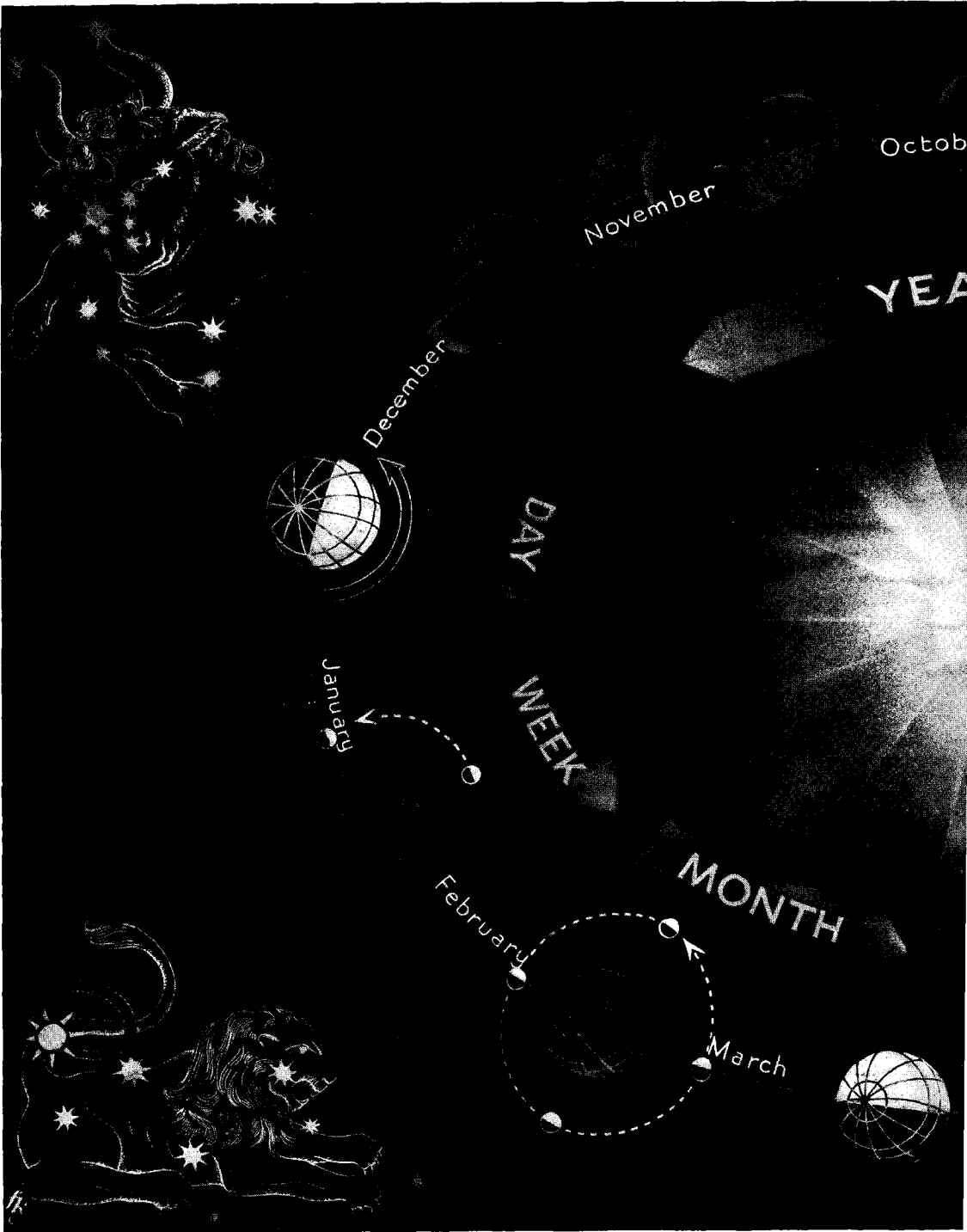
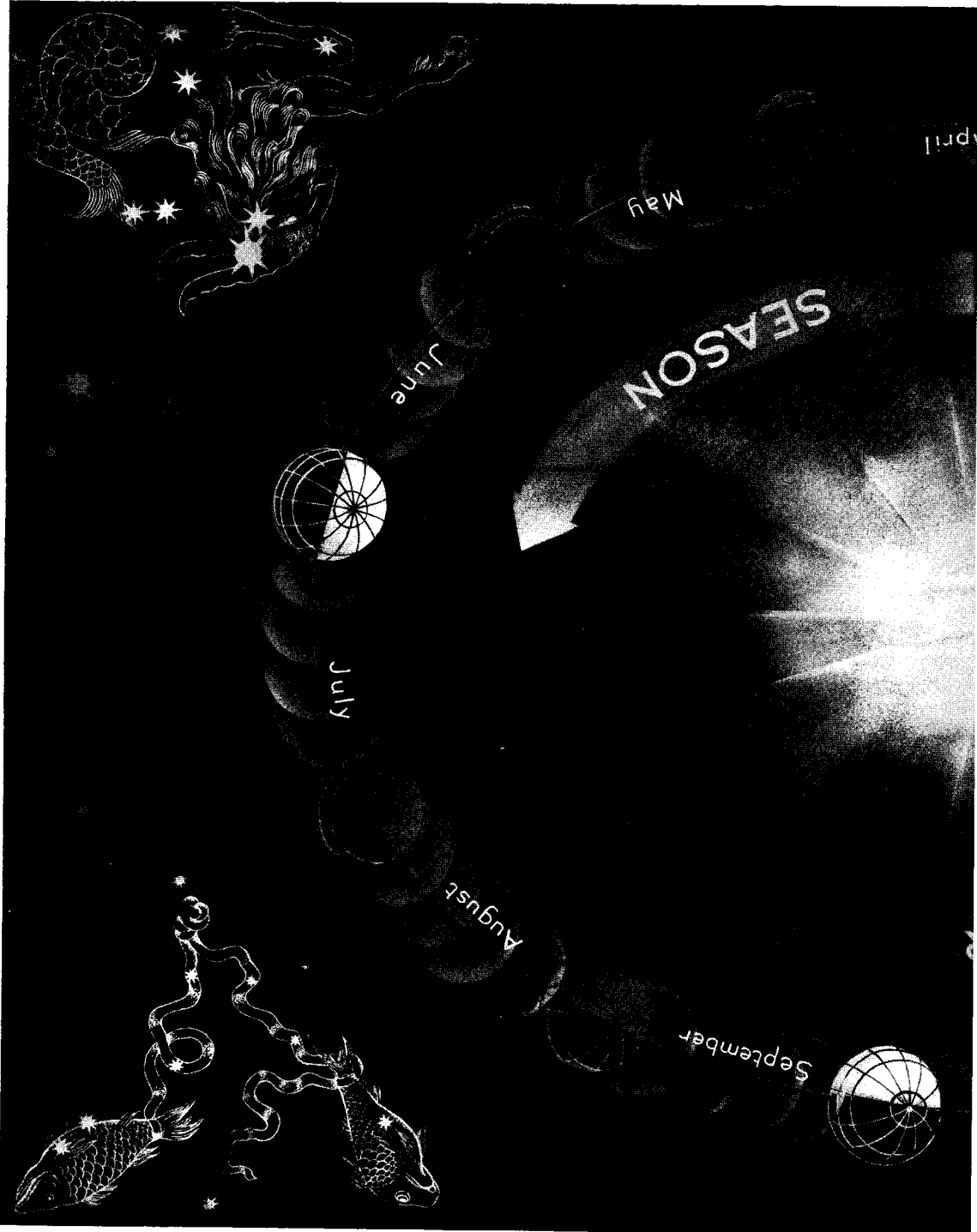

Fig. 92. REVOLUTION OF THE EARTH AROUND THE SUN

The single rotation of the globe on its axis is a day. A 90-degree revolution of the moon around the earth is a week; a full revolution of the moon is a month. A 90-degree revolution of the earth around the sun is a sea-

son. A full revolution is a year. The constellations of stars through which the sun passes during the year make up the zodiac. In February the sun is in the Fishes (*upper right*), in August in the Lion (*lower left*).



have developed on earth only with this specific inclination and that it seems highly improbable that any other planet of the assumed millions around other suns would offer an equal opportunity for a comparable evolution of beings. But this philosophy of the singularity of mankind in a universe so vast and so unimaginably populated with suns seems to violate all probability and logic.

We are accustomed to speaking of the pole as the "unmoving axial point." Yet the astronomers have discovered no fewer than twelve different aberrations of the earth's axis and suspect several others. These motions, however, are negligible. As the steadiness of the earth's path indicates, no extensive deviation has occurred for at least the last 500,000,000 years. The theories of far-reaching polar migrations and pendulation, which fascinated the public at the turn of the century, are obsolete. The movements of the earth's axis are slight, like those of the mast of a ship which sails on a fairly calm sea.

So infinitesimal are the movements that we are less impressed by them than by the ingenuity of the human brain in detecting them. The Swiss mathematician Euler concluded from wholly theoretical considerations that the axis of the earth makes a periodic deviation in cycles of 428 days. Long international discussion and investigation followed to prove the veracity of this theory. Needless to say, Euler was right, even though the value differed somewhat from his prediction.

The largest periodic deviation, one that was already known by ancient peoples, is the "precession." From the days of our childhood we are all familiar with tops, and every clever child knows that a top performs a three-fold movement: First, the top spins; this corresponds to the daily rotation of the earth on its axis. While spinning, the top revolves in wide circles, corresponding to the yearly revolution of the earth around the sun. Finally comes the third movement: while the top is revolving, it does not remain upright; its axis sways, constantly changing the angle of the top's axis to the ground. Similarly the axis of the earth wobbles because the globe is not a perfect sphere but bulges somewhat at the equator. The axis of the earth, and therefore the plane of the equator, tilts. The earth travels through space like an ocean liner which, cruising the sea, does not remain exactly perpendicular, but sways slowly from left to right and back again. Such swaying causes the two equinoxes (*Fig. 92, top and bottom*) to move backward through the earth's annual orbit, completing one circuit in 26,000 years.

At the vernal equinox the sun appears in specific relation to the zodiac. A year later because of the new position at which the equinox occurs, an arc second to the West, the sun appears an arc second to the West, too. So in the times of Abraham, the sun was seen in the Bull on March 21; when Aristotle lived, the sun was in the Ram; today, it is in Fishes on March 21; in future centuries it will move into the Water Carrier.

In 26,000 years the earth will have returned to its present position, the sun will have passed all twelve constellations of the zodiac and will, on March 21, once again be seen in the constellation of the Fishes.

With the swaying of the earth's axis, its pole describes a circle. Today the *Stella Polaris* is not exactly at the celestial pole, but it is moving closer to it and will ultimately deserve its name—but only temporarily. Twelve thousand years from now our axis will point toward *Vega* and mankind will look at this brilliant star as its *Stella Polaris*.

As the earth revolves around the sun, it is not alone but is accompanied by the moon, which attracts the earth and therefore distracts it from its orbit. At times the earth is pulled forward, at other times inward, then backward, then outward. (*Fig. 93*) Since the moon is $1/81$ as heavy as the earth, the two bodies revolve around a point that is $1/81$ of the way along a line from the center of the earth to the center of the moon. This point actually lies inside the globe of the earth, about 9,600 kilometers below the surface. Accurately, it is this point that circles around the sun, rather than the center of the earth.

But because the moon's orbit does not run exactly in the plane of the earth's equator, but is sometimes to the north and sometimes to the south of it, the position of the point changes; and the earth is thereby pulled not only inward and outward, forward and back, but also up and down, bumping along on its way around the sun like a car on a cobblestone road. The 26,000-year cycle of the precessional vibration is the effort of the earth to maintain its course despite all disturbing forces.

The distracting forces of the moon alter from day to day, undulating back and forth; these fluctuations complicate the problem of exact mathematical calculation. The difference in distance could be computed. But the earth is not a perfect globe, it bulges at the equator. When the moon approaches the plane of the equator, the distance between earth and moon diminishes a few miles and the attractive force increases; when the moon has crossed the plane of the equatorial bulge, the force decreases again. These rather minor but nonetheless perceptible deviations are mentioned to demonstrate the complexity of the problems facing the mathematician who endeavors to compute an exact formula for the movement of the earth's axis.

Many more "gremlins" scoff at the astronomer. There are the seasons: the hemisphere where it is summer is covered by a warm, light atmosphere. Over the other wintery half of the globe the atmosphere is cold and heavier. The difference amounts to about 16,000,000 tons. Like an unevenly loaded ship, the earth lists toward the heavier side.

A further disturbance comes from the sun. The sun does not stand firm as the pivot of the solar system, but shifts about 64 kilometers a year, describing a circle in the course of 40,000 years. The earth's axis follows this motion.

Not only sun and moon but also the other planets pull at the earth; and the pull each planet exerts increases or weakens with its own changes in position and distance from the earth. Who would dare to disentangle this Gordian knot of forces? In the days before electronic brains, *Milankovitch*, an astronomer in Yugoslavia, had the unbelievable patience to struggle for half a life-

time calculating the positions of the planets back over 650,000 years. It turned out that the changes in the positions of the planets coincided with four extraordinary deviations of the earth's axis. Milankovitch advanced the theory that these specific constellations of the planets caused an extraordinary swing of the earth's axis. The climate changed and an Ice Age began. This is one of many theories about the origin of the Ice Ages.

The Moon and Its Complex Orbit

The closest of our heavenly neighbors is the moon. By astronomical conceptions of distance, it is like a lantern hanging just outside our front window. It is a small sphere, hard, frozen and unchanging—a statue of stone. With neither clouds nor atmosphere to obscure its face, it stands out in bold relief, the harsh rays of the sun lighting it so sharply that our telescopes could discover a ship if there were one on its non-existent seas.

Thousands of human eyes have stared at the moon through telescopes of

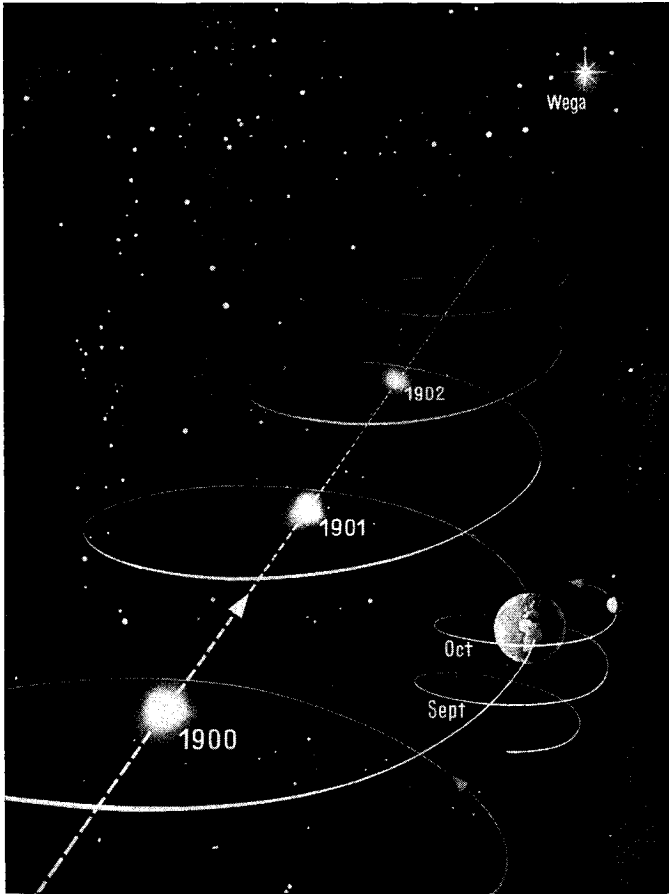

Fig. 93.
THE PATH OF
THE EARTH AND
THE MOON

Since the sun moves toward the star Vega in Hercules, dragging all its planets along with it, the earth does not describe ellipses around the sun but a spiral along the sun's road. The earth's spiral is encircled by the corresponding spiral of the moon. To contain several spirals in the area of the picture, the spirals are compressed to about one-half their actual extension. (Based on an illustration in *La Rousse*.)

all sizes night after night for 300 years, and one might assume that by now we would know all about our companion in the sky, which is so near to us, so changeless and as faithful as a dog to its master. But as more facts have been collected, as more calculations have been performed, the problems of the moon and its course have become more involved. "The man in the moon" grins mockingly. Even so seemingly simple a problem as tracing the moon's course around the earth defies all mathematical analysis. Newton, Gauss and Euler combined could not checkmate this king of the night in its moves over the starry chessboard of the heavens. Newton, who knew of no difficulties in calculation said that his "head never ached except when he was studying the lunar theory."

In *Fig. 93* the movement of the sun is drawn as a straight line. This line is a gross oversimplification. In fact, the sun does not move in a straight line but wanders in a decidedly erratic curve. It describes a circle in the course of 40,000 years. Then it moves at a rate of 19 km/sec toward a point in the constellation of Hercules. Finally it revolves around the center of our galaxy at a speed estimated between 120 to 270 km/sec. In *Fig. 93* all these labyrinthine curves are expressed as one straight line. Around the flying sun the earth revolves in the spirals, designated 1900, 1901, etc. While the earth is circling once around the sun, the moon revolves twelve to thirteen times around the earth. Thus the moon's orbit is far from a circle. And even this simplified version—for the sun does *not* move in a straight line—makes a rather exciting picture.

Basically, all movements in the universe are "falling" ones: the sun is falling into the center of the galaxy, the earth is falling into the sun, the moon is falling toward the earth. Yet none of these bodies is actually falling. Like bicycles or airplanes, they will not fall despite gravitational attraction so long as they move at a good clip.

The average distance of the moon from the earth is somewhat less than 400,000 kilometers and its mass is 1/81 that of the earth. If both stood still, the moon would fall to earth in a straight line, a fall that would have an initial speed of 0.25 mm/sec. But since both are moving, the moon, instead of falling, travels around the earth at better than half a mile a second. Thus the moon's orbital motion is a combination of its own forward speed and the pull of the earth.

Like all astronomical "circles" the moon's orbit around the earth is eccentric. The distance between moon and earth varies by about 40,000 kilometers, or a tenth of the mean distance. When the moon crosses our line of vision to the sun, the sun's disc is eclipsed. (*Fig. 94*) But only if the moon happens to be near the earth at the time is there a total eclipse. If the moon is far off, its disc is not large enough to hide the sun completely, and the result is a ring-shaped eclipse.

The force of attraction, and with it the rate of fall, changes with distance. The closer the moon gets to the earth, the more rapidly it travels. When the

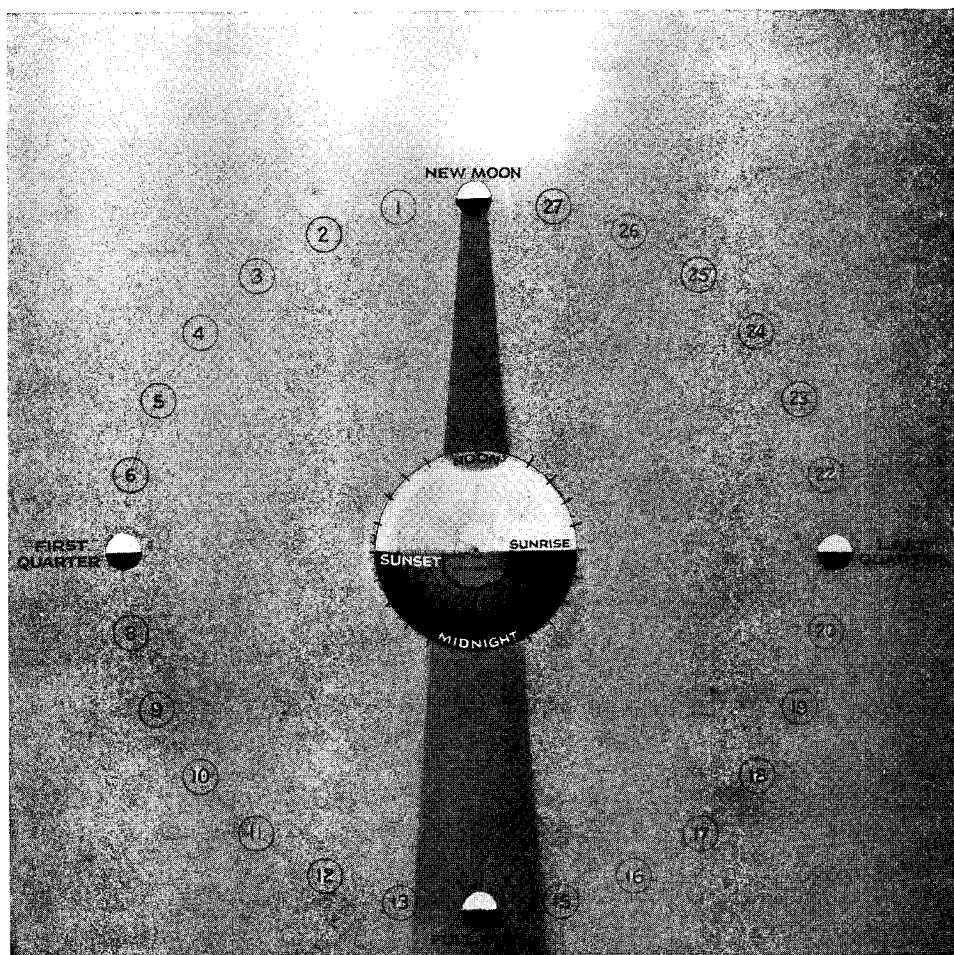

Fig. 94. PHASES AND ECLIPSES OF THE MOON

Only the sunlit part of the moon can be seen. When the moon is between sun and earth (*top*), its dark side faces us and we see nothing (new moon). When the moon is opposite the sun (*bottom*) we see the full face of the moon (full moon). Lunar eclipses occur when the full moon passes through the shadow of the earth; solar eclipses, when the new moon crosses the vision-line of sun and earth.

moon approaches the bulging equator, its speed increases; but it slows down again when it wanders toward the higher parallels of latitudes—every hour a different speed!

The sun attracts the moon twice as strongly as the earth does. This play of forces among sun, earth, and moon changes constantly. At some times the sun and earth pull together; at other times, like players disputing possession of a ball, they pull against each other. The planets stand on the outskirts of the fray, exerting a small influence of their own on the moon. Under favorable conditions the position of Jupiter can be determined from disturbances

in the moon's orbit. And, to complete the picture of forces, the moon attracts the earth, making the earth's orbit slightly ragged, like a line drawn with a bumpy-edged ruler.

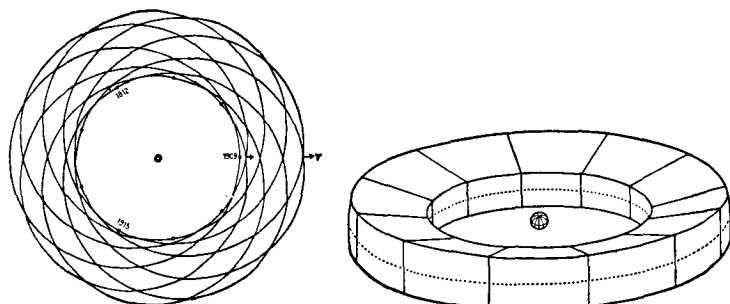

Fig. 95.
THE COURSE OF THE
MOON

- a. Diagram of the moon's motion over the 19 years of the lunar cycle.

- b. Diagram of the area in which the moon moves, approaching or receding, ascending or descending, in its monthly path around the earth.

Fig. 95, b, which looks like an automobile tire, represents the area in which the moon moves around the earth, the sphere pictured in the center. The drawing indicates the extent to which the moon approaches or recedes from the earth, and also how far it deviates from the plane of the equator. During every monthly revolution the moon touches all four limiting walls of the tire. If we follow the path of the moon we get the arabesque in *Fig. 95, a*. This line, necessarily drawn on one level but actually wandering through several planes, circles inside the tire sixty-six times before returning to its starting point. Over 18 years must pass before the moon touches the same point again. So if you happen to see the moon in a curious position—picturesquely framed in your window or balancing like a ball on the television antenna of the house next door—don't expect to see it there soon again. You have to wait eighteen years and eleven days, the cycle of the lunar calendar called saros.

It should be easier now to understand why scores of mathematicians have had to toil for years and even decades over lunar calculations, and why monumental works have been published on the motion of the moon. One such formula, developed by the French mathematician Pontécoulant, filled twenty-three printed pages, one of which is reproduced in *Fig. 5*.

The World of the Moon

The motion of the moon is a problem; the moon itself is a riddle. Theories about the nature and the origin of the moon have been presented by the

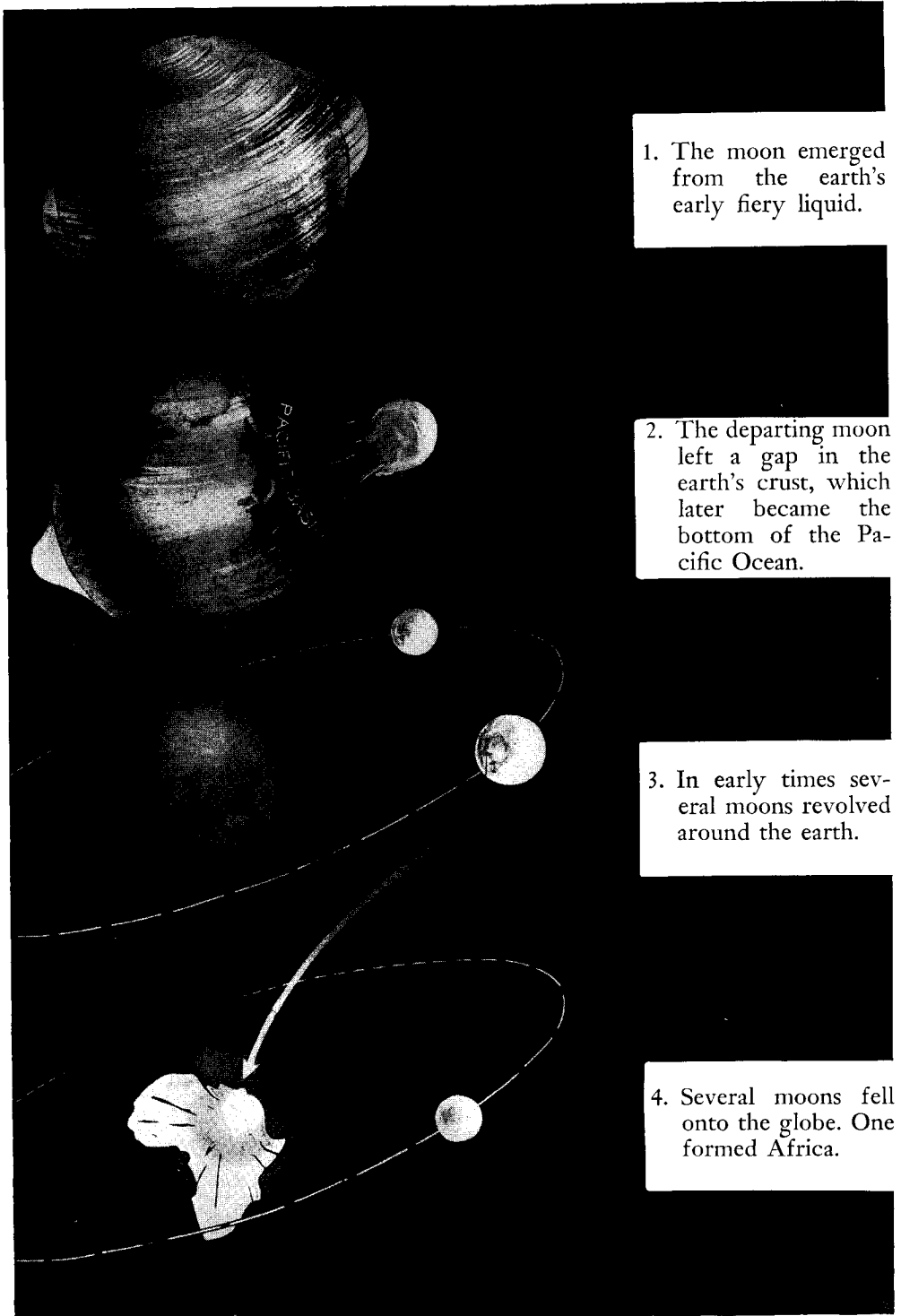
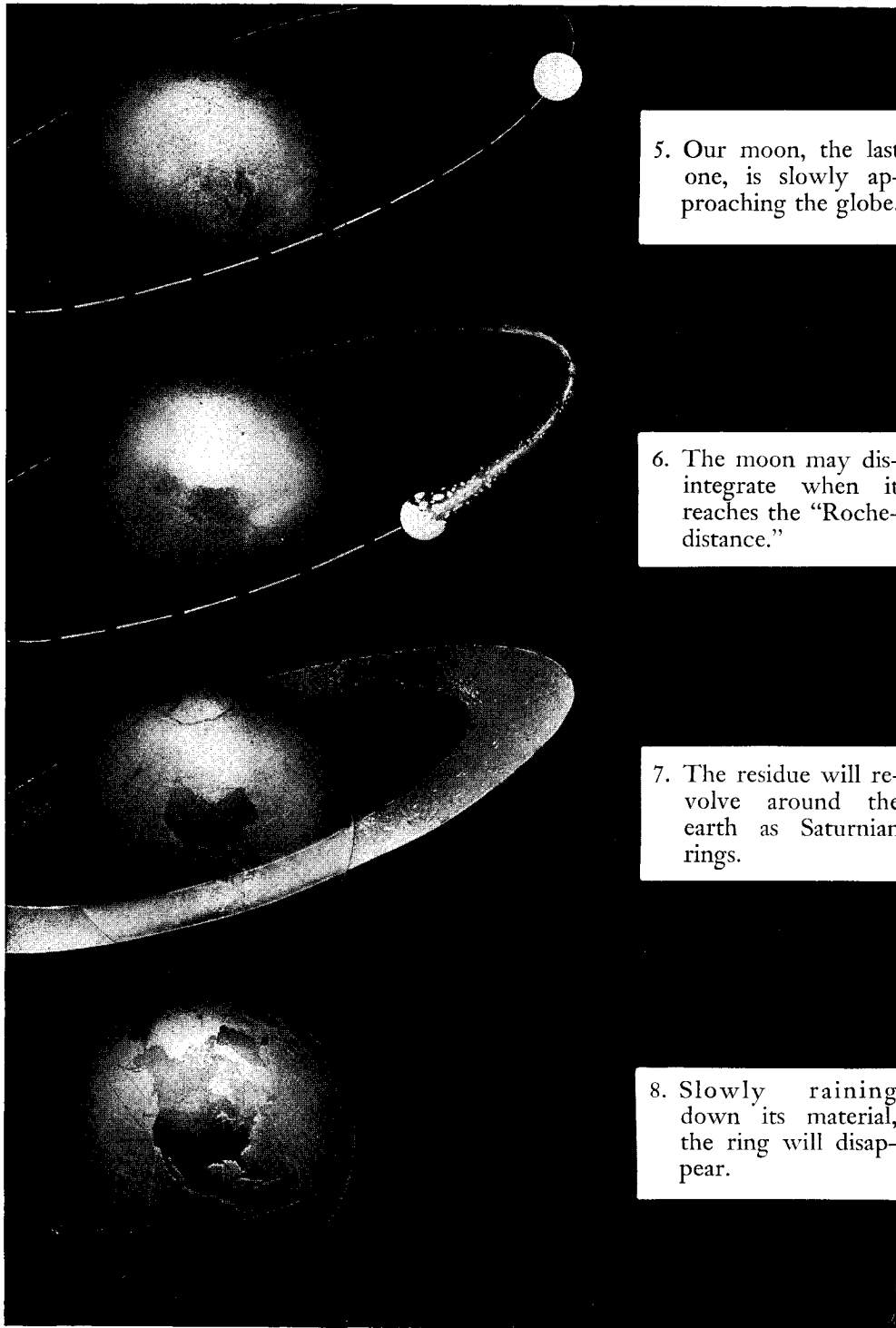

Fig. 96. HYPOTHESES ABOUT THE MOON



5. Our moon, the last one, is slowly approaching the globe.

6. The moon may disintegrate when it reaches the "Roche-distance."

7. The residue will revolve around the earth as Saturnian rings.

8. Slowly raining down its material, the ring will disappear.

dozen. Many are attractive; none is so convincing that it has become accepted. On pages 210ff we heard about a new version of the rather old planetesimal theory, which maintains that the planetary system originated as a cloud of dust whose particles agglomerated into larger bodies: planets and moons. It was the surface of the moon, which bears the scars of such a violent process, that gave rise to the planetesimal theory.

Other scientists adhere to the older theory that the moon is the "daughter of the earth," as many myths of primitive peoples fabricated. In modern times it was Charles Darwin's son George Darwin who refashioned this idea most elaborately. (*Fig. 96*) George Darwin suggested that the moon is a fragment that broke off from the earth when the earth was two and a half times as large as it is now, and rotating six to eight times as rapidly. The centrifugal force of the earth's rotation at that time formed a high tide of semi-liquid matter at the equator, and this detached itself and flew off. The flight, which constituted the birth of the moon, still continues, with the moon moving away from the earth at about half a mile every thousand years.

Later, like a stone tossed into the air, it will return to earth. When the returning moon comes within 10,000 miles of the earth, it will, according to Roche's law, break into pieces and form a "Saturn's ring" around the globe. Stones from this ring will slowly rain down on earth. Thus, eventually, shattered to fragments, the moon like a prodigal son will re-enter its father's house.

It is possible that the earth once had two moons. The theory of cosmic ice (*Welt-Eis-Lehre*) even suggests a series of them. Some theorists have speculated that Africa is a moon which fell to earth and stuck there, like a snowball thrown at a wall; this, however, is not in line with Roche's formula. Another hypothesis goes so far as to say that the deep basin of the Pacific Ocean may be a hole left in the earth's crust when the moon was torn away. (*Fig. 96, 2*)

However the moon was born, today it is a dead world. There is little likelihood that there has ever been any life on it. A sphere of this size and mass does not have the gravitational force to hold together the restless atoms of an atmosphere. The moon is not only smaller than the earth, but it is also made up of lighter material. It would take 49 moons to fill the space of our terrestrial globe; but it would take 80 to equal the earth's weight.

Since the moon has no atmosphere, there is no wind, water or moisture on it. Consequently there is no weathering, although the sudden transition from sharp hot sunlight to cold shadow should affect the rocks, splitting and exfoliating them. During the 300 years that the moon has been under close surveillance, its landscape has remained relatively unchanged. Now and then an occasional observer has claimed to have seen a small cloud of dust whirling up from the surface, as though a meteorite had struck, or a rock had hurtled from a cliff. One moon-gazer declared he had beheld steam boiling up from the ground, but no definite proof of such occurrences has ever been found.

Held in thrall by the earth's strong attraction, the moon always turns the same side toward us, so that we know only half of the moon's surface.

The mountains on the moon only appear similar to those on earth; actually they are quite different. Their first striking characteristic is their height. Although the moon is only one-fiftieth the size of the earth, its mountains are higher than ours. Peaks like Mt. Everest are not unusual. The lunar mountains must make an overwhelming impression when seen at close range, brightly illuminated by unscattered sunlight against a black sky in a landscape framed by a sharply curved horizon. The mountains on the moon were not formed by pressure and traction, as ours were; there are no mountain chains like the Rockies or the Andes. There are great plains which Galileo misinterpreted as oceans and called "maria," one of the largest the Mare Imbrium, "The Sea of Showers." But there are no showers on the moon because there is no water. The Mare Imbrium is a flat plain almost circular in shape, probably a lake of frozen magma. Inside and outside the great maria are smaller, also circular, plains, here and there encircled by a ring-shaped mountain. Considering the Lilliputian dimensions of the lunar world, these plains are imposing, the diameters of some exceeding 1,100 kilometers. Sicily could fit into one of them without even snow-capped Mt. Etna's being visible beyond the towering borders. In some places the small plains overlap larger ones, as if boys had been throwing snowballs and had hit the same spot twice. (*Fig. 97*)

Beside these plains, and sometimes even within them, we see "craters," altogether about 30,000 in number. Actually they are not so much craters as filled-in holes in the moon's crust. These pseudo-craters are what make the moon look like a ball of clay at which thousands of shells have been fired. In contrast to the plains, the craters are rather small, ranging up to over 160 kilometers in diameter. Their floor lies below the surface level, fully as far below as the crest of the crater walls is above. An explorer who climbed the wall to its summit would have to descend about twice as far in order to reach the crater bottom. In the center of many craters a cone rises, similar to the kind made by a raindrop when it splashes on the surface of water.

Up to now nobody has explained the origin of the maria and craters convincingly. At first they were considered extinct volcanoes. After the discovery of the central cones the volcano theory was discarded and the craters were regarded as frozen bubbles of once boiling magma. The advocates of the planetesimal theory describe the craters as spots where the last moon-forming meteorites struck the still semi-liquid surface of the hardening globe. Scattered across the lunar landscape, they are the tombstones of buried planetesimals. From some of the craters cracks radiate in all directions; the longest are those from the great crater Tycho. They streak the entire surface of the hemisphere, making the moon look like a cracked bowl.

The "Voyage to the Moon" has been described more or less fancifully hundreds of times. Roughly, this is what awaits us when our space rocket

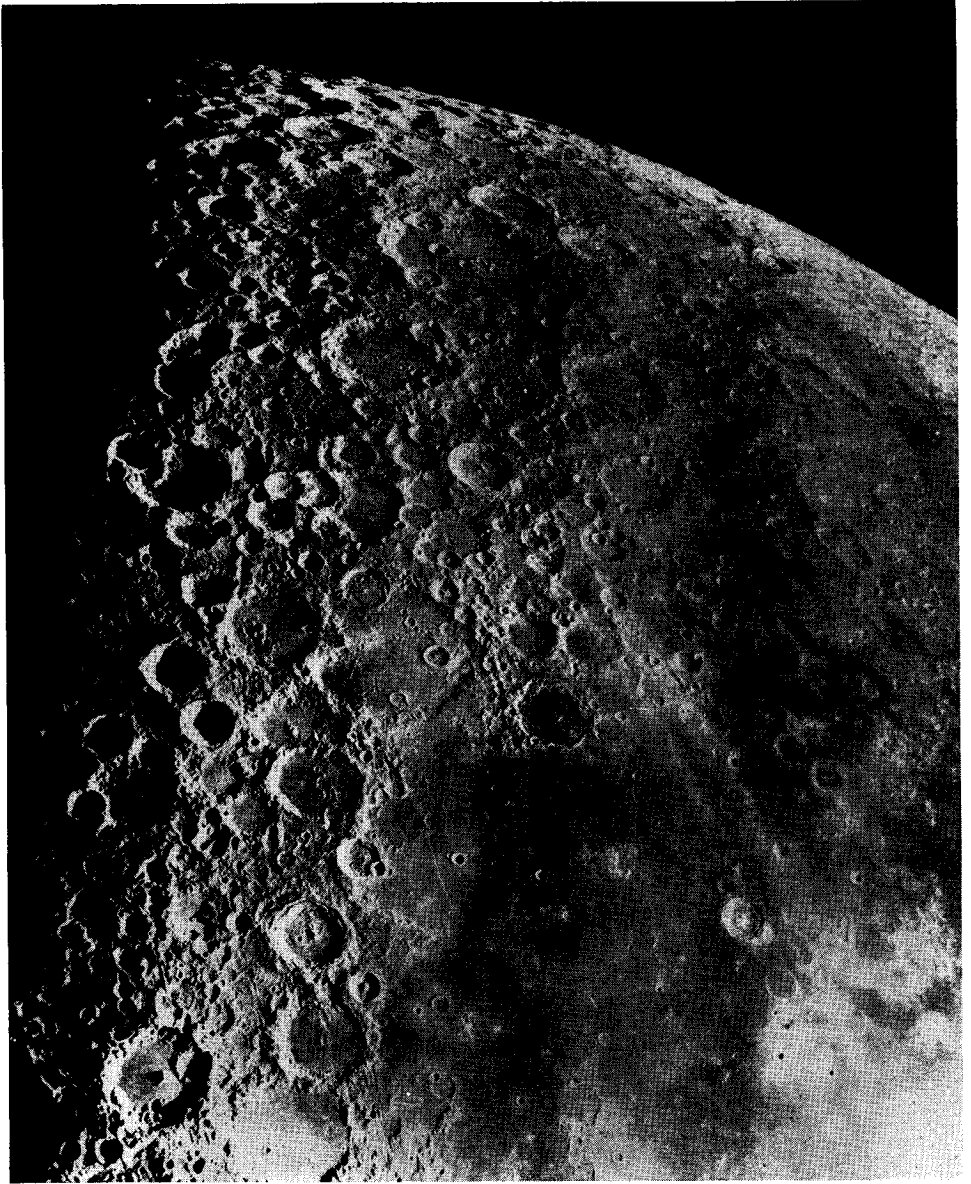

Fig. 97. THE MOON'S SURFACE

The surface of the moon is covered by high mountains interspersed with "craters" and circular mountains which puzzle science and stimulate scientists to ever new theories about our enigmatic trabant.

lands on the barren ground of this first way station for travelers to outer space. We will not step jauntily from the ship crying "Oh!" and "Ah!" like sightseers on a cruise, then sweep the landscape with field-glasses and start taking snapshots. The force of gravity is so weak that we will have to move cautiously lest we go flying off. Since there is no air on the moon, we will have to carry oxygen tanks or more advanced means of providing oxygen which will have been invented long before space travel begins. Yet, masks or no, conversation will not be possible; there is no atmosphere to carry sounds. We could stand next to a cannon and not hear it fire.

On the earth, the sun's radiation must pass through the atmosphere. But with no atmosphere to filter its rays, the sunshine on the moon is ten times as bright as on earth and probably mixed with deadly short waves. Anyone whose eyes were not protected by dark glasses would be instantly blinded. And the heat of the sun is proportionally intense. Yet in the shade it is unbearably cold, because there is no circulating air to moderate the temperature. A bare hand would be seared where the sun struck it and simultaneously frozen on the other side which was in shadow. The extreme contrasts of heat and cold would shatter a camera or any other fragile object.

On the earth the blueness of the sky is a phenomenon produced by the scattering of the sun's rays in our atmosphere. On the moon, the sky is pitch-black. For the same reason, from the moon the sun would appear as a sharply outlined disc, just the way children draw it. The stars do not twinkle as ours do. They are sharp points of light, twenty times as bright and a hundred times as many as we see from the earth. Since a single revolution of the moon takes a month, fourteen days elapse between the rising and setting of the sun. A day on the moon is equivalent to a month on earth.

From the moon the earth appears four times larger in diameter than the moon from the earth. Like the moon, the earth forms either a crescent or a disc, depending on its phase. Its position in the sky seems almost fixed, but it revolves completely every twenty-four hours. It will look like a desk globe carved in relief and painted in soft colors. The oceans will be clearly distinguishable from the continents, the deserts yellow, the great forests dark, the polar caps white; and along the high mountain ranges a fringe of everlasting snow will shimmer. The great rivers, the Nile, the Ganges, the Mississippi, the Volga, will be recognizable as veins. In the shaded portion, cities like New York, Paris and Shanghai will glow faintly as hazy points. A considerable part of the earth is usually concealed by clouds; by observing them, the watcher will be able to follow the paths of the rains and the thunderstorms. The picture of the living earth will contrast markedly with the deadly landscape of the moon.

After we visitors to the moon have scanned the landscape, we will probably turn to the study of details, take samples of rocks—pumice stone?—climb the mountains and walk across the wide plains. This will be the beginning of the moon's geography or, more properly, selenography. But this depress-

ing landscape will soon seem as dreary as a diorama made of plaster. We look up with longing at the great ball in the sky, the earth, and yearn for its blue oceans, its winds and clouds, its snow-capped mountains and flowering meadows. We will be filled with nostalgia for people who move without harness, helmets or oxygen tanks, without fear of deadly radiation, scorching heat, freezing cold, blinding light. We will long to mingle again with people who walk and talk and complain about the weather. With a sigh of relief, we will board the rocket for our return to the earth.

*The Impact of Astronomy on the
Mind of Modern Man*

Achievements rob as well as enrich us. When Adam tasted the fruit of the Tree of Knowledge, he forfeited Paradise. Mankind's oldest story has never lost its moral and modern science has pointed to it once again. The invention of calculus and the telescope opened man's eyes to the range of the universe, overwhelming in its splendor. But the cost of this new knowledge was proportionate to its immensity: man once again lost his paradise which had seemed so solidly established and so well-equipped for man.

Man finds himself, as in a nightmare, perched on a globe, revolving in vast dark space. He feels impelled to cry out to heaven—but heaven has vanished into an unfathomable void where no cry can reach even the nearest celestial body roving its lonely course. If this crumb of stone and metal, trailing along in the wake of the sun, were to vanish, the universal scheme of things would change no more than the history of mankind would be affected by the crushing of an ant by a speeding car.

No matter how unpalatable, we must concede that earth and man are a trifle in the universe. But what of the sun, the mother of so many planets, the star whose light cannot be gazed at for even a second by the human eye without blinding it? The astronomer to whom we direct this appeal disillusion us quickly, "Your sun is but one glowing point in the midst of billions. Its extinction would be as unnoticed as the erasure of a sparkling microbe under the prow of a ship in a phosphorescent sea."

Sensing our disbelief, he points to a photograph of the Milky Way, where stars are strewn like flour dust. "Try to find your sun," he scoffs. We stammer something about the magnitude of the universe. He smiles. "The universe? You need a hundred thousand photographs like this to make an atlas of our little galaxy."

"Little galaxy?"

"Of course. Our galaxy is only one of millions," and he places a photo-

graphic plate against the light. We see hundreds of blurred spots as on an old blotter.

"You need a million plates like this to view all the galaxies of our universe."

"You say 'our universe.' Are there others?"

He shrugs his shoulders. "We have every reason to think so."

We leave, feeling so lost, so minute, that we want to hide our head like a child under the covers during a lightning storm.

The following morning the light of the sun floods our room. We remember the words of the astronomer—a dot among millions. But if this is a dot, how marvelous a universe where dots are suns! From our window we see the azure-blue sky with its floating white fleecy clouds. We see the second-story branches of the tree on the lawn sway in the soft morning breezes, each branch contributing to the methodical design. Every branch is covered by leaves, each perfectly formed, composed of millions of cells, each cell of millions of molecules. Each molecule is a constellation of atoms, and in every atom electrons revolve like planets around the sun. So the great circle of the pattern of things is closed: macro-planets above us in the sky, micro-planets beneath us in the atom—and man just halfway between electrons and stars. Can this be coincidence?

We cannot provide the answer. But we are convinced of the basic truth: that the universe is an indivisible entity. There is nothing "great" and nothing "small," nothing in the millions of galaxies that does not obey the natural laws governing our minute planet. Nowhere is there a sun shining on its planets with more maternal warmth than ours has for us. Nowhere is there a crystal more symmetrical than the diamond, nowhere a tree whose structure fits its environment better than the tree on the lawn. Mother-love is the same everywhere and never greater than the love with which a cat defends her kittens. Form may differ and size may vary, but the innate nature of things is the same everywhere. We find nothing in other worlds that does not or could not exist on earth.

Earth may be called a nothing, but Earth is also everything.

PART FOUR

Earth

Where wast thou when I laid the foundations of the earth? declare, if thou hast understanding.

Who hath laid the measures thereof, if thou knowest? or who hath stretched the line upon it?

Whereupon are the foundations thereof fastened? or who laid the corner stone thereof;

When the morning stars sang together, and all the sons of God shouted for joy?

Or who shut up the sea with doors, when it brake forth, as if it had issued out of the womb?

When I made the cloud the garment thereof, and thick darkness a swaddling band for it,

And brake up for it my decreed place, and set bars and doors

And said, Hitherto shalt thou come, but no further: and here shall thy proud waves be stayed?

The Structure of the Globe

The Slow-Moving Clock of Earth's History

IN *Fig. 98* the earth's history, more than 3,000,000,000 years long, is scaled down to a twenty-four-hour day. Looking at the dial of the geological clock we grasp immediately the peculiar character of the planet's history. The epochs are inconceivably long, and their length makes it obvious that geological transformations occur imperceptibly, like the graying of a man's hair. Mountains *do* "rise," but since the days of Hannibal, Mont Blanc may not have risen more than the length of a fountain pen. Islands change their geographical or astronomical positions; there is little doubt about *that*, but the rate is no more than half an inch every year. California seems to be "breaking away from the continent" and might become an island, but if it should, this will not happen in less than 500,000 years—or it may take as long as 60,000,000 years.

The third principle the figure illustrates is the increasing tempo of geologic developments. The closer epochs are to the present, the shorter they become. The progress of the earth's history may be compared to the motion of a comet, starting at a crawl and then gradually moving faster. It took about a billion years for the earth's crust to cool off sufficiently to offer a livable milieu for the first organisms. Another billion years elapsed before the "living crystals" became simple worms. In the third billion years, evolution steadily speeded up, and climbed from worm to mollusc, from fish to amphibian, from reptile to bird, to mammal and to ape. When at the end of this three-billion-year day the clock struck midnight, man stepped out on the stage, and the second day, the day of man, began. The echo of his cue has barely died away.

Even if we stretch the geological day into a whole year, man's existence is a mere tick on the clock of geology. Let us say a year-long movie is filmed in order to depict the entire history of the earth. In this scale every second represents a century. It is not necessary to sit through all the early reels. The story of the earth is so monotonous in its initial stages that we can skip the first days and even weeks. The whole winter, spring and half the summer will pass before there are even the first manifestations of life, and it will be autumn before early plants start to cover the barren ground. During the

fall more and more creatures fill the screen; yet not until it is almost time to ring in the New Year can we witness the entrance of man. From January 1 to December 31 the movie has unreeled, twenty-four hours a day; yet only fifteen minutes before the end does the history of civilization begin. Its epochs follow one another so quickly that the pyramids spiral into cathedrals and the cathedrals dissolve into skyscrapers.

Man is only ephemeral, but the planet is so lively that even he feels the breath of the globe. One day he notices a crack in the cellar wall. When he complains, the builder shrugs: "It's no surprise to me. All houses are cracking; the rocks beneath the town are shifting." At the seashore an old fisherman points to a sandbar a hundred feet from shore: "When I was a boy a farmhouse stood there on a green meadow—the sea devours the land." The tracks of the railroad have to be elevated. The water level of the swamp is rising. Everywhere signs of life are evident to the eye that has learned to see. Earth is alive and we live in a particularly vivid period. In the history of the earth long epochs of calm are interrupted by short periods of unrest. We experience a sequence of warm and cold periods, each over a hundred thousand years. Because large areas of the northern hemisphere were covered with ice during the cold intervals, we call this whole sequence of changing climate an Ice Age. It is only about thirty thousand years since the massive sheet of snow and ice retreated from its southernmost advance, and the traces of the geological bad-weather spell are apparent everywhere. Our landscape resembles a garden after a hurricane—trees knocked down, the gravel swept from the driveway and a puddle blocking the entrance. Our numerous inland lakes, the broad estuaries and deltas of our rivers, the rugged crests of our mountain ranges and the numerous ice-carved valleys are eloquent vestiges of a recent geological storm.

Man owes his ascent to the turbulence of this epoch. In times of geological lull, the motionless landscapes brooding for millions of years, mammals are not impelled to adapt themselves to radical changes of environment and therefore are not stimulated to develop new species. It is not accidental that man rose during the restive Tertiary period. Children of the earth, we are born in its labors.

The Age of the Earth

The origin of this globe upon which we find ourselves is obscure; none of the cosmogonic theories is satisfying. It seems certain, however, that the earth was never a gaseous sphere, and is not a "child of the mother sun." Small bodies like the earth could hardly have broken away from that great ball with its enormous gravitational force.

Only one fact about the early days of the earth is fairly well established—

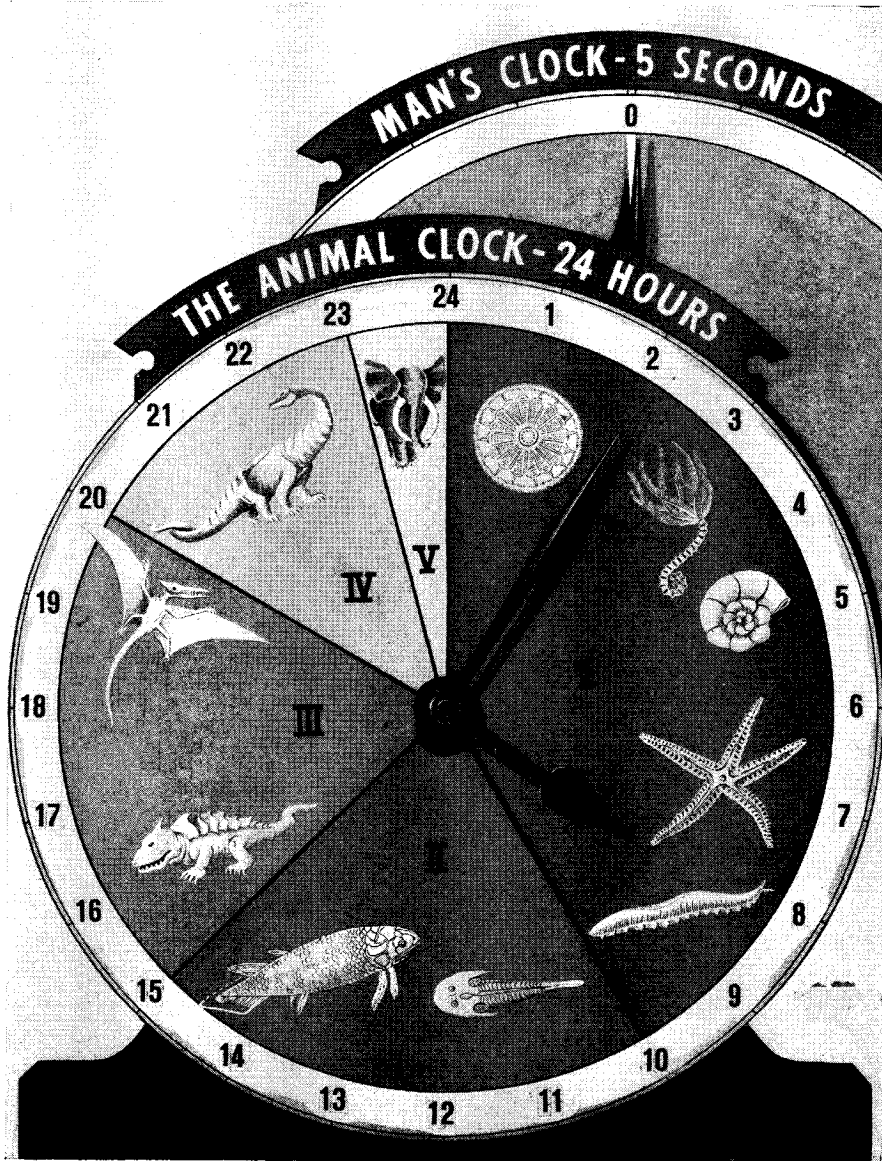

Fig. 98. THE CLOCK OF GEOLOGY

If we relate the development of life on earth to a 24-hour day, the entire history of mammals would occupy only one hour, and that of man, a few seconds.

the time of its birth. All pieces of evidence point to an age of not less than 3,500,000,000 years nor more than 5,000,000,000 years. The most elaborate of the modern methods for determining the earth's age is based on the uranium calculation. While we cannot know when uranium itself was created, we can tell, as described on page 111, how long a given deposit has been lying where it is found.

The oldest accessible geological strata in the northern latitudes, the Canadian Shield in North America and the Scandinavian Shield in Europe, point to an age of from 2,000,000,000 to 3,000,000,000 years for *their* existence, the age of the globe probably being considerably higher.

The Size and Mass of the Globe

The center of the earth is about 6,370 kilometers below the crust, depending on where we stand, because the earth is not a mathematically correct globe as Newton had demonstrated. We learned, on page 142, how the astronomers of the nineteenth century tried to determine within a yard the deviation of the globe from a perfect sphere, and how near they came to an ideal result.

The mass of the globe is about 6×10^{21} tons. It is determined by the earth's path around the sun, the forces acting between earth, moon and sun, and the minor deviations which occur when the moon and other planets approach the earth. These calculations are generally known. The methods which are based on terrestrial observations are less well known and even more striking.

In 1774 the English astronomer Nevil Maskelyne compared the attractive force of an isolated mountain with the attractive force of the earth. In open country, the undisturbed pendulum hangs perpendicularly. In the neighborhood of a mountain, it is somewhat deflected toward the mountain. Since the mass of an isolated mountain can be calculated, the degree of deviation of the pendulum from the perpendicular indicates how many times the pull of the earth surpasses the attractive force of the mountain.

This figure was later confirmed by several parallel computations. Instead of a mountain, a large sphere of lead was used to deflect a pendulum. In another version of the experiment a sizable ball of lead was placed under a balance scale on which a known mass rested. The mass was then attracted not only by the gravitational pull of the earth, but also by the leaden sphere, and was correspondingly heavier. From the increase in the weight of the mass it is easy to calculate how many times more than the sphere of lead the globe was pulling. Thus the physicists who performed these calculations confirmed the findings of the astronomers.

The Interior of the Globe: We Walk on an Eggshell

We know very little about the interior of the globe. It is necessary to emphasize this ignorance, because we see so many pictures and descriptions

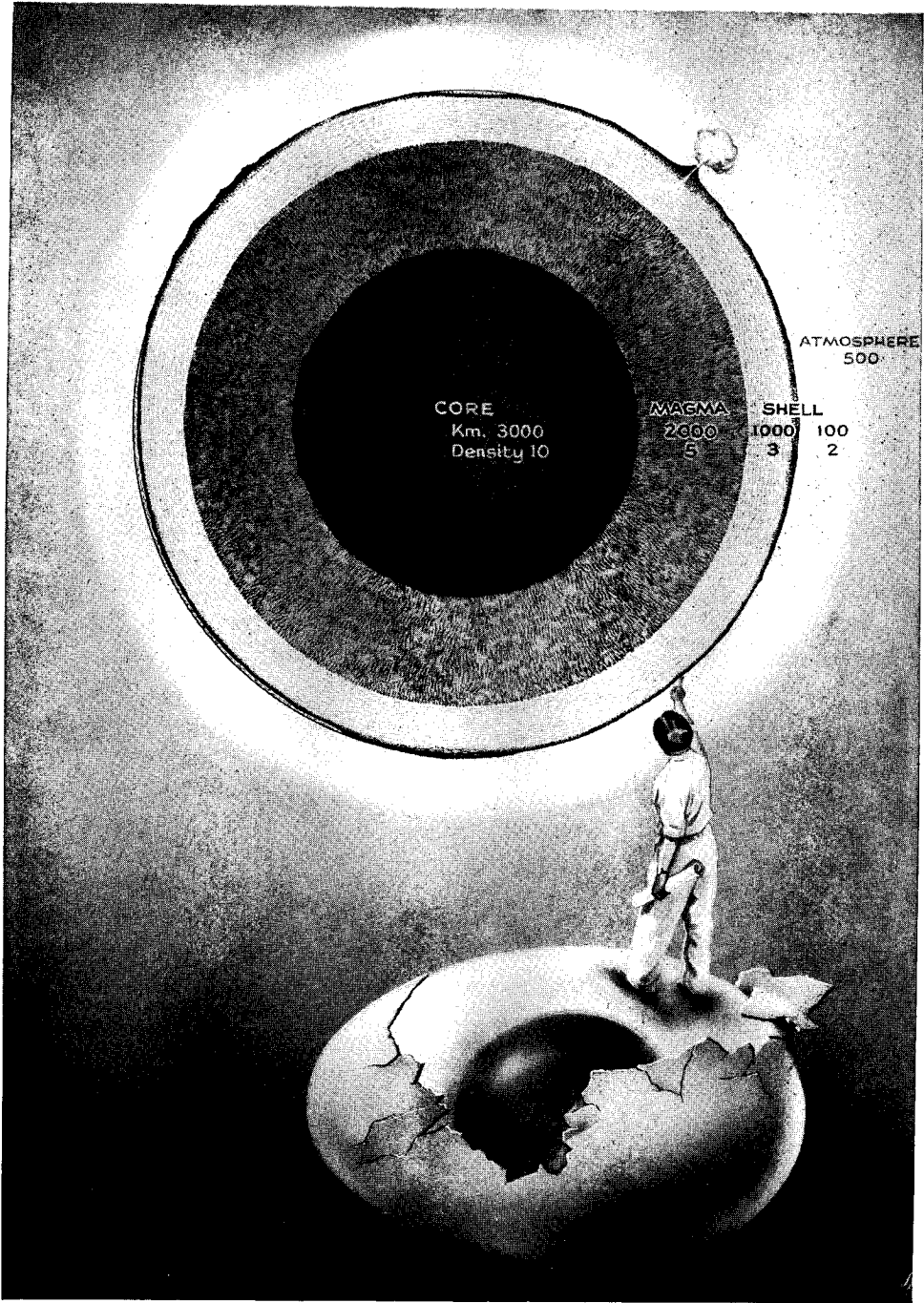

Fig. 99. WE WALK ON AN EGGSHELL

We know little more about the interior of the earth than a difference in densities at specific depths. There would seem to be a core, ten times as dense as water, an intermediate layer five times as dense as water and a shell with a hardened crust.

of the structure of the globe which purport to be established facts. The globe is shown as having a central mass similar to the yolk of an egg. The core is surrounded by onion-layers and on it, in bold letters, are the words "Nickel-Iron Core." Such a diagram, and all similar representations which show the globe opened like an anatomical figure are instructive but we should be aware that, actually, we know almost nothing positive about the interior of the earth. The opinions of geologists differ widely. Therefore it is necessary to draw a clear line between fact and fantasy.

The shape and mass of the earth are known. The density of the globe in comparison to that of water is 5.2. The density of the rocks on the surface of the globe is about half of this mean density, 2.8. The center of the earth is about 6,370 kilometers below the crust. Thus far man has explored about 6 kilometers. If you draw a light pencil line on the wall 6 feet from the floor, and another $1/14$ of an inch below the first, you will have a rough picture of this distance. Actually, only our drills have gone that deep. Man himself has descended only half the way. Everything below is unknown and everything said or pictured about the interior of the globe is hypothetical.

Man's descent revealed that pressure and heat increase as we penetrate downward. The weight of the strata of rock above mine-shafts, which are no more than half a mile below the surface, exerts enough pressure to make the walls of the shafts bulge inward and the floors arch upward, as though they were made of dough rather than rock. But the "doughy" rock is not soft. On the contrary, it is more compact than the "hard" rocks on the surface. While a drill cuts through the superficial strata easily, the deeper it penetrates, the more difficult boring becomes until finally the rock grasps the drill so strongly that it is as though a child held a fork which his mother cannot pry loose. When the Simplon Tunnel was cut through the Alps, the massive wooden beams shattered like matchsticks under the pressure of rock above. Pressure creates heat, and the temperature below the earth's crust rises 4° to 6° with every 100 meters of descent. Inside the Simplon Tunnel, the temperature climbed to more than 50° C. and the streams of water that spurted from the cracks were steaming hot.

Nevertheless, we are confronted with a paradox which highlights the danger of reasoning hastily from the known to the unknown. Lava which bubbles up from layers presumably ten or a hundred times deeper than the pits is never hotter than $1,500^{\circ}$ centigrade.

Earthquakes provide another source of information about the interior of the earth. However, they give only indirect information. They tell us about the density and the physical behavior of an otherwise obscure material. When disturbances occur in the interior of the globe, shock waves are emitted. These waves are registered by sensitive devices called seismographs. Diverging in all directions, some waves travel to the surface, others, toward the center, returning like an echo. Still others undulate beneath the crust of the globe and are recognizable even after seven to eight circulations along

the periphery of the sphere. All our speculations about the internal structure of the earth are based upon observation of these waves. They reveal that the earth's internal mass is not uniform and that the density does not increase gradually toward the center.

The earth has a core with a density 8 to 12 times that of water and a radius of 1,300 kilometers. The core is surrounded by a mesosphere about 3,400 kilometers thick, with a density of about 6; and an outer sphere identical with the "crust," about 1,800 kilometers thick and a density of about 4. The outer layer of this zone is the "rocky crust" with the almost transparent thinness of 30 to 40 kilometers and a density of 2.7. If anyone should want to memorize the gradations in density, he may simplify: 8, 6, 4, 2. That is all we know. Everything else is conjectural.

Aside from seismographic recordings, we have material witnesses from the outer world, the meteorites. Two kinds of meteorites fly against our globe, stony and metallic. The stony meteorites are pieces of hardened magma. They tell us that magma, identical with the magma from our volcanoes, is one of the basic constituents of cosmic bodies.

The metallic meteorites are alloys of 90 per cent iron and 10 per cent nickel. Since the earth is $5\frac{1}{2}$ times as heavy as water, the nickel-iron alloy 9 times as heavy and magma only twice as heavy, the geology of the pre-atomic age proclaimed that the globe has a core of nickel-iron with a covering of magma which has hardened into rock on the surface.

This theory stood in high esteem as long as we knew no more than those who originated it. Then the laws of gaseous spheres became known, and just as they set aside the cosmogonies of Kant and Laplace so did they also invalidate this theory of the nickel-iron core. The pressure in the interior of the globe must be enormous, around 3,000,000 atmospheres. When pressure surpasses 1.4 million times the air pressure at sea level (= one atmosphere), the orbits of the atoms break. When the increasing pressure reaches a certain point, the pressured material becomes suddenly just twice as dense as before. Even gases become as rigid as metals, a process which is called metalization.

It may well be that the interior of the globe forms a core as dense as nickel but it need not necessarily be nickel! Some geophysicists say it cannot be nickel. The age of the earth is too short by far for nickel and iron to have separated from the viscous solar matter of which the planets are composed. They tend to the hypothesis that the globes of all planets are composed of uniform solar matter and that the core of the earth is a highly compressed gas with the properties of a rigid metal.

The frozen crust is very thin—only a few dozen kilometers in depth! Compared to the entire globe the earth's outer husk is far thinner than an eggshell. Break a raw egg carefully and you will notice a half-transparent pellicle under the shell. Blow at the membrane and it will quiver. A raw egg, minus its chalky shell, with its yolk as the core, its flabby white as the

bulk and its trembling film the cover, is a model of the earth we live on. To walk on so fragile a lining seems frightening. Yet their basins hold the oceans and the ground carries the weight of the Himalayas. Dinosaurs and mammoths stamped on it. Man has no reason for fear.

The Stony Book of Earth's History

*The Chapters in Earth's History:
The Geological Periods*

THE STORY of the earth is written in a stony volume, the leaves of which are the geologic strata. (Fig. 100) Every 100,000,000 years or so, a page is completed and a new sheet added. The stony leaves cannot be turned, but they have been tattered by wind and weather. Some are torn; others are crumpled as though the book had lain in the sun; elsewhere pages are pushed up into folds of mountains; rivers, like bookworms, have eaten their way through the lines.

The ancient Chinese had a maxim: "The beginning of wisdom is to call things by their right names." Unhappily this principle has not yet been fully adopted by science. We still suffer from an immense heritage of names picked at random. A geologist who found ancient strata in Wales referred to the old Roman name for Wales and labeled them "Cambrian." The next geologic period was christened with the cumbersome name "Ordovician" after an extinct Welch tribe. An almost impassable jungle of odd names ensnares the newcomer and disheartens him—as if the matter were not difficult enough even with a comprehensible nomenclature. An iconoclast should throw out these dusty idols and introduce a more logical system.

To make the embarrassing multitude of odd names and mammoth numbers as palatable as possible, in the following timetable the periods are grouped as if there had been three ages, paralleling the three eras in the history of civilization: Primordial, Medieval, Modern. The pivotal point in this artificial sequence of ages is the Carboniferous Epoch, just in the middle of the "Medieval Times." It may well be compared to the Renaissance in human history, since it was an epoch of similar significance for the earth's history.

Favored by a warm and humid climate, swamps inundated wide areas. Plants, hitherto mostly hidden beneath the water, rose to become trees of gigantic size. The vertebrates left the swamps and the three dominant classes of dry-land animals—insects, birds and reptiles—appeared in their first sketchy designs. But after many millions of years the age of ascent became an age of decline. The swamp forests sank down and the sinking layers were



Fig. 100. THE STONY BOOK OF EARTH

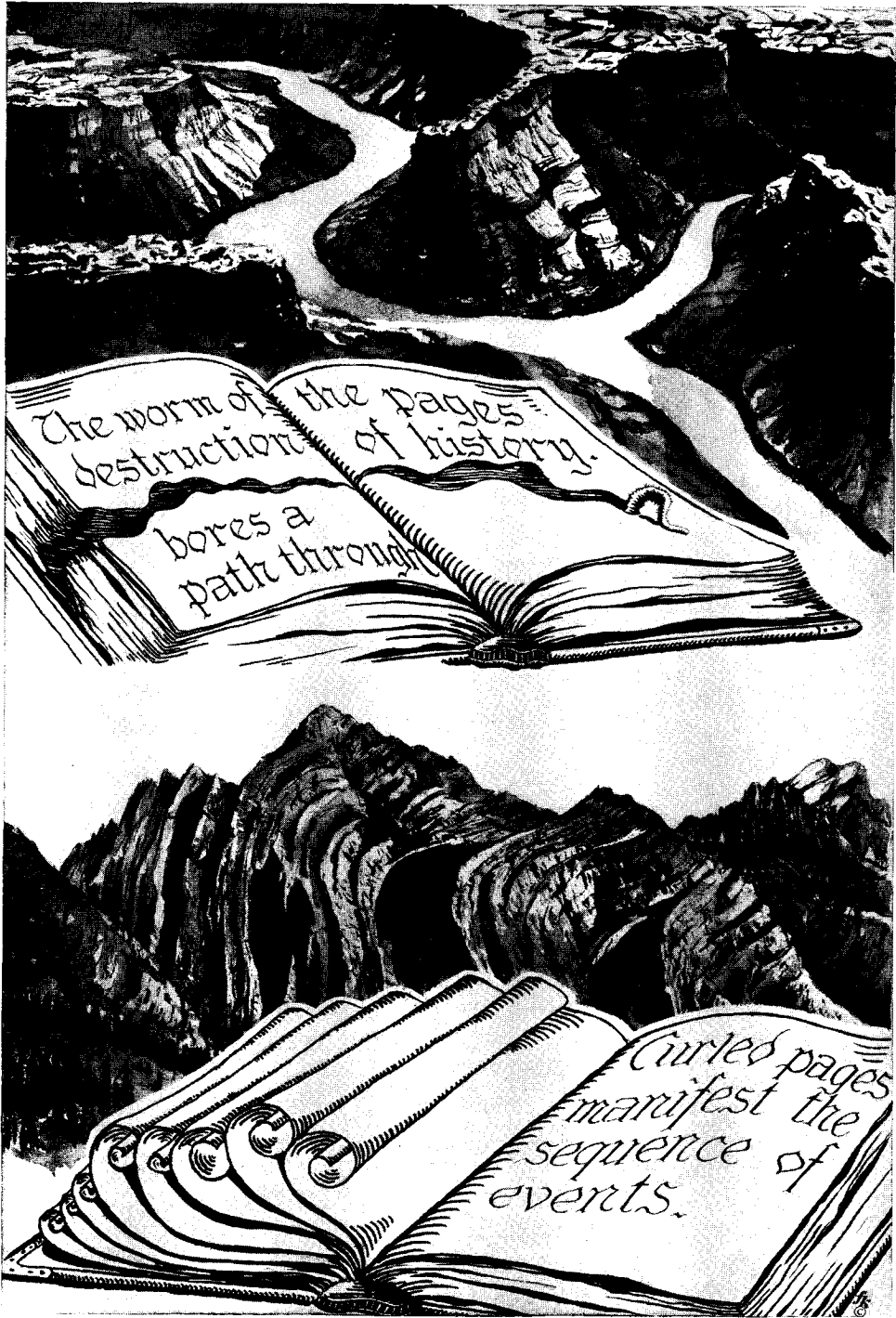

Fig. 100. THE STONY BOOK OF EARTH

compressed by succeeding layers above them and carbonized into coal. Thus solar energy was stored until man came and lifted the "black diamonds."

THE GEOLOGICAL PERIODS

(Each unit represents one million)

<i>Period</i>	<i>Approximate Duration</i>	<i>Years Ago</i>	
Quaternary		from 1 to present	} Modern
Tertiary	65	from 65 to 1	
Cretaceous	60	from 125 to 65	
Jurassic	30		} Medieval
Triassic	40	from 225 to 125	
Permian	30		
Carboniferous	60		
Devonian	35	from 350 to 225	
Silurian	30		
Ordovician	50		
Cambrian	100?	, from 1,000 to 350	} Primordial
Proterozoic (Algonquian)	500?		
Archeozoic	1,000?		

*The Pages in the Book of
Earth's History: Rocks*

In previous times it was believed that if we penetrated deeper toward the center of the globe the strata would become hotter and more fluid, until finally we reached a fiery liquid something like the "fire of Hell." In all geological books of the last century imaginary fiery caverns below the crust of the earth are often pictured as a glowing red. These subterranean caverns are mythical reminiscences of the medieval hell. There can be no burning caves in those depths. Not even fluid masses can flow there. The pressure of the upper layers prohibits the interior mass from melting. Although very hot, the minerals must be compressed into a uniform rigid substance. Only when the pressure lessens can this compact mass become plastic and thereafter liquid. Only when the oxygen of the atmosphere combines with the inflammable compounds is the fire of the volcanoes kindled.

Near the surface of the crust the pressure is weaker and the temperature lower; here the magma passes through a plastic stage and finally solidifies into masses we call rock. Rocks which were formed inside the deeper levels

are called igneous or plutonic rocks. Inasmuch as "igneous" means molten in fire, and no fire was involved, the noncommittal term "plutonic," from the god of the underworld Pluto, is more appropriate. (*Fig. 101, 2*)

The plutonic rocks are by no means all alike. Depending on the speed and the pressure under which solidification took place, rocks made of the same material differ in their structure. If we look at several specimens of a common plutonic rock such as granite, we easily recognize differences. In one piece the crystals—feldspar—are large; in another, small. In one they are densely crowded; in another, widely scattered. The filling between the crystals—mica and quartz—may be coarse or fine, black, green, gray or brown. Coals and diamonds are both made of the same material—carbon—but the coal is manufactured in a slow, low-pressure process. Diamonds are the product of crystallization under extremely high pressure. When rocks are uniform and can be defined by a chemical formula, they are called minerals.

If cracks or craters permit magma to gush forth, it flows out as lava. Large areas of the United States are covered with lava. Cooling lava behaves like drying mud; it splits into polygons—most often hexagons. Whole ranges of mountains are built of hexagonal columns of basalt. Hard, like granite, basalt is preferred as a material for covering roads. The cobblestone streets of a medieval town may madden the driver but they fulfilled their historical task: they have survived by many centuries the funerals of its kings and the carnivals of its people.

Sometimes specific components of the magma separate or precipitate. Molten iron may well up and flow in subterranean rivers, gush forth in lakes and then, after cooling, crystallize into those precious deposits which man mines today. Minerals characterized by specific properties such as the ability to be fused or to conduct electricity are called metals. Yet the metals are so different in their physical and chemical behavior that a definition valid for all metals has yet to be agreed upon. Rocks containing a commercially valuable percentage of metal are called ores.

Exposed to the agents on the surface of the earth, the rocks change in character. Some of their compounds combine with oxygen and oxidize; others are water-soluble and are washed away. Some minerals combine with the traces of acids in air and water to produce salts which are often brightly colored. Thus the primary rocks, being comparatively few, changed into the multitude of secondary rocks which now fill collectors' cabinets and are the coveted material of gems.

Heat and cold cause rocks to crack and to exfoliate. The fragments split into ever finer particles, until they are ground into sand. Sand is the insoluble residue of worn and milled rock. The sand is blown away by winds and carried downward by rivers; finally, the fugitive particles settle on the floor of the oceans. The plants and animals of the sea contribute their organic and inorganic remains. The skeletons of floating radiolaria, the glassy boxes

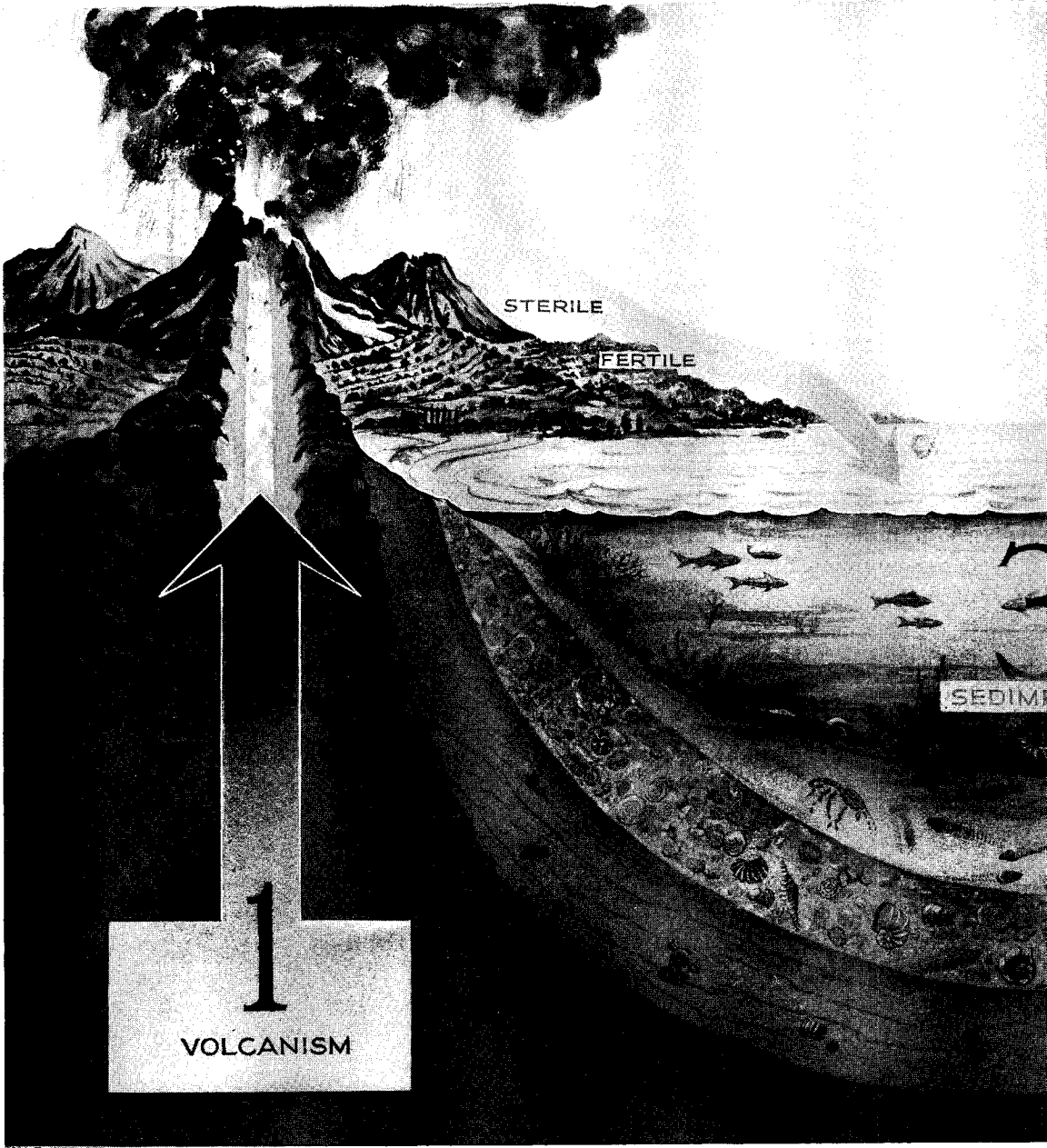
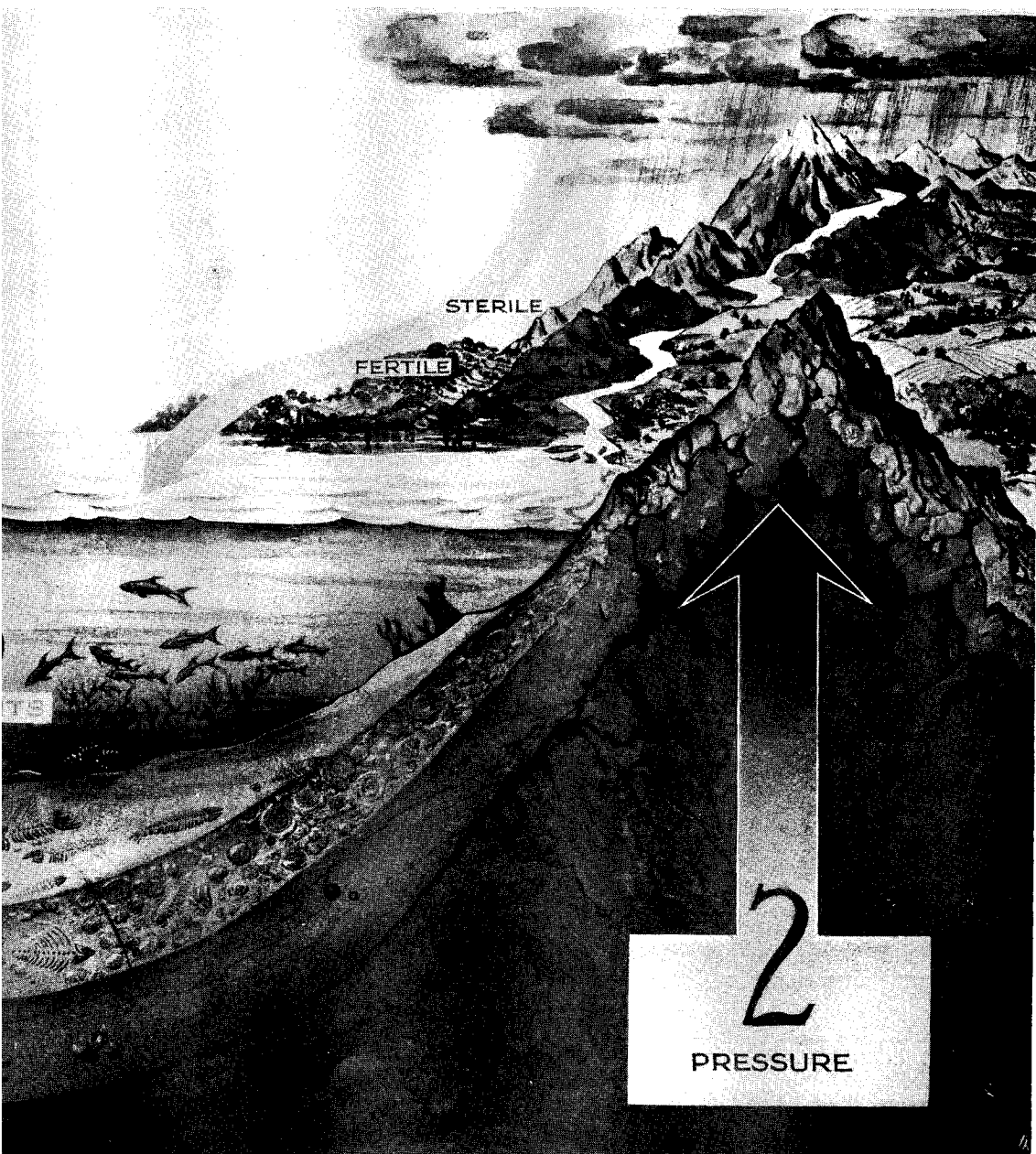

Fig. 101. FUNDAMENTAL ROCKS OF THE EARTH'S CRUST
1. Volcanic rocks magmatic in origin and hardened on or near the surface.



2. Plutonic rocks hardened inside the crust by compression.
3. Sedimentary rocks, formed from anorganic deposits and the residue of organisms.

of diatoms, the chalky shells of foraminifera, the hulls of microscopic crabs, the shells of snails and mussels—all sink down and cover the floor of the ocean as “sediment.”

One layer after another settles down, each new layer pressing the preceding one so that the sediment is stamped into a stony mass, or sedimentary rock. If the rock is composed mainly of sand, it is sandstone. (*Fig. 101, center*) If the limestone is composed of the microscopic shells of chalk animals (foraminifera), the white stone is the brittle chalk we use on the blackboard. When different kinds of rock press against each other or mix their masses, they change their structure or combine into new compounds. They may submerge again, be remelted and reappear on the surface in a new form—as metamorphic rocks. We all are acquainted with this process: when clay is baked it becomes brick; certain clay becomes porcelain; sand and Portland cement mixed become concrete; sand and lime, mortar; asphalt and gravel, macadam. So the little demigod has added his artificial rocks to the rich collection of natural stones.

*Text and Pictures in the Book of
Earth's History: Strata and Fossils*

Like any other book, the stony book of earth demands that the reader be familiar with its language. It is not an easy idiom; the geologist must study for years before he becomes a “reader,” but thereafter the book of earth willingly discloses to him its hieroglyphic tales.

Let us open the cryptic folio and glance over its pages. The strata tell us the period in which the story was laid. The polish of a rock tells us whether the eroding agents were the steady flow of water or the violent winds. The markings on the rock, deep or superficial, crude or delicate, denote whether the currents were strong or moderate, whether the boulder had lain on the seashore, subjected to the tides, or in a desert, exposed to sand-carrying winds. Fine clays, richly intermixed with relicts of plants and animals, recall halcyon days.

Two hundred million years ago North Africa and large parts of South America were strewn with sand by long-lasting storms. Coarse grains covered one side of all slopes and finer grains, the other. Apparently the sand was airborne and not a sediment on the floor of an ocean. The fossils embedded in these strata were sparse and confirm our suspicions that the climate was unfavorable. In fact, this sandy period coincided with the Permian “Ice Age” over the southern hemisphere.

In the next 50,000,000 years the scenery changed. Africa, from Morocco down to the Gold Coast, and South America, from Bolivia to the Falkland Islands, were covered with a carpet of greenish-blue clay. Drowned in this

deposit are fossils of sea animals, testifying that an ocean flooded the continents. Its waters were cold; the climate, as the geologists say, "post-glacial." During the succeeding 20,000,000 years, shallow-water inhabitants appeared, and then the water gradually turned fresh. Plants and animals, typical of bays and brackish water, are interred in the covering layers. One stratum higher, traces of rivers are recognizable from floors of sand bordered by banks of gravel. It is possible to trace these rivers downward to their estuaries. These mouths of the rivers were later silted over and the streams turned into swamps abounding in typical amphibian life. Eventually the swamps dried up and their flora and fauna gave way to those of dry land.

The imprints of plants and animals engraved in the earth's layers are the oldest and most faithful pictures in the history of illustration. They are the first true lithographic plates, literally "written on stone."

The most trivial remainders of an extinct animal are cord-shaped droppings 400,000,000 years old found in a specific stratum of the Ordovician period. No other trace of the animal which produced this excrement has ever been found. Yet even this poor relic is not worthless to the scientific detective. Since it was cast off only on a certain shale of the Ordovician strata, he knows that whenever he finds droppings of this unknown animal, *Tomaculum problematicum*, the stratum belongs to this specific phase of the Ordovician period.

Somewhat more eloquent than isolated excrement are footprints on a once plastic and later petrified ground. In *Fig. 102* we see the footprints of a four-legged animal. With nothing more than these prints to go by, the paleontologist begins his laborious task of reconstruction. The slab is part of a stratum about 180,000,000 years old, of the early Triassic period. Since mammals of sufficiently great size and weight did not yet exist at this time, only an amphibian or a reptile could have made the marks. Since the hind legs apparently made much larger and deeper impressions than the front ones, the animal must have carried its main weight on its hind legs and may have resembled a small kangaroo. The distance between the footprints reveals his length, their depth in the once plastic ground gives his approximate weight, and the variations in depth between rear and front impressions tell the distribution of his weight. From the slant of the tracks can be determined the position of the legs, the breadth of the pelvis and the angles of the joints. These details lead to the conclusion that this Triassic animal, probably a reptile, was larger than a dog but smaller than a calf, and stood half-erect on his hind legs. The center plate (2) shows the blueprint and the picture (3) presents its reconstruction.

At the inner edge of one impression, the researcher discovers an unevenness not caused by the foot. This might have escaped a less skilled eye, but our geologist has been a detective of fossils for a good many years. He removes the tell-tale spot with a delicate instrument, examines it under a microscope and finds the remains of a partly chewed plant, evidently some

food dropped from the animal's mouth as it trotted along. The beast therefore must have been herbivorous. The chewed fragments cannot be immediately identified, but even at this point, science is not baffled.

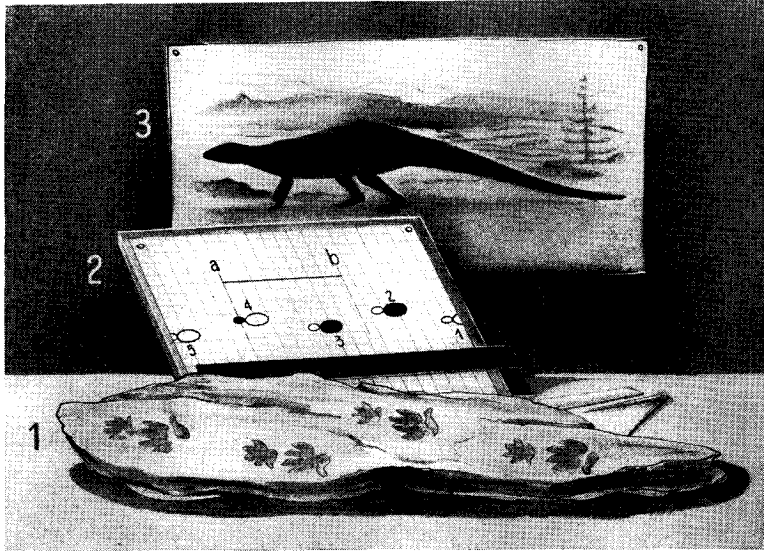

Fig. 102. FOSSILS

The paleontologist can reconstruct an extinct animal even if nothing else is preserved but the impressions of its feet.

In 1893 a German botanist, A. C. Weber, studied the different layers of peat moors. The decomposed plants of the deeper layers were not recognizable, but their pollen grains were, because pollen has a hard shell which resists fossilization. The pollen found in strata tells which plants flourished in the various periods. Weber investigated the peat bogs of Northern Europe, and through "pollen-analysis," as he called his method, he succeeded in tracing different types of sunken forests as far back as the last Ice Age. Twelve thousand years ago, Europe was still a tundra, a steppe with frozen ground. As the temperature rose, there appeared, successively, mixed growths of birches, willows, pines; later, oaks, hazels and alders; and, finally, beeches. Since those times the pines have shown a steady tendency to retreat from the coast of France eastward into Russia.

The paleontologist, in search of clues to the identification of this particular reptile, floats in water the remnants of vegetation discovered in the footprint, whirls them in a centrifuge and examines the sediment under a microscope. He finds pollen of horsetail, a plant common in swampy ground. But there are also a few pollen grains of conifers, which do not grow in swamps. He concludes that the swampland was surrounded by wooded heights.

This was confirmed by some pieces of petrified wood excavated near the Triassic specimen. Petrified trunks are eloquent documents of the past. If

the trunk shows no signs of annual rings, the trees must have grown at an equal rate throughout a tropical year, with no seasonal changes, for rings form only when cool and warm seasons alternate. When there are rings, the different thicknesses of the softer spring wood and the harder fall wood reveal the proportionate length and strength of the seasons. By comparing branches and knots on the different sides of the stem, the interpreter may be able to determine from which side the winds blew and the rains fell. When the differences are marked, the winds were strong and the rains violent.

Data so obtained are recorded in geological charts. New details are constantly being added throughout the years and so an initially empty map of a prehistoric province fills up slowly. Just as prospectors dream of striking oil or gold, so the geologist dreams of finding fossil lodes. He strolls along in fields, passes haystacks and railroad ties, but he is not really there. In his mind he wades in rubber boots through a Triassic swamp, where fern trees swing their fans, horsetails stand like chandeliers and dragonflies of gigantic size buzz through the air. He is searching for a reptile that is larger than a dog but smaller than a calf, with strong hind legs and slender forelegs. The reptile has left nothing but a footprint, yet he sees it standing half-upright, mangling a Permian plant. From between the angle of its jaws drips a bit of food. . . . This is the Arcadian life of the man who devotes himself to the idealistic pursuit of pure science.

Cracks and Wrinkles in the Book of Earth's History: Mountains and Grabens

The ground we walk on appears to be dead. Actually it is not. The few decades of man are too short to recognize that the ground is not at all dead, but alive. The fly that alights for a second on a napping man's forehead cannot be aware that this man who is now asleep at other times walks and works and that his features change during the decades. The fly knows as little of decades as we know of geological periods.

If every second a man lives were a decade, he would recognize that rocks are not rigid. They behave like the pieces of asphalt at the roadside. After they are exposed to the sun, they flow like molasses. The summer sun is not sufficient to make rocks malleable. But sufficient pressure, heat and time will do it. The giant of the fairy tale who squeezed a stone until water came out was no magician, only a man of great force.

When we drive through a valley we see the striations of different layers in the rocky walls. They may run parallel to the road for a mile. (*Fig. 103, 1*) Suddenly they loop upward (*2*). Five hundred yards farther on they are horizontal again. Curves or loops of geological strata are called "folds" (*2*). In *Fig. 100* a folded landscape is shown. If the impressed strata have not

enough room to curve, or if they are too rigid to bend, they will break. The pressure which broke the strata pushes the broken ends apart. They may be later separated by as much as half a mile so that it becomes difficult to locate them. A broken fold is called a "fault" (3).

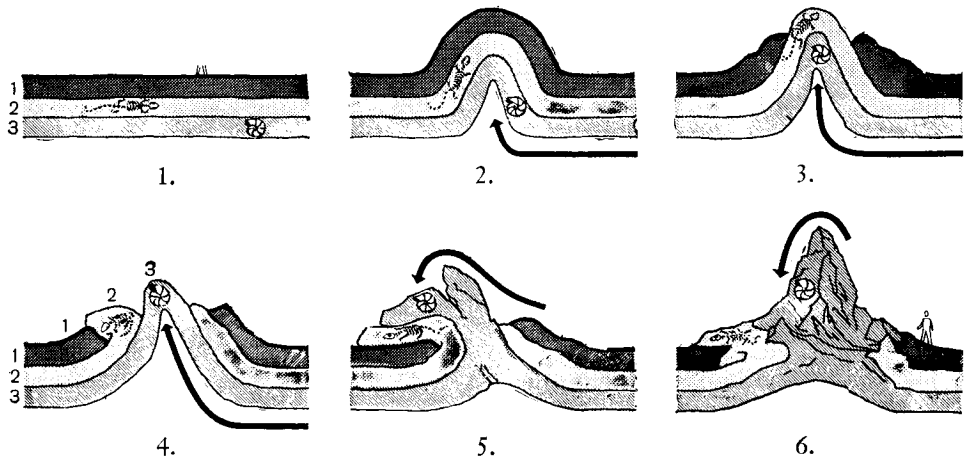

Fig. 103. THE LIFE OF GEOLOGICAL STRATA

1. Three geological strata in their original arrangement.
2. Pressure from below bends them into folds.
3. Layer 1 breaks, forming a fault, and layer 2 appears at the surface.
4. Layer 2 breaks and layer 3 appears at the surface.
5. The sequence of layers is reversed.
6. Fossils rise to alpine heights.

When the covering layer is broken, the underlying pushing layers force their way up through the crack (3). If there are fossils, the ascending layer carries them upward, too. Now, paradoxically enough, the second layer is on top. This layer, too, may crack and thereafter layer No. 3 appears in the open (4). It rolls out over layers Nos. 1 and 2 and the natural order is disarranged, 2 being higher than 1, and 3 being higher than 2. A layer that ascends from the depths is generally composed of older and harder rock and rises, without folding down, to form a mountain (5 and 6).

The famous Matterhorn in Switzerland is an example of the rise of a mountain from the depths. On its slopes ammonite shells are found thousands of feet higher than they ever lived. The hard rock of the Matterhorn stands in the midst of soft rock, and its hold may be rather weak. The prognosis of its geological future is ominous. Some day—that means in 50,000,000 or 150,000,000 years—the gigantic monolith which lured three generations of mountain-climbers to its deadly height may list like the Leaning Tower of Pisa and sink back into the sea of magma.

If through a gap in the crust magma wells up from the depths, a volcano arises. A volcano is a mountain built up of solidified magma. The cone may rise to a height of thousands of feet; some of the highest peaks in the world

are volcanoes, such as the Chimborasso in Ecuador, the Kilimanjaro in Africa, or the Fujiyama in Japan. The opening through which the lava spills out, often in stormy eruptions, is called the crater. Since the magma flows down equally on all sides of the rising cone, the volcano finally stands like an immense pyramid, admired for its beauty and revered by the people as the home of the deity who manifests itself here in grace and anger. In the United States, Mt. Rainier and Mt. Hood owe their harmonious contour to having once been live volcanoes.

A much more complex process than the rise of a solitary peak or a volcano is the building of a mountain range. There is no generally accepted theory and it would be hard to find two geologists who agreed on every detail, for many forces are involved in the complex process.

One of the several theories presently favored is the theory of the continental cores: Originally the globe was covered by water from which "cores of continents" emerged here and there, forced up by pressure. Two such old cores are still recognizable, one of them on the European side of the Atlantic as Scandinavia, another on the American side as the eastern part of Canada, the Canadian or Laurentian Shield. When a continent rises, the surrounding crust of the earth is stretched thin and forms a circular depression, called a geo-syncline, around the elevating core. If the geo-syncline is well defined it forms a trench, or "graben."



Fig. 104. THE EAST AFRICAN RIFT

The longest deepest geological trench runs from Turkey southward almost to the Cape of Good Hope.

The best-formed graben on the surface of the globe at present is the East African Rift, which cuts through the homeland of Christianity and is the stage of many biblical scenes. It starts in Turkey and runs along the eastern end of the Mediterranean through the Red Sea down the whole East African coast to the Straits of Madagascar. (*Fig. 104*) It exhibits all the characteristics of a geological trench. Earthquakes are common events; no known country on the globe is more harassed by them than the province of Anatolia in Asiatic Turkey. In the Syrian part of the graben at Baalbek towered the temple of Jupiter, one of the most magnificent monuments of ancient times. Early Christians as well as Moslems tried to destroy the pagan monument as the signs of their attempts clearly testify. But the immensity of the edifice thwarted their zeal. Yet two earthquakes felled the columns easily and half of the gigantic structure tumbled.

A few miles to the south the trench enters the Holy Land. Here the graben reaches its lowest level, the deepest land depression on earth. (*Fig. 105*) The Jordan River flows meandering from north to south. In the north it widens out to form the Sea of Galilee. Tiberias, famous for its beauty as well as for its hot springs gushing from cracks in the crust, does not count minor earthquakes; but every seven years a major quake resulting in considerable damage



Fig. 105.
THE BISECTION OF THE
HOLY LAND

The Jordan Valley, part of the East African Rift, gives Palestine its characteristic profile (*bottom*).

is common, and three times every century the town is more or less flattened. The frequent earthquakes in and near the graben are mentioned in the Bible, as in Psalm 114: "The mountains skipped like rams and the little hills like lambs. . . . Tremble, thou earth, at the presence of the Lord. . . ." The downfall of Sodom and Gomorrah is the first scientifically correct record of a tectonic earthquake in Western literature. A wide gap opened and swallowed the two towns with all their "sinners." A hundred miles away lies Jericho, the lowest inhabited place on earth, 350 meters below sea level, on the brittle Jordan terrace. No wonder its walls crumbled when rams' horns were blown by the besiegers!

Around 750 B.C., under the reign of King Usiah, a disastrous earthquake rocked the country "back and forth like a cradle." The book of the prophet Amos begins with the dating "two years before the earthquake." And, again, on the third day after Christ had been laid in the sepulcher, the country was shaken: "And, behold, there was a great earthquake and the tomb opened."

A graben is a wound in the flesh of the earth and, like a wound, it tends to heal. The pressure of the crust pushes the rims of the graben against each other and they well up to become rim mountains. All grabens are bordered by mountains. For example, the valley of the Upper Rhine is framed by the two parallel ranges, the Black Forest and the Vosges.

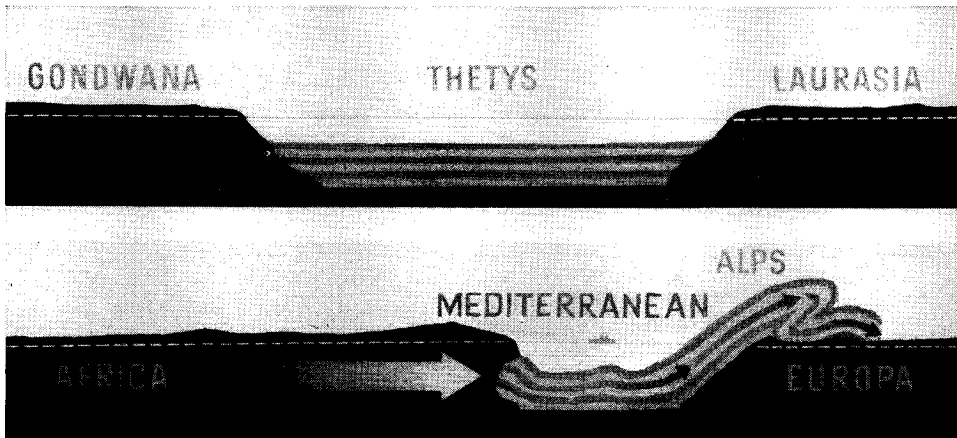

Fig. 106. THE THEORY OF THE DRIFTING CONTINENTS I

The birth of the Alps: Africa pushes against Europe and shovels the floor of the Mediterranean Sea up as the Alps.

The most prominent chain of rim mountains runs from the Pyrenees along the Alps to the Caucasus, the Himalayas and beyond. Presumably a long graben, an east-west counterpart to the still open north-south African Rift, bisected the Old World once and partly does so today. The Mediterranean Basin separates Africa from Europe but shows signs of healing. Both rims of this graben well up to form high mountains, the Atlas on the African

and the Alps on the European side. According to the theory of the floating continents which is presented in the next chapter, Africa pushed northward against Europe and shoveled the loose layers of the sea floor up so that the Alps rose.

If we condense all these ideas about the origin of mountains, we come to formulations no less audacious and "modernistic" than those of the new physics. Rocks are not hard but plastic. The crust of the earth is not a dead shell but a living skin which breaks up and suffers from wounds. These wounds heal and the scars that remain are the mountain ranges. Mountains rise from the depths.

According to the theory of the floating continents, America is drifting westward into the Pacific. At the bow of the continental steamer which has to drive against the hard floor of the Pacific, the coast wells up as mountains, as the Rockies in North America and the Andes in South America. (*Fig. 107*)

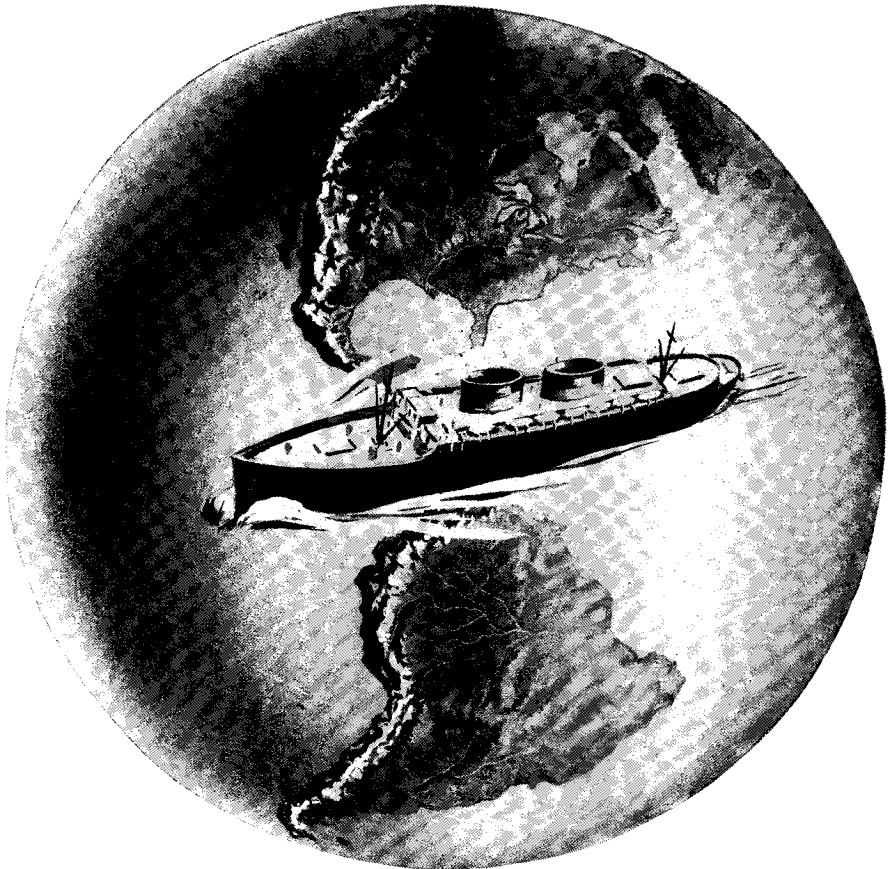

Fig. 107. THE THEORY OF DRIFTING CONTINENTS II
America is drifting into the Pacific. At the bow of the continental ship the west coast wells up as the Rockies and the Andes.

Under the impact of the firmly resisting floor of the Pacific, the coastal strip of the North American continent is breaking away. Vancouver Island and the Bay of San Francisco are two typical fracture areas. The earthquake of 1906 was caused by a sudden slipping of the coast. After the quake, a strip of land 150 kilometers long was dislocated about 6 meters to the northwest.

The cracking of the earth's crust and the consequent upsurge of mountains does not go on indefinitely in the same rhythm. Long periods of quiescence are interspersed with periods of activity, eruptive like periodic skin affections caused by an allergy. The earth has lived through several mountain-heaving periods. The oldest mountains still identifiable by their roots, the Laurentians in Canada, were raised at least 1,000,000,000 years ago. Five hundred million years later the next great upheaval occurred, the residue of which is found in Canada, Minnesota and Wisconsin. Two hundred million years later the Caledonians were pushed up; they flattened into the present hills of Scandinavia, Britain and Greenland. Three hundred million years ago the Northern Appalachians rose and the Southern Appalachians followed 50,000,000 years later. One hundred and fifty million years ago the Cretaceous upheaval began "delivering" the mountains of our present world: the Alps, Himalayas, Rockies and Andes.

This Cretaceous upheaval does not seem to have ended. All these ranges are still restive. The famous peak on the border of Germany and Austria, the Zugspitze, has increased a hand's breadth since 1900. Mt. Everest is growing fast. One year before the giant was conquered, the leader of an unsuccessful Swiss expedition said: "Anybody who wants to reach the top had better hurry because it gets harder every year." After the great earthquake in Assam in 1951, it is said, the peaks around Mt. Everest rose several dozen yards at one swift stroke. In 1883 the "extinct" volcano of Krakatoa exploded in the Sunda Straits; twenty years later the same thing happened to the "extinct" Mt. Pelée on Martinique. During World War II a new volcano, Paricutin, rose in the midst of peaceful farmland in Mexico. Who will deny the possibility of a future Mt. Rainier or Mt. Hood being born here before our eyes?

According to the theory of continental cores, the cores increase in size. With each upheaval the crown of mountains circles farther from the central core. Thus the continents widen and the oceans shrink. Finally—according to this hypothesis—the earth should dry up entirely. When the continents have reached their ultimate extent, all lands thus being raised above sea level, the stress on the crust will cease, the last collar of mountains will remain and the earth will be as dried up as its sister planet Mars. But these dire prophecies need not worry man. He will surely have a billion years to live on a trembling earth, amid fuming volcanoes, opening and closing grabens, rising and sinking mountains.

The Theory of the Floating Continents

The Birth of a Theory

IN 1823 THE English geographer Edward Sabine discovered a small island off the eastern coast of Greenland and determined its geographical location. In 1869 geographers rechecked the location and ascertained that the island was 420 meters farther west than the point given by Sabine. The difference exceeded the usual margin of error, but the geographers did not argue about it.

Forty years later another group of geographers, in the course of one of the periodic expeditions sponsored by the Danish government, checked the coast of Greenland again. A young participant, Alfred Wegener, found at this time that Sabine Island was about one kilometer to the west of the position given in 1869. He came to the conclusion that the island, not the measurements of the geographers, must be “wrong”; it must have changed its geographical position. On checking the positions of other arctic land masses, he found that they all drifted westward at varying speeds, and promoted the theory that Greenland is shifting about twelve feet to the west every year. America, too, is moving westward; the distance between Cherbourg and New York increases about one millimeter, one-twenty-fifth of an inch, every day. The American soldiers who crossed the Atlantic in World War II had to travel thirty feet farther than did their fathers in World War I.

All places on the surface of the globe change their geographical position. The architects of ancient Egypt would gape in amazement if they saw the Pyramid of Cheops today. It is now about two and a half miles south of where they erected it. If Ulysses were to revisit the scenes of the *Odyssey*, he would look in vain for Scylla and Charybdis. The Strait of Messina, whose width in ancient times was one and three-tenths miles, is now almost two miles across, and the whirlpool that once made the Narrows of Messina notorious has subsided into a mere current. The Strait of Gibraltar is about three times wider today than when it was known as the Pillars of Hercules. Rome is shifting toward the equator, North America is moving southwestward, Australia is approaching the South Pole, and the insular world of Polynesia is scattering.

There is a distinct difference between fact and theory. It is a fact that

frogs spend the first part of their lives in the water as tadpoles. That they do so because their ancestors were aquatic animals is a theory. That land masses change positions seems to be a fact. The explanation that Wegener gave is a theory, the "theory of the drifting continents," and one which is still a subject of discussion among geologists. Despite the debatability of the theory, in the ensuing paragraphs we will speak as if the assumptions were facts, just as an astronomer might present the theory of the "expanding universe" or the geneticist the theory of the genes. It would be tiresome to begin every paragraph with the statement that the topic presented therein is hypothetical.



Fig. 108. NINETEENTH CENTURY THEORIES ABOUT THE MIGRATION OF THE POLES

It was thought that the axis of the earth oscillates widely, that both the climates and the equatorial tide followed the migrating poles and the lands alternately sank below and rose above sea level.

The idea of the drifting continents had been expressed several times before: in the seventeenth century by Francis Bacon; in the eighteenth by the French father of modern zoology, George Louis Buffon; and in the nineteenth by the American astronomer, Edward Charles Pickering. Yet Wegener is justly called its creator, since in science the father of a theory is not the man who casually voices it but he who first recognizes the significance of an idea, devotes time and talent to a thorough investigation, correctly formulates his theory and is forced to overcome the resistance of the contemporary "guardians of the acknowledged truth"—and in so doing receives for "his" theory

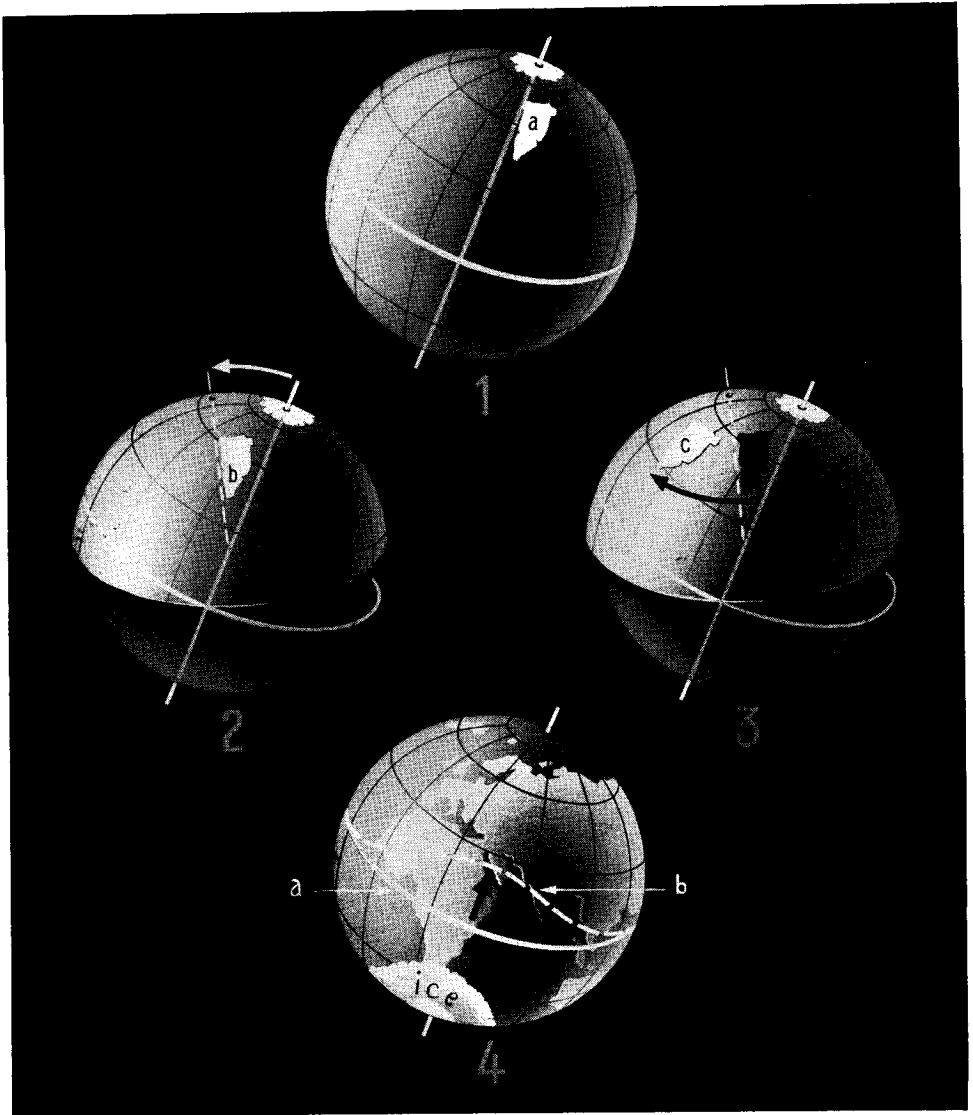

Fig. 109. PRESENT THEORIES ABOUT THE MIGRATION OF THE POLES

1. The crust of the earth sways over the stable core.
2. The island *a* wanders with the crust toward *b*.
3. Since the crust is plastic the island floats farther toward *c*.
4. When the polar ice progresses, the climatic equator is bent toward the other hemisphere.

the proper place in history. Thus the Roman naturalist Lucretius Carus and the German amateur scientists Goethe and Herder are considered only the precursors of the theory of evolution; Lamarck and Darwin are properly honored as its founders and the fathers of evolutionist thinking. Columbus is revered as the discoverer of America, even though seafarers of many nations

reached the coast of the continent several times before his expedition. James Watt is called the inventor of the steam engine and Einstein the creator of the theory of relativity, although both had "precursors."

Unfortunately, Wegener perished on a one-man skiing expedition into the immense vastness of Greenland. Starving amidst the frozen desert wastes, he erected a catafalque for himself out of snow, posted his skis as columns and died like a brave soldier at a forlorn outpost. His death affected the whole course of modern geology. Since then no successor of equal ingenuity and enthusiasm for the theory of the floating continents has emerged.

The Dismembered Continents

When the versatile Francis Bacon studied the first crude maps of America, he was immediately struck by the exactness with which the eastern coastline of the Americas fitted into the western coastline of Europe and Africa and expressed the idea that Europe, Africa and the Americas are fragments of a great primordial land mass. Wegener called it Pan-Gaea, the "Whole-World" of the early ages. (*Fig. 110*)

The portrait of Pan-Gaea that Wegener drew about 1910 is now outmoded and his explanation of continental drift based upon twist and polar motion is now considered oversimplified. Yet his ingeniously conceived picture illustrates the theory with unsurpassable clarity.

Not only do the outlines dovetail with one another but the mountain ranges of far-flung continents and islands match like the pieces of a broken dish. Even the sunken geological strata fit together, like the painted flowers on the fragments of the broken pieces of porcelain.

In the Northern Hemisphere a chain of mountains—the protruding scar of a trench that had once been open but now is healed—begins in Europe, runs across Scandinavia and continues westward through England and beyond the Atlantic into North America. In the Southern Hemisphere a long trench—actually not one trench but a chain of related trenches—runs through the South American continent, crosses the southern tip of Africa and continues to the coast of Australia. It is named the South-American-African-Australian Graben, shortened to "Samfrau." Originally the graben was not so long as it is now. Today the trench and its mountain chain are spread out across half of the globe. (*Fig. 111*) The homogeneity of this long chain of trenches manifests itself in many ways. Strata, ores, minerals and other deposits follow the grooves of the trenches. The most conspicuous of the many sporadic deposits is gold. On the American side there is the gold of Peru that played so sinister a role in the conquest of "El Dorado" by the Spaniards ending with the virtual extinction of the pre-Columbian peoples. Two hundred and fifty years later the gold of South Africa motivated the

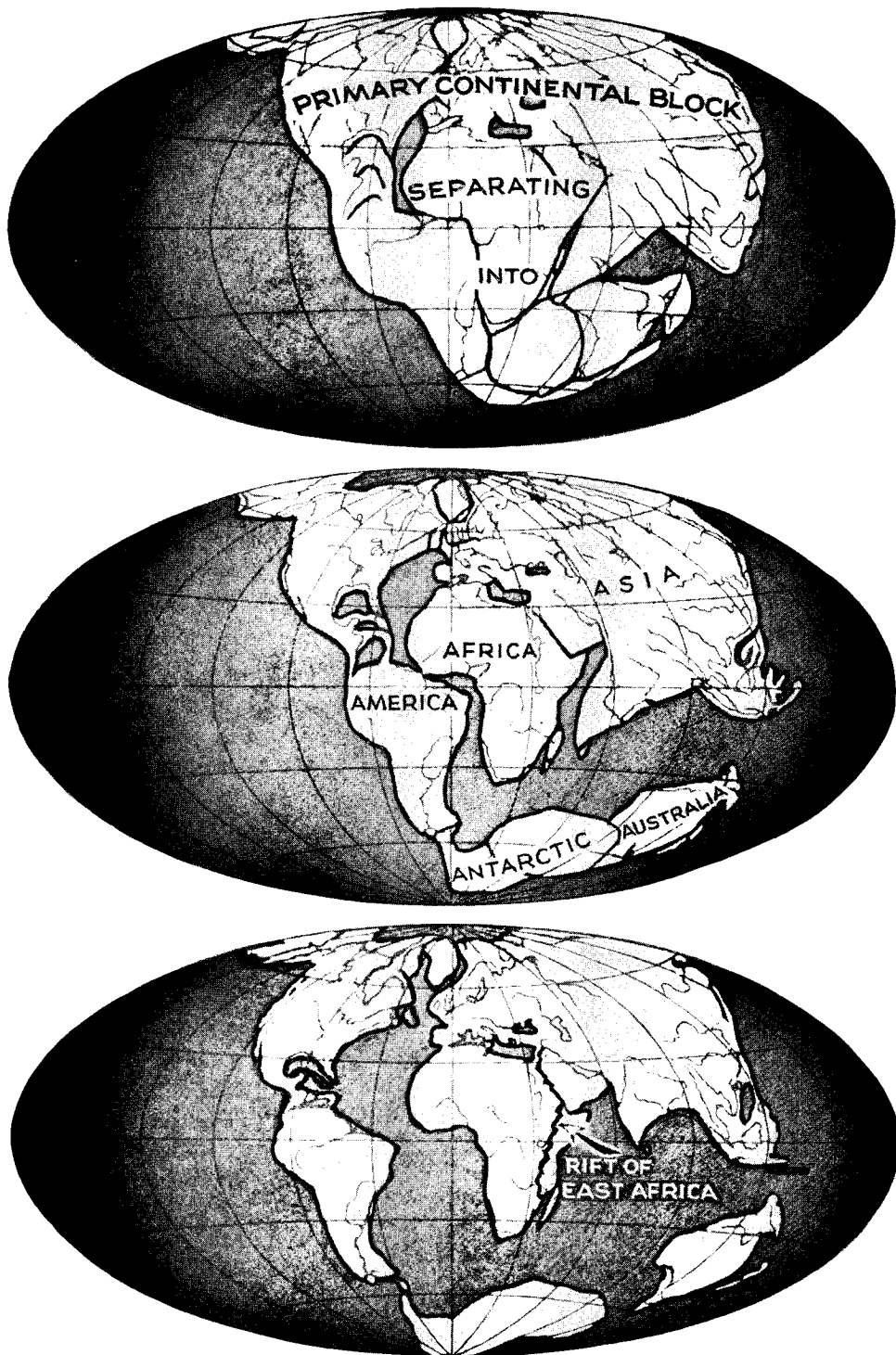

Fig. 110. THE THEORY OF THE DRIFTING CONTINENTS III
The present continents are the fragments of a once-unified continent
which broke into pieces. (Original drawing, Alfred Wegener)

British attack on the peaceful Boers. Tens of thousands of fortune seekers lured by fabulous deposits of gold migrated to the southeastern end of the Samfrau Graben where the vast deserts of the Australian hinterland became the setting for innumerable tragedies.

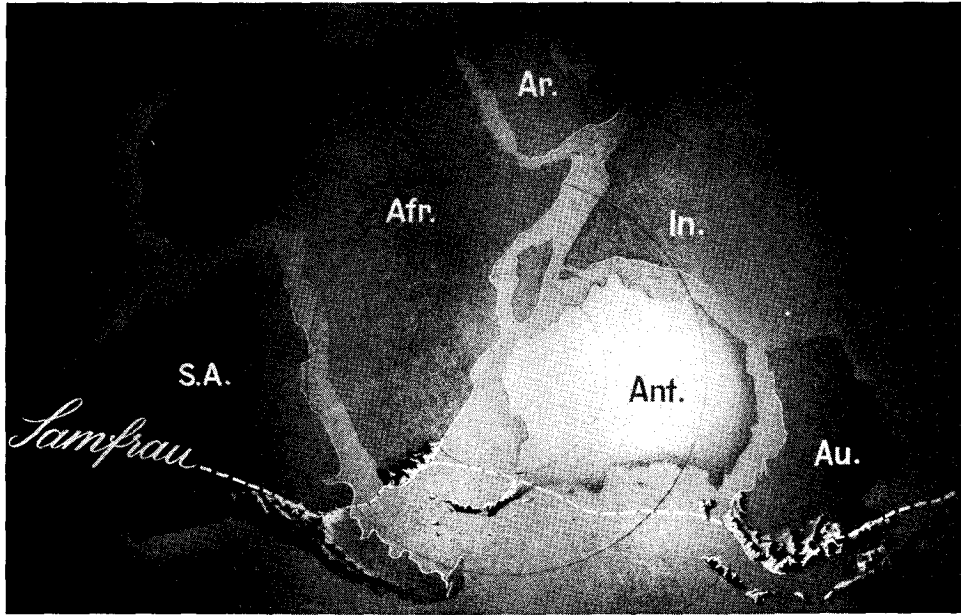

Fig. 111. THE THEORY OF THE DRIFTING CONTINENTS IV

The hypothesis about Gondwana: The continents of the Southern Hemisphere formed a great land mass centered around the South Pole. Later they disintegrated into South America, Africa, Arabia, India, Antarctica, Australia, Indonesia. A long fracture line Samfrau runs from the Andes to Australia.

The opponents of the theory point out that the contours of the continents, islands and strata do not always fit correctly. Yet the crust of the earth is not made of brittle porcelain but of semiplastic rock-dough. When continents have separated, their rims may retreat or, contrarily, may creep outward. The continent of North America lost about 100 miles in breadth as a result of the upward fold of the Appalachians, and the southern tip of Africa is being shortened at present by the rise of mountains north of the Cape. Finally, continental fragments rotate while drifting, much as lumps of ice do when they float in a river. (*Fig. 115*)

As the continents broke off, their plants and animals were separated. The forests of the carboniferous era, which are exploited today as coal beds and are revealingly scattered in a girdle extending from Pennsylvania eastward, then from France through Belgium, Silesia, Poland to the Don and the Donetz basin, probably once formed a single broad belt of green. The distribution of several species of spiders, crabs and scorpions, molluscs and earth-

worms, and also early mammals supports the theory. Seacows are an often cited example. Fresh-water mammals, they live mainly in the estuaries of great rivers and on neighboring coasts. Of the several small groups that still survive, one is found at the estuary of the Amazon River in South America and another opposite it in Africa, at the mouth of the Congo. Could this be mere coincidence? Proponents of the theory also point to monkeys found both in Africa and in South America.

There are, of course, other possible explanations for the present distribution of animals and plants, such as the classic geological doctrine that the continents remained firm but that the seas changed their levels and extensions, and that land bridges temporarily connected the now separate continents, but such theories depend on just as many assumptions, leaving so many questions open that a modern, dynamic approach seems justified, even if it, too, leaves many problems unsolved.

The Battle between Laurasia and Gondwana

The theory of continental drift shared the fate of many scientific theories. The idea was fascinating, but it was far less easy to insert the facts into the framework of the theory than the first "continental drifters" expected. The idea of a primordial Pan-Gaea, one great unit, proved untenable. Geological facts point to the assumption that the early land masses were gathered into two groups—a southern mass centered around the Antarctic continent, and a northern mass around Greenland. They were, and still are, separated by a graben. Today this graben runs from the Antilles eastward, through the bottom of the Atlantic, then continues as the basin of the Mediterranean, and runs over the Asiatic continent to the Himalayas. As a counterpart of the Southern Samfrau, this graben could be called the Anti-Medi-Him, the graben of the *Antilles*, the *Mediterranean* and the *Himalayas*.

As sketched in *Fig. 112*, the Anti-Medi-Him runs between the northern black and the southern white arrows. All lands south of the Anti-Medi-Him—South America, Africa, India, Australia, Polynesia, and Antarctica—are parts of "Gondwana," a vast land mass which once formed a unit. Gondwana is not a figment of the imagination, not a conception of Wegener's. It is a historical reality recognized long before the advent of the drift theory. Eduard Suess, a leading nineteenth-century geographer, named it after a province in India—one of those frequent misnomers in science. It should be labeled simply and unmistakably what it is—the Southlands.

The opposing lands north of the Anti-Medi-Him—North America, Greenland, Europe and North Asia (Eurasia)—are grouped together as Laurasia. "Laur" is an abbreviation of Laurentian, referring to the region of Canada near the St. Lawrence River, considered the oldest part, the geological "heart-

land," of the North American continent. Much better than Laurasia would be the simple name, the Northlands.

These two land masses, Laurasia and Gondwana, move independently, each one tending toward the equator—pulled, for the most part, by centrifugal force—where they collide and then rebound. During the past 500,000,000 years the two land masses seem to have struck five times. For the first 250,000,000 years Gondwana was the more active; since the carboniferous period,

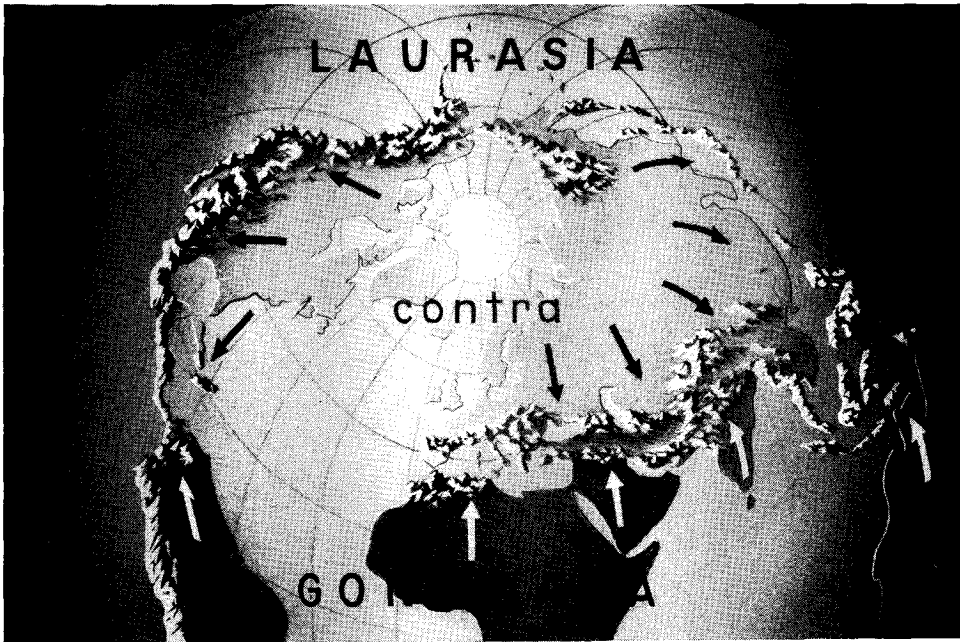

Fig. 112. THE THEORY OF THE DRIFTING CONTINENTS V

The battle between Laurasia and Gondwana: The northern masses of Laurasia fight against the southern masses of Gondwana. Present battle points are the Antilles, the Mediterranean, Turkey, Northern India, Indonesia, Japan. The front extends along the Anti-Medi-Him graben.

Laurasia has taken the initiative. The Anti-Medi-Him graben between them widens or narrows, depending upon the phase of the "battle." In periods of separation it becomes wider and is filled with water. It is then truly a "mediterranean"—the middle space between lands. Geologists refer to the Mediterranean Sea as Tethys, the Grecian goddess of the sea and mother of Achilles.

At present the two masses are said to be approaching each other. (Fig. 112) Inevitably, the crust of the earth cracks all along this restive trench, lava erupts and volcanoes flare up. Anti-Medi-Him volcanoes are Popocatepetl on the American side; Etna, Stromboli and Vesuvius in Southern Europe. Farther to the east are the volcanoes of Hauran, to which the Psalmist referred when he said: "He toucheth the hills, and they smoke."

North and South America are not, as one might think, two halves of an originally uniform continent. North America belongs to Laurasia; South America, to Gondwana. They are as different as their counterparts in the Old World—Europe and Africa. At times they approach each other, crushing Central America between them. When they disengage, the Central American land masses are dismembered and the fragments lost in the sea of magma.

Today the pivotal point of the battle between Laurasia and Gondwana is the eastern end of the Mediterranean Sea, where the three continents of the Old World—Africa, Asia and Europe—meet. Here, under the impact of Africa's thrust, the earth trembles, so to say, incessantly as far back as man has recorded history. Here Sodom vanished and, when Jupiter on the heights of the Trojanic mountain Ida shook his head, said Homer, the floor beneath the feet of men trembled. Here are the islands on which the Greek phi-

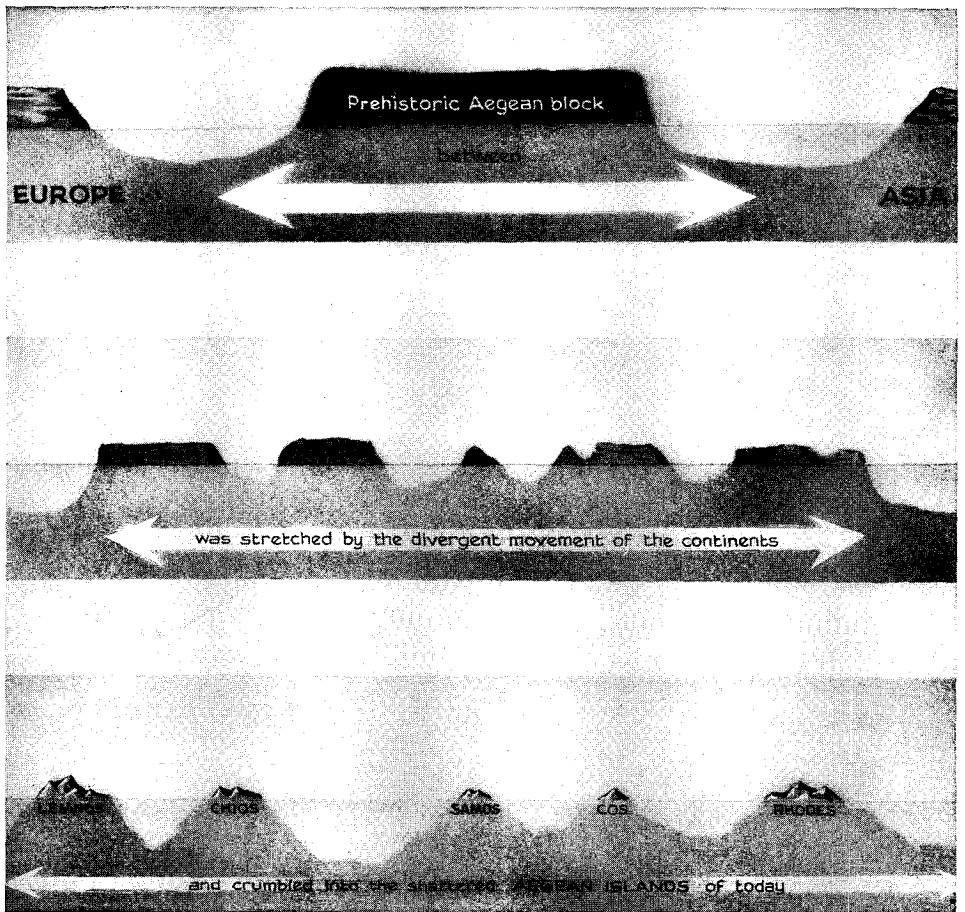

Fig. 113. THE THEORY OF THE DRIFTING CONTINENTS VI
The dismembering of the continents: The Ionic islands are the fragments of a dismembered "Aegean block."

losophers lived, scattered over the Ionian Sea and there lay Pompeii under the ashes of Vesuvius for 1,800 years. The fury of the battle is undiminished. On the eastern front, in 1883, the island of Krakatoa exploded like a dynamite cache; on the western front, Mt. Pelée, thought to be extinct, erupted and scorched the flourishing town of St. Pierre on Martinique on a sunny festival morning while the people filled the churches. All perished but one—a criminal who was chained in a cave and was protected from the all-parching heat wave. It was the opposite of Sodom: not the one righteous man but the one wicked man was saved.

In the diary of geology a millennium is not more than a second in man's life, and we, living only a fraction of a geologic second, might be considered travelers in a crash between the Gondwana Express and the Laurasian Limited while the cars are telescoping into one another. Abraham, we may say, who traveled in the first car, witnessed the destruction of Sodom; he himself was rescued. Pliny, spectator of the erupting Vesuvius, traveling in the next car, suffocated under the ashes near Pompeii. Goethe experienced the destruction of Lisbon in 1755; Axel Munthe, the earthquake of Messina in 1903. In the Antilles the two cars "Jamaica" and "Cuba" are turning over. Jamaica is being pushed up and slipping southward; Cuba is shifting northward; between them opens a vast chasm plunging to a depth of 20,000 feet.

Like the Antilles, the islands of the Ionian Sea between Europe and Asia should be doomed. The theory of the drifting continents assumes that a once solid block of land is slowly being stretched out and that the Aegean islands are the peaks of drowning mountains, still barely above water like the stacks of a sinking ship. (*Fig. 113*) Man speaks of them as peaceful and paradisaical; actually they are death-houses and the day of execution is not far off—on the calendar of geology.

Current Continental Movements

Both the Laurasia and Gondwana land masses are now breaking up. Gondwana was the first to crack and its fragments—Africa and India, Australia, Polynesia and Antarctica—have drifted far. But their "diaspora" is not yet at an end. India, moving eastward, is wedging itself into the Asiatic mainland. As it advances it plows up the land mass before it, piling up high mountains. (*Fig. 114*) India may be much larger than the maps show. Its northeastern part has thrust its way under Afghanistan and Tibet, lifting them up so that Tibet rose to become the highest country of Laurasia and the highlands of India are the scene of violent earthquakes. Africa is disintegrating along its edges. Several coastal areas have already been detached and others are at the point of breaking off. Spain, geologically a piece of Africa and hence a Gondwanian province, has attached itself to Europe and

has become a part of Laurasia. The seam where it is joined is typically wrinkled and elevated, forming the Pyrenees. Thus the Pyrenees, not the Strait of Gibraltar, represent the geological boundary between Africa and Europe. On the east side, the peninsula of Arabia has also become part of Laurasia. A third fragment is the island of Madagascar, which floated away from the mainland during the early Tertiary period. Parallel to the disintegrating east coast runs the East African Rift. (*Fig. 104*)

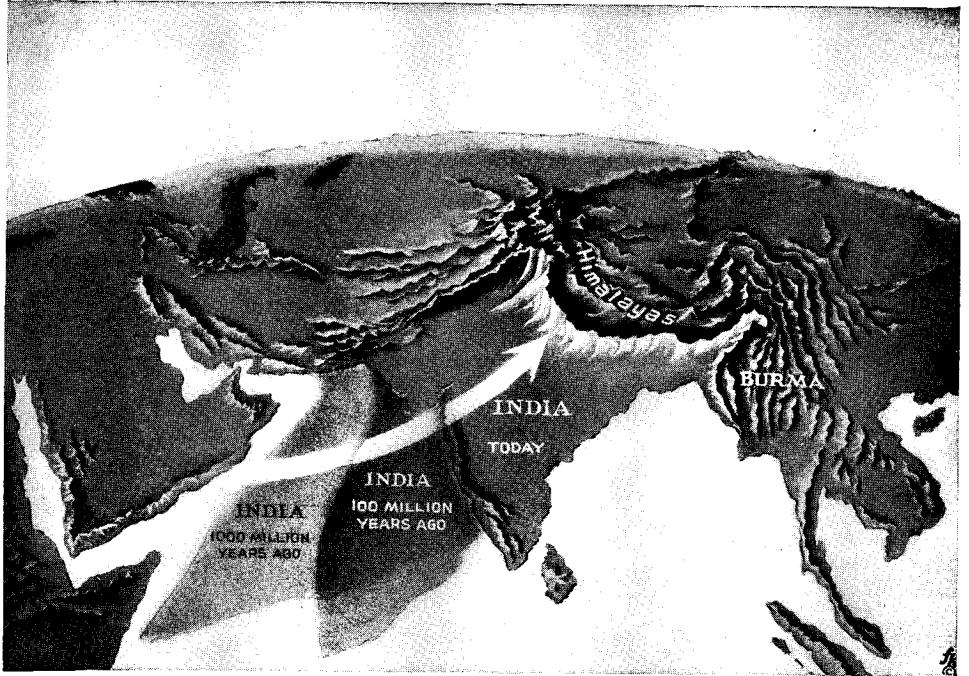

Fig. 114. THE THEORY OF THE DRIFTING CONTINENTS VII

India drifts northward and pushes its mass under the Asian continent. Its pressure heaps up the Himalayan mountains.

As a fortune-teller reads a man's future in the lines of his palm, so the fate of Africa is told in its rifts. Like Madagascar, Somaliland will float eastward as an island and Nyassa will follow it. After that, the province of the Cape of Good Hope, where the rise of mountains foretells the critical stress, will break off. The Desert of Kalahari will float after it, no longer a desert but an oceanic island, flourishing like Zanzibar.

While the bow of a traveling continent is piled up into mountains, some magma clings to the "stern," tearing away pieces of land. Hence, islands are drifting in the wake of the floating continents and on most of them volcanoes are active. More than 75 per cent of the presently active volcanoes stand on these backwash islands in the sea of magma. Asia offers the most spectacular example.

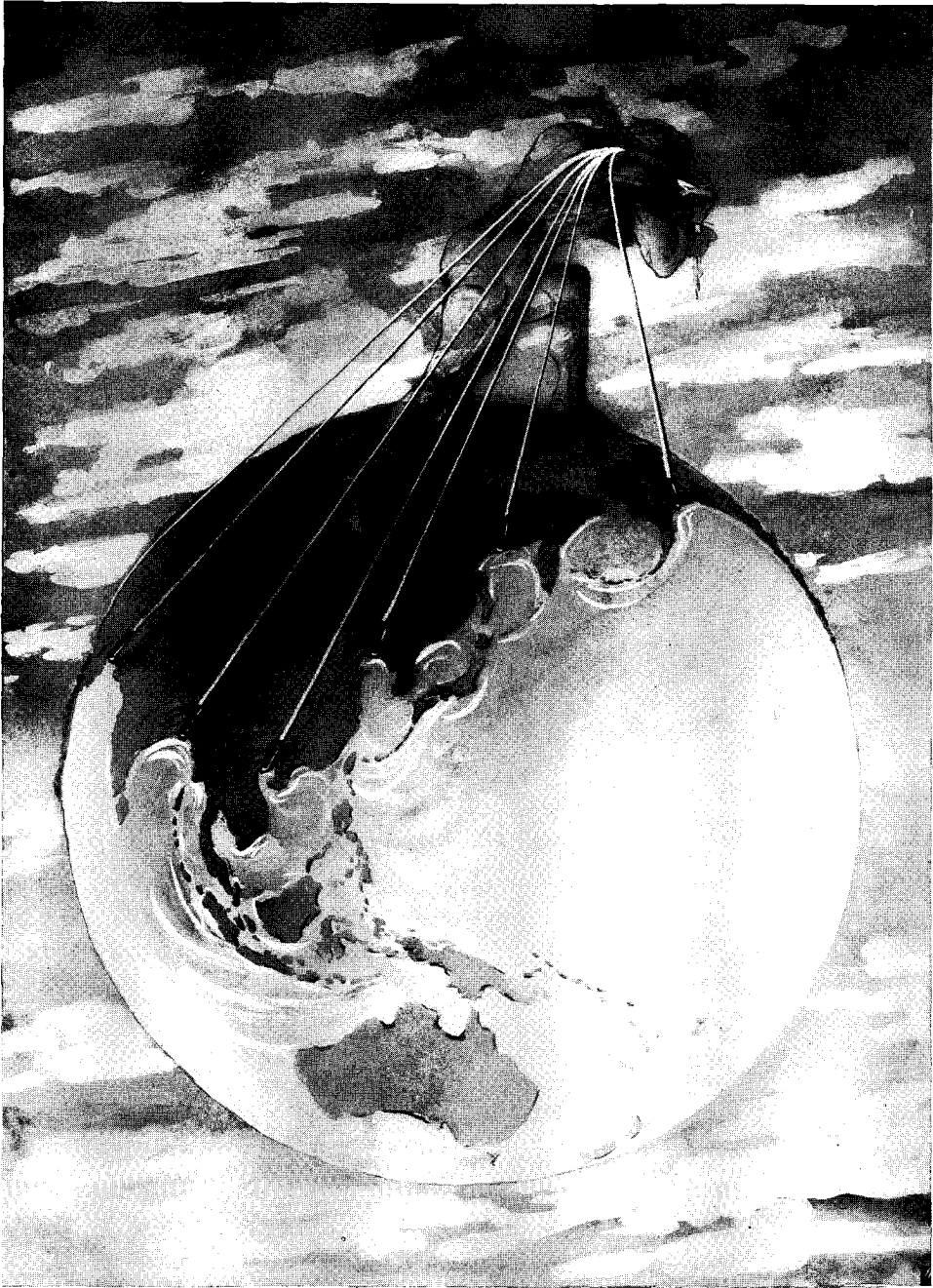

Fig. 115. THE THEORY OF THE DRIFTING CONTINENTS VIII
The backwash islands: The continent of Asia swings around to north and west. At its stern it loses continental fragments which drift in its backwash as islands.

Asia is turning to the northwest, its backwash being along the southern and eastern shores. The chains of islands that girdle the continent from the Aleutians in the north, over the Kuriles, Japan, the Philippines, to the scattered world of the Southern Pacific, all of them volcanic and all fragile, are the foam on the waves in the wake of the traveling ship. (*Fig. 115*)

All modern science has become dynamic. The time-honored concept of a monumental, enduring universe has exploded into the fireworks of drifting galaxies; the "forever unbreakable" atom has been split into the lightning of mesons and neutrinos; matter, the "eternal matter," has radiated away in waves. The theory of the floating continents is a timely attempt to attack geological problems with a dynamic, one could almost say a biological, approach. This is a merit the work of Wegener will never lose. The theory may be discarded; its animating influence can never be lost.

The Air

The Lower Atmosphere, Troposphere and Stratosphere

M

AN IS LIVING at the bottom of a sea several hundred miles high, a sea not of water but of air, called the atmosphere.

We say that the atmosphere is "light," and we are right when we contrast the gaseous atmosphere with the watery hydrosphere and the stony lithosphere. Actually, the atmosphere is made up of an immense number of atoms combined into molecules—quadrillions of them in every cubic centimeter—and it is far from light. The atmosphere is so heavy that, in a vacuum tube, it pushes water up to a height of 10 meters and mercury to more than 750 millimeters (about a yard). The air we carry on our shoulders weighs as much as several iron safes. (Fig. 116) We are not crushed by it only because we breathe it in, so that the blood and all the tissues exert the same atmospheric pressure against the outer world as the atmosphere does against the body. In the same way, a deep-sea fish does not feel the tremendous pressure of the mile-high mass of water above it. But if a man jumped out of a stratospheric plane into the thin-aired space, the pressure within his body would cause him to burst like an overblown toy balloon.

Material lighter than air is buoyant. Water vapor ascends into the higher levels where, after cooling off, it condenses into clouds, and drifts on top of the heavier air layers as wood drifts on the surface of a pond.

Eighty per cent of the atmosphere's molecules are packed in this lowest layer which has a supporting capacity up to about 10 kilometers. Above this limit, air is so rarefied that clouds cannot stay afloat. Therefore, normal water-carrying clouds do not rise above this layer. This bottom-most layer, characterized by the density of its molecules, its water

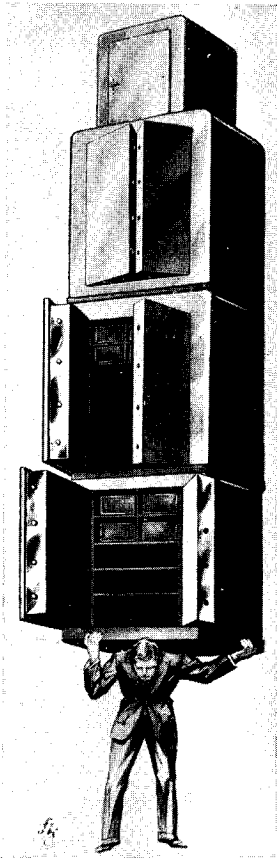

Fig. 116.
THE ATMOSPHERIC PRESSURE

We do not feel this weight because it is compensated by the internal counter-pressure of the fluids and gases of our body.

content, the mainly vertical movements of its air and its phenomena of "weather," which is a combination of humidity, clouds, rain, snow, winds and changes in temperature, is called the troposphere. Pilots, more practical than scientists, call the troposphere "trouble-sphere." An objective name for it would be "weathersphere."

Above the weathersphere is a sphere five times as high, called the stratosphere. It is characterized by the thinness of its air; in the stratosphere man must provide himself artificially with oxygen. The men who climbed to the peak of Mt. Everest had to be equipped with oxygen apparatus. In the stratosphere the movements of air are no longer vertical but only horizontal; this sphere is, therefore, well suited for air travel. Our present airplanes reach only the lowest borderline of the high-reaching stratosphere; the upper levels do not have enough air to support the wings of planes and are accessible only to "missiles." So far man has not risen higher than 25 kilometers, or one-fifth of the way he has to climb through the stratosphere to reach its upper border.

When man will travel in rockets through the higher levels of the stratosphere, he will see the sky above him as it really is: no clouds, no poetic blue—just black cosmic space, the stars needle-sharp points of unsparkling light, the sun a defined disc with no glare. The earth below him will appear as a sphere. No sign of life will be recognizable to him. Cities will have shrunk to points, like fly specks on an electric bulb. Only memory and imagination will tell him that these tiny specks are populated by a million people hustling and bustling about. He will see the world he lives in more clearly not only physically but also philosophically. This widening of his vision will be the greatest gain from the conquest of the stratospheric heights.

The Upper Atmosphere

Early in the century we were taught that "naturally" the atmosphere keeps getting thinner and colder as we ascend, until the cold void of cosmic space is reached. But, as is customary in science, reality deviates from the seemingly logical scheme. If we could ascend into the air freely, we would find that as we rose the temperature fell, until, after 30 kilometers up, the thermometer stood at -50° . But at twice this height, it would suddenly become so hot that we could fry an omelet simply by holding the pan outside the balloon.

This surprising rise in temperature is caused by the ozone in this layer. Ozone is a product of the ultraviolet radiation of the sun. The oxygen molecules of the air, which are normally composed of two atoms, O_2 , are here combined into three, O_3 , ozone, and this transformation produces heat.

The ozone layer is about 25 kilometers deep. Beyond it the temperature again sinks down to about the freezing point, but thereafter it rises once more.

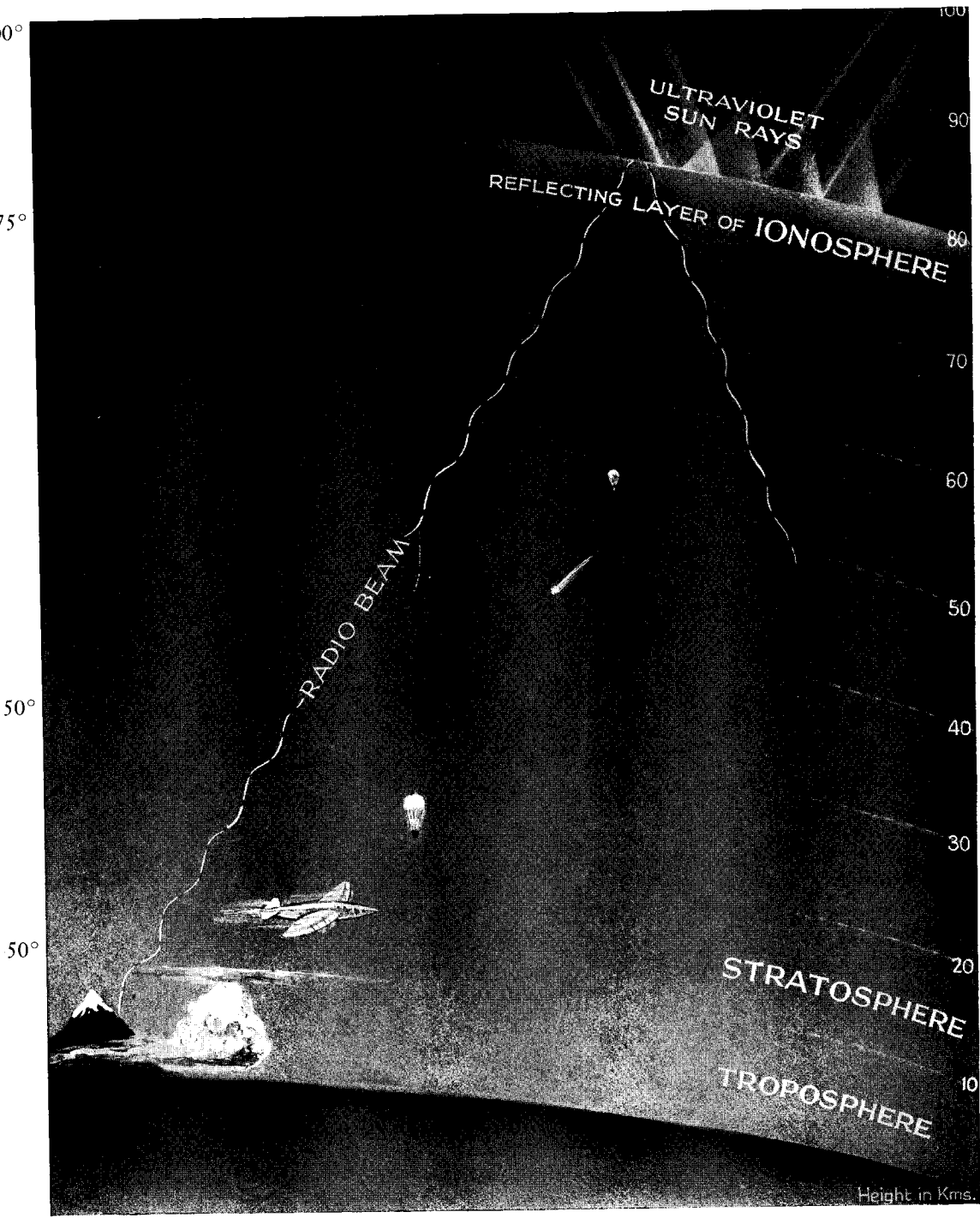

Fig. 117. OUR PRESENT KNOWLEDGE OF THE ATMOSPHERE

and at 100 kilometers the temperature is about the same as we experience here on earth. With farther ascent the temperature rises steadily and reaches degrees that contradict all expectations of previous times. It is assumed that at 300 kilometers the temperature is above $1,000^{\circ}$ and that at higher levels the temperature is more than $2,000^{\circ}$ or even $3,000^{\circ}$. Such temperatures will present some problems to moon-minded space travelers!

These high temperatures, contradicting all that was taught at the beginning of the century, were calculated by an English physicist, Oliver Heaviside, an "outsider" who was ridiculed by his contemporaries. Twelve years after his predictions were made known and scorned as fantasies, the existence of this layer was proved. But by then Heaviside had died and so shared the tragic fate of the other explorer of the atmospheric heights—Gockel, the discoverer of the cosmic radiation.

Heaviside based his calculations on the correct assumption that the short waves of sunlight push specific electrons out of specific atoms of the air, ionizing them. In contrast to about 500 ionized atoms at sea level, the air in this sphere is populated by 10^{10} ions per cubic centimeter and is, therefore, called the ionosphere. Ionization produces heat and this heat production accounts for the high temperature at this level. Since the energy of the short waves is consumed in this process of ionization, sunlight arrives at the ground without any short-wave lengths. The short waves above the ionosphere will make cosmic flights many times more dangerous than anyone imagines today.

Since the ionosphere is the first layer of gas the sun waves meet on their journey to the earth, the state of the ionosphere "mirrors" the radiation of the sun. Observation of the ionosphere has become one of the most useful methods of discerning the fine fluctuations in the radiation of the sun. The ionosphere is, so to say, a Palomar mirror floating high above us, and specialized for sun research.

The liberated electrons electrify the ionosphere and this electrified high-altitude layer reflects specific wave-lengths of the radio scale, thus acting as a mirror which sends the radio waves back to earth. Without the reflecting ionosphere the waves would radiate into cosmic space and be lost. Reflected, they return and undulate in angles between ionosphere and earth and at specific points they can be received. With the changing radiation of the sun, the ionospheric mirror changes its altitude, its width and the smoothness of its surface. If sunspots erupt on the sun, their strong radiation tears wide holes in the ionosphere, hundreds of miles in diameter.

A distorted mirror cannot reflect undistorted images. Radio listeners are at the mercy of sunspots. Only when the sun's surface is spotless and even, can the air-wave fan bask in the pleasures of long-range reception.

When radio waves are sent out into cosmic space, faint echoes return from spheres that are far above the earth's atmosphere. Some come back from "mirrors" that must be even farther than the orbit of the moon. Nothing is known about these mysterious spheres and speculation about them is pre-

mature—"there are more things in heaven and earth than are dreamt of in our philosophy."

Where the ionosphere ends—where does it end?—the fourth and highest story of the atmospheric house begins, we may say the penthouse of the atmosphere. It is named the exosphere—the extreme, or outermost, layer—or the sphere of dissipation, because here the gravitational effect of the globe becomes so weak that the molecules of the gases dissipate and escape into empty space. These last frontiers of the atmosphere are entirely hypothetical; in our time nothing is known about the outer spheres and all numerical notations are vague and arbitrary. Since the earth did not gain any substantial mass during the last 500,000,000 years despite a steady hail of meteors and meteorites from outer space, we can assume that a corresponding number of atoms and molecules escape. The atmospheres of the planets seem to "feed" cosmic space.

When we summarize all known facts about the atmosphere and add these speculations, we conclude that no small surprise will be in store when man's missiles and instruments reach the borderline of his cosmic home.

The Circulatory System of the Atmosphere

We light a candle and blow cigarette smoke toward it. (*Fig. 118, 1*) Borne on the stream of warm air, the smoke rises. This is a simple illustration of the basic principle of weather and climate. Warmed air becomes lighter and rises because its molecules spread out and there are fewer to each unit of space (1). As the air rises and gets farther away from the source of heat, the movement of the molecules decreases (2). The molecules draw closer together, the air becomes heavier and moves downward again. Warm air rises; cold air falls.

The departure of the warm air leaves an "empty" space around the base of the candle. This semi-vacuum sucks in the surrounding air, creating a draft, or "wind" (3). These three movements—ascend of hot air, descent of cold air and refilling of the partial vacuum by a rush of wind—cause the air to move in circles. If the rising air is humid, it will, while cooling off, lose its water content because cold air cannot carry as many water molecules as warm air. The molecules of water huddle together like sheep in a cold wind and condense into drops which fall as dew or rain.

Now we place a grapefruit or a soccer ball next to the candle to represent the earth. The candle is the sun, and the line on the grapefruit closest to the candle flame is the equator. Tracing the course of the cigarette smoke around the grapefruit, we have a model of the earth's circulatory system. (*Fig. 119*)

Above the equator is a zone of rising air. When this air has gone high enough to cool off, it heads downward again. But it cannot plummet straight

down because the warm air coming up is in its way. Pushed aside, it has to settle in the latitudes north and south of the equator. Flooded by a steady "air-fall" of cold, dry air descending from the heights, these latitudes are zones of relative coolness and aridity, in contrast to the warm, damp girdle

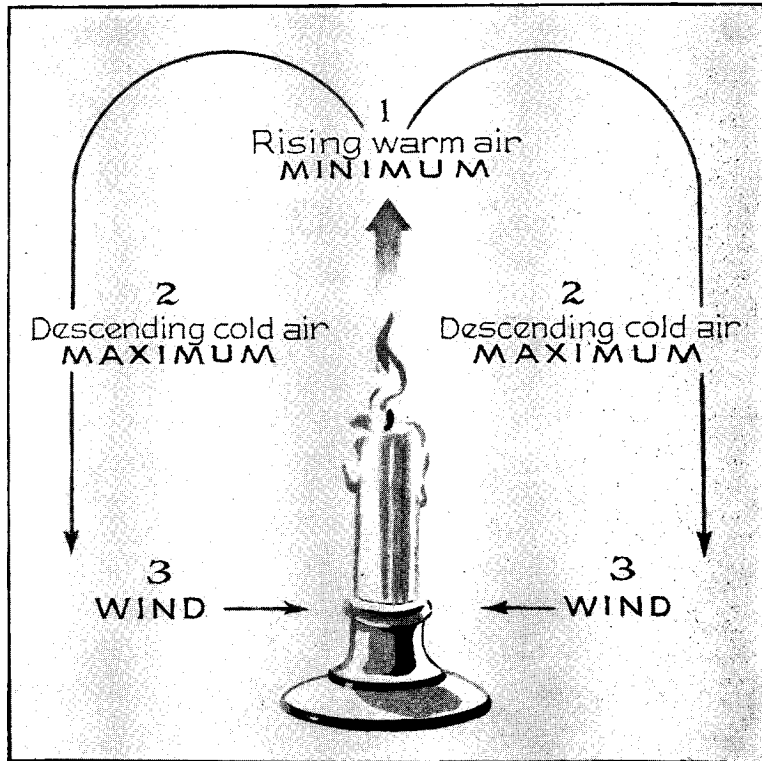

Fig. 118. CIRCULATION SYSTEM OF THE AIR

Circulation systems of air on the sun-warmed surface of the earth follow the pattern of the air around a burning candle.

along the equator. The rain forests of the Amazon, the "fever swamps" of Africa and the jungles of southern Asia are typical of equatorial landscapes. The prairies of North America, the pampas of South America and the steppes of Russia are landscapes characteristic of the higher or "horse" latitudes, a medieval term whose meaning is no longer recognizable. From the horse latitudes, dry air blows back into the vacuum over the equatorial zone in the form of steady prevailing winds, called trade winds, or passats, because sailing ships relied on them to cross the sea. Warm air rising at the equator and causing daily rain; cool air descending in the horse latitudes, and trade winds carrying the air back to the equator—that is the course of the air around the globe.

Because of the earth's rotation from west to east, the trade winds do not

blow straight to the equator along the longitudinal lines of the meridians. Instead, they move toward the equator at an oblique angle. They blow from the northeast in the Northern Hemisphere and from the southeast in the Southern Hemisphere. Columbus, who sailed with the trade winds, was

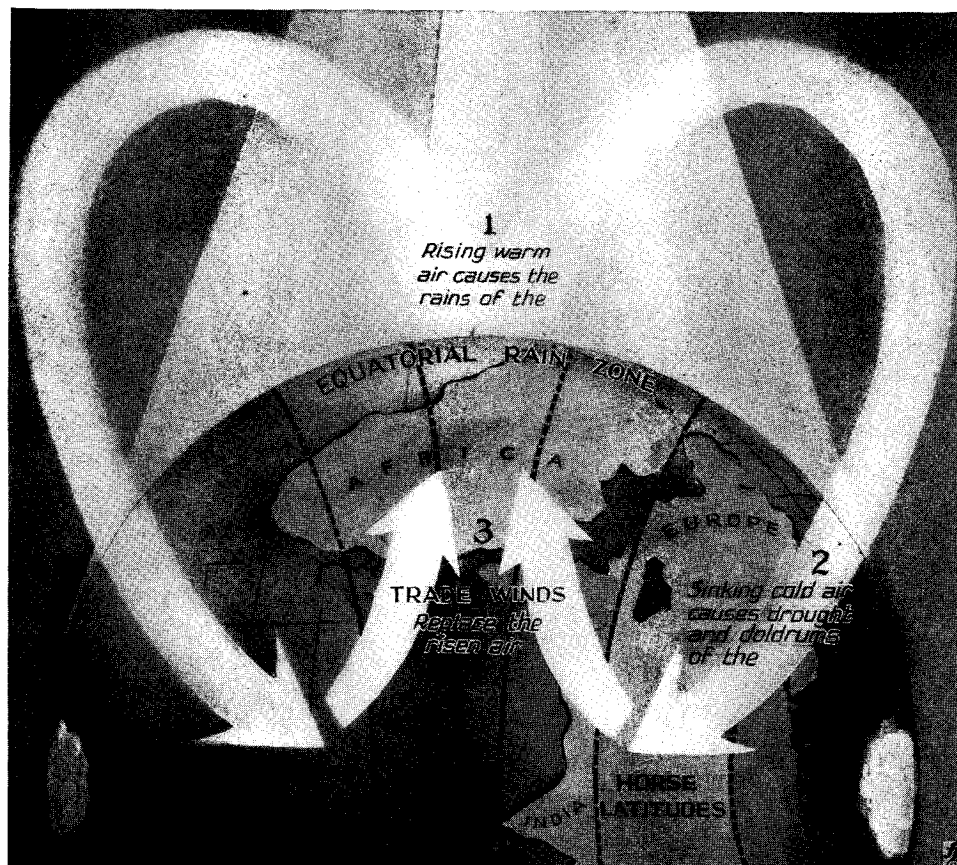

Fig. 119. CIRCULATION OF AIR AROUND THE GLOBE

carried not directly westward but southwest into the Antilles. If he had landed in the area of Chesapeake Bay, the story of the New World might have taken another course. So the winds determine the course of a ship, and the lane of a sailing caravel becomes the path of history.

When during World War II bombers returned from high-altitude flights, their crews reported that they had encountered head winds so strong that the planes stood still. Then, turning downwind, they were driven with incredible velocities. Thus the jet streams of the high altitudes were discovered. The jet stream is a strong wind that, in contrast to the winds of lower altitudes, blows constantly from west to east around the globe at an altitude of 10 to 15 kilometers. The jet streams are weak near the poles and near the equator and are strongest above a latitude of 30° —which in

America means over the Antilles and in Europe over the Mediterranean Basin.

The jet stream girdles the globe with a rolling band of quick-flowing air. It is a welcome trade wind for air traffic. Pilots who exploit the air streams for their west-east flight across the American continent fly from coast to coast

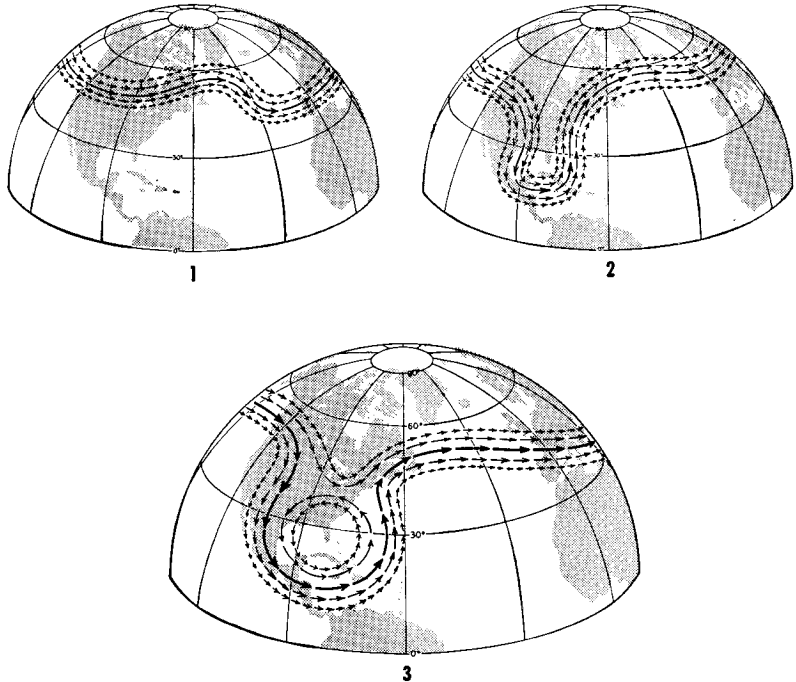

Fig. 120. THE JET STREAM

Based on diagrams by Irving Geis.
From Scientific American, 1954.

The jet stream is a high altitude wind of the lower stratosphere. It circles around the globe from west to east, with its highest speed over the area of 30 degrees latitude. The stream undulates and periodically, at the height of oscillation, masses of cold polar air break away and float southward as cold spells. Thus the jet stream acts as one of the basic elements of our weather.

in a few hours. There is little doubt that the air traffic of the future will use the jet stream just as sailors once crossed the Atlantic with the trade winds.

If the earth revolved around the sun perpendicular to the ecliptic and not at an angle of 23° , and if the globe were uniformly covered with water or land so that the climate did not vary, the jet stream would be uniform, too. But the changes in seasons, the interference of warmer and cooler air from continents and oceans, and other still unknown reasons cause changes in the air stream. Sometimes the girdle of the jet stream contracts and wanders to the north, where it bottles up the cold air over the pole. The warm air of the equatorial latitudes expands to the north and the countries are flooded with warm air. At other times the jet stream wanders southward; then the arctic air can spread out, and the countries affected become cold. Occa-

sionally the jet-stream fluctuates violently, whole pools of polar air are torn away and drift over the countries as "cold fronts." The jet stream acts like an atmospheric eggbeater which whirls the arctic air and sprays splashes of cold air toward the south. It sheds the mixed blessings of weather changes over the countries between the 30° and 60° latitudes where the majority of mankind live. (*Fig. 120*)

The Water

Clouds

AIR RISING from the ground lifts with it a considerable amount of water vapor from the surfaces of oceans and lakes, from soil, plants and machines. In the cooler heights the molecules condense and form crystals or drops. When large numbers of molecules take part in the process, the condensed masses are seen from the ground as clouds. (*Fig. 121*) Clouds at high levels float in thin, dry, cold air and are composed of crystals aggregated into flakes. Widely dispersed in regular patterns, they form an airy latticework through which the blue sky is seen by day and the stars at night.

Despite their delicacy the flakes are heavier than air; they drift slowly downward and melt into drops as they glide through the layers of the lower and warmer atmosphere. The lofty lattice of crystals thickens into cloudlets that look like tufts of cotton.

Drops of water do not remain suspended for long unless a soaring wind lifts them up. They tend to fall from sheer weight. Since every cloud is composed of falling drops, all clouds spell rain. But the way from cloud to earth is long and during their journey the drops gradually evaporate. Only when the air through which they pass is sufficiently humid do the drops retain their water and reach the ground as "rain." Therefore, every weather forecaster has to measure the humidity with a hygrometer, and only when the water content of the air nears the point of saturation does he predict the arrival of the drops on the ground as rain.

In England and western France the air is kept moist by winds from the Atlantic, and showers fall often. The sun may shine brightly at breakfast. The tourist in the British Isles is jubilant over the "grand day" and prepares for a picnic in the country. The Englishman, however, ignores the seducing beauty of the morning. Without a look at the sky he hangs his umbrella, his constant companion, on his arm and leaves for town. By lunchtime rain is pouring down.

The weather in arid regions is the reverse. When, after six months of drought, clouds gather on the horizon, the stranger from a humid country goes out armed with raincoat and umbrella. The native smiles at the naïveté. He knows that rain will not arrive for ten days or so. The stage is set for rain. The clouds are thunder-dark, and rain does fall from them. But the air between cloud and ground is so dry that the drops evaporate as soon as they



Fig. 121. CLOUDS

Masses of water vapor which rise with the warm air into the cold heights of the atmosphere condense into visible clouds. Different circumstances produce different forms of clouds at various levels.

leave the cloud. It may take weeks before the atmosphere is sufficiently moist to let the raindrops pass the route from cloud to ground. Even if the rain pours forth in sheets easily seen, even if the drops drum against the roofs, people on the street walk dry below the canopy of drops until the slowly lowering curtain of rain reaches the lowest level of air. It is a strange experience to have one's shoulders drenched while one's shoes stay dry. Any single drops that reach the ground are instantly swallowed by the baked soil, leaving not a trace.

Out of the whirlwind God asked Job: "Knowest thou the ordinances of heaven? Canst thou set the dominion thereof in the earth? Canst thou lift up thy voice to the clouds, that abundance of waters may cover thee?" For almost 3,000 years the answer was "No." It seemed to be an axiom that man must accept rain and sunshine as the heavens decreed. But in the twentieth century man revolted. He began to lift up to the clouds not only his voice but himself, to scatter dry ice and other condensing agents, such as silver iodide, on "sterile" clouds, that an abundance of water might cover his lands. The task is not simply to make clouds yield rain by causing their fine, suspended droplets to condense into bigger ones; the more difficult part of rain production is to bring the falling drops to the ground.

Our present methods are only a beginning. The man of the future will direct damp oceanic winds over deserts and blow the steam from volcanoes over arid mountains. Transmitters beamed at chosen regions may unbalance the molecules of air, spilling rain on command. Some day the dwellers on the earth will cease to be the sky-gazing victims of climatic caprice.

Cyclones

As a ship moves across the water, it pushes the sea aside at the bow and leaves a kind of vacuum at the stern. The displaced water, tending to fill this vacuum, returns in a circular motion, like the air in the circulating system in *Fig. 118*. As the boat courses ahead, the wake takes the shape of a spiral. In a similar fashion, when air is heated by a sun-baked plain, it is pushed upwards. Here it does not stand still but the succeeding air masses push it sideways. Cooled and therefore condensed and heavier, the air bends to return to the ground but in most cases it is driven away and meanders in spirals. This spiral circulation system is called a cyclone. (*Fig. 122*)

On hot and humid days, we can watch cyclones taking shape before our eyes. The heated air which rises from the ground is not visible. An invisible "chimney" leads the rising air vertically upward. But in the cooler heights the air condenses into clouds which flutter over the chimney. The "smoke banners" above the atmospheric furnaces warn of a thunderstorm and are called, appropriately, thunderheads. The cold air sliding down the sides forms

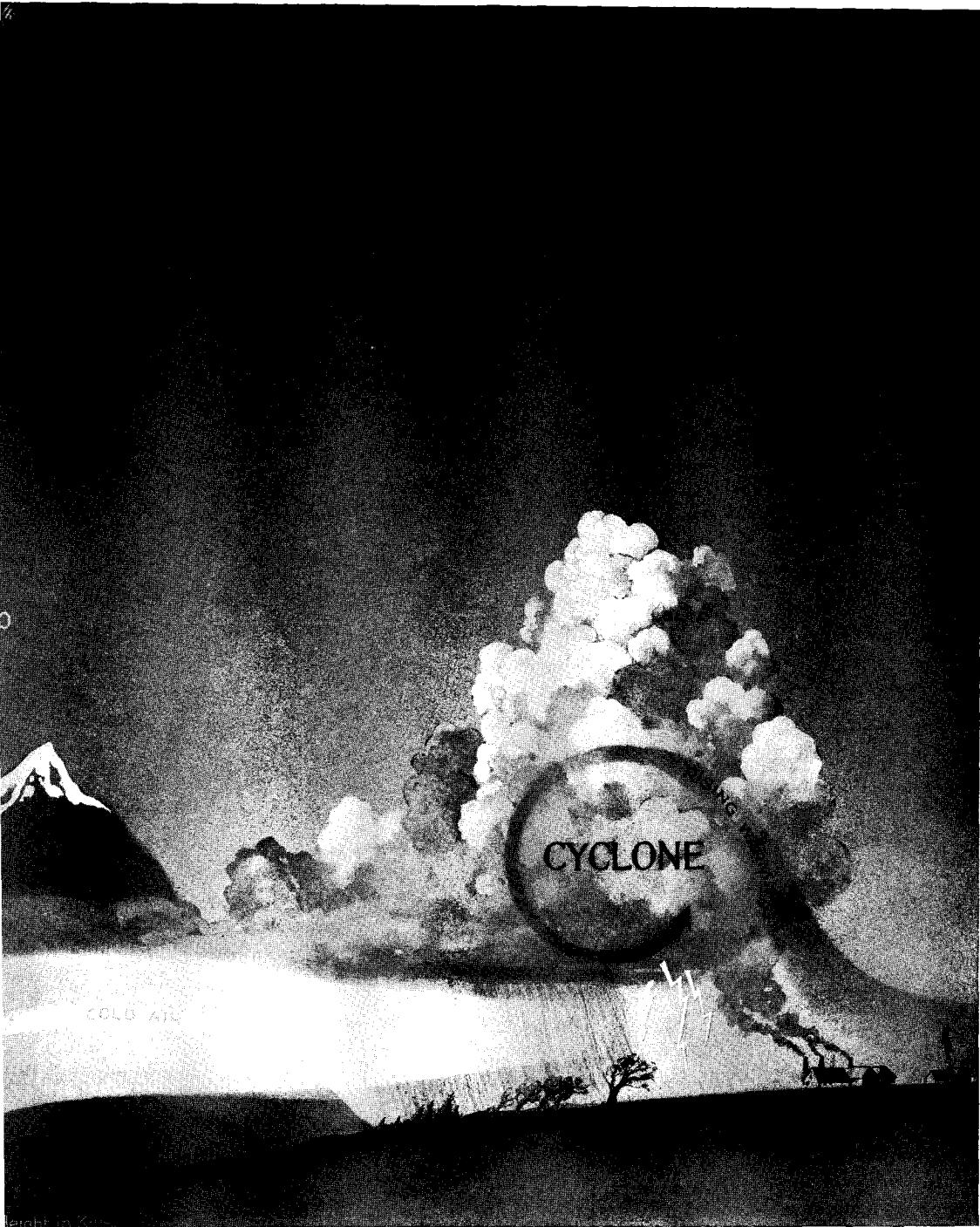

Fig. 122. THE BAD WEATHER CYCLONE

The simplest and most easily observed type of weather event is the thunderstorm. On warm, humid days the water-laden air rises rapidly and high and forms a towering local cloud, the thunderhead. The finer processes which cause the thunderstorm are illustrated in *Fig. 123.*

a canopy of clouds—an anvil upon which lightning is forged. The swiftly ascending warm air and the resting air masses rub against each other like the discs of an electrical friction machine which turn in opposite directions. The molecules of the moving air masses are combed and electrons torn away from the atoms. Since damp air is a good conductor, the electrons use the ascending vapor as a conveyor to the clouds, and the clouds build up a charge whose tension is finally released as streaks of lightning.

The cyclone is a region of turbulent movement, a “storm center.” The hotter the day, the faster the air rises, reaching speeds up to 300 km/hr. Rapid cyclones are called whirlwinds, hurricanes, tornadoes or typhoons. Their suction may be so strong that if they wander near the ground, trees are felled, houses collapse and entire sections of towns may disappear from the map. Five German flyers, for scientific purposes, penetrated a storm center in gliders. They were sucked upward so violently that not only did their craft shatter and ascend like kites but the men themselves, instead of falling, shot upward, too, and were pulled to freezing heights. Only one of them escaped alive, with frozen face and hail-smashed fingers, to tell the story of their “ascent to hell.”

Lightning and thunder shake up the clouds. Molecules that have been suspended separately condense and large drops pelt down. The cyclone, discharging itself in lightning and thunder, shooting hail like bullets, moves through the blue of the sky like a frigate of an armada sweeping down across the sea. Low-hanging clouds trail in a long line behind it. In striking contrast to the tempestuous cyclone the clouds in the track of the cyclone spray the thirsty land with fine rain.

Most of the moisture for cyclones rises from the tropical ocean currents which continually evaporate great quantities of water. Since ocean currents, especially warm ones, are the production lines of rain, cyclones trail along on them as if they were highways. When the rain route reaches a coast, a cyclone maintains its course unless opposed by climatic obstacles; where a mountain stands in its way, the cyclone is pushed upward to cooler heights, becomes unable to retain its vapor and sheds copious rain over the coastal slopes.

The most profitable supply line for rain is the path of the summer monsoon across the Indian Ocean. In summer the South Asian mainland becomes very hot. In May, Delhi has an average daytime temperature of 104° , and it does not cool off at night. Naturally the air rises rapidly. Sea air from the Indian Ocean flows into the vacuum thus created. This warm, damp stream of air is the famous summer monsoon. After sweeping over the mainland, the moist air must climb the slopes of the Himalayas. Cooled off, it loses its vapor in quantities unsurpassed on any other spot on the globe. The rainy season there, although not long, produces 1,600 to 3,200 millimeters (400 to 800 inches) of rainfall, almost forty times as much as falls on New York during all four seasons of the year.

The main rain-route in the Western world lies along the Gulf Stream.

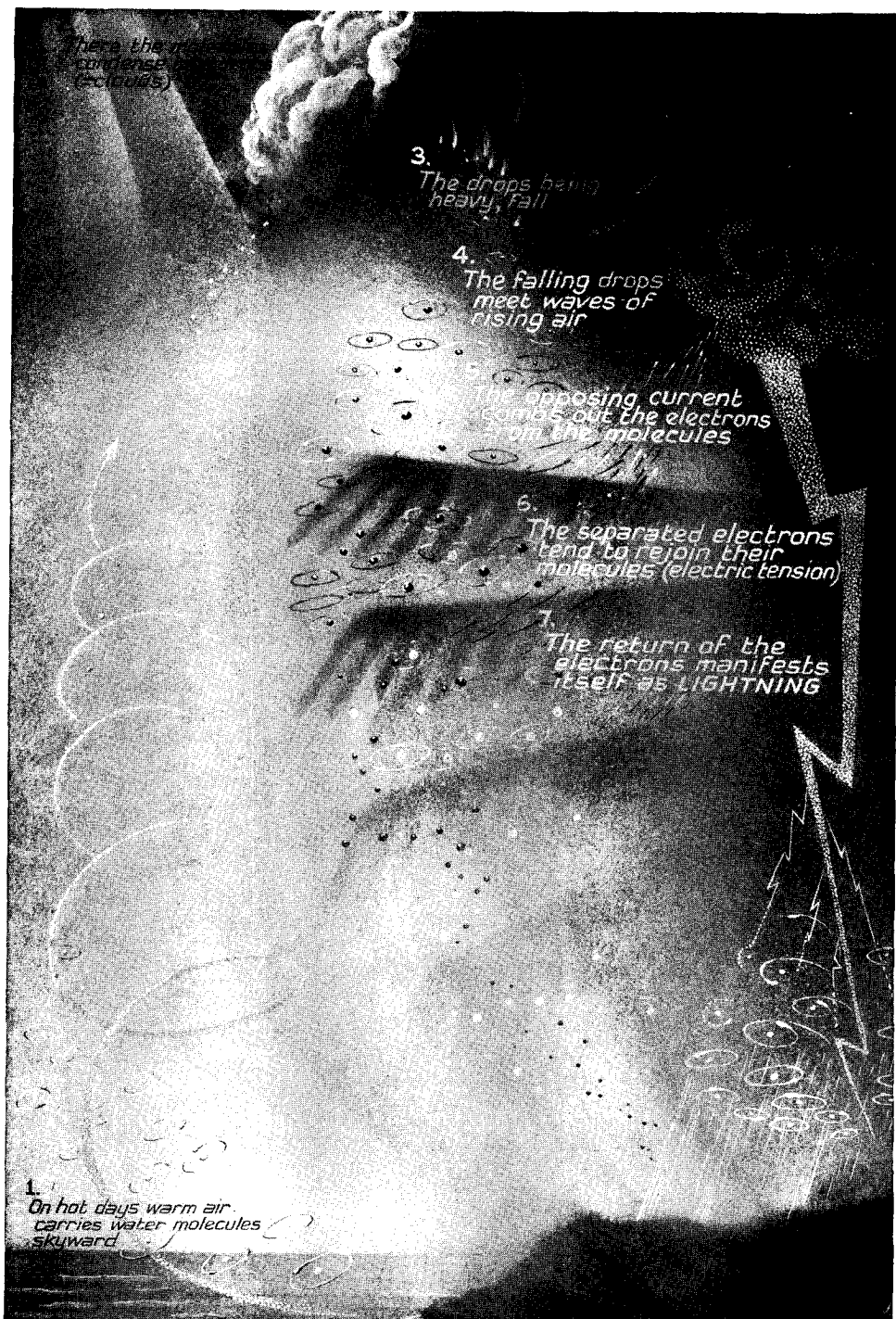

Fig. 123. THUNDERSTORM

(Fig. 124) The warm, damp air of the Gulf moves with this current from the southern Atlantic northward near the eastern coast of the continent up to Newfoundland. There it collides with the cold air brought from the north by the Labrador Current. The warm vapor is condensed into droplets, and most of the year a thick mist hovers over the coast of Newfoundland. Like many ships before it, the first airplane to cross the Atlantic from Europe, in April of 1928, lost its way in this notorious fog bank and the whole world, waiting tensely, feared it was gone. Then came the historic news: the successful pioneer fliers had made an emergency landing in the dense fog. From the lonely lighthouse where they had found refuge they were transferred to New York for a triumphal reception.

The mixing of warm air from the Gulf Stream with cold air from the Labrador Stream builds up one cyclone after another. They travel with the

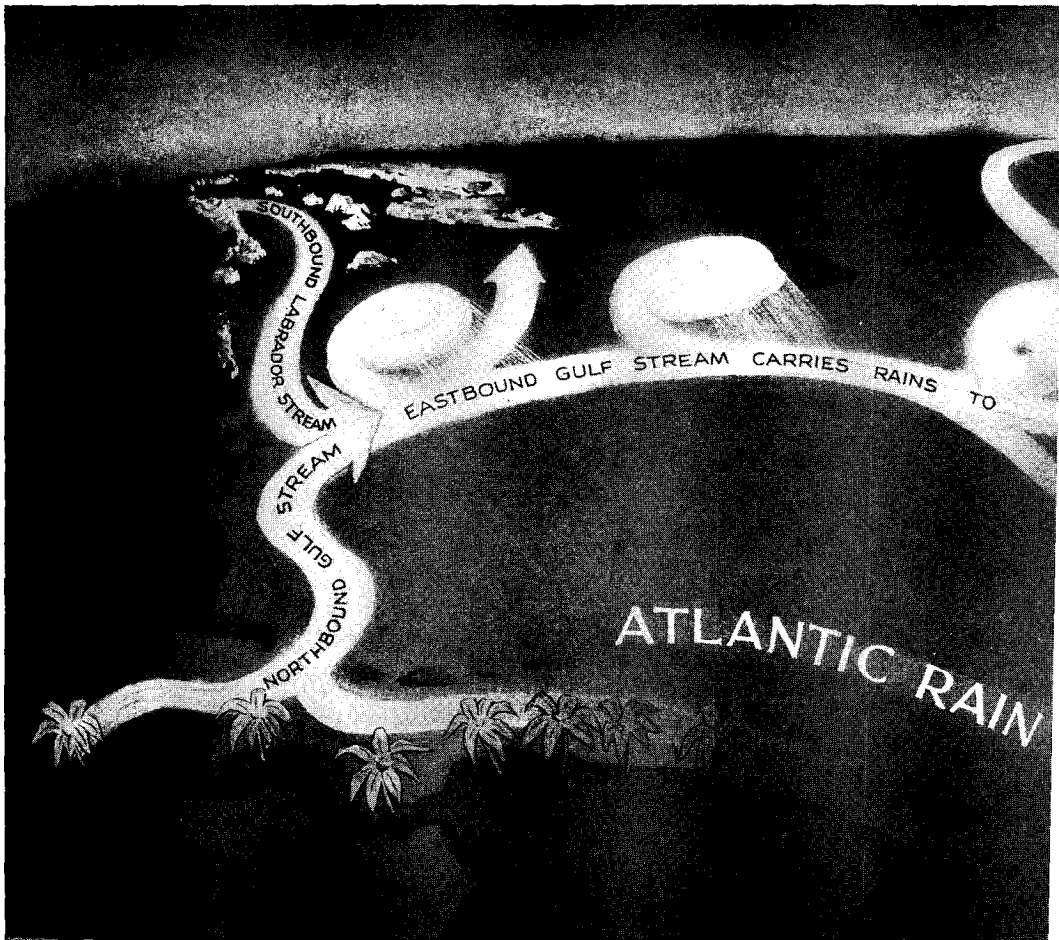
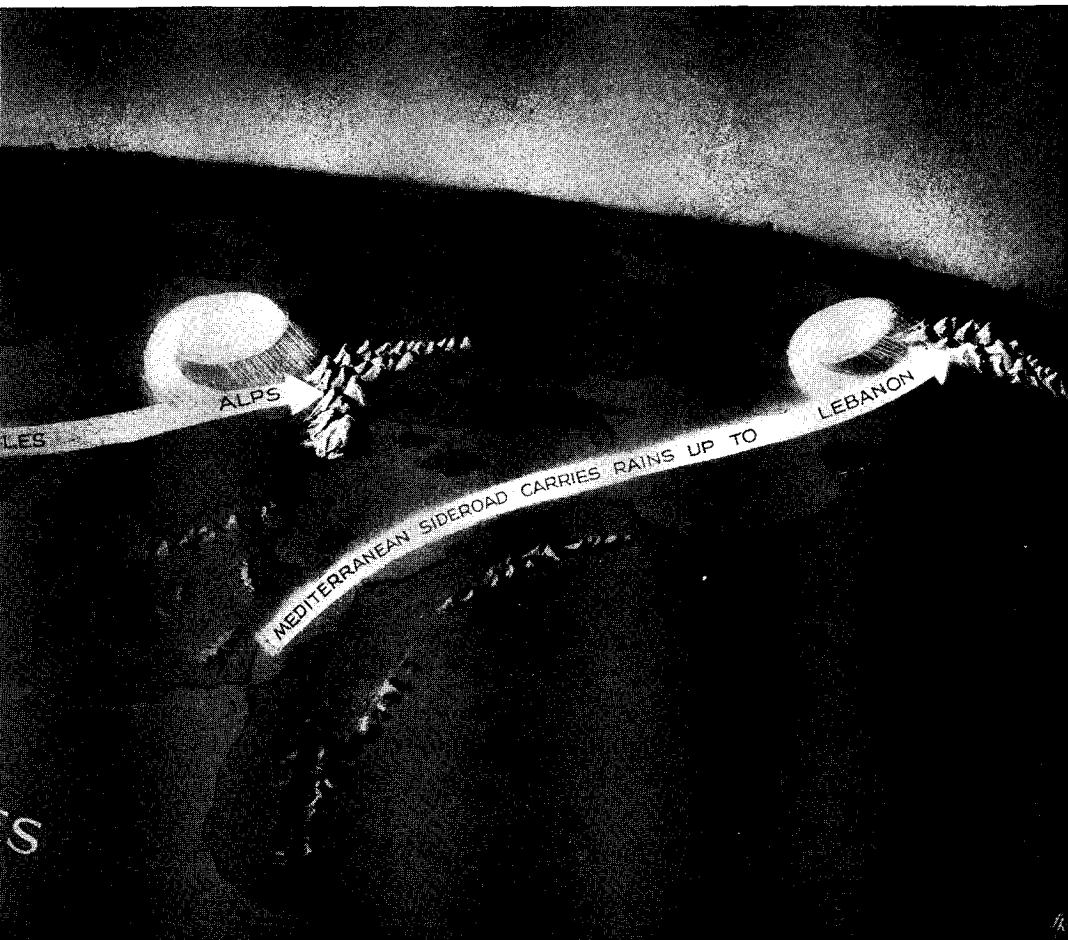

Fig. 124. THE RAIN ROUTE OF THE ATLANTIC

The bad weather cyclones of the Atlantic form over Newfoundland after the collision of the warm air of the Gulf Stream and the cold air of

slowly cooling Gulf Stream eastward over the North Atlantic and, as "bad-weather cyclones," bring rain to Europe. Newfoundland is the "factory" where two conveyor belts, the Gulf Stream from the south and the Labrador Stream from the north, assemble their air parts into cyclones and ship them eastward. European rain is "made in U.S.A."

The British Isles receive the first downpour. After the cyclones have lost their first rains on the coast of the Channel, over Britain, northern France, Belgium and the Netherlands, they travel inland, and the amount of precipitation decreases steadily until the cyclones reach the Alps. There, for the first time in its long journey, the humid Gulf Stream air encounters mountains which force it to climb to cooler heights and release all its remaining vapor. The towns on the northern slopes of the Alps, Lyons and Geneva, Zurich and Munich, Salzburg and Vienna, are the "continental terminals" of the



the Labrador Stream. They travel eastward across the Atlantic to Europe. Their terminal stations are the Alps and the mountains on the eastern slopes of Asia.

Atlantic cyclones. A European associates two ideas with Salzburg: Mozart and rain.

An inconceivable amount of water falls day after day from the atmosphere onto the earth. Count slowly: 21, 22, 23 . . . In the second it takes you to go from one number to the next, 4,000,000 gallons of water rain from the clouds, and an additional quarter of a million gallons settles on forests and pastures as dew.

One not too distant day, television stations will be able to present a panorama of events from every part of the globe: "The title of tonight's telecast is *Rain*." Sitting in front of your television set, you will see within an hour a downpour in Bengal; the bursting of a dam on the Yangtze River; a flood on the Volga; typhoon waves over Bali; plunging freshets in Taurus; boulders swept thunderingly down from the heights of the Atlas Mountains; a tropical thunderstorm over the Gold Coast; a tornado over the pampas; a flood in the Mississippi delta; snow flurries over Alaska; and the almost uninterrupted gale over the ice fields of the Antarctic.

"Are we dreaming? Can the earth withstand this constant pelting, four million gallons of water every second?" The earth *has* withstood this deluge for 2,000,000,000 years and has passed through epochs when many times as much water fell. The floods do the earth no more harm than a daily bath does the body. The earth is alive and, like a tumbling dolphin, always emerges clean and dripping, ever more beautiful.

The Weather Map

To chart atmospheric conditions geographically, meteorologists draw a weather map. (*Fig. 125*) When a geographer maps a country, he marks the various elevations and draws lines connecting points of the same altitude. The course of the lines indicates the profile of the landscape. If the lines are wide apart, they denote a landscape with small differences in elevation. If they are close together, the landscape must be mountainous. The meteorologist proceeds in the same way. He measures the air pressure in various areas and connects the corresponding points. The numbers found next to the lines in *Fig. 125* indicate the pressure. Numbers below 1,000 indicate "low" pressure; above 1,000, "high" pressure.

Looking at the weather map, which shows the course and the degree of the differences in atmospheric pressure, it is easy to deduce the direction and the speed of the flowing air. Lines close together signify sharp differences in pressure and strong winds. Widely spaced lines indicate a moderate decline in pressure and smoothly flowing air. Lines almost touching show a decline so abrupt and a rush of air so swift as to constitute a "storm center."

The point at which the pressure is lowest is called the low, or the minimum.

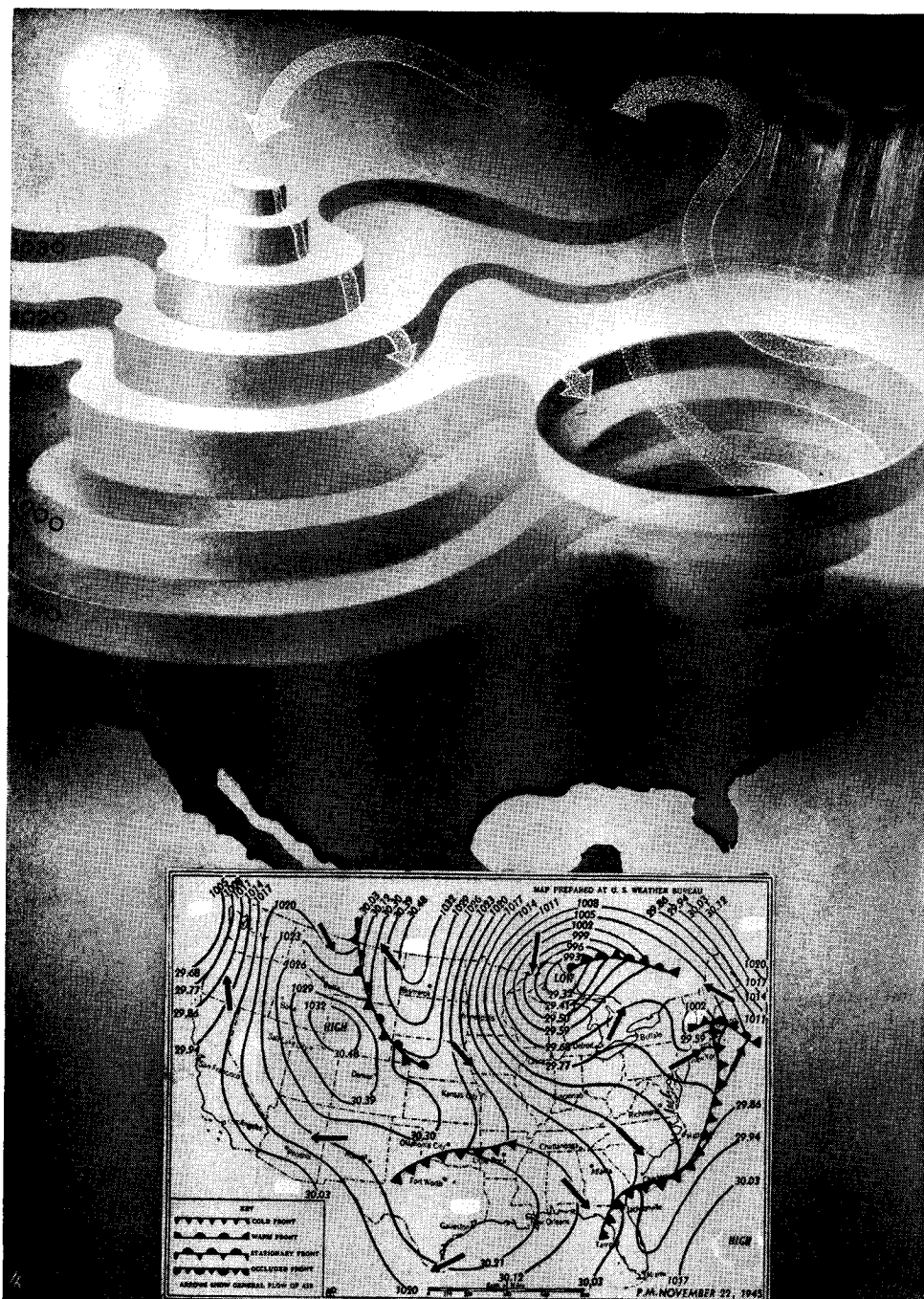

Fig. 125. WEATHER MAP

The weather chart (*bottom*) is pictured as a plastic diagram (*above*). Air flows from the “high” to the “low” and rises from there again. The winds move around the “high” clockwise, around the “low” counterclockwise (*arrows*).

The center of greatest pressure is called the high, or maximum. The minima are areas in which warm light air is rising. The maxima are areas in which heavy cold air from the upper spheres of the atmosphere is descending. The bordering lines between different air masses are called "fronts," warm fronts or cold fronts, depending on whether the approaching air mass is warmer or colder. In the upper part of the illustration, the so-called "air body" over the North American continent is represented as a three-dimensional structure.

The minima, where the humid air rises and clouds form in the cold upper spheres, are bad weather areas. (*Fig. 125, upper right*) Maxima, where the cold dry air descends, are clear weather regions. (*Fig. 125, upper left*) If air were visible we would see the maxima as peaks, the minima as eddies. Like water flowing down mountains into valleys, air dips from the heights of the maxima into the minima. Generally the air flows in spirals rather than in direct lines, partly because of the rotation of the globe.

Over every continent maxima and minima move along set paths at so regular a rate that meteorologists speak of weather routes. In regard to specific geographic areas it is almost as easy to predict the arrival of an approaching minimum or maximum, a cold front or a warm front, as it is to announce the arrival of an airplane. Generally the air flows from west to east with a tendency to slip southward. Over the North American continent the maxima and minima travel mostly from the Pacific to the Atlantic coast where the warm air over the Gulf Stream forms a low pressure channel. The cyclones are almost automatically steered into this "valley" and travel thereafter across the Atlantic.

The Subsoil Water

The high percentage of water in almost all organic substances is a source of perpetual wonder. The eyes reading these words are 90 per cent water. The brain that at this moment is considering this fact is 87 per cent water. The next time you buy bread, bear in mind that half of what you are paying for is just ordinary tap water. But console yourself with the thought that the plant which produced the wheat paid a far greater "water tax." Turn on the faucet in the tub and let it run until the tub is brimful. This is the same amount of water the wheat stalks had to draw from the ground through their roots to provide the few cups of flour baked into your loaf.

The average soil contains so much liquid that plants practically stand in water. All plants are "water plants." The soil is made up of crumbs, separated by small spaces. These spaces fill up with water by capillary action. Like the fine holes of a wet sieve, the small interstices do not easily yield up their fluid content. Each crumb of soil has a delicate, skin-tight coat of water so adherent that only the strong suction of a plant root can peel it from the

crumb. This capillary adhesion accounts for the astonishing fact that even the soil of the desert, for us the symbol of dryness, is permeated with water below the sun-dried surface. When dehydrated in a laboratory it gives off vapor, like a wet cloth on a hot stove. The desert *is* sterile but not because of a complete absence of water; plants standing in the shadeless desert from sunrise to sunset lose more water by evaporation than they are able to replace by extracting water from the tenacious crumbs of the subsoil.

In regions with an average amount of rain, the soil receives more water than the crumbs and the spaces between them are able to hold, and the excess trickles down. Since water cannot evaporate from the deeper strata, the lower

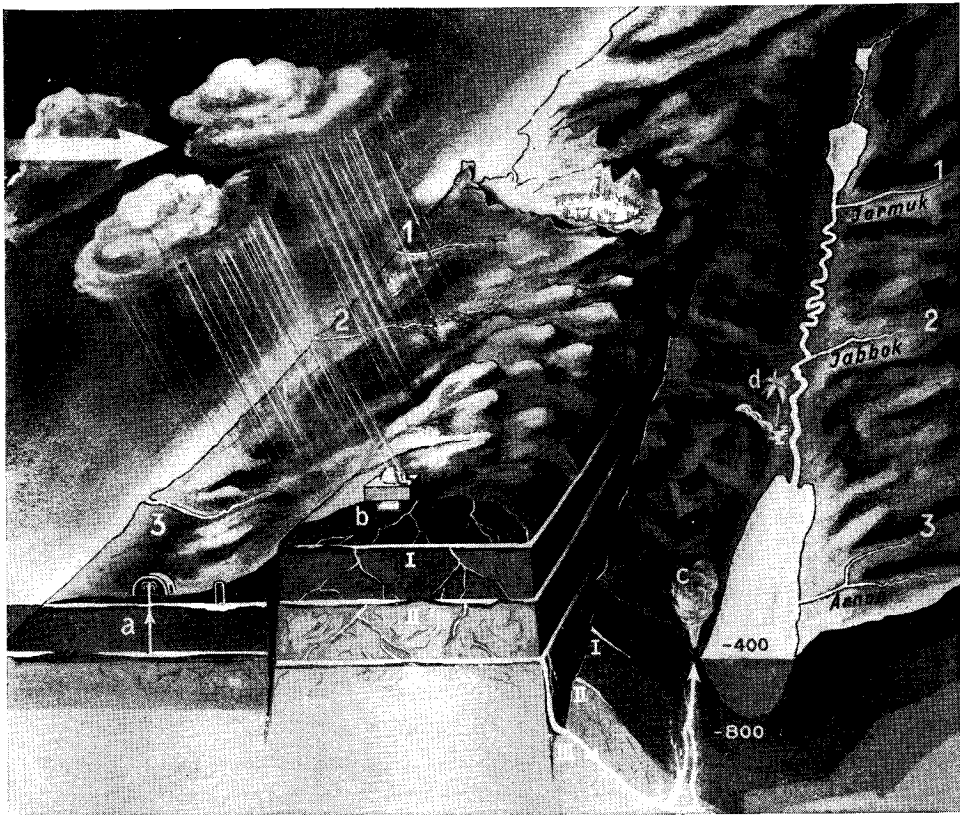

Fig. 126. WATER DISTRIBUTION

A typical example of water distribution is seen in the Holy Land. From the western sea side the rains of the Atlantic rain route reach their terminus. They deliver enough water for the western slopes. The eastern slopes stay dry. The sparse water is collected on the roofs in cisterns (b). The rain drips through the geological layers and collects in different water tables, I, II, III. From here the water is lifted by wells (a). The percolated water reappears through cracks in the Jordan Valley as hot springs (c). The few cold water springs irrigate oases (d). The three rivers from inland, 1, 2, 3, are intercepted by the graben and consequently the coastal country has but three corresponding rivulets.

layers become saturated. Wherever soil strata are bored in the course of sinking mine-shafts, water drips and often gushes from the cracks. Geological layers that are soluble or soft are washed away, so that in some places wide subterranean lakes spread out.

In the geological period—preceding our Tertiary and Quaternary, and called the Cretaceous, from the Latin word for chalk—an immense shallow sea of warm water covered much of the Western world, including parts of the North American continent. It was filled with “chalk animals.” The small ones were drifting Globigerinae (which compose the writing chalk of today); the larger ones, mussels and snails. When these animals died, their shells covered the bottom of the sea in layers which finally became thousands of feet thick. The preceding layers were covered by the later ones and compressed into rock, sedimentary rock. (*Fig. 101*) Most of our present mountains are lime or chalk mountains, prefabricated on the floor of this Cretaceous sea. The author of Psalm 104 reveals an astounding depth of insight into the nature of things when he sings: “Thou coveredst it with the deep as with a garment; the waters stood above the mountains.”

Lime is brittle, one of the first facts of natural history children learn when pieces of colored chalk break in their hands. Lime is not only brittle, it is also affected by acidulous water. All limestone mountains are vulnerable to weathering. Again the Holy Land is a demonstrative example, because it is a geological massif of limestone honeycombed by hundreds of caves, many of which are mentioned in the Bible: the cave of Machpelah at Hebron, which Abraham bought as a family grave; the cave of Samson; the cave where David found Saul asleep; the cave of the prophet Elijah.

All chalk mountains are pierced by caves or tunneled by subterranean beds of rivers which corroded their way through the water-soluble layers. The Hellenes were amazed by the river Meander, which disappears inside a mountain and returns, flowing in the opposite direction. The famous Adelsberg Grottoes near Trieste and the Carlsbad Caverns in New Mexico are dried beds of subterranean ponds and rivers made accessible to tourists; they have become meccas for sightseers. The water that drips from the ceilings of these caverns carries traces of lime from the soluble limestone layers above. Where the drops of water ooze, fingers of lime, stalactites, hang down like icicles. Where the drops fall to the floor, similar fingers, stalagmites, thrust upward until stalactite meets stalagmite and they unite in a column. The water that trickles down from the walls and rests in puddles on the floor deposits its salts along its course, the salts often colored and iridescent. As time passes, these deposits accumulate and build up into odd shapes, some resembling lichens or mushrooms, others simulating nightmare-like creatures.

The greatest subterranean reservoir is a water-saturated layer 700 meters below the surface of the Sahara Desert; 200 meters deep, it is as large as all France and filled with water. The French Government has begun to bring this water to the surface to reclaim the vast desert that separates the Mediter-

anean basin from the African tropics by planting an "Avenue of Oases" across the Sahara. If this ambitious project is realized, one of the greatest barriers between the European world and the Dark Continent will fall and a new epoch in the history of the Western world as well as that of Africa will begin.

The Oceans

Just as two-thirds of the living organism consists of water, a water with 0.1 per cent of salt content, more than 60 per cent of the globe is covered by salty seas. On the Western Hemisphere the land masses predominate; but the Eastern Hemisphere is almost entirely covered by the Pacific Ocean, whose surface is larger than that of all the continents put together. A traveler from another planet would describe the earth as a sphere of water with islands rising from the seas. (*Fig. 127*)



Fig. 127. A SPHERE OF WATER

The continental flatlands are, in general, only slightly elevated above the level of the sea. Nowhere does the height of the land above the ocean's surface equal the depth of the suboceanic floor. If gigantic bulldozers were to grade the surface of the planet, leveling all elevations, the debris would not fill up the seas. The globe would be completely covered by water.

The deeper parts of the oceans are apparently products of relatively recent geological epochs: they are populated by relatively modern species and contain no archaic relicts. This, along with other symptoms, leads us to assume that the amount of water on earth is increasing. We do not know how the oceans came into being. Nor are we sure about the origin of the salt in the sea. The classic theory is that rains and rivers extracted salts from the land and salted the sea, so that we now find the soluble salts in the ocean and the insoluble ones in the soil of the continents.

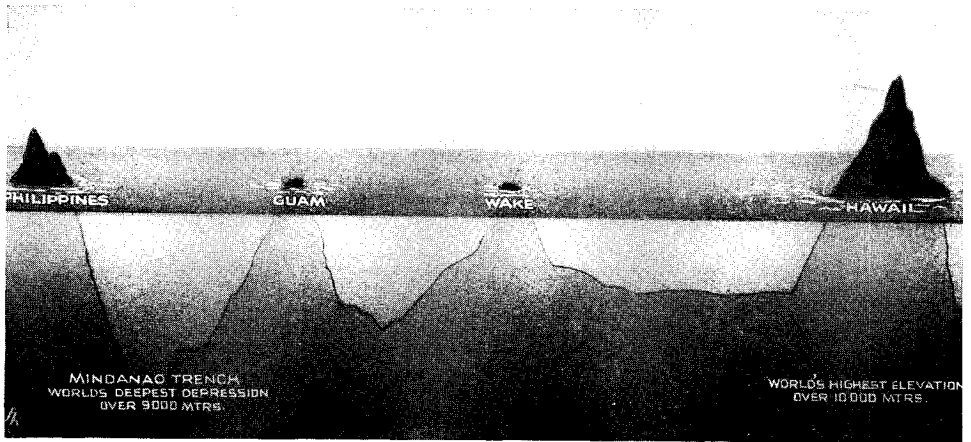

Fig. 128. THE PROFILE OF THE PACIFIC OCEAN

The floor of the Pacific reaches downward to the deepest depressions on earth. Since the Hawaiian mountains rise directly from the deep sea floor, they are the highest elevations found on the globe's crust.

The composition of the ocean salts is not, however, what would be expected if they were derived from the upper layers of the continents. Their mixture is suspiciously similar to that of volcanic gases. It seems probable that cracks in the earth's crust and volcano craters are the sources, both prehistoric and present, of the salt in the sea or, at least, a considerable part of it. Sea water itself may come from the cracked bottom of the oceans, from suboceanic volcanoes, the seas being steadily replenished not only by rain and rivers but also by suboceanic gushers. The research of tomorrow, with electrical devices and deep-sea photography, will reveal the facts.

The two large oceanic basins are fundamentally different. The ancient Pacific, covering almost half the globe, is not uniform. It has a deep central section and a relatively shallow periphery. The central section is an almost circular depression of about 30,000,000 square kilometers. The depression, the center of which is near the Hawaiian Islands, ends at about 1,000 kilometers from the coastlines of the surrounding continents. Its bottom, 6 kilometers deep, is twice the average depth of oceanic floors. Where the depression and the shallow off-shore zones meet, the floor drops steeply,

and the crust of the earth is fractured. The clefts themselves sink to abysmal depths—some to 12,000 kilometers. (*Fig. 128*)

Consequently the adjoining countries like Japan, South Asia, the Hawaiian Islands, Alaska and California, are fracture areas, plagued by earthquakes and dotted with volcanoes so numerous that it has been said the Pacific is girdled by a ring of fire. Of the earth's 500 active volcanoes, 300 are in or on the Pacific depression and another 100 are close to its borders.

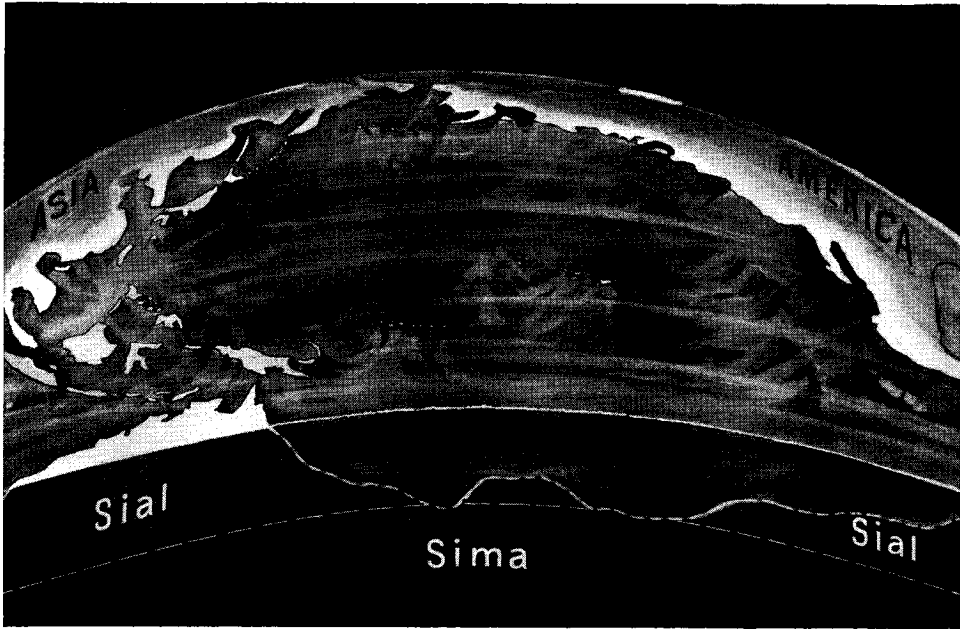

Fig. 129. THE HOLE IN THE PACIFIC

The deep and sharply defined floor of the Pacific Ocean gave rise to the hypothesis that it is a hole left by the moon when it separated from the earth.

The floor of the central Pacific depression lacks the topmost layer which covers the rest of the earth's crust, called the "sial" because it is composed mainly of *silicon* and *aluminum*. The lower layer of the earth's crust, composed of *silicon* and *magnesium* and called the "sima," is laid bare. It does not seem too far-fetched to theorize that in the Pacific depression area the superficial crust was torn away from the globe. G. H. Darwin and Edward Pickering both expressed the idea that here the moon shot away from the earth, and that the Pacific depression is, in effect, the earth's empty womb after the birth of her child, the moon. (*Fig. 96*) It is a rather wild speculation but, strangely enough, widely acclaimed.

The Atlantic is smaller and younger than the Pacific, and its floor is not a hole bordered by canyons. The theory of the floating continents considers the Atlantic a hiatus which opened when America broke away from the

Old World and floated westward. The gap grows larger, presumably a millimeter every day. Down its center a range of mountains as high as the Alps runs from north to south, paralleling the coasts. The highest peaks of these sub-Atlantic Alps protrude above the water as tiny islands, like the Azores or the Canaries. (*Fig. 130*)

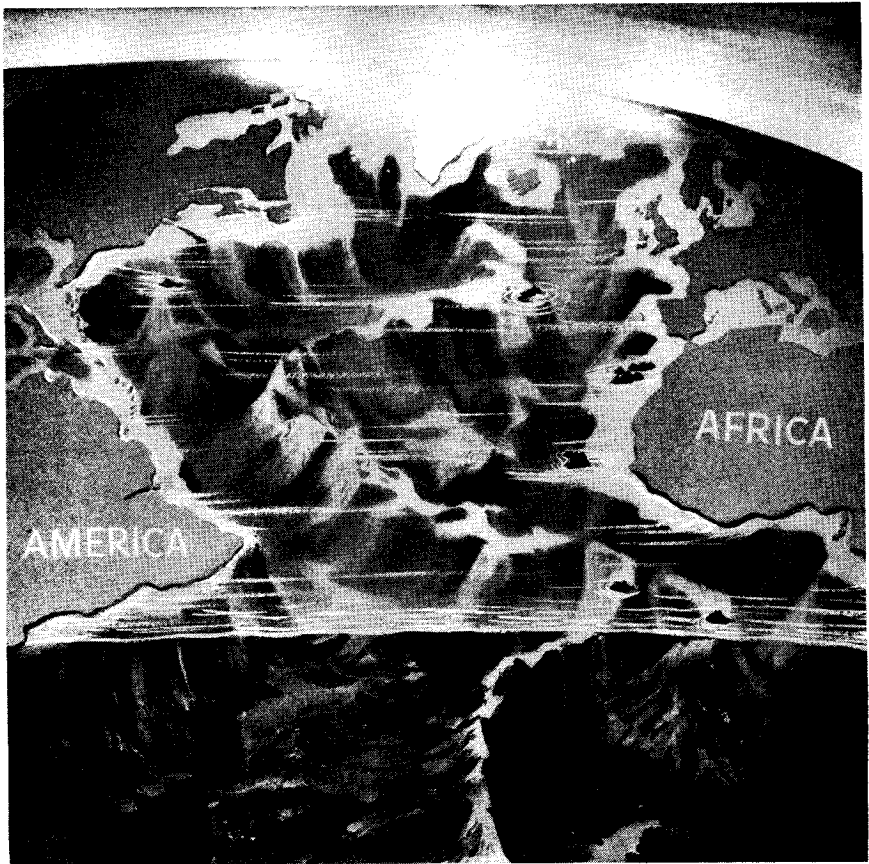

Fig. 130. THE BOTTOM OF THE ATLANTIC OCEAN

The floor of the Atlantic Ocean differs basically from that of the Pacific. The Atlantic is divided by a mountain range which parallels the coasts of the continents and seems to confirm the theory of the drifting continents.

In the future, men will plumb the depths of the seas and will find the sub-oceanic world no less challenging than the mountain ranges above the continental floors. Climbers, who a hundred years before attacked the Matterhorn and Mt. Everest, may now descend into the chasms of the sea. Gravity will not bother them but they will have to fight against the monsters of the deep sea. The naturalist, who in times past strolled over the meadows chasing butterflies, will now float among fields of sea lilies and anemones. A new

realm for adventure may lure "tourists" into the depths which hitherto have served only as the graves of drowned sailors.

The Ocean Currents

The waters of the ocean are not stagnant. They move in currents and tides, and the agents and patterns of their motion are far more complex than one might at first suspect.

The most effective impulse moving the oceanic waters is the rotation of the globe. Turning from west to east the earth pulls the water with it. If the planet came to a sudden stop, a high global wave, sweeping from west to east, would overflow all lands and drown all continental life. Centrifugal force pulls the waters from the poles toward the equator. Where they meet in the equatorial zone, the level of the sea is higher than it is near the poles. Every current provokes a countercurrent to balance the distribution of the water. Since centrifugal force is stronger at the surface of the sea, the countercurrents crawl along the ocean floor. Diverted by land masses, they have to travel along the coasts in curves, like cars winding their way through mountainous country.

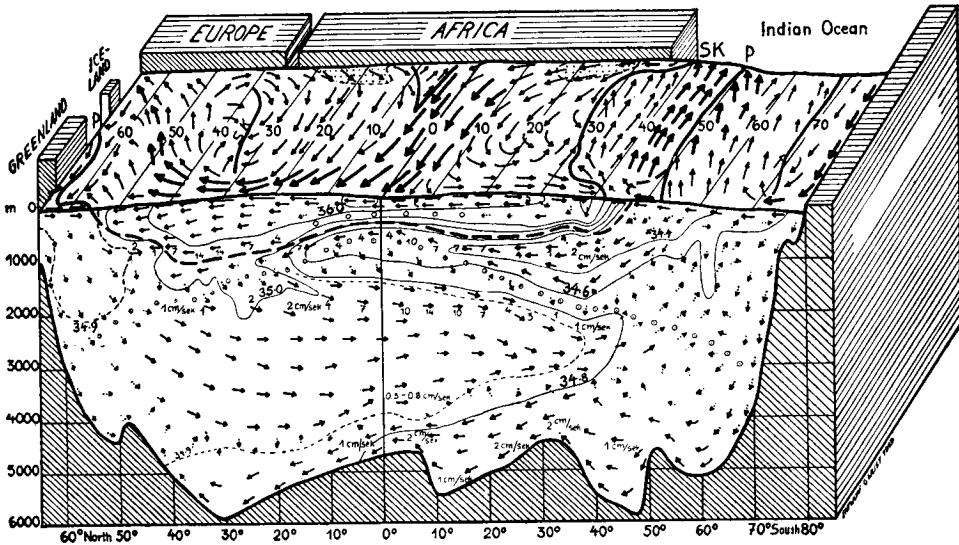

Fig. 131. DIAGRAM OF OCEAN CURRENTS (After O. Wüst)

Fig. 131 is a three-dimensional diagram of the Atlantic seen from the American side, Europe and Africa in the background, Greenland at the left, Antarctica at the right. Only in the southern part, between the southern tip of Africa and the Antarctic, can the oceanic currents flow freely. The northern two-thirds is enclosed as the Atlantic basin. Here the water streams

in two circles, one south and the other north of the equator. The east coasts of the two American continents are washed by the warm waters of the equatorial current. The western shores are not so fortunate; their coastal currents carry icy polar water. The surf that breaks on the beaches at San Francisco is colder than the surf at the same latitude on the Atlantic shore.

Along the west coast of the South American continent runs the cold Humboldt or Peru Current, famous as the feeding ground of innumerable birds that nest on the cliffs of the Chilean coast. The coldness of its water is not definitely explained. It seems as if the prevailing winds well up the cold deep sea water against the coast. The upturned water is rich in minerals which provide the microscopic organisms of the plankton with material to build their tiny skeletons. The organisms of the plankton are the food of little crabs, snails and dwarf fish. These, in turn, are the prey of larger ones, and so the chain of slaughter goes, until the murderers are large enough to attract sea birds—"the files of pelicans, the low-moving black clouds of cormorants, the rainstorms of plunging gannets probably cannot be equaled in any other part of the world." (U. S. Bureau of Fisheries, 1908) Lighting on the overcrowded cliffs, the birds heap up piles of their excrement, guano, famous throughout the world as the fertilizer Chile saltpeter. This bird excrement is the wealth of Chile. The steadily running production belt of the guano plant is the Humboldt Current with its mineral-rich water.

On the east coast of the Americas the warm water of the equatorial current flows to the north as the Gulf Stream, so called because the stream meets the continent at the Gulf of Mexico and there becomes a coastal current. Twenty miles wide and traveling at four miles an hour, it carries 500 trillion gallons per minute along the coast. The water gradually cools off until, at the coast of Newfoundland, it meets the cold Labrador Stream; here the warm and cold waters and their warm and cold air masses blend to form the fog of Newfoundland and the bad weather cyclones of the Atlantic route, described on page 318 and in *Fig. 124*.

The Gulf Stream is the aorta of Western civilization in both the Old World and the New. America's east coast is inhabited only as far north as the Gulf Stream heats the water on its shore. Even after crossing the Atlantic the current is still warm enough to give England and France their mild climate. The British Islands are hothouses heated by the warm water of the Gulf Stream. The mild air with its high moisture content provides rain for the continental plains of Europe as far east as the Carpathian Mountains.

Many dreams have been blueprinted by world planners, such as melting the polar ice caps, damming the Straits of Gibraltar and opening the Isthmus of Panama. Let us imagine that the last of these projects were realized. What would be the consequence? Only a weakened Gulf Stream would run to Newfoundland. The Labrador current, freed of opposition, would push southward. The port of New York would be icebound in winter, Florida would have to change its anachronistic name because it would no longer be

the *provincia florida*. Northern Europe, which, like a widow on a meager pension, just manages to get along on its modest supply of warmth and rain, would become arid; Lapland's climate would come to England; gone would be the emerald turfs of Eire and the woolly lambs of Scotland. No more perfumes and champagne in France; a Scandinavian chill would numb the gaiety of Parisian life. With a decrease in the amount of rain over Europe, the ice caps on the Alps would become thin; the peaks, relieved of their burden, would push upward, inch by inch. Fifty years after the breakthrough of the isthmus in Central America, earthquakes might harass the inhabitants of the alpine countries. Cracks in the mountains would deplete the lakes and the odor of suffocated fish would fill the air with a pestilential stench. This frightful vision could be prolonged but the brief sketch is sufficient to demonstrate how so inapparent a phenomenon as an ocean current influences the course of civilization.

The predominantly horizontal currents and undercurrents are linked by more or less vertical currents, which are sometimes so steep they are "waterfalls," the Niagaras of the high seas. The superficial ones have long been known; now, as submarines cruise deeper and deeper, new ones are being detected, some of unsuspected dimensions. During World War II such a waterfall was found off the coast of England, apparently provoked by the great difference in temperature between the warm Gulf Stream and the cold waters of the northern seas.

Strong currents result from the passage of wide, unhampered currents of the open sea through constricted narrows. When a volume of water passes through a wide opening it moves slowly; when the same amount of water in the same time unit must pass a narrow opening, it must flow more rapidly. The notorious Strait of Gibraltar was recognized as one of the earliest examples of this phenomenon.

The waters of the Mediterranean are warmer than those of the Atlantic. Under the hot summer sun, more water evaporates from the Mediterranean, and its level tends to fall. Cold water from the Atlantic flows through the Strait of Gibraltar to replace the loss. Countering the cold flood, a strong undercurrent spills back into the Atlantic over an undersea sill. Sailing through this Strait was so dangerous for ships of olden times that, as legend tells us, "the rocks at the sides of the strait are not firm; from time to time an ugly giant pushes them together, crushing any ship that dares to force the passage." Only since Hercules killed the giant, goes the legend, have the rocks of Gibraltar been stable and hence they are called the Pillars of Hercules. The undercurrent there is sometimes so violent that the first oceanographers had to abandon their investigations.

The narrows become tumultuous when several currents converge or the tides compete and the different currents fight for the right of way. In olden times the currents of the Strait of Messina between Sicily and the Italian mainland were just as ill-famed as the Pillars of Hercules. Here two great

eddies, Scylla and Charybdis, alternate with the hours of tides and winds. No sailor could avoid meeting one or the other of them, so that it became proverbial to say: "*Incidit in Scyllam qui vult vitare Charybdim.*" Homer's description is hardly exaggerated when he tells how Ulysses clung to a branch of a tree until his disgorged ship reappeared beneath him from the depth. The updraft of the whirlpools is so vehement that even today with the widened straits and weakened whirlpools deep-sea creatures caught by the eddy are cast up on the beaches.

In our times of safe navigation in great ships these currents have lost their horror. Today we read of the currents and the undertows in the English Channel solely in reports about the long-distance swimmers who try to cross the tricky narrows, while the ordinary travelers suffer only in their cabins from the rough crossing. The waters around the Orkney and Shetland Islands are dreaded by all sailors for their currents and countercurrents and the eddies in the times of the tides. The most gigantic eddy in the Western world is the Maelstrom between Lofoten Island and the coast of Norway. It is so impressive that Edgar Allan Poe chose it as a theme for his masterful story, "Descent into the Maelstrom." He describes how a fisherman, caught unawares, was sucked down by the giant funnel but miraculously was able to save himself.

Tides

The most impressive motions of the oceanic waters are the tides, provoked by the attraction of the sun and moon. Although the sun's mass is immensely greater than the moon's, the sun is so far away that its attractive force is but half that of our small satellite. The planets, too, attract the earth, especially Venus, which is relatively close, and the faraway but immense Jupiter. Tides of record height occur when these four heavenly bodies pull together in the same direction.

Normal tides are determined by the position of sun and moon. When sun and moon are in such position as to pull at the same time and in the same direction, the tides are highest and are called spring tides; when they counteract each other, the tides are weak and are called neap tides.

The line running between sun, moon and earth is rarely a straight one. The distances of the sun and moon are not constant. Nor are the moon and sun both always on the same side of the equator: the moon may be pulling to the north and the sun to the south. These three are only a few of the many variations that occur during the year. An enormous amount of effort has been expended during the last centuries to calculate the tides correctly; Newton was one of the first who labored with this problem. Artistic clocks have been constructed to provide seafarers with information about their times and

strengths; most recently the calculation of tides has become one of the tasks for electronic brains. Like the currents, the tides would not be so complex if the globe were entirely covered by water. But the tidal waves, too, are cooped up into basins by the continents.

If we sway back and forth in the bathtub, the water rises and falls in "tides." The height of these tides depends on different factors, such as the length of the tub, the quantity of water that swings and the rhythm that sets the water in motion. In the middle of the tub the water changes its level only a little; at the ends of the tub it rises high and even sloshes over the rim. The water in the enclosed oceanic basins behaves similarly. On the east coast of Maine the tidal wave is almost imperceptible. But between Maine and Nova Scotia toward the north, the tidal wave is confined more and more, and in the Bay of Fundy, the tide reaches a high-water mark of 20 meters. The life of the people living on its shore is completely attuned to the arrival and departure of this daily high tide.

If, however, the geography of an oceanic basin conflicts with the hydro-mechanics of the tide, the tidal action may be dwarfed. The tidal wave may cross the basin in its short diameter. The local rhythm of the swinging water may not harmonize with the swing of the daily tides. The shore line may be so jagged that it consumes the strength of the tide. Dozens of factors interact to favor or thwart the tides. One of the show places for tides is the famous Mont St. Michel on the French coast, where the great Atlantic tide is funneled into the narrows of the English Channel. Tourists from all over the world gather on the galleries around the medieval cathedral to observe the onrushing flood when the spring tide is due. With the punctuality of a rising theater curtain, the tide rolls in. High combers race over the barely covered sand, like white horses pounding down the home stretch. So exciting is the charge of the waters that the spectators, infected by the general emotion, yell like the crowd at the finish of a Derby.

As a rule, the timetable of the tides is geared to the movements of the moon. Each day the tides arrive about fifty-five minutes later than on the day before. As pictured in *Fig. 108* the hydrosphere of the earth is an elastic covering on the globe. When an elastic ball is stretched, it extends in both directions. As the moon-attracted water rises on one side of the globe, a corresponding tide is pulled up on the other. This explains why the tides follow each other in periods of half-days. But they are capricious. Some water basins have two daily tides, others have only one; some follow the moon, others follow the sun. On some Pacific islands, the tides arrive every twelve hours so exactly that the natives need no clocks; to tell the time they look at the beach.

Since the moon revolves somewhat more slowly than the earth rotates, appearing about fifty-five minutes later every day, the tides, too, move somewhat more slowly than the globe and act as a brake. Some geophysicists surmise that the earth rotated more quickly in early times, the daily rotation of the planet taking no more than three or four hours. The tides, they say,

slowed down the day to its present length and will slow it down further, until the day is as long as the month; then the moon will stand still over a specific point of the globe, as Joshua asked it to do on the day of his battle against the Canaanites. If that comes to pass, the tidal wave, too, will stand still, its crest, unmoved, raised toward the moon.

The Land

The Landscape in a Humid Climate

MAN DOES NOT LIVE ON the “planet” or on “continents,” but in scenic compositions of soil, air, water and vegetation, called landscapes. At the beginning there were no landscapes on earth—“the Spirit of God brooded over the waters.”

Slowly, as continents arose, the rocks were exposed to the weathering agents, and landscapes formed, in accordance with the different climates. A climate rich in moisture is called humid; climate poor in moisture, arid.

The difference between humid and arid countries lies not so much in the amount of yearly precipitation but in its seasonal distribution. In humid countries the rain falls during most of the year; the precipitations are moderate “showers,” the drops coming down gently and doing little or no harm to the landscape.

In arid zones, long periods of drought are interrupted by brief periods of rain. The rain pours down in torrents and the flood, so suddenly appearing and disappearing, does more harm than good. In humid climate, water is a constructive force; in arid climate, it is a destructive agent—and the two types of landscapes appear as different as if they were on two planets.

Like metamorphic rocks, water changes its character, varying from an invisible gas to a liquid to ice. As a rule, water departs from the higher clouds as snow. When the peaks of the mountains reach to the heights of the “eternal snow,” precipitation settles in flakes. Each new snowfall adds another layer to the ones beneath, compressing them into ice. Actually, it is not eternal snow but eternal ice that covers the alpine heights.

The ice slips down from the slopes and fills the spaces between the peaks and crests as if they were bowls. When the “bowls,” often circular and called “cirques,” are filled, the ice creeps over the brim, and in due course, following the line of least resistance, crawls slowly downward as a frozen stream—a glacier. This term was introduced by French naturalists, the first to study the ice of high mountains, since in their homeland are the magnificent and easily accessible glaciers of Chamonix on the northern slope of Mont Blanc. The ice of a well-developed glacier, like the Columbia Ice Shield in the Canadian Rockies, piles up to a dozen or even a hundred yards. Since ice is weighty, it is estimated that the mass of eternal ice presses the alpine mountains down into the sea of magma as much as several hundred meters. If the glaciers



Fig. 132. GLACIER

A glacier scrapes and polishes the ravines of the high mountains into wide smooth-walled valleys, easily recognizable as products of glaciers.

were to melt, the mountains would rise, inch by inch, like ships whose cargo is being discharged.

The frozen river of the glacier moves slowly, no more than 150 meters a year. Even by sheer weight this moving plane of ice would scrape the valley.

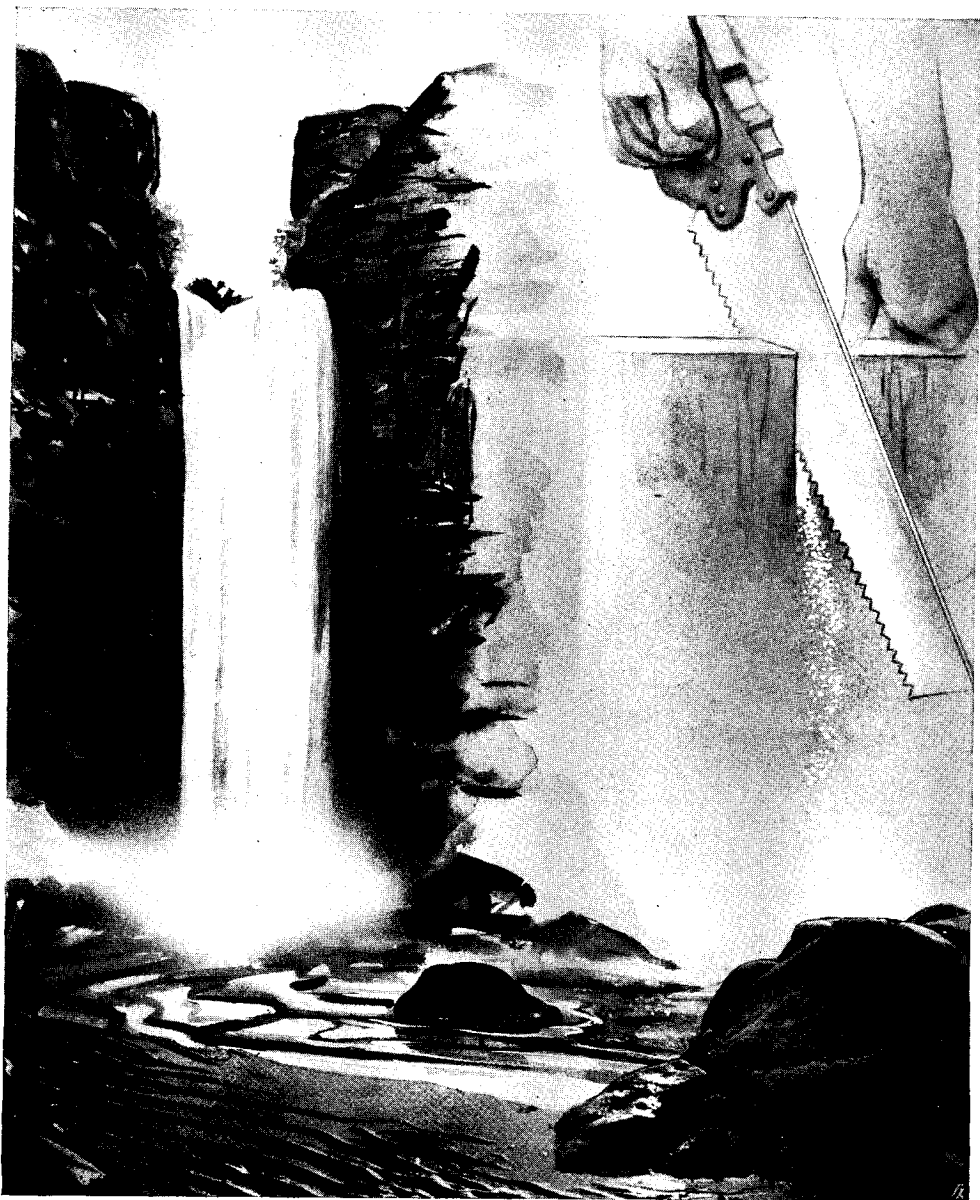

Fig. 133. WATERFALLS

Water cuts its way through the mountains like a saw. The narrow ravines subsequently widen into open valleys.

Yet the glacier is equipped with powerful scraping tools, rocks which have fallen from the bordering slopes. The fallen rocks do not remain on the surface of the glaciers very long. Their pressure creates heat and the ice beneath each rock melts. Slowly the rock sinks until it reaches the ground, and the under side of the glacier becomes armed with teeth of rugged rocks which

scratch grooves into the bedrock over which they pass. Rolled over and against each other again and again, the rocks are blunted and transformed into boulders. The beds of the glaciers are plastered with thousands of boulders which the frozen river carries slowly down the mountainside. The glacier is a running belt of ice, the first model of a conveyor belt on earth. At the lower end of the glacier the boulders roll out and heap up into a moraine. (Fig. 132) The valley, thus carved by ice and ground by rolling boulders, can be recognized easily as the product of a glacier. Glacier valleys are wide, straight and U-shaped in cross sections; the walls, smoothly polished.

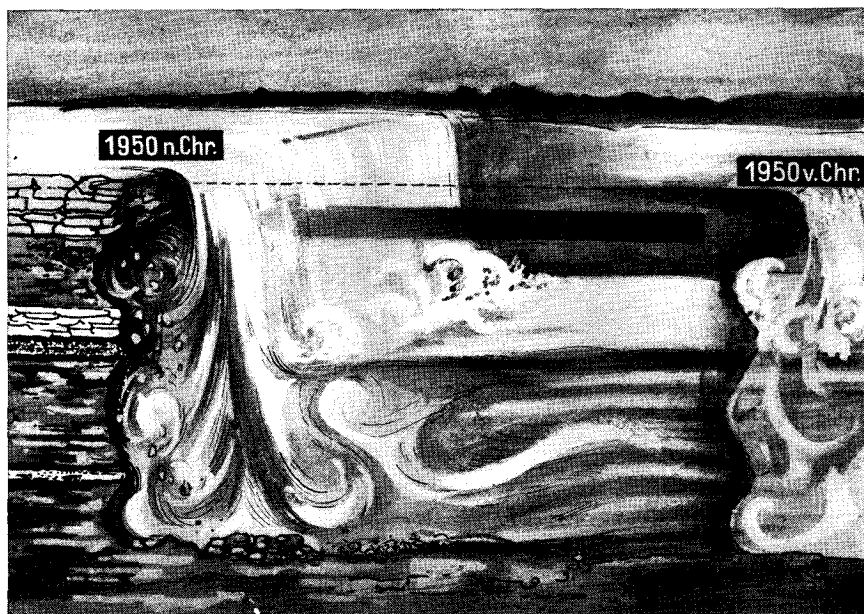

Fig. 134. ALL WATERFALLS RECEDE MORE OR LESS SLOWLY

During the Ice Ages, North America, like Greenland today, was covered by a high sheet of ice southward to a line running roughly from St. Louis to New York. In those cold times—the last Ice Age was about 30,000 years ago—glaciers started in mountains that have never been alpine and they filled the valleys down to the lowlands. In the area of the Great Lakes, in Vermont and even Connecticut, the vestiges of glaciers are still to be seen. The migrating ice carried big boulders far over the plains. When the ice melted, the boulders were stranded and are seen today in the plains as erratic blocks. The retreat of the ice is still going on, the glaciers of America and Europe becoming shorter because the climate is getting warmer.

From the “tongue” of the glacier the melting water seeps out and runs rapidly down the mountains. While the glacier is a scraper, water forces its way through the mountain like a saw, cutting deep ravines and steep gorges and V-shaped valleys which differ from the ice-born U-shaped glacier-

valleys. (*Fig. 133*) V and U are the symbols of the two types of valleys.

Rocks that fall into the flowing torrents remain jagged and rip the ground. Growing blunt in time, they turn into boulders; boulders become stones, stones become pebbles, pebbles become gravel, and the gravel is ground into sand. In lower altitudes the water slows up and loses its cutting force. Instead of forcing its way through the rocks as it does on mountain heights, it meanders leisurely between the foothills. The slopes recede and the V-shaped angle of the valley widens out. As the rocks roll down from the slopes and the soil is washed away, the bordering hills flatten and finally the stream flows through a gently rolling landscape, a peneplain. (*Fig. 136*)

Where water has to descend abruptly from a higher to a lower level, it does so either by cascading over chutes or by leaping in one jump, as a waterfall. North America has a spectacular specimen of a waterfall in Niagara Falls, which carries the waters of the Niagara River from the higher Lake Erie into the lower Lake Ontario. Niagara Falls exhibits the "biology" of waterfalls; they recede. The water of Niagara Falls streams over a floor of several sedimentary layers of limestone. (*Fig. 134*) The top stratum is stronger than the underlying ones. As the river sweeps over the brink of the falls, it sucks out the softer understrata, leaving an unsupported ceiling. Every ten years or so a small shelf gives way under the impact of the rapidly flowing water, and the fragments are hurled into the roaring abyss. With the loss of the ledge the river loses a small part of its upper floor and the falls recede at this point. The speed of the recession gives a clue to the falls' age—Niagara must have been born about 16,000 years ago.

Geologically-old waterfalls do not exist. All waterfalls destroy themselves. The same is true of rivers. Rivers are "waterfalls" because their water falls. Nibbling at their banks, gnawing at their beds, they burrow into the ground and their headwaters eat their way back through the mountain. The formula for a river's action is paradoxical: the water wanders forward, the river wanders backward. This retrogression may become fatal. In young countries the irrigating rivers flow at fairly even distances and are fairly parallel. If we look at the map of Europe we find in Northern Europe almost parallel streams—the Loire, Seine, Maass, Rhine, Elbe, Oder, Weichsel, Niemen and Duna—running northward; in Southern Europe we see the parallel lines of the Danube, Pruth, Dniester, Bug, Dnieper, Don and Volga running southward.

The tributaries of the great streams, flowing at approximately right angles toward them, also run almost parallel; often two tributaries flow in opposite directions from the continental divide in almost the same line. As they corrode their beds back toward the "divide," their sources approach each other. In due time the two river heads meet. Now the struggle starts. The river that flows on a lower level drains water from the higher one. (*Fig. 137*) The captured water must follow the victorious stream and flow in the opposite direction. After shifting into reverse gear, the tributary no longer

LIFE HISTORY OF A MOUNTAIN

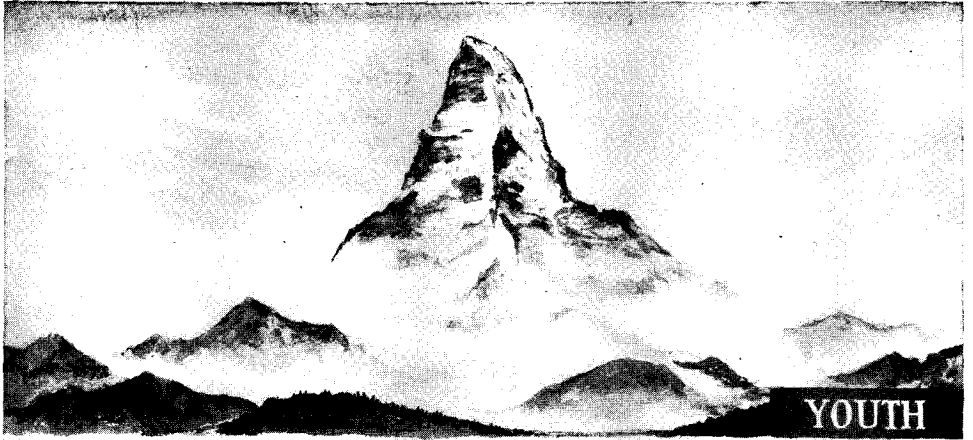

Fig. 135. FROM HEIGHTS TO HILLS

LIFE HISTORY OF A VALLEY

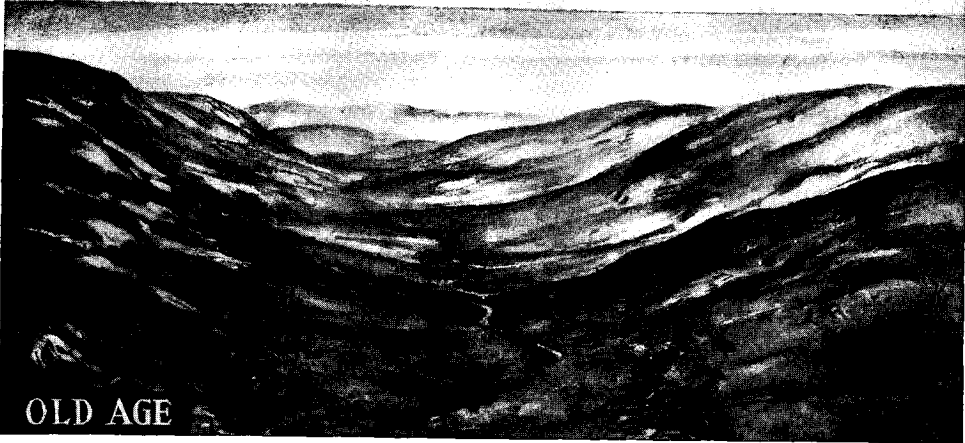

Fig. 136. FROM MOUNTAINS TO MOUNDS

contributes water to its mainstream; on the contrary, the lower river drains the water of the higher, so that the main river is diverted into the valley of its captor stream. Its upper course gone, the lower course dwindles. The region where the two originally independent streams met is often characterized by an S-curve. The Rhine, flowing on a south-north course from the Swiss Alps to the North Sea, is distorted in the midst of its journey by a "knee." Here where, today, from east and west tributaries join the Rhine, the river detours



Fig. 137. RIVAL RIVERS

The headwaters of rivers constantly burrow deeper. Sometimes the sources of two rivers fuse. The river on the lower level drains the water from the river on the higher level. The drained river reverses its direction.

for a few dozen miles from east to west. This small detour, insignificant as it is as a natural phenomenon, had considerable importance for the colonists of this fertile stretch of valley. It is within this short east-west strip where the south-facing slopes are protected from the winds of the north and exposed to the sun all day long that the grapes of the famous Scharlachberger, Johannisberger and Rudesheimer Rhine wines are grown. And so the gourmet of today enjoys the fruits of a battle that two rivers fought eons ago.

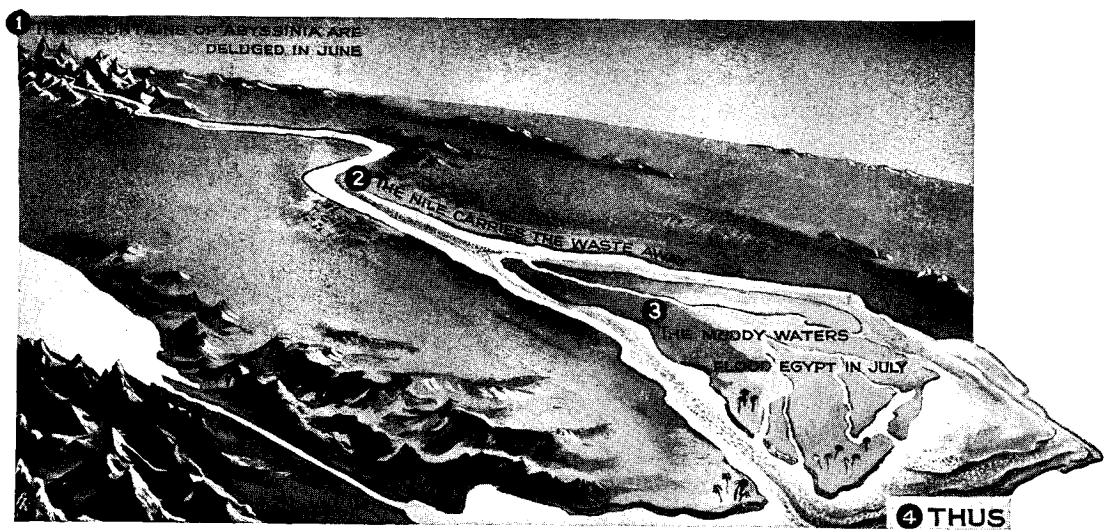

Fig. 138. DELTAS

The waters of the Nile drain the mountains of Ethiopia and deposit the Abyssinian soil off the coast of Egypt.

Streaming from higher levels to lower ones, the rivers steadily carry material of the land into the seas, partly chemically by dissolving the soluble compounds, partly mechanically by the force of their current. The waters take on the colors of the ingredients carried away: the Yellow River in China, the Blue Nile in Africa, the Red River in Texas. The Colorado transports more soil than a freight train of equal length and speed could carry. The Mississippi robs so much soil from its wide drainage system that the level of the Midwestern plains has fallen three feet in the last 15,000 years. The Missouri, which carries an annual 200,000,000 tons of fertile soil into the Mississippi, is appropriately baptized the Big Muddy. Rivers are the robbers of the lands, but they are also the builders. The Rhine is a conveyor belt, depleting the mountains all along its course, feeding with its deposits near its mouth the plains of the Netherlands, or low countries. If the Swiss were to exact an export tariff upon soil, the Dutch would have to pay them duty. Amsterdam lies in Dutch territory but on Swiss soil. Egypt is geologically a province of Abyssinia. (Fig. 138) Every year, early in the summer, torrential rains drench the Ethiopian mountains. Six weeks later, in the middle

of July, the yellow water reaches Egypt. The Nile rises and the Egyptians praise "their" sacred Nile. Through thousands of irrigation canals the muddy water is distributed over the parched land, and "the season" begins. The famous onions of Egypt grow on Abyssinian soil.

Every year half an inch of mud is spread over the plains of Egypt. As a result, the delta is rising, almost three feet every thousand years. When Joseph's brothers came with their gifts, they rode over the roofs of the palace of Menes, who reigned two thousand years before their time. As the war-chariots of the Romans entered Alexandria, they rattled over the thrones of the Pharaohs. The cars of today roll on the shoulders of the Romans. As we tread upon them, others will tread upon us. (*Fig. 139*)

Thus the mountain's loss is the valley's gain. When we stand on a bridge in the foothills of the mountains during a seasonal rain and watch the muddy water stream past, we mourn for the "good earth" that is flowing away. Yet the soil is not lost. The loot of the mountains is strewn into the lap of the lowlands. The death of the mountains is the birth of the plains. One teaspoon of mountain rock dissolved in a quart of rain—that is the formula the mother mountain feeds her geological child, the plain.

The Landscape in a Dry Climate

In a dry climate, water, the main landscape-forming agent in humid zones, is missing. It is not entirely absent but it appears on the yearly stage only in one or a few short scenes, and then it wrecks the set. The amount that pours down on those rare days equals or sometimes even surpasses the total annual rainfall in humid countries. Jerusalem, situated in a typical arid landscape at the edge of a desert, has an annual total of precipitation higher than that of New York. The oases on the southern slopes of the mountains of the Sahara get all their rain in two or three heavy rainfalls during the winter.

The fury of the downpour is overwhelming. After day-long sandstorms which pile the entrances of houses foot-high with sand, the rain splashes down. In a matter of hours the landscape is flooded, squares are converted into lakes and streets into streams. From the nearby mountains rocks are loosened and plunge into gorges, shattering in a thousand pieces. The water fills up canyons so rapidly that the caravans which use them as the only available roads through the mountains are drowned when they do not take refuge in time. In the foothills the wide stony dry beds of the rivers are turned into rapids. Their boulders, which were still as death during the drought, come alive, topple against each other as if a sorcerer had called them to life and cause a roar which is audible for miles, as though an invading army had launched an attack with an initial barrage. The waters splashing from the slopes are as brown as chocolate. The thin topsoil is washed down the hills. It is difficult to decide whether this tempest is a grace or a curse.

When the rain has ceased, the landscape is coated by a sticky mud that hardens in a couple of days and covers the land with a blanket of fertile topsoil. Before long this soil also is desiccated by the sun, and begins to crumble into powder. Relentless winds, with no forests or underbrush to brake them and no grasses to mollify their fury, sweep the dust of fertility away—into the eyes and lungs of children who sicken with conjunctivitis and trachoma, and become prone to tuberculosis, the incidence of which is very high in arid countries.

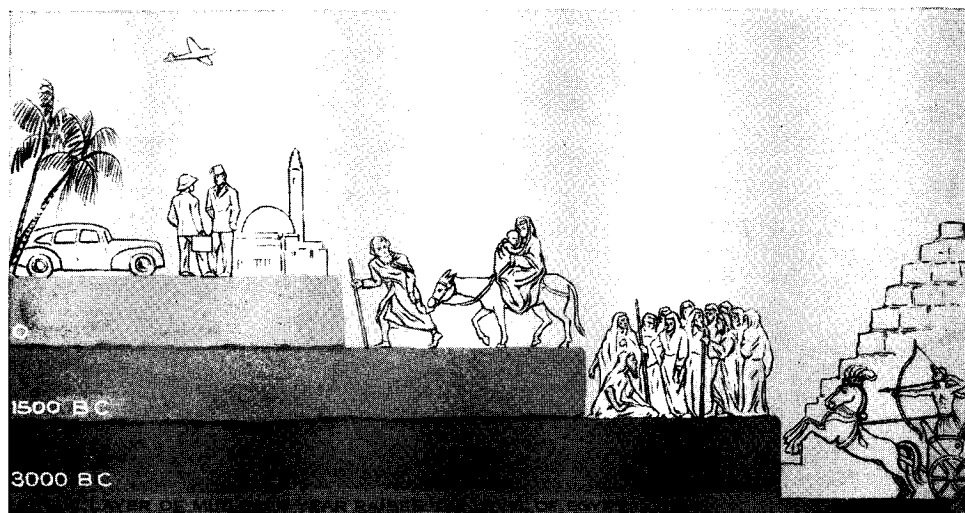

Fig. 139. WE WALK ON THE SHOULDERS OF THE PHARAOHS
 Since the Nile deposits a layer of Abyssinian mud every year, the floor of Egypt rises about one yard in a thousand years.

In humid landscapes covered by vegetation, the slopes of the mountains overgrown by forests, the rains trickle down from branch to branch and from root to root. In arid and barren landscapes the water runs down the hills with accelerating speed, following the law of gravity. The eroding effect increases in proportion to the square of the velocity. The torrent racing at 30 miles per hour cuts its way with a force 900 times as great as a stream flowing at 1 mile per hour. The few annual torrents devastate the country like battles. With nothing to hamper them, wind and water knife through the arid landscape, cutting deep valleys with vertical walls—canyons.

In contrast to the burning heat of the open country, the shaded depths of the canyons stay cool. Since here and there a forlorn spring drips from the cracked walls, a few sparse plants grow in patches of green. These sunken valleys are the natural “deepways” through the arid country used by travelers to cross the land since earliest times. Yet canyons are not designed as caravan roads for the peaceful traveler. Mountain lions use them as hiding places; hijackers lie in wait for their easy prey, and in the winding country

pipeline the traveler may be caught like a rat in a maze. No less menacing is nature. A far-away downpour, unnoticed by the wanderer, will suddenly fill the ravine with water. The traveler hears the roaring tide, but too late to escape.

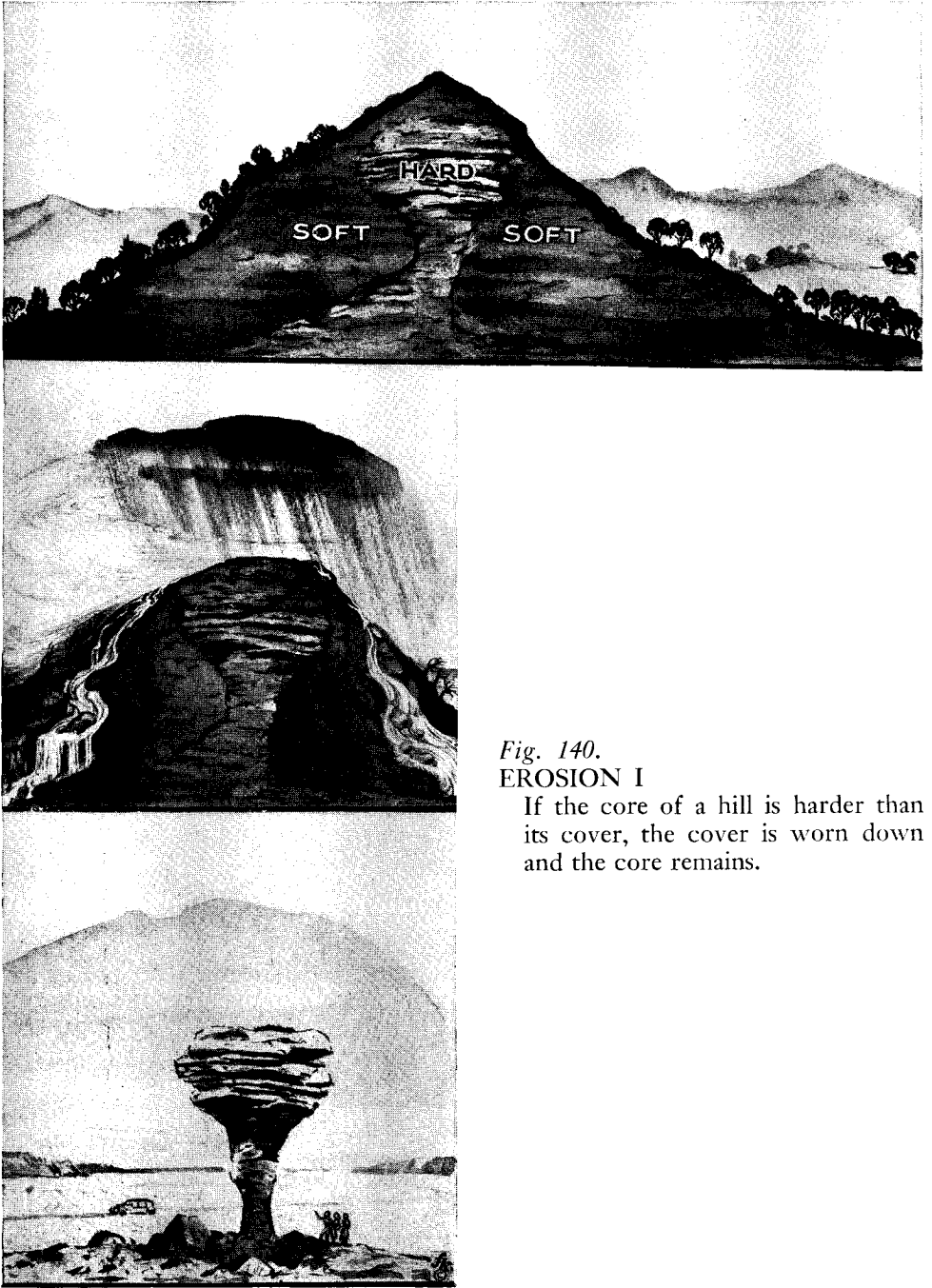

Fig. 140.

EROSION I

If the core of a hill is harder than its cover, the cover is worn down and the core remains.

The Psalms are transformed from lofty poetry into realistic records when we realize that the psalmist lived in an arid landscape. He thanked God for being with him in the "deep dark valley" (the canyons), for rescuing him from "the waters" (the canyon-filling deluges), from "roaring beasts" (the

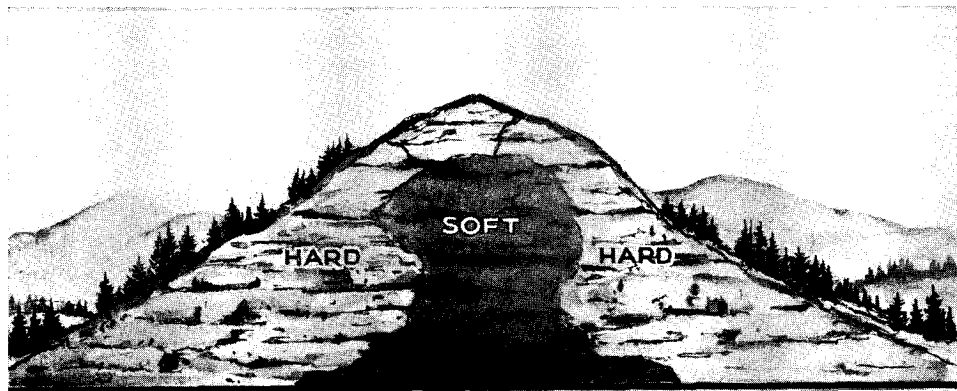

Fig. 141.
EROSION II

If the core of a hill is softer than the cover, the core is washed out and a cave is formed.



mountain lions), from his "enemies" (the canyon "muggers"). "Yea, though I walk through the valley of the shadow of Death, I will fear no evil, for Thou art with me; Thy rod and Thy staff they comfort me." (Psalms 23:4)

"Then the channels of water were seen. . . . He sent from above, He took me, He drew me out of many waters. He delivered me from my strong enemy. . . . He brought me forth also into a large place. . . . [the opening of a canyon]" (Psalms 18). Psalms are canyon poetry.

Erosion

The life of the earth's crust is an interaction of constructive and destructive forces. Constructive forces are: the pressure of the magma folding up the crust to mountains; the aggregation of sediment on the floor of the oceans and its compression to sedimentary rock; the transformation of sterile rock into fertile soil.

Intimately connected with the constructive processes are the destructive ones. Soil cannot be formed without depriving rock of material; it cannot be drenched by rain without losing soluble ingredients; the sediments on the floor of the lakes and oceans could not be deposited unless the rivers bring along the materials from the lands they traverse.

The total effect of all these destructive actions on the surface of the globe is called erosion. Erosion starts on the peaks of the high mountains where the first and most important agent of erosion, gravity, initiates the dismantling process. The Greek philosopher Heraclitus said: "You cannot swim across the same river twice." Neither can you climb the same mountain twice. With every step upward, some stones will roll beneath your feet. When the alpine goat jumps over a crevasse, a few pebbles slip from under its hooves and may roll down a hundred or even a thousand feet. When the shepherd leads his flock to the mountain pasture, every hoof leaves a scar on the profile of the slope. The leaf blown from the mountain ash bears away a few grains of soil, for the plant's roots have dissolved and have drawn up materials from the mountain's interior. The bee that flies down to the valley with pollen on its thigh is stealing a bit of the mountain's treasure. The honey you spread on your breakfast roll is a spoonful of looted mountain.

Every rock not firmly fastened to the structure of the mountain will sooner or later fall and thereby diminish the height of the mountain. Every peak is girdled with heaps of fallen rock. As long as the slope is steep the fragments topple downward; when the angle of descent flattens to 40°, the rocks stop rolling and heap up, forming "scree," which are the first beds of vegetation. Even if the vegetation of the scree is poor, a dwarf shrub and a few grasses, the scree is significant as the highest outpost of vegetation. Plants protect

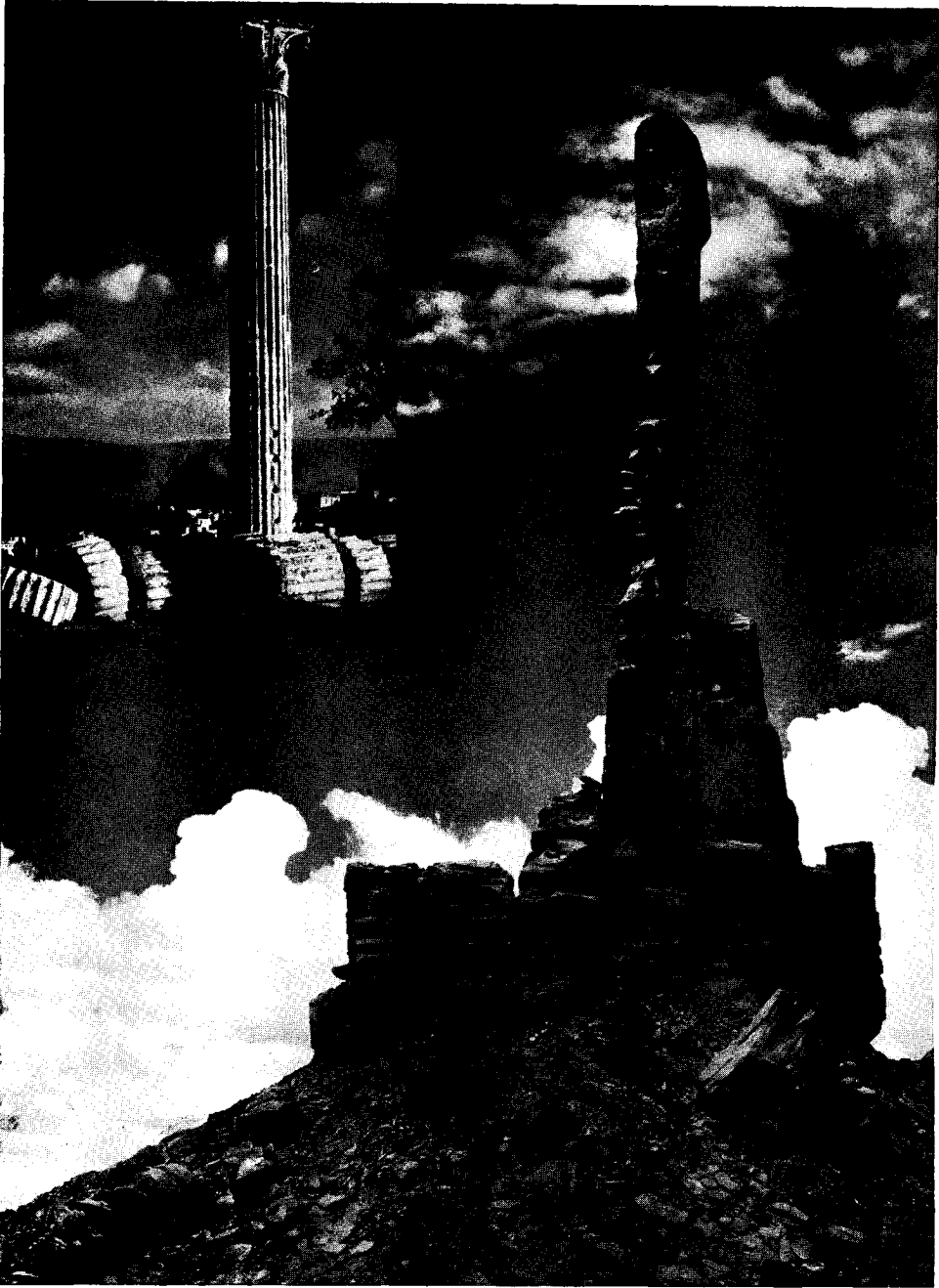

Fig. 142. THE REST ARE RUINS

the rock from sun and rain, and hold the pieces of fragmented rocks together for centuries.

Second to gravity, variation in temperature is the enemy of mountains,

especially the high mountains. The barren heights have no protection from the sun by day and the cold at night. The daily range in temperature in those barren heights is enormous. When Jacob quarrels with his father-in-law Laban, he says: "In the day heat consumed me and the frost by night." He did not say "in summer" and "in winter."

In barren landscapes every day of the year is characterized by a wide range of temperature. By day the rocks expand, by night they contract; this daily push and pull makes them crack. The inexperienced canyon traveler becomes frightened when twilight falls. A barrage begins over his head and the echo resounds along the winding walls of the ravine as in a western movie. Fragments of "shells" hurtle whistling through the air. The alpinists say: the mountains become alive. The opposite is true. The mountains are shot by firing squads. In canyons the upper rim is exposed to the scorching sun all day, while the lower parts remain cool. The witness of the "battle" fears for the survival of the mountain. But the chipping of a bit here and a splinter there is a trifle to the millions of tons that stay behind. (*Fig. 142*)

Now and then a "bullet" shot from the rock will roll into a crack and get jammed there. The "bullet," which may be a boulder in a crevasse or a grain of sand in a hair-fine slit, will slide down when a drop in temperature widens the crack or shrinks the bullet. With a return of warmth the jammed rock will act like a splitting wedge and will widen the crack. A stone may be trapped in this fashion only once in a thousand times; the action may be on a microscopic scale; it may take a hundred years for the jammed fragment to move. But there are millions of cracks and millions of splinters and millions of years in geology.

Water is a far more destructive agent than the comparatively small number of splinters which occasionally wedge into cracks, because water fills *all* openings, seeping into every tiny crack. When at night the water freezes it expands about one-tenth. Children fill bottles with water, put them outside the window on cold winter nights and wait for the "bomb" to explode. In high mountains, water wages war with "time bombs" set by day and detonated by night.

Another enemy of mountains is the wind. The force of wind in the heights is enormous; the peaks swing like the masts of ships. The wind widens the cracks and tears protruding rocks loose so that they thunder down; small stony pieces—pebbles, gravel or sand—are blown away.

The wind that batters the peaks so obviously carries a subversive "fifth column": grains of sand and dust, molds, bacteria, water vapor. One of the fundamental differences between humid and arid countries is the tiny, almost imperceptible difference between the ingredients of the moist winds of the humid climate and those of the dry winds in arid countries. Atmospheric moisture always contains carbon dioxide, which combines with water molecules into an acid. This acid in turn combines with calcium to form calcium carbonate; calcium carbonate is water-soluble. When rocks rich in

calcium, such as limestone, sandstone, chalk and marble, are drenched with rain, their calcium is washed away as calcium carbonate.

The high electric charge of lightning activates the normally inert nitrogen in the atmosphere so that it combines with water into nitric acid, which is also poisonous to rock. In volcanic countries the air is contaminated with sulphuric acid; near the seashore the air is enriched with chlorine and iodine. All of these mere traces of acids attack the defenseless rock.

Destruction of rock by humid air is called weathering. In town and in the country, trees and houses tell you which is the "weather side." Here acids have eaten away the stones and tiles, molds and mosses have settled in green patches on walls and barks. A walk through a churchyard reveals how brief a time gravestones, chosen for their hardness, really last. In less than a century the graven "Immortal Love" and "Eternal Memory" weather away and the dates tell us of the flow of destruction as accurately as a calendar.

Most of our present mountains—the Alps, the Himalayas, the Rockies, the Andes—are covered by sedimentary layers rich in calcium, and therefore vulnerable to erosion. In limestone mountains water seeps through the ubiquitous cracks deep down between the strata until it is stopped by an impermeable layer of shale or clay. The water, prevented from seeping away, spreads out across this layer, forming a subterranean water level. (*Fig. 126*) Slowly the limestone layer inside the mountain is dissolved and the mountain becomes honeycombed. Caves are formed; their ceilings crack under the weight of the mountain; the higher strata cave in and break. (*Fig. 141*)

Crevices open and the rain water tumbles down through them, lost to the production of plants and topsoil. As long as a mountain is covered by its natural carpet of plants and soil, rain is retained by the sponge of topsoil, which can hold moisture for months. With the soil-holding framework of roots gone, the orphaned soil flies off with the wind, flows away with the seasonal rains. The forests, the protecting coats of the mountain, grow thin; the trees degenerate into brushwood, the shrubs into the knee-high maquis or macchia, as the inhabitants of the eroded Mediterranean countries call this dwarf vegetation. Only a carpet of shabby grass remains, but this, too, becomes patchy, and the rocks begin to protrude like the bones of an emaciated body. A thousand years later the skeleton of a desiccated mountain mars the landscape. No one who has seen the mountains around Trieste will ever forget the depressing picture of the eroded "karst" which became the prototype of all denuded landscapes.

In arid zones it is not water but sand that weathers the mountains away. The tourist is impressed when he sees in Egypt an ancient monument as fresh as though the sculptor had put aside his chisel yesterday instead of 4,000 years ago. Then, walking around to its windward side, he finds the hieroglyphics erased and the reliefs flattened as if they had been rubbed with sandpaper. They have been, for in Egypt, as in all countries bordered by deserts, the wind is a blowing sander. Let a microscope stay in the open for an hour

and under its lens you will see files and chisels—grains of sand. The sculptured princesses have been standing in the open for three thousand years—no wonder their noses are snub.

The nearby mountains—and all others in similar countries—are in no better shape. Their peaks are rugged, their slopes are shorn, their heights are being leveled inch by inch. But again, man has not to worry about the fate of mountains. Geological periods are of unimaginable duration; destructive forces are balanced by productive counter-forces. Geologists speak of isostasy, meaning the equilibrium between the elevations above and the depressions beneath the surface of the globe. The continents are supposed to float on the sea of magma like icebergs in water. The visible part is only one-tenth or so of the submerged mass. When, by erosion, the top of the mountain dwindles, the main mass thrusts up from the depth. According to this “Law of Isostasy”—not yet proved—neither will the basins of the sea be filled. The floor of the ocean sinks as new masses are added by the deposits of the rivers. Isostasy holds the scales in equilibrium.



Fig. 143. SAND CARVING

Erosion of the landscape, as if gigantic erasers were at work, deprives the mountains not only of height but also of character. They become so uniform that geographers and historians find it difficult and often impossible to identify historical places in arid landscapes. Mt. Hermon on the northern frontier of Palestine stands in a humid climate and is a truly majestic peak crowned with

snow. It is a "personality," like Mont Blanc or Mt. Etna. But the heights of the Holy Land are shaven into uniformity by the sandy winds from the deserts. Mt. Moriah, where Abraham prepared to sacrifice Isaac, Mt. Nebo from which Moses saw the Promised Land, the mountain which is believed to be the site of the Sermon on the Mount—all now are alike, skulls in a potter's field. (*Fig. 146*)

If, as happens so often, soft and hard rocks are intermingled, the hard resist while the soft disappear. If a hard stratum rests on a softer one, and the soft layer has given way, the arc of a "natural bridge" spans the sands. (*Fig. 143*) When, on the contrary, layers of sandstone cover basalt or granite, and are blown away, a "castle" may tower over the denuded plain, or picturesque sculptures provide an open air show: cones and sugar loafs, tables, petrified giants, villains frozen to stone by the thundering command of the Lord. (*Fig. 140*) They are not exhibited long; rocks are carved into boulders, boulders into "melons," melons into "bread," bread into "rolls," and rolls into "beans" and "peas."

When the Lord was tempted by Satan in the desert, the tempter said: "Command that these stones be made bread." Why does he say "bread"? Boulders in the desert, carved and polished in the wind, assume the form of bread. The oft-quoted proverb, "You will reap what you have sown," is based upon the legend that Christ once passed the field of a peasant who was clearing away pebbles. When Christ asked: "What are you sowing here?" the man peevishly retorted: "Can't you see? Peas." Pebbles, carried during the rainy season from the slopes are a normal feature in the biblical landscape. The Bible is the chronicle of an arid country.

Deserts

Deserts are not, as was once thought, the floors of dried-up seas. Looking at the map we are struck by the extent of the deserts on the globe. Little room is left for man on the planet he proudly calls "his." Three-fifths is inundated by water, and of the remainder, more than a fourth is made up of uninhabitable "badlands."

Deserts are not distributed at random; they gird the globe in two strips running parallel to the equator but at a considerable distance from the rainy equatorial zone. (*Fig. 144*) Deserts are the children of the horse latitudes where the air of the great global circulation system, having disposed of its equatorial moisture, returns to earth as a dry and drying wind. (*Fig. 119*)

The general climatic conditions are not sufficient to produce a desert. Local factors have to add their unfavorable effects. The two most frequent geographical factors are cold oceanic currents along the coast and high mountain ranges between the cool coastal strip and the hot interior of the

continent. The deserts on the North American continent are typical products of this cooperation. Along the west coast there flows the cold Californian current from north to south. The warm breezes from the Pacific are cooled by the cold water and their moisture condenses into the ill-famed fogs along the California coast. When the misty air is driven eastward, it warms up and expands. Its capacity to hold vapor increases and the mist dissipates. The air becomes clear and from the blue sky an unblinking sun glares over the landscape. In warm latitudes foggy coasts mean rainless lands in the interior.

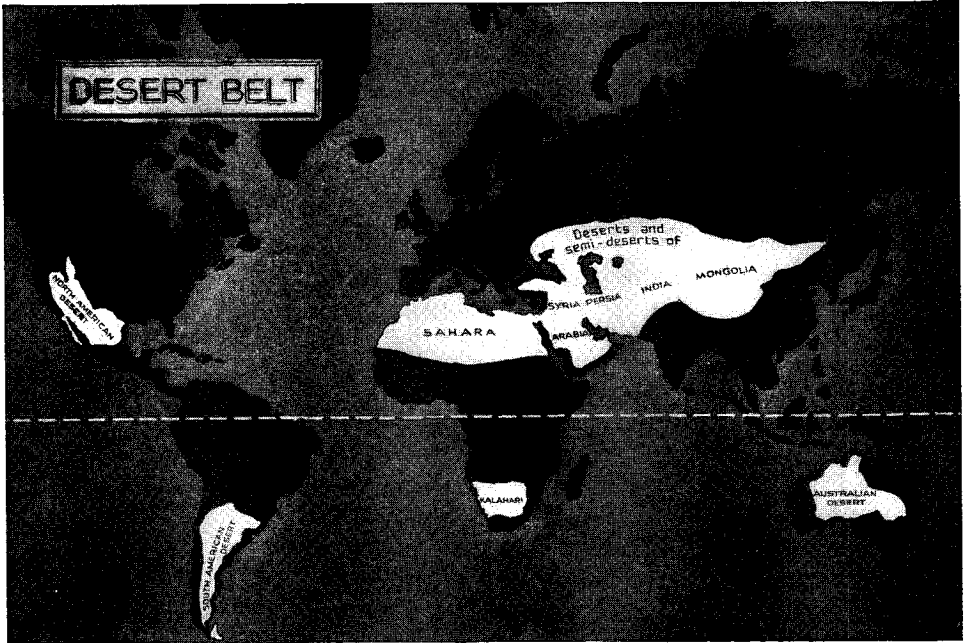

Fig. 144. THE DESERT BELT

Deserts girdle the globe in two belts north and south of the humid equatorial zone.

The coastal mountains are the second detrimental factor. They stall the humid air from the ocean. On its way into the interior, the wind, which must rise along the slopes, cools off and its capacity to hold moisture lessens. Clouds form and dispose of their vapor as rain. The coastal slopes are rich in precipitation and are fertile. The land on the other side of the mountains lies in the rain-shadow and stays dry.

California, with its fertile coastal plain, its mountain range as barrier and the deserts behind the mountains, is typical. Along the coast of the South American continent there flows, as a counterpart of the California Current, the cool Peru Current. Here, too, fog shrouds the coast most of the year, the high Andes stall the moist winds and on the lee side of the mountain range the badlands begin, the deserts of Peru and Chile. Similar conditions produce the deserts of North and South Africa, Arabia, Syria and Australia.

Deserts are by no means literally seas of sand. Less than 20 per cent of desert land is covered by sand or sand dunes. Large parts are covered by stones; barren, rugged mountains rise as badlands; and wide areas are semi-deserts dotted with rather sparse but picturesque flora, as everyone who has crossed Arizona or New Mexico knows. Deserts are not entirely dead. Plants and animals have adapted themselves marvelously and neither day nor night life is missing. Even occasional thunderstorms and downpours quench the thirsty landscape and its inhabitants.

The interior of the North American continent is spared the fate of most desert areas only because just enough moisture blows in from the Great Lakes and the Gulf of Mexico to supply the minimum of water needed to maintain a sparse grass cover. Still fresh in our memory are the "Dust-Bowl Years" of the thirties, a warning that the peril of desiccation also menaces this continent. (Fig. 145) Deserts are aggressive. Their sands move inexorably onward and rarely disinter what they have entombed. The steady winds sweep the sand across the plains, pile it up in dunes and shift the dunes yard by yard. All along the borders between the Old Roman Empire and the arid stretches of Africa and Asia the *castella romana*, the outposts of ancient civilization, are buried under the advancing tides of the deserts. Like a child's cap sticking up out of a snowdrift, here and there the arch of a temple protrudes; a frieze at which people on the street once gazed in admiration is today a lowly bank on which the camel driver rests along his plodding way.

In North America and Europe the winds blow mostly from the west. If the sand of the Pacific shore were marked with radioactive isotopes, its migration eastward could be followed with Geiger counters. If the counters were coupled with automatically lighted lamp posts, the advance of the sand could be registered from town to town. In Europe the sand of the Atlantic coast wanders from France to Russia. People in Moscow swallow the dust that once lay on the streets of Paris. Deserts are on the march.

Earth is not doomed, though man may be by his own follies. Only a small part of the globe's surface is habitable; arable land is scarce. Man cannot wait for future geological epochs of restoration. He depletes the land quickly and before long he sees himself facing starvation. He starts his "civilization" by clearing forests and draining swamps. The land thus reclaimed he ravishes with his merciless plow; he scatters seeds in the pierced flesh of the planet. To harvest bumper crops he intoxicates the exploited soil with artificial fertilizers and while he carries away sheaves of grain on his shoulders, he leaves the soil exhausted.

The havoc man has effected has been evident since early times. Leaders of nations all over the world—Moses in Israel, Confucius in China and the Mayan rulers—promulgated rules for the conservation of soil. But greed triumphed over need. Solomon embellished his temple with the cedar logs of the Lebanon; the Romans stored their clothes in cedar chests. The famous balsam firs of Gilead were tapped to exhaustion for balm. The soft woods

were charred for charcoal. There are no more forests on Ithaca in which to hunt boars, as Ulysses did. Plato lamented over mountains which looked like "the limbs of a once rosy body now gripped by a morbid consumption." What would he say if he could see the Mediterranean countries of today? The desolated coasts of the Mediterranean from Gibraltar to the Bosphorus are a great mausoleum of a murdered hero.

Yet modern man has at last opened his eyes and has become increasingly aware that he is heading for disaster. Studies have been made of soil erosion and conservation. The importance of forests was recognized and reforesta-

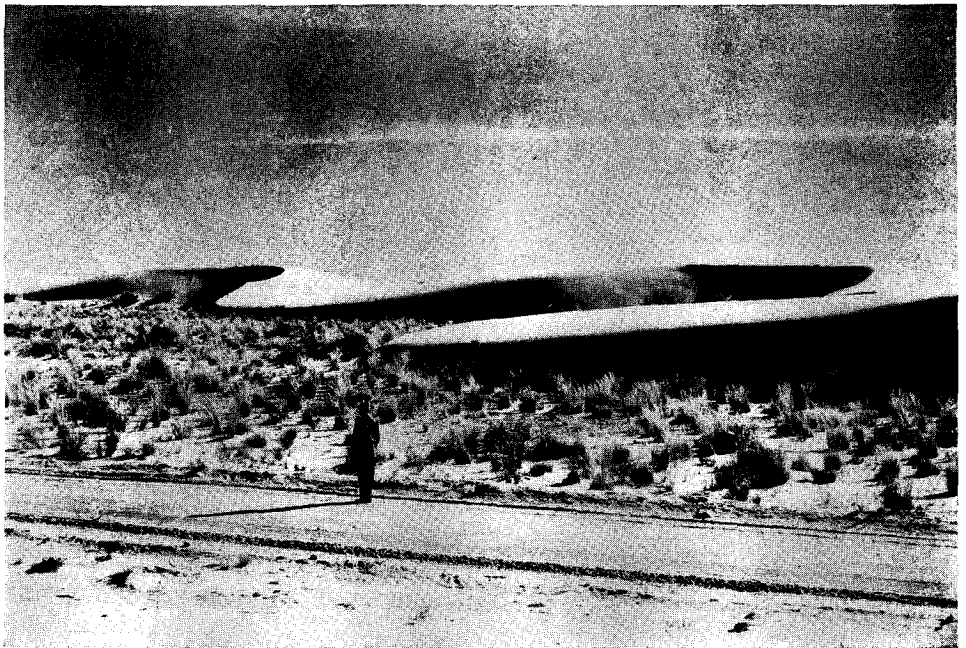

Fig. 145a. DESERTS ON THE MARCH
The tides of sands . . .

tion was begun. The Italians were the first to reforest denuded mountains; other countries, at first skeptical, followed their example. In the middle of Russia the marching deserts are halted by broad bands of forests across thousands of miles of open countryside; it is expected that the roots of the trees will arrest the sand and their foliage will sieve the winds. In the United States airplanes are sent over the wastelands to scatter seeds of hardy grass encased in damp fertilizer—fertility pills against sterility ills.

An outstanding example of the revival of a country which at the beginning of the century had been pronounced dead by almost all authorities is the Holy Land, where over the wretched heights of Judea, Deborah for thousands of years "heard her lost children weeping in the wind." (*Figs. 146, 147*)

All deserts around the globe are "promised" lands. The master of the atom

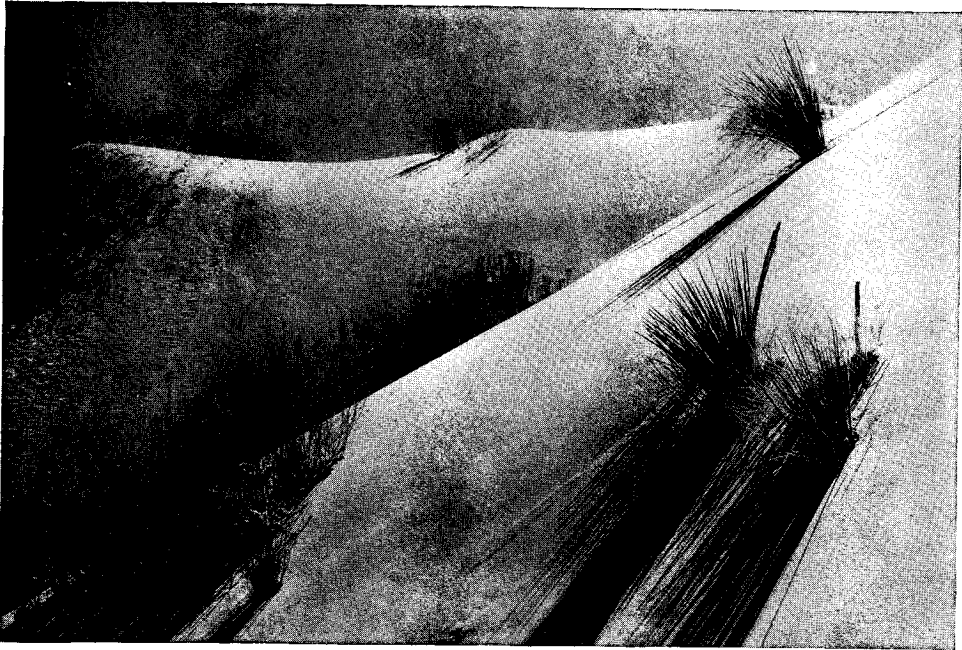

Fig. 145b. The desperate struggle . . .

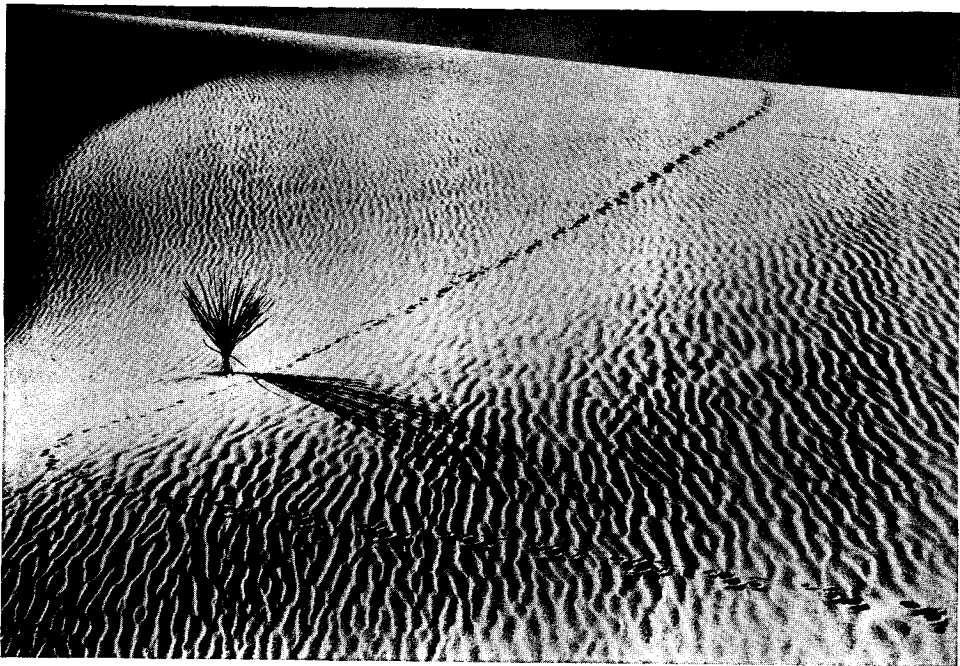

Fig. 145c. . . . The silent end.

National Park Service, U.S.A.

and the wizard of the formula will not be so foolish as to persevere in the plundering of this planet or to retreat before the marching deserts. He has accepted the challenge and there is no doubt as to who will win. When man stops exploiting the soil ruthlessly and learns to respect it as he would a living being and to treat it as carefully as he treats his cow or his dog, it will become again what the poets call it: Mother Earth.

Geology, a Stepping Stone

Mountain climbers who undertake such exploits as scaling giant peaks do not move up in a single uninterrupted climb. After reaching one level, they rest in preparation for the next stage of the ascent.

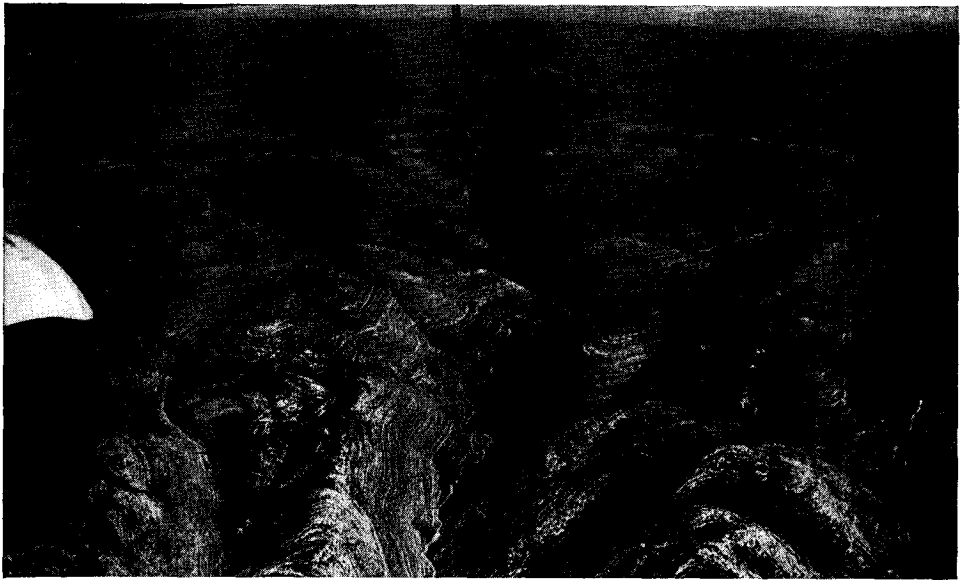

Fig. 146. EROSION

“. . . The whole land is made desolate, because no man layeth it to heart.”

The climber in the steep world of science must do the same. Before going to the next stage we pause and look back at the levels we have passed. We started from the depths of nothingness, space, which actually is not void, but an extension of the mysterious mass-energy. Creative in its essence, in a process not yet comprehended and perhaps forever beyond our grasp, it formed the basic components of all familiar things, such as electrons and mesons. It combined them into the nuclei of atoms and so began the ascending road of evolution from atom to molecule, from gas to dust, from cosmic cloud to star, and as stars began to whirl as galaxies—the universe was born.

In terms of the universe, the earth is but a mote of dust lit by the spark

of a lesser star. The tiny cinder, however, has its glory, too. Its story, written in the Stony Book of Earth, illustrated by the imprints of fossil plants and animals, is full of thrills. On the very first page we learned that man lives on a sphere spinning in space and that everything that is "on top" is at its antipode twelve hours later. We found that the *terra firma* on which we so confidently rely is a paper-thin shell covering a cauldron of seething magma, on which continents float like floes of ice on Arctic waters. The rocks we walk on are not unyielding, but, seen across the eons, plastic, and mountains rise and fall. The earth's crust lives just as the skin of man's body. Wounds open to form trenches which cut the continents and the floors of the seas—and heal. Their scars range over the earth as chains of mountains, such as the Urals and Himalayas. Along their rims volcanoes flare up while the earth trembles, and through clouds of smoke and the hail of ashes, lava pours out to



Fig. 147. REFORESTATION

"Instead of the thorn shall come up the fir tree and instead of the briar shall come up the myrtle."

cover the country where it lies dormant for millions of years. But slowly it is converted into fertile soil and so the stage is set for Life. Crystals start to move, viruses evolve into bacteria. Molds thrive on stones and mosses thrust their roots into the awakening soil. Plants sprout and plains are transformed into green fields and forests. Animals which wiggle through the water for millions of years develop at an exasperatingly slow pace, but eventually leave the swamps for dry land. Thus begins the story of more complex forms of life on earth from fish to dinosaur, from platypus to man.

In many respects the appearance of man is remarkable, but especially so in one less obvious respect—the awakening of intellectual reflection. Creative mass-energy, after billions of years of evolution, becomes in man's brain con-

scious of itself and of the wonder of the world. Philosophy and science are born and the riddle of the universe is pondered—at first through Oriental contemplation and the Bible's concept of universe and man, then through Greek philosophy, once more by the efforts of Newton to construct the "Frame of the System of the World," and latest by combining relativity and quantum mechanics, the cyclotron and the Palomar Mirror to devise our modern Design of the Universe.

INDEX

Page references in bold face refer to illustrations; those in light face to text.

INDEX

- absolute zero, 75
- Adams, John Couch, 233
- Adelsberg Grottoes, 324
- Adonis (asteroid), 222
- Aegean block, 298
- Aegean islands, 299
- aerolites, 241
- Africa, disintegrating, 299
- air, 303 ff.
 - circulation of, 309
 - circulation system of, 307
 - cold fronts, 311
 - humidity, 312
 - pressure, 320
- alchemy, 13
- Alpha Centauri, 132, 140, 188
- alpha particles, 90
- Alps, origin, 287
- alternating current, 74
- americium, 119
- Andes, 288
- Andromeda nebula, 153, 164 ff.
- Antilles, 299
- Anti-Medi-Him graben, 296
- anti-mesons, 93
- anti-protons, 93
- Appalachians, 289, 295
- Archimedes, 5
- argon, 67
- Aristarchus, 4, 134
- Aristotle, 6, 7, 15, 33
- Arrhenius, Svante, 86
- astatine, 64
- asteroids, 221 ff., 222, 223
 - Adonis, 224
 - Eros, 224
 - Hermes, 223
 - Hidalgo, 224
- astronomical calculation, 138
- astronomical camera, 137
- astronomical measurements, discrepancies,
 - 141, 142
- astronomy, 131 ff.
 - modern, 131 ff.
 - of tomorrow, 154
 - radio, 64, 151
- astrophysics, 174
- Atlantic Ocean floor, 328
- Atlantic Ocean, origin, 327
- atmosphere, 303 ff., 305
 - pressure unit, 91
 - temperature of, 304
 - upper, 304
- atom, 51 ff.
 - an electrical system, 92
 - as "solar system," 54
 - as vibrating energy cloud, 123, 125
 - bombardment, 102 ff., 103, 105
 - definition of Newton, 18
 - distances, 59
 - ionization, 54
 - main shell, 64
 - model, 37, 55, 64, 103, 123
 - modern concept of, 123
 - nucleus, 87 ff.
 - nucleus portrait, 88
 - numbers of, 54
 - orbit, 54, 63
 - shells, 63, 64
 - size, 54
 - stability, 63
 - subshells, 64
 - transformation, 99
 - wave concept, 125
- atomic
 - age, 119
 - bombs, 115
 - clock, 244
 - theory of Democritus, 4, 51
 - waves, 82
- atoms
 - number in drop, 54
 - number in earth, 54
 - number in human body, 54
 - number in universe, 54
- Azores, 328
- backwash islands, 300, 301
- Bacon, Francis, 291, 293
- Bacon, Roger, 7
- Balmer, Johann Jacob, 143
- Balmer's Ladder, 143

Barium, 114
 Barnard, E. E., 210
 basalt, 277
 Bay of Fundy, 333
 B elot, Emile, 208
 berkelium, 119
 Bernoulli, John, 12
 beryllium, 106
 Bessel, Friedrich Wilhelm, 139, 140, 142
 beta particles, 90
 Bethe, Hans, 176
 Bible, 7, 8, 10, 14, 287
 (erosion), 353
 Biela's comet, 237
 binding loss, 179
 Black Forest, 287
 Bode's law, 215
 bodies, 18, 29
 Bohr, Niels, 90
 bolometer, 149
 Bondi, Hermann, 173
 boron, 121
 boulders, 338
 Bouvard, Alexis, 233
 Brahma, 31 ff.
 British climate, 330
 Broglie, Prince of, 38
 Bruno, Giordano, 9, 35
 Buffon, George Louis, 208, 291

cadmium, 121
 calcium, 350
 calcium carbonate, 350
 calculus, 16, 18
 Caledonians, 289
 calendar, 245
 California, 353, 354
 earthquakes, 289
 geological, 289, 355
 Californian Current, 354
 californium, 119
 Cambrian, 273
 Canary Islands, 328
 canyon, 344, 345
 carbon calendar, 112
 carbon dioxide, 68, 350
 carbon monoxide, 237
 carbon, radioactive, 68
 Carboniferous Epoch, 273
 Carlsbad Caverns, 324
 Carus, Lucretius, 292
 Cassini division, 228
 Cassini, Giovanni Domenico, 228
 causality, law of, 19, 125
 caves, 324, 351
 center of gravity, 16

Central America, 298, 299
 centrifugal force, 243
 chalk, 280, 324
 Charybdis, 332
 chemical affinity, 66
 chemistry, 66 ff.
 Chile, 330
 Chile saltpeter, 330
 Chinese, 32
 chlorine, 68
 Christ (in the desert), 353
 Christina, Queen of Sweden, 35
Chronology of Ancient Kingdoms Amended,
 14
 circumference of globe, 4
 cirques, 335
 clay, 280
 climate
 arid, 335
 dry, 344
 equatorial, 308
 horse latitudes, 308
 humid, 335
 clouds, 312 ff., 313
 coal deposits, 295
 Coal Sacks, 158
 Colorado River, 343
 colors, 80
 Columbia Ice Shield, 335
 Columbus, Christopher, 309
 combustion, 67, 68
 comet, 235 ff., 236
 (Halley), 18, 19
 orbits of, 236
 speed of, 236
 computers, in astronomy, 155
 concepts, 16
 concrete, 280
 Confucius, 355
 conservation, soil, 356
 continental cores, theory of, 285, 289
 continental movements, 299
 continents, dismembered, 293
 Copernicus, 8, 18, 134
 corona, 180
 lines, 180
 corpuscle, 84
 cosmic dust, 168
 cosmic ice, 228, 256
 cosmic radiation, 93 ff., 94, 122
 cosmic space, hydrogen content, 153
 cosmic space, temperature of, 75, 154
 cosmogenies
 of the solar system, 207-212
 of the universe
 balanced universe, 173

cosmogenies of the universe (cont.)
 exploding universe, 167-171
 pulsating universe, 171-173
 Cretaceous Period, 324
 Cretaceous Sea, 324
 Cretaceous upheaval, 289
 critical mass, 119
 Curie, Marie, 54
 Curie, Pierre, 54
 curium, 54, 119
 current, alternating, 74, 75
 curvature of space, 21, 46, 171
 cyanogen, 237
 cyclones, 314 ff., **315**
 Atlantic, 319
 bad weather cyclones, 319
 cyclotron, 102
 Cygnus (Swan, constellation of), 153, 158

dark clouds in cosmos, 158
 dark masses in cosmos, 165
 Darwin, Charles, 199, 292
 Darwin, George H., 256, 327
 Davy, Humphry, 44
 day, astronomical, 245
 deltas, **343**
 Democritus, 4, 51, 52
 Descartes, René, 35, 36
 desert belt, **354**
 deserts, 353 ff.
 water content, 323
 deuterium, 99, 104
 deuterons, 99
 diffraction patterns, 81
 dimensions, 25
 Dirac, Paul Adrien, 169, 172
 Doppler effect, 145, **146**
 double star, **150**
 drifting continents, theory of, **287, 288**
 dust bowl, 355
 dust migration, 356
 dwarf star, 60
 dwarf vegetation, 351
 dynamite, 115
 dynamo, 75

$E = m \times c^2$, 39, 40, 72, 93, 97, 179
 earth, 243 ff.
 age, 266
 center, 268
 circumference, 4
 core of, 271
 crust of, 271
 density of, 270
 distance from sun, 244
 history, clock of, 265
 inclination of axis, 245
 interior of, 268
 irregular clock, 244
 mass, 268
 migration of axis, 248, 249, **291**
 orbit of, 244
 oscillation of axis, 248
 pole, 248
 pressure, 60
 radius, 142
 revolution around the sun, 245
 rotation, 244
 shape of, 142
 structure of, 265 ff.
 why a sphere?, 243
 earthquakes, 270, 286 ff.
 in the Bible, 287
 of Assam, 1951, 289
 of Baalbeck, 287
 of San Francisco, 289
 of Turkey, 286
 East African Rift, **285, 286, 300**
 eclipse, 251
 lunar, 252
 solar, 47, 251
 ecliptic, 215
 Eddington, Arthur, 171, 174, 208
 Egypt, 343, 345
 Einstein, Albert, 16, 20, 22, 25, 28, 34, 38,
 39, 41-48, 85, 87, 125, 126
 concept of the field, 42
 Einstein Effect, 41, 86
 Einstein tower, **147**
 electric field, 44
 electrical pole, 58
 electricity, 44, 56
 negative, 58
 electromagnetic waves, 34, 72 ff., 73, 74
 electron, 37, 41, 45, 56, **57, 124**
 as wave, **38, 124**
 charge, 58
 discovery of, 56
 in cosmic hydrogen, 153, 154
 inside atoms, 63
 jumps, 78, 80
 leaps, **78, 80**
 photograph, 58
 size, 58
 speed of, 56
 volt, 95
 vortex, 58
 weight, 58
 electron-microscope, 58

- elements, 63, 66 ff., 99
 - artificial, 54
 - Periodic Table, 68 ff.
 - symbols for, 63
 - transformation, 102
- Emden, 174
- empty space, 153
- Encke, Johann, 233
- energy, 38, 39, 40, 44, 45, 46
 - nuclear, 91
- English Channel, 332
- Ens Unum Eternum et Infinitum*, 31
- equator
 - bulge, 243
 - climate, 308
 - climatic, 292
 - migrations, 291
 - tide, 291, 329
- equinox, 245 ff.
- Eratosthenes, 4
- erosion, 346, 347, 348 ff.
 - gravity as cause, 348
 - in arid climates, 345
 - variation of temperature as cause, 349
 - water as cause, 350
 - wind as cause, 350
- erratic blocks, 338
- ether, 33 ff., 36, 42, 84
 - vortex, 35, 36
- Euclid, 4, 19, 20, 21
- Eudoxus, 4
- Euler, Leonhard, 248
- evaporation, 76
- Evening Star, 216
- exchange force, 91
- exosphere, 307
- exploding universe, 167 ff., 170

- Faraday, Michael, 34, 43, 44
- fat, 110
- fault, 284
- Fermi, Enrico, 93
- field, 42, 43, 125
 - electric, 44
 - gravitational, 43, 44
 - magnetic, 44
 - theory of gravitational, 44
- floating continents, theory of, 290 ff.
- folds, 283
- footprints, basis for geological reconstruction, 281
- force, 27
- formula for mass-energy, Einstein's, 39
- fourth dimension, 26
- Franklin, Benjamin, 58
- Fraunhofer, Joseph, 145, 179
- Fraunhofer gaps, 185, 191
- Fraunhofer lines, 185, 191
- Fresnel, Augustin Jean, 223
- fronts, atmospheric, 322

- galaxies, 164 ff.
 - distances, 165
 - evolution, 165
 - groups, 166
 - proto-galaxies, 169
 - recession, 166, 167
 - red shift, 166
 - shape of, 165
 - spiral, 164
 - theory of receding galaxies, 166
- galaxy (*see* Milky Way), 164 ff.
- Galileo, 9, 10, 24, 35, 125, 134, 225
- Galileo's laws, 43
- Galle, Johann, 233
- gamma rays, 82, 90
- Gamow, George, 169, 171
- gas, rare, 66, 67
- gaseous spheres, theory of, 174
- Gauss, Karl Friedrich, 221
- Geiger counter, 107, 112
- geology, 265 ff.
 - charts, 283
 - clock of, 265
 - epochs (*see* periods)
 - names, 273
 - periods, 273 ff., 276
 - timetable, 265, 276
- geometry, 21
- geosyncline, 285
- glacier, 335 ff., 336
- glacier valleys, 338
- Globigerinae, 324
- globular clusters, 161, 162
- Gockel, Albert, 93, 137
- Goethe, Johann Wolfgang von, 14, 31, 292, 299
- gold, 293
- Gold, Thomas, 173
- Gondwana, 295, 296 ff.
- graben, geological, 285 ff.
- granite, 277
- graphite, 121
- gravitation, 15, 16, 41, 42, 43, 46
 - law of, 15
- gravitational field, 43
- gravitons, 42
- gravity, 348
 - role in geology, 259
- Greenland, 290
- guano, 330
- Gulf Stream, 316, 318, 322, 330

Hahn, Otto, 114
 half-life of rad. act. atoms, 89, 107
 Halley, Edmund, 15, 18
 Halley's Comet, 237
 halogens, 68
 Hawaii, 326
 heat, 75 ff.
 Heaviside, Oliver, 306
 heavy substances, 59 ff.
 heavy water, 100
 as moderator, 121
 Hegel, Georg F. W., 140
 Heissenberg, Werner, 123
 helium
 in stars, 184
 in sun, 176 ff.
 nuclei, 95
 synthesis in sun, 97, 177
 helium-atom, 63, 66
 Hellenic science, 4
 Henderson, Thomas, 139
 Heraclitus, 348
 Herder, Gottfried, 292
 Herschel, Wilhelm, 134, 233
 Hertz, Heinrich, 84
 Hidalgo (asteroid), 222
 high, atmospheric, 322
 Himalayas, 300, 316
 Hindu philosophy, 31
 Holmes, Oliver Wendell, 228
 Hooke, Robert, 15, 17, 18
 horse latitudes, 308, 353
 Horse-head nebula, 134, 135
 hot springs, 323
 Hubble, Edwin Powell, 167
 Humboldt, Alexander von, 239
 Humboldt Current, 330
 hurricanes, 316
 Huxley, Aldous, 31
 Huygens, Christian, 33, 84
 Hyades, 47
 hydrogen, 63, 64
 bomb, 98
 in combustion, 68
 in cosmic space, 75, 152 ff., 168
 name, 63
 spectrum, 144
 hygrometer, 312

 ice, 335
 Ice Age, 250, 266, 338
 ice, cosmic, 228, 256
 indeterminability, principle of, 123
 India, 299, 300
 Indian Ocean, 316
 induction, 44

 inert gas, 66, 67
 inertia, 43
 interferometer, 33, 148
 interstellar matter, 168
 ionization, 76, 77, 78, 306
 ionosphere, 183, 239, 306 ff.
 influence on radio, 306
 ions, 76
 iron
 in comets, 241
 in core of earth, 271
 in corona of sun, 180
 in meteorites, 241
 origin, 208
 island universes, 167
 isostasy, 352
 isotopes, 98 ff., 100
 radioactive, 107, 108, 122

 Jeans, James, 124, 208
 Jefferson, Thomas, 239
 Jerusalem, 344
 jet streams, 309, 310
 Joliot-Curie, Frederic, 100, 106
 Jordan Valley, 286, 323
 Jupiter, 223 ff.
 comet-family of, 235
 influence on tides, 332
 interior pressure, 60
 moons of, 225

 Kant, Immanuel, 207
 Kant-Laplacian theory, 207
 karst, 351
 Kepler, Johann, 10, 18, 39, 221
 Kepler's formulas, 39
 keyboard of light, 79
 keyboard of radiation, 74, 79
 Krakatoa, 289, 299
 krypton, 67, 114

 Labrador Current, 318, 330
 Ladder of Balmer, 143
 Lamarck, T. B. P., 292
 Langley, S. P., 88
 Laplace, Pierre Simon, 46, 142, 207
 Lattes, Guilio, 92
 Laurasia, 296 ff., 297
 Laurentian Shield, 285
 Laurentians, 289
 lava, 277
 law of causality, 19
 law of gravitation, 15
 law of protons, 98
 Lawrence, Ernest, 102
 laws of Newton, 18

laws of the universe, 160
 Lebedev, Petr N., 86
 Leibniz, Gottfried Wilhelm, 12, 17, 18, 19
 Lemaitre, Abbé Georges, 168
 Lemonnier, Pierre, 232
 Leonids, 239
 Leukippus, 52
 Leverrier, Urbain, 45, 233
 Lick Observatory, 201
 light, 33 ff., 46, 78 ff., 84
 double nature of, 84 ff.
 keyboard of, 79
 rays, 46
 -second, 39, 132
 speed of, 39, 42, 46, 132
 waves, 72
 -year, 39
 lightning, 316
 lime, 324
 limestone, 351
 lines, parallel, 20
 straight, 20
 lithium, 63, 106
 Locke, John, 12, 17, 24
 Los Alamos, 120
 low, atmospheric, 320
 Lowell, Percival, 234

 macadam, 280
 macchia, 351
 Maelstrom, 332
 Magellanic clouds, 160 ff., 165
 magma, 271, 276 ff.
 magnetic field, 44
 magnetic storms, 183
 magnetism, 44
 Maori, 228
 maquis, 351
 Marius, Simeon, 225
 Mars, 218 ff., 219
 Maskelync, Nevil, 268
 mass, 38, 39, 40, 45, 46
 mass unit (MU), 97
 mass-energy, 38, 44
 Einstein's formula for, 39
 matter, 31 ff., 36, 76
 first dynamic concept of, 35 ff.
 reversed, 93
 waves, 37
 Matterhorn, 284
 maximum, atmospheric, 307, 322
 Maxwell, James Clerk, 44, 84
 Mayan, 355
 Meander River, 324
 medieval concept of matter, 33 ff.
 Mediterranean Sea, 297

 Megh Nad Saha, 149
 Mendeleev, Dimitri I., 66
 Mercury, 45, 46, 216
 transit of, 216
 meson, 92 ff.
 metalization, 271
 metals, 277
 meteor, 238 ff.
 meteorite, 239 ff., 240, 271
 crater in Arizona, 240, 241
 mass of, 240
 Meyer, Lothar, 66
 Michelson, Albert A., 33
 microcosm, 132
 Milankovitch, A., 249
 Milky Way, 135, 153 ff.
 aspect, 165
 center, 152, 159
 Coal Sacks, 158
 content, 158
 dark clouds, 152 ff.
 extension, 159
 position of earth in, 160
 radio emission, 152
 structure, 156 ff.
 minerals, 277
 minimum, atmospheric, 307, 320
 minor planets, 221 ff.
 mirror telescope, 13 ff., 134
 Mississippi River, 343
 Missouri River, 343
 moderators, 121
 monsoon, 316
 Mont Blanc, 335
 Mont St. Michel, 333
 moon, 249, 250 ff.
 course of, 253
 craters, 257
 definition of, 222
 distance from earth, 251
 eclipses, 252
 formula of motion, 17, 253
 future, 256
 influence on tides, 332
 mare, 210, 257
 mass of, 251, 256
 mountains on, 257
 origin, 253, 256, 327
 phases, 252
 radiation, 259
 surface, 211, 258
 visit to, 259
 world of, 253
 Morning Star, 216
 mortar, 280
 Moses, 355

motion, 22, 24, 43
 mountain range, 285
 mountains, 283 ff.
 Chimborasso, 285
 Everest, 289
 Fujiyama, 285
 Hermon, 352, 353
 Kilimanjaro, 285
 Krakatoa, 289
 Matterhorn, 284
 Moriah, 353
 Mount of the Sermon, 353
 Mt. Blanc, 335
 Nebo, 353
 Paricutin, 289
 Pelée, 289, 299
 Vesuvius, 297, 299
 Zugspitze, 289
 Mt. Wilson telescope, 138

 nebula
 Andromeda, 164 ff.
 Crab, 197
 Horsehead, 134, 135
 North America, 9, 158
 Orion, 158
 Ring nebula in Lyra, 197
 negative electricity, 58
 neon, 67
 Neptune, 229, 232, 233
 neptunium, 117
 Nereid, 234
 neutrino, 91, 95
 neutrons, 91, 104 ff.
 rule of, 98
 Newfoundland, 318 ff., 330
 Newton, Isaac, 8, 10, 11 ff., 22, 24, 25, 34, 36,
 40, 42, 46, 48, 54, 84, 86, 125, 126, 142,
 251, 332
 Newton's laws, 39
 Niagara Falls, 339
 nickel, in meteorites, 241
 in core of the earth, 270, 271
 Nile River, 343
 nitric acid, 351
 nitrogen, 351
 noble gases, 66
 North America, 298, 355
 North America nebula, 9, 158
 Northern Lights, 183
 nuclear
 bullet, 104
 energy, 91
 fission, 102 ff.
 liquid, 60
 reactions, 76, 77, 91
 reactor, 120
 nucleonics, 91
 nucleons, 90 ff.
 nucleus of atom, 90
 density of, 87, 102
 dimensions, 87
 portrait of, 88
 size of, 87
 structure, 87
 numbers in science, 52

 ocean currents, 316, 329 ff.
 oceans, 325 ff.
 origin of, 326
 Ohm's law, 39
 Ordovician, 273, 281
 ore, 277
 Orion nebula, 134, 135, 158
 oxydation, 68
 oxygen, 68
 ozone, 304

 Pacific Ocean
 basin, 326
 depression, 327
 extension surface, 325
 floor, 326, 327
 packing loss, 96
 Palestine, 286, 286, 287, 298, 323, 324, 344,
 352
 Palomar mirror, 13, 135, 138, 167
 Pan-Gaea, 293, 296
 parallax, 139
 Paricutin volcano, 289
 passats, 308
 peneplain, 339
Perennial Philosophy, The, 31
 perihelion of Mercury, 45
 Periodic Table, 65, 66 ff., 119
 Perseids (meteors), 239
 Peru Current, 330, 354
Philosophiae Naturalis Principia Mathe-
matica of Newton, 8, 18, 19
 Phobos (moon), 222, 226
 phosphorus, radioactive, 109
 photoelectricity, 85
 photon, 42, 85, 125
 Piazzi, Giuseppi, 221
 Pickering, Edward Charles, 291, 327
 pile, atomic, 120
 Pillars of Hercules, 290, 333
 Planck, Max, 84 ff.
 planetary system, 45, 46, 207 ff.
 planetesimals, 210, 211
 planets, 45
 distances between, 212

- planets (cont.)
 - minor, 221 ff.
 - movements of, 45, 215 ff.
 - orbits of, 215
 - plane of motion, 215
 - size, 175
 - trans-Neptunian, 234
- Plato, 355
- Pliny, 299
- Pluto, 229, 232, 234
- plutonic rocks, 277
- plutonium, 115 ff., 117, 119, 121
- Poe, Edgar Allan, 332
- polar night, 245
- polarization, 33
- pole, 248
 - migration of, 291, 292
- pollen-analysis, 282
- Pompeii, 299
- porcelain, 280
- positrons, 58, 93
- precession, 248
- principle of indeterminability, 123
- prism, 149
- probability, 89, 125
- promethium, 119
- protons, 90 ff.
- protoplanets, 210
- Psalms as canyon poetry, 347
- Ptolemy, 194
- pycnosis, 36 ff., 37
- pycnotic substance, 36
- Pyramid of Cheops, 290
- Pyrenees, 300
- Pythagoras, 4

- quantum, 42, 85
- quantum leap, 64, 78, 79
- quantum mechanics, 55, 64, 78, 126, 153

- radiation, 38, 39, 72 ff., 78, 84 ff.
 - cosmic, 93 ff., 94, 122
 - keyboard of, 74
 - pressure, 86, 176
- radio astronomy, 64, 151 ff.
- radio stars, 153
- radio telescope, 151
- radio waves, and ionosphere, 306
- radioactive battery, 122
- radioactive isotopes, 107, 108, 122
- radioactive phosphorus, 109
- radioactivity, 54, 89
- radio-carbon, 68, 112
- radio-cobalt, 110
- radium, 88
- radon, 67

- rain
 - artificial, 314
 - formation of, 312
 - in arid countries, 344
 - in different climates, 335
 - role in erosion, 351
- rain forests, 308
- rain routes, 316, 318
- rare gas, 66
- Red River, 343
- red shift, 86, 167 ff.
- reforestation, 356, 359
- relativity, 20 ff., 23, 45, 48
- resonance, 117, 145
- reversed matter, 93
- Rhine River, 342, 343
- Rhine Valley, 287
- Richet, 140
- rivers, origin of, 339
- rivers, rivaling, 342
- rivers, S-curves, 342
- Roche limit, 222, 224, 226, 256
- rock, 270 ff.
 - igneous, 277
 - metamorphic, 280
 - origin, 278
 - plutonic, 277
 - sedimentary, 280
- rocket, 155
- Rocky Mountains, 288
- Royal Society, London, 15, 48
- Rutherford, Ernest, 90, 102

- Sabine, Edward, 290
- Sabine Island, 290
- Sagittarius, 159
- Sahara Desert, 324
- Saint Augustine, 169
- salt, in sea water, 326
- salt, table, 66, 68
- salt-formers, 68
- salts, 68, 277
- Salzburg (rain), 320
- Samfrau-graben, 293, 295
- sand, 277, 351 ff., 355
- sandstone, 280
- satellites, definition, 222
- Saturn 224 ff., 227
 - moons of, 227
 - rings of, 227
 - temperature, 78
- Scheiner, J., 10
- Schiaparelli, Giovanni, 220
- Schmidt, Bernhardt, 137
- Schmidt camera, 137

Schopenhauer, A., 31
 Schrödinger, E., 38, 124, 125
 science
 Hellenic, 4
 in antiquity, 3
 in the Middle Ages, 7 ff.
 screes, 348
 Scylla, 290, 332
 seacows, 296
 seasons, 245, 249
 Secchi, P. A., 180
 sediment, 280, 348
 seismograph, 270
 Shakespeare, 54
 Shapley, Harlow, 161
 Shield, Canadian, 268
 Shield, Scandinavian, 268
 shooting stars, 238
 Sial, 327
 Sima, 327
 Simplon Tunnel, 270
 Sirius, companion of, 60, 140, 141
 Sirius, in Egyptian calendar, 148
 Sirius, motion, 140
 snow, 335
 sodium, 68
 -chloride, 68
 Sodom, 298
 and Gomorrah, 287
 soil
 desert, 323
 erosion, 348, 356
 loss in arid countries, 351
 restoration, 356, 358
 water content, 322
 solar eclipse, 47
 solar matter, 271
 solar radiation, 180
 solar system, 207 ff., 213, 214
 origin of, 209
 Bélot, theory, 208
 dust theory, 210 ff.
 Kant-Laplacian theory, 207
 Urey's theory, 211
 sound waves, 72
 South America, 298
 space, 18, 22, 27, 31, 34, 43, 44, 45
 curvature of, 21, 46, 171
 emptiness of, 153
 relation to mass, 172
 space-time-continuum, 26
 Spain, 299
 spectrogram, 143, 150
 spectrum, 41, 79, 143, 154, 179
 analysis, 143 ff.
 duplication, 150
 red shift, 147
 violet shift, 147
 speed of light, 39, 42, 46, 132
 Spinoza, B., 31, 44
 spinthariscopes, 89
 spiral galaxy, 164
 stalactites, 324
 stalagmites, 324
 stars, 184 ff.
 Aldebaran, 185, 188
 Alpha Centauri, 132, 140, 188
 Altair, 188
 Antares, 185
 Betelgeuse, 185
 blue giants, 164, 165
 blue supergiants, 161
 blue-white giants, 164
 Capella, 185, 188
 Cepheids, 201
 clusters, 161
 distances, 59, 140
 distribution in Milky Way, 201
 double, 189
 dwarf, 60
 Epsilon Aurigae, 185
 Eta Carinae, 194
 explosion, 60, 197, 204, *see also* super-
 nova
 fixed, 201
 giants, 164
 Hyades, 201
 luminosity, 138
 magnitude, 138
 motion, 159
 Pleiades, 201
 pressure, 60
 properties of, 184
 radio emission, 151 ff.
 red giants, 165
 Rigel, 185
 rotation, 147
 S. Doradus, 161
 Sirius, 188
 61 Cygni, 140
 size of, 186
 spectrum, 144
 Stella Polaris, 249
 temperature of, 144, 184
 yellow dwarfs, 165
 Zeta Aurigae, 190
 storm center of cyclone, 320
 Strait of Gibraltar, 290, 331
 Strait of Messina, 290, 331
 strata, geological, 280 ff., 284
 stratosphere, 304, 305

- strontium, 114
 Struve, F. G. Wilhelm, 139
 Suess, Eduard, 296
 sugar, 110
 sulphuric acid, 351
 sun, 45, 47, 174 ff.
 atmosphere, 179
 chromosphere, 180
 composition, 144
 corona, 78, 180
 distance, 174
 helium synthesis, 176 ff.
 influence on tides, 332
 mass, 176
 path, 251
 photosphere, 180
 prominences, 182
 radio emission, 151
 rotation, 174
 seen from planets, 230, 231
 size, 175
 surface, **181**
 temperature, 174 ff.
 tower, spectographic, 147, 148
 volume, 176
 sun-day, 174
 sunlight, 143
 sunspots, **181**, 182, 183
 and ionosphere, 306
 super-nova, 60, 196 ff.

 Table, Periodic, 66 ff., 119
 table salt, **66**, 68
 Tao, 31 ff., 35
 technetium, 119
 telescope, 134, 135, 141
 maximum range, 138
 mirror, 13, 15
 temperature, 75 ff.
 absolute, 75
 of atmosphere, 304 ff., **305**
 of cosmic space, 75
 of stars, 144
 of sun, 174 ff.
 of universe, 169
 tennis ball theory, **92**
 Tethys, 297
 Thales, 4, 134
 theory of
 floating continents, 290 ff.
 gaseous spheres, 174
 light, 84 ff.
 receding galaxies, **166**
 universal field, 126
 thermo-nuclear reaction, 98

 thunder, 316
 thunderheads, 314
 thunderstorm, **315**, **317**
 tides, 332 ff.
 time, 18, 25, 31, 40, 45
 Titius, 215
Tomaculum problematicum, 281
 topsoil, 351
 tornadoes, 316
 tracer-atoms, 109
 trade winds, 308, 309
 transmitter of electromagnetic waves, 74
 triangulation, **139**
 Triton (asteroid), 234
 Trojans, **222**, 223
 troposphere, 304
 typhoons, 316

 "undulation theory," of light, 33, 84
 Ungava Crater Lake, 241
 universal field theory, 126
 universe
 age of, 242
 balanced, 173
 composition of, 144
 diameter of, 167
 exploding, 167 ff.
 laws of, 160
 mass of, 169
 pulsating, 171
 temperature of, 169
 universes, island, 167
Upanishads, 31
 uranium, 63, 111 ff., 266
 as geological clock, 111
 fission, 112 ff., **113**
 in meteorites, 242
 isotope-separation, 116
 reactor, **120**
 transformation into plutonium, **115**
 Uranus, 229, 232
 Urey, Harold, 210, 211
 Ussher of Arlet, 8

 valleys, glacier, 338
 valleys, types of, 339
 Van de Hulst, H. C., 152
 Van der Waals, 91
 Vega, 250
 Venus, 216
 transit of, 216
 Vesuvius, 299
 violet catastrophe, 84-85
 Vogt, J. G., 36, 38
 volcanoes, 284 ff., 297, 300
 as source of sea salts, 326

volcanoes (cont.)
 distribution, 327
 undersea, 326
 vortex, 35, 56
 Vosges, 287

 water, 60
 as tracer, 107
 chemistry, 68
 compressibility, 60
 content in organic substances, 322
 covering globe, 325
 end product of combustion, 67
 heavy, 100, 121
 in metabolism, 110
 landscaping, 338
 precipitation, 335
 role in destruction of mountains, 350, 351
 role in nature, 76
 role in universe, 228
 stages of, 76
 subsoil, 322
 subsoil distribution, 323
 tables, 323
 vapor, 303
 waterfalls, 337, 338, 339
 wave theory of matter, 36
 waves, 29, 34, 42, 72, 72 ff., 83
 electromagnetic, 74
 energy of, 73
 frequencies, 73, 74
 weather, 304
 in arid regions, 312
 in England, 312
 in France, 312
 map, 320 ff., 321
 routes, 322
 weathering, 351
 Weber, A. C., 282
 week (astronomical), 245
 Wegener, Alfred, 290 ff.
 Weizsäcker, C. F. von, 176, 210
Welt-Eis-Lehre, 228, 256
 whirlwinds, 316
 Whitehead, Alfred North, 30, 48
 Widmannstätten figures, 241
 Wilson chamber, 58, 59, 238
 wind
 jet streams, 309, 310
 on weather maps, 320
 role in erosion, 350
 Wollaston, 179
 world-ether, 33 ff.
 world-ice hypothesis, 228, 256
 Wren, 15

 xenon (rare gas), 67, 114
 x-rays, 81 ff., 82

 year (astronomical), 245
 Yukawa, Hideki, 91

 zero, absolute, 75
 zero (mathematical value), 52 ff.
 Zodiac Light, 159
 Zugspitze, change in height, 289