

PRACTICAL HPLC METHOD DEVELOPMENT

SECOND EDITION



Lloyd R. Snyder • Joseph J. Kirkland • Joseph L. Glajch

1

GETTING STARTED

- 1.1 Introduction
- 1.2 What is Known Before Starting
 - 1.2.1 Nature of the Sample
 - 1.2.2 Separation Goals
- 1.3 Sample Pretreatment and Detection
- 1.4 Developing the Separation
 - 1.4.1 Selecting an HPLC Method and Initial Conditions
 - 1.4.2 Getting Started on Method Development
 - 1.4.3 Improving the Separation
 - 1.4.4 Repeatable Separation
- 1.5 Completing the HPLC Method
 - 1.5.1 Quantitation and Method Validation
 - 1.5.2 Checking for Problems
 - 1.5.3 Method Ruggedness

1.1 INTRODUCTION

Every day many chromatographers face the need to develop a high-performance liquid chromatography (HPLC) separation. Whereas individual approaches may exhibit considerable diversity, method development often follows the series of steps summarized in Fig. 1.1. In this chapter we review the importance of each of these steps, in preparation for a more detailed examination in following chapters.

Our philosophy of method development is based on several considerations. There exists today a good practical understanding of chromatographic separation and how it varies with the sample and with experimental conditions. Any systematic approach to HPLC method development should be based on this knowledge of the chromatographic process. In most cases, a desired separation can be achieved easily with only a few experiments. In other cases, a considerable amount of experimentation may be needed. A good method-development

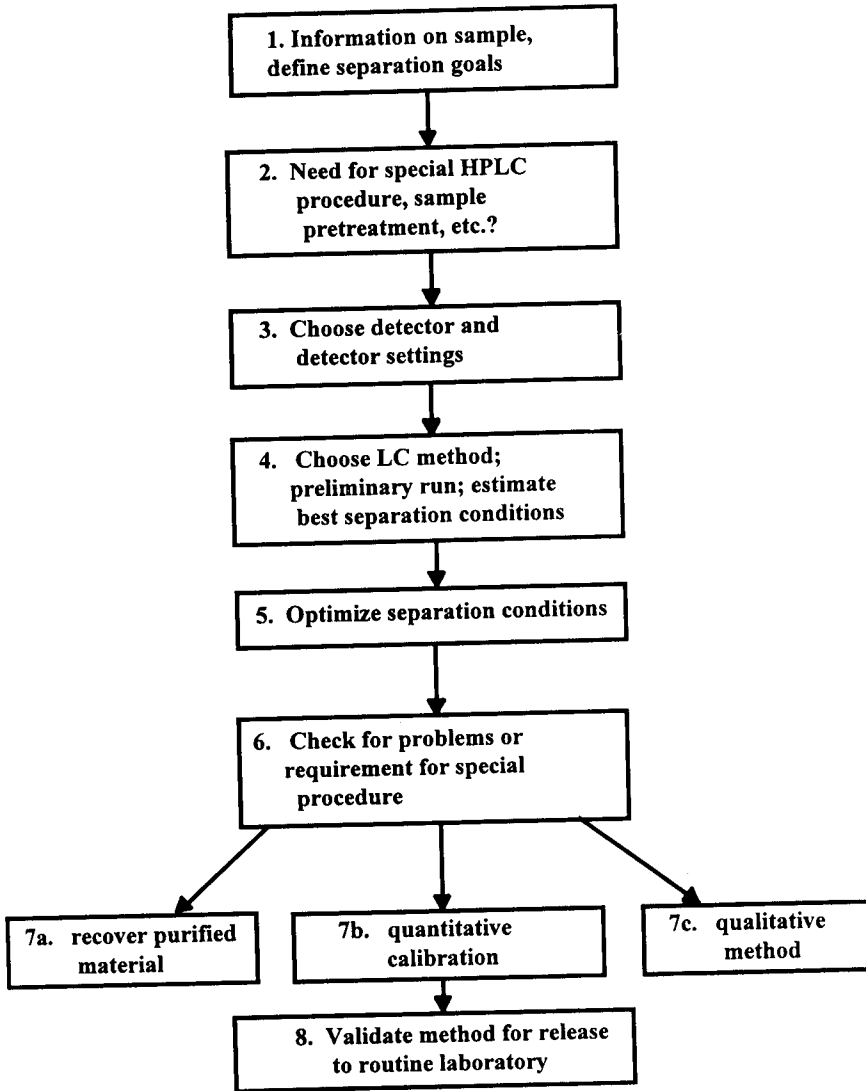

FIGURE 1.1 Steps in HPLC method development.

strategy should require only as many experimental runs as are necessary to achieve the desired final result.

Ideally, every experiment will contribute to the end result so that there are no wasted runs. Usually, this requires that the results of each chromatographic run be assessed before proceeding with the next experiment. Sometimes the chemical structures of the sample components are known, other times this is not the case. The method-development scheme described in this book will usually work in either situation. Finally, method development should

be as simple as possible, yet it should allow the use of sophisticated tools such as computer modeling (Chapter 10) if these are available.

1.2 WHAT IS KNOWN BEFORE STARTING

1.2.1 Nature of the Sample

Before beginning method development, we need to review what is known about the sample. The goals of the separation should also be defined at this point. The kinds of sample-related information that can be important are summarized in Table 1.1. Ideally, a complete description of the sample is available; for example, an antihistamine tablet contains the active ingredient and various water-soluble excipients. The goal of HPLC separation in this case might be an assay of antihistamine content, so the primary interest is in the properties of the antihistamine that will affect its HPLC separation. Another situation might require analyzing a raw material for its major component and any contaminants. An example is provided by Fig. 1.2, which shows possible components of crude samples of the pharmaceutical product pafenolol (compound 6). In this case the chemical structures of possible contaminants can be inferred from the synthetic route used to prepare pafenolol, together with known side reactions leading to by-products. A total of six compounds can be expected in pafenolol (compound 3 can be ruled out because of its instability).

The chemical composition of the sample can provide valuable clues for the best choice of initial conditions for an HPLC separation. Depending on the use made of this sample information, two somewhat different approaches to HPLC method development are possible. Some chromatographers try to match the “chemistry” of the sample to a best choice of initial HPLC conditions. To do this, they rely heavily on their own past experience (i.e., separation of compounds of similar structure) and/or they supplement this information with data from the literature. Other workers proceed directly to an initial chromatographic separation, paying little attention to the nature of the sample. These two kinds of HPLC method development might be characterized as

TABLE 1.1 Important Information Concerning Sample Composition and Properties

Number of compounds present
Chemical structures (functionality) of compounds
Molecular weights of compounds
pK_a values of compounds
UV spectra of compounds
Concentration range of compounds in samples of interest
Sample solubility

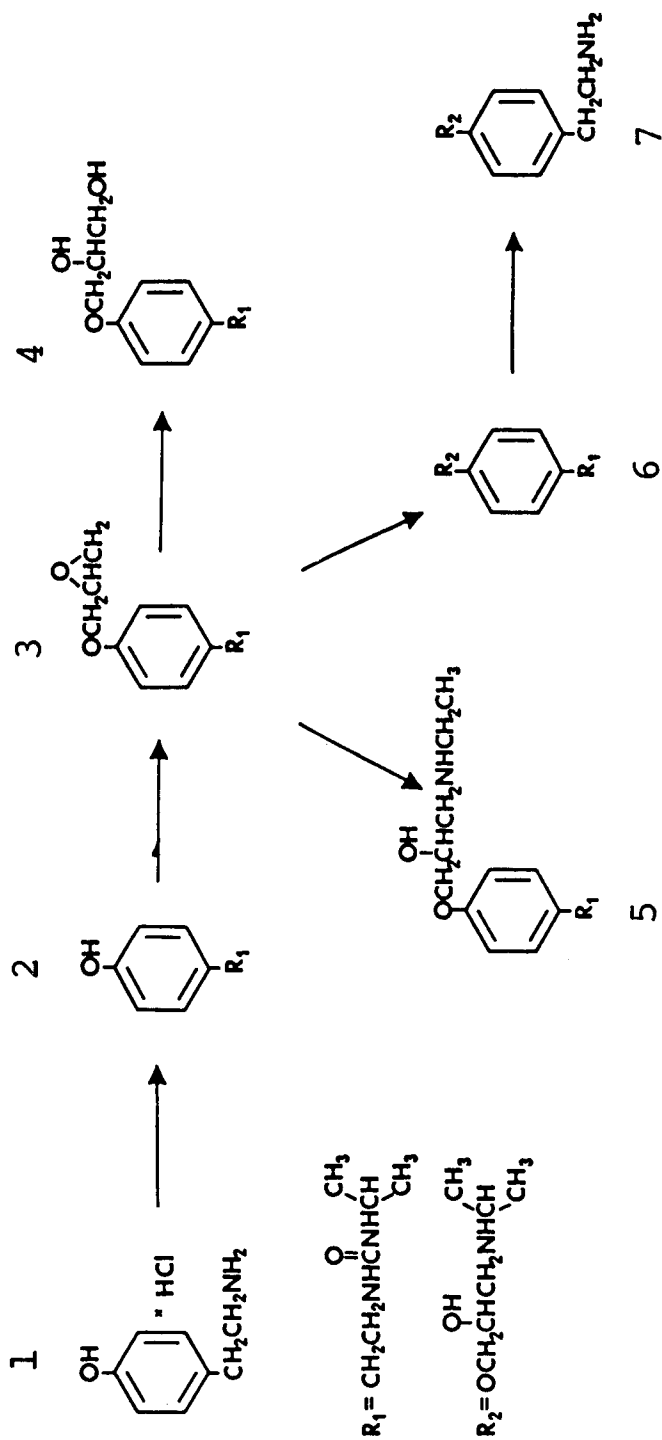

FIGURE 1.2 Compounds present in crude samples of pafenolol. (Reprinted with permission from Ref. 1.)

theoretical vs. empirical. Once an initial separation has been carried out, the choice of ensuing experiments can be made on the basis of similar considerations (theoretical vs. empirical).

Either a theoretical or an empirical approach to HPLC method development can be successful, and a “best” strategy is often some blend of these two procedures. In this book we emphasize empirical procedures in combination with techniques for minimizing the number of required experimental runs. However, theoretical considerations and the chemical composition of the sample are not ignored. It should also be kept in mind that the composition of many samples is not fully known at the beginning of HPLC method development (e.g., samples containing impurities, degradation products, metabolites, etc.). In these cases an empirical approach may be the only option.

1.2.2 Separation Goals

The goals of HPLC separation need to be specified clearly. Some related questions that should be asked at the beginning of method development include:

- *Is the primary goal quantitative analysis, the detection of an (undesired) substance, the characterization of unknown sample components, or the isolation of purified material?* The use of HPLC to isolate purified sample components for spectral identification or other purposes is discussed in Chapter 13.
- *Is it necessary to resolve all sample components?* For example, it may be necessary to separate all degradants or impurities from a product for reliable content assay, but it may not be necessary to separate these degradants or impurities from each other. When the complete separation of a sample by means of a single HPLC run proves difficult, the separation of a smaller subset of sample components is usually much easier.
- *If quantitative analysis is requested, what levels of accuracy and precision are required?* A precision of ± 1 to 2% for major components of a sample is usually achievable, especially if sample pretreatment is not required. Means for improving assay precision are discussed in Chapter 14.
- *For how many different sample matrices should the method be designed?* A particular compound may be present in different sample types (e.g., a raw material, one or more formulations, an environmental sample, etc.). Will more than one HPLC procedure be necessary? Is a single (or similar) procedure for all samples desirable?
- *How many samples will be analyzed at one time?* When a large number of samples must be processed at the same time, run time becomes more important. Sometimes it is desirable to trade a decrease in sample resolution for a shorter run time [e.g., by shortening the column or increasing flow rate (Section 2.3.3.1)]. When the number of samples for analysis at

one time is greater than 10, a run time of less than 20 min often will be important.

- *What HPLC equipment and operator skills are present in the laboratory that will use the final method? Can the column be thermostated, and is an HPLC system for gradient elution available? Will the method be run on equipment of different design and manufacture [especially older models with increased extracolumn band broadening (Section 2.3.3.3)]? What HPLC experience and academic training do the operators have?*

Agreement on what is required of the method should be obtained before method development begins.

1.3 SAMPLE PRETREATMENT AND DETECTION

Samples come in various forms:

- Solutions ready for injection
- Solutions that require dilution, buffering, addition of an internal standard, or other volumetric manipulation
- Solids that must first be dissolved or extracted
- Samples that require sample pretreatment to remove interferences and/or protect the column or equipment from damage

Direct injection of the sample is preferred for its convenience and greater precision. However, most samples for HPLC analysis require weighing and/or volumetric dilution before injection. Best results are often obtained when the composition of the sample solvent is close to that of the mobile phase, since this minimizes baseline upset and other problems.

Some samples require a partial separation (pretreatment) prior to HPLC, because of a need to remove interferences, concentrate sample analytes, or eliminate “column killers.” This means that it is important to know the nature of the sample matrix and the probable concentrations of various analytes. In many cases the development of an adequate sample pretreatment procedure can be more challenging than achieving a good HPLC separation. Sample pretreatment is discussed in Chapter 4.

Before the first sample is injected during HPLC method development, we must be reasonably sure that the detector selected will sense all sample components of interest. Variable-wavelength ultraviolet (UV) detectors normally are the first choice, because of their convenience and applicability for most samples. For this reason, information on the UV spectra can be an important aid for method development. UV spectra can be found in the literature, estimated from the chemical structures of sample components of interest, measured directly (if the pure compounds are available), or obtained

during HPLC separation by means of a photodiode-array (PDA) detector. When the UV response of the sample is inadequate, other detectors are available (fluorescence, electrochemical, etc.), or the sample can be derivatized for enhanced detection. In Chapter 3 we discuss sample detection and related aspects in detail.

1.4 DEVELOPING THE SEPARATION

1.4.1 Selecting an HPLC Method and Initial Conditions

Figure 1.3 outlines the strategy recommended for choosing the experimental conditions for the first separation. Based on a knowledge of sample composition and the goals of separation, the first question is: Which chromatographic method is most promising for this particular sample? In this book we assume that HPLC has been chosen, but this decision should not be made before considering the alternatives. For information on other chromatographic procedures, see Refs. 2 to 8.

If HPLC is chosen for the separation, the next step (Fig. 1.3) is to classify the sample as *regular* or *special*. We define *regular samples* as typical mixtures of small molecules (<2000 Da) that can be separated using more-or-less standardized starting conditions. Exceptions or *special samples* are usually better separated with a different column and customized conditions, as summarized in Table 1.2. The separation of inorganic ions and synthetic polymers is not discussed in this book; for these topics see Refs. 8 and 9, respectively.

Regular samples can be further classified as *neutral* or *ionic*. Samples classified as *ionic* include acids, bases, amphoteric compounds, and organic salts (ionized strong acids or bases). Table 1.3 summarizes the appropriate experimental conditions for the initial (reversed-phase) separation of regular samples. If the sample is *neutral*, buffers or additives are generally not required in the mobile phase. Acids or bases usually require the addition of a buffer to the mobile phase. For basic or cationic samples, "less acidic" reversed-phase columns (Section 5.2) are recommended, and amine additives for the mobile phase may be beneficial. Using these conditions, the first exploratory run is carried out and then improved systematically as discussed below.

On the basis of the initial exploratory run of Fig. 1.3, isocratic or gradient elution can be selected as most suitable (Section 8.2.2). At this point it may also be apparent that typical reversed-phase conditions provide insufficient sample retention, suggesting the use of either ion-pair (Section 7.4) or normal-phase (Part II of Chapter 6) HPLC. Alternatively, the sample may be strongly retained with 100% acetonitrile as mobile phase, suggesting the use of non-aqueous reversed-phase (NARP) chromatography or normal-phase HPLC (Sections 6.6 to 6.8). Some characteristics of reversed-phase and other HPLC methods are summarized in Table 1.4 and are discussed further in Chapters 6, 7, and 11.

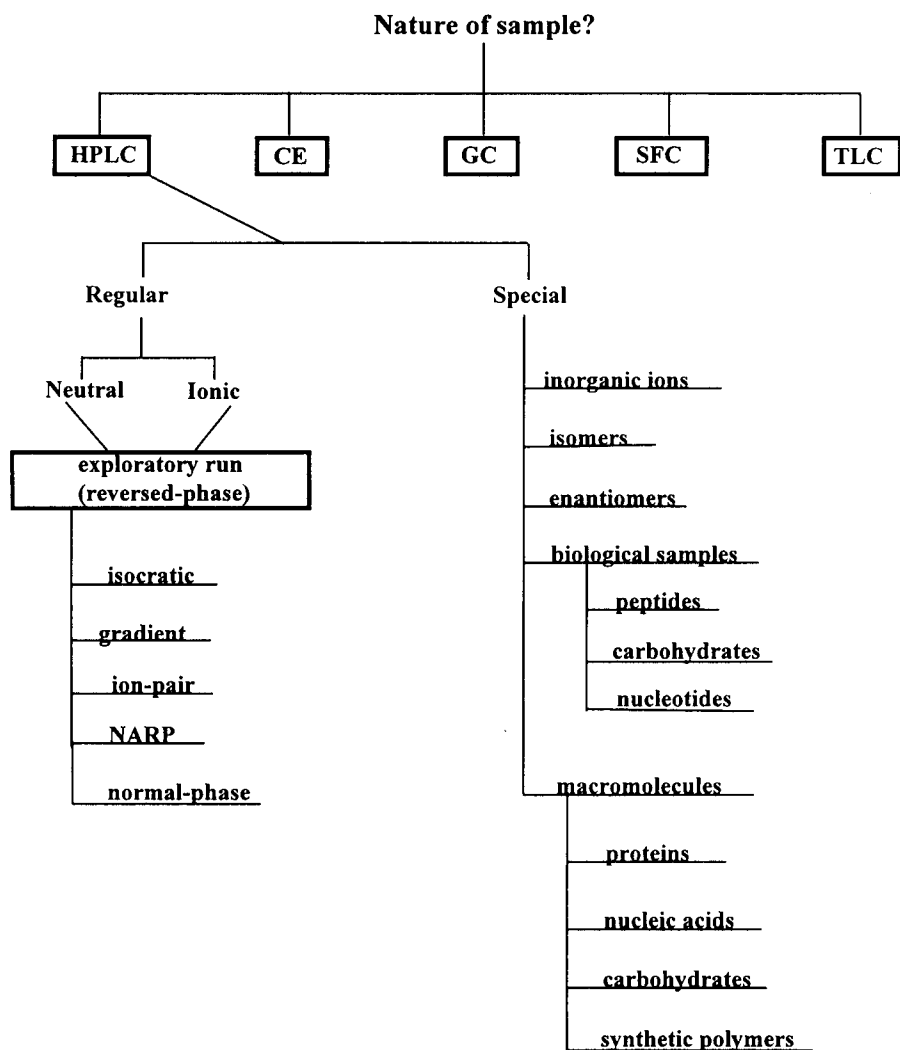

FIGURE 1.3 Using information about the sample to select conditions for the initial experimental separation.

When the goal of separation is the isolation of purified material, an optimized final HPLC method will differ from one developed for routine quantitative analysis. However, the beginning of method development proceeds in exactly the same way for both cases [e.g., use of a standard-diameter (0.4 to 0.5-cm-ID) column and the other conditions of Table 1.3]. This approach is discussed in detail in Chapter 13.

TABLE 1.2 Handling of Special Samples

Sample	Requirements
Inorganic ions	Detection is primary problem; use ion chromatography [9].
Isomers	Some isomers can be separated by reversed-phase HPLC and are then classified as regular samples; better separations of isomers are obtainable using either (1) normal-phase HPLC or (2) reversed-phase separations with cyclodextrin-silica columns (Chapter 6).
Enantiomers	These compounds require "chiral" conditions for their separation; see Chapter 12.
Biological	Several factors make samples of this kind "special": molecular conformation, polar functionality, and a wide range of hydrophobicity; see Chapter 11.
Macromolecules	"Big" molecules require column packings with large pores (>>10-nm diameters); in addition, biological molecules (Chapter 11) require special conditions as noted above.

TABLE 1.3 Preferred Experimental Conditions for the Initial HPLC Separation

Separation Variable	Preferred Initial Choice
Column	
Dimensions (length, ID)	15 × 0.46 cm
Particle size	5 μm ^a
Stationary phase	C ₈ or C ₁₈
Mobile phase	
Solvents A and B	Buffer-acetonitrile
% B	80–100% ^b
Buffer (compound, pH, concentration)	25 mM potassium phosphate, 2.0 < pH < 3.0 ^c
Additives (e.g., amine modifiers, ion-pair reagents)	Do not use initially ^d
Flow rate	1.5–2.0 mL/min
Temperature	35–45°C
Sample Size	
Volume ^e	< 25 μL
Weight ^e	< 100 μg

^a 3.5-μm particles are an alternative (Chapter 5), using a 7.5-cm column.

^b For an initial isocratic run; an initial gradient run is preferred (Section 8.2.2).

^c No buffer required for neutral samples; for pH < 2.5, pH-stable columns are recommended (Section 5.4.3.5).

^d Section 9.1.1.3.

^e Smaller values required for smaller-volume columns (e.g., 7.5 × 0.46-cm, 3.5-μm column).

TABLE 1.4 Characteristics of Primary HPLC Methods

Method/Description/Columns ^a	When Is the Method Preferred?
Reversed-phase HPLC Uses water–organic mobile phase Columns: C ₁₈ (ODS), C ₈ , phenyl, trimethylsilyl (TMS), cyano	First choice for most samples, especially neutral or nonionized compounds that dissolve in water–organic mixtures
Ion-pair HPLC Uses water–organic mobile phase, a buffer to control pH, and an ion-pair reagent Columns: C ₁₈ , C ₈ , cyano	Acceptable choice for ionic or ionizable compounds, especially bases or cations
Normal-phase HPLC Uses mixtures of organic solvents as mobile phase Columns: cyano, diol, amino, silica	Good second choice when reversed-phase or ion-pair HPLC is ineffective; first choice for lipophilic samples that do not dissolve well in water–organic mixtures; first choice for mixtures of isomers and for preparative-scale HPLC (silica best)

^a All columns (except unbonded silica) recommended here are packed with bonded-phase silica particles (see Chapter 5). This list is representative but not exhaustive.

1.4.2 Getting Started on Method Development

Here and elsewhere we assume that the sample is regular (not special, as in Table 1.2), unless noted otherwise. Although the initial and final conditions required for special samples will differ from those listed in Table 1.3 for regular samples, the general strategy and approach to method development is similar for both regular and special samples. Our discussion of the separation of regular samples will therefore prove applicable in many respects to method development for special samples.

With the initial conditions of Table 1.3, the only remaining decision before the first sample injection is the percent organic in the mobile phase (% B). One approach is to use an isocratic mobile phase of some average solvent strength (e.g., 50% B). This is illustrated for the separation of a mixture of triazine herbicides in Fig. 1.4*a* (the separations of Fig. 1.4 are computer simulations based on experimental HPLC data [11,12]). Three well-separated peaks are shown in Fig. 1.4*a*. However, this sample contains a total of six components; with this mobile phase, the last three bands elute at 2 to 4 hr as broad, barely visible peaks. So, it would be easy to conclude (erroneously) from this run that there are only three components in this sample or that some of these six compounds coelute in Fig. 1.4*a*.

Because of the problem illustrated by Fig. 1.4*a*, it is usually *not* recommended to begin method development with an intermediate-strength mobile phase (as in Fig. 1.4*a*). A better alternative is to use a very strong mobile phase first (e.g., 80 to 100% B), then reduce % B as necessary. This approach

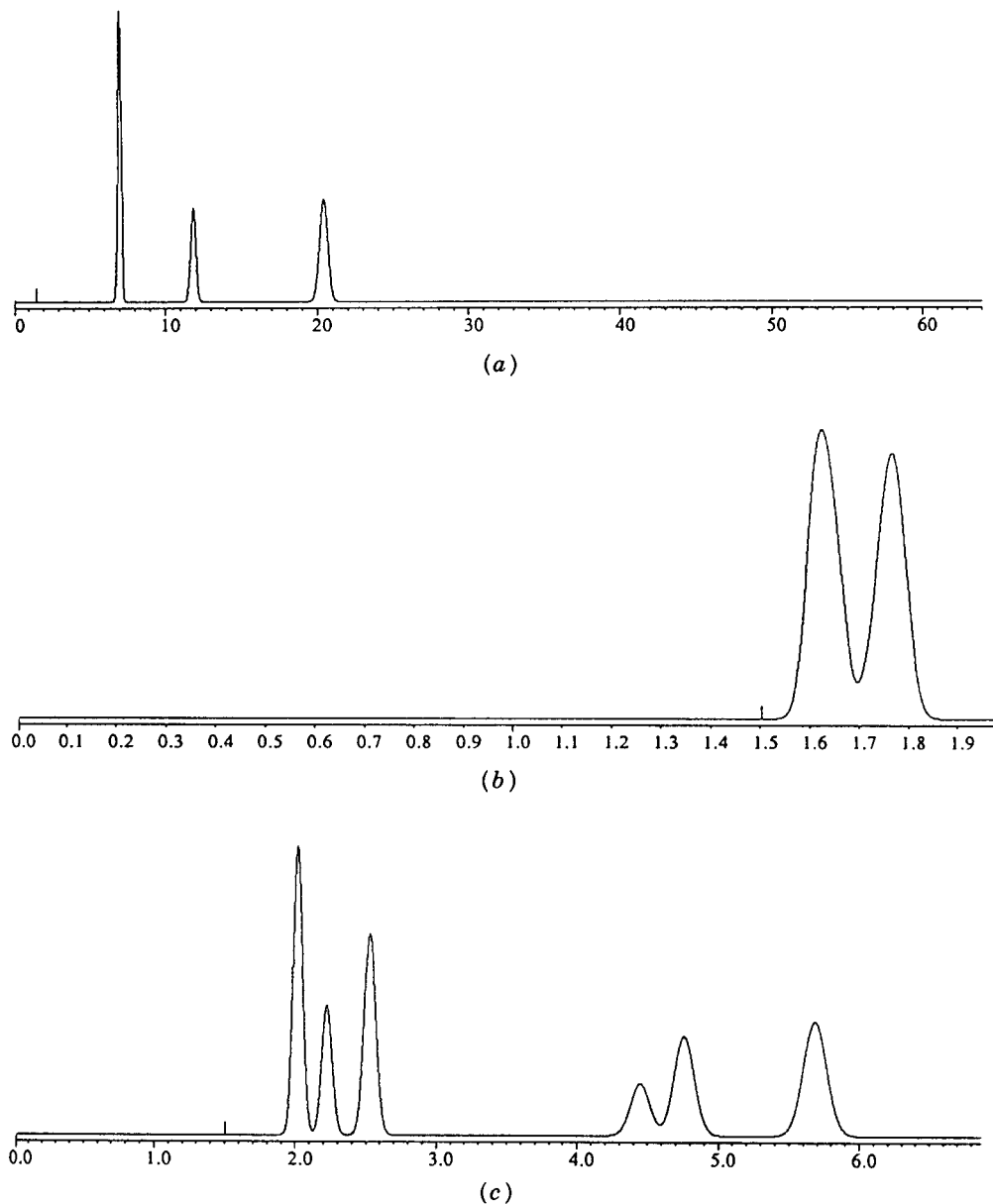
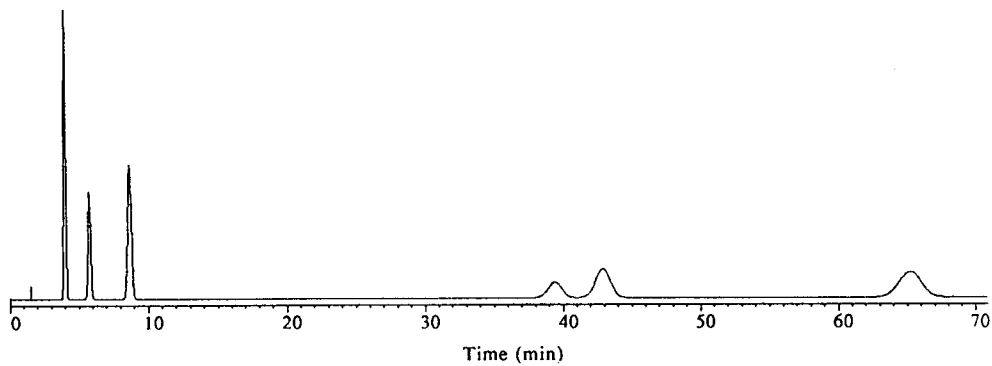
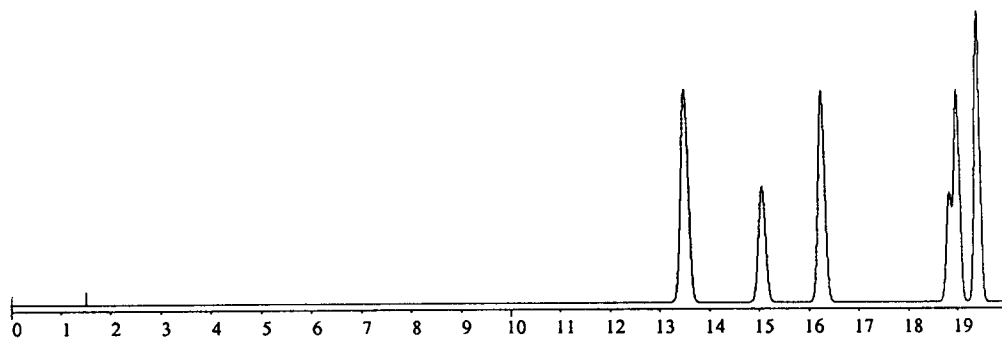

FIGURE 1.4 Separation of a mixture of triazine herbicides as a function of mobile-phase conditions. Conditions: 25×0.46 -cm C_{18} column; methanol-water mobile phase; ambient temperature; 1.7 mL/min. (a) 50% B; (b) 100% B; (c) 80% B; (d) 60% B; (e) gradient 5–100% B in 20 min; (f) 70% B (isocratic). (Computer simulations as in Refs. 11 and 12, based on the experimental data of Ref. 10.)



(d)



(e)

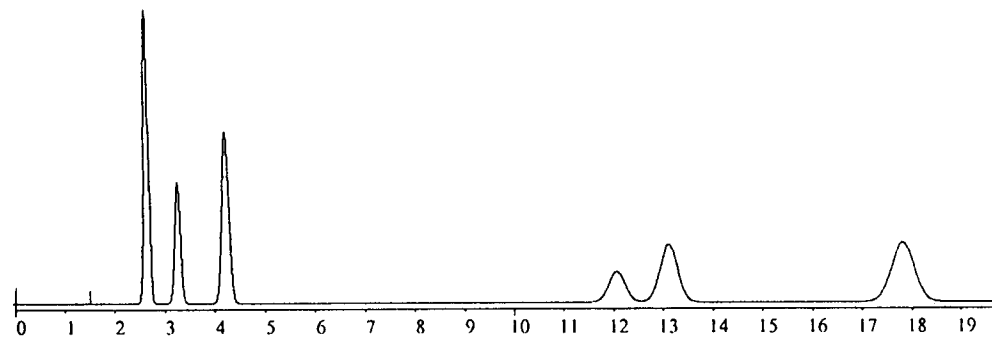

(f)

FIGURE 1.4 (Continued)

is illustrated in Fig. 1.4*b–d*. The initial separation with 100% B (Fig. 1.4*b*) results in rapid elution of the entire sample, but only two band groups are separated. Decreasing solvent strength to 80% B (Fig. 1.4*c*) shows the rapid separation of all six bands. A further decrease to 60% B (Fig. 1.4*d*) provides improved resolution but a much longer run time, with a broadening of later bands and reduced detection sensitivity.

An alternative to initial isocratic separation is the use of gradient elution, as in the separation of Fig. 1.4*e*. There are several advantages to an initial gradient run, as discussed in Section 8.2.2. For example, it is possible from such a run to (1) determine whether isocratic or gradient elution is the best approach, and (2) estimate the best solvent strength for the next trial (isocratic) separation. An initial gradient separation is also advantageous for method development since it provides generally better resolution of the sample than will be obtained by isocratic separation with a strong solvent (cf. Fig. 1.4*b* vs. Fig. 1.4*e*).

1.4.3 Improving the Separation

The separation achieved in the first one or two runs usually will be less than adequate. After a few additional tries, it may be tempting to accept a marginal separation, especially if no further improvement is observed. However, experienced workers realize that a good separation requires more than minimal resolution of the individual sample bands, particularly for a routine procedure used to analyze a number of samples. Specifically, the experienced chromatographer will consider several aspects of the separation, as summarized in Table 1.5.

Separation or resolution (Section 2.2) is a primary requirement in quantitative HPLC analysis. Usually, for samples containing five or fewer components, baseline resolution ($R_s > 1.5$) can be obtained easily for the bands of interest. This level of resolution favors maximum precision in reported results. Resolu-

TABLE 1.5 Separation Goals in HPLC Method Development

Goal ^a	Comment
Resolution	Precise and rugged quantitative analysis requires that R_s be greater than 1.5.
Separation time	<5–10 min is desirable for routine procedures.
Quantitation	≤2% (1 SD) for assays; ≤5% for less-demanding analyses; ≤15% for trace analyses.
Pressure	<150 bar is desirable, <200 bar is usually essential (new column assumed).
Peak height	Narrow peaks are desirable for large signal/noise ratios.
Solvent consumption	Minimum mobile-phase use per run is desirable.

^a Roughly in order of decreasing importance but may vary with analysis requirements.

tion usually degrades during the life of the column and can vary from day to day with minor fluctuations in separation conditions. Therefore, values of $R_s = 2$ or greater should be the goal during method development for simple mixtures. Such resolution will favor both improved assay precision and greater method ruggedness. Samples containing 10 or more components will be more difficult to separate, and here the separation goal often must be relaxed to $R_s > 1.0$ to 1.5.

Some HPLC assays do *not* require baseline separation of the compounds of interest. This is most often the case when any of several compounds might be present, but only one compound is likely to be expected in a given sample. This might be the case when screening a water or soil sample for the possible presence of some contaminant (e.g., qualitative analysis for different herbicides). In such cases only enough separation of individual herbicides is required to provide characteristic retention times for peak identification. Another example is provided by phenylthiohydantoin (PTH)-amino acid samples obtained during the sequencing of a protein. Each sample corresponds to the removal of a single amino acid from the protein molecule, and it is required to identify that amino acid (as the PTH derivative). Therefore, it is not necessary to achieve baseline separation of individual PTH-amino acids from each other, since all that is required is enough difference in retention times to identify the particular compound. This is illustrated in the separation of Fig. 1.5*a* for such an assay procedure. Several band pairs in this chromatogram are not baseline resolved, but this does not interfere with the accurate identification of each PTH-amino acid.

The time required for a separation (run time \approx retention time for last band) should be as short as possible. This assumes that the other goals of Table 1.5 have been achieved, and the total time spent on method development is reasonable. The run-time goal should be compared with the 2-h setup time typically required for an HPLC procedure (i.e., mobile phase prepared, column installed and equilibrated, stable baseline achieved, replicate standards injected to confirm precision, reproducible retention, and acceptable separation). Thus if only two or three samples are to be assayed at one time, a run time of 20-30 min is not excessive. When lots of 10 or more samples are to

FIGURE 1.5 Improving method ruggedness by mapping separation as a function of various conditions. Sample: PTH amino acids. Conditions: 25 \times 0.46-cm Zorbax PTH column; mobile phase is 34% B, where A is 6 mM phosphate buffer, pH 3.15, and B is 53% acetonitrile-THF; 35°C; 1.4 mL/min. Identification of bands (W, L, F, . . .) is usual terminology for amino acids (Fig. 11.2). (a) Separation of total sample; (b) effect of buffer concentration on separation of band pairs H/Y and M/R; (c) effect of acetonitrile-THF ratio on separation of band pairs Y/P/V and F/L; (d) effect of pH on separation of band pairs T/D/G. (Reprinted with permission from DuPont Zorbax PTH Column *User's Guide*.)

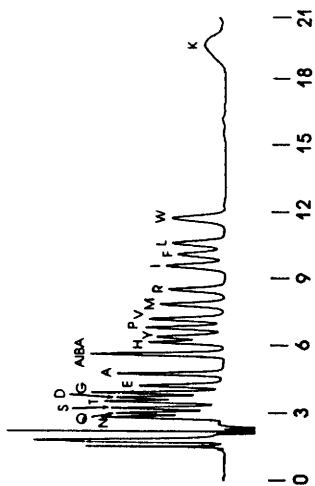

(a)

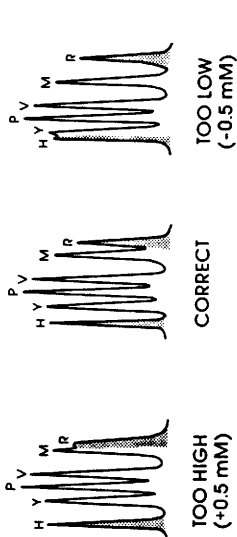

(b)

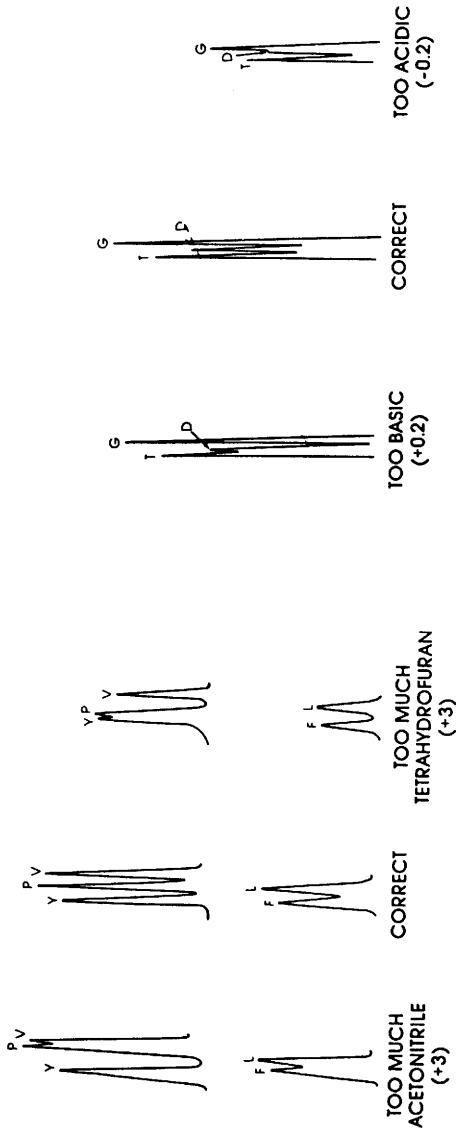

(c)

(d)

be assayed, run times of 5 to 10 min are desirable. There is rarely any reason to seek run times of a minute or less, although fast separations are not detrimental. One exception is on-line monitoring for process control, for which there is growing interest in run times of a minute or less.

Conditions for the final HPLC method should be selected so that the operating pressure with a new column does not exceed 170 bar (2500 psi, 17 MPa), and an upper pressure limit below 2000 psi is desirable. There are two reasons for this pressure limit, despite the fact that most HPLC equipment can be operated at much higher pressures. First, during the life of a column, the back pressure may rise by a factor of as much as 2, due to the gradual plugging of the column by particulate matter. Second, at lower pressures (<170 bar), pumps, sample valves, and especially autosamplers operate much better, seals last longer, columns tend to plug less, and system reliability is significantly improved. For these reasons, a target pressure of less than 50% of the maximum capability of the pump is desirable.

When method development is begun with the preferred conditions of Table 1.3, many samples require only the adjustment of mobile-phase strength (% B) to achieve an acceptable separation. This is illustrated in Fig. 1.4f for the separation of this herbicide sample. A mobile phase of 70% methanol-water provides good resolution ($R_s > 1.8$) and a run time of 18 min, with easy detection and precise quantitation of later bands. Other samples may require further work, involving a change in selectivity or improved column conditions (column dimensions, particle size, and flow rate); see the discussion of Chapter 2.

When dealing with more challenging samples, or if the goals of separation are particularly stringent, a large number of method-development runs may be required to achieve acceptable separation. In some cases a strictly experimental approach to method development may not be feasible because of the work and cost involved. Within the past decade, computer simulation [11,12] has emerged as an accepted tool in HPLC method development. Computer simulation or "optimization" allows a few experimental runs to be used with a computer to predict a large number of additional separations. For example, only two gradient separations of the sample shown in Fig. 1.4 would allow the prediction of both isocratic and gradient separation as a function of % B. Computer simulation is discussed in greater detail in Chapter 10.

1.4.4 Repeatable Separation

As the experimental runs described above are being carried out, it is important to confirm that each chromatogram can be repeated. When changing conditions (mobile phase, column, temperature) between method-development experiments, enough time must elapse for the column to come into equilibrium with the new mobile phase and temperature. Usually, column equilibration is achieved after passage of 10 to 20 column volumes of the new mobile phase through the column. However, this should be confirmed by carrying out a repeat experiment under the same conditions. When constant retention times

are observed in two such back-to-back repeat experiments ($\pm 0.5\%$ or better), it can be assumed that the column is equilibrated and the experiments are repeatable. For reversed-phase separations, longer equilibration times can result when one of the two mobile phases being interchanged contains $<10\%$ organic [13].

Failure to ensure column equilibration and repeatable chromatograms can be a serious impediment to HPLC method development. This problem becomes critical if a computer is used to predict retention and separation on the basis of prior experiments (Chapter 10). Column equilibration can be extremely slow for certain reversed-phase HPLC conditions: addition of basic modifiers or ion-pair reagents to the mobile phase, the use of tetrahydrofuran as solvent, or the use of mobile phases without organic solvent.

1.5 COMPLETING THE HPLC METHOD

The final procedure should meet all the goals that were defined at the beginning of method development. The method should also be robust in routine operation and usable by all laboratories and personnel for which it is intended.

1.5.1 Quantitation and Method Validation

Many HPLC procedures will be used for routine quantitative analysis. Accurate results require the use of standards and a calibration procedure, as discussed in Chapter 14. Once the HPLC method is finalized, it should be validated as summarized in Table 1.6 and Chapter 15. Usually, full validation is preceded by an abbreviated check of the method for specificity, linearity, accuracy, precision, recovery, sensitivity, and so on. Prior to the final evaluation of method performance, a written assay procedure should be prepared and checked for clarity and consistency. The actual validation protocol may vary in length from 1 day to 2 weeks, depending on the importance of the method. Ideally, this method evaluation will be able to identify any potential problems that might arise from differences in equipment or operators.

Because column-to-column reproducibility can be a problem in routine HPLC analysis, columns from two or more different lots should be tested to confirm repeatability. Any unexpected results should be investigated to establish the cause and prevent repeated errors in later routine operation. Finally, the effects of different experimental conditions on separation should be defined as part of ensuring method ruggedness (see Section 1.5.3).

The requirements of Table 1.6 apply to HPLC methods that must meet stringent standards of precision, accuracy, ruggedness, and transferability. In other cases, all that may be required is a single successful separation or a quick, "rough" answer to a specific problem. For such samples, many of the recommendations of Tables 1.5 and 1.6 can be relaxed or eliminated. Some of the steps of Fig. 1.1 may also prove unnecessary. Common sense and

TABLE 1.6 Completing the Method^a

-
1. Preliminary data to show required method performance
 2. Written assay procedure developed for use by other operators
 3. Systematic validation of method performance for more than one system or operator, using samples that cover the expected range in composition and analyte concentration; data obtained for day-to-day and interlaboratory operation
 4. Data obtained on expected life of column and column-to-column reproducibility
 5. Deviant results studied for possible correction of hidden problems
 6. All variables (temperature, mobile-phase composition, etc.) studied for effect on separation; limits defined for these variables; remedies suggested for possible problems (poor resolution of key band pair, increased retention for last band with longer run times, etc.)
-

^a Applicable primarily to routine or quality-control methods.

an awareness of the actual goals of each method-development project are then sufficient.

1.5.2 Checking for Problems

As method development proceeds, various problems can arise, some of which are listed in Table 1.7. Initial chromatograms may contain bands that are noticeably broader than expected (lower plate number), or bands may tail appreciably. Later, during use of the method, it may be found that replacing the original column with an “equivalent” column from the same (or different)

TABLE 1.7 Possible Problems Uncovered During Method Development and Validation

Problem	Comment
Low plate numbers	Poor choice of column, secondary retention, poor peak shape effects (Chapter 5)
Column variability	Poor choice of column, secondary retention effects (Chapter 5)
Short column life	Poor choice of column (Chapter 5), need for sample pretreatment (Chapter 4), $3 > \text{pH} > 7$
Retention drift	Insufficient column equilibration (Chapters 6 to 8), need for sample pretreatment (Chapter 4), loss of bonded phase (Chapter 5)
Poor quantitative precision	Need for better calibration, identification of sources of error (Chapter 14)
New interference peaks discovered	Initial separation inadequate or initial samples not representative

supplier causes an unacceptable change in the separation. Consequently, a routine laboratory may not be able to reproduce the method on another, nominally equivalent column. Column life may also prove to be undesirably short (e.g., failure after less than 100 sample injections). Replicate sample injections (same column) may not yield the same chromatogram, assay precision may be poor, or retention times may drift from the beginning to end of a series of runs. Additional peaks that interfere with the determination of analytes may appear in the chromatograms of later samples.

For routine methods that are to be used for long time periods, it is important to anticipate and test for these and other problems before the method is released. The undesirable alternative is to discover that the method does not perform acceptably after it is introduced into routine application. Method irreproducibility can jeopardize the performance of a quality-control or production laboratory. These problems are discussed throughout the book. For additional information on diagnosing and correcting HPLC problems of this kind, see Ref. 14.

1.5.3 Method Ruggedness

A rugged method is one that tolerates minor variations in experimental conditions, can be run easily by an average chromatographer, and does not require an identical HPLC system for its use. Rugged methods are essentially trouble-free and transferable. Method ruggedness can be confirmed by intensive testing of the method during validation. Ruggedness can also be designed into a method by studying the effects of different variables on the separation. This approach is illustrated in Fig. 1.5 for the separation of 20 PTH-amino acids. Figure 1.5*a* shows the separation of a total sample. Figure 1.5*b–d* show the effects of a change in operating conditions on the separation of various critical band pairs. For example, in Fig. 1.5*d*, a change in pH of only 0.2 unit shifts band D so that it overlaps either T or G.

Data as in Fig. 1.5 can prove useful in various ways. First, these chromatograms define band pairs whose separation is critically affected by different variables. At the same time, the allowable error in mobile-phase composition is defined. Thus, Fig. 1.5*d* shows that pH must be controlled within ± 0.1 unit for acceptable separation of this group of compounds. Second, the data of Fig. 1.5 facilitate troubleshooting when separation as in Fig. 1.5*a* is inadequate. For example, if bands T and D are poorly separated, the conclusion is that the pH is probably too high (Fig. 1.5*d*). Figure 1.5*d* can also be used to estimate how much pH must be changed to restore the separation of these two bands. Finally, if a change in separation is caused by a new column whose retention properties are not identical to the original column, different variables can be adjusted to improve the separation, using the data of Fig. 1.5 as a guide.

Studies of separation as a function of conditions are particularly important for variables that are difficult to control (e.g., temperature for an HPLC method that uses an unthermostated column). Similarly, pH is difficult to

measure with an accuracy better than ± 0.05 unit; many separations show an unacceptable change in retention for pH changes this small. See Section 10.6 for a discussion of how ruggedness can be improved with the use of computer simulation. In subsequent chapters we provide a more detailed account of HPLC method development, as well as present additional background material relating to this topic.

REFERENCES

1. S. O. Jansson and S. Johansson, *J. Chromatogr.*, **242** (1982) 41.
2. E. Heftmann, ed., *Chromatography, 5th. ed.*, Elsevier, Amsterdam, 1992.
3. C. F. Poole and S. K. Poole, *Chromatography Today*, Elsevier, Amsterdam, 1991.
4. R. L. Grob, ed., *Modern Practice of Gas Chromatography*, 3rd ed., Wiley-Interscience, New York, 1995.
5. R. Weinberger, *Practical Capillary Electrophoresis*, Academic Press, San Diego, CA, 1993.
6. J. G. Kirchner, *Thin-Layer Chromatography*, 2nd ed., Wiley-Interscience, New York, 1978.
7. M. L. Lee and K. E. Markides, eds., *Analytical Supercritical Fluid Chromatography and Extraction*, Chromatography Conferences, Inc., Provo, UT, 1990.
8. H. Small, *Ion Chromatography*, Plenum, New York, 1989.
9. W. W. Yau, J. J. Kirkland, and D. D. Bly, *Modern Size-Exclusion Liquid Chromatography*, Wiley-Interscience, New York, 1979.
10. T. Braumann, G. Weber, and L. H. Grimme, *J. Chromatogr.*, **261** (1983) 329.
11. L. R. Snyder, J. W. Dolan, and D. C. Lommen, *J. Chromatogr.*, **485** (1989) 65.
12. J. W. Dolan, D. C. Lommen, and L. R. Snyder, *J. Chromatogr.*, **485** (1989) 91.
13. Z. Li, S. C. Rutan, and S. Dong, *Anal. Chem.*, **68** (1996) 124.
14. J. W. Dolan and L. R. Snyder, *Troubleshooting LC Systems*, Humana Press, Totowa, NJ, 1989.

2

BASICS OF SEPARATION

- 2.1 Introduction
- 2.2 Resolution: General Considerations
 - 2.2.1 Measurement of Resolution
 - 2.2.2 Minimum Resolution
- 2.3 Resolution as a Function of Conditions
 - 2.3.1 Effect of Solvent Strength
 - 2.3.2 Effect of Selectivity
 - 2.3.2.1 Changes in the Mobile Phase
 - 2.3.2.2 Changes in the Column
 - 2.3.2.3 Changes in Temperature
 - 2.3.3 Effect of Column Plate Number
 - 2.3.3.1 Column Conditions and Separation
 - 2.3.3.2 Plate Number as a Function of Conditions
 - 2.3.3.3 Extra-column Effects
- 2.4 Sample-Size Effects
 - 2.4.1 Volume Overload: Effect of Sample Volume on Separation
 - 2.4.2 Mass Overload: Effect of Sample Weight on Separation
 - 2.4.3 Avoiding Problems Due to Too Large a Sample Size
 - 2.4.3.1 Higher-Than-Expected Sample Concentrations
 - 2.4.3.2 Trace Analysis

2.1 INTRODUCTION

Most chromatographers have some idea of how a change in experimental conditions will affect an HPLC chromatogram. In reversed-phase separations (Section 6.2), an increase in the mobile-phase percent organic (% B) will shorten run time but usually leads to increased band overlap. If the flow rate is decreased, run time increases, but the separation usually improves. Sometimes (but not always) changing the column will improve separation. This awareness of how conditions affect the chromatogram is a combination of training and experience. But often what is known about HPLC works only

some of the time. That is, our knowledge is a mixture of more helpful and less helpful facts. In this chapter we review some basics of HPLC separation: more helpful facts that can ensure that method development starts out in the right direction. A number of important terms and definitions that are referred to in later chapters are also introduced.

2.2 RESOLUTION: GENERAL CONSIDERATIONS

The chromatogram of Fig. 2.1a shows the partial separation of six different bands. Bands 1 and 4 are well separated from other sample components, but bands 2, 3, 5, and 6 are partially overlapped. Chromatographers measure the quality of separations as in Fig. 2.1a by the *resolution* R_s of adjacent bands. Two bands that overlap badly have a small value of R_s :

$$R_s = \frac{2(t_2 - t_1)}{W_1 + W_2} \quad (2.1)$$

Here t_1 and t_2 are the retention times of the first and second adjacent bands and W_1 and W_2 are their baseline bandwidths. The resolution of two adjacent bands with $R_s = 1$ is illustrated in Fig. 2.2. Resolution R_s is equal to the distance between the peak centers divided by the average bandwidth. To increase resolution, either the two bands must be moved farther apart, or bandwidth must be reduced.

2.2.1 Measurement of Resolution

Resolution can be estimated or measured in three different ways:

1. Calculations based on Eq. 2.1
2. Comparison with standard resolution curves
3. Calculations based on the valley between the two bands

Equation 2.1 can be used for the measurement of resolution whenever the bands are well separated, so that retention times and bandwidths can be determined reliably. The manual determination of baseline bandwidth W involves (1) the construction of tangents to each side of each band, and (2) the measurement of the distance between the intersections of these tangents with the baseline (Fig. 2.2). This measurement is somewhat awkward at first, which may make the corresponding determination of R_s imprecise. An alternative approach gives more reliable values of R_s : bandwidths at half-height ($W_{1/2}$; see Fig. I.1., Appendix I) are measured for bands 1 and 2, $W_{0.5,1}$ and $W_{0.5,2}$. Then

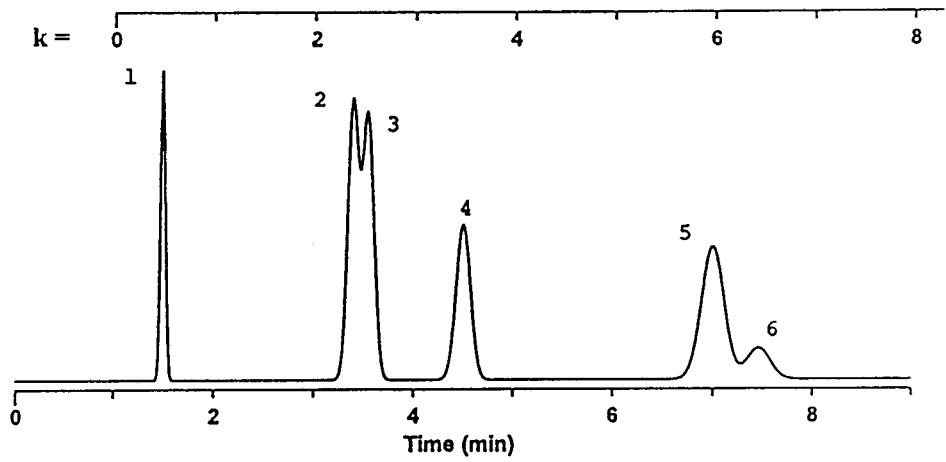

(a)

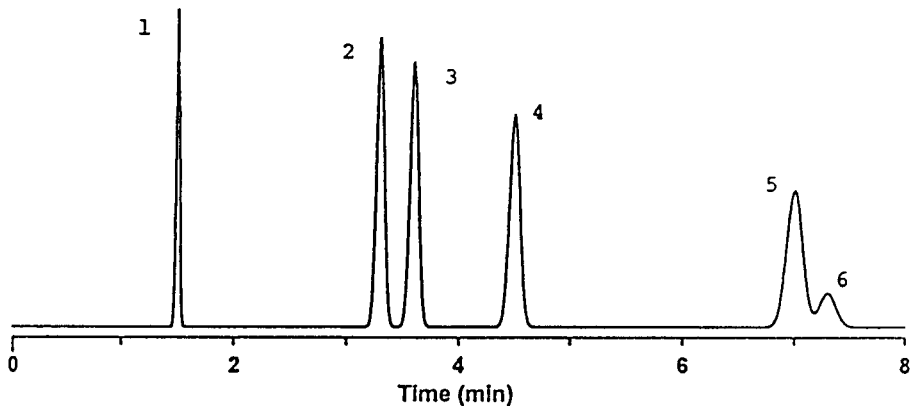

(b)

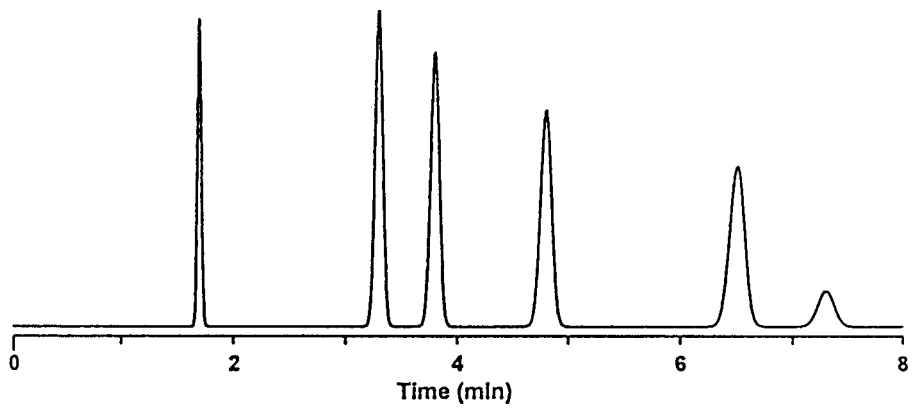

(c)

FIGURE 2.1 HPLC separations of a hypothetical sample. See the text for details.

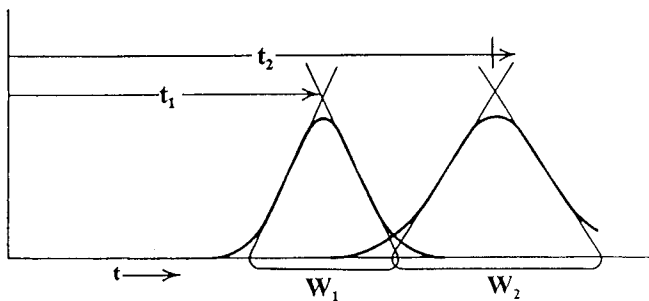

FIGURE 2.2 Calculation of resolution R_s for two adjacent bands 1 and 2. See the text for details.

$$R_s = \frac{1.18(t_2 - t_1)}{W_{0.5,1} + W_{0.5,2}} \quad (2.2)$$

Calculations of R_s using Eq. 2.1 or 2.2 may not be reliable when R_s is less than 1.

A comparison of two adjacent bands with standard resolution curves can also be used to determine values of R_s . This approach does not require any calculations, is quite convenient, and is applicable to overlapping bands ($0.4 < R_s < 1.3$). The use of standard resolution curves is illustrated in Fig. 2.3. “Ideal” representations of two overlapping bands can be calculated as a function of relative band size and resolution (assumes Gaussian peak shapes; Appendix I). In Fig. 2.3, relative band size (height or area) varies from 1/1 to 4/1 to 16/1 from left to right. Resolution varies from 0.6 to 1.25 from top to bottom. Actual overlapping bands can be compared with the ideal curves of Fig. 2.3 to match “real” and “ideal” as closely as possible. It does not matter whether the larger band elutes first or last; just mentally transpose the two peaks.

Once a match has been achieved, the R_s value of Fig. 2.3 for the closest match is then the resolution of the real band pair. This method of estimating R_s is illustrated in Fig. 2.1a for band pair 5/6. For this example, the peak heights and areas of the two bands are in an approximate ratio of 4/1. A comparison of band pair 5/6 with the examples of Fig. 2.3 (4/1 case) suggests that $R_s \approx 1.0$. Similarly, the resolution of band pair 2/3 in Fig. 2.1a is $R_s \approx 0.7$ (the band-size ratio is 1/1). Figures I.2 to I.7 (Appendix I) provide a more detailed set of standard resolution curves for estimating R_s in this manner.

A third way of estimating R_s , based on the height of the valley between two adjacent bands, can be used for $0.8 < R_s < 1.5$. This procedure provides more precise values of R_s , but requires slightly more effort than the standard-resolution-curve approach. See Fig. I.8 (Appendix I) and the related discussion.

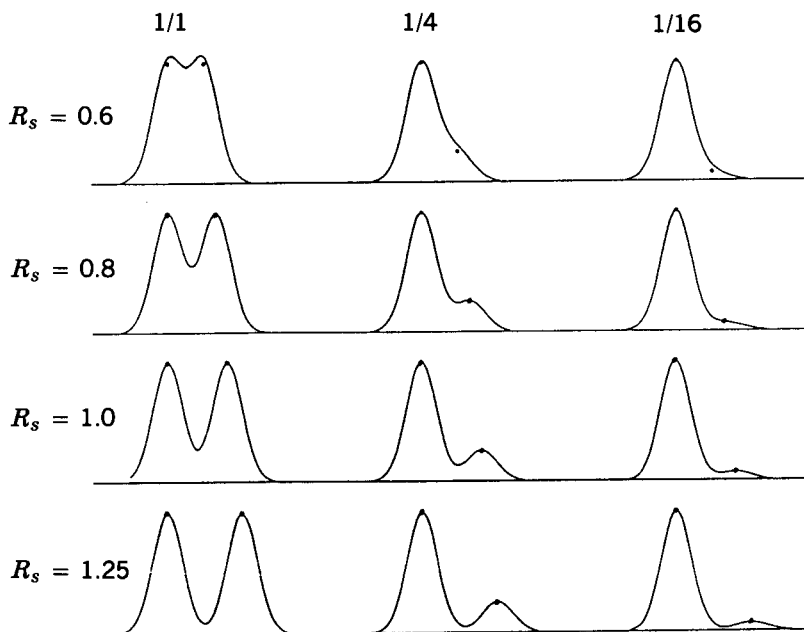

FIGURE 2.3 Standard resolution curves for the separation of two bands as a function of resolution R_s and relative band size (area).

2.2.2 Minimum Resolution

Chromatograms that contain more than two bands (as in Fig. 2.1a) will have different R_s values for each band pair. There are five adjacent band pairs in Fig. 2.1a and four corresponding values of R_s for this separation. A common objective in HPLC separation is to separate all bands of interest with some minimum resolution. If the accurate quantitation of sample components is a goal of HPLC method development, baseline resolution of all bands is desirable. Baseline resolution occurs when the detector trace for the first band returns to the baseline before the next band begins to leave the column. This is the case for all band pairs in Fig. 2.1b except 5/6. With baseline resolution of all bands (as in Fig. 2.1c), the HPLC data system is able to draw an accurate baseline under each band, thereby increasing the accuracy of band-area or peak-height measurements (and resulting calculations of sample concentrations). Baseline resolution corresponds to $R_s > 1.5$ for bands of similar size. When allowances are made for (1) adjacent bands of dissimilar size and (2) the usual deterioration of an HPLC method during day-to-day use, $R_s = 2.0$ or greater is a desirable target for method development.

It is convenient to define the *critical band pair* in each chromatogram obtained during method development. The critical pair is that band pair

with the smallest value of R_s . In Fig. 2.1a, band pair 2/3 is the critical pair ($R_s = 0.7$). In method development the separation conditions are changed systematically to improve separation of the critical band pair. This process continues until acceptable resolution of the entire sample is obtained, as illustrated in Fig. 2.1. In the initial separation (Fig. 2.1a), band pair 2/3 is critical and its resolution must be improved. A change in conditions from the separation of Fig. 2.1a results in the chromatogram of Fig. 2.1b. Now, band pair 2/3 is adequately resolved, but there is little improvement in the separation of band pair 5/6. As a result, band pair 5/6 is now critical for this separation. Further changes in conditions often result in adequate separation of the entire sample, with $R_s > 2$ for all bands shown in Fig. 2.1c. Resolution of an entire chromatogram is usually expressed as R_s for the critical band pair of interest in that separation (e.g., $R_s = 0.7$ for the chromatogram of Fig. 2.1a, since $R_s = 0.7$ for critical band pair 2/3).

The appearance of the chromatogram can be misleading as a measure of the resolution of the critical band pair. If two bands overlap with $R_s < 0.5$, these two bands will appear as a single band (see examples of Figs. I.2 to I.7). The chromatographer might then conclude (incorrectly) that the sample has been completely separated. Surprises of this kind can be avoided if it is known how many compounds are present in the sample; there should be as many separated bands as there are compounds.

For samples of initially unknown composition, there is always the possibility that two bands will be unresolved for some set of experimental conditions (and appear as a single band). A change in separation conditions and/or the use of certain detectors [e.g., diode-array detectors (Section 3.2.6)] can help diagnose and solve problems of this kind. The discovery of unresolved band pairs is also facilitated by the use of peak tracking (Section 10.7). When the composition of incoming samples can change, later samples may contain compounds that were not present during method development. If the possibility of new bands in the chromatogram can be anticipated, it is advisable to create as much extra space in the chromatogram as possible [i.e., try to achieve greater resolution than is otherwise required ($R_s \gg 2$)]. Keep in mind, however, that excess resolution always means a run time that is longer than necessary (Section 2.3.3.1).

In most cases, the quality of an HPLC separation is adequately described in terms of critical resolution and run time. Various mathematical functions have been proposed to evaluate separation quantitatively [1,2]. These *optimization criteria* or *chromatographic response functions* are intended to take into account the various goals of method development, and to weight each goal (resolution, run time, sensitivity, etc.) accurately according to the requirements of the HPLC method. Chromatographic response functions have been used in computer-assisted method development (Chapter 10) to select automatically the “best” separation conditions for a final method. We feel that these chromatographic response functions are of limited value in most cases. It generally

suffices if R_s is greater than 2 for all bands of interest and the run time is acceptably short.

When some experimental condition (e.g., gradient time t_G) is varied for the purpose of improving resolution, it is convenient to plot critical resolution vs. that variable (t_G). This results in a *resolution map*. An example is shown in Fig. 2.4. Figure 2.4a shows a chromatogram of this peptide sample for a 120-min gradient time. Bands 9 to 15 are indicated by an arrow, and this group of bands is of particular interest (hardest to separate). A resolution map for this separation as a function of gradient time is shown in Fig. 2.4b. The critical band pair and the resolution R_s of this band pair are shown for each gradient time. The separation of bands 9 to 15 is also shown for three different gradient times: 52 min, 93 min, and 185 min (critical band pair is solid black). For a gradient time of 52 min, bands 9/10 overlap completely, and $R_s = 0$. Similarly, for a gradient time of 185 min, bands 11/12 overlap completely with $R_s = 0$. For the intermediate separation (93-min gradient), however, a maximum value of R_s is observed ($R_s = 1.2$), corresponding to the best separation of the sample for a gradient time below 220 min. A resolution map allows rapid assessment of resolution vs. any separation variable. See the additional examples and related discussion in Section 10.2.

2.3 RESOLUTION AS A FUNCTION OF CONDITIONS

The separation of any two bands in the chromatogram can be varied systematically by changing experimental conditions. Resolution R_s can be expressed in terms of three parameters (k , α , and N) which are directly related to experimental conditions:

$$R_s = 1/4 (\alpha - 1) N^{1/2} \frac{k}{1 + k} \quad (2.3)$$

(selectivity) (efficiency) (retention)

Here k is the average retention factor for the two bands (formerly referred to as the capacity factor, k'), N is the column plate number, and α is the separation factor; $\alpha = k_2/k_1$, where k_1 and k_2 are values of k for adjacent bands 1 and 2. Equation 2.3 is useful in method development because it classifies the dozen or so experimental variables into three categories: retention (k), column efficiency (N), and selectivity (α). This simplifies the systematic variation of conditions to achieve some desired separation. It is convenient to regard k , N , and α as independent of each other, so that changes can be made in each variable without affecting the other two. However, this is only a rough approximation, especially as regards k and α .

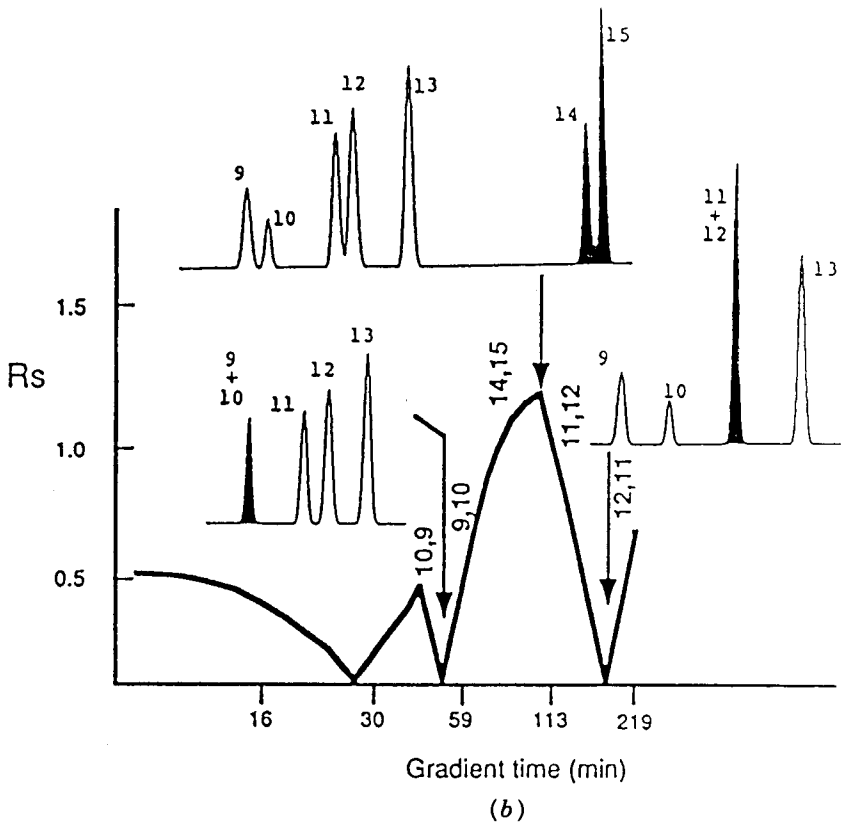
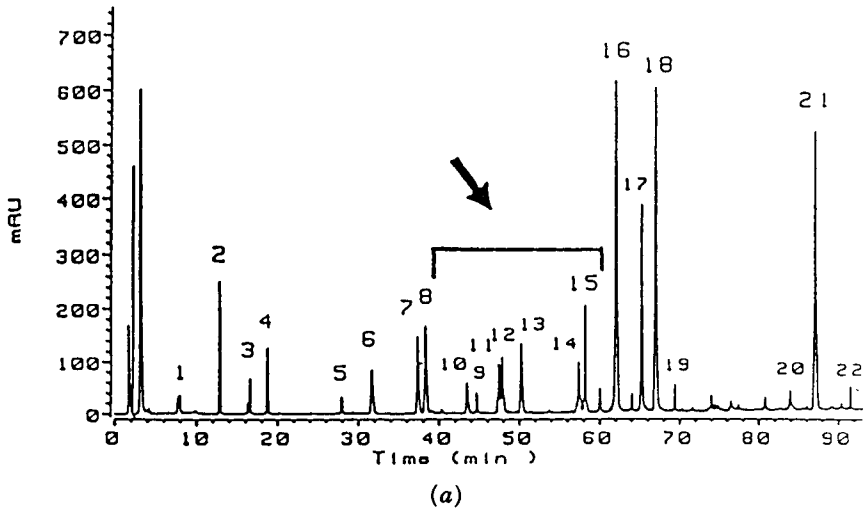

FIGURE 2.4 Resolution map for the separation of a peptide mixture by gradient elution. (a) Chromatogram for 120-min gradient; (b) resolution map with separation of bands 9 to 15 superimposed for gradient times of 52, 93, and 185 min. See the text for details. (Reprinted with permission from Ref. 3.)

The retention factor k is given as

$$k = \frac{t_R - t_0}{t_0} \quad (2.4)$$

where t_R is the band retention time (see Fig. 2.2) and t_0 is the column dead time. The column dead time is related to the column dead volume V_m (volume of mobile phase inside the column) and flow rate F as

$$t_0 = \frac{V_m}{F} \quad (2.5)$$

and can be determined as described in Section 2.3.1. Equation 2.3 assumes that the retention times of the two bands are similar, which for overlapping bands ($R_s < 1.5$) requires a plate number typical of HPLC ($N > 2000$). Several other equations for resolution, similar to Eq. 2.3, have been derived [4]. For overlapping bands, these various equations for R_s are approximately equivalent.

Figure 2.5a illustrates the effect of k , α , and N on resolution. When conditions are changed so that k becomes smaller (earlier elution), resolution usually becomes worse. When k is made larger, resolution usually improves. If α is increased, the two bands move apart, thereby increasing R_s significantly. When column efficiency N is increased, the bands become narrower and better separated, but their relative positions in the chromatogram do not change. Figure 2.5b illustrates which strategy is best for an overlapping critical band pair whose resolution must be increased. When the two bands have retention times close to t_0 [small k , Fig. 2.5b(i)], the best approach is an increase in k . When the two bands are partially overlapped and $t_R \gg t_0$ [Fig. 2.5b(ii)], either α or N must be increased. Unless only a small increase in R_s is required (<30%), however, it is usually better to attempt an increase in α for this situation. When the two bands are badly overlapped with $t_R \gg t_0$ [Fig. 2.5b(iii)], an increase in α is normally required.

The parameters k and α are determined by those conditions that affect retention or the equilibrium distribution of the sample between the mobile phase and the column packing:

1. Composition of the mobile phase
2. Composition of the stationary phase (column)
3. Temperature

Changes in the mobile or stationary phases will generally affect both k and α but will have less effect on N . The column plate number N is primarily

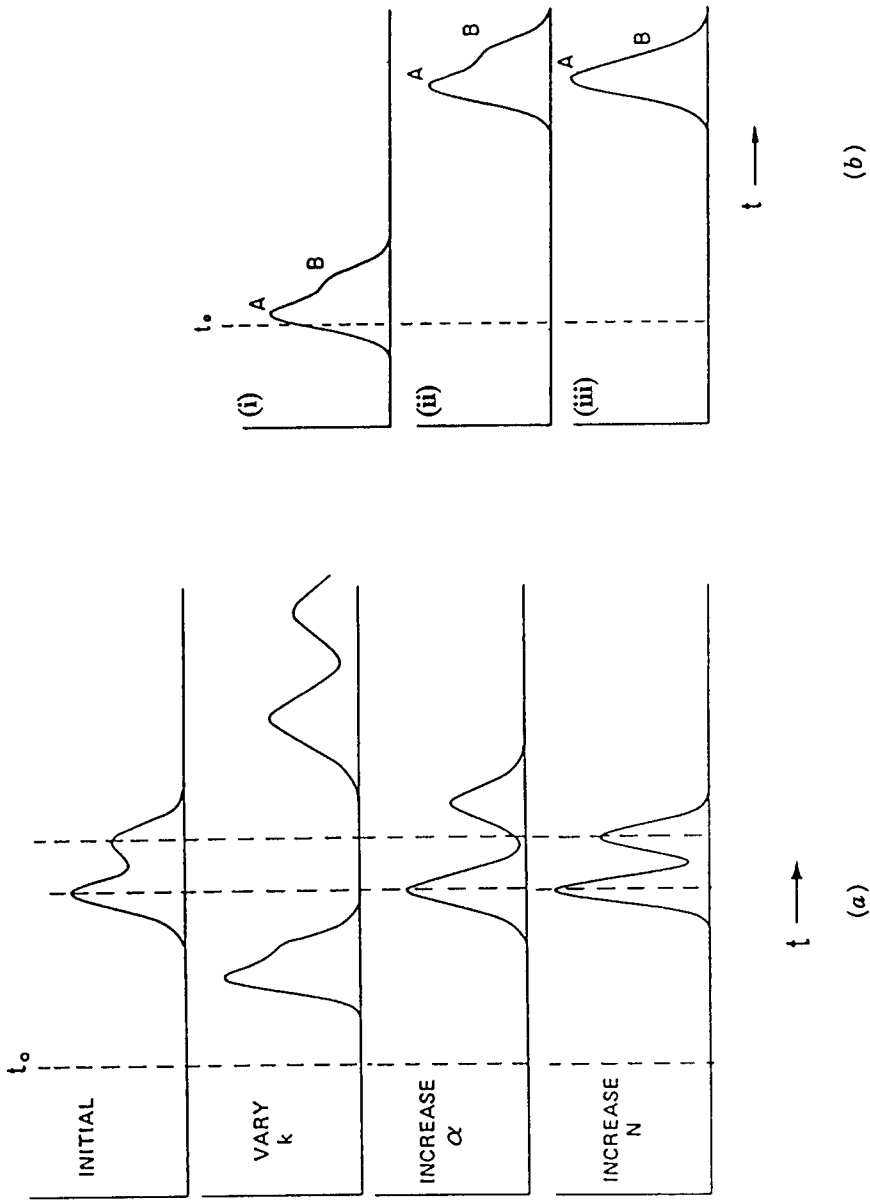

FIGURE 2.5 Effects of k , α , and N on separation. See the text for details.

dependent on column quality and can be varied by changing *column conditions*:

1. Flow rate
2. Column length
3. Particle size

A change in these conditions will not affect k or α as long as the mobile phase and stationary phase type are not changed.

In method development it is advisable first to change conditions that will optimize values of k and α , then (optionally) vary column conditions. In this way initial experiments can be used to obtain good values of k and α that will not change if only column conditions are varied further.

2.3.1 Effect of Solvent Strength

According to Eq. 2.3, resolution increases when sample retention k increases; if two sample components elute near t_0 ($k \approx 0$), then $R_s \approx 0$. Sample retention can be controlled by varying the *solvent strength* of the mobile phase. A *strong solvent* decreases retention and a *weak solvent* increases retention. Table 2.1 summarizes the primary means for varying solvent strength with different HPLC methods. In this chapter reversed-phase HPLC is assumed unless stated otherwise.

The effect of solvent strength on a reversed-phase separation is illustrated in Fig. 2.6 for the repetitive injection of a five-component sample with a change in mobile phase (varying percent methanol) between each injection. The initial separation with 70% methanol (Fig. 2.6a) has a short run time but poor resolution of the sample; the mobile phase is too strong and values of k are too small. This suggests the use of a weaker solvent: 60% methanol in Fig. 2.6b. Some improvement in resolution has resulted, but the mobile phase is still too strong. A change to 50% methanol in Fig. 2.6c results in baseline separation of all five bands. However, band 1 elutes close to t_0 (marked by the baseline disturbance at about 2 min after injection), and as a result the baseline under band 1 is poorly defined. This would lead to less accurate quantitation of band 1 in this separation. Further decreases in percent methanol to 40% [part (d)] and 30% [part (e)] result in a well-defined baseline under all bands, as well as improved resolution but longer run times. Later bands also broaden and band 5 would be difficult to detect or quantitate accurately in part (e) with 30% methanol as mobile phase. The run time in Fig. 2.5e is also excessive (60 min).

A mobile phase of 40 to 45% methanol provides the best separation for the sample of Fig. 2.6. Baseline resolution of all sample bands is achieved, the run time is reasonable (15 to 20 min), the last band has not broadened to the point where detection and quantitation are compromised, and the first

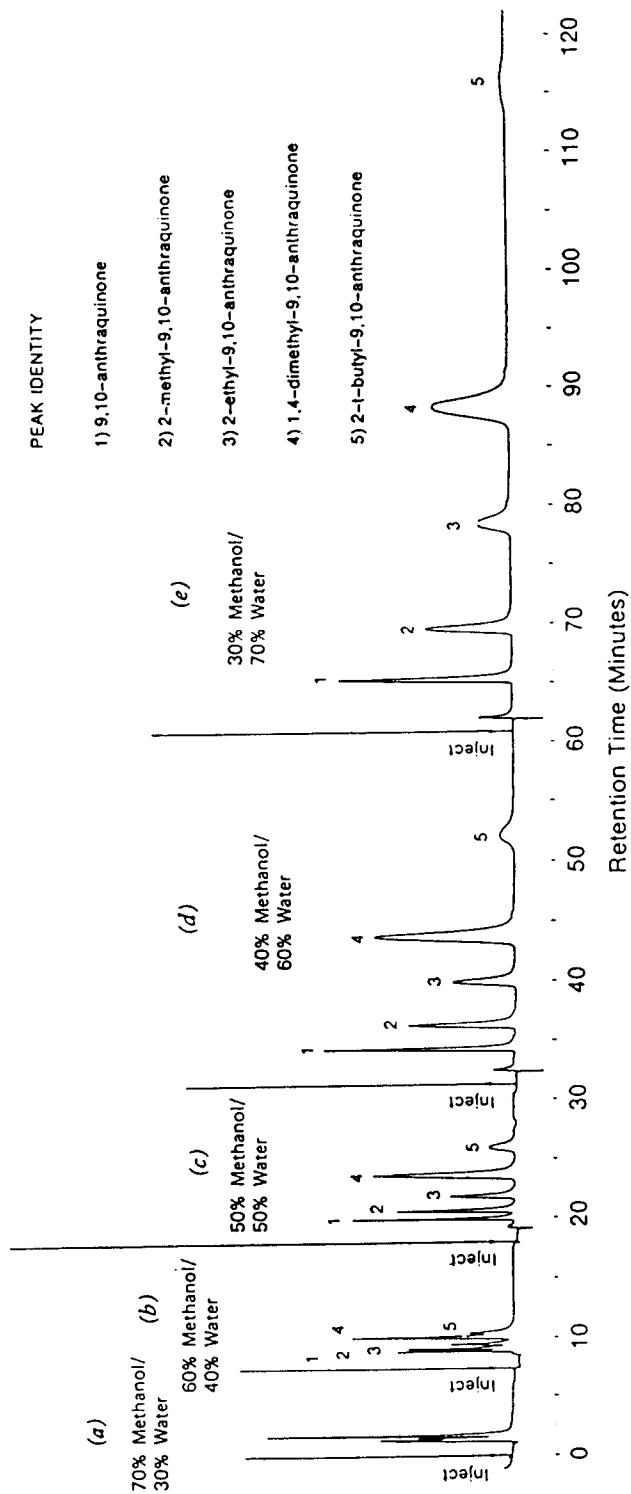

FIGURE 2.6 Separation of a mixture of anthraquinones by reversed-phase HPLC and various mobile phases. Conditions: Permaphase ODS column, 50°C, 1.0 mL/min, UV detection at 254 nm. Mobile phases described in the text for parts (a) to (e). (Reprinted with permission from Ref. 5.)

band is well away from the initial baseline disturbance at t_0 . In most cases, an intermediate solvent strength will be preferred so that $0.5 < k < 20$ for all bands. This optimum value of % B (A is the weak and B the strong solvent component; see Table 2.1) can be determined by systematic trial-and-error experiments as in Fig. 2.6. It is also possible to use an initial gradient elution separation to determine more easily the optimum solvent strength (% B) for isocratic separation (Section 8.2.2.2).

In evaluating successive method development experiments as in Fig. 2.6, it is important to know an approximate value of t_0 for the HPLC system. A value of t_0 can be estimated in various ways:

1. First significant baseline disturbance
2. Use of a very strong solvent as the mobile phase
3. Calculation from column dimensions
4. Injection of an unretained sample

In Fig. 2.6c–e, a characteristic baseline disturbance can be seen at about 2 min following injection. There is a rapid deflection of the trace above and below the baseline at t_0 , caused by the difference in compositions of the sample solution and the mobile phase. When an initial baseline deflection of this shape is seen, it is safe to assume that this corresponds to t_0 . Occasionally, peaks leave the column before t_0 (often at $0.5 t_0$) as a result of their exclusion from the pores of the column packing. This can confuse the determination of t_0 based solely on an initial baseline disturbance.

The use of a strong mobile phase provides a more reliable estimate of t_0 , as illustrated in Fig. 2.6a (70% methanol–water). In this case the sample leaves the column as a more-or-less unresolved plug, and the initial rise of the detector trace at 2 min marks t_0 . Values of t_0 can also be determined from Eq. 2.5 using an estimate of V_m (mL) from the length L (cm) and internal diameter d_c (cm) of the column:

$$V_m \approx 0.5Ld_c^2 \quad (2.6)$$

Values of t_0 estimated from Eqs. 2.5 and 2.6 can be in error by 10 to 20%, but this is acceptable for the purposes of method development. Equations 2.5 and 2.6 are especially easy to apply for the case of 0.46-cm-ID columns, which are most often used in HPLC.

$$V_m \approx 0.1 L \quad (0.46\text{-cm-ID column only}) \quad (2.7)$$

Thus, for a 25×0.46 -cm column, $V_m = 0.1 \times 25 = 2.5$ mL. If the flow rate is 1.5 mL/min, $t_0 = 2.5/1.5 = 1.67$ min (Eq. 2.5). Finally, an unretained compound can be injected, in which case its retention time equals t_0 . Uracil or a

concentrated solution of sodium nitrate (detection at 210 nm) is often used for this purpose in reversed-phase HPLC.

Once a value of t_0 has been determined, values of k can be estimated from Eq. 2.4. This can be done visually (no calculations) by simply marking off the time axis in units of t_0 ; then $k = 0$ for one t_0 unit, $k = 1$ for two t_0 units, and so on. This k -ruler is illustrated in Fig. 2.1a (see the top scale, labeled “ $k=$ ”), for which $t_0 = 1.0$ min. Band 1 has $k = 0.4$ ($t_R = 1.4$ min), and band 6 has $k = 6.3$. When adjusting solvent strength, it is important to make rough estimates of k for the first and last bands in the chromatogram. The goal of solvent strength adjustment is to position all the bands within a k range of roughly 0.5 to 20 ($0.5 < k < 20$). This range in k will generally (not always!) avoid problems from the initial baseline disturbance overlapping the first band; when $k > 0.5$, early-eluting impurity bands are also less likely to overlap an analyte band. When $k < 20$, excessive broadening of the last band and run times that are too long will be avoided.

2.3.2 Effect of Selectivity

Many samples will be resolved adequately after solvent strength (% B) is adjusted for acceptable retention. This is the case in Fig. 2.6d for 40% methanol as mobile phase. Other samples, however, may show incomplete separation, even though $0.5 < k < 20$ for all sample bands. This is true for the separations of Fig. 2.1a and b. The next step in method development (after adjusting % B for $0.5 < k < 20$) is a change of conditions that will vary band spacing or selectivity (values of α). Changes in α can be created by a change in the mobile phase, a change in the type of column packing, or a change in temperature. Usually, it is best to start with changes in the mobile phase.

2.3.2.1 Changes in the Mobile Phase. The mobile phase selected depends on the HPLC method, as summarized in Table 2.1. For reversed-phase conditions,

TABLE 2.1 Controlling Sample Retention by Changing Solvent Strength

HPLC Method	How Solvent Strength Is Usually Varied ^a
Reversed phase	Water (A) plus organic solvent (B) (e.g., water–acetonitrile); increase in % B decreases k .
Normal phase	Nonpolar organic solvent (A) plus polar organic solvent (B) (e.g., hexane–propanol); increase in % B decreases k .
Ion pair	Same as reversed phase.
Ion exchange	Buffered aqueous solution plus added salt (e.g., 5 mM sodium acetate plus 50 mM NaCl); increase in ionic strength (NaCl concentration) decreases k .

^a Mobile-phase composition given first.

TABLE 2.2 Illustrative Changes in the Mobile Phase (from Run 1 to Run 2) That Can Be Used to Vary Selectivity (α) in Reversed-Phase HPLC

Variable ^a	Example ^b	
	Run 1	Run 2
Change % B (all)	40% ACN	45% ACN
Change organic solvent (all)	40% ACN	50% MeOH
Mix organic solvents (all)	40% ACN	20% ACN + 25% MeOH
Change pH (ionic)	pH 2.5	pH 3.5
Change ion-pair reagent concentration (ionic)	No reagent	25 mM octane sulfonate
Change buffer or buffer concentration (ionic)	25 mM citrate buffer	50 mM acetate buffer
Change additive concentration (ionic)	No additive	10 mM TEA
Add complexing agent (special)	No agent	10 mM silver nitrate

^a "All" means that this variable can be used for both neutral and ionic samples; "ionic" means that this variable is only effective for samples that contain ionized or ionizable compounds; "special" indicates samples that can interact with the complexing agent.

^b ACN, acetonitrile; MeOH, methanol; TEA, triethylamine.

Table 2.2 summarizes some changes in the mobile phase that could change selectivity. Generally, it is better to start with the first variable (change in % B) and proceed sequentially down the list. These selectivity effects are discussed in detail in Chapters 6 and 7.

Solvent-Strength Selectivity. Often, a range of % B values will result in $0.5 < k < 20$, so that a choice of % B values is available (e.g., 35 to 45% in Fig. 2.6). Many samples (but not the example of Fig. 2.6) will exhibit significant changes in band spacing when % B is changed by 5 to 10%, allowing better resolution of the sample. Thus, in the process of adjusting % B for a good retention range, it is also possible to select a particular % B value for the best band spacing and resolution.

Solvent-Type Selectivity. A change in organic solvent type is a powerful way to change band spacing for both reversed- and normal-phase HPLC. Usually, it is the stronger solvent component (B solvent) that will be changed for this purpose. There are many solvents to choose from, which complicates the selection of preferred solvents for this purpose. The *solvent-selectivity triangle* [6] shown in Fig. 2.7 is a useful guide for choosing among different solvents for the purpose of a large change in band spacing. Solvents are attracted to sample molecules in the mobile phase by a combination of dipole and hydrogen-bonding interactions. As a result, solvent selectivity is expected to depend on the dipole moment, acidity, and basicity of the solvent molecule.

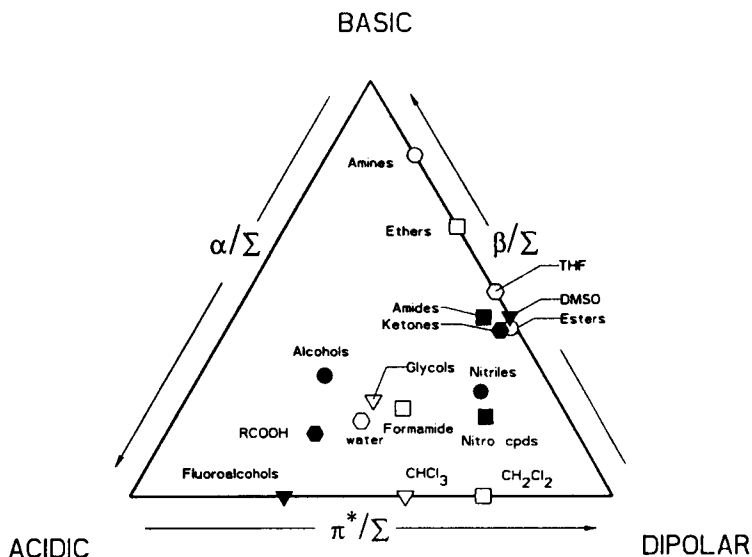

FIGURE 2.7 Solvent-selectivity triangle. See the text for a discussion. (Reprinted with permission from Ref. 6.)

In Fig. 2.7, acidic solvents are found near the acidic corner of the triangle, basic solvents are located near the basic corner, and solvents that are predominantly dipolar in their interaction with sample molecules will be near the dipolar corner.

To create large changes in selectivity by a change in the B-solvent, the old and new solvents should fall in a different part of the solvent-selectivity triangle. For example, ethyl ether is close to the basic corner, and CH_2Cl_2 (methylene chloride) is close to the dipolar corner of Fig. 2.7. Therefore, these two solvents should differ significantly in their selectivity. If ethyl ether is used in the first experiment (normal-phase HPLC) and a change in band spacing is needed, a change to methylene chloride in the next experiment should result in a large change of selectivity. Solvent-type optimization for both reversed- and normal-phase HPLC, including preferred solvents for this purpose, is discussed in detail in Chapter 6.

Optimizing Solvent-Type Selectivity. A change of the strong solvent (B-solvent) often results in large changes in band spacing, such that bands that were formerly overlapped are now resolved and bands that were formerly resolved are now overlapped. As a result, a mixture of the two strong solvents often provides intermediate band spacing and acceptable resolution. This is illustrated in the hypothetical separations of Fig. 2.8. The first two experiments are designed to adjust solvent strength and the range of k values. It is advisable to start with a relatively strong mobile phase, 80% acetonitrile–water in this

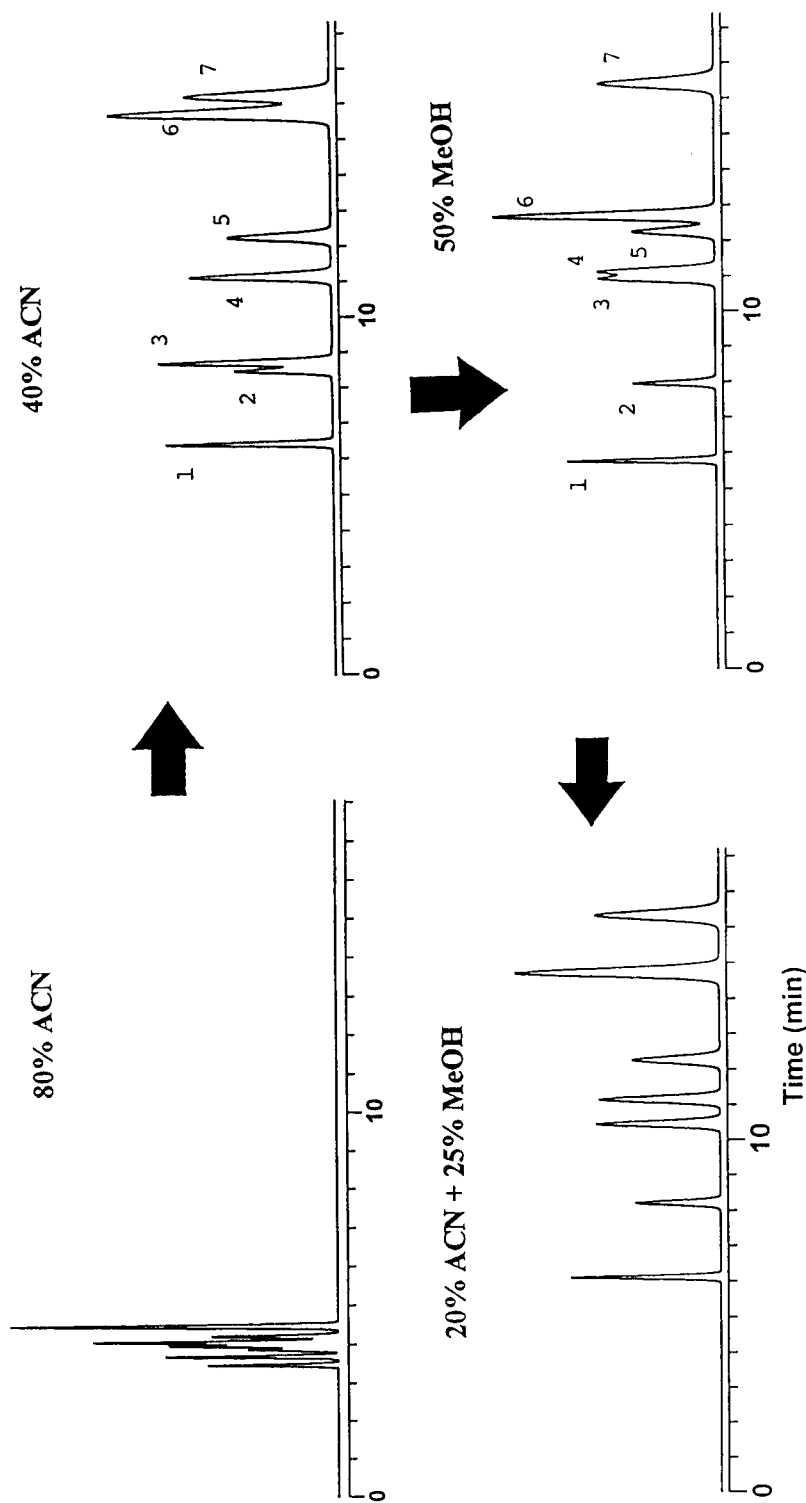

FIGURE 2.8 Hypothetical series of method-development experiments, beginning with a strong mobile phase of 80% acetonitrile–water (80% ACN). MeOH refers to methanol. See the text for details.

case. The sample is weakly retained (as expected) and leaves the column quickly with poor resolution of the sample. The second experiment (40% ACN) provides adequate retention and resolution is improved. However, some band overlap occurs (bands 2/3 and 6/7) because of poor peak spacing. The organic solvent is then changed from acetonitrile (ACN) to methanol (50% MeOH) and a third run is carried out. Band spacing changes, but new band pairs are overlapped (3/4 and 5/6). By mixing these two mobile phases (equal volumes of 40% ACN and 50% MeOH), a final separation intermediate between the second and third runs (20% ACN + 25% MeOH) is obtained with acceptable resolution of all bands. The procedure of Fig. 2.8 can also be used when varying other conditions (e.g., pH, temperature, concentration of an ion-pair reagent, buffer, or other mobile-phase additive). In Chapters 6 to 9 we describe the general procedure of Fig. 2.8 in more detail and provide several (real) examples.

Other Solvent Properties. Different solvents for use in HPLC method development should also possess certain practical properties. Low viscosity, vapor pressures that are not too high (boiling point $>40^{\circ}\text{C}$), good transmittance of low-wavelength UV light (Section 3.2.2.2), and minimal toxicity are important characteristics, as well as commercial availability of the highly purified solvent at a reasonable price. Appendix II furnishes further information on the properties of solvents of interest in HPLC (see also Refs. 7 and 8).

Selectivity for Ionic Compounds. For ionic samples that contain ionized or ionizable components, further changes in the mobile phase are possible as a means of varying selectivity: change of pH, use of ion-pairing reagents or amine additives, change of buffer or buffer concentration, and so on. These effects are discussed in Chapter 7.

Selective Complexation. In rare cases it may be possible to add a complexing agent to the mobile phase that interacts selectively with one or more sample components: silver ion complexes with *cis*-olefins and amines, mercury complexes with alkyl sulfides, borate complexes with *cis*-diols, various metal ions complex with chelating compounds, and so on. Complexing agents are also used for chiral separations (Section 12.1.2). If a complexing agent is used, the equilibrium between the sample compound and complexing agent must be rapidly reversible; otherwise, broad bands and poor chromatography are likely to result. An example of complexation in HPLC is shown in Fig. 2.9, where a crown ether is used to complex selectively with primary amines. This 11-component mixture of primary and secondary amines is poorly resolved in the absence of the complexing agent [chromatogram (a)], but the addition of the agent to the mobile phase [chromatogram (b)] selectively retains the primary amines (bands NA through SER) and allows their improved separation.

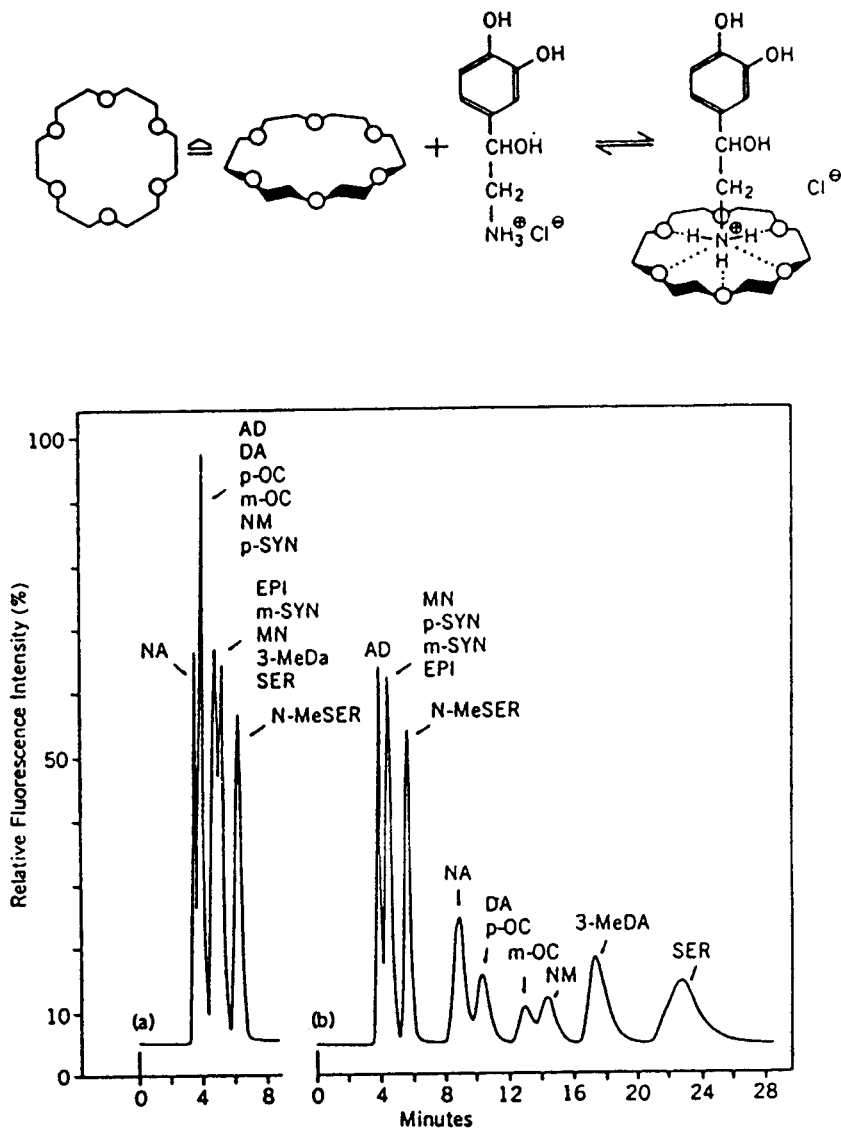

FIGURE 2.9 Effect of crown-ether complexing agent on band spacing of primary and secondary amines by reversed-phase HPLC. NA, DA, *p*-OC, *m*-OC, NM, 3-MeDA, and SER are primary amines. (a) 0.01 M HCl mobile phase; (b) same, plus 5 g/L 18-crown-6. (Reprinted with permission from Ref. 9.)

2.3.2.2 Changes in the Column. The nature of the column packing can have a major effect on band spacing. In most cases it is not practical to combine different packings into a single column, although columns of different type have been connected in series [10]. Therefore, a change in the column necessarily involves an abrupt change in selectivity, as opposed to the continuous changes in selectivity that are possible by changing mobile-phase composition. This limits the ability of the column (by itself) to fine-tune band spacing for samples that contain a relatively large number of components. For this reason *a change in the column usually should be combined with changes in the mobile phase to optimize band spacing*. A change in the column should be considered only after changes in the mobile phase have been tried.

Most HPLC column packings are made by bonding an organic layer onto the internal surface of porous silica particles (Section 5.2.3). The resulting column packing can exhibit differences in selectivity as a result of a number of factors:

1. The chemical nature or functionality of the bonded phase [e.g., C₁₈, phenyl or cyano (for reversed-phase HPLC)]
2. The amount of bonded phase per unit surface of the silica particle (e.g., 2 vs. 4 $\mu\text{mol}/\text{m}^2$)
3. The way in which the bonded phase is attached to the silica surface [e.g., monofunctional vs. polyfunctional silane reactions (Section 5.2.3.1)]
4. The nature of the silica surface, which varies among different silica sources (Section 5.2)

Systematic and reproducible changes in selectivity are best achieved by varying column functionality (e.g., for reversed-phase HPLC, by changing from a C₁₈ column to a cyano or phenyl column). Changes in selectivity can also be achieved by a change in the source (supplier) of the column due to differences in the manufacturing process or the starting silica. However, such changes in column source (e.g., for different C₁₈ columns) are not recommended for the development of rugged methods, as discussed in Chapter 5.

2.3.2.3 Changes in Temperature. An increase in column temperature by 1°C will usually decrease retention (k) by 1 to 2%. A change in k can also result in changes in α , so temperature is a potentially useful parameter for changing band spacing and improving resolution. One advantage of using temperature for optimizing selectivity is convenience. No change in the column is required, nor is it necessary to make up a new mobile phase; however, for a large increase in temperature it may be necessary to reduce % B to maintain $0.5 < k < 20$. Temperature can be regulated by means of the HPLC system controller, which facilitates manual method development and enables automated method development based on changes in temperature.

Many examples have been reported where changes in temperature result in useful changes in band spacing. Favorable temperature selectivity effects are more likely to occur for the separation of ionizable samples, but some neutral samples have shown significant changes in α with temperature. For specific examples and a further discussion, see Sections 6.3.4, 6.6.4, 7.3.2.4, 7.4.4.2, and 9.4 and Chapters 11 and 12.

Until recently, temperature has not been widely used for controlling band spacing, because of certain considerations:

1. The HPLC equipment is often not equipped with a column thermostat.
2. Many HPLC columns are not stable at higher temperatures, particularly for a mobile phase pH below 3 or above 6.
3. Solvent viscosity and vapor pressure depend strongly on temperature, which restricts the practical range in which temperature can be varied.
4. It has been assumed that a change in temperature is usually less effective for changing values of α .

These considerations have been undergoing a reexamination [11], and it is expected that in the future temperature will be used increasingly for the purpose of controlling band spacing and facilitating HPLC method development. Since a change in temperature can affect k as well as α , to maintain constant retention times and resolution during routine HPLC analysis, it is desirable to have a column thermostat [especially for ionic samples (Section 7.3.3.3)]. The same thermostat can be used in method development to select an optimum temperature. Stable column packings are now available for high-temperature operation at low pH, and conditions for extended column life at higher temperatures and high pH have been determined (Sections 5.2.3.4 and 5.4.3.5).

2.3.3 Effect of Column Plate Number

At some point during experiments aimed at adjusting retention and band spacing, a promising chromatogram will be obtained. Hopefully, this chromatogram will meet the initial goals of the separation as discussed in Section 1.2.2. In other cases, further improvement in the separation is required. Equation 2.3 states that resolution increases for all bands when N is increased as long as values of k and α do not change. So, if resolution needs to be improved after adjusting k and α values, an increase in N is one option. Conversely, if the separation has more resolution than required ($R_s \gg 2$), this excess resolution can be traded for a shorter run time (by reducing column length and/or increasing flow rate). An increase in N can always be achieved by increasing column length and/or reducing flow rate (but with an increase in run time). Therefore, changes in instrument conditions that affect N can be regarded as a way of trading resolution for run time.

The column plate number increases with several factors:

1. Well-packed columns (column “quality”)
2. Longer columns
3. Lower flow rates (but not too low)
4. Smaller column-packing particles
5. Lower mobile-phase viscosity and higher temperature
6. Smaller sample molecules
7. Minimum extracolumn effects

Column quality or performance is discussed in Chapter 5. Column performance can be defined in terms of values of N and band asymmetry (band shape) for a test substance run under “favorable” conditions (see below). The column plate number N is defined by

$$N = 16 \left(\frac{t_R}{W} \right)^2 \quad (2.8)$$

As discussed earlier, manual measurement of the baseline bandwidth W may be subject to error. Therefore, a more practical equation for N is

$$N = 5.54 \left(\frac{t_R}{W_{1/2}} \right)^2 \quad (2.8a)$$

Here t_R is band retention time and $W_{1/2}$ is the bandwidth at half-height (Fig. I.1). Another relationship that is used to measure N is

$$N = 2\pi \left(\frac{t_R h'}{A} \right)^2 \quad (2.8b)$$

where h' is the peak height and A is the peak area. Equation 2.8b is often used in HPLC data systems to determine a value of N .

Band shape is characterized by an *asymmetry factor* or *tailing factor* as described in Section 5.3.2 (Fig. 5.17). Each of these band-shape functions will have a value close to 1.0 for “good” (symmetrical) bands. Band shape and plate number can be combined into a single column descriptor: a corrected plate number. One commonly used relationship of this kind is the Dorsey–Foley equation [12]:

$$N = \frac{41.7(t_R/W_{0.1})^2}{(B/A) + 1.25} \quad (2.8c)$$

$W_{0.1}$ is bandwidth at 10% above baseline, and A and B are as defined in Fig. 5.17 (see the related discussion of band shape). A value of N from Eq. 2.8b will be smaller than one from Eq. 2.8a when the peak exhibits tailing. Equation 2.8c can be used for fronting bands by replacing B/A with its reciprocal A/B [13].

Even bands that appear to be symmetrical will usually have a small amount of tailing. As a practical consequence, if two adjacent bands with $R_s < 2$ differ greatly in size, it is *highly advantageous to position the smaller peak first and the larger peak second*. Otherwise, the tail of the larger peak will overlap the smaller peak and make its quantitation difficult.

Column quality as measured by N is best determined with an ideal test system, rather than with the sample and conditions of the method under development. Ideal conditions for reversed-phase HPLC consist of the following:

1. A small, neutral compound as test sample (e.g., toluene or naphthalene).
2. Flow rate of 1 mL/min for columns with $0.4 < ID < 0.5$ cm; a flow rate that is proportional to (column-diameter)² should be used for columns with smaller or larger diameters.
3. Mobile-phase viscosity (η) of less than 1 cP (e.g., 0 to 100% acetonitrile-water for temperatures $> 20^\circ\text{C}$).
4. Temperature of $< 40^\circ\text{C}$ (depending on the HPLC equipment, higher-temperature operation can give misleading results).
5. Equipment that is well plumbed [minimal extracolumn band broadening (Section 2.3.3.3)].

Representative values of the ideal N value for columns of varying length and particle size are provided in Table 5.9. If a new column has an N value less than two-thirds of this ideal value, it should be replaced with a better column. The ideal value of N generally will be larger than the value for the method under development.

The effects of column length, flow rate, and particle size on N are discussed in the following section. These conditions can be varied to further improve the separation (better resolution or shorter run time). Mobile-phase viscosity, temperature, and sample molecular weight are determined by the conditions of separation after values of k and α have been optimized. Therefore, further changes in these variables will not be carried out as part of optimizing N .

2.3.3.1 Column Conditions and Separation. A change in column conditions (column length, flow rate, particle size) will cause a change in N without affecting k or α values. So, once retention and selectivity have been adjusted for improved separation, N can be increased (or decreased) without affecting k or α . When a change in column conditions is made, a change in pressure can also result. The pressure drop across the column is given by

$$P \approx \frac{250L\eta F}{d_p^2 d_c^2} \quad (2.9)$$

here P is the pressure in psi, L the column length (cm), η the mobile-phase viscosity (cP; see Table II.3 of Appendix II), F the flow rate (mL/min), d_p the particle diameter (μm), and d_c the column ID (cm). P will also vary with how well the column is packed.

Usually, resolution, run time, and column pressure are of primary concern when varying column conditions and N , although maximizing sensitivity (by minimizing bandwidth) is of interest in trace analysis. The systematic improvement of separation by a change in N and column conditions is illustrated in Table 2.3 and Fig. 2.10. These chromatograms are computer simulations (Section 10.2.1) based on actual experiments and a fundamental and reliable model of band spreading in HPLC [15–18]. Referring to Table 2.3, entry 1 (25-cm column, 1 mL/min) is for the separation that resulted from the optimization of k and α values. Resolution is very good ($R_s = 2.9$), the pressure is acceptable (990 psi), but the run time is somewhat long (21 min). In this case, a decrease

TABLE 2.3 Effect of Column Conditions on Separation of a Pesticide Sample^a

	Column Conditions ^b			R_s	Run Time (min)	Pressure (psi)
	L (cm)	F (mL/min)	d_p (μm)			
1	25 ^c	1.0	5	2.9	21	990
2	25	2.0	5	2.3	11	1980
3	15	1.0	5	2.2	13	594
4	15	1.4	5	2.0	9	830
5	10	2.0	3	2.2	4	2200
6	10	1.8	3	2.2	5	1980
7	8	2.0	3	1.9	3	1756
8	8	1.7	3	2.0	4	1490
9	25 ^d	2.0	5	2.2	11	1980
10	8 ^d	1.7	3	1.3	4	1490

^a See Fig. 2.10 for details.

^b L is the column length, F the flow rate, and d_p the particle size.

^c Conditions following adjustment of conditions for optimized k and α values.

^d Data for an older HPLC system with greater extra-column band spreading; $\sigma_{ec} = 0.02$ vs. 0.005 mL in other examples.

FIGURE 2.10 Effect of column conditions on separation of a pesticide sample. Conditions for a) 25 × 0.46-cm Zorbax SB-C8 column; 40% acetonitrile–water; 30°C; 1.0 mL/min. Conditions for b)–e) as shown in Figure. Sample: 1, atrazine metabolite; 2, metribuzin metabolite; 3, fenam sulfoxide; 4, fenam sulfone; 5, diuron; 6, propanil; 7, pronamide metabolite; 8, SWEP. (Computer simulations based on data of Ref. 14.)

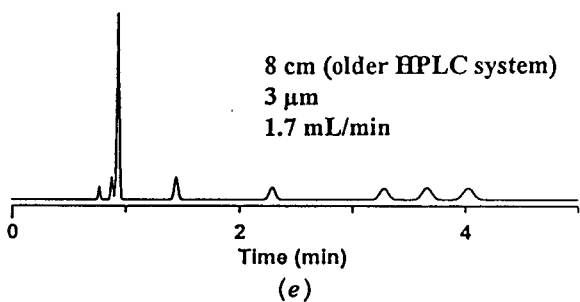
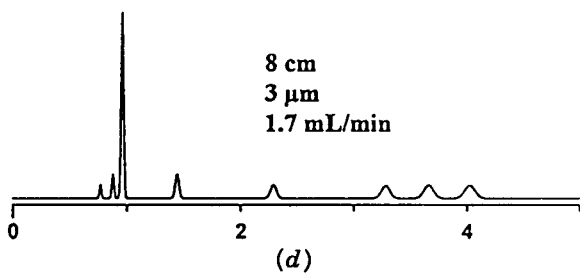
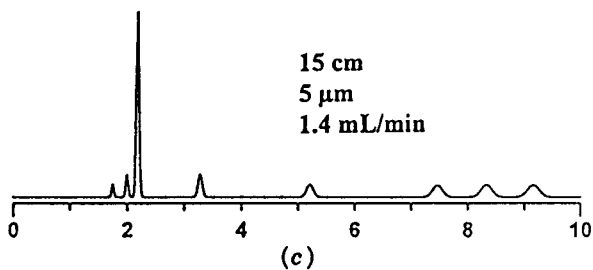
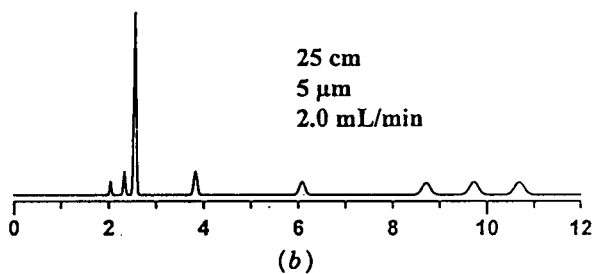
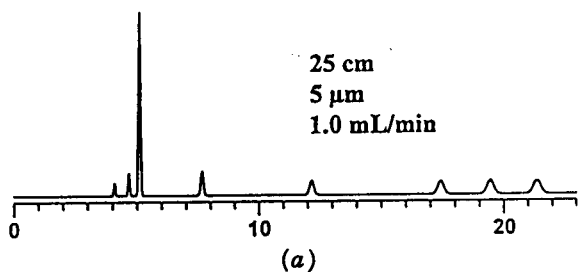

in N (as long as $R_s > 2$) can be traded for a decrease in run time. The simplest and most convenient change in column conditions is an increase in flow rate, provided that the column pressure does not exceed the desired pressure limit (e.g., 2000 psi). Entry 2 of Table 2.3 shows that a flow rate of 2.0 mL/min provides a run time of 11 min, with acceptable resolution ($R_s = 2.3$) and pressure (1980 psi). These first two runs are illustrated in Fig. 2.10a and b.

If a further shortening in run time is desired, the next option to explore is a shorter column. For a 15-cm column at 1.0 mL/min, entry 3 of Table 2.3 shows acceptable resolution ($R_s = 2.2$) and pressure (590 psi), with a run time of 13 min. For this column, the flow rate can be increased to 1.4 mL/min (entry 4) before resolution drops to the minimum acceptable value ($R_s = 2.0$). Pressure is acceptable (830 psi) and the run time is now only 9 min. This is the best separation seen so far (Fig. 2.10c).

Usually, a further reduction in run time can be achieved by reducing the particle size. Table 2.3 shows several runs (entries 5 to 8) with a 3- μm column and varying column lengths and flow rates. The best separation is obtained with a 8-cm column and a flow rate of 1.7 mL/min (entry 8, Fig. 2.10d). Resolution ($R_s = 2.0$) and pressure (1490 psi) are acceptable, and the run time is only 4 min. The successive experiments of Table 2.3 provide a logical approach to the best possible column conditions for this separation.

Some caution should be exercised when changing the column (different length or particle size). The packing in different columns of the same type (especially from different manufacturers) may vary sufficiently to cause changes in α (Section 5.4.1). For some (less reproducible) column packings, this might require reoptimization of mobile-phase conditions to achieve the best band spacing. Smaller-particle (3- μm) columns are also easier to plug, mainly because smaller-pore frits are required to contain the particles in the column (Section 5.4.3.1). However, the use of 3.5- μm packings with 2.0- μm frits seems to provide the advantages of a smaller particle with none of its disadvantages (Section 5.2.2).

2.3.3.2 Plate Number as a Function of Conditions. A well-developed theory exists for column plate number as a function of all experimental conditions [18]. If the plate height $H = N/L$ is defined (L is column length), H will vary with the velocity u of the mobile phase as it passes through the column ($u = L/t_o$). Two different expressions for this relationship have been described:

$$H = A' + \frac{B'}{u} + C'u \quad (\text{van Deemter et al. [19]}) \quad (2.10)$$

$$H = A''u^{1/3} + \frac{B''}{u} + C''u \quad (\text{Kennedy and Knox [20]}) \quad (2.10a)$$

Here A' , B' , C' , A'' , B'' , and C'' are constants for a particular sample compound and set of experimental conditions as flow rate is varied. Equations 2.10 and

2.10a are generally similar and have been used interchangeably to describe how plate number varies with flow rate or velocity u . There is an optimum flow rate for which H is a minimum and N is a maximum. This is illustrated in Fig. 2.11 for the separation of a fatty acid ester as a function of flow rate and temperature. The optimum flow rate for this sample is between 0.4 and 0.6 $\mu\text{L}/\text{min}$ (note that this is a capillary column with ID = 0.2 mm). As the temperature is increased, the optimum plate height H remains the same ($H = 17 \mu\text{m}$), but H increases with flow rate more slowly at higher temperatures.

The plate height H and velocity u can be expressed as dimensionless quantities: *reduced parameters*, $h = H/d_p$ and $\nu = ud_p/D_m$. The Knox equation (Eq. 2.10a) then assumes the form [20]

$$h = A\nu^{1/3} + \frac{B}{\nu} + C\nu \quad (2.11)$$

Equation 2.11 has been used to compare column efficiencies and to understand the effect of separation conditions on the plate number N . For well-packed columns of varying particle size and differing conditions, the coefficients A , B , and C will generally be roughly constant (e.g., $A = 1$, $B = 2$, and $C = 0.05$ for porous particles). However, values of B and C vary somewhat with the value of k for the band [15]. This reduced-parameter Knox equation is illustrated in Fig. 2.12 for porous and pellicular (nonporous) columns.

HPLC columns are usually operated at flow rates higher than the optimum (0.4 to 0.6 $\mu\text{L}/\text{min}$ for the 0.2-mm-ID column of Fig. 2.11), because higher flow rates allow shorter run times without much loss in resolution. Under these higher flow rate conditions (typically $> 0.5 \text{ mL}/\text{min}$ for a 0.46-cm-ID column), higher plate numbers will be observed for smaller particles, smaller sample molecules, less viscous mobile phases, and higher temperatures. The effect of temperature can be seen in Fig. 2.11.

2.3.3.3 Extracolumn Effects. The preceding discussion ignores the possible effect of the HPLC equipment on separation. Band spreading can occur in several parts of the system and contribute to bandwidth W :

- In the column as discussed in preceding sections (W_c)
- In the injector or autosampler (W_s)
- In the lines and connectors between the column and autosampler or detector (W_{lc})
- In the detector flow cell (W_{fc})

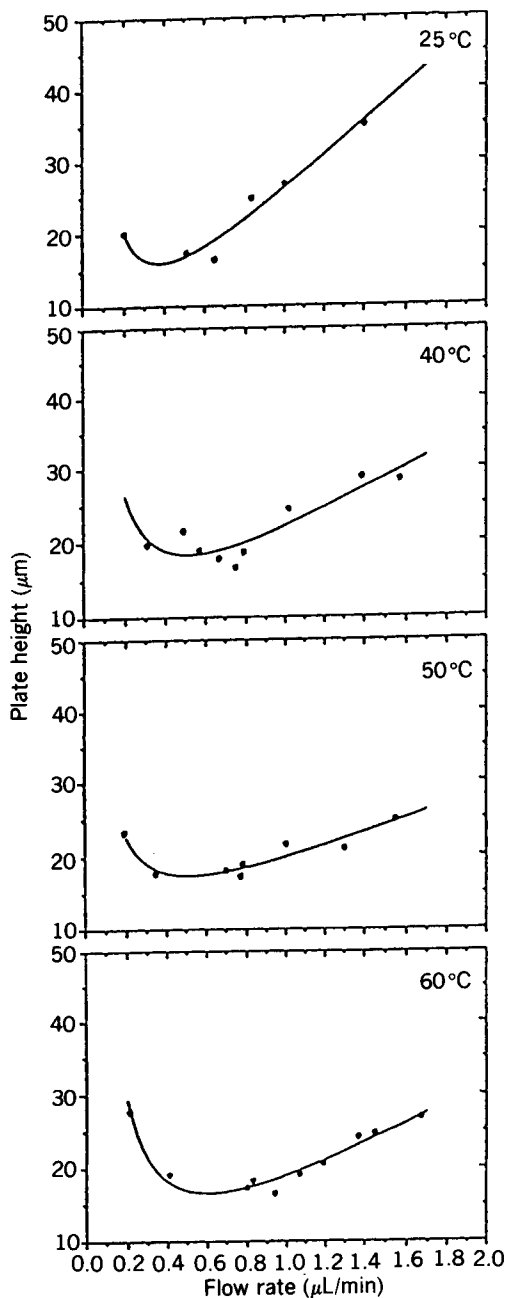

FIGURE 2.11 Dependence of plate height H on mobile-phase flow rate. Methyl ester of C_{16} fatty acid; 40×0.02 -cm $5\text{-}\mu\text{m}$ C_{18} column; 85% acetonitrile–water mobile phase. (Reprinted with permission from Ref. 33.)

These contributions to the bandwidth W observed in the chromatogram add as follows:

$$W^2 = W_c^2 + W_s^2 + W_{lc}^2 + W_{fc}^2 \quad (2.12)$$

As long as the bandwidth contributions W_s , W_{lc} , and W_{fc} are each less than about $\frac{1}{3}W$, their effect on W can be neglected. Band broadening within the column W_c is given by Eq. 2.8, which can be expressed in volume units V (baseline band volume) as

$$V = \frac{4V_R}{\sqrt{N}} \quad (2.13)$$

Since V_R is given as

$$V_R = V_m(1 + k) \quad (2.14)$$

then

$$V = \frac{4V_m(1 + k)}{\sqrt{N}} \quad (2.15)$$

Here V_m is the column dead volume (Eq. 2.5), which is proportional to the internal volume of the column. Thus, bandwidths V will be smaller for shorter, narrower columns (smaller V_m) packed with smaller particles (larger N per

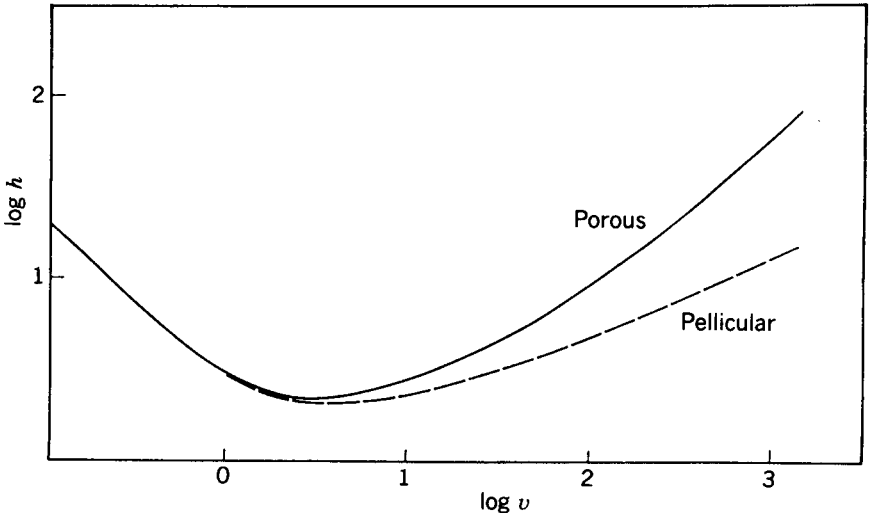

FIGURE 2.12 Theoretical dependence of column efficiency on flow rate. Knox equations for porous and nonporous columns (reduced parameter plots). See the text for details. For porous column, Eq. 2.10a with $A = 1$, $B = 2$, and $C = 0.05$. For nonporous columns, Eq. 2.10a with $A = 1$, $B = 2$, and $C = 0.003$.

unit length). V is also smaller for bands that are less retained (smaller k values). When V is small, extracolumn effects contribute to a greater extent and well-designed HPLC equipment becomes more important.

The contribution of the autosampler to bandwidth W_s is usually due mainly to the volume of the injected sample (Section 2.4.1). Extra-column contributions W_{ic} can be reduced by minimizing the diameter and lengths of connecting tubing, and by ensuring that all connections are made properly with zero-dead-volume fittings. Finally, contributions W_{fc} can be minimized by using well-designed flow cells of minimum volume (e.g., 0.5 to 2 μL). For a further discussion of extracolumn band broadening and its control in practical HPLC systems, see Ref. 22.

Because smaller-particle columns must be shorter to avoid high pressures, the resulting separation is more subject to extra-column band broadening. The first eight experiments of Table 2.3 assume a well-designed HPLC system (e.g., a Hewlett-Packard 1090). The method-development laboratory often has access to high-quality equipment with minimal extra-column band broadening. However, this may not be true for laboratories that routinely perform HPLC assays. Entries 9 and 10 of Table 2.3 illustrate method performance when older, less-well-designed HPLC equipment is used for the separation. For the 25-cm, 5- μm (2.0 mL/min) method (Table 2.3), resolution is not much affected by which system is used: $R_s = 2.3$ (newer system) and $R_s = 2.2$ (older system). However, for the 8-cm, 3- μm (1.7 mL/min) method, resolution is considerably degraded on the older system: $R_s = 1.3$ vs. 2.0 for the newer system (compare Fig. 2.10*d* and *e*). For these reasons, 5- μm particles are usually preferred for methods that will be run with equipment that can contribute greater extracolumn band broadening (e.g., as in many production or quality-control laboratories).

2.4 SAMPLE-SIZE EFFECTS

Except for Chapter 13 and the present section, it is assumed in this book that sample size is so small that it has no effect on the retention, plate number, or resolution of individual peaks within the chromatogram. For a broad range of sample sizes (e.g., < 25 μL and < 10 μg for 0.4- to 0.5-cm ID columns), this is usually the case. If the column length or diameter is reduced, the allowable sample volume or weight decreases in proportion to column volume. Similarly, use of a more efficient column (larger N , other factors equal) will require smaller sample volumes or weights. The separation of basic compounds on silica-based, reversed-phase column packings sometimes requires a 10-fold or greater reduction in sample weight (< 1 μg) to avoid excessive band broadening and tailing (as a result of silanol interactions [23]).

The accidental or intentional increase of sample size beyond these limits leads to a predictable change in separation, which is the subject of this section. As sample size is increased, peaks eventually broaden and the plate number

N decreases, retention times decrease, and sample resolution worsens. We refer to this situation as *column overload*.

An understanding of the effects of sample size on HPLC separation is of value for three different situations:

1. To avoid an undesirable change in separation due to a sample size that is too large
2. To increase detection sensitivity for trace analysis, by using the largest possible sample size (Section 14.5.4)
3. To maximize the recovered weight of purified product in preparative HPLC (Chapter 13)

A change in resolution and/or retention that results from the injection of a sample whose volume or weight is too large is referred to as *volume overload* or *mass overload*, respectively.

2.4.1 Volume Overload: Effect of Sample Volume on Separation

For analytical separations it is usually preferable that the sample is dissolved in the mobile phase. For this case there is no difference in solvent strength (k values) between the sample solvent and the mobile phase. If the sample is introduced to the column as a plug of volume V_s , and if the baseline (4σ) volume of a peak for a small-volume sample is V_c , the peak volume V for a large sample volume will be [24]:

$$\begin{aligned} V &= \left(\frac{4}{3}V_s^2 + V_c^2\right)^{1/2} \\ &\approx (V_s^2 + V_c^2)^{1/2} \end{aligned} \quad (2.16)$$

The effect of an increase in sample volume V_s on peak width and shape is illustrated in Fig. 2.13 and Table 2.4. When the ratio of sample volume to peak volume (V_s/V_c) is less than 0.1, there is no significant effect of sample volume on peak width or separation. As sample size is increased further, however, the sample peak begins to broaden, and eventually (for $V_s/V_c > 5$, e.g., sample 4 in Fig. 2.13) the peak develops a flat top.

As long as the sample volume V_s is less than 0.4 times the peak volume for a small sample V_c , the increase in peak width and the loss in sample resolution will be $< 10\%$; this is usually acceptable. This criterion ($V_s < 0.4V_c$) should be applied to the critical peak pair. As an example, assume a 15×0.46 -cm column and $0.5 < k < 20$. For a typical plate number $N = 10,000$, values of V_c will range from 90 to 1300 μL , and therefore the maximum sample volume will vary from 35 to 500 μL [i.e., the maximum value of V_s varies strongly with k for the analyte(s)]. Larger sample volumes can be used when resolution is not limiting or the sample is dissolved in a solvent weaker than the mobile phase.

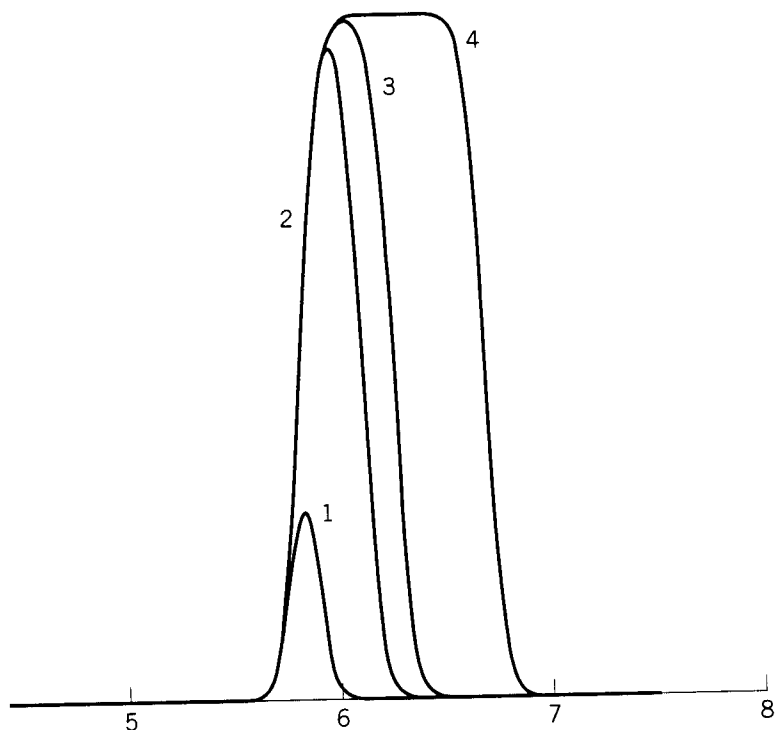

FIGURE 2.13 Effect of sample volume V_s on peak width and shape. $V_s/V_c = 0.3(1)$; $3(2)$; $5(3)$; $15(4)$. (Computer simulations as in Ref. 25. Courtesy of Geoff Cox, Prochrom R&D.)

TABLE 2.4 Effect of Sample Volume (Loop Injection) on Peak Width and Height (Eq. 2.13)

V_s/V_c^a	V^b	Relative Peak Height
<0.05	(1.00)	—
0.1	1.01	0.10
0.2	1.03	0.19
0.3	1.06	0.28
0.4	1.10	0.36
0.6	1.22	0.49
1.0	1.53	0.65
1.5	2.00	0.75
2.0	2.52	0.79
5.0	5.86	0.85
10.0	11.6	0.86 (maximum)

^a V_s is the sample volume; V_c is the baseline peak volume for a small-volume sample.

^b V is the observed peak volume.

Injection of the sample from a loop leads to mixing of the sample with mobile phase before the sample enters the column (due to laminar flow). As a result, the volume of the sample during injection is typically increased (by about 50%); that is, the effect of sample volume on peak broadening is usually somewhat greater than predicted by Eq. 2.16. Table 2.4 summarizes the effect of sample volume on peak width and height, based on Eq. 2.16. Note that the effect of sample volume on peak width is less important for wider bands (larger V_c), because for a given sample volume V_s , the ratio V_s/V_c is then smaller. This means that early (narrower) bands in the chromatogram are most affected by large-volume samples, similar to the case for other extra-column band-broadening processes (Section 2.3.3.3).

A sample may be provided as a solution in a solvent other than the mobile phase. When the sample solvent is weaker than the mobile phase, larger sample volumes can be injected without adverse effects on peak width and separation. Conversely, injection of the sample in a solvent stronger than the mobile phase often leads to broadening and/or distortion of early bands in the chromatogram [26–28] and should be avoided if possible. If it is inconvenient to change the sample solvent, smaller injection volumes (< 10 to $20 \mu\text{L}$) of sample dissolved in a strong solvent (e.g., 100% B) can sometimes be tolerated. Dilution of the sample with the weaker A-solvent (e.g., water in reversed-phase HPLC) followed by injection of a proportionately larger sample volume is also effective in minimizing sample-solvent-related problems. See the further discussion in Section 5.4.2.

2.4.2 Mass Overload: Effect of Sample Weight on Separation

Even when a small sample volume is injected, it is possible for the mass of the sample to overload the column so as to broaden sample peaks and change peak shape. This happens because the column has a limited capacity to retain sample (i.e., the stationary phase can become saturated with the sample). The uptake of a compound X by the column can be approximated by the Langmuir isotherm [29], which is illustrated in Fig. 2.14a by a log-log plot of stationary phase uptake of X vs. the concentration of X in the mobile phase (at equilibrium). For small concentrations of X [X] in the mobile phase (e.g., $[X] < 3$ in Fig. 2.14a), the uptake of X by the column is proportional to the concentration of X in the mobile phase (linear isotherm behavior). Under linear-isotherm conditions (sample weight less than some maximum value), no change will be observed in sample retention, peak width N , or resolution as sample weight is varied. At higher concentrations of X in the mobile phase (> 10 in Fig. 2.14a), linear isotherm behavior is no longer observed, with predictable effects on the separation (see Fig. 2.14b). Here a sample compound has been injected repeatedly, varying only sample weight, and the resulting chromatograms have been superimposed. Injection 1 involves a small sample weight, so there is no peak distortion. The injection of successively larger samples (2 to 5), however, results in the formation of nested peaks having a

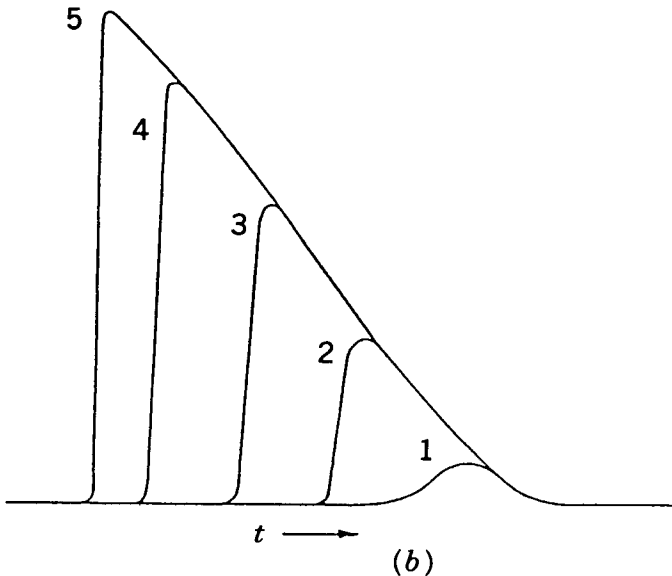
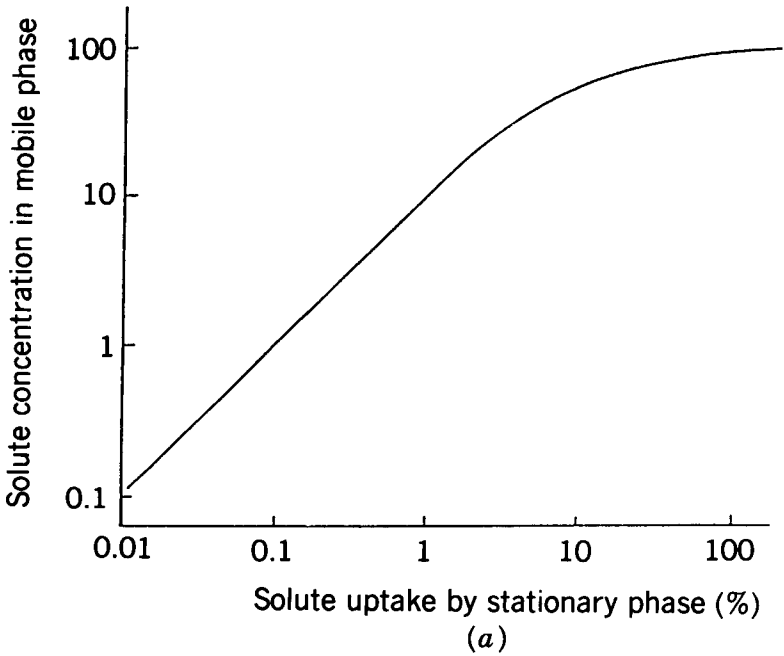

FIGURE 2.14 Effect of sample weight on peak width and shape. (a) Plot of solute uptake by the column (as a percentage of the saturation capacity) vs. solute concentration in the mobile phase; (b) superimposed solute peaks (1 to 5) for injections of different sample mass. (Reprinted with permission from Ref. 30.)

right-triangle shape. The larger the sample weight, the wider is the resulting peak (sample weights increase from 1 to 5 in Fig. 2.14*b*).

As long as the weight of individual sample components in the injected sample is not excessive (typically less than 1 to 2 mg for 0.46-cm ID columns), each band moves through the column independent of other bands. In Fig. 2.15*a* the sample size is 1 mg for the reversed-phase separation of each of these two xanthines (15 × 0.46-cm column). One milligram each of the two compounds was injected separately (—) and as a mixture (----), and the three chromatograms were superimposed. There is little difference in the resulting bands for this moderately overloaded separation, whether the compounds are injected alone or in mixture with each other. Similar behavior is seen in Fig. 2.15*b* for separations where 2.5 mg of each compound was injected.

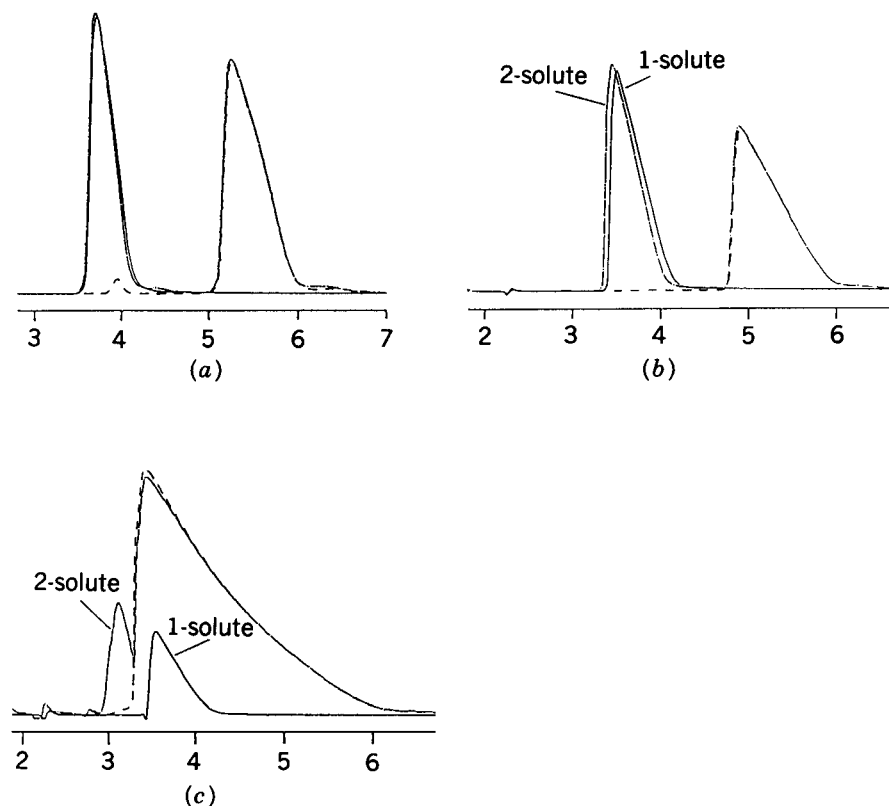

FIGURE 2.15 Separation of xanthine sample as a function of sample weight. Overlapping chromatograms for injection of individual compounds and mixture. Compounds are hydroxyethyltheophylline (HET) and hydroxypropyltheophylline (HPT); column is 15 × 0.46-cm Zorbax C8; mobile phase is 20:5:75% methanol–acetonitrile–buffer. (a) 1.0 mg of each compound; (b) 2.5 mg of each compound; (c) 2.5 mg of HET and 25 mg of HPT. (Reprinted with permission from Ref. 31.)

The right-triangle band shapes shown in Fig. 2.15*a* and *b* are the result of sample weights that are roughly 100 to 250-fold larger than maximum sample weights (10 μg each compound) for linear-isotherm behavior. For further discussion of sample-size effects, see Section 13.2.

2.4.3 Avoiding Problems Due to Too Large a Sample Size

When carrying out HPLC separation for the purposes of sample analysis, it is desirable that values of k , N , and R_s remain constant for different samples being analyzed by the same procedure. This condition simplifies both quantitation and peak identification based on retention time. Constant values of k and N in turn require sample sizes small enough so that separation is not affected. The sample volume is normally kept constant for HPLC analysis, and for this case a large-volume sample will not result in sample-to-sample changes in separation.

2.4.3.1 Higher-Than-Expected Sample Concentrations. If the concentration of an analyte changes from sample to sample, it is possible that mass overload will result for high-concentration samples and cause loss of resolution, change in retention time, and so on. The effect of analyte concentration or weight on separation should be determined for the final HPLC procedure (after method development), and a maximum analyte concentration or weight w_{max} should be established. Samples exceeding this concentration should be diluted and rerun. The maximum value of w_{max} for either reversed- or normal-phase separation can be estimated from the following relationship (see Section 13.4):

$$w_{\text{max}} \approx 50 \left(\frac{1+k}{k} \right)^2 d_c^2 \quad (2.17)$$

Here w_{max} is in micrograms and d_c is the column ID in centimeters. The maximum sample size is the same for both short and long columns [32]. Note that the value of w_{max} is for each compound in the sample, *not* for the total sample weight. For example, if no component of the sample comprises more than 10% of the sample weight, the maximum sample weight will be 10-fold greater than w_{max} . Equation 2.17 overestimates w_{max} whenever the column-packing pore diameter $\gg 10$ nm, the particle size < 5 μm , ionized acids are present in the sample, or (especially) basic sample compounds are subject to silanol interactions (Section 7.3.3.2).

2.4.3.2 Trace Analysis. In trace analysis or for analytes with poor detectability, it is desirable to maximize the analyte signal or concentration C in the flow cell (Eq. 3.5). Usually, the quantity of analyte injected for trace analysis will be too small to overload the column, but other components of the sample

may result in column overload and adverse effects on the separation of the analyte. That is, when the injected weight of one compound is large enough, it can affect the separation of a second, adjacent band. This is illustrated in Fig. 2.15c. In Fig. 2.15b, 2.5 mg of each compound was injected and the presence of one compound in the sample did not affect the separation of the second compound. In Fig. 2.15c the amount injected of the second compound was increased 10-fold (25 mg), and now the separation of the first band is affected markedly. For injection of the first compound by itself, the retention time is 3.6 min; for injection of this compound in the presence of 25 mg of the second compound, its retention time shifts to 3.1 min and the band becomes narrower. Some similar examples more closely related to trace analysis are shown in Fig. 13.5.

When a sample contains excessive amounts of interfering compounds, the best approach is a sample cleanup to remove these interfering compounds (Chapter 4). In trace analysis, it is advantageous to inject a sample volume that is as large as possible. Table 2.4 suggests that V_s/V_c usually should not exceed a value of 0.4; otherwise, significant peak broadening and loss of resolution can result. However, if the band of interest is well resolved from adjacent bands, and if enough sample is available, larger sample volumes can increase peak height by more than two-fold (Table 2.4). If the sample is dissolved in a solvent that is much weaker than the mobile phase, larger volumes can be injected with a proportionate increase in band size and no additional band broadening.

REFERENCES

1. J. C. Berridge, *Techniques for the Automated Optimization of HPLC Separations*, Wiley, New York, 1985, pp. 19–27.
2. P. J. Schoenmakers, *Optimization of Chromatographic Selectivity*, Elsevier, Amsterdam, 1986, Chapter 4.
3. R. C. Chloupek, W. S. Hancock, and L. R. Snyder, *J. Chromatogr.*, **594** (1992) 65.
4. J. P. Foley, *Analyst*, **116** (1991) 1275.
5. DuPont application sheet, Instrument Products Division, DuPont Co., Wilmington, DE.
6. L. R. Snyder, P. W. Carr, and S. C. Rutan, *J. Chromatogr. A*, **656** (1993) 537.
7. *High Purity Solvent Guide*, Burdick & Jackson Laboratories, Muskegon, MI.
8. *HPLC Solvent Reference Manual*, J.T. Baker, Inc., Phillipsburg, NJ.
9. M. Weichmann, *J. Chromatogr.*, **235** (1982) 129.
10. J. J. Kirkland, B. E. Boyes, and J. J. DeStefano, *Amer. Lab.*, **26** (1994) 36.
11. R. C. Chloupek, W. S. Hancock, B. A. S. Marchylo, J. J. Kirkland, B. E. Boyes, and L. R. Snyder, *J. Chromatogr. A*, **686** (1994) 45.
12. J. P. Foley and J. G. Dorsey, *Anal. Chem.*, **55** (1983) 730.
13. M. S. Jeansonne and J. P. Foley, *J. Chromatogr.*, **594** (1992) 1.

14. Unpublished data from laboratory of LC Resources Inc., McMinnville, OR, 1992.
15. R. W. Stout, J. J. DeStefano, and L. R. Snyder, *J. Chromatogr.*, **282** (1983) 263.
16. L. R. Snyder and J. W. Dolan, *Amer. Lab.*, August 1986, p. 37.
17. L. R. Snyder and M. A. Stadalius, in *High-Performance Liquid Chromatography. Advances in Perspectives*, Vol. 4, C. Horvath, ed., Academic Press, San Diego, CA, 1986, p. 195.
18. S. G. Weber and P. W. Carr, in *High Performance Liquid Chromatography*, P. R. Brown and R. A. Hartwick, eds., Wiley-Interscience, New York, 1989, p. 1.
19. J. J. van Deemter, F. J. Zuiderweg, and A. Klinkenberg, *Chem. Eng. Sci.*, **5** (1956) 271.
20. G. J. Kennedy and J. H. Knox, *J. Chromatogr. Sci.*, **10** (1972) 549.
21. J. S. Yoo, J. T. Watson, and V. L. McGuffin, *J. Microcol. Sep.*, **4** (1992) 349.
22. J. W. Dolan and L. R. Snyder, *Troubleshooting LC Systems*, Humana Press, Totowa, NJ, 1989, pp. 98–103.
23. M. A. Stadalius, J. S. Berus, and L. R. Snyder, *LC/GC*, **6** (1988) 494.
24. J. C. Sternberg, *Adv. Chromatogr.*, **2** (1966) 231.
25. L. R. Snyder, J. W. Dolan, and G. B. Cox, *J. Chromatogr.*, **483** (1989) 63.
26. M. Tsimidou and R. Macrae, *J. Chromatogr.*, **285** (1984) 178.
27. N. E. Hoffman, S.-L. Pan, and A. M. Rustum, *J. Chromatogr.*, **465** (1989) 189.
28. N. E. Hoffman and A. Rahman, *J. Chromatogr.*, **473** (1989) 260.
29. J. H. Knox and H. M. Pyper, *J. Chromatogr.*, **363** (1986) 1.
30. B. L. Karger, L. R. Snyder, and C. Horvath, *An Introduction to Separation Science*, Wiley-Interscience, New York, 1973, p. 134.
31. J. E. Eble, R. L. Grob, P. E. Antle, and L. R. Snyder, *J. Chromatogr.*, **405** (1987) 31.
32. H. Poppe and J. C. Kraak, *J. Chromatogr.*, **255** (1983) 395.
33. Y. S. Yoo, J. T. Watson, and V. L. McGuffin, *J. Microcol. Sep.*, **4** (1992) 349.

BIBLIOGRAPHY

1. C. F. Poole and S. K. Poole, *Chromatography Today*, Elsevier, Amsterdam, 1991. (a general review of the principles of chromatography)
2. L. R. Snyder, in *Chromatography*, 5th ed., E. Heftmann, ed., Elsevier, Amsterdam, 1992, Chapter 1. (a general review of the principles of chromatography)
3. G. Guiochon, in *High-Performance Liquid Chromatography: Advances and Perspectives*, Vol. 2, C. Horvath, ed., Academic Press, San Diego, CA, 1980. (a discussion of optimization in liquid chromatography, including detailed discussions of column efficiency and extracolumn effects)
4. S. G. Weber and P. W. Carr, in *High Performance Liquid Chromatography*, P. R. Brown and R. A. Hartwick, eds., Wiley-Interscience, New York, 1989. (the most recent in-depth discussion of the factors that determine column efficiency)

3

DETECTION SENSITIVITY AND SELECTIVITY

(WITH IRA KRULL AND MIKE SZULC)

- 3.1 Introduction
- 3.2 UV Detection
 - 3.2.1 General Considerations
 - 3.2.2 Choice of Wavelength
 - 3.2.2.1 Sample Absorbance as a Function of Molecular Structure
 - 3.2.2.2 Mobile-Phase Absorbance as a Function of Composition
 - 3.2.3 Signal, Noise, and Assay Precision
 - 3.2.4 Maximizing Signal/Noise Ratio for Better Assay Precision
 - 3.2.5 Detector Linearity
 - 3.2.6 Diode-Array UV Detectors
- 3.3 Other HPLC Detectors
 - 3.3.1 Universal Detection
 - 3.3.2 Fluorescence Detection
 - 3.3.3 Electrochemical Detection
 - 3.3.4 Mass Spectrometer Detection (LC-MS)
 - 3.3.4.1 Mass Analyzers
 - 3.3.4.2 Ionization Methods
 - 3.3.5 Selecting the Mass Spectrometric Detector
 - 3.3.6 Less Common Detectors

3.1 INTRODUCTION

In most cases HPLC method development is carried out with ultraviolet (UV) detection using either a variable-wavelength (spectrophotometric) or a diode-array detector (DAD). Therefore, the major part of this chapter is concerned with UV detection, which can provide an adequate response for most samples. Alternative detectors are selected primarily when:

- Samples have little or no UV absorbance.
- Analyte concentrations are too low for UV detection.
- Sample interferences are important.
- Qualitative structural information is required.

Detector type and operation affect the relative response of sample components and potential interferences in three interrelated ways: sensitivity, selectivity, and baseline noise. The importance of adequate *detection sensitivity* is illustrated in Fig. 3.1*a* for the separation of an aged sample of *n*-butanol. Using UV detection at 200 nm, no peaks are detected in the chromatogram. If 184 nm is selected for detection (Fig. 3.1*b*), eight different peaks are clearly visible. *Detection selectivity* is illustrated in Fig. 3.2. In Fig. 3.2*a* the analyte of interest (riboflavin, arrow) is almost completely overlapped by early-eluting interferences. In this case, a change from UV detection (Fig. 3.2*a*) to fluorescence detection (Fig. 3.2*b*) provides much better detection selectivity and permits a quantitative assay for riboflavin. Figure 3.3 shows the importance of *baseline noise* in limiting detection and quantitation. In Fig. 3.3*a* the signal/noise (S/N') ratio is only 4, which precludes a precise measurement of peak height or area. In the same separation with different detector settings (Fig. 3.3*b* and *c*), baseline noise is much reduced, with an increase in S/N' ratio to a value of 19 in Fig. 3.3*c*.

3.2 UV DETECTION

3.2.1 General Considerations

Figure 3.4 illustrates some general features of all UV detectors. The light source is typically a deuterium lamp, which provides acceptable light intensity from 190 to 400 nm. When measurements at visible wavelengths (400 to 700 nm) are required, a higher-energy tungsten-halide lamp is often used (although a deuterium lamp is still usable above 400 nm). However, most HPLC applications are carried out using wavelengths below 400 nm. Light from the lamp passes through a UV-transmitting flow cell connected to the column and impinges on a diode (or a phototube in older systems) that measures the light intensity I . Usually, light from the lamp is also directed to a reference diode for measurement of the original light intensity I_0 . The detector electronics then convert the signal from the two diodes into absorbance A , which is transmitted to the data system:

$$A = \log \frac{I_0}{I} \quad (3.1)$$

Analyte concentration C in the flow cell is related to absorbance A , analyte molar absorptivity ϵ , and flow-cell length L_{fc} by Beer's law:

$$A = C\epsilon L_{fc} \quad (3.2)$$

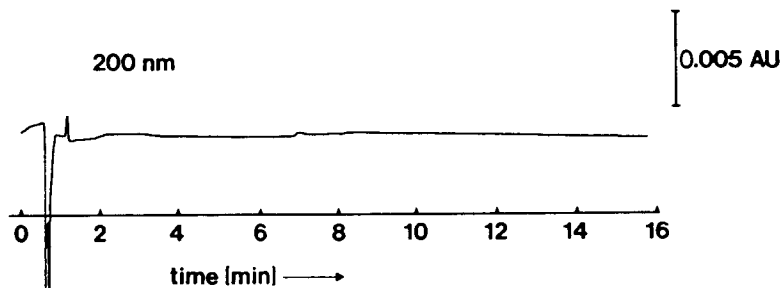

(a)

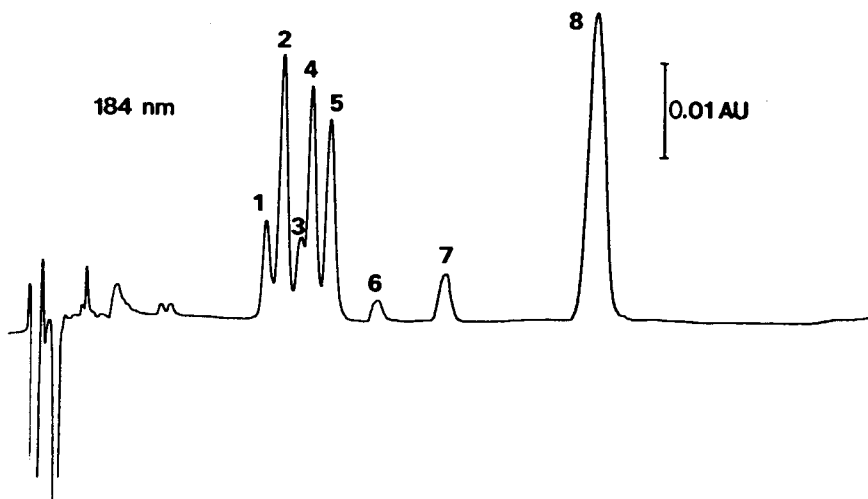

(b)

FIGURE 3.1 Detection sensitivity as a function of detection conditions: separation of aged *n*-butanol sample by reversed-phase HPLC. Conditions: 15×0.46 -cm, $7\text{-}\mu\text{m}$ C_8 column; mobile phase, 25% acetonitrile–1 mM phosphoric acid; 2.0 mL/min; ambient; UV detection. (a) detection at 200 nm; (b) detection at 184 nm. (Reprinted with permission from Ref. 1.)

A general goal in selecting experimental conditions that affect detection is to maximize the signal S (equal to A at peak maximum) of sample components of interest.

Variable-wavelength detectors also include a means of selecting the wavelength used for detection (e.g., 220 nm). This wavelength selection is achieved

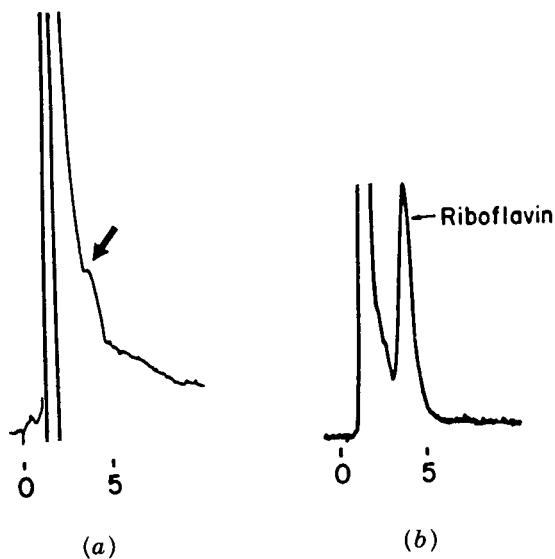

FIGURE 3.2 Detection selectivity as a function of detection conditions: separation of riboflavin in dog-food extract by cation-exchange HPLC. Conditions: 100×0.21 -cm Zipax SCX column; mobile phase, water; 1.0 mL/min; ambient temperature. (a) UV detection at 365 nm; (b) fluorescence detection, excitation at 365 nm, emission at 530 nm. (Reprinted with permission of DuPont Instrument Products Division.)

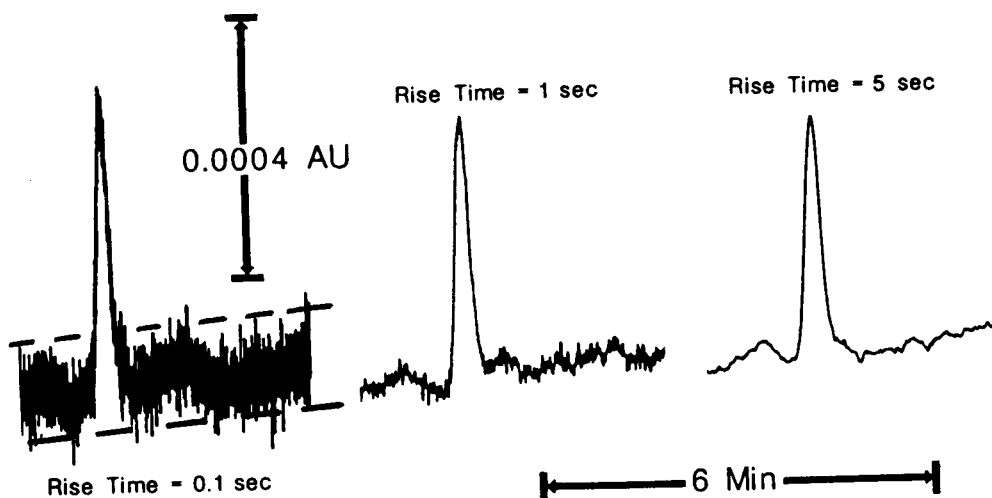

FIGURE 3.3 Signal/noise (S/N') ratio: Noise as a function of detection conditions; rise time varies as shown from 0.1 to 5 s. (Reprinted with permission from Ref. 2.)

with a diffraction grating as illustrated in Fig. 3.4*b*. Light from the lamp enters the grating assembly through an entrance slit and is focused on the grating by mirror *A*. The orientation of the grating can be varied so as to direct monochromatic light of a selected wavelength onto a second mirror *B*, and from there to the exit slit. For variable-wavelength detectors, the grating assembly is positioned between the lamp and the flow cell. Diode-array detectors (DADs) (Section 3.2.6) have the grating assembly positioned after the flow cell, so that light of different wavelengths can be measured (and results stored) simultaneously with an array of sensing diodes.

3.2.2 Choice of Wavelength

For many samples, good analytical results will be obtained only by careful selection of the wavelength used for detection. This choice requires a knowledge of the UV spectra of individual sample components. If analyte standards are available, their UV spectra can be measured prior to HPLC method development. Alternatively, a DAD (Section 3.2.6) permits the acquisition of UV spectra for all sample components during method development. A significant amount of additional information is available through the routine use of a DAD in HPLC.

3.2.2.1 Sample Absorbance as a Function of Molecular Structure. The wavelength chosen for UV detection must provide acceptable absorbance by the various analytes in the sample, combined with acceptable light transmittance by the mobile phase. For some samples it may also be important to select a wavelength at which sample interferences have minimal absorption. Figure 3.5, which shows the UV absorption spectra of dilute solutions of two compounds [amitryptiline (AMI) and imiprimine (IMI)], can be used to illustrate some of the considerations involved in the selection of a detection wavelength. If both compounds are of interest and maximum detection sensitivity is needed, detection at 210 nm might be a good choice. Here each compound exhibits near-maximum absorbance, and several different solvents and mobile-phase additives can also be used at this wavelength (Section 3.2.2.2). If sample interferences (e.g., near t_0) complicate the separation and quantitation of these two compounds, 240 to 250 nm might be a better choice of wavelength. Most interferences will absorb much less above 240 nm, compared to detection at 210 nm. If IMI is the analyte and AMI an interferent (and if trace analysis is not involved), 290 to 300-nm detection might be preferred, since in this wavelength region only IMI has appreciable absorbance.

The detector signal *A* is proportional to the molar absorptivity ϵ of the compound of interest (Eq. 3.2). For UV detection to provide adequate sensitivity for the analysis of major sample components, ϵ must be greater than 10 at some wavelength above 185 nm. This will be the case for most compounds of interest. For trace analysis, on the other hand, values of ϵ above 1000 are

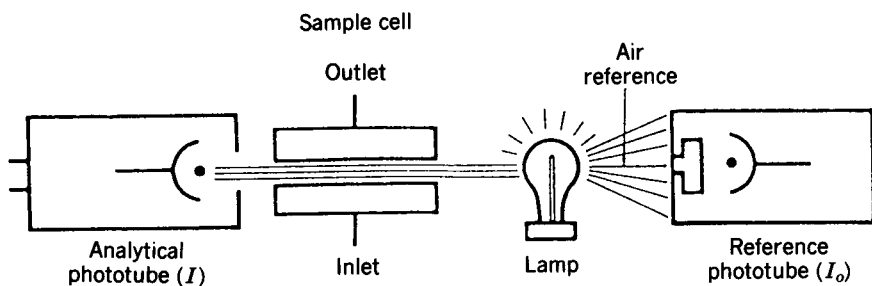

(a)

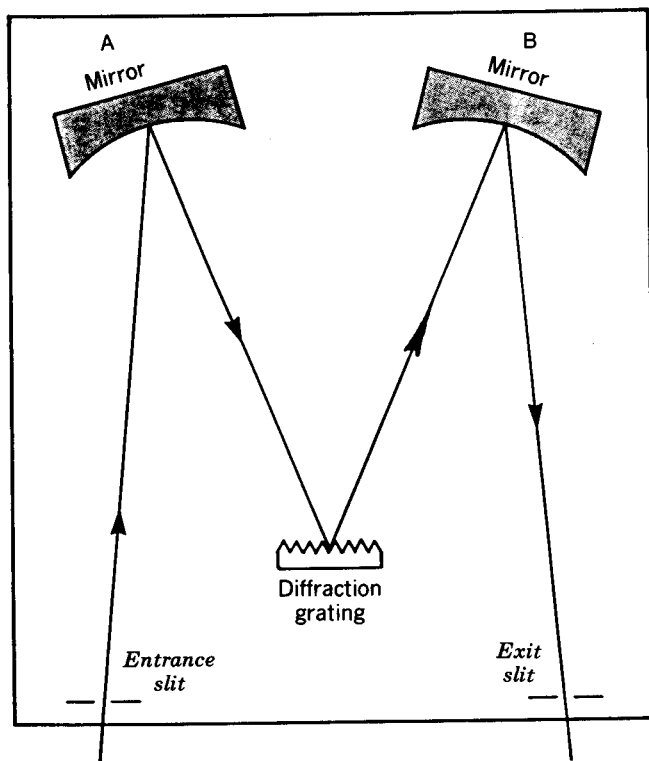

(b)

FIGURE 3.4 UV detectors: (a) schematic; (b) grating assembly. See the text for details. (Reprinted with permission from Ref. 3.)

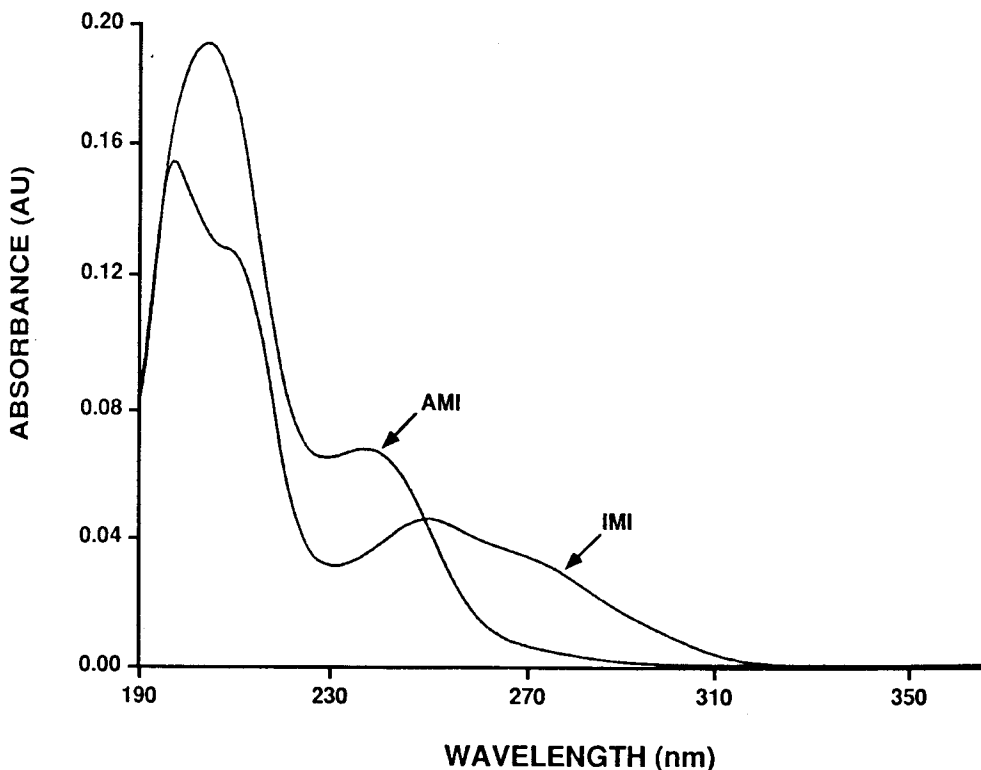

FIGURE 3.5 UV spectra for two tricyclic antidepressant compounds, amitriptyline (AMI) and imipramine (IMI). (Reprinted with permission from Ref. 2.)

usually required. The trace analysis of compounds with ϵ below 100 is usually not possible with UV detection.

The only organic compounds for which UV detection is completely unsuitable are saturated hydrocarbons and their amino or nitrile derivatives. Saturated hydrocarbons substituted by ether ($-\text{O}-$), hydroxy ($-\text{OH}$), chloro ($-\text{Cl}$), carboxy ($-\text{COOH}$), or ester ($-\text{COOR}$) groups have marginal absorptivity ($\epsilon < 100$) and may require detection at low UV values (185 to 210 nm). Figure 3.6 illustrates the variation of ϵ with wavelength for some representative compounds of this type. When the detection wavelength is less than 210 nm, sample interferences generally absorb strongly and the choice of mobile-phase solvents and additives is somewhat restricted. Wavelengths of < 200 nm are available with many UV detectors, but detection in this region is less rugged and convenient [1].

Compound types other than those mentioned above generally have larger values of ϵ and can be detected at higher wavelengths (> 210 nm). Wavelength maxima and molar absorptivities ϵ for various functional groups are summa-

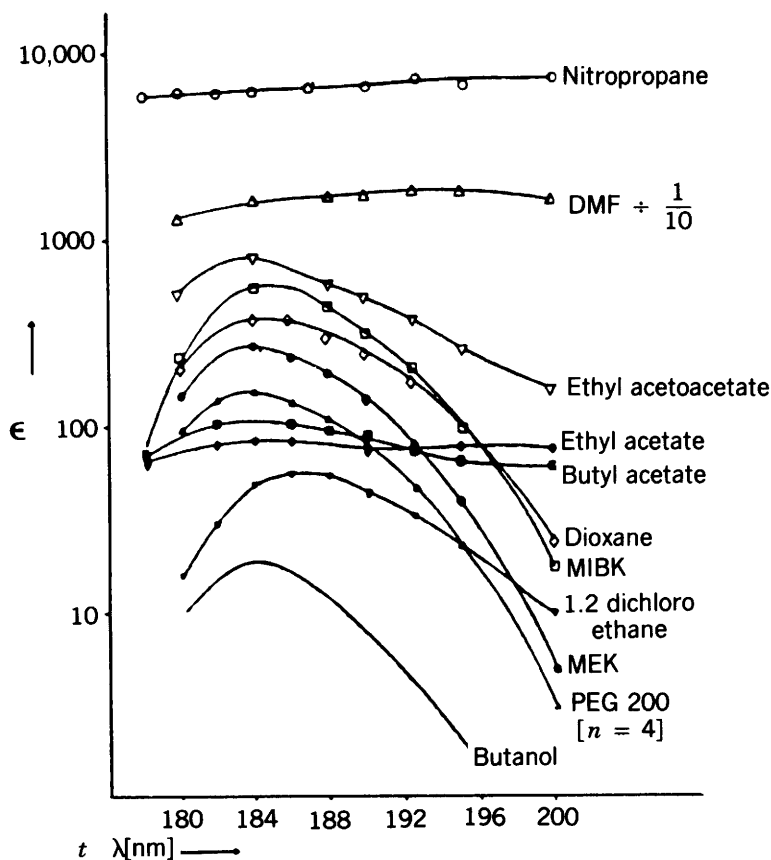

FIGURE 3.6 UV spectra of compounds that absorb only at low wavelengths. (Reprinted with permission from Ref. 1.)

ized in Table 3.1. Aromatic compounds usually have ϵ values above 1000 at wavelengths above 210 nm.

3.2.2.2 Mobile-Phase Absorbance as a Function of Composition. The mobile phase (without sample) must transmit sufficiently at the wavelength used for detection. As the light intensity reaching the detector phototube (Fig. 3.4) decreases, baseline noise increases and detection sensitivity may be reduced. One study indicates that baseline noise will increase significantly when $A > 0.7$ for the mobile phase [5]. This result suggests that mobile-phase absorbance should usually be less than 0.5 at the wavelength used for detection. When the absorbance A of the mobile phase exceeds a value of about 1.0, the detector may become unusable.

Table 3.2 summarizes absorbance vs. wavelength for a number of solvents and additives used in reversed-phase HPLC. Water is effectively nonabsorbing

TABLE 3.1 Representative Molar Absorptivity Values for Some Common Functional Groups

Compound Type	Chromophore	Wavelength (nm)	Molar Absorptivity
Acetylide	$-\text{C}\equiv\text{C}-$	175–180	6,000
Aldehyde	$-\text{CHO}$	210	1,500
		280–300	11–18
Amine	$-\text{NH}_2$	195	—
Azido	$\text{C}=\text{N}$	190	5,000
Azo	$-\text{N}=\text{N}$	285–400	3–25
Bisulfide	$-\text{S}-\text{S}$	194	5,500
		255	400
Bromide	$-\text{Br}$	280	300
Carboxyl	$-\text{COOH}$	200–210	50–70
Ester	$-\text{COOR}$	205	50
Ether	$-\text{O}-$	185	1,000
Iodide	$-\text{I}-$	260	400
Ketone	$\text{C}=\text{O}$	195	1,000
		270–285	15–30
Nitrate	$-\text{ONO}_2$	270	12
Nitrile	$-\text{C}\equiv\text{N}$	160	—
Nitrite	$-\text{ONO}$	220–230	1,000–2,000
		300–400	10
Nitro	$-\text{NO}_2$	210	Strong
Nitrose	$-\text{N}=\text{O}$	302	100
Oxime	$-\text{NOH}$	190	5,000
Sulfone	$-\text{SO}_2$	180	—
Sulfoxide	$\text{S}=\text{O}$	210	1,500
Thioether	$-\text{S}-\text{O}$	194	4,600
		215	1,600
Thioketone	$\text{C}=\text{S}$	205	Strong
Thiol	$-\text{SH}$	195	1,400
Unsaturation	$-(\text{C}=\text{C})_3-$	260	35,000
Conjugated	$-(\text{C}=\text{C})_4-$	300	52,000
	$-(\text{C}=\text{C})_5-$	330	118,000
Aliphatic	$-\text{C}=\text{C}-$	190	8,000
	$-(\text{C}=\text{C})_2-$	210–230	21,000
Alicyclic	$-(\text{C}=\text{C})_2-$	230–260	3,000–8,000
Miscellaneous	$\text{C}=\text{C}-\text{C}\equiv\text{C}$	291	6,500
compounds	$\text{C}=\text{C}-\text{C}=\text{N}$	220	23,000
	$\text{C}=\text{C}=\text{C}=\text{O}$	210–250	10,000–20,000
		300–350	Weak
	$\text{C}=\text{C}-\text{NO}_2$	229	9,500
Benzene	C_6H_6	184	46,700
		202	6,900
		255	170
Diphenyl	$\text{C}_{12}\text{H}_{10}$	246	20,000

Source: Ref. 1, with permission.

TABLE 3.2 UV Absorbance of Reversed-Phase Mobile-Phase Components as a Function of Wavelength

Solvents	Absorbance (AU) at Wavelength (nm) Specified											
	200	205	210	215	220	230	240	250	260	280		
Acetonitrile	0.05	0.03	0.02	0.01	0.01	<0.01						
Methanol	2.06	1.00	0.53	0.37	0.24	0.11	0.05	0.02	<0.01			
Degassed	1.91	0.76	0.35	0.21	0.15	0.06	0.02	<0.01				
Isopropanol	1.80	0.68	0.34	0.24	0.19	0.08	0.04	0.03	0.02	0.02		
Tetrahydrofuran												
Fresh	2.44	2.57	2.31	1.80	1.54	0.94	0.42	0.21	0.09	0.05		
Old	>2.5	>2.5	>2.5	>2.5	>2.5	>2.5	>2.5	>2.5	2.5	1.45		
Acids and Bases												
Acetic acid, 1%	2.61	2.63	2.61	2.43	2.17	0.87	0.14	0.01	<0.01			
Hydrochloric acid, 6 mM (0.02%)	0.11	0.02	<0.01									
Phosphoric acid, 0.1%												
Trifluoroacetic acid												
0.1% in water	1.20	0.78	0.54	0.34	0.20	0.06	0.02	<0.01				
0.1% in acetonitrile	0.29	0.33	0.37	0.38	0.37	0.25	0.12	0.04	0.01	<0.01		
Ammonium phosphate, dibasic, 50 mM	1.85	0.67	0.15	0.02	<0.01							
Triethylamine, 1%	2.33	2.42	2.50	2.45	2.37	1.96	0.50	0.12	0.04	<0.01		
Buffers and Salts												
Ammonium acetate, 10 mM	1.88	0.94	0.53	0.29	0.15	0.02	<0.01					
Ammonium bicarbonate, 10 mM	0.41	0.10	0.01	<0.01								
EDTA (ethylenediaminetetraacetic acid), disodium, 1 mM	0.11	0.07	0.06	0.04	0.03	0.03	0.02	0.02	0.02	0.02		

TABLE 3.3 Useful Solvent Mixtures with Low Background Absorbances (< 0.5 AU) at ≥ 200 nm

Aqueous mobile-phase mixtures	
0–26%	methanol–water
0–28%	isopropanol
0–20%	THF
0–100%	acetonitrile–water
ACN–water with additives	
0.2%	acetic acid
0.4%	trifluoroacetic acid
250 mM	NaCl
> 25 mM	potassium (or sodium) phosphate (pH < 5)
25 mM	sodium (or potassium) phosphate (pH 6.8)

above 180 nm, so this mobile-phase component can be ignored. Next, consider the solvents and additives that might be used with detection at 200 nm ($A < 0.5$). Table 3.3 illustrates typical mixtures of solvent and water (no additives) where UV detection at 200 nm or higher can be used. For acetonitrile–water mixtures, detection at 200 nm or higher is possible with up to the designated concentrations of additives listed in Table 3.3. Detection in the region 185 to 200 nm is more restrictive. At 190 nm, HPLC-grade acetonitrile has $A \approx 1.0$, so that its maximum concentration in the mobile phase is 50%. The only additives that are practical below 200 nm in concentrations above 1 mM are phosphoric acid and aliphatic amines.

Normal-phase chromatography (Part II of Chapter 6) uses solvents that are generally more strongly absorbing, so that detection at higher wavelengths is usually required. Table 3.4 summarizes absorbance data for some useful solvents at different wavelengths. Note that the solvents and additives of

TABLE 3.4 UV Absorbance of Normal-Phase Solvents as a Function of Wavelength

Solvent	Absorbance (A) at Wavelength (nm) Indicated						
	200	210	220	230	240	250	260
Ethyl acetate	>1.0	>1.0	>1.0	>1.0	>1.0	>1.0	0.10
Ethyl ether	>1.0	>1.0	0.46	0.27	0.18	0.10	0.05
Hexane	0.54	0.20	0.07	0.03	0.02	0.01	0.00
Methylene chloride	>1.0	>1.0	>1.0	1.4	0.09	0.00	0.00
Methyl- <i>t</i> -butyl ether	>1.0	0.69	0.54	0.45	0.26	0.11	0.05
<i>n</i> -Propanol	>1.0	0.65	0.35	0.15	0.07	0.03	0.01
<i>i</i> -Propanol	>1.0	0.44	0.20	0.11	0.05	0.03	0.02
Tetrahydrofuran	>1.0	>1.0	0.70	0.50	0.30	0.16	0.09

Source: Ref. 6.

Tables 3.2 to 3.4 may contain UV-absorbing impurities or develop absorption as a result of degradation when exposed to light and air. Therefore, the absorbance values in Tables 3.2 to 3.4 may represent maximum absorbances for HPLC-grade solvents. If the solvent absorbance is significantly greater than in Tables 3.2 to 3.4, the material is probably contaminated. Note that the values for triethylamine in Table 3.2 are for an impure sample; however, even fresh samples of some aliphatic amines may absorb significantly at 220 nm or below.

3.2.3 Signal, Noise, and Assay Precision

Precise results are of prime importance when carrying out quantitative analysis by HPLC (Chapter 14). Detection affects assay precision via the signal/noise (S/N') ratio. Signal (S) refers to the baseline-corrected absorbance of the analyte peak, and noise (N') refers to the width of the baseline as illustrated in Fig. 3.3. Baseline noise usually has two components: a short-term (high-frequency) contribution from stray light and the detector electronics, and a long-term contribution from temperature fluctuations, pump "noise," and/or a dirty column. In Fig. 3.3 high-frequency noise is more important for a rise time (detector time constant) of 0.1 s, and long-term noise is more important for a rise time of 5 s.

A rough estimate of assay precision as a function of S/N' is possible. The baseline width N' can be approximated by a Gaussian distribution of width 4σ . Therefore, a single-point measurement of baseline absorbance on each side of the peak has an uncertainty or standard deviation $\sigma_i = N'/4$. The measurement of peak height then is the result of three measurements (one on each side of the peak plus the peak maximum), so the uncertainty of the resulting peak height measurement (1 SD) is roughly $(3^{1/2})\sigma_i \approx N'/2$. The coefficient of variation (CV) due to low values of S/N' is then

$$\begin{aligned} \text{CV} &\approx 100 \frac{N'/2}{S} \\ &\approx \frac{50}{S/N'} \end{aligned} \quad (3.3)$$

For example, in the example of Fig. 3.3 (rise time = 0.1 s), $S/N' = 4.2$, and the estimated maximum precision of peak-height measurement would be $50/4.2 = \pm 12\%$.

If assay precision is affected by noise (small S/N' values), the imprecision (CV) should increase for smaller peak absorbance values (S) or smaller concentrations of the analyte. This effect is often observed, as illustrated by the data of Fig. 3.7. Here assay precision (CV) is plotted vs. peak absorbance (for varying analyte concentrations) for the assay of seven different tricyclic antidepressants in serum. At higher sample concentrations (higher absorbance

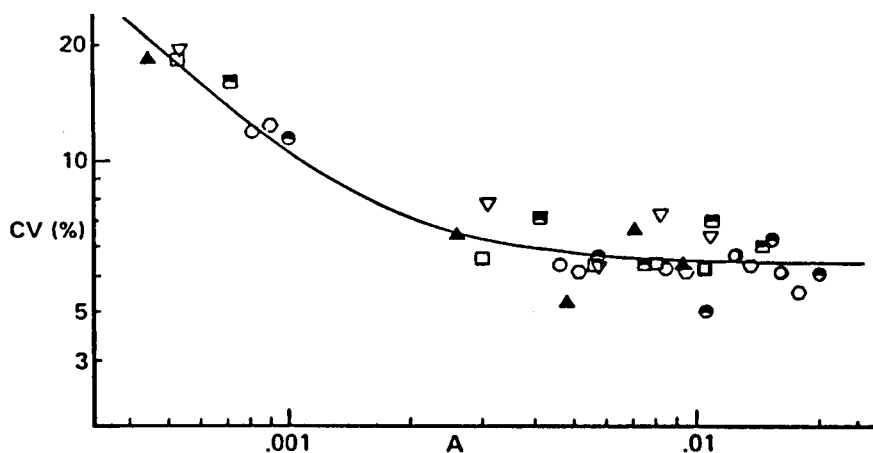

FIGURE 3.7 Dependence of assay precision on analyte concentration and S/N' ratio. Data points refer to different concentrations (6 to 360 ng/mL) of seven tricyclic antidepressant analytes separated by the same HPLC procedure. The coefficient of variation (CV) is plotted vs. peak height (absorbance). (Reprinted with permission from Ref. 7.)

or larger S/N' ratio at constant N'), precision is no longer affected by S/N' ratio and becomes constant ($CV \approx 6\%$) in Fig. 3.7. At lower concentrations, the CV increases as analyte concentration decreases. Thus the dependence of the assay CV on analyte concentration can be used to determine whether an increase in S/N' ratio will yield greater precision. If the CV does not change with concentration, an increase in S/N' ratio will have no effect on precision. Conversely, if the CV increases as sample concentration decreases, an increase in S/N' ratio will lead to better assay precision.

Estimates of assay imprecision by means of Eq. 3.3 are probably conservative in most cases, because data systems often use averaging and smoothing techniques to minimize the effect of noise on precision. Equation 3.3 is useful, however, in obtaining a rough estimate of the maximum impact of noise on assay precision. With this caveat, an equation can be derived (from Eqs. 3.2, 3.3, and 3.6) which relates the minimum quantifiable mass or sample concentration to experimental conditions:

$$\text{minimum mass } (\mu\text{g}) = \frac{1.25 \times 10^5 M V_m (1 + k) N'}{(CV) N^{1/2} L_{fc} \epsilon} \quad (3.4)$$

Here M is the analyte molecular weight [Daltons (Da)], V_m the column dead volume (mL), N' the baseline noise (in units of A), CV the desired precision (%), N the plate number, L_{fc} the optical pathlength of the flow cell (cm), and ϵ the analyte molar absorptivity. The minimum analyte concentration ($\mu\text{g}/\text{mL}$) can also be calculated:

$$\text{minimum analyte concentration } (\mu\text{g/mL}) = \frac{\text{minimum mass } (\mu\text{g})}{\text{sample volume (mL)}} \quad (3.5)$$

Experimental minimum concentrations may be somewhat smaller than values determined from these calculations, as a result of smoothing by the data system.

3.2.4 Maximizing Signal/Noise Ratio for Better Assay Precision

When assay precision varies with analyte concentration, better precision can be obtained by increasing the S/N' ratio. This can be achieved by either an increase in signal S or a decrease in noise N' . A maximum signal can be achieved by selecting the wavelength that gives maximum absorbance (e.g., = 210 nm for AMI in Fig. 3.5). Since noise does not vary much with wavelengths above 200 nm, the wavelength maximum also corresponds to maximum S/N' ratio. For wavelengths below 200 nm, noise increases rapidly (especially for detector lamps that have aged), and then the wavelength maximum may not be the same as the wavelength for maximum S/N' value.

An increase in signal S can also be achieved (Eq. 3.2) either by an increase in analyte concentration in the flow cell or an increase in flow-cell pathlength (provided that there is no significant increase in peak volume to cause extra-column band-broadening, see Section 2.3.3.3). The concentration C in the flow cell is given [8] by

$$C = \frac{0.4C_0V_s(N)^{0.5}}{V_m(1+k)} \quad (3.6)$$

In summary, the signal S can be increased in the following ways:

- Increase in the analyte concentration C_0
- Increase in the injected sample volume V_s
- Increase in column efficiency N
- Decrease in the column volume V_m
- Decrease in analyte retention k

However, some of these means of increasing C and S can be counterproductive if carried to extremes. Thus, too large a sample volume may lead to peak broadening, with loss of resolution and a resultant peak sensitivity that approaches a limiting value (Table 2.4). Similarly, a column that has a very small volume (short or narrow diameter) or small particles ($< 5 \mu\text{m}$) can lead to peaks that are so narrow that extra-column effects lead to losses in sensitivity and sample resolution (Sections 2.3.3.3, 5.2.2). Also, when $k < 1$, baseline disturbances or sample interferences near t_0 may more than offset any increase in C and S predicted by Eq. 3.6.

Noise may be reduced in several ways, depending on whether high-frequency or long-term noise is most prevalent. The effect of both kinds of noise on precision also depends on the data-handling and integration parameters chosen for a particular assay. High-frequency noise can be removed by increasing the detector time constant τ or rise time (rise time $\approx 2\tau$), as illustrated in Fig. 3.3. At the same time, increasing τ can eventually result in peak broadening and tailing, with a resulting loss in signal. Further information derived from data such as in Fig. 3.3 is instructive. As shown in Table 3.5, as τ increases from 0.1 to 1.0 s, noise decreases almost fourfold, and the peak height is unchanged. That is, the high-frequency noise is much reduced but peak width is unaffected. Increasing τ to 4 s reduces the noise further, from 3×10^{-5} to 2×10^{-5} A. The signal (either height or area) is also decreased by 6%, due to peak broadening as a result of the larger time constant. However, the S/N' ratio increases further, to a maximum value of 21.5 for a τ of 2.0 s. Continued increase in τ results in a decrease in signal but not in noise, so that the S/N' ratio then decreases (as does sample resolution).

For the example above, the optimum value of τ is 2.0 s. In other cases, the optimum value of rise time will depend on the initial peak width and the relative importance of high-frequency vs. long-term noise. The optimum rise time or time constant also depends on whether peak height or area is used for quantitation. Peak heights are preferred for trace analysis (Section 14.5.4).

Because noise increases as light intensity falls off, an increase in high-frequency noise can be expected as the detector lamp ages. A doubling of the noise was noted in one study when the lamp energy dropped to 15% of its original value [5]. Assay precision is degraded significantly by detector noise, which can increase with lamp age. Therefore, the precision of a method can vary with time for the same detector or when different detectors are used.

Pump pulsations can contribute to long-term noise. Baseline noise of this type is characterized by a regular rise and fall of the baseline, which parallels the cycle time of the pump. Some pumps are much more prone than others to pulsation noise, but the use of pulse dampers can markedly reduce the effect of pump pulsation. When on-line blending is used to prepare the mobile phase and the absorbances of the two (or more) solvents being mixed are different, the mobile phase leaving the pump may show oscillations in absor-

TABLE 3.5 Effect of Rise Time on Detection Sensitivity^a

Rise Time τ (s)	Signal (Peak Height) (10^{-5} A)	Noise (10^{-5} A)	S/N' Ratio
0.1	46	11.0	4.2
1.0	46	3.0	15.3
2.0	43	2.0	21.5
4.0	39	2.0	19.5
5.0	38	2.0	19.0

^a Same system as in Fig. 3.3.

bance. The result is a repeating up-and-down movement of the baseline similar to that observed from pump pulsations but with a different pump cycle time. This absorbance-related noise can be eliminated by adding a nonretained, UV-absorbing compound to one of the two solvents being mixed on-line to equalize their absorbances: See the similar discussion in Section 8.5.3 for drifting baselines in gradient elution.

Still another kind of long-term noise results from contamination of the column by prior sample injections. Such samples may contain compounds that leave the column at a later time; over time, several such late eluters (from different prior samples) may overlap to produce an irregular baseline. This effect is illustrated in Fig. 3.8 for the analysis of a pharmaceutical drug in plasma. Figure 3.8*a* shows the chromatogram for the initial sample injection. In this case, the run time (for elution of EP, the compound of interest) is about 15 min. However, late eluters continue to leave the column and appear in subsequent chromatograms as a noisy baseline. Baseline noise of this kind is fairly common when “dirty” samples are analyzed (e.g., samples of biological origin, environmental samples such as water or soil extracts, organic reaction

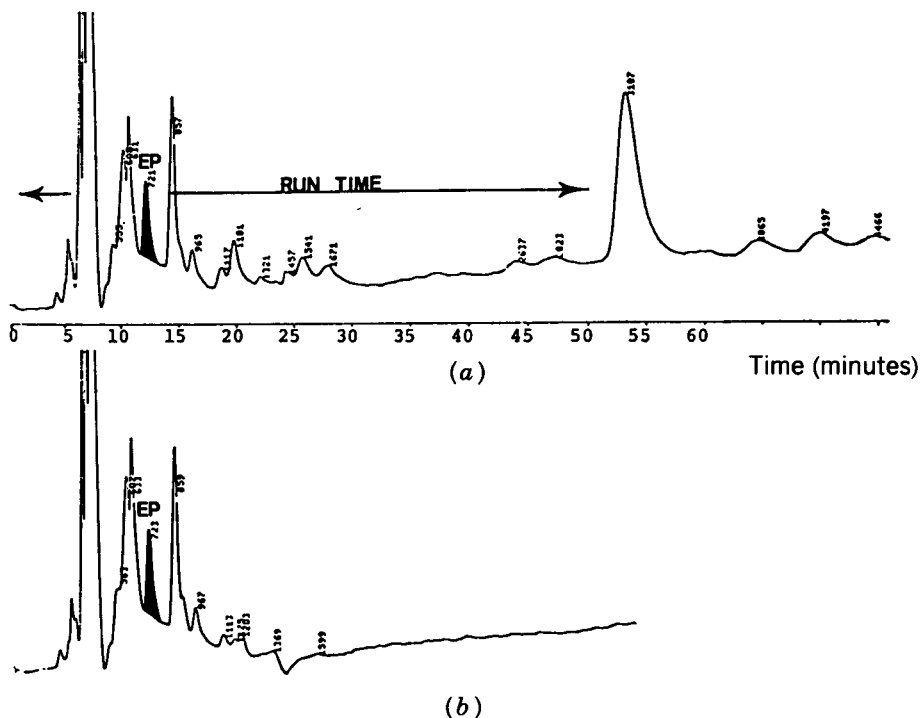

FIGURE 3.8 Effect of late eluters on long-term baseline noise. Isocratic reversed-phase analysis of plasma extract for drug EP. (a) Separation without column switching; (b) separation with column switching. (Reprinted with permission from Ref. 9.)

mixtures, etc.). Noise due to late eluters can be reduced in several ways: sample cleanup prior to HPLC (Chapter 4), column cleanup with a strong solvent (Chapter 5), use of guard columns (Chapter 5), gradient elution (Chapter 8), or column switching (Section 4.6). Figure 3.8*b* shows the ability of column switching to eliminate bands that elute after 25 min in the separation of Fig. 3.8*a*. Sample pretreatment can also enhance detection by removing sample interferences and/or concentrating the analyte (Sections 4.5 and 4.6). Table 3.6 summarizes a systematic approach for maximizing detection sensitivity (S/N' ratio).

3.2.5 Detector Linearity

Under ideal conditions, the relationship in Eq. 3.2 will be obeyed over a wide range of absorbance values, typically for values of A up to at least 1.0. Assuming a minimum noise of $2 \times 10^{-5} A$ and a minimum quantifiable signal ($CV = 20\%$, $S/N' = 2.5$ from Eq. 3.3), a dynamic range of about 2×10^4 is therefore available. A wide dynamic range is one of many reasons for the popularity of UV detectors.

Detection linearity can be somewhat compromised if measurements are made on the side of a steep absorption band (e.g., at 220 nm for AMI in Fig. 3.5). When several analytes having different UV spectra are present in a sample, it may not be possible to detect each compound at a wavelength maximum. However, this is not often a practical problem, as linearity is usually observed for $A < 0.1$ even when measurements are made on the side of absorption bands.

TABLE 3.6 Systematic Approach for Maximizing UV Detection Sensitivity (S/N')^a

-
1. Select wavelength for maximum ϵ (S).
 2. Inject largest possible sample volume (S).
 3. Concentrate sample for increase in mass injected (S).
 4. Reduce k to minimum possible (but no baseline upset or interference peaks) (S).
 5. Consider alternative (non-UV) detector if Eq. 3.4 indicates UV detection unlikely to be acceptable (S).
 6. Increase detector time constant (N').
 7. Ensure that aged lamp is replaced with newer lamp (S , N').
 8. Use pulse damper to eliminate pump noise if necessary (N').
 9. Match UV absorbance of A and B solvents if on-line mixing is used (N').
 10. Minimize late eluters with sample cleanup, gradient elution, or column switching (N').
-

^a(S) and (N') for each operation indicates an effect on signal or noise, respectively.

3.2.6 Diode-Array UV Detectors

As indicated in the discussion of Fig. 3.4, diode-array detectors (DADs) allow simultaneous collection of chromatograms at different wavelengths during a single run. Following the run, a chromatogram at any desired wavelength (usually between 190 and 400 nm) can be displayed. DADs therefore provide more information on sample composition than is provided by a single-wavelength run. The UV spectrum of each separated peak is also obtained as an important tool for selecting an optimum wavelength for the final HPLC method. Finally, by examining the UV spectrum for a peak from beginning to end, peak purity can be evaluated. If a single component is present in the peak, the UV spectra obtained across the peak should be superimposable (however, this is not a proof of peak purity; see below).

After the initial stages of method development when most of the peaks in the chromatogram are at least partially resolved ($R_s > 1.0$), UV spectra can be collected for each peak with a DAD. The selection of an optimum wavelength can then proceed as for the discussion of Fig. 3.5 (assuming that analyte standards or their UV spectra were not available initially). Peak identification and peak purity can also be carried out at this stage in method development. Figure 3.9*a* illustrates peak identification via the comparison of the UV spectrum for a standard with a sample peak that elutes at the same retention time. By overlapping these two spectra, it is apparent that they are identical and the two bands are therefore presumed to comprise the same compound. Peak purity is best evaluated by similarly comparing spectra obtained at the beginning, middle, and end of the band, as illustrated in Fig. 3.9*b*. In this case it appears that an impurity overlaps the front of the sample peak, since the

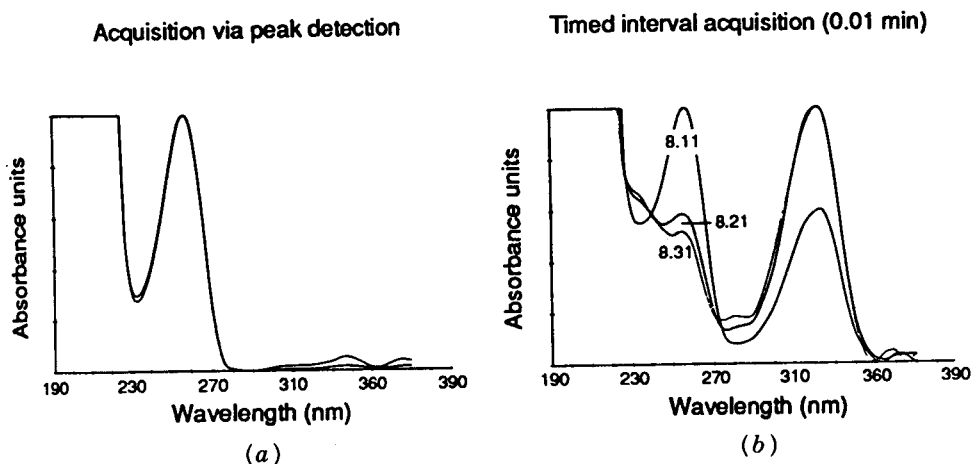

FIGURE 3.9 Use of spectra from diode-array detection to (a) confirm peak identity or (b) test for peak purity. (Reprinted with permission from Ref. 2.)

spectrum obtained at 8.11 min differs significantly from later spectra collected at 8.21 and 8.31 min.

Peak purity can be evaluated further in terms of *ratiograms*. These are plots of the ratio of absorbances collected at two different wavelengths, as illustrated in Fig. 3.10. The pure peak in this example is naphthalene, which has greater absorbance at 280 nm than at 254 nm. Its ratiogram (shown below the chromatogram) is rectangular, because the absorbance ratio (less than 1) is constant across this pure peak. The peak with a shoulder consists of naphthalene plus 8% of biphenyl as impurity. Biphenyl has greater absorbance at 254 vs. 280 nm (positive ratiogram, the opposite of naphthalene), so that the second ratiogram changes from negative to positive during the transition from pure naphthalene to mainly biphenyl. Tests for peak purity as in Figs. 3.9 and 3.10 are equivocal, because sample components are often chemically related and have the same or similar UV spectra (e.g., impurities, degradation products, homologs and oligomers, or metabolites). If the DAD is to confirm the presence of an overlapping peak successfully, the UV spectra of the two peaks must differ significantly, the relative concentration of one of the two peaks must fall within about 5 to 95% of the other, and the resolution of the two

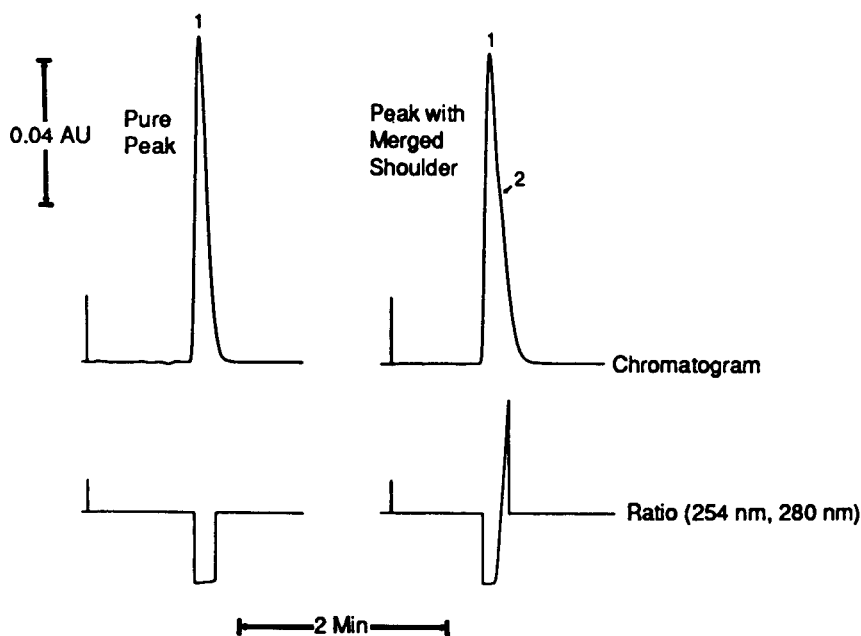

FIGURE 3.10 Use of ratiograms with diode-array detection as a test of peak purity. Ratiograms appear under each chromatogram. Peak identification: 1, naphthalene (440 ng); 2, biphenyl (40 ng). Conditions: 10×0.32 -cm RP-18 column; 95% acetonitrile-water; 1.0 mL/min; 254-nm detection in chromatograms. (Reprinted with permission from Ref. 2.)

peaks must be greater than 0.3. *It must be emphasized that use of a DAD alone is by no means conclusive in establishing peak purity.* Peak collection, followed by other qualitative analysis techniques, such as infrared (IR), nuclear magnetic resonance (NMR), mass spectroscopy, and so on, are often used to increase assurance of peak purity. Another way to test peak purity is to separate the sample by an alternative method, for example, reversed-phase HPLC followed by normal-phase HPLC.

Once a preferred wavelength has been selected on the basis of UV spectra for various sample peaks, the DAD can be used to examine chromatograms at different wavelengths so as to confirm the advantage of the wavelength chosen. This technique is illustrated in Fig. 3.11 for the separation of a peptide sample at 215 and 280 nm. In this case, 215 nm is obviously preferred for the detection of all the peptides in the sample. It is known that peptides that contain aromatic amino acids absorb appreciably at 280 nm, whereas other peptides do not. This effect allows a provisional characterization of the peptides seen at 280 nm in terms of aromatic amino acid content.

The use of a DAD is also important for *peak tracking* or the matching of peaks that contain the same compound between different experimental runs during method development. See Section 10.7 for further details.

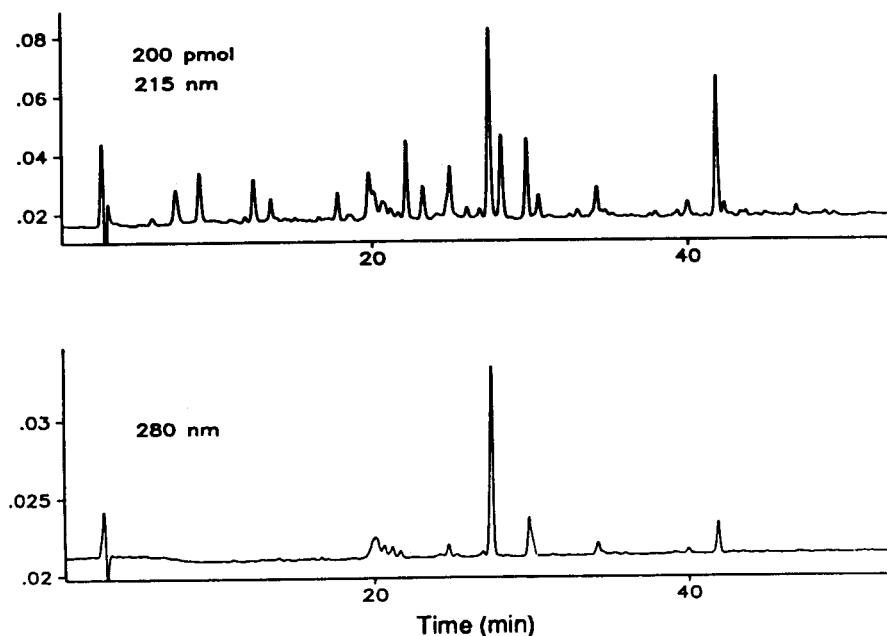

FIGURE 3.11 Display of a single chromatogram at different wavelengths using diode-array detection; peptide sample, acetonitrile–water gradient. (Reprinted with permission from Ref. 2.)

3.3 OTHER HPLC DETECTORS

Occasionally, a UV detector may prove unsuitable because the analyte(s) of interest have no UV absorptivity. More often, the analyte(s) has only a small absorptivity ($\epsilon < 100$), the mobile phase may not allow low-UV detection, and/or the analyte concentration is relatively low, so that the required S/N' ratio cannot readily be achieved using UV detection. Before giving up on the use of a UV detector, Eq. 3.4 should be used to confirm that UV detection is inapplicable. If UV detection appears unpromising, other HPLC detectors can be considered.

3.3.1 Universal Detection

Apart from the lack of sensitivity for some compounds, UV detection is further compromised by possible large differences in ϵ (100- to 1000-fold) for different sample components. Thus, in the case of samples of unknown composition (where calibration standards do not exist, at least initially), peak size is often a poor indication of relative peak concentration. For example, regulatory agencies may require that raw materials prior to formulation into final products be characterized in terms of all impurities present in amounts greater than 0.1% w/w. However, the initial chromatogram with UV detection cannot be used to identify peaks whose concentrations exceed 0.1%, because of uncertainty as to the values of ϵ for each peak. Some impurities with very low values of ϵ may not even be detected, while other impurities present in low concentration may give disproportionately large peaks.

So-called *universal detectors* give a response for almost all sample components, including those with poor UV sensitivity. Also, the detector signal usually varies much less among different sample components than for the case of UV detection. Universal detectors are used primarily in two applications: (1) for samples with very low values of ϵ , and (2) to provide a more representative analysis for unknown samples by means of area normalization. The latter assumes that area percent values will more closely match percent w/w values when analyte standards are unavailable for calibration. Universal detectors can also be used with mobile phases that absorb strongly in the ultraviolet.

The oldest and most widely used detector of this kind is the *refractive index (RI) detector*. Since the refractive index is a physical property of all compounds, any compound can be detected (in theory) at least at moderate levels. However, because mobile-phase components, including solvents and additives, will also show significant refractive index response, gradient elution using RI detectors is impractical. In addition, other factors, such as a need for stringent temperature control, the effects of dissolved gases in the mobile phase, and a lack of sensitivity for trace analysis, limit the use of the RI detector for many routine applications.

A second type of universal detector is the *evaporative light-scattering (ELS) detector*. A schematic of an ELS detector is shown in Fig. 3.12. The effluent

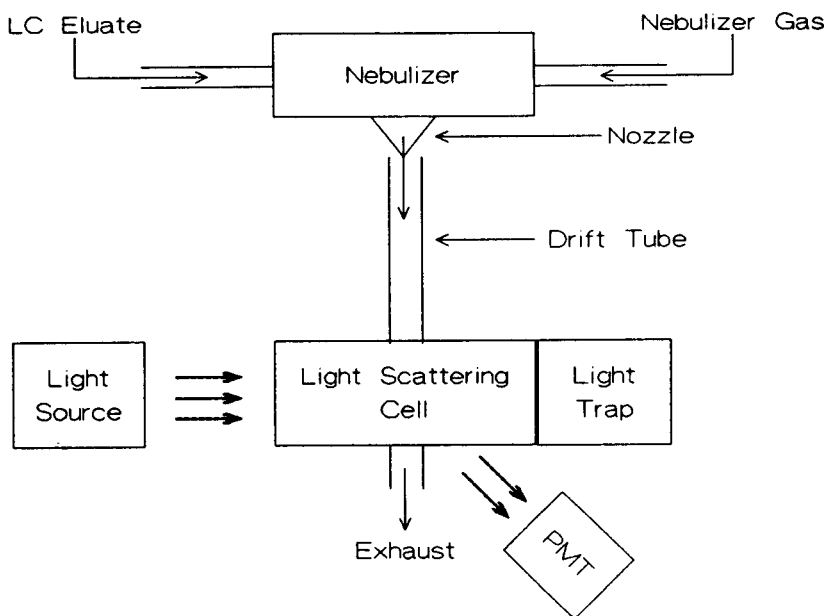

FIGURE 3.12 Schematic of an evaporative light-scattering (ELS) detector. (Reprinted with permission from Ref. 10.)

from the column is nebulized and evaporated as it passes through the drift tube, and particles of analyte are detected as they pass through the light-scattering cell. Therefore, the use of ELS detectors is restricted to nonvolatile analytes and volatile mobile phases. However, because of the ability to use an ELS with gradient elution, it is being used more frequently in these methods, especially for impurity analyses.

Each of these two detectors has a similar sensitivity for typical samples, allowing the analysis of compounds present in the range of $0.1 \mu\text{g/mL}$ and higher (this detection sensitivity is about two orders of magnitude poorer than UV detection for compounds with a good chromophore). Table 3.7 summarizes some other features of these two detectors. RI detectors are discussed further in Ref. 11, and ELS detectors are reviewed in Ref. 10.

3.3.2 Fluorescence Detection

Detection based on analyte fluorescence (FL) can be exquisitely sensitive and selective, making it ideal for trace analysis and complex sample matrices. FL detection is typically three orders of magnitude more sensitive than UV. HPLC procedures with FL detection are used routinely for assays in the low ng/mL range, and concentrations of low pg/mL often can be measured. The linearity range for these detectors is potentially similar to that of UV detectors (e.g., 10^3 to 10^4).

TABLE 3.7 Characteristics of Universal HPLC Detectors

Characteristic	RI Detector	ELS Detector
Use with gradient elution?	No	Yes
Use on-line mixing for isocratic separation?	No	Yes
Use with volatile samples?	Yes	No
Use with nonvolatile buffers or additives?	Yes	No
Effect of mobile-phase contamination?	Serious	Minimal
Adversely affected by changes in mobile-phase temperature	Yes	No
Negative analyte peaks possible?	Yes	No
Magnitude of baseline upset at t_0	Large	Small
Detector linearity?	Yes	No
Special venting required?	No	Yes
Convenient operation?	No	Yes

A parallel benefit of FL vs. UV detection is its ability to discriminate analyte from interference or background peaks. This is illustrated in Fig. 3.2 for the analysis of riboflavin in a complex sample matrix using detection by UV [part (a)] vs. FL [part (b)]. Since few analytes possess natural FL, derivatization with a reagent that possesses a fluorophore (Section 4.7) must usually precede use of this detector. Among the functional groups or sample types for which such reagents are available are carboxylic acids, alcohols, aldehydes, amines, peptides, ketones, phenols and thiols. References 12 and 13 provide examples of such reagents and procedures for their use in HPLC with FL detection. See also Section 4.7.

Figure 3.13 shows a schematic for a typical FL detector. Light from the lamp passes through an excitation filter, which provides essentially monochromatic light of the desired wavelength for excitation of sample molecules. This exciting light passes through the column effluent in the flow cell, causing sample molecules to fluoresce (emit) at a higher wavelength than that used for excitation. A second (emission) filter is positioned so as to collect light at 90° to the original direction of excitation. In this way, only light that results from sample FL passes on to the photomultiplier tube for quantitation of the emission signal.

Three general detector designs similar to that of Fig. 3.13 are available: filter-filter (as in Fig. 3.13), grating-filter, and grating-grating. *Gratings* allow a choice of any desired wavelength, whereas *filters* are limited to a single wavelength (unless the filter is changed). Grating-grating fluorimeters permit selection of any excitation or emission wavelength; therefore, they are convenient for method development. Filter-filter instruments, on the other hand, are simpler and easier to use, are cheaper and more sensitive, and are better suited for transferring an HPLC method between different laboratories.

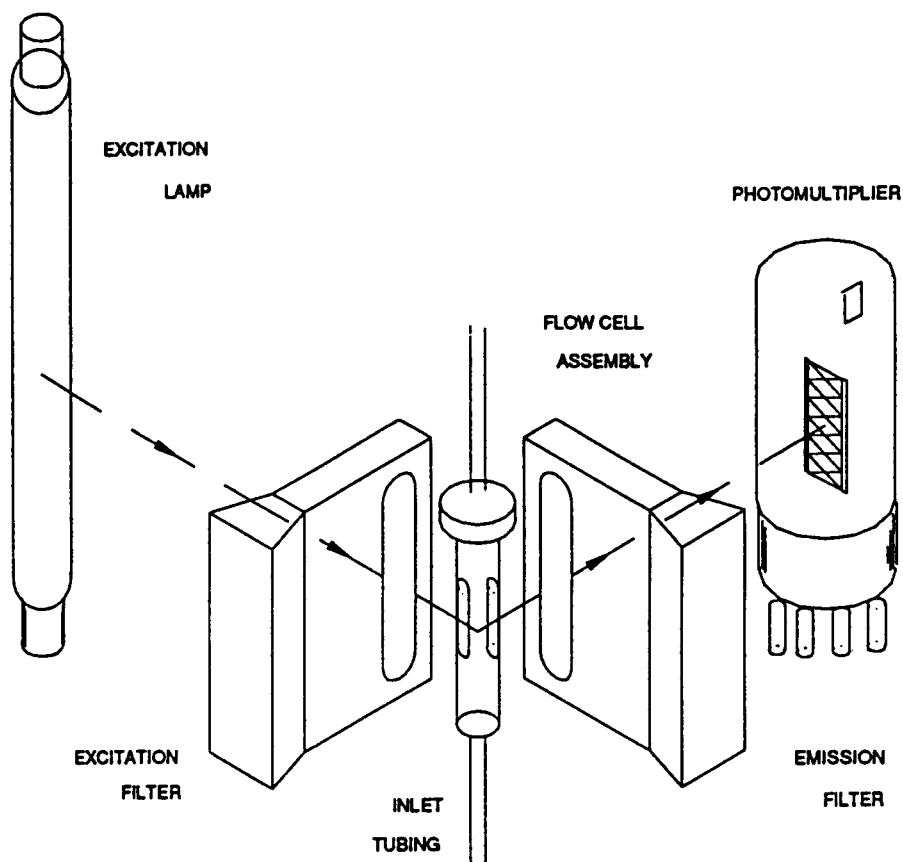

FIGURE 3.13 Schematic of a filter-filter fluorescence detector. (Reprinted with permission from Ref. 12.)

Therefore, filter-filter detectors are more useful for routine application. In addition to these differences in grating vs. filter instruments, FL detectors have many other features that can differ in major ways from one instrument to another: design of the flow cell and how excited light is collected, the choice of lamps used for excitation (deuterium, xenon, xenon-mercury, etc.), and single- vs. dual-beam designs. These many individual features lead to major differences in performance (e.g., sensitivity, linearity) among various FL detector models and difficulties in transferring methods among different instruments.

Differences in detector design can cause problems in transferring an HPLC method from one laboratory to another. A further complication in the use of

FL detectors, especially during method development, is that the FL signal and optimum wavelengths for excitation and emission can be strongly dependent on separation conditions: temperature, solvent polarity and viscosity, pH, and so on. This means that the final separation conditions may require a compromise between good separation and good detection. The need for this compromise can complicate HPLC method development. See Ref. 12 for details on these and other problems associated with the use of these detectors.

3.3.3 Electrochemical Detection

Electrochemical (EC) detectors commonly used in HPLC can be classified according to their operation: (1) direct-current amperometry (DCA) or (2) conductivity. Conductivity detectors are used mainly for ion chromatography [14] and are not discussed further here. DCA detectors resemble FL detectors in terms of both sensitivity and selectivity. Usually, FL detectors are more selective and DCA detectors are more sensitive, as illustrated in the two chromatograms of Fig. 3.14 for the two detectors.

Compounds that exhibit EC activity are more common than compounds that fluoresce. Whereas FL detectors are often used after sample derivatization with a fluorophoric reagent, derivatization usually is not used for EC detection. However, there are a large number of well-studied derivatization reagents

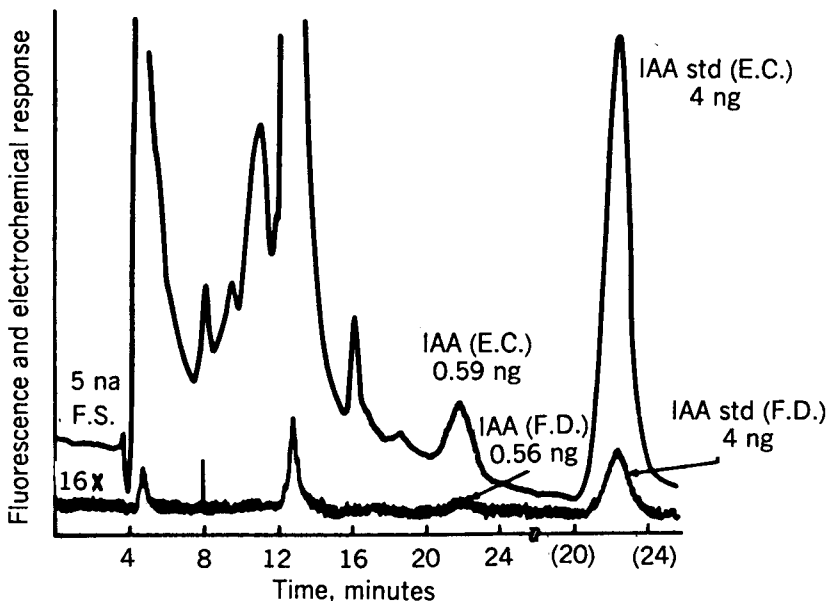

FIGURE 3.14 HPLC separation with fluorescence detection. Anion-exchange analysis of indole acetic acid (IAA) from a single cotton abscission zone using electrochemical (EC) or fluorescence (FD) detection. (Reprinted with permission from Ref. 15.)

and approaches that can convert a non-EC active analyte into one that is active [16–21]. These approaches comprise both pre- and post-column derivatization methods, and even the use of immobilized enzymes post-column, photolytic reactions post-column, and dual electrodes (upstream–downstream; generator–collector) that lead to improved downstream detection of non-EC active analytes [20–24].

When greater sensitivity is required than can be obtained from UV detection, the choice is usually between a FL or an EC detector. If the analyte(s) is EC active, a DCA detector is usually preferred because sample derivatization and related problems are usually avoided. It is even possible to use chemically modified electrodes that can detect otherwise non-EC active analytes, such as proteins and other biopolymers [16,24].

In all forms of LCEC, current generated at a working electrode is actually being measured; thus EC detection in LC is a form of voltammetry. Usually, the working electrode is held at a fixed potential. When this electrode is placed in a flowing stream of mobile phase, it will generate a background current due to any oxidation or reduction of the mobile phase or contaminants. If an EC analyte passes the working electrode, it will be oxidized (or reduced) by the working electrode, increasing the background current. The selectivity of EC detection is tuned by choosing the appropriate potential of the working electrode, such that only the analyte(s) of interest may be detected. In some cases it is advantageous to pulse the potential of the working electrode (triple-pulse waveform, pulsed amperometric detection, differential pulse voltammetry, etc.), especially when oxidized or reduced analytes foul the electrode surface. Here, the current is measured only during a specified applied voltage, a technique known as pulsed amperometric detection [23–26].

EC detection can be performed in either the oxidative or reductive mode, depending in part on the analyte. Oxidative EC detection is more commonly used because it is generally easier to (1) operate and run routine samples, (2) maintain the working electrode surface activity, and (3) avoid some of the preparatory steps needed for routine reductive EC detection. Reductive EC methods also suffer from a poor signal/noise ratio due to the reduction of dissolved oxygen in the solution. Despite these drawbacks, it is possible to use reductive EC detection using dual-electrode techniques, particularly if dissolved oxygen is carefully excluded from the mobile phase and injected samples. The final choice of oxidative vs. reductive EC detection will depend in large part on the type of analyte (see Table 3.8).

Detector response for a given analyte is controlled by its molecular structure and concentration and by the applied potential within the detector cell. Compound types that are well suited for DCA detection are shown in Table 3.8. The applied potential for DCA detection can be optimized by repeating the sample separation–detection (or flow injection analysis–EC) with different values of the applied potential, as illustrated in Fig. 3.15. Here a mixture of catecholamines is separated at potential readings of 0.6 to 0.8 V. For a potential of less than 0.6 V, little oxidation of the analytes occurs and detector response

TABLE 3.8 Some Compound Types Sensed by the Electrochemical Detector^a

Oxidation	Reduction
Phenolics	Ketones
Oximes	Aldehydes
Dihydroxy	Oximes
Mercaptans	Conjugated acids
Peroxides	Conjugated esters
Hydroperoxides	Conjugated nitriles
Aromatic amines, diamines	Conjugated unsaturation
Purines	Activated halogens
Heterocyclic rings ^b	Aromatic halogens
	Nitro compounds
	Heterocyclic rings ^b

^a Compound types generally not sensed include ethers, aliphatic hydrocarbons, alcohols, and carboxylic acids.

^b Depending on structure.

is minimal. Between 0.6 and 0.8 V, detector response climbs rapidly and then levels off at higher voltages. At the same time, detector noise increases and interferences become progressively more important as the voltage increases. In this case, the optimum operating potential is about 0.8 V. The optimal operating potential is a function of the analyte's structure and the nature of the working electrode material [24]. A hydrodynamic voltammogram plot (similar to a plot of UV absorbance vs. wavelength) can be created from data like those shown in Fig. 3.15, where the current vs. applied potential defines the best situation for a fixed set of separation–detection conditions [22].

The advantages of DCA detection in terms of improved sensitivity and selectivity (vs. UV detection) are offset by several practical factors. Apart from the fact that the sample must be EC active, DCA detectors are less rugged. The working electrodes can foul and require frequent cleaning. Detector response is affected by temperature, flow rate (pump pulsations), and extraneous electrical signals from the laboratory. Solvents of exceptional purity and frequent recalibration may be required in some cases. Finally, the mobile phase must meet certain requirements (which vary with different electrodes) in terms of ionic strength and water content. These requirements generally rule out the use of EC detection for most normal-phase separations. However, there are examples that demonstrate this ability successfully, with suitable mobile-phase additives (salts) to perform nonaqueous LCEC [23].

The most common cell design for liquid chromatography with EC detection is the thin-layer cell. Positioning the auxiliary electrode directly across from the working electrode helps to minimize iR drop between the two electrodes. As a result, a wider linear dynamic range is achieved, since higher concentrations of injected analyte will not lead to significant changes in the working

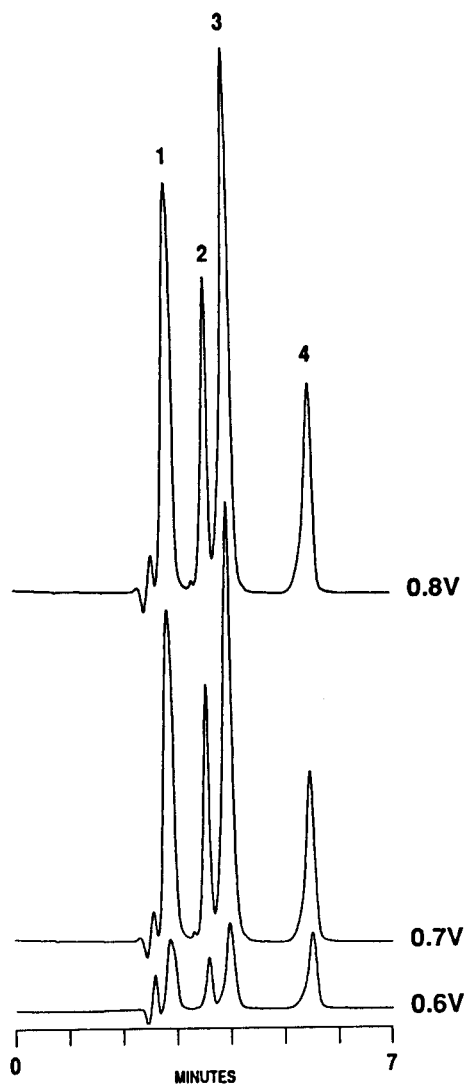

FIGURE 3.15 Effect of applied potential on detector response for catecholamines using electrochemical (DCA) detection. Conditions: 25×0.46 -cm $10\text{-}\mu\text{m}$ Zorbax C18 column; 2% methanol-buffer (25 mM phosphate, pH 2, plus 5 mM triethylamine). (Reprinted with permission from Ref. 27.)

electrode potential. In this type of cell, only a few percent of the analyte in the eluant undergoes an EC reaction, and it is often referred to as an amperometric detector.

Coulometric EC detectors use a porous graphite working electrode, so that all of the mobile phase and analyte come into contact with the electrode. Coulometric electrochemical detectors for LC generally convert almost 100%

of the analyte [24]. Intuitively, it may seem that coulometric detectors are more sensitive than amperometric detectors, since more of the analyte is converted. However, it is the signal/noise ratio that determines the sensitivity, and it is generally acknowledged that in most cases amperometric detectors are more sensitive [24,28].

Most working electrodes are made of glassy carbon, which is highly resistant to organic mobile phases. Ag/AgCl reference electrodes and stainless-steel auxiliary electrodes are used most commonly. An approach that offers added selectivity is the use of two working electrodes, either in parallel or series [23,24,27]. In the parallel case, the electrodes are directly across from each other in the flowing stream, held at slightly different potentials (0.1 to 0.2 V). The ratio of the current produced at the two electrodes can be compared to that of a pure standard for confirmatory work, since this ratio should be different for most compounds. As an example, Table 3.9 illustrates the measured (parallel) dual-electrode response ratios for a series of standard known peptides from a protein (cyt C) tryptic digest using glassy carbon working electrodes poised at 1.0 and 0.9 V vs. Ag/AgCl [29].

This two-working-electrode technique is analogous to dual-wavelength monitoring using UV analysis [24]. By plotting the dual-electrode response ratio throughout a chromatographic peak (similar to dual-wavelength absorbance ratioing, discussed in Section 3.2.6), it is possible to demonstrate the purity of a peak. Multichannel EC arrays have also been described, in both amperometry and coulometry systems, so that a much larger amount of potential vs. current data can be obtained for an eluting HPLC peak in a very short

TABLE 3.9 Dual-Electrode Response Ratios for Peptides^{a-c}

Peptide Number	Response Ratios
1	1.33 ± 0.02
2	2.00 ± 0.05
3	1.35 ± 0.02
4	1.64 ± 0.04
5	1.51 ± 0.03
6	1.38 ± 0.01
7	3.3 ± 0.08
8	2.67 ± 0.02
9	2.0 ± 0.04
10	3.0 ± 0.02
11	1.54 ± 0.05

^a Tryptic peptides from bovine cytochrome C.

^b Applied potentials were 1.0 and 0.9 V.

^c N = 3; numbers represent average ± standard deviation.

Source: Ref. 29, with permission.

time frame [30–33]. This type of multielectrode array detector in LCEC can provide similar informational content to a DAD but now using electrochemistry rather than optical spectroscopy for compound identification and purity determination.

Many compounds do not show EC reaction with typical working electrode materials such as glassy carbon. Thus, the use of chemically modified electrodes has been studied widely [24,34,35]. These electrodes are modified with groups that will allow oxidation or reduction of otherwise unconvertible species. Furthermore, derivatization of nonelectroactive analytes with electroactive tags has also been successful [19–24,36].

3.3.4 Mass Spectrometer Detection (LC–MS)

The use of a mass spectrometer for HPLC detection is becoming commonplace, despite the high cost of such detectors and the need for a skilled operator [37,38]. A mass spectrometer can facilitate HPLC method development and avoid common problems by:

- Tracking and identifying individual peaks in the chromatogram between experiments (see Section 10.7)
- Distinguishing compounds of interest from minor compounds or interferences
- Recognizing unexpected and overlapping interference peaks to avoid a premature finish to method development

An example of the use of LC–MS is shown in Figure 3.16 for the separation and concomitant identification of six pesticides [39]. The reversed-phase separation of all six compounds is shown in Fig 3.16*a* using a total ion current output from the mass spectrometer. Mass spectral analysis of each peak is shown in Fig. 3.16*b* and the mass fragmentation patterns can be used to identify each peak.

Mass spectrometers have three distinct features: (1) the source, (2) the analyzer, and (3) the detector, and differences in these three components differentiate the types of MS techniques that are useful with HPLC. For all MS techniques, an analyte is first ionized in the source, since the MS can only detect charged species. Ions of discrete mass/charge ratios (m/z) are then separated and focused in the mass analyzer. The final focused beam impinges on a detector that determines the intensity of the beam. The analyzer is thus comparable to the prism or monochromator for spectrophotometric techniques, except that ions of discrete m/z ratios are separated and focused rather than photons of discrete wavelengths. The energy detectors are also similar except that the MS usually utilizes an electron multiplier rather than a photomultiplier.

Total Ion Current Chromatogram

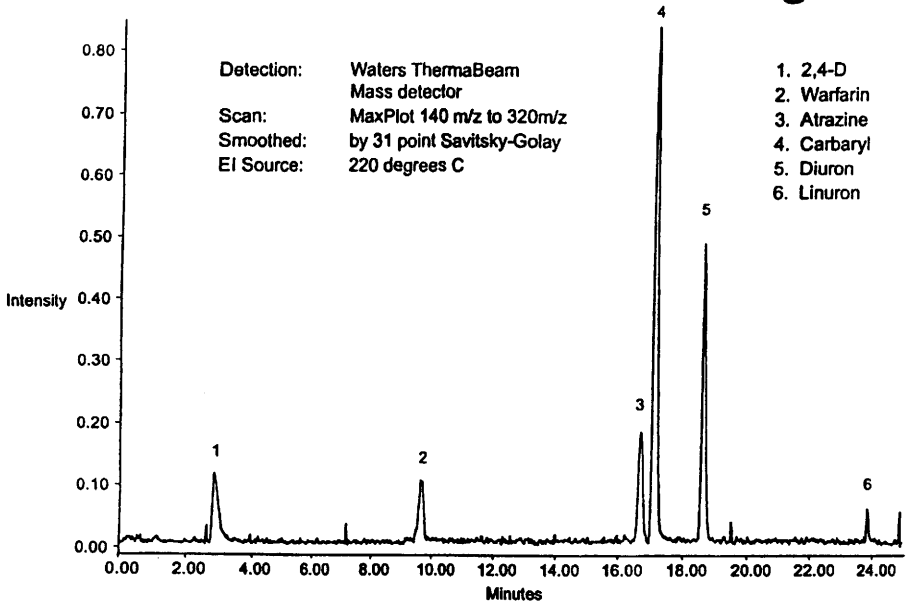

Mass Spectrum Index Plot

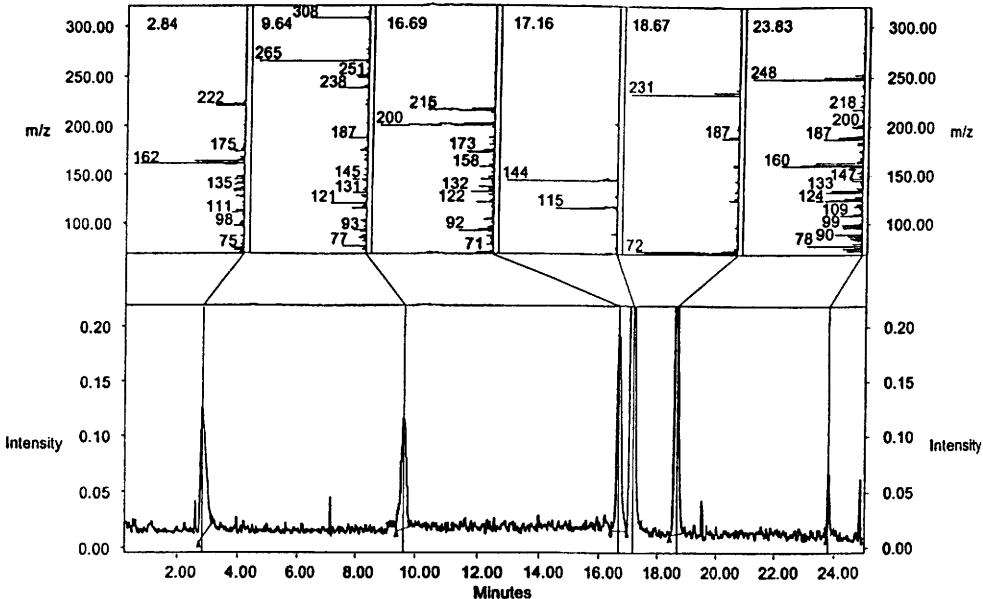

Selection of the ion source differentiates among different MS techniques for HPLC applications. Different techniques are often referred to based solely on the source utilized. Samples are run by electron ionization (EI), chemical ionization (CI), fast-atom bombardment (FAB), electrospray ionization (ESI), thermospray (TSP), laser desorption (LD), and so on. The exception to this is when a time-of-flight mass analyzer (TOFMS) is utilized; in this case, the method is referred to by the mass analyzer itself. Now that both ESI–TOFMS and matrix-assisted laser desorption ionization (MALDI) have become commonplace in TOFMS instruments, different nomenclatures are used to distinguish the two techniques.

3.3.4.1 Mass Analyzers. There are many types of mass analyzers in MS, including magnetic and electrostatic sectors, quadrupole, ion trap (ITP), time-of-flight (TOF), and Fourier transform ion cyclotron resonance (ICR) mass analyzers. Perhaps the most commonly utilized mass analyzer interfaced with HPLC is the triple quadrupole. One instrument (the LCQ from Finnigan) employs an electrospray ion source (ESI) together with an octopole (dual-quadrupole) ion filter (focusing) arrangement prior to an ion-trap mass analyzer. This system is interfaced with an HPLC system but can also be interfaced with capillary electrophoresis [40]. There are many commercial LC–MS instruments on the market and most offer totally integrated, often benchtop, turnkey systems that can be used for routine LC–MS analyses.

A quadrupole MS employs four symmetrically arranged parallel rods. Diagonally opposed rods are connected together electrically to a radio-frequency (RF) and direct current (DC) voltage generator. Ions extracted into the quadrupole region drift toward the detector and are influenced by the combined DC and oscillating RF fields. By ramping the alternating-current (AC) and DC fields such that values corresponding to the peaks within the stability diagram are maintained, ions of successive m/z are permitted to pass through the quadrupoles and impinge on the detector. In this way the mass spectrum is generated.

In the triple-quadrupole (quad) system, the two end quads function as resolving elements while the middle quad becomes the source for collisionally induced dissociation (CID). This then generates MS/MS spectra for individual analyte parent ions, by first selecting the ion for a given analyte (usually,

FIGURE 3.16 Separation by reversed-phase HPLC and mass spectral characterization of six pesticides. Conditions: 15×0.20 -cm Nova-Pak C_{18} column; mobile phase: (A) 10 mM ammonium acetate; (B) 100% ACN, gradient 15% B for 2 min, then to 35% B in 15 min, hold for 3 min, then to 100% B in 2 min, hold for 3 min, back to 15% B; 0.35 mL/min; 300 ng of each compound injected. Detection by Waters ThermaBeam mass detector scanned from 140 to 320 m/z ; EI source at 220°C. (Reprinted with permission from Ref. 39.)

parent), collisionally inducing fragmentation of that original ion, and then separating and collecting the group of fragment ions to identify the species that produced the first parent ion in the first quadrupole.

In the LCQ ion trap, it is even possible to produce within the trap MS^n , with $n > 1$ sets of fragment ions, so that instead of just MS/MS , one can effectively generate $MS/MS/MS$ (or MS^3) and higher-order fragmentation spectra. This approach leads to improved selectivity for an individual peak/analyte and additional MS information to deduce its structure. The ion trap is fundamentally quite different from the triple-quadrupole mass analyzer, and although somewhat newer, it seems to be gaining in popularity among users. The LCQ appears to be the first commercial LC-MS system that makes use of the ion trap, albeit in conjunction with two preceding quads.

3.3.4.2 Ionization Methods. Electron-impact mass spectrometry (EI-MS) is the most familiar and commonly utilized form of MS today, and is a staple of all environmental labs. The EI-MS may provide both quantitative and qualitative information. However, for those labs that need to assay for larger molecules (e.g., biopolymers), EI-MS is inadequate. (The EI process requires that volatile compounds be introduced into the MS.) Because many analytes in HPLC are polar and nonvolatile, this technique is not useful for on-line LC-MS. Fortunately, other ionization methods exist that are based on the desorption of nonvolatile and thermally labile compounds directly from solutions or solid surfaces.

Desorption ionization methods include thermospray (TSP) [41], ^{252}Cf plasma desorption (PD) [42], field desorption (FD) [43], fast-atom bombardment (FAB) [44], liquid secondary-ion mass spectrometry (LSIMS) [45], laser desorption (LD) [46–51], electrospray ionization (ESI) [52], and matrix-assisted laser desorption ionization (MALDI) [46–51]. Each of these methods can be interfaced with LC with varying degrees of success. However, the most popular commercially available interfaces for LC are the atmospheric-pressure ionization interfaces (API) of electrospray (ESI), ion spray (ISP), and thermospray (TSP).

Electrospray. Since the beginning of the 1990s, electrospray has been utilized extensively and has revolutionized the field of MS. A spray is generated at ambient pressure and a high voltage is supplied to the eluting solvent. There are some variations on the original electrospray (ESP) technique, most notably the use of a sheath or supporting gas, which has often been termed *ion spray*. As the eluant is sprayed at ambient pressure, an organic sheath liquid is commonly mixed with an eluting aqueous solvent to reduce surface tension and enhance evaporation of the charged droplets. Analyte molecules that are generated via electrospray contain various charged states (varying amounts of adducted sodium ions or protons).

This multicharging produces a nearly Gaussian distribution of peaks (often referred to as an *envelope*) corresponding to the different m/z ratios of the multiply charged ions. Only those analytes capable of sustaining such multiple charges, such as proteins, peptides, and nucleic acids, generally are amenable to this type of MS analysis by ESP or ISP. Due to the multicharging, the m/z charge ratios of very large molecular weight species (e.g., proteins) are well within the instrumental limits of commercially available quadrupoles, even low-mass-range instruments. This feature, along with a marked absence of aberrant peaks, a mass accuracy of 0.01% or better, subpicomole detection limits, and a mass range that is greater than 100,000 Da, has propelled ESP-MS to the forefront of MS.

Ion Spray. The difference between ion spray and electrospray is that ion spray employs pneumatic nebulization to aid in the solvent evaporation of the tiny droplets generated. This added feature has permitted the analysis of mixtures that do not include an organic modifier, used previously to decrease droplet surface tension and enhance solvent evaporation. The absence of the organic modifier simplifies the coupling of the ESI source to conventional LC and increases the solubility of polar molecules within the mixture. ESP and ion spray (ISP) are among the most important and most commonly used methods of sample introduction and ionization for LC-MS interfacing. Both have been interfaced with many varieties of LC and CE and are available commercially from many vendors. These techniques generate multiply charged or singly charged ions without the need for further ionization; thus electron impact or chemical ionization (CI) is not involved.

Thermospray. Thermospray (TSP) employs both heat and spraying action to remove solvent from analyte ions, leaving intact gaseous ions. This technique also needs no further ionization steps. The liquid eluant from the LC entering the thermospray source is heated at the interface. The combination of the applied heat and the jet expansion into the partial vacuum creates a fine mist of tiny droplets, retaining nonvolatile molecules. The solvent is eventually removed from each droplet via evaporation, leaving predominantly singly protonated analyte molecules. These molecules have been precharged in solution by the addition of ammonium acetate or have become charged via gas-phase ion/molecule reactions. The resulting ions are analyzed with a mass analyzer. This process of desolvation is very similar to that of the electrospray source.

The requirement of low pressure within the mass analyzer is provided by evacuating the vaporizing chamber by auxiliary vacuum pumps. In this manner, flow rates of up to 2 mL/min may be introduced directly into the MS source. A drawback to this source is that for the analysis of large molecules (MW > 10,000), singly charged species are outside the mass range of most commercially available quadrupole instruments. For this reason, ESP and ISP are used as the ion source and sample introduction system in most commercial

instruments. An example of the power of ESP is shown in Fig. 3.17 for a series of proteins and the multiply charged ions formed [37]. Clearly, the LC-ESP-MS approach becomes even more powerful in peptide mapping strategies, where each peptide can be resolved in the triple-quadrupole instrument and collisionally induced to fragment, and sequencing of the peptides is derived. Amino acid sequencing is now feasible using this approach, especially when each peptide of the protein map is first separated by HPLC methods [37,38].

Matrix-Assisted Laser Desorption Ionization. Time-of-flight mass spectrometry (TOFMS) has become one of the most important MS instruments in recent years as a result of the introduction of matrix-assisted laser desorption ionization (MALDI) as the ion source. Thus almost all manufacturers of TOFMS provide MALDI as a routine ion source. In TOFMS, ionic species are accelerated through a drift tube under an applied accelerating potential. Depending on their mass/charge ratios, ions reach the detector region at different times. Resolution is affected by differences in drift time, which is a function of several parameters, including (1) the length of the drift tube, (2) accelerating potentials and devices, and (3) differences in the ions present in the ionized sample.

With the inclusion of reflectron devices, continuous gradient (curved) reflectrons, and similar devices, resolution of TOFMS is now comparable

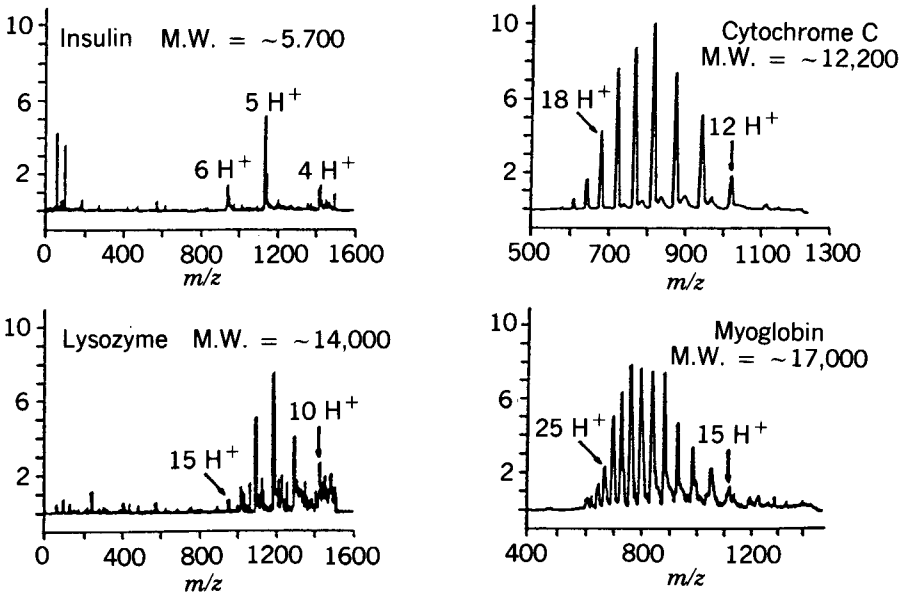

FIGURE 3.17 Typical ion envelope from multiply charged peptide and protein ions in ESP. (Reprinted with permission from Ref. 37.)

to that of most other MS techniques; resolution of 0.1 to 1.0 Da is now routine. Therefore, the resolution possible by TOFMS is now comparable to that of a triple-quad or ion-trap instrument. However, the mass range of TOFMS is much larger, even without multiply charged ions being formed.

Another important advantage of TOFMS is its simplicity of construction, sample introduction, and routine operation. It can be a turnkey, benchtop instrument, easily maintained and repaired, compatible with direct sample introduction. Multiple sample introduction is also possible. Using MALDI as the ion source, the laser beam can be varied to produce different degrees of ionization and fragmentation patterns. Scanning of the beam permits rapid sample analysis, often for hundreds of individual samples on the same platform in the ion source. Only seconds are needed to scan an individual sample in the static mode, thus permitting hundreds of samples to be assayed in a few minutes. This is difficult to achieve on other MS instruments with other types of sample introduction or ion sources. Most of the work in MALDI-TOFMS described currently has been in a static mode (off-line) and not interfaced with a flowing stream such as LC. However, research activity in this area has resulted in numerous papers in LC-MALDI-TOFMS, just as for LC-ESP-TOFMS [37,46-51].

Figure 3.18 illustrates a typical MALDI-TOFMS output for a mixture of higher-molecular-weight protein standards run under typical MALDI matrix conditions using sinapinic acid as the matrix component [35]. Resolution of this TOFMS unit permits unambiguous identification of every protein to within ± 1 Da. Another advantage of MALDI-TOFMS is that it requires very small amounts of sample for correct identification, even for total peptide mapping and amino acid sequencing of individual peptide components.

3.3.5 Selecting the Mass Spectrometric Detector

In selecting an MS ion source, one must ensure that the mass range and resolution of the instrument are compatible with the expected molecular weights of the analytes. If the MS instrument has a range of only a few thousand daltons, then ESP, ISP, or TSP probably is best for a protein to generate multiply charged ions. For low-MW analytes, any interface or ion source could suffice, such as electron impact, chemical ionization, laser desorption, or FAB. Using high-resolution LC methods to separate individual sample components reduces the need for very high resolution in the MS since overlapping components will not be eluting into the MS. However, to identify each of these species correctly, high-resolution instruments are preferred.

The ideal system is a high-resolution separation step coupled with a high-resolution MS through an interface or ion source that will provide both individually charged and/or multiply charged ions derived from every analyte species.

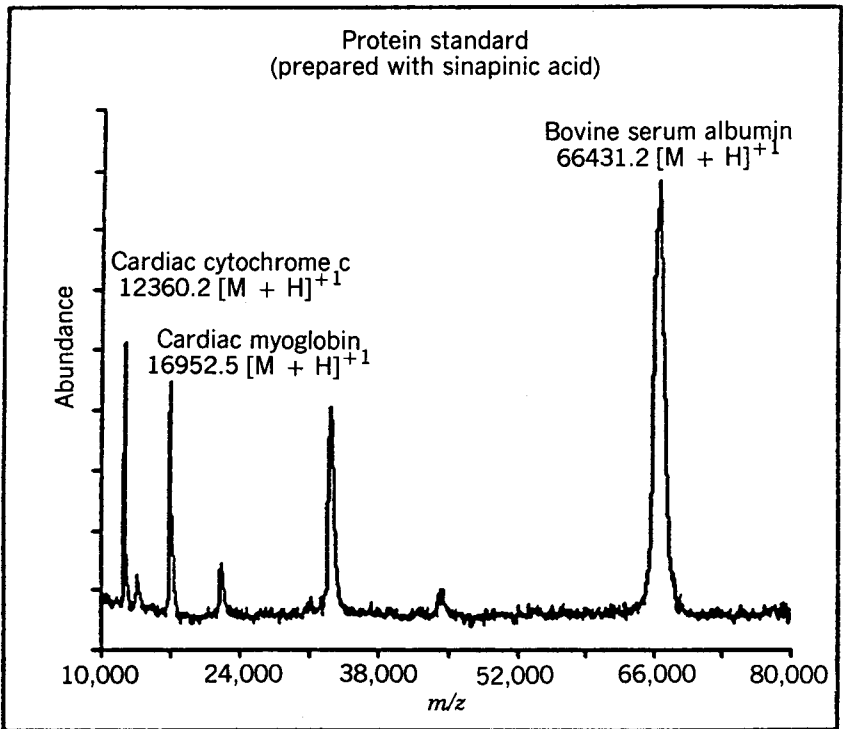

Component	MW	Concentration
Equine cardiac cytochrome c	12359.2 Da	0.20 μM
Equine cardiac myoglobin	16951.5 Da	0.40 μM
Bovine serum albumin	66430.2 Da	2.85 μM

FIGURE 3.18 MALDI-TOFMS spectra from a Hewlett-Packard G2025A system for a mixture of protein standards, as indicated. Operating conditions: mass range, 100,000 Da; mass filter, 8000 Da; polarity, positive or negative; laser energy (337 nm, nitrogen laser), 4 to 7 μJ . (Reprinted with permission from Ref. 53.)

Commercial instruments are moving toward providing LC-ESP/ISP/TSP interfaced to the MS systems.

3.3.6 Less Common Detectors

A number of other HPLC detectors are currently in use, but their application is not yet sufficiently widespread to justify a detailed discussion in this book. Table 3.10 provides a summary of some of their pertinent characteristics. See Refs. 57 and 58 for further details.

TABLE 3.10 Less Common HPLC Detectors

Detector	Comments
Reaction detectors	Incorporate a chemical reaction module between the column and a UV or fluorescence detector, to convert the analyte(s) to a more easily detected species. Used primarily for trace analysis. Limited by the complexity and lack of ruggedness of these systems in most cases. Method development complicated by the separate and often conflicting requirements of the mobile phase and reaction medium.
Radioactivity	Extremely sensitive and specific for samples that are radiolabeled, such as environmental studies involving agricultural chemicals or pharmaceutical tracer studies. Limited use in other areas.
Infrared (IR)	Used only with a limited range of organic solvents. Limited primarily to the analysis of synthetic polymers. Alternative applications where the solvent is removed prior to detection are not well established.
Low-angle laser light scattering (LALLS)	Provides measurements of analyte molecular weight, particularly suited for use with synthetic and biopolymers [54].
Optical activity (polarimeter)	Used to detect enantiomers (Chapter 12).
Viscometer	Provides on-line measurement of changes in viscosity of the mobile phase plus analyte vs. the mobile phase. Well suited for carrying out assays of molecular-weight distribution for synthetic and biological polymers [55,56].

REFERENCES

1. S. van der Wal and L. R. Snyder, *J. Chromatogr.*, **225** (1983) 463.
2. D. Wickam, in *A Practical Guide to HPLC Detection*, D. Parriott, ed., Academic Press, San Diego, CA, 1993, p. 67.
3. R. Blain, in *A Practical Guide to HPLC Detection*, D. Parriott ed., Academic Press, San Diego, CA, 1993 p. 39.
4. C. F. Poole and S. A. Schuette, *Contemporary Practice of Chromatography*, Elsevier, Amsterdam, 1984, p. 375.
5. J. B. Li, *LC/GC*, **10** (1992) 856.
6. *High Purity Solvent Guide*, Burdick & Jackson Laboratories, Muskegon, MI, 1980.
7. S. van der Wal and L. R. Snyder, *Clin. Chem.*, **27** (1981) 1233.
8. B. L. Karger, M. Martin, and G. Guiochon, *Anal. Chem.*, **46** (1974) 1640.
9. F. Erni, H. P. Keller, C. Morin, and M. Schmitt, *J. Chromatogr.*, **204** (1981) 65.
10. C. Parriott, in *A Practical Guide to HPLC Detection*, D. Parriott, ed., Academic Press, San Diego, CA, 1993, p. 256.

11. M. Munk, in *A Practical Guide to HPLC Detection*, D. Parriott, ed., Academic Press, San Diego, CA, 1993, p. 5.
12. B. O. Flaherty, in *A Practical Guide to HPLC Detection*, D. Parriott, ed., Academic Press, San Diego, CA, 1993, p. 111.
13. *Chromatography Catalog/Guide*, Regis Technologies, Inc., Morton Grove, IL, 1993, pp. 58–61.
14. I. S. Krull, in *Chromatography and Separation Chemistry: Advances and Developments*, S. Ahuja, ed., ACS Symposium Series 297, American Chemical Society, Washington, DC, 1986, p. 137.
15. P. B. Sweetser and D. G. Schwartzfager, *Plant Physiol.*, **61** (1978) 254.
16. L. Dou, J. Mazzeo, and I. S. Krull, *BioChromatography*, **5**(2) (1990) 74.
17. I. S. Krull, C. M. Selavka, M. Lookabaugh, and W. R. Childress, *LC/GC*, **7**(9) (1989) 758.
18. I. S. Krull, M. E. Szulc, and S.-L. Wu, *LC/GC*, **11**(5) (1993) 350.
19. I. S. Krull, C. M. Selavka, W. Jacobs, and C. Duda, *J. Liq. Chromatogr.*, **8**(15) (1985) 2845.
20. C. Lavrich and P. T. Kissinger, in *Therapeutic Drug Monitoring and Toxicology by Liquid Chromatography*, S. H. Y. Wong, ed., Marcel Dekker, New York, 1985, Chapter 8.
21. G. Li, M. E. Szulc, D. H. Fisher, and I. S. Krull, in *Electrochemical Detection in Liquid Chromatography and Capillary Electrophoresis*, P. T. Kissinger, ed., Chromatographic Science Series, Marcel Dekker, New York, in preparation (1997).
22. W. R. LaCourse, C. M. Selavka, and I. S. Krull, *Anal. Chem.*, **59** (1987) 1366.
23. D. C. Johnson, S. G. Weber, A. M. Bond, R. M. Wightman, R. E. Shoup, and I. S. Krull, *Anal. Chim. Acta*, **180** (1986) 187.
24. P. T. Kissinger and W. R. Heineman, eds., *Laboratory Techniques in Electroanalytical Chemistry*, Marcel Dekker, New York, 1984, Chapter 20.
25. L. D. Libera, *J. Chromatogr.*, **536** (1991) 283.
26. W. R. LaCourse and D. C. Johnson, *Anal. Chem.*, **65** (1993) 50.
27. R. D. Rocklin, in *A Practical Guide to HPLC Detection*, D. Parriott, ed., Academic Press, San Diego, CA, 1993, p. 145.
28. R. G. Elkin and J. E. Griffith, *J. Assoc. Off. Anal. Chem.*, **68** (1985) 1028.
29. L. Chen and I. S. Krull, *Electroanalysis*, **6** (1994) 1.
30. J. C. Hoogvliet, J. M. Reijn, and W. P. van Bennekom, *Anal. Chem.*, **63** (1991) 2418.
31. W. R. Matson, P. H. Gamache, M. F. Beal, and E. D. Bird, *Life Sci.*, **41**(7) (1987) 905.
32. C. N. Svendsen, *Analyst*, **118**(2) (1993) 123.
33. W. R. Matson, P. Langlais, L. Volicer, P. H. Gamache, E. Bird, and K. A. Mark, *Clin. Chem.*, **30** (1984) 1477.
34. T. Hayashi, H. Tsuchiya, and H. J. Naruse, *J. Chromatogr.*, **274** (1985) 318.
35. J. Wang, *Electroanalysis*, **3** (1991) 255.
36. B. N. Jones and J. P. Gilligan, *J. Chromatogr.*, **266** (1988) 471.
37. W. M. A. Niessen and J. van der Greef, *Liquid Chromatography–Mass Spectrometry*, Chromatographic Science Series 58, Marcel Dekker, New York, 1992.
38. *Techniques in Protein Chemistry*, Vols. I–VIII, Academic Press, San Diego, CA, 1989–1995.

39. Private communication, G. Fallick, Waters Corp., Milford, MA, 1996.
40. Technical literature on LCQ, *Analytical Newsletter*, Summer 1995, Finnigan/MAT Instruments, San Jose, CA.
41. C. R. Blakely and M. L. Vestal, *Anal. Chem.*, **55** (1983) 750.
42. B. Sundqvist and R. D. Macfarlane, *Mass Spectrom. Rev.*, **4** (1985) 421.
43. L. Prokai, *Field Desorption Mass Spectrometry*, Marcel Dekker, New York, 1990.
44. M. Barber, R. S. Bordoli, G. J. Elliott, R. D. Sedgwick, and A. N. Tyler, *Anal. Chem.* **54** (1982) 645A.
45. P. A. Lyon, ed., *Desorption Mass Spectrometry: Are SIMS and FAB the Same?* American Chemical Society, Washington, DC, 1985.
46. M. Karas and F. Hillenkamp, *Anal. Chem.*, **60** (1988) 2299.
47. K. K. Murray and D. H. Russell, *Amer. Lab.*, **38** (June 1994).
48. E. R. Williams, G. C. Jones, Jr., L. L. Fang, T. Nagata, and R. N. Zare, *SPIE Appl. Spectrosc. Mater. Sci. II*, **1636** (1992) 172.
49. A. P. L. Wang, X. Guo, and L. Li, *Anal. Chem.*, **66** (1994) 3664.
50. R. M. Whittal and L. Li, *Anal. Chem.*, **67** (1995) 1950.
51. I. S. Krull, R. Mhatre, and J. Cunniff, *LC/GC*, **12(12)** (1994) 914.
52. R. D. Smith, J. A. Loo, C. G. Edmonds, C. J. Barinaga, and H. R. Udseth, *Anal. Chem.*, **62** (1990) 882.
53. *MALDI-TOFMS System*, Technical literature, HP G2025A, Hewlett-Packard, Burlington, MA and San Jose, CA, 1994.
54. I. S. Krull, R. Mhatre, and J. Cunniff, *LC/GC*, **13** (1995) 30.
55. P. K. Dutta, D. Gillespie, K. Hammons, and M. A. Haney, *J. Pharm. Biomed. Anal.*, **9** (1991) 865.
56. P. K. Dutta, K. Hammons, B. Willibey, and M. A. Haney, *J. Chromatogr.*, **536** (1991) 113.
57. J. R. Chapman, in *A Practical Guide to HPLC Detection*, D. Parriott, ed., Academic Press, San Diego, CA, 1993, p. 173.
58. E. J. Woolf, in *A Practical Guide to HPLC Detection*, D. Parriott, ed., Academic Press, San Diego, CA, 1993, p. 211.

4

SAMPLE PREPARATION

(WITH RON MAJORS AND GREG SLACK)

- 4.1 Introduction
- 4.2 Types of Samples
- 4.3 Preliminary Processing of Solid and Semisolid Samples
 - 4.3.1 Reducing Sample Particle Size
 - 4.3.2 Drying the Sample
 - 4.3.3 Filtration
- 4.4 Sample Pretreatment for Liquid Samples
 - 4.4.1 Liquid-Liquid Extraction
 - 4.4.1.1 Theory
 - 4.4.1.2 Practice
 - 4.4.1.3 Problems
 - 4.4.2 Solid-Phase Extraction
 - 4.4.2.1 SPE vs. LLE
 - 4.4.2.2 SPE vs. HPLC
 - 4.4.2.3 Uses of SPE
 - 4.4.2.4 SPE Devices
 - 4.4.2.5 SPE Apparatus
 - 4.4.2.6 SPE Method Development
 - 4.4.2.7 Column Chromatography for Sample Pretreatment
 - 4.4.3 Membrane Separations
- 4.5 Sample Pretreatment for Solid Samples
 - 4.5.1 Traditional Extraction Methods
 - 4.5.2 Newer Extraction Methods
 - 4.5.2.1 Supercritical Fluid Extraction
 - 4.5.2.2 Microwave-Assisted Solvent Extraction
 - 4.5.2.3 Accelerated Solvent Extraction
 - 4.5.3 Comparison of Methods for Extraction of Solids
- 4.6 Column Switching
 - 4.6.1 Principle of Operation
 - 4.6.2 Developing a Column-Switching Method: General Considerations
 - 4.6.3 Examples of Column Switching for Sample Cleanup

4.7 Derivatization

4.7.1 Detectability

4.7.1.1 UV Detection

4.7.1.2 Fluorescence Detection

4.7.2 Pre- and post-column Derivatization

4.7.2.1 Pre-column Derivatization

4.7.2.2 Post-column Derivatization

4.7.3 Chiral Analysis by Derivatization

4.1 INTRODUCTION

Sample preparation is an essential part of HPLC analysis, intended to provide a reproducible and homogeneous solution that is suitable for injection onto the column. The aim of sample preparation is a sample aliquot that (1) is relatively free of interferences, (2) will not damage the column, and (3) is compatible with the intended HPLC method; that is, the sample solvent will dissolve in the mobile phase without affecting sample retention or resolution. It may also be desirable to concentrate the analytes and/or derivatize them for improved detection or better separation. Sample preparation begins at the point of collection, extends to sample injection onto the HPLC column, and encompasses the various operations summarized in Table 4.1. Options 1 to 4, which include sample collection, transport, storage, preliminary processing, laboratory sampling, and subsequent weighing/dilution, all form an important part of sample preparation. Although these steps can have a critical effect on the accuracy, precision, and convenience of the final method, only option 3 (preliminary sample processing) is discussed here. See Refs. [1–4] for a discussion of options 1, 2, and 4. This chapter is devoted primarily to options 5 to 8 of Table 4.1, which encompass what is usually meant by *sample pretreatment*.

Whereas HPLC is predominantly an automated procedure, sample pretreatment often is carried out in a manual mode. As a result, sample pretreatment can require more time for method development and routine analysis than is needed for HPLC separation and data analysis. Sample pretreatment also includes a large number of methodologies, as well as multiple operational steps and can therefore be a challenging part of HPLC method development. Finally, method precision and accuracy are frequently determined by the sample pretreatment procedure [5,6], including operations such as weighing and dilution. For all these reasons, the development of a sample pretreatment procedure deserves careful advance planning.

A sample pretreatment procedure should provide quantitative recovery of analytes, involve a minimum number of steps, and (if possible) be easily automated. Quantitative (99+%) recovery of each analyte enhances sensitivity

TABLE 4.1 Sample Pretreatment Options

Option	Comment
1. Sample collection	Obtain representative sample using statistically valid processes.
2. Sample storage and preservation	Use appropriate inert, tightly sealed containers; be especially careful with volatile, unstable, or reactive materials; stabilize samples, if necessary; biological samples may require freezing.
3. Preliminary sample processing	Sample must be in a form for more efficient sample pretreatment (e.g., drying, sieving, grinding, etc.); finer dispersed samples are easier to dissolve or extract.
4. Weighing or volumetric dilution	Take necessary precautions for reactive, unstable, or biological materials; for dilution, use calibrated volumetric glassware.
5. Alternative sample processing methods	Solvent replacement, desalting, evaporation, freeze-drying, etc.
6. Removal of particulates	Filtration, solid-phase extraction, centrifugation.
7. Sample extraction	Methods for liquid samples (Table 4.2) and solid samples (Tables 4.3 and 4.4).
8. Derivatization	Used mainly to enhance analyte detection; sometimes used to improve separation (enantiomers, Section 12.1).

and assay precision, although this does not mean that all of the analyte present in the original sample must be included in the final injected sample. For example, for a series of sample-pretreatment steps in a given method, aliquots of intermediate fractions may be used for further sample preparation or for an intermediate injection. If recovery is less than 100%, the sample pretreatment must be reproducible. A smaller number of sample-pretreatment steps plus automation reduces the overall time and effort required and decreases the opportunity for imprecision errors by the analyst.

Many sample preparation techniques have been automated, and appropriate instrumentation is commercially available. Automation approaches vary from using a robot for performing manual tasks to dedicated instruments optimized to perform a specific sample preparation technique. Although automation can be expensive and elaborate, it is often desirable when large numbers of samples must be analyzed and the time or labor per sample are excessive. The decision to automate a sample pretreatment procedure is often based on a cost justification or, in some cases, when operator safety is involved (i.e., to minimize exposure to toxic substances or other possible health hazards).

4.2 TYPES OF SAMPLES

Sample matrices can be classified as organic (including biological) or inorganic, and may be further subdivided into solids, semi-solids (including creams, gels, suspensions, colloids), liquids, and gases. Gaseous samples usually are analyzed by gas chromatography rather than HPLC. However, gaseous samples that are labile, thermally unstable, or prone to adsorb to metal surfaces are sometimes better handled by HPLC. Trapping is required to analyze gaseous samples by HPLC. The gas sample is either (1) passed through a solid support and subsequently eluted with a solubilizing liquid or (2) bubbled through a liquid that traps the analyte(s). An example of the HPLC analysis of a gaseous sample is U.S. Environmental Protection Agency (EPA) Method TO-11 for volatile aldehydes and ketones [7]. Here an air sample is passed through an adsorbent trap coated with 2,4-dinitrophenylhydrazine, which quantitatively converts aldehydes and ketones into their 2,4-dinitrophenylhydrazones. The hydrazones are then eluted with acetonitrile and separated by reversed-phase HPLC. Table 4.2 summarizes a number of procedures for the initial preparation of gaseous, liquid, or solid samples. The remainder of this chapter is devoted to the pretreatment of samples of most concern: semivolatile and nonvolatile analytes in various matrices.

Compared to gases or solids, liquid samples are much easier to prepare for HPLC. Many HPLC analyses are based on a “dilute and shoot” procedure, where the concentration of solubilized analyte is reduced by dilution to avoid overloading the column or saturating the detector. Sample preparation for solid samples can be more demanding. In some cases the sample is easily dissolved and is then ready for injection or further pretreatment. In other cases the sample matrix may be insoluble in common solvents, and the analytes must be extracted from the solid matrix. There are also cases where the analytes are not easily removed from an insoluble matrix—because of inclusion or adsorption. Here more rigorous techniques, such as Soxhlet extraction, supercritical fluid extraction (SFE), ultrasonication, or solid–liquid extraction, may be necessary. Table 4.3 lists some traditional methods for the recovery of analytes from solid samples, and Table 4.4 describes some more recent methods. Once analytes have been quantitatively extracted from a solid sample, the resulting liquid fraction can either be injected directly into the HPLC apparatus or subjected to further pretreatment.

4.3 PRELIMINARY PROCESSING OF SOLID AND SEMI-SOLID SAMPLES

4.3.1 Reducing Sample Particle Size

It is desirable that solid samples be reduced in particle size since finely divided samples (1) are more homogeneous, allowing more representative sampling

TABLE 4.2 Typical Sample Pretreatment Methods for Gases, Liquids, and Suspensions

Sample Type	Methods of Sample Pretreatment	Principles of Technique	Comments
Volatile organics, gases	Solid-phase trapping	Gaseous sample passed through tube packed with adsorbent (e.g., silica gel, activated carbon); trapped analytes are eluted with strong solvent.	Gas flow rate critical for trapping efficiency; watch for aerosol formation, adsorbent overloading, and irreversible adsorption of reactive analytes; chemical complexing reagents may be useful to improve trapping efficiency; purge and trap technique.
	Liquid trapping	Gaseous sample is passed through solution, which is a good solvent for analytes that remain behind; gas usually passes through solution unabsorbed.	Flow rate should be low enough so as not to create foams or aerosols; complexing agents may be added to solvent to aid trapping; temperature can be lowered for very volatile species.
Liquid	Solid-phase extraction	Liquid is passed through solid phase, which selectively removes analyte (or interferences); analyte can be eluted with strong solvent; in some cases interferences are retained and analytes allowed to pass through solid phase unretained; same mechanisms as HPLC.	Wide variety of stationary phases available for selective removal of desired inorganic, organic, and biological analytes; specialty phases for drugs of abuse, carbohydrates, catechol amines, and many other classes of compounds, trace enrichment of water.
	Liquid-liquid extraction	Sample is partitioned between two immiscible phases, which are chosen to maximize differences in solubility.	Beware of formation of emulsions—break them with heat, addition of salt (Section 4.4.1.3); change K_D value by different solvent or chemical-equilibrium-affecting additives (such as buffers for pH adjustment, salts for ionic strength, complexing agents, ion-pairing agents, etc.); many published methods; continuous extractions for low K_D or large volumes.
Dilution	Sample is diluted with solvent compatible with HPLC mobile phase to avoid column overload or to be in linear range of detector.	To avoid band spreading, solvent should not be too strong for HPLC mobile phase and should be miscible with HPLC mobile phase; “dilute and shoot” is a typical sample preparation method for simple liquid samples such as pharmaceutical formulations.	

Evaporation	Liquid is removed by gentle heating at atmospheric pressure with flowing air or inert gas or under vacuum.	Do not evaporate too quickly; bumping can lose sample; watch for sample loss on wall of container; don't overheat to dryness; best under inert gas such as N ₂ ; rotary evaporator works best; automated systems (e.g., Turbovap) available.
Distillation	Sample is heated to boiling point of solvent, and volatile analytes are concentrated in vapor phase, condensed, and collected.	Mainly for samples that can easily be volatilized; sample can decompose if heated too high; vacuum distillation can be used for low-vapor-pressure compounds; steam distillation is rather gentle since maximum temperature is 100°C.
Microdialysis	A semipermeable membrane is placed between two aqueous liquid phases and sample solutes transfer from one liquid to the other based on differential concentration.	Enrichment techniques such as SPE are required to concentrate dialyzate; microdialysis is used for examination of extracellular chemicals in living plant and animal tissue, in fermentation broths; has been used on-line with micro-LC columns; dialysis with molecular-weight cutoff membranes can also be used on-line to deproteinate samples prior to HPLC since large proteins cannot pass through membranes; ultrafiltration and reverse osmosis can be used similarly.
Lyophilization	Aqueous sample is frozen and water removed by sublimation under vacuum.	Good for nonvolatile organics; large sample volume can be handled; possible loss of volatile analytes; inorganics can be concentrated.
Suspensions	Filtration	Highly recommended to prevent backpressure problems and to preserve column life; membrane filters must be compatible with solvent so they don't dissolve during experiment; use large-porosity (> 2 μm) filters for maximum flow or small-porosity filters (< 0.2 μm) to remove bacteria.
Centrifugation	Sample is placed in tapered centrifuge tube and spun at high velocity; supernatant liquid is decanted.	Quantitatively removing solid sample from tube sometimes presents practical problem; ultracentrifuge normally not used for simple particulate removal.
Sedimentation	Sample is allowed to settle when left undisturbed in a sedimentation tank; settling rate dependent on Stokes' radius.	Extremely slow process; manual recovery of different-size particulates at different levels, depending on settling rate.

TABLE 4.3 Traditional Extraction Methods for Solid Samples

Method of Sample Pretreatment	Principles of Technique	Comments
Solid-liquid extraction	Sample is placed in stoppered container and solvent is added to dissolve analyte of interest; solution is separated from solid by filtration (sometimes called "shake/filter" method).	Solvent is sometimes boiled or refluxed to improve solubility; sample is in finely divided state to aid leaching process; sample can be shaken manually or automatically; sample is filtered, decanted, or centrifuged to separate from insoluble solid.
Soxhlet extraction	Sample is placed in disposable porous container (thimble); constantly refluxing solvent flows through the thimble and dissolves analytes, which are collected continuously in boiling flask.	Extraction occurs in pure solvent; sample must be stable at boiling point of solvent; slow, but extraction is carried out unattended until complete; inexpensive; best for freely flowing powders; excellent recoveries (used as standard to which other solid-extraction methods are compared).
Forced-flow leaching	Sample is placed in flow-through tube with solvent flowing through it. Tube is heated to near solvent's boiling point.	Suitable for particulate samples; solvent can be pumped or pushed through with high-pressure N ₂ ; smaller volume of solvent than Soxhlet; yields similar results and is faster.
Homogenization	Sample is placed in a blender, solvent is added, and sample is homogenized to a finely divided state; solvent is removed for further workup.	Used for plant and animal tissue, food, environmental samples; organic or aqueous solvent can be used; dry ice or diatomaceous earth can be added to make sample flow more freely; small dispersed sample promotes more efficient extraction.
Sonication	Finely divided sample is immersed in ultrasonic bath with solvent and subject to ultrasonic radiation. An ultrasonic probe or ultrasonic cell disrupter can also be used.	Dissolution is aided by ultrasonic process; heat can be added to increase rate of extraction; safe; rapid; best for coarse, granular materials; multiple samples handled simultaneously; efficient contact with solvent.
Dissolution	Sample is treated with dissolving solvent and taken directly into solution with or without chemical change.	Inorganic solids may require acid or base to dissolve completely; organic samples often can be dissolved directly in solvent; filtration may be required after dissolution.

TABLE 4.4 Modern Extraction Methods for Solid Samples

Method of Sample Pretreatment	Principles of Technique	Comments
Accelerated solvent extraction (ASE)	Sample is placed in a sealed container and heated to above its boiling point, causing pressure in vessel to rise; extracted sample is removed automatically and transferred to vial for further treatment.	Greatly increases speed of liquid–solid extraction process; automated; vessel must withstand high pressure; extracted sample is diluted and requires further concentration; safety provisions are required because of overpressured, high-temperature solvents.
Automated Soxhlet extraction	Combination of hot solvent leaching and Soxhlet extraction; sample in thimble is first immersed in boiling solvent, then thimble is raised for conventional Soxhlet extraction/rinsing with solvent refluxing and finally, concentration.	Manual and automated versions available; uses less solvent than traditional Soxhlet; solvent is recovered for possible reuse; decreased extraction time due to two-step process.
Supercritical fluid extraction	Sample is placed in flow-through container and supercritical fluid (e.g., CO ₂) is passed through sample; after depressurization, analyte extracted is collected in solvent or trapped on adsorbent, followed by desorption by rinsing with solvent.	Automated and manual versions available; to affect “polarity” of SF fluid, density can be varied and solvent modifiers added; sample collected is usually concentrated and relatively contaminant-free because CO ₂ is removed after extraction; matrix effects extraction process; method development may take longer than other modern methods.
Microwave-assisted extraction	Sample is placed in an open or closed container and heated by microwave energy, causing extraction of analyte into a solvent.	Extraction solvent can range from microwave absorbing (MA) to nonmicrowave absorbing (NMA); in MA, sample is placed in high-pressure container and heated well above its boiling point as in ASE; in NMA, container can be open and there no pressure rise; safety provisions are required with organic solvents in microwave oven (MA/NMA) and for high pressures of MA.
Thermal extraction	Form of dynamic headspace sampling but the sample is heated to much higher (controlled) temperatures, up to 350°C.	System must be constructed of fused quartz or fused silica so that extracted analytes do not react with hot metal surfaces; system cold spots should be avoided; used for low-vapor-pressure compounds.

with greater precision and accuracy, and (2) dissolve faster and are easier to extract because of their greater surface area. Methods for reducing the particle size of solid samples are outlined in Table 4.5.

Grinding with a mortar and pestle is recommended for many solid samples and most will withstand the thermal rigor of grinding. If the sample contains thermally labile or volatile compounds, it is important to minimize heating during the grinding process. If the sample is very hard, a diamond mortar constructed with a cylinder of hardened steel may be required. A close-fitting steel rod fits inside the cylinder and the sample is pulverized by hammering on the rod. If the material is soft, a ball mill is recommended. Here the sample is placed into a porcelain cylinder containing porcelain, stainless steel, or hard flint balls. After the cylinder is sealed, it is rotated, shaken, or vibrated until the material inside is ground into a finely divided state. This material may then be sieved to achieve a more homogeneous sample.

Malleable or elastic samples such as rubber or plastic must be cooled before grinding to make them brittle. For this, dry ice can be added directly to a mortar or ball mill. The dry ice should be prepared from carbon dioxide that is free from impurities that might contaminate the sample. When lower temperatures are required to solidify the sample, pulverizing the sample under liquid nitrogen can be carried out in a freezer mill or cryogenic pulverization system.

4.3.2 Drying the Sample

Solid samples are often received for analysis in a damp or wet state. Removal of water or drying the sample to constant weight is usually necessary for reliable assay. Inorganic samples such as soil should be heated at a temperature from 100°-110°C to ensure the removal of moisture. Hydrophobic organic samples seldom require heating, since water absorption is minimal. However, organic vapors can also be adsorbed by solid organic samples, and a heating step can remove these contaminants. For hygroscopic or reactive samples (e.g., acid anhydrides), drying in a vacuum desiccator is recommended. Samples that can oxidize when heated in the presence of air should be dried under vacuum or nitrogen. Biological samples generally should not be heated to above 100°C, and temperatures above ambient often should be avoided to avoid sample decomposition. Sensitive biological compounds (e.g., enzymes) often are prepared in a cold room at less than 4°C to minimize decomposition. Samples of such materials should be maintained at these low temperatures until the HPLC analysis step. Freeze-drying (lyophilization) often is used to preserve the integrity of heat-sensitive samples (especially biologicals). This is carried out by quick-freezing the sample, followed by removal of frozen water using sublimation under vacuum.

4.3.3 Filtration

Particulates should be removed prior to injection because of their adverse effect on column life (Section 5.4.3.1). The most common methods for remov-

TABLE 4.5 Methods for Reducing Sample Particle Size

Particle-Size-Reduction Method	Description of How Sample Reduction is Carried Out
Blending	Mechanical blender chops a semi-soft substance into smaller parts; can also refer to the blending of a nonhomogeneous sample into a more consistent form.
Chopping	Mechanically cutting a sample into smaller parts.
Crushing	Tungsten carbide variable jaw crushers reduce large, hard samples to 1- to 15-mm diameters.
Cutting	Cutting mills can reduce soft-to-medium hard materials (< 100 mm diameters) by using rotating and stationary cutting knives; reduced size depends on sieves used in combination with mill.
Grinding	Mortar and pestle most popular; mechanical mortar grinders automate and standardize grinding to analytical fineness done manually with a mortar and pestle; both wet and dry grinding are used; fineness of approximate 10- μ m diameters can be achieved.
Homogenizing	Making a sample more uniform in texture and consistency by breaking down into smaller parts and blending.
Macerating	Breaking down a soft material into smaller parts by tearing, chopping, cutting, etc.
Milling	Disk mills pulverize < 20-mm-diameter hard samples by feeding between stationary and rotating disks with adjustable gap settings; generally reduced to 100 μ m in diameter. Rotor-speed mills combine impact and shearing processes to grind soft-to-medium hard and fibrous materials down to 80 μ m; ball mills grind material to submicron fineness by developing high grinding energy via centrifugal or planetary actions using agate, tungsten carbide, or PTFE-coated stainless steel balls; a soil mill will gently pulverize dried samples of soils, sludges, clays, and similar material by rotating nylon brushes that throw a sample against a chamber wall.
Mincing	Breaking down a meat or vegetable product into smaller parts by tearing, chopping, cutting, dicing, etc.
Pressing	Generally refers to squeezing liquid from a semi-solid material (e.g., plants, fruits, meat) for the purposes of further analysis.
Pulverizing	Electromechanically driven rod or vibrating base is used to break particles down mechanically into smaller units; can be performed in wet or dry state; freezer mill can be used with liquid N ₂ to treat malleable samples.
Sieving	Passing a sample through a metal or plastic mesh of a uniform cross-sectional area (square openings from 3 μ m to 123 mm) to separate particles into uniform sizes; both wet and dry sieving can be used.

ing particulates from the sample are filtration, centrifugation, and sedimentation. Several approaches to filtration are given in Table 4.6. Paper filtration is a relatively straightforward technique. The lower the porosity of the filter medium, the cleaner the filtrate and the longer the filtering time. Vacuum filtration speeds up this process. Membrane filters can be purchased for placement into commercial filter holders. However, many HPLC users prefer disposable filters equipped with Luer fittings. Here, the sample is placed in a syringe and filtered through the membrane using gentle pressure.

A variety of membrane materials with different nominal porosities and dimensions are available for filtration; manufacturers' literature provides specifications. For most samples encountered in HPLC, filters in the range 0.25- to 2- μm nominal porosity are recommended. The porosity values are approximate and the type of membrane can have some influence on the filtration range. Membranes with 0.25- μm pores remove the smallest of particulates (and large macromolecules). If the sample contains colloidal material or a large amount of fine particulates, considerable pressure may be required to force the liquid sample through the filter. Manufacturers of membrane filters usually provide detailed information on solvent compatibility. If an inappropriate solvent is used, the filter may dissolve (or soften) and the sample become contaminated. More expensive, functionalized membranes and SPE disks and cartridges not only are used for filtration but also remove particulates (Section 4.4.2).

4.4 SAMPLE PRETREATMENT FOR LIQUID SAMPLES

Table 4.2 provides an introduction to sample preparation methods for liquid samples, but most laboratories need only a few of these procedures. For example, distillation is limited to volatile compounds, although vacuum distillation for high boilers in environmental samples can extend the application of this technique [8]. Lyophilization is usually restricted to the purification and handling of biological samples (Chapter 11). In the following sections we deal with those methods in more common use in most HPLC laboratories: liquid-liquid and liquid-solid (solid-phase) extraction.

4.4.1 Liquid-Liquid Extraction

Liquid-liquid extraction (LLE) is useful for separating analytes from interferences by partitioning the sample between two immiscible liquids or *phases*. One phase in LLE often is aqueous and the second phase an organic solvent. More-hydrophilic compounds prefer the polar aqueous phase, whereas more-hydrophobic compounds will be found mainly in the organic solvent. Analytes extracted into the organic phase are easily recovered by evaporation of the solvent, while analytes extracted into the aqueous phase can often be injected directly onto a reversed-phase HPLC column. The following discussion as-

TABLE 4.6 Filtration in HPLC

Filtration Media	Typical Products	Recommended Use	Comments
Filter paper	Cellulose	For removal of larger particles ($> 40 \mu\text{m}$)	Beware of filter paper fibers getting into sample; ensure solvent compatibility of filter paper.
Membrane filters	Nylon, PTFE, polypropylene, polyester, polyether sulfone, polycarbonate, polyvinylpyrrolidone	For removal of small particles ($< 10 \mu\text{m}$)	Plug easily with "dirty" samples; prefiltering may be needed; porosities from 0.25 to 2 μm most popular; possible solvent compatibility problems; for ultrafiltration membrane filters, see Section 4.4.3.
Functionalized membranes	Ion-exchange membranes, affinity membranes	Can remove both particulates and matrix interferences	Can be plugged with dirty samples; prefiltering may be needed; possible solvent-compatibility problems.
SPE cartridges	Silica- and polymer-based	Can remove both particulates and matrix interferences	Particles of silica-bonded phase can pass into filtrate; plasticizers may extract from syringe barrel and plastic frits; metallic ions may extract from metal frits; beware of plugging and batch-to-batch irreproducibility.
SPE disks	PTFE- and fiberglass-based	Can remove both particulates and matrix interferences	Sometimes need filter holder; PTFE membranes are delicate; can pass large volumes at high flow rate; beware of plugging and batch-to-batch irreproducibility.

sumes that an analyte is extracted into the organic phase from an aqueous sample, but similar approaches are used when the analyte is extracted into an aqueous phase.

Figure 4.1 summarizes the steps involved in a LLE separation. Since extraction is an equilibrium process with limited efficiency, significant amounts of the analyte can remain in both phases. Chemical equilibria involving changes in pH, ion pairing, complexation, and so on, can be used to enhance analyte recovery and/or the elimination of interferences. The LLE organic solvent is chosen for the following characteristics:

- Low solubility in water ($< 10\%$)
- Volatility for easy removal and concentration after extraction
- Compatibility with the HPLC detection technique to be used for analysis (avoid solvents that are strongly UV absorbing)
- Polarity and hydrogen-bonding properties that enhance recovery of the analytes in the organic phase (see the discussion in Section 2.3.2.1 and Appendix II)
- High purity to minimize sample contamination

4.4.1.1 Theory. The Nernst distribution law states that any species will distribute between two immiscible solvents so that the ratio of the concentrations remains constant:

$$K_D = \frac{C_o}{C_{aq}} \quad (4.1)$$

where K_D is the distribution constant, C_o the concentration of the analyte in the organic phase, and C_{aq} the concentration of the analyte in the aqueous phase. A more useful expression is the fraction of analyte extracted (E) into the organic phase, given by

$$E = \frac{C_o V_o}{C_o V_o + C_{aq} V_{aq}} = \frac{K_D V}{1 + K_D V} \quad (4.2)$$

where V_o is the volume of organic phase, V_{aq} the volume of aqueous phase, and V the phase ratio V_o/V_{aq} .

Many LLE procedures are carried out in separatory funnels and typically require tens or hundreds of milliliters of each phase. For one-step extractions, K_D must be large (e.g., > 10) for the quantitative recovery of analyte in one of the two phases, since the phase ratio V must be maintained within a practical range of values [e.g., $0.1 < V < 10$ (see Eq. 4.2)]. In most separatory-funnel LLE procedures, quantitative recoveries ($> 99\%$) require two or more extractions. For successive multiple extractions, with pooling of the analyte phases from each extraction, the fraction of analyte extracted E is

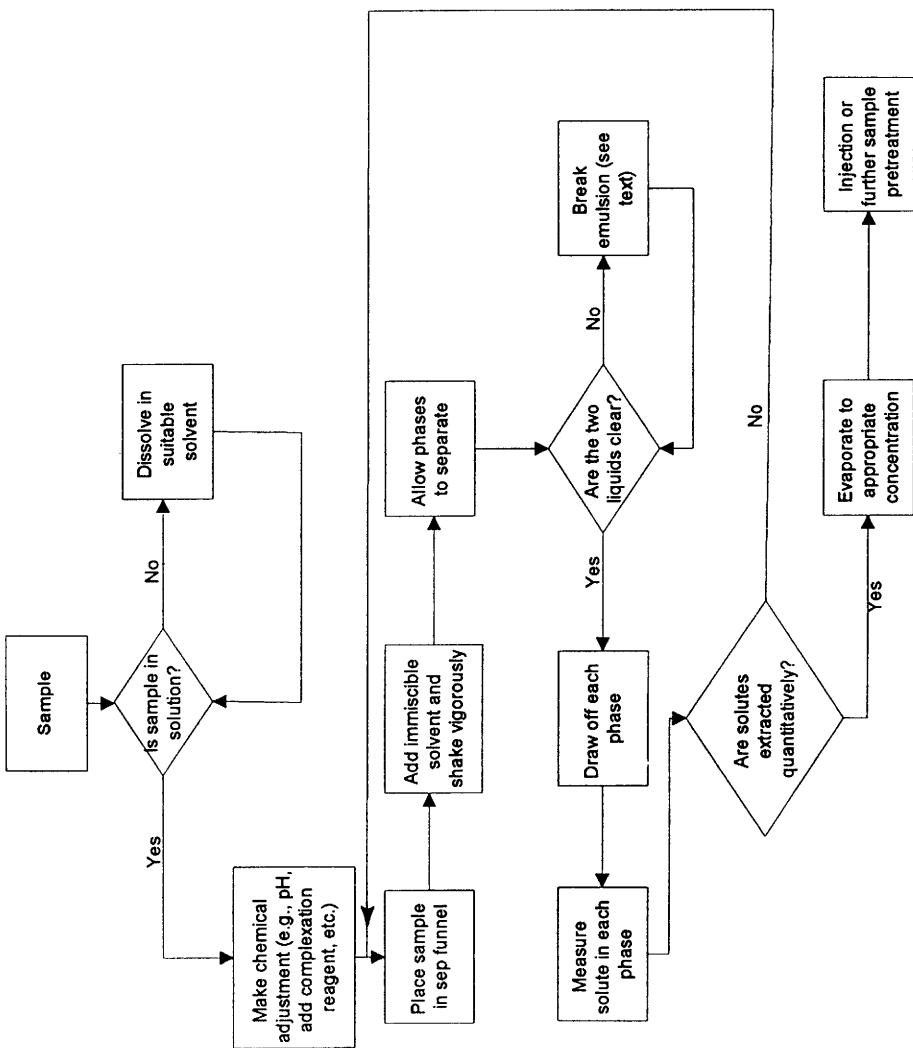

FIGURE 4.1 Schematic of LLE process.

$$E = 1 - \left(\frac{1}{1 + K_D V} \right)^n \quad (4.3)$$

where n is the number of extractions. For example, if $K_D = 5$ for an analyte and the volumes of the two phases are equal ($V = 1$), three extractions ($n = 3$) would be required for >99% recovery of the analyte. Several approaches can be used to increase the value of K_D :

- The organic solvent can be changed to increase K_D .
- If the analyte is ionic or ionizable, K_D can be increased by suppressing its ionization to make it more soluble in the organic phase (see the discussion in Section 4.4.1.2). The analyte can also be extracted into the organic phase by ion pairing (Section 7.4), provided that the analyte is ionized and an ion-pair reagent is added to the organic phase.
- *Salting out* can be used to decrease an analyte's concentration in the aqueous phase by the addition of an inert neutral salt (e.g., sodium sulfate) to the aqueous phase.

4.4.1.2 Practice. Table 4.7 provides examples of typical extraction solvents, as well as some unsuitable (water-miscible) solvents. Apart from miscibility considerations, the main selection criteria is the polarity P' of the solvent (Table II.1 of Appendix II) in relation to that of the analyte. The maximum K_D value occurs when the polarity of the extraction solvent matches that of the analyte. For example, extraction of a polar analyte from an aqueous sample matrix would best be accomplished with a more polar (large P') organic solvent. An optimum-polarity organic solvent can conveniently be selected by blending two solvents of different polarity (e.g., hexane and chloroform) and measuring K_D vs. the composition of the organic phase [9]. The solvent mixture that gives the largest value of K_D is then used for the LLE procedure. Further changes in K_D can be achieved, with improvement in the separation of analytes from interferences, by varying organic-solvent *selectivity*. Solvents from different regions of the solvent-selectivity triangle (Fig. 2.7, Section 2.3.2.1) are expected to provide differences in selectivity; see also the discussion in Ref. 10.

In solvent extraction, ionic analytes often can be transferred into either phase, depending on the selected conditions. For example, consider the extraction of an organic acid from an aqueous solution. If the aqueous phase is buffered at least 1.5 pH units above its pK_a value, the analyte will be ionized and prefer the aqueous phase; less polar interferences will be extracted into the organic phase. If the pH of the aqueous solution is lowered ($\ll pK_a$) so that the analyte is no longer ionized, the analyte will be extracted into the organic phase, leaving more polar interferences in the aqueous phase. Equilibria involving pH are discussed further in Section 7.2. The principles of acid-base extraction as a function of pH are the same for LLE and HPLC.

TABLE 4.7 Extraction Solvents for LLE^a

Aqueous Solvents	Water-Immiscible Organic Solvents	Water-Miscible Organic Solvents (Unsuitable for LLE)
Pure water	Aliphatic hydrocarbons	Alcohols (low molecular weight)
Acidic solution	(hexane, isooctane,	Ketones (low molecular weight)
Basic solution	petroleum ether, etc.)	Aldehydes (low molecular weight)
High salt (salting-out effect)	Diethyl ether or other ethers	Carboxylic acids (low molecular weight)
Complexing agents (ion pairing, chelating, chiral, etc.)	Methylene chloride	Acetonitrile
Combination of two or more of the above	Chloroform	Dimethyl sulfoxide
	Ethyl acetate and other esters	Dioxane
	Aliphatic ketones (C ₆ and above)	
	Aliphatic alcohols (C ₆ and above)	
	Toluene, xylenes (UV absorbance!)	
	Combination of two or more above	

^a Any solvent from the first column can be matched with any solvent of the second column; water-miscible organic solvents should not be used with aqueous solvents to perform LLE.

If the analyte K_D is unfavorable, additional extractions may be required for improved recovery (Eq. 4.3). In this case a fresh portion of immiscible solvent is added to the original sample to extract additional solute, and all extracts are combined. Generally, for a given volume of final extracting solvent, multiple extractions are more efficient in removing a solute quantitatively than use of a single extraction volume. *Back extraction* can be used to reduce interferences further. For example, consider the example of an organic-acid analyte described above. If the analyte is first extracted at low pH into the organic phase, polar interferences (e.g., hydrophilic neutrals, protonated bases) are left behind in the aqueous phase. If a fresh portion of high-pH aqueous buffer is used for the back-extraction of the organic phase, the ionized organic acid is transferred back into the aqueous phase, leaving nonpolar interferences in the organic phase. Thus a two-step back-extraction allows the removal of both basic and neutral interferences, whereas a one-step extraction can eliminate one or the other of these interferences, but not both.

If the K_D value is very low or the required sample volume is large, it becomes impractical to carry out multiple extractions for quantitative recovery

of the analyte. Too many extractions are required, and the volume of total extract is too large (Eq. 4.3). Also, if extraction is slow, a long time may be required for equilibrium to be established. In these cases, continuous liquid-liquid extraction can be used, where fresh solvent is continually recycled through the aqueous sample. Continuous extractors using heavier-than-water and lighter-than-water solvents have been described [11]; examples are shown in Fig. 4.2. In each case an extraction solvent contained in a reservoir is refluxed continuously, the solvent vapor is condensed and bubbled through an immiscible sample solution, and the solvent plus extracted analyte is collected and fed back to the original solvent reservoir. In this way, analyte continually accumulates in the reservoir and is depleted from the sample solution until all the analyte is extracted from the sample. These extraction devices can run for extended periods (12 to 24 h); quantitative extractions (> 99% recovery) can be achieved even for small values of K_D .

For more efficient LLE, a countercurrent distribution apparatus can provide a thousand or more equilibration steps (but with more time and effort). This

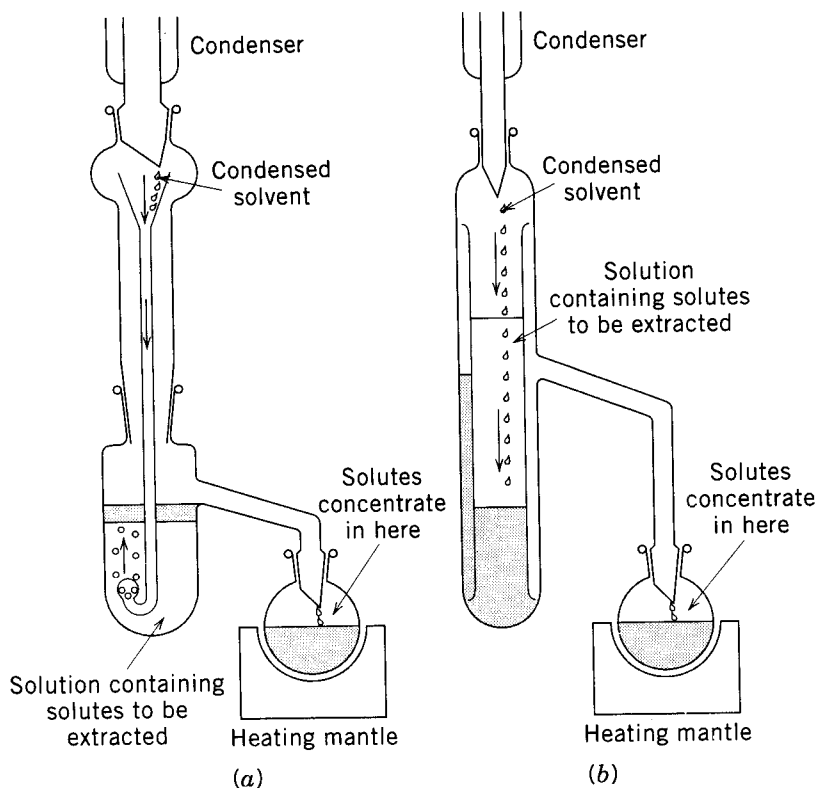

FIGURE 4.2 Apparatus for continuous extraction. (a) Extracting solvent less dense than the solution from which a solute is being extracted; (b) extracting solvent more dense than the solution from which a solute is being extracted.

allows the recovery of analytes having extremely small K_D values; countercurrent distribution also provides a better separation of analytes from interferences. Small-scale laboratory units are commercially available. For further information on the countercurrent distribution process, see Ref. 12.

In some cases, LLE can increase the analyte concentration in the extract fraction relative to its concentration in the initial sample. According to Eq. 4.2, by choosing a smaller volume of organic solvent, the analyte concentration can be increased by the volumetric ratio of organic-to-aqueous phases (assuming complete extraction into the organic phase). For example, assume 100 mL of aqueous sample, 10 mL of organic solvent, and a high K_D value (e.g., $K_D > 1000$). The concentration of the analyte in the organic phase will then increase by a factor of 10. For large aqueous/organic solvent ratios the organic solvent may be partially dissolved by the aqueous phase (Section 4.4.1.3). This effect can reduce the volume of the recovered organic solvent and make calculation of analyte recovery uncertain. This problem can be avoided by presaturating the aqueous solvent with organic solvent. Note that when the solvent ratio V_o/V_{aq} is small, the physical manipulation of the two phases becomes more difficult.

Microextraction is another form of LLE in which extractions are carried out with organic/aqueous ratios of 0.001 to 0.01. Analyte recovery may suffer compared to conventional LLE, but the analyte concentration in the organic phase is greatly increased and solvent use is greatly reduced. Such extractions are carried out conveniently in a volumetric flask. The organic extraction solvent is chosen to have a density less than that of water, so that the small volume of organic solvent accumulates in the neck of the flask for easy removal. For quantitative analysis, internal standards should be used and extractions of calibration standards carried out. Modern autosamplers are capable of performing microextractions automatically on small volumes of aqueous samples in 2-mL vials [13].

4.4.1.3. Problems. Some practical problems associated with LLE include:

- Emulsion formation
- Analytes strongly sorbed to particulates
- Analytes bound to high-molecular-weight compounds (e.g., drugs to proteins)
- Mutual solubility of the two phases

As noted in Fig. 4.3, emulsions are a problem that can occur with certain samples (e.g., fatty matrices) and solvent conditions. If emulsions are not “broken” with a sharp boundary between the aqueous and organic phases, analyte recovery can be affected adversely. Emulsions can be broken by:

- Adding salt to the aqueous phase
- Heating or cooling the extraction vessel

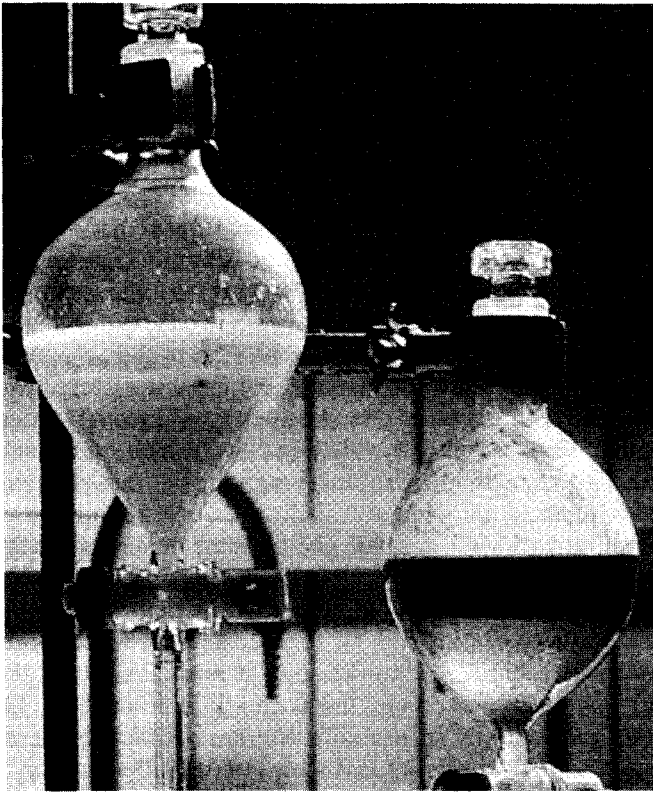

FIGURE 4.3 Emulsion in a separatory funnel compared to a normal two-phase system.

- Filtering through a glass-wool plug
- Filtering through phase-separation filter paper
- Adding a small amount of different organic solvent
- Centrifuging

If particulates are present in a sample, adsorption onto these particulates can result in low recovery of the analyte. In such cases, washing the particulates after filtration with a stronger solvent will recover the adsorbed analyte; this extract should be combined with the analyte phase from LLE. A stronger solvent for recovering adsorbed analyte may involve a change in pH, increased ionic strength, or the use of a more polar organic solvent.

Compounds that normally are recovered quantitatively in LLE may bind to proteins when plasma samples are processed, resulting in low recovery. Protein binding is especially troublesome when measuring drugs and drug metabolites in physiological fluids. Techniques for disrupting protein binding in plasma samples include:

- Adding a detergent
- Adding an organic solvent, chaotropic agent, or strong acid
- Diluting with water
- Displacing with a more strongly binding compound

Immiscible solvents have a small but finite mutual solubility, and the mutually dissolved solvent can change the relative volumes of the two phases. Therefore, it is a good practice to saturate each phase with the other so that the volume of phase containing the analyte can be known, allowing accurate and optimum determination of analyte recovery. The simplest procedure for saturation is to equilibrate the two phases in a separatory funnel without the sample, thereby saturating each phase. Aliquots of either phase can then be used for LLE.

4.4.2 Solid-Phase Extraction

4.4.2.1 SPE vs. LLE. Solid-phase extraction is the most important technique used in sample pretreatment for HPLC. SPE can be used in a fashion similar to LLE. Whereas LLE is a one-stage separation process, SPE is a chromatographic procedure that resembles HPLC and has a number of potential advantages over LLE:

- More complete extraction of the analyte
- More efficient separation of interferences from analytes
- Reduced organic solvent consumption
- Easier collection of the total analyte fraction
- More convenient manual procedures
- Removal of particulates
- More easily automated

Because SPE is a more efficient separation process than LLE, it is easier to obtain a higher recovery of the analyte. LLE procedures that require several successive extractions to recover 99+% of the analyte often can be replaced by one-step SPE methods. With SPE it is also possible to obtain a more complete removal of interferences from the analyte fraction. Reversed-phase SPE techniques are most popular, as only small amounts of organic solvent are required for elution, maintaining a high concentration of analyte (Section 4.4.2.6). Because there is no need for phase separation in SPE (as in LLE), the total analyte fraction is easily collected, eliminating errors associated with variable or inaccurately measured extract volumes. Finally, larger particulates are trapped by the SPE cartridge and do not pass through into the analyte fraction.

Some disadvantages of SPE vs. LLE include:

- Variability of SPE cartridges
- Irreversible adsorption of some analytes on SPE cartridges

The solvents used in LLE are usually pure and well defined, so that LLE separations are quite reproducible. Conversely, the solid-phase cartridges used in SPE tend to vary from lot to lot, so that method reproducibility is sometimes a concern with SPE procedures. The surface area of an LLE device (e.g., separatory funnel) is quite small compared with that of an SPE cartridge. For this and other reasons, irreversible binding of analyte (with lower recoveries) is less likely with LLE than with SPE.

4.4.2.2 SPE vs. HPLC. In its simplest form, SPE employs a small plastic disposable column or *cartridge*, often the barrel of a medical syringe packed with 0.1 to 0.5 g of sorbent. The sorbent is commonly a reversed-phase material (e.g., C₁₈-silica), and a reversed-phase SPE (RP-SPE) resembles both LLE and reversed-phase HPLC in its separation characteristics. In the following discussions, we assume RP-SPE unless noted otherwise. The packing is held in the syringe barrel by frits, just as in an HPLC column. The particle size ($> 40\text{-}\mu\text{m}$) typically is larger than that in HPLC (3 to 10 μm). Because of shorter bed lengths, larger particles, and less-well-packed beds, SPE cartridges are much less efficient ($N < 100$) than an HPLC column. Because of cost, irregularly shaped packings (rather than spherical particles) are generally used in SPE. Some SPE disks, however, do use the more expensive, 7- μm spherical SPE packings. Overall, the principles of separation, phase selection, and method development for SPE are similar to those for HPLC (see Chapters 6 and 7). One major difference between SPE and HPLC is that the SPE cartridge generally is used once and discarded, since potential interferences may remain on the cartridge.

In SPE, a liquid sample is added to the cartridge and a wash solvent is selected so that the analyte is either strongly retained ($k \gg 1$) or unretained ($k = 0$). When the analyte is strongly retained, interferences are eluted or “washed” from the cartridge so as to minimize their presence in the final analyte fraction. The analyte is then eluted in a small volume with a strong elution solvent, collected, and either (1) injected directly or (2) evaporated to dryness followed by dissolution in the HPLC mobile phase. In the opposite case, where the analyte is weakly retained, interferences are strongly held on the cartridge and the analyte is collected for further treatment. By either approach, interferences can be removed from the analytes of interest. The entire SPE operation is explained in detail in Section 4.4.2.6.

4.4.2.3 Uses of SPE. SPE is used for six main purposes in sample preparation:

- Removal of interferences and column killers
- Concentration or trace enrichment of the analyte

- Desalting
- Solvent exchange
- *In situ* derivatization
- Sample storage and transport

Interferences that overlap analyte bands in the HPLC separation complicate method development and can adversely affect assay results. In some cases, a large number of interferences in the original sample may make it impossible to separate these from one or more analyte bands with a single HPLC separation. SPE can be used to reduce or eliminate those interferences. *Column killers* such as hydrophobic substances (e.g., fats, oils, greases), polymeric materials, and particulates, which can either plug or deactivate the HPLC column, can often be removed by RP-SPE.

SPE can be used to increase the concentration of a trace component. If an SPE cartridge can be selected so that $k \gg 1$ for the analyte, a relatively large volume of sample can be applied before the analyte saturates the cartridge and begins to elute from the cartridge. The net result is a considerable increase in the concentration of analyte when eluted with a strong solvent ($k < 1$), which means an increase in detection sensitivity (called *trace enrichment*). An example of trace enrichment is the use of SPE to concentrate sub-parts per billion concentrations of polynuclear aromatic hydrocarbons [14] or pesticides [15] from environmental water samples using a reversed-phase SPE cartridge. A strong solvent (e.g., ACN or MeOH) elutes these analytes from the cartridge in a small concentrated volume, which saves evaporation time. The sample can then be redissolved in a solvent compatible with subsequent HPLC separation. Alternatively, a miscible weak solvent can be added to the SPE eluant to dilute the stronger solvent and allow direct injection of the resulting sample.

RP-SPE can be used to desalt samples, especially prior to ion-exchange HPLC. Conditions of pH and %-organic are selected to retain the analyte initially, which allows inorganic salts to be washed from the cartridge with water. The analyte can then be eluted (salt free) with organic solvent [16]. The remaining applications of SPE (solvent exchange, *in situ* derivatization, and sample storage/transport) are either seldom used or are less relevant to the intended audience for this book. For details, see Refs. 16 to 18.

4.4.2.4 SPE Devices. Several devices are used for SPE: (1) cartridge, (2) disk, and (3) coated fiber. The most popular configuration for an SPE device is the *cartridge*. A typical SPE disposable cartridge (syringe-barrel format) is depicted in Fig. 4.4a. The syringe barrel is usually medical-grade polypropylene, chosen for its purity. If trace levels of impurities such as plasticizers, stabilizers, or mold-release agents are present in the plastic used for cartridges, they can be extracted during the SPE process and contaminate the sample. The outlet of the syringe barrel normally has a Luer tip so that a needle can be affixed to direct effluent to a small container or vial. The frits maintaining the particle bed in the cartridge are of PTFE, polypropylene, or

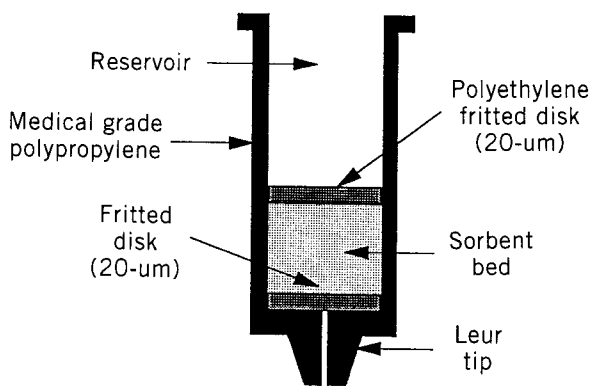

(a)

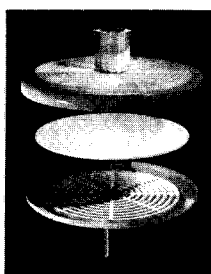

(b)

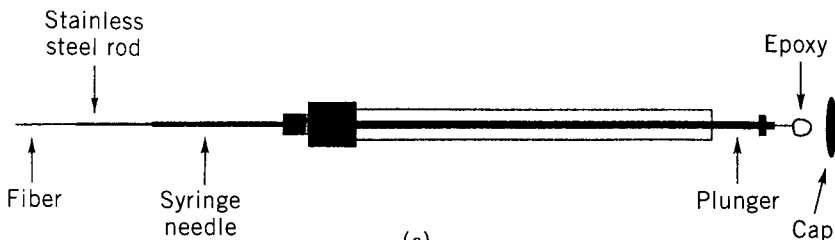

(c)

FIGURE 4.4 Design of SPE devices. (a) Disposable cartridge (syringe-barrel format); (b) disk with holder (courtesy of Alltech Associates); (c) SPME fused-silica fiber mounted on syringe plunger.

stainless-steel construction with a porosity of 10 to 20 μm to offer little flow resistance. SPE cartridges may vary in design to fit an automated instrument or robotics systems. Cartridges of glass or virgin PTFE are available for ultratrace analyses (subparts per billion) when the standard syringe-barrel plastics produce unacceptable concentrations of extractable interferences. SPE cartridges

are relatively inexpensive, so they are generally used a single time and discarded, because of the danger of sample cross contamination.

To accommodate a wide range of SPE applications, cartridges are also available with reservoir volumes (see Fig. 4.4a) of 0.5 to 10 mL, with packing weights of 35 mg to 2 g. For very large samples, “mega” cartridges have up to 10 g of packing and a 60-mL reservoir. Cartridges with a larger amount of packing should be used for “dirty” samples that can overload a low-capacity cartridge. However, cartridges containing 100 mg of packing or less are preferred for relatively clean liquid samples where cartridge capacity is not an issue. In most cases, it is desirable to collect the analyte in the smallest possible volume (e.g., for trace analysis), which means that the SPE cartridge generally should also be as small as possible.

The second most popular configuration is the SPE *disk* (Fig. 4.4b), which combines the advantages of membranes (see below and Table 4.8) and solid-phase extraction. Disks closely resemble membrane filters in appearance: they are flat, usually 1 mm or less in thickness with diameters ranging from 4 to 96 mm. The packing in SPE disks generally comprises 60 to 90% of the total membrane weight. Some disks are sold individually and must be installed in a reusable filter holder. Others are sold preloaded in disposable holders or cartridges with Luer fittings for easy connection to syringes. The physical construction of the SPE disks differs from membrane filters. SPE disks consist of:

- Flexible- or expanded-PTFE networks filled with silica-based or resin packings
- Rigid fiberglass disks with embedded packing material
- Packing-impregnated polyvinyl chloride
- Derivatized membranes

SPE disks and cartridges differ mainly in their length/diameter (L/d) ratio: disks have $L/d < 1$ and cartridges have $L/d \geq 1$. Compared to SPE cartridges, this characteristic of the disks permits higher flow rates and faster extraction (Table 4.8). For example, 1 L of relatively clean water can pass through a

TABLE 4.8 Comparison of a Typical Cartridge and Typical Disk for SPE

Parameter	Cartridge	Disk
Dimensions (height and diameter)	1.1 × 1.1 cm	0.05 × 4.7 cm
Cross-sectional (top) area	0.95 cm ²	11.34 cm ²
Packing weight	500 mg	500 mg
Flow at 85 kPa ^a	30 mL/min	100 mL/min
Linear velocity ^b	0.525 cm/s	0.15 cm/s

^a Typical flow.

^b At flow rate specified.

45-mm-diameter disk in approximately 15 to 20 min, whereas 2 hr is required when using a 15×8 -mm cartridge bed. Dirty water or water containing particulates, such as wastewater, can plug the porous disks, just as in the case of cartridges. In either case, prefiltering should be used prior to SPE treatment if the samples contain substantial particulates. Channeling, which causes uneven flow characteristics with subsequent lower analyte recovery, can occur with some cartridges. Because the packing material is embedded in the matrix, channeling is absent with disks. However, due to the thinness of the disk (typically 0.5 to 2 mm), compounds with low k values tend to have lower breakthrough volumes than for SPE cartridges.

SPE disks have been found useful for environmental applications such as the analysis of trace organics in surface water, which often require a large sample volume to obtain the necessary sensitivity. The U.S. Environmental Protection Agency has approved SPE technology as an alternative for LLE in the preparation of water samples for HPLC analysis [19]. Examples of approved methods include procedures for phenols [20], pesticides and polychlorinated biphenyls (PCBs), haloacetic acids in drinking water [21], and organochloropesticides in solid wastes [22]. A major advantage of SPE vs. conventional LLE is reduced consumption of organic solvents. SPE disks and cartridges require only a few milliliters of solvent per assay, compared to hundreds of milliliters for comparable multistep LLE separations.

Low-bed-mass, rigid fiberglass disks with 1.5 to 30 mg of embedded packing material are useful for pretreating small clinical samples (e.g., plasma or serum [23]). Here, the reduced sorbent mass and cross-sectional area reduce solvent consumption. An advantage of this type of disk is cleaner extracts due to reduced elution solvent volume, less interference from weakly retained compounds, and an absence of frits, which are a possible source of contamination.

Packing-impregnated polyvinyl chloride (PVC) disks and sheets provide capabilities similar to those of the above-discussed PTFE disks [24]. These membranes have 1- μm flow-through pores that allow fast separations. Although designed for protein purification, these disks can be used for other SPE applications as long as the solvents being used are compatible with PVC. Unfortunately, not as many stationary phases (i.e., ion exchange and affinity) are available in PVC disks as in cartridge and PTFE disk formats.

Derivatized membranes differ from sorbent-impregnated disks in that the membranes are functionalized through chemical reactions. These units are made from cellulose derivatized with groups such as diethylaminoethyl (DEAE), quaternary ammonium (QAE), and sulfonylpropyl (SP), and are therefore useful in the ion-exchange mode.

Coated fibers are used for solid-phase microextraction (SPME). In this design (Fig. 4.4c), a fine, solid, fused silica fiber is coated with a polymeric stationary phase such as a polydimethylsiloxane or polyacrylate [25,26]. The fiber is dipped into the solution to be analyzed, and analytes diffuse to and partition into the coating as a function of their distribution coefficients. The fiber is removed from solution and placed into the injection port of an HPLC

valve, where analytes are displaced with a strong solvent, analogous to the elution step in cartridge or disk SPE.

For the purposes of brevity, the SPE device discussed in the remainder of Section 4.4 will be referred to as a typical SPE cartridge. In most cases, other SPE devices will perform in similarly.

4.4.2.5 SPE Apparatus. The equipment needed to perform SPE can be very simple (Fig. 4.5). Gravity can be used as the driving force, but flow through the cartridge is extremely slow and impractical for general use. Thus, the most useful basic system (Fig. 4.5a) employs a syringe to push solvent or sample manually through the cartridge. This method may be difficult if the sample is viscous or contains particulates. In this case, a vacuum flask that can handle one cartridge at a time may be used instead (Fig. 4.5b). When several samples must be processed simultaneously, a vacuum manifold system for processing multiple cartridges at a time is recommended (Fig. 4.5c). A removable rack is located inside the vacuum manifold to hold test tubes for eluant collection. In some units a vacuum bleed valve, a flow-control valve, and a gauge are incorporated to allow better control of the solvent flow. In the most sophisticated units, individual controls for each cartridge are provided to ensure that there is an even flow distribution among all the cartridges. Finally, a sidearm vacuum flask is placed between the vacuum manifold and the vacuum source to collect rinses and wash solvent.

Regardless of the method used to force the sample solution through the SPE cartridge or other SPE device, the flow rate should not be too fast. Otherwise, there may be an insufficient time of contact of the sample with the stationary phase. For typical SPE applications, a flow rate of 10 mL/min or less is recommended for most cartridges [27] and 50 mL/min for a 90-mm disk [28].

When the number of samples increases, such that SPE sample preparation becomes a bottleneck, it becomes feasible to automate the entire process. There are three basic approaches to SPE automation: (1) dedicated SPE equipment, (2) modified liquid-handling systems, and (3) robotic workstations. The simplest and least expensive instrumentation is a *dedicated SPE device* which performs conditioning, washing, and elution. Such systems may use standard syringe barrel cartridges, special cartridges designed to fit the apparatus, or SPE disks. *Modified liquid-handling systems* are used primarily to perform liquid-handling functions such as dilution, mixing, and internal standard addition. Several commercial units perform automated SPE.

Robotic systems are the most versatile in performing and assisting in sample preparation functions. Although a robot can be interfaced to devices that perform all the steps of the SPE experiment, it is usually more time- and cost-effective to interface the robot to a dedicated SPE workstation. The robot serves to move sample containers to and from the SPE workstation as well as to and from other sample preparation devices (e.g., balances, mixers, dilutors, autosamplers, etc.) located on the laboratory bench.

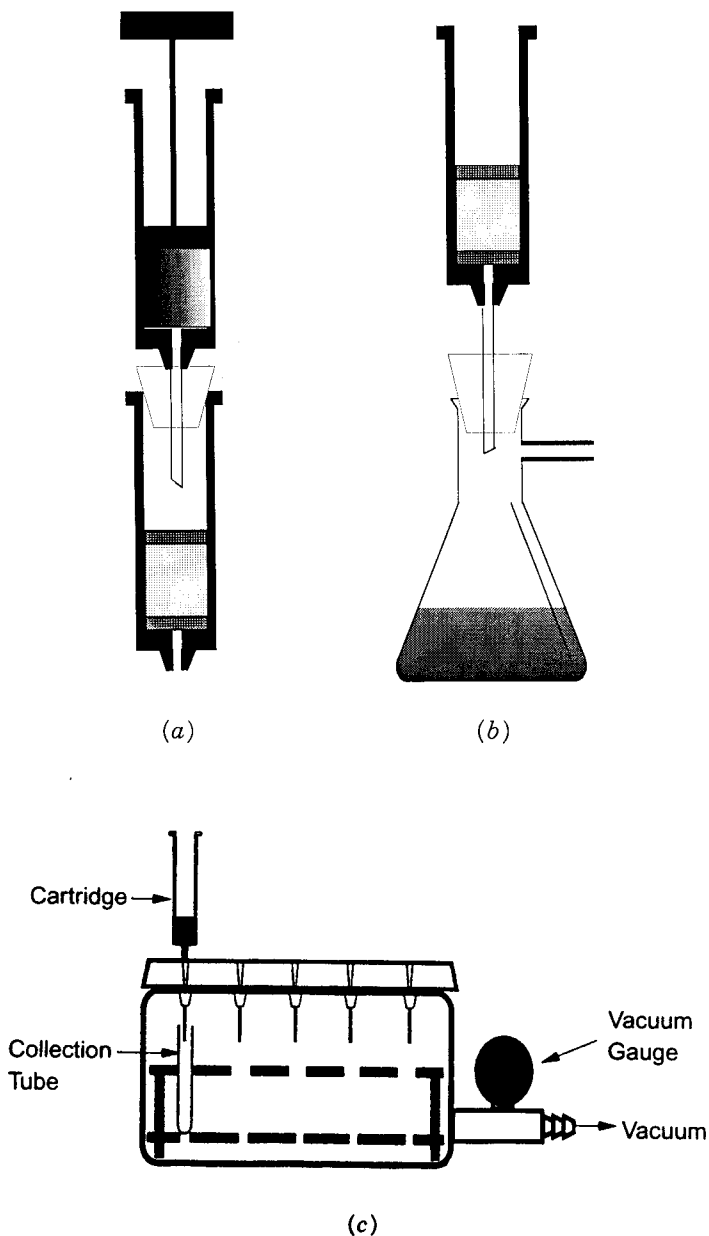

FIGURE 4.5 Schematics of SPE apparatus. (a) Pressurization with syringe (single cartridge); (b) use of vacuum flask (single cartridge); (c) schematic of multicartridge vacuum manifold system.

4.4.2.6 SPE Method Development

Overview of SPE Separations. The application of SPE generally involves four steps (Fig. 4.6a–d):

1. Conditioning the packing
2. Sample application
3. Washing the packing (removal of interferences)
4. Recovery of the analyte

In this discussion it is assumed that the operator is using RP-SPE and that the analyte is to be retained initially. In step 1 (Fig. 4.6a), carried out prior to addition of sample, the packing is “conditioned” by the passage of a few bed volumes of solvent C, typically methanol (MeOH) or acetonitrile (ACN), through the cartridge. The role of the conditioning step is twofold in that it (1) removes any impurities that may have collected while the cartridge was exposed to the laboratory environment, and (2) allows the sorbent to be solvated. Solvation is important because reversed-phase packings (especially C₈, C₁₈, or phenyl) that have been allowed to dry out often exhibit decreased sample retention. In addition, varying states of SPE phase dryness lead to nonreproducible analyte recoveries. Methanol is commonly used as conditioning solvent for RP-SPE packings or polar-bonded-phase packings such as cyano, amino, and diol. However, MeOH should not be used for silica gel, which is strongly deactivated by this solvent; an intermediate-polarity solvent such as methylene chloride is recommended for unmodified silica.

After the SPE packing is conditioned, the excess methanol (or other solvent) should be removed by a flow of air through the cartridge until solvent no longer drips from the bottom of the cartridge (step 1a; not depicted in Fig. 4.6). However, the airflow should not be continued past this point, as this can affect analysis reproducibility (especially with SPE disks). If the SPE packing is allowed to dry out before the sample is introduced, the conditioning step should be repeated before proceeding. With RP-SPE separations, removal of excess methanol can also be accomplished by purging the cartridge with a solvent that is miscible with the conditioning solvent and the sample (e.g., water or a buffer). A preconditioning water wash also serves to ready the SPE cartridge for introduction of an aqueous sample (step 2; Fig. 4.6b).

Step 2 (Fig. 4.6b) in the SPE experiment involves sample application (loading) where the sample dissolved in a weak solvent is added to the cartridge. This weak solvent allows strong retention of the analyte. For RP-SPE operations, a weak solvent is water or buffer, with up to 10% of added organic. For ion exchange, a similar solvent is acceptable, but the ionic strength of the sample solution should be as low as possible. See Table 4.9 for further information on loading solvents.

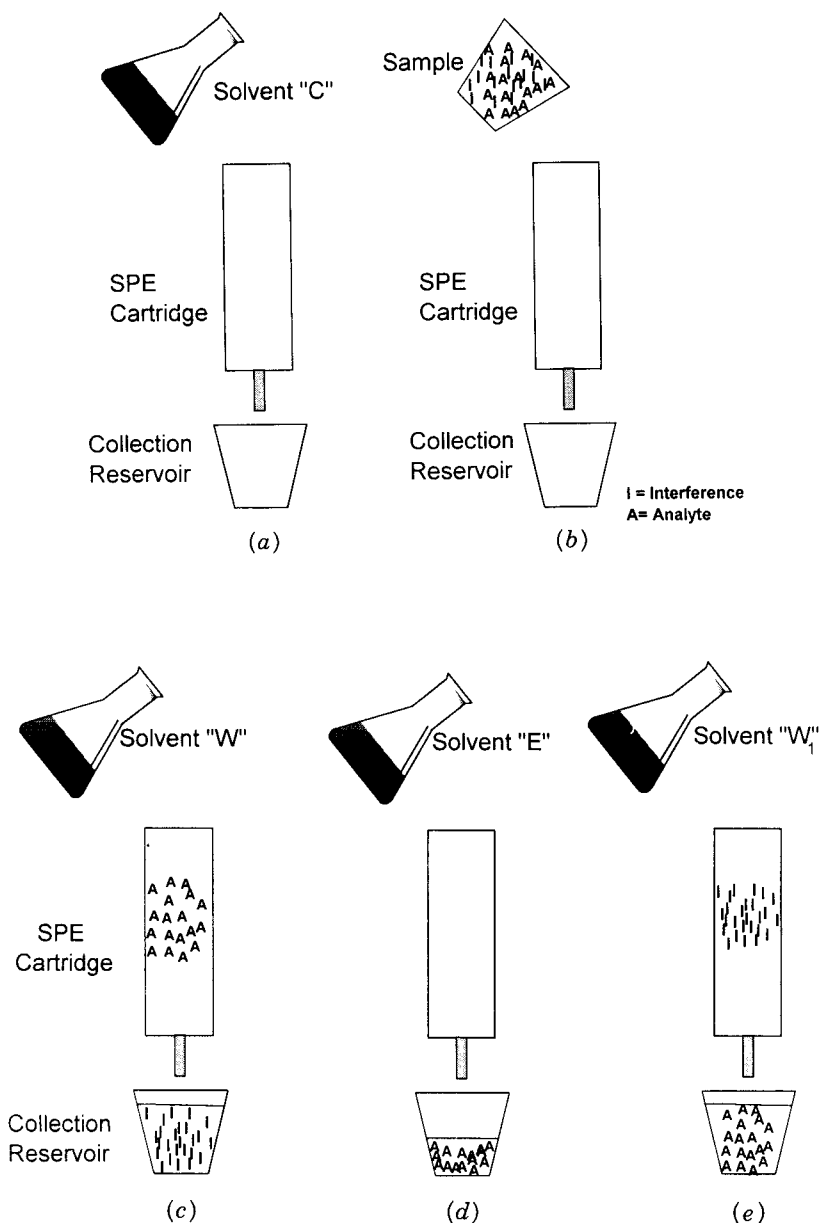
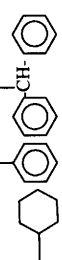



FIGURE 4.6 SPE options. (a) Step 1: sorbent conditioning step; (b) step 2: sample loading step; (c) step 3: analyte retained, interferences unretained; washed from cartridge with solvent W; (d) step 4: analyte eluted with strong solvent E; (e) interferences retained, analyte unretained; washed from cartridge with solvent W₁.

TABLE 4.9 Various SPE Phases and Conditions

Mechanism of Separation	Typical Phases	Structure(s)	Analyte Type	Loading Solvent	Eluting Solvent
Normal phase Adsorption	Silica, alumina, Florisil	-SiOH, AlOH, Mg ₂ SiO ₃	Slightly to moderately polar	Low P' (e.g., hexane, CHCl ₃)	High P' (e.g., methanol, ethanol)
Polar-bonded phase	Cyano, amino, diol	-CN, -NH ₂ , -CH(OH)-CH(OH)- (-CH ₂ -) ₁₇ CH ₃ , (-CH ₂ -) ₇ CH ₃	Moderately to strongly polar	Low P' (e.g., hexane, CHCl ₃)	High P' (e.g., methanol, ethanol)
Reversed phase	Octadecylsiloxane, octylsiloxane	(-CH ₂ -) ₁₇ CH ₃ , (-CH ₂ -) ₇ CH ₃	Hydrophobic (strongly nonpolar)	High P' (e.g., H ₂ O, CH ₃ OH/ H ₂ O, CH ₃ CN/H ₂ O)	Low P' (e.g., hexane, CHCl ₃)
Nonpolar bonded phase, strongly hydrophobic	Cyclohexyl, phenyl, diphenyl		Moderately nonpolar	High P' (e.g., H ₂ O, CH ₃ OH/ H ₂ O, CH ₃ CN/H ₂ O)	Intermediate, (e.g., methylene chloride, ethyl acetate)
Nonpolar bonded phase, intermediate hydrophobicity	Butyl, ethyl, methyl	(-CH ₂ -) ₃ CH ₃ , -C ₂ H ₅ , -CH ₃	Slightly polar to moderately nonpolar	High P' (e.g., H ₂ O) to moderate P (e.g., ethyl acetate)	High P' (e.g., acetonitrile, methanol)
Nonpolar bonded phase, low hydrophobicity	Amino 1 ^o , 2 ^o -amino	(-CH ₂ -) ₃ NH ₂ , (-CH ₂ -) ₃ NHCH ₂ CH ₂ NH ₂	Ionic (ionizable), acidic	Water or buffer (pH = pK _a + 2)	A. Buffer (pH = pK _a - 2) B. pH value where sorbent or analyte is neutral
Anion exchange Weak	Quaternary amine	(-CH ₂ -) ₃ N ⁺ (CH ₃) ₃	Ionic (ionizable), acidic	Water or buffer (pH = pK _a + 2)	C. Buffer with high ionic strength
Strong	Carboxylic acid	(-CH ₂ -) ₃ COOH	Ionic (ionizable), basic	Water or buffer (pH = pK _a - 2)	A. Buffer (pH = pK _a + 2) B. pH where sorbent or analyte is neutral C. Buffer with high ionic strength
Cation Exchange Weak	Alkyl sulfonic acid, aromatic sulfonic acid	(-CH ₂ -) ₃ SO ₃ H, 	Ionic (ionizable), basic	Water or buffer (pH = pK _a - 2)	A. Buffer (pH = pK _a + 2) B. pH value where analyte is neutral C. Buffer with high ionic strength
Strong					

The sample for SPE can be applied with a pipette or syringe, or pumped into the cartridge. The latter method is more convenient for large sample volumes (> 50 mL) such as environmental water samples. The sample and cartridge sizes must be matched so as not to overload the capacity of the cartridge. The sample solution should be passed through the cartridge without allowing it to dry out. The flow rate need not be precise in SPE, but it can be adjusted by varying the vacuum or the rate at which the contents from a syringe is delivered. Flow rates of 2 to 4 mL/min are usually acceptable.

Step 3 (Fig. 4.6c) provides for the removal of interferences by washing the cartridge with a solvent W of intermediate strength. Optimally, the wash step (step 3) is discontinued just before analyte begins to leave the cartridge. In this way, interferences that are more weakly retained than the analyte are washed from the cartridge, but no loss of analyte occurs. Water or a buffer is often used for the wash solvent in RP-SPE, but this may not provide maximum removal of interferences from the analyte fraction that is collected in step 4 (Fig. 4.6d). A small controlled amount of organic solvent may be added to the wash solution to aid in the removal of more hydrophobic substances; however, care must be taken that the analyte of interest is not removed at the same time. Because of the variability of the SPE separation from cartridge to cartridge, there must be some safety margin in the volume of wash solvent used to remove interferences from the cartridge. The ultimate goal is 100% recovery of the analyte in step 4 (Fig. 4.6d); otherwise, low and variable recoveries will result.

Step 4 (Fig. 4.6d) provides for elution and collection of the analyte fraction. If detection sensitivity is a major goal, the analyte should be collected in as small a volume as possible. This can be achieved with a strong elution solvent E, so that $k = 0$ for the analyte band during elution. Alternatively, the use of a weaker solvent E that still provides elution of the analyte (e.g., $k \approx 1$) will minimize the elution of more strongly retained interferences. This is an important consideration when late eluters are present in significant amounts, since these compounds may increase the required run time for the HPLC separation (see examples of Fig. 8.4). If an intermediate-strength elution solvent E is used with a resulting large volume of the analyte fraction, it is always possible to evaporate the eluant to dryness and redissolve the analyte in the HPLC mobile phase to reduce the final analyte-fraction volume. Evaporation to dryness is often required in any event, since the elution solvent E for SPE may be too strong a sample solvent for subsequent HPLC separation.

It is desirable to collect the analyte fraction in an elution solvent that will be a weak mobile phase for subsequent HPLC separation. In this case, larger volumes of the analyte fraction can be injected more conveniently and with greater detection sensitivity. There are two ways in which this goal can be achieved. First, if the analyte is an acid or base, the pH of the sample can be adjusted to suppress analyte ionization and maximize RP-SPE retention in steps 2 and 3 (Fig. 4.6b and c). Elution of the analyte in step 4 (Fig. 4.6d)

can then be effected by a change in pH so as to ionize the sample and reduce its retention. After the analyte fraction is collected, the pH of the fraction can be readjusted for optimum retention in the subsequent HPLC separation. A second approach is the use of a "weak" SPE column packing (cyano or short-chain alkyl), so that the elution solvent need not be so strong. In this case, a "strong" HPLC column (e.g., C₁₈) would be used to assay the SPE fraction.

SPE also can be used to retain impurities and allow the analyte(s) of interest to pass through the cartridge unretained (Fig. 4.6*a*, *b*, and *e*). This option does not provide for any concentration of the analyte in its SPE fraction. It is also not possible to separate the analyte from more weakly retained interferences. Therefore, this SPE mode usually provides dirtier analyte fractions, whereas the procedure of Fig. 4.6*c* and *d* allows the separation of analyte from both weakly and strongly retained sample components. For this reason the procedure of Fig. 4.6*e* is used much less often for sample pretreatment and is not discussed further.

SPE Phases. Because SPE is really a low-efficiency adaptation of HPLC, many phases used in HPLC are also available in SPE versions. Table 4.9 lists the more popular SPE phases and the analyte types retained by them. Bonded silicas are used more often, but other inorganic and polymeric materials are commercially available. In addition to the phases shown in Table 4.9, specialty phases are available for aldehydes and ketones from air [7], the isolation of drugs of abuse in urine [29], and catecholamines from plasma [30]. Florisil (activated magnesium silicate) and alumina are used more frequently in SPE than in HPLC; many published methods exist [31] for the isolation of pesticides using Florisil.

SPE cartridge packings are of lower quality and cost than corresponding HPLC packings, and this probably contributes to the problem of batch-to-batch retention variability. Whereas basic column packings with minimal silanol interactions are preferred in reversed-phase HPLC (Section 5.2.1), RP-SPE packings will generally be more acidic, and their silanol interactions will tend to be more pronounced and more variable from lot to lot. However, because SPE is usually practiced as an on-off technique, small differences in retention are less important than in HPLC.

An SPE packing should be selected (Table 4.9) that will retain the analyte strongly during sample application (Fig. 4.6*c*). Ionic or ionizable samples suggest the use of ion-exchange packings, especially since the analyte can be eluted with an aqueous mobile phase by a change in pH or an increase in ionic strength. The analyte fraction can then be injected directly into a reversed-phase HPLC column after pH adjustment to minimize analyte ionization and optimize its reversed-phase retention. Neutral analytes can be separated on either reversed- or normal-phase SPE packings. Normal-phase packings are recommended for more polar analytes, and RP-SPE packings are best for less polar, more hydrophobic analytes.

Guidelines. Before starting SPE method development, it is important to ask:

- What is known about the sample? What are the sample-matrix and analyte properties (polar or nonpolar, solubility, acid or base)? Does the analyte have any functional groups that can be exploited to affect a sample cleanup step? Are they different from the matrix?
- What is the expected analyte concentration or concentration range in the sample?
- What is the composition of the matrix? Does the matrix have any functional groups that might be exploited to effect a separation? Do any properties of the matrix suggest that some SPE phases should be avoided? What are the typical pH and ionic strength of the matrix? Does the matrix vary from sample to sample?
- What is the goal of sample pretreatment: Removal of interferences? Increased detection sensitivity? Removal of column killers?
- Can SPE accomplish the main goal, and is it the best choice?

Answers to these questions can facilitate SPE method development.

An overview of SPE method development is presented in Fig. 4.7. A rough guide to the selection of preferred conditions is shown, based on the known characteristics of the analyte (water-soluble vs. organic-soluble, ionic vs. non-ionic, etc.). Figure 4.7 classifies all analytes into eight different groups (bottom boxes in Fig. 4.7), and for each group several different SPE phases and elution solvents are suggested. However, Fig. 4.7 is at best a rough guide to the selection of final SPE conditions. Other factors besides the nature of the analyte can be important:

- What interferences are known to be present?
- What is the nature of the sample solvent?
- Is there a choice of sample solvent?
- What is the major goal of SPE separation for this sample?

A more empirical approach is, therefore, often followed. For example, based on the known characteristics of the analyte, several SPE phases are possible choices. Each of these phases can be tested for the retention of analytes and interferences, allowing a better choice of final conditions. Later in this section we provide an example of this approach. Some manufacturers assemble SPE method development kits that provide a selection of phases for testing in this way. To make phase and solvent selection easier, automated systems are also available [13,32–35]. These can be programmed to evaluate a number of SPE phases and eluting solvents.

Solid-phase extraction and HPLC separation are similar, so in each case the same considerations affect the best choice of mobile and stationary phases.

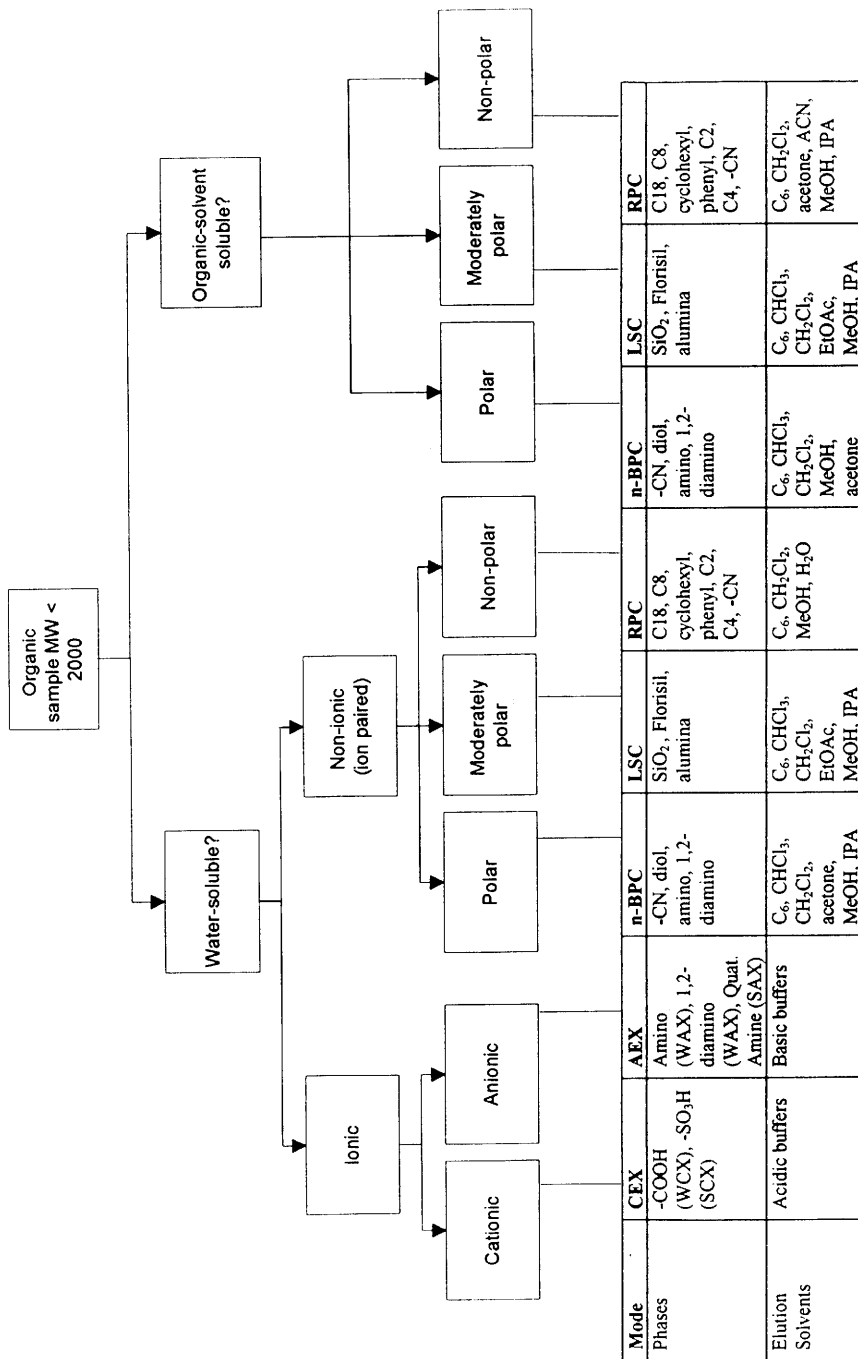

FIGURE 4.7 Overview of SPE phase and solvent selection.

For this reason, Chapters 2, 6, and 7 provide information that can be applied directly to SPE method development. A literature search on SPE methods for similar analyte–matrix pairs may also prove useful. SPE cartridge manufacturers have published extensive bibliographies (some in searchable electronic database formats) that can help to locate publications of interest [16,36,37] or provide initial conditions. Also, some manufacturers provide application notes for the same or similar compounds, and some offer consulting services for SPE method development. Table 4.10 provides a partial list of manufacturers that provide SPE packings and supplies.

INITIAL CONSIDERATIONS. Prior to selecting conditions for steps 1 to 4 (Fig. 4.6*a–d*), the SPE packing and sample solvent must be chosen. The choice of packing is discussed in the example later in the section, and further possibilities are given in Fig. 4.7 and Table 4.9. The main requirement of the packing is that strong retention of the analyte occurs in the solvent used to dissolve the sample. When the sample contains ionizable analytes such as organic acids or amines, a change in pH (rather than a change of solvent) can be used to retain and remove compounds from a RP-SPE cartridge.

Ion-exchange packings come in two forms: strong and weak (Section 7.5.1.4); strong ion exchangers are normally preferred if strong retention of the analyte is the main objective. Retention with weak ion exchangers is more dependent on pH; the choice of pH is a compromise between maintaining the ionic character of the stationary phase while ensuring that the ionic analyte remains in an ionic state. For example, using a carboxylic acid weak cation exchanger for the separation of protonated amines, the pH must be selected to ensure that the amine is in its protonated form while the carboxyl group is negatively charged. Thus pH is a powerful variable in optimizing retention or in releasing retained analyte from a weak ion exchanger.

To maximize analyte retention in step 2, the sample solvent should be a weak solvent for the analyte–packing combination. For reversed-phase packings, water is the preferred sample solvent, with as little added organic as possible. If the analyte is an acid or base, the pH should be adjusted to minimize analyte ionization. For normal-phase packings, hexane or other saturated hydrocarbon is the preferred solvent; the less polar the sample solvent, the better. For ion-exchange packings, the preferred sample solvent is water (small amounts of organic are not a problem) at the lowest possible ionic strength.

When using SPE it is important to run blanks to rule out potential contamination by extractables from the cartridge body, frits, and packing materials. If contamination is suspected, the cartridge should be rinsed with organic solvent (e.g., methanol, acetonitrile) or dilute acid (e.g., 0.01 *M* nitric acid) prior to use.

STEP 1 (CONDITIONING THE PACKING). This procedure was discussed above.

STEP 2 (SAMPLE APPLICATION). In some cases the sample is presented as a solution and the question is whether to leave the sample “as is” or to exchange

TABLE 4.10 Typical Suppliers of SPE Cartridges and Disks

Product	Supplier	Types of Products	Specialty Products
Bakerbond	J.T. Baker	Wide range of silica-based cartridges; 3M SPE disks	Drugs of abuse; glass body cartridge for trace analysis
Bond Elut	Varian Sample Preparation Products	Silica- and polymer-based products; 3M SPE disks	Drugs of abuse; SPE-matched HPLC columns; environmental-specific phases
Maxi-Clean	Alltech Associates	OEM and house-brand products; SPE disks; polymeric cartridges	Cartridges for ion chromatography sample cleanup; robot-compatible cartridges
Sep Pak	Waters Chromatography	Wide range of cartridges, polymeric cartridges	Large volume SPE cartridges for environmental applications, air sampling; specialty cartridges for EPA methods
SupelcoClean HEMA	Supelco Lida	General-purpose cartridges Polymeric-based SPE cartridges	Drugs of abuse; solid-phase microextraction PTFE body cartridge for trace analysis; ion chromatography cleanup cartridges
SPEC Isolute	Ansys International Sorbent Technology	Fiberglass disks and cartridges General-purpose cartridges	Drugs of abuse Cartridges for trace analysis
Clean Screen	United Chemical Technology	Drugs of abuse	Thin-film adsorbent cartridges
Empore	3M Corp.	Sorbent-embedded PTFE disks	Environmental disks for specific EPA methods

the original solvent for a new solvent. Convenience is usually an important consideration, suggesting use of the original sample solvent if possible. For aqueous sample solutions, RP-SPE is the preferred choice. If the sample is dissolved in a hydrocarbon solvent or other nonpolar organic, normal-phase SPE can be used. Ionic or ionizable analytes will usually be dissolved in water or a buffer, and either RP-SPE or ion exchange is applicable.

The volume of sample that can be applied to the SPE cartridge depends on (1) the size and type of cartridge (weight of packing), (2) retention of the analyte in the sample solvent, and (3) the concentrations of both analyte and interferences in the sample. Often, it is desired to apply as large a sample volume as possible, to maximize the concentration of analyte in the isolated SPE fraction for optimum detection sensitivity in the following HPLC separation. Although using a larger cartridge allows a larger sample volume, this may not affect detection sensitivity, since the maximum analyte concentration in the SPE fraction is determined by the sample volume/packing weight ratio. Therefore, when the amount of sample available is small, the smallest possible SPE cartridge that is not overloaded by the sample will be preferred. The capacity of the cartridge for analyte *plus* interferences is roughly 10 to 20 mg per gram of packing.

Once the cartridge size has been selected, the maximum sample volume can be determined by applying a large volume of sample and collecting small fractions. The fractions are then assayed for the analyte by HPLC, to determine the maximum sample volume before breakthrough of the analyte. When carrying out this experiment, the analyte concentration chosen should be the maximum value expected in the sample. (If the composition of the sample matrix is likely to vary, the allowable sample volume can also vary.) The final sample volume selected should be somewhat smaller than the value determined in this way, to allow for removal of impurities in step 3 without loss of analyte.

STEP 3 (WASHING THE CARTRIDGE). The object of this step is to remove as much as possible of the early-eluting interferences. This goal can be achieved by selecting a wash solvent W that provides intermediate retention of the analyte [e.g., $3 < k < 10$ under the conditions of separation (in the presence of the sample matrix)]. The analyst should use as large a volume of wash liquid as possible, to remove early-eluting impurities while retaining the analyte on the cartridge. This optimum wash-solvent volume can be determined in the same way that the maximum sample volume is determined (see above), by collecting fractions and assaying for the analyte.

There are two approaches for determining the best composition of the wash solvent. First, SPE method development seldom begins before there is an HPLC assay for the analyte standard. If the same kind of packing is intended for both SPE and HPLC (e.g., reversed-phase), the HPLC retention data can provide an initial estimate for the composition of the wash solvent. If the HPLC mobile phase is 30% ACN–buffer, the analyst should start with 30% ACN as the wash solvent. If the analyte begins to leave the column

before 5 to 10 cartridge volumes of wash solvent have been collected and analyzed [1 cartridge volume (μL) = 1 mg of packing], the wash solvent is too strong. Decrease % B and repeat the experiment.

A second approach is to apply the sample, then wash the cartridge with 5 to 10 bed volumes of successively stronger solvent (e.g., 25%, 50%, 75%, 100% B). Monitoring the extraction effluent at each concentration will determine the elution profile of the sample.

STEP 4 (ELUTING THE ANALYTE). The object of this step is to collect all the analyte in the smallest possible volume while excluding as much as possible of late-eluting interferences and column killers. A further goal is to obtain the analyte fraction in a form that can be injected directly onto the HPLC column. As discussed previously, these various goals are mutually contradictory. The use of a very strong elution solvent (so that $k = 0$ for the analyte) minimizes sample volume but makes it less likely that a large volume of the analyte fraction can be injected onto the HPLC column. An elution solvent just strong enough to elute the analyte with some retention (e.g., $k \approx 2$), minimizes contamination of the analyte fraction by late eluters but increases the volume and makes it less likely that the total analyte fraction can be injected directly. Use of a less-polar RP-SPE packing (e.g., cyano) can minimize this problem. When late-eluting interferences are a problem, the best approach is elution of the analyte with $1 < k < 5$. If detection sensitivity is critical so that all the analyte must be injected for HPLC, evaporation to dryness and redissolution of the analyte fraction may be required. Evaporation of aqueous samples is inconvenient, so lyophilization is an alternative. If normal-phase SPE is used, the analyte fraction will be in an organic solvent that is more easily removed by evaporation. Normal-phase SPE separation is also less likely to retain less-polar compounds that tend to elute late in reversed-phase HPLC.

If the analyte is an acid or base, solvent strength in the washing and elution steps of RP-SPE can be adjusted by means of a change in pH, as discussed above. This approach makes it easier to select conditions that allow direct injection of the total analyte fraction without contaminating the analyte fraction with late eluters that will increase HPLC separation times. SPE with ion-exchange packings is even more likely to furnish an ideal analyte fraction for subsequent HPLC analysis. Although silica-based HPLC columns generally should not be used outside a pH range of about $2 < \text{pH} < 8$ (Section 5.2.3.4) because of packing dissolution and degradation, the one-time use of SPE cartridges allows a wider range of pH. The presence of a small amount of dissolved silica or hydrolyzed bonded phase is unlikely to interfere with subsequent HPLC analysis. If dissolved silica in the analyte fractions is a problem, polymeric SPE cartridges are stable for $1 < \text{pH} < 14$ and may be a better choice.

Example of SPE Method Development: Isolation of Albuterol from Human Plasma. The isolation of albuterol (I) will be used to illustrate a typical SPE method development [38]. This drug is widely employed as a bronchodilator

in the treatment of asthma. The expected therapeutic concentration of (I) in

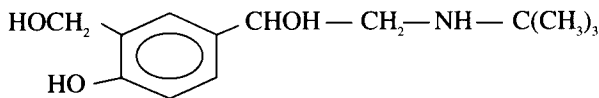

(I)

human plasma is quite low (maximum < 20 ng/mL after ingestion of an 8-mg tablet). Albuterol (MW 239) is a polar, hydrophilic compound with two ionizable functional groups: a phenol ($pK_a = 9.4$) and a secondary amine ($pK_a = 10.0$). In aqueous solution it exists primarily in an ionic state at any pH. For these reasons, albuterol partitions poorly into organic solvents from aqueous solutions, and an ion-pair isolation based on LLE was attempted initially. At $pH \ll 10$, the addition of an anionic ion-pair reagent to a LLE system would be expected to ion-pair with (I) and facilitate its extraction into the organic phase. It was determined subsequently that ion-pair extraction with diethylhexylphosphoric acid gave a high recovery of analyte in the organic phase. However, the extract was highly contaminated with endogenous plasma materials and the resulting HPLC chromatograms exhibited unacceptable background interferences.

SPE was tried next. There are several polar and nonpolar functionalities on (I) that might be exploited for SPE retention. Any of five different modes (nonpolar, cation exchange, anion exchange, polar, affinity) are expected to retain the drug. A trial-and-error investigation was carried out with these five modes to find an SPE wash solvent that would best remove interferences from the cartridge without affecting the analyte. A series of 17 different SPE phases from these five modes were scouted for best recovery with 23 solvent systems. Tritiated albuterol was added to human control plasma to investigate the retention and elution characteristics. Radiochemical analysis was used to assay column effluents and washings for (I) by collecting fractions and radiocounting. It was found that the ease with which (I) could be eluted from the different SPE phases was quite variable and dependent on the stationary phase and the eluting solvent used. Certain eluting solvents did not elute albuterol appreciably from some of the SPE cartridges, and these solvents were noted for possible use as wash solvents in step 2.

After the scouting experiments, four SPE cartridges (Table 4.11) were selected for further investigation. These phases appeared initially promising, extracts showing low levels of endogenous plasma material, good HPLC system compatibility, and reasonable recoveries of (I) from plasma. Two SPE phases (cyano, silica) proved acceptable, with the final method shown in Fig. 4.8. Many other examples of SPE method development can be found in Refs. 39 to 42 and in commercial reference guides [16,36,37] devoted to this important sample preparation technique.

TABLE 4.11 SPE Results for Recovery of Albuterol from Plasma

SPE Cartridge Type	Elution Solvent	Percent Recovery	Comments on Method
Cyano	10% 1 M NH ₄ Ac + 90% MeOH	89	Clean extract; small volume; acceptable
Silica	Same as above	94	Clean extract; small volume; acceptable
Phenylboronate phase	0.1 M H ₂ SO ₄	90	Clean extracts; small volume but elution solvent too acidic for HPLC system; unacceptable
C ₁₈	Isopropanol	92	Extract not clean enough; trace enrichment not reliable; unacceptable

4.4.2.7 Column Chromatography for Sample Pretreatment. Prior to the widespread use of SPE for sample pretreatment, similar separations were carried out by low-pressure or open-column liquid chromatography (LC). LC is still used as a sample pretreatment technique, especially for pesticide residues, drugs or endogenous compounds in biological fluids, and for fractionation of biomolecules on polydextran gels such as Sephadex (Pharmacia, Uppsala, Sweden). LC is very similar to SPE with disposable cartridges; the main differences are that (1) the LC column is usually considerably larger than a SPE cartridge, (2) the LC column is usually packed by the user, and (3) inorganic packings such as silica, alumina, and Florisil are used predominantly. Some characteristics of the LC approach are summarized in Table 4.12.

4.4.3 Membrane Separations

Membranes are usually made from synthetic organic polymers (e.g., PTFE, nylon, or polyvinyl chloride), cellulose, or glass fibers. Filtration (Section 4.3.3) and solid-phase extraction with disks (Section 4.4.2.4) represent the major applications of membranes for sample preparation. Analytes can also be moved across a membrane by diffusion as a result of chemical or electrochemical gradients. Ultrafiltration, reverse osmosis, dialysis, microdialysis, and electrodialysis are examples of techniques that use membranes for concentration, purification, and separation of analytes.

Membranes are produced in many forms: sheet, roll, disk, capsule, cartridge, spiral-wound, and hollow-fiber forms. Figure 4.9 shows the use of a typical flat semi-permeable membrane in a flowing dialysis system. Semi-permeable membranes allow the passage of certain compounds but not others. Microporous semi-permeable membranes permit selective filtration according to the size of their micropores. For example, molecular-weight cutoff membranes

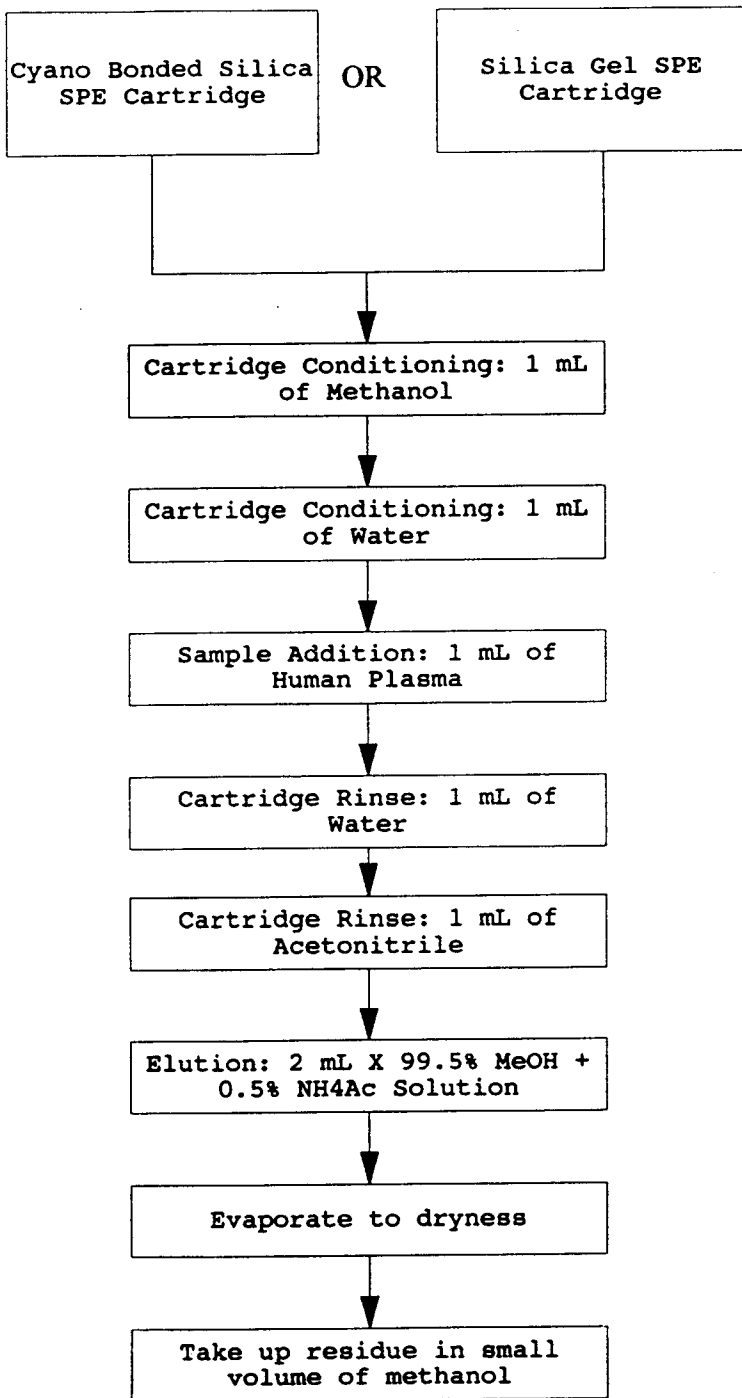

FIGURE 4.8 Method for the isolation of albuterol from human plasma. (Reprinted with permission from Ref. 37.)

TABLE 4.12 Characteristics of Column Liquid Chromatography vs. SPE for Sample Pretreatment

Advantages	Disadvantages
Easy to collect column effluent	Difficult to automate; more cumbersome and inconvenient
Can concentrate trace solutes from large volume	Greater chance of sample loss (e.g., adsorption, degradation, oxidation, evaporation)
Can work with two LC modes which use incompatible solvents (e.g., LSC using hexane → RPC with water)	More time consuming
	More difficult to quantitate and reproduce

allow passage of small molecules (i.e., drugs) while precluding passage of large molecules (i.e., proteins). Porous electrically charged or ion-exchange membranes have pore walls with fixed positive or negative charges. The passage of ionic molecules across the membrane is governed by pore size and membrane charge. In Fig. 4.9 the sample solution (donor) is placed on one side of the membrane; on the other side is a second liquid (acceptor). In some cases, interferences diffuse through the membrane, leaving a purified donor solution. More often, the analyte passes through the membrane into the acceptor solution, leaving interferences in the donor solution. An advantage of membrane separation techniques for RP-HPLC analysis is that both the donor and acceptor liquids are usually water or buffer. Membrane separations can be carried out in a static system or in a flowing system, with the latter more amenable to automation.

With the exception of filtration and SPE membranes, membrane separation techniques have not been used widely for HPLC sample preparation. However, for separating large macromolecules such as proteins from small molecules (i.e., drugs or drug metabolites), flow dialysis using a molecular-weight-cutoff membrane [43] can yield satisfactory results. Relative to other sample preparation techniques, membrane separations are slower and less efficient. Compared to SPE or LLE, membranes are less able to concentrate the analyte. Migration of neutral small molecules through a semipermeable membrane is the result of a difference in analyte concentration on either side of the membrane. Once the concentration becomes equalized, there is no further migration. Thus successful application of membrane techniques requires one of the following:

1. The removal of analytes to maintain the differential concentration (analyte removal is best accomplished by using a static system on the donor

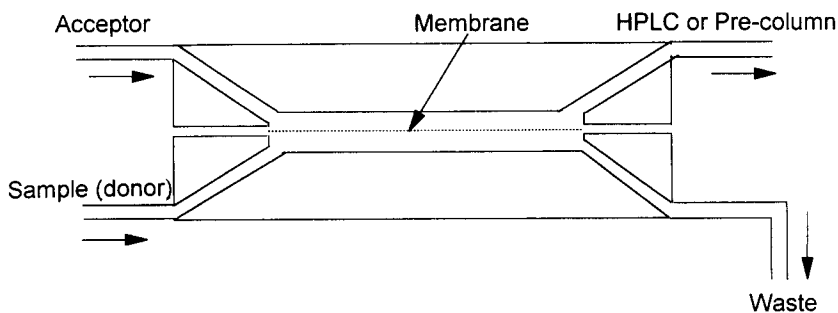

FIGURE 4.9 Schematic of typical application of a semimembrane in dialysis.

side and a flowing system on the acceptor side, with a means to trap or concentrate the analyte of interest)

2. A change of chemical state of the analyte (i.e., change from uncharged to a charged species)
3. The ability to use analyte recoveries $\ll 100\%$ (see the following example)

One of the more successful applications of membranes in sample preparation is the use of flow dialysis coupled to trace enrichment [44]. *Flow dialysis* is a membrane separation process in which the donor solution (containing the analyte) and the acceptor solution flow through channels that are separated by a semipermeable membrane, most often a molecular-weight-cutoff membrane (as in Fig. 4.9). Small molecules pass freely through the membrane, but molecules larger than the molecular-weight cutoff cannot penetrate. For systems prone to formation of emulsions (e.g., the extraction of eggs or fat-containing products such as milk), flow dialysis has shown to be an effective isolation technique that uses little or no organic solvent. Solutions with a high concentration of constituents such as proteins, humic substances, lipid macromolecules, or colloidal particles can be handled without deterioration of the membrane for long periods (weeks).

Analytes bound to proteins or trapped in or onto organelles cannot cross over the membrane boundary. Therefore, dialysis can be a useful technique to measure free vs. bound concentrations of drug substances. A wide variety of materials ranging from highly hydrophilic cellulose acetate to hydrophobic synthetic polymers (e.g., polysulfone) are available to provide unique selectivity for the membrane separation process.

Supported-liquid membrane enrichment techniques [45] are similar to flow dialysis, except that a porous PTFE membrane separates the two aqueous solutions. The technique is a combination of dialysis and liquid-liquid extraction. Initially, the membrane is impregnated with a water-insoluble organic solvent (e.g., *n*-undecane) and is placed in a mounting block. Compounds are extracted from the donor side into the membrane as a function of their

solubility in the supported liquid, where they are then reextracted from the membrane into the acceptor side. A simple example of the use of this technique is the enrichment of a carboxylic acid from an aqueous donor solution. By adjusting the pH of the donor solution below the pK_a value of the acid, the ionization of the carboxylic acid is suppressed, allowing the nonionic form to be extracted into the immobilized liquid on the membrane. The nonionized acid diffuses through the membrane to the acceptor side, which has a basic pH where the organic acid is extracted in its ionized form. Therefore, the carboxylate anion is concentrated since it no longer can reextract into the membrane. Enrichment factors (concentration of compound on acceptor side divided by concentration of compound on donor side) of several hundred can be achieved. Placing a sorbent trap or precolumn between the membrane device and the HPLC instrument enables the analyte to be concentrated even further. Valve switching (Section 4.6) enables the users to backflush the concentrated analytes into an HPLC injector. Some examples of supported liquid membranes include the analysis of aliphatic and aromatic amines in urine [46], field sampling and measurement of acidic herbicides in natural waters [47], and chlorophenols in water [48].

Microdialysis sampling, a specialized application of dialysis, uses small microprobes of fused silica tubing with a membrane at one end [49]. These probes can be placed in living systems (e.g., rat brain), and the diffusion of small organic molecules through the membrane can be monitored on-line by HPLC without disturbing the animal or plant. A microsyringe pump is used to pump the sample into a loop injector. Small microdialysis probes inserted into living systems allow analyte sampling studies that would be precluded by the use of other sample pretreatment methods. In most cases, no further sample cleanup is needed, and dialysates can be injected directly into the HPLC column. Microdialysis has proven useful in neurochemistry for *in vivo* studies of brain catecholamines in laboratory rats [50], in pharmacokinetics for studies of acetoaminophen in subcutaneous tissue [51], and in bioprocessing for the measurement of inositol triphosphates in a fermentation broth [52]. A disadvantage of microdialysis is that no calibration methods exist which allow for determining accurate *in vivo* concentrations.

Ultrafiltration (UF) sampling is similar to microdialysis, except that the driving force is flow through the membrane as a result of a pressure differential (10 to 100 psi) across the membrane. As in the case of dialysis, small molecules collect on the acceptor side. UF probes are slightly bigger than the microdialysis probes, so they cannot be accommodated as well in many living systems. UF membranes are available with 300 to 300,000 molecular-weight cutoffs. Some examples of the use of UF in sample preparation are the measurement of glucose in streptozocin diabetic mice [53] and the *in vivo* monitoring of acetaminophen in subcutaneous tissues [51].

UF membranes are also available as self-contained disposable devices for the hand processing of aqueous biological samples. UF separation is achieved

by first pouring a sample into a filter cup and then capping and applying air or gas pressure through the top cap. Concentrated proteins and other molecules greater than the cutoff rating are retained in the filter cup, while water, salts, and low-molecular-weight soluble components are collected in the filtrate collection cup. Examples of UF separation membranes are low-amino-acid and peptide-binding, regenerated cellulose membranes with 10,000 nominal molecular-weight cutoff limit (NMWL) and polysulfone membranes with higher binding capacity for proteins with 10K, 30K, 100K, and 300K NMWL; both types are available from Millipore (Bedford, Massachusetts).

Dialysis in a flowing system has also proved effective as an on-line sample preparation technique for the deproteinization of biological samples before HPLC analysis. The acceptor solvent is pumped to a trace enrichment column, which is later backflushed into the HPLC instrument. These techniques have been automated and are in routine use in many laboratories [54].

Advantages in the use of membrane procedures over other sample preparation techniques are:

- The risk of overloading with sample or matrix components is negligible.
- Most membrane processes are performed in a closed flow system that minimizes contamination and exposure to toxic or dangerous samples.
- The use of organic solvents is minimal.
- The flow system permits easy automation.

On the other hand, membranes have disadvantages compared to other sample preparation methods. For example, porous membranes are prone to fouling by particulates or macromolecules; once pores are blocked, flow rates decrease and membrane effectiveness diminishes. In some cases, samples must be pretreated before they can be dialyzed or cleaned up using other membrane techniques. For example, raw milk must first be "decreamed," and particulates removed from meat extracts before dialysis [55]. The efficiency of dialysis (amount of analyte in the acceptor phase divided by the amount of analyte in the donor phase) generally is only in the range 5 to 10%. With stopped-flow technique, efficiency can be improved to 30 to 50% [56], but at the expense of time. However, if a rapid change in donor solution concentration occurs (as might be the case when sampling in a process environment), the response time may be too slow for practical application.

4.5 SAMPLE PRETREATMENT FOR SOLID SAMPLES

A sample must be in a liquid state prior to HPLC analysis. Some insoluble solids contain soluble analytes such as additives in a solid polymer, fats in food, and polyaromatic hydrocarbons in soil. Contacting the sample with solvent allows the extraction of analytes, following which the solvent is sepa-

rated from the solid residue by decanting, filtration, or centrifugation. The filtrate is further treated, if necessary, prior to HPLC analysis. Tables 4.3 and 4.4 summarize some techniques used for the extraction ("leaching") of soluble analytes from an insoluble solid matrix.

4.5.1 Traditional Extraction Methods

No one solvent extraction technique can be used for all samples. Table 4.3 lists several traditional methods for the pretreatment of solid samples. Most of these methods (e.g., Soxhlet extraction and leaching) have been used for more than 100 years and are accepted by most scientists. Regulatory agencies such as the U.S. Environmental Protection Agency (EPA), the Food and Drug Administration (FDA), and their equivalents in other countries readily approve these classical approaches for extracting solid samples. However, these methods often use large amounts of organic solvents, which has encouraged a trend toward miniaturization.

Solvent extraction can assume many forms. The *shake-flask method*, in which solvent is added to the sample followed by agitation, works well when the analyte is highly soluble in the extraction solvent and the sample is quite porous. For fast extraction, the sample should be finely divided (Section 4.3.1). Heating or refluxing the sample in the solvent can speed up extraction. For faster and more complete extraction, *ultrasonic agitation* (sonication) often allows more effective solid-liquid contact. Gentle heating also aids extraction. Sonication is a procedure recommended for the pretreatment of many solid environmental samples, such as U.S. EPA Method 3550 for extracting nonvolatile and semi-volatile organic compounds from solids such as soils, sludges, and wastes. In this method, different extraction solvents and sonication conditions are recommended, depending on the type of pollutants and their concentration in the solid matrix.

In *forced-flow leaching*, the solid is packed into a short stainless steel column (e.g., 20 × 0.4 cm), and toluene is pumped under pressure (40 psi) through the column heated at 100 to 110°C. Results are comparable to those of Soxhlet extraction (below), but the extraction time is significantly reduced (e.g., 24 h to 0.5 h). Good recoveries of polyaromatic hydrocarbons from coal-ash samples has been demonstrated by this technique [57]. An advantage of forced-flow leaching is that the sample is subjected continuously to fresh, hot solvent, and the effluent from the column is easily collected for further treatment.

Soxhlet extraction has been the most widely used method for the extraction of solids. In this procedure, the solid sample is placed in a Soxhlet thimble (a disposable porous container made of stiffened filter paper), and the thimble is placed in the Soxhlet apparatus. Refluxing extraction solvent condenses into the thimble and extracts the soluble analytes (Fig. 4.10). The apparatus is designed to siphon the extract each time the chamber holding the thimble fills with solution. The siphoned solution containing the dissolved analytes returns to the boiling flask and the process is repeated until the analyte has

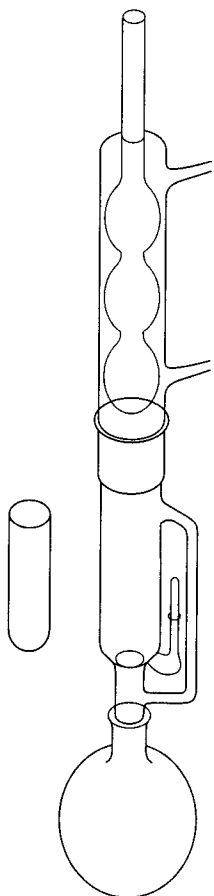

FIGURE 4.10 Soxhlet apparatus for the continuous extraction of solutes from solids (pictured with extraction thimble next to it.)

been removed from the solid sample and concentrated in the flask. Soxhlet extractions are usually slow (12 to 24 h or more), but the process takes place unattended. The most common extractors use hundreds of milliliters of very pure (and expensive!) solvent, but small-volume extractors and thimbles are available for milligram-size samples.

In Soxhlet extraction, fresh, hot extraction solvent is always presented to the sample, thus providing maximum analyte solubility. Since the flask with the boiling solvent accumulates the extracted analyte, it must be stable at the boiling point of the extraction solvent. Method development consists of finding a volatile solvent (e.g., boiling point $< 100^{\circ}\text{C}$) that has a high solubility for the analyte and a low solubility for the solid sample matrix. As the oldest form of efficient extraction, Soxhlet extraction is the accepted standard for comparison with newer extraction technologies such as SFE, accelerated sol-

vent extraction, and microwave-assisted extraction. Modern Soxhlet extractors (Table 4.4) speed up the extraction process by a factor of 8 to 10 using a combination of liquid–solid extraction and traditional Soxhlet extraction. Initially, the sample in the thimble is lowered into the boiling solvent and eventually raised above the solvent in the traditional Soxhlet fashion, where the last traces of analyte is extracted with fresh solvent.

4.5.2 Newer Extraction Methods

For many years the solvent extraction methods of Table 4.3 proved adequate for most laboratories. The newer methods of Table 4.4 were developed to address an increasing need for greater productivity, faster assays, and increased automation. Some of these methods are automated, more convenient versions of the methods of Table 4.3. Other techniques have been developed that are based on new principles. For the most part, these newer approaches are more expensive in terms of the initial purchase price but eventually result in lower cost per sample.

4.5.2.1 Supercritical Fluid Extraction. The physical state of a substance can be described by a phase diagram that defines regions corresponding to the solid, liquid, and gaseous states. Points along the curves in the diagram define situations where there is an equilibrium between two of the phases. In the phase diagram for carbon dioxide (CO_2 ; Fig. 4.11), the line between liquid and gas has a terminus (the critical point), unlike the line between solid and

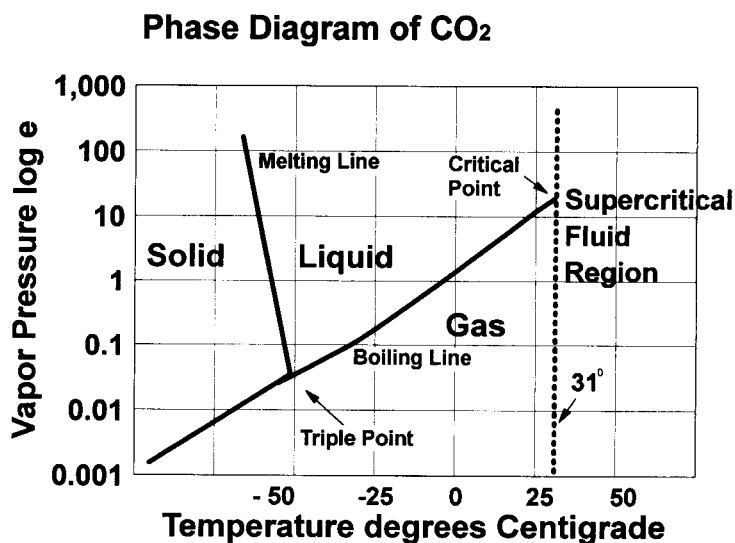

FIGURE 4.11 Phase diagram for CO_2 (pressure–temperature).

liquid. The critical point is defined by the critical temperature T_c and critical pressure P_c ; beyond the critical point (the supercritical region) a gas cannot be converted into the liquid state, regardless of pressure. A supercritical fluid (SF) exhibits gas-like mass transfer properties and liquid-like solubility properties, enabling it to carry out solvent extractions much more efficiently and rapidly than a solvent in the liquid state. Today, supercritical fluid extraction (SFE) is widely used for the extraction of nonpolar and moderately polar analytes from solid matrices. Several references [58–60] describe the instrumentation, methods development, and applications of SFE.

Fluids that can be used for SFE include CO_2 , NH_3 , N_2O , and pentane. N_2O and pentane are flammable, and NH_3 is chemically reactive and corrosive. Therefore, CO_2 is used most often for SFE; it is safe, chemically inert, nontoxic, noncorrosive, and available in high purity at reasonable cost. CO_2 is easily removed from the analyte collected and causes no disposal problems. Low-density supercritical CO_2 has the polarity of hexane (i.e., it is nonpolar). However, SF polarity increases with density, especially near the critical point; so at its highest density, SF- CO_2 resembles the polarity of solvents such as toluene, benzene, and ether.

While pure CO_2 is able to extract a wide variety of nonpolar and moderately polar analytes, it is less effective for more polar compounds. In other cases, CO_2 may not be able to displace analytes that are strongly adsorbed to the solid matrix. The addition of a small amount (up to 10% by volume) of polar organic solvents (methanol, methylene chloride, acetonitrile, etc.) to CO_2 can enhance its ability to dissolve more polar analytes and displace these compounds when they are adsorbed to the sample matrix. The addition of organic solvents to CO_2 has a slight effect on values of T_c and P_c , so that the temperature and pressure used for pure CO_2 may require modification.

For environmental analysis, the U.S. EPA has approved several SFE methods [e.g., total petroleum hydrocarbons, polyaromatic hydrocarbons (PAH), and organochloropesticides in soils and sludges]. SF- CO_2 also is an excellent solvent for fats, making it useful for extractions in the food industry. When high-fat solvent extracts contact reversed-phase HPLC mobile phases, fat can precipitate or strongly sorb to the hydrophobic stationary phase, leading to early column failure. Therefore, SFE can be used as a selective sample preparation technique to remove some of these column killers.

SFE is also used to separate classes of analytes by discrete changes in solvent strength (i.e., *density stepping* or *density programming*). The sequential fractionation of hops by density-stepping SFE is one example [61]. In the area of polymers, the penetrating power of SF- CO_2 allows the extraction of polymer additives such as antioxidants and plasticizers in less than an hour. Such extractions formerly required many hours by Soxhlet or ultrasonic extraction methods. Pharmaceutical chemists have found SFE useful for extraction of drugs from tablet formulations and tissue samples.

SFE Equipment. Figure 4.12 is a schematic of a supercritical fluid extractor. The essential parts include a carbon dioxide source, a pump (syringe or cooled-

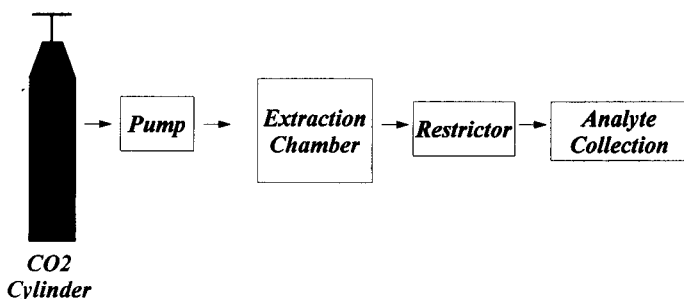

FIGURE 4.12 Block diagram of supercritical fluid extractor.

head reciprocating), an extraction chamber (or thimble) in which the sample is placed, a restrictor, and an analyte-collection device (normally, a vessel). Temperature is separately controlled for the pump head, the extraction chamber, the restrictor, and the collection device. The CO₂ is pumped as a liquid and remains so until it reaches the extraction chamber, where under the conditions of temperature and pressure it becomes a SF. The SF passes through the sample in the thimble for a period of time sufficient to extract the analyte. Past the thimble, the SF passes through a restrictor, where it depressurizes and returns to a non-SF state.

Selection of the restrictor is critical. Two types of restrictors are used primarily: a fixed restrictor consisting of a piece of capillary tubing, or a variable restrictor controlled by the user. The restrictor serves to control the supercritical conditions in the thimble and controls the precipitation of the analyte as the SF is exposed to atmospheric pressure and becomes a gas. The rapid expansion of the SF at this point causes Joule–Thompson cooling, and the restrictor must be heated to compensate for this temperature drop. Otherwise, the restrictor can plug if large quantities of analyte and/or matrix are extracted.

The analyte is collected just beyond the exit end of the restrictor (impinging surface) as an aerosol. Three collection (trapping) methods are used: (1) an empty vessel; (2) a packed trap filled with inert material such as glass or stainless-steel beads, SPE types of packing (20 to 40 μm), or GC solid packing materials; or (3) dissolution into a solvent. Analyte volatility determines the collection temperature and most favorable method for collection. For example, empty vessels are not well suited for collecting certain aerosols or high-volatility compounds since they may be swept along with the CO₂ gas. Solvent collection methods may also suffer from aerosol formation, which may occur when high-velocity CO₂ gas passes through the liquid. A solvent should be selected with minimal aerosol formation and with good analyte solubility, which helps in more effective trapping. Cooling this solvent can aid in the collection process. Instruments that use a packed trap for collection require a small dispenser pump to rinse analytes into a vial. The ability to trap the analyte is most critical and often the most difficult step in SFE.

SFE Method Development. In SFE, analytes extract differently from different matrices. For example, different SFE extraction conditions are required for the same PAH found in soils, fly ash, sludges, and sand. Known analytes trapped within an aged soil sample are more difficult than freshly spiked samples to extract [62]. Three criteria govern SFE extraction from a solid matrix [63]:

1. The relative attraction of the analyte to the matrix
2. The rate at which analyte moves from the matrix into the extraction solvent
3. The solubility of the analyte in the SF

Temperature affects all three of these factors and is an important variable in SFE method development. When high-density SF-CO₂ is unable effectively to extract the analyte of interest from the matrix, the addition of an organic solvent modifier can facilitate extraction by (1) solubilization of the analyte, (2) competition with the analyte for the surface of the matrix, and/or (3) modification of the matrix for release of the analyte. In the latter case, the modifier may "swell" or solubilize all or part of the matrix to aid penetration of the SF-CO₂. In extreme cases, chemical reagents (such as acetic anhydride for phenols in soil [64]) can be added to the SF to convert the analyte to a more readily extractable form.

Both polar and nonpolar solvents have been used as SF-CO₂ modifiers (co-solvents). The same general rules that guide the selection of solvent mixtures for non-SF solvent extraction (Section 4.4.1) can be applied to SFE as well. That is, both solvent polarity (P') and selectivity (Section 2.3.2) are important in affecting analyte recovery and separation from interferences. For a good discussion, see Ref 58. When selecting the starting conditions for SFE, the properties of the analyte are important: molecular weight, functional groups, polarity, solubility, volatility, pK_a , thermal stability, and concentration. Equally important are the matrix characteristics: particle size, homogeneity, porosity, composition, solubility, density, and so on. The matrix may also contain its own modifiers, such as water, fats, and/or oils. If the desired analyte is polar, matrix water can facilitate the extraction; fats and oils in the sample may have an opposite effect.

The physical form of the matrix is important in SFE. Preliminary sample preparation is usually required for bulk materials (solid pellets, hard soils, vegetable matter): grinding, sieving, drying, mixing, or wetting (Section 4.3). For non-porous or semi-porous materials, a smaller particle size allows for much faster extraction. In some cases a pH adjustment or addition of solvent into the extraction cell may aid the SFE process. Wet matrices such as sludge may require water removal for good recovery and reproducibility. Adding anhydrous sodium sulfate or diatomaceous earth to the matrix can produce a free-flowing powder [65].

The main variables that affect CO₂-SFE are pressure, temperature, flow rate, co-solvents, and extraction time. Pressure operates in combination with temperature to control the density of the SF. As pressure and density increase, the solvating power of the SF increases. Unlimited combinations of temperature and pressure can provide the same extracting SF-CO₂ density (g/mL). For thermally sensitive compounds, lower temperatures are preferred, while strongly bound analytes require higher temperatures. High flow rates or long extraction times may be necessary to remove all of the analyte from the extraction thimble. Low flow rates are preferable when the kinetics of the extraction process are slow.

As SFE matures, numerous published methods for matrix-analyte pairs will become available. Often, analysts use trial-and-error methods to optimize extraction-collection conditions. To aid method development, Fig. 4.13 provides a generic guide [66]; however, not every sample requires attention to all these steps. The method-development guide assumes that the analyst begins with standard samples investigated in the following order:

- Analytes on an inert matrix (e.g., diatomaceous earth, Celite, or filter paper); this allows the SF solubility of the analyte to be determined.
- Simulated samples on blank matrices (some blank matrices are offered as standards by commercial suppliers); alternatively, a typical clean matrix (as close to the actual sample as possible) should be created.
- Simulated samples on real matrices; when developing an SFE method, it is customary to compare the results to accepted preparation methods such as Soxhlet or liquid-liquid extraction.

For readers interested in more detail on SFE method development, consult Refs. 59 and 60.

4.5.2.2 Microwave-Assisted Solvent Extraction. With a microwave source, the sample plus extraction solvent are heated directly, as opposed to conventional heating of the extraction vessel. Two limiting forms of microwave-assisted solvent extraction (MASE) are used: (1) a microwave-absorbing (high dielectric constant) extraction solvent, or (2) a non-microwave absorbing (low dielectric constant) solvent. In the microwave-absorbing solvent approach, the sample and solvent are placed in a *closed* nonmicrowave-absorbing vessel. Microwave radiation heats the solvent to a temperature higher than its boiling point, and the hot solvent provides rapid extraction of analyte under moderate pressure (usually a few hundred psi). For these higher-pressure extractions, the containers used are made of PTFE, quartz, or advanced composite materials that combine optimum chemical and temperature resistance with good mechanical properties. This approach has been used for the extraction of additives in polymers, vitamins

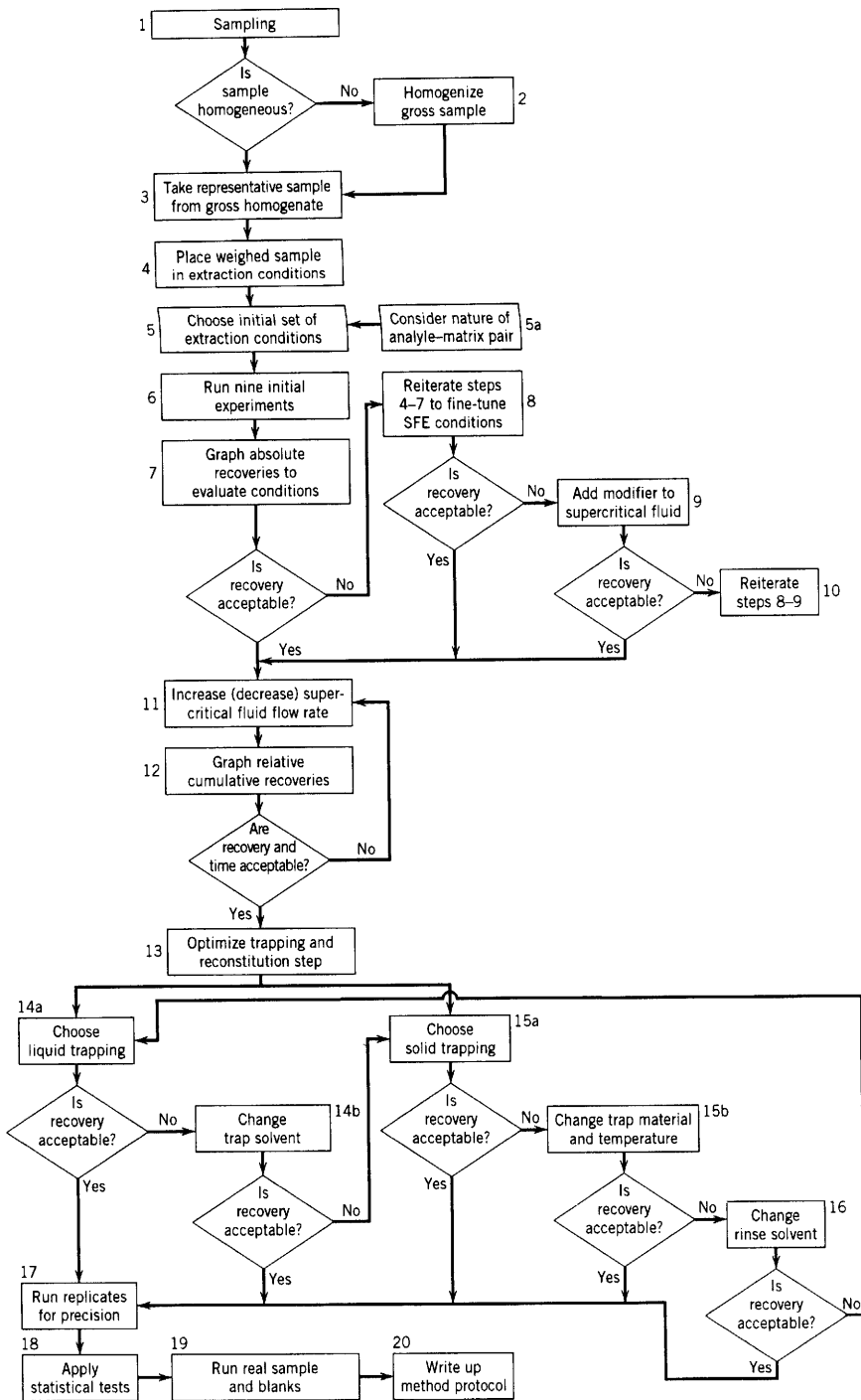

FIGURE 4.13 SFE method development flowchart. (Reprinted with permission from Ref. 66.)

in food, and priority pollutants (polyaromatic hydrocarbons, pesticides, PCBs) in soils and sediments [67–69].

In the nonmicrowave-absorbing solvent approach [70], the sample and solvent are placed in an open or closed vessel. The solvent does not become hot, since it absorbs little of the microwave radiation. The sample, which usually contains water or other high-dielectric components, absorbs the microwave radiation and releases the heated analytes into the surrounding liquid, which is selected for good analyte solubility. The latter approach is gentler because it is performed under atmospheric or low-pressure conditions and can be used with thermally labile analytes. Examples of the use of non-microwave-absorbing solvents include extractions of lipids from fish [70] and organochloropesticides from sediment samples [71].

MASE uses less solvent than do conventional Soxhlet or liquid–liquid extractions. Extraction can be controlled by a number of variables: choice of extraction solvent, heating time, pulsed heating vs. continuous heating, stirring vs. no stirring, closed container vs. open container (pressure), and external cooling of vessel vs. no cooling. In a typical microwave oven, multiple samples can be extracted simultaneously for increased throughput. MASE users are not exposed to the (often toxic) extraction solvents; however, safety precautions should be exercised when dealing with microwave radiation and closed pressurized containers.

4.5.2.3 Accelerated Solvent Extraction. The extraction vessel can be heated in a conventional oven instead of using microwave radiation. Accelerated solvent extraction (ASE) (Dionex Corp., Sunnyvale, California), also known as enhanced solvent extraction, in closed extraction vessels uses common organic solvents at high temperature (50 to 200°C) and pressure (150 to 2000 psi) to extract soluble analytes from solid samples [72,73]. Analyte recovery is enhanced and accelerated by the higher temperatures, and solvent volume can be reduced because of the high solute capacity in the heated solvents. The experimental apparatus used in ASE is similar to that used in SFE: a pump for transporting solvent into and out of the extraction vessel, extraction vessels with an automated sealing mechanism to withstand high pressures, an oven for heating the sample compartment, and collection vials to hold the collected extracts. ASE consists of the following steps: (1) sample cell loading (typical sample sizes 5 to 20 g); (2) solvent introduction and pressurization; (3) sample cell heating (under constant pressure); (4) static extraction; (5) transfer of extract to sealed vial with fresh vent wash of solid sample; (6) nitrogen purge of cell; and (7) loading of the sample. Once the sample is loaded into the extraction cell, the entire process is automated and time programmable. ASE provides unattended preparation for up to 24 samples serially.

Typical environmental applications of ASE include the extraction of bases, neutrals, and acids (BNA), polyaromatic hydrocarbons (PAHs), organophos-

phorus and chlorinated pesticides, and polychlorinated biphenyls (PCBs) from solid waste samples. Other applications include unbound fat in food and PCBs in animal tissue tissue [74,75].

4.5.3 Comparison of Methods for Extraction of Solids

Table 4.13 provides a comparison of popular methods for the extraction of solids. With the exception of microwave-assisted extractions in open containers, and SFE which uses supercritical CO₂, the extraction solvents used in these techniques are the same. Method-development times, recoveries, and reproducibility for these methods are roughly equivalent. Main differences are in speed, organic solvent use, degree of automation, and cost. SFE method development takes longer because of possible matrix effects and lack of a thorough understanding of the effect of co-solvents on analyte extraction. However, optimized SFE methods provide recovery and reproducibility equivalent to these more conventional extraction techniques. ASE, modern Soxhlet extraction, and SFE are more automated than MASE. MASE, sonication, and some SFE instruments have the advantage over ASE in that multiple extractions can take place simultaneously. All of these newer methods save time, labor, and solvents compared to older extraction methods.

4.6 COLUMN SWITCHING

Column switching (also called multidimensional column chromatography, coupled-column chromatography, and "boxcar" chromatography) is a powerful technique for the separation and cleanup of complex multicomponent samples. In this approach a portion of the chromatogram from an initial column (column 1) is transferred selectively to a second column (column 2) for further separation (see Fig. 4.14a). Column switching (CS) is used for:

- Removal of column killers prior to column 2
- Removal of late eluters prior to column 2
- Removal of interferences that can overlap analyte bands in column 2
- An alternative to gradient elution
- Trace enrichment

The achievement of one or more of these goals often results in increased sample throughput compared to single-column operation. The basic goal of CS is to maximize the injection of the analyte band onto column 2 while minimizing the injection of interfering compounds (i.e., the same goal as in sample preparation using SPE).

In HPLC, CS is achieved by connecting column 1 to column 2 via a high-pressure switching valve. In this way, the sample is partially separated on

TABLE 4.13 Comparison of Extraction Methods for Sample Preparation of Solids

Parameter	Sonication	Soxhlet (Traditional)	Soxhlet (Modern)	SFE	ASE (ESE)	Microwave-Assisted (CC) ^a	Microwave-Assisted (OC) ^b
Sample size (g)	20-50	10-20	10-20	5-10	5-15	2-5	2-10
Solvent volume (mL)	100-300	200-500	50-100	10-20	10-15	30	20-30
Temperature (°C)	Ambient-40	40-100	40-100	50-150	50-200	100-200	Ambient
Pressure	Atmospheric	Atmospheric	Atmospheric	2000-4000 psi	1500-2000 psi	1500-2000 psi	Atmospheric
Time (hr)	0.5-1.0	12-24	1-4	0.5-1.0	0.2-0.3	0.2-0.3	0.1-0.2
Degree of automation ^c	0	0	++	+++	+++	++	++
No. samples ^d	High	1	6	44	24	12	12
Cost ^e	Low	Very low	Moderate	High	High	Moderate	Moderate

^a Closed container.

^b Open container.

^c For the most complete commercial instrument; 0, no automation; +, some automation; ++, mostly automated; +++, fully automated.

^d Maximum number that can be handled in commercial instruments.

^e Very low, < \$1000; low, < \$10,000; moderate, \$10,000-20,000; high, > \$20,000.

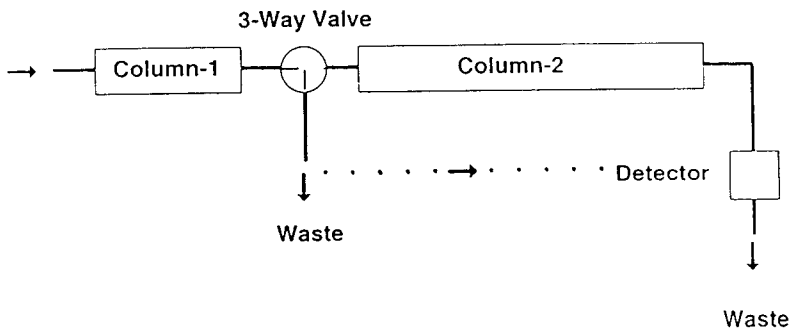

(a)

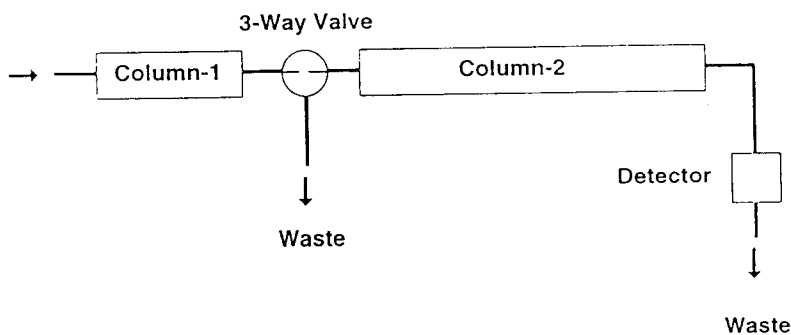

(b)

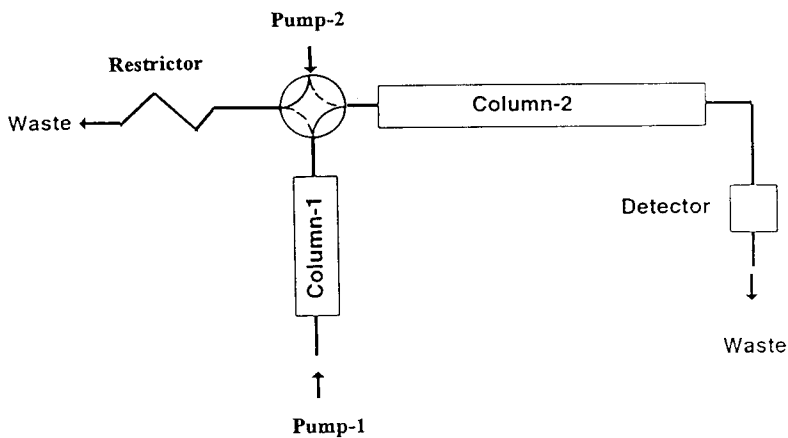

(c)

FIGURE 4.14 Column-switching arrangement for hypothetical sample. (a) One-pump system with three-way valve connecting column 1 to waste or detector; (b) same as (a) but valve is switched to connect column 1 and column 2; (c) two-pump version of (a). See the text for details.

column 1, and a fraction containing the analyte(s) is directed column 2 for final separation. CS can involve combinations of LC, GC, TLC, SFC, and CE. In this section, only LC-LC will be discussed. While CS is similar to the HPLC analysis of fractions provided by SPE (see Section 4.4.2), two major differences exist:

1. SPE cartridges are used only once and discarded; column 1 in CS is used repeatedly, although often for fewer injections (e.g., 50 to 100) than for the usual HPLC column. Therefore, in CS extra washing steps may be required to ensure that interferences are removed from column 1. Otherwise, these impurities can impair the performance of column 1 or show up as extraneous peaks that elute from column 2 in later analyses.
2. Column 1 has a higher efficiency (d_p in the range 5 to 10 μm) compared to an SPE cartridge (d_p in the 40- μm range). Thus, analyte bandwidths from column 1 are narrower, which allows better resolution on column 1 compared to an SPE cartridge and cleaner samples for easier final HPLC separation.

Table 4.14 summarizes some other advantages and disadvantages of CS. Before making a decision to employ CS, compare these features against those for off-line separation using SPE or other sample pretreatment (Table 4.12).

TABLE 4.14 Characteristics of Column Switching vs. SPE plus HPLC

Advantages	Disadvantages
Easy to automate, especially with modern chromatographs	Requires more complex hydraulics (or pneumatics), switching valves, more expense
Less chance of sample loss since experiment carried out in closed system	Difficult to handle trace compounds since very dilute and in large volume; can compensate for by on-column concentration (trace enrichment) method
Can configure switching system that best suits needs (e.g., backflush, heart cutting, on-column concentration)	Solvents from primary and secondary modes must be compatible both as to miscibility and strength requirements
Decreased total analysis time	
More reproducible	
Higher sample throughput	

4.6.1 Principle of Operation

Column switching can be carried out either manually or automatically, but most applications of CS are fully automated. Low-dead-volume switching valves are used, automatically actuated by timers or time-programmable events from a microprocessor-based chromatograph. An important experimental requirement for CS is the complete transfer of analyte from column 1 to column 2. This requires close control of the switching time. High-pressure switching valves are commercially available with from 2 to 10 (or more) ports. CS can be carried out with a single pump, but multiple pumps are usually preferred.

The simplest CS system (see Fig. 4.14a) uses a single pump with a three- or four-port valve placed between column 1 and column 2. In Fig. 4.14a, the valve position allows mobile phase from column 1 to bypass column 2 and flow directly to waste or the detector. In Fig. 4.14b the valve position is changed to allow mobile phase to pass from column 1 to column 2. An illustration of the operation and value of CS is provided by Fig. 4.15a–c. This hypothetical sample contains an analyte that elutes at 4.9 min in this chromatogram. However, late eluters require a run time of 60 min, which is excessive for a good method. These late eluters can be removed by means of the CS system of Fig. 4.14a. The same column packing is used in columns 1 and 2 (e.g., 5- μm C₈), but the length of column 1 is 3-cm and that of column 2 is 15 cm. Because of the shorter length, the sample clears column 1 in about 12 min (Fig. 4.15b). However, the analyte is poorly resolved from adjacent bands with this shorter column (and smaller value of N), as indicated by the peaks with the arrow in Fig. 4.15b. If column 1 is vented to waste prior to 0.5 min, then connected to column 2 for 1 min, and finally vented again to waste for the next 10 min, a fraction (0.5 to 1.5 min) containing the analyte is sent to and held in column 2, while the rest of the sample is discarded. This analyte (arrow) fraction is further separated on column 2 [after returning the valve to the position shown in (b)], producing the chromatogram of Fig. 4.15c. The analyte now is resolved to baseline for accurate quantitation in a run time of about 9 min. The overall assay time is the sum of the run times in Fig. 4.15b and c, or about 20 min. This is much shorter than the 60-min run time in Fig. 4.15a without CS.

The run time of Fig. 4.15c with CS can be shortened further if a four-way valve is used with a second HPLC pump (Fig. 4.14c). In this way the separations of samples on columns 1 and 2 can be carried out simultaneously, with a resulting total run time of about 12 min. An important additional advantage from the use of two pumps and simultaneous flow through each column is that pressure pulses due to abrupt changes in flow can be minimized, thus avoiding a possible loss of column efficiency due to void formation (Section 5.4.3.4). Pressure pulses can also adversely affect the detector baseline. A restrictor or dummy column is used in Fig. 4.14c to equalize the pressure drop for either position of the four-way valve. Most practical CS systems use two

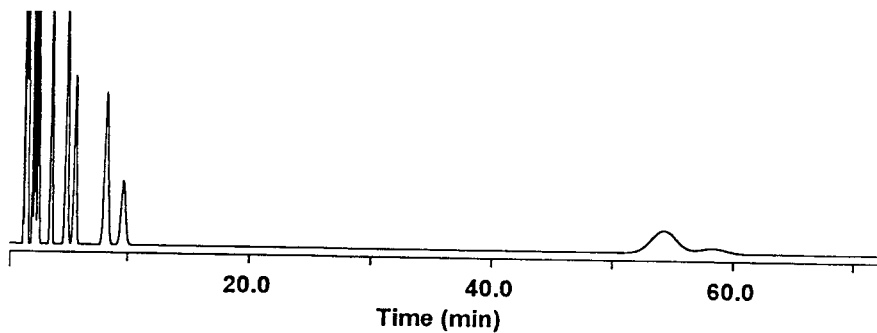

(a)

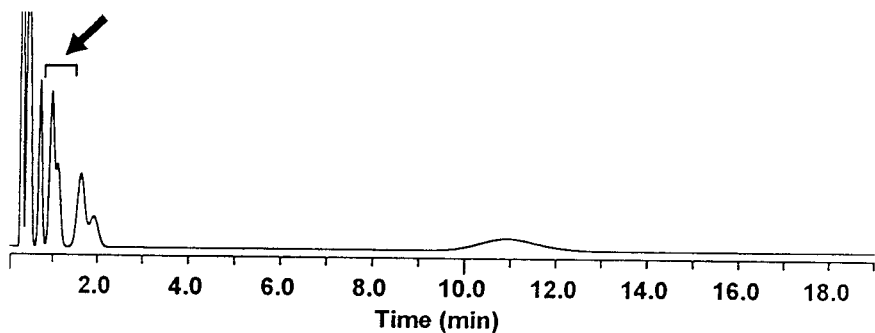

(b)

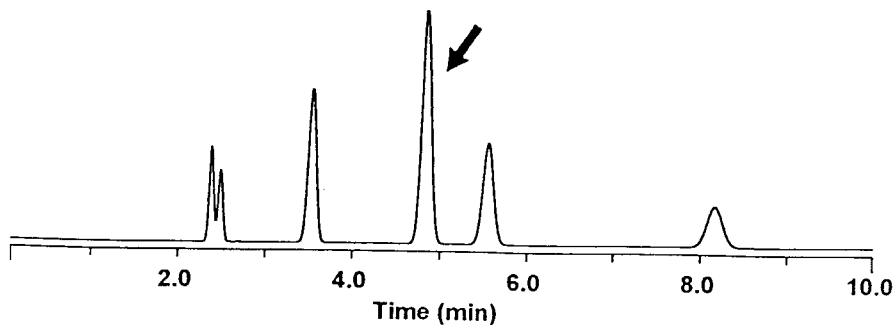

(c)

FIGURE 4.15 Column-switching chromatograms for hypothetical sample. (a) Sample chromatogram for column 1 and column 2 in series; (b) sample chromatogram with column 1 connected to detector; arrow indicates portion of chromatogram directed to column 2 by column switching; (c) sample chromatogram for column switching with column 1 and column 2.

pumps, since by judicious plumbing of columns and valves, a number of different column-switching operations can be carried out.

4.6.2 Developing a Column-Switching Method: General Considerations

Column switching is simplest and easiest to apply when the same mobile phase flows through each column, as in the example of Fig. 4.15. In this form of CS, assuming that columns of the required length are available, the major requirement is to select valve-switching times that allow the diversion of all the analyte(s) to column 2 while sending early- and late-eluting interferences to waste. The switching times can be determined by connecting column 1 to the detector, as in the dashed line of Fig. 4.14*a*, to obtain a corresponding chromatogram (as in Fig. 4.15*b*). For method development, it is best to inject the analyte standards rather than an actual sample, to avoid problems with band overlap or misassigned peaks. In the example of Fig. 4.15*b*, the analyte band leaves column 1 between 0.9 and 1.1 min. A close control of retention on column 1 is not always possible, because of changes in the column with use, as well as the effect of other sample components on retention. Therefore, a wider window (0.5 to 1.5 min in this example) is usually accepted to ensure complete transfer of the analyte to column 2.

The procedures of Fig. 4.14 can be extended to other applications, where different column packings and/or different mobile phases can be used for columns 1 and 2. Here, the major requirement is that the sample fraction sent to column 2 be in a solvent that is compatible with the mobile phase used for column 2. For example, an ion-exchange packing can be used for column 1 and a reversed-phase (RP) packing for column 2, if the mobile phase for column 1 is an aqueous buffer. In this case, an aqueous sample fraction is sent to column 2, and thus the sample solvent is weaker than the organic-water mobile phase for column 2. Similarly, a RP cyano packing could be used for column 1 and a C_8 or C_{18} packing for column 2, because the mobile phase for a cyano column will be weaker than that for a C_8 or C_{18} column (Section 6.2.2). The use of different packings in column 1 vs. column 2 also allows a change of selectivity between the two columns, which can be used to separate the analyte from a large number of interferences, as might be found in very complex samples. An example of this approach is provided in Fig. 6.26 for the CS assay of parts per trillion of a herbicide in a sample of green oats.

4.6.3 Examples of Column Switching for Sample Cleanup

Some samples contain components that can damage the column if the untreated sample is injected. Two rather common examples are found in pharmaceutical analysis: (1) the assay of drugs in blood or plasma, and (2) the assay of drugs in a cream or lotion matrix. Plasma samples contain protein that can build up on a RPC column and quickly lead to a loss of efficiency. Cream and lotion formulations contain oils or waxes that are very hydrophobic and

are retained on RP columns quite strongly. Figure 4.16 illustrates two CS schemes that were designed to deal with each of these kinds of sample.

The CS arrangement of Fig. 4.16*a* is used for plasma samples [76]. A C_8 or C_{18} packing is used in both columns and with the valve position shown in part (*a*) the sample leaves the sample valve (II) and is washed to valve I and column 1 with an aqueous buffer. The analyte is retained at the inlet of column 1 under these conditions, but protein washes through to waste. Although the passage of protein through column 1 leads to a loss of its efficiency, this has no practical impact, because column 1 serves only to "trap" the analyte. When the valve is rotated to the alternate position (dashed lines in Fig. 4.16*a*), mobile phase from pump 2 is diverted to valve I so as to backflush the analyte from column 1 onto column 2 and complete the separation. During further separation of the analyte on column 2, valve I is returned to its original position and a new sample is introduced to column 1.

In the system of Fig. 4.16*b*, a cream formulation serves as sample [77]. Column 1 contains a packing of the same bonded-phase type as in column 2 (e.g., C_{18}). However, the packing in column 1 is much less retentive: either nonporous or a wide-pore, low-surface-area material. The switching valve is positioned for flow of mobile phase from column 1 to column 2, allowing the analyte(s) to pass through to column 2, while the strongly retained cream components are held on column 1. When the analyte has left column 1, the valve position changes so that pump 1 sends the mobile phase directly to column 2 for the further separation of the analyte. In the meantime, pump 2 backflushes column 1 to remove the cream components and prepare column 1 for the next sample.

4.7 DERIVATIZATION

Derivatization involves a chemical reaction between an analyte and a reagent to change the chemical and physical properties of an analyte. The four main uses of derivatization in HPLC are to:

1. Improve detectability
2. Change the molecular structure or polarity of analyte for better chromatography
3. Change the matrix for better separation
4. Stabilize a sensitive analyte

Ideally, a derivatization reaction should be rapid, quantitative, and produce minimal by-products. Excess reagent should not interfere with the analysis or should be removed easily from the reaction matrix [78–81].

Derivatization often is a last resort when developing a method. The introduction of a reaction pre- or post-column adds complexity plus other sources

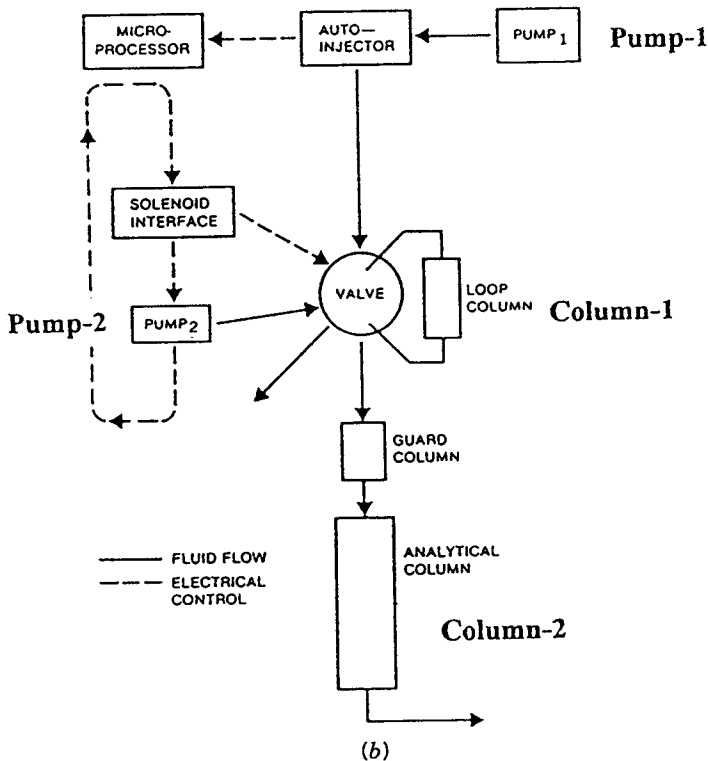
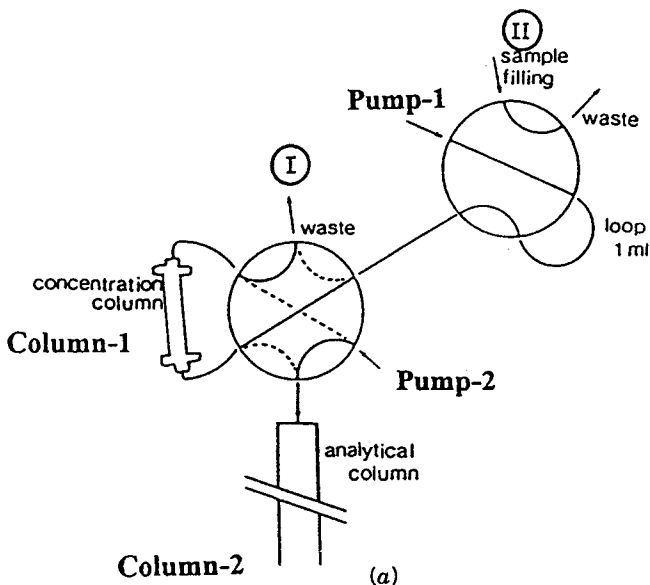

FIGURE 4.16 Column-switching arrangements for (a) removal of protein from plasma samples [76], and (b) removal of hydrophobic late eluters from a cream formulation [77]. See the text for details. (Reprinted with permission from Refs. 76 and 77.)

of error to the analysis, and increases the total analysis time. Although these procedures can be automated, the analyst must ensure that the derivatization step is quantitative (if necessary), and that no additional impurities are introduced in the analysis. Although derivatization has drawbacks, it may still be required to solve a specific separation or detection problem.

4.7.1 Detectability

Unlike GC, where derivatization is generally used to improve the volatility or change the polarity of an analyte, derivatization in HPLC (with the exception of chiral analysis in Section 4.7.3) is used predominately for the enhancement of analyte detectability. HPLC offers a wide range of separation modes (i.e., normal- and reversed-phase, chiral, and ion chromatography), and types of stationary phases and mobile-phase modifiers that can be used to minimize chemisorption, adsorption, and tailing.

The first consideration in choosing an HPLC derivatization method for detection enhancement is to decide which type of detection is best. In addition, a choice of pre- or post-column detection is needed (Section 4.7.2). Many classes of compounds can be derivatized (Table 4.15), including acids, alkaloids, amines, antibiotics, barbiturates and related compounds, hydroxy compounds, and steroids [79,82].

The two most common types of derivatization—the addition of a chromophore or fluorophore—allow detection of an analyte that cannot be detected in its normal form or to increase its sensitivity. Also, several derivatizing reagents permit electrochemical detection [78]. General considerations in choosing a derivatizing reagent are [80]:

1. The derivatizing agent must be stable.
2. The derivatizing agent and by-products formed during derivatization should not be detectable or must be separable from the analyte.
3. The analyte must be reactive with derivatizing reagent under convenient conditions.
4. If possible, reagents should be non-toxic.
5. The procedure should be adaptable to automation.

Many organic reactions can be used for analyte derivatization. However, for routine use, the best approach is to choose the proper derivatizing reagent using preprepared derivatization kits with step-by-step instructions. Several

TABLE 4.15 Functional Group and Derivatization Reagents

Functional Group	Chromotags ^a	Fluorotags ^b
Carboxylic acids, Fatty acids, Phosphonic acids	PNBDI	BrMaC
	DNBDI PBPB	BrMmC
Alcohols	DNBC	
	Dabsyl-Cl	
	NIC-1	
Aldehydes, Ketones	PNBA	Dansyl hydrazine
	DNBA	
Amines 1° 1° and 2°		Fluorescamine
		OPA
	DNBC	NBD-Cl
	SNPA	NBD-F
	SDNPA	Dansyl-Cl
	Dabsyl-Cl NIC-1	
Amino acids (peptides)	SBOA	Fluorescamine
	SDOBA	OPA
	Dabsyl-Cl	NBD-Cl
		NBD-F
		Dansyl-Cl
Isocyanates	PNBPA	
	DNBPA	
Phenols	DNBC	NBD-Cl
	Dabsyl-Cl	NBD-F
	NIC-1	Dansyl-Cl
Thiols		NBD-Cl
		NBD-F
		OPA

^a Chromotag abbreviations: Dabsyl-Cl, 4-dimethylaminiazobenzene-4-sulfinyl; DNBA, 3,5-dinitrobenzyloxyamine hydrochloride; NIC-1, 1-naphthylisocyanate; PBPB, *p*-bromophenacyl bromide; PNBA, *p*-nitrobenzyloxyamine hydrochloride; PNBDI, *p*-nitrobenzyl-*N,N'*-diisopropylisourea; DNBDI, 3,5-dinitrobenzyl-*N,N'*-diisopropylisourea; PNBPA, *p*-nitrobenzyl-*N-n*-propylamine hydrochloride; DNBPA, 3,5-dinitrobenzyl-*N-n*-propylamine hydrochloride; SNPA, *N*-succinimidyl-*p*-nitrophenylacetate; SDNPA, *N*-succinimidyl-3,5-dinitrophenylacetate; DNBC, 3,5-dinitrobenzyl chloride.

^b Fluorotag abbreviations: NBD-Cl, 7-chloro-4-nitrobenzo-2-oxa-1,3-diazole; NBD-F, 7-fluoro-4-nitrobenzo-2-oxa-1,3-diazole; fluorescamine, 4-phenylsprio(furan-2(3H),1'-phthalan-3,3-dione); OPA, *o*-phthaldehyde; dansyl-Cl, 5-dimethylaminonaphthalene-1-sulfonyl chloride; BrMmC, 4-bromomethyl-7-methoxycoumarin; BrMaC, 4-bromomethyl-7-acetoxycoumarin.

Source: Ref. 83.

reagents and derivatization methods are available from commercial sources (e.g., Regis Technologies, Inc., Morton Grove, Illinois, and Supelco, Bellefonte, Pennsylvania).

4.7.1.1 UV Detection. Typically, a reagent used for UV-visible detection will have two important functional groups. One functional group controls the reaction of the reagent with the analyte of interest, and the second is used for UV detection. The chromophore should have a large molar absorptivity, with an adsorption band that can be used to maximize detection and minimize background noise. Table 4.16 lists some of the common chromophores used for UV detection along with their maximum absorption wavelength and their molar absorption coefficient at 254 nm [80]. Reagents having a molar absorption coefficient of 10,000 or more allow detection in the low-nanogram range [78]. Table 4.15 lists commercially available derivatization reagents for UV detection. The analyte functional groups that these will derivatize are also shown in this table.

4.7.1.2 Fluorescence Detection. In addition to the considerations above for derivatizing reagents, fluorescent derivatization reagents require a fluorophore that possesses intense absorption bands and a large quantum yield [79]. Due to the special properties required for strong fluorescence response, there are fewer fluorescent derivation reagents than there are for UV detection [78] (Table 4.16). An example of the selectivity of fluorescence detection is the derivatization of catecholamines in biological samples. The reagents that are commonly used for the derivatization of amino compounds do not provide sufficient reaction selectivity for the catecholamines. However, reactions have been developed with trihydroxyindole (THI), ethylenediamine (ED), and 1,2-

TABLE 4.16 Chromophores of Interest for Enhanced UV Detection

Chromophore	Wavelength of Maximum Absorption (nm)	Molar Absorption Coefficient at 254 nm
Benzyl	254	200
4-Nitrobenzyl	265	620
3,5-Dinitrobenzyl	—	>10,000
Benzoate	230	Low
4-Chlorobenzoate	236	6,300
4-Nitrobenzoate	254	>10,000
2,4-Dinitrophenyl	—	>10,000
Toluoyl	236	5,400
Anisyl	262	16,000
Phenacyl	250	10,000
4-Bromophenacyl	260	18,000
2-Naphthacyl	248	12,000

Source: Ref. 81.

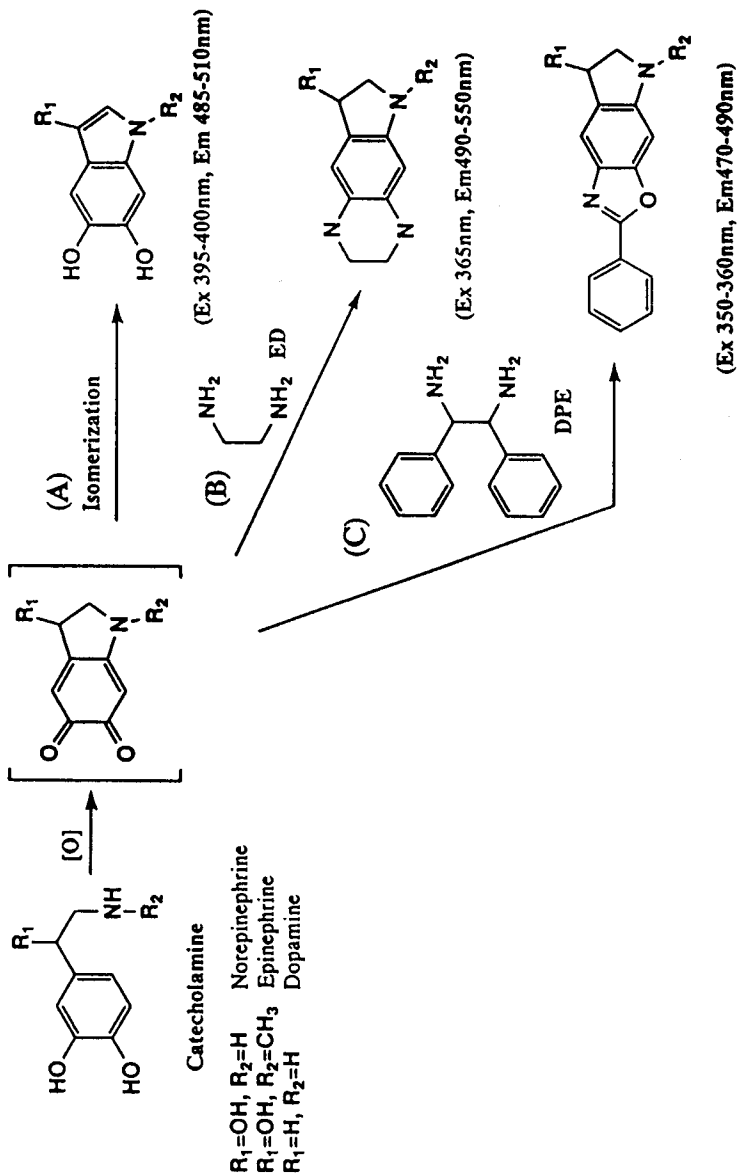

FIGURE 4.17 Fluorogenic reactions of catecholamines. (A) Formation of THI; (B) ethylenediamine; (C) with DPE reagent. (Reprinted with permission from Ref. 80.)

diphenylethylenediamine (DPE) that are highly selective for catecholamines (Fig. 4.17). THI provides the most selectivity but does not provide fluorescence with dopamine. For practical use, DPE is the best choice as the most sensitive tag for all the catecholamines. This method has been used to measure amines in human plasma (Fig. 4.18) [84]. The separation can be achieved on a RP column and requires a simple cleanup step with a cation-exchange solid-phase extraction cartridge [85].

4.7.2 Pre- and Post-column Derivatization

4.7.2.1 Pre-column Derivatization. There are several advantages for pre-column derivatization compared to post-column derivation. Pre-column deri-

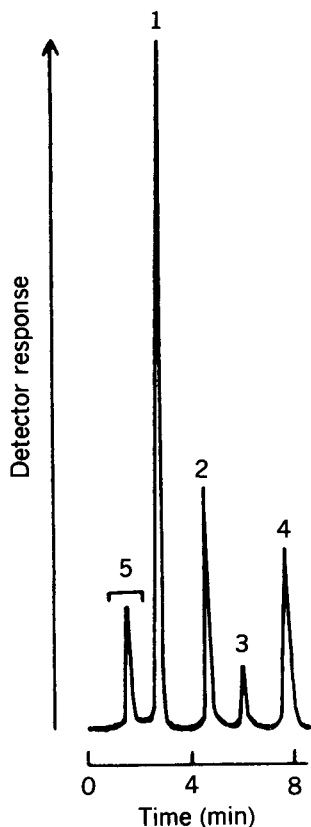

FIGURE 4.18 Chromatogram of DPE derivatives of catecholamines in human plasma. Column: TSK gel ODS-120T ($5\ \mu\text{m}$; $150 \times 4.6\text{-mm ID}$); mobile phase: ACN-MeOH- $50\ \text{mM}$ tris-hydrochloric acid buffer (pH 7.0) (5 : 1 : 4 v/v/v). Peaks with concentrations (pmol/mL plasma) in parentheses: 1, norepinephrine (1.72); 2, epinephrine (0.56); 3, dopamine (0.21); 4, isoproterenol (internal standard, 0.5). (Reprinted with permission from Ref. 84.)

vativization has fewer equipment and reaction chemical restrictions; the analyst can perform the derivatization, then transfer the sample to the appropriate vial for analysis. Pre-column derivatization can be performed manually or automated. Several manufacturers of analytical instrumentation or robotics offer automated pre-column derivatization. There are no time constraints on the kinetics of the derivatization reaction, provided that all the reagents, analytes, and derivatized species are stable. Finally, sample preparation procedures described in this chapter can be used to remove undesired by-products, sample interferences, and if necessary, change the sample solvent to be compatible with the HPLC mobile phase [79,80].

Some drawbacks of pre-column derivatization are the introduction of contaminants and loss of analyte through adsorption, undesired side reactions, possible sample degradation, sample transfer, and incomplete reactions. Also, additional time is required for derivatization, and the added complexity can result in poorer method precision.

4.7.2.2 Post-column Derivatization. Post-column derivatization is commonly accomplished using a reaction detector where the analyte is derivatized after the separation but prior to detection. Reaction detector design takes into account the dispersion of the sample within the reaction system [79]. The three most common approaches to reactor design are capillary, packed bed, and air segmented for fast (< 1 min), slow (1 to 5 min), and slower (5 to 20 min) reactions rates, respectively. The main advantages of post-column derivatization are minimal artifact formation; complete reaction is not essential as long as it is reproducible and the chromatography of analyte is unaffected.

The drawbacks to post-column derivatization are band broadening for all but very fast reactions, and the added complexity for both method development and routine applications. Important considerations are the kinetic requirements (a maximum reaction time of 30 min for completion) and possible incompatibility between the mobile phase and derivatizing reagents. Ensuring reagent and mobile-phase compatibility can also complicate HPLC method development, because the requirements of the derivatization must be considered along with those of the separation. The best mobile phase for separation may be incompatible for an optimized derivatization reaction [78].

TABLE 4.17 Functional Groups and Their Derivatives for Chiral Analysis

Functional Groups	Derivative
Amino groups	Amides, carbamates, ureas, thioureas, sulfamides
Hydroxyl groups	Esters, carbonates, carbamates
Carboxy groups	Esters, amides
Epoxides	Isothiocyanates, olefins (chiral platinum complexes)
Thiols	Thioesters

Source: Ref. 79.

TABLE 4.18 Characteristics of Chiral Analysis via Derivatization

Advantages	Limitations
The technique has been studied extensively and there is a wealth of information, making the technique easy and accessible.	For diastereomeric compounds the compounds of interest must be isolated and then derivatized, making automation difficult.
The methods use standard HPLC supports and mobile phases.	The purity of the derivatizing reagent is critical, since the presence of enantiomeric contamination can yield false measurement.
If detection is a problem, derivatization for detection and separation can be accomplished in one step.	Enantiomers that have different rates of reaction and/or equilibrium constants give results that do not provide the true enantiomeric ratios. Possible racemization of the product during sample processing.

4.7.3 Chiral Analysis by Derivatization

Unlike derivatization for nonchiral separations, the major use of chiral derivatization is to enhance the separation, not to improve detection. The separation of chiral compounds by non-derivative means is discussed in detail in Chapter 12. However, the oldest method of chiral separation is derivatization [86]. Thus there is a wealth of information available and several functional groups have been derivatized, as shown in Table 4.17. Chiral derivatization has been applied to both reversed- and normal-phase liquid chromatography. The key to chiral analysis is the ability to react an optically active target molecule with an optically active reagent.

There are several advantages and limitations to chiral analysis via derivatization (Table 4.18).

TABLE 4.19 Functional Groups and Achiral Reagents^a

Functional Group	Electron-Accepting CSP	Electron-Donating CSP
Carboxylic acids	NMA-1	DNA
Alcohols	NIC-1	ICDNA DNBC
Amines	NIC-1 NC-2	ICDNA DNBC
Amino acids	NC-2	DNBC
Thiols	NIC-1	ICDNA DNBC

^a Abbreviations in Table 4.15.

Source: Ref. 83.

In addition to the derivatization of chiral compounds, the use of achiral reagents can increase the selectivity of the chiral stationary phase (CSP) toward a chiral analyte. Some compounds do not have distinct enough binding sites to obtain adequate resolution on a CSP, and derivatization with achiral reagents allows their separation [83]. Table 4.19 (on page 169) lists the functional group and the reagent of choice as a function of the CSP that will be used for the separation. Further information on direct chiral separations is provided in Chapter 12.

REFERENCES

1. P. M. Gy, *Sampling of Heterogeneous and Dynamic Material Systems*, Elsevier, Amsterdam, 1992.
2. R. Smith and G. V. James, *The Sampling of Bulk Materials*, Royal Society of Chemistry, London, 1981.
3. L. H. Keith, ed., *Principles of Environmental Sampling*, American Chemical Society, Washington, DC, 1988.
4. D. C. Harris, *Quantitative Chemical Analysis*, 4th ed., W.H. Freeman, New York, 1994.
5. R. E. Majors, *LC/GC*, **9(1)** (1991) 16.
6. L. R. Snyder and S. Van der Wal, *Anal. Chem.*, **53** (1981) 877.
7. C. M. Druzik, D. Grosjean, A. Van Neste, and S. Parmar, *Int. J. Environ. Anal. Chem.*, **38** (1990) 495.
8. M. Hiatt, *Anal. Chem.*, **67** (1995) 4044.
9. L. R. Snyder, *Chemtech*, **9** (1979) 750.
10. L. R. Snyder, *Chemtech*, **10** (1980) 188.
11. T. S. Ma and V. Horak, *Microscale Manipulations in Chemistry*, Wiley, New York, 1976.
12. N. B. Mandava and Y. Ito, eds., *Countercurrent Chromatography: Theory and Practice*, Marcel Dekker, New York, 1988.
13. R. E. Majors and K. D. Fogelman, *Amer. Lab.*, **25(2)** (1993) 40W.
14. W. F. Lane and R. C. Loehr, *Environ. Sci. Technol.*, **256(5)** (1992) 983.
15. D. Barcelo, *Analyst*, **116(7)** (1991) 681.
16. P. D. MacDonald and E. S. P. Bouvier, eds., *Solid Phase Extraction Applications Guide and Bibliography*, Waters Corp., Milford, MA, 1995.
17. F. X. Zhou, J. M. Thorne, and I. S. Krull, *Trends Anal. Chem.*, **11** (1992) 80.
18. D. R. Green and D. Le Pape, *Anal. Chem.*, **59** (1987) 699.
19. A. Alfred-Stevens and J. W. Eichelberger, in *Methods for the Determination of Organic Compounds in Drinking Water (Supplement I)*, Environmental Monitoring Systems Laboratory, Office of R&D, U.S. EPA, Cincinnati, OH, 1990, pp. 33-63.
20. *3M Empore Extraction Disks Method Summary: Phenols*, Publication 78-6900-3714-4 (113.05) R1, 3M Corporation, St. Paul, MN, 1994.

21. *3M Empore Extraction Disks Method Summary, EPA Method 552.1: Haloacetic Acids and Dalapon in Drinking Water*, Publication 78-6900-373-4 (113.05) R1, 3M Corporation, St. Paul, MN, 1994.
22. *3M Empore Extraction Disks Method Summary: Pesticides and Polychlorinated Biphenyls*, Publication 78-6900-3715-1 (113.05) R1, 3M Corporation, St. Paul, MN, 1994.
23. G. M. Hearne and D. O. Hall, *Amer. Lab.*, **25(1)** (1993) 28H.
24. C. Markell, D. F. Hagen, and V. A. Bunnelle, *LC/GC*, **9** (1991) 332.
25. *Application Note/Information Package 413087*, Supelco Inc., Bellefonte, PA, 1996.
26. R. Shirey, *Advances and Applications of Solid Phase Microextractions (SPME)*, paper 23602 at Analytica, Munich, Germany, 1996, pp. 23-26.
27. B. A. Bidlingmeyer, *Liq. Chromatogr.*, **2** (1984) 578.
28. T. A. Dirksen, S. M. Price, and S. J. St. Mary, *Amer. Lab.*, **25(18)** (1993) 24.
29. G. E. Platoff and J. A. Gere, *Forens. Sci. Rev.*, **3** (1991) 117.
30. V. Dixit and V. M. Dixit, *J. Liq. Chromatogr.*, **14(14)** (1991) 2779.
31. R.-C. Hsu, I. Biggs, and N. K. Saini, *J. Agric. Food Chem.*, **39** (1991) 1658.
32. X.-H. Chen, J.-P. Franke, K. Ensing, J. Wijsbeek, and R. A. De Zeeuw, *J. Chromatogr.*, **613** (1993) 289.
33. R. E. Majors, *LC/GC*, **7** (1989) 92.
34. M. F. W. Nielen, A. J. Falk, R. W. Frei, U. A. T. Brinkman, P. Mussche, R. De Nijs, B. Ooms, and W. Smink, *J. Chromatogr.*, **393** (1987) 69.
35. R. E. Majors, *LC/GC*, **11(5)** (1993) 336.
36. *Applications Bibliography*, Varian Sample Preparation Products, Harbor City, CA, 1992.
37. *BakerBond SPE Bibliography*, J. T. Baker, Inc., Phillipsburg, NJ, 1994.
38. R. Bland, *Proceedings of the 3rd Annual International Symposium on Sample Preparation and Isolation Using Bonded Silicas*, Analytichem International, Harbor City, CA, 1986, pp. 93-116.
39. K. C. Van Horne, ed., *Sorbent Extraction Technology*, Analytichem International, Harbor City, CA, 1985, p. 125.
40. M. Zief and R. Kiser, *Amer. Lab.*, **22(1)** (1990) 70.
41. L. Jordan, *LC/GC*, **11(9)** (1993) 634.
42. E. S. P. Bouvier, *LC/GC*, **13(11)** (1995) 852.
43. G. M. Greenway, N. Kometa, and R. Macrae, *Food Chem.*, **43** (1992) 137.
44. D. C. Turnell, J. D. H. Cooper, B. Green, G. Hughes, and D. J. Wright, *Clin. Chem.*, **34** (1988) 1816.
45. J. A. Jonsson and L. Mathiasson, *Trends Anal. Chem.*, **11(3)** (1992) 106.
46. G. Audunsson, *Anal. Chem.*, **58** (1986) 2714.
47. L. Mathiasson, G. Nilve, and B. Ulen, *Int. J. Environ. Anal. Chem.*, **45** (1991) 117.
48. M. Knutsson, *Sampling and Sample Preparation of Polar Pollutants in Complex Matrices Especially Using Supported Liquid Membranes*, Ph.D. thesis, Analytical Chemistry, Univ. of Lund, Sweden, 1995.
49. M. C. Linhares and P. T. Kissinger, *Trends Anal. Chem.*, **11(5)** (1992) 171.

50. B. H. C. Westerink, *Trends Anal. Chem.*, **11(5)** (1992) 176.
51. M. C. Linhares and P. T. Kissinger, *Pharm. Res.*, **10(4)** (1993) 598.
52. T. Buttler, H. Jarskog, L. Gorton, G. Marko-Varga, and L. Ramnemark, *Amer. Lab.*, **26(12)** (1994) 28I.
53. E. M. Janie and P. T. Kissinger, *AACC TDM/Toxicol.*, **14(7)** (1993) 159.
54. D. C. Turnell, J. D. H. Cooper, B. Green, G. Hughes, and D. W. Wright, *Clin. Chem.*, **34** (1988) 1816.
55. M. M. L. Aerts, W. M. J. Beek, and U. A. T. Brinkman, *J. Chromatogr.*, **435** (1988) 97.
56. D. C. Turnell and J. D. H. Cooper, *J. Chromatogr.*, **395** (1987) 613.
57. F. Mangani, A. Cappiello, G. Crescentini, F. Bruner, and L. Bonfanti, *Anal. Chem.*, **59** (1987) 2066.
58. L. G. Randall, W. S. Miles, F. Rowland, and C. R. Knipe, *Designing a Sample Preparation Method Which Employs Supercritical Fluid Extraction (SFE)*, Publication 43 5091-2120E, Hewlett-Packard, Wilmington, DE, 1994.
59. M. McHugh and V. Krukonis, *Supercritical Fluid Extraction: Principles and Practice*, Butterworth, Stoneham, MA, 1987.
60. S. B. Hawthorne, *Anal. Chem.*, **62** (1990) 633A.
61. M. Verschucere, P. Sandra, and F. David, *J. Chromatogr. Sci.*, **30** (1992) 388.
62. M. D. Buford, S. B. Hawthorne, and D. J. Miller, *Anal. Chem.*, **65** (1993) 1497.
63. S. B. Hawthorne, "Factors Controlling Supercritical Fluid Extraction of Organic Pollutants," paper presented at the 7th Symposium on Handling of Environmental and Biological Samples in Chromatography, Lund, Sweden, May 7-10, 1995.
64. H.-B. Lee, T. E. Peart, and R. L. Hong-You, *J. Chromatogr.*, **605(1)** (1992) 109.
65. D. R. Gere and E. M. Derrico, *LC/GC*, **12** (1994) 352.
66. D. R. Gere and E. M. Derrico, *LC/GC*, **12** (1994) 432.
67. B. W. Renoe, *Amer. Lab.*, **26** (1994) 34.
68. E. Hasty and R. Revesz, *Amer. Lab.*, **27(4)** (1995) 66.
69. V. Lopez-Avila, R. Young, and W. F. Beckert, *Anal. Chem.*, **66** (1994) 1097.
70. J. R. J. Pare, J. M. R. Belanger, and S. Stafford, *Trends Anal. Chem.*, **13(4)** (1994) 176.
71. F. I. Onuska and K. A. Terry, *Chromatographia*, **36** (1993) 191.
72. B. E. Richter, J. L. Ezzell, W. D. Felix, K. A. Roberts, and D. W. Later, *Amer. Lab.*, **27(4)** (1995) 24.
73. J. L. Ezzell, B. E. Richter, W. D. Felix, S. R. Black, and J. E. Meikle, *LC/GC*, **13(5)** (1995) 390.
74. *ASE Application Note 321*, Dionex, Salt Lake City, UT, 1996.
75. *ASE Application Note 322*, Dionex, Salt Lake City, UT, 1996.
76. J. Lankelma and H. Poppe, *J. Chromatogr.*, **149** (1978) 587.
77. D. L. Conley and E. J. Benjamin, *J. Chromatogr.*, **257** (1983) 337.
78. C. F. Poole and S. K. Poole, *Chromatography Today*, Elsevier, Amsterdam, 1993.
79. S. Ahuja, *Selectivity and Detectability Optimization in HPLC*, Wiley, New York, 1989.

80. I. W. Wainer, *Liquid Chromatography in Pharmaceutical Development*, Aster Publishing, Springfield, OR, 1985.
81. B. King, and G. S. Graham, *Handbook of Derivatives for Chromatography*, Heyden, Philadelphia, 1979.
82. S. Ahuja, *J. Chromatogr. Sci.*, **17** (1979) 168.
83. *Regis Chromatography Catalog/Guide*, Regis Technology, Inc., Morton Grove, IL, 1993.
84. A. Mitsui, H. Nohta, and Y. Ohkura, *J. Chromatogr.*, **344** (1985) 61.
85. Y. Ohkura, M. Kai, and H. Nohta, *J. Chromatogr. B.* **659** (1994) 85.
86. J. Gal, *LC/GC*, **5** (1987) 106.

5

THE COLUMN

- 5.1 Introduction
- 5.2 Characteristics of Columns and Column Packings
 - 5.2.1 Column-Packing Particles
 - 5.2.1.1 Silica Packing Particles
 - 5.2.1.2 Porous Polymers
 - 5.2.1.3 Other Inorganic Supports
 - 5.2.2 Column Configuration
 - 5.2.3 Stationary Phases
 - 5.2.3.1 Bonded Silanes
 - 5.2.3.2 Other Stationary Phases
 - 5.2.3.3 Retention of the Bonded Phase in RPC
 - 5.2.3.4 Stability of Bonded-Phase Columns
 - 5.2.4 Sources of Retention and Selectivity Variability
- 5.3 Column Specifications
 - 5.3.1 Plate Number
 - 5.3.2 Peak Asymmetry and Peak Tailing
 - 5.3.3 Column Failure: How Long Should a Column Last?
 - 5.3.4 Retention Reproducibility
 - 5.3.5 Pressure Drop
 - 5.3.6 Bonded-Phase Concentration (Coverage)
- 5.4 Column Problems and Remedies
 - 5.4.1 Retention and Resolution Irreproducibility
 - 5.4.2 Band Tailing
 - 5.4.3 Why Do Columns Die?
 - 5.4.3.1 Column Frit Problems
 - 5.4.3.2 Strongly Held Sample Components
 - 5.4.3.3 Poorly Packed Columns
 - 5.4.3.4 Pressure Effects
 - 5.4.3.5 Chemical Attack
 - 5.4.3.6 Other Factors
 - 5.4.4 Suggested Column for Method Development

5.1 INTRODUCTION

The column is the heart of HPLC separation processes. The availability of a stable, high-performance column is essential in developing a rugged, reproducible method. Commercial columns can differ widely among suppliers, and even between supposedly identical columns from a single source. Such differences can have a serious impact on developing the desired HPLC method. Specifically, different columns can vary in plate number, band symmetry, retention, band spacing, and lifetime. In this chapter we give information about various column supports, stationary phases, and column packings. Problems in the use of columns are discussed, with appropriate remedies to ensure rugged, reproducible methods. We also consider the role of "good" columns in optimizing a routine HPLC procedure for best results.

When selecting an HPLC column, most users consider column-to-column reproducibility as very important when developing a method [1]. Chromatographers dislike having to redevelop HPLC methods for a new column after they standardize on a particular system. Several manufacturers guarantee the reproducibility of certain column performance criteria, such as column plate number (N), selectivity for certain samples and conditions, backpressure (pressure drop), and retention (k) values for specified test solutes. Therefore, the reputation of the manufacturer for producing superior products is important to many users. Price is an important factor to some, but the other factors discussed above usually are more important in developing a rugged, satisfactory method. Column cost is only a small part of the total expense in developing and using a rugged, dependable HPLC method (see Section 5.3).

5.2 CHARACTERISTICS OF COLUMNS AND COLUMN PACKINGS

5.2.1 Column-Packing Particles

Most column packings used for HPLC separations make use of a silica particle (*support*). Columns based on porous-polymer supports or other materials also are commercially available for use in certain separations. These non-siliceous packings are discussed later in terms of their desirability for particular applications. However, because of widespread use, we emphasize particles with a silica support and a bonded organic surface layer such as C_{18} or C_8 [1].

Several particle types are available for HPLC applications, as illustrated in Fig. 5.1. *Totally porous microspheres* are most commonly used because of the favorable compromise of desired properties: efficiency, sample loading, durability, convenience, and availability. These particles are available in a variety of diameters, pore sizes, and surface areas, so that all types of HPLC methods can be developed with these materials.

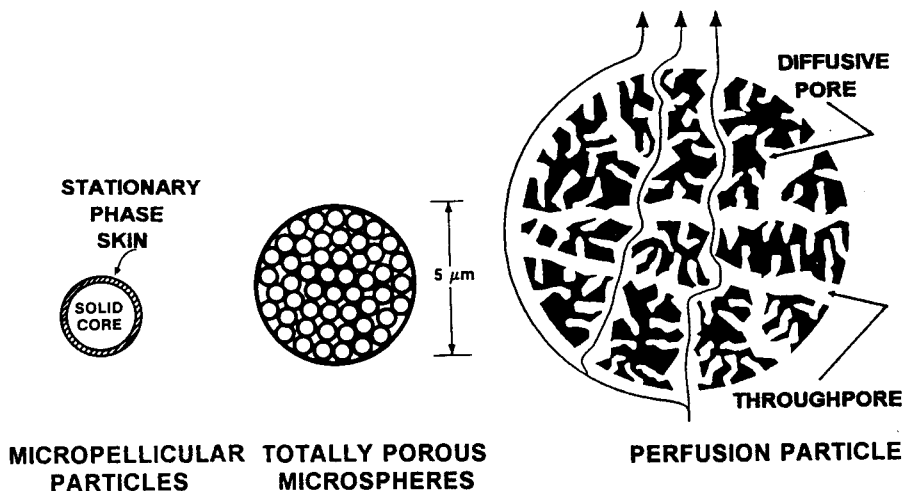

FIGURE 5.1 Particle types for HPLC. Figures represent approximate relative sizes of particles used.

Micropellicular particles have a solid core with a very thin outer skin of interactive stationary phase. These silica- or polymer-based particles, usually available in 1.5- to 2.5- μm sizes, display outstanding efficiency for macromolecules because of fast mass transfer kinetics [2,3]. These solid ultramicroparticles have limited sample load characteristics because of low surface areas, thus are best suited for analysis only. Columns of these ultramicroparticles generate very sharp (low volume) peaks. Therefore, HPLC equipment with minimum extra-column band broadening is required to ensure that sharp peaks are not broadened unnecessarily.

Perfusion particles contain very large pores (e.g., 4000 to 8000 Å) throughout the support and also include a network of smaller interconnecting pores (e.g., 300 to 1000 Å) between these large throughpores. At high flow rates, solutes can enter (and leave) this pore structure through a combination of convective (flow) and diffusion [4]. This effect minimizes band broadening, so that large porous particles resemble smaller particles in terms of column efficiency but with a fraction of the pressure drop. Experiences with this particle type are still quite limited, so that practical implications are incomplete. However, applications appear to be best suited for the preparative isolation of macromolecules such as proteins. Perfusion particles are less used for developing routine analytical separations of small molecules.

Particle size is very important in HPLC. Particle diameters of about 5 μm represent a good compromise for analytical columns in terms of column efficiency, backpressure, and lifetime. Smaller porous particles (e.g., 3 μm) are available for faster separations. Pellicular particles as small as 1.5 μm are useful for extremely rapid separations of macromolecules such as proteins

TABLE 5.1 Desired Particle Characteristics for HPLC Analytical Columns

Feature	Utility
5- μm totally porous particles	Most separations
3- μm totally porous particles	Fast separations
1.5- μm pellicular particles	Very fast separations (especially macromolecules)
$\pm 50\%$ (from mean) particle-size distribution	Stable, reproducible, more efficient columns with lower pressure drop
7- to 12-nm pores, 150 to 400 m^2/g (narrow pore)	Small molecule separations
15- to 100-nm pores, 10 to 150 m^2/g (wide pore)	Macromolecular separations

[2,3]. A narrow particle-size distribution ($< \pm 50\%$ from mean) in all materials ensures stable, high-efficiency packed beds with minimum pressure drop. On balance, columns of the 3- or 5- μm totally porous microspheres meet the requirements for most HPLC separations, and we recommend these for most method-development applications.

Table 5.1 summarizes the desired physical characteristics of particles for HPLC analysis and the importance of each feature. For separating small molecules, totally porous particles with 7- to 12-nm (70- to 120- \AA) pores typically are used. Porous particles with surface areas of 150 to 400 m^2/g are advantageous for separating small molecules. Table 5.2 lists typical physical properties for some of the narrow-pore, commercially available C_{18} columns. Molecules with molecular weights greater than 10,000 Da require particles with pore diameters larger than 15 nm, to allow easy access of these larger solutes to interactive surfaces within the pore structure. In every case, the goal is rapid solute diffusion within the pores and good column efficiency. Pore diameters at least four times the hydrodynamic diameter of the solute

TABLE 5.2 Physical Properties of Silica Supports for Some C_{18} Columns

Column	Pore Diameter (nm)	Surface Area (m^2/g)	Percent Volume Porosity (mL/mL)
Hypersil ODS	12	170	57
LiChrosorb C_{18}	10	355	71
Novapak C_{18}	6	N/A ^a	N/A ^a
Nucleosil C_{18}	10	350	69
Symmetry C_{18}	10	335	66
Zorbax ODS	6	300	55
Zorbax Rx, SB, XDB	8	180	50

Source: Taken in part from Ref. 5.

^a N/A, not available.

ensure that restricted diffusion of the solute does not degrade column efficiency [6]. Surface areas of wide-pore particles range from 10 to 150 m²/g, depending on pore size; wider pores mean smaller surface areas.

5.2.1.1 Silica Packing Particles. As mentioned previously, silica-based packings are presently the most popular HPLC column packing materials. This acceptance is based primarily on the favorable physical characteristics of silica supports. Totally porous silica particles can be prepared with a narrow pore-size distribution in a wide choice of pore sizes (e.g., 8, 30, 100 nm) and particle sizes (e.g., 10, 5, 3 μm). Thus, appropriate packings are available for both small and large molecules for both analytical and preparative applications. A strong advantage of most silica particles is their high mechanical strength. This permits the formation of efficient packed beds that are stable under high operating pressures for long periods. A major advantage of silica-based columns is that they provide the highest column efficiency of any of the materials used to produce packings for HPLC. Rigid, high-strength particles also produce columns that exhibit lower backpressures and longer lifetimes [7].

Although chromatographic silica is available in both spherical and irregularly shaped particles, columns of spherical particles have some inherent advantages. The stronger spherical particles are more easily and reproducibly packed into efficient columns. Columns of irregular particles can initially exhibit efficiency comparable to that of spherical particles of the same particle size, but irregular particles often develop higher backpressures during use (because of “fines” that may form from the fracturing of random-shaped particles). Larger, irregular particles are used extensively in preparative and process applications because of lower cost and other considerations (see Chapter 13).

A desirable property of silica supports is that the surface can be chemically modified with a large variety of bonded phases having different functionalities. Silica-based packings are compatible with water and all organic solvents, and no dimensional variation (e.g., swelling) in silica packings occurs with change in solvents. This feature permits the formation of packed beds that are stable during use with various solvent types and during gradient elution.

However, silica is not a perfect support for HPLC columns. An unfavorable characteristic of silica is its solubility at high pH [8]. For satisfactory lifetime, some silica-based columns (i.e., so-called “sil-gel” or xerogel types usually formed by the precipitation of soluble silicates) should not be used above pH 8. However, columns based on particles formed by the aggregation of silica sols (called sol-gel types) allow operation to at least pH 9 [5]. At pH > 9 the silica support can solubilize rapidly in some mobile phases, eventually causing the packed bed to collapse, with a drastic decrease in column efficiency and increased peak asymmetry. (However, when used with certain mobile phases, some sol-gel-based columns can be operated at pH 11 with good results; see Section 5.2.3.4.) Another undesirable characteristic of some silicas is a surface acidity that causes problems when separating basic compounds. Fortunately,

hydroxylated, that is, hydrated with a maximum surface silanol concentration of about $8 \mu\text{mol}/\text{m}^2$.

The hydrated silica surface can contain various kinds of silanol groups, as illustrated in Fig. 5.3. As shown at the top of Fig. 5.3, individual silanols exist as three general types [11,13,15]. These different silanol types can be identified and measured by magic-angle-spinning (MAS) ^{29}Si NMR [16] and diffuse-reflectance infrared spectroscopy with Fourier transform (DRIFT) [11]. Free or isolated (non-hydrogen-bonded) silanols generally occur in low concentrations. However, these free silanols can cause strong, deleterious binding of basic solutes because of their very acidic nature. Therefore, silicas with a higher concentration of free, more acidic silanols often show increased retention and broad, tailing peaks for basic samples.

Fully hydroxylated, silica-based packings with the highest concentration of geminal and associated silanols (Fig. 5.3) are most favored for the chromatography of basic compounds. These silica surfaces often contain a significant concentration of geminal silanols (Fig. 5.3), sometimes 25 to 30% of the total. Geminal silanols are less acidic than isolated silanols and generally are "friendly" for separating basic solutes. Associated or hydrogen-bonded silanols are in the highest concentration for the most desirable, fully hydroxylated HPLC silicas. These less acidic silanols also are "friendly" for separating basic solutes. Some commercial silica packings are in a partially hydroxylated state [11]. Packings from these materials usually are more acidic and less desirable for separating basic compounds.

The purity of the silica support is of strong concern in separating many polar compounds. As illustrated at the bottom of Fig. 5.3, some silicas are contaminated with certain metals (Fe, Al, Ni, Zn, etc.). These metal contaminants can complex with chelating solutes, causing asymmetrical or tailing peaks, or completely retaining compounds so that elution does not occur. Other metals in the silica lattice (especially aluminum) activate surface silanol groups so that they are highly acidic [17]. Therefore, highly purified silicas

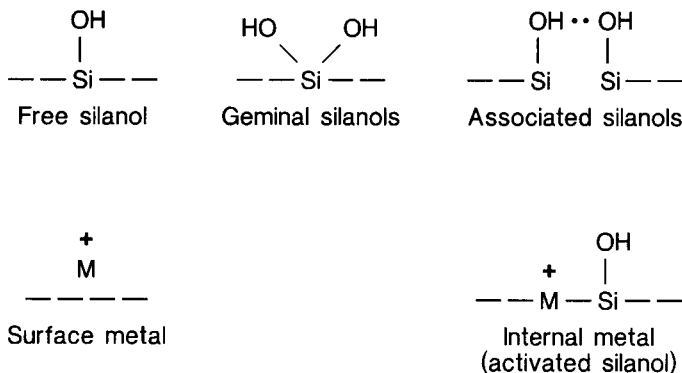

FIGURE 5.3 Surface of silica supports for HPLC.

TABLE 5.3 Typical Trace Element Analysis of Zorbax Rx-SIL Silica by ICP-AES/MS

Element	Content ^a (ppm)
Na	10
Ca	2
K	< 3
Al	1.5
Fe	3
Mg	4
Zn	1

^a Total: < 35 ppm (no other elements detected, < 1 ppm); 99.995% silica.

Data from Ref. 18.

are needed for many HPLC separations, especially with basic and highly polar compounds. Some silicas have extremely high purity, as shown by the analysis in Table 5.3 for one type [5]. Tests have been reported to characterize silicas for chromatographic properties such as surface acidity and chelation or complexation effects [15,18].

Some chromatographic silicas have been ranked according to their desirability as supports in columns for separating basic and acidic compounds. Older, less-pure, more-acidic silicas (called type A silicas) can be useful for separating neutral and nonionizable compounds. Newer, highly purified, less-acidic silicas (called type B) give generally better separations and are recommended for separating ionic and ionizable compounds, and especially basic materials. Table 5.4 lists some of these newer silicas that are claimed by manufacturers to be useful for separating basic compounds. This is a partial list in alphabetical order of type B silicas for the separation of basic compounds. The list of Table 5.4 continues to grow rapidly as users and manufacturers recognize the advantage of columns made from these high-purity chromatographic silicas.

TABLE 5.4 Some Silica-Based Supports and Columns Proposed for Separating Basic Compounds

Altima	RSIL
Betasil	Supelcosil ABZ+
DeltaBond	Supersphere RP
Encapharm RP	Symmetry
Hypersil-BDS	Synchropak RP-SCD
Inertsil	Techsphere-BDS
Kromasil	Vydac
LiChrospher Select B	YMC-Basic
Nucleosil AB	Zorbax Rx, SB, XDB

Source: Refs. 20 to 23.

Figure 5.4 compares separations for some basic drugs with C_{18} columns based on either type A or type B silica. The column with the less acidic silica support (type B) produces peaks with superior band shape and column efficiency. Large differences in retention, band spacing, and peak tailing often occur for separations performed with different silica supports. Techniques to minimize these differences are discussed in Section 7.3.3. Because of the inherent advantages of the type B silicas of Table 5.4, it is likely that most HPLC methods will be developed with these materials in the future (for both basic and non-basic samples).

5.2.1.2 Porous Polymers. Columns packed with porous, polymeric particles can also be useful for developing HPLC methods. Some of these polymer particles (e.g., polystyrene) are hydrophobic, meaning that they can be used directly for reversed-phase separations without the addition of a surface coating. Most polymer particles for reversed-phase HPLC are made of divinylbenzene-cross-linked polystyrene, similar to those used for resin ion exchangers. Particles of other polymers, such as substituted methacrylates and

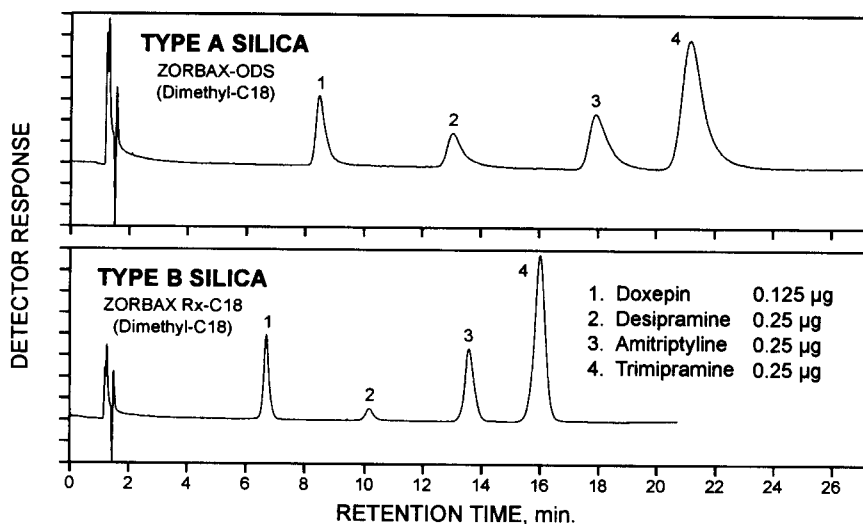

FIGURE 5.4 Comparison of tricyclic antidepressant separations with columns of type A and type B silica supports. Columns: 15×0.46 cm; mobile phase: 30% acetonitrile–70% 0.025 M sodium phosphate buffer, pH 2.5 + 0.2% each of triethylamine and trifluoroacetic acid; flow rate: 1.0 mL/min; 40°C; 254 nm detection; 5 μ L injected. (Reprinted with permission from Ref. 19.)

polyvinyl alcohols, also are commercial but are used less frequently. Both totally porous and pellicular particles are available. As with silica supports, porous polymer particles are made with narrow pores for small solutes and large pores for macromolecules. The main advantage of porous polymers is that they are applicable in the pH range 1 to 13. These columns can be used for separating highly basic solutes at high pH, where compounds exist in the free or non-ionized form. The use of porous polymers at high pH often produces good peak shape with highly basic compounds in the non-ionized state (free base), and Fig. 5.5 illustrates such an application. This approach represents an alternative to ion-pair chromatography for such compounds (see Section 7.4 for the ion-pair separation of basic compounds), and has the advantage that no ion-pair agents must be maintained in the mobile phase. Another potential advantage is that porous polymers have strong hydrophobic retention (relative to silica-based C_{18} columns), which may be useful for adequately retaining highly hydrophilic compounds. Wide-pore porous polymers

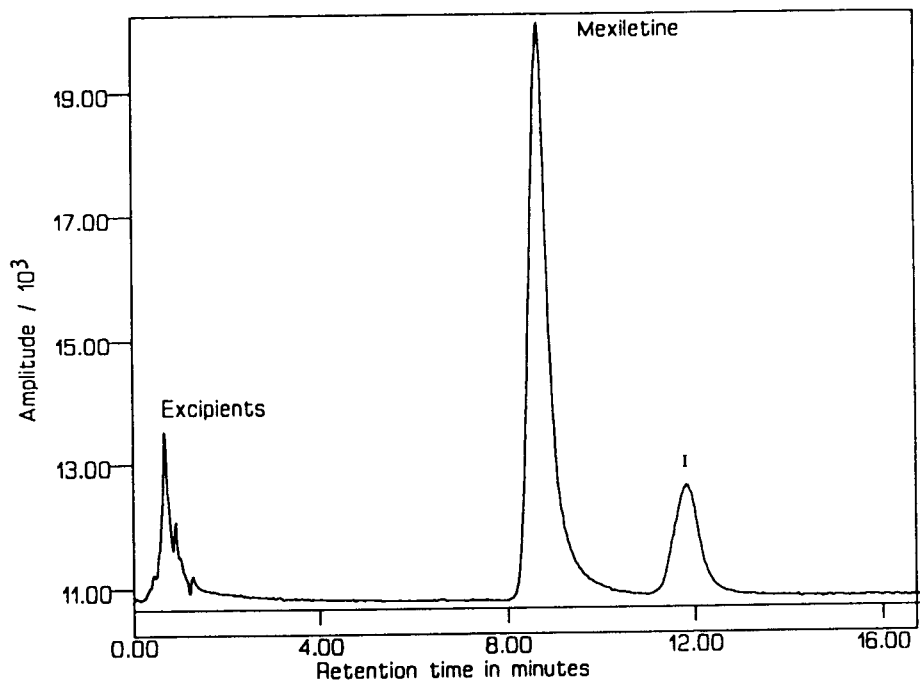

FIGURE 5.5 Chromatogram at pH 11 with porous polymer column: mexiletine with tablet matrix spiked with 1% of an impurity (I). Column: 12.5 × 0.4-cm Ashipak ODP-50; mobile phase: 28:72 (v/v) acetonitrile–water pH 11 with diethylamine; flow rate: 0.9 mL/min; 264 nm detection; injection: 20 μL. Note larger extinction coefficient for impurity. (Reprinted with permission from Ref. 24.)

also are useful for separating protein samples (see Section 11.2). Because of their stability at high pH, porous polymers allow the purging of strongly retained material from the column with 0.1 *M* sodium hydroxide.

Limitations of porous polymer columns are based on lower column efficiency, compared to silica-based columns with the same particle size. Published applications typically show less than one-half the plate number for analogous silica-based columns. A special problem with polymer columns is that this support swells differently in the presence of various organic modifiers. This property may contribute to the lower efficiency of polymer columns, since the packed bed can shift as a result of changes in particle swelling. Particle swelling can be more noticeable in gradient elution, where the organic solvent concentration changes during the separation. To minimize possible difficulties, some workers prefer to dedicate a polymer-based column to an isocratic separation with a single organic modifier.

Stationary-phase functionality can be changed in silica-based columns so as to vary selectivity in reversed-phase separations (Section 6.3.3). Porous polymer particles modified with other functional groups such as C_{18} , NH_2 , and CN also can provide changes in stationary-phase selectivity. However, only a few functionalities for polymer columns are currently available.

Modified polymer-column packings have a distinct edge for certain ion-exchange applications. Porous polymers (e.g., divinylbenzene-cross-linked polystyrene) with ionizable functional groups such as $-COOH$, $-SO_3H$, NH_2 , and NR_3^+ provide the basis for separating a wide range of acidic and basic compounds. These column packing materials are most used for separating and isolating materials from biological sources. Here, high-pH operation often is required for some separations, and for cleaning out endotoxins and other biological contaminants. In such applications, porous polymers have an advantage of longer stability, compared to silica-based columns. But compared to silica-based ion exchangers, polymeric ion exchangers usually suffer from the same limitations as other polymeric column packings: lower column efficiency and slower separations.

5.2.1.3 Other Inorganic Supports. Columns with other inorganic supports also are commercially available for developing HPLC methods. These columns generally are useful for specific applications because of special properties. However, there is much less experience with these materials than with the widely used silica-based and porous polymer columns. Underivatized, graphitized carbon is gaining increased acceptance as a column packing for reversed-phase chromatography. This material is prepared synthetically in porous spheres with various particle sizes. Separations with this packing are somewhat different than with silica-based, alkyl bonded-phase columns. The surface of the graphitized carbon provides the basis for retention—no other stationary phase is required. This column packing is generally more retentive than alkyl bonded-phase silicas or porous polymers. Graphitized carbon has proved useful

for separating certain geometric isomers, as illustrated in Fig. 5.6 (see also Ref. 26). Graphitized carbon columns also are useful for retaining and separating compounds that are too highly hydrophilic for adequate retention on C_{18} bonded-phase columns. For example, polar compounds such as pharmaceuticals have been separated. A specific advantage of these columns is that they are useful at any pH and temperature, since dissolution in mobile phases used for HPLC is not a problem.

Limitations of graphitized carbon columns are their lower efficiency and higher fragility compared to silica particles. Obtaining good peak shapes can also be a problem with some mobile phase/solute systems, particularly for components with larger k values. Because of their highly retentive nature, graphitized carbon columns require the use of highly purified mobile phases. Impurities tend to collect on the column bed and eventually elute as unwanted detector background. Adsorbed impurities can irreversibly alter column performance, so a sample cleanup step often is useful in extending column lifetime. Columns of this material are available only in short lengths and are expensive. A variety of pore sizes are not available at this time.

Both narrow- and wide-pore alumina particles are available for HPLC. Alumina is produced in different particle sizes but not in such variety as chromatographic silicas. Alumina particles are rather strong, so stable column beds can be prepared with these materials. Untreated aluminas can be used for normal-phase separations of weakly polar solutes (Section 6.6). For reversed-phase separations, the alumina support can be coated with a polymeric phase

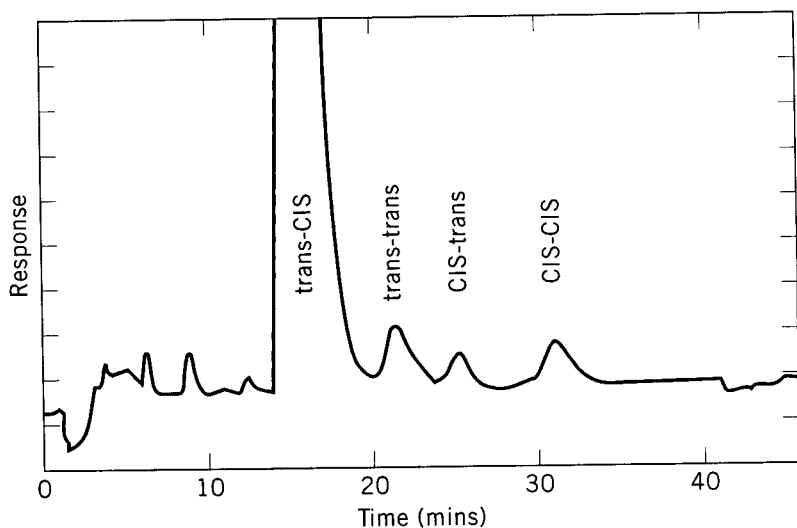

FIGURE 5.6 Separation of cis-trans isomers on graphitized carbon column. Sample: antiasthma agent (LY-170680); column: 10×0.46 -cm Hypercarb; mobile phase: 630 mL of methanol and 320 mL of dichloromethane, plus 6.8 mL of trifluoroacetic acid; 1.0 mL/min; UV detector, 238 nm. (Reprinted with permission from Ref. 25.)

such as polybutadiene [27]. Covalent bonding of alkyl stationary phases also can be performed through olefin hydrosilation on silicon hydride-modified alumina support [28]. However, the range of commercially available stationary-phase functionality is limited.

An advantage of alumina-based packings is that they are useful with mobile phases up to pH 12. Highly basic compounds can be separated using high-pH mobile phases without ion-pairing agents. Alumina-based packings cannot be used for carboxylic acid samples, because these compounds bind irreversibly to the alumina. Some commercial aluminas also are quite active toward basic compounds. Except for mobile phases with pH values above 10, alumina-based packings have applications quite similar to those for silica, with no obvious advantages. Consequently, alumina columns have not reached the general level of acceptance of popular silica-based units.

Zirconia-based packings are available for HPLC columns. The preparation and application of both porous microspheres [29] and nonporous ultramicrospheres [30] have been described. However, only columns of polymer-coated porous zirconia microspheres are commercially available now. These strong packings are useful with all known HPLC eluants throughout the pH range 1 to 14 and at temperatures up to 100°C. The ability to operate zirconia-based columns at high pH permits their use for separating highly basic compounds in the nonionized state. This approach provides an alternative to low-pH or ion-pair chromatography methods that are commonly used with silica-based-columns for such compounds. Because developments with zirconia packings are recent, different particle sizes, porosities, and stationary phases are not now available. As a result, the important applications and advantages for zirconia column packings over silica- and polymer-based materials are not yet defined.

An experimental complication with zirconia-based columns is that carbon dioxide must be rigorously excluded. Otherwise, the zirconia surface strongly binds carbon dioxide and chromatographic properties change during use [31]. Another consideration is that zirconia also strongly binds fluoride, phosphate, and other hard Lewis acids. This property suggests that the surface of this support must be carefully preconditioned with mobile phases containing these anions, to ensure repeatable separations. Zirconia surfaces also strongly bind carboxylic and sulfonic acids, perhaps precluding the possibility of separating mixtures containing these compounds [31].

5.2.2 Column Configuration

Most columns for HPLC method development use straight lengths of stainless-steel tubing with highly polished interior walls. Compression end fittings attach these columns to the HPLC apparatus. Stainless steel is useful with all organic solvents and most aqueous buffers. However, chloride-containing mobile phases can slowly cause "halide cracking" of the stainless steel (particularly

at low pH), so these should be used with caution. On balance, however, stainless-steel columns are recommended for most HPLC applications.

Commercial columns made from glass, glass-lined stainless steel, and plastic also are available for special applications where samples might interact deleteriously with stainless steel. However, few problems of this type with stainless-steel columns are documented. The surface area of the column internal wall is quite small, so the opportunity for unwanted interaction is low. Samples that strongly complex with the components of stainless steel (iron, chromium, and nickel) are most likely to cause problems.

Porous frits close the ends of columns and retain the packing particles. Typically, 2- and 0.5 μm -porosity stainless-steel frits are used for 5- and 3- μm particles, respectively. Any problems arising from stainless-steel columns usually can be traced to the inlet stainless-steel frit, which has a much higher surface area than column walls for possible deleterious sample interaction. Poor peak shapes and low sample yields are indications of possible frit problems. Less-interactive porous titanium and polymer frits are available for this infrequent problem.

Glass columns, recommended by some for samples of biological origin, are pressure limited (e.g., < 1000 psi) and restricted in their applications. Glass-lined stainless-steel columns allow conventional HPLC pressures, but these units are somewhat fragile and require careful handling. Experiences have shown that glass columns rarely are needed for separating biological samples and that (more convenient) stainless steel columns are adequate for most applications. Rigid polymer (PEEK) columns with polymer fittings are available for applications where other materials are not appropriate. These columns have aluminum outer shells that provide additional strength at high operating pressures.

Columns with soft outer polymer shells also are available. Radial compression columns (Waters Associates) allow *in situ* compression of the packing material by application of hydraulic pressure to the radius of the column. These columns are available for both analytical and preparative applications. The advantage of this column type is lower cost and a nonmetal construction. However, column efficiency and column-to-column reproducibility may be poorer with this approach, because of potential difficulties in forming an optimally packed column bed. Thermostatting these columns is also awkward, and additional hydraulic forming devices are required to connect columns for longer lengths.

Compression-fitting column types are available with the widest selection of different packing materials. Well-made columns of this type provide the highest level of performance and reproducibility. Alternatively, less-costly stainless-steel cartridge columns also are available in various dimensions with a wide range of packing materials. Cartridge columns are essentially blank tubes (without end fittings) filled with packing. Reusable holders or end fittings connect these packed tubes to the HPLC instrument. These generally less-costly cartridge columns are attractive for more routine measurements, partic-

ularly when highest performance is not required. To reduce cost, manufacturers typically do not measure the performance of individual cartridge columns. Instead, columns are tested by a random selection from a production lot. However, minimum performance is usually specified and sometimes warranted for each unit.

Table 5.5 summarizes column configurations that are commercially available for column packings. Analytical methods usually are best developed with 0.46- or 0.3-cm-ID columns having particles in the range 3 to 10 μm . Columns with 5- μm particles generally give the best compromise of efficiency, reproducibility, and reliability. Columns of 3- μm particles allow faster separations or higher efficiency, as discussed in Section 2.3.3.1. However, a typical complaint about 3- μm particle columns is that they have a tendency to plug more easily, which greatly reduces column lifetime. Columns with compression fittings are favored for most applications, particularly those in longer lengths requiring higher operating pressures. The availability of a variety of analytical column lengths allow optimization for almost any application.

Columns packed with 3.5- μm particles appear to be a good compromise between high performance and column lifetime [32]. This particle size substantially improves performance over columns of 5- μm particles; for the same column length, equivalent resolution is available in one-half the separation time [33]. Also, higher flow rates can be used without significant loss in column efficiency, so that even faster separations can be performed if needed (see Fig. 5.18). Since 2- μm porosity inlet frits are used in columns of 3.5- μm particles, these have much less tendency to plug than the 0.5- μm frits used in traditional columns of 3- μm particles. Columns of 3.5- μm particles require a narrow particle-size distribution with no "fines," which results in columns with modest back pressures.

Columns of 0.3 cm ID reduce solvent consumption to one-half of that of widely used 0.46-cm units. A fourfold decrease in solvent use occurs with narrow-bore columns of 0.21 cm, compared to 0.46-cm-ID columns. Microbore columns of ≤ 0.1 cm ID use even less solvent for separations, and some of these units are available in lengths up to 25 cm with particles in the range 3

TABLE 5.5 Column Configurations (Stainless Steel)^a

Type	Inner Diameter (cm)	Length (cm)	Particle Size (μm)
Analytical			
compression fittings	0.3–0.46	3–25	3–10
cartridge	0.3–0.46	7.5, 10	3–10
Microbore	0.1, 0.21	15, 25	3–8
Semipreparative	0.8–1.0	10–25	5–20
Preparative	2.0–5.0	10–25	5–20

^a Glass, glass-lined, plastic, and PEEK also available in some configurations.

to 8 μm . A major advantage of microbore columns is higher sample mass-detection sensitivity. These configurations are best suited for applications where the sample is mass (not volume) limited. Small-ID columns are especially useful (and often necessary) when interfacing an HPLC instrument with mass spectrometers and other instruments requiring small solvent input volumes. Because of limitations in obtaining homogeneous packed beds with these narrow-diameter columns, plate numbers sometimes are less than that obtained with comparable 0.46-cm-ID columns. Also, extra-column effects are often of overriding importance here, and special instrument components may be required for acceptable results, especially for column diameters of less than 0.3 cm.

As indicated in Table 5.5, semi-preparative and preparative stainless-steel columns with compression fittings are widely available in internal diameters ranging from 0.8 to 5.0 cm. (Even larger internal diameters are commercial, but these usually are more suited for pilot-plant and process operation.) Larger, less efficient particles (e.g., 10 to 15 μm) often are packed in these semipreparative and preparative columns. Column efficiency is not as important when separating with a higher sample load (see Section 13.4).

Not listed in Table 5.5 are packed capillary columns of fused silica with internal diameters as small as 50 μm . Available from a few suppliers, these columns largely are used to interface with mass spectrometers and are not well suited for most routine applications. A typical column dimension for this application is 25 or 50 cm \times 380 μm ID. Particles used in this configuration generally are 3 or 5 μm , but smaller particles have been reported. Special instrumentation is definitely required when using these columns because of very small peak volumes and the likelihood of extra-column peak broadening.

5.2.3 Stationary Phases

5.2.3.1 Bonded Silanes. Silica-based reversed-phase packings typically are made by covalently bonding an organosilane or by depositing a polymeric organic layer on the support surface. Most widely used are packings with surface-reacted organosilanes using the reactions shown in Fig. 5.7. Many bonded-phase packings are made with monofunctional reagents, as shown in Fig. 5.7a. Some commercial packings use a polymerized surface layer resulting from the reaction of trifunctional (also sometimes bifunctional) silanes with the silica surface (Fig. 5.7b and c). The approach in Fig. 5.7c is typically carried out with R groups that would react with chlorosilanes (e.g., amino or diol phases). These reactions usually involve trifunctional silanes [e.g., $(\text{EtO})_3\text{-Si-(CH}_2)_3\text{-NH}_2$] that are more difficult to reproduce.

Figure 5.8 shows various types of covalently bonded silanes used with silica supports. Figure 5.8a illustrates the lightly vertical-polymerized phase from the reaction of di- or trifunctional silanes. Polymeric bonded phases from such reactions may be more stable than monomeric phases at low pH. However, packings made in this manner can be more variable with respect to retention

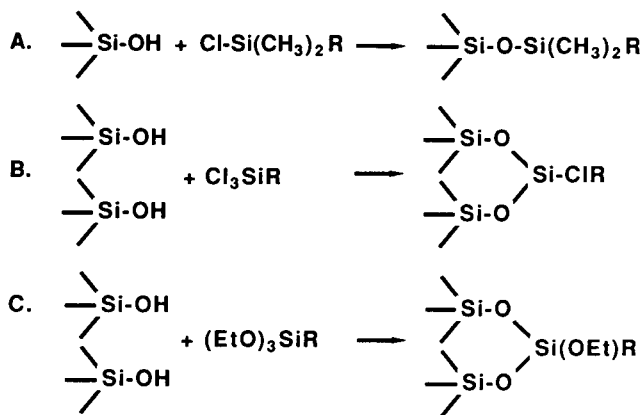

FIGURE 5.7 Chemistry of bonded-phase packings. (a) Reaction of surface silanol with chlorodimethylsilane; (b) reaction of surface silanols with trifunctional silane; (c) reaction of surface silanols with trifunctional alkoxy silane.

and selectivity compared with monofunctional phases. Figure 5.8*b* shows another type of bonded silane surface, called *horizontal polymerization*. These materials have been reported to exhibit superior stability in low- and high-pH environments [35], but definitive application data regarding retention, stability, and reproducibility characteristics are not available.

A wide variety of column packings with the monomeric structures illustrated in Fig. 5.8*c* and *d* are commercially available. The most commonly used process (Fig. 5.7*a*) involves the reaction of monofunctional chlorodimethylsilanes with silanol surface groups. Various alkyl and substituted alkyl silicas are made by this reaction, for example, *n*-octadecylsilane (ODS or C₁₈) bonded-phase materials. An advantage of monofunctional silane reactions as in Fig. 5.7*a* is that they are reproducible. One silanol group reacts with one silane molecule, producing predictable structures. Packings made by this route often exhibit the highest efficiency because of fast diffusion in and out of the thin stationary-phase layer (favorable kinetics). Available in this group are both dimethyl-substituted and the sterically protected structures discussed below.

Many manufacturers attempt to densely (“completely”) react the silica surface with the silane. However, because of the steric bulk of the bonded-phase ligands, all of the silanol groups on the surface cannot be reacted. As shown in Table 5.6, as the chain length or bulk of the silane increases, the percent of reacted silanol groups decreases. Even with the smallest silane (trimethyl or C₁), almost 50% of the silanol groups remain unreacted on the surface. These silanol groups are located under an “umbrella” of organic silane ligands but are still available for electrostatic interaction with appropriate solutes. Techniques to minimize the undesired effects of residual silanol groups while developing reproducible and rugged methods are the subject of Chapter 7.

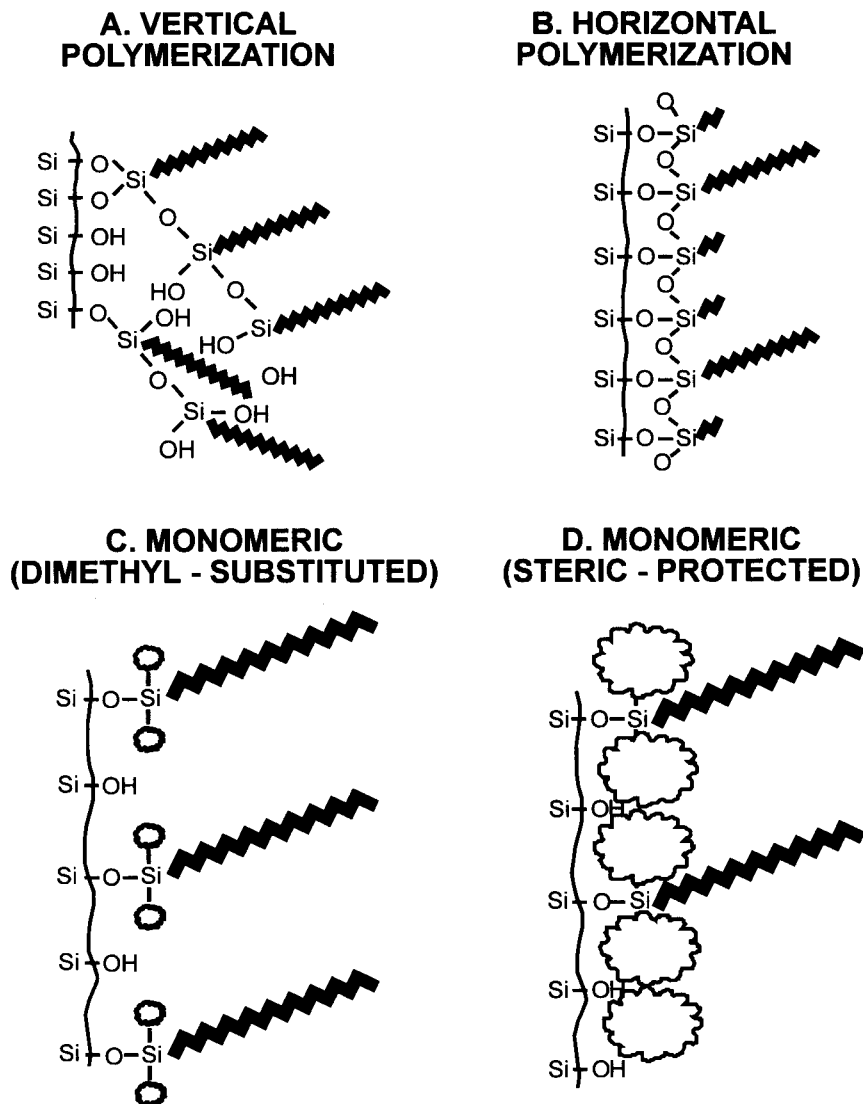

FIGURE 5.8 Types of C_{18} silane bonded phases. (Reprinted with permission from Ref. 34.)

Some manufacturers of columns with silane bonded phases (e.g., C_8 , C_{18}) use a process called *endcapping* to fully react (silanize) the silica support surface. Endcapping consists of a subsequent reaction of the bonded packing with a small silane such as trimethylchlorosilane, dimethyldichlorosilane, or (less often) hexamethyldisilazane. This approach increases coverage of the support by reacting some residual silanol groups to minimize unwanted interactions with solutes. However, endcapping cannot completely overcome the

TABLE 5.6 Effect of Silane Bonded-Phase Chain Length and Bulk on Silica Surface Coverage

Bonded Phase	Surface Coverage ($\mu\text{mol}/\text{m}^2$)	Reacted Silanols ^a (%)
Trimethyl	4.1	51
Dimethyl-3-cyanopropyl	3.6	45
Dimethyl- <i>n</i> -butyl	3.5	44
Dimethyl- <i>n</i> -octyl	3.2	40
Dimethyl- <i>n</i> -octadecyl	2.7	34
Triisopropyl	2.2	28
Diisopropyl-3-cyanopropyl	2.1	26
Diisopropyl- <i>n</i> -octyl	2.0	25
Diisobutyl- <i>n</i> -octadecyl	1.9	25

Source: Taken partially from Ref. 36.

^a Based on $8 \mu\text{mol}/\text{m}^2$ for fully hydrolyzed, unmodified silica.

disadvantages of an acidic silica support. Unfortunately, the small endcapping group can be readily hydrolyzed from the packing in reversed-phase separations at low pH, making this approach of questionable merit for rugged, long-term applications at $\text{pH} < 3$ [36]. Studies suggest that endcapped columns may be more stable at intermediate and higher pH (6 to 9) because of better protection of the silica support against dissolution [37].

5.2.3.2 Other Stationary Phases. Other methods of covalently attaching organic stationary phases have been reported [38,39], but commercial products based on these procedures are not now available. As mentioned previously, some column packings contain stationary phases prepared by polymerizing various monomers on a support. Polybutadiene-modified alumina and zirconia column packings and other polymeric stationary phases have been commercialized [40,41]. However, columns with these types of polymeric stationary phases have not reached a high level of popularity, perhaps because they offer no distinct advantages over more conventional bonded-phase column packings.

5.2.3.3 Retention of the Bonded Phase in RPC. The concentration of organic stationary phase (e.g., percent carbon) for a bonded-phase packing is a rough guide to the level of retention provided by a particular column. The surface area of the bonded-phase support is a major factor; the larger the surface area, the greater is retention (k). For separations involving only hydrophobic interactions, retention tends to increase with percent carbon, as long as the organic ligands are completely accessible to solutes. Solute retention sometimes takes place by a mixed mechanism involving hydrophobic interactions with the organic stationary phase and normal-phase interaction with the silanol groups on a silica support (Fig. 6.27c and related discussion). In this case, percent carbon will be less significant as an indicator of column retention.

Sample retention normally increases for bonded phases of greater length ($C_{18} > C_8 > C_3 > C_1$), but there is not much difference among longer-chain packings (i.e., $C_8 \approx C_{18}$). Sample retention can be controlled to a limited extent by the choice of bonded phase, but retention changes also result from changes in the surface area of the column packing and the type of silica support used. Figure 5.9 shows k values for several neutral, basic, and acidic compounds on a wide variety of bonded-phase C_{18} and C_8 columns from many manufacturers. Also given are the void volumes for these columns (measured by the unretained uracil marker), and whether the test compounds produced tailing peaks with the mobile phase used. The columns in this figure are arranged in decreasing order of retention for the neutral solute, toluene, representing retention only by hydrophobic interaction. The retention order of pyridine and phenol and pyridine and 4-butylbenzoic acid are indicative of different column selectivities. Peaks with tailing factors above 2.0 are listed as tailing peaks. Tailing peaks do not necessarily indicate a "bad" column, since the mobile phase was not optimized for these columns. The tests probes were chosen to show column differences and to test column performance.

5.2.3.4 Stability of Bonded-Phase Columns. The stability of bonded-phase packings is especially important in method development. Once the desired separation is obtained, column characteristics should remain unchanged for as long as possible. Good column stability minimizes the need for further adjustment of separation conditions or replacement of the column. When used under the same conditions, longer-chain alkyl-bonded-phase packings (e.g., C_{18} and C_8) are more stable than short-chain bonded phases. This feature is illustrated by the data in Fig. 5.10. Here a series of monomeric, dimethylsilane-modified phases were challenged continuously with aggressive 0.1% trifluoroacetic acid–acetonitrile (pH \approx 2) gradients at 50°C. Following each gradient, the k value for a neutral solute, 1-phenylheptane, was measured isocratically with a 1:1 mixture of 0.1% trifluoroacetic acid–water and acetonitrile. Figure 5.10 plots % k (value of k divided by value of k at the beginning of the experiment) for each organic stationary phase as a function of the column volumes of mobile phase passing through the column. (Note: 3000 column volumes for a 15×0.46 -cm column are about equivalent to 4500 mL of mobile phase or 2 weeks of 8-hour working days). The % k values in this figure are proportional to the quantity of stationary phase left in the column. The longer-chain C_{18} and C_8 ligands clearly are more stable in this test (less change in retention because of bonded-phase loss), which is one reason these phases are preferred by many users. As chain length decreases, the stability of the stationary phase also decreases, with the C_1 (trimethyl) phase being the least stable.

The stability (and lifetime) of silica-based bonded-phase columns is directly related to the types of silica supports and bonded phases. Column stability also is strongly dependent on mobile-phase pH and the type of buffer and organic modifier used. Loss of silane bonded phases (as in Fig. 5.10) results

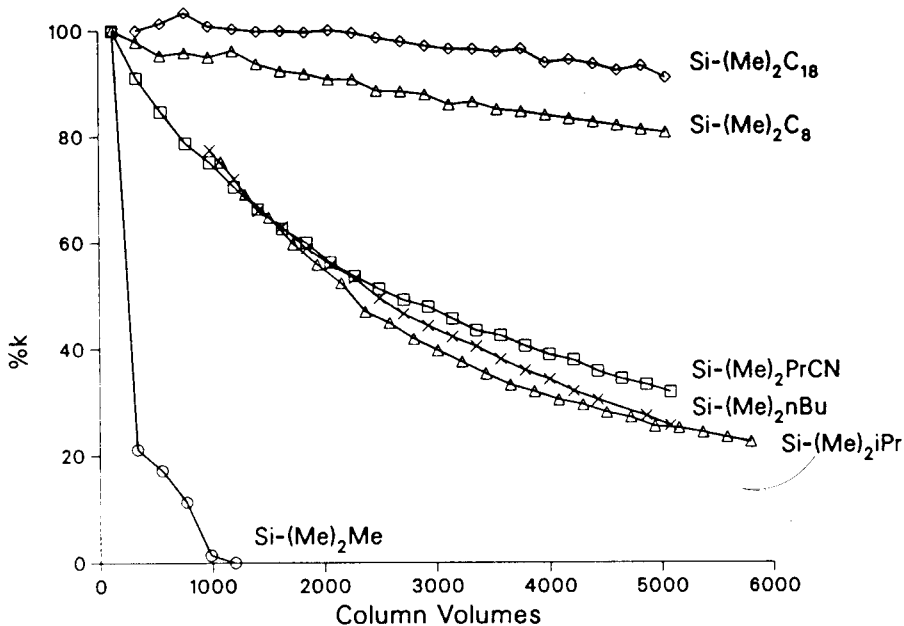

FIGURE 5.10 Effect of silane chain length on bonded-phase stability at pH 2. Columns: 15×0.46 cm; test: 0.1% trifluoroacetic acid-acetonitrile gradient, 0 to 100% in 80 min, flow rate: 1.0 mL/min; measurement: k of 1-phenylheptane at 50% acetonitrile-water with 0.1% trifluoroacetic acid; 50°C . (Reprinted with permission from Ref. 36.)

from hydrolysis of the Si—O—Si bond that binds the silane to the support. This degradation is accentuated at higher temperatures, low pH, and highly aqueous mobile phases, which are preferred conditions for many separations (see Section 7.3). As mentioned previously, polymerizing the silane stationary phase improves the stability of the bonded phase at low pH; however, column reproducibility may be compromised.

Another way to improve the stability of silane stationary phases at low pH is to use sterically protected functional groups [36,42,43]. Bulky monomeric silanes can minimize the hydrolysis of a silane covalently attached to the silica support, as illustrated in Fig. 5.11. Each Si—O—Si bond is individually protected because of the size of the two isobutyl groups attached to the silane Si atom. The use of sterically protecting functional groups is well known in solution chemistry, and this concept has been extended to the surface of chromatographic packings. Because of the steric bulk of the sterically protecting silane groups (e.g., diisopropyl, diisobutyl), packings made with this approach contain less carbon (lower surface coverage) and exhibit less retention than the conventional dimethyl-substituted bonded phases, as suggested by data in Table 5.6.

Sterically Protected Silane Resists Hydrolysis

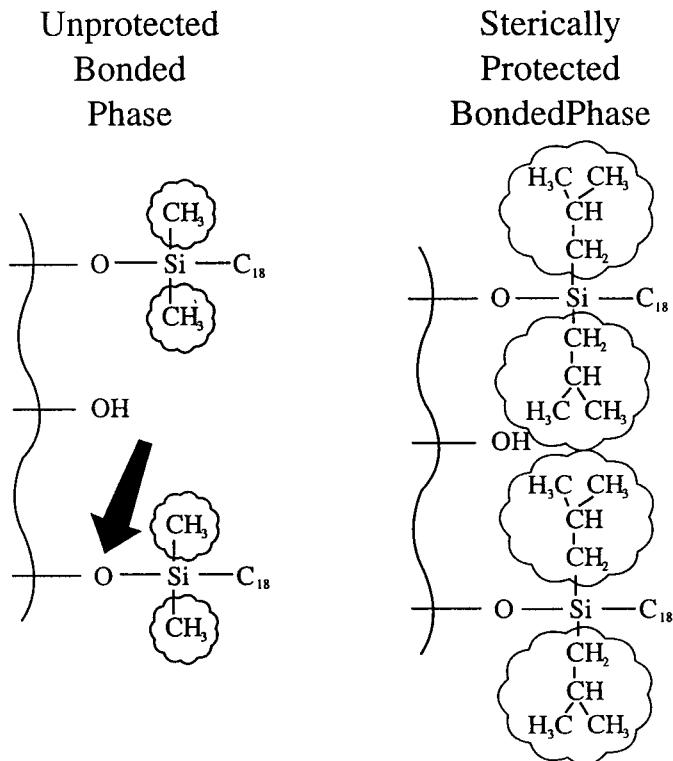

FIGURE 5.11 Hydrolysis of Si—O—Si bond of silane bonded phases. (Reprinted with permission from Ref. 44.)

The higher stability of sterically protected silica-based stationary phases is illustrated in Fig. 5.12, which compares different commercial C_{18} column packings tested under highly aggressive conditions. Diisobutyl- C_{18} columns made with both 8- and 30-nm pore size silica support show essentially no change in relative toluene retention after purging with more than 27,000 column volumes of a methanol–1% trifluoroacetic acid (pH \approx 0.9) mobile phase at 90°C. Sterically protected stationary phases are especially useful with short-chain silanes, shown previously (Fig. 5.10) to be less stable to degradation by hydrolysis. Figure 5.13 compares the stability of 3-cyanopropylsilane (CN) phases for monomeric dimethyl- and diisopropyl-substituted bonded silanes (pH 2.0, 50°C). The higher stability of sterically protected bonded phases is especially useful for maintaining stable and reproducible separations of biologicals such as peptides and proteins (Section 11.2). For these separations, the mobile phase

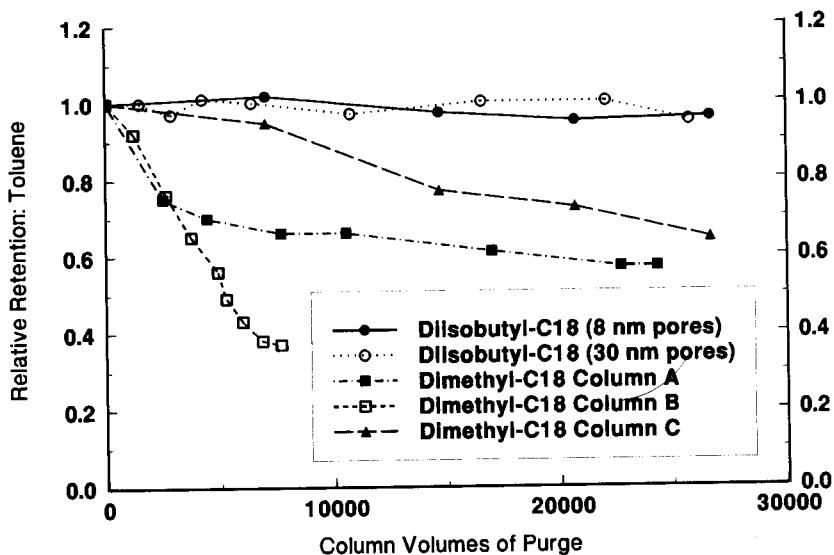

FIGURE 5.12 Silane bonded-phase degradation at low pH, high temperature. Columns: 15×0.46 cm; mobile phase: 50% methanol-water + 1.0% trifluoroacetic acid ($\text{pH} \approx 0.9$); flow rate: 1.0 mL/min; 90°C ; test with toluene as in Fig. 5.10. (Data taken with permission partly from Ref. 34.)

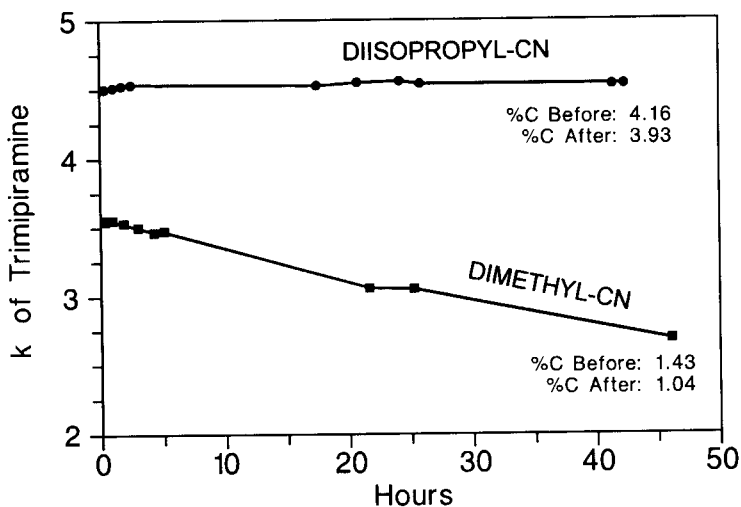

FIGURE 5.13 Comparison of stability for short-chain cyano-bonded phases. Columns: 15×0.46 cm; mobile phase: 28:72 acetonitrile-0.1% trifluoroacetic acid adjusted to $\text{pH} 2.0$ with triethylamine; flow rate: 1.0 mL/min; 50°C .

is usually maintained at a low pH (typically, $\text{pH} \approx 2$), and it is often desirable to carry out such separations at higher temperatures (see Ref. 45 and Section 11.2).

Although most separations are best performed at low pH ($\text{pH} \leq 3$; see Chapter 6), some separations are performed at higher pH because:

1. Compounds of interest are unstable at low pH.
2. Needed selectivity is not available at low pH (and a pH change must be used).
3. Protonated (hydrophilic) basic compounds are too poorly retained at low pH.

As mentioned previously, some silica-based columns should not be used at $\text{pH} > 8$ because of rapid dissolution of the silica support and a resulting collapse of the column bed. Studies with higher pH mobile phases have shown that the Si—O—Si group connecting the silane to the silica support is slowly (if at all) attacked [5,34]. Rather, loss of silane bonded phase with higher pH mobile phases apparently is caused by dissolution of the silica support. In this way, bonded silane is undermined and ultimately falls from the surface.

Other studies suggest that column degradation at high pH is highly dependent on the type of silica support and the nature of the silane stationary phase [5,37,46]. For example, the data in Fig. 5.14 show that densely bonded dimethyl- C_{18} phases on certain highly purified silicas (open symbols) exhibit unusual stability at pH 9, based on changes in column efficiency (plate heights). (Since k values for bonded phases decrease only slowly with aging at high pH, retention is a less accurate measure of column stability. Plate height and peak symmetry are better guidelines.) The data in Fig. 5.14 and other reports suggest that silica supports made by the sol-gel process (i.e., aggregation of silica sols) are useful up to at least pH 9 with certain mobile phases. Columns of fully reacted, endcapped alkyl bonded phases on sol-gel silicas can be routinely used up to at least pH 11, providing organic buffers and $< 40^\circ\text{C}$ operation are maintained [46,46a]. On the other hand, packings with silicas made by the silicate-gel process (gelation of soluble silicates—solid symbol in Fig. 5.14) degrade more rapidly [5].

Degradation of silica-based columns at intermediate and high pH is minimized by using endcapped column packings [37,46a]. Apparently, the added reaction of silanol groups by small endcapping silanes creates a more effective hydrophobic barrier that retards dissolution of the silica support. Figure 5.15 shows that the k increase of a strongly basic drug, trimipramine, for an endcapped C_8 column is much lower than that for a comparable non-endcapped C_8 column when both were purged with a strongly aggressive pH 7 phosphate mobile phase at 60°C . These results indicate that acidic silanol groups exposed

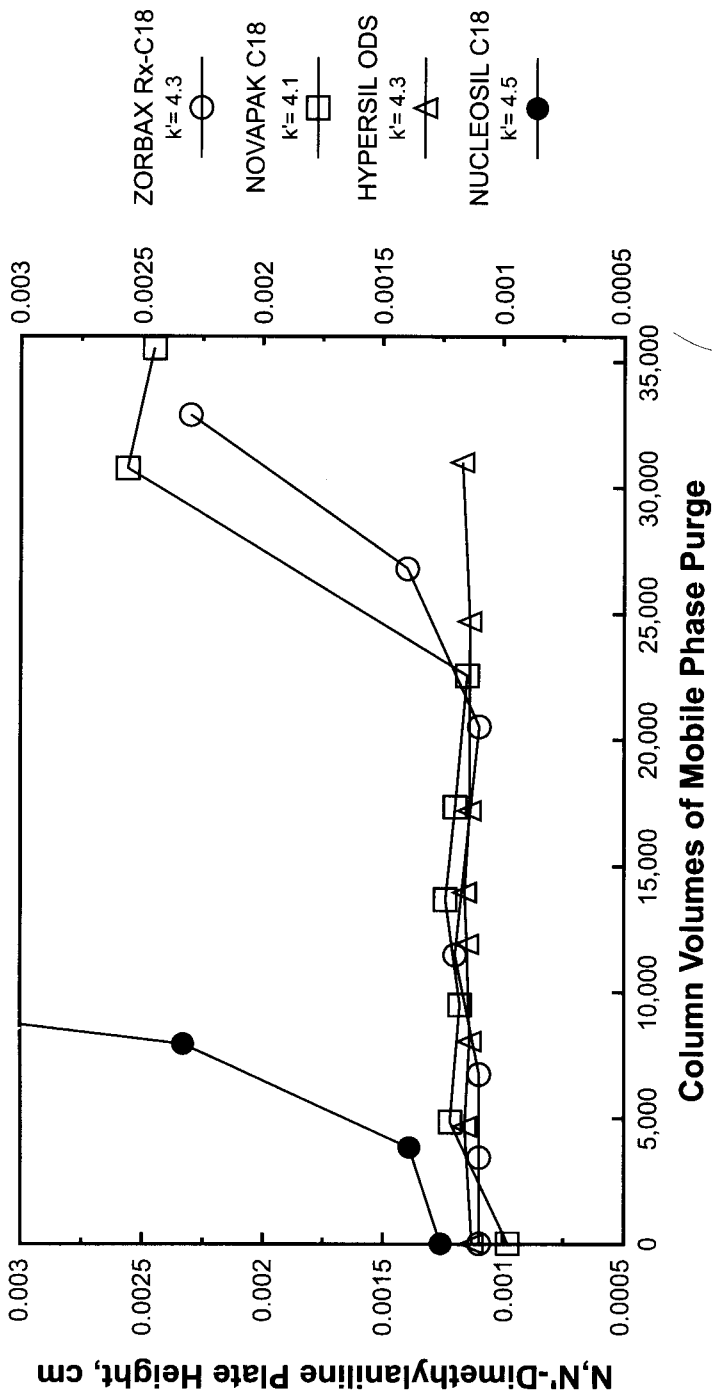

Column Volumes of Mobile Phase Purge

FIGURE 5.14 Stability of C₁₈ columns at pH 9. Columns: 15 × 0.46 cm; mobile phase: 1 : 1 acetonitrile–0.01 M phosphate, pH 9.0; solute: *N,N'*-dimethylaniline; flow rate: 1.0 mL/min; 22°C. (Reprinted with permission from Ref. 34.)

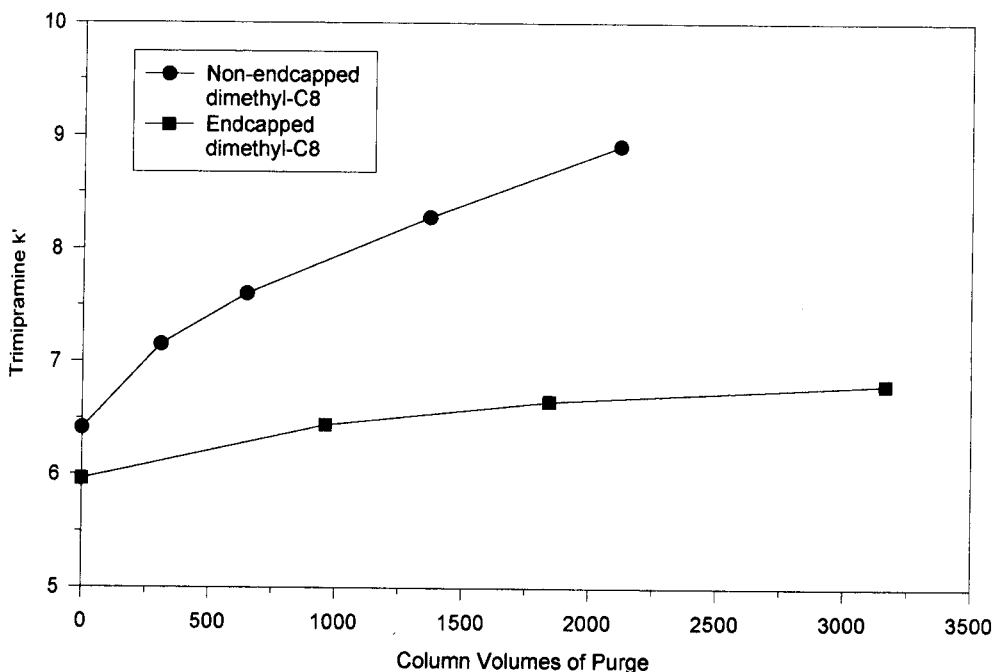

FIGURE 5.15 Comparative stability of non-endcapped and endcapped C₈ columns. Columns: 15 × 0.46 cm, dimethyl-C₈ and double-endcapped dimethyl-C₈ (Zorbax XDB-C8) purge: 20% methanol–80% 0.25 M sodium phosphate buffer, pH 7.0; 60°C; 1.0 mL/min; test: 60% acetonitrile–40% sodium phosphate buffer, 0.01 M, pH 7.0; 1.5 mL/min; 40°C. (Reprinted with permission from Ref. 37.)

by dissolution of the silica support surface by this mobile phase caused additional retention of the basic drug. This undesirable effect was inhibited by endcapping groups on the endcapped column.

The rate of degradation for silica-based columns at intermediate and high pH also is strongly influenced by the mobile phase used and the operating temperature [46,46b]. Therefore, steps should be taken to reduce the rate of solubility of the silica support used for bonded-phase columns. Systematic silica-support dissolution and chromatographic column stability studies at intermediate and high pH have shown that the approaches in Table 5.7 should be followed for developing rugged HPLC methods at pH 7 or greater [5,46].

Although further studies are needed to better define the conditions and limits of high-pH operation with silica-based columns, it is now clear (utilizing the conditions listed above) that certain silica-based columns can be used routinely at pH 9 and even higher pH. Figure 5.16 shows that the solubility of a silica-based C₁₈ bonded-phase column is measurably decreased (and column lifetime increased) by using borate or glycine buffers (also other

TABLE 5.7 Approaches for Developing Rugged Methods at pH 7 or Greater

Use densely bonded (full reacted) long-chain alkyl stationary phases (C_{18} , C_8 , etc.) for best column lifetime.

Use silica supports made from the sol-gel process (Hypersil, Kromasil, Spherisorb, Zorbax) to minimize silica support degradation.

Use organic, citrate, and borate buffers to minimize silica support dissolution (avoid phosphate, ammonium, and carbonate, if possible).

Maintain buffer concentration at 0.01 to 0.05 M .

Set column temperature at $\leq 40^\circ C$.

Use buffer cations $Li^+ > Na^+ > K^+ > NH_4$ for best column stability.

Use endcapped columns for greater column stability.

Add basic mobile-phase modifier (e.g., triethylamine) for superior long-term separation reproducibility.

organic-based buffers) rather than commonly used carbonate and phosphate buffers. Columns with silica supports made by aggregating silica sols (Zorbax, Hypersil, Spherisorb, Kromasil) are much more stable at intermediate and higher pH than are those prepared from conventional chromatographic silicas of the xerogel type (silicate gel) [37,46].

Densely bonded and carefully endcapped alkyl-bonded columns made from sol-based silicas can be used routinely to at least pH 11, provided that appro-

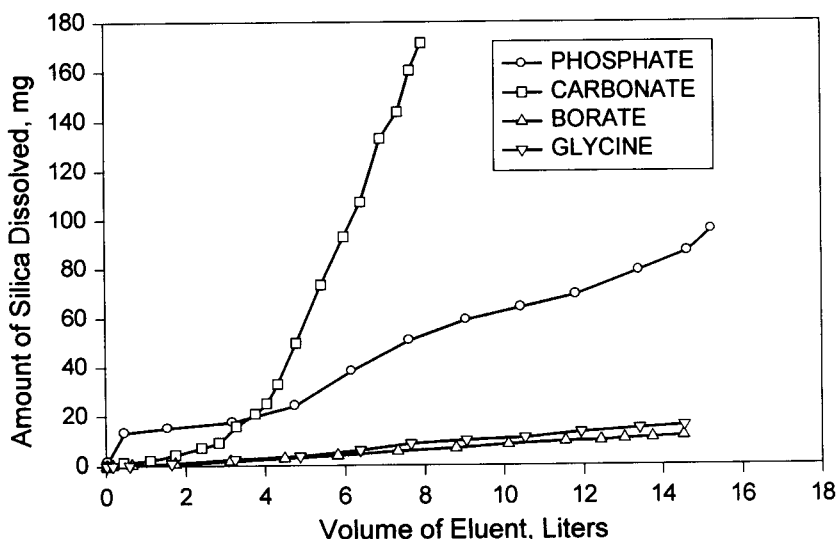

FIGURE 5.16 Effect of pH 10 buffer anions on silica support dissolution. Columns: Zorbax Rx-C18, 15×0.46 cm; continuous nonrecycled purge: 50% methanol-50% 0.1 M buffers, pH 10; 1.0 mL/min; $25^\circ C$. Dissolved silica by silicomolybdate color reaction. (Reprinted with permission from Ref. 46.)

appropriate operating conditions are used [37,46a]. High-pH conditions are favorable for separating basic compounds, since they are in a free, non-ionic state. Also, with silica-based columns, unreacted silanol groups are totally ionized at high pH, creating a less interactive surface than at intermediate pH where silanol groups can be only partially ionized. However, for high-pH operation with silica-based columns, certain operating conditions apparently must be used to minimize silica support dissolution:

- Less-soluble supports made from sol-gel silicas
- Densely bonded, highly endcapped packings with longer-chain alkyl ligands
- Organic or borate buffers (avoid phosphate and carbonate!)
- Operating temperature of $\leq 40^{\circ}\text{C}$

Figure 5.17a shows the initial separation of a mixture of strongly basic β -blocker drugs ($\text{p}K_a = 9.5$ to 9.7) for a densely bonded and endcapped C_8 column, using the above conditions. Figure 5.17b shows the same column after about 31,000 column volumes of a pH 11 mobile phase (approximately three months of 8-hour-day operation). Even under these high-pH conditions, this silica-based column exhibited excellent peak shape, good efficiency, and adequate stability for routine operation. Note, however, that shorter column lifetime can always be expected when operating silica-based columns at pH values above 8.

5.2.4 Sources of Retention and Selectivity Variability

Changes in retention and selectivity due to differences in bonded-phase columns with the same functionality (i.e., C_{18} , C_8 , etc.) come from several sources:

- Differences in the silica support
- Choice of silane: monofunctional or polyfunctional
- Completeness of bonding: partially or fully reacted
- Presence or absence of endcapping
- Bonding chemistry
- Support surface area

Each of these factors can render the final HPLC method less reproducible. Retention and selectivity variations due to differences in the silica support were discussed earlier in the chapter. For example, retention variations can be caused by surface area differences. Increasing the surface area of the support increases the amount of organic stationary phase and retention. Both retention and especially selectivity differences can arise from differences in the type and concentration of silanol groups on the silica support surface.

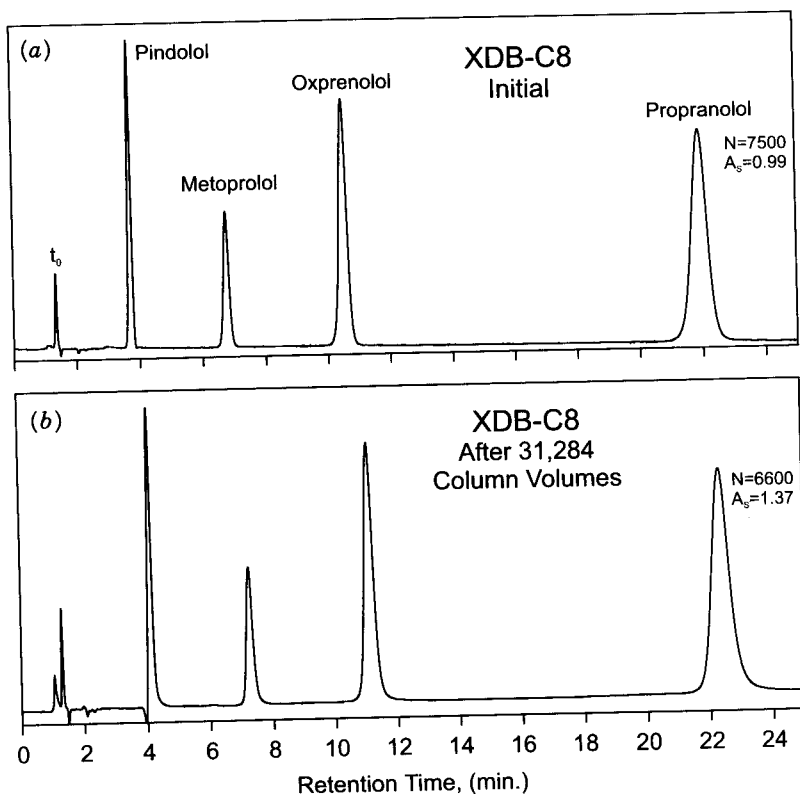

FIGURE 5.17 Stability of silica-based bonded-phase column at pH 11. Column: 15×0.46 cm, double-encapped dimethyl-C8 (Zorbax XDB-C8); mobile phase: 55% methanol–45% 0.05 M 1-methylpiperidine–HCl, pH 11.0; flow rate: 1.0 mL/min; 24°C ; UV detector, 215 nm; sample: pindolol, metoprolol, oxprenolol, and propranolol, $\text{p}K_a = 9.5$ to 9.7 (0.165, 0.413, 0.413, and 0.083 mg/mL, respectively); 5- μL injection. (Adapted from Ref. 46a)

Separations of basic compounds with columns made from the less acidic, more highly purified (type B) silica supports show less variation from lot to lot, even from different manufacturers. In any case, methods developed on a given column should be confirmed (validated) for at least two other lots before adoption (see Section 15.9). Columns of the same kind (e.g., C_{18}) from different manufacturers rarely will give the same separation [47].

Separations with columns made from monofunctional silanes are more reproducible from batch to batch than are columns prepared from polyfunctional silanes. Fully reacted (densely bonded) packings are more reproducible and more stable than are packings with partially reacted (lower-silane-concentration) surfaces. (Partially reacted supports can usually be identified when the coverage is substantially less than the values given in Table 5.6).

Significant selectivity differences may also occur for fully vs. partially reacted packings of the same bonded phase (e.g., C₁₈). Selectivity and peak shape differences can be seen between packings that are endcapped, depending on the particular sample being separated. Finally, differences in the silanization reaction conditions can result in retention variations between similar bonded-phase packings from different manufacturers. For method development, many users prefer monofunctional-silane bonded-phase packings that are fully reacted. Column packings that have different stationary-phase functionalities are summarized in Table 5.8 with comments on their applicability for method development.

5.3 COLUMN SPECIFICATIONS

The requirements for a given separation usually determine the type and configuration of the column to be used (particle size, length, internal diameter, etc.). In Section 2.3.3 we discuss the value of columns with different lengths and particle sizes. There are many possible suppliers for a given type of column; however, these columns can vary greatly in performance. Therefore, certain information concerning column specifications and performance is needed for use in method development and subsequent routine operation. Column requirements of interest include:

- Plate number N for a given value of k
- Peak asymmetry factor (A_s)
- Selectivity (α) value for two different solutes
- Column back pressure
- Retention (k) reproducibility
- Bonded-phase concentration (if applicable)
- Column stability

Where possible, information on these features should be obtained from the column manufacturer before purchase. Many manufacturers provide data on individual columns for the first four items above, including a test chromatogram for each column. Some manufacturers include data regarding retention reproducibility. Data on bonded-phase concentration and column stability is rarely available but may be found for some columns in scientific publications. Some suppliers warrant their columns (e.g., 60 days) so that the user is assured of a certain level of performance and lifetime.

5.3.1 Plate Number

The column plate number (N) is an important characteristic of a column. N defines the ability of the column to produce sharp, narrow peaks for achieving

TABLE 5.8 Useful Column Packings for HPLC^a

Method	Comments
Reversed-phase (and ion-pair) method	
C ₁₈ (octadecyl or ODS)	Rugged; highly retentive; widely available
C ₈ (octyl)	Similar to but slightly less retentive than C ₁₈
C ₃ , C ₄	Less retentive; used mostly for peptides and proteins
C ₁ [trimethylsilyl (TMS)]	Least retentive; least stable
Phenyl, phenethyl	Moderately retentive; some selectivity differences
CN (cyano)	Moderately retentive; used for both reversed and normal phase
NH ₂ (amino)	Weak retention; used for carbohydrates; less stable
Polystyrene ^b	Stable with 1 < pH < 13 mobile phases; better peak shape and longer column life for some separations
Normal-phase method	
CN (cyano)	Rugged; fairly polar; general utility
OH (diol)	More polar than CN
NH ₂ (amino)	Highly polar; less stable
Silica ^b	Very rugged; cheap; less convenient to operate; used in prep LC
Size-exclusion method	
Silica ^b	Very rugged; adsorptive
Silanized silica	Less adsorptive, wide solvent compatibility; used with organic solvents
OH (diol)	Less stable; used in aqueous SEC (gel filtration)
Polystyrene ^b	Used widely for organic SEC (GPC); generally incompatible with water and highly polar organic solvents
Ion-exchange method	
Bonded phase	Less stable and reproducible
Polystyrene ^b	Less efficient; stable; more reproducible

^a Silica-based bonded phases, except as noted.

^b No bonded phase on these packings.

good resolution of band pairs with small α values. The measurement of column plate number is discussed in Section 2.3.3. Table 5.9 shows typical plate numbers (small, neutral sample molecules, MW \approx 200) for well-packed HPLC columns of various lengths and particle sizes. Note that these values are obtained under "optimum" conditions—low-viscosity mobile phases and a flow rate of 0.5 to 2.0 mL/min. The following equation can be used to estimate the column plate number for small molecules under these optimum conditions:

$$N \approx \frac{3500L \text{ (cm)}}{d_p \text{ (\mu m)}} \quad (5.1)$$

Where L is column length and d_p is the particle diameter.

Most manufacturers specify the conditions they use to measure N . This test can be repeated if a problem arises with the column. If the plate number for a new column is significantly lower ($N < 80\%$ of the claimed value), the column should be returned to the manufacturer for replacement or refund once the possibility of an instrument problem has been eliminated. Instrument and related extra-column problems are common with very short or small-bore columns, resulting in lower-than-expected column plate numbers.

For an existing HPLC method, the plate number of a new column should be determined for a particular sample compound, using standard (specified) separation conditions. Since column plate number is dependent on specific experimental factors, values for compounds of interest may be smaller than the optimum value measured for a small neutral solute. For large solute molecules or viscous mobile phases, the value of N may be only a fraction (e.g., one-half or one-third) of the optimum value. Secondary retention for some solutes (i.e., from silanol effects) also can cause broader peaks and a smaller-than-expected plate number. Possible problems should be anticipated, and appropriate columns and mobile phases should be selected accordingly. If deleterious silanol effects are still found as method development proceeds, corrective action should be taken at the earliest possible time. The use of certain columns and the addition of certain mobile-phase modifiers can often correct such problems, as discussed in Section 7.3.

Some users maintain a systematic record of N values vs. time or number of injected samples for compounds of interest, so that column efficiency is

TABLE 5.9 Plate Number for Well-Packed HPLC Columns Under Optimized Test Conditions

Particle Diameter (μm)	Column Length (cm)	Plate Number N
10	15	6,000–7,000
10	25	8,000–10,000
5	10	7,000–9,000
5	15	10,000–12,000
5	25	17,000–20,000
3	5	6,000–7,000
3	7.5	9,000–11,000
3	10	12,000–14,000
3	15	17,000–20,000

known at any time. This record helps the operator to monitor column performance and anticipate when column replacement (or repair) is required. A record of N values vs. some measure of use also is useful for judging the overall performance of columns from a particular manufacturer.

As discussed in Section 9.1.1.2, 15- or 25-cm columns of 5- μm particles are preferred as a starting point for method development. This configuration provides a large enough N value for most separations, and such columns are quite reliable. A particular advantage of initially using a column with large N values is that closely overlapping peaks are more easily recognized. If a larger N value is required for a particular separation, additional column lengths can be connected with low-volume fittings.

Short columns of 3- μm particles are useful for carrying out very fast separations (e.g., < 5 min.). However, columns of particles smaller than 3 μm often are less suited for routine applications since they are (1) more susceptible to sampling problems, (2) more operator dependent, and (3) more affected by instrumental band-broadening effects. However, as mentioned previously (Section 5.2.2), studies suggest that the use of closely sized 3.5- μm particles is a practical alternative that minimizes these problems [32]. Figure 5.18 shows an example of a rapid separation produced by a column of 3.5- μm particles. With this separating system, good plate numbers and band symmetries were found for large acidic antibiotics separated rapidly at a high mobile-phase flow rate.

5.3.2 Peak Asymmetry and Peak Tailing

While the column plate number is a useful measure of column quality, peak shape is equally important in method development. Columns and experimental conditions that provide symmetrical peaks always are preferred. Peaks with poor symmetry can result in:

- Inaccurate plate number and resolution measurement
- Imprecise quantitation
- Degraded resolution and undetected minor bands in the peak tail
- Poor retention reproducibility

A useful and practical measurement of peak shape is the peak asymmetry factor, A_s , calculated as in Fig. 5.19 [48]. Peak asymmetry is measured at 10% of full peak height. Good columns produce peaks with A_s values of 0.95 to 1.1 (exactly symmetrical peaks have an A_s of 1.0). For accurate measurement of symmetry, bands should be measured with a magnified time scale. Asymmetrical bands often appear symmetrical when observed in a compressed (long-time-scale) chromatogram.

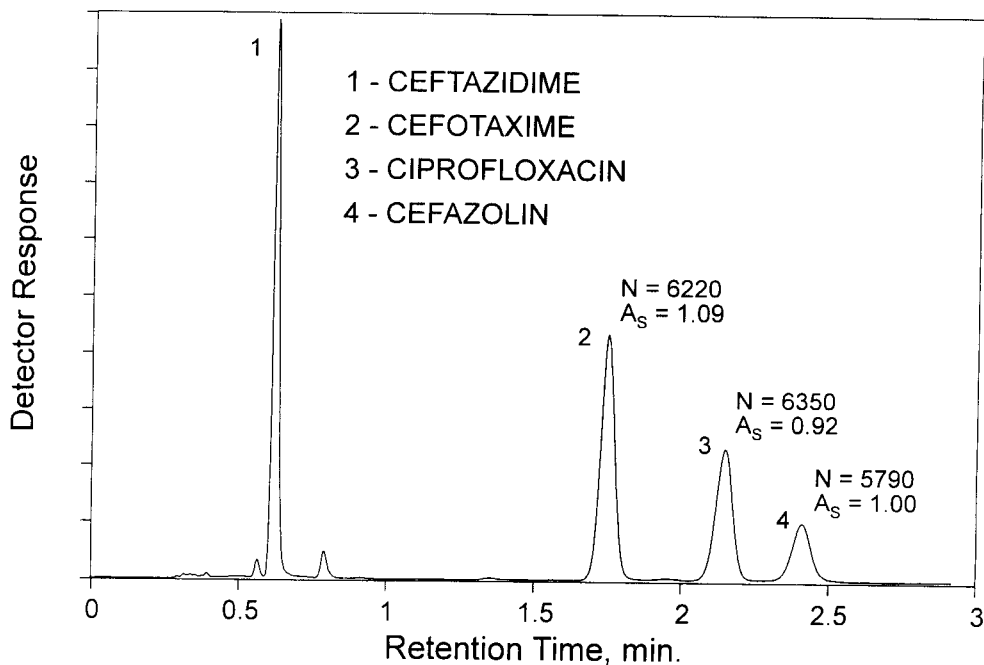

FIGURE 5.18 High-speed separation of antibiotics. Column: 8.0×0.46 -cm Zorbax SB-C8 ($3.5 \mu\text{m}$); mobile phase: 8:92 acetonitrile–0.1% trifluoroacetic acid; flow rate: 3.0 mL/min; sample: $1 \mu\text{L}$ containing 0.40, 0.36, 0.10, and $0.35 \mu\text{g}$ each of 1 to 4, respectively; 60°C ; 260-nm detection. (Reprinted with permission from Ref. 33.)

Figure 5.20 shows the effect of shape and width of bands for a range of A_s values. Manufacturers sometimes specify A_s values of 0.95 to 1.3 for new columns. Samples of interest generally should have A_s values of <1.5 . The separation of Fig. 5.18 shows peaks with A_s values of about 1.0 for antibiotic drugs. Another useful way to define peak shape is by the peak tailing factor (PTF) calculated as shown in Fig. 5.19. Some groups, such as the U.S. Pharmacopeia, prefer to specify peak symmetry by this method. In this approach the value is calculated at 5% of full peak height. Peak asymmetry and the peak tailing factors are easily interconverted, as shown in Table 5.10.

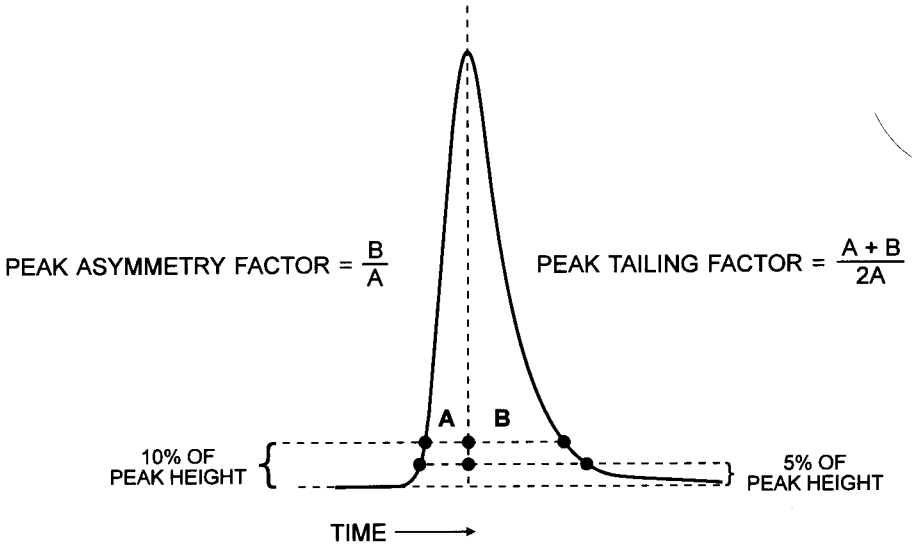

FIGURE 5.19 Determining peak asymmetry and peak tailing factors. (Reprinted with permission from Ref. 48.)

5.3.3 Column Failure: How Long Should a Column Last?

The stability and useful lifetime of a well-made column are dependent on how the operator uses and treats the column. All columns are expected to “die” eventually. A column should be replaced when it no longer provides the performance needed for the particular analysis. If the plate number decreases by 50%, or resolution falls to about three-fourths of the original value (e.g., to $R_s = 1.5$ from an initial 2.0 value), a new column may be required. A column whose performance has degraded somewhat may still be useful for a given assay. Increased peak asymmetry value, A_s , to >1.5 may also be a sign that the column should be changed. Although techniques described later

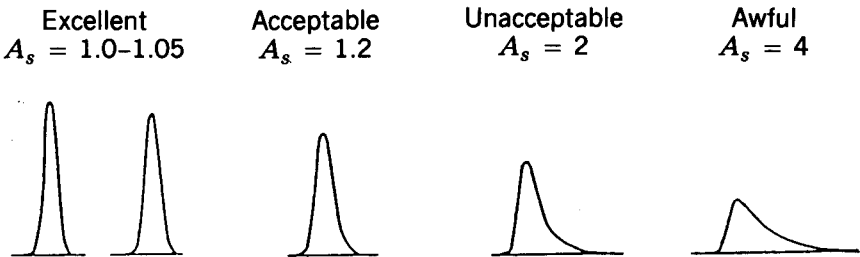

FIGURE 5.20 Peak shapes for different asymmetry factor values.

TABLE 5.10 Peak Asymmetry and Peak Tailing Factor Relationship

Peak Asymmetry Factor (at 10%)	Peak Tailing Factor (at 5%)
1.0	1.0
1.3	1.2
1.6	1.4
1.9	1.6
2.2	1.8
2.5	2.0

in this chapter are useful for rejuvenating columns whose performance has degraded, many labs do not attempt the regeneration of low-performance columns. The requirement to produce needed results rapidly often dictates that the column be replaced with a new one, so that the routine assay can be reestablished as soon as possible.

How long the column lasts before replacement is largely a function of the type of samples injected. Typically for clean samples, 1000 to 2000 analyses per column is reasonable. A clean sample refers to a homogeneous solution whose components are completely eluted during the time between sample injections (e.g., a formulated sample, a drug, or a reaction intermediate). However, the cautions discussed in preceding sections must be followed closely. For clean samples, column cost per analysis is about \$0.20, representing only about 1% of the total cost per analysis. For more complex and dirtier samples, or those in marginal assay conditions, 200 to 500 samples per column are reasonable. Here, column cost per analysis is about \$1, representing about 4% of the total cost per analysis. For samples of biological origin or highly complex materials (e.g., extracts of liver, highly organic soil, etc.), 50 to 200 samples per column is more typical. For these situations, column cost per sample is about \$3, representing only about 10% of the total cost per analysis. Since column costs per analysis are small, this is a strong argument that an efficient, well-performing column should always be in place during use of a developed method, to provide timely, high-quality results.

Note that the low cost of the column per sample combined with the high cost of sample pretreatment (filtration, extraction, etc.; see Chapter 4) may make some sample pretreatment procedures uneconomical. In those cases, it may be cheaper to minimize sample pretreatment and accept a shorter column life. Pretreatment steps also can decrease analysis precision and sometimes do not fit well into the routine of the laboratory. Of course, no compromise in other separation goals should be accepted merely to reduce column cost. Many labs also do not use guard columns because of cost and the inconvenience of knowing when to change guard columns and their cost. To increase column

lifetime, some laboratories use specially designed low-volume precolumn filters at the column inlet to remove particulates. However, these devices must be replaced periodically before they become plugged. Therefore, whether or not a sample should be pretreated depends on the sample itself and the analysis goals. Chapter 4 can help determine whether a sample should be pretreated prior to the analytical separation, and which approach might be best for a particular sample.

5.3.4 Retention Reproducibility

The reproducibility of retention times or k values among different columns can be specified by chromatographing a series of standards, preferably including both polar and nonpolar molecules. The column manufacturer often describes a test that can be used to evaluate the original column performance. This test can be repeated in the user laboratory periodically to determine the retention performance of different columns or the performance of a single column during use. Often, a more practical approach is for the user to identify a compound of interest (e.g., a drug), and to use this compound with typical operating conditions to follow retention reproducibility. Closely similar retention times (or k values) should be found for test compounds when run under standard conditions. The use of system suitability tests for routine analyses (Section 15.11) can provide these data if the separations are designed properly and the data recorded appropriately.

Long-term reproducibility of columns from the same manufacturer is an important factor for developing a rugged, repeatable method. Several manufacturers now claim long-term reproducibility of their bonded-phase columns. For example, Fig. 5.21 shows the manufacturing reproducibility for one commercial C_{18} column over a four-year period. Minor and equivalent changes in k values for toluene (neutral) and N,N -dimethylaniline (basic) indicate variations in the surface areas of the silica support during this period. The important requirement is that the selectivity value (α) for these two solutes remained stable during this production period. Few manufacturers supply information of this type, so the user must conduct such tests, if needed.

5.3.5 Pressure Drop

Similar column permeabilities or backpressures will be found for well-packed columns having the same operating conditions, column dimensions, and particle size. The pressure drop for columns packed with spherical particles can be approximated by

$$P = \frac{3000L\eta}{t_0 d_p^2} \quad (5.2)$$

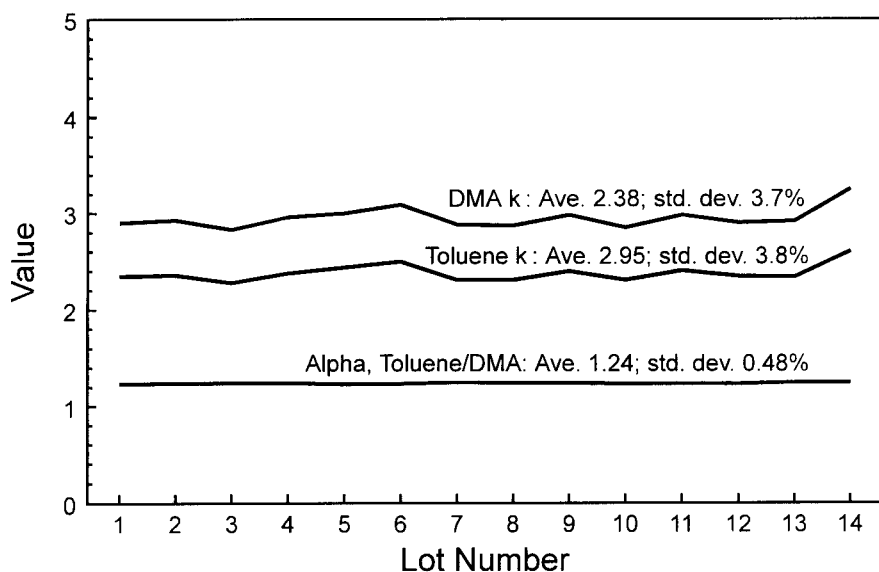

FIGURE 5.21 Four-year reproducibility of monomeric silane bonded-phase columns. Zorbax Rx-C18 production, 1990–1994; columns: 15×0.46 cm; mobile phase: 50:50 acetonitrile–0.1 mM NaH_2PO_4 ; flow rate: 1.6 mL/min; test solutes: *N,N'*-dimethylaniline and toluene; 22°C. (Reprinted with permission from Ref. 44.)

where P is the pressure (psi), L the column length (cm), η the mobile-phase viscosity (cP), t_0 the column dead time, and d_p the particle diameter (μm). New spherical-particle columns should have a pressure drop no greater than about 30% in excess of that predicted by Eq. 5.2. Columns packed with irregular particles may give higher backpressures. Some suppliers report a backpressure measured for a particular column under specified operating conditions.

5.3.6 Bonded-Phase Concentration (Coverage)

Well-made bonded-phase silica columns have a dense population of organic groups attached to the surface of the silica support. The actual coverage depends on the size of the organic ligand: high surface concentrations are more difficult to obtain with larger silane groups because of steric hindrance. Fully (densely) bonded packings will have surface concentrations for the different silane groups (micromoles of bonded phase per square meter of packing surface area) equivalent to those in Table 5.6, or greater. Columns with densely reacted, sterically protected groups have a lower concentration of silane groups (1.9 to 2.2 $\mu\text{mol}/\text{m}^2$) because of additional steric hindrance by the large protecting groups [36]. Better column-to-column retention reproducibility and column life can be expected for column packings with fully reacted surfaces as defined in Table 5.6.

5.4 COLUMN PROBLEMS AND REMEDIES

Problems often arise during the use of a column. In this section we consider how to recognize these problems and deal with them so that effective method development is possible. We now discuss the three most important kinds of problems in HPLC method development: (1) variability in retention and resolution, (2) band tailing, and (3) short column lifetime. Reference 49 should also be consulted for routine procedures relating to the preventive maintenance and repair of columns and equipment.

5.4.1 Retention and Resolution Irreproducibility

Reproducible retention and resolution for the peaks in a chromatogram are very important when developing routine methods. If sample retention is not repeatable from run to run, it is impossible to draw accurate conclusions concerning a desirable change in conditions for improved separations. For this reason it is important to check column retention during method development at least daily, using a particular set of conditions for this purpose. Values of k and α should not change by more than 2 to 3% over time. Changes in resolution (arising from change in k , N , or α) can be a function of (1) the column and its operation, (2) instrumental effects, or (3) variations in separation conditions. Table 5.11 summarizes the types of retention and resolution variation that can occur in HPLC and the causes for each variation.

TABLE 5.11 Retention and Resolution Variations in HPLC

Effect	Cause	Main Changes
Column-to-column differences	Variation in support, bonding	k , α
Column changes during use	Disturbance in bed	N
	Loss of bonded phase	k , α
	Dissolution of silica support	N
	Buildup of noneluted material	k , N
Extra-column effects	From system to system: large injection volume; large tubing volume between injection valve and column and/or column and detector; large detector volume; large volume fittings	N
Poor control of separation	Changes in mobile phase, composition	k , α
	Changes in flow rate	N^a
	Changes in temperature	k , α , N^a
Slow column equilibration	Insufficient re-equilibration time	k , α
Column overload	Too large a sample mass	k , N

^a Changes in N usually are small.

Columns must maintain constant retention and acceptable resolution during use. Otherwise, the accuracy and precision of the method are compromised, and new columns may be required frequently. Sometimes, a new column may give a different (unsatisfactory) separation. This may mean that the operating conditions for the method must be modified to reestablish the required separation. Often, the developed method will be transferred to another laboratory, where an equivalent column is required for acceptable results. Therefore, the operator should be alert to sources of column irreproducibility. Discussed below are practical remedies for handling this problem.

Retention reproducibility can be a major problem in developing a good HPLC method. Problems associated with irreproducibility are usually solved by:

1. Initially selecting a good column of less-acidic highly purified support (if silica based) and maintaining the same stationary phase, particle size, and column dimensions throughout the application.
2. Eliminating “chemical” or silanol effects for silica-based columns by using favorable mobile-phase conditions (pH, buffer type and concentration, additives, etc.).
3. Making sure that the column is properly equilibrated with the mobile phase (Section 9.1.1.5).
4. Using proper laboratory techniques that ensure stable day-to-day operation.
5. Using retention mapping to provide corrective action when required (Section 10.6).
6. Stockpiling columns, or establishing a continuing supply of the same column; alternatively, testing several column lots to ensure that the particular column selected will work for the final method.

As described earlier, the same type of column (e.g., C_{18}) from different manufacturers often shows substantial differences in both retention and resolution. These differences are due to variations in silica substrate and bonding chemistry. As a result, columns from different manufacturers are rarely interchangeable (see Ref. 50). Figure 5.22 shows that the two C_{18} columns from different manufacturers gave entirely different separations for a plant hormone mixture. Separations on a C_{18} column from company X often differ markedly from those obtained on a C_{18} column from company Y, and this is often due to differences in the silica supports used.

As discussed in Section 5.1 and illustrated in Figs. 5.9 and 5.22, column-to-column variations in retention can occur because of various chemical (silanol and other) effects. For basic samples, these variations are minimized by using separation parameters that include:

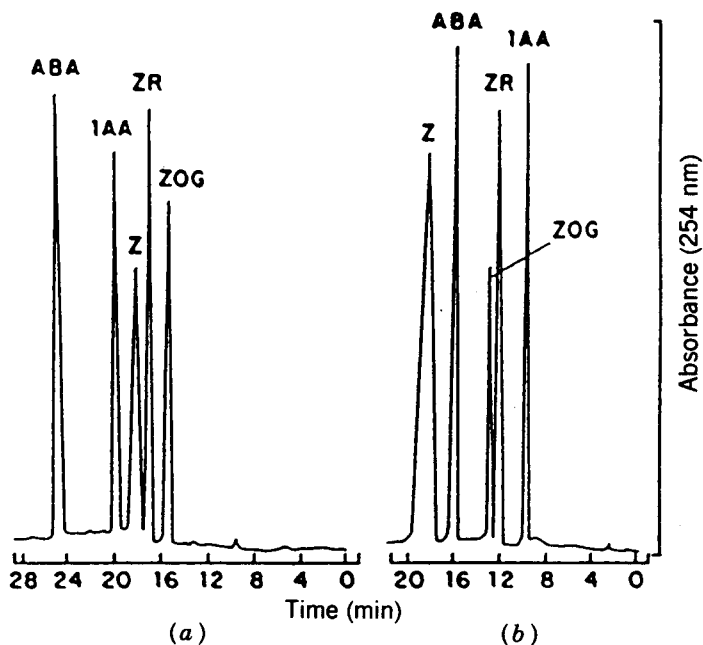

FIGURE 5.22 Selectivity differences for different C_{18} bonded-phase columns: separation of plant hormones by reversed-phase gradient elution. Columns: (a) Hypersil ODS, (b) Spherisorb ODS; mobile-phase gradient: 0 to 50% methanol–water (pH 3.3). Compounds: IAA, indole-3-acetic acid; Z, zeatin; ZR, zeatin riboside; ABA, abscisic acid; ZOG, zeatin-*o*-glucoside. (Reprinted with permission from Ref. 51.)

- A less-acidic, highly purified silica support (Table 5.4)
- pH ≤ 3 mobile phase (for reversed phase)
- Buffer concentration ≥ 20 mM (K^+ often preferred because of higher solubility and better suppression of unwanted silanol interactions)

Initially, the mobile phase should be kept as simple as possible to facilitate good reproducibility and fast column equilibration. If tailing or misshapen peaks occur, the operator then has the additional options to:

- Add 30 mM triethylamine (for basic compounds) or ammonium acetate (for acidic compounds) to the mobile phase (triethylamine acetate for unknowns)
- If tailing persists, replace the triethylamine with 10 mM dimethyloctylamine (or dimethyloctylamine acetate)
- Reduce sample mass to < 1 μ g

In effect, the steps above create conditions for a “generic column” that minimize the difference between bonded-phase columns from different manu-

facturers for separating basic compounds. One study has shown [20] that the use of a non-acidic column plus low-pH mobile phase gave some lot-to-lot variation in the retention of basic compounds, but these variations were reduced to acceptable levels by adding triethylamine to the mobile phase. Section 7.3.3.2 should be consulted for further details on optimum conditions for separating ionic or ionizable compounds.

Poor retention reproducibility and tailing peaks often occur in poorly buffered mobile phases, that is, selection of the wrong buffer (Section 7.2.2), too low a buffer concentration, or a pH out of the effective range of a buffer (keep within 1 pH unit from the pK_a of the ionizable buffer constituent!). Increasing the buffer concentration (or decreasing sample size) usually improves this situation. Some of these approaches in developing acceptable retention behavior for more than 150 drugs of pharmaceutical interest are discussed in Ref. 52. The use of mobile-phase modifiers to minimize silanol effects is described in Section 7.3.3.2.

Changes in retention and resolution often occur from poor control of experimental conditions. Changes in the mobile phase can cause variations in the chromatogram, either during the day or from day to day. Manually prepared mobile phases should be carefully blended using solvents at the same temperature (weighing is the most accurate). On-line mixing of the solvents by the instrument often minimizes compositional errors. However, if results are unexpected, instrument mixing accuracy should be checked manually. The proportioning valves in some low-pressure mixing units are prone to malfunction, particularly when buffers of high concentration are used. Also, when delivery is less than 10% of any one solvent, on-line mixing is less accurate than manual preparation of the mobile phase. If an error in mobile-phase composition is suspected, carefully prepare a new batch of mobile phase and repeat the separation. Manually blended solvents should be used to check suspect on-line-mixed solvents.

Variations in retention also can take place because of selective solvent fractionation by evaporation. This effect can occur either during degassing of the mobile phase or on standing. Note, however, that this problem is of minor significance in reversed-phase HPLC [53], except for the case of volatile buffers such as ammonia and bicarbonate. Solvent degassing, either by vacuum or preferably by helium purge (≈ 5 min of vigorous sparging with a gas-dispersion tube), should be carried out by the same procedure each time. This approach ensures repeatability even if some selective solvent fractionation occurs. Uptake of carbon dioxide, which can change the pH of the mobile phase, is minimized by slowly and continuously bubbling helium through the mobile-phase reservoir during use, to blanket contents of the reservoir. Commercial on-line solvent degassers often are effective. However, with these devices, changing solvents involves large hold-up volumes that require extensive purging before the new solvent is properly equilibrated in the system.

Flow-rate variations from equipment problems cause sudden changes in the retention of all bands and random fluctuations in peaks from run to run.

If a flow-rate variation occurs, the detector baseline may shift or larger-than-normal baseline noise may occur. Also, the backpressure on the column inlet may show larger-than-usual variations. Flow-rate changes due to check valve problems also can create pressure surges that can be detrimental to column performance and lifetime. Flow-rate accuracy (within $\approx 1\%$) can be determined by measuring the volume of column effluent for a specific time period and calculating the mL/min (e.g., time to fill a 2- or 5-mL volumetric flask). Note, however, that this method may not detect short-term flow variations since this flow-rate measurement integrates over a finite time period. Reference 49 provides additional insight on how to detect and solve such problems.

Too large a sample mass can cause retention times and/or N values to decrease for peaks that are overloading the column. The usual solution to this problem is to find empirically the maximum sample size that gives maximum retention times and plate numbers for peaks of interest. Typically, this sample size is 10 to 50 μg of sample for column internal diameters of about 0.46 cm; less than 1 μg of a basic sample may overload the column when silanol interactions are a major factor in the retention process. A useful approach is to start with a larger sample (10 to 50 μg , unless this overloads the detector) and then decrease the size until constant retention times are found.

Column temperature change is a common cause of varying retention (see Figs. 7.6 and 11.9). This is especially the case when separating ionic or ionizable compounds where significant variations in α can occur with temperature change. For maximum precision, the column should be thermostatted to maintain the temperature to $\pm 0.2^\circ\text{C}$. If no thermostat is available, an insulated column reduces the effect of laboratory temperature changes. *Separations by ion-pair HPLC and RPC with ionic or ionizable compounds should always use thermostatted columns.*

Retention variations with unthermostatted columns are reduced by minimizing changes in laboratory temperature. A constant-temperature environment is particularly important to minimize column temperature changes when using automatic sampling and unattended operation. Here, column temperature variations will result in drifting retention times that may fall outside the narrow "windows" required by some automatic data-handling systems.

Should variations in retention occur as a result of column change during use of a method, predictable modifications in operating conditions (solvent strength, solvent mixture, etc.) can be used to re-establish an acceptable separation. This goal can often be realized without re-developing the method if knowledge of the effects of the various operational variables is available. Retention "maps" for the compounds of interest are helpful for this purpose; see Section 10.3 and the discussion of Fig. 1.5. Documentation of the effect of minor changes in operating variables during method development is especially valuable for making appropriate adjustments when resolution degrades.

As mentioned previously, columns of a given type from the same manufacturer can show significant batch-to-batch retention and selectivity variations. A particular separation developed on one column may not be the same when

using a second column of the same type from a new lot. A preferred way to test whether a method will function reliably is to evaluate columns from several (three or more) different lots or batches. Acceptably reproducible retention and selectivity should occur with all lots before the method should be considered sufficiently rugged (robust) for routine application. Peaks of interest should be separated with at least the minimum resolution required for the desired measurement, taking into account a reasonable loss in resolution with use. Reproducibility problems are minimized by using columns from a manufacturer who can deliver (and warrant) a high-quality, reproducible product. Some manufacturers can provide columns from the same (large) lot over a several-year period when lot-to-lot variations cannot be avoided by optimizing the mobile phase. Columns from a single lot should be closely similar with respect to retention and chromatographic performance.

5.4.2 Band Tailing

Conditions resulting in tailing or asymmetrical peaks should be avoided. Band tailing causes inferior separations and reduced precision (especially when using automatic data systems); poor column-to-column reproducibility may also be associated with tailing bands (silanol interactions). In this section, band tailing in method development is discussed as a function of the column and its history. Reference 49 contains a general discussion of the problems and solutions associated with tailing bands (see also Section 7.3.3.2).

Column plate numbers and band resolution are overestimated when tailing peaks are involved. Tailing peaks can trail into a closely eluting following peak, reducing the ability to quantitate each peak accurately. For band asymmetries of 1.2 (peak tailing factor ≈ 1.15), the peak-half-width method (Eq. 2.8a) can produce positive plate numbers as large as 30%, resulting in calculated resolution errors of up to 15% [48]. Therefore, peaks with good symmetry are always desired when initially developing methods that require a high level of precision and long-term repeatability.

Peak asymmetry or band tailing can arise from several sources, as summarized in Table 5.12. An initial bad column (poorly packed) from the manufac-

TABLE 5.12 Causes of Asymmetrical (Tailing) Peaks

Bad column; plugged frit or void
Buildup of "garbage" on column inlet
Sample overload
Wrong solvent for sample
Extra-column effects
Chemical or secondary retention (silanol) effects
Inadequate or inappropriate buffering
Contaminating heavy metals

turer is an occasional source of asymmetrical peaks. New columns showing undue peak asymmetry with neutral compounds should not be used for method development. Such columns should be returned to the manufacturer for replacement after possible system problems have been eliminated.

Tailing peaks are common with heavily used columns. During use, columns can develop severe band tailing (Fig. 5.23a) or even double peaks for each component (Fig. 5.23b). Such effects usually arise from a void in the inlet of the column and/or a dirty or partially plugged inlet frit. Difficulties associated with a plugged inlet frit often can be eliminated by carefully replacing the inlet frit of the column (without disturbing the packing!). Problems due to voids at the column inlet sometimes are reduced by filling the inlet void with additional packing. The original performance of the column rarely is achieved or maintained by this approach, although reversing the direction of flow through the column is helpful [54]. Filling a column void is most practical for the case of expensive columns (e.g., chiral or preparative columns). In other cases, this approach should be used only in an emergency or as a last resort.

The development of broader tailing peaks (as in Fig. 5.23) during use may also indicate the buildup of strongly retained sample components ("garbage") on the column inlet. This buildup sometimes can be eliminated by purging the column with a strong solvent. A 20-column-volume purge (about 30 mL for a 15×0.46 -cm column) with a mixture of 96% dichloromethane and 4% methanol with 0.1% ammonium hydroxide is often effective for reversed-phase columns; methanol can be used for a normal-phase column. In difficult cases, backflushing the column at a low flow rate with a strong solvent may be necessary. In developing a routine method, an effective approach is to reduce the possibility of strongly retained sample component buildup by using a guard column, as discussed in Section 5.4.3.2. Some methods also require an effective pretreatment procedure (see Chapter 4).

Overloading the column with sample also causes broadened tailing (or fronting) peaks. This undesirable effect usually can be eliminated by reducing the sample mass injected (increase detector sensitivity, if required), until plate

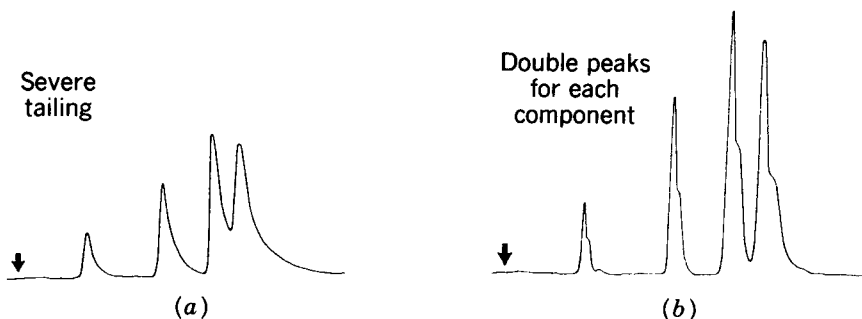

FIGURE 5.23 Some symptoms of column problems.

number, peak shape, and retention are constant. See Section 2.4 and Chapter 13 for further information on column overload.

Injecting the sample in a solvent that is stronger than the mobile phase usually results in early bands that are distorted and tailing, as illustrated in Fig. 5.24. In this example, injecting a sample in pure acetonitrile produced broader asymmetrical bands than did a separation in which the sample was injected with the appropriate 18% acetonitrile–water mobile phase. When the sample is poorly soluble in the mobile phase (or weaker solvents), small volumes in a stronger solvent can be injected (e.g., $< 25 \mu\text{L}$ for a 0.46-cm-ID column). However, poorer band shapes, sample precipitation, column blockage, and compromised quantitation may result. For poorly soluble materials, dissolving the sample in a strong solvent, then diluting with an equal volume of the mobile phase often is successful for sample injection.

Extra-column effects associated with the HPLC equipment can cause band tailing and broadening. These band-spreading effects are associated with (1) large sample-injection volumes, (2) too much volume in the lines between the sampling valve, the column, and the detector, and (3) the volume of the detector flow cell. All such extra-column effects combine to increase peak tailing and decrease apparent column number, as discussed in Section 2.3.3.3. This type of tailing is most pronounced for early-eluting

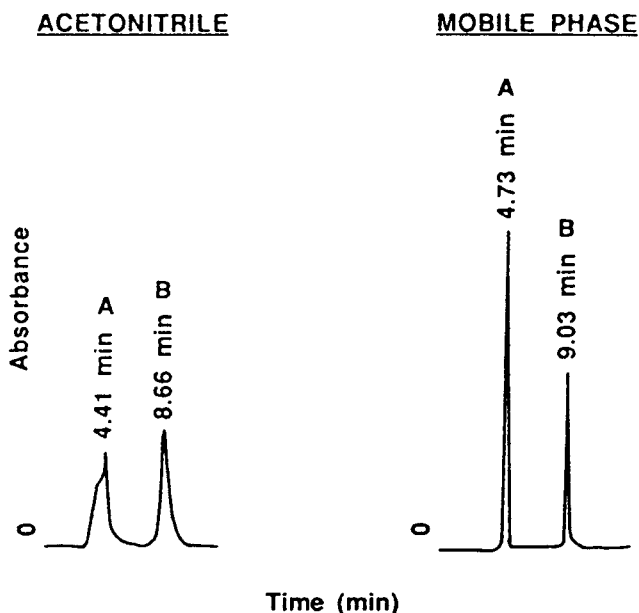

FIGURE 5.24 Sample-solvent injection effects. 30- μL sample volume; mobile phase: 18% acetonitrile–water; caffeine (peak A) and salicylamide (peak B) injected in pure acetonitrile and in 18% acetonitrile-water mobile phase. (Reprinted with permission from Ref. 55.)

peaks, since they have the smallest volume (narrowest peaks). Figure 5.25a illustrates this effect. Here the early-eluting, narrower peaks from this column of 3- μm particles show significant tailing because of extra-column band broadening associated with this "standard" HPLC system. Later-eluting peaks of increasing volume exhibit progressively less tailing. When early peaks tail the most, it is a good indication that extra-column effects are present. In Fig. 5.25b, peak tailing is less pronounced and retention times are shorter because of the use of a lower-dead-volume microbore HPLC apparatus. Note especially that the plate numbers for the peaks with the microbore hardware in Fig. 5.25b are significantly larger than the peaks formed with the standard hardware in Fig. 5.25a.

Peak broadening and tailing due to extra-column effects should be eliminated or minimized before attempting to develop a separation by:

- Injecting small sample volumes (typically, $\leq 25 \mu\text{L}$)
- Using short connecting tubing of small internal diameter (e.g., $< 20 \text{ cm}$ of 0.007 in. ID) between the sample valve and the column and between the column and the detector

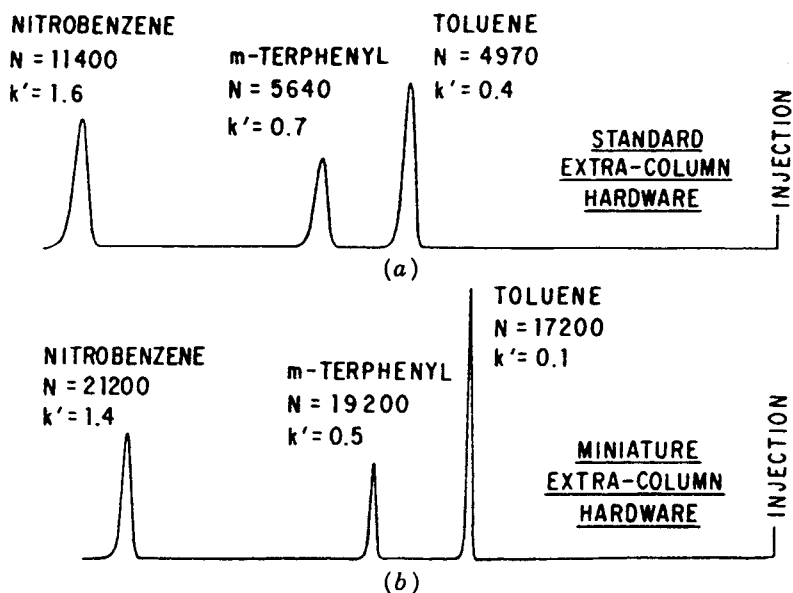

FIGURE 5.25 Band tailing from extra-column effects. Column: $15 \times 0.45\text{-cm}$, 3- μm Spherisorb silica; mobile phase: hexane-acetonitrile (99:1 v/v); flow rate: 2.0 mL/min. (a) Commercial chromatograph with 10- μL sampling valve and 8- μL detector cell; (b) low-volume system with 0.5- μL sampling valve and 1- μL detector cell. (Reprinted with permission from Ref. 56.)

- Making sure that all tubing connections are made correctly from “matched” fittings
- Using a cleanly swept, low-volume detector cell ($< 8 \mu\text{L}$) (for useful discussions of extra-column effects, see Refs. 49 and 56)

Tailing or asymmetrical peaks can occur because of various chemical effects, including a mismatch between the mobile/stationary phase combination and the sample. Such undesirable effects often are eliminated by using mobile phases that contain acetate plus triethylamine (resulting in the “generic column” of Section 5.4.1). Sometimes, the problem with tailing peaks only is eliminated by changing to an entirely different mobile phase–stationary phase combination (e.g., from reversed phase to normal phase).

Contaminating metals (Al, Fe, Ni, etc.) in the column can produce band tailing for certain compounds. The tailing of basic drugs due to metal contamination of a C_{18} packing is illustrated in Fig. 5.26. The use of highly purified silica supports generally eliminates possible problems with heavy-metal complexation.

5.4.3 Why Do Columns Die?

Columns for normal-phase separations often are more stable than are columns used for the other HPLC procedures. Some normal-phase columns (e.g., silica, cyanopropyl) have useful lifetimes of more than one year when used with clean samples. Polymeric ion-exchange (resin) columns display similar stability. On the other hand, silica-based columns for reversed-phase, ion-pair, and ion-exchange chromatography are less rugged in the aqueous environments required for these separations. Even so, well-made columns can be stable under reversed-phase conditions for several months of continuous use (many hundreds or thousands of samples) if appropriate conditions are employed (Section 5.2.3). In the following sections we discuss briefly the main problems found with columns, and useful techniques for minimizing and correcting these problems.

Columns degrade (or “die”) for several reasons:

- Partially blocked (plugged) frit or column bed
- Adsorbed sample impurities (“garbage”)
- Initially poorly packed column
- Mechanical or thermal shock creating voids
- Chemical attack on the support or stationary phase

Some symptoms of impending column death are:

- Column backpressure increase
- Tailing bands

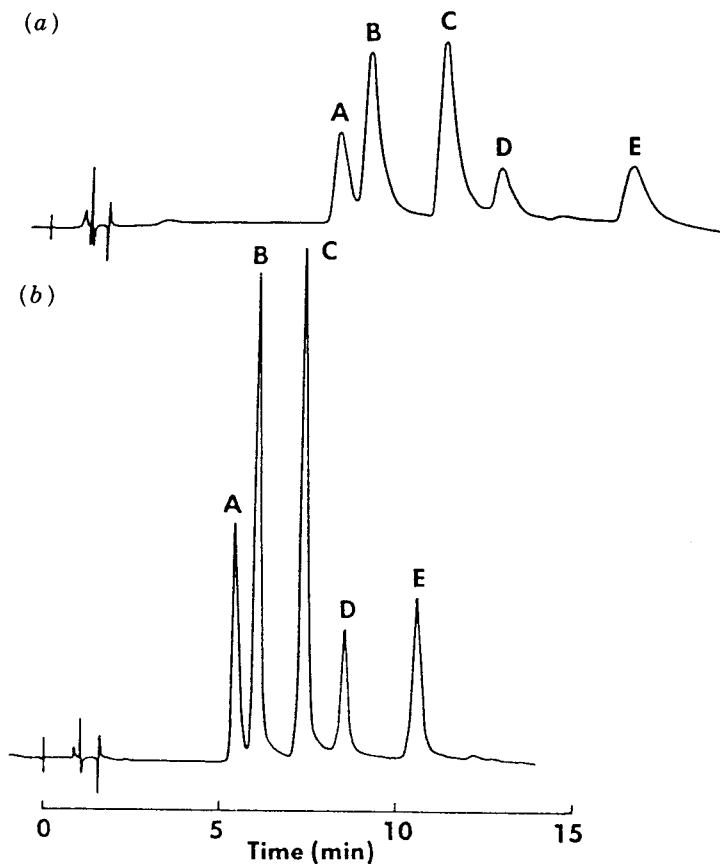

FIGURE 5.26 Tailing of basic drugs due to metal contamination of C_{18} silica. (a) Initial silica support; (b) after acid washing the silica support; mobile phase, 20 mM trimethylamine. (Reprinted with permission from Ref. 57.)

- Loss in plate number
- Loss of selectivity
- Retention (k) decrease (or increase for basic compounds on a silica-based column)

Table 5.13 summarizes common causes for column problems and the experimental condition by which this problem is recognized. For example, plugging of the frit or column bed will usually increase column backpressure (\times) and normally will strongly affect band shape (tailing) and column plate number ($\times\times$).

5.4.3.1 Column Frit Problems. The most frequent column problems encountered by practitioners are those associated with plugged inlet frits. The

TABLE 5.13 Troubleshooting Column Problems

Cause	Pressure	Tailing	Plates	Selectivity	Retention
Plugging	X	XX	XX		
Voids		XX	XX		
Adsorbed sample	?		X	X	XX
Chemical attack		X	X	XX	XX

plugged frit often is associated with the inlet of a guard column, if used (Section 5.4.3.2). As discussed above, unusual band shapes often arise from either a partially plugged inlet frit or a void in the inlet of the column. If a plugged frit is suspected, it can be confirmed by running a standard sample with known operating conditions. Problems associated with a dirty inlet frit often are eliminated by carefully replacing the inlet frit of the column without disturbing the packing. While changing the frit (don't try to clean!), the inlet of the column should be checked for a void. If the packing is not flush with the top of the column, settling of the packed bed is indicated. As discussed above, problems with voids at the column inlet sometimes are reduced by filling the inlet with more packing. If changing of the frit is not allowed, the column should be reverse-flushed with a strong solvent to see if the inlet frit can be freed of obstructing material. (*Note:* The column should be disconnected from the detector when attempting to flush out the frits to prevent possible plugging of the detector cell.)

Injection of samples containing particulates ultimately will block the column inlet, reducing the normal lifetime of the column. Particulates also arise from the wear of sample injector and pump seals. The use of a 0.25- or 0.5- μm *in-line filter* between the injection valve and the column inlet usually eliminates these problems. These low-volume filters are designed to minimize extra-column effects but must be replaced after a series of injections. Continued increase in column backpressure usually signals that the inlet filter needs replacing. In-line filters do not eliminate the desirability of removing obvious particulates from the sample. This is accomplished by filtering or centrifuging the sample before injection. Opalescent or cloudy samples should be treated with a 0.25- μm filter. The small filters that attach to hypodermic syringes are convenient for this operation. Finally, changing pump seals and sample-valve rotors regularly will minimize problems with frit pluggage. Particulates from worn seals and rotors are a major source of material that can plug frits.

5.4.3.2 Strongly Held Sample Components. Column life often can be shortened significantly by a buildup of strongly sorbed sample components at the column inlet. This buildup of noneluted components is especially a problem with complex samples such as extracts of biological tissues or fluids (e.g., serum), oil-containing formulations, and so on. Column contamination often is not a serious problem with essentially pure samples such as synthetic drugs.

The development of broader tailing peaks (as in Fig. 5.23) during the use of a column often signals the buildup of strongly retained contaminants on the column inlet. This buildup can be reduced by inserting a *guard column* between the sampling valve and the analytical column. The guard column is a well-packed short length (e.g., 1 to 2 cm) containing a packing equivalent to (or similar to) that in the analytical column. This unit captures strongly retained sample components and prevents them from entering the analytical column. Guard columns must be replaced at regular intervals, before strongly retained components elute into the analytical column. Some users prefer not to utilize guard columns because of the added expense and inconvenience of determining when to change to a fresh unit. The questionable quality of some guard columns also inhibits their use, particularly with low-volume, high-efficiency columns whose performance is especially affected by extra-column band broadening effects.

Flushing the column at least daily with a strong solvent (guard column removed!) enhances column life in isocratic separations. This preventive maintenance approach removes strongly retained components that slowly build up on the column inlet (see also Section 5.3.2). (Use methanol or acetonitrile for reversed phase; methanol for normal phase). In extreme cases, the column can be backflushed with a strong solvent. In gradient separations, cleansing of the column by strong solvents is conveniently accomplished by periodically allowing 100% of the strong (B) solvent at the end of the gradient to purge through the column for at least 20 to 30 column volumes. Dirty samples should be pretreated to remove strongly retained components (late eluters), also particulates. In Chapter 4 we discuss sample pretreatment methods. Alternatively, the proper use of a guard column is effective and strongly recommended for routine applications.

5.4.3.3 Poorly Packed Columns. The initial condition of the packed column and the way in which it is used largely determine column lifetime. Compaction of the packed bed after relatively short use usually results in a void in the column inlet and a sudden decrease in column plate number. A void can result when the column has been poorly packed. Unfortunately, the initial condition of a column (i.e., plate number, asymmetry factor, etc.) often is not a good indicator of whether the column bed will be stable. Bed stability can only be determined under the stress of actual use.

5.4.3.4 Pressure Effects. Sudden pressure surges and any kind of mechanical or thermal shock should be avoided to minimize changes in peak shape or N values that might require column replacement. All types of sudden mechanical and thermal shock (e.g., dropping the column on the lab bench or rapidly changing column temperature) also should be minimized. Voids can be caused by pressure surges that result from slow valve actuation during sample introduction, which is a special problem with some autosamplers. Pressure surges also can be a special problem with column switching

methods (Section 4.6). Special valves are available (e.g., Rheodyne MBB) that avoid the pressure surge of valve switching. Losses in resolution from pressure surges are minimized by using well-packed columns and by operating at lower column pressures. Pressure-related precautions usually are of minor importance for extending column life for silica-based HPLC columns; well-made columns are rugged. However, columns with other types of particles sometimes are too fragile to withstand significant flow, pressure, and temperature variations.

5.4.3.5 Chemical Attack. Useful column lifetime can be reduced significantly by loss of the stationary phase during separations. Stationary/mobile phase combinations that lead to a rapid loss of bonded phase should be avoided. (Follow the column manufacturer's recommendations.) Reversed-phase columns with short-chain silane groups are the least stable. In highly aggressive mobile phases (e.g., $\text{pH} < 2.0$), some columns of this type can lose most of the organic phase within a few hours [36]. Reversed-phase columns with long alkyl groups (C_8 or C_{18}) are usually considered relatively stable. However, even these columns will lose bonded phase when used at very low or high pH. Use of sterically protected silane stationary phases will provide additional stability in aggressive low-pH environments (Fig. 5.12). Nevertheless, many C_8 and C_{18} columns usually show good long-term stability, provided that proper operating procedures are followed ($2.5 \leq \text{pH} \leq 8.0$).

5.4.3.6 Other Factors. The stability of the bonded organic ligand on a reversed-phase column depends on the type and acidity of the silica used as the support [5,11,46]. Packings made with fully hydroxylated silicas having a homogeneous distribution of surface silanol groups show superior stability. Studies suggest that the stability of reversed-phase packings may be a function of the pH of the silica surface [12]. Higher bonded-phase stability apparently can occur for columns made with highly purified silica supports having a lower surface acidity (see Table 5.4).

Loss of stationary phase from silica-based columns is accelerated at higher temperatures. Figure 5.27 shows the large difference in the dissolution of the silica support for a densely bonded dimethyl- C_{18} column when the temperature is increased from 40 to 60°C while using a pH 7 phosphate buffer. Temperatures above about 40°C should be used with caution when operating at intermediate and high pH with phosphate buffers [46]. Use of organic buffers (e.g., TRIS, HEPES, citrate) can significantly increase column lifetime over that when phosphate buffers are used at intermediate pH (6 to 9) [46,46a]; see also Fig. 5.16. Columns operated at pH 4 to 6 are more stable at higher temperatures because of the lower silica solubility associated with the buffers commonly used in this pH range (acetate, citrate). Higher-temperature operation at $\text{pH} \leq 3$ can degrade the bonded stationary phase more rapidly and cause retention reproducibility problems

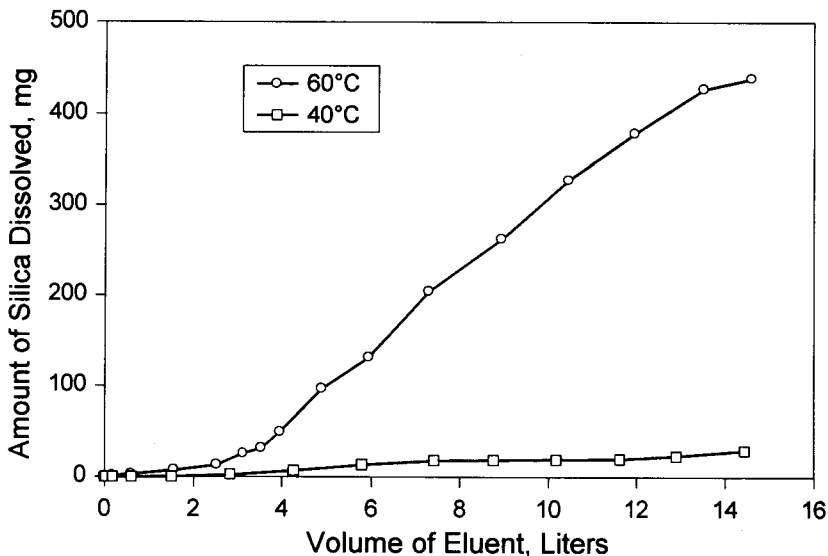

FIGURE 5.27 Effect of temperature on silica support dissolution with pH 7.0 phosphate buffer. Columns: Zorbax Rx-C18, 15 × 0.46 cm; continuous nonrecycled 20% acetonitrile–80% sodium phosphate buffer, 0.25 M, pH 7.0; 1.0 mL/min. (Reprinted with permission from Ref. 46.)

over the long term. An exception is columns of sterically protected stationary phases (Section 5.2.3). Silica-based columns of diisobutyl- C_{18} packings have been operated for long periods at 90°C and pH 0.9 without deterioration (see Fig. 5.12 and Ref. 45).

The insertion of a *precolum* (saturation column) packed with silica before the sampling valve sometimes increases the stability of silica-based columns used under harsh operating conditions, particular at pH > 8.0 [58]. This column (which can be packed with coarser particles) apparently conditions the incoming mobile phase with dissolved silicate, retarding silica dissolution from the analytical column. (A 0.2- μ m filter should be installed after this precolum to exclude particles from the injector.) However, several disadvantages are associated with the use of precolums:

- Higher overall column backpressures
- Inability to monitor analytical column pressure
- Slower column changeover and equilibration
- Gradient elution not practical

The result is that we do not recommend the general use of precolums; using a more stable column or less aggressive mobile phase is a better approach.

Microbial growth often occurs in buffers and aqueous mobile phases that are prepared and stored at ambient temperature for more than a day. Particulates from this source can plug the column inlet and reduce column life significantly. As a result, mobile phases that are free of organic solvents should be discarded at the end of each day. Alternatively, 200 ppm of sodium azide can be added to aqueous mobile phases to retard bacterial growth. (Careful disposal of aqueous mobile phases containing azides—toxic and potentially explosive—is mandatory). Alternatively, about 20% of organic modifier in the mobile phase retards bacterial growth. The organic modifier also assists in the mobile-phase degassing process.

The performance and lifetime of bonded-phase columns are best preserved by storing them in 100% organic solvent (preferably acetonitrile) where possible. Storage with buffered solutions (particularly those containing high concentrations of water and alcohols) should be avoided. When buffers are used, columns should be flushed with 15 to 20 column volumes of the same aqueous-organic mobile phase *without buffer* before converting to 100% organic for storage. Flushing densely bonded C_{18} columns with pure water should be avoided. Columns should be capped tightly during storage, to prevent the packed bed from drying out.

Table 5.14 summarizes steps to ensure good column lifetime and continued good performance. Reference 49 should be consulted for a detailed account of problems with columns and how to troubleshoot, minimize, and fix these difficulties.

5.4.4 Suggested Column for Method Development

Most HPLC methods use silica-based bonded-phase columns as the separating medium. For separations not requiring other types of column packings, we

TABLE 5.14 Steps for Ensuring Best Column Lifetime and Performance

-
1. Use well-packed columns.
 2. Minimize pressure surges; avoid mechanical and thermal shock.
 3. Use a guard column and an in-line filter.
 4. Flush column frequently with strong solvent.
 5. Pretreat dirty samples to minimize particulates and strongly retained components of no interest.
 6. Use stable stationary phase (C_{18} best).
 7. Use organic buffers when operating at intermediate pH (6 to 8).
 8. Use column temperatures of $< 40^{\circ}\text{C}$ (except sterically protected at low pH).
 9. Keep mobile-phase pH between 3.0 and 8.0 for most silica-based columns.
 10. Add 200 ppm sodium azide to aqueous mobile phases and buffers.
 11. For overnight and storage, purge out salt and buffers, leave in pure organic (preferably acetonitrile).
-

recommend the following column specifications as a starting point for most method-development studies:

- Column configuration: 25 or 15 × 0.46 cm
- Support particles: 5- μ m porous silica microspheres
- Pore size: 80 to 100 Å (except for macromolecules)
- Particle surface area: 150 to 350 m²/g
- Bonded phase: C₈ or C₁₈ (reversed phase); CN or diol (normal phase)

Columns with the properties listed above are widely available with good use properties. As method development proceeds, other column configurations, particle size, and so on, may be indicated.

REFERENCES

1. R. E. Majors, *LC/GC*, **9** (1991) 686.
2. K. Kalghatgi and C. Horvath, *J. Chromatogr.*, **443** (1988) 343.
3. K. K. Unger and H. Giesche, Ger. Pat. DE-3543 143.2 (1985).
4. N. B. Afeyan, N. F. Gordon, I. Mazsaroff, L. Varady, S. P. Fulton, Y. B. Yang, and F. E. Regnier, *J. Chromatogr.*, **519** (1990) 1.
5. J. J. Kirkland, M. A. van Straten, and H. A. Claessens, *J. Chromatogr. A*, **691** (1995) 3.
6. L. R. Snyder and M. A. Stadalius, in *High-Performance Liquid Chromatography: Advances and Perspectives*, Vol. 4, C. Horvath, ed., Academic Press, San Diego, CA, 1986, pp. 294–295.
7. T. D. Wilson and D. M. Simmons, *Chromatographia*, **35** (1993) 295.
8. R. K. Iler, *The Chemistry of Silica*, Wiley, New York, 1979, p. 639.
9. K. K. Unger, *Porous Silica*, Elsevier, Amsterdam, 1979.
10. J. L. Glajch, J. J. Kirkland, and J. Köhler, *J. Chromatogr.*, **384** (1986) 81.
11. J. Köhler, D. B. Chase, R. D. Farlee, A. J. Vega, and J. J. Kirkland, *J. Chromatogr.*, **352** (1986) 275.
12. J. Köhler and J. J. Kirkland, *J. Chromatogr.*, **385** (1987) 125.
13. J. Nawrocki, *Chromatographia*, **31** (1991) 177.
14. J. Nawrocki, *Chromatographia*, **31** (1991) 193.
15. H. Engelhardt, H. Low, and W. Götzinger, *J. Chromatogr.*, **544** (1991) 371.
16. D. W. Sindorf and G. E. Maciel, *J. Am. Chem. Soc.*, **105** (1983) 1487.
17. K. K. Unger, J. N. Kinkel, B. Anspach, and H. Giesche, *J. Chromatogr.*, **296** (1984) 3.
18. J. J. Kirkland, C. H. Dilks, Jr., and J. J. DeStefano, *J. Chromatogr.*, **635** (1993) 19.
19. J. J. Kirkland, B. E. Boyes, and J. J. DeStefano, *Amer. Lab.*, **26** (1994) 36.
20. M. A. Stadalius, J. S. Berus, and L. R. Snyder, *LC/GC*, **6** (1988) 494.
21. P. C. Sadek and P. W. Carr, *J. Chromatogr. Sci.*, **21** (1983) 314.

22. I. Wouters, S. Hendrickx, E. Roets, J. Hoogmartens, and H. Vanderhaeghe, *J. Chromatogr.*, **291** (1984) 59.
23. H. A. Claessens, L. A. Vermer, and C. A. Cramers, *LC/GC Int.*, **6** (1993) 692.
24. E. Lamparter, *J. Chromatogr.*, **635** (1993) 155.
25. B. J. Fish, *J. Pharm. Biomed. Anal.*, **11** (1993) 517.
26. J. H. Knox, B. Kaus, and G. R. Millard, *J. Chromatogr.*, **352** (1986) 3.
27. H. Figge, A. Deege, J. Köhler, and G. Schomburg, *J. Chromatogr.*, **351** (1986) 393.
28. J. J. Pesek, J. E. Sandoval, and M. Su, *J. Chromatogr.*, **630** (1993) 95.
29. L. Sun, M. J. Annen, F. Lorenzano-Porras, P. W. Carr, and A. V. McCormick, *J. Colloid Interface Sci.*, **163(2)** (1994) 464.
30. J. Yu and Z.-E. Rassi, *J. Chromatogr.*, **631** (1993) 91.
31. J. Nawrocki, P. W. Carr, M. P. Rigney, and A. McCormick, *J. Chromatogr. A*, **657** (1993) 229.
32. J. J. Kirkland, *J. Chromatogr. Sci.*, **31** (1993) 493.
33. K. M. Kirkland, D. A. McCombs, and J. J. Kirkland, *J. Chromatogr. A*, **660** (1994) 327.
34. J. J. Kirkland, and J. W. Henderson, *J. Chromatogr. Sci.*, **32** (1994) 473.
35. M. J. Wirth and H. O. Fatunmbi, *Anal. Chem.*, **65** (1993) 822.
36. J. J. Kirkland, J. L. Glajch, and R. D. Farlee, *Anal. Chem.*, **61** (1988) 2.
37. J. J. Kirkland, J. W. Henderson, J. J. DeStefano, M. A. van Straten, and H. A. Claessens, *J. Chromatogr.*, in print.
38. J. E. Sandoval and J. J. Pesek, U.S. Pat. 5,017,540, 1991.
39. C.-H. Chu, E. Jonsson, M. Auvinen, J. J. Pesek, and J. E. Sandoval, *Anal. Chem.*, **65** (1993) 808.
40. U. Bien-Vogelsang, A. Deege, H. Figge, J. Köhler, and G. Schomburg, *Chromatographia B*, **19** (1984) 265.
41. M. Hanson and K. K. Unger, *Trends Anal. Chem.*, **11** (1992) 368.
42. J. L. Glajch and J. J. Kirkland, U.S. Pat. 4,705,725, 1987.
43. J. L. Glajch and J. J. Kirkland, U.S. Pat. 4,847,159, 1989.
44. J. J. Kirkland, *Amer. Lab.*, **26** (1994) 28K.
45. B. E. Boyes and J. J. Kirkland, *Peptide Res.* **6** (1993) 249.
46. H. A. Claessens, M. A. van Straten, and J. J. Kirkland, *J. Chromatogr. A*, **728** (1996) 259.
- 46a. J. J. Kirkland and J. J. DeStefano, *GIT Verlag*, GIT Special, Chromatography International, June 1996, p. 62
- 46b. J. J. Kirkland, *J. Chromatogr. Sci.*, **34** (1996) 309.
47. J. P. Scholl, *J. Liq. Chromatogr.*, **17** (1994) 3369.
48. J. J. Kirkland, W. W. Yau, H. J. Stoklosa, and C. H. Dilks, Jr., *J. Chromatogr. Sci.*, **15** (1977) 303.
49. J. W. Dolan and L. R. Snyder, *Troubleshooting LC Systems*, Humana Press, Totowa, NJ, 1989.
50. P. E. Antle, A. J. Goldberg, and L. R. Snyder, *J. Chromatogr.*, **321** (1985) 1.
51. V. Sjut and M. V. Palmer, *J. Chromatogr.*, **270** (1983) 309.

52. R. W. Roos and C. A. Lau-Cam, *J. Chromatogr.*, **370** (1986) 403.
53. L. R. Snyder, *J. Chromatogr. Sci.*, **21** (1983) 65.
54. J. Vendrell and F. X. Aviles, *J. Chromatogr.*, **356** (1986) 420.
55. J. W. Dolan, *LC/GC*, **4** (1986) 1086.
56. K. W. Freebairn and J. H. Knox, *Chromatographia*, **19** (1984) 37.
57. M. Versele, *Liq. Chromatogr.*, **1** (1983) 217.
58. M. W. Dong, J. R. Gant, and P. A. Perrone, *LC/GC*, **3** (1985) 786.

6

NON-IONIC SAMPLES: REVERSED- AND NORMAL-PHASE HPLC

6.1 Introduction

Part I-Reversed-Phase Chromatography

6.2 Retention in Reversed-Phase Chromatography

6.2.1 Mobile-Phase Effects

6.2.1.1 Choice of % B

6.2.1.2 Mobile-Phase Strength

6.2.2 Column and Temperature Effects

6.3 Selectivity in Reversed-Phase Chromatography

6.3.1 Solvent-Strength Selectivity

6.3.2 Solvent-Type Selectivity

6.3.3 Column-Type Selectivity

6.3.4 Temperature Selectivity

6.4 Optimizing the Separation of Nonionic Samples in Reversed-Phase Chromatography

6.4.1 Getting Started

6.4.2 Optimizing Selectivity

6.4.2.1 Solvent-Strength (% B) Effects

6.4.2.2 Solvent-Type Effects Plus % B Effects

6.4.2.3 Use of Organic Solvent Mixtures

6.4.2.4 Column-Type Effects Plus % B Effects

6.4.2.5 Combined Use of Different Solvents Plus Column Types

6.5 Non-aqueous Reversed-Phase HPLC

Part II-Normal-Phase Chromatography

6.6 Retention in Normal-Phase Chromatography

6.6.1 General Aspects

6.6.1.1 Sample and Solvent Localization

6.6.2 Mobile-Phase Effects

6.6.2.1 Solvent Strength

6.6.2.2 Mobile-Phase Selectivity

6.6.3 Column-Type Effects

6.6.4 Temperature Effects

6.6.5 Use of Aqueous Mobile Phases for Hydrophilic Samples

- 6.7 Optimizing the Separation of Nonionic Samples in Normal-Phase Chromatography
 - 6.7.1 Initial Conditions
 - 6.7.1.1 Choice of Column
 - 6.7.1.2 Mobile-Phase Solvents
 - 6.7.2 Adjusting Retention
 - 6.7.3 Optimizing Selectivity
 - 6.7.4 Other Considerations
 - 6.7.4.1 Slow Column Equilibration and Solvent Demixing
 - 6.7.4.2 Changes in Stationary-Phase Water Content

6.1 INTRODUCTION

As discussed in Section 1.4, the nature of the sample determines the best approach to HPLC method development. The method-development strategy recommended in this book is summarized in Fig. 1.3, where various samples are classified as *regular* or *special*. *Regular* samples are divided further into neutral and ionic samples. Ionic samples contain one or more compounds that are ionic or ionizable (acids, bases, organic salts). This chapter deals with the separation of neutral samples containing only non-ionizable compounds. Method development for samples that contain ionic compounds is discussed in Chapter 7; however, many of the approaches described in this chapter for modifying the separation of neutral compounds are applicable to ionics as well. The recommended initial approach to method development for both neutral and ionic samples is provided in Chapter 9.

Part I - Reversed-Phase Chromatography

Reversed-phase chromatography (RPC) is the first choice for most regular samples. RPC is typically more convenient and rugged than other forms of LC and is more likely to result in a satisfactory final separation. High-performance RPC columns are efficient, stable, and reproducible (Section 5.3). Detection often is easier in RPC (especially for UV detectors) because of the solvents used. Finally, most workers have more experience with RPC than with other HPLC methods.

Although many organic compounds have limited solubility in the (aqueous) mobile phase, this is not a practical limitation because only small amounts (nanograms or micrograms) of sample are usually injected (see Section 2.4). In those cases where sample solubility in RPC mobile phases is exceptionally poor, normal-phase chromatography (NPC) is a preferred alternative. Similarly, samples that are unstable in aqueous media can also be separated by NPC using non-aqueous solvents.

Some samples cannot be easily separated by RPC and must be handled in a different manner. Special samples (Fig. 1.3) contain compounds that fall into

one of the following categories: very hydrophilic or hydrophobic compounds, achiral isomers, chiral isomers (enantiomers, Chapter 12), or biomolecules (Chapter 11). Inorganic ions and synthetic polymers are also “special” but are not discussed in this book. Very hydrophobic compounds are strongly retained in RPC and may require the use of non-aqueous conditions (non-aqueous reversed-phase chromatography or NARP, Section 6.5). Alternatively, such separations can be carried out by normal-phase chromatography (NPC) (see Part II of this chapter). Some very hydrophobic biological molecules can be separated by hydrophobic interaction chromatography (HIC); this is discussed in Chapter 11. Very hydrophilic samples may not have sufficient retention in RPC, even with mobile phases containing little or no added organic solvent. The separation of hydrophilic ionic samples is discussed in Chapter 7. Neutral hydrophilic compounds are best separated by NPC (Sections 6.6 and 6.7) because of their strong retention on NPC columns. Certain hydrophilic compounds can also be separated by hydrophilic interaction chromatography (HILIC), which is discussed in Section 6.6.5 and Chapter 11.

Achiral isomers (stereoisomers, diastereomers, positional isomers, etc.) can be separated in some cases by RPC. However, the separation of isomeric mixtures often requires either NPC (Section 6.7) or RPC with a cyclodextrin bonded phase (Section 6.3.3). The separation of enantiomers requires the use of special conditions, as discussed in Chapter 12.

6.2 RETENTION IN REVERSED-PHASE CHROMATOGRAPHY

The basis for RPC retention is shown schematically in Fig. 6.1. Separation by RPC is similar to the extraction of different compounds from water into an organic solvent such as octanol, where more hydrophobic (non-polar) compounds preferentially extract into the non-polar octanol phase. The column (typically, a silica support modified with a C_8 or C_{18} bonded phase) is less polar than the water–organic mobile phase. Sample molecules partition between the polar mobile phase and non-polar C_8 or C_{18} stationary phase, and more hydrophobic (non-polar) compounds are retained more strongly. For a given mobile-phase composition, the result is a differential retention of samples according to their hydrophobicity, with a resulting chromatogram such as that shown in Fig. 6.1. Hydrophilic (polar) compounds are less strongly held and elute from the column first; more hydrophobic (non-polar) compounds elute last. Compounds of intermediate polarity elute in the middle of the chromatogram.

The RPC retention of a compound is determined by its polarity and experimental conditions: mobile phase, column, and temperature. As shown in Table 6.1, there are several ways to change retention of most compounds in RPC. The detailed nature of reversed-phase retention is not understood completely [1–3], but it appears that retention can be approximated by a partition process. Regardless of the fundamental basis of retention, the consequences of changes

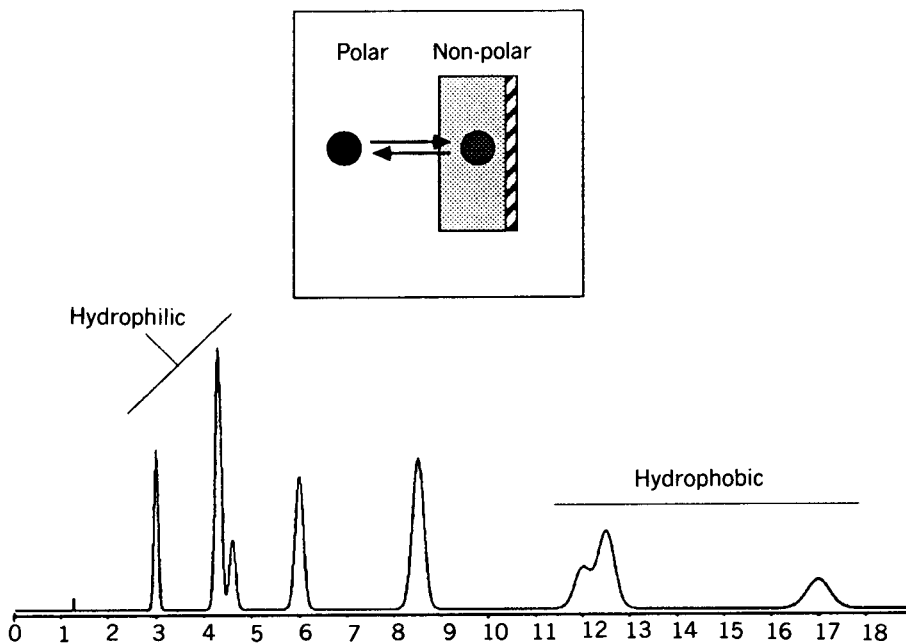

FIGURE 6.1 Schematic representation of reversed-phase process for non-ionic compounds. A solid dot refers to a sample molecule partitioning between the polar mobile phase and the non-polar stationary phase.

in experimental conditions (mobile phase, column, temperature) have been well studied and can lead to a systematic approach to RPC method development as described in this chapter and Chapter 9.

6.2.1 Mobile-Phase Effects

Retention (compound k values) is preferably adjusted by changing mobile-phase composition or *solvent strength*. In RPC, retention is less for stronger, less polar mobile phases. Solvent polarity can be measured by the polarity index P' (Table II.2 of Appendix II). Solvent strength depends on both the

TABLE 6.1 Techniques to Modify Retention in RPC

Decrease Retention	Increase Retention
More polar column (cyano, C_4)	Less polar column (C_8 , C_{18})
Less polar mobile phase (higher % B—more organic) (less polar organic solvent)	More polar mobile phase (lower % B—more water) (more polar organic solvent)
Higher temperature	Lower temperature

choice of organic solvent and its concentration in the mobile phase: % B, where A is water, B is organic, and % is volume %. An initial (and primary) goal in method development is to obtain the adequate retention of all sample compounds. As described in Chapter 2, a retention range of $0.5 < k < 20$ is allowable for samples to be separated using isocratic conditions although $1 < k < 10$ generally is preferred.

6.2.1.1 Choice of % B. An effective approach to method development begins with a very strong mobile phase (e.g., 100% ACN in Fig. 6.2). The initial use of a strong mobile phase makes it likely that the run time of the first experiment will be conveniently short, and strongly retained compounds will all be eluted. (Note that if no peaks are observed after 30 to 40 min with 100% ACN, another method may be needed; see Chapter 9 for proposed next steps.) For 100% ACN, the entire sample elutes near t_0 ($k < 0.2$), so a weaker mobile phase is required. Successive reductions in % ACN by 20% result in the 80% and 60% ACN separations of Fig. 6.2, neither of which is acceptable in terms of the retention of the first band ($t_0 = 1.0$ min, $k < 0.5$). Adequate retention is achieved for both 50% and 40% ACN ($0.5 < k < 20$ for both cases). If the mobile phase is much weaker ($< 30\%$ ACN), the retention for compound D would be unacceptably long ($k > 20$, as shown by plot D in Fig. 6.3). Note for both 50% and 40% ACN that the separation of all four compounds has been achieved, with slightly better resolution for 40% ACN ($R_s = 2.0$ for compounds B and C) at the cost of a longer run time. Many samples can be adequately separated by this simple approach of retention adjustment using solvent strength.

In Fig. 6.3, the retention data of Fig. 6.2 are plotted as $\log k$ vs. % B. The horizontal dashed lines for $k = 0.5$ and 20 define minimum and maximum % B values for acceptable retention: 30 to 56% B (dotted vertical lines). The dependence of RPC retention on % B has been studied exhaustively, as reviewed in Ref. 4. As a first approximation, plots of $\log k$ vs. % B are linear (as in Fig. 6.3):

$$\log k = \log k_w - S\phi \quad (6.1)$$

Here k_w is the theoretical value of k for only water as mobile phase (0% B), S is a constant for a given sample compound (conditions other than % B constant), and ϕ is the volume fraction of organic in the mobile phase [$\phi = (\% \text{ B}/100)$]. For most low-molecular-weight compounds (< 500 Da), $S \approx 4$.

A consequence of Eq. 6.1 and $S \approx 4$ is that k increases by a factor of 2 to 3 for a decrease of 10% B, as illustrated in Fig. 6.2 for compounds A to D. For example, the value of k for compound D increases from 9 to 23 as the mobile phase is changed from 40 to 30% B (Fig. 6.3). This *rule of 3* (approximate three-fold increase in k for a 10% B decrease) is useful in quickly estimating the best value of % B for acceptable retention of all sample compounds.

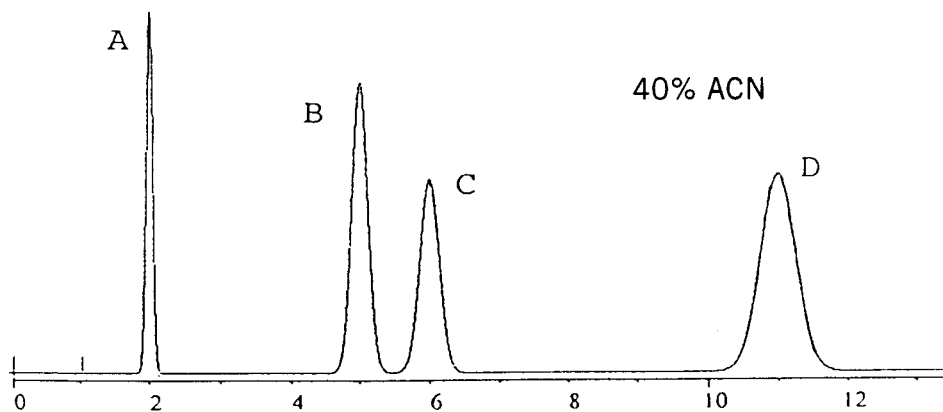
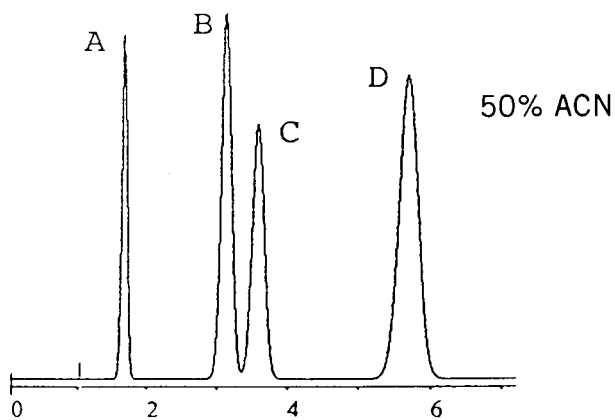
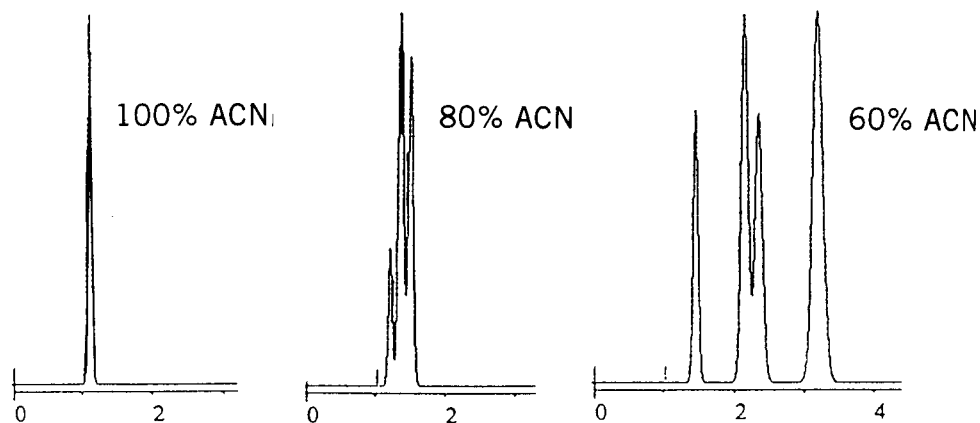

FIGURE 6.2 Effect of a change in percent organic on RPC separation of a hypothetical sample. Conditions: 15×0.46 -cm C_{18} column, 1.5 mL/min flow rate ($t_0 = 1.0$ min).

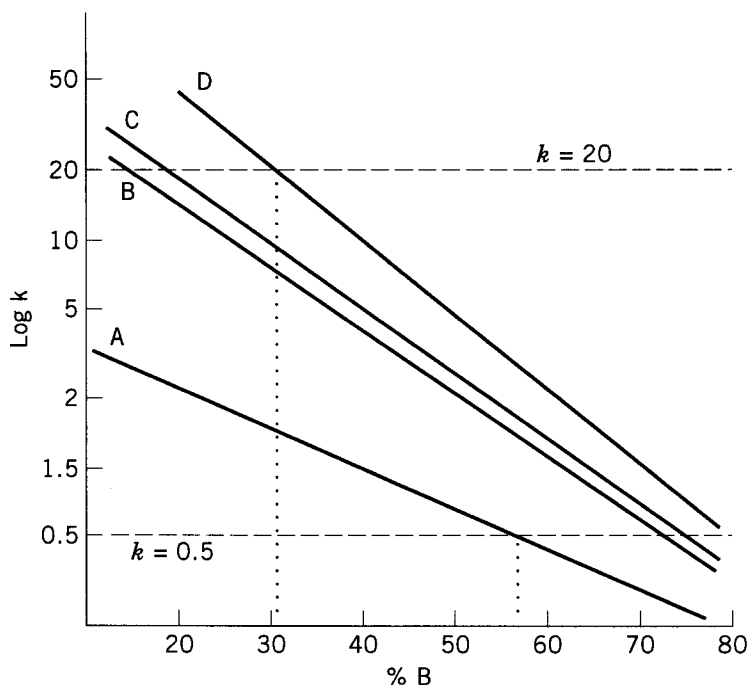

FIGURE 6.3 Plot of compound retention ($\log k$) vs. mobile phase strength (% B) for sample of Fig. 6.2. See the text for further details.

Systematic decrease of % B (as in Fig. 6.2) to investigate sample retention is a simple and convenient way to determine the best mobile-phase composition for a given sample. A faster alternative procedure uses gradient elution (Section 8.2.2).

6.2.1.2 Mobile-Phase Strength. Mobile-phase strength in RPC depends on both % B and the type of organic solvent. These effects are illustrated in the solvent-strength nomograph of Fig. 6.4 for three commonly used RPC solvents:

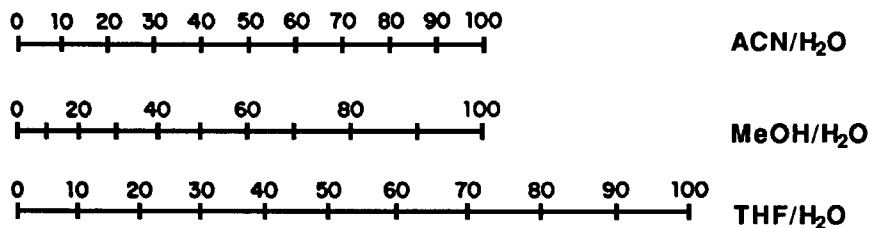

FIGURE 6.4 Solvent-strength nomograph for reversed-phase HPLC. (Adapted from data of Refs. 5 and 6.)

acetonitrile (ACN), methanol (MeOH), and tetrahydrofuran (THF). A vertical line connects % B values for mobile phases having the same strength (giving similar values of k). For example, 40% ACN should provide similar values of k and run time as 50% MeOH and 30% THF. Slightly different scales of mobile-phase strength have been reported by other workers [7,8]. These various scales are at best approximate for any particular sample and should be used only as a rough guide ($\pm 5\%$ B accuracy). The use of Fig. 6.4 in RPC method development is discussed further in Sections 6.3.2 and 6.4.2.2.

Figure 6.4 and other literature data suggest that RPC solvent strength varies as water (weakest) < methanol < acetonitrile < ethanol < tetrahydrofuran < propanol < (methylene chloride) (strongest). Thus, solvent strength increases as solvent polarity decreases. Appendix II includes polarity values P' for a number of common solvents.

Any of the foregoing solvents might be used with water for RPC, except methylene chloride, which is not water miscible. Because it is quite strong, methylene chloride-modified solvents can be used to clean RPC columns that have become contaminated by strongly retained sample components (Section 5.4.3.2). Acetonitrile (ACN) is the best initial choice of organic solvent for the mobile phase. ACN-water mixtures can be used with UV detection at low wavelengths (185 to 210 nm), which may be necessary for some samples (Section 3.2.2). ACN-water mixtures also have much lower viscosities, resulting in somewhat higher plate numbers and lower column pressures (both desirable). The next best organic solvent is methanol (MeOH), followed by tetrahydrofuran (THF). These three solvents are widely used to control selectivity and separation in RPC (Section 6.3.2). THF has some disadvantages: higher UV absorbance, reactivity with oxygen, and slower column equilibration when the mobile phase is changed. However, many workers have reported unique selectivity with THF.

Occasionally, a sample cannot be eluted from a column using 100% ACN. These very hydrophobic samples require the use of even stronger mobile phases (e.g., high-% THF-water, or THF-ACN). When the mobile phase contains no water, the HPLC mode is referred to as non-aqueous reversed-phase LC (NARP), as discussed in Section 6.5.

6.2.2 Column and Temperature Effects

RPC separations are usually carried out with silica-based, bonded-phase columns (Section 5.2.3). Sample retention depends on three characteristics of the column: type and concentration of bonded phase and column surface area. Retention varies with the nature of the bonded phase [9-11] and generally increases as the chain length or hydrophobicity of the bonded-phase group increases. For example, retention on a C_{18} column is usually slightly greater than on a C_8 column (other conditions, including bonded-phase density, being the same). RPC retention for non-polar, non-ionic compounds generally follows the pattern [9-12]

(weak) unbonded silica \ll cyano $< C_1$ (TMS) $< C_3 < C_4 <$
 phenyl $< C_8 \approx C_{18}$ (strong) (6.2)

This retention relationship is illustrated in Fig. 6.5 for both non-polar (anthracene) and polar (diethylphthalate) compounds on different commercial columns. Polystyrene and porous graphitic carbon columns (Section 5.2.3.2) are even more retentive than a C_{18} column, other factors being equal [13]. Column strength can be defined in terms of the bonded phase, a cyano column being weak and a C_{18} column strong.

k Comparison for Different Bonded Phases

1. Anthracene–Non-Polar

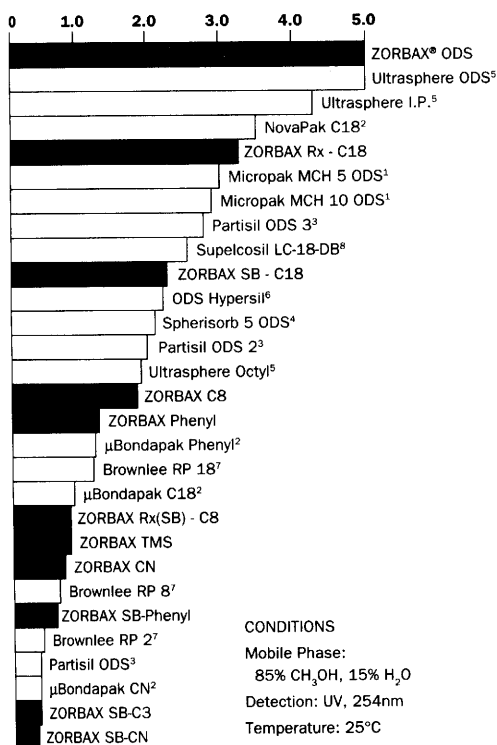

2. Diethyl Phthalate–Polar

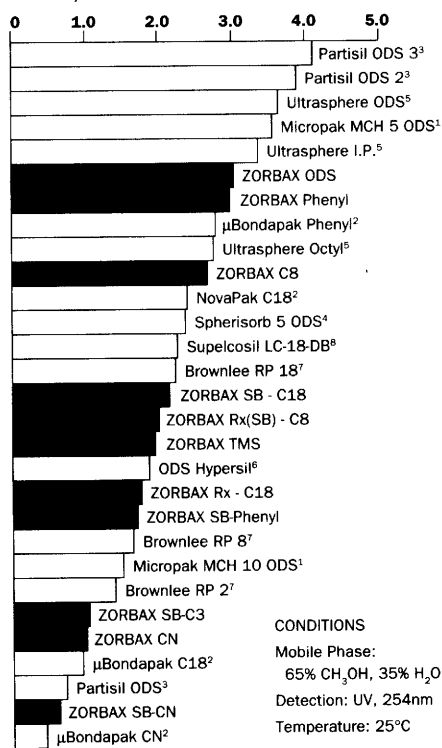

Company trademarks for chromatographic packings:

¹Varian ³Whatman ²Beckman
⁵Waters ⁴Phase Separations ⁶Shandon-Southern

⁷Brownlee
⁸Supelco

FIGURE 6.5 Retention of anthracene and diethyl phthalate on columns from different commercial sources. (From Ref. 12.)

Values of k are also proportional to column surface area. A typical column packing (8-nm pores) will have a surface area of about 250 m² per gram of packing, while particles with 30-nm pores will have a surface area of about 60 m²/g. Other conditions being the same, k values for a 30-nm-pore (low-surface-area) column will be about one-fourth as large (60:250) as k values for an 8-nm-pore column. Therefore, a wide-pore (low-surface-area) cyano column is quite weak and much less retentive than a narrow-pore (high-surface-area) C₁₈ column.

A change in column strength can be used to control sample retention (k range), but in most cases a change in solvent strength (% B) is more effective and convenient. Two exceptions can be noted, however. Very hydrophobic samples are strongly retained, and in some cases their elution from a strong column (e.g., narrow-pore C₁₈) may not be possible, even with NARP conditions (Section 6.5). In this case, the use of a weaker column (e.g., wide-pore cyano) may allow the convenient elution of the sample. Similarly, very hydrophilic samples may benefit from the use of a narrow-pore, highly retentive C₁₈ or (especially) graphitic carbon column.

An increase in temperature by 1°C will usually decrease values of k by 1 to 2% for non-ionic compounds. Thus, a change in temperature can be used to control sample retention (k range), similar to a change in % B. This is seldom used in RPC, however, since it is more effective to vary solvent strength. For very hydrophobic samples it can be useful to operate at higher temperatures with a very strong mobile phase (NARP, Section 6.5) and a very weak column.

6.3 SELECTIVITY IN REVERSED-PHASE CHROMATOGRAPHY

Adjusting the sample k range is only the first step in achieving adequate separation. Once overall sample retention is acceptable ($0.5 < k < 20$), it may be necessary to change the band spacing or selectivity (α) of different bands. Three main variables can be used in RPC to change selectivity for neutral samples: mobile-phase composition, column type, and temperature. A change in mobile-phase composition is generally the most effective and convenient and should be tried first. Changes in temperature are especially convenient but provide generally smaller changes in α . However, small changes in α are adequate for separating many samples.

6.3.1 Solvent-Strength Selectivity

The primary effect of a decrease in % B is to increase k for every sample component. In Fig. 6.2 a change in % B results in a similar change in k for compounds A to D. The selectivity (α) of adjacent peak pairs (e.g., compounds B/C) does not change much as % B is varied from 30 to 56% B (the range for which $0.5 < k < 20$), although resolution continues to increase as % B is decreased. In other

cases, however, the spacing of adjacent bands can change markedly as a function of % B. This *solvent-strength selectivity* is illustrated in the example of Fig. 6.6. Band pair A/B is critical for the 60% and 50% ACN separations (i.e., the resolution of compounds A and B is poor for a mobile phase of > 50% ACN). Since the separation of A and B improves for a decrease in % ACN, a further decrease in solvent strength to 40% ACN is expected to give even better resolution of this band pair, as observed in Fig. 6.6. However, the separation of band pair C/D becomes worse as solvent strength decreases, so that at 40% ACN, compounds C and D become the critical band pair.

When the resolution of one band pair increases and the resolution of another band pair decreases with a change in % B (as in Fig. 6.6), the identity of the critical band pair is changed. The best sample resolution will then occur for a % B value where both band pairs have the same resolution (where both pairs are critical). In the example of Fig. 6.6, the best separation is obtained for an intermediate solvent strength, namely 45% ACN.

There is generally some range of % B values that provide acceptable values of k for all compounds of a given sample. Within this range, a particular mobile phase (% B) will provide the best overall sample resolution (45% ACN in Fig. 6.6). The selection of an optimum solvent strength (% B) as in Fig. 6.6 can be achieved by systematic trial-and-error experiments. Thus, the runs for 40% and 50% ACN suggest that an intermediate % ACN value will provide a better separation of both band pairs, A/B and C/D. Computer programs as described in Section 10.2 can also be used to determine the optimum % B value more precisely and with a minimum of experiments.

Many different studies have shown that changing selectivity by changing solvent strength is often significant for RPC [14–19]. A big advantage of this approach for adjusting peak spacing is that it can be explored while % B is varied for optimum sample retention ($0.5 < k < 20$). Thus, little experimental effort is normally required in adjusting selectivity for adequate resolution. An example of solvent-strength selectivity is shown in Fig. 6.7 for the separation of a mixture of nitro-substituted benzene derivatives [16]. For 60% MeOH as mobile phase (Fig. 6.7a), band 7/8 (arrow) are critical, while for 50% MeOH (Fig. 6.7c), bands 2/3 (arrow) are critical. For this sample, the best separation is for an intermediate mobile-phase composition: 55% MeOH in Fig. 6.7b.

The use of solvent-strength selectivity is limited mainly by the retention range of the sample [i.e., the ratio k_z/k_a for the first (a) and the last (z) bands in the chromatogram]. This ratio can be 40 at most if $0.5 < k < 20$ is maintained. When this ratio is large (e.g., > 20), the acceptable variation of % B is small and possible changes in selectivity by changing % B are also small. However, this limitation becomes much less important when gradient elution is used (Section 8.4.2).

6.3.2 Solvent-Type Selectivity

A change in organic solvent type is often used to change peak spacing and improve resolution [5,20–25]. The selection of different RPC solvents for this pur-

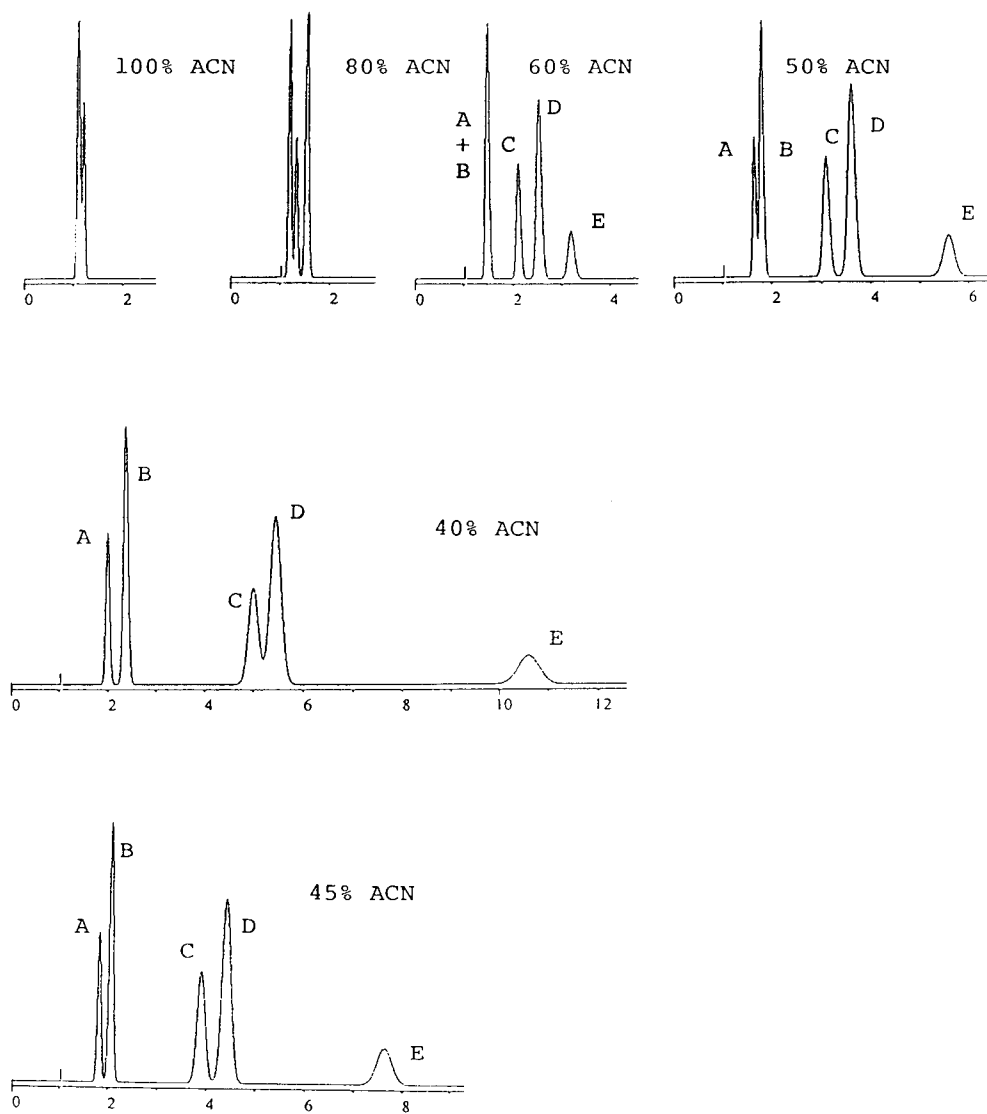

FIGURE 6.6 Solvent-strength selectivity: effect of a change in percent organic on RPC separation for a hypothetical sample. Conditions: 15×0.46 -cm C_{18} column, 1.5-mL/min flow rate.

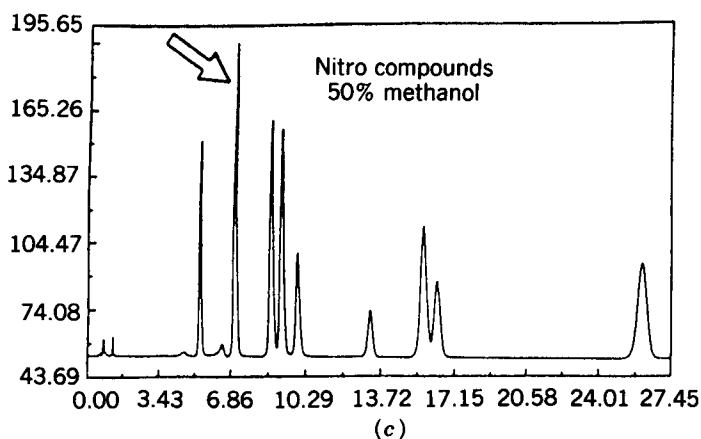
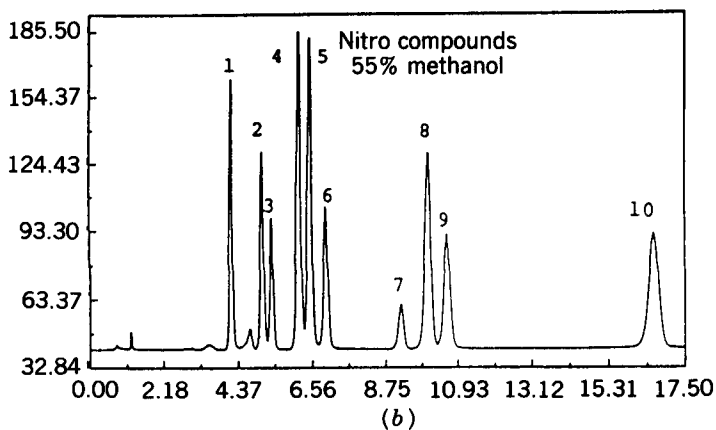
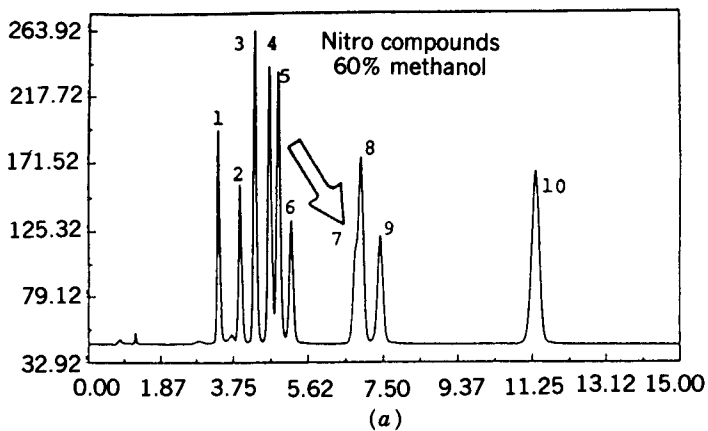

FIGURE 6.7 Separation of nitro-substituted benzenes as a function of solvent strength (percent methanol). Arrows show critical band pairs. (From Ref. 16.)

pose has been guided by solvent properties that are believed to affect selectivity: acidity, basicity, and dipolarity. Various organic solvents can be classified according to these properties [26], as shown in Figs. 2.6 and 6.8. This representation of selectivity, the *solvent-selectivity triangle*, is explained in more detail in Section 2.3.2. The key feature of this classification of solvents for practical method development is that only three solvents should routinely be chosen to provide the *best opportunity* for selectivity changes. Three water-miscible solvents in Fig. 6.8 differ significantly in their selectivity properties (shaded area) and are also acceptable in terms of UV absorptivity and viscosity: acetonitrile (ACN), methanol (MeOH), the tetrahydrofuran (THF). Therefore, these three solvents are recommended for solvent-type selectivity investigations in RPC. Intermediate selectivity (if needed for a particular sample) can be obtained by blending appropriate amounts of each of these solvents, as described more fully below.

A striking example of *solvent-type selectivity* is shown in Fig. 6.9. Here a change from 50% MeOH to 25% THF results in a complete reversal of the elution order of these four compounds! It should be noted, however, that changes in selectivity that do not involve band reversal can still be highly advantageous. Only a slight increase (2 to 5%) in the selectivity (or α value)

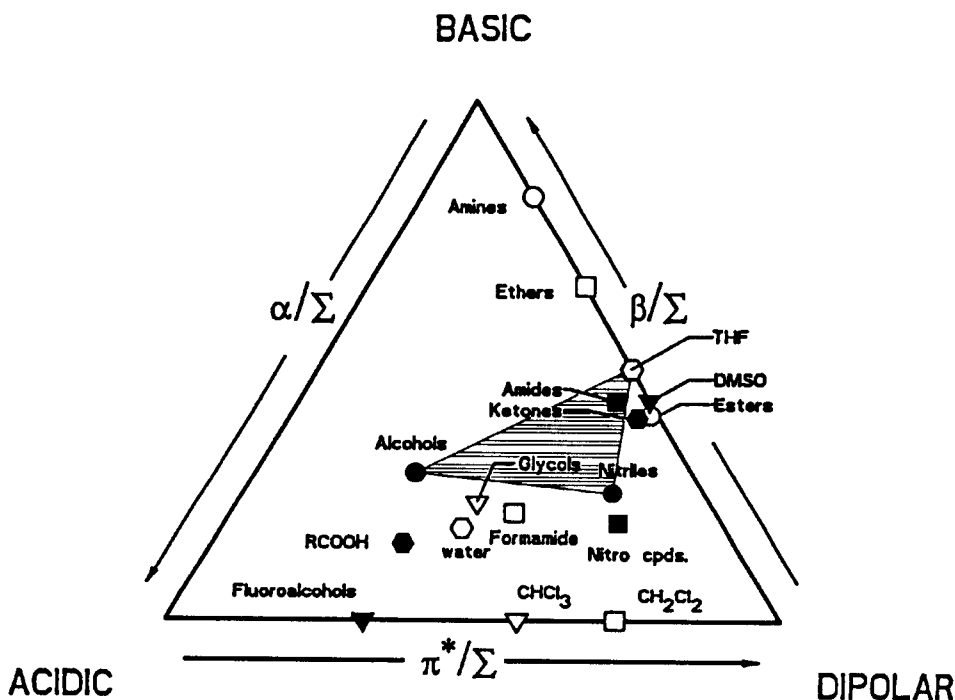

FIGURE 6.8 Modified solvent-selectivity triangle. Cross-hatched area refers to selectivity provided by MeOH, ACN, and THF. (Reprinted with permission from Ref. 26.)

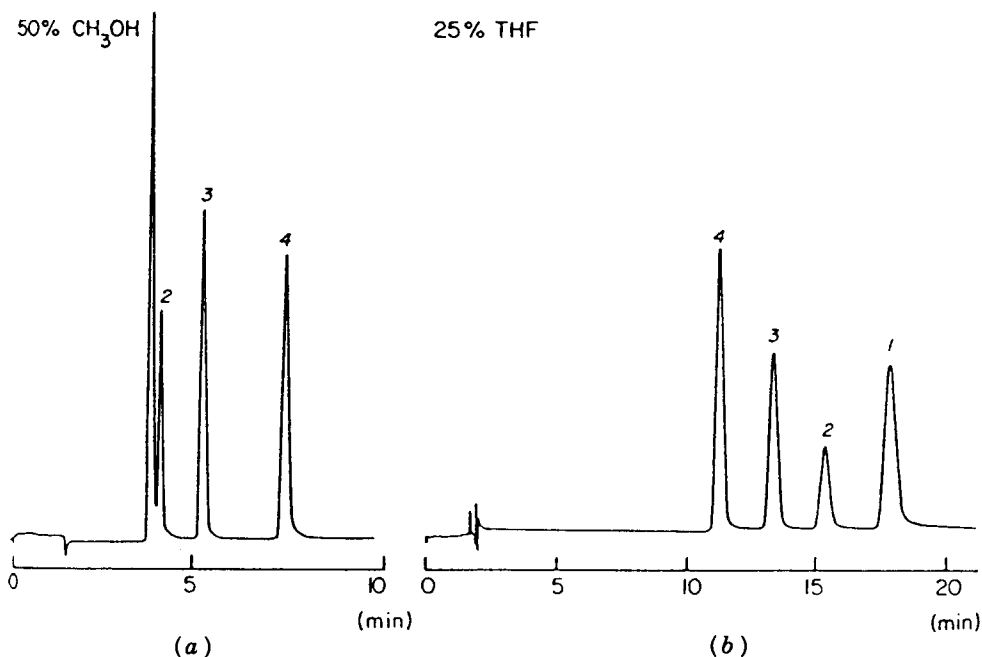

FIGURE 6.9 Solvent-type selectivity in RPC. (a) 50% MeOH-water; (b) 25% THF-water. Bands are: 1, *p*-nitrophenol; 2, *p*-dinitrobenzene; 3, nitrobenzene; 4, methyl benzoate. (Reprinted with permission from Ref. 22.)

for a critical band pair (by some change in experimental conditions) may be necessary to achieve acceptable resolution.

A more complex example of solvent-type selectivity is shown in Fig. 6.10 for a mixture of substituted benzenes. For 50% MeOH (Fig. 6.10a), overlapped peaks 1/2 are critical. Replacing MeOH in this mobile phase with THF requires a change in % B to maintain the same solvent strength (see Fig. 6.4). For 32% THF (Fig. 6.10b), peaks 1/2 are well separated, but now peaks 2/3 are critical. Therefore, some mixture of these two mobile phases should provide a better separation of the sample, and this is seen for a 1:4 blend of 50% MeOH and 32% THF (Fig. 6.10c). Note also in this example that the relative retention of peaks 4 to 6 reverses in going from 50% MeOH to 32% THF.

Solvents other than ACN, MeOH, and THF have found occasional use as a means of optimizing selectivity (e.g., dioxane, propanol, dimethylsulfoxide, 2-methoxyethanol) [27]. While useful differences in selectivity are observed for some samples with these alternative solvents, their use must be weighed against their less desirable properties: higher UV absorbance, higher column backpressure, and issues of purity and stability. Changing solvent type in RPC is usually the most effective procedure to alter selectivity and achieve the separation of multi-component neutral samples.

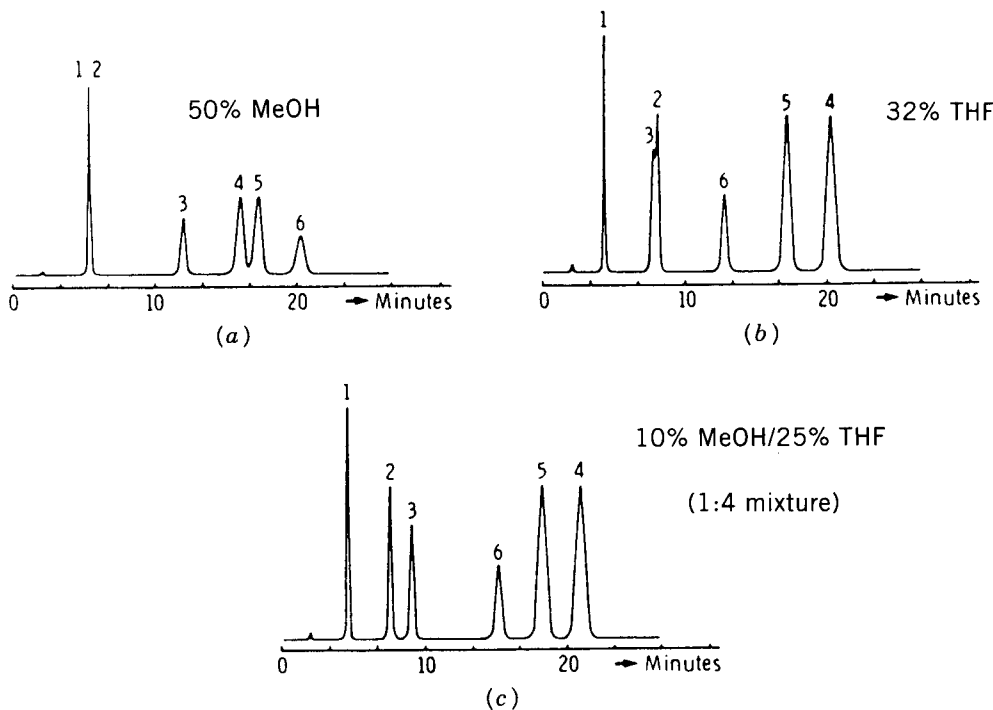

FIGURE 6.10 Solvent-type selectivity in RPC. (a) 50% MeOH–water; (b) 32% THF–water; (c) 10% MeOH–25% THF–water. Bands are: 1, benzyl alcohol; 2, phenol; 3, 3-phenylpropanol; 4, 2,4-dimethylphenol; 5, benzene; 6, diethylphthalate. (Reprinted with permission from Ref. 6.)

We emphasize this approach as a major tool in developing reversed-phase separations for complex samples.

6.3.3 Column-Type Selectivity

A change in column type can produce useful changes in selectivity [9–12,28,29]. In Fig. 6.11, changes in band spacing are evident in each chromatogram for these three different column types. For example, bands 6 and 7 are better separated on the phenyl and C_8 columns than on the cyano column. Conversely, bands 5 and 6 are better separated on the cyano column than on the C_8 column. The phenyl column provides the best separation of *this particular sample for this particular mobile phase*. A change in either % B or solvent type is likely to change selectivity further for each column, so it is possible that the phenyl column is not the only (or the best) column for the sample of Fig. 6.11.

A change in column type can also change overall sample retention as described in Section 6.2.2. This effect is illustrated in Fig. 6.11 for the separation

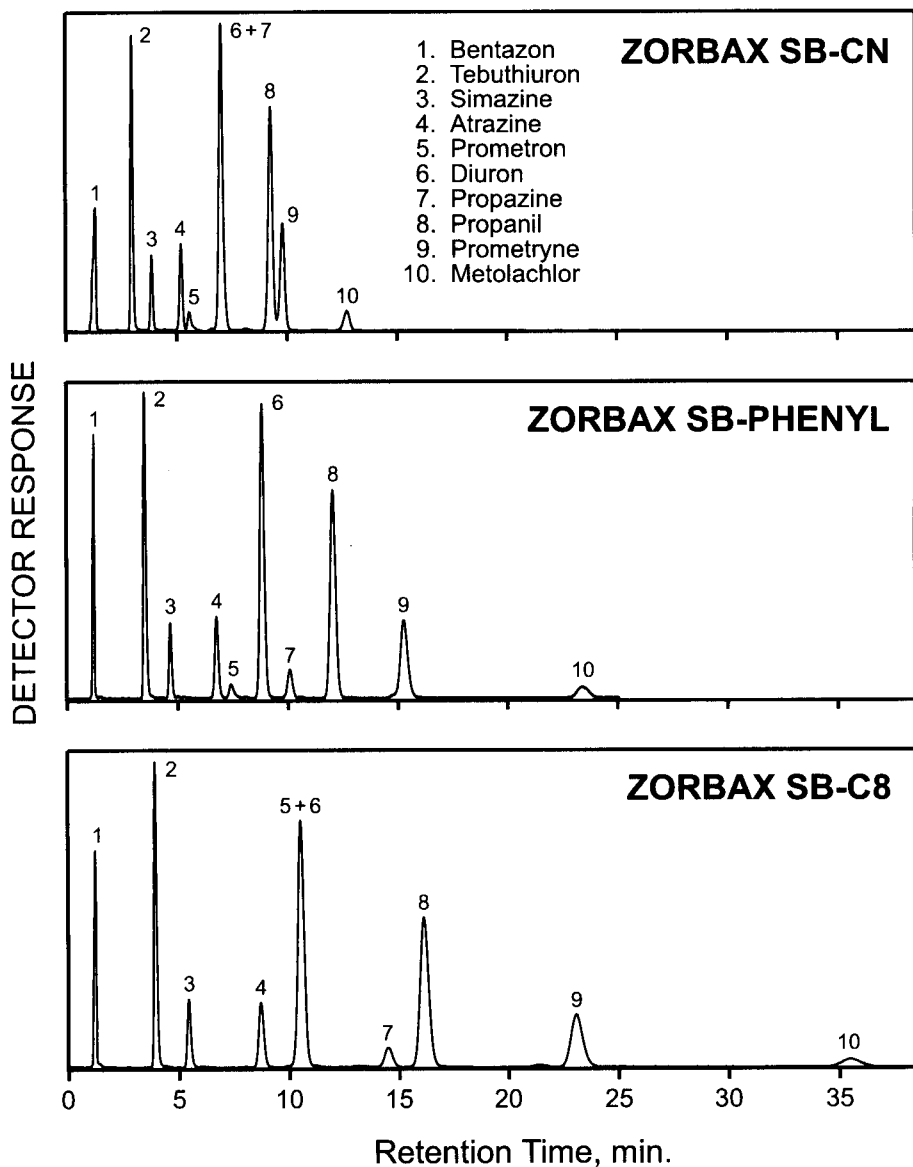

FIGURE 6.11 Effect of column type on selectivity. Columns: Zorbax SB-CN, SB-phenyl, SB-C8, 15×0.46 cm; 35% ACN–65% water; 1.0 mL/min; 22°C; 254-nm UV detection. (Reprinted with permission from Ref. 28.)

of a series of herbicides on three columns with different bonded-phase functionalities using 35% ACN–water. Retention is greater (and run time longer) on the “stronger” C_8 and phenyl columns vs. the “weaker” cyano column. A change of the column is usually less useful than a change in the mobile-phase type. For this reason, a change in column type for the purpose of improving selectivity and separation should be tried *after* the use of solvent-strength or solvent-type selectivity has failed. If the column is changed, the mobile phase must be reoptimized for the new column. Other studies [9,10,29] have shown that column selectivity is quite different for cyano, phenyl, and either C_8 or C_{18} columns. Usually, a C_8 or C_{18} column should be tried first, followed by a cyano, then by a phenyl column.

A change in selectivity by changing column type may also be advantageous if only one organic solvent can be used. For example, low-wavelength UV detection (< 210 nm) may be required, in which case only ACN and water are usable. If some or all of the sample components are unstable or potentially reactive with the mobile phase, a specific organic solvent may also be required. Band spacing changes in RPC can also be affected by changing the source of a given column type. For instance, a brand X C_{18} column could be replaced with a brand Y C_{18} column of the same length and column diameter. While selectivity changes may result in this case (especially for the case of ionic samples), *we do not recommend this approach*. Selectivity differences of this type can arise for a number of different reasons, such as type of silica used, technique and type of bonding chemistry, the presence or absence of endcapping, and other factors (see Chapter 5 for a more complete discussion). These differences are often difficult to control from batch to batch of column packing, are therefore less reproducible over time, and can result in RPC methods that are less rugged. This topic is discussed more fully in Section 7.3.3.

There is an important exception to the recommendation above *not* to use columns from a different source as a means of changing selectivity. Wide-pore RPC C_{18} columns prepared from polyfunctional (polymeric) silanes appear to provide a unique selectivity for polyaromatic hydrocarbons (PAH) that differ in “shape,” due to intramolecular crowding [30]. For this reason, wide-pore columns made with polyfunctional silanes are preferred for the separation of mixtures of PAH samples. It is also possible to characterize differences in C_{18} bonding and resulting column selectivity by means of the PAH test mixture described in Ref. 30; see Appendix V. RPC columns of similar selectivity, which may be interchangeable for some HPLC methods, can be inferred from the grouping of columns in Table V.2 of Appendix V (see also Fig. 5.9).

Column packings bonded with cyclodextrin (CD) are also used in RPC, especially for the separation of enantiomeric isomers (Section 12.5). These CD columns have also been found to be quite effective in separating other (achiral) isomers [31–33]. In this regard, CD-bonded columns compare favor-

ably with the use of normal-phase HPLC for isomer separation (Section 6.6.1). An example is shown in Fig. 6.12.

6.3.4 Temperature Selectivity

Values of k typically decrease at higher temperatures for the RPC separation of neutral compounds (Section 6.2.2). However, large changes in selectivity with temperature are less common with non-ionic solutes. Thus, a change in temperature is in most cases less effective for non-ionic compounds as a means of altering selectivity for improved separation. However, some examples exist such as the one shown in Fig. 6.13. Compounds 2 and 4 are twisted molecules (*o*- and *m*-terphenyl), while the remaining four compounds are planar, fused-ring polyaromatics. As the temperature is increased, the relative retention of the planar compounds decreases more rapidly than for the non-planar compounds. As a result, the critical bands 2 to 4 change their spacing as temperature is varied. Band 3 overlaps band 4 at 36°C, but moves toward band 2 as the temperature is raised and overlaps band 2 at 48°C. An optimum band spacing for this mobile phase/stationary phase system is obtained with a temperature of 42°C.

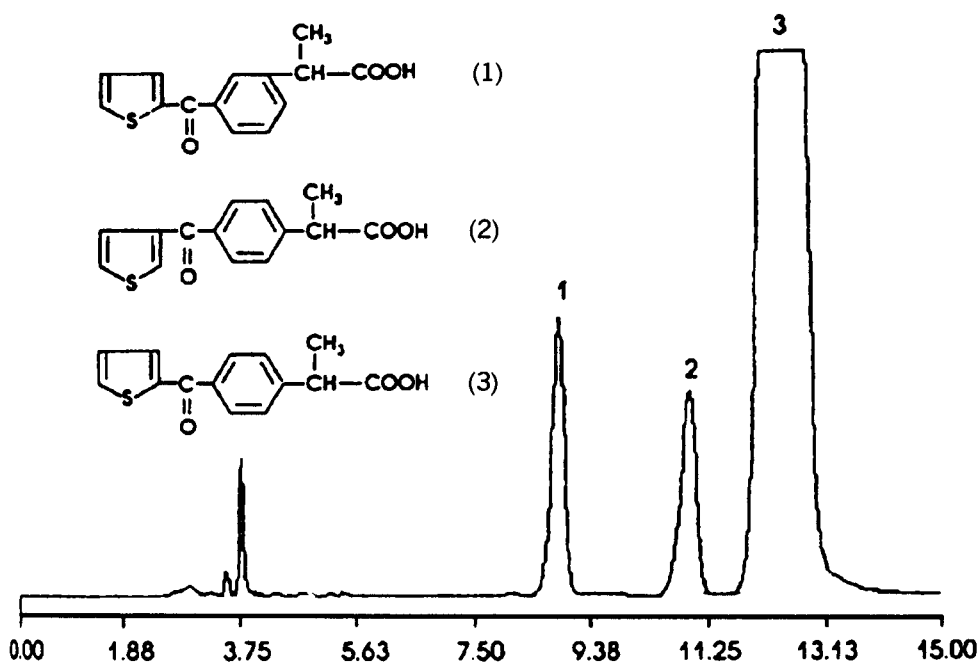
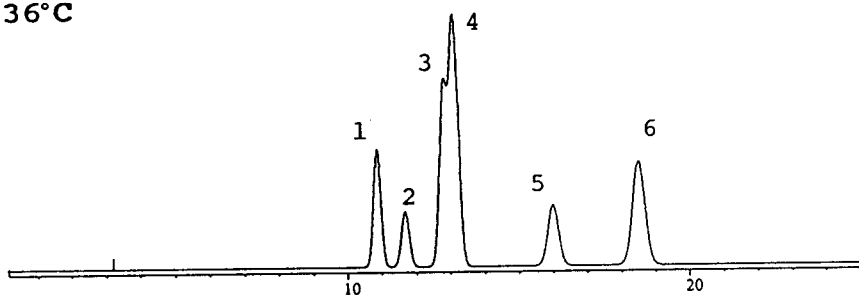
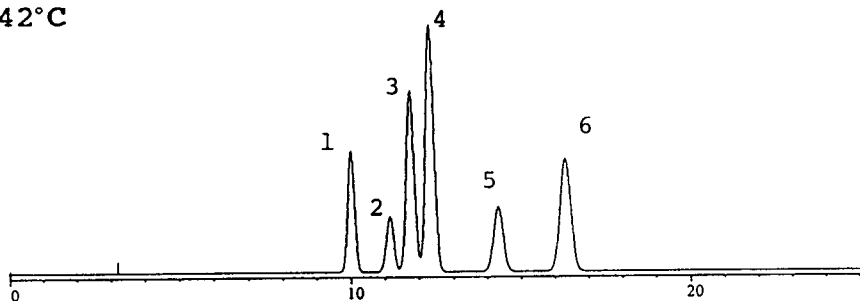

FIGURE 6.12 Separation of isomers with a cyclodextrin-bonded column. Conditions: 25 × 0.46-cm Cyclobond I column; 30% ACN–buffer (pH 4.5); 2.0 mL/min; 35°C. (Reprinted with permission from Ref. 32.)

36°C



42°C



48°C

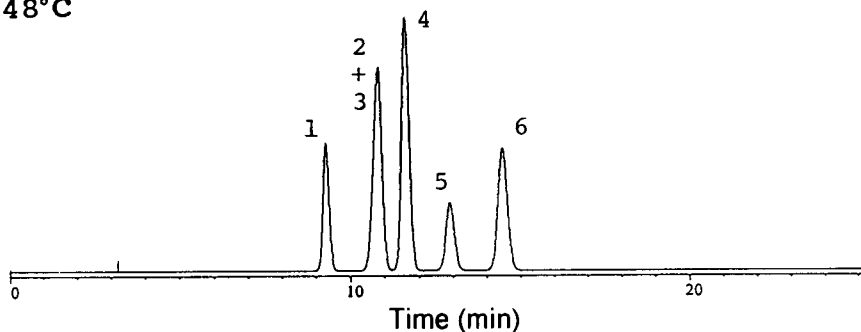

FIGURE 6.13 Effect of a change in temperature on selectivity for a mixture of polyaromatic hydrocarbons. Sample: 1, anthracene; 2, *o*-terphenyl; 3, fluoranthene; 4, *m*-terphenyl; 5, triphenylene; 6, chrysene. Conditions: 31.4 × 0.46-cm C₁₈ column; 80% ACN–water; 1.0 mL/min; temperature as indicated. (Chromatograms reconstructed from data of Ref. 34.)

6.4 OPTIMIZING THE SEPARATION OF NON-IONIC SAMPLES IN REVERSED-PHASE CHROMATOGRAPHY

The recommended initial approach for RPC method development, summarized in Chapter 9, is applicable for regular samples of any type (ionic or neutral). While adequate separation of most neutral samples should be achieved

able in this way, the chromatographer can carry out effective method development in other ways as well. In this section we describe some of these techniques, especially for those samples that require additional method-development experiments aimed at changing selectivity. These include:

- Use of solvent type plus % B (Section 6.4.2.2)
- Use of organic solvent mixtures (Section 6.4.2.3)
- Change in column type plus change in % B (Section 6.4.2.4)
- Combined use of different solvents plus column types (Section 6.4.2.5)

6.4.1 Getting Started

Recommended starting conditions for developing RPC methods for non-ionic compounds are summarized in Table 1.3. These parameters are selected to offer a good compromise among resolution, run time, and pressure [35]. A 15- or 25-cm, 5- μ m C₈ or C₁₈ column is preferred initially, with unbuffered ACN–water as the mobile phase. The flow rate should be 1 to 2 mL/min. The column temperature should be controlled at some temperature between 35 and 45°C, to avoid possible changes in retention and selectivity as room temperature varies. However, temperature control is less critical for separating non-ionic samples. If the optimum wavelength for UV detection is not known initially, detection at 210 nm is probably the best first choice (Section 3.2.2).

The recommended approach to RPC method development for the isocratic separation of neutral samples is outlined in Table 6.2. The first experiment can be carried out in either an isocratic or gradient mode. An initial isocratic experiment is assumed here; see the discussion in Section 8.2.2 and Section 9.2.1 for the (preferred) use of an initial gradient run. Figures 6.2 and 6.6 illustrate both the initial isocratic run (100% ACN) and the subsequent trial-and-error experiments that lead to satisfactory sample

TABLE 6.2 Recommended Approach for Reversed-Phase Method Development

-
1. Adjust % B for $0.5 < k < 20$ (preferably, $1 < k < 10$)
 2. Check for band tailing or low plate number
 3. Adjust selectivity if necessary
 - a. Fine-tune % B
 - b. Change organic solvent
 - c. Mix organic solvents
 - d. Change column type
 - e. Vary temperature
 4. Optimize column conditions (column length, particle size, flow rate)
-

retention ($0.5 < k < 20$). Samples that are retained either too strongly or too weakly for any value of % B require special handling (Section 9.2.2). In addition, if tailing bands, low column plate numbers (N), or other undesirable peak shape effects are observed, they should be dealt with before proceeding with further method development. Often, this will require remedies discussed in Chapter 7.

6.4.2 Optimizing Selectivity

Once the % ACN for acceptable sample retention has been established, it may be necessary to adjust selectivity for improved separation (i.e., either a shorter run time or better resolution). As described earlier in this chapter, there are many ways to change selectivity; a list of these possibilities is given in Table 6.3. Means of changing selectivity are listed in rough order of priority and are considered next.

TABLE 6.3 Options for Improving Selectivity^a

Vary solvent strength	<i>Advantages:</i> easy and convenient; α can be explored by varying % B for $0.5 < k < 20$. <i>Disadvantages:</i> provides less control over α than a change of solvent, especially if isocratic elution is used for samples where $k(\text{last band}) \gg k(\text{first band})$.
Change solvent type (ACN, MeOH, THF)	<i>Advantages:</i> preferred procedure for changing α when a change in % B is inadequate (possible changes in α are greater than for a change in % B alone). <i>Disadvantages:</i> less convenient than a change in % B—more runs required.
Mix different solvents	<i>Advantages:</i> provides intermediate selectivity for separating more than one critical band pair; expands the value of changing solvent type. <i>Disadvantages:</i> less convenient—requires a larger number of experimental runs.
Change column type	<i>Advantages:</i> change in selectivity comparable to that for a change in % B; a change in column type is useful when only one solvent type can be used (e.g., ACN). <i>Disadvantages:</i> less convenient because a new column must be installed and equilibrated; use of different column types connected in series for intermediate selectivity is less practical (mixed solvents are preferable).
Vary temperature	<i>Advantages:</i> convenient if column temperature control is available. <i>Disadvantages:</i> changes in α with temperature are usually smaller than for other variables.

^a In rough order of priority. Two or more options can be combined (e.g., varying solvent strength and/or changing solvent type when changing column type).

6.4.2.1 Solvent-Strength (% B) Effects. The use of solvent-strength selectivity (varying % B) is the first choice for separating unresolved bands, because of ease and simplicity. Selectivity effects based on solvent strength will usually be obvious during the adjustment of % B for acceptable retention ($0.5 < k < 20$), as in the examples of Figs. 6.6 and 6.7. The final choice of % B should take into account retention range ($0.5 < k < 20$), resolution, and run time. If no value of % ACN provides acceptable selectivity (unresolved bands), further changes in experimental conditions must be investigated. Whenever another means of changing selectivity is investigated, it is desirable to re-optimize % B for both $0.5 < k < 20$ and improved selectivity. Examples of this approach are given below.

6.4.2.2 Solvent-Type Effects Plus % B Effects. For most neutral samples, a change in organic solvent from ACN to MeOH or THF is likely to result in major changes in band spacing and the resolution of band pairs that were unresolved with ACN as solvent. This is illustrated for the separation of a steroid sample in Fig. 6.14. The three chromatograms on the left side of Fig. 6.14 for 24% ACN, 45% MeOH, and 19% THF each have $k = 20$ for the last band (same solvent strength). Whereas bands 1 and 3 are unresolved for 24% ACN, these two bands are baseline resolved with 45% MeOH and 19% THF. In addition, bands 4 to 6 change relative positions between the MeOH and THF runs.

Figure 6.14 also shows the benefit of optimizing % B for selectivity as well as for $0.5 < k < 20$ when the solvent is changed. For the case of ACN as solvent, band pair 1/3 is unresolved for both 24% ACN ($k = 20$ for last band) and 42% ACN ($k = 0.5$ for first band). In this case, any adjustment of % B (same modifier) to change selectivity will be unsuccessful for this mixture. With methanol as solvent, band pair 4/5 is critical for 45% MeOH ($k = 20$ for last band), but band pair 1/2 is critical for 65% MeOH ($k = 0.5$ for first band). Whenever a change in the critical band pair occurs on changing % B, an intermediate value of % B will give better resolution. In this case, the separation shown for 48% MeOH is optimum ($R_s = 1.5$). For THF as solvent, $0.5 < k < 20$ for $19\% < \% B < 37\%$. Band pair 1/2 is critical for 19% THF and band pair 4/6 is critical for 37% THF. The best resolution is found for an intermediate % B: 24% THF with $R_s = 1.9$.

The separations of Fig. 6.14 suggest a simple method development strategy that is useful for samples with about 10 or fewer components [16,36]. The first experiments aim at understanding separation (R_s , run time) as a function of % ACN. Usually, four or five runs will identify the best % ACN value, as in the examples of Figs. 6.2 and 6.6. If an acceptable separation results, no further experiments are required. For the steroid sample of Fig. 6.14, separation is not achieved as % ACN is varied, and solvents other than ACN are tried next. Use of the solvent nomograph (Fig. 6.4) allows a quick estimate of the best % MeOH value in a smaller number of runs. In Fig. 6.14, 48% MeOH provides $R_s = 1.5$ in a run time of 12 min.

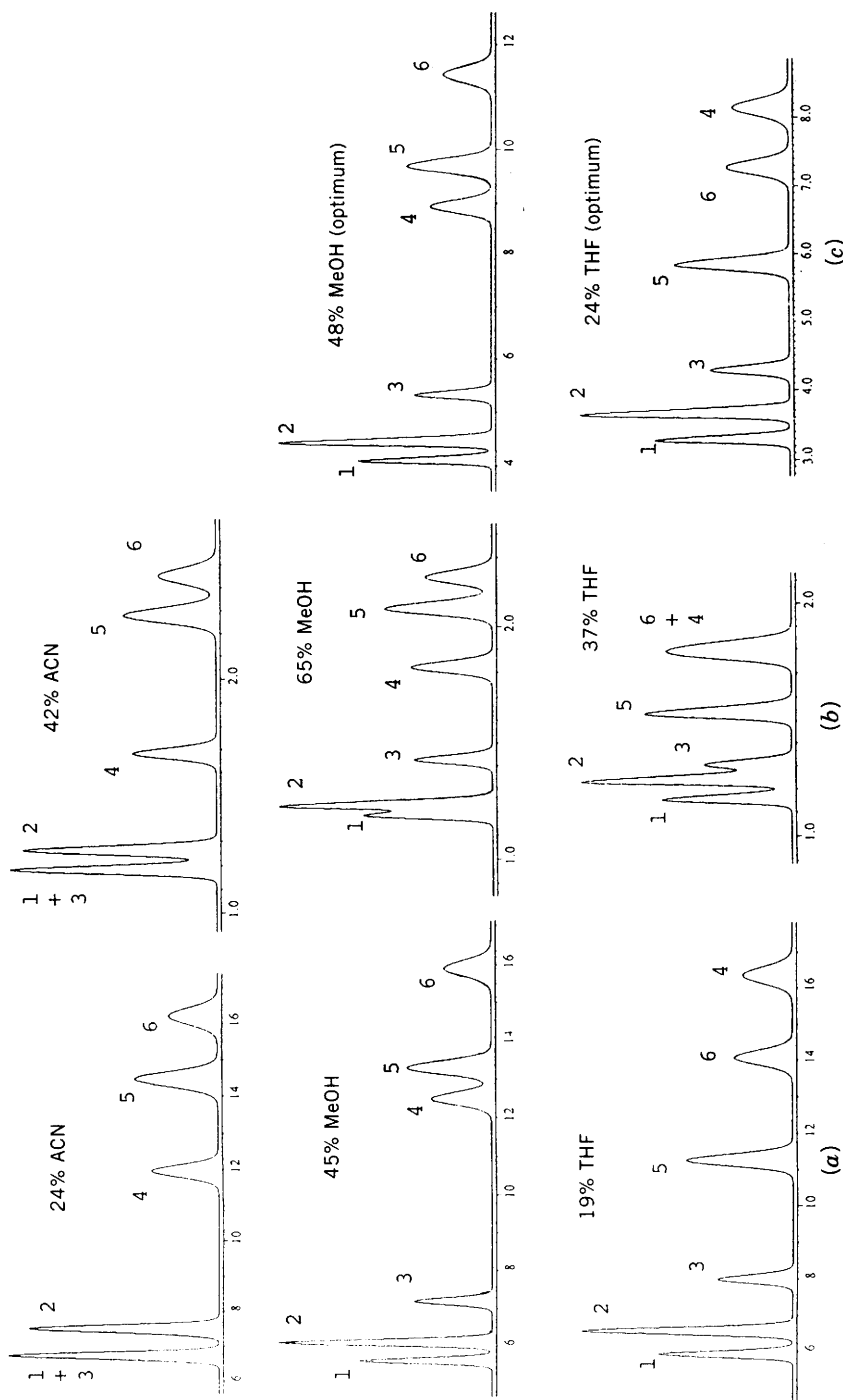

FIGURE 6.14 Solvent-strength and solvent-type optimization for a steroid sample. Sample: 1, prednisone; 2, cortisone; 3, hydrocortisone; 4, dexamethasone; 5, corticosterone; and 6, corticosterone. Conditions: 15×0.46 -cm Zorbax C8 column; 2.0 mL/min; 35°C. (Chromatograms reconstructed using data from Ref. 16.)

If either resolution or run time is unacceptable for ACN or MeOH as solvents, then a few additional experiments will provide the best value of % THF. In this case, 24% THF gives $R_s = 1.9$ and a run time of 9 min. Although this is the best separation shown in Fig. 6.14, there is no way of predicting in advance which solvent (ACN, MeOH, THF) will be best. The stepwise procedure of Fig. 6.14 ensures that a minimum number of experiments will be required to achieve an acceptable separation, assuming that some combination of solvent type and % B will be successful.

6.4.2.3 Use of Organic Solvent Mixtures. Another powerful approach to optimizing solvent-type selectivity is outlined in Fig. 6.15. This procedure holds solvent strength constant while blending ACN, MeOH, and THF in all possible proportions. Run 1 in Fig. 6.15 is the result of first adjusting % ACN so that $0.5 < k < 20$. If this separation is inadequate, further experiments (runs 2, 3, . . .) are carried out until an acceptable separation results. The mobile phases for runs 2 (MeOH) and 3 (THF) are selected from the solvent-strength nomograph (Fig. 6.4), based on the best % ACN value of run 1. Mobile phases for runs 4 to 7 are prepared from the mobile phases for runs 1 to 3 as follows:

Mobile Phase	Volume of Indicated Mobile Phases to Be Combined		
	Run 1	Run 2	Run 3
Run 4	1	1	
Run 5	1		1
Run 6		1	1
Run 7	1	1	1

For example, the mobile phase for run 4 is prepared by blending equal volumes of the mobile phases for runs 1 and 2.

Once the seven runs of Fig. 6.15 are completed, one can readily select a mobile-phase composition that provides the best resolution of the sample. As described originally [23], this procedure used a computer program for automatic method development (Section 10.3). However, the example of Fig. 6.16 illustrates step-by-step method development that does not require the use of a computer and may not require all seven runs of Fig. 6.15.

The nine-component sample of Fig. 6.16 is a mixture of substituted naphthalenes. Initial experiments with varying % ACN were used to obtain 52% ACN for $0.7 < k < 8$ (acceptable retention): run 1 in Fig. 6.16. Two overlapped band pairs (2/3, 6/7) are observed with 52% ACN, so a change in selectivity is needed for acceptable separation. Use of the solvent nomograph (Fig. 6.4)

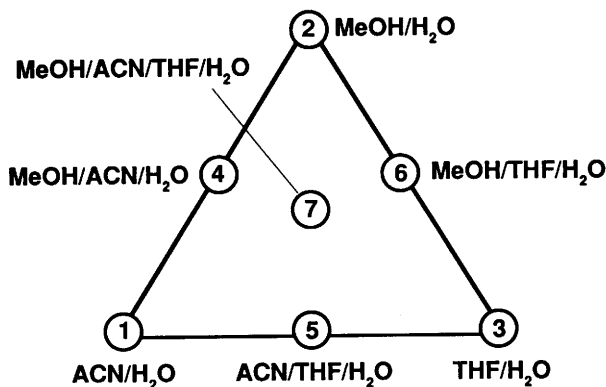

FIGURE 6.15 Plan for selectivity optimization in RPC based on mixtures of acetonitrile (ACN), methanol (MeOH), and tetrahydrofuran (THF). All mobile phases are of equal strength (see Fig. 6.4).

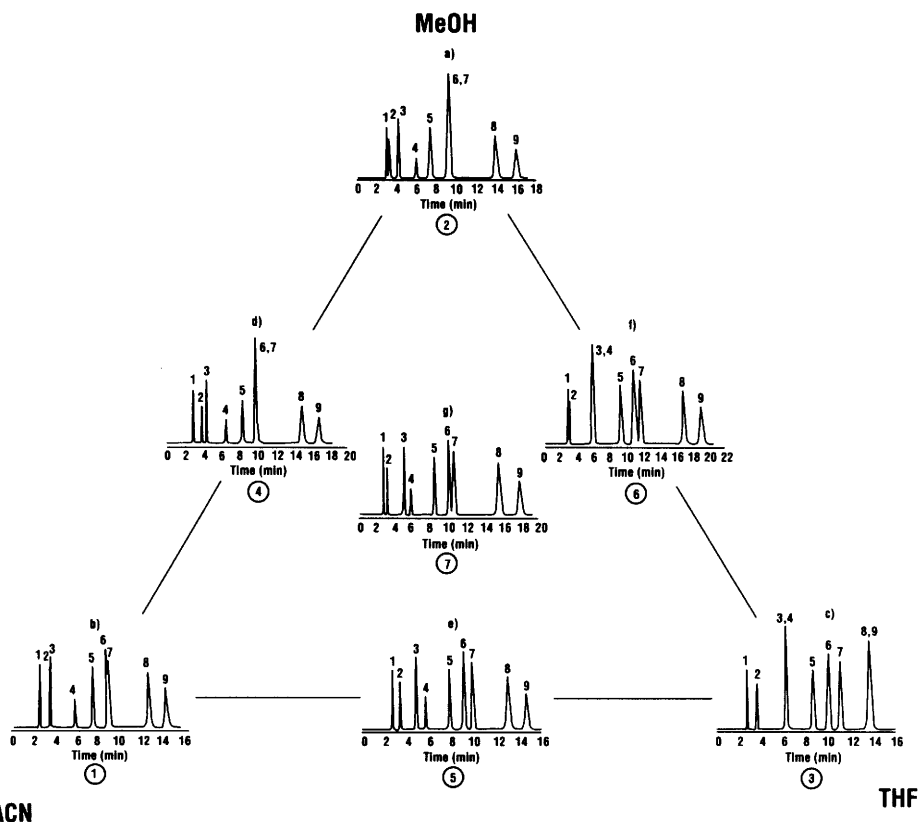

FIGURE 6.16 Seven chromatograms for solvent-selectivity experiments for substituted naphthalenes. Column 15 × 0.46-cm Zorbax-C8, flow rate 2.0 mL/min; 40°C. (Chromatograms from data in Ref. 23.)

suggests the use of 63% MeOH for the next experiment (run 2). Peak pairs 2/3 and 6/7 overlap in this run. Since peak pair 6/7 is unresolved in both runs 1 and 2, it is unlikely that a mixture of MeOH and ACN will be successful in separating all the components in this sample. (This conclusion is confirmed in the chromatogram of run 4 of Fig. 6.16, but in practice this experiment would not be required.)

Since mixtures of ACN and MeOH cannot separate the present sample, the next experiment is run 3 with a new solvent: THF. Again, the solvent nomograph provides an estimate of the required value of % B (39% THF). Note that for some samples the approximate nature of the nomograph of Fig. 6.4 may require one or two additional experiments to obtain values of % MeOH or % THF that give a similar run time as for run-1 with ACN, but in this case these additional experiments were not needed. In run 3 band pairs 3/4 and 8/9 overlap, *but these are different critical band pairs than were observed in run 1 (2/3, 6/7) or run 2 (1/2, 6/7). Therefore, some improvement in separation can be expected by blending the mobile phase for run 3 with that for either run 1 or 2.*

If a blend of mobile phases from runs 2 and 3 (run 6: MeOH-THF) is tried, band pair 3/4 is overlapped and band pair 1/2 is barely resolved. Further blending of mobile phases for runs 6 and 3 will still leave band pair 3/4 unresolved, while blends between runs 6 and 2 can provide only marginal separation of band pair 1/2. For this reason, a mixture of mobile phases from runs 1 and 3 should be tried next. This separation (run 5) shows baseline separation of all nine bands in the chromatogram. Further minor improvements in separation might be achieved by blending a little of the mobile phase for run 3 with more of the mobile phase for run 2, because the critical band pair for run 5 (6/7) is better resolved in run 3. For separations such as this that involve more than one critical band pair, the best mobile-phase composition will be the one that provides equal resolution for the two most critical band pairs in question (6/7 and either 3/4 or 8/9, in this case).

Several studies have demonstrated that an optimum mixture of these organic solvents (ACN, MeOH, THF) rarely requires all three solvents. However, for difficult separations, run 7 can provide additional selectivity information regarding the relative movement of the critical band pairs. Therefore, RPC method development can be carried out *more efficiently* by focusing first on conditions represented by the edges of the triangle in Fig. 6.15 (runs 1 to 6 only). The four-solvent run 7 should be run last, and only if needed.

The method-development approach of Fig. 6.14 can be used as a beginning for the procedure of Fig. 6.15. Thus, the experiments of Fig. 6.14 define the best values of % B for runs 1, 2, and 3 of Fig. 6.15. For (difficult) samples that require a combined approach (varying both solvent strength and type; Fig. 6.14 and Fig. 6.15), best values are obtained of % ACN, % MeOH, and % THF in the final mobile phase. Thus, the two procedures represented by the separations in Figs. 6.14 and 6.15 are highly complementary and extremely powerful. More important, samples that do not require this much control over

selectivity can be separated with just a few experiments, as in the examples of Fig. 6.6 (change in % B) or Fig. 6.14 (use of different solvent types).

6.4.2.4 Column-Type Effects Plus % B Effects. Columns of different type (C_8 or C_{18} , phenyl, cyano) can also be used to change selectivity, and this can be especially useful when *combined with changes in % B*. For a particular type of column, a certain selectivity will be observed and the adjustment of % B can be used to further "fine-tune" the selectivity, change retention times, and potentially reduce separation time. This is illustrated in the separations of Fig. 6.17 for a sample composed of substituted benzoic acids. Although this sample does not fit our definition of "neutral," under the low-pH conditions used for the separation, all compounds are protonated and uncharged (i.e., are effectively neutral).

Chromatograms are shown in Fig. 6.17a for the separation of this sample by three different columns (C_8 , phenyl, and cyano), using % MeOH values that give maximum sample retention ($k = 20$ for the last band). For these conditions, we might conclude that the phenyl column gives the best separation, since bands 4/6 partially overlap on the C_8 column and bands 1/2 are unresolved on the cyano column. However, the simplicity of this sample and its limited retention range allows the use of stronger mobile phases, as shown in Fig. 6.17b, where % B has been adjusted for each solvent to give $k = 0.5$ for the first band [e.g., 52% MeOH (b) vs. 26% MeOH (a) for the C_8 column].

A comparison of runs on the same column with different % MeOH values (Fig. 6.17a vs. b) shows significant changes in band spacing (i.e., solvent-strength selectivity). These two runs on each column allow the systematic adjustment of % MeOH for maximum resolution, leading to the chromatograms of Fig. 6.17c. The benzoic acid sample is better separated on the cyano column when the optimum value of 32% MeOH is selected. That is, resolution is acceptable and equal to that for the phenyl column ($R_s = 2.0$), but run time is shorter (5 min vs. 13 min).

6.4.2.5 Combined Use of Different Solvents Plus Column Types. The combined use of solvent- and column-type selectivity may be useful for the separation of extremely difficult samples. This approach is outlined in Fig. 6.18. Solvent-type selectivity is first investigated for a C_8 or C_{18} column using the approach of Fig. 6.15. If a satisfactory separation is obtained, no further improvement in selectivity is attempted. If separation is inadequate, the approach of Fig. 6.15 is repeated using a cyano column. (*Note:* The optimum mobile phase for one column will differ from that for another column.) If these experiments are unsuccessful, the procedure of Fig. 6.15 is repeated with a phenyl column.

The procedure of Fig. 6.18 has been used to separate a mixture of 20 PTH amino acids [29]. Figure 6.19 shows the best separations for each column, and the best overall resolution ($R_s = 1.2$) used a benzyl (similar to phenyl) column

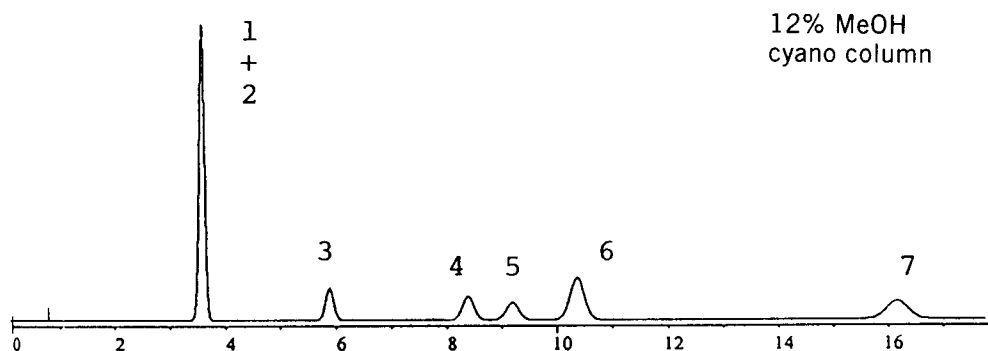
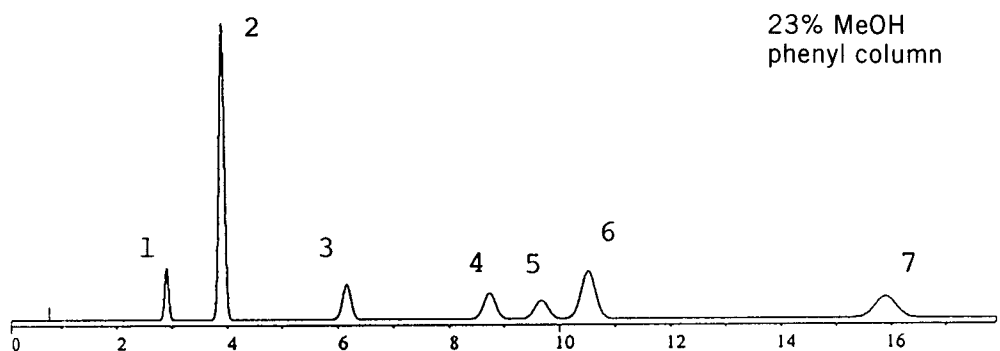
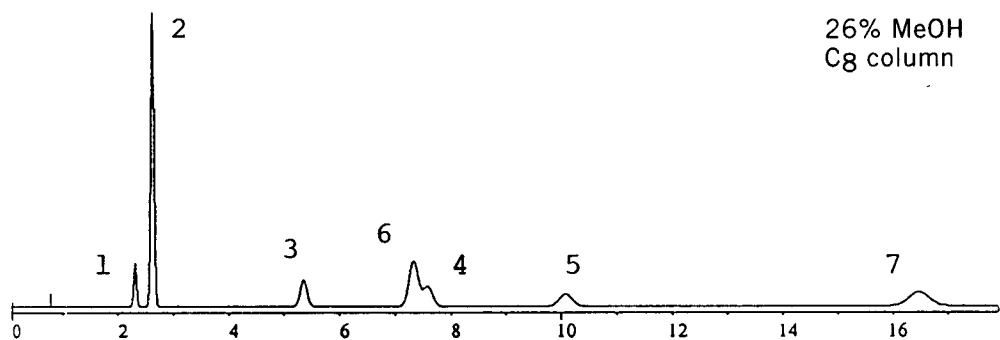

(a)

FIGURE 6.17 Separation of a mixture of substituted benzoic acids on three different column types. Conditions: 15×0.46 -cm, $5\text{-}\mu\text{m}$ columns; mobile phase as indicated, buffer is 25 mM citrate (pH 2.5); 2.0 mL/min; 35°C. (a) % MeOH adjusted to give $k = 20$ for last band; (b) % MeOH adjusted to give $k = 0.5$ for first band; (c) % MeOH adjusted to give maximum resolution. (Chromatograms are simulations based on data of Ref. 11.)

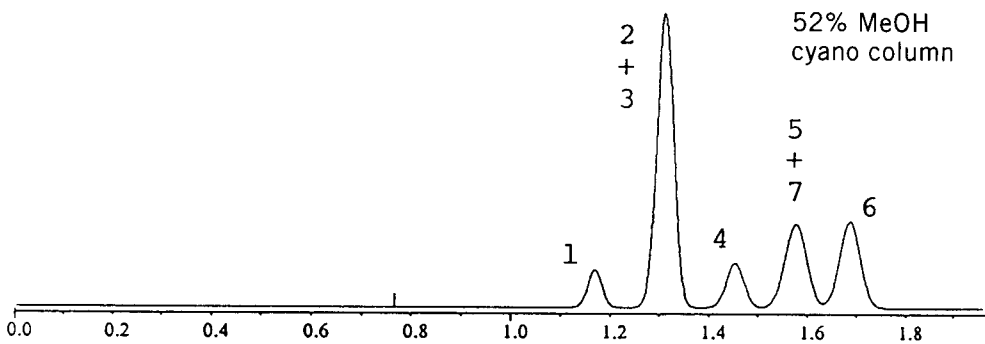
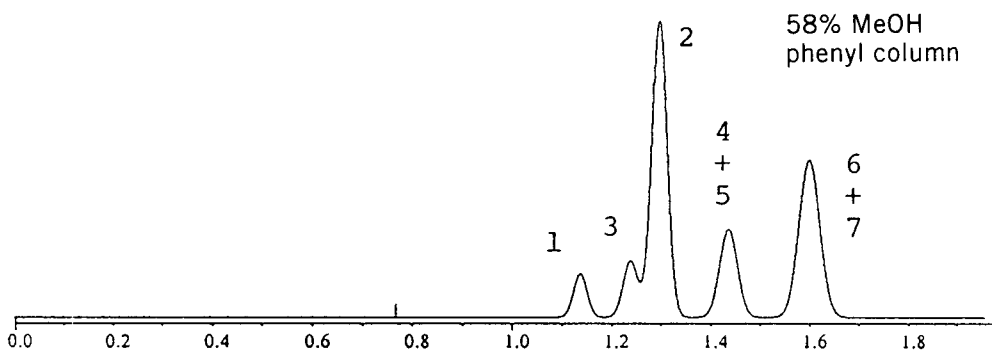
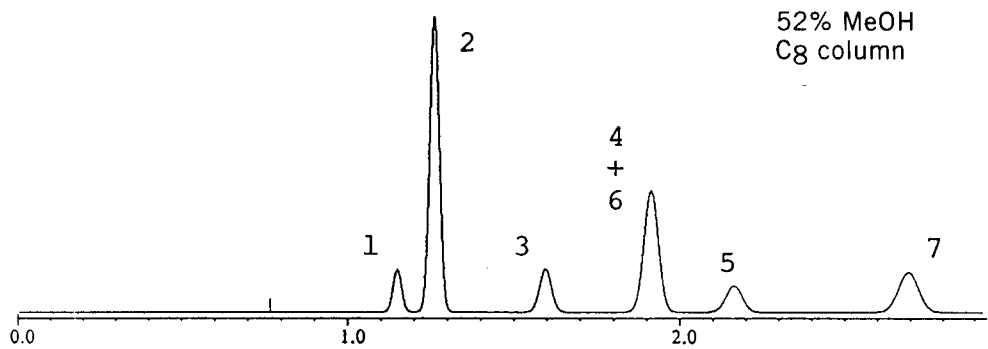

(b)

FIGURE 6.17 (Continued)

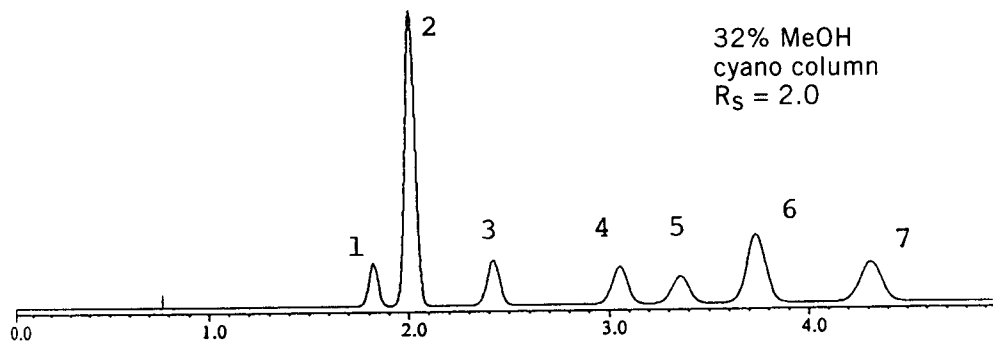
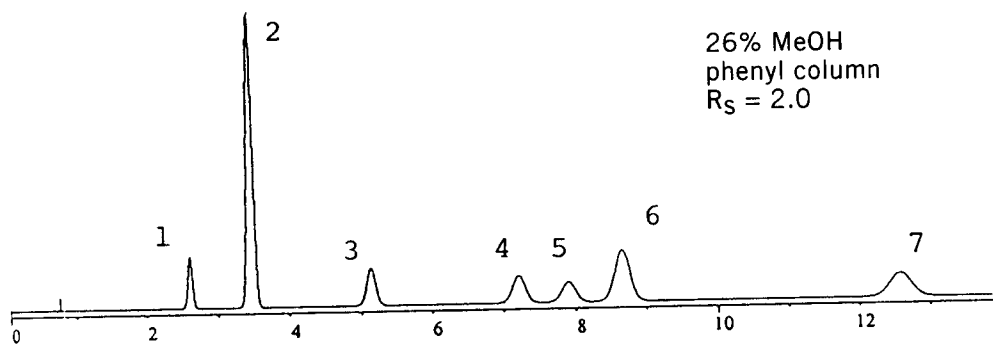
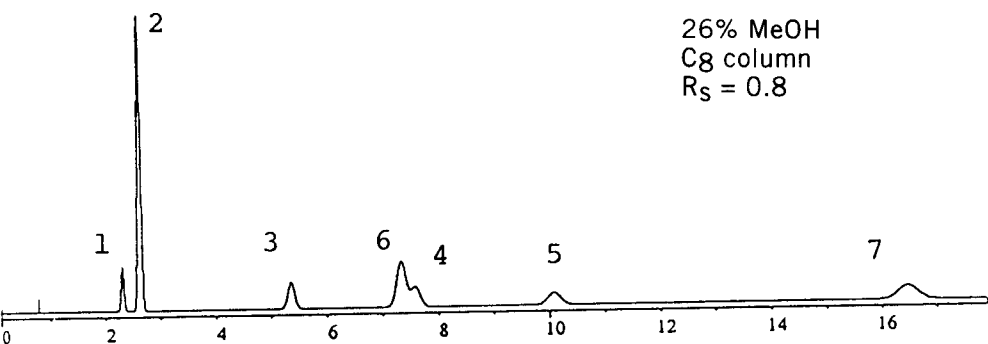

(c)

FIGURE 6.17 (Continued)

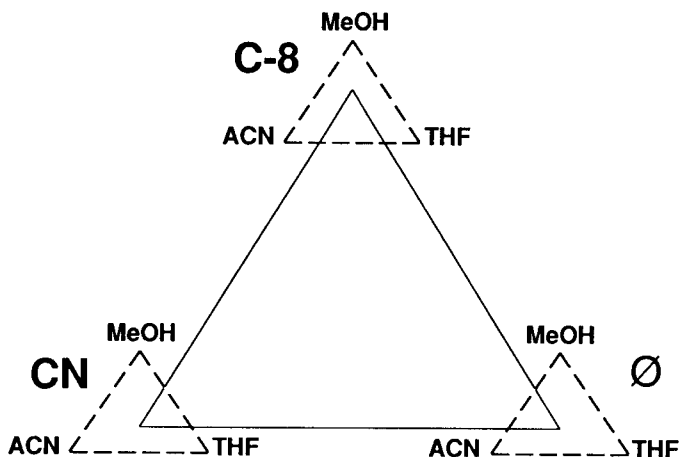

FIGURE 6.18 Method development using combined solvent- and column-type selectivity. Schematic diagram of experimental approach using C_8 , cyano, and phenyl (\emptyset) columns with mobile phases containing ACN, MeOH, and THF. Solvent strength and run time held constant. (Reprinted with permission from Ref. 29.)

and a mobile phase of 5% ACN, 15% MeOH, and 13% THF. Note that this separation is only marginally better than that for the C_8 ($R_s = 0.9$) or cyano ($R_s = 1.0$) columns.

6.5 NON-AQUEOUS REVERSED-PHASE HPLC

Non-aqueous reversed-phase (NARP) is reserved for very hydrophobic samples that are retained strongly or not eluted with 100% acetonitrile as the mobile phase (e.g., lipids or synthetic polymers) [37–40]. The mobile phase for NARP separations will be a mixture of more polar (A) and less polar (B) organic solvents. Often the A-solvent will be ACN or MeOH, while the B-solvent can be THF, chloroform, methylene chloride, acetone, methyl-*t*-butyl ether (MTBE) or various mixtures of these solvents. Sample retention again is controlled by varying % B and the type of strong solvent B.

FIGURE 6.19 Application of procedure of Fig. 6.18 to the separation of 20 PTH amino acids. Best mobile phase used for each separation on different columns. Conditions: 25×0.46 -cm columns, $6\text{-}\mu\text{m}$ particle size. Bonded phase: (a) CN; (b) benzyl; (c) C_8 . Mobile-phase flow rate 2.0 mL/min, column temperature 50°C . Mobile phases: A/B/C/D: methanol/acetonitrile/tetrahydrofuran/pH 2.1 phosphoric acid. (a) A = 9.2/B = 1.3/C = 21.0/D = 67.6; (b) A = 15.2/B = 5.4/C = 13.4/D = 66.0; (c) A = 0.8/B = 26.5/C = 4.5/D = 68.2. (Reprinted with permission from Ref. 29.)

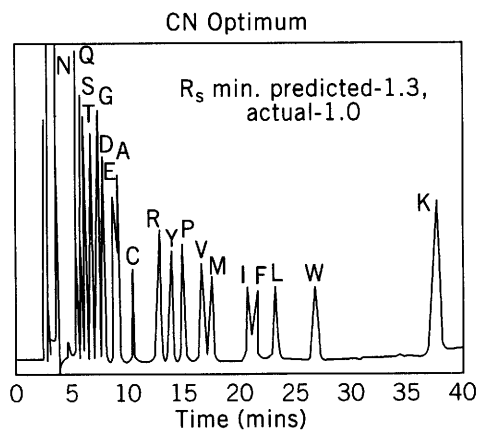

(a)

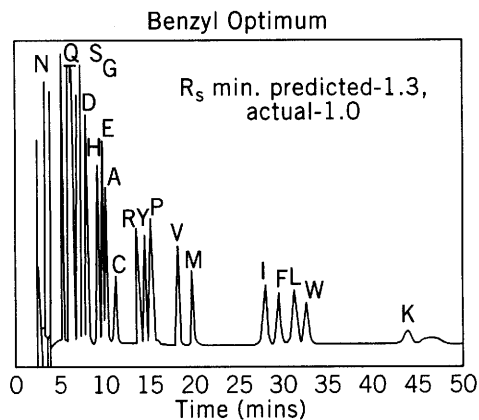

(b)

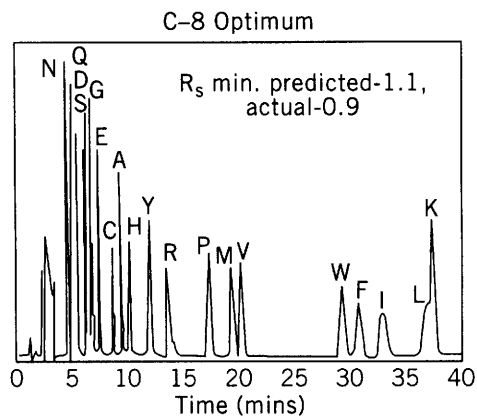

(c)

Figure 6.20 shows an example of NARP for the separation of various carotenes (*a*) in a mixture of standards (*b*) and in an extract from tomato (*c*). Lycopene (peak 1) is the main carotene present in the sample of Fig. 6.20c. Very hydrophobic samples are often insoluble in aqueous solvents, which is another reason to use NARP for such samples. A further illustration of the use of NARP for these types is described in Ref. 40, where a change in temperature was also used to obtain an optimum separation.

Method development for NARP is similar to that for RPC with the usual water-organic mobile phases. Mixtures of ACN (A) and THF (B) as mobile phase are a good starting point. If the sample is retained too strongly with 100% THF, less polar (stronger) B-solvents such as methylene chloride or chloroform can be tried instead. However, the use of methylene chloride or chloroform restricts UV detection to wavelengths higher than 236 or 250 nm, respectively.

NARP is less commonly used today, possibly because favored B-solvents such as methylene chloride preclude low-wavelength UV detection. Many samples that have been separated by NARP can be handled conveniently by means of normal-phase chromatography.

Part II Normal-Phase Chromatography

In normal-phase chromatography (NPC) the stationary phase is more polar than the mobile phase, the opposite of RPC. Usually, the mobile phase is a mixture of organic solvents without added water (e.g., isopropanol plus hexane) and the column packing is either an inorganic adsorbent (silica or occasionally alumina) or a polar bonded phase (cyano, diol, or amino) on a silica support. Regardless of the mobile or stationary phase used, *sample retention in NPC increases as the polarity of the mobile phase decreases (the opposite of RPC)*.

NPC has been used for separating both neutral and ionic (or ionizable) compounds, but neutral samples predominate. NPC for ionic samples can involve the use of water in the mobile phase [41–45], and the retention process is then somewhat complex [45]. When ionic samples are separated by NPC, it is usually advisable to add triethylamine to the mobile phase for basic compounds and acetic or formic acid for acidic compounds. Neutral samples are often separated equally well by either RPC or NPC, the main difference being a reversal of elution order for the two HPLC methods. In NPC, *less polar (hydrophobic) compounds elute first, while more polar (hydrophilic) compounds leave the column last*; this behavior can be contrasted with the opposite RPC behavior of Fig. 6.1. The reasons for using NPC were noted earlier and are summarized in Table 6.4.

The advantages and disadvantages of NPC are summarized in Table 6.5. Usually, RPC separation should be tried first, but an initial NPC separation may be preferred for reasons given in Table 6.4. More often, the need for a change from RPC to NPC will become apparent after initial RPC experiments show either inadequate retention or poor selectivity for different solvents and/or columns. A brief comparison of the selectivity differences of RPC and NPC is shown in Table 6.6.

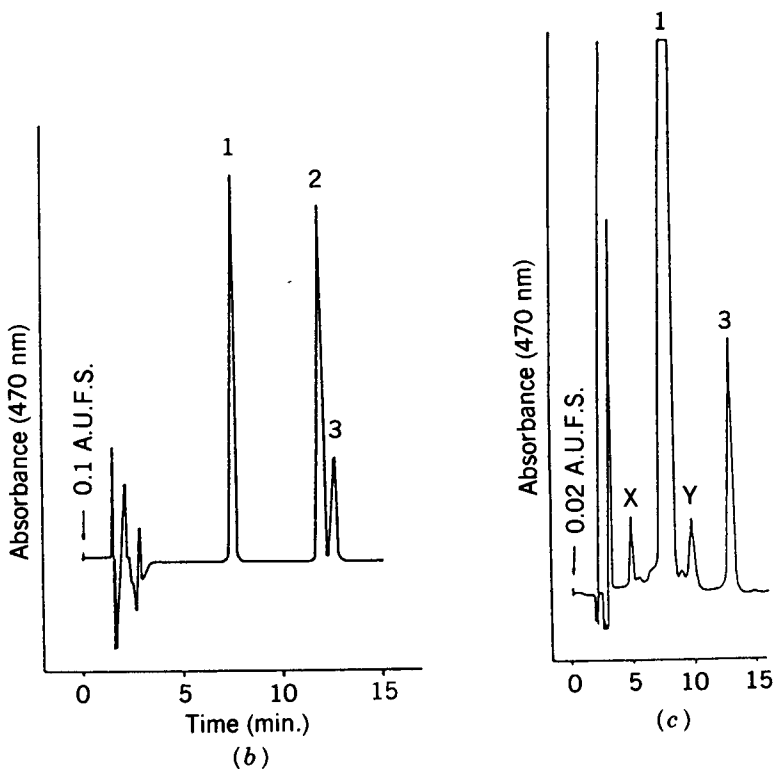
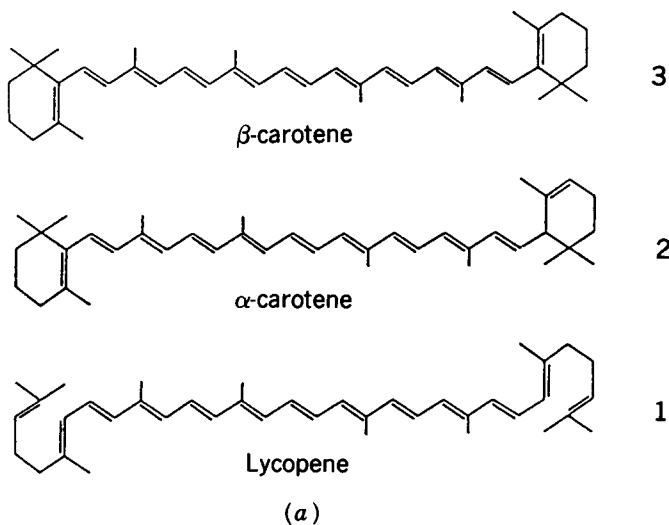

FIGURE 6.20 Non-aqueous reversed-phase (NARP) separations of carotenes. Conditions: 25×0.46 -cm C_{18} column; 8% chloroform-ACN mobile phase; 2.0 mL/min; ambient temperature; UV detection at 470 nm. (Reprinted with permission from Ref. 39.)

TABLE 6.4 Reasons to Use Normal-Phase Chromatography

1. The sample is unretained by RPC (too hydrophilic).
2. The sample is too strongly retained by RPC (too hydrophobic).
3. RPC separation is unable to achieve adequate band spacing ($\alpha \approx 1$).
4. The sample contains positional isomers, stereoisomers, or diastereomers.
5. Recovery of significant amounts of organic-soluble sample components is desired (preparative HPLC, Chapter 13).
6. The sample is dissolved in a non-polar solvent (causing direct-injection problems if using a RPC column).

6.6 RETENTION IN NORMAL-PHASE CHROMATOGRAPHY

6.6.1 General Aspects

While retention in RPC is believed to resemble a partition process (Fig. 6.1), retention in NPC, on the other hand, appears to occur by an adsorption process. This is illustrated in Fig. 6.21a for the retention of a sample molecule S from a mobile phase containing polar solvent molecules E. Prior to retention, the surface of the column packing (adsorbent) is covered with a layer of

TABLE 6.5 Characteristics of Normal-Phase Chromatography

Advantages	Disadvantages
<ol style="list-style-type: none"> 1. Very large changes in separation selectivity are possible by changing either the mobile phase or column packing (especially for inorganic packings such as silica). 2. Columns are quite stable when using non-aqueous mobile phases. 3. Many organic compounds are more soluble in normal-phase solvents (a special advantage in preparative HPLC). 4. Pressure drop is lower due to lower-viscosity solvents. 5. Useful for samples which may decompose in aqueous solutions. 	<ol style="list-style-type: none"> 1. Ionic samples are more easily separated by RPC. 2. Controlling solvent strength can be less predictable and more tedious than in RPC. 3. Column plate numbers in NPC are sometimes lower than in RPC. 4. Lower-boiling solvents are more prone to evaporation and bubble formation, especially at higher room temperatures (less convenient). 5. For unmodified silica: <ol style="list-style-type: none"> a. Retention can be variable because of water uptake by the column packing. b. Gradient elution may not be practical because of solvent demixing and water uptake by silica columns. 6. Higher cost of purchase and disposal of organic solvents.

TABLE 6.6 Comparison of Selectivity of NPC and RPC

Compounds having different functional groups

Larger α values for silica vs. C_{18} ; more similar α values for polar-bonded-phase NPC columns vs. C_{18} in RPC.

Homologs or compounds differing in carbon number

Larger α values for RPC vs. NPC

Isomers

Much larger α values for silica vs. C_{18} ; larger α values for polar-bonded-phase columns vs. C_{18} .

solvent molecules E. The retention of a sample molecule S then requires the displacement of molecules E, to provide a space for the adsorption of S.

6.6.1.1 Sample and Solvent Localization. Polar sample and solvent molecules (S and E in Fig. 6.21) are strongly attracted to polar groups (*adsorption sites*) on the surface of the column packing. The adsorption sites are silanols ($-\text{SiOH}$) in the case of silica. For cyano, amino, or diol columns commonly used in NPC, the bonded-phase ligands and/or silanols can be the adsorption sites. Polar sample molecules consist of one or more polar functional groups attached to a hydrocarbon residue such as hexane or benzene. The non-polar

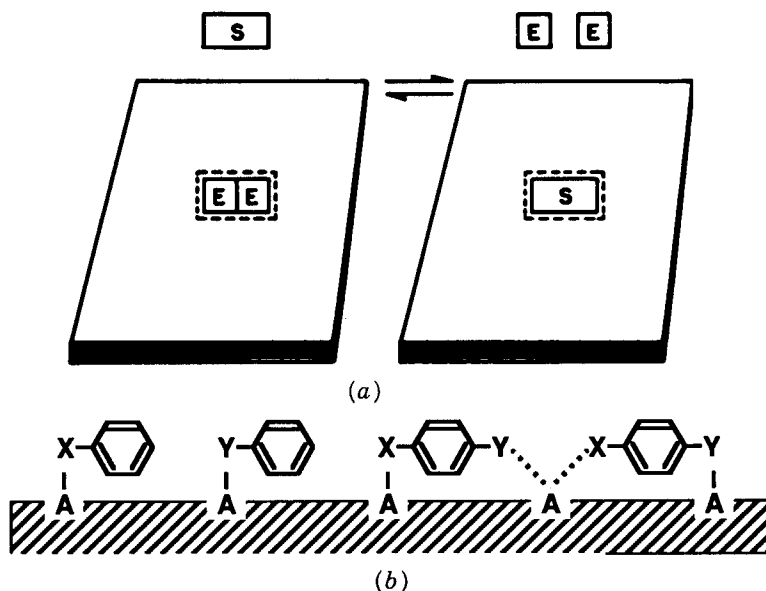

FIGURE 6.21 Hypothetical representation of normal-phase retention. S, sample molecule; E, molecule of strong solvent (B); X and Y are polar functional groups. See the text for details.

hydrocarbon will be attracted to adsorption sites only weakly, in contrast to the attached polar groups. This is illustrated in Fig. 6.21*b* for various benzene derivatives substituted by polar groups X and Y.

In the case of the mono-substituted compounds X-benzene and Y-benzene (Fig. 6.21*b*), the polar group X or Y is attracted to an adsorbent site A. When group X or Y is very polar, this attraction will be quite strong, and group X or Y becomes attached or *localized* onto an adsorbent site. When two or more polar groups are present in the same molecule, it may not be possible for each of these groups to localize at the same time, as illustrated in Fig. 6.21*b*. Localization of very polar solvent molecules is also possible, with the important practical consequence of enhanced selectivity control.

Polar sample and solvent molecules interact strongly with the stationary phase in NPC. As a result, NPC usually allows more control over selectivity than RPC, by changing either the strong solvent (B) or the column. This is illustrated in Table 6.7 for the NPC separation of two compounds on alumina with two different mobile phases. For 5 : 10 : 85 ACN–benzene–pentane (ABP) as mobile phase, the solutes 1,3,5-trinitrobenzene (TNB) and *N,N*-dimethyl-1-naphthylamide (DMN) have similar retention ($\alpha = 1.2$). When the mobile phase is changed to benzene, there is an extreme change in selectivity ($\alpha = 290!$). This change in selectivity arises from the differences in localization of the two solutes and the two strong solvents in each case; benzene does not localize, whereas ACN localizes strongly. The localization of the solvent acetonitrile competes with and reduces the strong localization of DMN, so that its retention is reduced. Since TNB is not highly localized (no very polar substituent group), the localization of ACN has less effect on the retention of TNB. These important solvent-selectivity localization effects are discussed further in Section 6.6.2.

For a detailed discussion of the fundamental nature of NPC separations, see Refs. 47 to 53. The strong interaction of solvents and solutes with NPC stationary phases requires a somewhat different approach to solvent classification and method development (Section 6.7 and Refs. 47 to 49) than was presented for RPC (Fig. 6.15).

TABLE 6.7 Selectivity in NPC Separation: Effect of a Change in Mobile Phase^a

Compound	Value of <i>k</i> for mobile phase indicated	
	5/10/85 ABP ^b	Benzene
1,3,5-Trinitrobenzene	5.9	0.3
<i>N,N</i> -dimethyl-1-naphthylamide	7.1	88
	$\alpha = 1.2$	290

^a Column: 25 × 0.38-cm packed with water-deactivated basic alumina.

^b A, acetonitrile; B, benzene; P, pentane.

Source: Ref. 46.

6.6.2 Mobile-Phase Effects

The mobile phase for NPC is chosen in the same general way as for RPC. A weak (non-polar) solvent A and a strong (polar) solvent B are first selected and then blended to obtain a mobile phase of intermediate polarity that will provide $0.5 < k < 20$ for the sample. During the adjustment of % B for adequate retention, changes in selectivity with % B should be noted so that the resolution of the critical band pair can be optimized (solvent-strength selectivity; compare the discussion of Figs. 6.6 and 6.7 for RPC). If separation is still inadequate, a different strong solvent can be selected for additional changes in selectivity. If further improvement in separation is required, mixtures of the latter strong solvents can be explored as in Fig. 6.16 for RPC.

6.6.2.1 Solvent Strength. The strength of different solvents or solvent mixtures for NPC can be represented by a parameter ϵ° [47,50] which can be measured experimentally. Values of ϵ° for some commonly used HPLC solvents are listed in Table 6.8 for silica as column packing (additional ϵ° values are given in Ref. 47 for both silica and alumina). Relative solvent strength for other NPC column packings (alumina, polar bonded phases) follows the same trend as in Table 6.8 (larger values of ϵ° for more polar solvents). This

TABLE 6.8 NPC Solvent Strength (ϵ°) and Selectivity^a

Solvent	ϵ°	Localization	Basic?	UV ^b
Hexane, heptane, octane	0.00	No	^c	201
1,1,2-Trifluoroethane (Freon FC-113)	0.02	No	^c	235
Chloroform	0.26	No	^c	247
1- or 2-Chloropropane	0.28	No	^c	225
Methylene chloride	0.30	No	^c	234
2-Propyl ether	0.32	Minor	^c	217
1,2-Dichloroethane	0.34	No	^c	234
Ethyl ether	0.38	Yes	Yes	219
MTBE ^d	0.48	Yes	Yes	225
Ethyl acetate	0.48	Yes	No	256
Dioxane	0.51	Yes	Yes	215
Acetonitrile	0.52	Yes	No	192
THF	0.53	Yes	Yes	230
1- or 2-Propanol	0.60	Yes	^e	214
Methanol	0.70	Yes	^e	210

^a Silica used as absorbent.

^b Minimum UV wavelength; assumes that maximum baseline absorbance (100% B) is 0.5 AU.

^c Solvent basicity is irrelevant for non-localizing solvents.

^d Methyl *t*-butyl ether.

^e Different selectivity due to presence of proton donor group.

Source: Refs. 47 and 48.

similar trend allows the easy selection of stronger (or weaker) B-solvents as required for NPC.

Once the weak and strong solvents have been selected, these can be blended to provide appropriate retention. This approach is illustrated in Fig. 6.22 for the separation of a two-component sample on a cyano column with mixtures of MTBE (polar) and hexane (nonpolar) as mobile phase. As % MTBE is increased from 3% to 12%, the run time decreases from 8 min to 4 min. For silica as adsorbent, a large number of studies have shown that retention is governed by the Soczewinski equation [54]:

$$\log k = c - n \log X_B \quad (6.3)$$

Here c and n are constants for a particular solute, B-solvent, and column, and X_B is the mole fraction of B-solvent in the mobile phase. The quantity n corresponds approximately to the number of polar, localizing groups in the solute molecule. A more convenient form of Eq. 6.3 which is of comparable reliability is

$$\log k = c' - n' \log(\% B) \quad (6.3a)$$

where c' and n' are also constant for a particular solute, B-solvent, and column.

A large number of NPC studies that verify Eq. 6.3 or Eq. 6.3a for silica as packing have been summarized [55,56]. Experimental data points for a solute fall close to a straight-line plot of $\log k$ vs. $\log \% B$ (Eq. 6.3 or Eq. 6.3a) over

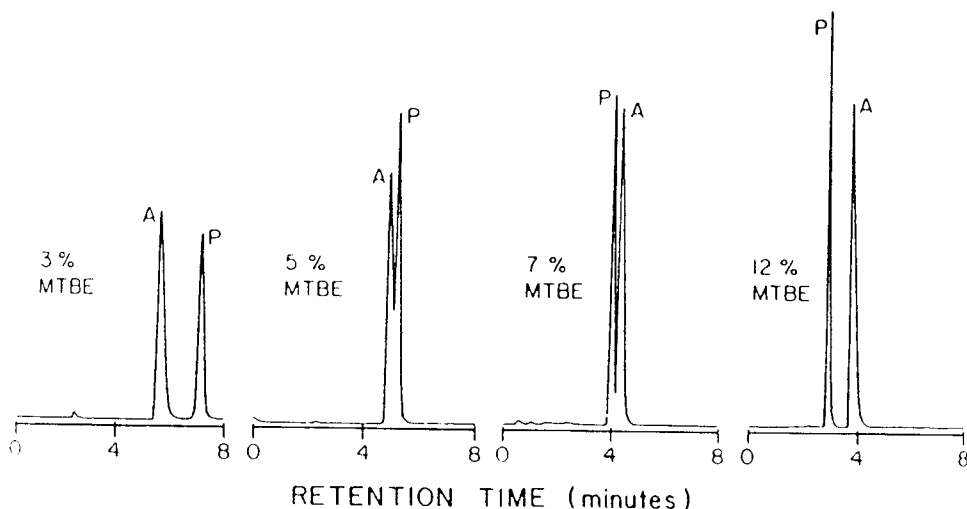

FIGURE 6.22 Solvent-strength effects in normal-phase chromatography. Separation of aniline (A) and phenol (P); 25×0.46 -cm cyano column, MTBE-hexane mobile phases, 1.0 mL/min [51].

a wide range in % B. The slopes of these plots typically vary from about 1 to 2, which gives rise to a "rule of 3" for the prediction of NPC retention as % B is varied: *a twofold increase in % B will cause about a threefold decrease in k*. The applicability of Eq. 6.3 or Eq. 6.3a for NPC with polar-bonded-phase columns has not been studied in as much detail, but some workers have reported that Eq. 6.1 (for RPC) also applies for NPC with polar bonded phases [57]. While Eqs. 6.3 and 6.3a have a sound fundamental basis, *the important conclusion is that change in retention is a regular function of % B*. In particular, the rule of 3 is widely useful for the practical adjustment of NPC retention when changing % B.

When changing the B-solvent for a change in selectivity, it is convenient to be able to adjust % B for similar retention (as in the RPC solvent-strength nomograph of Fig. 6.4). Figure 6.23 provides a solvent-strength nomograph for NPC separation with silica, while Fig. 6.24 provides a similar nomograph for NPC separation with any polar-bonded-phase column. The solvents described in Figs. 6.23 and 6.24 include preferred solvents for NPC, as discussed in the following section. The relationships shown in Figs. 6.23 and 6.24 are more approximate for NPC than those in Fig. 6.4 are for RPC, due to the much larger solvent selectivity effects encountered in NPC (e.g., as in Table 6.7). Similarly, when NPC mobile phases of the same strength (equal ϵ°) are mixed, the strength of the resulting mixture often changes (usually to a higher value of ϵ° and therefore a higher strength). As a result, adjusting mobile phase strength in NPC usually requires more trial-and-error experiments than in RPC.

6.6.2.2 Mobile-Phase Selectivity. As in the case of RPC separation, selectivity for NPC can be altered by varying % B or changing the B-solvent. Figure 6.22 shows a reversal of two bands as % MTBE is varied from 3% to 12%. Therefore, when initially adjusting % B for $0.5 < k < 20$ in NPC, attention should also be paid to selecting % B for maximum resolution of the critical band pair.

Large changes in NPC selectivity can be achieved by an appropriate change of B-solvent type. Whereas the basicity, acidity, or dipolarity of the solvent govern RPC selectivity, solvent localization is more important in NPC [47,48,60]. Therefore, a change from a non-localizing solvent such as methylene chloride to a localizing solvent such as ACN (see Table 6.8) can be expected to cause large changes in selectivity. For example, 1,5-dinitronaphthalene (DNN) and 2-acetonaphthalene (AN) are unresolved on silica ($\alpha = 1.0$) with 3% ACN-hexane as strong solvent (localizing), but these two compounds are separated with $\alpha = 3.1$ with 58% CH_2Cl_2 -hexane (non-localizing) [60]; see also the example of Table 6.7.

Basic localizing solvents such as amines and ethers (see Fig. 6.8) differ in selectivity from non-basic localizing solvents such as esters, nitriles, and nitro compounds. Table 6.8 summarizes some common HPLC solvents in terms of these selectivity-related properties: non-localizing, basic-localizing, and

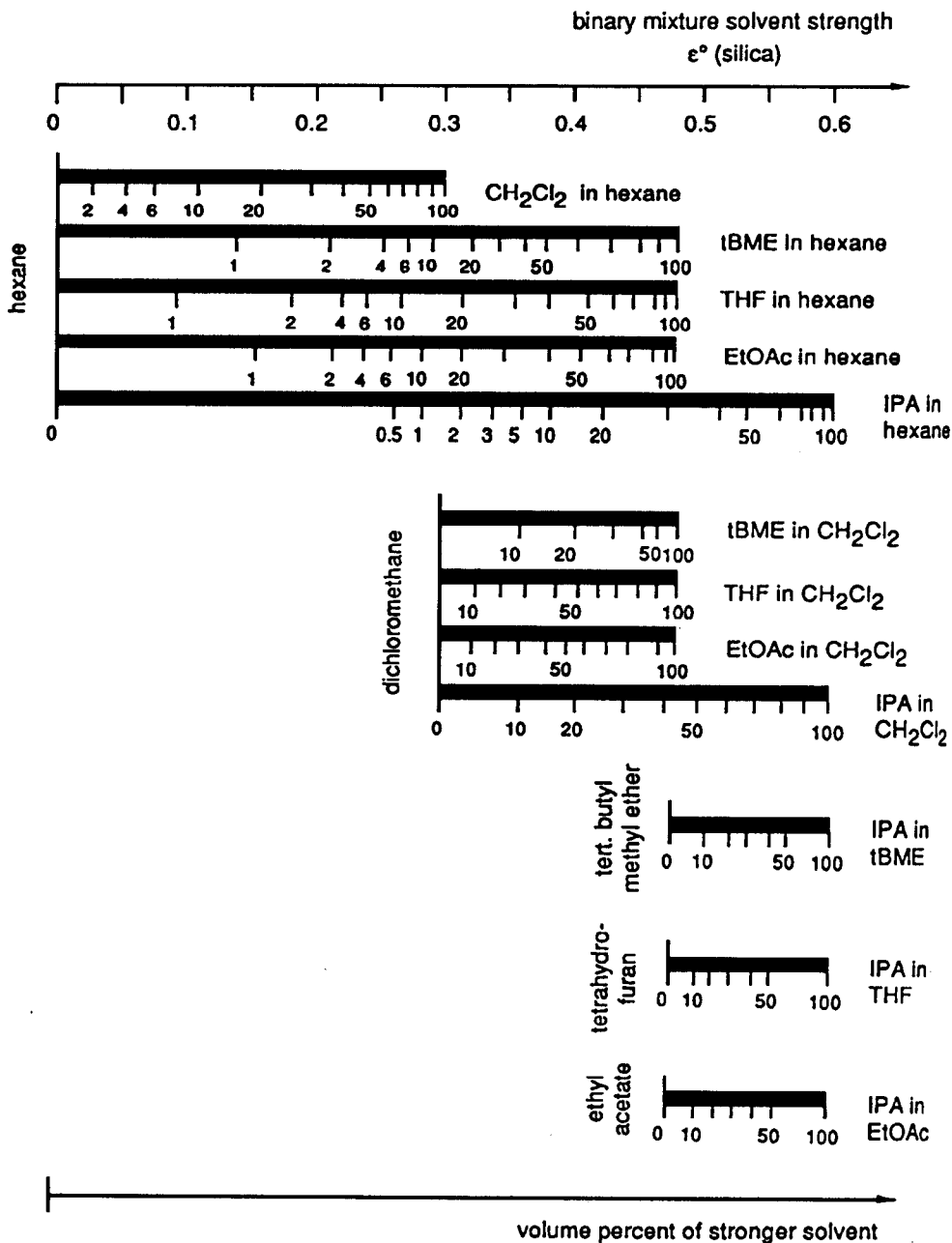
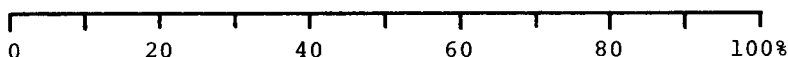
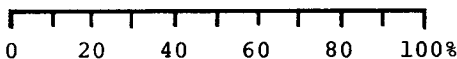

FIGURE 6.23 Solvent-strength nomograph for normal-phase HPLC and silica as column packing. Solvents are methyl-*t*-butyl ether (tBME), ethyl acetate (EtOAc), and 2-propanol (IPA). (Reprinted with permission from Ref. 58.)

MTBE/EtOAc



MC



PrOH

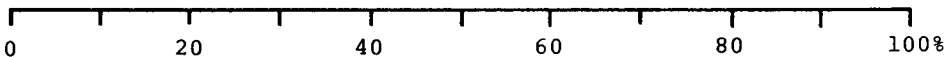

FIGURE 6.24 Solvent-strength nomograph for normal-phase HPLC and cyano or diol columns. Hexane (A) and B-solvent indicated in figure. MTBE, methyl-*t*-butyl ether; EtOAc, ethyl acetate; MC, methylene chloride; PrOH, propanol. (Compiled from data in Ref. 59 and unpublished data.)

non-basic-localizing. As an example of the importance of basicity in a localizing B-solvent, the separation on silica of the two compounds DNN and AN gives $\alpha = 1.0$ for 3% ACN as B-solvent (nonbasic localizing), and $\alpha = 1.3$ for 4% MTBE as B-solvent (basic localizing) [60]. Changes in α of this magnitude are very useful in HPLC method development.

The use of solvent-type selectivity in both NPC and RPC can be effected in similar fashion. Figure 6.25 for optimizing NPC selectivity resembles the

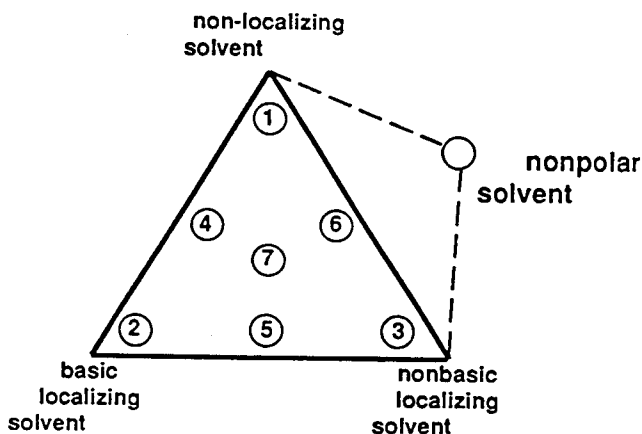

FIGURE 6.25 Plan for selectivity optimization in NPC based on mixtures with hexane of a non-localizing solvent (CH_2Cl_2), a basic-localizing solvent (MTBE), and a non-basic-localizing solvent (ACN or ethyl acetate). All mobile phases are of equal strength (Fig. 6.23 or 6.24). (From Ref. 60.)

approach of Fig. 6.15 for RPC. Three B-solvents are used: non-localizing, basic localizing, and non-basic localizing. Mixtures of these three B-solvents allow the controlled variation of selectivity for maximum changes in resolution.

6.6.3 Column-Type Effects

Commonly used NPC columns include cyano, silica, diol, and amino (roughly in this order of decreasing utility for analytical separation). Column strength can be defined as for the case of RPC separation [52]: silica (strong) \approx alumina \gg amino $>$ diol $>$ cyano. NPC with unmodified silica (compared to polar-bonded-phase) columns has advantages and disadvantages, as summarized in Table 6.9. Generally speaking, the use of silica columns is less convenient for analytical applications. However, isomer and preparative separations favor the use of unmodified silica.

Just as a change in strong solvent can have a major effect on NPC selectivity, so a change in column type can have similar effects. This has been documented in several systematic studies [47, 51–53]. Basic compounds (amines, ethers, esters, ketones, etc.; see Fig. 6.8) are preferentially retained on amino and diol columns (compared to cyano), while dipolar compounds (chloro, nitro, nitrile substituents) are more strongly retained on cyano columns (compared to amino or diol). The selectivity of each of these three columns is quite different [53].

An example of column-type selectivity in NPC is shown in Fig. 6.26 for the separation and analysis of a herbicide in a sample of oats. The oats sample was first extracted to recover the analyte, but the complexity of this natural

TABLE 6.9 Comparison of Silica vs. Polar-Bonded-Phase (PBP) Separations for NPC Separation

Feature	Comment
Convenience and reproducibility	PBP (cyano, diol, amino) columns preferred; silica columns require control of mobile-phase water content.
Column equilibration after change of mobile phase	Silica columns may require longer equilibration.
Column stability	Both silica and PBP columns are stable, but silica columns are more long lived.
Isomer selectivity	Silica columns preferred
Use with gradient elution	<i>Not</i> recommended with silica columns.
Preparative separation	Silica is usually favored because of lower cost, greater stability, higher loadability, and less danger of contaminating collected sample fractions.

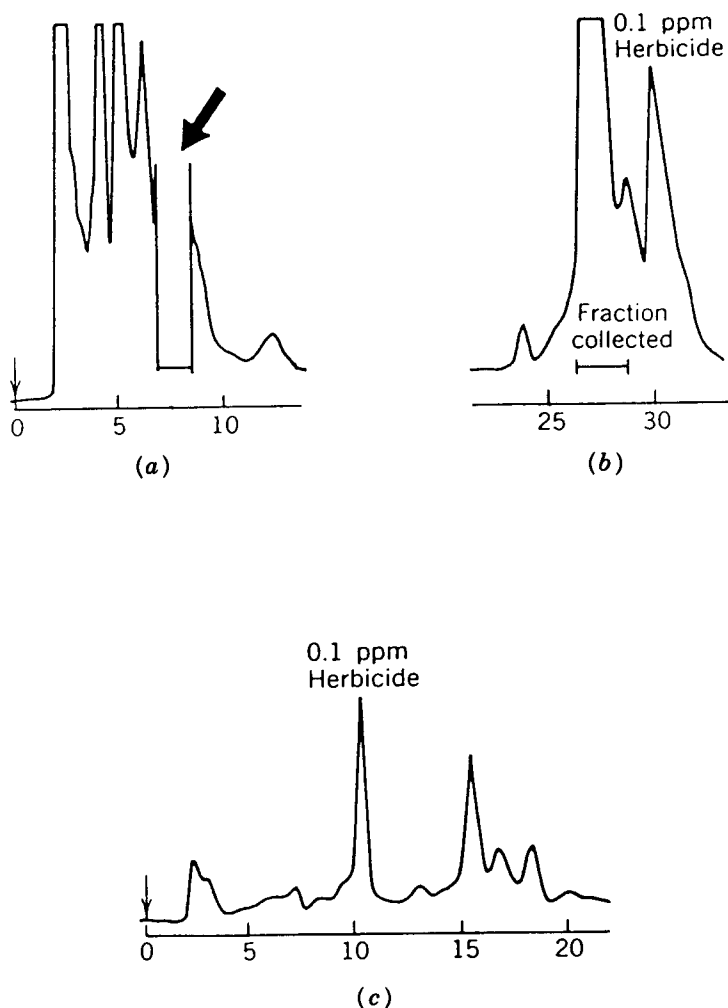

FIGURE 6.26 Separation of a herbicide contained in a green oats extract by sequential separation on a cyano, diol, and silica column. (a) Chromatogram from the cyano column; (b) chromatogram from the diol column; (c) chromatogram from the silica column. See the text for details. (Adapted from Ref. 61.)

product combined with the low concentration of the herbicide (100 ppb) makes this an impossible one-step HPLC separation. The initial separation of the sample was performed on a cyano column (Fig. 6.26a), but the herbicide was overlapped by a number of endogenous interferences. A fraction that included the herbicide and these interferences was collected (column switching), as indicated by the arrow in Fig. 6.26a. This fraction was diverted to a diol column for further separation with the same mobile phase (Fig. 6.26b).

The latter chromatogram shows the separation of the herbicide peak from several of the interferences from the cyano column. However, there is still a substantial coelution of herbicide and interference peaks. The herbicide fraction indicated in Fig. 6.26*b* was collected and re-separated on a silica column (Fig. 6.26*c*). At this stage the herbicide peak is substantially resolved from a number of additional interferences. This example shows the considerable difference in selectivity of these three NPC columns, since compounds that coelute on one column are separated on another.

6.6.4 Temperature Effects

A change in temperature usually will have only a minor effect on band spacing in NPC [62]. Therefore, temperature changes are rarely used for changing NPC selectivity. Temperature-related changes in α may occur for mobile phases that contain localizing solvents such as acetonitrile. These changes in α are probably due to the desorption of the localizing solvent at higher temperatures, with an accompanying increase in the relative retention of localizing sample compounds. However, it is likely that such band-spacing changes as a function of temperature can be duplicated more effectively by changes in the mobile phase (i.e., changing from a localizing to a non-localizing B-solvent). It should be noted that although temperature does not often change *selectivity* in NPC, temperature changes can markedly change the overall *retention* of all compounds. Therefore, it is important to control the temperature of the separation.

6.6.5 Use of Aqueous Mobile Phases for Hydrophilic Samples

Very hydrophilic samples may be unretained in RPC, but these samples should be well retained under NPC conditions. Unfortunately, very hydrophilic samples may not dissolve well in the non-aqueous mobile phases typically used in NPC. One solution to this problem is the use of special NPC columns that can be used with aqueous mobile phases. Carbohydrates are commonly separated on an amino column with mobile phases that consist of 60 to 80% ACN–water. Because carbohydrates are quite hydrophilic, and amino columns are relatively polar and therefore weak for RPC separation, the RPC retention

FIGURE 6.27 Normal-phase separations with water–organic mobile phases. (a) 25 × 0.46-cm amino column, 75% ACN–water mobile phase, 1.0 mL/min, 40°C; compounds: 1, fructose; 2, glucose; 3, sucrose; 4, maltose; (b) same conditions as in (a), except 65% ACN–water; compounds are oligosaccharides of indicated polymerization number; glucose (G) and maltose (M) indicated in each chromatogram [63]; (c) log *k* vs. % MeOH for crown ether sample DB18C6 and different RPC columns [64]. See the text for details. (Reprinted with permission from Refs. 63 and 64.)

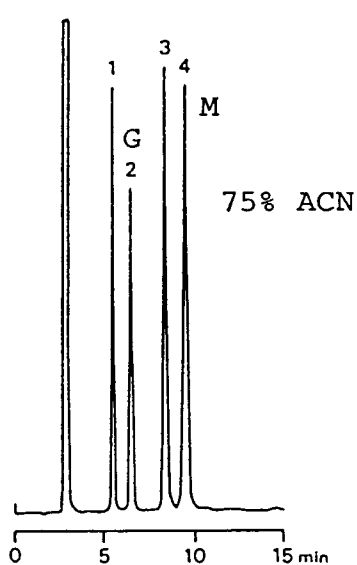

(a)

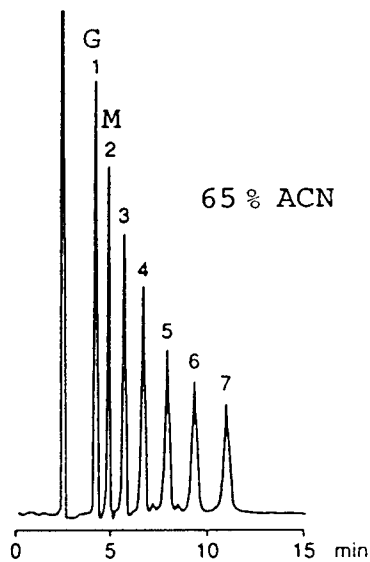

(b)

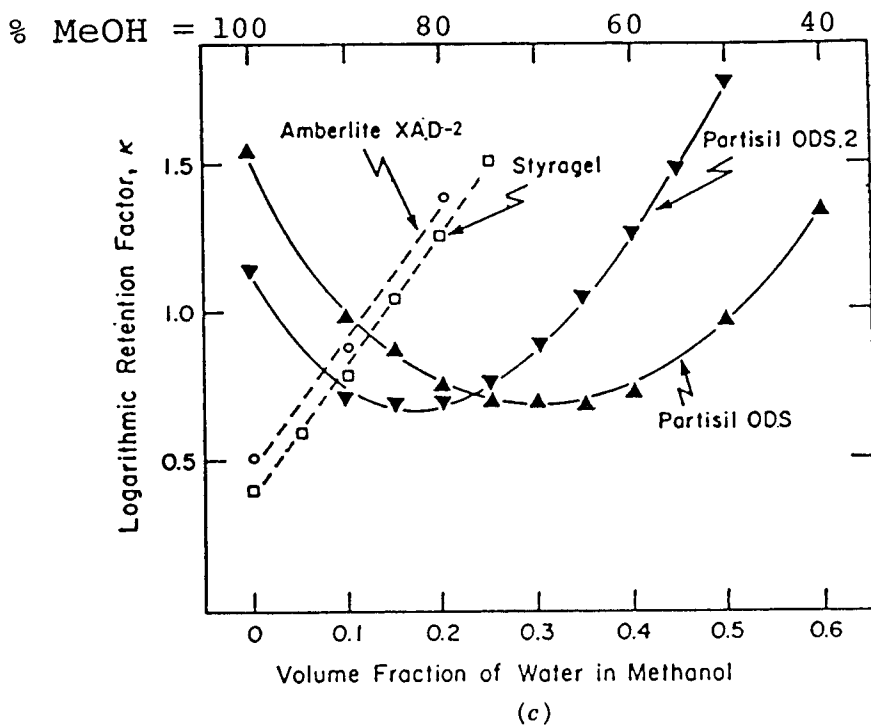

(c)

of these compounds under the latter conditions is unlikely. Furthermore, carbohydrate retention *increases* for an increase in % ACN, which is again unexpected for RPC separation.

Figure 6.27a and b show the separation of several sugars on an amino column for 65% and 75% ACN as mobile phase. The compounds glucose (G) and mannose (M) have shorter retention times (4 and 5 min, respectively) for 65% ACN than for 75% ACN (6 and 10 min). This decrease in retention for a more polar mobile phase (65% ACN) confirms NPC behavior in this system. NPC behavior has also been noted for C_8 - and C_{18} -silica RPC columns, as seen in Fig. 6.27c for the retention data of the neutral crown ether DB18C6. The retention of DB18C6 ($\log k$) is plotted in Fig. 6.27c vs. % MeOH-water (see scale at top of figure) for two C_{18} -silica (ODS) columns and two polymeric columns (Styragel and Amberlite). Retention on the C_{18} columns passes through a minimum at about 80% MeOH, whereas on the two polymeric columns retention decreases continuously as % MeOH increases.

The behavior in Fig. 6.27c has been interpreted as follows. On the polymeric columns, RPC behavior (k decreasing for higher % MeOH) is observed for all values of % MeOH, as expected. On the silica-based C_{18} columns, similar RPC behavior is noted at low % MeOH values, whereas NPC behavior is seen at high % MeOH (retention increasing for higher % MeOH). The latter NPC behavior is believed due to interaction of this sample with residual polar silanols on the column packing. Similar behavior (retention minimum at intermediate percent organic) has been observed for the separation of peptides under RPC conditions and also attributed to silanol interactions [65].

NPC separation with aqueous mobile phases has been defined as hydrophilic interaction chromatography (HILIC) and special HILIC columns have been designed for such separations [66] (e.g., poly-2-hydroxyethylaspartamide). Such columns are usually used with a decreasing organic gradient or increasing salt gradient. Volatile mobile phases can also be used. The order of elution is from least polar to most polar. Figure 6.28 shows the separation of a derivatized oligosaccharide mixture as a function of % ACN-water, using a HILIC column. NPC retention behavior is observed; retention decreases for lower % ACN. The excellent separation of this sample in this manner also should be noted, although gradient elution is required for the separation of all sample compounds. HILIC separations have been described for the separation of a broad range of samples of biological origin (e.g., peptides, amino acids, carbohydrates [66-68]; see also Chapter 11).

Amino or special HILIC columns with water-organic mobile phases offer a convenient approach to the separation of neutral, hydrophilic samples. If an initial gradient run is used to start method development, the gradient should be carried out from organic (weak) to water (strong). If an initial isocratic run is used, water can be used at first, with subsequent increase in percent organic, to achieve progressive separations resembling those of Fig.

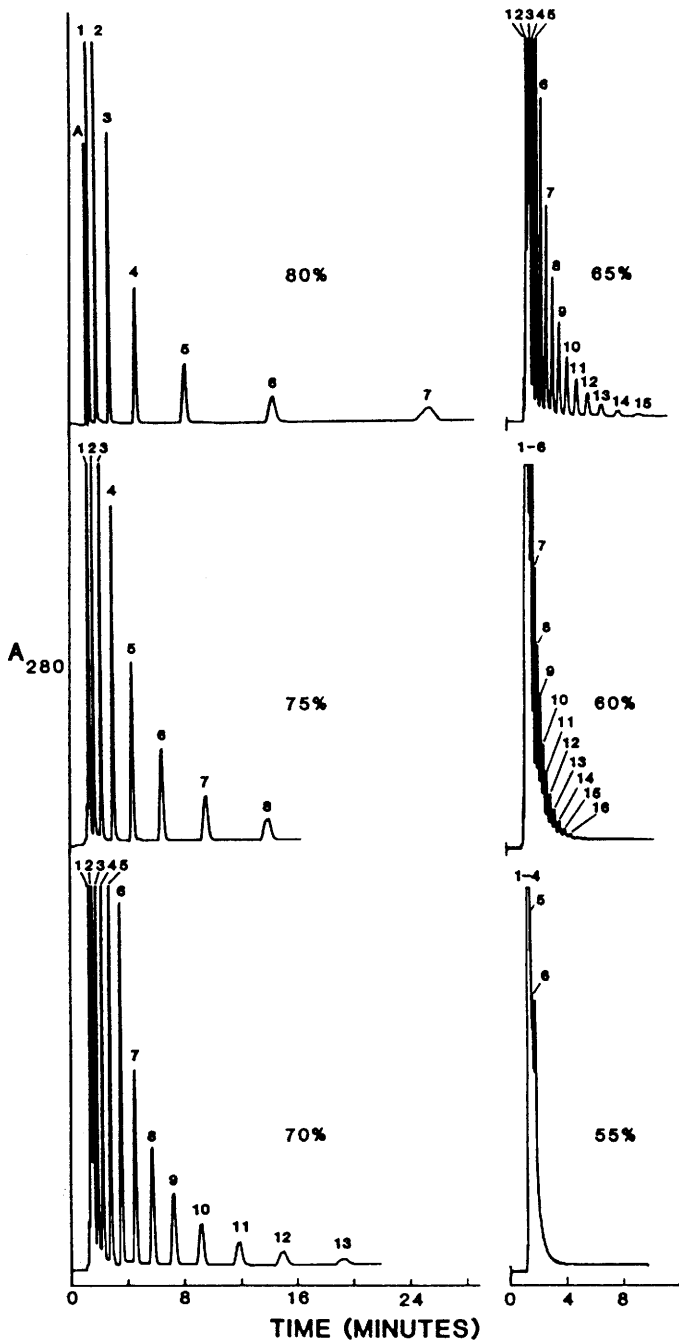

FIGURE 6.28 Normal-phase separations of derivatized oligosaccharide mixture on a HILIC column. Numbers in chromatograms refer to polymerization number for each compound. Conditions: 20×0.46 -cm PolyHydroxyethyl A column (PolyLC Inc.), acetonitrile–water mobile phases (% ACN shown for each separation), 2 mL/min, ambient. (Reprinted with permission from Ref. 66.)

6.2 for RPC. However, the bimodal (RPC/NPC) retention behavior illustrated in Fig. 6.27c is a potential complication for certain columns in such experiments.

6.7 OPTIMIZING THE SEPARATION OF NON-IONIC SAMPLES IN NORMAL-PHASE CHROMATOGRAPHY

6.7.1 Initial Conditions

The general approach to NPC method development is similar to that for RPC (Table 6.2) and is summarized in Table 6.10. Whereas the selection of the best column and initial mobile-phase solvents for RPC is somewhat restricted (typically, C_8 or C_{18} column, ACN-water), there is a wider choice for NPC. Table 6.11 summarizes some considerations that are important for the choice of initial NPC separation conditions.

6.7.1.1 Choice of Column. For an analytical procedure based on NPC, a cyano column will usually be the best initial choice; silica may be preferred for isomer separations or for the preparative recovery of organic-soluble compounds. Silica also offers potentially larger values of α compared to a cyano column. Diol and especially amino columns are somewhat less stable and are used primarily when separation on a cyano column is unsuccessful as a result of band overlap (Section 6.7.3). A 25×0.46 -cm column initially is preferred.

If silica (or alumina) is used for analytical separations, run-to-run changes in retention can be anticipated unless special precautions are taken (Section 6.7.4.2). Separation with one of the newer, less-acidic type B silicas (Section 5.2.1.1) can be advantageous for some samples. The potential difference in performance between a more-acidic type A silica and a less-acidic type B silica is illustrated in Fig. 6.29. With the type A silica column, benzanilide (peak 2) elutes after phenol (peak 3) as a strongly tailing band. Conversely, the column of highly purified type B silica exhibits elution of benzanilide prior to phenol with a symmetrical band.

TABLE 6.10 Recommended Approach for Normal-Phase Method Development

1. Adjust % B for $0.5 < k < 20$ (cyano column, hexane-propanol as mobile phase).
2. Check for band tailing.
3. Adjust selectivity if necessary:
 - a. Fine-tune % B.
 - b. Change organic solvent (MC, MTBE, ACN); fine-tune % B.
 - c. Mix organic solvents.
 - d. Change column type (diol, amino, silica); fine-tune % B.
4. Optimize column conditions (column length, particle size, flow rate).

TABLE 6.11 Normal-Phase HPLC Method Development: Conditions for the Initial Separation

Parameter	Comment
Column size and flow rate	25 × 0.46-cm, 5- μ m column preferred, 2 to 4 mL/min.
Column type	
Cyano	Best choice for analytical method. Stable column, convenient operation.
Silica	Best choice for preparative separation, especially for organic-soluble sample. Can provide maximum α , but analytical application requires control of mobile-phase water content (inconvenient).
Diol	Alternative to cyano column for a change in α , but less stable.
Amino	Alternative to cyano column for a change in α , but much less stable.
Alumina	Very little used in HPLC at present; unique selectivity but more potential problems (low plate number, variable retention, low recovery of sample).
A-solvent	
Hexane	Preferred for low-UV detection (> 200 nm) and less-polar samples; for ACN or MeOH as B-solvent requires addition of a co-solvent (e.g., methylene chloride).
FC113	Can be used with UV detection above 235 nm; excellent solubility characteristics (preparative separation); miscible with all B-solvents (convenient); nonflammable; use may be restricted because of its ozone-depletion properties.
Methylene chloride	Can be used for more polar samples with detection above 235 nm.
B-solvent	
1- or 2-Propanol	Preferred for low-UV detection (> 215 nm) and separation of more polar samples; good choice for initial gradient run with polar-bonded-phase column to characterize sample retention.
Methylene chloride	Good first choice for detection above 235 nm; may not be strong enough to elute very polar samples from a silica column.
MTBE	Good alternative for change in α ; detection above 225 nm.
Ethyl acetate	Good alternative for change in α ; detection above 255 nm.
ACN	Equivalent to ethyl acetate for change in α , but requires co-solvent for mixtures with hexane; detection above 195 nm.
Mobile-phase additives	Triethylamine for basic samples, acetic acid for acidic samples (if peak tailing is observed).
Temperature	Ambient, 35 or 40°C.
Sample size	< 50 μ L, < 50 μ g.
(for 0.46-cm-ID column)	

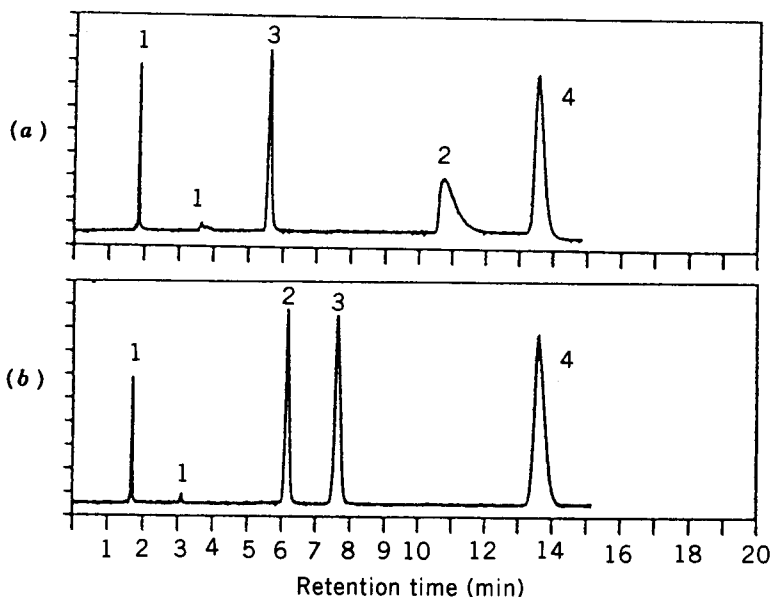

FIGURE 6.29 Difference in silica columns for NPC separation. (a) Acidic type A silica; (b) less acidic type B silica. Conditions: 15×0.46 -cm silica columns, 0.05% methanol–methylene chloride, 1.0 mL/min. Sample: 1, toluene; 2, benzanilide; 3, phenol; 4, benzyl alcohol; I, impurity. (Reprinted with permission from Ref. 69.)

6.7.1.2 Mobile-Phase Solvents. Table 6.11 summarizes possible choices of the A- or B-solvent. If detection at wavelengths < 225 nm is required, the best choice is hexane (A) and propanol (B). Hexane–propanol mobile phases also provide a wide range of solvent strength, especially for use with a cyano or other polar-bonded-phase column; this system should therefore provide effective separation of samples of quite different polarity.

1,1,2-Trifluoroethane (FC113) also has been used as the A-solvent in NPC [70]. It absorbs more strongly than hexane at low wavelengths, so UV detection is restricted to values above 235 nm. FC113 has better sample solubility than hexane and is miscible with all the B-solvents of Table 6.11; this represents a considerable experimental convenience. However, FC113 is on the list of ozone-depleting compounds whose use will be increasingly limited. Therefore, FC113 should be considered only when its properties are highly advantageous for a particular separation problem, especially for preparative applications.

6.7.2 Adjusting Retention

For isocratic separations, the next step is to adjust percent propanol to give $0.5 < k < 20$ for the cyano column. This can be done by beginning with 100%

propanol, then decreasing percent propanol (% B) by successive factors of 2: 50%, 25%, 12%, 6%, 3%, and so on. If α changes with % B, as in the example of Fig. 6.22, the value of % B can be further adjusted for both the desired range in k and for maximum α and resolution. For silica columns, propanol as B-solvent may be too strong, in which case a less polar solvent such as methylene chloride (MC) can be used instead (see Table 6.8). An initial gradient from 0 to 100% propanol-hexane can be used instead of the decreasing % B isocratic procedure, similar to the case for RPC separation (Section 8.2.2). An initial gradient run allows a decision as to whether isocratic or gradient elution is best and can provide an estimate of the best % B for isocratic separation.

6.7.3 Optimizing Selectivity

A change in α for NPC is best effected by a change in solvent type. After a value of percent propanol has been selected for $0.5 < k < 20$, the B-solvent can be changed [see Fig. 6.23 (silica) or Fig. 6.24 (polar bonded phases)]. For a cyano column, the approach of Fig. 6.25 is recommended, using MC as the non-localizing solvent (run 1), MTBE as the basic localizing solvent (run 2), and ACN or ethyl acetate as the non-basic localizing solvent (run 3). The use of ethyl acetate instead of ACN is more convenient, since ACN-hexane mixtures require MC as co-solvent. However, ethyl acetate restricts detection to > 256 nm. For ACN as B-solvent (with MC added to run 3 as co-solvent), detection can be carried out above 234 nm.

The procedure of Fig. 6.25 is illustrated for the separation of 11 substituted naphthalenes using silica as adsorbent in Fig. 6.30. The mobile-phase compositions for these separations are summarized in Table 6.12. Run 1 in Fig. 6.30 uses 58% MC-hexane as the mobile phase, but bands 8 and 9 overlap. Therefore, a change in the B-solvent type is suggested. Run 2 was carried out with 4% MTBE, the % B value being selected from Fig. 6.23. Now the critical band pair is 4/12. A blend of these two mobile phases is suggested, but the resulting mobile phase (for run 4) was found to be too strong. This often occurs for silica as column packing, when localizing and non-localizing solvents are mixed (as in this case; MC, non-localizing; MTBE, localizing). Therefore, the percent hexane was increased for the actual run 4 shown in Fig. 6.30 to give a run time similar to those for runs 1 and 2. The critical band pair for run 4 is 3/2; band pairs 4/8 and 9/12 also exhibit marginal resolution.

Runs 1, 4, and 2 of Fig. 6.30 show very large changes in α for several band pairs, but these runs do not suggest an optimum mobile phase for separating this sample. This situation is the result of both sample complexity and many large changes in relative band position. A further change in the B-solvent is suggested, namely run 3 with ACN. This run provides the best resolution seen so far; $R_s = 0.7$ for the resolution-limiting band pair 11/4. Therefore, mixtures of the mobile phases for run 3 with either run 1 or 2 are considered next.

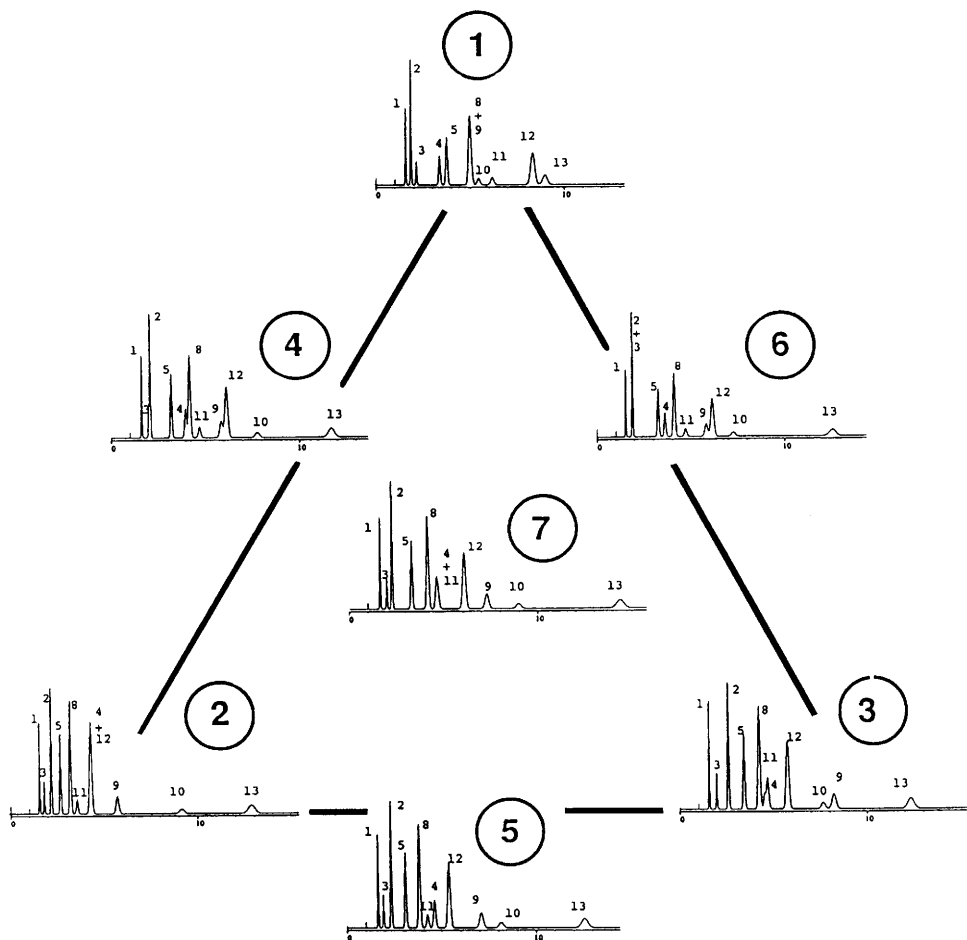

FIGURE 6.30 Seven chromatograms for solvent-selectivity experiments of Fig. 6.25 and Table 6.12. 15×0.46 -cm silica column, mobile phases as in Table 6.12, 2.0 mL/min, 35°C . Compounds are substituted naphthalenes: 1, 2-OCH₃; 2, 1-NO₂; 3, 1,2-(OCH₃)₂; 4, 1,5-(NO₂)₂; 5, 1-CHO; 8, 2-CHO; 9, 1-CH₂CN; 10, 1-OH; 11, 1-COCH₃; 12, 2-COCH₃; 13, 2-OH. (Chromatograms reconstructed from data in Ref. 60, omitting compounds 6 and 7.)

Mixing the mobile phases for runs 1 and 3 (run 6) produces complete overlap of bands 2 and 3 and marginal separation of bands 9 and 12. So the mixture of mobile phases for runs 2 and 3 is tried next. This separation (run 5) shows the best resolution so far; baseline resolution is achieved ($R_s = 1.6$). Had this not been the case, the mobile phases for runs 1, 2, and 3 could have been combined for run 7 (band-pair 4/11 overlapped). As in the case of RPC, mixing all three B-solvents (MC, MTBE, ACN) will seldom provide the best mobile phase. Therefore, changes in the mobile

TABLE 6.12 Summary of Separations of Fig. 6.25

Run	Mobile Phase (Vol %) ^a				Critical Bands ^b	
	Hexane	MC	MTBE	ACN	No.	R_s
1	42	58	0	0	8/9	0.3
2	96	0	4	0	4/12	0.3
3	87	10 ^c	0	3	11/4	0.7
4	77	22	1	0	3/2	0.8
5	92	5	2	2	11/4	1.6
6	69	30	0	1	2/3	0.1
7	89	9	1	1	4/11	0.4

^a Mobile-phase composition; MC, methylene chloride; MTBE, methyl-*t*-butyl ether; ACN, acetonitrile.

^b Critical band pair and its resolution R_s are indicated.

^c Methylene chloride was added as co-solvent to allow miscibility of hexane and ACN.

phase usually should be restricted to three-solvent (ternary) mixtures: two of these B-solvents plus hexane.

A similar procedure as in Fig. 6.30 for a cyano column has been reported [49], although changes in selectivity with change in the B-solvent were less pronounced than those observed in Fig. 6.30 with a silica column.

6.7.4 Other Considerations

6.7.4.1 Slow Column Equilibration and Solvent Demixing. Polar solvents can interact strongly with the surface of a NPC column, especially in the case of unmodified silica (or alumina). When a mobile phase containing a very polar, localizing B-solvent is replaced by a weaker mobile phase, the equilibration of the column with the new mobile phase (for constant sample retention) may take much longer than in RPC ($\gg 20$ column volumes). Therefore, equilibration of the column by a new mobile phase should be checked by replicate injections of the sample. No data should be used until retention times are constant (i.e., the column is equilibrated for use).

Gradient elution with unmodified silica or alumina columns is to be avoided if possible, especially if A- and B-solvents are of very different strength. The reason for this is the phenomenon of *solvent demixing*. When NPC gradient elution is carried out with a weak A-solvent and a strong (localizing) B-solvent, the B-solvent may be taken up by the column until the surface of the stationary phase is saturated. This would be the case, for example, if a 0 to 100% propanol-hexane gradient were carried out with a silica column. The mobile phase initially leaving the column would be pure hexane, as propanol is adsorbed by the silica packing. When column saturation occurs, there will be a sudden increase in % B (propanol) in the exiting mobile phase, and this sudden change in solvent strength can elute some sample components with low k values and poor separation [71].

6.7.4.2 Changes in Stationary-Phase Water Content. Water is the most polar common solvent, and it binds to unmodified silica (or alumina) columns quite strongly. Due to ambient humidity, non-aqueous NPC mobile phases will take up a certain quantity of water from the surrounding atmosphere. This dissolved water will then be extracted from the mobile phase by the column. As the water content of the column increases, sample retention times can be greatly reduced compared to a dry column. This is illustrated in Fig. 6.31 for the retention k of phenyl propanol as a function of the percent water added to the methylene chloride mobile phase (0.15% water saturates methylene chloride). As the water varies from 0 to 0.15% (0 to 100% saturation), k decreases from 18 to 4 for water-equilibrated columns.

Ambient humidity seldom remains constant, and because the equilibration of the column with water in the mobile phase can be a very slow process, column water content can vary from run to run. This effect will cause sample retention to vary, which is commonly seen with unmodified silica columns. One answer to this problem is to equilibrate the mobile phase with a certain (intermediate) quantity of water [e.g., 50% water saturation (or 0.075% water in Fig. 6.31)]. This procedure is somewhat tedious; for further details, see Appendix VI. Alternatively, the addition of 0.1 to 0.5% propanol or methanol to the mobile phase can sometimes be used to mimic the effects of added water and is much simpler to carry out [69].

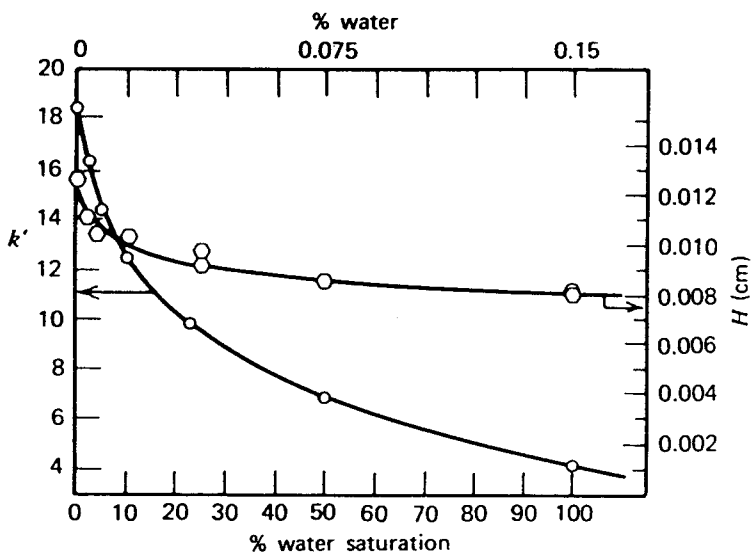

FIGURE 6.31 Retention of phenyl propanol on silica as a function of the water content of the mobile phase (methylene chloride). (Reprinted with permission from Ref. 62.)

REFERENCES

1. P. W. Carr, D. E. Martire, and L. R. Snyder, eds., "The Retention Process in Reversed-Phase Liquid Chromatography," *J. Chromatogr. A*, **656** (1993).
2. J. G. Dorsey and W. T. Cooper, *Anal. Chem.*, **66** (1994) 857A.
3. P. W. Carr, L. C. Tan, and J. H. Park, *J. Chromatogr. A*, **724** (1996) 1.
4. K. Valko, L. R. Snyder, and J. L. Glajch, *J. Chromatogr. A*, **656** (1993) 501.
5. P. J. Schoenmakers, H. A. H. Billiet, and L. de Galan, *J. Chromatogr.*, **185** (1979) 179.
6. P. J. Schoenmakers, H. A. H. Billiet, and L. de Galan, *J. Chromatogr.*, **218** (1981) 259.
7. P. J. Schoenmakers, H. A. H. Billiet, and L. de Galan, *J. Chromatogr.*, **205** (1981) 13.
8. D. P. Herman, H. A. H. Billiet, and L. de Galan, *J. Chromatogr.*, **463** (1989) 1.
9. P. E. Antle, A. P. Goldberg, and L. R. Snyder, *J. Chromatogr.*, **321** (1985) 1.
10. P. E. Antle and L. R. Snyder, *LC Mag.*, **2** (1984) 840.
11. J. J. DeStefano, J. A. Lewis, and L. R. Snyder, *LC/GC*, **10** (1992) 130.
12. *Mac-Mod Analytical Column Guide*, Mac-Mod Analytical, Chadds Ford, PA, 1995.
13. M.-C. Hennion, V. Coquart, S. Guenu, and C. Sella, *J. Chromatogr. A*, **712** (1995) 287.
14. C. M. Noyes, *J. Chromatogr.*, **266** (1983) 451.
15. M. A. Quarry, R. L. Grob, L. R. Snyder, J. W. Dolan, and M. P. Rigney, *J. Chromatogr.*, **387** (1987) 163.
16. L. R. Snyder, M. A. Quarry, and J. L. Glajch, *Chromatographia*, **24** (1987) 33.
17. M. de Smet and D. L. Massart, *J. Chromatogr.*, **410** (1987) 77.
18. F. Dondi, Y. D. Kahie, G. Lodi, G. Blo, C. Pietrogrande, and P. Reshiglian, *J. Chromatogr.*, **461** (1988) 281.
19. A. Bartha, H. A. H. Billiet, and L. de Galan, *J. Chromatogr.*, **464** (1989) 225.
20. B. L. Karger, J. R. Gant, A. Hartkopf, and P. H. Wiener, *J. Chromatogr.*, **128** (1976) 65.
21. S. R. Bakalyar, R. McIlwrick, and E. Roggendorf, *J. Chromatogr.*, **142** (1977) 353.
22. N. Tanaka, H. Goodell, and B. L. Karger, *J. Chromatogr.*, **158** (1978) 233.
23. J. L. Glajch, J. J. Kirkland, K. M. Squire, and J. M. Minor, *J. Chromatogr.*, **199** (1980) 57.
24. S. Nyiredy, ed., *J. Liq. Chromatogr.*, **12(1/2)** (1989).
25. J. L. Glajch and L. R. Snyder, *Computer-Assisted Method Development for High-Performance Liquid Chromatography*, Elsevier, Amsterdam, 1990.
26. L. R. Snyder, P. W. Carr, and S. C. Rutan, *J. Chromatogr. A*, **656** (1993) 537.
27. S. D. West, *J. Chromatogr. Sci.*, **25** (1987) 122; **27** (1989) 2.
28. J. J. Kirkland, B. E. Boyes, and J. J. DeStefano, *Amer. Lab.* **26(14)** (1994) 36.
29. J. L. Glajch, J. C. Gluckman, J. G. Charikovskiy, J. M. Minor, and J. J. Kirkland, *J. Chromatogr.*, **318** (1985) 23.
30. L. C. Sander and S. A. Wise, *LC/GC*, **8** (1990) 378.
31. D. W. Armstrong, W. DeMond, A. Alak, W. L. Hinze, T. E. Riehl, and K. H. Bui, *Anal. Chem.*, **57** (1985) 234.

32. F. C. Marziani and W. R. Sisco, *J. Chromatogr.*, **465** (1989) 422.
33. M. Paleologou, S. Li, and W. C. Purdy, *J. Chromatogr. Sci.*, **28** (1990) 311.
34. J. Chmielowiec and H. Sawatsky, *J. Chromatogr. Sci.*, **17** (1979) 245.
35. J. A. Lewis, L. R. Snyder, and J. W. Dolan, *J. Chromatogr. A*, **721** (1996) 15.
36. L. R. Snyder, J. W. Dolan, and D. C. Lommen, *J. Chromatogr.*, **485** (1989) 65.
37. N. A. Parris, *J. Chromatogr.*, **157** (1978) 161.
38. K. Aitzemuller, in *Practice of High Performance Liquid Chromatography*, H. Engelhardt, ed., Springer-Verlag, Berlin, 1986, p. 301.
39. M. Zakaria, K. Simpson, P. R. Brown, and A. Krstulovic, *J. Chromatogr.*, **176** (1979) 109.
40. N. E. Craft, S. A. Wise, and J. H. Soares, Jr., *J. Chromatogr.*, **589** (1992) 171.
41. R. J. Flanagan, G. C. A. Storey, R. K. Bhambra, and I. Jane, *J. Chromatogr.*, **247** (1982) 15.
42. R. J. Flanagan and I. Jane, *J. Chromatogr.*, **323** (1985) 173.
43. I. Jane, A. McKinnon, and R. J. Flanagan, *J. Chromatogr.*, **323** (1985) 191.
44. H. Lingeman, H. A. van Munster, J. H. Beynen, W. J. M. Underberg, and A. Hulshoff, *J. Chromatogr.*, **352** (1986) 261.
45. W. Golkiewicz, J. Kuczynski, W. Markowski, and L. Jusiak, *J. Chromatogr. A*, **686** (1994) 85.
46. L. R. Snyder, *J. Chromatogr.*, **63** (1971) 15.
47. L. R. Snyder, in *High-Performance Liquid Chromatography: Advances and Perspectives*, Vol. 3, C. Horvath, ed., Academic Press, San Diego, CA, 1983, p. 157.
48. L. R. Snyder, J. L. Glajch, and J. J. Kirkland, *J. Chromatogr.*, **218** (1981) 299.
49. M. de Smet, G. Hoogewijs, M. Puttmans, and D. L. Massart, *Anal. Chem.*, **56** (1984) 2662.
50. L. R. Snyder, *Principles of Adsorption Chromatography*, Marcel Dekker, New York, 1968.
51. P. L. Smith and W. T. Cooper, *J. Chromatogr.*, **410** (1987) 249.
52. A. W. Salotto, E. L. Weiser, K. P. Caffey, R. L. Carty, S. C. Racine, and L. R. Snyder, *J. Chromatogr.*, **498** (1990) 55.
53. M. Lubke, J.-L. le Quere, and D. Barron, *J. Chromatogr. A*, **690** (1995) 41.
54. E. Soczewinski, *Anal. Chem.*, **41** (1969) 179.
55. E. Soczewinski and J. Jusiak, *Chromatographia*, **14** (1981) 23.
56. E. Soczewinski, *J. Chromatogr.*, **388** (1987) 91.
57. T. Hamoir and D. L. Massart, *J. Chromatogr. A*, **673** (1994) 1.
58. V. R. Meyer and M. D. Palamareva, *J. Chromatogr.*, **641** (1993) 391.
59. L. R. Snyder, J. L. Glajch, and J. J. Kirkland, *Practical HPLC Method Development*, Wiley-Interscience, New York, 1988, p. 118.
60. J. J. Kirkland, J. L. Glajch, and L. R. Snyder, *J. Chromatogr.*, **238** (1982) 269.
61. J. F. K. Huber, I. Foggy, and C. Fioresi, *Chromatographia*, **13** (1980) 408.
62. L. R. Snyder and J. J. Kirkland, *Introduction to Modern Liquid Chromatography*, 2nd ed., Wiley-Interscience, New York, 1979, pp. 390–392.
63. H. Kutsuna, Y. Ohtsu, and M. Yamaguchi, *J. Chromatogr. A*, **635** (1993) 187.

64. A. Nahum and C. Horvath, *J. Chromatogr.*, **203** (1981) 53.
65. M. T. W. Hearn and B. Grego, *J. Chromatogr.*, **255** (1983) 125.
66. A. Alpert, *J. Chromatogr.*, **499** (1990) 177.
67. A. Alpert, M. Shukla, A. K. Shukla, L. R. Zieske, S. W. Yuen, M. A. J. Ferguson, A. Mehlert, M. Pauly, and R. Orlando, *J. Chromatogr. A*, **676** (1994) 191.
68. S. C. Churms, *J. Chromatogr. A*, **720** (1996) 75.
69. J. J. Kirkland, C. H. Dilks, Jr., and J. J. DeStefano, *J. Chromatogr. A*, **635** (1993) 19.
70. J. L. Glajch, J. J. Kirkland, and W. G. Schindel, *Anal. Chem.*, **54** (1982) 1276.
71. L. R. Snyder, in *High-Performance Liquid Chromatography: Advances and Perspectives*, Vol. 1, C. Horvath, ed., Academic Press, San Diego, CA, 1980, p. 230.

7

IONIC SAMPLES: REVERSED-PHASE, ION-PAIR, AND ION-EXCHANGE HPLC

- 7.1 Introduction
- 7.2 Acidic and Basic Samples
 - 7.2.1 Acid-Base Equilibria and Reversed-Phase Retention
 - 7.2.2 Choice of Buffers
 - 7.2.2.1 Buffer Capacity
 - 7.2.2.2 Buffer UV Absorbance
 - 7.2.2.3 Other Buffer Properties
 - 7.2.2.4 Preferred Buffers
 - 7.2.3 pK_a as a Function of Compound Structure
 - 7.2.3.1 Preferred Mobile-Phase pH
 - 7.2.4 Which HPLC Method Is Best for Ionic Samples?
- 7.3 Optimizing the Reversed-Phase Separation of Ionic Samples
 - 7.3.1 Initial Experiments
 - 7.3.2 Controlling Selectivity
 - 7.3.2.1 pH
 - 7.3.2.2 Solvent Strength (% B)
 - 7.3.2.3 Solvent Type
 - 7.3.2.4 Temperature
 - 7.3.2.5 Buffer Concentration
 - 7.3.2.6 Amine Modifiers
 - 7.3.2.7 Column Type
 - 7.3.3 Special Problems
 - 7.3.3.1 pH Sensitivity
 - 7.3.3.2 Silanol Effects
 - 7.3.3.3 Temperature Sensitivity
 - 7.3.4 Summary
- 7.4 Ion-Pair Chromatography
 - 7.4.1 Basis of Retention
 - 7.4.1.1 pH and Ion Pairing
 - 7.4.1.2 Ion-Pair Reagent Concentration
 - 7.4.1.3 Ion-Pair Reagent Type

- 7.4.2 Initial Experiments
- 7.4.3 Controlling Retention Range and Selectivity: Changes in % B, pH, and Ion-Pair Reagent Concentration
 - 7.4.3.1 Retention Range
 - 7.4.3.2 Selectivity
- 7.4.4 Other Changes in Selectivity
 - 7.4.4.1 Solvent Strength (% B)
 - 7.4.4.2 Temperature
 - 7.4.4.3 Buffer Concentration
 - 7.4.4.4 Solvent Type
 - 7.4.4.5 Buffer Type or Added Salt
 - 7.4.4.6 Amine Modifiers
- 7.4.5 Special Problems
 - 7.4.5.1 Artifactual Peaks
 - 7.4.5.2 Slow Column Equilibrium
 - 7.4.5.3 Poor Peak Shape
- 7.4.6 Summary
- 7.5 Ion-Exchange Chromatography
 - 7.5.1 Basis of Retention
 - 7.5.1.1 pH Effects
 - 7.5.1.2 Salt or Buffer Type
 - 7.5.1.3 Organic Solvents
 - 7.5.1.4 Column Type
 - 7.5.2 Method Development
 - 7.5.3 Mixed-Mode Separations
 - 7.5.4 Silica Columns

7.1 INTRODUCTION

The discussion of Fig. 1.3 divides *regular samples* into two groups, depending on whether the sample is neutral or ionic. An *ionic sample* is any mixture containing one or more ionized or ionizable organic compounds. The separation of neutral samples is treated in Chapter 6; this chapter covers the separation of ionic samples by reversed-phase, ion-pair, or ion-exchange HPLC. Some ionic samples are also included in the special sample categories of Fig. 1.3: biological samples (Chapter 11), chiral samples (Chapter 12), and inorganic ions. The separation of inorganic ions is not discussed in this book.

HPLC separations of ionic samples tend to be more complicated and difficult to understand. Also, these separations are often associated with problems not encountered with neutral compounds. On the other hand, band spacing is much more easily manipulated for ionic than for neutral samples, which improves the likelihood of a successful final separation.

7.2 ACIDIC AND BASIC SAMPLES

For the purposes of this chapter, the definition of an *ionic solute* is an organic molecule that contains one or more functional groups capable of acidic or basic behavior in the usual pH range: $2 < \text{pH} < 8$ for most silica-based columns and $1 < \text{pH} < 14$ for pH-stable columns. Strong acids or bases are compounds that are completely ionized in the pH range under investigation [e.g., alkane sulfonic acids ($\text{pH} > 2$), or tetraalkylammonium salts ($\text{pH} < 13$), or most alkyl amines for $\text{pH} < 8$]. Compounds whose ionic charge changes as a function of pH under the conditions of HPLC separation will be referred to simply as acids or bases. If the mobile-phase pH is restricted within narrow limits, the retention behavior of a particular acid (e.g., acetic acid) may resemble that of a strong acid ($\text{pH} > 7$, complete ionization), an acid ($3 < \text{pH} < 7$, ionization varying with pH), or a neutral compound ($\text{pH} < 3$, no ionization). Bases can be classified in similar fashion.

7.2.1 Acid-Base Equilibria and Reversed-Phase Retention

In reversed-phase chromatography (RPC), sample retention increases for more hydrophobic compounds (Section 6.2.1). When an acid (HA) or base (B) undergoes ionization (i.e., is converted from an uncharged species) it becomes much less hydrophobic (more hydrophilic). As a result, its retention k in RPC will be reduced 10- to 20-fold.

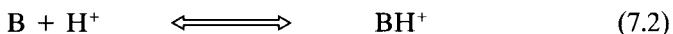

hydrophobic
hydrophilic
(more retained in RPC)
(less retained in RPC)

Acids lose a proton (and become ionized) as pH increases; bases gain a proton (and become ionized) as pH decreases. As pH increases, RPC retention for an acid decreases and retention for a base increases. This retention behavior is illustrated in Fig. 7.1, which plots the RPC retention of five different compounds as a function of mobile-phase pH. For $3 < \text{pH} < 9$, compounds 1 and 2 are acidic, compounds 4 and 5 are basic, and compound 3 is neutral.

This acid-base behavior is further illustrated in Fig. 7.2a for the (idealized) retention of a basic compound as a function of pH. When pH is varied over a sufficiently wide range, sample ionization and retention exhibit a characteristic S-shaped plot as shown (see also compound 4 in Fig. 7.1). At the midpoint of this retention-pH curve (dashed line in Fig. 7.2a), the pH is equal to the $\text{p}K_a$ value of the compound (i.e., BH^+ in the case of a base). Values of $\text{p}K_a$ for different acids or bases in the literature usually refer to the value measured in an aqueous buffer. If the HPLC mobile phase contains an organic solvent, the $\text{p}K_a$ value can vary somewhat with % B (Section 7.2.3).

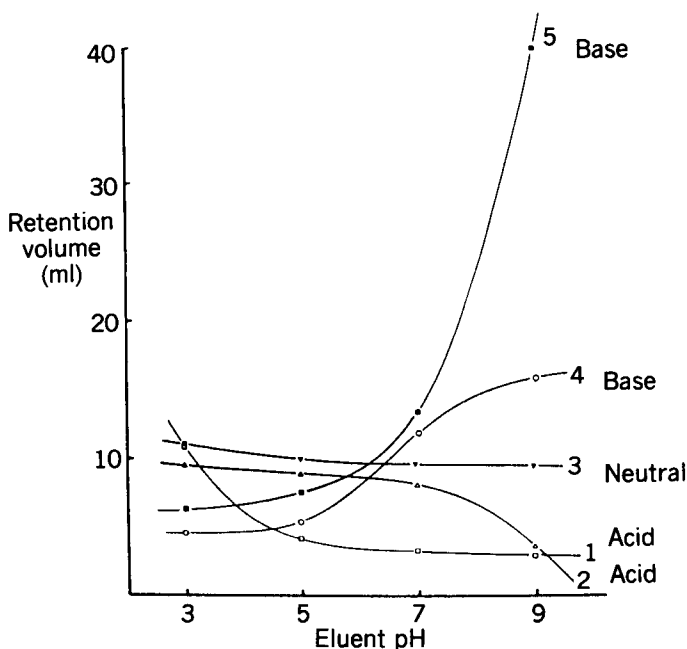

FIGURE 7.1 Effect of mobile-phase pH on reversed-phase retention as a function of sample type (acid, base, neutral). Column, 30×0.4 -cm μ Bondapak C₁₈; mobile phase, 0.025 M phosphate, 40% methanol; compounds: 1, salicylic acid; 2, phenobarbitone; 3, phenacetin; 4, nicotine; 5, methylamphetamine. (Reprinted with permission from Ref. 1.)

When $\text{pH} = \text{p}K_a$ for a compound, it is half ionized (i.e., the concentrations of B and BH^+ in the mobile phase are equal). Almost all of the pH-related change in retention occurs for pH values within ± 1.5 units of the $\text{p}K_a$ value (region B of Fig. 7.2a). Outside this range ($\text{pH} < 2.5$ or $\text{pH} > 5.5$ in Fig. 7.2a), the compound is either ionized or non-ionized, and its retention does not change much with pH (i.e., its retention behavior resembles that of a neutral compound). This situation is seen in Fig. 7.1 for compound 1 when $\text{pH} > 6$ and for compound 2 when $\text{pH} < 7$. For a detailed theoretical treatment of RPC retention of acids and bases as a function of pH, see Refs. 2 to 4.

The relationship between RPC retention and mobile-phase pH is more complicated for compounds that contain multiple acidic and/or basic groups [5]. When these groups are all the same (acidic or basic), retention as a function of pH is generally similar, as seen in Fig. 7.3a for a series of compounds [(pteroyl)oligo]glutamates that contain one, three, five, or seven ionizable acid ($-\text{COOH}$) groups. When one acidic and one basic group are present in the same molecule, a more complex (amphoteric) retention behavior is observed. This is illustrated in Fig. 7.3b for the RPC separation

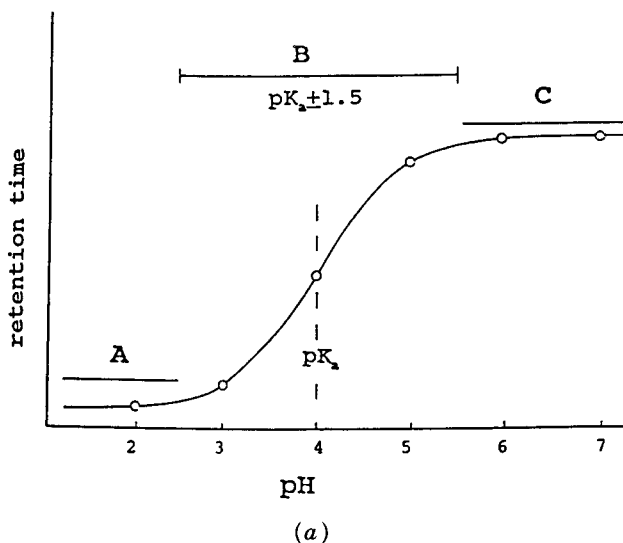

FIGURE 7.2 Retention and buffer capacity as a function of pK_a and pH. (a) Idealized dependence of retention on pH for a basic compound with $pK_a = 4.0$; (b) deterioration of peak shape as mobile-phase buffer capacity decreases; 3,5-Dimethylaniline solute ($pK_a = 3.8$); 25×0.46 -cm cyano column, 25% MeOH–buffer (25 mM potassium phosphate), 1 mL/min, 35°C . (Reprinted with permission from Ref. 3.)

of several amino acids. Here minimum retention is observed at intermediate pH values, because for $4 < \text{pH} < 8$, both the carboxyl and amino groups are ionized; thus the molecule is maximally ionized and hydrophilic (even though the *net* charge is zero).

7.2.2 Choice of Buffers

Whenever acidic or basic samples are separated, it is strongly advisable to control mobile-phase pH by adding a buffer. The measurement of pH (by a pH meter) for a mobile phase that contains organic solvent is imprecise, because electrode response tends to drift. Consequently, if a pH meter is to be used, *it is strongly recommended that the pH of the buffer be adjusted before adding organic*. This approach leads to some uncertainty in the actual pH value of the final mobile phase (because the addition of organic solvent can change the pH), but this problem is much less important than poor reproducibility of the mobile-phase pH (when pH is measured after addition of the organic solvent).

In selecting a particular buffer, several considerations should be kept in mind:

- Buffer capacity
- UV absorbance

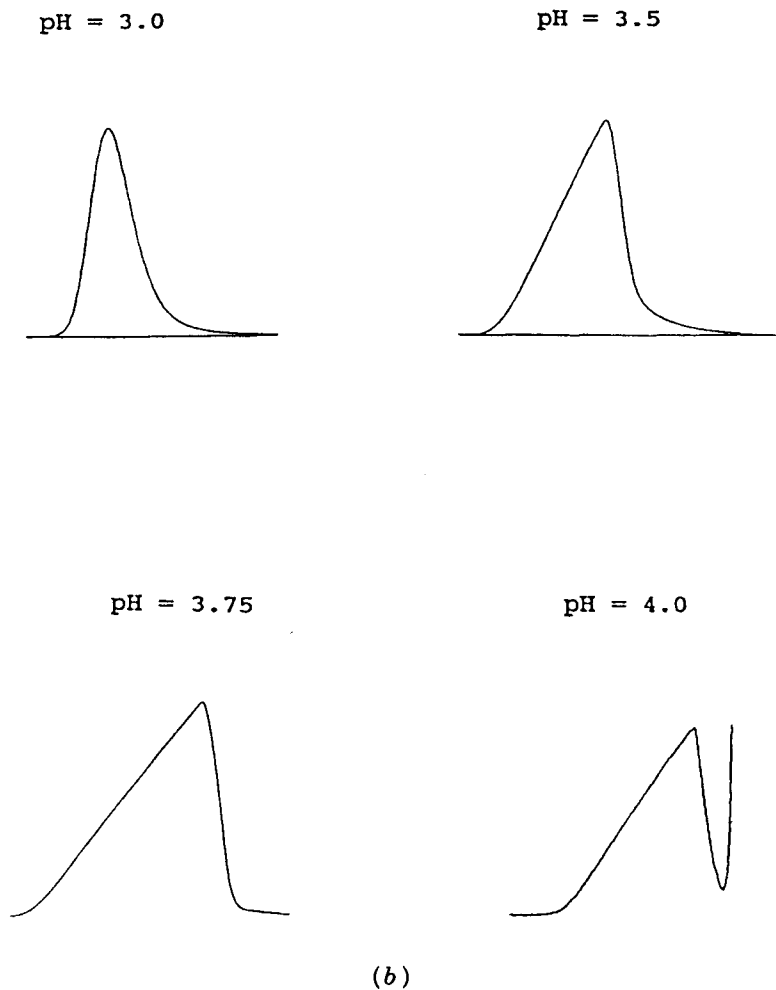
**FIGURE 7.2** (Continued)

- Other properties: solubility, stability, interaction with the sample and/or column, volatility, corrosion of HPLC system, and so on.

7.2.2.1 Buffer Capacity. Buffer capacity is determined by pH, buffer pK_a , and buffer concentration. As for the case of a sample compound, buffer ionization occurs over a range in pH given by $pK_a \pm 1.5$. Only in this pH range can the buffer be effective in controlling pH. Therefore, to be on the safe side, the buffer selected for a particular separation should be used to control pH over a range $\approx pK_a \pm 1.0$ (see the discussion below of Fig. 7.2b). For RPC separations, a buffer concentration of 10 to 50 mM is usually adequate. This assumes that the volume of injected sample is small and/or

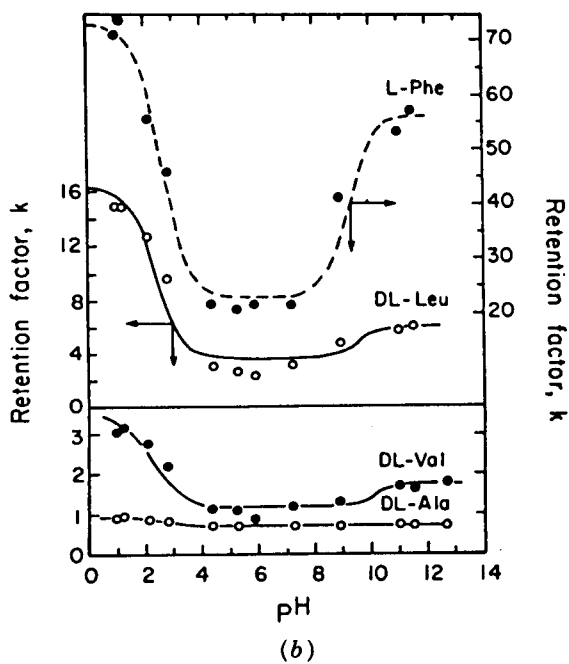
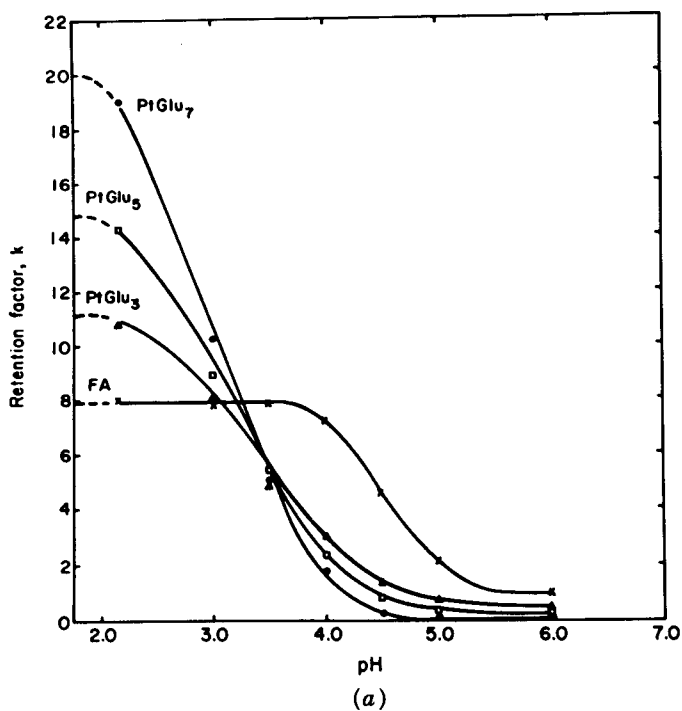

TABLE 7.1 Buffers for Use in HPLC Separation

Buffer	pK_a	Buffer Range ^a	UV Cutoff ^b
Trifluoroacetic acid	>>2	1.5–2.5	210 nm (0.1%)
Phosphoric acid/mono- or di-K phosphate	2.1	< 3.1	< 200 nm (0.1%)
	7.2	6.2–8.2	
	12.3	11.3–13.3	< 200 nm (10 mM)
Citric acid/tri-K citrate	3.1		
	4.7	2.1–6.4	230 nm (10 mM)
	5.4		
Formic acid/K-formate	3.8	2.8–4.8	210 (10 mM)
Acetic acid/K-acetate	4.8	3.8–5.8	210 nm (10 mM)
Mono-/di-K carbonate	6.4	5.4–7.4 ^c	< 200 nm (10 mM)
	10.3	9.3–11.3	< 200 nm (10 mM)
Bis-tris propane ^e · HCl/Bis-tris propane	6.8	5.8–7.8	215 nm (10 mM)
	9.0	8.0–10.0	225 nm (10 mM)
Tris ^d · HCl/tris	8.3	7.3–9.3	205 nm (10 mM)
Ammonium chloride/ammonia	9.2	8.2–10.2	200 nm (10 mM)
1-Methylpiperidine · HCl/1-Methylpiperidine	10.1	9.1–11.1	215 nm (10 mM)
Triethylamine · HCl/triethylamine	11.0	10.0–12.0	< 200 nm (10 mM)

^a pH range allowed with this buffer (conservative estimate).

^b Absorbance < 0.5 A; from Ref. 7.

^c Requires addition of an acid (e.g., acetic or phosphoric).

^d Tris(hydroxymethyl)aminomethane.

^e 1,3-bis [Tris(hydroxymethyl)methylamino] propane.

the sample is not heavily buffered at a pH quite different from that of the mobile phase. Higher buffer concentrations (> 50 mM) provide increased buffer capacity but may not be soluble in the mobile phase for high % B. Higher buffer concentrations also may adversely affect the operation of HPLC systems constructed of stainless steel. A buffer concentration of 25 mM is usually a good compromise. Table 7.1 summarizes data on the usable pH range for several buffers that are popular for use with HPLC.

A mobile phase with marginal buffer capacity will give less reproducible separations for compounds that are partially ionized at the pH of the mobile phase. In this case, retention may change from run to run, and distorted peaks

FIGURE 7.3 Dependence of retention on pH for the case of sample molecules substituted by more than one acidic or basic group. (a) Sample: pteroyl-oligo- γ -L-glutamates [one (= FA, folic acid), three, five, or seven carboxyl groups] vs. pH; Partisil ODS-2 column; mobile phase: 6% acetonitrile–buffer (0.1 M phosphate); 45°C. (Reprinted with permission from Ref. 5.) (b) Samples: amino acids (phenylalanine, leucine, valine, alanine); XAD-4 column packing; 40 mM phosphate buffer. (Reprinted with permission from Ref. 6.)

may result. This is illustrated in Fig. 7.2*b* for the RPC separation of 3,5-dimethylaniline (DMA) for pH values between 3 and 4 using a 25 mM phosphate buffer. The pK_a of the buffer is 2.1, so buffer capacity will be reduced significantly when the mobile phase pH is > 3.1 . For these experimental conditions (25% MeOH–buffer), the pK_a of the solute (DMA) is 3.8 (i.e., it will be partially ionized for $2.8 < \text{pH} < 4.8$). In Fig. 7.2*b* the peak shape of the solute deteriorates progressively as the pH is increased above 3 (reduced buffer capacity), and the peak becomes quite distorted for $\text{pH} > 3.5$ (very little buffer capacity; see the further discussion of Section 7.2.2.4).

7.2.2.2 Buffer UV Absorbance. Ideally, the buffer should transmit light at or below 220 nm so as to allow low-UV detection. All of the buffers of Table 7.1 except citrate meet this criterion. Sometimes it is necessary to carry out UV detection at 200 nm or lower. Several buffers from Table 7.1 qualify for very low UV detection (phosphate, carbonate, ammonia). However, buffer absorbance at low UV wavelengths can be strongly increased by the presence of impurities. The UV-cutoff values of Table 7.1 are for purified reagents.

7.2.2.3 Other Buffer Properties. Buffer solubility and stability, possible interaction with the equipment, sample, and/or column, and volatility are also of interest for some applications. Inorganic buffers such as phosphate are marginally soluble in solutions that contain high concentrations of organic. Methanol–water mobile phases provide higher solubility than acetonitrile–water or THF–water solutions, and for this reason methanol may be the first choice of organic solvent. Inorganic buffers are usually relatively stable, although with volatile buffers it may be difficult to maintain a constant pH (especially with helium sparging). For example, mobile-phase pH tends to increase on standing for carbonate buffers, due to loss of CO_2 over time. Trifluoroacetic acid (TFA) is largely ionized and relatively non-volatile when $\text{pH} < 2.5$ (as is typical for peptide and protein separations with this buffer; Section 11.2.1). Some buffers degrade on standing and may increase their UV absorbance during storage or long-term use (e.g., TFA, triethylamine).

Citrate buffers have been claimed to attack stainless steel, but other reports [8] suggest that citrate can be used with HPLC equipment if the system is flushed to remove citrate at the end of each day. The main disadvantage of a citrate buffer is its higher UV absorbance, which limits UV detection to wavelengths above 230 nm. Some buffers are able to interact with the sample by means of ion pairing (e.g., trifluoroacetate buffers with cationic samples [9], triethylamine with anionic samples, etc.). Although such ion-pair interactions are not undesirable *per se*, occasionally they may complicate the interpretation of the chromatogram as separation conditions are changed (see Section 7.3).

Volatile buffers are useful for two kinds of applications. If purified sample components are to be recovered (preparative HPLC, Chapter 13), it is convenient to be able to remove the buffer by evaporation or lyophilization. Buffers such as ammonium carbonate, ammonium formate, ammonium acetate, and

trifluoroacetic acid are useful in this regard. Volatile buffers may also be required for use with some detectors [e.g., light scattering (Section 3.3.1) or mass spectrometer (Section 3.3.4)].

7.2.2.4 Preferred Buffers. Reversed-phase HPLC separations generally are carried out with C_8 or C_{18} bonded-phase silica-based columns that are less stable outside the pH range 2 to 8. Therefore, the buffer (or buffers) should be able to control pH between 2 and 8. It is also desirable if the buffer allows detection at 210 nm or lower. Table 7.1 suggests the use of a phosphate buffer for controlling pH in the range 2.1 to 3.1 or 6.2 to 8.2. Acetate is an acceptable choice for $3.8 < \text{pH} < 5.8$, and phosphate plus acetate in combination can control pH reasonably well over the range $2 < \text{pH} < 8$. (Note that silica-based columns are less stable with phosphate buffers in the pH 6.2–8.2 and 11.3–13.3 ranges; see Sections 5.2.3.4 and 5.4.3.6).

Citrate has the advantage that a single buffer can be used to explore a wide range in pH: $2.1 < \text{pH} < 6.4$. A further characteristic of this buffer is that if citric acid (A, pH 2.5) and trisodium citrate (B, pH 6.5) buffers having equal concentrations are blended, pH varies almost linearly with % B over this pH range (see Appendix IV for details). This approach can provide a convenient and rapid means of varying pH predictably during method development, simply by blending pH 2.5 and pH 6.5 buffers. Once an optimum pH value has been established, it may prove desirable to substitute acetate or (especially) phosphate for citrate to allow detection at a lower wavelength. However, it should be noted that a change in buffer can result in a change in selectivity [10,11]. Appendix IV provides more detailed information on the preparation of buffers having a desired pH.

7.2.3 $\text{p}K_a$ as a Function of Compound Structure

When optimizing mobile phase pH, it is useful to know the approximate $\text{p}K_a$ values of the various sample components. This information allows mobile-phase composition to be restricted to a useful range of pH values (e.g., $\text{p}K_a \pm 1.5$ for the variation of band spacing as a function of pH, or a pH outside this range can be used if the effect of pH on retention is to be minimized for greater method ruggedness). If $\text{p}K_a$ values for the various sample components are unavailable, they can be approximated from the structures of the sample molecules. Table 7.2 summarizes $\text{p}K_a$ values in water for some common acid or base substituent groups in typical sample molecules. More reliable estimates of $\text{p}K_a$ as a function of molecule structure can be obtained from Ref. 12 for various pharmaceutical compounds or by computer calculation (e.g., using the $\text{p}K_{\text{calc}}$ software from CompuDrug (Budapest) [13]).

For several reasons, the data of Table 7.2 should be used with caution. First, values of $\text{p}K_a$ for a substituent group (e.g., $-\text{COOH}$) can vary greatly, depending on the electronegativity of adjacent substituent groups. For example, the $\text{p}K_a$ value of acetic acid is 4.8, while the $\text{p}K_a$ value of trichloroacetic

TABLE 7.2 pK_a Values for Acidic or Basic Functional Groups

Group	pK_a			
	Acid		Base	
	Aliph ^a	Arom ^b	Aliph ^a	Arom ^b
Sulfonic acid, $-\text{SO}_3\text{H}$	1	1		
Amino acid, $-\text{C}(\text{NH}_2)-\text{COOH}$	2-4		9-12	
Carboxylic acid, $-\text{COOH}$	4-5	4-5		
Thiol, $-\text{SH}$	10-11	6-7		
Purine		2-4		9
Phenol, $-\text{OH}$		10-12		
Pyrazine			1	
Sulfoxide, $-\text{SO}$			1-2	
Thiazole			1-3	
Amine, $-\text{NH}_2$, $-\text{NR}_2$, pyridine			8-11	5
Imidazole				7
Piperazine			10	

Source: Ref. 13.

^a Aliph, aliphatic substituent (e.g., acetic acid for $-\text{COOH}$).

^b Arom, aromatic substituent (e.g., benzoic acid for $-\text{COOH}$).

acid is 0.7. Second, as organic solvent is added to the mobile phase, there is a further change in values of pH and pK_a [14]. When the mobile-phase pH is adjusted as recommended above (before adding organic), data from one study [3] show little difference between pK_a values measured in water and in water-methanol mixtures for acidic samples (benzoic acid derivatives). This same study showed a decrease in apparent pK_a for basic samples (anilinium derivatives) of about 0.3 units per 10% added methanol. Other studies [14,15] show a decrease in pK_a for pyridine derivatives: -0.1 to -0.3 units in pK_a for each 10% addition of methanol, acetonitrile, or THF.

It is also possible to infer compound acidity or basicity and approximate values of pK_a from separations where pH is varied as in Fig. 7.2a (i.e., $pK_a = \text{pH}$ for retention that is halfway between the highest and lowest values at extreme pH values). For example, in Fig. 7.1 the pK_a value of compound 4 (a base) is about 7. Similarly, compound 1 is an acid with $pK_a < 4$. Computer software has been described [3] which allows the estimation of pK_a values from three experimental RPC runs where pH is varied (as part of method development, see Section 10.2.1.1). Another study [16] describes the classification of all sample components as either acidic, basic, neutral, strongly acidic, or strongly basic by means of isocratic HPLC experiments where pH and ion-pair-reagent concentration are varied. The latter procedure has also been extended for use with gradient elution [17].

7.2.3.1 Preferred Mobile-Phase pH. The most common acid or base substituents in a sample molecule are amine [$-\text{NH}_2$, $-\text{N}(\text{CH}_3)_2$, etc.], basic heterocy-

clic, and carboxylic acid ($-\text{COOH}$) groups. Aromatic amines, pyridines, and both aromatic and aliphatic carboxylic acids have aqueous $\text{p}K_a$ values in the range 4 to 5, while aliphatic amines have $\text{p}K_a = 8$ to 11. RPC columns normally are used in the pH range 2 to 8, which largely eliminates any control of ionization and retention for aliphatic amines. Therefore, changes in retention as a function of pH are most likely to be found in the pH range 3 to 6 for compounds other than alkyl amines.

The choice of a "best" starting pH for HPLC method development is affected by several considerations. For the optimization of band spacing and separation, it is desirable that sample retention changes as pH is varied. In this case, pH should be varied over the range $\approx \text{p}K_a \pm 1$. In other cases, we might want a more rugged separation that remains the same for small changes in pH; this would suggest a $\text{pH} < (\text{p}K_a - 2)$ or $> (\text{p}K_a + 2)$. Whether we are dealing with known samples (where $\text{p}K_a$ values can be estimated in advance of separation) or unknown samples (whose $\text{p}K_a$ values can be approximated experimentally), it is usually best to begin RPC method development with a mobile phase whose pH can vary somewhat without affecting separation ($\text{pH} < 3$; see the discussion in Section 7.3.1).

7.2.4 Which HPLC Method Is Best for Ionic Samples?

For regular ionic samples, we have a choice of three HPLC methods: reversed-phase, ion-pair, or ion-exchange chromatography. Because of its simplicity, freedom from problems, and better column performance, RPC usually is the best starting point. If RPC separation proves inadequate, the addition of an ion-pair reagent to the mobile phase can be considered next. The extent of ion-pair vs. reversed-phase separation can be controlled by the concentration of the ion-pair reagent; there is therefore a continuous transition from RPC to IPC retention as the reagent concentration is increased from zero to some maximum value. So initial reversed-phase experiments can be quite useful for the later optimization (if needed) of an ion-pair HPLC separation. Special considerations may suggest starting with either ion-pair or ion-exchange chromatography, as discussed in Sections 7.4 and 7.5.

7.3 OPTIMIZING THE REVERSED-PHASE SEPARATION OF IONIC SAMPLES

7.3.1 Initial Experiments

Reversed-phase method development for ionic samples proceeds in a manner somewhat similar to that for neutral samples (Section 6.4). The choice of experimental conditions for the first separation can be guided by the recommendations of Table 1.3. The primary difference between this initial experiment for ionic vs. neutral samples is the need for (1) a buffered mobile phase

and (2) a reversed-phase column that exhibits minimal silanol effects (i.e., a "basic" RPC column; Section 5.2.1). Alternatively, a column with a non-silica matrix can be used instead (e.g., polystyrene, graphitized carbon, etc.; Section 5.2.1). However, best results usually will be obtained with a less acidic silica-based column from Table 5.4.

For basic samples, silanol interactions (Section 7.3.3.2) can lead to poor band shape and reduced column efficiency. A low-pH mobile phase usually will give better column performance for these samples (Section 7.3.3.2). Also, a low-pH method generally will be more rugged, because small changes in pH are less likely to affect the retention of most samples. Finally, when first beginning HPLC method development, it is not known that pH variation will be required to achieve an acceptable separation; so *a mobile-phase pH < 3 is recommended for initial experiments.*

The next step is to adjust mobile-phase strength (% B) to provide an acceptable k range for the sample: $0.5 < k < 20$. Ionic samples are less likely to be retained strongly, and also are more likely to give a wide range of k values. For these reasons, the best approach in method development is an initial gradient elution run. If a wide-range gradient is used (e.g., 5 to 100% B), care must be taken to avoid precipitation of the buffer at high % B. This may require a lower buffer concentration (e.g., 5 to 10 mM), or a more soluble buffer (e.g., 0.1% trifluoroacetic acid). An initial gradient run can be followed by estimating the % B for good isocratic retention ($0.5 < k < 20$, Section 8.2.2). The use of an initial gradient also provides information on the sample k range (i.e., is an isocratic separation practical?). If an isocratic separation appears unfeasible for the pH value initially chosen, it is possible that a change in pH or the addition of an ion-pair reagent will reduce the sample retention range and still allow isocratic separation (as discussed below). Alternatively, if the k range is too wide, the sample can be separated using gradient elution (Chapter 8).

After mobile-phase strength (% B) has been selected for acceptable retention, band spacing may require adjustment—either to maximize sample resolution or to reduce the retention range so as to allow isocratic separation. Finally, column conditions can be varied to provide the best compromise between resolution, run time, and column pressure (Section 2.3.3).

7.3.2 Controlling Selectivity

Compared to method development for neutral samples, controlling band spacing in the reversed-phase separation of ionic samples involves additional options in the choice of separation conditions. Changes in selectivity also can be more predictable if the acidic or basic properties of the sample (pK_a values) are known. Often, a change in pH is the most effective way to vary separation selectivity. Other variables that are also effective in varying band spacing are % B, solvent type (methanol, acetonitrile, THF), and temperature, as well as column type (C_8 or C_{18} , phenyl, cyano) and buffer concentration. Note that

the use of higher temperatures with buffered mobile phases can adversely affect column lifetime, especially for $\text{pH} < 3$ or > 7 .

7.3.2.1 pH. As can be seen from Fig. 7.1, a change in pH can result in a 10-fold or greater change in k for an ionic compound. It may therefore be necessary to adjust % B at the same time pH is varied. On the other hand, if neutral compounds are present in the sample, a change in pH will not have much effect on run time if the last-eluting band is neutral. In the latter case, pH can be varied without a need to adjust % B.

On the basis of an initial gradient run (methanol-buffer at pH 2.5) and Table 8.2, the isocratic separation of Fig. 7.4a was carried out. The retention range is adequate ($2 < k < 10$), but bands 6/7 are unresolved. At this point, if the effect of pH is to be studied, it is best to carry out one or two additional runs with pH varying by about 1 unit. Figure 7.4b and c show these separations for a pH equal to 3.5 and 4.5. The retention range for pH 3.5 is still satisfactory ($0.8 < k < 6$), but now bands 5/6 are unresolved and bands 8/9 overlap. Because the critical band pair has changed from 6/7 (pH 2.5) to 5/6 (pH 3.5), it is likely that a better separation can be obtained at an intermediate pH. The separation at pH 4.5 (Fig. 7.4c) provides inadequate sample retention ($0.4 < k < 1.8$) and resolution. If separation at this pH is to be investigated further, the methanol concentration must first be decreased from that used in Fig. 7.4 (35% B).

Examining the three separations of Fig 7.4a-c, the logical choice for the next experiment is a pH value between 2.5 and 3.5 (e.g., pH 3.0). This separation is shown in Fig. 7.4d, with acceptable resolution for all bands ($R_s = 1.8$ for critical band pair 3/4). A slight improvement can be achieved by moving band 4 equidistant between bands 3 and 5. This can be accomplished (not shown, but note Fig. 7.4a and b) by an increase in pH to 3.1, for which $R_s = 1.9$ (critical band pairs 3/4 and 4/5).

Figure 7.4 illustrates the remarkable control over band spacing that is possible by varying pH for the separation of a group of compounds of similar acid-base functionality (i.e., in this case, a mixture of benzoic acids). When mixtures of acids, bases, and/or neutrals are involved, even more significant changes in band spacing can be expected, as suggested by the data of Fig. 7.1. However, the use of pH optimization for purposes of controlling band spacing and separation must always be balanced against method ruggedness [i.e., the effect of small, unavoidable variations in mobile-phase pH on retention and separation when a new batch of mobile phase is prepared (Section 7.3.3.1)].

Even for simple pH-dependent separations as in Fig. 7.4, it may be difficult to keep track of peak identity between chromatograms. Some acidic or basic samples undergo a change in absorbance as pH is varied, so that band size for a given compound may not remain constant between runs at different values of pH. For these and other reasons, it is sometimes necessary to carry out several experiments using rather small changes in pH (e.g., 0.2 to 0.5 units). Injecting standards to confirm peak identity in all runs may also be

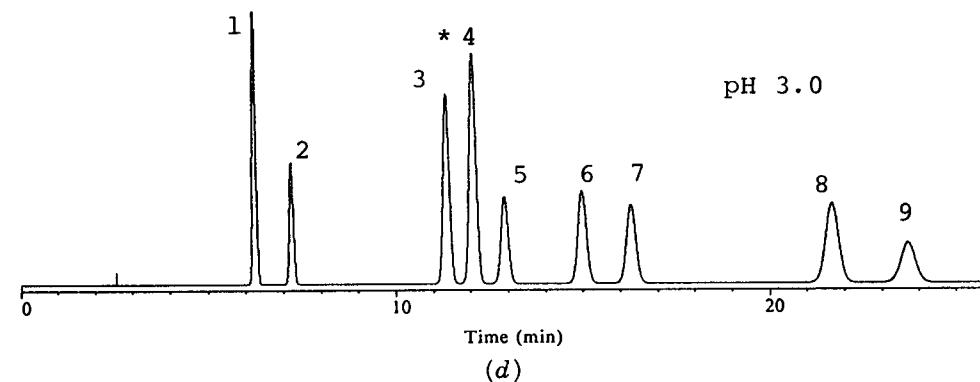
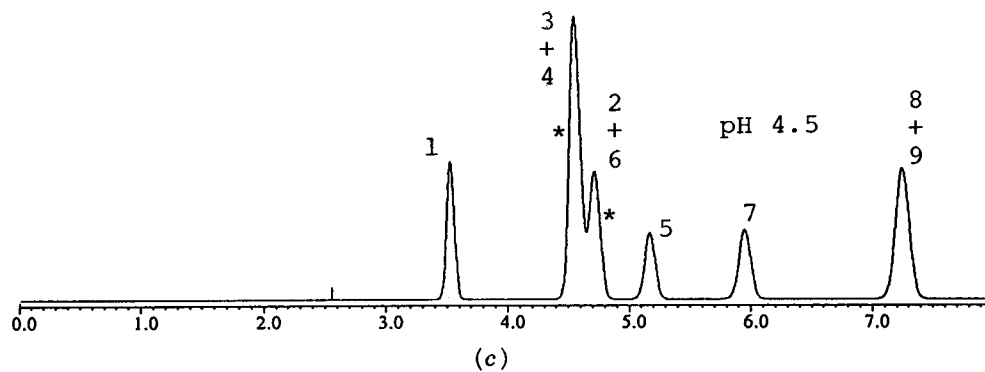
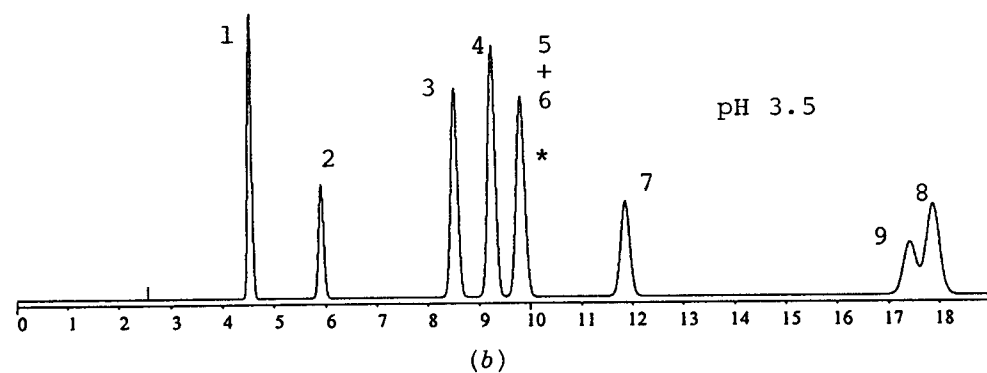
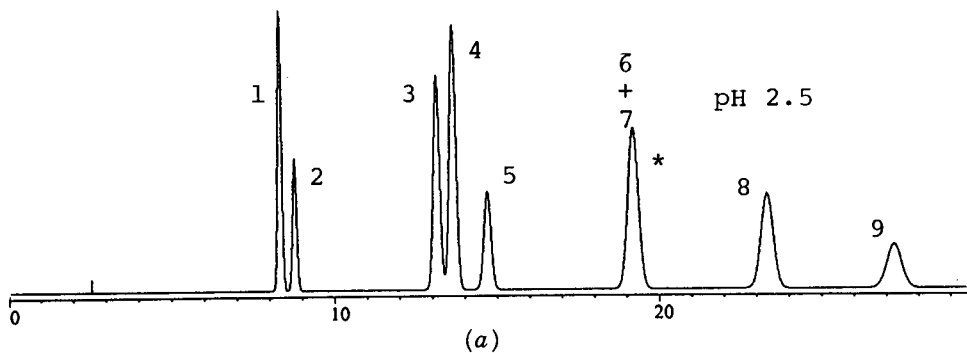

required for the logical optimization of pH. See the discussion of peak tracking in Section 10.7.

7.3.2.2 Solvent Strength (% B) When varying pH for purposes of changing band spacing, it may be necessary to change % B at the same time to maintain a satisfactory k range. This adjustment can lead to additional changes in selectivity. Thus, band spacing is expected to vary with % B as in the case of neutral samples (Section 6.3.1). This is illustrated in Fig. 7.5 for the separation of a mixture of substituted anilines at pH 3.5 with methanol–buffer mobile phases. For a change from 20% to 40% methanol, the separation order of the last four bands changes from $5 < 6 < 7 < 8$ to $6 < 5 \approx 8 < 7$. Because of additional sample–stationary phase interactions involved in the reversed-phase separation of ionic samples (vs. neutrals), the resulting changes in selectivity when % B is varied should be generally larger for ionic samples. Therefore, the importance of solvent strength as a variable for optimizing selectivity should always be kept in mind.

The discussion of the paragraph above might suggest that the simultaneous variation of pH and % B will be generally advantageous by taking advantage of the independent optimization of α for each variable. This appears to be the case for acidic samples (benzoic acid derivatives [19]) but not for basic samples (aniline derivatives [20]). After % B was adjusted for $0.5 < k < 20$ and an optimum pH was selected for α and resolution, it was found for the latter sample (anilines) that further adjustment of % B did not improve resolution. Conversely, if the pH was not changed and % B was optimized for selectivity, further changes in pH did not improve separation. This interesting result appears related to the observation that pH and pK_a do not vary much with % B in the case of acidic samples, whereas pH and pK_a do vary with % B in the case of basic samples [3,14]. Thus, a change in % B to change selectivity for basic samples will in some cases be equivalent to a change in pH, due to the variation of pH and/or pK_a with % B. That is, either pH or % B can be changed for a similar change in selectivity, but the combination of these two variables may not provide further improvement in separation.

7.3.2.3 Solvent Type. Solvent type (acetonitrile, methanol, THF) is expected to affect selectivity for ionic samples in much the same way as for neutrals. Therefore, a change in solvent is a potentially useful variable for optimizing separation. Methanol may be preferred to acetonitrile for separat-

FIGURE 7.4 Separation of substituted benzoic acids as a function of pH. Sample: 1, 2-nitro; 2, phthalic; 3, impurity; 4, 2-fluoro; 5, 3-cyano; 6, 2-chloro; 7, 3-nitro; 8, 3-fluoro; 9, 2,6-dimethyl. Conditions: 25-cm Zorbax C8 column; 35% methanol–buffer (25 mM sodium acetate); 35°C; 1.0 mL/min. (Simulated chromatograms based on experimental data of Ref. 18.)

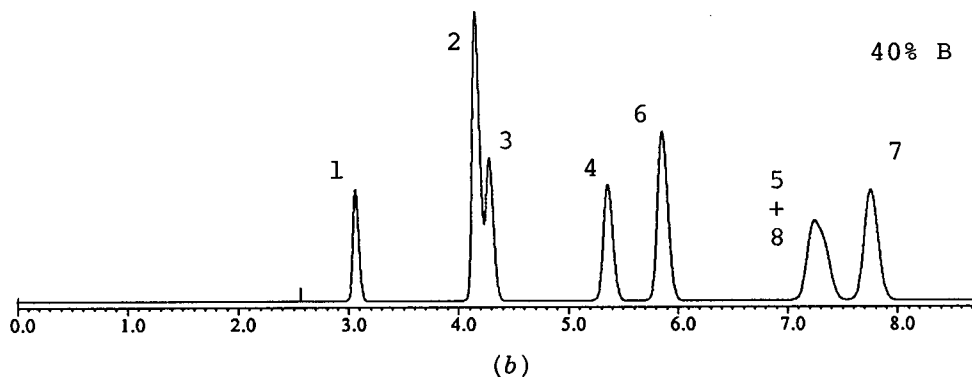
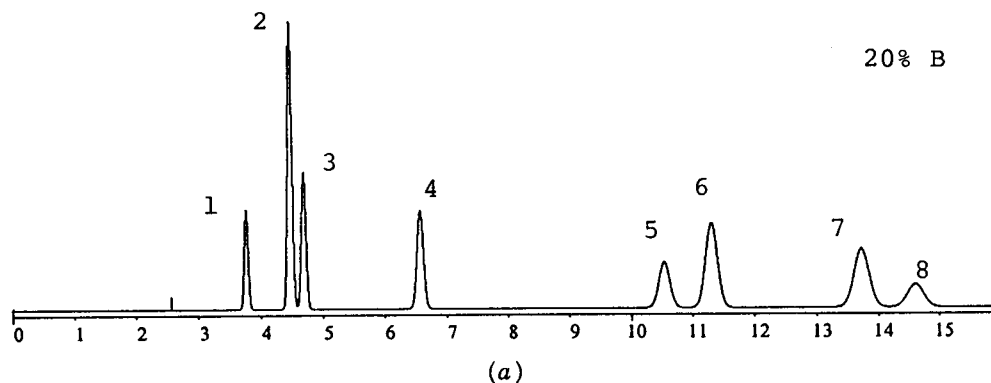

FIGURE 7.5 Separation of substituted anilines as a function of percent methanol (% B). Sample: 1, 4-methoxy; 2, *N*-ethyl; 3, 3-methyl; 4, 3,5-dimethyl; 5, 4-chloro; 6, 3-cyano; 7, 3-chloro; 8, 2-chloro. Conditions: 25-cm Zorbax SB-C8 column; methanol–buffer (25 mM sodium citrate, pH 3.5); mobile phases; 35°C; 1.0 mL/min. (a) 20% methanol; (b) 40% methanol. (Simulated chromatograms based on experimental data of Ref. 3.)

ing some ionic samples (more hydrophobic samples that require a larger % B), because of the greater solubility of most buffers in methanol–water mixtures compared to mobile phases that contain acetonitrile or THF.

7.3.2.4 Temperature. As noted in Section 6.3.4, temperature generally has a minor effect on band spacing for the RPC separation of neutral samples. This is not the case for ionic samples, because several different retention-related processes can be involved in these separations, each responding differently to a change in temperature [21] (e.g., changing ionization of sample

compounds, hydrophobic retention of ionized vs. non-ionized molecules of the same compound, silanol interactions involving the ionized species, and change of pH and pK_a with temperature). It can be expected that maximum changes in selectivity with temperature will occur for pH values that result in the partial ionization of compounds of interest (i.e., intermediate values of pH). This effect is illustrated in Fig. 7.6 for the separation of the benzoic acid sample of Fig. 7.4 as a function of temperature. For pH 3.2 that is equal to the average pK_a value of this sample (so all compounds are partially ionized), the best separation is observed for an intermediate temperature (40°C, Fig. 7.6b). Note that the combination of either low or high pH with elevated temperatures can lead to a rapid loss of bonded phase with most RPC columns (Section 5.4.3.6).

7.3.2.5 Buffer Concentration. The effect of buffer concentration on the RPC retention of ionic samples is expected to be relatively minor, as suggested by the data of Ref. 18 for the separation of substituted benzoic acids. An important exception to this generalization can be expected, however, for the combination of basic samples and silica-based columns whose silanols are significantly ionized. Silanol ionization (Eq. 7.3a) can be expected at any pH for acidic (type A) RPC columns and for any silica-based column when $pH > 6$. These ionized silanols can strongly retain protonated bases or other cations by means of an ion-exchange process (Section 7.3.3.2; see Eq. 7.3). An increase in buffer concentration will then selectively decrease the retention of all cationic sample ions, due to increasing competition from buffer cations. An example of this effect for the separation of PTH-amino acid samples with a Zorbax C8 column has been reported (Ref. 22 and Fig. 1.5b). A change in buffer concentration as a means of changing selectivity is usually not advisable, however, because silanol ionization is generally not reproducible from one batch of columns to the next, leading to variable sample retention and separation.

7.3.2.6 Amine Modifiers. The addition of amine modifiers to the mobile phase can affect the separation of basic samples, often resulting in much improved peak shapes (Section 7.3.3.2). Often, the retention of basic compounds will decrease as the concentration of an amine additive is increased, due to blockage of ionized silanols by the amine. This can lead to useful changes in selectivity. One study [23] described the simultaneous optimization of % B, pH, and methylamine concentration for the separation of a drug that contained 13 metabolites. The use of amine modifiers to affect selectivity also depends on the presence of ionized silanols (as in Section 7.3.2.5), and these tend to vary from column to column of the same type. For this reason, varying the amine concentration is not a first choice for the control of selectivity. Rather, if an amine is added to the mobile phase, its concentration should be large enough to suppress silanol effects as much as possible.

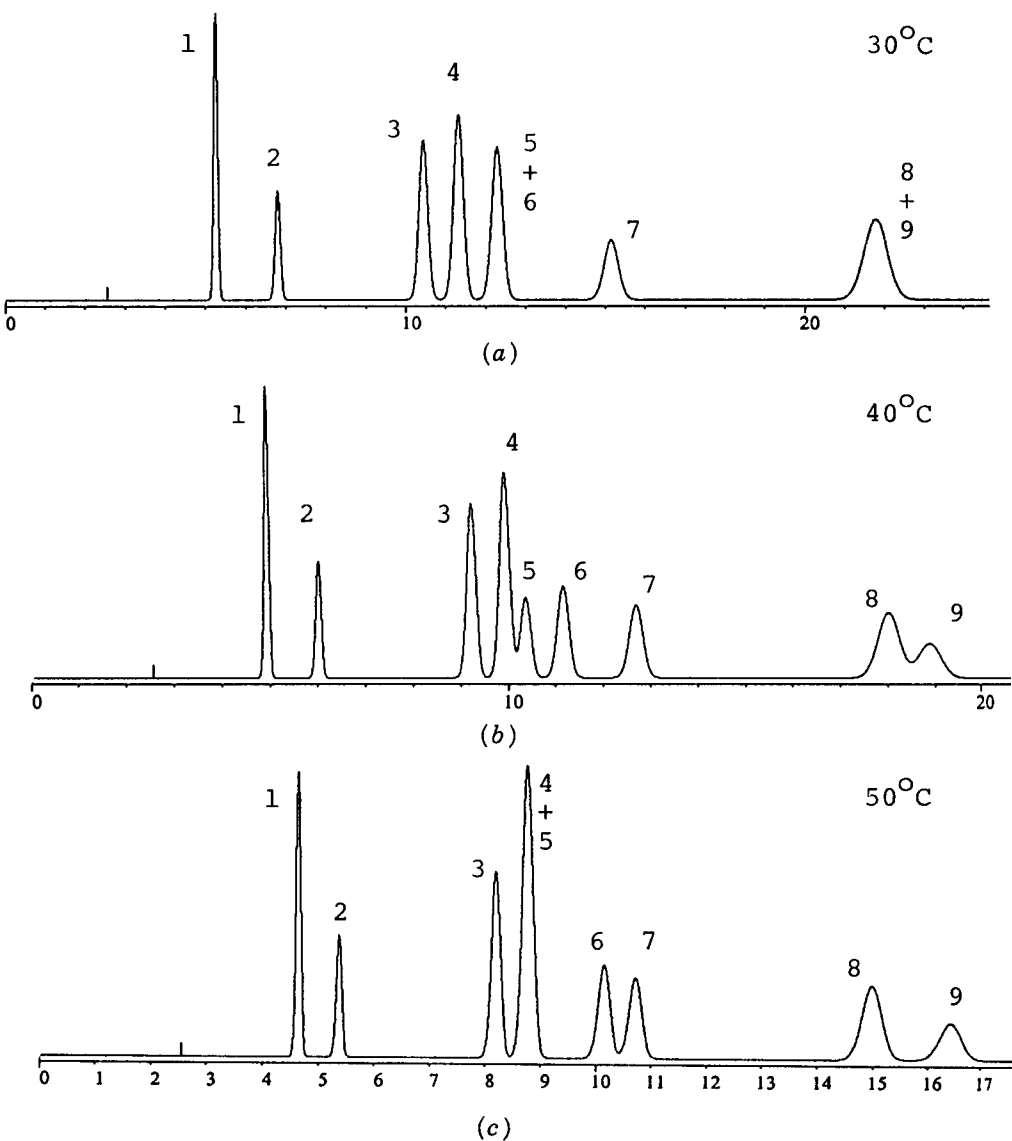

FIGURE 7.6 Separation of substituted benzoic acids as a function of temperature. Sample and conditions as in Fig. 7.4, except that pH is 3.2. (a) 30°C; (b) 40°C; (c) 50°C. (Simulated chromatograms based on experimental data of Ref. 18.)

7.3.2.7 Column Type. Section 6.3.3 gives examples of useful changes in band spacing for neutral samples as a result of a change in column type (C_8 , phenyl, cyano). Similar selectivity changes for columns of different type have been reported for ionic samples [24]. Because of the many other variables that are available for changing the band spacing of ionic samples and their greater convenience in method development, a change in column type usually should be reserved for samples that show poor band spacing *after* optimizing other variables.

Separations of basic samples have been carried out using “bare” silica columns and organic–buffer mobile phases [25]. It appears that retention occurs by an ion-exchange process that involves protonated bases and ionized silanols (Eq. 7.3). The use of a silica column is recommended only when more conventional RPC conditions with a bonded-phase column are unsuccessful.

7.3.3 Special Problems

RPC methods for ionic samples are subject to a number of problems that are either not found for neutral samples or are more important for ionic samples.

7.3.3.1 pH Sensitivity. When the mobile-phase pH is close to the pK_a values of one or more sample components, small changes in pH (as little as 0.1 unit) can have a major effect on band spacing and sample resolution. This pH sensitivity is compounded by difficulty in formulating buffers to a precise pH; many laboratories will not be able to measure buffer pH more accurately than ± 0.05 to 0.1 unit. *For this reason, the ruggedness of the final method in terms of pH should be a major concern during method development for ionic samples.*

There are several ways in which the problem of pH sensitivity can be minimized. First, determine the pH sensitivity of the method. If the mobile-phase pH must be held within narrow limits (± 0.1 unit or less), precise pH control can be achieved by accurately measuring the buffer ingredients (by weight or volume) rather than by using a pH meter to titrate the buffer to the desired pH. Second, if a precise adjustment of pH in this way cannot be assured, carry out separations with mobile phases that are 0.2 unit higher or lower than the target pH and include these chromatograms in the method procedure. Such separations can be used by the operator to adjust the mobile-phase pH when sample resolution is inadequate, due to an incorrect pH; see the example of Fig. 1.5d. Finally, the best approach for a method that is pH sensitive is to design or rework the method to make it more rugged. Often, the exact conditions (especially pH) that favor maximum resolution may not favor method ruggedness. Minor changes in separation conditions sometimes result in a much more rugged method with only a small sacrifice in resolution. See the discussion in Refs. 19 and 26 and Section 10.6.

7.3.3.2 Silanol Effects. Ionic samples, especially basic compounds, can interact with the silanols of silica-based columns (Section 5.2.1.1). This can lead

different "basic" RPC columns [27a]. Alternatively, the use of a polymeric (non-silica) RPC column eliminates problems due to silanols, if the separation can be achieved with a lower plate number (polymeric columns typically are less efficient than comparable silica-based columns).

Some workers recommended working at high pH (e.g., > 7) for the separation of basic compounds [15]. Weak bases (e.g., anilines, pyridines) may be non-ionized at higher pH values, thereby eliminating retention according to Eq. 7.3 and its attendant problems. Some columns also show *less* tailing at high pH than at low pH, possibly because enough silanols are ionized so as to no longer limit column capacity. For high-pH separations, one study [15] reported more tailing for acetonitrile as solvent vs. methanol or THF. For further information, see Refs. 27 to 32. Silica-based columns are less stable for pH over 6 and often cannot be used for pH greater than 8. However, densely bonded alkyl, endcapped columns made with sol-gel silica supports apparently can be routinely used up to at least pH 11 when organic buffers and temperatures $\leq 40^\circ\text{C}$ are used [32a,32b; see also Section 5.2.3.4 and 5.4.3.5].

An alternative approach for suppressing silanol interactions with basic compounds has been proposed recently [33]. The addition of 0.02 to 0.05% hexanenitrile to the mobile phase gave much improved peak shapes for several aniline derivatives and a moderately acidic column (Spherisorb C₈). Whether this procedure will also be effective for aliphatic amines (which interact more strongly with silanols) was not determined. "Dynamically modified" silica has also been suggested for the improved RPC separation of basic compounds [34,35]. Bare silica is used as column packing, and 0 to 20 mM of a quaternary long-chain alkyltrimethylammonium ion is added to the mobile phase. This additive apparently blocks the silanols while covering the surface of the packing with an alkyl layer that mimics C₁₈ packing. Reproducibility and peak shape are claimed to be superior to separations carried out with basic RPC columns [34].

Occasionally, acidic compounds are observed to give tailing or excessively broad bands in RPC separation. The addition of acetic acid or acetate to the mobile phase has proven beneficial in such cases.

7.3.3.3 Temperature Sensitivity. As seen in Fig. 7.6, a small change in temperature for the separation of an ionic sample can have a noticeable effect on sample resolution. Therefore, the need for column thermostating is greater for the separation of ionic compounds than for neutral samples. If the column is to be maintained at ambient temperature, the effect on separation of a change in temperature should be investigated. This precaution will anticipate possible problems due to uncontrolled ambient temperature fluctuations.

7.3.4 Summary

Method development for the reversed-phase separation of ionic samples proceeds in similar fashion as for non-ionic samples (Section 6.4) but with some

important differences. This is summarized in Fig. 7.7. If an acceptable separation is obtained at any stage of this series of studies, further work can be omitted or proceed to step 8 (vary column conditions).

STEP 1. Carry out an initial gradient from 5 to 100% methanol in 60 min, with a 25 mM potassium phosphate buffer (pH 2.5), a 15×0.46 -cm less acidic C_8 or C_{18} column at 2 mL/min, and the other conditions of Table 1.3. Alternatively, carry out an initial isocratic separation with 60% methanol (other conditions the same). A lower starting % B value can be used for ionic samples (60% B) compared to neutral samples (80 to 100% B, Section 6.2.2.1), because ionic samples are usually less strongly retained.

STEP 2. Use the initial gradient chromatogram to determine whether isocratic elution is possible (see Fig. 8.6 and related discussion). If isocratic elution is possible, estimate the best % B for isocratic separation (Table 8.2). If isocratic elution is not recommended, go to step 2a below.

Alternatively, from the initial isocratic separation, estimate a % B value that will give $k \approx 10$ for the last band; assume that a 10% reduction in % B (e.g., change from 60% B to 50% B) will increase k by a factor of 3 ("rule of 3," Section 6.2.1.1).

STEP 2a. If isocratic elution is not recommended on the basis of an initial gradient run, or if no isocratic run results in acceptable retention ($0.5 < k < 20$) due to an excessive retention range for the sample, there are three alternatives:

- Adjust pH and % B together to give a good retention range ($0.5 < k < 20$).
- Develop a gradient elution method (Chapter 8).
- Use ion-pair HPLC to obtain a good retention range (Section 7.4.3.1).

The likelihood that a pH change or the use of ion pairing can improve the retention range can be inferred from the pK_a values of early and late bands in the chromatogram (if known). For example, for a mobile phase pH of 2.5, if the first band has $k < 0.5$ and is a pyridine derivative, while the last band has $k > 20$ and is neutral, an increase in pH to 6 or 7 should result in decreased ionization for the pyridine derivative and an increase in its retention without affecting the retention of the last band. Then, an increase in % B can be used to adjust the retention of all bands into a range of $0.5 < k < 20$. See the additional discussion in Sections 7.2.1 and 7.4.1 and the example of Fig. 7.8.

STEP 3. Perform an isocratic separation with a % B value suggested by the first experimental run (if gradient elution is used for further method development, the approach is similar, but see the discussion in Chapter 8). If necessary, adjust % B to give a k range of 0.5 to 20. If an improvement in selectivity is needed, further vary mobile-phase strength (± 5 to 10% B) to determine the

REVERSED-PHASE

ION-PAIR

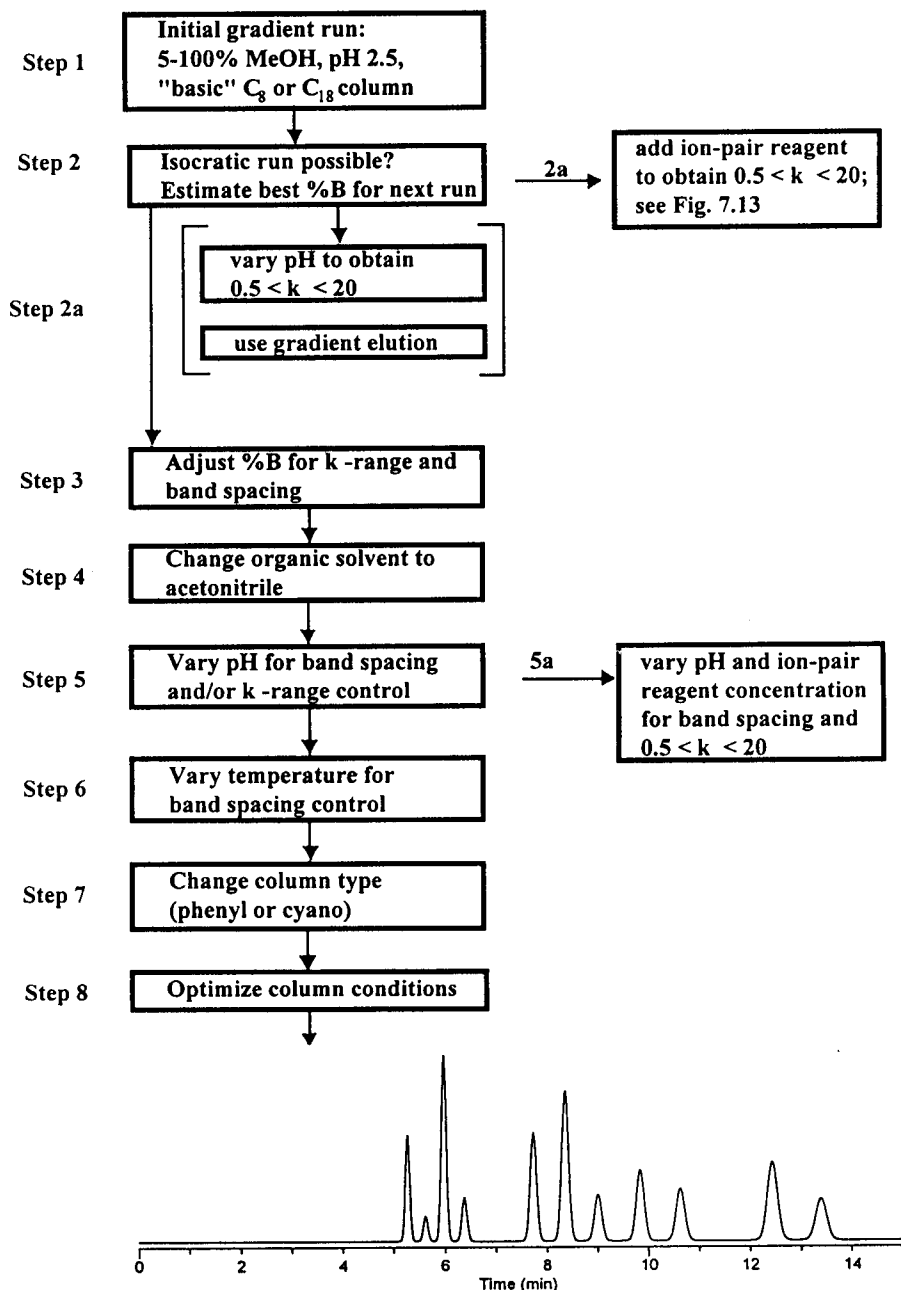

FIGURE 7.7 Summary of method development for the reversed-phase separation of ionic samples. See the text for details.

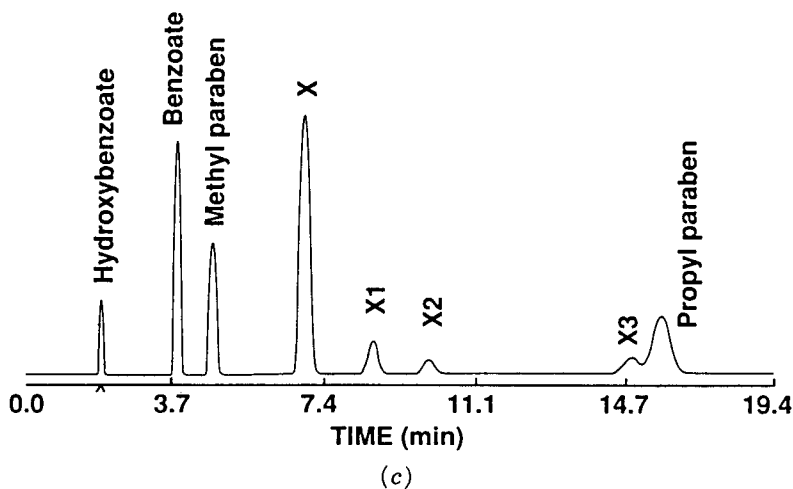
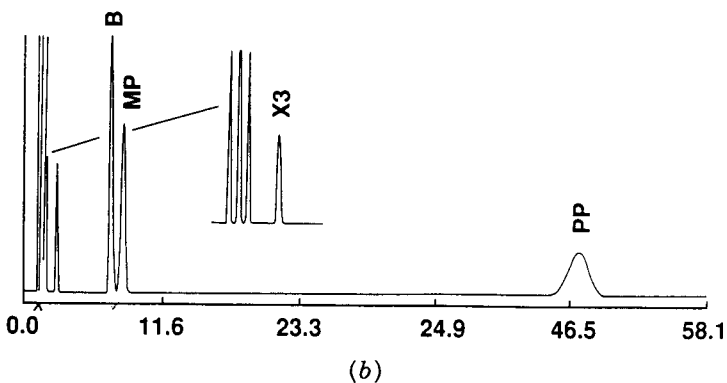
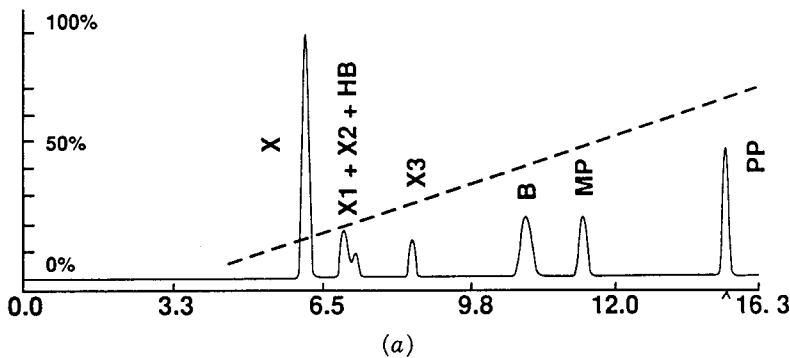

FIGURE 7.8 Separation of a proprietary mixture of acids, bases, and neutrals. Sample: X, basic drug substance; X1 to X3, basic drug degradates; HB, acidic degradate of neutral preservatives MP and PP; B, acidic preservative. Conditions: (a) 15×0.46 -cm Zorbax SB-C8 column; gradient from 5 to 100% methanol-buffer (25 mM potassium acetate, pH 3.5) in 20 min; 1.0 mL/min; 30°C; (b) same as (a), except isocratic separation with 30% B; (c) same, except isocratic ion-pair separation with 40% methanol-buffer (65 mM octane sulfonate) at 1.5 mL/min. (Unpublished data from the laboratory of LC Resources, McMinnville, Oregon.)

effect of % B on band spacing and separation. Adequate separation may be achieved by selecting a value of % B that provides both acceptable retention and good resolution. If an acceptable retention range is not possible, return to step 2a.

STEPS 4 AND 5. If an adequate separation is not obtained in step 3 because of poor band spacing, change to acetonitrile as solvent (use Fig. 6.4) and adjust % B as needed for good retention and separation. Alternatively, vary pH as in the example of Fig. 7.4, to determine an optimum pH for the separation. For most samples the recommended change in pH is as shown in Fig. 7.4: 2.5, 3.5, 4.5. If it is known that the pK_a values for the sample are > 5 , try pH values of 4, 5, and 6 instead. During the variation of pH, it may be necessary to change % B to maintain $0.5 < k < 20$. At the same time, fine-tuning % B for further control over band spacing should be investigated.

STEP 5a. If the pK_a value of an acidic sample is < 2 or that of a basic sample is > 8 , it may be necessary to use ion-pair HPLC (or a pH-stable, polymeric column) for further control of band spacing (Section 7.4).

STEPS 6 AND 7. Further changes in band spacing are possible by changing column type, temperature, or (less frequently) buffer concentration.

STEP 8. When band spacing has been optimized, consider a change in column length, flow rate, or particle size to improve the separation further. See the related discussion in Section 2.3.3.1.

7.4 ION-PAIR CHROMATOGRAPHY

Ion-pair and reversed-phase HPLC share several features. The column and mobile phase used for these separations are generally similar, differing mainly in the addition of an ion-pair reagent to the mobile phase for ion-pair chromatography (IPC). For most applications that involve ionic samples, RPC separation as in Section 7.3 should be explored first, before considering IPC. IPC separations are more complicated to develop and use and are subject to additional experimental problems (Section 7.4.5). If RPC method development (Fig. 7.7) is unable to provide an adequate separation due to poor band spacing, IPC provides an important additional selectivity option. Thus IPC is a logical follow-up for RPC separations that need improvement.

For some samples the first chromatogram may suggest that isocratic RPC is not an alternative to gradient elution, as illustrated in Fig. 7.8. The initial gradient separation of Fig. 7.8a indicates that a satisfactory isocratic separation will not be possible with this mobile phase (see discussion of Fig. 8.6), as confirmed in the isocratic separation of Fig. 7.8b with 30% B. In Fig. 7.8b the first band elutes with $k < 0.5$ and the last band has $k > 20$. However, a

consideration of the acid–base nature of early and late eluting bands points the way to narrowing of the retention range for satisfactory isocratic separation.

Early bands X to X3 are strongly basic, therefore ionized and weakly retained over the pH range 2 to 8; a change in pH will not affect their separation. Late bands MP and PP are neutral (and hydrophobic), so their retention is also unaffected by pH. However, the use of ion pairing with an anionic reagent can selectively increase the retention of these early cationic bands relative to later neutral bands, allowing the desired isocratic separation of this sample (Fig. 7.8c; see the following discussion).

7.4.1 Basis of Retention

Sample retention in IPC is illustrated in Fig. 7.9. The surface of a C_8 or C_{18} column packing is shown schematically in Fig. 7.9a as a rectangle covered by sorbed molecules of a negative ion-pair reagent (e.g., hexane sulfonate). The ion-pair reagent is attracted to the stationary phase because of its hydrophobic alkyl group, and the charge carried by the reagent ($C_6-SO_3^-$) thereby attaches to the stationary phase. This negative charge on the stationary phase is balanced by positive ions (Na^+) from the reagent and/or buffer. A positively charged sample ion (protonated base, BH^+) can now exchange with a Na^+ ion as shown (arrows), resulting in the retention of the sample ion by an ion-exchange process. Ion-pair HPLC carried out as in Fig. 7.9a bears a close resemblance to ion-exchange chromatography, as described in Section 7.5.

7.4.1.1 pH and Ion Pairing. Further detail describing retention in IPC is shown in Fig. 7.9b and c for the case of an acidic (anionic) sample $RCOOH$ and a positively charged ion-pair reagent (tetrabutylammonium, TBA^+). In Fig. 7.9b no ion-pair reagent is added to the mobile phase (simple RPC separation). At low pH, the non-ionized $RCOOH$ molecule is strongly retained vs. the ionized acid $RCOO^-$, so retention vs. pH under these conditions exhibits the characteristic pattern of Fig. 7.2a (reversed for the acidic sample of Fig. 7.9b vs. the basic sample of Fig. 7.2a). For the example of Fig. 7.9b, maximum retention occurs at low pH and minimum retention at high pH. In Fig. 7.9c, enough ion-pair reagent TBA^+ is added to the mobile phase so as to cover the stationary phase completely, thereby minimizing the retention of the neutral molecule $RCOOH$. However, the resulting positive charge on the stationary phase (from adsorbed TBA^+) causes a strong attraction of the negatively charged $RCOO^-$. When sample retention is plotted vs. pH under these ion-pairing conditions, maximum retention now occurs at high pH (where the sample is completely ionized), and minimum retention occurs at low pH (no sample ionization).

The nature of IPC as illustrated in Fig. 7.9c results in a retention process that is very different from reversed-phase HPLC in Fig. 7.9b. Therefore, large changes in separation selectivity for ionic samples can be anticipated upon

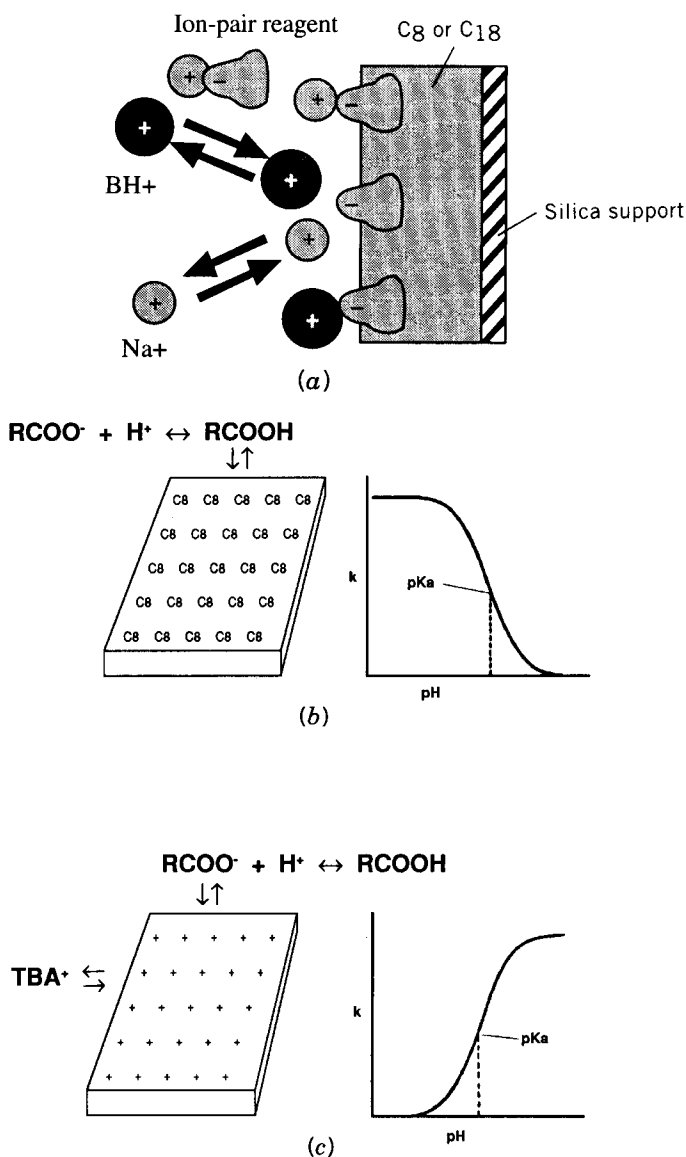

FIGURE 7.9 Pictorial representation of ion-pair chromatography retention. (a) Retention of a protonated base (BH⁺) during IPC; Na⁺ is the mobile-phase cation; ion-pair reagent is hexane sulfonate; (b) reversed-phase retention of carboxylic acid sample RCOOH on C₈ stationary phase as a function of pH; (c) sorption of ion-pair reagent (TBA⁺) onto stationary phase and retention of carboxylic acid sample (RCOO⁻) as a function of pH.

adding an appropriate ion-pair reagent to the mobile phase used for reversed-phase HPLC.

7.4.1.2 Ion-Pair Reagent Concentration. It is possible to vary the retention process continuously from reversed-phase to ion-exchange separation by changing the amount of ion-pair reagent taken up by the stationary phase. This is effected by varying the concentration of reagent in the mobile phase. Consider first the uptake by the C_{18} column of the sulfonate reagent P^- , as shown in Fig. 7.10a. The concentration of reagent in the stationary phase $(P^-)_s$ is plotted vs. the concentration of reagent in the mobile phase $(P^-)_m$, for two different reagents: C_6 -sulfonate and C_8 -sulfonate. For each reagent, column uptake increases for higher reagent concentrations in the mobile phase, but then levels off as the column becomes saturated with the reagent. Because the C_8 -sulfonate is more hydrophobic, it is retained more strongly and saturates the column at a lower mobile-phase reagent concentration. Therefore, a given reagent uptake by the column (e.g., 50% of saturation) is achieved with a lower concentration of the more hydrophobic C_8 -reagent than with the less hydrophobic C_6 -reagent. Sample retention is determined primarily by the uptake of reagent and the resulting charge on the column. Therefore, similar separations will result for either reagent (C_6 or C_8) when the reagent concentration in the mobile phase is adjusted to give the same molar uptake by the column (see also Fig. 7.12c and related discussion). For a more detailed discussion, see Ref. 36.

Next, consider the change in sample retention as the sulfonate ion-pair reagent concentration is increased (Fig. 7.10b). For an ionic, hydrophilic sample compound BH^+ , retention occurs mainly as a result of the ion-exchange retention process of Fig. 7.9a or Fig. 7.10b. Thus, as the charge on the column increases due to an increase in $[P^-]_m$, k for the compound BH^+ also increases. Once the column becomes saturated with the reagent (maximum column charge), sample retention levels off. Because IPC retention involves an ion-exchange process, further increases in reagent concentration lead to an increase in the counterion concentration (Na^+), which competes with the retention of the sample ion on the column. Retention therefore goes through a maximum as the reagent concentration is increased. In IPC method development, the reagent concentration is usually varied from zero to a value that provides maximum retention of oppositely charged sample ions. This approach provides a wide range of separation selectivity, thereby improving chances for a good separation while avoiding excessive reagent concentrations that are expensive and conducive to poor separation.

When pH and ion-pair reagent concentration are varied simultaneously, considerable control is achievable over both retention range and band spacing. This is a result of the simultaneous retention of the sample by both reversed-phase and ion-exchange (or ion-pair) processes. As the uptake of reagent by the column increases, ion-exchange retention becomes more important, and reversed-phase retention becomes less important. This effect is

Retention of sample ion BH^+ 

FIGURE 7.10 Effect of ion-pair reagent concentration on separation. (a) Sorption of the ion-pair reagent as a function of concentration for reagents of differing hydrophobicity (C_6^- and C_8^- -sulfonates); (b) retention as a function of reagent concentration. See the text for details.

illustrated in Fig. 7.11 for the separation of a mixture of bile acids [plots of $\log k$ vs. pH; note that the y-axis starts at -0.5 unit in (a) and -0.2 unit in (b)]. Figure 7.11a shows the reversed-phase retention of the sample as a function of pH with no reagent added. Maximum retention of all components occurs at low pH and minimum retention at high pH. Upon the addition of 1 mM tetrabutylammonium ion (TBA^+) to the mobile phase, there is a small uptake of reagent by the column (5 to 10% saturation). This uptake increases sample retention at high pH by a factor of about 5. A small decrease in retention is found at low pH, due to the partial blockage of the stationary phase by the sorbed reagent. Usually, a much higher concentration of the ion-pair reagent (TBA^+) would be used to create a larger ion-pairing effect (see the discussion of Fig. 7.13c, which recommends about 100 mM for the example of Fig. 7.11 with 45% acetonitrile–buffer as mobile phase). Larger k values for the sample would then occur at high pH vs. low pH (as in Fig. 7.9c).

7.4.1.3 Ion-Pair Reagent Type. The change in sample retention as the ion-pair reagent concentration is varied is illustrated further in Fig. 7.12 for the separation of a positively charged base (Adr^+), a negatively charged acid (NpS^-), and a neutral compound (BzOH). With no added ion-pair reagent, the separation of Fig. 7.12a results. The protonated base Adr^+ is unretained ($k = 0$), and the other two compounds (BzOH and NpS^-) are retained adequately ($k \approx 5$). The addition of 14 mM octane sulfate as ion-pair reagent to

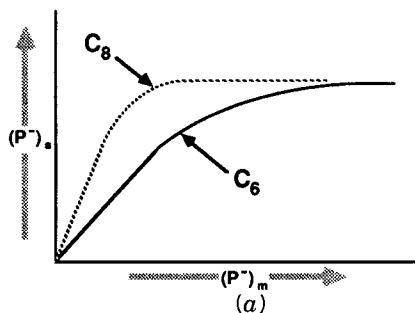
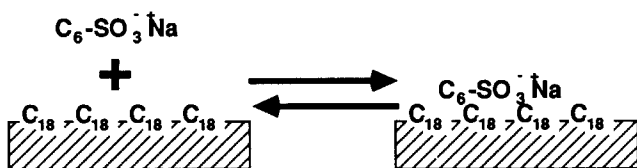
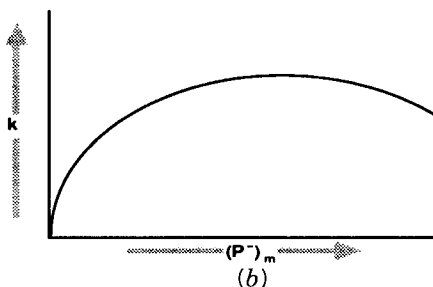
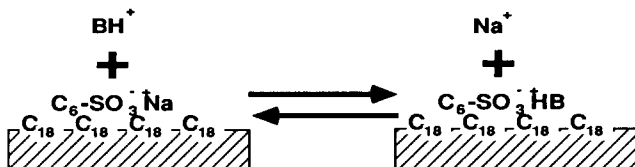
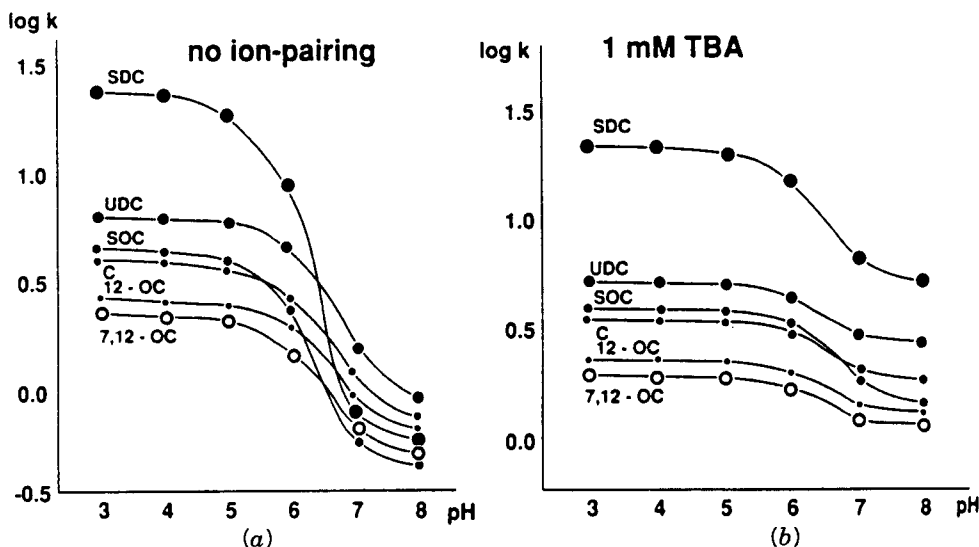

FIGURE 7.11 Effect of mobile-phase pH and ion-pair reagent concentration on the retention of different bile acids. Conditions: C_{18} column; 45% acetonitrile–buffer (phosphate); ambient temperature. (a) No ion-pair reagent; (b) 1 mM tetrabutylammonium (TBA) ion added. (Reprinted with permission from Ref. 37.)

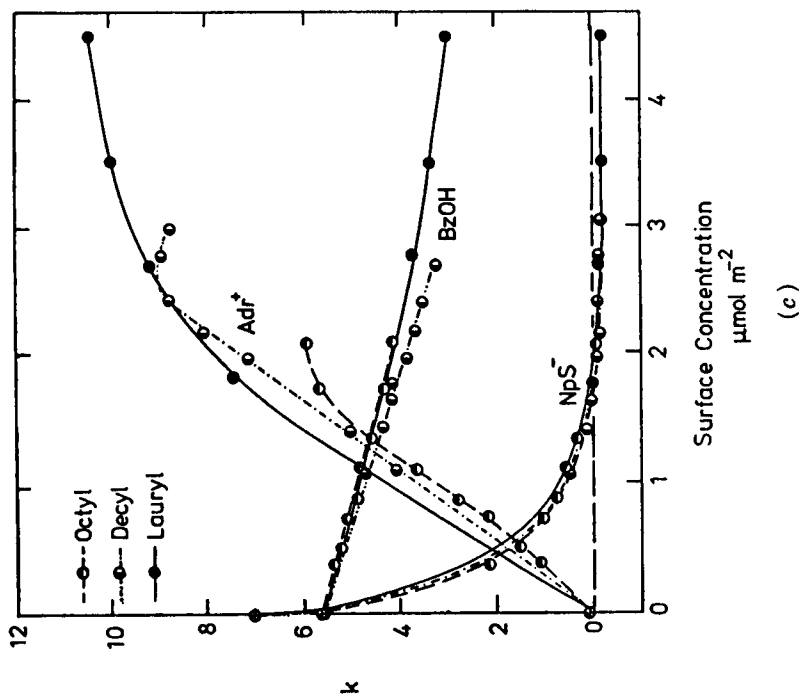
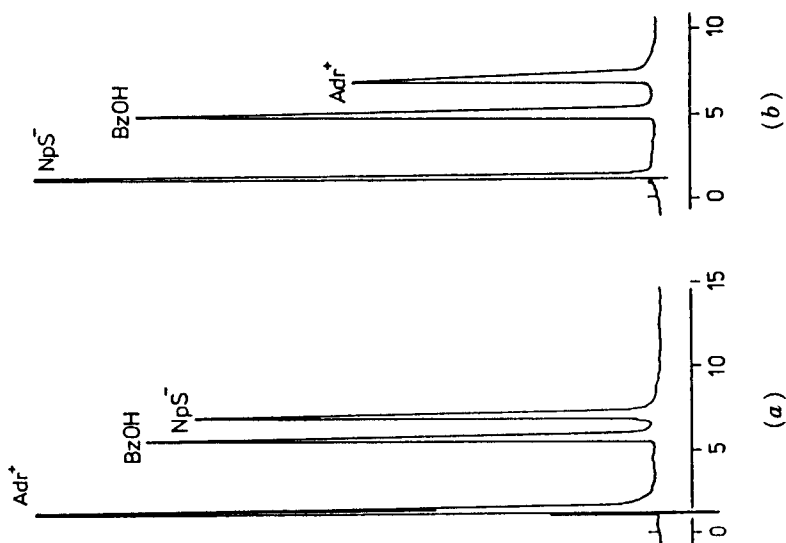

FIGURE 7.12 Effect of ion-pair reagent concentration and type on the separation of an ionic sample. Sample: adrenaline, Adr⁺; benzyl alcohol, BzOH; naphthalene sulfonate, NpS⁻. Conditions: C₁₈ column; 20% methanol-buffer (20 mM phosphate, pH 6); 25°C. (a) No added ion-pair reagent; (b) 14 mM octane sulfate [$1.6 \mu\text{mol/m}^2$ in (c)]; (c) plot of solute retention vs. reagent uptake by column ($\mu\text{mol/m}^2$); (Reprinted with permission from Ref. 38.)

the mobile phase ($1.6 \mu\text{mol}/\text{m}^2$ uptake by the column) changes the separation as seen in Fig. 7.12b. The neutral compound BzOH is retained somewhat less, while the two ionic species change places in the chromatogram. The much increased retention of Adr^+ in Fig. 7.12b is due to its attraction by the negative charge on the column (the result of sorbed, negatively charged reagent). The strongly decreased retention of NpS^- is due to its repulsion by this same negative charge on the stationary phase.

Figure 7.12c shows that separation as a function of added reagent depends only on the resulting charge on the column. Retention data for each of the three compounds are plotted vs. the μmoles of reagent taken up by the column for three different reagents: C_8^- , C_{10}^- , and C_{12}^- -sulfates. For a given concentration of sorbed reagent (μmoles per column), the retention times for each compound are approximately the same (i.e., the same separation results). *This means that identical separations can be achieved with different ion-pair reagents.* To achieve the same separation as with the C_{10} reagent, a larger mobile-phase concentration of the C_8 reagent is required or a lower concentration of the C_{12} reagent. This can also be seen in Fig. 2 of Ref. 39 and is discussed further in Ref. 40. In some cases, two ion-pair reagents will differ greatly in hydrophobicity, so that no reasonable concentration of the less hydrophobic reagent can provide the same column uptake and charge on the column packing as the more hydrophobic reagent. An example [41] is provided by trifluoroacetate (TFA) and heptafluorobutyrate (HFBA), two ion-pair reagents that are used commonly in the separation of peptides and proteins (Section 11.2). TFA is absorbed much less than is HFBA, and no concentration of TFA can provide a separation similar to that of HFBA when the latter is present at $>10 \text{ mM}$ in the mobile phase. For a more detailed description of the theory of ion-pair retention, see Refs. 38 and 42 to 44.

7.4.2 Initial Experiments

For an ionic sample, the conditions of the initial experiment for IPC will normally be the same as for reversed-phase separation (Fig. 7.7). That is, no ion-pair reagent will be used initially. Once it has been determined that IPC may be appropriate, a suitable ion-pair reagent is then added to the mobile phase. Other conditions remain the same, so the question is: what ion-pair reagent and what concentration?

Most ion-pair reagents used today are either alkyl sulfonates or tetraalkyl ammonium salts, either of which allow UV detection above 210 nm. Alkyl sulfates and perchlorate (ClO_4^-) have been used occasionally for the separation of basic compounds, but usually these IPC reagents have no special advantage. Sulfonates should be used for basic samples, to provide increased retention of protonated bases and other cations. Tetraalkylammonium salts are used for acidic samples, providing increased retention for ionized acids and other anions. The choice of reagent type (anionic or cationic) for mixtures of acids,

bases, and/or neutrals will depend on the initial chromatogram, as in the example of Fig. 7.8.

Mixtures of ion-pair reagents with opposite charge (e.g., a sulfonate plus a quaternary ammonium compound) are normally counterproductive, since the two reagents will associate and hence tend to neutralize the effect of each on sample retention. One study [45] reported the use of cetyltrimethylammonium (CTMA) and dodecanesulfonate (DS) in combination for the separation of basic samples, where the primary role of the CTMA was to reduce the effect of stationary-phase silanols. This study also reported that the use of two IPC reagents allowed further control over retention and selectivity.

The discussion of Section 7.4.1.3 makes it clear that similar separations can be obtained with ion-pair reagents differing in chain length, if reagent concentration is varied to provide the same stationary phase charge [e.g., C_6^- vs. C_{10} -sulfonates (as in Fig. 7.12c), or tetraethyl vs. tetrabutyl ammonium salts]. The choice of a particular ion-pair reagent (more or less hydrophobic) depends on mobile phase strength (% B), as discussed in Ref. 46. This is summarized in Fig. 7.13. Figure 7.13a, which shows reagent uptake by the column vs. the mobile-phase concentration of octane sulfonate. The different curves (0, 10, 25, 40) are for different percent methanol concentrations in the mobile phase. As expected, reagent uptake (retention) is less for higher % B values (just as for the retention of a sample compound).

The objective in selecting a particular ion-pair reagent is to be able to achieve a significant column uptake of the reagent for a reasonable reagent concentration. This approach allows a wide range of ion-pair selectivity to be explored by varying reagent concentration. The curves of Fig. 7.13a appear to level off at a maximum column uptake of about $300 \mu\text{mol/g}$, which can be achieved with a reagent concentration of about 40 mM for the case of 0% methanol. If the mobile phase is 40% methanol, a much higher concentration of this reagent ($\gg 40 \text{ mM}$) will be required to achieve maximum uptake by the column. Therefore, octane sulfonate is a less suitable reagent choice for a mobile phase containing more than 40% methanol. In this case, separation may benefit from the use of a more strongly retained reagent (e.g., C_{10} - or C_{12} -sulfonate).

Figure 7.13b summarizes the preferred sulfonate reagent and a concentration that can provide effective ion pairing (significant reagent uptake) for mobile phases that contain different concentrations of methanol. For example, if the mobile phase is 25% methanol-water, either C_8^- or C_{10} -sulfonate is recommended, with initial concentrations of about 30 or 10 mM, respectively. These initial concentrations (which provide about one-third of maximum reagent uptake by the column) can in each case be varied up or down so as to change the extent of reagent uptake and ion pairing, and thereby vary band spacing.

If acetonitrile or THF is used instead of methanol, Table 7.3 can be used to estimate the change in recommended reagent and its concentration. For example, for 25% acetonitrile as mobile phase, the equivalent percent metha-

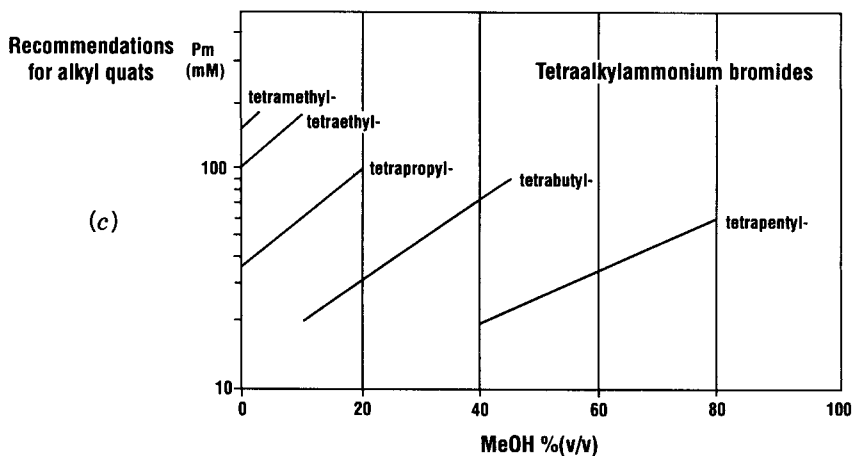
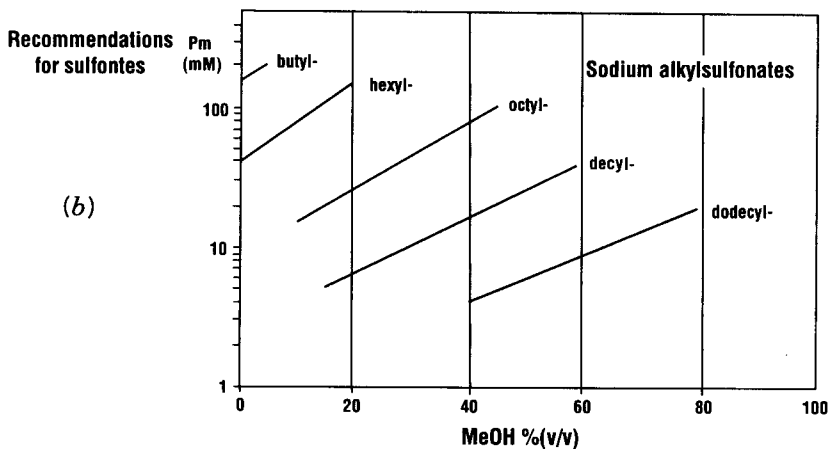
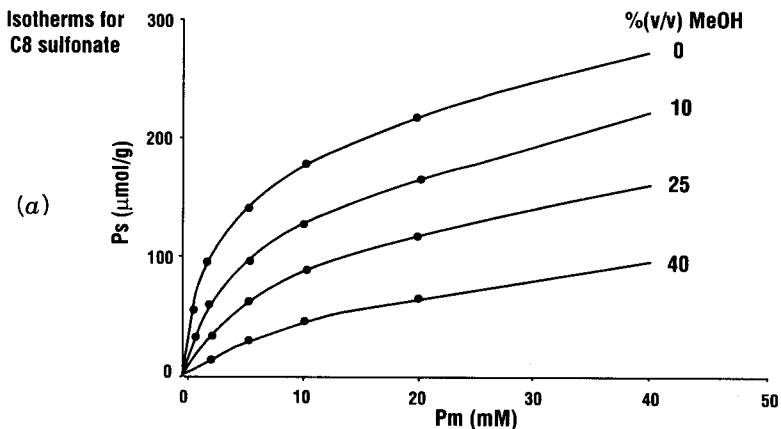

TABLE 7.3 Solvent-Strength Relationships (in percent) for Ion-Pair HPLC Using Anionic Ion-Pair Reagents (e.g., Alkyl Sulfonates)^a

Methanol	Acetonitrile	THF
0	0	0
10	3	1
20	8	4
30	13	8
40	19	14
50	25	21
60	32	30
70	39	(40) ^b
80	(46)	(51)
90	(53)	(64)
100	(60)	(78)

Source: Ref. 40.

^a For example, if 20% methanol provides a good retention range ($0.5 < k < 20$), then 8% acetonitrile or 4% THF should provide similar run times.

^b Approximate value.

nol is 50%. Figure 7.13*b* then suggests C₁₀- or C₁₂-sulfonate at an initial concentration of 25 or 5 mM, respectively. Figure 7.13*c* provides similar guidelines for the use of tetraalkyl quaternary ammonium reagents for separating acids.

7.4.3 Controlling Retention Range and Selectivity: Changes in % B, pH, and Ion-Pair Reagent Concentration

7.4.3.1 Retention Range. The separation of *neutral* samples allows the easy control of retention range during RPC method development. Mobile-phase composition (% B) is varied first to obtain $0.5 < k < 20$. If solvent type is varied, Fig. 6.4 can be used to estimate the change in % B required for the same retention range. There is, therefore, no special problem in finding and maintaining a % B value that provides a good retention range.

The situation can be somewhat different for the separation of ionic samples. Here, unexpectedly large changes in retention and retention range may occur

FIGURE 7.13 Selection of ion-pair type and concentration as a function of sample type and mobile phase strength (% B). Conditions: methanol-buffer mobile phase, C₁₈ column. (a) Uptake of C₈-sulfonate vs. reagent concentration for different % B values; (b) recommended alkyl sulfonate type and concentration for different % B values (basic samples); (c) recommended tetraalkylammonium ion and concentration for different % B values (acidic samples). (Reprinted with permission from Ref. 46.)

during attempts to vary selectivity via changes in pH, ion-pair reagent concentration, and so on. This makes method development for IPC somewhat more complicated than for RPC. On the other hand, these same extreme changes in retention can be used to advantage. For example, the use of ion-pair conditions for an ionic sample that appears initially to require gradient elution may permit isocratic separation with $0.5 < k < 20$. Also, if the acid-base properties (pK_a values) of sample bands are known in IPC, there is a high degree of predictability with regard to the effects of different variables on the relative retention of these bands. These observations are illustrated by the separations of Fig. 7.8.

In the gradient separation of Fig. 7.8a and the isocratic separation of Fig. 7.8b, the four compounds X to X2 and HB are weakly retained, while MP and PP are strongly retained. Isocratic separation with $0.5 < k < 20$ is not possible for this mobile phase. However, compounds X to X2 are all strong bases ($pK_a \approx 10$, Table 7.2), so these compounds will be positively charged for all reasonable pH values, while compounds MP and PP are neutral. This means that the addition of a sulfonate ion-pair reagent will selectively *increase* the retention of bands X to X2, while moderately *decreasing* the retention of bands MP and PP (as in Fig. 7.12c), thereby decreasing retention range to allow isocratic separation. Isocratic separation with addition of an ion-pair reagent is shown in Fig. 7.8c, and a reasonable retention range is now observed for this sample: $0.8 < k < 15$.

The adjustment of retention and retention range by means of pH changes or ion pairing can be pursued for other samples in similar fashion as in the example of Fig. 7.8. Keep in mind that sulfonate reagents strongly increase the retention of positively charged species and strongly decrease the retention of negatively charged species (and vice versa for tetraalkyl ammonium reagents). Any ion-pair reagent may reduce the retention of neutrals, but to a lesser degree. Similarly, an increase in pH results in increased ionization of acids and decreased ionization of bases. Thus, predictable changes in retention result, depending on the pK_a values for each compound, as mobile-phase pH and/or the type of concentration of the ion-pair reagent are varied. For further examples and discussion, see Ref. 16.

The preceding approach (prediction of changes in sample retention as pH or IPC reagent concentration is changed) requires a knowledge of the acid-base properties (pK_a values) of each band in the chromatogram plus peak tracking as discussed in Section 10.7. Alternatively, when sample pK_a values are not known initially, experiments where pH is varied (as in Fig. 7.1 or 7.4) allow estimates of acid-base behavior for each band. Once approximate pK_a values have been assigned to each band in this way, the predictable adjustment of retention and retention range (via changes in pH or reagent concentration) can proceed as above.

7.4.3.2 Selectivity. An alternative approach to the optimization of pH and ion-pair reagent concentration can be used [43] as outlined in Fig. 7.14. Buffers

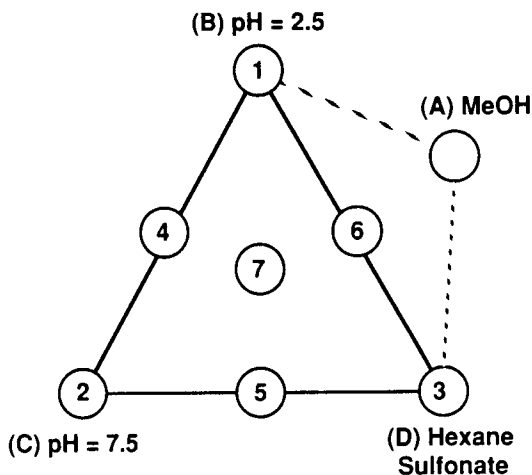

FIGURE 7.14 Experimental design for rapid optimization of retention range and selectivity in ion-pair HPLC. Simultaneous variation of mobile-phase pH and ion-pair reagent concentration. (Reprinted with permission from Ref. 43.)

at low pH (B), high pH (C), and lightly buffered intermediate pH plus ion-pair reagent (D) are blended with organic solvent (methanol, A) in a systematic manner that allows wide variations in both pH and ion-pair reagent concentration. This experimental design is conceptually similar to that discussed previously for optimizing solvent-type selectivity in reversed-phase HPLC (Fig. 6.15). The percent methanol in mobile phases 1 to 3 is adjusted to provide roughly equal run times for the sample of interest.

The first experiment in Fig. 7.14 (low pH, no. 1) requires adjustment of % B (methanol) to provide either a good retention range ($0.5 < k < 20$) or a retention for the last sample band of $k = 10$ to 20. Once this separation has been achieved, a similar approach is used for the second and third runs: high pH, no. 2; ion pairing, no. 3. In some cases, only a small variation in % B will be required among these three runs to maintain a constant run time. In other cases, a change of 10 to 20% B may be necessary.

The next step is to blend the three initial mobile phases (1 to 3) to produce mobile phases 4 to 7 (see the similar discussion of Fig. 6.15). This approach is conveniently accomplished by using citrate buffers of the same molarity for buffers 1 and 2, since mixtures of buffers 1 and 2 will vary linearly in pH according to the proportions of each buffer. Thus, mobile phase 4 will have a pH that is halfway between that of runs 1 and 2 (once a near-optimum pH is selected, citrate can be replaced by phosphate or acetate for low-UV detection). When all seven experimental runs have been carried out, the resulting chromatograms can be displayed in the format of Fig. 7.14; see the example of Fig. 7.15. The properties of the resulting mobile phases are summarized in Table 7.4. Further adjustment of experimental conditions pro-

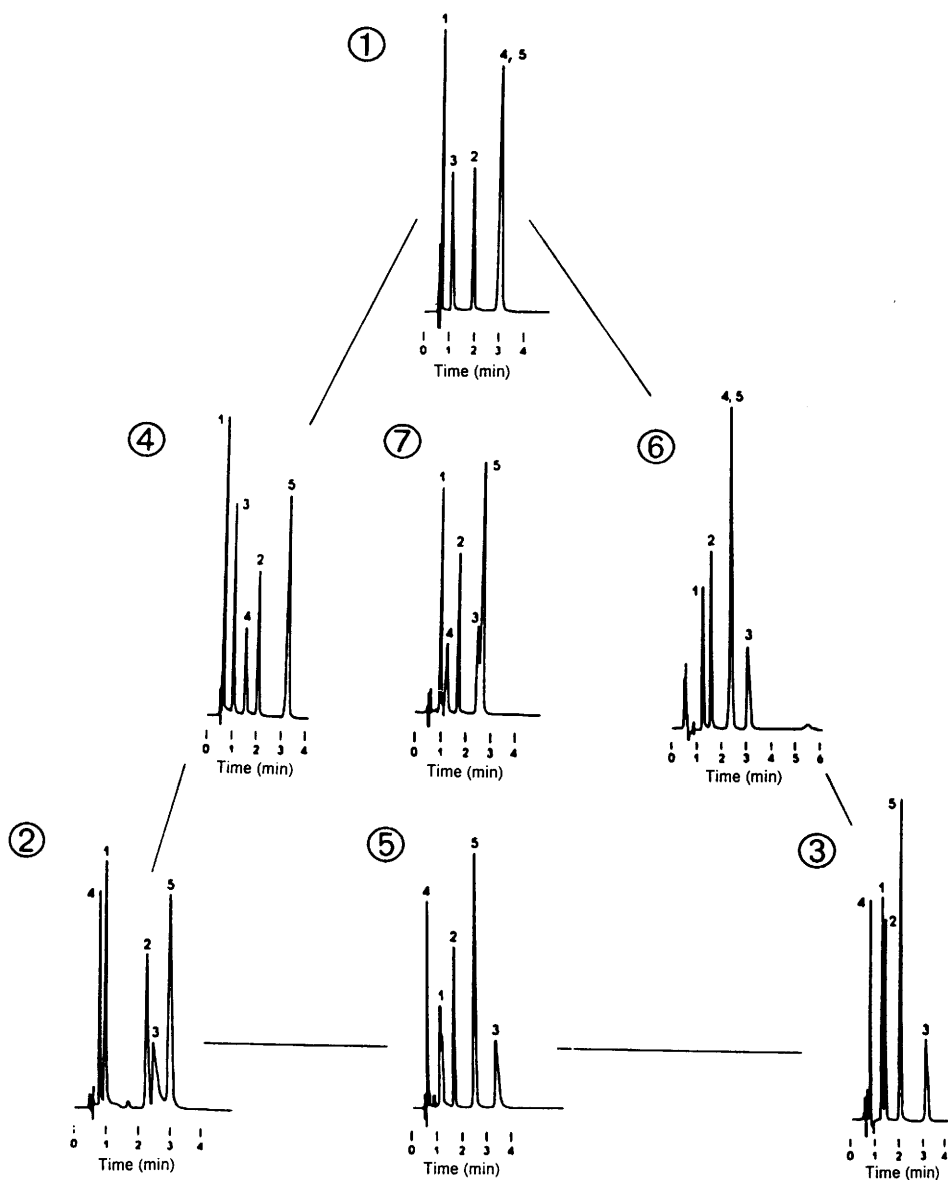

TABLE 7.4

Run	pH	Ion Pairing (%) ^a
1	Low (2.5)	0
2	High (7.5)	0
3	Intermediate (5.0)	100
4	Intermediate (5.0)	0
5	High (7.5)	50
6	Low (2.5)	50
7	Intermediate (5.0)	33

^a % Ion-pair reagent (based on Run 3).

ceeds as in the example of Fig. 6.16. This experimental approach for IPC is illustrated by the example of Fig. 7.15, for a mixture of five compounds that include one or more acids, bases, and neutrals.

The separations of Fig. 7.15 are effective in quickly identifying promising combinations of pH and ion-pair reagent concentration. Consider first those separations with a good retention range: $0.5 < k < 20$. Runs 1 to 5 in each case show a band eluting very near to t_0 ($k \approx 0$), while runs 6 and 7 each show a first band with $k > 1$ (acceptable retention). In all seven runs of Fig. 7.15, k for the last band is about 5. From these initial experimental runs (Fig. 7.15), it can be concluded that a pH of 2.5 to 5 and 33 to 50% ion pairing reagent (67 to 100 mM hexane sulfonate) is effective in maintaining a reasonable retention range.

The resolution in runs 6 and 7 (Fig. 7.15) is marginal, however, due to poor band spacing. The critical band pair differs in these two runs, so an intermediate pH is expected to provide improved resolution. Alternatively, sample resolution is good for run 4, which suggests that it might be beneficial to hold pH at 5.0 and vary the concentration of ion-pair reagent by blending mobile phases 4 and 7 together for better retention of the first band. The resulting

FIGURE 7.15 Application of optimization scheme of Fig. 7.14 for the separation of a cold-cough remedy. Sample: a mixture of five compounds: 1, phenylephrine; 2, glycerol guaicolate; 3, pseudoephedrine; 4, sodium benzoate; 5, methylparaben. Conditions: 15×0.46 -cm Zorbax C8 column, with mobile phases as follows:

Solvent	Vol % Solvent in Mobile Phases 1 to 7						
	1	2	3	4	5	6	7
A: methanol	30	27	34	29	30	32	30
B: pH 2.5 buffer	70	0	0	35	0	35	23
C: pH 7.5 buffer	0	73	0	36	36	0	24
D: 200 mM hexane sulfonate	0	0	66	0	33	33	22

(Reprinted with permission from Ref. 43.)

separation for this 50/50 blend of the two mobile phases is shown in Fig. 7.16 (run 4/7). The retention range for run 4/7 is acceptable ($1 < k < 7$), and resolution is almost adequate ($R_s = 1.3$). A comparison of runs 7 and 4/7 shows that a different blending of these two mobile phases can position band 3 halfway between bands 2 and 5 for an excellent final separation.

An alternative experimental procedure for the simultaneous optimization of pH and ion-pair reagent concentration has been reported [47]. It is better suited for the quantitative prediction of separation as a function of these variables. A four-level two-factor factorial design was used that requires 16 experiments with pH and reagent concentration varying. Similar optimization schemes have been reported by others [17]. The latter approaches require much more experimental work and should be reserved for very challenging samples.

7.4.4 Other Changes in Selectivity

7.4.4.1 Solvent Strength (%B). As discussed above, varying pH and ion-pair reagent concentration together allows a considerable control over both retention range and band spacing. Simultaneous changes in % B also may be required as a means of controlling retention range. Further small changes in

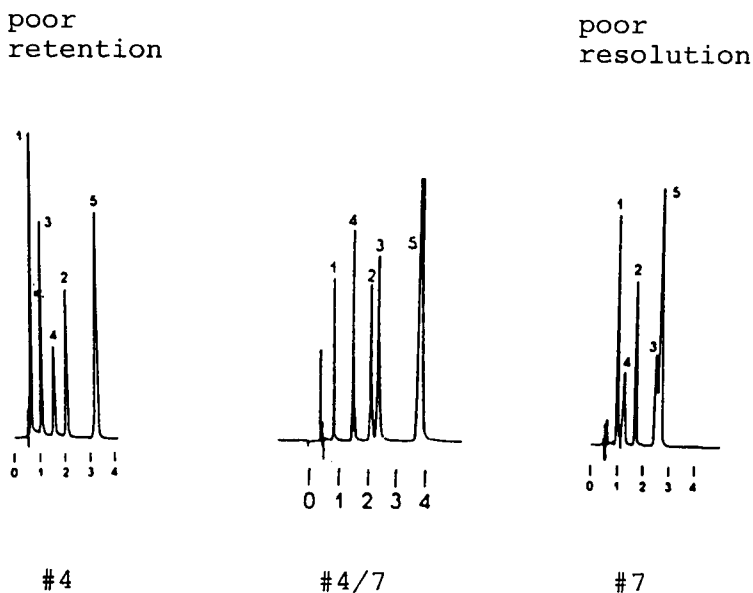

FIGURE 7.16 Continuation of method development for cough-cold remedy of Fig. 7.15. Chromatograms repeated for runs 4 and 7; new chromatogram for mobile phase prepared by blending mobile phases from runs 4 and 7 (4/7). (Reprinted with permission from Ref. 43.)

% B (while maintaining $0.5 < k < 20$) often result in useful changes in IPC band spacing [48–50], as illustrated in Fig. 7.17. The critical band pair for this separation is X3/propyl paraben (last two bands). An increase in percent methanol leads to a reduction in relative retention for all four protonated bases (X to X3) and a resulting increase in the resolution of the last two bands. Eventually, for a methanol concentration of 50%, band X overlaps the methyl paraben band (resulting in a new critical band pair). A mobile phase with 45% methanol provides the best separation in this case.

The result of Fig. 7.17 can be generalized as follows. When % B is increased for the IPC separation of a mixture of ionic and neutral compounds, the adsorption of the ion-pair reagent to the stationary phase will be reduced (as in Fig. 7.13a). This will cause a selective reduction in the retention of ionic compounds that are opposite in charge to the reagent. This in turn will cause a selective reduction in the relative retention of these ionic compounds as in Fig. 7.17.

7.4.4.2 Temperature. A change in selectivity with temperature is expected whenever two or more distinct processes contribute to sample retention. In the case of ion-pair HPLC, several of the following equilibrium processes are often involved: sample retention by ion-exchange and/or reversed-phase processes, ionization of the buffer and sample, and sorption of the ion-pair reagent. Therefore, it will be rare in IPC that a change in temperature does *not* lead to significant changes in band spacing. Several examples of major changes in α with temperature for IPC have been reported in the literature [51,52]. There is also a corollary to this frequent change in selectivity with temperature: *For reproducible separations by ion-pair HPLC, it is important to thermostat the column.*

7.4.4.3 Buffer Concentration. An increase in buffer (or salt) concentration will result in decreased retention for sample compounds that exhibit ion pairing. The reason is that these compounds undergo ion exchange under the conditions of separation (Figs. 7.9a and 7.10b). Thus, an increase in buffer (or salt) concentration in ion-pair HPLC serves mainly to mimic the effect of a decrease in the ion-pair-reagent concentration. Any selectivity effects due to a change in buffer concentration can therefore be simulated by varying reagent concentration. For this reason, buffer concentration is seldom used as a means of controlling selectivity in ion-pair HPLC.

7.4.4.4 Solvent Type. Changes in solvent type (methanol, acetonitrile, THF) in IPC have been used occasionally for the purpose of changing selectivity. In some cases [43,53–55] little change in band spacing was noted upon changing solvent type. In other studies, however, very significant and useful changes in selectivity have been observed for a change in solvent type [56]. This effect is illustrated in Fig. 7.18 for a mixture of catecholamines separated by ion-

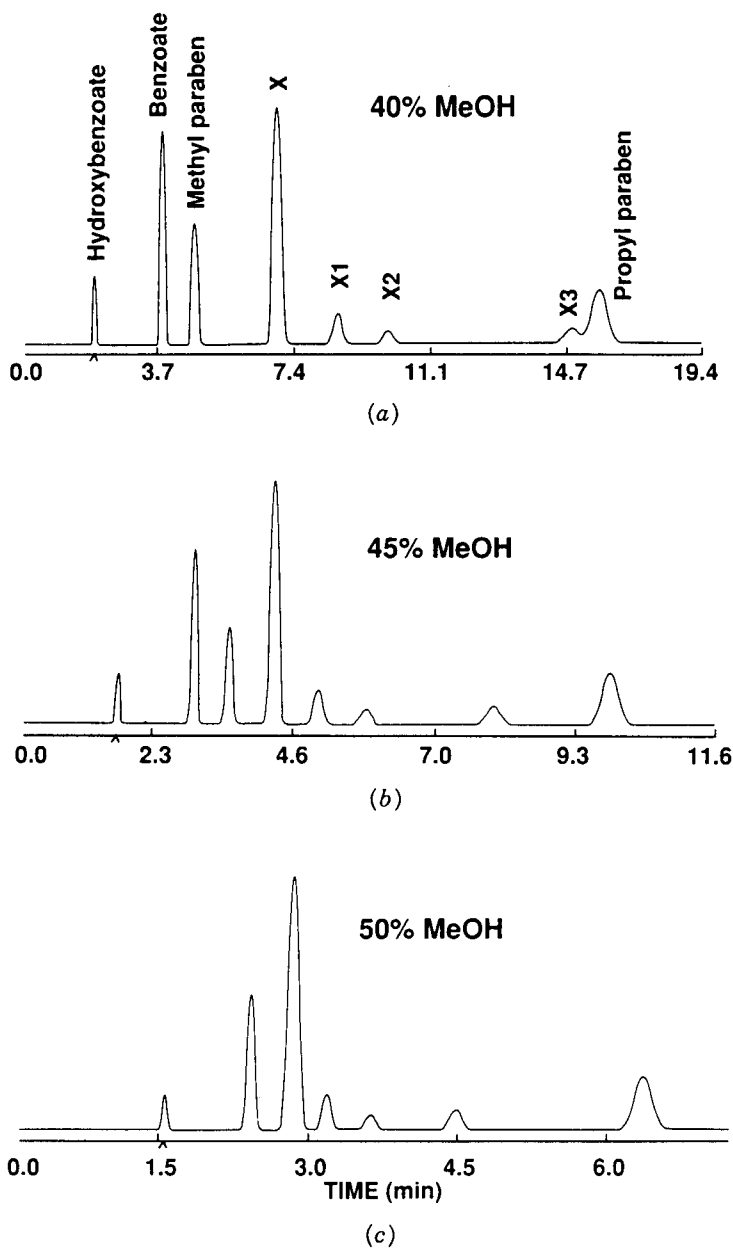

FIGURE 7.17 Effect of solvent strength (% B) on band spacing in ion-pair chromatography. Same sample and conditions as in Fig. 7.8c, except for changes in percent methanol; the separation of Fig. 7.8c is repeated in this figure (40% methanol). (Unpublished data from the laboratory of LC Resources, McMinnville, Oregon.)

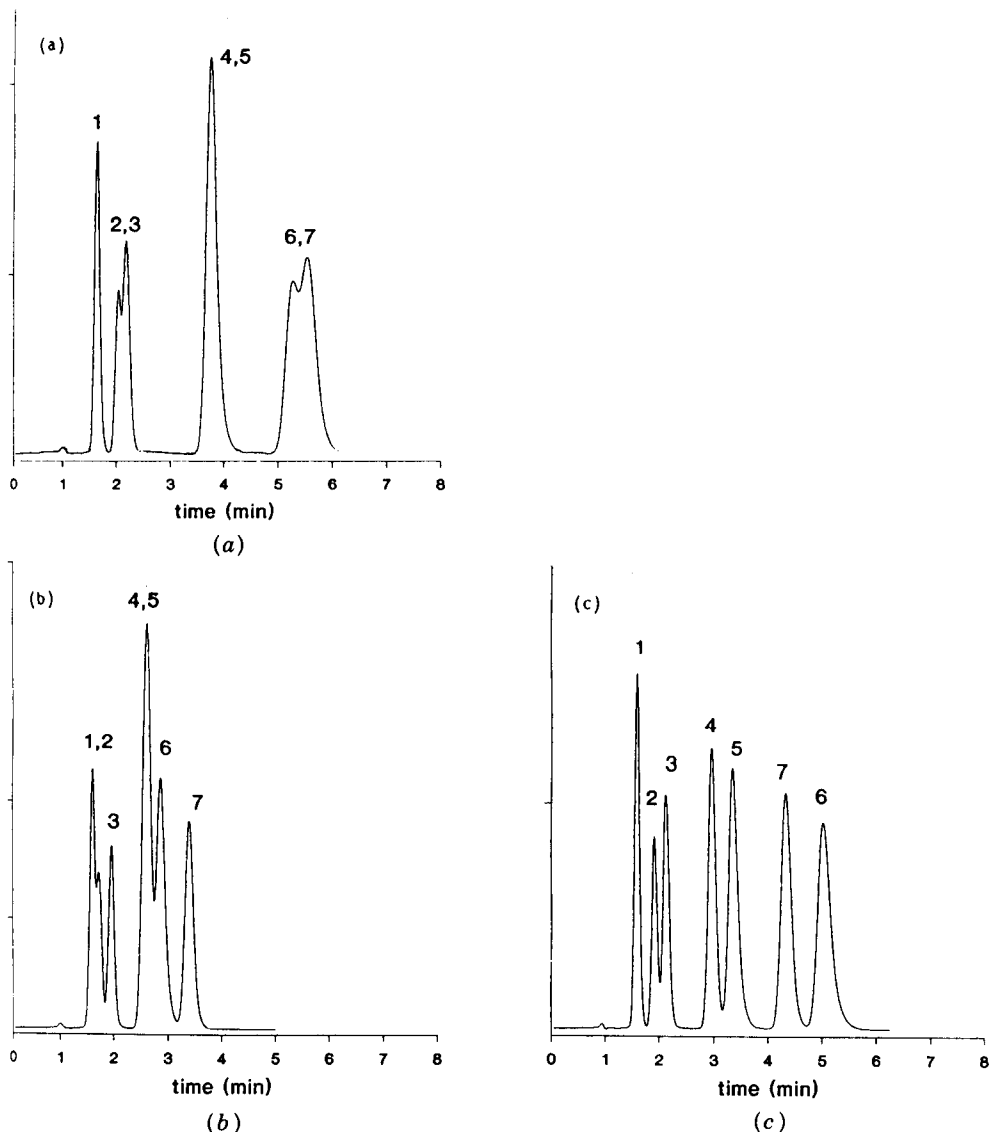

FIGURE 7.18 Effect of solvent type on band spacing in ion-pair chromatography; separation of catechol amines. Sample: 1, noradrenaline; 2, adrenaline; 3, octopamine; 4, 3,4-dihydroxyphenylalanine; 5, dopamine; 6, isoprenol; 7, tyrosine. Conditions: 15×0.46 -cm C_{18} column; buffer, 50 mM aqueous phosphate (pH 2.5); 1 mL/min; 25°C. (a) 10% methanol-buffer; (b) 2.5% THF; (c) 6% acetonitrile. (Reprinted with permission from Ref. 56.)

pair HPLC with different solvents: (a) 10% methanol, (b) 2.5% THF, and (c) 6% acetonitrile. In this example, acetonitrile is the preferred solvent. However, similar changes in band spacing might be achieved by changes in any of the variables discussed above (% B, pH, etc.).

Another example of solvent-type selectivity in IPC is shown in Fig. 7.19 for the formulated pharmaceutical product described in Figs. 7.8 and 7.17. When acetonitrile was used as organic solvent, and % B and the ion-pair concentrations were optimized, the separation of Fig. 7.19a resulted. The six intermediate bands (X to X2) are bunched together and marginally resolved. When methanol was substituted for acetonitrile and % B and ion-pair reagent

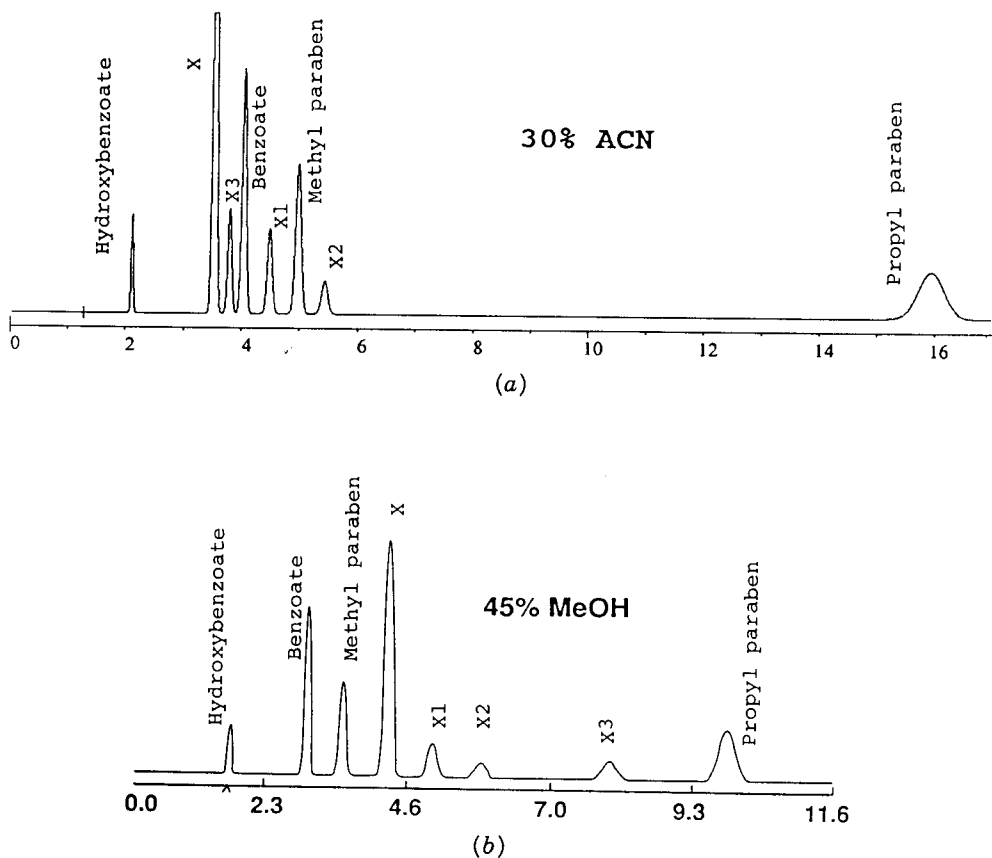

FIGURE 7.19 Effect of solvent type on band spacing in ion-pair chromatography. Same sample as in Fig. 7.17, except different organic solvents. (a) 15×0.46 -cm Zorbax SB-C8 column; 30% acetonitrile–buffer; buffer is 100 mM potassium acetate, pH 3.5, plus 27 mM octane sulfonate; 45°C; 2.0 mL/min; (b) separation as in Fig. 7.17b (45% methanol–water). (Unpublished data from the laboratory of LC Resources, McMinnville, Oregon.)

concentration was again optimized, the basic compounds X to X3 were substantially more retained, allowing the much improved separation shown in Fig. 7.19b. In this case, a change in solvent provided an expanded retention range for a critical group of bands (bands 2 to 6 in Fig. 7.19a) and much greater resolution.

When changing the organic solvent as in Figs. 7.18 and 7.19, it is convenient to use the solvent nomograph of (Fig. 6.4) as a means of holding solvent strength and run time constant. As discussed in Ref. 40, however, Fig. 6.4 is often less reliable for IPC. Therefore, it may be necessary to adjust % B further after changing solvent type on the basis of Fig. 6.4. When sulfonate ion-pair reagents are used, the relationships of Table 7.3 have been claimed to be more reliable than Fig. 6.4 (but not in the example of Fig. 7.19).

7.4.4.5 Buffer Type or Added Salt. The buffer usually is not varied in IPC for the purpose of changing selectivity. Neither is salt ordinarily added to the mobile phase. Since IPC is in part dependent on an ion-exchange process, similar effects as in ion-exchange chromatography (Section 7.4) can be expected when changing the buffer or adding salt (e.g., a decrease in ionic strength should lead to an increase in retention for compounds that interact with the ion-pair reagent).

7.4.4.6 Amine Modifiers. Amine modifiers have been added to the mobile phase in IPC for the purpose of changing selectivity in the separation of basic samples [53]. The ion-pair reagent will be anionic in this case (e.g., an alkyl sulfonate), and the amine modifier tends to ion-pair with the alkyl sulfonate, thus neutralizing its effect. For this reason it might be expected that a similar selectivity could be achieved either by adding amine modifier or reducing the concentration of the ion-pair reagent. In one example [53], however, this was not the case. That is, additional control over selectivity was provided by the use of an amine modifier.

7.4.5 Special Problems

The problems that can occur in reversed-phase separations of ionic samples (Section 7.2) are also applicable for ion-pair HPLC: pH sensitivity, silanol effects (less serious), temperature sensitivity (more serious), and peak tracking. Some additional difficulties can be anticipated.

7.4.5.1 Artifactual Peaks. Both positive and negative peaks sometimes are observed when the sample solvent is injected in IPC (blank run). These artifactual peaks can interfere in the development of an HPLC method or its routine use. For this reason, blank runs should be carried out both before beginning the development of an IPC method and after a promising separation has been achieved.

Problems with artifactual peaks are usually the result of differences in composition of the mobile phase and the sample solvent, an effect that can be magnified by the use of impure buffers, ion-pair reagents, or other mobile-phase additives. A good general rule in IPC is to match the compositions of the sample solvent and mobile phase as closely as possible (including reagent concentration), and to inject smaller (more concentrated) sample volumes (e.g., $<50 \mu\text{L}$). If the problem persists, a different lot of the ion-pair reagent should be tried. For a further discussion, see Ref. 57.

7.4.5.2 Slow Column Equilibration. Both the uptake and release of the ion-pair reagent by the column can be slow under some circumstances. For this reason, it is imperative to confirm that sample retention is reproducible after changing the mobile phase, when one or both mobile phases contain an ion-pair reagent. Column equilibration is generally slower when the ion-pair reagent is more hydrophobic (e.g., decane sulfonate vs. hexane sulfonate) and/or for the case of quaternary-ammonium reagents such as tetrabutylammonium [38]. When an IPC mobile phase is to be replaced, it may be advantageous to first remove the previous ion-pair reagent from the column with a wash solvent, followed by equilibration of the column with the new mobile phase.

Anionic reagents (e.g., sulfonates) are more readily removed with a wash solvent composed of 50 to 80% methanol-water. Quaternary ammonium reagents require the use of 50% methanol-buffer (100 to 200 mM) (e.g., 100 mM potassium phosphate salt with pH 4 to 5; the added potassium phosphate serves to reduce the interaction of the reagent ammonium group with silanols). In either case, a minimum of 20 column volumes of wash solvent should be used before checking for retention reproducibility (column equilibration) with the new mobile phase.

The initial equilibration of the column with a mobile phase that contains an ion-pair reagent may also be slow. The IPC method of Fig. 7.17*b* was believed initially to equilibrate after washing the column with 20 to 30 column volumes of mobile phase [58]. When samples were subsequently run for an extended period, however, it was found that a very slow decrease in retention for the basic compounds X to X3 occurred over a period of 11 h. To avoid a 12-h equilibration of the column at the beginning of every series of runs, it was necessary to store the column in the mobile phase upon completion of a series of runs. The latter expedient can allow a much more rapid column equilibration during startup.

The slow equilibration of the column with many ion-pair reagents can create problems if gradient elution is used under these conditions. Retention may be less reproducible, baselines can be more erratic, and other separation problems may arise. For this reason, ion-pair HPLC in a gradient mode is usually not recommended. An exception can be noted for the case of smaller ion-pair-reagent molecules such as trifluoroacetate (TFA) and triethylamine, whose equilibration with the column is faster. TFA is commonly used as an

additive for the gradient separation of peptides and proteins, with few resulting problems. Triethylamine has also been claimed [59] to work well as an ion-pair reagent in gradient elution.

7.4.5.3 Poor Peak Shape. Silanol effects can adversely alter peak shape in IPC, just as in reversed-phase separation. Therefore, when separating basic compounds, the column and mobile phase should be chosen with this in mind (Table 5.4, Section 7.3.3.2). When ion-pair reagents are used, however, silanol effects are often less important. The reason is that an anionic reagent confers an additional negative charge on the column packing, and this reduces the relative importance of sample retention by ion exchange with silanol groups. Similarly, cationic reagents are quite effective at blocking silanols because of the strong interaction between reagent and ionized silanol groups.

Some studies have shown peak fronting in IPC that can be corrected by operating at a higher column temperature [60]. Conversely, the separation of the sample of Fig. 7.19a is best carried out at a *lower* temperature. Using slightly different mobile-phase conditions (39% ACN and 25 mM potassium acetate with 27 mM octane sulfonate), the last two bands in the chromatogram are X3 (basic) and propyl paraben (neutral). Figure 7.20 shows the separation of X3 and propyl paraben using different temperatures; 28°C is the best temperature for this separation. The reason for this peculiar, peak-shape behavior is unclear, but it may be related to the presence of reagent micelles in the mobile phase for some experimental IPC conditions. In any case, when poor peak shape and/or low plate numbers are encountered in IPC, it is recommended to investigate the effect of temperature on band shape. Usually, either a lower or higher temperature will improve peak shape and plate number.

7.4.6 Summary

Initial experiments should be carried out without ion pairing (RPC conditions). Because of the added complexity and potential problems in the use of IPC, an ion-pair reagent should be added only to achieve specific objectives (e.g., better control over either retention range or band spacing). Whether or not an ion-pair reagent is added to the mobile phase, method development proceeds initially in similar fashion.

STEP 1. The initial separation (gradient elution preferred) is the same as for step 1 of reversed-phase method development (Section 7.3.4 and Fig. 7.7).

STEP 2. Use the initial gradient chromatogram to determine whether isocratic elution is possible (see Fig. 9.6). If isocratic elution is possible, estimate the best % B for isocratic separation (see Fig. 9.7). If isocratic elution is not recommended, go to step 2a.

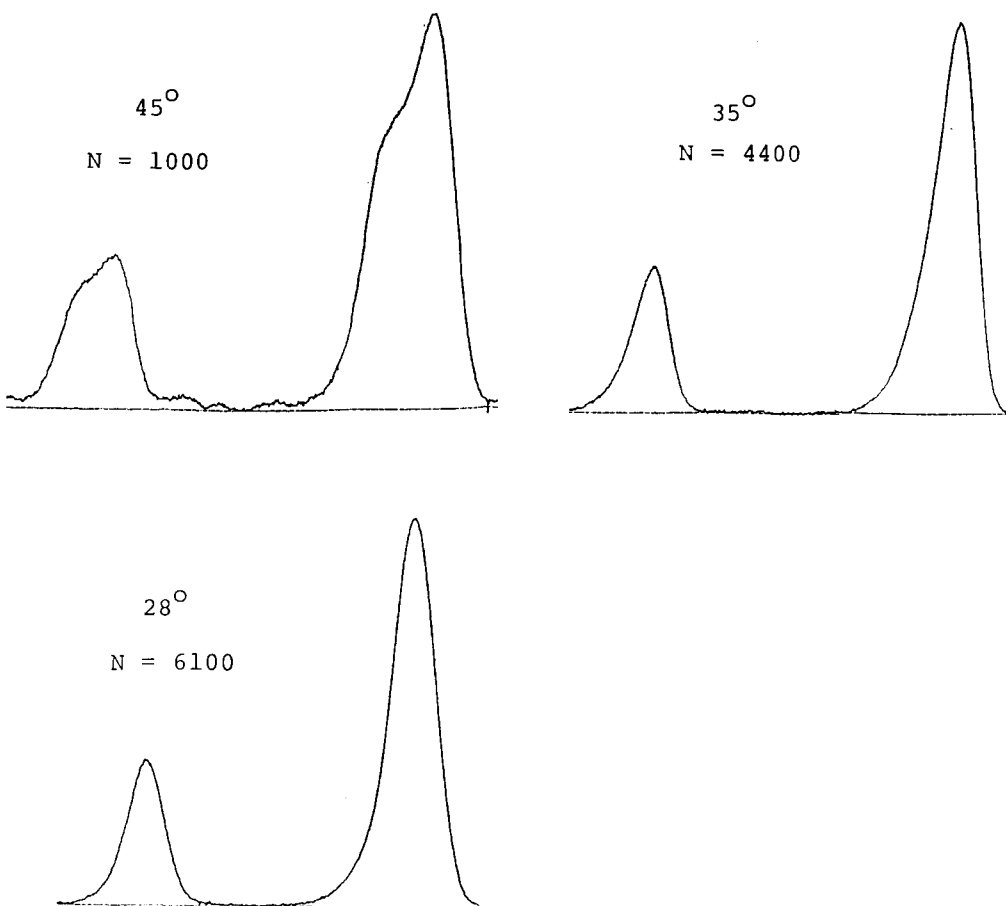

FIGURE 7.20 Effect of temperature on band shape in ion-pair chromatography. Separation as in Fig. 7.19a except for temperature and other conditions: 25×0.46 -cm Zorbax SB-C8 column; 39% acetonitrile–buffer; buffer is aqueous 25 mM potassium acetate (pH 3.5) with 27 mM octane sulfonate; 2 mL/min. (Unpublished data from the laboratory of LC Resources, McMinnville, Oregon.)

STEP 2a. If isocratic separation is desired but not possible for the conditions of step 1, two options are possible: a change in pH and/or the addition of an ion-pair reagent. The use of IPC requires the selection of an appropriate reagent; see Fig. 7.13 and the related discussion.

STEP 3. Adjust % b for $0.5 < k < 20$; fine-tune % B for improved selectivity and resolution.

STEP 4. Change solvent to acn and adjust % b for further improvement of selectivity and resolution.

STEPS 5 AND 5a. Vary pH and/or ion-pair reagent concentration for optimum band spacing. If the acid–base properties of each sample band are known, changes in pH or reagent concentration for desired changes in band spacing often can be predicted (as in the example of Fig. 7.8). An alternative is to explore a wide range of pH and reagent concentrations using the experimental scheme of Fig. 7.14.

STEPS 6 TO 8. Other steps in IPC method development are the same as for RPC. See Fig. 7.7 and the discussion of this scheme in Section 7.3.4. A change in column type (step 7) for IPC is expected to be less useful than in RPC, because the sorbed ion-pair reagent tends to “hide” the stationary phase from sample molecules (see Fig. 7.9 and related discussion).

7.5 ION-EXCHANGE CHROMATOGRAPHY

Immediately following the introduction of commercial HPLC equipment in 1968, ion-exchange chromatography (IEC) was an important HPLC method [61]. During the next decade, however, its application for the separation of most sample types gradually diminished compared to other HPLC methods. Today it is used infrequently, except for certain “special” samples. These include mixtures of biological origin (amino acids, oligonucleotides, peptides, proteins, nucleic acids), inorganic salts, and some organo-metallics.

Because of the similarity of ion-exchange and ion-pair HPLC retention (see below), many separations that are possible using IEC can also be achieved using IPC. For the separation of typical small-molecule samples, IPC may have certain advantages: higher column efficiencies, easier control over selectivity and resolution, and more stable and reproducible columns. Apart from the case of biological samples (Chapter 11), reasons for using ion-exchange instead of reversed-phase or ion-pair HPLC include the following.

Detectability. Many inorganic salts are not easily detected using typical HPLC detectors (Chapter 3). The technique of *ion chromatography* [62] with conductivity detection has overcome this problem to a large extent and is one of the reasons for the widespread use of ion chromatography for such samples. Organic ions with poor UV absorptivity are also candidates for this approach (e.g., alkyl amines or sulfonates). Similarly, the use of a mass spectrometer detector may require a mobile phase that is completely volatile. Ion-exchange chromatography with a volatile buffer meets this requirement, whereas most ion-pair reagents are not sufficiently volatile.

Preparative Separations. Once a compound has been isolated or purified by HPLC separation, it is necessary to remove the mobile phase. This is most

easily done if the mobile phase is completely volatile. Normally, the use of ion-pair reagents in preparative HPLC is avoided because of their relative non-volatility, while volatile buffers for ion exchange are available (e.g., trifluoroacetic acid, formic acid, or acetic acid; ammonium carbonate, formate, or acetate). If it is necessary to use IPC for sample purification and recovery, the ion-pair reagent can be removed from sample fractions by a subsequent ion-exchange separation (use an anion-exchange column for anionic reagents and a cation-exchange column for cationic reagents).

Multi-step Separation. To resolve very complex samples, it may be necessary in some cases (Section 4.6) to use two or more sequential, on-line separations. Most commonly an initial low-resolution separation is combined with a subsequent HPLC run, but two HPLC separations in series are also possible (Section 4.6). In either case, the mobile phase used for an earlier chromatographic run must not interfere with the following separation (e.g., the earlier mobile phase must not behave as a strong solvent in the second separation). The aqueous buffer-salt mobile phase used for ion exchange will normally allow direct injection of sample fractions onto a reversed-phase column used to separate these fractions further. The reason is that aqueous buffers are very weak solvents for reversed-phase separation.

7.5.1 Basis of Retention

Columns used for ion exchange are characterized by the presence of charged groups covalently attached to the stationary phase: anion-exchange columns carry a positive charge (usually a quaternary ammonium or amine group) and cation-exchange columns carry a negative charge (sulfonate or carboxylate groups). Cation-exchange columns are used for the separation of cations such as protonated bases, and anion-exchange columns are used for anionic or acidic samples.

If the stationary phase is represented by R^- (cation exchanger) or R^+ (anion exchanger), and the sample by X^+ (cation) or X^- (anion), retention in IEC can be represented as follows:

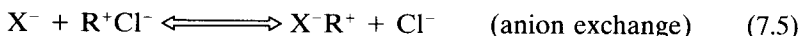
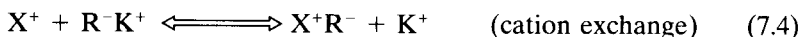

Here it is assumed that the counterion in the mobile phase is either K^+ or Cl^- , and the sample ion is univalent.

The effect of the counterion concentration on retention can be generalized for a sample ion of charge z and a univalent counterion as

$$k = \frac{\text{constant}}{(\text{counterion concentration})^z} \quad (7.6)$$

Thus an increase in salt or buffer concentration in IEC results in decreased retention, and the effect is greater for more highly charged sample compounds ($z > 1$). The ionic strength of the mobile phase is normally varied to control sample retention for $0.5 < k < 20$, and selectivity will also be affected for any two compounds of differing charge (Eq. 7.6).

7.5.1.1 pH Effects. IEC is typically used for acidic or basic samples. Since retention (Eqs. 7.4 and 7.5) requires that the sample molecule carry a charge opposite to that on the column, only the ionized form of the acid or base will be retained significantly. The discussion of Section 7.2 allows the effects of pH on retention in ion exchange to be understood and controlled. An increase in pH leads to greater sample ionization and retention in anion-exchange separations of acids, while a decrease in pH favors the retention of bases by cation-exchange HPLC (the opposite of RPC retention). Varying pH is usually a preferred way to change selectivity in ion-exchange separations.

7.5.1.2 Salt or Buffer Type. Different mobile-phase anions or cations are retained more or less strongly in ion exchange, and sometimes a particular salt is selected to provide stronger or weaker retention. Therefore, we can speak of strong or weak ionic displacers or counterions; a strong displacer reduces sample retention more than the same concentration of a weak displacer. In general, more highly charged displacers are stronger. The relative strength of different displacers in anion-exchange chromatography is

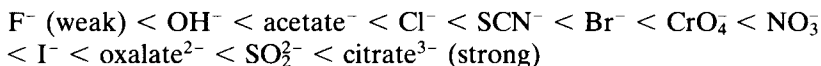

Similarly, displacer strength in cation-exchange chromatography varies as

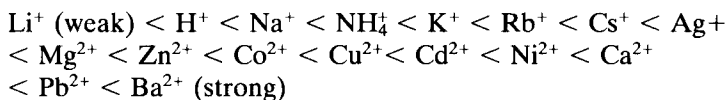

A change in the salt used for ion-exchange chromatography can also affect selectivity; see Section 11.2.2 for the ion-exchange separation of protein samples.

7.5.1.3 Organic Solvents. The addition of an organic solvent to the mobile phase results in decreased retention, just as in the case of reversed-phase HPLC. Solvents such as methanol or acetonitrile are also often used in ion exchange to create changes in selectivity.

7.5.1.4 Column Type. Four kinds of ion-exchange column can be distinguished: weak and strong cation exchangers (WCX and SCX, respectively)

and weak and strong anion exchangers (WAX and SAX, respectively). Strong ion exchangers carry ionic groups whose ionization does not change over the usual pH range ($2 < \text{pH} < 12$) [e.g., $-\text{SO}_3^-$ groups for cation exchange and $-\text{N}(\text{CH}_3)_3^+$ groups for anion exchange]. Weak ion exchangers lose their charge and sample retention for certain pH ranges (e.g., $-\text{COO}^-$ groups for cation exchange show a progressive loss in charge for $\text{pH} < 5$). Most applications of ion-exchange chromatography (except the separation of biological samples) make use of strong ion exchangers. Weak ion-exchange columns can be used as a means of changing selectivity or for reduced retention.

7.5.2 Method Development

The column selected must be matched to the sample components to be separated. For acidic or anionic compounds, use a strong anion-exchange column. For basic or cationic compounds, use a strong cation-exchange column. The simultaneous separation of sample anions and cations by ion exchange is usually not attempted. Next, select an aqueous buffer that enables the ionization of sample compounds. Typically, $\text{pH} > 6$ is used for anion exchange and $\text{pH} < 6$ is used for cation exchange. If the $\text{p}K_a$ values of the sample are known, $\text{pH} > \text{p}K_a$ for anion exchange and $\text{pH} < \text{p}K_a$ for cation exchange. The buffer concentration should be relatively low [e.g., 2 to 5 mM to avoid competition with the retention of sample ions (Eqs. 7.4 and 7.5)].

A B-solvent is selected next, typically the buffer plus 0.5 to 1.0 potassium sulfate or other salt (avoid using halides at $\text{pH} < 4$ with stainless-steel equipment). A 0 to 100% B gradient is used to determine the relative retention range of the sample, the applicability of isocratic separation, and the best % B for isocratic separation (similar to the discussion of Section 8.2.2 for RPC). For samples that do not elute under these conditions or that require $> 200 \text{ mM}$ salt in the mobile phase, there are several alternatives: (1) increase temperature, (2) add methanol, or (3) use a weak ion exchanger at a pH that results in a reduced charge on the column.

Once adequate retention has been achieved for isocratic elution ($0.5 < k < 20$), selectivity can be changed by varying % B or pH, the type of salt used in the mobile phase, or addition of small amounts ($< 25\%$) of methanol or isopropanol. Recent work [63,64] suggests that mobile phases containing $> 60\%$ methanol may be well suited to the cation-exchange separation of strongly basic and quaternary-ammonium compounds. For a further discussion of ion-exchange chromatography, see Refs. 65 and 66.

7.5.3 Mixed-Mode Separations

Mixed-mode separation refers to the use of columns that take advantage of more than one retention process. The most common example is a column that can exhibit both reversed-phase and ion-exchange behavior [67–69]. Com-

pounds with a charge opposite to that of the column are retained predominantly by ion exchange, and an increase in mobile-phase ionic strength will reduce their retention. Neutral compounds are retained predominantly by hydrophobic attraction, although more weakly than by typical reversed-phase columns. An increase in organic-solvent concentration (% B) will result in the decreased retention of neutral compounds. For higher salt concentrations in the mobile phase, the retention of both ionic and neutral compounds can increase with ionic strength [70], due to a "salting-out" effect similar to hydrophobic interaction chromatography (Section 11.2.3). This will occur at lower salt concentrations for columns having more hydrophobic or reversed-phase behavior.

There are two main reasons for the use of mixed-mode columns. First, a single column can be used for both ion-exchange and reversed-phase separations, similar to the use of a cyano column for both reversed-phase and normal-phase applications. Second, mixed-mode columns offer a unique selectivity;

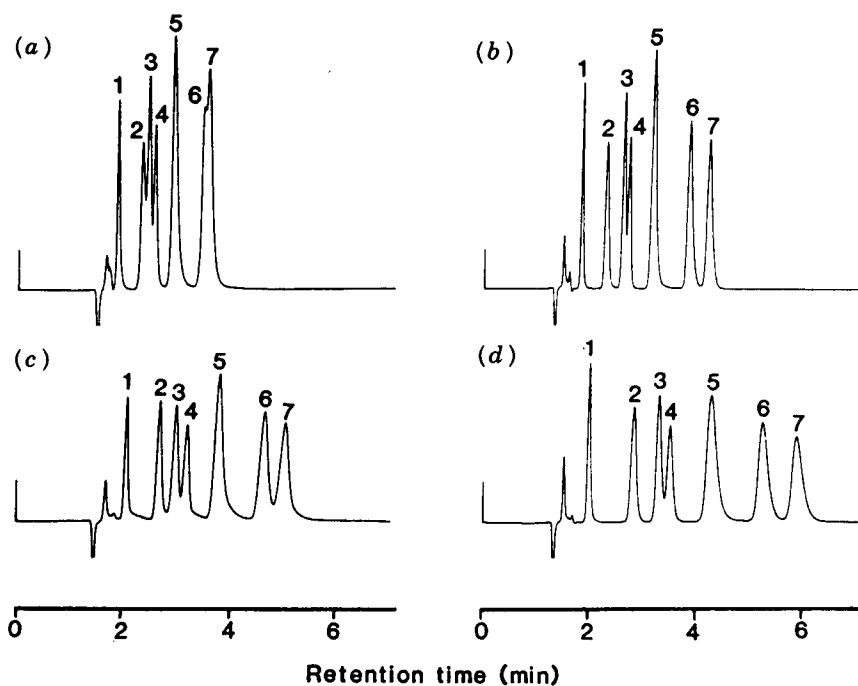

FIGURE 7.21 Separation of basic compounds on bare silica by ion exchange. Sample: 1, phendimetrazine; 2, phenylpropanolamine; 3, phentermine; 4, amphetamine; 5, morphine; 6, ephedrine; 7, methylamphetamine. Conditions: 25×0.5 -cm columns of Hypersil (a), Spherisorb S5W (b), Nucleosil 50-5 (c), and Zorbax BP-SIL (d); mobile phase is 90% methanol–ammonium nitrate pH 10.1; 2.0 mL/min; ambient. (Reprinted with permission from Ref. 71.)

one example is the clean separation of monoclonal antibodies from other proteins in cell culture samples [69]. So far, mixed-mode columns have been used mainly (and to a limited extent) for the separation of samples of biological interest (Chapter 11). Greater column-to-column variability can be expected, due to the more complicated reactions required for the production of mixed-mode columns.

7.5.4 Silica Columns

A less common but interesting form of IEC is carried out with "bare" silica columns [71–73] for the separation of strongly basic compounds ($pK_a > 8$). The mobile phase consists of 90% methanol/(ammonium nitrate buffer, pH 9 to 10), and retention is adjusted by varying ionic strength and/or pH. It is claimed that column efficiency N is comparable to the best values obtained by reversed-phase separations (Table 5.9), and columns are stable for about 2000 injections at pH 9 [74].

An example of these separations for a mixture of seven strongly basic compounds is shown in Fig. 7.21 using four different silica columns. The separations of Fig. 7.21 on bare silica show only minor differences in retention for four very different columns (Hypersil, A; Spherisorb, B; Nucleosil, C; and Zorbax, D). The efficiency of the Spherisorb column (B) is somewhat greater than for the other columns, and this column has been used for most of the published applications of IEC with bare silica. Compounds that can chelate with metals may exhibit tailing, but this can be corrected by washing the column with EDTA [75].

REFERENCES

1. P. J. Twitchett and A. C. Moffat, *J. Chromatogr.*, **111** (1975) 149.
2. W. R. Melander and C. Horvath, in *High-Performance Liquid Chromatography: Advances and Perspectives*, Vol. 2, C. Horvath, ed., Academic Press, San Diego, CA, 1980, p. 113.
3. J. A. Lewis, D. C. Lommen, W. D. Raddatz, J. W. Dolan, and L. R. Snyder, *J. Chromatogr.*, **592** (1992) 183.
4. P. J. Shoenmakers and R. Tijssen, *J. Chromatogr. A*, **656** (1993) 577.
5. B. T. Bush, J. H. Frenz, W. R. Melander, C. Horvath, A. R. Cashmore, R. N. Dryer, J. O. Knipe, J. K. Coward, and J. R. Bertino, *J. Chromatogr.*, **168** (1979) 343.
6. E. P. Kroef and D. J. Pietrzyk, *Anal. Chem.*, **50** (1978) 502.
7. J. B. Li, *LC/GC*, **10** (1992) 856.
8. J. W. Dolan, LC Resources, McMinnville, Oregon unreported studies, 1996.
9. D. Guo, C. T. Mant, and R. S. Hodges, *J. Chromatogr.*, **386** (1987) 205.
10. H. Otto and W. Wegscheider, *J. Chromatogr.*, **258** (1983) 11.

11. H. Otto and W. Wegscheider, *J. Liq. Chromatogr.*, **6** (1983) 685.
12. R. F. Doerge, ed., *Wilson and Gisvold's Textbook of Organic Medicinal and Pharmaceutical Chemistry*, J.B. Lippincott, Philadelphia, PA, 1982, Appendix B.
13. *pKalc Expert System*, CompuDrug Chemistry, Inc., Budapest, Hungary, 1992.
14. E. Bosch, P. Bou, H. Allemann, and M. Roses, *Anal. Chem.*, **68** (1996) 3651.
15. D. V. McCalley, *J. Chromatogr. A.*, **708** (1995) 185.
16. A. Bartha and G. Vigh, *J. Chromatogr.*, **485** (1989) 383.
17. G. K. C. Low, A. Bartha, H. A. H. Billiet, and L. de Galan, *J. Chromatogr.*, **478** (1989) 21.
18. J. W. Dolan, D. C. Lommen, and L. R. Snyder, *J. Chromatogr.*, **535** (1990) 55.
19. L. R. Snyder, J. W. Dolan, and D. C. Lommen, *J. Chromatogr.*, **535** (1990) 75.
20. J. A. Lewis, J. W. Dolan, L. R. Snyder, and I. Molnar, *J. Chromatogr.*, **592** (1992) 197.
21. W. Hancock, R. C. Chloupek, J. J. Kirkland, and L. R. Snyder, *J. Chromatogr.*, **686** (1994) 31.
22. J. L. Glajch, J. C. Gluckman, J. G. Charikofsky, J. M. Minor, and J. J. Kirkland, *J. Chromatogr.*, **318** (1985) 23.
23. J. S. Kiel, S. L. Morgan, and R. K. Abramson, *J. Chromatogr.*, **485** (1989) 585.
24. J. J. DeStefano, J. A. Lewis, and L. R. Snyder, *LC/GC*, **10** (1992) 130.
25. W. Golkiewicz, J. Kuczynski, W. Markowski, and L. Jusiak, *J. Chromatogr.*, **686** (1994) 85.
26. P. F. Vanbel, B. L. Tilquin, and P. J. Schoenmakers, *J. Chromatogr. A*, **697** (1995) 3.
27. M. A. Stadalius, J. S. Berus, and L. R. Snyder, *LC/GC*, **6** (1988) 494.
- 27a. D. V. McCalley, *J. Chromatogr. A*, **738** (1996) 169.
28. T. Welsch, H. Frank, and G. Vigh, *J. Chromatogr.*, **506** (1990) 97.
29. R. J. M. Vervoort, F. A. Maris, and H. Hendriks, *J. Chromatogr.*, **623** (1992) 207.
30. R. M. J. Vervoort, M. J. W. Derksen, and F. A. Maris, *J. Chromatogr. A*, **678** (1994) 1.
31. H. A. Claessens, E. A. Vermeer, and C. A. Cramers, *LC/GC Int.*, **6** (1993) 692.
32. D. V. McCalley, *J. Chromatogr.*, **636** (1993) 213.
- 32a. J. J. Kirkland and J. J. DeStefano, *GIT Verlag, GIT Special, Chromatography Special*, June 1996, 62.
- 32b. J. J. Kirkland, J. W. Henderson, J. J. DeStefano, M. A. van Straten, and H. A. Claessens, *J. Chromatogr. A*, in print.
33. S. D. McCrossen and C. F. Simpson, *J. Chromatogr. A*, **697** (1995) 53.
34. S. H. Hansen and J. Tjornelund, *J. Chromatogr.*, **556** (1991) 353.
35. P. Helboe, S. H. Hansen, and M. Thomsen, *Adv. Chromatogr.*, **28** (1989) 195.
36. A. Bartha, H. A. H. Billiet, L. de Galan, and G. Vigh, *J. Chromatogr.*, **291** (1984) 91.
37. D. S. Lu, J. Vialle, H. Tralongo, and R. Longerey, *J. Chromatogr.*, **268** (1983) 1.
38. J. H. Knox and R. A. Hartwick, *J. Chromatogr.*, **204** (1981) 3.
39. M. W. Dong, J. Lepore, and T. Tarumoto, *J. Chromatogr.*, **442** (1988) 81.

40. A. Bartha, G. Vigh, H. A. H. Billiet, and L. de Galan, *J. Chromatogr.*, **303** (1984) 29.
41. M. Patthy, *J. Chromatogr. A*, **660** (1994) 17.
42. M. T. W. Hearn, ed., *Ion-Pair Chromatography*, Marcel Dekker, New York, 1985.
43. A. P. Goldberg, E. Nowakowska, P. E. Antle, and L. R. Snyder, *J. Chromatogr.*, **316** (1984) 241.
44. H. Liu and F. F. Cantwell, *Anal. Chem.*, **63** (1991) 993.
45. P. Helboe, *J. Chromatogr.*, **523** (1990) 217.
46. A. Bartha, G. Vigh, and Z. Varga-Puchony, *J. Chromatogr.*, **499** (1990) 423.
47. R. C. Kong, B. Sachok, and S. N. Deming, *J. Chromatogr.*, **199** (1980) 307.
48. P. Jandera and H. Engelhardt, *Chromatographia*, **13** (1980) 18.
49. W. Lindbergh, E. Johansson, and K. Johansson, *J. Chromatogr.*, **211** (1981) 201.
50. P. M. J. Coenegracht, N. V. Tuyen, H. J. Metting, and P. J. M. Coenegracht-Lamers, *J. Chromatogr.*, **389** (1987) 351.
51. C. P. Terweij-Groen and J. C. Kraak, *J. Chromatogr.*, **138** (1977) 245.
52. N. Lammers, J. Zeeman, and G. J. deJong, *J. High-Resolution Chromatogr. and Chromatogr. Comm.*, **4** (1981) 444.
53. S. O. Jansson and S. Johansson, *J. Chromatogr.*, **242** (1982) 41.
54. M. Bieganowska, E. Soczewinski, and M. Janowska, *Chromatographia*, **18** (1984) 99.
55. K. Dihuidi, M. J. Kucharski, E. Roets, J. Hoogmartens, and H. Vanderhaeghe, *J. Chromatogr.*, **325** (1985) 413.
56. A. Bartha, G. Vigh, and J. Stahlberg, *J. Chromatogr.*, **485** (1989) 403.
57. J. W. Dolan and L. R. Snyder, *Troubleshooting LC Systems*, Humana Press, Totowa, NJ, 1989, pp. 429-435.
58. L. R. Snyder, LC Resources, Walnut Creek, California, personal communication, 1995.
59. C. Z. Chuang, F. A. Ragan, and C. Prasad, *J. Liq. Chromatogr.*, **17** (1994) 2383.
60. P. A. Asmus, J. B. Landis, and C. L. Vila, *J. Chromatogr.*, **264** (1983) 241.
61. L. R. Snyder and J. J. Kirkland, *Introduction to Modern Liquid Chromatography*, Wiley-Interscience, New York, 1974, Chapter 9.
62. H. Small, *Ion Chromatography*, Plenum, New York, 1989.
63. K. Croes, P. T. McCarthy, and R. J. Flanagan, *J. Chromatogr. A*, **693** (1995) 289.
64. B. Law and J. R. G. Appleby, *J. Chromatogr. A*, **725** (1996) 335.
65. P. R. Haddad and P. E. Jackson, *Ion Chromatography*, Elsevier, Amsterdam, 1990.
66. H. F. Walton and R. D. Rocklin, *Ion Exchange in Analytical Chemistry*, CRC Press, Boca Raton, FL, 1990.
67. J. T. Eleveld, H. A. Claessens, J. L. Ammerdorffer, A. M. van Herk, and C. A. Cramers, *J. Chromatogr. A*, **677** (1994) 211.
68. M. P. Henry, in *HPLC of Proteins, Peptides and Polynucleotides*, M. T. W. Hearn, ed., VCH, New York, 1991, Chapter 5.

69. D. R. Nau, in *HPLC of Proteins, Peptides and Polynucleotides*, M. T. W. Hearn, ed., VCH, New York, 1991, Chapter 11.
70. W. R. Melander, Z. El Rassi, and C. Horvath, *J. Chromatogr.*, **469** (1989) 3.
71. B. Law, R. Gill, and A. C. Moffat, *J. Chromatogr.*, **301** (1984) 165.
72. B. Law, *J. Chromatogr.*, **407** (1987) 1.
73. B. Law, *Methodol. Surv. Biochem. Anal.*, **22** (1992) 57.
74. B. Law and P. E. Chan, *J. Chromatogr.*, **467** (1989) 267.
75. B. Law and P. E. Chan, *J. Chromatogr.* **552** (1991) 429.

8

GRADIENT ELUTION

- 8.1 Introduction
- 8.2 Applications of Gradient Elution
 - 8.2.1 Gradient Elution for Routine Analysis
 - 8.2.1.1 Sample Retention Range
 - 8.2.1.2 High-Molecular-Weight Sample Components
 - 8.2.1.3 Late Eluters
 - 8.2.1.4 Maximizing Detection Sensitivity
 - 8.2.1.5 Dilute Sample Solutions
 - 8.2.1.6 Alternatives to Gradient Elution
 - 8.2.2 Gradient Elution for Method Development
 - 8.2.2.1 Isocratic or Gradient Separation?
 - 8.2.2.2 Estimating the Best Isocratic Conditions
 - 8.2.2.3 Estimating the Best Gradient Conditions
- 8.3 Principles of Gradient Elution
 - 8.3.1 Gradient vs. Isocratic Elution
 - 8.3.2 Effect of Gradient Steepness
 - 8.3.3 Effect of Gradient Range
 - 8.3.4 Effect of Gradient Shape
 - 8.3.4.1 Homologous or Oligomeric Samples
 - 8.3.4.2 Chromatograms with Peak Bunching
- 8.4 Developing a Gradient Separation
 - 8.4.1 Selecting Gradient Conditions
 - 8.4.1.1 Gradient Steepness
 - 8.4.1.2 Gradient Range
 - 8.4.1.3 Gradient Shape
 - 8.4.2 Varying Band Spacing
 - 8.4.2.1 Gradient Steepness
 - 8.4.2.2 Solvent Type
 - 8.4.2.3 Other Variables
 - 8.4.3 Adjusting Column Conditions
- 8.5 Experimental Considerations
 - 8.5.1 Effect of Equipment on Separation: System Dwell Volume
 - 8.5.1.1 Equipment Differences
 - 8.5.1.2 Changes in Separation for Different HPLC Systems
 - 8.5.1.3 Minimizing the Effect of Equipment Dwell Volume
 - 8.5.1.4 Determining the Dwell Volume

- 8.5.2 Reproducible Separation
 - 8.5.2.1 Column Regeneration
 - 8.5.2.2 Column Equilibration
 - 8.5.2.3 Inaccurate Gradients
- 8.5.3 Baseline Problems
 - 8.5.3.1 Drift
 - 8.5.3.2 Artifactual Bands
- 8.6 Summary of Gradient Elution Method Development
 - 8.6.1 Systematic Approach
 - 8.6.2 Computer Simulation

8.1 INTRODUCTION

As described in earlier chapters, isocratic separation uses the same mobile-phase composition throughout the separation (e.g., 50% methanol–water). In gradient elution, the composition of the mobile phase changes during the run (e.g., from 5 to 100% methanol–water). Binary-solvent mobile phases A and B generally are used in gradient elution, with the concentration of the strong solvent B (% B) increasing during the run. This is illustrated in the examples of Fig. 8.1, which show gradients of various shapes. Linear gradients are used most often and will be assumed here unless stated otherwise. The examples of Fig. 8.1 show a change in mobile-phase composition from 0 to 100% B in 20 min (5%/min for the linear plot gradient).

Gradient elution is required for many samples and preferred for others. Nevertheless, there is a strong bias against the use of gradient elution in many laboratories. Some of the reasons for preferring isocratic elution are as follows:

- Gradient equipment is not available in some laboratories.
- Gradient elution is more complicated, appearing to make both method development and routine application more difficult.
- Gradient elution cannot be used with some HPLC detectors (e.g., refractive index detectors).
- Gradient runs take longer, because of the need for column equilibration after each run.
- Gradient methods do not always transfer well, because differences in equipment can cause changes in separation.
- Baseline problems are more common with gradient elution, and solvents must be of higher purity.
- The use of certain column/mobile phase combinations is not recommended for gradient elution.

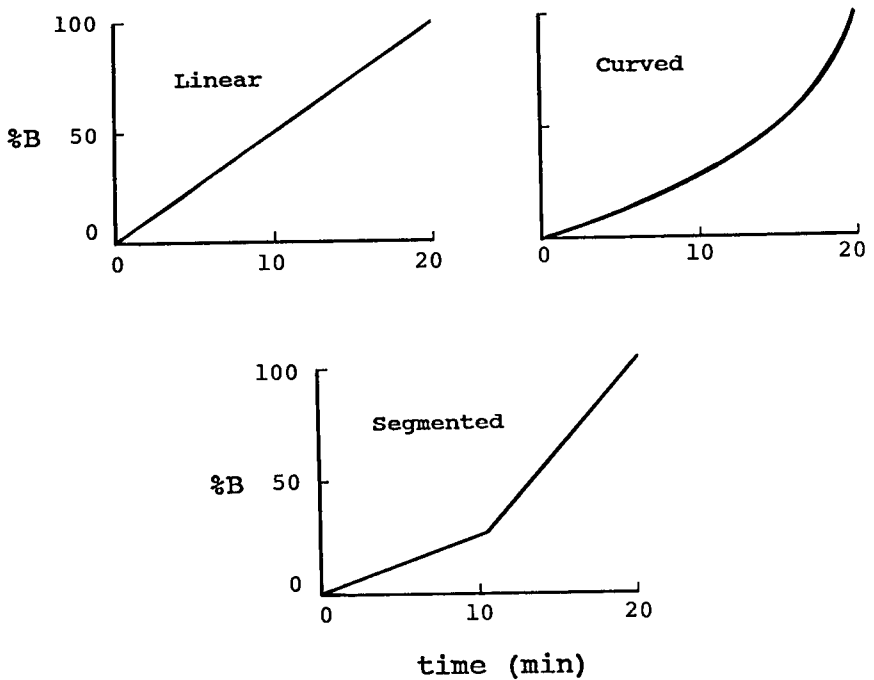

FIGURE 8.1 Various gradient shapes.

While the advantages and disadvantages of gradient elution must be weighed for each application, many separations are only possible using gradient elution. In this chapter we will see that separations by gradient elution are actually quite similar to those carried out isocratically, so that method development and routine applications of gradient elution are not much more difficult than for isocratic separation. In Section 8.5 we examine some of the gradient elution problems noted above and show how they can be avoided or minimized.

The following discussion is oriented mainly to reversed-phase conditions, but the use of gradient elution for other HPLC methods is governed by the same principles. Our present detailed and comprehensive understanding of gradient elution now permits accurate predictions of separation from a few initial experimental measurements ([1,2] and Section 10.2.2). For a thorough discussion of the principles of gradient elution, see Refs. 3-5.

8.2 APPLICATIONS OF GRADIENT ELUTION

The use of gradient elution for routine application is suggested for the following kinds of samples:

- Samples with a wide k range (i.e., where no isocratic conditions result in $0.5 < k < 20$ for all bands of interest).
- Samples composed of large molecules [e.g., with molecular weights above 1000 and especially, samples of biological origin (see Chapter 11)].
- Samples containing late-eluting interferences that can either foul the column or overlap subsequent chromatograms.
- Dilute solutions of the sample dissolved in a weak solvent (e.g., aqueous sample solutions for injection onto a reversed-phase column).

In addition, an initial gradient elution run is often the best starting point for HPLC method development, even where a final isocratic method may be possible.

8.2.1 Gradient Elution for Routine Analysis

8.2.1.1 Sample Retention Range. The usual reason for choosing gradient elution is that the sample has a wide retention range. This is illustrated in Fig. 8.2 for the separation of a mixture of dialkylphthalates. This homologous mixture consists of dimethyl (1), methyl ethyl (2), diethyl (3) through di-*n*-pentyl (9) phthalates, separated on a C_8 column with different acetonitrile-water mobile phases. Isocratic separation with 50% B gives good resolution (Fig. 8.2a; $R_s = 1.5$ for critical band pair 1/2, but the run time is long (70 min); also, later bands (8 and 9) are broad and marginally detectable. A stronger mobile phase (65 or 80% B; Fig. 8.2b and c) gives shorter run times, and bands 8 and 9 are now narrower for better detection and quantitation. However, the resolution of early bands 1 to 4 is much poorer ($R_s < 0.8$ for the critical band pair). No isocratic conditions result in adequate separation of this sample, because early bands require a weaker mobile phase (e.g., 50% B), and later bands are best separated with a stronger mobile phase (80% B).

This same sample is well separated using gradient elution (Fig. 8.2d): 20 to 100% B in 10 min. Now all bands are well resolved ($R_s = 1.5$ for the critical band pair 1/2, the run time is only 11 min, and all bands are eluted with narrow bandwidths for easy detection and accurate quantitation. Gradient elution is obviously a better choice for this and other samples with a wide retention range. An additional reason for using gradient elution is that late-eluting bands with $k > 20$ often exhibit tailing under isocratic conditions, as illustrated in Fig. 8.3a for the ion-exchange separation of a mixture of carboxylic acids. Gradient elution for this same sample (Fig. 8.3b) provides narrow, well-shaped bands at the end of the chromatogram, as well as improved separation of early bands. However, it should be noted that gradient elution does not solve all band-tailing problems.

8.2.1.2 High-Molecular-Weight Sample Components. Samples of this kind (peptides, proteins, synthetic polymers, etc.) are generally better separated

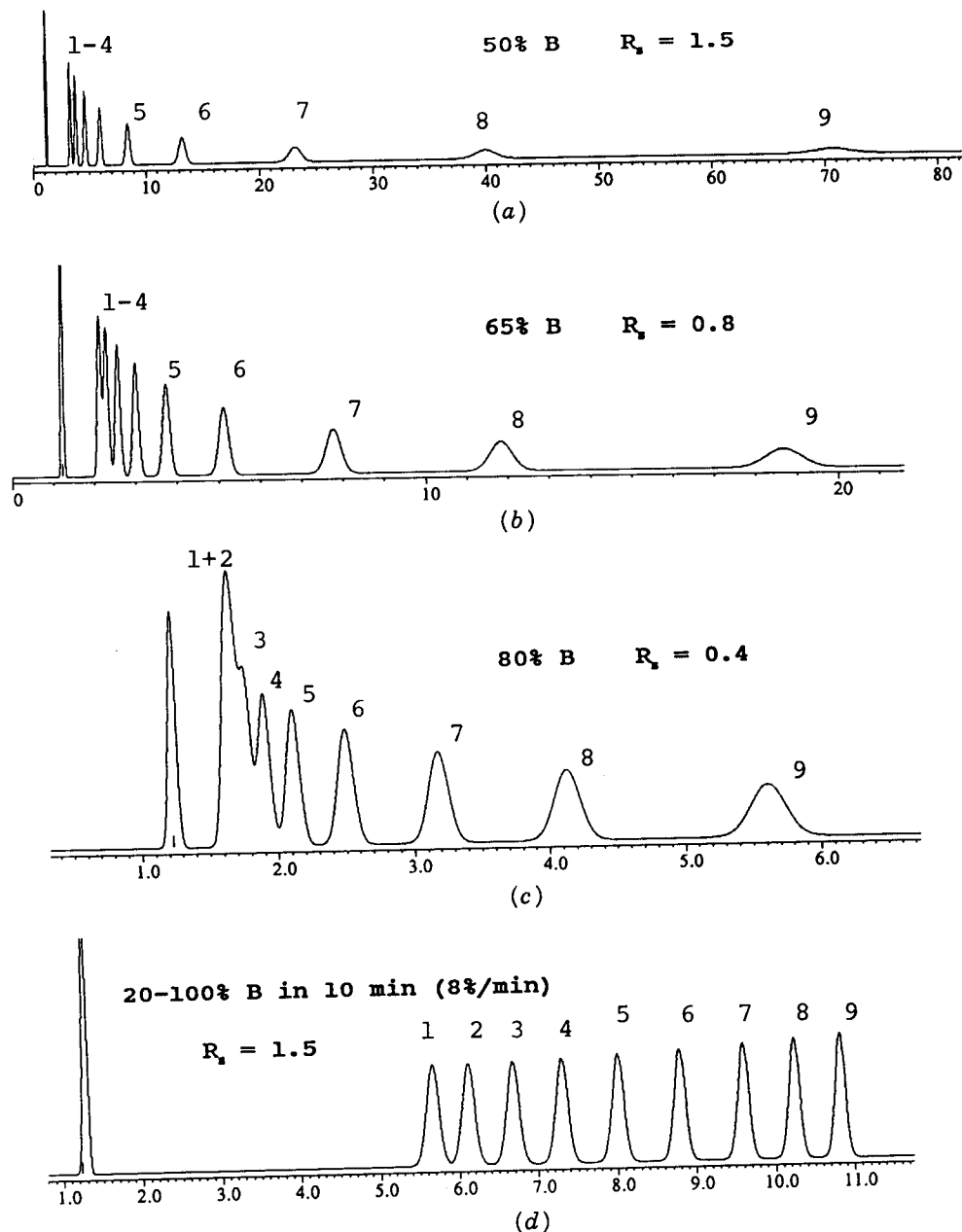
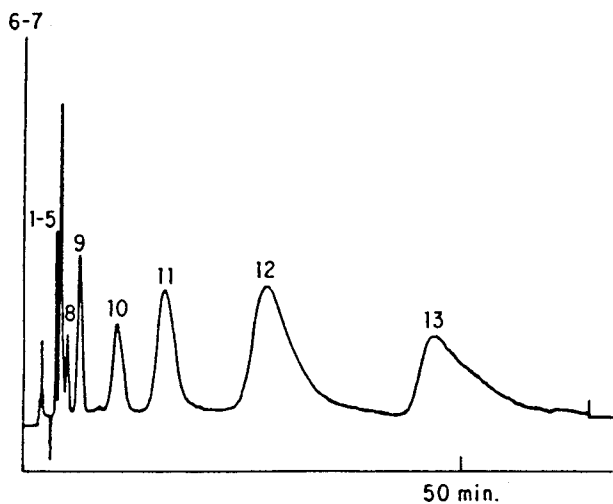
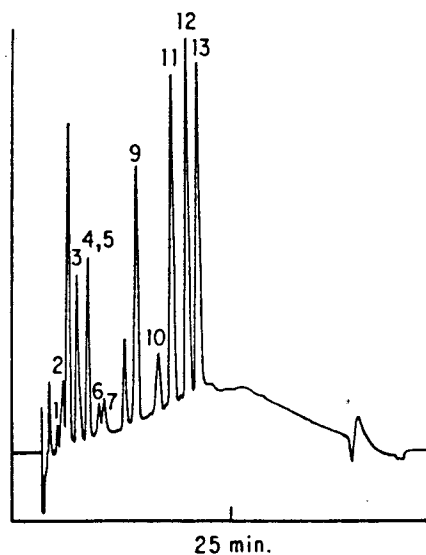

FIGURE 8.2 Separation of dialkylphthalate homologs by reversed-phase HPLC. Sample bands are C_2 (dimethyl, No. 1) through C_{10} (di-*n*-pentyl, No. 9); 25×0.46 -cm, $5\text{-}\mu\text{m}$ C_8 column; acetonitrile (B)–water mobile phases; 2 mL/min; 60°C . [These chromatograms are computer simulations derived from data in Ref. 6 (the accuracy of these computer simulations has been demonstrated in numerous examples; see, e.g., [1]).]



(a)



(b)

FIGURE 8.3 Separation of a mixture of aromatic carboxylic acids by ion-exchange chromatography. (a) Isocratic separation with 0.055 *M* sodium nitrate in the aqueous mobile phase; (b) gradient elution with sodium nitrate varying from 0.01 to 0.10 *M*. (Reprinted with permission from Ref. 7.)

by gradient elution, especially when reversed-phase conditions are used. The isocratic retention of such samples is often extremely sensitive to small changes in the mobile-phase composition (% B), making it difficult to control retention within acceptable limits [8,9]. For example, the isocratic RPC separation of carbonic anhydrase (a protein with a molecular weight of 29,000 Da) with propanol–water mobile phases exhibits a $\pm 20\%$ change in retention time for a variation of only $\pm 0.1\%$ B (Table VIII of Ref. 10). The HPLC separation of large biomolecules also often results in much better peak shapes when gradient elution is used instead of isocratic conditions.

8.2.1.3 Late Eluters. Some samples are well separated by isocratic elution ($0.5 < k < 20$ for bands of interest) but contain late-eluting interferences that either contaminate the column or interfere with subsequent separations. Figure 8.4a shows an isocratic separation where the quantitation of a single compound (shaded band labeled EP) is desired, but where later interference bands continue to elute indefinitely. Gradient elution would solve this problem by effecting the rapid elution of these later bands before injection of the next sample. Figure 8.4b shows the gradient separation of a wood-pulp extract for the determination of anthraquinone. A broad well-retained band (arrow) did not elute under isocratic conditions. The initial use of isocratic elution for these samples resulted in a rapid loss of column activity and inadequate separation, due to the buildup of strongly retained compounds on the column. Gradient elution (in place of isocratic separation) achieved the removal of strongly retained material in each run, thereby solving this problem.

8.2.1.4 Maximizing Detection Sensitivity. Detection sensitivity can be improved in isocratic separation by increasing % B so as to reduce k and band width (Eq. 2.15). There is often a limit to this approach, however, because of interference peaks and baseline disturbances near t_0 . In gradient elution, however, it is often possible to use steep gradients to achieve the same advantages of isocratic separation with small k ($k < 2$), without interferences of the kind encountered in isocratic elution (see Fig. 8.5a and b, first peak labeled with an asterisk). A further advantage of gradient elution for enhanced detection is that sample bands are about two-fold narrower (and peak heights are two-fold greater) than in corresponding separations ($k = k^*$) by isocratic elution [5].

8.2.1.5 Dilute Sample Solutions. For dilute samples dissolved in a weak solvent, gradient elution allows the injection of a large sample volume without any adverse effect on band broadening. Under these conditions, the sample undergoes on-column concentration at the column inlet during its injection, and relatively large sample volumes (e.g., 1 to 10 mL) are then possible. A similar on-column concentration is also observed in isocratic separation. However, due to the mixing of sample with mobile phase during injection, more band broadening due to the sample volume is typically observed in

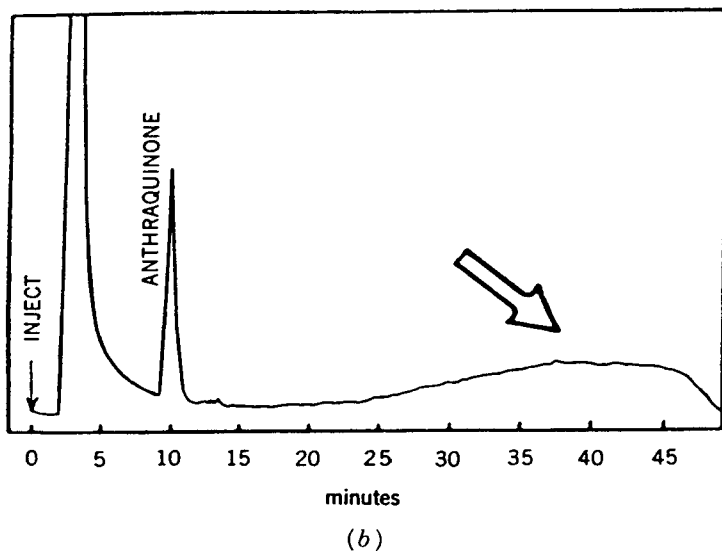
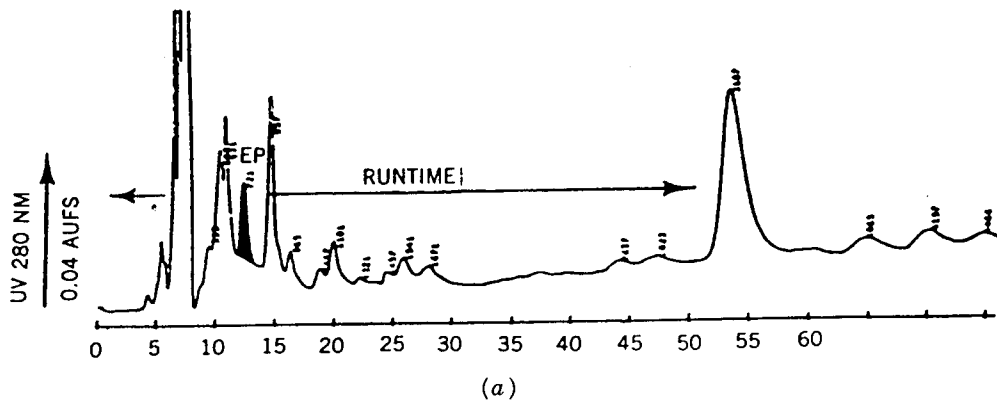

FIGURE 8.4 Samples with late eluters are good candidates for gradient elution. (a) Isocratic reversed-phase analysis of plasma extract for drug EP. (Reprinted with permission from Ref. 11.) (b) Analysis of anthraquinone in wood-pulp extract by reversed-phase gradient elution. (Reprinted with permission from Ref. 12.)

isocratic elution than in gradient elution (where the sample mixes during injection with the weaker A solvent rather than the stronger isocratic mobile phase).

Gradient elution is not applicable to every situation. The use of strongly retained additives in the mobile phase (e.g., amine modifiers, hydrophobic ion-pair reagents) complicates gradient elution, because column regeneration can be slow and separation can be less reproducible. Normal-phase separation

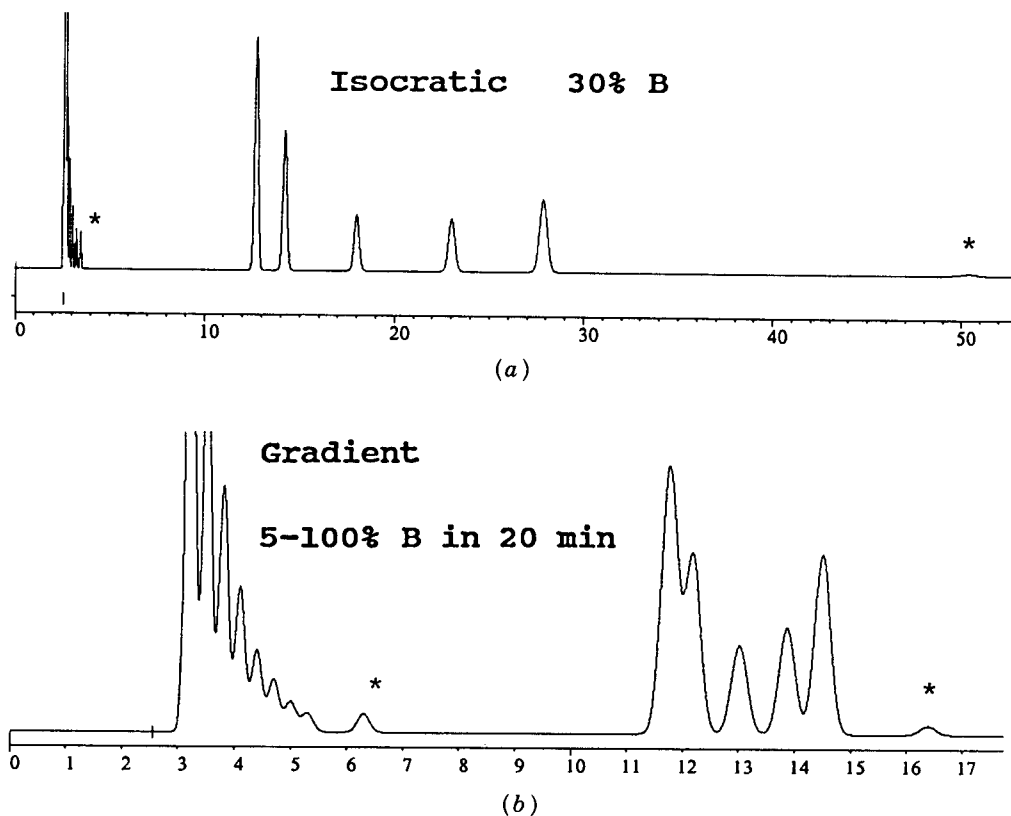

FIGURE 8.5 Separation of hypothetical sample by initial isocratic or gradient runs. Minor early- and late-eluting bands indicated by an asterisk; computer simulations.

on columns of non-bonded silica are subject to similar problems, because of the very strong retention of many polar solvents (e.g., propanol with silica as column packing); see “solvent demixing” in Section 6.8.4.1.

8.2.1.6 Alternatives to Gradient Elution. In some cases, an isocratic method may be preferred, even though the sample retention range is wider than $0.5 < k < 20$. The retention range can sometimes be reduced by using a more polar reversed-phase column (e.g., cyano). Polar, less retained compounds tend to interact more strongly with a more polar stationary phase, while non-polar compounds interact less strongly. Figure 6.11 provides an example of this behavior. Other studies suggest that the use of THF as strong solvent also tends to reduce the retention range relative to mobile phases that contain methanol or acetonitrile. Column switching (Section 4.6) is also a convenient alternative to gradient elution for some samples [13].

8.2.2 Gradient Elution for Method Development

When starting HPLC method development for a sample whose composition is undefined, there are several advantages to an initial gradient run, even when the final separation is to be carried out isocratically:

1. An initial gradient elution separation provides an estimate of the approximate retention range of the sample; this allows a choice between isocratic and gradient elution for subsequent experiments. Samples that are unsuitable for reversed-phase HPLC because of very weak or strong retention are also recognizable from this first gradient run (see Fig. 9.1c and *d* and related discussion).
2. If isocratic elution is the better choice, the initial gradient run allows an estimate of the best % B value for the next experiment. If gradient elution is preferred, the initial run allows an estimate of the best initial and final values of % B for the next gradient run; see Fig. 8.6, Tables 8.1 to 8.3, and the related discussion below.
3. An initial gradient elution run can provide a better, faster separation of the total sample (vs. isocratic separation), thereby advancing method development substantially (Fig. 8.3); the more peaks that can be separated in a starting run, the better.
4. An initial gradient run is less likely to overlook low-concentration components that elute either early or late; this is illustrated in the hypothetical separations of Fig. 8.5, where the analyte peaks labeled with an asterisk are more likely to be missed in the isocratic run.

The use of an initial gradient experiment to guide further HPLC method development is described in Ref. 14 and illustrated in Fig. 8.6a. A standard set of conditions is preferred: 15×0.46 -cm column, gradient from 5 to 100% acetonitrile in a gradient time $t_G = 60$ min, 2 mL/min (however, other column lengths, solvents, and flow rates are allowable). If most of the sample bands cluster near t_0 in this first run, the sample is too hydrophilic for reversed-phase separation. If no sample bands are observed in the chromatogram, either the detector response is poor (see Chapter 3) or the sample is too hydrophobic for reversed-phase separation. In either case, another approach is indicated; see the examples and discussion of Fig. 9.1c and *d*.

8.2.2.1 Isocratic or Gradient Separation? A chromatogram as in Fig. 8.6a, where early peaks elute later than $2t_0$ and later peaks elute before the end of the gradient, suggests that reversed-phase HPLC is suitable for the sample in question. The next step is to determine whether gradient or isocratic elution is preferable. This can be determined by noting the retention times for the first and last bands in the chromatogram (t_{R_a} and t_{R_z} in Fig. 8.6a). If we define

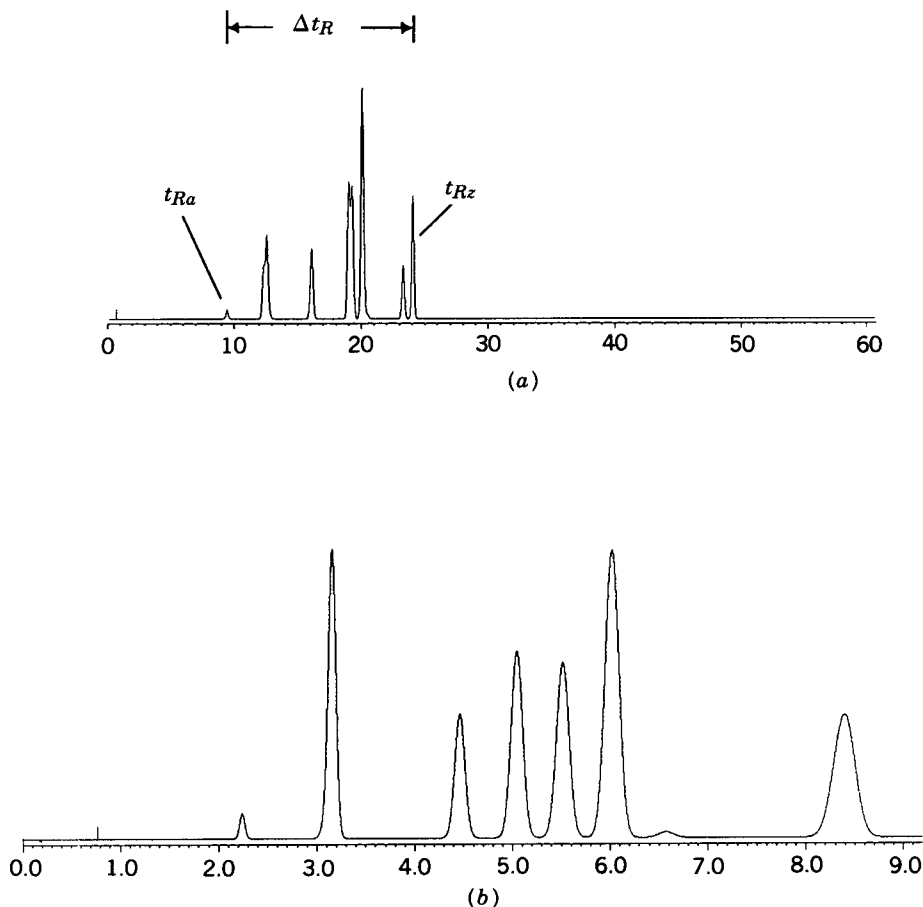

FIGURE 8.6 Use of an initial gradient run in HPLC method development. Substituted aniline sample [14,15]; conditions: 15×0.46 -cm column; 2.0 mL/min; 35°C. (a) 5 to 100% acetonitrile–water gradient in 60 min; (b) isocratic separation with 37% acetonitrile–water. See the text for details.

the retention time difference $\Delta t_R = t_{Rz} - t_{Ra}$, the ratio $\Delta t_R/t_G$ determines whether isocratic separation of the sample will be feasible. The maximum allowable k range is $0.5 < k < 20$, in which case $\Delta t_R/t_G$ should be less than 0.40. That is, the retention range of the sample should be less than 40% of the gradient time. Table 8.1 provides a convenient (and more accurate) summary of allowable values of t_{Rz} (for isocratic elution) based on an observed value of t_{Ra} . In Fig. 8.6a, the retention times of the first and last peaks are 9.5 and 24.5 min, respectively ($\Delta t_R/t_G = 0.25$). From Table 8.1 and a retention time of 9.5 min for the first band, isocratic retention is possible as long as the retention time for the last band is less than 32 min. This is the case for the sample of Fig. 8.6a (isocratic elution is possible).

TABLE 8.1 Determining Whether Isocratic Separation is Possible, Based on an Initial Gradient Run^a

t_{Ra} (min) ^b	Allowable Values of t_{Rz} for k Range Indicated (min) ^b	
	$1 < k < 10$	$0.5 < k < 20$
< 1.5	<i>c</i>	<i>c</i>
2	8	17
3	12	21
4	14	24
5	16	26
7	19	29
10	23	33
15	29	38
20	35	44
25	40	49
30	45	54
35	50	59
40	55	64
> 40	<i>d</i>	<i>d</i>
Uncertainty ^e	±3 min	±5 min

Source: Refs. 14 and 15.

^a See Fig. 8.6a. Conditions: 15 × 0.46-cm column, 5 to 100% ACN–water gradient in 60 min, 2 mL/min; these conditions are recommended whenever it is not certain that gradient elution will be required.

^b t_{ra} = retention time of first peak in separation

t_{Rz} = retention time of last peak in separation

^c Sample may not be sufficiently retained for reversed-phase separation; see Section 9.2.2.3.

^d Sample may be retained too strongly for reversed-phase separation; see Section 9.2.2.3.

^e Estimated uncertainty in these values.

Even though isocratic elution may be feasible (because $0.5 < k < 20$), it will sometimes be desirable to use gradient elution instead. In Section 6.3.1 we pointed out that a change in % B (equivalent to a change in k) can result in useful changes in selectivity, which for some samples may be the easiest way to achieve adequate separation. However, when the range in sample k values is large (e.g., $k_z/k_a > 20$, where k_a and k_z refer to isocratic k values for the first band a and the last band z), even small changes in % B will result in some bands falling outside the range $0.5 < k < 20$. This means that sample resolution cannot be altered very much by a change in % B because the allowable change in % B is limited. The use of gradient instead of isocratic elution in this situation (for a change in k and α) allows much larger changes in selectivity by changing gradient steepness instead of % B (Section 8.3.2). Gradient elution for this purpose (change in k and selectivity) is recommended whenever $\Delta t_R/t_G > 0.15$.

TABLE 8.2 Estimation of % B (ACN) for the First Isocratic Run, Based on the Retention Time t_{Rz} of the Last Peak in the Gradient Run^a

t_{Rz} (min)	(% B) _{est} to Give Indicated k for Last Band in Isocratic Run		
	$k = 5$	$k = 10$	$k = 20$
5	6	0	—
10	19	12	5
15	29	22	14
20	37	30	22
25	45	38	30
30	53	46	38
35	61	54	46
40	69	62	54
45	77	70	62
50	85	78	70
55	93	86	78
60	100	94	86
65	—	100	94

Source: Refs. 14 and 15.

^a Required conditions: 15×0.46 -cm column, 5 to 100% ACN in 60 min, 2 mL/min.

8.2.2.2 Estimating the Best Isocratic Conditions. If the test of Fig. 8.6a suggests isocratic conditions, the best value of % B for the next (isocratic) experiment can be determined from Table 8.2. The retention time t_{Rz} for the last band in the gradient separation is used to estimate a % B value that will provide a desired value of k for the last band in the isocratic separation of the sample. In the example of Fig. 8.6a, $t_{Rz} = 24$ min. From Table 8.2, for a 15×0.46 -cm column, a flow rate of 2 mL/min, and a gradient time of 60 min, the predicted mobile-phase composition is 37% B for $k = 10$ for the last band. Figure 8.6b shows the resulting isocratic separation of this sample (37% B). As expected, the k range for this separation is acceptable ($2 < k < 10$).

8.2.2.3 Estimating the Best Gradient Conditions. If the test of Table 8.1 suggests that gradient conditions are more appropriate for the sample, we can estimate the best values of initial and final % B from Table 8.3 for a sample molecular weight below 2000 Da. As an example, for a sample molecular weight below 2000 Da, assume that the retention time t_R for the first band is 10 min and for the last band 40 min. From Table 8.3 the recommended initial % B = 11% and the final % B = 68%. When the final gradient conditions have been selected, these % B values should be adjusted further as described in Section 8.4.1.

TABLE 8.3 Estimation of Initial and Final % B for Gradient Elution, Based on Retention Time t_R for First (a) and Last (z) Band in the Initial Gradient Run^a

t_{Ra} or t_{Rz}^b (min)	Initial % B	Final % B ^{b,c}
5	3	14
10	11	22
15	19	30
20	27	38
25	35	46
30	43	54
35	51	60
40	59	68
45	67	76
50	75	84
55	83	100
60 ^d	—	—

Source: Refs. 14 and 15.

^a See Fig. 8.6. Required conditions: 15 × 0.46-cm column, 5 to 100% ACN in 60 min, 2 mL/min.

^b Retention time for first peak a (for initial % B) or last peak z (for final % B).

^c For steeper gradients, % B (final) must be increased (by as much as 35%).

^d Normal-phase or non-aqueous reversed-phase HPLC may be required (Section 9.2.2.3).

8.3 PRINCIPLES OF GRADIENT ELUTION

In gradient elution, mobile-phase strength (% B) increases during the separation. This means that sample retention as measured by k decreases for each band as it migrates through the column. This situation is illustrated by the hypothetical plots of Fig. 8.7. It is assumed that band X is the first sample band to elute, and band Z is the last band. Consider the behavior of band X first. The solid curve marked "X" represents the fractional migration of this band from the column inlet (0.0) to the column outlet (1.0). At the beginning of the separation, % B is low and k for band X is large. Therefore, band X initially remains close to the column inlet (little or no migration). After some time, however, the increase in % B results in a k value for band X that is small enough ($k < 10$) to allow it to start moving through the column. The dashed curve marked "k (X)" in Fig. 8.7 represents the value of k for band X at different times during the separation. As time increases, k for band X continues to decrease and X migrates faster and faster. Eventually, at the band retention time t_x , X

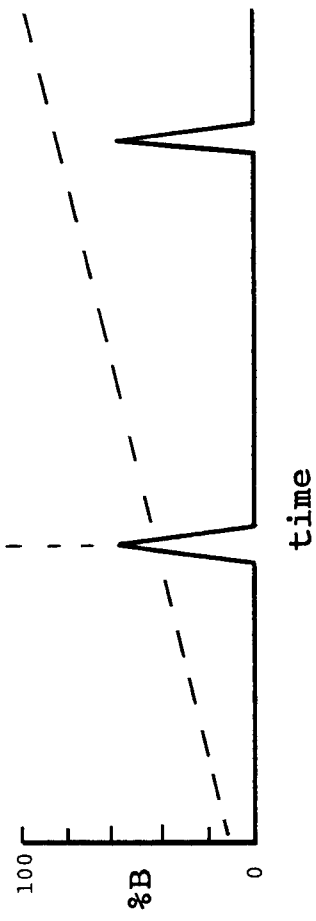
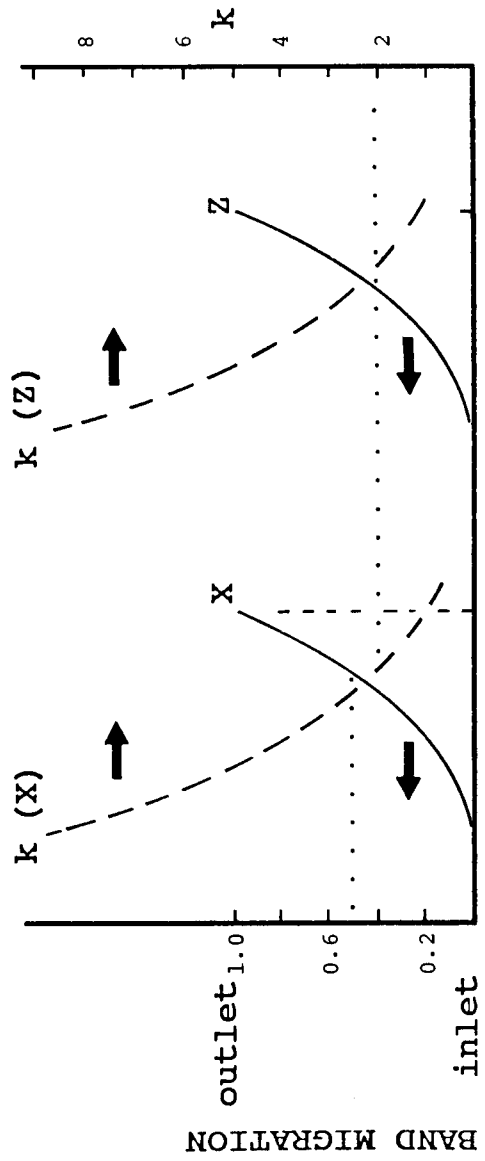

FIGURE 8.7 Band migration during gradient solution. Upper figure: solid curve, band migration; dashed curve, instantaneous value of k . See the text for details.

reaches the outlet of the column and appears in the detector to be recorded as a peak in the chromatogram.

The value of k for each band in isocratic elution is quite important in understanding and controlling HPLC separation. In gradient elution, k is equally important. But what is the k value for X in Fig. 8.7? Simple theory [3] provides the answer: the effective value of k in gradient elution is equal to k for the band when it has migrated halfway through the column. This is illustrated for band X in Fig. 8.7 by the upper dotted line, which in this case indicates a value of about $k = 2$ (lower dotted line) at the time the band has migrated halfway through the column. This average value of k in gradient elution, defined as k^* , determines sample resolution and bandwidth, just as in isocratic separation (see Eqs. 2.3 and 2.15).

In Fig. 8.7 it can be seen that the last band, Z, remains at the column inlet for a longer time, but eventually the mobile phase becomes strong enough for $k < 10$. Band Z then migrates through the column in similar fashion as for the first band, elutes at a retention time t_z , and its effective k value (k^*) is also equal to 2. Approximately constant values of k^* for different bands are typical of reversed-phase separations carried out with linear gradients (as in Fig. 8.7). As a result, every band in a linear-gradient chromatogram will have a similar width, and sample resolution will not necessarily be poorer at the beginning of the chromatogram as is so often the case in isocratic separation (see Figs. 8.2 and 8.3).

8.3.1 Gradient vs. Isocratic Elution

Each band in an isocratic separation is surrounded by the same mobile-phase composition (% B) during its passage through the column, and retention as measured by the capacity factor k does not change for a given band during separation. In gradient elution, the mobile phase surrounding a band changes during its elution through the column, as does the instantaneous value of k for the band. On the other hand, separated bands in an isocratic chromatogram will usually have quite different values of k , while in gradient elution the effective value of k (k^*) for different bands will be about the same.

When the average value of k^* for two adjacent bands in gradient elution is the same as in isocratic separation (other conditions the same), the resolution of the two bands will be comparable for both isocratic and gradient separation. Values of k^* in gradient elution can be estimated from experimental conditions [5]: gradient time t_G (min), flow rate F (mL/min), column dead volume V_m (mL, Eq. 2.6), the difference between the initial and final % B values ($\Delta\% B$), and a property S of the sample compound (Eq. 6.1):

$$k^* = \frac{87 t_G F}{V_m (\Delta\% B) S} \quad (8.1)$$

Equation 8.1 applies to bands that are not eluted early in the chromatogram (under isocratic or "semi-isocratic" conditions). For any band, the value of k at elution is given by

$$k = \frac{1}{(2/k^*) + (1/k_0)} \quad (8.1a)$$

where k^* is calculated from Eq. 8.1 and k_0 is the value of k at the beginning of the gradient. For samples with molecular weights of 100 to 500 Da, $S \approx 4$ and Eq. 8.1 can be approximated by

$$k^* = \frac{20t_G F}{V_m(\Delta\% \text{ B})} \quad (8.2)$$

Values of S for larger molecules can vary from 10 to 100, suggesting the use of less steep gradients for such samples; less steep gradients (smaller values of $\%/min = \Delta\% \text{ B}/t_G$) compensate for larger values of S in affecting k^* (Eq. 8.1); see further discussion in Section 11.2.1.1.

The effect of gradient steepness on k^* and separation is best measured by a corrected gradient steepness parameter G_s , where

$$G_s = \frac{V_m(\Delta\% \text{ B})}{Ft_G} \quad (8.2a)$$

which allows Eq. 8.2 to be rewritten as

$$k^* \approx \frac{20}{G_s} \quad (8.2b)$$

G_s is a corrected gradient steepness (measured by $\%/min$ change in B) times (column dead volume divided by flow rate); it is also equal to the $\% \text{ B}$ change per column volume of mobile phase. As long as the flow rate and column dimensions do not change, the usual measure of gradient steepness ($\%/min = \Delta\% \text{ B}/t_G$) can be used to describe changes in separation as a result of change in gradient steepness. The significance of G_s when flow rate or column length is varied is examined further in Section 8.4.3, which deals with the effect of column conditions (column length and flow rate) on separation.

Any desired value of k^* can be selected by our choice of experimental conditions. Gradient steepness is usually described in terms of $\%/min$, so Eq. 8.2 can also be expressed as

$$k^* \approx 20 \frac{F/V_m}{\%/min} \quad (8.3)$$

Note that as gradient steepness (%/min) decreases for the same column and flow rate, k^* becomes larger. If it is known that gradient elution will be required for a given sample, $k^* \approx 5$ is an attractive choice for the initial run, since this represents a good compromise in terms of resolution R_s , peak height for good detection, and run time (Section 2.3.1).

A larger value of k^* ($k^* \approx 17$) is chosen for the example of Fig. 8.6a (and Tables 8.1 and 8.2). A larger k^* requires a longer run time (larger value of t_G), other factors being equal, but provides somewhat increased overall resolution and is better suited for use in subsequent RPC method development [15], especially if isocratic separation is possible ($0.5 < k < 20$).

8.3.2 Effect of Gradient Steepness

Because of the similarity of isocratic and gradient elution, larger values of k^* should lead to the same effects as larger values of k : (1) resolution R_s , increasing initially as k^* increases, then leveling off; (2) bands becoming broader with a corresponding reduction in peak height; and (3) longer run times. This is illustrated in Fig. 8.8 for the separation of a 15-component herbicide mixture, where gradient time increases from 5 to 100 min and k^* increases from 0.7 (5 min) to 14 (100 min). As gradient steepness is reduced from 20 to 5 to 1%/min, the number of peaks that are clearly resolved increases from 9 to 14 to 15. This increase in resolution as gradient steepness is reduced (or gradient time is increased) is counterbalanced by a decrease in peak height (due to wider bands) and an increase in run time, just as in isocratic elution when % B is decreased. These effects in gradient and isocratic elution are conveniently compared as follows:

- An increase in %/min (gradient) is analogous to an increase in % B (isocratic).
- An increase in gradient k^* (Eq. 8.2 or 8.3) is analogous to an increase in isocratic k .

Once the similarity of isocratic and gradient elution is appreciated, method development for gradient elution can be performed in almost the same way as for isocratic separation. Retention (k^*) is optimized first, then selectivity (α) is varied as needed, and finally, column conditions (N) may be adjusted to improve the compromise between run time and resolution. This approach is examined in Section 8.4 (see also Section 9.5).

8.3.3 Effect of Gradient Range

Gradient range refers to the difference between the initial and final % B of the gradient. An initial exploratory run can be carried out with a full-range gradient (i.e., 5 to 100% B). Some C_8 or C_{18} columns are poorly wet by

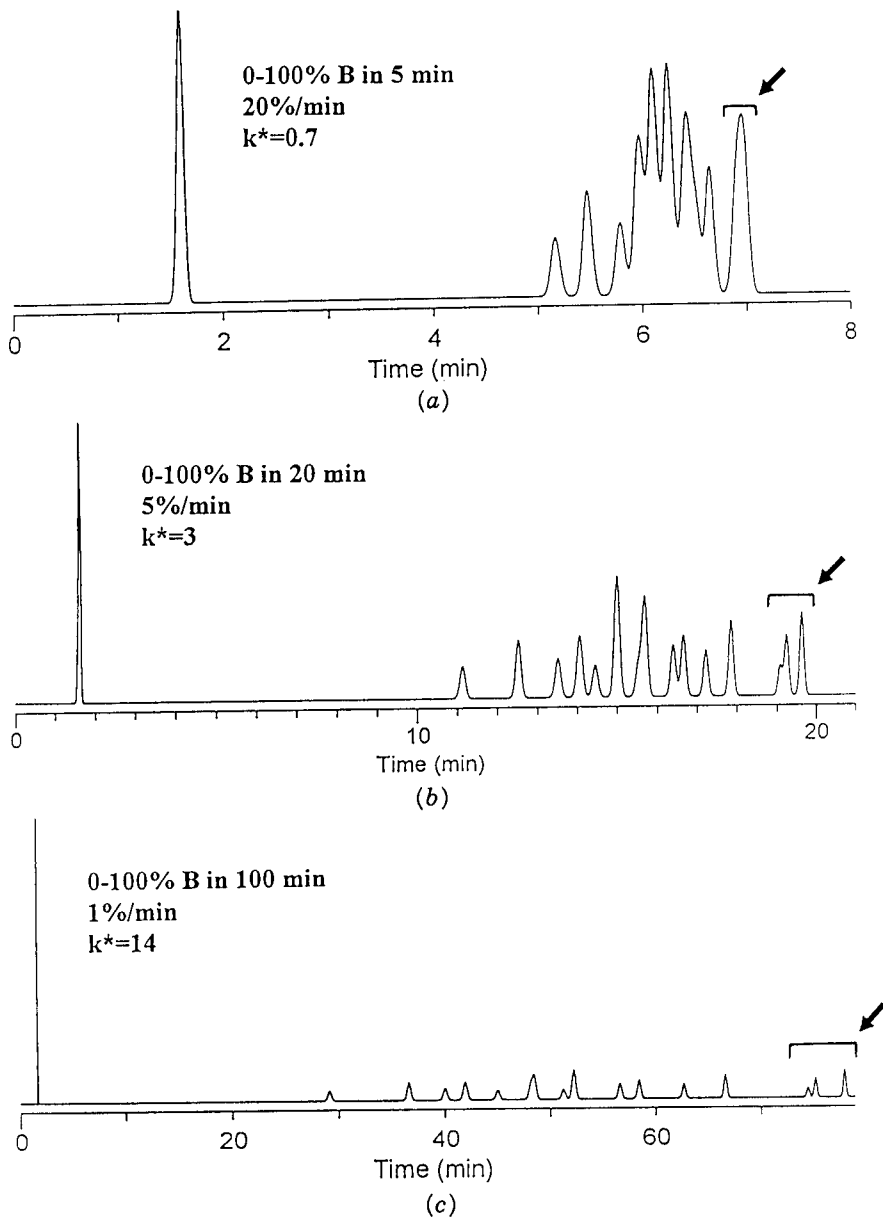

FIGURE 8.8 Gradient separation of a herbicide sample as a function of gradient time or steepness. Sample: mixture of nine phenylureas and six *s*-triazines. Conditions: 25×0.46 -cm, $10\text{-}\mu\text{m}$ C_{18} ; methanol-water gradients as indicated; 1.7 mL/min; ambient temperature. (Computer simulations based on data reported in Ref. 17.). Arrows indicate last three bands in chromatogram.

organic-free water and/or require extensive column equilibration between runs (Section 8.5.2). Also, some workers have reported "dramatically reduced lifetimes" for columns that have been subjected to 100% water as mobile phase [16]. These problems can be minimized by beginning the gradient with 5% B or higher; here "full-range gradients" will be understood as either 0 to 100% B or 5 to 100% B. Full-range gradients usually waste time, so the initial and final % B values should be adjusted during method development. The example of Fig. 8.8 is used in Figs. 8.9 and 8.10 to illustrate the effect of gradient range on separation.

Figure 8.9a shows a full-range separation of the herbicide sample for a gradient of 2%/min. The first band of interest has a retention time of 19 min (wasted time!), which means that the initial % B value should be increased. When the initial % B is increased to 40% B while maintaining the same 2%/min gradient (Fig. 8.9b), the gradient time is reduced from 50 min to 30 min but there is little change in the chromatogram (apart from a decrease in retention time for all bands). The critical band pair in these chromatograms has about the same resolution in the two runs: $R_s = 1.1$ in Fig. 8.9a and 1.0 in Fig. 8.9b.

When the initial mobile-phase composition is changed to 60% B (Fig. 8.9c, there is a noticeable loss in resolution ($R_s = 0.7$ for the critical band pair) along with a general compression of the early part of the chromatogram. That is, an initial % B value of 60% is too large, despite the further shortening of gradient time to 20 min in this run. The final run of Fig. 8.9d (initial % B = 50%) represents a reasonable compromise between resolution ($R_s = 0.9$ and run time for this sample. Note in Fig. 8.9c that when the initial % B value is increased beyond a certain value, the spacing between bands in the early part of the chromatogram (and their resolution) is reduced, while the spacing of later bands remains the same. A sufficiently large value of initial % B mainly affects early bands in the chromatogram; their k^* values are decreased (Eq. 8.1a for smaller k_0), leading to narrower, less resolved bands.

The separation of Fig. 8.9d can be considered to be optimized in terms of the initial % B value. However, the last band leaves the column at 18 min, before the gradient is completed at 27 min (arrow in Fig. 8.10a; same chromatogram as in Fig. 8.9d). Note that the gradient time is 25 min, but the gradient is "completed" at 27 min due to the effect of the extra time for the column dead volume (V_m). The 9-min interval between the last band and the end of the gradient is wasted; the gradient (and the separation) can be terminated at 18 min. This can be achieved by ending the gradient at 18 min (80% B) while maintaining gradient steepness at 2%/min; see Fig. 8.10b. This separation represents an optimum choice of both initial (50% B) and final (80% B) mobile-phase compositions.

If the gradient is ended prematurely (before the last band leaves the column), the usual effect is to increase the run time and to broaden later bands (with decreased detection sensitivity). This is illustrated in Fig. 8.10c and d for final % B values of 70 and 60%, respectively. Whereas the run of Fig.

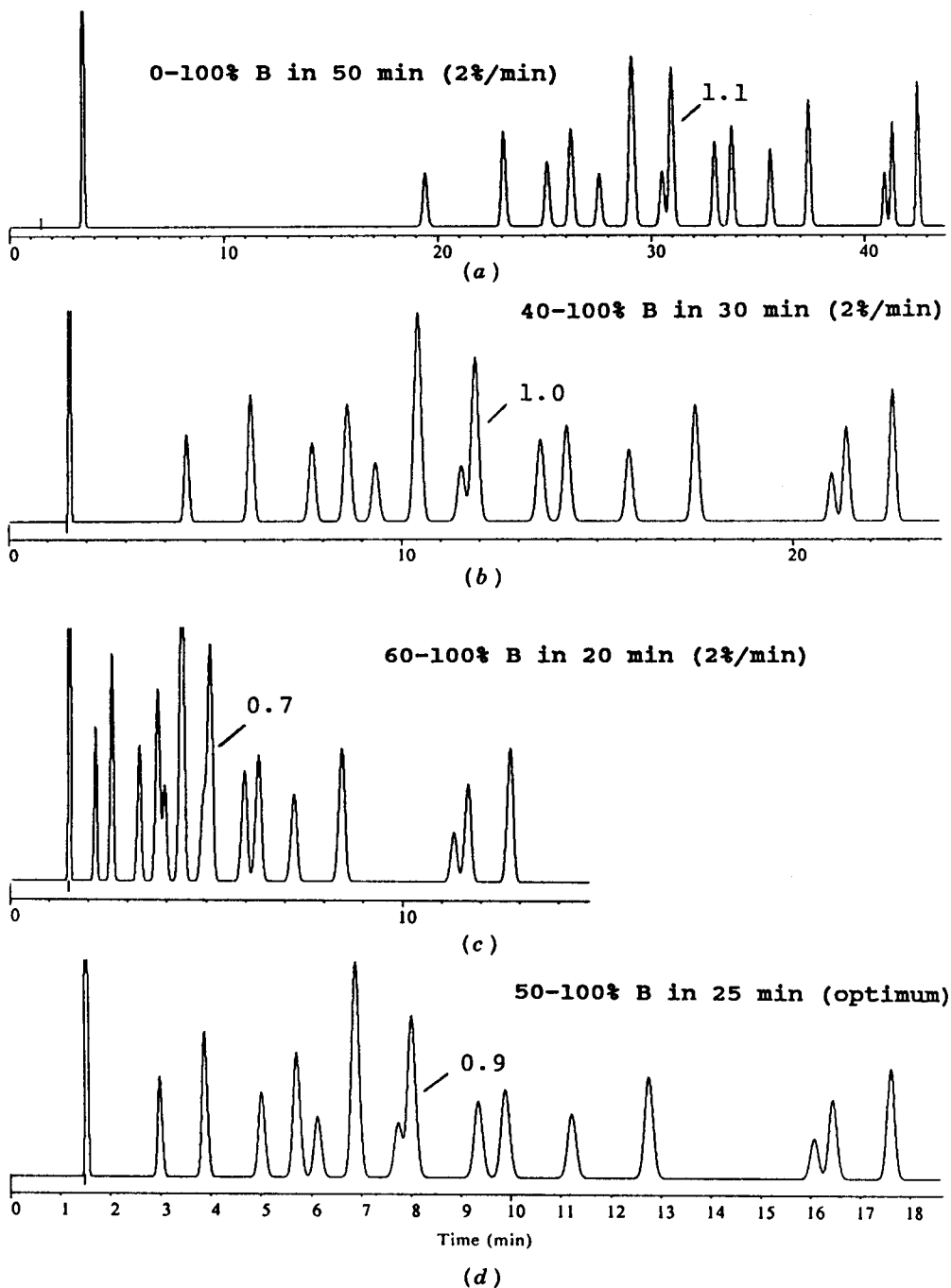

FIGURE 8.9 Gradient separation of a herbicide sample as a function of initial mobile-phase composition (% B). Gradient steepness is 2%/min; other conditions as in Fig. 8.8.

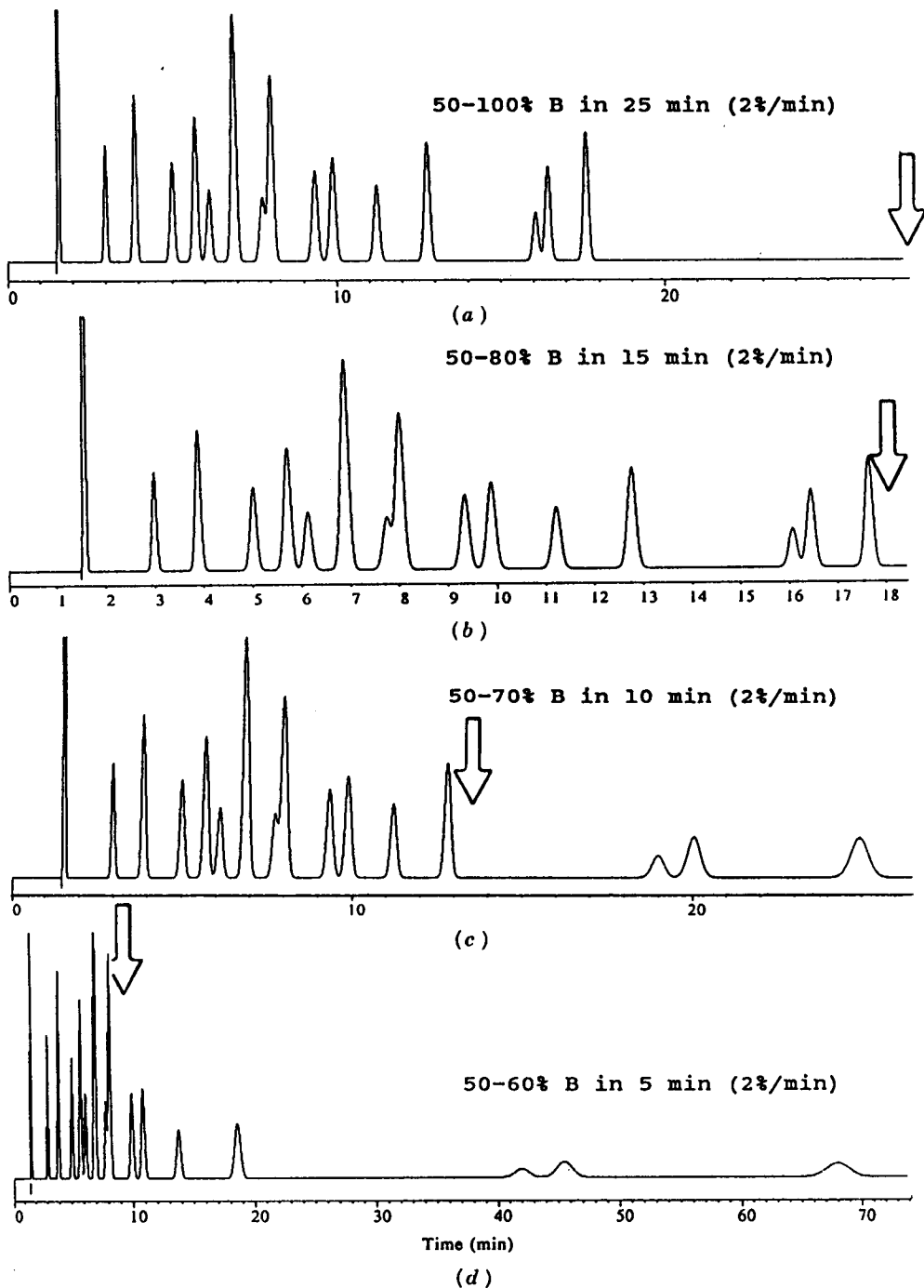

FIGURE 8.10 Gradient separation of a herbicide sample as a function of final mobile-phase composition (% B). Gradient steepness is 2%/min; other conditions as in Fig. 8.8.

8.10*b* is finished in 18 min, at which time column equilibration for the next run can be begun, the runs of Fig. 8.10*c* and *d* require 26 and 70 min, respectively, for their completion. Clearly, ending the gradient before elution of the last sample band is undesirable.

8.3.4 Effect of Gradient Shape

Most gradient separations involve linear gradients, as in the preceding examples. Linear gradients are easier to optimize and should be used in the preliminary stages of method development. However, non-linear gradients can provide a modest improvement in separation for some cases:

1. Homologous or oligomeric samples, where resolution normally decreases with increase in compound molecular weight and retention.
2. Chromatograms that have regions with either a large number of overlapping bands or a small number of widely separated bands.
3. Chromatograms where different regions exhibit optimum selectivity for gradients of differing steepness.

Optimizing gradient shape may require several experiments, and the potential advantage of a non-linear gradient is often marginal. The use of non-linear gradients makes more sense when computer simulation is available for the quick and convenient selection of the best conditions (Section 10.2.2).

8.3.4.1 Homologous or Oligomeric Samples. The gradient separation of these samples often exhibits a decrease in band spacing for later sample components. This is illustrated in Fig. 8.11*a* for the separation of a polystyrene sample into its oligomers. While the dimer through tetramer bands are baseline separated, later bands are increasingly less well resolved. The use of a convex gradient in Fig. 8.11*b* shows a more even spacing of these sample bands. The steeper initial gradient causes a decrease in k^* (Eq. 8.3) and a decrease in resolution and retention times, while the later less-steep gradient results in an increase in k^* and an increase in resolution and relative retention. The net result is a somewhat better overall separation in Fig. 8.11*b*, in about the same run time. Curved gradients as in Fig. 8.11*b* tend to equalize the resolution of all bands for samples of this kind.

A further study of oligomeric samples as in Fig. 8.11 has been reported [18]. It was shown that segmented gradients (as in Fig. 8.1) are able to provide the same improvement in separation for samples of this kind as can be achieved by curved gradients. Only two gradient segments are required, and the steepness of each segment must be optimized for best results (second segment less steep). The choice of initial % B is also critical for a more even band spacing. The main advantage of segmented gradients is that they are easier to optimize in a systematic manner. For this and other applications of non-linear gradients,

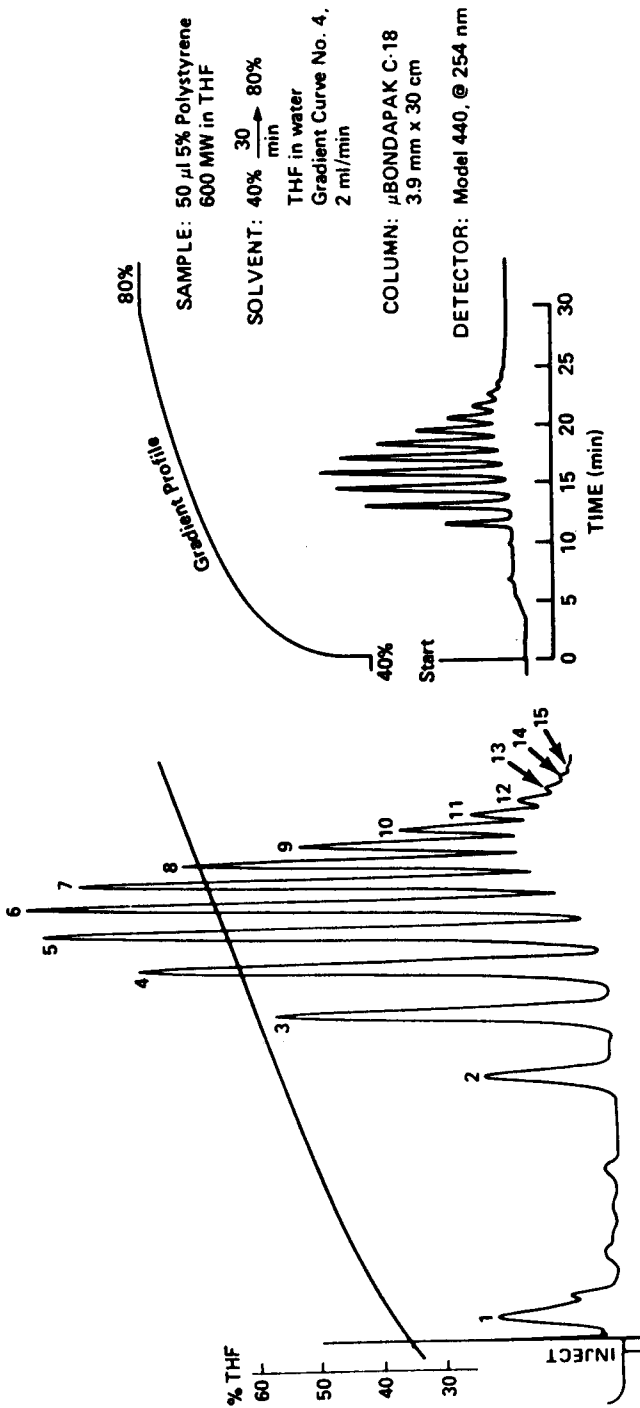

(b)

(a)

FIGURE 8.11 Separation of the oligomers of low-molecular-weight polystyrene by gradient elution. Conditions as shown in figure. (a) Linear gradient; (b) convex gradient. (Figure reprinted by permission of Waters Associates.)

we recommend that segmented gradients be explored before trying curved gradients. See Ref. 18 for further details.

8.3.4.2 Chromatograms with Peak Bunching. This situation also suggests the use of nonlinear gradients as a means of equalizing sample resolution. That is, a steeper gradient can be used in that part of the chromatogram where bands are widely separated (to save time), and/or a flatter gradient can be used in parts of the chromatogram where peaks are closer together (to increase resolution). This is illustrated for the gradient separation of 22 peptides in Fig. 8.12. In Fig. 8.12a the steepness of a linear gradient (0 to 47% B) has been adjusted to a value (0.63% B/min) that provides optimum band spacing and maximum resolution for critical band pairs 9/10, 11/12, and 14/15 (see Section 8.4.2). The resulting separation is adequate ($R_s = 1.3$), but the run time is somewhat long (75 min).

However, as seen in Fig. 8.12a, bands after band 15 (~48 min) are much better resolved, suggesting that this part of the sample can be separated with a steeper gradient for a reduction in run time. This shortening of the run time with no loss in sample resolution ($R_s = 1.3$) was achieved (Fig. 8.12b) by maintaining the original optimized gradient until bands 1 to 15 were eluted, then increasing gradient steepness for the fast elution of the remainder of the sample. In this way, the run time was reduced to 53 min, for a 30% savings in time. The use of non-linear gradients for further controlling selectivity is illustrated in Fig. 8.13d (Section 8.4.2).

8.4 DEVELOPING A GRADIENT SEPARATION

Method development for gradient elution can be carried out in the same systematic way as for isocratic separation. Thus, the proven strategies developed for isocratic method development can be used with equal advantage for gradient elution. The steps in gradient method development can be summarized as follows:

1. Select initial conditions in the same way as for isocratic separation: column, mobile-phase composition, flow rate, temperature, and so on (Table 1.3); whereas isocratic method development might be initiated with a strong mobile phase (80 to 100% B), the first gradient run should use a wide gradient range (e.g., 5 to 100% B). The initial separation

FIGURE 8.12 Gradient separations of a 22-component peptide sample (tryptic digest of r-human growth hormone). Conditions: 15 × 0.46-cm C₁₈ column; acetonitrile–water gradients with 0.1% trifluoroacetic acid; 40°C; 1.0 mL/min. (a) 0 to 47% B in 74 min; (b) 2:32:47% B in 0/48/56 min. (Reprinted with permission from Ref. 19.)

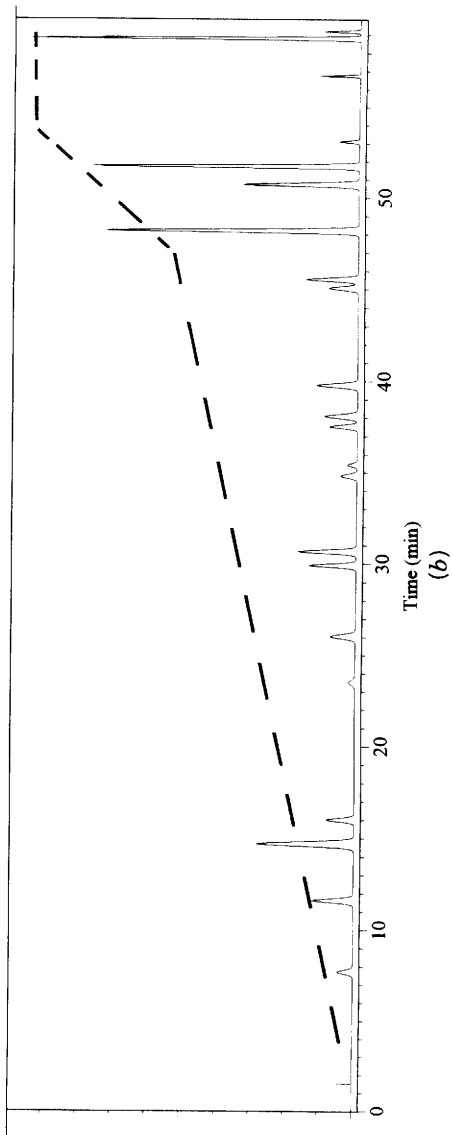
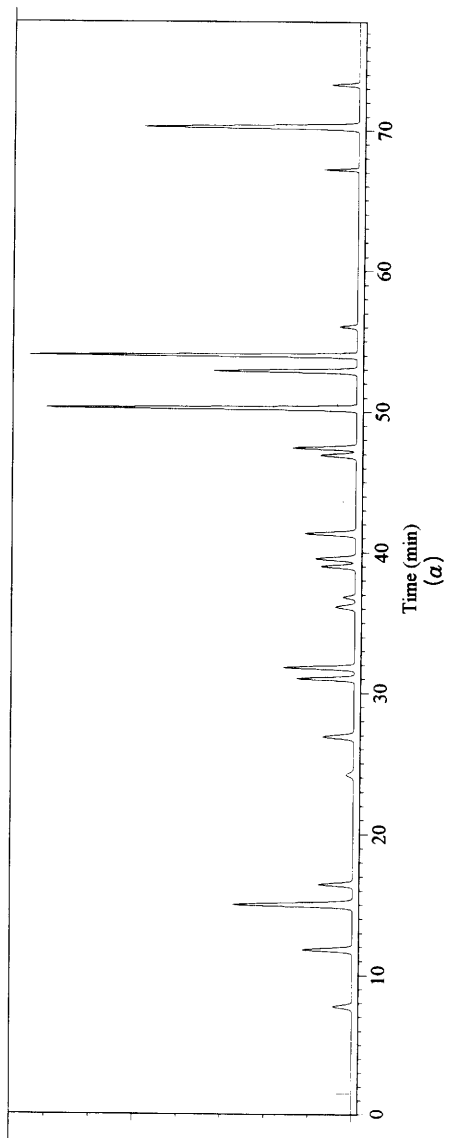

should be optimized initially for k^* (e.g., $k^* > 2$; Eq. 8.2). This requires a gradient that is not too steep.

2. The gradient range is next adjusted to minimize run time, by eliminating wasted space at the beginning and end of the chromatogram.
3. If overlapping bands are observed or the run time is too long, vary the selectivity (α).
4. (*optional*) Consider the use of a non-linear gradient shape as a means of further improving separation.
5. When band spacing has been optimized, vary column conditions for improvement of resolution and/or run time.
6. Determine the best protocol for column re-equilibration and investigate the effect of equipment differences on the separation (Section 8.5.1).

8.4.1 Selecting Gradient Conditions

Figures 8.8 to 8.10 illustrate the most important steps in the selection of optimized gradient conditions. These experiments can be compared to the trial-and-error adjustment of % B in isocratic separation for the purpose of controlling k .

8.4.1.1 Gradient Steepness. The initial selection of gradient steepness (as in Fig. 8.8) should be preceded by an estimate of experimental conditions that will provide $k^* > 2$ for all sample bands (Eq. 8.2). If it is known that gradient elution will be used for the final method, $k^* \approx 5$ is a good first choice. The column (and resulting value of V_m) and the flow rate will have been selected prior to carrying out the first gradient separation; a 15×0.46 -cm, $5\text{-}\mu\text{m}$ C₈ or C₁₈ column at 2 mL/min is a good choice. Usually a full-range gradient will be used for the first separation: [e.g., 5 to 100% B ($\Delta\% \text{ B} = 95$)]. Therefore, the only variable in Eq. 8.2 that is not specified is gradient time t_G (Eq. 8.2 assumes that $S \approx 4$). We can solve Eq. 8.2 for t_G :

$$t_G \approx 25 \frac{V_m}{F} \quad (5\text{--}100\% \text{ B}) \quad (8.4)$$

For example, for a 15×0.46 -cm column, $V_m \approx 0.1 \times 15 = 1.5$ mL (Eq. 2.7). If the flow rate is 2 mL/min, the recommended value of t_G is $25 \times 1.5/2 = 19$ min.

8.4.1.2 Gradient Range. If an initial gradient run is carried out for the conditions of Table 8.2, (5 to 100% B in 60 min; 15×0.46 -cm column; 2.0 mL/min; $k^* \approx 17$), best values of initial and final % B can be estimated from Table 8.3. Alternatively, the use of a 20-min gradient (for $k^* \approx 5$) can be followed by trial-and-error studies as in Figs. 8.9 and 8.10 to further optimize gradient range. If it is known that gradient elution will be required prior to an initial run, an initial 20-min gradient is recommended for small molecules (< 2000 Da).

8.4.1.3 Gradient Shape. The separation of Fig. 8.10*b* is roughly optimized for gradient range and steepness. At this point we should consider whether a non-linear (i.e., segmented) gradient can improve the separation further. For this example, this does not appear to be the case. That is, no region of the chromatogram is especially crowded with bands while other regions are relatively empty. The resolution provided by this separation is marginal, however; the next step in method development is to investigate conditions for an improved band spacing (which *might* be achieved with a segmented gradient; see Section 8.4.2.1).

8.4.2 Varying Band Spacing

A change in selectivity or band spacing can be achieved in gradient elution in the same way as for isocratic separation [i.e., by changing k or k^* (% B for isocratic elution; gradient steepness for gradient elution), solvent type, column type, pH, HPLC method, temperature, etc.]. The choice of which variable to study first is governed by the same considerations discussed for isocratic HPLC in Chapters 2, 6, and 7. Reversed-phase gradient elution is examined here by way of illustration, but the extension of this approach to other HPLC methods should be apparent.

In the reversed-phase separation of neutral samples, variables for changing selectivity can be prioritized as follows: mobile-phase strength (k^*) first, then solvent type (acetonitrile > methanol > THF), column type (C_8 or C_{18} > cyano > phenyl), and finally, temperature. In the case of ionic samples, pH and temperature are important variables for controlling selectivity. Varying the concentration of an ion-pair reagent in gradient elution is also effective for varying selectivity in the separation of ionic samples. However, because of the slow equilibration of reagent uptake by the column during the gradient, ion-pair gradient elution should be avoided. The required equilibration volume for ion-pair gradient elution has been discussed [20]. This study suggests that 5 to 10 column volumes are adequate for less hydrophobic ion-pair reagents (e.g., C_8 -sulfonate or smaller); however, longer times are required for C_{12} -sulfonate.

8.4.2.1 Gradient Steepness. Varying % B in isocratic separation causes k and α to change. An equivalent effect (change of k^* and α) can be achieved in gradient elution by varying gradient steepness G_s (Eq. 8.2). In isocratic elution, the k range of the sample limits the variation of k for selectivity control within fairly narrow limits. For example, if $2 < k < 10$, k can be reduced by no more than a factor of 4 ($k = 0.5$) nor increased by more than a factor of 2 ($k = 20$). Thus k can be varied by at most a factor of 8 (4×2) in this typical example. In the case of gradient elution, k^* (which is roughly the same for all bands) can be changed from 0.5 to 20, or by a factor of 40. This means that much larger changes in α and band spacing are possible in gradient elution by varying gradient steepness (or k^*) than in isocratic separation by varying % B (k). Furthermore, by the use of segmented gradients, k^*

can be optimized for different parts of the chromatogram so as to maximize overall selectivity and resolution. *Therefore, the control of band spacing by a change in k or k^* can be a much more powerful tool in gradient elution than for isocratic separation.*

Some samples show major changes in band spacing as gradient steepness is varied, whereas other samples do not. The herbicide sample of Fig. 8.8 does *not* exhibit significant changes in selectivity as gradient steepness is varied. The 16-component polyaromatic hydrocarbon (PAH) sample of Fig. 8.13, on the other hand, provides a good example of changes in band spacing with gradient steepness. For a gradient time of 7 min (Fig. 8.13a, 8.6%/min), the critical band pair is 3/4 (indicated by an asterisk) with a resolution of $R_s = 1.0$. When the gradient time is increased to 20 min (Fig. 8.13b, 3%/min), the resolution of band pair 3/4 increases ($R_s = 1.5$), as might have been expected for a flatter gradient. However, now the critical band pair is 14/15 (indicated by an asterisk) with $R_s = 0.9$. Thus, bands 3 and 4 are best separated with a flatter gradient, while bands 14 and 15 prefer a steeper gradient.

In isocratic elution, two chromatograms that exhibit a change in the critical band pair (when conditions are changed) suggest that an *intermediate* condition will give the best overall separation (largest R_s for the critical band pair). This is also the case for the gradient elution example of Fig. 8.13. An intermediate gradient time (12.5 min in Fig. 8.13c) gives a greater resolution for critical band pairs 3/4 and 14/15; $R_s = 1.4$. This separation is clearly better than that of Fig. 8.13a or b. Many samples show changes in band spacing as gradient steepness is varied, similar to that of Fig. 8.13 [1,17–19,21,22]; analogous isocratic examples (Sections 6.3.1, 7.3.2.2, and 7.4.4.1) further support this conclusion. To conclude, a change in gradient steepness is often the most effective way to change selectivity in gradient elution. It should be explored first, before other variables for altering selectivity are investigated.

The two critical band pairs of Fig. 8.13 that occur early and late in the chromatogram suggest the use of a segmented gradient for the further enhancement of selectivity. An initial flat gradient can be used to optimize the separation of bands 3/4, while a later steep gradient can be used to optimize the separation of bands 14/15. This is verified in the separation of Fig. 8.13d; a further increase in resolution is obtained ($R_s = 1.7$ vs 1.4 in Fig. 8.13c) in about the same run time. It is worth noting how much improvement in separation is possible between the run of Fig. 8.13b ($R_s = 0.9$, run time 18 min) and that of Fig. 8.13d ($R_s = 1.7$, run time 13 min) as a result of optimizing gradient steepness and shape.

Whether a segmented gradient as in Fig. 8.13d will be useful in other cases depends on sample molecular weight and the relative positions of the two or more critical band pairs in the chromatogram. When the critical band pairs are closer together, segmented gradients will be less useful, especially for the case of sample molecular weights below 1000 Da. Before developing a segmented-gradient method for the purposes of improving selectivity and resolution, it must first be shown that maximum resolution for two or more

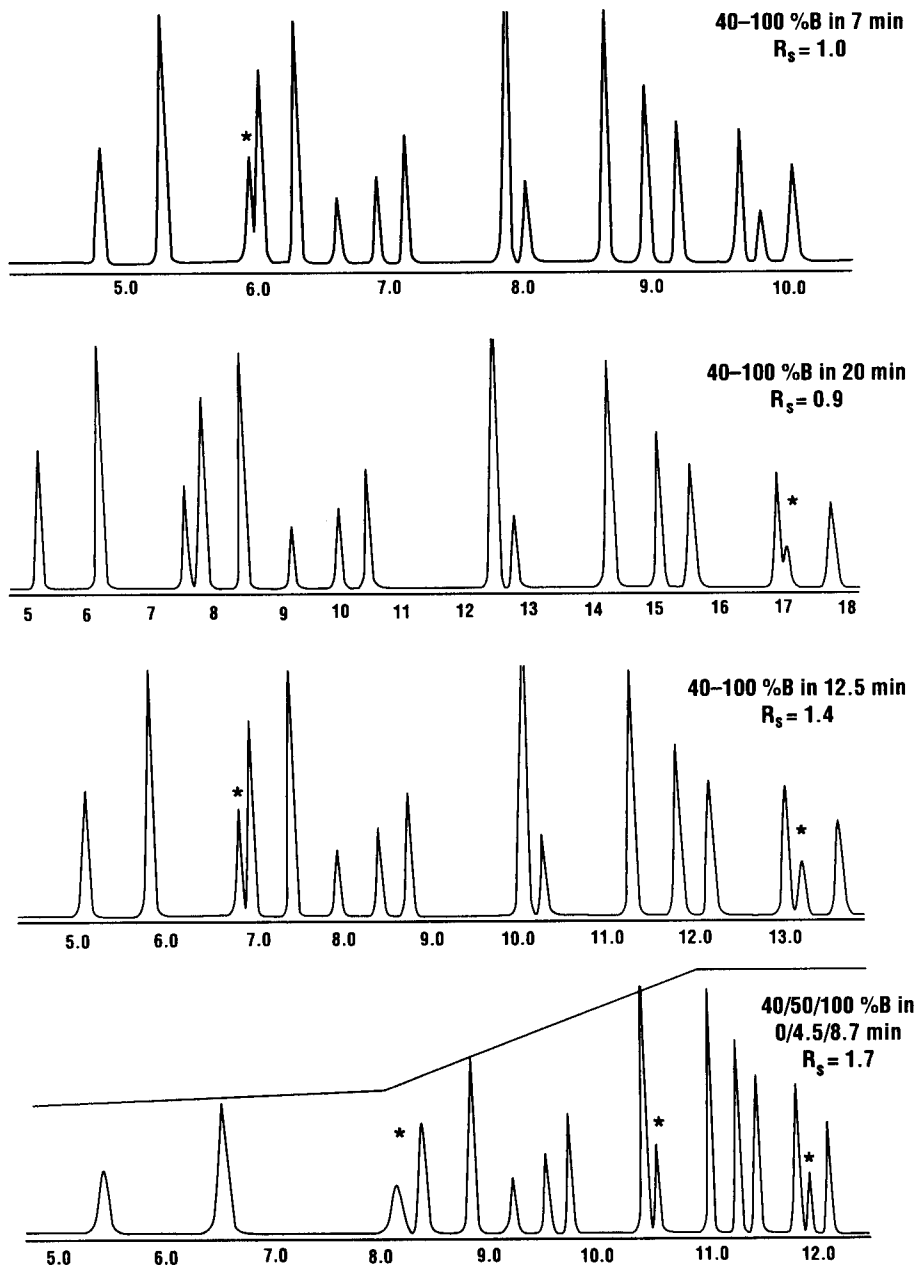

FIGURE 8.13 Gradient separations of a polyaromatic hydrocarbon sample as a function of gradient steepness. Sample: 16 compounds ranging from naphthalene to indenopyrene. Conditions: 15×0.46 -cm Supelco LC-PAH (reversed-phase) column; acetonitrile-water gradients; 2 mL/min; 35°C . (Computer simulations based on data of Ref. 21.)

critical band pairs occurs for different gradient steepness values. When that is the case, the initial gradient segment is selected to give acceptable resolution for the first-eluting critical pair. Shortly before that band pair leaves the column, the gradient steepness is changed to provide acceptable resolution of the next critical band pair (and so on for subsequent critical pairs). For a further discussion of this question and practical rules for optimizing these segmented gradients, see Refs. 18 and 23.

8.4.2.2 Solvent Type. A change in organic solvent is often useful as a means of changing selectivity in isocratic separation, especially for non-ionic samples (Chapter 6); similar effects have been observed for gradient elution [24,25]. An example is shown in Fig. 8.14 for the separation of a mixture of phenols. In Fig. 8.14a, a 0 to 100% acetonitrile–water gradient is used, and only bands 8/9 overlap. Since a change in selectivity is required to improve the resolution of bands 8/9, methanol was substituted for acetonitrile and the separation was repeated (Fig. 8.14b). Because there are no bands before 18 min in the separation of Fig. 8.14a, the second gradient (Fig. 8.14b) was started at 20% methanol–water (instead of 0% acetonitrile in Fig. 8.14b). Now the separation of bands 8/9 is improved, but band pair (2/3) has become critical.

Two isocratic separations with methanol and acetonitrile as solvents might give chromatograms similar to those of Fig. 8.14a and b (i.e., with a change in the critical band pair). When this occurs for isocratic separation, a mobile phase containing some combination of methanol and acetonitrile (50:50) can be used to achieve a (slightly) better separation than in either Fig. 8.14a or b. A similar approach could be used in the gradient separation of Fig. 8.14 (i.e., use some mixture of methanol and acetonitrile as solvent B). A better approach is indicated, however, by the fact that early bands (2/3) prefer acetonitrile and later bands (8/9) prefer methanol. This observation suggests the use of a gradient for which the methanol/acetonitrile ratio *increases* during the run. This approach was used in Fig. 8.14c, where the overall separation of the sample is clearly better than in either of the two preceding runs. In this case, the separation of band 2/3 is as good as with the acetonitrile–water gradient (Fig. 8.14a), while the separation of bands 8/9 is as good as for the methanol–water gradient (Fig. 8.14b). This ability of gradient elution to provide *different* selectivity changes for different parts of the chromatogram is a powerful tool for certain samples. Similar examples are reported in Ref. 25.

8.4.2.3 Other Variables. A number of reported studies have demonstrated changes in gradient elution selectivity as a function of other variables (applica-

FIGURE 8.14 Effect of solvent type on separation in gradient elution. Sample: mixture of phenols. Conditions: 30×0.42 -cm C_{18} column; gradients as in figure; 1.0 mL/min; ambient. (Reprinted with permission from Ref. 24.)

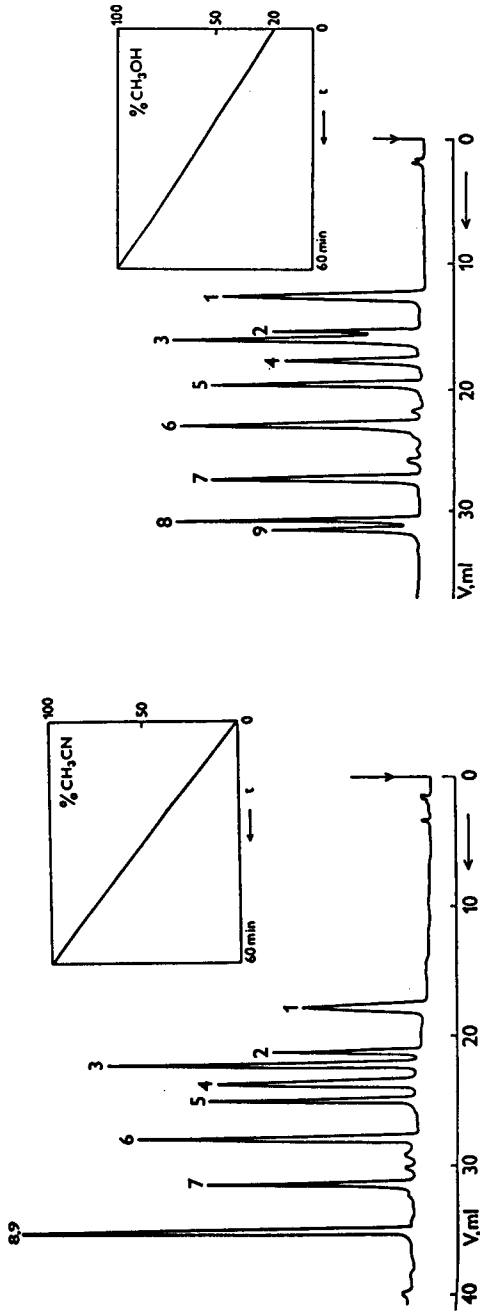

(a)

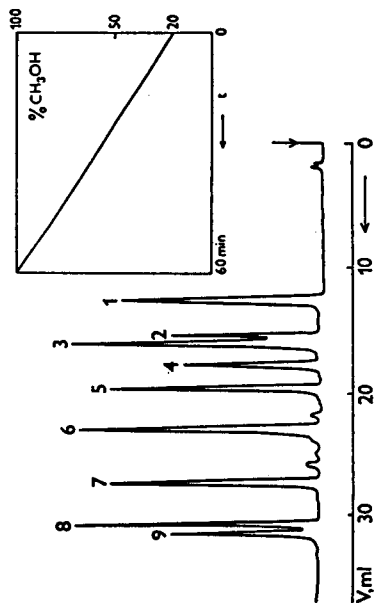

(b)

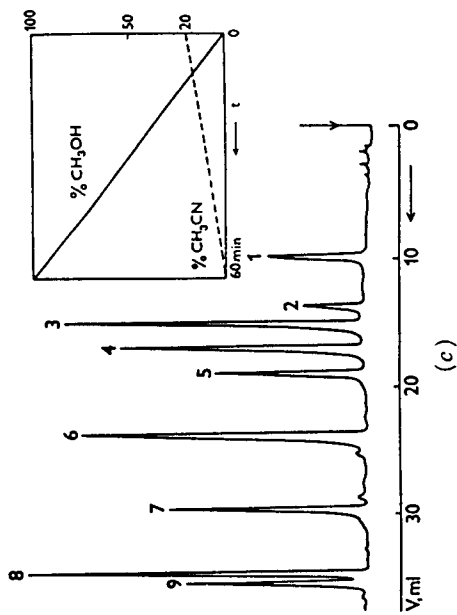

(c)

ble primarily for ionic samples): pH [26], ion-pairing reagent concentration (Fig. 11.11), temperature [27]; see also Fig. 11.9. For a prioritization of these and other variables, see the recommendations of Fig. 7.7 for isocratic separation. While selectivity effects in isocratic and gradient elution are quite similar, solvent-strength selectivity (k^*) is much more important in gradient elution than for isocratic separation. The use of buffers and ion-pair reagents in gradient elution requires more attention than in isocratic separation, due to poor solubility of some buffers in high-% B mobile phases and varying uptake of ion-pair reagents as % B is varied (Fig. 7.13, Section 8.5.2.2).

8.4.3 Adjusting Column Conditions

Once retention has been optimized in terms of k^* and α (including the possible use of segmented gradients), further improvements in separation are possible by varying column conditions: column length, particle size, and/or flow rate. In isocratic separation, a change in column conditions has no effect on k , so it is possible to change one column condition at a time (e.g., column length) without concern for changes in k or α . This is not the case for gradient elution, because k^* depends on column dimensions and flow rate (Eq. 8.2). Consequently, if *only* column length or flow rate is changed, the separation will be affected in two different ways: (a) the column plate number N will change in predictable fashion (Section 2.3.3.2), but (b) k^* (and possibly α) will change also. This effect is illustrated in Fig. 8.15 for a change in flow rate.

A group of six bands from each chromatogram of Fig. 8.15a (arrows) is shown in Fig. 8.15b (i.e., part of the whole chromatogram). A change in flow rate from 0.5 mL/min to 1.5 mL/min (constant gradient time) leads to major changes in band spacing: bands 5 and 5a coalesce, bands 6 and 6a begin to separate, and bands 6b and 7 reverse positions. One can take advantage of these selectivity changes in Fig. 8.15 by changing gradient time, as in Fig. 8.13, and this is usually the best approach. However, once k^* and α are optimized *prior* to changing column conditions, *the same k^* value must be maintained while changing column conditions*. Otherwise, what is gained in terms of N may be lost in terms of α .

Constant k^* is achieved by holding $G_s = (V_m/F) (\Delta\%B/t_G)$ constant. This is done most conveniently by varying gradient time t_G when changing flow rate (F) and/or column length (V_m). If column length is increased by some factor x , gradient time should be increased by the same factor x . If flow rate is decreased by some factor x , gradient time should be increased by the same factor x . The effects of a change in flow rate or column length on gradient elution run time (holding k^* constant) are thus the same as in isocratic separation (i.e., longer run times for longer columns or slower flow rates).

Figure 8.16 and Table 8.4 illustrate the optimization of column conditions while holding k^* and selectivity constant, for the herbicide sample of Fig. 8.8. After optimizing gradient conditions (Fig. 8.16a; 40 to 77% B in 25 min, 2 mL/min), resolution is still marginal: $R_s = 1.1$ (an asterisk marks the critical

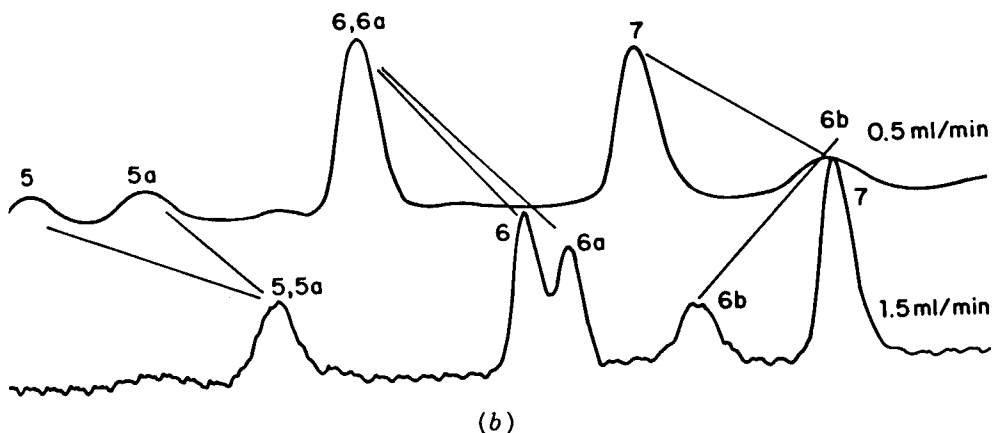
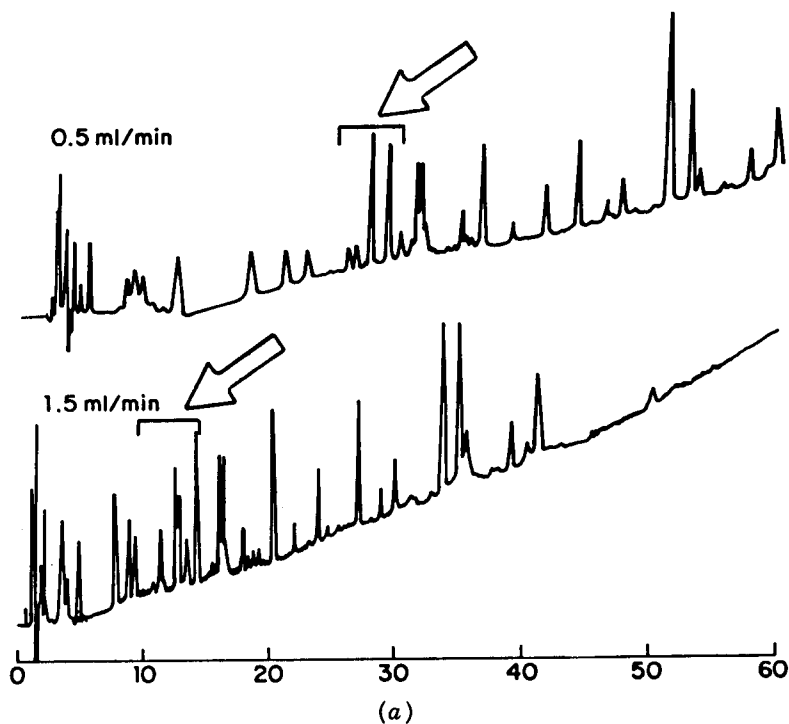

FIGURE 8.15 Effect of a flow-rate change on selectivity in gradient elution. Sample: peptides from tryptic digest of myoglobin. Conditions: 8×0.62 -cm C_8 column; 10 to 70% acetonitrile–water gradient in 60 min [0.1% trifluoroacetic acid in (a) and (b)]; flow rates as indicated; 35°C . (a) Entire chromatograms; (b) expansions of parts of each chromatogram from (a) (see arrows). (Reprinted with modifications from Ref. 28.)

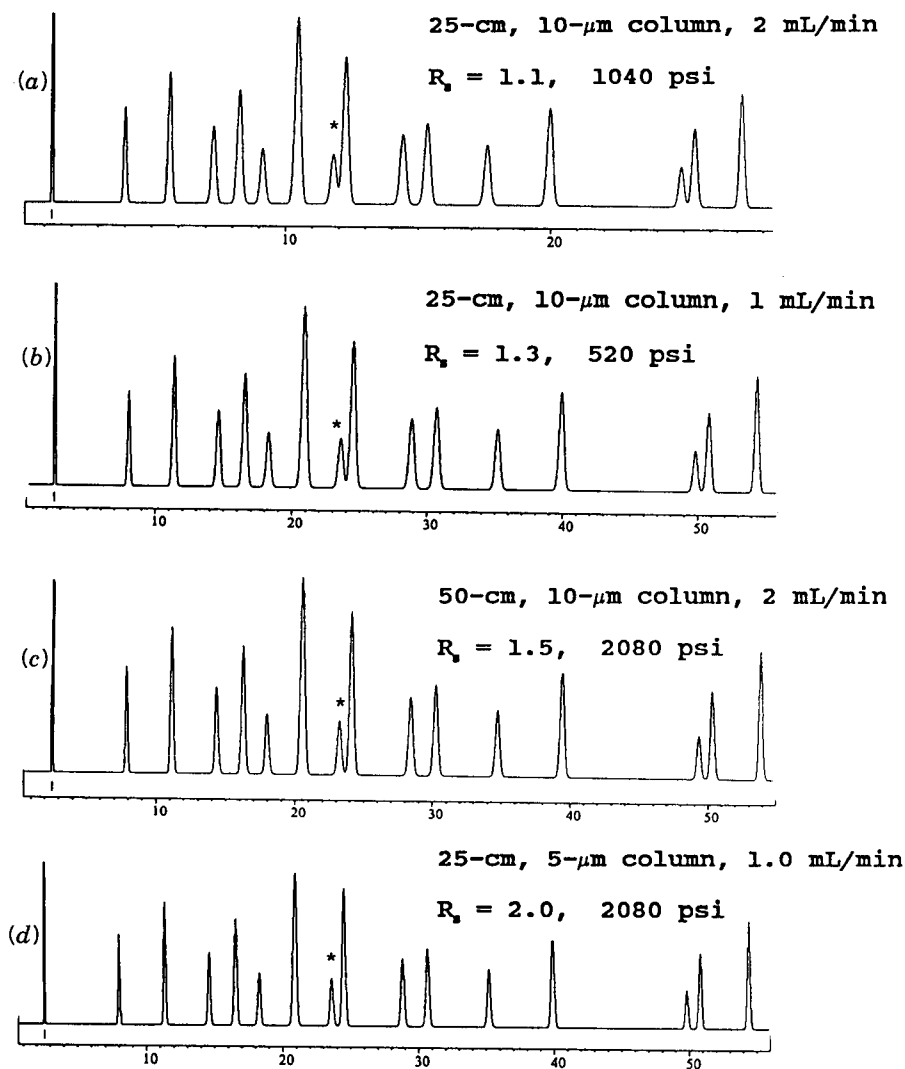

FIGURE 8.16 Gradient separation of a herbicide sample as a function of column conditions. Conditions of Fig. 8.8, except 40 to 77% B gradient (0.7%/min) and as noted in figure. See also Table 8.4.

band pair). A reduction in flow rate from 2 mL/min to 1 mL/min is expected to improve resolution. However, to maintain k^* constant, gradient time must be increased simultaneously from 25 min to 50 min. The resulting resolution increase in Fig. 8.16b ($R_s = 1.3$) is rather small for this doubling of run time, as is often the case when varying flow rate with small-particle ($< 10\text{-}\mu\text{m}$) columns. An increase in column length is usually more effective. Figure 8.16c shows the separation for a 50-cm column and the same flow rate as in Fig.

TABLE 8.4 Gradient Separation of a Herbicide Sample as a Function of Column Conditions, Holding k^* Constant^a

Column Conditions			Separation		
Length (cm)	Particle (μm)	Flow Rate (mL/min)	R_s	Time ^b (min)	Pressure (psi)
25	10	2.0	1.1	25	1040
25	10	1.0	1.3	50	520
50	10	2.0	1.5	50	2080
25	5	1.0	2.0	50	2080

^a Separations of Fig. 8.16. Column conditions specified in table; other conditions as in Fig. 8.8, except 40 to 77% B gradients.

^b Gradient time t_G .

8.16a. The gradient time must again be increased to 50 min to maintain k^* constant, but resolution is now marginally acceptable ($R_s = 1.5$).

At this point, a decrease in particle size from 10 μm to 5 μm can be considered. Figure 8.16d shows such a separation, with flow rate decreased at the same time, to maintain an acceptable column pressure. Resolution is quite good ($R_s = 2.0$) for a gradient time of 50 min. Note that a change in particle size alone does not require a change in gradient time to maintain k^* constant. In this case, flow rate was decreased because of the need for an acceptable pressure drop with this 5- μm -particle column, which in turn required an increased gradient time.

The choice of which column condition(s) to vary in gradient elution is the same as for isocratic separation (Section 2.3.3). In both cases, larger values of N can be obtained at the expense of longer run times. For minor improvements in resolution (10 to 20%), where an increase in run time is less important, it is convenient to reduce flow rate. When a larger increase in R_s is required, an increase in column length is generally preferred. If resolution must be increased without increasing run time or pressure, a decrease in particle size (accompanied by decrease in column length and/or flow rate) is the only option. When changing the column (length or particle size), it should be recalled that this may lead to detrimental changes in selectivity due to small differences in the column packing from batch to batch (Section 5.2.4). If resolution is greater than required after optimizing selectivity, this excess resolution can be traded for a shorter run time by increasing flow rate and/or reducing column length.

8.5 EXPERIMENTAL CONSIDERATIONS

Gradient elution is subject to the same experimental problems that can arise in isocratic separation and which adversely affect detection, reproducibility, precision, and so on. The within-run change in mobile-phase composition that

is unique to gradient elution can lead to additional effects and potential problems, some of which were listed at the beginning of this chapter. These gradient effects are examined in this section.

8.5.1 Effect of Equipment on Separation: System Dwell Volume

8.5.1.1 Equipment Differences. Two kinds of equipment are used for gradient elution: high-pressure mixing systems and low-pressure mixing systems, as illustrated in Fig. 8.17a. High-pressure mixing combines solvents A and B immediately after the pump (at high pressure), whereas low-pressure mixing

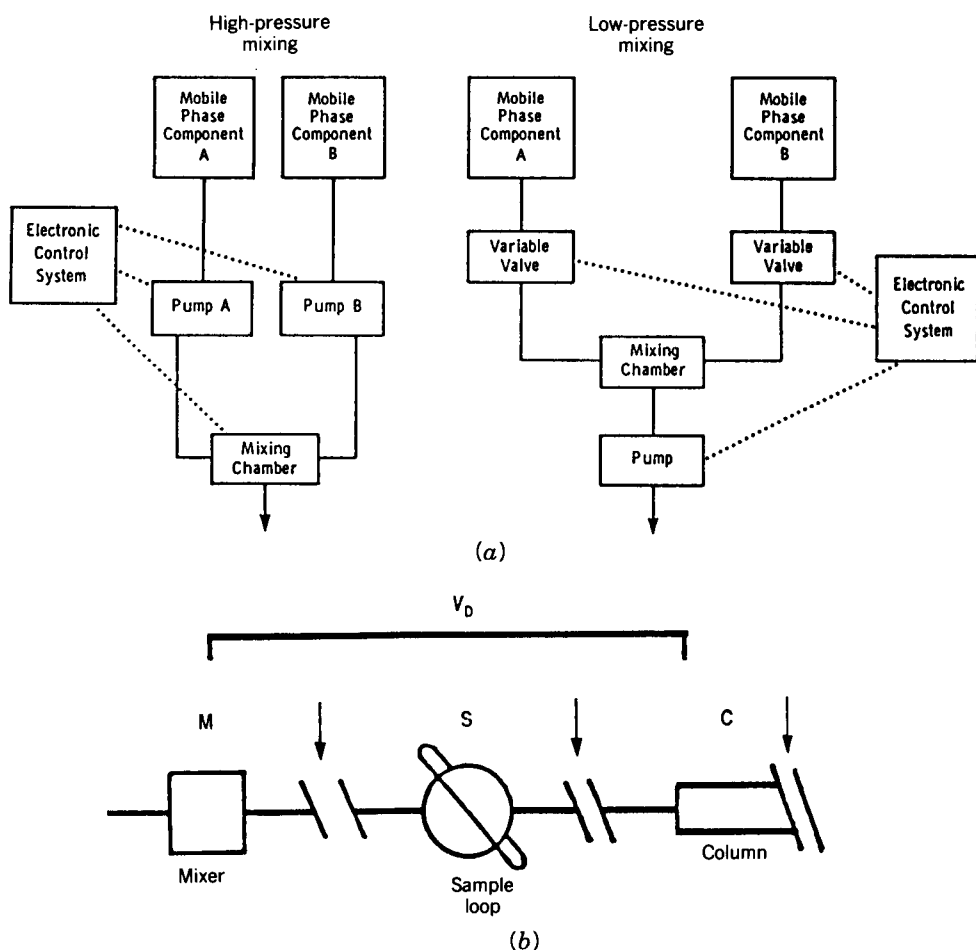

FIGURE 8.17 Different gradient equipment designs and dwell volume V_D . M, mixer; S, sampler; C, column; arrows indicate other modules, such as pump, filters, and so on. (Reprinted with permission from Refs. 29 and 30.)

combines the solvents before the pump. In high-pressure-mixing (HPM) systems, the gradient, once formed, moves directly to the autosampler or sample valve. For low-pressure-mixing (LPM) equipment, the gradient passes through the pump and associated modules before arriving at the sample injector.

The main effect on separation of the gradient equipment design is reflected in the hold-up or "dwell" volume V_D , as illustrated in Fig. 8.17*b*. Other factors being equal, LPM systems should have larger values of V_D . Table 8.5 summarizes values of the dwell volume for some representative HPLC equipment. The use of an autosampler usually adds significantly to V_D as a result of the hold-up volume of these devices. With inclusion of an autosampler, values of V_D usually range between 2 and 8 mL, but poorly plumbed equipment can have a dwell volume above 10 mL. Note that the volume of the sample loop adds to the dwell volume, so values of V_D for an HPLC system can vary if the loop is changed.

8.5.1.2 Changes in Separation for Different HPLC Systems. The primary effect of a difference in equipment dwell volume on gradient separations is to shift sample retention times to higher or lower values (by an amount related to the dwell time $t_D = V_D/F$). Increased dwell volume is also equivalent to adding an isocratic hold to the beginning of the gradient. These effects are illustrated in Fig. 8.18*a* for a hypothetical separation. For a dwell volume of

TABLE 8.5 Values of Dwell Volume V_D for Some Representative HPLC Gradient Systems

System	V_D (mL)	
	No Autosampler	With Autosampler
Beckman System Gold	2.3	
Bischoff ^a		1.0
DuPont 8800	5.5	
Hewlett-Packard 1090	0.5	2.3
IBM LC/9533	4.5	
Perkin-Elmer Analyst ^b	3.4	3.9
Perkin-Elmer Analyst ^c	6.1	6.6
Shimadzu ^d		3.1
Spectra-Physics 8700	4.5	
Varian Star ^e	1.0	
Waters Model 501	5.0	8.0 ^f

Source: Ref. 29.

^a Pump model 2250 with Alcott A/S model 2250.

^b Model 620 pump, model ISS 100C A/S; mixing coil removed.

^c Same as footnote *b*, except with mixing coil.

^d LC 10AD pump, ICI A/S model AS2000.

^e Model 9010 pump, model 9090 A/S.

^f WISP model 712.

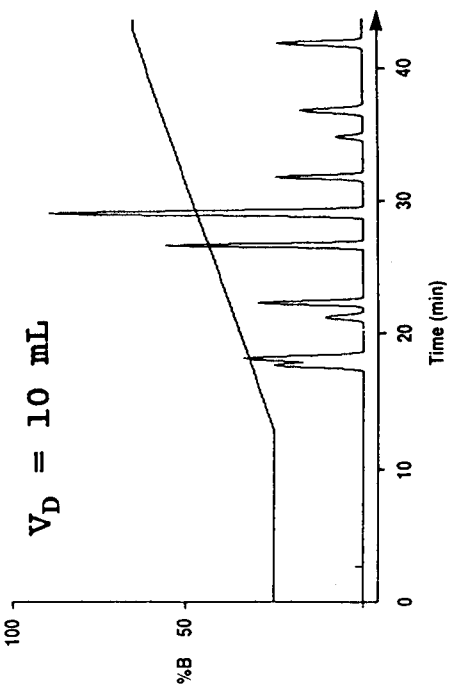
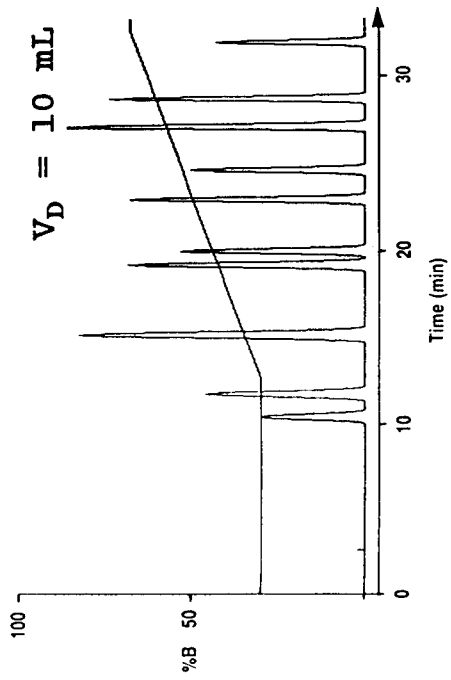
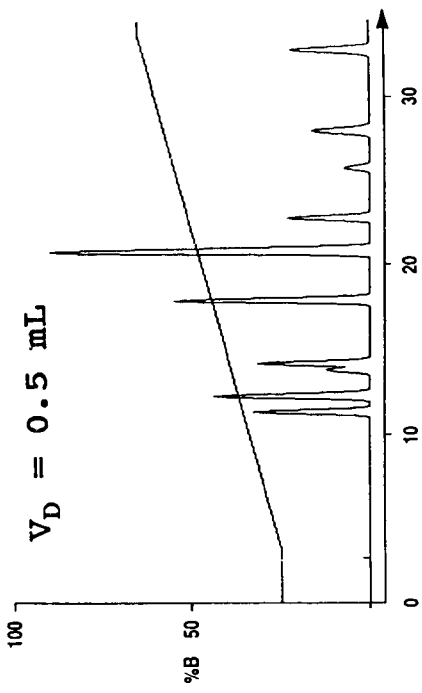
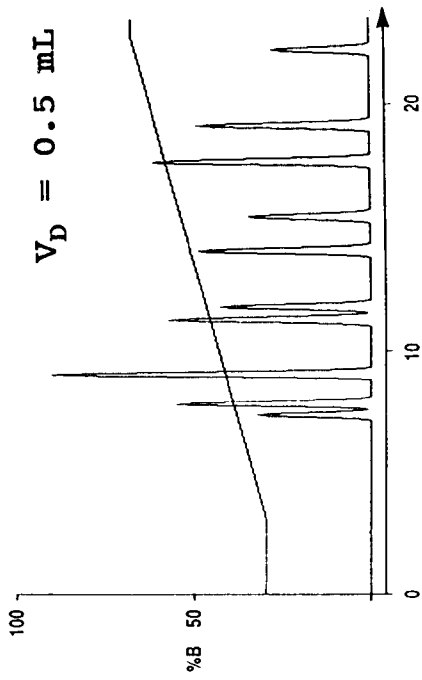

(a)

(b)

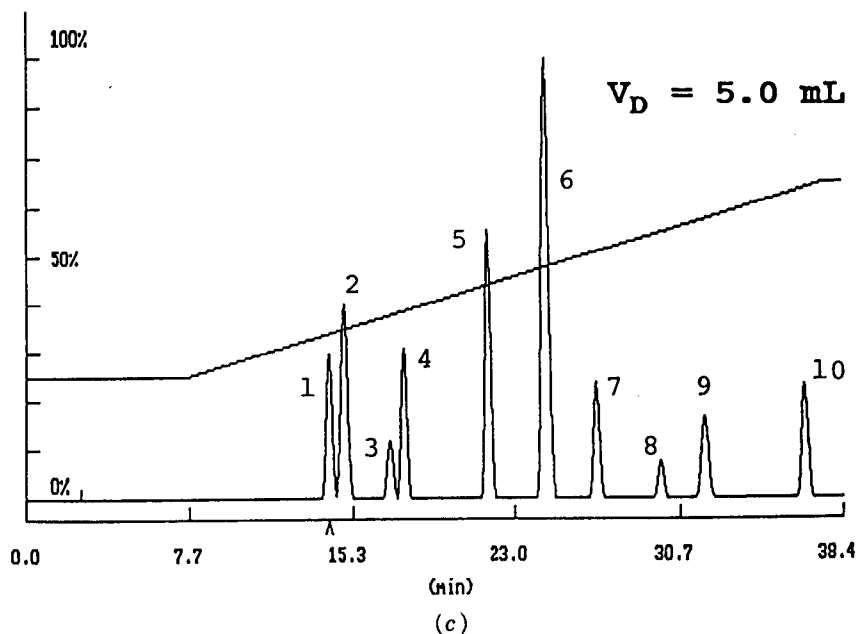

FIGURE 8.18 Effect of differing dwell times on gradient separation. Hypothetical samples, 1 mL/min flow rate. (a) Typical sample; (b,c) atypical sample. See the text for details. (Reprinted with permission from Ref. 29.)

0.5 mL and a flow rate of 1 mL/min, the dwell time $t_D = 0.5$ min and the last peak leaves the column at 22 min. The same separation carried out with a system having $V_D = 10$ mL and $t_D = 10$ min shows the last band leaving the column at 31.5 min [i.e., an increase in retention time by an amount (9.5 min) equal to the difference in t_D values]. Early bands show longer retention for the 10-mL system, but the difference in retention times (vs. the 0.5-mL system) is not as great (≈ 3 min). In addition, the resolution of early bands is somewhat better for separation with the 10-mL system. The behavior seen in Fig. 8.18a is typical of what can be expected when gradient separations are carried out on HPLC systems having different values of V_D .

For some samples the effects seen in Fig. 8.18a are accompanied by changes in band spacing and resolution at the front of the chromatogram. This effect is illustrated for a different sample in Fig. 8.18b and c. In Fig. 8.18c, the use of a system with $V_D = 5$ mL separates bands 1 to 4 with baseline resolution. However, the use of equipment having different dwell volumes (0.5 or 10 mL) results in major changes in band spacing and a loss in sample resolution (Fig. 8.18c). It is possible to anticipate which samples will behave in this way (Fig. 8.18b and c); samples that have early bands whose spacing (selectivity) changes with either gradient steepness or the value of initial % B are likely to cause problems of the kind illustrated in Fig. 8.18b. See also the discussion of Ref.

29. The use of computer simulation (Section 10.2.2) allows the effect of system dwell volume on separation to be predicted without the need for additional experiments or the use of a system with a different dwell volume.

A further effect of a change in system dwell volume on gradient separation is illustrated in Fig. 8.19 for the repetitive analysis of a series of samples. In Fig. 8.19a for a system with $V_D = 0.5$ mL, the gradient reaches the autosampler soon after sample injection (marked by arrows). At the end of each gradient run, the column is reequilibrated by flushing the column with the starting mobile phase. In Fig. 8.19b the same separation is carried out on a system with $V_D = 10$ mL. Because of the delay in arrival of the gradient at the autosampler, the second and following samples are injected before the previous gradient is completed. As a result, these samples are eluted under initial conditions of high % B, and early bands (A to D) are therefore unresolved.

The phasing problem seen in Fig. 8.19b due to differences in dwell volume for different HPLC systems can be avoided by allowing additional time for column equilibration. The required additional time is equal to the increase in dwell time. For the example of Fig. 8.19, the increase in dwell volume is 9.5 mL and the flow rate is 1 mL/min. Therefore, the column equilibration time should be increased by the difference in t_D , equal to the difference in dwell volume divided by flow rate: $9.5/1 = 9.5$ min. See Section 8.5.1.3 and Ref. 29 for a further discussion of these dwell-volume-related effects.

It should be apparent from the preceding discussion that the final gradient method must take into account possible differences in dwell volume among HPLC systems that will be used for the analysis. Otherwise, a method that works on one HPLC system may be unsatisfactory when used with different equipment. System-dwell-volume effects become more important as column diameter is decreased because the lower flow rate required for these columns leads to a large delay in the arrival of the gradient at the column inlet ($t_D = V_D/F$). Therefore, separations that involve columns of narrow diameter (e.g., 1 mm or smaller) generally require special gradient elution equipment that has very small values of V_D [31].

8.5.1.3 Minimizing the Effect of Equipment Dwell Volume. Because dwell-volume differences are a major reason that gradient methods may not transfer well between different systems, it is important to state the dwell volume of the original system in the method procedure. In addition, it is helpful to develop gradient methods that can tolerate differences in dwell volume. Three procedures for minimizing the effects of variable dwell volume on separation have been reported. First (and best), some system controllers allow the injection of the sample at a precise time *after* the gradient is begun. If sample injection is delayed by the time t_D , the arrival of the gradient and the sample at the column inlet occurs at the same time. This procedure eliminates the effect of dwell volume on the separation [32]. The first run (from the start of the gradient) is longer (because of the larger V_D and t_D values), but later run times are the same, regard-

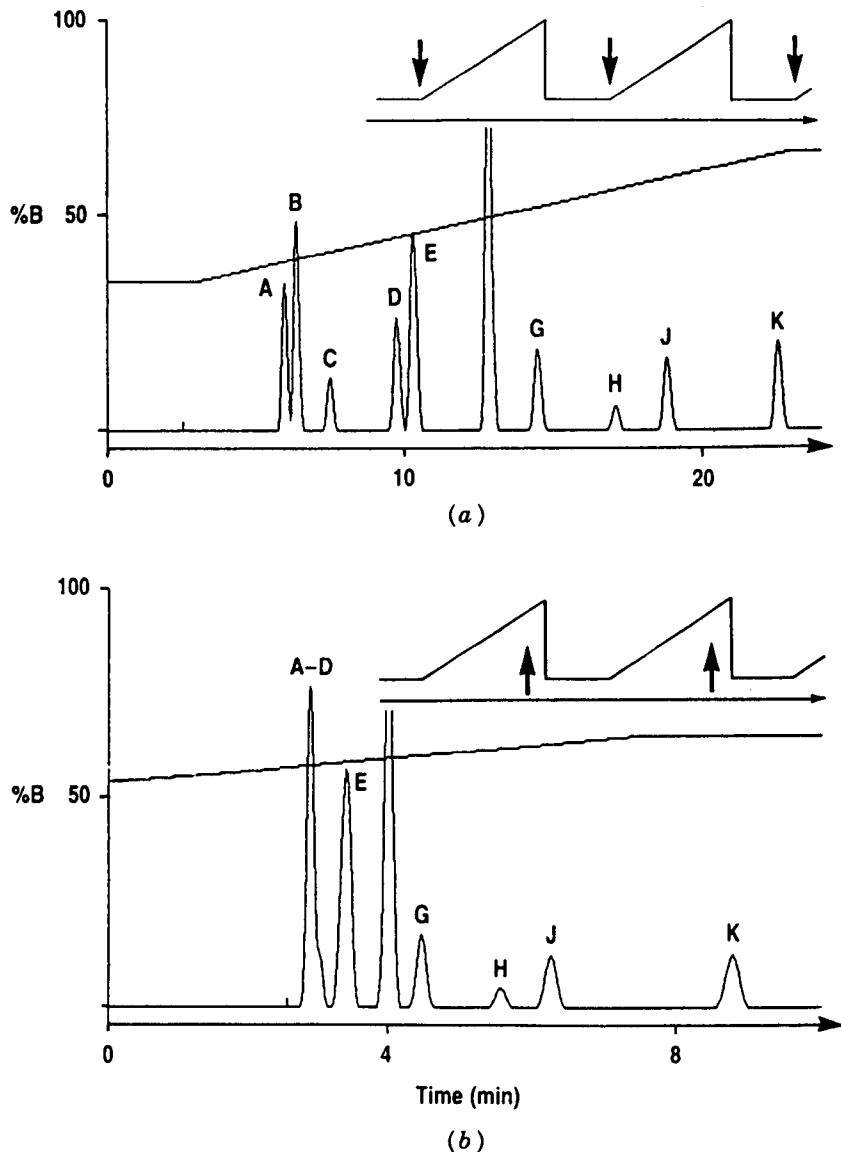

FIGURE 8.19 “Calamitous” effect of differing dwell times on gradient separation for sequential sample injection. Hypothetical sample, 35 to 65% B in 20 min, 1 mL/min flow rate, 5.0-min column equilibration with A-solvent between runs. (a) Separation and gradient profile for an HPLC system having a dwell volume $V_D = 0.5$ mL; (b) same for system having $V_D = 10$ mL (for second and subsequent samples). (Reprinted with permission from Ref. 29.)

less of V_D . If calculations are made from the time of sample injection, retention times for different gradient systems will be the same.

Second, if an initial isocratic step can be incorporated into the gradient, this step can be shortened for use with systems with larger values of V_D , and lengthened for systems with smaller V_D values. In this manner, the sample and gradient again arrive at the column inlet at the same time [33]. By way of illustration, assume that a method is developed using a system with $V_D = 5$ mL. If the initial isocratic step for this method was made equal to 5 mL, the gradient lags the sample by $5 + 5 = 10$ mL. The same gradient lag can be achieved on other systems (with different values of V_D) by either shortening or lengthening the isocratic step. For example, if separation is to be carried out on a second system with $V_D = 2$ mL, the isocratic step must be increased to 8 mL for the same separation ($8 + 2 =$ same 10 mL gradient delay). Similarly, for separation with a system having $V_D = 10$ mL, the isocratic hold would be reduced to 0 mL ($0 + 10 = 10$ mL). With this approach, the run time for every sample is the same on each HPLC system (of varying V_D). Sample retention times are also the same from system to system. However, the run time per sample is longer than for the previous option (injection of the sample after a time t_D).

Third, if the initial mobile phase composition $> 20\%$ B, it is advantageous to start with a steep gradient from 5% B to this initial % B. For example, if the initial mobile phase is 30% B, precede this gradient with a gradient segment from 5 to 30% B in 1 to 2 min. This has the effect of holding the sample at the column inlet until the start of the original gradient (30% B) arrives at the column inlet. Dwell-volume effects as in Fig. 8.18 are thereby avoided; however, all retention times will be shifted by an amount equal to the difference in dwell time for the two systems. The run time for the first sample will be increased for higher V_D systems, but later samples will have the same run time, regardless of V_D . Again, the run time per sample is longer than for injection of the sample after a time t_D (first option).

8.5.1.4 Determining the Dwell Volume. The value of V_D for the equipment used must be known before developing a gradient method. The dwell volume of an HPLC gradient system can be measured as follows. Disconnect the column from the system and connect the column inlet and outlet lines with a zero-volume connector. Use methanol as A and B solvents, and add 0.1% acetone to the B solvent. Adjust the detector wavelength (≈ 260 nm) so as to place the B-solvent absorbance at full scale (0.1 AU) and run a linear gradient from 0 to 100% B in 20 min at 1.0 mL/min. This provides a graphic display of the gradient, as in Fig. 8.20a (solid curve). Determine the time when the absorbance is halfway between start and finish, subtract 10 min (half the gradient time), and the result is $t_D = V_D/F$; see Ref. 29 for further details.

It is also important to verify that the gradient equipment is operating properly before beginning gradient method development. The gradient display determined as in Fig. 8.20a also allows the user to evaluate the performance

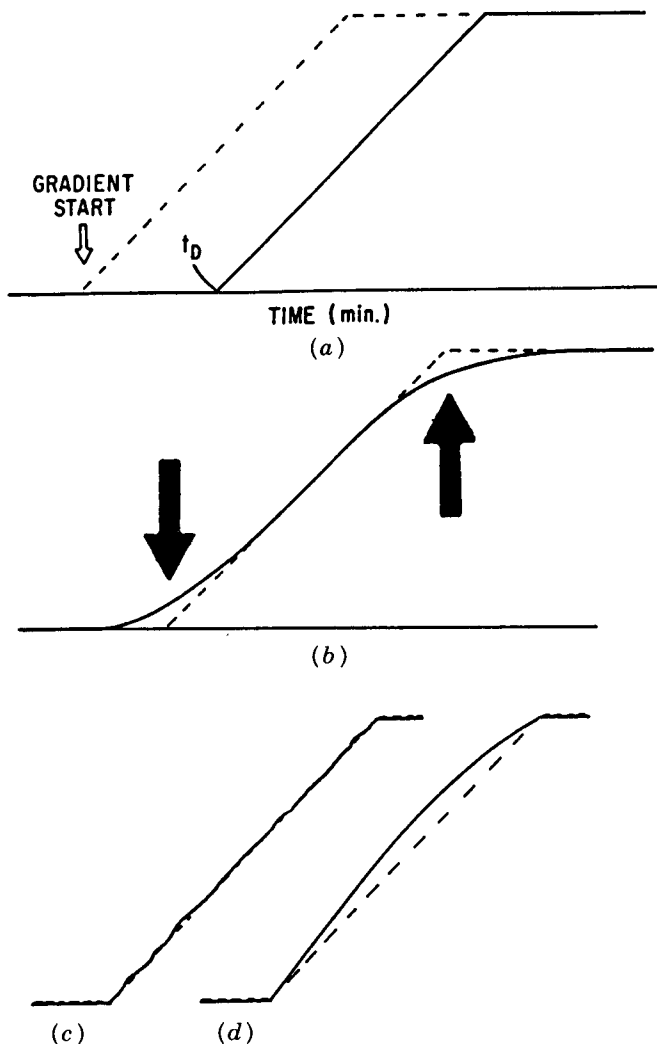

FIGURE 8.20 The gradient profile for an HPLC system and its interpretation. (a) Gradient delay due to equipment dwell volume; (b) gradient rounding due to dispersion within the system; (c) irregular gradient due to mixing errors; (d) gradient non-linearity. See the text for details. (Reprinted with permission from Ref. 34.)

of the HPLC system, as illustrated in Fig. 8.20*b-d*. Some rounding of the beginning and end of the gradient is expected (arrows, Fig. 8.20*b*), due to dispersion of the gradient as it moves through the equipment. The deviation of the actual gradient (solid curve) from expected values (dashed curve) of 0 and 100% B (arrows) should not exceed 3%.

The gradient may also exhibit an irregular rather than linear trace (Fig. 8.20*c*). Deviations between the actual and expected gradients should not ex-

ceed 1 to 2%; this can also be checked by running a series of step gradients in 10% B increments. Finally, the actual gradient may be non-linear (Fig. 8.20*d*). In the latter case, reference to the equipment manual may allow adjustment of the HPLC system (gradient former) to eliminate gradient non-linearity.

8.5.2 Reproducible Separation

8.5.2.1 Column Regeneration. In the preceding section we examined problems in method reproducibility that are caused by differences in gradient equipment. Irreproducible separation can also arise in gradient elution for other reasons. Method development often uses samples composed of pure standards, whereas actual samples may contain late-eluting interferences. If the final % B in the gradient is selected to match the elution of the last band of interest (as in Fig. 8.10*b*), late-eluting material present in actual samples may build up on the column, thereby changing column efficiency and retention (as in the example of Fig. 8.4*b*). The result will be a gradual change in the separation of samples that contain such late eluters. Because samples that require gradient elution also often contain late eluters, it is common practice at the end of gradient elution to hold at 100% B or to ramp the gradient quickly to 100% B so as to wash the column for some period (e.g., 2 to 5 column volumes) with strong solvent as a means of column cleansing.

8.5.2.2 Column Equilibration. Column equilibration in gradient elution refers to a flush of the column with the A-solvent (starting mobile phase) after the last gradient run and prior to the next sample injection; see Fig. 8.19*a*. In gradient elution it is advisable to equilibrate the column completely with the starting mobile phase prior to sample injection and the start of the next gradient. If complete column equilibration is *not* achieved, early bands in the chromatogram may exhibit variable retention and separation. Column equilibration normally requires 5 to 10 column volumes of the starting mobile phase (e.g., 7 to 15 mL for a 15×0.46 -cm column). However, this equilibration volume will vary with the mobile phase and sample, so the completeness of column equilibration needs to be verified for each application. Complete equilibration can be checked by (1) flushing the column with more than 30 column volumes of starting mobile phase, (2) carrying out a gradient separation, (3) flushing the column with the proposed volume of starting mobile phase (e.g., 5 to 10 column volumes), and (4) immediately repeating the separation. If the retention times for early bands do not change between these two runs, the volume of equilibration solvent used is adequate (it may be more than is required). The volume of equilibration solvent specified for a gradient method should also take into account possible differences in system dwell volume; see Fig. 8.19 and the related discussion. When additives such as ion-pair reagents or amine modifiers are used in the mobile phase, these compounds should be added to both the A and B solvents.

It is also possible to carry out a *reversed gradient* for the purpose of column equilibration. This refers to a gradient (following elution of the sample) from the final to initial % B values (e.g., if the original gradient is 10 to 80% B, column equilibration can be achieved by running a gradient from 80 to 10% B). The alternative of an immediate change in % B from the final value to the initial value at the end of the run (80% to 10% B, followed by washing the column with 10% B) is recommended, however, because it is simpler and equally effective.

Rapid equilibration of the column between gradient runs is promoted by avoiding 0% B as the starting mobile phase (water or buffer without added organic). If possible, the initial mobile-phase composition should be > 3% B. Gradients with a limited range (e.g., 30 to 50% B) will usually require a smaller equilibration volume, since the difference in initial and final mobile-phase compositions is small. One study has advocated the addition of 3% propanol to the A-solvent as a means of accelerating column equilibration [35]. It has not been shown, however, that the simpler expedient of starting the gradient at 5% B requires a much longer column equilibration.

When analyzing a series of samples by a gradient method, it is advisable to maintain a constant equilibration time between samples. The water used for the mobile phase may often be contaminated by components that accumulate at the head of the column and are then eluted during the gradient. The resulting artifactual peaks increase in size in proportion to the length of the equilibration time (or the amount of water that has been used to equilibrate the column). See Section 8.5.3.2 for further details.

8.5.2.3 Inaccurate Gradients. Poor separation reproducibility can also be caused by inaccuracies in the gradient. Inaccurate gradients are more likely to result in differences in separation between different gradient systems, but it is also possible for the same gradient equipment to cause changes in retention from run to run. This is more likely for very flat gradients and high-molecular-weight samples. In such cases, the mixing of A- and B-solvents by the gradient equipment can lead to random variations in mobile-phase composition (e.g., by 0.1 to 0.3%) vs. the value programmed into the gradient controller. Normally, such small (random) errors would have little effect on sample retention times. However, for larger sample molecules, even such small variations in % B can result in sizable shifts in retention time in gradient elution. In extreme cases, this can result in a splitting of a single peak into one or more artifactual peaks [36].

When it is suspected that variable retention times are due to random fluctuations in % B as a result of inaccurate gradient mixing, this problem can be reduced by avoiding the use of pure solvents A and B in the solvent reservoirs. Thus if the gradient range is 20 to 50% B, use 20% B in the A-reservoir and 50% B in the B-reservoir. For this example, the effect would be to reduce errors in gradient mixing (instantaneous values of % B) by a factor of 0.3 vs. the use of pure solvents A and B.

8.5.3 Baseline Problems

Baseline drift and artifactual bands are much more common in gradient vs. isocratic elution. One example is provided by Fig. 8.3*b*, where the gradient run exhibits a rising baseline during the separation (3 to 23 min). In other cases, a blank gradient run (no sample injected) may show apparent bands in the chromatogram as well as drift. *It is always desirable to carry out a blank run (e.g., 5 to 100% B) prior to beginning method development for gradient elution.*

8.5.3.1 Drift. An upward drift in the baseline during gradient elution (as in Fig. 8.3*b*) is fairly common and is usually caused by differences in UV absorbance of the A- and B-solvents used. Thus in reversed-phase gradient elution, the concentration of the organic solvent B increases during the separation, and the UV absorbance of organics is always greater than that of water. Gradient drift of this kind is therefore fairly common with UV detectors. Absorbance-related baseline drift can be confirmed by running a blank gradient; the baseline will be linear and drift upward for a time equal to the gradient time t_G . This kind of drift will be more noticeable, the lower the detector wavelength and the more sensitive the detector setting. It is especially pronounced for THF as solvent, because of the greater absorbance of THF below 250 nm.

Absorbance-related drift can be eliminated by *absorbance matching* (i.e., adding a UV-absorbing compound to the A-solvent so as to increase the absorbance of the A-solvent to equal that of the B-solvent). Any UV-absorbing species can be used, but this additive *must* be unretained (very hydrophilic) under reversed-phase conditions and not react or interact with the sample. Compounds of this kind include inorganic ions such as nitrate, nitrite, or azide, small organic ions (e.g., formate, acetate), and hydrophilic, low-molecular-weight compounds such as urea, thiourea, or formamide [37,38]. The matching of A- and B-solvent absorbances can be done conveniently by trial and error. For example, assume that the observed baseline drift is ± 0.10 AU (from beginning to end of the gradient). Now add a small quantity of the UV-absorber to the A-solvent and determine its effect on baseline drift (e.g., baseline drift is reduced from 0.10 AU to 0.05 AU). From this it can be concluded what quantity of added UV absorber will completely eliminate baseline drift (twice the initial addition, in this example).

A second kind of baseline drift in gradient elution can be recognized by a curved baseline in the blank gradient, with a maximum signal near 50% B (instead of 100% B, as in the previous example). Baseline drift of this kind is due to refractive index (RI) effects [39]; most UV detectors are sensitive to a change in refractive index of the mobile phase, and organic-water solutions generally have maximum RI values at $\approx 50\%$ organic. RI-related baseline drift cannot be eliminated by solvent matching as in the preceding example. Its effects are strongly related to the design of the detector flow cell and

optics, so the use of a different UV-detector model may be required to reduce drift of this kind.

Some data systems permit subtraction of a blank gradient from the sample gradient, which results in the elimination of baseline drift. However, this expedient is less desirable than correction of baseline drift, because of possible errors introduced by the subtraction process.

8.5.3.2 Artifactual Bands. When a blank gradient is run, especially for lower-wavelength UV detection and higher-sensitivity settings, bands of significant size may appear in the chromatogram. Artifactual bands of this kind can obviously complicate method development for gradient elution. Such interferences usually arise from hydrophobic, UV-absorbing impurities associated with either the mobile phase or equipment. The mobile phase is more likely to be the problem (i.e., water, the organic solvent, or mobile-phase additives). A few simple experiments can serve to isolate the problem and point the way to a remedy.

The first step is to isolate the source of contamination. Begin by equilibrating the column with A-solvent (water) for 30 min, then carry out a blank gradient (0 to 100% B in 15 min), equilibrate for 5 min, and repeat the blank gradient. If the artifactual peaks are much larger in the first run, contamination of the water is probable. If there is no difference in the two blank runs, the organic solvent is more likely the problem. Possible contamination of mobile-phase additives can be checked by repeating a blank gradient with the additive(s) removed. Once a contaminated mobile-phase solvent or component has been identified, a "clean" source of that material must be substituted for the original material (e.g., material from a different bottle or vendor).

If the preceding experiments are inconclusive as to the source of contamination, the gradient contamination may have been introduced by the HPLC system. In this case a systematic substitution of each module can be used to isolate and fix the problem.

8.6 SUMMARY OF GRADIENT ELUTION METHOD DEVELOPMENT

The following step-by-step approach will work for most samples. It is important to keep in mind the similarity of method development for isocratic and gradient separation, since this allows experience acquired with isocratic separations (Chapters 6 and 7) to be applied to gradient methods as well.

8.6.1 Systematic Approach

Similar considerations govern the design of both gradient and isocratic methods. For example, when changing conditions during gradient method develop-

ment, equilibrate the column with 10 to 20 column volumes of the A-solvent and repeat each experiment to confirm that the column is fully equilibrated.

Before Starting. A blank gradient should be carried out initially, to ensure that there are no problems with the baseline (drift or artifactual peaks). Any problems should be corrected, as discussed in Section 8.5.

Initial Gradient Run. Begin with a linear 5 to 100% acetonitrile–buffer gradient in 60 min at a flow rate of 2 mL/min and the other conditions of Table 1.3 (same for both isocratic and gradient elution; a 15×0.46 -cm column is preferred). Confirm that gradient elution is necessary (Fig. 8.6), and then estimate the best initial and final % B values (gradient range) for this sample (Table 8.3). Alternatively, if it is certain that gradient elution will be required, begin with a 20-min gradient (for $k^* \approx 5$).

Optimizing Gradient Steepness. Using the foregoing estimates for the best gradient range, estimate a “good” gradient time for these conditions from Eq. 8.4 and perform this separation (run 2). Repeat this separation (run 2a) to confirm repeatable separation and adequate column equilibration between runs (e.g., with 10 to 20 column volumes of the starting mobile phase). Next determine the effect of gradient time on the separation [e.g., vary gradient time two-fold or more (run 3)]. Of special interest is any change in resolution of critical band pairs as gradient time is varied. Many samples will show maximum resolution for an intermediate gradient time, as in the example of Fig. 8.13. In such cases, it is usually worthwhile to adjust gradient time to achieve this maximum resolution. At the same time, further adjust the initial and final % B values as necessary (see Figs. 8.9 and 8.10).

Optimizing Conditions. If band spacing and resolution require improvement, a further change in selectivity can be attempted in the same way as for isocratic separation (Sections 6.3, 6.6, and 7.3.2). In the case of the reversed-phase separation of neutral samples, a change in solvent type (acetonitrile, methanol, THF, or mixtures thereof) should be explored next. If that proves unsuccessful, a different column (cyano, phenyl) can be tried. Gradient steepness should be re-optimized, following any change in solvent or column type. For the separation of ionic samples, variation of pH or temperature should be investigated before changing column type. The combination of a change in gradient steepness and temperature has been found especially convenient and effective for some ionic samples [27]; see also Section 9.5.

Complex Gradients. In some cases, as in Figs. 8.12 and 8.13, a segmented gradient may be able to reduce run time and/or increase resolution. In other cases, as in Figs. 8.13 to 8.15, selectivity can be optimized for individual groups

of compounds within the chromatogram by the use of segmented or “complex” gradients. Curved gradients should be avoided if possible.

Optimizing Column Conditions. When an optimum band spacing has been achieved as above, resolution and/or run time can be further improved by varying flow rate, column length, or particle size. When changing column length or flow rate, it is important to maintain the optimum band spacing achieved previously (selectivity optimization) by keeping k^* constant. This requires a proportionate increase in gradient time when increasing column length, and a proportionate decrease in gradient time when increasing flow rate. See the example of Fig. 8.16 and Table 8.4.

Other Considerations. Once the experimental conditions for the separation of the sample have been selected, column equilibration should be adjusted to ensure the reproducible retention of early bands while striving for minimum overall run time (which includes the time for column equilibration). This step requires determination of the minimum volume of initial mobile phase that will achieve column equilibration.

If the gradient method is to be used with other HPLC equipment, the possible effect of a change in dwell volume on separation must be considered. Three modifications of the gradient procedure have been described to minimize the effect of the equipment on the separation (Section 8.5.1.3); which approach is preferred in a given case depends on the separation conditions and the available gradient equipment. The possible need for a larger between-sample equilibration volume so as to avoid the phasing problem of Fig. 8.19 should also be kept in mind.

8.6.2 Computer Simulation

The technique of computer simulation for use in gradient elution method development is described in detail in Section 10.2.2. Two initial experimental runs can be used to predict separation as a function of all gradient and column conditions. With computer simulation, each subsequent (simulated) experiment requires only a few minutes of computer time. This means that a large number of such experiments are possible within a few hours, with easier interpretation of the results. Optimizing a gradient separation often requires a considerable number of trial-and-error experiments, as can be seen from the successive experiments of Figs. 8.8 to 8.10, 8.13, and 8.16. It may also be necessary to anticipate problems that can arise from a change in dwell volume, as illustrated in Figs. 8.18 and 8.19. For some very difficult samples (e.g., [40]), the development of “good” gradient methods is hardly possible by trial-and-error experiments in the laboratory, but computer simulation can prove successful with relatively little time or effort. Computer simulation for the

development of gradient elution methods has other uses which are discussed further in Section 10.2.2.2.

REFERENCES

1. J. W. Dolan, D. C. Lommen, and L. R. Snyder, *J. Chromatogr.*, **485** (1989) 91.
2. T. Sasagawa, Y. Sakamoto, T. Hirose, T. Yoshida, Y. Kobayashi, and Y. Sato, *J. Chromatogr.*, **485** (1989) 533.
3. L. R. Snyder, in *High-Performance Liquid Chromatography: Advances and Perspectives*, Vol. 1, C. Horvath, ed., Academic Press, San Diego, CA, 1980, p. 207.
4. P. Jandera and J. Churacek, *Gradient Elution in Column Liquid Chromatography*, Elsevier, Amsterdam, 1985.
5. L. R. Snyder and M. A. Stadalius, in *High-Performance Liquid Chromatography: Advances and Perspectives*, Vol. 4, C. Horvath, ed., Academic Press, San Diego, CA, 1986, p. 195.
6. M. A. Quarry, R. L. Grob, and L. R. Snyder, *J. Chromatogr.*, **285** (1984) 19.
7. J. Aurenge, *J. Chromatogr.*, **84** (1973) 285.
8. S. Terabe, H. Nishi, and T. Ando, *J. Chromatogr.*, **212** (1981) 295.
9. J. P. Larmann, J. J. DeStefano, A. P. Goldberg, R. W. Stout, L. R. Snyder, and M. A. Stadalius, *J. Chromatogr.*, **255** (1983) 163.
10. M. A. Stadalius, H. S. Gold, and L. R. Snyder, *J. Chromatogr.*, **296** (1984) 31.
11. F. Erni, H. P. Keller, C. Morin, and M. Schmitt, *J. Chromatogr.*, **204** (1981) 65.
12. K. H. Nelson and D. Schram, *J. Chromatogr. Sci.*, **21** (1983) 218.
13. D. W. Patrick and W. R. Kracht, *J. Chromatogr.*, **318** (1985) 269.
14. L. R. Snyder and J. W. Dolan, *J. Chromatogr. A*, **721** (1996) 3.
15. J. A. Lewis, L. R. Snyder, and J. W. Dolan, *J. Chromatogr. A*, **721** (1996) 15.
16. P. J. Schoenmakers, private communication, 1996.
17. T. Braumann, G. Weber, and L. H. Grimme, *J. Chromatogr.*, **261** (1983) 329.
18. B. F. D. Ghrist and L. R. Snyder, *J. Chromatogr.*, **459** (1988) 43.
19. R. C. Chloupek, W. S. Hancock, and L. R. Snyder, *J. Chromatogr.*, **594** (1992) 65.
20. M. Patthy, *J. Chromatogr.*, **592** (1992) 143.
21. J. W. Dolan, L. R. Snyder, and M. A. Quarry, *Chromatographia*, **24** (1987) 261.
22. M. Kunitani, D. Johnson, and L. R. Snyder, *J. Chromatogr.*, **371** (1986) 313.
23. B. F. D. Ghrist and L. R. Snyder, *J. Chromatogr.*, **459** (1988) 25.
24. P. Jandera, J. Churacek, and H. Colin, *J. Chromatogr.*, **214** (1981) 35.
25. J. J. Kirkland and J. L. Glajch, *J. Chromatogr.*, **255** (1983) 27.
26. C. Z. Chuang, F. A. Ragan, Jr., and C. Prasad, *J. Chromatogr.*, **534** (1990) 13.
27. R. C. Chloupek, W. S. Hancock, B. A. Marchylo, J. J. Kirkland, B. E. Boyes, and L. R. Snyder, *J. Chromatogr. A*, **686** (1994) 45.
28. J. L. Glajch, M. A. Quarry, J. F. Vasta, and L. R. Snyder, *Anal. Chem.*, **58** (1986) 280.
29. L. R. Snyder and J. W. Dolan, *LC/GC*, **8** (1990) 524.

30. C. F. Poole and S. A. Schuette, *Contemporary Practice of Chromatography*, Elsevier, Amsterdam, 1984, p. 366.
31. F. Andreolini and A. Trisciani, *J. Chromatogr. Sci.*, **28** (1990) 54.
32. H. Nakamura, T. Konishi, and M. Kamada, *Anal. Sci.*, **4** (1988) 655.
33. S. K. MacLeod, *J. Chromatogr.*, **540** (1991) 373.
34. L. R. Snyder and J. W. Dolan, *DryLab G User's Manual*, LC Resources, Inc., Walnut Creek, CA, 1987.
35. L. A. Cole and J. G. Dorsey, *Anal. Chem.*, **62** (1990) 16.
36. J. W. Dolan, *LC/GC*, **4** (1986) 1178; **5** (1987) 24.
37. V. V. Berry, *J. Chromatogr.*, **236** (1982) 279.
38. S. van der Wal and L. R. Snyder, *J. Chromatogr.*, **255** (1983) 463.
39. S. M. McCown, D. Southern, B. E. Morrison, and D. Gartiez, *J. Chromatogr.*, **352** (1986) 465.
40. B. F. D. Ghrist, L. R. Snyder, and B. S. Cooperman, in *HPLC of Biological Macromolecules*, K. M. Gooding and F. E. Regnier, eds., Marcel Dekker, New York, 1990, p. 403.

BIBLIOGRAPHY

1. P. Jandera and J. Churacek, *Gradient Elution in Column Liquid Chromatography*, Elsevier, Amsterdam, 1985. (the best book available on gradient elution)
2. J. J. Kirkland and J. L. Glajch, *J. Chromatogr.*, **255** (1983) 27. (systematic approach for optimizing solvent selectivity in gradient elution)
3. L. R. Snyder, in *High-Performance Liquid Chromatography: Advances and Perspectives*, Vol. 1, C. Horvath, ed., Academic Press, San Diego, CA, 1980, p. 207; L. R. Snyder and M. A. Stadalius, in *High-Performance Liquid Chromatography: Advances and Perspectives*, Vol. 4, C. Horvath, ed., Academic Press, San Diego, CA, 1986, p. 195. (together, summarize a simplified but reliable theory of gradient elution)
4. J. W. Dolan and L. R. Snyder, *LC/GC*, **5** (1987) 970; J. W. Dolan, L. R. Snyder, and M. A. Quarry, *Chromatographia*, **24** (1987) 261; J. W. Dolan, D. C. Lommen, and L. R. Snyder, *J. Chromatogr.*, **485** (1989) 91; N. Lundell, *J. Chromatogr.*, **639** (1993) 97, 117. (articles and reviews that cover the computer prediction of gradient elution separation based on theory)
5. B. F. D. Ghrist and L. R. Snyder, *J. Chromatogr.*, **459** (1988) 25, 43. (detailed discussion of the development of gradient methods using segmented gradients)
6. L. R. Snyder and J. W. Dolan, *LC/GC*, **8** (1990) 524. (definitive discussion of separation variability due to differences in HPLC equipment)

9

SYSTEMATIC APPROACH TO THE REVERSED-PHASE SEPARATION OF REGULAR SAMPLES

9.1 Introduction

9.1.1 Some Guiding Principles

9.1.1.1 Classifying the Sample

9.1.1.2 Initial Separation Conditions: The Column and Flow Rate

9.1.1.3 Initial Separation Conditions: The Mobile Phase

9.1.1.4 Other Initial Separation Conditions

9.1.1.5 Ensuring Accurate Retention Data

9.1.1.6 Confirming Good Column Performance

9.1.1.7 Peak Tracking

9.2 Getting Started

9.2.1 Initial Conditions

9.2.2 Adjusting the Retention Range

9.2.2.1 Isocratic Separation

9.2.2.2 Gradient Separation

9.2.2.3 Early or Late Eluters

9.2.2.4 Very Hydrophobic Cations

9.2.2.5 Complex Samples

9.2.2.6 No Real Peaks

9.2.3 Evaluating Peak Shape and Plate Number

9.3 Completing Isocratic Method Development

9.3.1 Optimizing Retention and Selectivity

9.3.1.1 Sample A: An Easy Separation

9.3.1.2 Sample B: A Typical Separation

9.3.1.3 Sample C: A Difficult Separation

9.3.1.4 Further Improvements in Separation

9.3.1.5 Changing the Method for Later Samples or Applications

9.3.2 Optimizing Column Conditions

9.4 Alternative to Completing Isocratic Method Development

9.5 Completing Gradient Method Development

9.1 INTRODUCTION

In this chapter we summarize the selection of suitable experiments for a first attempt at separation by reversed-phase chromatography (RPC). Specific conditions are described for an initial separation, the results of which are used to determine a second experiment. This trial-and-error process is continued until a successful separation is achieved. Guidelines are provided at each step for the selection of conditions for the next run. The present method-development approach (summarized in Table 9.1) should result in the satisfactory separation of many samples, and it provides a good start for work on more difficult samples. The procedure described here is based on the discussion of earlier chapters and incorporates a number of practical considerations that have not yet been discussed.

It is assumed in this chapter that goals for the separation have been established (Section 1.2.2). These include adequate resolution, a reasonable run time, and—very important—a rugged method that can be carried out in other laboratories with a minimum of problems (Chapter 15). It is assumed also that the sample is in a form ready for injection (Chapter 4) and that detection is not a problem (Chapter 3). In Chapters 6 to 8 we have examined the variation of HPLC separation with experimental conditions, showing how an acceptable separation can be developed for different kinds of samples. Many experimental options are available, and effective method development depends on how we prioritize these options. This choice may depend on what is known about the sample and what kinds of HPLC equipment are available. However (as described in this chapter), *for most regular samples, method development with reversed-phase conditions can proceed in exactly the same way*. A regular sample is any sample that is not “special” (Table 9.2); regular samples are of molecular weight below 1000 Da and can contain neutral and/or ionic compounds.

Prior to starting method development for a regular sample, a published method may be available for the HPLC separation of the same or similar sample. This information can be useful for choosing detection conditions or designing a sample pretreatment procedure. However, published methods often prove less satisfactory for the HPLC separation of the sample, because of a poor initial choice of separation conditions for the original method or batch-to-batch differences in the column (variable α values, Section 5.4.1). It is often preferable to redevelop an HPLC separation from the beginning (using the approach described in this chapter) rather than improve a published method by attempting minor changes in the original separation conditions.

It is useful (but not essential) to know the chemical structures and properties of the various sample compounds prior to method development. Information about the sample components can be helpful as an aid in sample pretreatment (Chapter 4), to select the best means of detection (Chapter 3), or if problems are encountered during method development. If standards for each sample component are available, method development is greatly simplified. In this

TABLE 9.1 Overall Plan for Achieving an Acceptable Reversed-Phase HPLC Separation

-
1. Determine if the sample is *regular* or *special* (Table 9.2); for special samples, proceed as referenced in Table 9.2; for regular samples, proceed as described here.
 2. Choose separation conditions for the first run (Table 9.3).
 3. Carry out the first run and classify the sample as in Fig. 9.1.
 - a. For isocratic methods (Fig. 9.1a), proceed as in Section 9.3 and Table 9.5, or Section 9.4.
 - b. For gradient methods (Fig. 9.1b), proceed as in Section 9.5.
 - c. For early-eluting samples (Fig. 9.1c), increase retention by (1) changing pH, (2) adding an ion-pair reagent, (3) changing the column (polystyrene or graphite), or (4) changing to normal-phase conditions.
 - d. For late-eluting samples (Fig. 9.1d), use (1) NARP or (2) normal-phase conditions.
 4. For isocratic methods, use the initial gradient run to estimate the best value of % B for the second (isocratic) run (Table 9.4).
 5. Evaluate the quality of bands in the second run (plate number, bandwidth, band shape); bands that are too wide or asymmetric indicate that initial separation conditions (column, pH, additives, etc.) must be changed; if the second run is OK, all runs including the second run should be run in duplicate to ensure column equilibration and repeatable retention times.
 6.
 - a. For isocratic methods, proceed as described in Table 9.5 and Section 9.3; vary % ACN to improve band spacing and resolution; if required, change from ACN to MeOH and optimize % MeOH for band spacing and resolution; if required, blend ACN and MeOH and optimize ternary-solvent mobile-phase composition.
 - b. For isocratic methods, as an alternative to step 5 (especially for ionic samples), proceed as in Section 9.4. Vary % ACN and temperature to achieve $0.5 < k < 20$ and vary band spacing; select conditions for best resolution of the sample.
 7. For isocratic methods, if adequate separation is not achieved in step 6a or b, vary other conditions according to the priorities of Table 9.8.
 8. For gradient methods, optimize band spacing and resolution by varying gradient steepness and temperature (Section 9.5). If satisfactory band spacing and resolution are not achieved, vary solvent type in the same way as for isocratic separation (step 5). If satisfactory separation is not achieved, change other conditions as in Table 9.8.
 9. For gradient methods, finalize the gradient conditions (initial and final % B, gradient steepness, gradient shape) to achieve improved resolution or shorter run time as in Section 8.4.1.
 10. For either isocratic or gradient methods, consider a change in column conditions (column length, flow rate, particle size) for an increase in resolution or a decrease in run time.
-

Once a satisfactory separation is achieved, further changes in conditions are unnecessary. In some cases, no experiments beyond step 6 will be required.

TABLE 9.2 Special Samples^a

Sample Type	Reference
Inorganic ions	Ref. 1
Enantiomers	Chapter 12
Biomolecules	Chapter 11
Synthetic polymers	Ref. 2
Carbohydrates	Section 6.6.5
Isomers ^b	Sections 6.3.3 and 6.6

^a Samples not listed here are classified as regular.

^b Isomers other than enantiomers may be separated adequately by the procedure described in this chapter; if not, consult the normal-phase separation guidelines in Appendix III.

chapter we assume that such standards are available. However, method development for any regular sample can be carried out in essentially the same way, *regardless* of whether the sample composition is known or standards are available.

In some cases it is possible to carry out several method-development experiments consecutively and postpone any interpretation of the results until all the experiments are completed. Computer-optimization procedures based on this approach are described in Sections 10.3 and 10.4. If an HPLC system is available that can perform these experiments automatically, and *if the experimental conditions are selected carefully*, this can be a useful and efficient procedure. For many samples, however, automated HPLC development is still far from a reality. For this and other reasons, we favor the present step-by-step approach, which involves interpreting the chromatograms from prior experiments before choosing conditions for the next HPLC run. This procedure has the advantage of minimizing the total number of experiments required for samples that prove easy to separate, and it can also take advantage of computer-optimization software (Section 10.2).

9.1.1 Some Guiding Principles

Our recommendations for the RPC method development of regular samples are based on a number of considerations summarized in this section (see also Refs. 3 and 4):

- Vary those conditions that can change selectivity appreciably.
- Avoid practical problems that can affect method ruggedness.
- Minimize the number of necessary experiments; take advantage of computer simulation (Chapter 10) where possible.

- Select experiments that work for any regular sample, so that HPLC methods for samples of unknown composition (ionic or neutral) can be developed in the same way (“one size fits all”).
- Defer experiments that are less easily carried out (e.g., change of column, change of pH, use of complicated solvent mixtures, etc.).

These considerations lead to a simple but effective strategy for method development that is summarized in Table 9.1 and described in detail in Sections 9.2 to 9.5. This procedure, which involves changes in percent acetonitrile, percent methanol, and/or temperature, should result in the development of an acceptable method for most samples. When this is not the case, further experiments can be carried out as described in Chapters 6 and 7.

9.1.1.1 Classifying the Sample. The first step in method development is to characterize the sample as regular or special (Table 9.2). If the sample is regular, proceed as described in this chapter. If the sample is special, see Table 9.2 for references to other chapters or the literature. Separations of regular samples respond in predictable fashion to changes in solvent strength (% B) and type (acetonitrile, ACN; methanol, MeOH) or temperature. A 10% decrease in % B (e.g., from 50% B to 40% B) increases retention by about threefold, and selectivity usually changes as either % B or solvent type is varied. An increase in temperature causes a decrease in retention (1 to 2% per °C), as well as changes in selectivity (especially for ionic samples).

It is possible to separate many regular samples just by varying solvent strength and type (Section 9.3). Alternatively, varying solvent strength and temperature can separate many ionic samples and some non-ionic samples (Section 9.4). Therefore, RPC method development for all regular samples (both neutral and ionic) can be carried out initially in the same way (see Section 9.3 to start). Special samples have additional requirements and usually are best separated by other means (Table 9.2).

9.1.1.2 Initial Separation Conditions: The Column and Flow Rate. The choice of the initial column, mobile phase, and temperature is quite important and is summarized in Table 9.3. The general requirements for the column are detailed in Chapter 5. To avoid problems from irreproducible sample retention during method development, it is important that columns be stable and reproducible. A C₈ or C₁₈ column made from specially purified, less acidic silica (minimal metal contamination) and designed specifically for the separation of basic compounds (Table 5.4) is generally suitable for all samples and is strongly recommended. If temperatures >50°C are used at low pH (Section 9.4), sterically protected bonded-phase column packings are preferred (Section 5.2.3.4).

The column should also provide (1) reasonable resolution in initial experiments, (2) short run times (including column equilibration and duplicate runs; Section 9.1.1.5), and (3) an acceptable pressure drop for different mobile phases. A 5- μ m, 15 \times 0.46-cm column with a flow rate of 2 mL/min is a good

TABLE 9.3 Initial Conditions for Reversed-Phase HPLC Method Development

Separation Variable	Preferred Initial Choice
Column packing	C ₈ or C ₁₈ ; less acidic silica (Table 5.4); if temperatures > 50°C are planned, more stable, sterically protected packings are preferred (Sections 5.2.3.4).
Column configuration	15 × 0.46-cm column, 5-μm particles. ^a
Flow rate	2.0 mL/min.
Mobile phase	Acetonitrile–water (neutral samples) or acetonitrile–buffer (ionic samples); buffer is 25–50 mM potassium phosphate at pH 2–3 (lower pH preferable if column is stable). For the initial experiment, a 5–10% B gradient in 60 min is recommended; alternatively, see the isocratic approach of Fig. 9.2.
Temperature	35 or 40°C.
Sample size	< 50 μL; 50–100 μg ^b

^a An alternative is the use of a 7.5 × 0.46-cm column of 3.5-μm particles; the latter column will provide faster runs with similar resolution.

^b Often, smaller sample weights are required for ionic samples.

initial choice; these conditions provide (1) reasonable plate numbers ($N \approx 8000$), (2) a run time of < 15 min for $k < 20$, and (3) a maximum pressure < 2500 psi for any mobile phase made from mixtures of water, acetonitrile, and/or methanol. A column of this size and type is also often a good choice for the final HPLC method. See further discussion in Ref. 3. For faster separations (Section 5.2.2), a 7.5 × 0.46-cm column of 3.5-μm particles is a good alternative.

9.1.1.3 Initial Separation Conditions: The Mobile Phase. Because of its favorable UV transmittance and low viscosity, the preferred organic solvent (B) for the mobile phase is acetonitrile (ACN). However, methanol (MeOH) is a reasonable alternative. Tetrahydrofuran (THF) is less desirable because of its significant UV absorbance below 250 nm, its chemical reactivity, and other problems noted below. Despite the unique and potentially useful selectivity of THF, more convenient and rugged RPC methods often result if this solvent is avoided.

The initial mobile-phase pH should be selected with two considerations in mind. First, a low pH that protonates column silanols and reduces their chromatographic activity is generally preferred. Second, a low pH (< 3) is usually quite different from the pK_a values of common acidic and basic functional groups (Table 7.2). Therefore, at low pH the retention of these compounds will not be affected by small changes in pH and the RPC method will be more rugged. For columns that are stable at low pH, a pH of 2 to 2.5 is recommended. For less stable columns, a pH of 3.0 is a better choice. Changes in pH for the purpose of changing selectivity (Section 7.3.2.1) should be deferred to a later time in method development, after other changes in condi-

tions have been tried. The reason is that pH optimization is often not necessary, can require a large number of experiments to carry out, and leads to less rugged final methods. A mobile phase pH of 2 to 3 is best maintained using a 25 to 50 mM potassium phosphate buffer (i.e., 25 to 50 mM phosphoric acid, adjusted to the desired pH with KOH).

Mobile-phase additives such as triethylamine and ion-pair reagents should be avoided during early experiments aimed at method development. These additives may require longer column equilibration times, which can be a problem in both method development and routine use of the method. Additives such as these occasionally introduce additional problems (erratic baselines, poor peak shape) as well as complicate the preparation of the mobile phase. Some samples may require the use of amine modifiers when poor peak shapes or low plate numbers are encountered (Sections 5.4 and 7.3.3). Other samples may require an ion-pair reagent to achieve adequate sample resolution (Section 7.4). However, the need for mobile-phase additives will become apparent as method development proceeds.

9.1.1.4 Other Initial Separation Conditions. The separation temperature can be selected to achieve different goals. A primary requirement is that the column temperature not change, and most temperature controllers operate best above ambient ($> 30^{\circ}\text{C}$). Higher-temperature operation also gives lower operating pressures and higher plate numbers, because of a decrease in mobile-phase viscosity. A temperature of 35 or 40°C is usually a good starting point. However, ambient temperature is required if the method will be used in laboratories that lack column thermostating.

If possible, the sample should be dissolved initially in water (1 mg/mL) or a dilute solution of acetonitrile in water. For the final RPC method, the best sample solvent is the mobile phase. Many samples cannot be dissolved directly in either water or the mobile phase. These samples should be dissolved in either acetonitrile or methanol and diluted with water or mobile phase before injection. At first, a 25- to 50- μL injection (25 to 50 μg) can be used for maximum detection sensitivity; smaller injection volumes are required for column diameters of below 0.46 cm and/or particles smaller than 5 μm . The weight and/or volume of sample used for subsequent injections can be reduced as necessary for a linear detector response or to improve band shape and width (Section 2.4).

9.1.1.5 Ensuring Accurate Retention Data. It is important in method development to confirm the repeatability of all experiments. This requires that the column be completely equilibrated before retention data are collected for interpretation. Equilibration is required whenever the column, mobile phase, or temperature is changed during method development, usually by flow of at least 10 column volumes (15 mL for a $15 \times 0.46\text{-cm}$ column) of the new mobile phase before the first injection. Some mobile phases may require a much longer column equilibration time [e.g., mobile phases that contain THF,

amine modifiers such as triethylamine or tetrabutylammonium, and any ion-pair reagent (especially those with more than 10 carbons in an alkyl group)].

When carrying out method development, the chromatographer varies conditions from one experiment to the next. During the initial stages of method development, changes in the mobile phase or column temperature are preferable to a change in the column. When changing the mobile phase or temperature, it is possible to vary each of these parameters continuously, which makes it more likely to find just the right selectivity for a multicomponent sample. Changes in mobile phase and temperature can also be more convenient than a change in the column (assuming that a column thermostat is available).

Column equilibration and reproducible data can be confirmed by (1) washing the column with at least 10 column volumes of the new mobile phase (8 min for a 15×0.46 -cm column at 2 mL/min), (2) injecting the sample, (3) washing the column with at least 5 column volumes of the new mobile phase, and (4) reinjecting the sample. If the column is equilibrated, retention times should not change by more than 0.02 min between the two runs. If larger retention changes are seen, further sample injections should be made until constant retention (± 0.02 min) is observed or retention stops changing in the same direction. After column equilibration, retention for a thermostatted column should not vary from run to run by more than ± 0.05 min within a day. This entire sequence of steps usually can be completed in less than 1 hour for each new mobile phase to be studied.

Some method-development projects may require a larger number of runs that are carried out over several days. In such cases, there is always the risk that the retention properties of the column may change due to column fouling or loss of bonded phase; this means that retention data obtained on different days may not be comparable. For situations such as this, it is a good idea to run a "reference run" at the beginning of each day. The "reference run" can be carried out with one or more of the analytes as sample, using conditions that give $k > 1$. Retention times for the reference run should be the same (± 0.1 min) from day to day for thermostatted separations (retention times vary by 1 to 2% per $^{\circ}\text{C}$ change in temperature). Day-to-day changes in selectivity (changes in α of more than 1%) are more serious than changes in retention time. Typically, a change in α of 1% means a change in resolution of $R_s = \pm 0.2$ unit; larger changes in R_s can be detrimental to the separation.

9.1.1.6 Confirming Good Column Performance. Once the first or second experimental run has been carried out, it is important to examine the chromatogram for peak shape and plate number. The asymmetry factor (Fig. 5.19) should fall between 0.9 and 1.5 (preferably 0.9 to 1.3), and the isocratic plate number for later, well-resolved bands should be > 4000 for a 15-cm, 5- μm column at 2 mL/min. In the case of gradient runs, peak width at half-height should not be greater than 0.4 min (5 to 100% B gradient in 60 min, 15-cm column). The latter plate-number or peak-width values are

for a sample molecular weight of less than 1000 Da. The measurement of a column plate number from a gradient chromatogram using Eq. 2.8 is not valid, as these apparent values of N will usually be much too high.

If method development is continued with tailing or broad peaks, a considerable waste of time and effort is likely. Later attempts to improve column performance are likely to create simultaneous changes in sample retention and a worsening of separation, which may require a complete reoptimization of the band spacing.

9.1.1.7 Peak Tracking. Peak tracking refers to the matching of bands for the same compound between runs where conditions have been changed. The importance of peak tracking and means for achieving it are discussed in Section 10.7. If standards are available, two samples of differing composition (different concentrations of the standards) can be used in successive separations (same conditions) to accomplish both peak tracking and peak identification (Section 10.7.1). At the same time, these duplicate injections can be used to confirm that retention times are constant and the column is equilibrated as described above. If standards are not available for peak tracking, then peak size plus relative retention, diode-array spectra (Section 3.2.6), and/or LC-MS (Section 3.3.4) can be used instead. However, all these approaches except LC-MS assume that a change in mobile phase will not affect the UV spectrum of a compound. This can be a bad assumption when pH is varied, and some variation in UV spectra is possible for changes in solvent type or temperature.

9.2 GETTING STARTED

9.2.1 Initial Conditions

The selection of initial experimental conditions depends on sample type: neutral or ionic. We will define ionic samples as either (1) containing one or more acids, bases, or organic salts or (2) being of completely unknown composition (i.e., the sample *could* contain acids or bases). For regular samples, the conditions of Table 9.3 are used initially: a 15-cm, 5- μm C_8 or C_{18} column, an acetonitrile–water mobile phase, a flow rate of 2 mL/min, a temperature of 35 or 40°C (unless no column thermostating is available), and a suitable sample size. For ionic samples, a 25 to 50 mM potassium phosphate buffer (pH 2 to 3) is added to the water of the mobile phase. If it is not known whether the sample is neutral or ionic, it is best to use this same buffer and pH.

The initial (“scouting”) separation can be carried out using either isocratic or gradient elution. Gradient separation is strongly recommended (Section 8.2.2), but isocratic runs are acceptable. The initial gradient should be 5 to 100% acetonitrile (ACN) in 60 min. This first gradient run can be used to determine (1) whether isocratic or gradient elution is recommended (Table 9.4 and following discussion) and (2) if special reversed-phase conditions will

be needed. Several examples of an initial gradient run are illustrated in Fig. 9.1. Each of these cases will be examined in turn.

9.2.2 Adjusting the Retention Range

The first goal of RPC method development is to select experimental conditions that will provide a usable retention range for the sample. If isocratic elution is possible, this means conditions for $0.5 < k < 20$; if the k range exceeds these limits, gradient elution will be necessary. However, isocratic methods are often preferred and may be required. When an initial chromatogram suggests a wide retention range ($0.5 > k > 20$) for an ionic sample, the use of an ion-pair reagent often permits isocratic separation with $0.5 < k < 20$ (e.g., Fig. 7.8 and related discussion). Similar changes in retention range can also be achieved by a change in pH, to ionize late-eluting compounds (for reduced retention) or reduce the ionization of early-eluting sample components (for later elution).

9.2.2.1 Isocratic Separation. The gradient separation of Fig. 9.1a is typical of samples where reversed-phase isocratic separation is possible. Ignoring the “solvent peak” at t_0 , the first band elutes at 37 min, and the last band leaves the column at 49 min (i.e., the retention range is relatively narrow). An approximate isocratic k range can be estimated for any column and flow rate from the gradient retention range (Fig. 9.1a, $\Delta t_R = 49 - 37 = 12$ min) divided by the gradient time ($t_G = 60$ min) as follows [5]:

$\Delta t_R/t_G$	Isocratic Retention
0.25	$1 < k < 10$
0.40	$0.5 < k < 20$

An isocratic range of $1 < k < 10$ or less is preferred, but a range of $0.5 < k < 20$ is usable. For the separation of Fig. 9.1a, $\Delta t_R/t_G = (12/60) = 0.2$. Therefore, isocratic separation is feasible for this sample.

Alternatively, for the conditions recommended in Table 9.3 (15×0.46 -cm column, 2.0 mL/min), Table 9.4 can be used to interpret the initial gradient chromatogram. To determine whether isocratic separation is possible, locate the retention time of the first band (37 min) in the first column of Table 9.4 (t_R), and determine the corresponding value in the second (“iso?”) column (61 min; interpolated between 59 and 64 min). If the retention time of the last band (49 min) is less than this value (61 min), the isocratic retention range is less than $0.5 < k < 20$ and isocratic separation is possible. In this case, because $49 < 61$, isocratic separation is again recommended. The % ACN for isocratic elution of the last band with $k = 7$ also can be estimated from Table 9.4. Locate the retention time of the last band (49 min) in the first column of

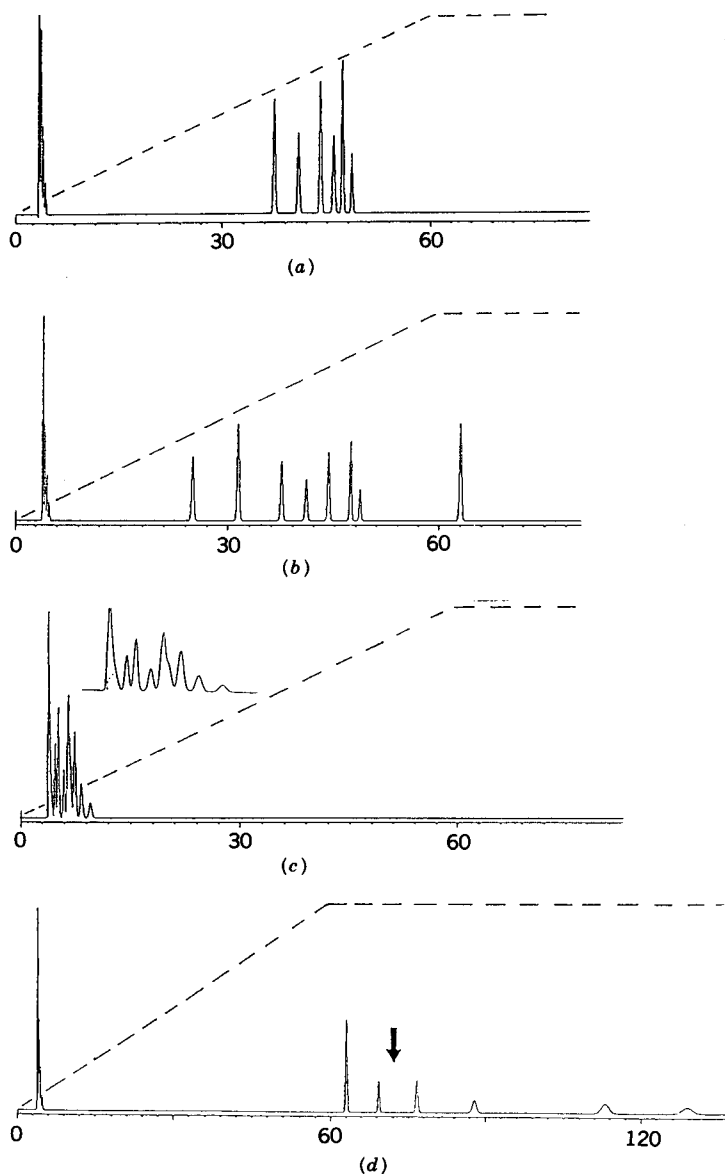

FIGURE 9.1 Examples of an initial gradient run for the RPC method development of different hypothetical samples (run 1 of Table 9.5 or 9.10). (a) Sample for which isocratic elution is feasible; (b) sample for which gradient elution is recommended; (c) sample that is insufficiently retained for RPC (inset shows expansion of chromatogram); (d) sample that is too strongly held for RPC; (e) sample that is too complex for a single HPLC separation. The arrow marks the arrival of the end of the gradient at the column outlet ($t_G + t_0 + t_D$). (Reprinted with permission from Ref. 3.)

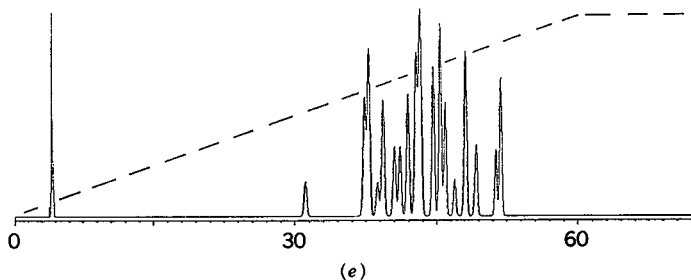

FIGURE 9.1 (Continued)

Table 9.4, and determine the corresponding % ACN value in the last column (“isocratic % B”): 81% ACN. The second method development run for this example would therefore use 81% ACN as the mobile phase.

As an alternative to an initial gradient run, a series of isocratic experiments can be performed. The initial run should use either 80 or 100% ACN, and

TABLE 9.4 Use of the Initial Gradient Run (Run 1) to Guide Further Method Development^a

t_R^b (min)	iso? (t_R) ^c (min)	Gradient		Isocratic
		Initial % B ^d	Final % B ^e	% B ($k = 7$) ^f
5	26	0	18	4
10	33	7	27	16
15	38	15	35	25
20	44	23	43	34
25	49	32	52	42
30	54	40	60	50
35	59	48	68	58
40	64	57	77	66
45	<i>f</i>	65	85	74
50	<i>f</i>	73	93	82
55		82	100	90
60				98

^a Adapted from Tables 8.1 to 8.3 for a 15×0.46 -cm column, 2.0 mL/min flow rate, and acetonitrile–water mobile phases. See the text for details.

^b Retention time of first or last band.

^c For a retention time of the first band in the t_R column, the corresponding retention time in this column is the maximum value for isocratic separation to be feasible.

^d For a retention time of the first band in the t_R column, the corresponding value in this column gives the recommended initial % ACN for the gradient.

^e For a retention time of the last band in the t_R column, the corresponding value in this column gives the recommended final % ACN for the gradient.

^f For a retention time of the last band in the t_R column, this column gives the recommended % ACN for isocratic separation in run 2.

the ACN concentration should be reduced successively in 20% increments until $k > 2$ for the last band ($t_R > 2$ min). When $k > 2$, the % ACN value can be reduced in 10% steps until $0.5 < k < 20$. This approach is illustrated in Fig. 9.2 for a typical four-component sample (later referred to as sample A). The first experiment (a), with 80% acetonitrile (ACN), yields a k range for the sample of $0.1 < k < 0.3$. Therefore, 80% ACN as mobile phase is too strong for this sample. However, very little time (≈ 1 min) was required for this experiment, and important information was obtained. In a situation like this, where the mobile phase is much too strong, a 20% decrease in organic can be tried. The resulting separation for 60% ACN is shown in Fig. 9.2b ($0.9 < k < 1.2$, along with subsequent 50% (c) and 40% ACN (d) runs (note also the change in band spacing for this sample as % ACN is varied; peak 4 moves relative to the other peaks as % ACN is changed). The 40% ACN ($R_s = 1.8$, $5 < k < 7$) provides acceptable separation for this example.

Alternatively, the k values for the last band in the initial run (Fig. 9.2a) can be used to estimate a good value of % ACN, using the "rule of 3" (Section 6.2.1.1). A 10% reduction in organic should increase k by about a factor of 3. Based on the initial 80% ACN run ($0.1 < k < 0.3$), we estimate for $k > 1$ that 50% ACN would be a good second experiment. In this example, this would have eliminated one of the experiments (60% ACN) and reduced the effort required to achieve the final separation with 40% ACN.

9.2.2.2 Gradient Separation. If the initial gradient separation (run 1) suggests that isocratic elution is not feasible, then further experiments (and the final method) should be carried out in a gradient mode. Figure 9.1b illustrates this case. Here the retention times of the first and last bands (25 and 63 min, respectively) suggest that isocratic elution will not be possible, assuming that all the bands eluting after 5 min are of interest. The value of $\Delta t_R/t_G = (63 - 25)/60 = 0.63$, which is much too large for isocratic separation. Similarly, in Table 9.4, the maximum retention time for the last band (for isocratic separation) is 49 min, confirming the need for a gradient separation of this sample. Table 9.4 can also be used to determine the best initial and final % ACN values for the next gradient run. For the initial % ACN, the 25-min value (first-band retention time) in the t_R column suggests 32% ACN ("initial % B" column); similarly, for the final % ACN, 63 min (last band retention time) in the t_R column suggests 100% ACN ("final % B" column). The next method-

FIGURE 9.2 Isocratic RPC method development for a four-component sample (see the text for details). Sample (see Table 9.6): 1, G; 2, H, 3, I; 4, K. Conditions: 15×0.46 -cm Zorbax SB-C8 column; acetonitrile-buffer mobile phases as indicated (2 mM potassium phosphate, pH 6.5); 35°C; 2.0 mL/min. (a) 80% ACN; (b) 60% ACN; (c) 50% ACN; (d) 40% ACN. [Computer simulations (DryLab) using data of Ref. 3.]

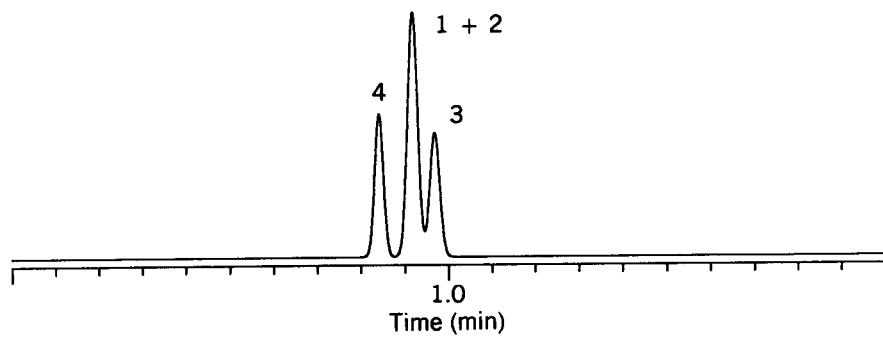

(a)

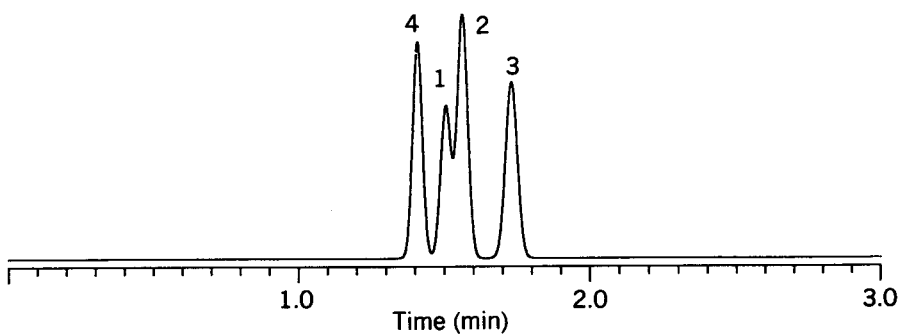

(b)

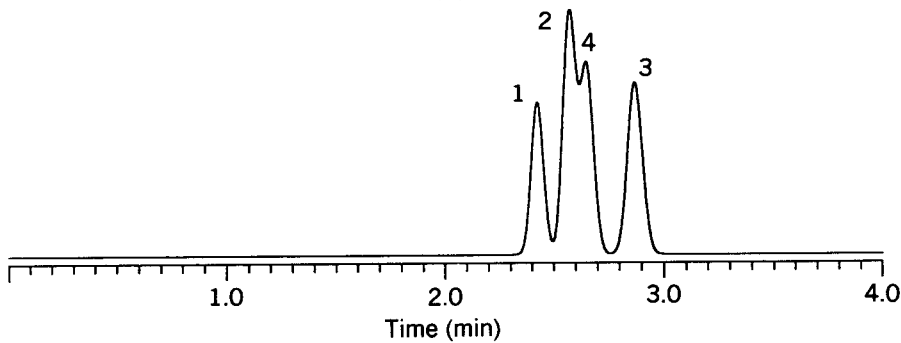

(c)

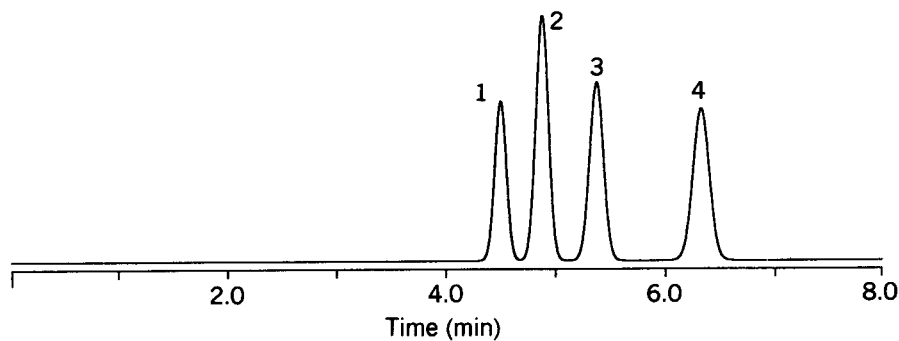

(d)

development run (run 2) should therefore be carried out with a 32 to 100% ACN gradient.

9.2.2.3 Early or Late Eluters. An initial gradient separation may show either early or late elution of the sample. Early elution as in Fig. 9.1c is more common and may be observed for basic samples that are ionized under the conditions of separation ($2 < \text{pH} < 3$). For weak bases ($\text{p}K_a < 8$), an increase in pH (e.g., to pH 6 or 7) will decrease sample ionization and provide a desirable increase in isocratic retention. For strong bases ($\text{p}K_a > 8$), the addition of a sulfonate ion-pair reagent can similarly increase retention (Section 7.4). Early elution of the sample is also possible for neutral or acidic compounds that are very hydrophilic (e.g., small, water-soluble organic molecules such as carbohydrates). These samples are likely to be separated better by normal-phase HPLC (Part II of Chapter 6, especially Section 6.6.5). In some cases, a more retentive column packing (high-surface-area polystyrene or graphitized carbon) may provide sufficiently increased RPC retention.

When the sample components elute mainly after the completion of a 5 to 100% ACN gradient (as in Fig. 9.1d), four alternatives are possible. First, the use of a THF-water mobile phase may result in satisfactory elution of the sample, because THF is considerably stronger than acetonitrile. Second, non-aqueous reversed-phase (NARP) HPLC can be tried (Section 6.5), where the water is replaced by a stronger, less-polar organic such as MTBE, THF, methylene chloride, or ethyl acetate. A gradient from acetonitrile to this stronger solvent may result in the elution of the sample under gradient conditions.

A third approach exists for the case of neutral samples that are too strongly retained in RPC. Compared to RPC, normal-phase HPLC (Part II of Chapter 6) is expected to provide reduced retention and therefore a better separation. The retention of unsubstituted hydrocarbon samples under normal-phase conditions may be too weak; however, these samples are often better separated by gas chromatography [6].

Finally, a decrease in retention can be achieved by the use of wide-pore (lower-surface-area), more-polar columns such as cyano or triisopropyl.

9.2.2.4 Very Hydrophobic Cations. Compounds that are both cationic and very hydrophobic represent a special case of late elution as in Fig. 9.1d, one that requires a different approach. When silica-based reversed-phase columns are used, hydrophobic cations can be held by both reversed-phase (C_8 or C_{18}) and normal-phase (silanol) interactions (Fig. 6.27c and related discussion). Reversed-phase interaction leads to stronger retention with low-% B mobile phases, and normal-phase interaction leads to stronger retention with high-% B mobile phases. Examples of this kind of behavior have been reported [7,8], where, as % B increases, sample retention first decreases (RPC behavior) and then increases (NPC behavior). However, in most such cases, acceptable

retention will usually be observed for an *intermediate* solvent strength (e.g., 50% B).

For extremely hydrophobic cations, one or the other of these two interactions may result in strong retention *regardless* of mobile-phase composition (% B), so that it proves impossible to elute the sample from a C₈ or C₁₈ column. In one example of this kind (a basic peptide substituted with a very large alkyl group [9]), it was found that an acceptable separation could be obtained with NARP conditions and a wide-pore polymeric column (less retentive and no silanols). A less-retentive silica-based reversed-phase column (wide-pore cyano) performed better, due to acceptable retention plus a higher plate number. The latter column also had reduced silanol effects, due to the selection of a less-acidic cyano column (Table 5.4). A further decrease in retention for hydrophobic cations can be expected as a result of (1) increasing temperature, (2) reducing silanol effects (Section 7.3.3.2), or (3) adding a cationic ion-pair reagent to the mobile phase.

9.2.2.5 Complex Samples. An example of this type is shown in Fig. 9.1e. This sample exhibits a large number of overlapping bands that are bunched together in the middle of the chromatogram, as opposed to overlapping bands at the beginning of separation (Fig. 9.1c). Overlapping bands at the beginning of separation usually can be separated (their retention range expanded), by changing to more retentive conditions. Samples as in Fig. 9.1e contain too many components for their complete separation by a single RPC separation. A good discussion of this problem has been given [10,11], which suggests that an alternative approach to separation should be explored for "complex" samples.

When only one or a few sample compounds are of interest, it is often possible to select separation conditions that allow the resolution of these few compounds from the rest of the sample. An example is provided [12] by the reversed-phase separation of a 38-peptide mixture from the enzymatic hydrolysis of the protein tissue plasminogen activator (TPA). No single set of conditions (temperature and gradient steepness varied) was able to separate this entire sample, but any individual peptide could be separated from the remaining 37 peptides with a particular choice of gradient steepness and temperature.

The total separation of complex samples can be approached in different ways. Some form of multidimensional separation is one option (i.e., where two or more separation procedures are used sequentially). Initial fractions from the first separation are further separated in a second or following separation. Column switching is a widely applicable technique for achieving multidimensional separation (Section 4.6), especially when only one or a few compounds are of interest. In this procedure, an initial separation of the sample is carried out on a first column, and a fraction containing the analyte is diverted via a switching valve to a second column where the column packing and/or mobile phase is different (for a change in selectivity). An example of column

switching for this purpose is given in Fig. 6.26 for the assay of parts per trillion of a herbicide metabolite in a sample of oats. A second approach for such samples is the use of a selective detector such as the mass spectrometer, which can recognize (and approximately quantitate) individual compounds even when they overlap in the chromatogram.

Another procedure for dealing with complex samples is to try very different separation conditions so as to “open up” the chromatogram and provide more room between the first and last peaks (some examples of this can be seen in Figs. 2.9 and 7.19). Often a change from reversed-phase to normal-phase separation, or vice versa, will change substantially the bunching of a critical group of compounds. If ionizable compounds are present, a change in pH and/or the use of ion pairing can have a very large effect on peak bunching. The reverse of the latter approach is illustrated in Fig. 7.8*b* vs. *c*, where it was desired to reduce the sample retention range (and therefore *increase* peak bunching) so as to avoid a need for gradient elution.

9.2.2.6 No Real Peaks. Other possibilities not illustrated in Fig. 9.1 are also possible, following an initial gradient run. The chromatogram may show no peaks at all after t_0 . This is sometimes due to a poor detector response, or the injection of too small a sample. The use of a “universal” detector such as the evaporative light-scattering detector (Section 3.3.1) can solve most problems of this kind. An absence of peaks may also be an indication of some equipment malfunction (faulty gradient mixing, detector bulb burned out, etc.). Finally, if no peaks are observed after about 30 min with the strongest solvent (i.e., 100% B), it is likely that the wrong separation system is being used. For example, if no peaks are visible with a RP system using 100% ACN, then the solutes of interest likely are too highly retained. Changing to a less-retentive RP column (e.g., lower surface area, wide-pore cyano or triisopropyl) may produce desired elution. However, a more useful approach may be to change to a different method, for example, normal-phase HPLC (see Part II of Chapter 6).

Alternatively, there may be a number of artifactual peaks caused by impure mobile-phase solvents or additives (Section 8.5.3.2). Before carrying out the initial gradient run as in Fig. 9.1, it is recommended performing a blank gradient run to ensure an absence of artifactual peaks in the chromatogram.

9.2.3 Evaluating Peak Shape and Plate Number

Once some of the bands in the chromatogram are at least partly resolved (as in the 40% ACN run of Fig. 9.2), they should be examined for peak width and symmetry. Any indication of peak tailing or distortion requires attention (Sections 5.4.2, 5.4.3, and 7.3.3). Silanol effects for silica-based columns are of special concern, because silanol interactions should be minimized for a final rugged method. Changes in separation conditions for the specific purpose of reducing silanol effects can also cause changes in retention and selectivity.

TABLE 9.5 Systematic Approach to HPLC Method Development for Regular Samples and Isocratic Separation

Experiment	Questions
Run 1^a See Table 9.3 for other conditions; 5 to 100% ACN gradient ^b in 60 min	1.1 Can reversed-phase HPLC be used (no early or late eluters)? 1.2 Is the sample too complex for a single RPC run? 1.3 Is isocratic or gradient elution preferable?
Run 2^c % ACN ^b selected from run 1 and Table 9.4	2.1 Symmetrical peaks? 2.2 Plate number reasonable? 2.3 Is the <i>k</i> range reasonable? 2.4 Is the separation acceptable? ^d 2.5 What % ACN should be used for run 3 (increase or decrease by 10%; change <i>k</i> by $\frac{1}{3}\times$ or $3\times$, respectively) ^e ?
Run 3^c % ACN increased by 10 vol % ^e	3.1 What is the best % ACN for this separation? 3.2 Is the separation acceptable? ^d
Run 3a^c Best % ACN from runs 2 and 3	3.3 Adequate separation confirmed? ^d
Run 4^c Runs 2 and 3 used to estimate best % MeOH (Table 9.7 or Fig. 6.4)	4.1 Is the <i>k</i> range acceptable? 4.2 Is separation acceptable? 4.3 What % MeOH should be used for run 5?
Run 5^c % MeOH increased by 10 vol % ^e	5.1 What is the best % MeOH for this separation? 5.2 Is the separation acceptable? ^d 5.3 Does the critical band change between best ACN and MeOH runs? (If so, run 6)
Run 5a^c Best % MeOH from runs 4 and 5	5.4 Adequate separation confirmed? ^d
Runs 6 and 7^c Blend mobile phases (1 : 1) from runs 2 and 4 plus runs 3 and 5 ^f	6.1 Adequate separation possible with any blend of water, methanol, and acetonitrile? ^d
Run 7a^c Optimum blend of water, methanol, and acetonitrile	7.1 Adequate separation confirmed? ^d 7.2 Adequate separation possible with any ACN–MeOH blend?

^a Isocratic run with 80 to 100% ACN is an alternative (Fig. 9.2).

^b No buffer required for non-ionic samples.

^c Duplicate runs, with different samples if standards available.

^d Optimize column conditions (optional).

^e 10% decrease in % B unless the “rule of 3” predicts $k > 20$ for last band; in that case, increase B by 10%.

^f Blend equal volumes of mobile phases from runs 2 and 4 or 3 and 5; see discussion of Fig. 6.15.

Therefore, method-development experiments that are carried out before silanol effects are eliminated may have little final value, because retention and band spacing will require re-optimization after correction of silanol effects. *Peak-shape problems in method development should be corrected as soon as they are recognized.*

A low plate number N is another indication of some problem, usually caused by the choice of initial conditions (assuming that the column is known to be "good"). Table 5.9 provides typical N values for columns of different length and particle size. If experimental values of N are less than half of these values (e.g., < 4000 plates for a 15-cm, 5- μm column at 2 mL/min), experiments should be carried out for the purpose of analyzing and solving the problem (Sections 5.4 and 7.3.3). When the sample molecular weight is > 500 Da, however, somewhat lower values of N can be expected.

9.3 COMPLETING ISOCRATIC METHOD DEVELOPMENT

If the initial gradient run as in Fig. 9.1a suggests that isocratic separation is possible, the separation of most "regular" samples can be achieved using the approach of Table 9.5. If further changes in selectivity are necessary after various combinations of acetonitrile and methanol have been investigated, Chapter 6 or 7 should be consulted for further options. In this section, three examples will be used to illustrate the method-development process of Table 9.5. These examples are drawn from a mixture of 11 substituted benzenes (Table 9.6) whose separation has been studied as a function of mobile-phase composition (acetonitrile-methanol-water mixtures [3]). Various compounds from this study have been combined into new samples of varying complexity, to illustrate typical outcomes of the method-development process.

9.3.1 Optimizing Retention and Selectivity

The following examples are based on an initial gradient experiment. If gradient equipment is not available, runs 1 to 3 of Table 9.5 can be replaced with three or four isocratic runs, as in Fig. 9.2.

TABLE 9.6 Compounds Used to Formulate the Various Samples Described in Section 9.3

A	Benzonitrile	G	2-Nitrotoluene
B	<i>p</i> -Cresol	H	3-Nitrotoluene
C	2-Chloroaniline	I	Toluene
D	2-Ethylaniline	J	4-Nitro- <i>m</i> -xylene
E	<i>N</i> -Ethylaniline	K	4-Nitro- <i>m</i> -toluene
F	3,4-Dichloroaniline		

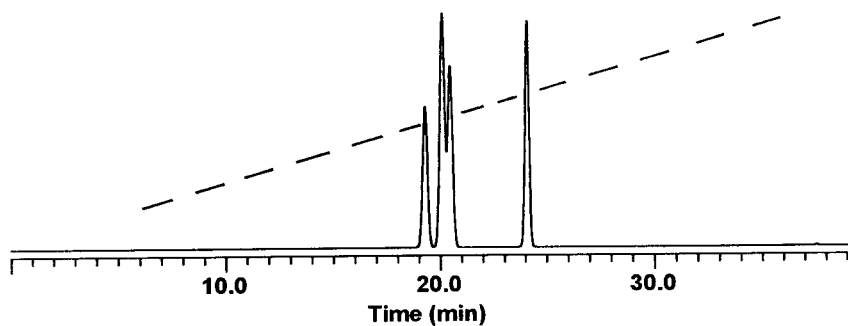

(a)

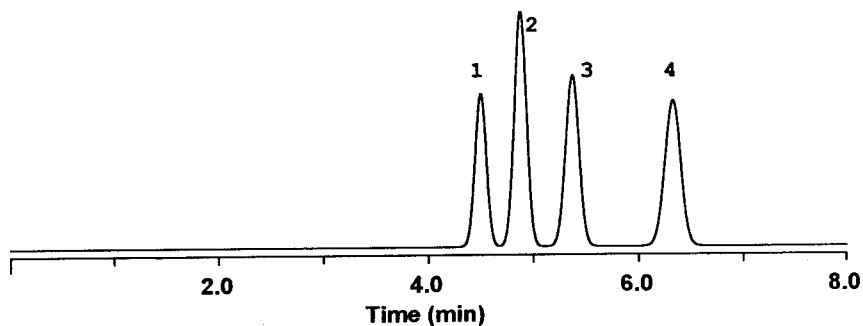

(b)

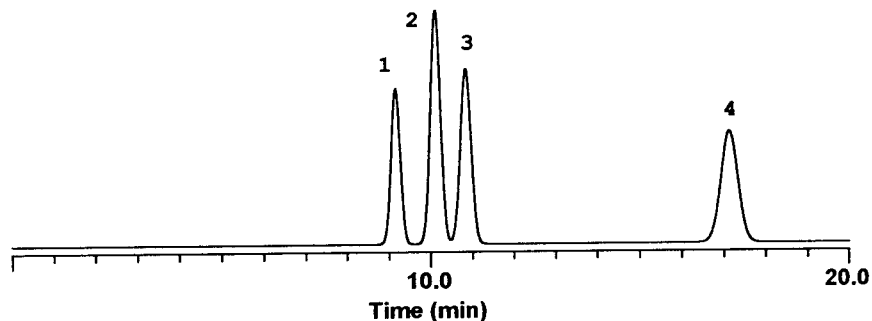

(c)

FIGURE 9.3 RPC method development for sample A of Fig. 9.2 according to plan of Table 9.5 (beginning with a gradient separation). Conditions and sample as in Fig. 9.2 except as follows: (a) 5 to 100% ACN gradient in 60 min; (b) isocratic separation with 40% ACN; (c) isocratic separation with 30% ACN. [Computer simulations (Dry-Lab) using data of Ref. 3.]

9.3.1.1 Sample A: An Easy Separation. Figure 9.3 (on page 421) illustrates method development for the same four-component sample as in Fig. 9.2, but employing an initial gradient run in place of the 80% ACN isocratic run of Fig. 9.2. The initial gradient run (Fig. 9.3a: run 1, 5 to 100% ACN in 60 min) is used to determine the best next experiment. The retention times for the first and last peaks are 19 and 24 min, respectively. From Table 9.4, the maximum retention time for the last peak is 43 min, so isocratic elution is quite feasible. The isocratic mobile phase recommended by Table 9.4 (for last band $k = 7$) is 40% ACN. This corresponds to run 2 of Table 9.5 and is shown in Fig. 9.3b. The observed k range for this separation is $5 < k < 7$ and the resolution is $R_s = 1.8$. Depending on what is required of this RPC method, this second run might be considered adequate, in which case *no further change in separation conditions is required*.

If an increase in resolution or other improvement in separation is considered advisable, the next step is to vary % ACN (run 3 of Table 9.4). A 10% increase in acetonitrile (to 50%) should give an estimated k range of 1.7 to 2.3 ("rule of 3," Section 6.2.1.1), while a 10% decrease in % ACN (to 30%) should result in a k range of about 15 to 21 (i.e., retention should be acceptable for either 30 or 50% ACN). However, the separation shown in Fig. 9.3c for 30% ACN (run 3) is disappointing, in that resolution is worse ($R_s = 1.5$, due to changes in selectivity with % ACN), and the run time is longer. A comparison of Fig. 9.3b and c suggests that a mobile phase with >40% ACN will give $R_s < 1.8$, because the critical band pair 1/2 (for >40% ACN) loses resolution as % ACN increases. For this reason, 40% ACN (Fig. 9.3b) would be judged near-optimum in terms of resolution, and only three experiments have been required to arrive at this conclusion. Further "fine tuning" experiments could have been carried out to further improve this result, but 40% ACN actually does give the best result.

9.3.1.2 Sample B: A Typical Separation. Figure 9.4 shows the successive method-development experiments for the separation of a nine-component sample. The initial gradient run (Fig. 9.3a: run 1 of Table 9.5; 5 to 100% ACN/60 min) plus Table 9.4 indicate that isocratic separation is possible [retention times of 9 min (first peak) and 24 min (last peak)]. Similarly, the retention time of the last peak suggests an isocratic mobile phase of 40% ACN. This separation (Fig. 9.3b: run 2 of Table 9.5) shows the separation of all nine

FIGURE 9.4 RPC method development for sample B according to plan of Table 9.5 (beginning with a gradient separation). Sample (see Table 9.6): 1, A; 2, B; 3, D; 4, F; 5, G; 6, H; 7, I; 8, J; 9, K. Conditions as in Fig. 9.2 except (a) 5 to 100% ACN gradient in 60 min; (b) isocratic separation with 40% ACN; (c) isocratic separation with 30% ACN; (d) isocratic separation with 49% ACN (optimum). [Computer simulations (DryLab) using data of Ref. 3.]

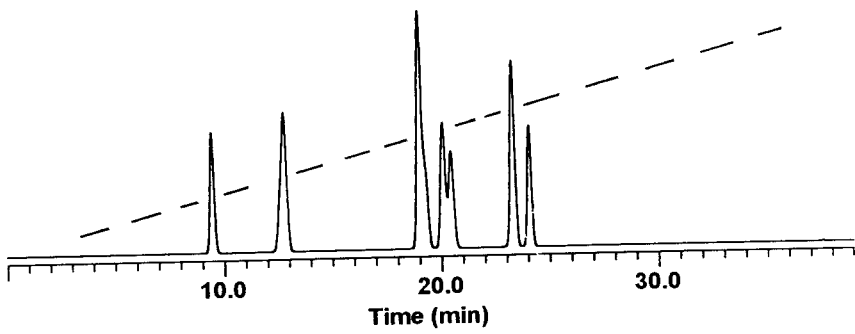

(a)

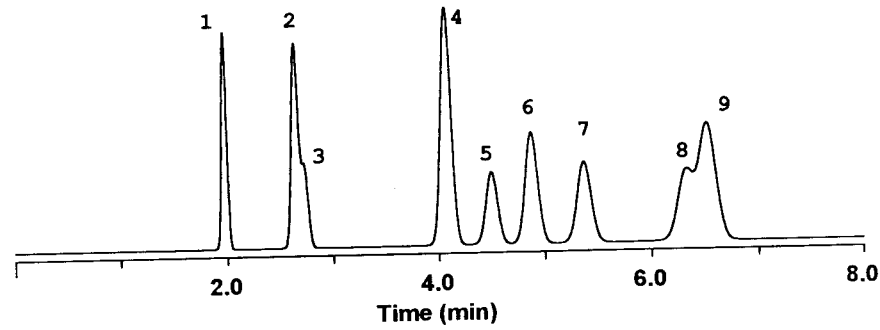

(b)

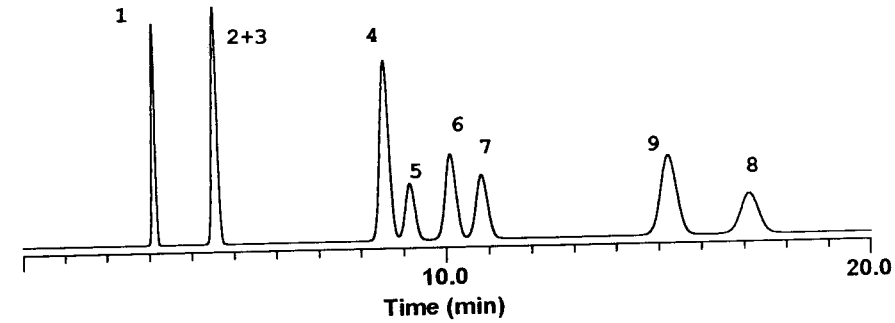

(c)

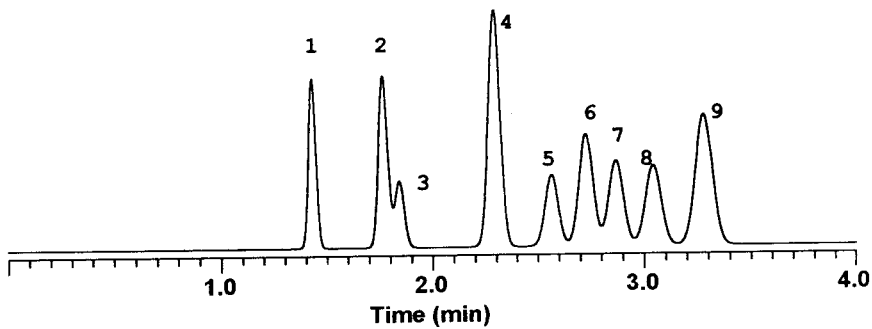

(d)

compounds in the sample, but with poor resolution for peak pairs 2/3 and 8/9. As in the previous example, a change in mobile phase to 30% ACN (run 3 of Table 9.5) is tried next. Figure 9.4c shows that bands 2 and 3 are now totally overlapped, while bands 8/9 separate with a reversal in retention order. These two runs (30 and 40% ACN) suggest that an increase in % ACN will result in a better separation of bands 2/3 and 8/9 than is found in the 40% ACN run. For a mobile phase of 49% ACN (obtained by successive trial and error), this is indeed the case (Fig. 9.4d); however, the resolution for this separation is still marginal ($R_s = 0.9$). Because the run time is very short (<4 min), the further improvement of this separation can make use of a change in column conditions (Section 9.3.2 and Fig. 9.7b).

9.3.1.3 Sample C: A Difficult Separation. The addition of two more compounds to sample B results in an 11-component mixture (sample C) that is more difficult to separate and requires all the experiments outlined in Table 9.5. Figure 9.5 is a schematic representation of these experiments. After an initial gradient run (run 1), isocratic experiments with two different values of % ACN (runs 2 and 3) are carried out with $0.5 < k < 20$. If the latter runs do not suggest a mobile phase that can provide adequate separation of the sample, one or two additional experiments (4 and 5) are run with methanol (MeOH) in place of acetonitrile. The methanol mobile phases for runs 4 and 5 are selected to have about the same solvent strengths (and run times) as for runs 2 and 3, respectively (Table 9.7). If the latter two runs do not lead to a successful separation with some % MeOH as mobile phase, the methanol and acetonitrile mobile phases are compared to see if there is a change in the critical band pair(s) upon changing solvents. If this is the case, mixtures of methanol and acetonitrile are used next as mobile phase (runs 6 and 7). When runs 2 through 7 have been completed, it should be clear whether any mobile phase composed of water, methanol, and/or acetonitrile can provide a satisfactory separation. Occasionally, additional runs 8, 9, and 10 (Fig. 9.5) may prove useful for a more precise understanding of separation, especially for mobile phases containing < 20% or > 80% B when computer simulation (Section 10.2) is used.

The experiments leading to the separation of sample C according to the scheme of Fig. 9.5 are shown in Fig. 9.6a. The initial gradient run (a, 5 to 100% ACN/60 min) has the same first and last peaks as in Fig. 9.4. Therefore, isocratic separation is possible and the recommended mobile phase for run 2 is 40% ACN (Table 9.4). Run 3 with 30% ACN is carried out next. Peaks 1, 3, and 4 are poorly separated in both runs 2 and 3, suggesting that a successful separation cannot be achieved with any % ACN value.

Based on Figs. 9.6a–c (see Table 9.7), runs 4 and 5 are carried out with 40% MeOH [part (d)] and 50% MeOH [part (e)]. Peaks 1 and 2 are unresolved with either methanol–water mobile phase, suggesting that the separation of this sample cannot be achieved using any methanol–water mobile phase. However, there is a change in the critical peak pair (1/2 vs. 3/4) when methanol

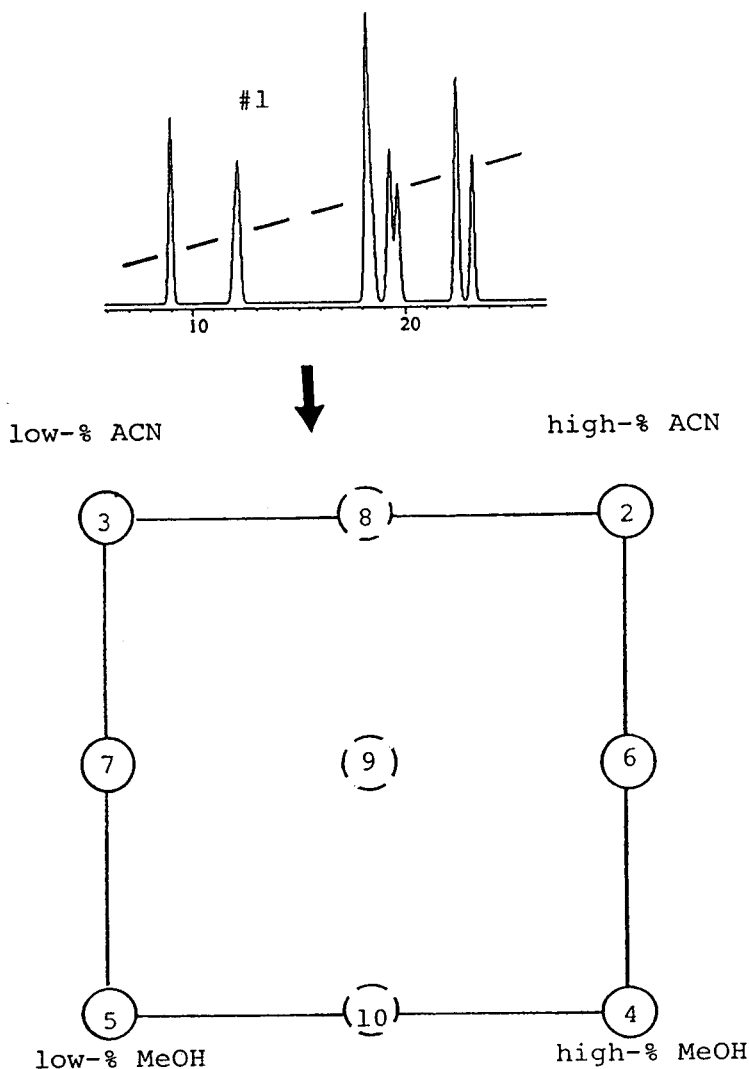

FIGURE 9.5 Experimental design for method development strategy of Table 9.5. See the text for details.

replaces acetonitrile in the mobile phase. This suggests that some mixture of methanol and acetonitrile will provide a better separation of this sample.

Blending the 40% ACN and 50% MeOH mobile phases (1:1) gives a mobile phase containing 20% ACN and 25% MeOH [Fig. 9.6f: run 6]. As expected, this separation is better than that provided by either of the binary-solvent mobile phases (bands 1 and 3 are the critical pair; $R_s = 1.1$). The 30% ACN and 40% MeOH mobile phases are mixed next, to give run 7 [Fig. 9.6g: 15%

TABLE 9.7 Equal-Solvent-Strength Mixtures of Methanol (MeOH) and Acetonitrile (ACN) with Water^a

% ACN	% MeOH	% ACN	% MeOH
5	7	55	65
10	14	60	70
15	21	65	74
20	28	70	78
25	34	75	82
30	40	80	86
35	45	85	90
40	50	90	95
45	55	95	98
50	60	100	100

^a See also Fig. 6.4.

ACN and 20% MeOH]. The latter separation shows poorer resolution of band pairs 1/3, 6/7, and 8/9. Because the resolution of critical peak pair 1/3 is better in run 6 [Fig. 9.6f: 45% organic] compared to run 7 [Fig. 9.6g: 35% organic], a further increase in organic is expected to improve the separation of Fig. 9.6f. The use of 53% organic [Fig. 9.6h:) 23% acetonitrile + 30% methanol] provides the best separation seen so far; $R_s = 1.3$. This can be improved further by a change in column conditions (Section 9.3.2).

9.3.1.4 Further Improvements in Separation. If a further improvement in separation is required after the various experiments of Table 9.5 or Fig. 9.5 have been carried out, there are two alternatives. First, column conditions can be optimized as described in following Section 9.3.2. This may be the preferred approach, whenever resolution is at least marginal ($R_s > 0.8$) and a longer run time is not a problem. Second, further changes in selectivity can be attempted by varying other separation conditions (e.g., temperature, column type, pH, use of ion pairing, etc.). The choice of which variable to try first in this situation is indicated in Table 9.8, which lists these variables in order of preference for both neutral and ionic samples. In some cases, other

FIGURE 9.6 RPC method development for sample C according to plan of Table 9.5 and Fig. 9.5 (beginning with a gradient separation). Sample (see Table 9.6): 1, A; 2, B; 3, C; 4, D; 5, E; 6, F; 7, G; 8, H; 9, I; 10, J; 11, K. Conditions as in Figs. 9.2 and 9.4 except for additional compounds in sample and use of different mobile phases: (a) run 1, 5 to 100% ACN in 60 min; (b) run 2, 40% ACN; (c) run 3, 30% ACN; (d) run 4, 40% MeOH; (e) run 5, 50% MeOH; (f) run 6, 20% ACN + 25% MeOH; (g) run 7, 15% ACN + 20% MeOH; (h) run 8, mobile-phase water reduced: 23% ACN and 30% MeOH ($R_s = 1.3$). [Computer simulations (DryLab) using data of Ref. 3.]

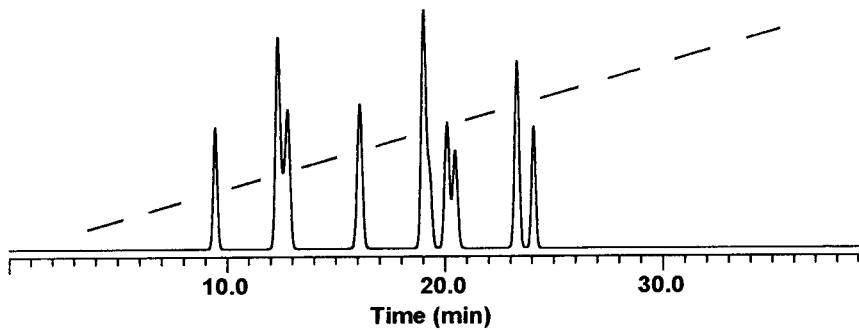

(a)

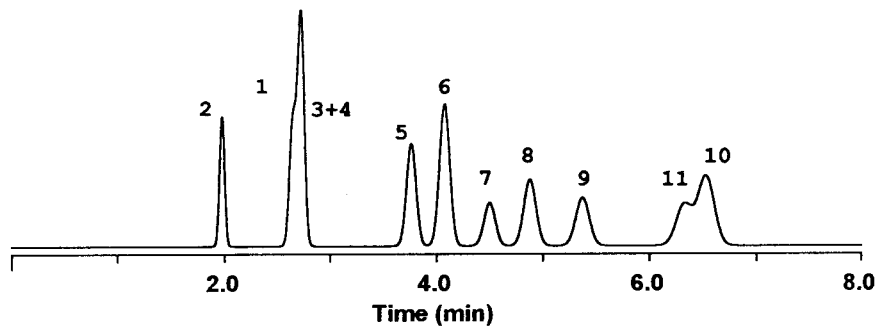

(b)

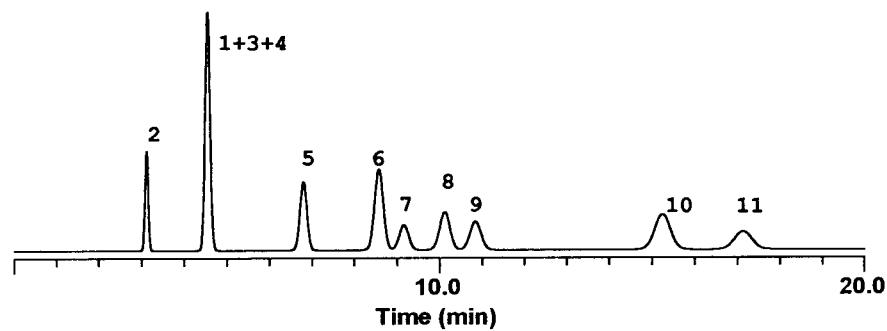

(c)

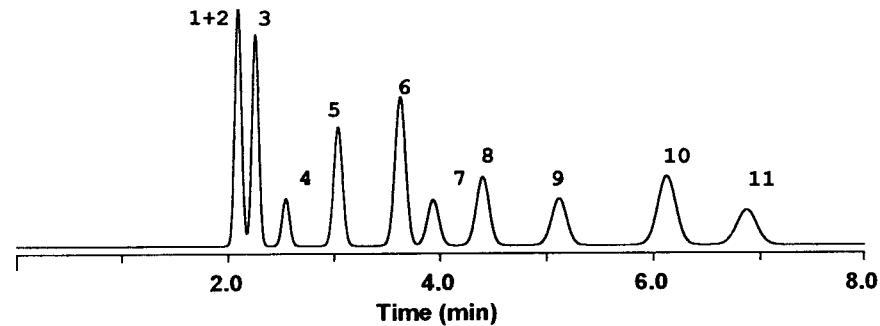

(d)

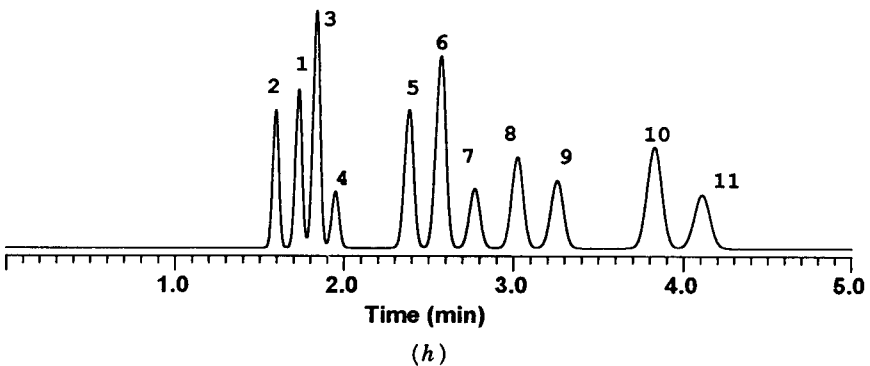
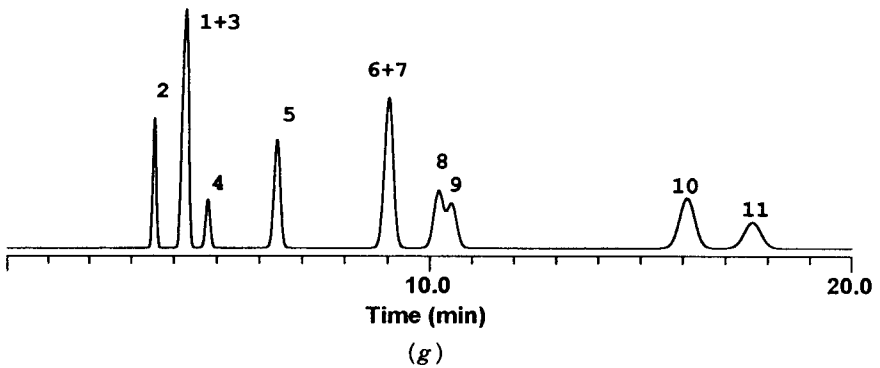
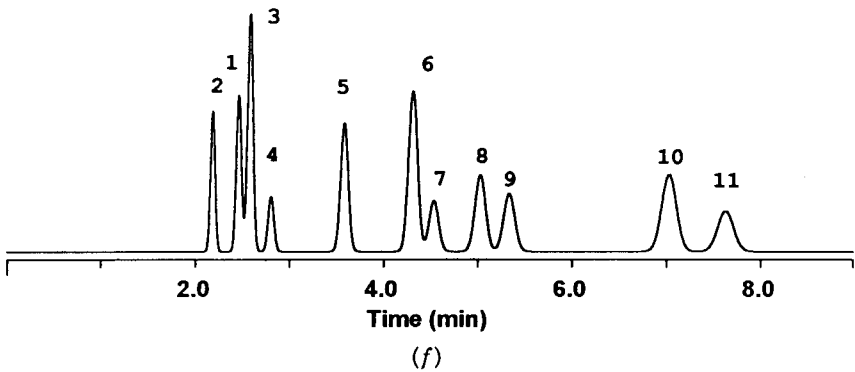
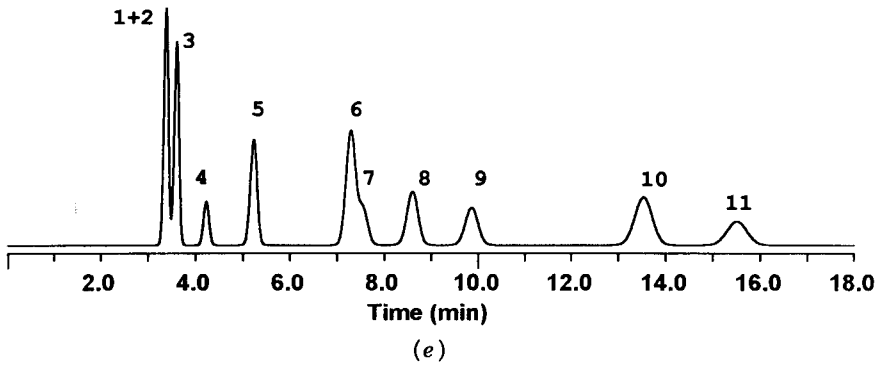

FIGURE 96. (Continued)

considerations may suggest a different prioritization of further experiments. The investigation of these additional variables should be guided by the general discussion of Sections 6.3, 7.3.2, and 7.4.

9.3.1.5 Changing the Method for Later Samples or Applications. Sometimes, the initial sample for which a method is developed will not be representative of later samples. The most common example is when a new interference, impurity, metabolite, or degradation product appears in a later sample. This becomes a problem when the new sample component overlaps an analyte band in the chromatogram. Two approaches are possible in this situation. First, because of the limited number of experiments required in Table 9.5, method development can be repeated beginning with run 2 and continued until the separation of all sample components of interest has been achieved. A second (trial-and-error) approach is to adjust different conditions (% B, proportions of ACN, MeOH, THF, temperature, pH, etc.) to see if a small change in the method will result in a better separation. The first procedure will more often result in the desired separation with the least work.

The method initially developed will sometimes be intended for “quick and rough” application during the early stages of a research project. For example, the method may be used for an approximate assay of product in different samples or as a function of reaction conditions. At a later time, more stringent assay procedures may be required, application of the method to different sample matrices may be needed, and/or additional sample components may be encountered. The use of a standardized approach to method development as in Table 9.5 by different groups within an organization often makes it easier to compare results from initial studies with data obtained at a later time (using a necessarily different HPLC method). This approach also makes better use of experiments carried out during initial method development research, because it can provide confirmation of later work and avoid some surprises.

TABLE 9.8 Additional Variables for Changing Selectivity and Separation When the Approach of Table 9.4 Has Been Unsuccessful^a

Neutral Samples	Ionic Samples
Column type; cyano or phenyl column (Section 6.3.3)	Temperature (Section 7.3.2.4)
Temperature (Section 6.3.4)	pH (Section 7.3.2.1)
THF as solvent (Section 6.3.2)	Column type; cyano or phenyl column (Section 7.3.2.7)
Different C ₁₈ column (Section 6.3.2)	Ion-pair reagent (Section 7.4.3.2)
	THF as solvent
	Buffer type or concentration; amine modifiers (Section 7.3.2)

^a Variables arranged in order of decreasing promise for reversed-phase HPLC.

When the successive change or improvement of a method is anticipated, it is advantageous to use the same column packing throughout method development.

9.3.2 Optimizing Column Conditions

A change in column length, particle size, or flow rate can sometimes be used to achieve an acceptable final separation, especially when only a minor improvement in resolution is required. The advantages and disadvantages of using different column conditions to improve separation are summarized in Table 9.9. Flow rate provides the most convenient and predictable changes in separation (no change in k), but only small increases in resolution (for lower flow) are likely, with a considerable increase in run time. Increased column length provides a larger increase in resolution with less increase in run time.

A smaller particle size is capable of providing better resolution with no increase in run time, or faster separations with no loss in resolution. However, a change in either column length or particle size can occasionally result in changes in selectivity, due to column-packing variability. In this case, it may be necessary to readjust the mobile-phase composition, to restore the original band spacing. In Fig. 9.4*d*, resolution of this sample is marginal ($R_s = 0.9$, despite optimization of % ACN), but the run time is short (< 4 min). In such cases, the first choice is an increase in column length with a decrease in flow

**TABLE 9.9 Pros and Cons of Changing Column Conditions
(for isocratic separations)**

Variable	Features
Decrease flow rate	Can provide a modest increase in resolution Increases run time, decreases pressure No unintended change in selectivity (same column)
Increase column length	Significant increase in resolution Significant increase in run time and pressure Unintended change in selectivity possible ^a
Decrease particle size	Can provide a large increase in resolution Provides best compromise between resolution, run time and pressure Unintended change in selectivity possible ^a Resulting shorter columns make extra-column effects more important Column problems (blockage) more likely for particles $< 3.5 \mu\text{m}$

^a A change in selectivity can occur because the column packing comes from a different batch which is not identical to that contained in the first column used (Section 5.2.4).

rate. This option maintains pressure constant with a significant increase in resolution and only a modest increase in run time. Fig. 9.7*a* and *b* illustrate the effect of a change in column length from 15 cm (*a*) to 25 cm (*b*), with a simultaneous change in flow rate from 2 mL/min (*a*) to 1 mL/min (*b*). Resolution is increased from $R_s = 0.9$ to 1.4, while run time increases to 11 min. For a sample of this complexity (9 components), this could be an acceptable separation. To increase resolution without increasing run time, decrease particle size (e.g., from 5 to 3.5 μm) and length (e.g., from 25 to 15 cm) simultaneously.

A similar increase in resolution can be achieved for sample C in Fig. 9.6*h*, as shown in Fig. 9.7*c* and *d*. For the same change in column conditions (to a 25-cm column, 1.0 mL/min), resolution is increased from $R_s = 1.3$ (marginal) in (*c*) to 2.0 (acceptable) in (*d*), while run time increases from 4.5 to 14 min. Column conditions can also be changed to *decrease* run time, whenever sample resolution is greater than required ($R_s \gg 2$). Usually, the best approach is a decrease in column length plus an increase in flow rate.

9.4 ALTERNATIVE TO COMPLETING ISOCRATIC METHOD DEVELOPMENT

The approach of Table 9.5 as illustrated in Figs. 9.3 to 9.6 is based on simultaneous changes in solvent type (ACN and MeOH) and strength (% B). An alternative approach is to vary solvent strength (% B) and temperature (T) together [13–16]. This method-development strategy can be more convenient and it involves fewer runs, especially when carried out in a gradient mode (Section 9.5). A change in temperature can have a pronounced effect on selectivity for the case of ionic samples but is less effective for neutral samples.

Figure 9.8*a* shows the sequence of runs, following an initial gradient run. Runs 1 and 2 correspond to runs 2 and 3 of Fig. 9.5. Runs 3 and 4 of Fig. 9.8*a* are then repeats of runs 2 and 3, but with the temperature increased. These four runs can suggest further changes in either % ACN or T for improved band spacing and separation. If computer simulation is used (Section 10.2), the four runs of Fig. 9.8*a* allow separation to be predicted for any value of % ACN or T . The approach of Fig. 9.8*a* is more effective for ionic samples than for neutral samples, and compounds with multiple polar substituents compared to unsubstituted or monosubstituted compounds [15,16].

If the temperature is increased above 50°C, it becomes important to thermostat the sample valve and the mobile phase entering the column [13]. Otherwise, the bandwidths can increase by a factor of 2 or more, leading to poor resolution of the sample. For operation with low-pH mobile phases, it is necessary to use a stable column packing (polymeric or sterically protected phases; Section 5.2.3.4).

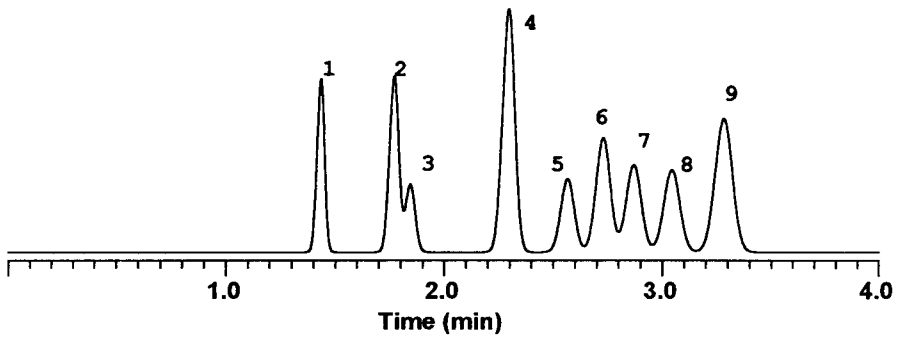

(a)

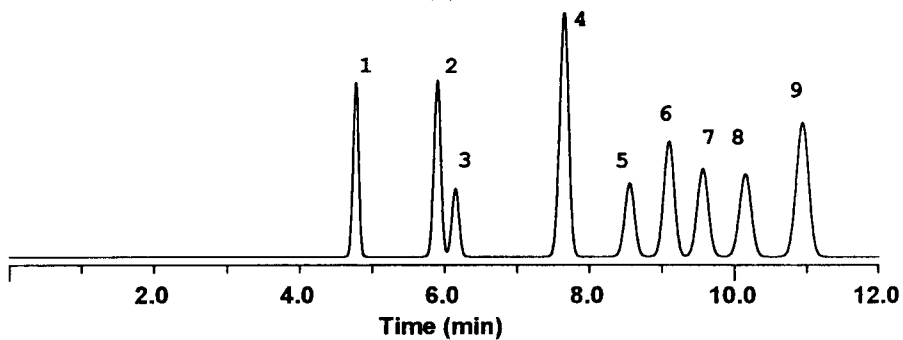

(b)

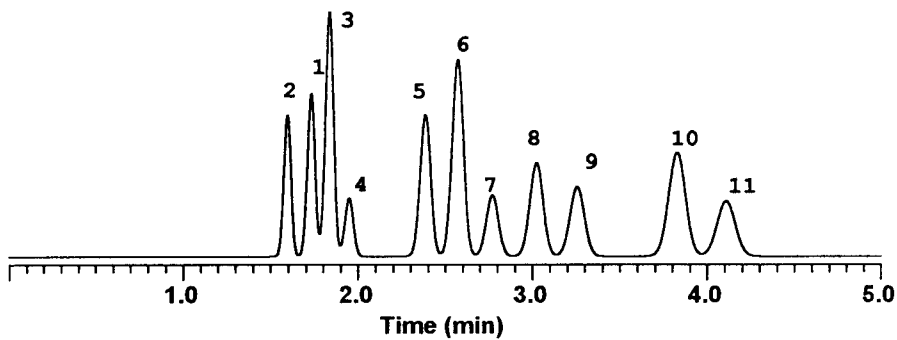

(c)

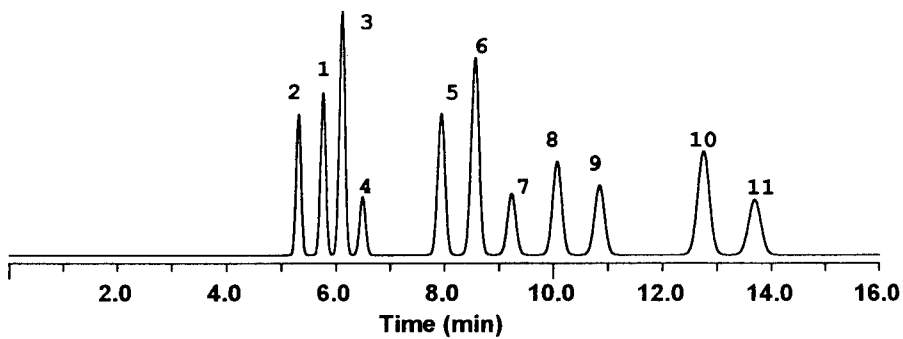

(d)

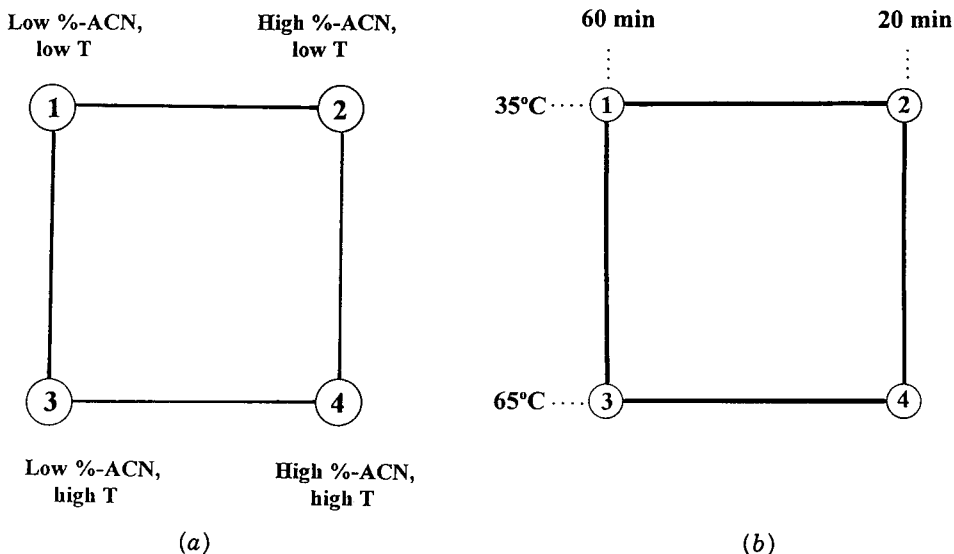

FIGURE 9.8 Method development based on changes in solvent strength and temperature. (a) Isocratic method; (b) gradient method. See the text for details.

9.5 COMPLETING GRADIENT METHOD DEVELOPMENT

An initial gradient separation as in Fig. 9.1b suggests that isocratic elution is impractical. Even when isocratic separation is possible, gradient elution may provide a satisfactory separation with less method development effort, because solvent-strength selectivity can be used more effectively in gradient elution (cf. Sections 6.3.1 and 8.4.2). Simple changes in gradient steepness provide a powerful means for adjusting band spacing for most samples [15,16].

Table 9.10 outlines the recommended approach to the development of a gradient method. This method development strategy will be illustrated (Fig. 9.9) with a sample that contains 19 basic drug compounds. The first experiment is the same as for isocratic method development: an exploratory gradient run from 5 to 100% ACN in 60 min (Fig. 9.9a). The resulting chromatogram is evaluated using Table 9.4. The retention times of the first and last bands in Fig. 9.9a are 2 and 23 min. According to Table 9.4, an isocratic method may be possible, but just barely. When isocratic separation is marginal because of the expected wide range in k values, especially when the sample contains a

FIGURE 9.7 Use of a change in column conditions to improve separation. (a) Same as Fig. 9.4d (15-cm column, 2.0 mL/min); (b) same as (a), except 25-cm column and 1.0 mL/min; (c) same as Fig. 9.6h (15-cm column, 2.0 mL/min); (d) same as (c), except 25-cm column and 1.0 mL/min.

TABLE 9.10 Systematic Approach to HPLC Method Development for Regular Samples and Gradient Separation^a

Run 1.	5–100% B in 60 min (1.6%/min); 15 × 0.46-cm column, 2.0 mL/min; 35 to 40°C.
Run 2.	Adjust initial and final % B values according to Table 9.4; increase gradient steepness to about 5%/min; examine the critical band pairs in runs 1 and 2; is $R_s > 0.7$ possible with any gradient steepness?
Run 3.	Repeat the separation of run 2, except for an increase in temperature to 60 to 70°C.
Run 4.	Repeat the separation of run 3, except for a threefold increase in gradient time; examine the critical band-pairs in runs 1 to 4; is any gradient steepness or temperature likely to result in $R_s > 0.7$ for all bands?
Run 5.	If $R_s > 0.7$ appears possible, perform a separation under these conditions.
Run 6.	If R_s requires an increase, change column conditions to achieve this goal.
Run 7.	If changes in gradient steepness or temperature do not permit an adequate separation of the sample, then explore the use of methanol or acetonitrile–methanol mixtures as in Table 9.5 or Fig. 9.5 (use steeper gradients instead of high percent organic). If this approach fails, explore the use of other variables of Table 9.8.

^a See Table 9.3 for other conditions. Perform successive experiments until a successful separation is achieved.

large number of components (>10), the development of a final separation will usually be much easier using gradient elution. For this reason, further experiments were carried out in a gradient mode.

The next step is to adjust the gradient range for “best” values of the initial and final % B. From Table 9.4, the recommended initial % B is 0% (first-band retention time = 2 min), and the recommended final % B is 47% (last-band retention time = 23 min). The second experiment should be carried out with this new gradient range and a steeper gradient (about 5%/min) to explore the effect of gradient steepness on band spacing. A run with 0 to 47% B in 10 min is shown in Fig. 9.9*b* [other conditions the same as in part (*a*)]. Fourteen bands were resolved in part (*a*) and 17 bands are visible in part (*b*). Contrary to the usual case (Section 8.3.2), an increase in gradient steepness (*b* vs. *a*) has resulted in *better* overall separation of this sample. The critical band pairs in run-2 (Fig. 9.9*b*) are 3/4 and 8/9. Since these bands are also unresolved in run 1, no further adjustment of gradient steepness can resolve these bands.

The next step is a change in temperature, especially for ionic samples (as in the present case). Run 2 is repeated with an increase in temperature up to 60 to 70°C (other conditions the same). This experiment is shown in Fig. 9.9*c* (60°C), where significant changes in band spacing are observed. Bands 3/4 are now partially resolved, but bands 12/13 have merged together. Since the critical resolution of the sample is still $R_s < 0.7$, run 4 is carried out with a flatter gradient (for a change in band spacing): 0 to 47% ACN in 30 min (Fig. 9.9*d*).

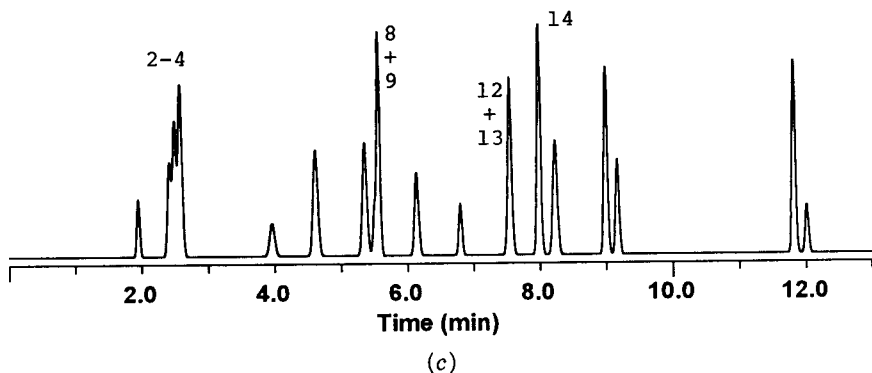
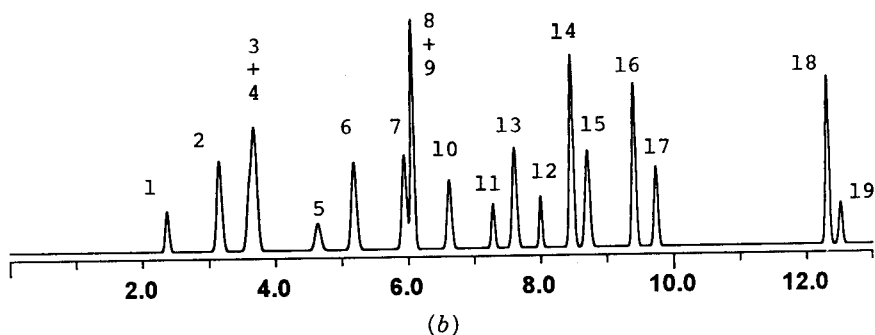
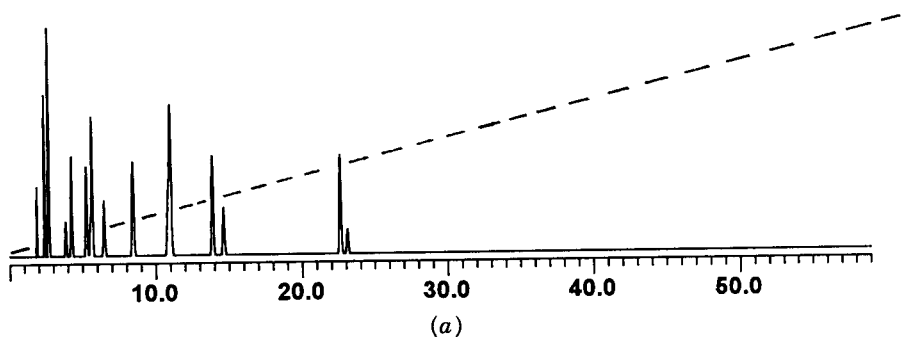
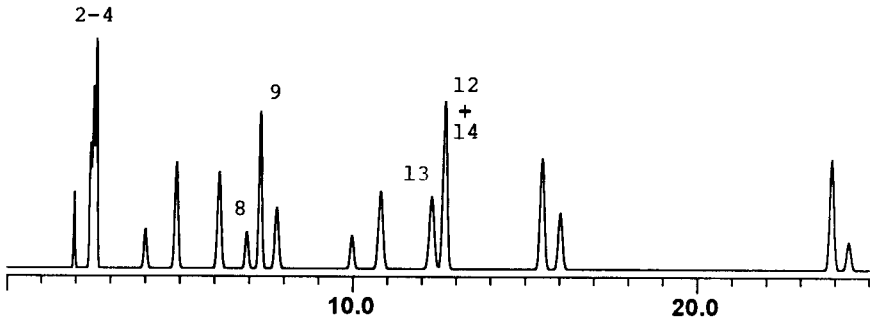
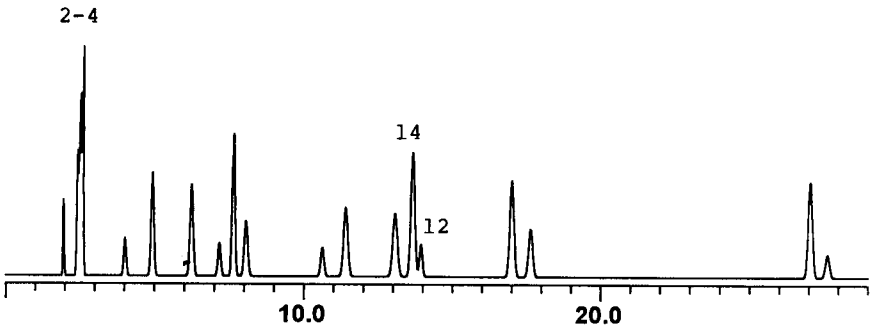

FIGURE 9.9 Method development for a 19-component basic drug sample. Conditions: 15×0.46 -cm $5\text{-}\mu\text{m}$ Zorbax Rx-C18 column; gradient runs with 0.1% TFA–water as A-solvent and 0.1% TFA–acetonitrile as B-solvent; 2.0 mL/min; other conditions as noted for each chromatogram. (a) 5 to 100% B in 60 min, 30°C; (b) 0 to 47% B in 10 min, 30°C; (c) 0 to 47% B in 10 min, 60°C; (d) 0 to 47% B in 30 min, 60°C; (e) 0 to 47% B in 36 min, 60°C; (f) 0 to 47% B in 72 min, 30×0.46 -cm column, $3.5\text{-}\mu\text{m}$ particles, 2 mL/min. Insert shows expansion of bands 1 to 3 for better visualization. (Computer simulations using data of Ref. 13.)



(d)



(e)

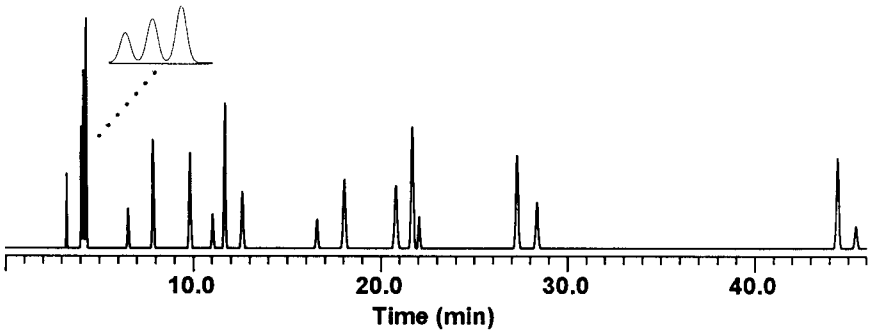

(f)

FIGURE 9.9 (Continued)

All but one band pair (12/14) are now resolved with $R_s > 0.7$, and bands 12/14 can be separated by a change in gradient steepness, as seen in part (c). A comparison of Fig. 9.9c and d suggests the use of a longer gradient; run 5 with a gradient time of 36 min is shown in Fig. 9.9e; $R_s > 0.7$ for all 19 bands.

Further changes in band spacing could be attempted by changing to methanol as solvent and repeating some of the experiments of Fig. 9.9a–e. However, this could involve considerable additional work with no promise of success, because of the large number of sample components. A more reasonable approach at this point is to improve resolution by a change in column conditions (see the similar discussion of Section 9.3.2). In the present example, a change to a more efficient 30×0.46 -cm $3.5\text{-}\mu\text{m}$ column of the same kind (two 15-cm Zorbax RX-C18 columns in series) gave the separation of Fig. 9.9f, where $R_s > 1.3$ for all sample components in a run time of under 50 min. Note that column backpressure for $3.5\text{-}\mu\text{m}$ particle columns may limit the usable length to < 30 cm in some cases; a higher temperature often can be used to decrease the mobile phase viscosity and column back pressure.

When changing column length (or flow rate) in gradient elution, it is necessary to change gradient time at the same time (Section 8.4.3) to maintain the same selectivity and band spacing. If column length is increased by a factor x , the gradient time must be increased by this same factor. If flow rate is increased by x -fold, the gradient time must be *decreased* x -fold. A change in particle size does not require any adjustment of gradient time. Since the separation of Fig. 9.9f uses a 30-cm column vs. a 15-cm column in earlier runs, the gradient time must be increased by (30/15)-fold, to 72 min. Because the last band leaves the column at 46 min in this last run [part (f)], it would be possible to shorten the gradient to 0 to 30% ACN in 45 min (Section 8.3.3).

REFERENCES

1. H. Small, *Ion Chromatography*, Plenum, New York, 1989.
2. W. W. Yau, J. J. Kirkland, and D. D. Bly, *Modern Size-Exclusion Liquid Chromatography*, Wiley-Interscience, New York, 1979.
3. J. A. Lewis, L. R. Snyder, and J. W. Dolan, *J. Chromatogr. A*, **721** (1996) 15.
4. L. R. Snyder, *Today's Chem. Work*, **5** (1996) 29.
5. L. R. Snyder and J. W. Dolan, *J. Chromatogr. A*, **721** (1996) 3.
6. S. R. Lipsky and M. L. Duffy, *LC/GC*, **4** (1986) 898.
7. K. E. Bij, C. Horvath, W. R. Melander, and A. Nahum, *J. Chromatogr.*, **203** (1981) 65.
8. M. I. Aguilar and M. T. W. Hearn, in *HPLC of Proteins, Peptides and Nucleotides*, M. T. W. Hearn, ed., VCH, New York, 1991, Chapter 8.
9. L. R. Snyder, LC Resources, Walnut Creek, California, unreported experiments, 1992.

10. D. P. Herman, H. A. H. Billiet, and L. de Galan, *Anal. Chem.*, **58** (1986) 2999.
11. H. A. H. Billiet and L. de Galan, *J. Chromatogr.*, **485** (1989) 27.
12. R. C. Chloupek, W. S. Hancock, B. A. Marchylo, J. J. Kirkland, B. E. Boyes, and L. R. Snyder, *J. Chromatogr. A*, **686** (1994) 45.
13. P. L. Zhu, L. R. Snyder, J. W. Dolan, N. M. Djordjevic, D. W. Hill, L. C. Sander, and T. J. Waeghe, *J. Chromatogr. A*, **756** (1996) 21.
14. P. L. Zhu, L. R. Snyder, and J. W. Dolan, *J. Chromatogr. A*, **756** (1996) 41.
15. P. L. Zhu, L. R. Snyder, J. W. Dolan, D. W. Hill, L. Van Heukelem, and T. J. Waeghe, *J. Chromatogr. A*, **756** (1996) 51.
16. P. L. Zhu, L. R. Snyder, J. W. Dolan, N. M. Djordjevic, D. W. Hill, J.-T. Lin, L. C. Sander, and L. Van Heukelem, *J. Chromatogr. A*, **756** (1996) 63.

14

QUANTITATION (INCLUDING TRACE ANALYSIS)

- 14.1 Introduction
 - 14.1.1 Accuracy, Precision, and Linearity
 - 14.1.2 Limits of Detection and Quantitation
- 14.2 Measurement of Signals
 - 14.2.1 Noise
 - 14.2.2 Peak Height
 - 14.2.3 Peak Area
 - 14.2.4 Peak Height vs. Peak Area for Quantitation
- 14.3 Quantitation Methods
 - 14.3.1 Normalized Peak Area
 - 14.3.2 External Standard Calibration
 - 14.3.3 Internal Standard Calibration
 - 14.3.4 Method of Standard Addition
- 14.4 Sources of Error in Quantitation
 - 14.4.1 Sampling and Sample Preparation
 - 14.4.2 Chromatographic Effects
 - 14.4.3 Data System Effects
- 14.5 Trace Analysis
 - 14.5.1 Sample Preparation
 - 14.5.2 Column Resolution
 - 14.5.3 Sample Injection
 - 14.5.4 Detection
 - 14.5.5 Calibration
 - 14.5.6 General Strategy

14.1 INTRODUCTION

One of the strengths of HPLC is that it is an excellent quantitative analytical technique. HPLC can be used for the quantitation of the primary or major component of a sample (including pure samples), for mixtures of many com-

pounds at intermediate concentrations, and for the assessment of trace impurity concentrations (parts per billion or lower) in a matrix. Properly designed, validated, and executed analytical methods should show high levels of both accuracy and precision for a main component analysis (± 1 to 2% precision and accuracies within 2% of actual values). Trace-level quantitation often is not as good; however, accuracy within 10% of the true value and precision of ± 10 to 20% at the lowest levels of quantitation are still achievable.

A critical requirement for a quantitative method is an ability to measure a wide range of sample concentrations with a (preferably) linear response for each analyte. The UV detector is the most widely used for accurate and precise quantitation in HPLC, and many of the examples in this chapter are based on UV detection. However, other detectors (see Chapter 3) are available and can be appropriate at times. To achieve the best results with an HPLC method, it is necessary to understand and have control of the factors that affect quantitation. In this chapter we deal with these aspects of quantitation, including basic measurements of signal, types of calibration methods, sources of error, and trace analysis. Further details on these subjects can be found in Refs. 1 to 5.

14.1.1 Accuracy, Precision, and Linearity

The development of good quantitative HPLC methods requires an understanding of the critical concepts of accuracy, precision, and linearity. Although the techniques used to assess each of these for a specific method are described more fully in Chapter 15, the basic concepts are described here.

Accuracy is defined as the closeness of the measured value to the true value. The “true value” can be determined by a variety of techniques (Section 15.2); making accurate measurements in a HPLC method routinely also involves the use of proper calibration techniques (Section 14.3) and minimizing sources of error (Section 14.4).

Precision refers to the reproducibility of multiple measurements of a homogeneous sample. This can include reproducibility of results using different instruments, analysts, sample preparations, laboratories, and so on, obtained on a single day or over multiple days. Different levels of precision are often assessed as part of method validation, and these are described more fully in Section 15.3.

The *linearity* of a method is a measure of how well a calibration plot of response vs. concentration approximates a straight line, or how well the data fit to the linear equation:

$$y = mx + b \quad (14.1)$$

where y is the response, x the concentration, m the slope, and b the intercept of a line fit to the data. Ideally, a linear relationship (with $b \approx 0$) is preferred because it is more precise, easier for calculations, and can be de-

fined with fewer standards. Also, UV detector response for a dilute sample is expected to follow Beer's law, and be linear (with $b \approx 0$). Therefore, a linear calibration gives evidence that the system is performing properly throughout the concentration range of interest. In addition, a method that is linear (and with $b \approx 0$) permits a quick, convenient check with one (preferably two) points to confirm calibration accuracy. If the calibration check values show more than a 2σ deviation from values of the original calibration, a full recalibration may be required. A linear response with $b \neq 0$ or a non-linear response may be appropriate for some methods, as described in Section 14.3.

14.1.2 Limits of Detection and Quantitation

The *minimum detectable amount* of analyte [often referred to as the *limit of detection* (LOD)] is the smallest concentration that can be detected reliably. The LOD is related to both the signal and the noise of the system and usually is defined as a peak whose signal-to-noise (S/N') ratio is at least 3:1. For example, Fig. 14.1a shows a typical example where the signal is three times the detector noise. Here, the noise (peak to peak) is 10 units, while the signal is 30 units.

The *minimum quantifiable amount* [often known as the *limit of quantitation* (LOQ)] is the concentration that can be quantitated reliably with a specified level of accuracy and precision. The limit of quantitation can be defined in either of three ways. One method uses a technique similar to that for LOD but requires a S/N' ratio of at least 10, as shown in Fig. 14.1b. In this case, the peak-to-peak noise is 10 units, and the signal is 100 units (measured from the midpoint of the noise to the apex of the signal peak). The second method is to define a certain level of precision and determine experimentally how large a peak needs to be for that level of precision. This can be accomplished by injecting sample concentrations that result in various S/N' values (e.g., 3, 5, 10, 15, and 20) and determining the precision from multiple injections of each sample concentration. A third technique assumes that the baseline noise is approximated by a Gaussian distribution with a width of 4 standard-deviation units (SD) wide ($N' = 4\sigma$). As described in Section 3.2.3, measurement imprecision is affected by baseline noise (one measurement on each side of the peak) and signal (peak height measurement), so the effective uncertainty is approximately $3^{1/2}\sigma \approx N'/2$. The coefficient of variation (CV) at low values of S/N' (as described in Eq. 3.3) $\approx 50/(S/N')$. Therefore, for a S/N' of 5, if $\sigma \approx N'/2$, the estimated maximum precision using peak-height measurements would be $50/5$ or $\pm 10\%$. The LOD and LOQ are described further in Section 15.6.

The third important feature in quantitation is the *maximum level of quantitation*, defined as the highest concentration that can reliably be determined using the conditions of the method. Often, this is determined by the limit of linearity of the detector (i.e., when the detector no longer shows a linear

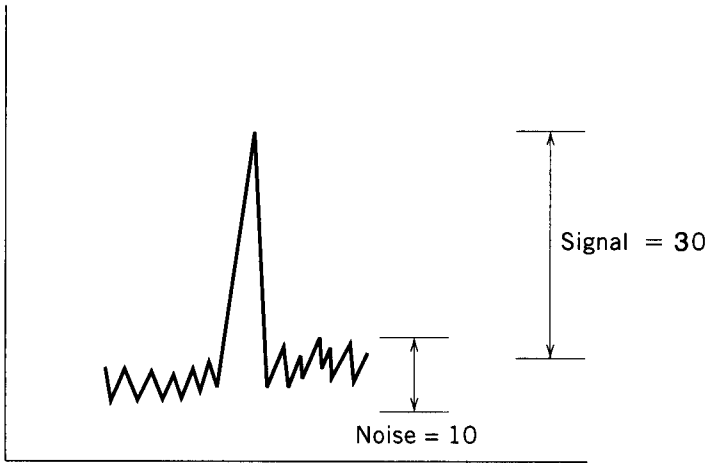

(a)

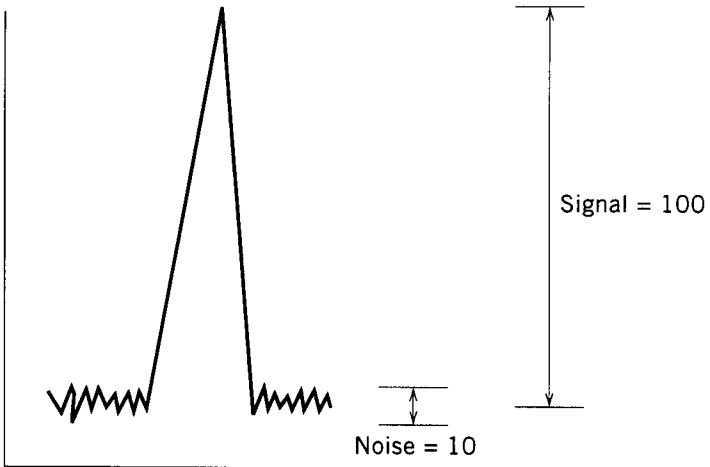

(b)

FIGURE 14.1 Signal-to-noise (S/N') ratio for peak at (a) limit of detection (LOD) = 3:1; (b) limit of quantitation (LOQ) = 10:1.

response with specified increase in concentration). The maximum and minimum quantifiable amounts will define the range of the method (see Section 15.5 for more discussion). If quantitation of higher concentrations is needed, dilution of the sample to bring it into a measurable quantitation range often is the easiest and most appropriate way to effectively extend the range of the method.

14.2 MEASUREMENT OF SIGNALS

14.2.1 Noise

The precision of any signal measurement (which is related to the assay result) is affected by the size of the peak (signal) relative to the noise. *Noise* refers to uncertainty in the value of the baseline signal in the absence of analyte. There are three basic categories of noise: short-term, long-term, and baseline drift. Each of these three types is illustrated in Fig. 14.2.

Short-term noise (also known as *high-frequency noise*) is of primary interest for most S/N' measurements. Short-term noise can be due to a number of factors, including detector noise, pulsations of the pumping system, and electronic noise in the integration system. This high-frequency noise component (typically with periodicity > 1 Hz) ultimately limits the ability to measure any signal in HPLC.

Long-term noise (variations in the signal with a frequency < 0.1 Hz) often is indicative of some external source or problem with the system. Figure 14.2*b* shows an example of long-term noise with a frequency of one cycle every 3 min. Causes of long-term noise include:

- Poor on-line mixing of solvent components causing slight variations in the mobile phase over time
- Temperature variations
- Bleed of stationary phase from the column (especially during gradient elution)
- Late-eluting compounds from prior injections

Typically, long-term noise of this type, once it is identified, can be corrected before implementing an HPLC method. Reference 6 provides many good suggestions for correcting problems related to noise. Baseline noise and its effect on assay precision are discussed further in Section 3.2.3.

Baseline drift, which can be considered a special type of long-term noise, can occur even in well-developed and validated methods. The most noticeable type of baseline drift is seen in gradient elution, where the composition of the solvent is deliberately changed during the course of the run; therefore, the response of the detector (typically, UV) may change as a function of solvent composition. This type of baseline drift is illustrated in Fig. 14.2*c*. Reproducible baselines can be established, and both peak height and peak area measurements are possible even when baseline drift due to gradient elution is evident. The use of modern data systems can help this process; however, severe baseline drift often requires manually overriding automated peak integration algorithms, complicating the overall analysis. Techniques that can be used to eliminate baseline drift during gradient elution are discussed in Section 8.5.3.

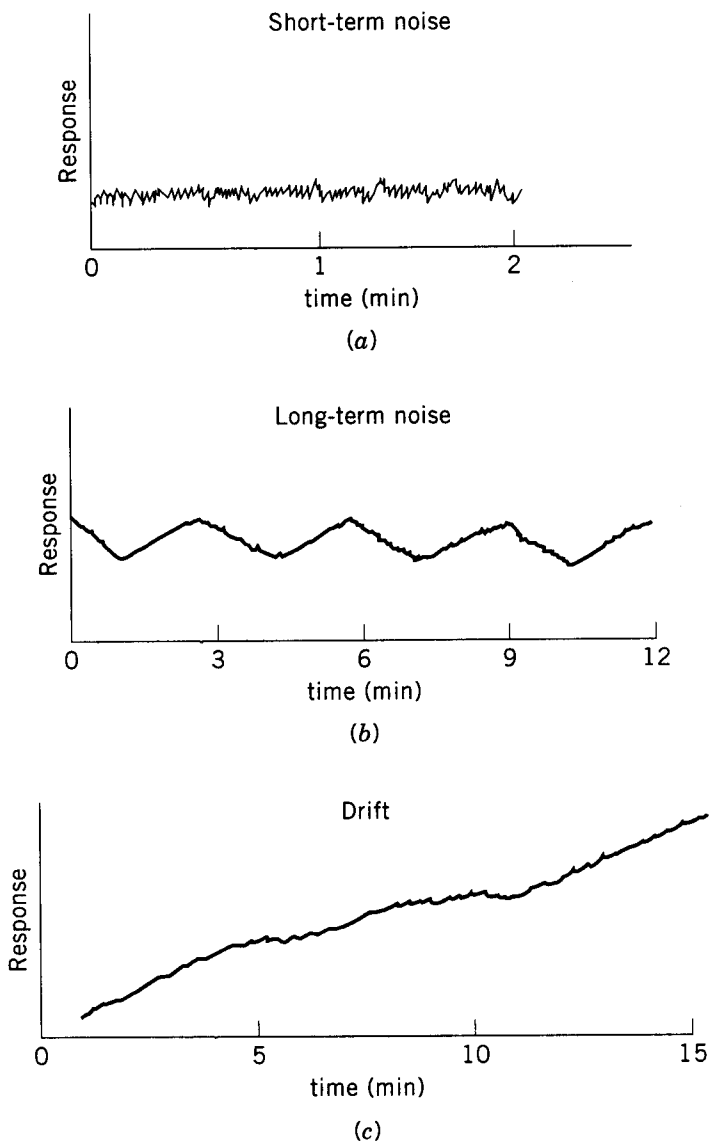

FIGURE 14.2 Types of noise in HPLC chromatograms. (a) Short-term noise; (b) long-term noise, (c) drift.

Late-eluting peaks or peaks from previous injections also can appear as baseline drift. These “peaks” elute as very broad bands and sometimes are indistinguishable from other types of baseline drift. This baseline problem often occurs in isocratic separations when late-eluting compounds are not cleaned off the column after each injection. This type of baseline drift can be minimized or eliminated by techniques described in Section 5.4.3.2.

Baseline drift also can be due to changes in the detector. Some refractive index detectors are especially sensitive to temperature fluctuations; any changes in the temperature of the detector cell can cause severe drift in the output signal. Baseline drift also can occur in UV detectors due to changes in the intensity of the lamp (aging) or the detector diodes or phototubes. Although such changes are often on a time scale much longer than the chromatographic run, the drift can become significant if the components of the detector are near the end of their usable life. Detector noise is discussed further in Section 3.2.3.

14.2.2 Peak Height

The simplest way to measure the response of a detector to a compound is by determining the peak height of the signal. This method of peak measurement is the preferred approach for trace analysis (Section 14.5). For a well-resolved single component, the peak height is the distance between the baseline and the apex of the peak, where the baseline value is the average of many data points taken before the start of the peak and after the end of the peak, as illustrated in Fig. 14.3 for peak 2. If the baseline is changing because of long-term noise or drift, the measurement of the peak height needs to be modified, as for peak 3 in Fig. 14.3. Here the baseline must be interpolated from the beginning to the end of the peak, as shown by the dashed line. For peaks that are not resolved completely, peak heights can be determined using a tangent skimming method, as illustrated by the major component and peak 1 in Fig. 14.3. However, tangent skimming should be used only for small peaks on the tailing edge of a large preceding peak. Although measurement of peak height is a simple manual procedure, most modern data systems also will calculate peak height. However, it is important to verify that the proper baseline has been established, especially for situations such as those shown in Fig. 14.3.

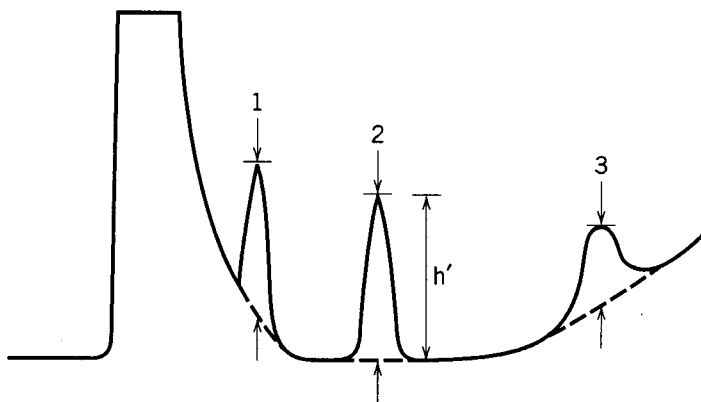
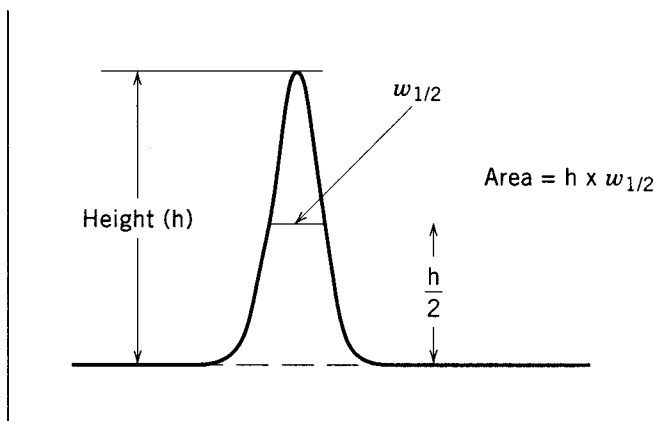

FIGURE 14.3 Peak-height measurement in HPLC. (Reprinted with permission from Ref. 7.)

14.2.3 Peak Area

Peak area is the most widely used technique for quantitating response in HPLC. The area of a well-resolved peak is defined as the integral of the signal response over time from the beginning until the end of the peak. This definition is relatively straightforward in theory. However, in practice, the accurate and precise measurement of peak area relies on a number of factors. First is the need to establish the correct baseline, especially in the presence of short- or long-term noise. Second, it is necessary to define accurately the beginning and end of the peak (i.e., when the signal can be differentiated from noise at the beginning and when the signal has returned to the baseline value). This can be difficult for a non-symmetrical or tailing peak, leading to inaccurate quantitation. Third, the number of data points necessary to collect across the peak should be large enough to assess accurately the actual peak area. It has been shown that nine data points can accurately describe a Gaussian peak, but that up to 32 points are required for a non-Gaussian (tailing) peak [8]. For most cases, at least 15 points across the peak of interest are recommended; this typically means that the sampling rate for the data system must be at least 3 to 5 points per second (even higher sampling rates for early-eluting sharp peaks and especially for methods using columns of 3- μm particles run at higher flow rates).

Peak area typically is calculated using an integrator or computerized data system. However, peak areas can also be measured manually, as shown in Fig. 14.4*a* and *b*. With a data system, the peak area is the summation of signal/time "slices" across the peak, as shown schematically in Fig. 14.4*c*. This method of integration can be very precise if executed properly (typically, precisions better than $\pm 0.2\%$ for peaks with large S/N'). Note, however, that peak detection algorithms for most data systems (hence, peak area calculations) rely on a threshold value to determine when the peak begins and ends; differentiation of real peaks from short-term noise must also be accomplished. The improper setting of a peak threshold can influence the accuracy of quantitation, as shown in Fig. 14.5. Here the integrated peak area is shown as a function of different peak thresholds for both a symmetrical ($A_s = 1.00$) and an asymmetrical ($A_s = 1.58$) peak. Because of the flatter response on the tailed portion of the asymmetrical peak, the peak-detection algorithm identified the end of the peak too early in each case relative to the peak end identified for the same threshold with the symmetrical peak. The recovered peak areas (expressed as a percentage of the true peak area) ranged from 99.6 to 99.9% for the symmetrical peak, but only from 92.3 to 97.8% for the asymmetrical peak. Each data system or integrator is slightly different; therefore, the proper functioning of a particular system must be ensured for the user to rely on the data generated. Manufacturers should provide information on optimum settings as part of instrument purchase; however, instrument accuracy should also be checked periodically to make sure that the measurement of peak area is consistent.



(a)

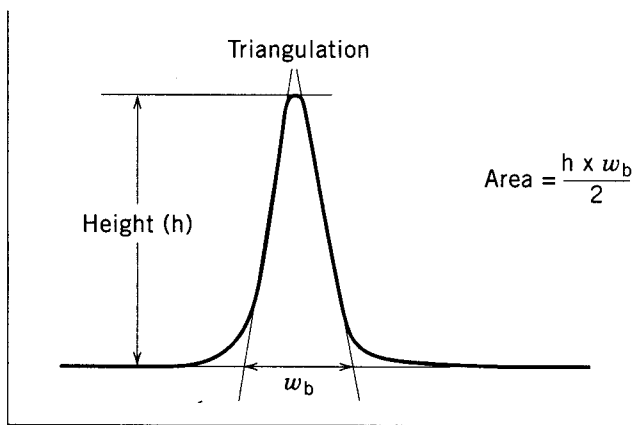

(b)

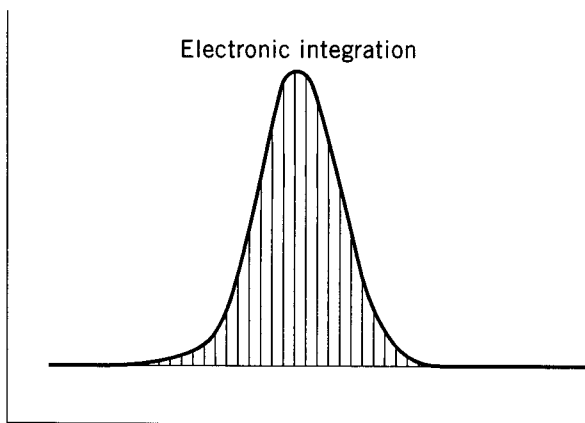

(c)

FIGURE 14.4 Methods of peak area quantitation in HPLC. (a) method of height \times width at half-height; (b) method of triangulation; (c) Electronic (data systems).

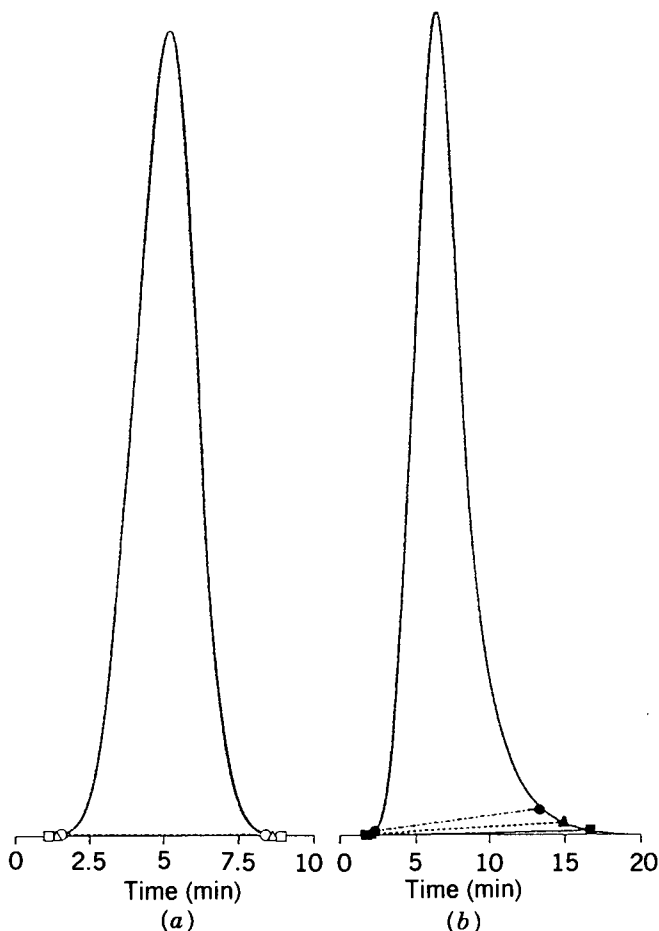

FIGURE 14.5 Integrated peak area as a function of threshold for (a) a symmetrical peak ($A_s = 1.00$) and (b) a tailing peak ($A_s = 1.58$). Recovered peak areas $\square = 99.9\%$, $\Delta = 99.8\%$, $\circ = 99.6\%$, $\blacksquare = 97.8\%$, $\blacktriangle = 95.3\%$, $\bullet = 92.3\%$. (Reprinted with permission from Ref. 9.)

14.2.4 Peak Height vs. Peak Area for Quantitation

Either peak height or peak area can be used for quantitation in HPLC, as long as proper calibration is used with either method (Section 14.3). While peak-area quantitation is popular in HPLC, this method is not always the best. For well-behaved nearly symmetrical peaks, peak height can be as precise and more accurate than peak area measurements. Various operating variables affect the response measurement; these effects are different for peak height or peak area quantitation, as summarized in Table 14.1. Here, the effect is given for a small change in an operating parameter on the measurement of

TABLE 14.1 Preferred Quantitation Method for Changing LC Parameters

Changing Experimental Condition	Possible Cause	Parameter Changed	Quantitation Method Preferred	
			Area	Peak Height
Mobile phase/ stationary phase	Gradient elution; mobile- phase fractionation Change in adsorbent activity	k	×	
Velocity	Loss of stationary phase Pumping imprecision, flow rate change	N		×
Column efficiency	Compression of column bed Loading of column inlet with strongly retained components Column packing degradation	N	×	
Temperature	Column not thermostatted	k	×	
Peak shape	Non-Gaussian peaks from chemical effects, slow detector response, poorly packed column, etc.	—	×	× ^a
Sample volume	Irreproducible injection	V_s	—	—

^a For badly tailing peaks.

peak height or peak area. For example, a small change in the flow rate (F) will affect the peak height measurement ($\leq F^{-0.2}$) less than it will effect the peak area measurement (F^{-1}). A change in column conditions that affects plate number N usually will affect peak height but not peak area measurements. Table 14.2 shows a more detailed list of experimental conditions and whether area or peak height quantitation is preferred. Finally, peak height often is the preferred method of quantitation for trace analysis (Section 14.5.2). Since incomplete resolution of the trace analyte often is a problem, peak-height quantitation is more accurate because of less potential interference in determining peak size.

14.3 QUANTITATION METHODS

Peak-height or peak-area measurements only provide a response in terms of detector signal. This response must be related to the concentration or mass

TABLE 14.2 Effect of Chromatographic Parameters on Precision of Quantitative Analysis in LC Using Concentration-Dependent Detector

Changing Parameter	Approximate Effect on Quantitation Method	
	Peak Height, h'	Peak Area, A
k	$\frac{1}{1+k}$	No change
N	$N^{1/2}$	No change
u	$\leq u^{-0.2}$	$\frac{1}{u}$

of the compound of interest. To accomplish this, some type of calibration must be performed, whether within the same chromatographic run or a different one. The four primary techniques for quantitation are normalized peak area, and three using calibration: external standard, internal standard, and the method of standard addition.

14.3.1 Normalized Peak Area

After completion of a run and the integration of all significant peaks in the chromatogram, the total peak area can then be calculated. The area percent of any individual peak is referred to as the normalized peak area. An example of this is shown in Fig. 14.6, where one main peak has 96% of the total area, and four other minor components contribute peak areas of from 0.6 to 1.4% of the total. The technique of normalized peak area is actually not a calibration

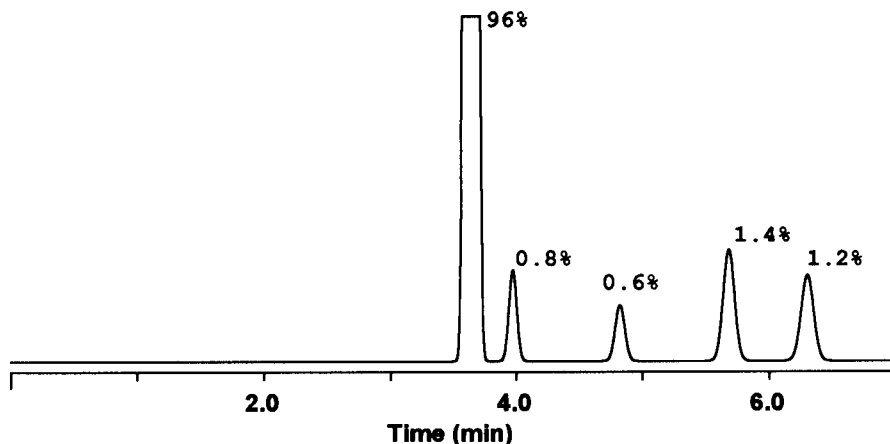
**FIGURE 14.6** Normalized peak area for main component and four minor components.

method per se, since there is no comparison to known amounts for any peak in the chromatogram. However, this technique is widely used to estimate the relative amounts of small impurities or degradation compounds in a purified material.

The proper use of a normalized-peak-area technique assumes that the response factor for each component is identical (i.e., that the responses per unit of concentration of peaks 2 to 5 are the same as the response for the main peak 1 in Fig. 14.6). This is rarely true in UV detection, where even closely related compounds can have different molar absorptivities. However, the technique of normalized peak area is especially useful in early method-development studies, when characterized standards of all components are not available. Despite the probable inequality of response factors, it is expedient to use normalized peak areas for these analyses.

While different compounds rarely have the same UV absorbance, bulk-property detectors, such as refractive index (RI) or evaporative light scattering (ELS) do exhibit similar responses for many unrelated compounds. Their use with normalized peak areas is more reliable; further discussion of these detectors is found in Section 3.3.1. Unfortunately, bulk property detectors usually are much less sensitive than UV detection of strongly absorbing compounds.

14.3.2 External Standard Calibration

The most general method for determining the concentration of an unknown sample is to construct a calibration plot using external standards, as shown in Fig. 14.7. Standard solutions (sometimes called calibrators) are prepared at known concentrations (1.0, 2.0, and 3.0 mg/mL in this case). A fixed volume

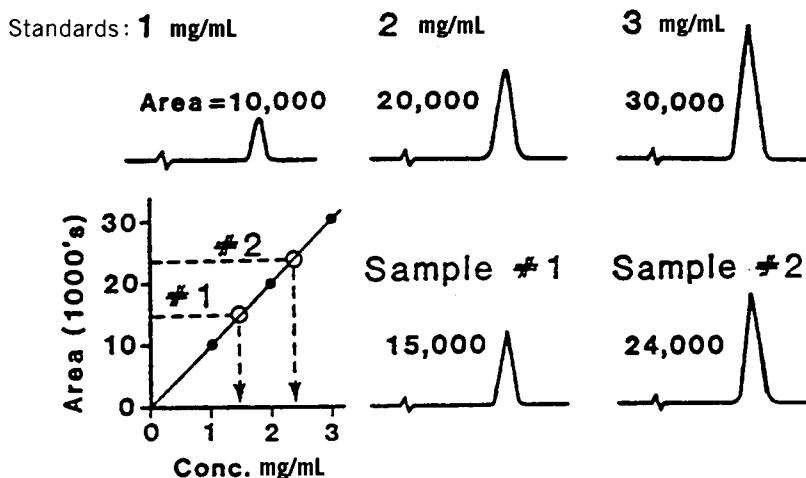

FIGURE 14.7 Calibration plot for external standard method.

of each standard solution is injected and analyzed, and the peak responses are plotted vs. concentration. The calibrators in this method are referred to as *external standards*, since they are prepared and analyzed in separate chromatograms from those of the unknown sample(s). Unknown samples are then prepared, injected, and analyzed in exactly the same manner, and the concentration is determined graphically from a calibration plot, or numerically using response factors.

The calibration plot should be linear and have a zero intercept, as in Fig. 14.7. In this case, unknown samples 1 and 2 have concentrations of 1.5 and 2.4 mg/mL, respectively. If the response is linear with a zero intercept, the calibration plot theoretically can be determined with only one standard. However, in practice two or more standard concentrations are recommended. The concentration of the standards should be similar to the concentration expected for the samples. In Fig. 14.7, both samples fall within the concentration range of the standards, so an interpolation provides an accurate measurement of sample concentration. If the sample concentration falls outside the range of standards used, extrapolation of the calibration plot should be used with caution. In unusual cases where the calibration plot is not linear, sample concentration can be determined by interpolation of results between standards and/or fit to a non-linear equation; however, many more standards are required, and this technique should be used only when no other option exists. In many such cases, the chromatography can be improved to provide a linear response as a function of analyte concentration in the range needed for analysis. Dilution of the sample to bring the concentration into a range for linear response is another possible option.

A second technique for determining the concentration of unknown samples uses *response factors*. A response factor, RF (sometimes called a *sensitivity factor*), can be determined for each standard as follows:

$$\text{RF} = \frac{\text{standard area (or peak height)}}{\text{standard concentration}} \quad (14.2)$$

In the example of Fig. 14.7, RF is exactly 10,000 for all three standards and is the slope of the calibration line, since the intercept is exactly zero. This response factor (RF) can be used to calculate the sample concentration as follows:

$$\text{sample concentration} = \frac{\text{sample area (or peak height)}}{\text{RF}} \quad (14.3)$$

If two or more standards are measured (at different concentrations), RF can be taken as the average value of response factors for all standards. This use of multiple standards (while requiring additional measurements) has the advantage of minimizing the uncertainty in determining RF.

The external standard approach is preferred for most samples in HPLC that do not require extensive sample preparation. A major source of error for the external standard approach is the reproducibility of sample injection. For automated, loop-filled injectors used on most autosamplers, the precision of injection is typically better than 0.5%, and this is adequate for most analyses. If manual (syringe) injection is used, method precision is poorer and other calibration techniques (described below) often are employed. Less precise results also can be obtained from automated, loop-filled injectors that employ partial filling of a sample loop.

For good quantitation using external standards, the chromatographic conditions must remain constant during the separation of all standards and samples (same chromatographic conditions, volume injected, etc.). In addition to their customary use for calibration, external standards are often used to ensure that the total chromatographic system (equipment, column, conditions) is performing properly and can provide reliable results. The use of standards to validate system performance is referred to as *system suitability* (Section 15.11), and this is usually performed before sample analyses begin.

Calibrations are best prepared in the sample matrix, to ensure quantitative accuracy. Trace analysis samples often are prepared in the matrix, so that the sample preparation step is an integral part of the calibration procedure, as discussed in Section 14.5.5.

14.3.3 Internal Standard Calibration

Another technique for calibration involves the addition of an *internal standard* to the calibration solutions and samples (see below). The internal standard is a different compound from the analyte, but one that is well resolved in the separation. The internal standard can compensate for changes in sample size or concentration due to instrumental variations. One of the main reasons for using an internal standard is for samples requiring significant pretreatment or preparation (Chapter 4). Often, sample preparation steps that include reaction (i.e., derivatization), filtration, extraction, and so on, result in sample losses. When added prior to sample preparation, a properly chosen internal standard can be used to correct for these sample losses. The internal standard should be chosen to mimic the behavior of the sample compound in these pretreatment steps.

With the internal standard method, a calibration plot is produced by preparing and analyzing calibration solutions containing different concentrations of the compound of interest with a fixed concentration of the internal standard added. An example of this approach is shown in Figs. 14.8 and 14.9 for the analysis of methomyl insecticide using benzanilide as an internal standard. Figure 14.8 shows the chromatogram of a calibration mixture. The ratio of peak area of methomyl to the benzanilide internal standard is determined for each calibration solution prepared, and this ratio is plotted vs. the methomyl

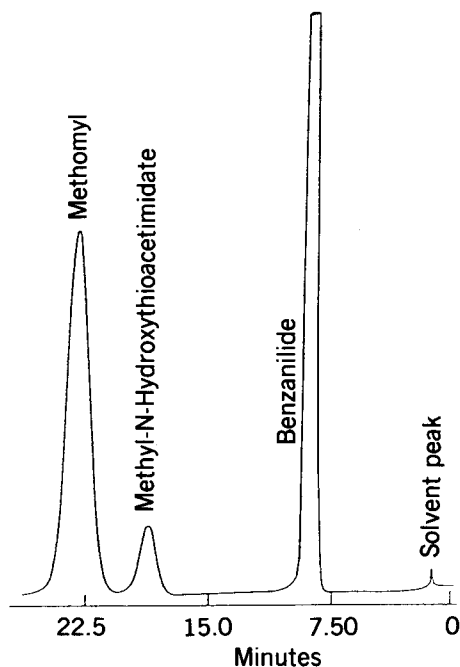

FIGURE 14.8 Separation of calibration mixture containing lannate methomyl insecticide with internal standard. Column: 100×0.21 -cm 1% β, β' -oxydipropionitrile on Zipax, $< 37 \mu\text{m}$; mobile phase, 7% chloroform in *n*-hexane; flow rate 1.3 mL/min; detector, UV 254 nm, sample injection $20 \mu\text{L}$. (Reproduced with permission from Ref. 10.)

concentration in Fig. 14.9 using solutions with known concentrations of methomyl. This plot can be used directly to determine the concentration of methomyl in samples. The concentration can also be calculated by determining the response factor (RF) for the internal standard plot if the latter is linear with a zero intercept:

$$\text{RF} = \frac{AR_{mb}}{M} \quad (14.4)$$

where AR_{mb} is the area ratio of the methomyl–benzanilide in the calibration standard solutions and M is the methomyl concentration in the calibration standard solutions. In this case, RF is the slope of the line in Fig. 14.9. The concentration of methomyl in a sample (C_s) is then given by

$$C_s = \frac{A_m/A_b}{\text{RF}} \quad (14.5)$$

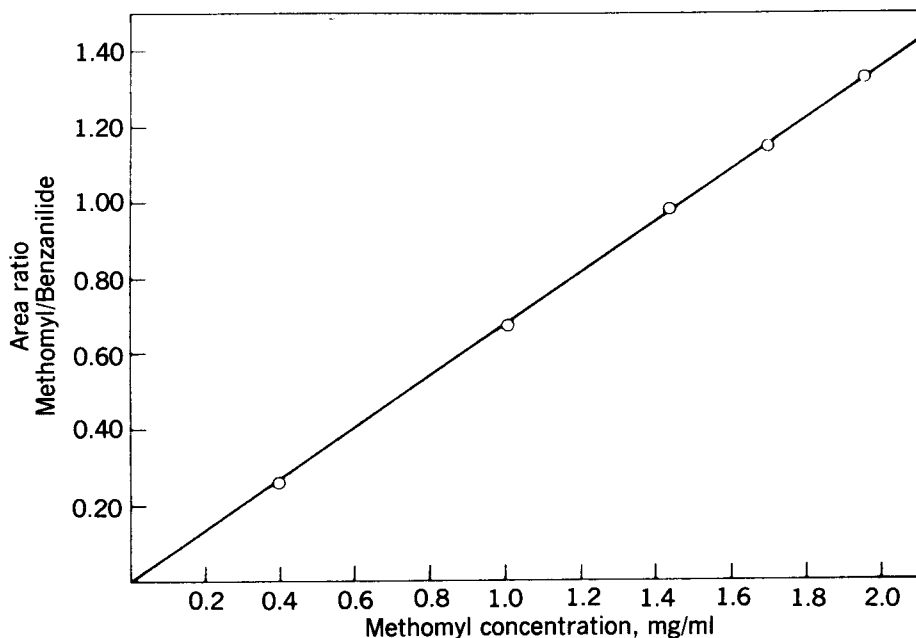

FIGURE 14.9 Peak-area ratio calibration with internal standard. Conditions: same as in Fig. 14.8. (Reprinted with permission from Ref. 10.)

Requirements for a proper internal standard include:

- Well resolved from the compound of interest and other peaks
- Similar retention (k) to the analyte
- Should not be in the original sample
- Should mimic the analyte in any sample preparation steps
- Does *not* have to be chemically similar to analyte
- Commercially available in high purity
- Stable and unreactive with sample or mobile phase
- Should have a similar detector response to the analyte for the concentration used

Perhaps the most challenging requirement is that the internal standard must be separated from all compound(s) of interest in the separation. For a simple mixture, this may not be difficult; however, a complex mixture often makes this requirement more difficult to achieve, and use of an internal standard may not be practical.

Although an internal standard does have advantages in certain situations, it does not always produce improved results. For example, the precision of measurement using an internal standard can be poorer than an external stan-

dard calibration method due to the uncertainty in measuring two peaks rather than just the analyte. For this reason, and the additional complexity of selecting another compound without interference from other peaks, the use of internal standards usually is reserved for methods that require extensive sample preparation. The external-standard calibration method is preferred for most analyses.

14.3.4 Method of Standard Addition

A calibration standard ideally should be prepared in a blank matrix to provide the best calibration for actual samples. Thus, a blank matrix of drug formulation components without the drug substance or an animal feed without added compound usually can be used for standard calibration solutions. In some cases, however, it is not possible to prepare a representative standard solution that does not already contain the analyte of interest. For example, a serum sample without endogenous insulin is difficult to prepare as a blank matrix. In these cases, the method of *standard addition* can be used to provide a calibration plot for quantitative analysis.

The method of standard addition is most often used in trace analysis (Section 14.5). In this approach, different weights of analyte(s) are added to the sample matrix, which initially contains an unknown concentration of the analyte. Extrapolation of a plot of response found for the standard-addition calibration concentrations to zero concentration defines the original concentration in the unspiked sample. An example of this is shown in Fig. 14.10 for the analysis of 5-hydroxyindoleacetic acid (HIAA) in human cerebrospinal fluid. The slope of this calibration plot is equal to the response factor RF for this assay, which can then be used to calculate the analyte concentration in the original sample (with no added analyte). As shown in Fig. 14.10, the original concentration of HIAA in this example was 60 ng/mL. This method of calibration does not eliminate the need to obtain proper separation of interfering compounds, or other factors, such as stable baselines in the chromatogram. An important aspect of the method of standard addition is that the response prior to spiking additional analyte should be high enough to provide a reasonable S/N' ratio (> 10); otherwise, the result will have poor precision.

14.4 SOURCES OF ERROR IN QUANTITATION

Errors in any part of the HPLC method can have an effect on accuracy and/or precision. Good accuracy in HPLC relies on:

- A representative sample
- Minimum overlap of bands or interferences
- Good peak shape
- Accurate calibration with purified standards
- Proper data handling, including integration

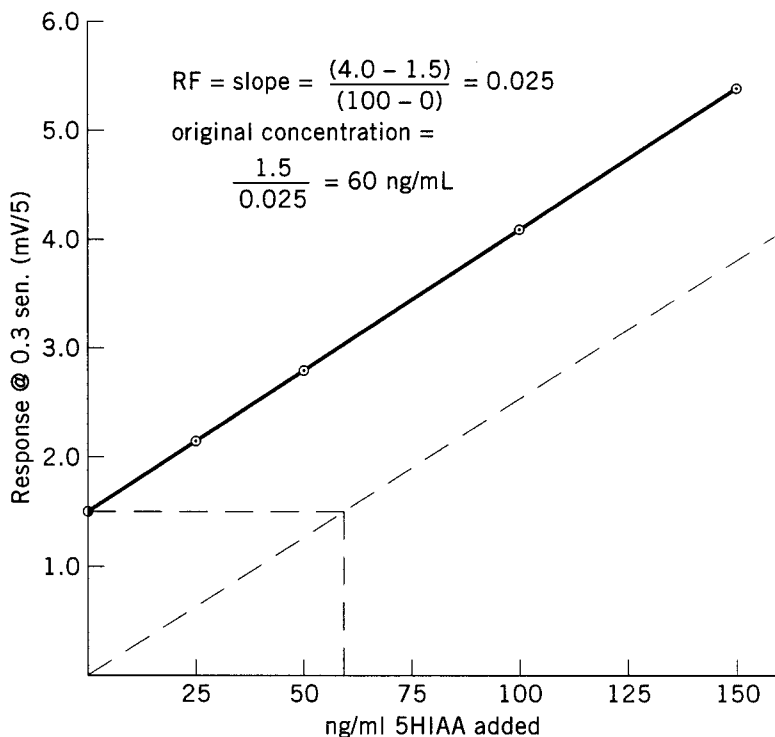

FIGURE 14.10 Standard-addition calibration. Column, $30 \times 0.4\text{-cm } \mu\text{Bondapak-C}_{18}$; mobile phase, 89% 0.01 *M* sodium acetate, pH 4.0 (with acetic acid)–11% acetonitrile; flow rate 1.9 mL/min; detector, fluorometer; sample injection 10 μL , 5-hydroxyindoleacetic acid (5HIAA). (Adapted with permission from Ref. 11.)

Good precision depends on:

- Sample preparation technique
- Instrument reproducibility, including injection technique
- Acceptable S/N' ratio for the peak of interest
- Good peak shape
- Proper data handling, including integration
- Method of quantitation or calibration

Overall, the imprecision of a quantitative result can be expressed as the sum of all precision errors expressed as

$$\sigma_{\text{tot}}^2 = \sigma_a^2 + \sigma_b^2 + \sigma_c^2 + \dots \quad (14.6)$$

where σ_{tot}^2 is the overall precision error [sometimes called the *coefficient of variation (CV)*] and σ_a^2 , σ_b^2 , and σ_c^2 refer to the precision error from various sources (*a, b, c*), such as injection, *S/N'* of the detector, or sample pretreatment. The consequence of Eq. 14.6 is that only those factors that are major will contribute significantly to the precision error of the overall analysis. For example, if four sources of imprecision are:

Source	Percent Error
Volumetric error	0.4
Sample pretreatment error	4.0
Injection error	0.3
<i>S/N'</i> ratio from detector	1.0

the overall precision error would be

$$\begin{aligned}\sigma_{\text{tot}} &= (0.4^2 + 4.0^2 + 0.3^2 + 1.0^2)^{1/2} \\ &= 4.15\%\end{aligned}\tag{14.7}$$

In this particular example, the contribution from the sample pretreatment dominates the overall imprecision of the method. Elimination of all other sources of imprecision would not improve the method precision significantly. Therefore, to improve method precision significantly, it is usually necessary to reduce the major contribution to imprecision (sample pretreatment, in this case). Primary sources of error in HPLC result from sampling and sample preparation, chromatographic effects, and signal processing or data handling. Each of these is discussed in terms of the effect on accuracy and/or precision. See also the discussion of Sections 3.2.3 and 3.2.4.

14.4.1 Sampling and Sample Preparation

A primary reason for inaccurate and imprecise results in HPLC is the nature of the sample. The sample to be analyzed must be homogeneous and representative of the total bulk material. This is particularly true for solid samples, although non-homogeneous liquids also can be problematic. For example, if a container of animal feed is not well mixed, a small sample taken from one part of the container may not be representative of the entire contents. Thorough mixing, appropriate sampling equipment (such as the use of a sample thief, a device designed for obtaining representative solid samples), and other techniques should be considered to assure a representative sample. Further discussion of sampling procedures can be found in Chapter 4.

Sample preparation for HPLC typically involves preparing a solution for injection. Simple dilution of a liquid sample can usually be performed with a precision of better than 0.5%. However, care must be taken to use proper glassware, including calibrated volumetric flasks and pipettes, that are designed for quantitative use. This typically means using volumetric flasks and pipettes of at least 25 and 10 mL, respectively, and minimizing the number of transfers and dilutions needed. The use of autopipettors is common in many laboratories; however, delivery of small volumes (0.1 to 5 mL) from autopipettors can also degrade overall method precision. Improved precision can be obtained by using careful weighing of samples and solutions rather than volumetric transfers. Care must be taken to dissolve samples in solvents completely; thorough mixing or other agitation may be needed to ensure complete dissolution. The sample should be prepared in mobile phase (ideally) or a solvent that is weaker than the mobile phase to maintain good peak shapes (especially for early-eluting compounds).

Sample injection with a properly maintained and calibrated autosampler provides reproducible injections ($CV < 0.5\%$) and rarely limits overall analysis precision. Manual (syringe) injection is typically no better than 2 to 3% (unless an overfilled sampling loop is used with manual loading) and should be avoided if precise results are needed. When manual injection must be used, use of an internal standard calibration can improve precision, as described in Section 14.3.3. A sufficient sample size must be injected to provide a peak large enough for accurate quantitation. However, if too large a sample is injected (either large volume or large mass), the chromatography can be severely compromised and quantitative results may be poor. Typically, sample size should not exceed 1 to 10 μg of solute per gram of packing. Larger samples can be used if resolution is adequate, but the response factor should be checked for linearity (especially peak-height quantitation). Sample size and its effects on separations are discussed further in Section 13.2.2.

Sample pretreatment often is a major source of imprecision for HPLC methods. Solvent extraction, chemical reactions (such as derivatization), and solid-phase extraction are examples of pretreatment steps that are required for some samples for good separations and detection. However, these pretreatment steps can cause errors of 5 to 10% even with proper procedures. Chapter 4 contains more information on each of these techniques. Errors associated with sample pretreatment are also discussed in Ref. 12.

14.4.2 Chromatographic Effects

The HPLC method and associated instrumentation can be sources of error for quantitation. A primary focus of this book is to develop good chromatographic methods with:

- Reasonable retention for all peaks ($0.5 < k < 20$; preferably $1 < k < 10$)
- Resolution between critical peak pairs of > 1.5 (preferably > 2.0)

- Peak signal-to-noise (S/N') ratio > 50 for quantitation
- Reproducible separations: day to day, different columns, instruments, and so on

Poorly shaped peaks (fronting or tailing) are a major cause of poor quantitation. Use of peak area rather than peak height can improve measurement precision even with non-Gaussian peaks; however, severely tailing peaks make it difficult to define the beginning and end of the peak properly, resulting in inaccurate quantitation (see Fig. 14.5). Peaks that elute near the void volume ($k < 0.5$) often will be poorly shaped or overlap chromatographic artifacts in or near the void volume. Peaks with excessive retention ($k > 20$, isocratic) become smaller in height and broader, both presenting problems for accurate quantitation.

Resolution of $R_s > 2.0$ between the peak of interest and the nearest adjacent peak is strongly desired for good quantitation. While it is feasible to quantitate two peaks with $R_s < 1.5$, there will be some overlap of peak area that contributes to an inaccuracy for the peak of interest. This is true if the relative peak heights for adjacent peaks are significantly different and/or if one of the peaks is tailing. The larger peak (especially if it elutes first) will contribute a significant error to the accurate assessment of the smaller peak; the converse is less of a problem. Appendix I shows resolution curves and a table of errors due to overlapping bands of different sizes (Table I.1). The desirable resolution of $R_s > 2.0$ also takes into account the inevitable degradation of column performance during routine use.

Detector conditions should be chosen that provide a significant S/N' ratio for accurate and precise quantitation. Final results are affected by the baseline stability of the detector, short-term noise or baseline drift, and the sensitivity toward the compound of interest. In addition, care must be taken to work in the linear range of detector response for the compound(s) of interest to generate good calibration plots (Section 14.3). Detector effects are discussed further in Chapter 3.

Various separation parameters can also affect peak separation and quantitation. Temperature or mobile-phase composition changes can affect both retention and separation, especially the precision of peak-height measurements. These effects are minimized by proper column thermostating (particularly for ionizable compounds) and accurate blending of solvents (either by the instrument or manually). Flow-rate variations can affect overall retention, but have a greater effect on the precision of peak area than peak height with concentration-dependent detectors such as UV. Gradient elution using modern HPLC systems can be as precise as isocratic separation, but care must be taken to ensure the proper functioning of the gradient-forming devices and mixers.

Finally, short, high-efficiency columns (i.e., 3.5- μm particles packed in columns of less than 10 cm in length) can provide advantages in speed and

throughput. However, instrumental conditions must be appropriate for good peak shape and quantitation. To obtain the expected increase in peak height for better detection and quantitation, one study with 8-cm columns of 3.5- μm particles found that the sample injection volume had to be limited to $\leq 20 \mu\text{L}$, and a detector rise time $< 0.2 \text{ s}$ was required [13].

14.4.3 Data System Effects

While most modern data analysis systems are adequate for determining peak areas and heights, proper integration parameters must be used for good quantitation. Results depend on:

- How the systems filter or average short-term noise
- The number of points/sec of data collected
- Data collection parameters specified
- The computer algorithms used to process the data

Some systems provide validation packages or information on data-handling performance. However, the user should assess performance with typical samples to assure proper quantitation.

For most data systems, the user needs to specify operating parameters for data collection and analysis. The primary goal of peak detection and integration settings is threefold: to establish the baseline noise level, to establish the proper start of each peak, and to establish the proper end of each peak. The two main parameters typically are (1) a setting relating to the noise (above which a “peak” is detected) and (2) the peak width for the narrowest peak expected (defined by the “start” and “end” of each peak). The baseline noise level can be established with reasonable accuracy if enough data points are collected (typically, 3 to 5 points per second for most chromatograms is sufficient; for very fast separations, 10 to 15 points per second are required). The start and end of the peak are related to the “noise” or sensitivity setting of the data system. However, the peak-width parameter often is more important to establish these points properly. This is because if the setting for an expected peak width is too narrow, the peak will “pass by” before the data system identifies it as a peak. Conversely, if the setting for peak width is too wide, the peak start will be identified too soon and the peak end identified too late, leading to inaccurate peak integration. A good rule is to take the narrowest expected peak in the chromatogram and set the peak width parameter to 50% of this value. The peak width can be considered the “coarse adjustment knob”, while the noise parameter is the “fine adjustment knob” for peak detection and integration [14].

Another consideration for data systems is how *data bunching* affects the accurate collection and storage of chromatographic information. Data bunching is a technique used by most systems to save only enough data points to

define the overall chromatogram and peaks properly without saving more data points than are necessary, thus creating excessively large data files. For example, many of the points in “flat” baseline portion of a chromatogram are not needed to represent the separation accurately and therefore are not saved in the data file. Data bunching and its effects on quantitation are described in Ref. 15.

14.5 TRACE ANALYSIS

HPLC is a powerful technique for the analysis of trace (e.g., $\leq 0.01\%$) components in a wide variety of sample types. Reasons for the utility of HPLC for this application include:

- High resolving power for accurate measurements
- Sensitive and selective detection often available
- Minimal pretreatment for some samples
- Original sample sometimes can be preconcentrated for higher sensitivity

The goals of trace analysis often are somewhat different than for quantitative assays of major components in a mixture. Frequently, the analytical problem is to measure very small concentrations of one (or a few) component(s) in a complex sample. The main goal is to make an accurate determination of the trace compound(s); high precision measurements generally are not needed. While many assays require precisions in the range 1 to 2% (Section 15.3), trace analyses usually are performed with precisions of 5 to 15% because of limitations imposed by low analyte concentrations. Fortunately, such precisions are adequate for most trace analyses. The following sections discuss how sample preparation, column resolution, sample injection, sample detection, and quantitative calibration uniquely influence the measurement approaches used in trace analysis.

14.5.1 Sample Preparation

In a few instances, samples can be injected into the HPLC column directly without prior treatment (e.g., analysis of additives in soft-drink beverage [16]). However, in most cases samples for trace analysis must be processed in some way before final HPLC analysis is possible. In Chapter 4 we describe methods for preparing and preconcentrating an analyte in a sample to enhance the sensitivity of a trace analysis. These methods include the use of solid-phase extraction, liquid–liquid extraction, filtration, coupled columns, and column back-flushing techniques.

Sample pretreatment can also be used to ensure better analysis accuracy. Samples intended for analysis often contain a mixture of neutral, basic, and

acidic components, plus compounds that vary in hydrophobicity. Sample pretreatment methods can systematically reject certain classes of compounds, while retaining those desired classes. The best sample pretreatment method will eliminate the maximum number of potential interferences while quantitatively recovering the desired analyte. The highest level of method selectivity and trace analysis accuracy usually is obtained when the sample pretreatment step and the HPLC separation are based on different principles (e.g., ion exchange for sample pretreatment and reversed-phase for HPLC).

A special form of sample preparation in trace analysis involves the use of *restricted internal access columns* in which a separate sample pretreatment step is not required. These columns sometimes are used for directly injecting blood plasma and similar samples for trace analysis of analytes where proteins are potentially interfering substances. The packing in these columns has a hydrophilic outer surface or coating which has no affinity for proteins and a typical hydrophobic surface (e.g., C_{18}) in the pores. Proteins in the injected sample are too large to enter the narrow pores that are used and are not retained by the hydrophilic outer surface. Therefore, proteins pass unretained through the column (before t_0). Smaller solutes (e.g., drugs) enter the porous network, undergo the usual hydrophobic interactions, and are retained for subsequent measurement. An example of this approach is shown in Fig. 14.11 for the direct analysis of phenobarbital in blood plasma. Here, the value determined by this method closely agreed with an analysis based on immunoassay.

A disadvantage of restricted access columns is that they are limited to selected sample types. Another disadvantage is that they do not remove interferences as effectively as solid-phase extraction; the primary role is column protection, by allowing proteins to pass through the column unretained. Also, the sensitivity of the analysis is based strictly on detector sensitivity and the volume of sample that can be injected—analyte concentration enrichment is limited. Finally, some users experience limited column lifetime with this direct injection method, presumably because the column packing eventually becomes fouled with extraneous material from samples.

14.5.2 Column Resolution

For maximum freedom from interferences and best measurement accuracy, the trace peak(s) of interest should be separated completely from neighboring peaks. When two peaks are close together, measurement of the trace component is most accurate when it elutes prior to a major constituent, as in Fig. 14.12*b*. If, instead, the trace peak elutes on the trailing edge of a principal peak, as in Fig. 14.12*a*, accurate measurement becomes more difficult and sometimes impossible. Sometimes, a trace component may be masked completely by earlier-eluting major peaks, and a major increase in resolution then must be obtained before the desired trace analysis is possible.

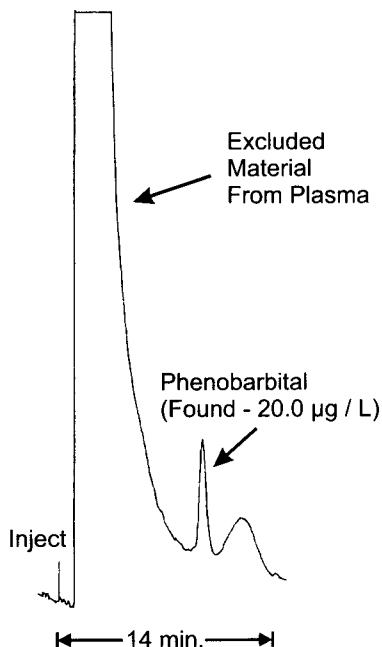

FIGURE 14.11 Trace analysis with restricted access column. Column: 15×0.46 -cm experimental protein-modified C_8 ; mobile phase: 20% acetonitrile–80% 0.1 M potassium phosphate buffer, pH 6.5; flow rate: 1.0 mL/min; temperature: ambient; detection: UV, 230 nm; sample: $10 \mu\text{L}$ of patient plasma. (Reprinted with permission from Ref. 17.)

Trace analyses usually are best carried out using isocratic conditions, since more reproducible retention times and best detection baselines are obtained. Trace analysis by gradient elution is also feasible and may be preferred in certain situations, as discussed in Section 14.5.6. However, with gradient elution, measurement precision may suffer and analyses can be more time consuming. An approach often preferred for routine trace analyses involving samples with components in a wide k range is to use an isocratic method with column switching, as discussed in Chapter 4 and described further in Ref. 18.

Quantitation of trace components should be performed by peak-height measurements. This method is least influenced by potentially overlapping peaks (best accuracy) but still is capable of adequate precision. Peak-height ratios for adjacent, symmetrical peaks with a resolution of 1.0 can vary as much as 30:1 and still produce quantitative accuracies of about 3%. Under the same conditions, peak-area ratios can vary only about 3:1 for the same measurement accuracy. Therefore, most trace analytes should exhibit separations of at least $R_s = 1.0$ from neighboring peaks of a similar size for good peak-height measurements, and an even higher resolution if the overlapping peak(s) have much larger peak heights.

The chromatographic column invariably dilutes a sample during passage through the column when a sample is injected in an isocratic separation. The

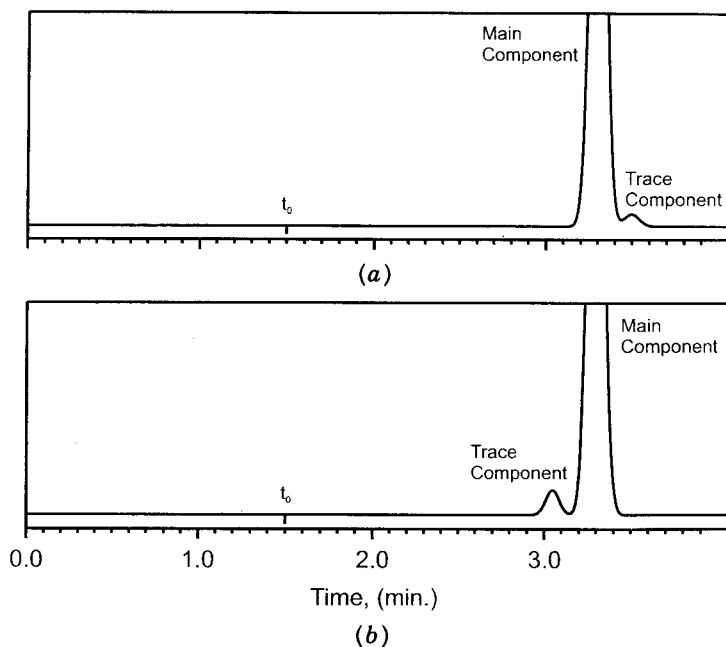

FIGURE 14.12 Importance of relative band position for the analysis of a trace component.

result is that component peaks are at a lower concentration when they elute, making detection of a trace component more difficult. The amount that an injected sample is diluted is approximated by [19]

$$\frac{c_{\max}}{c_0} = \frac{V_s N^{0.5}}{V_r (2\pi)^{0.5}} \quad (14.8)$$

where c_{\max} is the elution concentration at the peak maximum, c_0 the initial concentration in the sample, V_s the injected volume, N the column plate number, and V_r the retention volume of the trace component; see also Table 2.4 and related discussion. Dilution of the sample as it passes through the column depends on the volume of injected sample and solute k value. If the sample volume is large, the dilution is proportional to $1/(1+k)$.

Equation 14.8 predicts increased peak-height sensitivity for a trace component when the plate number N is large. However, if longer columns are used to increase N , V_r also is increased, and component concentration (and resulting sensitivity) is decreased by dilution. The best compromise for sensitive trace analyses is to use a short, efficient column with at least 5000 plates that produces very sharp peaks and still provides the needed resolution for the component(s) of interest. Highly efficient 7.5-cm columns with 3.5- μm particles (Section 5.2.2) are especially suited for trace analyses, as illustrated in Fig.

14.13. The peak-height sensitivity for measuring chloramphenicol in an extract of rat urine was approximately doubled with a 8-cm column of 3.5- μm particles over that of a 15-cm column of comparable 5- μm particles. In addition, analysis time was halved.

Each parameter of the resolution equation (α , k , and N , Eq. 2.3) can be varied independently to optimize the accuracy and sensitivity of a trace analysis by improving band spacing and sharpening peaks, respectively. Therefore, exclusive of other parameters (e.g., detector type), the sensitivity and accuracy of a trace analysis can be improved significantly by optimizing chromatographic parameters affecting the separation. The peak-height sensitivity for a trace analysis is especially affected by the k value (or retention V_r) for the solute of interest. Since peak height and sensitivity are inversely proportional to k value, operating at low k values can significantly enhance trace analysis sensitivity. However, the k value for the solute of interest must be large enough to provide separation from extraneous components, particularly material eluting at or near t_0 . For maximum sensitivity, peak-height trace analyses should be carried out in a k range of about 0.5 to 1.5, if possible [20]. Since most interferences occur early in the chromatogram, selection of a larger k value may favor separation selectivity and analyte measurement accuracy at the expense of sensitivity.

Increasing the separation factor α is the most powerful technique for ensuring the specificity and accuracy of a trace analysis. As discussed in Chapters 6 to 9, adjusting α is usually accomplished by varying the mobile-phase and/or stationary-phase type or concentration, or by changing the column temperature for ionizable compounds. Optimizing these parameters generally allows adequate resolution for most trace components. However, once an apparently adequate separation of the trace component from potential interfering materials is obtained, the accuracy of the proposed method for the intended samples must be confirmed.

There are three approaches for checking separation specificity and resulting method accuracy, based on a change in the separation assay method, as summarized in Table 14.3. A change in the chromatographic conditions (Table 14.3) can show sufficient differences in band spacings so as to provide another method for cross-check purposes. However, a more powerful and highly-recommended approach is to develop a second HPLC (reference) method, based on a different separating system. For example, the reference method

FIGURE 14.13 Effect of particle size on trace analysis. Columns: Zorbax SB-C8, 15 \times 0.46-cm, 5- μm particles and (experimental) 8.0 \times 0.46 cm, 3.5- μm particles; mobile phase: 25% acetonitrile–75% 0.1% aqueous trifluoroacetic acid, pH 3.0 with ammonium hydroxide; flow rate: 1.0 mL/min; temperature: ambient; detector: UV, 278 nm; sample: 20 μL of rat urine extract containing 20 ng of chloramphenicol. (Adapted from Ref. 13.)

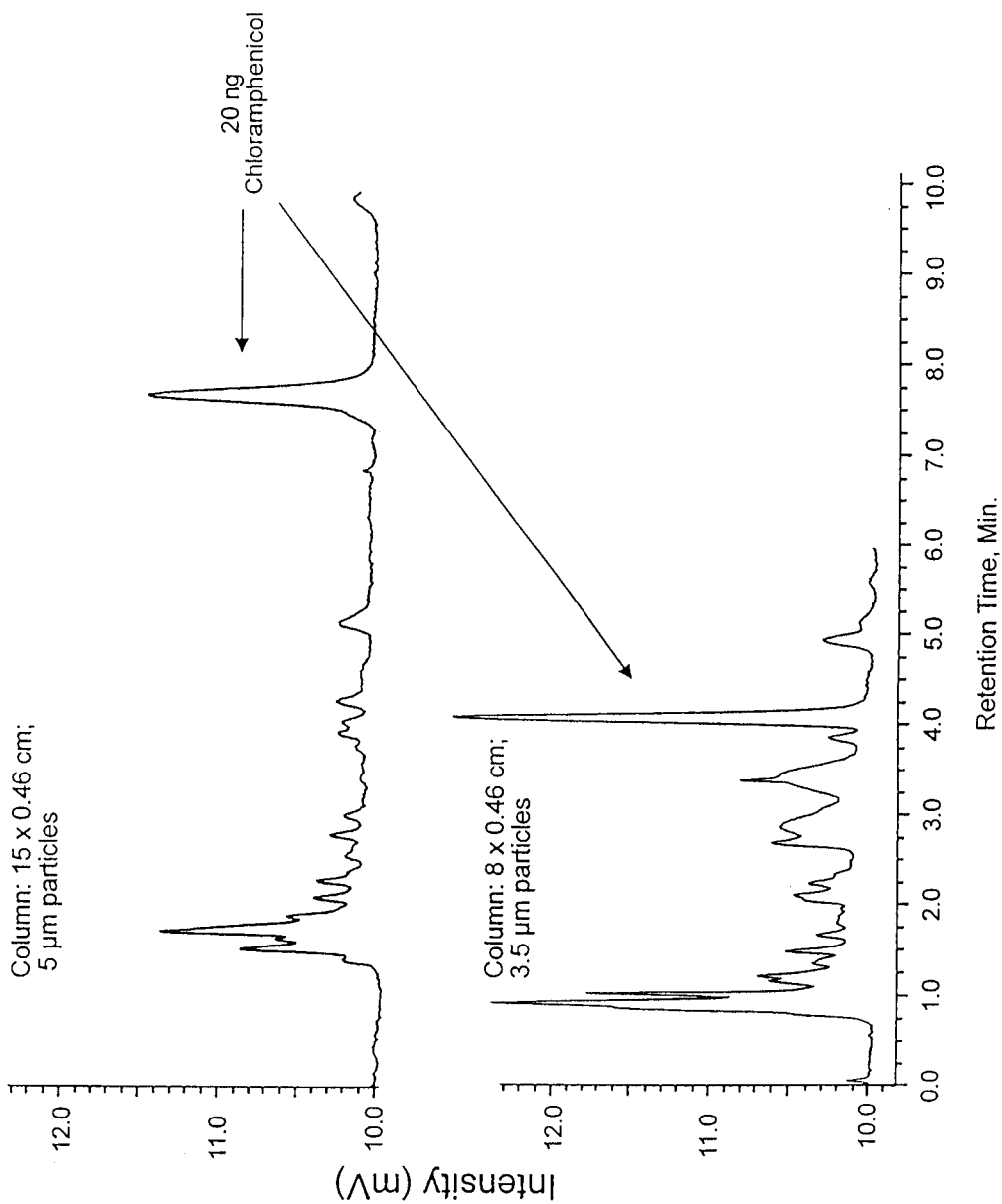

TABLE 14.3 Chromatographic Cross-Check Methods for Trace Analyses

Change of chromatographic conditions
% B, temperature
pH change (ionizable compounds only)
Solvent change
Column bonded-phase functionality change
Change of HPLC method
Normal phase instead of reversed phase
Ion pair or ion exchange instead of reversed phase
Change in separation method
CZE
GC
SFC

may be based on an NPC, ion-pair, or ion-exchange separation rather than the initially proposed routine RPC method. Because of significant band-spacing changes between chromatograms for the two different separation methods, the hope is that the analyte will not be overlapped by the same interference. If each of the separating methods is checked for interferences during method development, it would be expected that an occasional interference for one method will not be a problem for the other method. However, if the two alternative methods give different results for the sample, it is likely that the lower value obtained from either method is correct because of a lower level of interference.

An alternative approach to confirming specificity and trace analysis accuracy by chromatography is to trap the analyte fraction from the proposed routine method and reinject it using the second (reference) separation method. Any interference for the proposed routine method is likely to be better separated in the second (reference) separation. Since there is little opportunity for other peaks to overlap with the analyte in the reference separation, the accuracy of the trace analysis is likely to be confirmed. The column-switching procedures of Chapter 4 and Refs. 18 and 21 provide the most convenient approach for the routine use of the fraction-collection and reinjection method for trace analysis.

Another approach for ensuring the accuracy of a proposed trace analysis method is to develop measurements based on an entirely different separations principle (e.g., capillary zone electrophoresis, gas chromatography, supercritical-fluid chromatography, etc.). A useful strategy is to compare results from typical samples of interest obtained with the proposed routine HPLC method with those from a second altogether-different method. Replication of results (within the precision of the two methods) provides strong evidence of the accuracy for the proposed routine HPLC method. This approach is particularly useful when samples from different matrix types (e.g., different animals or different crops) are to be investigated.

Measurement sensitivity often can be further increased and analysis time decreased by first optimizing the α value for the target analyte. For a separation system with constant H and k [19],

$$\frac{c_{\max}}{c_0} \approx \frac{\alpha - 1}{\alpha} \quad (14.9)$$

Therefore, this relationship means that if the α value is increased only modestly, resolution is significantly increased. If the increased resolution is much larger than needed, the user can shorten the column to reduce peak dilution and increase the analysis sensitivity (sharper peaks).

14.5.3 Sample Injection

For maximum sensitivity in trace analysis, sample volumes as large as possible should be injected. Sampling valves with larger-volume sample loops are convenient for this operation. However, as discussed in Section 2.4.1, too large a sample volume will overload the column and may result in distorted peaks with less increase in peak heights than might be predicted. A good approach is to start with a sample volume that is about one-fifth the volume of the earliest peak of interest (calculated as baseline peak width in minutes multiplied by flow rate in mL/min, as measured with a very small sample volume). The sample volume is then increased until the expected increase in peak height per concentration unit does not occur, or resolution from neighboring overlapping components becomes limiting. Typically for a 15×0.46 -cm column, sample volumes in the range 50 to 500 μL are tolerated, depending on the k value of the trace analyte; larger sample volumes are allowed for solutes of higher k .

If the mass of sample is very limited (e.g., a drop of blood from a baby's heel), detection sensitivity can be substantially increased by using a smaller-ID column. Figure 14.14 shows that for the same sample mass, detection sensitivity is increased about fourfold for a 0.2-cm-ID column over a comparable 0.46-cm-ID column. Similarly, for the same sample mass, detection sensitivity is about doubled for a 0.3-cm-ID column, compared to using a 0.46-cm-ID column. Note, however, that if the amount of available sample is large so that larger amounts (mass) of sample can be injected into the column (e.g., a pharmaceutical tablet), there is no sensitivity advantage in using smaller-diameter columns.

Very large sample volumes often can be injected into columns if the analyte is in a solvent that is weaker than the mobile phase. Here the analyte accumulates at the column inlet because the k value is large in the weak injecting solvent. This *on-column enrichment* method is useful for enhancing the detection sensitivity of certain analytes. For maximum sample enrichment in RPC, the sample should be injected in the weakest possible mobile phase (high water concentration). The mobile-phase organic then is increased, using either

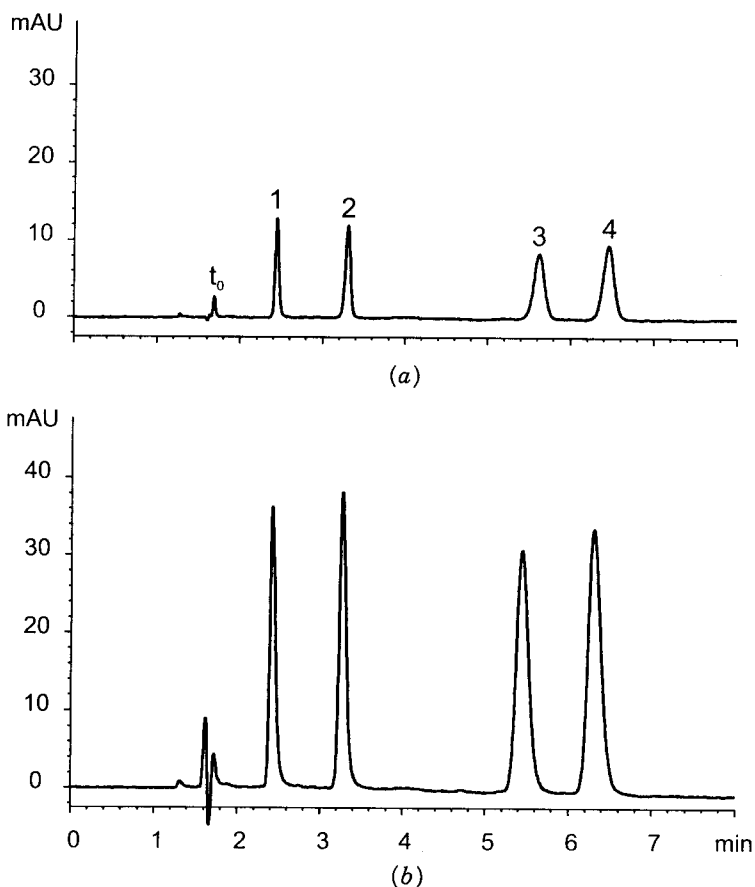

FIGURE 14.14 Effect of column internal diameter on peak sensitivity for B-vitamins: equivalent sample mass. Columns: 15 cm, Zorbax SB-C8; mobile phase: 26% methanol–0.1% phosphoric acid with 10 mM hexane sulfonic acid; flow rate 1.0 mL/min; 40°C; UV detection, 230 nm; sample: 1, B₃, nicotinamide (0.42 μ g); 2, B₆, pyridoxine (0.42 μ g); 3, B₂, riboflavin (0.1 μ g); 4, B₁, thiamine (0.42 μ g); 2- μ L sample volume. (a) 0.46-cm-ID column; (b) 0.21-cm-ID column. Courtesy of Rockland Technologies, Inc.

a gradient or a step change in the mobile phase. An example of this approach is shown in Fig. 14.15 for the trace determination of cyclosporin (peptide of MW 1202) in urine. Figure 14.15a is a chromatogram of a blank, showing that 1.8 mL of urine could be injected directly into the column. After injecting a urine sample containing the analyte, the analyst purged the column with a weak mobile phase (water, followed by 32% acetonitrile–water) to eliminate extraneous components. A step-gradient change to 50% acetonitrile–water

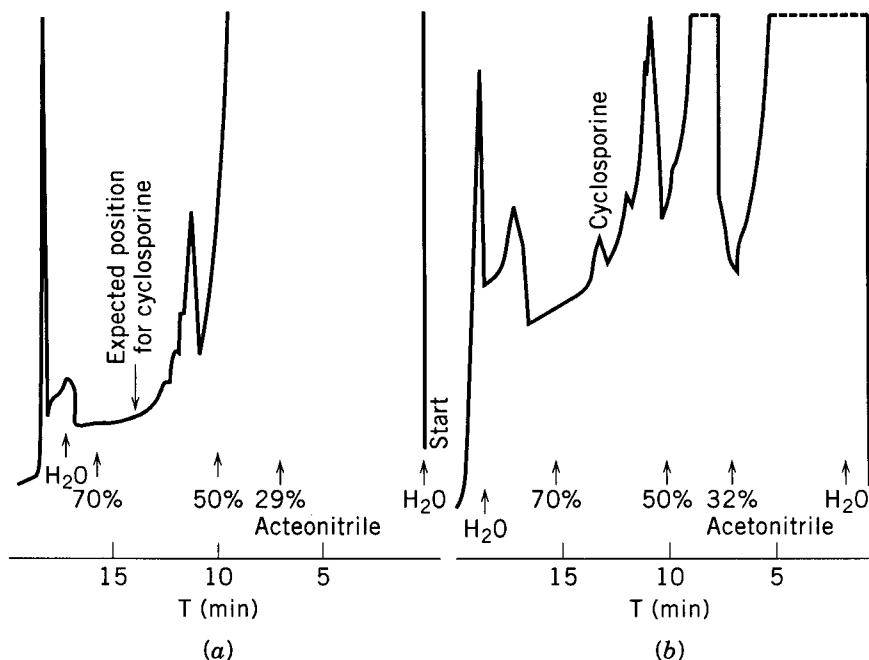

FIGURE 14.15 On-column trace enrichment with a step gradient. Column: 3×0.4 cm, Merck RP-8, $5 \mu\text{m}$; step gradient with acetonitrile and $0.1 M$ ammonium carbonate; flow rate: 4 mL/min ; 70°C ; detector: UV, 215 nm ; sample: 1.78 mL ; (a) urine blank; (b) 360 ppb cyclosporin (MW 1202) in urine. (Reprinted with permission from Ref. 22.)

then eluted the cyclosporin at the 360-ppb concentration as a sharp, easily measured peak, as in Fig. 14.15b. Finally, the more strongly retained sample components of no interest were stripped from the column with another step change to 70% acetonitrile–water; the column was regenerated with a final water flush. In favorable cases, it is possible to inject a liter or more of an aqueous sample into an analytical column, resulting in up to a $20,000\text{-fold}$ concentration of a trace component.

A special problem in trace analysis is that the column must be freed of sample contaminants before another analysis is attempted. Otherwise, the residual late-eluting peaks can seriously disturb the detector baseline, making the trace analysis imprecise or inaccurate. Late eluters can be minimized by using a better sample cleanup method, such as a solid-phase extraction pretreatment with the same column type (Section 4.4.2). Alternatively, a column-switching or back-flushing technique can be used (Section 4.6). Strongly retained components also can be often cleared from the column by using gradient elution or step gradients to increase the strength of the mobile phase after the trace analyte has eluted.

14.5.4 Detection

The selectivity of the HPLC detector often is highly important in the development of a sensitive and accurate trace analysis method. Ultimate detector sensitivity is a function of both the signal/noise response of the detector and the ability to discriminate the trace analyte in the sample. Detection systems most widely used for HPLC trace analyses are based on UV spectrophotometry, fluorometry, electrochemistry, and mass spectrometry. (Radiochemical detectors are strictly restricted to measuring radiolabeled compounds.) These detectors have different levels of potential selectivity, as summarized in Table 14.4.

Many compounds of interest have sufficiently large UV extinction coefficients (see Table 3.1) so as to allow highly sensitive trace measurements with simple, single-wavelength UV detectors (usually 254 nm). Variable-wavelength UV detectors offer much more flexibility, since they can be operated at the absorption maximum for the trace component for highest sensitivity. Alternatively, the absorption wavelength sometimes can be set at a value that gives the greatest freedom from potential neighboring peaks and still provides adequate sensitivity for the analyte of interest. As indicated in Section 3.2.2, while maximum sensitivity for many compounds often is found at low wavelengths (≤ 220 nm), detection specificity can be quite poor under these conditions, since many extraneous compounds also absorb and interfere under these conditions. The diode-array UV detector usually provides no additional possibilities for higher sensitivity but can be useful in checking the trace analysis for specificity, as discussed in Section 3.2.6. However, for accurate trace analyses, the S/N' ratio must be reasonably high for such cross-checks to be meaningful.

Fluorescent and electrochemical (EC) detection are much more sensitive (up to 1000-fold) and compound-selective than UV. Fluorescence detection usually is based on derivatizing the component of interest, since most compounds do not have useful native-fluorescing properties. Figure

TABLE 14.4 Detectors Most Used for HPLC Trace Analyses

Less-selective detectors
Single-wavelength UV
Variable-wavelength UV
Diode-array UV
Moderately selective detectors
Fluorescent
Electrochemical
Highly selective detectors
Mass spectrometer
Radiodetector

14.16 shows the determination of trace phenolics in waste water using 2-(9-anthrylethyl)chloroformate as a fluorometric derivatizing agent. The derivatization step can cause problems with method specificity, since derivatization reactions can also occur with other compounds in the sample for the same fluorescence, as illustrated by other peaks in Fig. 14.16. Also, the attachment of a large fluorophore group to different molecules can produce derivatives with similar reversed-phase retention, so that careful adjustment of band spacings may be required.

While EC detection is available for compounds that can be reduced or oxidized (Section 3.3.3), this method is most used for trace analytes that can be readily oxidized. Only a relatively small number of analytes are EC active, which reduces the potential impact of this detection method. Also, derivatization to improve EC sensitivity is less useful. In general, the EC detection is more sensitive than fluorescence, but less selective, as illustrated by the comparison in Fig. 3.14. Therefore, EC detection usually is selected to increase sensitivity and not to improve selectivity. While EC detection is less convenient

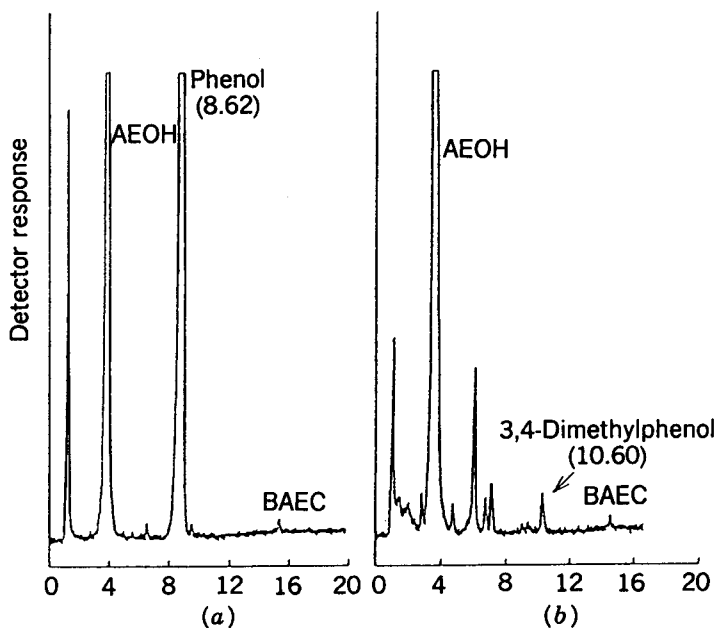

FIGURE 14.16 Analysis of phenolics in wastewater using fluorimetric detection with gradient. Column: 25×0.4 -cm LiChrospher 100 RP-18; mobile phase: 70% acetonitrile–30% water to 100% acetonitrile in 10 min; flow rate: 1.0 mL/min; ambient temperature; detection: fluorescence, $\lambda_{\text{exc}} = 256$ nm, $\lambda_{\text{em}} = > 418$ nm. (a) 0.065 mg of phenol per 100 mL of wastewater; AEOH, 2-(9-anthrylethyl)chloroformate reagent; BAEC, bicarbonate by-product of reagent; (b) 0.0048 mg of 3,4-dimethylphenol per 100 mL of wastewater. (Reprinted with permission from Ref. 23.)

experimentally than UV or fluorescence detection, the very high potential sensitivity of EC makes this approach especially useful for certain applications, such as the neurogenic amines shown in Fig. 14.17.

14.5.5 Calibration

The various methods of preparing quantitative calibrations for compounds have been described in Section 14.3. As discussed in Section 14.5.2, peak-height calibrations are much preferred for trace analyses, because of the strong potential for better accuracy; peak-height measurements are much less interfered by neighboring peaks than are peak-area measurements. Peak-height calibrations also are more convenient, and satisfactory trace analysis methods usually can be developed with modest effort.

The simple external standardization method described in Section 14.3.2 is most used for trace analysis. Most calibrations for trace components are conducted in the sample matrix (e.g., blood serum). Here, the calibrants are added to a reliable blank (matrix without the analyte) and carried through the sample preparation steps. The calibration range should cover the expected analyte concentrations in the samples to be analyzed, and analyses should not be attempted at concentrations below or above those actually calibrated. Some analysts prepare a new calibration for each batch of samples to ensure optimum results. Separation selectivity should be adjusted so that the analyte is in a "clear" portion of the chromatogram, and elutes prior to any large neighboring peak, as indicated in Section 14.5.2. The limit of detection (LOD) usually is determined by the S/N' ratio of the separating detection system and the extent of overlap with neighboring peaks.

In a well-designed trace analysis system, the calibration plot for separating an analyte should extrapolate through the zero point. Extrapolation through a value below the zero point indicates a loss of analyte in the separating system. To ensure adequate precision in a trace analysis involving a sample preparation step (extraction, solid-phase extraction, etc.), an absolute analyte recovery of at least 75% is considered desirable for most systems. Inclusion of an appropriate internal standard can improve the precision of trace analyses, where recoveries are considerably less than 100%, or variable. Extrapolation of a calibration plot to a point above the zero point strongly suggests a baseline

FIGURE 14.17 Separation of trace neurogenic amines with electrochemical detection. Column: 7.5×0.46 -cm Zorbax SB-C8, $3.5 \mu\text{m}$; mobile phase: $0.14 M$ sodium acetate/ 20 mM EDTA- 0.75 mM octyl sulfonate- 9% methanol, pH 3.5; flow rate: 1.5 mL/min ; temperature: 26°C ; sample: $20 \mu\text{L}$; electrochemical detector: 0.75 V vs. Ag/AgCl; DOPA, dihydroxyphenylalanine; DHBA, dihydroxybenzyl amine; DOPAC, dihydroxyphenylacetic acid; NE, norepinephrine; DA, dopamine; HIAA, hydroxyindoleacetic acid; EP, epinephrine; AVA, homovanillic acid; 5HT, hydroxytryptamine; 3MT, methoxytyrosine. (Reprinted with permission from Ref. 24.)

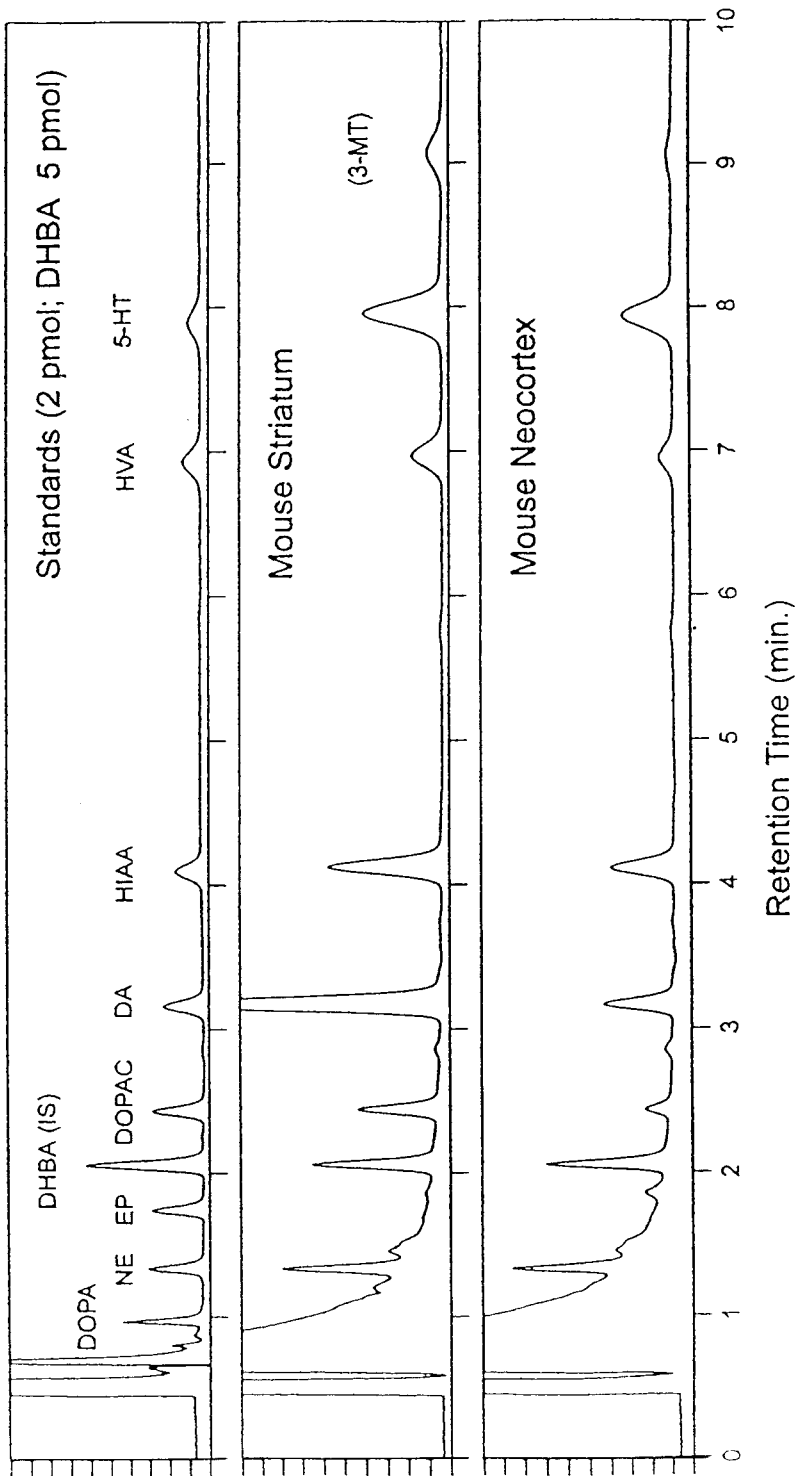

TABLE 14.5 Preferred Conditions for High Sensitivity in Trace Analysis

Use a selective detector with a large S/N' ratio.
Use peak-height measurements.
Set the k value at 0.5 to 1.5 if resolution from adjacent peaks permits.
Use a short, efficient column, preferably with more than 5000 plates.
Inject as large a sample volume as possible.
Use a narrow-bore column if the sample is mass limited (otherwise, a 0.4- to 0.5-cm-ID column).
Preconcentrate the sample for highest sensitivity; clean up if required.
Use a pulseless pump capable of precise mobile-phase delivery.
Select the HPLC system exhibiting the largest α value for trace component.

interference as well as the possibility of some analyte in the original sample matrix. The method of standard additions is often used (Section 14.3.4) if a sample blank is not available.

14.5.6 General Strategy

The overall strategy for developing a trace analysis method is summarized by the preferred conditions listed in Table 14.5. As suggested previously, in trace analysis there is always a competition between measurement sensitivity and specificity (accuracy). For example, maximum sensitivity often occurs in the low UV, where detection selectivity is poor; sensitivity is increased for smaller k values, but separation selectivity may be compromised. Sensitivity is increased by injecting a larger sample mass or volume, but column overload may result with loss in specificity because of band broadening. The conditions listed in Table 14.5 give approaches that can be used to improve measurement sensitivity but does not address the problem of maintaining method specificity or accuracy. Approaches that can be used to ensure method specificity or accuracy of a trace analytical method are summarized in Table 14.6.

TABLE 14.6 Ways to Ensure the Specificity and Accuracy of a Trace HPLC Method

-
1. Anticipate and eliminate potential interferences (Chapter 4).
 - a. Optimize sample preparation for recovery of analyte with minimum interferences.
 - b. Use different sample preparation and HPLC separation approaches to reject the maximum number of interferences.
 2. Optimize α value to obtain needed resolution for trace component with minimum overlap from neighboring peaks (Chapter 9).
 3. Select detector and detecting conditions for maximum freedom from possible interferences (Chapter 3).
-

TABLE 14.7 Advantages of Gradient Elution for Trace Analysis

Experimental Condition	Result
Can operate at a small effective k value without interference from early-eluting compounds	Higher sensitivity
Can use larger sample volumes	Higher sensitivity
Easy control of band spacing to eliminate overlap with interferences	Better accuracy

Although isocratic conditions are used for most trace analysis methods, gradient elution can provide a solution to some of the problems that can arise when attempting an isocratic method. The advantages of gradient elution are summarized in Table 14.7. Interferences at or near t_0 often can be better separated from weakly retained analytes by injecting the sample in a low-strength (low % B) mobile phase, then imposing a gradient to elute the peak of interest at a higher % B. This approach maintains the analyte at a small effective k value (sharp peak) while improving resolution from potentially interfering earlier-eluting interferences (see Fig. 14.15).

Larger sample volumes often can be injected when gradient elution is used. Here, the sample is injected at a low effective k value (lower % B), where the analyte is tightly held at the column inlet without band broadening. Increasing the % B with the gradient then elutes the analyte as a sharp peak for high sensitivity. This approach is similar to that given in Fig. 14.15 for on-column concentrating an analyte by using a step increase in % B for the separation.

Modifying gradient elution conditions also can be used to change band spacings, as discussed in Section 8.4.2. Changing gradient steepness is a convenient way to eliminate band overlap for more accurate measure of a trace analyte. An illustration of this is shown in Fig. 14.18. Here analyte 2 in a plasma sample is badly overlapped by an unknown component (*) when a 2%/min acetonitrile gradient was used. Decreasing the gradient to 1.6%/min acetonitrile changed the band spacing and allowed the measurement of analyte 2 (and the other two analytes of interest) without interference for accurate analyses.

However, there are some disadvantage or limitations to using gradient elution for trace analysis. First, a major limitation of gradient elution for trace analysis is artifactual peaks that often occur in blank gradients. Second, gradient operation usually results in longer analysis times, mainly because the column must be re-equilibrated before the next run. Third, some detectors cannot be used with gradient elution (Table 3.7). Finally, gradients can cause strongly sloped baselines or less-stable detector baselines, limiting the overall detectability and accuracy of measuring the analyte. Nevertheless, gradient operation for trace analysis should be considered if an isocratic approach proves unworkable or inconvenient.

Preferred conditions for a trace analysis in HPLC are summarized in Table 14.5. A typical trace-analysis method-development sequence might involve the following steps (with references indicated):

1. Selectively isolate the analyte by liquid-liquid or solid-phase extraction, usually into a volatile organic solvent (e.g., dichloromethane, methyl-*t*-butyl ether) (Chapter 4).
2. Concentrate the sample by solvent evaporation (if analyte is not volatile) (Chapter 4).
3. Select a 7.5×0.46 -cm column with 3- or 3.5- μm particles and a C_{18} or C_8 bonded stationary phase (Chapter 5).

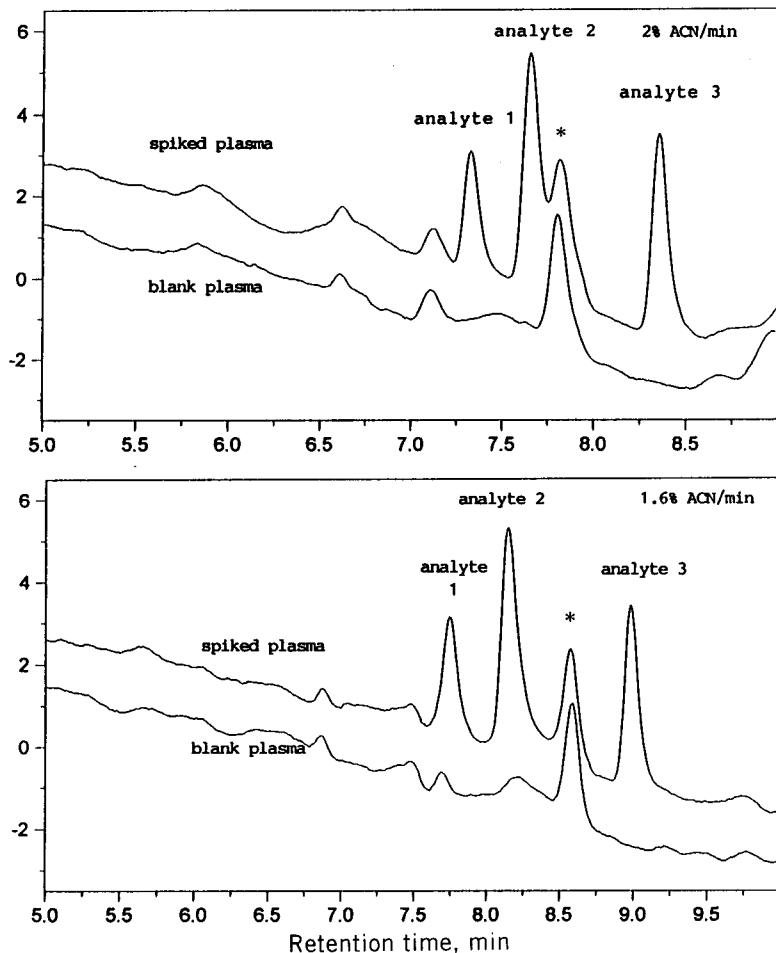

FIGURE 14.18 Changing gradient steepness to resolve a trace analyte.

4. Start with a UV detector, using the systematic approach of Table 3.4.
5. Develop the optimum separation using a relatively high concentration of analyte to ensure the required resolution from potential interfering compounds (Chapters 6 to 9).
6. Optimize the sample injection volume and construct a peak-height calibration for the concentration range of interest (Sections 2.4.1 and 14.2.2).
7. If sensitivity is insufficient, use an EC or fluorimetric detector, if possible (Chapter 3).

This method-development sequence is not general, but it does fit many samples that require trace analysis. Each sample may need a special approach to allow the sensitivity and accuracy needed to solve a particular problem.

REFERENCES

1. S. T. Balke, *Quantitative Liquid Chromatography: A Survey of Chemometric Methods*, J. Chromatography Library, Vol. 29, Elsevier, Amsterdam, 1984.
2. E. Grushka and I. Zamir, in *Chemical Analysis*, Vol. 98, *High Performance Liquid Chromatography*, P. R. Brown and R. A. Hartwick, eds., Wiley, New York, 1989, Chapter 13.
3. E. Katz, ed., *Quantitative Analysis Using Chromatographic Techniques*, Wiley, New York, 1987.
4. S. Ahuja, in *Chemical Analysis*, Vol. 115, *Trace and Ultratrace Analysis by HPLC*, J. P. Winefordner, ed., Wiley, New York, 1992.
5. L. R. Snyder and J. J. Kirkland, *Introduction to Modern Liquid Chromatography*, 2nd ed., Wiley, New York, 1979, Chapter 13.
6. J. W. Dolan and L. R. Snyder, *Troubleshooting LC Systems*, Humana Press, Totowa, NJ, 1989.
7. N. Hadden et al., *Basic Liquid Chromatography*, Varian Aerograph, Walnut Creek, CA, 1971.
8. S. Cram and S. N. Chesler, *Anal. Chem.*, **43** (1971) 1922.
9. U. D. Neue, D. J. Phillips, T. H. Walter, M. Capparella, B. Alden, and R. P. Fisk, *LC/GC Int.*, **8(1)** (1995) 28.
10. R. E. Leitch, *J. Chromatogr. Sci.*, **9** (1971) 531.
11. G. M. Anderson and W. C. Purdy, *Anal. Lett.*, **10** (1977) 493.
12. L. R. Snyder and S. van der Wal, *Anal. Chem.*, **53** (1981) 877.
13. K. M. Kirkland, D. A. McCombs, and J. J. Kirkland, *J. Chromatogr. A*, **660** (1994) 327.
14. G. Ouchi, Brego Research, San Jose, California, private communication, May 1996.
15. G. Ouchi, *LC/GC*, **13(9)** (1995) 714.
16. D. S. Smyly, B. B. Woodward, and E. C. Conrad, *J. Assoc. Off. Anal. Chem.*, **59** (1976) 14.

17. S. H. Y. Wong, Medical College of Wisconsin, Milwaukee, WI, personal communication, March 1996.
18. L. R. Snyder and J. J. Kirkland, *Introduction to Modern Liquid Chromatography*, 2nd ed., Wiley, New York, 1979, Chapter 16.
19. B. L. Karger, M. Martin, and G. Guiochon, *Anal. Chem.*, **46** (1974) 1640.
20. J. J. Kirkland, *Analyst (London)*, **99** (1974) 859.
21. R. W. Frei and K. Zech, eds., *Selective Sample Handling and Detection in High-Performance Liquid Chromatography*, Elsevier, Amsterdam, 1988, Chapters 1 and 2.
22. P. Schauwecher, R. W. Frei, and F. Erni, *J. Chromatogr.*, **136** (1977) 63.
23. W. A. Landzettel, K. J. Hargis, J. B. Caboot, K. L. Adkins, T. G. Strein, H. Veening, and H.-D. Becker, *J. Chromatogr. A*, **718** (1995) 45.
24. B. E. Boyes, Rockland Technologies, Inc., Newport, Delaware, personal communication, 1995.
25. L. R. Snyder, LC Resources, Walnut Creek, California, unreported studies, 1996.

15

COMPLETING THE METHOD: VALIDATION AND TRANSFER

- 15.1 Introduction
 - 15.1.1 General Approach to Method Validation
- 15.2 Accuracy
 - 15.2.1 Comparison to a Standard
 - 15.2.2 Analyte Recovery
 - 15.2.3 Method of Standard Addition
- 15.3 Precision
- 15.4 Linearity
- 15.5 Range
- 15.6 Limit of Detection and Limit of Quantitation
- 15.7 Specificity
 - 15.7.1 Spiking of Potential Interferents
 - 15.7.2 Sample Degradation
 - 15.7.3 Peak Collection and Analysis
 - 15.7.4 Additional On-Line Detection
 - 15.7.5 Chromatographic Cross-Check
 - 15.7.6 Changing HPLC Conditions
- 15.8 Ruggedness
- 15.9 Robustness
- 15.10 Stability
- 15.11 System Suitability
- 15.12 Documentation of Validation Results and the Final Method
- 15.13 Interlaboratory Crossover Studies (Transferability)
 - 15.13.1 Determining Equivalence
- 15.14 Method Validation Protocol

15.1 INTRODUCTION

Much of this book has dealt with the theory and practice of developing an HPLC method. However, getting an acceptable separation and detection of the compounds is only the first step in a completed method that may be performed for long periods in other laboratories. If the method is used with a product or process, it may be submitted for both internal and official regulatory approval. This could involve agencies such as the Food and Drug Administration (FDA), the Environmental Protection Agency (EPA), or their counterparts around the world.

The transfer of a method is best accomplished by a systematic method validation process. Many workers view validation only as a test of the acceptability of the method using the conditions (e.g., flow rate, sample size, column type) prescribed. However, the real goal of the validation process is to challenge the method and determine limits of allowed variability for the conditions needed to run the method. It is important to have a well-conceived validation plan for testing the method and acceptance criteria *before* starting the validation process. Included in this plan should be a detailed procedure describing the entire method (including calibration standard and sample preparation, separation, data handling, and calculations) that can conveniently be executed by others. Many official groups have established guidelines or standard procedures for method validation, and some other recommendations exist in published references [1–7]. However, these guidelines are generally not specific or apply only to certain applications. In this chapter we define each of the major items that should be in a good method validation. Preferred approaches for each phase of a validation process are also given. An example method validation protocol is included at the end of the chapter.

15.1.1 General Approach to Method Validation

Just as method development will vary with sample and separation goals, so will method validation. An assay for a major component requires a different approach and acceptance criteria than a method for a trace impurity. The frequency with which a method will be used (many times a day, once a day only for a short study, once a month, etc.) also influences the type of validation studies that are needed.

An iterative approach to overall method validation often is appropriate. The use of a method early in its development may require only limited validation. For example, for initial R&D studies on a new drug candidate, the analyses may be performed in a single laboratory, perhaps by one operator on a single instrument. Preliminary toxicology studies on a new pesticide can also be performed under very controlled conditions, which minimizes the need for complete validation studies. An HPLC method for an active drug substance used in initial formulation studies may not require a study of detection limit or ruggedness. Therefore, it is best to prioritize the components of validation

studies. In a good validation plan the important studies will be done early and anticipate future needs. Typically, specificity, linearity, accuracy, and precision studies are needed first; complete studies of stability and ruggedness often can come later.

A final method may be performed at different sites around the world. Differences in HPLC instrumentation, laboratory equipment, and reagent sources, and variations in the skills and background of personnel may require specific features in the HPLC method. In addition, the development of different formulations of the same drug with varying strengths or physical forms may require flexibility in method procedures. A method developed for the assay of the main component in a tablet may have to be adapted to function in a lotion, cream, or aerosol. The analysis for residual drug in manufacturing equipment (often needed for cleaning-validation studies) also requires method modifications. While these types of applications involve method adaptations, the adapted method often will be based on the initial method development study. Requirements for validation at later stages of product development or commercialization may be more stringent, requiring additional studies.

A preferred approach to method validation is to define and carry out the critical studies needed for each step in a manner that allows use of the new and existing information in subsequent method improvements or validations. In addition, the routine use of a method outside the originating laboratory can provide valuable information on ruggedness (use of different columns, reagents, instruments, etc.). This information from different laboratories should be accumulated during routine use. These later results may indicate that the method should be modified to improve certain characteristics. This iterative process continues until a formal, complete validation is performed and documented (usually prior to submission of a drug application, transfer of the final method to a new site, etc.).

The remainder of this chapter focuses on the individual components of a method validation study. These include accuracy, precision, linearity, range, limit of detection, limit of quantitation, specificity, ruggedness, robustness, stability of samples, reagents, instruments, and system suitability criteria. In addition, method documentation, data from interlaboratory crossover studies, and techniques for determining equivalent performance are discussed. For each component of the study, an important consideration is the need to determine (before the validation starts) what constitutes an acceptable result for that study. These *acceptance criteria* will vary depending on the type of method and its intended use. For example, good precision is more important for an assay of the major component than for a single trace-level impurity.

15.2 ACCURACY

The accuracy of a measurement is defined as the closeness of the measured value to the true value. In a method with high accuracy, a sample (whose

“true value” is known) is analyzed and the measured value should ideally be identical to the true value. Typically, accuracy is represented and determined by recovery studies, but there are three ways to determine accuracy: (1) comparison to a reference standard, (2) recovery of the analyte spiked into blank matrix, or (3) standard addition of the analyte.

15.2.1 Comparison to a Standard

Determining accuracy by direct comparison to a reference standard (a standard reference material) is the preferred technique for an analyte (e.g., purified drug substance) that is not in a complex sample matrix. If the analyte is widely assayed, a certified standard may be obtained from an external source, such as the National Institute for Standards and Technology (NIST) or suppliers specializing in reference standard materials. However, for new compounds in commercial development, such as a pesticide or drug candidate, reference standards usually are not available. In these cases, a “special lot” of material, can be used as a reference standard. It is important to secure highly purified and extensively characterized material (by several methods) to assure authenticity as a standard. Appropriate tests on this standard could include elemental analysis, mass spectrometry, UV-Vis, IR, NMR (perhaps examining multiple elements), analysis for residual solvents and/or water, and differential scanning calorimetry. Of course, the “standard” should chromatograph as a single, well-defined peak using the HPLC method to be validated. Additional chromatographic methods such as TLC, GC, CE, or another HPLC method (e.g., RPC or NPC) can also be used to confirm that a single pure compound exists for use as a reference standard. See also discussion of Sections 3.2.6, 9.1.1.7, 10.7, and 15.7 for evaluating peak purity.

Accuracy determination for an HPLC method should be carried out with a minimum of nine measurements using at least three concentrations (including separate weighing plus preparation for each sample). This approach minimizes any variability and/or bias in sample preparation technique and analysis for one sample at only one concentration. An example would be three replicate measurements each of three different concentration preparations. All nine values are averaged and used for the final accuracy determination. The results of these measurements then are compared to results obtained by other methods or results reported on a certificate of analysis from an external source.

15.2.2 Analyte Recovery

If the HPLC method is used to measure an analyte in a complex sample matrix (e.g., a formulation), a spiked recovery method can be used. Here a well-characterized standard is still required, but the experiments are performed in

the presence of the matrix. Because other components of the matrix may interfere with the separation, detection, or accurate quantitation of the analyte, potential effects from matrix components must be investigated. Analyte reference standard is added to a blank matrix (sometimes called a *placebo*) at various levels. This blank matrix could take many forms. For example, in an analysis of a drug formulation, it would include all the formulation ingredients except the analyte to be measured. For a pesticide residue in crops, it would be a matrix of untreated crops.

The recovery at each level is determined by comparison to the known amount added. For a major component assay, spiked levels typically should be at 50, 75, 100, 125, and 150% of the level expected for the analyte in a normal assay. A minimum of three replicate measurements should be performed at each level. Other spiked concentration levels may also be appropriate (such as 75, 100, and 125% or 80, 90, 100, 110, and 120%), but the critical factor is to bracket the expected concentration range for the final product. An injection of the blank matrix should be made to determine matrix background effects, if present. If any interferences are found in the blank matrix which overlap the peak(s) of interest, the separation should be modified to improve resolution, as described in Chapters 6 to 9.

Sometimes, it is necessary to analyze for more than one component in a given matrix, for example, multiple impurities in a pure compound or multiple active compounds in a formulation or blend. In this case, two approaches are possible. The first is to spike in at appropriate levels each compound of interest individually in a matrix containing the inactive ingredients and representative levels of the other components to be measured. The second approach is to spike all components equally at their representative levels, using a blank matrix that contains none of the components to be analyzed. Either approach can be appropriate, depending on personal preference and the likelihood of interactions among the various components.

15.2.3 Method of Standard Addition

In the method of standard addition, known amounts of an analyte are spiked at different levels into a sample matrix that already contains some (unknown) quantity of the analyte. The concentration of the analyte in the original sample may then be determined mathematically (see Section 14.3.4). In general, for standard addition, a good approach is to add 25, 50, and 100% of the expected analyte concentration to the matrix in different experiments. The unspiked sample and each of the spiked samples should be analyzed (usually in triplicate) and the measured amounts reported vs. the amount added. This method is used when it is difficult or impossible to prepare a suitable blank matrix without the analyte. An example would be the analysis of insulin in a normal blood sample, where background levels of insulin will always be present. Further details of standard addition are discussed in Section 14.3.4.

15.3 PRECISION

Precision can be defined as “the degree of agreement among individual test results when the procedure is applied repeatedly to multiple samplings of a homogeneous sample” [2]. A more comprehensive definition proposed by the International Conference on Harmonisation (ICH) [6] divides precision into three types: (1) repeatability, (2) intermediate precision, and (3) reproducibility.

Repeatability is the precision of a method under the same operating conditions over a short period of time. One aspect of this is instrumental precision. This is measured by the sequential, repetitive injection of the same homogeneous sample (typically, 10 or more times), followed by the averaging of the peak-area or peak-height values and determination of the relative standard deviation (RSD; see below) of all injections. A second aspect is sometimes termed *intra-assay precision* and involves multiple measurements of the same sample (different preparations) by the same analyst under the same conditions.

Intermediate precision is the agreement of complete measurements (including standards) when the same method is applied many times within the same laboratory. This can include full analysis on different days, instruments, or analysts, but would involve multiple preparation of samples and standards. *Reproducibility* examines the precision between laboratories and is often determined in collaborative studies or method transfer experiments.

The precision assessment during initial method validation often applies to the first two of these: repeatability and intermediate precision. Reproducibility is usually determined during method transfer or crossover to another laboratory or location. Precision often is expressed by the standard deviation (SD) or relative standard deviation (RSD) of a data set. If a set of n measurements is performed on a sample, the average value obtained from those n measurements is defined as

$$x = \frac{\sum_{i=1}^n x_i}{n} \quad (15.1)$$

where x_i are the individual measurements on the sample. The standard deviation of these data is then

$$SD = \sqrt{\frac{\sum_{i=1}^n (x_i - x)^2}{n - 1}} \quad (15.2)$$

and the relative standard deviation (RSD) or coefficient of variation (CV) is

$$\text{RSD (\%)} = \frac{100 \text{ SD}}{x} \quad (15.3)$$

Details on practical statistics for handling data can be found in Refs. 8 and 21.

Data to assess precision often are collected as part of other studies that concern linearity (Section 15.4) or accuracy (Section 15.2). Typically, 6 to 15 replicate measurements are made on single samples at each concentration level. For an HPLC assay of a major component, methods with a relative standard deviation (RSD) of 1 to 2% may be required. A major limitation for achieving still better precision is the use of volumetric glassware, whose precision is limited to about 0.5%. Errors of this kind can be reduced by weighing every volume aliquot (pipetting, fill to mark, etc.) and correcting weights to volume using solvent densities; weighing is more precise than volumetric dispensing. For the assessment of low-level impurities, precision of 5 to 10% RSD usually is acceptable, depending on the sample complexity.

Less precise methods (RSD \geq 2%) can still be useful, even when a particular sample needs to be defined accurately. A simple, although time-consuming method is to increase the number of replicates performed. For example, if a particular assay method has a precision of 3% RSD, a single measurement can define the value of $X \pm 3\%$. By analyzing 10 samples and determining the average, the uncertainty in the value can be reduced by $\sqrt{10}$, thus defining the value to $X \pm (3\%/\sqrt{10})$, or $X \pm 0.95\%$.

15.4 LINEARITY

As described in Section 14.1.1, the linearity of a method is a measure of how well a calibration plot of response vs. concentration approximates a straight line. Linearity can be assessed by performing single measurements at several analyte concentrations. The data are then processed using a linear least-squares regression. The resulting plot slope, intercept, and correlation coefficient provide the desired information on linearity. An example of this approach is shown in Fig. 15.1. The numerical value of the slope and intercept will depend on the responses measured, but intercepts greater than 2% (relative to the target level response) are typically expected with well-designed HPLC methods for major component analysis. A linearity correlation coefficient above 0.999 is acceptable for most methods, especially for major components in assay methods. Methods with linearity poorer than this may have to be treated as non-linear and use more complicated multi-point calibrations or non-linear response modeling.

The least-squares method of determining linearity can have serious shortcomings if response must be measured over one or more orders of magnitude. Here the slope, intercept, and correlation coefficient can be unduly influenced by data at low or high concentrations. Small changes in the calculated value

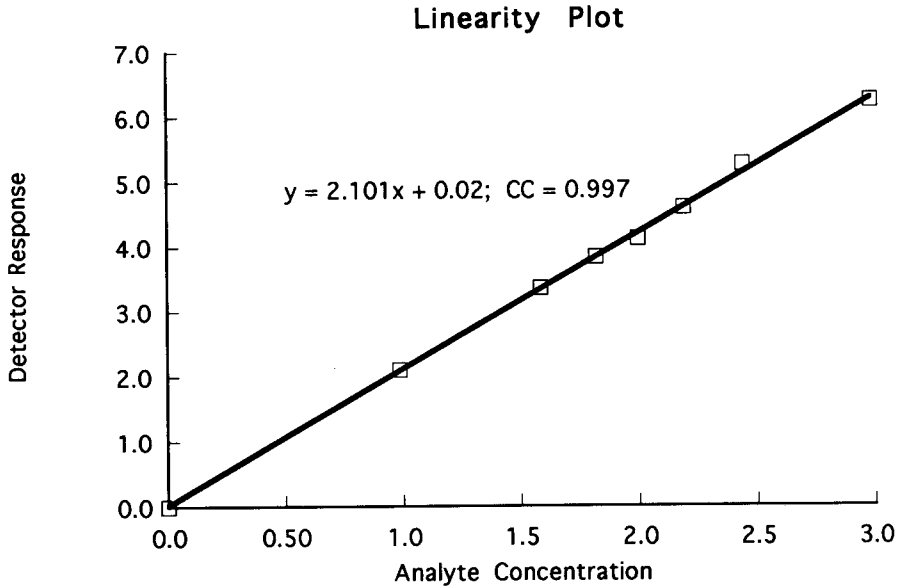

FIGURE 15.1 Typical linearity plot of detector response vs. analyte concentration.

of either the slope or intercept can lead to errors in estimating the true value for a sample. Therefore, a better method of assessing linearity is desired.

A generally superior method for determining method linearity over wide concentration ranges is shown in Fig. 15.2 [9]. This approach involves determining the response factor at each measured concentration and plotting this response factor (or sensitivity) vs. analyte concentration (or log concentration for a wide range). This response factor (RF) is calculated as

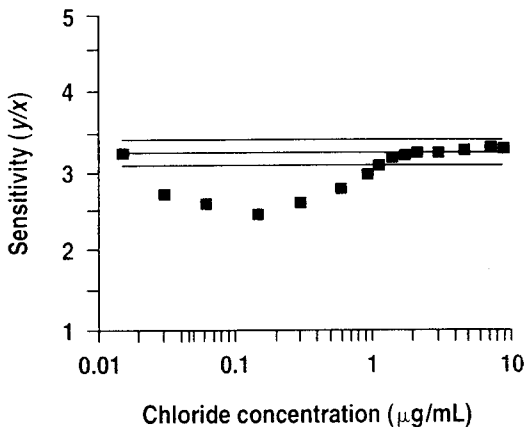

FIGURE 15.2 Linearity plot using sensitivity vs. concentration. (Used with permission from Ref. 9.)

$$RF = \frac{DR}{C} \quad (15.4)$$

where DR is the detector response (peak area or peak height) and C is the concentration of the analyte.

Ideally, the response factor should be independent of concentration if the method is truly "linear" over an extended range of concentrations and $b \approx 0$ (b is the intercept, as defined in Eq. 14.1). In the case of Fig. 15.2, the response factor is independent of concentration for ranges of 1.2 to 10.0 $\mu\text{g/mL}$. At lower concentrations this relationship deviates, and the assumed linearity no longer holds.

Although the response factor method uses only response slope information, implicit information is available for intercept and correlation as well. For example, a non-zero intercept is manifested by a "bending" of the flat linear plot at low concentrations (Fig. 15.2), while non-linearity at high concentrations will also show a change in this sensitivity vs. concentration plot. A perfect correlation at all concentration levels will show no deviation from the middle horizontal line of Fig. 15.2 (representing the average response factor for the higher concentration samples). However, scatter about the line is acceptable within a reasonable limit, based on the needs of the analysis method. This information can be more explicitly seen by a plot of residuals vs. measured analyte concentration, as shown for another data set (that of Fig. 15.1) in Fig. 15.3. The residual for each data point is the difference between the measured value at a certain concentration and the calculated value using the slope and

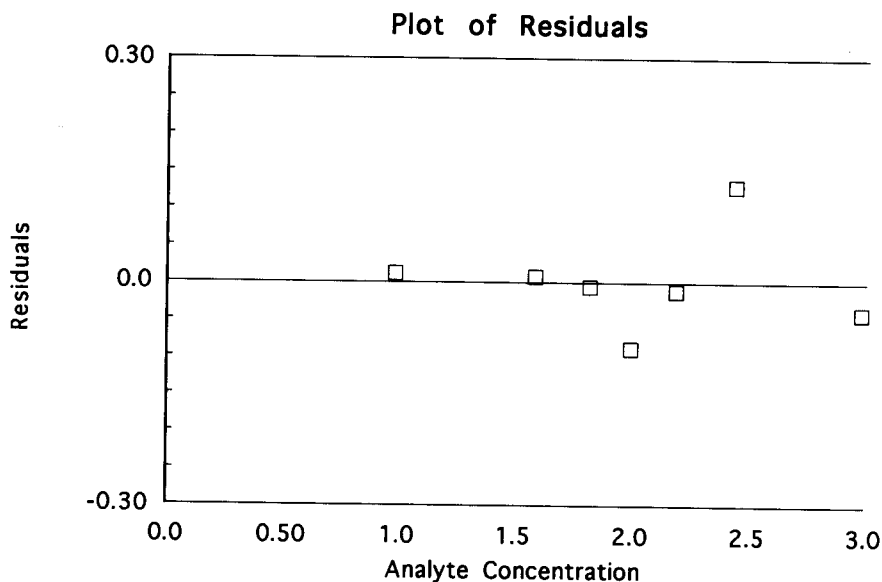

FIGURE 15.3 Plot of residuals vs. analyte concentration for data of Fig. 15.1.

intercept determined by a fit of all data. In this case, the residuals should be distributed both above and below the zero residual line (representing random precision of the method), with no obvious outliers. The approaches used in Figs. 15.2 and 15.3 can be useful to determine whether a systematic error exists in the method.

Linearity data can be obtained in several ways. A convenient technique is to create one stock solution of analyte and perform serial dilutions (e.g., 1:5, 1:10, 1:20) to obtain the necessary concentrations for analysis. Serial dilution helps avoid errors inherent in the independent preparation of several concentrations. Repeating this process at least three times with different stock solutions generates three complete sets of linearity and response factor plots (as in Figs. 15.1 to 15.3) and permits a measure of linearity repeatability. In addition, it is recommended that these linearity studies be performed using at least five different concentration levels (see the range discussion below for actual levels).

15.5 RANGE

The *range* of a method can be defined as the lower and upper concentrations for which the analytical method has adequate accuracy, precision, and linearity. While a desired concentration range is often known before starting the validation of a method, the actual working range results from data generated during validation studies. The range of concentrations examined will depend on the type of method and its use. For a major component assay, concentrations of standards should be measured at or near the expected target measurement level. The concentration range should encompass values expected in samples to be measured. A good strategy is to perform studies at 50, 75, 100, 125, and 150% of target levels. This range also has the potential to demonstrate that the method is linear outside the limits of expected use (typically 90 to 110%).

Major component assays of pharmaceuticals often are used to measure content uniformity for a dosage unit. The *U.S. Pharmacopeia* (USP) definition of *content uniformity* allows a single value to deviate from the target by as much as 25% and still pass the test [10]. Therefore, a prudent linearity validation will encompass a range of at least $\pm 25\%$ even if the assay is expected to fall within ± 5 to 10% of the target value. Furthermore, drug stability data (especially those in accelerated studies) can generate values outside the anticipated specification range. This requires that the validation extend well beyond the expected specification level or target values for the assay of unstressed product. In cases where the sample concentration is above the calibration range, dilution of the sample to the appropriate concentration is recommended.

Methods for determining impurities, degradants, and other related substances can generate concentrations that vary over several orders of magnitude, depending on method sensitivity. A recommended range to be exam-

ined in validation studies in pharmaceutical and related samples should start at the limit of quantitation (typically $< 0.1\%$) and extend up to at least 5% of the concentration of the major component. Measurements beyond this range typically are not needed since related substances are rarely tolerated at higher levels in a raw material or finished product. For applications to other types of sample, this recommended range may need to be adjusted; however, the key point is to validate the expected range of all potential samples.

15.6 LIMIT OF DETECTION AND LIMIT OF QUANTITATION

Two important characteristics of a method are the *limit of detection* (LOD) and *limit of quantitation* (LOQ). In Chapters 3 and 14 we describe *how* to determine these characteristics, and such studies are considered to be an important part of any method validation. The limit of detection (LOD) can be defined as the smallest level of analyte that gives a measurable response. The LOD is often based on a certain signal-to-noise (S/N') ratio, typically 2 or 3. We recommend that a S/N' ratio of 3 be used as the limit of detection for HPLC methods.

The limit of quantitation (LOQ) can be defined as the smallest concentration of analyte which gives a response that can be accurately quantified. The LOQ can also be defined as the level at which precision is poorer than a certain value (e.g., $RSD > 3\%$). The latter definition often is used if the method requires a certain precision at the lowest level of determination. The LOQ can be set at some arbitrary defined level, such as a S/N' ratio of 10. Figure 15.4 illustrates how precision is related to relative sample concentration. At relative analyte concentrations greater than 20, the precision for this example is independent of S/N' ($RSD \approx 1\%$) and depends on other factors. For relative analyte concentrations below 5, the precision is determined by S/N' . Based on Fig. 15.4, a S/N' ratio of 10 (relative analyte concentration of = 4 in this example) should result in a precision of better than 3%

The LOD and LOQ values determined during method validation are affected by the separation conditions: columns, reagents, and especially instrumentation and data systems. Instrumental changes, particularly pumping systems and detectors, or the use of contaminated reagents can result in large changes in S/N' ratio (especially affecting baseline noise and drift). Further discussion of these effects can be found in Chapter 14.

15.7 SPECIFICITY

The single most important aspect of most analytical methods is *specificity*, which can be defined as the ability to measure accurately the concentration

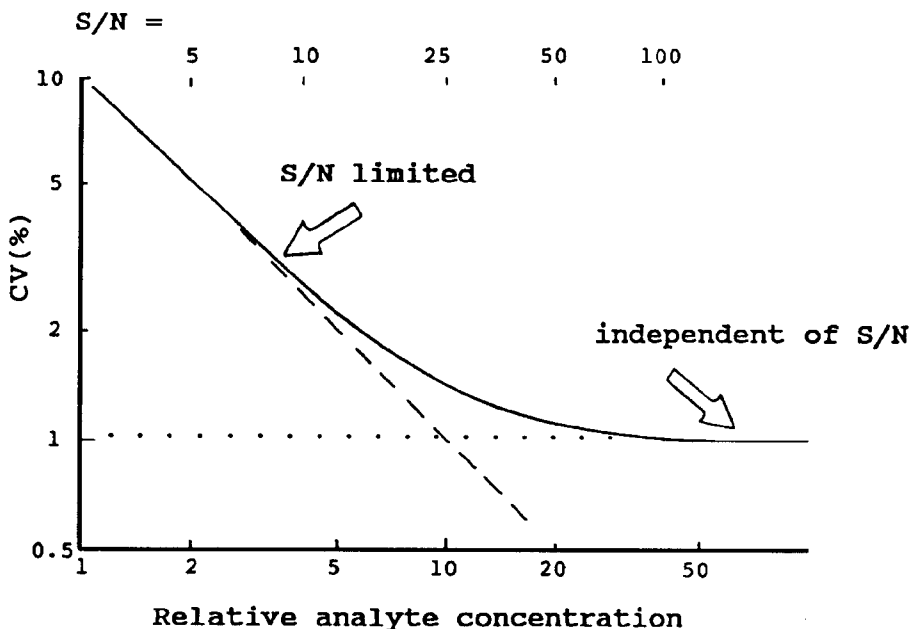

FIGURE 15.4 Dependence of precision on sample concentration and signal/noise (S/N') ratio.

of an analyte in the presence of all other sample materials. If specificity is not assured, method accuracy, precision, and linearity all are seriously compromised. Assuring specificity is the first step in developing and validating a good method. Techniques for adjusting band spacing and increasing resolution between peaks to assure specificity are discussed in Chapters 6 to 9. Method specificity should be reassessed continually during validation and subsequent use of the method. New or previously unknown compounds in later samples may interfere with a method that was validated properly during initial development.

The determination of method specificity can be achieved in two ways. First and most desirable, all potential interfering compounds can be tested to demonstrate their separation from the peak(s) of interest with a specified resolution (usually $R_s \geq 2$; see Section 2.2.2). In Chapters 6 to 9 we describe systematic ways to modify sample retention to achieve this goal. A second method for achieving specificity is the use of selective detectors (Section 3.3), especially for coeluting compounds. For example, a selective detector (e.g., electrochemical or radioactivity) will respond to some compounds but not to others. In the case of a radioactive compound, even if a non-radioactive species completely coelutes, the detector will only “see” the compound of interest.

In this case, an accurate measurement of that compound is feasible, despite the lack of chromatographic separation.

The use of a specific UV wavelength can also be effective in optimizing measurement selectivity. The selective UV detection of an analyte also can be enhanced by derivatization and measurement at a wavelength selective for the resulting derivative. An example is the use of DABS-Cl (4-dimethylaminoazobenzene-4'-sulfonyl chloride) to derivatize amino acids for subsequent detection at 436 nm. This approach permits the analysis of these analytes in the presence of other compounds which absorb only at lower wavelengths [11]. While a valid approach to assure specificity, selective detection is still not preferred to adequate separation of the compounds of interest. Coeluting compounds, especially if present in large molar excess to the species of interest, can cause irreproducible separation even when selective detection is used [12].

Specificity of a developed method often is difficult to ensure. However, there are a number of techniques that can be used in method validation experiments that will increase confidence in specificity. These procedures include:

- Spiking known interferents
- Sample degradation studies
- Peak collection with subsequent analysis by other techniques
- Specific on-line detection such as LC/MS or multiple-wavelength scanning
- Use of another chromatographic method
- Changing conditions of the HPLC method (e.g., alternative solvents or different gradient slopes)

These procedures to ensure method specificity are discussed individually in the following sections.

15.7.1 Spiking of Potential Interferents

The most straightforward technique for assessing specificity is to add a small amount of a known contaminant, degradation product, or other impurity to the sample and determine that the added species is well separated from the compound to be measured. However, in early method development studies, all potential interfering compounds are not necessarily known or available, so additional techniques to assess interferents may be required, as described below.

15.7.2 Sample Degradation

Another technique for assessing specificity is to deliberately degrade the sample and look for the appearance of other peaks in the chromatogram (repre-

senting degradation products of the sample). This approach can be carried out either in the presence or absence of other matrix components (e.g., formulation ingredients), depending on the projected use for the method. The purity of the assay peak of interest in the degraded sample often will need to be determined by another technique. This could include on-line methods such as LC-MS or diode-array wavelength scanning (Section 15.7.4) or "off-line" methods such as peak collection with spectral analysis (Section 15.7.3) to assure that another component is not hidden under the main component peak. Other peaks will often appear with sample degradation, but they are of no concern for assay of that sample if they are well resolved from the peak(s) of interest. Degradation studies often use reactions that involve acid, base, heat, light, and oxidation (see Table 15.2 example). Typically, studies are designed so that 10 to 30% of the original sample is degraded. In this way the generated peaks are likely to be realistic degradants rather than (for $\geq 30\%$ degradation) secondary chemical products that are less likely to occur in real samples. In addition, degradation studies such as these will often indicate which "real" degradation peaks will form and where they may elute. This information is also useful in developing stability-indicating methods.

15.7.3 Peak Collection and Analysis

Method specificity is best determined by collecting the peak of interest and subjecting it to independent analysis. This could include mass spectral characterization, IR, NMR, a specific bioassay, or other appropriate characterization method. Any co-eluting compound is likely to be discovered by these complementary analyses. The peak also can be collected in thirds (first part of the peak, heart cut of the middle of the peak, last part of the peak) and independently reinjected. If another species is partially co-eluting with the main peak of interest, a partial separation often is seen on re-analysis of the isolated fraction(s). An example of this is shown in Fig. 15.5. In this case the last part of the main peak in Fig. 15.5a (after 5.78 min) is collected and re-injected using the same or higher-resolution chromatographic conditions. In Fig. 15.5b there is now clear evidence of a second, partially separated peak which is hidden under the main peak of Fig. 15.5a under normal conditions. To be effective, the procedure of Fig. 15.5 should involve the collection of no more than 10% of the total band; a 5% fraction is collected in the separation of Fig. 15.5a (5.78–5.90 min).

15.7.4 Additional On-Line Detection

Specific on-line detection systems, such as diode-array UV and LC-MS, also may be helpful in assessing method specificity. Many users employ "peak purity" techniques built into diode-array UV systems to show that the spectra across a peak are consistent, thus lending credence to a single species (see the discussion in Section 3.2.6). Although this peak-purity method is useful,

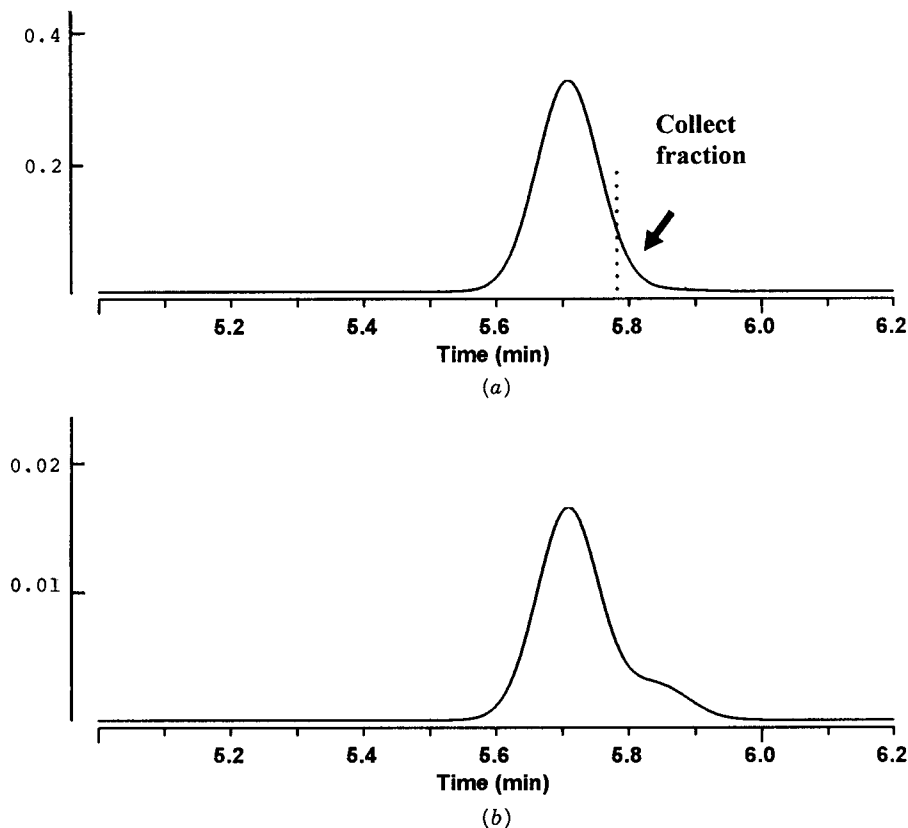

FIGURE 15.5 Fractional collection and re-injection to determine peak purity. Collected fraction of main peak in (a) is subjected to the same analysis conditions in (b), which shows evidence of a partially coeluting compound.

it relies on a significant difference in UV spectra between the compound of interest and potential interferences. However, if an interferent has the same retention (within ± 0.02 min) as the compound of interest, or if the spectra of the two compounds are similar or identical, this peak-purity technique is not reliable.

On-line LC-MS systems are especially useful in determining peak purity, assuming that different masses or mass patterns can be observed for potentially overlapping species. Unfortunately, LC-MS systems are expensive, generally unavailable for routine use, and often not amenable to solvent systems used for HPLC. These limitations restrict the applicability of this powerful method. However, LC-MS systems are becoming more available and versatile, and the routine use of LC-MS in method-development laboratories is dramatically

increasing. In addition, peak collection and off-line MS analysis (although cumbersome and time consuming) may provide information similar to that of on-line LC-MS. An approach used by some laboratories is to develop the method using solvents and operating conditions that are compatible with mass spectral detection. However, confirmation of peak purity by MS can be limiting if isomers are involved, because of similar mass spectral patterns. Isomers are typical impurities in many preparations, so that other cross-check methods for purity are required (Section 15.7.5).

15.7.5 Chromatographic Cross-Check

Another powerful technique to define peak homogeneity or purity is to use a different chromatographic method. For example, if the original method is developed on a reversed-phase C_{18} column, a normal-phase method can be used as an alternative. The second HPLC method can be used either on the entire sample, or (better) on an individual peak collected from the C_{18} column. An example of this is shown in Fig. 15.6 for further characterization of the major peak (9.0 min retention time). The initial separation, shown in Fig. 15.6a, resolves five compounds from the main peak. Collecting the main peak only and reinjecting it using another chromatographic method (illustrated in Fig. 15.6b) shows an additional minor impurity that was hidden under the main peak in Fig. 15.6a.

Other separation techniques, such as thin-layer chromatography (TLC), gas chromatography (GC), ion exchange, and capillary electrophoresis (CE), also may be appropriate for checking peak purity, depending on the type of sample. CE is a technique highly complementary to HPLC, and its use to assure the specificity of an HPLC method is growing. An example of this approach is shown in Fig. 15.7 [13]. In this case, the best reversed-phase HPLC separation of rabbit liver Cd,Zn-MT metallothionein isoforms was obtained at pH 2.5, but only two major peaks are fully resolved (Fig. 15.7a). When the sample was separated by CE, at least four peaks are resolved, as shown in Fig. 15.7d.

15.7.6 Changing HPLC Conditions

Modifying the conditions of the original HPLC method can change selectivity so as to resolve previously overlapping peaks. If no new peaks appear, this is evidence that all compounds have been resolved and the method is specific. For example, if two or more runs with % B or gradient steepness varying are used to develop a gradient (or isocratic) method, the lack of interfering or coeluting peaks in all gradients may be evidence of specificity. Similarly, separation results with other solvents, columns, temperatures, pH, additives, and so on, acquired during method development can provide further evidence of peak purity. While important information on method specificity often is

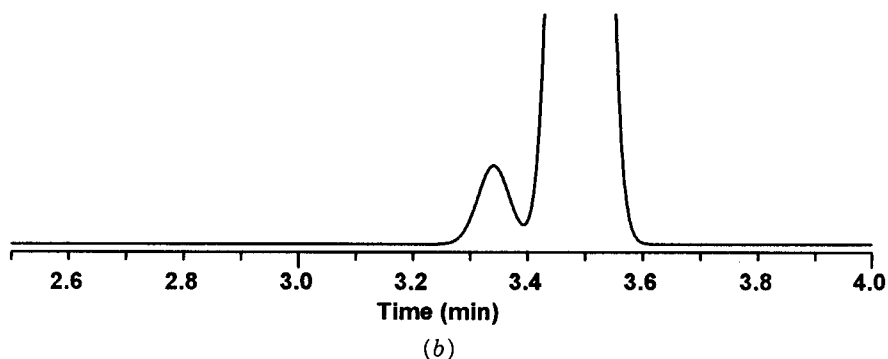
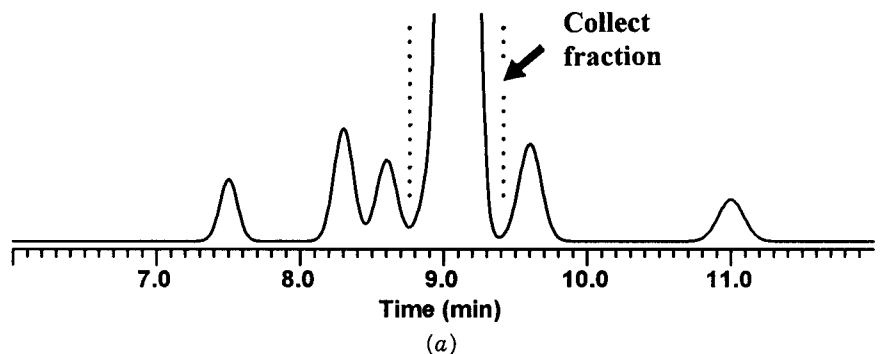

FIGURE 15.6 Collection of a peak and reinjection using a different chromatographic method. Main peak in (a) is collected and reinjected in (b), which shows evidence of a coeluting peak from the original separation.

contained in the data generated during the method development, the cross-check methods described in Sections 15.7.3 and 15.7.4 usually are required to obtain a high degree of confidence of peak purity.

15.8 RUGGEDNESS

Method *ruggedness* is defined as the reproducibility of results when the method is performed under actual use conditions. This includes different analysts, laboratories, columns, instruments, sources of reagents, chemicals, solvents, and so on. Method ruggedness may not be known when a method is first developed, but insight is obtained during subsequent use of that method. Good method development procedures require the systematic evaluation of the important factors that influence method ruggedness. In this way, an initial

method can be developed that increases the likelihood of good performance after validation and during subsequent use.

The strategy for determining method ruggedness will vary depending on the type and complexity of the method and the time available for validation. Determining method ruggedness may be limited to a few critical experiments, such as checking effects of different columns (same manufacturer and type) or the effects of running the method in a different laboratory. In this case, all other factors are kept constant, including mobile phases and reagents. The same sample is used, and the final results (assay value, level of impurities, etc.) are compared to assess equivalence. This approach is useful when time for ruggedness testing is limited. Often, the real ruggedness of a method can only be determined over time by experience in different laboratories. However, as the need for method ruggedness increases, a more comprehensive plan for predicting ruggedness is needed.

15.9 ROBUSTNESS

The concept of *robustness* of an analytical procedure has been defined by the ICH [6] as “a measure of its capacity to remain unaffected by small, but deliberate variations in method parameters.” A good practice is to vary important parameters in the method systematically and measure their effect on separation. For example, if a method uses a 36% ACN–water mobile phase, performing the analysis at 33, 36, 39% ACN/water to determine the effect of mobile phase on retention and selectivity can help define method ruggedness to a change in percent organic. Similar studies should be performed changing all variables (e.g., mobile-phase additives, column temperature, flow rate, etc.; see Fig. 1.5 as an example). Many of these data are obtained during method development if systematic studies of separation variables are performed as recommended in Chapters 6 to 9. The use of parameter mapping procedures is especially effective in defining robustness (see Section 10.6).

The most important aspect of robustness is to develop methods that allow for expected variations in the separation parameters. For example, if an equivalent separation of two components can be obtained at pH 3.0 or pH 4.5, but the separation changes significantly with a ± 0.1 shift in pH at 3.0 (but not at

FIGURE 15.7 Specificity of HPLC separation: RP-HPLC separation of rabbit liver Cd, Zn-MT isoforms at different pH values. Column: 25 \times 0.46-cm Vydac-C₈; flow rate: 1.0 mL/min; ambient temperature; UV detection: 214 nm; mobile phase: acetonitrile in 10 mM sodium phosphate buffer two-step gradient at (a) pH 2.5; (b) pH 7.0; (c) pH 11.0; (d) CE of rabbit liver Cd,Zn-MT isoforms; column: 57 cm \times 75- μ m fused silica; running buffer: 10 mM sodium phosphate adjusted to pH 2.5; running voltage 30 kV; UV detection at 200 nm. (Reprinted with permission from Ref. 13.)

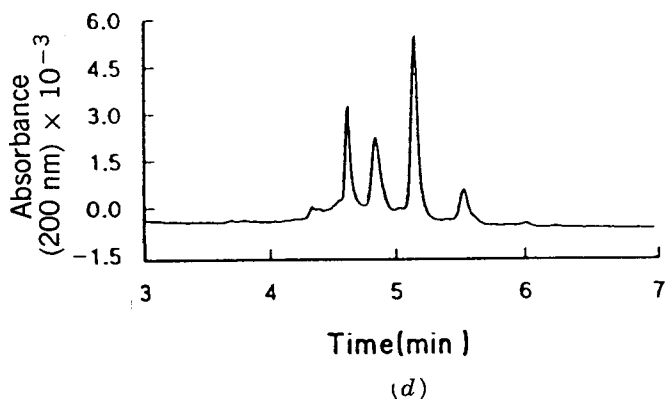
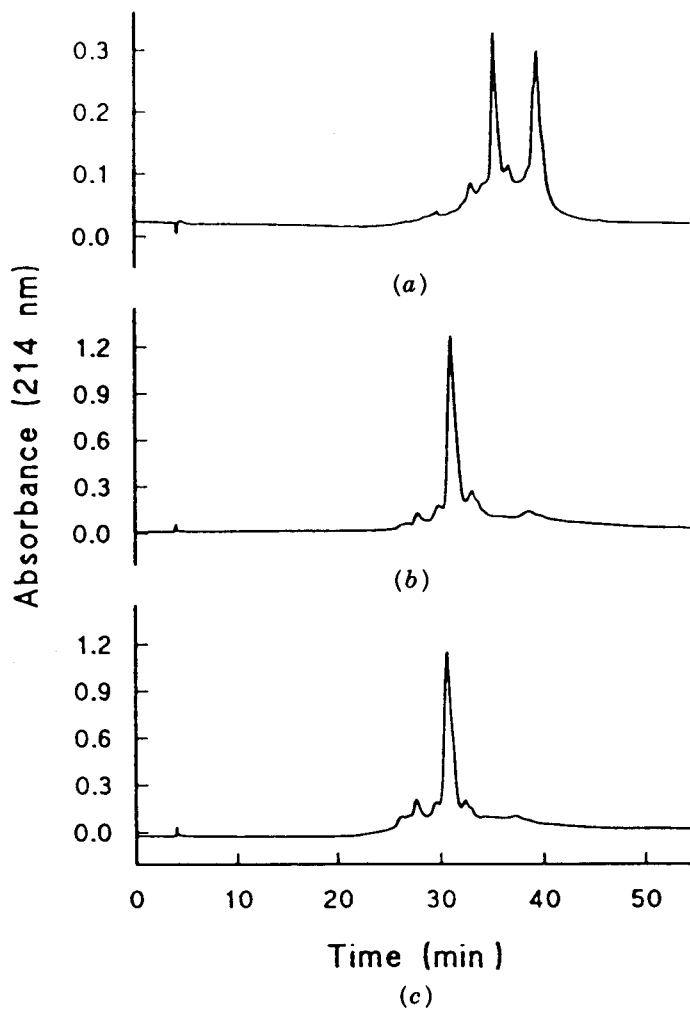

pH 4.5), it would be better to select pH 4.5. An effective way to examine method robustness is with a statistical experimental design to evaluate the many parameters simultaneously. A proper design can minimize the number of experiments needed while still providing information on the effects of individual parameters. Typically, a multivariate screening study is first performed on all known or suspected factors that could influence the method. In this first study, the suspected factors are examined (briefly) to determine which ones exhibit a significant effect on the method. The results of this first study will indicate only those factors that are important. A second, more detailed evaluation of the important factors is undertaken, typically using three levels for each factor. The results of this study can be used to quantitate the effects of each factor. The use of experimental design in method development is beyond the scope of this book, but details on general experimental design can be found in Refs. 14–17. In addition, the use of computer simulations (e.g., DryLab) can be very useful to examine the effects of method robustness (Sections 10.2 and 10.6).

Attention to the foregoing considerations will significantly improve the quality of the final method. The one exception, however, is the column. There is the possibility that a column from a different manufacturing lot will not give reproducible retention of all sample components, possibly resulting in an unacceptable separation (Section 5.3). For this reason it is important to evaluate columns from at least three different lots during method development and validation to ensure that reproducible columns can be obtained. If significant lot-to-lot variations in sample retention are observed, appropriate steps should be taken to avoid future problems. One approach is to stockpile enough columns from a “good” batch for all future uses of the method. Another approach is to determine whether small changes in conditions (% B, temperature, pH, etc.) can be used to minimize or correct any undesirable changes in retention from lot to lot.

15.10 STABILITY

To generate reproducible and reliable results, the samples, standards, and reagents used for the HPLC method must be stable for a reasonable time (e.g., one day, one week, one month, depending on need). For example, the analysis of even a single sample may require 10 or more chromatographic runs to determine system suitability, including standard concentrations to create a working analytical curve and duplicate or triplicate injections of the sample to be assayed. Therefore, a few hours of standard and sample solution stability can be required even for a short (10-min) separation. When more than one sample is analyzed (multiple lots of one sample or samples from different storage conditions from a single lot), automated, overnight runs often are performed for better lab efficiency. Such practices add requirements for greater solution stability.

The stability of all reagents and solutions is important with regard to both time and temperature. If a solution is not stable at room temperature, decreasing the temperature to 2 to 8°C can improve stability of samples and standards; autosampler chillers are available for this purpose. Stability is also important in relation to the actual analysis time. For example, analyses using a 100-min gradient run require longer reagent stability than a 5-min isocratic separation. Typically, 24-hr stability is desired for solutions and reagents that need to be prepared for each analysis. Longer-term stability (days or weeks) of standard solutions is desirable; otherwise, the standard solutions may need to be prepared fresh every time the analysis is performed.

Mobile phases should be chosen to avoid stability problems, especially the use of amine additives or specific solvents. For example, mobile phases containing THF are known to be susceptible to oxidation. These mobile phases should be prepared daily with fresh THF. Some buffered mobile phases cause problems; for example, phosphate and acetate provide good media for microbial growth. Sodium azide (0.1%) is often added to the mobile-phase buffer to inhibit such growth; adding more than 5% of organic solvent is also effective.

Long-term column stability is critical for method ruggedness. Even the best HPLC column will eventually degrade and lose its initial performance, often as a function of the number of samples injected. Details on column stability are provided in Section 5.4.

15.11 SYSTEM SUITABILITY

Prior to the analysis of samples each day, the operator must establish that the HPLC system and procedure are capable of providing data of acceptable quality. This is accomplished with system suitability experiments, which can be defined as tests to ensure that the method can generate results of acceptable accuracy and precision. The requirements for system suitability are usually developed after method development and validation have been completed. The criteria selected will be based on the actual performance of the method as determined during its validation. For example, if sample retention times form part of the system suitability criteria, their variation (SD) during validation can be determined. System suitability might then require that retention times fall within a ± 3 SD range (based on validation results) during routine performance of the method.

The USP defines parameters that can be used to determine system suitability prior to analysis [18]. These parameters include plate number (N), tailing factor, k and/or α , resolution (R_s), and relative standard deviation (RSD) of peak height or peak area for repetitive injections. Typically, at least two of these criteria are required to demonstrate system suitability for any method.

The RSD of peak height or area of five repetitive injections of a standard solution is normally accepted as one of the standard criteria. For an assay

method of a major component, the RSD should typically be less than 1% for these five repetitive injections. For the measurement of a compound at trace levels, such as an impurity standard run at or near the limit of quantitation, a higher RSD (5 to 15%) is acceptable.

A second criterion tests chromatographic behavior. The plate number and/or tailing factor are used if the run contains only one peak (e.g., an assay using an external standard). For chromatographic separations with more than one peak, such as an internal standard assay or an impurity method expected to contain many peaks, some measure of separation such as α or R_s is recommended. Reproducibility of t_R or k values for a specific compound also defines system performance.

15.12 DOCUMENTATION OF VALIDATION RESULTS AND THE FINAL METHOD

An important aspect of any method validation is documentation of the validation experiments with appropriate conclusions. This documentation can take the form of a memo, short report, or a more formal writeup. It should be reviewed by someone not directly involved with the method development or validation experiments. If a plan for validation and desired acceptance criteria has been established (Section 15.1), the validation report should compare these criteria with the corresponding results. Deviations from the experimental plan/or and data that fail to support predetermined method criteria may require additional method development and/or validation. Sometimes the results of a validation may not exactly meet the goals or criteria set out before starting. If the method still can be used to obtain adequate results (even though the original goals are not met), a proper explanation and documentation in the validation report are adequate. Since method validation is often performed in stages (preliminary validation early in development; full validation later), more than one report often is required. Therefore, a formal system to document changes and additional information is recommended.

A second requirement is a formal, written procedure that can be used by others to perform the method routinely. The developer of an HPLC method may unconsciously perform certain steps without realizing that these are important for executing the method properly. Detailed procedures must be passed on in writing to others who will use the method.

Two general approaches often are used for method description. The first is to describe the method in preliminary abstract form, typically in a 2- to 5-page writeup. The contents of such a description are shown in Table 15.1 along with typical examples. Sufficient detail should be provided so that an experienced analyst can run the method adequately. This level of method write-up typically is provided in submissions to regulatory agencies, such as the FDA or EPA. Therefore, the method description should be sufficiently detailed to allow a proper review for intended use.

TABLE 15.1 General Method Description (Abstract)

-
1. *Method overview (including separation principles and intended use of the method).* Example: This method uses reversed-phase HPLC for the determination of impurities in a drug substance. The method is applicable to the analysis of purified drug substance in its final form.
 2. *Instrumental parameters.* Include instrumentation needed (specific models or manufacturers if necessary); composition of mobile phase, including gradient elution profile (if applicable), flow rate, column temperature requirements, autosampler, detector (including wavelength for analysis and reference); a description of column type and source.
 3. *Reagents and preparation of solutions.* Include all solvents, reagents, and other chemicals (possibly including sources) needed for the method; a description of preparation of sample and standard solutions, including concentration, pH measurement (if appropriate), storage, and stability.
 4. *System suitability.* Describe experiments to assess system suitability.
 5. *Sample analysis.* Describe procedures used to analyze a typical sample, including any standards analysis.
 6. *Sample of calculations and/or data analysis.* Give a typical example of calculations needed and/or data analysis performed.
 7. *Sample chromatogram.* Provide a typical example of an expected chromatogram. This might include more than one example and should be labeled if multiple peaks are expected to be present.
 8. *References.* Include appropriate references to outside literature, reports, troubleshooting guides, etc.
-

A second approach for method writeup is to provide a detailed description of each step required to perform the method. This is often referred to as a standard operating procedure (SOP). This type of writeup (typically 10 pages or more) is especially desirable when the method is to be performed by those having little experience with similar methods or with less-skilled analysts. Each step should be described in detail to minimize confusion in running the method properly. This type of writeup often is used when transferring a method to a production or quality-control laboratory.

Whichever technique is used to describe the method, it is recommended that an analyst not involved with the method read the method description (and even execute the method) to ensure that instructions are clear and concise. A well-designed and validated method is of little use if not properly documented for transfer to the appropriate laboratory.

15.13 INTERLABORATORY CROSSOVER STUDIES (TRANSFERABILITY)

A validated method often will be used in other laboratories. Therefore, a formal method transfer or interlaboratory crossover study should be per-

formed to qualify the other laboratory. This step can be performed as part of the initial method validation, but often occurs later when the need arises. The method validation report and the method description can serve as the basis for the method transfer. However, a formal protocol describing the required experiments is also recommended. This should also involve formal, method-specific training of the personnel in the receiving laboratory before starting the crossover studies. Representative samples should be used for this study, and care must be taken to ensure that these samples are homogeneous and identical for both laboratories. The purpose of the method transfer is to assess the method performance, not possible changes in sample or matrix. Often a “control lot” of material or a reference sample is used for these studies.

15.13.1 Determining Equivalence

An important aspect of any method transfer or crossover study is determining whether the results are equivalent. Typically, statistical tests are used, such as:

- *t*-test
- *F*-test
- Analysis of variance (ANOVA)
- *Q*-test

Each of these tests has a specific purpose in analyzing data. The *t*-test compares the mean results obtained from two experiments or determines if a sample mean is different from a standard value. An *F*-test is used to compare the variances obtained from two studies. Analysis of variance (ANOVA) techniques are used to compare more than two sets of data, such as multiple laboratories in the same test. Statistical equivalence is usually evaluated by comparing the data at the 95% confidence level. When performing these analyses and comparisons, data will occasionally fall outside the range of acceptable values. In this case, the data may be statistically rejected by the appropriate use of a *Q*-test (also known as the Dixon criteria). Further details on the use of these methods can be found in any good statistical reference book, such as Refs. 19, 20, or 21.

In some cases, statistical equivalence is not obtained, particularly if the method is very precise. For example, a method may have a precision of 0.5% (RSD) in one laboratory and the mean assay values obtained in two different laboratories are different by 1.5%. This would indicate a statistically significant bias in the results. However, if the analysis required results to be measured only within 2% of the actual value, this difference would be of no *practical* significance. In those cases it may be necessary to determine analytical equivalence of the data sets by judging whether the differences observed are meaningful compared to the specifications, sample variability, day-to-day variability, or other criteria. The lack of statistical equivalence by itself is not sufficient

TABLE 15.2 Method Validation Protocol Example*Major Component Assay of an Active Drug Substance in a Pharmaceutical Formulation*Specificity^a

1. Inject a sample of all known or suspected compounds related to the drug substance. These would include synthetic precursors to the final compound, other chemicals and solvents used in the reaction, and/or reasonable degradation products. *All compounds separated from analyte peak by $R_s \geq 2$.*
2. Inject a sample of other excipients used to make the tablet. *All compounds separated from analyte peak by $R_s \geq 2$.*
3. Subject the drug substance and/or tablet form to the following conditions for sufficient time to achieve 10 to 30% degradation of the initial material:
 - a. 0.1 N HCl (acid)
 - b. 0.1 N NaOH (base)
 - c. 50°C (heat)
 - d. 600 foot-candles of UV light
 - e. 3% hydrogen peroxide solution

If these conditions are too extreme and result in $> 30\%$ degradation, change the strength and/or time of degradation. More extreme conditions than this should be avoided unless it is likely that the compound ultimately will be subjected to these extremes. *All compounds generated are separated from analyte peak by*

$R_s \geq 2$.

4. Collect the analyte peak for the drug substance and:
 - a. Re-inject on a different chromatographic method (another HPLC method, CE, GC, etc.)
 - b. Analyze the peak (either before or after solvent stripping) by other spectral techniques (IR, NMR, MS).
No appearance or other evidence of additional compounds.
5. Collect the analyte peak for the drug substance in three parts (beginning, middle, and end) and re-analyze by the same HPLC method (see Fig. 15.5). *No appearance or other evidence (peak shape) of additional compounds.*
6. Change the conditions of the HPLC method (percent organic solvent in reversed-phase, solvent type, gradient slope (in a gradient separation), temperature, ionic strength and/or pH of buffer, etc.), and look for additional peaks separating from the analyte peak. *No appearance or other evidence of additional compounds.*

Accuracy

7. Into a solution of blank matrix for the tablet (containing all ingredients except for the drug substance), spike the drug substance at levels of 50, 75, 100, 125, and 150% of the target level in the tablet. This procedure should be performed at least three times using separately prepared blank matrix and drug substance and preferably over 2 or more days. The results of analysis by the HPLC method should be compared to the known amount added for each spike. *Average recovery of analyte should be 99 to 101% at each level.*

(Continued)

TABLE 15.2 (Continued)

Linearity

8. This characteristic should be evaluated as part of the accuracy study above.

Linearity can additionally be tested by preparing standard solutions of the drug substance alone, preferably in the mobile-phase solvent used for injection, over at least the range anticipated for routine analysis. An extended range can also be examined ($< 50\%$ of target level and $> 150\%$ of target level) if desired for other types of analysis (equipment cleaning methods, concentrated solutions of drug substance used in process work, etc.). *Method should exhibit linearity in the desired range. Linearity should be measured and reported as a constant response factor over the range of desired measurements.*

Precision: Repeatability of Injection

9. Prepare a standard solution of the drug substance (in the mobile-phase solvent, preferably). Inject a sample from the standard solution at least 10 times (preferably more—up to 30 or 40 is sometimes desirable). Measure the response for each injection and calculate the precision using Eqs. 15.1 to 15.3. *Relative standard deviation (RSD) should be $\leq 1.0\%$.*

Precision: Repeatability (Intra-Assay)

10. Individually prepare multiple solutions of the drug substance (in the mobile-phase solvent, preferably). Inject a sample from each solution at least three times. Measure the response for each injection and calculate the precision using Eqs. 15.1 to 15.3. *Relative standard deviation (RSD) should be $\leq 2.0\%$.*

Precision: Intermediate

11. Assay a sample of the drug substance several times over a period of at least a few days (in the mobile phase solvent, preferably). Include appropriate standard preparations and use the prescribed method conditions, but on different instruments, analysts, and so on. Determine the assay value for each sample and calculate the precision using Eqs. 15.1 to 15.3. *Relative standard deviation (RSD) should be $\leq 2.0\%$.*

Range

12. The usable range for the method can be determined from the accuracy, linearity, and precision studies done above. *Usable range should encompass all levels for typical routine analysis. Linearity, accuracy, and precision should meet the requirements listed above for all levels in the range.*

Limit of Detection

13. Using a standard solution of drug substance that results in an S/N' ratio of at least 30, sequentially dilute the sample and measure using the HPLC method. Continue dilutions until the S/N' ratio is approximately 3.

Limit of Quantitation

14. Using a standard solution of drug substance that results in an S/N' ratio of at least 30, sequentially dilute the sample and make multiple measurements (at
-

TABLE 15.2 (Continued)

least six different injections of each solution) with the HPLC method. Continue this process until one of the following occurs:

- a. The S/N^a ratio is approximately ≈ 10 .
- b. The calculated precision (SD) for any set of six measurements is $\leq 3\%$ (or whatever SD deemed appropriate for the required level of quantitation).

Stability

15. Sample stability. Prepare a standard solution of drug substance in the tablet matrix and analyze the same solution repeatedly. If only short-term stability is needed, the analyses can be performed in one day. Longer-term stability of the same sample solution may be determined over days or even weeks, if required. *Stability of sample should be sufficient to perform the method routinely under normal laboratory conditions.*
16. Reagent stability. Check the stability of each critical reagent, including (but not necessarily limited to):
 - a. Solvents
 - b. Buffers
 - c. Additives*Stability of reagents, solvents, and so on, should be sufficient to perform the method routinely under normal laboratory conditions.*

Ruggedness

17. In a manner similar to stability studies, a standard solution of the drug substance with matrix should be analyzed while systematically varying operating conditions. The measured value of the drug substance level and effects on precision, retention, and separation factors should be noted. The conditions examined should include (but not necessarily limited to) the following:
 - a. Different operators in the same lab
 - b. Different instruments in the same lab
 - c. Different laboratories
 - d. Changing source of reagents and solvents
 - e. Changing to a new column (same type and manufacturer)*The method should be rugged enough with respect to all critical parameters so as to allow routine laboratory use.*

Robustness

18. Change (slightly) parameters of the separation including percent organic solvent (± 2 to 5%), gradient slope (by 2 to 5%, if appropriate), column temperature (± 1 to 5°C), buffer pH (up to ± 0.5 pH unit), buffer ionic strength, level of additive(s) in the mobile phase. Representative chromatograms should be prepared to show the effects of each variable measured, compared to the normal method conditions. Plots or tables of measured results (response factors, assay value determined, etc.) should also be provided. *The method should be robust enough with respect to all critical parameters so as to allow routine laboratory use.*

^a For each parameter we describe a possible experiment and show the most desirable results in italic type.

to deem a method unusable if the differences are not analytically significant (i.e., significant to the *user* of the data).

Proper method validation, documentation, and transfer are critical to the long-term success of any HPLC method. Systematic method development will provide some data on method ruggedness, but a well-designed and executed validation still is required.

15.14 METHOD VALIDATION PROTOCOL

A suggested sample method validation protocol is shown in Table 15.2 (pages 709–711). This example is for the reversed-phase HPLC assay of a drug substance in a tablet, but the general principles can be applied to other analyses, such as assay of pure drug substance, impurity methods, or trace-level determinations of contaminants. The desired results will vary depending on the type of analysis method and the expected rigor or measurement needed (i.e., specifications for an analyte, control levels, etc.). The studies are listed roughly in the order normally performed, but are subject to change depending on the needs of a particular method.

REFERENCES

1. *Guideline for Submitting Samples and Analytical Data for Methods Validation*. U.S. Department of Health and Human Services, Food and Drug Administration, Rockville, MD, Feb. 1987.
2. *Reviewer Guidance: Validation of Chromatographic Methods*, Center for Drug Evaluation and Research (CDER), 1994-615-023, 1302/02757, U.S. Government Printing Office, Washington, DC, Nov. 1994.
3. *United States Pharmacopeia XXIII*, Section 1225, United States Pharmacopeia Convention, Rockville, MD, 1994, pp. 1982–1984.
4. *Acceptable Methods*, Health Protection Branch, Health and Welfare Canada, Ottawa, July 1992.
5. *The Rules Governing Medicinal Products in the European Community*, Vol. III, *Guidelines on the Quality, Safety, and Efficacy of Medicinal Products for Human Use* (addendum), Office for Official Publications of the European Communities, Luxembourg, July 1990, pp. 1–16.
6. International Conference on Harmonisation, “Draft Guideline on Validation of Analytical Procedures for Pharmaceuticals; Availability,” *Fed. Reg.*, **59(40)** (March 1, 1994), 9750.
7. J. M. Green, *Anal. Chem.*, **68** (1996) 305A.
8. J. C. Miller and J. N. Miller, *Statistics for Analytical Chemistry*, 3rd ed., Ellis Horwood PTR Prentice Hall, London, 1993.
9. R. Cassidy and M. Janoski, *LC/GC*, **10(9)** (1992) 692.

10. *United States Pharmacopeia XXIII*, Section 905, United States Pharmacopeia Convention, Rockville, MD, 1994, pp. 1838–1840.
11. D. Drnevich and T. C. Vary, *J. Chromatogr. Biomed. Appl.*, **613(1)** (1993) 137.
12. T. Fornstedt and D. Westerlund, *J. Chromatogr.*, **648** (1993) 315.
13. M. P. Richards and J. H. Beattie, *J. Chromatogr.*, **648** (1993) 459.
14. G. E. Box, W. G. Hunter, and J. S. Hunter, *Statistics for Experimenters: An Introduction to Design, Data Analysis, and Model Building*, Wiley, New York, 1978.
15. G. T. Wernimont, in *Use of Statistics to Develop and Evaluate Analytical Methods*. W. Spendley, ed., Association of Official Analytical Chemists, Washington, DC, 1985.
16. S. N. Deming and S. L. Morgan, *Experimental Design: A Chemometric Approach*. 2nd ed., Elsevier, Amsterdam, 1993.
17. Y. Vander Heyden, K. Luypaert, C. Hartmann, D. L. Massart, J. Hoogmartens, and J. De Beer, *Anal. Chim. Acta*, **312(3)** (1995) 245.
18. *United States Pharmacopeia XXIII*, Section 621, United States Pharmacopeia Convention, Rockville, MD, 1994, pp. 1776–1777.
19. M. G. Natrella, *Experimental Statistics*, Handbook 91, National Bureau of Standards, Washington, DC, 1963.
20. J. K. Taylor, *Quality Assurance of Chemical Measurements*, Lewis Publishers, Chelsea, MI, 1988.
21. D. L. Massart, B. G. M. van de Ginste, S. N. Deming, Y. Michotte, and L. Kaufman, *Chemometrics: A Textbook*, Elsevier, Amsterdam, 1988.

APPENDIX I

PLATE NUMBER AND RESOLUTION

I.1 GAUSSIAN BANDS

When HPLC separations are carried out correctly, individual bands will closely resemble a Gaussian curve as in Fig. I.1. The standard deviation σ of a Gaussian band ($W = 4\sigma$) can be calculated as

$$\sigma = \frac{t_R}{N^{1/2}} \quad (\text{I.1})$$

Here t_R is the band retention time and N is its plate number. Figure I.1 shows how band width is related to the distance from the baseline. For example, baseline bandwidth W measured by the tangent method equals 4σ . This same value can be measured by drawing a line parallel to the baseline between points on the curve with values that are 13.4% of the peak height (see Fig. I.1). Bandwidth at halfheight $w_{1/2}$ equals $(2.354/4)W$ or 2.354σ . These relationships lead to Eqs. 2.8 and 2.8a which are used to calculate values of N . Because most bands are slightly asymmetric (non-Gaussian), the value of N calculated for a band will generally be lower when W is used than when $w_{1/2}$ is used.

I.2 SAMPLE RESOLUTION AND RELATED ERRORS

Adjacent bands that overlap to a greater or lesser extent can be approximated by adding the individual Gaussian bands together. For bands that are

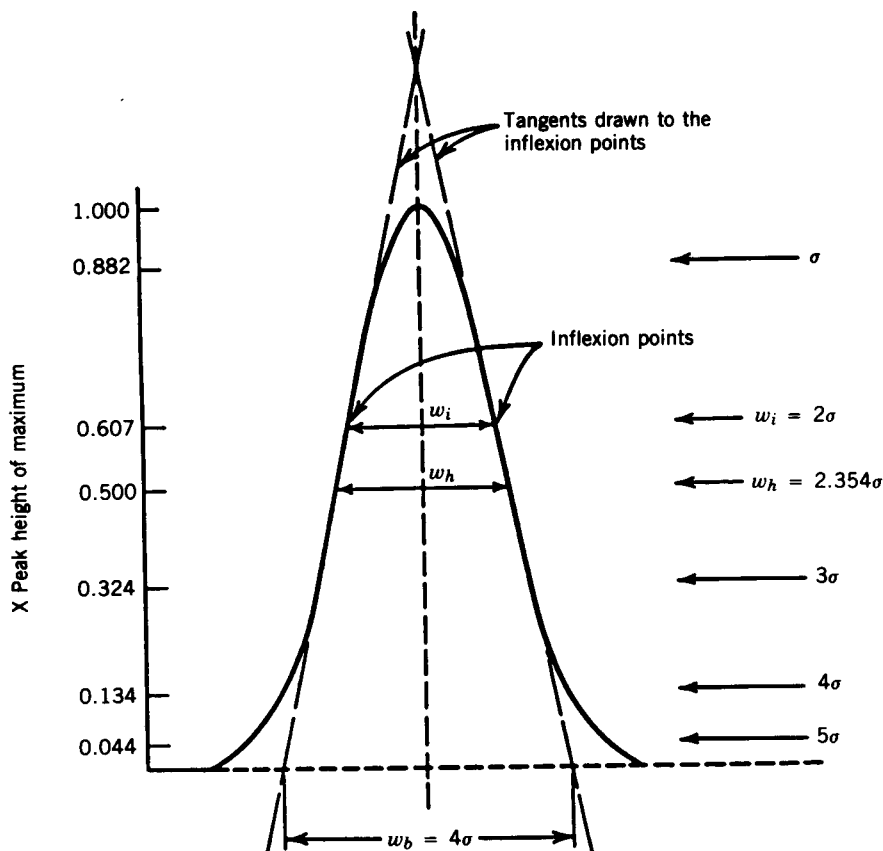

FIGURE I.1 Gaussian band and some related relationships. (Reprinted with permission from Ref. 1.)

perfectly Gaussian, therefore, separation as a function of resolution R_s can be calculated exactly. This is illustrated for two adjacent bands in Figs. I.2 to I.7. The solid curve in each case is what would be seen in the chromatogram, while the two points marked for each band pair represent the top of the band for the injection of a single compound. When $R_s > 1.0$, the points and the observed tops of the two bands coincide, indicating little error in a peak-height measurement due to interference of the other band. A visual comparison of actual overlapping bands with the examples of Figs. I.2 to I.7 allows an estimate of the value of R_s for the two bands in the experimental chromatogram.

The arrow shown in each of the examples of Figs. I.2 to I.7 indicates the cut point that would provide equal purity (% shown) of each fraction. For

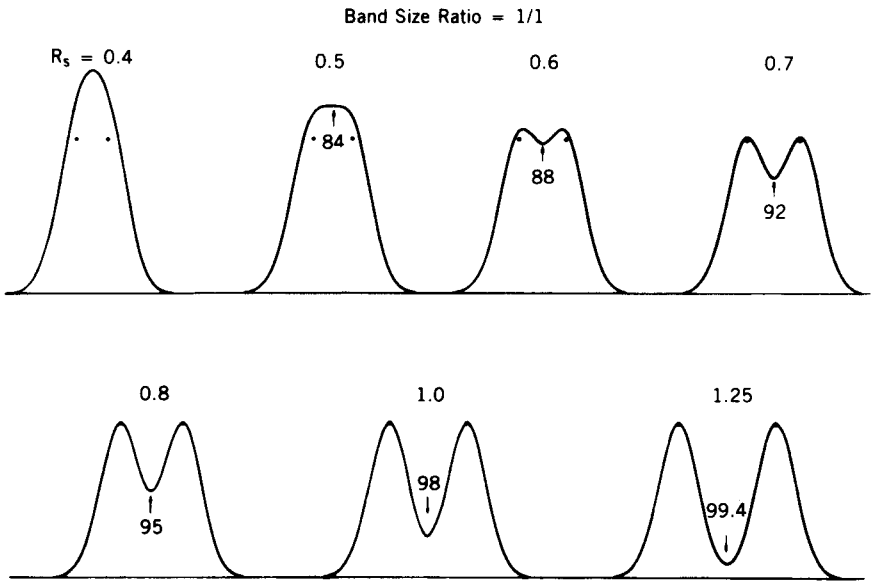

FIGURE I.2 Calculated resolution curves for different values of R_s and band pairs with an area ratio of 1:1. (Reprinted with permission from Ref. 2.)

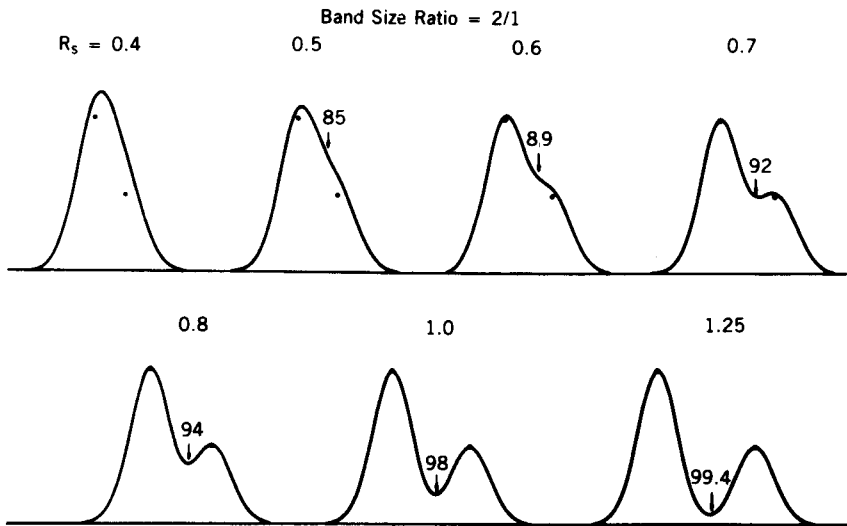

FIGURE I.3 Calculated resolution curves for different values of R_s and band pairs with an area ratio of 2:1. (Reprinted with permission from Ref. 2.)

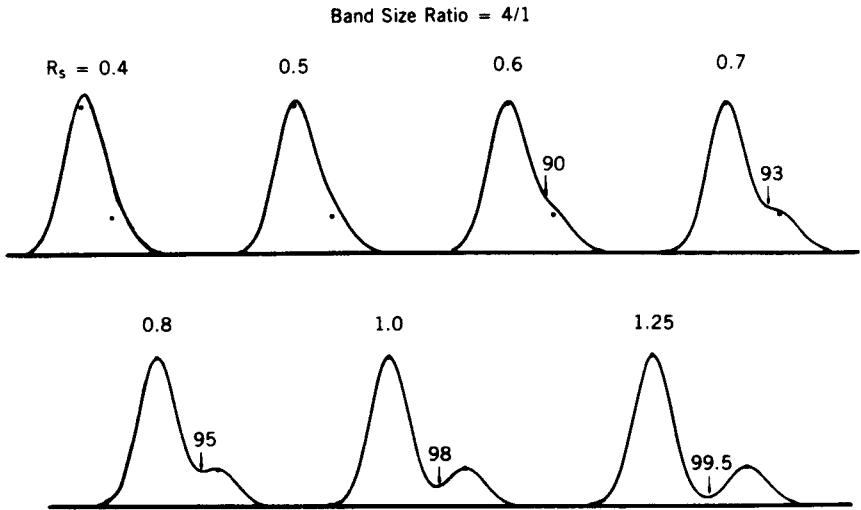

FIGURE 1.4 Calculated resolution curves for different values of R_s and band pairs with an area ratio of 4:1. (Reprinted with permission from Ref. 2.)

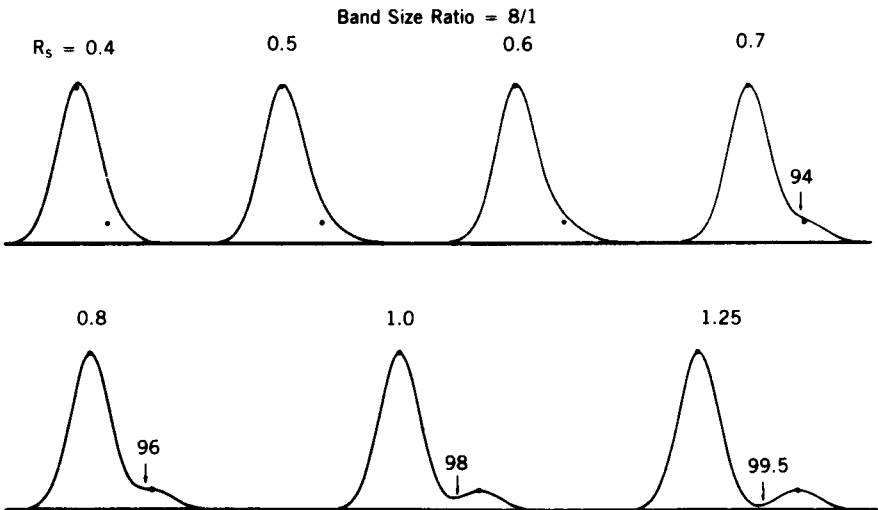

FIGURE 1.5 Calculated resolution curves for different values of R_s and band pairs with an area ratio of 8:1. (Reprinted with permission from Ref. 2.)

Band Size Ratio = 16/1

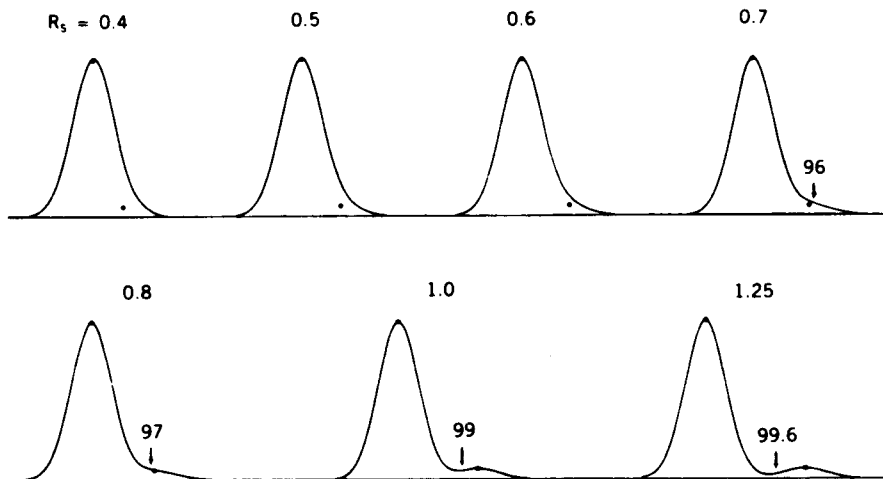

FIGURE I.6 Calculated resolution curves for different values of R_s and band pairs with an area ratio of 16:1. (Reprinted with permission from Ref. 2.)

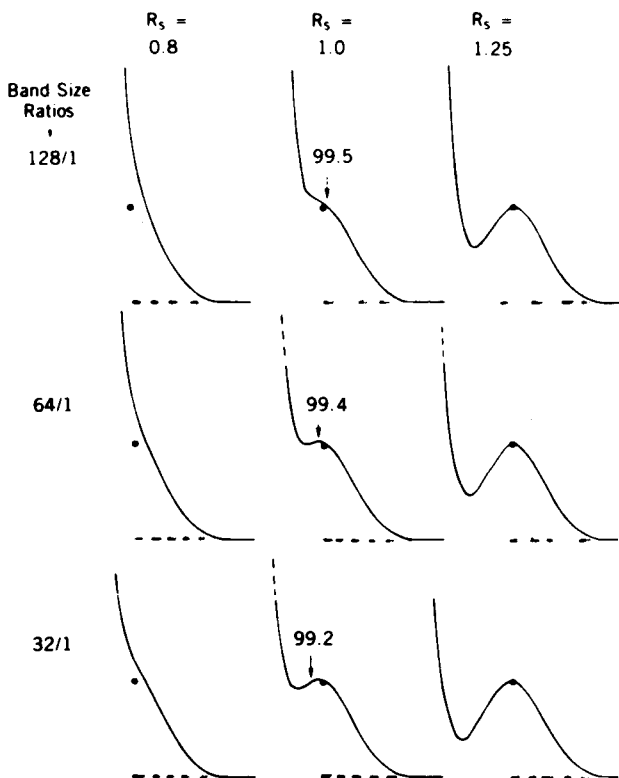

FIGURE I.7 Calculated resolution curves for different values of R_s and band pairs with area ratios of 32:1, 64:1, and 128:1. (Reprinted with permission from Ref. 2.)

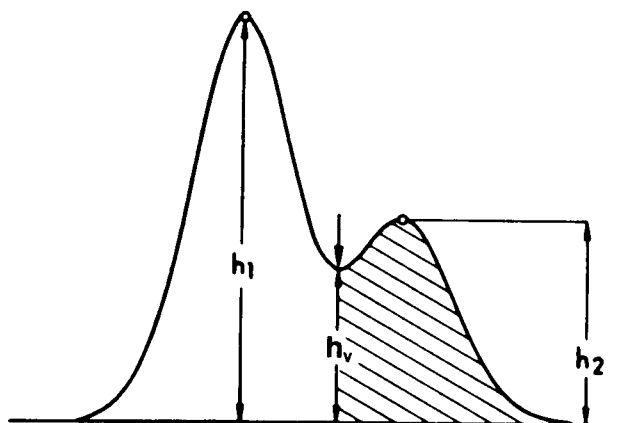

FIGURE I.8 Measuring the relative valley height for two overlapping bands. (Reprinted with permission from Ref. 2.)

example, for $R_s = 0.7$ in Fig. I.3, if the mobile phase is collected as fraction A to the time indicated by the arrow, and as fraction B thereafter, the purity of compound A in the first fraction will equal 92%, and the purity of compound B in the second fraction will equal 92% ("equal-purity" cutpoint). By rejecting material near the cutpoint, the purity of each fraction can be increased substantially.

Figures I.2 to I.7 provide visual estimates of the error in a peak-height measurement as a result of insufficient sample resolution. Similar estimates in the error of a band-area measurement can be obtained from the height of the valley between the two peaks (Fig. I.8). This valley height h_v is expressed as a percentage of the height of the smaller of the two bands.

TABLE I.1 Calculated Error in Band Area Due to Band Overlap as a Function of the Height of the Valley Relative to the Height of the Smaller Band (h_v)^a

Value of h_v (%)	Error (%) in the Area of the Smaller Band			
	2/1	4/1	8/1	16/1
10	< 1	< 1	< 1	< 1
20	< 1	1	1	1
30	1	2	2	2
40	1	2	3	3
50	2	4	4	5
60	3	5	6	7
70	5	7	8	9

^a Assumes band areas calculated from perpendicular drop through the valley, as line h_v in Fig. I.8.

TABLE I.2 Estimating Resolution R_s from the Valley Height h_v ^a

h_v (%)	R_s for Band-Size Ratio Indicated				
	1/1	2/1	4/1	8/1	16/1
3	1.46	1.50	—	—	—
5	1.35	1.42	1.48	1.52	—
8	1.26	1.33	1.40	1.45	—
10	1.22	1.29	1.35	1.41	1.47
15	1.14	1.21	1.27	1.33	1.39
20	1.07	1.15	1.21	1.27	1.33
30	0.97	1.06	1.12	1.19	1.24
40	0.90	0.98	1.06	1.12	1.18
50	0.83	0.92	1.00	1.07	1.12
60	0.78	0.87	0.95	1.02	1.08
70	0.73	0.82	0.90	0.97	1.03
80	0.68	0.78	0.86	0.93	0.99

^a See Fig. I.8.

Table I.1 summarizes these errors in band area, assuming that a perpendicular drop from the valley divides the areas of the two bands for integration. The error is always less than 1% for the larger band and can be ignored.

Table I.2 allows a more precise estimate of values of R_s from measured values of the valley height h_v . When $h_v < 10\%$, Eq. 2.1 can also be used. It should be noted that the values of Tables I.1 and I.2 assume no band tailing. Band tailing in actual chromatograms will usually affect the data of Tables I.1 and I.2 significantly, especially when the band-area ratio is greater than 10. This can make estimates of error (Table I.1) or resolution (Table I.2) unreliable.

REFERENCES

1. C. F. Poole and S. A. Schuette, *Contemporary Practice of Chromatography*, Elsevier, Amsterdam, 1984, p. 9.
2. L. R. Snyder and J. J. Kirkland, *Introduction to Modern Liquid Chromatography*, 2nd ed., Wiley-Interscience, New York, 1979, Chapter 2.

APPENDIX II

PROPERTIES OF SOLVENTS USED IN HPLC

Chromatographers have a choice among hundreds of solvents for use as mobile-phase components, sample solvents, or in sample pretreatment. A particular selection is usually affected by solvent characteristics that relate to detection, separation, flow resistance (column pressure drop or mobile phase viscosity), and miscibility. Commercial availability in adequate purity and at a reasonable price are also important factors. The solvent properties described in this appendix will be useful to chromatographers when it comes to selecting one or more solvents.

II.1 DETECTION

The choice of mobile-phase solvent can have a profound effect on the ease and sensitivity of HPLC detection. The lowest usable (cutoff) wavelength is important for UV detectors (Tables 3.2 and 3.3), solvent refractive index (RI) affects the sensitivity of RI detection for a particular sample, and solvent volatility (boiling point) is important for evaporative light-scattering detectors. Table II.1 summarizes these and other properties that may affect detection for a number of common solvents. Additional data are provided for most HPLC-grade solvents in Refs. 2 and 3 (e.g., complete UV spectra for most HPLC-grade solvents, blank gradients for some A- and B-solvent combinations, etc.).

II.2 SEPARATION

Mobile-phase solvents can affect separation by their polarity and selectivity. More polar solvents cause increased retention in RPC and reduced retention

TABLE II.1 Some Solvent Properties of Interest in HPLC Method Development^a

Solvent	UV Cutoff (nm)	Refractive Index (20°C)	Viscosity (cP)	Boiling Point (°C)	Miscibility Number (M) ^b	Polarity (P')	Eluotropic Values		
							Alumina	C ₁₈	Silica
Acetone	330	1.3587	0.36	56.29	15,17	5.1	0.56	8.8	0.53
Acetonitrile	190	1.3441	0.38	81.60	11,17	5.8	0.65	3.1	0.52
<i>n</i> -Butyl acetate	254	1.3942	0.734	126.11	22	4.0	—	—	—
1-Butanol	215	1.3993	2.98	117.5	15	3.9	—	—	—
Chlorobenzene	287	1.5249	0.80	131.69	21	2.7	—	—	—
1-Chlorobutane	220	1.4021	0.45	78.44	—	1.0	—	—	—
Chloroform	245	1.4458	0.57	61.15	19	4.1	0.40	—	0.26
Cyclohexane	200	1.4242	1.0	80.72	28	0.2	0.04	—	—
Cyclopentane	200	1.4064	0.44	49.26	—	0.1	0.05	—	—
Decahydronaphthalene	200	1.4758	2.42	191.7	—	—	—	—	—
<i>o</i> -Dichlorobenzene	295	1.5514	1.32	180.48	—	2.7	—	—	—
Dimethyl acetamide	268	1.4384	0.84	166.1	—	6.5	—	—	—
Dimethyl formamide	268	1.4305	0.92	153.0	12	6.4	—	7.6	—
Dimethyl sulfoxide	268	1.4783	2.24	189.0	9	7.2	0.62	—	—
1,4-Dioxane	215	1.4224	1.37	101.32	17	4.8	0.56	11.7	0.51
Ethyl acetate	256	1.3724	0.45	77.11	19	4.4	0.58	—	0.48
Ethylene dichloride	228	1.4448	0.79	83.48	—	3.5	0.49	—	—
Ethyl ether	215	1.3524	0.24	34.55	23	2.8	0.38	—	0.43
Glyme	220	1.3796	0.46	83.5	—	—	—	—	—
Heptane	200	1.3876	0.40	98.43	29	0.1	0.01	—	0.00
Hexadecane	190	1.4340	—	287.0	—	0.5	—	—	—
Hexane	195	1.3749	0.31	68.7	29	0.1	0.01	—	0.00
Isooctane	215	1.3914	0.50	99.24	29	0.1	0.01	—	—
Isobutyl alcohol	220	1.3959	—	107.7	15	4.0	—	—	—
Isopropyl alcohol	205	1.3772	2.40	82.26	15	3.9	0.82	8.3	0.6
Methanol	205	1.3284	0.55	64.7	12	5.1	0.95	1.0	0.7

2-Methoxyethanol	210	1.4020	1.72	124.6	—	5.5	—	—	—
Methyl <i>tert</i> -butyl ether	210	1.3689	0.27	55.2	—	2.5	0.35	—	0.48
Methyl ethyl ketone	329	1.3788	0.43	79.64	17	4.7	0.51	—	—
Methyl isoamyl ketone	330	1.4072	0.80	144.9	—	4.0	—	—	—
Methyl isobutyl ketone	334	1.3957	0.506	116.5	—	4.2	0.43	—	—
Methyl <i>n</i> -propyl ketone	331	1.3901	0.51	102.4	—	4.5	—	—	—
Methylene chloride	233	1.4241	0.44	39.75	20	3.1	0.42	—	0.30
<i>n</i> -Methyl-2-pyrrolidone	285	1.4680	1.67	202.00	—	6.7	—	—	—
Pentane	190	1.3575	0.23	36.07	—	0.0	0.00	—	0.00
Propyl alcohol	210	1.3856	2.3	97.2	—	4.0	0.82	—	—
Propylene carbonate	280	1.4210	—	241.7	—	6.1	—	—	—
Pyridine	—	1.5102	0.95	115.25	16	5.3	0.71	—	—
Tetrahydrofuran	212	1.4072	0.55	66.0	17	4.0	0.45	3.7	0.53
Toluene	284	1.4969	0.59	110.62	23	2.4	0.29	—	0.22
1,2,4-Trichlorobenzene	308	1.5717	0.566	213.5	—	—	—	—	—
Trichloroethylene	273	1.4767	0.567	87.19	25	1.0	—	—	—
Trichlorotrifluoroethane	231	1.3557	0.711	47.57	—	0.0	—	—	0.02
Trifluoroacetic acid	210	1.2850	0.926	71.8	—	—	—	—	—
Water	190	1.3330	1.00	100.0	—	10.2	—	—	—
<i>o</i> -Xylene	288	1.5054	0.81	144.41	—	2.5	0.26	—	—

Source: Ref. 1; Original data were obtained from Ref. 2 with the exceptions noted in ^b.

^a Missing values indicate that data are unavailable.

^b All pairs whose *M* numbers differ by 15 units or less are miscible in all proportions at 15°C. Each pair whose *M* number difference is 16 has a critical solution temperature between 25 and 75°C, approximately 50°C preferably. A difference of 17 or more corresponds to immiscibility or to a critical solution temperature above 75°C. Miscibility data were obtained from Ref. 4.

TABLE II.2 Classification of Solvents According to Normalized Selectivity^a

Solvent	Normalized Selectivity Factors			Solvent	Normalized Selectivity Factors		
	π^*/Σ	α/Σ	β/Σ		π^*/Σ	α/Σ	β/Σ
<i>Aromatics</i>							
Benzene	0.86	0.00	0.14	Triethylamine	0.16	0.00	0.84
Toluene	0.83	0.00	0.17	Tributylamine	0.20	0.00	0.80
<i>p</i> -Xylene	0.81	0.00	0.19	<i>Carboxylic acids</i>			
Fluorobenzene	0.90	0.00	0.10	Acetic acid	0.31	0.54	0.15
Chlorobenzene	0.91	0.00	0.09	<i>Esters</i>			
Bromobenzene	0.93	0.00	0.07	Methyl acetate	0.55	0.05	0.40
Iodobenzene	1.00	0.00	0.00	Ethyl acetate	0.55	0.00	0.45
Phenyl oxide	0.84	0.00	0.16	γ -Butyrolactone	0.64	0.00	0.36
Anisole	0.77	0.00	0.23	Ethylacetoacetate	0.60	0.00	0.40
Nitrobenzene	0.72	0.00	0.28	<i>Ethers</i>			
Benzonitrile	0.69	0.00	0.31	Diethyl	0.36	0.00	0.64
Dibenzylether	0.66	0.00	0.34	Diisopropyl	0.36	0.00	0.64
Acetophenone	0.65	0.00	0.35	Dibutyl	0.34	0.00	0.66
Quinoline	0.58	0.00	0.42	Tetrahydrofuran	0.51	0.00	0.49
Pyridine	0.58	0.00	0.42	1,2-Dimethoxyethane	0.54	0.00	0.46
2,6-Lutidine	0.51	0.00	0.49	<i>p</i> -Dioxane	0.60	0.00	0.40
Benzyl alcohol	0.45	0.32	0.22				

<i>Alcohols</i>									
Methanol	0.28	0.43	0.29						
Ethanol	0.25	0.39	0.36					0.56	0.38
Propanol	0.24	0.36	0.40					0.55	0.40
Butanol	0.22	0.37	0.41					0.59	0.41
Isopropanol	0.22	0.35	0.43						
<i>t</i> -Butanol	0.19	0.33	0.48					0.60	0.25
Glycol	0.39	0.38	0.23						
Hexachloro-2-propanol	0.25	0.75	0.00						
Trifluoroethanol	0.32	0.68	0.00					0.64	0.19
<i>Amides</i>									
Formamide	0.46	0.33	0.21					0.73	0.00
<i>N,N</i> -Dimethylformamide	0.56	0.00	0.44					0.57	0.00
<i>N,N</i> -Dimethylacetamide	0.54	0.00	0.46					1.00	0.00
Hexamethylphosphoramide	0.46	0.00	0.54					0.57	0.00
Tetramethylurea	0.51	0.00	0.49					0.83	0.43
<i>N</i> -Methylpyrrolidinone	0.57	0.00	0.43					0.45	0.17
<i>Ketones</i>									
Acetone									0.06
2-Butanone									0.05
Cyclohexanone									0.00
<i>Nitriles</i>									
Acetonitrile								0.60	0.15
<i>Nitro compounds</i>									
Nitromethane								0.64	0.17
<i>X-miscellaneous</i>									
Methylene chloride								0.73	0.27
Chloroform								0.57	0.43
Ethylene chloride								1.00	0.00
Dimethyl sulfoxide								0.57	0.00
Sulfolane								0.83	0.00
Water ^{a,b}								0.45	0.43

Source: Ref. 5.

^a See Fig. 2.5 for a plot of these values.

^b The β value used for water was 0.48, which is based on more recent estimates.

TABLE II.3 Viscosity of RPC Mobile Phases as a Function of Composition and Temperature

(a) Mobile-phase viscosity at 25°C (η_{25}) for reversed-phase systems

Mobile Phase(%v organic/water)	η_{25} (cP) ^a		
	MeOH	ACN	THF
0	0.89	0.89	0.89
10	1.18	1.01	1.06
20	1.40	0.98	1.22
30	1.56	0.98	1.34
40	1.62	0.89	1.38
50	1.62	0.82	1.43
60	1.54	0.72	1.21
70	1.36	0.59	1.04
80	1.12	0.52	0.85
90	0.84	0.46	0.75
100	0.56	0.35	0.46

^a MeOH, methanol; ACN, acetonitrile; THF, tetrahydrofuran (THF values approximate).

(b) Variation of the viscosity (cP) of methanol–water and acetonitrile–water mixtures with temperature^a

Temperature (°C)	Water Content (% v/v)										
	0	10	20	30	40	50	60	70	80	90	100
15	0.63	1.05	1.40	1.69	1.91	2.02	2.00	1.92	1.72	1.43	1.10
	0.40	0.54	0.70	0.81	0.89	0.98	1.09	1.30	1.23	1.18	1.10
20	0.60	0.93	1.25	1.52	1.72	1.83	1.83	1.75	1.57	1.32	1.00
	0.37	0.50	0.56	0.69	0.81	0.90	0.99	1.13	1.10	1.14	1.00
25	0.56	0.84	1.12	1.36	1.54	1.62	1.62	1.56	1.40	1.18	0.89
	0.35	0.46	0.52	0.59	0.72	0.82	0.89	0.98	0.98	1.01	0.89
30	0.51	0.76	1.01	1.21	1.36	1.43	1.43	1.36	1.23	1.04	0.79
	0.32	0.43	0.45	0.52	0.65	0.74	0.80	0.86	0.87	0.90	0.79
35	0.46	0.69	0.91	1.09	1.21	1.26	1.24	1.19	1.07	0.92	0.70
	0.30	0.39	0.43	0.47	0.59	0.68	0.72	0.76	0.78	0.73	0.70
40	0.42	0.64	0.83	0.98	1.08	1.12	1.11	1.05	0.96	0.82	0.64
	0.27	0.36	0.41	0.44	0.54	0.62	0.65	0.68	0.70	0.72	0.64
45	0.39	0.58	0.76	0.89	0.98	1.02	1.00	0.96	0.87	0.75	0.58
	0.25	0.33	0.38	0.43	0.50	0.58	0.59	0.61	0.64	0.61	0.58
50	0.37	0.54	0.70	0.82	0.90	0.94	0.93	0.89	0.82	0.71	0.54
	0.24	0.31	0.36	0.41	0.46	0.53	0.55	0.57	0.60	0.60	0.54
55	0.36	0.50	0.65	0.76	0.84	0.88	0.88	0.84	0.77	0.67	0.51
	0.23	0.29	0.34	0.38	0.43	0.49	0.51	0.53	0.56	0.53	0.51
60	0.33	0.47	0.61	0.72	0.79	0.81	0.81	0.77	0.70	0.61	0.47
	0.22	0.27	0.31	0.35	0.41	0.46	0.49	0.50	0.53	0.52	0.47
65	0.28	0.45	0.59	0.68	0.72	0.72	0.69	0.64	0.58	0.51	0.40
	—	—	—	—	—	—	—	—	—	—	—

^a The composition is given in % (v/v) of water at 20.5°C. Upper figures, methanol–water mixture; lower figures, acetonitrile–water mixture.

Source: Refs. 6–8.

in NPC. Table II.1 lists polarity values P' for 46 solvents. These polarity values range from $P' = 0$ for a non-polar solvent like pentane to $P' = 10.2$ for the very polar solvent water. Relative solvent strength values for some of these solvents are also listed in Table II.1 for use in normal-phase (alumina, silica) chromatography. See also Figs. 6.4 (reversed-phase), 6.23, and 6.24 (normal phase).

Selectivity depends both on solvent polarity and the position of a solvent in the solvent-selectivity triangle (Fig. 2.7). The latter classification of solvent selectivity is based on the interaction of the solvent with sample molecules as a dipole, an acid, or a base. Table II.2 summarizes these selectivity interactions ($x = \pi^*/\Sigma$, α/Σ , β/Σ) for a number of common solvents. The x values of Table II.2 are normalized in terms of solvent polarity, so if different strong solvents B are diluted with a weaker solvent A to give mobile phases A/B of the same polarity and solvent strength, solvent selectivity will be determined mainly by the selectivity factors x of Table II.2. By choosing solvents with very different selectivity factors from Table II.2, mobile-phase selectivity can be varied significantly.

The first column of values in Table II.2 ($x = \pi^*/\Sigma$) gives the fractional polarity of the solvent due to dipole interactions, the second column ($x = \alpha/\Sigma$) gives the fractional polarity due to the acidity of the solvent, and the third column ($x = \beta/\Sigma$) gives the fractional polarity due to solvent basicity. For example, among the alcohol solvents, methanol receives 28% of its polarity from its dipole, 43% from its acidity, and 29% from its basicity. Similarly, among the amine solvents, triethylamine has 16% of its polarity from its dipole, and 84% from its basicity; it has no acidity for chromatographic separation.

II.3 SOLVENT VISCOSITY

To maintain an acceptable pressure drop (< 2500 psi or < 160 bar) with a reasonable flow rate through the column, the mobile-phase viscosity should be as low as possible. Pressure drop is proportional to mobile-phase viscosity (Eq. 2.9). Viscosity values η at 20°C for several pure solvents are listed in Table II.1. For non-aqueous mobile phases (NPC or NARP), the viscosity η can be estimated as a function of the viscosities of the A- and B-solvents (η_a and η_b) and their mole fractions (X_a and X_b):

$$\log(\eta) = X_a \log(\eta_a) + X_b \log(\eta_b) \quad (\text{II.1})$$

The volume fractions of each solvent can be substituted for X_a and X_b in Eq. II.1 with little error. Equation II.1 is not reliable for mobile phases that contain water, due to their non-ideal behavior as a result of the very strong interactions between water molecules. Viscosities at 25°C for RPC mobile-phase mixtures are listed in Table II.3a. Viscosity decreases with temperature,

as illustrated in Table II.3b for mobile-phase mixtures that were recommended in Chapter 9 (acetonitrile–water and methanol–water).

II.4 SOLVENT MISCIBILITY

Mobile phases formulated for HPLC separations must be miscible, preferably in all proportions. Whether any two solvents from Table II.1 will be miscible in all proportions can be estimated by calculating the difference in their miscibility numbers M , shown in Table II.1. For example, hexane has $M = 29$ and acetonitrile has $M = 11$, so the difference is $29 - 11 = 18$. If this difference is >17 , the two solvents will not be miscible in all proportions, which is the case for hexane and acetonitrile. Water is miscible with a limited range of organic solvents, mainly those with polarity values P' equal to 5 or greater and including ethanol and propanol.

REFERENCES

1. C. Seaver and J. Przytek, *LC/GC*, **13** (1995) 220.
2. *Burdick & Jackson Solvent Guide*, 3rd ed., Burdick & Jackson Laboratories, Muskegon, MI, 1990.
3. *HPLC Solvent Reference Manual*, J. T. Baker Chemical Co., Phillipsburg, NJ, 1985.
4. B. A. Bidlingmeyer, *Practical HPLC Methodology*, Wiley, New York, 1992, p. 245.
5. L. R. Snyder, P. W. Carr, and S. C. Rutan, *J. Chromatogr.*, **656** (1993). 537.
6. L. R. Snyder and P. E. Antle, *Liq. Chromatogr.*, **3** (1985) 99.
7. H. Colin, J. C. Diez-Masa, G. Guiochon, T. Czajkowska, and I. Miedziak, *J. Chromatogr.*, **167** (1978) 41.
8. M. A. Quarry, R. L. Grob, and L. R. Snyder, *J. Chromatogr.*, **285** (1984) 1.

APPENDIX III

RETENTION IN REVERSED-PHASE AND NORMAL-PHASE HPLC AS A FUNCTION OF SAMPLE MOLECULAR STRUCTURE

In this book we recommend an approach to HPLC method development that largely ignores the structures of individual sample compounds. One exception is the case of samples that contain acidic or basic compounds, where predictable changes in retention can be created by a change in mobile phase pH (Section 7.2). If ion-pair or ion-exchange chromatography is used for such samples, it is useful to know whether the sample contains acidic or basic compounds. Another exception occurs for "special" samples (Fig. 1.3), which benefit from separation conditions that are generally different from those chosen for "regular" samples; see Chapters 11 and 12.

If a separation method is required where the molecular structures of the sample compounds are known, it is possible to estimate relative retention for either reversed-phase (RPC) or normal-phase (NPC) separation. Such predictions are usually quite approximate, but even rough estimates of retention may be helpful in some cases. See the further discussion of Section 10.5.1, which describes a computer program for reversed-phase HPLC based on this approach.

III.1 SUBSTITUENT EFFECTS

In Table III.1 the effect on retention of adding a substituent group to an aromatic molecule is shown for some representative RPC and NPC conditions. For example, adding an alkyl carbon (methyl or methylene group) to a sample molecule increases its RPC retention 1.5- to 2.5-fold, but has less effect on

TABLE III.1 Retention as a Function of Sample Molecular Structure for Substituted Benzenes: Effect on k of Different Substituent Groups

Group	Relative Value of k^a			
	RPC		NPC	
	30% ACN	60% ACN	Hexane	CH ₂ Cl ₂
Phenyl	12.3	3.2	13	1.5
-Br	2.8	1.7	0.7	0.6
-CH ₃	2.5	1.5	1.2	0.9
-CH ₂ -	2.2	1.5	1.0	0.7
-Cl	2.3	1.5	0.7	0.4
-F	1.3	1.0	0.8	0.7
-OCH ₃	1.1	1.0	24	3.5
-H ^b	(1.0)	(1.0)	(1.0)	(1.0)
-CO ₂ CH ₃	0.9	0.8	390	13
-CN	0.5	0.6	310	10
-CHO	0.4	0.6	410	13
-OH	0.2	0.3	1,400	60
-NH ₂	0.2	0.4	6,700	180
-CONH ₂	0.1	0.2	90,000	1,800
-SO ₂ NH ₂	0.1	0.2	—	—

Source: Refs. 1 and 2.

^a Compared to benzene (-H); C₁₈ column for RPC [1], silica for NPC [2].

^b Compound before substitution (benzene).

NPC retention (0.7- to 1.2-fold). Therefore, RPC is a better HPLC method for the separation of homologs or other compounds, differing only in alkyl carbon number. Similarly, adding a polar group such as hydroxyl to a sample molecule decreases its RPC retention (by a factor of 0.2 to 0.3), whereas this same change in molecular structure increases NPC retention (by a factor of 60 to 1400). If a very pronounced separation of a compound from a hydroxylated derivative were required (as in preparative HPLC, Chapter 13, where large values of α are preferred), NPC separation on a silica column would be preferred over a similar separation by RPC.

Table III.1 shows that retention decreases with increasing substituent polarity for RPC and increases for NPC. That is, more polar compounds will elute first in RPC and last in NPC. The effect of a substituent group on retention decreases for a stronger mobile phase (e.g., 60% ACN vs. 30% ACN (RPC) or CH₂Cl₂ vs. hexane (NPC) in Table III.1). A corollary to this observation is that α values usually decrease for higher values of % B, although there are important exceptions to this rule (Section 6.3.1). For silica as column packing, differences in solute functionality cause a larger change in retention than is observed for RPC separation. Thus, other factors equal, NPC with silica will

give larger values of α for compounds differing in functionality. This increased selectivity for silica vs. RPC is not as pronounced when polar-bonded-phase packings are used for NPC separation. The RPC data of Table III.1 are for aromatic functional groups, but similar changes in retention are found for the same functional groups as aliphatic substituents.

III.2 ISOMER SEPARATIONS

As noted in Chapter 6, NPC is usually better for separating achiral isomers than RPC. This ability of NPC for isomer separations arises from two effects: (1) the more rigid or "ordered" structure of most NPC column packings, and (2) localization effects as illustrated in Fig. 6.21*b*. The adsorption sites A in Fig. 6.21*b* occupy fixed positions, and the polar solute groups X and Y will differ in their ability to interact with these sites according to the positions of groups X and Y within the sample molecule. Intramolecular electronic and

TABLE III.2 Examples of Isomer Selectivity in NPC Separation

(a) Separation of aniline isomers

Compound	Normal Phase ^a		Reversed Phase ^b
	<i>k</i>	α	α
2,6-Dimethylaniline	2.8		
3,4-Dimethylaniline	9.5	3.4	1.02
<i>N,N</i> -Diethyl-2-methylaniline	0.3		
2-Methyl-4- <i>n</i> -butylaniline	5.1	17	1.20

Source: Ref. 3.

^a Cyano column with 0.2% 2-propanol as mobile phase.

^b C₈ column, 60% MeOH-buffer as mobile phase.

(b) Separation of aromatic isomers on an alumina column with 10% CH₂Cl₂ as mobile phase

Compound	<i>k</i>	α
<i>m</i> -Iodoanisole	2.2	
<i>p</i> -Iodoanisole	4.1	1.9
1-Methoxynaphthalene	4.6	
2-Methoxynaphthalene	12.9	2.8
Phenanthrene	6.5	
Anthracene	27.5	4.2

Source: Ref. 4.

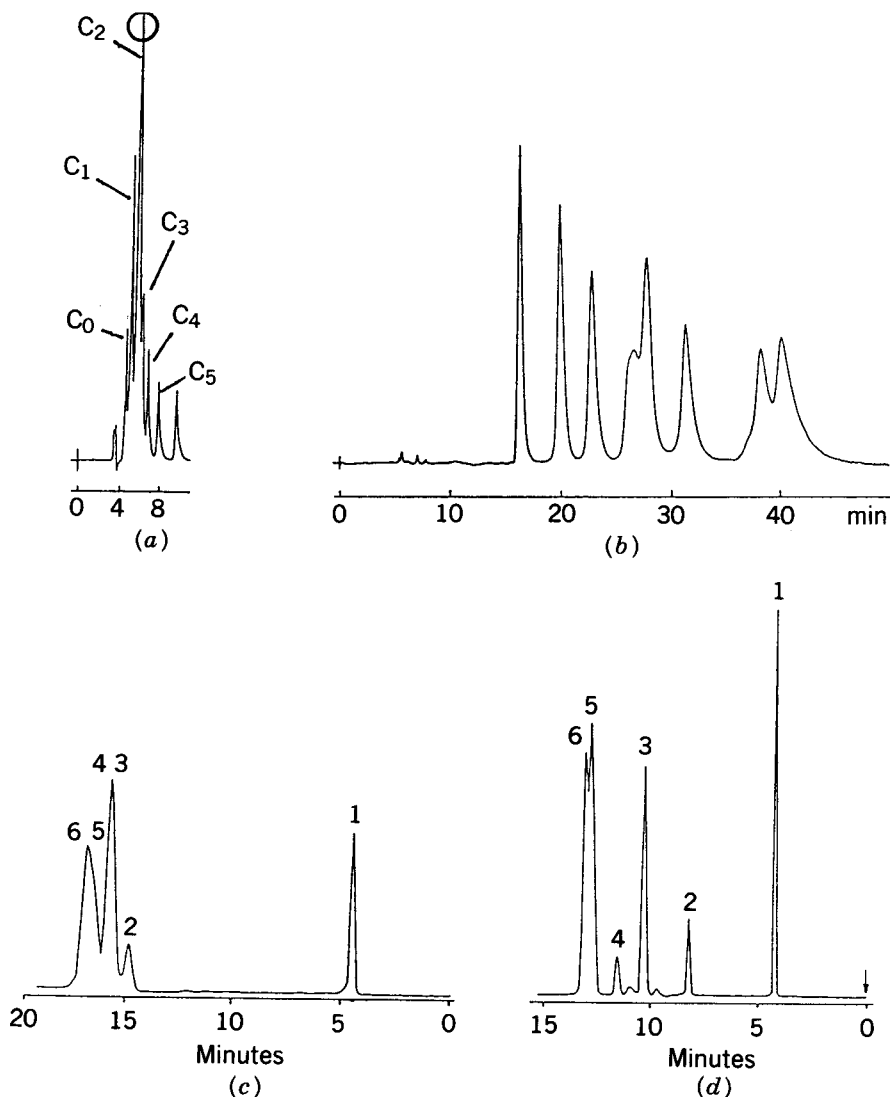

FIGURE III.1 Comparison of isomer separations by reversed-phase vs. normal-phase HPLC. (a) RPC separation of aniline mixture; 20×0.44 -cm C_{18} column, 80% MeOH-buffer (pH 7.0), 0.75 mL/min [3]; (b) NPC separation of C_2 -anilines from (a); 20×0.44 -cm cyano column, 0.2% 2-propanol-isooctane, 0.75 mL/min [3]; (c) RPC separation of five cis-trans isomers of retinol (bands 2 to 6); 15×0.46 -cm C_{18} column, 80% MeOH-water, 1 mL/min, 40°C [5]; (d) NPC separation of sample of (c); 25×0.4 -cm silica column, 8% dioxane-hexane, 1 mL/min, 40°C [5]. See the text for details. (Reprinted with permission from Refs. 3 and 5.)

steric effects will further affect the localization and interaction of individual sample substituents X and Y. As a result, isomeric mixtures of compounds are usually better separated by NPC than by RPC, due to differences in the ability of different isomers to align their polar functional groups with adsorption sites (somewhat like a lock-and-key fit). Several examples in Table III.2 illustrate better isomer separations by NPC.

In Table III.2a the separation of some aniline isomers by NPC with a cyano column is compared with RPC separation of these same compounds. In the first example, NPC separates 2,6-dimethylaniline from the 3,4-isomer with $\alpha = 3.4$. The RPC separation of these two compounds results in almost complete overlap ($\alpha = 1.02$). In the second example of Table III.2a, two isomeric C₅-substituted anilines are very well resolved by NPC ($\alpha = 17$), whereas RPC separation is much poorer ($\alpha = 1.20$).

In Table III.2b, NPC separation with alumina is shown for several aromatic hydrocarbon isomers: *m*- and *p*-iodoanisole, 1- and 2-methoxynaphthalene, and phenanthrene/anthracene. In each case, a large value of α results ($\alpha \gg 1$), allowing the easy separation of these isomeric compounds. Inorganic adsorbents such as silica and alumina are more ordered and rigid than their polar-bonded-phase counterparts, and the inorganic adsorbents therefore provide generally better separations of isomers.

Figure III.1 compares NPC and RPC separation of isomeric compounds in two samples. In Fig. III.1a, a mixture of alkyl-substituted anilines is separated by RPC. Compounds of the same carbon number (C_0 = aniline, C_1 = methyl anilines, etc.) are unresolved as shown further by the data of Table III.2a. However, compounds differing in carbon number are well separated from each other. Figure III.1b shows the further separation of the C₂ fraction (circled in Fig. III.1a) using NPC (cyano column); all eight isomers are resolved. Figure III.1c and d compare the separation of five cis-trans isomers of retinol (bands 2-6) by (c) RPC and (d) NPC. The better separation of these isomers in (d) is apparent.

A vast number of studies have been reported that attempt to further relate HPLC retention to molecular structure and separation conditions. For a summary of some of these approaches, see Refs. 6 to 8 for RPC retention and Ref. 9 for NPC retention.

REFERENCES

1. R. M. Smith, *J. Chromatogr.*, **656** (1993) 381.
2. L. R. Snyder, *Principles of Adsorption Chromatography*, Marcel Dekker, New York, 1968, p. 264.
3. L.-A. Truedsson and B. E. F. Smith, *J. Chromatogr.*, **214** (1981) 291.
4. L. R. Snyder, *J. Chromatogr.*, **20** (1965) 463.
5. B. Stancher and F. Zonta, *J. Chromatogr.*, **234** (1982) 244.

6. P. W. Carr, D. E. Martire, and L. R. Snyder, eds., "The Retention Process in Reversed-Phase Liquid Chromatography," *J. Chromatogr.*, **656** (1993).
7. T. Hamoir, D. L. Massart, W. King, S. Kokot, and K. Douglas, *J. Chromatogr. Sci.*, **31** (1993) 393.
8. K. Valko and P. Siegel, *J. Chromatogr.*, **631** (1993) 49.
9. L. R. Snyder, *Principles of Adsorption Chromatography*, Marcel Dekker, New York, 1968.

APPENDIX IV

PREPARING BUFFERED MOBILE PHASES

Buffered mobile phases can be prepared by the following sequence of operations:

1. Combine the buffer ingredients with water to obtain the aqueous buffer (solution A).
2. Confirm or adjust the pH of solution A with a pH meter.
3. Combine a given volume (e.g., 200 mL) of organic (solution B) with a given volume (e.g., 800 mL) of solution A from step 2 to obtain the final mobile phase (20% organic buffer in this example).
4. Check the pH of the final mobile phase (optional).

Because a pH measurement for a mobile phase that contains organic is unreliable due to drift of the pH meter, step 4 above is only useful for detecting major errors in the formulation. Most laboratories elect to skip step 4.

The usual approach in step 1 is to formulate aqueous buffers of differing pH (A1 and A2), then combine these two solutions in the right proportions to obtain solution A with the desired pH. If the pH is adjusted in step 2, the same two solutions can be used to titrate the final buffer to the desired pH as measured by the pH meter. The precision of a pH measurement (step 2) in most laboratories is usually no better than ± 0.05 to 0.10 unit, which can cause significant changes in the resolution of some samples. When an HPLC method is pH sensitive, step 2 should be used only for an approximate confirmation of pH. By combining accurate weights of the buffer ingredients with accurate volumes of distilled and degassed water (without further adjusting

TABLE IV.1 Formulation of Low-pH Phosphate Buffers (25°C) of Some Desired pH

Solution A1: 0.1 M phosphoric acid. For accurate buffer formulations, the phosphoric acid used to prepare this buffer must be titrated for the amount of H_3PO_4 present.

Solution A2: 0.1 M monobasic sodium monophosphate. Combine 13.8 g of $\text{NaH}_2\text{PO}_4 \cdot \text{H}_2\text{O}$ with water in a 1-L flask, dissolve, dilute to volume and mix thoroughly.

pH Desired	Volume (mL) of A1	Volume (mL) of A2
2.0	565	435
2.2	455	545
2.4	345	655
2.6	250	750
2.8	175	825
3.0	110	890
3.2	55	945

Source: G. Gomori, in *Meth. Enzymology I*, S. P. Colowick and N. O. Kaplan, eds., Academic Press, New York (1955) 145.

TABLE IV.2 Formulation of Acetate Buffers (25°C) of Some Desired pH

Solution A1: 0.1 M acetic acid. Combine 6.0 g (5.8 mL) of glacial acetic acid with water in a 1-L flask, dilute to volume, and mix thoroughly.

Solution A2: 0.1 M sodium acetate. Combine 8.2 g of $\text{C}_2\text{H}_3\text{O}_2\text{Na}$ (or 13.6 g of $\text{C}_2\text{H}_3\text{O}_2\text{Na} \cdot 3\text{H}_2\text{O}$) with water in a 1-L flask, dilute to volume, and mix thoroughly.

pH Desired	Volume (mL) of A1	Volume (mL) of A2
3.6	926	74
3.8	880	120
4.0	820	180
4.2	736	264
4.4	610	390
4.6	510	490
4.8	400	600
5.0	296	704
5.2	210	790
5.4	176	824
5.6	96	904

Source: G. Gomori, in *Meth. Enzymology I*, S. P. Colowick and N. O. Kaplan, eds., Academic Press, New York (1955) 145.

pH), the pH of the buffer solution can be controlled within narrow limits (± 0.02 unit). Buffer concentrates whose pH is known quite accurately are also commercially available.

Acids or bases (e.g., triethylamine, acetic acid) are sometimes added to the mobile phase as a means of improving peak shape and plate number (Section

TABLE IV.3 Formulation of Citrate Buffers (25°) of Some Desired pH

Solution A1: 0.1 M citric acid. Combine 21.0 g of citric acid with water in a 1-L flask, dilute to volume, and mix thoroughly.

Solution A2: 0.1 M sodium citrate. Combine 29.4 g of $C_6H_5O_7Na_3 \cdot 2H_2O$ with water in a 1-L flask, dilute to volume, and mix thoroughly.

pH Desired	Volume (mL) of A1	Volume (mL) of A2
3.0	930	70
3.2	870	126
3.4	810	190
3.6	750	260
3.8	700	300
4.0	660	340
4.2	610	370
4.4	560	440
4.6	510	490
4.8	460	540
5.0	410	590
5.2	360	640
5.4	320	680
5.6	270	726
5.8	230	764
6.0	190	810
6.2	140	856
6.4	60	940
6.6	40	960
6.8	30	970
7.0	15	985

Source: G. Gomori, in *Meth. Enzymology I*, S. P. Colowick and N. O. Kaplan, eds., Academic Press, New York (1955) 145.

TABLE IV.4 Formulation of Intermediate-pH Phosphate Buffers (25°C) of Some Desired pH

Solution A1: 0.1 M monobasic sodium monophosphate. Combine 13.8 g of $NaH_2PO_4 \cdot H_2O$ with water in a 1-L flask, dilute to volume, and mix thoroughly.

Solution A2: 0.1 M dibasic sodium phosphate. Combine 26.8 g of $Na_2HPO_4 \cdot 7H_2O$ (or 35.9 g of $Na_2HPO_4 \cdot 12H_2O$) with water in a 1-L flask, dilute to volume, and mix thoroughly.

pH Desired	Volume (mL) of A1	Volume (mL) of A2
5.6	948	52
5.8	920	80
6.0	877	123
6.2	815	185
6.4	735	265
6.6	685	315
6.8	510	490
7.0	390	610
7.2	280	720
7.4	190	810
7.6	130	870
7.8	85	915
8.0	53	947

Source: G. Gomori, in *Meth. Enzymology I*, S. P. Colowick and N. O. Kaplan, eds., Academic Press, New York (1955) 145.

TABLE IV.5 Formulation of High-pH Tris^a Buffers (25°C) of Some Desired pH

Solution A1: 0.1 M Tris (free base). Combine 12.11 g of Tris with water in a 1-L flask, dilute to volume, and mix thoroughly.

Solution A2: 0.1 M HCl. Obtain a 0.1M HCl solution or prepare by appropriate dilution of a stronger solution.

pH Desired	Volume (mL) of A1	Volume (mL) of A2
7.1	50	45.7
7.2	50	44.7
7.3	50	43.4
7.4	50	42.0
7.5	50	40.3
7.6	50	38.5
7.7	50	36.6
7.8	50	34.5
7.9	50	32.0
8.0	50	29.2
8.1	50	26.2
8.2	50	22.9
8.3	50	19.9
8.4	50	17.2
8.5	50	14.7
8.6	50	12.4
8.7	50	10.3
8.8	50	8.5
8.9	50	7.0

Source: R. G. Bates and V. E. Bower, *Anal. Chem.*, **28** (1956) 1322.

^a Tris(hydroxymethyl)aminomethane

7.3.3.2). When these additives are not used as the primary buffering agent, they should be added to the desired quantity (concentration) of the buffer first; then the mixture should be adjusted to the desired pH by titrating with acid or base.

IV.1 RECIPES FOR SOME COMMONLY USED BUFFERS

The pH of a buffered solution remains approximately constant as the buffer is diluted or concentrated, or when one ionized cation (Na⁺, K⁺) or anion (Cl⁻, Br⁻) is replaced by another. The formulations of Tables IV.1 to IV.4 are based on a final buffer concentration of 0.1 M and sodium as cation; however, formulations for other buffer concentrations and/or the use of different cations (potassium is usually preferred) can be inferred from these data. The pH of buffers that are more dilute or more concentrated, or which contain different cations may differ slightly from these values. The exact pH value of

TABLE IV.6 Formulation of High-pH Glycine Buffers (25°C) of Some Desired pH

Solution A1: 0.2 M Glycine. Combine 15.01 g of Glycine with water in a 1-L flask, dilute to volume, and mix thoroughly.

Solution A2: 0.2 M NaOH. Obtain a 0.2 M NaOH solution or prepare by appropriate dilution of a stronger solution.

pH Desired	Volume (mL) of A1	Volume (mL) of A2
8.6	25	2.0
8.8	25	3.0
9.0	25	4.4
9.2	25	6.0
9.4	25	8.4
9.6	25	11.2
9.8	25	13.6
10.0	25	16.0
10.4	25	19.3
10.6	25	22.75

Source: G. Gomori, in *Meth. Enzymology I*, S. P. Colowick and N. O. Kaplan, eds., Academic Press, New York (1955) 145.

the mobile phase is usually unimportant in method development. What is important is that the final pH of the mobile phase can be reproduced (preferably within ± 0.02 unit) each time a new batch of mobile phase is prepared. Note that solutions only buffer effectively ± 1 pH unit from the pI of the ionizable constituent (e.g., acetate with a pI = 4.6 is an adequate buffer in the range pH 3.6 to 5.6; see Table IV.2).

Tables IV.5 to IV.6 show formulations for two organic-based buffers which are especially useful in the range pH 7 to 10.6. These organic buffers may be particularly useful to minimize silica-based column degradation (see Sections 5.4.3.6, 7.2.2.4, and 11.2.3).

APPENDIX V

CHARACTERIZING THE DIFFERENCES AMONG C₈ OR C₁₈ REVERSED-PHASE COLUMNS FROM DIFFERENT SUPPLIERS

Columns of the same nominal type (e.g., C₈ or C₁₈) from different companies will often exhibit important differences in retention. These differences can arise from the following column packing characteristics (Section 5.2.4):

- Differences in the silica particle (e.g., acidity) (Table 5.4)
- Choice of silane and bonding process (e.g., monomeric vs. polymeric phases) (Section 5.2.3.1)
- Concentration of bonded phase ($\mu\text{mol}/\text{m}^2$, Section 5.2.3.1)
- Presence or absence of endcapping
- Particle surface area

As a result, a column from one supplier that is nominally equivalent to a column from a different source (e.g., C₁₈ columns in both cases) may not be a suitable replacement in an HPLC assay. It is useful to be able to compare different C₈ or C₁₈ columns in terms of sample retention. This allows columns to be identified that can be expected to perform similarly or quite differently in a given assay. Similar columns may be interchangeable for a given assay, which gives the chromatographer a choice of usable columns. Quite different columns can be used to test the sensitivity of an assay to the column; if the assay “works” for two such columns, it is likely that a number of other columns will also be usable.

Figure 5.9 provides useful retention data for a large number of commercial columns. Relative retention data are provided for acid, base, and neutral sample compounds. If two columns show similar retention for each compound

in this test mixture, it is more likely that these same two columns will be interchangeable for some HPLC assay. If relative and absolute retention of the test mixture is quite different for two columns, these two columns can serve as a test of the sensitivity of the assay procedure to differences in the column.

There are two additional ways of comparing C₈ and/or C₁₈ columns. Column acidity has been noted as an important column characteristic, and several relatively non-acidic columns were listed in Table 5.4. A ranking of some other columns according to their relative acidity is given in Table V.1. Columns that are close together in this table can be expected to be similar in terms of acidity, and such columns should perform similarly for the separation of basic compounds. The data in support of Table V.1 were collected between 1983 and 1987, which raises the question of whether these data are still representative of columns produced today. Since manufacturers try to maintain the same separation characteristics for their columns over time, it seems likely that the ranking of Table V.1 is still useful. Several silicas claimed to be less acidic and highly purified have been made available by manufacturers in recent years (see Table 5.4). However, insufficient data are available to place these silicas in the ranking of Table V.1.

**TABLE V.1 Ranking of C₈ or C₁₈ Columns
According to Relative Acidity**

	Column
(less acidic)	Zorbax RX
	Vydac
	Nucleosil
	Supelcosil DB
	μBondapak
	Novapak
	Partisil
	RSil
	Polygosil
	Spherisorb
	Lichrosorb
	Chrompack
	Rainin
	IBM
	Hypersil
	Perkin-Elmer
	Supelcosil
	Zorbax
(more acidic)	Micropak

Source: Ref. 1.

TABLE V.2 Ranking of C₁₈ Columns According to Shape Selectivity^a

0.5 ≤ $\alpha_{\text{TBN BAP}} \leq 0.9$			1.0 < $\alpha_{\text{TBN BAP}} < 1.7$			1.7 ≤ $\alpha_{\text{TBN BAP}} \leq 2.2$		
Column	Manufacturer	Column	Manufacturer	Column	Manufacturer			
Bakerbond C18	J. T. Baker	ES Industries BF-C18	ES Industries	Erbasil C18 L	Carlo Erba			
Wide-Pore Chromspher PAH	Chrompack	LiChrospher 100 RP-18	E. Merck	Pecospher 5 Cr C18	Perkin-Elmer			
Bio-Rad RP 318	Bio-Rad	Bakerbond C18	J. T. Baker	Partisphere C18	Whatman			
Supelcosil LC-PAH	Supelco	Erbasil C18 M	Carlo Erba	Zorbax ODS	Mac-Mod (distributor)			
Vydac 201TP Spherisorb PAH	Separations Group	LiChrospher 60 RP-select B	E. Merck	Serva C18	Serva			
Erbasil C18 H	Phase Separations	Partisil 5 ODS-2	Whatman	Partisil 5 ODS-3	Whatman			
	Carlo Erba	Partisil 5 ODS	Whatman	Hypersil ODS (HP)	Shandon			
		Spherisorb ODS-1	Phase Separations	Microsorb C18	Rainin			
		Brownlee ODS 5A	ABI	J&W Accuphase ODS 2	J&W Scientific			
		Sepralyte C18	Analytichem	Novapak C18	Waters			
		Spherisorb ODS-2	Phase Separations	Ultrasphere ODS	Beckman			
				Capcell C18 SG120Å	Shiseido			
				Supelcosil LC-18	Supelco			
				IBM ODS	IBM			
				Brownlee Spheri 5 RP-18	ABI			
				ODS Hypersil	Shandon			
				Cosmosil C18-P	Nacalai Tesque			
				J&W Accuphase ODS	J&W Scientific			
				YMC 120 Å "A"	YMC			
				Adsorbosphere C18 H5	Alltech			
				Supelcosil LC-18-DB	Supelco			

Source: Ref. 2.

^a Selectivity coefficients were determined using 85% acetonitrile/water mobile phase at 2 mL/min at ambient temperature (25 ± 2°C). Within each category, columns are listed (from top to bottom) in order of increasing $\alpha_{\text{TBN BAP}}$ values; however, because these values may vary with different column lots, individual $\alpha_{\text{TBN BAP}}$ values are not listed. The ranges shown above should not be construed to reflect lot-to-lot variability.

A second way of characterizing the column is in terms of *shape selectivity* [2]. It has been shown that the separation of certain polyaromatic hydrocarbons (PAHs) is quite sensitive to column source, and it has been suggested that this is caused by “slots” in the stationary phase that are sensitive to the shape of sample molecules. It is therefore reasonable that this column characteristic will affect the retention of other samples as well. Table V.2 summarizes the results from a large number of commercial columns. Three different groups are defined according to the value of α for a particular pair of PAHs. Columns in the same group are more likely to give similar results than columns in different groups. Polyfunctional-silane bonded phases (e.g., Vydac 201TP) have low values of the selectivity factor $\alpha_{\text{TN/BaP}}$, while monofunctional-silane bonded phases (e.g., Zorbax ODS) have high values. The classification of Table V.2 thus distinguishes these two types of packing.

The concentration of the bonded phase ($\mu\text{mol}/\text{m}^2$) can affect both absolute retention and selectivity. A higher concentration of a particular ligand (e.g., C_{18}) generally gives greater retention, other factors being equal. A higher bonded-phase concentration can also affect shape selectivity [3]. Endcapping mainly affects the retention of basic compounds, which are retained more strongly for non-endcapped phases. Values of k for all compounds increase in proportion to packing surface area, but selectivity is not affected by small differences in surface area.

APPENDIX V

1. M. A. Stadalius, J. S. Berus, and L. R. Snyder, *LC/GC*, **6** (1988) 495.
2. L. C. Sander and S. A. Wise, *LC/GC*, **8** (1990) 378.
3. L. C. Sander and S. A. Wise, *Anal. Chem.*, **67** (1995) 3284.

APPENDIX VI

ADJUSTING MOBILE-PHASE WATER CONTENT FOR NORMAL-PHASE HPLC

As discussed in Section 6.7.4.2, columns packed with silica or other polar inorganic solids (e.g., alumina) are affected by water. If the mobile phase contains water, the column packing will tend to extract some of this water from the mobile phase and become less retentive. In the case of less-polar mobile phases for NPC (e.g., methylene chloride/hexane), the solubility of water in the mobile phase is often quite low (e.g., $< 0.01\%$). The column, on the other hand, can adsorb a considerable quantity of water (several percent w/w). As a result, any change in mobile-phase water content will require a large volume of the new mobile phase (as much as several hundred column volumes) to achieve column equilibration and constant retention times. When carrying out NPC separations, changes in mobile-phase water content are common, because room humidity can vary and water can be adsorbed onto the inside of glass containers used to hold the mobile phase. As a result, it is common to see changes in retention from run to run in NPC.

In some cases, the effect of varying mobile-phase water concentrations on sample retention can be minimized by adding 0.1 to 0.5% of methanol or propanol to the mobile phase. However, this can sometimes result in peak distortion and a drastic loss in column efficiency. A more reliable procedure for eliminating the effect of water on NPC separations is to add a certain quantity of water to the mobile phase, so that further (accidental) changes in water content are relatively minor. This can be regarded as similar to the action of a buffer in maintaining constant pH. The problem of varying water is most severe for water-immiscible mobile phases which can dissolve no more than 0.1% water. In these cases, the addition of half as much water to the mobile phase as can be dissolved at saturation ("50% water saturation") has been found to be effective.

Since the solubility of water in typical binary-solvent NPC mobile phases will usually not be known and is not easily measured, it is not feasible simply to add a certain quantity of water to the mobile phase. Furthermore, the dissolution of liquid water by adding and shaking can be quite slow and impractical. An alternative procedure is therefore required. One approach is to saturate a portion of mobile phase with water, then blend this portion with an equal volume of ("dry") mobile phase that has not been treated with water. In some cases the mobile phase can be saturated with water by adding excess water and shaking for an extended period. However, this is less effective for less-polar mobile phases that contain solvents such as hexane and methylene chloride. Similarly, if the mobile phase contains water-miscible solvents (methanol, THF, etc.), some of the latter solvent may be extracted into the excess water used to saturate the mobile phase.

A more convenient and reliable means for saturating the mobile phase with water is as follows. To 25 g of 100- to 200-mesh laboratory silica, add 5-mL portions of water, followed by shaking in a closed container after each addition. Continue the addition of water until the resulting powder is *not* free flowing (lumps are formed that do not break up with continued shaking). At this point, add back 5 g of silica, and shake until free flowing. The resulting water-saturated silica is next used to prepare water-saturated mobile phase. To 100 mL of mobile phase, add 2 g of water-saturated silica and stir vigorously for 30 min. Allow the silica to settle, and decant the mobile phase into a storage container. Add an equal volume of mobile phase that has not been water saturated, mix, and use.

The procedure above assumes that the starting mobile phase is free of water, which will be close enough to the actual situation when solvents from the bottle are mixed and stored in closed containers. The nominally water-free mobile phase can be further dried by the addition of activated silica, stirring, and decanting (similar to the procedure for saturating mobile phase with water). Activated silica can be prepared from silica by heating in air at 150°C for 4 h, followed by cooling in a closed container. For further details concerning the preparation of 50% water-saturated NPC mobile phases, see Ref. 1.

REFERENCE

1. L. R. Snyder and J. J. Kirkland, *Introduction to Modern Liquid Chromatography*, 2nd ed., Wiley-Interscience, New York, 1979, pp. 374-383.