

Comprehensive Coordination Chemistry II

FROM BIOLOGY TO NANOTECHNOLOGY

EDITORS-IN-CHIEF

**Jon A McCleverty
Thomas J Meyer**

**Edited by
D.E. Fenton**

**Volume 6
Transition Metal Groups 9 - 12**

Introduction to Volume 6

This volume is concerned with fundamental developments in the coordination chemistry of the elements of Groups 9–12 since 1982. The individual chapters cover the coordination chemistry of cobalt, iridium, nickel, palladium, platinum, copper, silver and gold, zinc and cadmium, and mercury. Unfortunately, because of factors beyond the Editors' control, the manuscript for the proposed chapter on rhodium was not available in time for publication.

Each author has selected material in such a way as to give the most effective review of discoveries and new interpretations. The style of coverage mainly uses formal oxidation state (highest to lowest) and the nature of the ligand donor atom (C, Group 5, Group 6, halides, H, mixed donor atoms) to define progression through this chapter. Uni- up to polydentate ligands (cyclic and acyclic) and mono- through oligo- to polynuclear species are covered with an emphasis on compounds for which full structural characterization is available.

Throughout this volume it has been the intention not only to highlight the fundamental developments in this field, but also to indicate the very important connections between these fundamentals, and developments in other related fields, with cross-references to the later volumes. For example, if one regards a metallo-protein, or a metallo-enzyme, as a highly elaborated coordination complex, the metal site of which is comprised of one or more metals and their ligating atoms, then the study of the chemistry of the metal centers in such species can be regarded as bio-coordination chemistry. Furthermore, in order to gain insight into metallobiosites for which the structure is not known, it is possible to consider simulating the immediate coordination environment of that metallobiosite through the use of synthetic analogues derived from small-molecule compounds. Our understanding of the bio-coordination chemistry of cobalt, nickel, copper, and zinc has advanced considerably since 1982 and generic issues relating to this chemistry appear in Volume 8.

Application of coordination compounds in medicine, materials chemistry, and as catalysts are mentioned and are cross-referenced to a fuller discussion in Volume 9. Comment is made on application of complexes in nanotechnology, and on the molecular modeling of complexes. The material cannot be totally comprehensive because of space limitations, but is selected in such a way to give the most effective review of discoveries and new interpretations.

Since 1982 there have been enormous developments in metal-based chemistry, particularly the emergence of supramolecular chemistry – “chemistry beyond the molecule,” molecular architecture, and molecular engineering. *Comprehensive Supramolecular Chemistry* was published in 1996, a survey which contains much of interest to coordination chemists. Consequently in this volume review material relating to supramolecular systems is mainly restricted to developments since 1990.

There has been a considerable expansion of the literature in the period under review. In 1982 CAS abstracted 16,095 publications in the CA inorganic section and this number rose to 21,579 abstracts in 2001 – a total of 401,312 abstracts were published in the period 1982–2001 [Source: CAPLUS database on STN]. Although these numbers refer to inorganic chemistry as a whole they nevertheless give an indication of the probable corresponding increase in papers relating specifically to coordination chemistry and clearly indicate the enormity of the task undertaken by the authors of the chapters in this volume. As the Volume Editor I cannot thank them enough for their dedication and diligence in preparing such detailed and stimulating reviews.

D E Fenton
Sheffield, UK
February 2003

Introduction to Volume 5

This volume presents a survey of significant developments in the chemistry of Groups 7 and 8 of the transition metals since the publication of *Comprehensive Coordination Chemistry* (CCC) in 1987. The material for each element is organized by oxidation state of the metal and also by the nature of the ligands involved, with additional sections covering special features of the coordination chemistry and applications of the complexes.

Manganese, Technetium, and Rhenium

The coverage for manganese and rhenium is from 1982, whereas for technetium the earlier literature is included, as technetium did not feature in CCC (1987). The biological role of manganese has been a significant driving force for recent studies of its coordination chemistry and this area is treated in some detail, as are the uses of manganese complexes for selective oxidations. For technetium much of the literature is closely linked to the applications of ^{99m}Tc complexes in diagnostic nuclear medicine and the development of first- and second-generation agents is placed in the context of the reported coordination chemistry. The potential role of radioactive rhenium complexes for therapy is a comparatively recent theme, and is again placed against the backdrop of a systematic account of the fundamental coordination chemistry of the element.

Iron, Ruthenium, and Osmium

The coverage for iron commences in 1984–1985 and aims to provide a broad-based introduction to important advances in the chemistry of this element over the past 20 years. A comprehensive coverage of the chemistry of iron over this period would be impossible and the authors have done an admirable job in selecting the most important papers in the primary literature and have made extensive reference to the review literature to give as broad an overview as possible. Similar constraints apply to the coverage of ruthenium and osmium in both high and low oxidation states. However, the coverage in these two chapters gives an excellent overview of the primary literature since 1982 and leads the reader naturally to the important review literature for these elements.

It would be invidious to pick any particular area of activity in the chemistry of these elements for particular attention, but very significant advances have been made in many aspects of the coordination chemistry of iron, ruthenium, and osmium. Our understanding of the roles which iron can play in biological systems and the subtle chemical control over iron metabolism has increased enormously since 1987 and they represent beautiful aspects of applied coordination chemistry. Much iron coordination chemistry is designed to further understand biomimetic aspects. In low-oxidation-state ruthenium chemistry, renewed interest in photovoltaic cells is generating a resurgence in $\{\text{Ru}(\text{bpy})_3\}$ chemistry. In high-oxidation-state ruthenium and osmium chemistry, the utilization of complexes as increasingly selective catalytic or stoichiometric oxidizing agents shows no sign of abating.

Finally, we would like to thank the authors involved with these elements for their fortitude in approaching such a potentially enormous task with good humor and a positive attitude.

E C Constable
Basel, Switzerland
April 2003

J R Dilworth
Oxford, UK
April 2003



ELSEVIER



COMPREHENSIVE COORDINATION CHEMISTRY II

From Biology to Nanotechnology

Second Edition

Edited by

J.A. McCleverty, University of Bristol, UK

T.J. Meyer, Los Alamos National Laboratory, Los Alamos, USA

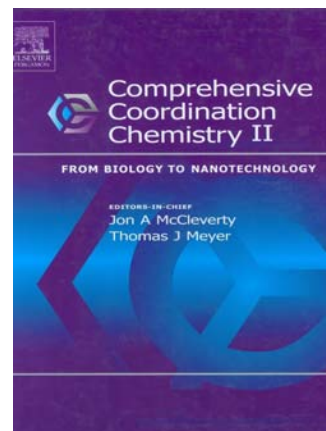

Description

This is the sequel of what has become a classic in the field, Comprehensive Coordination Chemistry. The first edition, CCC-I, appeared in 1987 under the editorship of Sir Geoffrey Wilkinson (Editor-in-Chief), Robert D. Gillard and Jon A. McCleverty (Executive Editors). It was intended to give a contemporary overview of the field, providing both a convenient first source of information and a vehicle to stimulate further advances in the field. The second edition, CCC-II, builds on the first and will survey developments since 1980 authoritatively and critically with a greater emphasis on current trends in biology, materials science and other areas of contemporary scientific interest. Since the 1980s, an astonishing growth and specialisation of knowledge within coordination chemistry, including the rapid development of interdisciplinary fields has made it impossible to provide a totally comprehensive review. CCC-II provides its readers with reliable and informative background information in particular areas based on key primary and secondary references. It gives a clear overview of the state-of-the-art research findings in those areas that the International Advisory Board, the Volume Editors, and the Editors-in-Chief believed to be especially important to the field. CCC-II will provide researchers at all levels of sophistication, from academia, industry and national labs, with an unparalleled depth of coverage.

Bibliographic Information

10-Volume Set - Comprehensive Coordination Chemistry II

Hardbound, ISBN: 0-08-043748-6, 9500 pages

Imprint: ELSEVIER

Price:

USD 5,975

EUR 6,274 Books and electronic products are priced in US dollars (USD) and euro (EUR). USD prices apply world-wide except in Europe and Japan. EUR prices apply in Europe and Japan. See also information about conditions of sale & ordering procedures -<http://www.elsevier.com/wps/find/bookconditionsofsale>.

[cws_home/622954/conditionsofsale](http://www.elsevier.com/wps/find/cws_home/622954/conditionsofsale), and links to our regional sales offices http://www.elsevier.com/wps/find/contact.cws_home/regional

GBP 4,182.50

030/301

Last update: 10 Sep 2005

Volumes

Volume 1: Fundamentals: Ligands, Complexes, Synthesis, Purification, and Structure

Volume 2: Fundamentals: Physical Methods, Theoretical Analysis, and Case Studies

Volume 3: Coordination Chemistry of the s, p, and f Metals

Volume 4: Transition Metal Groups 3 - 6

Volume 5: Transition Metal Groups 7 and 8

Volume 6: Transition Metal Groups 9 - 12

Volume 7: From the Molecular to the Nanoscale: Synthesis, Structure, and Properties

Volume 8: Bio-coordination Chemistry

Volume 9: Applications of Coordination Chemistry

Volume 10: Cumulative Subject Index

10-Volume Set: Comprehensive Coordination Chemistry II



ELSEVIER



COMPREHENSIVE COORDINATION CHEMISTRY II

Volume 6: Transition Metal Groups 9 - 12

Edited by
D.E. Fenton

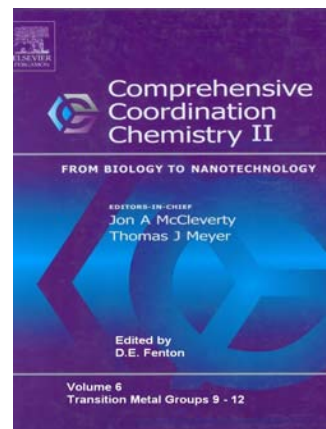

Contents

Cobalt (P.V. Bernhardt, G. Lawrance)
Iridium (L.J. Yellowlees, K. Macnamara)
Nickel (F. Meyer, H. Kozlowski)
Palladium (N.M. Kostic, L-M.Dutca)
Platinum (T.W. Hambley)
Copper (R. Mukherjee)
Silver and Gold (M. Concepcion Gimeno, A. Laguna)
Zinc (S.J. Archibald)
Cadmium and Mercury (D.K Breitinger)

6.1

Cobalt

P. V. BERNHARDT

University of Queensland, Brisbane, Australia

and

G. A. LAWRENCE

University of Newcastle, Callaghan, Australia

6.1.1	INTRODUCTION	2
6.1.1.1	Introductory Remarks and General Scope	2
6.1.1.2	Synthesis, Reactivity, and Structure	4
6.1.2	METAL COMPLEXES	5
6.1.2.1	Co ⁻¹ , Co ⁰ , and Co ¹	6
6.1.2.1.1	Carbon	6
6.1.2.1.2	Silicon	9
6.1.2.1.3	Nitrogen	9
6.1.2.1.4	Phosphorus	13
6.1.2.1.5	Arsenic	15
6.1.2.1.6	Oxygen	16
6.1.2.1.7	Sulfur	16
6.1.2.1.8	Halogens	17
6.1.2.1.9	Hydrogen	17
6.1.2.2	Co ^{II}	19
6.1.2.2.1	Carbon	19
6.1.2.2.2	Nitrogen	21
6.1.2.2.3	Phosphorus	39
6.1.2.2.4	Arsenic	41
6.1.2.2.5	Oxygen	42
6.1.2.2.6	Sulfur	49
6.1.2.2.7	Halogens	54
6.1.2.3	Co ^{III}	55
6.1.2.3.1	Carbon	55
6.1.2.3.2	Silicon and tin	58
6.1.2.3.3	Nitrogen	58
6.1.2.3.4	Phosphorus	79
6.1.2.3.5	Arsenic	81
6.1.2.3.6	Oxygen	82
6.1.2.3.7	Sulfur and selenium	90
6.1.2.3.8	Halogens	97
6.1.2.3.9	Hydrogen	98
6.1.2.4	Co ^{IV} and Co ^V	98
6.1.2.4.1	Carbon	98
6.1.2.4.2	Nitrogen	98
6.1.2.4.3	Oxygen	99
6.1.3	BIOLOGICAL CHEMISTRY OF COBALT	99
6.1.3.1	Metalloproteins and Cofactors	99
6.1.3.1.1	Cobalamins (<i>B</i> ₁₂)	99
6.1.3.1.2	Non-corrin proteins	106
6.1.3.1.3	Biomimetic chemistry	109
6.1.3.1.4	DNA binding, intercalation, and scission	112

6.1.3.1.5	Biological electron transfer	114
6.1.3.1.6	Medicinal chemistry	114
6.1.4	INDUSTRIAL AND ANALYTICAL APPLICATIONS OF COBALT COMPLEXES	114
6.1.4.1	Organic Transformations	114
6.1.4.1.1	Oxidations	115
6.1.4.1.2	Carbonylation and formylation	116
6.1.4.1.3	Cycloadditions and asymmetric synthesis	116
6.1.4.1.4	Other catalytic reactions	118
6.1.4.2	Polymerization	118
6.1.4.3	Electrocatalysis and Analytical Sensors	119
6.1.4.4	Environmental	120
6.1.4.5	Technology	120
6.1.5	CONCLUSION	122
6.1.6	REFERENCES	122

6.1.1 INTRODUCTION

6.1.1.1 Introductory Remarks and General Scope

Since the publication of the first edition of this volume, the field of cobalt coordination chemistry has continued to grow apace. Historically, cobalt has been a popular metal for coordination chemists, driven in part by the generally inert and diamagnetic nature of the trivalent oxidation state that has permitted detailed studies in solution and in the solid state by key physical methods.

Even after all these years subsequent to the first edition of *Comprehensive Coordination Chemistry* (CCC, 1987), cobalt has maintained its appeal, as is evident in [Figure 1](#). A survey of the chemical literature (1900–2001) revealed that 60% of the ca. 30,000 articles on Co coordination chemistry have appeared since the early 1980s. Clearly, this level of activity presents a daunting task for reviewers with a brief to cover that particular period, and hence this review necessarily is selective in capturing the present state of Co coordination chemistry and its impact. The nature of information retrieval has also changed significantly since the early 1980s, notably through the availability of on-line computer-based data retrieval, which permits and indeed demands a distillation of the field without exhaustive referencing. Subsequently, partly in a bid to capture the field as widely as possible, we have chosen to make use of secondary references along with primary references. This has been essential, given the space available, and we trust the following presents a representative “taste” of the more recent coordination chemistry literature of Co.

In the period since the mid-1980s, great advances have been made in our understanding of transition metal ions in biological systems, and Co chemistry has been an unexpected beneficiary. At the time of the first volume, little was known about the biological chemistry of Co aside from the cobalamin (Vitamin B₁₂) cofactors. Since then, advances in molecular biology and protein expression coupled with the emergence of even more sophisticated structural and spectroscopic methods have led to the identification of at least eight distinctly different, Co-dependent (non-corrin) proteins. In parallel, the substitution of Co for spectroscopically silent ions (e.g., zinc) in metalloproteins has been an invaluable tool in the determination of active site structure and mechanism. In [Section 6.1.3](#), we discuss the multifarious aspects of biological Co chemistry; most of these are very recent indeed.

The view taken in the analogous chapter in the first edition of this publication¹ was that Co coordination chemistry could be captured under the concepts of *synthesis*, *structure*, and *reactivity*. What has changed since that time is not the correctness of these generalizations, but rather the growth of their sophistication and the rise of a further key concept—*applications*, particularly in the areas of catalysis and (bio)technology. In [Section 6.1.4](#) we hope to alert the reader to the wide range of uses of particular Co compounds that have emerged since the early 1980s. It is noteworthy that a number of these compounds, synthesized at the turn of the twentieth century, were ahead of their time given that the scientific areas in which they ultimately found application, particularly biology, were then still in their infancy.

Cobalt chemistry has become more targeted, with much published work directed towards an application, albeit long-term, or else towards elucidation of an existing problem making use of growing synthetic and instrumental sophistication. The era of synthesis and characterization as an art in itself is passing for Co chemistry; it seems that chemical research itself, not just the electrons

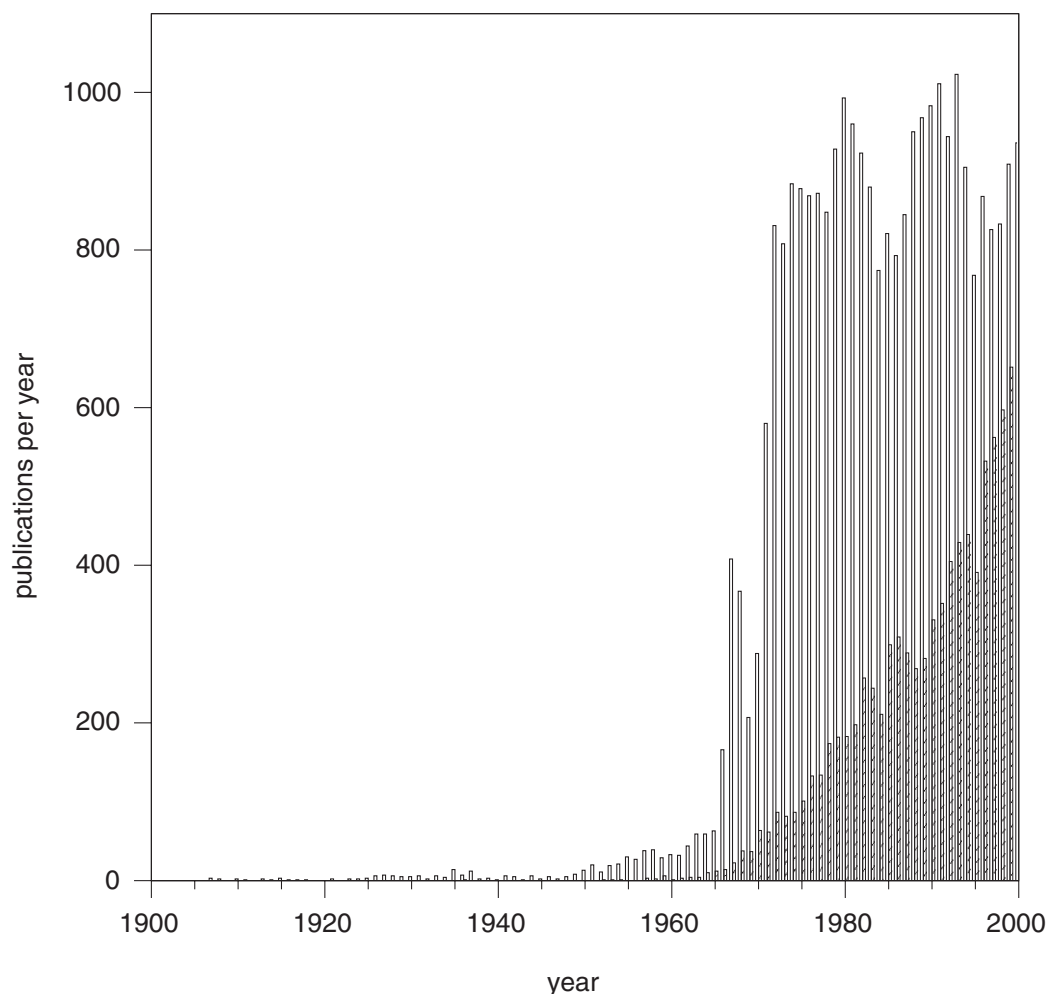

Figure 1 Publications per year featuring cobalt complexes (unshaded bars) and publications reporting at least one crystal structure of a Co-containing complex (shaded bars).

and nuclei that underpin its achievement, must have a “spin”. The changing times are reflected in focused reviews of the field. Well over 1,000 reviews and books featuring aspects of Co coordination chemistry have appeared during the past two decades.

It is appropriate to identify our approach to developing the present review in the context of the Co chapter in *CCC*(1987). The first-edition chapter on Co featured a focused discussion and tabulation of synthetic methods, and many of these basic methods are still employed in synthesis today. Consequently, to avoid repetition, there will be diminished description here where prior appropriate methods have been provided, and only newer developments featured. The last two decades feature the development of many mixed-donor and sophisticated multidentate and macrocyclic ligands, which found limited coverage in the previous edition, and these will be discussed in more detail herein. Reaction kinetics and mechanism were also described thoroughly in the previous edition. We shall not reiterate this material, since the core mechanisms of many reactions involving Co compounds are now adequately defined.

Structural aspects were discussed, but not heavily, in the first edition. The complexity of new compounds (and macromolecules) now being investigated has driven many of the technological advances in X-ray crystallographic data collection and structure solution over the last two decades. Small-molecule ($m.w. < 1,000 \text{ g mol}^{-1}$) structure determinations are now routinely carried out, and Co complexes constitute a significant proportion of these. Indeed, the incorporation of crystal structures in most papers reporting new synthetic coordination chemistry is now a standard feature; much more so than at the time of *CCC*(1987) (Figure 1). Inevitably, most of the new compounds described herein have been the subject of crystal structure determinations, rather

Table 1 Selected reviews and monographs focusing on Co coordination chemistry.

<i>Subject area</i>	<i>Subsets (and selected references)</i>
<i>General descriptive/synthetic chemistry</i>	Cobalt–carbon-bonded compounds ^{10–12} coordination compounds ^{2–9,13–15} molecular modeling ^{16,17} substitution/isomerization ^{18–22}
<i>Structural aspects</i>	redox reactions ²³ coordinated ligand reactions ²⁴ organometallic systems ²⁵
<i>Kinetics and mechanisms</i>	optical, NMR, EPR, IR, and Raman ^{26–30}
<i>Spectroscopy</i>	dioxygen ^{31–37} DNA/proteins ³⁸ porphyrins/corrins ^{39,40} model compounds ^{41,42} organic synthesis ^{24,43–46} inorganic materials ^{47,48} catalysis ^{49–53} polymers and polymerization ^{54–58} magnetism ⁵⁹ photochemistry, solar cells ^{60–62}
<i>Bioinorganic chemistry</i>	
<i>Applications</i>	

than being identified solely through the use of “sporting” physical methods. Nevertheless, advanced instrumentation, including high-field NMR and electrospray-ionization MS, has augmented the range of physical techniques, so that structural assignment in solution has become more firmly based, as an important complement to solid state structural determination. The very complexity of many new molecules required us to adopt a different approach to reporting compared with *CCC*(1987), with extensive reliance here on line drawings, as distinct from tables, to illustrate effectively the complexes described.

Apart from *CCC*, regular general reviews of Co chemistry have appeared in the period 1984–1998 in *Coordination Chemistry Reviews*.^{2–9} These provide distilled supplementary reading covering a large part of the preceding two decades. Organometallic chemistry in particular is further served by an annual survey, which has appeared in the 1980s and 1990s in *Organometallic Chemistry*; several recent examples of these are cited in [Table 1](#) along with a selection of reviews and monographs also featuring Co chemistry.^{10–62}

6.1.1.2 Synthesis, Reactivity, and Structure

There are relatively few key synthetic reagents for entry into Co coordination chemistry. Of these, simple compounds are dominant: for low-valent Co chemistry, $\text{Co}_2(\text{CO})_8$; for cobalt(II) and cobalt(III) chemistry, the simple CoX_2 ($\text{X} = \text{halide}$) salts in hydrated or anhydrous forms. More sophisticated reagents for synthesis have been developed during the last century, but sophistication also frequently involves specificity; the “boutique” precursor, with limited general application. Occasionally, a general concept can be identified as overarching a suite of synthons. For example, an aspect of trivalent Co chemistry that has attracted attention over recent decades is the introduction of labile leaving groups into an inherently inert system. The capacity to have available, in designated coordination sites, ligand molecules that can be readily replaced by other nucleophiles is a sophistication that was not previously so readily achieved. The range of reactivities found for coordinated ligands in Co^{III} chemistry is vast, and the simple hydrolysis rates from the pentaamminecobalt(III) core ([Table 2](#)) adequately defines the spectrum from seriously inert to highly labile leaving groups.⁶³

One of the earlier employed labile ligands was perchlorato, but the dangers in working with this strongly oxidizing anion are well documented and its use as a ligand in compounds bearing oxidizable (organic) ligands is frowned upon these days, if tolerated at all. Indeed, the establishment of the labile, non-oxidizing trifluoromethanesulfonato (CF_3SO_3^-) ligand over the last two decades has obviated the need to employ notorious perchlorato complexes as synthons.⁶⁴ More elaborate leaving groups, such as $^-\text{OTeF}_5$,⁶⁵ have subsequently appeared. Further, the develop-

Table 2 $[\text{Co}(\text{NH}_3)_5\text{X}]^{(3-n)+}$ aquation rate constants for anionic and neutral leaving groups (X^{n-} , $n=0-3$, at 25°C); selective lability of coordination sites in complexes of this inherently inert metal offers synthetic opportunities.

X^{n-}	$k_{\text{obs}}(\text{s}^{-1})$	X	$k_{\text{obs}}(\text{s}^{-1})$
PO_4^{3-}	1.5×10^{-9}	NH_3	5.8×10^{-12}
NO_2^-	1.2×10^{-8}	$\text{S}(\text{CH}_3)_2$	1.6×10^{-6}
CH_3COO^-	2.7×10^{-8}	OH_2	5.9×10^{-6}
CF_3COO^-	1.5×10^{-7}	$\text{OH}(\text{CH}_3)$	5.9×10^{-5}
SO_4^{2-}	8.9×10^{-7}	$\text{OP}(\text{OCH}_3)_3$	2.5×10^{-4}
Cl^-	1.7×10^{-6}	$\text{NH}_2\text{SO}_2\text{NH}_2$	$\sim 1 \times 10^{-2}$
Br^-	6.5×10^{-6}	$\text{NH}_2\text{COCH}_2\text{F}$	1.3×10^{-2}
NO_3^-	2.7×10^{-5}	$\text{CH}_3\text{COOCH}_3$	$\sim 2 \times 10^{-2}$
CH_3SO_3^-	2.0×10^{-4}	$\text{NH}_2\text{SO}_2\text{C}_6\text{H}_4\text{NO}_2$	3.8×10^{-2}
FSO_3^-	2.2×10^{-2}	$\text{OC}(\text{CH}_3)_2$	$\sim 4 \times 10^{-2}$
CF_3SO_3^-	1.5×10^{-2}	$\text{NH}_2\text{SO}_2\text{C}_6\text{H}_4\text{CH}_3$	$\sim 1 \times 10^{-1}$
ClO_4^-	$\sim 1 \times 10^{-1}$	$\text{N}_4\text{O} (\text{N}_3^- + \text{NO}^+)$	$\gg 10^{-1}$

ment of solvated complexes, where weakly coordinating solvent molecules such as sulfolane or acetone occupy key substitution sites, has expanded the armory of synthons. Chemical treatment of a normally robust ligand to generate a very short-lived intermediate, such as azide with NO^+ forming an N_4O entity that rapidly decomposes to release N_2 and N_2O and leave a “naked” coordination site, provides yet another route which has been established for some decades but not heavily exploited.⁶³

Reaction mechanisms in Co chemistry continue to attract interest, and the level of sophistication and depth of understanding of reactions has grown. The elucidation of reaction mechanisms in Co chemistry has benefited from the application of high pressure to provide activation volumes, which in concert with reaction volume information allows a full volume profile analysis.⁶⁶ A parallel advance has been the study of electrode reactions at high pressures.⁶⁷ Study of self-exchange reactions for a series of $\text{Co}^{\text{III/II}}$ systems has provided mechanistic insight into heterogeneous electrode redox reactions, including establishing a simple relationship with the homogeneous self-exchange process. Nevertheless, in light of the ample treatment of this area of Co chemistry in *CCC*(1987), mechanistic studies will receive a limited coverage in this chapter, which by no means reflects the contribution of this area to our control of the element’s chemistry. It simply reflects the fact that space within this review, unlike the scope and breadth of Co coordination chemistry, is limited.

There are now many on-line and CD-ROM databases of important structural and thermodynamic data of relevance to Co chemistry. The Cambridge Structural Database is the first port of call when seeking complete structural information (molecular dimensions) of any carbon-containing Co complex, and we shall not attempt to duplicate this invaluable resource through the tabulation of structural data. Complex formation constants of relevance to this review (mostly with divalent Co) are to be found in Martell’s *Critical Stability Constants*, which is updated regularly and checked rigorously, or in focused reviews. For this reason, no tables of thermodynamic data will be presented. Specific redox potentials (for example $\text{Co}^{\text{III/II}}$ couples) may be found within a range spanning more than 2 V, and although some examples will be mentioned, no attempt will be made here to assemble a “representative” table of redox potential data. The reader is referred to either compendia such as the *Encyclopedia of Electrochemistry of the Elements* or to the original papers, which often themselves present focused collections of electrochemical potentials.

6.1.2 METAL COMPLEXES

The bulk of this chapter is devoted to the descriptive coordination chemistry of Co with a diversity of ligands, addressed separately for the key Co^{II} and Co^{III} oxidation states as well as for each of low-valent and high-valent cobalt. Throughout the chapter, ligand types are treated separately. Given the omnipresence of mixed-ligand complexes, we have tackled this problem by focusing on a particular class of ligand while other ligands that complete the coordination sphere are viewed as “spectators”.

6.1.2.1 Co⁻¹, Co⁰, and Co¹

Of the known low-valent forms of Co, Co⁻¹ is rarely met while the coordination chemistries of the more commonly encountered zero- and monovalent Co are dominated by four-coordinate tetrahedral complexes. For Co¹ (*d*⁸), coordination numbers from three to six are known but with the extremities very rarely found, and four-coordinate tetrahedral (paramagnetic) and five-coordinate trigonal bipyramidal (diamagnetic) most common. Traditionally, the low oxidation state compounds are susceptible to oxidation in air and the tendency toward the formation of cluster compounds is strong. Low-valent Co chemistry remains dominated by carbonyl chemistry, although increasing numbers of examples of low-valent compounds with no carbonyl groups are appearing, as is evident from the following sub-sections.

6.1.2.1.1 Carbon

The chemistry of the low-valent Co—C bond is extensive, and dominantly the regime of organometallic chemistry, which is covered in the companion *Comprehensive Organometallic Chemistry* series; hence the coverage here will be limited. There are few examples of carbon-only compounds of cobalt, a notable exception being the buckminsterfullerene cations [Co_{*n*}(C₆₀)_{*m*}]⁺ (where *n*, *m* range up to 5); these form by a combination of laser vaporization and molecular beam approaches. One example is the [Co(C₆₀)₃]⁺ ion, which appears to adopt a planar structure with the Co surrounded by three C₆₀ molecules.⁶⁸ In the [CoC₆₀]⁺ ion, the metal assists gas phase reactions to produce metallated [CoC₆₀(CH₂)_{*n*}]⁺ (*n* = 1–5) species.⁶⁹

(i) Cyanides

Organocyanocobaltate(I) chemistry has been reviewed.⁷⁰ Mononuclear and polynuclear forms are known, and CN⁻ continues to appear regularly as a co-ligand, as it does in other Co oxidation states, and examples of it as co-ligand appear throughout the review.

(ii) Carbonyls

The diversity and depth of studies in this field is exceptional, and a detailed exposure cannot be provided here. Aspects of this chemistry appear in detail in the companion series *Comprehensive Organometallic Chemistry*. Here, we will concentrate on compounds that are CO-rich, and attempt to provide an overview of their chemistry.

Small Co metal clusters Co_{*n*}⁻ (*n* = 2–8) react with CO, with sequential addition leading to the saturated Co species [Co₂(CO)₇]⁻, [Co₃(CO)₁₀]⁻, [Co₄(CO)₁₂]⁻, [Co₅(CO)₁₃]⁻ and [Co₆(CO)₁₅]⁻.⁷¹ This points towards one of the features of low-valent Co carbonyls; a tendency to form stable clusters. Reactivity of Co_{*n*}⁻ with O₂ is higher but leads to cluster fragmentation, whereas N₂ is essentially unreactive. Entry into carbonyl chemistry of low-valent Co is frequently via the well-known dimer Co₂(CO)₈. A range of reactions commencing with this compound has been developed, as follows.

(a) *Simple substitution reactions.* Direct substitution in Co₂(CO)₈ produces a range of dinuclear compounds. Reaction with phosphines or arsines readily produces derivatives such as Co₂(CO)₆L₂ where the core stereochemistry is retained. Substitution with some rearrangement may also occur; for example, reaction with (*t*-Bu)₂PH by heating in toluene yields the phosphido bridged compound (**1**).⁷² Whereas {Co₂(CO)₆} complexes of alkynes R—C≡C—R' formed from substitution in Co₂(CO)₈ have been known for some time and are reasonably stable to attack by nucleophiles and electrophiles, when heated with an alkene they react in a regiospecific [2 + 2 + 1] cycloaddition to form a cyclopentenone.⁷³

(b) *Cleavage reactions.* These reactions involve monomer formation through cleavage of the Co—Co bond. Reaction of Co₂(CO)₈ in liquid SO₂ in the presence of AsF₅ leads to Co—Co bond cleavage and yields monomeric [Co(CO)₄(SO₂)]AsF₆, providing a simple route to cationic Co^I sulfur dioxide complexes.⁷⁴ Tetra-coordinated monomeric Co^I is readily obtained via reductive cleavage of the Co—Co bond in Co₂(CO)₈ and also in substituted derivatives such as Co₂(CO)₆L₂ (L = a phosphine, phosphite or arsine), under a nitrogen atmosphere. Subsequently, pentacoordinated Co^I can be achieved by addition of entities such as trimethyltin (Equation (1)).⁷⁵ One example is the trigonal bipyramidal arsine complex Co(Me₃Sn)(CO)₃(AsPh₃), where the carbonyl ligands occupy the equatorial positions.^{75,76}

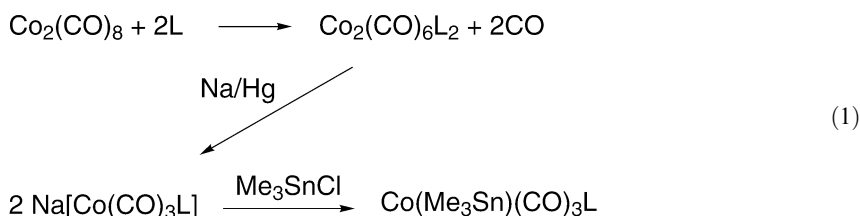
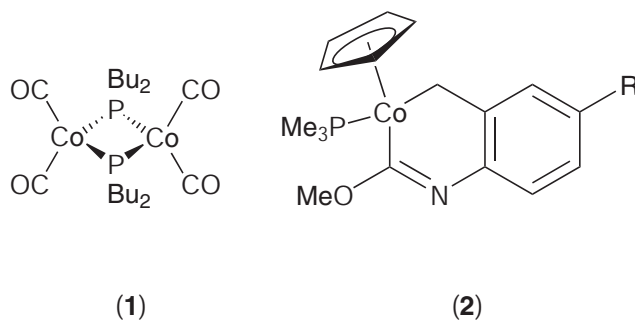

Mononuclear acyl Co carbonyl complexes $\text{ROC}(\text{O})\text{Co}(\text{CO})_4$ result from reaction of $\text{Co}_2(\text{CO})_8$ with RO^- .⁷⁷ These also form via the carbonylation of the alkyl precursor. The $\text{ROC}(\text{O})\text{Co}(\text{CO})_4$ species undergo a range of reactions, including CO ligand substitution (by phosphines, for example), decarbonylation to the alkyl species, isomerization, and reactions of the coordinated acyl group involving either nucleophilic attack at the C or electrophilic attack at the O atom.

(c) *Cluster formation.* Clusters with at least three metals are accessible. The dimer $\text{Co}_2(\text{CO})_8$ reacts in THF at -15°C with $\text{B}_2\text{H}_6 \cdot \text{THF}$ to form $[(\text{CO})_4\text{Co}(\text{BH}_2)] \cdot \text{THF}$.⁷⁸ This is a useful synthetic reagent, mainly because it is a very active reducing agent which can condense with metal fragments to yield clusters, as illustrated by the formation of the “tailed” cluster $(\text{CO})_9\text{Co}_3\text{C}(\text{CH}_2)_n\text{OH}$ ($n=4, 5$), where the Co atoms form a commonly encountered equilateral triangular arrangement.

Mixed-metal clusters are also accessible from $\text{Co}_2(\text{CO})_8$. For example, the following reaction (Equation (2)) leads to a purple-black Au–Fe–Co cluster with a trigonal bipyramidal array of metals, via a long-known mixed Co–Fe red-brown colored cluster intermediate.⁷⁹

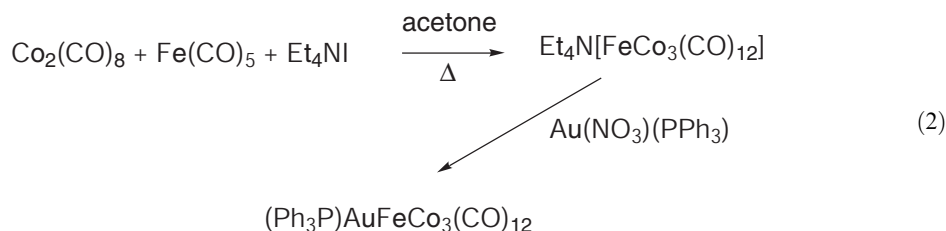

Likewise, reaction of $\text{Co}_2(\text{CO})_8$ with $\text{Ru}(\text{CO})_5$ yields $[\text{RuCo}_3(\text{CO})_{12}]^-$, which can be reacted with HCl to form the hydride-containing cluster $\text{HRuCo}_3(\text{CO})_{12}$.⁸⁰ A trinuclear mixed-metal cluster featuring a $\mu_3\text{-S}^{2-}$ ion, $(\mu_3\text{-S})\text{Co}_2\text{Fe}(\text{CO})_9$, is formed from reaction of $\text{Co}_2(\text{CO})_8$, $\text{Fe}(\text{CO})_5$, and $\text{C}_2\text{H}_5\text{SH}$, where $[\text{Co}(\text{CO})_4]^-$ and S^{2-} are intermediate species.⁸¹ Clusters such as this have reactive M–M bonds useful for further synthesis, but do not undergo total fragmentation.

The $(\mu_3\text{-X})\text{Co}_3(\text{CO})_9$ core, which has three tetrahedral $\{\text{Co}(\text{CO})_3\}$ units each bonded to a central entity in a trigonal array, is a common cluster geometry, as are analogs with Co substitution. A recent example of such a structure is via the reaction of $\text{Co}_2(\text{CO})_8$ with $(\text{C}_6\text{F}_5)_2\text{S}$, which yields $(\mu_3\text{-S})\text{Co}_3(\text{C}_6\text{F}_5)(\text{CO})_8$.⁸²

These types of clusters represent some of the more modest sizes and geometries detected in homo- and hetero-metal carbonyl clusters. From dimetallic up to pentadecametallic clusters have been defined by crystal structures, and assembly of the metal centers in these clusters adopt a number of well-defined arrangements.⁸³ Redox activity in these polymetallic clusters is anticipated and has been observed. Routes to large carbonyl polymetal clusters have been reviewed.^{83,84}

Water-soluble carbonyls are relatively rare. A route to such a species involves reaction at room temperature of the sulfonated phosphine $\text{P}(\text{PhSO}_3)_3^{3-}$ as its water-soluble Na^+ salt with $\text{Co}_2(\text{CO})_8$ in a two-phase water/toluene mixture, whereupon the product forms in the aqueous phase in high yield.⁸⁵

Complex clusters incorporating multiple-bridging groups such as O^{2-} , CCl , and CCO_2 have been known for some time, with clear synthetic routes available.⁸⁶ Typical species include $(\mu_3\text{-CCl})\text{Co}_3(\text{CO})_9$, $(\mu_3\text{-CCO}_2)\text{Co}_3(\text{CO})_9$, and $\text{Co}_4(\mu_4\text{-O})[(\mu_3\text{-CCO}_2)\text{Co}_3(\text{CO})_9]_6$. Substitution of further carbonyls can lead to chiral clusters.

Main-group cobalt carbonyl clusters are well known, with neutral clusters such as $\text{Sn}\{\text{Co}(\text{CO})_4\}_4$ and anionic clusters such as $[\text{Bi}\{\text{Co}(\text{CO})_4\}_4]^-$ reported.⁸⁷ Synthesis proceeds for the former as follows (Equation (3)):

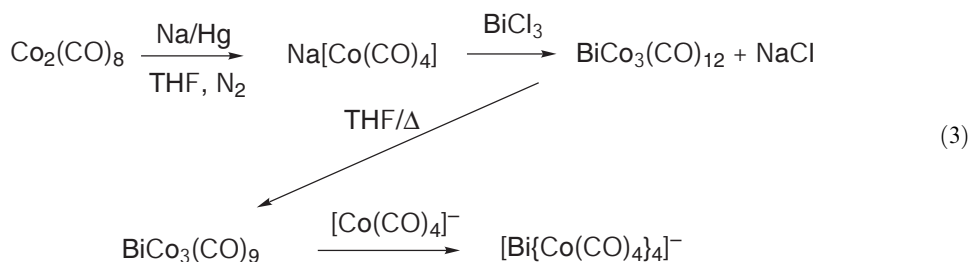

(d) *Photochemical reactions.* Photoreactivity is exhibited by many carbonyl complexes. Photo-substitution reactions, where a CO ligand is commonly replaced, are assumed to proceed by an associative mechanism. A simple example is given in the reaction below (Equation (4)).⁸⁸

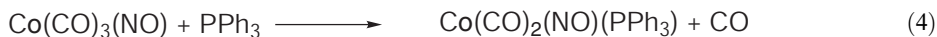

Photooxidation of $\text{Co}_2(\text{CO})_8$ is a complex reaction, with major products being the simple monomers $\text{Co}(\text{O}_2)(\text{CO})_n$ ($n = 1, 2$) with the dioxygen bound side-on (η^2).⁸⁹ The same products arise from reaction of Co atoms with CO and O_2 at 10–12 K.

(e) *Other reactions.* Reduction reactions from a higher oxidation state offer an alternative route to low-valent Co compounds. For example, cobalt(II) chloride serves as a precursor for generation of $[\text{Co}(\text{CO})_4]^-$ by treatment with NaBH_4 or Na_2S under a CO atmosphere.⁹⁰ This, in turn, catalyzes the double carbonylation of aryl halides (RX) to give RCOCOOH in the presence of $\text{Ca}(\text{OH})_2$.

Dendrimers incorporating Co carbonyls and other organocobalt species have been the subject of a recent review.⁹¹ This sets the scene for a likely growth of interest in such systems in the future.

(iii) Alkyls and aryls

The field of alkyl and aryl Co complexes in low formal oxidation states has been extensively studied, and is frequently associated with cluster chemistry.⁹² Alkyl and aryl ligands, with or without additional functionality, are often co-ligands with π acceptors such as carbonyls and/or phosphines, e.g., $(\text{MeOCOCH}_2)\text{Co}(\text{CO})_3(\text{PPh}_3)$.⁹³ A simple example of a cluster is $(\text{RC})\text{Co}_3(\text{CO})_9$, where the triangular $\{\text{Co}(\text{CO})_3\}_3$ moiety is capped by the η^3 -alkyl fragment, which occupies the apex of a distorted Co_3C tetrahedron.

Cobalt incorporation in a ring is one less common way in which Co–alkyl bonding is observed. One interesting example is the cobaltadihydroquinoline (2).⁹⁴ This arises from reaction of $(\text{Cp})\text{Co}(\text{PMe}_3)(\text{CO})$ (Cp = cyclopentadienyl anion) with an aryl isocyanide (CNR) and CH_2ClI in benzene, which first forms the carbenoid cation $[(\text{Cp})\text{CoCH}_2\text{Cl}(\text{PMe}_3)(\text{CNR})]^+$, then yielding the cobaltadihydroquinoline on addition of KOH to a methanolic solution. A crystal structure defines a slightly distorted octahedral environment for the Co center.

(iv) Other carbon-bonded ligands

Complexation of CO_2 to Co demands a somewhat different approach. C-bound $\eta^1\text{-CO}_2$ is invariably a co-ligand with multidentate unsaturated N-donor ligands, particularly imines, and

discussion of this area is deferred until Section 6.1.2.1.3(v). Close analogs which bind Co are carbonyl sulfide (COS) and carbon disulfide (CS₂).⁹⁵ The latter has been characterized in a η^2 -C,S coordination mode to cobalt. These undergo reductive cleavage to produce sulfido and thiocarbonyl ligands.

The first transition metal isonitrilate complex reported was the tetrahedral Co⁻¹ complex [Co(C \equiv NPh*)₄]⁻ where Ph* = 2,6-Me₂C₆H₃,⁹⁶ characterized by a crystal structure analysis. Oxidation yields the zerovalent dimer Co₂(C \equiv NPh*)₈, which features two bridging isonitrile groups.

6.1.2.1.2 Silicon

Silicon-cobalt bonds are essentially exclusive to low-valent cobalt. The companion series *Comprehensive Organometallic Chemistry* provides a coverage. Although monomers such as Co(CO)₄-(SiEt₃) are known, silyls tend to be found more often in clusters; for example, reaction of Na[Co(CO)₄] in THF at -5 °C with MeSiHCl₂ yields MeSiCo₃(CO)₉.⁹⁷ Typically, Si-hydride and Si-halogen bonds can be replaced by Co carbonyl units, such as in the reaction of SiH₄ with Co₂(CO)₈ in dry hexane in a sealed tube, which forms SiCo₄(CO)₁₄.⁹⁸ A recently characterized simple cluster with a silicon-bonded chelate is (μ -PhSiCH₂CH₂SiPh) Co₂(CO)₆, formed from substitution in Co₂(CO)₈.⁹⁹

6.1.2.1.3 Nitrogen

The most commonly encountered N-donor ligands, the amines, are not usually associated with Co in its low oxidation states. However, unsaturation coupled with chelation opens up many opportunities for the stabilization of monovalent Co with N donors such as imines, porphyrins, and pyrazoles.

(i) Amines

The monovalent Co chemistry of amines is sparse. No structurally characterized example of low-valent Co complexed exclusively to amines is known. At low potentials and in non-aqueous solutions, Co^I amines have been identified electrochemically, but usually in the presence of co-ligands that stabilize the reduced complex. At low potential, the putative monovalent [Co(cyclam)]⁺ (cyclam = 1,4,8,11-tetraazacyclotetradecane) in NaOH solution catalyzes the reduction of both nitrate and nitrite to give mixtures of hydroxylamine and ammonia.¹⁰⁰ Mixed N-donor systems bearing π -acceptor imine ligands in addition to amines are well known, but these examples are discussed separately in Section 6.1.2.1.3.

(ii) Pyridine and oligopyridines

The π -acceptor ability of these unsaturated ligands offers more extensive low-valent Co chemistry than found with amines. Photochemical irradiation of [Co(py)₆](BPh₄)₂ (py = pyridine) results in reduction to the Co^I complex with the anion as the electron donor.¹⁰¹ The same Co^I complex has been found to catalyze the cyclotrimerization of but-2-yne and hex-1-yne at room temperature,¹⁰¹ and to reduce CO₂ at atmospheric pressure forming a carbonyl complex.¹⁰² The formally monovalent [Co(bpy)₃]⁺ and [Co(phen)₃]⁺ complexes (bpy = 2,2'-bipyridine; phen = 1,10-phenanthroline) have been well characterized. The crystal structure of [Co(bpy)₃]Cl is known¹⁰³ and the coordination geometry is almost identical to that of the divalent analog [Co(bpy)₃]Cl₂, suggesting considerable electron delocalization stabilizing this rare low-valent CoN₆ compound.

The [Co(terpy)₂]⁺ ion (terpy = 2,2';6',2''-terpyridine) has been found to catalyze the reduction of CO₂ when the divalent precursor is immobilized on electrode surfaces. The vinyl-substituted terpy analog was electropolymerized to give a film that reduced the overpotential for CO₂ reduction in DMF and MeCN by more than 1 V.¹⁰⁴ The activity of this surface-confined species was superior to that of the complexes in solution.¹⁰⁵ Similarly, in water, the [Co(terpy)₂]²⁺ ion immobilized and reduced *in situ* within a Nafion film also catalyzes the reduction of CO₂¹⁰⁶ and H⁺ ions.¹⁰⁷

(iii) Porphyrins

Most recent advances in the area of low-valent Co porphyrin chemistry involve their use as reduction catalysts of organic substrates, and this work appears in [Section 6.1.4.3](#).

(iv) Pyrazole and related ligands

By far the most studied pyrazole-containing ligand is the symmetrical monoanionic tripod hydridotrispyrazolylborate, Tp (3). Substituents introduced at each of the 3-, 4- or 5-positions (3,5-Me₂Tp¹⁰⁸, 3-*i*Pr,4-BrTp¹⁰⁹) have led to a number of sterically encumbered threefold symmetric complexes and some remarkable Co coordination chemistry has ensued. Hydride substitution at the B atom is also possible by organic groups such as *p*-bromophenyl, which enables further functionalization of the ligand.¹¹⁰

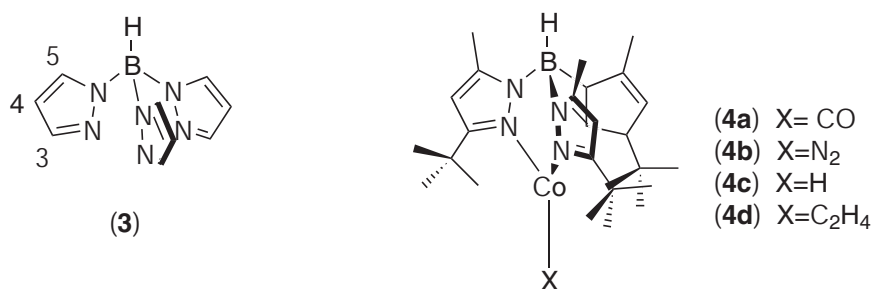

The diamagnetic (3-*t*Bu,5-MeTp)Co(CO)₂ has been prepared and structurally characterized.¹¹¹ In solution it spontaneously loses CO to give the paramagnetic (3-*t*Bu, 5-MeTp)Co(CO) (4a). In the presence of CO, the two complexes are in equilibrium. A Mg reduction of (4a) yielded the dimer [(3-*t*Bu,5-MeTp)Co](μ-CO)₂·Mg(THF)₄.¹¹² The crystal structure of this compound shows a linear CO bonding mode. However, in the crystal structures of the di mononuclear neopentyl analogs [(3-*np*Tp)Co]₂(μ-N₂) and (3-*np*Tp)Co(CO) the CO and N₂ ligands are bent away from the pseudo-threefold axis of the complex by about 30°. Hydrogenation of the mononuclear dinitrogen complex (4b) produced the hydride (4c), whereas reaction with ethylene yields the corresponding olefin complex (4d), all of which were structurally characterized (Figure 2).¹¹³

(v) Imines

Polyimines of low-valent Co are now well represented, particularly with macrocyclic or mixed-donor ligands. The monovalent Co complex (5) of the 14-membered macrocyclic hexamethyl diimine (hmd), may be generated electrochemically from its divalent precursor. Furthermore,

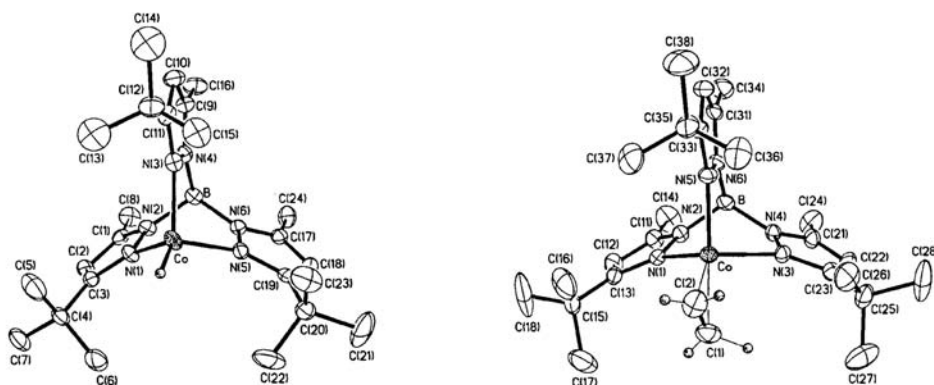
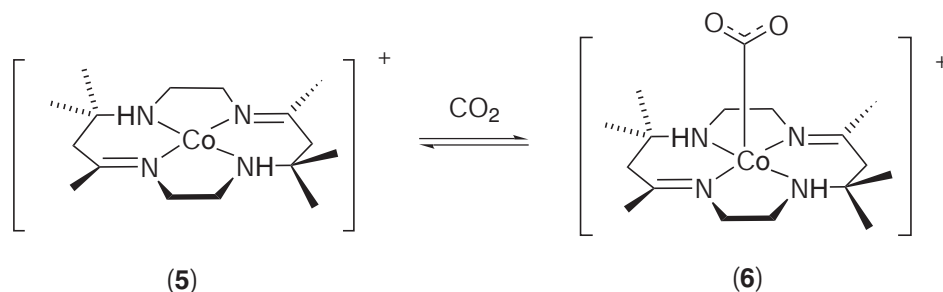

Figure 2 Crystal structures of the monovalent hydrido (4c) (left) and ethylene (4d) (right) complexes of *i*-Pr-5-MeTp (reproduced with permission of the American Chemical Society from *Organometallics*, 1999, 18, 300–305).

cyclic voltammetry of $[\text{Co}(\text{hmd})]^{2+}$ in 0.1M $\text{Et}_4\text{NClO}_4\text{-DMSO}$ in the presence of CO_2 showed a pronounced anodic shift in the $\text{Co}^{\text{II/I}}$ potential, indicating a large CO_2 binding constant for the monovalent complex.¹¹⁴ Subsequently it was found that (5) rapidly forms a purple 1:1 adduct (6) with CO_2 in MeCN ($K_a=1.2 \times 10^4 \text{ M}^{-1}$).¹¹⁵ In ultrapure MeCN, (6) slowly reacts to give $[\text{Co}(\text{hmd})]^{2+}$, CO, and HCO_3^- .



The dinuclear complex $[\text{Co}_2(\text{hmd})_2(\mu\text{-CO}_2\text{H})(\text{ClO}_4)_3]$ and the monomeric carbonyl $[\text{Co}(\text{hmd})(\text{CO})(\text{ClO}_4)]$ were crystallized and structurally characterized. The structure of the dinuclear complex finds both Co ions in a square pyramidal environment, with axial sites occupied by the bridging ligand. A $\mu\text{-}\eta^1:\eta^1$ coordination mode ($\text{Co-C}(\text{OH})\text{O-Co}$) was defined involving a distorted trigonal planar C atom. The thermodynamics and kinetics of complex formation between pulse radiolytically generated (5) and the species H^+ , CO_2 , and CO were also studied in aqueous formate solutions.¹¹⁶ Subtle stereochemical influences were revealed in parallel investigations of the N-based *meso* and *rac* diastereomers of (5) and (6), the *rac* isomer having both amine H atoms *syn* to the coordinated CO_2 . Although the *meso* and *rac* isomers have identical $\text{Co}^{\text{II/I}}$ redox potentials, their CO_2 binding constants in DMSO differ by a factor of 100 (*rac* being more stable) indicating that steric effects are at work.¹¹⁷ The effects of solvent dielectric constant and electrolyte were also explored. A similar, but independent, CO_2 binding study was published soon after,¹¹⁸ also incorporating the thermodynamics and kinetics of binding CO and H^+ to the *rac* and *meso* isomers of the same complex. Hydrogen bonding was also found to be a factor in stabilizing (6).¹¹⁹ The solution structures of the five-coordinate (6) and its six-coordinate solvated adduct were examined with XANES and EXAFS together with the related (5), $[\text{Co}(\text{hmd})(\text{CO})]^{2+}$, $[\text{Co}(\text{hmd})]^{2+}$, and $[\text{Co}(\text{hmd})(\text{CO}_3)]^{2+}$. The edge position of (6) and $[\text{Co}(\text{hmd})]^{2+}$ are the same, whereas the edge position for six-coordinate $[(\text{MeCN})\text{Co}(\text{hmd})(\text{CO}_2)]^{2+}$ shows significant metal-to- CO_2 charge transfer consistent with a Co^{III} C-bound carboxylate.¹²⁰ The pressure dependence of this five- to six-coordinate equilibrium was studied,¹²¹ with high pressures favoring the six-coordinate form.

Photoreduction of CO_2 using *p*-terphenyl as a photosensitizer and a tertiary amine as a sacrificial electron donor is efficiently catalyzed by $[\text{Co}(\text{hmd})]^{2+}$ using continuous and flash photolysis, and charge separated species (Co^{I} and terphenyl cation) were identified.¹²² Similarly, photoreduction of $[\text{Co}(\text{hmd})]^{2+}$ by several bis-bipyridyl Ru^{II} photosensitizers leads to Co^{I} -mediated reduction of CO_2 .¹²³ The tetramethyl-tetramine (tmt) relative $[\text{Co}(\text{tmt})(\text{NCMe})_2]^{2+}$ also undergoes facile one-electron reduction in MeCN to give the corresponding monovalent species (7), which is a potent Lewis acid toward a variety of monodentate ligands (pyridine; 2,6-lutidine; 1-Me-imidazole; Br^-).

Electrogenerated monovalent Co complexes of the well-known open chain N_2O_2 Schiff base ligands salen (8), salphen (9), and their substituted derivatives undergo oxidative additions with alkyl halides. Reactions of the complex with substrates within the series RBr ($\text{R} = \text{Pr}, \text{Bu}, t\text{-Bu}$) proceed at different rates. The reaction occurs by an inner-sphere alkyl-bridged electron transfer, with a $\text{Co}^{\text{I}} \cdots \text{R}^+ \cdots \text{X}^-$ transition state, which is sensitive to distortions of the complex in different configurations.¹²⁴

A crystal structure of the CO_2 derivative of (8), $\text{K}[\text{Co}(\text{salen})(\eta^1\text{-CO}_2)]$, has been reported in which the Co-C bond is 1.99 Å, the C-O bonds are both equivalent at 1.22 Å and the O-C-O angle is 132° .¹²⁵ Carboxylation of benzylic and allylic chlorides with CO_2 in THF-HMPA was achieved with (8) electrogenerated by controlled-potential electrolysis,¹²⁶ in addition to reductive coupling of methyl pyruvate, diethyl ketomalonate and *p*-tolylcarbodiimide via C-C bond formation. Methyl pyruvate is transformed into diastereomeric tartrates concomitant with oxidation to the divalent $\text{Co}(\text{salen})$ and a free-radical mechanism is proposed involving the homolytic cleavage of the Co-C bond. However, reaction with diphenylketene (DPK) suggests an alternative pathway for the reductive coupling of CO_2 -like compounds.

analogs, the bis-pyridine complex decomposes rapidly in solution unless stabilized by excess pyridine. This was correlated with structural parameters, most notably the compressed ON–Co–NO coordination angle. Electrochemistry of the four-coordinate $[\text{Co}(\text{P}(\text{OEt})_3)_2(\text{NO})_2]^+$ in MeCN at Pt or Hg electrodes reveals two consecutive reductions and a single oxidation process. The less negative reductive wave yields a stable neutral species in the absence of oxygen.¹³³ The novel pseudo-tetrahedral complex (**11**) also bears two P donors and two NO ligands, but a ferrocenyl group bridges the two phosphines.¹³⁴ The interaction between the two metallic centers bridged by the two Cp–PPh₂ linkers was studied by ⁵⁷Fe Mössbauer spectroscopy and cyclic voltammetry.

The doubly bridged nitrosyl complex $[(\text{Cp})\text{Co}]_2(\mu\text{-NO})_2$ has attracted a considerable amount of interest with regard to its electronic ground state. *Ab initio* calculations carried out on this d^9 – d^9 species predicted a triplet ground state 280 cm⁻¹ lower in energy than the singlet state, and the authors suggested that the magnetic properties of the compound be more closely examined.¹³⁵ In response, experimental reinvestigation of the magnetic susceptibility of the complex found that the compound is actually diamagnetic in the solid state (from 5 K to 280 K) and in benzene solution (in the range 303–327 K).¹³⁶

Coordinated nitrosyl can participate in further chemistry, as illustrated in the following example. Methylation of $[(\text{Cp})\text{Co}(\text{NO})]^-$ with MeI in THF at –40° gives (Cp)Co(Me)(NO) which in the presence of PPh₃ undergoes NO migratory insertion to give (Cp)Co(N(O)Me)(PPh₃). The ethyl, isopropyl, and *p*-methyl-benzyl analogs behave similarly.¹³⁷

(viii) Nitriles and azides

These are adequate ligands for low-valent Co, but their chemistry is somewhat limited. Dicobalt hexacarbonyl complexes of propargyl acetates and acetylenic acetals couple efficiently with diethylaluminum cyanide to produce the corresponding complexed propargyl nitriles and cyanohydrins.¹³⁸ Electron-poor dipolarophiles such as alkynes, alkenes, and nitriles undergo 1,3-dipolar cycloadditions with azido Co complexes to give five-membered heterocycles such as triazoles (from nonterminal alkynes), triazolines (from alkenes), and tetrazoles (from nitriles).¹³⁹ Tetra-cyanoethylene is an effective one-electron oxidant and also is capable of forming sigma-bonded complexes such as (Cp)Co(CO)(TCNE).^{140,141}

6.1.2.1.4 Phosphorus

Most work done on the coordination chemistry of phosphorus ligands bonded to Co lies within the realm of organometallic chemistry where the P donor is in the minority of non-C-bonded ligands. Examples such as these where the principal ligands are CO, Cp, and olefins, will not be discussed here. Tertiary phosphines (trialkyl and triaryl) and phosphite esters dominate the examples of phosphorus coordinated to Co, as they are excellent ligands for low-valent Co. Of the monodentate P donors, PMe₃, PEt₃, P(*i*-Pr)₃, P(ch)₃, and PPh₃ are the most commonly encountered examples.

(i) Monodentate phosphines

The simple tetrahedral complex $[\text{Co}(\text{PMe}_3)_4]\text{PF}_6$ reacts with formaldehyde to give the trigonal bipyramidal derivative $[\text{Co}(\text{CO})(\text{PMe}_3)_4]\text{PF}_6$ where the CO ligand is in an equatorial position. Curiously, the BPh₄⁻ salt reacts to give the axially bound CO isomer in addition to the *cis*-octahedral Co^{III} dihydrido species $[\text{CoH}_2(\text{PMe}_3)_4]^+$.¹⁴² Reaction of $[\text{Co}(\text{PMe}_3)_4]^+$ with O₂ in MeCN yields the octahedral divalent phosphine oxide complex *trans*- $[\text{Co}(\text{MeCN})_2(\text{OPMe}_3)_4]^{2+}$ and its X-ray crystal structure was determined.¹⁴³ The dioxygen complex $[\text{Co}(\text{PMe}_3)_4(\text{O}_2)]^+$ (with $\bar{\nu}_{\text{O-O}} = 880 \text{ cm}^{-1}$) was identified as an intermediate.

The tetrahedral halide-bridged monovalent compounds $[\text{Co}(\text{PPh}_3)_2\text{X}]_n$ (X = Cl, Br) or $[\text{Co}(\text{PPh}_3)\text{X}]_n$ (X = Cl, I), may be prepared by reduction of CoX₂ with NaBH₄ in the presence of PPh₃.¹⁴⁴ The $[\text{Co}(\text{PPh}_3)_2\text{Br}]_n$ analog reacts further with PPh₃ to form paramagnetic tetrahedral monomeric Co(PPh₃)₃Br. Although Co(PPh₃)₃Cl is formally a homolog of its illustrious Rh^I analog Rh(PPh₃)₃Cl (Wilkinson's catalyst), their structures and reactivities are in no way similar. Unlike the square planar diamagnetic Rh complex, Co(PPh₃)₃Cl is tetrahedral and paramagnetic.

Nevertheless, the $\text{Co}(\text{PPh}_3)_n\text{X}$ compounds are excellent synthons for a variety of low-valent phosphine complexes, as the $\text{Co}-\text{P}$ bonds are quite stable, allowing the investigation of ligand addition and substitution reactions at the remaining coordination site(s). For example, the first Co^{I} siloxide complex $\text{Co}(\text{PPh}_3)_3(\text{OSiMe}_3)$ was synthesized and characterized structurally by reaction of $\text{Co}(\text{PPh}_3)_3\text{Cl}$ with trimethylsilylanolate.¹⁴⁵ The paramagnetic tetrahedral $\text{Co}(\text{PMe}_3)_3\text{Br}$ reversibly binds ethylene in a variety of solvents (toluene, acetone, and MeOH) to give the diamagnetic $\text{CoBr}(\text{C}_2\text{H}_4)(\text{PMe}_3)_3$ species.¹⁴⁶ By contrast, reaction of $\text{Co}(\text{PMe}_3)_3\text{Br}$ with diphenylacetylene yields different mononuclear diamagnetic Co-alkyne species depending on the solvent; $\text{CoBr}(\text{C}_2\text{Ph}_2)(\text{PMe}_3)_3$ forms in toluene, whereas in acetone the salt $[\text{Co}(\text{PMe}_3)_3(\text{C}_2\text{Ph}_2)]\text{Br}$ is also present. MeCN is also found to be a competitive ligand in these systems.¹⁴⁷ Homologs of the form $[\text{Co}(\text{PMe}_3)_3(\text{RC}\equiv\text{CR}_1)]^+$ ($\text{R} = \text{Ph}$, $\text{R}_1 = \text{Me}$, pentyl; $\text{R}, \text{R}_1 = \text{Me}$) were also prepared from $\text{Co}(\text{PMe}_3)_3\text{Br}$.¹⁴⁸ The alkyne ligand acts as a four-electron donor but is weakly bound. Reaction of $\text{HC}\equiv\text{CPh}$ in excess with $\text{Co}(\text{PMe}_3)_3\text{Br}$ and NaBPh_4 in MeOH gave the phosphonium salt $[\text{Me}_3\text{P}(\text{CH}_2\text{CH}(\text{OMe})\text{Ph})]\text{BPh}_4$, which was characterized in the solid state by X-ray diffraction and in solution by ^1H and ^{31}P NMR.¹⁴⁹ Addition of aryl halides (ArX) to $\text{Co}(\text{PPh}_3)_3\text{Me}$ yield ArAr and ArMe when $\text{Ar} = 4\text{-toluyl}$, but exclusively ArMe for 1- and 2-bromonaphthalene and 4-bromobiphenyl.¹⁵⁰

In the four-coordinate complexes (**12**) ($\text{X} = \text{Cl}, \text{Br}$) the phenol phosphine is coordinated as a monodentate.¹⁵¹ In the presence of base, the phenolate O atom deprotonates and coordinates to give (**13**). The five-membered chelate ring in this complex is resistant to protonation, and ring-opening is not observed even in the presence of CO or C_2H_4 .

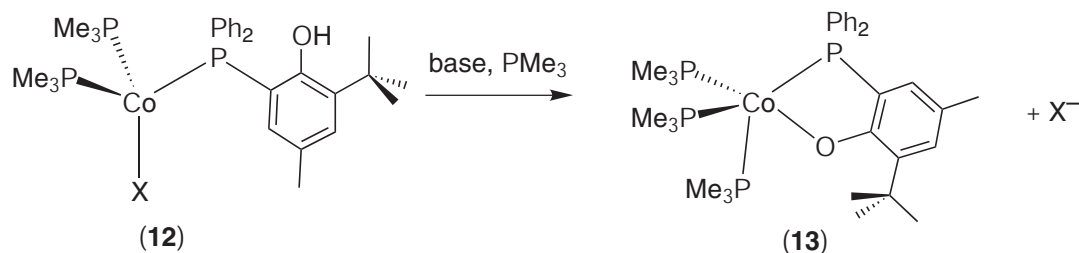

At least partial substitution of other inherently strong ligands by phosphines can be achieved. Trialkylphosphines substitute partially into arylisocyanide complexes $[\text{Co}(\text{CNR})_5]^+$, with monosubstitution and at best disubstitution observed, influenced by the steric bulk of the phosphine.¹⁵²

(ii) Multidentate phosphines

There is a wide range of examples extant, but a selection illustrates recent chemistry sufficiently. There are many Co complexes, both monomers and clusters, of the facially coordinating tridentate phosphine triphos (1,1,1-tris((diphenylphosphino)methyl)ethane) and its dimethylphosphino (mtriphos) or diethylphosphino (ettriphos) analogs. The novel mixed P-ligand complex $\text{Co}(\text{triphos})(\text{P}_3)$ reacts with $\text{AuCl}(\text{PR}_3)$ ($\text{R} = \text{Me}$ or Ph) and $\text{Au}_2\text{Cl}_2(\text{Ph}_2\text{PCH}_2\text{PPh}_2)$ in the presence of TIPF_6 to give the P_3 -bridged compound (**14**). The Au atom is sandwiched between the two cyclic P_3 units of each $\text{Co}(\text{triphos})(\text{P}_3)$ moiety.¹⁵³ Similarly, treatment of $\text{Co}(\text{triphos})(\text{P}_3)$ with Cu^{I} and Ag^{I} salts affords $[\text{M}\{\text{Co}(\text{triphos})(\text{P}_3)\}_2]^+$ ($\text{M} = \text{Cu}, \text{Ag}$).¹⁵⁴ The protonated form $[\text{Co}(\text{triphos})(\text{P}_3\text{H})]\text{CF}_3\text{SO}_3$, also containing an η^3 -coordinated P_3 unit, reacts with $\text{Pt}(\text{PPh}_3)_2$ to give the trinuclear compound $[(\text{triphos})\text{Co}]_2(\text{P}_6\text{H}_2)\text{PtPPh}_3(\text{CF}_3\text{SO}_3)_2$.¹⁵⁵ In this compound, the P_6 fragment bears a $\text{P}-\text{P}$ bond between two different P_3 moieties and this novel ligand is stabilized by coordination to three metal-ligand fragments.

The dinucleating hexaphosphine eHTP binds as a bridging bis-tridentate ligand and several dicobalt complexes have been isolated, such as (**15**).¹⁵⁶ The solution conformational behavior of (**15**) was examined with NMR, which identified a number of solvent- and temperature-dependent shifts of the methylene bridge and chelate ring proton resonances.¹⁵⁷ Chemical shift changes for the $\text{P}-\text{CH}_2-\text{P}$ proton resonances were assigned to CO shielding from different rotational conformers, whereas variations in the chelate ring resonances were attributed to trigonal-bipyramidal/square-pyramidal coordination geometry changes. In the same study, reduction of (**15**) with the naphthalenide anion produced the zerovalent $\text{Co}-\text{Co}$ -bonded dimer $\text{Co}_2(\text{CO})_2(\text{eHTP})$. In dry

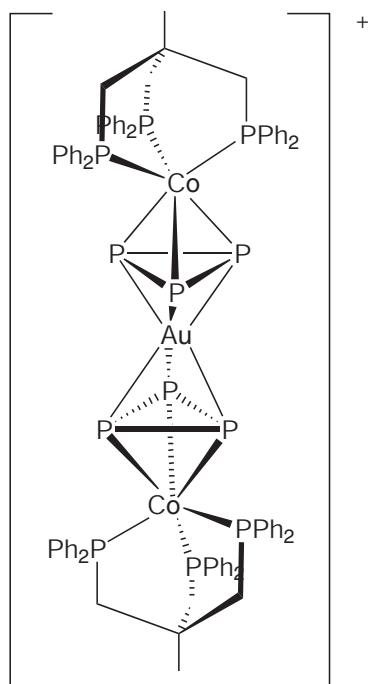

(14)

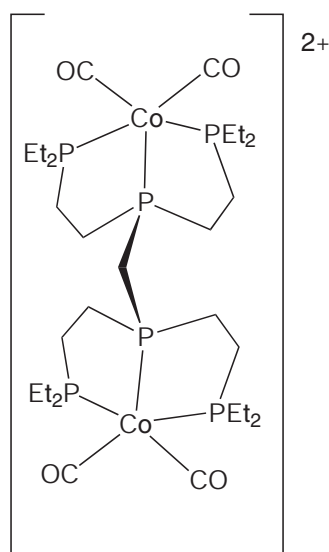

(15)

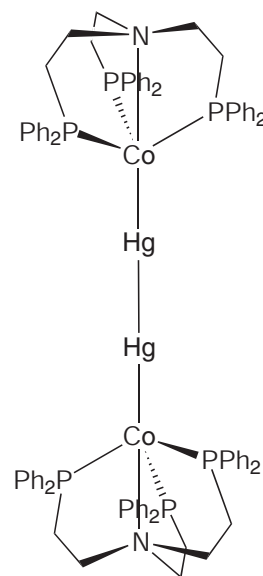

(16)

MeCN, the divalent analog $\text{Co}_2\text{Cl}_4(\text{eHTP})$ undergoes P oxidation (by dioxygen) at each donor atom to produce the corresponding hexaphosphine oxide.¹⁵⁸

A rather unusual Co–Hg–Hg–Co moiety was stabilized by the NP_3 tripod tris(2-diphenylphosphinoethyl)amine (tdppea) in (16).¹⁵⁹ The complex is converted to the monomer $[\text{Co}(\text{tdppea})(\text{CO})]^+$ by reaction with either CO or CO_2 at room temperature and atmospheric pressure. The five-coordinate mixed tri-/dimethylphosphite complex $\text{Co}(\text{P}(\text{O})(\text{OMe})_2)(\text{P}(\text{OMe})_3)_4$ has been reported along with its Rh and Ir analogs.¹⁶⁰ There is a range of other ligands incorporating both P and N donors. One deceptively simple example is 2-(diphenylphosphino)pyridine (dpppy), whose chemistry has been reviewed.¹⁶¹ The dpppy ligand can chelate in both a simple fashion, as in the tetrahedral monomer $[\text{Co}(\text{dpppy})(\text{NO})_2]^+$, and in a bridging mode, as in the dimer (17).¹⁶²

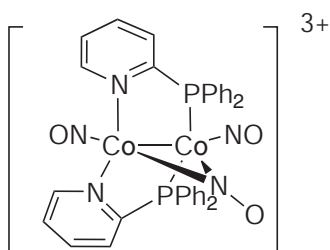

(17)

Diphosphinoamines ($\text{X}_2\text{P}-\text{NR}-\text{PX}_2$) are examples of a more unusual potentially chelating diphosphine. The dimer $\text{Co}_2(\text{F}_2\text{PN}(\text{CH}_3)\text{PF}_2)_3(\text{CO})_2$ has three of these ligands bridging symmetrically between the two tetrahedral Co centers, which also carry a terminal CO group; this molecule can undergo reduction with LiEt_3BH in THF to form a stable mixed valence (d^9-d^{10}) radical anion.¹⁶³

6.1.2.1.5 Arsenic

Low-valent arsenic complexes of Co are few and these bear mostly C ligands such as CO (see Section 6.1.2.1.1 for an example).

6.1.2.1.6 Oxygen

Stable low-valent Co is not often found with simple O-donor ligands such as water, hydroxide, dioxygen, and oxoanions. Carboxylate anions are also not frequently met as ligands in low-valent Co chemistry. One interesting compound, however, is the Co cluster-substituted carboxylic acid $\mu_3\text{-}[(\text{CO})_9\text{Co}_3]\text{CCOOH}$, which can perform its function as a carboxylate ligand; for example, it reacts with $\text{Co}(\text{OAc})_2$ in THF to yield $\text{Co}_2[(\text{CO})_9\text{Co}_3\text{CCOO}]_4(\text{THF})_2$.¹⁶⁴ This class of compound catalyzes the selective hydrogenation of 2-butenal.

6.1.2.1.7 Sulfur

(i) Sulfides

Sulfide-capped triangular Co clusters are a well-known feature in organometallic systems. A number of examples will serve to illustrate this. The simple monomeric phosphine complex $(\text{Ph}_3\text{P})_2\text{CoBr}_2$ reacted with Na_2S yields the symmetric cluster $\text{Co}_6\text{S}_8(\text{PPh}_3)_6$, where the six Co atoms form a distorted octahedral core with each octahedral face bridged by a $\mu^3\text{-S}^{2-}$ atom.¹⁶⁵ Each Co is identically surrounded by four S and one P atom in a distorted square-pyramidal environment. In a quite different approach, reaction of CoCl_2 , 2-aminobenzenethiol (Habt), NaOCH_3 , and $\text{P}(t\text{-Bu})_3$ in the absence of air with following addition of Li_2S yields a cluster of this type, $\text{Co}_3(\mu_3\text{-S})(\text{abt})_3(\text{P}(t\text{-Bu})_3)$.¹⁶⁶ The paramagnetic sulfide-capped cluster $\text{Co}_3(\text{CO})_9(\mu_3\text{-S})$ has been developed as a reagent for the synthesis of $\text{Co}_3(\text{CO})_7(\mu\text{-SR})(\mu_3\text{-S})$ species via reaction with organic compounds possessing S—S or S—H bonds.¹⁶⁷

The heteronuclear cluster $[\text{Mo}_3\text{CoS}_4(\text{H}_2\text{O})_{10}]^{4+}$ has been reported, where the Co is formally zerovalent.¹⁶⁸ The core structure (18) features two edge-linked cubane units with Co—S bridging the two clusters.

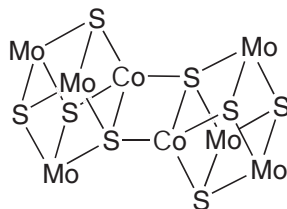

(18)

(ii) Thioethers

Multidentate thioethers are readily introduced into the coordination sphere of low-valent cobalt. As an example, the tridentate thioethers 1,3,5-trithiacyclohexane and tris(methylthio)methane both replace three facially arranged carbonyl ligands in $\text{Co}_3(\text{CO})_9(\mu\text{-CPh})$, leaving the cluster otherwise intact.¹⁶⁹

(iii) Thiolates

In organometallic systems in particular, clusters with bridging alkylthiolates are well known, as exemplified by $\text{Co}_2(\text{Cp})_2(\mu\text{-SCH}_3)_2$, which undergoes reactions with alkyne-cobalt complexes to yield trinuclear clusters.¹⁷⁰

(iv) Thiocarbamates

Dithiocarbamates in stable low-valent Co systems are rare and usually restricted to organometallic systems. An example is the heteronuclear metal cluster $\text{WCo}_2(\mu_3\text{-S})(\mu_3\text{-SCNET}_2)(\text{CO})_4(\text{S}_2\text{CNET}_2)$, characterized by a crystal structure, and formed by reaction of $\text{Co}_2(\text{CO})_8$ with $\text{W}(\text{CO})(\text{PhCCPh})(\text{S}_2\text{CNET}_2)_2$ and subsequent rearrangement in solution following carbonyl loss from an intermediate.¹⁷¹ The three metals are arranged in a triangular array, bicapped by the

sulfido and thiocarboxamido anions. Each Co is also bonded to two terminal carbonyl groups, the remaining ligands binding to the tungsten center.

(v) Thioureas

A rare example of thiourea coordination to low-valent Co is of a disubstituted thiourea as bridging ligand, observed in the cluster $\text{Co}_3(\text{CO})_7(\mu_3\text{-S})(\mu\text{-}\eta^2\text{-PhNC(S)NHCH}_2\text{Ph})$ which is formed by reaction of $\text{Co}_2(\text{CO})_8$ with the thiourea.¹⁷² The crystal structure of the product defines a tetrahedral Co_3S core with all carbonyls in terminal positions and the deprotonated thiourea bridging two Co centers via the S and an amido N.

6.1.2.1.8 Halogens

Compounds containing Co and only halogen ligands are extremely rare in low oxidation states. However, halogen is a common companion ligand in low-valent Co chemistry, particularly to phosphorus (see Section 6.1.2.1.4), where they are often the leaving group in substitution reactions. Of course, the effectiveness of a leaving group is determined by its stability in isolation, so it is no surprise that halides play a similar role across all oxidation states of Co coordination chemistry.

6.1.2.1.9 Hydrogen

(i) Hydrides

Cobalt compounds with hydride as the sole ligand are not usually observed, and hydride compounds, at least in isolable form, include other companion ligands. However, using a time-of-flight atom-probe field ion microscope, the interaction between hydrogen and Co atoms in an external electric field led to the Co hydrides CoH , CoH_2 , and CoH_3 ,¹⁷³ although these species have no extended stability. Recent advances in the chemistry of hydrides in general have been reported in a monograph.¹⁷⁴

The effect of stoichiometry, substituent, and temperature were investigated in reactions between the hydride $\text{HCo}(\text{tdppep})$ (**19**) and a number of alkynes.¹⁷⁵ The σ -acetylide complex (**20**) and the σ -alkenyl (**21**) are formed from the stoichiometric reaction with ethyl propiolate. However, when a ten-fold excess of ethyl propiolate is used, the acetylide complex is formed quantitatively and one equivalent of alkyne is hydrogenated to alkene. Forcing conditions and a large excess of

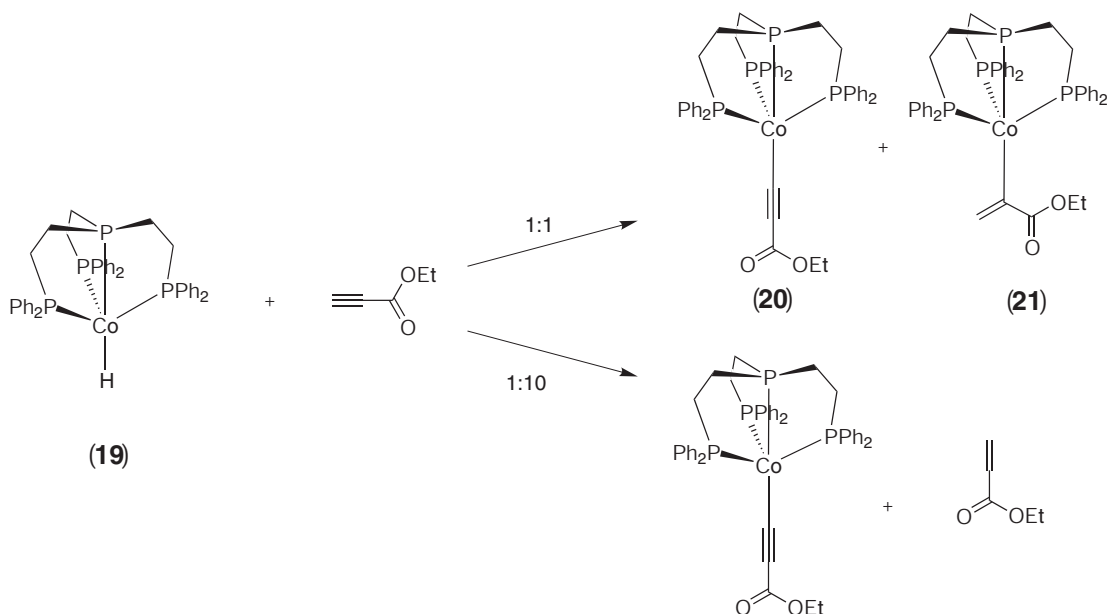

alkyne were required to form the analog (tdppep)Co(C≡CPh). The electrochemical behavior of these Co^I σ -acetylides was also reported.

Unusually short NMR T₁ relaxation values were observed for the metal-bonded H-ligands in HCo(dppe)₂, [Co(H₂)(dppe)]⁺ (dppe = 1,2-bis(diphenylphosphino)ethane), and CoH(CO)(PPh₃)₃.¹⁷⁶ A theoretical analysis incorporating proton-metal dipole-dipole interactions was able to reproduce these T₁ values if an r_{Co-H} distance of 1.5 Å was present, a value consistent with X-ray crystallographic experiments. A detailed structural and thermodynamic study of the complexes [H₂Co(dppe)₂]⁺, HCo(dppe)₂, [HCo(dppe)₂(MeCN)]⁺, and [Co(dppe)₂(MeCN)]²⁺ has been reported.¹⁷⁷ Equilibrium and electrochemical measurements enabled a thorough thermodynamic description of the system. Disproportionation of divalent [HCo(dppe)₂]⁺ to [Co(dppe)₂]⁺ and [H₂Co(dppe)₂]⁺ was examined as well as the reaction of [Co(dppe)₂]⁺ with H₂.

The electrochemical behavior of monovalent phosphite ester Co hydrides of the type HCo(PR₃)₄ (PR₃ = P(OEt)₃, PPh(OEt)₂, PPh₂(OEt)) in CH₂Cl₂ and MeCN was examined.¹⁷⁸ Cyclic voltammetry in CH₂Cl₂ identified a reversible single electron oxidation to [HCo(PR₃)₄]⁺, followed by a second irreversible oxidation, for all the ligands employed. In MeCN, the behavior was similar, but stability of the compounds in this solvent was diminished. Bulk electrolysis gave a new Co^{II} hydride, [HCo(P(OEt)₃)₄]BPh₄.

The monovalent hydride HCo(PPh(OEt)₂)₄ is a versatile synthon and catalyst. Photoirradiation of HCo(PPh(OEt)₂)₄ generates the coordinatively unsaturated complex HCo(PPh(OEt)₂)₃ which catalyzes H transfer from secondary alcohols to carbonyl compounds.¹⁷⁹ Intermediate coordination of the carbonyl compound to HCo(PPh(OEt)₂)₃ was proposed. The rate-determining step involves hydride transfer to the carbonyl carbon at the stage of transformation of the hydrido aldehyde/ketone complex into its alkoxo derivative. A kinetic analysis showed that aldehydes reacted considerably faster than ketones, attributable to steric repulsion hindering approach by the Co complex to the carbonyl group. Reaction of HCo(PPh(OEt)₂)₄ with *p*-MeC₆H₄N₂⁺ affords the paramagnetic [HCo(PPh(OEt)₂)₄]⁺. When reacted with NO⁺, the dinitroso complex [Co(NO)₂(PPh(OEt)₂)₂]⁺ is formed and protonation with HBF₄·Et₂O to give the dihydrogen complex [Co(H₂)(PPh(OEt)₂)₄]⁺ occurs.¹⁸⁰ Reaction of the monovalent HCo(tdpepa) (hydrido monomer of (16)) with CS₂, SCNPh, or OCNPh affords the corresponding η^2 -bonded sulfide, isothiocyanate, or isocyanate.¹⁸¹

HCo(N₂)(PPh₃)₃ has been shown to promote C—O bond cleavage selectively in allylic and vinylic trimethylsilyl ethers, resulting in Co(OSiMe₃)(PPh₃)₃ and free olefin at room temperature.¹⁸² The mechanism of C—O bond cleavage involves insertion of the olefinic double bond into the Co—H bond, followed by β elimination of the Me₃SiO group from the transition metal complex. The same group reported that C—O bonds in aryl and alkyl carboxylates (R'CO₂R) are selectively cleaved by the same complex.¹⁸³ The reaction products are accounted for by assuming insertion of the ester C=O bond into the Co—H bond, followed by abstraction of the β alkoxo group by Co. Other derivatives prepared include Co(OCH(CF₃)OEt)(PPh₃)₃ (from trifluoroacetic acid) and Co(OPh)(PPh₃)₃ from (phenyl acetate). Borohydride is well known to form non-classical η^2 -bonded complexes through a pair of bridging H atoms. The diamagnetic monovalent Co(terpy)(H₂BH₂) undergoes rapid exchange between its terminal and bridging H atoms, as shown by NMR.¹⁸⁴

(ii) Dihydrogen

Dihydrogen is an effective and usually η^2 -bonded ligand, as exemplified here. The remarkably stable η^2 -H₂ complex [Co(tdppep)(H₂)]PF₆ (**22**) was prepared via three routes: protonation of the hydride HCo(tdppep) by a strong acid; displacement of N₂ by H₂ in [(Co(tdppep)(N₂))]PF₆; or H₂ addition to the 16-electron fragment [Co(tdppep)]⁺.¹⁸⁵ X-ray crystallography identified a trigonal-bipyramidal geometry with the H₂ ligand presumably *trans* to the bridgehead P donor, although the actual position of the H₂ ligand was not resolved. The complex catalytically isomerizes dimethyl maleate to dimethyl fumarate. However, an unusual counter-ion dependence was seen for the reaction with H₂ and two salts of the dinitrogen complex (**10**) in the solid state.¹⁸⁶ With BPh₄⁻ as the counter ion, the classical dihydro distorted octahedral complex [(tdppep)Co(H)₂]⁺BPh₄ (**23**) results (characterized by its X-ray crystal structure), rather than the non-classical [(tdppep)Co(η^2 -H₂)]PF₆ (**22**).¹⁸⁵ Both reactions are reversible upon treatment with N₂. In solution the complexes are indistinguishable and consistent with a η^2 -bonded H₂ ligand.

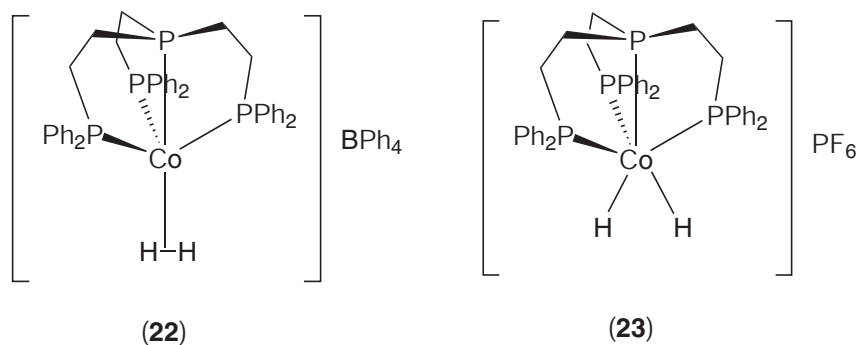

6.1.2.2 Co^{II}

Cobalt(II) is a key oxidation state, and the range of compounds extant is truly vast. Four-coordinate tetrahedral and six-coordinate octahedral complexes, in particular, abound, with five-coordinate trigonal bipyramidal complexes also common. However, three- to eight-coordinate compounds have been reported, with examples at the extrema sparse, and their formation is usually particularly dependent on ligand topology. Traditionally, the complexes of this d^7 paramagnetic ion are considered to be labile and ligand exchange facile.

6.1.2.2.1 Carbon

(i) Cyanides

Cyanide complexes have a venerable history (see *CCC*(1987)),¹ and find utilization in many industrial processes including as synthetic catalysts e.g., Co cyanides on inorganic supports catalyze alkylene oxide polymerization,¹⁸⁷ molecular magnetic materials, in electroplating, and in mining. Their pharmacology and toxicology is well explored

(f) *Mononuclear*. Given the long history of cyanide complexes, it is not intended to cover simple complexes to any marked extent. One interesting example is the characterization of the well-known anion $[\text{Co}(\text{CN})_5]^{3-}$ formed inside Zeolite Y by treatment of the Co zeolite first with CsCl and then with methanolic NaCN.¹⁸⁸ This encapsulated complex has been shown to reversibly bind dioxygen in the zeolite lattice with high selectivity, whereas the usual reaction is irreversible formation of a dioxygen-bridged dimer. The simple aquapentacyanocobaltate(II) ion is an efficient catalyst for photolytic hydrogen evolution.¹⁸⁹ In aprotic solutions, a synthetic, spectroscopic and X-ray structural study has identified the existence of species with from one to five cyanide ions coordinated to cobalt.¹⁹⁰ The $\text{Li}_3[\text{Co}(\text{CN})_2] \cdot 3\text{DMF}$ species was isolated and structurally defined, and a salt of $[\text{Co}(\text{CN})_4]^{2-}$ was also isolated.

(g) *Oligonuclear and polymeric*. The Co-Co linked dimer $[\text{Co}_2(\text{CN})_{10}]^{6-}$, which is readily prepared in liquid ammonia as solvent, reacts with water to yield a number of products identified by ⁵⁹Co NMR, including $[\text{HCo}(\text{CN})_5]^{3-}$.¹⁹¹ Monomeric species such as $\text{Li}_3[\text{Co}(\text{CN})_5] \cdot 3\text{DMF}$ can form and may be isolated from aprotic solvents. Cyanide features as a bridging ligand as well as a terminal monodentate in polymetallic species. A recent example of a mixed-metal Co^{II}/Mn^{II} dimer arises from reaction of *trans*-Mn(CN)(CO)(dppm)₂ (dppm = bis(diphenylphosphino)methane) with CoCl₂ in THF, which leads to the μ -cyano complex $\text{Cl}_2(\text{THF})\text{Co}^{\text{II}}(\mu\text{-NC})\text{Mn}^{\text{II}}(\text{CO})(\text{dppm})_2$, defined by a crystal structure which shows the Co^{II} center is pseudo-tetrahedral.¹⁹²

(ii) Carbonyls

Cobalt(II) carbonyls are rarely met, except as transient redox products from stable lower-valent precursors.

(iii) Carbon dioxide

Carbon dioxide is activated by metal complexes, including Co^{II} , to undergo a range of reactions: oxidative coupling with unsaturated substrates; insertion into $\text{M}-\text{X}$ bonds; and insertion into $\text{M}-\text{M}'$ bonds. The $\text{Co}(\text{dmg})_2(\text{H}_2\text{O})_2$ complex reacts with CO_2 to form $\text{Co}(\text{dmg})_2(\text{H}_2\text{O})(\text{CO}_2\text{H})$ bearing a $\text{Co}-\text{C}$ bond.¹⁹³ Insertion of CO_2 into the core of the substituted Tp di(μ -hydroxo)dicobalt(II) complex (**24**) leads to the bridged carbonato complex (**25**).¹⁹⁴ Electrochemical reduction of CO_2 is activated by $\text{Co}^{\text{II}}(\text{cyclam})$ and analogs, promoting the two-electron reduction in aqueous acid to form CO and H_2O .¹⁹⁵ Coordination of CO_2 to the reduced complex as intermediate is implicated.

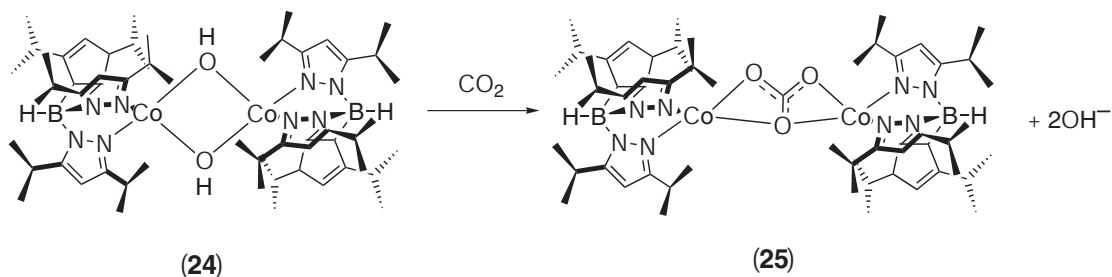

(iv) Alkyls and aryls

No attempt to cover the coordination chemistry of unsaturated cyclic anions such as cyclopentadienyl is made here, due to their coverage in the companion series on *Comprehensive Organometallic Chemistry*. The only example to be mentioned here, because it is the first example of a high-spin Co^{II} organometallic complex, is $\text{Co}(\text{Cp})(\text{Tp})$.¹⁹⁶

Simple alkyl and aryl σ -bonded complexes are conveniently prepared by reaction of an alkylating reagent with a halocobalt(II) precursor. All-alkyl systems are rare, but the pentamethylcobaltate(II) anion is known.¹⁹⁷ More typically, the coordination sphere of the metal contains additional co-ligands, particularly with P, S, or N donors. Some examples that reflect the style of reactions extant appear below.

Reaction of $\text{Li}(2-\text{((Me}_3\text{Si)}_2\text{C)pyridine})$ with CoCl_2 in ether yields the thermally stable bis cobalt(II) dialkyl complex, which is planar with *trans*-disposed C,N-chelates.¹⁹⁸ The strained four-membered rings are reflected in a $\text{C}-\text{Co}-\text{N}$ angle of $69.6(2)^\circ$, while $\text{Co}-\text{C}$ and $\text{Co}-\text{N}$ distances are $2.094(6)\text{ \AA}$ and $1.919(4)\text{ \AA}$ respectively. Earlier, related chemistry produced the tetrahedral ion with only $\text{Co}-\text{C}$ bonds, $[\text{Co}(\text{CH}(\text{SiMe}_3)_2)_4]^{2-}$, and an ion $[\text{CoCl}(\text{CH}(\text{SiMe}_3)_2)_2]^-$, with two $\text{Co}-\text{C}$ bonds and a rare trigonal planar geometry.¹⁹⁹

Examples with S- and P-donor companion ligands abound. The thioether-containing complex $\text{Ph}(\text{ttb})\text{CoCl}$ ($\text{ttb} = \text{tris}((\text{tert-butylthio})\text{methyl})\text{borate}$) can be reacted with either Me_2Mg or MeLi in THF to yield the alkylcobalt(II) compound $\text{Ph}(\text{ttb})\text{CoMe}$ in high yield.²⁰⁰ The high-spin divalent tetrahedral complexes $\text{Co}(\text{pnp})\text{X}$ ($\text{pnp} = ^-\text{N}(\text{SiMe}_2\text{CH}_2\text{PPh}_2)_2$; $\text{X} = \text{Cl}, \text{Br}$) are conveniently prepared from CoX_2 and $\text{Li}(\text{pnp})$,²⁰¹ and subsequently react with alkylating reagents to form low-spin square-planar $\text{Co}(\text{pnp})\text{R}$ ($\text{R} = \text{alkyl}$) compounds. Treatment of CoCl_2 with organolithium precursor compounds yields low-spin Co^{II} dialkyls which include (**26**).²⁰²

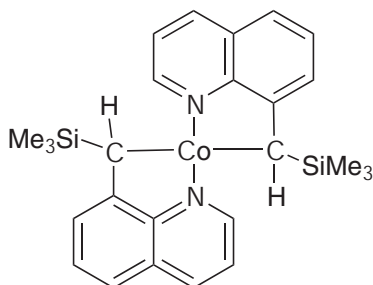

(26)

Bis(aryl)cobalt(II) compounds have been prepared by reaction of $R'MgX$ (where $R' = C_6H_{6-n}Cl_n$; $n = 2-4$) with $Co(PR_3)_2Cl_2$.²⁰³ They undergo both thermally and oxidatively induced decomposition, with the corresponding biphenyl a product. The reactions of alkyl-cobalt complexes have been reviewed recently, and include thermolysis, photolysis, oxidation, and reduction reactions.²⁵ Homolysis of the Co—C bond is a feature of reactions.

6.1.2.2.2 Nitrogen

All known types of N-donor ligands are found in complexes with divalent Co, so our treatment of this topic will be selective in an endeavor to provide an overview of this vast area. There is a crossover in stability of divalent Co complexes going from hard amine donors (almost all being oxygen sensitive) to the highly unsaturated polyimines, which are rather difficult to oxidize. Divalent Co forms a variety of N-donor complexes of all electronic ground states (high and low spin) depending on the ligand field strength and symmetry.

(i) Amines

(h) *Monodentate*. The simplest classical amine complex is the hexaammine. The $[Co(NH_3)_6]^{3+/2+}$ redox potential is -0.04 V (vs NHE) making the $[Co(NH_3)_6]^{2+}$ ion air sensitive as well as substitution labile. Nevertheless, the divalent hexaammine complex has been thoroughly characterized. The X-ray crystal structure of $[Co(NH_3)_6]Cl_2$ has been reported at both 294 K and 128 K, revealing six crystallographically identical Co—N bonds of 2.170(2) Å in the room-temperature structure and no phase change at lower temperature.²⁰⁴ By contrast, differential scanning calorimetric study of $[Co(NH_3)_6](ClO_4)_2$ and $[Co(NH_3)_6](BF_4)_2$ found that these complexes were polymorphic between 100 K and 300 K.²⁰⁵ In solution, the changes in Co—N bond length upon reduction from Co^{III} to Co^{II} have been studied with EXAFS. The bond length changes report on the inner sphere reorganizational energy of the complex, and this allowed the calculation of outer sphere electron transfer cross reaction rates using semi-classical theory that were in excellent agreement with experiment.²⁰⁶

(i) *Multidentate*. The ethane-1,2-diamine (en) complex of Co^{II} represents this category of ligands well. Crystal structures of the air-sensitive $[Co(en)_3]^{2+}$ with simple anions have been known for some time. A hydrothermal reaction of $CoBr_2$ with $Na_3Sb_4S_8$ and en led to the isolation of $[Co(en)_3]CoSb_4S_8$ comprising $[Co(en)_3]^{2+}$ cations and infinite $[CoSb_4S_8]^{2-}$ layers which form a novel open framework structure.²⁰⁷ Low-dimensional structures of the type $[Co(en)_3]Sb_2S_4$ and $[Co(en)_3]Sb_4S_7$ have also been reported.²⁰⁸

Although somewhat more stable than its hexaammine relative, the air-sensitive $[Co(en)_3]^{2+}$ is still substitutionally labile and racemizes rapidly in solution. Chiral discrimination in its (racemic) solutions has been observed in outer sphere electron transfer reactions with optically active oxidants including $[Co^{III}(EDTA)]^-$,^{209,210} $[Cr(ox)_3]^{3-}$,^{211,212} Co^{III} oxalate, malonate, and acetylacetonate (acac) complexes.²¹³

(j) *Macrocyclic*. Like most divalent amines of Co, the bis macrocyclic $[Co(tacn)_2]^{2+}$ (tacn = 1,4,7-triazacyclononane) complex (27) is a high-spin, air-sensitive complex. Its crystal structure and spectroscopy have been reported.²¹⁴ When fewer than six N-donors are present, divalent Co complexes become more stable. Electrochemical oxidation of the putative five-coordinate complex (28) $[(H_2O)Co(teta)]^{2+}$ (teta = *meso*-5,5,7,12,12,14-hexamethyl-1,4,8,11-

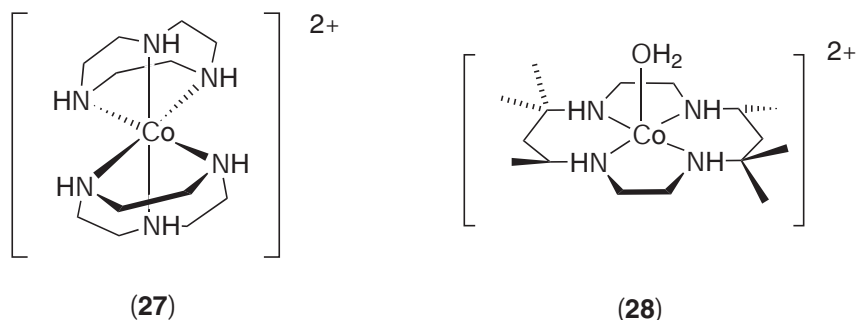

tetraazacyclotetradecane) has been studied, and the effect of ligands *trans* to the aqua ligand upon oxidation of the complex was examined.²¹⁵ The *trans*-Co(teta) (OSO₂CF₃)₂ complex has been structurally characterized, providing a rare example of triflate coordinated to divalent Co.²¹⁶

In methanolic MeCN, the resulting photoreduced Co^{II} complex of the unsubstituted (cyclam) analog of (28) mediates electron transfer in the reduction of CO₂ to CO and formate with *p*-terphenyl as the photocatalyst and tertiary amines as sacrificial electron donors.²¹⁷ Similarly, photoreduction of CO₂ to formate can be achieved by the same complex using phenazine as the photosensitizer, the Co complex as electron mediator, and Et₃N as an electron donor.¹²² The multi-step photoreduction of O₂ to H₂O₂ is achieved with [Co(cyclam)(OH₂)₂]²⁺ (and various C-methylated analogs) generated *in situ* by oxidative quenching of photoexcited [Ru(bpy)₃]²⁺.²¹⁸

The remarkable physical properties exhibited by the divalent macrobicyclic cage complex [Co(sep)]²⁺ (29) are unparalleled in Co chemistry.²¹⁹ The complex, characterized structurally, is inert to ligand substitution in its optically pure form and resists racemization in stark contrast to its [Co(en)₃]²⁺ parent. The encapsulating nature of the sep ligand ensures outer sphere electron transfer in all redox reactions. For example, unlike most divalent Co amines, the aerial oxidation of (29) does not involve a peroxo-bound intermediate.

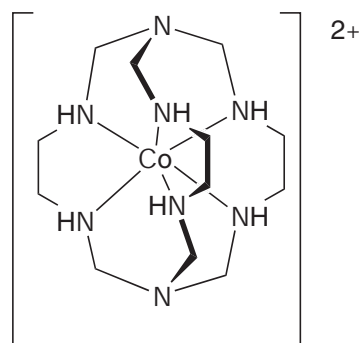

(29)

Larger cavity cages have been reported by reaction of [Co(tame)₂]³⁺ (30) (tame = 1,1,1-tris(aminomethyl)ethane) with paraformaldehyde and isobutyraldehyde leading to the expanded octamethylated cage (31), with distinctly different properties to any other hexaamine.²²⁰ Foremost, the Co^{III/II} redox potential of (31) is more than 1 V positive of the couple found in the smaller cavity cage (29). In fact, (31) is resistant to oxidation by O₂ and H₂O₂; a unique feature in Co hexaamine chemistry. N-Based diastereomers were crystallized and characterized structurally. Controlled potential electrolysis of these isomers led to the observation of two distinctly different Co^{III} complexes; one yellow and the other a most unusual blue in color.

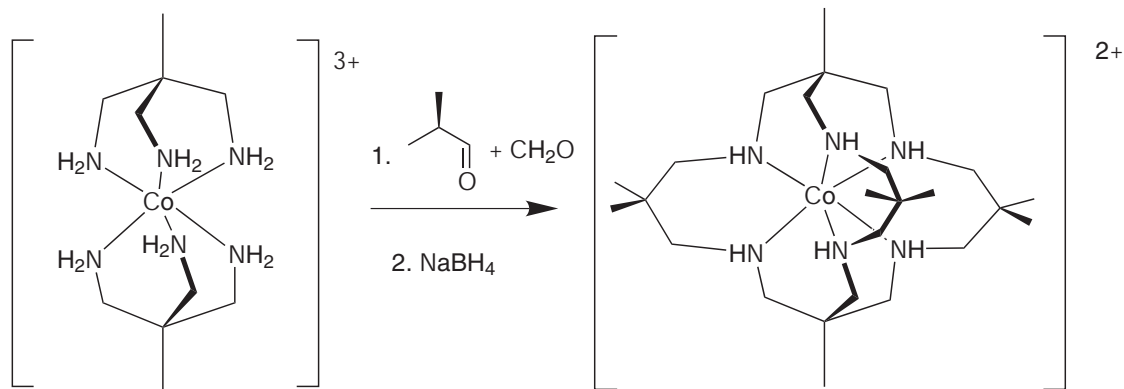

(30)

(31)

Smaller macrobicycles and macrotricycles bearing less than six N-donors are also known. These ligands comprise tertiary or secondary amines and are derived from insertion of one or more straps between pairs of potentially bridgehead N-donors contained within a small ring macrocycle, and in this sense they may be considered analogs of the well-known azacryptands. The inability to offer six N-donors, and the presence of tertiary amines in these ligands leads to the preference for divalent over trivalent Co.

The small bowl-shaped tetraamine 3⁵-adamanzane (1,5,9,13-tetraazabicyclo[7.7.3]nonadecane) comprises the 16-membered macrocyclic tetraamine ([16]aneN₄) with one pair of diagonally opposite N atoms linked by a trimethylene bridge. The crystal structure of its Co^{II} complex (**32**) reveals a distorted tetrahedral CoN₄ array, with the metal ion slightly too large to be bound symmetrically within the confines of the small cavity (Figure 3).²²¹ Solution behavior is more complicated. The tetrahedral complex exhibits limited stability in aqueous solution, although its electronic spectrum is essentially the same as its pseudotetrahedral [16]aneN₄ parent, with five- and six-coordinate Co^{II} complexes being formed in the presence of coordinating anions (Cl⁻) and solvents. Kinetic analysis showed that Cl⁻ ions accelerate extrusion of the Co²⁺ ion from the small cage.

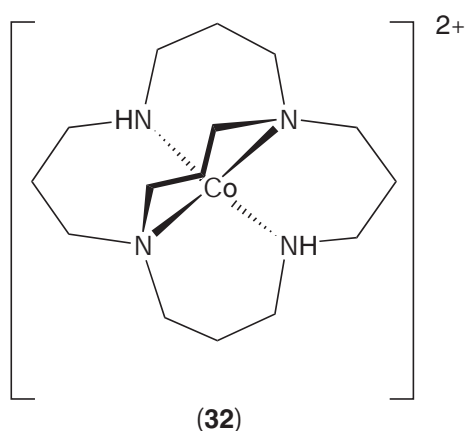

(ii) Pyridine and oligopyridines

(k) *Monodentate*. Pyridine complexes of Co^{II} may take several forms depending on the method of preparation. Blue tetrahedral [Co(py)₄]²⁺ is well known in addition to the polymeric halide-bridged six-coordinate {Co(py)₂X₂}_n species in the solid state. Investigations of the solution equilibria between these four- and six-coordinate species are well documented. The tetrahedral [Co(py)₄]²⁺ ion has been shown to catalyze the aromatization of 1,4-dihydropyridine²²² and also

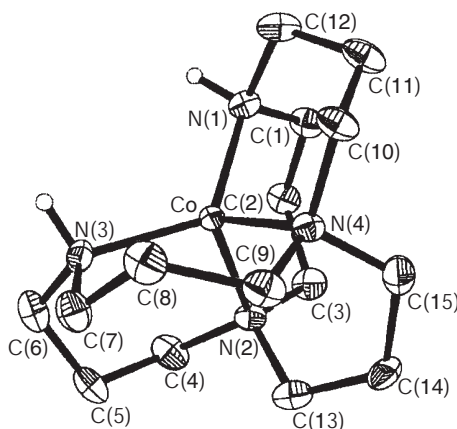
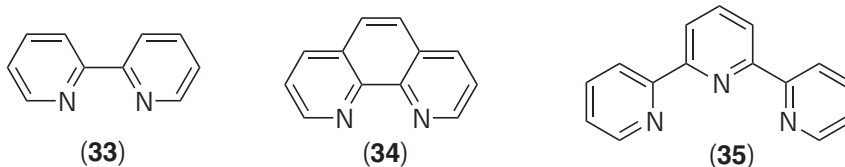

Figure 3 View of complex (**32**) with alkyl H-atoms omitted (reproduced with permission of the American Chemical Society from *Inorg. Chem.*, **2001**, 40, 2323–2334).

1,3-dipolar cycloadditions.²²³ More recently, the crystal structure of a novel square planar form $[\text{Co}(\text{py})_4]\text{Cl}(\text{PF}_6)$ has been reported.²²⁴ The formation and low-energy collision-induced dissociation of $[\text{Co}(\text{py})_6]^{2+}$ and derivative complexes has been investigated by electrospray ionization mass spectrometry.²²⁵

Halopyridinecobalt(II) complexes have been explored in detail, and exhibit either distorted octahedral or tetrahedral geometries, depending on ligands involved. The preparation and characterization of dihalotetrakis(3,5-dimethylpyridine)cobalt(II) complexes with chloro, bromo and iodo ligands have been reported.²²⁶ The crystal structure of the elongated octahedral chloro complex defines the chloride ions in a *trans* disposition with $\text{Co}-\text{Cl}$ distance of 2.455(2) Å, with $\text{Co}-\text{Br}$ and $\text{Co}-\text{I}$ being 2.63 Å and 2.88 Å respectively. The difluoro analog has also been characterized separately, with an equivalent structure and $\text{Co}-\text{F}$ distance of 2.016(3) Å.²²⁷ IR spectroscopy shows clear differences between the coordinated chloride complex and a pyridinium tetrachlorocobaltate(II) species. In a related study, halocobalt(II) complexes of 2-, 3- and 4-methylpyridine have been examined,^{228,229} and molecular mechanics studies supplemented crystal structural studies. A correlation between solid-state structure and thermal properties was defined. In the dibromobis(2-bromopyridine) cobalt(II) complex,²³⁰ a slightly distorted tetrahedral geometry was defined by a crystal structure analysis. A series of four- or six-coordinate 2-, 3- and 4-methylpyridine compounds of formula CoL_2X_2 or CoL_4X_2 ($\text{X} = \text{Br}, \text{I}$) have been prepared and their thermal stability examined.²³¹ Dibromobis(2,4-dimethylpyridine)cobalt(II) and bromotetrakis(2,4-dimethylpyridine)cobalt(II) have been prepared and characterized by X-ray crystal structures.²³² The former exhibits tetrahedral geometry and the latter the more rarely observed five-coordinate square pyramidal geometry. Thermal decomposition occurs with release of pyridines from the former in one step at 335 °C, whereas three successive steps releasing one (at 130 °C), one (at 193 °C), and two (at 360 °C) pyridines are observed for the latter. Thermal decomposition of a large series of $\text{Co}(\text{Rpy})_2\text{X}_2$ ($\text{Rpy} = \text{substituted pyridine}, \text{X} = \text{Cl}, \text{Br}$) has been probed by thermogravimetric analysis,²³³ with pyridine loss a primary process prior to halide loss. The temperature and pressure effects on the equilibrium between octahedral $\text{Co}(\text{Mepy})_4\text{X}_2$ and tetrahedral $\text{Co}(\text{Mepy})_2\text{X}_2$ ($\text{Mepy} = 3\text{-methylpyridine}; \text{X} = \text{Cl}, \text{Br}$) has been probed.²³⁴ Higher pressure favors the octahedral species, whereas higher temperature favors the tetrahedral species.

(1) *Multidentate*. Complexes of the bidentate bpy (33) and phen (34) ligands share many common features. The $[\text{Co}(\text{bpy})_3]^{2+}$ and $[\text{Co}(\text{phen})_3]^{2+}$ ions typically possess high-spin ($S = 2$) electronic ground states, but they are close to the high/low-spin crossover, in contrast to their (exclusively) high-spin hexamine relatives. The crystal structures of $[\text{Co}(\text{phen})_3]^{2+}$ with a number of simple and more complex anions have been reported, including perchlorate²³⁵, antimony tartrate,²³⁶ benzene-1,2-dioxyacetate²³⁷ and octa- and nonanedioate.²³⁷ The latter two dicarboxylate salts inhibit the growth of *Candida albicans*.



An interesting study of the $[\text{Co}(\text{bpy})_3][\text{MCr}(\text{ox})_3]$ system ($\text{ox} = \text{oxalato dianion}$) found that when $\text{M} = \text{Na}^+$ the Co^{II} complex is high spin, but when $\text{M} = \text{Li}^+$, the compound assumes a low-spin electronic ground state due to contraction of the counter ion network surrounding the bpy complex.²³⁸ Optical spectroscopy and magnetic susceptibility studies reveal that $[\text{Co}(\text{bpy})_3][\text{LiCr}(\text{ox})_3]$ exhibits temperature-dependent spin-crossover behavior. A related system, $[\text{Co}(\text{bpy})_3][\text{MCr}(\text{ox})_3](\text{ClO}_4)$, where M is a divalent transition metal ion, has been investigated. The separate cationic and anionic tris-chelate complexes within this network are necessarily homochiral.²³⁹

Encapsulation of $[\text{Co}(\text{bpy})_3]^{2+}$ within zeolite frameworks has also been shown to have a remarkable influence on the electronic spin state of the complex.²⁴⁰ Distortions imparted on the tris-chelate complex by the confines of the zeolite “supercage” are found to be responsible for stabilizing the unusual low-spin electronic ground state.^{241,242} The $[\text{Co}(\text{bpy})_3]^{3+/2+}$ couple has been measured for the encapsulated complex and it has been found that the complexes remain within the zeolite and do not exchange with the bulk solution.²⁴³ Electrochemistry of $[\text{Co}(\text{bpy})_3]^{3+/2+}$ immobilized within a sol-gel has also been studied.²⁴⁴

The structural and magnetic properties of divalent Co complexes of the tridentate terpy (**35**) are distinctly different. The high-spin/low-spin equilibrium of $[\text{Co}(\text{terpy})_2]^{2+}$ has attracted considerable attention and a marked anion dependence has been identified. In the solid state, $[\text{Co}(\text{terpy})_2]\text{I}_2$ exhibits a temperature-dependent magnetic moment coupled with temperature-dependent Co—N bond lengths.²⁴⁵ At 295 K, the intermediate magnetic moment (μ_{eff} 3.2 B.M.) and Co—N_{central,distal} bond lengths (1.942(7) Å and 2.104(5) Å) are consistent with a high/low-spin equilibrium in the solid state. On cooling to 120 K, the bond lengths (1.912(5), 2.083(4) Å) and magnetic moment (μ_{eff} 2.2 B.M.) reflect an exclusively low-spin electronic ground state. By contrast, $[\text{Co}(\text{terpy})_2](\text{ClO}_4)_2$ exhibits a much higher room-temperature solid state magnetic moment (4.2 B.M.) and longer Co—N_{central,distal} bond lengths (2.03 Å and 2.14 Å).²⁴⁶ In the nitrate salt the Co—N bond lengths are longer again.²⁴⁷ Solid state optical and EPR spectroscopy have also been used to study the temperature and anion dependence of this spin equilibrium.²⁴⁸ The structurally imposed Co—N_{central} bond compression of the terpy ligand directs the Jahn–Teller enforced tetragonal elongation along one of the N_{distal}—Co—N_{distal} axes of the complex to remove the orbital degeneracy of the 2E (O_h) electronic ground state.

In solution, $[\text{Co}(\text{terpy})_2]^{2+}$ is also in a high-spin/low-spin equilibrium. Ultrasonic absorption measurements determined the spin equilibrium relaxation time in both water and MeOH solution to be less than 2 ns.²⁴⁹ Electron-donating functional groups such as methoxyl appended to the terpy ring result in a shift towards the high-spin form of the complex,²⁵⁰ as does replacement of one pyridyl ring with a pyrazole.²⁵¹

Further extension of the terpy structure generates a novel class of oligopyridines that typically behave quite differently from the mono-, bi-, and terpyridyl analogs. Steric repulsion between the two distal pyridyl rings disfavors planarity of oligopyridines larger than terpy, and enforces a helical conformation. Mononuclear and dinuclear Co^{II} complexes of quaterpyridine (**36**), and its substituted derivatives,^{252,253} and quinquepyridine^{222,254} (**37**) have been reported where the distinctly non-planar helically disposed ligand occupies the equatorial coordination sites of the six- or seven-coordinate ion. In solution the Co^{II} 4',4'''-di-(*p*-chlorophenyl)quinquepyridine complex is typically mononuclear but can be crystallized as either a 1:1 (Figure 4) or 2:2 (helical) complex.^{255,256} Double helical, homometallic, oligonuclear complexes of Co^{II} predominate when at least six donor atoms can be provided by the ligand i.e., sexipyridine (**38**) and higher oligomers. In these cases, pairs of tridentate (terpy-like) chelates are forced to bind separate Co^{II} centers. The introduction of a second bridging bis-tridentate oligopyridine completes the six-coordinate geometry of the two Co^{II} centers. For example, (**38**) forms a double helical 2:2 ($[\text{Co}_2\text{L}_2]^{4+}$) complex with each ligand binding in a bridging bis-tridentate manner.²⁵⁷ A substituted derivative of septipyridine forms a double helical 2:2 complex comprising two $[\text{Co}(\text{terpy})_2]^{2+}$ moieties with each strand containing a single non-coordinated pyridyl ring; one central and the other terminal (Figure 4).²⁵⁸ The nonadentate novipyridine forms a trinuclear double helicate $[\text{Co}_3\text{L}_2](\text{PF}_6)_6$ as shown by mass spectrometry and elemental analysis.²⁵⁹

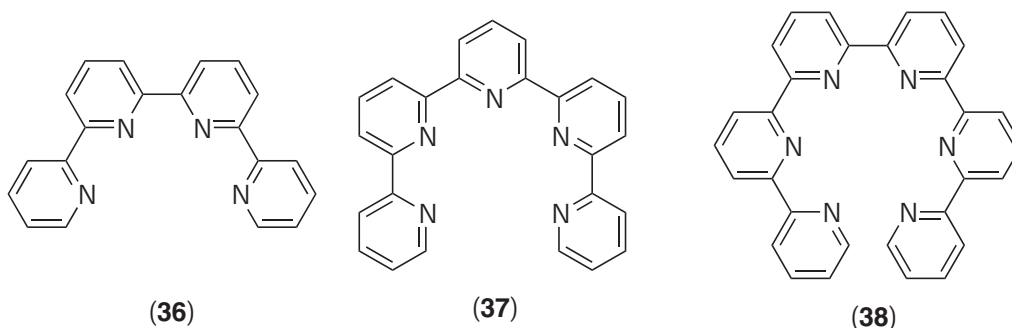

The linear bis-bidentate ligand bis(pyridylpyrazolyl)borate (**39**) ligand reacts with $\text{Co}(\text{OAc})_2$ in MeOH to yield a discrete cyclic nanostructure $[\text{Co}_8\text{L}_{12}(\text{PF}_6)]^{3+}$.²⁶⁰ This complex was characterized intact by ESMS, with the anion apparently trapped in the central cavity, a concept supported by the crystal structure of the perchlorate analog (Figure 5). Other oligopyridine ligands complexed with divalent Co include the tripodal tris(2-pyridylmethyl) amine (**40**),²⁶¹ and the novel dinucleating bis(2-pyridylmethyl)amine dimer (**41**).²⁶²

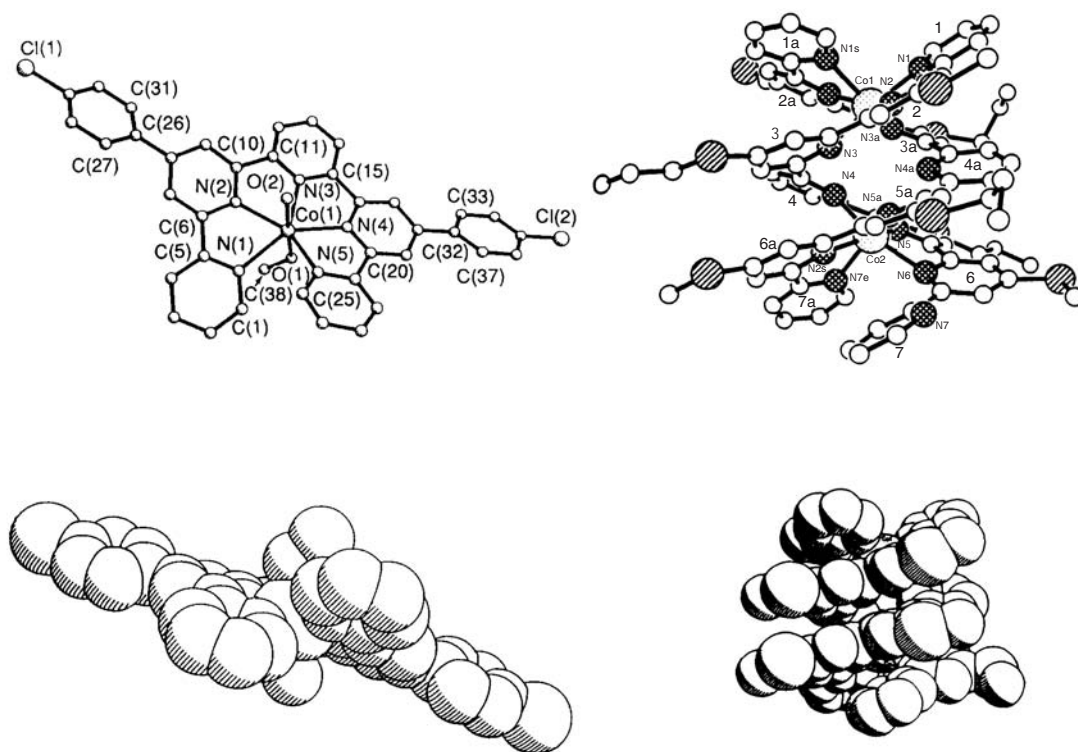

Figure 4 Mononuclear quinquepyridine ($4',4'''$ -bis(4-chlorophenyl analogue) Co^{II} complex (left, reproduced with permission of the Royal Society of Chemistry from *J. Chem. Soc., Chem. Commun.*, **1992**, 768–771) and dinuclear septipyridine ($4',4''''$ -bis(4-mercaptomethylphenyl)- $4''''',4''''''$ -bis(4-mercaptopropylphenyl) derivative) dicobalt(II) complex (right, reproduced with permission of the American Chemical Society from *Inorg. Chem.*, **1993**, 32, 5477–5484). Space filling representations also shown.

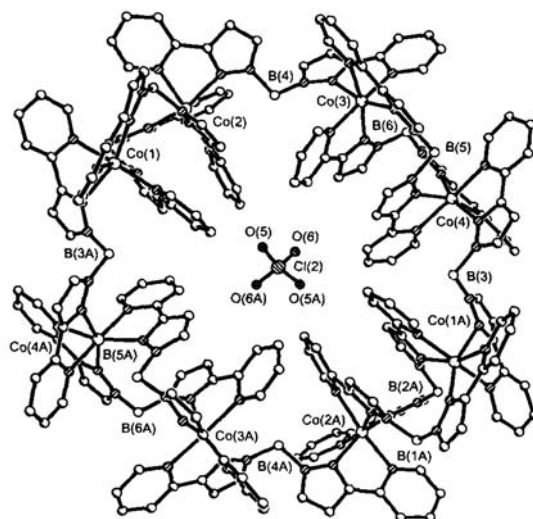
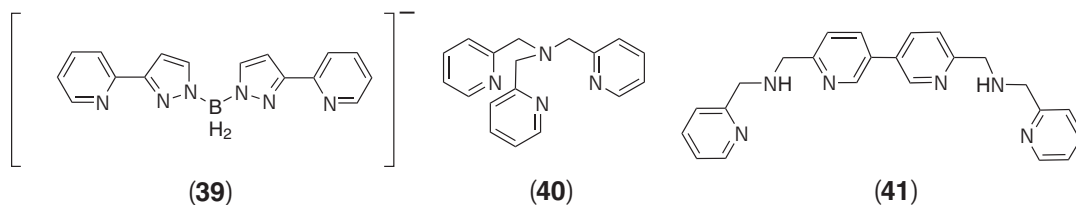

Figure 5 Cyclic octacobalt(II) complex of (39) with encapsulated ClO_4^- ion. H-atoms omitted (reproduced with permission from the Royal Society of Chemistry from *J. Chem. Soc., Chem. Commun.*, **1997**, 1361–1362).



(iii) Porphyrins

Cobalt complexes of these compounds and their properties have been widely studied for some time. Substituted porphyrin complexes of divalent Co catalyze a wide variety of useful inorganic and organic transformations. The catalytic four-electron reduction of dioxygen to water in aqueous solution close to its thermodynamic potential is of great importance to fuel cell and battery technology. However, the two-electron reduction of O_2 to H_2O_2 is a more common and much less useful side reaction. Anson, Collman, and co-workers have published a series of papers using bridged dicobalt “face-to-face” porphyrins, some of which are efficient catalysts of the four-electron reduction of O_2 to H_2O .^{263,264} Participation of both Co ions in O_2 binding (in a sandwich configuration) and in inner sphere electron transfer was implicated. Later, a superoxo-bridged dicobalt co-facial porphyrin complex, an intermediate in the four-electron reduction, was isolated and characterized.²⁶⁵

Anson and co-workers have shown that two Co ions were not necessary for four-electron O_2 reduction.²⁶⁶ The *meso*-substituted complex porphyrin Co(TPyP) (**42**) complex bears four active pyridyl donors which readily react with four equivalents of $[Ru(NH_3)_5(OH_2)]^{2+}$ to produce the tetra-ruthenated derivative. The four Ru centers are sufficiently remote that their $Ru^{III/II}$ potentials coincide. Under steady state conditions $[Co(TPyP)]\{Ru(NH_3)_5\}_4^{8+}$ (**43**) adsorbed onto a pyrolytic graphite working electrode catalyzes the reduction of dioxygen (Figure 6).

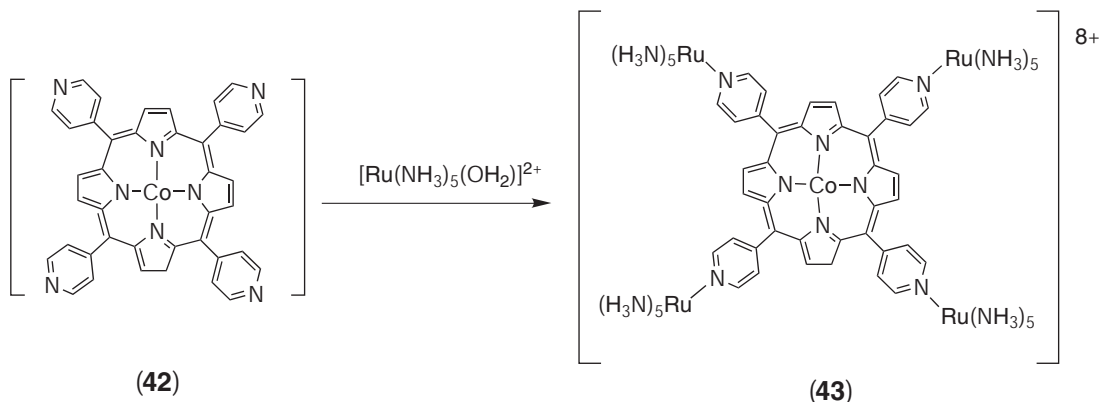

Of the total current passed, 72% results in complete reduction to H_2O , while the remainder generates H_2O_2 .²⁶⁷ Catalytic activity was somewhat lower when the complex was confined to a Nafion polyelectrolyte film coated on a graphite electrode.²⁶⁸ The roles of the Ru and Co centers in catalysis were elucidated by varying the number of Ru centers and their ancillary ligands. A tri-(pentaammine)ruthenated analog was also an efficient four-electron catalyst,²⁶⁹ although the di-, mono-, and non-ruthenated analogs could only act as two-electron reductants. It was established²⁶⁸ that (**43**) is a (homogeneous) two-electron O_2 reduction catalyst in solution, illustrating the importance of a rapid supply of electrons to the complex (adsorbed to an electrode surface) to ensure complete reduction before dissociation of the intermediate peroxo-bound form. This foreshadowed the fact that the four-electron reduction did not involve redox cycling of the four peripheral Ru centers in parallel. Subsequently it was established that Ru^{II} -pyridine π -back bonding (ultimately into the $Co^{II}-O_2$ reaction center) was the key factor in determining two- or four-electron reduction at the Co center of the porphyrin. Attachment of $\{Os(NH_3)_5\}^{3+}$ groups to the pyridyl rings (in a η^2 fashion, not involving the N-donor) instead of $\{Ru(NH_3)_5\}^{3+}$ led to

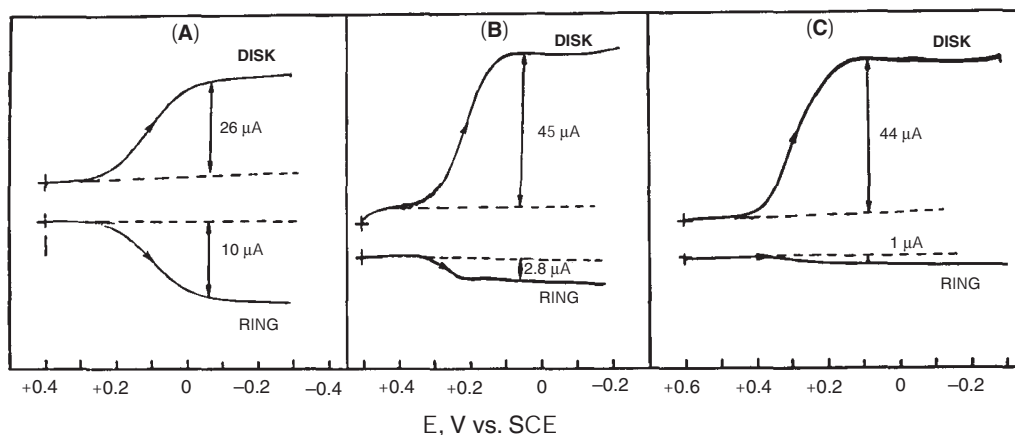
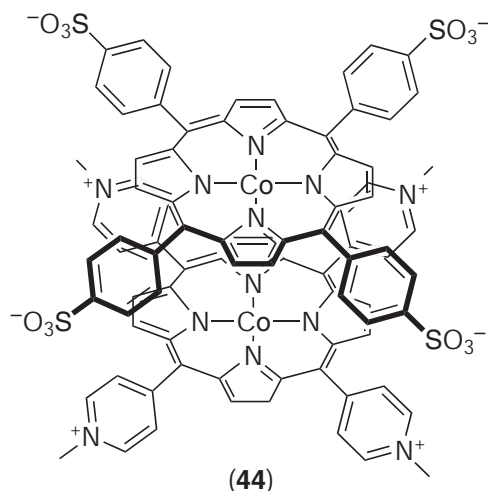

Figure 6 Steady state rotating ring-disk voltammograms of (A) compound (**42**); (B) compound (**43**) and (C) a Ru-bridged polymer of (**43**) each adsorbed to a graphite working electrode. Disk current shows reduction of O_2 while ring current reveals the presence of H_2O_2 simultaneously reoxidised at the ring anode poised at +1.0 V (reproduced with permission of the American Chemical Society from *Acc. Chem. Res.*, **1997**, *30*, 437–444).

significant (30%) four-electron O_2 reduction at a potential more positive than the $Os^{III/II}$ couple, thus ruling out participation of the peripheral subunits in electron transfer.²⁶⁸

More recently, even simpler non-covalently linked porphyrin dimers, self-assembling through hydrophobic²⁶⁸ or electrostatic²⁷⁰ interactions have been shown to achieve the four-electron reduction of O_2 to H_2O . The Co^{II} complex of the parent porphine ligand and its tetra-methyl derivative $Co(TMP)$ aggregate in aqueous solutions, and in the absence of bulky *meso*-substituents, can form cofacial dimers in solution and on electrode surfaces reminiscent of the covalently linked analogs.²⁷¹ The porphyrin ion pair (**44**) comprising $[Co(TMpyP)]^{4+}$ (Mpy = 4-methylpyridinium) and $[Co(TSpP)]^{4-}$ (Sp = 4-sulfonatophenyl) similarly spontaneously dimerizes to form an active four-electron O_2 reduction catalyst.²⁷⁰ The inter-planar separation (~ 3.1 Å) is close to that required for O_2 insertion between the Co centers of the cofacial assembly.



These studies have led to the development of other Co porphyrins with potential applications in a variety of areas with the common theme of catalyzing the efficient reduction of O_2 . These systems are explored in [Section 6.1.4](#).

(iv) Imidazole, pyrazole, and related ligands

The fact that imidazole (Him) residues are particularly popular transition metal binding sites within metalloproteins is a major driving force for investigations of this heterocycle. The divalent

oxidation state is preferred for the hexakisimidazolecobalt ion, and a number of complexes of this class have been characterized structurally including $[\text{Co}(\text{Him})_6]^{2+}$,^{272,273} $[\text{Co}(\text{Meim})_6]^{2+}$,²⁷⁴ and $[\text{Co}(\text{vinyl-im})_6]^{2+}$.²⁷⁵ The structures of simple tetrahedral complexes $\text{Co}(\text{Him})_2(\text{OAc})_2$ and its propionate analog were determined, and were found to be very similar to their Zn^{II} analogs. The implications of these results are relevant to Co^{II} -substituted Zn proteinases. Ternary complexes such as $[\text{Co}(\text{ATP})(\text{Him})]^{2-}$ were studied by potentiometric pH titration as a simple model for competition between ligating groups of biological relevance. The Him ligand was found to form more stable adducts than NH_3 at physiological pH, as proton competition for Him was negligible at pH 7.4, unlike NH_3 .²⁷⁶ Some examples of multidentate imidazole-containing ligands that have been complexed with Co^{II} include histamine (4-(2'-aminoethyl)imidazole) and its glycol and sarcosyl derivatives, which, when reacted with Co^{II} in aerated aqueous solution, form mixtures of O_2 adducts that were studied by potentiometry, NMR, and spectrophotometry.²⁷⁷

Monomeric, pseudo-tetrahedral complexes of the type $\text{Co}(\text{Tp}')\text{L}$ and dinuclear centrosymmetric five-coordinate complexes of the form $\text{Tp}'\text{Co}(\text{L})_2\text{CoTp}'$ ($\text{Tp}' = 3\text{-}i\text{Pr}, 4\text{-BrTp}; 3\text{-}t\text{Bu}, 5\text{-MeTp}; \text{L} = \text{NCS}^-, \text{NCO}^-, \text{and } \text{N}_3^-$) have been synthesized.²⁷⁸ The ligand-field spectral data for the monomeric complexes indicate a strong, trigonally distorted tetrahedral ligand field. In an elegant study, the tris-trisubstituted 3,4- Ph_2 ,5-MeTp reacts with CoI_2 to form the pseudotetrahedral (3,4- Ph_2 ,5-MeTp)CoI (**45**). Steric effects from the 4-Ph group on the 3-Ph group prevent the formation of bis (octahedral) complexes, whereas the isomeric ligand (3,4- Ph_2 ,5-Mepz)(3-Me-4,5- $\text{Ph}_2\text{pz})_2\text{B}$ does form an octahedral complex (**46**), with (unsubstituted) Tp as the ancillary tridentate ligand.²⁷⁹

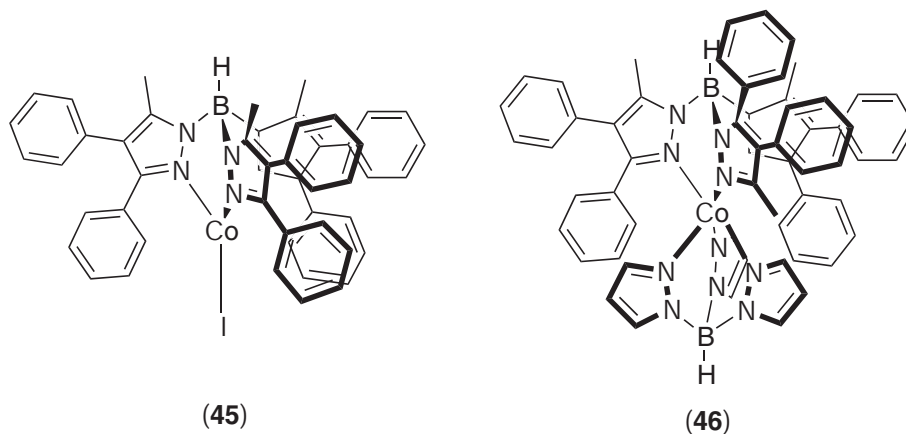

Compounds of the $[\text{Co}(3\text{-}t\text{Bu}, 5\text{-MeTp})\text{X}]^{n+}$ family have been found to exhibit a number of remarkable properties in the coordination and stabilization of small molecules and ions in the labile fourth coordination site.²⁸⁰ The iodo derivative (3- $t\text{Bu}$,5-MeTp)CoI has been prepared and its X-ray crystal structure reported.²⁸¹ Reduction of (3- $t\text{Bu}$,5-MeTp)CoX ($\text{X} = \text{Cl}, \text{I}$) under N_2 generates the monovalent N_2 complex (**4b**) which upon reaction with O_2 yields the novel divalent side-on bound superoxo complex (3- $t\text{Bu}$,5-MeTp)Co(O_2) which was structurally and spectroscopically characterized ($r_{\text{O-O}} = 1.262(8) \text{ \AA}$, $\nu_{\text{O-O}} = 961 \text{ cm}^{-1}$).¹²⁹ This complex is stable in the solid state, but decomposes in solution to give $[(3\text{-}t\text{Bu}, 5\text{-MeTp})\text{Co}]_2(\mu\text{-OH})_2$.²⁸² The dioxygen-bridged dimer $[(3\text{-}t\text{Bu}, 5\text{-MeTp})\text{Co}]_2(\mu\text{-O}_2)$ is an intermediate and can be prepared independently by reaction of $[(3\text{-}t\text{Bu}, 5\text{-MeTp})\text{Co}]_2(\mu\text{-N}_2)$ with oxygen²⁸² or from reaction of the monovalent carbonyl (**4a**) with oxygen.²⁸³ This later study showed that, at low temperature, the dimer is in equilibrium with its monomer. The crystal structure of $[(3\text{-}t\text{Bu}, 5\text{-MeTp})\text{Co}](\mu\text{-O}_2)$ was also determined. An independent study found that reaction of the 3,5-diisopropyl dihydroxo-bridged dimer (**24**) with a stoichiometric amount of H_2O_2 generates the unusual planar, side-on bound peroxy-bridged dinuclear complex $[(3,5\text{-}i\text{Pr}_2\text{Tp})\text{Co}]_2(\mu\text{-}\eta^2\text{:}\eta^2\text{-O}_2)$ (**47**) on the basis of two intense absorptions attributable to $\text{O}_2^{2-} \rightarrow \text{Co}^{\text{II}}$ LMCT transitions in the UV-visible spectrum and a low energy $\bar{\nu}_{\text{O-O}}$ vibration in the resonance Raman spectrum.²⁸⁴ This group had previously identified a similar $\mu\text{-}\eta^2\text{:}\eta^2$ binding mode in a peroxy-bridged dicopper(II) oxyhemocyanin model complex. Compound (**47**) is highly reactive and decomposes by hydroxylation of one of its isopropyl groups (at the secondary C atom) to give a novel μ -alkoxo- μ -hydroxo dinuclear compound $\text{Co}_2(\mu\text{-OH})(\mu\text{-}3\text{-OCMe}_2\text{-}5\text{-iPrpz})(3,5\text{-}i\text{Pr}_2\text{pz})_2\text{BH}(3,5\text{-}i\text{Pr}_2\text{Tp})$ (**48**) where the deprotonated hydroxyl group and a hydroxo ligand bridge the two Co ions.

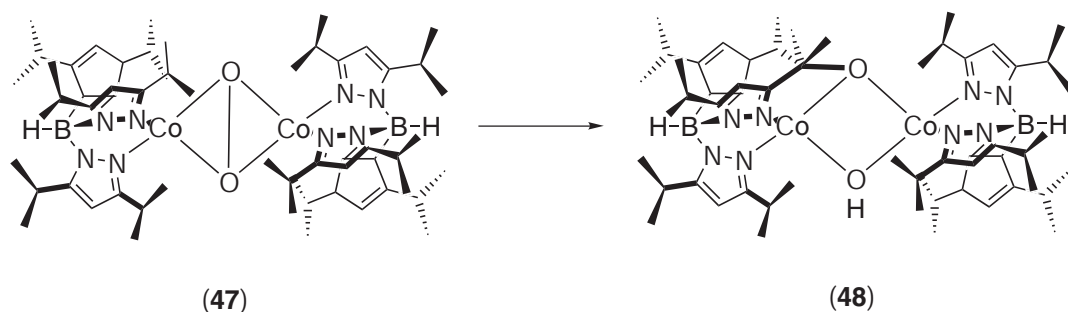

Somewhat similar observations were made separately in a study of the heterogeneous reaction between solid (3-*t*Bu,5-MeTp)CoH (**4c**) and O₂ which led to hydroxylation of one *t*-butyl group and coordination of the resulting deprotonated hydroxymethyl group.²⁸⁵ The complex was crystallized as the mononuclear (((3-(OCH₂)Me₂C)pz)(3,5-*t*Bu₂pz)₂BH)Co(3-*t*Bu,5-MeTp) adduct (**49**) which exhibited a trigonal bipyramidal CoN₄O coordination geometry. In solution, the reaction with O₂ proceeds via a spectroscopically observable hydroperoxide (HOO⁻) which decomposes to give (3-*t*Bu,5-MeTp)Co(OH) and (3-*t*Bu,5-MeTp)Co(O₂).

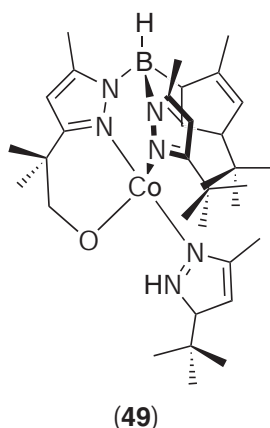

A number of other homo-substituted (threefold-symmetric) Tp derivatives have been complexed with Co^{II}. The 15-electron four-coordinate alkyl complex (3,5-*i*Pr₂Tp)Co(CH₂CH₃) was prepared and structurally characterized. Despite bearing a ligand with β H-atoms, the complex is resistant to β-hydride elimination.²⁸⁶ The same group subsequently reported an extended series of these compounds including (3,5-*i*Pr₂Tp)CoR where R = η³-allyl, η¹-*p*-methylbenzyl and η¹-1-α-naphthylmethyl.²⁸⁷ Independently, the paramagnetic analogs (3-*t*Bu,5-MeTp)CoR (R = Me, Et, *n*-Bu) were prepared, and the related (3-*t*BuTp)Co(Me) complex was structurally characterized.¹¹³ Like the di-isopropyl analog, these alkyls are thermally stable and show no tendency to β-eliminate. When the alkyl complexes are reacted with CO, homolytic cleavage of the Co—C bond is found instead of migratory insertion. The crystal structure of the fluorinated Tp complex (3-CF₃,5-MeTp)Co(η²-NO₃)(MeCN) reveals a distorted octahedral N₄O₂ coordination sphere.²⁸⁸ This complex catalyzes the oxidation of cyclohexane by cumene hydroperoxide to give a 1:1 mixture of cyclohexanol and cyclohexanone at a rate 50% faster than the nonfluorinated complex.

Octahedral bis-Tp complexes bearing different substituents on the separate Tp ligands have been prepared by sequential ligand substitution. The tetrahedral Co(3-*i*Pr,4-BrTp)Cl reacts with Tp or 3-*i*Pr,4-BrTp to form the corresponding hetero-bis-Tp complex Co(3-*i*Pr,4-BrTp)(Tp) and the symmetrical Co(Tp)₂.¹⁰⁹ However, reaction with the bulkier 3-PhTp leads to the coordination of only two pyrazolyl groups in (**50**) featuring an agostic B—H—Co interaction, as shown by X-ray crystallography. A similar agostic B—H—Co interaction was identified in the bis-pyrazolyl-dihydroborate analog Co(3-*i*Pr,4-BrTp)((3-Phpz)₂BH₂). Substitution of both hydrides by phenyl groups leads to Co(3-*i*Pr,4-BrTp)((3-Phpz)₂BPh₂) (**51**) which is strictly five-coordinate. By comparison, the Co(3-*i*Pr,4-BrTp)((3-Ph-pz)₄B) adduct is tetrahedral.

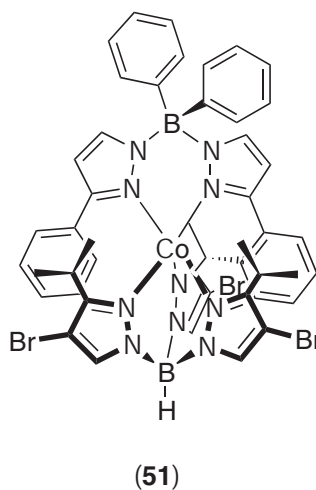
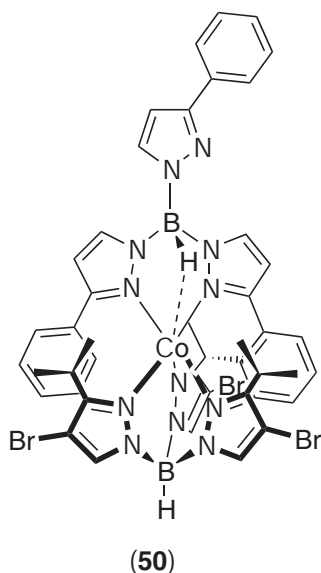

The synthesis of heterosubstituted Tp ligands (lacking a C_3 symmetry axis) has enabled a systematic investigation of substituent effects on both structure and reactivity of their Co complexes. The homo- (3-PhTp) and hetero- ((3-Phpz) $_2$ (3-*t*Bupz)BH) trisubstituted ligands were complexed to Co^{II}. Four- or five-coordinate complexes ensued, depending on the steric demands of the substituents.²⁸⁹ The {(3-PhTp)Co} moiety is able to coordinate two additional ligands such as NCS⁻, pyrazole (Hpz) and MeOH, whereas the more sterically demanding {(3-Phpz) $_2$ (3-*t*Bupz)BH)Co} unit forms tetrahedral complexes. Crystal structures of the five-coordinate (3-PhTp)Co(NCS)(Hpz) and four-coordinate ((3-Phpz) $_2$ (3-*t*Bupz)BH)Co(NCS) were reported. The structures of the asymmetric hexacoordinate complexes ((3,5-Me $_2$ pz)(3,5-Ph $_2$ pz)BH)Co(η^2 -NO $_3$)(THF) and ((3,5-Ph $_2$ pz)BH $_2$)((3,5-Ph $_2$ pz) $_2$ (3,5-Me $_2$ pz)BH)Co were established by X-ray crystallography.²⁹⁰ An agostic H—Co interaction in the former (2.035 Å) was identified. The symmetrical analog ((3-Ph,5-MeTp)Co(η^2 -NO $_3$)(THF) was also investigated for comparison. The symmetrical bis-bidentate coordinated tetrahedral Co((3-Ph $_2$ pz) $_2$ BH $_2$) $_2$ (CoN $_4$) and octahedral mixed ligand complexes (3-PhTp)Co((3-Ph $_2$ pz) $_2$ BH $_2$) (CoN $_5$ H) have been isolated and characterized structurally.²⁹¹ The presence of an adjacent phenyl substituent prevents participation of the nitrile group as a bridging ligand, thus avoiding coordinative polymerization in the tetrahedral CoN $_4$ complex Co((3-Ph,4-CNpz) $_2$ BH $_2$) $_2$.²⁹²

A Co *K*-edge X-ray absorption spectroscopic study of Co(Tp) $_2$, Co(3,5-Me $_2$ Tp) $_2$, and Co(3,4,5-Me $_3$ Tp) $_2$ was undertaken at 295 K and 77 K to investigate the ground electronic states of the complexes. EXAFS analysis indicates that the three complexes are all structurally similar, with Co—N bond lengths consistent with high-spin ground states, and these are unchanged upon cooling from 295 K to 77 K. However, the complexes are gradually converted from high-spin to low-spin state with increasing pressure, with Co(3,4,5-Me $_3$ Tp) $_2$ showing the greatest change in spin state of the three complexes.²⁹³ Heterodinuclear pyrazole-bridged complexes were reported by the reaction of (mes)Ru(pz) $_2$ (Hpz), as one example, with CoCl(3-*i*Pr,4-BrTp) to give (mes)Ru(μ -pz) $_2$ (μ -Cl)Co(3-*i*Pr,4-BrTp).²⁹⁴

(v) Imines and oximes

Imines, either acyclic or macrocyclic but invariably multidentate, have a rich coordination chemistry that has been investigated at length. The π -accepting ability of imine donors results in the stabilization of lower oxidation states relative to their saturated amine analogs, and there exist many air-stable divalent imine complexes of Co, in contrast to amine relatives. The hexamethyl-diene (**52**) has been the most intensively studied ligand of this class, particularly when complexed with Co. In addition, Co complexes of the dimethyl (**53**),^{295,296} tetramethyl (**54**),²⁹⁷ pentamethyl (**55**)²⁹⁸ and octamethyl (**56**)²⁹⁹ macrocyclic dienes are also known. In the presence of

bidentate chelates such as amino acids²⁹⁷ or carbonate³⁰⁰, *cis* configurational isomers are formed, whereas monodentate ligands usually lead to *trans* isomers.²⁹⁷

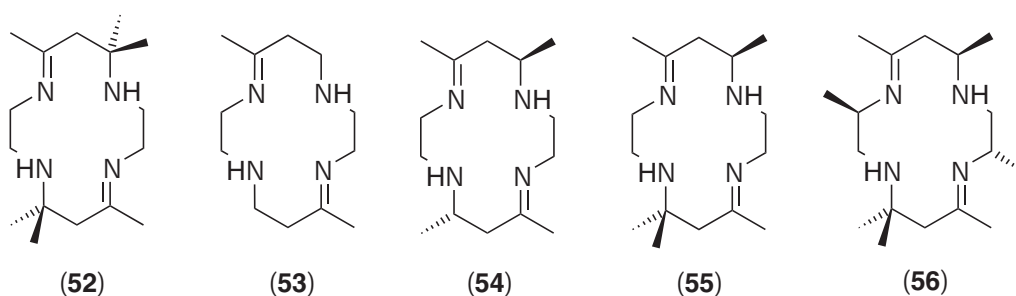

In an interesting variation, aerial oxidative dehydrogenation of the trivalent octamethyl diene complex (57) generates the divalent tetraimine complex (58).³⁰¹

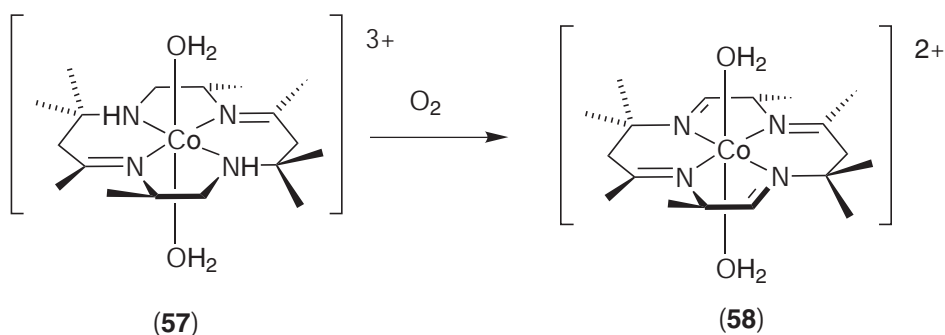

The macrocyclic tetraene 2,3,9,10-Me₄[14]tetraene (tmt) may be synthesized by a metal-directed condensation between trimethylenediamine (tn) and 2,3-butanedione in the presence of Co(OAc)₂, ultimately resulting in the *trans*-dichloro Co^{III} complex [Co(tmt)Cl₂]⁺ (59).³⁰²

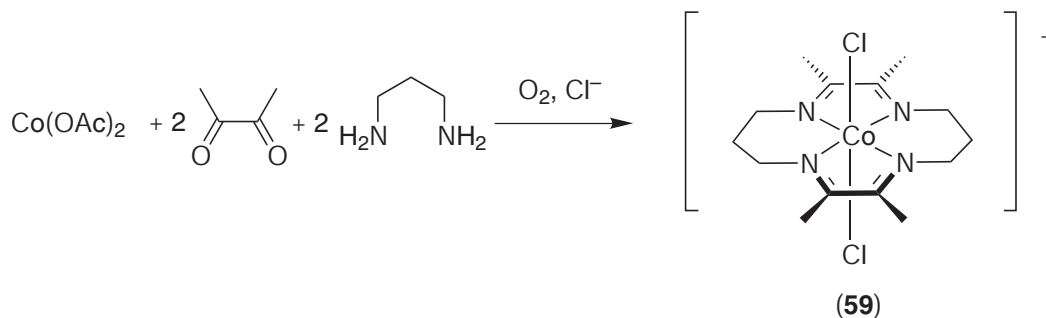

The 14-membered tetraaza-annulenes (such as tmtaa (60)) are somewhat similar to porphyrins in that they are highly conjugated, tetradentate dibasic acids. The crystal structure of the *trans*-dipyridyl adduct of (61) reveals coordination by the four macrocyclic N donors and the two axial pyridines. The macrocycle exhibits its characteristic non-planar (saddle-shaped) conformation.³⁰³ Complex (61) undergoes three reversible one-electron oxidations (0.01, 0.55, and 1.04 V vs. SCE) and one low potential reduction (-1.65 V).³⁰⁴ Oxidation of the complex by controlled-potential electrolysis resulted in an absorbance shift of the visible band from 595 nm to 543 nm after removal of the first electron, but removal of the second electron produced little change in the spectrum. This two-electron oxidized species exhibited an isotropic EPR spectrum consistent with a ligand-centered radical. Reduction to the monovalent complex resulted in a visible maximum shift to 629 nm. Divalent pyridyl and trivalent superoxo adducts were also examined. The potential uses for Co complexes of tetraaza-annulenes to bind and reduce O₂ was recognized some time ago, and a large class of substituted analogs of (61) was patented for this purpose.²⁶⁷

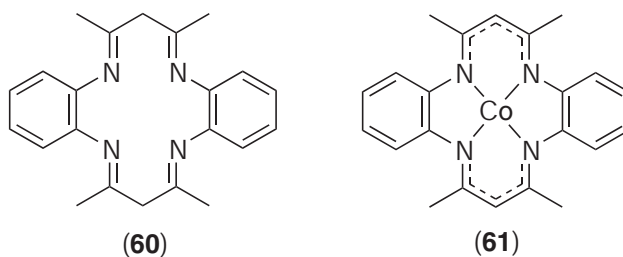

Divalent Co forms a trigonally symmetric seven-coordinate complex (**62**) with the N_4O_3 pyridine N-oxide trenpyo.³⁰⁵ The effect of spin state on the electron-transfer properties of the six-coordinate $[Co(pdci)_2]^{2+}$ family (**63**) ($R = t\text{-Bu}, i\text{-Pr}, p\text{-tol}, Bz$) was studied.³⁰⁶ The reversible $Co^{III/II}$ and $Co^{II/I}$ potentials were correlated with the solvent dielectric constant and H-bonding acceptor ability. Although no correlation was found between the N-substituent type and either the electron transfer rate constant or half-wave potentials, some correlation did exist between the substituent type and the magnetic moment of the central divalent complex. Much later, the use of Co complexes of this class as propylene oligomerization catalysts in the presence of polymethylaluminumoxane was patented.³⁰⁷ Dinucleating cryptands derived from the 2:3 condensation of tris(2-aminoethyl)amine (tren) and various dialdehydes (1,3-benzenedicarbaldehyde, 2,5-furyldialdehyde and 2,6-pyridinedicarbaldehyde (**64**)) have been prepared and Co^{II} complexes have been reported.³⁰⁸

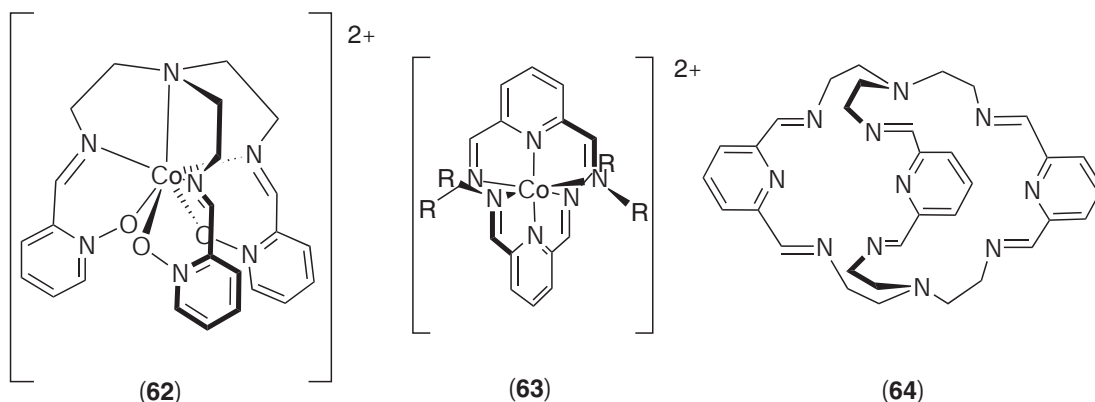

Salicylaldehyde condenses with primary amines (RNH_2) to form bidentate monobasic ligands of the form $o\text{-(HO)C}_6\text{H}_4\text{CH=NR}$. In a novel example, a ferrocenylamine adduct Hsalfc (**65**) results in the bis complex $Co(\text{salfc})_2$.³⁰⁹ The serine derivative (**66**) as its Co^{II} complex $Co(\text{salser})_2$ is an efficient catalyst for conversion of a number of secondary alcohols to their corresponding ketone in the presence of O_2 and 2-methylpropanal³¹⁰ or ethyl 2-oxocyclopentanecarboxylate.³¹¹ This versatile catalyst also oxidizes hydrocarbons such as cyclohexane to cyclohexanol and cyclohexanone (1:9).³¹² The tyrosine analog (**67**) (as its methyl ester) $Co(\text{saltyr})_2$ oxidizes benzylic substrates to their ketone.³¹³ The requirement of an aliphatic aldehyde or ketone in these processes is such that an active Co^{III} -superoxo species (identified in EPR experiments) is formed.³¹⁴ Electrochemical oxidation of the 1-(3'-aminopropyl)pyrrole analog $Co(\text{salappr})_2$ in MeCN produces a conducting polymeric film at the electrode surface, which is catalytically active in the electroreduction of O_2 and CO_2 .³¹⁵

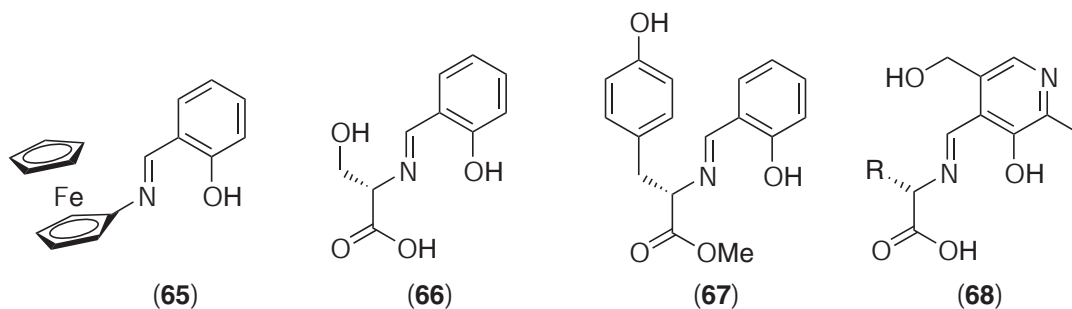

Pyridoxal is a biologically important aromatic aldehyde also bearing an *ortho* hydroxyl group. A variety of tridentate Schiff base ligands incorporating amino acids have been prepared from this aldehyde (H_2pdxaa) (**68**) and also from salicylaldehyde (H_2salaa), and their Co complexes bind O_2 .³¹⁶ Coordinating solvents are required to activate the $Co(pdxaa)$ and $Co(salaa)$ complexes for O_2 binding, unless amino acids with coordinating side groups (e.g., aa = histidine) are present. Either 1:1 or 2:1 $Co:O_2$ adducts are formed dependent on the bulk of the amino acid side groups, which hinder dimerization and enhance reversibility. The reaction of $H_2pdxphe$ with Co^{II} in the presence of H_2O_2 generates $[Co(pdxphe)_2]^-$ which is converted to the novel asymmetric complex where one phenyl alanine α -C atom has been hydroxylated, while the other bears a hydroperoxy group.³¹⁷ Schiff base complexes derived from sulfanilamide, homosulfanilamide, and *p*-aminoethyl-benzenesulfonamide coupled with heterocyclic and aromatic aldehydes were investigated for their ability to inhibit three isozymes of carbonic anhydrase (CA, one bovine and two human enzymes). Unusually, several of the free ligands were more active against the membrane-bound bovine CA than the human isozymes, which contrasts with other known CA inhibitors. However, metal complexes of these Schiff bases (including Co^{II}) showed a reverse activity.³¹⁸

The divalent $Co(salen)$ complex (**69a**) is one of the most versatile and well-studied Co coordination compounds. It has a long and well-documented history and we shall not restate this here. Recent applications of (**69a**) as both a synthetic oxygen carrier and as a catalyst for organic transformations are described in Sections 6.1.3.1.2 and 6.1.4.1 respectively. Isotropic shifts in the 1H NMR spectrum of low-spin $Co(salpn)$ (**69b**) were investigated in deuterated chloroform, DMF, DMSO, and pyridine.³¹⁹ Solvent-dependent isotropic shifts indicate that the single unpaired electron, delocalized over the tetradentate π -electron system in $CHCl_3$, is an intrinsic property of the planar four-coordinate complex. The high-spin/low-spin equilibrium of the 3-carboxy derivative of $Co(salen)$ was studied by variable-temperature magnetic susceptibility measurements and EPR spectroscopy in a number of substituted pyridine solutions.³²⁰ In the five-coordinate 2-methylpyridine adduct, a quartet ground state was found, whereas the 4-methylpyridine adduct is low-spin (doublet).

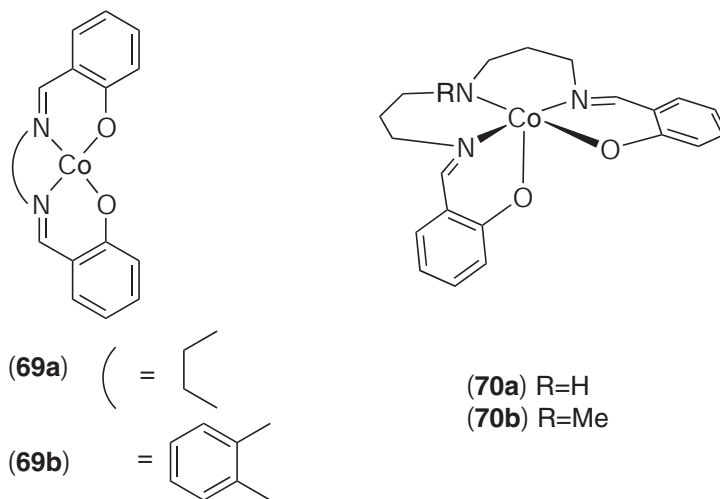

Divalent cobalt complexes of the pentadentate Schiff base $H_2saldtn$ bearing a bis(trimethylene) triamine linker and its N-methyl derivative $H_2salMedtn$ have also been intensively investigated. A study of the structures, electrochemical behavior, and O_2 reactivity of the complexes $Co(saldtn)$ (**70a**), $Co(salMedtn)$ (**70b**) and aromatic-substituted analogs has been reported.³²¹ A linear correlation was found between the $Co^{III/II}$ redox potential and $\log K_{O_2}$ values. Electronic and steric factors of the $Co-O_2$ complexes with aromatic and N-substituted derivatives of (**70a**) were examined with regard to their ability to catalyze phenol oxidation.³²² The conversion of 2'-hydroxychalcones to flavanones occurs in MeOH in the presence of O_2 .³²³ Compound (**70b**) catalyzes the oxidation of 1-hexene by O_2 to give a mixture of 2-hexanone and 2-hexanol.³²⁴ The more commonly encountered auto-oxidation, Wacker-type (peracids) and peroxy metalocycle mechanisms do not apply in this case.³²⁵ Rather, reaction of (**70b**) with H_2O_2 (generated *in situ* by oxidation of the primary alcohol solvent, or as a reagent) results in a hydroperoxy radical Co complex as the active species, which attacks the olefin double bond. Ultimately the alkyl hydroperoxide decomposes to give the ketone and secondary alcohol products. By contrast with

the en-based system, the dien-linked analog Co(saldien) adopts a trigonal bipyramidal structure, with *trans* imine groups.³²⁶

An EPR study of the monomeric O₂ adducts of the Schiff base complexes of Co(bzacen)(py) (**71a**) and the thiobenzoyl analog Co(Sbzacen)(py) (**71b**) characterized the five-coordinate mono(pyridine) precursors and the six-coordinate O₂ adducts.³²⁷ Increased covalency in the Co—S bonds was seen in the EPR parameters, indicative of π -backbonding. Substituent effects on the aromatic rings had no effect on the EPR spectra, but these were reflected in the observed redox potentials. Furthermore, the S-donors stabilize the Co ion in lower oxidation states, which was consistent with destabilization of the O₂ adducts.

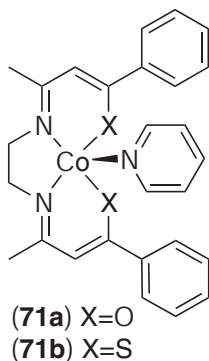

Ditopic macrocyclic imines may be formed by condensation of 2,6-diformyl-4-methylphenol with tn. Heterodinuclear complexes such as (**72**) have been made, with both metal ions in square pyramidal coordination geometries.³²⁸ Variable-temperature magnetic susceptibility data (4.2–385 K) were complicated and fit to an expression derived from a Hamiltonian that included axial and rhombic single-ion zero-field effects, spin–orbit coupling for the Co ion, and an isotropic exchange interaction. The two metal binding sites may be tailored for different metal ions if individual diamine linkers are used. For example, a heterobinucleating ligand comprising salen and saldtn units has been made and the isomorphous series of compounds (**73**) (M^{II} = Mn, Fe, Co) has been characterized.³²⁹ The thiocyanate derivatives are similar except the SCN[−] ligand forms part of a one-dimensional zigzag coordination polymer (N-bound to M^{II}, S-bound to Co). Interestingly, magnetic susceptibility experiments reveal that the Co^{II} ions (in the N₂O₂ site) in the acetate structures are high spin, whereas in the thiocyanate structure they are low spin. The M^{II} ions in the six-coordinate site are all high spin. Replacement of 2,6-diformyl-4-methylphenol with 3,6-diformylpyridazine leads to a dinucleating macrocycle, with two independent, but closely spaced, N₄ donor sets and the structure of its dicobalt(II) complex (**74**) was reported.³³⁰ Single-electron reduction generates a mixed valent complex exhibiting a NIR intervalence transition.

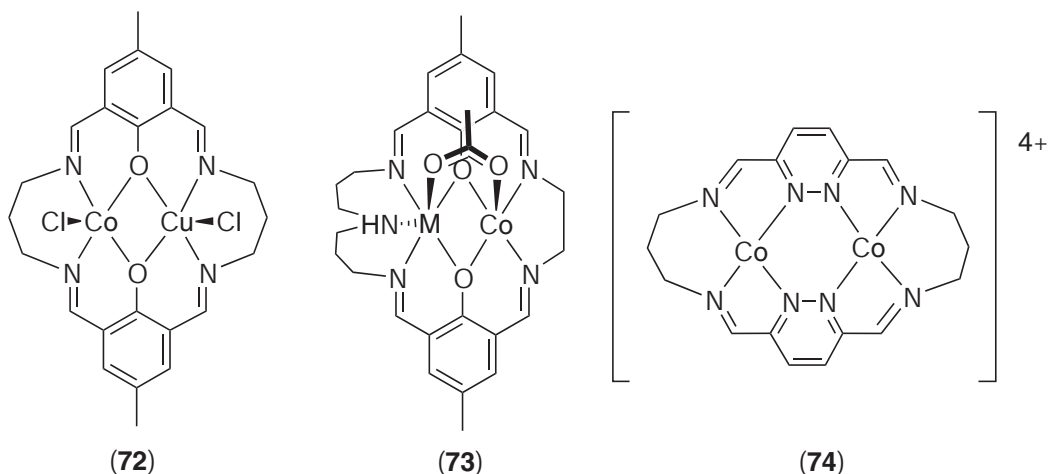

Low-spin square pyramidal divalent complexes of the form [Co(hmd)(X)]ⁿ⁺ (X = OH₂ (**75**) and OClO₃[−]) have been structurally characterized.³³¹ The rate of outer-sphere ([Co(OH₂)₆]³⁺) and

potentially inner-sphere $[\text{Co}(\text{OH}_2)_5\text{Cl}]^{2+}$ oxidation of $[\text{Co}(\text{hmd})]^{2+}$ has been investigated and variations in reactivity by more than four orders of magnitude were found.³³² Other oxidants studied included $[\text{Ru}(\text{bpy})_3]^{3+}$ ³³³ and the novel hydroperoxopentaaquachromium(III) ion.³³⁴ Oxygenation of (75) gives the trivalent peroxo-bridged dimer $[\{(\text{H}_2\text{O})(\text{hmd})\text{Co}\}_2(\mu\text{-O}_2)]^{4+}$, which may be deoxygenated in acidic solution.³³⁵ In an electrochemical study, the O_2 and O_2^- coordination chemistry of the $[\text{Co}(\text{hmd})]^{2+}$ system in DMSO was investigated.³³⁶ The divalent complex forms an adduct with O_2 ($K_a=54\text{ M}^{-1}$), which is reduced at potentials more positive than the formal potential of the O_2/O_2^- couple owing to the high affinity of the divalent complex for superoxide. The reduction and oxidation kinetics of $[(\text{hmd})\text{Co}(\text{OOH})]^{2+}$ by a variety of inner and outer sphere electron transfer agents has been reported.³³⁷ The unusual S-bonded sulfite complex $[(\text{H}_2\text{O})\text{Co}(\text{hmd})(\text{SO}_3)]^+$ has been characterized structurally and found to undergo photoisomerization to its O-bound linkage isomer. A mechanism involving Co^{II} and the SO_3^{2-} was proposed.³³⁸

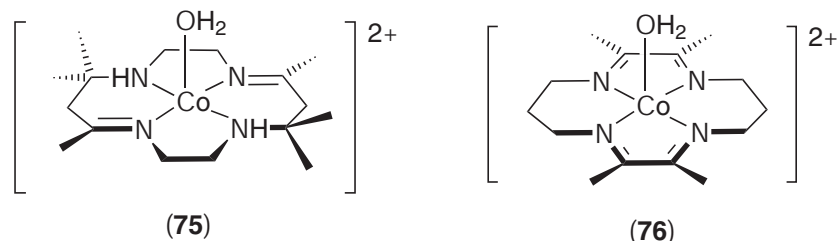

The tmt complex (76) reacts slowly with O_2 but this reaction may be catalyzed by $\text{Fe}_{\text{aq}}^{2+}$ in acidic aqueous solution. A kinetic study revealed first-order dependence on complex, O_2 , and $\text{Fe}_{\text{aq}}^{2+}$ which leads to the trivalent Co complex and H_2O as products,³³⁹ bypassing hydrogen peroxide as an intermediate. Formation of the intermediates $[(\text{tmt})\text{CoOOFe}]^{4+}$ then $[(\text{tmt})\text{Co}(\text{OOH})]^{2+}$ was proposed to account for these observations. However, adsorption of (76) on graphite electrodes makes the complex an active catalyst for the reduction of O_2 to H_2O_2 in a single voltammetric step.³⁴⁰ By comparison, (75) exhibits two separate voltammetric steps in the reduction of O_2 at more negative potentials. In a study somewhat related to these oxygenation reactions, the catalytic auto-oxidation of azide by (76) in the presence of dioxygen was observed.³⁴¹

Air-sensitive divalent Co complexes of the tropocoronand ligand TC^{2-} in addition to larger ring relatives were prepared in an extensive investigation. The square-planar 14-membered $\text{Co}(\text{TC})$ (low-spin) complex (77) changes to tetrahedral (high spin) for the 20-membered analog (78).³⁴² The dihedral angle between the two five-membered aminotroponimate chelate rings increases from 9° (pseudo-planar) to 85° , which was attributed to torsional strain within the polymethylene linker chains of the macrocycle.

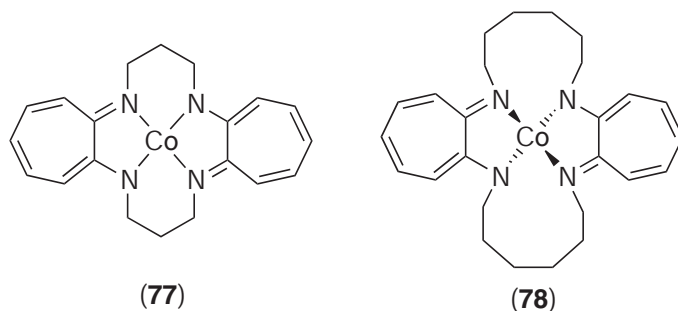

In contrast with the Schiff base salen, salicylaldehyde oxime (79) (salox) complexes of Co have received comparatively little attention, but a series of bis-bidentate divalent complexes of the form *trans*- $\text{Co}(\text{salox})_2(\text{DMSO})_2$ have been reported.³⁴³ The heterocyclic bidentate oxime violurate (1H,3H-pyrimidine-2,4,5,6-tetrone 5-oximate, Hvi) (80) and its *N*-methyl (mvi) and *N,N'*-dimethyl (dmvi) derivatives form high-spin divalent $[\text{Co}(\text{vi})]^+$ and $\text{Co}(\text{vi})_2$ complexes, whereas $[\text{Co}(\text{vi})_3]^-$ is low spin.³⁴⁴ The mixed-ligand $\text{Co}(\text{dmvi})_2(\text{phen})$ complex is also low spin. The crystal structure of *cis*- $\text{Co}(\text{pxo})_2\text{Br}_2$ (pxo = 2-acetylpyridine-1-oxide oxime) is isostructural with the Ni^{II} relative.³⁴⁵ The dichloro complex also adopts a *cis* configuration. The tridentate dioximes 2,6-diformyl-4-methylphenol dioxime and 2,6-diacetyl-4-methylphenol dioxime (Hdampo) form binuclear complexes of the type (81a) and (81b) respectively.³⁴⁶ Cobalt oxide nanoparticles were prepared by

pyrolysis of $\text{Co}(\text{pao})_2$ (Hpao = pyruvic acid oxime, $\text{Me}(\text{HOOC})\text{C}=\text{NOH}$). Electron microscopy showed the products were nanocrystalline with various morphologies (rod-like or quantum dot).³⁴⁷

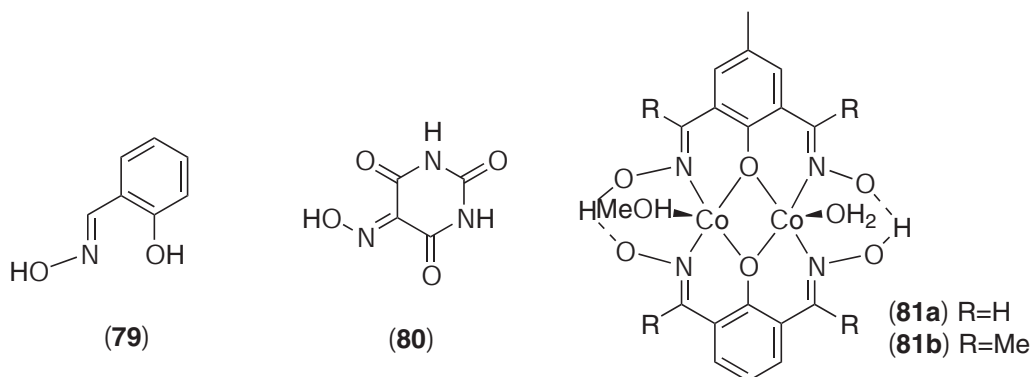

(vi) Amides

N-Containing heterocycles bearing carbonyl functional groups adjacent to the ring heteroatom(s) are ubiquitous in nature. As N-deprotonation accompanies coordination, they may be considered formally as amide ligands. A number of divalent Co complexes of purines and pyrimidines showing a variety of coordinating modes have been studied, such as 5-chlorouracil (monodentate, tetrahedral $[\text{Co}(\text{ur})(\text{OH}_2)_3]^+$)³⁴⁸ and cytosine (bis-bidentate, $\text{Co}(\text{cyt})_2\text{Cl}_2$).³⁴⁹ A range of divalent 4-oxopteridine Co complexes with substituents at the 2-, 6- and 7-positions of the bicyclic ring system have been prepared. Electronic and IR spectral data on the series of complexes indicate that all are coordinated to Co via the O atom in the 4-position and the pyrazine ring N in the 5-position.³⁵⁰

The tren derivative (**82**) was used to synthesize monomeric complexes with terminal hydroxo ligands. Trigonal bipyramidal complexes of the trianionic ligand with both divalent and trivalent hydroxocobalt were reported; the latter is a rare example of a trigonal bipyramidal, paramagnetic Co^{III} .³⁵¹ A feature of their structures is the presence of intramolecular H bonds from the urea cavity of the ligand to the coordinated hydroxo O atom, which results in an unusually long Co—O bond (Figure 7). The tripodal tetradentate triamide (**83**) is structurally similar to tren, and the ligand enforces an unusual trigonal pyramidal coordination geometry on divalent metal ions, including Co (Figure 7).³⁵²

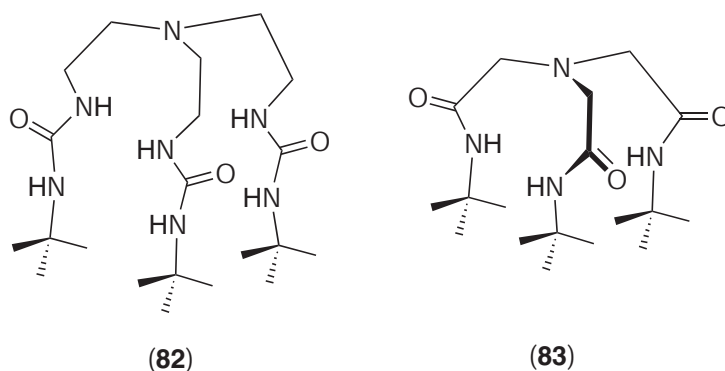

(vii) Nitrosyl

The structures of the oxime complex $\text{Co}(\text{NO})(\text{dmg})_2$ (**84**) and its diphenylglyoxime analog exhibit strongly bent Co—NO groups, which are easily oxidized to the corresponding nitro compound.³⁵³ A mechanistic study of NO transfer from $\text{Co}(\text{NO})(\text{dmg})_2$ to hemoglobin established that the reaction involves NO association with the protein subsequent to dissociation of NO from the Co complex.³⁵⁴ This mechanism is also consistent with the observation of nitrate complexes in reactions

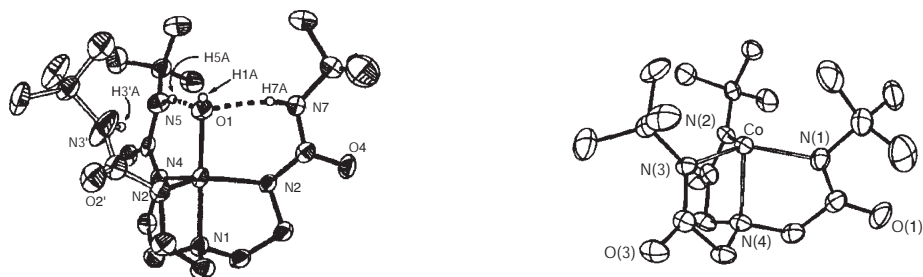
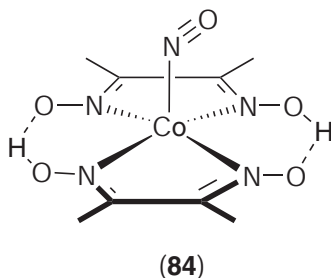

Figure 7 Tripodal triamide complexes of (left) **(82)** with hydroxocobalt(III) (divalent complex is similar) (reproduced with permission of the American Chemical Society from *Inorg. Chem.*, **2001**, *40*, 4733–4741) and (right) **(83)** with Co^{II} (reproduced with permission of the American Chemical Society from *Inorg. Chem.*, **1998**, *37*, 1527–1532).

of these metal nitrosyls with O_2 . This process is also relevant to the oxidation of oxymyoglobin (MbO_2 , Fe^{II}) to metmyoglobin (Mb^+ , Fe^{III}) by $\text{Co}(\text{NO})(\text{dmg})_2$, where the free NO released from the Co complex oxidizes the heme.³⁵⁵ Nitrate formation accompanying the production of Mb^+ is proposed to arise from isomerization of the initially formed peroxynitrite ion. Furthermore, the $\text{Co}(\text{dmg})_2$ product is an effective trap for the O_2 released from MbO_2 . The 8-quinolinolate (qn) complexes $\text{Co}(\text{qn})_2$ and $\text{Co}(\text{NO})(\text{qn})_2$ react with NO forming $\text{Co}(\text{NO}_3)(\text{qn})_2\text{L}$ ($\text{L} = \text{py}$, DMF), releasing N_2O .³⁵⁶



(viii) *Nitriles, azide, cyanates, and thiocyanates*

These rod-shaped ligands share a sterically efficient terminal N-donor and their divalent Co chemistry is well established. They will be discussed here only with selected examples. $[\text{Co}(\text{NCMe})_6](\text{TFPB})_2$ ($\text{TFPB}^- = \text{tetrakis}(3,5\text{-bis}(\text{trifluoromethyl})\text{phenyl})\text{borate}$) has been synthesized and characterized in the solid state along with a number of other divalent transition metal analogs.³⁵⁷ As a result of the extremely poor coordinating ability of the anion and facile loss of MeCN ligands from the cation, the salt is an excellent source of “naked” Co^{2+} ions. Thermolysis up to 100°C leads to the loss of one MeCN and formation of a η^2 -bound nitrile, whereas above 130°C decomposition occurs with loss of MeCN and abstraction of fluoride from the anion to form CoF_2 .

Reactions of nitriles may be promoted by the presence of divalent Co. The conversion of sterically unhindered nitriles RCN ($\text{R} = \text{Me}$, Et, *n*-Pr, *n*-Bu) into the corresponding amidines $\text{RC}(\text{NH}_2)=\text{NH}$ occurs in the presence of $\text{Co}(\text{NO}_3)_2 \cdot 6\text{H}_2\text{O}$ and the ketoxime $\text{Me}_2\text{C}=\text{NOH}$. The metal free amidinium ions were crystallized as their nitrate salts.³⁵⁸

The well-known tetrahedral $[\text{Co}(\text{NCS})_4]^{2-}$ ion has continued to attract attention from analytical chemists, physical chemists, and spectroscopists. The inelastic electron tunneling (IET) spectrum of $(\text{Me}_4\text{N})_2[\text{Co}(\text{NCS})_4]$ was compared with IR and Raman spectra of the same complex.³⁵⁹ The vibrational bands due to the Me_4N^+ were prominent in all three spectra, but Co-ligand stretches were absent from the IET spectra. The lowest ${}^4A_2 \rightarrow {}^4T_2$ electronic transition was strong in the IET spectrum but absent from the IR spectrum. The electric dipole allowed ${}^4A_2 \rightarrow {}^4T_1$ electronic transition was observed in both the IET and IR spectra and no fine structure was observed. Complex formation equilibria between Co^{II} and SCN^- were studied calorimetri-

cally in both aqueous solution and in micellar solution of the surfactant Triton X-100. The formation of $[\text{Co}(\text{NCS})_3]^-$ is virtually negligible in any of the solutions examined, whereas $[\text{Co}(\text{NCS})]^{2+}$ is formed only in the aqueous phase and $[\text{Co}(\text{NCS})_4]^{2-}$ is formed mainly in micelles as ion pairs.³⁶⁰ The $[\text{Co}(\text{NCS})]^{2+}$ ion was also identified as a major species in an independent study involving conductivity and visible absorption spectroscopy of DMSO–water solutions of $\text{Co}(\text{NCS})_2$.³⁶¹

The intense blue color of $[\text{Co}(\text{NCS})_4]^{2-}$ has been exploited as a spectroscopic signal for a number of analytical methods for determining Co^{II} in solution. A method for the determination of trace concentrations (1–15 μg) of Co^{II} as its NCS^- complex was reported by fixing the complex on a coagulated material composed of anion and cation exchange resins, followed by colorimetry (using a densitometer).³⁶² Methods for simultaneously determining Fe^{II} and Co^{II} have been reported that are applicable to a disparate range of samples (e.g., blood and steel) involving complexation of Co with NCS^- and chelation of Fe with *N*-phenylcinnamohydroxamic acid (HPCHA) to form their respective blue $[\text{Co}(\text{NCS})_4]^{2-}$ and red $[\text{Fe}(\text{NCS})_2(\text{PCHA})_2]^-$ complexes, which extract quantitatively into EtOAc from dilute HCl solution.³⁶³ Spectrophotometric detection of tamoxifen citrate,³⁶⁴ lignocaine,³⁶⁵ mefloquine,³⁶⁶ mebeverine,³⁶⁷ the surfactant Pluronic F-68,³⁶⁸ trazodone.HCl and amitriptyline.HCl³⁶⁹ have also been reported through their association with divalent Co– NCS^- adducts.

Octahedral coordination of N-bonded thiocyanate was achieved in $[\text{Co}(\text{NCS})_6]^{4-}$ accidentally as a polyammonium salt while trying to coordinate a tetraamine.³⁷⁰ Thiocyanate is frequently met as a co-ligand in Co chemistry. A recent example where both monodentate and bridging thiocyanate occur is the trinuclear Co^{II} complex $[\text{Co}_3(\text{amt})_6(\text{SCN})_6] \cdot 2\text{H}_2\text{O}$ (amt = 4-amino-3,5-dimethyl-1,2,4-triazole), where bridging between pairs of antiferromagnetically coupled Co centers involves both an SCN^- and two amt ligands.³⁷¹ The complex forms simply from reaction of $\text{Co}(\text{NCS})_2 \cdot 6\text{H}_2\text{O}$ in water with the amt ligand. A general method for synthesis of anionic thiocyanate Co complexes (such as $[\text{Co}(\text{NCS})_4]^{2-}$), as well as neutral mixed-ligand species, by oxidation of a sacrificial Co anode has appeared.³⁷²

Azide appears as both an effective monodentate and bridging ligand. As an example, the one-dimensional 1,3-azido bridged coordination polymer is defined by the structure of $[\text{Co}(\text{py})_4(\text{N}_3)]\text{PF}_6$.³⁷³ A μ -1,1 bridging mode has been observed for N-bound cyanate in conjunction with di-2-pyridyl ketone in an unusual tetranuclear dicubane- Co^{II} complex where two vertices are missing from the core. Ferromagnetic coupling between the Co centers was found.³⁷⁴

6.1.2.2.3 Phosphorus

(i) Monodentate phosphines

Examples of monodentate phosphines appear as companion ligands in other parts of the review, and only limited additional examples will be presented here. The reactivity of $\text{Co}(\text{NO}_2)_2$ toward a variety of monodentate phosphines such as PMe_3 , PET_3 , PMe_2Ph , PMePh_2 , and PPh_3 has been investigated.³⁷⁵ For PMe_3 and PMe_2Ph , five-coordinate square–pyramidal $\text{Co}(\text{NO}_2)_2(\text{PR}_3)_3$ complexes were isolated, but for PET_3 only the pseudo-octahedral, formally trivalent $\text{Co}(\text{NO})-(\text{NO}_2)_2(\text{PET}_3)_2$ was obtained. The analogs $\text{Co}(\text{NO})(\text{NO}_2)_2(\text{PMe}_3)_2$ and $\text{Co}(\text{NO})(\text{NO}_2)_2(\text{PMe}_2\text{Ph})_2$ were prepared indirectly from the dinitro precursor by reaction with NO gas. The resultant Co^{III} species contain both O-bonded and N-bonded NO_2 . Reactions of R_3PI_2 (R = Et, Pr, Bu, PhMe_2 , Ph_2Me , Ph_2Pr , Ph, *m*- MeC_6H_4), with unactivated Co metal in dry ether produce $[\text{PR}_3]\text{I}[\text{Co}(\text{PR}_3)\text{I}_3]$ in quantitative yield,³⁷⁶ and the X-ray crystal structure of $[\text{PPh}_3]\text{I}[\text{Co}(\text{PPh}_3)\text{I}_3]$ is reported. However, the reaction with PPhMe_2 is more complicated and generates the Co^{III} compound $\text{Co}(\text{PPhMe}_2)_2\text{I}_3$ as an additional product. The simple tetrahedral complex $\text{CoCl}_2(\text{PPh}_3)_2$ bound to a polymer support catalyzes the oxidation of alcohols to aldehydes (e.g., benzyl alcohol to benzaldehyde, 86% yield) and the preparation of anhydrides from reaction of acid chlorides with carboxylic acids.³⁷⁷

(ii) Multidentate phosphines

Chelating phosphines are effective ligands for Co^{II} . The $[\text{Co}(\text{mtriphos})_2]^{2+}$ cation (**85**) was formed by controlled potential electrolysis of its trivalent relative and characterized by EPR

and spectrophotometry.³⁷⁸ This divalent CoP_6 species has a low-spin electronic ground state with a large Jahn-Teller distortion. The $\text{Co}^{\text{III/II}}$ electron self-exchange reaction is very fast ($\sim 10^4 \text{ M}^{-1} \text{ s}^{-1}$), which is consistent with other low-spin/low-spin $\text{Co}^{\text{III/II}}$ couples. The nephelauxetic effect of the P donors is responsible for stabilizing the low-spin state in Co^{II} .

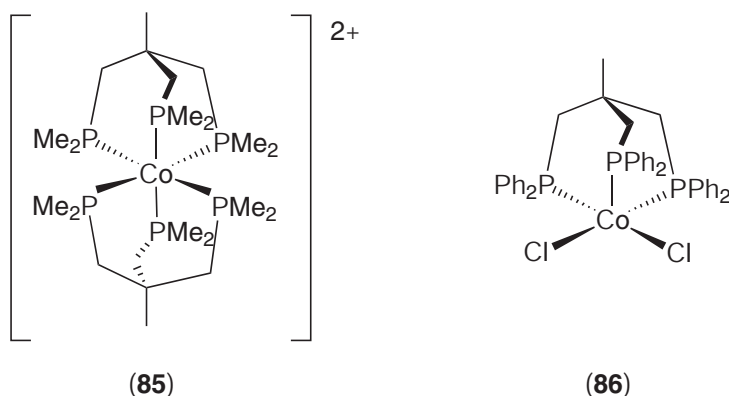

The bi- and tridentate phosphines dppp (1,3-bis(diphenylphosphino)propane) and dppep (bis(2-diphenylphosphinoethyl)phenylphosphine) have been complexed with Co and their divalent four- and five-coordinated thiophenolate complexes $\text{Co}(\text{dppp})(\text{SPh})_2$ and $\text{Co}(\text{dppep})(\text{SPh})_2$ have been isolated and structurally characterized.³⁷⁹ Somewhat related to dppp is the bidentate silane $\text{Ph}_2\text{PCH}_2\text{SiMe}_2\text{CH}_2\text{PPh}_2$, which forms high-spin, pseudo-tetrahedral dihalocobalt(II) complexes.³⁸⁰

The five-coordinate triphos complex **(86)** undergoes selective substitution of its Cl groups on activation with KPF_6 in the first substitution step and by TIPF_6 in the second. This enabled the synthesis of mixed-ligand complexes of the type $[\text{Co}(\text{triphos})(\text{L})(\text{L}')]^{2+}$, e.g., the divalent hydride $[\text{Co}(\text{triphos})\text{H}(\text{PEt}_3)]^+$.³⁸¹ Homo-disubstituted compounds $\text{Co}(\text{triphos})\text{L}_2$ are directly accessible from $\text{Co}_{\text{aq}}^{2+}$ as the starting material.³⁸² Depending on the reaction conditions, a variety of products including $[(\text{triphos})\text{Co}(\text{S}_2\text{CPEt}_3)]^{2+}$, $[(\text{triphos})\text{Co}(\text{S}_2\text{C}(\text{H})\text{PEt}_3)]^{2+}$, and $[(\text{triphos})\text{Co}(\mu\text{-CS}_2)\text{Co}(\text{triphos})]^{2+}$ are obtained from the reaction of the $[\text{Et}_3\text{P}][\text{CS}_2]$ adduct with $\text{Co}_{\text{aq}}^{2+}$ and triphos. Triphos may also be substituted by its diethylphosphino analog (etriphos).³⁸³ Reaction of the template $\{(\text{triphos})\text{Co}\}^{2+}$ with potentially bridging ligands (L) generates dinuclear $[(\text{triphos})\text{Co}(\text{L})\text{Co}(\text{triphos})]^{n+}$ species. When L is oxalate, a biscobalt(II) complex is formed, whereas when L is the dianion derived from 2,5-dihydroxy-1,4-benzoquinone, two-electron transfer within the dimetallic unit occurs and a biscobalt(III) complex results.³⁸⁴ Single-electron reduction of the dinuclear $[(\text{triphos})\text{Co}(\text{L})\text{Co}(\text{triphos})]^{2+}$ complexes (L = dianion of tetrahydroxybenzene or tetrahydroxyanthracene) by cobaltocene gave the corresponding mixed-valence monocation $[(\text{triphos})\text{Co}(\text{L})\text{Co}(\text{triphos})]^+$.³⁸⁵ The tetrahydroxybenzene bridged system exhibits a strong metal-metal interaction leading to delocalized class-III behavior while the extended tetrahydroxyanthracene bridging ligand leads to only partial electron localization. Reaction of the pseudo-tetrahedral complex $(\eta^2\text{-triphos})\text{CoCl}_2$ with O_2 yields the mixed phosphine/phosphine oxide ligands triphos-O and triphos- O_2 , the latter being formed in quantitative yield using catalytic amounts of the Co precursor.³⁸⁶ Complexes of triphos-O and triphos- O_2 , proposed as intermediates in the oxygenation reaction, were isolated and fully characterized structurally.

The coordination chemistry and catalytic applications of chelating P,O-donor ligands (phosphine esters, ketophosphines and phosphinocarboxylates) has been reviewed.³⁸⁷ A variety of divalent complexes of keto-phosphine ligands of the form $\text{CoX}_2(\text{Ph}_2\text{PCH}_2\text{C}(\text{O})\text{Ph})_2$ (X = Cl, Br, I) have been investigated.³⁸⁸ These complexes exhibit tetrahedral-octahedral equilibria in MeOH, but this does not involve coordination of the keto O atom, but instead by the solvent. The crystal structure of the pseudotetrahedral complex **(87)** was reported with the ligand binding as a monodentate P-donor. When reacted with TIPF_6 , the square planar Co^{II} complex **(88)** is formed initially and then is transformed in solution to the six-coordinate **(89)**. Reaction of **(87)** with bases (NaH , NaOMe , $\text{K}[\text{OSiMe}_3]$) in toluene or THF at 0°C gives deprotonated tris-P,O-chelated octahedral cobalt(III) enolates of the form $\text{Co}(\text{Ph}_2\text{PCHC}(\text{O})\text{Ph})_3$ where *fac* **(90a)** and *mer* **(90b)** isomers are observed.³⁸⁸ The potentially tridentate ligand benzylbis(2-ethoxyethyl)phosphine (L) reacts with CoCl_2 to give the monodentate P-coordinated tetrahedral CoCl_2L_2 complex, but when reacted with $\text{CoCl}_2 \cdot 6\text{H}_2\text{O}$ and AgCF_3SO_3 the *trans*-(P,O)- $\text{CoL}_2(\text{O}_3\text{SCF}_3)_2$ complex is the result.³⁸⁹

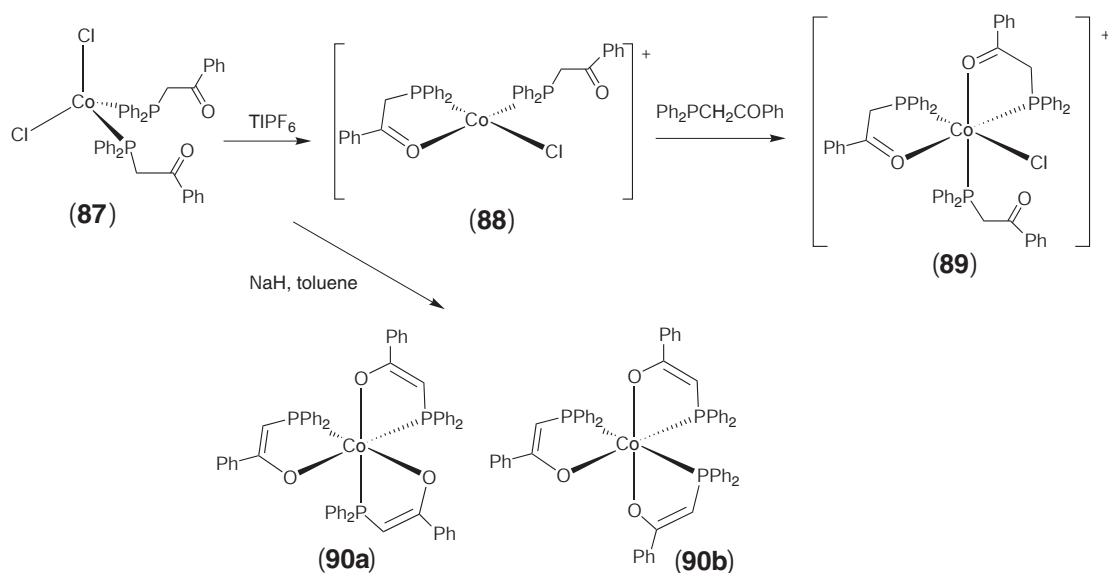

The P-N chelate **(91)** (dapdmp) exhibits a variety of coordination geometries in complexes with divalent Co. Pseudotetrahedral $\text{Co}(\text{dapdmp})\text{X}_2$ ($\text{X} = \text{Cl}, \text{Br}, \text{I}, \text{NCS}$), low-spin five-coordinate $[\text{Co}(\text{dapdmp})_2\text{X}]^+$ ($\text{X} = \text{Cl}, \text{Br}, \text{I}$), planar $[\text{Co}(\text{dapdmp})_2]^{2+}$ and pseudo-octahedral $\text{Co}(\text{dapdmp})(\text{NO}_3)_2$ were all identified.³⁹⁰ The tetradentate P_2N_2 Schiff base complex **(92)** is formed by reacting the free ligand with CoI_2 . The iodo complex is low spin and square pyramidal.³⁹¹

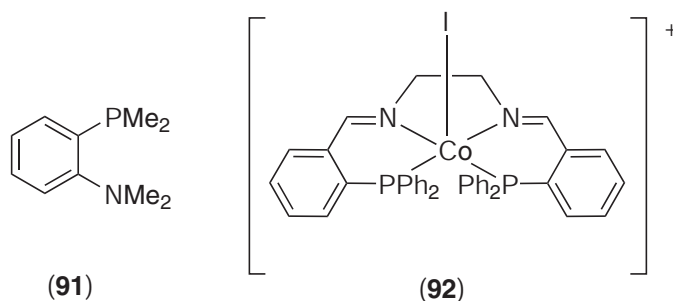

Tetrahedral, high-spin halo(amidodiphosphine)cobalt(II) complexes $\text{Co}(\text{L})\text{X}$ where $\text{X} = \text{Cl}, \text{Br}, \text{I}$ and tridentate $\text{L} = ^-\text{N}(\text{SiMe}_2\text{CH}_2\text{PPh}_2)_2$ have been described.³⁹² Amongst a range of reactions with organic halides studied, they undergo a one-electron oxidation reaction with PhCH_2X to yield five-coordinate cobalt(III) complexes $\text{Co}(\text{L})\text{X}_2$.²⁰¹

6.1.2.2.4 Arsenic

(i) Monodentate and multidentate arsines

Arsenic is an obvious replacement for phosphorus particularly in multidentate ligands, and some limited examples will suffice to define this fact. The rigid aromatic diarsine nas (1,8-naphthylenebis(dimethylarsine)) forms a divalent tris bidentate complex $[\text{Co}(\text{nas})_3]^{2+}$ **(93)** upon reaction with $\text{Co}_{\text{aq}}^{2+}$ (Cl^- , Br^- and ClO_4^- salts), but similar treatment of $\text{CoI}_2 \cdot 6\text{H}_2\text{O}$ gave the five-coordinate $[\text{Co}(\text{nas})_2\text{I}]$.³⁹³ Mixed donor As-chelate complexes of Co^{II} have been reported. The ligand $o\text{-C}_6\text{H}_4(\text{AsMe}_2)(\text{PMe}_2)$ forms only 2:1 ligand:Co complexes such as $[\text{CoL}_2\text{X}]^+$ ($\text{X} = \text{Cl}, \text{Br}, \text{I}$), which are low spin and five-coordinate in solution.³⁹⁰ By comparison, $o\text{-C}_6\text{H}_4(\text{AsR}_2)(\text{CO}_2\text{H})$ ($\text{R} = \text{Et}, \text{cyclohexyl}$ and $p\text{-tolyl}$) reacts with $\text{Co}(\text{OAc})_2$ to give the neutral bis complex of the ligand monoanion CoL_2 .³⁹⁴ Electronic spectra and magnetic susceptibility measurements are consistent with a pseudo-tetrahedral geometry.

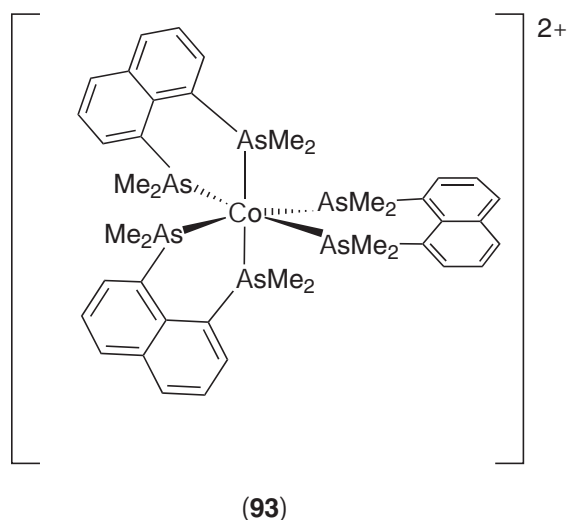

6.1.2.2.5 Oxygen

Oxygen-donor ligands represent, along with nitrogen, the most likely to be met in Co^{II} chemistry. The variety of ligands reported is extensive.

(i) Aqua, hydroxo, and oxo

Water and its successively deprotonated forms hydroxide and oxide are classical ligands for Co in both its di- and trivalent oxidation states. Whereas H₂O is typically found as a monodentate ligand, hydroxide may be monodentate or else bridge two metals (μ_2), and oxide can be any of monodentate, dibridging (μ_2) or tribridging (μ_3), with tetrabridging (μ_4) rare but known. Acidity of any ligand is enhanced by the influence of additional coordinated metal ions. Indeed, the fully deprotonated oxo ligand is only encountered in divalent Co chemistry as a bridging ligand; terminal oxo complexes do not feature.

The chemistry of the aqua ions has been extensively covered in a monograph with that title.³⁹⁵ The hexaaquacobalt(II) ion undergoes exchange rapidly³⁹⁶ and often serves as an entry point into the chemistry of both Co^{II} and Co^{III}. Although commonly found as a monodentate, several examples of water as a bridging ligand between two Co^{II} centers have appeared. An example is Co₂(μ -OH₂)(μ -OCCCCl₃)₂(OCCCCl₃)₂(tmen)₂ (where tmen = *N,N,N',N'*-tetramethylethane-1,2-diamine).³⁹⁷ This dimeric structure with a bridging aqua ligand is stabilized by intramolecular hydrogen bonding.

Apart from water, hydroxide and oxide are well-established ligands for Co^{II}. This includes the latter ions adopting bridging modes. An example of a complex featuring both the (μ_2 -OH) and (μ_3 -O) ligands is the cluster (94).³⁹⁸ The dicobalt complex (95) bears both bridging hydroxide and acetate ligand and is stabilized by the trimethylated 1,4,7-triazacyclononane ligand.³⁹⁹ The substituted Tp dimer (24) reacts with one equivalent of H₂O₂ to give the reactive trivalent μ -oxo dimer (96), which was isolated and characterized structurally.⁴⁰⁰ The polymeric trimethylacetate complex [Co(OH)_{*n*}(OCCMe₃)_{2-*n*}]_{*m*} is transformed upon recrystallization from non-polar aromatic solvents into discrete clusters such as Co₆(μ_3 -OH)₂(μ -OCCMe₃)₁₀(HOCCMe₃)₄, where each hydroxide ions bridge three Co centers.⁴⁰¹ A cluster featuring μ_4 -oxo groups is also reported.

Perhaps the highest nuclearity complex containing divalent Co ever structurally characterized is the cluster Co₂₄(μ_3 -OH)₁₄(μ -OH)₄(μ_3 -OMe)₂(μ_3 -Cl)₂Cl₄(mph)₂₂ (Hmph = 2-methyl-6-hydroxypyridine), which has a high-spin ground state and indications of superparamagnetic behavior.⁴⁰² It self-assembles from reaction of the sodium salt of Hmph with CoCl₂ in methanol. Polyiron oxo chemistry offers another class of readily prepared clusters in which Co^{II} plays a cameo role as a core metal, as in the cluster Fe₁₆CoO₁₀(OH)₁₀(OBz)₂₀, where Co occupies a center of symmetry of the compact Fe₁₆CoO₁₀(OH)₁₀ core, surrounded by the twenty coordinated benzoates.⁴⁰³ Large

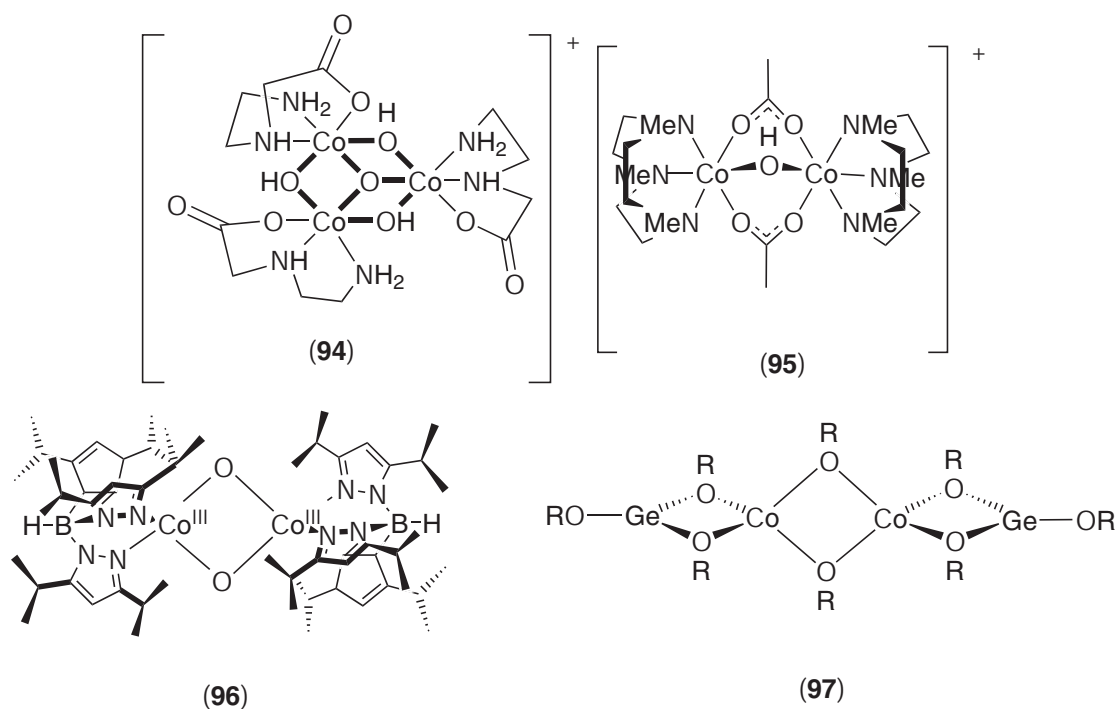

clusters are accessible via thermal “dimerization” of smaller clusters, as exhibited by heating $\text{Co}_4(\mu_3\text{-OH})_2(\text{OOCMe}_3)_6(\text{EtOH})_6$ in decalin, which forms an octanuclear oxo-bridged cluster with ethanol loss.⁴⁰⁴ An unusual cluster where oxo groups play a key structural role forms when $\text{Co}(\text{OAc})_2$ is heated with $\text{Me}_3\text{SiNPEt}_3$ at 180 °C and recrystallized from diethyl ether.⁴⁰⁵ The blue crystals obtained are of $[\text{Co}_7(\mu_4\text{-O})_2(\text{OOCCH}_3)_8(\text{NCO})_2(\text{HNPEt}_3)_4] \cdot 2\text{OEt}_2$, where the Co centers are arranged in a $\{\text{Co}(\text{Co})_6\}$ octahedron with two μ_4 -oxo ions and four bridging acetates linking the octahedral central Co to the six peripheral Co centers, four of which have a distorted trigonal bipyramidal geometry while the other two adopt tetrahedral coordination.

Definitive structural characterization of Co in a solid state oxide lattice has been achieved for a single crystal of partially Co^{II} -exchanged zeolite A.⁴⁰⁶ Dehydration at high temperature and low pressure for two days afforded the characteristic color change from light pink to deep blue. Exposure to H_2S gas gave a black crystal whose X-ray structure was determined. Four Co^{II} ions were found recessed into the large cavity of the zeolite at six-oxygen ring sites, each coordinated to three framework oxygens ($\text{Co}-\text{O}$ 2.24(1) Å) and to one H_2S sulfur ($\text{Co}-\text{S}$ 2.60(2) Å)

A pH-controlled interconversion from a dicobalt(II) complex where each Co carries a single monodentate hydroxo group to a compound with a shared μ -hydroxo group has been reported; a pendant arm dinucleating polyimine macrocycle completes the coordination sphere of the two Co ions.⁴⁰⁷ The process features interchangeable coordination geometries, as the yellow-green μ -hydroxo compound is octahedral and the purple dihydroxo compound trigonal prismatic.

(ii) Dioxygen

Dioxygen can bind reversibly to several classes of Co^{II} complexes including porphyrins, peptides, Schiff bases, and macrocyclic polyamines. Diverse physical studies of dioxygen binding have been reported. Thermodynamics and kinetics of dioxygen binding to Co^{II} have been well studied, as exemplified by a recent study involving macrocyclic tetraamines.⁴⁰⁸ Binding to Co^{II} complexes of tetraimine “lacunar” macrocycles is typically fast and differences in dissociation rates define dioxygen affinity (see Section 6.1.3.1.3). Dioxygen complexes of particularly μ -phenoxo and μ -alkoxo bridged dimetal complexes of compartmental ligands has appeared recently.⁴⁰⁹ Dioxygen binding to Co^{II} porphyrins has also been observed and the catalytic reduction of dioxygen to water has been a motivating force driving their study (see Section 6.1.2.2.2).

(iii) Neutral oxygen donors

Apart from water as the ubiquitous neutral solvent donor for cobalt(II) chemistry, other neutral O donors are known, including alcohols, ketones, amides, and sulfoxides. The complex $[\text{Co}(\text{DMSO})_6][\text{CoCl}_4]$ has been characterized by an X-ray structure, which confirmed monodentate O coordination around the octahedral Co center.⁴¹⁰ Formally neutral molecules such as amine N-oxides and nitrosoalkanes are effective ligands. A ligand such as nitrosomethane (MeNO) can be considered to benefit from resonance forms such as $\text{H}_3\text{C}-\text{N}^+-\text{O}^-$, where its capacity as an O-donor ligand would be clearly enhanced. This ligand has been characterized in $[\text{Co}(\text{MeNO})_4]^{2+}$, whereas pyridine-*N*-oxide (pyo) exists in the octahedral complex $[\text{Co}(\text{pyo})_6]^{2+}$. The same ligand forms a range of ionic complexes with cobalt(II) halides, including the tetrahedral anion $[\text{Co}(\text{pyo})\text{I}_3]^-$.⁴¹¹ The triarsine oxide tetrahedral complex ion $[\text{Co}(\text{OAsR}_3)_4]^{2+}$ was prepared by light-catalyzed decomposition of tetrakis(alkylisocyanide)-bis (triarsine)cobalt(II) in dichloromethane.⁴¹²

(iv) Alkoxides and aryloxides

Cobalt(II) alkoxides are known and monomeric forms are part of a wider review.⁴¹³ The interest in these compounds pertains to a potential role in catalysis. For example, a discrete cobalt(II) alkoxide is believed to form *in situ* from a chloro precursor during reaction and performs the catalytic role in the decomposition of dialkyl pyrocarbonates to dialkyl carbonates and carbon dioxide.⁴¹⁴ A number of mononuclear alkoxide complexes of cobalt(II) have been characterized by crystal structures, as exemplified by $[\text{CoCl}(\text{OC}(t\text{-Bu})_3)_2\cdot\text{Li}(\text{THF})]$.⁴¹⁵ The Co ion in this structure and close relatives has a rare distorted trigonal-planar coordination geometry due to the extreme steric crowding around the metal.

Polymeric forms have also been reported. One example, which also includes germanium heteroatoms terminating the chain, is the oligomer $(\text{RO})\text{Ge}(\text{RO})_2\text{Co}(\text{RO})_2\text{Co}(\text{RO})_2\text{Ge}(\text{OR})$, (**97**) where each Co center is surrounded by four bridging *tert*-butoxide ions.⁴¹⁶ These form via a photochemically induced labile solvent complex, or else through thermally induced substitution into carbonyl compounds.

(v) Ethers

(m) Acyclic. Ether oxygens are not considered strong donors for cobalt. Nevertheless, simple ethers can be the sole occupant of the Co^{II} coordination sphere, as exhibited in the crystal structure of the $[\text{Co}(\text{THF})_6]^{2+}$ ion.⁴¹⁷ Ethers are met as a component donor group in mixed-donor polydentates; an example is the N,O,N-donor bis(pyrazolyethyl)ether,⁴¹⁸ which binds meridionally to Co^{II} . The weak character of the ether bond is illustrated in the reaction of benzylbis(2-ethoxyethyl)phosphine (bbp) with CoCl_2 .³⁸⁹ Reacted alone, the tetrahedral $\text{Co}(\text{bbp})_2\text{Cl}_2$ forms with the ligand a P-bound monodentate; however, when $\text{Ag}(\text{O}_3\text{SCF}_3)$ was included, the octahedral *trans*(P),*trans*(O),*trans*(O)- $\text{Co}(\text{bbp})_2(\text{O}_3\text{SCF}_3)_2$ forms where the ligand is P,O-chelated and in addition the weak ligand triflate is also bound. However, ³¹P NMR suggests the solution structure is different, with a dimer believed to form.

(n) Macrocyclic. Crown ethers also do not form strong complexes with Co^{II} , and crown ethers with pendant groups carrying strong donors tend to coordinate Co ion via the pendant donors rather than involve the ether oxygens. A measure of the poor capacity of the ether oxygen as a donor is exemplified in the structure of $[\text{Co}(\text{ONO}_2)(\text{OH}_2)_5](\text{NO}_3)\cdot\text{H}_2\text{O}\cdot(18\text{-crown-6})$, the product of an attempted crown ether complexation, where the ether oxygens are only linked by hydrogen bonding to coordinated water molecules.⁴¹⁹ However, syntheses leading to ether coordination have appeared, usually in non-aqueous media. Reaction of 15-crown-5 with anhydrous CoCl_2 in acetonitrile yields the blue cation $[\text{Co}(15\text{-crown-5})(\text{MeCN})_2]^{2+}$, with the ether surrounding the Co as part of a rare pentagonal bipyramidal structure with apical acetonitrile donors.⁴²⁰ Hydration leads to replacement of the acetonitrile groups by water, while retaining the intact ether coordination. An ethanol analog is also known, as well as 18-crown-6 complexes. Complexes of $\text{Co}(\text{ClO}_4)_2$ with 16-crown-5 and a lariat ether derivative 15-(2,5-dioxahexyl)-15-methyl-[16-crown-5] have been prepared and the latter structurally characterized.⁴²¹ The Co ion is again heptacoordinated with five crown ether O atoms in the equatorial plane (average Co—O 2.20(2) Å), with a pendant-arm oxygen and a water molecule in apical sites. One novel approach involves reaction of

$\text{Co}_2(\text{CO})_8$ with HCl gas in the presence of 15-crown-5 and water in toluene. This led to a complex species which included seven-coordinate pentagonal bipyramidal Co^{II} centers (**98**) which included the metal ion in the macrocyclic polyether.⁴²²

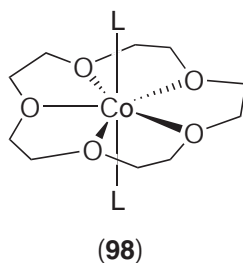

(vi) *Ketones and esters*

Monoketones are poor ligands. Di-2-pyridylketone $(\text{py})_2\text{C}=\text{O}$ accommodates this deficiency in an unusual way when it reacts with $\text{Co}(\text{OAc})_2$ to form clusters, including $[\text{Co}_4(\text{HQ})_4(\text{OAc})_4] \cdot \text{H}_2\text{O}$, where the monodeprotonated hydrated gem-diol form of the ketone (HQ^-) (Equation (5)) binds as an ionic ligand.⁴²³ This cluster adopts a tetranuclear cubane shape with four deprotonated O atoms of the diol occupying the alternating vertices to the Co ions.

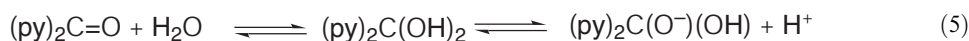

The well-established chemistry of β -diketones has been widely reported previously. These monoanionic enolate chelates readily form complexes with cobalt. A more elaborate recent example is a pyridine with *t*-Bu-CO-CH₂-CO arms attached in the 2- and 6-positions, which acts as a pentadentate tritopic chelator when reacted with Co^{2+} to form the octanuclear cluster $\text{Co}_8\text{O}_2\text{L}_6$.⁴²⁴ Polyvinyl ketone forms coordination polymers with Co^{II} and other divalent ions which exhibit 1:2 metal:ketone stoichiometry, suggesting the coordination is β -diketone-like.⁴²⁵ Alkylation of β -diketones at the central C atom has been achieved through reaction of their Co^{II} or Co^{III} complexes with alkyl halides; for example, the adamantyl group has been introduced into pentane-2,4-dione (Hacac) by this route.⁴²⁶

The β -ketoesters $[\text{RC}(\text{O}^-)=\text{CHC}(\text{O})\text{OR}]^-$ are close analogs which also chelate effectively. A useful general method for synthesis of Co^{II} compounds of these molecules has been reported, which uses the lithium, caesium, or trimethylsilyl enolate of the β -ketoester reacting with a Co^{II} salt in tetrahydrofuran.⁴²⁷

(vii) *Amides*

Divalent Co complexes of N-bound amides are discussed in Section 6.1.2.2.2. Examples of simple O-bound amides consist of acetamides (H_2NCOCR_3), *N*-alkylacetamides ($\text{R}'_3\text{CNHCOCR}_3$), *N,N*-diakylacetamides ($(\text{R}'_3\text{C})_2\text{NCOCR}_3$), dimethylformamide (Me_2NCHO) and *N*-alkylpyrrolidones. As an example, acetamide forms an octahedral complex *trans*- $[\text{Co}(\text{acetamide})_4(\text{OH}_2)_2]^{2+}$, where the Co—O(amide) distance lies in the range 2.10–2.13 Å.⁴²⁸

(viii) *Carbonates, carbamates, and carboxylates*

Carbonate is a well-established ligand, but its coordination diversity continues to surprise. Elaborate bridging modes have been reported for carbonate; for example, a μ_4 -carbonato-bridged Co^{II} compound $[\text{Co}_2(2,2'\text{-bipyrimidine})(\text{OH}_2)_2(\mu\text{-CO}_3)(\mu\text{-OH})]^+$ has been characterized.⁴²⁹

Acetate remains the classical carboxylate ligand, with the capacity to bind in monodentate (μ_1), bidentate chelate (μ_2), or bridging ($\mu_1:\mu_1$) modes. Whereas early chemistry featured simple μ_1 coordination, more frequent examples of bridging coordination are now appearing. A typical example is the dinuclear complex with three acetate bridges, $\text{Co}_2\text{L}_2(\text{OOCCH}_3)_3$ (L = bis[2-dimethylaminoethyl]iminomethyl]benzene,⁴³⁰ (**99**) where the geometry around each Co is a

trigonal bipyramid. Elaborate oligomeric complexes based on heptanuclear Co^{II} fragments supported by carboxylates have been reported, and three heptanuclear cages characterized structurally, including $\text{Co}_7(\text{OH})_2(\text{OCCMe}_3)_4(\text{chp})_8(\text{H}_2\text{O})_{0.25}$ (chp = 6-chloro-2-pyridonate).⁴³¹ The alternate use of phthalate leads to a tridecanuclear cage. Complex **(100)** features both bridging and terminal carboxylates, and reflects the differing reactivities of the two coordination modes, since it undergoes carboxylate exchange reactions with other simple monocarboxylates featuring selective terminal carboxylate substitution by bulky carboxylates.⁴³² A tetracobalt(II) cluster featuring only oxygen donor anionic ligands can be formed in a relatively straightforward self-assembly reaction (Equation (6)).⁴³³

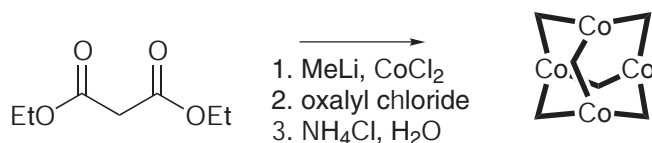

(6)

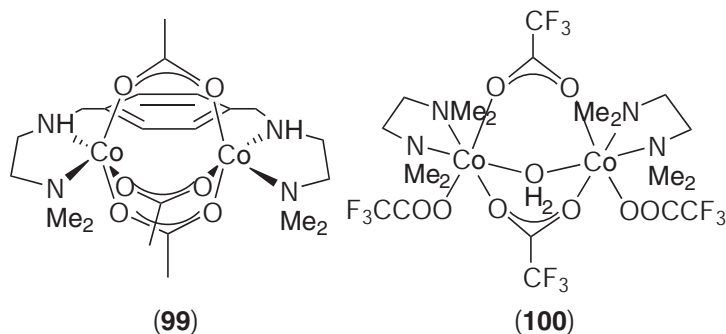
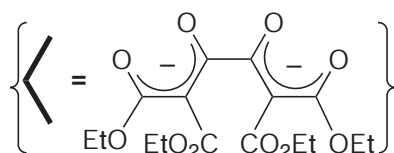

Simple polycarboxylates are well known ligands, and but a few examples appear here. Succinate features in an example of a three-dimensional ferrimagnetic Co^{II} carboxylate, $\text{Co}_5(\text{OH})_2(\text{C}_4\text{H}_4\text{O}_4)_4$ which has a three-dimensional array of layers of edge-sharing Co octahedral pillared by succinate ions, the Co octahedra forming 12-membered rings within the layers.⁴³⁴ This was prepared, in a typical example of hydrothermal reactions for this class of compound, by reacting CoCl_2 , succinic acid, KOH and water in a 2:3:8:120 ratio in a sealed vessel at 180° for 72 h. Citrate, a member of a class of carboxylic acids found in biological fluids, has a key role in several biochemical processes in lifeforms ranging from bacteria to humans. Previously, its interaction with Co has not been well elucidated, but the synthesis from aqueous solution of a 1:2 Co: citrate mixture at pH 8, and subsequent spectroscopic and structural characterization of octahedral $[\text{Co}(\text{citrate})_2]^-$ has now appeared.⁴³⁵ It may offer a source of bioavailable cobalt.

Pyromellitate, the tetracarboxylate of benzene, forms red crystals of formula $[\text{Co}_2(\text{C}_6\text{H}_2(\text{COO})_4)_4] \cdot 18\text{H}_2\text{O}$ from aqueous silica gel, and feature infinite chain-like polyanions with $[\text{Co}(\text{OH})_4[\text{C}_6\text{H}_2(\text{COO})_4]_2]_n^{2n-}$ stoichiometry where Co is in an octahedral environment of four waters and two *trans*-disposed carboxylates.⁴³⁶

An example of a cage molecule based on resorcinarene and carrying polycarboxylate pendants is shown in **(101)**. When the ligand was treated in dilute aqueous acid with CoCl_2 and the pH raised to ~ 6 with carbonate ion, $[\text{Co}_4\text{L}_2]^{8-}$ was formed and characterized by a crystal structure.⁴³⁷ The two resorcinarene molecules are linked by four octahedral Co^{II} ions each bound to an iminodiacetate unit from separate resorcinarenes, creating an oblate spherical cavity big enough to encapsulate small molecules.

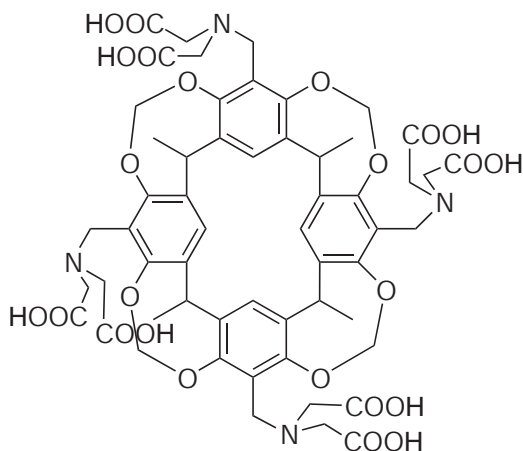

(101)

Organic carbamates (RNHCOO^-) commonly display monodentate coordination, as exemplified in the structurally characterized tetrahedral $\text{Co}(\text{bmc})_2\text{Cl}_2$,⁴³⁸ ($\text{bmc} = N$ -(benzimidazolyl-2-yl)- O -methylcarbamate). An unusual route to a carbamate complex involves the reaction of $\text{Co}_2(\text{CO})_8$ in the presence of a fourfold excess of the stable radical species tmpo , which yields the blue $\text{Co}_4\text{O}(\text{OOCNC}_9\text{H}_{18})_6$ cluster, presumably via a $\text{Co}(\text{CO})_2(\text{tmpo})$ intermediate, with the nitroxyl radical serving as oxidant.⁴³⁹

(ix) Oxoanions of N , S , P , and the halogens

The oxoanions of these elements represent an extensive set of potential ligands, characterized by a dominant, but not exclusive, tendency towards O bonding. Practically every known oxoanion has been introduced into the Co coordination sphere during the last century.

(o) *Nitrogen oxoanions.* Nitrate and nitrite both bind to Co^{II} , as monodentate or bidentate ligands. Nitrate is found as a monodentate co-ligand in a wide range of structures, as exemplified by octahedral *trans*- $\text{Co}(\text{cb-im})_4(\text{NO}_3)_2$ ($\text{cb-im} = 4'$ -cyanobenzyl-1-imidazole)⁴⁴⁰ It is also met in mononuclear complexes as a bidentate chelate, as in the distorted octahedral $[\text{Co}(\text{bpa})_2(\text{NO}_3)](\text{NO}_3)$ ($\text{bpa} = \text{bis}(2\text{-pyridyl})\text{amine}$).⁴⁴¹ An example featuring both monodentate and bidentate nitrate in the same complex ion is $\text{Co}(\text{ddae})(\text{NO}_3)_2$ ($\text{ddae} = \text{bis}(2\text{-}(3,5\text{-dimethyl-1-pyrazolyl)ethyl)ethylamine}$),⁴⁴² the $\text{Co}-\text{O}$ (monodentate) distance is $2.060(8)\text{ \AA}$ whereas the $\text{Co}-\text{O}$ (chelate) distances are longer at $2.172(8)\text{ \AA}$ and $2.216(8)\text{ \AA}$, reflecting strain in the four-membered ring.

Syntheses of many nitrate complexes are straightforward, such as by reaction of hydrated cobalt(II) nitrate with stoichiometric amounts of ligand in alcohol, although whether nitrate is incorporated into the coordination sphere or simply acts as a counterion is hard to predict. Perhaps some of the more interesting compounds appearing including coordinated nitrate are the so-called "molecular ladders"; a simple example is $[\text{Co}(\text{NO}_3)_2(4,4'\text{-bpy})_{1.5}]_\infty$ as MeCN or CHCl_3 solvates.⁴⁴³ This polymeric structure comprises $4,4'$ -bpy ligands bridging Co centers forming both the rungs and side rails of the ladder, with chelated nitrates completing the Co coordination sphere. The solvent molecules are enclathrated in the large square hydrophobic cavities of the structure.

Although the bulk of work with NO_2^- as a ligand features Co^{III} , nitrite can also be O - or N -bonded to Co^{II} , and both modes have been observed in complexes formed by the reaction of several PR_3 compounds with $\text{Co}(\text{NO}_3)_2$, as well as in mixed nitro/nitroso complexes.³⁷⁵ The product $\text{Co}(\text{NO})(\text{NO}_2)(\text{PEt}_3)_2$ reacts with dioxygen to form $\text{Co}(\text{NO}_3)_2(\text{OPEt}_3)_2$, a distorted octahedral structure with bidentate nitrate and *cis* phosphine oxides (102).

(p) *Sulfur oxoanions.* The various oxoanions of sulfur are known to bind effectively to Co^{II} , and a few examples will suffice to define the chemistry. Sulfate is reported to bind as either a monodentate or bidentate chelate to divalent Co . Sulfate in a bridging role to Co^{II} has also been observed, as the 2-aminopyrimidine (ampy) complex (103), where two bridging sulfates and the two Co^{II} centers form an eight-membered ring.⁴⁴⁴ A μ_3 -coordination mode for sulfate has been observed in the product of the reaction of $\text{Co}(\text{CF}_3\text{COO})_2$ with SOCl_2 in dimethoxyethane (dme)

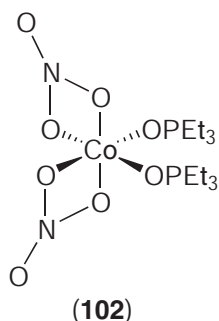

under a nitrogen atmosphere, the cluster $\text{Co}_3\text{Cl}(\text{CF}_3\text{COO})_3(\text{SO}_4)(\text{dme})_3$.⁴⁴⁵ The Co ions occupy corners of an equilateral triangle, each in a distorted octahedral environment which includes a sulfate ion acting as a tripod ligand bridging to each Co center (**104**). Sulfite is formed as a chelate bound through two O donors when SO_2 is reacted with $[\{(\text{triphos})\text{Co}\}_2(\mu\text{-Cl})_2]^{2+}$; likewise, CO_2 and CS_2 form CO_3^{2-} and CS_2O^{2-} chelates in metal-assisted oxidations.⁴⁴⁶

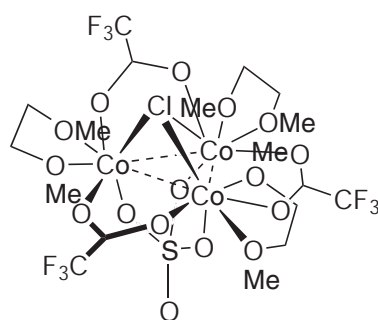
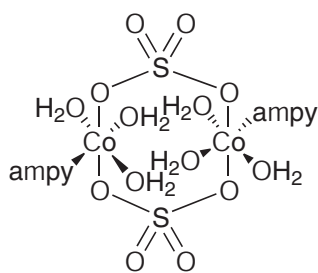

(q) *Phosphorus oxoanions*. Phosphate and its protonated forms, as well as polyphosphates, have been well characterized in complexes with divalent cobalt, being involved in monodentate, chelate, and bridging coordination modes. It is usually met with other companion ligands; even simple compounds such as $\text{Na}_2\text{Co}(\text{H}_2\text{PO}_4)_4 \cdot 2\text{H}_2\text{O}$ finds Co in an octahedral environment comprising four dihydrogen phosphates and two aqua ligands.⁴⁴⁷ Anhydrous compounds featuring only phosphate ligands such as $\text{Na}_4\text{Co}_3(\text{PO}_4)_2(\text{P}_2\text{O}_7)$ have appeared, albeit as structurally complex polymeric solids.⁴⁴⁸

Apart from inorganic phosphates, analogs with C—P bonds, the phophonates (RPO_3^{2-}) and phosphinates (R_2PO_2^-), are known ligands for Co^{II} . They may be present as the sole ligand; for example, diphenylphosphinate forms the polymeric $[\text{Co}(\text{R}_2\text{PO}_2^-)_2]_\infty$ where the metal is tetrahedrally bound with double phosphinate bridges.⁴⁴⁹

Recently, highly branched macromolecular polyamidoamine dendrimers have been prepared with Co^{II} bound where the metal ions have additional exchangeable coordination sites.⁴⁵⁰ These macromolecules show a capacity for catalyzing the hydrolysis of phosphate esters, presumably via intermediate bound phosphoester species.

(r) *Halogen oxoanions*. The suite of oxoacids HXO (hypohalous), HXO_2 (halous), HXO_3 (halic), and HXO_4 (perhalic) in principle all form anions capable of coordination to cobalt. Of all possibilities, perchlorate is the best known of the halogen oxoanions, although it is a weak ligand and met more often as a counter ion. As mentioned in Section 6.1.1.2, ClO_4^- complexes are potentially hazardous due to their inherent thermal instability particularly in coexistence with organic ligands. Nevertheless, there are many examples of it found as a ligand for Co^{II} , for example in tetrakis(2,6-diethylphenylisocyanide)bis(perchlorato)cobalt(II).⁴⁵¹ Also, a Co^{II} corrinato derived from Vitamin B_{12} has been isolated and structurally characterized with a coordinated axial perchlorato ligand bound to the face opposite the one used for nucleotide binding in cobalamin.⁴⁵²

(s) *Other oxoanions*. Transition metal oxoanions can also act as ligands. As an example, the $\text{trans-Co}(\text{py})_4(\text{HCrO}_4)_2$ complex of Co^{II} with hydrogenchromate(VI) and pyridine has been characterized by an X-ray structure.⁴⁵³ The complex efficiently oxidizes benzyl halides to aldehydes.

(x) Mixed O, N Donors

Mixed O, N donor molecules are truly extensive and structurally diverse, and only a few selected examples will be presented. In line with other 2-substituted pyridine analogs reported in this chapter, it is worthwhile noting the chemistry of 2-pyridone (or 2-hydroxypyridine, Hopy), which can form O-bonded monodentate complexes such as $\text{Co}(\text{Hopy})_4(\text{NO}_3)_2$, but as the monoanion is an effective chelate ligand, forming $\text{Co}(\text{opy})_2$ and $\text{Co}(\text{bpy})(\text{opy})_2$ compounds.⁴⁵⁴ An unusual solid state melt reaction with $\text{Co}(\text{OAc})_2$ yields the dodecanuclear cluster $\text{Co}_{12}(\text{OH})_6(\text{OAc})_6(\text{opy}^-)_{12}$.⁴⁵⁵

Polydentate ligands resulting from the Schiff base condensation of primary amines and aldehydic phenols have a venerable history; the products are, when deprotonated, strong ligands for Co^{II} (see Section 6.1.2.2.2). While this chemistry is sufficiently well established to need little discussion, one recent example illustrates the sometimes unexpected outcomes of supposedly straightforward syntheses. Reaction of $\text{Co}(\text{OAc})_2$ with salpnH_2 (the propane-1,2-diamine analog of salen) yields a Co^{II} trimer where the two end Co ions are tetracoordinated by the salpn ligands but the phenolic oxygens all bridge to the central Co ion and each terminal Co is also linked to the central Co by a bridging acetate.⁴⁵⁶ Macrocyclic polyether–polyamine ligands are an extensive family, which have been widely exposed in the literature. One example is the mixed donor macrocycle (**105**), which forms a $[\text{Co}(\text{L})(\text{NO}_3)](\text{NO}_3)$ complex with all five macrocycle donors coordinated in addition to a chelated nitrate, giving a rare example of seven-coordinate Co^{II} .⁴⁵⁷

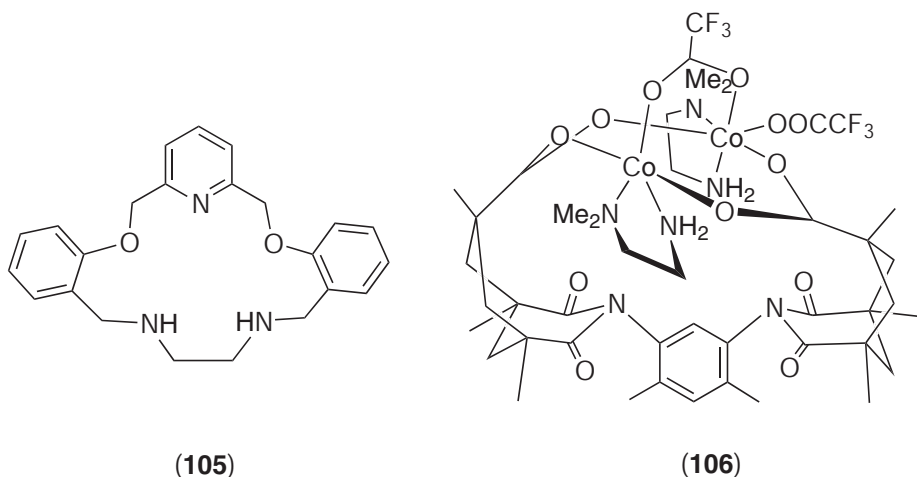

Mixed-donor ligands featuring carboxylate groups appear throughout this chapter. One example of a polycarboxylate-derived ligand is the convergent dicarboxylate ligand formed from Kemp's triacid and xylenediamine, shown as a dinuclear complex in (**106**) with diamine and trifluoroacetate co-ligands. The cobalt(II) complex of this with 2,9-dimethyl-1,10-phenanthroline as co-ligand adopts a highly distorted trigonal bipyramidal geometry. However, in the presence of alkali metal ions the structure adopts an unusual distorted trigonal pyramidal form.⁴⁵⁸ Since binding of the alkali metal also leads to significant changes in the visible spectrum, this complex functions as a metallochromoionophore. The participation of this ligand and other carboxylates in dinuclear cobalt(II) binding had been demonstrated earlier,⁴⁵⁹ when seeking models of non-heme dinuclear proteins.

6.1.2.2.6 Sulfur*(i) Sulfides*

Sulfide is a well-established ligand for Co. In addition to S^{2-} , the protonated form SH^- is known as a ligand, with a linear polymer of $[\text{Co}(\text{cyclam})(\text{SH})]^+$ cations, where the SH^- acts as a bridging group, forming from reaction of $\text{Co}(\text{ClO}_4)_2 \cdot 6\text{MeCN}$ with SH^- in the presence of the cyclam macrocycle.⁴⁶⁰ Further, the bridged dinuclear complex $[\{(\text{cyclam})\text{Co}\}_2(\mu\text{-SH})_2]^{2+}$ forms on varying the Co:S ratio, and $[\{(\text{cyclam})\text{Co}\}_2(\mu\text{-S})_2]^{2+}$ (**107**) results if disulfide S_2^{2-} is used instead of SH^- , with all products defined by X-ray crystallography. Not only bridging sulfide, but selenide

and telluride also, are found in $\{(\text{Me}_3\text{P})_3\text{Co}\}_2(\mu\text{-X})_2$ ($\text{X} = \text{S}, \text{Se}, \text{Te}$), featuring a planar Co_2X_2 metallocycle (**108**).⁴⁶¹ These form in a number of ways, including oxidation of $\text{Co}(\text{Me}_3\text{P})_3\text{Cl}$ with $\text{Te}, \text{Se},$ or S .

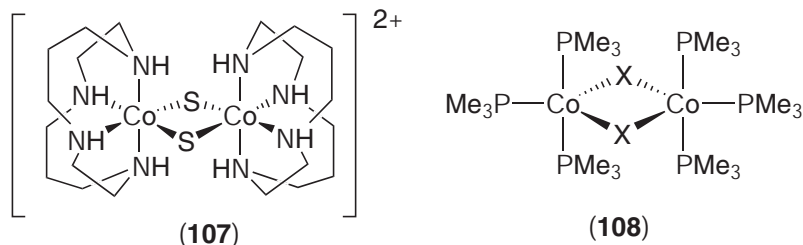

(ii) Thioethers

Thioethers lack the capacity to neutralize positive charge and display weak σ -donor properties. Consequently, they do not readily displace strong donor solvents (water) or strongly bonding anions (such as halides) from the coordination sphere. As a consequence, many thioether complex syntheses employ aprotic or alcoholic solvents and precursor complexes with weakly bound solvents (such as DMSO or acetone) or anions (such as CF_3SO_3^-). Despite the synthetic challenges, a wide range of complexes has been reported, particularly with the cyclic polythioethers, where the macrocyclic effect overcomes many of the above difficulties.

A range of polythioether macrocycles is known, along with mixed thioether–ether and thioether–amine analogs. Macromonocyclic ligands and their Co complexes have been known for some time, with the three most frequently encountered ligands being [9]aneS₃ (**109**), [14]aneS₄ (**110**) and [18]aneS₆ (**111**). Crown thioether chemistry has been reviewed.⁴⁶² The most intensively studied cyclic thioether is (**109**), which forms bis-ligand complexes of both Co^{II} and Co^{III} , both six-coordinate, the former Jahn–Teller distorted low-spin.⁴⁶³ The $\text{Co}^{\text{II}}\text{—S}$ distances range from 2.240(7) Å to 2.356(6) Å. The purple Co^{II} complex may be oxidized reversibly to Co^{III} (+0.68 V) and reduced reversibly to the green Co^{I} (−0.29 V), stabilized by π delocalization. The S₆ crown thioether (**111**) forms a low-spin octahedral complex by reaction with cobalt(II) picrate in refluxing acetone/acetonitrile for a short period, and is one of the few examples of a structurally characterized divalent CoS_6 complex.⁴⁶⁴ A $\text{Co}^{\text{II}}\text{S}_6$ Jahn–Teller distorted octahedral complex with Co—S distances in the range 2.251(1)–2.479(1) Å was found.⁴⁶⁵ The $\text{Co}^{\text{III/II}}$ couple (+0.84 V) shifts to a slightly more positive potential (+0.89 V) if the ring size is increased to 24 atoms with additional methylene groups. A much more rapid $\text{Co}^{\text{III/II}}$ self-exchange electron transfer in the CoS_6 systems compared with CoN_6 analogs ($\sim 10^5$ -fold faster) has been assigned for the S ligands to both extensive delocalization of metal electron density over the ligands and a small reorganization of the coordination sphere with oxidation state change due to comparable Co—S distances in the di- and trivalent oxidation states.

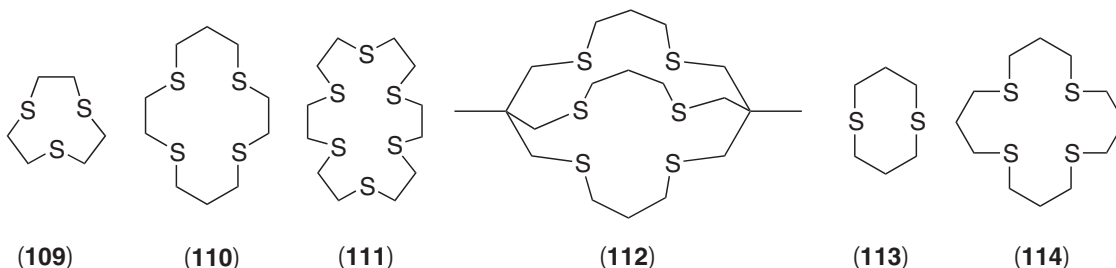

The S₆ macrobicyclic cage (**112**), when complexed to divalent Co, also exhibits four short and two long Co—S bonds in a distorted octahedral environment.⁴⁶⁶ Smaller cyclic thioethers such as (**113**) and [16]aneS₄ (**114**) react with $\text{Co}(\text{BF}_4)_2$ in acetonitrile in the absence of air to form square–pyramidal CoS_4N complexes, with the solvent completing the coordination sphere.⁴⁶⁷ A wide range of mixed-donor ligands incorporating thioethers have appeared as ligands for Co^{II} , but their coordination chemistry is generally not unusual. One example of a mixed S,O-macrocyclic characterized by a crystal structure is $[\text{Co}([20]\text{aneS}_4\text{O}_2)]^{2+}$.⁴⁶⁸

(iii) Thiolates

Thiolates (RS^-) represent an extensive family of ligands, and include chelating forms. Thiolates are known to act as monodentate donors, but often act in a bridging role. There is a clear biological interest, through participation of thiolates (cysteine residues) as donors in many metalloproteins both as terminal S donors and bridging ligands in, for example, Fe-S clusters.

Cobalt(II) alkylthiolates of the types $[\text{Co}(\text{SR})_4]^{2-}$, $[\text{Co}_2(\text{SR})_6]^{2-}$, and $[\text{Co}_4(\text{SR})_{10}]^{2-}$ have been reported and structurally characterized.⁴⁶⁹ Tetrahedral, dark green $[\text{Co}(\text{SR})_4]^{2-}$ ions are fairly well known and studied. The PhS^- complex can be formed by reaction of $\text{Co}(\text{S}_2\text{COC}_2\text{H}_5)_3$ with $\text{K}(\text{PhS})$ and isolated as the Ph_4P^+ salt.⁴⁷⁰ Reaction of CoCl_2 with sodium 2-aminobenzenethiolate and Et_4NCl in MeOH yields the tetrahedral $(\text{Et}_4\text{N})_2[\text{Co}(\text{SC}_6\text{H}_4\text{NH}_2)_4]$, where coordination is through the S (Co—S 2.295(2) Å) and not the N atom.⁴⁷¹ The electronic spectrum implies an equilibrium in solution between the tetrahedral form characterized in the solid state and an octahedral form. A new mixed halide–thiolate cluster complex of cobalt(II) arises from reaction of NaSPh and Et_4NCl with CoCl_2 in methanol.⁴⁷² The $[\text{Co}_4(\text{SPh})_6\text{Cl}_4]^{2-}$ cluster ion crystal structure shows the four Cl ions bind to different Co centers and define a tetrahedron, whereas the S-donors are arranged in an irregular octahedron. Each Co center exhibits distorted tetrahedral symmetry, while the core itself consists of a distorted Co_4 tetrahedron.

More complex coordination modes can arise if other potential donors are in appropriate positions. For example, reaction of anhydrous CoCl_2 with tris(*t*-butoxy)silanethiol (tbstH) in acetonitrile in the presence of Et_3N as base yields $\text{Co}(\text{tbst})_2(\text{MeCN})$, where the tbst^- chelates through the S and one of the O atoms to form a trigonal bipyramidal structure.⁴⁷³ Chelated dithiolates also form complexes with Co^{II} ; the classical chelator $o\text{-C}_6\text{H}_4\text{S}_2^{2-}$ binds in a complex with a $\text{Co}^{\text{II}}\text{S}_2\text{P}_3$ donor set, with a tripodal phosphine occupying the other sites (115).⁴⁷⁴ The 2,3-disulfanylmaleonitrile chelate binds in a square–planar $\text{Co}^{\text{II}}\text{S}_4$ arrangement with stacking in the crystal allowing for S atoms to interact axially with another Co center.⁴⁷⁵

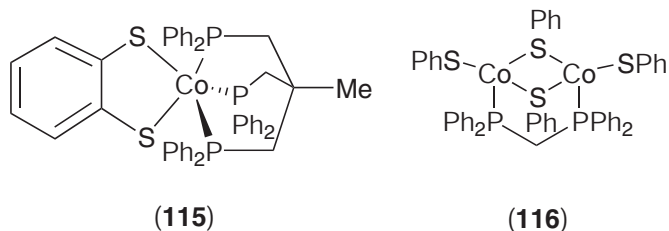

Thiolates often bind in concert with other strong donors. An unusual example is the dimeric $\text{Co}_2(\text{dppm})(\mu\text{-SPh})_2(\text{SPh})_2$, which displays terminal and bridging modes for the thiolate, as well as bridging by the diphosphine ligand in (116).⁴⁷⁶ Clusters $[\text{Co}_3(\mu\text{-SR})_6(\text{PET}_3)_3]^+$ involving thiols and phosphines form readily from the reaction of an alkylthiolate with cobalt(II) acetate in the presence of excess PET_3 .⁴⁷⁷ The three cobalts form a triangle, with six symmetrically bridging thiolates and a terminal phosphine on each cobalt. The cluster can be oxidized or reduced in one-electron steps.

Thiolates coupled with other donors are effective chelators. Pyridine-2-thiolate (pyt) forms four-membered chelate rings to Co^{II} in $\text{Co}(\text{pyt})_2$ compounds which are conveniently formed by anodic oxidation at a Co electrode in an acetonitrile solution of the ligand.⁴⁷⁸ These are able to be oxidized further to tris(pyt)cobalt(III) compounds. The ligand 2-methyl-1-[methyl-(2-pyridin-2-ylethyl)amino]propane-2-thiolate (pyat) forms distorted tetrahedral cobalt(II) complexes $\text{Co}(\text{pyat})\text{X}$ ($\text{X} = \text{Br}, \text{SCN}$), where pyat acts as an N_2S -tridentate, the first examples of this type defined by crystal structures.⁴⁷⁹ Four-coordination appears to persist in solution regardless of solvent, and only one diastereomer is detected and predicted by molecular mechanics due to a favorable conformation of the ligand. It is suggested the complexes are structural mimics of metalloproteins such as peptide deformylase, which possess a His_2Cys site. Cobalt(II) binding to thiolates in biological molecules has been probed. Interaction of a 34-amino acid peptide derived from α -fetoprotein with cobalt(II) and zinc(II) has been examined by UV–visible and CD spectroscopy, and coordination by two thiolate (from cysteine) and two imine (from histidine) donors with similar protein conformations is implied.⁴⁸⁰ The Co ion acts in the opposite way to the zinc in the sense that the former catalyzes the loss of the anti-growth form of the peptide whereas with the latter there is stabilization.

1,1-Dithiolates ($R_2C=CS_2^{2-}$) and analogs dithiocarbimates ($RN=CS_2^{2-}$), trithiocarbonates ($-S-CS_2^{2-}$), and dithiocarbonates ($-O-CS_2^{2-}$) were introduced in *CCC*(1987) (Section 47.8.10),¹ and will not be exhaustively reviewed here. The dithiolates and their selenium analogs have continued to attract attention because of potential applications of their complexes as superconducting materials; the first molecular superconductor was a nickel dithiolate complex. One extensively studied family of ligands is 1,3-dithiole-2-thione-4,5-dithiolate (dmit) and its isologs (117).^{481,482} Although work has concentrated on Ni and Pd chemistry, complexes such as $[Co(dmit)_2]^{2-}$ have been reported, along with mixed-ligand species such as $[Co(Cp)(dmit)]^-$.

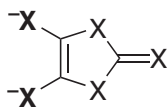

(117) [X = S, Se]

(iv) Dithioacids and thiosemicarbazones

The dithioacid family of ligands includes dithiocarbamates ($R_2N-CS_2^-$), xanthates ($RO-CS_2^-$), thioxanthates ($RS-CS_2^-$) and dithiocarboxylates ($R-CS_2^-$), which have been described in *CCC*(1987, Section 47.8.10).¹ The ligands are prepared by addition of a suitable nucleophile to the carbon center in CS_2 , usually in the presence of a base. It has been established for some decades that they bind to Co almost exclusively as bidentate chelates, including S-donors acting as bridging ligands in dinuclear systems.

Chelating thiosemicarbazone ($RNH-CS-NH-N=CR'R''$, Htsc) complexes of Co^{II} were briefly mentioned in *CCC* (1987, Section 47.8.6), with tetrahedral, trigonal bipyramidal, and octahedral forms known for compounds of empirical formula $Co(Htsc)_2X_2$ ($X = Cl^-, Br, I^-$), the geometry influenced by R groups present. Chelation as an *S,N*-bidentate is dominant, but not exclusive, with *N,N*-bidentate known. Since the last edition, driven by potential medical applications as fungicides and antimicrobials, more extensive examples of thiosemicarbazone cobalt(II) complexes have appeared, with 1, 2, 3, or 4 donors coordinated, almost invariably including the S and usually a N atom as donors. The ligands commonly bind in an N-deprotonated (thiolene) form, although neutral coordination (as a thione) can occur.⁴⁸³ Reported complexes are typically mononuclear, although coordination polymers have been proposed. Octahedral coordination has been proposed in most cases, though tetrahedral and trigonal bipyramidal geometries have been suggested. For example, octahedral $Co(mftsc)_2X_2$ and tetrahedral $Co(mftsc)X_2$ (with mftsc = 5-methyl-2-furaldehyde thiosemicarbazone) have been reported, with coordination through both the S and azomethine N atoms supported.⁴⁸⁴

Ligands of higher denticity have appeared. Tridentate coordination as an *S,N,O*-donor is reported for the cobalt(II) complex of salicylaldehyde *N*(4)-cyclohexylthiosemicarbazone, with four- or five-coordinate complexes proposed where additional sites are occupied by heterocyclic bases.⁴⁸⁵ A mixed ligand complex $Co(stsc)(amN)_3$ where stsc = salicylaldehyde thiosemicarbazone and amN is an aromatic amine has been reported, with the stsc bound as an *S,N,O*-tridentate dianion.⁴⁸⁶ Methyl 2-pyridyl ketone thiosemicarbazone forms a bis(tridentate)cobalt(II) complex with N_4S_2 -coordination, from spectroscopic evidence and by analogy to the crystal structure of the copper(II) analog.⁴⁸⁷ Tridentate S_2N -binding is proposed in octahedral cobalt(II) complexes of 2-acetyl thiophene thiosemicarbazone, involving the azomethine N, cyclic thioether S and thiol S.⁴⁸⁸ The complexes proved effective as fungicides against several species. Vanillin thiosemicarbazone (vtsc), as the $[Co(vtsc)_2(H_2O)_2]^{2+}$ complex, also displays fungicidal activity.⁴⁸⁹ Tetradentate (N_2S_2 -donor) examples bound to cobalt(II) of the form benzil-bis(4-alkylthiosemicarbazone) have been proposed, where the dianion forms apparently octahedral $Co(dtc)(OH_2)_2$.⁴⁹⁰

Introduction of an organometallic moiety has been achieved by coupling ferrocenecarbaldehyde with thiosemicarbazide, with the resulting thiosemicarbazone (fctsc) forming the presumably octahedral cobalt(II) complex $Co(fctsc)_2Cl_2$,⁴⁹¹ which showed antibacterial activity. Acetylferrocene thiosemicarbazone complexes of Co were reported earlier,⁴⁹² including a species of the same form as that given above.

The cobalt(II) complexes may be readily oxidized to cobalt(III) species. For example, use of different cobalt(II) salts in syntheses have been reported to direct the formation of either tetrahedral cobalt(II) species or oxidized octahedral cobalt(III) species.⁴⁹³ Also, μ -peroxodicobalt(III)

complexes of 2,6-diacetylpyridine-bis(N(4)-azacyclic thiosemicarbazones) form by rapid reaction of the cobalt(II) complex in organic solvents with oxygen; the kinetics have been probed in detail.⁴⁹⁴

Fungicidal activity of cobalt(II) and other divalent metals of tsc compounds have been observed, and is usually greater than for the free ligand.⁴⁹⁵ Broad antimicrobial activity has been reported for the cobalt(II) complex of acetophenone-4-(2'-carboxy-5'-sulfophenyl)-3-thiosemicarbazone.⁴⁹⁶

(v) Thioureas

Thiourea ($\text{H}_2\text{NC(S)NH}_2$, tu), as typically an S-bound monodentate ligand, has been commonly observed. The simple S-bound tetrahedral tetrakis(thiourea)cobalt(II) ion has been defined by an X-ray crystal structure.⁴⁹⁷ The S-coordination of thiourea has also been defined in high-spin, octahedral cobalt(II) complex $\text{Co(phen)(tu)(H}_2\text{O)Cl}_2$.⁴⁹⁸ A similar coordination mode is observed in aqua(thiourea)(semicarbazidediacetato)cobalt(II).⁴⁹⁹ Cobalt(II)-coordinated thiourea has also been defined in a crystal structure of Co(tsd)(tu) (tsd = thiosemicarbazide diacetate).⁵⁰⁰ Digestion of $[\text{Co}_2(\text{CNCHMe}_2)_{10}]^{4+}$ in ethanol with an excess of thiourea produces octahedral monomers *trans*- $[\text{Co}(\text{CNCHMe}_2)_4(\text{tu})_2]^{2+}$,⁵⁰¹ rather than the presumed initial cleavage and addition product $[\text{Co}(\text{CNCHMe}_2)_5(\text{tu})]^{2+}$, assigned to a preference for a structure with two strongly σ -bonding ligands in *trans* dispositions. Lability of the thiourea cobalt(II) systems has been probed in a study of ⁶⁰Co exchange in $\text{Co(SCN)}_2(\text{tu})_2$.⁵⁰²

Substituted thioureas have been extensively studied over the decades. Reaction of CoX_2 (X = Cl, Br) with substituted phenylthioureas yield a range of complexes involving halide and thiourea as ligands, characterized by spectroscopy and thermogravimetric analysis.⁵⁰³ Both $[\text{Co}(\text{Rtu})_4(\text{OH}_2)_2]^{2+}$ (Rtu = thiourea, phenylthiourea, allylthiourea) and $[\text{Co}(\text{Rtu})_2(\text{OH}_2)_4]^{2+}$ (Rtu = diphenylthiourea) have been prepared and characterized as low-spin octahedral species.⁵⁰⁴ The octahedral bis(phenylthiourea)bis(dithiolate)cobalt(II) complex, one of a number of complexes of phenylthiourea, chlorophenylthiourea and bis(diphenylphosphanothioyl)methane prepared and characterized,⁵⁰⁵ proved the most biologically active of those tested.

Chelated species are less common. The substituted thiourea *N*-ethoxycarbonyl-*N*-[3-(*p*-anisyl)pyrazol-5-yl]thiourea (eatu) acts as a monoanionic O,S-chelate to cobalt(II), forming Co(eatu)_2 .⁵⁰⁶ Whereas ethylenethiourea (etu) has been observed to act as a S-donor monodentate in $\text{Co}(\text{etu})_2\text{X}_2(\text{H}_2\text{O})_2$ (X = Cl, Br), it binds as an S,N-chelate in $\text{Co}(\text{etu})_2(\text{OOCCH}_3)_2$.⁵⁰⁷ Both violet octahedral and blue tetrahedral cobalt(II) compounds $\text{Co}(\text{pptu})_2\text{Cl}_2$ and $\text{Cp}(\text{pptu})\text{Cl}_2$ respectively were prepared with bidentate *N*-2-(5-picolyl)-*N'*-phenylthiourea (pptu) chelated.⁵⁰⁸ Refluxing Co powder with thiourea in 4-methylpyridine provides a route to isothiocyanates, which form by decomposition of thiourea to ammonium thiocyanate⁵⁰⁹ with one product, $\text{Co}(\text{pic})_4(\text{NCS})_2$, characterized by a crystal structure.

(vi) Mixed S, N and S, O ligands

Ligands with S donors in addition to N and or O donors bound to Co^{II} are reasonably large in number. For example, the 4-amino-3-alkyl-1,2,4-triazole-5-thione can bind Co^{II} as a chelate employing the primary amine and thione substituents on the five-membered ring,⁵¹⁰ whereas the trifluoromethyl ligand (afmt) forms $[\text{Co}(\text{afmt})_2(\text{H}_2\text{O})_2](\text{NO}_3)_2$, defined as the all-*trans* isomer by a crystal structure.

The simple ligand 4-methylpyridine-2-thiolate (pyt) participates in a lantern-type heteronuclear complex $(\text{MeCN})\text{Co}(\text{pyt})_4\text{Pt}$ where the four thiolate groups bind Pt^{II} in its preferred square-planar arrangement while the four pyridine groups and the acetonitrile bind the Co^{II} center in a square-pyramidal geometry (**118**).⁵¹¹ The complex forms readily by reaction of $[\text{Pt}(\text{pyt})_4]\text{Cl}_2$ with CoCl_2 in basic solution, and the complex characterized was obtained following recrystallization from acetonitrile. The complex has a close Co–Pt distance of 2.573(2) Å, enforced by the short donor separation in the bridging ligands.

An unusual S,N-chelate is the anion $\text{R}'\text{NH-PR}_2\text{-S}^-$, which has no carbon atoms amongst the four-membered chelate ring atoms, and forms a tetrahedral bis Co^{II} “spirocyclic” complex.⁵¹² Higher denticity ligands also feature in the literature. A dipyrazoyl-dithioether ((**119**), bddh) forms a simple octahedral *cis*- α - $\text{Co}(\text{bddh})(\text{NCS})_2$ complex.⁵¹³ The ketal coronand (**120**) forms a

complex with Co^{II} which leads to a change in orientation of the bipyridyl unit from *anti* in the free ligand to *syn* in the complex.⁵¹⁴ One example of a simple S,O chelate reported is the dianion of 2-mercaptophenol (spo). This forms strong complexes of the type $[\text{Co}(\text{spo})_2]^{2-}$, clearly defined in a crystal structure determination.⁵¹⁵

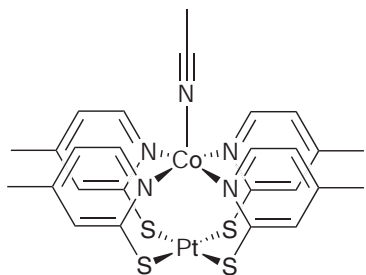

(118)

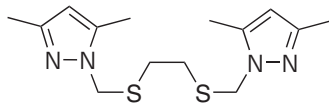

(119)

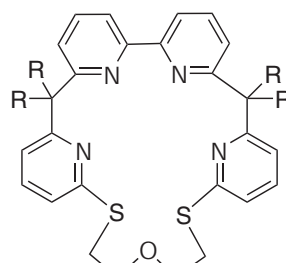

(120)

6.1.2.2.7 Halogens

(i) Halides

Halides are common coligands, partly because Co^{II} halides feature as a common entry point into Co chemistry. As such, examples are scattered throughout the chapter.

(*t*) *Mononuclear.* Cobalt(II) with halide ligands alone occurs in the well-known tetrahedral $[\text{CoX}_4]^{2-}$. Electrochemical oxidation of Co in a HX/acetonitrile solution containing a neutral tertiary phosphine provides a route to crystalline $[\text{CoX}_4]^{2-}$ as the phosphonium salts.⁵¹⁶ The same complex anion has also been reported with rhenocene cations, as $[\text{Cp}_2\text{Re}]_2[\text{CoBr}_4]$, characterized by a crystal structure.⁵¹⁷ The 1,5-pentanediammonium form of $[\text{CoCl}_4]^{2-}$ has also appeared.⁵¹⁸ Apart from $[\text{CoCl}_4]^{2-}$, the ions $[\text{Co}_2\text{Cl}_6]^{2-}$ and $[\text{CoCl}_3(\text{MeCN})]^-$ have been structurally characterized as counterions to a Co^{II} crown ether complex cation.⁴²⁰

Speciation of halocobalt(II) compounds in solution has been examined. Absorption spectra of CoCl_2 and CoBr_2 in aqueous halide solutions (up to 5 M) were measured over the temperature range 25–90 °C and used to probe speciation in solution.⁵¹⁹ At low temperatures and halide concentrations, octahedral aquahalo complexes dominate, with a transformation to tetrahedral $[\text{CoX}_4]^{2-}$ complexes occurring as temperature and halide ion concentration rises. Thermodynamic data for all complexation reactions were determined, and geological implications discussed. Octahedral/tetrahedral transformations have also been probed in the molten state, with addition of halide ion (Cl, Br) to cobalt(II) in ammonium/calcium nitrate melts leading to apparently tetrahedral species with at least two halide ions coordinated to the Co ion.⁵²⁰ From spectroscopic studies, extraction of cobalt(II) halides from aqueous solution with quaternary ammonium chloride and bromide salts is thought to involve formation of dinuclear anionic complexes.⁵²¹ The kinetics of complex formation reactions for cobalt(II) with halide ions (Cl, Br, I) have been studied,⁵²² and an associative interchange mechanism proposed.

The simple tetrahedral $[\text{CoX}_4]^{2-}$ ions can undergo substitution, with neutral species such as $\text{Co}(\text{L}^+)\text{Cl}_3$ reported [$\text{L}^+ = (1\text{H-benzimidazol-2-ylmethyl})\text{-}(\text{ethyl})\text{ammonium-N-3}$],⁵²³ as well as the long-established CoL_2Cl_2 species with neutral ligands such as monoimines.

Mixed ligand halocobalt compounds abound, and only a few illustrative examples of simple complexes appear here. Octahedral dihalotetra(imine)cobalt(II) complexes of the simple monoimines butyraldoxime and acetaldoxime with the halogens chloride or bromide were prepared and characterized by X-ray structures, which revealed stabilization arising from intra- and in one case inter-molecular hydrogen bonding.⁵²⁴ Decomposition occurs, however, in a moist atmosphere. Cobalt(II) chloride and bromide reacted with aminopyridines yielded complexes that were characterized by a range of physical methods, with the propeller-shaped octahedral complex $\text{Co}(\text{3-aminopyridine})_4\text{Cl}_2$ characterized by a single crystal X-ray structure.⁵²⁵

Surface complexation to form a tetrahedral $\text{Co}(\text{L})\text{X}_2$ species is proposed to account for the adsorption of cobalt(II) chloride and bromide from acetone and ethanol solution onto silica gel modified with 3-amino-1,2,4-triazole,⁵²⁶ supported by electronic and ESR spectroscopy.

(u) *Oligonuclear and polymeric.* Halides are well established as bridging ions in a wide range of coordination polymers, and feature in this role as one of several ligands in often complicated structures. The facile formation of triangulo-trihalocobalt(II) moieties, similar to Ti, V, Fe, and Ni homologs, and their structural characterization represents an interesting sub-class, featuring compounds such as $[\text{Co}_3\text{Cl}_5(\text{tmen})_3]^+$.⁵²⁷ One apical halide is readily replaced by hydroxide.

6.1.2.3 Co^{III}

Trivalent Co is one of the most thoroughly investigated ions in transition metal chemistry. The overwhelmingly inert and mostly diamagnetic complexes encountered offer ease of handling and facile spectroscopic characterization, which have assisted to drive the field. Six-coordinate octahedral geometry is particularly dominant in this oxidation state, with nitrogen donors particularly favored. Nevertheless, a range of other coordination numbers (from four to seven) and geometries has been observed. Despite a century of exploration, cobalt(III) chemistry continues to reward and surprise the investigator.

6.1.2.3.1 Carbon

(i) Cyanides

Cyanide has an extended history as a ligand for Co^{III} , and only some aspects will be mentioned here. The $[\text{Co}(\text{CN})_6]^{3-}$ ion is well known, and mononuclear Co^{III} complexes with a mixture of cyanide and other ligands abound in the literature; some examples appear elsewhere in this chapter. The pentacyanocobalt(II) ion reacts in solution with air to form peroxo-bridged (and, on oxidation, superoxo-bridged) Co^{III} dimers $[\{(\text{CN})_5\text{Co}\}_2(\mu\text{-O}_2)]^{5-/6-}$. With Co^{III} -cyanide complexes usually C-bound, one important paper reports the isolation of the elusive isocyano complex $[\text{Co}(\text{NH}_3)_5(\text{NC})]^{2+}$, formed through a selenium-abstraction reaction involving N-bound selenocyanate.⁵²⁸ One other interesting recent example is the $[\text{Co}(\text{dbsq})(\text{CN})_4]^{2-}$ octahedral ion, which includes the chelated radical anion of 3,5-di(*tert*-butyl)-1,2-semiquinone (dbsq).⁵²⁹ The complex was characterized by a crystal structure and by ESR spectroscopy, and was formed by reaction of the Co^{II} tetramer $[\text{Co}(\text{dbsq})_2]_4$ with $\text{Bu}_4\text{N}(\text{CN})$ in THF via a cyanide-induced redox reaction. The coordinated cyanides display the usual essentially linear $\text{Co}-\text{CN}$ bonds with average $\text{Co}-\text{C}$ distances of 1.89(2) Å. An interesting example of bridging cyanide occurs in the trivalent Co cluster $[\text{Co}_8(\text{tacn})_8(\text{CN})_{12}(\text{OTs})_{12}]$ (**121**), which forms from boiling equimolar mixtures of $[\text{Co}(\text{tacn})(\text{OH}_2)_3](\text{OTs})_3$ and $\text{Co}(\text{tacn})(\text{CN})_3$ in water.⁵³⁰ The tridentate tacn ligands cap the “external” coordination sites of each Co ion situated at a vertex of the cube.

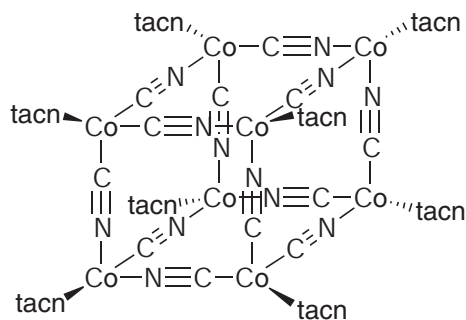

(121)

(ii) Carbonyls

High-valent Co complexes incorporating carbonyl ligands are rare, and those extant are outside the scope of this review. The companion series *Comprehensive Organometallic Chemistry* covers this area.

(iii) Alkyls and aryls

The Co^{III}-alkyl bond was established some time ago with the characterization of simple complexes with Co—CH₃ or other Co—R groups. Incorporation of R⁻ as an axial ligand in Co^{III} porphyrins, Schiff base and bis(dimethylgloximate) compounds were early types defined, and examples continue to appear. This is a key feature of cobalamin (B₁₂) model complexes and a review of this area appears in Section 6.1.3.1.1. The deceptively simple isoelectronic alkyl homologs of [Co(NH₃)₆]³⁺ and [Co(en)₃]³⁺, (122)⁵³¹ and (123), have appeared since the first edition of CCC.^{532,533}

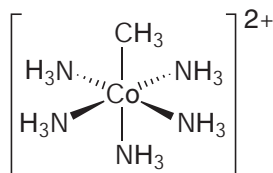

(122)

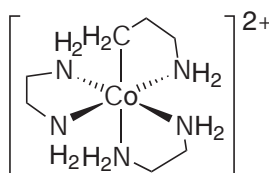

(123)

Introduction of several CH₃⁻ ligands into the Co^{III} coordination sphere is facilitated with phosphine ligands in other sites. For example, the octahedral [Co(CH₃)₂(PMe₃)₄]⁺ is known, and the Co—C bonds are sufficiently stable to be unaffected by phosphine exchange in THF with the chelate dmpep (Me₂PCH₂CH₂PMe₂), which results in [Co(CH₃)₂(PMe₃)₂(dmpep)]⁺.⁵³⁴

Trivalent five-coordinate methyl (124) and six-coordinate (*trans*) methyl pyridyl complexes of the octaethylporphyrin dianion (OEP) have been reported.⁵³⁵ In (124) the square-pyramidal geometry results in an axial Co—C distance of 1.973 Å and the Co is displaced 0.10 Å out of the porphyrin plane towards the methyl group. The latter complex, with a pyridine *trans* to the methyl ligand, finds the Co ion centered in the plane of the porphyrin and with a Co—C distance of 2.018 Å; the elongation reflecting a strong mutual *trans* effect of the Me and py axial ligands. This is relevant to the methyl transfer ability of these complexes as B₁₂ mimics (Section 6.1.3.1.1), as base coordination in the site *trans* to the Me ligand accelerates Co—C homolysis in the natural systems. The ethyl analog of (124) has also been characterized.⁵³⁶

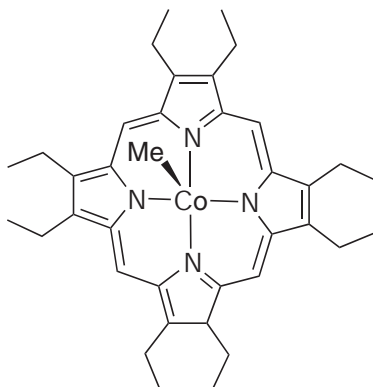

(124)

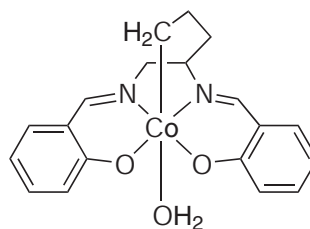

(125)

Introduction of a pendant coordinated alkyl chain to Co(salen) has been achieved through condensation of salicylaldehyde with the branched ethylenediamines H₂NCH((CH₂)_nCl)CH₂NH₂ (*n* = 2–5). Complexation to Co^{II}, reduction to Co^I, and subsequent intramolecular alkylation results in the novel complex (125).⁵³⁷ Oxidative addition of several alkyl halides to the Co^I compound generated on reduction of divalent [Co(pabo)(Hpabo)]²⁺ (Hpabo = 2-(2'-pyridylethyl) amino-3-butanone oxime) led to the alkylcobalt(III) compounds [RCo(pabo)(Hpabo)]⁺.⁵³⁸ A pseudo-octahedral geometry was defined by several crystal structures, with Hpabo and pabo acting as bi- and tridentates respectively, and the alkyl group occupying the remaining site.

A series of trivalent organocobalt complexes of the form [RCo(cyclam)(OH₂)]⁺ have been reported, where R = Me, Et, Pr, CH₂Cl, CH₂Br, CH₂OMe, and CH₂Ph.⁵³⁹ These compounds

are photosensitive, decomposing to Co^{II} and carbon-centered radicals when irradiated with visible light. These carbon-centered radicals abstract hydrogen atoms from thiols ($\text{C}_2\text{H}_5\text{SH}$, cysteine, or glutathione), generating thiol radicals.⁵⁴⁰ In the absence of light, the alkyl complexes are air-stable in acidic aqueous solutions whereas the benzyl complex undergoes rapid homolysis of the $\text{Co}-\text{C}$ bond. Visible light photolysis of the methylcobalt(III) complex causes nicking of supercoiled DNA; the complex is inactive in the absence of light, implying a photo-initiated radical mechanism.⁵⁴¹

Reaction of the 1,5-diazacyclooctane- N,N' -diacetate complex (**126**) with H_2O_2 in the presence of KCN forms an octahedral complex (**127**) containing the now pentadentate ligand coordinated through a deprotonated carbon atom in addition to the N_2O_2 donors. A particularly short $\text{Co}-\text{C}$ distance (1.941(4) Å) was found.⁵⁴² The cyclic thioether 1,4-diaza-7-thiacyclodecane was prepared recently, and, in addition to the anticipated N_2S -bonded Co^{III} complex, a C-bonded form involving the anion 1,4-diamino-7-thiacyclodecan-8-ide was described.⁵⁴³

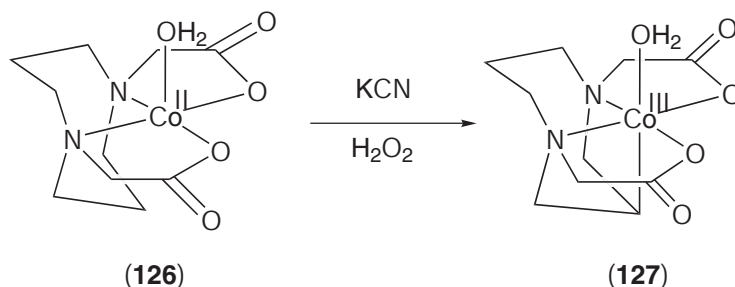

Carboranes also offer the capacity for $\text{Co}^{\text{III}}-\text{C}$ bond formation. Perhaps the best-known example of a mixed cyclopentadienyl-metallocarborane sandwich complex is the cobalt(III) compound $(\text{Cp})\text{Co}(1,2-\text{C}_2\text{B}_9\text{H}_{11})$, which serves as a precursor for other species.⁵⁴⁴

Ylide compounds of cobalt(III) have been reported, but are usually traditional organometallic compounds. For example, the cobalt(III) ylide complex $[(\text{Cp})\text{Co}(\text{CH}_2\text{PMe}_3)(\text{PMe}_3)\text{Br}]^+$ made from a labile Co^{I} precursor has been described.⁵⁴⁵ Reaction of $o\text{-C}_6\text{H}_4(\text{OSiMe}_3)(\text{NC})$ with CoCl_2 in methanol in the presence of air affords an octahedral Co^{III} complex ion (**128**) with a monocarbene ligand producing a $\text{Co}^{\text{III}}\text{C}_6$ environment.⁵⁴⁶ This is similar to the analogous oxazolidin-2-ylidene chemistry.⁵⁴⁷ The monoanionic tricarbene ligand hydrotris(3-ethyl-imidazoline-2-yliden-1-yl)borate (triset) forms the Co^{III} complex $[\text{Co}(\text{triset})_2](\text{BF}_4)$.⁵⁴⁸ From its crystal structure, the hexacarbene complex does not display $\text{M}-\text{C}$ multiple bonding, which might have been expected with an electron-rich stabilized carbene and a high-valent metal.

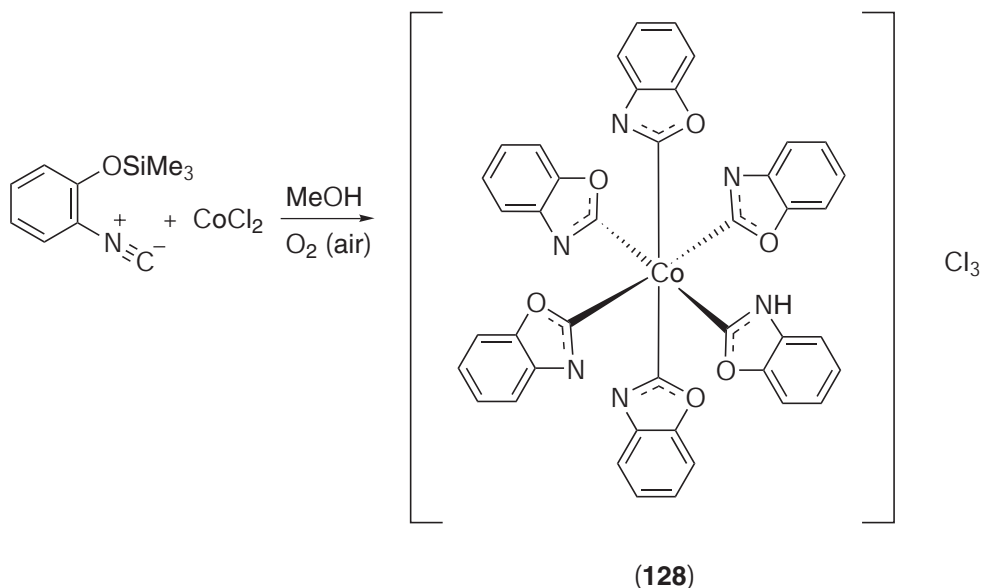

6.1.2.3.2 Silicon and tin

There appear to be no well-characterized Co^{III}—Si bonded compounds. Interactions with silicates, particularly on surfaces, are through oxygen atoms. The use of the complex [Co(en)₂(LL)]Cl₃ (where LL = (MeO)₃SiCH₂CH₂CH₂NHCH₂CH₂NH₂) permits bonding of the substitution-inert CoN₆ species to a silica surface.⁵⁴⁹

There are few well-established examples of Co^{III}—Sn bonds. Stannanes R₃SnH react with OEP complexes (**124**) or the divalent Co(OEP) to form Co(OEP)SnR₃.⁵⁵⁰ This is also accessible from R₃SnCl and [Co^I(OEP)]⁻. The structure shows a square-pyramidal Co displaced 0.777 Å out of the porphyrin plane and towards the Sn, which is 2.510(2) Å distant from the Co^{III} center.

6.1.2.3.3 Nitrogen

(i) Amines

The trivalent Co coordination chemistry of amines is simply immense. Amines, both mono- and multidentate, are typically thermally and air stable, often commercially available, easily derivatized, and are well matched to the electronic needs of trivalent Co. Space does not permit a discussion of all categories of amines that have been investigated since CCC(1987) nor their limitless permutations when bound to mostly six-coordinate Co. Much of the synthetic and mechanistic work that underpins Co amine chemistry has long been known and will not be restated here. The emphasis here will be on novelty rather than breadth. That is, recent innovative aspects of the structure, reactivity, and applications of selected, but representative, collections of these simple but ever-present compounds will be our focus.

(v) *Monodentate*. The hexaamminecobalt(III) ion is the simplest closed-shell octahedral coordination compound of the first transition series. With only 84 electrons and effectively no conformational isomers, the [Co(NH₃)₆]³⁺ ion has been an ideal subject for computational chemists. Quantum mechanical calculations have dealt with vibrational^{551–553} and electron transfer^{554–559} properties of this ion. Ligand field⁵⁶⁰ and molecular mechanics^{561–563} calculations have also been reported.

The [Co(NH₃)₆]³⁺ ion is inert to substitution reactions, like most Co^{III} compounds, and it possesses a high positive charge and 18 strong hydrogen bond donors. These features result in the complex ion having a strong tendency for ion pairing, and a number of investigations of the association between the complex and inorganic anions have been reported.^{564–571} Liquid crystalline phases containing the [Co(NH₃)₆]³⁺ ion have also been studied.^{572,573} Second sphere coordination of [Co(NH₃)₆]³⁺ through NH⁺⋯O bonding to ionophores such as crown ethers are also well known.^{574,575} The affinity of [Co(NH₃)₆]³⁺ for DNA and RNA has been the subject of a considerable amount of attention but discussion of this topic is deferred until Section 6.1.3.1.4.

However, there are a number of other miscellaneous biological roles played by this complex. The [Co(NH₃)₆]³⁺ ion has been shown to inhibit the hammerhead ribozyme by displacing a Mn²⁺ ion from the active site.⁵⁷⁶ However, [Co(NH₃)₆]³⁺ does not inhibit ribonuclease H (RNase),⁵⁷⁷ topoisomerase I,⁵⁷⁸ or hairpin ribozyme,⁵⁷⁹ which require activation by Mg²⁺ ions. The conclusions from these studies were that an outer sphere complex formation between the enzyme and Mg_{aq}²⁺ is occurring rather than specific coordination of the divalent ion to the protein. These results are in contrast to DNase I inhibition by the same hexaammine complex. Inhibition of glucose-induced insulin secretion from pancreatic cells by [Co(NH₃)₆]³⁺ has been found.⁵⁸⁰ Intracellular injection of [Co(NH₃)₆]³⁺ into a neurone has been found to cause characteristic changes to the structure of its mitochondria, and this offers a simple technique to label neuronal profiles for examination of their ultrastructures.⁵⁸¹

The solid state chemistry of various [Co(NH₃)₆]³⁺ salts has been investigated. Phase transitions⁵⁸² and conformational changes⁵⁸³ have been studied by variable temperature crystallography. The thermal decomposition of a number of [Co(NH₃)₆]³⁺ salts has been reported.^{584–587}

Outer-sphere electron transfer reactions involving the [Co(NH₃)₆]^{3+/2+} couple have been thoroughly studied. A corrected [Co(NH₃)₆]^{3+/2+} self-exchange electron transfer rate ($8 \times 10^{-6} \text{ M}^{-1} \text{ s}^{-1}$ for the triflate salt) has also been reported,⁵⁸⁸ which is considerably faster than an earlier report. A variety of [Co(NH₃)₆]^{3+/2+} electron transfer cross reactions with simple coordination compounds,⁵⁸⁹ organic radicals,^{590,591} metalloproteins,⁵⁹² and positronium particles (electron/positron pairs)⁵⁹³ as redox partners have been reported.

The simplest member of the hexakis-alkylamines, $[\text{Co}(\text{MeNH}_2)_6]^{3+}$, possesses a prominent UV ligand-to-metal charge transfer transition.⁵⁹⁴ The hexamine and a number of $[\text{Co}(\text{MeNH}_2)_5\text{X}]^{2+}$ ($\text{X} = \text{halide}$) analogs exhibit photoactivity, with ligand substitution, i.e., release of MeNH_2 , occurring upon either excitation into the $\text{N} \rightarrow \text{Co}$ or $\text{X} \rightarrow \text{Co}$ LMCT bands. Incorporation of these complexes into thin films of the copolymer of glycidyl methacrylate and ethyl acrylate gave a photosensitive material that underwent base-initiated crosslinking upon exposure to 254 nm radiation.^{594,595} This property may be utilized for pattern delineation at the 1–2 μm level. Higher hexakis-alkylamines of Co are yet to be synthesized.

(w) *Multidentate*. The $[\text{Co}(\text{en})_3]^{3+}$ ion is one of the most commonly encountered coordination compounds in undergraduate teaching laboratories as both a precursor^{596,597} and as a product.⁵⁹⁸ The chirality of the $[\text{Co}(\text{en})_3]^{3+}$ complex ion is central to many studies of its chemistry, and it has been the subject of many fundamental investigations that have dealt with the influence of a chiral molecule on its environment and its spectroscopy. There are numerous X-ray crystal structures of both racemic^{599–609} and resolved^{610–614} $[\text{Co}(\text{en})_3]^{3+}$ salts of both simple and complex anions. A novel isotopic crystallographic study⁶¹⁵ found that deuteration of $([\text{Co}(\text{en})_3](\text{C}_2\text{O}_4)_2) \cdot 3\text{H}_2\text{O}$ led to crystallization of $([\text{Co}(\text{d}_4\text{-en})_3]_2 \cdot \text{D}_2\text{O})_2(\text{C}_2\text{O}_4)$ as a racemate in a centrosymmetric space group whereas the nondeuterated analog crystallized in an acentric space group. The isotope effect on the strength of intermolecular H bonding was held responsible for this unusual phase transformation.

It is usually found that the conformation of the three chelate rings in $[\text{Co}(\text{en})_3]^{3+}$ is such that each C–C vector lies approximately parallel (*lel*) with respect to the molecular C_3 axis. This has been examined with a number of experimental and theoretical methods including NMR and IR,⁶¹⁶ vibrational circular dichroism⁶¹⁷ spectroscopy as well as molecular mechanics calculations.⁶¹⁸

Ion-pairing constants of $[\text{Co}(\text{en})_3]^{3+}$ with simple inorganic anions have been reported^{571,619} and the rotational correlation times of ion-paired complexes with lanthanoid complex anions have been studied.⁶²⁰ More specifically, and fundamental to the resolution of racemic $[\text{Co}(\text{en})_3]^{3+}$ mixtures, are diastereoselective ion pairing investigations with chiral anions such as tartrate. This has continued to be a major focus of investigation with a variety of theoretical,⁶²¹ chromatographic,^{622–625} and spectroscopic techniques including circular dichroism⁶²⁶ and NMR.⁶²⁷

The adsorption⁶²⁸ and ion exchange^{629–631} reactions of chiral $[\text{Co}(\text{en})_3]^{3+}$ with clays have been studied. When the $[\text{Co}(\text{en})_3]^{3+}$ ion exchanges with lamellar clays such as fluorhectorites, it increases the interplanar separation of the lamellae and influences the selectivity for intercalation of small molecules and atoms (H_2 , D_2 , Ne , and O_2) within the clay over larger ones such as isobutane and neopentane.⁶³¹

The $[\text{Co}(\text{en})_3]^{3+}$ ion has been shown to be a useful template for the synthesis of unusual cobalt, aluminum, gallium, and magnesium phosphates exhibiting framework,^{632–637} layered^{638–641} and chain⁶⁴² structures, as well as for the hydrothermal synthesis of novel zeolites^{643,644} and other framework structures such as molybdenum phosphates.⁶⁴⁵

A number of electrochemical studies of the $[\text{Co}(\text{en})_3]^{3+/2+}$ couple have been reported, investigating the effects of pressure^{646,647} and solvation^{648,649} on the redox potential and electron transfer rate. The self-exchange $[\text{Co}(\text{en})_3]^{3+/2+}$ electron transfer rate has been determined, and its pressure dependence investigated.⁶⁵⁰ Outer sphere electron transfer cross reactions of the $[\text{Co}(\text{en})_3]^{3+}$ ion with a variety of cationic,⁶⁵¹ neutral,⁶⁵² and anionic^{653,654} coordination compounds in addition to reduced viologens,^{590,655} flavins, and polymer-immobilized reductants^{656,657} have been studied, with the rates of electron transfer usually conforming to predictions from Marcus theory. Ion pairing with potential redox partners may lead to ion pair charge transfer (IPCT) transitions. Excitation into the IPCT transition leads to photoinduced electron transfer between the paired ions. Examples of this include $[\text{Co}(\text{en})_3]^{3+}$ paired with tetraphenylborate⁶⁵⁸ and a number of cyanometallate anions.⁶⁵⁹ As a result of its high isotopic abundance, the technique of ⁵⁹Co NMR has been used as a sensitive probe for the chemical environment of the metal ion. Studies of $[\text{Co}(\text{en})_3]^{3+}$ within micelles⁶⁶⁰ and surfactants⁶⁶¹ are known.

There are many variations on the simple tris(bidentate) structure of $[\text{Co}(\text{en})_3]^{3+}$, such as expansion of the chelate ring size to six and seven (propane-1,3- and butane-1,4-diamine) or the introduction of alkyl groups and fused rings for chirality and rigidity (propane-1,2-diamine and *meso* and *rac*-cyclohexane-1,2-diamine). These analogs, although yielding interesting chemistry, will not be explored here.

Tridentate amines come in a variety of forms. Diethylenetriamine (dien) (**129**) and its bis-trimethylene homolog ditn (**130**) may adopt either facial or meridional coordination modes. Furthermore, the *fac*- $[\text{Co}(\text{dien})_2]^{3+}$ complex may exist as either the centrosymmetric *meso* or dissymmetric *rac* isomer where the secondary amines are *trans* or *cis* respectively.⁶⁶² However,

there are some triamines that coordinate exclusively in a facial configuration due to stereochemical requirements of the ligand. Some examples include the symmetrical tripods tame⁶⁶³ (**131**), *cis,cis*-cyclohexane-1,3,5-triamine (tach)⁶⁶⁴ (**132a**) (including its 2,4,6-trihydroxy analog, taci⁶⁶⁵ (**132b**)) and triazatrishomobenzene (**133**).⁶⁶⁶

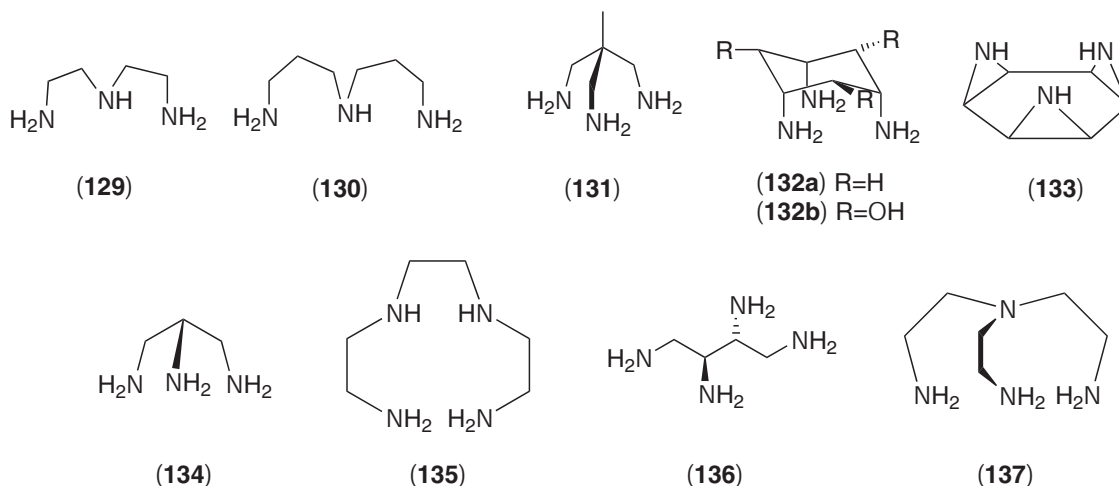

The less symmetrical and more rigid propane-1,2,3-triamine (trap) (**134**) has also been complexed with Co^{III}.⁶⁶⁷ Even more isomers arise with linear tetraamines such as triethylenetetraamine (trien)⁶⁶⁸ (**135**) or its branched homolog *rac*-butane-1,2,3,4-tetraamine⁶⁶⁹ (**136**) when bound to Co^{III}, and this number proliferates when the amine is asymmetric. The tripodal tris(2-aminoethyl)amine (tren) (**137**) may bind as tri- or tetradentate to Co in various oxidation states;^{670,671} the latter binding mode resulting in a single stereoisomer. There are simply too many combinations of these amines and their co-ligands to do justice to their chemistry in this review. A review of trivalent Co amine chemistry is available, which covers this area in greater detail than space permits herein.⁶⁷²

(x) *Macrocyclic*. There are many potential rewards for synthetic efforts devoted to the closure of open chain multidentate amines to afford their macrocyclic analogs. Enhanced complex stability (particularly upon conversion to the divalent state) and greater stereochemical control are the two most obvious benefits. Additionally, the ring may provide a scaffold onto which extra functional groups may be attached to give so-called pendent arm macrocycles. General reviews concerned with complexation and structural aspects of N-functionalized polyazamacrocycles (of various sizes, in complexes with a range of metal ions) have appeared.^{673,674}

The smallest macrocyclic amine is the facially coordinating tridentate 1,4,7-triazacyclononane (tacn or [9]aneN₃) (**138a**). The [Co(tacn)₂]³⁺ ion exhibits physical properties typical of other hexaamines, and the complex has been thoroughly characterized.^{463,675} Like other macrocyclic amines, the outer sphere electron transfer reactions involving the [Co(tacn)₂]^{3+/2+} couple with proteins⁶⁷⁶ and simple coordination compounds⁶⁷⁷ as well as its electrochemistry⁶⁷⁸ have been well studied.

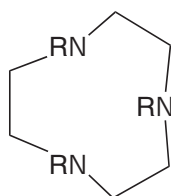

- | | |
|--|--|
| <p>(138a) R=H
 (138b) R=Me
 (138c) R=<i>i</i>-Pr
 (138d) R=<i>i</i>-Bu
 (138e) R=CH₂CH₂NH₂
 (138f) R=CH₂CH₂CH₂NH₂</p> | <p>(138g) R=CH₂-2-pyridyl
 (138h) R=CH₂COO⁻
 (138i) R=(<i>R</i>)CH(CH₃)COO⁻
 (138j) R=(<i>S</i>)CH(CH₃)OH
 (138k) R=2-CH₂(Me-imidazole)
 (138l) R=CH₂-pyrazole</p> |
|--|--|

In contrast to its secondary amine parent, the *N*-trimethylated derivative (**138b**) (tmtacn) has a distinct preference for 1:1⁶⁷⁹ or 2:2³⁹⁹ metal:ligand stoichiometries as a consequence of steric effects of its methyl groups. Face-sharing octahedral, bridged dinuclear complexes of the type $[(\text{tmtacn})\text{Co}]_2(\mu\text{-X})_3]^{n+}$ (where $\text{X} = \text{OH}^-$, Cl^- , Br^- , AcO^-) are known where the metals can be in either their di- or trivalent states (or mixed valence).^{399,680} The sterically encumbered tris-isopropyl (**138c**) and isobutyl (**138d**) analogs of tacn have been reported and complexed with Co^{III} .⁶⁸¹ Mononuclear complex formation is favored in these cases.

A vast array of hexadentate, threefold symmetric tris-*N*-substituted derivatives of tacn have been reported incorporating a variety of pendent groups such as those seen in (**138e**),⁶⁸² (**138f**),⁶⁸³ (**138g**),⁶⁸⁴ (**138h**),^{685,686} (**138i**),⁶⁵² (**138j**),^{687,688} (**138k**)⁶⁸⁹ and (**138l**),⁶⁹⁰ each of which has been complexed with Co^{III} and characterized. Wieghardt and co-workers have identified many interesting trisubstituted tacn derivatives featuring phenolate or thiophenolate ligating groups that, when complexed with Co^{III} , are capable of stabilizing ligand-centered radicals. Examples include homo- and heterotrisubstituted tacn ligands such as tris(3,5-di-*tert*-butyl-2-hydroxybenzyl), tris(3-*tert*-butyl-5-methoxy-2-hydroxybenzyl), diacetate-(3,5-di-*tert*-butyl-2-hydroxybenzyl), diacetate-(2-mercaptobenzyl), diacetate-(3,5-di-*tert*-butyl-2-mercaptobenzyl), dimethyl-(3-*tert*-butyl-5-methoxy-2-hydroxybenzyl), and di-isopropyl-(3,5-di-*tert*-butyl-2-hydroxybenzyl) where Co^{III} -phenoxyl or Co^{III} -phenylthiyl radicals are formed upon oxidation of the complex.^{691–693} Pendent arms bearing donors capable of bridging two metal centers (alkoxides, phenolates, and thiophenolates) have been reported and the degree of magnetic coupling mediated by the bridging ligand has been studied.^{694,695} Mono-*N*-substituted derivatives of tacn in complexes with Co^{III} include 2-aminoethyl⁶⁹⁶ and the versatile ethylene-bridged bis-macrocycle 1,2-bis(1,4,7-triaza-1-cyclononyl)ethane (dtne),⁶⁹⁷ which is capable of both mononuclear and dinuclear complex formation.

The Co^{III} coordination chemistry of the 12-membered macrocyclic tetraamine 1,4,7,11-tetraazacyclododecane (**139**) (cyclen or [12]aneN₄) has been extensively studied. A feature of this macrocycle, like tacn, is that its small ring size restricts its mode of coordination. All known Co^{III} cyclen complexes exhibit *cis*-N₄X₂ coordination geometries, where the macrocycle folds to leave a pair of *cis* coordination sites available for other ligands, although *N*-based isomers are known. There has been a particular focus on the reactivity of the $[\text{Co}(\text{cyclen})(\text{OH}_2)(\text{OH})]^{2+}$ ion (**140**) towards polyphosphate and phosphate ester hydrolysis, and its relevance to biomimetic chemistry (see Section 6.1.3.1.3). Attachment of active substituents to the cyclen N donors may be achieved with standard alkylation procedures. A number of Co complexes of tetra-*N*-substituted cyclen derivatives bearing both coordinating (2-carbamoyl ethyl⁶⁹⁸) and non-coordinating (2-cyanoethyl⁶⁹⁹) pendent arms have been reported. The incorporation of C substituents on the ring instills chirality in the ligand and its complexes. Examples of this approach include a homochiral C-tetraethyl cyclen Co complex which forms diastereomeric pairs of complexes with bidentate coordinated amino acids such as methionine⁷⁰⁰ and methyltyrosine.⁷⁰¹

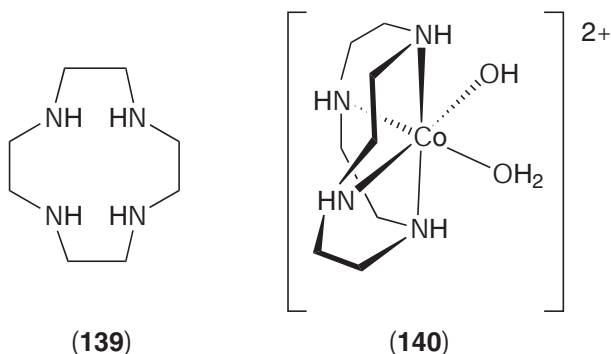

The 14-membered macrocycle 1,4,8,11-tetraazacyclotetradecane (cyclam or [14]aneN₄), unlike cyclen, is capable of encircling most transition metal ions and in the case of Co^{III} the *trans* configuration is much preferred by comparison with the folded *cis* isomer. Electrochemical reduction of *cis*- $[\text{Co}(\text{cyclam})(\text{OH})_2]^+$ in 3M NaOH leads to rapid isomerization to the *trans* form, and the relative stabilities of the *trans* and *cis* isomers of the di- and trivalent complexes were determined from a thermodynamic cycle.⁷⁰² This preference for *trans* orientation of the non-macrocyclic donors has enabled the isolation and investigation of many Co complexes without the complications of isomerization. Some novel examples include *trans*- $[\text{Co}(\text{cyclam})(\text{O}_2^-)(\text{OH}_2)]^{2+}$

(141), which exists in equilibrium with its peroxy-bridged dinuclear analog (142).⁷⁰³ The mononuclear hydroperoxo analog was found to accelerate the rate of I^- oxidation (to I_3^-) by three orders of magnitude relative to H_2O_2 .⁷⁰⁴

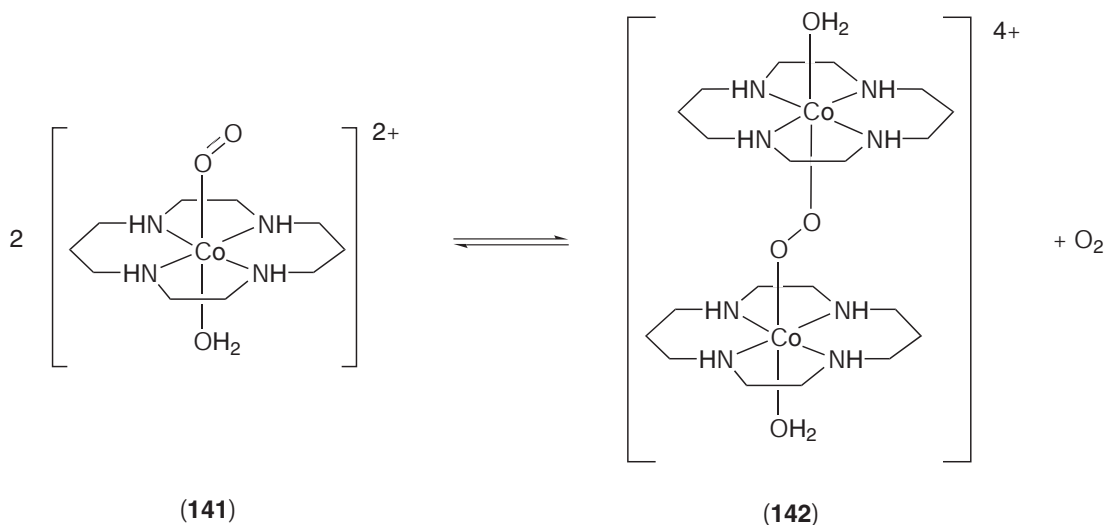

Due to their ease of synthesis (from the cation-templated condensation reaction of ethylenediamine and acetone), C-methylated analogs of cyclam such as *meso* and *rac* 5,5,7,12,12,14-hexamethylcyclam (teta (143a) and tetb (143b) respectively) have been extensively studied, where the stereogenic C-atoms in the 7- and 14-positions of the ring lead to distinctly different coordination chemistries. The racemic ligand (143b) has been resolved and its resulting chiral Co^{III} complexes have been investigated.⁷⁰⁵ A number of crystallographic^{706,707} and spectroscopic^{100,708} studies of these ligands in complexes with Co^{III} have been reported. The steric effects of the C-methyl groups influence the reactivity and stereochemistry of their resulting Co complexes significantly relative to the unsubstituted cyclam parent. The unusual hydroperoxocobalt complex $[Co(teta)(MeCN)(OOH)](ClO_4)_2$ has been isolated and structurally characterized.⁷⁰⁹ The O—O stretch in the IR spectrum appears at 815 cm^{-1} and photolysis of an acidic aqueous solution of the complex results in homolytic splitting of the Co—O bond, yielding the diaqua complex as a product. The reaction of aminomethylmalonate with *cis*- $[Co(tetb)Cl_2]^+$ in DMSO in the presence of Et_3N yielded a novel 2-iminocarboxylato complex via oxidative decarboxylation of the malonate ligand. The reaction is specific for Co^{III} complexes containing C—Me-substituted cyclic tetraamines.⁷¹⁰

A remarkable variety of methylated analogs are known and their Co^{III} complexes have all been synthesized and characterized. Examples include 5,7-dimethylcyclam (*meso* isomer) (144),^{711,712} 5,12-dimethylcyclam (*meso* (145) and *rac* isomers),^{713,714} 5,5,7-trimethylcyclam (146),⁷¹¹ 5,7,12,14-tetramethylcyclam (147),⁷¹⁵ 1,5,8,12-tetramethylcyclam (148)⁷¹⁶ and 3,10-*C-meso*-3,5,7,7,10,12,14,14-octamethylcyclam (149).⁷¹⁷

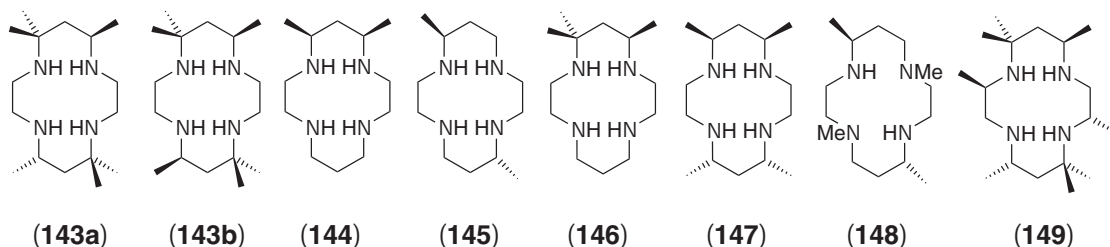

Ligating pendent arms have been attached to the cyclam ring to give penta- and hexadentate coordinated cyclams coordinated to Co. *N*-functionalization of the macrocycle is synthetically more straightforward, although the resulting (tertiary) amine donors are less effective ligands due to the increased steric effects of the pendent group. An example of this that has been complexed to Co^{III} is the hexadentate 5,12-dimethyl-7,14-diphenyl-4,11-diacetato-cyclam.⁷¹⁸

Actually, C-substituted cyclams are more common in the coordination chemistry of Co, with ligating pendent groups typically attached to the trimethylene ring C atoms. The synthetic

strategies are many and varied. An unusual example concerns conversion of *trans*-[Co(teta)Cl₂]⁺ to its 5-hydroxymethyl analog by aerial oxidation of the precursor in refluxing MeOH containing Et₃N.⁷¹⁹ 5-Aminomethyl-2,5,10,12-tetramethylcyclam was prepared by nucleophilic addition of MeNO₂ to the imine precursor, followed by reduction of the pendent nitromethyl group.⁷²⁰ The chlorocobalt(III) complex of this pentaamine ligand was characterized structurally and rapid base hydrolysis of the chloro ligand was reported.

The *trans*⁷²¹ (**150**) and *cis*^{722,723} (**151**) isomers of the hexadentate ligand 6,13-diamino-6,13-dimethylcyclam (also known as diammac) have been complexed with Co^{III} and characterized structurally, spectroscopically, and electrochemically. The ligands are synthesized by a metal-directed condensation reaction between [Cu(en)₂]²⁺, EtNO₂, and formaldehyde, followed by reduction of the nitro groups. Each isomer may coordinate in but one hexadentate configuration, thus the isomers [Co(*trans*-diammac)]³⁺ (**152**) and [Co(*cis*-diammac)]³⁺ (**153**) provide a unique example of *trans/cis* isomerism at a metal center predetermined by ligand stereochemistry. In [Co(*trans*-diammac)]³⁺, the Co—N bond lengths are amongst the shortest reported for a Co^{III} hexaamine, and this leads to unusually high-energy electronic maxima and a particularly negative Co^{III/II} redox potential.⁷²¹ By contrast, the structural,⁷²³ spectroscopic, and electrochemical⁷²² properties of [Co(*cis*-diammac)]³⁺ are typical of other hexaamines such as [Co(en)₃]³⁺. A rapid Co^{III/II} self-exchange electron transfer rate was determined⁷²¹ for [Co(*trans*-diammac)]³⁺ and, coupled with its particularly negative Co^{III/II} redox potential, it was found to efficiently catalyze the reduction of H⁺ when adsorbed in its divalent form to a Hg working electrode.⁷²⁴

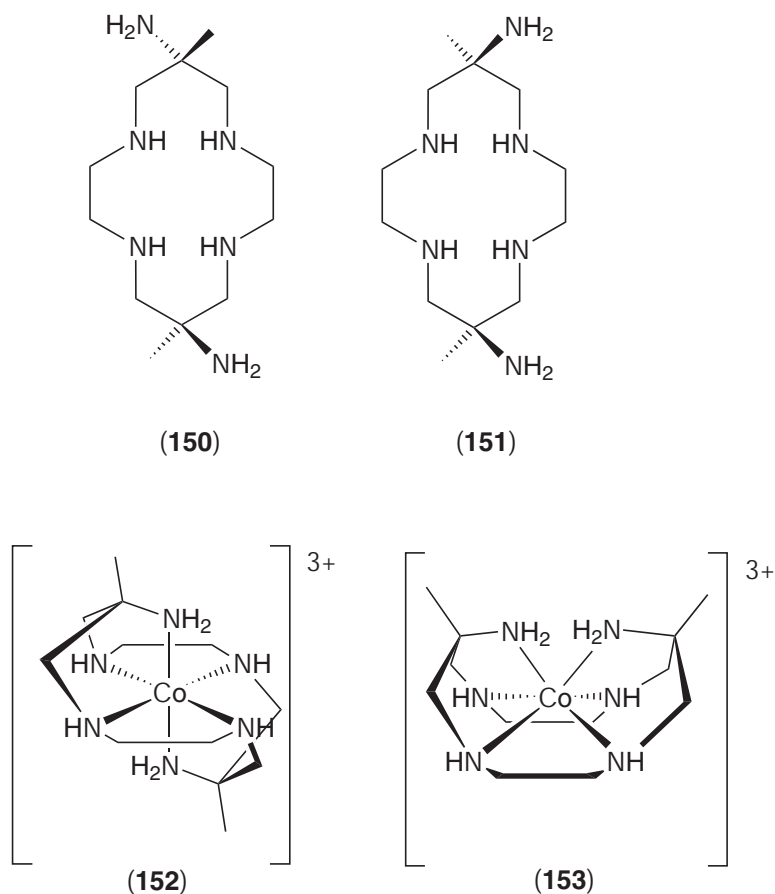

Other coordination modes of *trans*-diammac have been identified where one (**154**) or both (**155**) primary amines are free from the metal.^{721,725} An extension of this concept involves attachment of active functional groups such as crown ethers selectively at one primary amine to generate ditopic ligands capable of electrochemically sensing alkali metal ions through their inductive effect on the Co^{III/II} redox potential. One example is provided by (**156**); further, the 15-crown-5 and 18-crown-6 analogs were also prepared.⁷²⁶

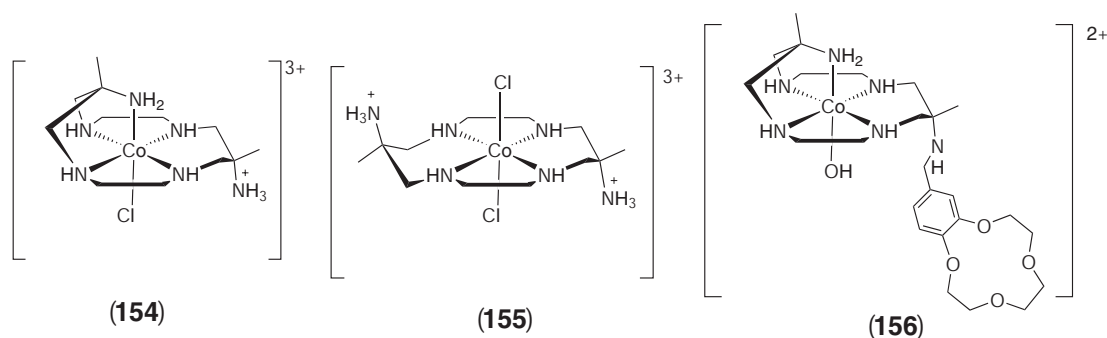

Some diammac analogs complexed with Co^{III} include 6,13-diamino-6,13-diethylcyclam (*trans* and *cis* isomers),⁷²⁷ and the isomeric *meso*-5,7,12,14-tetramethyl-6,13-diaminocyclam (**157**) (*trans* isomer). The 6-amino-6-methyl analog (ammac) may only occupy five coordination sites and its greater degree of flexibility leads to *trans* (**158**)^{728,729} and *cis* (**159**)⁷³⁰ coordination modes when bound to Co^{III} . The ability to isolate non-interconverting isomeric forms of these pentaamine Co^{III} complexes has enabled the investigation of steric and electronic effects on the rates of reactions at the sixth coordination site such as base hydrolysis of coordinated Cl^- ^{728,730,731} and nitrito to nitro linkage isomerism.⁷³² The introduction of ferrocyanide as a ligand (N bound to Co) into the sixth coordination site of these Co complexes results in a novel class of dinuclear mixed valent compounds (**160**) exhibiting a prominent $\text{Fe}^{\text{II}} \rightarrow \text{Co}^{\text{III}}$ metal-to-metal charge transfer transition in the visible region of the spectrum.^{733,734} A number of other examples of mono-C-substituted cyclam ligands coordinated to Co^{III} include 5-(4'-imidazolyl)cyclam,⁷³⁵ and 6-amino-6-(4'-aminobenzyl)cyclam.⁷³⁶⁻⁷³⁸

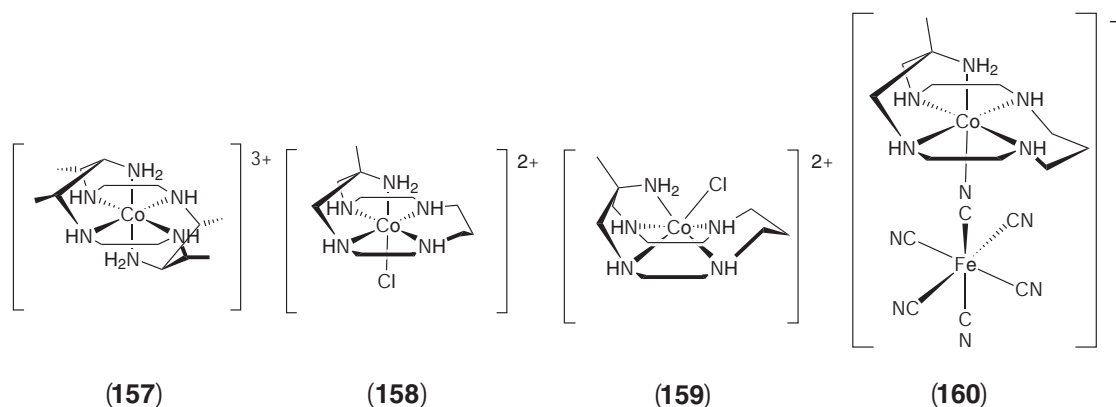

Sargeson and co-workers pioneered the metal template syntheses of a class of ligands that effectively encapsulate the metal ion within a macrobicyclic N_6 array or secondary amines. Most of this work focused on $[\text{Co}(\text{en})_3]^{3+}$ as a template onto which two “caps” were attached using Mannich reactions involving formaldehyde and a potentially tribasic nucleophile such as NH_3 or MeNO_2 , leading to the sepulchrate (sep) (**161**)⁷³⁹ and substituted sarcophagine (sar) (**162a**)⁷⁴⁰ Co^{III} cage complexes, respectively (Equation (7)). The initial reports of this chemistry focused on (**161**) and its Co^{II} analog. Remarkable physical properties of this system were reported,²¹⁹ including an unusually inert divalent complex. The $[\text{Co}(\text{sep})]^{3+/2+}$ self-exchange rate constant was found to be several orders of magnitude greater than that of the $[\text{Co}(\text{en})_3]^{3+/2+}$ parent. Moreover, the cage redox couple is reversible.

The C-capped $[\text{Co}(\text{sar})]^{3+}$ (**162a**) (and its various homo- and hetero-disubstituted derivatives) exhibit very similar structural⁷⁴¹ and physical properties, although the sar class of ligands has the advantage of being isolable as the metal-free base,⁷⁴² in contrast to sep which is unstable in the absence of Co. A number of electrochemical investigations of $[\text{Co}(\text{sep})]^{3+}$ and $[\text{Co}(\text{sar})]^{3+}$ (and its substituted analogs) have appeared.^{743,744} The facile and reversible one-electron redox chemistry of these complexes has led to their employment as electron relays in the photoinduced oxidation of coordination compounds such as $[\text{Ru}(\text{bpy})_3]^{2+}$ ⁷⁴⁵⁻⁷⁴⁷ and organic photosensitizers such as

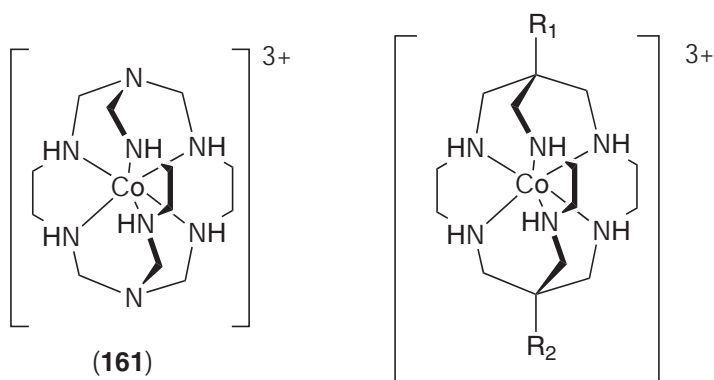

- (162a) $R_1=R_2=H$ (162e) $R_1=CH_3R_2=H$
 (162b) $R_1=R_2=NO_2$ (162f) $R_1=CH_3R_2=NO_2$
 (162c) $R_1=R_2=NH_2$ (162g) $R_1=CH_3R_2=NH_2$
 (162d) $R_1=R_2=Cl$ (162h) $R_1=CH_3R_2=4-py$

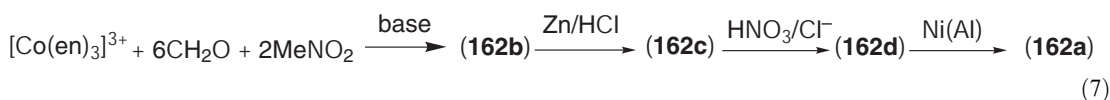
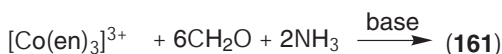

anthracene.^{748,749} Outer sphere electron transfer between divalent Co cages and metalloproteins such as plastocyanin⁷⁵⁰ and cytochrome *c*⁷⁵¹ has been demonstrated. The amino substituents of $[Co(NH_2)_2sar]^{3+}$ have been used to attach a variety of functional groups through either reductive alkylation^{752,753} or amide coupling.⁷⁵⁴

Other “capping” reagents and templates have been employed to create Co cages with different substituents, donor atoms, and chelate ring sizes. The acyclic hexaamine complex $[Co(sen)]^{3+}$ (**163**) offers one set of facially coordinated primary amines when bound to Co^{III} and this template has been used to synthesize a number of similar cages bearing an inert methyl group at one cap. By analogy with the chemistry employed in the synthesis of $[Co(sep)]^{3+}$, the group 15 hydrides NH_3 ,²¹⁹ PH_3 ,⁷⁵⁵ and AsH_3 ⁷⁵⁶ with CH_2O have been used as capping reagents for $[Co(sen)]^{3+}$ to form their respective cages (**164a–c**). Synthesis of the P- and As-capped cages required anhydrous conditions (and paraformaldehyde), and the P-oxide analog of (**164b**) was also isolated from the synthesis of its phosphine cage precursor.⁷⁵⁵ The longer As—C bonds in (**164c**) induce a conformational change (*le*₃ to *ob*₃) in the ethylenediamine chelate rings of the cage relative to their precursor conformers.⁷⁵⁶ The Co^{III} complex of the hexadentate ligand *N,N',N''*-tris(2'-aminoethyl)-1,4,7-triazacyclononane (**165**) also offers three facially coordinated primary amines, and this complex reacts with formaldehyde and either NH_3 or $MeNO_2$ to give the corresponding tricyclic cages (**166a–c**).⁶⁸²

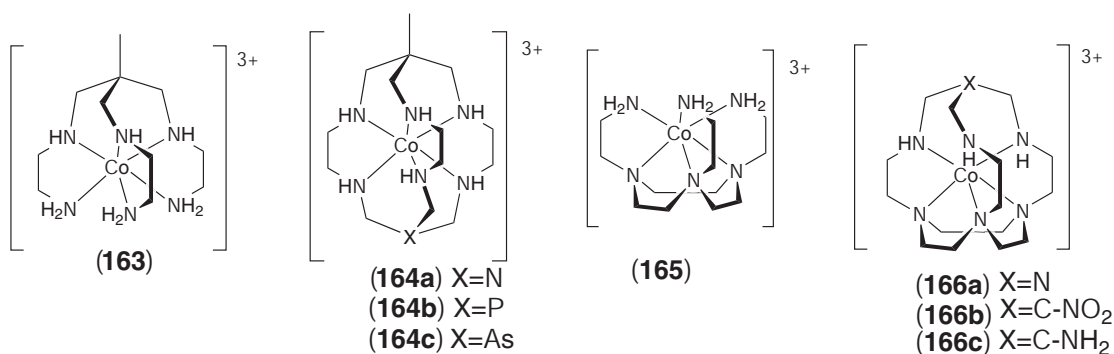

The use of formaldehyde with carbon acids including higher aldehydes, ketones, and esters has seen the expansion of this chemistry to incorporate many other substituents into the cap of the cage. *N*-benzylation of 4-methylpyridine enhances the acidity of the methyl group sufficiently to enable its employment as a carbon acid. The pyridyl-capped cage (**162h**) results.⁷⁵⁷ Condensation of the diketone dibenzoylmethane with $[\text{Co}(\text{sen})]^{3+}$ and formaldehyde leads to a diphenyl-substituted diimine cage, which may be reduced to the corresponding amine (**167**), with stereogenicity induced at the reduced imine C atoms.⁷⁵⁸ Methyl aryl ketones (ArCOCH_3) are also sufficiently acidic to enable their use as capping reagents for $[\text{Co}(\text{sen})]^{3+}$ in combination with paraformaldehyde, which leads to the corresponding aroyl-substituted cage ($\text{Ar} = \text{phenyl, naphthyl, phenanthryl, anthracenyl, anthroquinonyl}$).⁷⁵⁹ These compounds have been proposed as candidates for DNA intercalation⁷⁶⁰ and also as photosensitizers.

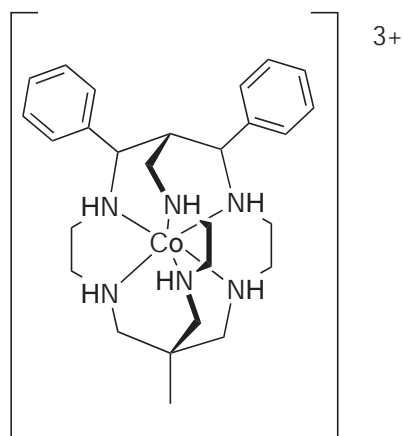

(167)

Variations on the basic bicyclo-icosane (20-membered) $[\text{Co}(\text{sar})]^{3+}$ cage structure were a later development. Instead of capping the $[\text{Co}(\text{en})_3]^{3+}$ or $[\text{Co}(\text{sen})]^{3+}$ templates, “strapping” reactions involving the threefold cross linking of $[\text{Co}(\text{tame})_2]^{3+}$ (**30**) with combinations of aldehydes have been achieved, albeit in poorer yields. The first example of this approach involved the synthesis of the pentamethyl expanded bicyclo-tricosane (23-membered) triimine cage (**168**) with formaldehyde and propionaldehyde as the strapping reagents, followed by imine reduction to the hexamine (**169**). The hexamine exhibits contrasting physical properties with its smaller-cavity $[\text{Co}(\text{sar})]^{3+}$ relatives (**162**) such as an anodically shifted $\text{Co}^{\text{III/II}}$ redox potential, elongated $\text{Co}-\text{N}$ bond lengths and red-shifted electronic maxima.⁷⁶¹ Substitution of propionaldehyde with isobutyraldehyde in this synthesis leads to further stabilization of divalent Co . The ensuing octamethylated hexamine analog of (**169**) (with *gem*-dimethyl groups on each strap), is as stable in the divalent oxidation state as compound (**31**), and the trivalent complex is only accessible through using controlled potential electrolysis.²²⁰

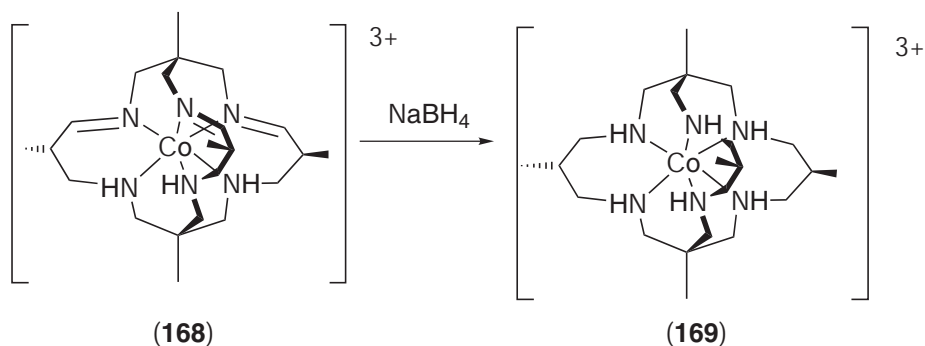

(168)

(169)

(ii) Pyridine and oligopyridines

(y) *Monodentate*. No trivalent Co complexes bearing six pyridine ligands are known. The *trans*-[Co(py)₄(OH)₂]³⁺ and [Co(py)₄(OH)₂]⁺ complexes are known, but they are highly reactive in acidic chloride solution to ligand substitution and ultimately to reduction to the divalent state.⁷⁶²

(z) *Multidentate*. There are many parallels between the coordination chemistries of the bidentate ligands 2,2'-bipyridine (bpy) and 1,10-phenanthroline (phen). Both ligands form five-membered chelate rings comprising a pair of pyridyl N-donors, and they stabilize the trivalent forms of their Co complexes relative to the unknown [Co(py)₆]³⁺ analog. This can be attributed to the chelate effect but also to the elimination of H...H repulsion in the pyridyl complex through the formation of covalent C—C bonds in their place. Both [Co(bpy)₃]³⁺ and [Co(phen)₃]³⁺ are well-characterized, stable low-spin complexes. The crystal structures of both [Co(phen)₃](ClO₄)₃ and [Co(bpy)₃](ClO₄)₃ have been reported.⁷⁶³ The [Co(bpy)₃]³⁺ ion has been crystallized with a number of paramagnetic complex anions and the magnetic and spectroscopic properties of these systems have been studied.^{764,765} Furthermore, it is found that the inert chiral Co^{III} complex induces the crystallization of chiral, anionic three-dimensional coordination polymers of oxalate-bridged metal complexes of the form [M^{II}₂(ox)₃]_n²ⁿ⁻ or [M^IM^{III}(ox)₃]_n²ⁿ⁻.⁷⁶⁴

Outer sphere electron transfer reactions involving these complexes have been extensively investigated. The high Co^{III/II} redox potentials of the bpy and phen complexes make them ideal one-electron oxidants. The pressure-dependence of their redox potentials have been examined, with substantial (ca. 200 mV) negative shifts being found at high pressure (10 kbar).⁷⁶⁶ Outer sphere reactions of [Co(bpy)₃]³⁺ and [Co(phen)₃]³⁺ with simple coordination compounds have revealed a number of interesting features. Reaction with Cr_{aq}²⁺ led to a variety of products including [Cr₂(bpy)(OH)₂(OH₂)₆]⁴⁺, Co_{aq}²⁺, [Co(bpy)(OH)₂]₄³⁺, in addition to uncomplexed (intact) bpy and reduced bpy.⁷⁶⁷ The kinetics of oxidation of a series of [Ru(NH₃)₅X]²⁺ complexes (X = substituted pyridine) by [Co(bpy)₃]³⁺ have been studied,⁷⁶⁸ with the electron transfer rates being correlated with Hammett sigma parameters of the pyridyl substituents. Oxidation of the [Cr(bpy)₃]²⁺ and [Cr(phen)₃]²⁺ ions by their Co^{III} analogs were found to be significantly non-adiabatic,⁶⁵¹ a result confirmed in other outer sphere reactions involving these oxidants where a large driving force is operant.⁷⁶⁹ A number of other studies of electron transfer with Co^{II}^{589,770} and ferrocene⁷⁷¹ have appeared. Outer sphere electron transfer reactions between proteins and polypyridylcobalt complexes are discussed in Section 6.1.3.1.5.

Chiral recognition of Δ-[Co(phen)₃]³⁺ has been observed in a modified β-cyclodextrin.⁷⁷² Chiral discrimination has also been seen in photoinduced energy transfer from luminescent chiral lanthanoid complexes⁷⁷³ to [Co(phen)₃]³⁺ and between photoexcited [Ru(bpy)₃]²⁺ and [Co(phen)₃]³⁺ co-adsorbed on smectite clays.⁷⁷⁴ The [Co(bpy)₃]³⁺ ion has been incorporated into clays to generate ordered assemblies and also functional catalysts. When adsorbed onto hectorite, [Co(bpy)₃]³⁺ catalyzes the reduction of nitrobenzene to aniline.⁷⁷⁵ The ability of [Co(phen)₃]³⁺ to bind to DNA has been intensively studied, and discussion of this feature is deferred until Section 6.1.3.1.4.

The structures of Co complexes of the tridentate terpy invariably exhibit a compression of the Co—N_{central} coordinate bonds relative to the Co—N_{distal} bond lengths, as a consequence of restraints imposed by the meridionally disposed pair of five-membered chelate rings. This is clearly seen in the [Co(terpy)₂Cl₃] crystal structure⁷⁷⁶ where the Co—N_{central,distal} bond lengths are 1.86 Å and 1.93 Å respectively. Like their amine analogs, there are countless examples of more complicated mixed-donor pyridyl-based ligands complexed with Co and these examples cannot be covered in a review of this breadth. Some miscellaneous examples of mixed-donor polypyridyl-amine complexes of Co^{III} include di(2-pyridyl)methanamine (170),⁷⁷⁷ and *N,N,N',N'*-tetrakis(2-pyridylmethyl)ethylenediamine (171).⁷⁷⁸

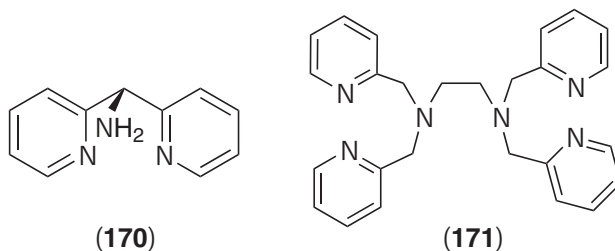

(iii) Porphyrins, corrinoids, and polypyrroles

Trivalent complexes of porphyrins (like their divalent analogs) have found many uses in sensor technology and catalysis. *Meso*-tetraphenylporphyrin (H_2TPP) (**172**), the most common of all synthetic porphyrins, has been used extensively in this regard. The $\{Co^{III}(TPP)\}$ moiety has been incorporated into a chemically modified, heat-treated glassy carbon electrode to produce an amperometric sensor for hydrazine operating at 0.5 V vs. Ag/AgCl, incorporated into a flow injection analysis system.⁷⁷⁹ A substituted analog $Co(TmapP)$ ($Tmap = 4$ -trimethylammonium-phenyl) also exhibited catalytic electro-oxidation of hydrazine in solution.⁷⁸⁰

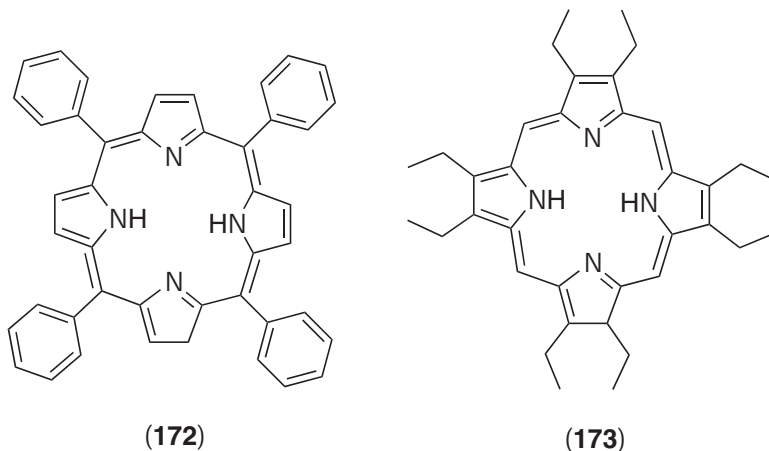

It has been shown that Co^{III} porphyrins are effective oxygenation catalysts. Alkyl- and aryl-substituted Co complexes of the dianions of H_2TPP and H_2OEP (**173**) undergo dioxygen insertion reactions to form alkyl(aryl) peroxy intermediates, which have been isolated and characterized.⁷⁸¹ The alkylperoxy complexes ultimately break down to release the corresponding alcohol. Peroxidation of fatty acids and esters (linoleic acid, methyl linoleate, and linolenic acid) has been achieved with $Co(TPP)Cl$ as a precursor, which initiates an auto-oxidative radical-chain reaction in oxygen-saturated MeCN solution. Another transformation catalyzed by a Co porphyrin is the oxidation of $CH_2=CHCH=CHCO_2Et$ to $MeCH_2COCH=CHCO_2Et$ catalyzed by $Co(T(2,6-Cl_2Ph)P)$.⁷⁸²

A detailed chemical and electrochemical investigation of the oxidation and coupled chemical reactions of alkyl substituted trivalent $Co(TPP)R$ ($R = Bu, Et, Me, Ph$) found that one- or two-electron oxidation of the Co^{III} σ -bonded complexes led to R group migration to give the *N*-aryl or *N*-alkyl Co^{II} porphyrins.⁷⁸³ The rates of migration (from Co to N) in the series varied by six orders of magnitude. Determination of the $Co-C$ bond dissociation enthalpies and entropies revealed that the $Co^{IV}-C$ bond in the singly oxidized species is significantly weaker than the $Co^{III}-C$ bond of the precursor. A high-valent $Co^{IV}=O$ intermediate was postulated as the active species in the catalytic hydroxylation of alkanes by an electron-deficient Co^{III} porphyrin in the presence of *m*-chloroperbenzoic acid with high regioselectivity.⁷⁸⁴ $Co(TPP)(NO_2)(py)$ is capable of oxo-transfer catalysis, involving a pentacoordinate $Co(TPP)(NO_2)$ intermediate which can stoichiometrically oxidize allyl bromide.⁷⁸⁵ Both radical and nonradical oxo-transfer steps are involved in the mechanism, suggesting a peroxy intermediate in the reaction of reduced $Co(TPP)(NO)$ with dioxygen. Kinetics of the reaction of the porphyrin complex $Co(TTP)Cl$ with a range of substituted imidazoles ($R-im$) has shown that $Co(TTP)(R-im)Cl$ is formed rapidly, then undergoes slower interconversion by rate-determining chloride ionization to the cationic complex $[Co(TTP)(R-im)]Cl$, a process sensitive to hydrogen-bonding interactions.⁷⁸⁶

The ring-contracted analogs of the porphyrin family (corroles) and their hexahydro derivatives (corrins) have attracted a considerable amount of attention because of their biological relevance (the Co -corrin moiety is found in co-enzyme B_{12} , see Section 6.1.3.1.1) and also due to their potential use in optoelectronics and catalysis. By analogy with their porphyrin relatives, substituents on the corrole ring may be found at the *beta* (pyrrole) or *meso* (methine) positions. An important distinction between these ligands is that the smaller ring corrole is a tribasic acid, in contrast to its dibasic porphyrin analogs. The 5,10,15-triphenylcorrole (H_3TPC) (**174**) may be synthesized in one pot by reaction of benzaldehyde with an excess of pyrrole (the same reagents used in the synthesis of H_2TPP).⁷⁸⁷ The crystal structure of $Co(TPC)(PPh_3)$ was also reported.

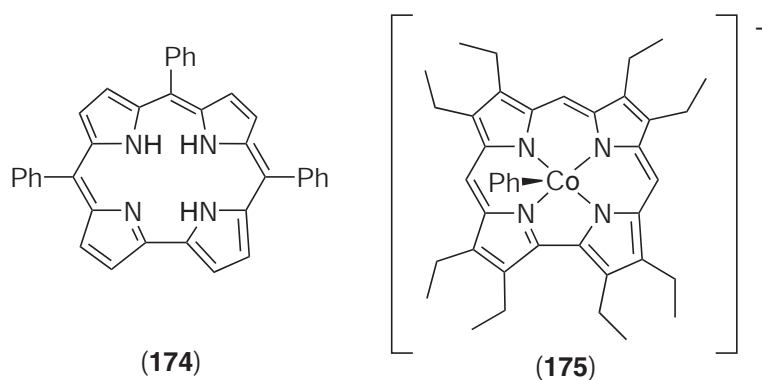

In the tris-pentafluorophenyl analog (TFPC), in contrast to other Co corroles, aromatic amines can substitute PPh_3 to form six-coordinate trivalent bis(amine) complexes.⁷⁸⁸ Bis-chlorosulfonation of TFPC occurs regioselectively to give the 2,17-(pyrrole)-bis-chlorosulfonated derivative fully characterized as its triphenylphosphinecobalt(III) complex.⁷⁸⁹ The amphiphilic bis-sulfonic acid was also obtained.

Electrochemical oxidation of the Co^{III} complex of the octamethylcorrole trianion (OMC) identified two reversible, ligand-centered responses, and two metal-centered reductions, depending on solvent.⁷⁹⁰ Similarly, the octaethyl analog $[\text{PhCo}(\text{OEC})]^-$ (175) undergoes sequential facile ligand-centered oxidations and the crystal structures of the one and two-electron oxidised complexes $\text{PhCo}(\text{OEC})$ and $[\text{PhCo}(\text{OEC})]\text{ClO}_4$ have been determined.⁷⁹¹ A number of *meso*-phenyl substituted derivatives of OMC were reported and spectroscopic measurements indicated the maintenance of ligand planarity despite the insertion of the bulky aromatic groups.⁷⁹² The structures of a number of alkylcobalamin complexes have been investigated by molecular mechanics calculations, and it was concluded that the structure of the ground state is influenced by the same factors that control the strength of the $\text{Co}-\text{C}$ bond in these compounds.⁷⁹³ A density functional theory analysis of these complexes has been reported and the results from this study are consistent with experimentally observed structural and magnetic data for the ground state electronic configurations of these compounds.⁷⁹⁴ Dimeric corrole complexes of Co have been investigated bearing bridges such as anthracene.⁷⁹⁵ This and other “face-to-face” Co-corrole dimers are capable of catalyzing the four-electron reduction of O_2 to water.⁷⁹⁶

Co-corrins are also efficient catalysts of a number of (bio)organic transformations including the oxidation of quinols,⁷⁹⁷ raising the possibility of their use as catalytic generators of oxygen-based radicals for targets such as DNA. The nitrosyl phthalocyanine complex $\text{Co}(\text{Pc})(\text{NO})$ (176) reacts with pyridine in air at high pressure to give the nitro complex $\text{Co}(\text{Pc})(\text{py})(\text{NO}_2)$ which is an oxidant for the stoichiometric and catalytic oxidation PPh_3 to Ph_3PO (in an inert atmosphere) regenerating the nitrosyl complex.⁷⁹⁸

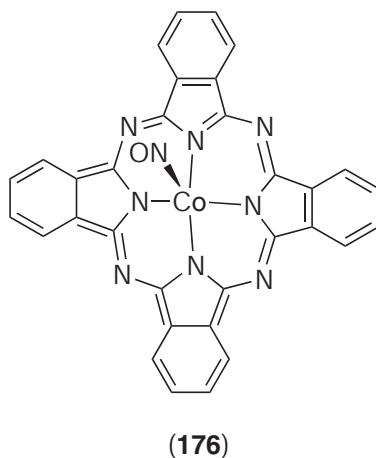

(iv) Imidazole, pyrazole, and related ligands

These heterocyclic unsaturated ligands share similar coordination chemistry with trivalent Co. The isomers imidazole (Him) and pyrazole (Hpz) are monodentate ligands in their neutral state. Upon deprotonation, they gain the ability to act as bridging ligands. Oxidation of $[\text{Co}(\text{Him})_6]^{2+}$ with H_2O_2 generates the trivalent octahedral complex.⁷⁹⁹ The first three pK_a values of the $[\text{Co}(\text{Him})_6]^{3+}$ ion were determined to be 8.65, 9.88, and 10.63. The pK_a values of coordinated imidazole itself (or as part of a histidyl residue) have been determined for $[\text{Co}(\text{NH}_3)_5(\text{Him})]^{3+}$,⁸⁰⁰ $[\text{Co}(\text{en})_2(\text{Him})(\text{OH}_2)]^{3+}$ ⁸⁰¹ and in the peptide histidylglycylglycine complex $\text{Co}(\text{hisglygly})(\text{NH}_3)_2$.⁸⁰² In these cases, the imidazole pK_a is in excess of 10. The Co^{III} complex of the peptide N-(2-(4-imidazolyl)ethyl)pyridine-2-carboxamide (PyepH), a molecule resembling part of the metal-chelating portion of the antitumor drug bleomycin, has been prepared.⁸⁰³ Electrochemical reduction of the compound in DMF or MeOH gives rise to an unstable Co^{II} species. The photoactive Co complex showed high capacity for DNA cleavage under UV illumination.⁸⁰⁴ The imidazole group was found to be capable of bridging two Co centers in both trinuclear and tetranuclear analogs of this system.⁸⁰⁵ The imidazole-bridged binuclear and trinuclear ammine complexes $[\{(\text{H}_3\text{N})_5\text{Co}\}_2(\text{im})]^{5+}$ and *cis*- $[(\text{H}_3\text{N})_4\text{Co}\{(\text{im})\text{Co}(\text{NH}_3)_5\}_2]^{7+}$ have been synthesized, and the crystal structure of the latter complex reported.⁸⁰⁶

Studies of the reactivity of imidazole coordinated to Co^{III} have identified some interesting chemistry. The imidazole ligand in *cis*- $[\text{Co}(\text{en})_2\text{Cl}(\text{Him})]^{2+}$ may be nitrated (at the 4-position) under mild conditions with a HNO_3 - H_2SO_4 nitrating mixture, whereas the pyridine analog cannot be nitrated without complex decomposition.⁸⁰⁷ Nucleophilic displacement of the nitro group of the coordinated ligand by Cl^- was also found. Treatment of $[\text{Co}(\text{NH}_3)_5(\text{Him})]^{3+}$ with $\text{Br}_{2(\text{aq})}$ in acetate or phosphate buffer between pH 4 and 6 results in exclusive formation of the oxidized $[\text{Co}(\text{NH}_3)_5(2,4,5\text{-oxo-im})]^{2+}$ complex (2,4,5-oxo-im = conjugate base of imidazolidine-2,4,5-trione, or parabanic acid). A mechanism involving a tetrabrominated imidazole intermediate was proposed.⁸⁰⁸ Chlorination results in the same product. An unusual linkage isomerization of $[\text{Co}(\text{NH}_3)_5(4\text{-Meim})]^{3+}$ (from adjacent to remote methyl group isomer) was observed and a mechanism involving a largely dissociative transition state was proposed.⁸⁰⁹

There are relatively few reports of trivalent Tp complexes by comparison with mono- and divalent systems. One interesting example involved transmetallation (from Sn to Co) in the reaction of TpSnCl_3 with $[\text{Co}(\text{CO})_4]^-$ to give a mixture of products from which $[\text{Co}(\text{Tp})_2][\text{trans}-(\text{CO})_4\text{Co}(\text{Cl}_2\text{Sn})_2\text{Co}(\text{CO})_3]$ was isolated and characterized by X-ray crystallography.⁸¹⁰

(v) Imines

Cobalt(III)-directed reactions, where the metal either directs the stereochemistry or activates the coordinated precursor, have played an important role in the development of imine coordination chemistry. Mixed donor imines coordinated to Co^{III} have been produced by metal-templated reactions. Anation of $[\text{Co}(\text{NH}_3)_5(\text{OH}_2)]^{3+}$ by 5-bromo-2-oxopentanoate at pH 5 gives two major products, the 2-oxo-2-cyclopropylethanoato complex and the 5-hydroxy-2-oxopentanoato complex, both which were converted to tetraammine-iminocarboxylato chelates by attack of an adjacent deprotonated ammine ligand.⁸¹¹ The tridentate monoimine analog of dien (dienim) is formed directly by condensation of acetaldehyde with ethylenediamine in the presence of CoCl_2 and H_2O_2 , and isolated as the *mer*- $[\text{Co}(\text{dienim})(\text{en})\text{Cl}]\text{ZnCl}_4$ complex.⁸¹² A series of α -amino acid complexes $[\text{Co}(\text{en})_2(\text{H}_2\text{NCH}(\text{R})\text{CO}_2)]^{2+}$ ($\text{R} = \text{CH}_2\text{OH}$, CH_2SMe , CMe_2SMe , $\text{CH}(\text{Me})\text{OH}$) react with SOCl_2 in DMF, undergoing β -elimination to give the related imine complex or else reacting further to give chelated isothiazole-3-carboxylato complexes.⁸¹³ Intramolecular condensation between *N*-bound aminoacetaldehyde and the terminal primary amine of coordinated trien (**135**) leads to the imine, $[\text{Co}(\text{tetraenim})\text{Cl}]^{2+}$; the (hydrated) carbinolamine intermediate was also identified. The carbinolamine results from condensation of the aldehyde with the most acidic coordinated amine *trans* to Cl^- and this species is unable to dehydrate until after ligand rearrangement that permits formation of a planar imine *N*-donor.⁸¹⁴ Methylene imines coordinated to Co (**(177)**⁸¹⁵ and **(178)**⁷⁵⁶) have been isolated from reactions of hexaaminocobalt(III) precursors with formaldehyde in anhydrous solvent. These imines are highly reactive towards nucleophiles and are rapidly hydrolysed in neutral aqueous solution, but are stable in strong acid. The trigonally symmetric potentially heptadentate triacid trensal forms charge neutral complexes with most trivalent metal ions, including Co^{III} (**(179)**), although the apical tertiary amine does not coordinate in this case.⁸¹⁶

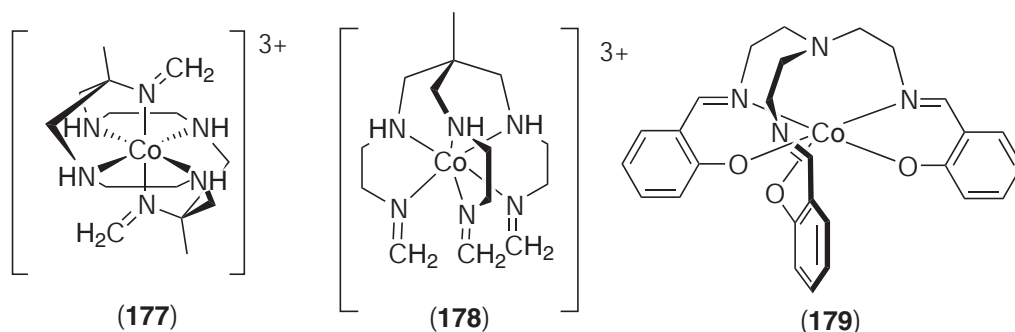

Complexes of imine ligands formed from salicylaldehyde have been widely investigated. Oxygenation of Co(salen) (**69a**) in alcoholic (ROH) solution involves a rate-determining proton transfer from ROH to the coordinated O₂ ligand, ultimately affording the corresponding alkoxy-cobalt(III) complex (**180**), which may be hydrolyzed to the hydroxocobalt(III) derivative in water.⁸¹⁷ The rate of oxidation of Co(salen) in MeOH solution is increased rapidly in the presence of Bu₃SnCl, leading to [Co(salen)Cl][BuSn(OMe)Cl₂] where the trivalent Co moiety may be considered a ligand for the Sn complex.⁸¹⁸ The coordinatively saturated Co(saldtn)(OH) complex (**181**) catalyzes the selective aldol condensation between dibenzoylmethanes and formaldehyde in methanol to give 1,1,3,3-tetrabenzoylpropanes, which undergo a retro-Claisen reaction to give 1,3-dibenzoylpropanes in CH₂Cl₂.⁸¹⁹ The complex of the substrate anion is the reactive species.

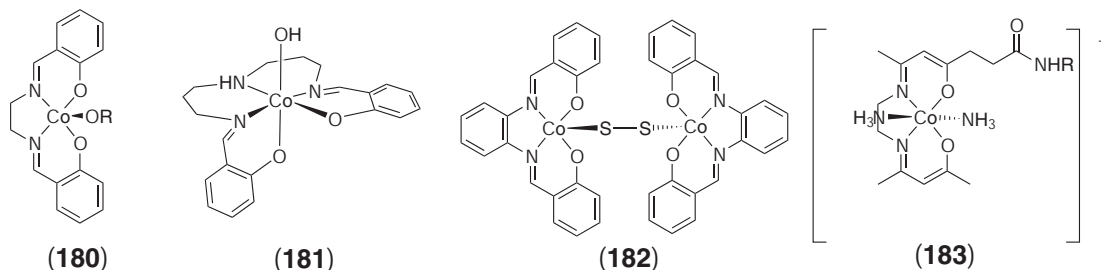

Spectroelectrochemistry of the trivalent peroxo-bridged dimer {(DMSO)(salen)Co}₂(μ-O₂) in DMSO has been investigated.⁸²⁰ Two-electron, controlled-potential oxidation liberates O₂ leaving the solvated complex [Co(salen)(DMSO)₂]⁺, while reduction produces the divalent compound. By analogy with the dioxygen/peroxide chemistry of these systems, treatment of Co(salpn) (**69b**) with elemental S in THF or pyridine gives the tetrasulfide complexes {(L)(salphn)Co}₂(S₄) (L = THF, py), whereas in the presence of Na⁺ in THF the trivalent μ-persulfido complex (**182**) [(salphn)Co(μ-S₂)Co(salphn)Na(THF)₂]BPh₄ results. A S—S distance 1.962(9) Å was determined from its crystal structure.⁸²¹ Removal of the Na⁺ ion (not shown here), which bonds with the O donors and the bridging persulfide, leads to decomposition of the complex.⁸²²

Complexes based on (**183**) ([Co(acacen)(NH₃)₂]⁺ with a peptide spacer attached to one of the methyl groups) have been patented as potential agents that bind to surface histidine residues on proteins.^{823,824} The potential uses for this are as bactericides, antimicrobial or antiviral agents, as reducing agents, or for protein labeling. Inhibition of proteins such as carbonic anhydrase, thermolysin,⁸²⁵ α-thrombin⁸²⁶ and a zinc finger-containing transcription factor⁸²⁷ was demonstrated by this class of compound. The activity of these compounds was found to be dependent on the amino acid residues in the linker. The structure and spectroscopy of the 3-chloro derivative of the parent complex *trans*-[Co(acacen)(NH₃)₂]⁺ were reported separately.⁸²⁸

The kinetics of electron transfer (both heterogeneous and homogeneous) involving trivalent Co complexes of hmd^{590,829} and tmt^{830,831} have been well studied. [Co(hmd)(OH₂)₂]³⁺ undergoes photoreduction in an aqueous acidic solution using [Ru(bpy)₃]²⁺ as photosensitizer and phenol as the sacrificial electron donor.⁸³² Ligand substitution reactions of *trans*-[Co(hmd)X₂]ⁿ⁺ at the labile (X) sites have been thoroughly investigated. Examples of leaving groups (X) include halide^{833–835} and aqua.⁸³⁶

The UV irradiation of a mixture of [Co(NH₃)₅(OAc)](ClO₄)₂ with the divalent precursor (**184**) in 0.1 M HClO₄ yields the methyl complex *rac*-[MeCo(hmd)(OH₂)₂]²⁺ (**185**). The complex was crystallized and its structure has been determined.⁸³⁷ The alkyl homologs [RCo(hmd)(OH₂)₂]²⁺

(R = Et, Pr), prepared independently, undergo unimolecular homolysis (effectively the reverse process) and the activation enthalpy for these processes were determined.⁸³⁸

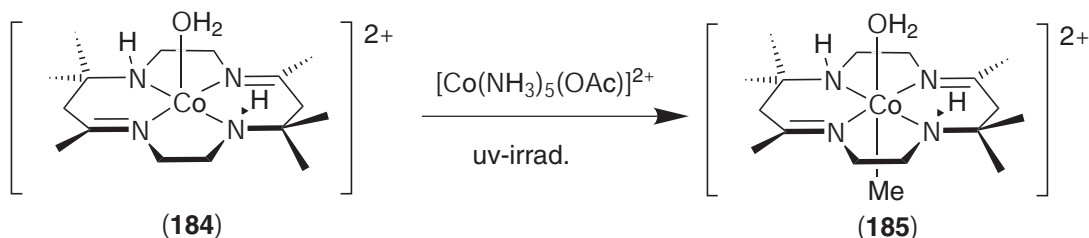

Methylation of $[\text{Co}(\text{tmt})]^{2+}$ with MeI leads to the potent methyl carbanion donor *trans*- $[\text{Co}(\text{tmt})\text{Me}_2]^+$ (**186**). Reaction of this complex with variety of methyl-lead(IV) compounds in MeCN is rapid, leading to the same monomethylcobalt(III) product, but resulting in different methylated Pb derivatives depending on the reaction stoichiometry and Pb compound.⁸³⁹ The same complex rapidly transfers Me groups to Zn^{2+} and Cd^{2+} in MeCN,⁸⁴⁰ or Pb^{2+} and Sn^{2+} in water.^{302,841} The kinetics of Co—C bond formation in the reactions with primary alkyl and substituted primary alkyl radicals has been found to be influenced more by the structure of the macrocycle than by the nature of the radicals.⁸⁴²

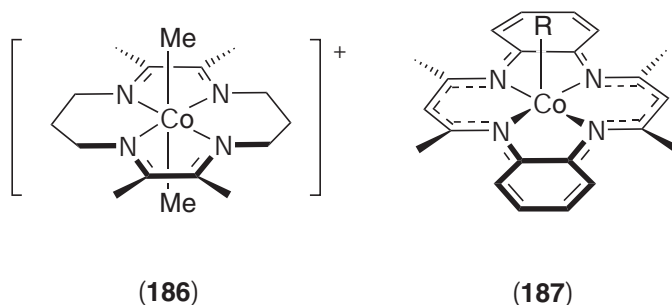

The alkyl complexes $\text{RCo}(\text{tmtaa})$ (**187**) (R = Me, Et, or Ph), were synthesized and studied by cyclic voltammetry.⁸⁴³ Two anodic waves, assigned to single-electron, ligand-centered, oxidative processes were observed that were only moderately influenced by the R group. Two cathodic waves were found. Growth of thin films by electropolymerization on a Pt electrode was achieved during which the Co—C bond remained intact. An interesting example of an axially bound alkyl group is provided by the norbornyl complex (**188**), prepared by reacting $\text{Co}(\text{tmtaa})$ with norbornene in the presence of dioxygen. The crystal structure of this novel pendent arm macrocyclic complex was reported.^{844,845} In contrast to the saddle-shaped tmtaa complexes, the 6,13-dimethyl analog adopts a planar conformation when bound to Co^{II} , stabilizing the Co^{I} oxidation state by 250 mV and destabilizing the trivalent state by 160 mV relative to the tmtaa complex.⁸⁴⁶

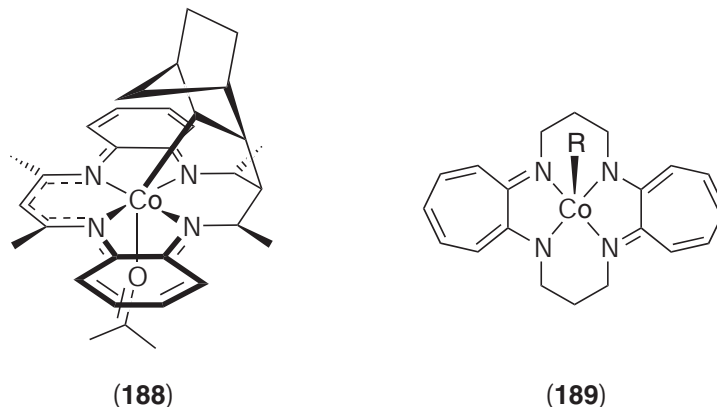

Cobalt complexes of the fused 7-membered ring unsaturated analogs of the dibenzo-[14]tetraazaannulenes, the tropocoronands (H_2TC), have also been reported. The crystal structure

of five-coordinate $\text{ClCo}(\text{TC})$ has been determined ((**189**) where $\text{R} = \text{Cl}$).⁸⁴⁷ The alkyl derivatives $\text{RCo}(\text{TC})$ ($\text{R} = \text{Et}, \text{Pr}$) were prepared, but were diamagnetic in contrast to the chloro precursor. The alkyl complexes homolyze in solution either on exposure to light or at elevated temperatures in the dark, to afford the corresponding divalent tropocoronand complex and an alkyl radical.⁸⁴⁸ Five-coordinate thiolate and nitrosyl derivatives have also been prepared.⁸⁴⁹

(vi) Oximes

Although oxime complexes of Co share many of the physical properties of their imine relatives, the presence of an ionizable OH group attached to the coordinated $\text{N}=\text{C}$ group leads to these ligands binding in their anionic forms. For this reason, the trivalent oxidation state is preferred in the Co coordination chemistry of oximes.

The hexadentate so-called clathrochelates are formally derived from $\text{Co}(\text{dmg})_3$ with borate "caps" at either end; the archetypal example being the trivalent (**190**). Like the hexamine analog $[\text{Co}(\text{sep})]^{3+}$ cage, the encapsulated metal ion is insulated from its surrounding solvent. Furthermore, the low charge of the complex decreases outer sphere (solvent, ion pairing) contributions to electron transfer and a number of structural and electron transfer investigations have been reported for these systems.⁸⁵⁰⁻⁸⁵² Increasing the bulk of the oxime substituents (diphenglyoxime, cyclohexanedioxime) decreases further the outer sphere contributions to electron transfer leading to an enhancement of the $\text{Co}^{\text{III/II}}$ self-exchange rate.⁸⁵³ Further, Co complexes bearing a variety of different caps including ferrocenylborate,⁸⁵⁴ butylborate,⁸⁵⁵ phenylborate,⁸⁵⁶ and trichlorostannate(IV)⁸⁵⁷ have been reported.

A variety of 4-substituted-1,2-benzoquinone-2-oximes (Me, Cl, Br) (analogs of the green pigment ferroverdin) form tris bidentate Co^{III} complexes, that are mixtures of *fac* and *mer* isomers.⁸⁵⁸ Another ferroverdin analog, 1-phenyl-2-(hydroximino)-1,3-butanedionate, forms a tris-bidentate Co^{III} complex which has been synthesized and characterized structurally.⁸⁵⁹ A trigonally symmetric (*fac*) isomer was observed. The hexadentate tripod-like trioxime $\text{MeC}(\text{CH}_2\text{NHCM}_2\text{C}(\text{Me})=\text{NOH})_3$ (H_3tox) was synthesized from the triamine tame (**131**) and 2-chloro-2-methyl-3-nitrosobutane.⁸⁶⁰ The complex with Co^{III} was crystallized in both its tri-positive (fully protonated) and singly deprotonated dipositive forms. Attempts to cap $[\text{Co}(\text{H}_3\text{tox})]^{3+}$ with aqueous borate and phenyl boronate were unsuccessful, resulting instead in partial ligand hydrolysis. Oxamide oxime forms a trigonally symmetric tris-bidentate Co^{III} complex $[\text{Co}(\text{H}_2\text{oxao})_3]^{3+}$ and its structure was determined by single crystal X-ray diffraction.⁸⁶¹ The bis-bidentate (N,O) complexes *trans*- $\text{Co}(\text{HQ})\text{Q}(\text{L})_2$ ($\text{H}_2\text{Q} = 2\text{-oximinopropionic}$ or $2\text{-oximino-3-phenylpropionic}$ acids; $\text{L} = \text{monodentate aromatic N-donor}$) were reported.⁸⁶² Extension of this ligand by addition of a glycyl residue produces the tridentate ligand N-(2-oximinopropionyl) glycinate and its bis Co^{III} complex (*mer* isomer) was also characterized.⁸⁶³

One of the most commonly encountered oxime ligand systems involves the cooperative coordination of two bidentate *dmg* anions. When coordinated in a *trans* configuration internal hydrogen bonding between *cis*-disposed protonated and deprotonated oxime groups ($\text{N}-\text{O}-\text{H} \cdots \text{O}-\text{N}$) leads to a 14-membered pseudo-macrocyclic CoN_4 array, as seen in the structures of *trans*- $[\text{Co}(\text{dmg})_2\text{X}_2]^+$ ((**191**) $\text{X} = \text{H}_2\text{O}$ ⁸⁶⁴ and py ⁸⁶⁵). There has been a substantial effort devoted to the biomimetic chemistry of cobalamins (B_{12}) using polyoxime ligands, and a discussion of this area is to be found in Section 6.1.3.1.1.

Alkyl Co oxime complexes have been used as chain transfer catalysts in free radical polymerizations.^{866,867} Regioselective hydronitrosation of styrene (with NO in DMF) to $\text{PhCMe}=\text{NOH}$ is catalyzed by $\text{Co}(\text{dmg})_2(\text{py})\text{Cl}$ in 83% yield.^{868,869} Catalytic amounts of the trivalent $\text{Co}(\text{dmg}_2\text{tn})\text{I}_2$ (**192**) ($\text{X} = \text{I}$) generate alkyl radicals from their corresponding bromides under mild reaction conditions, allowing the selective preparation of either saturated or unsaturated radical cyclization products.⁸⁷⁰

(vii) Amides

Amides offer both O and N-donors for Co coordination. N-bound amides are accessible through hydrolysis of their corresponding coordinated nitrile or by linkage isomerization of the O-bound form. The preparation of an extensive series of pentaamminecobalt(III) complexes of (monodentate-coordinated) amides of the form RCONH_2 ($\text{R} = \text{H}, \text{Me}, \text{CF}_3, \text{CH}_2\text{Cl}, \text{CH}_2\text{F}, \text{CH}=\text{CH}_2, \text{Ph}$,

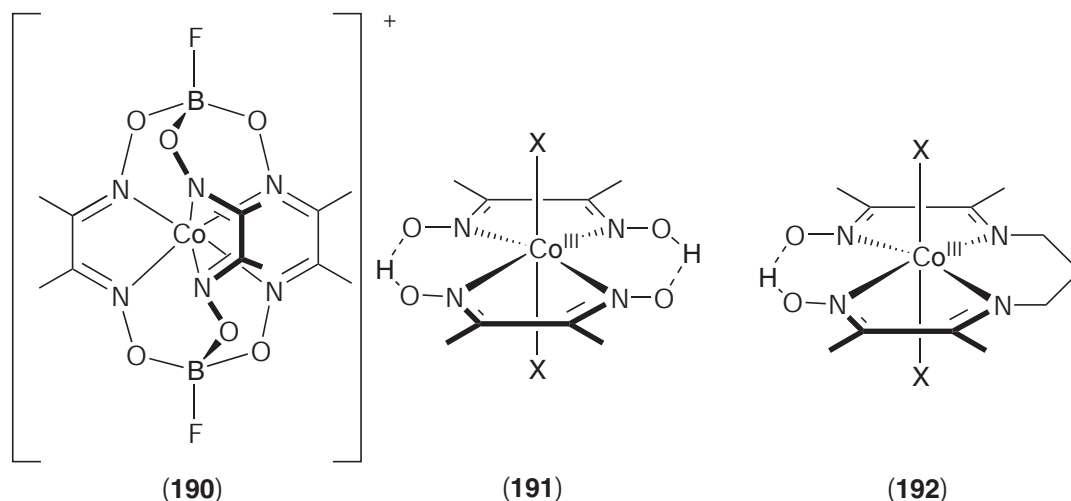

p-C₆H₄F, *o*-C₆H₄NO₂) has appeared.⁸⁷¹ N-Bound amides are quite acidic ($pK_a < 4$) and are able to be isolated in both their neutral (enol) [(H₃N)₅CoNH=C(OH)R]³⁺ and monoanionic (amidate) [(H₃N)₅CoNHCOR]²⁺ forms. For example, the N-bound amidate form of the phenylurea complex (193) is stable, whereas the protonated form (194) spontaneously undergoes linkage isomerization to the O-bound isomer (195). This reaction is in competition with ligand hydrolysis via [Co(NH₃)₅(NCO)]²⁺ to give [Co(NH₃)₆]³⁺.⁸⁷² Interestingly, (195) does not undergo hydrolysis but instead ligand substitution (aquation) occurs to give [Co(NH₃)₅(OH₂)]³⁺ and unbound urea.

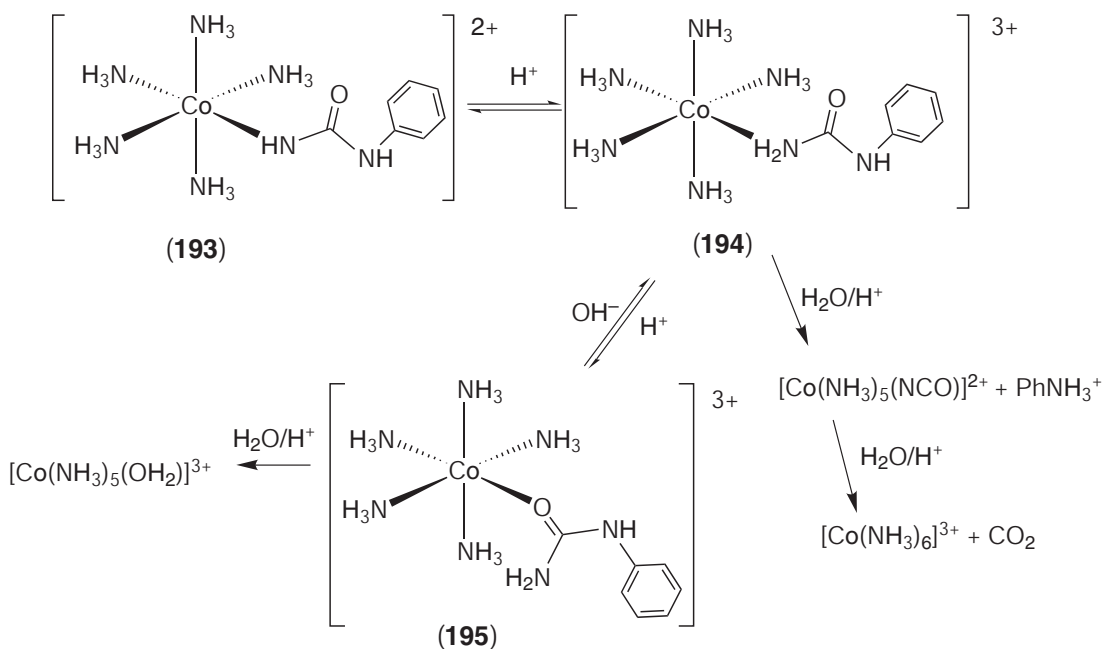

Addition of [Co(en)₂(gly)]²⁺ to a solution of SOCl₂ in DMF followed by hydrolysis resulted in oxidation and formylation of the glycinate ligand. The *N*-formyloxamato complex and elemental S were identified as products.⁸⁷³ Multidentate amides met as peptides, for example, invariably bind through at least one deprotonated peptide N atom. A number of mixed ligand Co^{III} complexes of the dipeptide gly-gly have been prepared. The peptide coordinates in a meridional configuration, and the crystal structure of *mer*-Co(gly-gly)(en)(NCS) was reported.⁸⁷⁴ The corresponding nitro complex undergoes a condensation reaction at the N terminus with CH₂O to give an unusual 1,3-oxazine, which is coordinated through carboxylato O, peptide N, and imine N atoms.⁸⁷⁵ The dipeptides (H₂dipep = L-met-gly, gly-L-met, L-met-L-ala and L-ala-L-met) have been complexed with Co. A number of compounds of the form [Co(dipep)₂]⁻,

$[\text{Co}(\text{dipep})(\text{en})]^+$ and $\text{cis-}[\text{Co}(\text{dipep})(\text{NH}_3)_2]^+$ were prepared and characterized by NMR and CD spectroscopy.⁸⁷⁶ The dipeptides coordinate through the terminal and peptide N atoms, the carboxylate and the S atom of the side chain. The complexes $\text{Co}(\text{dipep})(\text{NO}_2)_3$ (H_2dipep = gly-gly, gly-L-ala, gly-L-val, gly-L-nva, gly-L-leu, β -ala-gly) were prepared and interproton NMR coupling over five bonds of the peptide was identified.⁸⁷⁷ The crystal structure and CD absorption spectrum of the tripeptide complex $\text{Co}(\text{NH}_3)_2(\text{L-ala-gly-gly})$ has been reported. The sole methyl side chain on the tetradentate ligand (at the N terminal end) is in an equatorial position.⁸⁷⁸ Proline residues attached to either end of dien result in the pentadentate ligand $\text{H}_2\text{prodien}$, which was characterized structurally, as well as with CD spectroscopy, as its complex $[\text{Co}(\text{prodien})(\text{OH}_2)]^+$.⁸⁷⁹ The ^{15}N NMR spectra of a number of dipeptide, tripeptide, and tetrapeptide complexes of Co^{III} were measured. Coordination of oligopeptides resulted in large upfield shifts for both amine and deprotonated amide nitrogens, and specific *trans* effects were also identified.⁸⁸⁰

The novel tetrabasic ligand 1,3-bis(5-methylpyrazole-3-carboxamido)propane forms a trinuclear $\text{Co}^{\text{III}}\text{-Co}^{\text{II}}\text{-Co}^{\text{III}}$ complex (**196**). The tetradentate diamide-pyrazolyl chelates encircle the terminal trivalent metal ions while the central divalent Co is in a distorted tetrahedral environment provided by the four bridging pyrazolyl rings.⁸⁸¹

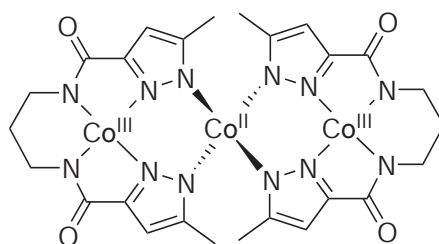

(196)

The Co^{III} complexes of the macrocycle 5,7-dioxocyclam and a pendent pyridylethyl derivative (**197**) have been structurally characterized.⁸⁸² The ligands bind in their enol tautomeric forms in the complexes when isolated from acidic solution, as shown by X-ray crystallography and IR spectroscopy. The tripodal triamides (**198**) and (**199**) have been synthesized and their Co complexes exhibit a pronounced cathodic shift of their $\text{Co}^{\text{III/II}}$ redox couples relative to the hexamine analog $[\text{Co}(\text{sen})]^{3+}$ (**163**).⁸⁸³ The crystal structure of (**198**) was reported. Amide analogs of the macrobicyclic $[\text{Co}(\text{sar})]^{3+}$ cages (**200**), using ester groups as capping fragments, have been synthesized.^{884,885} Alternatively, homologous cages derived from tris(cyclohexane-1,2-diamine)cobalt(III) undergo oxidative dehydrogenation to give diamide complexes where one of the cyclohexyl rings has undergone aromatization.⁸⁸⁶

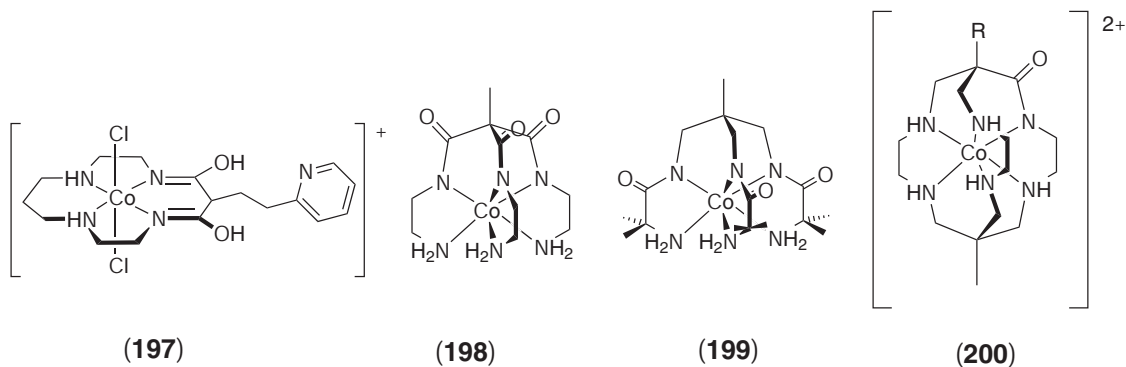

(197)

(198)

(199)

(200)

Examples of paramagnetic ($S = 1$) trivalent Co complexes are unusual, but multidentate amide ligands provide a significant proportion of known examples. The square planar tetraamide amide complex (**201**) bears a ligand formally derived from a pair of biuret molecules bridged by a 1,2-diphenylethyl moiety.⁸⁸⁷ The crystal structure reveals that the Co-N bonds are on average shorter than those found in diamagnetic (octahedral) Co^{III} amide complexes. Similarly, (**202**) is square planar, as shown by an X-ray crystal structure.⁸⁸⁸ A spin triplet ground state was also identified in the solid state. An octahedral diamagnetic complex is formed upon addition of two equivalents of pyridine to an aqueous solution, but no adduct forms in aprotic solvents.

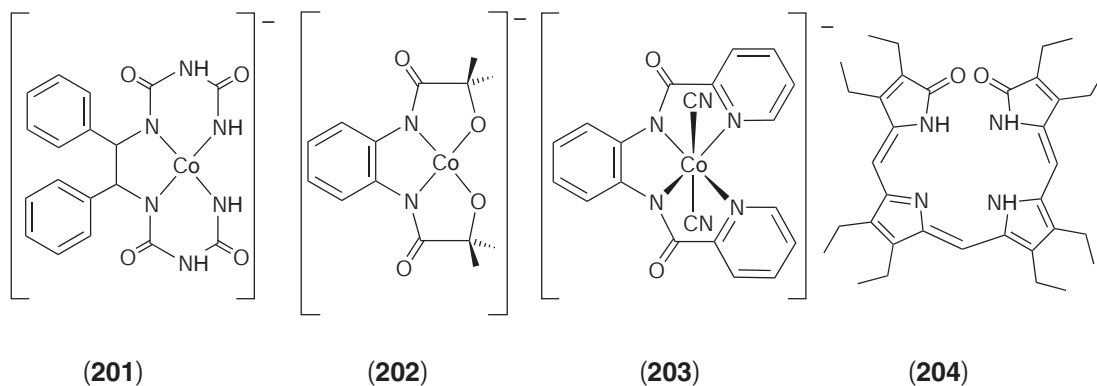

The dianionic tetradentate ligand 1,2-bis(pyridine-2-carboxamido)-benzenate (bpc) is non-innocent. The anion **(203)** can be oxidized to $\text{Co}(\text{bpc}_{\text{ox}})(\text{CN})_2$ which has a $S = 1/2$ ground state, and the crystal structure of the complex has been determined.⁸⁸⁹ The open chain tetradentate octaethylbilindione **(204)** (H_3OEB) bears a tetrapyrrole unit found in biliverdin, an intermediate in heme catabolism and a commonly found pigment. Carbonyl groups at opposite ends of the open chain porphyrin relative forbid the adoption of planar conformations by this ligand in contrast to porphyrins themselves.⁸⁹⁰ Instead, the tetrapyrrole ligand adopts a helical conformation; the monomeric $\text{Co}(\text{OEB})$ complex has been characterized by X-ray crystallography and spectroscopic techniques. The compound exhibits a rich electrochemistry, with four electrochemically reversible redox states $[\text{Co}(\text{OEB})]^n$ ($n = -2, -1, 0, \text{ and } +1$).⁸⁹¹ The monopositive complex has also been characterized structurally, and spectroscopic evidence indicates that it is a divalent complex of the 2-electron oxidized ligand, i.e., $[\text{Co}^{\text{II}}(\text{OEB}_{\text{ox}})]^+$. A ligand-centered radical has been observed upon reaction of this compound with pyridine to give the $[\text{Co}^{\text{III}}(\text{OEB}^{\cdot-})(\text{py})_2]^-$ species.⁸⁹²

Epoxidation of norbornene with *t*-BuOOH or PhI as terminal oxidant catalyzed by the Co^{III} complex of **(205)** was explored.⁸⁹³ Co catalysis is associated with the Co^{III} - to Co^{II} -driven formation of *t*-BuOO radicals. By contrast, there is no evidence for radical intermediates in Co catalysis with PhIO and an oxo-cobalt(IV) species was postulated instead in this case. The chiral square planar complex of 2,4-bis((*R*)-2-methylbutyramido)-2,4-dimethylpentan-3-one and other close relatives were prepared and characterized by NMR and X-ray crystallography.⁸⁹⁴ Asymmetric epoxidation of styrenes with these complexes and PhIO were achieved in varying yields with modest enantiomeric excess. The pyridyl-substituted pentadentate ligand, *N,N'*-bis(2-(2'-pyridyl)ethyl)-2,6-pyridinedicarboxamide ($\text{H}_2\text{py}_3\text{p}$), when complexed with Co^{III} , catalyzes the selective oxygenation of phenols to the corresponding *p*- or *o*-quinones.⁸⁹⁵ Crystal structures of the $[\text{Co}(\text{py}_3\text{p})\text{X}]^{n+}$ ($\text{X} = \text{H}_2\text{O}$, $n = 1$; $\text{X} = \text{OH}^-$, *t*-BuOO⁻, $n = 0$) complexes have been reported.⁸⁹⁶ The *t*-butylperoxo complex oxidizes alkanes such as cyclohexane via homolytic scission of the O—O bond. The *t*-BuO[·] radicals liberated abstract an H atom from cyclohexane and the cyclohexyl radical reacts with O_2 to give a mixture of cyclohexanol and cyclohexanone. The bis(pyridyl-

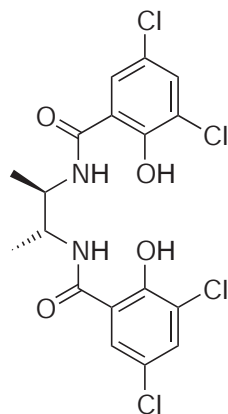

(205)

azolylethyl) analog H_2pypz_2p has also been synthesized and its analogous pentadentate coordinated Co^{III} complexes have been reported.⁸⁹⁷ By contrast, the pentadentate coordinated complex $[Co(pypz_2p)(OH_2)]^+$ is converted quantitatively to the bis-bidentate $[Co(pypz_2p)_2]^-$ in solution. The influence of the strong field amide N-donors is the driving force for this transformation.

(viii) Nitrosyl

Bound nitrosyl can display either a linear or bent geometry. The ^{15}NO NMR shifts for five-coordinate Co^{III} complexes with Schiff base or dithiocarbamate basal ligands and bent apical nitrosyl ligands have been reported.^{898,899} As in C-nitroso groups, bent ^{15}NO ligand resonances are strongly deshielded (by 500–800 ppm) relative to comparable linear nitrosyls, and both ^{59}Co and ^{15}NO shielding was found to decrease with the $Co-N-O$ angle.

Nitrosyl complexes of Co porphyrins have attracted considerable attention. As an example, $Co(TPP)(NO)$, and some methoxy and nitroaromatic homologs, were prepared and the $Co-NO$ bonding interaction was probed using cyclic voltammetry and reflectance IR spectroelectrochemistry. These experiments revealed $\bar{\nu}_{N=O}$ vibrations for the one- and two-electron oxidized complex; the latter being consistent with an effectively σ -bonded nitrosyl.⁹⁰⁰ An extended series of $Co(TPP)(NO)$ analogs bearing an even greater variety of aromatic substituents was reported by reaction of the precursor Co porphyrin with NO or with $NOBF_4$, then reduction with cobaltocene. The complexes are diamagnetic, display $\bar{\nu}_{N=O}$ bands around $1,690\text{ cm}^{-1}$ and possess a bent nitrosyl ligand ($Co-N-O \sim 120^\circ$).⁹⁰¹ Spectroelectrochemical IR experiments showed that the complexes undergo a reversible one-electron oxidation of their porphyrin ring and a one-electron reduction of the Co center.⁹⁰² An accurate crystal structure of $Co(OEP)(NO)$ was determined in order to probe apparent structural distortions found in the Fe analog.⁹⁰³ The $Co-N$ vector was within 2° of perpendicular to the porphyrin plane, whereas the $Fe-N$ vector was tilted by more than 6° . Equatorial $M-N(\text{porphyrin})$ bond length asymmetry was seen in both structures, which was correlated with the axial $M-N(O)$ tilt angle. Subsequent theoretical studies confirmed this structural correlation.⁹⁰⁴

Coordination of NO to the divalent tetrasulfonated phthalocyanine complex $[Co(TSPc)]^{4-}$ results in a complex formally represented as $[(NO^-)Co^{III}(TSPc)]^{4-}$ ($k_f = 142\text{ M}^{-1}\text{ s}^{-1}$, $K_a = 3.0 \times 10^5\text{ M}^{-1}$). When adsorbed to a glassy carbon electrode, $[Co(TSPc)]^{4-}$ catalyzes the oxidation and reduction of NO with catalytic currents detectable even at nanomolar concentrations. Electrochemistry of the same complex in surfactant films has also been studied.⁹⁰⁵ Bent nitrosyl complexes of the paramagnetic trivalent tropocoronand complex $Co(NO)(TC)$ (**(189)**, $R = NO$) have also been reported.⁸⁴⁹

(ix) Nitriles, azides, isocyanides, cyanates, and thiocyanates

Nitrile coordination chemistry of Co has attracted attention as the influence of the trivalent metal ion greatly enhances the reactivity of the $C\equiv N$ bond toward nucleophilic attack, especially hydrolysis. Amine complexes of Co^{III} have been popular scaffolds upon which to perform these reactions. Following syntheses of the pentaamminecobalt(III) complexes of 2- and 4-nitrobenzotrile, base hydrolysis of the coordinated nitrile to the corresponding carboxamides was investigated. Rate constants for nitrile hydrolysis for these and a number of other substituted aromatic nitrile analogs were correlated with the Hammett substituent parameters.⁹⁰⁶ The N-bonded nitrile complexes $[Co(\text{tetren})(NCR)]^{3+}$ ($R = \text{Me, Ph, } p\text{-MeOC}_6\text{H}_4$; tetren = linear tetraethylenepentamine) were prepared and the kinetics of base hydrolysis were studied. The reactions involved displacement of the nitrile to give the hydroxopentamine as opposed to nucleophilic attack at the nitrile carbon, i.e., the corresponding carboxamido complex is not formed.⁹⁰⁷

The ammonioacetonitrile complex (**206**) reacts with NH_3 to produce the amidine-bonded aminoacetamide (**207**) complex, whereas in aqueous base it hydrolyzes to the amido-*N*-bonded glycinamide complex (**208**).⁹⁰⁸ Acid-catalyzed linkage isomerization to first the *O*-bound form (**209**) precedes formation ultimately of the amino-bonded isomer (**210**) as the stable product upon deprotonation of the free amine above pH 6.

The 1,3-dipolar cycloadditions of N_3^- with coordinated nitriles (**211**) may result in formation of 5-substituted tetrazole complexes (**212**). Some examples include $[Co(NH_3)_5(N_4R)]^{2+}$ ($R = p\text{-methylphenyl, } p\text{-chlorophenyl, } p\text{-nitrophenyl (N1 bound), } m\text{-formylphenyl (N2 bound)}$).

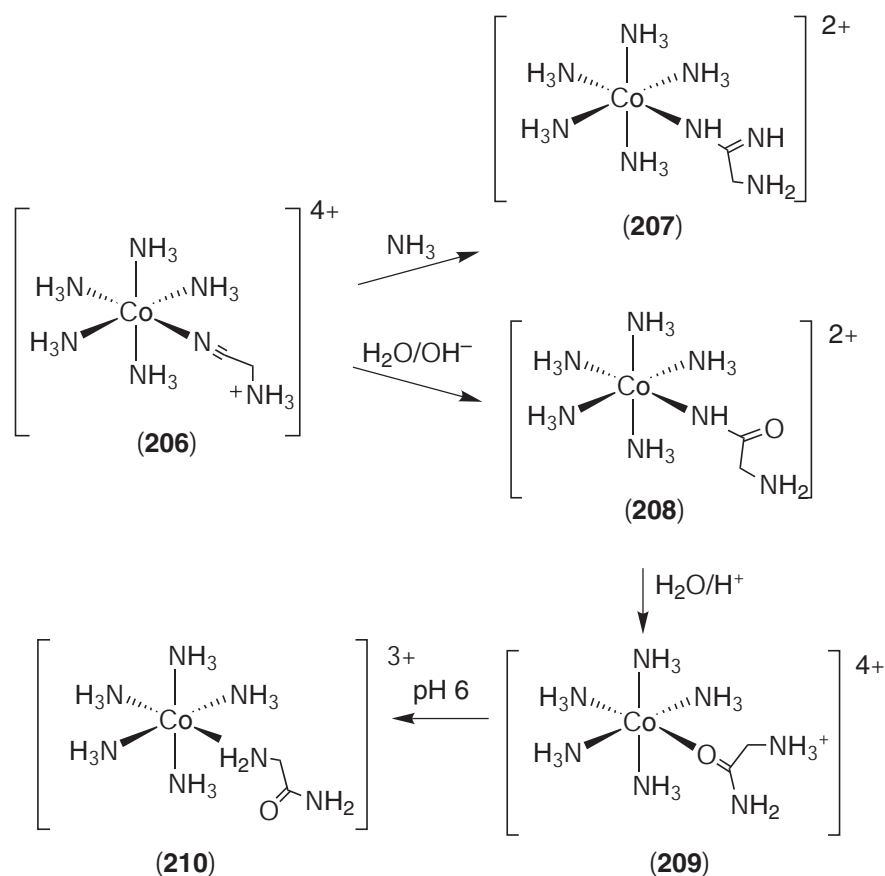

The kinetics of the reaction is first order in both nitrile complex and azide.⁹⁰⁹ NaN_3 reacts with $[\text{Co}(\text{tetren})(\text{NCMe})]^{3+}$ at pH 5.7 to give the 5-methyltetrazolato complex $[\text{Co}(\text{tetren})(\text{N}_4\text{CMe})]^{2+}$. The reaction is biphasic, involving the initial rapid formation of the N1-bonded tetrazole followed by the slow linkage isomerization to the N2-bonded complex.⁹⁰⁷

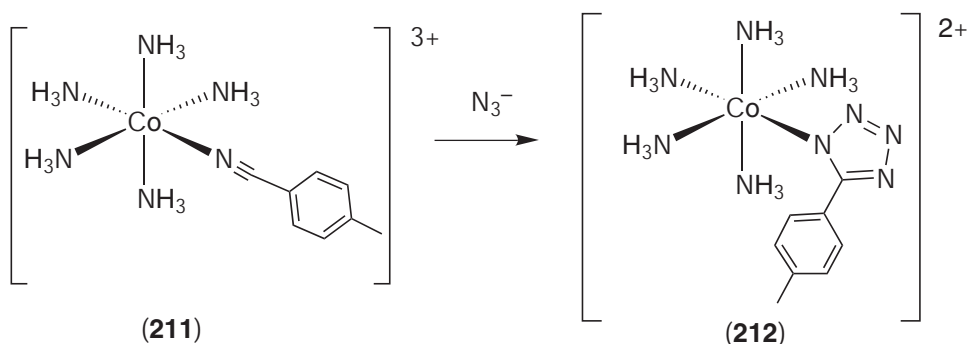

The ambidentate isomers 3-cyanopyridine and 4-cyanopyridine have been complexed to the pentaamminecobalt(III) moiety and their corresponding linkage isomers $[(\text{H}_3\text{N})_5\text{Co}(\text{NCpy})]^{3+}$ and $[(\text{H}_3\text{N})_5\text{Co}(\text{pyCN})]^{3+}$ have been prepared.⁹¹⁰ Their electron transfer cross reactions with $[\text{Fe}(\text{CN})_5(\text{OH}_2)]^{3-}$ were investigated and were found to proceed in two stages. In the first stage, pyCN-bridged $\text{Fe}^{\text{II}}-\text{Co}^{\text{III}}$ dinuclear complexes are formed as intermediates, but their fate depends on the linkage isomer present that undergoes rapid inner-sphere electron transfer. The binuclear $(\text{H}_3\text{N})_5\text{Co}^{\text{III}}(\text{NCpy})\text{Fe}^{\text{II}}(\text{CN})_5$ complex undergoes inner-sphere electron transfer followed by

complex dissociation, whereas the $(\text{H}_3\text{N})_5\text{Co}^{\text{III}}(\text{pyCN})\text{Fe}^{\text{II}}(\text{CN})_5$ isomer simply dissociates to its reactants without electron transfer taking place. For the latter systems, outer-sphere electron transfer is more competitive. The Cr^{II} reduction of the nitrile-bonded pentaamminecobalt(III) complexes of 3- and 4-cyanobenzoic acid has also been studied.⁹¹¹ The reaction between Cr^{II} and $[(\text{H}_3\text{N})_5\text{Co}(\text{NCCH}_2\text{I})]^{3+}$ gave the unusual dinuclear complex $[(\text{H}_3\text{N})_5\text{Co}(\text{NCCH}_2)\text{Cr}(\text{OH}_2)_5]^{5+}$ as the only product.⁹¹² The Hg^{II} analog was also prepared.

The potentially bridging 2-cyano-acetylacetonato anion has been complexed with Co in its N-bound form to give $[\text{Co}(\text{NH}_3)_5(\text{NCC}(\text{C}(\text{O})\text{Me})_2)]^{2+}$. The bridged dicobalt(III) complex $[(\text{H}_3\text{N})_5\text{Co}(\mu\text{-NCC}(\text{C}(\text{O})\text{Me})_2)\text{Co}(\text{tn})_2]^{5+}$ was also prepared.⁹¹³ Inner-sphere electron transfer between $[\text{Co}(\text{NH}_3)_5(\text{NCC}(\text{C}(\text{O})\text{Me})_2)]^{2+}$ and Cr^{II} was verified by blocking the acac coordination site with a non-reducing metal ion, which inhibited reaction with divalent Cr. The cyanoborane complexes $[\text{Co}(\text{NH}_3)_5(\text{NCBH}_2\text{R})]^{3+}$ ($\text{R} = \text{Et}_3\text{N}$, py, PPh_3) were prepared from the triflatopentaammine precursor in acetone; further, the syntheses of some alkane nitrile analogs were described as well as the kinetics of their base-catalyzed hydration reactions.⁹¹⁴

Coordinated azide complexes have been widely reported. The azido complex $[\text{Co}(\text{NH}_3)_5(\text{N}_3)]^{2+}$ has been well explored. Amongst its applications, it is an efficient photoinitiator of polymerization of 2-hydroxyethyl methacrylate (HEMA).⁹¹⁵ The interaction of Me_3SiN_3 with *mer*- $\text{CoMe}_3(\text{PMe}_3)_3$ gives the octahedral $\text{CoMe}_2(\text{N}_3)(\text{PMe}_3)_3$ complex. This azido complex and its trigonal bipyramidal carbonyl derivative $\text{Co}(\text{N}_3)(\text{CO})_2(\text{PMe}_3)_2$ were characterized structurally.⁹¹⁶

The complex $[\text{Co}(\text{NH}_3)_5(\text{OSO}_2\text{CF}_3)]^{2+}$ undergoes triflate substitution by cyanate and condensation with acetone to form the unusual bis-bidentate imine complex (**213**)⁹¹⁷ in a reaction reminiscent of the classic Curtis condensation of acetone with ethylenediamine. Apart from the novelty of the synthesis, the reported crystal structure was only the second of a CoN_6 complex bearing a cyanate ligand.

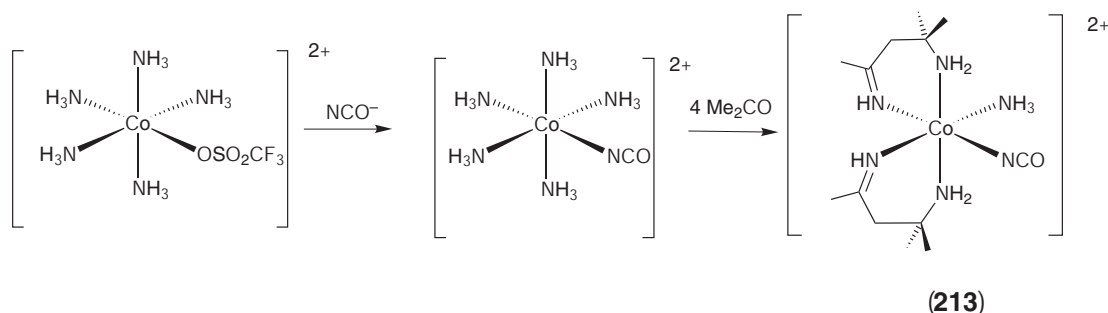

The coordination chemistry of the ambidentate SCN^- and its linkage isomerism when bound to Co^{III} has been reviewed.¹⁹ With Co^{III} , the N-bound isomer is thermodynamically stable and commonly observed, and the Co-NCS unit (typical Co-N 1.90 Å) is usually linear, although some deviations from strict linearity are sometimes found in practice. A more unusual monomeric complex is *mer*- $\text{Co}(\text{NCS})_3(\text{PMe}_3)_3$, formed via reaction of $\text{Co}(\text{NCS})_2(\text{PMe}_3)_2$ with NO , where a disproportionation leads to the CoN_3P_3 species as well as $[\text{Co}(\text{NO})_2(\text{PMe}_3)_2]$ $[\text{Co}(\text{SCN})_4]$.⁹¹⁸

6.1.2.3.4 Phosphorus

Phosphorus ligands bound to cobalt are met more broadly in the parallel *Comprehensive Organometallic Chemistry* series, but some representative examples not also including Co-C bonded species are presented here.

(i) Mono- and bidentate phosphines

The bicyclic phosphite ester $\text{P}(\text{OCH}_2)_3\text{CMe}$ and the bidentate bis-diphosphite $((\text{MeO})_2\text{PCH}_2\text{CH}_2\text{P}(\text{OMe})_2)$ form trivalent CoP_6 complexes of the form (**214**) and (**215**). A photophysical study observed emission from the ${}^3\text{T}_{1g}$ electronic state in both complexes.⁹¹⁹ Photolysis of (**215**) in aqueous solution at 300 K results in photoaquation. An NMR investigation reported the longitudinal relaxation times (T_1) of ${}^{59}\text{Co}$ and ${}^{31}\text{P}$ nuclei across a series of CoP_6^{3+} complexes (where P was $\text{P}(\text{OMe})_3$ or a mono or bicyclic phosphite ester).⁹²⁰ The magnitude of T_1 decreased as the

symmetry of the ligands was lowered and the ^{59}Co - ^{31}P coupling constants decreased as the exocyclic group in the monocyclic phosphite ligand was enlarged.

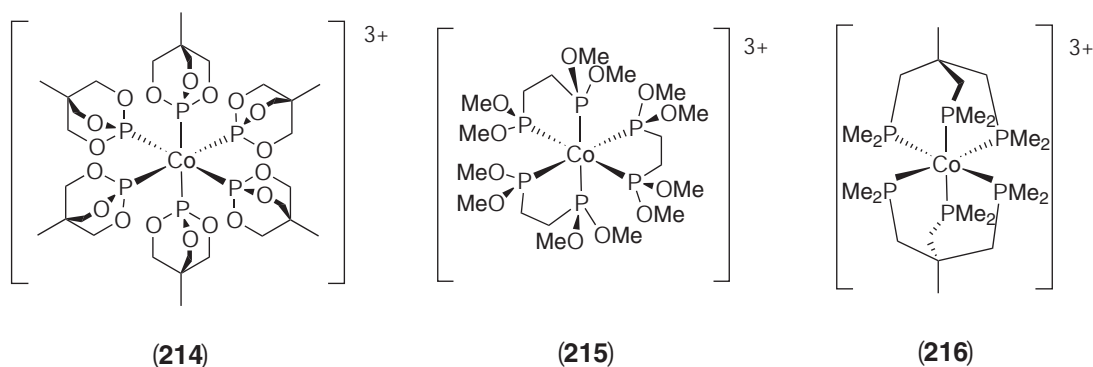

The reaction of $\text{trans}[\text{Co}(\text{acac})_2(\text{PPh}_3)_2]\text{PF}_6$ with PR_3 ($\text{R} = \text{Me}$ or Et) in MeOH yields $\text{trans}[\text{Co}(\text{acac})_2(\text{PR}_3)_2]\text{PF}_6$. These *trans* complexes are stable in dry solvents, but are rapidly hydrolyzed in wet MeOH to give $\text{trans}[\text{Co}(\text{acac})_2(\text{PR}_3)(\text{H}_2\text{O})]^+$ and isomerize to $\text{cis}[\text{Co}(\text{acac})_2(\text{PR}_3)_2]^+$ in the presence of a catalytic amount of activated charcoal.⁹²¹ The *cis* isomers did not undergo aquation under similar conditions. X-ray crystal structure analyses showed that the $\text{Co}-\text{P}$ bonds in the *trans* isomers were longer by approximately 0.07 \AA than those of the corresponding *cis* isomers. The $\text{Co}-\text{O}$ bonds *trans* to the phosphine ligands were also longer than those of the mutually *trans* $\text{Co}-\text{O}$ bonds, owing to the strong *trans* influence of phosphine ligands. In a comprehensive systematic study a larger number of monodentate phosphine bis(acac)cobalt(III) complexes were prepared. The observed ratios of the *cis* and *trans* isomers of $[\text{Co}(\text{acac})_2(\text{P}(\text{R}_n\text{Ph}_{3-n})_2)]^+$ depend upon the bulkiness ($\text{R} = \text{Me}$ or Et) and basicity of the phosphine.⁹²² The *trans* isomers exhibit a strong absorption band in the expected $d-d$ transition region, which was assigned to a charge transfer transition between the Co^{III} ion and a phosphine ligand, whereas the *cis* isomers exhibit the first $d-d$ band split into two components by the lower symmetry ligand field. Other systems studied included $\text{trans}[\text{Co}(\text{acac})_2(\text{H}_2\text{O})(\text{P}(\text{R}_n\text{Ph}_{3-n}))]^+$, $\text{trans}[\text{Co}(\text{acac})_2(\text{amine})(\text{PMe}_2\text{Ph})]^+$, and $\text{trans}(\text{P},\text{P})\text{-Co}(\text{acac})(\text{CN})_2(\text{P}(\text{R}_n\text{Ph}_{3-n}))_2$. The crystal structures of a number of these complexes were subsequently reported.⁹²³

Five-coordinate complexes of the form $\text{Co}(\text{PR}_3)_2\text{X}_3$ ($\text{X} = \text{Cl}, \text{Br}; \text{PR}_3 = \text{PMe}_3, \text{PEt}_3, \text{PMe}_2\text{Ph}, \text{PEt}_2\text{Ph}, \text{PEtPh}_2$) were prepared by oxidation of their divalent $\text{Co}(\text{PR}_3)_2\text{X}_2$ precursors at low temperature.⁹²⁴ The intensely colored, paramagnetic ($\mu_{\text{eff}} = 2.9-3.3 \text{ B.M.}$) Co^{III} complexes were formulated as trigonal-bipyramidal species on the basis of vibrational and UV-visible spectroscopic data. Coordinate bond lengths for $\text{Co}(\text{PEt}_3)_2\text{X}_3$ and $\text{Co}(\text{PEt}_2\text{Ph})_2\text{X}_3$ were obtained by Co and Br K-edge EXAFS spectroscopy and average values of $\text{Co}-\text{P}$ 2.30 , $\text{Co}-\text{Cl}$ 2.20 , and $\text{Co}-\text{Br}$ 2.36 \AA were obtained.

The bidentate phosphine dppe (1,2-bis(diphenylphosphino)ethane) and the aminophosphine eddp (2-aminoethyl-diphenylphosphine) form mixed ligand (N, P, O) complexes such as $\text{Co}(\text{acac})(\text{edpp})_2$ and $\text{Co}(\text{acac})(\text{en})(\text{dppe})$. A preference for *trans* $\text{N}-\text{Co}-\text{P}$ and $\text{P}-\text{Co}-\text{P}$ configurations over $\text{N}-\text{Co}-\text{N}$ was found for the bis(edpp) complexes.⁹²⁵

(ii) Multidentate phosphines

The tripodal phosphine mtriphos (1,1,1-tris(dimethylphosphinomethyl)ethane) forms a stable trivalent complex (216) that has been characterized by X-ray diffraction.¹¹⁹ The $\text{Co}-\text{P}$ bond distances ($2.291(9)-2.357(7) \text{ \AA}$) are longer than those normally found in Co^{III} -phosphine complexes. A number of trivalent CoP_4X_2 and CoP_3X_3 ($\text{X} = \text{Cl}^-$ and Br^- but not I^-) complexes have been prepared incorporating chelating phosphines such as the bidentate $o\text{-C}_6\text{H}_4(\text{PPh}_2)_2$, the tridentate $\text{PhP}(\text{CH}_2\text{CH}_2\text{PPh}_2)_2$, and the tripodal $\text{P}(\text{CH}_2\text{CH}_2\text{PPh}_2)_3$ and linear $\text{Ph}_2\text{PCH}_2\text{CH}_2\text{PPhCH}_2\text{CH}_2\text{P}(\text{Ph})\text{CH}_2\text{CH}_2\text{PPh}_2$ tetraphosphines.⁹²⁶ Mixed donor P,N,O-ligands such as $o\text{-C}_6\text{H}_4(\text{CH}=\text{NCH}_2\text{CH}_2\text{PPh}_2)(\text{OH})$ have been prepared by standard Schiff base condensation reactions.⁹²⁷ On deprotonation these ligands coordinate as tridentates to give trivalent bis complexes of the form $[\text{CoL}_2]^+$. The distortions in the free ligand predispose it for coordination in a *fac* geometry to Co with *cis*- PPh_2 groups, as shown by X-ray crystallography. Another

example is the linear P_2N_2 tetradentate which forms *cis-α*- (217) and *cis-β*-[Co^{III}(L)(aa)]ⁿ⁺ (aa = oxalate or acetylacetonate) complexes.⁹²⁸

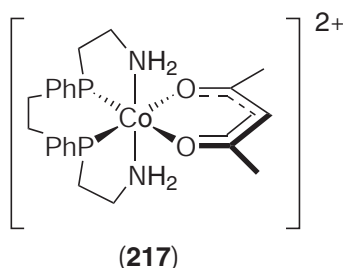

6.1.2.3.5 Arsenic

(i) Monoarsines and multidentate arsines

The Co coordination chemistry of As donors is less developed than that of phosphorus, although there are obvious parallels between the two. Treatment of Me_3AsI_2 with Co metal powder gives both trivalent ($[CoI_3(AsMe_3)_2]$) and divalent ($[AsMe_3I][CoI_3(AsMe_3)]$) complexes as products.⁹²⁹

$CoAs_6$ complexes bearing chelating tertiary arsines are well known. Preparation of the homoleptic $CoAs_6$ and $CoAs_3P_3$ complexes $[Co(o-C_6H_4(AsMe_2)_2)_3]^{3+}$ and $[Co(o-C_6H_4(PMe_2)(AsMe_2))_3]^{3+}$ have been described,⁹³⁰ and the X-ray structure of $[Co(o-C_6H_4(AsMe_2)_2)_3](BF_4)_3$ reveals a Co ion coordinated (Co—As 2.365(2)–2.395(2) Å) within an approximately D_3 symmetrical ligand field. The Co^{III} complexes of a variety of the bi- $(o-C_6H_4(AsMe_2)_2)$ tri- $(MeAs(o-C_6H_4AsMe_2)_2)$, $MeC(CH_2AsMe_2)_3$ and tetradentate ($(As(CH_2CH_2CH_2AsMe_2)_3)$ arsines have appeared and their ⁵⁹Co NMR spectra studied.⁹³¹ The characteristic chemical shift range for $CoAs_6$ complexes was identified as about –350 ppm to +200 ppm relative to $[Co(CN)_6]^{3-}$. Solvent effects were identified in the $CoAs_6$ chromophores, but these were diminished in $CoAs_3I_3$ and $CoAs_4I_2$ complexes.

The CD spectra of a series of *cis*- $[CoX_2(o-C_6H_4(AsMe_2)_2)_2]^+$ complexes ($X^- = Cl, OH, NO_3, NO_2$) were reported,⁹³² and the absolute configurations of the resolved enantiomers were inferred. In a related study the chiral and diastereomeric octahedral Λ -*cis-α* and Δ -*cis-β* Co complexes of the linear tetraarsine $Me_2As(CH_2)_3As(Ph)(CH_2)_2As(Ph)(CH_2)_3AsMe_2$ gave complex CD spectral patterns for their *d-d* electronic transitions, and the conclusions of this study were that CD of complexes of such soft donor atoms are not useful for establishing absolute configuration.⁹³³ A number of bidentate chelate complexes of the saturated diarsines dmae (1,2-bis(dimethylarsino)ethane) and dmap (1,3-bis(dimethylarsino)propane) have been reported including *trans*- $[CoX_2(dmap(e))_2]^+$ ($X^- = Cl, Br, I$), *cis*- $[CoX_2(dmap)_2]^+$ ($X^- = Cl, Br$), $[Co(CO_3)(dmap(e))_2]^+$, and $[Co(acac)_{3-n}(dmap)_n]^{n+}$ ($n = 0, 1, 2$).⁹³⁴ Isomerization of *cis*- $[CoCl_2(dmap)_2]^+$ to the *trans* isomer in MeOH is one hundred times faster than that reported for *cis*- $[CoCl_2(o-C_6H_4(AsMe_2)_2)_2]^+$ at the same temperature. The crystal structure of *trans*- $[CoCl_2(dmap)_2]ClO_4$ was subsequently reported.⁹³⁵

Trivalent Co complexes of the mixed donor amino arsine emda (2-aminoethyl)dimethylarsine have been synthesized.⁹³⁶ Examples include *trans*(X,X), *cis*(As,As)- $[CoX_2(edma)_2]^+$ ($X^- = Cl, Br$, and I), *trans*(As,As)- and *trans*(As,N)- $[Co(acac)(edma)_2]^{2+}$, *trans*(As,N)- $[Co(CO_3)(edma)_2]^+$, $[Co(acac)_2(edma)]^+$, and *fac*- $[Co(edma)_3]^{3+}$. The *fac*- $[Co(edma)_3]^{3+}$ complex was resolved and the absolute configuration of the (+)₄₉₀ CD isomer was assigned as Λ on the basis of the CD spectrum. Racemization of this complex was first order in both complex and hydroxide ions. The crystal structure of $[Co(acac)_2(edma)]ClO_4$ has been reported.⁹³⁷

Uncomplexed chirotopic tertiary As atoms are known to undergo slow inversion and so chiral polyarsines may be resolved into their enantiomeric and diastereomeric forms. The mixed donor tetradentate ligand (*R**,*S**)-1-[(2-dimethylarsinophenyl)methylarsino]-2-[(2-aminophenyl)methylphosphino]benzene was prepared stereoselectively and the crystal structure of its dichlorocobalt (III) complex was reported.^{938,939} The same group reported the syntheses of the chiral tetraarsine 1-(chloromethyl)-1,1-bis(((2-dimethylarsinophenyl)methylarsino)methyl)ethane and the hexaarsine 1,1,1-tris(((2-dimethylarsinophenyl)methylarsino)methyl) ethane,⁹⁴⁰ the latter providing the first example of a chiral hexaarsine.⁹⁴⁰ The three diastereomers of the tetraarsine bind to Co^{III} stereoselectively.

6.1.2.3.6 Oxygen

(i) Aqua, hydroxo, and oxo

H_2O , HO^- and O^{2-} are all accessible and well-studied ligands for cobalt(III). The hexaqua-cobalt(III) ion is only stable in concentrated acids of non-reducing anions, being a powerful oxidant which oxidizes water. It has been characterized in the solid state as an octahedral ion with $\text{Co}-\text{O}$ 1.873(5) Å.⁹⁴¹ Due to its instability, it is not a very useful entry point into synthetic cobalt(III) chemistry. Invariably, coordinated water is consequently found in mixed-ligand cobalt(III) complexes. The $\text{p}K_{\text{a}}$ of water is reduced substantially on coordination, and the highly polarized aqua ligand is deprotonated around neutral pH to form hydroxo complexes. For trivalent (inert) cobalt, which does not tend to undergo subsequent oligomerization reactions, this is usually a reversible process. Further deprotonation to an isolated oxo ligand is rare, with this ligand found in metal-bridging environments where the presence of several metal ion centers promotes its formation. Of historical significance is the report of the crystal structure of Werner's hexol cation $[\text{Co}\{\text{Co}(\text{OH})_2(\text{NH}_3)_4\}_3]^{6+}$, where the core Co^{III} is surrounded by six bridging hydroxides linked to three distal Co^{III} centers, obtained serendipitously when attempting to grow crystals of carbonatopentamminecobalt(III) nitrate from water.⁹⁴² Another compound from the Werner collection characterized structurally recently is the $(\mu\text{-amido})(\mu\text{-hydroxo})(\mu\text{-superoxo})$ hexaamminedicobalt(III) complex.⁹⁴³ Hydroxo-bridged complexes reported prior to 1988 have been reviewed in detail,⁹⁴⁴ and will not be covered here.

Although there is a tendency to associate coordinated water with Werner-type complexes, where it is extensively established, organometallic aqua ions are known.⁹⁴⁵ The simple $[(\text{Cp}^*)\text{Co}(\text{OH}_2)_3]^{2+}$ has been established, and is prepared via Equation (8). The lower $\text{p}K_{\text{a}}$ is 5.9, similar to values in aminocobalt(III) compounds, and reversible deprotonation and dimerization has been identified as part of the reactions of the aqua ion.⁹⁴⁶

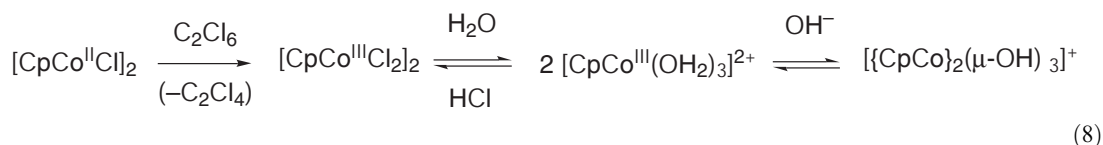

Multiple bridging involving the oxo and hydroxo anions is well established with Co^{III} . A number of bridging modes can be considered as possible, and examples of most will be exemplified below. Although well established in iron chemistry, the mono-bridged oxygen analog is not well established in Co chemistry. Dihydroxy-bridged systems, however, are well known; an example is $(\text{en})_2\text{Co}(\mu\text{-OH})_2\text{Co}(\text{edda})$, which also features different ligand sets around each octahedral Co center.⁹⁴⁷ The trihydroxy-bridged systems are less commonly reported, but examples exist; a simple one is the structurally characterized $[\{(\text{tacn})\text{Co}\}_2(\mu\text{-OH})_3]^{3+}$.⁹⁴⁸ Two examples of $\mu_3\text{-oxo}$ in a cobalt(III) complex are in the partial cubane $[\text{Co}_3\text{L}_3(\mu\text{-OH})_3(\mu_3\text{-O})]\text{Cl}$ (L = ethylenediamine-*N*-acetate)⁹⁴⁹ and in the cubane $\text{Co}_4(\mu_3\text{-O})(\mu\text{-OAc})_4(\text{py})_4$.⁹⁵⁰ Another compound with $\mu_3\text{-oxo}$ bonding arises from reaction involving salicylaldehyde, leading to a species with a triangular $\{\text{Co}_3(\mu_3\text{-O})(\mu_2\text{-OPh})\}$ core.⁹⁵¹ A $\mu_3\text{-O}$ coordination mode is found in $[\text{Co}_4\text{O}_4(\text{OAc})_2(\text{bpy})_4]^{2+}$,⁹⁵² where each Co is in a distorted octahedral environment. The red dicobalt (**218**), green-black partial cubane tricobalt (**219**) and brown cubane tetracobalt (**220**) structures have all been characterized by X-ray crystallography, and their synthesis is straightfor-

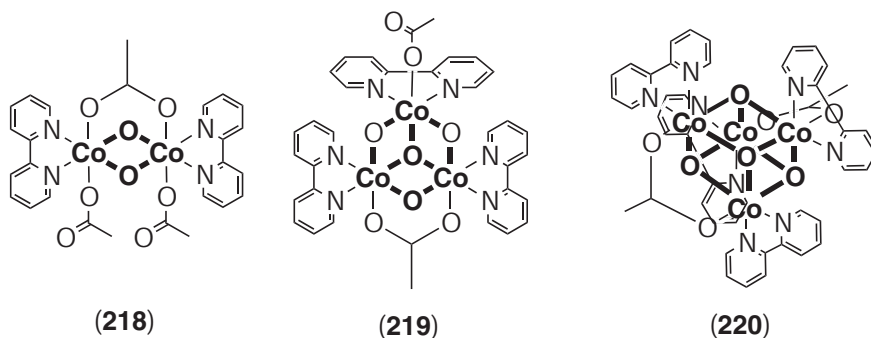

ward. The first two form via reaction in 3:1 MeOH:H₂O and the latter through “dimerization” in DMSO, as in Equations (9–11).

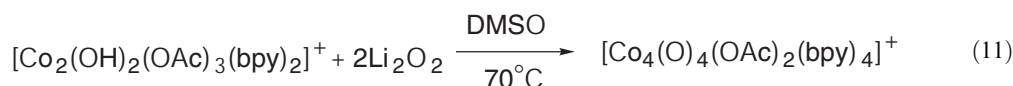
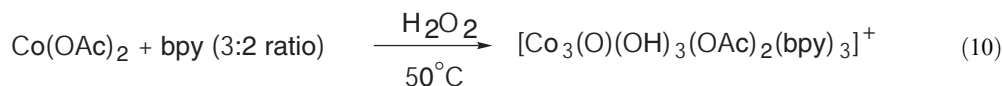
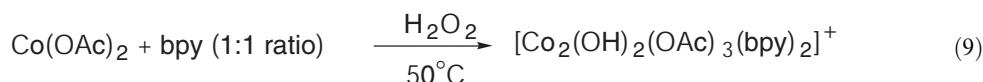

Further, a $\mu_4\text{-O}$ is reported in the structurally more complex cluster $\text{Co}_8\text{O}_4(\text{OBz})_{12}(\text{MeCN})_3(\text{H}_2\text{O})$, where the $\text{Co}^{\text{III}}_4\text{O}_4$ cubane bridges through each of four $\mu_3\text{-O}$ groups in the core to a Co^{II} five-coordinate site, making the oxo groups $\mu_4\text{-O}$ by this attachment (Figure 8).⁹⁵³

Heteronuclear bridged systems featuring hydroxo and or oxo ligands are also known. An example of this category is the hydroxo-bridged heterotrinnuclear complex ion $[\text{Cu}\{(\text{HO})_2\text{Co}(\text{en})_2\}_2]^{2+}$, where the Cu^{II} is surrounded by four bridging hydroxides linking in pairs from two octahedral Co^{III} centers.⁹⁵⁴ Another related example, where in this case the central metal is in an octahedral environment, is the series $[\text{M}^{\text{II}}\{(\text{HO})_2\text{Co}(\text{en})_2\}_3]^{5+}$ ($\text{M} = \text{Ni}, \text{Zn}, \text{Mg}$), prepared by reaction of $[\text{Co}(\text{en})_2(\text{OH})_2]^{3+}$ with MCl_2 in water at $\text{pH} \sim 8$.⁹⁵⁵ Yet another, where the concept is extended to the central metal ion being an eight-coordinated ion, is the series $[\text{M}^{\text{III}}\{(\text{HO})_2\text{Co}^{\text{III}}(\text{NH}_3)_4\}_4]^{7+}$ ($\text{M} = \text{Ce}, \text{Y}, \text{La}, \text{Pr}, \text{Gd}$).⁹⁵⁶

Oxo ligands find their fullest expression in polyoxometallates, dominantly of high-valent Mo and W. Polyoxometallates have been extensively reviewed.^{957–959} An example of a polyoxometalate cluster incorporating cobalt(III) is $[\text{CoW}_{12}\text{O}_{40}]^{5-}$. This has the Co^{III} in an unusual tetrahedral geometry, as in the Co^{II} analog from which it can be oxidized reversibly.⁹⁶⁰ The trivalent complex is a strong oxidizing agent.

(ii) Dioxygen, superoxide, and peroxide

The interaction of dioxygen with Co centers has its roots in the very beginning of Co chemistry. Biorelevance is a theme that retains a sturdy interest in these systems to the present time (see Section 6.1.3.1.3). Dioxygen can bind reversibly to Co complexes where they retain their integrity as monomers. Further, binding which generates a dimer can be reversible, as observed with $[\text{Co}(\text{terpy})(\text{bpy})\text{X}]^{2+}$ in polar non-aqueous solvents where X is a labile group such as trifluoromethanesulfonate or 4-chloro-3-nitrobenzenesulfonate.⁹⁶¹ Peroxide (O_2^{2-}) as a bridging

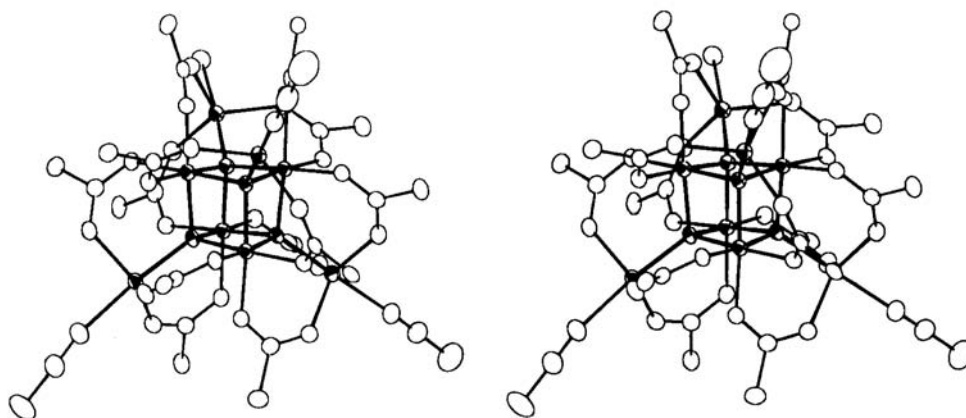
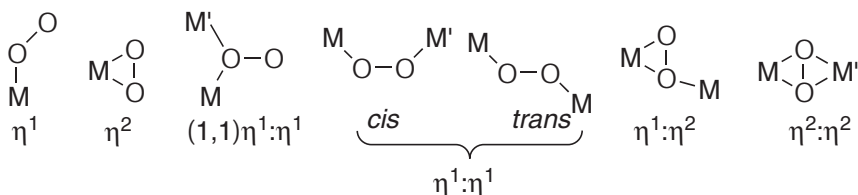

Figure 8 Stereoview of the $[\text{Co}_8\text{O}_4(\text{OBz})_{12}(\text{MeCN})_3(\text{OH}_2)]$ cluster, with phenyl rings and H-atoms omitted (reproduced with permission of the American Chemical Society from *Inorg. Chem.*, **1995**, *34*, 4160–4166).

ligand between two cobalt(III) centers is an enduring theme in Co chemistry, as is superoxide (O_2^-). The commonly brown μ -peroxo complexes are usually easily oxidized to the typically green μ -superoxo complexes, as defined in the first edition.

Dioxygen and its ions can bind in mononuclear and dinuclear structures in a number of ways,⁹⁶² as illustrated in Scheme 1. The typical reaction of dioxygen with Co compounds involves a number of these binding forms, outlined in Scheme 2. Mononuclear Co^{III} -peroxo complexes are relatively rare, but yellow trigonal bipyramidal complexes $[\text{Co}(\text{O}_2)\text{L}_2]^+$ (L = chelating phosphines dppe or dppp) have been characterized structurally where the O_2^{2-} is bonded to the Co in the side-on η^2 form ($\text{Co}-\text{O}$ 1.858(7)–1.881(4) Å), with $\text{O}-\text{O}$ stretching frequencies ($\sim 870\text{ cm}^{-1}$) consistent with Co^{III} -peroxo speciation.⁹⁶³



Scheme 1

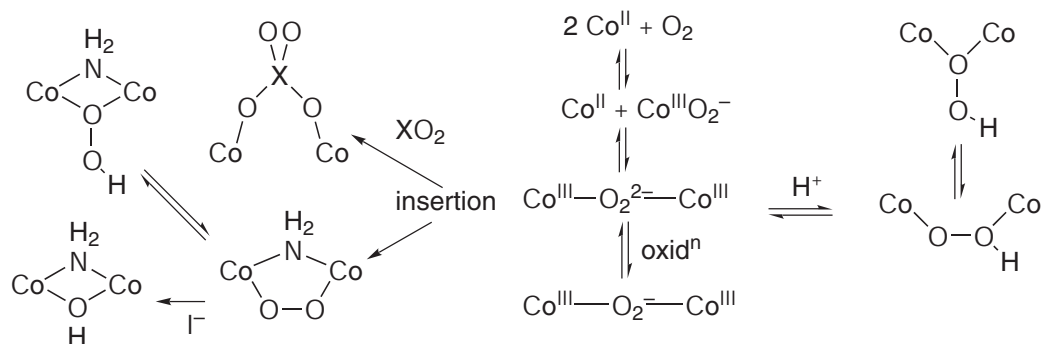

Scheme 2

Dioxygen anions (peroxide and superoxide) in a bridging mode are more common. As representative examples, a selection of structurally characterized dicobalt dioxygen complexes is collected in Table 3. It is notable that the type of companion ligands influences the bridged dioxygen moiety. For example, the presence of a polyamine with unusually short $\text{Co}-\text{N}$ distances has an effect on the superoxide $\text{O}-\text{O}$ distance, which is shorter than in the simple decaammine analog.⁹⁶⁴ Raman spectroscopy provides one method for monitoring behavior in solution for both superoxo and peroxo compounds, with the position of the strong Raman-active O_2 vibration reflecting bond strength. Multiple bridging also influences both Raman and structural parameters. A rare

Table 3 Some structurally characterized dicobalt dioxygen complexes.

Dioxygen unit	Other bridging groups	Other ligands	References
<i>cis</i> - μ -peroxo	Ph_2PO_2 , phenoxo	polyimine/amine	966
<i>cis</i> -bis(μ -superoxo)	hydroxo	polyamine	967
<i>cis</i> - μ -peroxo	acetato, alkoxo	polyimine/amine	968
<i>trans</i> - μ -peroxo		bpy, terpy	961
<i>trans</i> - μ -superoxo		polyamine	964
<i>cis</i> - μ -peroxo	hydroxo	imidazole/thioether	969
<i>cis</i> - μ -peroxo	thiolate	polyamine	970
<i>trans</i> - μ -peroxo		polyamine/imine	971
<i>trans</i> - μ -superoxo		polyamine/imine	971
<i>cis</i> - μ -peroxo	thiosulfato	polyamine	972
<i>trans</i> - μ -peroxo		aminosugar	973

example of a $\mu_3(\eta^1, \eta^2)$ -peroxy bridge between Co^{III} and Pb^{II} has been reported in a macrocyclic polyimine compartment ligand where phenoxo groups link metals in each compartment.⁹⁶⁵

Examples are tending to be more sophisticated and complex in form. For example, a dinuclear complex featuring a bridging phosphinate and phenolate in addition to peroxide (**221**) has been reported,⁹⁶⁶ as a model for phosphodiester systems. Apart from dicobalt(III) systems, a mixed-valence $\text{Co}^{\text{II,III}}$ di- μ -superoxo complex (**222**) has been prepared.⁹⁶⁷ Transition between the three redox states $\text{Co}^{\text{II,II}}$, $\text{Co}^{\text{II,III}}$, and $\text{Co}^{\text{III,III}}$ is electrochemically reversible.

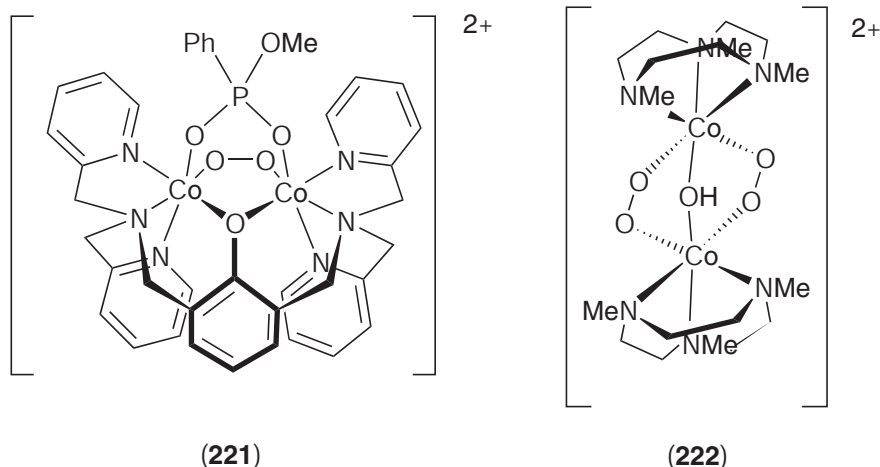

A detailed study of the reaction of the Co^{II} complex of 1,4,7,10,13-pentaazapentadecane ([15]aneN₅) with dioxygen to form Co^{III} complexes has been reported.⁹⁷⁴ Formation equilibrium constants for the superoxo ($2.2 \times 10^7 \text{ M}^{-1}$) and peroxy ($1.2 \times 10^{20} \text{ M}^{-2}$) were calculated, as well as ligating properties of superoxide and peroxide towards $[\text{Co}[15]\text{aneN}_5(\text{OH}_2)]^{3+}$ (10^{12} M^{-1} and $2 \times 10^{37} \text{ M}^{-2}$ respectively), defining the strength of the dioxygen anion complexes. The formation constant with superoxide is similar to a value of 10^8 M^{-1} deduced for the transient superoxo complex of $\text{Co}^{\text{II}}(\text{EDTA})$.⁹⁷⁵ The mechanism of the superoxo monomer $[\text{Co}(\text{CN})_5(\text{O}_2)]^{3-}$ decomposition in aqueous solution has been examined,⁹⁷⁶ and involves partial decomposition to a pentacyanocobaltate intermediate which binds an undissociated dioxygen-bound monomer to form the dimer $[\{(\text{NC})_5\text{Co}\}_2(\mu\text{-O}_2)]^{6-}$. This in turn hydrolyzes to form $[\text{Co}(\text{CN})_5(\text{OH})]^{3-}$ and $[\text{Co}(\text{CN})_5(\text{OOH})]^{3-}$.

(iii) Neutral oxygen donor ligands

In the same way that H_2O is an excellent monodentate ligand for Co^{III} , simple alcohols ROH are known to bind effectively to cobalt(III) as monodentate ligands. They can be conveniently introduced into the coordination sphere where other sites are occupied by amines through simply dissolution of the trifluoromethanesulfonatecobalt(III) precursor in the pure alcohol,⁹⁷⁷ or less readily by reaction of the halocobalt(III) complexes with silver ion in the alcohol, and are reasonably inert to substitution. Introduction of polyalcohols is possible through the same paths; for example, the complex $[\text{Co}(\text{tacn})(\text{inisol})]^{2+}$ has been reported, albeit with the hexahydroxycyclohexane (inisol) monodeprotonated and hence a superior ligand to the neutral alcohol.⁹⁷⁸

(iv) Alkyl peroxides

A number of alkylperoxy Co^{III} complexes including mainly polyimine ligands have been prepared, exemplified by (**223**).⁹⁷⁹ Hydroxylation of saturated hydrocarbons, preferentially at the more nucleophilic C—H bonds, yields alcohols, ketones, and *t*-butylperoxy products, whereas olefins form epoxides if they carry no allylic H atoms.

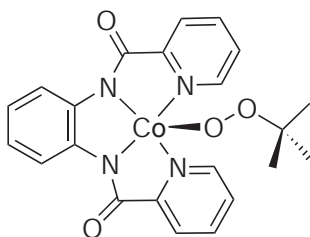

(223)

β -Diketonate cobalt(III) complexes with alkyl peroxy adducts have been prepared recently and characterized structurally, and their value in hydrocarbon oxidation and olefin epoxidation examined.⁹⁸⁰ Compounds $\text{Co}(\text{acac})_2(\text{L})(\text{OO}t\text{-Bu})$ with $\text{L} = \text{py}$, 4-Mepy and 1-Meim, as well as the analog of the first with dibenzoylmethane as the diketone, were prepared. A distorted octahedral geometry with the monodentates *cis* is consistently observed, and the Co—O bond distance for the peroxy ligand lies between 1.860(3) Å and 1.879(2) Å.

(v) Ketones and esters

The monoketone bis(2,2',*N,N'*-bipyridyl)ketone forms a $[\text{Co}^{\text{III}}\text{L}_2]^+$ complex on reaction with $[\text{Co}(\text{NH}_3)_4(\text{CO}_3)]^+$ in water.⁹⁸¹ As reported for a quite different Co^{II} complex, the ketone is hydrated to form the gem diol which binds as a monodeprotonated O-donor along with the two pyridine groups in a tridentate chelate, with very little distortion from octahedral observed in the complex. This appears to represent a facile route for this type of inherently poor donor to achieve coordination. Chelated β -diketonate anions are long-studied examples of O-donor chelates, and continue to be examined. A simple example is the *cis*- $[\text{Co}(\text{acac})_2(\text{NH}_3)_2]^+$ (*acac* = 2,4-pentanedionate), structurally characterized and utilized to produce molecular mechanics force field parameters for β -diketones bound to Co^{III} .⁹⁸²

Amino acid esters act as chelates to Co^{III} ; for example, the β -alanine isopropyl ester is known as both a chelate and as an *N*-bonded monodentate,⁹⁸³ and the mechanism of hydrolysis of the ester, which is activated by coordination, to yield chelated β -alanine has been closely examined.

(vi) Carbonates, carbamates, and carboxylates

Carbonate is a well-known ligand for Co^{III} , and can adopt monodentate, chelate, and bridging roles. Recent structurally characterized examples, obtained from prolonged aerial oxidation of a solution of cobalt(II) nitrate and ammonium carbonate in aqueous ammonia, are chelated carbonate in $[\text{Co}(\text{NH}_3)_4(\eta^2\text{-CO}_3)]^+$ and bridging carbonate in $[(\text{NH}_3)_3\text{Co}(\mu\text{-OH})_2(\mu\text{-CO}_3)\text{Co}(\text{NH}_3)_3]^{2+}$.⁹⁸⁴ The four-membered chelate ring is strained, with the internal O—Co—O angle typically near 70°. The protonated form, hydrogen carbonate (HCO_3^-), is usually met as a monodentate; however, chelation has now been reported in the crystal structure of the bicyclic tetraamine complex of (32), $[\text{Co}(\text{adz})(\text{HCO}_3)]^{2+}$, where protonation appears to occur at the non-coordinated O atom.⁹⁸⁵

Carbamates ($\text{R}_2\text{NCOOR}'$) may be *O* or *N* bonded. Base-promoted isomerization of carbamates from the *O*- to the deprotonated *N*-bound form in pentaamminecobalt(III) complexes have been defined.⁹⁸⁶

Carboxylates (RCOO^-) in simple form or as components of more elaborate polydentate ligands, are commonly met as strong ligands in cobalt(III) chemistry. Monocarboxylate anions can adopt roles as monodentate, bidentate, or bridging anions. Complexes are usually relatively inert to substitution, with hydrolysis of acetato slower than halo ligands. Acetato complexes can be prepared simply by substitution reactions, replacing coordinated solvents and labile anionic groups such as trifluoromethanesulfonate. Acetate in its three possible coordination modes appears in the one dinuclear complex $(\text{py})(\eta^1\text{-OAc})_2\text{Co}(\mu\text{-OH}_2)(\mu\text{-O},\text{O-OAc})_2\text{Co}(\eta^2\text{-OAc})(\text{py})$ (224).⁹⁸⁷ A range of other examples where carboxylates form one of a suite of ligands or one of

the donor groups in polydentate ligands is met elsewhere in this chapter. Simple $[\text{Co}(\text{NH}_3)_5(\text{OOCR})]^{2+}$ ions with long-chain alkyl R groups have been examined for use as catalysts in dishwashing and laundry detergents.

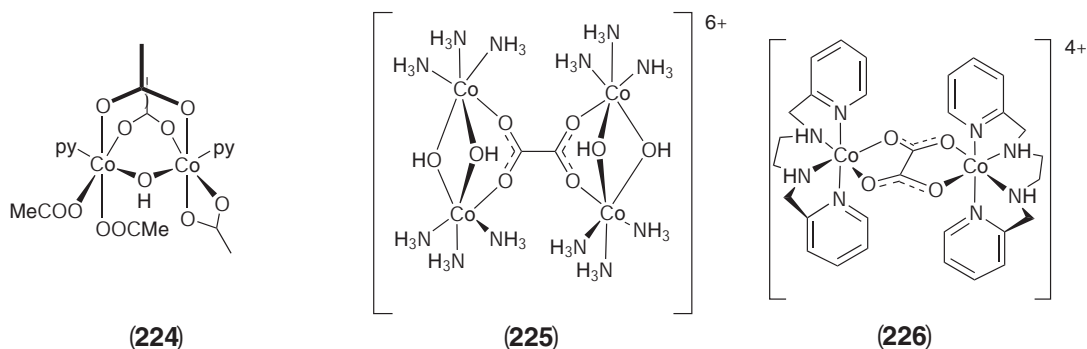

The classical chelating diacid, oxalic acid, has been studied for many years. It has the potential to bind through any combination ranging from one to four oxygen atoms, including bonding to up to four separate metal ions. The latter arrangement is achieved in the cluster (225).⁹⁸⁸ More recently, a simple dinuclear μ_4 -oxalato complex where the ligand chelates a cobalt(III) on each side has been reported (226).⁹⁸⁹

An interesting example of the detailed rearrangement chemistry possible on Co^{III} is the study of pentaamminecobalt(III) complexes of malonic and phthalamic acids, which can bond through the carboxylate group or else the deprotonated amide nitrogen.⁹⁹⁰ The former complexes are readily prepared directly from the amidic acids, whereas the latter form from base hydrolysis of precursors such as (for malonamato-*N*) cyanoacetate-*N*. The *N*-bound compounds undergo in water the usual amide-*N* to amide-*O* rearrangement but, concurrently, an amide-*N* to carboxylate-bonded rearrangement.

(vii) *Oxoanions of N, S, P, and the halogens*

(aa) *Nitrogen oxoanions.* The best-known nitrogen oxoanions are nitrate (NO_3^-) and nitrite (NO_2^-). The ambidentate nature of the latter as a monodentate ligand is well known, with *O*-bound (nitrito) and *N*-bound (nitro) isomerism on cobalt(III) well studied, but still producing new insights.⁷³² Complexes incorporating nitrite are readily formed; for example, reaction of hydrated $\text{Co}(\text{ClO}_4)_2$ with ethylenediamine and NaNO_2 in aqueous solution in air affords the yellow, crystallographically defined *trans*- $[\text{Co}(\text{en})_2(\text{NO}_2)_2](\text{ClO}_4)$.⁹⁹¹ Of course, the anion with nitrite as the sole ligand, $[\text{Co}(\text{NO}_2)_6]^{3-}$, is well known, and the nitro ligands are readily displaced by, for example, amines and cyanide, as well as rapidly forming a range of mixed aquanitro complexes in aqueous solution, as defined from solution NMR studies.⁹⁹² The nitrate and nitrite anions can also act as bidentates and in bidentate bridging modes. Chelated nitrate is exemplified in the complex of the tripodal ligand *N*-(2-aminoethyl)-*N,N*-bis(3-aminopropyl)amine (abap), $[\text{Co}(\text{abap})(\text{O}_2\text{NO})](\text{ClO}_4)_2$,⁹⁹³ where the $\text{O}-\text{Co}-\text{O}$ angle is reduced to 66.1° while the other angles around the plane that includes the nitrate and Co are expanded to as much as 99.9° to compensate. The nitrate ion has been characterized in a bridging mode along with two hydroxide ions (227), formed via a tris(alcohol) intermediate.⁹⁷⁸ For nitrite, the μ_2 -*N,O* bridging mode is found in the dimer (228).⁹⁹⁴

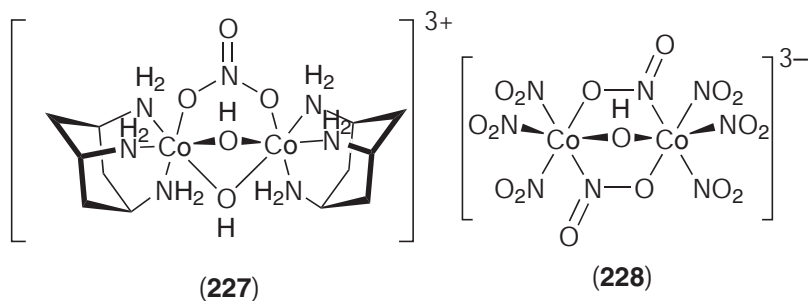

(bb) *Sulfur oxoanions*. The sulfur oxoanions all can form complexes with cobalt(III) via simple substitution reactions in solution, and are usually *O*-bound in form. However, S coordination is found in the thiosulfate ion ($\text{S}_2\text{O}_3^{2-}$), which can act as a *O,S*-chelate in simple complexes such as $[\text{Co}(\text{en})_2(\text{S}_2\text{O}_3)]^+$,⁹⁹⁵ and adopt a bridging mode as in the dinuclear complex (229).⁹⁷⁰ Coordinated *S*-bound thiosulfato in $[\text{Co}(\text{NH}_3)_5(\text{S}_2\text{O}_3)]^+$ can be cleanly oxidized by peroxomonosulfate to produce the coordinated $\text{S}_2\text{O}_5^{2-}$ ion.⁹⁹⁶

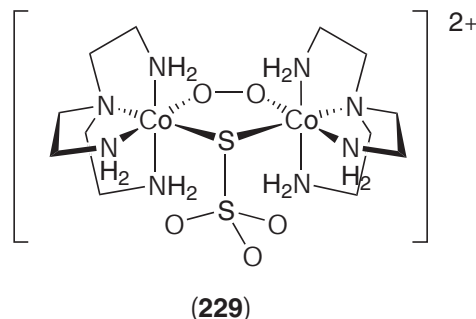

Sulfite (SO_3^{2-}) complexes may also be *S*- and *O*-bound; a solution NMR study of sulfite reacting with several simple aquaaminocobalt(III) complexes has identified both monodentate *O*- and *S*-bound linkage isomers.⁹⁹⁷ The SO_3^{2-} ion has been characterized in both monodentate⁹⁹⁸ and bridging modes.⁹⁹⁹ The *S*-bonded coordination of monodentate sulfite was established in a crystal structure of $[\text{Co}(\text{hmd})(\text{OH}_2)(\text{SO}_3)]^+$.³³⁸ The photochemistry is complex, and involves photoisomerization to *O*-bound sulfite as well as photoredox formation of Co^{II} , with secondary photolysis yielding Co^{I} . The reverse *O* to *S* linkage isomerization is usually observed spontaneously in solution, as exemplified by the reaction of $[\text{Co}([\text{16}] \text{aneN}_5)(\text{OSO}_2)]^+$ ($[\text{16}] \text{aneN}_5 = 1,4,7,10,13$ -pentaazacyclohexadecane);¹⁰⁰⁰ the *O*-sulfite complex is also rapidly cleaved to the aqua compound in acidic solution. The trinuclear complex $\text{Ni}\{\text{Co}(\text{en})_2(\text{SO}_3)_2\}_2$ (and other M^{II} analogs) has the sulfite ions *S*-bound to Co^{III} and *O* bound to the central Ni atom.¹⁰⁰¹ Thermolysis in air of several of the mixed-metal compounds above 750°C yielded spinel oxides. Reaction of CoCl_2 with $\text{Na}_2\text{S}_2\text{O}_4$ in aqueous ammonia in air yields similar type of complex, the mixed oxidation state trinuclear complex $[\text{Co}^{\text{II}}[(\text{O}_3\text{S})_3\text{Co}^{\text{III}}(\text{NH}_3)_3]_2]^{4-}$, where the central Co^{II} lies in an octahedral CoO_6 environment provided by six O atoms of bridging sulfite groups.⁹⁹⁹ The reactions of sulfur(IV) in solution (as $\text{SO}_3^{2-}/\text{HSO}_3^-$) with aquaaminocobalt(III) complexes has been reviewed.¹⁰⁰²

The sulfate ion, well known as a monodentate and simple bidentate ligand, has been observed also as a bridging ligand, as exemplified in $[(\text{en})_2\text{Co}(\text{OS}(\text{O}_2)\text{O})_2\text{Co}(\text{en})_2]^{2+}$.¹⁰⁰³ The *cis*-bis(μ -sulfato) bridge undergoes hydrolysis to *cis*- $[\text{Co}(\text{en})_2(\text{OSO}_3)(\text{OH}_2)]^+$ in acidic solution, hydrolyzing further with loss of coordinated sulfate in aqueous base to the dihydroxo complex.

The use of *O*-bound CF_3SO_3^- as a labile leaving group was established with the reported syntheses of complexes with one, two, and three triflate groups, namely $[\text{Co}(\text{NH}_3)_5(\text{OSO}_2\text{CF}_3)]^{2+}$, *cis*- $[\text{Co}(\text{en})_2(\text{OSO}_2\text{CF}_3)_2]^+$, and *fac*- $\text{Co}(\text{dien})(\text{OSO}_2\text{CF}_3)_3$.¹⁰⁰⁴ These are readily formed by reaction of the corresponding chloro complexes with the anhydrous triflic acid eliminating HCl, and this permits introduction of a wide range of neutral and ionic ligands into the coordination sphere in substitution reactions.⁶⁴

(cc) *Phosphorus oxoanions*. Monophosphate (PO_4^{3-}), diphosphate ($\text{P}_2\text{O}_7^{4-}$) and triphosphate ($\text{P}_3\text{O}_{10}^{5-}$) and their various protonated forms have been coordinated to cobalt(III) in a range of complexes. The *cis*- $[\text{CoL}(\text{OH})(\text{OH}_2)]^{2+}$ ($\text{L} =$ tetraamine) ions are rapidly anated by phosphate to form $\text{CoL}(\text{PO}_4)$, with a chelating phosphate.¹⁰⁰⁵ Coordinated polyphosphates are stable to hydrolysis except where a *cis*-coordinated hydroxy group exists, but hydrolytic cleavage can be catalyzed by addition of two molar equivalents of another hydroxyaquacobalt(III) complex, which form bridging intermediates with a coordinated nucleophile available for attack. Those with 3-aminopropyl(amine), 6-(4-amino-2-azabutyl)-6-methyl-1,4-diazacycloheptane and trien (135) "spectator" tetraamine ligands bound in the other sites have proved particularly effective.^{1006,1007}

Mono-, di-, and polyesters of phosphates have also been bound as ligands. Acidity of the remaining phosphate acid sites rises as ester groups are introduced, facilitating the ligation of the esters. Interest in the esters of phosphate is high because of their biological relevance (after all, DNA can be considered from a basic chemical viewpoint as simply an oligomeric phosphate diester). Further examples of this chemistry are provided in Section 6.1.3.1.3.

Trimethylphosphate, despite being neutral, is known to form the simple complex $[\text{Co}(\text{NH}_3)_5(\text{OP}(\text{OMe})_3)]^{3+}$; this reacts with nucleophiles $\text{X}^{n-} = \text{S}_2\text{O}_3^{2-}$, I^- and SCN^- in that order of reactivity to produce $[\text{Co}(\text{NH}_3)_5(\text{O}_2\text{P}(\text{OMe})_2)]^{3+}$ and MeX up to 150-fold faster than in the absence of coordination.¹⁰⁰⁸ Both hydroxide and water are ineffective in this reaction, with simple ligand hydrolysis occurring more rapidly than any reaction.

(*dd*) *Halogen oxoanions*. The halogen oxoanions are *O*-donor ligands for Co^{III} . Perchlorato complexes are the type most likely to be met, since the weak, labile perchlorato ligand serves as a good leaving group for further chemistry. For example, perchloratocobalt(III) porphyrins bind acetylene reversibly in anhydrous dichloromethane.¹⁰⁰⁹ Despite this, the hazards of these thermally unstable perchlorato complexes have been well documented and their use is not recommended.

(*ee*) *Other oxoanions*. There have been other oxoanions, including metal-centered anions, reported as ligands for Co^{III} . An example is the coordination of molybdate ion in $[\text{Co}(\text{NH}_3)_5(\text{OMoO}_3)]^+$ via reaction of the aquacobalt complex and molybdate.¹⁰¹⁰ The rapid hydrolysis kinetics supports $\text{Mo}-\text{O}$ and not $\text{Co}-\text{O}$ bond cleavage, unfortunately limiting synthetic usefulness of this compound.

(*viii*) *Mixed O, N ligands*

The variety and extent of research devoted to ligands carrying both *O*- and *N*-donors is simply immense. The type of cobalt(III) systems extant include amino acids, amino alcohols, amino ethers, amino phosphates, amino phenolates, as well as amide and imine analogs of these. These are met as simple chelates or more elaborate polydentates. Here, we highlight a strictly limited selection of examples to illustrate the type of systems reported; no attempt at exhaustive review has been made.

(*ff*) *Aminoacids*. Simple aminoacid complexes have been studied for decades, with strong interest in their stereochemical and chiroptical properties. An example of a well-characterized complex featuring only aminoacids in the coordination sphere is the *mer*- $\text{Co}(\text{gly})_2(\beta\text{-ala})$, which has been characterized with glycinate and β -alaninato ligands chelated and in a *trans*(*O5*) arrangement, as one of several isomers isolated.¹⁰¹¹ Column chromatography using ionic resins usually features as the best mode of separation of geometric isomers of this type.

The best known of the synthetic polyaminoacids is the tetraanion EDTA, and a wide range of analogs of the N_2O_4 donor set have subsequently appeared.¹⁰¹² An example is the propionate analog EDTP. The additional methylene in each carboxylate arm and ensuing twist-boat six-membered chelate rings with Co^{III} ¹⁰¹³ lower the ligand field strength of the chelate as reflected in visible absorption maxima, which shift from bands at 18,630 and 26,040 cm^{-1} for EDTA to 18,000 cm^{-1} and 24,800 cm^{-1} for EDTP. The tetradentate analog EDDA ($(-\text{O}_2\text{CCH}_2)_2\text{NHCH}_2\text{CH}_2\text{NHCH}_2\text{CO}_2^-$) has been structurally characterized as *uns-cis-mer*- $\text{Co}(\text{EDDA})(\text{pic})$ (**230**).¹⁰¹⁴ Intramolecular reaction of a Co^{III} EDDA complex leading to a macrocyclic aminoacid involves a precursor complex of tetradentate EDDA and a bidentate diamine bearing two 3-chloropropyl groups. This undergoes efficient intramolecular alkylation in basic solution to form the 1,4-bis(carboxymethyl)-1,4,8,11-tetraazacyclotetradecane complex.¹⁰¹⁵ The smallest member of the carboxymethylated en family is the N_2O -donor monoacetate EDMA

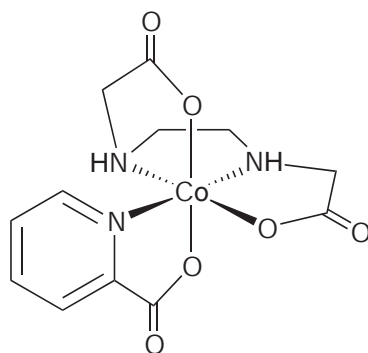

(230)

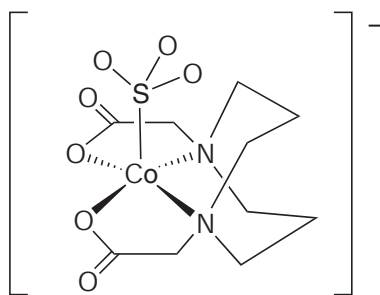

(231)

(($^-O_2CCH_2$) $NHCH_2CH_2NH_2$), which forms a bis complex $mer-[Co(EDMA)_2]^+$.¹⁰¹⁶ This undergoes isomerization in aqueous base to a mixture of other forms.

The N,N' -substituted ligand (**231**) forms an unusual square-based pyramidal Co^{III} complex with SO_3^{2-} in the axial site, presumably stabilized by the strong *trans* influence of the SO_3^{2-} ligand.⁹⁹⁸ The enzyme inhibitor α -aminomalonic acid ($^-O_2CCH(NH_2)CO_2^-$, ama), when reacted with $[Co(2,3,2-tet)Cl_2]^+$ (2,3,2-tet = N,N' -bis(2'-aminoethyl)propane-1,3-diamine) under various conditions, undergoes halide substitution to produce both the simple $[Co(2,3,2-tet)(N,O-ama)]^+$ (**232**) and other species which underwent metal-directed condensations involving the acidic carbon and a nitrogen of the polyamine, such as (**233**).¹⁰¹⁷

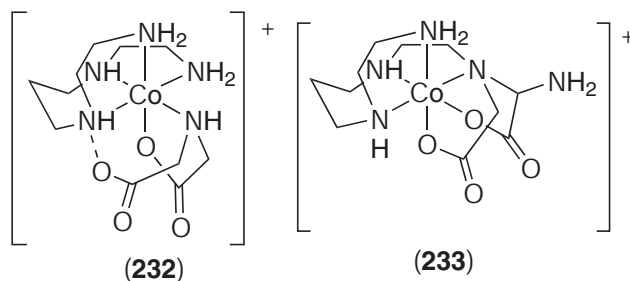

(*gg*) *Aminophosphates*. Phosphate and phosphite groups can be attached to amines conveniently through reaction with haloalkylphosphates or analogs. One example features a pendant triazamacrocycle, which acts as a hexadentate ligand to form octahedral complexes (**234**) with both Co^{III} and Co^{II} .¹⁰¹⁸

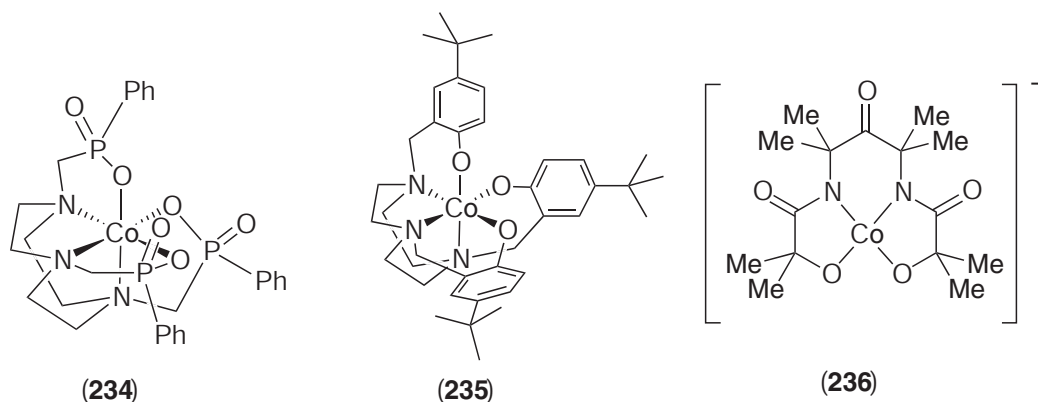

(*hh*) *Aminophenolates*. An N -pendant phenolate ligand based on tacn (**235**) readily forms a 1:1 complex with Co^{III} .¹⁰¹⁹ Further, this reacts with Fe^{2+}_{aq} or Fe^{3+}_{aq} to form mixed trinuclear complexes $(CoL)_2Fe$ where the Fe is sandwiched between two sets of three phenolate oxygens which bridge between the cobalt(III) and iron(II)/(III) centers. Macrocyclic ligands featuring amine and phenolate donor groups, particularly with side-by-side compartments where phenolate ions act as bridging donors to two metal ions, abound.

(*ii*) *Amidoalcoholates*. The methylated diamidialcoholate (**236**) forms another example of the rare square planar cobalt(III) geometry,¹⁰²⁰ with steric congestion presumably blocking facile entry to the axial sites.

6.1.2.3.7 Sulfur and selenium

(i) Sulfides and selenides

Sulfide is a strong ligand, but compounds containing S^{2-} as the only ligand are rare. One example is the compound $M_9Co_2S_7$, formed in a melt with $M_2(CO_3)$ ($M = K, Rb, Cs$) and S , where both Co^{III} and Co^{II} centers are present in trigonal planar CoS_3 units.¹⁰²¹ More typically, sulfide is a companion ligand in mixed-ligand systems. These are often clusters, as exemplified by the mixed

oxidation state (formally 4Co^{III} , 2Co^{II}) diamagnetic cluster $\text{Co}_6\text{S}_8(\text{PEt}_3)_6$ (**237**).¹⁰²² This type of cluster spontaneously self-assembles from reaction of metal salt, chalcogen, and ancillary ligand.

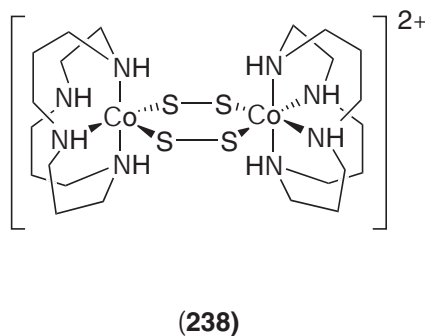
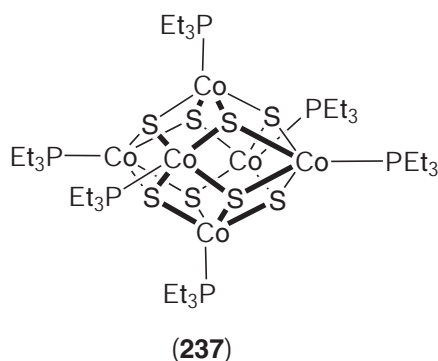

A Co^{III} compound containing only selenium as a ligand, $[\text{Co}_3(\text{Se}_4)_6]^{3-}$, has also been reported, prepared by reaction of $\text{CoCl}_2 \cdot 6\text{H}_2\text{O}$ with Li_2Se_6 in DMF at 100°C .¹⁰²³ This trimer includes Se_4^{2-} as a linear chelating fragment, bound in bidentate and bridging arrangements; the average of $\text{Co}^{\text{III}}\text{—Se}$ distances reported was 2.37 Å.

Apart from S^{2-} , the disulfide ion S_2^{2-} is an effective ligand. Reaction of the hexakis(acetonitrile) adducts of CoX_2 ($\text{X} = \text{BPh}_4^-$ or ClO_4^-) with S_2^{2-} or S_4^{2-} , with a tetraaza macrocycle also present, yields the dimer $[\{([15]\text{aneN}_4)\text{Co}\}_2(\mu\text{-S}_2)_2]^{2+}$ (**238**) where the two Co^{III} centers are bridged by two disulfido groups, forming a six-membered Co_2S_4 ring.¹⁰²⁴

(ii) Thioethers and selenoethers

The acyclic and macromonocyclic polythioethers were well illustrated in *CCC* (1987 Section 47.8.3.2).¹ Only a few recent examples will be given of this chemistry here.

(jj) *Acyclic*. The simple dimethylsulfide complex ion $[\text{Co}(\text{NH}_3)_5(\text{SMe}_2)]^{3+}$ was prepared from reaction of Me_2S with the trifluoromethanesulfonato precursor complex in sulfolane at 80°C .¹⁰²⁵ It is hydrolyzed slowly in aqueous acid, but undergoes rapid base-promoted hydrolysis, with Co—S cleavage.

Linear thioethers of the type $\text{MeS}(\text{CH}_2)_n\text{S}(\text{CH}_2)_m\text{S}(\text{CH}_2)_n\text{SMe}$ ($n = m = 2$; $n = 2$, $m = 3$) form octahedral dihalo tetrathioether complexes by air oxidation of a solutions of CoX_2 ($\text{X} = \text{Cl}$, Br , I) and the ligand in nitromethane.¹⁰²⁶ In addition, $[\text{Co}(\text{MeSCH}_2\text{CH}_2\text{SMe})_2\text{X}_2]^+$ and a $\text{Co}^{\text{III}}\text{S}_6$ compound comprising one each of the tridentate and bidentate ligands were prepared.

Apart from well-established thioether chelates, coordination of selenium analogs has also now appeared. The chelate 2,5-diselenahexane reacts with CoX_2 ($\text{X} = \text{Cl}$, Br , or I) in an aprotic solvent in the presence of dry air and NaBPh_4 to form the air-stable Co^{III} complex $[\text{Co}(\text{CH}_3\text{SeCH}_2\text{CH}_2\text{SeCH}_3)_2\text{X}_2]\text{BPh}_4$, as a mixture of *cis* and *trans* isomers.¹⁰²⁷

(kk) *Macrocyclic*. The macromonocyclic polyethers and their Co^{III} complexes have been known for some time, with *ttcn* ($[9]\text{aneS}_3$) (**109**) and $[14]\text{aneS}_4$ (**110**) classic examples. The mixed-ligand complex $[\text{Co}(\text{tacn})(\text{ttcn})]\text{Br}_3$ offers the opportunity to compare the thioether and aza macrocycles within the one compound.¹⁰²⁸ Average Co—S and Co—N distances were 2.247 Å and 1.961 Å respectively, and the complex displayed reversible $\text{Co}^{\text{III/II}}$ and $\text{Co}^{\text{II/I}}$ couples near 0.0 V and -1.15 V vs NHE respectively. Larger macrocycles with more thioether donors have been reported; a recent example is the octahedral $\text{Co}^{\text{III}}\text{S}_6$ system with 1,4,7,11,14,17-hexathiacycloicosane ($[20]\text{aneS}_6$) coordinated.¹⁰²⁹ More recently, the synthetically demanding organic chemistry leading to macrobicyclic polythioethers has been developed. The hexathia macrobicyclic tricosane cage complex of Co^{III} has subsequently been reported (**239**).⁴⁶⁶ Metal-directed condensations of CH_2O and MeNO_2 (or NH_3) with their corresponding acyclic hexadentate Co^{III} complexes lead to their corresponding mixed-donor cage complexes, for example (**240**)¹⁰³⁰ and (**241**).¹⁰³¹ The asymmetric CoN_4S_2 cage is also known.¹⁰³² The electrochemical and magnetic properties of these mixed-donor complexes are quite distinct from their $\text{Co}^{\text{III}}\text{N}_6$ relatives (**161**) and (**162**). For example, the divalent CoN_3S_3 cage complex is low spin in contrast to its high-spin hexamine relatives. The octadentate ligand tetrakis((2-aminoethyl)thiomethyl)methane, with four identical

aminothioether arms, can similarly be capped to form an N_3S_3 cage with an exocyclic N,S chelate.¹⁰³³ The tri- and divalent Co cage complexes have been characterized.

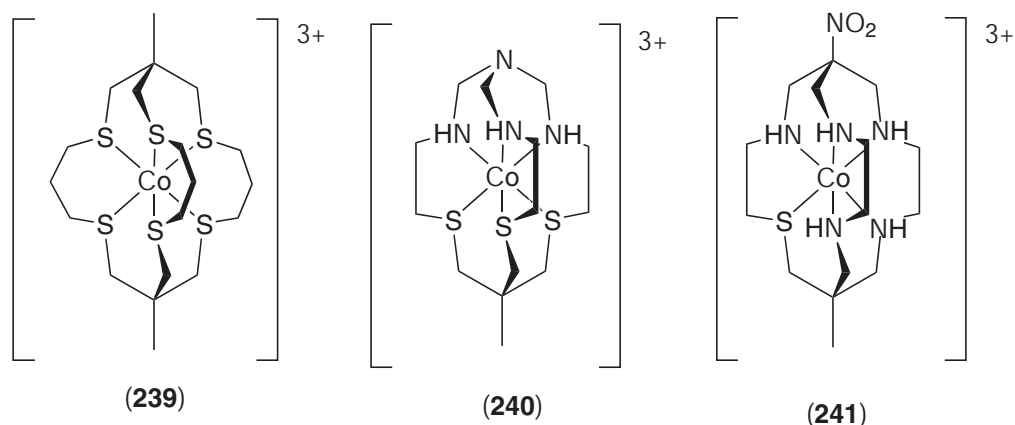

(iii) Thiolates

Thiolates are strong ligands and a rich coordination chemistry with cobalt(III) exists. Normally, thiols are employed directly in synthesis, and this is the usual entry into their coordination chemistry. However, alternative approaches do appear from time to time, and recently the cobalt-mediated direct thiolation of an aromatic ring in bidentate phenyl(2-pyridyl)diazene using dithiocarbamate ion to produce a coordinated tridentate thiolate has been reported.¹⁰³⁴

A reactive five-coordinate thiolate cobalt(III) complex (**242**) was prepared to model the active site of nitrile hydratase, a cobalt(III) or iron(III) metalloenzyme promoting the conversion of nitriles to amides.¹⁰³⁵ The synthesized complex is facile in its uptake and release of azide and thiocyanate, indicating that ligand displacement in the presence of an appropriate non-leaving group environment is not too slow for catalytic paths in non-redox active Co metalloenzymes. Other model compounds for nitrile hydratase feature new octahedral Co^{III} complexes with carboxamido nitrogen (Co—N 1.91 Å) and thiolate sulfur (Co—S 2.23 Å) donors.¹⁰³⁶ Hydrogen peroxide, or even air and activated charcoal, readily converts the sulfides to sulfinato groups.

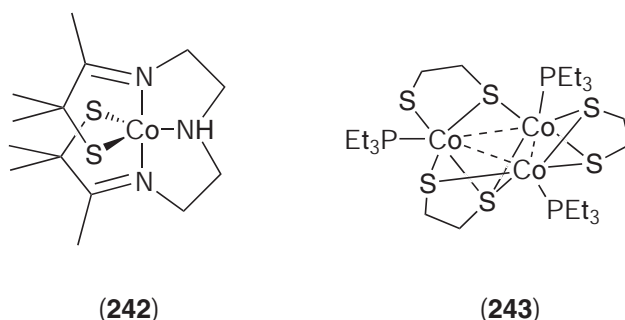

Chelation of *iso*-maleonitriledithiolate (imdt) has been structurally characterized in the octahedral cobalt(III) complex $trans-[Co(imdt)_2(P(n-Bu)_3)_2]^-$, formed via reaction of cobalt(II) ion with $K_2(imdt)$ in the presence of the phosphine.¹⁰³⁷ Simple chelating thiolates such as $^-SCH_2CH_2S^-$ not only form mononuclear compounds, but participate in bridging in clusters such as $[Co_3(SCH_2CH_2S)_3(PEt_3)_3]^{3+}$ (**243**).¹⁰³⁸

When electrochemical oxidation of Co metal is carried out in an acetonitrile solution of phosphinothiol ligands, tris(phosphinothiolate)cobalt(III) compounds are formed.¹⁰³⁹ The octahedral P,S-chelated $Co(2-(Ph_2P)-6-(Me_3Si)C_6H_3S)_3$ compound has been characterized structurally.

Thiolates are candidates for oxygenation reaction leading to sulfenates (RSO^-) and sulfinates (RSO_2^-). Oxygenation by H_2O_2 -urea of the cobalt(III) complex of the N_2S_2 ligand bis(carboxamido-*N*)dithiolato with *tert*-butyl isocyanide in the axial sites produced the first (carboxamido-*N*) bis(sulfenato-*S*)cobalt(III) complex, in a reaction asserted to model oxygenation of nitrile hydra-

tase thiolate ligands.¹⁰⁴⁰ Oxidation of thiolates to sulfinates has been achieved in the cobalt(III) complex of *N,N'*-(3-mercapto-3-methyl-butyl)-*o*-phenylenediamine with axial *t*-butyl isocyanide groups, yielding an octahedral product defined by a crystal structure.¹⁰⁴¹ The two oxidized thiolates (now SO₂ groups) lie *trans* to two deprotonated carboxamido N atoms; there is some structural resemblance to Co nitrile hydratases, where thiolate oxidation has been proposed for enzyme activity. Oxidation of thiolates to sulfinates by H₂O₂ has also been described for the mononuclear octahedral CoN₃S₃ complex of the trianion of *N,N',N*-tris(2-thiobenzyl)-1,1,1-tris(aminomethyl)ethane, whereas a related thiolate-bridged dinuclear dicobalt(III) complex is resistant to oxidation.¹⁰⁴² The *cis,cis,cis*-[Co(pyet)₂]⁺ complex (pyet = 2-((2-pyridylmethyl)amino)-ethanethiol) is converted to sulfenato and sulfinato complexes by molecular oxygen alone in the presence of activated charcoal.¹⁰⁴³

Tri-*tert*-butoxidesilanethiolate forms complexes with both Co^{II} and Co^{III}. Reaction of the thiol with a Co^{II} ammine in water yields a dimer which undergoes oxidation in an ammonia-saturated atmosphere to form octahedral [Co(SSi(O-*t*-Bu)₃)₂(NH₃)₄]⁺, the first silanethiolate characterized structurally.¹⁰⁴⁴

(iv) Thiocarbamates

Thiocarbamate (tc, RHNCSO⁻) is a monodentate ambidentate ligand, and both oxygen- and sulfur-bonded forms are known for the simple pentaamminecobalt(III) complexes. These undergo redox reactions with chromium(II) ion in water via attack at the remote O or S atom of the S- and O-bound isomers respectively, with a structural *trans* effect suggested to direct the facile electron transfer in the former.¹⁰⁴⁵ A cobalt-promoted synthesis utilizing the residual nucleophilicity of the coordinated hydroxide in [Co(NH₃)₅(OH)]²⁺ in reaction with MeNCS in (MeO)₃PO solvent leads to the O-bonded monothiocarbamate, which isomerizes by an intramolecular mechanism to the S-bound isomer in water.¹⁰⁴⁶

The dithioacid ligands dithiocarbamates (R₂N-CS₂⁻), xanthates (RO-CS₂⁻), thioxanthates (RS-CS₂⁻), and dithiocarboxylates (R-CS₂⁻), appeared in CCC (1987, Section 47.8.10). Dithiocarbamate (dtc⁻) ligands are usually bidentate chelates, although monodentate coordination is known. Their chemistry, and that of the related xanthates and thioxanthates, has been extensively examined in the past, and recent chemistry has been more limited. A long-established, facile route to distorted octahedral Co(dtc)₃ is via reaction of Na⁺R₂NCS₂⁻ with CoCl₂ in the presence of oxygen. The four-membered planar chelate ring is characterized by a small bite angle, typically below 80°.¹⁰⁴⁷

Cobalt(III) complexes of formula *cis*- and *trans*-[Co(dtc)L₄]²⁺ and [Co(dtc)₂L₂]⁺ where dtc = dimethyl-, diethyl- or piperidino-dithiocarbamate were prepared with phosphites P(OMe)₃, P(OEt)₃ and 4-ethyl-2,6,7-trioxa-1-phosphabicyclo[2.2.2]octane as ligands L.¹⁰⁴⁸ Whereas Co—P bonding is found, as defined in the crystal structures of each of the two forms of complexes isolated, a linkage isomer in which the phosphite is O bound was detected for the bis(dithiocarbamate) compounds.

The dinuclear dialkyldithiocarbamate precursor [Co₂(dtc)₅]⁺ reacted with diamine mustards *N,N*- and *N,N'*-bis(2-chloroethyl)ethylenediamine (bce, dce) and their non-chlorinated analogs yield [Co(dtc)₂(diamine)]⁺.¹⁰⁴⁹ The bce and dce compounds were prepared and tested as potential hypoxia-selective cytotoxins, but did not prove of value as potential bioreductive anticancer drugs, partly due to their redox instability.

Examples in organometallic systems are known. Reaction of thiuram disulfides, (R₂NCS₂)₂, with Co(Cp)(CO)₂ produces dithiocarbamate pseudo-octahedral cobalt(III) complexes Co(Cp)(dtc)₂ with one chelated and one monodentate dtc, also accessible via Co(Cp)I(dtc).¹⁰⁵⁰ Fluxional behavior, including monodentate–chelate exchange, was observed for some complexes in temperature-dependent NMR studies. The Co(Cp)I(dtc) complex was defined in a crystal structure.

A mixed cobalt(III)–copper(I) one-dimensional polymer featuring Cu₃Br₃ units linking to tris(dithiocarbamate)cobalt(III) complexes through two of three interligand chelate sites forms readily from reaction of Co(S₂CNR₂)₃ with CuBr.¹⁰⁵¹ With CuI, a novel and more complex infinite double-stranded polymer featuring CuI₂Cu and Cu₆I₆ linkers results. Dithiocarbamate pendant to a polyether macrocycle (**244**) is an unusual example of a simple chelating ligand. This reacts as the sodium salt with aqueous CoSO₄ to form a tris(dtc)cobalt complex.¹⁰⁵² This complex has the potential to bind appropriate metal ions in the three pendant polyether cavities.

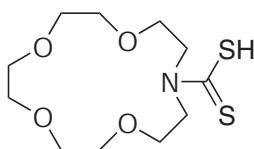

(244)

(v) Thiosemicarbazones

Thiosemicarbazone ($\text{RNH-CS-NH-N}=\text{CR}'\text{R}''$, tsc) complexes of cobalt(III) have been extensively studied since the early 1980s and continue to attract attention, gaining particularly from an interest in their biological activity and potential cytotoxicity. A truly extensive range of tsc compounds has now been reported, although structural definition of their complexes widely relied on basic analytical and spectroscopic techniques up to the late 1980s, when X-ray crystal structural studies of tsc compounds became more common. A review of thiosemicarbazone and *S*-alkyldithiocarbazate complexes has appeared.¹⁰⁵³

The ligands are synthetically quite accessible through a number of routes (Scheme 3). Co^{II} complexes are formed in an inert atmosphere, with oxidation through to Co^{III} readily achieved in air. The ligands are poorly soluble in water, but their complexes are more soluble, enhancing their value in pharmacological applications. Various complexes have exhibited antitubercular, anti-leprotic, antiviral, antimalarial, and antitumor activity,¹⁰⁵³ with complexes of tridentate ligands usually exhibiting higher activity.

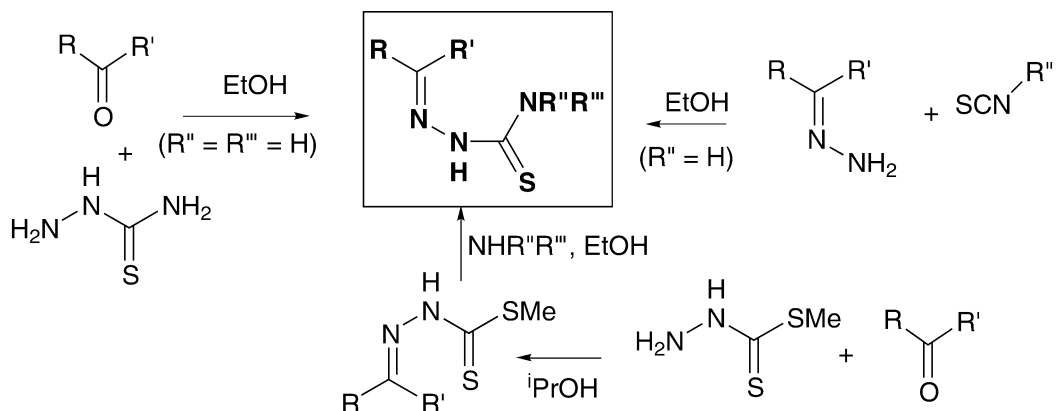

Scheme 3

Primarily, studies with structural characterization are discussed below. Typically, tsc ligands displaying *N,S*-bidentate, or else tridentate coordination for ligands carrying additional functionality, have been described. The *mer*-bis(tridentate) distorted octahedral geometry occurs as the dominant form of cobalt(III) complexation reported, as evident from the selected examples following. Pyridine-2-carbaldehyde thiosemicarbazone (pcts^-) acts as a tridentate ligand, binding through one S and two N atoms in $[\text{Co}(\text{pcts})_2](\text{NCS})$, as defined by a crystal structure.¹⁰⁵⁴ Redox activity and reaction with cell thiols is believed to be involved in the cytotoxicity of metal complexes of this ligand against some melanoma and erythroleukemia cells. Methyl pyruvate and α -ketoglutaric acid thiosemicarbazides form bis(tsc)cobalt(III) complexes, the crystal structure of the latter determined wherein the ligand acts as a tridentate in a distorted octahedral geometry.¹⁰⁵⁵ The octahedral cobalt(III) ion $[\text{Co}(\text{datsc})_2]^+$, where tridentate ligand coordination occurs as defined by a crystal structure, is formed following reaction of dimethyl-2-acetylpyridine-*N*-oxide thiosemicarbazone (datscH) with CoCl_2 .¹⁰⁵⁶ The potentially tridentate ligand 2-pyridineformamide *N*(4)-methylthiosemicarbazone (pntscH) forms following Na reduction of 2-cyanopyridine in dry methanol in the presence of the semicarbazide. The $[\text{Co}(\text{pntsc})_2](\text{ClO}_4)$ has the thiolato S and both the pyridine and imine N atoms bound.¹⁰⁵⁷ The neutral octahedral *mer*-

Co(kbtsc)(Hkbtsc) has the 2-ketobutyric acid thiosemicarbazone (H_2kbtsc) bound as both a mono- and di-anion, with small differences between the two forms found in the crystal structure.¹⁰⁵⁸

A range of S,N,O-donor ligands bound to Co have appeared. Pyridoxal (3-hydroxy-5-(hydroxymethyl)-2-methylpyridine-4-carbaldehyde) thiosemicarbazone (hhtsc) also forms an octahedral mer -[Co(hhtsc)₂]⁺ ion, where the tridentate binding of the ligand has N-donors *trans* and S and O donors *cis*.¹⁰⁵⁹ However, for the phenylpyruvic acid thiosemicarbazone (H_2pptsc) dianion bound as an S,N,O-tridentate in the octahedral mer -[Co(pptsc)₂]⁻, the S donors are *cis*-disposed and the N- and O-donor pairs each *trans*.¹⁰⁶⁰ Tridentate S,N,O-chelation of octahedral cobalt(III) by pyruvic acid thiosemicarbazone dianion (patsc) in mer -[Co(patsc)₂]⁻, of 5-formyluracil thiosemicarbazone (ftsc) in [Co(ftsc)₂]₂(SO₄), and of glyoxylic acid thiosemicarbazone (gatsc) in [Co(OH₂)₆][Co(gatsc)₂]₂·3H₂O are also defined by crystal structures.^{1061–1063} The patsc compound displays an electrochemically reversible Co^{III/II} couple. The [Co(ftsc)₂]⁺ compound exhibited low activity against human leukemic cell lines.

Both the 2-furfural thiosemicarbazone and semicarbazone Co complexes proved potent in their cytotoxicity against a wide range of cancer cell lines, with suppression associated with DNA nicking and fragmentation rather than base alkylation, intercalation, or crosslinking.¹⁰⁶⁴ Potent antineoplasticity or cytotoxicity is displayed by a range of heterocyclic thiosemicarbazones and thioureas and their Co complexes.¹⁰⁶⁵ Cytotoxicity was also established both *in vitro* and in tissue cultures for [Co(qtsc)₂]₂X (qtsc = S,N,N-tridentate quinoxaline-2-carboxaldehyde thiosemicarbazone; X = Cl, Br).¹⁰⁶⁶ The cobalt(III) complex of 3-acetylisquinoline thiosemicarbazide displays less antifungal activity than the 2-acetylpyridine analog.¹⁰⁶⁷

(vi) Thioureas and selenoureas

Thiourea (tu) dominantly forms S-bonded complexes with octahedral cobalt(III), with the *trans*-bis(thiourea)cobalt(III) moiety common along with multidentate N- and O-donors in other sites. These are readily prepared; for example, reaction of *trans*-[Co(dmg)₂(OH₂)₂]⁺ with thiourea at pH 3–4 in hot aqueous solution yields the bis(thiourea) complex on slow cooling.¹⁰⁶⁸ Alternatively, in a one-pot reaction, heating an alkaline mixture of cobalt(II) and dimethylglyoxime in air to ~80 °C, lowering the pH to 1–2, then treating with thiourea produces the same complex. Further, the selenourea analog forms identically. The *trans* arrangement of the two-coordinated thiourea molecules has been confirmed by a crystal structural characterization of the dimethylglyoxime cobalt(III) complex cation [Co(dmg)₂(tu)₂]⁺,¹⁰⁶⁹ and of the methylglyoxime analog [Co(mg)₂(tu)₂]⁺. The ability of the former compound to stimulate the biosynthetic capacities of micromycetes is also noted. Further, the *trans*-bis(thiourea)bis(α-furylglyoximate)cobalt(III) nitrate has been characterized by a crystal structure analysis, with thiourea S-bonded.¹⁰⁷⁰ Thiourea is a co-ligand along with 1,2-cyclohexanedione dioxime (cdd) in [Co(cdd)₂(tu)₂]₂(SiF₆), for which a crystal structure defines the octahedral geometry with the thioureas in a *trans* disposition.¹⁰⁷¹ A detailed study of the kinetics of substitution by thiourea and other neutral ligands in *trans*-[Co(salen)(OH₂)₂]⁺ indicates very rapid substitution by the first ligand followed by a slower second substitution.¹⁰⁷²

Thiourea has the potential to bind through either the S or the amine N atoms, and the existence of linkage isomers may be anticipated. The ambidentate ligands thiourea, NO₂⁻ and SO₃²⁻, in interactions with *cis*- and *trans*-[Co(en)₂(OH₂)₂]³⁺ ion, display N,S-, O,N- and O,S- linkage isomerization processes, followed by ⁵⁹Co NMR studies.¹⁰⁷³ Equivalent reactions have been reported for the bis(2,2'-dipyridyl) and bis(1,10-phenanthroline) analogs.¹⁰⁷⁴ With *mer*-Co(dien)Cl₃ in aqueous solution, *mer*-[Co(dien)(tu)₃]³⁺ forms with both S- and N-bound thiourea (tu) isomers detected, amongst other analogs.¹⁰⁷⁵

(vii) Mixed donor sulfur and selenium ligands

There are growing and diverse numbers of examples of polydentate ligands which feature S-donors in concert with N, O, or P-donors. One simple, but interesting, example is 2-pyridine-thiolate (pt). This ligand can bind as a monodentate, a chelate and in bridging modes as a versatile electron-rich ligand, and its coordination chemistry has been reviewed.^{1076,1077} The restricted “bite” of the N,S four-membered ring chelate has obvious structural effects. The *mer*-Co(pt)₃ complex has been reported, with intraligand S—Co—S angles below 73° and *trans* S—Co—S angles

around 166°. ¹⁰⁷⁸ The complex is able to be formed in several ways; via transmetallation from a Zn^{II} cluster of the ligand with Co^{II} in methanol, by base-promoted ligand substitution in tris (acetylacetonate)cobalt(III), or by reaction of the ligand salt with Co(ClO₄)₂ in acetone in air. Typically, across a range of structures for this ligand and close analogs, Co—S and Co—N distances are ~2.28 Å and ~1.92 Å respectively, with the S—Co—N angle near 73°. Mixed ligand complexes of pt with diamines form by reaction of both diamine and 2,2'-dipyridyldisulfide with Co(ClO₄)₂ in ethanol. ¹⁰⁷⁹ One of the products, [Co(en)₂(pt)]²⁺, spontaneously resolves upon recrystallization, i.e., as a conglomerate. The ligand, when chelated in [Co(en)₂(pt)]²⁺, also undergoes a series of stepwise oxidation reactions from thiolato to sulfenato, sulfinato, and sulfonato ligands, with some S,O-isomerization reactions also possible. ¹⁰⁸⁰ This is outlined in Scheme 4.

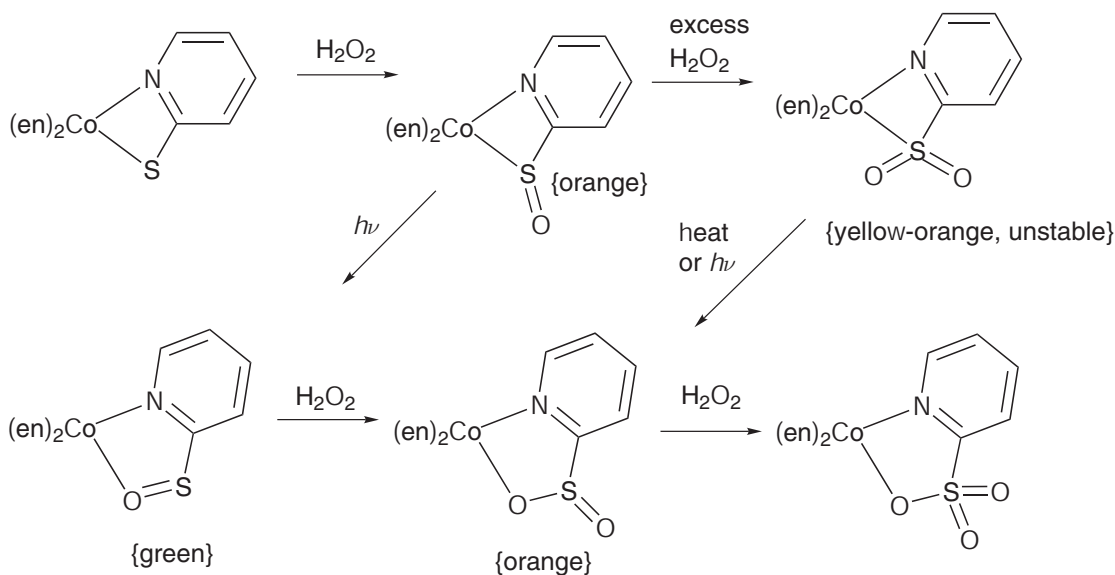

Chelation of pt to Co^{III} has been observed in the complex [Co(mpyct)₂(PBu₃)₂]⁺, which has a CoN₂S₂P₂ donor set, with the two phosphines in apical sites around an elongated octahedron. ¹⁰⁸¹

The selenium analog of pt, 2-pyridineselenolate (ps), is known and a series of [Co(ps)_{3-n}(en)_n]ⁿ⁺ complexes have been prepared and characterized. ¹⁰⁸² Oxidation by peracetic acid produced seleninato (−SeO₂) and selenonato (−SeO₃) complexes, which were shown by structural studies to undergo change from Se to O coordination, relaxing in the process from a four- to a five-membered chelate ring system.

The *N,S*-chelate 2-aminoethanethiolate (aet[−]) forms stable cobalt(III) complexes, including clusters where the S can take on a bridging role. Reaction of [Co(NH₃)₅Cl]²⁺ with Ni(aet)₂ in water for several hours affords the black tetranuclear compound Co₄(aet)₈, which features aet[−] in simple chelate and bridging roles (245). ¹⁰⁸³ The simple monomeric complex [Co(aet)₂(en)]⁺ has been reported; ¹⁰⁸⁴ when heated in water at 50 °C, the trimer Co{Co(aet)₃}₂ is one product, with the central Co surrounded by six bridging S atoms.

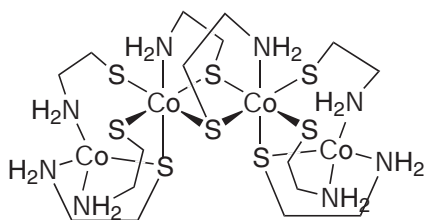

(245)

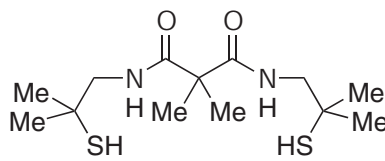

(246)

Novel Co^{III} surfactants containing aminothioether ligands have been described.¹⁰⁸⁵ These involve $[\text{Co}(\text{en})_2(\text{NH}_2\text{CH}_2\text{CH}_2\text{SR})]^{3+}$ monomers (R = 6-, 8- or 12-carbon alkyl chain) and $[(\text{en})_2\text{Co}(\text{NH}_2\text{CH}_2\text{CH}_2\text{S}-(\text{CH}_2)_n-\text{SCH}_2\text{CH}_2\text{NH}_2)\text{Co}(\text{en})_2]^{6+}$ dimers ($n = 8, 12$). The aminothioliolate in $[\text{Co}(\text{en})_2(\text{SCH}_2\text{CH}_2\text{NH}_2)]^{2+}$ is oxidized first to a coordinated sulfinate complex and then, more slowly, to a coordinated sulfinate using oxo diperoxo complexes $\text{MO}(\text{O}_2)_2$ and $\text{MO}(\text{OH})(\text{O}_2)_2$ ($\text{M} = \text{W}, \text{Mo}$).¹⁰⁸⁶ Oxygen atom transfer from peroxide to the coordinated S acceptor is involved. The sulfinate-carboxylate chelate in the cobalt(III) complex *trans*(*t*-N,S)-[Co(tren)-(S(O)₂CH(CH₃)COO)]⁺ photolyzed with visible light undergoes irradiation-induced desulfurization and yields an organic peroxide complex which was characterized by a crystal structure.¹⁰⁸⁷

The di-N-carboxamido dithiolato N_2S_2 ligand (**246**) forms an unusual square-planar Co^{III} complex which mimics the active site of cobalt-containing nitrile hydratases.¹⁰⁸⁸ Hexacoordination of Co^{III} is only achieved with addition of strong ligands like cyanide and isocyanides in axial sites, which occurs along with an expansion of the Co-donor distances in the equatorial plane, as defined by EXAFS studies.

Reaction of the thiol group in $\text{HSCH}_2\text{CH}_2\text{NH}_2$ with a haloalkane carrying an additional functional group can produce a range of new tridentate ligands. An example is the 5-methylimidazolyl terminated (ati), which readily forms a *fac*-Co(ati)₂ complex (**247**) by oxidation of a Co^{II} -ligand mixture, with all equivalent donor types in *trans* arrangements.¹⁰⁸⁹ This type of chemistry is convenient and straightforward, with the sodium salt of the thiol in dry alcohol very reactive when presented with, particularly, iodo- or bromoalkanes. Reaction of a dithiol usually leads to dithioethers, and elaboration of the chemistry is reasonably straightforward.

Macrocycles featuring multiple N,S donors have been reported. The saturated macrocycle [18]ane N_2S_4 readily forms a Co^{II} complex upon reaction with $\text{Co}(\text{NO}_3)_2 \cdot 6\text{H}_2\text{O}$ in ethanol, and this is oxidized in air to the Co^{III} complex,¹⁰⁹⁰ which has all six donors bound in an octahedral form but showing a small tetrahedral distortion of the four S-donors out of the best S_4 plane. Metal-directed $\text{CH}_2\text{O}/\text{EtNO}_2$ cyclization of a diaminodithioether, followed by Zn/HCl reduction leads to an amino-appended N_2S_2 macrocycle which has been complexed as a pentadentate to Co^{III} (**248**).^{1091,1092} A somewhat similar ligand, but carrying two carboxylate pendants, binds octahedral Co^{III} with a $\text{N}_2\text{S}_2\text{O}_2$ chromophore (**249**), the two O-pendants in *trans* dispositions.¹⁰⁹³

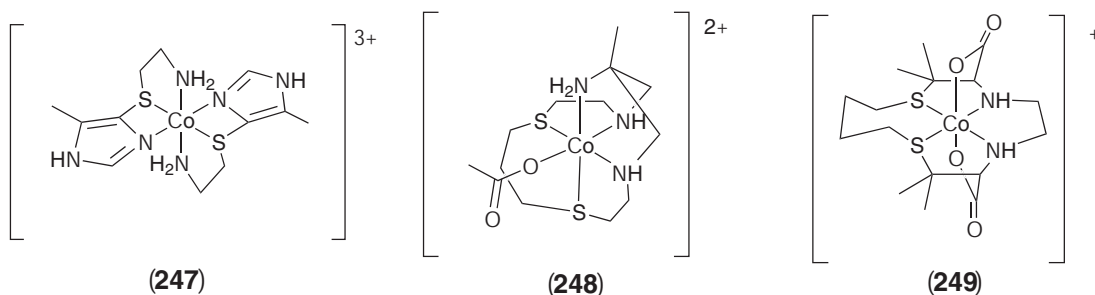

A suite of S_2P_2 -donor ligands $\text{H}_3\text{CS}(\text{CH}_2)_2\text{PPh}(\text{CH}_2)_n\text{PPh}(\text{CH}_2)_2\text{SCH}_3$ ($n = 2$ or 3) has been coordinated to Co^{III} to give distorted octahedral $[\text{Co}(\text{SPPS})\text{Cl}_2]^+$ compounds, with a range of geometric isomers identified.¹⁰⁹⁴ Both Co-S and Co-Cl bond elongation is observed when these are located *trans* to a phosphine. Chelated acetylacetonato ligands were also introduced in place of chloro ligands, forming a mixture of *cis*- α and *cis*- β isomers. A related example, but with the donor locations inverted, is the $\text{Me}_2\text{P}(\text{CH}_2)_2\text{S}(\text{CH}_2)_3\text{S}(\text{CH}_2)_2\text{PMe}_2$ (mtdmp) ligand, which reacts with *trans*-[Co(py)₄Cl₂]Cl to afford, after addition of NaPF_6 , the green *trans*(Cl,Cl)-[Co(mtdmp)Cl₂](PF₆).¹⁰⁹⁵

6.1.2.3.8 Halogens

(i) Halides

Halides are ubiquitous co-ligands for cobalt(III), and are met throughout this review. Anation of (solvent)cobalt(III) complexes by halide has been examined from time to time. An example is substitution of coordinated acetonitrile in $[\text{Co}(\text{L})(\text{MeCN})_2]^{3+}$ (L = tetraaza-macrocycle) by Cl^- and Br^- .¹⁰⁹⁶ A mechanism involving interchange from within tight ion pairs was proposed. Halobridged polymeric complexes are well known with both classical and organometallic complexes.

An example of an unusual cobalt(III) complex is the $[\{(Cp^*)Co\}_2(\mu-X)_3]^+$ ion ($X = Cl, Br, I$),⁹⁴⁶ with three bridging halide ions present.

6.1.2.3.9 Hydrogen

(i) Hydrides

Limited examples of cobalt(III) hydrides are extant, and they tend to be quite reactive species. Equilibration of $[Co(bpy)_3]^+$ with acid produces the trivalent hydrido complex $[HCo(bpy)_2(OH_2)]^{2+}$ and free (protonated) bpy.¹⁰⁹⁷ A mechanism was proposed in which bpy radical generation (bpyH) via outer-sphere reduction of the protonated bipyridinium monocation by the monovalent Co complex is rate determining. The hydrido complex results from reaction of the Co^{II} complex with the radical bpyH. Reaction of divalent (**75**) (*meso* and *rac* isomers) with pulse radiolytically generated $H\cdot$ generates the trivalent hydride $[HCo(hmd)]^{2+}$;¹¹⁸ a kinetic and thermodynamic analysis is reported. Mixtures of the porphyrin complex $Co(TMeOPP)$ and alkyl radicals such as $\cdot C(Me)_2CN$ and $\cdot C(Me)(CH(Me)_2)CN$ react with alkenes and alkynes to form alkyl and vinyl complexes and with alkyl halides and epoxides to form alkyl and β -hydroxyalkyl complexes. The intermediate trivalent hydride $HCo(TMeOPP)$ is implicated, which adds to unsaturated substrates or, in its deprotonated form, reacts as a nucleophile $[Co(TMeOPP)]^-$ with alkyl halides and epoxides.¹⁰⁹⁸ Sequential one-electron electrochemical reduction of the hexamine $[Co(tacn)_2]^{3+}$ leads to an unstable monovalent complex, which undergoes protonation at a mercury electrode to afford the hydride. The trivalent hydride is believed to decompose via disproportionation to H_2 and a Co^{II} species.¹⁰⁹⁹

6.1.2.4 Co^{IV} and Co^V

The chemistry of high-valent Co is not extensive. Whereas there are now several examples of Co^{IV} , the higher oxidation state Co^V has not been well established. Since Co^{IV} has a d^5 ground state, electron paramagnetic resonance spectroscopy offers an effective way of identification.¹¹⁰⁰ Early studies proposed Co^{IV} complexes formed with some dithiocarbamate, Schiff base, and dimethylglyoximate complexes.¹¹⁰¹ $[Co(dtc)_3]^+$ ions form from oxidation of the well-known Co^{III} precursors, and magnetic moments (~ 2.5 B.M) support the d^5 Co^{IV} assignment. Delocalization of electron density onto the ligands is an issue in nominally Co^{IV} compounds, with the extreme alternative representation being a Co^{III} -ligand radical species. Consequently, the development of a wide range of stable well-characterized Co^{IV} compounds remains unattained, because the metal is likely to oxidize its bound ligand(s) or to oxidize solvents in which the complex is formed. A brief coverage of some more recent examples follows.

6.1.2.4.1 Carbon

The simple methylidyne compound $[HC\equiv Co]^+$ has been formulated as a Co^{IV} species.¹¹⁰² The norbornyl anion (nor), as the lithium salt, reacts with $CoCl_2$ to produce the brown, paramagnetic tetrahedral $Co(nor)_4$. This can undergo both reduction (to $[Co(nor)_4]^-$) and oxidation (with $AgBF_4$) to what appears to be $[Co(nor)_4]^+$, a diamagnetic tetrahedral compound. This remains one of the very few established examples of Co^V .

The alkyl complex $[Co(4-CNpy)(dmg)_2(R)]^+$ has been reported.¹¹⁰³ The cyclopentadienyl complex $[(Cp)(PPh_3)Co(C_4Ph_4)]^+$ has been detected in frozen haloalkane solvent,¹¹⁰⁴ but has no long-term stability.

6.1.2.4.2 Nitrogen

N donor ligands for tetravalent Co must be carefully designed in order to prevent disproportionation (ligand dehydrogenation/Co reduction). A key feature is that no H atoms must be present on the C atoms adjacent to the coordinated N-donor. A range of multidentate amide ligands capable of stabilizing high oxidation states of Co have been reported. The Co^{IV} complex (**250**) ($X = 4-t$ -Butyridine) of the dioxo-salphen analog was prepared by Co^{IV} oxidation of the trivalent analog. The

presence of four ionizable donor atoms enables the ligand to stabilize this high formal oxidation state and the compound was characterized structurally.¹¹⁰⁵ The frozen solution EPR spectrum (10 K) of the complex exhibits an eight-line pattern from hyperfine coupling (16 G) of the single unpaired electron to the Co nucleus ($I=7/2$), centered at $g=2.011$. The emergence of three visible maxima in the spectrum of this complex not seen in the precursor was also indicative of metal-centered oxidation. Two sequential reversible electrochemical oxidations of the Co^{III} complex were observed 0.39 V and 0.84 V more positive than the Fc/Fc^+ reference. The square-planar tetravalent complex (**251**) has been reported along with its 4,5-dihalobenzo analogs.¹¹⁰⁶ EPR data in toluene at 5.9 K are consistent with a single unpaired electron residing on the metal center. The complex slowly oxidizes H_2O , yielding the trivalent complex. Replacement of the *gem* dimethyl groups of (**251**) with spiro-cyclohexyl moieties and attachment of methoxyl aromatic substituents results in an effective one-electron oxidant in cyclohexane solutions. A number of charge transfer salts of this tetravalent complex with single electron reductants such as ferrocene, N,N' -tetramethyl-*p*-phenylenediamine and $\text{Mg}(\text{TPP})$ were isolated.¹¹⁰⁷ Reaction with PhSH gave PhSSPh and with Bu_3SnH gave the tributyltin dimer, while the reduced trivalent monoanionic complex precipitates quantitatively following reaction.

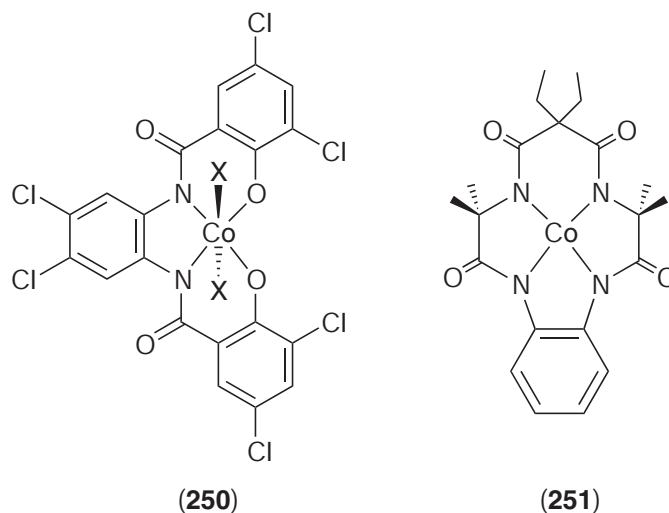

6.1.2.4.3 Oxygen

A high-valent oxocobalt porphyrin complex has been suggested as the reactive hydroxylating intermediate for alkane hydroxylation involving an electron-deficient Co^{III} porphyrin and μ -chloroperbenzoic acid.⁷⁸⁴ The bis(tridentate) coordinated Co complex (**252**) undergoes electrochemical oxidation to a Co^{IV} species.¹¹⁰⁸ EPR spectroscopy identified a single unpaired electron with a characteristic eight-line hyperfine coupling pattern due to the ^{59}Co nucleus ($I=7/2$).

6.1.3 BIOLOGICAL CHEMISTRY OF COBALT

At the time of the first volume of *CCC*(1987), the biological chemistry of cobalt was almost exclusively concerned with the cobalamins. The field has expanded and developed markedly since then. New cobalt-containing proteins have been characterized and applications of traditional cobalt coordination compounds in biology developed. These developments are illustrated below in some detail, as the field was not reviewed in the first edition.

6.1.3.1 Metalloproteins and Cofactors

6.1.3.1.1 Cobalamins (B_{12})

Cobalamin chemistry is the best-established area of cobalt biological chemistry. The 15-membered tetraazamacrocyclic corrin ring (incorporating four pyrrole residues) is the binding site for

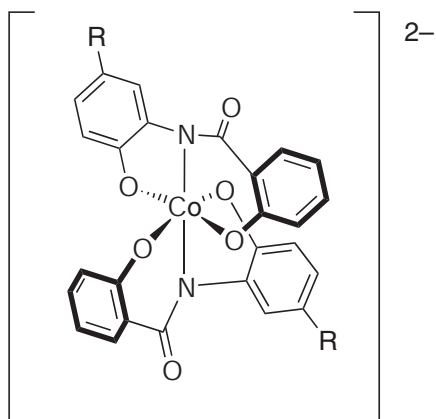

(252)

Co within all compounds of the so-called cobalamin (or B₁₂) family. The biological functions of cobalamin cofactors are defined by their axial substituents; either a methyl or an adenosyl group. Both cofactors participate in biosynthesis; the former in methyl transfer reactions while the latter is a free radical initiator, abstracting H atoms from substrates. Decades after their initial characterization, the fascination with the biological chemistry of cobalamins remains.¹¹⁰⁹

In mammals and in the majority of bacteria, cobalamin regulates DNA synthesis indirectly through its effect on a step in folate metabolism, catalyzing the synthesis of methionine from homocysteine and 5-methyltetrahydrofolate via two methyl transfer reactions. This cytoplasmic reaction is catalyzed by methionine synthase (5-methyltetrahydrofolate-homocysteine methyltransferase), which requires methyl cobalamin (MeCbl) (253), one of the two known coenzyme forms of the complex, as its cofactor. 5'-Deoxyadenosyl cobalamin (AdoCbl) (254), the other coenzyme form of cobalamin, occurs within mitochondria. This compound is a cofactor for the enzyme methylmalonyl-CoA mutase, which is responsible for the conversion of *L*-methylmalonyl CoA to succinyl CoA. This reaction is involved in the metabolism of odd chain fatty acids via propionic acid, as well as amino acids isoleucine, methionine, threonine, and valine.

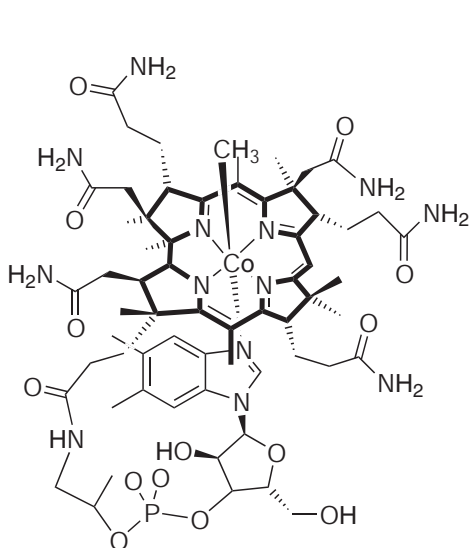

(253)

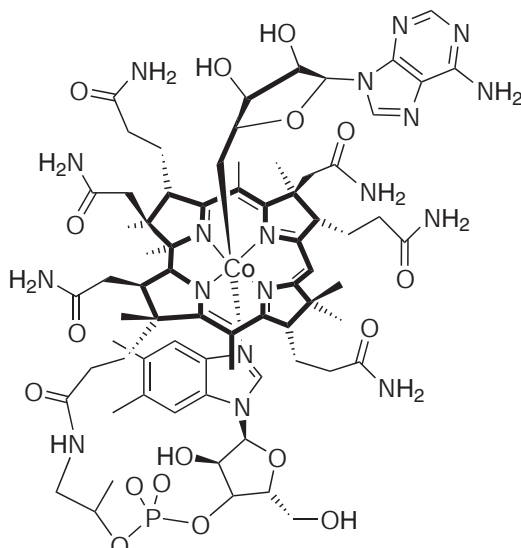

(254)

As Co-containing organometallic compounds, cobalamins are unique in nature, and they have a genetic history of more than four billion years. Their biosynthesis, absorption, transport, and metabolism have been well documented in organisms of both marine and terrestrial origin.¹¹¹⁰⁻¹¹¹²

Mammalian intestinal absorption requires the presence of two receptors and two transporters, which is itself a unique feature. Specific transporters such as intrinsic factor, transcobalamin, and haptocorrin have been characterized,¹¹¹³ as well as a number of receptors for passage across cell membranes. A number of biochemical studies on cell uptake¹¹¹⁴ and receptors^{1115,1116} of cobalamins have been reported. Genetic disorders that impair the synthesis, transport, or transmembrane passage of cobalamins and their consequences have been reviewed.^{1117,1118}

The mechanistic and structural chemistry of B₁₂ may be separated into (i) investigations of cobalamin cofactors both apart from and in complex with their enzymes, and (ii) biomimetic model complexes, both structural and functional.

(i) B₁₂ cofactors

Naturally, the biosynthesis of cobalamins themselves require delivery of Co ions at a particular point in the reaction scheme. Cobaltochelatase catalyzes the ATP-dependent insertion of Co^{II} into the corrin ring during the biosynthesis of coenzyme B₁₂ in *Pseudomonas denitrificans*. Cobaltochelatase is a heterodimeric enzyme (140 KDA and 450 KDA subunits each inactive in isolation), and the two components have been isolated and purified to homogeneity.¹¹¹⁹ The reaction product is divalent cobyrinic acid, demonstrating that hydrogenobyrinic acid and its diamide (255) are precursors of AdoCbl.

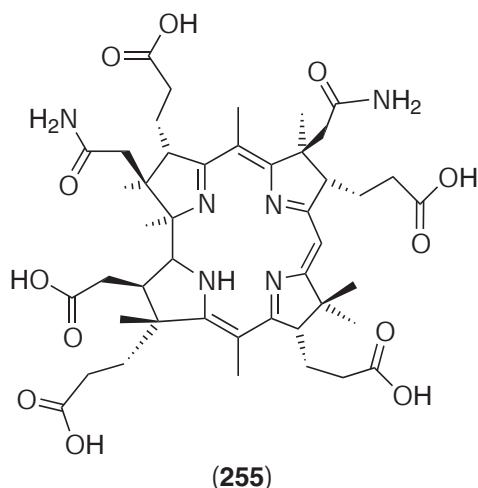

The structures of cobalamins both in isolation and as cofactors in complex with an enzyme have been probed with a variety of techniques including X-ray crystallography^{1120–1124} and EXAFS,^{1125,1126} in addition to spectroscopic methods such as NMR¹¹²⁷ and EPR¹¹²⁸ and also via molecular mechanics calculations.⁷⁹³ As one example, an NMR study of some cobalamins and their cobinamide analogs (lacking the axially coordinated dimethylbenzimidazole) has been reported.¹¹²⁹ Hydrogen bonding interactions involving the aqua ligand in aquacobalamin previously identified crystallographically persist in solution. In the cobinamides, removal of the axial benzimidazole produces characteristic changes in the amide nitrogen and proton chemical shifts of the proximal side chains.

Reduction of aquacobalamin with Zn/AcOH gives the five-coordinate hydrido complex, which reacts with ethylene to give EtCbl.¹¹³⁰ The same compound may be prepared by using the ethylating agent [Et₃O]BF₄ in aqueous solution.¹¹³¹ The interactions of MeCbl with the complex anions [Pt(CN)₄]²⁻, [PtCl₄]²⁻, and [Pt(SCN)₄]²⁻ have been investigated by UV-visible and ¹H NMR spectroscopy.¹¹³² At least three Pt binding sites on MeCbl were identified, one of which is located on the methyl ligand side of the macrocycle, and is implicated in methyl transfer in the presence of a Pt^{IV} complex. The reaction of MeCbl with I₂ in MeOH forms a stable charge transfer complex. In water this species reacts resulting in cleavage of the Co—C bond.¹¹³³ The mechanism involves electron transfer from MeCbl to I₂ to generate a MeCbl⁺ radical, which undergoes a chloride-induced heterolytic cleavage to yield the Cbl radical and CH₃Cl. The EtCbl analog was also studied. The solution structure of the glutathionyl analog GsCbl, which has been found to be a substrate for MeCbl formation in the presence of *S*-adenosylmethionine and a thiol

reductant, was investigated by multinuclear NMR,¹¹²⁷ establishing *S*-coordination by the ligand. Interactions between cobalamins and NO have been investigated with absorption and EPR spectroscopy.^{1134,1135} Marked spectral changes are seen upon reaction of divalent cobalamin with NO, which are consistent with NO-effected oxidation to the trivalent state.¹¹³⁴ This trivalent Co–NO complex is stable, but transfers its NO ligand to hemoglobin concomitant with reduction to the divalent state. Homolytic cleavage of the trivalent Co–C(Me or Ado) also resulted in the reduction of the Co. Nitrosylcobalamin had diminished ability to serve as a cofactor for methionine synthase, and observation that aquacobalamin could quench NO-mediated inhibition of cell proliferation suggests that interactions between NO and cobalamins may have important biological consequences.

A mechanistic study of dealkylations of a variety of adenosylcobalamins was conducted in acidic solution resulting in competitive homolytic and acid-induced hydrolytic Co–C bond scission pathways.¹¹³⁶ Two hydrolytic mechanisms were identified; one involving initial depurination followed by elimination from the organometallic intermediate, while the second involved ring-opening protonation at the ribofuranosyl oxygen. These reactions were sensitive to substituents on the adenosyl ligand. The limiting homolytic Co–C bond dissociation rate was found to be insensitive to alkyl ligand substituents.

Sonolytically generated ·OH radicals lead to Co–C bond cleavage in MeCbl in oxygenated aqueous solution.¹¹³⁷ Under anaerobic conditions, H· scavenging by O₂ is circumvented and reduction to divalent MeCbl occurs instead, which after protonation releases methane. A bioconjugate of cobalamin and the alkylating agent chlorambucil behaves similarly, which suggests that sonorelease of an active alkylating agent from a bioconjugate may be a viable and less toxic alternative method for the selective release of anticancer drugs.¹¹³⁸ The rate of Co–C bond dissociation in micellar solutions of BzCbl have been studied as a function of detergent concentration and pH.¹¹³⁹

5-Methyltetrahydromethanopterin:co-enzyme M methyltransferase (MtrA) is a membrane-associated corrinoid-dependent enzyme that uses a methyl transfer reaction to drive an energy-conserving Na⁺ ion pump. The purified enzyme exhibits a rhombic EPR signal indicative of a base-on divalent cobalamin, and was inactive in this form. One-electron reduction with Ti^{III} citrate generates the active monovalent species, and reaction with 5-methyltetrahydromethanopterin leads to methyl group transfer to the Co complex. The reaction is reversible upon reincubation with tetrahydromethanopterin.¹¹⁴⁰ The structural properties of the soluble deletion mutant of MtrA (lacking the C-terminal hydrophobic tail) have also been studied.¹¹⁴¹ However, the expressed apoprotein was devoid of its Co prosthetic group and incorrectly folded. Unfolding with guanidinium chloride and successful refolding proceeded with Ti^{III} citrate, suggesting that the monovalent cobalamin is the species that binds to the apoprotein. EPR spectroscopy of the divalent reconstituted protein revealed that the Co is bound in its base-off form and that a His residue is coordinated.

Although the system is catalytically inactive, adenylethylcobalamin (AdoEtCbl) undergoes Co–C bond cleavage to the enzyme-bound hydroxocobalamin upon interaction with the apoprotein of diol dehydratase.¹¹⁴² These results imply that the C–Co bond of AdeEtCbl is activated by the enzyme and undergoes heterolysis in contrast to homolysis of the C–Co bond of AdoCbl in the normal catalytic process. Diol dehydratase undergoes suicide inactivation by the physiological substrate glycerol, which causes irreversible cleavage of the Co–C bond in the cofactor, which remains tightly bound to the enzyme. Recombinant proteins co-purified to homogeneity exist as an A₂B₂ tetramer; a reactivating factor for the glycerol-inactivated holoenzyme that exchanges the enzyme-bound, adenine-lacking cobalamin for free adenosylcobalamin.¹¹⁴³

Methionine synthase forms a ternary complex with homocysteine and 5-methyltetrahydrofolate prior to catalyzing a methyl group transfer from the MeCbl cofactor to homocysteine, generating the monovalent cofactor and methionine. The trivalent MeCbl cofactor is restored by methyl transfer from 5-methyltetrahydrofolate to produce tetrahydrofolate prior to release of both products. In cobalamin-dependent methionine synthase, the cofactor may be converted to its EPR-active (but biologically inactive) divalent form. In acid frozen solutions the axial dimethylbenzimidazole substituent is protonated and hence not coordinated.¹¹²⁸ Reduction of the inactive divalent cofactor to its monovalent form during turnover may be achieved by flavodoxin (from *E. coli*) but not with the corresponding ferredoxin.¹¹⁴⁴ EPR spectroscopy revealed that binding of flavodoxin to divalent cobalamin methionine synthase results in a change in the coordination number of the Co from five to four with loss of the coordinated His residue. Methionine synthase exists in two different conformations that interconvert in the divalent cobalamin oxidation state. In the primary turnover conformation, the enzyme reacts with homocysteine and methyltetra-

hydrofolate but is unreactive toward adenosylmethionine and flavodoxin. In the reactivation conformation, the enzyme is active toward adenosylmethionine and flavodoxin but unreactive toward methyltetrahydrofolate, and a model has been proposed where these conformational changes control access to the cobalamin cofactor and regulate cobalamin reactivity in methionine synthase.¹¹⁴⁵ An additional cobalamin-dependent enzyme that has been characterized is the Fe-S protein CO dehydrogenase.¹¹⁴⁶

Oxidative addition of gaseous or liquid halogenated organic pollutants may be achieved with cobalamins immobilized on solid state supports in the presence of reductants, and this application has been patented.¹¹⁴⁷ In DMF solution containing tetrabutylammonium bromide and acetic acid, Vitamin B₁₂ itself mediated the reduction of CH₂Cl₂ in the presence of styrene to give cyclopropylbenzene in quantitative yields with high efficiency.¹¹⁴⁸ A pathway involving formation and electroreductive cleavage of a chloromethylene-Co^{III} intermediate to liberate a chloromethylene radical, which then attacks styrene, was suggested. The reaction is highly sensitive to solvent and the presence of water as a proton donor leads to 1-chloro-3-phenylpropane as a byproduct.

(ii) B₁₂ model complexes

There are many biomimetic model Co complexes of the cobalamins.¹¹⁴⁹ The primary criterion for an effective B₁₂ model has been that the complex may be reduced to the monovalent state and undergo facile oxidative addition to generate a stable alkylcobalt(III) complex. The two main classes of B₁₂ model complexes that have been investigated are Co oximes and Schiff base complexes. The former class shares the planar CoN₄ array of their biological analogs whereas the majority of effective Schiff base B₁₂ model complexes comprise equatorial *cis*-N₂O₂ donor sets.

The stabilization of axially coordinated alkyl groups by trivalent Co complexes of the tetradentate Schiff base salen, and analogs, is a feature that has prompted many studies relevant to B₁₂ biomimetic chemistry. The mixed aldehyde/ketone Schiff base complex *trans*-EtCo(salacacen)-(OH₂) (**256**) exhibits a number of structural features (elongated Co—OH₂ bond, non-planar CoN₂O₂ moiety) that are desirable in a B₁₂ model complex.¹¹⁵⁰ A variety of salen complexes bearing secondary alkyls or a bulky diamine in the equatorial position were synthesized and characterized. The complexes RCo(salen)(4-picoline) (R = *n*-Pr, *i*-Bu) are six-coordinate and their coordination geometry is similar to that seen in 5'-deoxyadenosylcobalamin.¹¹⁵¹ By contrast, the bulkier EtCo(Me₄salen) (derived from 2,3-dimethylbutane-2,3-diamine) offers a rare example of a five-coordinate square-pyramidal geometry for this class of compound coupled with a highly reactive Co—C bond. The template syntheses of [RCo(bzacen)(L)]⁺ (bzacen = benzoylacetone condensed with ethylenediamine, R = Me, Et, L = py₂, en) has been described.¹¹⁵² The presence of an alkenyl substituent on the ethylenediamine bridge of Co(salen) leads to an interesting pendent alkyl complex. The overall reaction mechanism involves oxidation of the divalent precursor to give the alkoxycobalt(III) analog followed by attack on the double bond by the metal and ultimately addition to the carbocation by the alcohol.¹¹⁵³

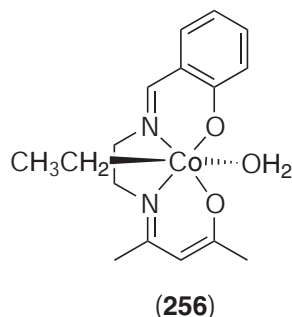

Tridentate Schiff base analogs (bearing a single aromatic residue and a diamine) are capable of stabilizing alkyl ligands. The primary amine of *N*-methylthylenediamine (Me-en) condenses with *o*-hydroxyacetophenone in the presence of Co^{II} to produce the complex Co(MesalMeen)(Me-en), which after reduction to the monovalent state may undergo oxidative addition with MeI to give [MeCo(salMeen)(Me-en)]⁺.¹¹⁵⁴ The dimethylamino analogs Co(MesalMe₂en)(N₃)(*o*-(MeCO)-C₆H₄O) and Co(MesalMe₂en)(SCN)(*o*-(MeCO)C₆H₄O) have also been reported.¹¹⁵⁵

Like their macrocyclic imine counterparts, Co oximes complexes are capable of stabilizing alkyl groups in their axial coordination sites. Alkyl complexes containing bis-dioxime bidentate and mixed imine–oxime tetradentate ligands of Co have been extensively studied as B₁₂ model complexes. The crystal structures of the organocobalt bis-glyoximate (H₂glo = HO–N=CHCH=N–OH) complexes, *trans*-RCo(glo)₂(py) (R = Me, Et, *i*-Pr) have been reported.¹¹⁵⁶ The coordinate bond lengths in the *trans* (py)–Co–R group both increase with increasing alkylation of R due to both steric bulk (Co–C) and σ -donating strength of the alkyl group (*trans* influence on Co–N). In comparison, the structures of the dimethylglyoxime analogs RCo(dmg)₂(py) (**257**) are less sensitive to alkyl group variations. Dealkylation may be achieved through protonation, and reactions of an extensive homologous series of RCo(dmg)₂(py) complexes (R = Me, CH₂Cl, CHCl₂, Et, CHMe₂, Bu, (CH₂)₂CH=CH₂, CH₂CHMeCH=CH₂) with trifluoroacetic acid (Htfa) were studied by NMR. The reactions are stepwise; the first acid equivalent results in reversible protonation of the complex, the second proton releases the pyridine ligand while irreversible alkyl protonation occurs in excess acid.¹¹⁵⁷ The *cis*-Co(dmg)₂(tfa)₂ product was structurally characterized. The synthesis and characterization of the diphenylglyoximate series *trans*-RCo(dpg)₂(L) were reported (dpg = diphenylglyoxime, R = Cl, Me, Et, CH₂Cl or *i*-Bu; L = py, 3,5-lutidine, γ -picoline, P(OMe)₃).¹¹⁵⁸ The crystal structure of MeCo(dpg)₂(py) found that the Co–C bond length was little affected by the methyl-to-phenyl substitution. Mixed oxime complexes such as (N₃)Co(dmg)(dpg)(py) have only recently been described.¹¹⁵⁹

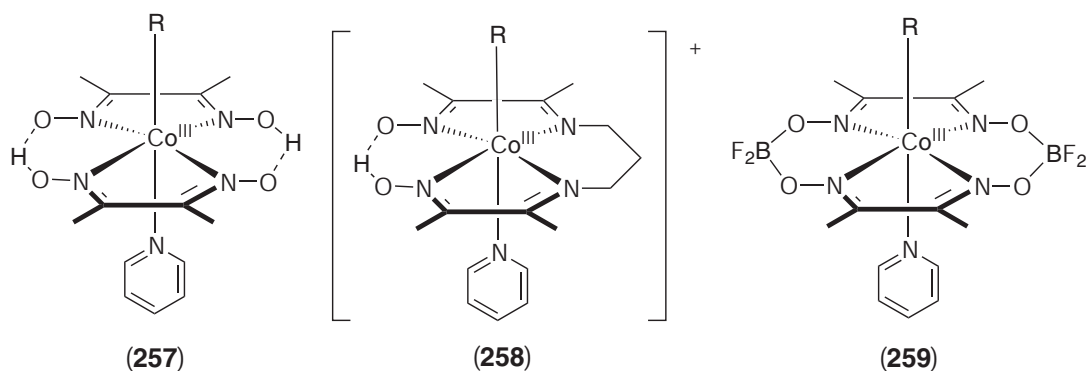

The *trans* dihalo (Cl[−] and Br[−]) Co^{III} complexes of the linear tetradentate dmg₂tn react with alkylating agents and NaBH₄ and ultimately pyridine to give the so called “Costa-type” B₁₂ model complexes [RCo(dmg₂tn)(py)]⁺ (**258**) in good yields (R = Et, CHMe₂, CH₂CMe₃, CH₂CF₃, CH₂CO₂Me, CH₂Ph, CH₂SiMe₃).¹¹⁶⁰ The X-ray crystal structures of the R = CH₂CMe₃ analog shows that the dmg₂tn ligand is more distorted from planarity than bis(dmg) cobaloxime relatives, and the Co–N bonds are longer. The carbonyl complex Co(dmg₂tn)(CO) may also be used as precursor to the homologs [RCo(dmg₂tn)L]⁺ (R = CH₂OMe, CH₂SMe, CH₂Cl, CH₂NO₂, CH₂CN, L = monodentate ancillary ligand).¹¹⁶¹ Axial Co–N bond lengthening was observed with increasing electron-donating ability of the R group. Introduction of alkyl substituents onto the trimethylene linker has been studied.¹¹⁶² Dimethylation of the central CH₂ group results in a complex with greater rates of py ligand dissociation. This is correlated with the crystallographically determined structure, which shows that the planar py ligand leans away from the more sterically demanding CH₂CMe₂CH₂ moiety compared with the dmg₂tn complex. The tetramethylene-bridged analogs [RCo(dmg₂bn)(OH₂)]⁺ were prepared in an effort to increase ligand-effected distortions that ultimately lead to a weakening of the Co–C bond, as seen in coenzyme B₁₂ through folding of the equatorial corrin ring. Although the crystal structure of [EtCo(dmg₂bn)(OH₂)]⁺ exhibits somewhat elongated Co–C and C–O bonds and an extended Co–C–C bond angle (119.3(5)°) the N₄ array is effectively planar,¹¹⁶³ in contrast to the Cu^{II} relative. The structure of the [EtCo(dmg₂bn)(Him)]⁺ analog has also been reported, although two different ligand conformations were identified within the asymmetric unit.¹¹⁶⁴ It has been noted that imidazole, once deprotonated, may form μ -imidazolato dimers and such species have been identified by NMR and crystallography.¹¹⁶⁵ Near-IR FT-Raman spectroscopy was used to investigate the influence of electronic and steric effects on the Co–Me stretching frequency. It was found that for the series MeCo(dmg₂tn)L, the Co–C frequency decreased (from 505 cm^{−1} to 455 cm^{−1}) with increasing electron-donating character of L.¹¹⁶⁶ The ethylmethyl glyoxime analog

$[(\text{Bz})\text{Co}(\text{emg}_2\text{tn})(\text{OH}_2)]^+$ has been shown to perform an unusual Co-to-C migration of the axial alkyl group upon photolysis, with the benzyl group attacking one of the oxime C atoms.¹¹⁶⁷

1,5,6-Trimethylbenzimidazole (Me_3Bzm) is an appropriate analog for the axial 5,6-dimethylbenzimidazole ligand in cobalamins. The complexes $[\text{RCo}(\text{dmg}_2\text{tn})(\text{Me}_3\text{Bzm})]^+$ ($\text{R} = \text{Me}, \text{Et}$ and CF_3CH_2) have been characterized structurally and the rates of substitution of the axial benzimidazole ligand were determined.¹¹⁶⁸ The comparable crystal structures of $[\text{MeCo}(\text{dmg}_2\text{tn})\text{L}]^+$ ($\text{L} = 1\text{-Meim}, 1,2\text{-Me}_2\text{im}$) show the steric influence of the 2-Me group, which extends the axial Co—N bond length from 2.042(2) Å to 2.100(4) Å, while the Co—C bond length is unaffected.¹¹⁶⁹ Novel 3-membered metallocycles (Co—C—N) have been formed by attack of a halomethyl axial ligand on the oxime ligand.^{1170,1171} An example of this is illustrated in Figure 9.

The tridentate 2-(2-pyridylethyl)amino-3-butanone oxime (Hpeab) is also an effective ligand for the formation of B_{12} model complexes with Co^{III} .⁵³⁸ Compounds of the general formula $[\text{RCo}(\text{peab})(\text{Hpeab})]^+$ ($\text{R} = \text{Me}, \text{Et}, \text{CH}_2\text{CF}_3, n\text{-Bu}$ and CH_2Cl) have been synthesized. Crystal structures show that Hpeab binds as a bidentate, while the peab anion coordinates as a tridentate, including the pyridyl group in the coordination sphere. The axial geometry in $[\text{MeCo}(\text{peab})(\text{Hpeab})]^+$ is closer to that found in methylcobalamin than has been reported for other B_{12} models.

An electrochemical study of the diaqua bis(dioxime), tetradentate dmg_2tn and macrocyclic $\text{dmg}_2(\text{BF}_2)_2$ (**259**) Co complexes has been reported.¹¹⁷² Both tetradentate ligands stabilize the divalent oxidation state relative to the bis(dmg) analog, with the trimethylene link in dmg_2tn being more effective in this role. The acyclic and macrocyclic diphenylborinic acid adducts $\text{dmg}_2(\text{BPh}_2)$ and $\text{dmg}_2(\text{BPh}_2)$ have also been reported.¹¹⁷³ Cyclic voltammetry and spectroelectrochemistry of the (**256**) series ($\text{R} = i\text{-Pr}, \text{neopentyl}, i\text{-Bu}, \text{Et}, \text{Bz}, \text{Me}, \text{HO}(\text{CH}_2)_2, \text{CH}_3\text{COOCH}_2$ and CF_3CH_2) was explored.¹¹⁷⁴ A marked influence of axial group bulk on the reactivity of the lower oxidation was found, and this was attributed to their ability to form stable bisalkyl complexes. The series $[\text{LCo}(\text{dmg}_2\text{tn})\text{Cl}]^+$ ($\text{L} = \text{py}, 4\text{-CNpy-}, 4\text{-Brpy-}, 4\text{-MeOpy}, 4\text{-Me}_2\text{Npy}$) and $[\text{Co}(\text{dmg}_2\text{tn})(\text{py})_2]^+$ were also synthesized. As L becomes more basic, the first $\text{Co}^{\text{III/II}}$ potential is shifted cathodically, although ligand substitution reactions following reduction complicate the voltammetry.¹¹⁷⁵

The Co complexes of the *o*-phenylenediamine-linked dioxime Hdmg_2Ph bearing a variety of monodentate ligands (halides and pseudo halides) in the axial coordination sites have been synthesized.¹¹⁷⁶ B_{12} model complexes $[\text{RCo}(\text{dmg}_2\text{Ph})(\text{L})]^+$ ($\text{R} = \text{Me}, \text{Et}, \text{Me}_2\text{CH}, \text{Bz}, \text{ch}; \text{L} = \text{py}, \text{H-im}, \text{or PPh}_3$) were prepared by the oxidative addition reactions of the alkyl halide to the *in situ*-generated monovalent dibromo complex.

Replacement of the axial pyridine by phosphine has been achieved with the synthesis of the complexes $[\text{MeCo}(\text{dmg}_2\text{tn})\text{L}]^+$ ($\text{L} = \text{P}(\text{OMe})_2\text{Ph}, \text{P}(\text{OEt})\text{Ph}_2, \text{PEtPh}_2, \text{P}(\text{OMe})_3, \text{P}(p\text{-Me}_2\text{NC}_6\text{H}_4)_3, \text{P}(\text{CH}=\text{CH}_2)\text{Ph}_2, \text{P}(\text{CHMe}_2)\text{Ph}_2, \text{PCyPh}_2, \text{P}(\text{CH}_2\text{CH}_2\text{CN})\text{Ph}_2, \text{PPh}_3$), which were characterized by ^1H NMR spectroscopy and crystallography for the trimethyl phosphite and triphenyl phosphine derivatives. The phosphine/phosphite ligand dissociation rates are twice as fast as bis(dmg) analogs, and vary by four orders of magnitude across the series.

In contrast with the role of cofactor B_{12} in methionine synthase (methyl group transfer to a thiol), functional B_{12} model complexes have provided a formidable challenge. Several oxime alkyl-cobalt (structural) B_{12} models when reacted with arene- and alkanethiolates lead only to

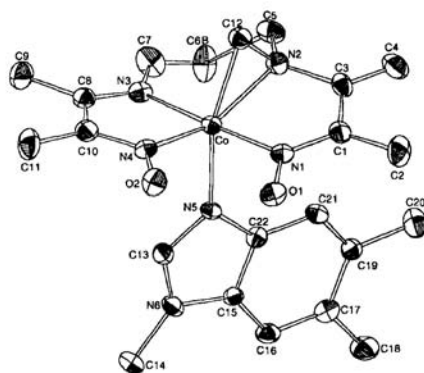

Figure 9 Pendent alkyl complex resulting from intramolecular attack of the chloromethyl axial ligand in $[(\text{ClCH}_2)\text{Co}(\text{dmg}_2\text{tn})(\text{Me}_3\text{Bzm})]$ on the coordinated tetradentate dioxime (reproduced with permission of the American Chemical Society from *Inorg. Chem.*, **1997**, *36*, 3854–3860).

thiolate coordination *trans* to the alkyl group.¹¹⁷⁷ An example is *trans*-[(EtS)Co(dmgl)₂(Me)]⁻ which exhibits a particularly long Co—S bond consistent with the strong *trans* influence of alkyl ligands.

6.1.3.1.2 Non-corrin proteins

(i) Native cobalt-dependent proteins

Aside from B₁₂ cofactors, there are at this time eight known Co-dependent proteins, in addition to so-called chaperone proteins that are involved in Co transport and uptake.¹¹⁷⁸ Methionine aminopeptidase (MetAP) represents the first Co-containing (non-corrin) protein to be characterized by X-ray crystallography. The enzyme is present in prokaryotes and eukaryotes and its function is to hydrolyze N-terminal methionine residues from polypeptides. Since the enzyme is isolated as the apoprotein, the identity of the native metal ion has not been established absolutely. However, MetAP from *Salmonella typhimurium* is active upon addition of Co²⁺, but not divalent Mg, Mn, or Zn. The crystal structure of MetAP from *E. coli* revealed a pair of Co^{II} ions bridged by two carboxylate residues (Glu235 and Asp108). Each metal is in a square-pyramidal coordination environment (260) which includes a weak Co—Co bonding interaction.¹¹⁷⁹ The vacant *trans* sixth coordination sites may be for substrate binding, or for coordination of a hydroxo ligand that itself is the active nucleophile. More recently, the crystal structure of MetAP from the thermophile *Pyrococcus furiosus* has been reported and a pair of Co ions were again revealed at the active site.¹¹⁸⁰ MetAP from other organisms as well as different metalloproteases (leucine (Zn₂) and proline (Mn₂) aminopeptidase) also employ a pair of transition metals at their active sites.

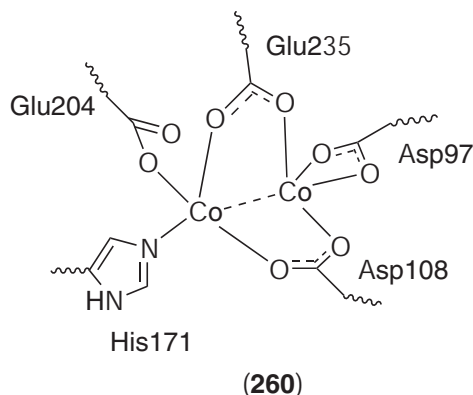

Proline dipeptidase cleaves dipeptides where proline is adjacent to the N-terminal residue. The enzyme is a homodimer, with one Co ion tightly bound in each subunit. However, it has been shown that an additional Co^{II} ion must be added (per subunit) for activity. This second ion is relatively weakly bound and may be substituted by Mn^{II} with somewhat attenuated activity. Curiously, the active site ligands identified in metallohydrolases such as MetAP are conserved in this enzyme despite a generally low sequence similarity.

Nitrile hydratase from various organisms has been well studied and even employed in industrial processes requiring the large-scale hydrolysis of nitriles to amides. The active site structure is believed to comprise two peptide N-donors and three cysteine thiolates bound to Co^{III} on the basis of a high sequence similarity with a structurally characterized Fe^{III} nitrile hydratase. The role of the Co^{III} ion is thought to be that of a Lewis acid that activates a hydroxo ligand for attack on the nearby nitrile. A number of biomimetic systems have recently been studied in an effort to better understand the properties of this enzyme.^{1040,1041,1181–1183}

Glucose isomerase catalyzes the conversion of D-glucose to D-fructose and has also been used extensively on an industrial scale.¹¹⁸⁴ Some, but not all, enzymes of this family require Co specifically, while others can function with other divalent ions. Environmental and health issues limit the concentrations of Co in culture media during D-fructose production and other metal ions are being sought as substitutes. Although the active site structure remains unknown, EXAFS, optical and EPR spectroscopy has suggest a low-spin divalent Co ion, bound by N and O-donors only (no S-donors).

Other less well-characterized Co-containing proteins include methylmalonyl-CoA carboxytransferase (or transcarboxylase); this is a complex multi-subunit enzyme comprising three different types of subunit, two of which contain Co.¹¹⁸⁵ A catalytically important high-spin divalent Co ion has been identified, but only the Co-free (biotin-containing) subunit has been structurally characterized. The Co-porphyrin containing aldehyde decarboxylase acts on fatty aldehyde substrates and is an important energy source in many organisms.¹¹⁸⁶ The rearrangement of L-lysine to L- β -lysine is catalyzed by lysine 2,3-aminomutase in the presence of pyridoxal phosphate, an Fe-S cluster and either divalent Co or Zn.¹¹⁸⁷ Although there are similarities with B₁₂ chemistry (activation by S-adenosylmethionine leading to an adenosyl-bound cofactor) no cobalamins are present nor do they activate the enzyme. Furthermore, the Co ions are not bound within the Fe-S cluster as shown by EPR spectroscopy. Bromoperoxidase specifically requires Co for activity (oxidative C-Br bond formation), but the ion is weakly bound and as yet the essential role of the metal in this enzyme is not well understood.¹¹⁸⁸

(ii) Cobalt-modified proteins

Apart from its natural occurrence, Co may find its way into other proteins either adventitiously or deliberately. A study was undertaken where the blood, serum, and plasma of workers occupationally exposed to Co were analyzed for the element.¹¹⁸⁹ When separated by gel electrophoresis under denaturing conditions, the Co fractions in all blood, serum, and plasma samples showed a similar protein pattern. A variety of proteins of differing size were found to bind Co in fractions collected at pH 5, whereas only hemoglobin was found in the pH 7 fractions. The conclusions were that *in vivo* Co is bound to plasma proteins, perhaps albumin and hemoglobin.

(l) *Active site structure and spectroscopy.* Due to its well-understood coordination chemistry, characteristic spectral properties, lability and compatible ionic radius and charge, divalent Co is a useful active site substituent for spectroscopically silent metal ions such as Zn^{II} and Cu^I, and Co substitution has been used as a structural probe of protein active sites. The paramagnetic NMR shifts induced by divalent Co substituted for the native diamagnetic metal ion at the active site is a useful tool in the interpretation of NMR spectra of the protein. The binding of L- and D-phenylalanine and carboxylate inhibitors to Co^{II}-substituted carboxypeptidase A in the presence of pseudohalogen N₃⁻, NCO⁻, and NCS⁻ was studied by ¹H NMR.¹¹⁹⁰ The proton signals of the bound histidine residues were sensitive to the interactions between the inhibitors and the metal. Enzyme-inhibitor complexes with characteristic NMR features were identified. L-Phe formed a 1:1 complex, whereas D-Phe bound stepwise, first to a non-metal site and then to the Co ion forming a 2:1 complex. The carboxylates CH₃COO⁻ and PhCH₂COO⁻ also formed 2:1 adducts stepwise with the enzyme, but 2-phenylpropionate gave a 2:1 complex without any detectable 1:1 intermediate. The pseudohalides N₃⁻, NCO⁻, and NCS⁻ generated complexes directly with the Co^{II}:L-Phe adduct but indirectly with the D-Phe and carboxylate inhibitor, 2:1 complexes displacing the inhibitor from the metal. Inhibitor binding constants have also been determined from ¹³C NMR T₁ and T₂ measurements on the ¹³C-enriched amino acid inhibitors,¹¹⁹¹ and EPR spectroscopy has been employed as well to gain insight to the active site structure.¹¹⁹² Substitution of Cu^I by Co^{II} in blue copper proteins has also been achieved for the purpose of NMR investigations. Assignment of the ¹H NMR spectrum of *Pseudomonas aeruginosa* Co-substituted azurin has been made with contact-shifted signals from amino acid residues as distant as 10 Å from the metal being achieved.¹¹⁹³ Resonances due to the five amino acid residues known to reside at the metal binding site of oxidized (Cu^{II}) azurin (His46, His117, Cys112, Met121 and Gly45) were identified. However, there are metal-dependent differences; most notable being that Met121 appears to be only weakly interacting with the metal ion in the Co protein whereas Gly45 is apparently strongly bound to Co in contrast to the native Cu protein. Overall, a distorted tetrahedral N₂OS geometry for the Co ion was assigned. Metal ion-induced conformational changes in *Serratia* protease (one Zn ion per native protein, replaced by Co) were investigated by small-angle X-ray scattering. The protein is an elongated ellipsoid of approximately 110 × 40 × 40 Å with a large cleft in its central region. Comparisons of the native (Zn) enzyme with the apoenzyme show small but significant differences in their radii of gyration, maximum particle dimensions, and intraparticle pair-distance distributions.¹¹⁹⁴

The Zn^{II} ion of angiotensin-converting enzyme (ACE) has been replaced by Co^{II} to give an active, chromophoric enzyme and inhibitor binding has been identified spectroscopically. Visible and MCD spectroscopy were used to characterize the catalytic metal binding site in the

Co-substituted enzyme and in a number of enzyme-inhibitor complexes.¹¹⁹⁵ The visible absorption spectrum of Co ACE exhibits a single weak broad maximum (525 nm) in contrast to the spectra of enzyme-inhibitor complexes, which display red-shifted and more intense maxima (525–637 nm). The presence of S—Co charge-transfer bands in the spectra of the tetrahedral Co ACE-inhibitor complex confirm direct ligation of the thiol group. The optical spectrum of Co-substituted *Aeromonas* aminopeptidase is perturbed by the presence of equimolar concentrations of D-amino acid hydroxamates and acyl hydroxamate inhibitors. D-Valine and D-leucine hydroxamate each produces a splitting of the characteristic 527 nm maximum of the Co enzyme to give three new maxima between 570 nm and 480 nm, whereas hydroxamates of L-valine and L-leucine produce little change in the spectrum.¹¹⁹⁶ Conversion of yeast Cu^I-thionein to the Co^{II} derivative has been achieved. The optical spectrum of the Co protein is virtually identical to those of Co-substituted metallothioneins originating from vertebrates. Characteristic charge transfer bands and *d-d* transitions led to the proposal of a tetrahedral Co-thiolate coordination with three bridging cysteine S-donors.¹¹⁹⁷ Superoxide dismutase has a crucial role in defense against cytotoxic O₂⁻. It contains both Zn^{II} and Cu^{II} binding sites and these have been replaced by Co^{II} in all three combinations, i.e., Co^{II}—Co^{II}; E—Co^{II}, and Co^{II}—E where E represents a vacancy at either the Cu or Zn binding site.¹¹⁹⁸ The cobalt-protein derivatives have been characterized by optical absorption, CD, and fluorescence spectroscopy. The Co^{II}—Co^{II} protein exhibits an optical spectrum corresponding to the sum of the spectra of the other two derivatives, although the CD spectra were not additive, suggesting that the presence of Co^{II} in one site strongly affects the geometry of the neighboring site. Fluorescence spectra illustrated that Co^{II} ions exert a different quenching effect on tyrosine emission, depending on whether they are located in the Zn^{II} or in the Cu^{II} site.

(*mm*) *Activity and inhibition.* There are many Zn-dependent enzymes that retain their catalytic activity or that are equally sensitive to inhibition upon substitution by divalent Co. Although the chelating ligand *N,N*-diethyldithiocarbamate anion is an inhibitor of (Zn-dependent) bovine carbonic anhydrase (CA), no removal of Zn could be detected even at a very high concentrations of anion. At identical pH values a larger inhibitory effect was found for the Co-substituted enzyme, but Co^{II} was removed from the protein by the ligand at pH less than 7. However, Co ion remained bound at pH 10, and a five-coordinate Co^{II} ion was observed spectroscopically.¹¹⁹⁹ The kinetics of complex formation between Co^{II}-substituted CA and OCN⁻, SCN⁻, and CN⁻ has also been studied.¹²⁰⁰ Formation of a 1:1 complex occurs exceedingly quickly and the explanation for this observation was that the anion enters a vacant coordination site on the metal, effecting a change in coordination number of the Co ion from 4 to 5. Reversible amide inhibition of Co-substituted CA by iodoacetamide, urethane, and oxamate has been reported,¹²⁰¹ and visible spectroscopy indicated coordination of the inhibitors to the metal with a deprotonated *N*-bound amide being the final product with O-bound linkage isomer intermediates being found in some cases.

Streptomyces griseus aminopeptidase specificity was studied using amino acid 4-nitroanilide substrates. The zinc enzyme hydrolyzes leucine 4-nitroanilide at a ten-fold faster rate than the Co enzyme, the Co enzyme hydrolyzes alanine 4-nitroanilide at a more than 20-fold faster rate than the zinc enzyme.¹²⁰² Activity of the bacterial enzyme *N*-succinyl-L-diaminopimelic acid desuccinylase was completely abolished following dialysis of the enzyme against metal chelators, but restored on addition of Co^{II} or Zn^{II}. The binding constants for both metals were similar and the Co enzyme was about twice as active as the Zn homolog.¹²⁰³ The enzyme is highly specific for its natural substrate, and given its essential role in bacterial growth it is an ideal target for the development of inhibitors with antibacterial potential. Divalent Co inhibits the Ca²⁺—Mg²⁺—ATPase activity of sealed muscle sarcoplasmic reticulum vesicles, of solubilized membranes, and of the purified enzyme. Inhibition by Co^{II} is likely due to free Co_{aq}²⁺ binding to the enzyme, which is reversible on addition of Ca²⁺ in millimolar concentrations, indicating that the Ca binding site is the one targeted by Co.¹²⁰⁴ The kinetic and spectral properties of native (Zn) and Co-substituted D-lactate dehydrogenase (a flavin-dependent enzyme) have been compared.¹²⁰⁵ Optical and MCD spectra are consistent with high-spin tetrahedral Co and the metal appears to be involved in substrate binding and reduction. The Zn-containing protein farnesyltransferase catalyzes the addition of a farnesyl isoprenoid to a conserved cysteine in peptide or protein substrates. Substitution of Zn by Co has no effect on catalytic activity, but reveals through optical spectroscopy a thiolate ligand at the active site as part of a pentacoordinate or distorted tetrahedral coordination sphere.¹²⁰⁶ Furthermore, the thiolate charge transfer band intensity is enhanced upon substrate binding, which was indicative of the formation of a second Co—thiolate bond corresponding to the thiolate group of the peptide substrate. Acetylpolymine amidohydrolase exhibits activity in both its native (Zn) form and upon Co substitutions, although the pH optima are different.¹²⁰⁷

Co-for-Zn substitution in alcohol dehydrogenase from *Saccharomyces cerevisiae* revealed a 100-fold increase in activity and a higher resistance of the modified protein to the inhibitory action of other divalent transition metals,¹²⁰⁸ making the Co-modified enzyme suitable for biotechnological applications.

The introduction of redox activity through a Co^{II} center in place of redox-inactive Zn^{II} can be revealing. Carboxypeptidase B (another Zn enzyme) and its Co-substituted derivative were oxidized by the active-site-selective *m*-chloroperbenzoic acid.¹²⁰⁹ In the Co-substituted oxidized (Co^{III}) enzyme there was a decrease in both the peptidase and the esterase activities, whereas in the zinc enzyme only the peptidase activity decreased. Oxidation of the native enzyme resulted in modification of a methionine residue instead. These studies indicate that the two metal ions impose different structural and functional properties on the active site, leading to differing reactivities of specific amino acid residues. Replacement of zinc(II) in the methyltransferase enzyme MT2-A by cobalt(II) yields an enzyme with enhanced activity, where spectroscopy also indicates coordination by two thiolates and two histidines, supported by EXAFS analysis of the zinc coordination sphere.¹²¹⁰

Divalent Co substitution in copper amine oxidase revealed 19% of the native specific activity (for MeNH₂) and 75% of the native reactivity toward phenylhydrazine. The major cause of this was a 68-fold increase in *K_m* for O₂. These investigations support the idea that electrons flow directly to bound O₂ without the need for a prior metal reduction and that the Cu does not redox cycle but simply provides electrostatic stabilization during reduction of O₂ to O₂⁻.¹²¹¹

6.1.3.1.3 Biomimetic chemistry

(i) Dioxygen binding

Although the natural O₂ storage and transport proteins hemoglobin and myoglobin bear no Co ions, there have nonetheless been many Co-containing functional models of these proteins reported in the literature. The key to a successful O₂ carrier is reversibility. That is, the metal must not undergo spontaneous auto-oxidation to generate superoxide or peroxide species, nor must the coordinated O₂ ligand be attacked by protons or reductants that may assist this process.

Some 6,13-disubstituted macrocyclic Co(tmtaa) (**60**) complexes were prepared by Busch and co-workers and their O₂ binding affinities were determined.¹²¹² The complexes slowly undergo oxidation, but the ligand remains intact. This group has made many contributions to the field of O₂ binding through a class of macrobicyclic ligands often referred to as the cyclidenes (or lacunar macrocycles). Examples of 14-, 15-, and 16-membered macrocycles bound to divalent Co have been reported. For example, the planar [14]cyclidene complex has a small cavity which is only capable of partially protecting a bound O₂ from attack by solvent. This is in contrast to the deep saddle-shaped cavities of the 15- and 16-membered homologs. Some Co complexes of the [16]cyclidene family ((**261**) is an example) bind O₂ reversibly at low temperature with an enhanced affinity and lower rate of auto-oxidation compared to the [14]cyclidene analogs, both features attributed to the more exposed O₂ ligand in the smaller macrocycle. Dioxygen affinity decreases monotonically with the length of the polymethylene bridging group from octamethylene to tetramethylene and no binding occurs with a trimethylene bridge.¹²¹³ The X-ray crystal structure of the Co-dioxygen adduct of (**261**) [Co(MeMeC₆-[16]cyclidene)(Me-Im)(O₂)](PF₆)₂ (Figure 10) reveals that the conformation of the ligand in the six-coordinate complex is crucial in protecting the O₂ ligand. Subsequently, the kinetics of O₂ binding to the vacant coordination site of the divalent complex were found to proceed with a very low activation barrier at rates comparable with the biological oxygen carriers myoglobin and hemoglobin.¹²¹⁴ An interesting discovery was that ionizable Me groups on the cyclidene ligand enhance the rate of auto-oxidation of the divalent O₂ adduct, which prompted the synthesis of unsubstituted cyclidenes and their Co complexes.¹²¹⁵ A lower O₂ binding constant was observed to the unsubstituted cyclidene complex, although the rates of dioxygen binding were as fast as those of the Me-substituted analogs, which pointed to differences in the complex dissociation rates as being responsible for the disparate O₂ affinities. Molecular dynamics calculations have been used to examine solution conformations of these complexes.¹²¹⁶

The ability of the ubiquitous Co(salen) complex and its tetradentate Schiff base analog complexes to bind O₂ reversibly has been central to most investigations of its coordination chemistry. A density functional computational investigation has been carried out on the O₂ carriers

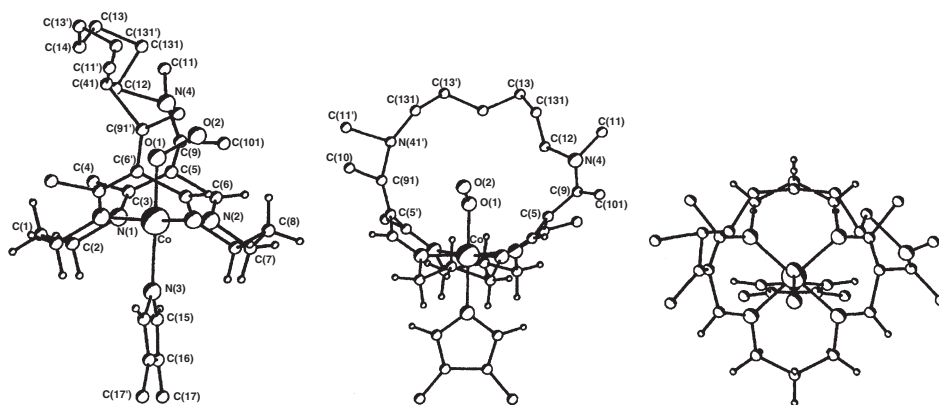
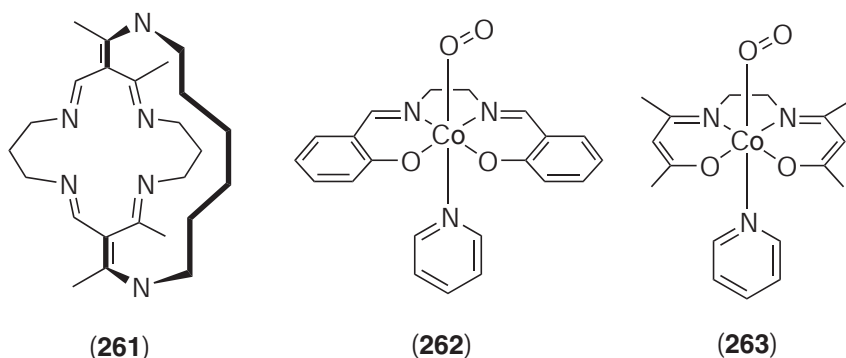

Figure 10 Three views of the Co-O₂ adduct of (261), with a disordered N-methylimidazole as the sixth ligand (reproduced with permission of the American Chemical Society from *Inorg. Chem.*, **1994**, *33*, 910–923).

(O₂)Co(salen)(py) (262) and (O₂)Co(acacen)(py) (263).¹²¹⁷ The calculated geometries and O₂ binding energies were consistent with experiment. The inclusion of effects due to the basis set superposition error and zero point correction attenuate the calculated binding energy. Magnetic susceptibility measurements showed that 22% of divalent Co(salen) exists as the high-spin ($S = 3/2$) Co(salen)(py)₂ complex in pyridine solution at 295 K and that lower temperatures favor the high-spin species.¹²¹⁸ In DMF-*d*⁷ temperature-dependent NMR experiments, the formation of antiferromagnetically coupled dimers at low temperature was indicated. The pressure dependence of the high-spin-low-spin spin equilibrium was studied at room temperature for the six-coordinate 3-carboxy derivatives of Co(salen)L₂, where L is a coordinating solvent. The high-spin-low-spin crossover was observed with near-edge XANES spectroscopy.¹²¹⁹ The pressures required to induce a spin transition were less than 1.1 GPa for L = pyridine, 4-*tert*-butylpyridine and H₂O (which are known to also undergo thermal spin crossover) and 6.5–9.0 GPa for L = 3-methylpyridine, which is normally high-spin at all temperatures.



The single-electron reduction and oxidation of Co(salen) is solvent dependent as a result of the available coordination sites perpendicular to the CoN₂O₂ plane.¹²²⁰ Furthermore, substituents on the phenyl rings modulate the observed redox potentials and subsequently the O₂ binding constants. Hammett correlations are obtained.¹²²¹ Potentiometric titrations were performed to determine the O₂ binding constants and species distribution as a function of pH for a variety of Schiff base Co complexes.¹²²²

The Co(salen) complex may be prepared *in situ* inside zeolite Y (but not zeolite 5A) by reaction of the free ligand with the Co^{II}-exchanged zeolite (a “ship in a bottle” approach).¹²²³ When reacted with pyridine, 1:1 O₂ adducts are formed that are too large to exit the interior of the material and although the O₂ complex formation constants are smaller, auto-oxidation is attenuated significantly within the zeolite cavity. Similar experiments were performed to compare the reactivity of Co(salen) within cubic (zeolite Y) and hexagonally symmetric (EMT) cavities.¹²²⁴ An analogous approach has been reported using porous organic matrices to encapsulate Co(salen) and its O₂ adduct.¹²²⁵ Further, an oxygen-sensitive membrane incorporating Co(salen) has been prepared via sol-gel methods with poly(*N*-vinylpyrrolidone) as the mediation agent.¹²²⁶

Well-dispersed silica and polymer/Co(salen) segments at a molecular level were obtained. Non-destructive immobilization of Co(salen) complexes within silica aero- and xerogels was also achieved with the sol-gel method using silylether-appended salen.¹²²⁷

The mononuclear O₂ adduct L(salchn)Co(O₂) (L = various substituted pyridines) bearing a fused cyclohexyl ring has been investigated by EPR spectroscopy.¹²²⁸ The effect of the basicity of the solvent *trans* to the dioxygen ligand on the *g* and *A* values was studied and discussed in terms of the degree of Co—O₂ back bonding. 1-Hydroxy-2-naphthaldehyde may be considered as a benzo-salicylaldehyde and Co complexes of its corresponding npthn analogs have been prepared with 2–6 methylene groups connecting the two N donors.¹²²⁹ Reversible O₂ binding occurs with the ethylenediamine analog Co(npthn) complexes in DMF, although the reaction is considerably more exothermic than for Co(salen).

(ii) Polyphosphate and phosphate ester hydrolysis

The biomimetic catalysis of polyphosphate hydrolysis by Co^{III} amines has received a great deal of attention. A number of tetraaminecobalt(III) complexes are known to be effective in this role. A stereochemical requirement is a *cis*-octahedral tetraamine complex where a pair of adjacent reactive coordination sites are present; one for a highly polarized hydroxo ligand (the nucleophile) and the other for the polyphosphate (the substrate). ATP,^{1230–1232} cAMP (adenosine 3',5'-cyclic monophosphate),¹²³³ triphosphate,^{1234,1235} and pyrophosphate hydrolysis have been shown to be catalyzed by the macrocyclic complex [Co(cyclen)(OH₂)(OH)]²⁺ (**140**). Monodentate coordination of a terminal phosphate group to produce a species of the type [Co^{III}(cyclen)(OPO₃PO₂R)(OH)]ⁿ⁺ (**264**) is followed by rapid intramolecular phosphate hydrolysis involving the *cis*-coordinated hydroxo ligand resulting in the [Co(cyclen)(OPO₃)(OH)]⁻ ion as a product.

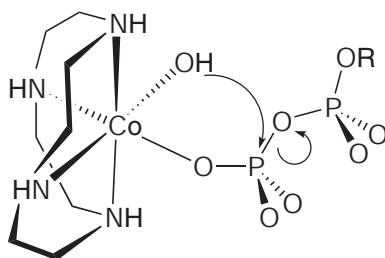

(264)

Phosphate monoester, diester,¹²³⁶ and triester¹²³⁷ hydrolysis is also catalyzed by this versatile ion, and it is known that the amine spectator ligands also influence the observed rates significantly.¹²³⁸ Measurable rate increases of up to 10⁷-fold have been reported with Co^{III} polyamine catalysts.¹²³⁹ The large difference in reactivity of monodentate hydroxyethylphosphate where a *cis*-hydroxy group is also bound, compared with the chelated ester occupying both sites, points to the role of the coordinated nucleophile in hydrolysis of the phosphoester.¹²⁴⁰ With additional aquahydroxycobalt(III) tetraamines present, however, ester hydrolysis is significantly accelerated, pointing to a dinuclear intermediate forming. Indeed, a product of this hydrolysis has been characterized as [(trpn)Co(OP(O₂)O)Co(trpn)]³⁺, supporting this view (trpn = tris(3-aminopropyl)amine).

Understanding the cooperative hydrolysis of phosphoesters by two metal ions, the presumed mechanism in endonucleases, is a current focus of attention, prompting study of dinuclear systems. Diester coordination can involve both terminal O atoms as donors, as exemplified in the bridged dinuclear complexes (**265**).¹²⁴¹ Ester cleavage is promoted in basic solution via nucleophilic attack by a deprotonated bridging hydroxide. The Co···Co separation (2.9 Å) in the dimer is much shorter than in dinuclear phosphodiesterases.¹²⁴² The diester is hydrolyzed by a mechanism involving double Lewis acid activation and attack from a neighboring bridging oxo ligand, with an exceptional 10¹²-fold rate acceleration reported. The hydrolysis of methyl aryl phosphate diesters bound to Co^{III} in the dinuclear ion [{"tame"}Co]₂(μ-OH)₂(μ-O₂P(OAr)(OMe))]³⁺ is base catalyzed, and sensitive to the basicity of the aryloxy leaving group and to variation of the "spectator" amine ligand.¹²⁴³ Further rate enhancements have been observed in carefully designed dinuclear Co^{III} cyclen complexes capable of binding monoester¹²⁴⁴

or diester¹²⁴⁵ substrates within a pocket between the pairs of reactive *cis* aqua/hydroxo ligands on each metal (266). A triply bridged dinuclear complex with a bridging phenylphosphonate ester has also been examined as a model of phosphodiester cleavage.⁹⁶⁶

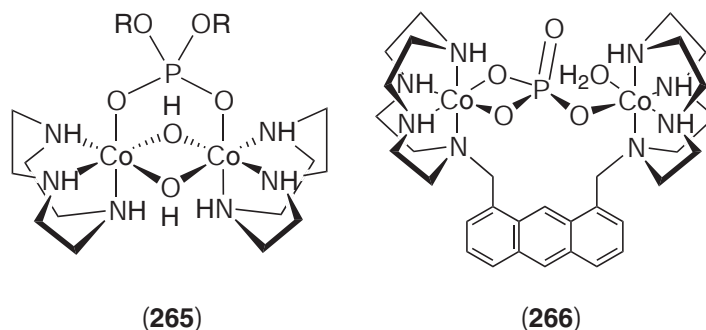

DNA (phosphodiester) hydrolysis has also been examined with $[\text{Co}(\text{cyclen})(\text{OH}_2)(\text{OH})]^{2+}$ as the active species.^{1239,1246} Significant rate enhancement of linear¹²⁴⁷ and supercoiled¹²⁴⁸ double-stranded polydeoxyribonucleotide hydrolysis is observed by immobilizing the Co complex on a polystyrene support. Wider exploration of reactions with DNA follow.

6.1.3.1.4 DNA binding, intercalation, and scission

The humble $[\text{Co}(\text{NH}_3)_6]^{3+}$ ion is an extremely effective hydrogen bond donor, and its high charge density ensures a strong association with oligonucleotide duplexes both large and small. These ion pairing interactions can influence the helical structure of DNA and its relatives considerably.¹²⁴⁹ The oligonucleotide- $[\text{Co}(\text{NH}_3)_6]^{3+}$ interaction has been studied with a wide variety of physical techniques including crystallography,¹²⁵⁰⁻¹²⁵⁵ electron microscopy,^{1256,1257} atomic force microscopy,¹²⁵⁸ circular dichroism,^{1259,1260} vibrational spectroscopy,^{1261,1262} NMR,¹²⁶³⁻¹²⁶⁵ and light scattering.^{1266,1267} Condensation of DNA^{1268,1269} is affected by the presence of this ion. It has been found that $[\text{Co}(\text{NH}_3)_6]^{3+}$ effects the conversion of B- (right-handed) to Z-DNA (left-handed) or B- to A-DNA (conformationally distinct right-handed helices) depending on the DNA sequences, and a number of spectroscopic and theoretical¹²⁷⁰ studies have investigated this phenomenon. Marked changes in the helical structure of the oligonucleotide such as bending and photosensitized cleavage of the helix have been observed.^{1271,1272}

The interaction of chiral $[\text{Co}(\text{en})_3]^{3+}$ with DNA and small oligonucleotides has been extensively studied. A ¹H NMR investigation revealed distinctly different chemical environments of the nucleotide protons of a dodecanucleotide in the presence of the different enantiomers, and concluded that Δ - $[\text{Co}(\text{en})_3]^{3+}$ binds with the dodecamer in the major groove, near the center of the duplex and binds more strongly than the corresponding Λ isomer.¹²⁷³ This interaction has been investigated with molecular dynamics simulations, and this study identified key H-bonding interactions responsible for the diastereoselectivity.¹²⁷⁴ A ⁵⁹Co and CD spectroscopic study¹²⁷⁵ of the interaction between the Δ - and Λ - $[\text{Co}(\text{en})_3]^{3+}$ with DNA identified a similar sequence selectivity (guanine) to that seen for $[\text{Co}(\text{NH}_3)_6]^{3+}$, and both enantiomers were found to induce a B-to-A DNA conversion in G-rich regions while leaving other sections of the duplex in the B conformation.¹²⁷⁶ However, Δ - $[\text{Co}(\text{en})_3]^{3+}$ binds more strongly to right-handed, guanine-rich DNA than Λ - $[\text{Co}(\text{en})_3]^{3+}$. The reverse is true for left-handed DNA. The two enantiomers bind in an indistinguishable manner to AT-rich DNA. These findings were subsequently supported by 2D NMR experiments.¹²⁷⁷ The B-Z DNA transformation in poly (dG-dC)(dG-dC) DNA, known to be assisted by $[\text{Co}(\text{NH}_3)_6]^{3+}$, has also been achieved with $[\text{Co}(\text{en})_3]^{3+}$.¹²⁶⁰ DNA has been shown to co-precipitate rapidly with $[\text{Co}(\text{en})_3]^{3+}$ at trace concentrations whereas charge neutral and anionic complexes are left in solution.¹²⁷⁸

The $[\text{Co}(\text{phen})_3]^{3+}$ complex is photoactive and a powerful oxidant in its excited state. The ion has no H-bonding groups and hence is considerably more hydrophobic¹²⁷⁹ than hexamine relatives. These properties have proven particularly useful. Aryl and alkyl substituted $[\text{Co}(\text{phen})_3]^{3+}$ complexes have received a great deal of attention due to their ability to intercalate within the helical structure of DNA through a combination of electrostatic and hydrophobic forces. The chirality of the tris-chelate complex is crucial in determining the degree of association between the complex and

DNA. A key paper by Barton and Raphael¹²⁸⁰ reported that (right-handed) B-DNA associates strongly with Δ -[Co(4,7-Ph₂-phen)₃]³⁺ but not with its Λ enantiomer. Upon irradiation DNA nicking was achieved, which was attributed to photooxidation by the Co^{III} complex when closely bound to the helix activating strand scission. The area of DNA intercalation by [Co(phen)₃]³⁺ and other similar complexes has received a great deal of attention subsequently.¹²⁸¹ The DNA double helix has been shown to be an efficient conduit for intermolecular electron transfer between photoexcited [Ru(phen)₃]²⁺ and [Co(phen)₃]³⁺, where both complexes are intercalated within the double helix.¹²⁸² This concept was extended to the same intermolecular electron transfer reaction on the surface of starburst dendrimers.¹²⁸³ Electrochemical methods have been employed to quantify the association constants between the Co complex and various oligonucleotides,^{1284–1286} and to gauge the effect of DNA binding on the rate of diffusion of the Co complex.¹²⁸⁷ The concept of association between the DNA double helix and the complementary [Co(phen)₃]³⁺ unit has been extended to DNA-modified electrodes with potential biotechnological applications.^{1288–1293} Adsorptive transfer stripping voltammetry at a hanging mercury drop electrode has been used to detect conformational changes of DNA due to binding of DNA intercalators.¹²⁹⁴

The molecules bleomycin A₂ and B₂, (**267a**) and (**267b**), comprise a potent chemotherapeutic agent for the treatment of cancer. The anti-cancer activity lies in the drug's ability to achieve DNA strand scission in tumor cells through the production of peroxy species. A single bleomycin molecule is capable of cleaving both strands of DNA in the presence of its required cofactors Fe_{aq}²⁺ and O₂ without dissociating from the helix. There are a number of N donors (in bold) that participate in binding the Fe cofactor and produce hydroperoxide as a ligand that initiates strand cleavage. Substitution of Co for Fe enables interactions between the drug and DNA fragments to be investigated by NMR spectroscopy. Conformational properties of the HO₂-Co^{III}-bleomycin A₂ (**267a**) (Form I) and Co^{III}-bleomycin (Form II) complexes bound to DNA oligomers were examined by NMR.¹²⁹⁵ Form I binds in slow exchange to the oligomers d(GGAAGCTTCC)₂ and d(AAACGTTT)₂, whereas Form II binds with DNA in fast exchange on the NMR time scale. The association constant of Form II with d(GGAAGCTTCC)₂ (pH 7.4, 25 °C) is $1.7 \times 10^5 \text{ M}^{-1}$. A later 2D NMR study of the complex formed between Co-bleomycin and other oligonucleotides gave a well-defined picture, which found that the bithiazole tail of bleomycin is partially intercalated between T19 and A20 of the duplex and that the metal binding domain is poised for abstraction of the T19 H4' in the minor groove.¹²⁹⁶ The interaction between the Co^{III} complex of a bleomycin functional model (AMPHIS-NET) and the oligonucleotide d(CGCAATTGCG)₂ were examined by 2D NMR methods and molecular dynamics calculations.¹²⁹⁷ The 1:1 cobalt(III) complex of AMPHIS-NET binds in the minor groove of the oligonucleotide at the central AATT site. Cross peaks also indicate that the metal binding moiety of the Co^{III}-AMPHIS-NET complex interacts with the oligonucleotide two base pairs beyond the central AATT site in the minor groove.

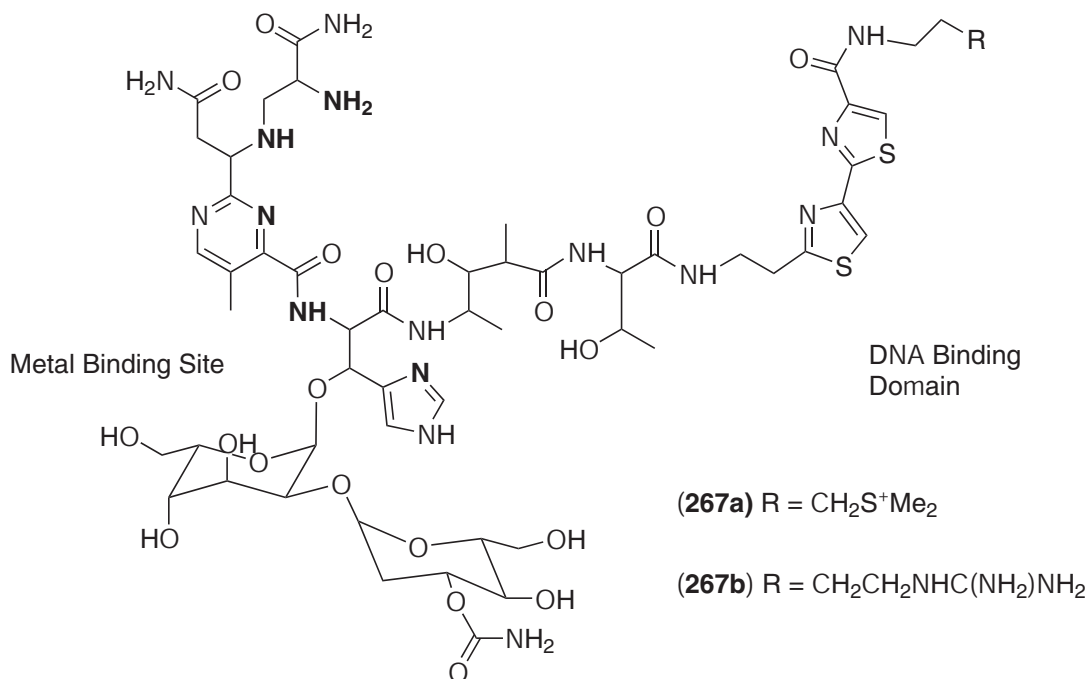

6.1.3.1.5 Biological electron transfer

Association of $[\text{Co}(\text{NH}_3)_6]^{3+}$ with acidic amino acid residues on the surface of proteins has been exploited in the “promotion” of electron transfer reactions of redox active proteins at electrode surfaces.^{1298,1299} The $[\text{Co}(\text{phen})_3]^{3+}$ and $[\text{Co}(\text{bpy})_3]^{3+}$ ions are particularly attractive high-potential, single-electron, outer-sphere oxidants lacking any potential hydrogen bonding sites. The oxidation of blue copper proteins with $[\text{Co}(\text{phen})_3]^{3+}$ and $[\text{Co}(\text{bpy})_3]^{3+}$ has been studied in a series of papers from Sykes and co-workers,^{1300–1305} and other groups.^{1306–1309} Reactions of the Co^{III} complexes with ferrocyclochromes,^{1310–1318} Fe–S clusters,¹³¹⁹ molybdoenzymes,¹³²⁰ and galactose oxidase¹³²¹ have also been reported. Enantioselective oxidation of ferrocyclochrome *c* by optically pure $[\text{Co}(\text{bpy})_3]^{3+}$ was interpreted as evidence for the closeness of approach of the Co^{III} complex to a hydrophobic, and inherently chiral, pocket of the protein.¹³²² Like the bpy and phen homologs, the $[\text{Co}(\text{terpy})_2]^{3+}$ ion has been used as a single-electron oxidant of a number of biological targets.^{1305,1323} With the $[\text{Co}(\text{phen})_3]^{3+/2+}$ couple, the $[\text{Co}(\text{terpy})_2]^{3+/2+}$ system has been used as a high potential mediator in redox potentiometry of biological redox centers.¹³²⁴

6.1.3.1.6 Medicinal chemistry

Co porphyrins have been found to play interesting and varied roles in medicine. Co protoporphyrin and *meso*-substituted porphyrins administered subcutaneously to normal adult rats led to decreases in food intake and sustained decreases in body weight, while direct injection of the compound into the brain produced similar changes in food intake and body weight, but requiring about 1–2% of the parenteral dose.¹³²⁵ Similar effects were observed with genetically obese rats, chickens, and dogs. These studies demonstrate that porphyrins can act on the central nervous system to regulate appetite and to produce long-sustained diminutions in body weight and content of fat in animals; pharmaceutical compositions for these porphyrins for the treatment of obesity have been patented.¹³²⁶

The high CN^- affinity of trivalent $[\text{Co}(\text{TSP})]^{4-}$ has led to its investigation as a potential cyanide antidote either alone or in various combinations with the cyanide antagonists NaNO_2 and $\text{Na}_2\text{S}_2\text{O}_3$.¹³²⁷ The study found that administration of $[\text{Co}(\text{TSP})]^{4-}$ alone protects against the lethal effects of cyanide, and that the complex adds to the protection provided by $\text{Na}_2\text{S}_2\text{O}_3$ and/or NaNO_2 . Co protoporphyrin administered in conjunction with organ transplantation has been found to enhance organ survival. Inhibition of cytotoxicity *in vitro* and prolongation of graft survival in therapy of heart allograft recipients has been demonstrated.¹³²⁸ It is known that CoCl_2 is a potent inducer of heme oxygenase *in vivo* in animals, so the possibility of the biosynthesis of Co protoporphyrin was examined in human hepatoma cells by incubating them with CoCl_2 and protoporphyrin and δ -aminolevulinic acid, the precursor of protoporphyrin.¹³²⁹ Both types of treatment led to a potent induction of heme oxygenase mRNA, with Co protoporphyrin formation demonstrated in cells incubated with the metal and δ -aminolevulinic acid, which demonstrated that incorporation of Co into the porphyrin is necessary for induction, and indicated that the role of CoCl_2 (as its porphyrin complex) was to activate the heme oxygenase gene via a heme-responsive transcription factor.

The therapeutic potential of sarcophagine cage complexes in general has been reviewed.⁷⁶⁰ For Co cages, in particular (162), the irreversible nature of coordination means that the metal is a spectator in systems examined to date. Most of the uses for this class of Co complex in biology relate to the nature of the substituents introduced at the cap. Long alkyl substituents result in complexes that exhibit surfactant-like properties and these have been found to exhibit antiparasitic activity.^{1330–1332} The anthracenyl-substituted (cationic) Co cage (unlike anthracene itself) associates strongly with DNA and irradiation of the intercalated complex at 254 nm leads to single-strand cleavage of DNA.¹³³³

6.1.4 INDUSTRIAL AND ANALYTICAL APPLICATIONS OF COBALT COMPLEXES

6.1.4.1 Organic Transformations

The use of transition metal compounds in organic synthesis, where they may be involved in stoichiometric reactions or catalytic reactions, has grown consistently, as recent reports illustrate.^{1334–1337}

Catalysts for promoting organic transformations are as diverse as are the reactions they catalyze, and there are a growing number of examples featuring Co extant in the literature. Nevertheless, Co features less commonly than some other metal ions, but may find application in a range of characteristic organic reactions such as alkylation, conjugate addition, oligomerization, acylation, rearrangement, and functional group synthesis. It remains true to say that applications of Co compounds in catalysis are limited relative to other metals such as palladium and ruthenium, and this presents an area for future development of the chemistry of the element. This section does not aim to be exhaustive in its coverage, but to give examples of applications and recent developments in the field; some examples have appeared already for selected complexes throughout the review.

Both heterogenous and homogenous catalysts featuring Co have been reported. The macromolecular heterogenous catalysts are outside the scope of this report, which concentrates on molecular systems. However, it is noted that surfaces can promote reactions in concert with molecular systems. For example, surface reactions between $\text{Co}_2(\text{CO})_8$ and an inorganic oxide involves disproportionation and tight ion pair formation, leading to catalytically active $\text{Mg}[\text{Co}(\text{CO})_4]_2$.¹³³⁸ Further, surfaces may be templated with organic molecules capable of binding metal ions strongly, providing modified surfaces for catalytic activity,¹³³⁹ or else complex ions may be intercalated in layered inorganic solids such as double hydroxides.¹³⁴⁰ Intercalation of phthalocyanines and porphyrins of cobalt(II), as well as polyoxometallates including cobalt(II), has been established in these anionic clays. Photocatalysis by transition metal complexes has been widely studied also.¹³⁴¹ Amongst systems identified, cobalt(III) complexes of oxalate and dithiooxalate feature in their use for hydrogen generation from thiols, which also leads to disulfides.

6.1.4.1.1 Oxidations

Cobalt(III)–alkylperoxo complexes find use in the oxidation of hydrocarbons.^{1342,1343} Since they release $\text{ROO}\cdot$ and $\text{RO}\cdot$ radicals upon mild heating in solution, they are effective oxidants under mild conditions, and produce catalytic systems in the presence of excess ROOH . Aliphatic C–H bond oxidation by $\text{Co}^{\text{II}}\text{OOR}$ ($\text{R} = \text{Co}^{\text{II}}$, alkyl, H) complexes including a hydrotris(pyrazolyl) borate ligand have also been reported, with homolysis of the peroxo O–O bond believed to be important in oxygenation of the C–H bond.¹³⁴⁴

Regioselective hydroperoxygation of $\alpha,\beta,\gamma,\delta$ -unsaturated carbonyl compounds with O_2 and triethylsilane was achieved with a Co^{II} porphyrin complex, to give the corresponding γ -hydroperoxy- α,β -unsaturated carbonyl derivative in good yield.¹³⁴⁵ The same group extended this range of reactions to include other conjugated olefins such as styrene and acrylic esters.¹³⁴⁶ 4-Aryl-substituted derivatives of $\text{Co}(\text{TPP})$ catalyze the oxidation¹³⁴⁷ or epoxidation¹³⁴⁸ of organic substrates such as alkenes, allylic or benzylic substrates, alcohols, and hydrocarbons at ambient conditions in the presence of O_2 and 2-methylpropanal.

The 4-methoxy derivative of the Schiff base complex $\text{Co}(\text{salphn})$ (**69b**) catalyzes the mild epoxidation of olefins in one atmosphere of O_2 in the presence of a cyclic ketone reductant.¹³⁴⁹ The catalytic dioxygenolysis of 3-methylindole to 2-(*N*-formylamino)acetophenone has been investigated within a series of electronically and sterically designed $\text{Co}(\text{salen})$ (**69a**) complexes. The cathodic shifts in the $\text{Co}^{\text{III/II}}$ redox potential and steric bulk each slow the reaction.¹³⁵⁰ Substituted anilines undergo oxidation by *t*-butyl hydroperoxide in the presence of $\text{Co}(\text{salen})$ analogs to give the corresponding nitrobenzene.¹³⁵¹ A $\text{Co}(\text{salen})(\text{OO-}t\text{-Bu})$ intermediate was implicated in the mechanism. The catalysis of phenol oxidation reactions was investigated using $\text{Co}(\text{salen})$ analogs, particularly coniferyl and sinapyl alcohols as substrates. This oxidation of monomeric and dimeric lignin model compounds was also studied with a view to its relevance to practical pulp bleaching conditions.¹³⁵²

Complexes of the $\text{Co}(\text{salen})$ family are capable of mediating the electrocatalytic reduction of O_2 to H_2O_2 .¹³⁵³ The reduction potential is pH dependent, irreversible, and diffusion controlled. The biphenyl-derived dimer of $\text{Co}(\text{salphn})$ (joined at the 4-positions of the two *o*-phenylenediamine rings) adsorbs onto a graphite electrode and also catalyzes the reduction of O_2 which is believed to involve axial coordination of O_2 .¹³⁵⁴ An electrochemical investigation of the cyclohexane fused analog $\text{Co}(\text{salchn})$ identified a reversible $\text{Co}^{\text{III/II}}$ response in deoxygenated non-aqueous solution in addition to O_2 reduction waves on aeration. An XPS analysis of an anodically formed film of the complex on a platinum electrode identified the Co complex in its trivalent oxidation state. In aerated solution, catalytic oxidation of alkenes such as cyclohexene and 4-methyl-1-cyclohexene was observed.¹³⁵⁵

Cobalt(II) bis(1,3-diketone) complexes find use for the conversion of olefins into alcohols, ketones, and paraffins, by contacting the olefins with an oxygen-containing gas in the presence of the Co catalysts.¹³⁵⁶ Cobalt catalysts supported on or incorporated into other materials are also recognized as effective heterogeneous catalysts. Co(salen) can be incorporated into the intercrystalline cavities in zeolites, and catalyzes the oxidation of cyclohexene with aqueous peroxide to form cyclohexane-1,2-diol, 2-cyclohexenol and 2-cyclohexenone.¹³⁵⁷ Crosslinked polystyrene is an efficient support for thiosemicarbazone cobalt (II) complexes.¹³⁵⁸ This functionalized polymer, when 10% crosslinked, shows potential as a catalyst for the epoxidation of cyclohexene and styrene. It is also able to catalyze the decomposition of peroxide. Polymer-immobilized EDTA was prepared by redox initiation with sodium EDTA and ceric ion of copolymerization of methacrylic acid and acrylonitrile. The Co complex proved useful for the peroxidation of benzaldehyde, in a selective and high-yielding reaction.¹³⁵⁹ Immobilization of a Co^{III} complex on chemically modified silica has recently been described, and efficiently oxidized alkylaromatics with air and without requiring a solvent.¹³⁶⁰ Immobilized catalysts present the opportunity for more environmentally friendly industrial processes to be developed.

6.1.4.1.2 Carbonylation and formylation

Hydroformylation promoted by metal compounds is sufficiently extensive to attract annual reviews of work in the field.^{52,1361,1362} However, Co catalysts form a smaller subset. Of the more established Co catalysts, Co₂(CO)₈ continues to be well studied. The equilibrium reaction pertinent to hydroformylation (Equation (12)), has been recently reviewed.¹³⁶³

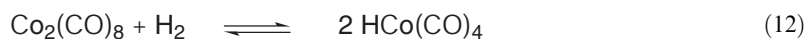

The attainment of regio- and enantioselectivity are continuing challenges, which form the basis of investigations of new catalytic systems. For example, novel mixed-metal catalysts such as (CO)₂Co(μ-CO)(μ-HC≡CBu)Rh(CO)₂ promote the stereospecific synthesis of *Z*-only BuC(CHO)=CHSiMe₂Ph from 1-hexyne and HSiMe₂Ph.¹³⁶⁴

A recent example where Co₂(CO)₈ serves as a precatalyst is in the preparation of linear and branched aldehydes via propylene hydroformylation in supercritical CO₂ (93–186 bar; 66–108 °C). Cyclohexane carbaldehyde is produced from cyclohexene using Co₂(CO)₈ and an acid RCOOH, or else is successful with another established Co catalyst, Co(OOCR)₂, assumed to form *in situ* in the former case. Oligomerization of aldehydes such as n-butanal is achieved with Co₂(CO)₆L₂ as catalyst (L = CO, PR₃).¹³⁶⁴

High yielding and chemoselective hydrocarbonylation of benzyl chloride and bromide and substituted analogs in a mixed organic/aqueous NaOH two-phase system occurs in the presence of Co₂(CO)₈ as catalyst and polyethylene glycol as phase transfer agent.¹³⁶⁵ Proposed intermediates in the catalysis are species such as η¹- and η³-benzylacetylcobalt carbonyls. Polynuclear Co₄(CO)₁₁(SMe₂) promotes the hydroformylation of alkenes to aldehydes.¹³⁶⁶ Carbonylation of organic halides to form esters with Co(PPh₃)_mX_n compounds as catalyst has been examined,¹³⁶⁷ with yields of up to 80% established in a two-phase benzene aqueous NaOH system with tetrabutylammonium bromide as phase transfer agent. Anhydrous CoCl₂ with [PhEt₂N][BH₃] is a useful reagent for hydroboration and carbonylation of alkenes to dialkylketones, after oxidation with H₂O₂/NaOH.¹³⁶⁸ The oxidative carbonylation of aromatic primary amines employs Co(salen) as a catalyst, and produces ureas in high yields, including cyclic ureas.¹³⁶⁹

6.1.4.1.3 Cycloadditions and asymmetric synthesis

Asymmetric, enantioselective, and regiospecific synthesis is of particular importance for sophisticated syntheses of relevance to the pharmaceutical industry and other industries demanding “boutique” chemicals. The field is attracting continuing effort, and the type of reaction where Co catalysts appear are diverse and activity strong, so it is only possible to give a flavor of the field here. An example is in the Diels–Alder reaction (Equation (13)), which occurs in high yield and with 97% enantiomeric excess where the CoI₂/Zn catalyst incorporating the aminophosphine–phosphinite ligand (268) is employed.¹³⁷⁰

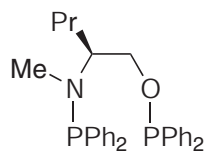
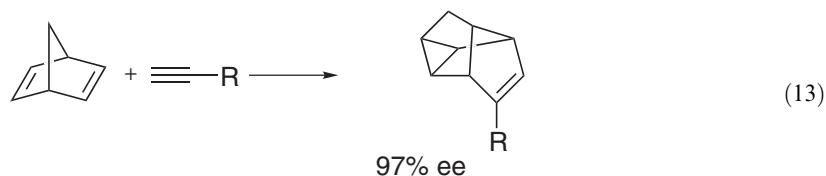

(268)

The potential of chiral Co(salen) analogs in asymmetric N, S, and P oxidations has been realized and the preparations of a number of these compounds have been patented.¹³⁷¹ Chiral Schiff base complexes derived from 2,2'-diamino-1,1'-binaphthalene or 1,2-diaminocyclohexane and various salicylaldehydes have been synthesized and complexed with cobalt (**269**).¹³⁷² The crystal structure of Co(phsaldpen) (derived from 2-hydroxybenzophenone and *rac*-1,2-diphenylethylenediamine) has been determined where the two Ph groups on the chelate ring occupy axial positions and hinder access to the apical coordination sites.¹³⁷³ The Co^{III/II} couple is ca. 300 mV anodically shifted relative to Co(salen). The *meso* isomer was also prepared. Chiral tridentate Schiff base complexes have also been exploited as catalysts for stereoselective cycloaddition reactions.¹³⁷⁴ Cyclopropanecarboxylates were obtained with excellent enantioselectivity (>95% ee) from reaction of styrene derivatives and *t*-butyl α -diazoacetate, using the advanced chiral Co^{II}-salen complex (**270**).¹³⁷⁵ Chiral trivalent Co(salen)(OAc) analogs immobilized on the mesoporous siliceous material (MCM-41) achieve hydrolytic kinetic resolution of racemic epoxides (epichlorohydrin, 1,2-epoxyhexane, epoxy-styrene and epoxy-cyclohexane) to their diols.¹³⁷⁶

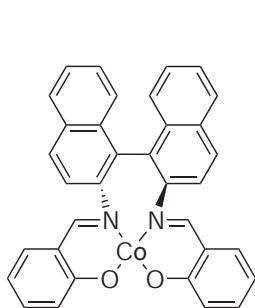

(269)

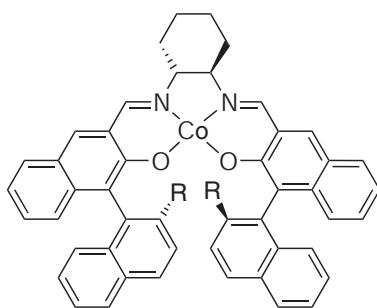

(270)

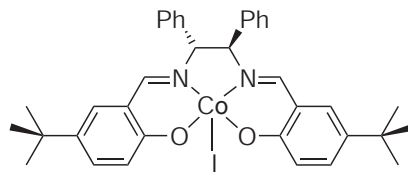

(271)

Catalysts of the Co(salen) family incorporating chiral centers on the ligand backbone are useful in asymmetric synthesis and the field has been reviewed.^{1377,1378} In two examples, the hydroxylation reaction (Equation (14)) involving (**269**) proceeds with 38% ee,¹³⁷⁹ whereas the cyclopropanation reaction with (**271**) (Equation (15)) proceeds with 75% ee and with 95:5 *trans:cis*.¹³⁸⁰ A Co(V) salen carbenoid intermediate has been suggested in these reactions.

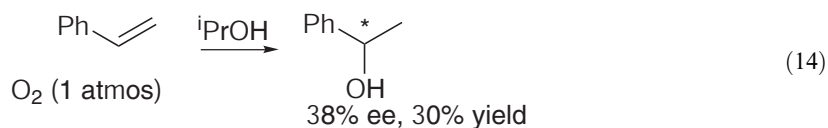

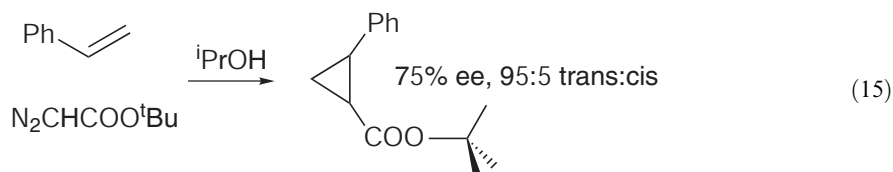

Optically active β -ketoiminato cobalt(III) compounds based on chiral substituted ethylenediamine find use as efficient catalysts for the enantioselective hetero Diels–Alder reaction of both aryl and alkyl aldehydes with 1-methoxy-(3-(*t*-butyldimethylsilyloxy)-1,3-butadiene.¹³⁸¹ Cobalt(II) compounds of the same class of ligands promote enantioselective borohydride reduction of ketones, imines, and α,β -unsaturated carboxylates.¹³⁸²

6.1.4.1.4 Other catalytic reactions

A selected assortment of other organic transformations not discussed above is given here. Catalysis of the condensation reaction between *p*-nitrobenzaldehyde and *p*-aminotoluene by thiourea complexes of cobalt(II) and zinc(II) has been observed, and activation by substrate coordination to the complex in the activated state is implied.¹³⁸³ Reductive nitrosation of olefins, α,β -unsaturated and α,β,γ -unsaturated carbonyl compounds have been reported with Me_3CONO and Et_3SiH in the presence of Co^{II} porphyrin catalysts to give the respective acetophenoximes, α -hydroxyimino and γ -hydroxyimino- α,β -unsaturated carbonyl compounds in good yields. The potential role of cyclodextrins functionalized with polyamines as enzymes models and chiral receptors has been reviewed.¹³⁸⁴ Their application as artificial hydrolases is exemplified by the 900-fold enhancement of hydrolysis of *p*-nitrophenyl acetate by a cyclodextrin carrying an appended cyclen macrocycle bound to a cobalt(III) ion, which also carries two *cis*-coordinated water molecules.¹³⁸⁵ These two adjacent sites provide the opportunity for both substrate binding and provision of a coordinated nucleophile for attack of the ester group. The potential of metal complexes, including those of cobalt, as synthetic nucleases has been reviewed.¹³⁸⁶

Isomerizations are another category of reaction where Co complexes act as catalysts. Mixed S,P donor complexes $\text{Co}(\text{SCN})_2(\text{PR}_3)_2$ catalyze the isomerization of 1-butene to 2-butene in the presence of NaBH_4 , with $\text{CoH}(\text{SCN})(\text{PR}_3)_2$ proposed as the active species.¹³⁶⁶ A cyclopentadienyl complex (**272**) is active in the isomerization of quadricyclene to norbornadiene.

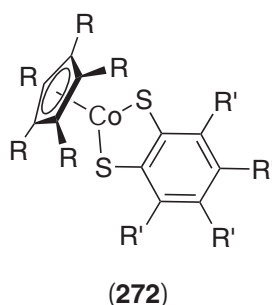

Rearrangement of trivalent (5-hexenyl)Co(salen) proceeds via a radical chain process leading to the isomeric cyclopentylmethyl complex.¹³⁸⁷ The efficiency with which this rearrangement occurs is dependent on the presence of trace impurities or O_2 . The selective reaction of alcohols (ROH) with arylglyoxals (ArCOCHO) to give α -aryl- α -hydroxyacetic esters $\text{ArCH}(\text{OH})\text{CO}_2\text{R}$ is catalyzed by compounds of this family.¹³⁸⁸

6.1.4.2 Polymerization

Polymerization employing Co complexes as catalysts or else polymers incorporating functionality that includes Co ions represent aspects of polymerization reactions of interest here. Cobalt-mediated free-radical polymerization of acrylic monomers has been reviewed.⁵⁵ Co^{II} porphyrins act as traps for dialkylcyanomethyl radicals.¹⁰⁹⁸ Alkyl complexes of $\text{Co}(\text{TMeSP})$

(Mes = mesitylene) have been shown to initiate and control living free radical polymerization of poly methyl acrylates and block copolymers of methyl and butyl acrylate.^{58,1389,1390} Oxygen transfer polymerization, using the reversible oxygen carrier Co(TPP)(py), which serves as both oxygen supplier and a fully recoverable initiator, has been reported.¹³⁹¹ Vinyl monomers are converted under mild conditions to polymeric peroxides. Similarly, Co(TPP) in the presence of O₂ has been found to catalyze the room-temperature free radical polymerization of styrene and methyl methacrylate.¹³⁹² The same group reported the oxidative polymerization of indene with Co(TPyP), leading to the formation of poly(indene peroxide) with narrow polydispersity.¹³⁹³ Dual behavior of Co(TPyP) as a dioxygen carrier as well as an initiator was implicated in this study.

Dichloro(2,6-bis(imino)pyridine)cobalt(II) has been characterized by X-ray diffraction.¹³⁹⁴ Upon treatment with methylaluminoxane, a highly active ethylene polymerization catalyst for production of highly linear polyethylene is produced that yields polymer of MW up to 600,000. Poly(salicylaldehyde acrylate) crosslinked with divinylbenzene has been derivatized with thiosemicarbazone, semicarbazone oxime, and ethylenediamine, and their formation of coordination polymers with cobalt(II) probed.¹³⁹⁵ Novel metal halide-complexed polymer films, including that of cobalt(II), were prepared with poly(arylene ether phosphine oxide).¹³⁹⁶ Metal complexation to the polymer was defined by IR and ³¹P NMR studies. Imprinted polymers have been prepared which use a cobalt(III) imine complex as the template in a surface grafting technique, and their use for reversible dioxygen binding explored.¹³⁹⁷ Polymer materials with immobilized metal complexes of defined structures such as these have potential for application in catalysis, gas storage, and sensor technology.

6.1.4.3 Electrocatalysis and Analytical Sensors

Electrocatalysis employing Co complexes as catalysts may have the complex in solution, adsorbed onto the electrode surface, or covalently bound to the electrode surface. This is exemplified with some selected examples. Cobalt(I) coordinatively unsaturated complexes of 2,2'-dipyridine promote the electrochemical oxidation of organic halides, the apparent rate constant showing a first order dependence on substrate concentration.^{1398,1399} Catalytic reduction of dioxygen has been observed on a glassy carbon electrode to which a cobalt(III) macrocycle tetraamine complex has been adsorbed.^{1400,1401}

Recent studies on Co porphyrin chemistry have focused on their use as catalysts of reactions involving coupled electron and atom transfer, where the substrate is typically coordinated in a coordination site axial with respect to the CoN₄ plane. Coupled with glucose oxidase, (GO), [Co(TMpyP)]⁴⁺ adsorbed into a Nafion film was used to monitor O₂ depletion (through glucose oxidation during GO turnover), and the voltammetric current from the porphyrin was used to determine glucose concentrations.¹⁴⁰² Independently, Kadish and co-workers have investigated the reactions of monovalent [Co^I(TMpyP)]³⁺ with O₂ to give a superoxo-Co^{II} complex that is stable in DMF solution. In oxygenated DMF solution, electrogenerated monovalent [Co(TMpyP)]³⁺ catalyzes the epoxidation of cyclohexene.¹⁴⁰³ Although monovalent [Co(TPP)]⁻ was inactive, the single-electron reduced complex generated chemically, electrochemically, and using pulse radiolysis and assigned as a π -radical, catalytically reduces CO₂ to CO and HCO₂⁻.¹²¹ Fluorination of the porphyrin results in an anodic shift of the potential at which catalysis occurs.

The consequences of polychlorination of porphyrins on redox properties of complexes has been investigated.¹⁴⁰⁴ The highly chlorinated porphyrin β -octachloro-*meso*-tetrakis(3,5-dichloro-2,6-dimethoxyphenyl)porphyrin exhibits a substantial anodic shift for reduction of over 0.5 V and a smaller shift for oxidation versus the unchlorinated precursor. Contrastingly, small potential shifts for the octabromo-substituted 5,10,15,20-tetraphenylporphyrinate arise from the dominance of macrocycle "ruffling" over electronic effects. In the polychloro complex, distortion does not compensate fully for electron-withdrawing effects of the Cl substituents.

Flow-injection spectrophotometric analysis of cobalt(II) has been developed employing pyridoxal 4-phenylthiosemicarbazone as chelating agent in strongly acidic medium, forming an intense yellow-colored 1:2 complex ($\lambda_{\max} = 430 \text{ nm}$, $\varepsilon_{\max} = 1.35 \times 10^4 \text{ M}^{-1} \text{ cm}^{-1}$), with very few interferences at the low pH used, and detection down to 0.4 $\mu\text{g mL}^{-1}$.¹⁴⁰⁵ Direct, simple spectrophotometric analysis of Co down to similar levels has also been reported using 2'-hydroxyaceto-hydroxyacetophenone thiosemicarbazone,¹⁴⁰⁶ amongst a number of analogous studies. A sophisticated flow-injection method that allows for the simultaneous detection of Co and Ni via complexation with 2-hydroxybenzaldehyde thiosemicarbazone has been described.¹⁴⁰⁷ This relies

on different formation rates of the two complexes. This technique has also been applied to determination of Co and Fe simultaneously.¹⁴⁰⁸

A cobalt(II)–ethanolamine complex sorbed onto Dowex-50Wx2 resin serves as a heterogeneous catalyst for luminol chemiluminescence, and was developed as a flow-through sensor for hydrogen peroxide and glucose.¹⁴⁰⁹ Electroactive Co complexes may play a key role in the analytical detection of compounds electrochemically. For example, nitrate in vegetables has been detected accurately in the mg/kg range by forming a complex with thiocyanate and nitric oxide, generated chemically from nitrate ion, and employing polarographic analysis.¹⁴¹⁰

6.1.4.4 Environmental

There is a range of environmental activities employing or dealing with cobalt; this is a growing area, and only a very few selected examples follow to identify the breadth of the field. In their monovalent oxidation state, Co porphyrin complexes are effective dechlorination catalysts of chlorinated hydrocarbons. Electropolymerization of a pyrrole-substituted *meso*-tetraphenylporphyrin (TPP) complex of Co onto a carbon support produces a catalyst that can reductively dechlorinate benzyl chloride¹⁴¹¹ and other organic halides.¹⁴¹² Similarly, Co(TPP) adsorbed onto a graphite foil electrode has been used as a sensor for the catalytic dechlorination of organic pollutants when reduced to its monovalent state. The aim of this work was to screen toxic organohalogen pollutants in environmental monitoring situations.¹⁴¹³ Catalytic electrochemical reduction of *trans*-1,2-dibromocyclohexanes is also achieved with Co porphyrins at potentials more than 1 V positive than in the absence of catalyst.¹⁴¹⁴ Nitrotoluene reduction is catalyzed by Co hematoporphyrin as a preliminary step to enhance biodegradability of these waste products.¹⁴¹⁵

The treatment of waste water containing sulfide ions by catalytic aerial oxidation in the presence of a Co^{II} tetrasulfophthalocyanine catalyst removed over 95% of sulfide over a period of several hours.¹⁴¹⁶ Removal by precipitation of cobalt(II) from waste water in the presence of other complexing agents was achieved by the addition of *N,N*-diethyl-*N'*-benzoylthiourea. The use of substituted thioureas can be applied to removal of other heavy metals also.¹⁴¹⁷ The very low toxicity of several halo(2,3-dimethylpyrazolone-5-thione)cobalt(II) complexes allowed their use in the development of granulated slow-release fertilizers using collagen hydrolyzate as the organic filler, to deliver Co as a micronutrient.¹⁴¹⁸

6.1.4.5 Technology

Cobalt complexes find application commercially, or else have been developed for commercial use, in a surprising range of tasks. Even the simplest of complexes may be employed. It has been found that $[\text{Co}(\text{NH}_3)_6]^{3+}$ salts with oxidizing anions (nitrate, nitrite, and perchlorate) may be used as gas generants for the rapid inflation of automobile airbags.¹⁴¹⁹ These compounds are proposed as alternatives to highly toxic sodium azide, which is the most widely used gas generant in this application. Upon detonation, in the presence of co-oxidizers, $[\text{Co}(\text{NH}_3)_6] (\text{NO}_3)_3$ liberates gaseous N_2 , O_2 , and water vapor which inflate the airbag. The same complex cation may be induced to release ammonia on heating at an appropriate stage of electrographic image formation, enhancing image contrast and density markedly.¹⁴²⁰ In testimony to its versatility, $[\text{Co}(\text{NH}_3)_6]^{3+}$ also finds application in a peroxide-free bleaching mixture in concert with polyoxyethylene lauryl ether and sodium carbonate.¹⁴²¹ More elaborate complexes have been patented to enhance the bleaching effect of peroxide, as distinct from replacing it, including Co complexes with tripodal ligands and polyamide–polyamine dendrimers. At the other extreme, fabric dyes of dark green Co complexes with glyoxal anil arylhydrazones have appeared.¹⁴²² Potential uses of Co coordination complexes are diverse. A quite different application, making use of cobalt's redox chemistry, uses (pyridine)bis(dialkylglyoximate)cobalt(III) chloride complexes along with acetylene black as cathodes in an effective rechargeable conducting polymer battery where poly(*p*-phenylene sulfide) anodes and LiClO_4 -propylene carbonate electrolyte also feature.¹⁴²³ The complex Co (TMeOPP) (MeOP = 4-methoxyphenyl) has been incorporated into the cathode of an Al–O battery (where Al is the anode) with the goal being the use of this technology as a power source in spacecraft.¹⁴²⁴

Somewhat unanticipated applications can arise. For example, a process for the production of ultrapure hydrogen peroxide for the electronics industry has been patented recently,¹⁴²⁵ which uses the macrobicyclic hexamine complex (29) supported on an inert material for dioxygen

reduction. Cobalt(III) EDTA has been patented as a component in polymers to produce flame-retardant plastics,¹⁴²⁶ and simple hexa(alkylamine)cobalt (III) complexes have been examined as new photoinitiators for deep-UV resist materials, via efficient photoredox decomposition which releases free amine to initiate crosslinking.⁵⁹⁴ Some other, and by no means exhaustive, examples of developing technological applications are presented below.

Inorganic crystal engineering employing self-assembly processes promises to lead to the future development of planned solids which may have application as molecular-scale devices such as molecular wires. A recent example is $[\text{Co}^{\text{II}}_2(4,4'\text{-bpy})_3(\text{NO}_3)_4]_\infty$ in solids where the pseudo-octahedral metal provides an appropriate junction in “molecular ladder” structures.¹⁴²⁷ Other mixed organic–inorganic composite materials have been developed relying on the differing stereochemistries around two metal centers; for example $\text{Co}(\text{bpy})\text{Mo}_3\text{O}_{10}$ has chains of edge-sharing Mo-based polyhedra where octahedral CoN_2O_4 units link these to form a two-dimensional covalent network.¹⁴²⁸

Molecular magnets are a rapidly expanding field, where some Co compounds are finding a role.¹⁴²⁹ A series of $\text{Co}^{\text{II}}_2(\text{OH})_3\text{X}$ compounds, where X is an exchangeable organic radical anion produce new metal–radical magnets which feature stacks of Co^{II} hydroxide layers interlayered with organic radicals. The imino-nitroxide radical (**273**) is an example that produces a successful system.

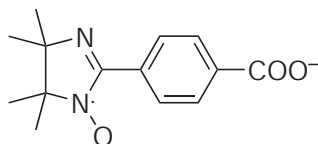

(273)

Other molecular magnets have been based on polycyano metal complexes. For example, the Prussian Blue analog $\text{Co}^{\text{II}}_3[\text{Fe}^{\text{III}}(\text{CN})_6]_2 \cdot n\text{H}_2\text{O}$, which is prepared by substitution of hexacyanoferrate(III) into the $\text{Co}^{2+}_{\text{aq}}$ coordination sphere, is a species with a significant photomagnetic effect.¹⁴³⁰ A stable $\text{Co}^{\text{III}}\text{-NC-Fe}^{\text{II}}$ pair arises via internal electron transfer. Solids with intermediate stoichiometries can be formed, such as $\text{Rb}_{1.8}\text{Co}_4[\text{Fe}(\text{CN})_6]_{3.3} \cdot 13\text{H}_2\text{O}$. Further, polynuclear species such as $[\text{Cr}^{\text{III}}(\text{CN})_3[(\text{CN})\text{Co}^{\text{II}}\text{L}]_3]^{3+}$ where L is a pentaamine ligand, have been prepared and magnetic properties examined. Yet another family of magnetic materials are clusters based on polyoxometallates.¹⁴³¹ Mixed-metal clusters such as $[\text{Co}^{\text{II}}_4(\text{H}_2\text{O})_2(\text{PW}_9\text{O}_{34})_2]^{10-}$ and $[\text{WCo}^{\text{II}}_3(\text{H}_2\text{O})(\text{Co}^{\text{II}}\text{W}_9\text{O}_{34})_2]^{12-}$ have been examined, with ferro- and anti-ferromagnetism found in selected examples.

Diagnostic processes in medicine and pharmaceutical applications featuring metal complexes are expanding rapidly.^{1432,1433} Of radionuclides of possible value, ^{55}Co complexes have potential for use in positron emission tomography since they undergo β^+ decay with a suitable half-life and energy. To date, however, it has been studied very little. Likewise, cobalt-based drugs are not a high-profile area of development currently, although there are some advances. Cobalt(III) complexes of macrocyclic polyimines have been patented for use as anti-inflammatory agents, due to their superoxide coordination chemistry which is, in effect, antioxidant behavior.¹⁴³⁴

New solid state materials are a major research target. Most, such as Co nanocrystals, Co nitride films, and zirconia-supported cobalt, do not involve formal coordination compounds, and are outside the scope of this review. One interesting application of a Co compound, however, has appeared recently. Carbon nanoflasks, a new form of fullerene-type carbon, use $\text{Co}(\text{CO})_3\text{NO}$ as the source of carbon in their synthesis.¹⁴³⁵ Upon decomposition, the $\text{Co}(\text{CO})_3\text{NO}$ yields fcc Co particles, of from several nanometers to hundreds of nm in size. The cobalt-filled carbon flasks have tube-neck widths of from 50 nm to over 100 nm, whereas the body of the flask ranges from 100 nm to 500 nm, but can reach over 1 mm. Following acid treatment of the sample to remove cobalt, opened and empty carbon flasks are readily obtained. Sol–gel glasses, based on metal oxides/hydroxides that dissolve in ROH partially forming alkoxides¹⁴³⁶ do not feature Co as a metal, partly at least because the Co^{III} aqua ion is a powerful oxidant which oxidizes water, and partly because appropriate oligomerization does not apply. However, a major blue pigment as a colorant is the cubic spinel CoAl_2O_4 , where the cobalt(II) lies in a CoO_4 tetrahedron. In another example, a transparent glass with Mg–Al spinel nanocrystallites doped with tetrahedrally coordinated Co^{2+} operates as a new saturable absorber Q switch for Er:glass lasers.¹⁴³⁷ A novel

route to Co_3O_4 thin films on glass substrates has been established by firing at 500°C the tributylammonium salt of $[\text{Co}(\text{EDTA})]^-$ adhered to the glass.¹⁴³⁸ Pillared clays are an area of growing interest, and Co compounds find application in this field; for example, montmorillonites expanded with small amounts of $[\text{Co}^{\text{III}}_3(\text{H}_2\text{NCH}_2\text{CH}_2\text{O})_6](\text{ClO}_4)_3$ and an aluminum compound (final Si:Co ratio from 38 to 128) and calcinated by firing at 500°C in air proved to be significantly enhanced in thermal stability.¹⁴³⁹

6.1.5 CONCLUSION

At the beginning of the twenty-first century, it is still true to say that Co remains a firm favorite for traditional Werner-type coordination chemistry, with perhaps less emphasis on organometallic chemistry than is the case with other transition metals. However, Co coordination compounds are appearing in greater diversity than before and ever more examples of polynuclear systems are appearing. Although the basic synthetic routes established for decades have remained as entry points into Co chemistry, the application of these routes with a wider range of potential ligands and the development of more “boutique” reagents has expanded the possible and encompassed some of the (at least previously considered) impossible. Statements such as “no examples of this type exist” and “it is very unlikely that these can be prepared” simply spur research; it seems that often examples do not exist or are thought unlikely simply because effort has not been spent sufficiently, rather than there being an inherent chemical barrier. After all, that simple polyamine coordination complexes including cobalt(III)–carbon bonds could be easily prepared was not anticipated several decades ago, yet examples continue to expand. Given the growth in chemistry since the early 1980s generally, it is dangerous to predict the paths Co chemistry will travel in the next few decades. However, it takes no great foresight to suggest, broadly, that biologically relevant and advanced materials chemistry of Co will grow more significant in this time. Retrospection and prognostication aside, Co remains today an enticing and rewarding center for coordination chemistry.

6.1.6 REFERENCES

1. Buckingham, D. A.; Clark, C. R. In *Comprehensive Coordination Chemistry*; Wilkinson, G.; Gillard, R. D.; McCleverty, J. A., Eds.; Pergamon: Oxford, 1987; Vol. 4, pp 635–900.
2. Hay, R. W. *Coord. Chem. Rev.* **1984**, *57*, 1–73.
3. Hay, R. W. *Coord. Chem. Rev.* **1986**, *71*, 37–112.
4. Housecroft, C. E. *Coord. Chem. Rev.* **1990**, *98*, 123–250.
5. Davies, M. B. *Coord. Chem. Rev.* **1993**, *124*, 107–181.
6. Davies, M. B. *Coord. Chem. Rev.* **1994**, *134*, 195–305.
7. Davies, M. B. *Coord. Chem. Rev.* **1996**, *152*, 1–85.
8. Davies, M. B. *Coord. Chem. Rev.* **1997**, *164*, 27–160.
9. Davies, M. B. *Coord. Chem. Rev.* **1998**, *169*, 237–361.
10. Whittlesey, M. K. *Organomet. Chem.* **2000**, *28*, 367–403.
11. Carr, N. *Organomet. Chem.* **1999**, *27*, 81–131.
12. Simpson, S. J. *Organomet. Chem.* **1998**, *26*, 367–403.
13. Cotton, S. A. *Annu. Rep. Prog. Chem., Sect. A: Inorg. Chem.* **2000**, *96*, 229–253.
14. Cotton, S. A. *Annu. Rep. Prog. Chem., Sect. A: Inorg. Chem.* **1999**, *95*, 165–188.
15. Shibata, M. *Topics in Current Chemistry, No. 110: Modern Syntheses of Cobalt(III)*; Springer-Verlag: Berlin, 1983.
16. Comba, P.; Hambley, T. W. *Molecular Modelling of Inorganic Compounds*, 2nd ed.; Wiley: London, 2001.
17. Marques, H. M.; Brown, K. L. *Coord. Chem. Rev.* **1999**, *190–192*, 127–153.
18. House, D. A. *Comments Inorg. Chem.* **1997**, *19*, 327–350.
19. Buckingham, D. A. *Coord. Chem. Rev.* **1994**, *135/136*, 587–621.
20. Hay, R. W. *Mech. Inorg. Organomet. React.* **1994**, *8*, 133–143.
21. Hay, R. W. *Mech. Inorg. Organomet. React.* **1991**, *7*, 157–167.
22. Ghosh, M. C.; Bhattacharya, P.; Banerjee, P. *Coord. Chem. Rev.* **1988**, *91*, 1–34.
23. Geue, R. J.; Hanna, J. V.; Hohn, A.; Qin, C. J.; Ralph, S. F.; Sargeson, A. M.; Willis, A. C. *Adv. Chem. Ser.* **1997**, *253*, 137–150.
24. Browne, R. J.; Buckingham, D. A.; Clark, C. R.; Sutton, P. A. *Adv. Inorg. Chem.* **2000**, *49*, 307–373.
25. Tada, M. *Rev. Heteroat. Chem.* **1999**, *20*, 97–144.
26. Weit, S. K.; Ferraudi, G.; Grutsch, P. A.; Kutal, C. *Coord. Chem. Rev.* **1993**, *128*, 225–243.
27. Solomon, E. I.; Tuzcek, F.; Root, D. E.; Brown, C. A. *Chem. Rev.* **1994**, *94*, 827–856.
28. Zarembowitch, J. *New J. Chem.* **1992**, *16*, 255–267.
29. Kanamori, K. *Trends Inorg. Chem.* **1990**, *1*, 127–149.
30. Granger, P.; Raya, J.; Hirschinger, J.; Richert, T.; El Bayed, K. *J. Chim. Phys. Phys.-Chim. Biol.* **1994**, *91*, 828–840.
31. Hikichi, S.; Akita, M.; Moro-oka, Y. *Coord. Chem. Rev.* **2000**, *198*, 61–87.

32. Bianchini, C.; Zoellner, R. W. *Adv. Inorg. Chem.* **1997**, *44*, 263–339.
33. Cabani, S. *React. Funct. Polym.* **1996**, *28*, 167–182.
34. Busch, D. H.; Alcock, N. W. *Chem. Rev.* **1994**, *94*, 585–623.
35. Cabani, S.; Ceccanti, N.; Tine, M. R. *Pure Appl. Chem.* **1991**, *63*, 1455–1464.
36. Fallab, S.; Mitchell, P. R. *Adv. Inorg. Bioinorg. Mech.* **1984**, *3*, 311–377.
37. Martell, A. E. *Acc. Chem. Res.* **1982**, *15*, 155–162.
38. Ludwig, M. L.; Matthews, R. G. *Annu. Rev. Biochem.* **1997**, *66*, 269–313.
39. Asperger, S.; Cetina-Cizmek, B. *Croat. Chem. Acta* **1996**, *69*, 1305–1328.
40. Pratt, J. M. *Met. Ions Biol. Syst.* **1993**, *29*, 229–286.
41. Kimura, E. *Curr. Opin. Chem. Biol.* **2000**, *4*, 207–213.
42. Kramer, R.; Gajda, T. *Perspect. Bioinorg. Chem.* **1999**, *4*, 209–240.
43. Scheffold, R.; Rytz, G.; Walder, L. *Synth. Methods* **1983**, *3*, 355–440.
44. Freeman, F. In *Org. Synth. Oxid. Met. Compd.*; Mijs, W. J.; De Jonge, C. R. H. I., Eds.; Plenum: New York, 1986, pp 315–371.
45. Fletcher, A. J.; Christie, S. D. R. *J. Chem. Soc., Perkin I* **2000**, 1657–1668.
46. Katsuki, T. *Recent Res. Dev. Pure Appl. Chem.* **1997**, *1*, 35–44.
47. Schubert, U.; Husing, N. *Synthesis of Inorganic Materials* **2000**, Wiley: New York.
48. Wilkinson, A. P. *ACS Symp. Ser.* **1999**, *727*, 39–52.
49. Pflatz, A. *Mod. Synth. Methods* **1989**, *5*, 199–248.
50. Ziessel, R. *Catal. Met. Complexes* **1993**, *14*, 217–245.
51. Mukaiyama, T.; Yamada, T. *Bull. Chem. Soc. Jpn.* **1995**, *68*, 17–35.
52. Ungvary, F. *Coord. Chem. Rev.* **1999**, *188*, 263–296.
53. Vincent, J.-M.; Rabion, A.; Fish, R. H. *ACS Symp. Ser.* **2000**, *767*, 172–181.
54. Archer, R. D. *Inorganic and Organometallic Polymers* **2001**, Wiley: New York.
55. Davis, T. P.; Kukulj, D.; Haddleton, D. M.; Maloney, D. R. *Trends Polym. Sci.* **1995**, *3*, 365–373.
56. Crivello, J. V.; Fan, M. *Macromol. Symp.* **1995**, *98*, 253–268.
57. Bennett, A. M. A. *ChemTech* **1999**, *29*, 24–28.
58. Wayland, B. B.; Mukerjee, S.; Poszmik, G.; Woska, D. C.; Basicckes, L.; Gridnev, A. A.; Fryd, M.; Ittel, S. D. *ACS Symp. Ser.* **1998**, *685*, 305–315.
59. Kahn, O. *Spec. Publ. – Roy. Soc. Chem.* **2000**, *252*, 150–168.
60. Garcia, C. G.; De Lima, J. F.; Iha, N. Y. M. *Coord. Chem. Rev.* **2000**, *196*, 219–247.
61. Fujita, E.; Brunschwig, B. S.; Cabelli, D.; Renner, M. W.; Furenlid, L. R.; Ogata, T.; Wada, Y.; Yanagida, S. *Stud. Surf. Sci. Catal.* **1998**, *114*, 97–106.
62. Sutin, N.; Creutz, C.; Fujita, E. *Comments Inorg. Chem.* **1997**, *19*, 67–92.
63. Lawrance, G. A. *Adv. Inorg. Chem.* **1989**, *34*, 145–194.
64. Dixon, N. E.; Lawrance, G. A.; Lay, P. A.; Sargeson, A. M.; Taube, H. *Inorg. Synth.* **1990**, *28*, 70–76.
65. Abney, K. D.; Long, K. M.; Anderson, O. P.; Strauss, S. H. *Inorg. Chem.* **1987**, *26*, 2638–2643.
66. Stochel, G.; van Eldik, R. *Coord. Chem. Rev.* **1999**, *187*, 329–374.
67. Swaddle, T. W.; Tregloan, P. A. *Coord. Chem. Rev.* **1999**, *187*, 255–289.
68. Kurikawa, T.; Nagao, S.; Miyajima, K.; Nakajima, A.; Kaya, K. *J. Phys. Chem. A* **1998**, *102*, 1743–1747.
69. Kan, S. Z.; Byun, Y. G.; Freiser, B. S. *J. Am. Chem. Soc.* **1994**, *116*, 8815–8816.
70. Carter, S. J.; Stuhl, L. S. *Rev. Inorg. Chem.* **1985**, *7*, 341–363.
71. Kapiloff, E.; Ervin, K. M. *J. Phys. Chem. A* **1997**, *101*, 8460–8469.
72. Chandler, D. J.; Jones, R. A.; Ratliff, K. S. *Inorg. Synth.* **1989**, *25*, 177–179.
73. Chung, Y. K. *Coord. Chem. Rev.* **1999**, *188*, 297–341.
74. Hartmann, G.; Mews, R. *Chem. Ber.* **1986**, *119*, 374–377.
75. Loubser, C.; Lotz, S.; Ellis, J. E. *Inorg. Synth.* **1992**, *29*, 174–182.
76. Loubser, C.; Dillen, J. L. M.; Lotz, S. *Polyhedron* **1991**, *10*, 2535–2539.
77. Kovacs, I.; Ungvary, F. *Coord. Chem. Rev.* **1997**, *161*, 1–32.
78. Basil, J. D.; Aradi, A. A.; Bhattacharyya, N. K.; Rath, N. P.; Eigenbrot, C.; Fehlner, T. P. *Inorg. Chem.* **1990**, *29*, 1260–1270.
79. Low, A. A.; Lauher, J. W. *Inorg. Synth.* **1990**, *27*, 188–191.
80. Oldani, F.; Bor, G. *Inorg. Synth.* **1989**, *25*, 164–167.
81. Marko, L.; Takacs, J. *Inorg. Synth.* **1989**, *26*, 243–246.
82. Gervasio, G.; Vastag, S.; Bor, G.; Natile, G.; Marko, L. *Inorg. Chim. Acta* **1996**, *251*, 35–39.
83. Zanello, P. *Struct. Bonding* **1992**, *79*, 103–214.
84. Schmid, G. *Struct. Bonding* **1985**, *62*, 52–85.
85. Herrmann, W. A.; Kohlpaintner, C. W.; Hanson, B. E.; Kang, X. *Inorg. Synth.* **1998**, *32*, 8–25.
86. Cen, W.; Fehlner, T. P. *Inorg. Synth.* **1997**, *32*, 228–230.
87. Whitmire, K. H.; Hutchinson, J. C.; Burkart, M. D.; Lee, J.; Ezenwa, S.; McKnight, A. L.; Jones, C. M.; Bachman, R. E. *Inorg. Synth.* **1997**, *32*, 220–228.
88. Vogler, A.; Kunkely, H. *Coord. Chem. Rev.* **1998**, *177*, 81–96.
89. Almond, M. J. *Chem. Soc. Rev.* **1994**, *23*, 309–317.
90. Itoh, K.; Miura, M.; Nomura, M. *Bull. Chem. Soc. Jpn* **1988**, *61*, 4151–4152.
91. Cuadrado, I.; Moran, M.; Casado, C. M.; Alonso, B.; Losada, J. *Coord. Chem. Rev.* **1999**, *193–195*, 395–445.
92. Comstock, M. C.; Shapley, J. R. *Coord. Chem. Rev.* **1995**, *143*, 501–533.
93. Zucchi, C.; Boese, R.; Albers, K.; Herbrich, T.; Toth, G.; Bencze, L.; Palyi, G. *Eur. J. Inorg. Chem.* **2001**, 2297–2304.
94. Werner, H.; Hofmann, L.; Ziegler, M. L.; Zhan, T. *Organometallics* **1986**, *5*, 510–513.
95. Pandey, K. K. *Coord. Chem. Rev.* **1995**, *140*, 37–114.
96. Leach, P. A.; Geib, S. J.; Corella, J. A. II; Warnock, G. F.; Cooper, N. J. *J. Am. Chem. Soc.* **1994**, *116*, 8566–8574.
97. Ullah, S. S.; Kundu, K.; Karim, M. M.; Khan, A. Z. *J. Bangladesh Acad. Sci.* **1995**, *19*, 57–60.
98. Mackay, K. M.; Tan, C. C. *J. Chem. Res., Synop.* **1982**, 229.
99. Bourg, S.; Boury, B.; Carre, F. H.; Corriu, R. J. P. *Organometallics* **1998**, *17*, 167–172.

100. Benelli, C.; Dei, A.; Gatteschi, D.; Pardi, L. *Inorg. Chim. Acta* **1989**, *163*, 99–104.
101. Biagini, P.; Funaioli, T.; Fachinetti, G.; Laschi, F.; Zanazzi, P. F. *J. Chem. Soc., Chem. Commun.* **1989**, 405–407.
102. Fachinetti, G.; Funaioli, T.; Zanazzi, P. F. *J. Chem. Soc., Chem. Commun.* **1988**, 1100–1101.
103. Szalda, D. J.; Creutz, C.; Mahajan, D.; Sutin, N. *Inorg. Chem.* **1983**, *22*, 2372–2379.
104. Arana, C.; Yan, S.; Keshavarz-K, M.; Potts, K. T.; Abruna, H. D. *Inorg. Chem.* **1992**, *31*, 3680–3682.
105. Arana, C.; Keshavarz, M.; Potts, K. T.; Abruna, H. D. *Inorg. Chim. Acta* **1994**, *225*, 285–295.
106. Yoshida, T.; Iida, T.; Shirasagi, T.; Lin, R.-J.; Kaneko, M. *J. Electroanal. Chem.* **1993**, *344*, 355–362.
107. Abe, T.; Kaneko, M. *J. Mol. Catal. A: Chem.* **2001**, *169*, 177–183.
108. Frauendorfer, E.; Agrifoglio, G. *Inorg. Chem.* **1982**, *21*, 4122–4125.
109. Calabrese, J. C.; Domaille, P. J.; Thompson, J. S.; Trofimenko, S. *Inorg. Chem.* **1990**, *29*, 4429–4437.
110. White, D. L.; Faller, J. W. *J. Am. Chem. Soc.* **1982**, *104*, 1548–1552.
111. Detrich, J. L.; Reinaud, O. M.; Rheingold, A. L.; Theopold, K. H. *J. Am. Chem. Soc.* **1995**, *117*, 11745–11748.
112. Detrich, J. L.; Konecny, R.; Vetter, W. M.; Doren, D.; Rheingold, A. L.; Theopold, K. H. *J. Am. Chem. Soc.* **1996**, *118*, 1703–1712.
113. Jewson, J. D.; Liable-Sands, L. M.; Yap, G. P. A.; Rheingold, A. L.; Theopold, K. H. *Organometallics* **1999**, *18*, 300–305.
114. Gangi, D. A.; Durand, R. R. Jr. *J. Chem. Soc., Chem. Commun.* **1986**, 697–699.
115. Fujita, E.; Szalda, D. J.; Creutz, C.; Sutin, N. *J. Am. Chem. Soc.* **1988**, *110*, 4870–4871.
116. Creutz, C.; Schwarz, H. A.; Wishart, J. F.; Fujita, E.; Sutin, N. *J. Am. Chem. Soc.* **1989**, *111*, 1153–1154.
117. Schmidt, M. H.; Miskelly, G. M.; Lewis, N. S. *J. Am. Chem. Soc.* **1990**, *112*, 3420–3426.
118. Creutz, C.; Schwarz, H. A.; Wishart, J. F.; Fujita, E.; Sutin, N. *J. Am. Chem. Soc.* **1991**, *113*, 3361–3371.
119. Ando, T.; Kita, M.; Kashiwabara, K.; Fujita, J.; Kurachi, S.; Ohba, S. *Bull. Chem. Soc. Jpn.* **1992**, *65*, 2748–2755.
120. Fujita, E.; Furenliid, L. R.; Renner, M. W. *J. Am. Chem. Soc.* **1997**, *119*, 4549–4550.
121. Behar, D.; Dhanasekaran, T.; Neta, P.; Hosten, C. M.; Ejeh, D.; Hambricht, P.; Fujita, E. *J. Phys. Chem. A* **1998**, *102*, 2870–2877.
122. Ogata, T.; Yanagida, S.; Brunschwig, B. S.; Fujita, E. *Energy Convers. Manage.* **1995**, *36*, 669–672.
123. Fujita, E. *Coord. Chem. Rev.* **1999**, *185–186*, 373–384.
124. Puxeddu, A.; Costa, G. *J. Chem. Soc., Dalton Trans.* **1982**, 1285–1289.
125. Gambarotta, S.; Arena, F.; Floriani, C. *J. Am. Chem. Soc.* **1982**, *104*, 5082.
126. Folest, J. C.; Duprilot, J. M.; Perichon, J.; Robin, Y.; Devynck, J. *Tetrahedron Lett.* **1985**, *26*, 2633–2636.
127. Kushi, Y.; Kuramoto, M.; Hayashi, Y.; Yamamoto, T.; Yamamoto, A.; Komiya, S. *J. Chem. Soc., Chem. Commun.* **1983**, 1033–1034.
128. Herrmann, R.; Pombeiro, A. J. L. *Monatsh. Chem.* **1988**, *119*, 583–589.
129. Egan, J. W. Jr.; Haggerty, B. S.; Rheingold, A. L.; Sendlinger, S. C.; Theopold, K. H. *J. Am. Chem. Soc.* **1990**, *112*, 2445–2446.
130. Bianchini, C.; Peruzzini, M.; Zanobini, F. *Organometallics* **1991**, *10*, 3415–3417.
131. Klein, H. F.; Beck, H.; Hammerschmitt, B.; Koch, U.; Koppert, S.; Cordier, G.; Paulus, H. *Z. Naturforsch., B: Chem. Sci.* **1991**, *46*, 147–156.
132. Roustan, J. L.; Ansari, N.; Le Page, Y.; Charland, J. P. *Can. J. Chem.* **1992**, *70*, 1650–1657.
133. Seeber, R.; Albertin, G.; Mazzocchin, G. A. *J. Chem. Soc., Dalton Trans.* **1982**, 2561–2562.
134. Gerbase, A. E.; Vichi, E. J. S.; Stein, E.; Amaral, L.; Vasquez, A.; Horner, M.; Maichle-Mossmer, C. *Inorg. Chim. Acta* **1997**, *266*, 19–27.
135. Demuyne, J.; Mougenot, P.; Benard, M. *J. Am. Chem. Soc.* **1987**, *109*, 2265–2267.
136. Berg, D. J.; Andersen, R. A. *J. Am. Chem. Soc.* **1988**, *110*, 4849–4850.
137. Weiner, W. P.; Bergman, R. G. *J. Am. Chem. Soc.* **1983**, *105*, 3922–3929.
138. Stuart, J. G.; Nicholas, K. M. *Synthesis* **1989**, 454–455.
139. Kemmerich, T.; Nelson, J. H.; Takach, N. E.; Boebme, H.; Jablonski, B.; Beck, W. *Inorg. Chem.* **1982**, *21*, 1226–1232.
140. Macazaga, M. J.; Delgado, M. S.; Masaguer, J. R. *J. Organomet. Chem.* **1986**, *310*, 249–254.
141. Baumann, F.; Heilmann, M.; Matheis, W.; Schulz, A.; Kaim, W.; Jordanov, J. *Inorg. Chim. Acta* **1996**, *251*, 239–248.
142. Peres, Y.; Dartiguenave, M.; Dartiguenave, Y.; Britten, J. F.; Beauchamp, A. L. *Organometallics* **1990**, *9*, 1041–1047.
143. Dartiguenave, M.; Dartiguenave, Y.; Oliver, M. J.; Beauchamp, A. L. *J. Coord. Chem.* **1990**, *21*, 275–281.
144. Carriedo, C.; Royo, P. *An. Quim., Ser. B* **1986**, *82*, 62–65.
145. Kownacki, I.; Kubicki, M.; Marciniak, B. *Polyhedron* **2001**, *20*, 3015–3018.
146. Capelle, B.; Beauchamp, A. L.; Dartiguenave, M.; Dartiguenave, Y.; Klein, H. F. *J. Am. Chem. Soc.* **1982**, *104*, 3891–3897.
147. Capelle, B.; Dartiguenave, M.; Dartiguenave, Y.; Beauchamp, A. L. *J. Am. Chem. Soc.* **1983**, *105*, 4662–4670.
148. Bouayad, A.; Dartiguenave, M.; Menu, M. J.; Dartiguenave, Y.; Belanger-Gariepy, F.; Beauchamp, A. L. *Organometallics* **1989**, *8*, 629–637.
149. Habbadi, N.; Dartiguenave, M.; Dartiguenave, Y. *Phosphorus, Sulfur, Silicon Relat. Elem.* **1990**, *53*, 223–226.
150. Michman, M.; Chocron, S.; Nussbaum, S.; Schumann, H.; Mohtachemi, R.; Kannert, G. *J. Organomet. Chem.* **1986**, *315*, 113–118.
151. Klein, H. F.; Brand, A.; Cordier, G. *Z. Naturforsch., B: Chem. Sci.* **1998**, *53*, 307–314.
152. Becker, C. A. L.; Homsy, N. K. *Inorg. Chim. Acta* **1984**, *89*, 95–104.
153. Di Vaira, M.; Stoppioni, P.; Peruzzini, M. *J. Chem. Soc., Dalton Trans.* **1990**, 109–113.
154. Di Vaira, M.; Ehses, M. P.; Peruzzini, M.; Stoppioni, P. *Polyhedron* **1999**, *18*, 2331–2336.
155. Di Vaira, M.; Stoppioni, P. *Polyhedron* **1994**, *13*, 3045–3051.
156. Askham, F. R.; Stanley, G. G.; Marques, E. C. *J. Am. Chem. Soc.* **1985**, *107*, 7423–7431.
157. D'Avignon, A.; Askham, F. R.; Stanley, G. G. *Inorg. Chem.* **1990**, *29*, 3363–3371.
158. Saum, S. E.; Askham, F. R.; Fronczek, F. R.; Stanley, G. G. *Polyhedron* **1988**, *7*, 1785–1788.
159. Ceconi, F.; Ghilardi, C. A.; Midollini, S.; Moneti, S. *J. Chem. Soc., Dalton Trans.* **1983**, 349–352.
160. Hitchcock, P. B.; Klein, S. I.; Nixon, J. F. *J. Organomet. Chem.* **1983**, *241*, C9–C12.
161. Zhang, Z. Z.; Cheng, H. *Coord. Chem. Rev.* **1996**, *161*, 1–39.
162. Roustan, J. L.; Ansari, N.; Ahmed, F. R. *Inorg. Chim. Acta* **1987**, *129*, L11–L12.

163. Dumond, D. S.; Richmond, M. G. *J. Am. Chem. Soc.* **1988**, *110*, 7547–7549.
164. Lei, X.; Shang, M.; Fehlner, T. P.; Werner, R.; Haase, W.; Hautot, D.; Long, G. J. *J. Organomet. Chem.* **1997**, *541*, 57–70.
165. Hong, M.; Huang, Z.; Lei, X.; Wei, G.; Kang, B.; Liu, H. *Inorg. Chim. Acta* **1989**, *159*, 1–2.
166. Chen, Z.-N.; Kang, B.-S.; Zhou, Z.-Y.; Li, W.-J.; Tong, Y.-X.; Lu, Z.-L.; Su, C.-Y. *Bull. Chem. Soc. Jpn* **1998**, *71*, 1805–1809.
167. Vastag, S.; Gervasio, G.; Marabello, D.; Szalontai, G.; Marko, L. *Organometallics* **1998**, *17*, 4218–4225.
168. Shibahara, T.; Akashi, H.; Yamasaki, M.; Hashimoto, K. *Chem. Lett.* **1991**, 689–692.
169. Rasanen, T. M.; Jaarskelainen, S.; Pakkanen, T. A. *J. Organomet. Chem.* **1997**, *548*, 263–268.
170. Muir, K. W.; Rumin, R.; Petillon, F. Y. *J. Organomet. Chem.* **2001**, *635*, 110–118.
171. Jeffery, J. C.; Went, M. J. *J. Chem. Soc., Dalton Trans.* **1990**, 567–572.
172. Liu, S.; Yan, H.; Hu, X.; Liu, Q. *Huaxue Xuebao* **1992**, *50*, 1173–1177.
173. Bialek, B.; Stepień, Z. M. *Vacuum* **2001**, *63*, 241–248.
174. Peruzzini, M.; Poli, R. *Recent Advances in Hydride Chemistry* **2001**, Elsevier Science: Amsterdam.
175. Bianchini, C.; Innocenti, P.; Meli, A.; Peruzzini, M.; Zanobini, F.; Zanello, P. *Organometallics* **1990**, *9*, 2514–2522.
176. Gusev, D. G.; Vymenits, A. B.; Bakmutov, V. I. *Inorg. Chem.* **1991**, *30*, 3116–3118.
177. Ciancanelli, R.; Noll, B. C.; DuBois, D. L.; DuBois, M. R. *J. Am. Chem. Soc.* **2002**, *124*, 2984–2992.
178. Daniele, S.; Mazzocchin, G. A.; Ugo, P.; Albertin, G.; Antoniutti, S.; Bordignon, E. *J. Chem. Soc., Dalton Trans.* **1994**, 695–701.
179. Onishi, M.; Matsuda, M.; Takaki, I.; Hiraki, K.; Oishi, S. *Bull. Chem. Soc. Jpn* **1989**, *62*, 2963–2967.
180. Albertin, G.; Amendola, P.; Antoniutti, S.; Bordignon, E. *J. Chem. Soc., Dalton Trans.* **1990**, 2979–2984.
181. Bianchini, C.; Meli, A.; Scapacci, G. *Organometallics* **1983**, *2*, 1834–1838.
182. Komiyama, S.; Srivastava, R. S.; Yamamoto, A.; Yamamoto, T. *Organometallics* **1985**, *4*, 1504–1508.
183. Hayashi, Y.; Yamamoto, T.; Yamamoto, A.; Komiyama, S.; Kushi, Y. *J. Am. Chem. Soc.* **1986**, *108*, 385–391.
184. Wink, D. J.; Cooper, N. J. *J. Chem. Soc., Dalton Trans.* **1984**, 1257–1259.
185. Bianchini, C.; Mealli, C.; Meli, A.; Peruzzini, M.; Zanobini, F. *J. Am. Chem. Soc.* **1988**, *110*, 8725–8726.
186. Bianchini, C.; Mealli, C.; Peruzzini, M.; Zanobini, F. *J. Am. Chem. Soc.* **1992**, *114*, 5905–5906.
187. Wehmeyer, R. M. *PCT Int. Appl.* **2001**, 2001004177.
188. Taylor, R. J.; Drago, R. S.; Hage, J. P. *Inorg. Chem.* **1992**, *31*, 253–258.
189. Rozenkevich, M. B.; Sakharovskii, Y. A. *Int. J. Hydrogen Energy* **1989**, *14*, 431–436.
190. Carter, S. J.; Foxman, B. M.; Stuhl, L. S. *Inorg. Chem.* **1986**, *25*, 2888–2894.
191. Napanadze, T. S.; Tarasov, V. P.; Gulya, A. P.; Tsintsadze, G. V.; Buslaev, Y. A. *Koord. Khim.* **1990**, *16*, 248–251.
192. Connelly, N. G.; Hicks, O. M.; Lewis, G. R.; Orpen, A. G.; Wood, A. J. *J. Chem. Soc., Dalton Trans.* **2000**, 1637–1643.
193. Lysyak, T. V.; Adae, I. S. *Zh. Neorg. Khim.* **1995**, *40*, 1302.
194. Kitajima, N.; Hikichi, S.; Tanaka, M.; Moro-oka, Y. *J. Am. Chem. Soc.* **1993**, *115*, 5496–5508.
195. Costamagna, J.; Ferraudi, G.; Canales, J.; Vargas, J. *Coord. Chem. Rev.* **1996**, *148*, 221–248.
196. Brunker, T. J.; Barlow, S.; O'Hare, D. *J. Chem. Soc., Chem. Commun.* **2001**, 2052–2053.
197. Kauffmann, T.; Saelker, R.; Voss, K. U. *Chem. Ber.* **1993**, *126*, 1447–1452.
198. Leung, W.-P.; Lee, H.-K.; Zhou, Z.-Y.; Mak, T. C. W. *J. Organomet. Chem.* **1993**, *443*, C39–C40.
199. Hay-Motherwell, R. S.; Wilkinson, G.; Hussain, B.; Hursthouse, M. B. *Polyhedron* **1990**, *9*, 931–937.
200. Beaven, S.; Riordan, C. G.; Liable-Sands, L. M.; Incarvito, C. D.; Rheingold, A. L. *J. Am. Chem. Soc.* **2001**, *123*, 331–332.
201. Leznoff, D. B.; Fryzuk, M. D.; Thompson, R. C. In *Monogr. Ser. Int. Conf. Coord. Chem.*; 1999, Vol. 4, pp 165–170.
202. Leung, W.-P.; Lee, H. K.; Weng, L.-H.; Zhou, A.-Y.; Mak, T. C. W. *J. Chem. Soc., Dalton Trans.* **1997**, 779–783.
203. Anton, M.; Muller, G.; Sales, J.; Vinaixa, J. *J. Organomet. Chem.* **1982**, *239*, 365–375.
204. Newman, J. M.; Binns, M.; Hambley, T. W.; Freeman, H. C. *Inorg. Chem.* **1991**, *30*, 3499–3502.
205. Migdal-Mikuli, A.; Mikuli, E.; Wrobel, S.; Hetmanczyk, L. Z. *Naturforsch., A: Phys. Sci.* **1999**, *54*, 590–594.
206. Brunschwig, B. S.; Creutz, C.; Macartney, D. H.; Sham, T. K.; Sutin, N. *Faraday Discuss. Chem. Soc.* **1982**, 113–127.
207. Stephan, H.-O.; Kanatzidis, M. G. *J. Am. Chem. Soc.* **1996**, *118*, 12226–12227.
208. Stephan, H.-O.; Kanatzidis, M. G. *Inorg. Chem.* **1997**, *36*, 6050–6057.
209. Lappin, A. G.; Marusak, R. A.; Osvath, P. *Inorg. Chem.* **1987**, *26*, 4292–4294.
210. Warren, R. M. L.; Haller, K. J.; Tatehata, A.; Lappin, A. G. *Inorg. Chem.* **1994**, *33*, 227–232.
211. Marusak, R. A.; Osvath, P.; Kemper, M.; Lappin, A. G. *Inorg. Chem.* **1989**, *28*, 1542–1548.
212. Tatehata, A.; Mitani, T. *Chem. Lett.* **1989**, 1167–1170.
213. Tatehata, A.; Akita, H. *Bull. Chem. Soc. Jpn* **1991**, *64*, 1985–1987.
214. Reinen, D.; Ozarowski, A.; Jakob, B.; Pebler, J.; Stratemeier, H.; Wieghardt, K.; Tolksdorf, I. *Inorg. Chem.* **1987**, *26*, 4010–4017.
215. Kang, C.; Anson, F. C. *J. Electroanal. Chem.* **1996**, *407*, 233–236.
216. Knoch, F.; Thaler, F.; Schindler, S. Z. *Kristallogr.* **1996**, *211*, 717–718.
217. Matsuoka, S.; Yamamoto, K.; Ogata, T.; Kusaba, M.; Nakashima, N.; Fujita, E.; Yanagida, S. *J. Am. Chem. Soc.* **1993**, *115*, 601–609.
218. Premkumar, J.; Ramaraj, R. *J. Chem. Soc., Dalton Trans.* **1998**, 3667–3672.
219. Creaser, I. I.; Geue, R. J.; Harrowfield, J. M.; Herlt, A. J.; Sargeson, A. M.; Snow, M. R.; Springborg, J. *J. Am. Chem. Soc.* **1982**, *104*, 6016–6025.
220. Geue, R. J.; Jin Qin, C.; Ralph, S. F.; Sargeson, A. M.; Willis, A. C.; Skelton, B. W.; White, A. H. *Chem. Commun.* **1999**, 2351–2352.
221. Broge, L.; Pretzmann, U.; Jensen, N.; Sotofte, I.; Olsen, C. E.; Springborg, J. *Inorg. Chem.* **2001**, *40*, 2323–2334.
222. Fu, Y.-J.; Gao, Z.-S.; Yang, H.; Dai, W.; Wang, D.; Hu, H.; Tang, W.; Zhang, Z.; Mak, T. C. W. *Acta Crystallogr., Sect. C: Cryst. Struct. Commun.* **1999**, *C55*, 349–351.
223. Chen, H.; An, T.; Fang, Y.; Zhu, K. *J. Mol. Catal. A: Chem.* **1999**, *147*, 165–172.
224. Beattie, J. K.; Hambley, T. W.; Klepetko, J. A.; Masters, A. F.; Turner, P. *Polyhedron* **1996**, *15*, 473–479.
225. Kohler, M.; Leary, J. A. *J. Am. Soc. Mass Spectrom.* **1997**, *8*, 1124–1133.

226. Kansikas, J.; Leskela, M.; Kenessey, G.; Werner, P.-E.; Liptay, G. *Acta Chem. Scand.* **1994**, *48*, 951–959.
227. Kenessey, G.; Lashgari, K.; Machula, G.; Liptay, G. *Acta Chem. Scand.* **1994**, *48*, 705–710.
228. Liptay, G.; Kenessey, G.; L., B.; Wadsten, T.; Mink, J. *J. Therm. Anal.* **1992**, *38*, 899–905.
229. Kenessey, G.; Parkanyi, L.; Werner, P.-E.; Keseru, G. M.; Wadsten, T.; Bihatsi, L.; Liptay, G. *Struct. Chem.* **1994**, *5*, 123–128.
230. Hiltunen, L.; Ninisto, L.; Kenessey, G.; Keseru, G. M.; Liptay, G. *Acta Chem. Scand.* **1994**, *48*, 456–460.
231. Liptay, G.; Mink, J.; Kenessey, G. *Thermochim. Acta* **1993**, *214*, 71–83.
232. Kansikas, J.; Leskela, M.; Kenessey, G.; Wadsten, T.; Liptay, G. *Acta Chem. Scand.* **1996**, *50*, 267–274.
233. Thornton, D. A.; Verhoeven, P. F. M.; Desseyn, H. O.; Hofmans, H. *Thermochim. Acta* **1987**, *113*, 161–169.
234. Kojima, K. *Bull. Chem. Soc. Jpn* **1987**, *60*, 603–607.
235. Boys, D.; Escobar, C.; Wittke, O. *Acta Crystallogr., Sect. C: Cryst. Struct. Commun.* **1984**, *C40*, 1359–1362.
236. Warren, R. M. L.; Oehrstroem, L.; Opiteck, G. J.; Shang, M.; Lappin, A. G. *Inorg. Chim. Acta* **1994**, *225*, 75–82.
237. Geraghty, M.; McCann, M.; Devereux, M.; Cronin, F.; Curran, M.; McKee, V. *Met.-Based Drugs* **1999**, *6*, 41–48.
238. Sieber, R.; Decurtins, S.; Stoekli-Evans, H.; Wilson, C.; Yufit, D.; Howard, J. A. K.; Capelli, S. C.; Hauser, A. *Chem.-Eur. J.* **2000**, *6*, 361–368.
239. Coronado, E.; Galan-Mascaros, J. R.; Gomez-Garcia, C. J.; Martinez-Agudo, J. M. *Inorg. Chem.* **2001**, *40*, 113–120.
240. Mizuno, K.; Lunsford, J. H. *Inorg. Chem.* **1983**, *22*, 3484–3486.
241. Tiwary, S. K.; Vasudevan, S. *Chem. Phys. Lett.* **1997**, *277*, 84–88.
242. Tiwary, S. K.; Vasudevan, S. *Inorg. Chem.* **1998**, *37*, 5239–5246.
243. Briot, E.; Bedioui, F.; Balkus, K. J. Jr. *J. Electroanal. Chem.* **1998**, *454*, 83–89.
244. Howells, A. R.; Zambrano, P. J.; Collinson, M. M. *Anal. Chem.* **2000**, *72*, 5265–5271.
245. Figgis, B. N.; Kucharski, E. S.; White, A. H. *Aust. J. Chem.* **1983**, *36*, 1527–1535.
246. Figgis, B. N.; Kucharski, E. S.; White, A. H. *Aust. J. Chem.* **1983**, *36*, 1537–1561.
247. Takusagawa, F.; Yohannes, P. G.; Mertes, K. B. *Inorg. Chim. Acta* **1986**, *114*, 165–169.
248. Henke, W.; Kremer, S. *Inorg. Chim. Acta* **1982**, *65*, L115–L117.
249. Beattie, J. K.; Binstead, R. A.; Kelso, M. T.; Del Favero, P.; Gregory Dewey, T.; Turner, D. H. *Inorg. Chim. Acta* **1995**, *235*, 245–251.
250. Hathcock, D. J.; Stone, K.; Madden, J.; Slattery, S. J. *Inorg. Chim. Acta* **1998**, *282*, 131–135.
251. Ayers, T.; Scott, S.; Goins, J.; Caylor, N.; Hathcock, D.; Slattery, S. J.; Jameson, D. L. *Inorg. Chim. Acta* **2000**, *307*, 7–12.
252. Lehn, J. M.; Sauvage, J. P.; Simon, J.; Ziessel, R.; Piccinni-Leopardi, C.; Germain, G.; Declercq, J. P.; Van Meerssche, M. *Nouv. J. Chim.* **1983**, *7*, 413–420.
253. Constable, E. C.; Hannon, M. J.; Harverson, P.; Neuburger, M.; Smith, D. R.; Wanner, V. F.; Whall, L. A.; Zehnder, M. *Polyhedron* **2000**, *19*, 23–34.
254. Gheysen, K. A.; Potts, K. T.; Hurrell, H. C.; Abruna, H. D. *Inorg. Chem.* **1990**, *29*, 1589–1592.
255. Constable, E. C.; Walker, J. V.; Tocher, D. A.; Daniels, M. A. M. *J. Chem. Soc., Chem. Commun.* **1992**, 768–771.
256. Constable, E. C.; Daniels, M. A. M.; Drew, M. G. B.; Tocher, D. A.; Walker, J. V.; Wood, P. D. *J. Chem. Soc., Dalton Trans.* **1993**, 1947–1958.
257. Chotalia, R.; Constable, E. C.; Neuburger, M.; Smith, D. R.; Zehnder, M. *J. Chem. Soc., Dalton Trans.* **1996**, 4207–4216.
258. Potts, K. T.; Keshavarz-K, M.; Tham, F. S.; Raiford, K. A. G.; Arana, C.; Abruna, H. D. *Inorg. Chem.* **1993**, *32*, 5477–5484.
259. Potts, K. T.; Wentland, M. P.; Ganguly, D.; Storrier, G. D.; Cha, S. K.; Cha, J.; Abruna, H. D. *Inorg. Chim. Acta* **1999**, *288*, 189–199.
260. Jones, P. L.; Byrom, K. J.; Jeffery, J. C.; McCleverty, J. A.; Ward, M. D. *J. Chem. Soc., Chem. Commun.* **1997**, 1361–1362.
261. Allen, C. S.; Chuang, C.-L.; Cornebise, M.; Canary, J. W. *Inorg. Chim. Acta* **1995**, *239*, 29–37.
262. Suzuki, M.; Ueda, I.; Kanatomi, H.; Murase, I. *Chem. Lett.* **1983**, 185–188.
263. Collman, J. P.; Denisevich, P.; Konai, Y.; Marrocco, M.; Koval, C.; Anson, F. C. *J. Am. Chem. Soc.* **1980**, *102*, 6027–6036.
264. Durand, R. R., Jr.; Bencosme, C. S.; Collman, J. P.; Anson, F. C. *J. Am. Chem. Soc.* **1983**, *105*, 2710–2718.
265. Collman, J. P.; Hutchison, J. E.; Lopez, M. A.; Tabard, A.; Guillard, R.; Seok, W. K.; Ibers, J. A.; L'Her, M. *J. Am. Chem. Soc.* **1992**, *114*, 9869–9877.
266. Anson, F. C.; Shi, C.; Steiger, B. *Acc. Chem. Res.* **1997**, *30*, 437–444.
267. Akashi, K.; Suga, N.; *Eur. Pat. Appl.* **1983**, 73456.
268. Dai, S.; Burleigh, M. C.; Shin, Y. *U.S.* **2001**, 6251280.
269. Steiger, B.; Shi, C.; Anson, F. C. *Inorg. Chem.* **1993**, *32*, 2107–2113.
270. D'Souza, F.; Hsieh, Y.-Y.; Deviprasad, G. R. *Chem. Commun.* **1998**, 1027–1028.
271. Song, E.; Shi, C.; Anson, F. C. *Langmuir* **1998**, *14*, 4315–4321.
272. Suresh, E.; Venkatasubramanian, K. Z. *Kristallogr.* **1997**, *212*, 239–240.
273. Zhao, P.-S.; Jian, F.-F.; Lu, L.-D.; Yang, X.-J.; Wang, X.; Raj, S. S.-S.; Fun, H.-K. *Wuji Huaxue Xuebao* **2000**, *16*, 964–968.
274. Marzotto, A.; Bianchi, A.; Valle, G.; Clemente, D. A. *Acta Crystallogr., Sect. C: Cryst. Struct. Commun.* **1989**, *C45*, 582–585.
275. Baran, Y.; Linert, W. *J. Chem. Crystallogr.* **1999**, *29*, 1077–1079.
276. Saha, N.; Sigel, H. *J. Am. Chem. Soc.* **1982**, *104*, 4100–4105.
277. Gajda, T.; Henry, B.; Delpuech, J.-J. *Inorg. Chem.* **1997**, *36*, 1850–1859.
278. Trofimenko, S.; Calabrese, J. C.; Kochi, J. K.; Wolowiec, S.; Hulsbergen, F. B.; Reedijk, J. *Inorg. Chem.* **1992**, *31*, 3943–3950.
279. Huang, J.; Lee, L.; Haggerty, B. S.; Rheingold, A. L.; Walters, M. A. *Inorg. Chem.* **1995**, *34*, 4268–4270.
280. Theopold, K. H.; Reinaud, O. M.; Doren, D.; Konecny, R. *Stud. Surf. Sci. Catal.* **1997**, *110*, 1081–1088.
281. Reinaud, O. M.; Rheingold, A. L.; Theopold, K. H. *Inorg. Chem.* **1994**, *33*, 2306–2308.
282. Reinaud, O. M.; Theopold, K. H. *J. Am. Chem. Soc.* **1994**, *116*, 6979–6980.

283. Reinaud, O. M.; Yap, G. P. A.; Rheingold, A. L.; Theopold, K. H. *Angew. Chem., Int. Ed. Engl.* **1995**, *34*, 2051–2052.
284. Hikichi, S.; Komatsuzaki, H.; Kitajima, N.; Akita, M.; Mukai, M.; Kitagawa, T.; Moro-oka, Y. *Inorg. Chem.* **1997**, *36*, 266–267.
285. Thyagarajan, S.; Incarvito, C. D.; Rheingold, A. L.; Theopold, K. H. *Chem. Commun.* **2001**, 2198–2199.
286. Shirasawa, N.; Akita, M.; Hikichi, S.; Moro-oka, Y. *Chem. Commun.* **1999**, 417–418.
287. Shirasawa, N.; Nguyet, T. T.; Hikichi, S.; Moro-oka, Y.; Akita, M. *Organometallics* **2001**, *20*, 3582–3598.
288. Gorun, S. M.; Hu, Z.; Stibrany, R. T.; Carpenter, G. *Inorg. Chim. Acta* **2000**, *297*, 383–388.
289. Lukaszewicz, M.; Ciunik, Z.; Wolowicz, S. *Polyhedron* **2000**, *19*, 2119–2125.
290. Ruman, T.; Ciunik, Z.; Goclan, A.; Lukaszewicz, M.; Wolowicz, S. *Polyhedron* **2001**, *20*, 2965–2970.
291. Siemer, C. J.; Meece, F. A.; Armstrong, W. H.; Eichhorn, D. M. *Polyhedron* **2001**, *20*, 2637–2646.
292. Siemer, C. J.; Goswami, N.; Kahol, P. K.; Van Stipdonk, M. J.; Eichhorn, D. M. *Inorg. Chem.* **2001**, *40*, 4081–4084.
293. Hannay, C.; Hubin-Franskin, M.-J.; Grandjean, F.; Briois, V.; Itie, J.-P.; Polian, A.; Trofimenko, S.; Long, G. J. *Inorg. Chem.* **1997**, *36*, 5580–5588.
294. Carmona, D.; Lahoz, F. J.; Atencio, R.; Edwards, A. J.; Oro, L. A.; Lamata, M. P.; Esteban, M.; Trofimenko, S. *Inorg. Chem.* **1996**, *35*, 2549–2557.
295. Hay, R. W.; Bembi, R. *Inorg. Chim. Acta* **1982**, *65*, L207–L209.
296. Hay, R. W.; Fraser, I.; Owen, N. C. *Polyhedron* **1998**, *17*, 1611–1615.
297. Ali, M. A.; Hay, R. W.; Lawrance, G. A. *Inorg. Chim. Acta* **1983**, *70*, 65–70.
298. Hay, R. W.; Ali, M. A.; Jeragh, B. J. *Chem. Soc., Dalton Trans.* **1988**, 2763–2767.
299. Lu, T. H.; Chen, B. H.; Chung, C. S. *J. Chin. Chem. Soc. (Taipei)* **1992**, *39*, 343–345.
300. Szalda, D. J.; Fujita, E.; Creutz, C. *Inorg. Chem.* **1989**, *28*, 1446–1450.
301. Chen, B.-H.; Lai, C.-Y.; Chung, C.-S.; Liao, F.-L.; Wang, S.-L. *J. Chin. Chem. Soc. (Taipei)* **1994**, *41*, 627–629.
302. Rapsomanikis, S.; Ciejka, J. J.; Weber, J. H. *Inorg. Chim. Acta* **1984**, *89*, 179–183.
303. Sister, E.; Gottfried, V.; Kapon, M.; Kaftory, M.; Dori, Z.; Gray, H. B. *Inorg. Chem.* **1988**, *27*, 600–604.
304. Bailey, C. L.; Bereman, R. D.; Rillema, D. P. *Inorg. Chem.* **1986**, *25*, 3149–3153.
305. Gou, S.; You, X.; Yu, K.; Lu, J. *Inorg. Chem.* **1993**, *32*, 1883–1887.
306. Zhu, T.; Su, C. H.; Lemke, B. K.; Wilson, L. J.; Kadish, K. M. *Inorg. Chem.* **1983**, *22*, 2527–2530.
307. Bennett, A. M. A. *PCT Int. Appl.* **1999**, 9951550.
308. Abidi, R.; Arnaud-Neu, F.; Drew, M. G. B.; Lahely, S.; Marrs, D.; Nelson, J.; Schwing-Weill, M.-J. *J. Chem. Soc., Perkin Trans. 2* **1996**, 2747–2756.
309. Bracci, M.; Ercolani, C.; Floris, B.; Bassetti, M.; Chiesi-Villa, A.; Guastini, C. *J. Chem. Soc., Dalton Trans.* **1990**, 1357–1363.
310. Kalra, S. J. S.; Punniyamurthy, T.; Iqbal, J. *Tetrahedron Lett.* **1994**, *35*, 4847–4850.
311. Punniyamurthy, T.; Iqbal, J. *Tetrahedron Lett.* **1994**, *35*, 4007–4010.
312. Punniyamurthy, T.; Kalra, S. J. S.; Iqbal, J. *Tetrahedron Lett.* **1995**, *36*, 8497–8500.
313. Maikap, G. C.; Guhathakurta, D.; Iqbal, J. *Synlett* **1995**, 189–190.
314. Punniyamurthy, T.; Bhatia, B.; Reddy, M. M.; Maikap, G. C.; Iqbal, J. *Tetrahedron* **1997**, *53*, 7649–7670.
315. Losada, J.; del Peso, I.; Beyler, L.; Hartung, J.; Fernandez, V.; Moebius, M. *J. Electroanal. Chem.* **1995**, *398*, 89–93.
316. Casella, L.; Gullotti, M. *Inorg. Chem.* **1986**, *25*, 1293–1303.
317. Jitsukawa, K.; Yamamoto, T.; Atsumi, T.; Masuda, H.; Einaga, H. *J. Chem. Soc., Chem. Commun.* **1994**, 2335–2336.
318. Popescu, A.; Simion, A.; Scozzafaa, A.; Briganti, F.; Supuran, C. T. *J. Enzyme Inhibition* **1999**, *14*, 407–423.
319. Migita, K.; Migita, C. T.; Iwaizumi, M. *J. Chem. Soc., Dalton Trans.* **1984**, 1195–1201.
320. Thery, P.; Zarembowitch, J. *Inorg. Chem.* **1986**, *25*, 2001–2008.
321. Zanello, P.; Cini, R.; Cinquantini, A.; Orioli, P. L. *J. Chem. Soc., Dalton Trans.* **1983**, 2159–2166.
322. Corden, B. B.; Drago, R. S.; Perito, R. P. *J. Am. Chem. Soc.* **1985**, *107*, 2903–2907.
323. Maruyama, K.; Tamanaka, K.; Nishinaga, A.; Inada, A.; Nakanishi, T. *Tetrahedron Lett.* **1989**, *30*, 4145–4148.
324. Zombeck, A.; Hamilton, D. E.; Drago, R. S. *J. Am. Chem. Soc.* **1982**, *104*, 6782–6784.
325. Hamilton, D. E.; Drago, R. S.; Zombeck, A. *J. Am. Chem. Soc.* **1987**, *109*, 374–379.
326. Boca, R.; Elias, H.; Haase, W.; Huber, M.; Klement, R.; Muller, L.; Paulus, H.; Svoboda, I.; Valko, M. *Inorg. Chim. Acta* **1998**, *278*, 127–135.
327. Roberts, D. A.; Bush, J. M.; Tsao, Y. Y.; Katovic, V.; Fortman, J. J.; Cummings, S. C. *Inorg. Chem.* **1983**, *22*, 1804–1809.
328. Lambert, S. L.; Spiro, C. L.; Gagne, R. R.; Hendrickson, D. N. *Inorg. Chem.* **1982**, *21*, 68–72.
329. Furutachi, H.; Okawa, H. *Inorg. Chem.* **1997**, *36*, 3911–3918.
330. Brooker, S.; Kelly, R. J.; Plieger, P. G. *Chem. Commun.* **1998**, 1079–1080.
331. Szalda, D. J.; Schwarz, C. L.; Endicott, J. F.; Fujita, E.; Creutz, C. *Inorg. Chem.* **1989**, *28*, 3214–3219.
332. Rotzinger, F. P.; Kumar, K.; Endicott, J. F. *Inorg. Chem.* **1982**, *21*, 4111–4112.
333. Lee, S.; Bakac, A.; Espenson, J. H. *Inorg. Chem.* **1990**, *29*, 2480–2482.
334. Wang, W. D.; Bakac, A.; Espenson, J. H. *Inorg. Chem.* **1993**, *32*, 5034–5039.
335. Hay, R. W.; Bembi, R. *Inorg. Chim. Acta* **1984**, *86*, 65–70.
336. Webley, W. S.; Durand, R. R. Jr.; Anson, F. C. *J. Electroanal. Chem. Interfacial Electrochem.* **1987**, *229*, 273–283.
337. Wang, W.-D.; Bakac, A.; Espenson, J. H. *Inorg. Chem.* **1995**, *34*, 4049–4056.
338. Gibney, S. C.; Ferraudi, G.; Shang, M. *Inorg. Chem.* **1999**, *38*, 2898–2905.
339. Marchaj, A.; Bakac, A.; Espenson, J. H. *Inorg. Chem.* **1993**, *32*, 2399–2403.
340. Bhugun, I.; Anson, F. C. *Inorg. Chem.* **1996**, *35*, 7253–7259.
341. Solomon-Rapaport, E.; Masarwa, A.; Cohen, H.; Meyerstein, D. *Inorg. Chim. Acta* **2000**, *307*, 41–46.
342. Jaynes, B. S.; Doerrer, L. H.; Liu, S.; Lippard, S. J. *Inorg. Chem.* **1995**, *34*, 5735–5744.
343. Cupertino, D.; McPartlin, M.; Zissimos, A. M. *Polyhedron* **2001**, *20*, 3239–3247.
344. Garcia-Espana, E.; Ballester, M. J.; Lloret, F.; Moratal, J. M.; Faus, J.; Bianchi, A. *J. Chem. Soc., Dalton Trans.* **1988**, 101–104.
345. Chiumia, G. C.; Craig, D. C.; Imdadullah; Phillips, D. J. *Inorg. Chim. Acta* **1993**, *209*, 213–217.

346. Black, D.; Blake, A. J.; Dancey, K. P.; Harrison, A.; McPartlin, M.; Parsons, S.; Tasker, P. A.; Whittaker, G.; Schroder, M. *J. Chem. Soc., Dalton Trans.* **1998**, 3953–3960.
347. Zhang, Z.; Liu, R.; Zhao, M.; Qian, Y. *Mater. Chem. Phys.* **2001**, *71*, 161–164.
348. Singh, U. P.; Ghose, R.; Ghose, A. K. *Cryst. Res. Technol.* **1989**, *24*, K121–K124.
349. Qui, D. T.; Bagieu, M. *Acta Crystallogr., Sect. C: Cryst. Struct. Commun.* **1990**, *C46*, 1645–1647.
350. Burgmayer, S. J. N.; Stiefel, E. I. *Inorg. Chem.* **1988**, *27*, 4059–4065.
351. MacBeth, C. E.; Hammes, B. S.; Young, V. G., Jr.; Borovik, A. S. *Inorg. Chem.* **2001**, *40*, 4733–4741.
352. Ray, M.; Hammes, B.; Yap, G. P. A.; Rheingold, A. L.; Borovik, A. S. *Inorg. Chem.* **1998**, *37*, 1527–1532.
353. Englert, U.; Straehle, J. *Gazz. Chim. Ital.* **1988**, *118*, 845–855.
354. Doyle, M. P.; Pickering, R. A.; Dykstra, R. L.; Cook, B. R. *J. Am. Chem. Soc.* **1982**, *104*, 3392–3397.
355. Doyle, M. P.; Pickering, R. A.; Cook, B. R. *J. Inorg. Biochem.* **1983**, *19*, 329–338.
356. Maejima, T.; Miki, E.; Tanaka, M.; Tezuka, H.; Mizumachi, K.; Ishimori, T. *Bull. Chem. Soc. Jpn.* **1990**, *63*, 1596–1601.
357. Buschmann, W. E.; Miller, J. S. *Chem.-Eur. J.* **1998**, *4*, 1731–1737.
358. Kopylovich, M. N.; Kukushkin, V. Y.; Guedes da Silva, M. F. C.; Haukka, M.; Frausto da Silva, J. J. R.; Pombeiro, A. J. L. *J. Chem. Soc., Perkin Trans. 1* **2001**, 1569–1573.
359. Hipps, K. W.; Mazur, U. *J. Phys. Chem.* **1987**, *91*, 5218–5224.
360. Ishiguro, S.; Sotobayashi, T.; Satoh, K.; Saito, K. *Inorg. Chem.* **1988**, *27*, 1152–1155.
361. Pilarczyk, M.; Klinszporn, L. *Pol. J. Chem.* **1994**, *68*, 577–582.
362. Suzuki, K.; Ohzeki, K.; Kambara, T. *Bull. Chem. Soc. Jpn.* **1983**, *56*, 2624–2626.
363. Afeworki, S.; Chandravanshi, B. S. *Mikrochim. Acta* **1987**, *2*, 143–152.
364. Sastry, C. S. P.; Rao, J. S. V. M. L.; Rao, K. R. *Talanta* **1995**, *42*, 1479–1485.
365. Issa, Y. M.; Shoukry, A. F.; Rizk, M. S.; Atia, E. M. *J. Chem. Technol. Biotechnol.* **1995**, *64*, 379–385.
366. Adelusi, S. A.; Onyekweli, A. O. *Pakistan J. Scient. Ind. Res.* **1996**, *39*, 22–24.
367. Sreedhar, K.; Sastry, C. S. P.; Reddy, M. N.; Sankar, D. G. *Mikrochim. Acta* **1997**, *126*, 131–135.
368. Ghebeh, H.; Handa-Corrigan, A.; Butler, M. *Anal. Biochem.* **1998**, *262*, 39–44.
369. Ayad, M. M.; Khalil, H. M.; El-Henawee, M.; Hosny, M. *Scientia Pharmaceutica* **1999**, *67*, 241–251.
370. Mali, T. N.; Hancock, R. D.; Boeyens, J. C. A.; Oosthuizen, E. L. *J. Chem. Soc., Dalton Trans.* **1991**, 1161–1163.
371. Tang, J.-K.; Wang, H.-M.; Cheng, P.; Liu, X.; Liao, D.-Z.; Jiang, Z.-H.; Yan, S.-P. *Pol. J. Chem.* **2000**, *74*, 1651–1654.
372. Chakravorti, M. C.; Subrahmanyam, G. V. B. *Can. J. Chem.* **1992**, *70*, 836–838.
373. Goher, M. A. S.; Mautner, F. A. *Polyhedron* **1999**, *18*, 2339–2344.
374. Barandika, M. G.; Cortes, R.; Serna, Z.; Lezama, L.; Rojo, T.; Urtiaga, M. K.; Arriortua, M. I. *Chem. Commun.* **2001**, 45–46.
375. Alnaji, O.; Dartiguenave, M.; Dartiguenave, Y.; Simard, M.; Beauchamp, A. L. *Inorg. Chim. Acta* **1991**, *187*, 31–38.
376. Godfrey, S. M.; Lane, H. P.; McAuliffe, C. A.; Pritchard, R. G. *J. Chem. Soc., Dalton Trans.* **1993**, 1599–1604.
377. Leadbeater, N. E.; Scott, K. A. *J. Org. Chem.* **2000**, *65*, 4770–4772.
378. Iwatsuki, S.; Kato, H.; Obeyama, K.; Funahashi, S.; Koshino, N.; Kashiwabara, K.; Suzuki, T.; Takagi, H. D. *Inorg. Chem. Commun.* **2000**, *3*, 501–504.
379. Wei, G.; Hong, M.; Huang, Z.; Liu, H. *J. Chem. Soc., Dalton Trans.* **1991**, 3145–3148.
380. Meehan, P. R.; Alyea, E. C.; Shakya, R. P.; Ferguson, G. *Polyhedron* **1997**, *17*, 11–16.
381. Bianchini, C.; Masi, D.; Mealli, C.; Meli, A.; Sabat, M. *Gazz. Chim. Ital.* **1986**, *116*, 201–206.
382. Rupp, R.; Huttner, G.; Kircher, P.; Soltek, R.; Buchner, M. *Eur. J. Inorg. Chem.* **2000**, 1745–1757.
383. Bianchini, C.; Meli, A.; Orlandini, A. *Inorg. Chem.* **1982**, *21*, 4161–4165.
384. Heinze, K.; Huttner, G.; Zsolnai, L.; Jacobi, A.; Schober, P. *Chem.-Eur. J.* **1997**, *3*, 732–743.
385. Heinze, K.; Huttner, G.; Walter, O. *Eur. J. Inorg. Chem.* **1999**, 593–600.
386. Heinze, K.; Huttner, G.; Zsolnai, L. *Chem. Ber./Recl.* **1997**, *130*, 1393–1403.
387. Bader, A.; Lindler, E. *Coord. Chem. Rev.* **1991**, *108*, 27–110.
388. Braunstein, P.; Kelly, D. G.; Tiripicchio, A.; Ugozzoli, F. *Inorg. Chem.* **1993**, *32*, 4845–4852.
389. Chadwell, S. J.; Coles, S. J.; Edwards, P. G.; Hursthouse, M. B. *J. Chem. Soc., Dalton Trans.* **1995**, 3551–3559.
390. Hale, A. L.; Levason, W.; Tuttlebee, H. E. *Inorg. Chim. Acta* **1982**, *60*, 73–79.
391. Lane, H. P.; Watkinson, M.; Bricklebank, N.; McAuliffe, C. A.; Pritchard, R. G. *Inorg. Chim. Acta* **1995**, *232*, 145–150.
392. Fryzuk, M. D.; Leznoff, D. B.; Thompson, R. C.; Rettig, S. J. *J. Am. Chem. Soc.* **1998**, *120*, 10126–10135.
393. Sindellari, L.; Zarli, B.; Sitran, S.; Celon, E. *Inorg. Chim. Acta* **1982**, *64*, L79–L81.
394. Parmar, S. S.; Kaur, H. *Transition Met. Chem. (Weinheim)* **1982**, *7*, 167–169.
395. Richens, D. T. *The Chemistry of Aqua Ions* **1997**, Wiley: Chichester.
396. Helm, L.; Merbach, A. E. *Coord. Chem. Rev.* **1999**, *187*, 151–181.
397. Turpeinen, U.; Hamalainen, R.; Reedijk, J. *Polyhedron* **1987**, *6*, 1603–1610.
398. Ama, T.; Miyazaki, J.; Hamada, K.; Okamoto, K.; Yonemura, T.; Kawaguchi, H.; Yasui, T. *Chem. Lett.* **1995**, 267–268.
399. Chaudhuri, P.; Querbach, J.; Wiegardt, K.; Nuber, B.; Weiss, J. *J. Chem. Soc., Dalton Trans.* **1990**, 271–278.
400. Hikichi, S.; Yoshikawa, M.; Sasakura, Y.; Komatsuzaki, H.; Moro-oka, Y.; Akita, M. *Chem.-Eur. J.* **2001**, *7*, 5011–5028.
401. Sidorov, A. A.; Fomina, I. G.; Talismanov, S. S.; Aleksandrov, G. G.; Novotortsev, V. M.; Nefedov, S. E.; Eremenko, I. L. *Russ. J. Coord. Chem.* **2001**, *27*, 548–559.
402. Brechin, E. K.; Harris, S. G.; Harrison, A.; Parsons, S.; Whittaker, A. G.; Winpenny, R. E. P. *J. Chem. Soc., Chem. Commun.* **1997**, 653–654.
403. Micklitz, W.; McKee, V.; Rardin, R. L.; Pence, L. E.; Papaedthymiou, G. C.; Bott, S. G.; Lippard, S. J. *J. Am. Chem. Soc.* **1994**, *116*, 8061–8069.
404. Sidorov, A. A.; Fomina, I. G.; Ponina, M. O.; Aleksandrov, G. G.; Nefedov, S. E.; Eremenko, I. L.; Moiseev, I. I. *Russ. Chem. Bull.* **2000**, *49*, 958–959.
405. Ackermann, H.; Leo, R.; Massa, W.; Dehnicke, K. Z. *Anorg. Allg. Chem.* **2000**, *626*, 608–610.

406. Yeom, Y. H.; Kim, Y.; Seff, K. *J. Phys. Chem.* **1996**, *100*, 8373–8377.
407. Wendelstorf, C.; Kramer, R. *Angew Chem., Int. Ed. Engl.* **1997**, *36*, 2791–2793.
408. Cabani, S.; Ceccanti, N.; Pardini, R.; Tine, M. R. *Polyhedron* **1999**, *18*, 3295–3303.
409. Suzuki, M.; Furutachi, H.; Okawa, H. *Coord. Chem. Rev.* **2000**, *200–202*, 105–129.
410. Ciccarese, A.; Clemente, D. A.; Marxotto, A.; Valle, G. *J. Crystallogr. Spectr. Res.* **1993**, *23*, 223–229.
411. Jin, S.; Nieuwenhuyzen, M.; Wilkins, C. J. *J. Chem. Soc., Dalton Trans.* **1992**, 2071–2078.
412. Becker, C. A. L.; Al-Jowder, O. *Synth. React. Inorg. Met.-Org. Chem.* **1996**, *26*, 1719–1733.
413. Bryndza, H. E.; Tam, W. *Coord. Chem. Rev.* **1988**, *88*, 1163–1188.
414. Greener, B.; Walton, P. H. *J. Chem. Soc., Dalton Trans.* **1997**, 3733–3740.
415. Olmstead, M. M.; Power, P. P.; Sigel, G. *Inorg. Chem.* **1986**, *25*, 1027–1033.
416. Veith, M.; Kaefer, D.; Koch, J.; May, P.; Stahl, L.; Huch, V. *Chem. Ber.* **1992**, *125*, 1033–1042.
417. Schneider, J. J.; Goddard, R.; Kruger, C. *Z. Naturforsch., B: Chem. Sci.* **1995**, *50*, 448–459.
418. Dowling, C.; Murphy, V. J.; Parkin, G. *Inorg. Chem.* **1996**, *35*, 2415–2420.
419. Liu, H.; Wang, X.; Zhang, X.; Ren, X. *Lanzhou Daxue Xuebao, Ziran Kexueban* **1992**, *28*, 84–90.
420. Kireeva, O. K.; Bulychev, B. M.; Strel'tsova, N. R.; Bel'skii, V. K.; Dunin, A. G. *Polyhedron* **1992**, *11*, 1801–1807.
421. Lu, T.; Yang, G.; Ji, L.; Inoue, Y.; Ouchi, M.; Yu, K. *Transition Met. Chem.* **1999**, *24*, 375–379.
422. Atwood, J. L.; Junk, P. C. *Polyhedron* **2000**, *19*, 85–91.
423. Tsohos, A.; Dionyssopoulou, S.; Raptopoulou, C. P.; Terzis, A.; Bakalbassis, E. G.; Perlepes, S. P. *Angew Chem., Int. Ed.* **1999**, *38*, 983–985.
424. Saalfrank, R. W.; Seitz, V.; Heinemann, F. W.; Gobel, C.; Herbst-Irmer, R. *J. Chem. Soc., Dalton Trans.* **2001**, 599–603.
425. Hassan, R. M.; El-Gahami, M. A.; Abd-Alla, M. A. *J. Mater. Chem.* **1992**, *2*, 613–615.
426. Gonzalez, A.; Guell, F.; Marquet, J.; Moreno-Manas, M. *Tetrahedron Lett.* **1985**, *26*, 3735–3738.
427. Harris, P. G.; Houghton, R. P.; Taylor, P. L. *Polyhedron* **1992**, *11*, 2957–2960.
428. Kravchenko, V. V.; Sadikov, G. G.; Rukk, N. S.; Savinkina, E. V.; Zaitseva, M. G.; Butman, L. A.; Alikberova, L. Y.; Stepin, B. D. *Zh. Neorg. Khim.* **1989**, *34*, 1492–1499.
429. Armentano, D.; De Munno, G.; Lloret, F.; Julve, M. *Inorg. Chem.* **1999**, *38*, 3737–3744.
430. Yamami, M.; Tanaka, M.; Sakiyama, H.; Koga, T.; Kobayashi, K.; Miyasaka, H.; Ohba, M.; Okawa, H. *J. Chem. Soc., Dalton Trans.* **1997**, 4595–4602.
431. Brechin, E. K.; Graham, A.; Parkin, A.; Parsons, S.; Seddon, A. M.; Winpenny, R. E. P. *J. Chem. Soc., Dalton Trans.* **2000**, 3242–3252.
432. Hagen, K. S.; Lachicotte, R.; Kitaygorodskiy, A. *J. Am. Chem. Soc.* **1993**, *115*, 12617–12618.
433. Saalfrank, R. W.; Stark, A.; Burak, R. *Inorg. Synth.* **1992**, *29*, 275–278.
434. Livage, C.; Egger, C.; Nogs, M.; Ferey, G. *J. Mater. Chem.* **1998**, *8*, 2743–2747.
435. Matzapetakis, M.; Dakanali, M.; Raptopoulou, C. P.; Tangoulis, V.; Terzis, A.; Moon, N.; Giapintzakis, J.; Salifoglou, A. *J. Biol. Inorg. Chem.* **2000**, *5*, 469–474.
436. Robl, C.; Hentschel, S. *Mater. Res. Bull.* **1991**, *26*, 1355–1362.
437. Fox, O. D.; Dalley, N. K.; Harrison, R. G. *J. Am. Chem. Soc.* **1998**, *120*, 7111–7112.
438. Sokol, V. I.; Porai-Koshits, M. A.; Davydov, V. V.; Zaitsev, B. E.; Palisnkin, M. V.; Kukalenko, S. S. *Zh. Neorg. Khim.* **1989**, *34*, 884–891.
439. Jaitner, P.; Veciana, J.; Sporer, C.; Kopacka, H.; Wurst, K.; Ruiz-Molina, D. *Organometallics* **2001**, *20*, 568–571.
440. Sun, W.-Y.; Fei, B.-L.; Okamura, T.; Zhang, Y.-A.; Ye, T.; Tag, W.-X.; Ueyama, N. *Bull. Chem. Soc. Jpn* **2000**, *73*, 2733–2738.
441. Castillo, O.; Luque, A.; De la Pinta, N.; Roman, P. *Acta Crystallogr., Sect. E: Struct. Rep. Online* **2001**, *E57*, m384–m386.
442. Driessen, W. L.; de Graaff, R. A. G.; Parlevliet, F. J.; Reedijk, J.; de Vos, R. M. *Inorg. Chim. Acta* **1994**, *216*, 43–49.
443. Losier, P.; Zaworotko, M. J. *Angew Chem., Int. Ed. Engl.* **1997**, *35*, 2779–2782.
444. Lumme, P. O.; Knuutila, H. *Polyhedron* **1995**, *14*, 1553–1563.
445. Estienne, P. J. *Acta Crystallogr., Sect. C: Cryst. Struct. Commun.* **1985**, *C41*, 338–341.
446. Ceccconi, F.; Ghilardi, C. A.; Midolini, S.; Moneti, S.; Orlandini, A. *J. Organomet. Chem.* **1987**, *323*, C5–C9.
447. Guesmi, A.; Zid, M. F.; Driss, A. *Acta Crystallogr., Sect. C: Cryst. Struct. Commun.* **2000**, *C56*, 511–512.
448. Sanz, F.; Parada, C.; Amador, U.; Monge, M. A.; Ruiz Valero, C. *J. Solid State Chem.* **1996**, *123*, 129–139.
449. Du, J.-L.; Rettig, S. J.; Thompson, R. C. *Can J. Chem.* **1991**, *69*, 277.
450. Wang, D.; Tran, H.; Yu, X.; Lew, L.; Margerum, L. D. *Prepr. Ext. Abstr. ACS Natl. Meet., Am. Chem. Soc., Div. Environ. Chem.* **2001**, *41(1)*, 282–285.
451. Becker, C. A. L.; Cooper, J. C. *Inorg. Chim. Acta* **1991**, *182*, 25–32.
452. Kraeutler, B.; Keller, W.; Hughes, M.; Caderan, C.; Kratky, C. *J. Chem. Soc., Chem. Commun.* **1987**, 1678–1680.
453. Hu, H.; Hu, Y.; Wei, X.; Chen, B.; Guo, F. *Chem. Res. Chin. Univ.* **1992**, *8*, 84–88.
454. Rawson, J. M.; Winpenny, R. E. P. *Coord. Chem. Rev.* **1995**, *139*, 313–374.
455. Clegg, W.; Garner, C. D.; Al-Samman, M. H. *Inorg. Chem.* **1983**, *22*, 1534–1538.
456. Gerli, A.; Hagen, K. S.; Marzilli, L. G. *Inorg. Chem.* **1991**, *30*, 4673–4676.
457. Bailey, N. A.; Fenton, D. E.; Kitchen, S. J.; Lilley, T. H.; Williams, M. G.; Tasker, P. A.; Leong, A. J.; Lindoy, L. F. *J. Chem. Soc., Dalton Trans.* **1991**, 2989–2994.
458. Watton, S. P.; Davis, M. I.; Pence, L. E.; Rebek, J. Jr.; Lippard, S. J. *Inorg. Chim. Acta* **1995**, *235*, 195–204.
459. Hagen, K. S.; Lachicotte, R.; Kitaygorodskiy, A.; Elbouadili, A. *Angew. Chem., Int. Ed. Engl.* **1993**, *32*, 1321–1324.
460. Pleus, R. J.; Waden, H.; Saak, W.; Haase, D.; Pohl, S. *J. Chem. Soc., Dalton Trans.* **1999**, 2601–2610.
461. Klein, H. F.; Gass, M.; Koch, U.; Eisenmann, B.; Schaefer, H. *Z. Naturforsch., B: Chem. Sci.* **1988**, *43*, 830–838.
462. Cooper, S. R.; Rawle, S. C. *Struct. Bonding* **1990**, *72*, 1–72.
463. Kueppers, H. J.; Neves, A.; Pomp, C.; Ventur, D.; Wiegardt, K.; Nuber, B.; Weiss, J. *Inorg. Chem.* **1986**, *25*, 2400–2408.
464. Hartman, J. R.; Hints, E. J.; Cooper, J. C. *J. Chem. Soc., Chem. Commun.* **1984**, 386–387.
465. Hartman, J. R.; Hints, E. J.; Cooper, S. R. *J. Am. Chem. Soc.* **1986**, *108*, 1208–1214.
466. Osvath, P.; Sargeson, A. M. *J. Chem. Soc., Chem. Commun.* **1993**, 40–42.

467. Wolford, T. L.; Musker, A. K. *Inorg. Chim. Acta* **1991**, *182*, 19–23.
468. Lucas, C. R.; Liu, S.; Bridson, J. N. *Can J. Chem.* **1995**, *73*, 1023–1034.
469. Hagen, K. S.; Holm, R. H. *Inorg. Chem.* **1984**, *23*, 418–427.
470. Coucouvanis, D.; Murphy, C. N.; Simhon, E.; Stremple, P.; Draganjac, M. *Inorg. Synth.* **1982**, *21*, 23–28.
471. Huang, J.; Dewan, J. C.; Walters, M. A. *Inorg. Chim. Acta* **1995**, *228*, 199–206.
472. Tremel, W.; Krebs, B.; Greiwe, K.; Simon, W.; Stephan, H. O.; Henkel, G. *Z. Naturforsch., B: Chem. Sci.* **1992**, *47*, 1580–1592.
473. Becker, B.; Radacki, K.; Konitz, A.; Wojnowski, W. *Z. Anorg. Allg. Chem.* **1995**, *621*, 904–908.
474. Janssen, B. C.; Sernau, V.; Huttner, G.; Asam, A.; Walter, O.; Buchner, M.; Zsolnai, L. *Chem. Ber.* **1995**, *128*, 63–70.
475. Rodrigues, J. V.; Santos, I. C.; Gama, V.; Henriques, R. T.; Waeremborgh, J. C.; Duarte, M. T.; Almeida, M. J. *Chem. Soc., Dalton Trans.* **1994**, 2655–2660.
476. Wei, G.; Liu, H.; Huang, Z.; Hong, M.; Huang, L.; Kang, B. *Polyhedron* **1991**, *10*, 553–560.
477. Barbaro, P.; Ceconi, F.; Ghilardi, C. A.; Midolini, S.; Orlandini, A.; de Biani, F. F.; Laschi, F.; Zanello, P. *J. Chem. Soc., Dalton Trans.* **1996**, 4337–4344.
478. Garcia-Vazquez, J. A.; Romero, J.; Sousa, A. *Coord. Chem. Rev.* **1999**, *193–195*, 691–745.
479. Chang, S.; Karambelkar, V. V.; Sommer, R. D.; Rheingold, A. L.; Goldberg, D. P. *Inorg. Chem.* **2002**, *41*, 239–248.
480. MacColl, R.; Eisele, L. E.; Stack, R. F.; Hauer, C.; Vakharia, D. D.; Benno, A.; Kelly, W. C.; Mizejewski, G. J. *Biochim. Biophys. Acta* **2001**, *1528*, 127–134.
481. Pullen, A. E.; Olk, R.-M. *Coord. Chem. Rev.* **1999**, *188*, 211–262.
482. Olk, R.-M.; Olk, B.; Dietzsch, W.; Kirmse, R.; Hoyer, E. *Coord. Chem. Rev.* **1992**, *117*, 99–131.
483. Saha, N.; Mukherjee, N. *Synth. React. Inorg. Met.-Org. Chem.* **1984**, *14*, 1151–1171.
484. Jouad, E. M.; Riou, A.; Allain, M.; Khan, M. A.; Bouet, G. M. *Polyhedron* **2001**, *20*, 67–74.
485. Bindu, P.; Kurup, M. R. P. *Synth. React. Inorg. Met.-Org. Chem.* **2000**, *30*, 557–567.
486. Naik, S.; Purohit, K. M.; Patel, R. N. *J. Inst. Chem. (India)* **1995**, *67*, 94–96.
487. Souza, P.; Matesanz, A. I.; Fernandez, V. *J. Chem. Soc., Dalton Trans.* **1996**, 3011–3013.
488. Jha, R. R.; Sahu, S. R. *Asian J. Chem.* **1998**, *10*, 717–722.
489. Thimmaiah, K. N.; Chandrappa, G. T.; Lloyd, W. D.; Parkanyi, C. *Transition Met. Chem.* **1985**, *10*, 299–302.
490. Amin, R. R. *Asian J. Chem.* **2000**, *12*, 349–354.
491. Li, W.; Liu, Y.; Sun, Y.; Zhheng, Y.; Ao, J.; Li, J.; Hu, X. *Neimenggu Daxue Xuebao, Ziran Kexueban* **1998**, *29*, 376–380.
492. Garg, B. S.; Kapur, L. *Inorg. Chim. Acta* **1992**, *173*, 223–227.
493. West, D. X.; Galloway, D. S. *Transition Met. Chem.* **1988**, *13*, 410–414.
494. El-Toukhy, A. *Inorg. Chim. Acta* **1991**, *180*, 85–91.
495. Bamgboye, T. T.; Bamgboye, O. A. *Inorg. Chim. Acta* **1988**, *133*, 247–249.
496. Patel, N. C.; Patel, I. J. *J. Inst. Chem. (India)* **1996**, *68*, 150–151.
497. Kamara, R.; Declercq, J. P.; Germain, G.; Van Meerssche, M. *Bull. Soc. Chim. Belg.* **1982**, *91*, 171–172.
498. Suescun, L.; Mariezcurrena, R. A.; Momburu, A. W. *Acta Crystallogr., Sect. C: Cryst. Struct. Commun.* **1999**, *C55*, 2065–2068.
499. Burshtein, I. F.; Gerbeleu, N. V.; Bannova, I. I.; Bologa, O. A.; Lozan, V. I. *Koord. Khim.* **1987**, *13*, 1690–1694.
500. Malinovskii, T. I.; Petukhov, L. I.; Gerbeleu, N. V. *Dokl. Akad. Nauk SSSR* **1982**, *266*, 857–861.
501. Becker, C. A. L.; Odisitse, S. *Synth. React. Inorg. Met.-Org. Chem.* **2000**, *30*, 1547–1560.
502. Naidu, G. R. K.; Naidu, P. R. *Acta Cienc. Indica, [Ser.] Chem.* **1983**, *9*, 221–223.
503. West, D. X.; Galloway, C. P.; Paulson, C. A.; Bunting, R. K.; Pannell, L. K. *Transition Met. Chem.* **1989**, *14*, 420–424.
504. Misra, S. N.; Jain, R. K.; Joshi, G. K. *J. Indian Chem. Soc.* **1983**, *60*, 328–330.
505. Aly, A. A. M.; Kamal, M. M.; El-Meligy, M. S.; El-Said, A. I. *Z. Naturforsch., B: Chem. Sci.* **1987**, *42*, 233–237.
506. Ibrahim, M. K. A.; Abd El-Hadi, A. K.; Darwish, F. *J. Indian Chem. Soc.* **1993**, *70*, 671–674.
507. Artemenko, M. V.; Sereda, E. S.; Kuznetsova, E. P.; Fomenko, V. V. *Ukr. Khim. Zh. (Russ. Ed.)* **1990**, *56*, 121–123.
508. West, D. X.; Van Roekel, S. A.; Bunting, R. K. *Transition Met. Chem.* **1988**, *13*, 53–57.
509. Harris, J. D.; Eckles, W. E.; Hepp, A. F.; Duraj, S. A.; Fanwick, P. E.; Richardson, J.; Gordon, E. M. *Mater. Des.* **2001**, *22*, 625–634.
510. Menzies, C. M.; Squattrito, P. *J. Inorg. Chim. Acta* **2001**, *314*, 194–200.
511. Kitano, K.; Tanaka, K.; Nishioka, T.; Ichimura, A.; Kinoshita, I.; Isobe, K.; Ooi, S. *J. Chem. Soc., Dalton Trans.* **1998**, 3177–3182.
512. Deeg, A.; Kuchen, W.; Langsch, D.; Mootz, D.; Peters, W.; Wunderlich, H. *Z. Anorg. Allg. Chem.* **1991**, *606*, 119–132.
513. Haanstra, W. G.; Driessen, W. L.; Reedijk, J.; Frohlich, R.; Krebs, B. *Inorg. Chim. Acta* **1991**, *185*, 175–180.
514. Newkome, G. R.; Taylor, H. C. R.; Fronczek, F. R.; Gupta, V. K. *J. Org. Chem.* **1986**, *51*, 970–974.
515. Kang, B.; Weng, L.; Liu, H. L.; Wu, D.; Juang, L.; Lu, C.; Cai, J.; Chen, X.; Lu, J. *Inorg. Chem.* **1990**, *29*, 4873–4877.
516. Casey, A. T.; Vecchio, A. M. *Transition Met. Chem.* **1987**, *12*, 295–298.
517. Ishchenko, V. M.; Bulychiev, B. M.; Bel'skii, V. K.; Soloveichik, G. L.; Ellert, O. G.; Seifulina, Z. M. *Koord. Khim.* **1985**, *11*, 851–856.
518. Criado, J. J.; Jimenez-Sanchez, A.; Cano, F. H.; Saez-Puche, R.; Rodriguez-Fernandez, E. *Acta Crystallogr., Sect. B: Struct. Sci.* **1999**, *B55*, 947–952.
519. Pan, P.; Susak, N. J. *Geochim. Cosmochim. Acta* **1989**, *53*, 327–341.
520. Kerridge, D. H.; Nikolic, R.; Stojic, D. *J. Chem. Soc., Dalton Trans.* **1986**, 1663–1668.
521. Ivanov, I. M.; Danilovich, V. S. *Zh. Neorg. Khim.* **1997**, *42*, 869–874.
522. Abe, Y.; Kitamura, N. *Bull. Chem. Soc. Jpn* **1992**, *65*, 2280–2282.
523. Cooley, J. A.; Kamaras, P.; Rapta, M.; Jameson, G. B. *Acta Crystallogr., Sect. C: Cryst. Struct. Commun.* **1995**, *51*, 1811–1813.
524. Hierso, J.-C.; Bouwman, E.; Ellis, D. D.; Perez Cabero, M.; Reedijk, J.; Spek, A. L. *J. Chem. Soc., Dalton Trans.* **2001**, 197–201.

525. Csoregh, I.; Kenedey, G.; Wadsten, T.; Liptay, G.; Carson, B. R. *Z. Kristallogr.* **2000**, *215*, 547–553.
526. Dias Filho, N. L. *Colloids Surf., A* **1998**, *144*, 219–227.
527. Handley, D. A.; Hitchcock, P. B.; Leigh, G. J. *Inorg. Chim. Acta* **2001**, *314*, 1–13.
528. Jackson, W. G.; Rahman, A. F. M. M. *Inorg. Chem.* **1990**, *29*, 3247–3250.
529. Arzberger, S.; Soper, J.; Anderson, O. P.; La Cour, A.; Wicholas, M. *Inorg. Chem.* **1999**, *38*, 757–761.
530. Heinrich, J. L.; Berseth, P. A.; Long, J. R. *J. Chem. Soc., Chem. Commun.* **1997**, 1231–1232.
531. Kofod, P.; Harris, P.; Larsen, S. *Inorg. Chem.* **1997**, *36*, 2258–2266.
532. Poznyak, A. L.; Pavlovskii, V. I. *Koord. Khim.* **1987**, *13*, 1381–1383.
533. Shkol'nikova, L. M.; Poznyak, A. L. *Zh. Neorg. Khim.* **1995**, *40*, 604–611.
534. Karsch, H. H. *Chem. Ber.* **1983**, *116*, 1656–1668.
535. Summers, J. S.; Petersen, J. L.; Stolzenberg, A. M. *J. Am. Chem. Soc.* **1994**, *116*, 7189–7195.
536. Cao, Y.; Petersen, J. L.; Stolzenberg, H. *Inorg. Chim. Acta* **1997**, *263*, 139–148.
537. van Arkel, B.; van der Baan, J. L.; Balt, S.; Bickelhaupt, F.; de Bolster, M. W. G.; Kingma, I. E.; Klumpp, G. W.; Moos, J. W. E.; Spek, A. L. *J. Chem. Soc., Perkin Trans. 1* **1993**, 3023–3032.
538. Dreos, R.; Felluga, A.; Nardin, G.; Randaccio, L.; Siega, P.; Tazher, G. *Eur. J. Inorg. Chem.* **2001**, 267–276.
539. Bakac, A.; Espenson, J. H. *Inorg. Chem.* **1987**, *26*, 4353–4355.
540. Huston, P.; Espenson, J. H.; Bakac, A. *J. Am. Chem. Soc.* **1992**, *114*, 9510–9516.
541. Riordan, C. G.; Wei, P. *J. Am. Chem. Soc.* **1994**, *116*, 2189–2190.
542. Kanamori, K.; Broderick, W. E.; Jordan, R. F.; Willett, R. D.; Legg, J. I. *J. Am. Chem. Soc.* **1986**, *108*, 7122–7124.
543. Song, Y. S.; Becher, J.; Kofod, P.; Larsen, E.; Springborg, J. *Acta Chem. Scand.* **1996**, *50*, 853–861.
544. Plesek, J.; Hermanek, S.; Stibr, B. *Inorg. Synth.* **1983**, *22*, 235–237.
545. Hofmann, L.; Werner, H. *J. Organomet. Chem.* **1985**, *289*, 141–155.
546. Tamm, M.; Hahn, F. E. *Coord. Chem. Rev.* **1999**, *182*, 175–209.
547. Plaia, U.; Stolzenberg, H.; Fehlhammer, W. P. *J. Am. Chem. Soc.* **1985**, *107*, 2171–2172.
548. Frankel, R.; Kernbach, U.; Bakola-Christianopoulou, M.; Plaia, U.; Suter, M.; Ponikwar, W.; Noth, H.; Moinet, C.; Fehlhammer, W. P. *J. Organomet. Chem.* **2001**, *617–618*, 530–545.
549. Chang, S. A.; Huang, C. S.; Murphy, P. D. *Inorg. Chem.* **1985**, *24*, 4216–4218.
550. Cao, Y.; Petersen, J. L.; Stolzenberg, A. M. *Inorg. Chem.* **1998**, *37*, 5173–5179.
551. Richardson, D. E.; Sharpe, P. *Inorg. Chem.* **1991**, *30*, 1412–1414.
552. Richardson, D. E.; Sharpe, P. *Inorg. Chem.* **1993**, *32*, 1809–1812.
553. Schiebe, P.; Prandl, W.; Wulf, K.; Papoular, R.; Paulus, W.; Heger, G. *Physica B* **1997**, *234–236*, 64–65.
554. Formosinho, S. J.; Arnaut, L. G. *Theochem* **1994**, *116*, 105–124.
555. Geselowitz, D. A. *Inorg. Chim. Acta* **1988**, *154*, 225–228.
556. Larsson, S.; Staahl, K.; Zerner, M. C. *Inorg. Chem.* **1986**, *25*, 3033–3037.
557. Newton, M. D. *J. Phys. Chem.* **1986**, *90*, 3734–3739.
558. Newton, M. D. *ACS Symp. Ser.* **1989**, *394*, 378–392.
559. Wu, J. H.; Reynolds, C. A. *J. Am. Chem. Soc.* **1996**, *118*, 10545–10550.
560. Brorson, M.; Dyxenburg, M. R.; Galsboe, F.; Simonsen, K. *Acta Chem. Scand.* **1996**, *50*, 289–293.
561. Hambley, T. W. *Inorg. Chem.* **1988**, *27*, 2496–2501.
562. Deeth, R. J.; Paget, V. J. *J. Chem. Soc., Dalton Trans.* **1997**, 537–546.
563. Bernhardt, P. V.; Comba, P. *Inorg. Chem.* **1993**, *32*, 2798–2803.
564. Boudin, S.; Chardon, J.; Daturi, M.; Raveau, B. *J. Solid State Chem.* **2001**, *159*, 239–243.
565. Iida, M. *Rec. Res. Dev. Phys. Chem.* **2000**, *4*, 35–46.
566. Iida, M.; Miyagawa, Y.; Kohri, S. *Bull. Chem. Soc. Jpn.* **1993**, *66*, 2398–2401.
567. Jiang, R.; Anson, F. C. *J. Phys. Chem.* **1992**, *96*, 10565–10571.
568. Kunkely, H.; Vogler, A. *Collect. Czech. Chem. Commun.* **2001**, *66*, 119–124.
569. Reynolds, P. A.; Figgis, B. N. *Aust. J. Chem.* **1990**, *43*, 1929–1934.
570. Yokoyama, H.; Kon, H. *J. Phys. Chem.* **1991**, *95*, 8956–8963.
571. Yokoyama, H.; Kon, H.; Hiramoto, T.; Shinozaki, K. *Bull. Chem. Soc. Jpn.* **1994**, *67*, 3179–3186.
572. Iida, M.; Tracey, A. S. *J. Phys. Chem.* **1991**, *95*, 7891–7896.
573. Mizuno, Y.; Miyagawa, Y.; Kitagawa, Y.; Iida, M.; Tada, Y.; Yokoyama, H. *Langmuir* **1998**, *14*, 7058–7064.
574. Colquhoun, H. M.; Lewis, D. F.; Stoddart, J. F.; Williams, D. J. *J. Chem. Soc., Dalton Trans.* **1983**, 607–613.
575. Shaw, J.; Everett, G. W. *Inorg. Chem.* **1985**, *24*, 1917–1920.
576. Horton, T. E.; DeRose, V. J. *Biochemistry* **2000**, *39*, 11408–11416.
577. Jou, R.; Cowan, J. A. *J. Am. Chem. Soc.* **1991**, *113*, 6685–6686.
578. Kim, S.; Cowan, J. A. *Inorg. Chem.* **1992**, *31*, 3495–3496.
579. Young, K. J.; Gill, F.; Grasby, J. A. *Nucleic Acids Res.* **1997**, *25*, 3760–3766.
580. Tsubamoto, Y.; Eto, K.; Noda, M.; Daniel, S.; Suga, S.; Yamashita, S.; Kasai, H.; Wakui, M.; Sharp, G. W. G.; Kimura, S.; Kadowaki, T. *J. Biol. Chem.* **2001**, *276*, 2979–2985.
581. Littlewood, P. M.; Simmons, P. J. *Brain Res.* **1988**, *445*, 165–170.
582. Figgis, B. N.; Sobolev, A. N.; Reynolds, P. A. *Acta Crystallogr., Sect. B: Struct. Sci.* **1998**, *B54*, 613–625.
583. Bernal, I.; Yufit, D. S.; Howard, J. A. K. *Z. Kristallogr.* **2001**, *216*, 413–416.
584. Saito, A. *Thermochim. Acta* **1991**, *177*, 197–212.
585. Zivkovic, Z. D. *J. Therm. Anal.* **1994**, *41*, 99–104.
586. Ingier-Stocka, E.; Rycerz, L. *J. Therm. Anal. Calorim.* **1999**, *56*, 547–552.
587. Khalil, L. H.; Moussa, N. A.; Mikhail, S. *J. Mater. Sci.* **1992**, *27*, 557–568.
588. Hammershoi, A.; Geselowitz, D.; Taube, H. *Inorg. Chem.* **1984**, *23*, 979–982.
589. Creaser, I. I.; Sargeson, A. M.; Zanella, A. W. *Inorg. Chem.* **1983**, *22*, 4022–4029.
590. Howes, K. R.; Pippin, C. G.; Sullivan, J. C.; Meisel, D.; Espenson, J. H.; Bakac, A. *Inorg. Chem.* **1988**, *27*, 2932–2934.
591. Tsukahara, K.; Wilkins, R. C. *Inorg. Chem.* **1985**, *24*, 3399–3402.
592. Chapman, S. K.; Davies, D. M.; Vuik, C. P. J.; Sykes, A. G. *J. Chem. Soc., Chem. Commun.* **1983**, 868–869.
593. Fantola Lazzarini, A. L.; Lazzarini, E.; Mariani, M. *J. Chem. Soc., Faraday Trans.* **1994**, *90*, 423–428.

594. Kutal, C.; Weit, S. K.; MacDonald, S. A.; Willson, C. G. *J. Coat. Technol.* **1990**, *62*, 63–67.
595. Kutal, C.; Weit, S. K.; Willson, C. G. *Polym. Mater. Sci. Eng.* **1989**, *61*, 195–198.
596. Harrowfield, J. M.; Lawrence, G. A.; Sargeson, A. M. *J. Chem. Educ.* **1985**, *62*, 804–806.
597. Hamilton, D. E. *J. Chem. Educ.* **1991**, *68*, A144–A146.
598. Jackman, D. C.; Rillema, D. P. *J. Chem. Educ.* **1989**, *66*, 343.
599. Barnes, J. C.; Paton, J. D. *Acta Crystallogr., Sect. B* **1982**, *B38*, 1588–1591.
600. Rius, J.; Gali, S. *Cryst. Struct. Commun.* **1982**, *11*, 829–834.
601. Fuertes, A.; Miravittles, C.; Ibanez, R.; Martinez-Tamayo, E.; Beltran-Porter, A. *Acta Crystallogr., Sect. C: Cryst. Struct. Commun.* **1988**, *C44*, 417–421.
602. Mizuta, T.; Tada, T.; Kushi, Y.; Yoneda, H. *Inorg. Chem.* **1988**, *27*, 3836–3841.
603. House, D. A.; McKee, V.; Robinson, W. T. *Inorg. Chim. Acta* **1989**, *160*, 71–76.
604. Lappin, A. G.; Haller, K. J.; Warren, R. M. L.; Tatehata, A. *Inorg. Chem.* **1993**, *32*, 4498–4504.
605. Moron, M. C.; Palacio, F.; Pons, J.; Casabo, J.; Solans, X.; Merabet, K. E.; Huang, D.; Shi, X.; Teo, B. K.; Carlin, R. L. *Inorg. Chem.* **1994**, *33*, 746–753.
606. Bernal, I.; Cai, J.; Myrcek, J. *ACH – Models Chem.* **1995**, *132*, 451–474.
607. Pink, M.; Billing, R. Z. *Kristallogr.* **1996**, *211*, 203–204.
608. Haussuehl, S.; Schreuer, J. Z. *Kristallogr.* **1998**, *213*, 161–167.
609. Cai, J.; Zhang, Y.; Hu, X.; Feng, X. *Acta Crystallogr., Sect. C: Cryst. Struct. Commun.* **2000**, *C56*, 661–663.
610. Nassimbeni, L. R.; Niven, M. L.; Cruywagen, J. J.; Heyns, J. B. B. *J. Crystallogr. Spectrosc. Res.* **1987**, *17*, 99–107.
611. Kuroda, R. *Inorg. Chem.* **1991**, *30*, 4954–4959.
612. Farrugia, L. J.; Peacock, R. D.; Stewart, B. *Acta Crystallogr., Sect. C: Cryst. Struct. Commun.* **2000**, *C56*, 149–151.
613. Matsuki, R.; Shiro, M.; Asahi, T.; Asai, H. *Acta Cryst., Sect. E: Struct. Reports Online* **2001**, *E57*, m448–m450.
614. Hua, X.; Larsson, K.; Neal, T. J.; Wyllie, G. R. A.; Shang, M.; Graham Lappin, A. *Inorg. Chem. Commun.* **2001**, *4*, 635–639.
615. Myrcek, J. *Pol. J. Chem.* **1997**, *71*, 844–847.
616. Miller, S. E.; House, D. A. *Inorg. Chim. Acta* **1989**, *157*, 29–32.
617. Young, D. A.; Freedman, T. B.; Lipp, E. D.; Nafie, L. A. *J. Am. Chem. Soc.* **1986**, *108*, 7255–7263.
618. Hambley, T. W. *J. Comput. Chem.* **1987**, *8*, 651–657.
619. Graciani, M. d. M.; Moya, M. L. *Gazz. Chim. Ital.* **1991**, *121*, 491–494.
620. Hitchens, T. K.; Bryant, R. G. *J. Phys. Chem.* **1995**, *99*, 5612–5615.
621. Miyoshi, K.; Izumoto, S.; Yoneda, H. *Bull. Chem. Soc. Jpn.* **1986**, *59*, 3475–3482.
622. Sakaguchi, U.; Yamamoto, I.; Izumoto, S.; Yoneda, H. *Bull. Chem. Soc. Jpn.* **1983**, *56*, 153–156.
623. Miyoshi, K.; Sakamoto, Y.; Ohguni, A.; Yoneda, H. *Bull. Chem. Soc. Jpn.* **1985**, *58*, 2239–2246.
624. Searle, G. H. *Aust. J. Chem.* **1987**, *40*, 375–379.
625. Tatehata, A.; Asaba, Y. *Bull. Chem. Soc. Jpn.* **1988**, *61*, 3145–3151.
626. Sakaguchi, U.; Tsuge, A.; Yoneda, H. *Inorg. Chem.* **1983**, *22*, 1630–1634.
627. Marusak, R. A.; Lappin, A. G. *J. Phys. Chem.* **1989**, *93*, 6856–6859.
628. Yamagishi, A. *Inorg. Chem.* **1985**, *24*, 1689–1695.
629. Barrer, R. M.; Craven, R. J. B. *Stud. Surf. Sci. Catal.* **1986**, *28*, 521–529.
630. Barrer, R. M.; Craven, R. J. B. *J. Chem. Soc., Faraday Trans. 1* **1987**, *83*, 779–787.
631. Barrer, R. M.; Craven, R. J. B. *J. Chem. Soc., Faraday Trans.* **1992**, *88*, 645–651.
632. Gainsford, G. J.; Morgan, K. R.; Rae, A. D. *Acta Crystallogr., Sect. C: Cryst. Struct. Commun.* **1998**, *C54*, 1564–1566.
633. Distler, A.; Lohse, D. L.; Sevov, S. C. *J. Chem. Soc., Dalton Trans.* **1999**, 1805–1812.
634. Natarajan, S.; Neeraj, S.; Choudhury, A.; Rao, C. N. R. *Inorg. Chem.* **2000**, *39*, 1426–1433.
635. Sevov, S. C. *Angew. Chem., Int. Ed. Engl.* **1996**, *35*, 2630–2632.
636. Choudhury, A.; Neeraj, S.; Natarajan, S.; Rao, C. N. R. *Angew. Chem., Int. Ed.* **2000**, *39*, 3091–3093.
637. Chiang, R.-K. *Inorg. Chem.* **2000**, *39*, 4985–4988.
638. Morgan, K.; Gainsford, G.; Milestone, N. *J. Chem. Soc., Chem. Commun.* **1995**, 425–426.
639. Gray, M. J.; Jasper, J. D.; Wilkinson, A. P.; Hanson, J. C. *Chem. Mater.* **1997**, *9*, 976–980.
640. Wilkinson, A. P.; Gray, M. J.; Stalder, S. M. *Mater. Res. Soc. Symp. Proc.* **1996**, *431*, 21–26.
641. Stalder, S. M.; Wilkinson, A. P. *Chem. Mater.* **1997**, *9*, 2168–2173.
642. Jasper, J. D.; Wilkinson, A. P. *Chem. Mater.* **1998**, *10*, 1664–1667.
643. Feng, P.; Bu, X.; Stucky, G. D. *Nature* **1997**, *388*, 735–741.
644. Bu, X.; Feng, P.; Gier, T. E.; Stucky, G. D. *J. Solid State Chem.* **1998**, *136*, 210–215.
645. Lu, J. J.; Goh, N. K.; Chia, L. S. *Chem. Commun.* **1998**, 1709–1710.
646. Sachinidis, J. I.; Shalders, R. D.; Tregloan, P. A. *Inorg. Chem.* **1996**, *35*, 2497–2503.
647. Fu, Y.; Swaddle, T. W. *Chem. Commun.* **1996**, 1171–1172.
648. Lay, P. A.; McAlpine, N. S.; Hupp, J. T.; Weaver, M. J.; Sargeson, A. M. *Inorg. Chem.* **1990**, *29*, 4322–4328.
649. Maksymiuk, K.; Galus, Z. *Electrochim. Acta* **1989**, *34*, 415–423.
650. Jolley, W. H.; Stranks, D. R.; Swaddle, T. W. *Inorg. Chem.* **1990**, *29*, 385–389.
651. Zahir, K.; Espenson, J. H.; Bakac, A. *Inorg. Chem.* **1988**, *27*, 3144–3146.
652. Saenz, G.; Warren, R. M. L.; Shang, M.; Lappin, G. *J. Coord. Chem.* **1995**, *34*, 129–137.
653. Segal, M. G. *J. Chem. Soc., Dalton Trans.* **1987**, 2485–2487.
654. Kim, D.-Y.; Jung, M.-J.; Oh, C.-E.; Doh, M.-K.; Lee, D.-J. *J. Coord. Chem.* **1996**, *37*, 217–225.
655. Atherton, S. J.; Tsukahara, K.; Wilkins, R. G. *J. Am. Chem. Soc.* **1986**, *108*, 3380–3385.
656. Kurimura, Y.; Takato, K.; Suzuki, N. *Bull. Chem. Soc. Jpn.* **1986**, *59*, 2356–2358.
657. Maksymiuk, K.; Doblhofer, K. *Electrochim. Acta* **1994**, *39*, 217–227.
658. Wang, Z.; Kutal, C. *Inorg. Chim. Acta* **1994**, *226*, 285–291.
659. Billing, R.; Vogler, A. *J. Photochem. Photobiol., A* **1997**, *103*, 239–247.
660. Mizuno, Y.; Iida, M. *J. Phys. Chem. B* **1997**, *101*, 3919–3926.
661. Iida, M.; Miyagawa, Y.; Kohri, S.; Ikemoto, Y. *Bull. Chem. Soc. Jpn.* **1993**, *66*, 2840–2846.
662. Tatehata, A.; Yamada, S.; Muraida, A. *Bull. Chem. Soc. Jpn* **2000**, *73*, 1135–1142.

663. Geue, R. J.; Snow, M. R. *Inorg. Chem.* **1977**, *16*, 231–241.
664. Ishii, M.; Umehara, M.; Nakahara, M. *Bull. Chem. Soc. Jpn.* **1987**, *60*, 125–129.
665. Hegetschweiler, K.; Weber, M.; Huch, V.; Geue, R. J.; Rae, A. D.; Willis, A. C.; Sargeson, A. M. *Inorg. Chem.* **1998**, *37*, 6136–6146.
666. Schwesinger, R.; Piontek, K.; Littke, W.; Schweikert, O.; Prinzbach, H.; Krueger, C.; Tsay, Y. H. *Tetrahedron Lett.* **1982**, *23*, 2427–2430.
667. Comba, P.; Hambley, T. W.; Zipper, L. *Helv. Chim. Acta* **1988**, *71*, 1875–1880.
668. Utsuno, S.; Yoshikawa, Y.; Tahata, Y. *Inorg. Chem.* **1985**, *24*, 2724–2726.
669. Zimmer, A.; Kuppert, D.; Weyhermuller, T.; Muller, I.; Hegetschweiler, K. *Chem.-Eur. J.* **2001**, *7*, 917–931.
670. Rivas, J. C. M.; Brammer, L. *Acta Crystallogr., Sect. C: Cryst. Struct. Commun.* **1998**, *C54*, 757–760.
671. Massoud, S. S.; Mautner, F. A.; Abu-Youssef, M.; Shuaib, N. M. *Polyhedron* **1999**, *18*, 2287–2291.
672. Hendry, P.; Ludi, A. *Adv. Inorg. Chem.* **1990**, *35*, 117–198.
673. Bernhardt, P. V.; Lawrance, G. A. *Coord. Chem. Rev.* **1990**, *104*, 297–343.
674. Wainwright, K. P. *Coord. Chem. Rev.* **1997**, *166*, 35–90.
675. Wiegardt, K.; Schmidt, W.; Herrmann, W.; Kueppers, H. J. *Inorg. Chem.* **1983**, *22*, 2953–2956.
676. Swarts, J. C.; Sykes, A. G. *Inorg. Chim. Acta* **1996**, *242*, 165–169.
677. Crawford, P. W.; Schultz, F. A. *Inorg. Chem.* **1994**, *33*, 4344–4350.
678. Turner, J. W.; Schultz, F. A. *Inorg. Chem.* **1999**, *38*, 358–364.
679. Searle, G. H.; Wang, D. N.; Larsen, S.; Larsen, E. *Acta Chem. Scand.* **1992**, *46*, 38–42.
680. Bossek, U.; Nuehlen, D.; Bill, E.; Glaser, T.; Krebs, C.; Weyhermueller, T.; Wiegardt, K.; Lengen, M.; Trautwein, A. X. *Inorg. Chem.* **1997**, *36*, 2834–2843.
681. Diebold, A.; Elbouadili, A.; Hagen, K. S. *Inorg. Chem.* **2000**, *39*, 3915–3923.
682. Hammershoi, A.; Sargeson, A. M. *Inorg. Chem.* **1983**, *22*, 3554–3561.
683. Bushnell, G. W.; Fortier, D. G.; McAuley, A. *Inorg. Chem.* **1988**, *27*, 2626–2634.
684. Christiansen, L.; Hendrickson, D. N.; Toftlund, H.; Wilson, S. R.; Xie, C. L. *Inorg. Chem.* **1986**, *25*, 2813–2818.
685. Wiegardt, K.; Bossek, U.; Chaudhuri, P.; Herrmann, W.; Menke, B. C.; Weiss, J. *Inorg. Chem.* **1982**, *21*, 4308–4314.
686. Boeyens, J. C. A.; van der Merwe, M. J. *Inorg. Chem.* **1997**, *36*, 3779–3780.
687. Robb, J.; Peacock, R. D. *Inorg. Chim. Acta* **1986**, *121*, L15–L17.
688. Belal, A. A.; Farrugia, L. J.; Peacock, R. D.; Robb, J. *J. Chem. Soc., Dalton Trans.* **1989**, 931–935.
689. Di Vaira, M.; Mani, F.; Stoppioni, P. *J. Chem. Soc., Chem. Commun.* **1989**, 126–127.
690. De Martino Norante, G.; Di Vaira, M.; Mani, F.; Mazzi, S.; Stoppioni, P. *J. Chem. Soc., Dalton Trans.* **1992**, 361–365.
691. Sokolowski, A.; Adam, B.; Weyhermueller, T.; Kikuchi, A.; Hildenbrand, K.; Schnepf, R.; Hildebrandt, P.; Bill, E.; Wiegardt, K. *Inorg. Chem.* **1997**, *36*, 3702–3710.
692. Muller, J.; Kikuchi, A.; Bill, E.; Weyhermuller, T.; Hildebrandt, P.; Ould-Moussa, L.; Wiegardt, K. *Inorg. Chim. Acta* **2000**, *297*, 265–277.
693. Kimura, S.; Bill, E.; Bothe, E.; Weyhermueller, T.; Wiegardt, K. *J. Am. Chem. Soc.* **2001**, *123*, 6025–6039.
694. Beissel, T.; Birkelbach, F.; Bill, E.; Glaser, T.; Kesting, F.; Krebs, C.; Weyhermueller, T.; Wiegardt, K.; Butzlaff, C.; Trautwein, A. X. *J. Am. Chem. Soc.* **1996**, *118*, 12376–12390.
695. Beissel, T.; Glaser, T.; Kesting, F.; Wiegardt, K.; Nuber, B. *Inorg. Chem.* **1996**, *35*, 3936–3947.
696. Fortier, D. G.; McAuley, A. *J. Chem. Soc., Dalton Trans.* **1991**, 101–109.
697. Wiegardt, K.; Tolksdorf, I.; Herrmann, W. *Inorg. Chem.* **1985**, *24*, 1230–1235.
698. Kong, D. Y.; Xie, Y. Y. *Polyhedron* **2000**, *19*, 1527–1537.
699. Kong, D.-Y.; Meng, L.-H.; Ding, J.; Xie, Y.-Y.; Huang, X.-Y. *Polyhedron* **2000**, *19*, 217–223.
700. Kobayashi, K.; Tsuboyama, S.; Tabata, N.; Tsuboyama, K.; Sakurai, T. *Anal. Sci.* **1996**, *12*, 531–533.
701. Kobayashi, K.; Takahashi, H.; Nishio, M.; Umezawa, Y.; Tsuboyama, K.; Tsuboyama, S. *Anal. Sci.* **2000**, *16*, 1103–1104.
702. Tsintavis, C.; Li, H. L.; Chambers, J. Q.; Hobbs, D. T. *J. Phys. Chem.* **1991**, *95*, 289–297.
703. Shinohara, N.; Ishii, K.; Hirose, M. *J. Chem. Soc., Chem. Commun.* **1990**, 700–701.
704. Bakac, A.; Assink, B.; Espenson, J. H.; Wang, W. D. *Inorg. Chem.* **1996**, *35*, 788–790.
705. Mok, K. F.; House, D. A. *Inorg. Chim. Acta* **1988**, *148*, 209–213.
706. Bembi, R.; Drew, M. G. B.; Singh, R.; Roy, T. G. *Inorg. Chem.* **1991**, *30*, 1403–1406.
707. Lu, T. H.; Chen, B. H.; Chung, C. S. *Acta Crystallogr., Sect. C: Cryst. Struct. Commun.* **1993**, *C49*, 1912–1914.
708. Yashiro, M.; Komiyama, M.; Kuroda, K.; Miura, S.; Yoshikawa, S.; Yano, S. *Bull. Chem. Soc. Jpn.* **1994**, *67*, 3276–3281.
709. Guzei, I. A.; Bakac, A. *Inorg. Chem.* **2001**, *40*, 2390–2393.
710. Yashiro, M.; Miura, S.; Matsuyama, T.; Yoshikawa, S.; Komiyama, M.; Yano, S. *Inorg. Chem.* **1994**, *33*, 1003–1004.
711. Mochizuki, K.; Ikeuchi, K.; Kondo, T. *Bull. Chem. Soc. Jpn.* **1998**, *71*, 2629–2634.
712. Chen, B.-H.; Lai, C.-Y.; Yuan, Y.; Chung, C.-S. *J. Chem. Soc., Dalton Trans.* **1994**, 2959–2961.
713. Hay, R. W.; Bembi, R.; House, D. A. *J. Chem. Soc., Dalton Trans.* **1984**, 1921–1925.
714. Hay, R. W.; House, D. A.; Bembi, R. *J. Chem. Soc., Dalton Trans.* **1984**, 1927–1930.
715. Panneerselvam, K.; Lu, T.-H.; Tung, S.-F.; Liu, G.-S.; Chi, T.-Y.; Chung, C.-S. *Acta Crystallogr., Sect. C: Cryst. Struct. Commun.* **1998**, *C54*, 714–716.
716. Chi, T.-Y.; Pariya, C.; Hwu, J. R.; Chung, C.-S. *Inorg. Chim. Acta* **1999**, *285*, 107–115.
717. Horn, E.; Roy, T. G.; Hazari, S. K. S.; Dey, B. K.; Dey, L.; Tiekink, E. R. T. *Z. Krist.* **2001**, *216*, 71–72.
718. Chen, L.; Thompson, L. K.; Bridson, J. N.; Xu, J.; Ni, S.; Guo, R. *Can. J. Chem.* **1993**, *71*, 1805–1809.
719. House, D. A.; Harnett, M.; Robinson, W. T.; Couldwell, M. C. *J. Chem. Soc., Chem. Commun.* **1984**, 979–980.
720. Hay, R. W.; Pujari, M. P.; Korybut-Daszkiewicz, B.; Ferguson, G.; Ruhl, B. L. *J. Chem. Soc., Dalton Trans.* **1989**, 85–91.
721. Bernhardt, P. V.; Lawrance, G. A.; Hambley, T. W. *J. Chem. Soc., Dalton Trans.* **1989**, 1059–1065.
722. Bernhardt, P. V.; Comba, P.; Hambley, T. W. *Inorg. Chem.* **1993**, *32*, 2804–2809.
723. Bernhardt, P. V.; Jones, L. A.; Sharpe, P. C. *Inorg. Chem.* **1997**, *36*, 2420–2425.
724. Bernhardt, P. V.; Jones, L. A. *Inorg. Chem.* **1999**, *38*, 5086–5090.

725. Curtis, N. F.; Siriwardena, A. *Aust. J. Chem.* **1991**, *44*, 1023–1040.
726. Bernhardt, P. V.; Hayes, E. J. *Inorg. Chem.* **2002**, *41*, 2892–2902.
727. Bernhardt, P. V.; Byriel, K. A.; Kennard, C. H. L.; Sharpe, P. C. *Inorg. Chem.* **1996**, *35*, 2045–2052.
728. Hambley, T. W.; Lawrance, G. A.; Martinez, M.; Skelton, B. W.; White, A. H. *J. Chem. Soc., Dalton Trans.* **1992**, 1643–1648.
729. Bernhardt, P. V.; Macpherson, B. P.; Martinez, M. *Inorg. Chem.* **2000**, *39*, 5203–5208.
730. Lawrance, G. A.; Manning, T. M.; Maeder, M.; Martinez, M.; O'Leary, M. A.; Patalinghug, W. C.; Skelton, B. W.; White, A. H. *J. Chem. Soc., Dalton Trans.* **1992**, 1635–1641.
731. Martinez, M.; Pitarque, M.-A.; van Eldik, R. *Inorg. Chim. Acta* **1997**, *256*, 51–59.
732. Bozoglian, F.; Gonzalez, G.; Martinez, M.; Queirolo, M.; Sienra, B. *Inorg. Chim. Acta* **2001**, *318*, 191–196.
733. Bernhardt, P. V.; Martinez, M. *Inorg. Chem.* **1999**, *38*, 424–425.
734. Bernhardt, P. V.; Macpherson, B. P.; Martinez, M. *J. Chem. Soc., Dalton Trans.* **2002**, 1435–1441.
735. Kimura, E.; Shionoya, M.; Mita, T.; Iitaka, Y. *J. Chem. Soc., Chem. Commun.* **1987**, 1712–1714.
736. Amadei, G. A.; Dickman, M. H.; Wazze, R. A.; Dimmock, P.; Earley, J. E. *Inorg. Chim. Acta* **1999**, *288*, 40–46.
737. Amadei, G. A.; Earley, J. E. *Inorg. Chim. Acta* **1999**, *293*, 245–247.
738. Ghiggino, K. P.; Grannas, M. J.; Koay, M. S.; Mariotti, A. W. A.; McFadyen, W. D.; Tregloan, P. A. *Aust. J. Chem.* **2001**, *54*, 101–104.
739. Creaser, I. I.; Harrowfield, J. M.; Herlt, A. J.; Sargeson, A. M.; Springborg, J.; Geue, R. J.; Snow, M. R. *J. Am. Chem. Soc.* **1977**, *99*, 3181–3182.
740. Geue, R. J.; Hambley, T. W.; Harrowfield, J. M.; Sargeson, A. M.; Snow, M. R. *J. Am. Chem. Soc.* **1984**, *106*, 5478–5488.
741. Clark, I. J.; Geue, R. J.; Engelhardt, L. M.; Harrowfield, J. M.; Sargeson, A. M.; White, A. H. *Aust. J. Chem.* **1993**, *46*, 1485–1505.
742. Bottomley, G. A.; Clark, I. J.; Creaser, I. I.; Engelhardt, L. M.; Geue, R. J.; Hagen, K. S.; Harrowfield, J. M.; Lawrance, G. A.; Lay, P. A.; Sargeson, A. M.; See, A. J.; Skelton, B. W.; White, A. H.; Wilner, F. R. *Aust. J. Chem.* **1994**, *47*, 143–179.
743. Bond, A. M.; Lawrance, G. A.; Lay, P. A.; Sargeson, A. M. *Inorg. Chem.* **1983**, *22*, 2010–2021.
744. Hupp, J. T.; Liu, H. Y.; Lay, P. A.; Petri, W. H. F.; Sargeson, A. M.; Weaver, M. J. *J. Electroanal. Chem. Interfacial Electrochem.* **1984**, *163*, 371–379.
745. Lay, P. A.; Mau, A.; Sasse, W. H. F.; Creaser, I. I.; Gahan, L. R.; Sargeson, A. M. *Inorg. Chem.* **1983**, *22*, 2347–2348.
746. Mok, C. Y.; Zanella, A. W.; Creutz, C.; Sutin, N. *Inorg. Chem.* **1984**, *23*, 2891–2897.
747. Creaser, I. I.; Gahan, L. R.; Geue, R. J.; Launikonis, A.; Lay, P. A.; Lydon, J. D.; McCarthy, M. G.; Mau, A. W. H.; Sargeson, A. M.; Sasse, W. H. F. *Inorg. Chem.* **1985**, *24*, 2671–2680.
748. Mau, A. W. H.; Sasse, W. H. F.; Creaser, I. I.; Sargeson, A. M. *Nouv. J. Chim.* **1986**, *10*, 589–592.
749. Creaser, I. I.; Hammershoei, A.; Launikonis, A.; Mau, A. W. H.; Sargeson, A. M.; Sasse, W. H. F. *Photochem. Photobiol.* **1989**, *49*, 19–23.
750. Pladziejewicz, J. R.; Accola, M. A.; Osvath, P.; Sargeson, A. M. *Inorg. Chem.* **1993**, *32*, 2525–2533.
751. Conrad, D. W.; Scott, R. A. *J. Am. Chem. Soc.* **1989**, *111*, 3461–3463.
752. Gajhede, M.; Hammershoei, A.; Skov, L. K. *Acta Chem. Scand.* **1991**, *45*, 474–481.
753. Yeh, G. C.; Beatty, A. M.; Bashkin, J. K. *Inorg. Chem.* **1996**, *35*, 3828–3835.
754. Burnet, S.; Choi, M.-H.; Donnelly, P. S.; Harrowfield, J. M.; Ivanova, I.; Jeong, S.-H.; Kim, Y.; Mocerino, M.; Skelton, B. W.; White, A. H.; Williams, C. C.; Zeng, Z.-L. *Eur. J. Inorg. Chem.* **2001**, 1869–1881.
755. Hohn, A.; Geue, R. J.; Sargeson, A. M.; Willis, A. C. *J. Chem. Soc., Chem. Commun.* **1989**, 1644–1645.
756. Hohn, A.; Geue, R. J.; Sargeson, A. M.; Willis, A. C. *J. Chem. Soc., Chem. Commun.* **1989**, 1648–1649.
757. Geue, R. J.; Korybut-Daszkiewicz, B.; Sargeson, A. M. *J. Chem. Soc., Chem. Commun.* **1993**, 1454–1456.
758. Geue, R. J.; Korybut-Daszkiewicz, B.; Sargeson, A. M. *Chem. Commun.* **1996**, 1569–1570.
759. Angus, P. M.; Bygott, A. M. T.; Geue, R. J.; Korybut-Daszkiewicz, B.; Mau, A. W. H.; Sargeson, A. M.; Sheil, M. M.; Willis, A. C. *Chem.-Eur. J.* **1997**, *3*, 1283–1291.
760. Sargeson, A. M. *Coord. Chem. Rev.* **1996**, *151*, 89–114.
761. Geue, R. J.; Hohn, A.; Ralph, S. F.; Sargeson, A. M.; Willis, A. C. *J. Chem. Soc., Chem. Commun.* **1994**, 1513–1515.
762. Gooden, D. A.; Ewart, H. A.; Hyde, K. E. *Inorg. Chim. Acta* **1989**, *166*, 263–271.
763. Niederhoffer, E. C.; Martell, A. E.; Rudolf, P.; Clearfield, A. *Cryst. Struct. Commun.* **1982**, *11*, 1951–1957.
764. Decurtins, S.; Schmale, H. W.; Pellaux, R.; Schneuwy, P.; Hauser, A. *Inorg. Chem.* **1996**, *35*, 1451–1460.
765. Hernandez-Molina, M.; Lloret, F.; Ruiz-Perez, C.; Julve, M. *Inorg. Chem.* **1998**, *37*, 4131–4135.
766. Cruanes, M. T.; Drickamer, H. G.; Faulkner, L. R. *J. Phys. Chem.* **1992**, *96*, 9888–9892.
767. Ali, G.; Lewis, N. A. *Inorg. Chim. Acta* **1990**, *167*, 5–13.
768. Bakac, A.; Butkovic, V.; Espenson, J. H.; Marcec, R.; Orhanovic, M. *Inorg. Chem.* **1987**, *26*, 3249–3253.
769. Fu, Y.; Cole, A. S.; Swaddle, T. W. *J. Am. Chem. Soc.* **1999**, *121*, 10410–10415.
770. Braun, P.; Van Eldik, R. *J. Chem. Soc., Chem. Commun.* **1985**, 1349–1350.
771. Cavasino, F. P. *J. Phys. Chem.* **1985**, *89*, 3578–3582.
772. Kano, K.; Hasegawa, H. *J. Am. Chem. Soc.* **2001**, *123*, 10616–10627.
773. Metcalf, D. H.; Snyder, S. W.; Demas, J. N.; Richardson, F. S. *J. Am. Chem. Soc.* **1990**, *112*, 5681–5695.
774. Joshi, V.; Ghosh, P. K. *J. Am. Chem. Soc.* **1989**, *111*, 5604–5612.
775. Davison, N.; McWhinnie, W. R. *Inorg. Chim. Acta* **1987**, *131*, 9–10.
776. Figgis, B. N.; Kucharski, E. S.; White, A. H. *Aust. J. Chem.* **1983**, *36*, 1563–1571.
777. Bernhardt, P. V.; Comba, P.; Mahu-Rickenbach, A.; Stebler, S.; Steiner, S.; Varnagy, K.; Zehnder, M. *Inorg. Chem.* **1992**, *31*, 4194–4200.
778. McCusker, J. K.; Walda, K. N.; Magde, D.; Hendrickson, D. N. *Inorg. Chem.* **1993**, *32*, 394–399.
779. Hou, W.; Ji, H.; Wang, E. *Talanta* **1992**, *39*, 45–50.
780. Pang, D.; Deng, B.; Wang, Z. *Electrochim. Acta* **1994**, *39*, 847–851.
781. Kendrick, M. J.; Al-Akhdar, W. *Inorg. Chem.* **1987**, *26*, 3971–3972.
782. Matsushita, Y.; Sugamoto, K.; Matsui, T. *Chem. Lett.* **1992**, 2165–2168.

783. Fukuzumi, S.; Miyamoto, K.; Suenobu, T.; Van Caemelbecke, E.; Kadish, K. M. *J. Am. Chem. Soc.* **1998**, *120*, 2880–2889.
784. Nam, W.; Kim, I.; Kim, Y.; Kim, C. *Chem. Commun.* **2001**, 1262–1263.
785. Goodwin, J.; Bailey, R.; Pennington, W.; Rasberry, R.; Green, T.; Shasho, S.; Yongsavanh, M.; Echevarria, V.; Tiedeken, J.; Brown, C.; Fromm, G.; Lyerly, S.; Watson, N.; Long, A.; De Nitto, N. *Inorg. Chem.* **2001**, *40*, 4217–4225.
786. Mahmood, A.; Liu, H. L.; Jones, J. G.; Edwards, J. O.; Sweigart, D. A. *Inorg. Chem.* **1988**, *27*, 2149–2154.
787. Paolesse, R.; Mini, S.; Sagone, F.; Boschi, T.; Jaquinod, L.; Nurco, D. J.; Smith, K. M. *Chem. Commun.* **1999**, 1307–1308.
788. Mahammed, A.; Giladi, I.; Goldberg, I.; Gross, Z. *Chem.-Eur. J.* **2001**, *7*, 4259–4265.
789. Mahammed, A.; Goldberg, I.; Gross, Z. *Org. Lett.* **2001**, *3*, 3443–3446.
790. Kadish, K. M.; Koh, W.; Tagliatesta, P.; Sazou, D.; Paolesse, R.; Licoccia, S.; Boschi, T. *Inorg. Chem.* **1992**, *31*, 2305–2313.
791. Will, S.; Lex, J.; Vogel, E.; Adamian, V. A.; Van Caemelbecke, E.; Kadish, K. M. *Inorg. Chem.* **1996**, *35*, 5577–5583.
792. Paolesse, R.; Licoccia, S.; Fanciullo, M.; Morgante, E.; Boschi, T. *Inorg. Chim. Acta* **1993**, *203*, 107–114.
793. Marques, H. M.; Brown, K. L. *Inorg. Chem.* **1995**, *34*, 3733–3740.
794. Rovira, C.; Kunc, K.; Hutter, J.; Parrinello, M. *Inorg. Chem.* **2001**, *40*, 11–17.
795. Guillard, R.; Jerome, F.; Gros, C. P.; Barbe, J.-M.; Ou, Z.; Shao, J.; Kadish, K. M. *Comptes Rendus de l'Academie des Sciences, Serie IIC: Chimie* **2001**, *4*, 245–254.
796. Jerome, F.; Gros, C. P.; Tardieux, C.; Barbe, J.-M.; Guillard, R. *New J. Chem.* **1998**, *22*, 1327–1329.
797. Novodarova, G. N.; Vol'pin, M. E. *Catal. Lett.* **1990**, *4*, 265–269.
798. Ercolandi, C.; Pennesi, G. *Inorg. Chim. Acta* **1985**, *101*, L41–L42.
799. Navon, G.; Panigel, R. *Inorg. Chem.* **1989**, *28*, 1405–1407.
800. Hoq, M. F.; Shepherd, R. E. *Inorg. Chem.* **1984**, *23*, 1851–1858.
801. Brodsky, N. R.; Nguyen, N. M.; Rowan, N. S.; Storm, C. B.; Butcher, R. J.; Sinn, E. *Inorg. Chem.* **1984**, *23*, 891–897.
802. Hawkins, C. J.; Martin, J. *Inorg. Chem.* **1986**, *25*, 2146–2154.
803. Delany, K.; Arora, S. K.; Mascharak, P. K. *Inorg. Chem.* **1988**, *27*, 705–712.
804. Farinas, E.; Tan, J. D.; Baidya, N.; Mascharak, P. K. *J. Am. Chem. Soc.* **1993**, *115*, 2996–2997.
805. Brown, S. J.; Olmstead, M. M.; Mascharak, P. K. *Inorg. Chem.* **1989**, *28*, 3720–3728.
806. Hawkins, C. J.; Horn, E.; Martin, J.; Palmer, J. A. L.; Snow, M. R. *Aust. J. Chem.* **1986**, *39*, 1213–1220.
807. Rowan-Gordon, N.; Nguyenpho, A. A.; Mondon-Konan, E.; Turner, A. H.; Butcher, R. J.; Okonkwo, A. S.; Hayden, H. H.; Storm, C. B. *Inorg. Chem.* **1991**, *30*, 4374–4380.
808. Blackman, A. G.; Buckingham, D. A.; Clark, C. R.; Simpson, J. *Inorg. Chem.* **1991**, *30*, 1635–1642.
809. Hoq, M. F.; Johnson, C. R.; Paden, S.; Shepherd, R. E. *Inorg. Chem.* **1983**, *22*, 2693–2700.
810. Curnow, O. J.; Nicholson, B. K.; Severinsen, M. J. *J. Organomet. Chem.* **1990**, *388*, 379–390.
811. Lawson, P. J.; McCarthy, M. G.; Sargeson, A. M. *J. Am. Chem. Soc.* **1982**, *104*, 6710–6716.
812. Jackson, W. G.; Walsh, R. J. *Inorg. Chem.* **1991**, *30*, 4813–4820.
813. Hartshorn, R. M.; Sargeson, A. M. *Aust. J. Chem.* **1992**, *45*, 5–20.
814. Browne, J. M. W.; Wikaira, J.; Hartshorn, R. M. *J. Chem. Soc., Dalton Trans.* **2001**, 3513–3519.
815. Bernhardt, P. V.; Jones, L. A. *J. Chem. Soc., Dalton Trans.* **1998**, 1757–1761.
816. Elerman, Y.; Kabak, M.; Svoboda, I.; Geselle, M. *Acta Cryst., Sect. C: Crystal Structure Communications* **1994**, C50, 1694–1696.
817. Nishinaga, A.; Kondo, T.; Matsuura, T. *Chem. Lett.* **1985**, 905–908.
818. Cunningham, D.; Higgins, T.; Kneafsey, B.; McArdle, P.; Simmie, J. *J. Chem. Soc., Chem. Commun.* **1985**, 231–232.
819. Maruyama, K.; Kubo, K.; Toda, Y.; Kawase, K.; Mashino, T.; Nishinaga, A. *Tetrahedron Lett.* **1995**, *36*, 5609–5612.
820. Cameron, J. H.; Turner, S. C. *J. Chem. Soc., Dalton Trans.* **1992**, 3285–3289.
821. Gambarotta, S.; Fiallo, M. L.; Floriani, C.; Chiesi-Villa, A.; Guastini, C. *J. Chem. Soc., Chem. Commun.* **1982**, 503–505.
822. Floriani, C.; Fiallo, M.; Chiesi-Villa, A.; Guastini, C. *J. Chem. Soc., Dalton Trans.* **1987**, 1367–1376.
823. Meade, T. J.; Gray, H. B.; Takeuchi, T., *PCT Int. Appl.* **1996**, 9618402.
824. Meade, T. J.; Takeuchi, T.; Gray, H. B.; Simon, M.; Louie, A. Y. *PCT Int. Appl.* **1997**, 9721431.
825. Takeuchi, T.; Bottecher, A.; Quezada, C. M.; Meade, T. J.; Gray, H. B. *Bioorg. Med. Chem.* **1999**, *7*, 815–819.
826. Takeuchi, T.; Boettcher, A.; Quezada, C. M.; Simon, M. I.; Meade, T. J.; Gray, H. B. *J. Am. Chem. Soc.* **1998**, *120*, 8555–8556.
827. Louie, A. Y.; Meade, T. J. *Proc. Natl. Acad. Sci. U.S.A.* **1998**, *95*, 6663–6668.
828. Boettcher, A.; Takeuchi, T.; Hardcastle, K. I.; Meade, T. J.; Gray, H. B.; Cwikel, D.; Kapon, M.; Dori, Z. *Inorg. Chem.* **1997**, *36*, 2498–2504.
829. Feng, D.; Schultz, F. A. *J. Electroanal. Chem. Interfacial Electrochem.* **1988**, *250*, 107–116.
830. Fukuzumi, S.; Mochizuki, S.; Tanaka, T. *Inorg. Chem.* **1989**, *28*, 2459–2465.
831. Ho, P. H. C.; Newhall, P. M.; Nofhle, R. E. *J. Fluorine Chem.* **1990**, *50*, 299–308.
832. Hirata, J.; yagi, M.; Oriyama, T.; Kaneko, M.; Kurimura, Y. *J. Chem. Soc., Faraday Trans.* **1996**, *92*, 969–972.
833. Poon, C. K.; Lau, T. C.; Wong, C. L.; Kan, Y. P. *J. Chem. Soc., Dalton Trans.* **1983**, 1641–1645.
834. Schwarz, C. L.; Endicott, J. F. *Inorg. Chem.* **1989**, *28*, 4011–4018.
835. Bambi, R.; Roy, T. G.; Jhanji, A. K.; Maheswari, A. *J. Chem. Soc., Dalton Trans.* **1990**, 3531–3534.
836. Endicott, J. F.; Kumar, K.; Schwarz, C. L.; Perkovic, M. W.; Lin, W. K. *J. Am. Chem. Soc.* **1989**, *111*, 7411–7420.
837. Szalda, D. J.; Schwarz, C. L.; Creutz, C. *Inorg. Chem.* **1991**, *30*, 586–588.
838. Lee, S.; Espenson, J. H.; Bakac, A. *Inorg. Chem.* **1990**, *29*, 3442–3447.
839. Dimmit, J. H.; Weber, J. H. *Inorg. Chem.* **1982**, *21*, 1554–1557.
840. Dimmit, J. H.; Weber, J. H. *Inorg. Chem.* **1982**, *21*, 700–703.
841. Rapsomankis, S.; Donard, O. F. X.; Weber, J. H. *Appl. Organomet. Chem.* **1987**, *1*, 115–118.
842. Bakac, A.; Espenson, J. H. *Inorg. Chem.* **1989**, *28*, 4319–4322.
843. Leij, F.; Morelli, G.; Ricciardi, G.; Rosa, A. *Inorg. Chim. Acta* **1990**, *176*, 189–194.
844. Kofod, P.; Moore, P.; Alcock, N. W.; Clase, H. J. *J. Chem. Soc., Chem. Commun.* **1992**, 1261–1263.

845. Kofod, P.; Alcock, N.; Moore, P. *Acta Chem. Scand.* **1993**, *47*, 1083–1090.
846. Lukes, P. J.; McGregor, A. C.; Clifford, T.; Crayton, J. A. *Inorg. Chem.* **1992**, *31*, 4697–4699.
847. Jaynes, B. S.; Ren, T.; Liu, S.; Lippard, S. J. *J. Am. Chem. Soc.* **1992**, *114*, 9670–9671.
848. Jaynes, B. S.; Ren, T.; Masschelein, A.; Lippard, S. J. *J. Am. Chem. Soc.* **1993**, *115*, 5589–5599.
849. Franz, K. J.; Doerr, L. H.; Spingler, B.; Lippard, S. J. *Inorg. Chem.* **2001**, *40*, 3774–3780.
850. Borchardt, D.; Pool, K.; Wherland, S. *Inorg. Chem.* **1982**, *21*, 93–97.
851. Borchardt, D.; Wherland, S. *Inorg. Chem.* **1984**, *23*, 2537–2542.
852. Nielson, R. M.; Weaver, M. J. *J. Electroanal. Chem. Interfacial Electrochem.* **1989**, *260*, 15–24.
853. Borchardt, D.; Wherland, S. *Inorg. Chem.* **1986**, *25*, 901–905.
854. Murguia, M. A.; Borchardt, D.; Wherland, S. *Inorg. Chem.* **1990**, *29*, 1982–1986.
855. Kubow, S. A.; Takeuchi, K. J.; Grzybowski, J. J.; Jircitano, A. J.; Goedken, V. L. *Inorg. Chim. Acta* **1996**, *241*, 21–30.
856. Murguia, M. A.; Wherland, S. *Inorg. Chem.* **1991**, *30*, 139–144.
857. Voloshin, Y. Z.; Bel'skii, V. K.; Trachevskii, V. V. *Polyhedron* **1992**, *11*, 1939–1948.
858. Basu, P. *Polyhedron* **1992**, *11*, 3037–3040.
859. Sharma, R. P.; Bhasin, K. K.; Tiekink, E. R. T. *J. Coord. Chem.* **1995**, *36*, 225–230.
860. Engelhardt, L. M.; Harrowfield, J. M.; McNiven, S. J.; Skelton, B. W.; White, A. H. *Aust. J. Chem.* **1990**, *43*, 1803–1816.
861. Megnamisi-Belombe, M.; Jokwi, I.; Ngameni, E.; Roux, R. Z. *Naturforsch., B: Chem. Sci.* **1993**, *48*, 1719–1722.
862. Lampeka, R. D.; Uzakbergenova, Z. D.; Skopenko, V. V. Z. *Naturforsch., B: Chem. Sci.* **1993**, *48*, 409–417.
863. Fritsky, I. O.; Lampeka, R. D.; Skopenko, V. V.; Simonov, Y. A.; Dvorkin, A. A.; Malinowsky, T. I. Z. *Naturforsch., B: Chem. Sci.* **1993**, *48*, 270–276.
864. Pyckhout, W.; Lenstra, A. T. H.; Tyrlik, S. K. *Bull. Soc. Chim. Belg.* **1987**, *96*, 575–580.
865. Xu, D.; Lei, L.; Xu, Y.; Cheng, C.; Chen, J. *Acta Crystallogr., Sect. C: Cryst. Struct. Commun.* **1992**, *C48*, 1399–1402.
866. Melby, L. R.; Janowicz, A. H.; Ittel, S. D. *Eur. Pat. Appl.*, **1986**, 196783.
867. Muir, A. V. G.; Lawson, J. R.; Haddleton, D. M. *PCT Int. Appl.* **1995**, 9527737.
868. Okamoto, T.; Oka, S. *J. Chem. Soc., Chem. Commun.* **1984**, 289–290.
869. Okamoto, T.; Kobayashi, K.; Oka, S.; Tanimoto, S. *J. Org. Chem.* **1987**, *52*, 5089–5092.
870. Giese, B.; Erdmann, P.; Gobel, T.; Springer, R. *Tetrahedron Lett.* **1992**, *33*, 4545–4548.
871. Fairlie, D. P.; Angus, P. M.; Fenn, M. D.; Jackson, W. G. *Inorg. Chem.* **1991**, *30*, 1564–1569.
872. Fairlie, D. P.; Jackson, W. G.; McLaughlin, G. M. *Inorg. Chem.* **1989**, *28*, 1983–1989.
873. Grondahl, L.; Hammershoi, A.; Hartshorn, R. M.; Sargeson, A. M. *Acta Chem. Scand.* **1995**, *49*, 781–791.
874. Solujic, L. R.; Herak, R.; Prelesnik, B.; Celap, M. B. *Inorg. Chem.* **1985**, *24*, 32–37.
875. Solujic, L.; Prelesnik, B.; Herak, R.; Milosavljevic, S.; Nelson, J. H.; Nikolic, A. *Inorg. Chem.* **1990**, *29*, 4703–4707.
876. Okamoto, K.; Takaki, M.; Yonemura, T.; Konno, T.; Hidaka, J. *Inorg. Chim. Acta* **1990**, *175*, 31–39.
877. Juranic, N.; Likić, V.; Parac, T.; Macura, S. *J. Chem. Soc., Perkin Trans. 2* **1993**, 1805–1810.
878. Evans, E. J.; Hawkins, C. J.; Rodgers, J.; Snow, M. R. *Inorg. Chem.* **1983**, *22*, 34–38.
879. Lee, B.-W.; Oh, C.-E.; Doh, M.-K. *Bull. Korean Chem. Soc.* **1998**, *19*, 457–462.
880. Juranic, N.; Vuk-Pavlovic, S.; Nikolic, A. T.; Chen, T.-B.; Macura, S. *J. Inorg. Biochem.* **1996**, *62*, 17–26.
881. Billson, T. S.; Crane, J. D.; Fox, O. D.; Heath, S. L. *Inorg. Chem. Commun.* **2000**, *3*, 718–720.
882. Jyo, A.; Terazono, Y.; Egawa, H. *Anal. Sci.* **1995**, *11*, 51–57.
883. Angus, P. M.; Elliott, A. J.; Sargeson, A. M.; Willis, A. C. *J. Chem. Soc., Dalton Trans.* **1999**, 1131–1136.
884. Geue, R. J.; Petri, W. R.; Sargeson, A. M.; Snow, M. R. *Aust. J. Chem.* **1992**, *45*, 1681–1703.
885. Angus, P. M.; Elliott, A. J.; Sargeson, A. M.; Willis, A. C. *J. Chem. Soc., Dalton Trans.* **2000**, 2933–2938.
886. Schmid, S.; Rae, A. D.; Geue, R. J.; McCarthy, M. G.; Sargeson, A. M.; Willis, A. C. *Acta Crystallogr., Sect. B: Struct. Sci.* **1992**, *B48*, 463–470.
887. Langkjaer, M.; Larsen, E.; Larsen, S. *Acta Chem. Scand., Ser. A* **1985**, *A39*, 187–197.
888. Collins, T. J.; Richmond, T. G.; Santarsiero, B. D.; Treco, B. G. R. T. *J. Am. Chem. Soc.* **1986**, *108*, 2088–2090.
889. Dutta, S. K.; Beckmann, U.; Bill, E.; Weyhermueller, T.; Wieghardt, K. *Inorg. Chem.* **2000**, *39*, 3355–3364.
890. Balch, A. L.; Mazzanti, M.; Noll, B. C.; Olmstead, M. M. *J. Am. Chem. Soc.* **1994**, *116*, 9114–9121.
891. Attar, S.; Balch, A. L.; Van Calcar, P. M.; Winkler, K. *J. Am. Chem. Soc.* **1997**, *119*, 3317–3323.
892. Attar, S.; Ozarowski, A.; Van Calcar, P. M.; Winkler, K.; Balch, A. L. *Chem. Commun.* **1997**, 1115–1116.
893. Koola, J. D.; Kochi, J. K. *J. Org. Chem.* **1987**, *52*, 4545–4553.
894. Ozaki, S.; Mimura, H.; Yasuhara, N.; Masui, M.; Yamagata, Y.; Tomita, K.; Collins, T. J. *J. Chem. Soc., Perkin Trans. 2* **1990**, 353–360.
895. Hirao, T.; Moriuchi, T.; Ishikawa, T.; Nishimura, K.; Mikami, S.; Ohshiro, Y.; Ikeda, I. *J. Mol. Catal. A: Chem.* **1996**, *113*, 117–130.
896. Chavez, F. A.; Nguyen, C. V.; Olmstead, M. M.; Mascharak, P. K. *Inorg. Chem.* **1996**, *35*, 6282–6291.
897. Chavez, F. A.; Olmstead, M. M.; Mascharak, P. K. *Inorg. Chem.* **1997**, *36*, 6323–6327.
898. Bultitude, J.; Larkworthy, L. F.; Mason, J.; Povey, D. C.; Sandell, B. *Inorg. Chem.* **1984**, *23*, 3629–3633.
899. Groombridge, C. J.; Larkworthy, L. F.; Marecaux, A.; Povey, D. C.; Smith, G. W.; Mason, J. *J. Chem. Soc., Dalton Trans.* **1992**, 3125–3131.
900. Kini, A. D.; Washington, J.; Kubiak, C. P.; Morimoto, B. H. *Inorg. Chem.* **1996**, *35*, 6904–6906.
901. Richter-Addo, G. B.; Hodge, S. J.; Yi, G.-B.; Khan, M. A.; Ma, T.; Van Caemelbecke, E.; Guo, N.; Kadish, K. M. *Inorg. Chem.* **1996**, *35*, 6530–6538.
902. Kadish, K. M.; Ou, Z.; Tan, X.; Boschi, T.; Monti, D.; Fares, V.; Tagliatesta, P. *J. Chem. Soc., Dalton Trans.* **1999**, 1595–1602.
903. Ellison, M. K.; Scheidt, W. R. *Inorg. Chem.* **1998**, *37*, 382–383.
904. Ghosh, A.; Wondimagegn, T. *J. Am. Chem. Soc.* **2000**, *122*, 8101–8102.
905. Zilbermann, I.; Hayon, J.; Katchalski, T.; Ydgar, R.; Rishpon, J.; Shames, A. I.; Korin, E.; Bettelheim, A. *Inorg. Chim. Acta* **2000**, *305*, 53–60.
906. Lopez de la Vega, R.; Ellis, W. R., Jr.; Purcell, W. L. *Inorg. Chim. Acta* **1983**, *68*, 97–101.
907. Hay, R. W.; McLaren, F. M. *Transition Met. Chem. (Dordrecht)* **1999**, *24*, 398–402.

908. Angus, P. M.; Jackson, W. G.; Sargeson, A. M. *Inorg. Chem.* **1993**, *32*, 5285–5290.
909. Hall, J. H.; Lopez de la Vega, R.; Purcell, W. L. *Inorg. Chim. Acta* **1985**, *102*, 157–162.
910. Szecey, A. P.; Haim, A. *J. Am. Chem. Soc.* **1982**, *104*, 3063–3069.
911. Balahura, R. J.; Kupferschmidt, W. C.; Purcell, W. L. *Inorg. Chem.* **1983**, *22*, 1456–1461.
912. Kupferschmidt, W. C.; Jordan, R. B. *J. Am. Chem. Soc.* **1984**, *106*, 991–995.
913. Balahura, R. J.; Ferguson, G.; Johnston, A.; Ruhl, B. L. *Polyhedron* **1986**, *5*, 2075–2080.
914. Pinnell, R. P.; Ballew, N. L.; Batchelder, A. M.; Bleha, J. L.; Swatik, S. A.; Zanella, A. W. *Synth. React. Inorg. Met.-Org. Chem.* **2000**, *30*, 1917–1927.
915. Billaud, C.; Sarakha, M.; Bolte, M. *Eur. Polym. J.* **2000**, *36*, 1401–1408.
916. Chiu, K. W.; Wilkinson, G.; Thornton-Pett, M.; Hursthouse, M. B. *Polyhedron* **1984**, *3*, 79–85.
917. Fairlie, D. P.; Turner, M.; Byriel, K. A.; McKeon, J. A.; Jackson, W. G. *Inorg. Chim. Acta* **1999**, *290*, 133–138.
918. Alnaji, O.; Peres, Y.; Dahan, F.; Dartiguenave, M.; Dartiguenave, Y. *Inorg. Chem.* **1986**, *25*, 1383–1386.
919. Houlding, V. H.; Miskowski, V. M. *Inorg. Chem.* **1984**, *23*, 4671–4675.
920. Socol, S. M.; Lacle, S.; Verkade, J. G. *Inorg. Chem.* **1987**, *26*, 3221–3224.
921. Suzuki, T.; Kashiwabara, K.; Kita, M.; Fujita, J.; Kaizaki, S. *Inorg. Chim. Acta* **1998**, *281*, 77–84.
922. Katoh, K.; Sugiura, H.; Kashiwabara, K.; Fujita, J. *Bull. Chem. Soc. Jpn.* **1984**, *57*, 3580–3586.
923. Suzuki, T.; Kaizaki, S.; Kashiwabara, K. *Inorg. Chim. Acta* **2000**, *298*, 131–140.
924. Levason, W.; Ogden, J. S.; Spicer, M. D. *Inorg. Chem.* **1989**, *28*, 2128–2131.
925. Atoh, M.; Kinoshita, I.; Kashiwabara, K.; Fujita, J. *Bull. Chem. Soc. Jpn.* **1982**, *55*, 3179–3186.
926. Hale, A. L.; Jewiss, H. C.; Levason, W. *Inorg. Chim. Acta* **1985**, *97*, 85–90.
927. Dilworth, J. R.; Howe, S. D.; Hutson, A. J.; Miller, J. R.; Silver, J.; Thompson, R. M.; Harman, M.; Hursthouse, M. B. *J. Chem. Soc., Dalton Trans.* **1994**, 3553–3562.
928. Kashiwabara, K.; Jung, M.; Fujita, J. *Bull. Chem. Soc. Jpn* **1991**, *64*, 2372–2377.
929. Bricklebank, N.; Godfrey, S. M.; McAuliffe, C. A.; Pritchard, R. G. *J. Chem. Soc., Dalton Trans.* **1996**, 157–160.
930. Jewiss, H. C.; Levason, W.; Webster, M. *Inorg. Chem.* **1986**, *25*, 1997–2001.
931. Fitzpatrick, M. G.; Hanton, L. R.; Levason, W.; Spicer, M. D. *Inorg. Chim. Acta* **1988**, *142*, 17–19.
932. Jackson, W. G.; Bosnich, B. *Inorg. Chem.* **1983**, *22*, 2846–2850.
933. Jackson, W. G.; McLaren, J. W.; Bosnich, B. *Inorg. Chem.* **1983**, *22*, 2842–2845.
934. Iwata, K.; Kojima, M.; Fujita, J. *Bull. Chem. Soc. Jpn.* **1985**, *58*, 3003–3009.
935. Simonsen, K.; Hamada, M.; Suzuki, N.; Kojima, M.; Ohba, S.; Galsbol, F.; Saito, Y.; Fujita, J. *Bull. Chem. Soc. Jpn.* **1990**, *63*, 2904–2910.
936. Nemoto, K.; Kita, M.; Kojima, M.; Fujita, J. *Bull. Chem. Soc. Jpn.* **1989**, *62*, 1517–1523.
937. Kita, M.; Nemoto, K.; Kashiwabara, K.; Fujita, J.; Goto, M.; Miyamoto, T.; Ohba, S. *Bull. Chem. Soc. Jpn.* **1993**, *66*, 1687–1692.
938. Doyle, R. J.; Salem, G.; Willis, A. C. *J. Chem. Soc., Chem. Commun.* **1994**, 1587–1588.
939. Doyle, R. J.; Salem, G.; Willis, A. C. *J. Chem. Soc., Dalton Trans.* **1997**, 2713–2723.
940. Doyle, R. J.; Habermehl, N.; Salem, G.; Willis, A. C. *J. Chem. Soc., Dalton Trans.* **2000**, 3603–3608.
941. Beattie, J. K.; Best, S. P. *Coord. Chem. Rev.* **1997**, *166*, 391–415.
942. Bernal, I.; Gonzalez, M. T.; Cetrullo, J.; Cai, J. *Struct. Chem.* **2001**, *12*, 73–79.
943. Spingler, B.; Scanavy-Grigorieff, M.; Werner, A.; Berke, H.; Lippard, S. J. *Inorg. Chem.* **2001**, *40*, 1065–1066.
944. Springborg, J. *Adv. Inorg. Chem.* **1988**, *32*, 55–169.
945. Koelle, U. *Coord. Chem. Rev.* **1994**, *135/136*, 623–650.
946. Koelle, U.; Fuss, B. *Chem. Ber.* **1984**, *117*, 743–752.
947. Okamoto, K.; Hidaka, J.; Ama, T.; Yasui, T. *Acta Crystallogr., Sect. C: Cryst. Struct. Commun.* **1991**, *C47*, 2099–2101.
948. Larsen, E.; Larsen, S.; Paulsen, G. B.; Springborg, J.; Wang, D. N. *Acta Chem. Scand.* **1994**, *48*, 107–112.
949. Ama, T.; Shiro, M.; Takeuchi, A.; Yonemura, T.; Kawaguchi, H.; Yasui, T. *Bull. Chem. Soc. Jpn* **1997**, *70*, 2685–2692.
950. Beattie, J. K.; Hambley, T. W.; Klepetko, J. A.; Masters, A. F.; Turner, P. *Polyhedron* **1998**, *17*, 1343–1354.
951. Bill, E.; Krebs, C.; Winter, M.; Gerdan, M.; Trautwein, A. X.; Floerke, U.; Haupt, H. J. *P. C. Chem. Eur. J.* **1997**, *3*, 193–210.
952. Dimitrou, K.; Foltling, K.; Streib, W. E.; Christou, G. *J. Am. Chem. Soc.* **1993**, *115*, 6432–6433.
953. Dimitrou, K.; Sun, J.-S.; Foltling, K.; Christou, G. *Inorg. Chem.* **1995**, *34*, 4160–4166.
954. Shafi, K. V. P. M.; Nethaji, M.; Sathyanarayana, D. N. *J. Chem. Soc., Dalton Trans.* **1996**, 3179–3184.
955. Mueller, S.; Thewalt, U. Z. *Naturforsch., B: Chem. Sci.* **1989**, *44*, 160–257s.
956. Hodgson, D. J.; Michelsen, K.; Pedersen, E. J. *J. Chem. Soc., Chem. Commun.* **1988**, 1558–1559.
957. Rhule, J. T.; Hill, C. L.; Judd, D. A.; Schinazi, R. F. *Chem. Rev.* **1998**, *98*, 327–357.
958. Pope, M. T.; Muller, A. *Polyoxometallates: From Platonic Solids to Anti-retroviral Activity*; Kluwer Academic Publishers: Dordrecht, 1994.
959. Pope, M. T. *Heteropoly and isopoly oxometalates* **1983**, Springer-Verlag: Berlin.
960. Kazansky, L. P.; McGarvey, B. R. *Coord. Chem. Rev.* **1999**, *188*, 157–210.
961. Ramprasad, D.; Gilicinski, A. G.; Markley, T. J.; Pez, G. P. *Inorg. Chem.* **1994**, *33*, 2841–2847.
962. Gubelmann, M. H.; Williams, A. F. *Struct. Bonding* **1983**, *55*, 1–65.
963. Ohishi, T.; Kashiwabara, K.; Fujita, J.; Ohba, S.; Ishii, T.; Saito, Y. *Bull. Chem. Soc. Jpn* **1986**, *59*, 385–393.
964. Bernhardt, P. V.; Lawrence, G. A.; Hambley, T. W. *J. Chem. Soc., Dalton Trans.* **1990**, 235–241.
965. Furutachi, H.; Fujinami, S.; Suzuki, M.; Okawa, H. *Chem. Lett.* **1999**, 763–764.
966. Seo, J. S.; Hynes, R. C.; Williams, D. J.; Chin, J.; Sung, N.-D. *J. Am. Chem. Soc.* **1998**, *120*, 9943–9944.
967. Hayashi, Y.; Obata, M.; Suzuki, M.; Uehara, A. *Chem. Lett.* **1997**, 1255–1256.
968. Kayatani, T.; Hayashi, Y.; Suzuki, M.; Uehara, A. *Bull. Chem. Soc. Jpn* **1994**, *67*, 2980–2989.
969. Bouwman, E.; Driessen, W. L. *J. Am. Chem. Soc.* **1988**, *110*, 4440–4441.
970. Yamanari, K.; Mori, M.; Dogi, S.; Fuyuhiko, A. *Inorg. Chem.* **1994**, *33*, 4807–4809.
971. Schmidt, S.; Heinemann, F. W.; Grohmann, A. *Eur. J. Inorg. Chem.* **2000**, 1657–1667.
972. Yamanari, K.; Mori, M.; Dogi, S.; Fuyuhiko, A. *Chem. Lett.* **1993**, 1855–1858.

973. Tanase, T.; Onaka, T.; Nakagoshi, M.; Kinoshita, I.; Shibata, K.; Doe, M.; Fuji, J.; Yano, S. *Inorg. Chem.* **1999**, *38*, 3150–3159.
974. Maeder, M.; Maecke, H. R. *Inorg. Chem.* **1994**, *33*, 3135–3140.
975. Belloni, J.; Lecheheb, A. *Radiat. Phys. Chem.* **1987**, *29*, 89–92.
976. Gubelmann, M. H.; Ruettimann, S.; Bocquet, B.; Williams, A. F. *Helv. Chim. Acta* **1990**, *73*, 1219–1227.
977. Lawrance, G. A. *Chem. Rev.* **1986**, *86*, 17–33.
978. Hausherr-Primo, L.; Hegetschweiler, K.; Ruegger, H.; Odier, L.; Hancock, R. D.; Schmalte, H. W.; Gramlich, V. J. *Chem. Soc., Dalton Trans.* **1994**, 1689–1701.
979. Saussine, L.; Brazis, E.; Robine, A.; Mimoun, H.; Fischer, J.; Weiss, R. *J. Am. Chem. Soc.* **1985**, *107*, 3524–3540.
980. Chavez, F. A.; Briones, J. A.; Olmstead, M. M.; Mascharak, P. K. *Inorg. Chem.* **1999**, *38*, 1602–1608.
981. Sommerer, S. O.; Baker, J. D.; Jensen, W. P.; Hamza, A.; Jacobson, R. A. *Inorg. Chim. Acta* **1993**, *210*, 173–176.
982. Comba, P.; Jakob, H.; Nuber, B.; Keppler, B. K. *Inorg. Chem.* **1994**, *33*, 3396–3400.
983. Baraniak, E.; Buckingham, D. A.; Clark, C. R.; Moynihan, B. H.; Sargeson, A. M. *Inorg. Chem.* **1986**, *25*, 3466–3478.
984. Junk, P. C.; Steed, J. W. *Polyhedron* **1999**, *18*, 3593–3597.
985. Broge, L.; Sotofte, I.; Olsen, C. E.; Springborg, J. *Inorg. Chem.* **2001**, *40*, 3124–3129.
986. Fairlie, D. P.; Jackson, W. G. *Inorg. Chem.* **1990**, *29*, 3139–3145.
987. Coucouvanis, D.; Reynolds, R. A. I.; Dunham, W. R. *J. Am. Chem. Soc.* **1995**, *117*, 7570–7571.
988. Wieghardt, K.; Siebert, H. *Inorg. Synth.* **1985**, *23*, 107–116.
989. Glerup, J.; Goodson, P. A.; Hodgson, D. J.; Michelsen, K. *Inorg. Chem.* **1995**, *34*, 6255–6264.
990. Angus, P. M.; Jackson, W. G. *Inorg. Chim. Acta* **1998**, *268*, 85–91.
991. Maxcy, K. R.; Turnbull, M. M. *Acta Crystallogr., Sect. C: Cryst. Struct. Commun.* **1999**, *C55*, 1984–1986.
992. Buist, R. J.; Au-Yeung, S. C. T.; Eaton, D. R. *Can. J. Chem.* **1985**, *63*, 3558–3567.
993. Fanshawe, R. L.; Blackman, A. G. *Inorg. Chem.* **1995**, *34*, 421–423.
994. Golobic, A.; Stefane, B.; Polanc, S. *Polyhedron* **1999**, *18*, 3661–3668.
995. Murdoch, A. R.; Tyree, T.; Otterbein, W.; Kinney, L.; Carreras, M.; Cooper, J. N.; Elder, R. C. *Inorg. Chem.* **1985**, *24*, 3674–3679.
996. Johnson, M. D.; Balahura, R. J. *Inorg. Chem.* **1988**, *27*, 3104–3107.
997. Kapanadze, T. S.; Elerdashvili, M. A.; Tarasov, V. P.; Tsintsadze, G. V.; Buslaev, Y. A. *Koord. Khim.* **1989**, *15*, 248–255.
998. Broderick, W. E.; Kanamori, K.; Willett, R. D.; Legg, J. I. *Inorg. Chem.* **1991**, *30*, 3875–3881.
999. Ballet, B.; Bino, A.; Cohen, S.; Rubin, H.; Zor, T. *Inorg. Chim. Acta* **1991**, 188.
1000. Hay, R. W.; Fraser, I. *Transition Met. Chem.* **1991**, *16*, 122–125.
1001. Hong, K.-P.; Park, H. S.; Kwon, Y.-U. *Bull. Korean Chem. Soc.* **1999**, *20*, 163–167.
1002. Dash, A. C. *J. Indian Chem. Soc.* **2000**, *77*, 583–592.
1003. Buckingham, D. A.; Clark, C. R.; Simpson, J.; Robinson, W. T. *Inorg. Chem.* **1988**, *27*, 3544–3547.
1004. Dixon, N. E.; Jackson, W. G.; Lawrance, G. A.; Sargeson, A. M. *Inorg. Synth.* **1983**, *22*, 103–107.
1005. Massoud, S. S.; Milburn, R. M. *Inorg. Chim. Acta* **1989**, *163*, 87–91.
1006. Geue, R. J.; Sargeson, A. M.; Wijesekera, R. *Aust. J. Chem.* **1993**, *46*, 1021–1040.
1007. Engelhardt, L. M.; Keegan, E. A.; Lawrance, G. A.; White, A. H. *Aust. J. Chem.* **1989**, *42*, 1045–1055.
1008. Jackson, W. G.; McGregor, B. C. *Inorg. Chim. Acta* **1984**, *83*, 115–124.
1009. Setsune, J.; Ito, S.; Takeda, H.; Ishimaru, Y.; Kitao, T.; Sato, M.; Ohya-Nishiguchi, H. *Organometallics* **1997**, *16*, 597–605.
1010. Holder, A. A.; Dasgupta, T. P. *J. Chem. Soc., Dalton Trans.* **1996**, 2637–2643.
1011. Juranic, N.; Prelesnik, B.; Manojlovic-Muir, L.; Andjelkovic, K.; Niketic, S. R.; Celap, M. B. *Inorg. Chem.* **1990**, *29*, 1491–1495.
1012. Douglas, B. E.; Radanovic, D. J. *Coord. Chem. Rev.* **1993**, *128*, 139–165.
1013. Parvez, M.; Maricondi, C.; Radanovic, D. J.; Djuran, M. I.; Bosnich, B. *Inorg. Chim. Acta* **1991**, *182*, 177–186.
1014. Billing, D. G.; Dobson, S. M.; Patrick, G.; Carlton, L. *Acta Crystallogr., Sect. C: Cryst. Struct. Commun.* **1991**, *47*, 1964–1966.
1015. Ware, D. C.; Toney, D. M.; Baker, L.-J.; Brothers, P. J.; Clark, G. R. *Chem. Commun.* **1996**, 1303–1304.
1016. Okamoto, K.-I.; Hidaka, J.; Kawaguchi, H.; Yasui, T. *Inorg. Chim. Acta* **1991**, *180*, 41–45.
1017. Kojima, T.; Usui, T.; Shimada, A.; Yoshiro, M.; Tanase, T.; Yoshioka, R.; Kuroda, R.; Yano, S.; Hidai, M.; Kato, M.; Kobayashi, K.; Sakurai, T.; Yoshikawa, S. *Inorg. Chem.* **1991**, *30*, 4535–4541.
1018. Cole, E.; Copley, R. C. B.; Howard, J. A. K.; Parker, D.; Ferguson, G.; Gallagher, J. F.; Kaitner, B.; Harrison, A.; Royle, L. *J. Chem. Soc., Dalton Trans.* **1994**, 1619–1629.
1019. Auerbach, U.; Weyhermueller, T.; Wieghardt, K.; Nuber, B.; Bill, E.; Butzlaff, C.; Trautwein, A. X. *Inorg. Chem.* **1993**, *32*, 508–519.
1020. Collins, T. J.; Ozaki, S.; Richmond, T. G. *J. Chem. Soc., Chem. Commun.* **1987**, 803–804.
1021. Bronger, W.; Koelman, W.; Schmitz, D. Z. *Anorg. Allg. Chem.* **1995**, *621*, 405–408.
1022. Ceconi, F.; Ghilardi, C. A.; Midollini, S.; Orlandini, A. *Inorg. Chim. Acta* **1983**, *76*, L183–L184.
1023. Muller, U.; Ha-Eierdanz, M.-L.; Krauter, G. Z. *Naturforsch., B: Chem. Sci.* **1991**, *46B*, 175–182.
1024. Pleus, R. J.; Saak, W.; Pohl, S. Z. *Anorg. Allg. Chem.* **2001**, *627*, 250–253.
1025. Ellis, A.; Fultz, A.; Hicks, R.; Morgan, T.; Parsons, L., Jr.; Saderholm, M. J.; Smith, L. A.; Stabb, M.; Starnes, J. K. *Aust. J. Chem.* **1992**, *45*, 2049–2055.
1026. Jenkinson, J. J.; Levason, W.; Perry, R. J.; Spicer, M. D. *J. Chem. Soc., Dalton Trans.* **1989**, 453–455.
1027. Brown, J. L.; Kemmitt, T.; Levason, W. *J. Chem. Soc., Dalton Trans.* **1990**, 1513–1515.
1028. Kueppers, H. J.; Wieghardt, K.; Steenzen, S.; Nuber, B.; Weiss, J. Z. *Anorg. Allg. Chem.* **1989**, *573*, 43–62.
1029. Grant, G. J.; Shoup, S. S.; Hadden, C. E.; VanDerveer, D. G. *Inorg. Chim. Acta* **1998**, *274*, 192–200.
1030. Gahan, L. R.; Hambley, T. W.; Sargeson, A. M.; Snow, M. R. *Inorg. Chem.* **1982**, *21*, 2699–2706.
1031. Donlevy, T. M.; Gahan, L. R.; Hambley, T. W. *Inorg. Chem.* **1994**, *33*, 2668–2676.
1032. Bruce, J. I.; Gahan, L. R.; Hambley, T. W.; Stranger, R. *Inorg. Chem.* **1993**, *32*, 5997–6002.
1033. Gahan, L. R.; Donlevy, T. M.; Hambley, T. W. *Inorg. Chem.* **1990**, *29*, 1451–1454.

1034. Santra, B. K.; Lahiri, G. K. *J. Chem. Soc., Dalton Trans.* **1997**, 1883–1888.
1035. Shearer, J.; Kung, I. Y.; Lovell, S.; Kaminsky, W.; Kovacs, J. A. *J. Am. Chem. Soc.* **2001**, *123*, 463–468.
1036. Tyler, L. A.; Noveron, J. C.; Olmstead, M. M.; Mascharak, P. K. *Inorg. Chem.* **2000**, *39*, 357–362.
1037. Kang, B.-S.; Chen, Z.-N.; Lin, Z.; Zhang, H.-X.; Liu, H.-Q.; Huang, X.-Y. *J. Coord. Chem.* **1999**, *46*, 409–424.
1038. Jiang, F. L.; Xie, X. L.; Hong, M. C.; Kang, B. S. *J. Chem. Soc., Dalton Trans.* **1995**, 1447–1451.
1039. Perez-Lourido, P.; Romero, J.; Garcia-Vazquez, J. A.; Sousa, A.; Zubieta, J.; Maresca, K. *Polyhedron* **1998**, *17*, 4457–4464.
1040. Heinrich, L.; Li, Y.; Vaissermann, J.; Chottard, J.-C. *Eur. J. Inorg. Chem.* **2001**, 1407–1409.
1041. Rat, M.; Alves de Sousa, R.; Vaissermann, J.; Leduc, P.; Mansuy, D.; Artaud, I. *J. Inorg. Biochem.* **2001**, *84*, 207–213.
1042. Kersting, B.; Siedle, G. Z. *Naturforsch., B: Chem. Sci.* **2000**, *55*, 1179–1187.
1043. Yamanari, K.; Kawamoto, T.; Kushi, Y.; Konorita, T.; Fuyuhiko, A. *Bull. Chem. Soc. Jpn* **1998**, *71*, 2635–2643.
1044. Becker, B.; Zalewska, A.; Konitz, A.; Wojnowski, W. Z. *Anorg. Allg. Chem.* **2001**, *627*, 271–279.
1045. Balahura, R. J.; Johnson, M.; Black, T. *Inorg. Chem.* **1989**, *28*, 3933–3937.
1046. Jackson, W. G.; Jurisson, S. S. *Inorg. Chem.* **1987**, *26*, 1060–1064.
1047. Lee, C.-R.; Tan, L.-Y.; Wang, Y. *J. Phys. Chem. Solids* **2001**, *62*, 1613–1628.
1048. Matsui, H.; Kita, M.; Kashiwabara, K.; Fujita, J. *Bull. Chem. Soc. Jpn* **1993**, *66*, 1140–1148.
1049. Ware, D. C.; Palmer, H. R.; Bruijn, F. B.; Anderson, R. F.; Brothers, P. J.; Denny, W. A.; Wilson, W. R. *Anti-Cancer Drug Design* **1998**, *13*, 81–103.
1050. Cullen, E. P.; Doherty, J.; Manning, A. R.; McArdle, P.; Cunningham, D. *J. Organomet. Chem.* **1988**, *348*, 109–122.
1051. Healy, P. C.; Skelton, B. W.; White, A. H. *J. Chem. Soc., Dalton Trans.* **1989**, 971–976.
1052. Granell, J.; Green, M. L. H.; Lowe, V. J.; Marder, S. R.; Mountford, P.; Unders, G. C.; Walker, N. M. *J. Chem. Soc., Dalton Trans.* **1990**, 605–614.
1053. West, D. X.; Padhye, S. B.; Sonawane, P. B. *Struct. Bonding* **1991**, *76*, 1–50.
1054. Garcia-Tojal, J.; Garcia-Orad, A.; Alvarez Diaz, A.; Serra, J. L.; Urriaga, M. K.; Arriortua, M. I.; Rojo, T. *J. Inorg. Biochem.* **2001**, *84*, 271–278.
1055. Ferrari, M. B.; Fava, G. G.; Pelosi, G.; Tarasconi, P. *Polyhedron* **2000**, *19*, 1895–1901.
1056. Murugkar, A.; Bendre, R.; Kumbhar, A.; Padhye, S.; Pritchard, R.; McAuliffe, C. A. *Indian J. Chem., Sect. A* **1999**, *38A*, 977–980.
1057. West, D. X.; Swearingen, J. K.; Valdes-Martinez, J.; Hernandez-Ortega, S.; El-Sawaf, A. K.; Van Meurs, F.; Castineiras, A.; Garcia, I.; Bermejo, E. *Polyhedron* **1999**, *18*, 2919–2929.
1058. Sonawane, P.; Chikate, P.; Kumbhar, A.; Padhye, S.; Doedens, R. J. *Polyhedron* **1994**, *13*, 395–401.
1059. Ferrari, M. B.; Fava, G. G.; Pelosi, G.; Rodriguez-Arguelles, M. C.; Tarasconi, P. *J. Chem. Soc., Dalton Trans.* **1995**, 3035–3040.
1060. Sonawane, P.; Kumbhar, A.; Padhye, S.; Butcher, R. J. *Transition Met. Chem.* **1994**, *19*, 277–282.
1061. Chikate, R.; Sonawane, P.; Kumbhar, A.; Padhye, S.; Butcher, R. J. *Inorg. Chim. Acta* **1993**, *205*, 59–65.
1062. Belicchi Ferrari, M.; Bisceglie, F.; Pelosi, G.; Tarasconi, P.; Albertini, R.; Bonati, A.; Lunghi, P.; Pinelli, S. *J. Inorg. Biochem.* **2001**, *83*, 169–178.
1063. Burstein, I. F.; Gerbeleu, N. V.; Bologa, O. A.; Verezhan, A. V.; Malinovskii, T. I. *Dokl. Akad. Nauk SSSR* **1988**, *300*, 1382–1386.
1064. Hall, I. H.; Lackey, C. B.; Kistler, T. D.; Durham, R. W. Jr.; Jouad, E. M.; Khan, M.; Thanh, X. D.; Djebbar-Sid, S.; Benali-Baitich, O.; Bouet, G. M. *Pharmazie* **2000**, *55*, 937–941.
1065. Hall, I. H.; Rajendran, K. G.; West, D. X.; Liberta, A. E. *Anti-Cancer Drugs* **1993**, *4*, 231–240.
1066. Sreekala, R.; Mohammed Yusuff, K. K. *Synth. React. Inorg. Met.-Org. Chem.* **1994**, *24*, 1773–1788.
1067. Scovill, J. P.; Blaney, M. W.; West, D. X.; Liberta, A. E.; Pannell, L. K.; Lewis, K. *Transition Met. Chem.* **1992**, *17*, 377–380.
1068. Proskina, N. N.; Ivanova, V. Y.; Khalak, M. I.; Stratulat, A. A. *Zh. Neorg. Khim.* **1986**, *31*, 1438–1440.
1069. Gerbeleu, N.; Coropchanu, E.; Deseatnik, A.; Simonov, Y.; Bologa, O.; Tiurin, J.; Labliuk, S.; Kravtsov, V. *An. Stiint. Univ. "Al. I. Cuza" Iasi, Chim.* **1999**, *7*, 281–284.
1070. Hussain, M. S.; Al-Mohdhar, H. M.; Schlemper, E. O. *J. Crystallogr. Spectrosc. Res.* **1989**, *19*, 77–91.
1071. Simonov, Y. A.; Gerbeleu, N. V.; Gdaniec, M.; Bourosh, P. N.; Koropchanu, E. B.; Bologa, O. A. *Russ. J. Coord. Chem.* **2001**, *27*, 341–352.
1072. Tauzher, G.; Garlatti, R. D.; Costa, G. *Inorg. Chim. Acta* **1983**, *75*, 145–148.
1073. Kapanadze, T. S.; Tsintsadze, G. V.; Kokunov, Y. V.; Buslaev, Y. A. *Polyhedron* **1990**, *9*, 1379–1382.
1074. Tarasov, V. P.; Kapanadze, T. S.; Tsintsadze, G. V.; Baranovskii, I. B.; Buslaev, Y. A. *Koord. Khim.* **1985**, *11*, 655–660.
1075. Tarasov, V. P.; Kapanadze, T. S.; Baranovskii, I. B.; Tsintsadze, G. V.; Drobyshev, S. G.; Buslaev, Y. A. *Dokl. Akad. Nauk SSSR* **1983**, *270*, 894–897.
1076. Raper, E. S. *Coord. Chem. Rev.* **1997**, *165*, 475–567.
1077. Raper, E. S. *Coord. Chem. Rev.* **1996**, *153*, 199–255.
1078. Constable, E. C.; Palmer, C. A.; Tocher, D. A. *Inorg. Chim. Acta* **1990**, *176*, 57–60.
1079. Kita, M.; Yamanari, K.; Shimura, Y. *Chem. Lett.* **1983**, 141–144.
1080. Murata, M.; Kojima, M.; Hoika, A.; Miyagawa, M.; Hirotsu, M.; Kakajima, K.; Kita, M.; Kashino, S.; Yoshikawa, Y. *Coord. Chem. Rev.* **1998**, *174*, 109–131.
1081. Chen, Z.-N.; Zhang, H.-X.; Kang, B.-S.; Sun, J. *Synth. React. Inorg. Met.-Org. Chem.* **1998**, *28*, 245–261.
1082. Kita, M.; Tamai, H.; Ueta, F.; Fuyuhiko, A.; Yamanari, K.; Nakajima, K.; Kojima, K.; Murata, M.; Yamashita, S. *Inorg. Chim. Acta* **2001**, *314*, 139–146.
1083. Konno, T.; Hidaka, J.; Okamoto, K.-I. *Bull. Chem. Soc. Jpn.* **1995**, *68*, 1353–1359.
1084. Yonemura, T.; Okamoto, K.; Ama, T.; Kawaguchi, H.; Yasui, T. *Chem. Lett.* **1993**, 1123–1126.
1085. Iida, M.; Sakamoto, A.; Yamashita, T.; Shundoh, K.; Ohkawa, S.; Yamanari, K. *Bull. Chem. Soc. Jpn.* **2000**, *73*, 2033–2041.
1086. Ghiron, A. F.; Thompson, R. C. *Inorg. Chem.* **1988**, *27*, 4766–4771.
1087. Kojima, M.; Akhter, F.; Nakajima, K.; Yoshikawa *Bull. Chem. Soc. Jpn.* **1996**, *69*, 2889–2895.

1088. Heinrich, L.; Li, Y.; Provost, K.; Michalowicz, A.; Vaissermann, J.; Chottard, J.-C. *Inorg. Chim. Acta* **2001**, *318*, 117–126.
1089. Verweij, P. D.; Sital, S.; Bouwman, E.; Driessen, W. L.; Reedijk, J.; Wood, J. S. *Inorg. Chim. Acta* **1991**, *182*, 187–195.
1090. Blake, A. J.; Reid, G.; Schroder, M. *J. Chem. Soc., Dalton Trans.* **1994**, 3291–3297.
1091. Lawrance, G. A.; Martinez, M.; Skelton, B. W.; White, A. H. *Aust. J. Chem.* **1991**, *44*, 113–121.
1092. Wei, G.; Allen, C. C.; Hambley, T. W.; Lawrance, G. A.; Maeder, M. *Inorg. Chim. Acta* **1997**, *261*, 197–200.
1093. Okamoto, K.-I.; Fushimi, N.; Konno, T.; Hidaka, J. *Bull. Chem. Soc. Jpn.* **1991**, *64*, 2635–2643.
1094. Kashiwabara, K.; Ito, Y.; Kita, M.; Fujita, J.; Nakajima, K. *J. Chem. Soc., Dalton Trans.* **1997**, 39–45.
1095. Kashiwabara, K.; Taguchi, N.; Takagi, H. D.; Nakajima, K.; Suzuki, T. *Polyhedron* **1998**, *17*, 1817–1829.
1096. Kildahl, N. K.; Antonopoulos, G. *J. Coord. Chem.* **1986**, *14*, 293–307.
1097. Creutz, C.; Schwarz, H. A.; Sutin, N. *J. Am. Chem. Soc.* **1984**, *106*, 3036–3037.
1098. Gridnev, A. A.; Ittel, S. D.; Fryd, M.; Wayland, B. B. *Organometallics* **1993**, *12*, 4871–4880.
1099. Abdel-Hamid, R.; El-Sagher, H. M.; Abdel-Mawgoud, A. M.; Nafady, A. *Polyhedron* **1998**, *17*, 4535–4541.
1100. Rieger, P. H. *Coord. Chem. Rev.* **1994**, *135/136*, 203–286.
1101. Vol'pin, M. E.; Levitin, I. Y.; Sigan, A. I.; Nikitav, A. T. *J. Organomet. Chem.* **1985**, *279*, 263–280.
1102. Li, J.; Feng, D.; Feng, S. *Science in China, Series B: Chemistry* **1999**, *42*, 283–289.
1103. Toscano, P. J.; Barren, E.; Seligson, A. L. *Organometallics* **1989**, *8*, 2085–2088.
1104. Kelly, R. S.; Geiger, W. E. *Organometallics* **1987**, *6*, 1432–1439.
1105. Anson, F. C.; Collins, T. J.; Coots, R. J.; Gipson, S. L.; Richmond, T. G. *J. Am. Chem. Soc.* **1984**, *106*, 5037–5038.
1106. Collins, T. J.; Powell, R. D.; Slebodnick, C.; Uffelman, E. S. *J. Am. Chem. Soc.* **1991**, *113*, 8419–8425.
1107. Patterson, R. E.; Gordon-Wylie, S. W.; Woomer, C. G.; Norman, R. E.; Weintraub, S. T.; Horwitz, C. P.; Collins, T. J. *Inorg. Chem.* **1998**, *37*, 4748–4750.
1108. Koikawa, M.; Gotoh, M.; Okawa, H.; Kida, S.; Kohzuma, T. *J. Chem. Soc., Dalton Trans.* **1989**, 1613–1616.
1109. Marsh, E. N. *Essays Biochem.* **1999**, *34*, 139–154.
1110. Nolan, C. V.; Fowler, S. W.; Teyssie, J. L. *Mar. Ecol.: Prog. Ser.* **1992**, *88*, 105–116.
1111. Nicolas, J.-P.; Gueant, J.-L. *Bull. Acad. Natl. Med. (Paris)* **1994**, *178*, 551–568.
1112. Raux, E.; Schubert, H. L.; Warren, M. J. *Cellular and Molecular Life Sciences* **2000**, *57*, 1880–1893.
1113. Adkins, Y.; Lonnerdal, B. *Biochim. Biophys. Acta* **2001**, *1528*, 43–48.
1114. Gill, D. S.; Wickramasinghe, S. N. *Clin. Lab. Haemat.* **1985**, *7*, 143–149.
1115. Ramanujam, K. S.; Seetharam, S.; Ramasamy, M.; Seetharam, B. *Biochim. Biophys. Acta* **1990**, *1030*, 157–164.
1116. Gueant, J. L.; Schohn, H.; Brule, H.; Saunier, M.; Grasbeck, R.; Nicolas, J. P. *Biochim. Biophys. Acta* **1991**, *1073*, 614–618.
1117. Kapadia, C. R. *Gastroenterologist* **1995**, *3*, 329–344.
1118. Shevell, M. I.; Cooper, B. A.; Rosenblatt, D. S. *Mol. Genet. Basis Neurol. Dis. (2nd Ed.)* **1997**, 1301–1321.
1119. Debussche, L.; Couder, M.; Thibaut, D.; Cameron, B.; Crouzet, J.; Blanche, F. *J. Bacteriol.* **1992**, *174*, 7445–7451.
1120. Shibata, N.; Masuda, J.; Tobimatsu, T.; Toraya, T.; Suto, K.; Morimoto, Y.; Yasuoka, N. *Structure (London)* **1999**, *7*, 997–1008.
1121. Randaccio, L.; Geremia, S.; Nardin, G.; Slouf, M.; Srnova, I. *Inorg. Chem.* **1999**, *38*, 4087–4092.
1122. Masuda, J.; Shibata, N.; Morimoto, Y.; Toraya, T.; Yasuoka, N. *Structure (London)* **2000**, *8*, 775–788.
1123. Bauer, C. B.; Fonseca, M. V.; Holden, H. M.; Thoden, J. B.; Thompson, T. B.; Escalante-Semerena, J. C.; Rayment, I. *Biochemistry* **2001**, *40*, 361–374.
1124. Suto, R. K.; Brasch, N. E.; Anderson, O. P.; Finke, R. G. *Inorg. Chem.* **2001**, *40*, 2686–2692.
1125. Frisbie, S. M.; Chance, M. R. *Biochemistry* **1993**, *32*, 13886–13892.
1126. Fonda, E.; Michalowicz, A.; Randaccio, L.; Tauzher, G.; Vlaic, G. *Eur. J. Inorg. Chem.* **2001**, 1269–1278.
1127. Brown, K. L.; Zou, X.; Savon, S. R.; Jacobsen, D. W. *Biochemistry* **1993**, *32*, 8421–8428.
1128. Frasca, V.; Banerjee, R. V.; Dunham, W. R.; Sands, R. H.; Matthews, R. G. *Biochemistry* **1988**, *27*, 8458–8465.
1129. Brown, K. L.; Zou, X. *Magn. Reson. Chem.* **1997**, *35*, 889–895.
1130. Chemaly, S. M.; Pratt, J. M. *J. Chem. Soc., Dalton Trans.* **1984**, 595–599.
1131. King, G. J.; Gazzola, C.; Blakeley, R. L.; Zerner, B. *Inorg. Chem.* **1986**, *25*, 1078.
1132. Fanchiang, Y. T.; Pignatello, J. J. *Inorg. Chim. Acta* **1984**, *91*, 147–151.
1133. Fanchiang, Y. T. *Organometallics* **1985**, *4*, 1515–1522.
1134. Rochelle, L. G.; Morana, S. J.; Kruszyna, H.; Russell, M. A.; Wilcox, D. E.; Smith, R. P. *J. Pharmacol. Exp. Ther.* **1995**, *275*, 48–52.
1135. Brouwer, M.; Chamulitrat, W.; Ferruzzi, G.; Sauls, D. L.; Weinberg, J. B. *Blood* **1996**, *88*, 1857–1864.
1136. Jensen, M. P.; Halpern, J. *J. Am. Chem. Soc.* **1999**, *121*, 2181–2192.
1137. Howard, W. A. Jr.; Bayomi, A.; Natarajan, E.; Aziza, M. A.; El-Ahmady, O.; Grissom, C. B.; West, F. G. *Bioconjugate Chem.* **1997**, *8*, 498–502.
1138. Grissom, C. B.; West, F. G.; Howard, W. A. Jr. *PCT Int. Appl.* **1998**, 9808859.
1139. Nome, F.; Frescura, V. L. A.; Zanette, D.; Rezende, M. C. *Bol. Soc. Chil. Quim.* **1990**, *35*, 89–96.
1140. Gaertner, P.; Weiss, D. S.; Harms, U.; Thauer, R. K. *Eur. J. Biochem.* **1994**, *226*, 465–472.
1141. Harms, U.; Thauer, R. K. *Eur. J. Biochem.* **1996**, *241*, 149–154.
1142. Toraya, T.; Watanabe, N.; Ichikawa, M.; Matsumoto, T.; Ushio, K.; Fukui, S. *J. Biol. Chem.* **1987**, *262*, 8544–8550.
1143. Toraya, T.; Mori, K. *J. Biol. Chem.* **1999**, *274*, 3372–3377.
1144. Hoover, D. M.; Jarrett, J. T.; Sands, R. H.; Dunham, W. R.; Ludwig, M. L.; Matthews, R. G. *Biochemistry* **1997**, *36*, 127–138.
1145. Jarrett, J. T.; Huang, S.; Matthews, R. G. *Biochemistry* **1998**, *37*, 5372–5382.
1146. Maupin-Furlow, J.; Ferry, J. G. *J. Bacteriol.* **1996**, *178*, 340–346.
1147. Marks, T. S.; Maule, A. *PCT Int. Appl.* **1989**, 8910772.
1148. Njue, C. K.; Nuthakki, B.; Vaze, A.; Bobbitt, J. M.; Rusling, J. F. *Electrochem. Commun.* **2001**, *3*, 733–736.
1149. Toscano, P. J.; Marzilli, L. G. *Prog. Inorg. Chem.* **1984**, *31*, 105–204.
1150. Darbieu, M. H.; Dahan, F.; Costes, J. P.; Laurent, J. P.; Cros, G. *J. Chem. Soc., Dalton Trans.* **1988**, 129–132.
1151. Chen, H.; Han, D.; Li, T.; Yan, H.; Tang, W.; Chen, J.; Zheng, P.; Chen, C. *Inorg. Chem.* **1996**, *35*, 1502–1508.

1152. Levitin, I.; Tsikalova, M.; Sazikova, N.; Bakhmutov, V.; Starikova, Z.; Yanovsky, A.; Struchkov, Y. *Inorg. Chim. Acta* **1998**, *270*, 169–176.
1153. Blaauw, R.; Kingma, I. E.; Laan, J. H.; van der Baan, J. L.; Balt, S.; de Bolster, M. W. G.; Klumpp, G. W.; Smeets, W. J. J.; Spek, A. L. *Perkin 1* **2000**, 1199–1210.
1154. Levitin, I. Y.; Tsikalova, M. V.; Bakhmutov, V. I.; Yanovskii, A. I.; Struchkov, Y. T.; Vol'pin, M. E. *J. Organomet. Chem.* **1987**, *330*, 161–178.
1155. Mondal, N.; Dey, D. K.; Mitra, S.; Malik, K. M. A. *Polyhedron* **2000**, *19*, 2707–2711.
1156. Bresciani-Pahor, N.; Randaccio, L.; Zangrando, E.; Toscano, P. J. *Inorg. Chim. Acta* **1985**, *96*, 193–198.
1157. Alcock, N. W.; Atkins, M. P.; Golding, B. T.; Sellars, P. J. *J. Chem. Soc., Dalton Trans.* **1982**, 337–343.
1158. Lopez, C.; Alvarez, S.; Font-Bardia, M.; Solans, X. *J. Organomet. Chem.* **1991**, *414*, 245–259.
1159. Gupta, B. D.; Tiwari, U.; Barclay, T.; Cordes, W. *J. of Organomet. Chem.* **2001**, *629*, 83–92.
1160. Parker, W. O. Jr.; Bresciani-Pahor, N.; Zangrando, E.; Randaccio, L.; Marzilli, L. G. *Inorg. Chem.* **1985**, *24*, 3908–3913.
1161. Polson, S. M.; Cini, R.; Pifferi, C.; Marzilli, L. G. *Inorg. Chem.* **1997**, *36*, 314–322.
1162. Yohannes, P. G.; Bresciani-Pahor, N.; Randaccio, L.; Zangrando, E.; Marzilli, L. G. *Inorg. Chem.* **1988**, *27*, 4738–4744.
1163. Choo, P. L.; Mulichak, A. M.; Jones, R. W. Jr.; Bacon, J. W.; Pett, V. B.; Zacharias, D. E. *Inorg. Chim. Acta* **1990**, *171*, 183–192.
1164. McFarland, C. A.; Gross, S. A.; Winfield, J. S.; Pett, V. B. *Inorg. Chim. Acta* **1994**, *221*, 35–40.
1165. Moore, S. J.; Kutikov, A.; Lachicotte, R. J.; Marzilli, L. G. *Inorg. Chem.* **1999**, *38*, 768–776.
1166. Hirota, S.; Polson, S. M.; Puckett, J. M. Jr.; Moore, S. J.; Mitchell, M. B.; Marzilli, L. G. *Inorg. Chem.* **1996**, *35*, 5646–5653.
1167. Daikh, B. E.; Hutchison, J. E.; Gray, N. E.; Smith, B. L.; Weakley, T. J. R.; Finke, R. G. *J. Am. Chem. Soc.* **1990**, *112*, 7830–7832.
1168. Parker, W. O. Jr.; Zangrando, E.; Bresciani-Pahor, N.; Marzilli, P. A.; Randaccio, L.; Marzilli, L. G. *Inorg. Chem.* **1988**, *27*, 2170–2180.
1169. Pahor, N. B.; Randaccio, L.; Zangrando, E. *Inorg. Chim. Acta* **1990**, *168*, 115–121.
1170. Marzilli, L. G.; Polson, S. M.; Hansen, L.; Moore, S. J.; Marzilli, P. A. *Inorg. Chem.* **1997**, *36*, 3854–3860.
1171. Dreos, R.; Felluga, A.; Nardin, G.; Randaccio, L.; Siega, P.; Tazher, G. *Inorg. Chem.* **2001**, *40*, 5541–5546.
1172. Costa, G.; Tavagnacco, C.; Puxeddu, A.; Balducci, G.; Kumar, R. *J. Organomet. Chem.* **1987**, *330*, 185–199.
1173. Dreos, R.; Tazher, G.; Vuano, S.; Asaro, F.; Pellizer, G.; Nardin, G.; Randaccio, L.; Geremia, S. *J. Organomet. Chem.* **1995**, *505*, 135–138.
1174. Seeber, R.; Marassi, R.; Parker, W. O. Jr.; Kelly, G. *Inorg. Chim. Acta* **1990**, *168*, 127–138.
1175. Gerli, A.; Marzilli, L. G. *Inorg. Chem.* **1992**, *31*, 1152–1160.
1176. Ramanujam, V. V.; Alexander, V. *Inorg. Chem.* **1987**, *26*, 3124–3134.
1177. Polson, S. M.; Hansen, L.; Marzilli, L. G. *Inorg. Chem.* **1997**, *36*, 307–313.
1178. Kobayashi, M.; Shimizu, S. *Eur. J. Biochem.* **1999**, *261*, 1–9.
1179. Roderick, S. L.; Matthews, B. W. *Biochemistry* **1993**, *32*, 3907–3912.
1180. Tahirov, T. H.; Oki, H.; Tsukihara, T.; Ogasahara, K.; Yutani, K.; Ogata, K.; Izu, Y.; Tsunasawa, S.; Kato, I. *J. Mol. Biol.* **1998**, *284*, 101–124.
1181. Heinrich, L.; Mary-Verla, A.; Li, Y.; Vaissermann, J.; Chottard, J.-C. *Eur. J. Inorg. Chem.* **2001**, 2203–2206.
1182. Tyler, L. A.; Olmstead, M. M.; Mascharak, P. K. *Inorg. Chim. Acta* **2001**, *321*, 135–141.
1183. Tyler, L. A.; Olmstead, M. M.; Mascharak, P. K. *Inorg. Chem.* **2001**, *40*, 5408–5414.
1184. Bhosale, S. H.; Rao, M. B.; Deshpande, V. V. *Microbiol. Rev.* **1996**, *60*, 280–300.
1185. Harmon, F. R.; Goss, N. H.; Wood, H. G. *Biochemistry* **1982**, *21*, 2847–2852.
1186. Dennis, M.; Kolattukudy, P. E. *Proc. Natl. Acad. Sci. U.S.A.* **1992**, *89*, 5306–5310.
1187. Petrovich, R. M.; Ruzicka, F. J.; Reed, G. H.; Frey, P. A. *J. Biol. Chem.* **1991**, *266*, 7656–7660.
1188. Itoh, N.; Morinaga, N.; Kouzai, T. *Biochim. Biophys. Acta* **1994**, *1207*, 208–216.
1189. Schumacher-Wittkopf, E. *Toxicol. Environ. Chem.* **1984**, *8*, 185–193.
1190. Bertini, I.; Luchinat, C.; Messori, L.; Monnanni, R.; Auld, D. S.; Riordan, J. F. *Biochemistry* **1988**, *27*, 8318–8325.
1191. Luchinat, C.; Monnanni, R.; Roelens, S.; Vallee, B. L.; Auld, D. S. *J. Inorg. Biochem.* **1988**, *32*, 1–6.
1192. Martinelli, R. A.; Hanson, G. R.; Thompson, J. S.; Holmquist, B.; Pilbrow, J. R.; Auld, D. S.; Vallee, B. L. *Biochemistry* **1989**, *28*, 2251–2258.
1193. Salgado, J.; Jimenez, H. R.; Donaire, A.; Moratal, J. M. *Eur. J. Biochem.* **1995**, *231*, 358–369.
1194. Katsuya, Y.; Sato, M.; Katsube, Y.; Matsuura, Y.; Tomoda, K. *J. Biol. Chem.* **1992**, *267*, 12668–12672.
1195. Bicknell, R.; Holmquist, B.; Lee, F. S.; Martin, M. T.; Riordan, J. F. *Biochemistry* **1987**, *26*, 7291–7297.
1196. Wilkes, S. H.; Prescott, J. M. *J. Biol. Chem.* **1987**, *262*, 8621–8625.
1197. Hartmann, H. J.; Weser, U. *Biochem. Biophys. Res. Commun.* **1985**, *132*, 277–283.
1198. Salvato, B.; Beltrami, M.; Ricchelli, F.; Tallandini, L. *Biochim. Biophys. Acta* **1989**, *998*, 14–20.
1199. Morpurgo, L.; Desideri, A.; Rigo, A.; Viglino, P.; Rotilio, G. *Biochim. Biophys. Acta* **1983**, *746*, 168–175.
1200. Prabhanada, B. S.; Ritter, E.; Grell, E. *Biophys. Chem.* **1987**, *26*, 217–224.
1201. Rogers, J. I.; Mukherjee, J.; Khalifah, R. G. *Biochemistry* **1987**, *26*, 5672–5679.
1202. Ben-Meir, D.; Spungin, A.; Ashkenazi, R.; Blumberg, S. *Eur. J. Biochem.* **1993**, *212*, 107–112.
1203. Lin, Y. K.; Myhrman, R.; Schrag, M. L.; Gelb, M. H. *J. Biol. Chem.* **1988**, *263*, 1622–1627.
1204. Cuenca, A.; Henaof, F.; Gutierrez-Merino, C. *Eur. J. Biochem.* **1990**, *194*, 663–670.
1205. Morpeth, F. F.; Massey, V. *Biochemistry* **1982**, *21*, 1318–1323.
1206. Huang, C.-C.; Casey, P. J.; Fierke, C. A. *J. Biol. Chem.* **1997**, *272*, 20–23.
1207. Sakurada, K.; Ohta, T.; Fujishiro, K.; Hasegawa, M.; Aisaka, K. *J. Bacteriol.* **1996**, *178*, 5781–5786.
1208. Cavaletto, M.; Pessione, E.; Vanni, A.; Giunta, C. *J. Biotech.* **2000**, *84*, 87–91.
1209. Zisapel, N.; Blank, T.; Sokolovsky, M. *J. Inorg. Biochem.* **1983**, *18*, 253–262.
1210. Gencic, S.; LeClerc, G. M.; Gorlatova, N.; Peariso, K.; Penner-Hahn, J. E.; Grahame, D. A. *Biochemistry* **2001**, *40*, 13068–13076.
1211. Mills, S. A.; Klinman, J. P. *J. Am. Chem. Soc.* **2000**, *122*, 9897–9904.

1212. Dzugan, S. J.; Busch, D. H. *Inorg. Chem.* **1990**, *29*, 2528–2532.
1213. Busch, D. H.; Jackson, P. J.; Kojima, M.; Chmielewski, P.; Matsumoto, N.; Stevens, J. C.; Wu, W.; Nosco, D.; Herron, N.; Ye, N.; Warburton, P. R.; Masarwa, M.; Stephenson, N. A.; Christoph, G.; Alcock, N. W. *Inorg. Chem.* **1994**, *33*, 910–923.
1214. Rybak-Akimova, E. V.; Masarwa, M.; Marek, K.; Warburton, P. R.; Busch, D. H. *Chem. Commun.* **1996**, 1451–1452.
1215. Kolchinski, A. G.; Korybut-Daszkievicz, B.; Rybak-Akimova, E. V.; Busch, D. H.; Alcock, N. W.; Clase, H. J. *J. Am. Chem. Soc.* **1997**, *119*, 4160–4171.
1216. Rybak-Akimova, E. V.; Kuczera, K.; Jas, G. S.; Deng, Y.; Busch, D. H. *Inorg. Chem.* **1999**, *38*, 3423–3434.
1217. Henson, N. J.; Hay, P. J.; Redondo, A. *Inorg. Chem.* **1999**, *38*, 1618–1626.
1218. Migita, K.; Chikira, M.; Iwaizumi, M. *J. Chem. Soc., Dalton Trans.* **1983**, 2281–2286.
1219. Roux, C.; Zarembowitch, J.; Itie, J. P.; Verdaguer, M.; Dartyge, E.; Fontaine, A.; Tolentino, H. *Inorg. Chem.* **1991**, *30*, 3174–3179.
1220. Kapturkiewicz, A.; Behr, B. *Inorg. Chim. Acta* **1983**, *69*, 247–251.
1221. Kasuga, K.; Iida, Y.; Yamamoto, Y.; Aihara, M.; Kudo, M. *Inorg. Chim. Acta* **1984**, *84*, 113–116.
1222. Motekaitis, R. J.; Martell, A. E. *Inorg. Chem.* **1988**, *27*, 2718–2724.
1223. Herron, N. *Inorg. Chem.* **1986**, *25*, 4714–4717.
1224. De Vos, D. E.; Feijen, E. J. P.; Schoonheydt, R. A.; Jacobs, P. A. *J. Am. Chem. Soc.* **1994**, *116*, 4746–4752.
1225. Krebs, J. F.; Borovik, A. S. *Chem. Commun.* **1998**, 553–554.
1226. Kuraoka, K.; Yazawa, T.; Chujo, Y. *Chem. Commun.* **2000**, 2477–2478.
1227. Murphy, E. F.; Schmid, L.; Buerger, T.; Maciejewski, M.; Baiker, A.; Guenther, D.; Schneider, M. *Chem. Mat.* **2001**, *13*, 1296–1304.
1228. Sakata, K.; Murase, I. *Inorg. Chim. Acta* **1982**, *64*, L239–L241.
1229. Ashmawy, F. M.; Issa, R. M.; Amer, S. A.; McAuliffe, C. A.; Parish, R. V. *J. Chem. Soc., Dalton Trans.* **1986**, 421–426.
1230. Meyer, G. R.; Cornelius, R. J. *Inorg. Biochem.* **1984**, *22*, 249–258.
1231. Massoud, S. S. *J. Inorg. Biochem.* **1994**, *55*, 183–191.
1232. Tafesse, F.; Massoud, S. S.; Milburn, R. M. *Inorg. Chem.* **1993**, *32*, 1864–1865.
1233. Komiya, M.; Sumaoka, J.; Yonezawa, K.; Matsumoto, Y.; Yashiro, M. *J. Chem. Soc., Perkin Trans. 2* **1997**, 75–78.
1234. Cornelius, R. D.; Norman, P. R. *Inorg. Chim. Acta* **1982**, *65*, L193–L195.
1235. Norman, P. R.; Cornelius, R. D. *J. Am. Chem. Soc.* **1982**, *104*, 2356–2361.
1236. Chin, J.; Banaszczuk, M.; Jubian, V.; Zou, X. *J. Am. Chem. Soc.* **1989**, *111*, 186–190.
1237. Hay, R. W.; Govan, N. *Transition Met. Chem. (Dordrecht)* **1998**, *23*, 721–725.
1238. Kim, J. *J. Korean Chem. Soc.* **1998**, *42*, 240–244.
1239. Hettich, R.; Schneider, H.-J. *J. Am. Chem. Soc.* **1997**, *119*, 5638–5647.
1240. Connolly, J. A.; Banaszczuk, M.; Hynes, R. C.; Chin, J. *Inorg. Chem.* **1994**, *33*, 665–669.
1241. Williams, N. H.; Cheung, W.; Chin, J. *J. Am. Chem. Soc.* **1998**, *120*, 8079–8087.
1242. Wahnou, D.; Lebus, A.-M.; Chin, J. *Angew. Chem., Int. Ed. Engl.* **1995**, *34*, 2412–2414.
1243. Williams, N. H.; Wyman, P. J. *J. Chem. Soc., Perkin Trans. 2* **2001**, 2068–2073.
1244. Vance, D. H.; Czarnik, A. W. *J. Am. Chem. Soc.* **1993**, *115*, 12165–12166.
1245. Chung, Y.; Akkaya, E. U.; Venkatachalam, T. K.; Czarnik, A. W. *Tetrahedron Lett.* **1990**, *31*, 5413–5416.
1246. Dixon, N. E.; Geue, R. J.; Lambert, J. N.; Moghaddas, S.; Pearce, D. A.; Sargeson, A. M. *Chem. Commun.* **1996**, 1287–1288.
1247. Jeung, C.-S.; Song, J. B.; Kim, Y.-H.; Suh, J. *Bioorg. Med. Chem. Lett.* **2001**, *11*, 3061–3064.
1248. Jeung, C. S.; Kim, C. H.; Min, K.; Suh, S. W.; Suh, J. *Bioorg. Med. Chem. Lett.* **2001**, *11*, 2401–2404.
1249. Plum, G. E.; Bloomfield, V. A. *Biopolymers* **1988**, *27*, 1045–1051.
1250. Brennan, R. G.; Westhof, E.; Sundaralingam, M. *J. Biomol. Struct. Dyn.* **1986**, *3*, 649–665.
1251. Gao, Y.-G.; Robinson, H.; van Boom, J. H.; Wang, A. H. J. *Biophys. J.* **1995**, *69*, 559–568.
1252. Gessner, R. V.; Quigley, G. J.; Wang, A. H. J.; Van der Marel, G. A.; Van Boom, J. H.; Rich, A. *Biochemistry* **1985**, *24*, 237–240.
1253. Harper, A.; Brannigan, J. A.; Buck, M.; Hewitt, L.; Lewis, R. J.; Moore, M. H.; Schneider, B. *Acta Crystallogr., Sect. D: Biol. Crystallogr.* **1998**, *D54*, 1273–1284.
1254. Kieft, J. S.; Tinoco, I. Jr. *Structure (London)* **1997**, *5*, 713–721.
1255. Nunn, C. M.; Neidle, S. *J. Mol. Biol.* **1996**, *256*, 340–351.
1256. Plum, G. E.; Arscott, P. G.; Bloomfield, V. A. *Biopolymers* **1990**, *30*, 631–643.
1257. Schnell, J. R.; Berman, J.; Bloomfield, V. A. *Biophys. J.* **1998**, *74*, 1484–1491.
1258. Liu, D.; Wang, C.; Li, J.; Lin, Z.; Tan, Z.; Bai, C. *J. Biomol. Struct. Dyn.* **2000**, *18*, 1–9.
1259. Kankia, B. I.; Buckin, V.; Bloomfield, V. A. *Nucleic Acids Res.* **2001**, *29*, 2795–2801.
1260. Parkinson, A.; Hawken, M.; Hall, M.; Sanders, K. J.; Rodger, A. *Phys. Chem. Chem. Phys.* **2000**, *2*, 5469–5478.
1261. Benevides, J. M.; Wang, A. H. J.; Thomas, G. J. Jr. *Nucleic Acids Res.* **1993**, *21*, 1433–1438.
1262. Theophanides, T.; Tajmir-Riahi, H. A. *J. Biomolec. Struct. Dyn.* **1985**, *2*, 995–1004.
1263. Braunlin, W. H.; Anderson, C. F.; Record, M. T. Jr. *Biochemistry* **1987**, *26*, 7724–7731.
1264. Braunlin, W. H.; Xu, Q. *Biopolymers* **1992**, *32*, 1703–1711.
1265. Robinson, H.; Wang, A. H. J. *Nucleic Acids Res.* **1996**, *24*, 676–682.
1266. He, S.; Arscott, P. G.; Bloomfield, V. A. *Biopolymers* **2000**, *53*, 329–341.
1267. Widom, J.; Baldwin, R. L. *Biopolymers* **1983**, *22*, 1595–1620.
1268. Arsoctt, P. G.; Ma, C.; Wenner, J. R.; Bloomfield, V. A. *Biopolymers* **1995**, *36*, 345–364.
1269. Deng, H.; Bloomfield, V. A. *Biophys. J.* **1999**, *77*, 1556–1561.
1270. Cheatham, T. E. III; Kollman, P. A. *Structure (London)* **1997**, *5*, 1297–1311.
1271. Kumar, C. V.; Tan, W. B.; Betts, P. W. *J. Inorg. Biochem.* **1997**, *68*, 177–181.
1272. Kumar, C. V.; Buranaprapuk, A. *Angew. Chem., Int. Ed. Engl.* **1997**, *36*, 2085–2087.
1273. Watt, T. A.; Collins, J. G.; Arnold, A. P. *Inorg. Chem.* **1994**, *33*, 609–610.

1274. Svensson, B.; Woodward, C. E.; Arnold, A. P.; Collins, J. G.; Lafitani, J. *J. Phys. Chem.* **1995**, *99*, 10412–10416.
1275. Xu, Q.; Jampani, S. R.; Deng, H.; Braunlin, W. H. *Biochemistry* **1995**, *34*, 14059–14065.
1276. Watt, T. A.; Tong, C.; Arnold, A. P.; Collins, J. G. *Biochem. Mol. Biol. Int.* **1996**, *38*, 383–391.
1277. Fry, J. V.; Collins, J. G. *Inorg. Chem.* **1997**, *36*, 2919–2921.
1278. Fujiwara, K.; Kojo, R.; Okada, K.; Kodama, Y. *Anal. Chem.* **1990**, *62*, 504–508.
1279. Yokoyama, H.; Shinozaki, K.; Hattori, S.; Miyazaki, F.; Goto, M. *J. Mol. Liq.* **1995**, *65/66*, 357–360.
1280. Barton, J. K.; Raphael, A. L. *J. Am. Chem. Soc.* **1984**, *106*, 2466–2468.
1281. Rehmann, J. P.; Barton, J. K. *Biochemistry* **1990**, *29*, 1701–1709.
1282. Purugganan, M. D.; Kumar, C. V.; Turro, N. J.; Barton, J. K. *Science* **1988**, *241*, 1645–1649.
1283. Ben-Avraham, D.; Schulman, L. S.; Bossmann, S. H.; Turro, C.; Turro, N. J. *J. Phys. Chem. B* **1998**, *102*, 5088–5093.
1284. Carter, M. T.; Bard, A. J. *J. Am. Chem. Soc.* **1987**, *109*, 7528–7530.
1285. Carter, M. T.; Rodriguez, M.; Bard, A. J. *J. Am. Chem. Soc.* **1989**, *111*, 8901–8911.
1286. Welch, T. W.; Thorp, H. H. *J. Phys. Chem.* **1996**, *100*, 13829–13836.
1287. Aslanoglu, M.; Isaac, C. J.; Houlton, A.; Horrocks, B. R. *Analyst* **2000**, *125*, 1791–1798.
1288. Millan, K. M.; Mikkelsen, S. R. *Anal. Chem.* **1993**, *65*, 2317–2323.
1289. Millan, K. M.; Saraullo, A.; Mikkelsen, S. R. *Anal. Chem.* **1994**, *66*, 2943–2948.
1290. Li, Z.; Wang, H.; Dong, S.; Wang, E. *Anal. Sci.* **1997**, *13*, 305–310.
1291. Pang, D.-W.; Abruna, H. D. *Anal. Chem.* **1998**, *70*, 3162–3169.
1292. Erdem, A.; Kerman, K.; Meric, B.; Akarca, U. S.; Ozsoz, M. *Electroanalysis* **1999**, *11*, 586–588.
1293. Erdem, A.; Meric, B.; Kerman, K.; Dalbasti, T.; Ozsoz, M. *Electroanalysis* **1999**, *11*, 1372–1376.
1294. Fojta, M.; Havran, L.; Fulneckova, J.; Kubicekova, T. *Electroanalysis* **2000**, *12*, 926–934.
1295. Mao, Q.; Fulmer, P.; Li, W.; DeRose, E. F.; Petering, D. H. *J. Biol. Chem.* **1996**, *271*, 6185–6191.
1296. Hoehn, S. T.; Junker, H.-D.; Bunt, R. C.; Turner, C. J.; Stubbe, J. *Biochemistry* **2001**, *40*, 5894–5905.
1297. Yang, Y.; Huang, L.; Pon, R. T.; Cheng, S.-F.; Chang, D.-K.; Lown, J. W. *Bioconjugate Chem.* **1996**, *7*, 670–679.
1298. Armstrong, F. A.; Henderson, R. A.; Kim, H. O. W.; Sykes, A. G. *Biochim. Biophys. Acta* **1982**, *681*, 161–167.
1299. Armstrong, F. A.; Driscoll, P. C.; Hill, H. A. O. *FEBS Lett.* **1985**, *190*, 242–248.
1300. Chapman, S. K.; Watson, A. D.; Sykes, A. G. *J. Chem. Soc., Dalton Trans.* **1983**, 2543–2548.
1301. Chapman, S. K.; Knox, C. V.; Kathirgamanatham, P.; Sykes, A. G. *J. Chem. Soc., Dalton Trans.* **1984**, 2769–2773.
1302. Jackman, M. P.; Sinclair-Day, J. D.; Sisley, M. J.; Sykes, A. G.; Denys, L. A.; Wright, P. E. *J. Am. Chem. Soc.* **1987**, *109*, 6443–6449.
1303. Jackman, M. P.; McGinnis, J.; Sykes, A. G.; Collyer, C. A.; Murata, M.; Freeman, H. C. *J. Chem. Soc., Dalton Trans.* **1987**, 2573–2577.
1304. McGinnis, J.; Sinclair-Day, J. D.; Sykes, A. G.; Powls, R.; Moore, J.; Wright, P. E. *Inorg. Chem.* **1988**, *27*, 2306–2312.
1305. Kyritsis, P.; Dennison, C.; Kalverda, A. P.; Canters, G. W.; Sykes, A. G. *J. Chem. Soc., Dalton Trans.* **1994**, 3017–3023.
1306. Rush, J. D.; Koppenol, W. H.; Garber, E. A. E.; Margoliash, E. *J. Biol. Chem.* **1988**, *263*, 7514–7520.
1307. Christensen, H. E. M.; Conrad, L. S.; Ulstrup, J. *Acta Chem. Scand.* **1992**, *46*, 508–514.
1308. Christensen, H. E. M.; Ulstrup, J.; Sykes, A. G. *Biochim. Biophys. Acta* **1990**, *1039*, 94–102.
1309. Christensen, H. E.; Conrad, L. S.; Ulstrup, J. *Arch. Biochem. Biophys.* **1993**, *301*, 385–390.
1310. Konig, B. W.; Veerman, E. C.; Van Gelder, B. F. *Biochim. Biophys. Acta* **1982**, *681*, 54–61.
1311. Butler, J.; Chapman, S. K.; Davies, D. M.; Sykes, A. G.; Speck, S. H.; Osheroff, N.; Margoliash, E. *J. Biol. Chem.* **1983**, *258*, 6400–6404.
1312. Tordi, M. G.; Silvestrini, M. C.; Adzamli, K.; Brunori, M. *J. Inorg. Biochem.* **1987**, *30*, 155–166.
1313. Rush, J. D.; Levine, F.; Koppenol, W. H. *Biochemistry* **1988**, *27*, 5876–5884.
1314. Kjaer, A. M.; Ulstrup, J. *Inorg. Chem.* **1987**, *26*, 2052–2058.
1315. Cheddar, G.; Meyer, T. E.; Cusanovich, M. A.; Stout, C. D.; Tollin, G. *Biochemistry* **1989**, *28*, 6318–6322.
1316. Cheddar, G.; Tollin, G. *Arch. Biochem. Biophys.* **1991**, *286*, 201–206.
1317. Taniguchi, V. T.; Ellis, W. R. Jr.; Cammarata, V.; Webb, J.; Anson, F. C.; Gray, H. B. *Adv. Chem. Ser.* **1982**, *201*, 51–68.
1318. Meier, M.; van Eldik, R. *Chem.-Eur. J.* **1997**, *3*, 39–46.
1319. Przysiecki, C. T.; Tollin, G.; Meyer, T. E.; Staggers, J. E.; Cusanovich, M. A. *Arch. Biochem. Biophys.* **1985**, *238*, 334–343.
1320. Coury, L. A., Jr.; Murray, R. W.; Johnson, J. L.; Rajagopalan, K. V. *J. Phys. Chem.* **1991**, *95*, 6034–6040.
1321. SAYSALL, C. G.; BORMAN, C. D.; BARON, A. J.; MCPHERSON, M. J.; SYKES, A. G. *Inorg. Chem.* **1997**, *36*, 4520–4525.
1322. Sakaki, S.; Nishijima, Y.; Ohkubo, K. *J. Chem. Soc., Dalton Trans.* **1991**, 1143–1148.
1323. Im, S.-C.; Sykes, A. G. *J. Chem. Soc., Dalton Trans.* **1996**, 2219–2222.
1324. Johnson, J. M.; Halsall, H. B.; Heineman, W. R. *Anal. Biochem.* **1983**, *133*, 186–189.
1325. Galbraith, R. A.; Kappas, A. *Proc. Natl. Acad. Sci. U.S.A.* **1989**, *86*, 7653–7657.
1326. Johnson, M. R.; Frye, S. V. *U.S.A.*, **1992**, 5149697.
1327. McGuinn, W. D.; Baxter, L.; Pei, L.; Petrikovics, I.; Cannon, E. P.; Way, J. L. *Fundam. Appl. Toxicol.* **1994**, *23*, 76–80.
1328. Buelow, R.; Woo, J.; Iyer, S. *PCT Int. Appl.* **1998**, 9809618.
1329. Mitani, K.; Fujita, H.; Fukuda, Y.; Kappas, A.; Sassa, S. *Biochem. J.* **1993**, *290*, 819–825.
1330. Behm, C. A.; Creaser, I. I.; Korybut-Daszkiewicz, B.; Ceue, R. J.; Sargeson, A. M.; Walker, G. W. *J. Chem. Soc., Chem. Commun.* **1993**, 1844–1846.
1331. Behm, C. A.; Boreham, P. F. L.; Creaser, I. I.; Korybut-Daszkiewicz, B.; Maddalena, D. J.; Sargeson, A. M.; Snowdon, G. M. *Aust. J. Chem.* **1995**, *48*, 1009–1030.
1332. Karaman, M. E.; Pashley, R. M.; Bolonkin, N. K. *Langmuir* **1995**, *11*, 2872–2880.
1333. Moghaddas, S.; Hendry, P.; Geue, R. J.; Qin, C.; Bygott, A. M. T.; Sargeson, A. M.; Dixon, N. E. *J. Chem. Soc., Dalton Trans.* **2000**, 2085–2089.
1334. Welker, M. E. *Curr. Org. Chem.* **2001**, *5*, 785–807.

1335. Hegedus, L. S. *Coord. Chem. Rev.* **1998**, *168*, 49–175.
1336. Hegedus, L. S. *Coord. Chem. Rev.* **1998**, *175*, 159–270.
1337. Hill, C. L.; Prosser-McCartha, C. M. *Coord. Chem. Rev.* **1995**, *143*, 407–455.
1338. Homs, N.; Choplin, A.; Ramirez de la Piscina, P.; Huang, L.; Garbowski, E. *Inorg. Chem.* **1988**, *27*, 4030–4033.
1339. Brunel, D.; Belloçq, N.; Sutra, P.; Cauvel, A.; Lasperas, M.; Moreau, P.; Di Renzo, F.; Galarneau, A.; Fajula, F. *Coord. Chem. Rev.* **1998**, *178–180*, 1085–1108.
1340. Rives, V.; Ulibarri, M. A. *Coord. Chem. Rev.* **1999**, *181*, 61–120.
1341. Hennig, H. *Coord. Chem. Rev.* **1999**, *182*, 101–123.
1342. Chavez, F. A.; Mascharak, P. K. *Acc. Chem. Res.* **2000**, *33*, 539–545.
1343. Sawyer, D. T. *Coord. Chem. Rev.* **1997**, *165*, 297–313.
1344. Hikichi, S.; Komatsuzaki, H.; Akita, M.; Moro-oka, Y. *J. Am. Chem. Soc.* **1998**, *120*, 4699–4710.
1345. Matsushita, Y.-I.; Sugamoto, K.; Nakama, T.; Matsui, T. *J. Chem. Soc., Chem. Commun.* **1995**, 567–568.
1346. Sugamoto, K.; Matsushita, Y.-I.; Matsui, T. *J. Chem. Soc., Perkin Trans. 1* **1998**, 3989–3998.
1347. Mandal, A. K.; Iqbal, J. *Tetrahedron* **1997**, *53*, 7641–7648.
1348. Pozzi, G.; Montanari, F.; Quici, S. *Chem. Commun.* **1997**, 69–70.
1349. Takai, T.; Hata, E.; Yorozu, K.; Mukaiyama, T. *Chem. Lett.* **1992**, 2077–2080.
1350. Nishinaga, A.; Tsutsu, T.; Moriyama, H.; Wazaki, T.; Mashino, T.; Fujii, Y. *J. Mol. Catal.* **1993**, *83*, 117–123.
1351. Foerster, S.; Rieker, A.; Maruyama, K.; Murata, K.; Nishinaga, A. *J. Org. Chem.* **1996**, *61*, 3320–3326.
1352. Sipila, J.; Haikarainen, A.; Pietikainen, P.; Brunow, G.; Repo, T.; Anturaniemi, J.; Leskela, M. *ACS Symp. Ser.* **2001**, *785*, 286–296.
1353. Choi, Y.-K.; Park, J.-K.; Jeon, S. *Electroanalysis* **1999**, *11*, 134–138.
1354. Choi, Y.-K.; Chjo, K.-H.; Park, S.-M.; Doddapaneni, N. *J. Electrochem. Soc.* **1995**, *142*, 4107–4112.
1355. Szyk, E.; Biniak, S.; Larsen, E. *Journal of Solid State Electrochemistry* **2001**, *5*, 221–226.
1356. Mukoyama, M.; Isayama, S.; Kato, K.; Inoka, S.; Yamada, T.; Takai, T. *Jpn. Kokai Tokkyo Koho* **1990**, 02157242.
1357. Ernst, S.; Weber, A.; Weichert, J. *Chem.-Ing.-Tech.* **1999**, *71*, 147–149.
1358. Chettiar, K. S.; Sreekumar, K. *Polym. Int.* **1999**, *48*, 455–460.
1359. Wang, C.-C.; Li, W.-S.; Cheng, S.-K.; Chen, C.-Y.; Chen, C.-Y.; Kuo, J.-F. *J. Appl. Polym. Sci.* **2001**, *82*, 3248–3257.
1360. Das, B. K.; Clark, J. H. *J. Chem. Soc., Chem. Commun.* **2000**, 605–606.
1361. Ungvary, F. *Coord. Chem. Rev.* **1997**, *167*, 233–260.
1362. Ungvary, F. *Coord. Chem. Rev.* **1998**, *170*, 245–281.
1363. Tannenbaum, R.; Dietler, U. K.; Bor, G.; Ungvary, F. *J. Organomet. Chem.* **1998**, *570*, 39–47.
1364. Margheri, G.; Rosi, L.; Salvini, A.; Bianchi, M.; Frediani, P. *J. Mol. Catal. A Chem.* **1998**, *132*, 189–210.
1365. Zucchi, C.; Palyi, G.; Galamb, V.; Sompár-Szerencses, E.; Marko, L.; Alper, H.; Januszkiewicz, K.; Li, P. *Organometallics* **1996**, *15*, 3222–3231.
1366. Carles Bayon, J.; Claver, C.; Masdeu-Bulto, A. M. *Coord. Chem. Rev.* **1999**, *193–195*, 73–145.
1367. Hu, Y.; Wang, J.; Du, Z.; Xing, Z. *Xibei Shifan Daxue Xuebao, Ziran Kexueban* **1996**, *32*, 104–105.
1368. Rao, M. L. N.; Periasamy, M. *J. Organomet. Chem.* **1998**, *553*, 91–97.
1369. Bassoli, A.; Rindone, B.; Tollari, S.; Chioccare, F. *J. Mol. Catal.* **1990**, *60*, 41–48.
1370. Pardigon, O.; Buono, G. *Tetrahedron: Asymmetry* **1993**, *4*, 1977–1980.
1371. Declan, G.; Ryan, K.; Dalton, C.; Langan, I.; Wall, V.; Corr, D.; Coyne, E.; Furlong, P.; Bousquet, C., *PCT Int. Appl.*, **1996**, 9624601.
1372. Bernardo, K.; Leppard, S.; Robert, A.; Commenges, G.; Dahan, F.; Meunier, B. *Inorg. Chem.* **1996**, *35*, 387–396.
1373. Hirotsu, M.; Kojima, M.; Nakajima, K.; Kashino, S.; Yoshikawa, Y. *Bull. Chem. Soc. Jpn.* **1996**, *69*, 2549–2557.
1374. Jacobsen, E. N.; Schaus, S. E.; Dossetter, A. G.; Jamison, T. F. *PCT Int. Appl.* **2000**, 0050365.
1375. Niimi, T.; Uchida, T.; Irie, R.; Katsuki, T. *Tetrahedron Lett.* **2000**, *41*, 3647–3651.
1376. Kim, G. J.; Park, D. W. *Catal. Today* **2000**, *63*, 537–547.
1377. Canali, L.; Sherrington, D. C. *Chem. Soc. Rev.* **1999**, *28*, 85–93.
1378. Ito, Y. N.; Katsuki, T. *Bull. Chem. Soc. Jpn* **1999**, *72*, 603–619.
1379. Nishinaga, A.; Yamato, H.; Abe, T.; Maruyama, K.; Matsuura, T. *Tetrahedron Lett.* **1988**, *29*, 6309–6312.
1380. Jacobsen, E. N.; Kakiuchi, F.; Konsler, R. G.; Larrow, J. F.; Tokunaga, M. *Tetrahedron Lett.* **1997**, *38*, 773–776.
1381. Kezuka, S. T. M.; Ohtsuki, N.; Ikeno, T.; Yamada, T. *Chem. Lett.* **2000**, 824–825.
1382. Yamada, T.; Nagata, T.; Ikeno, T.; Ohtsuka, Y.; Sagara, A.; Mukaiyama, T. *Inorg. Chim. Acta* **1999**, *296*, 86–93.
1383. Eaton, D. R.; Majid, A.; Tong, J. P. K. *Inorg. Chim. Acta* **1982**, *61*, 25–31.
1384. Rizzarelli, E.; Vecchio, G. *Coord. Chem. Rev.* **1999**, *188*, 343–364.
1385. Akkaya, E. U.; Czarnik, A. W. *J. Am. Chem. Soc.* **1988**, *110*, 8553–8554.
1386. Hegg, E. L.; Burstyn, J. N. *Coord. Chem. Rev.* **1998**, *173*, 133–165.
1387. Samsel, E. G.; Kochi, J. K. *J. Am. Chem. Soc.* **1986**, *108*, 4790–4804.
1388. Maruyama, K.; Murakami, Y.; Yoda, K.; Mashino, T.; Nishinaga, A. *J. Chem. Soc., Chem. Commun.* **1992**, 1617–1618.
1389. Wayland, B. B.; Poszmik, G.; Mukerjee, S. L.; Fryd, M. *J. Am. Chem. Soc.* **1994**, *116*, 7943–7944.
1390. Basicckes, L.; Parks, G. F.; Wayland, B. B. *Polym. Prepr. (Am. Chem. Soc., Div. Polym. Chem.)* **2000**, *41*, 1886.
1391. Jayasharan, J.; Kishore, K. *J. Am. Chem. Soc.* **1998**, *120*, 825–826.
1392. Nanda, A. K.; Kishore, K. *Polymer* **2000**, *42*, 2365–2372.
1393. Nanda, A. K.; Kishore, K. *Macromolecules* **2001**, *34*, 1600–1605.
1394. Britovsek, G. J. P.; Bruce, M.; Ginson, V. C.; Kimberley, B. S.; Maddox, P. J.; Mastroianni, S.; McTavish, S. J.; Redshaw, C.; Solan, G. A.; Stroemberg, S.; White, A. J. P.; Williams, D. J. *J. Am. Chem. Soc.* **1999**, *121*, 8728–8740.
1395. Prabhakar, L. D.; Umarani, C. *Indian J. Chem., Sect. A* **1995**, *34A*, 621–624.
1396. Bonaplata, E.; Smith, C. D.; McGrath, J. E. *ACS Symp. Ser.* **1995**, *603*, 227–237.
1397. Sharma, A. C.; Joshi, V.; Borovik, A. S. *J. Polym. Sci., Part A: Polym. Chem* **2001**, *39*, 888–897.
1398. Budnikova, Y. G.; Kafiyatullina, A. G.; Kargin, Y. M.; Sinyashin, O. G. *Russ. J. Gen. Chem.* **2001**, *71*, 231–233.
1399. Budnikova, Y. G.; Kafiyatullina, A. G.; Kargin, Y. M.; Sinyashin, O. G. *Russ. J. Gen. Chem.* **2000**, *70*, 1445–1447.
1400. Kang, C. J. *Electroanal. Chem.* **2001**, *498*, 51–57.

1401. Bhugun, I.; Anson, F. C. *J. Electroanal. Chem.* **1997**, *430*, 155–161.
1402. Dong, S.; Kuwana, T. *Electroanalysis* **1991**, *3*, 485–491.
1403. Sazou, D.; Araullo-McAdams, C.; Han, B. C.; Franzen, M. M.; Kadish, K. M. *J. Am. Chem. Soc.* **1990**, *112*, 7879–7886.
1404. Autret, M.; Ou, Z.; Antonini, A.; Boschi, T.; Tagliatesta, P.; Kadish, K. M. *J. Chem. Soc., Dalton Trans.* **1996**, 2793–2797.
1405. Cristofol, E.; Sanchez Rojas, F.; Cano-Pavon, J. M. *Talanta* **1991**, *38*, 445–448.
1406. Murthy, G. V. R.; Reddy, T. S. *Chim. Acta Turc.* **1989**, *17*, 189–194.
1407. Fernandez, A.; Luque de Castro, M. D.; Valcarcel, M. *Anal. Chem.* **1984**, *56*, 1146–1151.
1408. Ballesteros, L.; Perez-Bendito, D. *Analyst* **1983**, *108*, 443–451.
1409. Lin, J.-M.; Shan, X.; Hanaoka, S.; Yamada, M. *Anal. Chem.* **2001**, *73*, 5043–5051.
1410. Ximenes, M. I. N.; Rath, S.; Reyes, F. G. H. *Talanta* **2000**, *51*, 49–56.
1411. Bedioui, F.; Bernard, P.; Moisy, P.; Bied-Charreton, C.; Devynck, J. *Mater. Sci. Forum* **1989**, *42*, 221–224.
1412. Ordaz, A. A.; Rocha, J. M.; Aguilar, F. J. A.; Granados, S. G.; Bedioui, F. *Analysis* **2000**, *28*, 238–244.
1413. Dobson, D. J.; Saini, S. *Anal. Chem.* **1997**, *69*, 3532–3538.
1414. Demel, R.; Dotterl, E.; Merz, A. *Acta Chem. Scand.* **1999**, *53*, 1038–1042.
1415. Hasan, S.; Cho, J. G.; Sublette, K. L.; Pak, D.; Maule, A. *J. Biotechnol.* **1992**, *24*, 195–201.
1416. Zhang, J. *Water Treat.* **1990**, *5*, 69–76.
1417. Schuster, M.; Koenig, K. H.; Lotter, H.; Drauz, K. *Ger. Offen.* **1990**, 3839222.
1418. Bikulova, A. T.; Ishmuratova, G. M.; Pozin, L. M. *Zh. Prikl. Khim.* **1995**, *68*, 727–730.
1419. Lund, G. K. *PCT Int. Appl.*, **1998**, 9806486.
1420. Alexandrovich, P. S.; Manthey, J. W.; May, J. W.; Sreekumar, C. *U.S.*, **1987**, 4681828.
1421. Danjo, H.; Sakaguchi, A.; Masuda, H.; Hatakeyama, Y. *Jpn. Kokai Tokkyo Koho*, **2000**, 2000034497.
1422. Hirsch, B.; Stolle, R. *Ger. (East)* **1983**, 202730.
1423. Tricedi, D. C. *Bull. Electrochem.* **1988**, *4*, 815–817.
1424. Niksa, M. J.; Wheeler, D. J. *J. Power Sources* **1988**, *22*, 261–267.
1425. Ledon, H.; Guillard, R.; Tabard, A.; Royal, G.; Broeker, G. *Fr. Demande* **2000**, 2791968.
1426. Nishihara, H. *Jpn. Kokai Tokkyo Koho*, **1999**, 11228735.
1427. Blake, A. J.; Champness, N. R.; Hubberstey, P.; Li, W.-S.; Withersby, M. A.; Schroder, M. *Coord. Chem. Rev.* **1999**, *183*, 117–138.
1428. Chesnut, D. J.; Hagrman, D.; Zapf, P. J.; Hammond, R. P.; La Duca, J. R.; Haushalter, R. C.; Zubieta, J. *Coord. Chem. Rev.* **1999**, *190–192*, 737–769.
1429. Laget, V.; Hornick, C.; Rabu, P.; Drillon, M.; Ziessel, R. *Coord. Chem. Rev.* **1998**, *178–180*, 1533–1553.
1430. Verdaguer, M.; Bleuzen, A.; Marvaud, V.; Vaissermann, J.; Seuleiman, M.; Desplanches, C.; Scuiller, A.; Train, C.; Garde, R.; Gelly, G.; Lomenech, C.; Rosemman, I.; Veillet, P.; Cartier, C.; Villain, F. *Coord. Chem. Rev.* **1999**, *190–192*, 1023–1047.
1431. Clemente-Juan, J. M.; Coronado, E. *Coord. Chem. Rev.* **1999**, *193–195*, 361–394.
1432. Reichert, D. E.; Lewis, J. S.; Anderson, C. J. *Coord. Chem. Rev.* **1999**, *184*, 3–66.
1433. Yam, V. W.-W.; Lo, K. K.-W. *Coord. Chem. Rev.* **1999**, *184*, 157–240.
1434. Dori, Z.; Gershon, D.; Scharf, Y. *Fr. Demande* **1987**, 2598616.
1435. Suwen, L.; Boeshore, S.; Fernandez, A. *J. Phys. Chem.* **2001**, *105*, 7606–7611.
1436. Mehrotra, R. C. *Struct. Bonding* **1992**, *77*, 1–36.
1437. Malyarevich, A. M.; Denisov, I. A.; Yumashev, K. V. *Applied Optics* **2001**, *40*, 4322–4325.
1438. Sato, M.; Hara, H.; Kuritani, H.; Nishide, T. *Sol. Energy Mater. Sol. Cells* **1997**, *45*, 39–43.
1439. Thomas, S.; Bertrand, J. A.; Occelli, M. L. *Chem. Mater.* **1999**, *11*, 184–187.

6.2

Iridium

L. J. YELLOWLEES and K. G. MACNAMARA
University of Edinburgh, UK

6.2.1	INTRODUCTION	149
6.2.2	IRIDIUM(VI)	149
6.2.3	IRIDIUM(V)	149
6.2.3.1	Boron Ligands	150
6.2.3.2	Silyl and Stannyl Ligands	150
6.2.3.3	Nitrogen, Phosphorus, Arsine, and Stibine Ligands	150
6.2.3.4	Oxygen Ligands	151
6.2.3.5	Halide Ligands	151
6.2.3.6	Hydrogen Ligands	151
6.2.3.7	Mixed-donor-atom Ligands	152
6.2.3.7.1	<i>C/Si</i>	152
6.2.4	IRIDIUM(IV)	153
6.2.4.1	Boron Ligands	153
6.2.4.2	Nitrogen, Phosphorus, Arsine, Stibine, Sulfur, Selenium, and Tellurium Ligands	153
6.2.4.3	Oxygen Ligands	155
6.2.5	IRIDIUM(III)	156
6.2.5.1	Mercury Ligands	156
6.2.5.2	Boron Ligands	156
6.2.5.3	Carbon Ligands	156
6.2.5.4	Silicon Ligands	157
6.2.5.5	Germanium Ligands	159
6.2.5.6	Tin Ligands	159
6.2.5.7	Nitrogen Ligands	159
6.2.5.7.1	<i>Ammine</i>	159
6.2.5.7.2	<i>Nitrosyl</i>	161
6.2.5.7.3	<i>Nitrile</i>	162
6.2.5.7.4	<i>Nitride</i>	162
6.2.5.7.5	<i>Urea</i>	162
6.2.5.7.6	<i>Nitrite</i>	162
6.2.5.7.7	<i>Cyanide</i>	163
6.2.5.7.8	<i>Pyridine</i>	163
6.2.5.7.9	<i>Phthalimide</i>	163
6.2.5.7.10	<i>Imidazole</i>	163
6.2.5.7.11	<i>Pyrazole</i>	164
6.2.5.7.12	<i>Chelate-ethylenediamine</i>	164
6.2.5.7.13	<i>α-diimine</i>	165
6.2.5.7.14	<i>Binuclear complexes</i>	167
6.2.5.7.15	<i>N_3 ligands</i>	168
6.2.5.7.16	<i>N_4 ligands</i>	169
6.2.5.8	Phosphorus Ligands	170
6.2.5.8.1	<i>Monodentate ligands</i>	170
6.2.5.8.2	<i>Bidentate ligands</i>	172
6.2.5.8.3	<i>Tridentate ligands</i>	174
6.2.5.8.4	<i>Arsine and antimony ligands</i>	174
6.2.5.9	Oxygen Ligands	174
6.2.5.9.1	<i>Monodentate ligands</i>	174
6.2.5.9.2	<i>Bidentate ligands</i>	175
6.2.5.9.3	<i>Tridentate ligands</i>	176

6.2.5.9.4	<i>Trinuclear complexes</i>	176
6.2.5.10	Sulfur and Selenium Ligands	176
6.2.5.10.1	<i>Monodentate ligands</i>	176
6.2.5.10.2	<i>Bidentate ligands</i>	177
6.2.5.10.3	<i>Binuclear complexes</i>	178
6.2.5.10.4	<i>Tridentate ligands</i>	178
6.2.5.10.5	<i>Halide ligands</i>	178
6.2.5.11	Hydrogen Ligands	178
6.2.5.12	Mixed-donor-atom Ligands	181
6.2.5.12.1	<i>C/N</i>	181
6.2.5.12.2	<i>C/P</i>	184
6.2.5.12.3	<i>C/O</i>	184
6.2.5.12.4	<i>Si/N</i>	185
6.2.5.12.5	<i>Si/P</i>	185
6.2.5.12.6	<i>N/P</i>	186
6.2.5.12.7	<i>N/O</i>	186
6.2.5.12.8	<i>N/S</i>	187
6.2.5.12.9	<i>P/O</i>	189
6.2.5.12.10	<i>P/S</i>	190
6.2.5.12.11	<i>P/Br</i>	190
6.2.5.12.12	<i>O/S</i>	190
6.2.5.12.13	<i>Multidentate ligands</i>	191
6.2.5.13	Biological Complexes	194
6.2.5.14	Catalytic Complexes	196
6.2.6	IRIDIUM(II)	197
6.2.6.1	Carbon Ligands	197
6.2.6.2	Tin Ligands	197
6.2.6.3	Nitrogen Ligands	197
6.2.6.4	Phosphorus Ligands	200
6.2.6.5	Oxygen Ligands	200
6.2.6.6	Sulfur Ligands	200
6.2.6.7	Halide Ligands	201
6.2.6.8	Hydrogen Ligands	201
6.2.6.9	Mixed-donor-atom Ligands	202
6.2.6.9.1	<i>C/P</i>	202
6.2.6.9.2	<i>N/P</i>	202
6.2.6.9.3	<i>N/S</i>	202
6.2.6.10	Biological Complexes	203
6.2.6.11	Catalytic Complexes	203
6.2.7	IRIDIUM(I)	203
6.2.7.1	Carbon Ligands	203
6.2.7.1.1	<i>Isocyanide</i>	203
6.2.7.1.2	<i>Carbonyl</i>	203
6.2.7.1.3	<i>Alkyls and aryls</i>	203
6.2.7.2	Silicon Ligands	204
6.2.7.3	Nitrogen Ligands	205
6.2.7.3.1	<i>Pyridine</i>	205
6.2.7.3.2	<i>Nitriles</i>	205
6.2.7.3.3	<i>Nitride</i>	205
6.2.7.3.4	<i>Nitrosyl</i>	205
6.2.7.3.5	<i>Amides</i>	206
6.2.7.3.6	<i>α-diimines</i>	206
6.2.7.3.7	<i>Pyrazole and derivatives</i>	207
6.2.7.3.8	<i>Bis-chelating Ligands</i>	208
6.2.7.3.9	<i>Polydentate N-donor ligands</i>	210
6.2.7.4	Phosphorus Ligands	211
6.2.7.4.1	<i>Monodentate Ligands</i>	211
6.2.7.4.2	<i>Polydentate ligands</i>	215
6.2.7.5	Arsine and Stibene Ligands	217
6.2.7.6	Oxygen Ligands	218
6.2.7.6.1	<i>Monodentate Ligands</i>	218
6.2.7.6.2	<i>Bidentate ligands</i>	219
6.2.7.7	Sulfur Ligands	220
6.2.7.7.1	<i>Monodentate Ligands</i>	220
6.2.7.7.2	<i>Bidentate ligands</i>	220
6.2.7.7.3	<i>Tridentate ligands</i>	221
6.2.7.7.4	<i>Binuclear complexes</i>	221
6.2.7.7.5	<i>Bimetallic complexes</i>	221
6.2.7.8	Selenium and Tellurium Ligands	221
6.2.7.9	Halide Ligands	222
6.2.7.10	Hydrogen Ligands	222
6.2.7.11	Mixed-donor-atom Ligands	222

6.2.7.11.1	C/N	222
6.2.7.11.2	C/P	222
6.2.7.11.3	Si/P	223
6.2.7.11.4	N/P	223
6.2.7.11.5	N/O	225
6.2.7.11.6	N/S	226
6.2.7.11.7	P/O	226
6.2.7.11.8	O/S	227
6.2.7.11.9	Multidentate ligands	227
6.2.7.11.10	Biological complexes	228
6.2.7.12	Catalytic Complexes	229
6.2.8	IRIDIUM(0)	230
6.2.8.1	Nitrogen Ligands	230
6.2.8.2	Phosphorus Ligands	230
6.2.8.2.1	Monomeric complexes	230
6.2.8.2.2	Dimeric complexes	231
6.2.8.3	Mixed-donor-atom Ligands	231
6.2.8.3.1	C/P	231
6.2.8.3.2	N/P	231
6.2.9	IRIDIUM (-I)	231
6.2.9.1	Phosphorus Ligands	232
6.2.9.2	Mixed-donor-atom Ligands	232
6.2.9.2.1	C/P	232
6.2.10	ABBREVIATIONS	232
6.2.11	REFERENCES	234

6.2.1 INTRODUCTION

The coordination chemistry of iridium has continued to flourish since 1985/86. All common donor atoms can be found bound to at least one oxidation state of iridium. The most common oxidation states exhibited by iridium complexes are I and III, although examples of all oxidation states from -I to VI have been synthesized and characterized. Low-oxidation-state iridium species usually contain CO ligands or P donor atoms, whereas high-oxidation-number-containing coordination compounds are predominantly hexahalide ones.

Complexes of Ir^{III} have over half the referenced entries in this chapter. The Ir^{III} metal center has a d^6 electronic configuration, and most of the Ir^{III} compounds have a coordination number of six with a geometry based on the octahedron. All the compounds have low-spin (t_{2g})⁶ configuration, and a majority are colorless or pale yellow. Donor atoms to Ir^{III} are many and various, with nitrogen being the most frequent. The second most common oxidation state is Ir^I with a d^8 electronic configuration, usually found in a square-planar arrangement. Most donor atoms bind to Ir^I and oxidative addition reactions feature regularly. Ir(-I), Ir⁰, Ir^{II}, Ir^{IV}, Ir^V and Ir^{VI} coordination compounds are more unusual.

The most common use of iridium coordination compounds remains in the catalysis field, although interest is developing in the luminescent properties of iridium compounds. The wide range of accessible oxidation states available to iridium (-I) to (VI) is reflected in the diverse nature of its coordination compounds.

6.2.2 IRIDIUM(VI)

Laser-ablated iridium atoms react with O₂ to give the linear dioxide OIrO and the side-bound dioxygen adduct (O₂)IrO₂ as primary reaction products.¹ IR spectra and DFT calculations in solid argon show that the (O₂)IrO₂ species is best formulated as a peroxide with iridium in the +6 oxidation state, providing the first example of an Ir^{VI} oxo complex. There are other references to Ir^{VI}, in the main as part of perovskite structures under high oxygen pressures.^{2,3}

6.2.3 IRIDIUM(V)

Iridium(V) complexes, although not common, take a variety of forms, including polynuclear and multidentate structures as well as five-, six- and seven-coordinate species, some of which are stable and have been characterized by X-ray crystallography.

6.2.3.1 Boron Ligands

A series of Ir^V boryl polyhydrides, cp*IrH₂XBR₂ (X = H and BR₂ = Bpin (**1**) (pin = O₂C₂Me₄), Bcat (**2**) (cat = O₂C₆H₄), BO₂C₆H₂-3,4-Me₂ (**3**); Bcy (**4**), X = Bpin and BR₂ = Bpin (**5**)) have been prepared and isolated by Hartwig and Kawamura according to Reaction Scheme 1.⁴ The X-ray crystal characterization of (**1**) is reported. (**1**) to (**5**) react regioselectively with alkanes to produce free functionalized products.

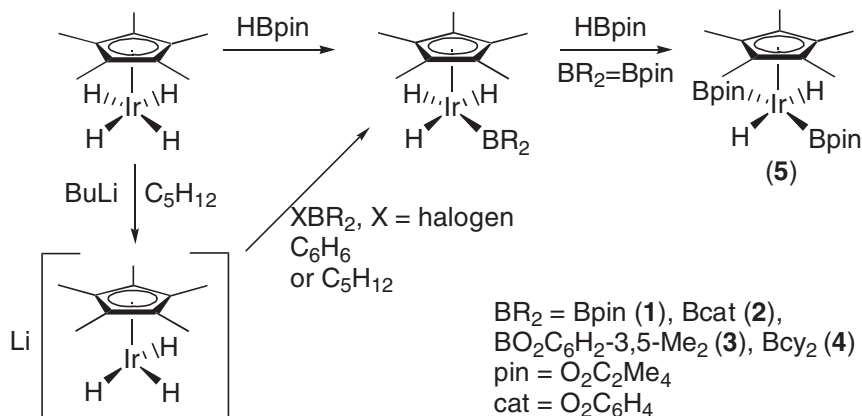

The crystal and molecular structure of (PPh₃)₂(CO)(H)Ir(μ³-B₃H₇) have been reported.⁵ The structure is interpreted as a capped octahedral, 7-orbital, 18-electron d⁴, Ir^V complex in which the metal–borane bonding occurs predominantly via three two-electron, two-center Ir–B bonds.

6.2.3.2 Silyl and Stannyl Ligands

The neutral Ir^V complex, cp*Ir(H)₂(SiEt₃)₂, has been studied by neutron diffraction and its structural characteristics compared to those of the isomorphous Rh analogue.⁶ The significant differences are longer metal–ligand distances and larger bond angles for the Ir species.

The dihydrobis(trialkylstannyl)–iridium(V) complex [cp*Ir(H)₂(SnMe₃)₂] was prepared by reaction of Me₃SnH and [(cp*Ir)₂Cl₄] or [cp*Ir(C₂H₄)₂].⁷ The hydrido-carbonyl equivalent, [cp*Ir(H)(CO)(SnMe₃)], was prepared by the reaction of Me₃SnH and [cp*Ir(CO)₂].

The pentahydride, IrH₅(PPh₃)₂, reacts with chelating silanes with loss of H₂ to form the seven-coordinate, distorted pentagonal-bipyramidal, silyl polyhydride complexes IrH₃(disil)(PPh₃)₂ (disil = dmsb (**6**), tids (**7**)) with monodentate silanes to give Ir(H₄(SiR₃)(PPh₃)₂) (R = Et (**8**), Ph (**9**)), and with triphenyltin hydride to give IrH₃(SnPh₃)₂(PPh₃)₂ (**10**), all examples of Ir^V.⁸ A crystal structure has been obtained for (**6**).

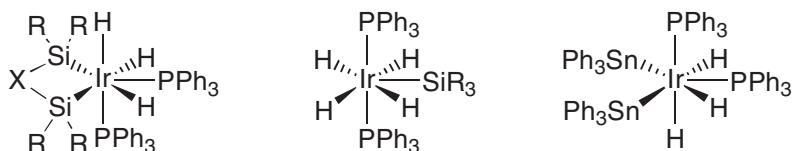

(**6**) X = C₆H₄, R = Me

(**7**) R = C₂H₅

(**8**)

(**9**) X = O, R = ⁱPr

(**10**) R = C₆H₅

6.2.3.3 Nitrogen, Phosphorus, Arsine, and Stibine Ligands

Oxidation of (PPh₄)₂[Ir(NH₃)Cl₅] with PhI(OAc)₂ in CH₂Cl₂ affords the Ir^V amido complex (PPh₄)[Ir(NH₂)Cl₅].²⁹

From the precursor complex, $\text{cp}^*\text{Ir}(\text{Me})_3(\text{otf})$ (**11**), a series of trisubstituted phosphine, arsine, and stibine (L) Ir^{V} complexes have been prepared, of the type $[\text{cp}^*(\text{L})\text{IrMe}_3](\text{otf})$ (L = PMe_3 (**12**), PEt_3 (**13**), PPh_3 (**14**), AsEt_3 (**15**), AsPh_3 , SbPh_3 (**16**)).⁹ Metathesis of the triflate anion of (**16**) for the tetraphenylborate anion afforded $[\text{cp}^*(\text{SbPh}_3)\text{IrMe}_3][\text{BPh}_4]$, which was characterized by single-crystal X-ray diffraction analysis. (**12**) was identified as a potential model for the proposed intermediate in the methane carbon–hydrogen bond activation pathway by $\text{cp}^*(\text{PMe}_3)\text{Ir}(\text{Me})(\text{otf})$. Reaction of (**11**) with excess dppm afforded $\text{cis}-[(\eta^2\text{-dppm})_2\text{IrMe}_2][\text{OTf}]$, characterized by single-crystal X-ray diffraction.

6.2.3.4 Oxygen Ligands

Quantitative yields of the green Ir^{V} complex $\text{Ir}(\text{O})(\text{mes})_3$ (**17**) were obtained by the interaction of trimesityliridium(III) and trimethylamine oxide, or by the interaction of dioxygen with $\text{Ir}(\text{mes})_3$ and $\text{Ir}(\text{mes})_4$.¹⁰ The molecular structure of (**17**) was determined by X-ray crystallography and is distorted tetrahedral, with $\text{Ir}=\text{O}$ and $\text{Ir}-\text{C}$ bond lengths of 1.725(9) Å and 1.989–2.034(12) Å, respectively.

The acetylacetonato (acac) ligand acts as a stabilizing ligand for the Ir^{V} complex $\text{Ir}(\text{acac})\text{H}_3(\text{SiEt}_3)(\text{Pcy}_3)$ (**18**).¹¹ In solution the hydride ligands are equivalent, and analysis of variable temperature ^1H NMR spectra gives values of ΔH^\ddagger and ΔS^\ddagger of 12.33 (± 0.76) kcal mol⁻¹ and 1.45 (± 1.84) cal K⁻¹ mol⁻¹, respectively. Ir^{V} can be stabilized by the O-donor, tris(diphenyloxyphosphoryl)methanide, as (**19**).¹²

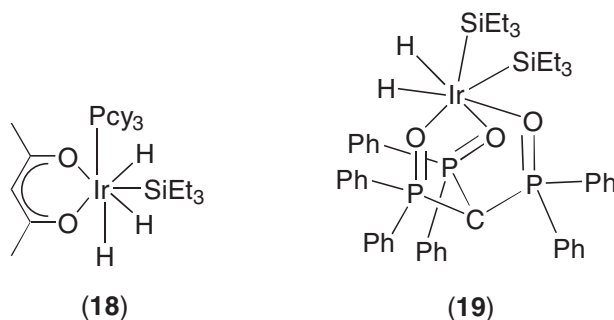

6.2.3.5 Halide Ligands

The deep red complex $\text{Cs}[\text{IrF}_5\text{Cl}]$ was isolated from a mixture of complexes $[\text{IrF}_n\text{Cl}_{6-n}]^-$, prepared by treatment of $[\text{IrCl}_6]^{2-}$ with BrF_3 in liquid HF .¹³ The IR and Raman spectra of $[\text{IrF}_5\text{Cl}]^-$ may be assigned according to point group C_{4v} . The interaction of IrF_6 and ZnS or B_2S_2 at elevated temperatures yields the Ir^{V} complex, $[\text{SF}_4]^+[\text{IrF}_6]^-$.¹⁴

6.2.3.6 Hydrogen Ligands

The polyhydrido phosphine Ir^{V} complex, $\text{IrH}_5(\text{Pcy}_3)_2$ (**20**), was prepared by Reaction Scheme 2 in good yield (75–85%).¹⁵ Treatment of $[\text{Ir}(\mu\text{-OMe})(\text{cod})]_2$ with Pcy_3 in methanol gives (**20**) and $\text{mer-IrH}_3(\text{CO})(\text{Pcy}_3)_2$.⁶²²

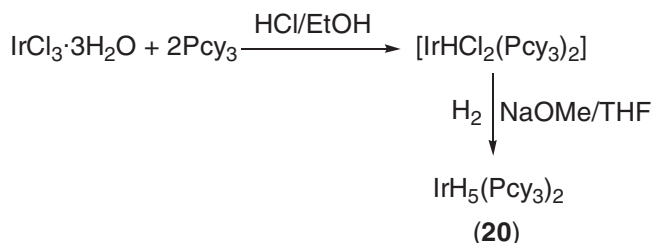

Scheme 2

The tetrahydride Ir^V complex, Tp*IrH₄ (**21**), Tp* = HB(3,5-Me₂pz)₃, has been prepared in very high yield from the hydrogenation of Tp*Ir(C₂H₄)₂ (**22**) under forcing conditions (C₆H₁₂, 90 °C, 2 atm, 3 days).¹⁶ A later preparation of (**21**) was by the photolysis of [Ir(η²-coe)H₂(Tp*)] in MeOH.¹⁷ (**21**) is proposed to have face-capped octahedral structures (C_{3v}), with each of the three Ir—H bonds *trans* to an Ir—N bond and the fourth hydride capping the IrH₃ face. However, density functional geometry optimizations and couple cluster calculations on Tp*IrH₄ demonstrate that a C_s edge-bridged, octahedral, tetrahydride structure and a C₁ η²-dihydrogen, dihydride structure are local minima, and the C_{3v} structure is a local maximum (second-order saddle point).¹⁸ NMR and IR experimental data support the assignment of the C_s and C₁ structures to (**21**). Heating (**22**) in neat HSiEt₃ at 80 °C gives the very stable compound Tp*IrH₃(SiEt₃) (**23**). A crystal structure of (**23**) shows C_{3v} symmetry in which the SiEt₃ group caps the IrH₃ face.¹⁹

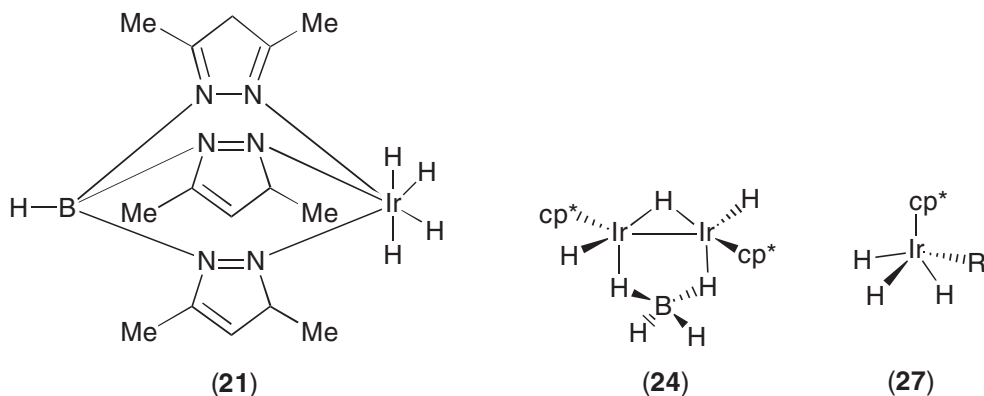

The reaction of LiBH₄ with [(cp*Ir)₂(μ-H)₃]PF₆ (**24**) gave the borohydride-bound dimer [(cp*Ir)₂H₃BH₄] (**25**).²⁰ Hydrolysis of (**25**) yielded the Ir^{IV} dimer [cp*IrH₃]₂. (**24**) reacts with LiEt₃BH to give the mononuclear salt (cp*IrH₃)[Li(THF)_x], which hydrolyzes to the Ir^V complex, cp*IrH₄ (**26**). Deprotonation of (**26**) with Me₃CLi in the presence of pmdeta (pmdeta = Me₂N(CH₂CH₂NMe)₂Me) gives cp*IrH₃[Li(pmdeta)], which reacts with Me₃SiO₃SCF₃, Me₃SnCl, and Ph₃SnBr to yield the novel Ir^V polyhydrides cp*IrH₃R (**27**) (R = SiMe₃, SnMe₃, SnPh₃). The X-ray structure of (**27**), R = SnPh₃, shows it to have the expected four-legged piano stool geometry. Reaction of (**24**) with PMe₃ gives the monohydride-bridged Ir^{III} dimer, [(cp*Ir(PMe₃)H)₂(μ-H)]PF₆ and LiEt₃BH.²¹ Protonation of the dimer with HBF₄ gives the Ir^V complex, [cp*Ir(PMe₃)H₃]BF₄ (**28**).

A large number of complexes of the type [cp*Ir(L)H₃]BF₄, where L = various phosphine and phosphite ligands, have been prepared from the neutral iridium dihydrides, cp*Ir(L)H₂ with HBF₄·Et₂O.²² The ¹H NMR spectra of the cations in the hydride region at low temperature display AB₂X spin systems (X = ³¹P), which are simplified to AB₂ spin systems in the ¹H{³¹P} spectra. A neutron diffraction study and crystal structure determination has also been undertaken for (**28**). Treatment of [cpIrH₂(P(CHMe₂)₃)] with HBF₄·OEt₂ gives the Ir^V species [cpIrH₃(P(CHMe₂)₃)]BF₄.²³

6.2.3.7 Mixed-donor-atom Ligands

6.2.3.7.1 C/Si

The Ir^{III} complex, cp*Ir(PMe₃)(Me)(otf), reacts with H₂Si(mes)₂ by oxidative addition of a C—H bond of a mesityl group to the Ir^{III} center to give the Ir^V species (**29**).²⁴ (**29**) isomerizes to an iridium silylene complex, [cp*Ir(PMe₃):Si(mes)₂(H)](otf), over 9 hours. cp*Ir(PMe₃)(Me)(otf) also undergoes oxidative addition with HSiPh₃ to give cp*Ir(PMe₃)(Ph)SiPh₂(otf). Replacing the triflate group with the less strongly coordinating anion (NaBAR or LiB(C₆F₅)₄(Et₂O)_{2.5}) gave (**30**), which has been characterized by X-ray crystallography.

6.2.4 IRIDIUM(IV)

Iridium(IV) complexes are less common when compared to Ir^{III} or Ir^I. There are examples of N, P, As, Sb, O, S, Se, Te, and halide ligands, often prepared by oxidation from an Ir^{III} salt. "Recent developments" (in 1991) in the chemistry of the platinum metals in high oxidation states were addressed by Levason, including complexes of Ir^{IV} and Ir^V.²⁵

6.2.4.1 Boron Ligands

The complex catalytic polarographic hydrogen wave of the Ir^{IV}-cystine complex (**31**) has been investigated in 1.2 M HCl.^{26,27}

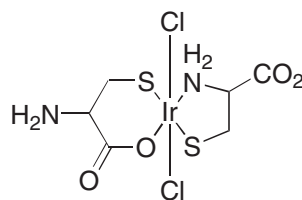

(31)

6.2.4.2 Nitrogen, Phosphorus, Arsine, Stibine, Sulfur, Selenium, and Tellurium Ligands

The Ir^{IV} complexes *trans*-[IrL₂Cl₄] (L = py, PEt₃, PEt₂Ph, PEtPh₂, AsEt₃, AsMe₂Ph, SMe₂, SMe), and *cis*-[Ir(L-L)Cl₄] (L-L = MeSCH₂CH₂SMe, MeSeCH₂CH₂SeMe, bpy, or phen) have been prepared by oxidation of the Ir^{III} analogues by Cl₂ or HNO₃.^{28,29} Similarly, the dark green Ir^{IV} complexes *trans*-[IrL₂Br₄] (L = py, PEt₃, PMe₂Ph, AsEt₃, AsMe₂Ph, SMe₂) have been obtained by the oxidation of the Ir^{III} salts by Br₂ or HNO₃. The complexes *trans*-[IrL₂Cl₄] (L = PPh₃, AsPh₃, SbPh₃) have been obtained directly from the reaction of IrCl₃·nH₂O + 2L, followed by the chlorination of the intermediate, [(IrL₂Cl₃)_n]. The synthesis of dark green *cis*-Ir(L-L)Br₄, where L-L = bpy or phen and *cis*-IrL₂X₄ (L = py or SbMe₃, X = Cl or Br), is also described. The Ir^{IV} complexes are characterized by elemental analysis, IR and UV-vis spectroscopy, and cyclic voltammetry. The crystal structures of *trans*-[Ir(AsEt₃)₂Br₄] and the dark purple, air-sensitive complex *cis*-Ir(phen)Cl₄ have been determined. The UV-vis spectra are interpreted as LMCT transitions, that is, X⁻ → Ir^{IV} transfers. Electrochemical studies show a reversible Ir^{IV/III} couple, with the reduction occurring at more positive values for the *cis* than for the *trans* complexes.

The Ir^{IV} complex (NH₄)[Ir(NH₃)Cl₅] has been prepared by the oxidation of the Ir^{III} analogue with Cl₂ at 330 °C, and its structure determined from powder diffraction studies.³⁰

The binuclear complex [Ir(PBA)Cl₂(MeOH)₂Cl₂] (**32**) (PBA = *N,N'*-*p*-phenylenebis(anisalideneimine)) has been prepared and characterized.³¹

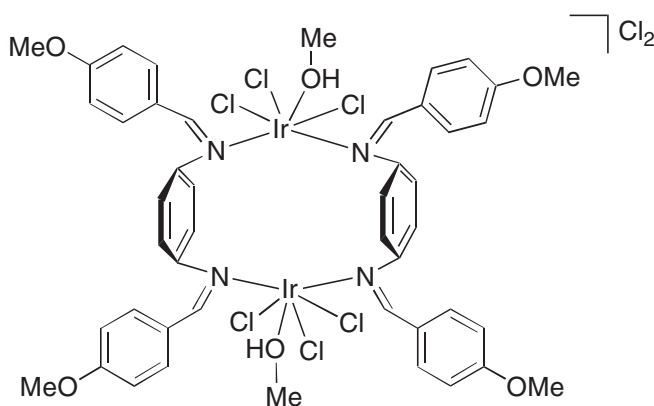

(32)

The paramagnetic complexes $[\text{IrCl}_4(\text{SeCl}_4)_2]$ and $[\text{IrCl}_4(\text{TeCl}_4)_2]$ have been prepared and show effective magnetic moments characteristic of the Ir^{IV} oxidation state.⁴² IR and ^{35}Cl NQR (Nuclear Quadruple Resonance) data indicate heteronuclear structures for the complexes with chloride bridges.

6.2.4.3 Oxygen Ligands

Complexes of Ir^{IV} with iminodiacetic acid ($\text{HN}(\text{CH}_2\text{COOH})_2$), nitrilotriacetic acid ($\text{N}(\text{CH}_2\text{COOH})_3$), and *trans*-1,2-cyclohexanediaminetetraacetic acid (L) have been studied by spectroscopic methods.⁴³

The electronic adsorption spectra for the complexes $[\text{Ir}(\text{OH})_6]^{n-}$, where $n=0-2$, have been resolved and peak maxima locations, molar extinction coefficients, oscillator strengths, and band half-widths calculated.⁴⁴ Bands have been assigned in the main part to be one-electron MLCT transitions. Spectrophotometrically determined rate constants for the OH reduction of the Ir^{VI} and Ir^{V} complexes at 25°C in 3M NaOH are $(2.59 \pm 0.09) \times 10^{-3} \text{ s}^{-1}$ and $(1.53 \pm 0.05) \times 10^{-4} \text{ s}^{-1}$ respectively. The activation energy for the reduction, $\text{Ir}^{\text{V}} \rightarrow \text{Ir}^{\text{IV}}$, is $17.5 \text{ kcal mol}^{-1}$. Cyclic voltammetry and potentiostatic coulometry of $[\text{Ir}(\text{OH})_6]^{2-}$ in 3M NaOH on a Pt electrode show that during the electro-oxidation compounds of Ir^{V} and Ir^{VI} are formed.⁴⁵

The decay of zinc tetrakis(*N*-methylpyridinium-4-yl)porphyrin π -radical cations in the presence of poly(styrenesulfonate) and Ir^{IV} oxides or $[\text{Ir}(\text{OH})_6]^{2-}$ has been studied at high pH.⁴⁶ The hexahydroxide species was found to be very reactive.

The aqueous solution chemistry of Ir in its higher oxidation states III, IV, and V has been explored by Sykes *et al.*^{47,48} Chemical and electrochemical oxidation of $[\text{Ir}(\text{H}_2\text{O})_6]^{3+}$ gives a brown-green Ir^{V} product, which undergoes chemical and electrochemical reduction to a blue and a purple Ir^{IV} complex. ^{17}O NMR studies are consistent with double- and single-bridged dimeric structures, with likely formulas $[(\text{H}_2\text{O})_4\text{Ir}(\mu\text{-OH})_2\text{Ir}(\text{H}_2\text{O})_4]^{6+}$ for the blue complex and $[(\text{H}_2\text{O})_5\text{Ir}(\mu\text{-O})\text{Ir}(\text{H}_2\text{O})_5]^{6+}$ for the purple one.

The reaction of $[\text{Ir}(\text{H}_2\text{O})_6]^{4+}$ with Cl^- ions has been studied at various temperatures, giving stability constants and the thermodynamic parameters ΔH° , ΔG° , and ΔS° for the substitution reactions.⁴⁹

The aquation of $[\text{IrCl}_6]^{2-}$ to $[\text{Ir}(\text{H}_2\text{O})\text{Cl}_5]^-$ and $\text{Ir}(\text{H}_2\text{O})_2\text{Cl}_4$ has been found to activate the complex toward the oxidation of insulin in acidic solutions, with measured rate constant of 25, 900 and $8,400 \text{ L mol}^{-1} \text{ s}^{-1}$, respectively.⁵⁰ The oxidation reaction proceeds via an outer-sphere mechanism.

The Ir^{IV} anion, $[\text{Ir}(\text{H}_2\text{O})\text{Br}_5]^-$, oxidises ascorbic acid at 20.0°C.⁵¹ This reaction is first order with respect to ascorbic acid concentration and first order with respect to the Ir^{IV} anion. Comparison of hexabromo-, hexachloro-, aquopentachloro-, and di-aquotetrachloroiridium(IV) reactions with ascorbic acid shows that replacing a halide ion with a water molecule increases the standard reduction potential of the Ir^{IV} complex and increases the rate of reaction.

(cod)bis(3,6-di-*tert*-butylcatecholate)iridium(IV), (**44**), has been prepared by the reaction between $[\text{Ir}(\text{cod})\text{Cl}]_2$ and the cobaltocenium salt of 3,6-di-*tert*-butyl-1,2-semiquinone in DCM.⁵² Single-crystal X-ray studies show the catecholate C—O lengths to be slightly shorter at the *trans* position to the olefin groups. Cyclic voltammetry results show two reversible couples; an oxidation at -0.092 V and a reduction at -0.636 V vs. Fc^+/Fc .

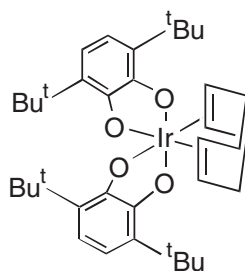

(44)

X-ray techniques have shown the compound $\text{Ba}_5\text{AlIr}_2\text{O}_{11}$ to have the two Ir centers in an octahedral coordination bound to AlO_4 tetrahedra, giving $[\text{Ir}_2\text{AlO}_{11}]^{10-}$ units.⁵³

6.2.5 IRIDIUM(III)

A significant number of Ir^{III} complexes arise from the oxidative addition reactions of Ir^I species. Such reactions may proceed via routine addition, whereas some proceed by ligand expulsion in conjunction with oxidative addition. Complexes containing Ir^{III} have a low-spin d^6 electronic configuration, and are usually to be found with an octahedral-based ligand set.

6.2.5.1 Mercury Ligands

Reaction between IrHCl₂(PPh₃)₂ and Hg(*o*-tolyl)₂ yields the red complex (45), in which the Ir–Hg bond has been confirmed by ³¹P–¹⁹⁹Hg coupling in ³¹P NMR spectroscopy. Addition of CO and I₂ gives [Ir(*o*-tolyl){Hg(*o*-tolyl)}Cl(CO)(PPh₃)₂] and [Ir(*o*-tolyl)Cl(HgI)(PPh₃)₂], respectively.⁵⁴

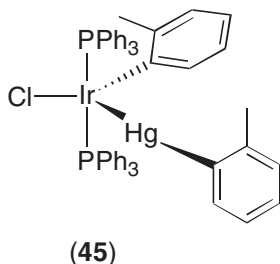

6.2.5.2 Boron Ligands

The bis(boryl) complex *mer-cis*-[Ir(PMe₃)₃Cl(Bcat)₂], (46), cat = 1,2-O₂C₆H₄, is formed according to Reaction Scheme 4.⁵⁵ The *mer-cis* geometry of (46) is confirmed by X-ray crystallography and NMR spectroscopy. Reaction of [IrCl(PEt₃)₃] with (Bcat)₂ yields [IrCl(PEt₃)₂(Bcat)₂]. X-ray crystallography reveals that the Ir center has a Y-shaped geometry, with a narrow B–Ir–B angle of 76.6(6)° and *trans* PEt₃ groups.⁵⁶

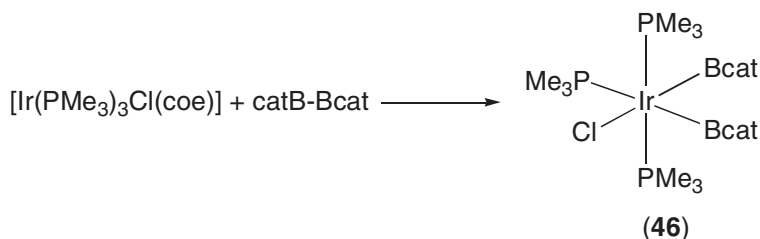

Scheme 4

6.2.5.3 Carbon Ligands

Reaction of [Ir(CO)₂I₂][−] with C₆H₁₃I yields the structurally characterized species Ph₄As-[Ir(CO)₂I₃(C₆H₁₃)], which shows *fac,cis* geometry for the anion.⁵⁷ The oxidative addition reaction is first order in both reactants. The structurally determined species [Ir(CO)₅Cl][Sb₂F₁₁]₂, formed from reaction of *mer*-Ir(CO)₃(SO₃F)₃ with SbF₅/HSO₃F, has a cation of C_{4v} symmetry with long Ir–C bonds (2.02(2) Å) and short C–O bonds (1.08(2) Å).⁵⁸ The vibrational spectrum is assigned with the help of density functional calculations.⁵⁹ Reaction of IrF₆ in SbF₅/CO yields [Ir(CO)₆][Sb₂F₁₁]₃, in which the Ir^{III} center is strictly octahedral.⁵⁸

Reaction of [Ir(CH₃)(CH=CHNEt₃)(C≡C(*p*-C₆H₄CH₃)(CO)(PPh₃)₂)]ClO₄ with aqueous HCl gives [Ir(C(CH₃)=CH(*p*-C₆H₄CH₃)(CH=CHNEt₃)(Cl)(CO)(PPh₃)₂)]ClO₄ and [Ir(CH=CHNEt₃)(Cl)₂(CO)(PPh₃)₂)]ClO₄ plus *cis*-CH₃CH=CH(*p*-C₆H₄CH₃), via an intramolecular coupling reaction.⁶⁰

The ionic iridium(III) carbene complex (47) is prepared from the reaction of [IrHCl(O₃SCF₃)(CO)(PPh₃)₂] with [RC≡NMe](O₃SCF₃).⁶¹ Addition of Na(barf) (barf = B(3,5-C₆H₃(CF₃)₂)₄) to [Ircp*(PMe₃)(CH₃)(OSO₂CF₃)] in CH₂Cl₂ yields the structurally determined species

[Ircp*(PMe₃)(CH₃)(ClCH₂Cl)](barf), (**48**), which confirms the linkage of CH₂Cl₂ to Ir through one Cl atom (Ir—Cl = 2.462(3) Å).⁶² Complex (**48**) can thermally activate CH₄ and terminal alkanes at 10 °C, and can induce C—H activation reactions in functionalized substrates. The X-ray structural determinations of [Ircp*(CO)₂I]BF₄ and [Ircp*(PMe₃)₂Cl]PF₆ are reported.^{63,64} [IrCl₂(CO)-(PMe₂Ph)₃]ClO₄ reacts with KOH to give [IrCl₂(CO₂H)(PMe₂Ph)₃], which is more basic than [IrCl₂(CO₂H)(CO)(PMe₂Ph)₂].⁶⁵

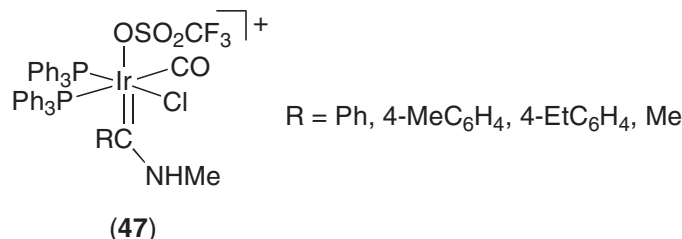

Reaction of [Ir(acac)(PMe₃)₂] with 3-vinyl-1-cyclopropene yields complex (**49**), rearranging on heating to give (**50**) initially and finally (**51**), which has been identified by X-ray crystallography.⁶⁶ Reaction between *mer*-[(Me₃P)₃Ir(H)₂Cl] and 2-ethynylpyridine in H₂O, or *mer*-[(Me₃P)₃Ir(H)(Ph)(Cl)] and 2-ethynylpyridine and Tl(PF₆) in CH₂Cl₂, leads to formation of (**52**), which has been structurally characterized.⁶⁷ The coordinatively unsaturated complexes Ir(H)₂X(PBu₂^tPh)₂ (X = Cl, Br, I, N₃, N=C=NSiMe₃, NHC(O)CH₃, OC(O)CF₃, OSO₂CF₃, OC(O)CH₃, SPh, OPh, F) bind CO.⁵⁰⁰ The initial product eliminates HX, where X = OC(O)CH₃, SPh, OPh, and F. The reaction of Ir(H)₂(F)-(PBu₂^tPh)₂ with CO in a glass vessel yields crystalline [Ir(H)₂(CO)₂(PBu₂^tPh)₂][SiF₅].⁵⁰⁰

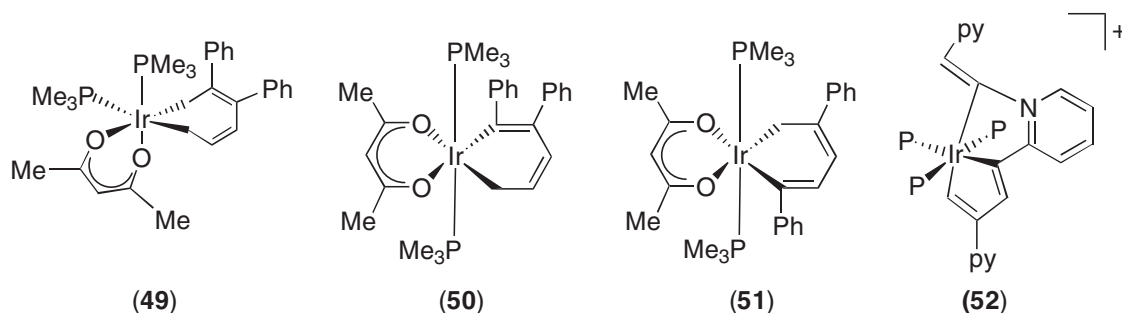

6.2.5.4 Silicon Ligands

The crystallographically characterized complex *mer*-Ir(PMe₃)₃(Cl)₂(SiMeCl₂), (**53**), which contains a short Ir—Si bond, is prepared by Reaction Scheme 5.⁶⁸ Reaction with Me₃SiCl yields the Ir—H complex (**54**).

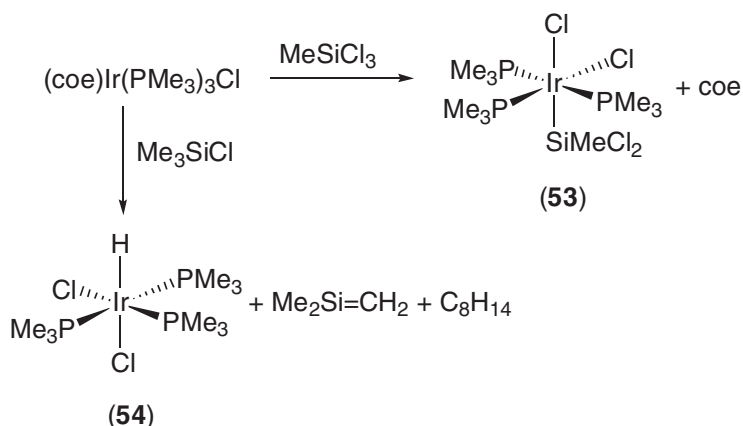

Scheme 5

The facial complexes $(\text{PMe}_3)_3\text{Ir}(\text{CH}_3)(\text{H})(\text{SiR}_3)$, (**55**), ($\text{R} = \text{EtO}, \text{Ph}, \text{Et}$) result from the oxidative addition of the corresponding silane to $\text{MeIr}(\text{PMe}_3)_4$.⁶⁹ On heating (**55**) in which $\text{R} = \text{OEt}$ and Ph , reductive elimination of methane forms iridasilacycles, as shown in reaction Scheme 6. The structure of compound (**55**) in which $\text{R} = \text{Ph}$ is confirmed by single-crystal diffraction studies.

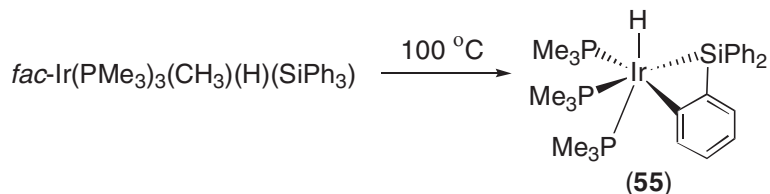

Scheme 6

The methyl analogue $\text{fac}-(\text{PMe}_3)_3\text{Ir}(o\text{-C}_6\text{H}_4\text{SiMe}_2)(\text{H})$ can also be prepared from the reaction of $\text{Ir}(\text{PMe}_3)_4\text{Cl}$ with LiSiMe_2Ph at room temperature in THF.⁵⁰⁷ Reaction of $\text{IrCl}(\text{CO})(\text{PEt}_3)_2$ with GeH_4 gives (**56**) as the major product and (**57**) as the minor product, as confirmed by ^{13}C NMR spectroscopy.⁷⁰ If SiH_3Y ($\text{Y} = \text{H}, \text{Cl}, \text{Br}, \text{I}$) is used in place of GeH_4 , then (**57**) is the only product formed. Reaction with SiH_2F_2 gives the product in which the hydride is *cis* to the SiHF_2 group.

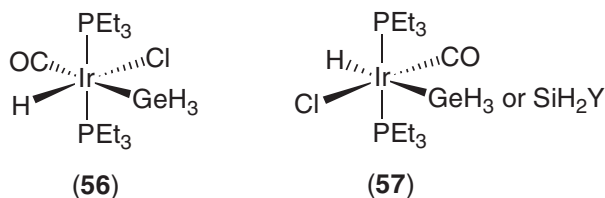

Oxidative addition of SiXRR'_2 ($\text{X} = \text{H}, \text{D}; \text{R} = \text{H}, \text{D}, \text{Cl}, \text{Ph}; \text{R}' = \text{Ph}, \text{}^t\text{Bu}$) to $\text{Ir}(\text{H})(\text{PMe}_3)_4$ yields $[\text{Ir}(\text{H})(\text{X})(\text{PMe}_3)_3(\text{SiRR}'_2)]$. The complexes with $\text{X} = \text{H}, \text{R} = \text{H}, \text{R}' = \text{Ph}$; $\text{X} = \text{H}, \text{R} = \text{Cl}, \text{R}' = \text{}^t\text{Bu}$ and $\text{X} = \text{H}, \text{R} = \text{R}' = \text{Ph}$ have been characterized by single-crystal X-ray diffraction techniques.⁷¹ $\text{Ir}(\text{H})_2(\text{SiEt}_3)(\text{cod})\text{L}$, (**58**), ($\text{L} = \text{PPh}_3, \text{AsPh}_3$) complexes are prepared from $[\text{Ir}(\text{OMe})(\text{cod})]_2$, HSiEt_3 , and L .⁷² The products are active catalyst precursors for the dehydrogenative silylation of alkenes. The complex (**58**), $\text{L} = \text{AsPh}_3$, has been characterized by X-ray diffraction.⁷³

Reaction Scheme 7 shows the synthesis of $[\text{Ir}(\text{PEt}_3)_2(\text{H})(\text{Cl})(\text{Si}(\text{}^i\text{Pr})_2\text{OH})]$, (**59**), and $[\text{Ir}(\text{PEt}_3)_2(\text{H})(\text{Cl})(\text{Si}(\text{}^i\text{Pr})_2\text{OL})]_2$, (**60**), which have been characterized by single-crystal diffraction studies.⁷⁴ (**59**) has a trigonal-bipyramidal structure with *trans* PEt_3 groups. In (**60**) the $\text{Ir}_2\text{Si}_2\text{Cl}_2\text{O}_2\text{Li}_2$ core is almost planar, with three-coordinate Li . The dinuclear compound is stable with respect to 12-crown-4, but reacts with H_2O to regenerate (**59**).

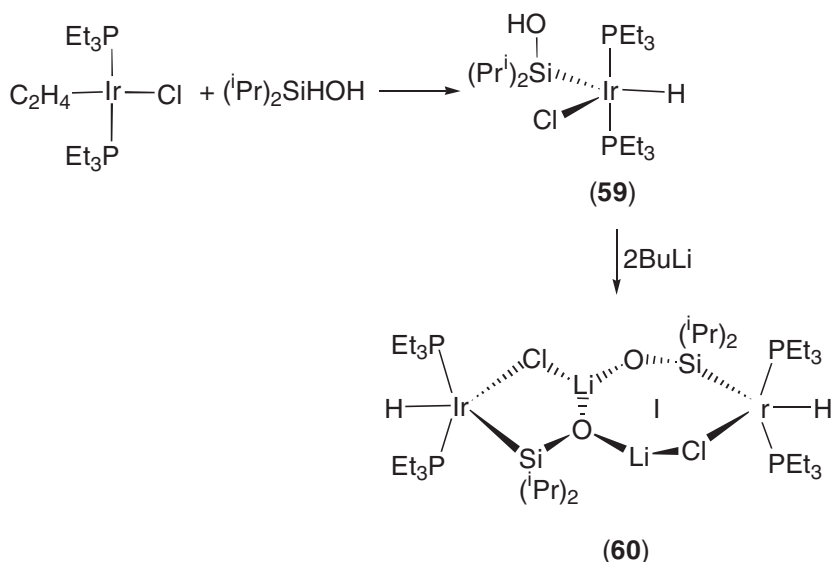

Scheme 7

The complex $[\text{IrH}_5\{\text{P}(\text{CHMe}_2)_3\}_2]$ reacts with neohexene to form $\text{IrH}\{\text{P}(\text{CHMe}_2)_3\}_2$, which undergoes an oxidative addition reaction with halo(methyl)silanes.⁷⁵ Reaction with MeSiCl_3 yields the structurally characterized species $[\text{Ir}(\text{SiCl}_2\text{Me})\text{Cl}(\text{H})\{\text{P}(\text{CHMe}_2)_3\}_2]$. The mixed-metal binuclear complex (**61**) reacts with Et_3SiH according to reaction Scheme 8.⁷⁶ Kinetic isotope studies revealed an electron-donating effect of β -deuterium on oxidative addition reactions.

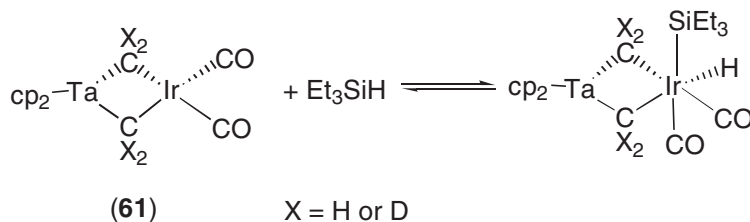

Scheme 8

6.2.5.5 Germanium Ligands

Treatment of $[\text{Ir}(\text{coe})_2\text{Cl}]_2$ with $\text{Ge}\{\text{N}(\text{SiMe}_3)_2\}_2$ leads to (**62**).⁷⁷ If the reaction proceeds in the presence of CO, then (**63**) results. Both product species have been characterized by X-ray crystallography.

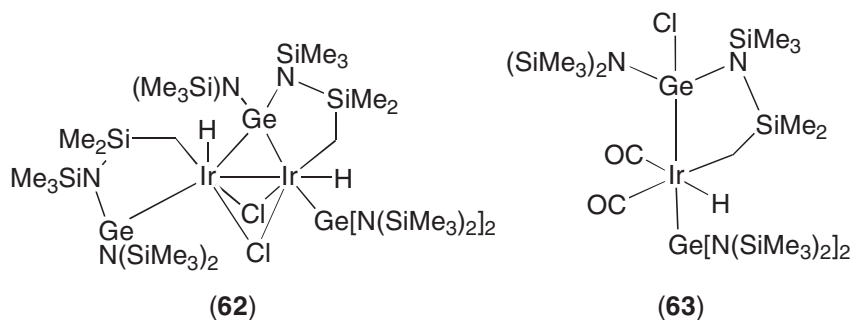

Reaction of Na_3IrCl_6 with $\text{Me}_4\text{NGeCl}_3$ in aqueous HF yields $(\text{Me}_4\text{N})_3[\text{Ir}(\text{GeF}_3)_5\text{Cl}]$.⁷⁸ Reaction of IrBr_3 with GeBr_2 in 6M HBr gives $[\text{Ir}(\text{GeBr}_3)_n\text{Br}_{6-n}]^{3-}$ ($n = 1, 2, 3$), with the species $[\text{Ir}(\text{GeBr}_3)_2\text{Br}_4]^{3-}$ labile to substitution.⁷⁹

6.2.5.6 Tin Ligands

The photocatalytic activity of $[\text{Ir}(\text{SnCl}_3)_5\text{H}]^{3-}$ in the dehydrogenation of methanol to give dimethoxymethane and dihydrogen is described.^{80,81} *Trans*- $[\text{IrClH}(\text{SnCl}_3)_4]^{3-}$ and *trans*- $[\text{IrCl}_2(\text{SnCl}_3)_4]^{3-}$ catalyze the dehydrogenation of 2-propanol via the dissociation of one SnCl_3^- ligand.⁸² The synthesis of substitutionally inert $[\text{IrBr}(\text{SnBr}_3)_5]^{3-}$ is described.^{79,83} Oxidative addition of two molar equivalents of HSnR_3 ($\text{R} = \text{Ph}, ^n\text{Bu}$) to $\text{Ir}(\text{XR}')(\text{tfb})(\text{Pcy}_3)$, $\text{XR}' = \text{OMe}, \text{OEt}, \text{O}^i\text{Pr}, \text{OPh}, \text{S}^n\text{Pr}$; tfb = tetrafluorobenzobarrelene, gives $[\text{IrH}_2(\text{SnR}_3)(\text{tfb})(\text{Pcy}_3)]$, (**64**), and $\text{R}'\text{XSnR}_3$.⁸⁴ The structure of (**64**), where $\text{R} = \text{Ph}$, has been determined by X-ray crystallography and has been shown to catalyze the addition of HSnP_3 to phenylacetylene.

6.2.5.7 Nitrogen Ligands

6.2.5.7.1 Ammine

The synthesis of chloride-free $[\text{Ir}(\text{NH}_3)_6](\text{NO}_3)_3$ from an acidic solution of IrCl_3 is detailed.⁸⁵ A high-yield preparation of $[\text{Ir}(\text{NH}_3)_6]\text{Cl}_3$ from IrCl_3 and NH_3 is reported.⁸⁶ This publication also describes procedures for the synthesis of *mer*- $[\text{Ir}(\text{NH}_3)_3\text{Cl}_3]$, *cis*- $[\text{Ir}(\text{NH}_3)_4\text{Cl}_2]\text{Cl} \cdot 1/2\text{H}_2\text{O}$,

Table 1 Rate constants and activation energies for H₂O exchange.

Complex	$K(\text{s}^{-1})$	$E_a(\text{kcal mol}^{-1})$
$\text{trans-}[\text{Ir}(\text{NH}_3)_4(\text{OH}_2)_2]^{3+}$	$k(90^\circ\text{C}) = 1.73(7) \times 10^{-6}$	693(17)
$\text{trans-}[\text{Ir}(\text{NH}_3)_4(\text{OH})(\text{OH}_2)]^{2+}$	$k(90^\circ\text{C}) = 7.6(7) \times 10^{-3}$	403(8)
$\text{trans-}[\text{Ir}(\text{NH}_3)_4(\text{OH}_2)\text{Cl}]^{2+}$	$k(60^\circ\text{C}) = 6.20(8) \times 10^{-5}$	475(55)

$\text{trans-}[\text{Ir}(\text{NH}_3)_4\text{Cl}_2]\text{Cl}\cdot\text{H}_2\text{O}$, $[\text{Ir}(\text{NH}_3)_5\text{Cl}]\text{Cl}_2$, $\text{trans-}[\text{Ir}(\text{NH}_3)_4(\text{OOCCH}_3)\text{Cl}]\text{CF}_3\text{SO}_3$, $[\text{Ir}(\text{NH}_3)_5(\text{OOCCH}_3)(\text{ClO}_4)_2]$, and $[\text{Ir}(\text{NH}_3)_5(\text{OH}_2)(\text{ClO}_4)_3]$, and their characterization by electronic and IR spectroscopy. The rate constants and activation energies for the exchange of a water ligand in 1M HClO₄ were measured as in Table 1.⁸⁷

The equilibrium reaction between $\text{cis-}[\text{Ir}(\text{NH}_3)_4(\text{OH}_2)_2]^{3+}$ and $\text{cis,cis-}[(\text{H}_2\text{O})(\text{NH}_3)_4\text{Ir}(\mu\text{-OH})\text{Ir}(\text{NH}_3)_4(\text{OH}_2)]^{5+}$ and $[(\text{NH}_3)_4\text{Ir}(\mu\text{-OH})_2\text{Ir}(\text{NH}_3)_4]^{4+}$ has been studied using spectrophotometry and IE-HPLC. Complementary studies on the en complexes are also presented.⁸⁸ The photocalorimetric (366 nm) enthalpies of aquation at 25 °C are 17.4 kcal mol⁻¹ and 2.3 kcal mol⁻¹ for $[\text{Ir}(\text{NH}_3)_5\text{X}]^{2+}$ (X = Cl⁻, I⁻), respectively.⁸⁹ The reaction of $[\text{Ir}(\text{NH}_3)_5(\text{OH}_2)(\text{ClO}_4)_3]$ in aqueous HClO₄ solution at 130–200 °C results in the release of Ir metal.⁹⁰ In alkaline solutions (0.1–0.01M NaOH), $[\text{Ir}(\text{NH}_3)_5(\text{OH}_2)]\text{Cl}_3$, $[\text{Ir}(\text{NH}_3)_5\text{X}]\text{X}_2$, and $\text{trans-}[\text{Ir}(\text{NH}_3)_4\text{X}_2]\text{ClO}_4$ (X = Cl, I) are reduced to Ir⁰ by NH₃ at 170 °C.⁹¹

Complexes (65) and (66) result from the reaction of IrCl₃ with inah and PPh₃ (inah = isonicotinic acid hydrazide).⁹² Reaction of Tröger's base (tb) (67) with IrCl₃ yields dark violet tb·2IrCl₃ (68).⁹³ (68) was not catalytically active towards the hydrosilylation of alkynes.

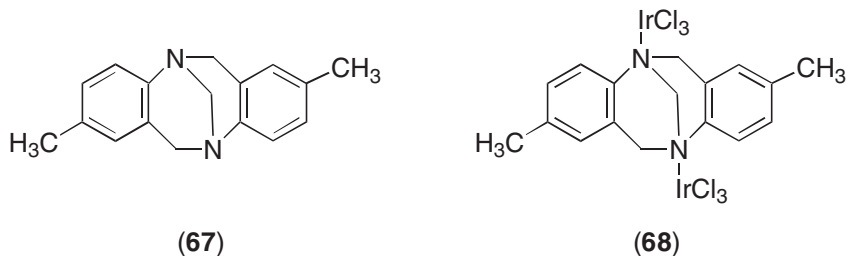
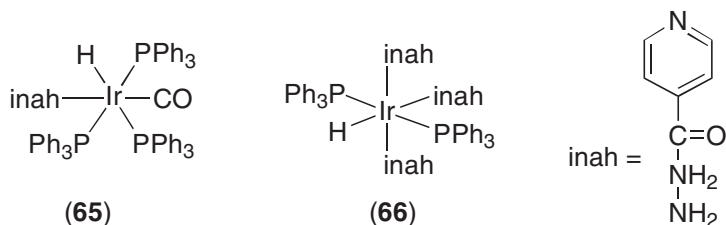

The binuclear species (69) and (70) are prepared from the reaction of $[\text{Ir}(\text{PEt}_3)_2(\text{C}_2\text{H}_4)_2\text{Cl}]$ with liquid NH₃, followed by treatment with NaBPh₄ or pyridine, respectively. Both structures are determined by X-ray crystallography and show Ir–Ir distances of 3.33 Å and 3.34 Å, respectively.⁹⁴

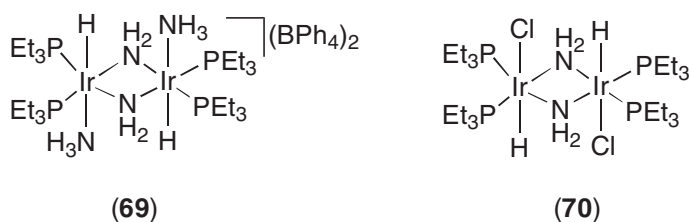

6.2.5.7.2 Nitrosyl

Reaction of $[\text{Ir}(\text{Me})_2\text{cp}^*(\text{L})]$, $\text{L} = \text{PPh}_3, \text{PMePh}_2, \text{PMe}_2\text{Ph}, \text{PMe}_3$, with NOBF_4 in CH_2Cl_2 affords $[\text{Ir}(\text{Me})_2\text{cp}^*(\text{NO})]\text{BF}_4$ and $[\text{Ir}(\text{Me})\text{cp}^*(\text{NO})\text{L}](\text{BF}_4)_2$, (**71**).⁹⁵ EPR spectroscopy shows that the reaction proceeds through the Ir^{IV} intermediate. Electrochemical or chemical reduction of (**71**) yields the EPR-active species $[\text{Ir}(\text{Me})\text{cp}^*(\text{NO})\text{L}](\text{BF}_4)$, in which the unpaired electron is partially delocalized on the Ir nucleus.

$[\text{Ir}(\text{NO})\text{Cl}_2(\text{PPh}_3)_2]$ reacts with NaSH to yield the square-pyramidal Ir^{III} complex $[\text{Ir}(\text{NO})(\text{SH})_2(\text{PPh}_3)_2]$, with a bent nitrosyl ligand⁷⁴⁷, and reaction with NaSPr^i affords the binuclear Ir^{III} species (**72**). Complex (**72**) contains two square-pyramidal Ir^{III} centers, each with a bent nitrosyl ligand. Reaction of (**72**) with benzoyl chloride gives the mixed-valent $\text{Ir}^{\text{I}}-\text{Ir}^{\text{III}}$ species $[\text{Ir}(\text{NO})(\text{PPh}_3)(\mu\text{-SPr}^i)_3\text{IrCl}_2(\text{PPh}_3)]$, characterized by X-ray diffraction.⁷⁴⁷ $[\text{Ir}(\text{NO})(\text{S-mes})_2(\text{PPh}_3)]$ converts to the structurally determined binuclear Ir^{III} complex $[\{\text{IrCl}(\mu\text{-5-C}_6\text{H}_2\text{-Me}_2\text{CH}_2)(\text{PPh}_3)\}_2(\mu\text{-mesSSmes})]$ on treatment with benzoyl chloride.⁷⁴⁷ *Trans*- $\text{Ir}(\text{mes})_2(\text{PMe}_3)_2$ reacts with NO to form the structurally characterized complex $\text{Ir}(\text{mes})_2(\text{NO})(\text{PMe}_3)_2$, with a bent IrNO moiety.⁴⁵⁶

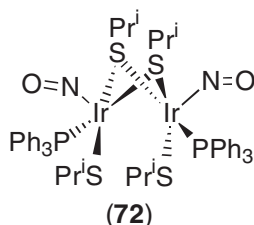

The nitrile species $[\text{Ir}(\text{NO})(\text{MeCN})_3(\text{PPh}_3)_2](\text{PF}_6)_2$ and $[\text{Ir}(\text{CO})(\text{MeCN})(\text{PPh}_3)_2]\text{PF}_6$ combine with paa, mpaa, and dppn, **L** (**73**), to give $[\text{Ir}(\text{NO})\text{L}(\text{PPh}_3)_2]^{2+}$ and $[\text{Ir}(\text{CO})\text{L}(\text{PPh}_3)_2]^+$, respectively, in which **L** is bound in a bidentate fashion.⁹⁶ The IR stretching frequencies ν_{NO} and ν_{CO} are $1,800\text{ cm}^{-1}$ and $1,900\text{ cm}^{-1}$, respectively.

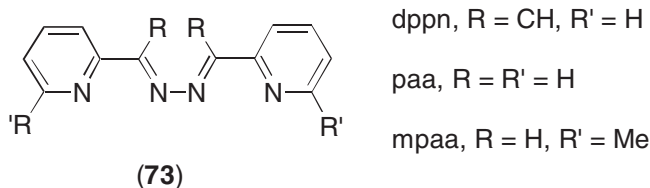

Reaction of $[\text{Ir}(\text{NO})(\text{paa})(\text{PPh}_3)_2](\text{PF}_6)_2$ with MeCN and EtOH yields the structurally determined species (**74**).^{97,98} The tridentate N_3 ligand is considered to be formed by the intramolecular insertion of NO into a methinic $\text{C}-\text{H}$ bond of the paa ligand. The OH group is strongly hydrogen bonded intramolecularly with the uncoordinated pyridyl N atom. Treatment of the linearly bonded NO species $[\text{Ir}(\text{NO})(\text{dppn})(\text{PPh}_3)_2](\text{PF}_6)_2$ ($\text{dppn} = 3,6\text{-bis}(2'\text{-pyridyl})\text{pyridazine}$) with X^- ($\text{X} = \text{Cl}, \text{I}$) affords the bent- NO -containing species $[\text{Ir}(\text{NO})\text{X}(\text{dppn})(\text{PPh}_3)](\text{PF}_6)$, which reacts with $[\text{PtCl}(\text{Me})(\text{DMSO})_2]$ or $[\text{PtI}(\text{Me})(\text{cod})]$ to give heterodinuclear (**75**), bridged by NO and dppn .⁹⁹ Nitrosoarene complexes of type (**76**) were investigated using XPS and IR spectroscopy.¹⁰⁰ The binding mode of the NO group could be identified using these techniques.

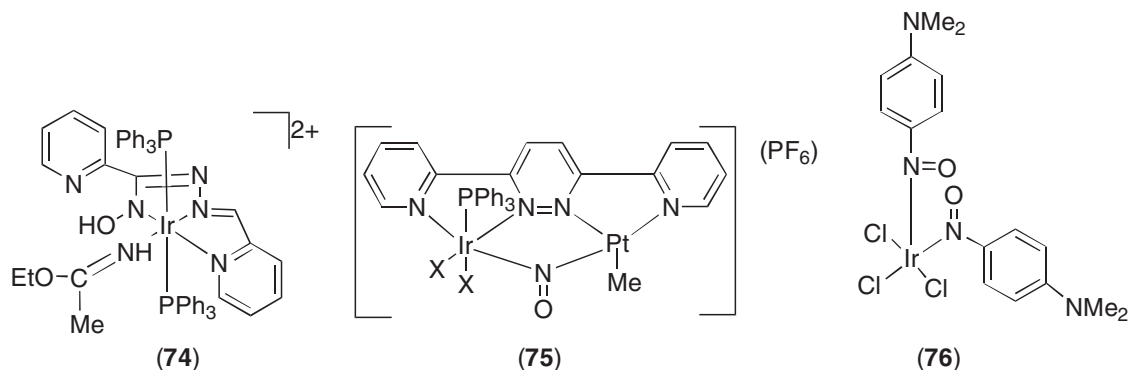

6.2.5.7.3 Nitrile

The complexes $[\text{IrXH}(\text{P}^i\text{Pr}_3)(\text{NCCH}_3)_3]\text{BF}_4$ ($\text{X} = \text{Cl}, \text{H}$) are prepared from $[\text{IrCl}(\text{coe})_2]_2$ and $[\text{Ir}(\text{OMe})(\text{cod})]_2$, and readily dissociate one CH_3CN ligand *trans* to H.¹⁰¹ Ethene inserts reversibly into the Ir—H bond, yielding $[\text{IrCl}(\text{Et})(\text{P}^i\text{Pr}_3)(\text{NCCH}_3)_3]\text{BF}_4$ and $[\text{Ir}(\text{Et})_2(\text{P}^i\text{Pr}_3)(\text{NCCH}_3)_3]\text{BF}_4$. Similar reactions occur with propene. The complexes $[\text{Ir}(\text{H})(-\text{C}\equiv\text{CPh})(\text{NCPh})(\text{CO})(\text{PPh}_3)_2]\text{ClO}_4$ and $[\text{Ir}(-\text{CH}=\text{CH}-\text{CH}=\text{CH})(\text{CO})(\text{NCMe})(\text{PPh}_3)_2]\text{ClO}_4$ were studied by X-ray absorption techniques. Ir L_{III} edge X-ray absorption spectroscopy confirmed the low-spin state of the Ir^{III} center. The bond distances, Ir—C and Ir—N, determined from EXAFS, are reciprocally proportional to the IR frequencies $\nu_{\text{C}=\text{O}}$ and $\nu_{\text{C}\equiv\text{N}}$.¹⁰²

6.2.5.7.4 Nitride

The Ir(III,IV,IV) complex $[\text{Ir}_3\text{N}(\text{SO}_4)_6(\text{OH}_2)_3]^{4-}$ undergoes ligand substitution of the three H_2O ligands with azide, Cl^- , Br^- , and NCS^- . The three H_2O ligands, one on each metal, are all equivalent towards substitution.¹⁰³ The rate constant for the reaction with azide is $17.3 \times 10^{-4} \text{ M}^{-1}\text{s}^{-1}$.

The monomeric terminal imido complexes cp^*IrNR ($\text{R} = \text{}^t\text{Bu}, \text{SiMe}_2\text{}^t\text{Bu}, 2,6\text{-Me}_2\text{C}_6\text{H}_3, 2,6\text{-}^i\text{Pr}_2\text{C}_6\text{H}_3$) were prepared from $[\text{cp}^*\text{IrCl}_2]_2$ and four equivalents of LiNHR in THF.¹⁰⁴ All four product species were structurally characterized by X-ray diffraction and exhibit short Ir—N distances (1.712(7)–1.759(3) Å) and nearly linear Ir—N—C (Si) angles. Some reactions of $\text{cp}^*\text{IrN}^t\text{Bu}$ are highlighted in Reaction Scheme 9. Complexes (77) and (78) have been studied by single-crystal X-ray diffraction.

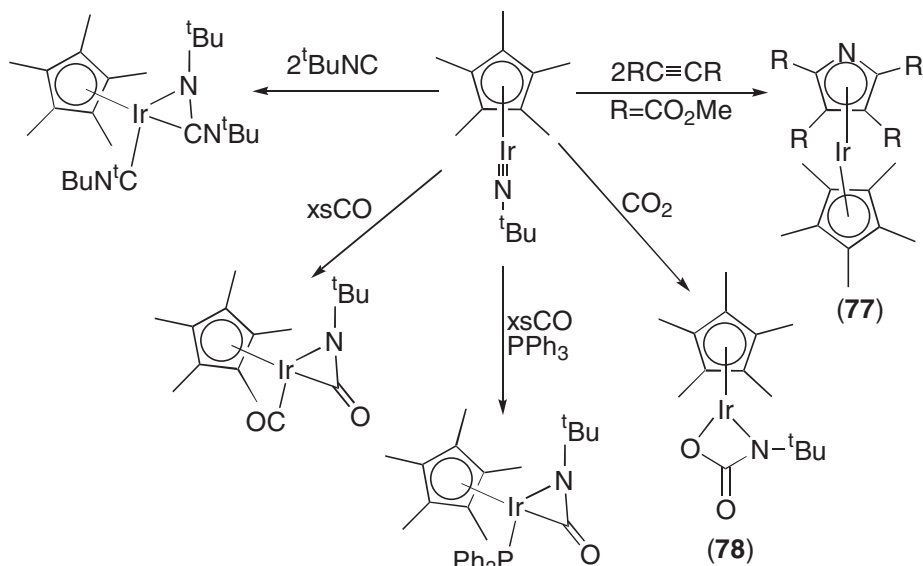

Scheme 9

6.2.5.7.5 Urea

The structure of $[\text{Ircp}^*(\text{PPh}_3)\text{N}(\text{Me})\text{C}(\text{O})\text{NC}(\text{O})\text{Me}]$, (79), has a piano-stool-type configuration.¹⁰⁵ The two N—C bond lengths in the iridacycle are 1.348(5) Å and 1.413(5)* Å, the difference arising from the different substituents on the N atoms.

6.2.5.7.6 Nitrite

The rate-limiting step in Reaction Scheme 10 was determined to be conversion of *trans*- $[\text{Ir}(\text{NO}_2)_4\text{Cl}_2]^{3-}$ to $[\text{Ir}(\text{NO}_2)_6]^{3-}$. The kinetics were studied gravimetrically between 80 °C and 126 °C.³⁵⁵ Addition of Cu^{2+} ions to the solution had a positive effect on the formation

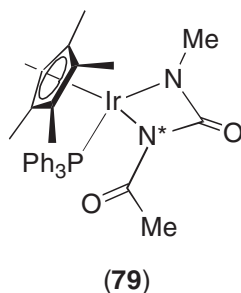

of $[\text{Ir}(\text{NO}_2)_6]^{3-}$, whereas Ni^{2+} , Fe^{3+} , and Al^{3+} all had negative effects.¹⁰⁷ *Fac*- $[\text{Ir}(\text{NO}_2)_3(\text{OH}_2)_3]$ and $[\text{Ir}(\text{NO}_2)_3\text{Cl}_3]$ have been characterized by UV-vis, IR, and ^{15}N NMR spectroscopy.¹⁰⁸ The complex $[\text{Ir}(\text{NO}_2)_6]^{3-}$ may be precipitated by $\{\text{C}_5\text{H}_5\text{N}(\text{CH}_2)_{15}\text{CH}_3\}\text{Cl}$ but not by AgNO_3 , whereas $[\text{Ir}(\text{CN})_6]^{3-}$ is precipitated by both species.¹⁰⁹

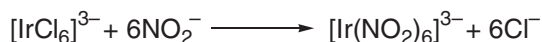

Scheme 10

6.2.5.7.7 Cyanide

Heating the double salts $[\text{Ir}(\text{OH}_2)(\text{NH}_3)_5][\text{Cr}(\text{CN})_5\text{X}]$ ($\text{X} = \text{CN}, \text{NO}$) under N_2 results in expulsion of H_2O and formation of $[(\text{NH}_3)_5\text{IrNCCr}(\text{CN})_4\text{X}]$. Thermogravimetric measurements yield activation energies of $5576.5 \pm 21 \text{ kcal mol}^{-1}$ and $536.8 \pm 21 \text{ kcal mol}^{-1}$ for $\text{X} = \text{CN}$ and NO , respectively, and indicate an $\text{S}_{\text{N}}1$ dissociative mechanism.¹¹⁰ Analogous studies on $[\text{Ir}(\text{NH}_3)_5(\text{OH}_2)_2][\text{M}(\text{CN})_4]_3$ ($\text{M} = \text{Ni}, \text{Pd}, \text{Pt}$) give activation energies of 452.3, 496, and $387.2 \text{ kcal mol}^{-1}$ for Ni, Pd, and Pt, respectively.¹¹¹

The mixed-metal complexes $\text{M}_3[(\text{M}'\text{Ir}^{\text{III}}(\text{CN})_6)_2 \cdot 13\text{H}_2\text{O}]$ ($\text{M} = \text{Cd}^{2+}, \text{Pd}^{2+}, \text{M}' = \text{Cr}^{3+}; \text{M} = \text{Co}^{2+}, \text{M}' = \text{Co}^{3+}$) are characterized by X-ray crystallography, IR spectroscopy, and thermal gravimetric analyses. The 3+ metal centers are octahedral and linked to M^{2+} metals by cyanide bridges.¹¹²

6.2.5.7.8 Pyridine

The complexes $[\text{Ircp}^*(\text{Cl})_2\text{L}]$ ($\text{L} = \text{py}, 2,3,4\text{-methyl pyridine}, 3,4\text{-ethylpyridine}$) have been prepared and characterized by IR spectroscopy.¹¹³ The synthesis of *trans*- $[\text{Ir}(4\text{-X-py})_4\text{Cl}_2]\text{NO}_3$, $\text{X} = \text{H}, \text{Me}$, is described and the structure of *trans*- $[\text{Ir}(\text{py})_4\text{Cl}_2] \cdot \text{Ag}(\text{NO}_3)_2$ is reported.¹¹⁴ Two distinct crystalline dimorphs of *fac*- $[\text{Ir}(\text{py})_3\text{Cl}_3]$ have been identified by their IR spectra and powder diffraction patterns.¹¹⁵ In solution, one converts irreversibly to the other. Reaction of *trans*- $[\text{Ir}(\text{py})_4\text{Cl}_2]\text{Cl}$ with $\text{K}_2\text{C}_2\text{O}_4$ in aqueous ethanol yields the structurally characterized complex *mer*- $[\text{Ir}(\text{py})_3\text{Cl}(\text{C}_2\text{O}_4)]$, which converts to *mer*- $[\text{Ir}(\text{py})_3\text{Cl}_3]$ on recrystallization from boiling conc. HCl .¹¹⁶

6.2.5.7.9 Phthalimide

The complexes *fac*- $[\text{IrL}_3\text{X}(\text{OH}_2)]$, $\text{HL} = \text{phthalimide}, \text{X} = \text{bpy}, \text{phen}$, have been prepared and characterized by IR and UV-vis spectroscopy, electronic conductance and magnetic measurements.¹¹⁷

6.2.5.7.10 Imidazole

The complex $[\text{imH}][\text{IrCl}_4(\text{im})_2]$, $\text{imH} = \text{imidazole}$, is prepared by the reaction of either H_2IrCl_6 or IrCl_3 with imidazole and HCl .¹¹⁸ X-ray diffraction confirmed the *trans* geometry around the Ir center and showed that the im ligands are nearly perpendicular to one another (84°). The complex is stable in aqueous solution $\text{pH} = 7.4$, as confirmed by ^1H NMR studies.

The synthesis of (**80**) from $[\text{Ircp}^*\text{Cl}_2]_2$ and 2,2'-biimidazole has been detailed.¹¹⁹ The X-ray structure of (**80**) shows the expected three-legged piano-stool arrangement round the Ir center.

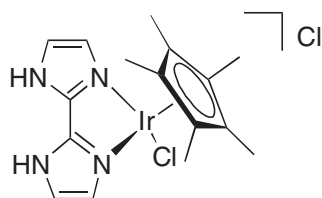

(80)

6.2.5.7.11 Pyrazole

The syntheses of $[\text{cp}^*\text{Ir}(\text{Cl})_2(\text{pz})\text{Rh}(\text{tfb})]$, $[\text{cp}^*\text{Rh}(\text{Cl})_2(\text{pz})\text{Ir}(\text{tfb})]$, and $[\text{cp}^*\text{IrCl}(\text{pz})_2\text{Rh}(\text{tfb})]$ have been reported; these complexes contain $\text{Ir}^{\text{III}}/\text{Rh}^{\text{I}}$, $\text{Rh}^{\text{III}}/\text{Ir}^{\text{I}}$, and $\text{Ir}^{\text{III}}/\text{Rh}^{\text{I}}$, respectively.¹²⁰

The acetone ligand in $[\text{IrH}_2(\text{Me}_2\text{CO})(\text{Hpz})(\text{PPh}_3)_2]\text{BF}_4$, (**81**), can be replaced by CO, $\text{P}(\text{OMe})_3$, CH_3CN , or Hpz.¹²¹ The reaction of $[\text{IrH}_2(\text{Hpz})_2(\text{PPh}_3)_2]\text{BF}_4$ with KOH yields $[\text{IrH}_2(\text{pz})(\text{Hpz})(\text{PPh}_3)_2]$, from which the pz ligand can be replaced by Cl^- or CH_3COO^- . Treatment of (**81**) with KOH affords $[\{\text{IrH}_2(\mu\text{-pz})(\text{PPh}_3)_2\}_2]$, which gives $[\text{IrH}_2(\text{Hpz})(\text{PPh}_3)_2]\text{BF}_4$ on addition of HBF_4 in diethyl ether. All species are characterized by ^1H and $^{31}\text{P}\{^1\text{H}\}$, NMR, and IR spectroscopy.

The Ir^{III} cationic pyrazole derivative $[\text{Ir}(\text{PPh}_3)_2(\text{CO})(\text{dmpzH-N})(\text{H})_2]\text{BF}_4$ has been characterized by X-ray crystallography, and shows a roughly octahedral Ir^{III} center with *trans* P ligands and *cis* H ligands.⁵³²

6.2.5.7.12 Chelate-ethylenediamine

The crystal structures of *mer*- $[\text{Ir}(\text{en})(\text{enH})\text{Cl}_3]\text{Cl}\cdot\text{H}_2\text{O}$ and *mer*- $[\text{Ir}(\text{en})(\text{en}^*)\text{Cl}_3]$ show that the coordination geometry of Ir is almost identical in the two complexes, with the only difference being in the conformation of the unidentate en^* and enH^+ groups.¹²² Density functional theory and *ab initio* calculations have been performed on the two complexes and the calculated conformations agree well with the X-ray diffraction values.¹²³ The enH^+ ligand is stabilized via intramolecular $\text{N}-\text{H}\cdots\text{Cl}$ hydrogen bonds.

The complexes $[\text{Ir}(\text{en})]^{3+}$ and $[\text{Ir}(\pm)\text{chxn}]_3^{3+}$, $\text{chxn} = \text{trans-1,2-diaminocyclohexane}$, can be used as structure-directing agents in the synthesis of aluminophosphates.¹²⁴ The compound $[\text{Ir}(\text{chxn})_3][\text{Al}_2\text{P}_3\text{O}_{12}]$ contained the two isomers $\Lambda(\text{lel}_2\text{ob})-[\text{Ir}(\text{S,S-chxn})_2(\text{R,R-chxn})]^{3+}$ and its mirror image $\Delta(\text{lel}_2\text{ob})-[\text{Ir}(\text{R,R-chxn})_2(\text{S,S-chxn})]^{3+}$, whereas $[\text{Ir}(\text{en})_3][\text{Al}_3\text{P}_4\text{O}_{16}]$ is composed of $\Delta, \Lambda-[\text{Ir}(\text{en})_3]^{3+}$ only. Crystallization of a racemic mixture of $[\text{Ir}(\text{en})_3]^{3+}$ from water gave an excess of the (+) enantiomer.¹²⁵

The reaction of $[\text{Ircp}^*\text{Cl}_2]_2$ with dab, dab = 1,4-bis(2,6-dimethylphenyl)-1,4-diaza-1,3-butadiene, in MeOH yields $[\text{Ircp}^*\text{Cl}(\text{dab})](\text{PF}_6)$, (**82**), on addition of Bu_4NPF_6 .¹²⁶ Reduction of (**82**) with NaBH_3CN affords $[\text{Ircp}^*(\text{dab})]$, (**83**). X-ray diffraction studies on (**82**) and (**83**) reveal that (**83**) is better considered as an ene-1,2-diamido Ir^{III} species.

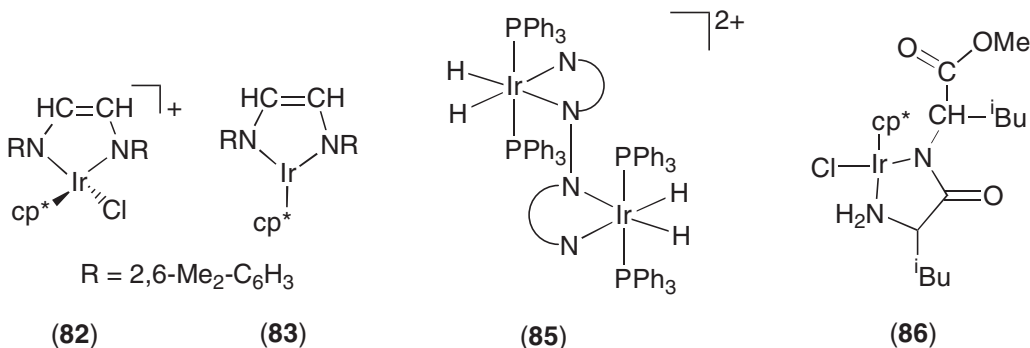

(82)

(83)

(85)

(86)

Treatment of $[\text{IrH}_2(\text{Me}_2\text{CO})_2(\text{PPh}_3)_2]\text{X}$, $\text{X} = \text{PF}_6, \text{SbF}_6$, with L , $\text{L} = \text{paa}$ or mpaa yields the mononuclear species $[\text{IrH}_2\text{L}(\text{PPh}_3)_2]\text{X}$, (**84**).¹²⁷ The X-ray structure of (**84**), $\text{L} = \text{mpaa}$, $\text{X} = \text{SbF}_6$, reveals the PPh_3 ligands in a *trans* position and *cis* hydrido ligands. Further reaction of (**84**) with $[\text{IrH}_2(\text{Me}_2\text{CO})_2(\text{PPh}_3)_2]\text{X}$ affords the binuclear species $[\{\text{IrH}_2(\text{PPh}_3)_2\}_2(\mu\text{-N-N})]\text{X}_2$, (**85**), and reaction with $\text{CuCl}_2 \cdot 2\text{H}_2\text{O}$, $[\text{PdCl}_2(\text{PhCN})_2]$, or $[\text{PtMe}_2(\text{DMSO})_2]$ gives the heterobimetallic complexes. All species are characterized by elemental analysis, conductivity measurements, IR and ^1H and ^{31}P NMR spectroscopy.

The tris chelate compounds $[\text{Ir}(\text{ArNNNAr})_3]$, $\text{Ar} = p\text{-C}_6\text{H}_4\text{X}$, $\text{X} = \text{H}, \text{Me}, \text{Cl}$, were prepared from $(\text{NH}_4)_2\text{IrCl}_6$ and excess 1,3-diaryltriazene and Et_3N .¹²⁸ The intensely colored compound formed from the reaction of Ir^{III} with dbpmp , $\text{dbpmp} = 3,5\text{-dibromopyridinylazo-5-methoxyphenol}$, and salicylic acid, $\lambda_{\text{max}} = 588 \text{ nm}$ ($\epsilon = 1.96 \times 10^5 \text{ L mol}^{-1} \text{ cm}^{-1}$), has been used for Ir detection in compounds and metal ores.¹²⁹ The kinetic and mechanistic studies of H_2O substitution at $[\text{Ircp}^*(\text{A-B})(\text{OH}_2)]^{2+/1+}$ ($\text{A-B} = \text{D/L-proline anion, picolinic acid anion, } [(-)(1R,2R)\text{-1,2-diaminocyclohexane}][(+)(1R,2R)\text{-1,2-diphenylethylenediamine}], \text{phen, bpy}$) support an I_{d} mechanism with a second-order rate constant dependent on A-B and incoming ligand L , $\text{L} = \text{py}$, dimethyl sulfide thiourea Br^- , I^- , N_3^- , NO_2^- , SCN^- .¹³⁰ The structure of the perchlorate salt of the complex, where $\text{A-B} = 1,2\text{-diaminocyclohexane}$, is reported.

The crystal structure of chloro-pentamethylcyclopentadienyl-*S*-leucyl-*S*-leucyl methyl ester-iridium(III), (**86**), indicates that the $\text{Ir-N}(\text{NH}_2\text{-linkage})$ is longer (2.129 Å) than that to the deprotonated peptide N atom (2.090 Å).¹³¹

6.2.5.7.13 α -diimine

Reaction of $[\text{Ircp}^*\text{Cl}_2]_2$ with chiral imine ligands and NaSbF_6 gives diastereomeric mixtures of $[\text{cp}^*\text{IrCl}(\text{imine})](\text{SbF}_6)$, imine ligands $\text{L}_1\text{--L}_6$ (**87**).¹³² The X-ray structures of the complexes of L_1 , L_2 , and L_3 are reported and contain the metal center in a pseudo-octahedral environment. Addition of AgSbF_6 yields the solvated complexes on precipitation of AgCl ; these are active Diels–Alder catalysts. A similar reaction between $[\text{Ircp}^*\text{Cl}_2]_2$ and NN^*H or ON^*H (**88**) affords the chiral complexes $[\text{Ircp}^*(\text{NN}^*)\text{Cl}]$ and $[\text{Ircp}^*(\text{ON}^*)\text{Cl}]$, respectively.¹³³ The structures of the $\text{R}_{\text{M}}, \text{S}_{\text{C}}$ diastereomers is given. In solution, the compounds epimerize in a first-order reaction.

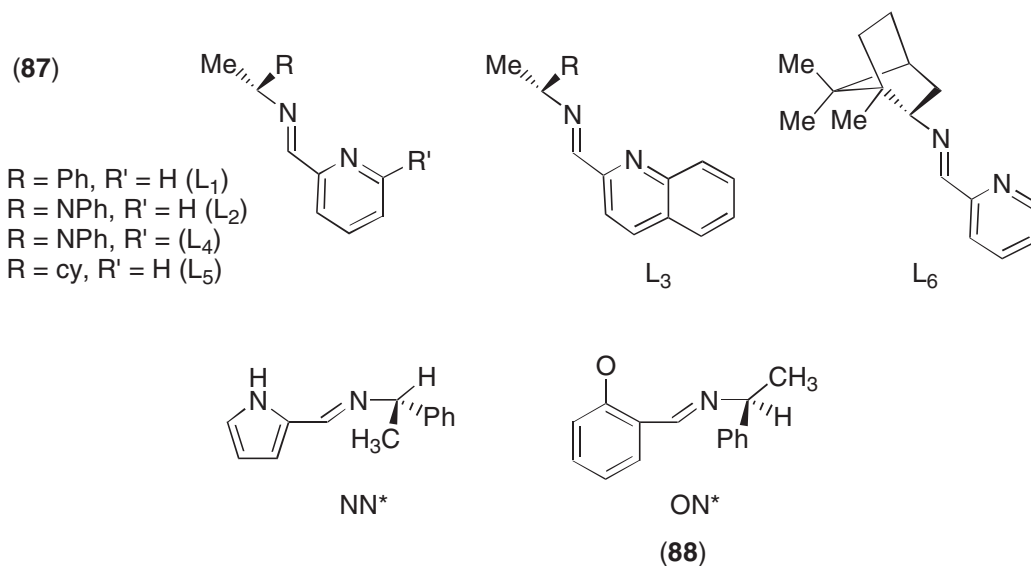

Derivatives of bpy and phen are the most common α -diimine ligands for Ir^{III} . A review by Sauvage, Barigelletti *et al.* in 2000 concentrates on the synthesis and luminescent properties of such compounds, including bidentate and tetradentate ligands with both N and C donor sites.¹³⁴ The emissive states are either charge transfer or ligand centered, depending on the ligand set. $[\text{IrN}_6]^{3+}$ complexes are found to be strong photooxidants, while the tris-cyclometalated $[\text{IrN}_3\text{C}_3]$ complexes are strong photoreductants.

The synthesis and characterization of *cis*- $[\text{Ir}(\text{diimine})(\text{hdpa})\text{Cl}_2]\text{Cl}$, diimine = bpy , phen , $\text{hdpa} = 2,2'\text{-dipyridylamine}$, is reported.¹³⁵ Emission studies suggest that it is the $\text{Ir}(\text{diimine})$

chromophore which is responsible for the phosphorescent behavior. The microwave-assisted synthesis and characterization (spectroscopic and electrochemical) of $[\text{Ir}(\text{diimine})_3]^{3+}$ and $[\text{Ir}(\text{diimine})_2\text{Cl}_2]^+$, diimine = bpy, 4,4'-Me₂-bpy, 4,4'-Ph₂-bpy, phen, 4,7-Ph₂-phen, 2,2'-biquinoline, is described.¹³⁶

Complexes (89) and (90) emit around 520 nm, with (90) having the greater emission intensity.¹³⁷ Emission is quenched by Cl⁻, Br⁻, and I⁻ ions, but not by NO₃⁻, SO₄²⁻, H₂PO₄⁻, PF₆⁻, or BF₄⁻ ions.

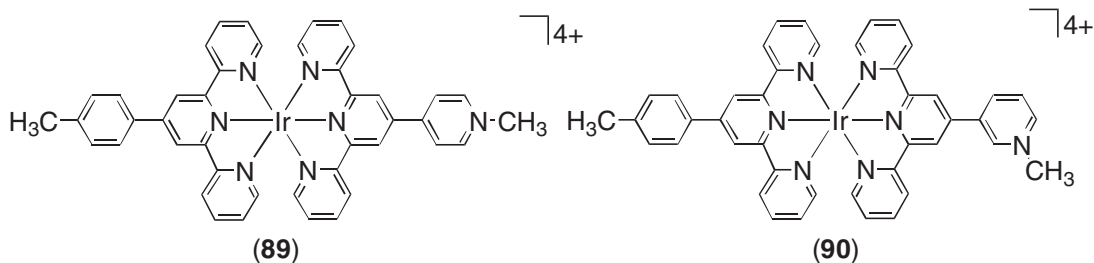

The synthesis of $[\text{Ircp}^*\text{Cl}(\text{bpy-cd})]\text{Cl}$, where bpy-cd is a β -cyclo-dextrin attached at the 6 position to a bpy ligand, is detailed.¹³⁸ The complexes $[\text{Ircp}^*(\text{diimine})\text{X}]^+$, X = Cl, H, diimine = bpy, phen, are active catalysts for the light-driven water-gas-shift reaction.¹³⁹ The hydride complexes luminesce at 77 K and room temperature, whereas the chloride complexes do not.¹⁴⁰ The three-legged piano-stool arrangement of the ligands in $[\text{Ircp}^*(\text{bpy})\text{Cl}]^+$ and $[\text{Ircp}^*(4,4'\text{-COOH-bpy})\text{Cl}]^+$ is confirmed by X-ray crystallography.^{141,142} Further mechanistic studies on the catalytic cycle shown in reaction Scheme 11 indicate that Cl⁻ is substituted by CO and the rate-determining step involves loss of CO₂ and H⁺ to leave the Ir^I species, which readily binds H⁺ to yield the Ir^{III}-hydride species.¹⁴³

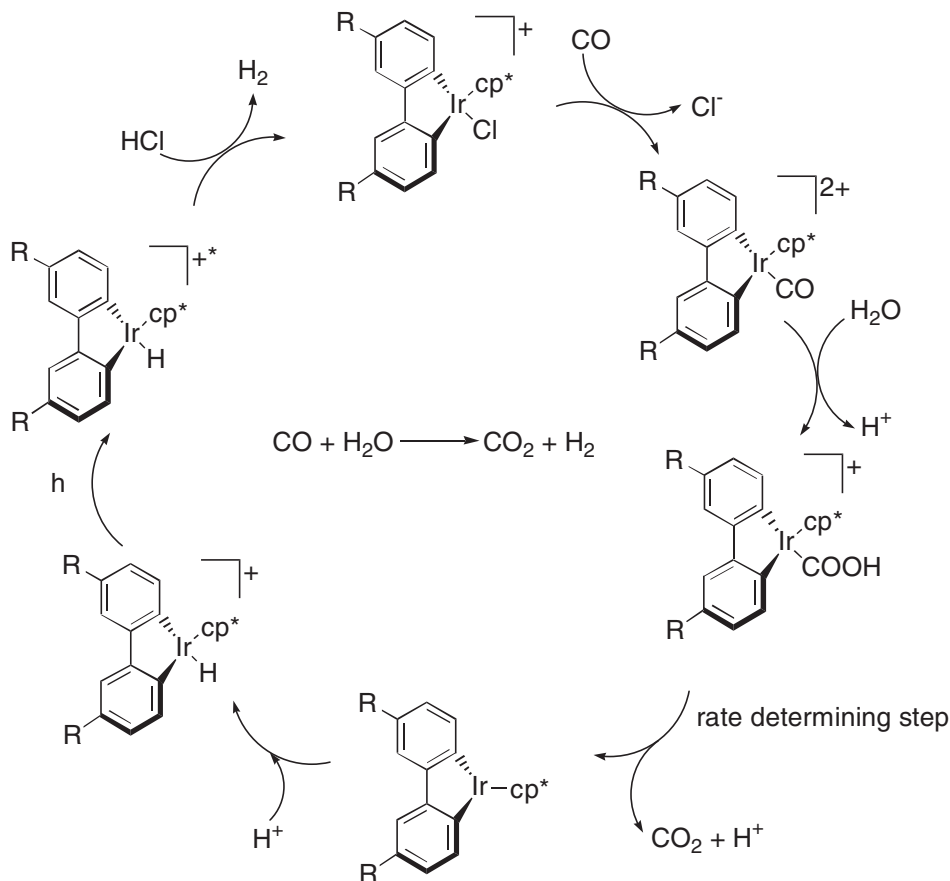

Scheme 11

Photoactivation of the hydride complex in the presence of HCl results in the release of H₂ and generation of the starting material. Extension of this work includes the electrochemical study of the Ir^{III/I} reduction process in [Ircp*LCl]⁺, L = bpy and phen derivatives, in anhydrous CH₃CN. When pyrrole-substituted bpy or phen ligands are used, then films may be grown on glassy carbon electrodes via oxidative polymerization reactions. The polymer films are electrocatalytically active in the hydrogen-generation process.¹⁴⁴

[IrL₂Cl₂]⁺ complexes, L = 4,4'-Me₂-bpy, bipyrimidine, biquinoline, 2-phenylazopyridine, have been studied by fast-atom bombardment mass spectroscopy in thioglycerol, glycerol, and tetraglyme matrices.¹⁴⁵ One or two chloride ligands are substituted by thioglycerol ligands in a thioglycerol matrix.

The functionalized polypyridine ligands (**91**) have been used to form a series of Ir^{III} complexes of general formula [Ir(ppy)₂(**91**)]⁺, (**92**), where ppy = monoanion of 2-phenylpyridine, (**170**).¹⁴⁶ The crystal structures of (**92**), where (**91**) = d and i, are reported.^{146,147} The complexes have an irreversible oxidation process primarily based on Ir—C σ-bonds, and a reversible reduction process primarily based on the polypyridine ligand. The redox and absorption properties are insensitive to X, whereas the luminescence properties may be fine-tuned by varying X.¹⁴⁶ Direct binding of the substituent X onto the pyridine ring, as in (**91e**), results in absorption maxima shifts as well as luminescence shifts.¹⁴⁸ Binuclear complexes [(ppy)₂Ir(μ-(L-OC(O)C₆H₄C(O)O-L)Ir(ppy)₂)(PF₆)₂], [(ppy)₂Ir(μ-L-OC(O)-L(ppy)₂)(PF₆)₂] and [(ppy)₂Ir(μ-L-OC(O)-L)Re(CO)₃Br]BF₆, where L = (**91k**), have also been synthesized and characterized.¹⁴⁹ The redox behavior of the binuclear compounds indicates that the metal-based orbitals interact only weakly, but the two chelating halves of the bridging ligands exhibit electronic interactions. Photo-induced energy transfer across the ester linkage occurs with low efficiency.¹⁴⁹

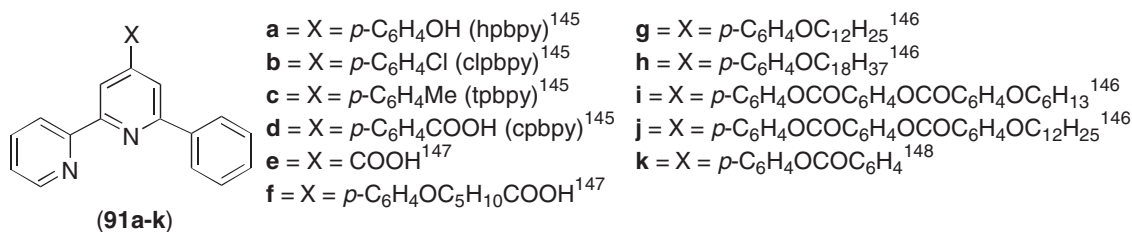

Determination of stability constants towards outer-sphere association reactions for *cis*-[Ir(phen)₂Cl₂]X, X = Cl⁻, Oac⁻, HCOO⁻, gives the following decreasing order: Cl⁻ > Oac⁻ > HCOO⁻.¹⁵⁰

The maximum zero-field splitting in the ligand-centered luminescence of [Ir(5,6-Me₂-phen)₂Cl₂]⁺ in glycerol is 3 ± 0.5 cm⁻¹, compared to <1 cm⁻¹ for [Ir(phen)₃]³⁺.¹⁵¹

The solution structure of [Ir(bpy)H₂(PRPh₂)₂]X, R = Me, Ph, X = PF₆, BF₄, CF₃SO₄, BPh₄, as determined from NMR studies, is compared to solid-state structure.¹⁵² The main difference between the two structures is the location of the counter ion X. In solution, X is positioned on the side of the bpy ligand remote from the Ir, whereas in the solid state X is found close to one of the pyridine rings and one hydride ligand. Theoretical calculations at the QM/MM (B3PW91/UFF) level support the experimental results.

The complex [(cp*)IrCl(2,2'-bpy-4,4'-COO(CH₂)₃-pyrrole)]ClO₄ has a typical three-legged piano-stool structure, with short Ir—cp* distances due to the strong π-acceptor properties of the bpy ligands.⁵⁴⁰

6.2.5.7.14 Binuclear complexes

The binuclear Ir complex (**93**) is produced from the direct coupling reaction of the Ir-bound 5-chloro-phen ligand as shown in reaction Scheme 12.¹⁵³ The nonplanar structure of the bridging ligand results in the electronic isolation of the two Ir centers. Hence both metal centers and ligands are oxidized and reduced, respectively, in two-electron processes.

Amido-bridged binuclear complexes of Ir^{III} and Ir^{II} are prepared by Reaction Scheme 13.¹⁵⁴ The molecular structures of (**94**) (R = Me) and (**95**) are reported. Dark red (**95**) has a single Ir—Ir bond (2.584(1) Å) and is diamagnetic.

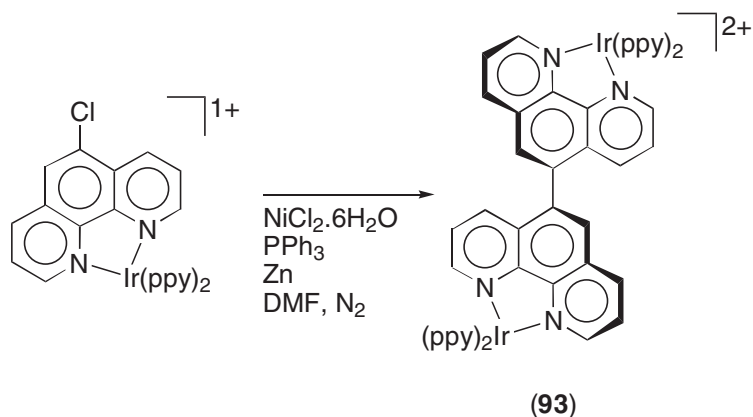

Scheme 12

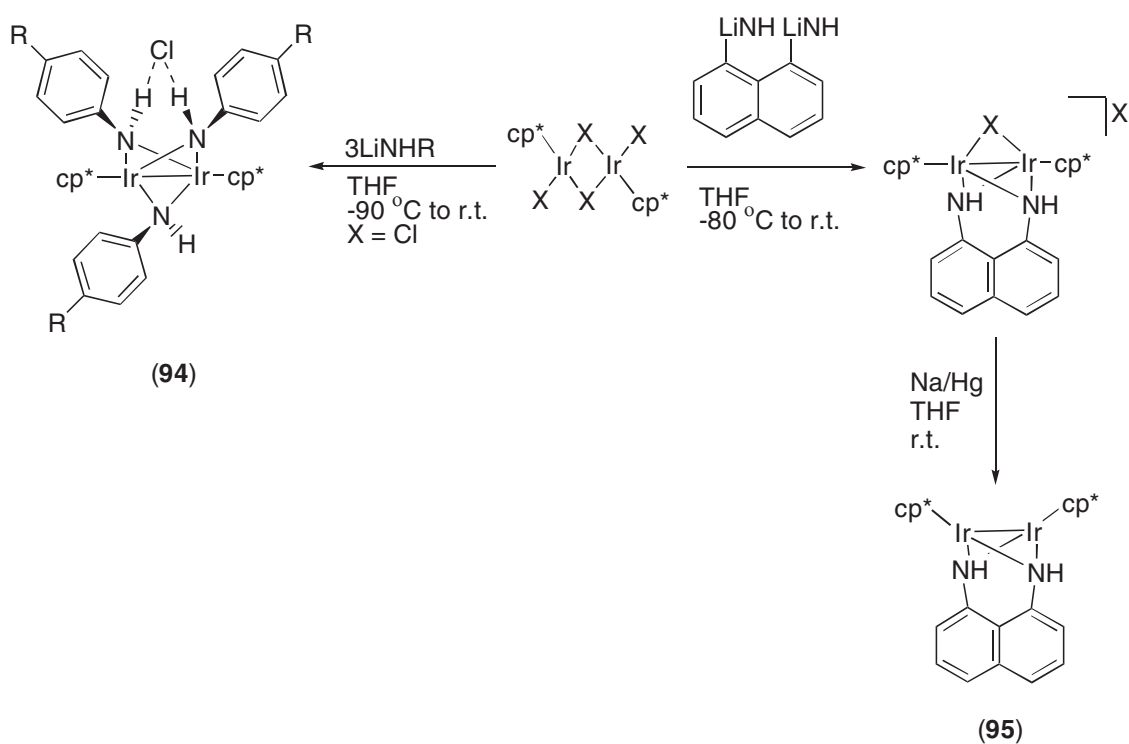

Scheme 13

The reaction of *fac*-[IrH₂(NCCH₃)₃(PⁱPr₃)]BF₄ with Kp_z gives [Ir₂(μ-H)(μ-pz)₂-H₃(NCCH₃)(PⁱPr₃)₂], **(96)**, which has been characterized by single-crystal X-ray diffraction.¹⁵⁵ The complex is rigid on the NMR timescale. The CH₃CN ligand is easily replaced by C₂H₄, CO, Hp_z. Reaction of **(96)** with CHCl₃ gives CH₂Cl₂ and [Ir₂(μ-H)(μ-pz)₂H₂Cl(NCCH₃)(PⁱPr₃)₂]. The bridged Ir₂ bis[imidazol-4-yl]alkene compounds **(97)** are obtained from the reaction of [cp*IrCl₂]₂ with the CH₂-bridged bis-imidazoles.¹⁵⁶

6.2.5.7.15 N₃ ligands

Reaction of dien, dien = diethylene-triamine, with IrCl₃·1.5H₂O yielded [Ir(dien)₂]Cl₃.¹⁵⁷ Separation of the *mer*-isomer was effected by chromatography on SP-Sephadex, with an X-ray structure

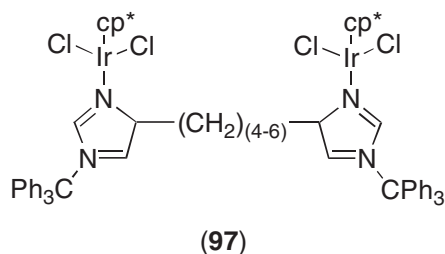

determination confirming the geometric form of the isolated species. Protonation of $[\text{Ir}(\text{HBpz}^*_3)(\text{CO})_2]$, $\text{pz}^* = 3,5\text{-dimethylpyrazol-1-yl}$, by $\text{HBF}_4 \cdot \text{OEt}_2$ affords $[\text{Ir}(\eta^3\text{-HBpz}^*_3)(\text{H})(\text{CO})_2]\text{BF}_4$, (**98**).¹⁵⁸ NaOMe and $^t\text{BuLi}$ attack a carbonyl carbon of (**98**), giving the methoxy-carbonyl and acyl hydrides, respectively. Photolysis of a benzene solution of $[\text{IrH}_2(\text{HBpz}^*_3)(\text{coe})]$ in the presence of $\text{P}(\text{OMe})_3$ gives $[\text{Ir}(\text{HBpz}^*_3)(\text{H})(\text{C}_6\text{H}_5)(\text{P}(\text{OMe})_3)]$.¹⁵⁹ When the reaction is carried out in diethyl ether or *tert*-butyl acrylate, then $[\text{Ir}(\text{HBpz}^*_3)\text{H}_2(\text{P}(\text{OMe})_3)]$ and $[\text{Ir}(\text{HBpz}^*_3)\text{H}_2(\text{CH}_2=\text{CHCO}^t\text{Bu})]$ result, respectively. Mechanistic studies suggest that the primary photoproduct is $[\text{Ir}(\text{HBpz}^*_3)\text{H}_2]$.

Combined Mössbauer and vibrational spectroscopic studies of $[\text{Ir}(\text{tpy})_2](\text{ClO}_4)_3$, $\text{tpy} = 2,6\text{-bis}(2\text{-pyridyl})\text{pyridine}$, in the solid state reveal the presence of three structural units: (i) mononuclear bis-tpy; (ii) oligomeric species with two bidentate and two bridging monodentate tpy ligands bound through terminal pyridine rings; and (iii) the same as (ii), except that the monodentate tpy ligands are bound through the central *N*-pyridine atoms.¹⁶⁰ The X-ray structure of $[\text{Ir}(\text{tpy})_2](\text{PF}_6)_3$ is reported.¹⁶¹ The family of complexes $[\text{Ir}(\text{tpy})_2](\text{PF}_6)_3$, $[\text{Ir}(^t\text{Bu-tpy})_2](\text{PF}_6)_3$, $[\text{Ir}(\text{tpty})_2](\text{PF}_6)_3$, and $[\text{Ir}(\text{tpty})(\text{Metpy})](\text{PF}_6)_3$, $^t\text{Butpy} = 4'-(3,5\text{-di-}^t\text{butylphenyl})\text{tpy}$, $\text{tpty} = 4'\text{-tolyltpy}$, $\text{Metpy} = 4'\text{-methyltpy}$, have long-lived excited states, 1.2, 6.8, 9.5, 5.8 μs , respectively, at 293 K in deaerated acetonitrile.¹⁶⁰ The complexes all show a ligand-based reduction. Linkage of a tetraaryl-porphyrin group containing H_2 , PH_2 , Au , PAu or Zn , PZn at the 4'-position of tpy gives rise to multicomponent arrays $\text{PH}_2\text{-Ir}$, PZn-Ir-PAu , where Ir is the $[\text{Ir}(\text{tpy})_2]^{3+}$ moiety.¹⁶² The triad PZn-Ir-PAu yields on irradiation the charged, separated, excited state $\text{PZn}^+\text{-Ir}^-\text{-PAu}$, which has a lifetime of 450 ns. The complexes $[\text{Ir}(\text{tpy-R})(4'\text{-C}_6\text{H}_4\text{-NCS-}p\text{-tpy})](\text{PF}_6)_3$, $\text{R} = \text{H}$, C_6H_5 , $\text{C}_6\text{H}_4\text{-CH}_3\text{-}p$, $\text{C}_6\text{H}_4\text{-Cl-}p$, have been synthesized.¹⁶³ All complexes exhibit intense, long-lived, yellow emission in CH_3CN at 298 K, and green emission in low-temperature alcohol glass. The complex $\text{R} = \text{H}$ has been used as a luminescent label for proteins.

6.2.5.7.16 N_4 ligands

Reaction of $\text{IrCl}_3 \cdot 3\text{H}_2\text{O}$ with (**99**) in aqueous EtOH affords *cis*- $[\text{IrCl}(\text{H})(\text{99})]\text{PF}_6$.¹⁶⁴ The *cis* arrangement of Ir-bound (**99**) is confirmed by X-ray crystallography. The analogous reaction with (**100**) yields *trans*- $[\text{IrCl}(\text{Et})(\text{100})]\text{PF}_6$ as determined by X-ray crystallography.¹⁶⁵

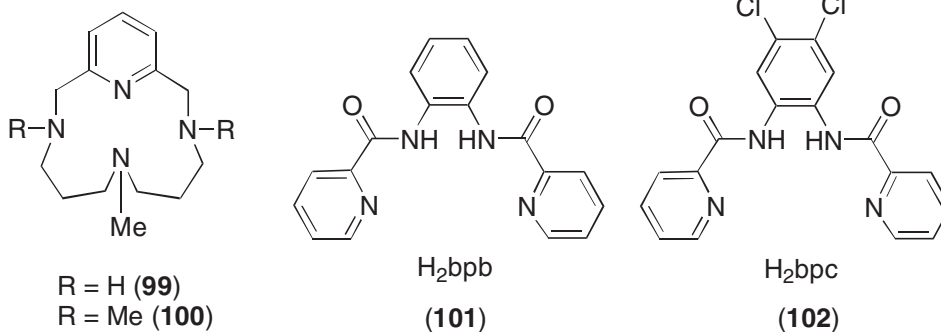

Treatment of $\text{Na}_2[\text{IrCl}_6]$ with H_2bpb (**101**) and H_2bpc (**102**) gives $\text{Na}[\text{Ir}(\text{bpb})\text{Cl}_2]$ and $\text{Na}[\text{Ir}(\text{bpc})\text{Cl}_2]$, respectively.¹⁶⁶ Both complexes undergo reversible, one-electron, ligand-based oxidations at +0.21 V and +0.31 V vs. ferrocenium/ferrocene, respectively, in CH_3CN .

The macrocyclic ligands (**103**) react with IrCl_3 in anhydrous EtOH to produce $[\text{Ir}(\mathbf{103})\text{Cl}_2]\text{Cl}$, characterized by IR, UV-vis, and NMR spectroscopy.¹⁶⁷ Both *cis*- and *trans*- $[\text{Ir}(\text{cyclam})\text{Cl}_2]\text{Cl}$ result from the reaction of IrCl_3 or $\text{Ir}(\text{thtp})_3\text{Cl}_3$, thtp = tetrahydrothiophene, with cyclam, cyclam = 1,4,8,11-tetrahydrodecane.¹⁶⁸ X-ray powder diagrams assign the *cis*- and *trans*-isomers as (*R,R,R,R/S,S,S,S*) and (*R,R,S,S*) configurations, respectively. The synthesis of the 14–16 membered, tetraazamacrocyclic-bound Ir complexes (**104**) is described. IR, UV/vis, ^1H NMR spectroscopic studies are detailed for all complexes.¹⁶⁹

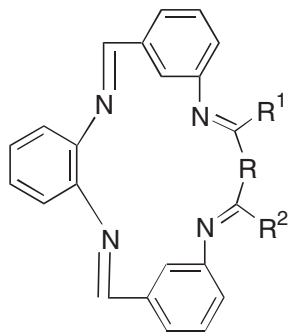

(103)

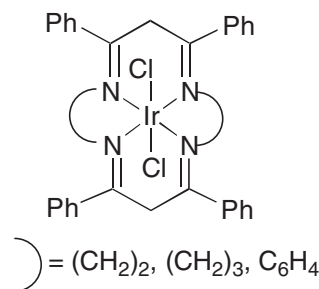
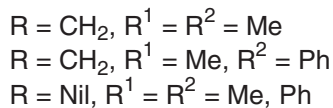

(104)

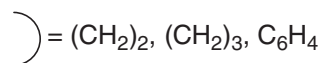

Successive oxidation of $[\text{Ir}(\text{pc})(\text{py})]_2$ with I_2 yields the mixed-valent species $[\{\text{Ir}(\text{py})(\text{pc})\}_2\text{I}]$ initially and then *trans*- $[\text{Ir}(\text{py})\text{I}(\text{pc})]$.¹⁷⁰ The latter compound has been characterized by X-ray crystallography. The spectrum of the mixed-valent material is reported. Reaction of $[\text{Ir}(\text{pc})]_2$ with NO in py yields nitrosyl intermediates, which immediately oxidize in air to give $[\text{Ir}(\text{py})(\text{NO}_2)\text{pc}]$.¹⁷¹ The structurally characterized species *pnp-trans*- $[\text{Ir}(\text{NO}_2)_2(\text{pc})]$, pnp = bis(triphenylbis(triphenylphosphine)iminium), is formed by air oxidation of $[\text{Irpc}]_2$ in CH_2Cl_2 and pnp(NO_2), and contains *N*-bound NO_2 ligands.¹⁷¹ In alkaline solution $[\text{Ir}(\text{pc})]_2$ is oxidized by air to give deep blue $[\text{Ir}(\text{OH})_2(\text{pc})]^-$, which may be acidified by HX ($X = \text{F}, \text{Cl}, \text{Br}, \text{I}$) yielding black-green $\text{H}[\text{IrX}_2\text{pc}]$.¹⁷² Further oxidation by Cl_2 , Br_2 , dibenzoyl peroxide results in oxidation of the pc ligand, affording $[\text{IrX}_2\text{pc}]$. $[\text{IrX}_2\text{pc}]^-$ exhibits three one-electron reduction processes. $[\text{Irpc}]_2$ reacts in methanol with excess $[\text{Bu}_4\text{N}]\text{OH}$ to give $[\text{Bu}_4\text{N}]\text{trans-}[\text{Ir}(\text{OH})(\text{OME})\text{pc}]$, which has been characterized by X-ray crystallography.¹⁷³

6.2.5.8 Phosphorus Ligands

6.2.5.8.1 Monodentate ligands

The X-ray structures of *cis*- $[\text{IrH}(\text{EH})(\text{PMe}_3)_4]^+$, $E = \text{O}, \text{S}$, confirm the *cis*-geometry of the Ir center.¹⁷⁴ In the complex where $E = \text{O}$, the O—H group points towards the hydride ligand, whereas when $E = \text{S}$ the S—H group points away from the hydride ligand. The structure *cis*- $[\text{IrH}(\text{OH})(\text{PMe}_3)_4]^+$ has also been determined by a neutron diffraction study at 20 K.¹⁷⁵ The X-ray structure of *trans,mer*- $[\text{IrCl}_2(\text{PMe}_3)_3(\text{PMe}_2\text{Ph})]\text{ClO}_4$ has been determined.¹⁷⁶ Low-temperature $^{31}\text{P}\{^1\text{H}\}$ NMR studies show that at -75°C in d_6 -acetone there is restricted rotation about the Ir— PMe_2Ph bond, and two rotamers can be identified. At 45°C the rotamers are in fast exchange. The single-crystal diffraction study of $[\text{IrCl}_2(\text{CO})(\text{PEt}_3)_2(\text{SOCl})]$ identifies *trans*- PEt_3 groups, *cis*-Cl ligands, and a Cl—S—O angle of $106.5(4)^\circ$.¹⁷⁷

The structure of *cis*- $[\text{Ir}(\text{H})\text{Cl}(\text{PEt}_3)_4][\text{B}(\text{cat})_2]$, $\text{B}(\text{cat})_2 = \text{bis}(\text{benzene-1,2-diolato})\text{borate}$, exhibits one long Ir—P bond *trans* to the hydride ligand and a short Ir—P bond opposite chloride, in agreement with the relative *trans* influence of these ligands.¹⁷⁸ The crystal structures of the series of complexes *mer*- $[\text{Ir}(\text{PMe}_2\text{Ph})_3\text{Cl}_n\text{H}_{3-n}]$ reveal that the Ir—P (but not Ir—Cl) distances decrease by ca. 0.04 Å per unit increase in hydride content.^{179–182} Replacement of PMe_2Ph ligands by P^iPr_3 results in similar trends, although the bulkier P^iPr_3 ligand gives longer Ir—P bonds.^{183,184}

The reactions of (**105**) are summarized in reaction Scheme 14. In all cases the products were identified by ^1H and ^{31}P NMR spectroscopy.⁵⁵⁶

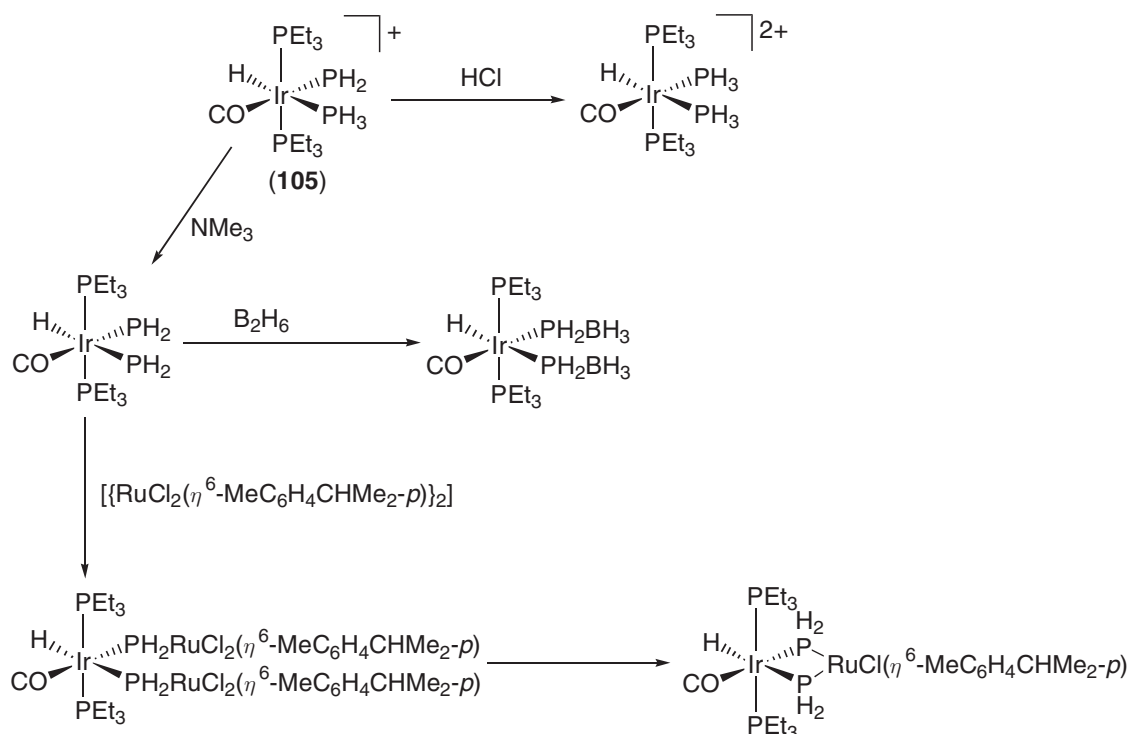

Scheme 14

Reaction of *mer*-IrCl₃P₃ (P = PBuPh₂, PMePh₂, PEt₂Ph) with RuCl₂P'₃ (P' = PPh₃, P(C₆H₄CH₃-*p*)) yields PP'ClRu(μ-Cl)₃IrPP'Cl.¹⁸⁵ ³¹P NMR spectroscopy shows that the PMe₂Ph ligands in *mer*-[IrCl₂(OH₂)(PMe₂Ph)₃](ClO₄) rapidly exchange and that the H₂O ligand *trans* to PMe₂Ph dissociates.¹⁸⁶ Treatment of [IrL₂(MeCN)P₃]⁺, (106), L = H, Me, P = PMe₂Ph, with HBF₄·OEt₂ in MeCN gives *cis,mer*-[IrL(MeCN)₂P₃]²⁺.¹⁸⁷ If the reaction of (106) with HBF₄·OEt₂ is carried out in the absence of MeCN, then the product species *cis,mer*-[IrH(MeCN)₂P₃]²⁺ + [IrH₄P₃]⁺ and *mer*-[IrMe(OEt₂)(MeCN)P₃]²⁺ (107) result for L = H and Me, respectively. The latter product (107) in the presence of H₂O yields *mer*-[IrMe(H₂O)(MeCN)P₃](BF₄)₂, which has been characterized by X-ray crystallography.

The H₂O ligand in *trans,mer*-[IrCl₂(OH₂)(PMe₂Ph)₃](ClO₄) (108) is readily substituted by NH₃ and PH₃.¹⁸⁸ The resulting PH₃-containing species may be deprotonated to give the structurally characterized product *trans,mer*-[IrCl₂(PH₂)(PMe₂Ph)₃]. Replacement of H₂O by H₂S in (108) gives the structurally determined species *trans,mer*-[IrCl₂(SH)(PMe₂Ph)₃]. Reaction of [Ir(CO)Cl(R)(X)(PPh₃)₂] with C₂H₂ and PPh₃ yields *cis,trans*-[Ir(R)(-CH=CH⁺ PPh₃)₂(CO)(PPh₃)₂]²⁺, R = H, CH₃, X = Cl, I, which gives *cis,trans*-[IrCl(-CH=CH⁺ PPh₃)₂(CO)(PPh₃)₂]²⁺ on treatment with HCl.¹⁸⁹ The latter product has been characterized by X-ray diffraction.

The species [Ir(H)Cl(PMe₃)₄]⁺ would be expected to adopt the *trans* geometry on electronic and steric grounds; however, it is the *cis* conformation which is found experimentally.¹⁹⁰ Quantum-mechanical calculations suggest that there is little energy difference between the two structures, but the *cis*-form is favored by the higher entropy of this lower-symmetry arrangement. Oxidative addition to [Ir(CO)₃(PEt₃)₂BF₄] and [Ir(CO)₂(PH₃)(PEt₃)₂BF₄] yields a variety of octahedral Ir^{III} complexes, which are characterized by ¹H, ¹³C, ¹⁹F, and ³¹P NMR spectroscopy.⁵⁷⁵ Addition of H⁺ to the metal center of the ortho-cyclometalated complexes [Ir{P(OC₆H₃Me-*o*)(OC₆H₄Me-*o*)₂}(cod)L], L = P(OC₆H₄Me-*o*)₃, PMePh₂, PMe₂Ph, PMe₃, is stereoselective and occurs *trans* to L, which isomerizes on heating to the thermodynamically stable isomer of [IrH(OC₆H₃Me-*o*)(OC₆H₄Me-*o*)₂(cod)L]⁺ in which the hydride is *trans* to the cyclometalated phosphite ligand.¹⁹¹ A further isomer, where the proton attacks the ortho-metalated C atom, is detected by UV-vis, ¹H, and ³¹P NMR spectroscopy.

The complexes [IrCl(PPh₃)₂S], [IrCl(diphos)S], and [IrCl(diphos)PPh₃] (diphos = Ph₂-PCH₂CH₂PPh₂, S = solvent) react with H₂ at 30 °C, 1 atm of H₂ in EtOH/C₆H₆, to form stable dihydrido Ir^{III} complexes.¹⁹² Computation of thermodynamic parameters reveals that the

enthalpy of formation of the dihydrido complexes is more exothermic for the Ir^I complexes than for the analogous Rh^I complexes.

The complexes IrCl(CO)P₂ (P = PMePh₂, PMe₂Ph, PMe₃) oxidatively add RBr, R = CH₂CO₂Et, CH₃CHCO₂Et, CH₃CHCOCH₃, EtCHNO₂, to give IrBrClR(CO)P₂.¹⁹³ CH₂I₂ and CH₂ClI give IrClI(CH₂Y)(CO)P₂, Y = I, Cl, respectively. In all cases the final compounds contain *trans* tertiary phosphine ligands.

Trans-[Ir(CO)X(PEt₃)₂], X = Br, Cl, reacts with ZH₃ (Z = P, As, Sb) in toluene to give [Ir(CO)XH(PEt₃)₂(ZH₂)] (109).¹⁹⁴ The X-ray structure of (109), with X = Cl, Z = As, is detailed. Treatment of (109), X = Br, Z = P, with HCl yields [Ir(CO)BrH(PEt₃)₂(PH₃)]⁺ and then [Ir(CO)BrClH(PEt₃)₂], and with H₂Se gives [Ir(CO)BrH(PEt₃)₂(SeH)].

Reaction of [Ir(cod)Cl]₂ with PPh₃ and AgBF₄ gives [Ir(η⁴-1,5-cod)(PPh₃)₂]BF₄ which gives [IrH₂Q₂(PPh₃)₂]BF₄ on treatment with H₂ and Q (Q = Me₂CO, H₂O).¹⁹⁵

Treatment of Ir(PPh₃)₂(CO)Cl with tdppmcy yields the trinuclear complex [Ir(CO)Cl]₃(tdppmcy)₂, (110).¹⁹⁶ [Ir(CO)Cl]₃(tdppmcy)₂ reacts with H⁺, H₂, and H⁻ to give [Ir(CO)ClH]₃(tdppmcy)₂³⁺, [Ir(CO)(Cl)H₂]₃(tdppmcy)₂, and [Ir(CO)H₃]₃(tdppmcy)₂, respectively.

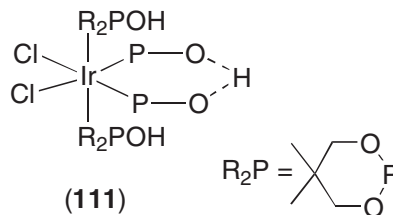
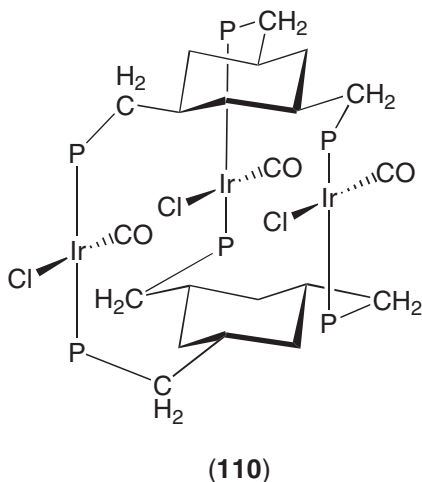

Reaction of the secondary phosphite 5,5-dimethyl-1,3-dioxo-2-phosphorinane OCH₂CMe₂CH₂O-P(O)H, R₂POH, with [IrCl₂(coe)₂]₂ affords the product species [IrCl₂(R₂POHOPR₂)(R₂POH)₂], (111), [IrH(R₂POHOPR₂)₂(R₂POH)], and [IrCl(R₂POHOPR₂)₂(R₂POH)].¹⁹⁷ Heating the phosphite with Ir(acac)(coe)₂ in toluene produces [Ir(acac)(R₂POHOPR₂)₂]. The synthesis of mixed phosphite/phosphine or arsine hydride complexes IrHCl₂[PPh(OEt)₂]₂L₂ and IrHCl₂P(OEt)₃L₂ (L = PPh₃, AsPh₃) has been described.¹⁹⁸ The hydride ligand may be substituted by the hydrazine ligands RNHNH₂, R = H, Me, Ph, C₆H₄NO₂-4, giving [IrCl₂(RNHNH₂){PPh(OEt)₂]₂⁺ and [IrCl₂(RNHNH₂){P(OEt)₃]₂⁺, respectively. The multinuclear complexes (112) and (113) have been synthesized from the anion [Ircp*Cl{PO(OMe)₂}]⁻ and spectroscopically characterized.^{199,200}

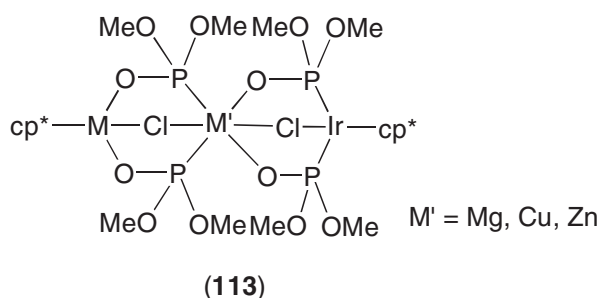
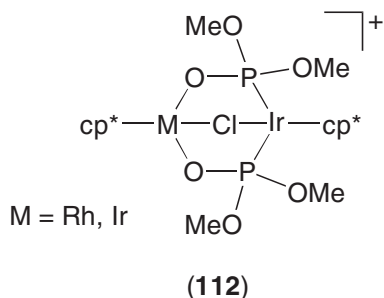

6.2.5.8.2 Bidentate ligands

The complex [Ir(μ-OCH₃)(η⁴-1,5-cod)]₂ reacts with bis(diphenyl-phosphino)methane, dppm, to give [IrH(η¹,η³-C₈H₁₂)}dppm], the structure of which has been confirmed by single-crystal X-ray

studies.²⁰¹ A reaction mechanism has been proposed as a result of deuteration experiments. The family of complexes $\text{Li}[\text{Ir}(\text{P-P})\text{I}_4]$, $\text{Li}(\mathbf{114})$, $\text{P-P} = \text{dppe}$ or *cis*-1,2-bis(diphenylphosphino) propane, has been synthesized.²⁰² The salt $\text{Ph}_4\text{As}(\mathbf{114})$, $\text{P-P} = \text{dppe}$, has been characterized by X-ray crystallography.

Oxidative addition of H_2 and Ph_3SiH to $\text{IrBr}(\text{CO})(\text{chiraphos})$, where *chiraphos* = 2*S*,3*S*-bis(diphenylphosphino)butane, leads to stable kinetic ($\mathbf{115a}$, $\mathbf{115b}$), followed by thermodynamic ($\mathbf{116a}$, $\mathbf{116b}$) diastereomers as shown in reaction Scheme 15.²⁰³ The crystal structure of *cis*- $[\text{IrH}_2(\text{chiraphos})_2]\text{BF}_4$ has been reported.²⁰⁴

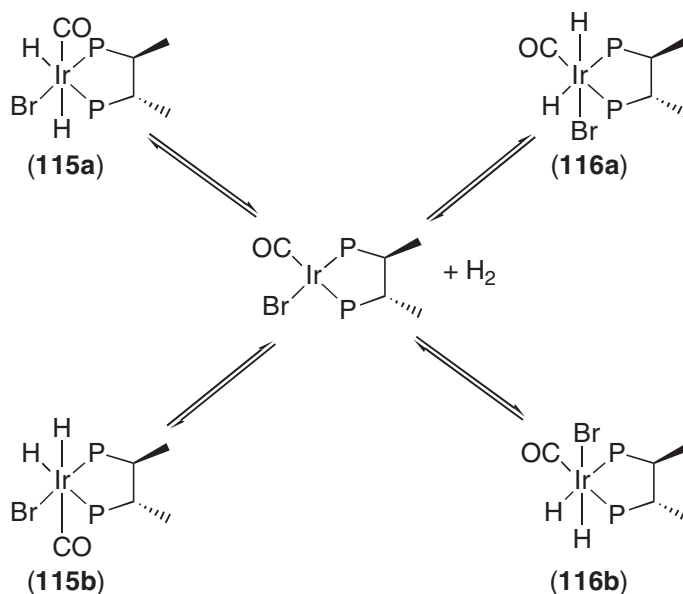

Scheme 15

Oxidative addition of silanes to $\text{IrX}(\text{CO})(\text{dppe})$, $\text{X} = \text{Br}, \text{CN}$, proceeds stereoselectively under kinetic control with hydride binding *trans* to CO and Si *trans* to $\text{P}(\text{dppe})$.²⁰⁵ When $\text{X} = \text{Br}$ the kinetic product isomerizes to the thermodynamically stable species, with H *trans* to Br and Si *trans* to $\text{P}(\text{dppe})$. NMR studies of H_2 addition to $\text{IrBr}(\text{CO})(\text{dppe})$ have proved sensitive to para-enriched H_2 .²⁰⁶ The complex $[\text{Ir}(\text{CH}_3)(\text{CO})(\text{CF}_3\text{SO}_3)_2(\text{dppe})]$, when dissolved in CH_2Cl_2 under 1 atmosphere of H_2 , yields CH_4 and $\text{IrH}(\text{CO})(\text{CF}_3\text{SO}_3)_2(\text{dppe})$ ($\mathbf{117}$).²⁰⁷ The complex ($\mathbf{118}$) proves to be an effective hydrogenation catalyst for ethane and 1-hexane. The cationic complexes ($\mathbf{118}$) and ($\mathbf{119}$) have been shown to polymerize isobutylene, norbornene, styrene, and β -pinene.²⁰⁸ Reaction of ($\mathbf{119}$) with H_2 yields $[\text{IrH}_2(\text{CO})_2\text{dppe}]^+$.²⁰⁹ Labeling and NMR studies show that the reaction involves conversion of coordinated CF_3 to CO . The synthesis of monomeric carboxylato(diphosphine)iridium(III) complexes has been described (diphosphine = diop ($\mathbf{120}$), binap ($\mathbf{121}$), and bdpp ($\mathbf{122}$)).²¹⁰ Some of these complexes catalyze the asymmetric hydrogenation of prochiral imines to amines.

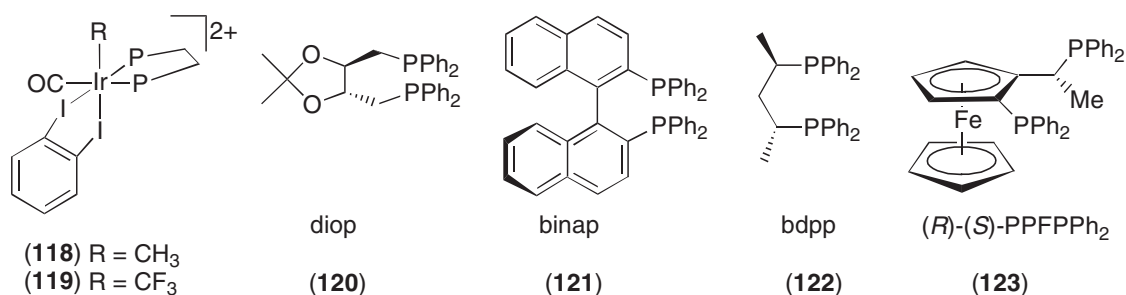

The diphosphine ligand (*R*)-(*S*)-PPFPPh₂ (**123**) binds to Ir^I to form the dinuclear species *cis* and *trans*-[Ir₂(μ-Cl)₂((*R*)-(*S*)-PPFPPh₂)₂] which oxidatively adds H₂O to give [(*R*)-(*S*)-PPFPPh₂)₂-Ir₂Cl₂(H)₂(μ-OH)₂].²¹¹ The X-ray structure of the *syn-trans* isomer has been determined.

6.2.5.8.3 Tridentate ligands

Oxidation of 3,5-di-*tert*-butyl catechol to 3,5-di-*tert*-butyl-*o*-benzoquinone by O₂ is catalyzed by the Ir^{III} catechol complex (**124**).²¹² The authors suggest that formation of the dioxygen adduct, as in reaction Scheme 16, is an important step in the process.

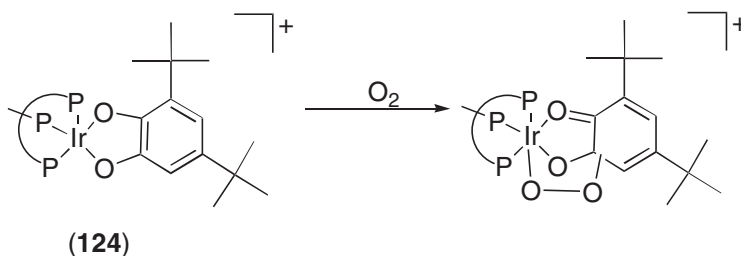

Scheme 16

The structure of [IrH₂X(cyttp)], X = Cl, I, cyttp = PhP(CH₂CH₂CH₂PR₂)₂, R = cyclohexyl, confirms an octahedral arrangement around Ir with the cyttp ligand taking up a *mer*-configuration around the metal.²¹³ Diastereoisomers were characterized by NMR spectroscopy.²¹⁴ [IrCl(CO)(Htriphos)] undergoes oxidative addition reactions with H₂, HCl, and Cl₂ to give [IrH₂(CO)(Htriphos)]⁺, [IrHCl(CO)(Htriphos)]⁺, and [IrCl₃(Htriphos)], respectively.⁶⁰⁸

6.2.5.8.4 Arsine and antimony ligands

Reaction of [IrCl(C₂H₄)₂]₂ and AsⁱPr₃ yields *trans*-[IrCl(C₂H₄)(AsⁱPr₃)₂], which on UV irradiation in MeCN gives [IrHCl(CH:CH₂)(MeCN)(AsⁱPr₃)₂], the molecular structure of which has been determined by X-ray crystallography.²¹⁵ The reaction of [IrCl(coe)₂]₂ with SbⁱPr₃ in the presence of H₂ affords *cis,mer*-[IrH₂Cl(SbⁱPr₃)₃], which gives [IrH₂Cl(CO)(SbⁱPr₃)₂] on treatment with CO.²¹⁶ Five co-ordinate [IrCl(C₂H₄)₂(SbR₃)₂] (**125**) results from the reaction of [IrCl(C₂H₄)₂]₂ with SbR₃ (R = ⁱPr, Me, Ph), and the X-ray structure of (**125**), where R = ⁱPr, confirms a distorted trigonal-bipyramidal geometry around Ir, with one stibine ligand and the two ethene ligands in the equatorial plane. The synthesis and characterization of [Ir(tetras)X₂]X, tetras = As(*o*-C₆H₄-AsMe₂)₃, X = Cl, Br, I, and *fac*-[Ir{MeC(CH₂AsMe₂)₃}Cl₃] have been detailed and the crystal structure of [Ir(tetras)(CO)Cl](BF₄)₂ reported.²¹⁷ All complexes undergo an irreversible Ir^{III}/Ir^I oxidation. The synthesis of *trans*-[IrCl(=CR₂)(SbⁱPr₃)(PⁱPr₃)], R = C₆H₅, *p*-C₆H₄Me, is reported.²¹⁸

6.2.5.9 Oxygen Ligands

6.2.5.9.1 Monodentate ligands

The single-crystal X-ray structure of *trans,mer*-[IrCl₂(OH₂)(PMe₂Ph)₃](ClO₄) exhibits a long Ir—O bond (2.189 Å) and a short Ir—P bond (2.249 Å) *trans* to it.²¹⁹ At room temperature the phosphine ligands are equivalent (³¹P NMR) via the five co-ordinate square-pyramidal intermediate [IrCl₂(PMe₂Ph)₃]⁺. Water exchange on [Ir(OH₂)₆]³⁺ proceeds by an associative interchange mechanism, as determined by ¹⁷O NMR studies, whereas it goes by an interchange mechanism on the deprotonated species [Ir(OH₂)₅(OH)]²⁺.²²⁰ Analogous studies on [Ircp*(OH₂)₃]²⁺ showed that H₂O exchange was 10¹⁴ times faster than for [Ir(OH₂)₆]³⁺ and proceeds by a dissociative mechanism.²²¹ The structure of [Ir(OH₂)₆]F₃·3H₂O has been studied by X-ray crystallography and NMR spectroscopy.²²² The aqua complexes [Ircp*(PMe₃)-R_F(OH₂)]X (R_F = CF(CF₃)₂, X = BF₄, B(Ar_F)₄; R_F = CF₂CF₃, CF₂CF₂CF₃, X = CF₃SO₃) and

[Ircp*(PPh₃)(CF₂CF₂CF₃)(OH₂)]BF₄ have been synthesized and their molecular structures determined by single-crystal X-ray diffraction studies.²²³ The complexes form hydrogen bonds from the H₂O ligands to the counterions or to additional outer-sphere water molecules. The dinuclear aqua ions [(H₂O)₄Cr(μ-OH)₂Ir(OH₂)₄]⁴⁺ and [(H₂O)₄Rh(μ-OH)₂Ir(OH₂)₄]⁴⁺ have been synthesized from oxygen-free alkaline media.²²⁴

The syntheses of Δ,Λ-[(en)₂Ir(μ-OH)₂Ir(en)₂](ClO₄)₄, (**126**), and Δ,Λ-[(H₂O)(en)₂Ir(μ-OH)Ir(en)₂(OH)](S₂O₆)_{1.5}(ClO₄)₄·2.75H₂O, (**127**), have been reported.²²⁵ The crystal structure of (**127**) shows that the terminal OH and H₂O ligands interact by a very short, symmetric H bond (2.429(9) Å). The thermodynamics and kinetics of the equilibrium reaction between (**126**) and (**127**) were studied spectrophotometrically at different pH values.

The binuclear complex [H(binap)Ir(μ-OMe)₂(μ-Cl)IrH(binap)]Cl catalyzes the hydrogenation transfer from methanol to alkynes via the five co-ordinate intermediate [IrHCl(OMe)(binap)].²²⁶

The phosphate diesters (O₂P(OR)₂), ethyl-4-nitrophenyl phosphate and bis(4-nitrophenyl)phosphate in *cis*-[(en)₂Ir(OH)(O₂P(OR)₂)]⁺, react intramolecularly with the *cis*-OH group at pH 8 to liberate nitrophenolate.²²⁷

Phenols react with [Ir(cod)(PMe₃)₃]Cl to yield *mer*-[(Me₃P)₃Ir(OAr)(H)(Cl)] (**128**).²²⁸ The structure for (**128**), where Ar = 2,4-dimethylphenyl, is given. Carboxylic acids react with [Ir(cod)(PMe₃)₃]Cl to afford *mer*-[(Me₃P)₃Ir(OC(O)R)(H)Cl], (**129**), with the structures of (**129**) reported where R = Ph (**130**), C₆H₄OH-2. (**130**) reacts with Ti[PF₆]₄ to form *mer*-[(Me₃P)₃Ir(η²-O₂CC₆H₅)(H)][PF₆], which has been crystallographically characterized.²²⁹

Addition of CO to Ir(SO₃F)₃ dissolved in HSO₃F gives crystals of *mer*-[Ir(CO)₃(SO₃F)₃].²³⁰ IR spectroscopy and X-ray structural determination confirm the *mer* configuration. In solution (HSO₃F) there is evidence (IR and NMR) of a mixture of *mer*- and *fac*-isomers.

The X-ray structure of [Ir(CO)(CH₃)(SO₄)(P(*p*-tolyl)₃)₂], (**131**), shows that the phosphine ligands are *trans* to one another and the SO₄²⁻ is chelated to the Ir^{III} center.²³¹ Carbonylation of (**131**) yields [Ir(CO)₃(P(*p*-tolyl)₃)₂]⁺, which has also been characterized by single-crystal diffraction studies, and [Ir(CO)₃(C(O)Me)(P(*p*-tolyl)₃)₂].

The complex [Ircp*(PMe₃)(CH₃)(otf)], otf = OSO₂CF₃, reacts with aliphatic C—H bonds (RH) and silane Si—H bonds (SiR₃H) to yield [Ircp*(PMe₃)(R)(otf)] and [Ircp*(PMe₃)(R){SiR₂(otf)}], respectively.²³² Treatment of *trans*-[Ir(CO)(PPh₃)₂Cl] (i) with HBF₄ gives [Ir(CO)(PPh₃)₂Cl(H)(BF₄)]; (ii) with Me₃OBf₄ yields [Ir(CO)(PPh₃)₂Cl(Me)(BF₄)]; and (iii) with Ag(otf) affords [Ir(CO)(PPh₃)₂(otf)].²³³ Further treatment of [Ir(CO)(PPh₃)₂(otf)] with H(otf) results in the formation of *trans,cis*-[Ir(PPh₃)₂(otf)₂(CO)(H)]. The rate constant for solvolysis of [Ir(NH₃)₅(otf)](otf)₂ to [Ir(NH₃)₅S](otf)₃, where S = H₂O, MeOH, DMSO, DMF, CH₃CN, py, is relatively independent of solvent.²³⁴ No simple relationship between rate constant and solvent properties was found. Base hydrolysis and aqation reactions of [Ir(NH₃)₅(otf)]²⁺ have also been investigated.²³⁵ The reaction between [cp*(PMe₃)Ir(otf)₂] and [(PPh₃)₂Pt(HC≡CPh)] or [(PPh₃)₂Pt(C₂H₄)] yields [cp*(PMe₃)Ir(μ-H)(μ-η²,η¹-PhC≡C)Pt(PPh₃)₂](otf)₂ and [cp*(PMe₃)-Ir(μ-H)(μ-η²,η¹-H₂C=CH)Pt(PPh₃)₂](otf)₂, respectively, with the latter product characterized by X-ray diffraction studies.²³⁶

6.2.5.9.2 Bidentate ligands

The series of complexes [Ir(acacX)_n(acac)_{3-n}], where acacX = CH₃COCXCOCH₃ and X = F, Cl, Br, I, n = 1, 2, 3, has been prepared.^{237–239} The molecular structures of Ir(acac)₃, Ir(acacCl)₃, Ir(acacBr)₃, and Ir(acacI)₃ have been determined. In the presence of Pcy₃, [Ir(acac)(coe)(Pcy₃)] (**132**) reacts with H₂, RC=CH, R = Ph, cy, Me₃Si, or HSiR₃, where R₃' = Et₃, Ph₃, HPh₂, to give [Ir(acac)H₂(Pcy₃)₂], [Ir(acac)H(C₂R)(Pcy₃)₂], and [Ir(acac)H(SiR₃)(Pcy₃)], respectively.²⁴⁰ In the absence of Pcy₃, the addition of three equivalents of PhC≡CH yields [Ir{κ³-CH=C(Ph)CH[C(O)CH₃]₂}(C₂Ph)(CPh=CH₂)(Pcy₃)], (**133**), which has been structurally characterized. The structure of (**134**), R = Et, has been confirmed by X-ray crystallography.

Trans oxidative addition of CH₃I to [Ir(acac)(cod)] affords the structurally determined complex [Ir(acac)(cod)(CH₃)₂].²⁴¹ The reaction of [(Npet)₂Ir]Cl, Npet = {*o*-(diphenylphosphino)benzylidene}ethylamino, with tetrachloro-*o*-quinone yields the structurally characterized product (**135**).²⁴² The synthesis and characterization of the water-soluble complex (**136**) have been described.²⁴³

The preparation and characterization of five co-ordinate [(triphos)Ir(cat)]Z, H₂cat = 9,10-phenanthrenecatechol, 1,2-naphthalenecatechol, 3,5-di-*tert*-butylcatechol, 4-methylcatechol, 4-carboxycatechol Et ester, tetrachlorocatechol, Z = BPh₄, PF₆, have been reported.²⁴⁴ All compounds

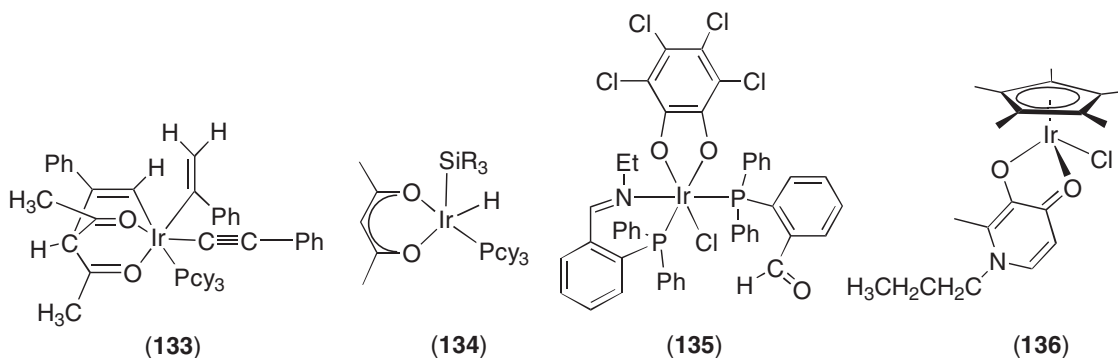

undergo electron-transfer reactions, and paramagnetic states have been studied by EPR spectroscopy. Most of the compounds react with O_2 to give $[(\text{triphos})\text{Ir}(\text{OO})(\text{sq})]\text{Z}$, Hsq = semiquinone derivative. The O_2 adducts are also redox active.

The synthesis and characterization of tris-chelate Ir^{III} complexes of 2-(acetylamino)benzoic acid, 2-(benzoylamino)benzoic acid, 2-[(2-aminophenylamino)carbonyl]benzoic acid, maleanilic acid, malea-1-naphthalenic acid, and 2-[(phenylamino)carbonyl]benzoic acid have been described.²⁴⁵

6.2.5.9.3 Tridentate ligands

The complex $[(\eta^2\text{-triso})\text{Ir}(\text{C}_2\text{H}_4)_2]$, (**137**), ($\text{triso} = \text{C}(\text{Ph}_2\text{PO})_3^-$), undergoes oxidative addition with Ph_3SiH to form the $\eta^3\text{-triso}$ complex $[\text{Ir}(\text{triso})(\text{C}_2\text{H}_4)\text{H}(\text{SiPPh}_3)]$, (**138**), according to Reaction Scheme 17.^{246,247} Both compounds catalyze the hydrosilylation of ethene.²⁴⁸

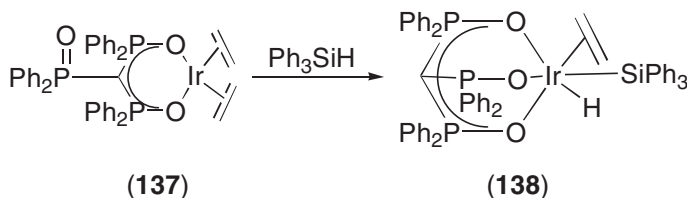

Scheme 17

6.2.5.9.4 Trinuclear complexes

The structure of the trinuclear complex $[\text{Ir}_3(\mu_3\text{-O})(\mu\text{-CH}_3\text{COO})_6(\text{OH}_2)_3](\text{NO}_3)_2$ has been determined.²⁴⁹ The average Ir–Ir distance is measured at 3.34 Å. Addition of HCl gave $[\text{Ir}_3(\mu_3\text{-O})(\mu\text{-CH}_3\text{COO})_6(\text{OH}_2)\text{Cl}_2]$. The trinuclear species are paramagnetic, with a magnetic moment equivalent to one unpaired electron per Ir_3 unit. The species $[\text{Ir}_3(\mu_3\text{-O})(\mu\text{-CH}_3\text{COO})_6(\text{OH}_2)_3]^{2+}$ can be electrochemically reduced to the $\text{Ir}^{\text{III}}/\text{Ir}^{\text{III}}/\text{Ir}^{\text{III}}$ form.²⁵⁰ The related complex $[\text{Ir}_3(\mu_3\text{-O})(\mu\text{-CH}_3\text{COO})_6(\text{py})_3]^+$, (**139**), has two reversible one-electron oxidation waves at +0.68 V and +1.86 V vs. Ag/AgCl in acetonitrile/0.1 M $[\text{Bu}_4\text{N}][\text{PF}_6]$.²⁵¹ The compound (**139**) has a featureless visible spectrum, whereas the mono-oxidized species (**139**)⁺ has bands at 688, 1,093, and 1,400 nm which have been assigned to transitions involving orbitals based on the $\mu_3\text{-O}$ bridging ligand.

6.2.5.10 Sulfur and Selenium Ligands

6.2.5.10.1 Monodentate ligands

Treatment of $[\text{Ir}(\text{coe})_2(\text{O}=\text{CMe}_2)_2]\text{PF}_6$ in acetone with DMSO followed by water yields the structurally characterized species (**140**), in which both *O*- and *S*-bonded DMSO ligands are

present.⁶³⁶ Reaction of IrCl_3 with ligand L, (**141**), in ethanol yields $\text{IrLCl}_3(\text{OH}_2)$, in which (**141**) binds to the metal center through the terminal S donor atom.²⁵²

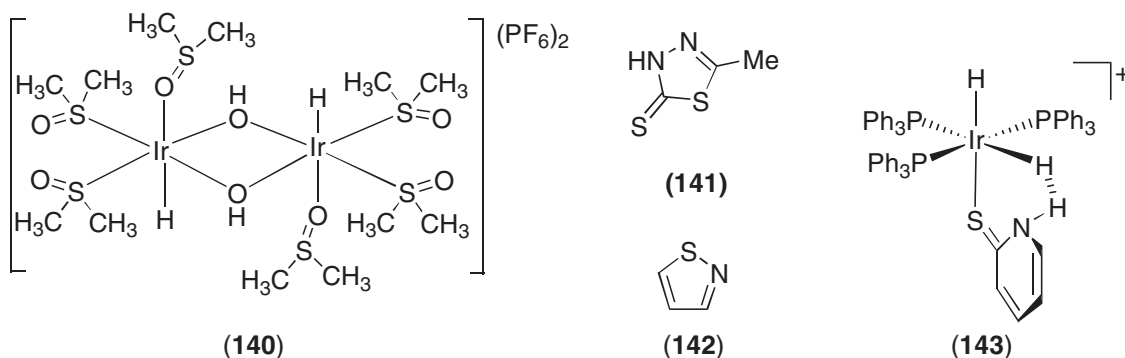

SF_4 reacts with *trans*- $\text{Ir}(\text{CO})(\text{X})(\text{PEt}_3)_2$, X = Cl, Br, in CD_2Cl_2 at 180 K to afford thermally stable $[\text{Ir}(\text{CO})\text{FX}(\text{PEt}_3)_2(\text{SF}_3)]$.²⁵³ The SF_3 ligand shows reversible fluxional behavior (200–300 K), as studied by ^{19}F and ^{31}P $\{^1\text{H}\}$ NMR spectroscopy.

The isothiazide ligand, (**142**), and its 3- and 5-methyl derivatives form the tris complexes $\text{IrCl}_3(\text{isothiazole})_3$ in which isothiazole and the 5-methyl derivative bind through the S atom, whereas 3-methylisothiazole binds through the N atom.²⁵⁴

The crystal structure of $[\text{IrCl}_4(\text{SCL}_2)_2](\text{SCL}_3)$ shows that the SCL_2^- ligands adopt a *cis* position around the metal.²⁵⁵ Oxidation of *trans*- $\text{Na}_7[\text{Ir}(\text{SO}_3)_4\text{Cl}_2] \cdot 5\text{H}_2\text{O}$ by $\text{Ce}(\text{SO}_4)_2$ or KMnO_4 results in formation of $\text{S}_2\text{O}_6^{2-}$ and SO_4^{2-} .²⁵⁶ Reaction of $\text{IrH}_3(\text{PPh}_3)_3$ with HBF_4 in the presence of pyridinethione, SpyH, affords $[\text{IrH}_2(\eta^1\text{-SpyH})(\text{PPh}_3)_3]\text{BF}_4$ (**143**).²⁵⁷ A further SpyH can replace one PPh_3 ligand, giving $[\text{IrH}_2(\eta^1\text{-SpyH})_2(\text{PPh}_3)_2]\text{BF}_4$. The structures of both Ir–SpyH compounds and $[\text{IrH}(\text{CO})(\eta^1\text{-SpyH})_2(\text{PPh}_3)_2]\text{BF}_4$ are reported and all show $\text{NH} \cdots \text{H Ir}$ proton–hydride interactions, as shown in (**143**). The related complexes $[\text{IrH}(\eta^1\text{-SpyH})(\eta^2\text{-Spy})(\text{PPh}_3)_2]\text{BF}_4$, $[\text{Ir}(\text{H})_2(\eta^1\text{-SpyH})_2(\text{Pcy}_3)_2]\text{BF}_4$, and $[\text{IrH}(\eta^1\text{-SpyH})_2(\eta^2\text{-Spy})(\text{Pcy}_3)]\text{BF}_4$ also exhibit the proton–hydride interaction.^{258–260} NMR studies indicate that such interactions are maintained in solution.

Reaction of $[\text{Ircp}^*\text{Cl}_2]_2$ with $(\text{MeS})_2\text{CH}_2$ and AgBF_4 gives $[\text{Ircp}^*\text{Cl}(\eta^2\text{-(MeS)}_2\text{CH}_2)]\text{BF}_4$, whereas treatment with $(\text{PhS})_2\text{CH}_2$ leads to $[\text{Ircp}^*\text{Cl}_2(\eta^1\text{-(PhS)}_2\text{CH}_2)]$, characterized by X-ray crystallography.²⁶¹

6.2.5.10.2 Bidentate ligands

Treatment of $[\text{Ircp}^*\text{Cl}_2]_2$ with dppmE_2 and TIBF_4 ($\text{dppmE}_2 = \text{Ph}_2\text{P}(\text{E})\text{CH}_2\text{P}(\text{E})\text{Ph}_2$, E = S, Se) gives $[\text{Ircp}^*\text{Cl}(\text{dppmE}_2)](\text{BF}_4)$ (**144**).^{262,263} Further reaction with NaH leads to the deprotonation of dppmE_2 and formation of $[\text{Ircp}^*\{\eta^3\text{-(EPPH}_2)_2\text{CH}\}]^+$. $\text{P}(\text{OMe})_3$ can displace the chloride ligand in (**144**) to produce $[\text{Ircp}^*(\text{P}(\text{OMe})_3)(\text{dppmE}_2)]^{2+}$, which gives $[\text{Ircp}^*(\text{PO}(\text{OMe})_2)(\text{dppmE}_2)]^+$ on treatment with NaI. The structure of (**145**) BF_4 has been determined. The analogous chemistry of the $(\text{EPPH}_2)_2\text{NH}$ ligands is described, with the crystal structure of $[\text{Ircp}^*\text{Cl}\{\eta^2\text{-(SePPH}_2)_2\text{N}\}]$ detailed.²⁶⁴ The $\eta^2\text{-(SePPH}_2)_2\text{N}$ ligand binds in a bidentate Se, Se' manner.

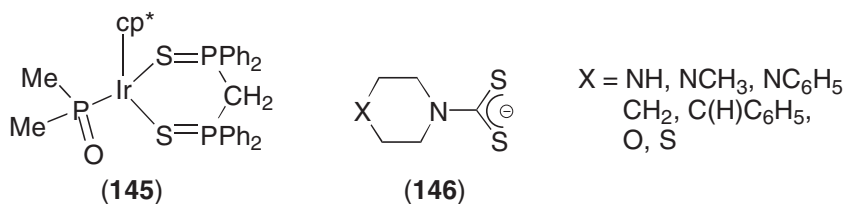

The synthesis and characterization of $[\text{Ir}(\text{S}_2\text{P}(\text{Me}_2\text{-C}_6\text{H}_3\text{-2,4})_2)_3]$ and $[\text{Ir}(\text{S}_2\text{CNMeR})_3]$, R = cyclohexyl, are reported.^{265,266} Further tris dithiocarbamate (**146**) Ir^{III} complexes have been prepared and characterized by UV-vis spectroscopy.²⁶⁷ The complex $[\text{Ircp}^*(1,2\text{-C}_6\text{H}_4\text{S}_2\text{-S,S}')]]$ has been prepared and characterized by X-ray structural analysis.²⁶⁸

6.2.5.10.3 Binuclear complexes

The complex $[\text{Ir}(\mu\text{-}^t\text{BuS})(\text{CO})\text{L}]_2$ reacts with dihalomethane to yield $[\text{IrX}(\mu\text{-}^t\text{BuS})(\text{CO})\text{L}]_2(\mu\text{-CH}_2)$, $\text{X} = \text{I}$, $\text{L} = \text{CO}$, $\text{P}(\text{OMe})_3$, PPh_3 , PPh_2Me , PMe_3 ; $\text{X} = \text{Br}$, $\text{L} = \text{PPh}_3$.²⁶⁹ The crystal structure of the product in which $\text{X} = \text{I}$ and $\text{L} = \text{P}(\text{OMe})_3$ has been determined and shows an Ir–Ir separation of 3.1980(4) Å. Reaction of $[\text{Ircp}^*\text{Cl}_2]_2$ with two molar equivalents of thiosalicylic acid ($\text{HSC}_6\text{H}_4\text{COOH}$, H_2tsal) and excess base gives $[\text{cp}^*\text{Ir}(\text{tsal})]_2$ (**147**).²⁷⁰

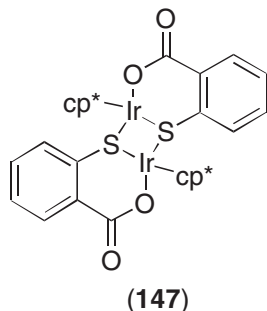

6.2.5.10.4 Tridentate ligands

Reaction of $[\text{Ircp}^*\text{Cl}_2]_2$ with AgBF_4 and $(\text{SPPPh}_2)_3\text{CH}$ in CH_2Cl_2 or Me_2CO to which Et_3N is added yields $[\text{Ircp}^*(\eta^3\text{-}(\text{SPPPh}_2)_3\text{C})\text{BF}_4]$, which has been structurally characterized.²⁷¹ The Ir^{III} complexes $[\text{Ircp}^*\text{L}^3](\text{PF}_6)_2$ ($\text{L}^3 = \text{MeC}(\text{CH}_2\text{ER})_3$, $\text{E} = \text{Se}$, $\text{R} = \text{Me}$; $\text{E} = \text{Te}$, $\text{R} = \text{Me}$, Ph) have been prepared and characterized by IR and multinuclear NMR spectroscopy.⁶⁴⁷

6.2.5.10.5 Halide ligands

A review of preparative methods for the synthesis of Ir–fluoro complexes is available.²⁷² Addition of I_2 to $[\text{Ir}((R)\text{-}(S)\text{-PPFP}(\text{Xyl})_2)\text{cod}]\text{BF}_4$ in THF yields $[\text{IrI}((R)\text{-}(S)\text{-PPFP}(\text{Xyl})_2)(\eta^3, \eta^2\text{-C}_8\text{H}_{11})]\text{BF}_4$, which has been characterized using X-ray crystallography.²⁷³ When the same reaction is carried out in CH_2Cl_2 , then the structurally characterized product $[\text{Ir}((R)\text{-}(S)\text{-PPFP}(\text{Xyl})_2)^+(\text{H})(\text{C}_8\text{H}_{11}\text{I})]^-$ is isolated. Abstraction of iodide from $\text{Ir}(\text{CF}_3)(\text{Cl})(\text{CO})(\text{PPh}_3)_2$ by AgSbF_6 in CH_3CN yields $[\text{Ir}(\text{CF}_3)\text{Cl}(\text{MeCN})(\text{CO})(\text{PPh}_3)_2](\text{SbF}_6)$ (**148**).²⁷⁴ The CH_3CN group can be displaced with $\text{CN-}p\text{-tolyl}$ or H^- to give $[\text{Ir}(\text{CF}_3)\text{Cl}(\text{CN-}p\text{-tolyl})(\text{CO})(\text{PPh}_3)_2]^+$ and $[\text{Ir}(\text{CF}_3)\text{HCl}(\text{CO})(\text{PPh}_3)_2]$, in which the CF_3 and H ligands are mutually *trans*. Addition of excess NaBH_4 to (**148**) affords *trans*- $[\text{Ir}(\text{CF}_3)\text{H}_2(\text{CO})(\text{PPh}_3)_2]$. The X-ray structure of *cis*- $[\text{Ir}(\text{CO})_2\text{I}_4]^- (\text{C}_{11}\text{H}_{12}\text{N})^+$ has been reported.²⁷⁵

The complex *mer*- $[\text{IrCl}_3(\text{PET}_2\text{Ph})_3]$ readily substitutes the Cl^- ligand *trans* to PET_2Ph with CN^- , to give the structurally characterized species *trans,mer*- $[\text{IrCl}_2(\text{CN})(\text{PET}_2\text{Ph})_3]$.²⁷⁶ Extended irradiation by white light gives the *cis,mer*- $[\text{IrCl}_2(\text{CN})(\text{PET}_2\text{Ph})_3]$ isomer, which has also been analyzed by X-ray diffraction.

The reaction of $[\text{IrBr}_2\text{cp}^*]_2$ with $[\text{Re}(\mu\text{-Br})(\text{CO})_3(\text{C}_4\text{H}_8\text{O})]$ yields the structurally characterized complex $[\text{cp}^*\text{Ir}(\mu\text{-Br})_3\text{Re}(\text{CO})_3]$.²⁷⁷ In solution the complex is in dynamic equilibrium with $[\text{cp}^*\text{Ir}(\mu\text{-Br})_3\text{Ircp}^*][(\text{CO})_3\text{Re}(\mu\text{-Br})_3\text{Re}(\text{CO})_3]$. The preparation of $[\text{cp}^*\text{Ir}(\mu\text{-Cl}_3)\text{Ru}(\text{PPh}_3)_2\text{Cl}]$ has been published.²⁷⁸

IrCl_3 reacts with excess active magnesium (Mg^*) or Et_2Mg to form the inorganic Grignard reagents $[\text{Ir}(\text{MgCl})_3]$ and $[\text{IrMgCl}\cdot\text{MgCl}_2]$, respectively.²⁷⁹ Hydrolysis or alcoholysis of THF solutions of the inorganic Grignard delivers finely divided X-ray amorphous Ir.

6.2.5.11 Hydrogen Ligands

The complex $\text{Ir}(\text{H})_2\text{Br}(\text{CO})(\text{dppe})$, formed via the oxidative addition of H_2 to $[\text{IrBr}(\text{CO})(\text{dppe})]$, has the hydrogen ligands in a *cis* configuration *trans* to Br^- and one of the P-donor atoms, as determined by X-ray crystallography.²⁸⁰ $[\text{Ir}(\text{PMe}_3)_4]\text{PF}_6$ undergoes oxidative addition of H_2O to yield stable *cis*- $[\text{IrH}(\text{OH})(\text{PMe}_3)_4]\text{PF}_6$ (**149**).²⁸¹ Exchange reactions of (**149**) with D_2O and MeOH afford *cis*- $[\text{Ir}(\text{H})(\text{OD})(\text{PMe}_3)_4]\text{PF}_6$ and *cis*- $[\text{IrH}(\text{OMe})(\text{PMe}_3)_4]\text{PF}_6$ (**150**), respectively.²⁸² (**149**) and

(150) have been crystallographically characterized, with (149) showing a much smaller Ir—O—H angle ($91(\pm 7)^\circ$) compared to Ir—O—CH₃ ($119.4(\pm 0.9)^\circ$) in (150). The complexes $[\text{IrH}(\text{H}_2)\text{bqL}_2]^+$, L = PPh₃, Pcy₃ and $[\text{IrH}_2(\text{H}_2)_2(\text{Pcy}_3)_2]^+$, have been synthesized and characterized by ¹H NMR spectroscopy.²⁸³

The structurally characterized iminol complex $[\text{IrH}_2\text{L}'(\text{PPh}_3)_2]\text{SbF}_6 \cdot 2\text{H}_2\text{O}$, (151), contains an O—H···H—Ir proton-hydride bond calculated at 1.58 Å.²⁸⁴ A series of related complexes replacing the amide Me group by ⁿBu, *p*-tolyl, Ph, *p*-FC₆H₄, 3,4-F₂C₆H₃ show a similar H···H interaction in common with complexes (152).²⁸⁵ (152) exhibits an intramolecular N—H···H—Ir hydrogen bond (1.80 Å), as evidenced by ¹H NMR studies.²⁸⁶ Replacement of one hydride ligand by a fluoride results in the complex $[\text{Ir}(\text{H})_2\text{F}(\text{PPh}_3)_2(\text{pyNHR})]$, which shows N—H···F—Ir hydrogen bonding.

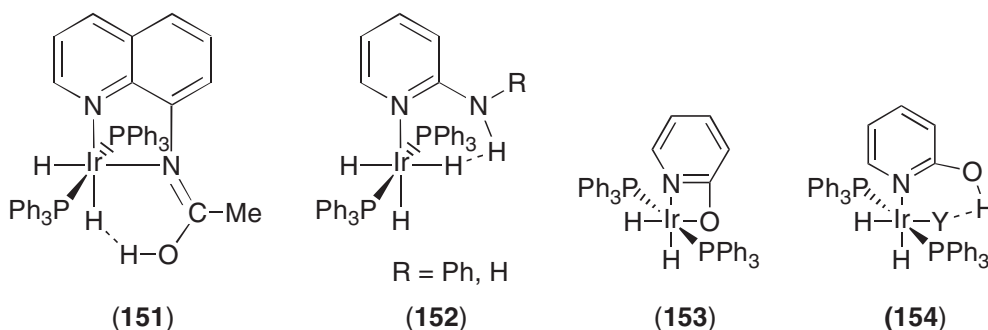

Treatment of $[\text{IrH}_5(\text{PPh}_3)_2]$ with 2-hydroxy-pyridine in benzene yields the structurally determined complex (153), which reacts with HY (Y = Cl, Br, I) to give (154).²⁸⁷

NMR studies indicate that the rotamer of (154), in which the *trans* H and Y ligands are transposed, is also formed. Replacement of 2-hydroxypyridine with 2-aminophenyl pyridine (pyNHPh) gives the complexes $[\text{Ir}(\text{PPh}_3)_2(\text{H})_2\text{Y}(\text{pyNHPh})]$, Y = F, Cl, Br, I, which show analogous hydrogen-bonding interactions to (154). The N—H···H—Ir hydrogen bonds are stronger than N—H···Cl—Ir bonds.

Synthesis of the complex $[\text{Ir}(\text{PPh}_3)_2(\text{H})(\text{OH}_2)(\text{bqNH}_2)]^+$ has been detailed.²⁸⁸ The H₂O ligand may be readily substituted by F[−], which has an intramolecular NH···F—Ir hydrogen bond. Treatment with HBF₄·Et₂O yields $[\text{Ir}(\text{PPh}_3)_2(\text{H})(\text{FH})(\text{bqNH}_2)]^+$, which exhibits Ir—F—H···NH₂ intramolecular bonding.

The synthesis and structural determination of (155), R = ⁱPr, have been reported. The structure shows hydrogen bonding between the hydrogen of the NHR group and the lone pair of electrons on the water oxygen.²⁸⁹ Replacing the H₂O ligand in (155), R = H, by fluoride gives the structurally determined complex $[\text{IrH}(\text{F})(\text{PPh}_3)_2(\text{bq-NH}_2)]$, with an H···F distance of 1.813 Å. A DFT study of the intramolecular hydrogen-bonded compounds has been detailed.²⁹⁰ Reaction of (155), R = H, with H₂ yields $[\text{Ir}(\text{H})_2(\text{bq-NH}_3)(\text{PPh}_3)_2]\text{BF}_4$, as characterized by ¹H NMR spectroscopy.²⁹¹ Replacing the NHR pendant arm in (155) by ^tBu and ⁱPr results in complexes (156) and (157), respectively, which have been studied by X-ray crystallography.²⁹² Note that for the ^tBu derivative an agostic interaction is observed, which is absent in the ⁱPr compound. Calculations (B3PW91/UFF) suggest that weak ligand–ligand interactions, such as parallel aromatic stacking between P—Ph and bq ligands, is important. Similar proton–hydride interactions are discussed for sulphur-bound ligands.^{258–260}

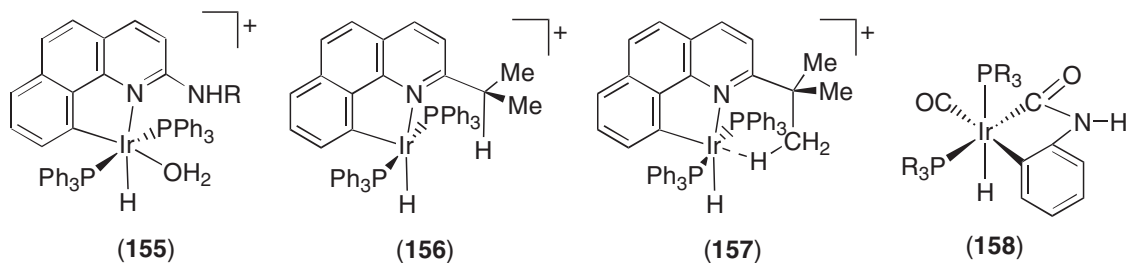

The reaction of $\text{IrCl}_3 \cdot 3\text{H}_2\text{O}$ with Pcy₃ and PPh₃ gives $[\text{IrHCl}_2(\text{Pcy}_3)_2]$ and $[\text{IrHCl}_2(\text{PPh}_3)_3]$, respectively.²⁹³ Further reaction of $[\text{IrHCl}_2(\text{PPh}_3)_3]$ with NaOEt in THF under H₂ yields

fac-[IrH₃(PPh₃)₃]. The carbonylation reaction of *trans*-Ir(PR₃)₂(CO)(NHAr), R = Ph, Ar = Ph, *o*-tolyl, *p*-tolyl, *p*-C₆H₄Cl, 2,6-C₆H₃Me₂, 3,5-C₆H₃Me₂; R = Me, Et, Ar = Ph, yields the hydride complex (**158**).^{517,520}

The *cis* and *trans* isomers of H₂IrCOL (L = C₆H₃(CH₂PⁱPr₂)₂) are prepared from HIr(PPh₃)₃(CO), according to reaction Scheme 18.²⁹⁴ Under H₂ pressure the *cis* form isomerizes into the *trans* species. Electrophiles such as [Ph₃C]BF₄, PhC(O)Cl, CS₂, and MeI directly attack the hydride ligands of the *trans* isomer. Addition of H₂ to [Ir(CO)Cl(P)₂] to afford [Ir(CO)Cl(H)₂P₂] is 45 times faster for the P = PPh₂(C₆H₄SO₃K-*m*)/H₂O system than for the P = PPh₃/toluene system.²⁹⁵

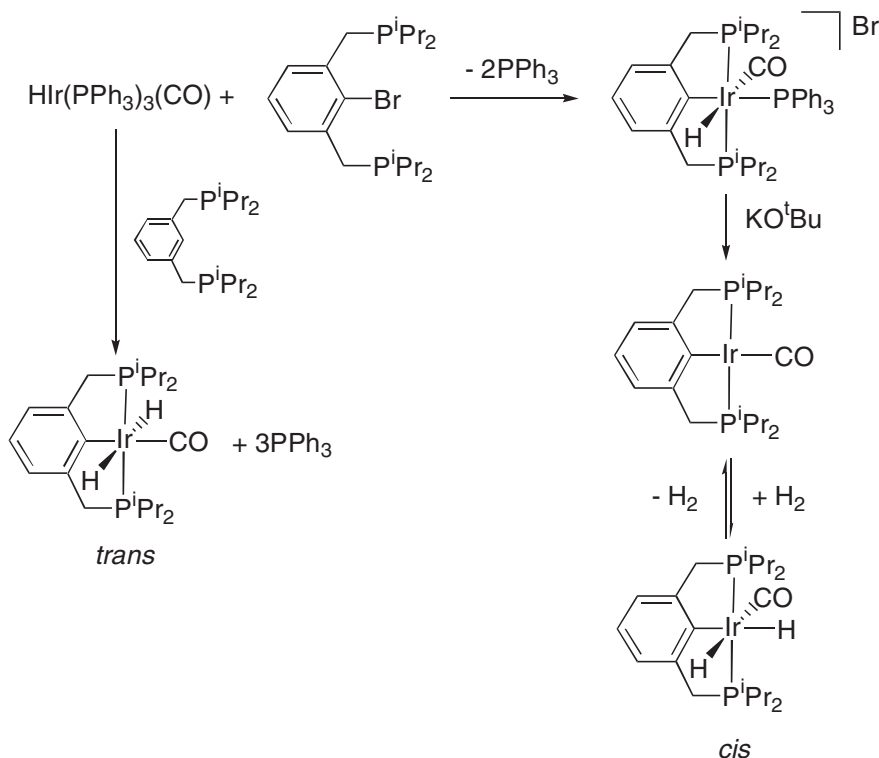

Scheme 18

Thermolysis of *trans*-[Ir(H)(OCH₃)(C₆H₅)(PMe₃)₃] yields *trans*-[Ir(H)₂](C₆H₅)(PMe₃)₃ and formaldehyde.²⁹⁶ Extensive mechanistic studies show that the β-hydride elimination process does not follow the usual pathway. Me₃NO selectively abstracts the proton from [IrH(CO)(PPh₃)₂L(A)]^{0,1+,2+}, A = C₂Ph, Cl, CH₃CN; L = CH₃CN, Cl, ClO₄, to give the *trans* elimination product [Ir(CO)(PPh₃)₂A]^{0,1+}.²⁹⁷ The rate-determining step is found to be formation of (PPh₃)₂L(A)(CO)Ir—H—ON + Me₃, where L = A = Cl. The rate varies with A and L.

Flash photolysis reactions of [Ir(H)₂Cl(L)(PPh₃)₂], L = CO, PPh₃, in deaerated benzene, proceed by ligand, L, dissociation to give [Ir(H)₂Cl(PPh₃)₂], followed by rapid H₂ elimination to yield IrCl(PPh₃)₂, which reacts with CO or PPh₃ to form [IrCl(CO)(PPh₃)₂] and [IrCl(PPh₃)₃], respectively, with rate constants of 25 × 10⁸ M⁻¹ s⁻¹ and 13 × 10⁷ M⁻¹ s⁻¹.²⁹⁸

Heating (at 100 °C), or photolysis by visible light, of the 1:1 mixture of [IrH₃(PPh₃)₃]:C₆₀ in toluene gives a product whose UV-vis spectrum is characteristic of η²-coordinated C₆₀.²⁹⁹

Density functional theory (B3LYP) has been used to investigate the mechanism of the *cis-trans* isomerization in Ir(H)₂(CO)(C₆H₃{CH₂P(H)₂})₂.³⁰⁰ The preferred mechanism involves two consecutive trigonal twists in which the complex passes through a distorted octahedral intermediate, as shown in reaction Scheme 19.

Intramolecular hydrogen exchange in IrX(H)₂(η²-H₂)(PR₃)₂, X = Cl, Br, I; R = H, Me, has been studied using density functional calculations (B3LYP).³⁰¹ The two lowest-energy processes are rotation of the H₂ ligand and oxidative addition of the η²-H₂ to form an intermediate Ir^V tetrahydride, which undergoes rapid reductive elimination to interchange the dihydrides and the dihydrogen.

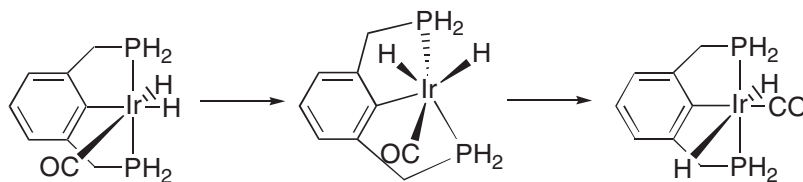

Scheme 19

Reaction of $[\text{IrH}_5(\text{PEt}_3)_2]$ with “ RhClL_2 ”, $\text{L} = \text{PEt}_3$ or $\text{L}_2 = \text{diphos}$, gives $[\text{L}_2\text{Rh}(\mu\text{-H})(\mu\text{-Cl})\text{-IrH}_2(\text{PEt}_3)_2]$.³⁰² The X-ray structure of the complex in which $\text{L} = \text{PEt}_3$ confirms a square-planar geometry around Rh and octahedral coordination to Ir. The Rh—Ir distance is 2.898(1) Å, and the asymmetrically bridging Cl^- ligand is closer to Rh. The X-ray structures of bimetallic complexes (**159**), where $\text{M} = \text{Mo}$ and W , show that the Mo—Irr distance of 2.641(1) Å is significantly shorter than the W—Irr distance at 2.706(1) Å.³⁰³

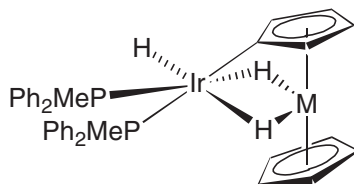

(159)

The preparation and NMR characterization of $[(\text{triphos})(\text{H}_{3-x})\text{Ir}(\mu\text{-H})_x\text{HgR}](\text{CF}_3\text{SO}_3)$, $\text{R} = n\text{-C}_{12}\text{-H}_{25}$, PhCH_2 , 2,4,6-Me₃C₆H₂, Ph, 4-ClC₆H₄, 2,4,6-Cl₃C₆H₂, in CD_2Cl_2 at -80°C have been described.³⁰⁴ The structures of complexes *cis*- $[\text{IrH}(\text{H}_2)\text{Cl}_2(\text{P}^i\text{Pr}_3)_2]$, (**160**), and $[\text{Ir}(\text{H})_2\text{Cl}(\text{P}^i\text{Bu}_2\text{Ph})_2]$, (**161**), have been studied by neutron diffraction.³⁰⁵ (**161**) contains a planar H_2IrCl fragment in a Y shape, with an H—Irr—H angle of 73° . ECP *ab initio* calculations show that the *cis* form of (**160**) is more stable than the *trans* configuration, with the Ir—H₂ interaction stronger in the *cis* form. The structure of $[\text{IrCl}_2(\text{NH}_3)\text{H}(\text{PCy}_3)_2]$ has been reported.³⁰⁶

6.2.5.12 Mixed-donor-atom Ligands

6.2.5.12.1 C/N

Thermolysis of (**162**), $\text{R} = p\text{-ClC}_6\text{H}_4$, $p\text{-FC}_6\text{H}_4$, results in loss of CO_2 and the formation of the kinetically stable side-bonded nitrile (**163**).³⁰⁷ The crystal structure of (**163**) in which $\text{R} = p\text{-Cl-C}_6\text{H}_4$ has been determined. The insertion product from the reaction of $[\text{Ir}(\text{PEt}_3)_2(\text{C}_2\text{H}_4)\text{Cl}]$ with aniline and norbornylene is $[\text{Ir}(\text{PEt}_3)_2(\text{NHPhC}_7\text{H}_{10})(\text{H})\text{Cl}]$, (**164**), which has been characterized by NMR spectroscopy and single-crystal X-ray diffraction.³⁰⁸ Decomposition of (**164**) proceeds via two competing pathways to give either norbornylene and a reactive Ir intermediate, or *exo*-2-(phenylamino)norbornane.

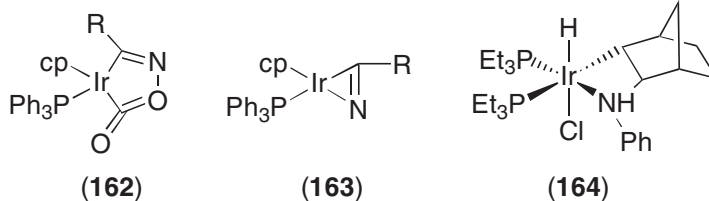

The synthesis and X-ray structural determination of a stable Ir^{III} hydride/alkylidene complex, (**165**), has been reported, in which the tridentate N_3 ligand is Tp^{Me_2} .³⁰⁹ The complex undergoes reversible hydride migration onto the electrophilic carbene atom, as shown in reaction Scheme 20.

The X-ray structures of two ortho-metalated compounds, **(166)**, have been discussed.³¹⁰ Weak interactions between the hydride ligand and C—H protons of the PPh₃ groups are recorded.

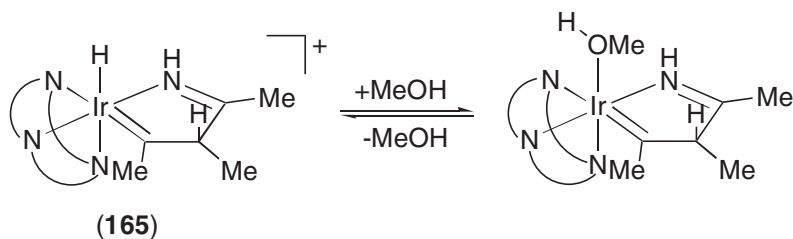
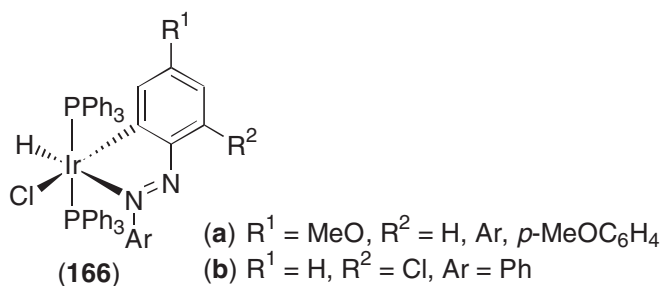

Scheme 20

Oxidative addition of [Fe{η⁵-C₅H₄(2-C₅H₄N)}{η⁵-C₅H₄PPh₂}] to [Ir(cod)Cl]₂ results in the structurally characterized species [Ir(H){Fe(η⁵-C₅H₃(2-C₅H₄N))(η⁵-C₅H₄PPh₂)}(cod)]PF₆, which contains the PNC-bound derivative of ferrocene.³¹¹ The syntheses and structures of **(167)**, **(168)**, and **(169)** are described.³¹²

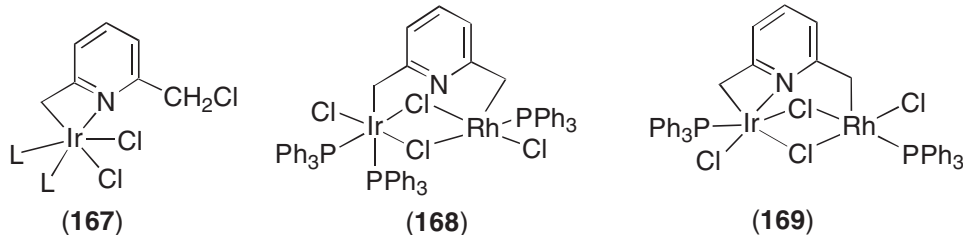

The most frequently reported mixed C/N-donor ligands are the 2-phenylpyridine anion, ppy (170), orthometalated 2,2'-bipyridine, C3N^bbpy (171), and derivatives, for example (172).

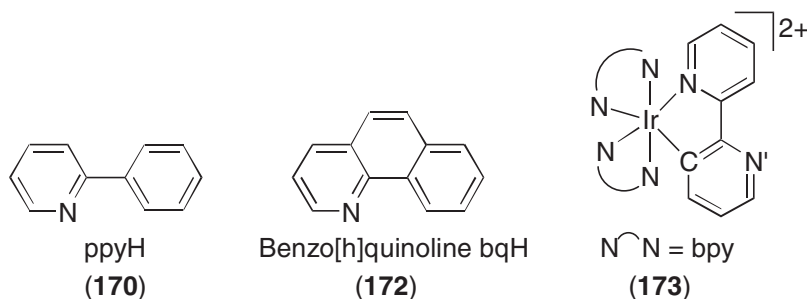

Complexes of the type [Ir(L)₂(S)₂](otf) have been prepared by reaction of [Ir(L)₂Cl]₂ with Ag(otf) in solvent S, L = ppy or ptpy, S = H₂O or CH₃CN.³¹³ The complexes were characterized by ¹H and ¹³C NMR spectroscopy, UV-vis absorption and emission spectroscopy, and cyclic voltammetry.

The species [Ir(bpy)₂(C3N^bbpy)]²⁺ (**173**) protonates at pH < 3, giving [Ir(bpy)₂(C3N^bHbpy)]³⁺, (**174**).³¹⁴ In strong acid (pH < 1.7), the one-electron reduction product of (**174**) reacts directly with H⁺ to give H₂. At higher pH, reduction of (**173**) is followed by disproportionation and then reaction with H⁺ or H₂O to yield H₂. In all cases the reduction site is N,N'-bound bpy.

Rate-constant data are reported. Pulse radiolysis of (173) or (174) in water plus 2-propanol produces the monoreduced species. Addition of small amounts of poly(styrenesulfonate), PSS, to the solution enhances decay of the monoreduced form of (173) and (174) and catalyzes the formation of H₂.³¹⁵ If colloidal Pt is added to the system, then the decay rate of (173)⁻ is further enhanced. The order of the reaction with respect to [Pt] changes from one at low [(173)] to nearly two upon increasing the concentration of (173), which suggests that adsorption of (173) onto Pt is important.³¹⁶ Similar physical measurements have been reported for the system containing (173) or (174), tetramethoxybenzene or dimethoxybenzene (DMB), and PSS.³¹⁷ Immobilization of (173) and [Ru(bpy)₃]²⁺ in a rigid porous SiO₂ matrix results in H₂ evolution when the matrix/aqueous DMB system is irradiated by an N₂ laser or Hg lamp.³¹⁸

The complex [Ir(ppy)₂(dpt-NH₂)]PF₆ (175), dpt-NH₂ = 4-amino-3,5-bis(2-pyridyl)-4*H*-1,2,4-triazole, (176), has been synthesized and characterized.³¹⁹ A reversible, one-electron oxidation of (175) is assigned to removal of an electron from an Ir *dπ*-based orbital. (175) luminesces at room temperature and 77 K. The complex (175), when immobilized in a polymeric matrix, acts as an oxygen sensor.³²⁰

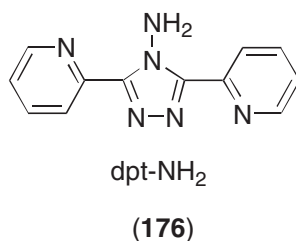

Further optical oxygen sensors which have been developed are those of [Ir(LH)(L)](PF₆)₂ and [Ir(L)₂]PF₆, LH = 2,6-bis(7'-methyl-4'-phenyl-2'-quinolyl)pyridine, immobilized in a polymeric matrix³²¹ and [Ir(ppy)₃]³⁺ immobilized in fluoropolymer film.³²²

Reactions of IrCl₃·H₂O with 2-(*p*-tolyl)pyridine(pty) and 3-methyl-2-phenylpyridine(mppy) gave [Ir(pty)₂Cl]₂ and [Ir(mppy)₂Cl]₂, respectively.³²³ Treatment with bpy afforded [Ir(pty)₂-bpy]Cl and [Ir(mppy)₂bpy]Cl. All complexes were characterized by UV-vis, emission spectroscopy, and cyclic voltammetry.

The electrochemical and spectroscopic properties of [Ir(ppy)₂Cl]₂, [Ir(bq)₂Cl]₂, [Ir(ppy)₂(NN)]Cl, and [Ir(bq)₂(NN)]Cl, NN = bpy or phen, have been reported.³²⁴ The binuclear species have metal-centered oxidations, and the monomers NN-based reductions. The mixed-ligand monomers exhibit dual emissions from MLCT states associated with both ortho-metalated (higher-energy) and NN ligands.^{325,326} Reaction of Hppy with Ir(acac)₃ gives *fac*-[Ir(ppy)₃].³²⁷ Similar reactions of phenyl-ring-substituted Hppy, namely 4*R*-Hppy, where R = Me, Pr, ^tBu, F, MeO, yields *fac*-[Ir(R-ppy)₃]. The structure of [Ir(Me-ppy)₂Cl]₂ has been detailed.³²⁸ Electrochemical studies on [Ir(ppy)₂(tap)]⁺ and [Ir(ppy)₂(hat)]⁺, tap = (177), hat = (178), show two reversible reductions on the tap or hat ligand and an irreversible oxidation.³²⁹

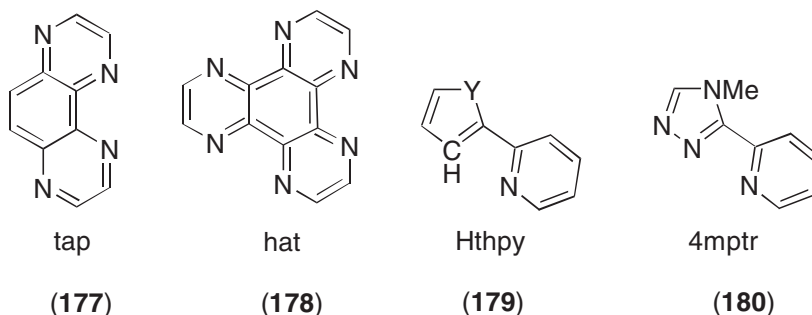

[Ir(ppy)₂hat]⁺ exhibits dual emission at 77 K. The bimetallic complex [(ppy)₂Ir(μ-hat)-Ru(bpy)₂]³⁺ has three reversible reduction waves; the first two involve the bridging hat ligand, and the third process is attributed to a bpy-based process.³³⁰ The complex also has an irreversible oxidation. Low-energy (~19,000 cm⁻¹) bands are assigned as Ru^{II} → hat π* transitions.

Reaction of [Ir(CO)(CH₃CN)(PPh₃)₂]PF₆ with bqH (172) gives the structurally characterized product *trans*-[Ir(H)(CO)(bq)(PPh₃)₂]PF₆, in which the CO ligand is *trans* to the orthometalated

C(3) cation of the ppy ligand.³³¹ The comparable species $[\text{Ir}(\text{H})(\text{OH}_2)(\text{bq})(\text{PPh}_3)_2]\text{SbF}_6$, has a similar structure.³³²

The syntheses and characterization of $[\text{Ir}(\text{ppy})_2\text{NN}]^+$ and $[\text{Ir}(\text{thpy})_2\text{NN}]^+$, NN = bpy, en, Hthpy = 2-(2-thienyl)pyridine, (**179**), in which the thpy ligand is C/N bound, are detailed.³³³

The lowest-energy excited states of $[\text{Ir}(\text{ppy})_2\text{NN}]^+$ and $[\text{Ir}(\text{thpy})_2\text{NN}]^+$ may be assigned to either a $^3(\pi-\pi^*)$ state on the C/N ligand or a $^3\text{MLCT Ir} \rightarrow \text{bpy}$ transition, depending on the environment of the complex. In the solid phase, a crystalline $[\text{Rh}(\text{ppy})_2\text{bpy}]\text{PF}_6$ lattice, the $^3(\pi-\pi^*)$ transition is at lowest energy, but the $^3\text{MLCT}$ state is lowest in solution.³³⁴ The ortho-metallated complex $[\text{Ir}(\text{ppy})_2(4\text{mptr})]\text{PF}_6$, 4mptr = 4-methyl-3-(pyridin-2-yl)-1,2,4-triazole, (**180**), has been synthesized and characterized by X-ray crystallography, NMR spectroscopy, electrochemical measurements, UV-vis absorption and emission spectroscopy.³³⁵ The *cis* ppy ligands have *trans* Ir—N bonds, and the 4mptr ligand coordinates through the pyridine nitrogen and N2 of the triazole ring. The complex has an irreversible oxidation (Ir based) and a reversible reduction (ppy based), and emits at room temperature (broad band at 582 nm) and at 77 K (highly structured band at 471 nm).

The complex *fac*- $[\text{Ir}(\text{Fppy})_3]$, Fppy = 2-(4,5-difluorophenyl) pyridine, has been used as a phosphorescent dye in polymer-based, organic, light-emitting diodes.³³⁶ The maximum external quantum efficiency reached is ~1.8%. Endothermic energy transfer from CBP (4,4'-*N,N'*-dicarbazole-biphenyl) to $[\text{Ir}(\text{F}'\text{ppy})_2(\text{pic})]$, $[\text{Ir}(\text{ppy})_2(\text{acac})]$, or $[\text{Ir}(\text{F}'\text{ppy})_2(\text{acac})]$, F'ppy = 2-(4,6-difluorophenyl) pyridine, leads to blue electroluminescence with an external quantum efficiency of 5.7%.^{337,338} Replacing CBP for 3-phenyl-4-(1'-naphthyl)-5-phenyl-1,2,4-triazole results in a 19% external quantum efficiency for $[\text{Ir}(\text{ppy})_2(\text{acac})]$.³³⁹ The X-ray structures of *fac*- $[\text{Ir}(\text{F}''\text{ppy})_3]$, where F''ppy = 3-C₆H₄(CF₃)-py-CF₃-5, 4-C₆H₄F-py-CF₃-5, 2-C₆H₄F-py-CF₃-5 and 3-CH₃OC₆H₄-py-CF₃-5, are reported.³⁴⁰ The complexes exhibit fully reversible reduction and oxidation waves. Most complexes show good electroluminescence efficiencies, with the peak emission maximum dependent on substituent. The electrochemiluminescence efficiencies of $[\text{Ir}(\text{ppy})_3]$ in CH₃CN, CH₃CN/H₂O (1:1), and aqueous 0.1 M KH₂PO₄ with tri-*n*-propylamine are 0.33, 0.0044, 0.00092, respectively, using $[\text{Ru}(\text{bpy})_3]^{2+}$ with an efficiency of 1.0 as the standard.³⁴¹

The syntheses, photophysical and electrochemical properties of $[\text{Ir}(\text{ppy})_2(\text{phen-NS-5})]\text{PF}_6$, (**181**), $[\text{Ir}(\text{ppy})_2(\text{phen-NHCOCH}_2\text{-5})]\text{PF}_6$, (**182**), and $[\text{Ir}(\text{ppy})_2(\text{phen-NH}_2\text{-5})]\text{PF}_6$ are reported.³⁴² Complexes (**181**) and (**182**) have been used to label amine- and sulfhydryl-modified oligonucleotides and human serum albumin to give luminescent bioconjugates.

Reaction of $[\text{M}(\text{ppy})_2\text{Cl}]_2$ with $[\text{M}'(\text{cod})\text{Cl}]_2$ affords the binuclear species $[(\text{ppy})_2\text{M}(\mu\text{-Cl})_2\text{-M}'(\text{cod})]$, M = M' = Rh, Ir, M = Rh, M' = Ir. Treatment of $[\text{Ir}(\text{ppy})_2\text{Cl}]_2$ with $[(\text{PR}_3)\text{PtCl}_2]_2$, R = Bu, Et, produces $[(\text{ppy})_2\text{Ir}(\mu\text{-Cl})_2\text{Pt}(\text{PR}_3)\text{Cl}]$.³⁴³

6.2.5.12.2 C/P

Bis-chelating C/P donor ligands on Ir^{III} are formed from the electrophilic addition of dichloro-carbene ligands to triphenylphosphine ligands.³⁴⁴ The X-ray crystal structures of (**183**) and (**184**) confirm the metallacycle ligand arrangement. Reaction of $[\text{IrCl}(\text{coe})_2]_2$ with PPh₃ gives $[\text{IrCl}(\text{PPh}_3)_3]$, which yields (**185**) after heating in cyclohexane.³⁴⁵

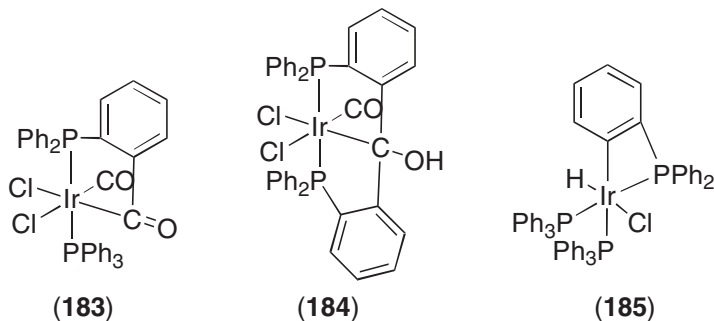

6.2.5.12.3 C/O

$[\text{Ir}(\text{coe})(\text{PMe}_3)_3\text{Cl}]$ undergoes oxidative addition with β -propiolactone to yield the structurally characterized complex *mer*- $[(\text{CH}_2\text{CH}_2\text{CO}_2)\text{Ir}(\text{PMe}_3)_3\text{Cl}]$, (**186**).³⁴⁶ The structure of the stable

16-electron α -acyl ester endolate Ir^{III} complex (**187**) has been reported.³⁴⁷ Complex (**187**) adds CO and CH₃CN reversibly.

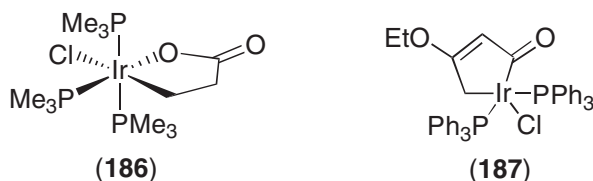

6.2.5.12.4 Si/N

The luminescence lifetimes of Δ RRR, Λ SSS, Δ RRS, and Λ SSR diastereomers (**188**), R = Ph, show that the symmetric forms are longer lived by a factor of two than the less symmetric species and are solvent dependent.³⁴⁸ The X-ray structure of R = Me confirms the *fac* arrangement of the Si/N ligands.³⁴⁹

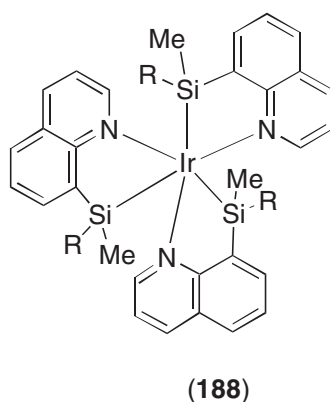

6.2.5.12.5 Si/P

Reaction of [Ir(cod)Cl]₂ with an excess of PPh₂CH₂CH₂SiMe₂H (Si/P) in THF affords Ir(PPh₂CH₂CH₂SiMe₂)₂Cl, whereas when two molar equivalents of the (Si/P) ligand are used, then the compound [Ir(PPh₂CH₂CH₂SiMe₂)(cod)(H)(Cl)] is isolated.³⁵⁰ Both Ir^{III} complexes have been characterized by X-ray diffraction, and show shorter equatorial bonds in the five co-ordinate species compared to the six coordinate complex.³⁵¹ When [Ir(CO)(PMe₃)₄]Cl is heated in toluene with PPh₂CH₂CH₂Si(mes)H₂ the *cis*-[Ir(PPh₂CH₂CH₂SiH(mes))(Cl)(H)(PMe₃)₂] complex results, and may be photolyzed to the structurally determined *trans* form in which the Cl ligand is *trans* to Si donor atoms.³⁵² The Cl ligand may be replaced in the *cis* form by metathesis with MeLi or EtMgBr. Heating [Ir(PPh₂CH₂CH₂SiH(mes))(R)(H)(PMe₃)₂] (R = Me, Et) leads to the reductive elimination of RH. Thermolysis of [Ir(PPh₂CH₂CH₂SiMe₂)(Et)(H)(PMe₃)₂], Ir(Si/P)₂(PMe₃)-(Et)(H), affords a 1:1 mixture of [Ir(Si/P)(PMe₃)₂(C₂H₄)] and [Ir(Si/P)(PMe₃)₂(H)₂].³⁵³

Photolysis of complex (**189**), R = mesityl, causes geometric isomerization to (**190**), with the structure (**190**) established by single-crystal diffraction studies.³⁵⁴ Reaction of Ph₂P(CH₂)₂Si(Me)₂-Si(Me)₂(CH₂)₂PPh₂ with *trans*-[Ir(PPh₃)₂(CO)Cl] yields complex (**191**) via an oxidative addition reaction to the Si-Si linkage.³⁵⁵

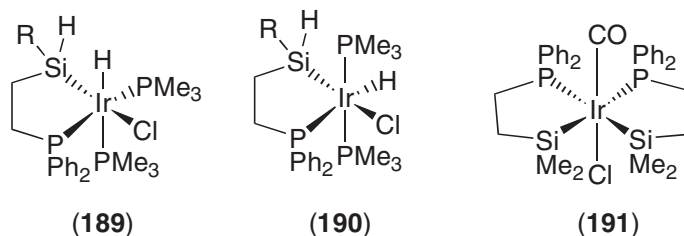

6.2.5.12.6 N/P

Reaction of $[\text{IrCl}(\text{cod})]_2$ and $o\text{-Ph}_2\text{PC}_6\text{H}_4\text{NHR}$, $\text{R} = \text{CH}_2\text{Ph}$, Et, yields the *P*-bound species $[\text{IrCl}(\text{cod})(o\text{-Ph}_2\text{PC}_6\text{H}_4\text{NHR})]$.³⁵⁶ Treatment with AgClO_4 affords the N/P-chelated complex $[\text{Ir}(\text{cod})(o\text{-Ph}_2\text{PC}_6\text{H}_4\text{NHR})]\text{ClO}_4$. Reaction of $[\text{IrCl}(\text{coe})_2]_2$ with $o\text{-Ph}_2\text{PC}_6\text{H}_4\text{NHR}$ gives $[\text{IrHCl}(o\text{-Ph}_2\text{PC}_6\text{H}_4\text{NR})(o\text{-Ph}_2\text{PC}_6\text{H}_4\text{NHR})]$, which forms $[\text{IrHCl}(o\text{-Ph}_2\text{PC}_6\text{H}_4\text{NHR})_2]\text{Cl}$, (**192**), on addition of HCl. The structure of (**192**), where $\text{R} = \text{CH}_2\text{Ph}$, shows that the H and Cl groups are in the axial positions and the chelate ligands have a mutual *cis* geometry.³⁵⁶

The structure of $[\text{IrCl}_2(\text{edmp})_2]\text{PF}_6$, (**193**), $\text{edmp} = (2\text{-aminoethyl})\text{dimethyl phosphine}$, confirms that the coordination geometry around the Ir center is approximately octahedral.³⁵⁷ If the edmp ligand is replaced by edpp, $\text{edpp} = (2\text{-aminoethyl})\text{diphenylphosphine}$, then the isomeric form (**194**) may be isolated and structurally characterized. The X-ray crystal structure of *fac*- $[\text{Ir}(\text{edmp})_3]\text{Cl}_3 \cdot 5\text{H}_2\text{O}$ has also been reported.³⁵⁸

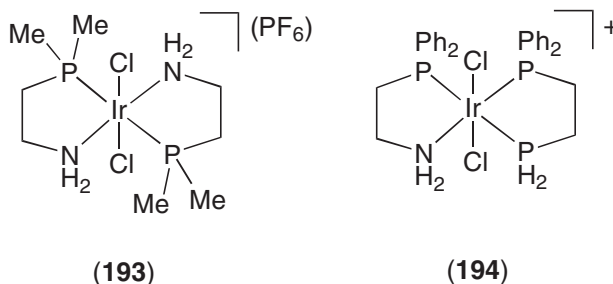

Treatment of $[\text{IrCl}(\text{CO})_2(p\text{-toluidene})]$ with azine phosphines of type *Z*, $E\text{-PPh}_2\text{CH}_2\text{C}(\text{tBu})=\text{N-N}=\text{C}(\text{Q})\text{R}$, $\text{Q} = \text{H}$, Me, $\text{R} = \text{an organic group}$, activates aryl, heterocyclic, alkenyl, or aliphatic C—H bonds to give cyclometalated Ir^{III} hydrides.³⁵⁹

6.2.5.12.7 N/O

The complex $\text{cp}^*\text{Ir}[\text{OC}(\text{Ph})=\text{NNCOPh}]$, (**195**), was obtained from the reactions of $\text{cp}^*\text{IrN}^t\text{Bu}$ or $[\text{cp}^*\text{Ir}(\mu\text{-OH})_3\text{Ircp}^*]\text{OH}$ with $(\text{PhCONH})_2$.³⁶⁰ X-ray structural analysis suggests that the product species should be considered as an electronically unsaturated Ir^{III} , 16-electron complex with normal oxide and amido bonds. The synthesis of the chiral half-sandwich complexes (**196**) and (**197**) has been detailed.³⁶¹

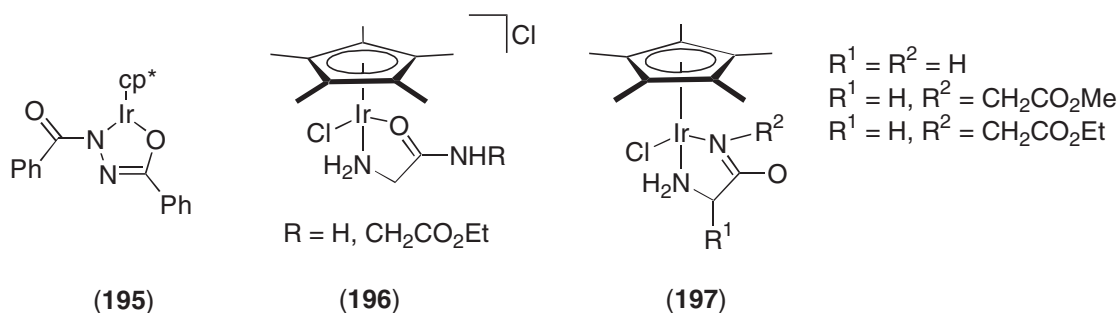

The biologically important 2-hydroxyiminocarboxylic acid ligands chelate to Ir^{III} centers to give (**198**), where $\text{R} = \text{CH}_3$, $\text{D}_o = \text{P}(\text{OMe})_3$, PMe_3 , PEt_3 , PPr_3 , PPh_3 , py; $\text{R} = \text{CH}_2\text{Ph}$, $\text{D}_o = \text{PEt}_3$, PPh_3 , py. The structure of (**198**), where $\text{R} = \text{CH}_3$, $\text{P} = \text{PMe}_3$, has been determined by X-ray crystallography.³⁶² Further related complexes, from the same laboratory and characterized by single-crystal diffraction studies, are (**199**), (**200**), and (**201**).³⁶³

Reaction of H_3IrCl_6 and 1,2-naphthoquinone-1-oxime (1-nqoH) (**202**) and py yields the structurally characterized species $[\text{pyH}][\text{Ir}(1\text{-nqo})(\text{py})\text{Cl}_3]$.³⁶⁴ In the absence of py, $[\text{Ir}(1\text{-nqo})_3]$ results. The spectral properties of the complexes $[\text{Ir}(\text{N/O})_2\text{Cl}_2]\text{Cl}$, where N/O ligands are as (**203**), have been reported.³⁶⁵ Tris chelates of (**204**), $[\text{Ir}(\text{204})_3]\text{Cl}_3$, bound through O and N*, have been characterized by IR and UV-vis absorption studies.^{366,367}

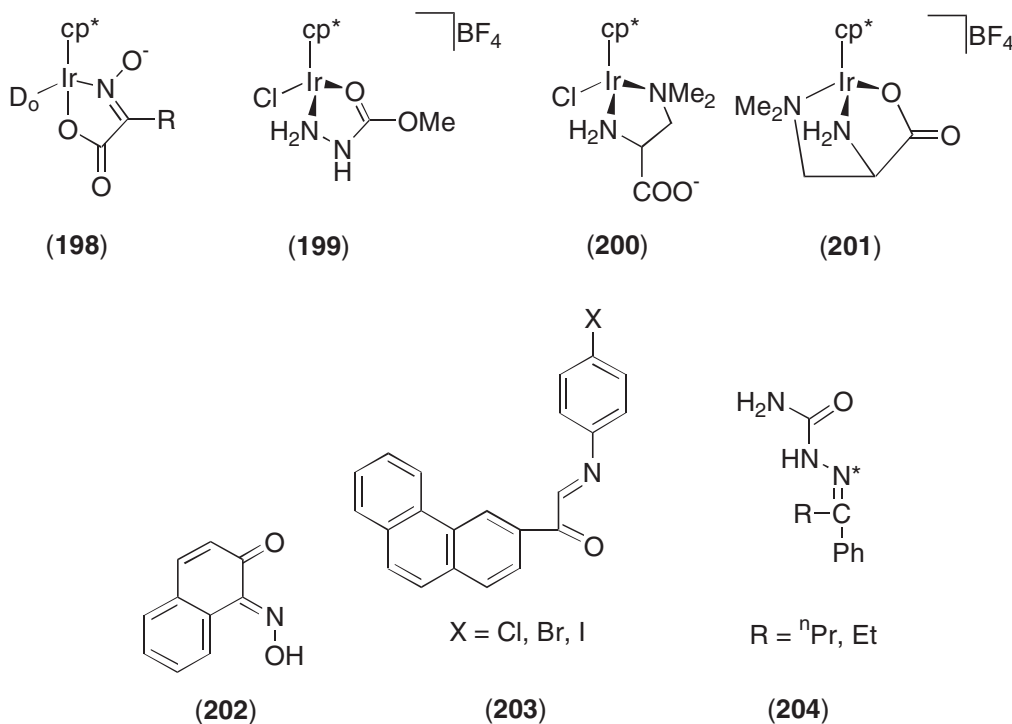

The synthesis and characterization of $[\text{cp}^*\text{Ir}(\text{aa})(\text{PPh}_3)]\text{BF}_4$, Haa = *L*-alanine, *L*-proline (pro), have been described.³⁶⁸ The crystal structure of $[\text{cp}^*\text{Ir}(\text{pro})\text{Cl}]$ (**205**) has been detailed. Reaction of (**205**) with $\text{HC}\equiv\text{CCMe}_3$ in the presence of NEt_3 gives the structurally characterized species $[\text{cp}^*\text{Ir}(\text{pro})(\text{C}\equiv\text{CCMe}_3)]$, which has the *R* configuration at the Ir center.³⁶⁹ In chloroform the complex epimerizes to the *S* form by an intramolecular mechanism.³⁷⁰ The structures of the py-containing complexes (**206**) and (**207**) have been reported.^{371,372}

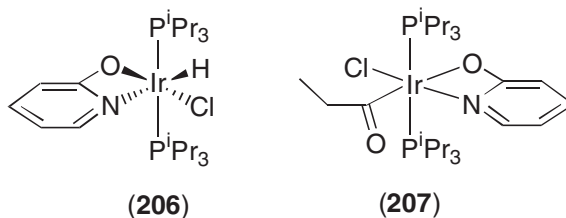

The guanylurea complexes $[\text{Ir}(\text{Gu})_2\text{Cl}_2]\text{Cl}$ and $[\text{Ir}(\text{Gu})_3]\text{Cl}_3$, Gu = $\text{H}_2\text{NC}(\text{:NH})\text{NHC}(\text{:O})\text{NH}_2$, have been prepared and characterized by IR and UV-vis absorption spectroscopy.³⁷³ The X-ray structure of $[\text{Ir}(\text{cp}^*)(\text{DMA})\text{Cl}]\text{PF}_6$, DMA = 1,3-dimethylalloxazino, (**208**) confirms that the O* and N* atoms are the chelate donors for binding to Ir^{III}. The complexes can be electrochemically reversibly reduced, and spectroelectrochemical studies (IR, UV-vis, EPR) confirm that the redox site is centered on the DMA ligand.³⁷⁴ The complex cation $[\text{cp}^*\text{Ir}(\text{bigOH})]^+$, big = bis(1-methylimidazol-2-yl)glyoxal, bigOH = (**209**), has been structurally characterized as its PF_6^- salt.³⁷⁵ The donor atoms of bigOH are denoted by an *.

The binuclear complex $[\text{cp}^*\text{Ir}(\mu\text{-H})(\mu\text{-S}^i\text{Pr})_2\text{Ircp}^*](\text{otf})$, (**210**), has been studied by X-ray crystallography.³⁷⁶ (**210**) reacts with nitrosobenzene to give the paramagnetic, structurally determined species $(\text{cp}^*\text{Ir}(\mu\text{-PhNO})(\mu\text{-S}^i\text{Pr})_2\text{Ircp}^*)^+$, in which the nitrosobenzene acts as a $\mu\text{-}\eta^1\text{:}\eta^1\text{-N,O}$ ligand. Reaction of 3-hydroxy-2-methyl-4(1H)-pyridine with $[\text{cp}^*\text{IrCl}_2]_2$ gave the trinuclear complex (**211**), which has been characterized by X-ray crystallography.³⁷⁷

6.2.5.12.8 N/S

The complex IrL_3 , HL = 8-quinolinethiol (**212**), has been prepared from an aqueous solution of $(\text{NH}_4)_3[\text{IrCl}_6]$ and NaL. An X-ray diffraction study confirms the *mer* configuration about the Ir

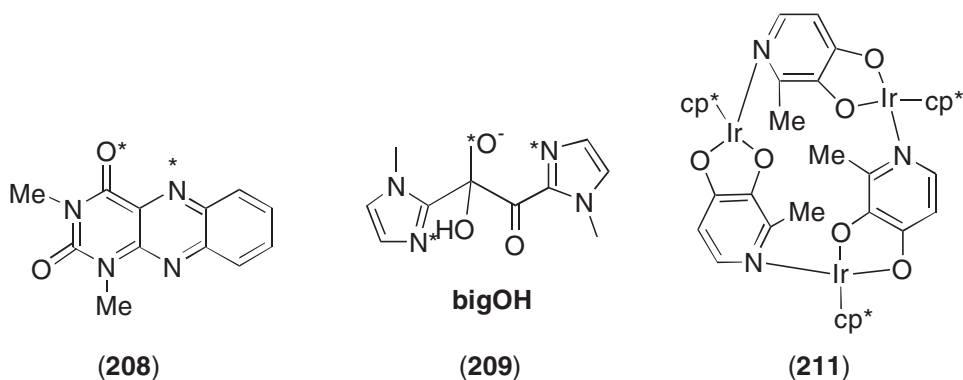

center.³⁷⁸ The 4-methyl derivative has an analogous structure.³⁷⁹ The redox chemistry of Ir complexes bound to **(212)** and its 2-, 4-, 5-, 6-, and 7-methyl derivatives shows a reversible one-electron reduction and a one-electron oxidation involving the ligand.³⁸⁰

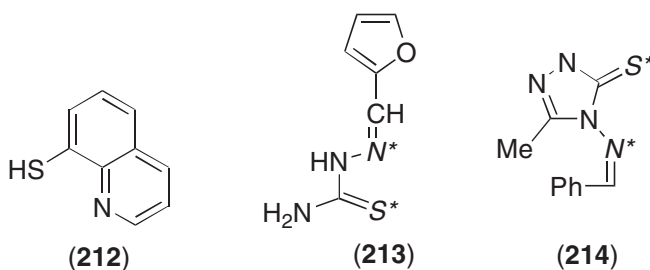

Reaction of $[\text{IrCl}(\text{cod})]_2$ with $\text{LiNHC}_6\text{H}_4\text{-}o\text{-SMe}$ gives $[\text{Ir}(\text{Me})(\text{SC}_6\text{H}_4\text{NH})(\text{cod})]$ by oxidative addition of the S—Me bond.³⁸¹ The octahedral complex $[\text{Ir}(\text{HL})_2\text{X}_2]\text{X}$, X = Cl, Br, HL = 2-furfuralthiosemicarbazone, **(213)** has been prepared and characterized by UV-vis, IR spectroscopy, and magnetic measurements.³⁸²

K_3IrCl_6 reacts with cystine (H_2L) to give $[\text{Ir}(\text{HL-O,S})(\text{HL-N,S})\text{Cl}(\text{OH}_2)]$ and $[\text{Ir}(\text{HL-N,S})\text{Cl}(\text{OH}_2)(\text{OH})]$, which have been characterized by XPS, IR spectroscopy, and TGA.³⁸³

The complex IrL_3 , HL = 3-methyl-4-benzylideneimino-5-mercapto-1,2,4-triazole **(214)**, which binds through the indicated S and N in a bidentate manner, has been prepared and characterized by physicochemical techniques.³⁸⁴

The synthesis and characterization of $[\text{Ir}(\text{N/S})_3]\text{Cl}_3$, N/S = thiosemicarbazones of methyl *n*-hexyl ketone and methyl *n*-pentyl ketone **(215)**, have been described.³⁸⁵ The complex $[\text{IrL}(\text{Cl})(\text{OH}_2)]$ **(216)**, $\text{H}_2\text{L} = N,N'$ -hexylenebis(monothioacetylacetonimine), has been prepared and characterized by UV-vis, IR, and ^1H NMR spectroscopy.³⁸⁶

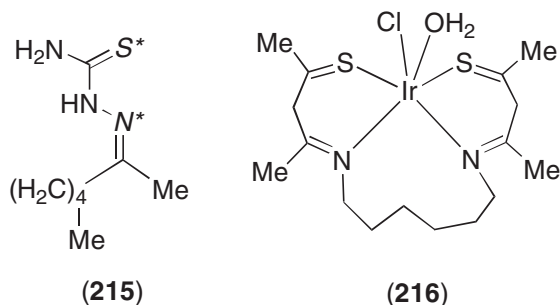

The synthesis of the $\text{Cu}^{\text{I}}/\text{Ir}^{\text{III}}$ Cu_4Ir_4 S/N-bridged polynuclear complex $[\text{Cu}\{\text{Ir}(\text{aet})_3\}_2\{\text{Ir}_2(\text{aet})_4(\text{cysta})\}]^{6+}$, Haet = $\text{H}_2\text{NCH}_2\text{CH}_2\text{SH}$, cysta = cystamine, has been discussed.³⁸⁷ Treatment of an aqueous solution of *fac*(*S*)- $[\text{Ir}(\text{aet})_3]$ with HNO_3 gave the structurally characterized complex $[\text{Ir}_2(\text{aet})_4(\text{cysta})](\text{NO}_3)_2$, **(217)**.³⁸⁸

Reaction of *fac*(*S*)- $[\text{Ir}(\text{aet})_3]$ with VCl_3 gave $[\text{V}\{\text{Ir}(\text{aet})_3\}_2]^{3+}$ according to Reaction Scheme 21.³⁸⁹ The structure of **(218)**(ClO_4)₃ confirms the linear-type structure. Cyclic voltammetric studies of **(218)** show irreversible oxidation and reduction processes.

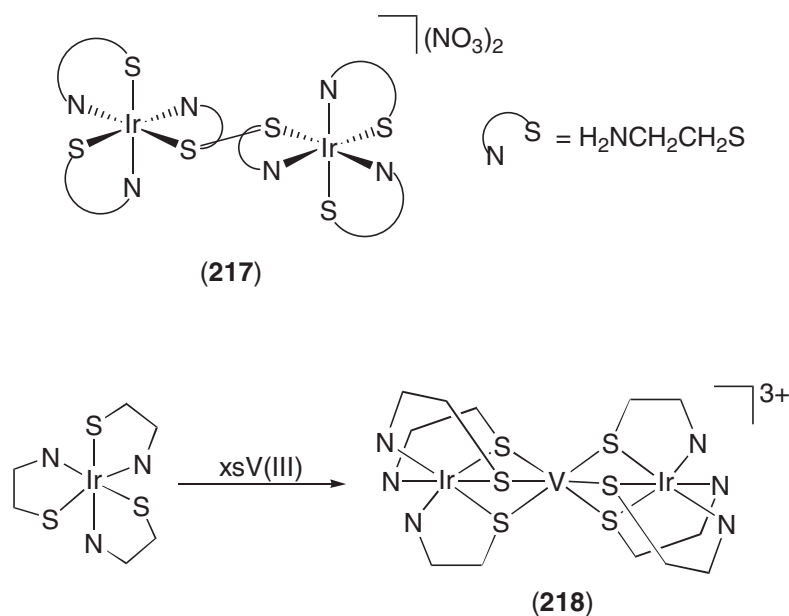

Scheme 21

6.2.5.12.9 P/O

Reaction of (1*R*)-endo-(+)-3-diphenylphosphinocamphor, (**219**), with $\text{IrCl}_3 \cdot 3\text{H}_2\text{O}$ gives *mer,trans*- $[\text{IrCl}_3(\mathbf{219})_2]\text{BF}_4$.³⁹⁰ In the complex ligand, (**219**) binds once in a unidentate manner through the P donor atom and again in a bidentate fashion through P and O. Treatment of $[\text{IrCl}(\text{coe})_2]_2$ with ${}^i\text{Pr}_2\text{PCH}_2\text{CH}_2\text{OMe}$ affords the structurally determined hydrido-iridium(III) complex (**220**), which reacts with H_2 and HCl to give $[\text{IrH}(\text{Cl})(\text{X})\{\kappa^1(\text{P})\text{-}{}^i\text{Pr}_2\text{PCH}_2\text{CH}_2\text{OMe}\}\{\kappa^2(\text{P},\text{O})\text{-}{}^i\text{Pr}_2\text{PCH}_2\text{CH}_2\text{OMe}\}]$, X = H and Cl, respectively.³⁹¹

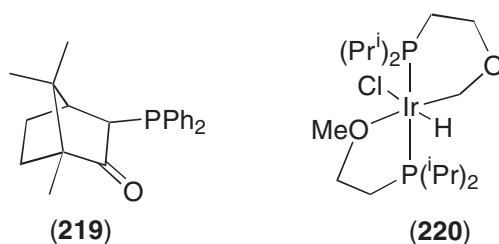

Reaction of (**220**) with $\text{HC}\equiv\text{CCO}_2\text{Me}$ yields $[\text{IrCl}(\text{C}\equiv\text{CCO}_2\text{Me})(\text{CH}=\text{CHCO}_2\text{Me})\{\kappa^1(\text{P})\text{-}{}^i\text{Pr}_2\text{PCH}_2\text{CH}_2\text{OMe}\}\{\kappa^2(\text{P},\text{O})\text{-}{}^i\text{Pr}_2\text{PCH}_2\text{CH}_2\text{OMe}\}]$. The phosphine ether ligand $\text{cy}_2\text{PCH}_2\text{CH}_2\text{OCH}_3$ coordinates to Ir^{III} in a bidentate manner through both P/O bonds (PO) and C/P (OCH₃) orthometalated linkages (CP) in $[\text{IrClH}(\text{PO})(\text{CP})]$, (**221**).³⁹¹ Reaction of (**221**) with H_2 yields $[\text{IrCl}(\text{H})_2(\text{PO})\text{P}]$, where $\text{P} = \eta^1\text{-}(\text{P})$ coordination of $\text{cy}_2\text{PCH}_2\text{CH}_2\text{OCH}_3$.³⁹² NMR studies show that the two ether O donors and the two *cis* H ligands are involved in fast exchange processes. Treatment of (**221**) with HCl and CO yields $[\text{IrH}(\text{Cl})_2(\text{PO})\text{P}]$ and $[\text{IrH}(\text{CO})\text{Cl}(\text{CP})(\text{P})]$, respectively.³⁹³ The structure of *mer*- $[\text{Ir}(\text{Cl})_3(\text{PO})\text{P}]$, in which the P donor atoms are in a *cis* configuration, is detailed.

Reaction of $[\text{cp}^*\text{IrCl}_2]_2$ with 2,6-dimethoxyphenyl(diphenylphosphine), *mdmpp*, gives (**222**), and with tris(2,6-dimethoxyphenyl)phosphine, *tdmpp*, gives (**223**).³⁹⁴ Addition of *tne* to a CH_2Cl_2 solution of (**222**) yields the structurally characterized complex (**224**), in which *tne* has inserted into a C—H aromatic bond.³⁹⁵ The complex (**223**) reacts with one molar equivalent of *tne* to give (**225**), and with two molar equivalents to give (**226**); both have been analyzed by X-ray crystallography.³⁹⁶

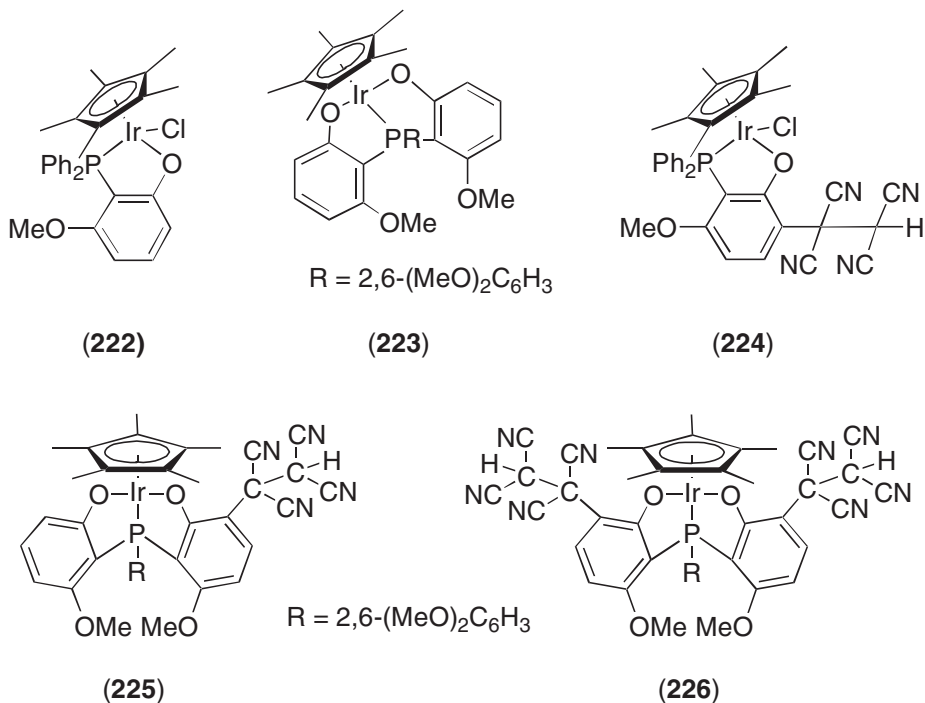

6.2.5.12.10 P/S

Treatment of *trans*-[IrCl(CO)(PPh₃)₂] with two equivalents of Ph₂P-CH₂CH₂-SR (R = Me, Et), P-SR, in CH₂Cl₂/MeOH affords [Ir(CO)(P-SR)₂]⁺, whereas reaction at 70 °C gives [IrH(CO₂Me)(P-SR)₂]⁺.³⁹⁷ A single-crystal X-ray diffraction study of [IrH(CO₂Me)(P-SEt)₂]BPh₄ reveals an octahedral geometry around Ir, with *trans* P atoms and *cis* S atoms. Reaction of [Ir(CO)-(P-SEt)₂]⁺ with HY (Y = Cl, BF₄) yields *trans*-[IrH(CO)(P-SEt)₂]²⁺ and *cis*-[IrH(CO)(P-SEt)₂]²⁺, respectively. The crystal structure of (227) has been reported.³⁹⁸

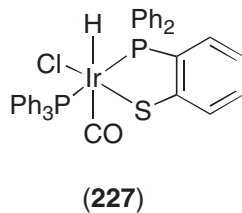

6.2.5.12.11 P/Br

Replacement of one phosphine ligand in [IrCl₃(η²-L)(η¹-L)], (228), L = PPh₂C₆F₄Br-*o*, by PR₃, PR₃ = PMePh₂, P(*p*-MeC₆H₄)₃, P(OMe)₃, P(OPh)₃, gave [IrCl₃(η²-L)(PR₃)].³⁹⁹ Electrochemical reduction of (228) at -1.5 V results in the formation of [IrBr₂(η²-L)L₂], [IrCl₂(η²-L)L₂] (229), and [IrClBr(η²-L)L₂], where L₂ = PPh₂(C₆F₄).

6.2.5.12.12 O/S

The synthesis of *fac*-L₃, L = PT = 2, mercaptopyridine-1-oxide (230), 3Me-PT, and 4Me-PT, and their characterization by UV-vis, IR, ¹H NMR spectroscopy, has been reported.⁴⁰⁰ The ligand HS-CH₂-CH(OH)-CH₂-OH, HL, binds to Ir^{III} in a bidentate manner, coordinating through the S atom and the primary alcohol O atom to form IrL₃.⁴⁰¹

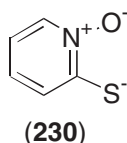
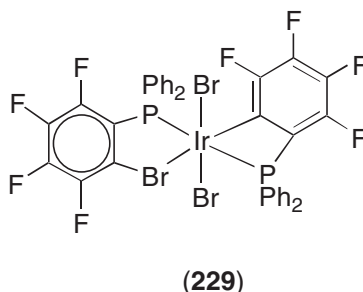
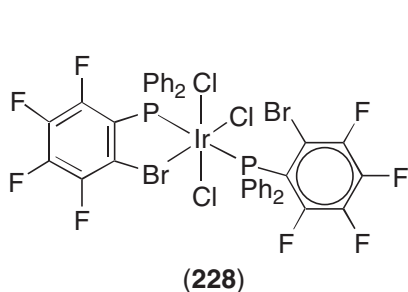

6.2.5.12.13 Multidentate ligands

Theoretical studies of catalytic alkane-dehydrogenation reactions by $[(PCP')IrH_2]$, $PCP' = \eta^3-C_6H_3(CH_2PH_2)_{2-1,3}$ and $[cpIr(PH_3)(H)]^+$, suggest that they proceed through similar steps in both cases; namely: (i) alkane oxidation, (ii) dihydride reductive elimination, (iii) β -H transfer from alkyl ligand to metal, (iv) elimination of olefin.⁴⁰² The calculated barriers to steps (i), (ii), and (iv) are more balanced for the PCP' system than for $cp(PH_3)$.

The cyclometalated dichlorocarbonyliridium(III) complex $[IrCl_2(CO)\{PPh_2CH_2C(tBu)=N-N=CH-(C_6F_4)\}]$, (**231**), has been characterized by 1H , ^{31}P , ^{13}C , ^{19}F NMR spectroscopy, and a single-crystal diffraction study.⁴⁰³

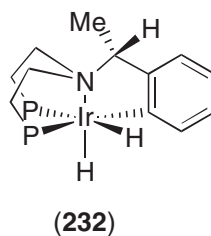
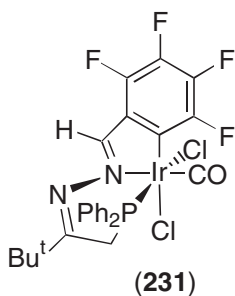

The crystal structure of (**232**) is reported. Ir complexes bound to the multidentate ligand as in (**232**) have proved successful in the enantioselective reduction of α,β -unsaturated ketones to allylic alcohols.⁴⁰⁴

The terdentate cyclometalated complexes $[Ir(L)(L^-)]^{2+}$ and $[Ir(L^-)_2]^+$, $L = 2,6$ -bis(7'-methyl-4'-phenyl-2'-quinoyl)pyridine (**233**), $L^- =$ monoanion of **L** (**234**), luminesce at 77 K in MeOH/EtOH ($\lambda_{max} = 592$ nm, $\tau = 20$ μ s) and at room temperature in deoxygenated acetonitrile ($\lambda_{max} = 620$ nm, $\tau = 325$ ns).⁴⁰⁵ Both compounds undergo four reversible, ligand-centered, one-electron reduction processes.

The electrochemical behavior of an aqueous/ethanol solution of $[Ir(sat)_2]Cl$, $satH =$ salicylaldehyde thiosemicarbazone (**235**), has been studied on mercury. A two-electron, ligand-based reduction at -1.09 V vs. SCE (independent of pH) is observed at fast scan rates.⁴⁰⁶

Bis(8-quinolyl)methyl silane $NSiHN$, (**236**), reacts with $[Ir(coe)_2Cl]_2$ to give $[Ir(NSiN)(coe)(H)Cl]$, which reacts with PPh_3 to give $[Ir(NSiN)(PPh_3)(H)Cl]$, and with half a molar equivalent of $LiB(C_6F_5)_4$ to afford $[(NsiN)(H)(coe)Ir(\mu-Cl)Ir(coe)(H)(NsiN)]B(C_6F_5)_4$.⁴⁰⁷ The crystal structures of the three $Ir(NSiN)$ complexes are reported.

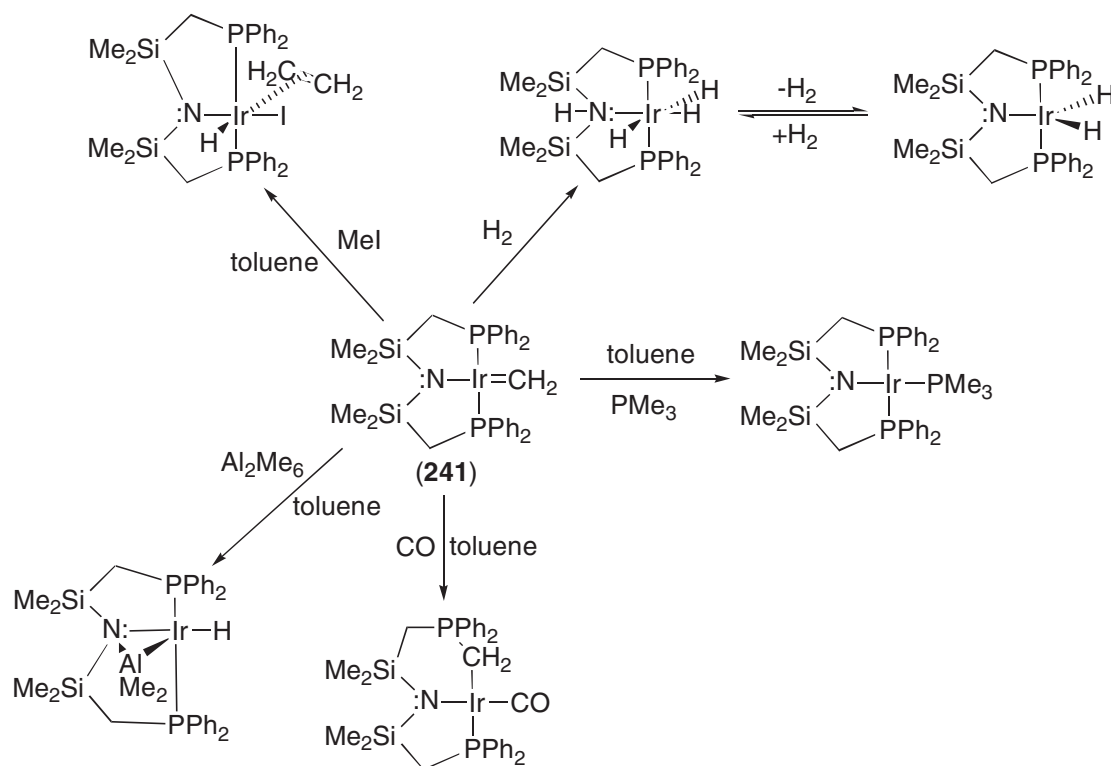

decomposes to *fac*-[Ir(η^2 -CH₂PPh₂)H{N(SiMe₂CH₂PPh₂)₂}], (**245**), which has been structurally characterized by X-ray analysis.⁴¹⁶ Further heating of (**245**) produces [Ir(PMePh₂)₂{N(SiMe₂-CH₂PPh₂)₂}].

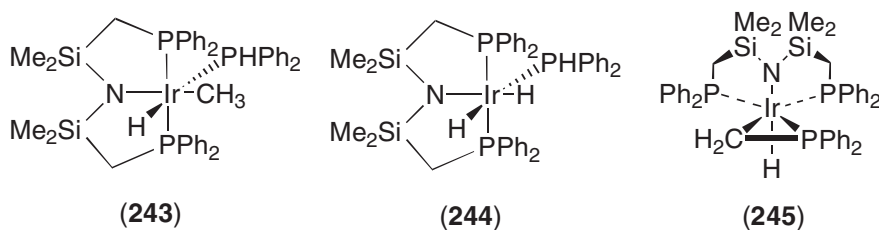

Reaction of the azine diphosphine *Z,Z*-Ph₂PCH₂C(^tBu)=N-N=C(^tBu)CH₂PPh₂ with [IrCl(CO)₂(*p*-toluidene)] gives the coordinatively saturated hydride (**246**).⁴¹⁷ Complex (**246**) dissolves in MeOH or EtOH, isomerizing to give (**247**). Isolation of (**247**) and dissolution in benzene or CH₂Cl₂ results in reversion to (**246**). (**247**) reacts with alkenes, alkynes, and H₂. Reaction of [Ir(cod)Cl]₂ and np₃ (np₃=N(CH₂CH₂PPh₂)₃) in the presence of NaBPh₄ yields the structurally characterized cation (**248**).⁴¹⁸

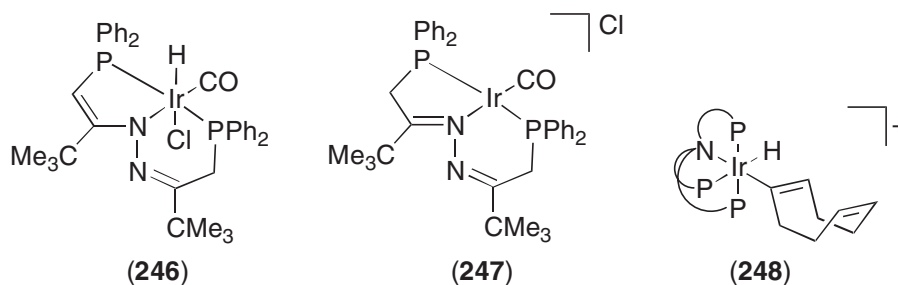

6.2.5.13 Biological Complexes

The hexanuclear Ir^{III} complex [L{IrCl₂cp*}₆], in which L is based on the amino glycoside neomycin B (**249**), has been characterized by IR, ¹³C, and ³¹P NMR spectroscopy, and by FAB MS.⁴¹⁹ The *in vivo* antitumor and antitrypanosomal effects of [IrY₄Cl₂]⁺ complexes, Y = primaquine, mepacrine, amodiaquine, lepidine, plasmoquine, pentaquine, and isopentaquine, have been reported.⁴²⁰ Similar studies of 27 complexes of general formula [IrY₃], where Y = dithiocarbamate or xanthate derivatives, found that the most active compounds have Y = pyrrolidine dithiocarbamate.⁴²¹

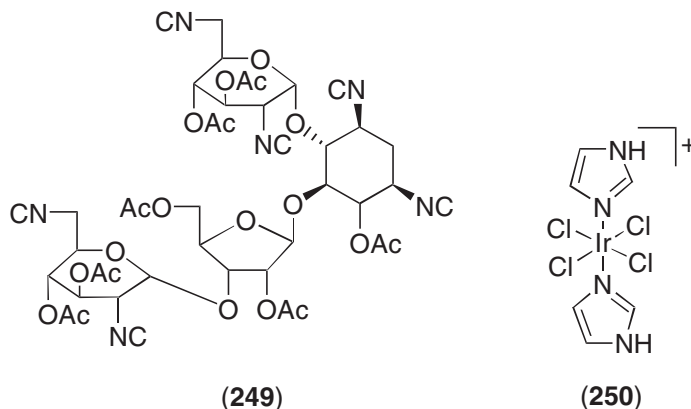

Dialysis experiments and DNA thermal denaturation studies of bisimidazole tetrachloroiridate(III), (**250**), suggest poor binding of (**250**) to DNA, with no formation of interstrand crosslinks.⁴²²

The DNA binding of [cp*Ir(dppz)(Aa)]ⁿ⁺, dppz = dipyrido[3,2-a:2',3'-c]phenazine, Aa = S-coordinated amino acid or peptide, has been investigated by UV-vis spectroscopy, 2D-NOESY, and gel electrophoresis. The complexes intercalate into DNA adjacent to T₂ from the major groove. The X-ray structural data for [cp*IrCl(dppz)](CF₃SO₃)₄ and [{cp*Ir(9-EtG)(Phen)](CF₃SO₃)₂, where GH = guanine, are reported.⁴²³

Treatment of [cp*Ir(OH₂)₃](CF₃SO₃)₂ with adenine (AH) and 9-ethyladenine (9-EtA) results in formation of the structurally determined species [{cp*Ir(A)}₄](CF₃SO₃)₄ and [{cp*Ir(9-EtAH-1)}₃](CF₃SO₃)₃, where A and 9-EtAH-1 are bridging, bidentate ligands.⁴²⁴ Analogous trimers were also formed from [cp*Ir(OH₂)₃]²⁺ and 5'-AMP²⁻ (5'-AMPH₂ = adenosine-5-monophosphate) or 5'-ATP⁴⁻ (adenosine-5'-triphosphate), whereas tetramers [{cp*Ir(B)(OH₂)₄]⁴⁺ resulted when B = guanine or hypoxanthine (HXH). The structure of the tetramer B = G is detailed.

K₃IrCl₆ reacts with amino acids to give K[Ir(HL)₂Cl₄], HL = α-alanine (Hal), L-methionine, K[Ir(Hal)(al)Cl₃], *cis*-K[Ir(gl)₂Cl₂] (Hgl = glycine), and [Ir(Hgl)₃(gl)Cl₂]. IR and UV-vis spectroscopy indicate binding through O- and N-donor atoms to the Ir center.⁴²⁵ Reaction between IrCl₃ and Schiff bases yields complexes [Ir(SB)₃], [Ir(SB')Cl(OH₂)₂], [Ir(SB'')Cl₂]_n, and [Ir(SB''')Cl(OH₂)_n], where SBH = Schiff base derived from anthranilic acid and benzaldehyde, acetophenone, vanillin, cinnamaldehyde, or *m*-hydroxyacetophenone; SB'H₂ = Schiff base derived from anthranilic acid and salicylaldehyde or *o*-hydroxyacetophenone; SB''H = Schiff base derived from *p*-aminobenzoic acid and benzaldehyde, acetophenone, vanillin cinnamaldehyde, or *m*-hydroxyacetophenone; and SB'''H₂ = Schiff base derived from *p*-aminobenzoic acid and salicylaldehyde or *o*-hydroxyacetophenone.⁴²⁶ The complexes with Schiff bases derived from anthranilic acid showed antifungal activity, but only weak antiviral activity.

Reaction of [(PPh₃)₂Ir(Cl)(N₂)(H)(FBF₃)] with 9-methylguanine (9-MeG) affords [(PPh₃)₂Ir(Cl)(H)(9-MeG)], and crystallization from methanol gives the structurally characterized species [(PPh₃)₂Ir(Cl)₂(H)(9-MeG)]BF₄, (**251**).⁴²⁷ Treatment of [(PPh₃)₂Ir(Cl)(N₂)(H)(OSO₂C₄F₉)] with 9-MeG yields [(PPh₃)₂Ir(Cl)(N₂)(H)(9-MeG)]C₄F₉SO₃ and [(PPh₃)₂Ir(Cl)(OH₂)(H)(9-MeG)]C₄F₉SO₃.

The X-ray structure of [cp*Ir(CNR)Cl₂], CNR = 1,3,4,6-tetra-*O*-acetyl-2-deoxy-2-isocyanoglycose, has been determined.⁴²⁸ The synthesis of chiral complexes of Ir^{III} with α-amino acid anions, L-L', of general formula [cp*Ir(Cl)(L-L')] (**252**), and their NMR spectroscopic characterization, have been detailed. The X-ray structures of (**252**), L-L' = L-proline and [cp*Ir(Cl)(L-His-OH)]Cl, His = histidine, are described.⁴²⁹ C-allylglycinate binds in a terdentate manner in (**253**), which has been characterized by X-ray diffraction studies.⁴³⁰ C-vinylglycinate forms complex (**254**).

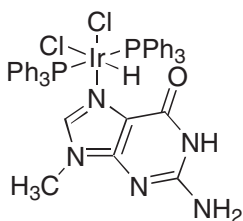

(251)

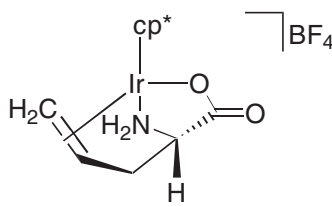

(253)

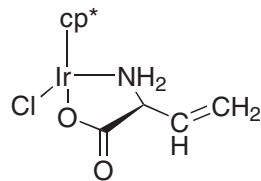

(254)

Reaction of $[\text{cp}^*\text{IrCl}_2]_2$ with $L', L' = N-(2,3,4,6\text{-tetra-}O\text{-acetyl-}\beta\text{-D-glucopyranosyl})\text{-thiocarbamate}$ and $\beta\text{-D-glucopyranosylthiourea}$ (**255**), L^2 , yields $[\text{cp}^*\text{IrCl}_2L']$ (**256**) and $[\text{cp}^*\text{Ir}(\text{Cl})_2L^2]$, respectively.⁴³¹ Treatment of $[\text{cp}^*\text{IrCl}_2]_2$ with 2-hydroxyiminocarboxylates affords complex (**257**), where, $X = \text{I}, \text{Cl}$; $R^1 = \text{Me}, \text{CH}_2\text{Ph}, \text{Ph}$; $R^2 = \text{H}, \text{Me}$.⁴³² The synthesis and characterization of (**258**) and (**259**) have been reported, including the X-ray diffraction study of (**259**).⁴³³ Reactions of $[\text{cp}^*\text{IrCl}_2]_2$ with N,N -dimethyl-2-hydroxyiminopropionic acid and N -(2-hydroxyiminopropionyl)-amino acids gave complexes (**260**) and (**261**), respectively. The crystal structures for complexes (**261**), $R = \text{CH}_2\text{CO}_2\text{H}$ and $\text{C}(\text{H})(\text{CH}_2\text{Ph})(\text{COOH})$, are given.⁴³⁴

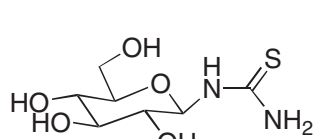

(255)

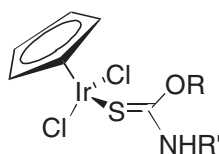

(256)

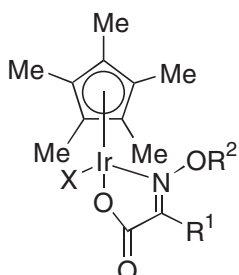
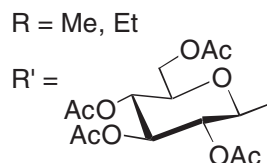

(257)

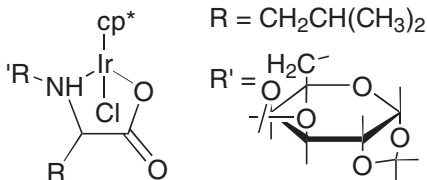

(258)

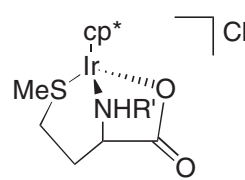

(259)

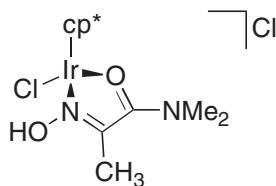

(260)

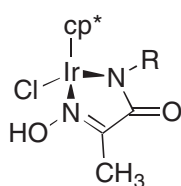

(261)

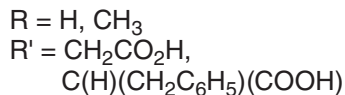

The series of complexes $[\text{cp}^*\text{IrCl}_2L]$, where $L = \text{H}_2\text{NRCO}_2\text{Me}$, $R = \text{CH}_2, \text{C}(\text{H})(\text{CH}_3), \text{C}(\text{H})(\text{CH}_2\text{CH}=\text{CH}_2), \text{CH}_2\text{CH}_2$, have been prepared and characterized. The complexes undergo ester-exchange reactions with CD_3OD .⁴³⁵ The ligands (**262**) and (**263**) form complexes $[\text{cp}^*\text{IrCl}(\text{262})]$ and $[\text{cp}^*\text{IrCl}(\text{263})]$ by reaction with $[\text{cp}^*\text{IrCl}_2]_2$. The structure of $[\text{cp}^*\text{IrCl}(\text{263})]$ establishes the bidentate binding of (**263**) to Ir via the N and hydroxyl O atoms.⁴³⁶ The complexes $[\text{Ir}(\text{H})_2(\text{aa})(\text{PPh}_3)_2]$, aa = L-alaninate, L-valinate, L-prolinate, L-phenylalaninate, have been synthesized and characterized. Reaction with $\text{HC}\equiv\text{CPh}$ gives *trans,mer*- $[\text{IrH}(\text{C}\equiv\text{CPh})_2(\text{PPh}_3)_3]$.⁴³⁷

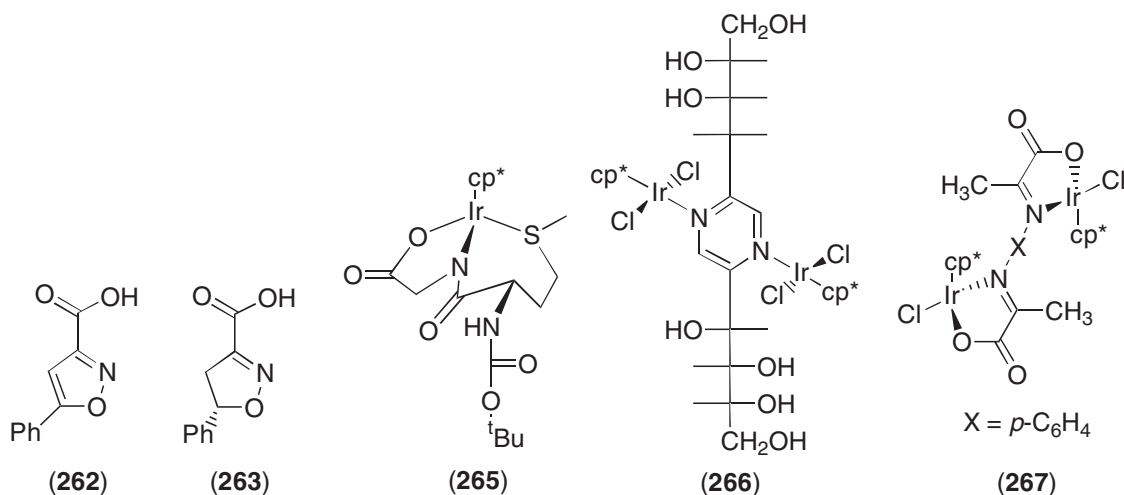

$[(ppy)_2Ir(\mu-Cl)]_2$ reacts with sodium salts of L' , where $L' =$ glycinate, L-alaninate, L-valinate, D-Leucinate, L-proline, and L-phenylalaninate, to give $[(ppy)_2IrL']$, (**264**). The crystal structure of (**264**), $L' =$ L-proline, is described.⁴³⁸ The X-ray diffraction analysis of (**265**) shows a five-membered and a seven-membered chelate ring.⁴³⁹ The synthesis and characterization of $[cp^*IrCl(L)]$, where $L =$ 2-amino-2-deoxy-D-gluconic acid, have been detailed.⁴⁴⁰ Reaction of $[cp^*IrCl_2]_2$ with the pyrazine derivative desoxyfructosazin, pfz, gives the water-soluble complex $[cp^*(Cl)_2Ir(pfz)Ir(Cl)_2cp^*]$, (**266**).⁴⁴¹ The dinuclear complex (**267**) has been prepared and characterized.⁴⁴²

6.2.5.14 Catalytic Complexes

A review of the photocatalyzed reduction of CO_2 and water-gas-shift reaction by Ir^{III} complexes containing bpy or phen has been published by Ziesel.⁴⁴³ Lohrenz and Jacobsen have written a review article on C—H activation by cationic Ir^{III} complexes.⁴⁴⁴ An extensive review by Sutin, Creutz, and Fujita on photo-induced generation of H_2 and reduction of CO_2 using polypyridine complexes of Co^{III} , Rh^{III} , Ir^{III} , Ru^{II} , and Re^I is available.⁴⁴⁵

The complex $[Ir(OH)_2Cl(OAc)AA]^+$, $AA = \alpha$ -amino acid, has been identified as the active catalytic species in the oxidative decarboxylation and deamination of α -amino acids by lead tetraacetate.⁴⁴⁶ $[Ir(ClO_4)(CO)(PPh_3)_2]$, (**268**), dehydrogenates $HOCH_2CH=CHPh$ under nitrogen to give $[Ir(H)_2(ClO_4)(CO)(PPh_3)_2]$, which then reacts with a further $HOCH_2CH=CHPh$ to give $PhCH=CHMe$, (**268**), and H_2O . Under an atmosphere of hydrogen, (**268**) catalyzes the isomerization of $HOCH_2CH=CHPh$ to $PhCH_2CH_2CHO$, followed by hydrogenation to $Ph(CH_2)_3OH$.⁴⁴⁷ The complexes $[cpIrCl(4,4'-X_2-bpy)]Cl$, $X = COOH, COO^iPr, Br, NO_2, NMe_2, [cp^*Ir(bpy)D]^+$, $D = H, Cl$, and $[cp^*Ir(phen)D]^+$ are successful water-gas-shift catalysts.^{448–450} The reaction is accelerated when $X =$ an electron-withdrawing group, and is inhibited by electron-donating groups.

The oxidation of 1-hexane by O_2 catalyzed by $[Ir(CH_3CN)_{5-x}Cl_x(NO_2)]^{2-x}$, $x = 0, 1, 2$, has been studied in CH_3CN under pressurized O_2 at 1.5 atm and $100^\circ C$.⁴⁵¹ When $x = 0$ the product of the reaction is 1,2-epoxy-hexane, whereas when $x = 1$ then 2,3-epoxy-hexane results. In the presence of the olefin activator $[Pd(PhCN)_2Cl_2]$, the species in which $x = 2$ oxidizes 1-hexane to 2-hexane. $IrCl_3$ catalyzes the oxidation of maltose and lactose by N -bromoacetamide in $HClO_4$, and the oxidation of mallibiose and cellobiose by N -bromosuccinimide in $HClO_4$.^{452,453} Addition of $[Hg(Oac)_2]$, which acts as a Br^- scavenger, to the solution accelerates the reaction. Theoretical studies of C—C and C—H bond activation by $[cp^*Ir(PMe_3)CH_3]^+$ on cyclopropane have been investigated with density functional calculations (B3LYP).⁴⁵⁴

The binuclear complexes $[IrL(H)I_2]_2$, $L =$ diphosphine, e.g., diop (**120**), binap (**121**), bdpp (**122**), are effective catalysts in the asymmetric hydrogenation of prochiral amines.⁴⁵⁵

6.2.6 IRIDIUM(II)

There are few Ir^{II}-containing complexes detailed in the literature. The monomeric compounds are all reported to be either EPR active, or to have a magnetic moment in agreement with their paramagnetic d^7 electronic configuration. More common are binuclear compounds with Ir^{II}–Ir^{II} single metal bonds, which are diamagnetic. The metal–metal bond may be unsupported or bridged by a variety of donor-atom ligands. Most binuclear species are strongly absorbing in the visible region of the spectrum.

6.2.6.1 Carbon Ligands

The synthesis and structure of *trans*-Ir(mes)₂(SEt₂)₂ (**269**) are reported.⁴⁵⁶ Paramagnetic (**269**) reacts with phosphines and amines to give *trans*-Ir(mes)₂X₂, where X = PMe₃, PMe₂Ph, PEt₂Ph, py, and 4-*tert*-butylpyridine, and with CO to give the Ir^I compound Ir(mes)(CO)₂(SEt₂).

6.2.6.2 Tin Ligands

The binuclear complex (**270**) contains two Ir^{II} centers, with an Ir–Ir distance of 2.878 Å.⁴⁵⁷

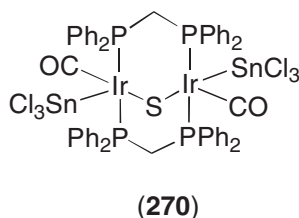

6.2.6.3 Nitrogen Ligands

The first crystallographically characterized, inorganic, Ir^{II} binuclear complex was reported in 1987 by Cotton and Poli.⁴⁵⁸ Dark green [Ir₂(form)₄], (**271**), has D_4 symmetry and a very short metal–metal distance (2.524(3) Å). In the same year Cotton and Poli published details of a related complex, (**272**), with a metal–metal bond distance of 2.517(1) Å.⁴⁵⁹ The Ir^{II} complex Ir₂(cod)-(μ-form)₂(O₂CCF₃)₂(H₂O), when treated with excess Et₃OBF₄ at room temperature in MeCN, gives the dication [Ir₂(cod)(μ-form)₂(MeCN)₃](BF₄)₂ but, when heated to reflux, gives the thermal substitution product [Ir₂(μ-form)₂(MeCN)₆](BF₄)₂.⁴⁶⁰

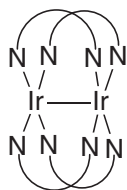

(271)

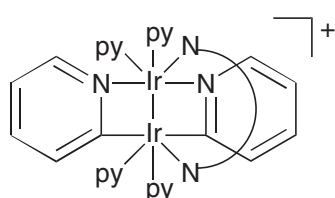

(272)

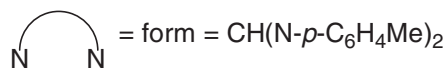

Oro *et al.* have synthesized binuclear Ir^{II} compounds from [Ir₂{μ-1,8-(NH)₂C₁₀H₆}(CO)₂(PPh₃)₂] by reaction with I₂, MeI or CH₂I₂.⁴⁶¹ The X-ray structure of the binuclear cation [Ir₂(μ-1,8-(NH)₂C₁₀H₆)(CH₃CN)₂(CO)₂(P^{*i*}Pr₃)₂]²⁺ shows a short intermetallic distance.⁴⁶² Oxidation of [{Ir(μ-aza)(CO)₂}]₂ (aza = 7-azaindolate), (**273**), by silver acetate yields the diamagnetic, binuclear Ir^{II}-containing complex (**274**) or the solvated equivalent [{Ir(μ-aza)(CO)₂(S)}₂]²⁺, (**275**) (S = acetone or acetonitrile) when oxidized by AgBF₄.⁴⁶³ Other binuclear Ir^{II} compounds are synthesized from [{Ir(μ-aza)(CO)₂}]₂ by reaction with halogens (Cl₂, Br₂, I₂) and chlorinated hydrocarbon solvents.

A dark red, amido-bridged complex is prepared from Na/Hg reduction of [cp*Ir{(μ²-NH)₂-C₁₀H₆-1,8}(μ²-Br)Ircp*}]Br yielding (**276**), a diamagnetic complex with an Ir^{II}–Ir^{II} metal bond

(2.584(1) Å).⁴⁶⁴ A purple-black, mixed-valence Ir^{II}–Ir^I binuclear compound, $[\{\text{Ir}(\text{cod})(\mu\text{-L})\}_2]\text{BF}_4$ (L = pz, 4-Mepz), is synthesized from the reaction of $[\text{Ir}(\text{cod})(\mu\text{-L})]_2$ with NOBF_4 .⁴⁶⁵ The binuclear cationic radical exhibits an EPR spectrum showing hyperfine coupling to two equivalent Ir. Cyclic voltammetry studies have shown a reversible, one-electron oxidation.⁴⁶⁶

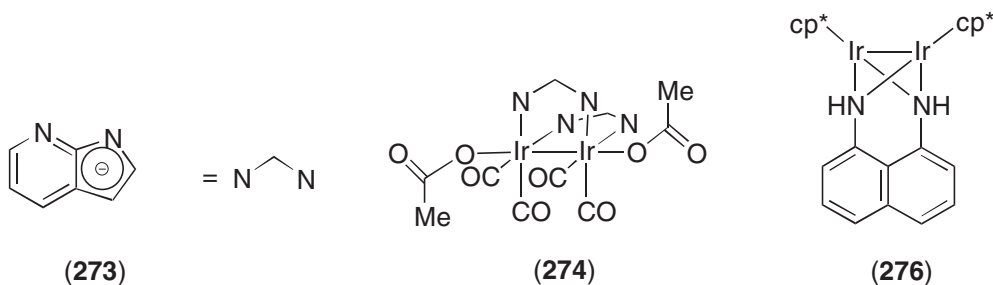

The energetics of the oxidative addition of I_2 to the Ir^I complexes $[\text{Ir}(\mu\text{-L})(\text{CO})_2]_2$ (L = S^tBu, 3,5-Me₂pz, 7-aza) have been studied using the results of reaction-solution calorimetric measurements, X-ray structure determination, and EHMO calculations.⁴⁶⁷ One equivalent of I_2 gives the Ir^{II} complexes $[\text{Ir}(\mu\text{-L})\text{I}(\text{CO})_2]_2$, (**277**). The enthalpies of reaction were found to be -528.3 ± 20.6 , -638.4 ± 16 , and -864.8 ± 41.6 kcal mol⁻¹ for L = S^tBu, 3,5-Me₂pz, 7-aza, respectively, and are consistent with a decrease of the strain associated with the formation of 3-, 4-, and 5-membered rings. The Ir–Ir bond distances are 2.638(1) Å and 2.637(1) Å for (**277**), L = S^tBu and 3,5 Me₂pz, respectively.

Reaction of the Ir^I complex $[\text{Ir}(\text{CO})_2(\mu\text{-pz})_2]_2$, (**278**), with CH_2I_2 in THF gave a 7:2:1 mixture of complexes (**279**), (**280**), and (**281**).⁴⁶⁸ Treatment of (**278**) with $\text{I}(\text{CH}_2)_2\text{I}$ gave (**280**) exclusively, and with $\text{I}(\text{CH}_2)_3\text{I}$ gave (**282**).

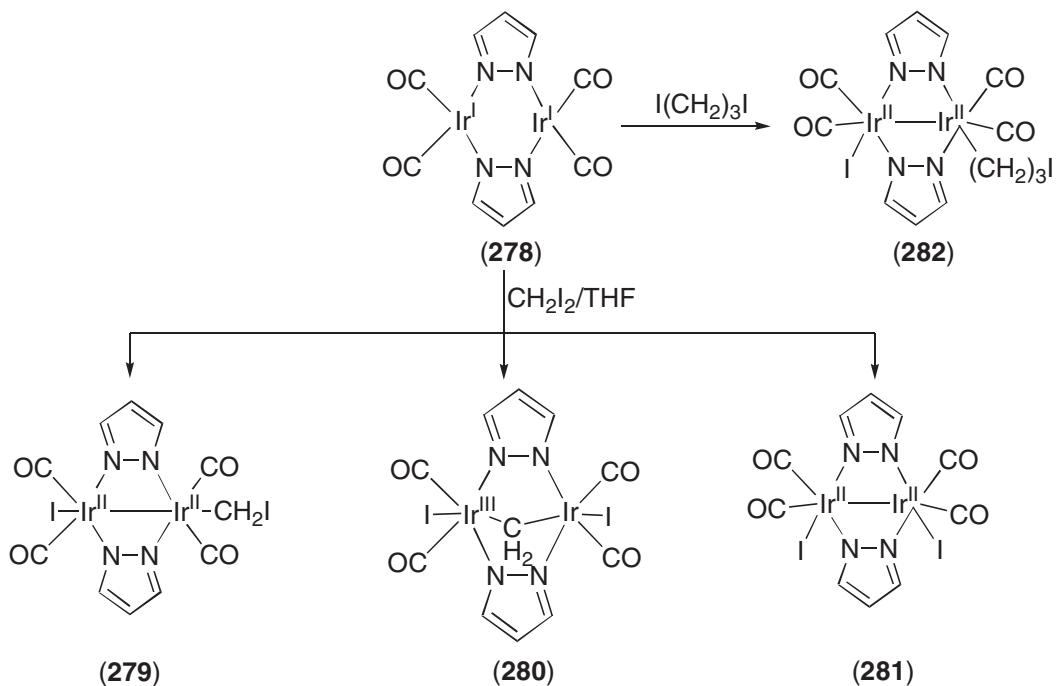

The binuclear complex $[\{\text{Ir}(\mu\text{-pz})(\text{NCBu}^t)_2\}_2]$, (**283**), oxidizes readily with $[\text{cp}_2\text{Fe}]^+$ to give the Ir^{II}–Ir^{II}-bonded dication (**284**), which adds I^- yielding the neutral complex (**285**).⁴⁶⁹ Reaction of (**283**) with I_2 gives (**285**) directly, which reacts with further I_2 to yield the Ir^{III} complex (**286**).

Dma (dimethyl acetylenedicarboxylate, $\text{MeO}_2\text{CC}::\text{CCCO}_2\text{Me}$), acts as a bridging ligand in the Ir^{II} complex $[\text{Ir}_2(\mu\text{-pz})(\mu\text{-SBU}^t)(\mu\text{-dma})(\text{CO})_2\{\text{P}(\text{OMe})_3\}_2]$, (**287**).⁴⁷⁰ X-ray diffraction studies show the crystals of (**287**) to be monolithic, space group $P21/n$. Oxidative addition of iodine to (**287**) gives (**288**). Complexes (**287**) and (**288**) have been characterized by X-ray crystallography. (**287**) has an Ir–Ir bond (2.614(2) Å), whereas there is no Ir–Ir interaction in (**288**) (3.626(2) Å). The

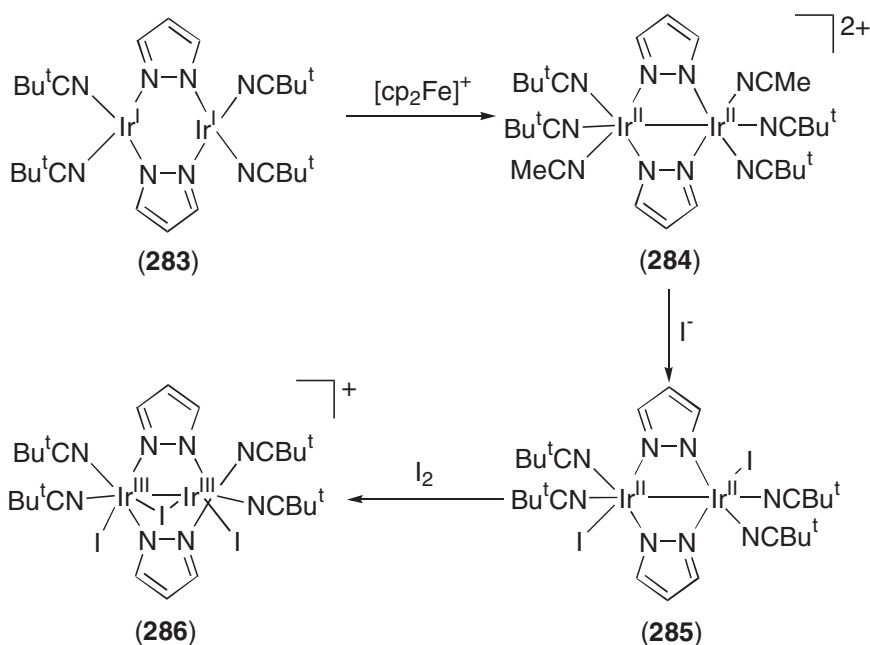

bridging framework remains unaltered between the two species. The related complexes of type $[\text{Ir}_2(\mu\text{-pz})(\mu\text{-SBu}^t)(\text{CO})_2\{\text{P}(\text{OMe})_3\}_2\text{I}(\text{R})]$, where $\text{R} = \text{CH}_3^-$ or CH_2I^- , have been prepared.⁴⁷¹

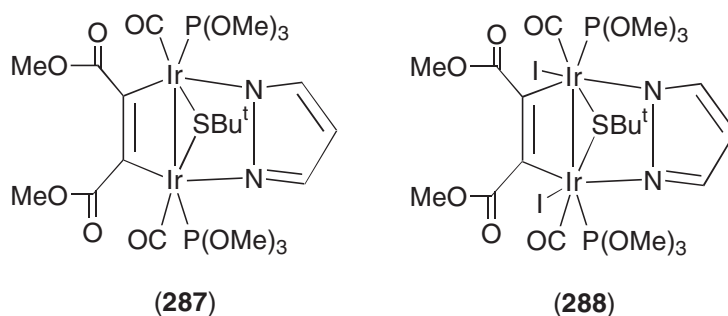

Monomeric Ir^{II} -containing complexes have been isolated for sterically demanding porphyrin-type ligands (por). Wayland *et al.*⁴⁷² generated Ir^{II} tetrakis(2,4,6-trisubstitutedphenyl)porphyrin by photolysis of the Ir-Me derivative in C_6D_6 according to Reaction Scheme 23.

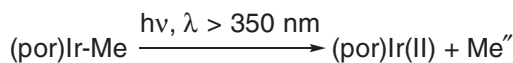

Scheme 23

The Ir^{II} dimer $[\text{Ir}(\text{oep})]_2$ (oep = octaethylporphyrin) has been prepared in low yield by photolysis of $(\text{oep})\text{IrCH}_3$ in C_6D_6 .⁴⁷³ This preparation has been improved by Chan *et al.*⁴⁷⁴, as shown in Reaction Scheme 24, where TEMPO = 2,2,6,6-tetramethyl-1-piperidinyloxy, free radical. The dimer undergoes several organometallic reactions, including oxidative addition of alkyl C—H bonds and alkene insertions.⁴⁷⁵

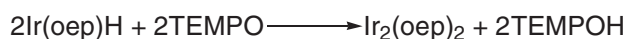

Scheme 24

Successive oxidation of $\text{bis}[\text{Ir}(\text{py})(\text{pc})]_2$ (pc = phthalocyaninato(2-)) with iodine yields the mixed-valence $\text{Ir}^{\text{III}}\text{-Ir}^{\text{II}}$ compound $[\text{Ir}(\text{py})(\text{pc})]_2\text{I}$ initially, and then the Ir^{III} monomer

$[\text{Ir}(\text{py})\text{I}(\text{pc})]\cdot\text{py}$.⁴⁷⁶ $[\text{Ir}(\text{pc})]$ reacts in MeOH with excess Bu_4NOH to yield $\text{Bu}_4\text{N}[\text{Ir}(\text{pc})\text{-(OMe)}(\text{OH})]$, which is characterized by X-ray diffraction.⁴⁷⁷

6.2.6.4 Phosphorus Ligands

One-electron oxidation of *trans*- $\text{Ir}(\text{R})(\text{CO})(\text{PPh}_3)_2$ ($\text{R} = \text{CH}_3, \text{CH}_2\text{CN}, \text{C}_6\text{H}_5$) in 1,2-dichloroethane containing PPh_3 produces stable $[\text{Ir}(\text{R})(\text{CO})(\text{PPh}_3)_3]^+$,⁴⁷⁸ according to Reaction Scheme 25.



Scheme 25

The radical Ir^{II} complex $[\text{Ir}(\text{CO})\text{Cl}(\text{PPh}_3)_3]\text{BF}_4$ is formed by the thermal and photoreaction of $[\text{Ir}(\text{NO})(\text{CO})\text{Cl}(\text{PPh}_3)_2]\text{BF}_4$ with PPh_3 and the dissociation of NO.⁴⁷⁹ The structure of $\text{Ir}_2(\text{Tc-bim})_2(\text{CO})_2(\text{CH}_3\text{CN})_2[\text{P}(\text{OEt})_3]_2$, with an unsupported metal–metal bond, is reported.⁴⁸⁰ The dimer is prepared via electro-oxidation of the monomeric Ir^{I} salt from an electrolyte-free acetonitrile solution. The phosphido-bridged di-iridium complex $[(\text{CO})(\text{PET}_3)\text{ClIr}(\mu\text{-Pcy}_2)_2\text{IrCl}(\text{PET}_3)(\text{CO})]$ is characterized by single-crystal X-ray crystallography and contains a single $\text{Ir}^{\text{II}}\text{—Ir}^{\text{II}}$ bond (2.762(1) Å).⁴⁸¹

Reactions of the Ir^{I} complexes (289) and (290) with H_2 and subsequent reaction of the dihydride products with dimethyl acetylenedicarboxylate, $\text{MeO}_2\text{CC}:\text{CCO}_2\text{Me}$ (dma), give the Ir^{II} complexes (291), (292), (293), and (294), as shown in Reaction Scheme 26.⁴⁸² The X-ray crystal-structure determination of (294) confirms the double insertion of the alkyne into each of the $\text{Ir}\text{—H}$ bonds of (293).

6.2.6.5 Oxygen Ligands

The one-step reaction of $\text{H}_2[\text{IrCl}_6]$ with MeCO_2Li under O_2 in a mixed solvent of acetic acid and acetic anhydride yields the Ir^{II} binuclear complex $[\text{Ir}_2(\mu\text{-O}_2\text{CMe})_2\text{Cl}_2(\text{CO})_2]$.⁴⁸³ Crystal-structure determinations of $[\text{Ir}_2(\mu\text{-O}_2\text{CMe})_2\text{Cl}_2(\text{CO})_2\text{L}_2]$, (295), where $\text{L} = \text{MeCN}, \text{DMSO},$ and py , are reported. The one-electron oxidation product for (295), $\text{L} = \text{py}$, is EPR active at 77 K; the odd electron occupies the $\delta_{\text{Ir}\text{—Ir}}^*$ orbital.

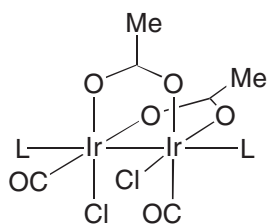

(295)

6.2.6.6 Sulfur Ligands

Reduction of $[\text{cp}^*\text{IrCl}(\mu\text{-SR})_2\text{Ircp}^*\text{Cl}]$ ($\text{R} = \text{Pr}^i, \text{cy}$) with excess Na/Hg affords the dark red, binuclear Ir^{II} complexes $[\text{cp}^*\text{Ir}(\mu\text{-SR})_2\text{Ircp}^*]$.⁴⁸⁴ X-ray diffraction studies of $\text{R} = \text{cy}$ confirm the two SR^- bridging units supporting the $\text{Ir}^{\text{II}}\text{—Ir}^{\text{II}}$ single bond. The bitetrahedral structure of $[(\text{PPh}_3)_2\text{Ir}(\mu\text{-S})_2\text{Ir}(\text{PPh}_3)_2]$, (296), is confirmed by single-crystal X-ray diffraction.⁴⁸⁵ (296) reacts with H_2 to give the binuclear Ir^{III} species $[\text{Ir}(\text{PPh}_3)_2(\text{H})](\mu\text{-S})_2$, which reacts further with H_2 to give $[\text{Ir}(\text{PPh}_3)_2(\text{H})](\mu\text{-S})(\mu\text{-SH})(\mu\text{-H})$.

The dark red Ir^{II} binuclear complex $[\text{Ir}(\text{CO})(\text{P}(p\text{-tolyl})_3)(\text{mnt})_2]_2$, formed via one-electron oxidation of $[\text{Ir}(\text{CO})(\text{P}(p\text{-tolyl})_3)(\text{mnt})]^-$ by ferrocenium, contains chelating mnt ligands bridging the $\text{Ir}\text{—Ir}$ bond.⁶³⁹ The X-ray crystal structure shows square-pyramidal geometry at each Ir, and an $\text{Ir}\text{—Ir}$ bond length of 2.706(2) Å.

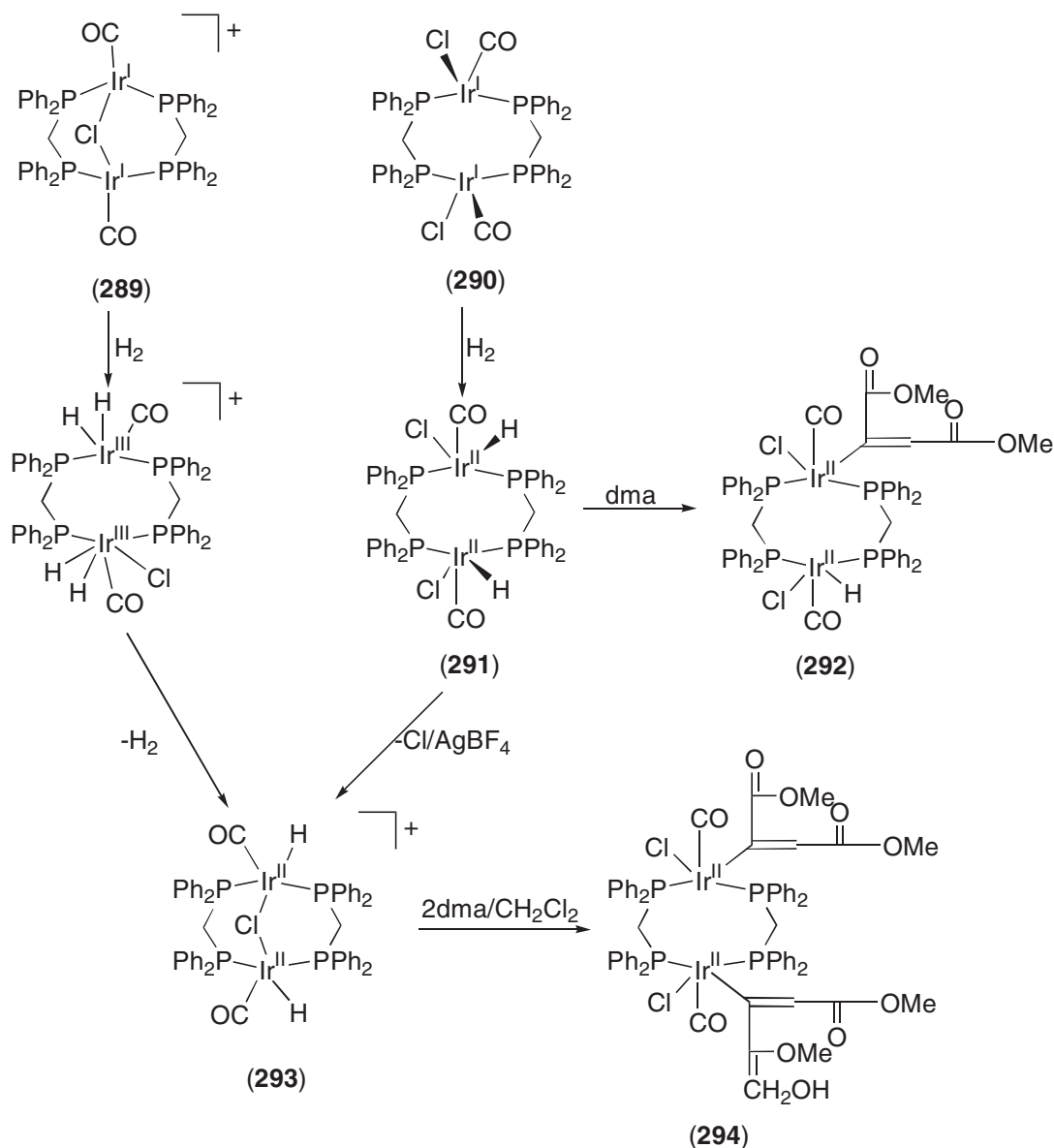

Scheme 26

6.2.6.7 Halide Ligands

The electronic spectra of $[\text{Ir}_2(\text{tmb})_4\text{L}_2]^{2+}$ binuclear compounds ($\text{L} = \text{Cl}, \text{Br}, \text{I}$) have intense $d\sigma \rightarrow d\sigma^*$ transitions between $37,000\text{ cm}^{-1}$ and $30,000\text{ cm}^{-1}$.⁴⁸⁶ $\text{Ir}^{\text{II}}-\text{Ir}^{\text{II}}$ stretching vibrations are observed between 140 cm^{-1} and 116 cm^{-1} , from which Ir_2 force constants are evaluated.

Reaction of equimolar amounts of $\text{Ir}(\text{OME})_2(\text{cod})_2$ and I_2 in CH_2Cl_2 affords the dark red, dimeric species $[(\text{cod})^{\text{I}}\text{Ir}(\mu\text{-I})_2\text{Ir}^{\text{I}}(\text{cod})]$ (**297**), which has been characterized by single-crystal X-ray diffraction.⁴⁸⁷

6.2.6.8 Hydrogen Ligands

Electrochemical oxidation of $\text{IrH}(\text{CO})(\text{PPh}_3)_3$ in CH_2Cl_2 yields the Ir^{II} -containing cation $[\text{IrH}(\text{CO})(\text{PPh}_3)_3]^+$, which is characterized by IR and EPR spectroscopy.⁴⁸⁸ EPR data suggest the cation has a square-pyramidal geometry, in agreement with DFT calculations. Further one-electron oxidation gives the stable Ir^{I} species $[\text{Ir}(\text{CO})(\text{PPh}_3)_3]^+$ according to reaction [Scheme 27](#).



Scheme 27

The binuclear Ir^{II} dihydride complex $[(\text{C}_5\text{Me}_5)\text{Ir}(\mu\text{-H})_2]_2$, (**298**), has been structurally characterized.⁴⁸⁹ (**298**) can abstract a proton from acidic organic compounds to give (**299**), can catalytically cleave C—C bonds in 1,2-diols, and can act as a catalyst for Michael addition reactions.⁴⁹⁰ Oxidative addition of dihydrogen to the sulphido-bridged complex (**300**) affords the Ir^{II}/Ir^{III} dihydride species (**301**), which rearranges to give (**302**).⁴⁹¹

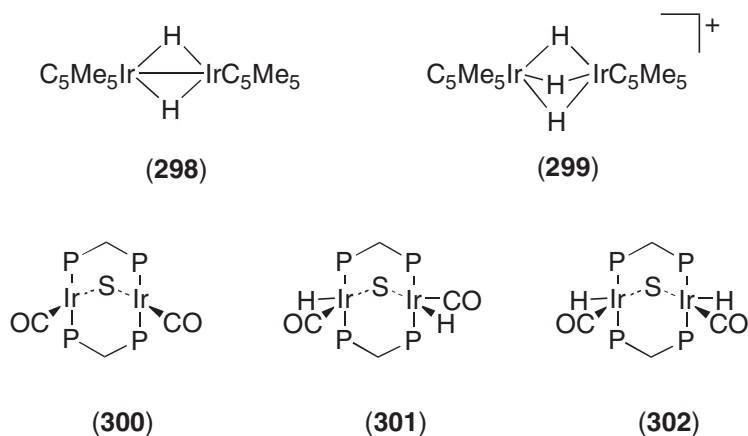

6.2.6.9 Mixed-donor-atom Ligands

6.2.6.9.1 C/P

The orange-red, divalent Ir complex $[\text{Ir}(\text{C}_5\text{H}_4\text{PPh}_2)_2\text{CO}]_2^{2+}$ was synthesized following the chemical oxidation of $[\text{Ir}(\text{C}_5\text{H}_4\text{PPh}_2)\text{CO}]_2$ by either $[\text{Fe}(\text{cp})_2]\text{BF}_4$ or AgPF_6 .⁴⁹² The Ir^{II} complex was characterized by IR (ν_{CO}) and NMR spectroscopy.

6.2.6.9.2 N/P

The Ir^{II} complex $[\text{Ir}(\text{PN}^t\text{Bu})_2]^{2+}$, $\text{PN}^t\text{Bu} = \text{O-Ph}_2\text{PC}_6\text{H}_4\text{-CH}=\text{N}^t\text{Bu}$, formed via one-electron oxidation of $[\text{Ir}(\text{PN}^t\text{Bu})_2]^+$, exhibits a rhombic EPR signal.⁷⁵¹

6.2.6.9.3 N/S

Photochemical oxidative addition of (**303**) with I_2 , MeI or CH_2I_2 gives dinuclear Ir^{II} complexes (**304**).⁴⁹³ The crystal structure of (**304**), $\text{R} = \text{I}$, $\text{R}' = \text{CH}_2\text{I}$, is reported.

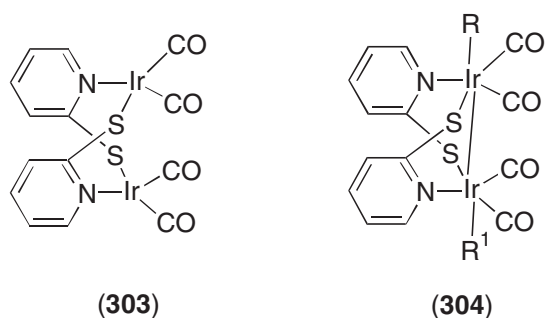

6.2.6.10 Biological Complexes

The *in vivo* antitumor and trypanocidal effects of dimeric $[\text{Ir}^{\text{II}}_2(\text{CH}_3\text{COO})_4(\text{L})_n]^0$ (L = classical organic antimalarial drugs, $n = 1, 2$) are reported.⁴⁹⁴ The dimeric complexes are characterized by IR spectroscopy. Further studies of monomeric Ir^{II} complexes, $\text{Ir}^{\text{II}}\text{L}_2$, where L = alkyl or aryl dithiocarbamates and xanthates, reveal no clear relation between antitumor and antitrypanosomal activities.⁴⁹⁵ Structure-activity data for the Ir^{II} complexes is presented.

6.2.6.11 Catalytic Complexes

An Ir^{II} intermediate in the carbonylation of ethanol, stabilized by the isoquinoline cation, has been isolated and characterized.⁴⁹⁶ $\text{IrCl}_3 \cdot 3\text{H}_2\text{O}$ is the catalyst precursor and HI the promoter. The intermediate analyzes as $(\text{C}_9\text{H}_8\text{N})[\text{Ir}(\text{CO})_2\text{I}_3(\text{COC}_2\text{H}_5)]$. The magnetic moment is measured at 1.33 B.M., which is indicative of Ir^{II} .

6.2.7 IRIDIUM(I)

The geometry of most Ir^{I} complexes is based on the square-planar arrangement of ligands that arises from the d^8 electronic configuration. Vaska's compound, $[\text{Ir}(\text{CO})\text{Cl}(\text{PPh}_3)_2]$, and derivatives thereof, and $[\text{Ir}(\text{cod})\text{Cl}]_2$ plus analogues prove to be the most useful Ir^{I} starting materials. Five-coordinate, trigonal-pyramidal structures also feature among Ir^{I} coordination compounds. Most Ir^{I} compounds are yellow or colorless, and all are diamagnetic. Common tools for characterization are NMR and IR spectroscopy.

6.2.7.1 Carbon Ligands

6.2.7.1.1 Isocyanide

$[\text{Ir}_2(\mu\text{-CNR})_2(\text{CNR})_2(\text{Me}_2\text{PCH}_2\text{PMe}_2)_2]$ ($\text{R} = 2,6\text{-Me}_2\text{C}_6\text{H}_3$) reacts with CO_2 to form $[\text{Ir}_2(\text{CN}(\text{CO}_2)\text{R})_2(\text{CNR})_2(\text{Me}_2\text{PCH}_2\text{PMe}_2)_2]$, which decomposes in CH_2Cl_2 to give $[\text{Ir}_2(\mu\text{-CO})(\mu\text{-H})(\text{C}(\text{O})\text{NHR})_2(\text{CNR})_2(\text{Me}_2\text{PCH}_2\text{PMe}_2)_2]\text{Cl}$, (**305**), which is structurally characterized.⁴⁹⁷ Labeling studies with $^{13}\text{CO}_2$ show that the $\mu\text{-CO}$ ligand in (**305**) is derived from CO_2 . The binuclear complexes $[\text{Ir}_2(\mu\text{-CNR})(\text{CNR})_4(\text{PMe}_2\text{CH}_2\text{PMe}_2)_2](\text{PF}_6)_2$, (**306**), ($\text{R} = 2,6\text{-Me}_2\text{-C}_6\text{H}_3$, ^tBu) have been synthesized.⁴⁹⁸ The X-ray structure of $\text{R} = 2,6\text{-Me}_2\text{-C}_6\text{H}_3$ reveals an A-frame structure and an Ir—Ir bond (2.7850(7) Å) bridged by a CNR ligand. Reaction with H_2 yields $[\text{Ir}_2(\mu\text{-H})_2(\text{CNR})_4(\text{PMe}_2\text{CH}_2\text{PMe}_2)_2](\text{PF}_6)_2$. Kinetic measurements reveal the reaction as first order in [**306**] and zero order in $[\text{H}_2]$.

The electronic absorption spectrum of orange $[\text{Ir}(\text{CNBu}^t)_4]^+$ shows a $dz^2 \rightarrow pz$ transition around 420 nm, whereas blue $[\text{Ir}_2(\text{tmb})_4]^{2+}$ ($\text{tmb} = 2,5\text{-diisocyano-2,5-dimethylhexane}$) absorbs strongly at 625 nm due to a $d\pi^* \rightarrow p\sigma$ transition.⁴⁹⁹

6.2.7.1.2 Carbonyl

The X-ray crystal structure determination of *trans*- $[\text{Ir}(\text{CO})_2(\text{P}^t\text{Bu}_2\text{Ph})_2][\text{SiF}_5]$ indicates an approximate square-planar geometry for the Ir cation.⁵⁰⁰ The deviation of the C—Ir—C angle (162.7°) from 180° is indicative of the strong backbonding from the Ir^{I} into the CO π^* orbitals. The complexes $\text{IrH}(\text{CO})_2(\text{P}^t\text{Bu}_2\text{Ph})$ and $\text{IrH}(\text{CO})(\text{P}^t\text{Bu}_2\text{Ph})_2$ are characterized by multinuclear NMR and IR spectroscopy.

6.2.7.1.3 Alkyls and aryls

Benzene addition to $\text{Ir}(\text{P}^t\text{Pr}_3)_2\text{Cl}$ is an exothermic reaction (22 kcal mol⁻¹), while addition to $\text{Ir}(\text{P}^t\text{Pr}_3)_2(\text{CO})\text{Cl}$ is endothermic (−5 kcal mol⁻¹).⁵⁰¹ The reaction enthalpies of substitution reactions to complexes containing the $\text{Ir}(\text{P}^t\text{Pr}_3)_2\text{Cl}$ fragment are supplied. Reaction of $\text{Ir}(\text{P}^t\text{Pr}_3)_2\text{Cl}$ with 2-pyridyl esters gives a μ^2 (C,O)-bound ketene, (**307**), where $\text{R}^2 = \text{R}^1 = \text{aryl}$ or $\text{R}^2 = \text{aryl}$,

6.2.7.3 Nitrogen Ligands

6.2.7.3.1 Pyridine

The bis pyridine complex $[\text{Ir}(\text{cod})\text{py}_2][\text{PF}_6]$, (**314**), is prepared by the reaction of $[\text{IrCl}(\text{cod})]_2$ with pyridine in the presence of NH_4PF_6 .⁵⁰⁸ Best yields were achieved from a water/acetone (1:1) solvent system. Reaction of (**314**) with equimolar amounts of $\text{P}(\text{C}_6\text{H}_{11})_3$ affords the substituted, air-stable species $[\text{Ir}(\text{cod})\{\text{P}(\text{C}_6\text{H}_{11})_3\}\text{py}][\text{PF}_6]$.

The reaction of $[\text{IrCl}(\text{cod})]_2$ with K^+ form^- ($\text{form} = \text{CH}(\text{N}-p\text{-C}_6\text{H}_4\text{Me})_2$) in PhMe yields $[\text{Ir}(\text{form})(\text{cod})]_2$,⁵⁰⁹ which on addition of two equivalents of AgOCOCF_3 produces $(\text{cod})\text{Ir}(\mu\text{-form})_2\text{Ir}(\text{OCOCF}_3)_2(\text{H}_2\text{O})$, (**315**), containing an $\text{Ir}^{\text{I}} \rightarrow \text{Ir}^{\text{III}}$ dative bond.⁵¹⁰ The H_2O ligand in (**315**) can be replaced by other donor ligands, and the crystal structure of $(\text{cod})\text{Ir}(\mu\text{-form})_2\text{Ir}(\text{OCOCF}_3)_2\text{py}$ (**316**) is reported. Cyclic voltammetric studies of (**315**) and (**316**) reveal that one-electron reduction of the Ir^{III} center is rapidly followed by loss of H_2O and py, respectively.

The synthesis, structure, and electrochemistry of Ir^{I} dinuclear complexes $[\text{Ir}(\mu\text{-L})(\text{cod})]_2$ ($\text{L} = 2\text{-aminopyridinato}(\text{ap})$ and $2\text{-anilinopyridinato}(\text{anp})$) are reported, in which the square-planar Ir^{I} centers are 3.0998 Å and 3.0681 Å apart, respectively.⁵¹¹ Both complexes may be reversibly oxidized to the mixed-valent species. The frozen EPR spectrum of the mono-oxidized anp species shows a rhombic signal with no resolved hyperfine splitting.

Preliminary data on the preparation of monomeric and dimeric Ir^{I} species $[\text{IrCl}(\text{cod})(\text{Haza})]$, ($\text{Haza} = 7\text{-azaindolate}(1\text{H-pyrrole}[2,3\text{-}b]\text{pyridine})$, (**317**)), $[\text{IrCl}(\text{CO})_2(\text{Haza})]$, and $[\{\text{Ir}(\mu\text{-aza})(\text{cod})\}_2]$ are given.⁵¹² The high-scale synthesis of pure $[\{\text{Ir}(\mu\text{-aza})(\text{cod})\}_2]$ is reported later,⁵¹³ it reacts with CO to afford the highly oxygen-sensitive binuclear complex $[\{\text{Ir}(\mu\text{-aza})(\text{CO})_2\}_2]$, in which the head-to-tail arrangement of the bridging aza ligands is non-interconvertible.

6.2.7.3.2 Nitriles

Reaction of $[\text{Ir}(\text{CO})(\text{PPh}_3)_2(\text{ClO}_4)]$ with the unsaturated nitriles L ($\text{PhCN}=\text{CHCN}$, *cis* and *trans* $\text{CH}_3\text{CH}=\text{CHCN}$, and $\text{CH}_2=\text{CHCH}_2\text{CN}$) produces $[\text{Ir}(\text{L})(\text{CO})(\text{PPh}_3)_2]\text{ClO}_4$, (**318**), where L is co-ordinated through the N atom.^{514,515} (**318**) reacts through with H_2 to give the Ir^{III} complex *cis*- $[\text{Ir}(\text{H})_2\text{L}(\text{CO})(\text{PPh}_3)_2]\text{ClO}_4$, (**319**). Both (**318**) and (**319**) show catalytic activity for the hydrogenation of L to $\text{PhCH}_2\text{CH}_2\text{CN}$ or $\text{CH}_3\text{CH}_2\text{CH}_2\text{CN}$ at 100 °C under 3 atm of H_2 . In the absence of H_2 , $\text{CH}_2=\text{CHCH}_2\text{CN}$ isomerizes to $\text{CH}_3\text{CH}=\text{CHCN}$.

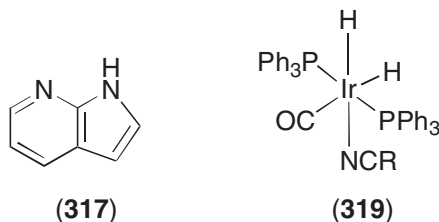

6.2.7.3.3 Nitride

The heterobimetallic, nitrido-bridged compounds $(\text{R}_3\text{SiO})_3\text{V}\equiv\text{N}-\text{Ir}(\text{CO})(\text{PPh}_3)_2$, (**320**), ($\text{R} = \text{Me}$, Et) were synthesized by condensation reactions between $\text{V}(\text{NSiR}_3)(\text{OSiR}_3)_3$ and $\text{IrF}(\text{CO})(\text{PPh}_3)_2$ and should be considered as adducts of $[(\text{R}_3\text{SiO})_3\text{V}\equiv\text{N}]^-$ and $[\text{Ir}(\text{CO})(\text{PPh}_3)_2]^+$.⁵¹⁶ Oxidative addition of MeI, O_2 , H_2 to (**320**) gives the Ir^{III} compound, which retains the $\text{V}\equiv\text{N}-\text{Ir}$ moiety. However, the nitrido linkage may be cleaved at Ir by silylating reagents ClSiMe_3 , ClSiEt_3 , or HSiEt_3 .

6.2.7.3.4 Nitrosyl

A series of square-planar Ir^{I} complexes, $[\text{Ir}(\text{NO})(\text{Sar})_2(\text{PPh}_3)]$, (**321**), ($\text{ar} = \text{C}_6\text{H}_2\text{Me}_3\text{-}2,4,6$ (mes), $\text{C}_6\text{H}_3\text{Me}_2\text{-}2,6$, and $\text{C}_6\text{H}_2\text{Pr}_3\text{-}2,4,6$) are prepared according to reaction Scheme 30, and all contain

a linear nitrosyl ligand ($\nu_{\text{NO}} = 1,802\text{--}1,825\text{ cm}^{-1}$).⁷⁴⁷ The X-ray diffraction study of (321) with ar = mes is reported.

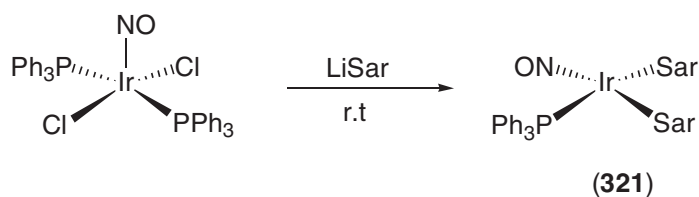

Scheme 30

6.2.7.3.5 Amides

The reaction of Vaska's compound with the lithium salts of aryl amides yields *trans*-Ir(PPh₃)₂(CO)(NHAr), (322), (ar = C₆H₅, *p*-C₆H₄Me, *o*-C₆H₄Me, 3,5-C₆H₃Me₂, 2,6-C₆H₃Me₂, *p*-C₆H₄Cl, *p*-C₆H₄NO₂).⁵¹⁷ Single-crystal X-ray diffraction studies of (322), ar = *p*-C₆H₄NO₂⁵¹⁸ and ar = 3,5-C₆H₃Me₂,⁵¹⁷ are reported and show a virtually planar Ir center, with the plane of the amido phenyl ring perpendicular to the square plane around Ir^I. All of the complexes except (322) with ar = *p*-C₆H₄NO₂ undergo rapid reactions with CO. The related complex (323) forms from a similar reaction of Vaska's compound with Li indolyl.⁵¹⁹ The X-ray crystal structure of (323) (R = Me) is reported. (323) is unreactive towards CO and protic acids, but reacts with triflic acid at the 3-position of the ring to give an indolenine cation. Reaction of *trans*-Ir(PR₃)₂(CO)Cl (R = Me, Et) and LiNHPPh in THF gives *trans*-Ir(PR₃)₂(CO)(NHPPh), (324).⁵²⁰ Benzene solutions of *trans*-Ir(PET₃)₂(CO)(NH^tBu) readily convert to the dimer species (325) when heated.

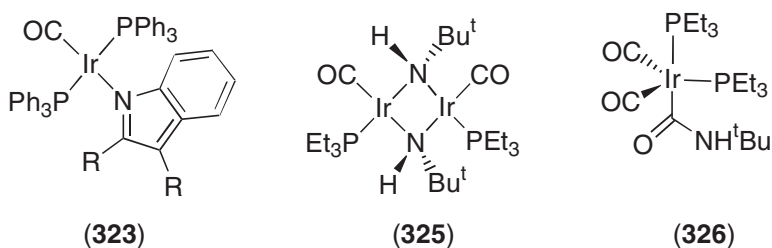

(325) reacts with CO to give the carbamoyl complex (326), and with PhC≡CH to give the bisalkynyl complex *trans*-Ir(PET₃)₂(CO)H(C≡CPh)₂.

The bridged amido complex [Ir{ μ -NH(*p*-tolyl)}]₂(CO)₄ is prepared according to Reaction Scheme 31.⁵²¹ The X-ray crystal structure reveals each Ir^I center to be in a roughly square-planar geometry, with an angle between the two Ir planes of 124.6°. The structure contains a single Ir—Ir bond of 2.933 Å. The bridging amido ligands undergo deprotonation by ^tBuLi in a stepwise manner, as shown in reaction Scheme 32.⁵²²

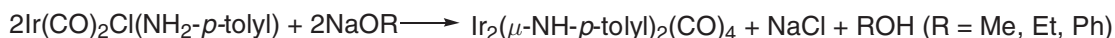

Scheme 31

(327) reacts with (PPh₃)AuCl to generate the tetranuclear complex (328).

6.2.7.3.6 α -diimines

[Ir(cod)Cl]₂ reacts with α -diimines LL (derived from glyoxal and biacetyl) to yield cationic [Ir(cod)LL]⁺.⁵²³ If the reaction is carried out in the presence of SnCl₂, then the pentacoordinate Ir(SnCl₃)(cod)LL species results. The compounds are active catalysts in the homogeneous hydrogen transfer from isopropanol to cyclohexanone or to acetophenone followed by hydrogenation

to phenylethanol.⁵²⁴ α,β -unsaturated ketones are reduced to saturated ketones and alcohols. Reaction pathways are discussed.

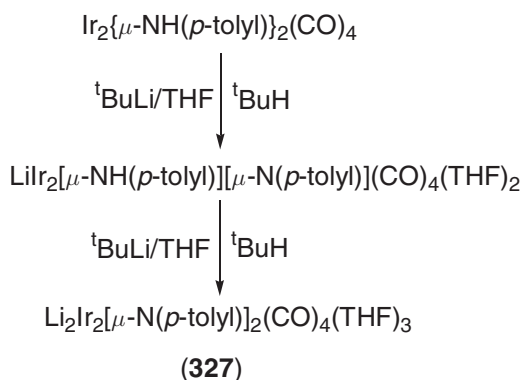

Scheme 32

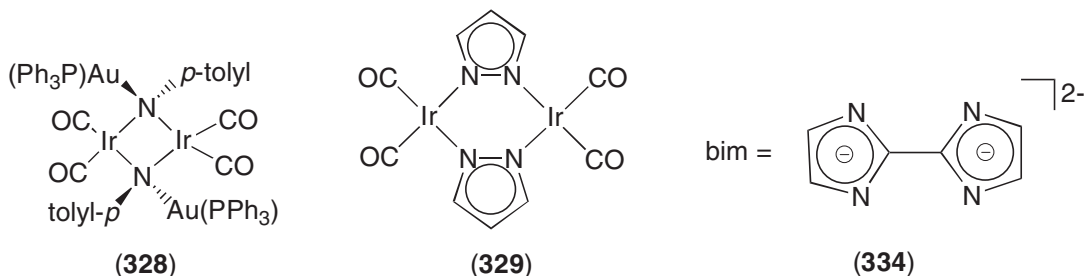

6.2.7.3.7 Pyrazole and derivatives

The pyrazole ligand may be found bridging a variety of binuclear Ir compounds and mixed-metal Ir species. Reaction of $[\text{Ir}(\mu\text{-pz}(\text{cod}))_2]$ (pz = pyrazole) with CO yields the yellow, stable, binuclear complex $[\text{Ir}(\mu\text{-pz})(\text{CO})_2]_2$, (**329**), with an Ir—Ir distance of 3.506 Å.⁵²⁵ Substitution of Me groups in the 3- and 5-positions of pz gives an analogous complex $[\text{Ir}(\mu\text{-dmpz})(\text{CO})_2]_2$ (dmpz = 3,5-dimethyl pyrazole), having an Ir—Ir distance of 3.245 Å. The structure of the mixed-metal compound $[\text{Me}_2\text{Ga}(\mu\text{-pz})_2\text{Ir}(\text{cod})]$ is also detailed. The structure of $[\text{Ir}(\mu\text{-dmpz})(\text{CO})(\text{Ph}_2\text{POC}_6\text{H}_4\text{CH}_3)]_2$ contains two square-planar Ir^I centers with an Ir—Ir distance of 3.307 Å.⁵²⁶

Electrochemical studies of $[\text{Ir}(\mu\text{-pz})(\text{cod}))_2]$ in CH_2Cl_2 reveal two one-electron oxidations. The position of the second oxidation depends on the nature of the supporting anion. Addition of CH_3CN to the solution causes the second oxidation process to shift to the same potential as the first wave, due to the strong complexation of two CH_3CN ligands.⁵²⁷ Comparative studies on $[\text{Ir}(\mu\text{-L})(\text{cod}))_2]$ (L = pz, 3-methylpyrazole (mpz), and dmpz) in THF shows that the first oxidation potential shifts to more negative potentials with increasing substitution.⁵²⁸ All three compounds exhibit an irreversible reduction. Electrogenerated chemiluminescence is observed by pulsing the working electrode between the anodic and cathodic peak potentials.

The electronic absorption and emission spectra and emission lifetimes of $[\text{Ir}(\mu\text{-L})(\text{CO})_2]_2$ (L = pz, mpz and dmpz) have been determined.⁵²⁹ The intense low-energy absorption band around 400 nm is assigned to a $dz^2 \rightarrow pz$ electronic transition. The three complexes all emit around 740 nm at 300 K and 670 nm at 77 K. The dimer excited states are stabilized relative to monomer levels by strong metal–metal bonding.

The Ir^I–Ir^{III} mixed-valent, pyrazole-bridged species $[\text{Ir}_2(\mu\text{-pz})_2(\text{CH}_3)(\text{CO})_2(\text{P}^i\text{Pr}_3)_2]\text{ClO}_4$, (**330**), is formed according to reaction Scheme 33.⁵³⁰ The X-ray diffraction data indicated that (**330**) contains a square-planar Ir^I center and a nearly regular square-pyramidal Ir^{III} center, connected via a weak metal–metal bond of 2.8694 Å. The two very different ν_{CO} stretching vibrations confirm the different Ir oxidation states.

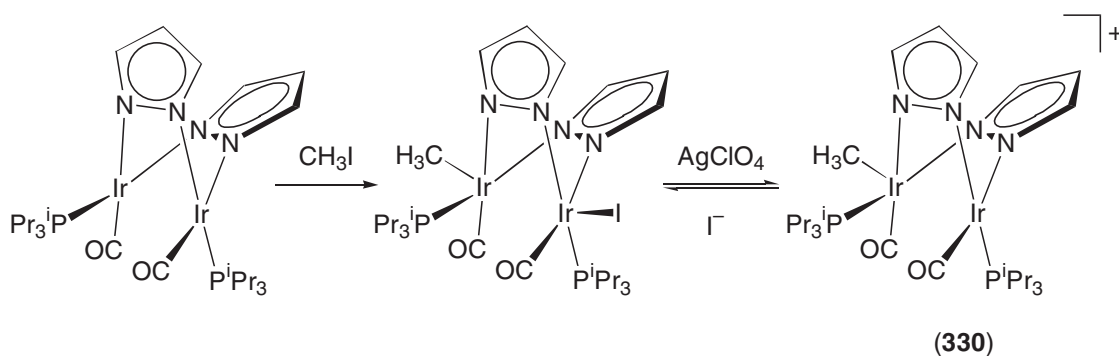

Scheme 33

The IR- and ^1H NMR-characterized, hetero-binuclear, pyrazole-bridged complex $[(\text{C}_5\text{Me}_5)\text{-Rh}(\mu\text{-Cl})_2(\mu\text{-pz})\text{Ir}(\text{tfb})]$ (tfb = tetrafluorobenzo[5.6]bicyclo[2.2.2]octa-2,5,7-triene) contains the unusual combination of oxidation states $\text{Rh}^{\text{III}}\text{-Ir}^{\text{I}}$.⁵³¹ The reaction of $\text{Ir}(\text{PPh}_3)_2(\text{CO})(\text{dmpz})$ with $\text{Au}(\text{tht})\text{X}$ (tht = tetrahydrothiophene, $\text{X} = \text{Cl}, \text{Br}$) affords the $\text{Ir}^{\text{I}}\text{-Au}^{\text{I}}$ derivative $\text{Ir}(\text{PPh}_3)_2(\text{CO})(\mu\text{-dmpz})\text{AuX}$, whereas reaction with $\text{Au}(\text{tht})\text{Cl}_3$ gives an unstable, yellow, bimetallic intermediate $\text{IrAu}(\text{PPh}_3)_2(\text{CO})(\text{dmpz})\text{Cl}_3$, which readily decomposes to $(\text{Audmpz})_n$ and $\text{Ir}(\text{PPh}_3)_2(\text{CO})\text{Cl}_3$.⁵³²

The heterodinuclear complex $[(\eta^6\text{-}p\text{-cymene})(\text{pz})\text{Ru}(\mu\text{-pz})_2\text{Ir}(\text{CO})_2]$ was prepared by reacting $[(\eta^6\text{-}p\text{-cymene})\text{Ru}(\text{pz})(\text{Hpz})]$ with $[\text{Ir}(\text{acac})(\text{CO})_2]^-$ ($p\text{-cymene} = p\text{-isopropylmethylbenzene}$, acac = acetylacetae).⁵³³ The X-ray structure of the protonated BF_4^- salt confirms two bridging pz ligands with no intermetallic interaction, and a further protonated Hpz ligand bound to the Ru^{II} center.

The donor–acceptor complexes $[\text{Ir}(\mu\text{-dmpz})(\text{CO})(\text{PPh}_2\{\text{O}(\text{CH}_2)_2\text{R}\})_2]_2$ exhibit photo-induced electron-transfer rate constants of 10^{12} s^{-1} and charge recombination rates slower than $2 \times 10^{10}\text{ s}^{-1}$ when $\text{R} = \text{pyridine}$ and 4-phenylpyridine.⁵³⁴ Further studies on these complexes revealed that recombination reactions were temperature dependent and slower for the deuterated acceptors.⁵³⁵

The binuclear complexes of formula $[\text{M}_2(\mu\text{-tz})_2(\text{L}_2)_2]$, (331), ($\text{tz} = \text{triazolate}$, $\text{M} = \text{Rh}, \text{Ir}$, $\text{L}_2 = \text{diolefin}, (\text{CO})_2$, or $(\text{CO})(\text{PPh}_3)$) have been prepared.⁵³⁶ Reaction with $[\text{Rh}(\mu\text{-Cl})_2(\text{L}_2)_2]$ yields the tetranuclear compounds $[\text{Rh}_2\text{Ir}_2(\mu^3\text{-tz})_2\text{Cl}_2(\text{L}_2)_4]$, (332), and the trinuclear mixed-metal complex $[\text{Rh}_2\text{Ir}(\mu^3\text{-tz})(\mu\text{-Cl})\text{ClL}_2(\text{CO})_4]$, (333), ($\text{L} = \text{cod}$) according to Reaction Scheme 34.

The anionic ligand 2,2'-bi-imidazolate (2-) (bim) (334) has been reported to bridge Ir^{I} and Rh^{III} centers to form binuclear and tetranuclear complexes, $[(\eta\text{-C}_5\text{Me}_5)\text{pyRh}(\text{bim})\text{Ir}(\text{tfb})](\text{ClO}_4)$ and $[\{(\eta\text{-C}_5\text{Me}_5)(\text{PR}_3)\text{Rh}(\text{bim})\text{Ir}(\text{tfb})\}_2](\text{ClO}_4)_2$ ($\text{R} = \text{Ph}, \text{OEt}$).⁵³⁷ Oligomerization reactions of the planar anion $[\text{Ir}(\text{CO})_2\text{Tcbim}]^-$ ($\text{H}_2\text{Tcbim} = 4,4',5,5'\text{-tetracyano-2,2'\text{-biimidazole}}$), studied as a function of concentration, revealed that at 10^{-3} M dimerization resulted, with a concomitant growth of a strong ($\epsilon = 18,500\text{ M}^{-1}\text{ cm}^{-1}$) absorption band at 475 nm.⁵³⁸ At higher concentrations (10^{-2} M), further oligomerization was observed. The chemistry of Tcbim and its complexes with Ir^{I} was reviewed in 1987 by Rasmussen.⁵³⁹

6.2.7.3.8 Bis-chelating Ligands

The structurally characterized complex $[\text{cp}^*\text{Ir}(4,4'\text{-}(\text{COOH})_2\text{-bpy})]$, $\text{cp}^* = \text{pentamethyl cyclopentadienyl}$, $\text{bpy} = 2,2'\text{-bipyridine}$, has a five-coordinate Ir^{I} center.⁵⁴⁰ The bpy mean plane makes an angle of ca. 75° with the cp^* mean plane. The π -acceptor properties of the bpy ligand lead to unusually short $\text{Ir}\text{-cp}^*$ distances. The black compound $[\text{IrCl}(\text{CO})(\text{bpy})]$ is formed when a mixture of $[\text{IrCl}(\text{C}_8\text{H}_{14})_2]_2$, (335), and bpy in CH_2Cl_2 is exposed to an atmosphere of CO, and it exhibits a single ν_{CO} stretching frequency of $1,996\text{ cm}^{-1}$.⁵⁴¹ If (335) is reacted with an excess of bpy, then the hydride complex $\text{IrH}(\text{bpy})_2 \cdot \text{CH}_2\text{Cl}_2$ is formed, with a $\nu_{\text{Ir-H}}$ stretch at $2,114\text{ cm}^{-1}$. The donor–acceptor properties of several derivatized bpy and 1,10-phenanthroline (phen) ligands ($\text{N}\cap\text{N}$) were characterized in $[\text{Ir}(\text{N}\cap\text{N})(\text{CO})_2](\text{PF}_6)$ by analyzing the symmetric ν_{CO} stretching vibration.⁵⁴² The 2,2'-dipyridylamine ligand (Hdipy), and its deprotonated form (dipy), coordinate to $\text{Ir}(\text{CO})_2$ and $\text{Ir}(\text{diolefin})$ fragments.⁵⁴³

The cationic $[\text{Ir}(\text{cod})(\text{bnda})](\text{BF}_4)$ complex ($\text{bnda} = 2,2'\text{-diamino-1,1'\text{-binaphthyl}}$), (336), catalyzes the enantioselective hydrogenation of (*Z*)- α -acetamidocinnamic acid to acetamidodihydrocinnamic

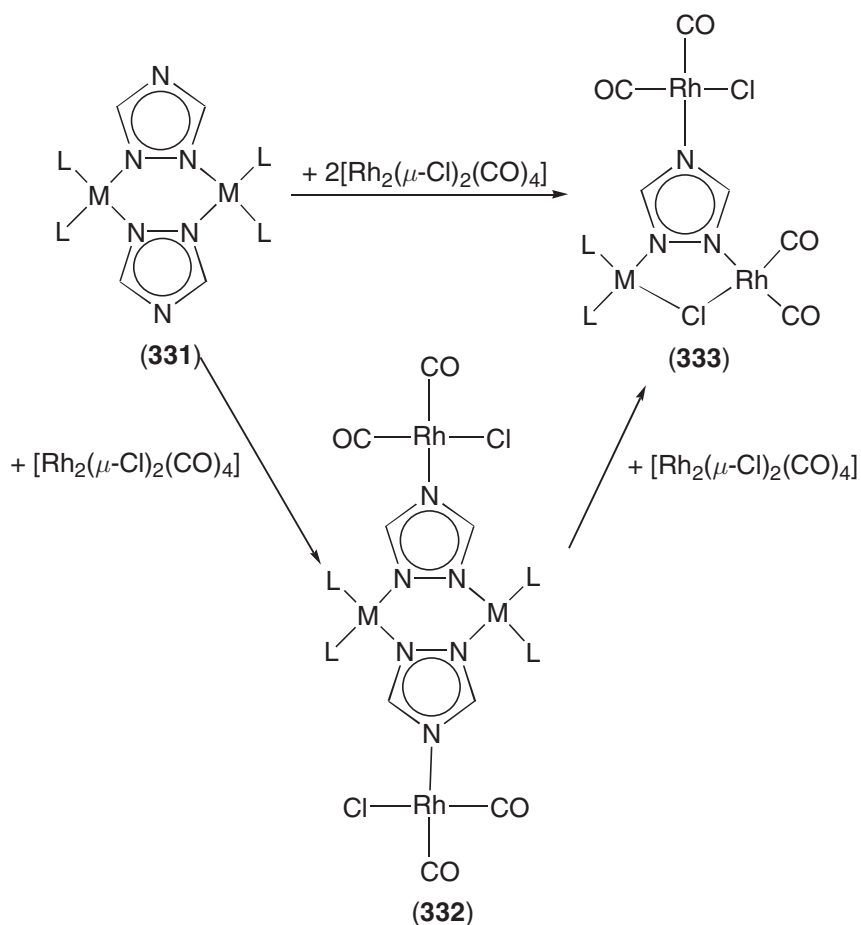

Scheme 34

acid at room temperature under 35 atm of H_2 .⁵⁴⁴ The bnda complex is prepared by the reaction of $[IrCl(cod)]_2$ with $AgBF_4$, followed by treatment with bnda.

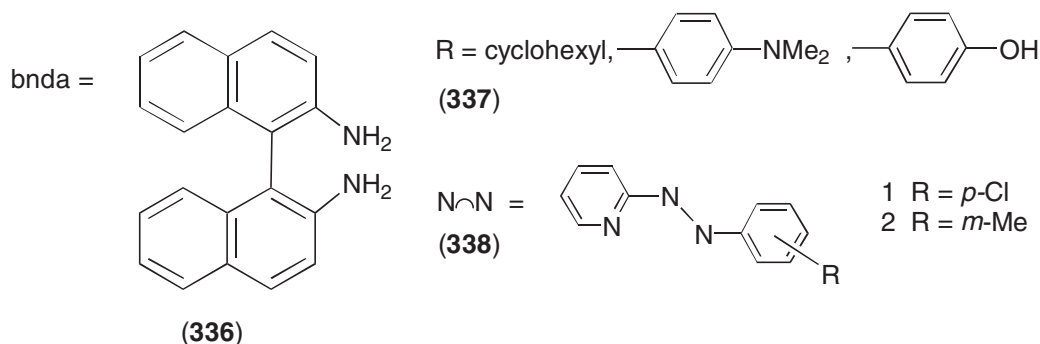

$[IrCl(cod)]_2$ reacts with α -diimines derived from glyoxal ($R-N=CH-CH=N-R$) (LL), $R = (337)$, in acetone containing PPh_3 and $AgBF_4$ to yield the pentacoordinate complexes of general formula $[Ir(cod)(LL)(PPh_3)](BF_4)$.⁵⁴⁵ Exposure to CO results in displacement of cod by two CO ligands. $[Ir(CO)(LL)(PPh_3)_2]ClO_4$ results from the reaction of *trans*- $[Ir(OCIO_3)(CO)(PPh_3)_2]$ with LL.

The structure and properties of azopyridine chelates ($N\curvearrowright N$) (338) of iridium, $[Ir(cod)(N\curvearrowright N)X]$ ($X = Cl, Br, I$), are detailed.⁵⁴⁶ The dark blue compounds $[Ir(cod)(N\curvearrowright N^1)Cl]$ and $[Ir(cod)(N\curvearrowright N^2)I]$ are characterized by X-ray crystallography and show a square-pyramidal geometry. The intense color has been assigned to an electronic transition primarily localized on the Ir-($N\curvearrowright N$) fragment. The complexes do not undergo oxidative addition reactions, in contrast to their bpy analogues.

6.2.7.3.9 Polydentate N-donor ligands

The tridentate N-donor ligand (**339**) forms square-planar Ir^I chloro complexes through coordination to the three N-donor atoms.⁵⁴⁷ Attempts to exchange directly the chloride ligand for hydride and methyl ligands were unsuccessful. However, routes were developed to the reactive methoxide and triflate complexes, which proved to be excellent starting materials for the synthesis of Ir^I and Ir^{III} methyl compounds. The structure, bonding, and thermodynamics of the methoxy species were analyzed by DFT methods. The X-ray crystal structure of the Ir^I methoxy species shows square-planar geometry at the metal center.

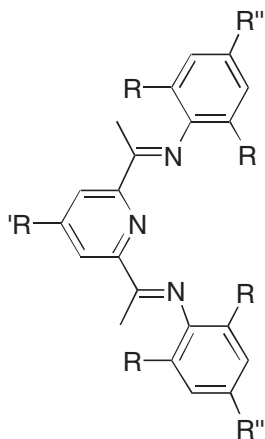

(339)

The tetradentate ligands (**340**) and (**341**) form 1:1 metal:ligand complexes with [IrCl(cod)]₂.⁵⁴⁸ The complexes were tested in the asymmetric hydrogenation of prochiral olefins, providing enantioselectivities up to 36%. The multitopic ligands L, (**342**) and (**343**), bind to Ir^I to form [IrL] species which have been characterized by elemental analysis, mass spectrometry, IR and NMR spectroscopy.⁵⁴⁹ The complexes show enantioselectivities of up to 30% for the hydrogenation of prochiral olefins under mild reaction conditions.

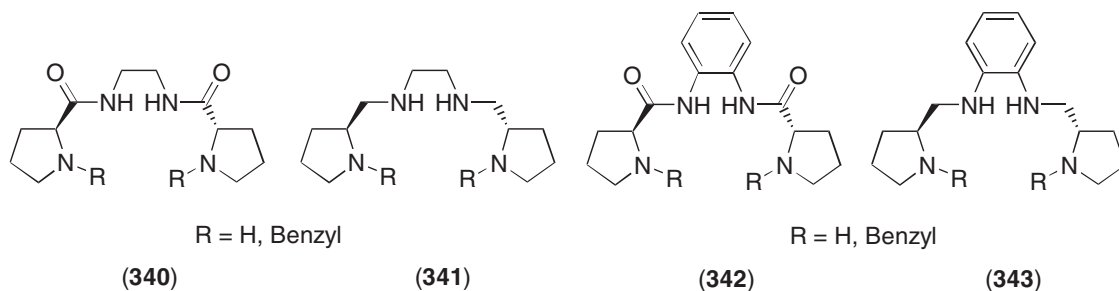

(340)

(341)

(342)

(343)

The theoretical study of complexes [IrLCl], [cpIrCl]¹⁻, and [IrCl₂(PH₃)₂]¹⁻, where L is a tridentate chelating ligand, has resulted in the establishment of criteria for selecting tridentate chelating ligands for the stabilization of hydridoalkyl complexes [(Me)Ir(L)(H)Cl].⁵⁵⁰

The bis-Ir^I complex (**344**) of the seleno sapphyrin ligand has been synthesized and characterized by X-ray diffraction studies.⁵⁵¹ The pairs of bound N atoms in (**344**) are bent towards the Ir^I centers, and the respective pyrrole rings are twisted from the macrocyclic plane. The coordination geometry around the Ir is close to square-planar, and the Ir—Ir distance is 4.233 Å. The Se center is not involved in bonding to the Ir centers.

The triazenide-bridged Ir/Rh complexes, general formula [RhL_m(μ-RNNNR)₂IrL_n], (**345**), L_m = cod, (CO)₂, (CO)(PPh₃), (CO){P(OMe)₃}, L_n = (CO)₂, (CO)(PPh₃), (CO){P(OMe)₃}, R = C₆Me₄Me-*p*, are electrochemically and chemically oxidized by one electron to form paramagnetic monocations.⁵⁵² The X-ray structure of (**345**), L_m = cod, L_n = (CO)₂, confirms the square-planar geometry of the Ir center. EPR studies of the monocations show coupling to both ¹⁰³Rh and ^{191,193}Ir whose magnitude depends on the ancillary ligands at the two metals.

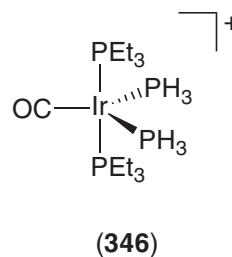
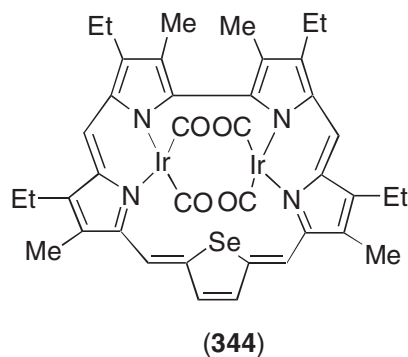

6.2.7.4 Phosphorus Ligands

6.2.7.4.1 Monodentate Ligands

Reactions of Vaska-type compounds $[\text{Ir}(\text{CO})\text{X}(\text{PR}_3)_2]$, where X = halide and R = alkyl, aryl, commonly yield Ir^{III} -containing complexes and are considered in the appropriate Ir^{III} section. The structure and chemistry of analogues of Vaska's compound will be addressed here. *Trans*- $[\text{IrCl}(\text{CO})\{\text{P}(\text{C}_6\text{H}_4\text{-}p\text{-Me})_3\}_2]$, characterized by X-ray crystallography, is structurally similar to Vaska's compound.⁵⁵³ The structures of *trans*- $[\text{IrCl}(\text{CO})\{\text{P}(\text{C}_6\text{H}_{11})_3\}_2]$ and $[\text{Ir}(\text{cod})\text{-}(\text{py})\{\text{P}(\text{C}_6\text{H}_{11})_3\}](\text{PF}_6)$ show approximate square-planar geometry at Ir, with distortions due to the size of the $\text{P}(\text{C}_6\text{H}_{11})_3$ ligand.^{554,555}

The initial product of reaction of $[\text{Ir}(\text{CO})\text{X}(\text{PEt}_3)_2]$, X = Cl or Br, at 180 K with PH_3 is identified by ^1H and ^{31}P NMR spectroscopy as (346), which converts to (105) at 230 K.⁵⁵⁶

The molecular conformation of *trans*- $[(^t\text{Bu})_2\text{PPh}]_2\text{Ir}(\text{CO})\text{Cl}$ has been investigated by $^{31}\text{P}\{^1\text{H}\}$ NMR spectroscopy and reveals four diastereoisomers: two major conformations in which the phenyl groups are mutually *anti* and orientated on the same side or opposite sides of the coordination plane, and two minor isomers in which the two phenyl groups are *syn* to the CO ligand.⁵⁵⁷

The electron density at the Ir nucleus of the series *trans*- $(\text{Ph}_3\text{P})_2\text{Ir}(\text{CO})(\text{X})$, *trans*, *cis*- $(\text{Ph}_3\text{P})_2(\text{H})_2\text{Ir}(\text{CO})(\text{X})$ (X = Cl or *pz-N*, *pz-N-H* = 3,5-dimethyl-, 3,5-dimethyl-4-nitro-, 3,5-bis(trifluoromethyl)pyrazole) and *trans*- $(\text{Ph}_3\text{P})_2(\text{CO})\text{Ir}[\mu\text{-}3,5\text{-dimethyl-pyrazole-}N,N']\text{AuX}'$ (X' = Cl, Br), studied by ^{193}Ir and ^{197}Au Mössbauer spectroscopy, is affected by the substituents on the heterocycle and the density of ligand X, but not by the presence of conformers.⁵⁵⁸ Electronic effects are transmitted from Au to Ir.

The study of rapid, intermolecular ligand exchange between square-planar complexes *trans*- $\text{Ir}(\text{CO})\text{L}_2\text{X}$ (X = Cl or Me, L = PPh_3 , $\text{P}(p\text{-tolyl})_3$, or PMePh_2) by variable-temperature ^{31}P NMR spectroscopy indicates that the reaction proceeds through dissociation of phosphine from the metal center and a subsequent associative substitution with other complexes.^{559,560} Ligand exchange between square-planar Ir and Pt complexes is slow.

A series of $\text{Ir}(\text{CO})\text{Cl}(\text{PR}_3)_2(\eta^2\text{-}3,3\text{-diphenylcyclopropane})$ complexes ($\text{PR}_3 = \text{PMe}_3$, PMe_2Ph , PMePh_2 , PEt_3) is prepared according to reaction Scheme 35.⁵⁶¹

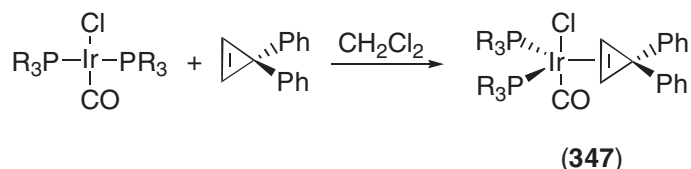

Scheme 35

The X-ray structure of (347), $\text{PR}_3 = \text{PMe}_3$, confirms the trigonal-bipyramidal structure, with the olefin and phosphine ligands lying in the equatorial plane. The equilibrium between free and bound olefin depends on the size of the tertiary phosphine. Further reaction of (347) with $\text{IrCl}(\text{CO})(\text{PMe}_3)_2$ results in formation of a bimetallic iridacyclobutene complex by a second-order process.

Trans-IrCl(CO)(PPh₃)₂ reacts with tppts (tppts = *m*-sulfonatophenyl sodium diphenyl phosphine; tppms is the potassium analogue) to give the water-soluble complex *trans*-IrCl(CO)(tppts)₂ in good yield (71%).⁵⁶² The hydroxo analogue *trans*-Ir(CO)(OH)(tppms)₂, (348), has excellent solubility in water. Reaction of (348) with H₂ yields *fac*-Ir(CO)(H)₃(tppms)₂ in H₂O, but 1:1 *fac/mer* mix when the reaction is carried out in DMSO.⁵⁶³ The tppms complexes of Ir have very similar spectroscopic characteristics to the PPh₃ analogue, and similar reactions in toluene. However, weak acid/base equilibria are evident for aqueous solutions of tppms, which are not observed in nonaqueous solvents. Hydrogen adds to *trans*-Ir(CO)ClL₂ (L = tppms, tppts) in H₂O and has a similar kinetic deuterium isotope effect to its PPh₃ analogue in toluene, indicating a common mechanism. Increasing the pH of the aqueous solution decreases the rate of H₂ addition, which is ascribed to protonation/hydrogen bonding to the Ir center.⁵⁶⁴ Further studies of the complexes reveal that [Ir(CO)(tppms)₃]⁺ is stable in H₂O but forms [Ir(CO)(DMSO)(tppms)₂]⁺ in DMSO. [Ir(CO)₂(tppms)₃]⁺ reacts with CO in DMSO to give [Ir(CO)₃(tppms)₂]⁺, but there is no reaction in H₂O. Reaction of *trans*-Ir(CO)ClL₂ with excess L in H₂O produces [Ir(CO)L₃]Cl; however, there is no reaction in DMSO.⁵⁶⁵

Vaska's analogue *trans*-[Ir(CO)Cl(Ph₂Ppy)₂], (349), (Ph₂Ppy = 2-diphenylphosphinopyridine) has two monodentate, P-bound Ph₂Ppy ligands. (349) undergoes a variety of reactions according to Reaction Scheme 36.⁵⁶⁶ The X-ray crystal structures of (350) and (351) are given. Complex (349) acts as a precatalyst in the hydroformylation of styrene at 80 °C and under 80 atm of CO/H₂.

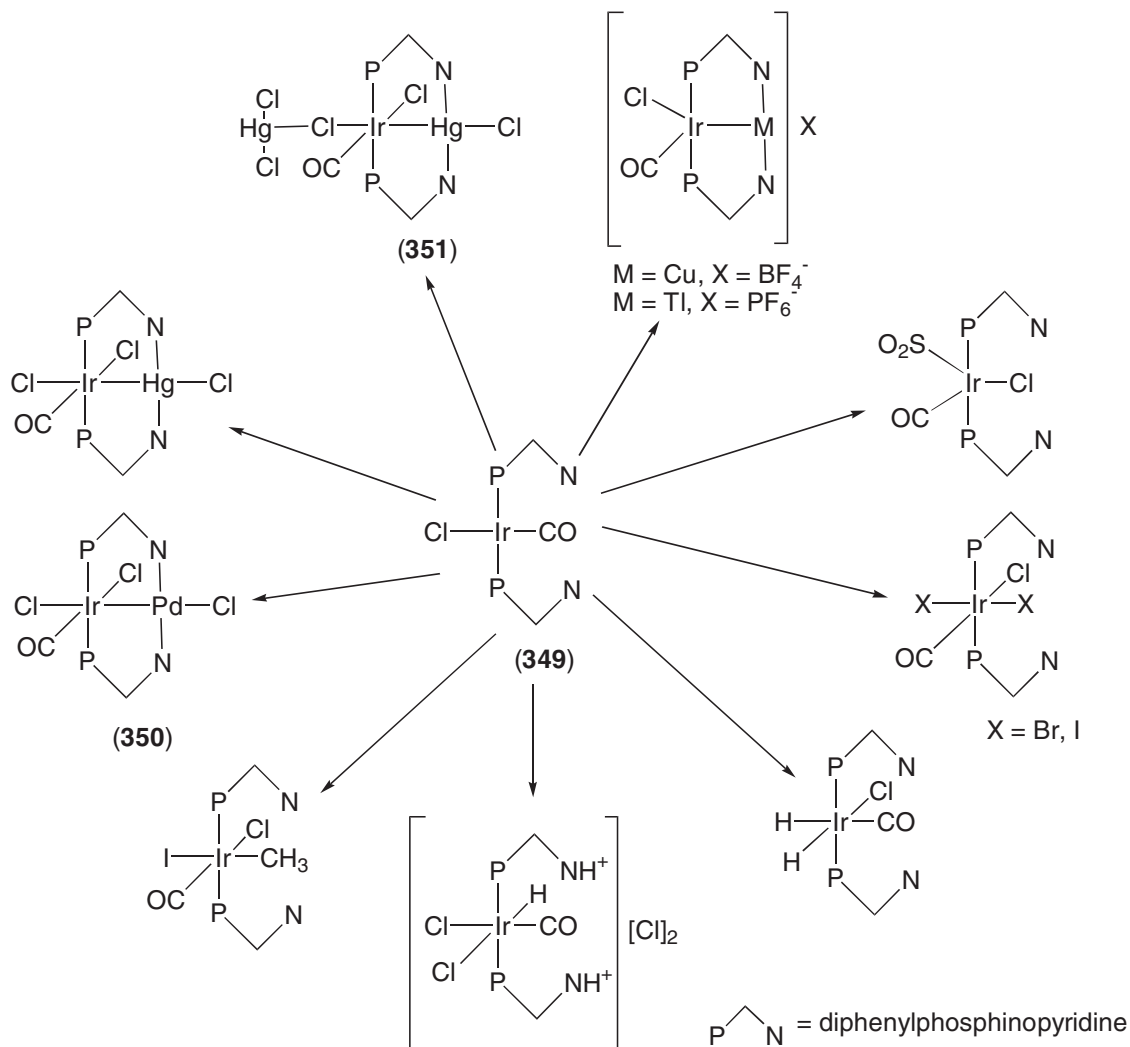

Scheme 36

The steric and electronic effects of phosphine ligands on the binding of small molecules to Ir^I were probed by studying reactions of O₂, SO₂, and CH₃I with *trans*-Ir(CO)(Cl)(PR₃)₂, where PR₃ = P(^tPr)₃ and P(^tBu)₂Me, compared to PR₃ = PPh₃, P(*p*-tolyl)₃, and Pecy₃. Increasing phosphine size inhibits O₂ reaction, but not SO₂ reaction.⁵⁶⁷

Treatment of *cis,cis*-1,3,5-tris[(diphenylphosphanyl)methyl]-cyclohexane (tdppmcy), (352), with Ir(PPh₃)₂(CO)Cl in toluene gives the trinuclear complex [Ir(CO)Cl]₃(tdppmcy)₂, (353), in which tdppmcy ligands act as bridging ligands to each of the Ir centers.⁵⁶⁸ Addition of H⁺, H₂, and H⁻ to (353) yields {[Ir(CO)ClH]₃(tdppmcy)₂}³⁺, [Ir(CO)ClH]₂(tdppmcy)₂, and [Ir(CO)H]₃(tdppmcy)₂, respectively.

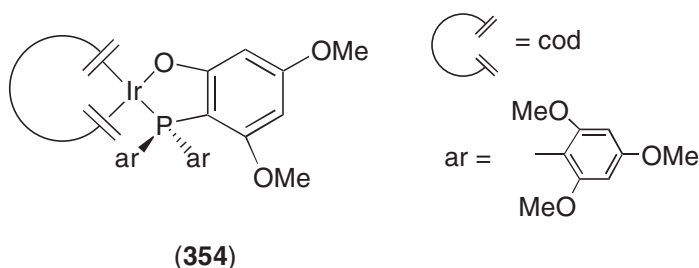
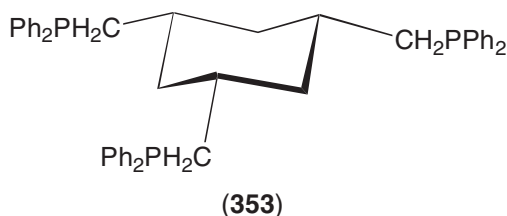

The structure of *trans*-[IrCl(CO)P(^tPr₃P)] confirms a Vaska-type geometry of Ir.⁵⁶⁹ The structure of [Ir{P(C₆H₅)₂CH₃}₄](BF₄) has been reappraised and found to belong to the space group R_c, and not to C₂/c as previously reported.^{570,571} The bond lengths and angles do not differ significantly from the earlier report. The structure of [Ir(PPh₃)₂(cod)](PF₆) reveals a square-planar geometry at Ir, but different Ir—P bond lengths at 2.367(2) Å and 2.326(3) Å.⁵⁷²

Treatment of [Ir(coe)₂Cl]₂ with PEt₃ in THF at room temperature yields [Ir(PEt₃)₃Cl].⁵⁷³ Heating the solution to 80 °C gives IrH₂Cl(PEt₃)₃.

[Ir(MeCN)(CO){P(CH₂Ph)₃}₂]ClO₄ reacts with CO to give [Ir(CO)_x{P(CH₂Ph)₃}_y]ClO₄ (*x* = 1, 2, 3, *y* = 3, 2) and with X (X⁻ = NCS⁻, ⁻C:CPh) to give [IrX(CO){P(CH₂Ph)₃}₂]; both have been characterized by IR spectroscopy.⁵⁷⁴ The trigonal-bipyramidal species [Ir(CO)₃(PEt₃)₂]BF₄ reacts with PH₃ to form [Ir(CO)₂(PH₃)(PEt₃)₂]BF₄.⁵⁷⁵ Both Ir species undergo oxidative addition reactions with HX (X = Cl, Br, I) and SiH₃Br.

A series of complexes [IrCl(cod)L] and [Ir(cod)L₂]⁺ (L = P(C₆H₄OMe-*o*)₃, PMe₂(C₆H₄OMe-*o*), PMe₂(C₆H₄OMe-*o*), PPh₂(C₆H₄OMe-*o*), PPh₂(C₆H₄NMe₂-*o*), PMe(C₆H₄OMe-*o*)₂, PPh₂(C₆H₄-OCHMe₂-*o*) have been synthesized and characterized by ¹H and ³¹P NMR spectroscopy.⁵⁷⁶ The O-containing ligands bind in a monodentate fashion, whereas the N-containing ligand chelates to the Ir center.

Reaction of [Ir(cod)Cl]₂ with two molar equivalents of P(C₇H₇)₃ yields the highly symmetric complex IrCl[P(C₇H₇)₃]₂, in which the phosphorus ligand acts as a tetradentate ligand.⁵⁷⁷ The X-ray crystal structure of the Rh analogue reveals Rh at the center of a trigonal bipyramid, with Cl and P in the axial positions and three double bonds forming the equatorial plane. However, reaction of [Ir(cod)Cl]₂ with an excess of tmpp (tmpp = tris(2,4,6-trimethoxyphenyl)phosphine) in the presence of KBF₄ yields the air-unstable, mono-demethylated complex (354).⁵⁷⁸ If the reaction is carried out in CH₃CN under a CO atmosphere, then *trans*-[Ir(CO)₂(tmpp)₂](BF₄) results, which has been characterized by X-ray crystallography and shows the expected square-planar geometry at Ir.

A further reaction of [Ir(cod)Cl]₂ with 3,4-dimethylphosphaferrocene, (355), yields the trigonal-bipyramidal complex [Ir(355)₃(cod)]BF₄, (356).⁵⁷⁹ (356) reacts with H₂ under pressure to give [Ir(355)₄H₂]⁺. Reaction of [Ir(cod)Cl]₂ with *o*-diphenylphosphinobenzoic acid ethyl ester (dpes), (357), yields [IrCl(cod)(dpes)], where dpes is acting as a monodentate P-donor-atom ligand.⁵⁸⁰ When dpes is reacted with [Ir(cod)₂]BF₄, then the structurally determined

species $[\text{Ir}(\text{cod})\text{dpes}(\text{H})](\text{BF}_4)$ results, in which the dpes is a tris-chelating ligand with P*, C*, and O* donor atoms.

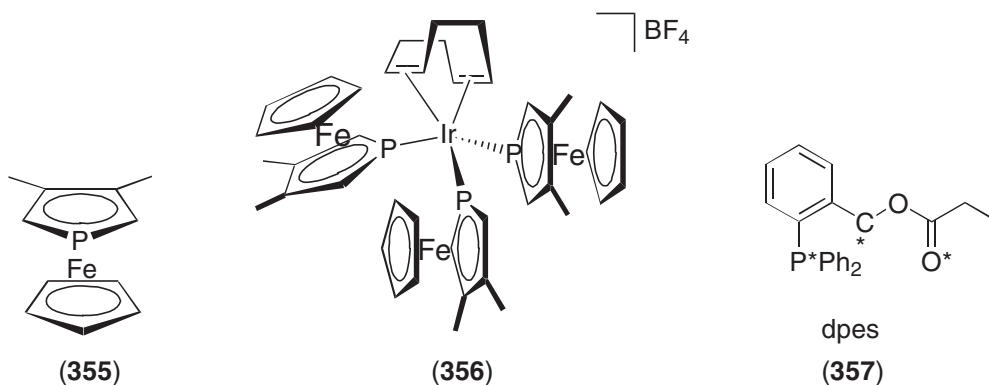

The crystal structure of $[\text{IrCl}(\text{tcep})_3]$ (tcep = tris(cyanoethyl)phosphine) as an MeCN solvate shows a distorted square-planar coordination geometry.⁵⁸¹ The structure of $[\text{Ir}(\text{cod})(\text{py})(\text{P}(2,6\text{-}(\text{OMe})_2\text{-C}_6\text{H}_3)_3)]\text{PF}_6$ shows approximately square-pyramidal geometry at the Ir atom, with one of the methoxy groups of the phosphine ligand weakly bound in the apical position (Ir–O, 2.724 Å).⁵⁸² The related complex $[\text{Ir}(\text{cod})(\text{py})(\text{P}(4\text{-OMe-C}_6\text{H}_4)_3)]\text{PF}_6$ reveals a square-planar coordination of Ir.⁵⁸³ Increasing the steric bulk of the phosphine ligands gives rise to distorted geometries around the Ir center. The binuclear Ir^I complex $[\text{Ir}_2(\text{CO})_2(\text{dmpm})_2(\mu\text{-CO}_3)]$ is characterized by single-crystal X-ray diffraction and shows a weakly interacting Ir···Ir bi-square-planar geometry.⁷⁴⁸

The synthesis of bimetallic, group 6 metal(0)–iridium(I) complexes bridged by dpmm (dpmm = $\text{Ph}_2\text{PCH}_2\text{PPh}_2$), of general formula $[(\text{OC})_3\text{M}'(\mu\text{-dpmm})_2\text{M}(\text{CO})\text{X}]$ ($\text{M}' = \text{Cr}, \text{Mo}, \text{W}$, $\text{M} = \text{Rh}, \text{Ir}$, $\text{X} = \text{Cl}, \text{Br}, \text{I}, \text{CO}$), by two independent routes is detailed by Shaw *et al.*⁵⁸⁴ The complexes are characterized by $^1\text{H}\text{-}\{^{31}\text{P}\}$ and $^{31}\text{P}\{^1\text{H}\}$ NMR and IR spectroscopy.

The Ir^I–Au^I complex (358) yields (359) and (360) following treatment with two or three equivalents of MeCN, respectively.⁵⁸⁵ Red (359) has a nearly planar $\text{Ir}(\text{CNCH}_3)_2\text{P}_2$ unit connected to a linear AuP_2 unit and an Ir–Au distance of 2.944(1) Å, as determined by X-ray crystallography. Yellow (360) has a similar structure, with a MeCN ligand added to Ir on the Ir–Au axis and an Ir–Au distance of 2.817(1) Å. (359) absorbs strongly at 492 nm, and has a fluorescence maximum at 540 nm and a phosphorescence band at 668 nm. In contrast, (360) has a strong visible absorption and a broad emission at 580 nm. Detailed assignment of the luminescent states of $[\text{AuIr}(\text{CO})\text{Cl}(\mu\text{-dpmm})_2][\text{PF}_6]$ has been made following analysis of emission, photoemission, and phosphorescence spectroscopic data.⁵⁸⁶

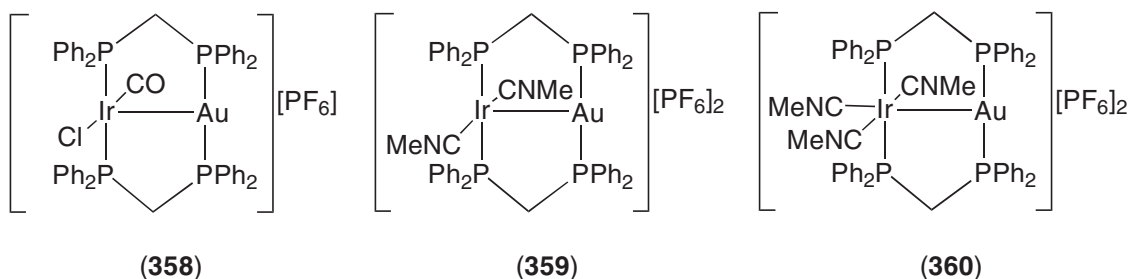

The dark green Ir/Pt acetylide complex $[(\text{RC}\equiv\text{C})\text{Pt}(\mu\text{-dpmm})_2(\mu\text{-C}\equiv\text{CR})\text{IrCl}]$, (361), was synthesized from $[\text{IrCl}(\text{coe})_2]_2$ and *trans*- $[\text{Pt}(\text{C}\equiv\text{CR})_2(\text{dpmm})_2]$ ($\text{R} = \text{Ph}, p\text{-tolyl}$).⁵⁸⁷ Reaction of (361) with H_2 and CO yields $[(\text{RC}\equiv\text{C})_2\text{Pt}(\mu\text{-dpmm})_2(\mu\text{-H})\text{IrH}(\text{Cl})]$ and $[(\text{RC}\equiv\text{C})\text{Pt}(\mu\text{-dpmm})_2(\mu\text{-C}\equiv\text{CPh})\text{Ir}(\text{CO})\text{Cl}]$, respectively. Treatment with large cations gives the red cationic species $[(\text{RC}\equiv\text{C})\text{Pt}(\mu\text{-dpmm})_2(\mu\text{-C}\equiv\text{CPh})\text{Ir}(\text{CO})]^+$, which reacts with H_2 affording $[(\text{RC}\equiv\text{C})\text{Pt}(\mu\text{-dpmm})_2(\mu\text{-C}\equiv\text{CPh})(\mu\text{-H})\text{IrH}(\text{CO})]^+$. The Pt/Ir heterotrimeric complexes (362) and (363) are prepared according to reaction Scheme 37, where $\text{P}^*\text{P}^*\text{P}^*$ = bis((diphenylphosphine) methyl)-phenylphosphine and $\text{L} = (2,6\text{-Me}_2)\text{C}_6\text{H}_4\text{NC}$.⁵⁸⁸ The X-ray structure shows a linear Pt–Pt–Ir geometry in (362) and an asymmetric A-frame in (363).

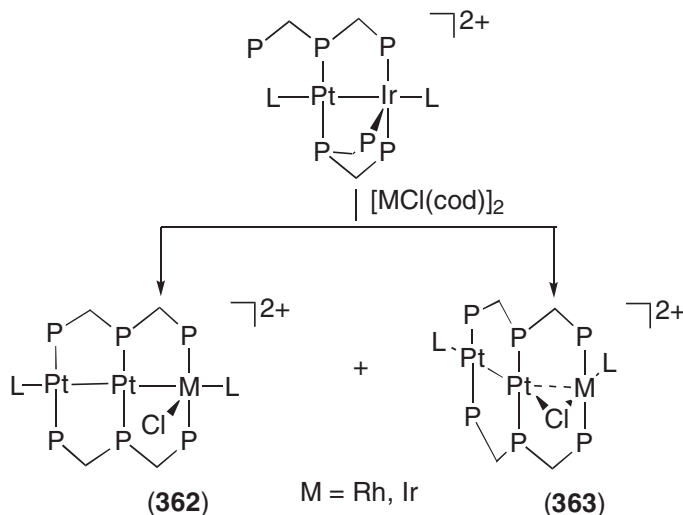

Scheme 37

The X-ray crystal structure of $[\text{IrCl}(\text{PF}_3)_2]_2$ confirms a binuclear species with bridging chloride ligands. The solid-state structure has intramolecular Ir—Ir distances of 2.942 Å, intermolecular Ir—Ir interactions of 3.271 Å, and infinite zigzag chains of Ir atoms. Other related complexes containing $\text{PF}_2(\text{NMe}_2)$, $\text{PF}(\text{O}_2\text{C}_6\text{H}_4)$, and $\text{OC}(\text{NMePF}_2)_2$ were synthesized, but only $[\{\text{IrCl}[\text{OC}(\text{NMePF}_2)_2]\}_2]$ shows evidence for extended metal–metal interactions.⁵⁸⁹

Oxidative addition to $[\text{Ir}_3(\mu\text{-PPh}_2)_3(\text{CO})_3(\text{dppm})]$ and $[\text{Ir}_3(\mu\text{-PPh}_2)_3(\text{CO})_4(^t\text{BuNC})_3]$ gives $[\text{Ir}_3(\mu\text{-PPh}_2)_3(\text{CO})_3(\text{dppm})\text{XY}]$ (X = I, Y = I, OH; X = H, Y = Cl) and $[\text{Ir}_3(\mu\text{-PPh}_2)_3(\text{CO})_4(^t\text{BuNC})_3(\text{R})\text{X}]$ (RX = MeI, BzBr, HCl, I₂, HgCl₂), respectively.⁵⁹⁰ In both cases reaction occurs at one Ir center. The structures of $[\text{Ir}_3(\mu\text{-PPh}_2)_3(\text{CO})_4(^t\text{BuNC})_3(\text{CH}_3)]\text{I}$ and $[\text{Ir}_3(\mu\text{-PPh}_2)_3(\text{CO})_3(\text{dppm})\text{I}(\text{OH})]$ are reported.

6.2.7.4.2 Polydentate ligands

The 1,2-bis(dicyclohexylphosphino)ethane (dcpe) bidentate ligand forms the mononuclear, square-planar Ir^I complexes $[\text{Ir}(\text{cod})(\text{dcpe})]\text{BPh}_4$, $[\text{Ir}(\text{dcpe})_2]\text{BPh}_4$, and $[\text{IrCl}(\text{CO})(\text{dcpe})]$, which have been characterized by IR, ¹H, and ³¹P{¹H} NMR spectroscopy.⁵⁹¹ Products of reaction with CO are discussed.

The structure of $[\text{Ir}(\text{cod})(\text{dppf})]\text{PF}_6$ shows approximately square-planar geometry at Ir, and the cp rings of the dppf ligand are close to parallel and staggered.⁵⁹² The systems $[\text{Ir}(\text{cod})(\text{LL})]\text{ClO}_4$, where LL = dppf, 1-diphenylphosphino-2-(*N,N*-dimethylamino)methyl ferrocene and 1,6-diferrocene-2,5-diazahexane, catalytically trimerize $\text{PC}\equiv\text{CH}$ to 1,3,5-triphenylbenzene.⁵⁹³ The electrochemistry of $[\text{Ir}(\text{dppf})_2]\text{BPh}_4$ shows two one-electron reductions at –1.560 V and –1.755 V vs. ferrocenium/ferrocene.⁷⁵³

The complexes $[\text{Ir}(\text{binap})(\text{cod})]\text{BF}_4$, binap = (364), and $[\text{Ir}(\text{H}_8\text{-binap})(\text{cod})]\text{BF}_4$, H₈-binap = (365), are selective catalysts in the enantioselective hydrogenation of prochiral 1,2-benzocycloalkanes to their corresponding alcohols.⁵⁹⁴ The structure of $[(\text{binap})\text{Ir}(\mu\text{-Cl})_2\text{Ir}(\text{binap})]$, (366), contains two slightly distorted square-planar Ir centers (Ir···Ir distance 3.322(2) Å), with a 126° angle between the coordination planes.⁵⁹⁵ The complex is a catalyst precursor for the asymmetric hydroamination of norbornene with aniline. Complex (366) and $[\text{Ir}_2(\mu\text{-Cl})_2\{(R)\text{-}(S)\text{-ppf-PPh}_2\}_2]$, (R)-(S)-ppf-PPh₂ = (S)-1-(diphenylphosphino)-2-[(R)-1-(diphenylphosphino)ethyl]ferrocene, react with $\text{Li}(\text{C}_6\text{H}_5\text{NH}_2)$ to ultimately yield the binuclear, aminato-bridged complexes (367) and (368), which have been characterized by X-ray crystallography.⁵⁹⁶ However, neither of the complexes shows catalytic activity in the hydroamination of olefins.

The potential tripodal ligand (369), R = H or Me, coordinates to Ir^I centers only via two P atoms in a *trans* geometry, leaving the third P center dangling but in fast exchange with the metal-bound phosphines.⁵⁹⁷ The complex $[\text{Ir}(\text{CO})(\text{mes})\text{dppe}]$, (370), dppe = 1,2-bis(diphenylphosphino) ethane, displays a slight tetrahedral distortion from square planarity.⁵⁹⁸ If (370) is heated in a benzene solution under C₂H₄, then the five-coordinate species $[\text{Ir}(\eta^2\text{-C}_2\text{H}_4)(\text{CH}_2\text{C}_6\text{H}_3(\text{CH}_3)_2)(\text{CO})(\text{dppe})]$ is formed. (370) undergoes stereospecific oxidative reactions with SiH₂Ph₂ and H₂.

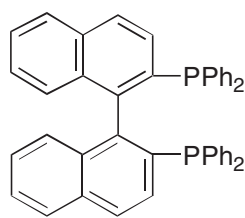
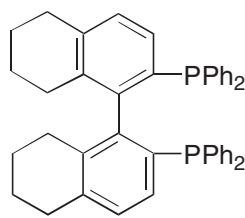
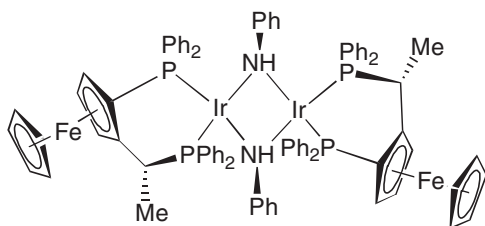
binap
(364)H₈-binap
(365)

(367)

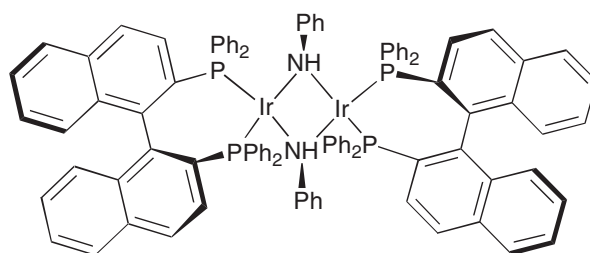

(368)

The photochemical carbonylation of benzene by $\text{IrH}(\text{CO})_2(\text{dppe})$ is shown to proceed via the square-planar intermediate $\text{IrH}(\text{CO})(\text{dppe})$.⁵⁹⁹ Equimolar quantities of $[\text{Ir}(\text{CO})_3(\text{PPh}_3)_2]\text{ClO}_4$ and $\text{MeN}(\text{P}(\text{OMe})_2)_2$ yield the crystallographically characterized $[\text{Ir}(\text{CO})(\text{MeN}(\text{P}(\text{OMe})_2)_2)(\text{PPh}_3)_2]\text{ClO}_4$, in which the Ir center has a distorted trigonal-bipyramidal geometry with a CP_4 donor-atom set.⁶⁰⁰ The axial sites are occupied by one PPh_3 ligand and by one end of the $\text{MeN}(\text{P}(\text{OMe})_2)_2$ ligand. Related complexes $[\text{Ir}(\text{MeN}(\text{P}(\text{OMe})_2)_2)(\text{PPh}_3)_2]\text{ClO}_4$ and $[\text{Ir}(\text{MeN}(\text{P}(\text{OMe})_2)_2)(\text{PPh}_3)]\text{ClO}_4$ are characterized by NMR spectroscopy.

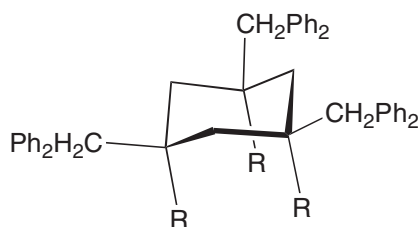

(369)

Reaction of *trans*- $[\text{IrCl}(\text{N}_2)(\text{PPh}_3)_2]$ with (371), $\text{R} = \text{CF}_3, \text{SiMe}_3, \text{Ph}$, at low temperature results in N_2 evolution and η^1 -binding of the diphosphines to Ir, which transforms to the metallacycle (372) at room temperature.⁶⁰¹ The chiral ligand biphos, (373), reacts with $[\text{Ir}(\text{cod})\text{Cl}]_2$ and AgBF_4 to form racemic $[\text{Ir}(\text{biphos})(\text{cod})]\text{BF}_4$, which proves to be catalytically inactive in the hydrogenation of α -acetoamidocinnamic acid.⁶⁰² If the reaction between a single crystal of enantiomerically pure biphos ligand and $[\text{Ir}(\text{cod})\text{Cl}]_2$ is carried out at -78°C , then enantiomerically pure $[\text{Ir}(\text{biphos})(\text{cod})]\text{BF}_4$ results.

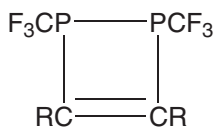

(371)

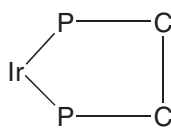

(372)

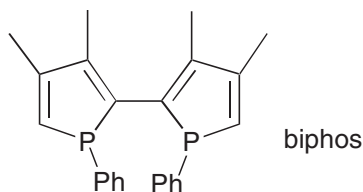

(373)

Other chiral diphosphine ligands (374), (375), (376), and (377) bind to iridium with little diastereoselectivity.⁶⁰³ The complexes are characterized by ^1H and $^{31}\text{P}\{^1\text{H}\}$ NMR spectroscopy.

All the $[\text{Ir}(\text{diphosphine})_2]\text{Cl}$ complexes undergo a quasi-irreversible, two-electron reduction process followed by a chemical reaction.

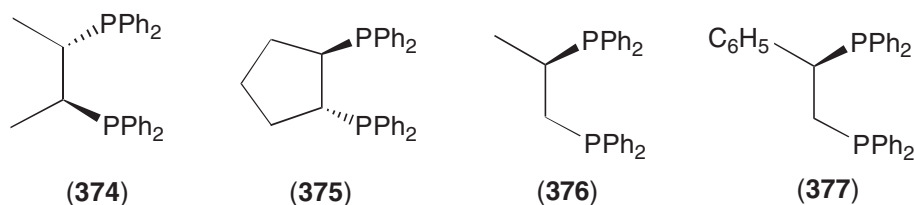

The optically pure ligands $\text{C}_6\text{H}_5\text{C}^*\text{H}(\text{Me})\text{N}(\text{CH}_2\text{CH}_2\text{PPh}_2)_2$ (*R*)-(+)- and (*S*)-(-)-pnp, in the presence of $[\text{Ir}(\text{cod})(\text{OMe})_2]$ and propan-2-ol, selectively reduce α,β -unsaturated ketones to optically pure allylic alcohols.⁶⁰⁴

The aqueous biphasic hydrogenation of dimethyl itaconate is accomplished with an Ir-(*R*)-(3-benzyl(*p*-sulfonate)-2,4-bis(diphenylphosphino)pentane) complex.⁶⁰⁵

Luminescent Ir complexes of diphosphine and diphosphinite calix[4]arene show emission maxima at 619 nm and 597 nm, respectively, at 77 K.⁶⁰⁶ The emission lifetimes are perturbed by addition of Li^+ , Na^+ , and UO_2^{2+} .

The reaction of P_4X_3 ($\text{X} = \text{S}, \text{Se}$) with $[\text{IrCl}(\text{cod})]_2$ in the presence of triphos (triphos = 1,1,1-tris((diphenylphosphino)methyl)ethane) yields the compounds $[(\text{triphos})\text{Ir}(\text{P}_3\text{X}_3)] \cdot \text{C}_6\text{H}_6$ according to Reaction Scheme 38.⁶⁰⁷ The crystal structure of $\text{X} = \text{S}$ shows that the compounds contain the (triphos)Ir moiety replacing a basal P atom of the cage.

The X-ray structure of $[\text{IrCl}(\text{CO})(\text{triphos})]$ confirms the trigonal-bipyramidal geometry of the Ir center, with the three phosphorus atoms occupying one axial and two equatorial positions and the Cl ligand in the remaining axial position.⁶⁰⁸

The tridentate ligand $\text{CF}_3\text{triphos}$ ($\text{CF}_3\text{triphos} = \text{CH}_3\text{C}\{\text{CH}_2\text{P}(m\text{-CF}_3\text{-C}_6\text{H}_4)_2\}_3$) reacts with $[\text{IrCl}(\text{cod})]_2$ to form $[\text{Ir}(\text{cod})(\text{CF}_3\text{triphos})]\text{Cl}$, (**378**), and with $[\text{Ir}(\text{CO})\text{Cl}(\text{PPh}_3)_2]$ to afford $[\text{IrCl}(\text{CO})(\text{CF}_3\text{triphos})]$.⁶⁰⁹ The $\text{CF}_3\text{triphos}$ complexes are more stable than the triphos analogues. The complex $[\text{IrCl}_3(\text{CF}_3\text{triphos})]$ is synthesized according to reaction Scheme 39.

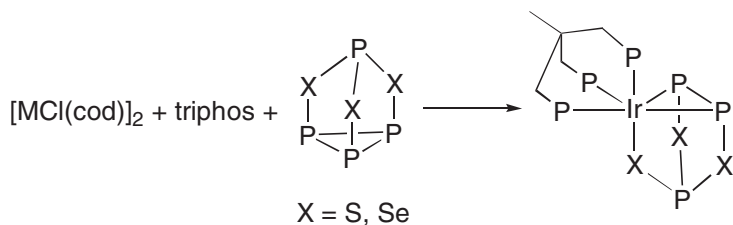

Scheme 38

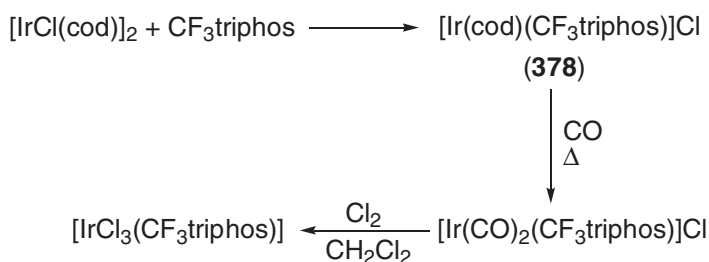

Scheme 39

6.2.7.5 Arsine and Stibene Ligands

Reaction of $[\text{IrCl}(\text{C}_2\text{H}_4)_2]_2$ with As^iPr_3 yields *trans*- $[\text{IrCl}(\text{C}_2\text{H}_4)(\text{As}^i\text{Pr}_3)_2]$, (**379**), which gives *trans*- $[\text{IrCl}(\text{CO})(\text{As}^i\text{Pr}_3)_2]$ and *trans*- $[\text{IrCl}(\text{N}_2)(\text{As}^i\text{Pr}_3)_2]$ on reaction with CO and Ph_2CN_2 , respectively.⁶¹⁰ The mixed As/P compound $[\text{IrCl}(\text{C}_2\text{H}_4)(\text{P}^i\text{Pr}_3)(\text{As}^i\text{Pr}_3)]$ is also reported.

The red, trimetallic Au₂Ir species (**380**) is formed according to reaction Scheme 40.⁶¹¹ The structures of (**380**) and (**381**) have been determined by X-ray crystallography. (**380**) shows significant Au–Ir interactions.

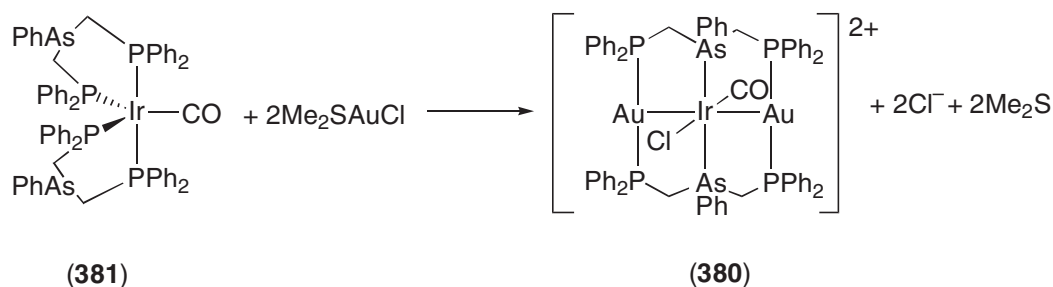

Scheme 40

Reaction of $[\text{IrCl}(\text{C}_2\text{H}_4)_2]_2$ with SbR_3 ($\text{R} = \text{}^i\text{Pr}, \text{Me}, \text{Ph}$) yields the five-coordinate complexes $[\text{IrCl}(\text{C}_2\text{H}_4)_2(\text{SbR}_3)_2]$ (**382**).⁶¹² The complex (**382**) $\text{R} = \text{}^i\text{Pr}$ has been characterized by X-ray crystallography and reveals one stibene and two olefinic ligands in the equatorial plane. NaC_5H_5 replaces the Cl ligand by C_5H_5 , and ethene may be substituted by different alkynes. Reaction of $[\text{IrCl}(\text{coe})_2]_2$ with Sb^iPr_3 gives *trans*- $[\text{IrCl}(\text{coe})(\text{Sb}^i\text{Pr}_3)_2]$, which rearranges in hexane to *anti,exo*- $[\text{IrHCl}(\eta^3\text{-C}_8\text{H}_{13})(\text{Sb}^i\text{Pr}_3)_2]$.⁶¹³

6.2.7.6 Oxygen Ligands

6.2.7.6.1 Monodentate Ligands

Reaction of *trans*- $\text{MeOIr}(\text{CO})(\text{PPh}_3)_2$ with tcn (tetracyanoethylene) gives the structurally determined trigonal-bipyramidal complex $\text{MeOIr}(\text{CO})(\text{PPh}_3)_2(\text{tcn})$, in which the tcn and CO ligands occupy axial sites.⁶¹⁴ The tcn ligand is η^2 -bound, with the olefinic bond parallel to the equatorial coordination plane. The structures of square-planar *trans*- $\text{Ir}(\text{CO})(\text{OH})(\text{Pcy}_3)_2$, *trans*- $\text{Ir}(\text{CO})(\text{OCH}_2\text{C}_6\text{H}_5)(\text{P}(p\text{-tolyl})_3)_2$, and *trans*- $\text{Ir}(\text{CO})(\text{O}-p\text{-C}_6\text{H}_4\text{CH}_3)(\text{P}(p\text{-tolyl})_3)_2$ are reported.⁶¹⁵

The square-planar complex (**383**) shows a monotropic smectic A-phase, and the X-ray diffraction study of the yellow form shows that the whole molecule adopts an extended rod-like shape with an all-*trans* conformation of the decyloxy chain.⁶¹⁶

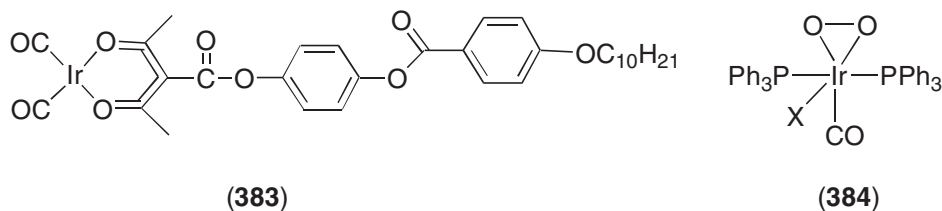

The complex *cis*- $\text{IrCl}(\text{CO})_2(\text{OPhVpy})$, $\text{OPhVpy} = \textit{trans}$ -4-alkoxy-4'-stilbazole), is mesomorphic and shows nematic and smectic phases below 140°C .^{617,618}

The electrochemical investigation on an Hg electrode of the interaction between $[\text{Ir}(\text{Me}_2\text{phen})(\text{cod})]$ and O_2 gives evidence of formation of an unstable adduct.⁶¹⁹

Reaction of *trans*- $[\text{Ir}(\text{CO})\text{X}(\text{PPh}_3)_2]$, X = halogen, is 10^8 – 10^9 times faster with singlet oxygen than with triplet oxygen and yields the same product species (**384**) in both cases.⁶²⁰

The rate constants for the $^1\text{O}_2$ reaction do not vary significantly with different ligands (X = F, Cl, Br). The reaction of *trans*- $[\text{Ir}(\text{CO})(\text{CH}_3\text{CN})(\text{PPh}_3)_2]^+$ with $^1\text{O}_2$ is slightly slower than for the halide analogues.⁶²¹ The peroxo compounds do not react with alkenes.

The reaction of $[\text{Ir}(\mu\text{-OR})(\text{cod})]_2$ (**385**), $\text{R} = \text{Me}, \text{Et}, \text{Ph}$, with Pcy_3 yields $[\text{Ir}(\text{OR})(\text{cod})(\text{Pcy}_3)]$, which undergoes alkoxy exchange with phenol and $\text{HC}\equiv\text{CPh}$.⁶²² The latter species has been characterized by X-ray diffraction. Reaction of (**385**) with the chelating triphosphine ligand ttp $\{\text{C}_6\text{H}_5\text{P}[\text{CH}_2\text{CH}_2\text{CH}_2\text{P}(\text{C}_6\text{H}_5)_2]_2\}$ or cyttp $\{\text{C}_6\text{H}_5\text{P}[\text{CH}_2\text{CH}_2\text{CH}_2\text{P}(\text{C}_6\text{H}_{11})_2]_2\}$ yields the monomeric species $[\text{Ir}(\text{OR})\text{ttp}]$ and $[\text{Ir}(\text{OR})(\text{cyttp})]$, respectively.⁶²³ Sulfur dioxide insertion reactions lead to the

metal sulfonates, for example $[\text{Ir}(\text{SO}_2\text{OC}_6\text{H}_5)(\text{ttp})\cdot\text{SO}_2]$. Alkoxyiridium complexes $\text{trans-ROIr}(\text{CO})(\text{PPh}_3)_2$, (**386**), $\text{R} = \text{Me, Ph, } ^1\text{Bu, } ^1\text{Pr}$, react with $\text{R}'\text{X}$, $\text{R}' = \text{Me, CH}_3\text{C}(\text{O}), \text{C}_6\text{H}_5\text{C}(\text{O}), \text{C}_6\text{H}_5\text{CH}_2\text{C}(\text{O}), \text{HC}(\text{O})$, $\text{X} = \text{Cl, I, H}$, to give esters, ROR' , but not ethers.⁶²⁴ Mechanistic studies on β -hydrogen elimination from (**386**) showed this process to be reversible, and it is followed by an associative displacement of the co-ordinated ketone or aldehyde by PPh_3 to yield $[\text{Ir}(\text{CO})(\text{PPh}_3)_3\text{H}]$.⁶²⁵

The rhodamine B-bound complex of Ir^{I} (**387**) shows only minor alterations in the absorption spectrum of bound rhodamine B as opposed to free dye; however, its fluorescence is strongly quenched.⁶²⁶ Fluorescence is intense when the rhodamine dye is attached to an Ir^{III} center. The authors conclude that the excited-state quenching mechanism is via electron transfer.

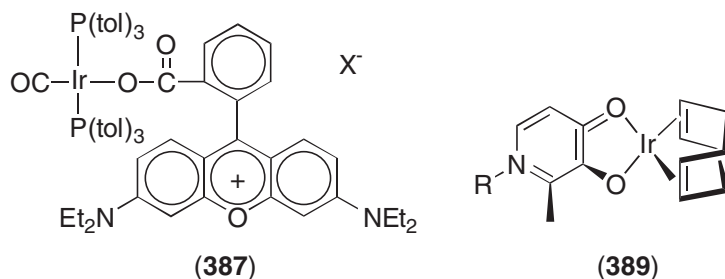

The yellow, air-stable, binuclear species $[\text{Ir}(\text{OMe})(\text{cod})]_2$ is a useful precursor in Ir alkoxy chemistry and may be prepared according to reaction Scheme 41.⁶²⁷



Scheme 41

The mixed-metal μ -oxo compounds $[\text{cp}_2\text{M}=\text{O}-\text{M}'(\text{PPh}_3)_2(\text{CO})]^+$ ($\text{M} = \text{Mo, W}$; $\text{M}' = \text{Rh, Ir}$) have been prepared by solvent displacement from $[\text{M}'(\text{CO})(\text{PPh}_3)_2(\text{CH}_3\text{CN})]^+$ by $\text{cp}_2\text{M}=\text{O}$, and the resulting complex is best described as having a dative interaction of the oxo-ligand with the unsaturated M' center.⁶²⁸ ¹H NMR studies show that the $\text{cp}_2\text{M}=\text{O}$ units rapidly exchange with solvent and with excess $\text{cp}_2\text{M}=\text{O}$.

6.2.7.6.2 Bidentate ligands

Diffuse reflectance spectra of racemic mixtures of $\text{Ir}(\text{CO})_2\text{L}$ ($\text{L} = R$ - and S -trifluoroacetylcamphorate) in the solid state reveal absorbance in the 440–610 nm region, which is attributed to Ir–Ir interactions.⁶²⁹ The crystal structure of the related compound, where $\text{L} = \text{trifluoroacetylcarvonnate}$, has an Ir–Ir distance of 3.290(1) Å.⁶³⁰ The bis(ethene) complex $[\text{Ir}(\text{acac})(\text{C}_2\text{H}_4)]$ undergoes a monosubstitution reaction with PR_3 ($\text{PR}_3 = \text{P}^i\text{Pr}_3, \text{PPh}_3, ^1\text{Pr}_2\text{PCH}_2\text{CH}_2\text{OMe}, ^1\text{Pr}_2\text{PCH}_2\text{CO}_2\text{Me}$) to yield $[\text{Ir}(\text{acac})(\text{C}_2\text{H}_4)(\text{PR}_3)]$, (**388**).⁶³¹ The X-ray structure of (**388**) with $\text{PR}_3 = \text{P}^i\text{Pr}_3$ is reported. UV irradiation of (**388**), where $\text{PR}_3 = ^1\text{Pr}_2\text{PCH}_2\text{CO}_2\text{Me}$, in the presence of excess P^iPr_3 , gives a hydrido(vinyl)iridium(III) complex. Reaction of $[\text{Ir}(\text{acac})(\text{C}_2\text{H}_4)(\text{P}^i\text{Pr}_3)]$ with $\text{CH}_2=\text{CHR}$ ($\text{R} = \text{CN, OC}(\text{O})\text{Me, C}(\text{O})\text{Me}$) affords $[\text{Ir}(\text{acac})(\text{CH}_2=\text{CHR})(\text{P}^i\text{Pr}_3)]$, which undergoes C–H activation on photolysis.

The five-coordinate complexes $\text{Ir}(\text{CO})(\text{PPh}_3)_2\text{L}$, where $\text{HL} = \beta$ -diketone, N -benzoyl- N -phenylhydroxylamine, salicylaldehyde, 8-hydroxyquinoline, 2-hydroxybenzophenone, 2-hydroxy-8-methoxybenzophenone, were prepared from $[\text{Ir}(\text{CO})(\text{PPh}_3)_2\text{Cl}]$.⁶³² The resulting compounds all underwent oxidative addition reactions with Br_2 . Reaction of $[(\text{cod})_2\text{IrCl}]_2$ with N -substituted 3-hydroxy-2-methyl-4-pyridine gives the bichelated complex (**389**).⁶³³

The dimeric Ir^{I} complexes $[(\text{dfepe})\text{Ir}(\mu\text{-X})]_2$, (**390**), ($\text{dfepe} = (\text{C}_2\text{F}_5)_2\text{PCH}_2\text{CH}_2\text{P}(\text{C}_2\text{F}_5)_2$, $\text{X} = \text{O}_2\text{CCF}_3, \text{OTf}$) have been synthesized, and for (**390**) with $\text{X} = \text{O}_2\text{CCF}_3$ have been characterized by X-ray crystallography.⁶³⁴ The structure revealed a hinged dimeric geometry, with a large interplanar angle of 82.7° defined by the two four-coordinated metal centers and an Ir–Ir distance of 4.307 Å. Both dimer species are reactive towards H_2 and alkane C–H bonds.

6.2.7.7 Sulfur Ligands

6.2.7.7.1 Monodentate Ligands

The square-planar Ir^I thiolate complex (391) has been prepared by the reaction of [Ir(NO)Cl₂(PPh₃)₂] with NaSmes (mes = C₆H₂Me₃-2,4,6).⁶³⁵ Reaction of (391) with propylene sulfide affords the Ir^{III} complex (392), as shown in Reaction Scheme 42. The X-ray structure of (392) confirms the square-pyramidal geometry of the Ir center and the bent nature of the Ir–N=O linkage.

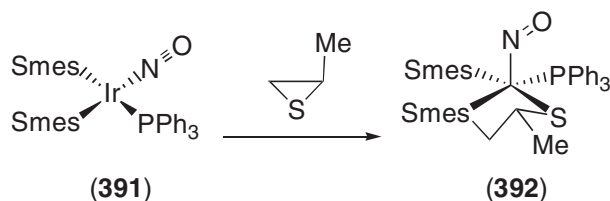

Scheme 42

The synthesis and structure of square-planar [IrCl(DMSO)₃] is reported.⁶³⁶ All the DMSO ligands are S-bonded to the Ir center with a short Ir–S bond (2.1957(9) Å), *trans* to Ir–Cl. Addition of H₂O to [IrCl(DMSO)₃] yields complex (393), as characterized by X-ray crystallography.

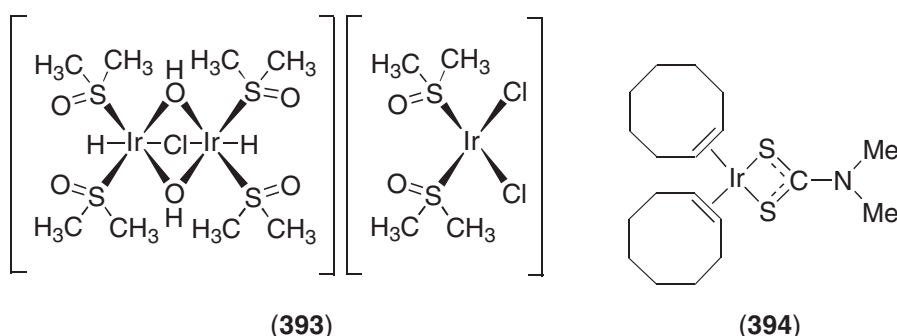

The equilibrium constants for SO₂ binding to *trans*-Ir(CO)L₂X (L = PPh₃, P(*p*-tolyl)₃, Pcy₃; X = Cl, Br, Me) show that SO₂ is binding as a Lewis acid and is enhanced by electron-donating groups on Ir.⁶³⁷ Increasing the steric bulk of the phosphine reduces the equilibrium constant for SO₂ binding. Reaction of SO₂ with [Ir(CO)(OR)L₂] (R = H, Me, ^tBu, L = PPh₃, P(*p*-tolyl)₃) results in insertion of the SO₂ into the iridium–methoxy bond to form an oxygen co-ordinated OS(O)OMe ligand. The X-ray structure of [Ir(CO)(OS(O)OMe)(SO₂)(PPh₃)₂] reveals Ir in a square-pyramidal environment, with the SO₂ ligand in the apical site and *trans* PPh₃ ligands.

The syntheses of several Ir complexes containing phosphine sulfide ligands of the type [Ir(cod)L₂]_nⁿ⁺ and [Ir(CO)₂L₂]_nⁿ⁺ (L = Me₃PS, Et₃PS, Ph₃PS; L₂ = MeP(S)(S)PMe₂, Et₂P(S)(S)PEt₂, Ph₂P(S)(S)PPh₂) and their characterization by elemental analysis, IR and ³¹P NMR spectroscopy, and conductance studies have been reported.⁶³⁸

6.2.7.7.2 Bidentate ligands

Acetonitrile solutions of IrLL'(mnt)ⁿ⁻ (mnt = maleonitriledithiolate, n = 1, L = L' = CO, P(OPh)₃; n = 1, L = CO, L' = PPh₃; n = 2, L = CO, L' = CN) and methyl viologen (MV²⁺) exhibit outer-sphere electron-transfer behavior ranging from optical [Ir(CO)₂(mnt)]⁻ to thermal [Ir(CO)(CN)(mnt)]²⁻.⁶³⁹ The structure of MV²⁺ [Ir(CO)₂(mnt)]₂ is reported and shows a cation–anion separation in the range 3.2–3.6 Å, with a square-planar Ir^I anion. The structure of (394) reports an essentially planar arrangement of the IrS₂CNMe₂ chelate system, as is the coordination plane defined by Ir, S atoms, and the two midpoints of the olefinic bonds.⁶⁴⁰

The synthesis and characterization (NMR, IR, UV-vis spectroscopy) of a series of complexes $\text{IrLL}'(\text{Et}_2\text{dtc})$ (**395**) ($\text{L} = \text{L}' = \text{CO}$, PPh_3 , $\text{P}(\text{OPh})_3$; $\text{L} = \text{CO}$, $\text{L}' = \text{PPh}_3$, $\text{L} + \text{L}' = \text{cod}$, dppe , dpfpe ; $\text{dtc} = N,N'$ -diethyldithiocarbamate) have been detailed.⁶⁴¹ The single-crystal structure of (**395**), $\text{L} = \text{CO}$, $\text{L}' = \text{PPh}_3$, has been determined. All of the complexes emit in the solid state at 77 K, with complexes (**395**), $\text{L} = \text{CO}$, $\text{L}' = \text{PPh}_3$, $\text{L} + \text{L}' = \text{dppe}$, and $\text{L} = \text{L}' = \text{P}(\text{OPh})_3$ emitting in CH_2Cl_2 at 293 K. Benzene solutions of (**395**), $\text{L} = \text{CO}$, $\text{L}' = \text{PPh}_3$, and $\text{L} + \text{L}' = \text{dppe}$ react with O_2 yielding $\text{IrLL}'(\text{Et}_2\text{dtc})(\text{O}_2)$, which will lose O_2 on irradiation.

6.2.7.7.3 Tridentate ligands

The half-sandwich complex $[\text{Ir}(\text{[9]aneS}_3)(\text{cod})]^+$, $[\text{9]aneS}_3 = 1,4,7\text{-trithiacyclononane}$, synthesized from $[\text{Ir}(\text{cod})\text{Cl}]_2$ and $[\text{9]aneS}_3$, reveals a five-coordinate Ir center with $[\text{9]aneS}_3$ bound facially via all three S-donor atoms.⁶⁴² Further single-crystal studies of $[\text{Ir}(\text{[9]aneS}_3)(\text{L}_2)]\text{PF}_6$, $\text{L} = \text{C}_2\text{H}_4$, C_8H_{12} , C_4H_6 , also show distorted five-coordinate geometries.⁶⁴³

6.2.7.7.4 Binuclear complexes

Reaction of $[\text{Ir}(\text{cod})\text{Cl}]_2$, (**396**), with $\text{HSR}-\text{NEt}_3$ ($\text{R} = \text{C}_6\text{F}_5$) yields the dinuclear complex $[\text{Ir}(\mu\text{-SR})(\text{cod})]_2$, and further reaction with CO gives the structurally determined complex (**397**), $[\text{Ir}(\mu\text{-SR})(\text{CO})_2]_2$.⁶⁴⁴ Both Ir centers in (**397**) are square planar, with the dihedral angle between the two IrS_2 planes being 114.05° and an Ir—Ir distance of $3.066(1) \text{ \AA}$. However, reaction of (**396**) with HSR gives (**397**) and the mixed-valence complex (**398**), $[(\text{cod})\text{Cl}(\text{SR})\text{Ir}(\mu\text{-SR})_2\text{I}(\text{cod})]$, which contains an octahedral Ir^{III} center bridged by two SR^- linkages to a square-planar Ir^{I} center. In (**398**) the dihedral angle is 151.99° and the Ir—Ir distance 3.660 \AA . Extension of the work yields the trimetallic compound $[\text{Ir}_3(\mu\text{-SR})_3(\mu\text{-CO})(\text{CO})_4(\text{PPh}_3)_2]$ ⁶⁴⁵, which contains an asymmetric Ir_3S_3 ring with one Ir—Ir bond ($2.665(1) \text{ \AA}$) doubly bridged by CO and SR^- . The molecular structures of $[\text{Ir}(\text{SR})(\text{CO})(\text{PPh}_3)_2]$ and $[\text{Ir}(\text{SR})(\eta^2\text{-O}_2)(\text{CO})(\text{PPh}_3)_2]$ are also reported.

6.2.7.7.5 Bimetallic complexes

The red, mixed-metal compound $[(\text{cod})\text{Ir}(\mu\text{-SPPH}_2)_2\text{Pt}(\text{S}_2\text{CN}^{\text{iPr}}_2)]$, prepared by the reaction of $[\text{Ir}(\text{cod})\text{Cl}]_2$ with $(\text{NH}_2^{\text{iPr}})_2[\text{Pt}(\text{S}_2\text{CN}^{\text{iPr}}_2)(\text{Ph}_2\text{PS})_2]$, has been characterized by X-ray crystallography.⁶⁴⁶ The structure reveals that both bridging ligands bind to the Ir center through the S atoms, with a Pt—Ir separation of $4.2728(8) \text{ \AA}$.

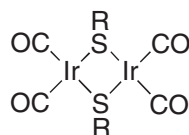

(397)

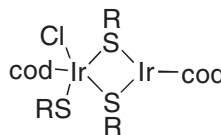

(398)

6.2.7.8 Selenium and Tellurium Ligands

Reaction of $[\text{Ir}(\text{cod})\text{Cl}]_2$ with two molar equivalents of L^3 ($\text{L}^3 = \text{MeC}(\text{CH}_2\text{ER})_3$, $\text{E} = \text{Se}$, $\text{R} = \text{Me}$; $\text{E} = \text{Te}$, $\text{R} = \text{Me}$, Ph) and two molar equivalents of NH_4PF_6 in CH_2Cl_2 affords the species $[\text{Ir}(\text{cod})(\text{L}^3)]\text{PF}_6$, (**399**), which have been characterized by analysis, IR and multinuclear NMR spectroscopy.⁶⁴⁷ The crystal structures of (**399**), $\text{E} = \text{Se}$, $\text{R} = \text{Me}$ and $\text{E} = \text{Te}$, $\text{R} = \text{Ph}$, reveal distorted square-pyramidal geometries and greater π -donation by the $\text{E} = \text{Te}$ ligand. Single-crystal X-ray diffraction studies of $\text{cis}-(\text{PPh}_3)_2\text{Ir}\{\text{Te}(2,4,6\text{-}^t\text{Bu}_3\text{-C}_6\text{H}_2)\}(\text{CO})$, formed from the reaction of $[(\text{PPh}_3)_2\text{Ir}(\text{CO})\text{Cl}]$ and $(2,4,6\text{-}^t\text{Bu}_3\text{-C}_6\text{H}_2)\text{TeLi}(\text{THF})_3$, confirm the *cis*-geometry of the PPh_3 ligands.⁶⁴⁸

6.2.7.9 Halide Ligands

Reaction of $[\text{IrCl}(\text{CO})\text{L}_2]$ ($\text{L} = \text{PMe}_3, \text{PEt}_3, \text{PPh}_3$) with Me_3SiX ($\text{X} = \text{Br}, \text{I}$) affords $\text{IrX}(\text{CO})\text{L}_2$ and Me_3SiCl .⁶⁴⁹ The phase-transfer-catalyzed, hydrogen-transfer reduction of 2-propanol has been realized using KF on alumina, $[\text{Ir}(\text{cod})\text{Cl}]_2$, and 18-crown-6 as phase-transfer agent.⁶⁵⁰

A theoretical and structural analysis of $[\text{Ir}_2(\mu\text{-Cl})_2\text{L}_4]$, where $\text{L}_4 = (\text{PF}_3)_4, (\text{PH}_3)_4, (\text{cod})_2, ((\text{C}_2\text{F}_5)_2\text{PC}_2\text{H}_4\text{P}(\text{C}_2\text{F}_5)_2)_2$, debates the factors which determine the degree of bonding between the coordination planes of the two metal centers.⁶⁵¹ One driving force would appear to be the attractive metal/metal interactions resulting from donor-acceptor interactions between the d_z^2 and p_z orbitals of the two metal atoms.

6.2.7.10 Hydrogen Ligands

A detailed review of the stereochemistry of H_2 oxidative addition and dihydride-transfer reactions involving Ir^{I} complexes of the type $\text{IrX}(\text{CO})\text{P}_z$ has been published by Deutsch and Eisenberg in 1988.⁶⁵² The addition reaction of H_2 to $[\text{Ir}(\text{bpm})(\text{CO})_2](\text{BPh}_4)$ ($\text{bpm} = \text{bis}(\text{pyrazol-1-yl})\text{methane}$) has been studied using parahydrogen NMR, and reveals a series of products containing metal-hydride linkages.⁶⁵³ Reaction of 2-phenyl-1-methylenecyclopropane with $\text{IrH}(\text{CO})(\text{PPh}_3)_3$ at room temperature yields $\text{Ir}(\eta^1:\eta^2\text{-CH}_2\text{CH}(\text{Ph})\text{CH}=\text{CH}_2)(\text{CO})(\text{PPh}_3)_2$, which has been characterized by X-ray crystallography.⁶⁵⁴ When the same reaction is carried out at 50°C , then the product species are 2-phenyl- and 1-phenyl-1,2-butadiene and $\text{Ir}(\eta^1:\eta^2\text{-C}_6\text{H}_4\text{CH}(\text{Me})\text{CH}=\text{CH}_2)(\text{CO})(\text{PPh}_3)_2$, whose structure has been confirmed by X-ray crystallography.

6.2.7.11 Mixed-donor-atom Ligands

6.2.7.11.1 C/N

$[\text{Ir}(\text{cod})\text{Cl}]_2$ reacts with lithium *N*-benzyl-2-imidazolate (LiBzim) to yield $[\text{Ir}_2(\mu\text{-Bzim})_2(\text{cod})_2]$ and then with CO to give the structurally characterized species **(400)**, in which one Ir coordinates to two N atoms of the imidazole ring and the other Ir to two C atoms.⁶⁵⁵

Reaction of $[\text{Ir}(\text{cod})\text{Cl}]_2$ with (6-methyl-2-pyridyl)methyl lithium yields the binuclear species $[(\text{cod})\text{Ir}(\mu\text{-CH}_2\text{-py-6-Me-C}, \text{N})_2]$, **(401)**.⁶⁵⁶ The Ir centers in **(401)** are $3.5889(3)\text{Å}$ apart, indicating little metal-metal interaction. Treatment of **(401)** with PPh_2Et yields $[(\text{cod})\text{Ir}(\text{PPh}_2\text{Et})_2(\text{CH}_2\text{-py-6Me})]$, which contains the monodentate, carbon-bound pyridylmethyl ligand.

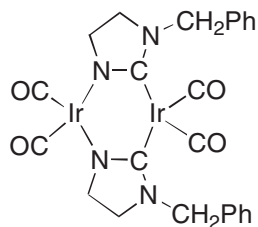
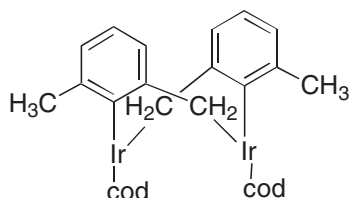
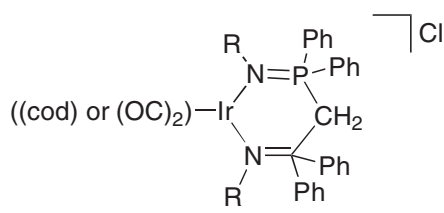
**(400)****(401)****(402)**

Reaction of $[\text{Ir}(\text{cod})\text{Cl}]_2$ with LiL ($\text{L} = \text{CH}_2\text{PPh}_2=N\text{-C}_6\text{H}_4\text{-CH}_3\text{-4}$, $\text{CH}(\text{PPh}_2=N\text{-C}_6\text{H}_4\text{-R-4})_2$, $\text{R} = \text{CH}_3, \text{NO}_2$, affords $[\text{Ir}(\text{L})(\text{cod})]$, in which ligand L is co-ordinated as a $\sigma\text{-N}, \sigma\text{-C}$ chelate.^{657,658} The structure of $[\text{Ir}(\text{CH}(\text{PPh}_2=N\text{-C}_6\text{H}_4\text{-CH}_3\text{-4})_2)(\text{cod})]$ is reported as containing a four-membered Ir-N-P-C metallacycle and one pendant iminophosphorane moiety. Further reaction with an excess of CO results in replacement of cod by $(\text{CO})_2$. When $[\text{IrL}(\text{cod})]$ or $[\text{IrL}(\text{CO})_2]$, where $\text{L} = \text{CH}(\text{PPh}_2=N\text{-C}_6\text{H}_4\text{-R-4})_2$, is treated with HCl , then product **(402)** results.

6.2.7.11.2 C/P

The monomeric Ir^{I} C/P-donor-atom compounds $[\text{Ir}(\text{tropp}^{\text{Ph}})_2]^+$, $\text{tropp}^{\text{Ph}} = \text{dibenzotropropyl-idenyl phosphine}$, are synthesized via reaction Scheme 43.⁷⁵⁵ The X-ray structural study of **(404)** shows a

similar geometry to its one-electron reduced analogue, (405). Complex (404) reacts with NaBH₄ to give [IrH(tropp^{Ph})₂], which can be further protonated with acid to give the Ir^{III} dihydride [IrH₂(tropp^{Ph})₂]⁺, (407).⁷⁵⁶ (407) may also be produced via the oxidative addition reaction of (404) with H₂. The X-ray structure (407) (PF₆) is reported.

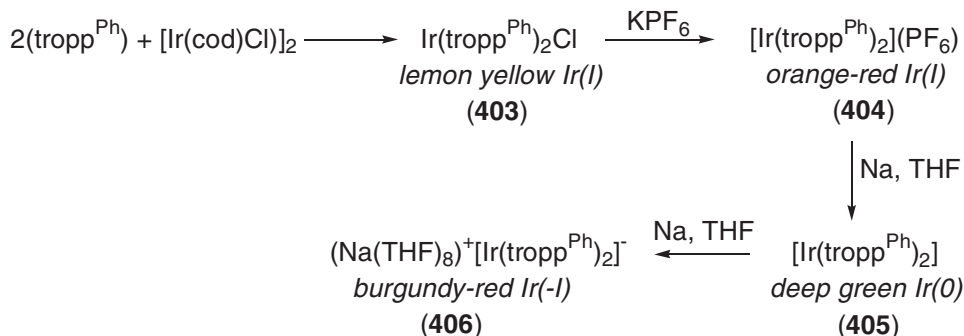

Scheme 43

6.2.7.11.3 Si/P

The reddish-orange complex (408) is formed by the reductive elimination of methane according to Reaction Scheme 44.⁶⁵⁹ X-ray crystal structure analysis revealed that (408) adopts a slightly distorted, five-coordinate, trigonal-bipyramidal geometry, with the silyl ligand occupying an axial site. Further work on the related complexes L_nIr(R)(H) (L_n = {μ²-(mes)-HSi(CH₂)₂PPh₂}(PMe₃)₂) led to the formation of the Ir^I intermediate L_nIr, which reacted with MeOH to generate Ir(H)₂{μ²-(mes)(OMe)Si(CH₂)₂PPh₂}(PMe₃)₂.⁶⁶⁰ Thermolysis of HMePhSi-SiMe₃ in the presence of Ir(PPh₂CH₂CH₂SiMe₂)(PMe₃)₃ yields HMe₂SiSiMe₂Ph.⁶⁶¹

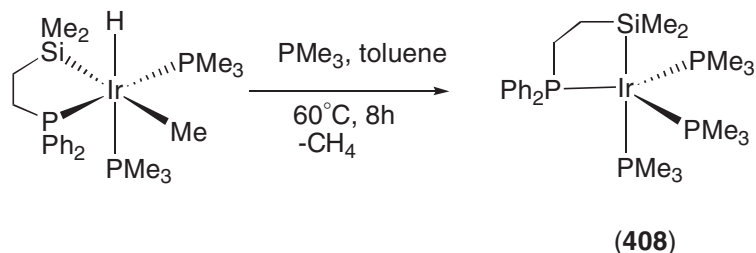

Scheme 44

6.2.7.11.4 N/P

The binuclear complex [{Ir(cod)Cl}₂(μ-dpnapy)], formed from a 1:1 reaction of [{Ir(cod)Cl}₂] and dpnapy, (409), contains the mixed-donor bridging ligand dpnapy, which binds to the two Ir centers through the P and terminal N* sites with no interaction between the two Ir centers.⁶⁶² Monochelated complexes such as *trans*-[Ir(CO)(dpnapy)₂Cl], *cis*-[Ir(CO)₂(dpnapy)Cl], and [Ir(cod)(dpnapy)] all involve coordination through the P atom. Pfaltz *et al.* report the synthesis and structure of square-planar Ir^I complexes containing P/N bidentate ligands (410).⁶⁶³ The cationic complexes (410) catalyze the enantioselective hydrogenation of imines, with the highest selectivity achieved in weakly coordinating solvents such as CH₂Cl₂.

The mixed-donor tridentate ligands bis[2-diphenylphosphino]ethyl benzylamine (dpba) and bis[2-(diphenylarsino)ethyl] benzylamine (daba) form square-planar complexes with IrCl and IrPPh₃ moieties.⁶⁶⁴

The coordinatively flexible P/N-donor ligand PN_n (411) reacts with [IrCl(cod)]₂ in the presence of AgPF₆ to yield [Ir(cod)(PN_n)](PF₆), (412).⁶⁶⁵ The X-ray structure of (412) PN_{n=1}, R = H, complex confirms the *cis* geometry of the ligand attached via N and P donor atoms to a square-pyramidal Ir^I cod fragment with a long ethereal oxygen—Ir bond in an apical position. The Ir^I

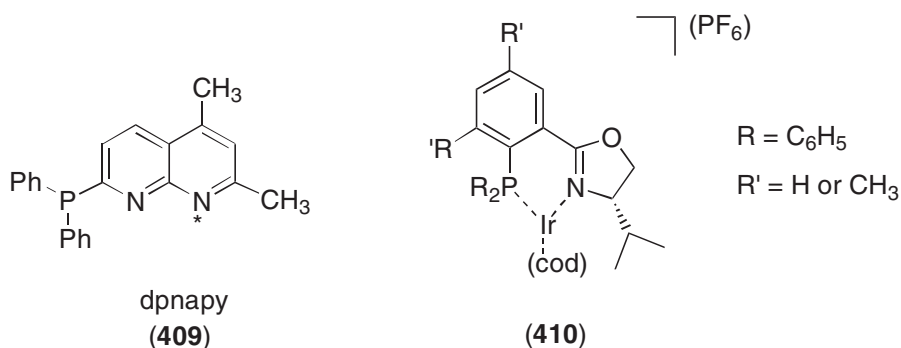

species undergoes intramolecular C—H bond activation at the benzylic position to give the structurally characterized Ir^{III} hydrido alkyl species (413). The structure of the related Ir^I complex, PN_{n=1}, Me, has no obvious interaction between the Ir and the O atom.⁶⁶⁶

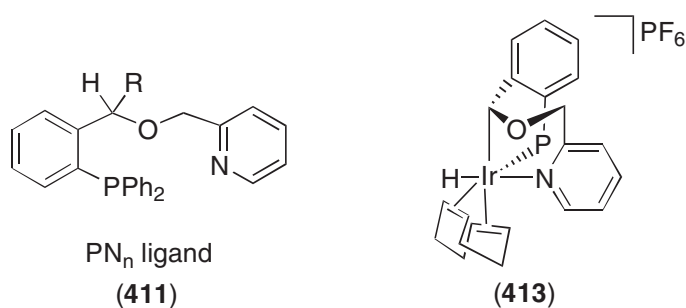

Treatment of [Ir(cod)Cl]₂ with the iminophosphoranophosphine ligands, L, Ph₂P*QP(Ph₂):NR (Q = CH₂, CH₂CH₂, 1,2-C₆H₄, R = *p*-C₆F₄CN, C₆H₂F(NO₂)₂, C₆H₃(NO₂)₂) yields [Ir(cod)L]⁺, in which L binds through the N atom and the P* atom of the ligand.⁶⁶⁷ Reaction of [Ir(cod)(THF)₂ClO₄] with L = Ph₂PC₆H₄NHC(O)Ph or Ph₂PC₆H₄C(O)NHPPh yields [Ir(cod)L]ClO₄, where L is acting as a P, N bidentate ligand.⁶⁶⁸ Treatment of [Ir(cod)Cl]₂ with Ph₂PC₆H₄NHR (R = CH₂Ph) yields [IrCl(cod)(Ph₂PC₆H₄NHR)], (414); here the amine moiety is uncoordinated.⁶⁶⁹ If AgClO₄ is added to (414), then the bis P/N-chelated species [Ir(cod)(Ph₂PC₆H₄NHR)] is generated, which when heated gives (415).

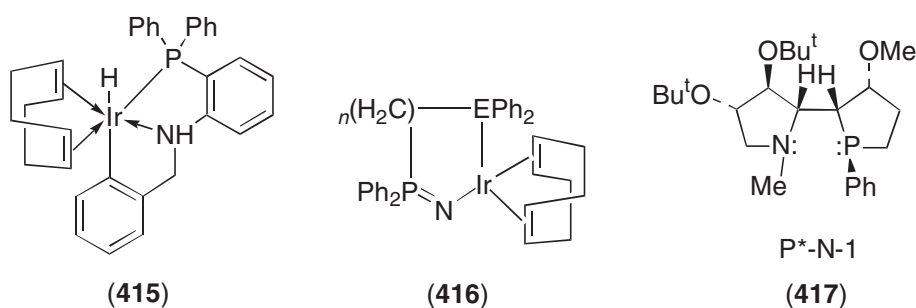

Oxidation of one phosphorus in Ph₂PCH₂PPh₂ and on Ph₂PC₂H₄AsPh₂ with Me₃SiN₃ gives the mixed-donor ligands Me₃SiN=PPh₂CH₂PPh₂ and Me₃SiN=PPh₂C₂H₄AsPh₂, respectively.⁶⁷⁰ These ligands react with [Ir(cod)Cl]₂ to form the metallacycles (416), where E = P, *n* = 1 and E = As, *n* = 2.

The chiral ligand P*-N-1 (417) reacts with [Ir(cod)Cl] in the presence of NaBPh₄ to yield [Ir(P*-N-1)(cod)]BPh₄, which contains a stereogenic phosphorus in addition to five contiguous stereoisomers in the ligand backbone.⁶⁷¹ The binuclear complex [I(CO)₂Ir(μ-Ph₂Ppy)₂CdI₂], (418), (Ph₂Ppy = 2-diphenylphosphinopyridine), characterized by X-ray crystallography, reveals an Ir—Cd distance of 2.784(1) Å.⁶⁷² The Ir center binds to the P-donor atoms and is in a distorted octahedral geometry. A solid sample of (418) excited with UV light emits at 739 nm, with a lifetime of 6.48 μs at room temperature.

6.2.7.11.5 N/O

A review of dinuclear complexes of Ir^I bridged via 2-pyridone ligands (N/O donor atoms), by Rawson and Winpenny, has been published in 1995.⁶⁷³

The 1,4-diaminoanthraquinolate ligand (1,4-da), (**419**), forms the binuclear complexes [Ir₂(μ-1,4-da)L₂] (L₂ = cod, (CO)₂, (CO)(PPh₃)), which undergo oxidative addition reactions with MeI and I₂.⁶⁷⁴ The crystal structure of [NEt₃H][Ir(cod)(HL)], HL = (**420**), exhibits square-planar Ir bound to the N⁻ and O⁻ of (**420**). The solid-state structure shows intermolecular, hydrogen-bonded dimers through the NH proton and the carbonyl oxygen (O*) atom.⁶⁷⁵ Additional hydrogen bonding also exists amongst cation protons, solvent protons, and the ligand.

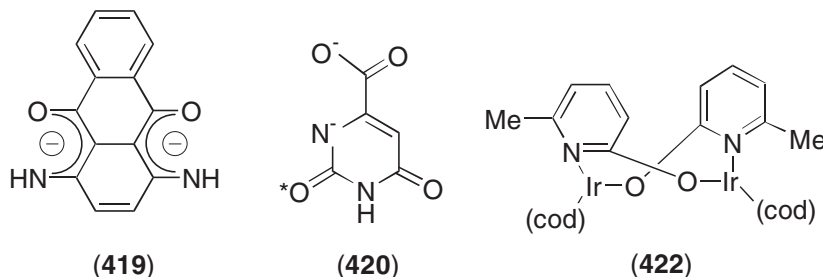

Reaction of [Ir(cod)Cl]₂ with NaL (L = 2-oxypyridinate (hp) or 6-methyl-2-oxypyridinate (mhp)) yields [Ir(cod)(μ-L)]₂ (**421**).⁶⁷⁶ The structure of (**421**), L = hp (**422**), reveals an Ir—Ir distance of 3.2412(1) Å. [Ir(cod)(hp)]₂ undergoes a one-electron, quasi-reversible oxidation at +0.332 V vs. Ag/AgCl. Reaction with Cl₂ gives the structurally characterized Ir^{III} complex [Ir(cod)(Cl)₂(hp)]. [Ir(cod)(mhp)]₂ is isostructural.⁶⁷⁷ Assignment of the ¹H NMR spectra is given.

The binuclear complex (**423**) is formed via reaction Scheme 45. Electrochemical oxidation of [NR₄](**423**) (R = Pr, Bu) yields the metal-centered, partially oxidized, conductive material [NR₄]_{0.5}(**423**).⁶⁷⁸ An EXAFS study indicates that the coordination sphere of the Ir is preserved upon oxidation. The color of the dinuclear complexes [Ir₂L(CO)₄]⁻ (L = dcbi, 4,5-dicarboxyimidazole, dcbsi, 4,5-dicarboxyl-2-methylimidazole) depends on the cation (NMe₄⁺, NH₄⁺, NEt₄⁺, NBu₄⁺) and is caused by intermolecular stacking interactions of the Ir metal.⁶⁷⁹

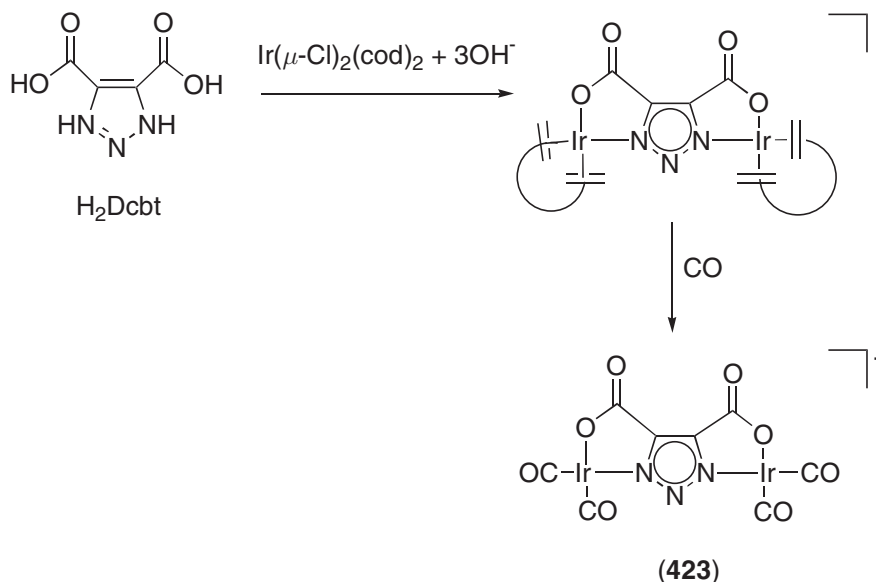

Scheme 45

The structure of [Ir₂dcbsi(CO)₄]⁻ (**424**) is reported.⁶⁸⁰ The binuclear compounds were all oxidized around +0.1 V vs. SCE, with the oxidation potential dependent on the solvent.⁶⁸¹ Oxidation of [NBu₄][Ir₂(dcbsi)(CO)₄] results in growth of a conducting film on the surface. The partially oxidized material [NBu₄]_{0.5}[Ir₂(dcbsi)(CO)₄] has been characterized by X-ray photoelectron spectroscopy.

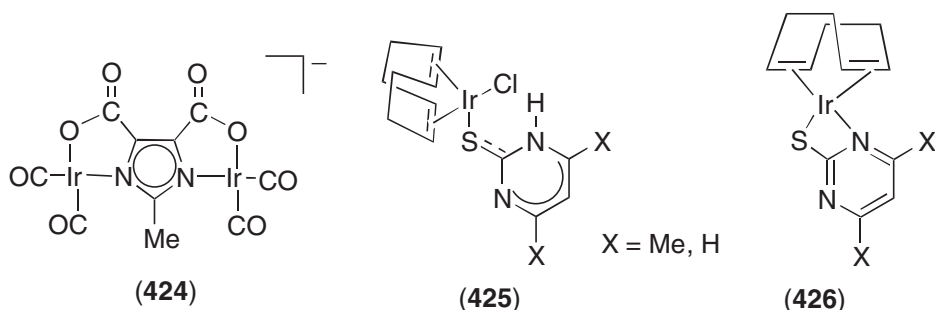

6.2.7.11.6 N/S

The mono- and bidentate complexes **(425)** and **(426)**, respectively, form from the reaction of $[\text{Ir}(\text{cod})\text{Cl}]_2$ with mercaptopyrimidine.⁶⁸² **(426)** reacts with CO, yielding the dicarbonyl analogue through displacement of cod. One CO ligand may be replaced by PPh_3 , but further addition of PPh_3 results in a five-coordinate species.

6.2.7.11.7 P/O

Reaction **Scheme 46** yields mixed P/O-donor ligand Ir^{I} complexes, which have been characterized by ^1H NMR spectroscopy.⁶⁸³ Reaction of $[\text{Ir}(\text{cod})\text{Cl}]_2$ with $\text{Ph}_2\text{PNHP}(\text{O})\text{Ph}_2$ yields the monodentate, P-bound complex $[\text{Ir}(\text{cod})\text{Cl}(\text{Ph}_2\text{PNHP}(\text{O})\text{Ph}_2)]$ (**427**), which gives the bidentate, P/O-bound species $[\text{Ir}(\text{cod})(\text{Ph}_2\text{PNP}(\text{O})\text{Ph}_2)]$, (**428**) according to reaction **Scheme 47**.⁶⁸⁴ Complex **(428)** undergoes a *cis* addition reaction with MeI to give $[\text{Ir}(\text{Me})(\text{cod})(\text{Ph}_2\text{PNP}(\text{O})\text{Ph}_2)]$, the structure of which has been characterized by X-ray crystallography.

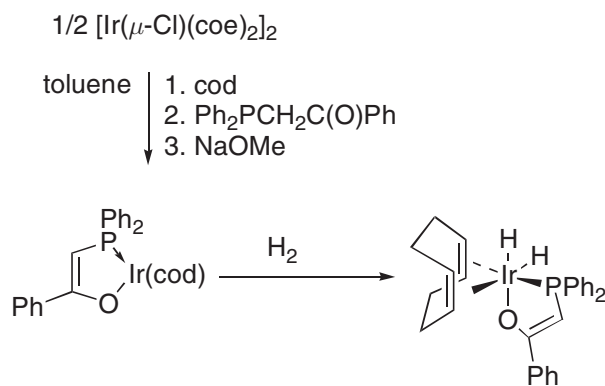

Scheme 46

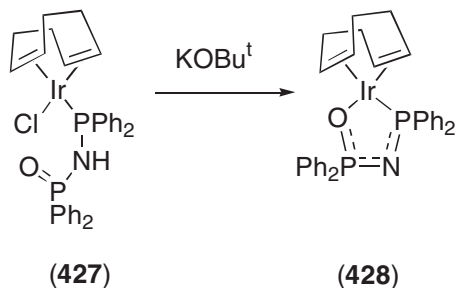

Scheme 47

6.2.7.11.8 O/S

The X-ray structure of (429) confirms the square-planar environment of the Ir center and the planar nature of the S/O ligand.⁶⁸⁵ The related complex (430) shows similar Ir—O (2.030(7) Å) and Ir—S (2.279(3) Å) distances to (429); however, the olefinic bonds are much longer in (430) than in (429): 1.52 Å and 1.38 Å, respectively.⁶⁸⁶

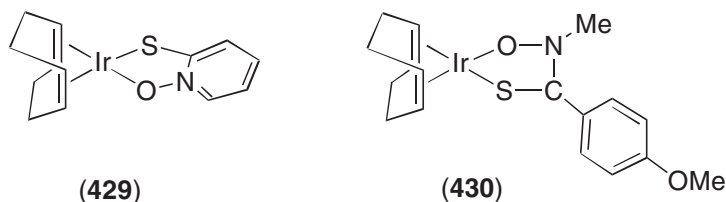

6.2.7.11.9 Multidentate ligands

Reaction of $[\text{Ir}(\text{cod})\text{Cl}]_2$ with tridentate diphosphine ligands, PNP, (431), (432), (433), and (434) yields the complexes $[\text{Ir}(\text{PNP})(\text{cod})]^+$, which prove to be active catalysts for the hydrogenation of imines.⁶⁸⁷

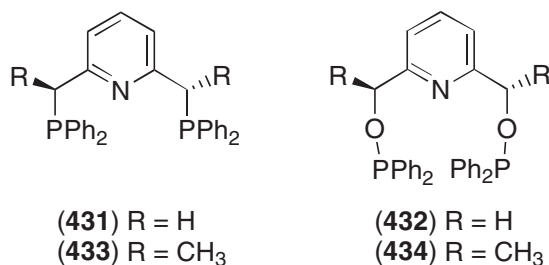

The Ir^{III} species (435) isomerizes reversibly in polar solvents (EtOH, MeOH) to give the Ir^I cation (436), which reacts rapidly with alkenes, alkynes, CO, and dihydrogen. The product species have all been characterized by $^1\text{H}\{^{31}\text{P}\}$ and ^1H NMR spectroscopy.^{688,689} Treatment of (435) with NEt_3 gave the neutral Ir^I species (437), which reacts with H_2 to give a *cis*-Ir^{III} species, and with olefins and acetylenes to give five-coordinated Ir^I adducts.⁶⁹⁰ All species are studied using ^1H , ^{13}C , and ^{31}P NMR spectroscopy.

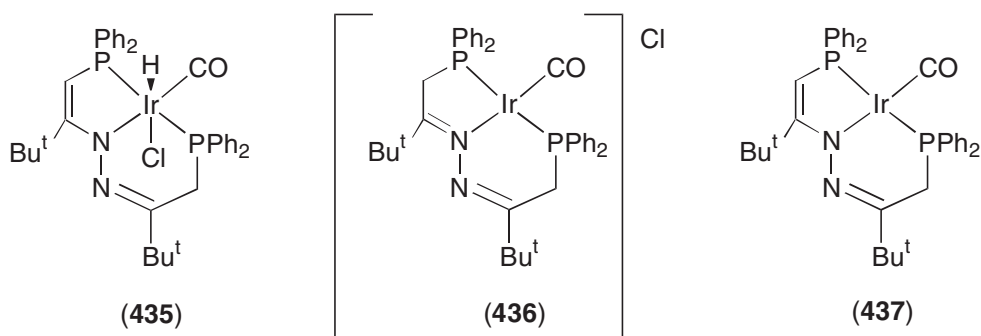

Reaction of $[\text{Ir}(\text{coe})\text{N}(\text{SiMe}_3\text{CH}_2\text{PPh}_2)_2]$ with excess 1,3-butadiene yields the structurally characterized, five-coordinate complex $[\text{Ir}(\text{C}_4\text{H}_6)[\text{N}(\text{SiMe}_2\text{CH}_2\text{PPh}_2)_2]$, which contains the P_2N ligand coordinated in a quasi-facial manner, and the 1,3-butadiene bound in a *s-cis*- η^4 - π mode.⁶⁹¹

The thermal and photochemical reactions of Ir^{III} complexes (438) and (439), respectively, yield the same product species (440), $\text{R}_2 = \text{Ph}_2, \text{Me}_2, \text{HPh}$.⁶⁹² Kinetic studies indicate that the reaction involves the direct reductive transfer of the methyl to the phosphide via a three-centered transition state. The crystal structures of (438) and (439) ($\text{R}_2 = \text{Ph}_2$) are reported.

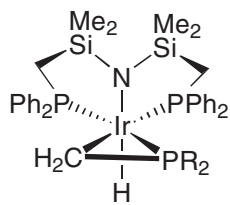

(438)

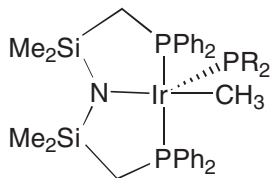

(439)

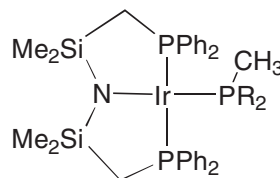

(440)

The complexes $[\text{Ir}(\text{cod})\text{dap}][\text{IrCl}_2(\text{cod})]$, $[\text{IrCl}(\text{CO})(\text{dap})]$, and $[\text{Ir}(\text{cod})(\text{dap})]\text{ClO}_4$, containing the tridentate ligand dap (dap = 2,6-diallylpyridine), have been characterized by IR and ^1H NMR spectroscopy.⁶⁹³

6.2.7.11.10 Biological complexes

The chloro bridges in $[\text{Ir}(\text{cod})\text{Cl}]_2$ are cleaved by α -amino acid esters to yield $[(\text{cod})\text{Ir}(\text{Cl})(\text{L})]$ (L = GlyOEt, L-AlaOMe, L-ValOMe).⁶⁹⁴

Prochiral aryl and dialkyl ketones are enantioselectively reduced to the corresponding alcohols using whole-cell bioconversions, or an Ir^{I} amino sulfide catalyst prepared *in situ*.⁶⁹⁵ Comparative studies show that the biocatalytic approach is the more suitable for enantioselective reduction of chloro-substituted ketones, whereas reduction of α,β -unsaturated compounds is better achieved using the Ir^{I} catalyst. An important step in the total synthesis of brevetoxin B involves hydrogenation of an ester using $[\text{Ir}(\text{cod})(\text{py})\{\text{P}(\text{cy})_3\}]\text{PF}_6$.⁶⁹⁶

Several transition-metal complexes were evaluated for their *in vitro* antifilarial activity, with (441) proving the most active towards infective larvae of *Molinema dessetae*.⁶⁹⁷ The study of the antimetastatic properties of Rh^{I} and Ir^{I} derivatives of $[\text{M}(\text{chel}(\text{L}-\text{L}))^{+0}]$, chel = pyridinalimine, acac; L-L = 1,5-hexadiene, cod, norbornadiene, reveals that the Rh^{I} complexes were more active than the Ir^{I} species.⁶⁹⁸ The same group reports a higher anti-inflammatory activity on carrageenin paw edema in rats for $[\text{Ir}(\text{cod})\text{Cl}]_2$ than for $[\text{Rh}(\text{cod})\text{Cl}]_2$.⁶⁹⁹

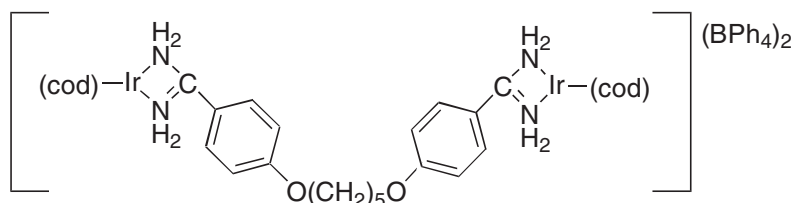

(441)

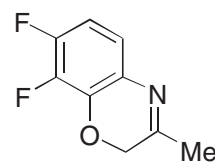

(442)

The *in vitro* trypanocidal and antitumor activities of $[\text{Ir}(\text{cot})\text{L}]$, cot = cyclotetraene, derivatives of dithiocarbamates and xanthates, have been investigated.⁷⁰⁰ The Ir complexes were characterized by IR spectroscopy, and MO calculations (Hückel) were performed on the ligands. Similar studies were performed on $[\text{Ir}(\text{nbr})\text{L}]$, nbr = norbornadiene, L = derivatives of alkyl and aryl xanthates;⁷⁰¹ and also on $[\text{Ir}_2(\text{cod})_2\text{L}]\text{X}_2$, where L = 2-hydroxystilbamidine, X = Cl, NO_3 , ClO_4 , BPh_4 , and $[\text{Ir}(\text{cod})\text{L}_2]\text{X}$, where L' = benzimidazole, R₅-2516, nifurtimox, niridazole. The complex $[\text{Ir}_2(\text{cod})_2(2\text{-hydroxystilbamidine})](\text{BPh}_4)_2$ showed the highest activity, as studied by optical microscopy of rats' kidneys.⁷⁰²

The key intermediate for the antibacterial agent levofloxacin, (*S*)-(-)-7,8-difluoro-2,3-dihydro-3-methyl-4H-1,4-benzoxazin, was prepared by the asymmetric hydrogenation of (442) by the catalyst system made *in situ* from $[\text{Ir}(\text{cod})\text{Cl}]_2$, biphosphine and bismuth(III) iodide.⁷⁰³ The product was isolated in 96% yield, with an enantiomeric purity of 90% for the biphosphine (2*S*,4*S*)-BPPM,(2*S*,4*S*)-*N*-(*t*-butoxy-carbonyl)-4-(diphenylphosphino)-2-[(diphenylphosphino)methyl]-pyrrolidine.

$\text{Ir}(\text{CO})_2(\text{aniline-dithiocarbamate})$ shows a moderate activity against Ehrlich ascites at 50 mg kg^{-1} .⁷⁰⁴ The synthesis of air-unstable $[\text{Ir}_2(\mu\text{-L})(\text{cod})_2]$, where $\text{H}_2\text{L} = \text{RiSSH}_2(1,2\text{-}O\text{-isopropylidene-2,5-dithio-}\alpha\text{-D-ribofuranose, XySSH}_2(1,2\text{-}O\text{-isopropylidene-3,5-dithio-}\alpha\text{-D-xylofuranose})$, is described.⁷⁰⁵

6.2.7.12 Catalytic Complexes

Table 2 details Ir^I complexes which are active catalysts in the given reactions. For more detailed descriptions of catalytic systems, see relevant section in series.

Table 2 Iridium(I)-based catalyst systems.

<i>Catalyst system</i>	<i>Catalyzed reaction</i>	<i>References</i>
[Ir(cod)(<i>S</i> -binap)]BF ₄ / Ir(cod) (<i>S</i> -H ₈ -binap)]BF ₄ + P(Ph) (C ₆ H ₄ Nme ₂ -2) ₂	Enantioselective hydrogenation of acyclic aromatic ketones PhCOR (R = alkyl, cycloalkyl) to alcohols	706
Ir(ClO ₄)(CO)(PPh ₃) ₂	(i) Hydrogenation of aliphatic ketones to alcohols	707
	(ii) Hydrogenation of aldehydes to alcohols	708
	(iii) Hydrogenation of unsaturated aldehydes	709
	(iv) Hydrogenation of unsaturated esters	710
	(v) Hydrogenation of 1,4-dicyanobutene	711
	(vi) Isomerization of allylic alcohols to ketones or aldehydes	712
	(vii) Carbonylation of benzyl alcohols to phenylacetic acids	713
IrCl(PPh ₃) ₃ or IrCl(CO)(PPh ₃) ₂ or [Ir(CO)(PPh ₃) ₃]ClO ₄	Hydrogenation of unsaturated aldehydes to alcohols	714
[Ir(cod)(PhCN)(PPh ₃)]ClO ₄	(i) Double bond migration of allylic alcohols to generate enols	715
	(ii) Hydrogenation of nitriles to amines	716
[Ir(cod)(RS(CH ₂) _n SR)]BF ₄ where <i>n</i> = 2–4, R = ⁱ Pr, Me	Hydrogenation of 1-hexene and itaconic acid	717
[Ir(cod)(tht)(PR ₃) ₃]ClO ₄ , R = Me, <i>p</i> -MePh, <i>p</i> -ClPh, OMe, OPh, [Ir(cod)(tht) ₂]ClO ₄ , [Ir(cod)(μ-L)] ₂ (ClO ₄) ₂ , L = tht, SMe ₂	Hydrogenation of 1-heptene to mixture of heptane and heptene isomers	718
[Ir(cod)(PPh ₃) ₂]ClO ₄	Oligomerization of phenylacetylene to 1,3-diphenylbut-1-yn-3-ene	719
[Ir(cod)(PPh ₃)(PhCN)]ClO ₄	Oligomerization of phenylacetylene to 1,3,5-triphenylbenzene	
[Ir(cod)(PPh ₃) ₂]PF ₆	Oligomerization of phenylacetylene to (<i>Z</i>) 1,4-diphenylbut-1-yn-3-ene	
[Ir(cod)(PPh ₂ R) ₂]X, R = Me, X = BF ₄ , PF ₆ , and R = Ph, X = BF ₄	Deuterium exchange into aromatic substrates	720
[Ir(cod)Cl] ₂ + (4 <i>R</i> , 5 <i>R</i> -mod-diop) + ⁿ Bu ₄ NI	Asymmetric hydrogenation of <i>N</i> - (α-methylbenzylidene)benzylamine, 2,3,3-trimethylindolenine	721
[Ir(cod)Cl] ₂ + bcpm + (a) ⁿ Bu ₄ NI or NiI ₃ (b) phthalimide + other imides or amides	Asymmetric hydrogenation of imines	722
	(i) Asymmetric hydrogenation of cyclic ketimines	723
	(ii) Asymmetric hydrogenation of 1-aryl-3,4-dihydro-6, 7-dimethoxyisoquinoline	724
[Ir(cod)Cl] ₂ + (<i>R</i>)-binap + 3,4,5,6-tetrafluorophthalimide	Asymmetric hydrogenation of 1-benzyloxymethyl-3,4-dihydro-6, 7-dimethoxyisoquinodine	725
[IrCl(CO) ₃] _n	Cycloisomerization of enynes	726
IrCl{HN(CH ₂ CH ₂ PPh ₂) ₂ }	Hydrogenation of cyclohexene	727
IrCl{HN(CH ₂ CH ₂ AsPh ₂) ₂ }		728
(a) [Ir(cod)I(NNR*)]	Asymmetric hydrogen transfer from propan-2-ol to prochiral ketones	729
(b) Ir(cod)(chiraphos)] ⁺ or [Ir(cod)(prophos)] ⁺		730
[Ir(cot) ₂ Cl] ₂ + NNN	Hydrogen transfer to PhCOMe	731
[Ir(cod)L ₂ ^P]PF ₆	Migration of double bond in allyl silanes	732
(a) [Ir(cod)Cl] ₂ + NN	Hydrogenation of alkyl aryl ketones	733
(b) [Ir(cod)Cl] ₂ +		734
(c) [Ir(cod)(NN*)Cl] ₂ + (NS)		735

Table 2 continued

Catalyst system	Catalyzed reaction	References
[Ir(cod)(PPh ₃ (PhCN)]BF ₄	Hydrogenation of double bond of vinyl epoxides	736
[Ir(cod)Cl] ₂ + (<i>R</i>)-dipof	Hydrosilylation of ketones	737
[Ir(dppe)(CO)Br] and [Ir(PPh ₂ Me) ₂ (CO)Cl]	Dimerization and cyclotrimerization of acetylenes	738
[Ir(cod)(Pcy ₃ (py))]PF ₆ + catecholborane	Hydroboration of olefins	739
[Ir(CO)Cl(PPh ₃) ₂]	Hydrosilylation of 1-alkynes	740
IrH(CO) ₂ (dppe) or IrBr(CO)(dppe) or IrCl(CO)(PPh ₃) ₂	Photochemical carbonylation of benzene	741
[Ir(dmp-S)(cod)] ⁺	Water-gas-shift reaction	742
[Ir(cod)Cl] ₂ + bdpop + KOH, Et ₃ N or NaOMe	Asymmetric transfer hydrogenation of ketones	743
[Ir(CO)Cl(PPh ₃) ₂]	Decarbonylation of formate esters	744
[Ir(cod)Cl] ₂ + binap + benzylamine	Hydrogenation of imines	745
[Ir(cod)(Ph ₃ P=S) ₂]ClO ₄	Hydrogenation of olefins	746

6.2.8 IRIDIUM(0)

There are few reported coordination compounds of Ir⁰. Monomeric Ir⁰ species are paramagnetic (*d*⁹ electronic configuration), and binuclear compounds are diamagnetic with a metal–metal bond.

6.2.8.1 Nitrogen Ligands

The dark brown Ir⁰ complex [Ir(NO)(μ-SBu^t)(PPh₃)₂], (**443**), is prepared according to Reaction Scheme 48.⁷⁴⁷ (**443**) contains two tetrahedral Ir⁰ centers with a linear nitrosyl ligand ($\nu_{\text{NO}} = 1,646 \text{ cm}^{-1}$ and $1,676 \text{ cm}^{-1}$), and is diamagnetic.

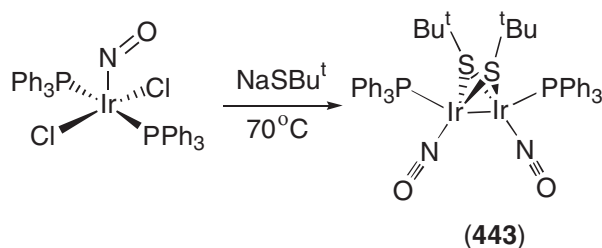

Scheme 48

6.2.8.2 Phosphorus Ligands

6.2.8.2.1 Monomeric complexes

The dark brown complex [Ir(dppf)₂] (**444**), dppf = 1,1'-bis(diphenylphosphine)ferrocene, is generated by either the one-electron reduction of [Ir(dppf)₂]⁺ (**445**) or by the comproportionation reaction of (**445**) and (**446**), as shown in Reaction Scheme 49.⁷⁵³ The geometrical environment of the Ir center in (**444**) is between the highly distorted, square-planar [Ir(dppf)₂]⁺ and the slightly irregular tetrahedral geometry of [Ir(dppf)₂]¹⁻. Complex (**444**) exhibits an EPR signal in toluene at 120 K in keeping with its *d*⁹ electronic configuration.⁷⁵⁴

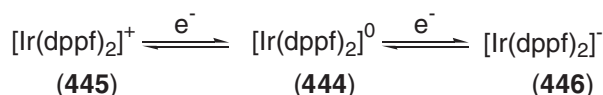

Scheme 49

6.2.8.2.2 Dimeric complexes

The dimer $[\text{Ir}(\text{CO})_2(\text{dmpm})]_2$, (**447**), ($\text{dmpm} = \text{bis}(\text{dimethylphosphino})\text{methane}$) is prepared via the reaction of $[\text{Ir}(\text{cod})\text{Cl}]_2$ and dmpm in toluene at 0°C .⁷⁴⁸ (**447**) reacts with Me_3NO and then further with CO_2 to produce a binuclear Ir^{I} complex (Reaction Scheme 50).

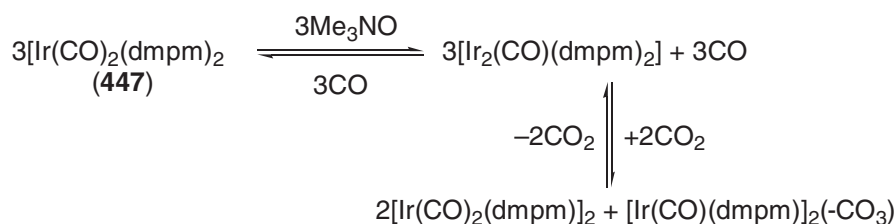

Scheme 50

The $\text{Ir}^{\text{II}}-\text{Ir}^0$ mixed-valence complex $\text{Ir}_2\{\text{MeN}[\text{P}(\text{OEt}^{\text{F}3})_2]_2\}_3\text{Cl}_2$, (**448**), ($\text{OEt}^{\text{F}3} = \text{OCH}_2\text{CF}_3$) is prepared by treatment of $[\text{Ir Cl}(\text{cod})]_2$ with three equivalents of $\text{MeN}[\text{P}(\text{OEt}^{\text{F}3})_2]$.⁷⁴⁹ X-ray diffraction analysis of (**448**) reveals the Ir^0 center coordinated to two bridging P atoms and one bidentate P_2 ligand, and the Ir^{II} center bound to the other end of the two bridging ligands and two terminal chloride ligands. The iridium metal centers are connected via a single metal-metal bond.

6.2.8.3 Mixed-donor-atom Ligands

6.2.8.3.1 C/P

The mixed-donor-atom Ir^0 -containing species $[\text{Ir}(\text{tropp}^{\text{Ph}})_2]$, (**405**), is prepared according to Reaction Scheme 43.⁷⁵⁵ The single-crystal X-ray structure of (**405**) reveals the two P centers of each tropp^{Ph} ligand are coordinated in *trans* positions, and the Ir center deviates significantly from square-planar geometry. The deep green, paramagnetic d^9 complex has a magnetic moment of 1.7 B.M. (**405**) reacts with H_2O to give the Ir^{I} hydride and hydroxide species (**449**) and (**450**), respectively, as shown in reaction Scheme 51.⁷⁵⁶

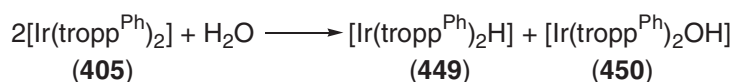

Scheme 51

The high-resolution EPR spectra of the 17-electron complex (**446**) have been studied in combination with pulse ENDOR and ESEEM techniques.⁷⁵⁰

6.2.8.3.2 N/P

The mixed-donor bidentate ligand $O\text{-Ph}_2\text{PC}_6\text{H}_4\text{-CH}=\text{NR}$ ($\text{R} = \text{Et}, \text{}^i\text{Pr}, \text{}^t\text{Bu}$) (PNalkyl) binds to Ir^{I} giving $[(\text{PNalkyl})_2\text{Ir}]^+$, which undergoes reversible electron transfer to the Ir^0 species at around -1.50 V vs. SCE .⁷⁵¹ The Ir^0 complex shows an axial EPR signal at 100 K ($g_{\parallel} = 2.032, g_{\perp} = 1.999$), with no appreciable coupling to ^{193}Ir .

6.2.9 IRIDIUM (-I)

Coordination compounds of d^{10} , diamagnetic, $\text{Ir}(-\text{I})$ are very rare and are almost always synthesized via reduction of the parent Ir^{I} d^8 complex. The synthesis, characterization, and chemical properties of highly reduced metal carbonyl anions, including Ir, have been reviewed by Ellis in 1990.⁷⁵²

6.2.9.1 Phosphorus Ligands

Chemical or electrochemical reduction of $[\text{Ir}(\text{dppf})_2]^+$, (**445**), in THF yields the Ir^0 complex (**444**) and the dark red $\text{Ir}(-\text{I}) d^{10}$ species $[\text{Ir}(\text{dppf})_2]^{1-}$, (**446**), according to Reaction Scheme 49.⁷⁵³ The crystal structure of $[\text{Na}(\text{THF})_5][\text{Ir}(\text{dppf})_2]\cdot\text{THF}$ shows that the $\text{Ir}(-\text{I})$ center is bound to two chelated *dppf* molecules in a slightly distorted tetrahedral environment. Reduction of Ir^1 to Ir^0 to $\text{Ir}(-\text{I})$ causes a stepwise decrease of the $\text{Ir}-\text{P}$ bond lengths of 0.04 Å and 0.05 Å, respectively, with a concomitant increase of the bite angle of diphosphine from 94.3° in (**445**) to 102.3° in (**446**).⁷⁵⁴

6.2.9.2 Mixed-donor-atom Ligands

6.2.9.2.1 C/P

X-ray structural studies of the diamagnetic anion (**406**) confirm that the $\text{Ir}(-\text{I})$ center is in a distorted coordination geometry intermediate between square planar and tetrahedral, with the P donor atoms in a *cis* position. The metal–ligand bond distances do not show significant changes among (**404**), (**405**), and (**406**). The $\text{Ir}^1/0$ and $\text{Ir}^0/(-\text{I})$ redox couples are measured at easily accessible potentials and are solvent dependent.

6.2.10 ABBREVIATIONS

acac = acetylacetonate
AH = adenine
Hal = α -alanine
5'-AMPH₂ = adenosine-5-monophosphate
[9]aneS₃ = 1,4,7-trithiacyclononane
ap = 2-aminopyridinato (ap) and
anp = 2-anilinopyridinato
5'-ATP⁴⁻ = adenosine-5'-triphosphate
aza = azindolate
big = bis(1-methylimidazol-2-yl)glyoxal
bim = 2,2'-bi-imidazolate (2-)
Bn = benzyl
bnda = 2,2'-diamino-1,1'-binaphthyl
bpm = bis(pyrazol-1-yl)methane
bpy = 2,2'-bipyridine
bq = 7,8-benzoquinolate
bqNH₂ = 2-amino-7,8-benzoquinolate
cat = 1,2-O₂C₆H₄
CBP = 4,4'-N,N'-dicarbazole-biphenyl
chel = pyridinalimine
cysta = cystamine
cod = 1,5-cyclooctadiene
coe = cyclooctene
cot = cyclotetraene
cp = cyclopentadienyl
cp* = pentamethylcyclopentadienyl
cy = C₆H₁₁
p-cymene = *p*-isopropylmethylbenzene
cyttp = C₆H₅P[CH₂CH₂CH₂P(C₆H₁₁)₂]₂
1,4-da = 1,4-diaminoanthraquinolate ligand
dap = 2,6-diallylpyridine
daba = bis[2-(diphenylarsino)ethyl] benzylamine
dcbi = 4,5-dicarboxyimidazole
dcbmi = 4,5-dicarboxyl-2-methylimidazole
dcp = 1,2-bis(dicyclohexylphosphino)ethane
dfep = (C₂F₅)₂PCH₂CH₂P(C₂F₅)₂

diphos = dppe
Hdipy = 2,2'-dipyridylamine ligand
dma = dimethyl acetylenedicarboxylate, $\text{MeO}_2\text{CC:CCO}_2\text{Me}$
DMA = 1,3-dimethylalloxazino
DMB = dimethoxybenzene
dmpm = bis(dimethylphosphino)methane
dmpz = 3,5-dimethyl pyrazole
dpba = bis[2-diphenylphosphino)ethyl] benzylamine
dpes = *o*-diphenylphosphinobenzoic acid ethyl ester
dpfpe = 1,2-bis(di(pentafluorophenyl)phosphino)ethane
dppe = 1,2-bis(diphenylphosphino)ethane
dppf = 1,1'-bis(diphenylphosphinoferrocene)
dppn = 3,6-bis(2'-pyridyl)pyridazine
dppz = dipyrido[3,2-a:2',3'-c]phenazine
dpt-NH₂ = 4-amino-3,5-bis(2-pyridyl)-4*H*-1,2,4-triazole
dte = *N,N'*-diethyldithiocarbamate
edmp = (2-aminoethyl)dimethyl phosphine
edpp = (2-aminoethyl)diphenylphosphine
9-EtA = 9-ethyladenine
form = *N,N'*-di-*p*-tolylformamide, $\text{CH}(\text{N-}i>p\text{-C}_6\text{H}_4\text{Me})_2$
Fppy = 2-(4,5-difluorophenyl)pyridine
Fppy = 2-(4,6-difluorophenyl)pyridine
GH = guanine
Hgl = glycine
His = histidine
Gu = $\text{H}_2\text{NC}(\text{:NH})\text{NHC}(\text{:O})\text{NH}_2$
Haza = 7-azaindolate (1*H*-pyrrole[2,3-*b*]pyridine
hp = 2-oxypyridinate
HXH = hypoxanthine
LiBzim = lithium *N*-benzyl-2-imidazolate
mdmpp = 2,6-dimethoxyphenyl(diphenylphosphine)
mes = $\text{C}_6\text{H}_2\text{Me}_3$ -2,4,6
mnt = maleonitriledithiolate
mph = 6-methyl-2-oxypyridinate
mppy = 3-methyl-2-phenylpyridine
4mptr = 4-methyl-3-(pyridin-2-yl)-1,2,4-triazole
mpz = 3-methylpyrazole
MV²⁺ = methyl viologen
nbr = norbornadiene
np₃ = $\text{N}(\text{CH}_2\text{CH}_2\text{PPh}_2)_3$
NSiN = Bis(8-quinolyl)methyl silane
1-nqoH = 1,2-naphthoquinone-1-oxime
Oac = acetate
oep = octaethylporphyrin
OEt^{F3} = OCH_2CF_3
otf = OSO_2CF_3
pc = phthalocyaninato(2-)
phen = 1,10 phenanthroline
(R)-(S)-PPFPP = (*S*)-1-(diphenylphosphino)-2-[(*R*)-1-(diphenylphosphino)ethyl]ferrocene
P[^]P[^]P = bis ((diphenylphosphine)methyl)phenylphosphine
PSS = poly(styrenesulfonate)
ptpy = 2-(*p*-tolyl)pyridine
py = pyridine
pz = pyrazole
pz-*N*-H = 3,5-dimethyl-, 3,5-dimethyl-4-nitro-, 3,5-bis(trifluoromethyl)pyrazole
satH = salicylaldehyde thiosemicarbazone
H₂Tcbim = 4,4',5,5'-tetracyano-2,2'-biimidazole
tcep = tris(cyanoethyl)phosphine
tene = tetracyanoethylene
tdmpp = tris(2,6-dimethoxyphenyl)phosphine

tdppmcy = *cis,cis*-1,3,5-tris[(diphenylphosphanyl)methyl]-cyclohexane

tetras = As(*o*-C₆H₄AsMe₂)₃

tfb = tetrafluorobenzobarrelene

Hthpy = 2-(2-thienyl)pyridine

tht = tetrahydrothiophene

tmb = 2,5-diisocyno-2,5-dimethylhexane

tmpp = tris(2,4,6-trimethoxyphenyl)phosphine

Tp^{Me2} = hydrotris(3,5-dimethyl-1-pyrazolyl)borate

tppts = *m*-sulfonatophenyl sodium diphenyl phosphine

tppms = *m*-sulfonatophenyl potassium diphenyl phosphine

triphos = 1,1,1-tris((diphenylphosphino)methyl)ethane

tropp^{Ph} = dibenzotropyliidenyl phosphine

ttp = C₆H₅P[CH₂CH₂CH₂P(C₆H₅)₂]₂

tz = triazolate

6.2.11 REFERENCES

- Citra, A.; Andrews, L. *J. Phys. Chem. A* **1999**, *103*, 4182–4190.
- Jung, D. Y.; Gravereau, G.; Demazeau, G. *Eur. J. Solid. State. Inorg. Chem.* **1993**, *30*, 1025–1037.
- Demazeau, G.; Jung, D. Y. *Eur. J. Solid. State. Inorg. Chem.* **1995**, *32*, 383–401.
- Kawamura, K.; Hartwig, J. F. *J. Am. Chem. Soc.* **2001**, *123*, 8422–8423.
- Bould, J.; Greenwood, N. N.; Kennedy, J. D.; McDonald, W. S. *J. Chem. Soc., Dalton Trans* **1985**, *9*, 1843–1847.
- Ricci, J. S.; Koetzle, T. F.; Fernandez, M. J.; Maitlis, P. M.; Green, J. C. *J. Organomet. Chem.* **1986**, *299*, 383–389.
- Ruiz, J.; Spencer, C. M.; Mann, B. E.; Taylor, B. F.; Maitlis, P. M. *J. Organomet. Chem.* **1987**, *325*, 253–260.
- Loza, M.; Faller, J. W.; Crabtree, R. H. *Inorg. Chem.* **1995**, *34*, 2937–2941.
- Alaimo, P. J.; Bergman, R. G. *Organometallics* **1999**, *18*, 2707–2717.
- Hay-Motherwell, R. S.; Hursthouse, M. B. *Polyhedron* **1993**, *12*, 2009–2012.
- Esteruelas, M. A.; Lahoz, F. J.; Oñate, E.; Oro, L. A.; Rodriguez, L. *Organometallics* **1996**, *15*, 823–834.
- Tanke, R. S.; Crabtree, R. H. *Organometallics* **1991**, *10*, 415–418.
- Preetz, W.; Tensfeldt, D. *Z. Anorg. Allg. Chem.* **1985**, *522*, 7–10.
- Holloway, J. H.; Rook, J. *J. Chem. Soc., Dalton Trans.* **1987**, 2285–2287.
- Brinkman, S.; Morris, R. H.; Ramachandran, R.; Park, S. *Inorg. Synth.* **1998**, *32*, 303–308.
- Paneque, M.; Poveda, M. L.; Taboada, S. *J. Am. Chem. Soc.* **1994**, *116*, 4519–4520.
- Ferrari, A.; Merlin, M.; Sostero, S.; Traverso, O.; Rueegger H.; Venanzi, L. M. *Helv. Chim. Acta* **1998**, *81*, 2127–2139.
- Webster, C. E.; Singleton, D. A.; Szymanski, M. J.; Hall, M. B.; Zhao, C.; Jia G.; Lin, Z. *J. Am. Chem. Soc.* **2001**, *123*, 9822–9829.
- Gutiérrez-Puebla, E.; Monge, A.; Panequw, M.; Povedam, M.L.; Taboada, S.; Trujillo, M.; Carmona, E. *J. Am. Chem. Soc.* **1999**, *121*, 346–354.
- Gilbert, T. M.; Hollander, F. J.; Bergman, R. G. *J. Am. Chem. Soc.* **1985**, *107*, 3508–3516.
- Gilbert, T. M.; Bergman, R. G. *J. Am. Chem. Soc.* **1985**, *107*, 3502–3507.
- Heinekey, D. M.; Millar, J. M.; Koetzle, T. F.; Payne, N. G.; Zilm, K. W. *J. Am. Chem. Soc.* **1990**, *112*, 909–919.
- Werner, H.; Wolf, J.; Hoehn, A. *J. Organomet. Chem.* **1985**, *273*, 395–407.
- Klei, S. R.; Tilley, T. D.; Bergman, R. G. *J. Am. Chem. Soc.* **2000**, *122*, 1816–1817.
- Levason, W. *Stud. Inorg. Chem.* **1991**, *11*, 470–529.
- Wang, C.; Xin, W.; Fu, X.; Wang, Y.; Zhang, Y. *Fenxi Shiyanshi* **1993**, *12*, 53–55.
- Wang, C.; Xin, W.; Fu, X.; Zhang, Y.; Yang, Y. *Fenxi Shiyanshi* **1992**, *20*, 368.
- Cipriano, R. A.; Hanton, L. R.; Levason, W.; Pletcher, D.; Powell, N. A.; Webster, M. *J. Chem. Soc., Dalton Trans.* **1987**, 1901–1916.
- Cipriano, R. A.; Hanton, L. R.; Levason, W.; Pletcher, D.; Powell, N. A.; Webster, M. *J. Chem. Soc., Dalton Trans.* **1988**, 2483–2490.
- Deflon, V. M.; Mossmer, C. M.; Strahle, J. *Anorg. Allg. Chem.* **1999**, *625*, 2186–2191.
- Ali, S. M. *J. Indian Chem. Soc.* **1989**, *66*, 905–906.
- Mura, P.; Segre, A.; Sostero, S. *Inorg. Chem.* **1989**, *28*, 2853–2858.
- Mura, P. *J. Am. Chem. Soc.* **1986**, *108*, 351–352.
- Mura, P.; Segre, A. *Angew Chem.* **1986**, *98*, 453–454.
- Bergamini, P.; Sostero, S.; Traverso, O.; Mura, P.; Segre, A. *J. Chem. Soc., Dalton Trans.* **1989**, 2367–2370.
- Ajo, D.; Attanasio, D.; Lucente, S.; Mura, P.; Segre, A. L.; De Zuane, F. *J. Magn. Magn. Mater.* **1992**, *104–107*, 1997–1998.
- Donato, A.; Mura, P.; Maldotti, A.; Sostero, S.; Traverso, O. *New J. Chem.* **1992**, *16*, 347–350.
- Maistrenko, V. N.; Rusakov, I. A.; Voloshin, N. D.; Murinov, Y. I.; Budnikov, G. K. *Koord. Khim.* **1987**, *13*, 1513–1519.
- Murinov, Y. I.; Maistrenko, V. N.; Rusakov, I. A.; Budnikov, G. K. *J. Electroanal. Chem. Interfacial Electrochem.* **1988**, *250*, 95–106.
- Hope, E. G.; Levason, W.; Webster, M.; Murray, S. G. *J. Chem. Soc., Dalton Trans.* **1986**, 1003–1009.
- Bond, A. M.; Colton, R.; Mann, D. R. *Inorg. Chem.* **1990**, *29*, 4665–4671.
- Volkov, S. V.; Pekhno, V. I.; Lapko, V. F.; Zhigotskii, E. A. *Zh. Neorg. Khim.* **1993**, *38*, 68–71.
- Basova, E. M.; Mondareva, L. G.; Ivanov, V. M. *Zh. Anal. Khim.* **1994**, *49*, 567–573.
- Ezerskaya, N. A.; Kiseleva, I. N.; Golovaneva, I. F.; Klyagina, A. P. *Koord. Khim.* **1990**, *16*, 1127–1131.

45. Kiseleva, I. N.; Ezerskaya, N. A.; Shubochkin, L. K. *Koord. Khim.* **1990**, *16*, 714–717.
46. Nahor, G. S. *J. Phys. Chem.* **1989**, *93*, 5808–5813.
47. Castillo-Blum, S. E.; Richens, D. T.; Sykes, A. G. *J. Chem. Soc., Chem. Commun.* **1986**, 1120–1121.
48. Castillo-Blum, S. E.; Richens, D. T.; Sykes, A. G. *Inorg. Chem.* **1989**, *28*, 954–960.
49. Zhao, W. *Gujiinshu* **2000**, *21*, 34–36.
50. Pikulski, M.; Gorski, W. *Anal. Chem.* **2000**, *72*, 2696–2702.
51. Scurloch, R. D.; Gilbert, D. D.; De Korte, J. M. *Inorg. Chem.* **1985**, *24*, 2393–2397.
52. Lange, C. W.; Pierpont, C. G. *J. Am. Chem. Soc.* **1992**, *114*, 6582–6583.
53. Lang, C.; Müller-Buschbaum, H. Z. *Anorg. Allg. Chem.* **1989**, *568*, 29–34.
54. Roper, W. R.; Saunders, G. C. *J. Organomet. Chem.* **1991**, *409*, C19–C22.
55. Dai, C.; Stringer, G.; Marder, T. B.; Baker, R. T.; Scott, A. J.; Clegg, W.; Norman, N. C. *Can. J. Chem.* **1996**, *74*, 2026–2031.
56. Clegg, W.; Lawlor, F. J.; Marder, T. B.; Nguyen, P.; Norman, N. C.; Orpen, A. G.; Quayle, M. J.; Rice, C. R.; Robins, E. G.; Scott, A. J.; Souza, F. E. S.; Stringer, G.; Whittell, G. R. *J. Chem. Soc., Dalton Trans.* **1998**, 301–309.
57. Ellis, P. R.; Pearson, J. M.; Haynes, A.; Adams, H.; Bailey, N. A.; Maitlis, P. M. *Organometallics* **1994**, *13*, 3215–3226.
58. Bach, C.; Willner, H.; Wang, C.; Rettig, S. J.; Trotter, J.; Aubke, F. *Angew. Chem., Int. Ed. Engl.* **1996**, *35*, 1974–1976.
59. Willner, H.; Bach, C.; Wartchow, R.; Wang, C.; Rettig, S. J.; Trotter, J.; Jonas, V.; Thiel, W.; Aubke, F. *Inorg. Chem.* **2000**, *39*, 1933–1942.
60. Chin, C. S.; Cho, H.; Won, G.; Oh, M.; Ok, K. M. *Organometallics* **1999**, *18*, 4810–4816.
61. Booth, B. L.; Wickens, A. C. *J. Organomet. Chem.* **1993**, *445*, 283–286.
62. Arndtsen, B. A.; Bergman, R. G. *Science* **1995**, *270*, 1970–1973.
63. Einstein, F. W. B.; Yan, X.; Sutton, D. *Acta Cryst.* **1991**, *C47*, 1977–1978.
64. Kaner, R. B.; Kouvetakis, J.; Mayorga, S. G. *Acta Cryst.* **1986**, *C42*, 500–501.
65. Deeming, A. J.; Proud, G. P. *J. Organomet. Chem.* **1986**, *301*, 385–390.
66. Hughes, R. P.; Trujillo, H. A.; Rheingold, A. L. *J. Am. Chem. Soc.* **1993**, *115*, 1583–1585.
67. Le, T. X.; Selnau, H. E.; Merola, J. S. *J. Organomet. Chem.* **1994**, *468*, 257–264.
68. Zolta, A. A.; Frolow, F.; Milstein, D. *J. Chem. Soc., Chem. Commun.* **1989**, 1826–1827.
69. Aizenberg, M.; Milstein, D. *J. Am. Chem. Soc.* **1995**, *117*, 6456–6464.
70. Ebsworth, E. A. V.; Moreton, S. *J. Organomet. Chem.* **1992**, *439*, 213–220.
71. Zarate, E. A.; Kennedy, V. O.; McCune, J. A.; Simons, R. S.; Tessier, C. A. *Organometallics* **1995**, *14*, 1802–1809.
72. Fernandez, M. J.; Esteruelas, M. A.; Jimenez, M. S.; Oro, L. A. *Organometallics* **1986**, *5*, 1519–1520.
73. Fernandez, M. J.; Esteruelas, M. A.; Oro, L. A.; Apreada, M. C.; Foces-Foces, C.; Cano, F. H. *Organometallics* **1987**, *6*, 1751–1756.
74. Goikhman, R.; Aizenberg, M.; Kraatz, H.-B.; Milstein, D. *J. Am. Chem. Soc.* **1995**, *117*, 5865–5866.
75. Yamashita, H.; Kawamoto, A. M.; Tanaka, M.; Goto, M. *Chem Lett.* **1990**, *11*, 2107–2110.
76. Hostetler, M. J.; Bergman, R. G. *J. Am. Chem. Soc.* **1992**, *114*, 787–788.
77. Hawkins, S. M.; Hitchcock, P. B.; Lappert, M. F.; Rai, A. K. *J. Chem. Soc., Chem. Commun.* **1986**, 1689–1690.
78. Antonov, P. G.; Lizogub, T. N.; Agapov, I. A.; Manasevich, D. S. *Zh. Prikl. Khim.* **1998**, *71*, 1057–1061.
79. Antonov, P. G.; Agapov, I. A.; Manasevich, D. S. *Zh. Prikl. Khim.* **1999**, *72*, 556–559.
80. Nomura, K.; Saito, Y.; Shinoda, S. *J. Mol. Catal.* **1989**, *50*, 303–313.
81. Makita, K.; Nomura, K.; Saito, Y. *J. Mol. Catal.* **1994**, *89*, 143–149.
82. Matsubara, T.; Saito, Y.; Yamakawa, T.; Shinoda, S. *J. Mol. Catal.* **1991**, *66*, 171–181.
83. Antonov, P. G.; Shkredov, V. F.; Agapov, I. A. *Zh. Prikl. Khim.* **1998**, *71*, 1967–1971.
84. Esteruelas, M. A.; Lahoz, F. J.; Oliván, M.; Onate, E.; Oro, L. A. *Organometallics* **1995**, *14*, 3486–3496.
85. Ichiishi, T.; Sato, A. Manufacture of Hexaammine Iridium Nitrate Solution. Patent JP 2,001,106,535, April, 17, 2001.
86. Galsboel, F.; Hansen, S. K.; Simonsen, K. *Acta Chem. Scand.* **1990**, *44*, 796–801.
87. Galsboel, F.; Moensted, L.; Moensted, O. *Acta Chem. Scand.* **1992**, *46*, 43–46.
88. Galsboel, F.; Kaas, K.; Nielsen, B.; Springborg, J. *Acta Chem. Scand.* **1995**, *49*, 44–52.
89. Harel, Y.; Adamson, A. W. *J. Phys. Chem.* **1986**, *90*, 6690–6693.
90. Rogin, N. Y.; Vershkov, A. V.; Mal'chikov, G. D. *Khim. Khim. Tekhnol.* **1989**, *32*, 19–21.
91. Rogin, N. Y.; Mal'chikov, G. D. *Koord. Khim.* **1989**, *15*, 561–566.
92. Pandey, R. N.; Kumar, S.; Kumar, A.; Kumar, S. K. *J. Indian Chem. Soc.* **1993**, *70*, 495–498.
93. Goldberg, Y.; Alper, H. *Tetrahedron Lett.* **1995**, *3*, 369–372.
94. Casalnuovo, A. L.; Calabrese, J. C.; Milstein, D. *Inorg. Chem.* **1987**, *26*, 971–973.
95. Diversi, P.; de Biani, F. F.; Ingrosso, G.; Laschi, F.; Lucherini, A.; Pinzino, C.; Zanello, P. *J. Organomet. Chem.* **1999**, *584*, 73–86.
96. Ghedini, M.; Longeri, M.; Neve, F. *J. Chem. Soc., Dalton Trans.* **1986**, 2669.
97. Ghedini, M.; Longeri, M.; Neve, F.; Manotti Lanfredi, A. M.; Tiripicchio, A. *J. Chem. Soc., Dalton Trans.* **1989**, 1217–1225.
98. Ghedini, M.; Longeri, M.; Neve, F.; Manotti Lanfredi, A. M.; Tiripicchio, A. *J. Chem. Soc., Dalton Trans.* **1987**, 847.
99. Neve, F.; Ghedini, M. *Inorg. Chim. Acta* **1990**, *175*, 111–114.
100. Vasapollo, G.; Nobile, C. F.; Sacco, A.; Gowenlock, B. G.; Sabbatini, L.; Malitesta, C.; Zambonin, P. G. *J. Organomet. Chem.* **1989**, *378*, 239–244.
101. Sola, E.; Navarro, J.; López, J. A.; Lahoz, F. J.; Oro, L. A.; Werner, H. *Organometallics* **1999**, *18*, 3534–3546.
102. Choy, J.-H.; Hwang, S.-H.; Yoon, J.-B.; Chin, C.-S.; Oh, M.; Lee, H. *Mat. Lett.* **1998**, *37*, 168–175.
103. Hills, E. F.; Richens, D. T.; Sykes, A. G. *Inorg. Chem.* **1986**, *25*, 3144–3148.
104. Glueck, D. S.; Wu, J.; Hollander, F. J.; Burgman, R. G. *J. Am. Chem. Soc.* **1991**, *113*, 2041–2054.
105. Dinger, M. B.; Henderson, W.; Oliver, A. G.; Rickard, C. E. F. *Acta Cryst.* **1999**, *C55*, 1778–1780.
106. Korenev, S. V.; Venediktov, A. B.; Belyaev, A. V. *Zh. Neorg. Khim.* **1990**, *35*, 350–354.
107. Venediktov, A. B.; Korenev, S. V. *Sib. Khim. Zh.* **1991**, *6*, 48–52.

108. Korenev, S. V.; Venediktov, A. B.; Malkova, V. I.; Fedotov, M. A. *Russ. J. Coord. Chem.* **1999**, *25*, 650–652.
109. Selig, W. S. *Fresenius' Z. Anal. Chem.* **1988**, *332*, 795–797.
110. Ribas, J.; Escuer, A.; Monfort, M. *Inorg. Chem.* **1985**, *24*, 1874–1878.
111. Ribas, J.; Serra, M.; Escuer, A. *Inorg. Chim. Acta* **1986**, *116*, 157–162.
112. Mullica, D. F.; Farmer, J. M.; Kautz, J. A. *J. Coord. Chem.* **1999**, *48*, 449–457.
113. Puebla, M. P.; Sarasa, M. D. *Opt. Pura. Apl.* **1987**, *20*, 201–219.
114. Gillard, R. D.; Mitchell, S. H. *Polyhedron* **1987**, *6*, 1885–1899.
115. Gillard, R. D.; Mitchell, S. H. *Polyhedron* **1989**, *8*, 2245–2249.
116. Edwards, N. S. A.; Gillard, R. D.; Hursthouse, M. B.; Lieberman, H. F.; Malik, K. M. A. *Polyhedron* **1993**, *12*, 2925–2928.
117. Sharma, C. L.; Narvi, S. S. *Acta Chim. Hung.* **1986**, *123*, 107–114.
118. Mura, P.; Casini, A.; Marcon, G.; Messori, L. *Inorg. Chim. Acta* **2001**, *312*, 74–80.
119. Ziessel, R.; Youinou, M.-T.; Balegroune, F.; Grandjean, D. *J. Organomet. Chem.* **1992**, *441*, 143–154.
120. Oro, L. A.; Carmona, D.; Garcia, M. P.; Lahoz, F. J.; Reyes, J.; Foces-Foces, C.; Cano, F. H. *J. Organomet. Chem.* **1985**, *296*, C43–C46.
121. Garcia, M. P.; Esteruelas, M. A.; Martin, M.; Oro, L. A. *J. Organomet. Chem.* **1994**, *467*, 151–159.
122. Galsboel, F.; Glowiak, T.; Hammershoei, A.; Hammershoei, B. S.; Larsen, S.; Wilgocki, M. *Acta Chem. Scand.* **1990**, *44*, 31–35.
123. Moc, J.; Wilgocki, M. *Journal of Molecular Structure* **2001**, *595*, 57–65.
124. Williams, D. J.; Kruger, J. S.; McLeroy, A. F.; Wilkinson, A. P.; Hanson, J. C. *Chem. Mater.* **1999**, *11*, 2241–2249.
125. Szabó-Nagy, A.; Keszthelyi, L. *Proc. Natl. Acad. Sci. USA* **1999**, *96*, 4252–4255.
126. Greulich, S.; Kaim, W.; Stange, A. F.; Stoll, H.; Fielder, J.; Zális, S. *Inorg. Chem.* **1996**, *35*, 3998–4002.
127. Lahoz, F. F.; Tiripicchio, A.; Neve, F.; Ghedini, M. *J. Chem. Soc., Dalton Trans.* **1989**, *6*, 1075–1081.
128. Colson, S. F.; Robinson, S. D. *Polyhedron* **1990**, *9*, 1737–1740.
129. Wang, Y.-C. *Fenxi Shiyanshi* **2000**, *19*, 74–79.
130. Poth, T.; Paulus, H.; Elias, H.; Dücker-Benfer, C.; van Eldik, R. *Eur. J. Inorg. Chem.* **2001**, 1361–1369.
131. Polborn, K.; Hoffmüller, W.; Beck, W. *New Cryst. Struct.* **2001**, *216*, 231–232.
132. Carmona, D.; Lahoz, F. J.; Elipse, S.; Oro, L. A. *Organometallics* **1998**, *17*, 2986–2995.
133. Brunner, H.; Köllnberger, T.; Burgemeister, M. Z. *Polyhedron* **2000**, *19*, 1519–1526.
134. Dixon, I. M.; Collin, J.-P.; Sauvage, J.-P.; Flamigni, L.; Encinas, S.; Barigelletti, F. *Chem. Soc. Rev.* **2000**, *29*, 385–391.
135. Lee, J. R.; Liou, Y. R.; Huang, W. L. *Inorg. Chim. Acta* **2001**, *319*, 83–89.
136. Yoshikawa, N.; Masuda, Y.; Matsumura-Inoue, T. *Chem. Lett.* **2000**, 1206–1207.
137. Goodall, W.; Williams, G. *J. Chem. Soc., Dalton Trans.* **2000**, 2893–2895.
138. Bruegger, N.; Deschenaux, R.; Ruch, T.; Ziessel, R. *Tetrahedron Lett.* **1992**, *33*, 3871–3874.
139. Ziessel, R. *J. Chem. Soc., Chem. Commun.* **1988**, 16–17.
140. Sandrini, D.; Maestri, M.; Ziessel, R. *Inorg. Chim. Acta* **1989**, *163*, 177–180.
141. Youinou, M. T.; Ziessel, R. *J. Organomet. Chem.* **1989**, *363*, 197–208.
142. Ziessel, R.; Nobalt-Chardon, S.; Deronzier, A.; Matt, D.; Toupet, L.; Balgroune F.; Grandjean, D. *Acta Cryst.* **1993**, *B49*, 515–519.
143. Ziessel, R. *J. Am. Chem. Soc.* **1993**, *115*, 118.
144. Caix, C.; Chardon-Noblat, S.; Deronzier, A.; Ziessel, R. *J. Electroanal. Chem.* **1996**, *403*, 189–202.
145. Divisia-Blohorn, B.; Kyriakakou, G.; Ulrich, J. *Org. Mass Spectrom.* **1985**, *20*, 463–466.
146. Neve, F.; Crispini, A.; Campagna, S.; Serroni, S. *Inorg. Chem.* **1999**, *38*, 2250–2258.
147. Neve, F.; Crispini, A. *Eur. J. Inorg. Chem.* **2000**, *5*, 1039–1043.
148. Neve, F.; Crispini, A.; Loiseau, F.; Campagna, S. *J. Chem. Soc. Dalton Trans.* **2000**, 1399–1401.
149. Neve, F.; Crispini, A.; Serroni, S.; Loiseau, F.; Campagna, S. *Inorg. Chem.* **2001**, *40*, 1093–1101.
150. Ganzha, L. N.; Partman, A.; Sof'in, M. V. *Neorg. Khim.* **1989**, *34*, 1528–1530.
151. Riesen, H.; Krausz, E. *J. Lumin.* **1992**, *53*, 263–265.
152. Macchioni, A.; Zuccaccia, C.; Clot, E.; Gruet, K.; Crabtree, R. H. *Organometallics* **2001**, *20*, 2367–2373.
153. Griffiths, P. M.; Loiseau, F.; Puntoriero, F.; Serroni, S.; Campagna, S. *J. Chem. Soc., Chem., Commun.* **2000**, 2297–2298.
154. Matsuzaka, H.; Ariga, K.; Kase, H.; Kamura, T.; Kondo, M.; Kitagawa, S.; Yamasaki, M. *Organometallics* **1997**, *16*, 4514–4516.
155. Sola, E.; Bakhmutov, V. I.; Torres, F.; Elduque, A.; López, J. A.; Lahoz, F. J.; Werner, H.; Oro, L. A. *Organometallics* **1998**, *17*, 683–696.
156. Miller, B.; Altman, J.; Leschke, C.; Schunack, W.; Sunkel, K. Knizek J.; Noth, H.; Beck, W. *Z. Anorg. Allg. Chem.* **2000**, *626*, 978–984.
157. Harada, K. *Bull. Chem. Soc. Jpn.* **1993**, *66*, 2889–2899.
158. Ball, R. G.; Ghosh, C. K.; Hoyano, J. K.; McMaster, A. D.; Graham, W. A. G. *J. Chem. Soc., Chem. Commun.* **1989**, 341–342.
159. Ferrari, A.; Polo, E.; Rügger, H.; Sostero, S.; Venanzi, L. M. *Inorg. Chem.* **1996**, *35*, 1602–1608.
160. Burger, K.; Wagner, F. E.; Vértés, A.; Bencze, E.; Mink, J.; Labádi, I.; Nemes-Vetéssy, Zs. *J. Physics and Chemistry of Solids* **2001**, *62*, 2059–2068.
161. Collin, J.-P.; Dixon, I. M.; Sauvage, J.-P.; Williams, J. A. G.; Barigelletti, F.; Flamigni, L. *J. Am. Chem. Soc.* **1999**, *121*, 5009–5016.
162. Dixon, I. M.; Collin, J.-P.; Sauvage, J.-P.; Flamigni, L. *Inorg. Chem.* **2001**, *40*, 5507–5517.
163. Lo, K. K.-W.; Ng, D. C.-M.; Zhu, N. *New J. Chem.* **2002**, *26*, 81–88.
164. Blake, A. J.; Hyde, T. I.; Schroder, M. *J. Chem. Soc., Dalton Trans.* **1988**, 1165–1168.
165. Moore, P.; Omar, H. A. A.; Alcock, N. W.; Pike, G. A. *J. Chem. Soc., Chem. Commun.* **1990**, *3*, 280–281.
166. Mak, S.-T.; Yam, V. W.-W.; Che, C.-M.; Mak, T. C. W. *J. Chem. Soc., Dalton Trans.* **1990**, 2555–2564.
167. Sharma, V. K.; Pandey, O. P.; Sengupta, S. K. *Bull. Soc. Chim. Fr.* **1991**, 469–472.
168. Monsted, L.; Monsted, O.; Nord, G.; Simonsen, K. *Acta Chem. Scand.* **1993**, *47*, 439–443.

169. Shakir, M.; Nasman, O. S. M.; Mohamed, A. K.; Varkey, S. P. *Synth. React. Inorg. Met.-Org. Chem.* **1995**, *25*, 1671–1684.
170. Huckstadt, H.; Homborg, H. *Z. Naturforsch.* **1997**, *52B*, 728–734.
171. Huckstadt, H.; Homborg, H. *Z. Naturforsch.* **1997**, *52B*, 1003–1010.
172. Huckstadt, H.; Homborg, H. *Z. Anorg. Allg. Chem.* **1997**, *623*, 292–298.
173. Huckstadt, H.; Homborg, H. *J. Porphyrins Phthalocyanines* **1999**, *3*, 169–171.
174. Milstein, D.; Calabrese, J. C.; Williams, I. D. *J. Am. Chem. Soc.* **1986**, *108*, 6387.
175. Stevens, R. C.; Bau, R.; Milstein, D.; Blum, O.; Koetzle, T. F. *J. Chem. Soc., Dalton Trans.* **1990**, 1429–1432.
176. Deeming, A. J.; Doherty, S.; Marshall, J. E. *Polyhedron* **1991**, *10*, 1857–1864.
177. Blake, A. J.; Cockman, R. W.; Ebsworth, E. A. V. *Acta Cryst.* **1992**, *C48*, 1658–1660.
178. Clegg, W.; Elsegood, M. R. J.; Scott, A. J.; Marder, T. B.; Dai, C.; Norman, N. C.; Pickett, N. L.; Robins, E. G. *Acta Cryst.* **1999**, *C55*, 733–739.
179. Robertson, G. B.; Tucker, P. A. *Aust. J. Chem.* **1987**, *40*, 1043.
180. Robertson, G. B.; Tucker, P. A. *Aust. J. Chem.* **1988**, *41*, 283.
181. Robertson, G. B.; Tucker, P. A. *Aust. J. Chem.* **1988**, *41*, 641.
182. Robertson, G. B.; Tucker, P. A. *Aust. J. Chem.* **1988**, *41*, 807.
183. Ditzel, E. J.; Robertson, G. B. *Aust. J. Chem.* **1993**, *46*, 529.
184. Ditzel, E. J.; Robertson, G. B. *Aust. J. Chem.* **1995**, *48*, 1183–1191.
185. Al-Ohaly, A. R.; Nixon, J. F. *Inorg. Chim. Acta* **1985**, *103*, 83–93.
186. Deeming, A. J.; Proud, G. P. *Inorg. Chim. Acta* **1985**, *100*, 233–235.
187. Johnson, T. J.; Hauger, B. E.; Lobkovsky, E. B. *J. Organomet. Chem.* **1992**, *424*, 371–380.
188. Deeming, A. J.; Doherty, S.; Marshall, J. E.; Powell, J. L.; Senior, A. M. *J. Chem. Soc., Dalton Trans* **1993**, 1093–1100.
189. Chin, C. S.; Lee, M.; Oh, M.; Won, G.; Kim, M.; Park, Y. J. *Organometallics* **2000**, *19*, 1572–1577.
190. Blum, O.; Carmielli, R.; Martin, J. N. L.; Milstein, D. *Organometallics* **2000**, *19*, 4608–4612.
191. De Waal, D. J.; Oosthuizen, H. E.; Singleton, E. S. *Afr. J. Chem.* **1987**, *40*, 193–199.
192. Khan, M. M. T.; Khan, B. T.; Ali, S. M. *J. Mol. Catal.* **1989**, *57*, 29–45.
193. Bennett, M. A.; Crisp, G. T. *Aust. J. Chem.* **1986**, *39*, 1363–1375.
194. Ebsworth, E. A. V.; Gould, R. O.; Mayo, R. A.; Walkinshaw, M. *J. Chem. Soc., Dalton Trans.* **1987**, 2831–2838.
195. Crabtree, R. H.; Mellea, M. F.; Mihelcic, J. M. *Inorg. Synth.* **1989**, *26*, 122–126.
196. Mayer, H. A.; Kaska, W. C. *Chem. Ber.* **1995**, *128*, 95–98.
197. Bennett, M. A.; Mitchell, T. R. B. *J. Organomet. Chem.* **1985**, *295*, 223–231.
198. Albertin, G.; Antoniutti, S.; Bordigon, E.; Menegazzo, F. *J. Chem. Soc., Dalton Trans.* **2000**, 1181–1189.
199. Valderrama, M.; Campos, P. *J. Coord. Chem.* **1996**, *39*, 97–104.
200. Scotti, M.; Valderrama, M.; Campos, P.; Klacui, W. *Inorg. Chim. Acta* **1993**, *207*, 141–145.
201. Esteruelas, M. A.; Oliván, M.; Oro, L. A.; Schultz, M.; Sola, E.; Werner, H. *Organometallics* **1992**, *11*, 3659–3664.
202. Chan, Y. N. C.; Meyer, D.; Osborn, J. A. *J. Chem. Soc., Chem. Commun.* **1990**, 869–871.
203. Kunin, A.; Farid, R.; Johnson, C. E.; Eisenberg, R. *J. Am. Chem. Soc.* **1985**, *107*, 5315–5317.
204. Brown, J. M.; Evans, P. L.; Maddox, P. J.; Sutton, K. H. *J. Organomet. Chem.* **1989**, *359*, 115–125.
205. Johnston, C. E.; Eisenberg, R. *J. Am. Chem. Soc.* **1985**, *107*, 6531–6540.
206. Duckett, S. B.; Newell, C. L.; Eisenberg, R. *J. Am. Chem. Soc.* **1993**, *115*, 1156–1157.
207. Cleary, B. P.; Eisenberg, R. *Inorg. Chim. Acta* **1995**, *240*, 135–143.
208. Albiets, P. J.; Cleary, B. P.; Paw, W.; Eisenberg, R. *J. Am. Chem. Soc.* **2001**, *123*, 12091–12092.
209. Albiets, P. J.; Houllis, J. F.; Eisenberg, R. *Inorg. Chem.* **2002**, *41*, 2001–2003.
210. Sablong, R.; Osborn, J. A. *Tetrahedron Asym.* **1996**, *11*, 3059–3062.
211. Dorta, R.; Togni, A. *Organometallics* **1998**, *17*, 3423–3428.
212. Barbaro, P.; Bianchini, C.; Frediani, P.; Meli, A.; Vizza, F. *Inorg. Chem.* **1992**, *31*, 1523–1529.
213. Yang, C.; Socol, S. M.; Kountz, D. J.; Meek, D. W.; Glaser, R. *Inorg. Chim. Acta* **1986**, *114*, 119–122.
214. Socol, S. M.; Yang, C.; Meek, D. W.; Glaser, R. *Can. J. Chem.* **1992**, *70*, 2424–2433.
215. Werner, H.; Ortman, D. A.; Ilg, K. Z. *Anorg. Allg. Chem.* **2000**, *626*, 2457–2462.
216. Werner, H.; Ortman, D. A.; Gevert, O. *Chem. Ber.* **1996**, *129*, 411–417.
217. Hill, A. M.; Levason, W.; Preece, S. R.; Frampton, C. S. *Inorg. Chim. Acta* **1997**, *254*, 99–104.
218. Ortman, D. A.; Weberndorfer, B.; Schoneboom, J.; Werner, H. *Organometallics* **1999**, *18*, 952–954.
219. Deeming, A. J.; Proud, G. P.; Dawes, H. M.; Hursthouse, M. B. *J. Chem. Soc., Dalton Trans.* **1986**, 2545–2549.
220. Cusanelli, A.; Frey, U.; Richens, D. T.; Merbach, A. E. *J. Am. Chem. Soc.* **1996**, *118*, 5265–5271.
221. Cusanelli, A.; Nicula-Dadci L.; Frey, U.; Merbach, A. E. *Chimia* **1996**, *50*, 618–620.
222. Shipachev, V. A.; Isakova, V. G.; Kozlova, S. G.; Baidina, I. A.; Gromilov, S. A. *J. Struct. Chem.* **1999**, *40*, 214–219.
223. Hughes, R. P.; Lindner, D. C.; Smith, J. M.; Zhang, D.; Incarvito, C. D.; Lam, K.-C.; Liable-Sands, L. M.; Sommer, R. D.; Rheingold, A. L. *J. Chem. Soc., Dalton Trans.* **2001**, 2270–2278.
224. Sanchez-Ortiz, V. A.; Martinez-Jardines, L. G.; Castillo-Blum, S. E.; Sykes, A. G. *J. Chem. Soc., Dalton Trans.* **1998**, 663–665.
225. Galsboel, F.; Larsen, S.; Rasmussen, B.; Springborg, J. *Inorg. Chem.* **1986**, *25*, 290–297.
226. Tani, K.; Iseki, A.; Yamagata, T. *J. Chem. Soc., Chem. Commun.* **1999**, 1821–1822.
227. Hendry, P.; Sargeson, A. M. *J. Am. Chem. Soc.* **1989**, *111*, 2521–2517.
228. Ladipo, F. T.; Kooti, M.; Merola, J. S. *Inorg. Chem.* **1993**, *32*, 1681–1688.
229. Ladipo, F. T.; Merola, J. S. *Inorg. Chem.* **1993**, *32*, 5201–5205.
230. Wang, C.; Lewis, A. R.; Batchelor, R. J.; Einstein, F. W. B.; Willner, H.; Aubke, F. *Inorg. Chem.* **1996**, *35*, 1279–1285.
231. Randall, S. L.; Miller, C. A.; See, R. F.; Churchill, M. R.; Janik, T. S.; Lake, C. H.; Atwood, J. D. *Organometallics* **1994**, *13*, 5088–5095.
232. Burger, P.; Bergman, R. G. *J. Am. Chem. Soc.* **1993**, *115*, 10462–10463.
233. Beck, W.; Bauer, H.; Olgemoeller, B. *Inorg. Synth.* **1989**, *26*, 117–121.
234. Lawrance, G. A. *Inorg. Chem.* **1985**, *24*, 323–326.

235. Curtis, N. J.; Lawrance, G. A.; Lay, P. A.; Sargeson, A. M. *Inorg. Chem.* **1986**, *25*, 484–488.
236. Cao, D. H.; Stang, P. J.; Arif, A. M. *Organometallics* **1995**, *14*, 2733–2740.
237. Isakova, V. G.; Baidina, I. A.; Morozova, N. B.; Igumenov, I. K. *Polyhedron* **2000**, *19*, 1097–1103.
238. Isakova, V. G.; Baidina, I. A.; Morozova, N. B.; Igumenov, I. K.; Rybakov, V. B. *J. Struct. Chem.* **1999**, *40*, 276–283.
239. Isakova, V. G.; Baidina, I. A.; Morozova, N. B.; Igumenov, I. K.; Rybakov, V. B. *J. Struct. Chem.* **1999**, *40*, 317–320.
240. Esteruelas, M. A.; Lahoz, F. J.; Onate, E.; Oro, L. A.; Rodriguez, L. *Organometallics* **1996**, *15*, 823–834.
241. Basson, S. S.; Leopoldt, J. G.; Purcell, W.; Schoeman, J. B. *Acta Cryst.* **1989**, *C45*, 2000–2001.
242. Barbaro, P.; Bianchini, C.; Mealli, C.; Masi, D. *Acta Cryst.* **1994**, *C50*, 1414–1417.
243. Lang, R.; Polborn, K.; Severin, T.; Severin, K. *Inorg. Chim. Acta* **1999**, *294*, 62–67.
244. Barbaro, P.; Bianchini, C.; Linn, K.; Mealli, C.; Meli, A.; Vizza, F.; Laschi, F.; Zanello, P. *Inorg. Chim. Acta* **1992**, *198–200*, 31–56.
245. Dayakar, G.; Lingaiah, P. *Asian, J. Chem.* **2001**, *13*, 1105–1108.
246. Tanke, R. S.; Crabtree, R. H. *J. Chem. Soc., Chem Commun.* **1990**, 1056–1057.
247. Tanke, R. S.; Crabtree, R. H. *J. Am. Chem. Soc.* **1990**, *112*, 7984.
248. Tanke, R. S.; Crabtree, R. H. *Organometallics* **1991**, *10*, 415–418.
249. Baranovskii, I. B.; Golubnichaya, M. A.; Koz'min, P. A.; Surazhskaya, M. D. *Zh. Beorg. Khim.* **1995**, *40*, 1634–1640.
250. Bashmakov, V. I.; Belyaev, A. N.; Simanova, S. A.; Burmistrova, N. M. *Zh. Prikl. Khim.* **1995**, *68*, 1259–1264.
251. Takahashi, K.; Umakoshi, K.; Kikuchi, A.; Sasaki, Y.; Tominaga, M.; Taniguchi, I. *Z. Naturforsch.* **1995**, *50B*, 551–557.
252. Fabretti, A. C.; Giusti, A. *Polyhedron* **1986**, *5*, 1927–1930.
253. Cockman, R. W.; Ebsworth, E. A. V.; Holloway, J. H. *J. Am. Chem. Soc.* **1987**, *109*, 2194–2195.
254. Sinha, A. I. P.; Tewari, S. P.; Sinha, B. K. *Vijnana Parishad Anusandhan Patrika* **1989**, *32*, 17–24.
255. Rybakov, V. B.; Aslanov, L. A.; Volkov, S. V.; Grafoc, A. V.; Pekhn'yo, V. I.; Fokina, Z. A. *Zh. Strukt. Khim.* **1992**, *33*, 146–148.
256. Vorob'ev-Desyatovskii, N. V.; Teterin, Y. A.; Sosul'nikov, M. I.; Shcherbakov, Y. S.; Nikolaev, A. V.; Panasjuk, S. L. *Zh. Obshch. Khim.* **1992**, *62*, 1935–1941.
257. Park, S. H.; Lough, A. J.; Yap, G. P. A.; Morris, R. H. *J. Organomet. Chem.* **2000**, *609*, 110–122.
258. Park, S.; Lough, A. J.; Morris, R. H. *Inorg. Chem.* **1996**, *35*, 3001–3006.
259. Lough, A. J.; Park, S. H.; Ramachandran, R.; Morris, R. H. *J. Am. Chem. Soc.* **1994**, *116*, 8306.
260. Park, S. H.; Ramachandran, R.; Lough, A. J.; Morris, R. H. *J. Chem. Soc., Chem. Commun.* **1994**, 2201.
261. Valderrama, M.; Contreras, R. Arancibia V.; Boys, D. *J. Organomet. Chem.* **2001**, *620*, 256–262.
262. Valderrama, M.; Contreras, R. *Bol. Soc. Chil. Quim.* **1995**, *40*, 111–115.
263. Valderrama, M.; Contreras, R. *J. Organomet. Chem.* **1996**, *513*, 7–15.
264. Valderrama, M.; Contreras, R.; Lamata, M. P.; Viguri, F.; Carmona, D.; Lahoz, F. J.; Elipe, S.; Oro, L. A. *J. Organomet. Chem.* **2000**, *607*, 3–11.
265. Mukherjee, R. N.; Shankar, S. *Indian J. Chem.* **1985**, *24A*, 939–941.
266. Sangari, H. S.; Sodhi, G. S. *Indian J. Chem.* **1990**, *29A*, 922–923.
267. Fabretti, A. C.; Preti, C.; Tassi, L.; Tosi, G.; Zannini, P. *Inorg. Chim. Acta* **1987**, *137*, 73–74.
268. Rimo, X.; Abe, M.; Suzuki, T.; Nishioka, T.; Isobe, K. *J. Organomet. Chem.* **1997**, *549*, 117–125.
269. Amame, M. E.; Maisonnat, A.; Dahan, F.; Prince, R.; Poilblanc, R. *Organometallics* **1985**, *4*, 773–780.
270. Henderson, W.; Nicholson, B. K.; Oliver, A. G.; Rickard, C. E. F. *J. Organomet. Chem.* **2001**, *625*, 40–46.
271. Valderrama, M.; Contreras, R.; Arancibia, V.; Munoz, P.; Boys, D.; Lamata, M. P.; Viguri, F.; Carmona, D.; Lahoz, F. J.; Lopez, J. A.; Oro, L. A. *J. Organomet. Chem.* **1997**, *545–546*, 507–517.
272. Isakova, V. G.; Levchenko, L. M.; Mitkin, V. N. *Iridium, Proc. Int. Symp., 1st, Nashville TN, Minerals, Metals and Materials Society, Warrendale PA* **2000**, 377–393.
273. Dorta, R.; Togni, A. *Organometallics* **1998**, *17*, 5441–5444.
274. Greene, T. R.; Roper, W. R. *J. Organomet. Chem.* **1986**, *299*, 245–250.
275. Kumbhar, A. S.; Padhye, S. B.; Kelkar, A. A.; Patil, R. P.; Chaudhari, R. V.; Puranik, V. G.; Dhaneshwar, N. N.; Tavale, S. S. *Polyhedron* **1996**, *15*, 1931–1935.
276. Deeming, A. J.; Vassos, A. E. *J. Chem. Soc., Dalton Trans.* **1997**, 3519–3524.
277. Da Silva, A. C.; Piotrowski, H.; Mayer, P.; Polborn, K.; Severin, K. *J. Chem. Soc., Dalton Trans* **2000**, 2960–2963.
278. Da Silva, A. C.; Piotrowski, H.; Mayer, P.; Polborn, K.; Severin, K. *Eur. J. Inorg. Chem.* **2001**, *3*, 685–691.
279. Aleandri, L. E.; Bogdanovic, B.; Bons, P.; Duerr, C.; Gaides, A.; Hartwig, T.; Hockett, S. C.; Lagarden, M.; Wilczok, U.; Brand, R. A. *Chem Mater.* **1995**, *7*, 1153–1170.
280. Johnson, C. E.; Eisenberg, R. *J. Am. Chem. Soc.* **1985**, *107*, 3148–3160.
281. Milstein, D.; Stevens, R. C.; Bau, R.; Blum, O.; Koetzle, T. F. *J. Chem. Soc., Dalton Trans.* **1990**, 1429.
282. Milstein, D.; Calabrese, J. C.; Williams, I. D. *J. Am. Chem. Soc.* **1986**, *108*, 6387–6389.
283. Crabtree, R. H.; Lavin, M.; Bonneviot, L. *J. Am. Chem. Soc.* **1986**, *108*, 4032.
284. Lee, J. C.; Rheingold, A. L.; Muller, B.; Pergosin, P. S.; Crabtree, R. H. *J. Chem. Soc., Chem. Commun.* **1994**, 1021.
285. Lee, J. C.; Peris, E.; Rheingold, A. L.; Crabtree, R. H. *J. Am. Chem. Soc.* **1994**, *116*, 11014–11019.
286. Peris, E.; Lee, J. C.; Crabtree, R. H. *J. Chem. Soc., Chem. Commun.* **1994**, 2573.
287. Peris, E.; Lee, J. C.; Rambo, J. R.; Einstein, O.; Crabtree, R. H. *J. Am. Chem. Soc.* **1995**, *117*, 3485.
288. Patel, B. P.; Crabtree, R. A. *J. Am. Chem. Soc.* **1996**, *118*, 13105–13106.
289. Patel, B.; Lee, D. H.; Rheingold, A. L.; Crabtree, R. H. *Organometallics* **1999**, *18*, 1615.
290. Clot, E.; Eisenstein, O.; Crabtree, R. H. *New J. Chem.* **2001**, *25*, 66–72.
291. Lee, D. H.; Patel, B. P.; Clot, E.; Eisenstein, O.; Crabtree, R. H. *J. Chem. Soc., Chem. Commun.* **1999**, 297.
292. Clot, E.; Eisenstein, O.; Dube, T.; Fallor, J. W.; Crabtree, R. H. *Organometallics* **2002**, *21*, 575–580.
293. Brinkmann, S.; Morris, R. H.; Ramachandran, R.; Park, S.-H. *Inorg. Synth.* **1998**, *32*, 303–308.
294. Rytchinski, B.; Ben-David, Y.; Milstein, D. *Organometallics* **1997**, *16*, 3786–3793.
295. Paterniti, D. P.; Roman, P. J.; Atwood, J. D. *J. Chem. Soc., Chem. Commun.* **1996**, 2659–2660.
296. Blum, O.; Milstein, D. *J. Organomet. Chem.* **2000**, *593–594*, 479–484.
297. Chin, C. S.; Oh, M.; Won, G.; Cho, H.; Shin, D. *Bull. Korean Chem. Soc.* **1999**, *20*, 85–88.

298. Wink, D. A.; Ford, P. C. *J. Am. Chem. Soc.* **1986**, *108*, 838–842.
299. Godshleger, N. F.; Denisov, N. N.; Nadochenko, V. A.; Kaplunov, M. G.; Kulikov, A. V. *Russ. Chem. Bull.* **1997**, *46*, 2032–2035.
300. Li, S.; Hall, M. B. *Organometallics* **1999**, *18*, 5682–5687.
301. Li, S.; Hall, M. B.; Eckert, J.; Jenson, C. M.; Albinati, A. *J. Am. Chem. Soc.* **2000**, *122*, 2903–2910.
302. Albinati, A.; Lehner, H.; Venanzi, L. M. *Inorg. Chem.* **1985**, *24*, 1483–1488.
303. Albinati, A.; Togni, A.; Venanzi, L. M. *Organometallics* **1986**, *5*, 1785–1791.
304. McGilligan, B. S.; Venanzi, L. M.; Wolfer, M. *Organometallics* **1987**, *6*, 946–950.
305. Albinah, A.; Bakhmuter, V. I.; Caulton, K. G.; Clot, E.; Eckert, J.; Eisenstein, O.; Gusar, D.; Grushin, V. V.; Hauger, B. E.; Klooster, W. T.; Klooster, T. F.; Koetzle, T. F.; McMullan, R. K.; O'Loughlin, T. J.; Pelissier, M.; Ricci, J. S.; Sigalas, M. P.; Vymontis, A. B. *J. Am. Chem. Soc.* **1993**, *115*, 7300.
306. Xu, W.; Lough, A. L.; Morris, R. H. *Can. J. Chem.* **1997**, *75*, 475–482.
307. Chetcuti, P. A.; Knobler, C. B.; Hawthorne, M. F. *Organometallics* **1986**, *5*, 1913–1914.
308. Casalnuovo, A. L.; Calabrese, J. C.; Milstein, D. *J. Am. Chem. Soc.* **1998**, *110*, 6738–6744.
309. Alias, F. M.; Poveda, M. L.; Sellin, M.; Carmona, E. *Organometallics* **1998**, *17*, 4124–4126.
310. Huang, L.-Y.; Aulwurm, U. R.; Heinemann, F. W.; Knoch, F.; Kisch, H. *Chem. Eur. J.* **1998**, *4*, 1641–1646.
311. Yoshida, T.; Tani, K.; Yamagata, T.; Tatsuno, Y.; Saito, T. *J. Chem. Soc., Chem. Commun.* **1990**, 292–294.
312. Yamasaki, K.; Saito, H.; Tadokoro, M.; Matsumoto, K.; Miyajima, S.; Nakamura, Y. *Bull. Chem. Soc. Jpn.* **1997**, *70*, 2155–2166.
313. Schmid, B.; Garces, F. O.; Watts, R. J. *Inorg. Chem.* **1994**, *33*, 9–14.
314. Slama-Schwok, A.; Gershuni, S.; Rabani, J. *J. Phys. Chem.* **1987**, *91*, 2986–2989.
315. Slama-Schwok, A.; Rabani, J. *J. Phys. Chem.* **1987**, *91*, 2989–2993.
316. Slama-Schwok, A.; Rabani, J. *J. Phys. Chem.* **1987**, *91*, 4394–4398.
317. Slama-Schwok, A.; Rabini, J. *J. Phys. Chem.* **1989**, *93*, 785–791.
318. Slama-Schwok, A.; Avnir, D.; Ottolenghi, M. *J. Am. Chem. Soc.* **1991**, *113*, 3984–3985.
319. Calogero, G.; Giuffrida, G.; Serroni, S.; Ricevuto, V.; Campagna, S. *Inorg. Chem.* **1995**, *34*, 541–545.
320. Di Marco, G.; Lanza, M.; Pieruccini, M.; Camagna, S. *Adv. Mater.* **1996**, *8*, 576–580.
321. Di Marco, G.; Lanza, M.; Mamo, A.; Stefio, I.; Di Pietro, C.; Romeo, G.; Campagna, S. *Anal. Chem.* **1998**, *70*, 5019–5023.
322. Amao, Y.; Ishikawa, Y.; Okura, I. *Anal. Chim. Acta* **2001**, *445*, 177–182.
323. Garces, F. O.; King, K. A.; Watts, R. J. *Inorg. Chem.* **1988**, *27*, 3464–3471.
324. Ohsawa, Y.; Sprouse, S.; King, K. A.; DeArmond, M. K.; Hanck, K. W.; Watts, R. J. *J. Phys. Chem.* **1987**, *91*, 1047–1054.
325. Wilde, A. P.; King, K. A.; Watts, R. J. *J. Phys. Chem.* **1991**, *95*, 629–634.
326. Colombo, M. G.; Hauser, A.; Guedel, H. U. *Inorg. Chem.* **1993**, *32*, 3088–3092.
327. Dedeian, K.; Djurovich, P. I.; Garces, F. O.; Carlson, G.; Watts, R. J. *Inorg. Chem.* **1991**, *30*, 1685–1687.
328. Garces, F. O.; Dedeian, K.; Keder, N. L.; Watts, R. J. *Acta Cryst* **1993**, *C49*, 1117–1120.
329. Didier, P.; Ortmans, I.; Mesmaeker, A. K.-D.; Watts, R. J. *Inorg. Chem.* **1993**, *32*, 5239–5245.
330. Ortmans, I.; Didier, P.; Mesmaeker, A. K.-D. *Inorg. Chem.* **1995**, *34*, 3695–3704.
331. Neve, F.; Ghedini, M.; Tiripicchio, A.; Ugozzoli, F. *Inorg. Chem.* **1989**, *28*, 3084–3086.
332. Lavin, M.; Holt, E. N.; Crabtree, R. H. *Organometallics* **1989**, *8*, 99.
333. Colombo, M. G.; Hauser, A.; Guedel, H. U. *Top. Curr. Chem.* **1994**, *171*, 143–171.
334. Colombo, M. G.; Guedel, H. U. *Inorg. Chem.* **1993**, *32*, 3081–3087.
335. Van Diemen, J. H.; Haasnoot, J. G.; Hage, R.; Muller, E.; Reedijk, J. *Inorg. Chim. Acta* **1991**, *181*, 245–251.
336. Lamansky, S.; Kwong, R. C.; Nugent, M.; Djurovich, P. I.; Thompson, M. E. *Org. Electronics* **2001**, *2*, 53–62.
337. Adachi, C.; Kwong, R. C.; Djurovich, P.; Adamovich, V.; Baldo, M. A.; Thompson, M. E.; Forrest, S. R. *Appl. Phys. Lett.* **2001**, *79*, 2082–2084.
338. Baldo, M. A.; Lamansky, S.; Burrows, P. E.; Thompson, M. E.; Forrest, S. R. *Appl. Phys. Lett.* **1999**, *75*, 4.
339. Adachi, C.; Baldo, M. A.; Thompson, M. E.; Forrest, S. R. *J. Appl. Phys.* **2001**, *90*, 5048–5051.
340. Grushin, V. V.; Herron, M.; LeCloux, D. D.; Marshall, W. J.; Petrov, V. A.; Wang, Y. *J. Chem. Soc., Chem. Commun.* **2001**, 1494.
341. Bruce, D.; Richter, M. M. *Anal. Chem.* **2002**, *74*, 1340–1342.
342. Lo, K. K. W.; Ng, D. C.-M.; Chung, C.-K. *Organometallics* **2001**, *20*, 4999–5001.
343. Polborn, K.; Severin, K. *Eur. J. Inorg. Chem.* **1998**, 1187–1192.
344. Clark, G. R.; Greene, T. R.; Roper, W. R. *J. Organomet. Chem.* **1985**, *293*, C25–C28.
345. Bennett, M. A.; Latten, J. L. *Inorg. Synth.* **1989**, *26*, 200–203.
346. Zlota, A. A.; Frolow, F.; Milstein, D. *Organometallics* **1990**, *9*, 1300–1302.
347. Lippmann, E.; Milke, J.; Suenkel, K.; Beck, W. *J. Organomet. Chem.* **1994**, *479*, 221–225.
348. Djurovich, P. I.; Cook, W.; Joshi, R.; Watts, R. J. *J. Phys. Chem.* **1994**, *98*, 398–400.
349. Djurovich, P. I.; Safir, A. L.; Keder, N. L.; Watts, R. J. *Inorg. Chem.* **1992**, *31*, 3195–3196.
350. Auburn, M. J.; Stobart, S. R. *Inorg. Chem.* **1995**, *24*, 318–323.
351. Auburn, M. J.; Holes-Smith, R. D.; Stobart, S. R.; Bakshi, P. K.; Cameron, T. S. *Organometallics* **1996**, *15*, 3032–3036.
352. Okazaki, M.; Tobita H.; Kawano, Y.; Inomata, S.; Ogino, H. *J. Organomet. Chem.* **1998**, *553*, 1–13.
353. Okazaki, M.; Tobita H.; Ogino, H. *Chem. Lett.* **1998**, 69–70.
354. Okazaki, M.; Kawano, Y.; Tobita, H.; Inomata, S.; Ogino, H. *Chem. Lett.* **1995**, *11*, 1005–1006.
355. Murakami, M.; Yoshida, T.; Ito, Y. *Chem. Lett.* **1996**, 13–14.
356. Park, S.; Johnson, M. P.; Roundhill, D. M. *Organometallics* **1989**, *8*, 1700–1707.
357. Uekusa, H.; Ohha, S.; Simonsen, K. P.; Kojima, M.; Fujita, J. *Acta Cryst.* **1992**, *C48*, 1111–1112.
358. Suzuki, T.; Rude, M.; Simonsen, K. P.; Morooka, M.; Tanaka, H.; Ohbe, S.; Galsbol, F.; Fujita, J. *Bull. Chem. Soc. Jpn.* **1994**, *67*, 1013–1023.
359. Perera, S. D.; Shaw, B. L. *J. Chem. Soc., Chem. Commun.* **1994**, 1203–1204.
360. Zambrano, C. H.; Sharp, P. R.; Barnes, C. L. *Polyhedron* **1996**, *15*, 3653–3657.

361. Kramer, R.; Maurus, M.; Bergs, R.; Polborn, K.; Sunkel, K.; Wagner, B.; Beck, W. *Chem. Ber.* **1993**, *126*, 1969–1980.
362. Bergs, R.; Lampeka, R.; Robl, C.; Beck, W. *Z. Naturforsch.* **1994**, *49*, 483–488.
363. Bergs, R.; Suenkel, K.; Robl, C.; Beck, W. *J. Organomet. Chem.* **1997**, *533*, 247–255.
364. Charalambous, J.; Henrick, K.; Musa, Y.; Rees, R. G.; Whiteley, R. N. *Polyhedron* **1987**, *6*, 1509–1512.
365. Upadhyay, R. K.; Rani, A.; Kumar, A. *Natl. Acad. Sci. Lett. (India)* **1986**, *9*, 9–12.
366. Chandra, S.; Singh, R. *Indian J. Chem.* **1988**, *27A*, 417–420.
367. Kumar, Y.; Tolani, S. P. *Croat. Chem. Acta* **1989**, *62*, 73–79.
368. Carmona, D.; Mendoza, A.; Lahoz, F. J.; Oro, L. A.; Lamata, M. P.; José, E. S. *J. Organomet. Chem.* **1990**, *396*, C17–C21.
369. Carmona, D.; Lahoz, F. J.; Atencio, R.; Oro, L. A.; Lamata, M. P.; José, E. S. *Tetrahedron Asym.* **1993**, *4*, 1425–1428.
370. Carmona, D.; Vega, C.; Lahoz, F. J.; Atencio, R.; Oro, L. A. *Organometallics* **2000**, *19*, 2273–2280.
371. Grotjahn, D. B.; Lo, H. C.; Groy, T. L. *Acta Cryst.* **1996**, *C52*, 300–302.
372. Grotjahn, D. B.; Lo, H. C.; Groy, T. L. *Acta Cryst.* **1996**, *C52*, 516–519.
373. Bhattacharjee, P.; Prasad, M.; Kumari, P. *Orient. J. Chem.* **1998**, *14*, 259–265.
374. Heilmann, O.; Hornung, F. M.; Fiedler, J.; Kaim, W. *J. Organomet. Chem.* **1999**, *589*, 2–10.
375. Albercht, M.; Kaim, W. *Z. Anorg. Allg. Chem.* **2000**, *626*, 1341–1348.
376. Iwasa, T.; Shimada, H.; Takami, A.; Matsuzaka, H.; Ishii, Y.; Hidai, M. *Inorg. Chem.* **1999**, *38*, 2851–2859.
377. Habereeder, T.; Warchhold, M.; Noth, H.; Severin, K. *Angew. Chem., Int. Ed.* **1999**, *38*, 3225–3228.
378. Aleksandrov, G. G.; Sergienko, V. S.; Asaks, J. V.; Leeis, J. E.; Pec, L. J.; Bankovskii, Y. A.; Ivanova, N. A.; Efimenko, I. A. *Zh. Neorg. Khim.* **1997**, *42*, 1820–1826.
379. Kuz'mina, L. G.; Kukina, G. A.; Lees, Y. A.; Grap, S. R.; Bankovskii, Y. A.; Efimenko, I. A.; Kurnakov, N. S. *Zh. Neorg. Khim.* **1996**, *41*, 215–223.
380. Ulakhovich, N. A.; Budnikov, G. K.; Gimatova, E. S.; Sturis, A. *Zh. Obshch. Khim.* **1987**, *57*, 1001–1006.
381. Fandos, R.; Martiez-Ripoll, M.; Otero, A.; Ruiz, M. J.; Rodriguez, A.; Terreros, P. *Organometallics* **1998**, *17*, 1465–1470.
382. Mukkanti, K.; Singh, R. P. *Indian Acad. Sci., Chem. Sci.* **1998**, *100*, 21–26.
383. Bukanova, A. E.; Sidorova, T. P.; Razgonyaeva, G. A.; Chuvaev, A. V.; Shubochkin, L. K. *Ah. Neorg. Khim.* **1990**, *35*, 2003–2006.
384. Sharma, S.; Chowdhary, V.; Parihar, M.; Goyal, R.; Gaur, S.; Santwana, M. R. K. *Indian J. Chem.* **1989**, *28A*, 809–811.
385. Usha, C. S. *Synth. React. Inorg. Met.-Org. Chem.* **1992**, *22*, 1565–1579.
386. Mishra, L.; Upadhyay, K. K. *Indian J. Chem.* **1993**, *32A*, 538–541.
387. Konno, T.; Okamoto, K.; Hidaka, J. *Inorg. Chem.* **1992**, *31*, 3875–3876.
388. Konno, T.; Miyashita, Y.; Okamoto, K. *Chem. Lett.* **1997**, *1*, 85–86.
389. Miyashita, Y.; Hamajima, M.; Yamada, Y.; Fujisawa, K. *J. Chem. Soc., Dalton Trans.* **2001**, 2089–2094.
390. Knight, D. A.; Cole-Hamilton, D. J.; Cupertino, D. C.; Harman, M.; Hursthouse, M. B. *Polyhedron* **1992**, *11*, 1987–1993.
391. Werner, H.; Schultz, M.; Windmueller, B. *Organometallics* **1995**, *14*, 3659–3668.
392. Lindner, E.; Gierling, K.; Keppeler, B.; Mayer, H. A. *Organometallics* **1997**, *16*, 3531–3535.
393. Lindner, E.; Gierling, K.; Fawzi, R.; Steimann, M. *Inorg. Chim. Acta* **1998**, *269*, 13–22.
394. Yamamoto, Y.; Kawasaki, K.; Nishimura, S. *J. Organomet. Chem.* **1999**, *587*, 49–57.
395. Yamamoto, Y.; Han, X.-H.; Sugawara, K.; Nishimura, S. *Angew. Chem., Int. Ed.* **1999**, *38*, 1242–1244.
396. Yamamoto, Y.; Han, X.-H.; Nishimura, S.; Sugawara, K.; Nezu, N.; Tanase, T. *Organometallics* **2001**, *20*, 266–272.
397. Zotto, A. D.; Mezzetti, A.; Dolcetti, G.; Rigo, P.; Pahor, N. B. *J. Chem. Soc., Dalton Trans.* **1989**, 607–613.
398. Dahlenburg, L.; Kuhlein, M. *Acta Cryst.* **1997**, *C53*, 1190–1192.
399. Lahuerta, P.; Latorre, J.; Solana, I. *J. Organomet. Chem.* **1987**, *322*, 377–383.
400. Song, B. L.; Cao, Y.; Niu, D. Z.; Lu, Z. S.; Zeng, C. *Chinese Chem. Lett.* **1990**, *1*, 263–264.
401. Kanth, K. M.; Thakur, A. K.; Mallik, R. K. *J. Indian Chem. Soc.* **1993**, *70*, 157–158.
402. Niu, S.; Hall, M. B. *J. Am. Chem. Soc.* **1999**, *121*, 3992–3999.
403. Perera, S. D.; Shaw, B. L.; Thronton-Pett, M. *Inorg. Chim. Acta* **1995**, *233*, 103–107.
404. Bianchini, C.; Farnetti, E.; Glendenning, L.; Graziani, M.; Nardin, G.; Peruzzini, M.; Rocchini, E.; Zanobini, F. *Organometallics* **1995**, *14*, 1489–1502.
405. Mamo, A.; Stefio, I.; Parisi, M. F.; Credi, A.; Venturi, M.; Pietro, C. D.; Campagna, S. *Inorg. Chem.* **1997**, *36*, 5947–5950.
406. Palaniappan, R. *Bull. Electrochem.* **1991**, *7*, 367–371.
407. Stradiotto, M.; Furdala, K. L.; Tilley, T. D. *J. Chem. Soc., Chem. Commun.* **2001**, 1200–1201.
408. Sharma, V. K.; Pandey, O. P.; Sengupta, S. K.; Halepto, D. M. *Transition Met. Chem.* **1989**, *14*, 263–266.
409. Fryzuk, M. D.; MacNeil, P. A.; Rettig, S. J. *Organometallics* **1985**, *4*, 1145–1147.
410. Fryzuk, M. D.; MacNeil, P. A.; Rettig, S. J. *Organometallics* **1986**, *5*, 2469.
411. Fryzuk, M. D.; MacNeil, P. A.; Rettig, S. J.; Stephan, M. *Acta Cryst.* **1996**, *C52*, 1115–1117.
412. Fryzuk, M. D.; MacNeil, P. A.; Massey, R. L.; Ball, R. G. *J. Organomet. Chem.* **1989**, *368*, 231–247.
413. Fryzuk, M. D.; MacNeil, P. A.; Ball, R. G. *J. Am. Chem. Soc.* **1986**, *108*, 6414.
414. Fryzuk, M. D.; Gao, X.; Joshi, K.; MacNeil, P. A.; Massey, R. L. *J. Am. Chem. Soc.* **1993**, *115*, 10581–10590.
415. Fryzuk, M. D.; Bhangu, K. *J. Am. Chem. Soc.* **1988**, *110*, 961.
416. Fryzuk, M. D.; Joshi, K.; Chadha, R. K. *J. Am. Chem. Soc.* **1989**, *111*, 4498–4500.
417. Perera, S. D.; Shaw, B. L. *J. Chem. Soc., Chem. Commun.* **1995**, 865–866.
418. Bianchini, C.; Masi, D.; Meli, A.; Peruzzini, M.; Sabat, M.; Zanobini, F. *Organometallics* **1986**, *5*, 2557–2559.
419. Krawielitzki, S.; Beck, W. *Chem. Ber./Recl.* **1997**, *130*, 1659–1662.
420. Craciunescu, D. G.; Molina, C.; Parrondo, I. E.; Alonso, M. P.; Doadrio-Villarejo, J. C.; Gutierrez-Rios, M. T.; Gaston de Iriarte, E.; Ghirvu, C. I. *An. R. Acad. Farm.* **1990**, *56*, 453–467.
421. Craciunescu, D. G.; Molina, C.; Doadrio-Villarejo, J. C.; Gutierrez-Rios, M. T.; Alonso, M. P.; Parrondo, I. E.; De Frutos, M. I.; Lopez, A. D. *An. R. Acad. Farm.* **1991**, *57*, 391–418.

422. Marcon, G.; Casini, A.; Mura, P.; Messori, L.; Bergamo, A.; Orioli, P. *Metal Based Drugs* **2000**, *7*, 195–200.
423. Herebian, D.; Sheldrick, W. S. *J. Chem. Soc., Dalton Trans.* **2002**, 966–974.
424. Annen, P.; Schildberg, S.; Sheldrick, W. S. *Inorg. Chim. Acta* **2000**, *307*, 115–124.
425. Bukanova, A. E.; Sidorova, T. P.; Chuvaev, A. V.; Razonyaeva, G. A.; Shubochkin, L. K. *Zh. Neorg. Khim.* **1989**, *34*, 456–461.
426. Sharma, V. K.; Pandey, O. P.; Sengupta, S. K. *J. Inorg. Biochem.* **1988**, *34*, 253–263.
427. Bauer, H.; Sheldrick, G. M.; Nagel, U.; Beck, W. *Z. Naturforsch.* **1985**, *40B*, 1237–1242.
428. Pill, T.; Polborn, K.; Beck, W. *Chem. Ber.* **1990**, *123*, 11–17.
429. Kraemer, R.; Polborn, K.; Wanjek, H.; Zahn, I.; Beck, W. *Chem. Ber.* **1990**, *123*, 767–778.
430. Zahn, I.; Polborn, K.; Wagner, B.; Beck, W. *Chem. Ber.* **1991**, *124*, 1065–1073.
431. Pill, T.; Beck, W. *Z. Naturforsch.* **1993**, *48B*, 1461–1469.
432. Lampeka, R.; Bergs, R.; Kraemer, R.; Polborn, K.; Beck, W. *Z. Naturforsch.* **1994**, *49B*, 225–232.
433. Zhou, Y.; Wagner, B.; Polborn, K.; Sunkel, K.; Beck, W. *Z. Naturforsch.* **1994**, *49B*, 1193–1202.
434. Lampeka, R.; Bergs, R.; Fernandez de Bobadilla, R.; Polborn, K.; Mihan, S.; Beck, W. *J. Organomet. Chem.* **1995**, *491*, 203–214.
435. Bergs, R.; Kraemer, R.; Maurus, M.; Schreiner, B.; Urban, C. M.; Polborn, K.; Sunkel, K.; Beck, W. *Z. Naturforsch.* **1996**, *51B*, 187–200.
436. Lampeka, R.; Mihan, S.; Beck, W. *Z. Naturforsch.* **1996**, *51B*, 581–587.
437. Severin, K.; Beck, W. *Z. Naturforsch.* **1995**, *50B*, 275–279.
438. Urban, R.; Kraemer, R.; Mihan, S.; Polborn, K.; Wagner, B.; Beck, W. *J. Organomet. Chem.* **1996**, *517*, 191–200.
439. Prem, M.; Polborn, K.; Beck, W. *Z. Naturforsch.* **1998**, *53B*, 1501–1505.
440. Krawielitzki, S.; Beck, W. *Z. Naturforsch.* **2001**, *56*, 69–72.
441. Krawielitzki, S.; Beck, W. *Z. Anorg. Allg. Chem.* **1998**, *624*, 1718–1722.
442. Severin, K.; Bergs, R.; Maurus, M.; Mihan, S.; Beck, W. *Z. Naturforsch.* **1995**, *50B*, 265–274.
443. Ziesel, R. *Catal. Met. Complexes* **1993**, *14*, 217–245.
444. Lohrenz, J. C. W.; Jacobsen, H. *Angew. Chem., Int. Ed.* **1996**, *35*, 1305–1307.
445. Sutin, N.; Creutz, C.; Fujita, E. *Comments Inorg. Chem.* **1997**, *19*, 67–92.
446. Rajanna, K. C.; Devi, Y. U.; Saipraash, P. K. *Oxid. Commun.* **1986**, *9*, 183–197.
447. Chin, C. S.; Shin, J. H.; Kim, J. B. *J. Organomet. Chem.* **1988**, *356*, 381–388.
448. Ziesel, R. *Angew. Chem.* **1991**, *103*, 863–866.
449. Ziesel, R. *Angew. Chem. Int. Ed.* **1991**, *30*, 844–847.
450. Ziesel, R. *J. Am. Chem. Soc.* **1993**, *115*, 118–127.
451. Quijije, L. A.; Mediavilla, M.; Pardey, A. J.; De Pardey, C. L.; Baricelli, P.; Moya, S. A. *React. Kinet. Catal. Lett.* **1997**, *62*, 251–256.
452. Tandon, P. K.; Singh, M. P. *Oxid. Commun.* **1999**, *22*, 424–431.
453. Singh, A. K.; Rahmani, S.; Vineeta, S.; Gupta, V.; Singh, B. *Oxid. Commun.* **2000**, *23*, 55–61.
454. Webster, C. E.; Hall, M. B. *Organometallics* **2001**, *20*, 5606–5613.
455. Ng, C. C.; Osborn, J. A. *J. Am. Chem. Soc.* **1990**, *112*, 9400–9401.
456. Danopoulos, A. A.; Wilkinson, G.; Hussain-Bates, B.; Hursthouse, M. B. *J. Chem. Soc., Dalton Trans.* **1992**, 3165–3170.
457. Balch, A. L.; Waggoner, K. M.; Olmstead, M. M. *Inorg. Chem.* **1988**, *27*, 4511–4513.
458. Cotton, F. A.; Poli, R. *Polyhedron* **1987**, *6*, 1625–1628.
459. Cotton, F. A.; Poli, R. *Organometallics* **1987**, *6*, 1743–1751.
460. Dunber, K. R.; Majors, S. O.; Sun, J.-S. *Inorg. Chim. Acta* **1995**, *229*, 373–382.
461. Fernández, M. J.; Modrego, J.; Lahoz, F. J.; López, J. A.; Oro, L. A. *J. Chem. Soc., Dalton Trans.* **1990**, 2587–2591.
462. Jiménez, M. V.; Sola, E.; López, J. A.; Lahoz, F. J.; Oro, L. A. *Chem. Eur. J.* **1998**, *4*, 1398–1410.
463. Ciriano, M. A.; Pérez-Torrente, J. J.; Oro, L. A. *J. Organomet. Chem.* **1993**, *445*, 273–281.
464. Matsuzaka, H.; Ariga, K.; Kase, H.; Kamura, T.; Kondo, M.; Kitagawa, S.; Yamasaki, M. *Organometallics* **1997**, *16*, 4514–4516.
465. Fjeldsted, D. O. K.; Stobart, S. R. *J. Chem. Soc., Chem. Commun.* **1985**, 908–909.
466. Bushnell, G. W.; Fjeldsted, D. O. K.; Stobart, S. R.; Zaworotke, M. J. *Organometallics* **1985**, *4*, 1110–1114.
467. Ciriano, M. A.; Dias, A. R.; Nunes, P. M.; Oro, L. A. *Struct. Chem.* **1996**, *7*, 337–354.
468. Harrison, D. G.; Stobart, S. R. *J. Chem. Soc., Chem. Commun.* **1986**, 285–286.
469. Tejel, C.; Ciriano, M. A.; Lopez, J. A.; Lahoz, F. J.; Oro, L. A. *Organometallics* **1997**, *16*, 4718–4727.
470. Pinillos, M. T.; Elduque, A.; Oro, L. A.; Lahoz, F. J.; Bonati, F.; Tripicchio, A.; Tiripicchio-Camellini, M. *J. Chem. Soc., Dalton Trans.* **1990**, 989–994.
471. Pinillos, M. T.; Elduque, A.; Lopez, J. A.; Lahoz, F. J.; Oro, L. A. *J. Chem. Soc., Dalton Trans.* **1991**, 1391–1395.
472. Zhai, H.; Bunn, A.; Wayland, B. *J. Chem. Soc., Chem. Commun.* **2001**, 1294–1295.
473. Del Rossi, K. J.; Wayland, B. B. *J. Chem. Soc., Chem. Commun.* **1986**, 1653–1655.
474. Chan, K. S.; Leung, Y.-B. *Inorg. Chem.* **1994**, *33*, 3187.
475. Del Rossi, K. J.; Wayland, B. B. *J. Organomet. Chem.* **1995**, *504*, 47–56.
476. Hückstädt, H.; Homborg, H. *Z. Naturforsch.* **1997**, *52*, 728–734.
477. Hückstädt, H.; Homborg, H. *J. Porphyrins Phthalocyanines* **1999**, *3*, 169–171.
478. Zecchin, S.; Zotti, G. *J. Organomet. Chem.* **1985**, *294*, 379–388.
479. Kubota, M.; Chan, M.; Boyd D. C.; Mann, K. R. *Inorg. Chem.* **1987**, *26*, 3261–3264.
480. Rasmussen, P. G.; Anderson, J. E.; Bailey, O. H.; Tamres, M. *J. Am. Chem. Soc.* **1985**, *107*, 279–281.
481. Jenkins, H. A.; Loeb, S. J.; M^cManus, N. T. *Inorg. Chim. Acta* **1989**, *159*, 83–86.
482. Sutherland, B. R.; Cowie, M. *Organometallics* **1985**, *4*, 1801–1810.
483. Kanemitsu, N.; Ebihara, M.; Kawamura, T. *J. Chem. Soc., Dalton Trans.* **1999**, 4413–4417.
484. Nishio, M.; Matsuzaka, H.; Mizobe, Y.; Hidai, M. *Inorg. Chim. Acta* **1997**, *263*, 119–123.
485. Linck, R. C.; Pafford, R. J.; Rauchfuss, T. B. *J. Am. Chem. Soc.* **2001**, *123*, 8856–8857.
486. Miskowski, V. M.; Smith, T. P.; Loehr, T. M.; Gray, H. B. *J. Am. Chem. Soc.* **1985**, *107*, 7925–7934.
487. Cotton, F. A.; Lahuerta, P.; Sanau, M.; Schwotser, W. *J. Am. Chem. Soc.* **1985**, *107*, 8284–8285.

488. Bond, A. M.; Humphrey, D. G.; Menglet, D.; Lazerev, G. G.; Dickson, R. S.; Vu, T. *Inorg. Chim. Acta* **2000**, 300–302, 563–571.
489. Hou, Z.; Fujita, A.; Koizumi, T.; Yamazaki, H.; Wakatsuki, Y. *Organometallics* **1999**, 18, 1979.
490. Hou, Z.; Koizumi, T.; Fujita, A.; Yamazaki, H.; Wakatsuki, Y. *J. Am. Chem. Soc.* **2001**, 123, 5812–5813.
491. Vaartstra, B. A.; O'Briem, K. N.; Eisenberg, R.; Cowie, M. *Inorg. Chem.* **1988**, 27, 3668–3672.
492. He, X.; Maisonnat, A.; Dahan, F.; Poilblanc, R. *J. Chem. Soc., Dalton Trans.* **1990**, 670–671.
493. Ciriano, M. A.; Viguri, F.; Oro, Z. *Angew. Chem.* **1987**, 99, 452–453.
494. Craciunescu, D. G.; Molina, C.; Parrondo-Iglesias, E.; Alonso, M. P.; Lorenzo, M. C.; Doradrio-Villarejo, J. C.; Gutierrez-Rios, M. T.; De Frutos, M. I.; Gaston de Iriarte, E. *An. R. Acad. Farm.* **1991**, 57, 15–35.
495. Craciunescu, D. G.; Parrondo-Iglesias, E.; Molina, C.; Doadrio, L. A.; Gaston de Iriarte, E.; Ghirvu, C. *An. R. Acad. Farm.* **1988**, 54, 46–69.
496. Padhye, S.; Yerande, R.; Patil, R. P.; Kelkar, A. A.; Chaudhari, R. V. *Inorg. Chim. Acta* **1989**, 156, 23–25.
497. Wu, J.; Fanwick, P. E.; Kubiak, C. P. *Organometallics* **1987**, 6, 1805–1807.
498. Wu, J.; Reinking, M. K.; Fanwick, P. E.; Kubiak, C. P. *Inorg. Chem.* **1987**, 26, 247–252.
499. Smith, D. C.; Miskowski, V. M.; Mason, W. R.; Gray, H. B. *J. Am. Chem. Soc.* **1990**, 112, 3759–3767.
500. Cooper, A. C.; Bollinger, J. C.; Huffman, J. C.; Caulton, K. G. *New J. Chem.* **1998**, 473–480.
501. Rosini, G. P.; Goldman, A. S.; Li, C.; Nolan, S. *Book of Abstracts, 213th ACS National Meeting*, San Francisco, USA, April 13–17, 1997; American Chemical Society, Washington, DC..
502. Grotjahn, D. B. *Organometallics* **1995**, 14, 5463–5464.
503. Lo, H. C.; Grotjahn, D. B. *J. Am. Chem. Soc.* **1997**, 119, 2958–2959.
504. Blum, O.; Frolow, F.; Milstein, D. *J. Chem. Soc., Chem. Commun.* **1991**, 258–259.
505. Su, M.; Chu, S. *J. Am. Chem. Soc.* **1999**, 121, 1045–1058.
506. Rees, W. M.; Churchill, M. R.; Fettingner, J. C.; Atwood, J. D. *J. Organomet. Chem.* **1987**, 319, 311–422.
507. Aizenberg, M.; Milstein, D. *Organometallics* **1996**, 15, 3317–3322.
508. Crabtree, R. H.; Morehouse, S. M. *Inorg. Synth.* **1986**, 24, 173–176.
509. Cotton, F. A.; Poli, R. *Inorg. Chim. Acta* **1986**, 122, 243–248.
510. Cotton, F. A.; Poli, R. *Inorg. Chem.* **1987**, 26, 590–595.
511. Kanematsu, N.; Ebihara, M.; Kawamura, T. *Inorg. Chim. Acta* **1999**, 282, 244–248.
512. Oro, L. A.; Ciriano, M. A.; Villarroja, B. E. *J. Chem. Soc., Dalton Trans.* **1985**, 1891–1898.
513. Ciriano, M. A.; Pérez-Torrente, J. J.; Oro, L. A. *Organomet. Chem.* **1993**, 445, 267–271.
514. Yang, K. J.; Kim, I. B.; Chin, C. S. *Transition Met. Chem.* **1987**, 12, 45–49.
515. Park, S. H.; Park, H. K.; Chin, C. S. *Transition Met. Chem.* **1985**, 24, 1120–1122.
516. Jones, C. M.; Doherty, N. M. *Polyhedron* **1995**, 14, 81–91.
517. Rahim, M.; Ahmed, K. J. *Organometallics* **1994**, 13, 1751–1756.
518. Rahim, M.; White, C.; Rheingold, A. L.; Ahmed, K. J. *Organometallics* **1993**, 12, 2401–2403.
519. Chen, S.; Noll, B. C.; Peslherbe, N. L.; DuBois, M. R. *Organometallics* **1997**, 16, 1089–1092.
520. Rahim, M.; Bushweller, H.; Ahmed, K. J. *Organometallics* **1994**, 13, 4952–4958.
521. Kolel-Veetil, M. K.; Rahim, M.; Edwards, A. J.; Rheingold, A. L.; Ahmed, K. J. *Inorg. Chem.* **1992**, 31, 3877.
522. Kolel-Veetil, M. K.; Ahmed, K. J. *Inorg. Chem.* **1994**, 33, 4945–4949.
523. Bikrani, M.; Fidalgo, L.; Garralda, M. A. *Polyhedron* **1996**, 15, 83.
524. Bikrani, M.; Fidalgo, L.; Garralda, M. A.; Ubide, C. *J. Mol. Cat. A.* **1997**, 118, 47–53.
525. Nussbaum, S.; Rettig, S. J.; Storr, A.; Trotter, J. *Can. J. Chem.* **1985**, 63, 692–702.
526. Farid, R. S.; Henling, L. M.; Gray, H. B. *Acta Cryst. C* **1993**, 49, 1363–1365.
527. Boyd, D. C.; Rodman, G. S.; Mann, K. R. *J. Am. Chem. Soc.* **1986**, 108, 1779.
528. Rodman, G. S.; Bard, A. J. *Inorg. Chem.* **1990**, 29, 4699–4702.
529. Marshall, J. L.; Hopkins, M. D.; Miskowski, V. M.; Gray, H. B. *Inorg. Chem.* **1992**, 31, 5034–5040.
530. Oro, L. A.; Sola, E.; López, J. A.; Torres, F.; Elduque, A.; Lahoz, F. J. *Inorg. Chem. Comm.* **1998**, 64–67.
531. Oro, L. A.; Carmona, D.; Garcia, M. P.; Lahoz, F. J. *J. Organomet. Chem.* **1985**, 296, C43–C46.
532. Bandini, A. L.; Banditelli, G.; Bonati, F.; Minghetti, G.; Demartin, F.; Manassero, M. *Inorg. Chem.* **1987**, 26, 1351–1357.
533. Carmona, D.; Ferrer, J.; Atencio, R.; Lahoz, F. J.; Oro, L. A.; Lamata, M. P. *Organometallics* **1995**, 14, 2057–2065.
534. Fox, L. S.; Marshall, J. L.; Gray, H. B. *J. Am. Chem. Soc.* **1987**, 109, 6901–6902.
535. Wiedenfeld, D.; Bachrach, M.; McCleskey, T. M.; Hill, M. G.; Gray, H. B.; Winkler, J. R. *J. Phys. Chem. B* **1997**, 101, 8823–8826.
536. Oro, L. A.; Pinillos, M. T.; Tejel, C. *J. Chem. Soc., Dalton Trans.* **1986**, 1087–1094.
537. Oro, L. A.; Carmona, D.; Lamata, M. P. *J. Chem. Soc., Dalton Trans.* **1986**, 15–21.
538. Tamres, M.; Bailey, O. H.; Anderson, J. E.; Rasmussen, P. G. *Spectrochim. Acta, Part A* **1986**, 42A, 741–746.
539. Rasmussen, P. G. *Understanding Molecular Properties: Symposium*. General Review; Reidel, Dordrecht, Netherlands: **1987**; pp 187–194.
540. Ziessel, R.; Noblat-Chardon, S.; Deronzier, A.; Matt, D.; Toupet, L.; Balgroune, F.; Grandjean, D. *Acta Cryst.* **1993**, B49, 515–519.
541. Morton, S.; Nixon, J. F. *J. Organomet. Chem.* **1985**, 282, 123–126.
542. Clauti, G.; Zassinovich, G.; Mestroni, G. *Inorg. Chim. Acta* **1986**, 112, 103–106.
543. Oro, L. A.; Ciriano, M. A.; Viguri, F.; Foces-Foces, C.; Cano, F. H. *Inorg. Chim. Acta* **1986**, 115, 65–73.
544. Pertici, P.; D'Arata, F.; Rosini, C. *J. Organomet. Chem.* **1996**, 515, 163–171.
545. Bikrani, M.; Garralda, M. A.; Ibarlucea, L.; Pinilla, E.; Torres, M. R. *Inorg. Chim. Acta* **1998**, 282, 230–236.
546. Shivakumar, M.; Gangopadhyay, J.; Chakravorty, A. *Polyhedron* **2001**, 20, 2089–2093.
547. Nüchel, S.; Bruger, B. *Organometallics* **2001**, 20, 4345–4359.
548. Alcón, M. J.; Iglesias, M.; Sánchez, F.; Viani, I. *J. Organomet. Chem.* **2000**, 601, 284–292.
549. Alcón, M. J.; Iglesias, M.; Sánchez, F.; Viani, I. *J. Organomet. Chem.* **2001**, 634, 25–33.
550. Vedernikov, A. N.; Shamov, G. A.; Solomonov, B. N. *Russ. J. Gen. Chem.* **1999**, 69, 1102–1114.
551. Lisowski, J.; Sessler, J. L.; Lynch, V. *Inorg. Chem.* **1999**, 34, 3567–3572.
552. Connelly, N. G.; Hayward, O. D.; Klanginsirikul, P.; Orpen, A. G.; Rieger, P. H. *Chem. Commun.* **2000**, 963–964.

553. Churchill, M. R.; Fettinger, J. C.; Rappoli, B. J.; Atwood, J. A. *Acta Cryst.* **1987**, *C43*, 1697–1699.
554. Kuwabara, E.; Bau, R. *Acta Cryst.* **1994**, *C50*, 1409–1411.
555. Abbassioun, M. S.; Hitchcock, P. B.; Chaloner, P. A. *Acta Cryst.* **1989**, *C45*, 331–333.
556. Ebsworth, E. A. V.; Mayo, R. A. *J. Chem. Soc., Dalton Trans.* **1988**, 477–484.
557. DiMeglio, C. M.; Luck, L. A.; Rithner, C. D.; Rheinglod, A. L.; Elcesser, W. L.; Hubbard, J. L.; Bushweller, C. H. *J. Phys. Chem.* **1990**, *94*, 6255–6263.
558. Bandini, A. L.; Banditelli, G. *J. Organomet. Chem.* **1991**, *410*, 241–245.
559. Thompson, J. S.; Atwood, J. D. *J. Am. Chem. Soc.* **1991**, *113*, 7429–7430.
560. Rominger, R. L.; McFarland, J. M.; Jeffery, M. J.; Jeitler, J. R.; Thompson, J. S.; Atwood, J. D. *J. Coord. Chem.* **1994**, *31*, 7–18.
561. Li, R. T.; Nguyen, S. T.; Grubbs, R. H.; Ziller, J. W. *J. Am. Chem. Soc.* **1994**, *116*, 10032–10040.
562. Joo, F.; Kovacs, J.; Katho, A.; Benyei, A. C.; Decuir, T.; Darensbourg, D. J. *Inorg. Synth.* **1998**, *32*, 1–8.
563. Roman, P. J.; Paterniti, D. P.; See, R. F.; Churchill, M. R.; Atwood, J. D. *Organometallics* **1997**, *16*, 1484–1490.
564. Paterniti, D. P.; Roman, P. J.; Atwood, J. D. *Organometallics* **1997**, *16*, 3371–3376.
565. Paterniti, D. P.; Francisco, L. W.; Atwood, J. D. *Organometallics* **1999**, *18*, 123–127.
566. Franció, G.; Scopelliti, R.; Arena, C. G.; Bruno, G.; Drommi, D.; Faraone, F. *Organometallics* **1998**, *17*, 338–347.
567. Bowden, A. A.; Atwood, J. D. *Coord. Chem.* **1998**, *46*, 203–209.
568. Mayer, H. A.; Kaska, W. C. *Chem. Ber.* **1995**, *128*, 95–98.
569. Dahlenburg, L.; Yardimcioglu, A. *J. Organomet. Chem.* **1985**, *291*, 371–386.
570. Clark, G. R.; Skelton, B. W.; Waters, T. N. *Acta Cryst.* **1987**, *C43*, 1708–1709.
571. Clark, G. R.; Skelton, B. W.; Waters, T. N. *J. Organomet. Chem.* **1975**, *85*, 375–394.
572. Chaloner, P. A.; Hitchcock, P. B.; Reisinger, M. *Acta Cryst.* **1992**, *C48*, 735–737.
573. Brunet, J.; Diallo, O.; Neibecker, D.; Roque, K. *Chemie* **1999**, 215–219.
574. Serban, I.; Serban, V. *Ser. Chim.* **1984**, *46–47*, 191–194.
575. Moreton, S. *Inorg. Chim. Acta* **1992**, *202*, 225–230.
576. Meintjies, E.; Singleton, E.; Schmutzler, R.; Sell, M. S. *Afr. J. Chem.* **1985**, *38*, 115–120.
577. Herberhold, M.; Bauer, K.; Milius, W. *J. Organomet. Chem.* **1995**, *502*, C1–C4.
578. Dunbar, K. R.; Haefner, S. C.; Uzelmeier, C. E.; Howard, A. *Inorg. Chim. Acta* **1995**, *240*, 527–534.
579. Sava, X.; Mézailles, N.; Ricard, L.; Methy, F.; Le Floch, P. *Organometallics* **1999**, *18*, 807–810.
580. Sjoval, S.; Johansson, M.; Anderson, C. *Organometallics* **1999**, *18*, 2198–2205.
581. Orpen, A. G.; Pringle, P. G.; Smith, M. B.; Worboys, K. *J. Organomet. Chem.* **1998**, *550*, 255–266.
582. Bedford, R. B.; Chaloner, P. A.; Hitchcock, P. B. *Acta Cryst.* **1993**, *C49*, 1461–1463.
583. Bedford, R. B.; Chaloner, P. A.; Hitchcock, P. B. *Acta Cryst.* **1994**, *C50*, 354–356.
584. Blagg, A.; Pringle, P. G.; Shaw, B. L. *J. Chem. Soc., Dalton Trans.* **1987**, 1495–1499.
585. Balch, A. L.; Catalano, V. J. *Inorg. Chem.* **1991**, *30*, 1302–1308.
586. Striplin, D. R.; Brozik, J. A.; Crosby, G. A. *Chem. Phys. Lett.* **1994**, *231*, 159–163.
587. McEwan, D. M.; Markham, D. P.; Pringle, P. G.; Shaw, B. L. *J. Chem. Soc., Dalton Trans.* **1986**, 1809–1814.
588. Tanase, T.; Toda, H.; Kobayashi, K.; Yamamoto, Y. *Organometallics* **1996**, *15*, 5272–5274.
589. Hitchcock, P. B.; Morton, S.; Nixon, J. F. *J. Chem. Soc. Dalton Trans.* **1985**, 1295–1301.
590. Asseid, F.; Browning J.; Dixon, K. R.; Meanwell, N. J. *Organometallics* **1994**, *13*, 760–762.
591. Del Zotto, A.; Costella, L.; Mezzetti, A.; Rigo, P. *J. Organomet. Chem.* **1991**, *414*, 109–118.
592. Bedford, R. B.; Chaloner, P. A.; Hitchcock, P. B. *Acta Cryst.* **1993**, *C49*, 1614–1616.
593. Lee, S.; Shim, S.; Kim, T. *J. Polym. Sci., Part A: Polym. Chem.* **1996**, *34*, 2377–2386.
594. Zhang, X.; Taketomi, T.; Yoshizumi, T.; Kumobayashi, H.; Akutagawa, S.; Mashima, K.; Takaya, H. *J. Am. Chem. Soc.* **1993**, *115*, 3318–3319.
595. Dorta, R.; Egli, P.; Zuercher, F.; Togni, A. *J. Am. Chem. Soc.* **1997**, *119*, 10857–10858.
596. Dorta, R.; Togni, A. *Helv. Chim. Acta* **2000**, *83*, 119–127.
597. Mayer, H. A. *Inst. Anorg. Chem.* **1993**, *77*, 53–56.
598. Cleary, B. P.; Eisenberg, R. *J. Am. Chem. Soc.* **1995**, *117*, 3510–3521.
599. Kunin, A. J.; Eisenberg, R. *J. Am. Chem. Soc.* **1986**, *108*, 535–536.
600. Mague, J. T.; Lloyd, C. L. *Organometallics* **1988**, *7*, 983–993.
601. Phillips, I. G.; Ball, R. G.; Cavell, R. G. *Inorg. Chem.* **1988**, *27*, 2269–2275.
602. Tissot, O.; Gouygou, M.; Dallemer, F.; Daran, J.; Balavoine, G. G. A. *Eur. J. Inorg. Chem.* **2001**, 2385–2389.
603. Morandini, F.; Pilloni, G. *Organometallics* **1995**, *14*, 3418–3422.
604. Bianchini, C.; Farnetti, E.; Glendenning, L.; Graziani, M.; Nardin, G.; Peruzzini, M.; Rocchini, E.; Zanobini, F. *Organometallics* **1995**, *14*, 1489–1502.
605. Bianchini, C.; Barbaro, P.; Scapacci, G. *J. Organomet. Chem.* **2001**, *621*, 26–33.
606. Gagnon, J.; Loeber, C.; Matt, D.; Harvey, P. D. *Inorg. Chim. Acta* **1996**, *242*, 137–142.
607. Vaira, M. D.; Mann, B. E.; Peruzzini, M.; Stoppioni, P. *Inorg. Chem.* **1988**, *27*, 3725–3729.
608. Janser, P.; Venanzi L. M.; Bachechi, F. *J. Organomet. Chem.* **1985**, *296*, 229–242.
609. Sülü, M.; Venanzi, L. M. *Inorg. Chim. Acta* **1999**, *293*, 70–79.
610. Werner, H.; Ortman, D. A.; Ilg, K. Z. *Anorg. Allg. Chem.* **2000**, *626*, 2457–2462.
611. Balch, A. L.; Catalano, V. J.; Olmstead, M. M. *J. Am. Chem. Soc.* **1990**, *112*, 2010–2011.
612. Werner, H.; Ortman, D. A.; Gevert, O. *Chem Ber.* **1996**, *129*, 411–417.
613. Ortman, D. A.; Gevert, O.; Laubender, M.; Werner, H. *Organometallics* **2001**, *20*, 1776–1782.
614. Janik, T. S.; Bernard, K. A.; Churchill, M. R.; Atwood, J. D. *J. Organomet. Chem.* **1987**, *323*, 247–59.
615. Miller, C. A.; Janik, T. S.; Lake, C. H.; Toomey, L. M.; Churchill, M. R.; Atwood, J. D. *Organometallics* **1994**, *13*, 5080–5087.
616. Barberá, J.; Elduque, A.; Giménez, R.; Lahoz, F. J.; López, J. A.; Oro, L. A.; Serrano, J. L.; Villacampa, B.; Villalba, J. *Inorg. Chem.* **1999**, *38*, 3085–3092.
617. Bruce, D. W.; Dunmur, D. A.; Esteruelas, M. A.; Hunt, S. E.; Le Lagadec, R.; Maitlis, P. M.; Marsden, J. R.; Sola, E.; Stacey, J. M. *J. Mater. Chem.* **1991**, *1*, 251–254.
618. Bruce, D. W.; Thornton, A. *Mol. Cryst. Liq. Cryst. Sci. Technol., Sect. A* **1993**, *231*, 253–256.

619. Costa, G.; Tavagnacco, C.; Balducci, G.; Mestroni, G.; Zassinovich, G. *J. Electroanal. Chem.* **1989**, *272*, 109–124.
620. Selke, M.; Karney, W. L.; Khan, S. I.; Foote, C. S. *Inorg. Chem.* **1995**, *34*, 5715–5720.
621. Selke, M.; Rosenberg L.; Salvo J.M.; Foote, C. S. *Inorg. Chem.* **1996**, *35*, 4519–4522.
622. Fernández, M. J.; Esteruelas, M. A.; Covarrubias, M.; Oro, L. A. *Organometallics* **1989**, *8*, 1158–1162.
623. Green, L. M.; Meek, D. W. *Organometallics* **1989**, *8*, 659–666.
624. Bernard, K. A.; Atwood, J. D. *Organometallics* **1989**, *8*, 795–800.
625. Zhao, J.; Hesslink, H.; Hartwig, J. F. *J. Am. Chem. Soc.* **2001**, *123*, 7220–7227.
626. Thorn, D. L.; Fultz, W. C. *J. Phys. Chem.* **1989**, *93*, 1234–1243.
627. Uson, R.; Oro, L. A.; Cabeza, J. A. *Inorg. Synth.* **1985**, *23*, 126–130.
628. Pilato, R. S.; Rubin, D.; Geoffroy, G. L.; Rheingold, A. L. *Inorg. Chem.* **1990**, *29*, 1986–1990.
629. Schurig, V.; Pille, W.; Peters, K.; Von Schnering, H. G. *Mol. Cryst. Liq. Cryst.* **1985**, *120*, 385–388.
630. Scheer, P.; Schurig, V.; Walz, L. *Acta Cryst.* **1990**, *C46*, 1442–1444.
631. Werner, H.; Papenfuhs, B.; Steinert, P. Z. *Anorg. Allg. Chem.* **2001**, *627*, 1807–1814.
632. Gopinathan, S.; Joseph, K.; Gopinathan, C. *Polyhedron* **1985**, *4*, 955–958.
633. Lang, R.; Schörwerth, A.; Polborn, K.; Ponikwar, W.; Beck, W.; Severin, T.; Severin, K. Z. *Anorg. Allg. Chem.* **1999**, *625*, 1384–1390.
634. Schnabel, R. C.; Roddick, D. M. *Organometallics* **1996**, *15*, 3550–3555.
635. Matsukawa, S.; Kuwata, S.; Hidai, M. *Inorg. Chem. Commun.* **1998**, 368–371.
636. Dorta, R.; Rozenberg, H.; Shimon, L. J. W.; Milstein, D. *J. Am. Chem. Soc.* **2002**, *124*, 188–189.
637. Randall, S. L.; Miller, C. A.; Janik, T. S.; Churchill, M. R.; Atwood, J. D. *Organometallics* **1994**, *13*, 141–147.
638. Claver, C.; Ruiz, A.; Masdeu, A. M.; Viñas, J.; Saballs, T. *J. Organomet. Chem.* **1989**, *373*, 269–278.
639. Megehee, E. G.; Johnson, C. E.; Eisenberg, R. *Inorg. Chem.* **1989**, *28*, 2423–2431.
640. Dahlenburg, L.; Kühnlein, M. *Acta Cryst.* **2001**, *C57*, 709–710.
641. Suardi, G.; Cleary, B. P.; Duckett, S. B.; Sleight, C.; Rau, M.; Reed, E. A.; Lohman, A. B.; Eisenberg, R. *J. Am. Chem. Soc.* **1997**, *119*, 7716–7725.
642. Blake, A. J.; Halcrow, M. A.; Schröder, M. *J. Chem. Soc., Chem. Commun.* **1991**, 253–256.
643. Blake, A. J.; Halcrow, M. A.; Schröder, M. *J. Chem. Soc., Dalton Trans.* **1994**, 1631–1639.
644. Fonseca, I.; Hernandez, E.; Sanz-Aparicio, J.; Terreros, P.; Torrens, H. *J. Chem. Soc., Dalton Trans.* **1994**, 781.
645. Antiñolo, A.; Fonseca, I.; Ortiz, A.; Rosales, M. J.; Sanz-Aparicio, J.; Terreros, P.; Torrens, H. *Polyhedron* **1999**, *18*, 959–968.
646. Blake, A.; Fotheringham, J. D.; Stephenson, T. A. *Acta Cryst.* **1990**, *C46*, 1102–1105.
647. Levason, W.; Orchard, S. D.; Reid, H.; Street, J. *J. Chem. Soc., Dalton Trans.* **2000**, 2537–2543.
648. Bonasia, P. J.; Arnold, J. *J. Organomet. Chem.* **1993**, *449*, 147–157.
649. Yamashita, H.; Kobayashi, T.; Hayashi, T.; Tanaka, M. *Chem. Lett.* **1989**, *3*, 471–474.
650. Goldberg, Y.; Alper, H. *J. Mol. Catal.* **1994**, *92*, 149–153.
651. Aullon, G.; Ujaque, G.; Lledos, A.; Alvarez, S.; Alemany, P. *Inorg. Chem.* **1998**, *37*, 804–813.
652. Deutsch, P. P.; Eisenberg, R. *Chem. Rev.* **1988**, *88*, 1147–1161.
653. Duckett, S. B.; Field, L. D.; Messerle, B. A.; Shaw, W. J.; Soler, L. P. *J. Chem. Soc., Dalton Trans.* **2000**, 2251–2253.
654. Nishihara, Y.; Yoda, C.; Osakada, K. *Organometallics* **2001**, *20*, 2124–2126.
655. Bonati, F.; Oro, L. A.; Pinillos, T.; Tejel, C. *J. Organomet. Chem.* **1994**, *465*, 267–274.
656. Chebi, D. E.; Fanwick, P. E.; Rothwell, I. P. *Organometallics* **1990**, *9*, 2948–2952.
657. Imhoff, P.; Nefkens, S. C. A.; Elsevier, C. J. *Organometallics* **1990**, *10*, 1421–1431.
658. Imhoff, P.; Van Asselt, R.; Ernsting, J. M.; Vrieze, K.; Elsevier, C. J. *Organometallics* **1993**, *12*, 1523–1536.
659. Okazaki, M.; Tobita, H.; Ogino, H. *Organometallics* **1996**, *15*, 2790–2793.
660. Okazaki, M.; Tobita, H.; Inomata, S.; Ogino, H. *J. Organomet. Chem.* **1998**, *553*, 1–13.
661. Okazaki, M.; Tobita, H.; Ogino, H. *Chem. Lett.* **1997**, 437–438.
662. Schiavo, S. L.; Grassi, M.; Munno, G. D.; Nicoló, F.; Tresoldi, G. *Inorg. Chim. Acta* **1994**, *216*, 209–216.
663. Schneider, P.; Koch, G.; Prétôt, R.; Wang, G.; Bohnen, F. M.; Krüger, C.; Pfaltz, A. *Chem. Eur. J.* **1997**, *3*, 887–892.
664. Khan, M. M. T.; Reddy, V. V. S.; Bajaj, H. C. *Polyhedron* **1987**, *6*, 921–929.
665. Kataoka, Y.; Imanishi, M.; Yamagata T.; Tani, K. *Organometallics* **1999**, *18*, 3563–3565.
666. Kataoka, Y.; Shizuma, K.; Yamagata, T.; Tani, K. *Chem. Lett.* **2001**, 300–301.
667. Law, D. J.; Bigam, G.; Cavell, R. G. *Can. J. Chem.* **1995**, *73*, 635–642.
668. Hedden, D.; Roundhill, D. M. *Inorg. Chem.* **1986**, *25*, 9–15.
669. Park, S.; Hedden, D.; Roundhill, D. M. *Organometallics* **1986**, *5*, 2151–2152.
670. Katti, K. V.; Cavell, R. G. *Organometallics* **1989**, *8*, 2147–2153.
671. Bianchini, C.; Cicchi, S.; Peruzzini, M.; Pietrusiewicz, K. M.; Brandi, A. *J. Chem. Soc., Chem. Commun.* **1995**, 833–834.
672. Kuang, S.; Xue, F.; Zhang, Z.; Xue, W.; Che, C.; Mak T. *J. Chem. Soc., Dalton Trans.* **1997**, 3409–3410.
673. Rawson, J. M.; Winpenny, R. E. P. *Coord. Chem. Rev.* **1995**, *139*, 313–374.
674. Elduque, A.; Aguilera, F.; Lahoz, F. J.; López, J. A.; Oro, L. A.; Pinillos, M. T. *Inorg. Chim. Acta* **1998**, *274*, 15–23.
675. James, S. L.; Mingos, D. M.; Xu, X.; White, A. J. P.; Williams, D. J. *J. Chem. Soc., Dalton Trans.* **1998**, 1335–1340.
676. Rodman, G. S.; Mann, K. R. *Inorg. Chem.* **1985**, *24*, 3507–3508.
677. Rodman, G. S.; Mann, K. R. *Inorg. Chem.* **1988**, *27*, 3338–3346.
678. Net, G.; Bayón, J. C.; Esteban, P.; Rasmussen, P. G.; Alvarez-Larens, A.; Piniella, J. F. *Inorg. Chem.* **1993**, *32*, 5313–5321.
679. Bayón, J. C.; Net, G.; Rasmussen, P. G.; Kolowich, J. B. *J. Chem. Soc., Dalton Trans.* **1987**, 3003–3007.
680. Net, G.; Bayón, J. C.; Butler, W. M.; Rasmussen, P. G. *J. Chem. Soc., Chem. Commun.* **1989**, 1022–1023.
681. Anderson, J. E.; Gregory, T. P.; Net, G.; Bayón, J. C. *J. Chem. Soc., Dalton Trans.* **1992**, 487–494.
682. Rojas, S.; Fierro, J. L. G.; Rodríguez, A.; Terreros, P. *J. Chem. Soc., Dalton Trans.* **2001**, 2316–2324.
683. Braunstein, P.; Chauvin, Y.; Nähring, J.; DeCian, A.; Fischer, J.; Tripicchio, A.; Ugozzoli, F. *Organometallics* **1996**, *15*, 5551–5567.
684. Slawin, A. M. Z.; Smith, M. B.; Woollins, J. D. *J. Chem. Soc., Dalton Trans.* **1996**, 1283–1293.
685. Theron, M.; Prucell, W.; Basson, S. S. *Acta Cryst.* **1996**, *C52*, 336–338.

686. Theron, M.; Prucell, W.; Basson, S. S. *Acta Cryst.* **1995**, *C51*, 1750–1752.
687. Sablong, R.; Osborn, J. A. *Tetrahedron Lett.* **1996**, *37*, 4937–4940.
688. Perera, S. D.; Shaw, B. L. *J. Chem. Soc., Chem. Commun.* **1995**, 865–866.
689. Perera, S. D.; Shaw, B. L.; Thornton-Pett, M. *J. Chem. Soc., Dalton* **1996**, 3111–3119.
690. Perera, S. D.; Shaw, B. L. *J. Chem. Soc., Dalton* **1998**, 2887–2891.
691. Fryzuk, M. D.; Joshi, K.; Chadha, R. K.; Rettig, S. J. *J. Am. Chem. Soc.* **1991**, *113*, 8724–8736.
692. Fryzuk, M. D.; Kiran, J.; Rettig, S. J. *Polyhedron* **1989**, *8*, 2291–2297.
693. Vasapollo, G.; Nobile, C. F.; Latronico, M.; Lanfranchi, M.; Pellinghelli, M. A. *J. Organomet. Chem.* **1987**, *336*, 429–439.
694. Krämer, R.; Polborn, K.; Wanjek, H.; Zahn, I.; Beck, W. *Chem. Ber.* **1990**, 767–778.
695. Hage, A.; Petra, D. G. I.; Field, J.; Schipper, D.; Wijnberg, J. B. P. A.; Kamer, P. C. J.; Reek, J. N. H.; Van Leeuwen, P. W. N. M.; Wever, R.; Schoemaker, H. E. *Tetrahedron Asym.* **2001**, *12*, 1025–1034.
696. Nicolaou, K. C.; Theodorakis, E. A.; Rutjes, F. P. J. T.; Sato, M.; Tiebes, J.; Xiao, X.-Y.; Hwang, C.-K.; Duggan, M. E.; Yang, Z. Couladouros E. A.; Sato, F.; Shin, J.; He, H.-M.; Bleckman, T. *J. Am. Chem. Soc.* **1995**, *117*, 10239–10251.
697. Loiseau, P. M.; Jaffé, J. J.; Craciunescu, D. G. *Int. J. Parasitol.* **1998**, *28*, 1279–1282.
698. Sava, G.; Zorzet, S.; Perissin, L.; Mestroni, G.; Zassinovich, G.; Bontempi, A. *Inorg. Chim. Acta* **1987**, *137*, 69–71.
699. Sava, G.; Piccini, P.; Mestroni, G.; Zassinovich, G.; Bontempi, A. *in vivo* **1987**, *1*, 27–30.
700. Craciunescu, D. G.; Molina, C.; Alonso, M. P.; Iglesias, E. P.; Lopez, A. D.; Doadrio-Villarejo, J. C.; Gaston de Iriarte, E.; Ghirvu, C. I.; Ercoi, N. *An. R. Acad. Farm.* **1990**, *56*, 181–200.
701. Craciunescu, D. G.; Molina, C.; Alonso, M. P.; Iglesias, E. P.; Doadrio-Villarejo, J. C.; Gutierrez-Rios, M. T.; Gaston de Iriarte, E.; Ghirvu, C. I.; Ercoi, N. *An. R. Acad. Farm.* **1990**, *56*, 469–486.
702. Craciunescu, D. G.; Iglesias, E. P.; Alonso, M. P.; Doadrio-Villarejo, J. C.; Rios, M. T. G.; De Frutos, M. I.; Molina, C.; Lorenzo-Molina, C.; Fombona, G. C. *et al. An. R. Acad. Farm.* **1993**, *59*, 73–97.
703. Satoh, K.; Inenaga, M.; Kanai, K. *Tetrahedron Asym.* **1998**, *9*, 2657–2662.
704. Craciunescu, D. G.; Scarcia, V.; Furlani, A.; Papaioannou, A.; Parrondo-Iglesias, E. *Met. Ions Biol. Med., Proc. Int. Symp., 1st* **1990**, 462–464.
705. Pàmies, O.; Net, G.; Ruiz, A.; Bo, C.; Poblet, J. M.; Claver, C. *J. Organomet. Chem.* **1999**, *586*, 125–137.
706. Zhang, X.; Kumobayashi, H.; Takaya, H. *Tetrahedron, Asym.* **1994**, *5*, 1179–1182.
707. Chin, C. S.; Park, S. C. *Bull. Korean Chem. Soc.* **1988**, *9*, 260–261.
708. Chin, S. C.; Park, S. C.; Shin, J. H. **1989**, *8*, 121–122.
709. Yang, K. J.; Chin, C. S. *Inorg. Chem.* **1987**, *26*, 2732–2733.
710. Yang, K. J.; Chin, C. S. *Bull. Korean Chem. Soc.* **1986**, *7*, 466–468.
711. Park, H. K.; Chin, C. S. *Bull. Korean Chem. Soc.* **1987**, *8*, 185–189.
712. Chin, C. S.; Park, J.; Kim, C.; Lee, S. Y.; Shin, J. H.; Kim, J. B. *Catal. Lett.* **1988**, *1*, 203–205.
713. Chin, C. S.; Jung, H. J.; Hong, S. G. *Bull. Korean Chem. Soc.* **1992**, *13*, 391–394.
714. Chin, C. S.; Lee, B.; Park, S. C. *J. Organomet. Chem.* **1990**, *393*, 131–135.
715. Chin, C. S.; Lee, B.; Kim, S.; Chun, J. *J. Chem. Soc., Dalton Trans.* **1991**, 443–448.
716. Chin, C. S.; Lee, B. *Catal. Lett.* **1992**, *14*, 135–140.
717. Gomis, A.; Net, G.; Ruiz, A.; Claver, C.; Alvarez-Larena, A. *Inorg. Chim. Acta* **2001**, *325*, 58–64.
718. Solé, J.; Bo, C.; Claver, C.; Ruiz, A. *J. Molecular Catalysis* **1990**, *161*, 163–171.
719. Chin, C. S.; Won, G.; Song, J. *Bull. Korean Chem. Soc.* **1994**, *15*, 961–966.
720. Ellames, G. J.; Gibson, J. S.; Herbert, J. M.; Kerr, W. J.; McNeill, A. H. *Tetrahedron, Lett.* **2001**, *42*, 6413–6416.
721. Morimoto, T.; Nakajima, N.; Achiwa, K. *Chem. Pharm. Bull.* **1994**, *42*, 1951–1953.
722. Morimoto, T.; Nakajima, N.; Achiwa, K. *Synlett.* **1995**, 748–750.
723. Morimoto, T.; Achiwa, K. *Tetrahedron Asym.* **1995**, *6*, 2661–2664.
724. Morimoto, T.; Suzuki, N.; Achiwa, K. *Heterocycles* **1996**, *43*, 2557–2560.
725. Morimoto, T.; Suzuki, N.; Achiwa, K. *Tetrahedron Asym.* **1998**, *9*, 183–187.
726. Chatani, N.; Inoue, H.; Morimoto, T.; Muto, T.; Murai, S. *J. Org. Chem.* **2001**, *66*, 4433–4436.
727. Khan, M. M. T.; Khan, B. T.; Safia, M. *React. Kinet. Catal. Lett.* **1985**, *29*, 63–70.
728. Khan, M. M. T.; Khan, B. T.; Begum, S. *J. Mol. Catal.* **1986**, *34*, 9–18.
729. Zassinovich, G.; Bettella, R.; Mestoni, G.; Bresciani-Pahor, N.; Geremia, S.; Randaccio, L. *J. Organomet. Chem.* **1989**, *370*, 187–202.
730. Spogliarich, R.; Kašper, J.; Graziani, M. *J. Organomet. Chem.* **1986**, *306*, 407–412.
731. De Martin, S.; Zassinovich, G.; Mestroni, G. *Inorg. Chim. Acta* **1990**, *174*, 9–11.
732. Matsuda, I.; Kato, T.; Sato, S.; Izumi, Y. *Tetrahedron Lett.* **1986**, *27*, 5747–5750.
733. Müller, D.; Umbrecht, G.; Weber, B.; Pfaltz, A. *Helv. Chim. Acta* **1991**, *74*, 232–240.
734. Inoue, S.; Nomura, K.; Hashiguchi, S.; Noyori, R.; Izawa, Y. *Chem. Lett.* **1997**, 957–958.
735. Petra, D. G. I.; Kamer, P. C. J.; Spek, A. L.; Schoemaker, H. E.; Van Leeuwen, P. W. N. M. *J. Org. Chem.* **2000**, *65*, 3010–3017.
736. Cho, I. S.; Lee, B.; Alper, H. *Tetrahedron Lett.* **1995**, *36*, 6009–6012.
737. Nishibayashi, Y.; Segawa, K.; Takada, H.; Ohe, H.; Uemura, S. *J. Chem. Soc., Chem. Commun.* **1996**, 847–848.
738. Field, L. D.; Ward, A. J.; Turner, P. *Aust. J. Chem.* **1995**, *52*, 1085–1092.
739. Evans, D. A.; Fu, G. C.; Hoveyda, A. H. *J. Am. Chem. Soc.* **1992**, *114*, 6671–6679.
740. Kopylova, L. I.; Pukhnarevich, V. B.; Voronkov, M. G. *Zh. Obshch. Khim.* **1991**, *61*, 2606–2607.
741. Kunin, A. J.; Eisenberg, R. *Organometallics* **1988**, *7*, 2124–2129.
742. Collin, J. P.; Ruppert, R.; Sauvage, J. P. *Nouv. J. Chim.* **1985**, *9*, 395–404.
743. Kvintovics, P.; Bakos, J.; Heil, B. *J. Mol. Catal.* **1985**, *32*, 111–114.
744. Zahalka, H. A.; Alper, H. *Organometallics* **1986**, *5*, 2497–2499.
745. Tani, K.; Onouchi, J.; Yamagata, T.; Kataoka, Y. *Chem. Lett.* **1995**, *10*, 955–956.
746. Claver, C.; Gili, F.; Vinas, J.; Ruiz, A. *Polyhedron* **1987**, *6*, 1329–1335.
747. Matsukawa, S.; Kuwata, S.; Hidai, M. *Inorg. Chem.* **2000**, *39*, 791–798.
748. Reinking, M. K.; Ni, J.; Fanwick, P. E.; Kubiak, C. P. *J. Am. Chem. Soc.* **1989**, *111*, 6459–6461.

749. Heyduk, A. F.; Nocera, D. G. *J. Chem. Soc. Chem. Commun.* **1999**, 1519–1520.
750. Deblon, S.; Liesum, L.; Harmer, J.; Schonberg, H.; Schweiger, A.; Grutzmacher, H. *Chemistry—A European Journal* **2002**, *8*, 601–611.
751. Barbaro, P.; Bianchini, C.; Laschi, F.; Midollini, S.; Moneti, S.; Scapacci, G.; Zanello, P. *Inorg. Chem.* **1994**, *33*, 1622–1630.
752. Ellis, J. E. *Adv. Organomet. Chem.* **1990**, *31*, 1–51.
753. Longato, B.; Riello, L.; Bandoli, G.; Pilloni, G. *Inorg. Chem.* **1999**, *38*, 2818–2823.
754. Böhler, C.; Büttner, T.; Deblon, S.; Frasca, G.; Frison, G.; Geier, J.; Laporte, C.; Läng, F.; Loss, S.; Maire, P.; Pé, N.; Schönberg, H.; Scherer, M.; Widauer, C.; Grützmacher, H. *Chimia* **2001**, *55*, 814–817.
755. Boulmaâz, S.; Mlakar, M.; Loss, S.; Schönberg, H.; Deblon, S.; Wörle, M.; Nesper, R.; Grützmacher, H. *J. Chem. Soc. Chem. Commun.* **1998**, 2623–2624.
756. Böhler, C.; Avarvari, N.; Schönberg, H.; Wörle, M.; Rügger, H.; Grützmacher, H. *Helv. Chim. Acta* **2001**, *84*, 3127–3147.

6.3

Nickel

F. MEYER

Georg-August-Universität Göttingen, Germany

and

H. KOZLOWSKI

Wroclaw University, Poland

6.3.1	INTRODUCTION	249
6.3.2	RELEVANCE IN BIOINORGANIC CHEMISTRY AND MATERIALS CHEMISTRY	249
6.3.2.1	Nickel in Biology	249
6.3.2.2	Nickel in Materials Chemistry	251
6.3.3	COMPLEXES OF NICKEL(III) AND NICKEL(IV)	252
6.3.3.1	Introduction	252
6.3.3.2	Cyano Complexes	252
6.3.3.3	Complexes with N-donor Ligands	252
6.3.3.3.1	<i>Complexes with nonmacrocyclic N-donor ligands</i>	252
6.3.3.3.2	<i>Complexes with macrocyclic N-donor ligands</i>	254
6.3.3.4	Complexes with Ligands Containing Phosphorus, Arsenic, and Antimony	259
6.3.3.5	Complexes with O-donor Ligands	260
6.3.3.6	Complexes with Ligands Containing S- and Se- donors	261
6.3.3.7	Halide Complexes	265
6.3.3.8	Complexes with Bioligands	266
6.3.3.8.1	<i>Complexes with peptides, amino acids, and related ligands</i>	266
6.3.3.8.2	<i>Complexes with oximes and related ligands</i>	267
6.3.3.8.3	<i>Complexes with porphyrins and related ligands</i>	268
6.3.3.9	Complexes with Mixed Donor Set Ligands	271
6.3.3.9.1	<i>Complexes with mixed {N,O} ligands</i>	271
6.3.3.9.2	<i>Complexes with mixed {N,S} ligands</i>	271
6.3.3.9.3	<i>Complexes with miscellaneous ligands</i>	273
6.3.4	COMPLEXES OF NICKEL(II)	275
6.3.4.1	Advances in Structural Trends and Spectroscopy of Nickel Complexes	275
6.3.4.1.1	<i>General structural features</i>	275
6.3.4.1.2	<i>Electronic absorption spectroscopy</i>	277
6.3.4.1.3	<i>NMR spectroscopy</i>	277
6.3.4.1.4	<i>EPR spectroscopy</i>	278
6.3.4.1.5	<i>XAS at the nickel K-edge</i>	279
6.3.4.1.6	<i>⁶¹Ni Mössbauer spectroscopy</i>	279
6.3.4.1.7	<i>Molecular modeling of nickel complexes</i>	279
6.3.4.2	Carbonyl Complexes	280
6.3.4.3	Cyano and Other Pseudohalide Complexes	281
6.3.4.3.1	<i>Cyano complexes</i>	281
6.3.4.3.2	<i>Fulminato, cyanato, thiocyanato, and related pseudohalide complexes</i>	281
6.3.4.4	Complexes with Nonmacrocyclic Nitrogen Donor Ligands	284
6.3.4.4.1	<i>Complexes with monodentate amino, amido, and imido ligands</i>	284
6.3.4.4.2	<i>Complexes with chelating amino and amido ligands</i>	286
6.3.4.4.3	<i>Complexes with chelating imine ligands</i>	291
6.3.4.4.4	<i>Complexes with chelating nitrogen ligands incorporating oximes and related functions</i>	292
6.3.4.4.5	<i>Complexes with chelating ligands incorporating N-heterocycles</i>	294
6.3.4.4.6	<i>Complexes with polypyrazolylborates and related tripodal ligands</i>	300

6.3.4.4.7	<i>Complexes of miscellaneous nitrogen ligands</i>	304
6.3.4.5	Complexes with Ligands Containing Phosphorus, Arsenic, and Antimony as Donor Atoms	304
6.3.4.5.1	<i>Complexes with mono- and oligodentate phosphine ligands</i>	304
6.3.4.5.2	<i>Complexes with phosphido and phosphinidene ligands</i>	307
6.3.4.6.3	<i>Complexes with mixed donor atoms involving phosphorus</i>	308
6.3.4.5.4	<i>Complexes with ligands containing arsenic and antimony</i>	314
6.3.4.6	Complexes with Oxygen Donor Ligands	314
6.3.4.6.1	<i>Complexes with monodentate oxygen ligands and carboxylates</i>	314
6.3.4.6.2	<i>Complexes with β-diketones and related ligands</i>	318
6.3.4.6.3	<i>Complexes with deprotonated hydroxamic acids, catechols, and related ligands</i>	319
6.3.4.6.4	<i>Complexes with miscellaneous oxygen ligands</i>	321
6.3.4.7	Complexes with Sulfur-, Selenium-, and Tellurium-containing Ligands	322
6.3.4.7.1	<i>Complexes with sulfido and monodentate thiol ligands</i>	322
6.3.4.7.2	<i>Complexes with dithiol ligands</i>	324
6.3.4.7.3	<i>Complexes with thioether and mixed thioether/thiol ligands</i>	326
6.3.4.7.4	<i>Complexes with dithiophosphates and related ligands</i>	329
6.3.4.7.5	<i>Complexes with xanthates and related ligands</i>	332
6.3.4.7.6	<i>Complexes with dithiocarbamate and related ligands</i>	334
6.3.4.7.7	<i>Complexes with thiooxalate and related ligands</i>	335
6.3.4.7.8	<i>Complexes with dithioketones and related ligands</i>	335
6.3.4.7.9	<i>Complexes with thiourea and related ligands</i>	336
6.3.4.7.10	<i>Complexes with dithiolene ligands</i>	337
6.3.4.7.11	<i>Complexes with selenium- and tellurium-containing ligands</i>	342
6.3.4.8	Halide Complexes	344
6.3.4.9	Mononuclear Complexes with Open-chain Ligands Containing Mixed Donor Atoms	346
6.3.4.9.1	<i>Complexes with mixed {N,O} ligands</i>	346
6.3.4.9.2	<i>Complexes with mixed {N,S} ligands</i>	354
6.3.4.9.3	<i>Complexes with mixed {N,O,S} ligands</i>	371
6.3.4.10	Complexes with Macrocyclic Ligands	373
6.3.4.10.1	<i>Complexes with 1,4,7-triazacyclononane-type ligands</i>	373
6.3.4.10.2	<i>Complexes with larger macrocyclic nitrogen ligands</i>	379
6.3.4.10.3	<i>Complexes with larger macrocycles containing mixed donor atoms</i>	400
6.3.4.11	Complexes with Bioligands	403
6.3.4.11.1	<i>Complexes with amino acids and amino acid derivatives</i>	403
6.3.4.11.2	<i>Complexes with peptides</i>	405
6.3.4.11.3	<i>Complexes with porphyrins and related ligands</i>	411
6.3.4.11.4	<i>Complexes with core-modified heteroanalogues of porphyrins</i>	417
6.3.4.11.5	<i>Complexes with carbohydrates</i>	419
6.3.4.11.6	<i>Complexes with nucleosides, nucleotides, and related ligands</i>	420
6.3.4.11.7	<i>Ligands for biomimetic and related nickel complexes</i>	421
6.3.4.12	Di- and Oligonuclear Ni ^{II} Complexes with Compartmental Dinucleating Ligands	424
6.3.4.12.1	<i>Complexes with bis(macrocylic) ligands</i>	425
6.3.4.12.2	<i>Di- and oligonuclear complexes with open-chain alkoxy- or phenolato-based dinucleating ligands</i>	427
6.3.4.12.3	<i>Di- and oligonuclear complexes with compartmental macrocycles incorporating O bridges</i>	433
6.3.4.12.4	<i>Di- and oligonuclear complexes with thiolate-based dinucleating ligands</i>	437
6.3.4.12.5	<i>Heterobimetallic Ni/Fe complexes as model systems for the Ni/Fe hydrogenase and CO-dehydrogenase/acetyl CoA synthase active sites</i>	443
6.3.4.12.6	<i>Di- and oligonuclear complexes with dinucleating ligands incorporating diazine, diazole, and triazenido bridging units</i>	448
6.3.4.12.7	<i>Model complexes for the urease active site</i>	454
6.3.4.12.8	<i>Chain complexes with oligo(pyridylamido) ligands</i>	461
6.3.4.13	Magnetic Properties of Polynuclear Complexes	463
6.3.4.13.1	<i>Complexes with bridging azido ligands</i>	463
6.3.4.13.2	<i>Cyanide-based oligo- and polynuclear complexes</i>	475
6.3.4.13.3	<i>Oligonuclear and polymeric complexes with other bridging ligands</i>	475
6.3.4.13.4	<i>Complexes with nitronyl nitroxide and verdazyl radical ligands</i>	479
6.3.4.14	Miscellaneous Complexes of Nickel(II)	480
6.3.4.14.1	<i>Complexes with silyl and silylene ligands</i>	480
6.3.4.14.2	<i>Hydride complexes</i>	481
6.3.5	COMPLEXES OF NICKEL(I)	482
6.3.5.1	Introduction	482
6.3.5.2	Complexes with Nitrogen Donor Ligands	482
6.3.5.2.1	<i>Complexes with macrocyclic nitrogen donor ligands</i>	482
6.3.5.2.2	<i>Complexes with nonmacrocyclic nitrogen donor ligands</i>	486
6.3.5.2.3	<i>Complexes with porphyrins and related ligands</i>	487
6.3.6.3	Complexes with Phosphines and Arsines	489
6.3.5.4	Complexes with Sulfur- and Selenium-containing Ligands	493
6.3.5.5	Miscellaneous Complexes of Nickel(I)	496
6.3.6	COMPLEXES OF NICKEL(0)	497
6.3.6.1	Carbonyl and Nitrosyl Complexes	497
6.3.6.1.1	<i>Carbonyl complexes</i>	497
6.3.6.1.2	<i>Nitrosyl complexes</i>	497

6.3.6.2	Complexes with CO ₂ , CS ₂ , and related ligands—Electroreduction of CO ₂	498
6.3.6.3	Complexes with Nitrogen-containing Ligands	501
6.3.6.4	Complexes with Dinitrogen and Dioxygen	501
6.3.6.5	Complexes with Phosphines, Arsines, and Stibines	502
6.3.6.5.1	Complexes with mono- and oligodentate phosphines and phosphido ligands	502
6.3.6.5.2	Complexes with diphosphenes, phosphabenzene, biphosphinine, and other unsaturated phosphorus donor ligands	506
6.3.6.6.3	Complexes with miscellaneous phosphorus donor ligands	509
6.3.6.5.4	Complexes with arsenic and antimony donor ligands	509
6.3.6.6	Miscellaneous Complexes of Nickel(0)	510
6.3.7	REFERENCES	511

6.3.1 INTRODUCTION

The basic properties of nickel and the coordination chemistry of nickel reported until 1983 have been comprehensively described in *Comprehensive Coordination Chemistry* (CCC, 1987). Hence, work published prior to 1983 will not be mentioned here, and the reader should generally refer to the respective chapters of CCC—only at some points specific reference to CCC is given. Also, the basic geometric preferences and the electronic and spectromagnetic properties of nickel in its various oxidation states will not be recapitulated, since an excellent overview is included in the first edition and only selected recent advances are added in this second edition.

Coordination chemistry in general—and the coordination chemistry of nickel in particular—has flourished since the early 1980s, stimulated by, *inter alia*, the discovery of an increasing number of fascinating nickel centers in metalloprotein active sites, the use of nickel in catalysis, and the booming interest in materials with specific physical properties related to magnetism, nonlinear optics, superconductivity, etc. As a consequence, an enormous amount of work dealing with nickel coordination compounds has appeared in the literature, and a comprehensive review is a mission impossible. We have tried to mention most of the important areas, but some unbalanced coverage is inevitable and we apologize in advance for all those studies that—albeit certainly important—we have overseen or omitted. Except for some isocyanide complexes, compounds in which Ni—C bonds play a dominant role are not included in this compilation.

For many years, the coordination chemistry of nickel has been included in annual reviews.^{1–10}

6.3.2 RELEVANCE IN BIOINORGANIC CHEMISTRY AND MATERIALS CHEMISTRY

6.3.2.1 Nickel in Biology

In 1975, Zerner discovered that urease is a nickel enzyme, and the role of Ni in biology has been rapidly expanding since then.^{11–18} The list of nickel-dependent enzymes includes urease, *E. coli* glyoxalase I (*E. coli* Glx I), [NiFe]-hydrogenase, methyl-CoM reductase (MCR), CO dehydrogenase (CODH), and acetyl CoA synthase (ACS), all of which have been crystallographically characterized. In addition, a Ni-containing superoxide dismutase (NiSOD) has been reported,¹⁹ and some enzymes such as peptide deformylase are active with Ni while not known to naturally occur as a Ni enzyme.^{20–22} Ni proteins are characterized by their diversity with respect to structure and function: urease and *E. coli* Glx I are nonredox enzymes that catalyze the hydrolysis of urea or the second reaction step in α -keto aldehyde detoxification (i.e., the isomerization of the glutathione adduct of the α -keto aldehyde), whereas [NiFe]-hydrogenase, MCR, CODH, ACS, and NiSOD are involved in various redox chemistries.

The dinuclear active site of urease (**1**) has been studied in great detail^{23–29} and has inspired manifold model studies—hence a separate section, Section 6.3.4.12.7, is dedicated to the coordination chemistry related to urease. *E. coli* Glx I is the first example of a Ni-dependent isomerase and contains a single Ni^{II} ion coordinated by two histidines, two axial carboxylates of glutamic acid, and two water molecules (**2**).^{30–32} It is not active with Zn bound, which is believed to result from the inability of the Zn-substituted enzyme to bind a second aqua ligand and to adopt a six-coordinate structure.

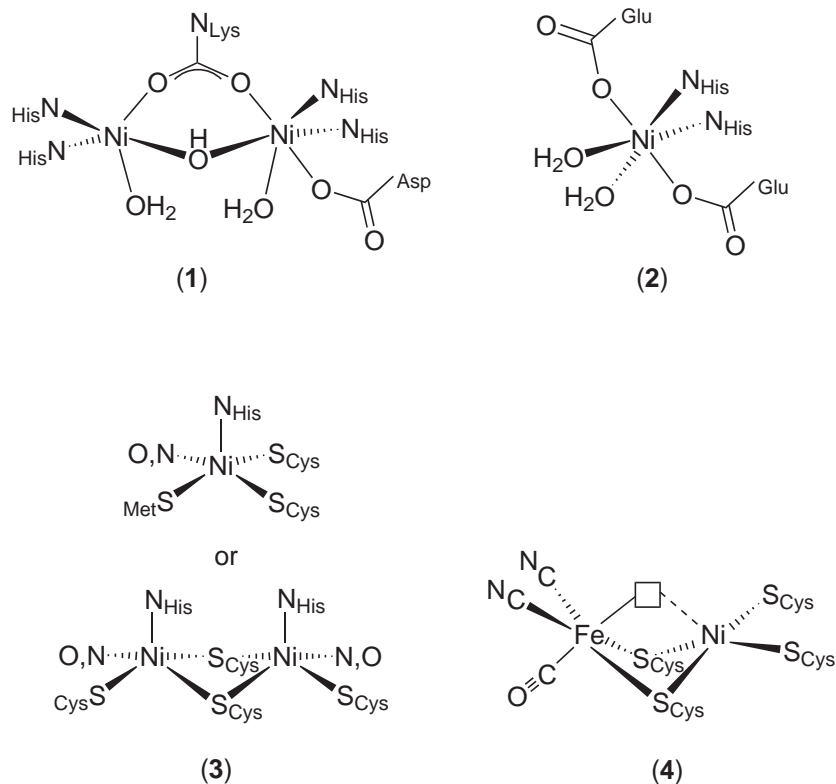

Nickel is found in thiolate/sulfide environment in the [NiFe]-hydrogenases and in CODH/ACS.³³ In addition, either a mononuclear Ni-thiolate site or a dinuclear cysteine-S bridged structure are assumed plausible for the new class of Ni-containing superoxide dismutases, NiSOD (3).³⁴ [NiFe]-hydrogenase catalyzes the two-electron redox chemistry of dihydrogen. Several crystal structures of [NiFe]-hydrogenases have demonstrated that the active site of the enzyme consists of a heterodinuclear Ni—Fe unit bound to thiolate sulfurs of cysteine residues with a Ni—Fe distance below 3 Å (4).^{35–39} This heterodinuclear active site has been the target of extensive model studies, which are summarized in Section 6.3.4.12.5.

CODHs catalyze the reversible dehydrogenation of CO and H₂O to CO₂ and has many functions important to the global carbon cycle.^{33,40} *Inter alia*, phototropic anaerobes have the ability to use CO as their carbon and energy source, which is based on the oxidation of CO to CO₂ catalyzed by CODHs. Some CODH enzymes also participate in the synthesis or disassembly of acetyl CoA. These so-called CODH/ACS enzymes thus have a dual role and contain two metal-containing active sites connected by a hydrophobic channel: the metallocluster found in the CODH subunit reduces CO₂ to CO, and that in the ACS subunit uses the formed CO and a methyl group to assemble acetyl CoA. Both sites contain nickel. Two structures of CODH enzymes appeared in 2001 and revealed that—contrary to previous assumptions—the Ni is completely integrated in the Fe/S cluster (5a, b).^{41,42} This has been proposed to allow the Ni ion to formally remain in the EPR silent Ni^{II} oxidation state even in the CO-reduced state, despite the fact that the Ni is the likely site of CO binding. Indeed, one of the two structures shows a fifth ligand bound to Ni (5b), but the overall structures of the clusters differ significantly, possibly indicating considerable rearrangement between different oxidation states.

The crystal structure of a CODH/ACS enzyme was reported only in 2002.^{43,44} It reveals a trio of Fe, Ni, and Cu at the active site (6). The Cu is linked to the Ni atom through two cysteine-S, the Ni being square planar with two terminal amide ligands. Planarity and amide coordination bear some resemblance to the Ni porphyrinoid in MCR. A two-metal ion mechanism is likely for acetyl CoA synthesis, in which a Ni-bound methyl group attacks an adjacent Cu—CO fragment with formation of a Cu-acyl intermediate. A methylnickel species in CODH/ACS has been identified by resonance Raman spectroscopy.⁴⁵

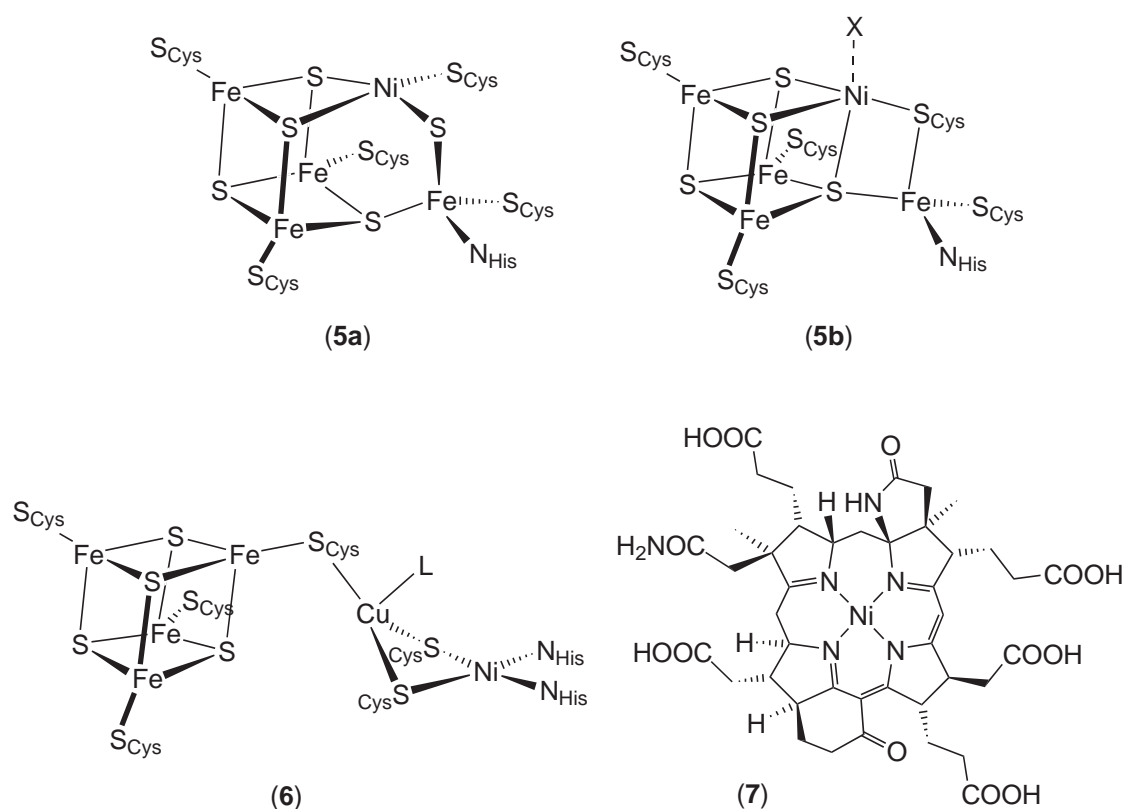

MCR catalyzes the final chemical step in methane formation by strictly anaerobic methanogens (methanoarchaea).⁴⁶ The reaction involves a formal two-electron reduction of a methylthioether, methyl-coenzyme M ($\text{H}_3\text{C-S-CoM}$), by N-7-mercaptoheptanoylthreonine phosphate (HTP-SH, coenzyme B, CoB-SH) to yield methane and the mixed disulfide CoM-S-S-CoB . The key component is an unusual Ni tetrahydrocorphinoid cofactor (F_{430} , (7)),^{47,48} and the assumed mechanism involves an intermediate Ni-CH_3 species. The redox chemistry of F_{430} has been the subject of numerous EPR studies (both on the enzyme and on model systems) as well as quantum chemical studies, where Ni^{I} , Ni^{II} , and Ni^{III} states have been characterized and proposed as intermediates in the catalytic cycle.^{49–51} Model systems for MCR are mentioned in the respective chapters dealing with Ni–porphyrin and Ni–tetraazamacroclic complexes as well as in [Section 6.3.4.11.7](#).

6.3.2.2 Nickel in Materials Chemistry

Nickel plays a prominent role in several areas of materials chemistry. However, in this review only in cases where Ni coordination chemistry is central to the physical properties will this relevance be mentioned specifically, and compounds are usually ordered according to their respective donor set. Some topical interplay between Ni coordination chemistry and materials science exists in the use of Ni-containing alkoxides for the synthesis of ceramic materials by MOCVD and sol–gel processes,⁵² the preparation and nanoscopic dendrimers incorporating Ni,^{53,54} the construction of 3D hybrid inorganic–organic porous materials with Ni coordination units,^{55,56} and the fabrication of supported Ni catalysts and Ni nanostructures through nanotechnology.^{57,58} The relevance of Ni complexes with dithiolene-type ligands in the areas of, *inter alia*, conducting and magnetic materials is mentioned in [Section 6.3.4.7.10](#). Paramagnetic high-spin Ni^{II} has found particular attention in the field of molecular magnetism, culminating in the recent discovery of the first single molecule magnets based on Ni^{II} centers.^{59–61} Magnetic properties of some prominent classes of polynuclear Ni^{II} compounds are presented in [Section 6.3.4.13](#).

6.3.3 COMPLEXES OF NICKEL(III) AND NICKEL(IV)

6.3.3.1 Introduction

There is increasing interest in high-valent Ni, both because of the relevance of Ni^{III} in some bioinorganic sites and because of the high reactivity of the high-valent species. An account of the chemistry of Ni^{III} and Ni^{IV} has been published,⁶² and the redox chemistry of nickel has been reviewed.⁶³ In particular, the general steric and electronic requirements and the methods of study of Ni^{III} and Ni^{IV} complexes have previously been summarized—hence these aspects will not be covered here. Also, the mechanisms and kinetics of electron transfer reactions of Ni^{III} and Ni^{IV} complexes have been reviewed.⁶⁴

Ligands used to fulfill the requirements for stabilizing Ni^{III} and Ni^{IV} states are particularly deprotonated amides and oximes as well as certain macrocyclic N-donor ligands. Since many studies of Ni^{II} complexes include reports on the electrochemical Ni^{II}/Ni^{III} redox potentials, the reader should also refer to the respective Ni^{II} sections when looking for individual ligand sets. Section 6.3.3 does not give an exhaustive compilation, but instead focuses on selected examples where the high-valent Ni states have been the central aspect of the work. Since dinuclear (and oligonuclear) complexes that incorporate Ni^{III} (or even Ni^{IV}) are usually prepared from the respective Ni^{II} compounds, these systems are not covered here (with few exceptions), and the reader should refer to the respective section of the Ni^{II} part for some further information.

6.3.3.2 Cyano Complexes

The Ni^{III} complex *trans*-[Ni(CN)₄(H₂O)₂][−] can be generated in aqueous solution by the oxidation of [Ni(CN)₄]^{2−}, either by bulk electrolysis or chemically.⁶⁵ Chlorine oxidation of aqueous solutions of [Ni(CN)₄]^{2−} has been the subject of a detailed kinetic study.⁶⁶ Three parallel paths were found, determined by the species present in Cl₂/H₂O solutions (Cl₂, Cl₂O, HOCl). The fastest reaction is oxidation by Cl₂O (1.3 × 10⁷ M^{−1} s^{−1} at 25 °C, μ = 0.10 M), the formation of which is catalyzed by acetic acid. The reaction is proposed to proceed via Cl⁺ transfer, affording a transient Ni^{IV} species.

trans-[Ni(CN)₄(H₂O)₂][−] is moderately stable at low concentrations in acidic solutions, but decays rapidly in base. The base decomposition is slower in the presence of excess cyanide.⁶⁷ The interaction of axially bound water with Ni^{III} has been investigated using electron spin echo envelope modulation with different pulse sequences.^{68,69} Cyclic voltammetry of [Ni(CN)₄(H₂O)₂][−] gives a formal reduction potential of 1.19 V (vs. NHE) for the [Ni^{III,II}(CN)₄]^{1−/2−} couple. Although it is a strong oxidizing agent, [Ni(CN)₄(H₂O)₂][−] coordinates excess cyanide to form [Ni(CN)₆]^{3−}, which gives an anisotropic EPR spectrum at −190 °C, with *g*_⊥ = 2.081 and *g*_∥ = 2.010. At −35 °C the frozen EPR spectrum collapses to an isotropic signal, because the six cyanides become equivalent due to dynamic Jahn–Teller distortion.⁶⁷

In addition, the labile aqua species *trans*-[Ni^{III}(CN)₄(H₂O)₂][−] is a useful source of various tetragonally elongated Ni^{III} complexes through the displacement of the axial water ligands. Ni^{III} complexes that have been prepared via this intermediate include [Ni(CN)₄(NCO)₂]^{3−}, [Ni(CN)₄(Cl)₂]^{3−}, [Ni(CN)₄(NCCH₃)₂][−], [Ni(CN)₄(py)₂][−], [Ni(CN)₄(N₃)₂]^{3−}, [Ni(CN)₄(imidazole)₂][−], [Ni(CN)₄(NH₃)₂][−], [Ni(CN)₆]^{3−}, and [Ni(CN)₄(bpy)][−]. The products can be detected and analyzed using EPR spectroscopy, indicating a variety of tetragonally elongated complexes with two equivalent axial donor ligands.⁶⁷

Cyanide binds to a series of Ni^{III} complexes with {N₃O₂} chelate ligands, and EPR spectra of the adducts indicate quasi-axial symmetry with a *g* pattern typical of low-spin, six-coordinate complexes with axial elongation and with a ²A₁ ground state. No direct spin interaction of the unpaired electron with the carbon atom of the cyanide takes place.⁷⁰

6.3.3.3 Complexes with N-donor Ligands

6.3.3.3.1 Complexes with nonmacrocyclic N-donor ligands

In CCl₄ suspension, chlorine oxidation of [Ni(diamine)₃]Cl₂ affords unstable orange [Ni(diamine)₃]Cl₃ (diamine = en, 1,3-propanediamine, 1,2-cyclohexanediamine, 1,2-diamino-2-methylpropane, *N*-methylethanediamine); some of these species are stable for a few weeks in a

glove-box.⁷¹ They have been characterized by EPR, IR, and diffuse reflectance electronic spectroscopy. EXAFS analysis of solid samples suggests a very slight shortening of the Ni—N distance on passing from Ni^{II} to Ni^{III}, although larger Debye–Waller factors are evident, possibly because of disorder induced by the Jahn–Teller effect in the low-spin d^7 systems.

Halogen oxidation of Ni^{II}–diamine complexes in solution is known to give either genuine Ni^{III} complexes $\{[\text{NiX}(\text{diamine})_2]\text{X}_2\}_n$ or Ni^{II}/Ni^{IV} mixed valence species $\{[\text{Ni}^{\text{II}}(\text{diamine})_2][\text{Ni}^{\text{IV}}\text{X}_2(\text{diamine})_2]\text{X}_4\}_n$. For the chlorination of $[\text{NiCl}_2(\text{en})_2]$, both products have finally been characterized, after much dispute in the literature over the nature of these materials.⁷² Either *trans*- $[\text{Ni}^{\text{III}}\text{Cl}_2(\text{en})_2]\text{Cl}$ or the mixed-valence compound $\{[\text{Ni}^{\text{II}}(\text{en})_2][\text{Ni}^{\text{IV}}\text{Cl}_2(\text{en})_2]\text{Cl}_4\}_n$ are obtained, depending upon the conditions. $\{[\text{Ni}^{\text{III}}\text{Cl}(\text{en})_2]\text{Cl}_2\}_n$ has been synthesized by anodic electrocrystallization from a solution of $[\text{Ni}_2(\mu\text{-Cl})_2(\text{en})_4]\text{Cl}_2$ (prepared *in situ* in MeOH, in the presence of excess LiCl). It has a one-dimensional (1D) structure with symmetrical halogen bridges,⁷³ as does $\{[\text{NiX}(\text{R,R-1,2-cyclohexanediamine})_2]\text{X}_2\}_n$.⁷⁴ Useful structural information for the mixed-valence species $\{[\text{Ni}^{\text{II}}(\text{en})_2][\text{Ni}^{\text{IV}}\text{Cl}_2(\text{en})_2]\text{Cl}_4\}_n$ is forthcoming from nickel and chlorine EXAFS.⁷⁵ The chloro-bridged 1D Ni^{II}/Ni^{IV} mixed-valence complexes $[\text{NiL}][\text{NiCl}_2\text{L}]\text{Cl}_4$ (L = 3,7-diazanonane-1,9-diamine)⁷⁶ and $\{[\text{Ni}^{\text{II}}(\text{en})_2][\text{Ni}^{\text{IV}}\text{Cl}_2(\text{en})_2]\text{Cl}_4\}_n$ ⁷⁷ have also been analyzed using XPS and EPR, respectively.

The X-ray determination of the crystal structure of $[\text{Ni}^{\text{III}}\text{Br}_2(\text{en})_2]\text{Br}$ shows a centrosymmetric cation, with $d(\text{Ni—N}) = 1.944 \text{ \AA}$ and $d(\text{Ni—Br}) = 2.635 \text{ \AA}$.⁷⁸ The long Ni—Br bond is as expected for this d^7 (d_{z^2})¹ complex, while the Ni—N bonds have shortened considerably upon oxidation. Data obtained from EXAFS measurements are quite consistent with these findings: $d(\text{Ni—N}) = 1.915 \text{ \AA}$; $d(\text{Ni—Br}) = 2.582 \text{ \AA}$.⁷⁹ Bromine oxidation of $[\text{NiBr}_2(\text{en})_2]$ affords discrete $[\text{Ni}^{\text{III}}\text{Br}_2(\text{en})_2]\text{Br}$, whereas with $[\text{NiBr}_2(\text{R,R-1,2-cyclohexanediamine})_2]$, the product is the 1D Ni^{III} complex $\{[\text{NiBr}(\text{R,R-1,2-cyclohexanediamine})_2]\text{Br}_2\}_n$. Since both Ni^{II} complexes, in MeOH solution, exhibit virtually identical CVs, it is proposed that the different solid-state structures for the two complexes are caused purely by strong $\text{NH} \cdots \text{Br} \cdots \text{HN}$ bonding in the 1D complex.

In most such chains, the bridging halogen atoms are distorted from the neighboring two Ni atoms due to strong electron-phonon interaction, giving rise to the mixed-valent Ni^{II}/Ni^{IV} 1D sequences or Peierls distorted charge density wave (CDW) states. In the case of stronger on-site Coulomb interaction, however, the Ni^{III} state or spin density wave state (SDW) becomes more stable, where the bridging halogens are located at the midpoints between neighboring two Ni atoms. This has been verified for several quasi-1D Ni^{III} complexes $\{[\text{NiX}(\text{R,R-1,2-cyclohexanediamine})_2]\text{Y}_2\}_n$ (X = Cl, Br, and mixed halides; Y = Cl, Br, mixed halides, NO₃, BF₄, ClO₄).⁸⁰ Strong antiferromagnetic coupling in $\{[\text{NiX}(\text{diamine})_2]\text{X}_2\}_n$ accounts for the observed diamagnetism. Work on the electronic structures of the quasi-1D halogen-bridged Ni^{III} complexes has been reviewed, emphasizing the strong electron-correlation.⁸¹

The octahedral Ni^{III} complex (**8**) has been obtained serendipitously and the structure of the perchlorate salt was determined.⁸² It features short equatorial Ni—N bonds of 1.952(5)–1.972(6) Å.

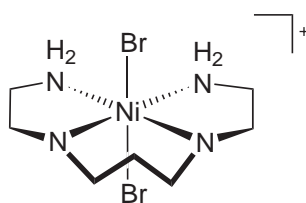

(8)

The structure of the Ni^{III} complex $[\text{Ni}(\text{bpy})_3]^{3+}$ has been determined.⁸³ It contains a $\{\text{NiN}_6\}$ center, and there is a significant shortening of the Ni—N bond lengths upon going from Ni^{II} to Ni^{III}. While the EPR data have been interpreted in terms of tetragonal elongation with the single electron in a d_{z^2} orbital, the structure shows two axial bonds 0.09 Å shorter than the average of the other four. Crystal packing forces have been assumed a more likely reason than dynamic in-plane distortion for this finding.⁸⁴ Cyclic voltammetry and spectroscopic techniques have been used to study the electrochemical oxidation of $[\text{Ni}(\text{bipy})_3]^{2+}$ in liquid sulfur dioxide. Four successive oxidations were observed, the first two of which were attributed to oxidation of the metal center. The procedure for separation and purification of the very strong solid oxidant $[\text{Ni}(\text{bipy})_3](\text{AsF}_6)_4$ has been described.⁸⁵

The complexes (**9**) are readily oxidized and the Ni^{II}/Ni^{III} conversion is reversible.⁸⁶ The Ni^{III} species obtained chemically by oxidation with $[\text{Fe}(\text{CN})_6]^{3-}$ is relatively stable and does not bind

CO or react with H^- . It has a $(d_{z^2})^1$ ground state. The Ni^{III} complex of **(10)** is described in Section 6.3.3.8.2. The tridentate bis-amide ligand **(11)** forms complexes $[\text{Ni}^{\text{II}}(\mathbf{11})_2]^{2-}$, $[\text{Ni}^{\text{III}}(\mathbf{11})_2]^-$, and $[\text{Ni}^{\text{IV}}(\mathbf{11})_2]$ with the metal ion in three consecutive oxidation states.⁸⁷ Redox potentials are 0.05 V and 0.51 V (vs. SCE) for the $\text{Ni}^{\text{II}}/\text{Ni}^{\text{III}}$ and $\text{Ni}^{\text{III}}/\text{Ni}^{\text{IV}}$ transitions, respectively. X-ray crystallography of the Ni^{II} and Ni^{IV} species reveals that the nickel is coordinated in tetragonally compressed geometry in both cases, with the expected decrease of the $\text{Ni}-\text{N}_{\text{amide}}$ (2.131(8) Å vs. 1.946(8) Å) and $\text{Ni}-\text{N}_{\text{py}}$ (1.994(7) Å vs. 1.846(8) Å) bond lengths upon oxidation. The Ni^{III} complex has $S = 1/2$ with the unpaired electron in a d_{z^2} orbital, while the Ni^{IV} compound is diamagnetic.

Ni^{III} Schiff base complexes have been produced by electrochemical oxidation of Ni^{II} complexes derived from naphthaldehyde, and identified by EPR spectroscopy.⁸⁸

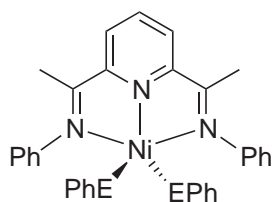

(9) E = S, Se

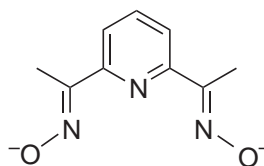

(10)

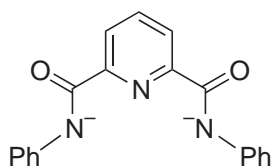

(11)

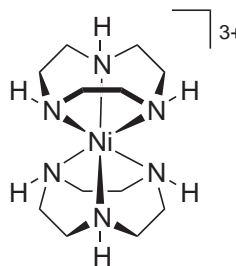

(12)

6.3.3.3.2 Complexes with macrocyclic N-donor ligands

Macrocyclic N-donor ligands continue to dominate Ni^{III} coordination chemistry. Their chemistry makes for a big part of the redox chemistry of Ni, although it has been shown that the cyclic nature of an N-donor ligand is not crucial for thermodynamic stabilization of Ni^{III} .^{89,90} Several reviews have appeared in the field,^{63,91–93} also dealing with kinetic aspects of redox reactions of Ni^{III} macrocyclic complexes.^{64,94} $E_{1/2}(\text{Ni}^{\text{II}}/\text{Ni}^{\text{III}})$ values for various Ni-macrocyclic complexes and general trends of the oxidation potential are summarized in Section 6.3.4.10.1(iii) for tacn-type ligands and in Section 6.3.4.10.2(iii) for larger N-macrocycles.

$[\text{Ni}(\text{[9]aneN}_3)_2]^{3+}$ (**12**) is a strong oxidant and exhibits a quasi-reversible one-electron redox process with a formal redox potential of +0.95 V (vs. NHE).⁹⁵ The trivalent complex exhibits UV and magnetic data consistent with a low-spin d^7 configuration of a Jahn–Teller distorted octahedral $\{\text{Ni}^{\text{III}}\text{N}_6\}$ center, which has been confirmed by the X-ray crystal structure of the dithionate salt of $[\text{Ni}(\text{[9]aneN}_3)_2]^{3+}$.⁸⁴ Similarly, for the Ni sandwich complexes with (*R*)-2-methyl-1,4,7-triazacyclononane it was found that $E_{1/2} = +0.94$ V (vs. NHE) and that the $\{\text{NiN}_6\}$ chromophore is retained in both oxidation states, +2 and +3.⁹⁶ The Ni^{III} complex shows only slight decomposition at pH 3 and is indefinitely stable in acetonitrile. The potentials for the $[\text{LNi}]^{3+/2+}$ couple are generally more negative for complexes containing the pure σ -donor tacn than those of a ligand containing three tertiary amine donors and pendant π -acceptor ligands that stabilize the +2 oxidation state; e.g., the difference is –400 mV compared to 1,4,7-tris(2-pyridylmethyl)-1,4,7-triazacyclononane bearing three pyridine N atoms.⁹⁷ Reinvestigation of the structure reported before as the Ni^{III} complex of 1,4,7-triazacyclononane-*N,N',N''*-triacetate^{98,99} failed to confirm the presence of Ni and indicated a Co complex instead.¹⁰⁰

The Ni^{II} sandwich complexes of 1-thia-4,7-diazacyclononane ([9]aneN₂S),¹⁰¹ 7-aza-1,4-dithiacyclononane ([9]aneNS₂),¹⁰² 1-oxa-4,7-diazacyclononane ([9]aneN₂O), and related tridentate macrocycles can all be oxidized to the corresponding Ni^{III} species. [Ni([9]aneN₂S)₂]³⁺ and [Ni([9]aneN₂O)₂]³⁺ were found to exhibit a distorted stereochemical arrangement with the S and O heteroatoms, respectively, occupying the axial sites of an elongated octahedron.¹⁰¹ $E_{1/2}$ values for the Ni^{II}/Ni^{III} redox couple indicate that the relative stability of the trivalent complex decreases along the series [9]aneN₃ > [9]aneN₂S > [9]aneNS₂ > [9]aneS₃ > [9]aneN₂O, which is assumed to be controlled by the strength of the metal–ligand interactions. Spectroscopic data confirm that these oxidations are metal-centered.¹⁰³ The effect of ring size and medium on the Ni^{II/III} redox couple potential for complexes of triazamacrocyclic ligands has been investigated: in the series of complexes [Ni([9]aneN₃)₂]²⁺, [Ni(**13**)₂]²⁺, and [Ni(**14**)₂]²⁺, according to voltammetric techniques the Ni^{III} state becomes more difficult to attain the larger the macrocyclic ring.¹⁰⁴

The kinetics formation of [Ni([9]aneN₃)₂]³⁺ have been studied in great detail. *Inter alia*, the volume of activation for peroxodisulfate oxidation of [Ni([9]aneN₃)₂]²⁺ has been determined ($-25.8 \pm 2.3 \text{ cm}^3 \text{ mol}^{-1}$),¹⁰⁵ and the kinetics of this reaction have been determined as a function of peroxodisulfate concentration and temperature.¹⁰⁶ The reaction is first-order in both reagents (second-order rate constant $1.13 \text{ mol dm}^{-3} \text{ s}^{-1}$ at 298 K), and the activation energy is $38 \pm 1.8 \text{ kJ mol}^{-1}$. In mixed solvents, the rate is slower.

The inner shell activation barriers to electron transfer in the [Ni([9]aneN₃)₂]^{2+/3+} couple have been studied,¹⁰⁷ and the entropy changes associated with the two half reactions [Ni^{III}([9]aneN₃)₂]³⁺ + e⁻ ⇌ [Ni^{II}([9]aneN₃)₂]²⁺ and [Ni^{III}L]⁰ + e⁻ ⇌ [Ni^{II}L]⁻ (L = 1,4,7-triazacyclononane-*N,N'*-*N''*-triacetate) have been determined through investigation of the temperature dependence of the $E_{1/2}$ (Ni^{III}/Ni^{II}) parameter over the 0.1–3.5 M concentration range of the background electrolyte (NaCl).¹⁰⁸ Molecular mechanics calculations have been performed on complexes [Ni([9]aneN₃)₂]^{2+/3+} to resolve the discrepancy between experimental inner-shell activation enthalpies and values predicted using the harmonic oscillator model.¹⁰⁹ It is found that most of the inner-shell barrier derives from M–N bond stretching.

A large amount of work has been devoted to the mechanism and kinetics of electron transfer reactions with [Ni([9]aneN₃)₂]³⁺,^{64,110} including studies of the oxidation of excess thiocyanate¹¹¹ and of hydrogen peroxide¹¹² by [Ni([9]aneN₃)₂]³⁺. Also, reactions of [Ni([9]aneN₃)₂]³⁺ with NO₂⁻ and NO have been studied in aqueous solution at 25 °C. NO₂⁻ reacts to form [Ni([9]aneN₃)₂]²⁺ and NO₃⁻, with electron transfer from NO₂⁻ to [Ni([9]aneN₃)₂]³⁺ proposed as the rate determining step. NO was found to react either via an outer-sphere-electron transfer reaction or via a pathway which leads to destruction of the complex.¹¹³ UV–visible spectroscopy and stopped-flow techniques have been used to investigate the base promoted decomposition of [Ni([9]aneN₃)₂]³⁺ in aqueous solution. It has been suggested that the reaction is initiated by deprotonation of [Ni([9]aneN₃)₂]³⁺ with the N-deprotonated species then decomposing further to yield Ni(aq)²⁺ and [Ni([9]aneN₃)(H₂O)₃]²⁺. The reaction has been postulated to proceed via mono- and bimolecular pathways.¹¹⁴ Electron transfer reactions of [Ni(**14**)₂]²⁺ have also been studied.¹¹⁵

Studies on the oxidative chemistry of Ni complexes with larger macrocycles, in particular with tetraazamacrocycles, are countless. Pulse radiolysis continues to be one of the methods used for generating azamacrocyclic Ni^{III} species.^{116,117}

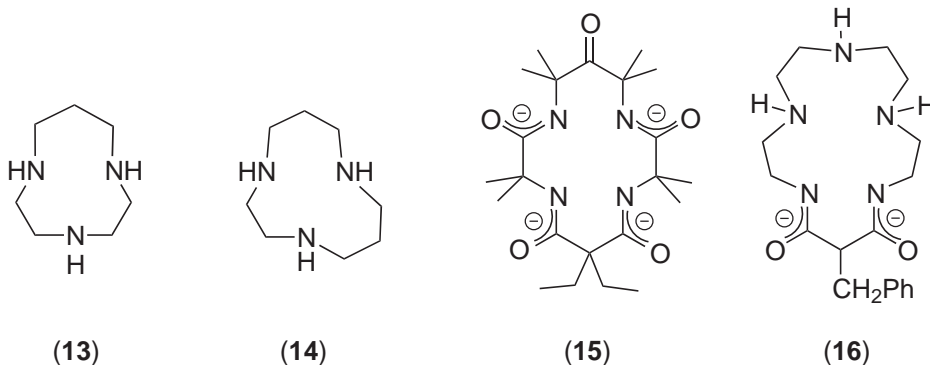

Aliphatic tetraazamacrocycles are well known to be effective in stabilizing Ni in higher oxidation states due to the very strong in plane σ -interactions which raise the energy of the (metallic) antibonding orbital from which the electron is extracted on oxidation. Table 1 lists characteristics

Table 1 Structurally characterized azamacrocyclic Ni^{III} complexes.

Complex	Structure	$d(\text{Ni}-\text{N})$ (Å)	$d(\text{Ni}-\text{X})$ (Å)	References
[Ni(tacn) ₂] ³⁺	Tetragonally distorted; octahedral	1.964(5)–2.111(5)		126
<i>trans</i> -[Ni(17)(NO ₃) ₂] ⁺	Axially elongated; octahedral	1.970(2)–1.978(2)	(X = O); 2.110(2), 2.114(2)	127
<i>trans</i> -[Ni(17)(NCS) ₂] ⁺	Axially elongated; octahedral	1.965(2), 1.979(2)	(X = N); 2.081(3)	128
<i>trans</i> -[Ni(18)Cl ₂] ⁺	Axially elongated; octahedral	1.983(2), 2.011(2)	(X = Cl); 2.4721(6)	129
<i>trans</i> -[Ni{H ₂ (19)}Cl ₂] ³⁺	Axially elongated; octahedral	1.970(14)–2.007(14)	(X = Cl); 2.401(6), 2.430(6)	130
<i>trans</i> -[Ni(20)Br ₂] ⁺	Axially elongated; octahedral	1.869(12), 1.969(14)	(X = Br); 2.664(1)	131
[Ni(16)(H ₂ O)] ⁺	Axially elongated; octahedral	N _{amide} (equatorial): 1.893(3), 1.887(5); N _{amine} (equatorial): 1.961(5), 1.965(4); N _{amine} (axial): 2.067(4)	(X = O); 2.340(4)	132
[Ni(15)] ⁻	Distorted square-planar (significantly nonplanar tetraamido ligand)	1.824(4)–1.849(4)		125

of structurally characterized azamacrocyclic Ni^{III} complexes. All of them have an axially elongated octahedral geometry, except for [Ni(**15**)]⁻ which is distorted square planar with the Ni atom sitting 0.09 Å above the mean plane of the N-donor atoms. Dioxo tetraaza macrocycles with amide sites such as (**16**) are often used for stabilizing Ni^{III}.^{118–123} The tetraamide macrocycle (**15**) is particularly well suited to stabilize nickel in the +3 oxidation state and features short Ni–N bonds.^{124,125} The purple complex [Ni(**15**)]⁻ has a very low affinity for axial ligands in solution: only addition of cyanide gives a color change to yellow, with the resulting EPR spectrum being rhombic. The use of ¹³CN confirms binding of a single cyanide.¹²⁵

Typically, the Ni–Cl and Ni–N bonds shorten on passing from the Ni^{II} to the Ni^{III} state, e.g., by about 0.09 Å in the case of *trans*-[Ni(**18**)Cl₂]⁺.¹²⁹ For this particular compound, quasi-reversible oxidation occurs at +1.14 V (vs. SCE) and the EPR spectrum ($g_{\perp} = 2.121 > g_{\parallel} = 2.019$) is indicative of axial symmetry. More sterically congested tetraazamacrocyclic ligands can promote the low-spin square planar geometry of the Ni^{II} complexes in aqueous solution and thus can make the Ni^{II}/Ni^{III} redox potential more anodic, as expected given the increasing difficulty experienced by the metal ion in coordinating axial coligands. This has been demonstrated for, *inter alia*, Ni complexes of a series of sterically congested cyclam derivatives (e.g., (**21**), (**22**) and various cyclohexane appended cyclam systems).¹³³ Ligands with pendant arms bearing potentially coordinating groups have been employed in order to circumvent the need for additional external ligands for stabilizing the Ni^{III} state (compare Section 6.3.4.10.2). However, in the case of some hexaazamacrocyclic ligands, the hydroxyethyl or cyanoethyl pendant arms have been found to not coordinate.¹³⁴ It should be mentioned that Ni complexes of hexaaza macrotricyclic ligands have also been investigated in detail with respect their Ni^{II}/Ni^{III} redox chemistry.^{135,136}

The electrochemical behavior of the Ni^{II} complex of (**23**) reveals that the *cis*-octahedral Ni^{II} species [Ni(**23**)H₋₁(H₂O)]⁺ rapidly rearranges to a nominally square planar form upon oxidation to Ni^{III} at ~+0.6 V vs. SCE, which is reversible upon reduction.¹³⁷ Ligand (**24**) with a weakly-binding sulfonamide moiety readily supports Ni^{III}: on treatment of the Ni^{II} complex in H₂O with S₂O₈²⁻, *trans*-[Ni(**24**)Cl₂]⁺ is generated.¹³⁸ Indirect evidence suggests that the Ni^{III} species is more stable than the complex with parent cyclam.

With respect to the ring size, it has been stated that neither the redox potentials nor the half-lives of the Ni^{III} species are directly correlated to the cavity of the macrocyclic ligand, but the redox potentials are dependent on solvation effects.¹³⁹ The effect of fused benzene rings and ring conformation has been monitored.¹⁴⁰ In Ni complexes of fluorine-containing cyclams (**25**) the higher oxidation state becomes successively destabilized with respect to Ni^{II}, while the lower oxidation state (i.e., Ni^I) becomes successively stabilized.¹⁴¹

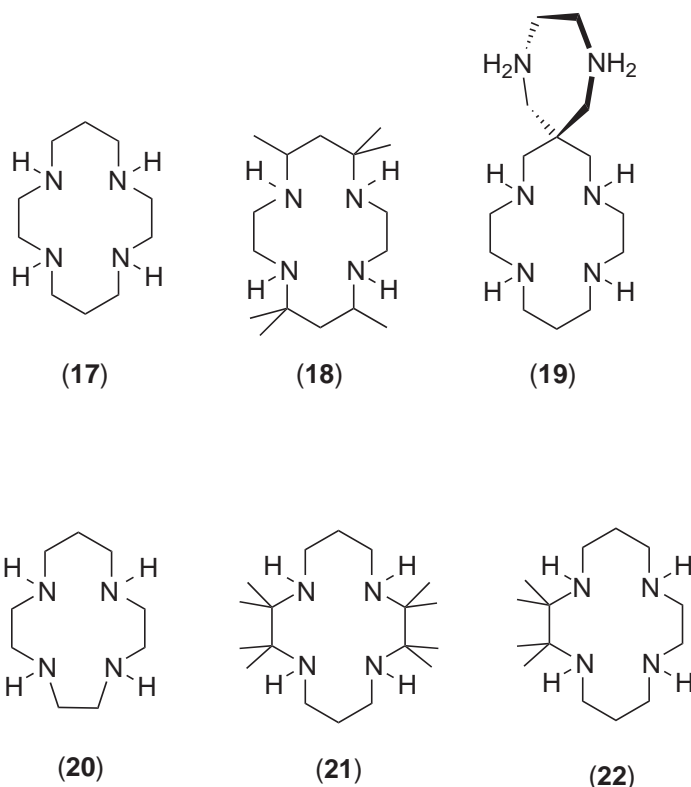

A violet transient forms when acid $[\text{Ni}(\mathbf{17})]^{3+}$ solutions are added to water buffered at $\text{pH } 7 \pm 1$. The color originates from a band at 539 nm , with a high extinction coefficient (1330 ± 100) assigned to a Ni^{III} complex of monodeprotonated cyclam ($\text{p}K_{\text{a}}$ of $[\text{Ni}(\mathbf{17})]^{3+}$ secondary amine: 7.1 ± 0.1).¹⁴² The latter undergoes decay by a second-order rate process, probably transfer of an electron from the amido nitrogen to a second Ni^{III} center, giving a Ni^{II} -cyclam radical complex which undergoes loss of a proton to give a Ni^{II} complex of the monoimine macrocycle. This is believed to be the general pathway of decomposition of Ni^{III} complexes with ligands having secondary N-donors.^{143,144} Systems with tertiary tetraaza macrocyclic ligands may be kinetically stabilized in aqueous solution.¹⁴⁵

The kinetics and mechanism of chloride and bromide substitution of diaquanickel(III) complexes with several ligands of the cyclam type have been studied. The data reveal a reversible process yielding $[\text{NiL}(\text{H}_2\text{O})\text{X}]^{2+}$ and are consistent with a dissociative mechanism, sterically more demanding axial groups substantially increasing the rate. In addition, a rearrangement step is observed subsequent to the formation of the monohalide complex.¹⁴⁶

Trivalent Ni complexes of tetraazamacrocycles are powerful single-electron oxidizing species, and much work has been carried out on the mechanism and kinetics of such reactions. Only selected examples can be mentioned here. These include the kinetics of reduction by Ti^{III} in aqueous solution, where an outer-sphere mechanism is favored,¹⁴⁷ the kinetics of the reduction of a range of eight Ni^{III} macrocycle complexes by reagents such as Fe^{II} ,¹⁴⁸ the reactions of Ni^{III} tetraazamacrocyclic complexes with iodide,¹⁴⁹ the kinetics of the reaction of $[\text{Ni}(\text{cyclam})]^{2+}$ in acidic aqueous solution with alkyl hydroperoxides,¹⁵⁰ and the kinetics of reduction of $[\text{Ni}(\text{cyclam})(\text{H}_2\text{O})_2]^{3+}$ and species $[\text{Ni}(\text{cyclam})\text{X}(\text{H}_2\text{O})]^{2+}$ ($\text{X} = \text{Cl}, \text{Br}$) by SO_2 in acid media.¹⁵¹ In the latter case, only SO_3^{2-} and HSO_4^- were detected; no evidence was found for $\text{S}_2\text{O}_6^{2-}$, which would be expected if SO_3^- were an important intermediate. Halide ions accelerated the reaction. A mechanism involving insertion of S^{IV} into $\text{Ni}^{\text{III}}-\text{X}$ bonds was proposed.

Studies have been carried out on the methylated complex $[\text{H}_3\text{C}-\text{Ni}^{\text{III}}(\mathbf{17})(\text{H}_2\text{O})]^{2+}$, which is obtained from the reaction of methyl radicals (generated by pulse radiolysis) with $[\text{Ni}(\mathbf{17})]^{2+}$. The volumes of activation are consistent with the coherent formation of $\text{Ni}-\text{C}$ and $\text{Ni}-\text{OH}_2$ bonds, as expected for the generation of a Ni^{III} complex from a square planar Ni^{II} precursor.¹⁵² The kinetics of reactions of $[\text{H}_3\text{C}-\text{Ni}^{\text{III}}(\mathbf{17})(\text{H}_2\text{O})]^{2+}$ involving homolysis, O_2 insertion and methyl transfer to $\text{Cr}^{\text{II}}(\text{aq})$ have been determined, and intermediates have been considered relevant as models for biological systems.¹⁵³ Comparing different alkyl radicals, rate constants for the

formation of σ -bonded organonickel(III) cations are most favorable for methyl radicals, and least favorable for secondary alkyls.¹⁵⁴

Complexes such as [Ni(**16**)] are known to stoichiometrically interact with O₂ to give 1:1 adducts and subsequently the autoxidized Ni^{III} species (compare Section 6.3.4.10.2(v)).¹⁵⁵ Such systems have been tested for the Ni^{III}-catalyzed cleavage of DNA (see Section 6.3.4.10.2(v)). It has been suggested that Ni^{II} macrocycle complexes with rather low Ni^{II}/Ni^{III} reduction potentials can be active inhibitors of aldehyde autoxidation.¹⁵⁶

Oxidation of encapsulated complexes with hexadentate sarcophagine-type ligands to the Ni^{III} cations was achieved by controlled potential coulometry in acetonitrile, or Ce^{IV} oxidation in aqueous solution; [(**26**)](CF₃SO₃)₃ could be isolated as a pure solid and is a strong oxidant (+0.90 V vs. NHE).¹⁵⁷ Since the Ni^{II} complex could be resolved into its enantiomers by fractional crystallization as bis((+)-tartrato)diantimonate salts, the optically pure Ni^{III} cations were obtained from these. The electron self-exchange rate between enantiomeric forms in the two oxidation states was measured using a stopped flow circular dichroism technique ($k_{ct} = 5,300 \pm 300 \text{ dm}^3 \text{ mol}^{-1} \text{ s}^{-1}$ at 298 K, $I = 0.2 \text{ M}$). The rate constant and the activation parameters are consistent with only minor rearrangements of the coordination spheres on electron transfer.

The redox behavior of Ni^{II} tetraazaannulene complexes can be tuned by the appropriate choice of substituents bound to the ligand scaffold.¹⁵⁸ It is interesting to note that in a series of Jäger-type Ni^{II} complexes, both the type (**27**) and type (**28**) systems give reversible oxidation, while (**29**) does not.¹⁵⁹

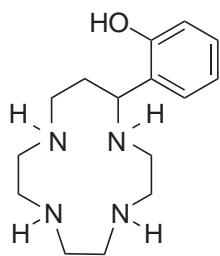

(23)

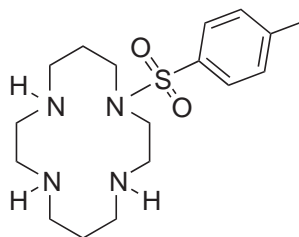

(24)

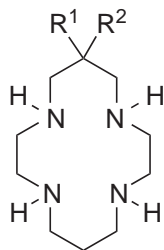
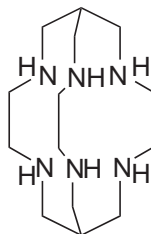
(25a) R¹ = F, R² = H, Me(25b) R¹ = R² = F

(26)

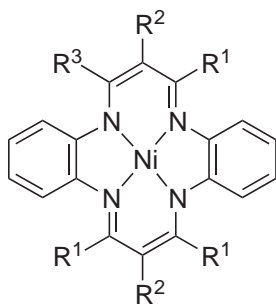

(27)

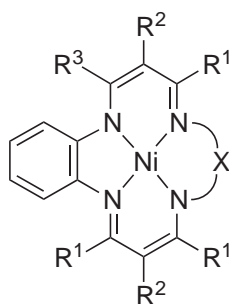

(28)

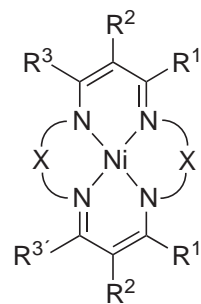

(29)

6.3.3.4 Complexes with Ligands Containing Phosphorus, Arsenic, and Antimony

The three main types of Ni^{III} complexes with P- and As-donor ligands are [NiX₃L₂], [NiX₃(L-L)], and [NiX₂(L-L)₂]⁺. Although the five-coordinate Ni^{III} complexes with phosphine or arsine ligands have long been known, more detailed investigations have been carried out since the early 1980s. Some 25 examples of this class have been described in a report which includes an account of their spectral and magnetic properties,¹⁶⁰ and high-valent Ni complexes with P- and As-donor ligands have been reviewed.¹⁶¹

A new method for synthesis of type [NiL₂X₃] phosphine complexes involves reaction of reagent grade metal powders with phosphoranes or arsanes in ether according to Equation (1).^{162,163} The Ni^{III} complex is formed quantitatively without use of an additional oxidizing agent. However, the procedure leads to products whose composition is very dependent on L and X; in the case of L = phosphane, the products include square planar [NiI₃(PR₃)]⁻ (R ≠ Me), [NiBr₂(PMe₂Ph)₂], and five-coordinate [NiI₃(PR₃)₂] (PR₃ = PMe₃, PMe₂Ph), as well as [NiBr₄(PR₃)₂] (PR₃ = PPh₂Pr, PMe₂Ph) which appears to be [PBrR₃][NiBr₃(PR₃)].¹⁶⁴ Nickel K-edge EXAFS data, supplemented by bromine K-edge data, have been used to obtain structural information relating to the complexes [Ni(PR₃)₂X₃] (PR₃ = PEt₃, PMe₂Ph; X = Cl, Br). These studies confirmed the occurrence of rare trigonal bipyramidal geometry for these Ni^{III} complexes,¹⁶⁵ in accordance with X-ray crystallographic results for [NiI₃(PMe₃)₂]¹⁶⁶ and [NiI₃(AsMe₃)₂] (30).¹⁶²

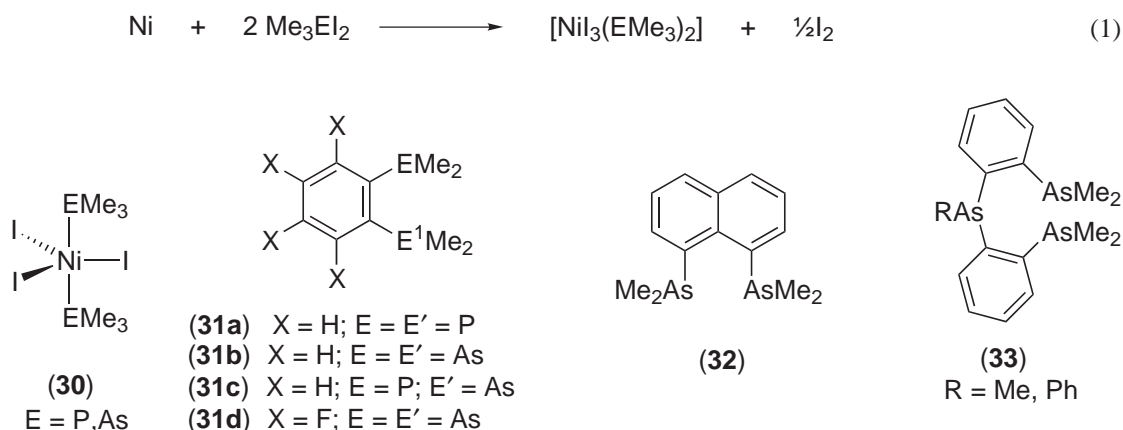

In contrast to the [NiX₃(PR₃)₂] complexes, [NiX₃(L-L)] with bidentate phosphines L-L lose X₂ on heating and revert to the Ni^{II} species. Various Ni^{III} complexes [NiCl₃(L-L)] have been obtained by Cl₂ or NOCl oxidation of the corresponding [NiCl₂(L-L)].¹⁶⁰ Nitric acid oxidation of [NiI₂(31b)] leads to *trans*-[NiI₂(31b)]⁺; corresponding Ni^{III} diphosphine complexes could not be made by this route.¹⁶⁷ EXAFS results are available for Ni^{II}, Ni^{III}, and Ni^{IV} complexes¹⁶⁸ of *o*-C₆X₄(EMe₂)₂ (X = H, E = P, As; X = F, E = As) and the crystal structure of tetragonal [NiBr₂(31d)₂]BF₄ has been determined. The polarized optical spectrum of the *d*⁷ Ni^{III} complex [NiCl₂(31a)₂]PF₆ at 19 and 298 K is consistent with an energy level ordering *xy* > *z*² > *xz* > *yz* > *x*² - *z*²,¹⁶⁹ in agreement with the crystal structure which showed the four P atoms of the didentate ligands occupying the equatorial plane and two chloride atoms occupying *trans*-axial positions.¹⁷⁰ UV-visible spectra of these ²A_{2g} ground state Ni^{III} complexes are very characteristic, consisting of a weak feature at ca. (12–14) × 10³ cm⁻¹, further *d-d* bands ca. 20,000 cm⁻¹, and charge transfer transitions ca. 25,000 cm⁻¹.

The electrochemistry of [NiX{P(CH₂CH₂PPh₂)₃}]⁺ (X = Cl, Br, I) shows reversible oxidation to the corresponding Ni^{III} species and irreversible oxidation to the corresponding Ni^{IV} species.¹⁷¹ In general, the chemistry of Ni^{IV} with P- and As-donor ligands is less extensive than that of Ni^{III}. Most Ni^{IV} complexes are of the [NiCl₂(L-L)₂]²⁺ type. Since these *t*_{2g}⁶ species are EPR silent, convincing evidence for the Ni^{IV} formulation usually comes from the UV-visible spectra which are very similar to those of the corresponding Co^{III} compounds. Pseudo-octahedral Ni^{IV} complexes of the type [NiX₂(31)₂][ClO₄]₂ (X = Cl or Br) have been prepared and characterized, and electrochemistry as a function of L has been studied.¹⁷² A combination of EXAFS and electronic spectroscopy have been used to determine the structure of such tetragonally distorted, pseudo-octahedral Ni^{IV} complexes, e.g., [NiCl₂(31a)₂]²⁺ (*d*(Ni—Cl) = 2.26 Å, *d*(Ni—P) = 2.22 Å), and [NiCl₂(31b)₂]²⁺ (*d*(Ni—Cl) = 2.27 Å, *d*(Ni—As) = 2.36 Å).^{172,173}

Five-coordinate Ni^{II} arsine complexes of the ligands **(31)**–**(33)** of formulas [Ni(L³)(L²)]²⁺ (L³ = tridentate **(33)**, L² = bidentate **(31d)**, **(32)**) and [Ni(L³)₂]²⁺ (the latter are also five-coordinate with a single “dangling” AsMe₂ group) have been studied electrochemically.¹⁷⁴ All complexes showed two oxidations and two reductions in CV experiments in CH₃CN. The second oxidation process was only reversible (at 100 mV s⁻¹) for [Ni(L³)₂]²⁺, and scan rates in excess of 500 mV s⁻¹ or temperatures (≤0 °C) were necessary to obtain reversible behavior for this process with [Ni(L³)(L²)]²⁺. The second process is irreversible in CH₂Cl₂ for [Ni(L³)(L²)]²⁺, presumably because of the need to coordinate a sixth donor atom to stabilize the formally low-spin *d*⁶ Ni^{IV}. Overall, the arsine donor sets stabilize (on the voltammetric timescale) all Ni oxidation states from 0 to +4 (compare Sections 6.3.6.3 and 6.3.6.5.4).

When [Ni(CH₃CN)₆](BF₄)₂ is treated with four equivalents of **(34)**, the orange diamagnetic complex **[35]**⁰ forms.¹⁷⁵ This has a remarkably mild Ni^{II}/Ni^{III} couple at -0.07 V, and the Ni^{III} complex is readily prepared by ferrocenium oxidation in acetone. The crystal structure of the Ni^{II} complex shows square planar {NiP₂O₂} coordination with two additional methoxy-O residing above and below the plane, but the Ni—OMe distances preclude any bonding interaction. However, the Ni^{III} complex has distorted octahedral geometry with these methoxy-O coordinated (mean *d*(Ni—P) 2.223(3) Å; mean *d*(Ni—O⁻) 1.918(5) Å; mean *d*(Ni—OMe) 2.192(1) Å).

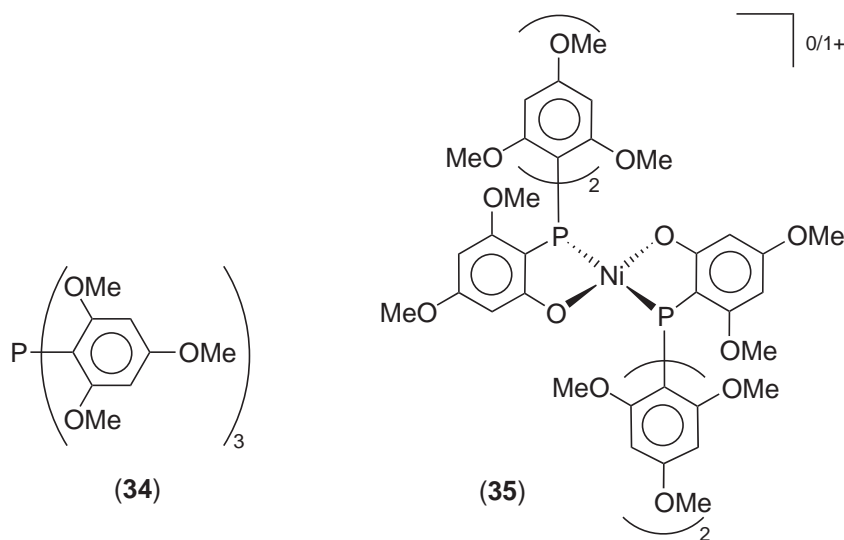

6.3.3.5 Complexes with O-donor Ligands

The low-spin {Ni^{III}O₆} compound [Ni(bipyO₂)₃]³⁺ (bipyO₂ = 2,2'-bipyridyl-1,1'-dioxide) is the product of constant-potential electrolysis of the Ni^{II} salt.¹⁷⁶ Its violet solutions show a rhombic EPR spectrum indicative of a Jahn–Teller-distorted (*d*₂₂)¹ ground state.

S₂O₈²⁻ has been used to oxidize Ni²⁺(aq) in the presence of molybdate ion. The Ni^{IV} product obtained was crystallized as (NH₄)₆[NiMo₉O₃₂]·6H₂O and its crystal structure (determined independently by two groups) revealed a severely distorted octahedral {O₆} environment for the Ni atom, with an average Ni—O bond length of 1.876(5) Å or 1.872(2) Å.^{177,178}

An EXAFS study of β-NiO(OH) indicates that the Ni^{III} sites experience Jahn–Teller distortion, with four Ni—O bonds at 1.87 Å and two at 2.03 Å; in the η-phase containing Ni^{III} and Ni^{IV} this is absent.¹⁷⁹

Reaction of NiCl₂·6H₂O with Bu^tCO₂H and KOH is reported to form a nonanickel cluster [Ni₉(Bu^tCO₂H)₄(μ₄-O)₃(μ₃-OH)₃(Bu^tCO₂)₁₂], which contains both Ni^{II} and Ni^{III}.¹⁸⁰

High-valent nickel complexes with oxo-bridges, in particular the Ni^{III}₂(μ-O)₂ core, are of interest in the context of O₂ activation and subsequent C—H oxidation. A first example of a bis(μ-oxo) core in Ni^{III} chemistry was found for **(36)** incorporating tris(pyrazolylborato) ancillary ligands. When the bis(μ-hydroxo)nickel(II) complex **(37)** was reacted with H₂O₂ at low temperatures, the bis(μ-oxo)nickel(III) complex **(36)** could be isolated and structurally characterized (Equation (2)).^{181,182}

(36) contains five-coordinate Ni ions with a slightly distorted square pyramidal geometry. It decomposes within 1 h at room temperature via oxidation of the tris(pyrazolylborato) ligand, with H-atom abstraction being the rate-determining step (compare also Section 6.3.4.4.6).

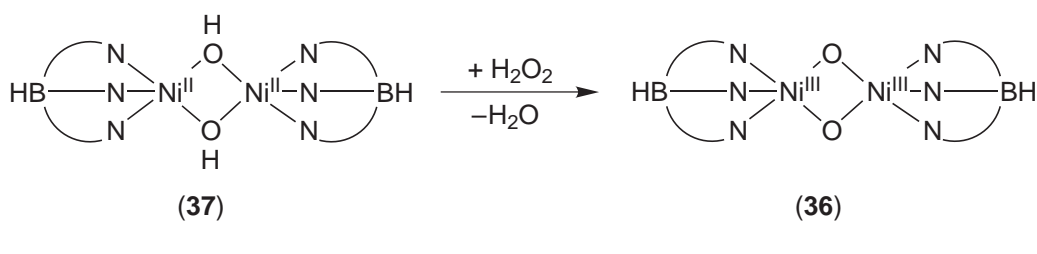

In a similar fashion, the bis(μ -oxo)nickel(III) complex **(38)** with six-coordinate metal ions was prepared at -90°C from the respective bis(μ -hydroxo)nickel(II) species.¹⁸³ Reaction with excess H_2O_2 afforded a unique bis(μ -superoxo)nickel(II) species. Average Ni—O and Ni—N bond lengths are significantly shorter for the Ni^{III} complex (1.871 Å and 2.143 Å, respectively) compared to the Ni^{II} starting material (2.081 Å and 2.185 Å, respectively). **(38)** decomposes at -20°C via partial hydroxylation of the ligand methyl groups.

Oxygenation of the Ni^{I} complex **(39)** leads to O_2 activation and O—O bond rupture with formation of a deep purple bis(μ -oxo)nickel(III) complex **(40)** supported by thioether ligands.¹⁸⁴ Its electronic structure has been investigated by spectroscopic and DFT methods.¹⁸⁵

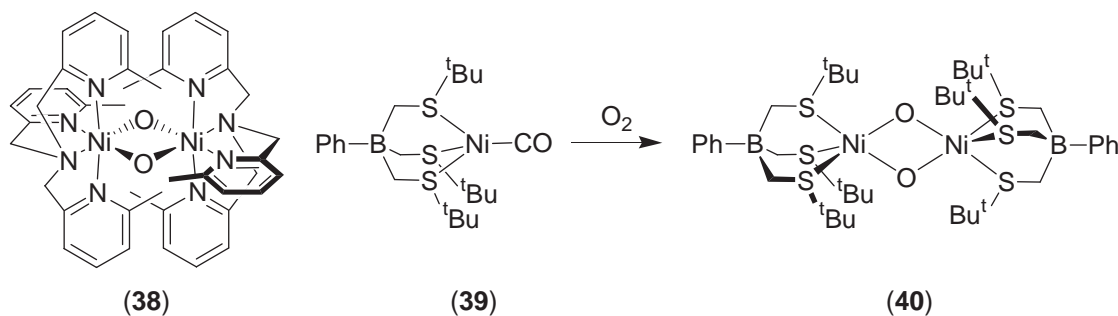

A thermally stable singly oxo-bridged dinickel(III) complex [$\{\text{Ni}^{\text{III}}(\text{salen})\}_2\text{O}$] **(41)** incorporating two high-spin d^7 ions has been prepared from the respective [$\text{Ni}^{\text{II}}(\text{salen})$] precursor and O_2 .¹⁸⁶ The Ni—O—Ni linkage is not linear (angle $146.3(2)^\circ$) and the $\text{Ni}^{\text{III}}\text{—O}$ distances are short (1.870(8) and 1.841(7) Å), while the Ni— O_{salen} and Ni— N_{salen} distances are substantially longer than for related Ni^{II} species. **(41)** shows a reversible redox process at $E_{1/2} + 1.05\text{ V}$ vs. SCE.

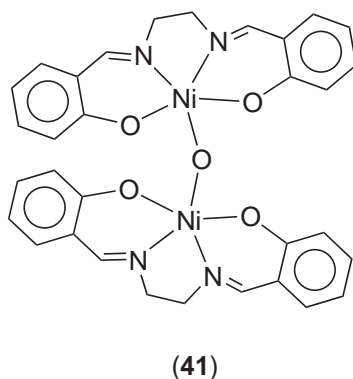

6.3.3.6 Complexes with Ligands Containing S- and Se- donors

Interest in high-valent nickel complexes with sulfur and selenium ligands is fired by the discovery of nickel–sulfur centers in numerous hydrogenase enzymes. These have remarkably low redox potentials (ca. -0.39 V to -0.64 V vs. SCE with a dependence of -60 mV/pH unit) for the formal couple $\text{Ni}^{\text{II}}/\text{Ni}^{\text{III}}$. Thiolate donors are known to stabilize the high-valent Ni^{III} state, and thus there has been much interest in the synthesis of biomimetic complexes with alkyl- and arylthiolate ligands. Since many studies of Ni^{II} complexes with ligands containing S-donors report redox

(vs. $\text{Cp}_2\text{Fe}/\text{Cp}_2\text{Fe}^+$), respectively, or chemically by air.¹⁹³ (47) has been structurally characterized and reveals slightly shortened average Ni—S bonds (2.152 Å vs. 2.166 Å in (45)).

The square planar complexes $[\text{Ni}(\mathbf{49a})_2]^{2-}$ and $[\text{Ni}(\mathbf{49b})_2]^{2-}$ show reversible waves at very low potentials of around -0.76 V (vs. SCE) in their cyclic voltammogram, assigned to the $\text{Ni}^{\text{II}}/\text{Ni}^{\text{III}}$ couple.^{194,195} The red-brown Ni^{III} species $[\text{Ni}(\mathbf{49a})_2]^-$ can be generated simply by exposing solutions of the Ni^{II} complex to air. Its EPR characteristics ($g_{\parallel} = 2.14 > g_{\perp} = 2.05$) suggest a less common (d_{xy})¹ ground state. No evidence has been found for axial ligation to Ni^{III} on dissolution in acetonitrile, pyridine or DMF. Presumably, the two bridging methylene groups, which hinder the axial sites, prevent this, and they are also responsible for the unusual stability of the complex. While cyclic voltammetry of $[\text{Ni}(\mathbf{49c})_2]^{2-}$ shows a reversible $\text{Ni}^{\text{II}}/\text{Ni}^{\text{III}}$ wave at around the same potential as for $[\text{Ni}(\mathbf{49a})_2]^{2-}$, the cyclohexyldithiolate complex decomposes on exposure to air.¹⁹⁶ Similarly, the $[\text{NiL}_2]$ complexes with ethane-1,2-dithiolate (edt) and ligand (49b) are less robust, but the $E_{1/2}$ value of $[\text{Ni}(\text{edt})_2]^{2-}$ with 0.75 V, and the EPR parameters of $[\text{Ni}(\mathbf{49b})_2]^-$ ($g_{\parallel} = 2.187 > g_{\perp} = 2.042$) are in close agreement with those of complex $[\text{Ni}(\mathbf{49a})_2]^-$.¹⁹⁷

Square planar Ni^{II} complexes (50a) and (50b) of the quinoxaline-2,3-dithiolate ligand are oxidizable in chemically reversible, electrochemically quasi-reversible processes to yield Ni^{III} species, also featuring the (d_{xy})¹ configuration.¹⁹⁸ Interestingly, the difference in protonation state makes for a 0.20 V difference in oxidation potential ((50a): +0.12 V; (50b): +0.32 V vs. SCE), consistent with the less basic S-donors in the thione form.

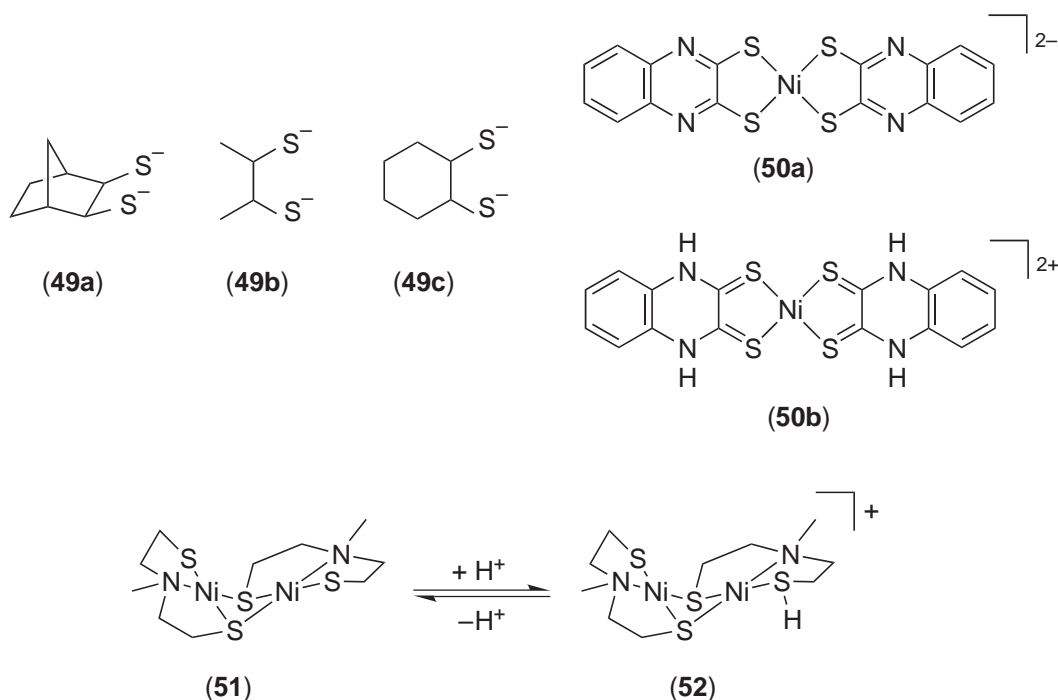

In combination with their inherent redox activity, Ni-bound thiolates may also become protonated, which is of relevance to the reactivity of the Ni/Fe hydrogenase active site. For example, the dinuclear Ni^{II} thiolate complex (51)¹⁹⁹ is reversibly protonated at a single terminal thiolate-S upon addition of $[\text{H}(\text{OEt}_2)_2]\{\text{B}[3,5-(\text{CF}_3)\text{C}_6\text{H}_3]_4\}$ to give (52).²⁰⁰ While (51) shows an irreversible one-electron oxidation at +390 mV (vs. NHE in CH_2Cl_2), oxidation of (52) is shifted anodically to +960 mV and a cathodic process is observed at -550 mV.

$[\text{Ni}(\text{[9]aneS}_3)_2]^{2+}$ shows a reversible oxidation at +0.97 V (vs. $\text{Cp}_2\text{Fe}/\text{Cp}_2\text{Fe}^+$). Spectroelectrochemistry and EPR spectroscopy of ⁶¹Ni-enriched samples confirms that the oxidation is metal centered.²⁰¹ Chemical oxidation to give deep orange $[\text{Ni}(\text{[9]aneS}_3)_2]^{3+}$ (53) is achieved by dissolving $[\text{Ni}(\text{[9]aneS}_3)_2]^{2+}$ in 70% HClO_4 or 98% H_2SO_4 , and the product was isolated as $[\text{Ni}(\text{[9]aneS}_3)_2][\text{H}_5\text{O}_2]_3[\text{ClO}_4]_6$. The single-crystal X-ray structure of this complex confirms octahedral homoleptic thioether coordination, where the Ni—S bond lengths (2.3129(25) Å) for the Ni^{III} complex cation are considerably shorter than those for the corresponding Ni^{II} complex cation, thereby confirming its formulation as a mononuclear Ni^{III} thioether complex cation.²⁰¹ The mixed complex $[\text{Ni}(\text{[9]aneN}_3)(\text{[9]aneS}_3)]^{2+}$ is electrochemically oxidized at 0.86 V (vs. $\text{Cp}_2\text{Fe}/\text{Cp}_2\text{Fe}^+$), or

chemically oxidized by NOPF_6 . The Ni^{III} species (**54**) shows an axial EPR spectrum with $g_{\perp} = 2.106$ and $g_{\parallel} = 2.063$.²⁰²

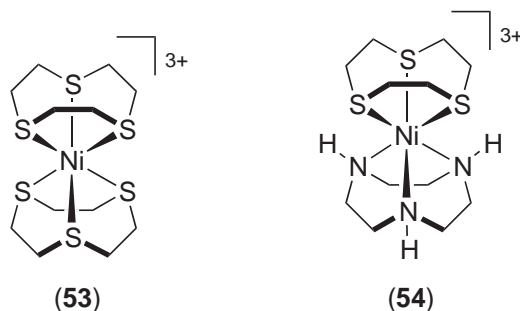

Some mixed valence polynuclear thiolate complexes such as $[\text{Ni}_4(\text{SC}_3\text{H}_7)_8\text{Br}]$ and $[\text{Ni}_4(\text{SC}_3\text{H}_7)_8\text{I}]$ have been prepared and characterized by single-crystal X-ray methods.²⁰³

The work on nickel complexes with dithiolene-type ligands such as dmit, mnt, dddt, etc., is extensive, usually focusing on magnetic or (super)conducting properties. In salts containing anions such as $[\text{Ni}(\text{dmit})_2]^-$ or $[\text{Ni}(\text{mnt})_2]^-$, the metal is usually formulated as Ni^{III} . The reader is referred to previous publications for some selected Ni^{III} complexes.^{204–209} An example of a structurally characterized neutral complex (formally Ni^{IV}) is (**55**), which shows a noticeably nonplanar $\{\text{NiS}_4\}$ central moiety, possibly due to an unusual conformation of the seven-membered rings.²¹⁰ Generally, the influence of the charge state of the complexes on the Ni—S bond lengths is quite small, i.e., 2.12–2.13 Å for neutral complexes vs. 2.13–2.15 Å for monovalent anions. The question whether the unpaired electron resides mainly on the metal or on the ligand had been investigated in great detail. Since the monoanions possess a single electron in their HOMO, interanion interactions are possible and a wide range of structures and properties in the solid state are found.²¹¹ Here, this field will not be covered comprehensively. Some recent work can be found elsewhere.^{212–221} As many studies deal with Ni–dithiolene complexes in different oxidation states, the reader should refer to the respective Ni^{II} section (Section 6.3.4.7.10), where more detailed information is given, also on complexes formally involving Ni^{III} and Ni^{IV} .

New work on high-valent Ni–dithiocarbamates involves the Ni^{III} species (**56**),^{222–228} (**57**),^{226–230} and (**58**)²³⁰ as well as the Ni^{IV} species (**59**).²²⁵ The structure of the type (**59**) Ni^{IV} compound $[\text{Ni}(\text{S}_2\text{CNET}_2)_3][\text{C}_3(\text{CN})_5]$ has been reported.²³¹ The Ni atom of the cation has a distorted octahedral geometry with $d(\text{Ni—S}) = 2.246(2)–2.257(2)$ Å. The type (**59**) complex $[\text{Ni}^{\text{IV}}(\text{60})_3]^+$ can be oxidized three times at the outer ferrocenyl units, where the second and third one-electron couple occur at the same potential.²³² EPR spectra of high-valent Ni–dithiocarbamate complexes have been interpreted in detail,²³³ and the photochemistry of Ni^{IV} dithiocarbamate complexes has been reviewed.²³⁴ Soft X-ray-induced photoreduction of the Ni^{IV} complex $[\text{Ni}(\text{S}_2\text{CNET}_2)_3](\text{BF}_4)$ results in square planar Ni^{II} species.²³⁵

Xanthate complexes $[\text{Ni}^{\text{II}}(\text{S}_2\text{COR})_3]^-$ can be oxidized electrochemically at rather mild potentials (–0.10 V to –0.16 V vs. SCE) in acetonitrile to yield the trivalent species (**61**). However, these are unstable and disproportionate readily according to: $2[\text{Ni}^{\text{III}}(\text{S}_2\text{COR})_3] \rightarrow 2[\text{Ni}^{\text{II}}(\text{S}_2\text{COR})_2] + \text{ROCS}\cdot\text{SS}\cdot\text{CSOR}$.^{236,237} The reaction, examined kinetically ($k(\text{first order}) = 1.0 \times 10^{-3} \text{ s}^{-1}$ at 253 K), prevents the isolation of pure samples. It is suggested that Ni^{III} systems (**61**) can formally be described as resonance hybrids of $\text{Ni}^{\text{III}}/\text{S}^-$ and $\text{Ni}^{\text{II}}/\text{S}$. Oxidation of (**62**) gives solvated Ni^{II} and $\text{ROCS}\cdot\text{SS}\cdot\text{CSOR}$.²³⁷ The octahedral anion $[\text{Ni}(\text{thioxanthate})_3]^-$ is oxidized electrochemically to the Ni^{III} species; it does, however, decompose at room temperature to the dimer $[\text{Ni}_2(\text{SEt})_2(\text{CS}_3)_2]^{2-}$ which has thiolato bridges and one CS_3 group chelated to each nickel.²³⁸

The reaction of $[\text{Ni}(\text{S}_2\text{COEt})_2]$ with Li_2Se and Se or with Li_2Te and Te gives complexes $[\text{Ni}_4\text{Se}_4(\text{Se}_3)_5(\text{Se}_4)]^{4-}$ and $[\text{Ni}_4\text{Te}_4(\text{Te}_2)_2(\text{Te}_3)_4]^{4-}$, respectively, in a spontaneous assembly reaction. Structures were verified by single-crystal X-ray crystallography, and $[\text{Ni}_4\text{Se}_4(\text{Se}_3)_5(\text{Se}_4)]^{4-}$ was found to possess a Ni_4Se_4 cubane core, while $[\text{Ni}_4\text{Te}_4(\text{Te}_2)_2(\text{Te}_3)_4]^{4-}$ has a Ni_4Te_4 cubane core. Ni—Se bond lengths vary from 2.338(7) Å to 2.442(8) Å, while Ni—Te bond lengths vary from 2.492(2) Å to 2.667(2) Å.^{239,240} Each Ni atom is located in a distorted octahedral environment, and is coordinated by three chalcogenide atoms in the cubane framework and by three chalcogenide atoms in the rings that bridge to the other three Ni atoms. Both compounds are diamagnetic and have been formulated as Ni^{IV} species, mainly based on charge balance considerations.

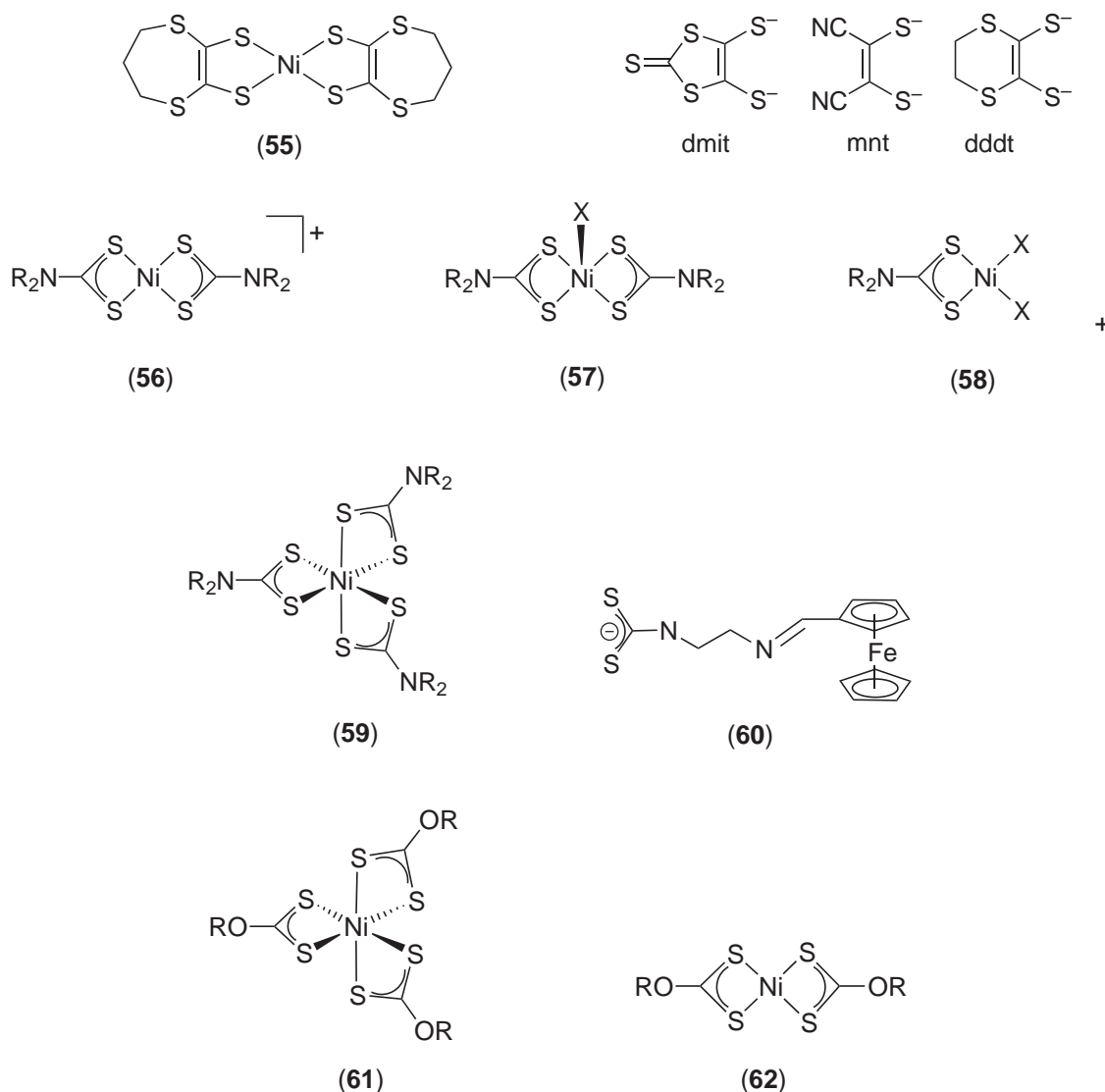

6.3.3.7 Halide Complexes

High valent nickel fluorides have attracted attention because of their possible involvement in the electrochemical fluorination of organic compounds (Simon's process), which is particularly efficient if nickel is used as the anode. $[\text{XeF}_5]_2[\text{NiF}_6]$ (prepared from NiF_2 , KrF_2 , anhydrous HF, and XeF_6) has been structurally characterized and contains octahedrally coordinated Ni^{IV} ($d(\text{Ni}-\text{F}) = 1.77 \text{ \AA}$); it is decomposed in a laser beam at 77 K to XeF_4 , F_2 , and NiF_x ($x = 2-3$).²⁴¹ Also, O_2^+ salts dissolve in anhydrous HF affording O_2F , which oxidizes NiF_2 to $[\text{NiF}_6]^{2-}$ salts.²⁴² The thermodynamically unstable fluorides NiF_4 and NiF_3 have been obtained by the addition of F^- acceptors such as BF_3 and XF_5 ($\text{X} = \text{As}, \text{Sb}, \text{Bi}$) to solutions of $[\text{NiF}_6]^{2-}$ in anhydrous HF at low temperature.²⁴³⁻²⁴⁵ At -65°C , the tan solid NiF_4 is precipitated; this is converted back to $[\text{NiF}_6]^{2-}$ quantitatively on treatment with F^- donors (XeF_6 or KF). Dry NiF_4 decomposes above -60°C to black NiF_3 with loss of F_2 . When $\text{K}_2[\text{NiF}_6]$ is the precursor, a pyrochlore form that contains small amounts of potassium, $\text{K}_{0.1}\text{NiF}_3$, is obtained. When K^+ is present at 20°C , a hexagonal tungsten bronze-type phase (H- NiF_3) is precipitated. Suspensions of NiF_4 in anhydrous HF decompose to a rhombohedral form of genuine NiF_3 (called R- NiF_3). The latter was shown by XAS at the nickel K-edge and UV-visible studies to have a mixed-valent composition $\text{Ni}[\text{NiF}_6]$.²⁴⁶ The three forms of NiF_3 differ in thermal stability, the pyrochlore form being the most stable (it loses F_2 at 138°C). R- NiF_3 thermally decomposes at $353-373 \text{ K}$ to give Ni_2F_5 .²⁴⁷ NiF_4 is

an extremely powerful oxidant; it converts $[\text{MF}_6]^-$ to MF_6 ($\text{M} = \text{Pt}, \text{Ph}$), while NiF_3 fluorinates perfluoropropene and oxidizes Xe to XeF_6 . Solutions of $[\text{NiF}_6]^{2-}$ in anhydrous HF, when treated with three equivalents of BF_3 , give yellow solutions with extreme oxidizing power; these probably contain solvated Ni^{III} .²⁴⁸ NiF_4 and R-NiF_3 have been employed for the fluorination of organic compounds.²⁴⁹

6.3.3.8 Complexes with Biologands

6.3.3.8.1 Complexes with peptides, amino acids, and related ligands

Ni^{III} peptide complexes have been studied and characterized using chemical and electrochemical oxidation, redox stoichiometry, substitution reactions, UV-visible spectral shifts and EPR.²⁵⁰ The complexes were found to be six-coordinate with tetragonal distortion. The $\text{Ni}^{\text{III}}/\text{Ni}^{\text{II}}$ electron transfer reactions are usually rapid (with good Marcus correlation)²⁵¹ and it was generally found that Ni^{III} peptides will add a second peptide or other chelating agents to form stable bis-peptide or ternary complexes. The reduction potentials of bis(dipeptide)nickelate(III) complexes are significantly lower than for mono(tripeptide)nickel(III) complexes, with E° values of 0.66 V for $[\text{Ni}^{\text{III}}(\text{H}_-1\text{G}_2)_2]^{2-}$ and 0.34 V for $[\text{Ni}^{\text{III}}(\text{H}_-1\text{Aib}_2)_2]^-$ ($\text{HAib} = \alpha$ -aminoisobutyric acid). C-methyl substitution has little effect on the potentials of the mono(tripeptide) complexes, but a large effect on the potentials of the bis(dipeptide) complexes.

Oxidation of blue bis(dipeptide)nickel(II) complexes yields violet-black solutions of Ni^{III} species, in most cases characterized *in situ* by means of EPR spectroscopy. These low-spin compounds rearrange in acid and then decompose to Ni^{II} species.²⁵² The low-spin Ni^{II} complex with the dipeptide of α -aminoisobutyric acid, $[\text{Ni}^{\text{II}}(\text{H}_-1\text{Aib}_2)_2]^{2-}$, can be oxidized to produce a dark olive green tetragonally compressed Ni^{III} complex, $[\text{Ni}^{\text{III}}(\text{H}_-1\text{Aib}_2)_2]^-$ (**63**) that was found to be very stable in neutral and basic solutions.²⁵³ Acid catalyzes the decomposition to give Ni^{II} , Aib_2 , and oxidized peptide fragments. A novel method, based on the influence of ^{61}Ni on the room temperature EPR spectra of Ni^{III} complexes, was applied to this nickel/ α -aminoisobutyric acid system to measure the electron transfer self-exchange rate constants.²⁵⁴ The exchange rate decreases when pyridine replaces one of the axial H_2O .

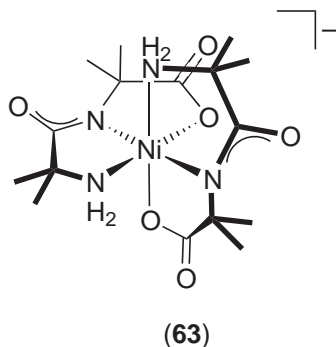

The kinetics and mechanism of the oxidation of $[\text{Co}(\text{edta})]^{2-}$ by four bis(dipeptide)nickel(III) complexes, $[\text{Ni}(\text{H}_-1\text{GG})_2]^-$, $[\text{Ni}(\text{H}_-1\text{GA})_2]^-$, $[\text{Ni}(\text{H}_-1\text{AG})_2]^-$, and $[\text{Ni}(\text{H}_-1\text{AA})_2]^-$ ($\text{GH} = \text{glycine}$, $\text{AH} = (\text{S})$ -alanine), have been investigated at 25.0°C and in 0.10 M perchlorate media.²⁵⁵ The reactions are first order in each reagent and have a complex dependence on pH. The dominant pathway over the pH range 4–10 involves the acid-catalyzed formation of a precursor complex through which electron transfer takes place. There is indirect evidence for a strong hydrogen-bonding interaction between the N-terminal amine hydrogen atoms of a coordinated dipeptide ligand and the carboxylate oxygen atoms of the probe complex. The bis(dipeptide) ligands are arranged meridionally around the Ni^{III} to produce a chiral center, and the complexes with optically active dipeptides exist as diastereomers which are readily separated by chromatography.²⁵⁵

Bis(tripeptide)nickelate(III) complexes of Gly_3 , GlyAlaGly , and GlyGlyAla , formed by the addition of excess tripeptide to solutions of (tripeptide)nickel(III), have been observed in solution and characterized by means of electronic spectra, EPR, reduction potentials, and rate measurements. Coordination was found to be a function of pH, with $\{\text{N}_5\text{O}\}$ coordination occurring at

pH 6–11.²⁵⁶ Ni^{III} peptide complexes undergo a variety of substitution and rearrangement reactions in acidic solution. The terminal N_{peptide} bonds to Ni in [Ni(H₋₃Gly₄)(H₂O)₂]⁻ and [Ni(H₋₃Gly_{4a})(H₂O)₂]⁻ (Gly_{4a} = tetraglycinamide) break rapidly in acid with first-order rate constants of 0.1–15 s⁻¹ as the hydrogen ion concentration increases (0.004–1.0 M). However, the other three equatorial Ni^{III}—N bonds are relatively inert to substitution. EPR spectra at room temperature and in frozen aqueous glasses have allowed to characterize several protonated species for these complexes and for Ni^{III} tripeptide complexes.²⁵⁷ These peptide complexes also undergo substitution reactions with a series of polypyridine and polyamine ligands such as 1,2-diaminoethane, 1,10-phenanthroline, etc. to yield stable ternary complexes.²⁵⁸ In diluted acid, phen chelates to an axial and an equatorial site while terpy coordinates to two axial sites and one equatorial site of the Ni^{III} ion.

6.3.3.8.2 Complexes with oximes and related ligands

Oximes have long been known to stabilize both Ni^{III} and Ni^{IV} in their complexes. There has been a great deal of work on the electron transfer kinetics and the reactions of high-valent Ni-oxime complexes, in particular with tris(dimethylglyoximate)nickelate(IV) or complexes of ligand (**64**) as oxidizing agent. This work is not described in detail here, but the reader should refer to a recent review.⁶⁴ *Inter alia*, kinetics of disproportionation of the Ni^{III} complexes of (**64**) have been recorded over a pH range and the disproportionation path has been established.²⁵⁹ Likewise, The reaction of Ni^{IV} complexes [Ni(**65**)₂]²⁺ and [Ni(**64**)₂]²⁺ with sulfite have been investigated in aqueous solution as a function of pH.²⁶⁰ Below pH ca. 5, the process is a single step two-electron transfer, but above this pH, the initial one-electron transfer is distinctly faster. The stoichiometry varied depending on whether oxidant or reductant was present in excess; both dithionate and sulfate were formed. The mechanism is inner-sphere, although probably with initial formation of a H-bonded adduct. In the reactions of [Co(edta)]²⁻ with chiral Ni^{IV} oxime complexes, significant enantiomeric excess has been observed, indicative of ion-pairing before outer-sphere electron transfer.²⁶¹ The Ni^{II}/Ni^{III} redox potential in the [Ni(**66**)₃]⁻ complex is very low, ~0.1 V vs. SCE in acetonitrile. Azoxime stabilizes effectively a higher oxidation state of Ni, and [Ni(**66**)₃] with trivalent Ni can be easily obtained.²⁶²

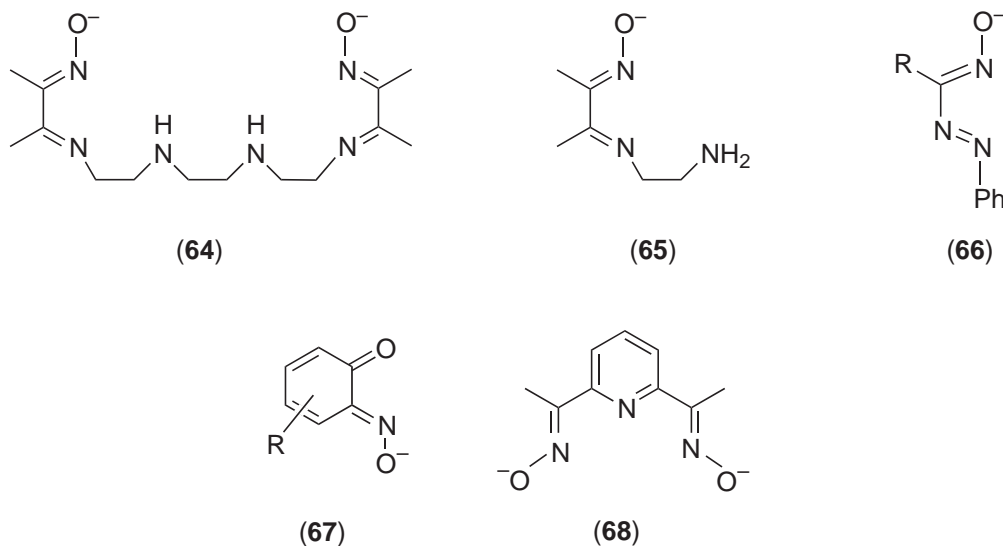

While quinones are not effective for stabilizing high oxidation states of Ni, their monooximes have been found to act as good N,O-bidentate ligands towards Ni^{III}. [Ni^{II}(**67**)₃]⁻ occur as equilibrium mixtures of *fac* and *mer* isomers in MeCN solution and display the reversible Ni^{II}/Ni^{III} couples *fac*-[Ni(**67**)₃]⁻/*fac*-[Ni(**67**)₃], and *mer*-[Ni(**67**)₃]⁻/*mer*-[Ni(**67**)₃].²⁶³ The former couple has a higher (by approximately 0.12 V) formal potential. These potentials are also sensitive to the substituent R, and the range 0.3–0.7 V vs. SCE is covered by the complexes studied. *fac*-[Ni(**67**)₃] is spontaneously transformed into the *mer* form in solution. For R = Me, the rate constant is estimated to be 0.02 s⁻¹ at 258 K. The dark-colored [Ni(**67**)₃] chelates behave as one-electron

paramagnets and in frozen solution they display rhombic EPR spectra ($g = 2.04, 2.14, 2.19$). Upon reduction, *mer*-[Ni(67)₃] is reconverted into the equilibrium mixture of *fac*- and *mer*-[Ni(67)₃]⁻.²⁶³

The Ni^{IV} complex with 2,6-diacetylpyridine dioxime, [Ni(68)₂], is one of the prototype Ni^{IV}-oxime systems and has been studied extensively. The corresponding Ni^{III} complex is much less accessible and cannot be isolated (its Ni^{III} formulation is established by a broad, nearly isotropic EPR signal with an average g -value of 2.086).²⁶⁴ However, two-electron reduction of [Ni(68)₂] by, *inter alia*, Fe^{II}, Sn^{II}, I⁻, or U^{IV} to give the Ni^{II} species entails pairs of one-electron steps.²⁶⁵ [Ni(68)₂]²⁻ has a very low Ni^{II}/Ni^{III} redox potential of -0.735 V in DMF (vs. SCE).

6.3.3.8.3 Complexes with porphyrins and related ligands

The catalytic cycle of F₄₃₀ is postulated to involve reduction of the Ni^{II} resting state to Ni^I followed by formation of a methyl-Ni^{III} transient from which methane is formed (compare Section 6.3.4.11.7). The latter Ni^{III} species prompts the current interest in high-valent Ni-porphyrin compounds.^{266–268} The question whether the tetrapyrrole ligand of F₄₃₀, which is unusual in its ability to stabilize Ni^I, can also give rise to high-valent Ni^{III}, has been tackled in many ways, including theoretical and model studies. DFT calculations suggest that Ni^{III} is indeed accessible, the special architecture of F₄₃₀ allowing occupation of the $d_{x^2-y^2}$ orbital.²⁶⁹ The electronic spin density profiles of this ($d_{x^2-y^2}$)¹ Ni^{III} species can be deceptive and closely mimic Ni^I species.

Redox properties of Ni porphyrins have been extensively studied and detailed reviews of the oxidative chemistry of nickel porphyrins,²⁶⁸ of their electrochemistry in nonaqueous media,²⁷⁰ and of the electronic structure description of high-valent metalloporphyrins based on quantum chemical calculations²⁷¹ have appeared. Ni porphyrins can be oxidized in up to three one-electron transfer steps,²⁷² depending upon the solvent, although the third oxidation is not always observed. The existing body of information for oxidized Ni porphyrins and hdroporphyrins suggests the existence of Ni^{III} cations, Ni^{II} porphyrin π cation radicals, and dications comprised of Ni^{III} porphyrin π dications. In most cases, the initial oxidations and reductions involve the porphyrin π -system, but examples where the first electron is removed from the central metal ion to give a Ni^{III} species^{273–275} are well documented in the literature. However, there still exist no structures of authentic Ni^{III} porphyrins.

As a general pattern, the site of oxidation, i.e., Ni^{III} vs. Ni^{II} π cation radical, is controlled by the relative ordering of the Ni d -orbitals and the highest occupied porphyrin orbital (HOMO). Axial ligation of the Ni^{II} itself makes it easier to oxidize the metal.^{274,275,280} Ni^{III} porphyrin complexes are paramagnetic and normally low spin with one unpaired electron; there appear to be no examples of Ni^{III} porphyrines with a high spin, $S = 3/2$, ground state. Particularly relevant to Ni^{III} porphyrins, which are typically hexacoordinated, are the tetragonally distorted energy schemes: for the compressed case, the unpaired electron resides in the $d_{x^2-y^2}$ orbital with an EPR signal in which $g_{\perp} < g_{\parallel}$. In the tetragonally elongated configuration, the unpaired electron is found in the d_{z^2} orbital with $g_{\perp} > g_{\parallel}$. In porphyrins, the ground state configuration is further confirmed by the EPR hyperfine interactions with the four pyrrole nitrogens in the case of the half-occupied $d_{x^2-y^2}$ orbital or with the axial ligands if the d_{z^2} orbital is half occupied. As in the case of the high spin Ni^{II} macrocycles, population of the $d_{x^2-y^2}$ orbital in Ni^{III} porphyrins will require an expansion of the Ni–N distances relative to low spin Ni^{II}. Hence, the conformational flexibility of the porphyrin necessary to accommodate this core expansion can control whether the $d_{x^2-y^2}$ orbital or d_{z^2} orbitals are occupied in Ni^{III} complexes.²⁶⁸

Oxidation of [Ni^{II}(TPP)] can give a Ni^{III} cation or a Ni^{II} π cation radical, depending on the anion and the solvent. ClO₄⁻ or PF₆⁻ anions can coordinate and thus stabilize the Ni^{III} form at low temperatures, while Ni^{III} was not formed when Br⁻ or water were added. Oxidation in the presence of ligands L such as thf, pyridine, or acetonitrile all yielded Ni^{III} species at low temperatures of the form [Ni^{III}(TPP)L₂]⁺ with the unpaired electron in the d_{z^2} orbital.²⁷³ These are stable under inert atmospheres for extended periods. [Ni^{II}(OEP)] only yields the π cation radical under the same experimental conditions that affords [Ni^{III}(TPP)]⁺.²⁷⁶ A resonance Raman study clearly distinguished between the two types of oxidation products and further supported the Ni^{II} π cation radical and Ni^{III} cation assignments.²⁷⁷ When the effects of solvent, counterion and peripheral substituents on the sites of oxidation by pulse radiolysis at RT were studied on a microsecond timescale, it was found that [Ni(TTP)] was oxidized to [Ni^{III}(TPP)]⁺ in several protic and aprotic solvents whereas addition of 10% water to CH₂Cl₂ yielded the π cation radical.²⁷⁸

Apparently, the different sites of oxidation are controlled by a combination of solvent and charge interactions. It has been speculated that the broad, room temperature EPR signal of $[\text{Ni}(\text{TPP})]^+$ results from mixing of the metal d and porphyrin π cation radical orbitals.²⁷³ Since OEPs are easier to oxidize than TPPs, it is perhaps not surprising that $[\text{Ni}(\text{OEP})]$ is simply oxidized to a π cation radical at all temperatures in the presence of weak ligands such as ClO_4^- or PF_6^- , whereas $[\text{Ni}^{\text{II}}(\text{TPP}\cdot)]^+$ undergoes the electronic isomerization to $[\text{Ni}^{\text{III}}(\text{TPP})]^+$ at low temperatures which also favor ligation of the Ni. Both $[\text{Ni}^{\text{II}}(\text{TPP}\cdot)]^+$ and $[\text{Ni}^{\text{II}}(\text{OEP}\cdot)]^+$ form Ni^{III} species in the presence of stronger ligands such as ethers, imidazoles, pyridines, alcohols, nitriles, and cyanides which lower the oxidation potentials of the Ni. Addition of CO or PPh_3 to solutions of $[\text{Ni}^{\text{II}}(\text{TPP}\cdot)]^+$ results only in reduction back to $[\text{Ni}^{\text{II}}(\text{TPP})]$, while addition of CN^- produces the short-lived Ni^{III} species $[\text{Ni}(\text{TPP})(\text{CN})_2]^-$ with a $(d_{x^2-y^2})^1$ ground state and ultimately results in reduction.

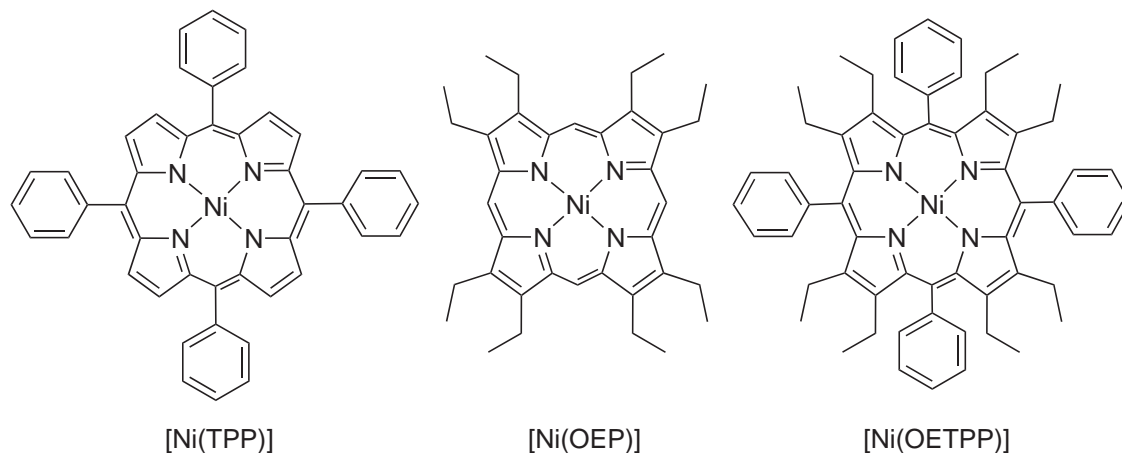

The radiolytic technique has also been applied to the reaction of alkyl radicals R with Ni^{I} porphyrins anions.²⁷⁹ In analogy with the postulated reaction of $\text{Ni}^{\text{I}}\text{F}_{430}$ to form $\text{CH}_3\text{Ni}^{\text{III}}\text{F}_{430}$, short lived R-Ni^{III} products have been detected.

Electrochemistry and spectroscopy of the π cation radical of *meso*-tetraalkylchlorin (tetramethyl) and various porphyrins (tetramethyl, tetraethyl, and tetra-*n*-propyl) indicate that these do not convert to Ni^{III} at low temperatures.²⁸⁰ Optical evidence reveals, however, that oxidation of the π cation radical of $[\text{Ni}(\text{pEt}_2\text{N})(\text{TPP})]$ leads to a Ni^{III} cation radical which can be further oxidized to a Ni^{III} porphyrin dication. Similar studies have been carried out for various other derivatives of *meso*-tetraarylporphyrins such as *N*-oxides of TPP and 5,10,15,20-tetramesitylporphyrin (TMP). Addition of trifluoroacetic acid (TFA) to the *N*-oxide of $[\text{Ni}^{\text{II}}\text{TMP}]$ at -25°C in CH_2Cl_2 results in $[\text{Ni}^{\text{III}}(\text{TMP})]^+$ with a rhombic EPR spectrum, $g = 2.40, 2.12, \text{ and } 2.04$.²⁸¹

In general, porphyrins that are easy to oxidize, such as the *meso*-tetraalkylporphyrins and hydroporphyrins should all be oxidized to π cation radicals and this trend is indeed observed. It is not until these molecules are doubly oxidized that evidence of Ni^{III} is found. The exceptions to this general trend are the β -dioxo- and trioxoporphyrins (i.e., hydroporphyrins with an additional two or three electron-withdrawing keto groups at the β positions, e.g., (69)).^{274,275} It was suggested that the β -dioxo- and trioxoporphyrins have a greater capacity to stabilize Ni^{III} than the porphyrin ring, due to the greater tendency of the former compounds to bind axial ligands and thereby relieve the strain of ruffling. Upon two electron-oxidation of Ni β -monooxoporphyrin in CH_3CN , a paramagnetic species with $g_{\text{av}} = 2.243$ and a broad line width of 160 G was observed at low temperatures and assigned to a dication comprised of a Ni^{III} π cation radical.²⁷⁴ Hydroporphyrins invariably are easier to oxidize as the number of double bonds decreases in the order hexahydroporphyrin > tetrahydroporphyrin (bacteriochlorin and isobacteriochlorin) > dihydroporphyrin (chlorin) > porphyrin.²⁸²

When multiple peripheral substituents, as in $[\text{Ni}(2,3,5,7,8,10,12,13,15,17,18,20\text{-dodecaphenylporphyrin})]$, $[\text{Ni}(5,10,15,20\text{-tetra}(t\text{-butyl})\text{porphyrin})]$, $[\text{Ni}(2,3,7,8,12,13,17,18\text{-tetracyclohexenyl-5,10,15,20-tetraphenylporphyrin})]$, and $[\text{Ni}(\text{OETPP})]$, cause the macrocycles to become nonplanar,^{283,284} the HOMOs of the porphyrins are destabilized and the molecules become easier to oxidize.^{283,285} In accord with the general discussion above, these compounds are oxidized to π cation radicals and remain so even at low temperatures in CH_2Cl_2 . However, upon addition of

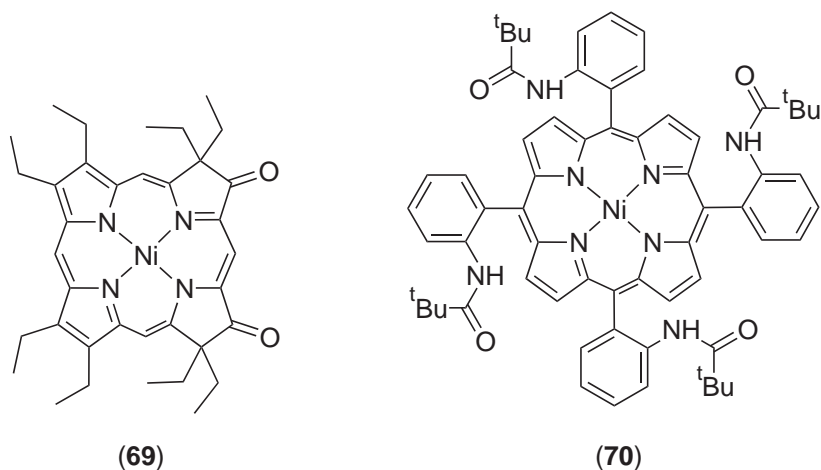

N-donor bases to these nonplanar Ni^{II} porphyrin π cation radicals, all the compounds exhibit EPR spectra at 110 K characteristic of Ni^{III} cations with an electron in the d_{z^2} orbital. Contradiction between the EPR and the other spectroscopic and structural data has been suggested to result from antiferromagnetic coupling of the unpaired electron in the $d_{x^2-y^2}$ orbital of the high spin Ni^{II} with the unpaired electron of the porphyrin radical, i.e., the high spin Ni^{II} radical becomes a pseudo Ni^{III}.²⁸⁶ Similarly, the structure of a dipyridine adduct of a Ni^{II} octaethylxophlorin radical has been reported which displays stereochemical parameters typical of high spin Ni^{II} but has a magnetic moment of $2.5 \mu_B$, i.e., one unpaired electron. Here again, antiferromagnetic coupling between the unpaired electrons of the high spin Ni^{II} and porphyrin radical has been invoked.²⁸⁷ DFT calculations and geometry optimizations have been carried out in order to predict the metrics of, e.g., the tetragonally elongated [Ni^{III}(TPP)(py)₂]⁺ and tetragonally compressed [Ni^{III}(TPP)(CN)₂]⁻.²⁸⁸ For the latter, a planar molecule was predicted (using a porphine rather than TPP skeleton) with equatorial Ni—N distances of 2.06 Å and axial Ni—C bonds of 1.92 Å, consonant with a tetragonally compressed configuration and the $d_{x^2-y^2}$ orbital occupancy observed experimentally.

The “picket fence” Ni^{II} complex [Ni(TpivPP)] ((70); TpivPP = *meso*- α - α - α - α -tetrakis(*o*-pivalamidophenyl)porphyrin) is reversibly oxidized by three electrons in two steps and generates as final product [Ni(Tipvv)]³⁺ which was characterized as a Ni^{IV} cation radical in solution by both UV–visible and EPR spectroscopy.²⁸⁹

Oxidation of the recently synthesized Ni^{II} tetraphenylcarbaporphyrins (“confused” porphyrins in which one pyrrole ring is inverted to form a Ni—C bond) clearly yield Ni^{III} species of the type [Ni^{III}(CTPP)X] which show line broadening upon substitution of ⁶¹Ni ($I=3/2$) and hyperfine interactions with a variety of counterions.²⁹⁰ The orbital occupancies of the Ni^{III} vary with ligand field strength. For Br⁻ and I⁻ complexes, the EPR data supports d_{z^2} occupancy whereas for NO₃⁻, a molecular orbital comprised of $d_{x,y}$ and $d_{x^2-y^2}$ is suggested.

The Ni complex of corrole (octaalkyl derivative (71)) is a $S=1/2$ low-spin Ni^{II} species with a ligand-centered π -cation radical, as evidenced by the isotropic EPR signal at $g=2.01$.^{291,292}

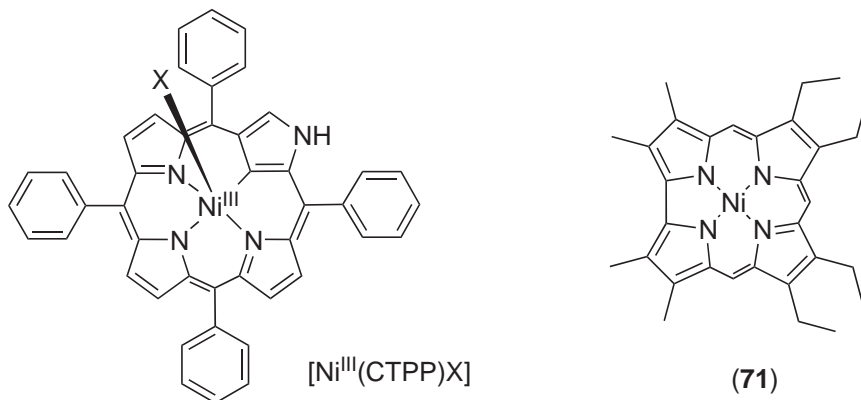

6.3.3.9 Complexes with Mixed Donor Set Ligands

6.3.3.9.1 Complexes with mixed {N,O} ligands

Ni complexes with salen-type $\{N_2O_2\}$ ligands (**72**) have received considerable attention with respect to their oxidation. The tetradentate salen ligands are intrinsically noninnocent, but the solvent was found to play a determining role in controlling the final oxidation site, since $Ni^{II} \rightarrow Ni^{III}$ oxidation of salen complexes $[Ni^{II}(L)]$ proceeds with the simultaneous coordination of two solvent molecules in axial positions to give six-coordinate species $[Ni^{III}(L)(S)_2]^+$ (S=solvent). Hence, oxidation to Ni^{III} occurs in strong donor solvents (such as DMF or DMSO), whereas in poorly coordinating solvents ligand oxidation or oxidative polymerization at the electrode surface takes place.^{293,294} For example, electrochemical oxidation of (**73**) in DMF or DMSO gives a Ni^{III} complex that interacts with a range of pyridines. According to EPR and electronic spectroscopy, genuine Ni^{III} complexes $[Ni(L)(py)_2]^+$ ($g_{av} = 2.12$) form with less basic pyridines, but with more basic pyridines (proton affinity $> 945 \text{ kJ mol}^{-1}$) intramolecular electron transfer from the ligand to Ni^{II} occurs, giving species $[Ni^{II}(L^{\cdot-})(py)_2]^+$ ($g = 2.00$).^{295,296} Cyclic voltammetry of complexes (**72**) in DMSO reveals a single, one-electron quasi-reversible oxidation wave at between +0.7 V and +1.0 V.²⁹⁴ In cases of metal-centered oxidation, EPR spectra of the electrochemically-oxidized complexes in frozen matrices show rhombic patterns characteristics of Ni^{III} , and the complexes invariably have a low-spin 2A_1 ground state, usually with $(d_{z^2})^1$ occupation. In order to reduce solvent influence, complexes (**74**) with $\{N_3O_2\}$ ligands bearing an additional backbone N-atom have been prepared. By changing the length of the backbone carbon bridge, structures can be controlled: in dien-based ligands, steric constraints prevent coordination of the backbone-N, while in trien-based systems the ligand acts as a pentadentate. An inverted ground state, $(d_{x^2-y^2})^1$, has been detected for the pyridine adducts in the latter case.⁷⁰

The Ni^{III} state is more easily attained with the $\{NOS\}$ donor-set ligand (**75a**) ($E_{1/2} = +0.75 \text{ V}$ vs. SCE) compared to the $\{NO_2\}$ analogue (**75b**), the latter showing only an ill-defined anodic response.²⁹⁷

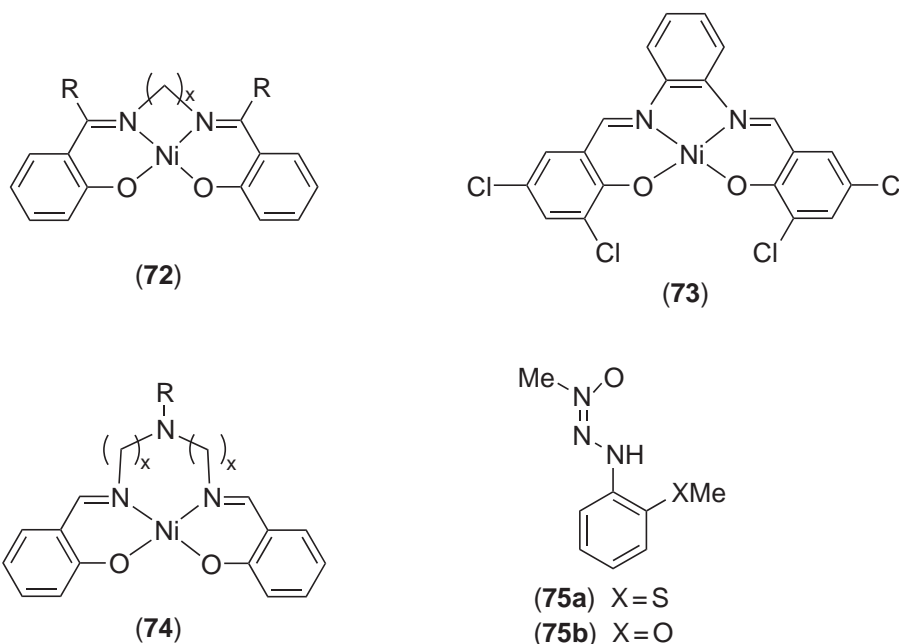

6.3.3.9.2 Complexes with mixed {N,S} ligands

In view of the low Ni^{II}/Ni^{III} redox potential of [NiFe] hydrogenase, the search for low-potential Ni^{II}/Ni^{III} complexes not only with pure S-donor but also with mixed $\{N/S\}$ environment has been of major interest, and significant advances in this field have been reported.^{298,299} Various mononuclear systems are listed in Figure 1 according to their redox potentials (usually in DMF). Homodinuclear Ni_2 and heterodinuclear NiM complexes with $\{N/S\}$ donor ligands, in particular

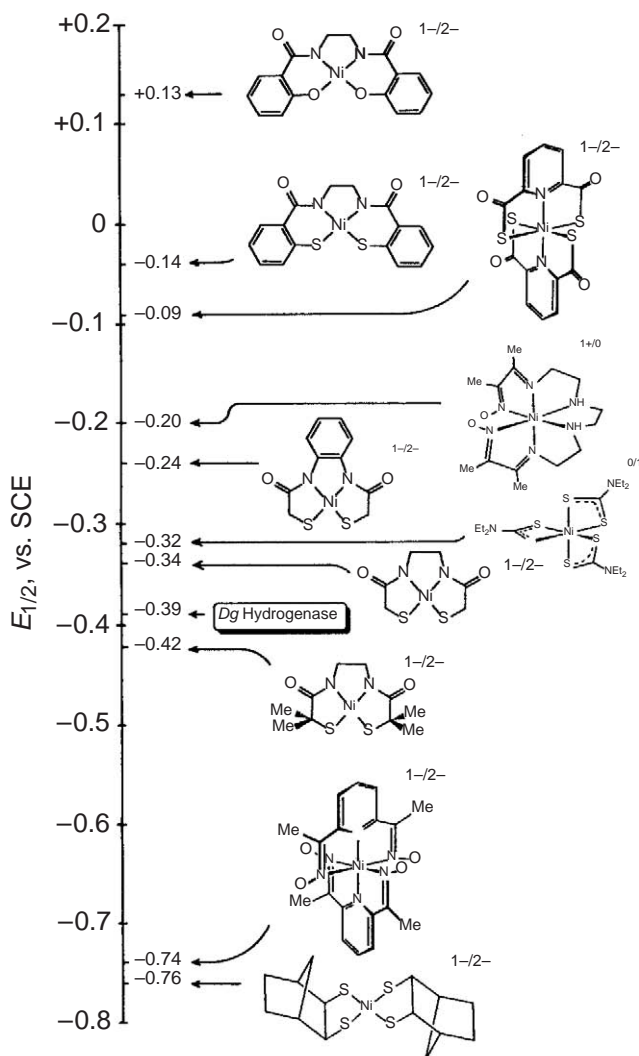

Figure 1 Comparative display of low-potential Ni^{II/III} redox couples²⁹⁸ (reprinted with permission from ref. 298; © 1991, American Chemical Society).

those with thiolato bridges, have been intensively studied with respect to their redox properties. These dinuclear compounds are not included here, but the reader should refer to Sections 6.3.4.12.4 and 6.3.4.12.5 for some further information.

A leading factor that influences the potentials is the presence of anionic (polarizable) ligands. The potentials are lowered in the following series: $\text{ArO}^- > \text{ArS}^- > \text{RS}^-$.²⁹⁸

The oxidation of $[\text{Ni}^{\text{II}}(\mathbf{76})_2]^{2-}$ with I_2 in MeOH affords $[\text{Ni}^{\text{III}}(\mathbf{76})_2]^-$, in which the tetragonally distorted octahedral geometry with an essentially planar $\{\text{NiS}_4\}$ fragment and a *mer*-configuration observed for Ni^{II} is preserved.²⁶⁴ The Ni—N and Ni—S distances decrease by 0.01 and 0.04 Å upon oxidation. Cyclic voltammetry of the Ni^{II} complex shows a reversible oxidation at -0.085 V (SCE) and the EPR spectrum of the ⁶¹Ni-enriched Ni^{III} species demonstrates the $(d_{z^2})^1$ ground state.

Complex (77) has been obtained by electrolysis of the respective Ni^{II} species ($E_{1/2} = -0.78$ V vs. Cp₂Fe/Cp₂Fe⁺ in DMF) and represents the first Ni^{III} complex with aliphatic thiolato donors that could be characterized crystallographically.³⁰⁰ The overall square planar structure is retained, but the Ni—N and Ni—S distances shorten by 0.023 Å and 0.057 Å, respectively, upon oxidation. While (77) is EPR-silent, its pyridine adduct shows an axial spectrum ($g = 2.313, 2.281, 2.000$) with N-hyperfine coupling of the z -component, indicative of a $(d_{z^2})^1$ ground state.

Selected further ligand scaffolds that give relatively stable Ni^{III} complexes with thioether or thiolate coordination are (78),³⁰¹ (79),³⁰² and (80).³⁰³ The latter can stabilize Ni^{III} and Ni^{IV}, where the Ni^{IV} species is prepared by oxidation with HNO₃.

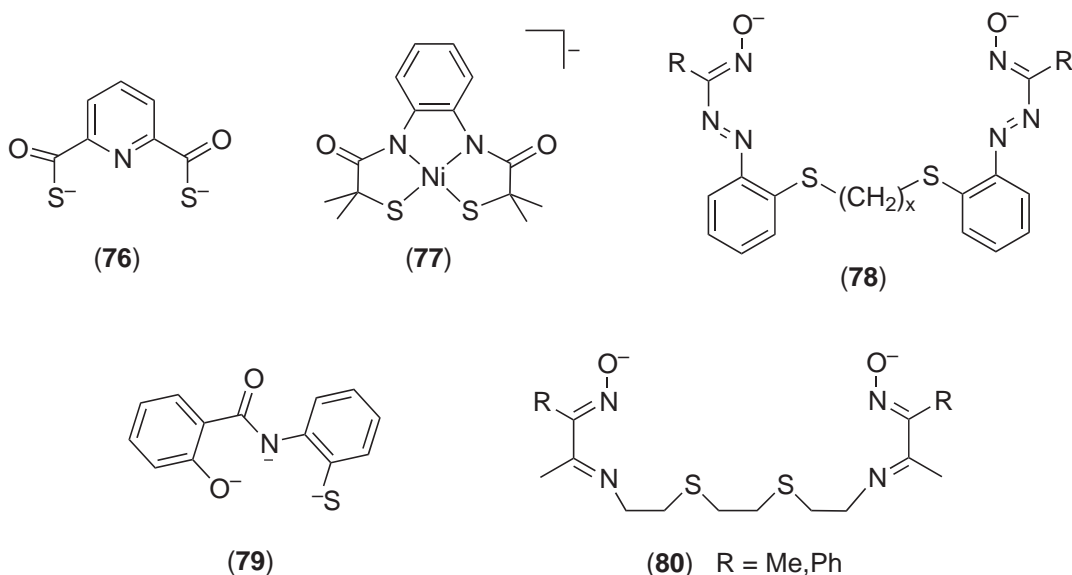

6.3.3.9.3 Complexes with miscellaneous ligands

Square planar, diamagnetic Ni complexes of type **(81)** have been shown to be best described as Ni^{II} species with singlet diradical character due to strong antiferromagnetic coupling of the two benzo-semiquinone π -radicals.¹⁹² Hence, these compounds are mentioned in the respective Ni^{II} sections. For **(82)**, oxidation from the dianion to the monoanion occurs by air, and the monoanion is stable in the solid and in solution. X-ray crystallography reveals that the distorted square planar structures with *cis* orientation of the two *o*-mercatophenolato ligands is retained upon oxidation, but the Ni—S distances shorten by ~ 0.035 Å and the Ni—O distances by ~ 0.025 Å.³⁰⁴

The hybrid phosphino or arsin/thio- or selenoether ligands (**83a,b**) are less effective at stabilizing high oxidation state Ni than diphosphines or diarsines.¹⁸⁸ Octahedral complexes [Ni(**84**)₂] and [Ni(**85**)₂]²⁺ containing mixed hard/soft donor sets undergo a reversible Ni^{II}/Ni^{III} oxidation at +0.66 V (in methanol) and at +0.93 V (in propylene carbonate), respectively. The Ni^{III} species can be generated chemically by oxidation with (NH₄)₂[Ce(NO₃)₆] at low temperature; they retain the stereochemistry of the Ni^{II} species and have a (*d_z*)¹ ground state.³⁰⁵ Compared to the related 1,4,7-triazacyclononane systems, the sandwich complex [Ni(**86**)₂]²⁺ shows a surprisingly low Ni^{II}/Ni^{III} potential of $E_{1/2} = +0.27$ V (vs. Cp₂Fe/Cp₂Fe⁺).³⁰⁶

The dinuclear complex [Ni₂{P(*o*-C₆H₄S)₃}₂]²⁻ (**87**) undergoes two reversible electrochemical oxidations at -0.57 V and -0.05 V (in DMF, vs. SCE) to give the Ni^{II}Ni^{III} and the Ni^{III}Ni^{III} species, both of which are thermally stable. Chemical oxidation of **(87)** by [Cp₂Fe]BF₄ yields the robust thiolato-bridged mixed-valent **(88)**, concomitant with substantial structural change.³⁰⁷ **(88)** is assigned class II behavior according to Robin and Day. Related mononuclear systems such as [(2-PhC₆H₄S)Ni{P(*o*-C₆H₄S)₂(Ph)}]⁻ cannot be oxidized to a stable Ni^{III}-thiolate species.

Five-coordinate Ni^{III} complexes (**89**) have been prepared by oxidation of the square planar Ni^{II} precursor complexes [Ni(L)X] with either X₂ or CuX₂, and the crystal structure of the iodo derivative has been determined. The geometry at Ni is best described as square pyramidal, with the Ni atom displaced approximately 0.34 Å out of the basal plane towards the apical I atom. EPR confirms the Ni^{III} oxidation state, in which the unpaired electron of the low-spin *d*⁷ system is situated in the *d_z* orbital.^{308,309} In aqueous solution full dissociation of both X anions occurs, while in acetone solution dissociation is not significant. The redox couple [Ni^{II}{NCN}(H₂O)]^{+/} [Ni^{III}{NCN}(H₂O)_{*n*}]²⁺ in water is +0.14 V (vs. SCE).

The salt [NBu₄][Ni(C₆Cl₅)₄] is the first homoleptic Ni^{III} organometallic; it has square planar coordination of nickel.³¹⁰ The first examples of organonickel(IV) complexes to be isolated and characterized are six-coordinate [Ni(Me)I(L)(PEt₃)₂] (**90**), which have been obtained via oxidative addition of MeI to [Ni(L)(PMe₃)₃].^{311,312} X-ray crystallography confirmed that the phosphine ligands are mutually *trans* and the methyl group is *trans* to the phenolate-O. These complexes are surprisingly stable, surviving at room temperature under argon for days. Their decomposition in

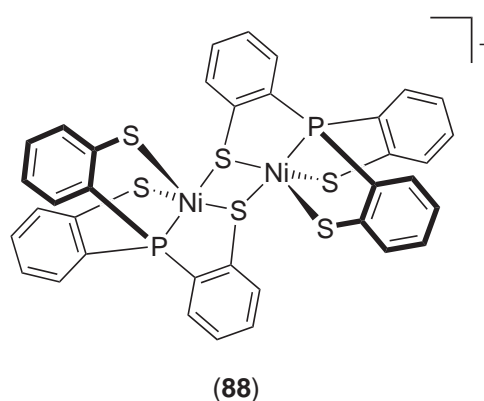
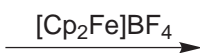
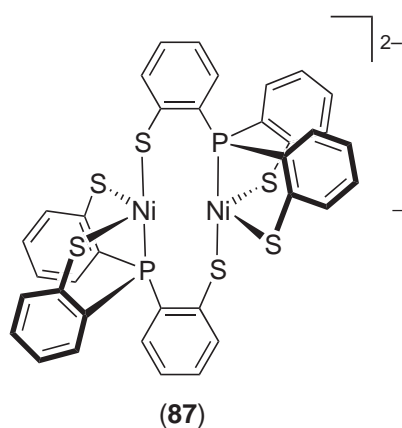
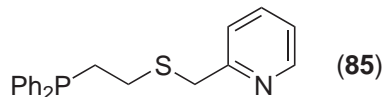
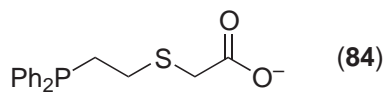
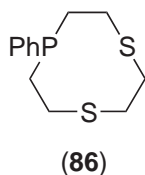
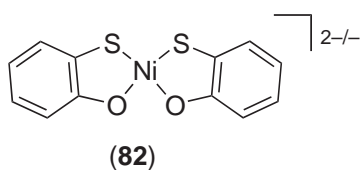
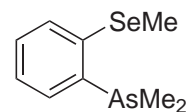
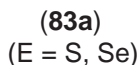
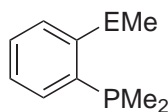
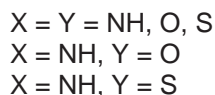
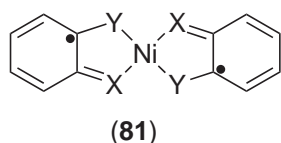

solution (with C—C bond formation between the methyl and aryl groups) is catalyzed by [Ni(PEt₃)₄]. Similarly, a bis(acylphenolato) complex of Ni^{IV} is accessible by reaction of [Ni(L)(PMe₃)₃] with CH₂I₂, I₂, or diiodoethane at -70 °C, which results in a dismutation reaction with formation of [Ni(L)₂(PMe₃)₂] (**91**) and [Ni₂(PMe₃)₂].^{312,313} Again, these Ni^{IV} complexes are thermally stable and surprisingly air stable. X-ray crystallography shows the two phosphine ligands mutually *trans*, the acyl groups mutually *cis*. Interestingly, while the precursor Ni^{II} complexes are acid sensitive, the Ni^{IV} complex is not. Since organonickel(IV) species are of obvious interest in considering mechanisms for Ni-catalyzed coupling reactions, reductive coupling reactions of (**90**) have been studied.³¹⁴

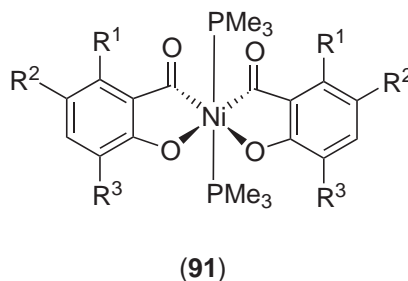
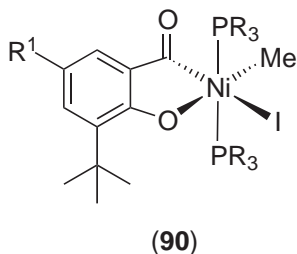
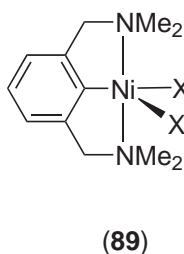

Complex (**92**) has been obtained from the reaction of 1,2-disilylbenzene and [Ni(dmpe)₂] at 80 °C.³¹⁵ The reaction is assumed to proceed via oxidative addition of Si—H bonds and subsequent elimination of H₂, and some intermediates have been detected spectroscopically. (**92**) is described as a Ni^{IV} species, but care has to be taken, since a related hexasilylpalladium complex, initially formulated as Pd^{VI},³¹⁶ should better be viewed as Pd^{II} with two side-on bound Si—Si

bonds.^{317,318} The same is valid for a related dinuclear (μ -silylene) (silyl)nickel complex (93), formulated as Ni^{III}.³¹⁹

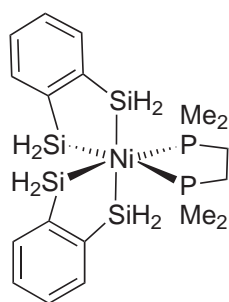

(92)

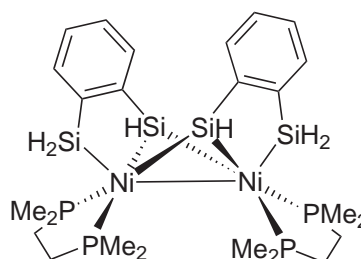

(93)

The formally Ni^{IV} complex [*commo*-1,1'-Ni(B₁₁H₁₁)₂]⁴⁻ should be mentioned, which has been isolated (as the Cs⁺ and Ph₃PMe⁺ salts) and characterized by ¹¹B and ¹H NMR spectroscopy.³²⁰

6.3.4 COMPLEXES OF NICKEL(II)

6.3.4.1 Advances in Structural Trends and Spectroscopy of Nickel Complexes

The electronic spectra and spectromagnetic properties of nickel complexes have been exhaustively described in *CCC* (1987)—in particular for Ni^{II}. Hence, the present discussion will be restricted to selected examples of more recent work and emerging new methods.

6.3.4.1.1 General structural features

Typical Ni—L bond lengths have been extracted from the Cambridge Structure Database (CSD) and listed in tabular form.³²¹ Also, Ni^{II}—L bond lengths from the CSD have been analyzed by the BDBO technique, which is related to the bond valence model (BVM) where the total bond order is equal to the oxidation state of any atom.³²² Selected mean Ni—L distances from the CSD source are collected in Table 2.

Ni has a smaller radius in square planar geometry than in tetrahedral, which is assumed to result from the non-Aufbau electron filling in *d*⁸ square planar species.³²² The well-known thermal octahedral \rightleftharpoons square planar transformation of Ni^{II} coordination compounds has been

Table 2 Selected mean Ni—L distances from the CSD.

	<i>Octahedral</i>	<i>Tetrahedral</i>	<i>Square planar</i>
Thiocyanate	2.070(31) ([Ni(NCS) ₆] ⁴⁺): 2.090(10))	1.919(16) ([Ni(NCS) ₄] ²⁻): 1.919(14))	1.859(9)
Pyridine	2.139(26)	1.907(11) ([Ni(py) ₄] ²⁺): 1.919(6))	
Imidazole	2.124(14) ([Ni(im) ₆] ²⁺): 2.129(4))		1.900(9)
Terminal chloride	2.438(38) ([NiCl ₆] ⁴⁻): 2.454 (62))	2.247(28) ([NiCl ₄] ²⁻): 2.259(13))	
Water	2.059(24) ([Ni(H ₂ O) ₆] ²⁺): 2.054(17))		

discussed in detail, particularly with respect to its dependence on thermal stabilities of the initial and final complexes, the electronic and steric properties of the ligands, and the equatorial-axial interactions of the ligands.³²³

Rules and trends for the *trans*-influence in mixed planar Ni^{II} complexes have been reviewed by considering structure data for 19 planar Ni^{II} complexes with mono- and bidentate ligands, [Ni(*trans*-XY)(*cis*-ZZ')].³²⁴ The Ni—X bond lengths primarily depend on the *trans*-influence of the ligand Y which increases in the order of donor strength O- < N- < P- < C-ligated group. The influence of the *cis*-ligands ZZ' is smaller. Whenever both hard and soft ligands are present in planar Ni^{II} complexes, a structure with a hard and a soft ligand in the *trans*-position is favored. This rule is substantial for the steric course of reactions yielding planar Ni^{II} complexes.

While tetrahedral Ni^{II} generally is paramagnetic, four-coordinate square planar Ni^{II} is usually assumed to have a closed-shell (diamagnetic) ground state, which results from the large antibonding σ -interaction of the four ligands with the $d_{x^2-y^2}$ metal orbital. This is not always true, however, since paramagnetic square planar Ni^{II} complexes (**94**) with a triplet ground state have been discovered.^{325,326} Also, the lack of ligand field bands $< 10,000\text{ cm}^{-1}$ is no longer an essential feature of planar Ni^{II} complexes, since planar compounds (**94**) show ligand field bands at $7,300\text{--}7,500\text{ cm}^{-1}$ (vs. $\sim 6,600\text{ cm}^{-1}$ for the tetrahedral species). While the structure of type (**94**) complexes in the solid state (planar or tetrahedral) depends on the R and R' substituents ((**94a**) and (**94e**): planar; (**94b**): two isomers, one planar and one tetrahedral; (**94f**): tetrahedral), all compounds are predominantly tetrahedral in solution.^{326,327} The ligand field spectra of the planar triplet complexes have been interpreted and well reproduced by extended AOM calculations.³²⁸ However, there has been some dispute about the origin of the paramagnetism of these square planar d^8 complexes, and s - d orbital mixing^{328,329} as well as the small chelate bite angle (which lowers the energy difference between $d_{x^2-y^2}$ and d_{xy} , Figure 2)³³⁰ have been claimed as the determining factors. Both the angular overlap model (AOM) extended by s - d mixing of central metal orbitals and the cellular ligand field (CLF) model are able to rationalize the experimental findings.³³¹ The importance of s - d mixing is emphasized by a study employing AOM in its molecular orbital oriented form (MO-AOM).³³²

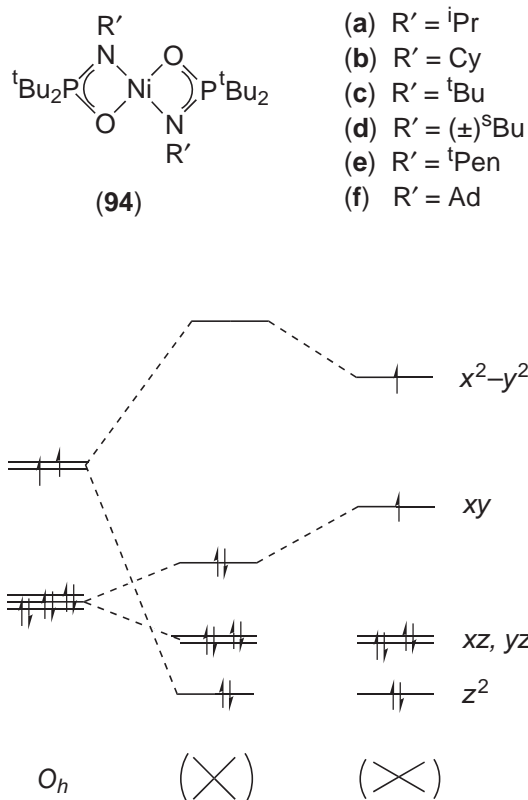
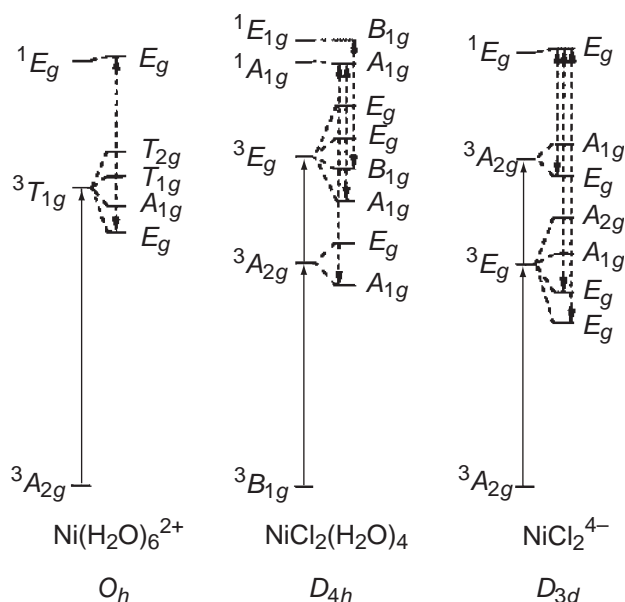

Figure 2 Orbital splitting illustrating the reduced tendency for spin pairing in planar d^8 species with decreasing bite angle.

6.3.4.1.2 Electronic absorption spectroscopy

Published $d-d$ spectral assignments for seven tetragonal Ni^{II} complexes $[\text{Ni}\{\text{N}_4\}\text{X}_2]$ with equatorial N_4 donor set have been analyzed within the CLF framework, which appears to reproduce the experimental data better than any other ligand field approach.³³³ Five out of seven spectra were shown to require reassignment due to unreasonable $e_\pi(\text{X})$ values. An essentially linear correlation exists between $e_\sigma(\text{N})$ and the equatorial Ni—N bond length over the range 2.0–2.3 Å.^{333–335} Equatorial and axial parameters are coupled inversely: as $e_\sigma(\text{N})$ decreases, $e_\sigma(\text{X})$ and $e_\pi(\text{X})$ increase, in accordance with Pauling's electroneutrality principle.³³³

The middle band of the three spin-allowed transitions of octahedral Ni^{II} complexes (${}^3A_{2g} \rightarrow {}^3T_{2g}$, ${}^3A_{2g} \rightarrow {}^3T_{1g}(\text{F})$, ${}^3A_{2g} \rightarrow {}^3T_{1g}(\text{P})$ in O_h symmetry) is often found to be split into two components (in particular in spectra of Ni^{II} complexes with halide or O-donor ligands), which is usually assigned to spin-orbit coupling of ${}^1E_g(\text{D})$ with ${}^3T_{1g}(\text{F})$. All crystal field states of interest are summarized in Scheme 1. The vibronic structure is also affected by coupling of the energetically excited states, and this has been analyzed in more detail by low-temperature, polarized single-crystal spectra and a quantitative time-dependent theoretical model (Figure 3).³³⁶ It rationalizes band positions, intensities, and the unusual vibronic progression, which is shown to arise from efficient intersystem crossing between the two excited states. This model linking point group symmetry, electronic states and potential energy surfaces is also illustrated in an educational paper and visualized in an electronic publication.³³⁷



Scheme 1 Electronic states involved in the absorption bands in the region of the first singlet–triplet intersection for octahedral, tetragonal and trigonal complexes of nickel(II).³³⁶ Solid arrows denote spin-allowed absorption transitions, dotted arrows connect pairs of interacting levels. (reprinted with permission from ref. 336; © 1998, American Chemical Society).

6.3.4.1.3 NMR spectroscopy

The NMR paramagnetic relaxation enhancement of the high-spin Ni^{II} ($S=1$) ion is strongly dependent on the rhombicity in the zero-field splitting (zfs) tensor, and much work has been devoted to the role of the zfs interactions and the interpretation of nuclear magnetic relaxation dispersion (NMRD) data.^{338–340} Since electronic relaxation times for high-spin Ni^{II} are quite short (typically 10^{-10} – 10^{-12} s), reasonably sharp and well-resolved signals can be observed in favorable cases. This is particularly true for pseudotetrahedral and pentacoordinate species, but less so for octahedral Ni^{II} where relaxation times are usually longer and resonances are consequently broader. A theory of the paramagnetic shift in pseudotetrahedral complexes of Ni^{II} based on the AOM has been developed, and it has been shown that the shifts are sensitive to delocalization of spin only from the metal $d_{\pm 1}$ orbitals (which are an equal mixture of d_{xz} and d_{yz}).³⁴¹

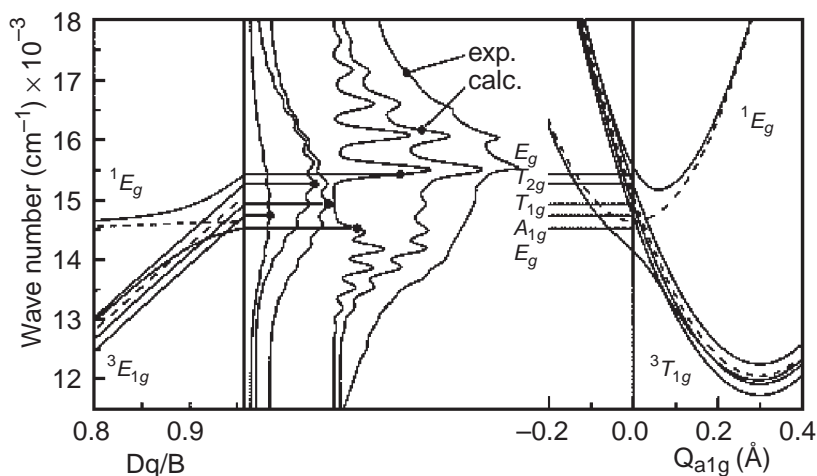

Figure 3 Crystal field states (left-hand panel) and potential energy surfaces (right-hand panel) for an octahedral complex of nickel(II) in the ${}^3T_{1g}/{}^1E_g$ energy range. Calculated spectra for the transition to each electronic state are shown in the central panel. Lines with markers connect electronic states and their corresponding calculated spectra. The total calculated spectrum (calc.) is obtained as the sum of the four individual spectra and is compared to the experimental spectrum of $\text{Ni}(\text{H}_2\text{O})_6^{2+}$ measured at 5 K³³⁶ (reprinted with permission from ref. 336; © 1998, American Chemical Society).

Selected applications of 1D-NMR spectroscopy in paramagnetic Ni^{II} chemistry include the conformational characterization of [14]ane N_4 complexes through ${}^1\text{H}$ NMR relaxation studies,³⁴² the identification of organometallic σ -aryl complexes of heteroporphyrins,³⁴³ a ${}^{13}\text{C}$ NMR study of inversion processes of (*meso*-2,3-butanediaminetetraacetato)nickelate(II),³⁴⁴ the use of solid-state ${}^{13}\text{C}$ CP/MAS NMR for defining the coordination and ligand conformation in weakly paramagnetic (β -monocarbonylenolato)nickel(II) complexes,³⁴⁵ and the determination of isotropic paramagnetic shifts in the NMR of N and C nuclei in nickel complexes.³⁴⁶

If the fine structure is not observable due to line broadening, 2D ${}^1\text{H}$ NMR spectroscopy of paramagnetic Ni^{II} complexes is a useful tool for signal assignment and for deducing structural information.³⁴⁷ While COSY experiments have been successfully employed for characterizing octahedral Ni^{II} complexes,³⁴⁸ a problem may arise from the antiphase structure within the multiplet of COSY cross-peaks, which leads to dramatic cancellation of intensities every time the J splitting is not resolved. Since this often happens in paramagnetic systems, other 2D experiments such as HOHAHA and EXSY have also been tested.³⁴⁹

While mononuclear octahedral Ni^{II} complexes often show relatively broad signals, nuclear relaxation enhancement and sharp signals may be observed in related dimer species.^{350,351} This has been taken advantage of for a detailed NMR investigation of a series of weakly ferromagnetically spin-coupled dinuclear octahedral Ni^{II} centers.³⁵²

6.3.4.1.4 EPR spectroscopy

Standard EPR spectroscopy at X-band ($\sim 9\text{ GHz}$; microwave quantum energy 0.3 cm^{-1}) or Q-band ($\sim 35\text{ GHz}$, 1.2 cm^{-1}) has often failed to excite transitions in the spin-triplet manifold of non-Kramers ($S = 1$) Ni^{II} systems unless the symmetry about the metal ion is high, because the magnitude of the zfs may be larger than the available microwave quantum. High-frequency/high-field EPR has now become a valuable tool to overcome this difficulty by the combination of sufficiently high-mm/sub-mm frequencies and magnetic fields, and hence the EPR signals of $S = 1$ systems with large zfs have become available.^{353,354} This has been applied to pseudo-octahedral Ni^{II} ions with $\{\text{N}_6\}$ ³⁵⁵ or $\{\text{N}_2\text{O}_4\}$ ³⁵⁶ donor sets (magnetically diluted by doping in a diamagnetic Zn^{2+} host) as well as to pseudotetrahedral $[\text{Ni}(\text{PPh}_3)_2\text{X}_2]$ ($\text{X} = \text{Cl}, \text{Br}$).³⁵⁴ For $[\text{Ni}(\text{PPh}_3)_2\text{Cl}_2]$, analysis of the two-dimensional (2D) field-frequency data set yielded spin-Hamiltonian parameters in agreement with, but with much higher accuracy than, powder magnetic susceptibility and magnetization measurements. A high value for the axial zfs parameter, $D \approx +13\text{ cm}^{-1}$, was determined and its sign corroborated by considering which transitions are detectable and which not. The $|D|$ value for $[\text{Ni}(\text{PPh}_3)_2\text{Br}_2]$ is much less ($\sim 5\text{ cm}^{-1}$) due to greater covalency, while the

magnitude of $|D|$ for $[\text{Ni}(\text{PPh}_3)_2\text{I}_2]$ ($\sim 27 \text{ cm}^{-1}$, due to the high spin-orbit coupling of iodine) was still too high and outside the available field and frequency range, thus precluding resonance observation.

Double quantum transitions have been analyzed in high-field EPR studies of Ni^{II} complexes with $\{\text{N}_6\}$ ^{355,357} and $\{\text{N}_4\text{O}_2\}$ ³⁵⁷ donor set.

6.3.4.1.5 XAS at the nickel K-edge

While X-ray absorption spectroscopy has proven extremely valuable for analyzing the active site structures of Ni-containing metalloenzymes such as $[\text{Fe},\text{Ni}]$ hydrogenases,³⁵⁸ it has found only scattered use in classical Ni coordination chemistry. However, it is a valuable tool for assigning Ni oxidation states, since it has been reported that the shift in energy of the Ni K-edge absorption towards higher values correlates with the increase in the oxidation state of Ni from +2 to +4. The inflection point energy of the Ni pre-edge structure shifts approx. 1 eV per unit change in valency.³⁵⁹ For example, the Ni K-edge position in the X-ray absorption spectrum of rhombohedral NiF_3 indicates that the compound has a mixed-valence composition $\text{Ni}^{\text{II}}[\text{Ni}^{\text{IV}}\text{F}_6]$.³⁶⁰ However, the edge energy cannot be used to determine formal oxidation states without specific information regarding the nature of the ligand environment.³⁶¹ For example, the edge energy shift that occurs upon oxidation is small or nonexistent in the case of complexes with many S-donor atoms, in accordance with XPS spectra revealing the involvement of the S-donors in the redox chemistry of such species.

Although not very prominent, nickel K-edge EXAFS data have been used to investigate Ni—L distances, in particular for the determination of the coordination environment of Ni in artificial metallopeptides. Examples include the Ni^{II} complex of a cyclic tetracysteinyll peptide which was shown to possess a distorted planar NiS_4 core,³⁶² and the structural characterization of metallopeptides designed as scaffolds for $\text{Ni}^{\text{II}}/\text{Fe}_4\text{S}_4$ bridged assemblies.³⁶³ Comparison of EXAFS data of synthetic Ni complexes and Ni metalloproteins, e.g., $[\text{FeNi}]$ hydrogenase, indicates whether the complexes are good structural models of the biological sites.^{361,364,365} Use of the XANES region extends the structural information, in particular with respect to coordination geometry. The edge energy, edge slope and the maximum absorbance of the edge region of the spectra are useful in determining the number of hard vs. soft donor sites. However, predictions become difficult in complexes with a larger number of S-donor atoms (i.e., low edge energy).³⁶¹ Application of Ni EXAFS for obtaining first coordination sphere structural data of classical Ni coordination compounds has been reported in several cases where no single crystals could be grown.^{366–371} Peaks in the Fourier transform (FT) of Ni K-edge XAFS data at approximately twice the Ni—L distance ($2R$) have been interpreted to arise from multiple scattering pathways involving the central Ni ion in linear L—Ni—L units. Hence, while such peak at $2R$ is observed for square planar *trans*- $[\text{NiBr}_2(\text{PEt}_3)_2]$, it is absent for tetrahedral $[\text{NiBr}_2(\text{PPh}_3)_2]$.³⁷²

Application of element-specific L absorption spectra and the “white light” sum rule to a series of Ni complexes appears to be an excellent tool for quantitatively determining the number of $3d$ vacancies.³⁷³

6.3.4.1.6 ^{61}Ni Mössbauer spectroscopy

While ^{61}Ni Mössbauer spectroscopy has proven valuable in solid-state chemistry, its application to problems in coordination chemistry is very rare. The parent ^{61}Co nucleus ($t_{1/2} = 99 \text{ min}$) serves as the radiation source. A bioinorganic model compound with a NiS_4 core has been investigated by ^{61}Ni Mössbauer spectroscopy in order to gain further evidence for a postulated formal Ni^{IV} oxidation state.³⁷⁴

6.3.4.1.7 Molecular modeling of nickel complexes

Molecular mechanics calculations have become a well established tool in the area of coordination chemistry, including the coordination chemistry of nickel^{375–379} where they are often applied for the analysis or the prediction of structures,³⁸⁰ the computation of isomer or conformer ratios and metal ion selectivities,^{381,382} and for simulating spectroscopic properties in combination with AOM calculations or by hybrid quantum mechanics/molecular mechanics (QMMM) methods.^{383,384} Details of the various approaches, e.g., the incorporation of d -electron stabilization energy

contributions by, *inter alia*, hybrid cellular ligand field/molecular mechanics methods,³⁸⁵ are found in the given references, although only a few selected examples can be cited here. MM techniques have also been applied for the computational analysis of bioinorganic nickel sites.

A crucial point is the use of a reliable force field, and various parameters for Ni^{II} have been developed and employed successfully.^{379,386–392} As an example, molecular mechanics calculations (MOMECS7 program) have been used to predict the isomer distributions of Ni^{II} complexes of chiral (95) and (96), and isomer ratios were in good agreement with observed ratios.³⁹³

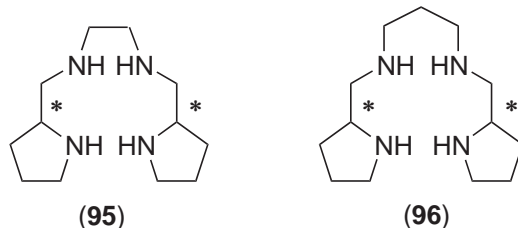

The possible conformations of six-membered Ni^{II} chelate rings have been identified by cluster analysis of all such chelate structures contained in the CSD. While most chelate rings are in the expected chair conformation, around 10% adopt the high-energy boat form due to ligand constraints. However, these structures were well reproduced by molecular mechanics calculations, irrespective of the starting conformation.^{380,394,395} In the case of some 16-membered tetraaza and tetrathia macrocycles the occurrence of high-energy conformations is attributed to artifacts of the metal incorporation mechanism.

Optimizing a MM model (MOMECS95, force field³⁹⁶) with regard to axial Ni \cdots H and Ni \cdots C interactions in a set of structurally characterized bis(diamine)nickel(II) complexes has allowed the deduction of a van der Waals radius for low-spin Ni^{II} of 1.35 Å.³⁹⁷

In a comparative study, the semiempirical PM3(tm) method was shown to be less effective than molecular mechanics for modeling the structures of Ni^{II} complexes with tetraaza macrocycles.³⁹⁸ In contrast, local DFT calculations (VWN5 method), coupled with appropriately large basis sets, accurately describes the geometries of the isomers of [Ni(cyclam)]²⁺.³⁹⁹

6.3.4.2 Carbonyl Complexes

While *cis*-[PtCl₂(CO)₂] is reasonably stable, related carbonyl complexes of the lighter homologue Ni^{II}, such as [NiCl₂(CO)] and [NiCl₂(CO)₂], are detectable only at very low temperature in solid argon matrices.^{400,401} However, the anionic compound [Ni(C₆F₅)₄]²⁻ has proven a valuable starting material for a convenient entry to the chemistry of square planar Ni^{II} carbonyl chemistry.⁴⁰² The halide-bridged dinuclear species (97) reversibly bind CO giving rise to the isolable derivatives (98). The chloro complex (98a) reacts with AgC₆F₅ to give (99). *cis*-[Ni(C₆F₅)₂(thf)₂] reacts with CO at -78 °C to give isolable (100), which has been crystallographically characterized. The high ν (CO) stretching frequencies (2,156 cm⁻¹, 2,130 cm⁻¹) are consistent with the CO acting as mainly a σ -donor with negligible π -backbonding. (100) easily decomposes above -40 °C by reductive elimination of C₆F₅-C₆F₅.

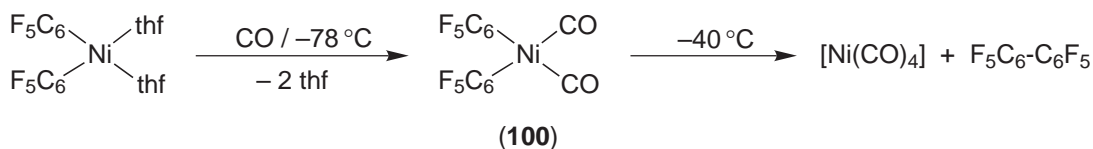
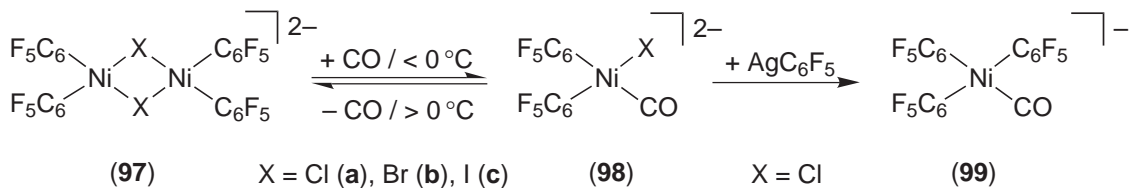

6.3.4.3 Cyano and Other Pseudohalide Complexes

6.3.4.3.1 Cyano complexes

The structure of $\text{Na}_2[\text{Ni}(\text{CN})_4] \cdot 3\text{H}_2\text{O}$ has been redetermined and the charge distribution analyzed by multipole refinements.⁴⁰³ The structure contains practically square planar $[\text{Ni}(\text{CN})_4]^{2-}$ ions, which are stacked on top of each other in almost linear chains. The bonding in $[\text{Ni}(\text{CN})_4]^{2-}$ has been investigated by MO calculations, confirming the expected σ -donation from cyanide orbitals and π -backbonding from the Ni d_{xy} orbitals.⁴⁰⁴ Its electronic spectrum has been analyzed and the MO energy sequence deduced.⁴⁰⁵ Ground state energies and electronic transitions have been calculated by the ZINDO technique.⁴⁰⁶ MCD results confirm the conventional $3d \rightarrow a_{2u}\{\text{Ni}4p_{z,p^*}(\text{CN})\}$ assignment of the intense UV bands at $3.2\text{--}4.5\ \mu\text{m}^{-1}$ and suggest an $a_{1g}(z^2) \rightarrow e_u$ assignment of the band at $5.0\ \mu\text{m}^{-1}$.⁴⁰⁷

Formation of $[\text{Ni}(\text{CN})_4]^{2-}$ from the reaction of $[\text{NiL}_2]^{2+}$ (L = ethylenediamine derivative) proceeds via a stable $[\text{LNi}(\text{CN})_2]$ intermediate.⁴⁰⁸ Formation of the intermediate is first order in CN^- , while the subsequent reaction is second order. The pH dependence, however, is different in each case. Oxidation of $[\text{Ni}(\text{CN})_4]^{2-}$ by aqueous chlorine to form *trans*- $[\text{Ni}^{\text{III}}(\text{CN})_4(\text{H}_2\text{O})_2]^{2-}$ follows distinct Cl_2O , Cl_2 , and HOCl pathways (with the first being the fastest) and proceeds through formation of a highly reactive Ni^{IV} intermediate.⁴⁰⁹ The ability of the $[\text{Ni}(\text{CN})_4]^-$ unit to bind to other metal ions through the cyanide N atoms has been extensively used for the construction of high nuclearity cyanide-based compounds. Since these are important in the field of molecular magnetism, they are mentioned in Section 6.3.4.13.2. One selected class is described here, since it incorporates various forms of cyanonickelate(II). The reaction between $[\text{Ni}(\text{H}_2\text{O})_6]^{2+}$ and $[(\text{Me}_3\text{tacn})\text{Cr}(\text{CN})_3]$ in aqueous solution generates $[(\text{Me}_3\text{tacn})_8\text{Cr}_8\text{Ni}_6(\text{CN})_{24}]^{12+}$, a cube of eight Cr^{3+} ions with each square face spanned by a $[\text{Ni}(\text{CN})_4]^{2-}$ unit.⁴¹⁰ In the course of cluster formation the cyanide ligands reorient from the $\text{Cr}^{\text{III}}\text{—C}\equiv\text{N}$ to the more stable $\text{Cr}^{\text{III}}\text{—N}\equiv\text{C}\text{—Ni}^{\text{II}}$ bridging arrangement. Use of NiI_2 in a similar reaction gives $[(\text{Me}_3\text{tacn})_8\text{Cr}_8\text{Ni}_5(\text{CN})_{24}]\text{I}_{10}$ with a Ni^{2+} ion missing from one of the cube faces.⁴¹¹ If this latter cyanide-rich cluster is reacted with additional $[\text{Ni}(\text{CN})_4]^{2-}$ in aqueous solution, $[(\text{Me}_3\text{tacn})_{10}\text{Cr}_{10}\text{Ni}_9(\text{CN})_{42}][\text{Ni}(\text{CN})_4]_3$ is formed, which incorporates square pyramidal (**101**) and trigonal bipyramidal $[\text{Ni}(\text{CN})_5]^{3-}$ (**102**) and square planar $[\text{Ni}(\text{CN})_4]^{2-}$ units in a single compound.⁴¹¹ $[\text{Ni}(\text{CN})_4]^{2-}$ has long been known to react with excess cyanide to generate $[\text{Ni}(\text{CN})_5]^{3-}$, and while the latter species favors a square pyramidal coordination geometry, a slightly distorted trigonal bipyramidal structure lies close in energy. The structure of $[(\text{Me}_3\text{tacn})_{10}\text{Cr}_{10}\text{Ni}_9(\text{CN})_{42}][\text{Ni}(\text{CN})_4]_3$ is claimed to support that this distortion from an ideal trigonal bipyramid is not a consequence of packing forces, but represents a local minimum structure for the free $[\text{Ni}(\text{CN})_5]^{3-}$ ion.⁴¹¹ Magnetic measurements now document the low-spin character of trigonal bipyramidal $[\text{Ni}(\text{CN})_5]^{3-}$, which is well established for the square planar form and for $[\text{Ni}(\text{CN})_4]^{2-}$.

The reaction of $\text{K}_2[\text{Ni}(\text{CN})_4]$ with $\text{B}(\text{C}_6\text{F}_5)_3$ followed by treatment with Ph_3CCl gives (**103**), which has a highly delocalized negative charge in the anion.⁴¹² (**103**) is an active cocatalyst for the Cp_2ZrMe_2 -mediated olefin polymerization. An extremely bent cyanide coordination with a very acute angle $\text{Ni}\text{—N}\equiv\text{C}$ of around $111.2(2)^\circ$ has been observed for the preorganized dinickel(II) site (**104**), where the short Ni—Ni distance is constrained by the dinucleating ligand scaffold.⁴¹³

Application of $[\text{Ni}(\text{CN})_4]^{2-}$ as a tumor imaging agent has been reported.⁴¹⁴

6.3.4.3.2 Fulminato, cyanato, thiocyanato, and related pseudohalide complexes

Nickel–azide coordination chemistry has received particular attention with respect to magnetic properties and molecular magnetism. Therefore, $\text{Ni}^{\text{II}}/\text{N}_3^-$ systems are covered in a separate section (Section 6.3.4.13.1).

The crystal structure of $[\text{N}(\text{C}_3\text{H}_7)_4]_2[\text{Ni}(\text{CNO})_4]$ containing the square planar tetrafulminato nickel(II) anion has been determined.⁴¹⁵ Due to the large cations separating the anions, this high-energy fulminato species is not explosive. $\text{C}\equiv\text{N}$ (114.0(5) pm and 113.6(5) pm) and $\text{N}\text{—O}$ distances (126.0(4) pm and 126.2(4) pm) are in the usual range for fulminato complexes, and the $\text{M}\text{—C}\equiv\text{N}\text{—O}$ units are almost linear. Based on spectroscopic and magnetic studies, bridging fulminato ligands have been proposed in a dimeric Ni^{II} complex.⁴¹⁶

The cyanato ligand generally tends to bind through its N atom to Ni^{II} and acts as an N-bound terminal ligand in mononuclear complexes. Complexes of the type $[\text{Ni}(\text{NCO})_2\text{L}_4]$ (L = py, H_2O)

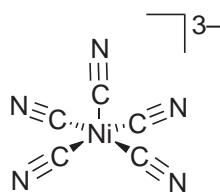

(101)

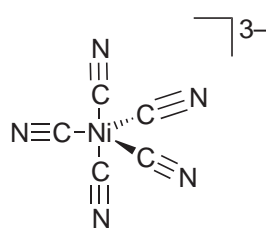

(102)

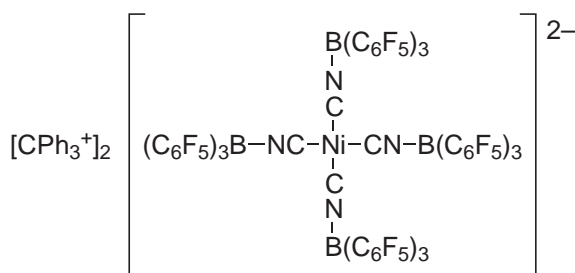

(103)

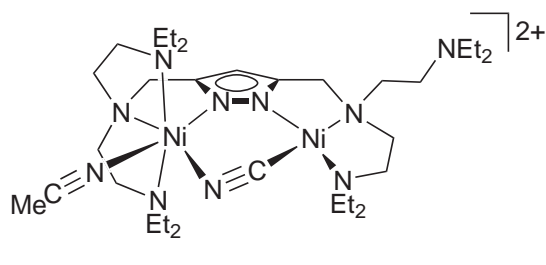

(104)

have been characterized structurally and spectroscopically.^{417,418} In several cases, cyanato complexes are formed from urea complexes upon heating (see Section 6.3.4.12.7). The bridging ability of the cyanate ion is manifest in some di- and polynuclear complexes where end-to-end (μ -1,3) linkages have been detected due to the use of tetradentate ligands that leave two accessible coordination sites at the metal center. If these sites are disposed in the *cis* position, doubly bridged dinickel(II) species such as $[\{\text{Ni}(\text{terpy})(\text{H}_2\text{O})\}_2(\mu\text{-NCO})_2](\text{PF}_6)_2$ ⁴¹⁹ and $[\{\text{Ni}(\text{Me}_6[14]\text{aneN}_4)\}_2(\mu\text{-NCO})_2](\text{ClO}_4)_2$ (105)⁴²⁰ result. Otherwise, 1D chains are obtained as in $[\{\text{Ni}(3,2,3\text{-tet})(\mu\text{-NCO})\}_n](\text{ClO}_4)_n$.^{420,421} In all these cases, however, the cyanate binding is asymmetric with rather long Ni—O distances (>2.21 Å) and with very different bond angles ((Ni—O—C) = 122 – 132°) and ((Ni—N—C) $> 150^\circ$). Bond angles of bridging SCN[−] and SeCN[−] ligands are even more asymmetric (see below). Magnetic properties of cyanato bridged Ni^{II} complexes have been analyzed, revealing that the antiferromagnetic component of the coupling constant J is lower compared to the azido systems, as a consequence of the large Ni—O distance and the asymmetry of the ligand.⁴²⁰

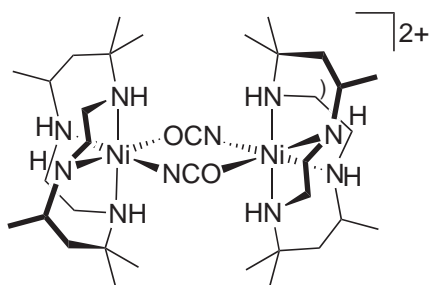

(105)

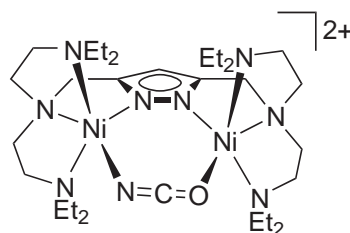

(106)

Enforced by the preorganized bimetallic array, a more symmetrical cyanato bridge has been observed in (106).⁴²² Triple μ -1,1,1-NCO linkages have been reported for heterobimetallic nickel/lanthanide systems.⁴²³

Thiocyanate is a common coligand found in Ni^{II} coordination compounds of multidentate chelate ligands.^{424–431} A convenient method of preparing Ni(NCS)₂ has been reported, which serves as a starting material for the preparation of various Ni^{II}–thiocyanate compounds.⁴³² A detailed magnetic analysis reveals antiferromagnetic ordering of Ni(NCS)₂ at $T_c = 52 \pm 1$ K.⁴³³ Solution studies show the presence of $[\text{Ni}(\text{NCS})_n]^{(2-n)+}$ with $n = 1$ – 4 in DMA and $n = 1$ – 2 in DMSO.^{434,435} In concentrated aqueous NaNCS, a value of 0.12 ± 0.041 mol^{−1} has been determined for the fourth consecutive binding constant.⁴³⁶

While SCN^- usually binds via its N atom to Ni^{II} (or it adopts a N,S bridging mode), rare S-coordination has also been observed.⁴³⁷ (107) involves both N- and S-coordinated terminal thiocyanate, where the Ni-S-C angle is $98.3(1)^\circ$, whereas the Ni-N-C angle is $168.7(2)^\circ$. S bonding seems to be stabilized by intermolecular H bonding to the uncoordinated thiocyanato-N atom.

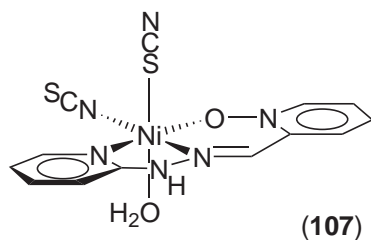

The $[\text{Ni}(\text{NCS})_6]^{4-}$ ion is almost perfectly octahedral, with Ni-N distances of around 209.5 pm and N-Ni-N angles around 89.5° . The Ni-N-C and N-C-S entities are practically linear.^{438,439} In $[\text{Ni}(\text{NCS})_2\text{L}_2]$ where L is a R-substituted pyridine, stereochemistry and spin state depend on the type and positions of R.⁴³¹ While for 2-Me- and 2-Et-pyridine square planar complexes are observed, other pyridins lead to coordination polymers with pseudo-octahedral Ni^{II} due to N,S-bridging thiocyanate. Ni^{II} thiocyanato complexes have been studied quite intensively as hosts for inclusion compounds.⁴⁴⁰⁻⁴⁴²

Bridging thiocyanate has received attention as magnetic exchange mediator in polynuclear Ni^{II} complexes. Besides discrete dinuclear complexes (108)^{443,444} and several trinuclear systems (109),^{445,446} 1D chain compounds with single (110, 111)^{447,448} or double bridges (112, 113)⁴⁴⁹⁻⁴⁵² and *cis* (110, 113)^{447,448,450} or *trans* (111, 112)^{449,451,452} orientation of the bridges have been characterized and their magnetic properties analyzed. The small bonding angle at the thiocyanate-S (around 100°) leads to orthogonality of the magnetic orbitals, and hence ferromagnetic coupling is usually observed.

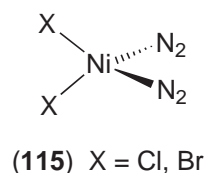
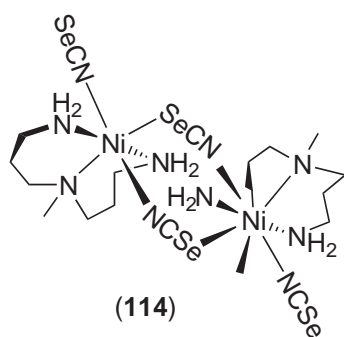
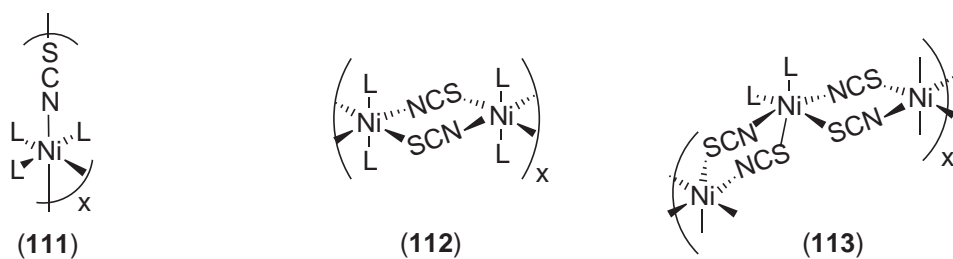
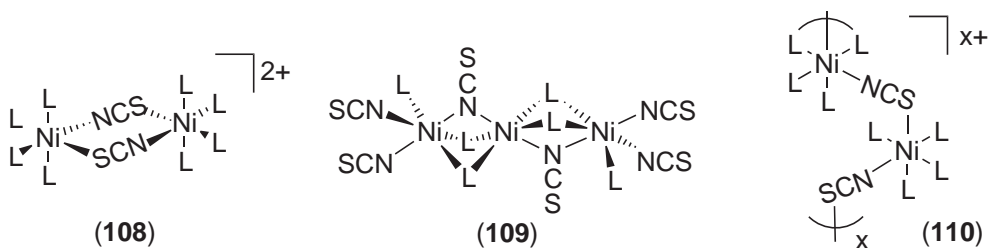

Selenocyanate binds via its N atom to Ni^{II},^{453,454} but is also able to bridge two Ni^{II} ions in the μ -1,3 mode. Compounds [LNi(NCSe)₂(H₂O)] (L = tridentate amine, e.g., bis(3-aminopropyl)amine or (2-aminoethyl)(3-aminopropyl)amine) undergo deaquation to form dinuclear selenocyanate bridged species [LNi(NCSe)(μ -NCSe)]₂ (**114**) upon heating.⁴⁵³ In (**114**), the Ni—Se—C and Ni—N—C angles are around 95° and 170°. Due to the resulting orthogonality, ferromagnetic superexchange is usually found for these compounds.^{455,456}

6.3.4.4 Complexes with Nonmacrocyclic Nitrogen Donor Ligands

6.3.4.4.1 Complexes with monodentate amino, amido, and imido ligands

A combination of matrix isolation IR and DFT studies have shown that condensation of monomeric NiX₂ (X = Cl, Br) in solid N₂ matrices initially gives species NiX₂⋯(N₂) with a physisorbed type of interaction. These can be converted by photolysis into pseudotetrahedral NiX₂(η^1 -N₂)₂ (**115**) moieties with end-on bound N₂ in a chemisorbed type of interaction below 10 K. On warming to ca. 20 K the chemisorbed species revert to the physisorbed state.⁴⁵⁷

Amines are very efficient donors for Ni^{II} ions. The most effective monodentate nitrogen-containing ligands are heterocyclic amines like imidazole (Im) or pyridine (py). Imidazole or substituted imidazoles may form classical complexes with six or fewer ligands bound to Ni^{II}. Powdered nickel dissolves in *N*-methylimidazole (*N*-MeIm) solutions of elemental sulfur to give red-colored salts [Ni(*N*-MeIm)₆]₈S₈.⁴⁵⁸ The Ni atom is surrounded by six ligands with parameters very close to those found in the classical imidazole complexes. In the *trans*-[Ni(NCS)₂(Im)₄] complex with a {NiN₆} chromophore, the Ni^{II} ion exhibits axially distorted octahedral geometry with *trans* N-bonded thiocyanate ligands.⁴⁵⁹ Structural studies on the [Ni(NCS)₂(alkylpyridine)_{*n*}] complexes have shown that there is a direct relation between the size and the position of alkyl substituents and the structure of the complexes formed. While a simple pyridine ligand gives six-coordinate complexes, e.g., in [NiCl₂(py)₄],⁴⁶⁰ substituted pyridines may give complexes with coordination numbers from four to six.⁴⁶¹ Using 2,4-dimethylpyridine (2,4-dmepy) the [Ni(NCS)₂(2,4-dmepy)₃] complex is obtained with five nitrogen atoms around the metal ion and with a geometry intermediate between a trigonal bipyramid and a tetragonal pyramid. The arrangement of the methyl substituents prevents coordination of a sixth ligand.

Methazolamide ((**116a**), Hmacm) and acetazolamide ((**116b**), H₂acm) contain two different nitrogen binding sites, the sulfoamide and thiadiazole nitrogen donors. The interaction of Hmacm with Ni^{II} ions and ammonia gives rise to [Ni(macm)₂(NH₃)₄].⁴⁶² Two sulfonamido molecules occupy the axial positions by binding through the deprotonated sulfonamide N atoms, while four ammonia N atoms form the equatorial plane. A similar complex, [Ni(Hacm)₂(NH₃)₄], is formed with H₂acm.⁴⁶³ Hacm coordinates through its thiadiazole nitrogen with the Ni—N distance being shorter (2.150 Å) than in the case of the sulfonamide Ni—N bond (2.216 Å). The shorter distance for the thiadiazole ligand indicates the effect of the π -electron delocalization in the thiadiazole ring.

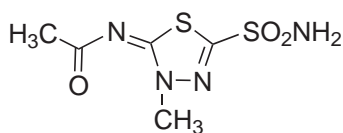

(**116a**) (Hmacm)

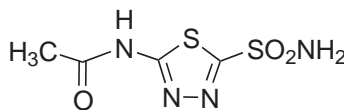

(**116b**) (H₂acm)

In contrast to amino ligands, Ni^{II} coordination chemistry with amido or imido ligands is much less developed. Parent [Ni(NH₂)₂] can be obtained by the reaction of NiBr₂ with KNH₂ in liquid NH₃.⁴⁶⁴ In the solid state, it contains [Ni₆(NH₂)₁₂] entities that consist of Ni octahedra surrounded by amide groups forming a cuboctahedron. There are at most weak NH⋯N bonds between the [Ni₆(NH₂)₁₂] clusters. Reaction of NaNH₂ with [Ni(NH₂)₂] gives Na₂[Ni(NH₂)₄]·2NH₃.⁴⁶⁵ This compound contains planar [Ni(NH₂)₄]²⁻ units that are oriented to form the ground and top of a prism capped by Na⁺ and (at a greater distance) NH₃. Upon further reaction with LiNO₃, LiCl, or LiBr, Li₃[Ni₄(NH₂)₁₁]·NH₃ is formed.⁴⁶⁶

Ni^{II}-amido complexes such as **(117)** react with small electrophiles by insertion either in the Ni—N bond (e.g., with CO₂ to form **(118)**) or in the N—H bond. With unsubstituted aryl groups (Ar = Ar' = Ph), both a monomeric complex **(117)** or a dimeric species **(119)** is formed, depending on the amount of PMe₃ added. Using bulky borylamide ligands, an almost linear, two-coordinate Ni^{II} complex could be obtained and structurally characterized.⁴⁶⁷ The N—Ni—N angle in **(120)** is 167.9°.

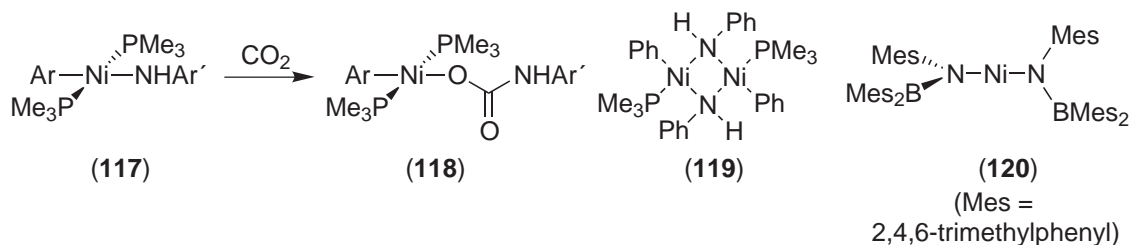

A first terminal imido complex of nickel **(121)** was prepared according to Equation (3).⁴⁶⁸ The synthesis goes via the Ni^{II} amido compound **(122)** and uses the steric bulk of the arylimido group for stabilization. The Ni^{II} center in **(121)** is planar and three-coordinate. Reaction of **(121)** with CO or benzyl isocyanide leads to formal nitrene transfer with formation of **(124)** and **(125)**, respectively. Further reaction with CO liberates the isocyanate and carbodiimide (Equation (4)).⁴⁶⁹

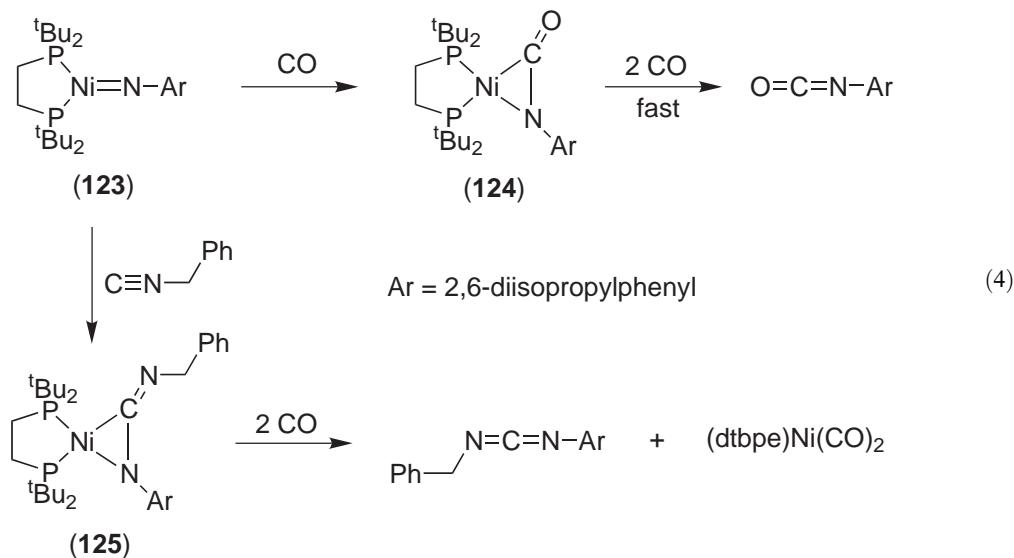
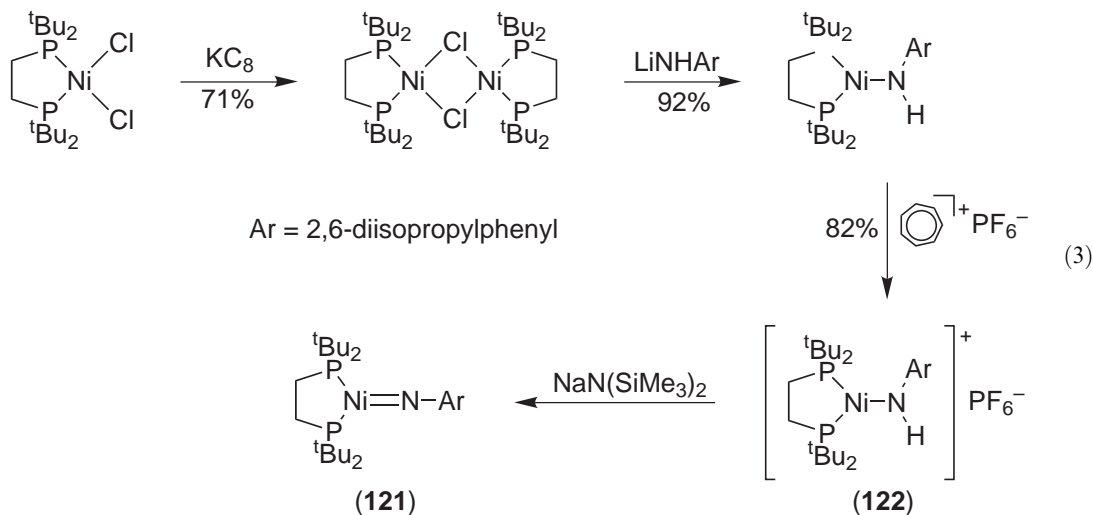

6.3.4.4.2 Complexes with chelating amino and amido ligands

With *C*- and/or *N*-substituted diamines square planar or octahedral Ni^{II} complexes are usually formed. 2-Methyl-1,2-propanediamine may form both octahedral⁴⁷⁰ or square planar complexes.^{471,472} The *C*-substituted diamine complexes with Ni^{II} often exhibit solid-state yellow to green-blue thermochromism which is usually explained by the square planar to octahedral isomeric transformation.^{473,474} The simultaneous substitution on diamine C and N atoms in *N*-isopropyl-2-methyl-1,2-propanediamine results in a set of three complexes [NiL₂]Br₂·3H₂O (**126a**), [NiL₂Br]Br (**126b**) and [NiL₂(NCS)₂]⁴⁷⁵ (**126c**) with square planar ({NiN₄} chromophore), distorted trigonal bipyramid ({NiN₄Br} chromophore), and *trans* octahedral ({NiN₆} chromophore) geometry, respectively. In the pentacoordinate complex the secondary N atoms are coordinated in axial positions while the Br atom and two primary N atoms define the basal plane. The square planar complex (**126a**), on heating, undergoes an irreversible exothermic isomerization after dehydration into complex (**126b**)—a unique example of the change from square planar to a trigonal bipyramidal species (yellow to green thermochromism). The isocyanide complex exists only as a six-coordinate species in the solid state as well as in solution. The smaller size of the coordinating atom and a higher ligand field of the NCS⁻ ion compared to the bromide ion allows the steric hindrance caused by the bulky substituents to be overcome. *N,N'*-dimethyl-1,2-ethanediamine forms with Ni(NO₃)₂ octahedral complexes exhibiting *cis-trans* isomerization. *cis*-[NiL₂(NO₃)₂] obtained from *cis*-[NiL₂(H₂O)₂][NO₃]₂ by heating may be transformed into *trans*-[NiL₂(NO₃)₂] on heating to 150 °C or by the presence of humidity.⁴⁷⁶

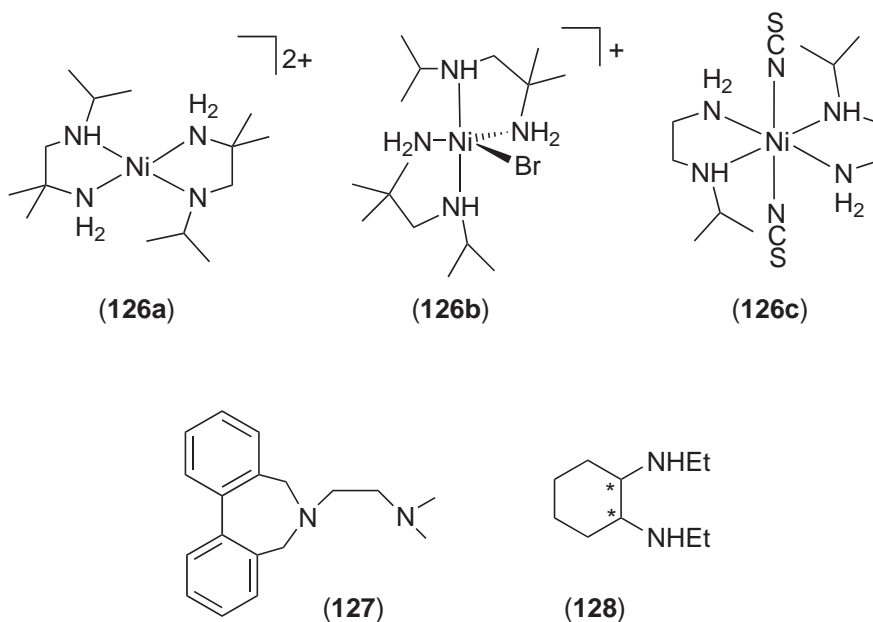

Equilibria between four-, five-, and six-coordinate complexes in solution are found in the case of ternary substituted [Ni(diamine)(β -kitenonate)]⁺ species for coordinating solvent with different donor strength.⁴⁷⁷ Increasing of the solvent donor strength as well as increasing the electron-withdrawing abilities of the substituents at the diamine and β -kitenonate ligands favors the formation of the six-coordinate species.

The heavily substituted diamine (**127**) forms with Ni^{II} a violet complex [NiCl₂(**127**)].⁴⁷⁸ The Ni atom is surrounded by two chlorine atoms and by two amino groups in a distorted tetrahedral geometry with a dihedral angle between the planes defined by Cl—Ni—Cl and N—Ni—N of 86.3°. The main reason for this unusual Ni—diamine complex structure is most likely the geometry of the resulting diazanic nickelacyclopentane ring that invariably shows a N—Ni—N angle ranging from 82° to 90°.

1,2-Cyclohexanediamines are simple analogues of 1,2-ethylenediamine^{479,480} and much of their coordination chemistry is very similar. Ni^{II} complexes may be used to separate the stereoisomers of 1,2-cyclohexanediamine.⁴⁸¹ The complex composed of Ni^{II} and optically active *N,N'*-diethylcyclohexane-1,2-diamine (**128**) shows an ability to recognize the shape of molecules in terms of the configuration of the various OH groups in aldolases during the epimerization of D-glucose to D-mannose.⁴⁸²

Amidines, i.e., bifunctional nitrogen compounds of general formula $R'NH-C(R)=NR'$, exhibit various bonding modes, with small amidino ligands favoring formation of dimeric complexes.^{483,484} N-silylated benzamidines with larger substituents usually form monomeric species.⁴⁸⁵ Ligand **(129)** (*siam*, $Me_3Si-NC(Ph)N-SiMe_3^-$) forms two complexes with Ni^{II} ion, $[Ni(siam)_2]$ and $[Ni(siam)(Hsiam)Br]$.⁴⁸⁶ The complex $[Ni(siam)_2]$ shows a distorted tetrahedral environment around the Ni^{II} ion. The distortion arises from the amidine groups resulting in the dihedral angle between the planes defined by atoms involved in the formation of two chelates, $NNi-NiNN$, of 96.1° . The $[Ni(siam)(Hsiam)Br]$ complex has a monodentately bound *Hsiam* ligand and a weakly distorted square planar geometry with a dihedral $NNi-NiBrN$ angle of 173.5° . $[Ni(siam)_2]$ is very reactive towards CO_2 : two moles of the starting complex can incorporate 5 mol of CO_2 that insert into five N—Si bonds (**(130)**, Figure 4). *Siam* coordinated to metal ions can stabilize metal-carbon bonds similar to the cyclopentadienyl ligand.⁴⁸⁷

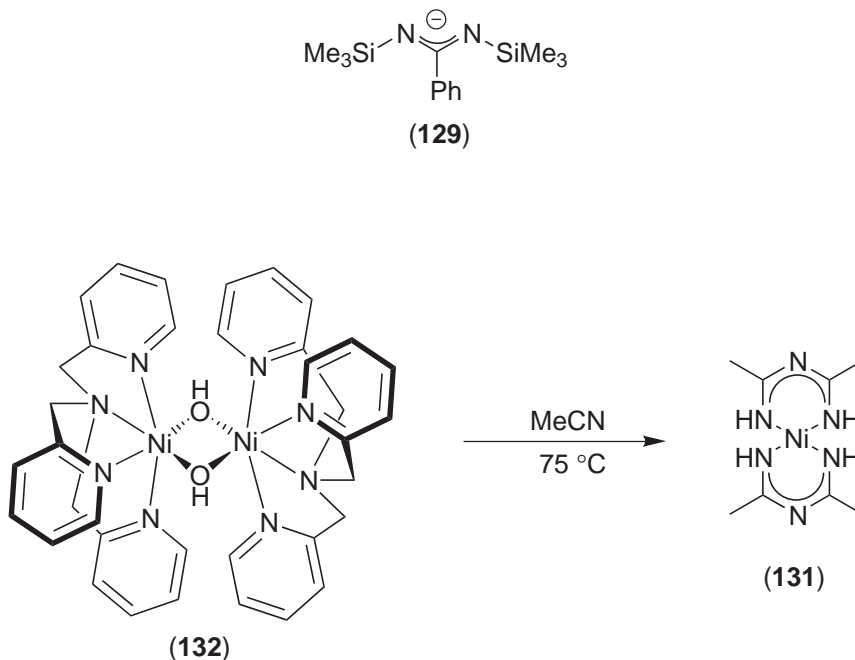

The square planar Ni^{II} complex **(131)** is formed upon reaction of MeCN with the dinuclear complex **(132)**. A sequence of Ni-mediated hydrolytic transformations, $MeCN \rightarrow$ acetamide and $NH_3 \rightarrow$ acetamide \rightarrow *N*-acetimidoylacetamide, is proposed.⁴⁸⁸ While the *N*-acetimidoylacetamide ligands are isoelectronic with acac, they have a much stronger ligand field.

From the reaction of $[Ni(acac)_2]$ with a variety of oxalamidines, di- and oligonuclear complexes with oxalic amidinato bridging ligands and square planar Ni^{II} have been obtained (**(133a)**).⁴⁸⁹ In contrast, the $(Ph_3P)BrNi$ fragment can only coordinate to sterically less demanding oxalamidines

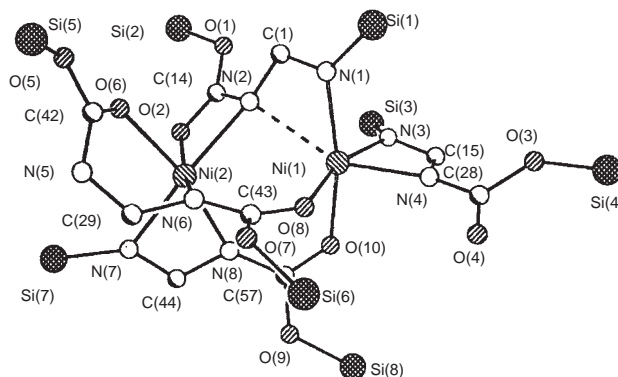
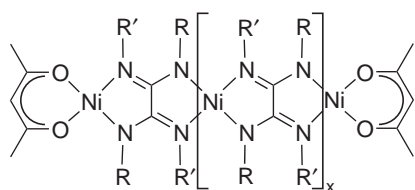
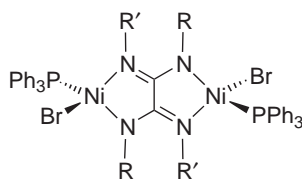

Figure 4 Crystal structure of **(130)**⁴⁸⁶ (reproduced with permission of Elsevier from *Inorg. Chem. Acta*, **1998**, *281*, 181–189).

and gives tetrahedral coordination of the metal ion (**133b**).⁴⁹⁰ Oxalamidines with additional donor atoms in the *N*-substituents have also been studied, e.g., in (**133c**).⁴⁹⁰



(133a)



(133b)

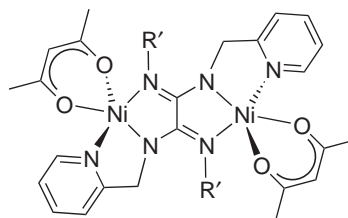

(133c)

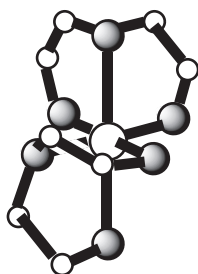
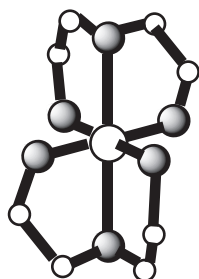
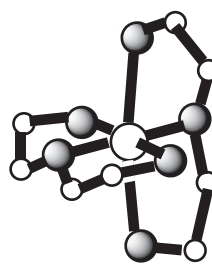
(134a)
(*u-fac*)(134b)
(*s-fac*)(134c)
(*mer*)

Triamine ligands bind Ni^{II} to usually give octahedral complexes both in the equimolar and bis(ligand) species.^{491,492} The bis-complexes of the tridentate diethylenetriamine (dien) can exist in three edge configurations: meridional (*mer*), symmetrical facial (*s-fac*), and unsymmetrical facial (*u-fac*) (**134**).⁴⁹³ The difference in energy between them is very small (only few kJ mol⁻¹). Thus, even the thermal transformation in the solid state between different isomers is possible. [Ni(dien)₂](SCN)₂ undergoes a phase transition (162–180 °C, Δ*H* = 29.4 kJ mol⁻¹) from the low-temperature ordered form *s-fac*-[Ni(dien)₂](SCN)₂ to a high-temperature unordered *mer* isomer.⁴⁹⁴ The latter isomer is metastable and transforms to the former one in the presence of humidity.

Dien is classified as an N-donor, polycentric, chelate and also chiral ligand.⁴⁹⁵ In octahedral [M(dien)₂]ⁿ⁺ complexes the configuration *u-fac* is chiral (*C*₂), the configuration *s-fac* is achiral (*C*_i) and the configuration *mer* is chiral due to nonplanarity of the central N atom. Different isomers can be obtained not only by thermal phase transition but also by appropriate complex synthesis.⁴⁹⁶ Two particular complexes in this context are [Ni(dien)₂](ca)·2H₂O (ca = chloranilate) and [Ni(dien)₂][Ni(CN)₄]·2H₂O. In the former complex the [Ni(dien)₂]²⁺ cation has nearly octahedral geometry. Two ligand molecules with terminal amino groups in *cis* and secondary amino groups in *trans* position define the *s-fac* configuration. The conformations of two independent chelate rings are enantiomeric with each other. In contrast, the metal ion in the [Ni(dien)₂]²⁺ unit of the second compound shows distorted octahedral geometry, but the two tridentate ligands are coordinated meridionally.

N-(2-aminoethyl)-1,4-diazacycloheptane ((**135**), dachen) is a tridentate ligand incorporating a mesocyclic diamine and is termed “structurally reinforced.”⁴⁹⁷ Like other polyamine ligands with steric bulk disposed above and below the complex plane, dachen stabilizes the low-spin square planar Ni^{II}. In aqueous solution it exists as the octahedral [Ni(dachen)(H₂O)₃]²⁺ cation, which upon reaction with ammonia yields the square planar complex [Ni(dachen)(NH₃)₂]²⁺, a rare example of a monodentate ammine ligand in a low-spin Ni^{II} complex.⁴⁹⁸

The choice of tridentate amine has a critical impact on the coordination mode of the ambidentate nitrite ligand, NO₂⁻.^{499,500} Complexes with substituted tri- and tetraamines have shown that bulky substituents may prevent the formation of the μ-NO₂⁻ bridged polymeric complexes, and the intramolecular hydrogen network may stabilize N coordination of nitrite.

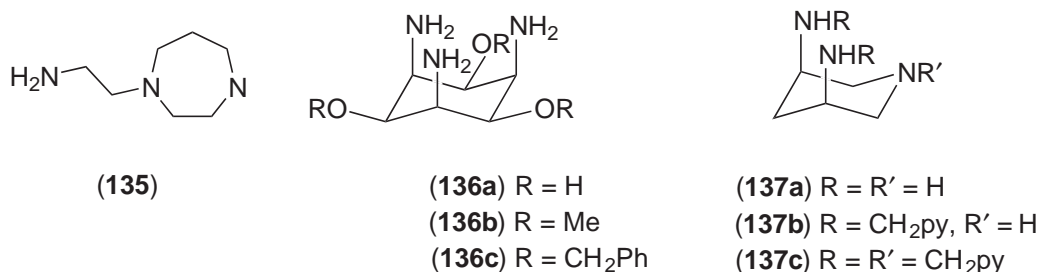

1,3,5-Triamino-1,3,5-trideoxy-*cis*-inositol (*taci*, **(136a)**) provides a rigid arrangement of three amino groups sterically constrained to facial coordination and hence is an effective chelator for Ni^{II}, much more effective than the related 1,3,5-triaminocyclohexane.⁵⁰¹ O-alkylated derivatives such as *all-cis*-2,4,6-trimethoxy-cyclohexane-1,3,5-triamine (*tmca*, **(136b)**) and *all-cis*-2,4,6-tribenzoxycyclohexane-1,3,5-triamine (*tbca*, **(136c)**) form particularly stable [Ni(*tmca*)₂]²⁺ and [Ni(*tbca*)₂]²⁺ complexes, which in the solid state show near octahedral coordination geometry with some trigonal distortion. The {NiN₆} core has almost ideal D_{3d} point group symmetry.⁵⁰² A potentiometric study performed for the Ni^{II} *tmca* system shows potent binding ability of this ligand toward Ni^{II}. In comparison to the parent ligand (**(136a)**), the stability constant is larger by two orders of magnitude for the 1:1 complex and about five orders of magnitude for the 1:2 complex. A comparison with other triamines shows that *tmca* belongs to the most effective triamine ligands for Ni^{II} ions. The data suggest that the methyl groups located on the periphery of the complex generate a lipophilic surface, whereas the hydrophilic part of the molecule is mostly hidden in the inside. Compared with the parent (nonmethylated) ligand, *tmca* complexes are stabilized by a more favorable entropy of hydration. [Ni(*taci*)(H₂O)₃]²⁺ is a valuable building block and can be attached to other moieties. Solvothermal reaction of NiCl₂, Nb(OEt)₅ and *taci* in a 1:1:1 ratio under alkaline conditions resulted in the formation of two Nb–Ni heteropolyoxometalate complexes [Ni(*taci*)₂]₂{*trans*-[Nb₆O₁₉][Ni(*taci*)₂]₂}·26H₂O and [Na(H₂O)₆]₂{*cis*-[H₂Nb₆O₁₉][Ni(*taci*)₂]₂}·18H₂O. In both compounds, two [Ni(*taci*)₂]²⁺ entities are each bonded to three Nb—O—Nb bridges of a central Nb₆O₁₉ unit, resulting in the formation of an approximately C_{3v} symmetric NiN₃O₃ coordination geometry.⁵⁰³

Stability constants for complexes of *cis*-3,5-diaminopiperidine (*dapi*, **(137a)**) with several divalent metal cations have their maximum for Ni^{II}. [Ni(*dapi*)₂]²⁺ forms directly in aqueous solution, and the centrosymmetric *trans* isomer was found exclusively in the solid state.⁵⁰⁴ Ligands **(137b)** and **(137c)** bearing additional pyridine donors form six-coordinate complexes [Ni(**(137b)**)Cl]⁺ and [Ni(**(137c)**)₂]²⁺.

Phosphinoimidic amidato ligands give Ni^{II} complexes (**(138a)**) and (**(138b)**), depending on the size of the R and R' substituents. For example, for R = Bu^t and R' = SiMe₃, halogeno-bridged type (**(138b)**) complexes with tetrahedral {NiN₂X₂} chromophores are formed. In the solid state, complexes (**(138a)**) can be either planar (e.g., R = Prⁱ, R' = Me) or tetrahedral (e.g., R = Ph, R' = SiMe₃), while in solution an equilibrium planar (diamagnetic) ⇌ tetrahedral (paramagnetic) is often observed. Higher temperatures shift the equilibrium towards the tetrahedral form.⁵⁰⁵ Distorted tetrahedral structures in the solid state are also observed for type (**(138a)**) and (**(138b)**) complexes with R = R' = Ph and X = PPh₂.⁵⁰⁶

Bis(8-quinoliny)amide acts as a tridentate pincer ligand towards Ni^{II} to give the square planar complex (**(139)**).⁵⁰⁷ A trigonal monopyramidal (TMP) coordination geometry around the Ni^{II} ion is rare.⁵⁰⁸ The tripodal ligand N[CH₂C(O)NHBu^t]₃, which contains a tertiary amine and three amides with appended *t*-butyl groups is very efficient in forming TMP complexes with Ni^{II}. The orange nickel complex (**(140)**) has a TMP structure with the three deprotonated amide nitrogen donors coordinated equatorially.^{509,510} The Ni^{II} ion lies nearly in the trigonal plane, displaced only 0.14 Å toward the vacant coordination site. (**(140)**) does not form trigonal bipyramidal species while dissolved in solvents, even in pyridine and water. The lack of reactivity can be explained by the nearly complete shielding of the vacant coordination site by the bulky amide substituents. This TMP ligand effectively stabilizes the divalent Ni^{II} state and leads to a high Ni^{II}/Ni^{III} redox potential.

Tetraamine ligands (2*S*,3*S*)-1,2,3,4-tetraaminobutane (*threo*-form, *ttab*) and (2*S*,3*R*)-1,2,3,4-tetraaminobutane (*erythro*-form, *etab*) (**(141)**) form oligonuclear and polymeric complexes with Ni^{II}. The solid-state structure of [Ni₈(*ttab*)₁₂]Br₁₆·17.5H₂O has been shown to contain discrete chiral [Ni₈(*ttab*)₁₂]¹⁶⁺ cubes with approximate *T* symmetry.⁵¹¹ Ni^{II} complexes of the tripodal tetraamine ligand *tren* are well established. In the linear complex cation [Ni₃(*tren*)₄(H₂O)₂]⁶⁺ (**(142)**)

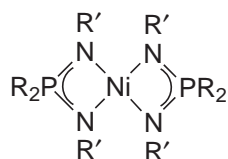

(138a)

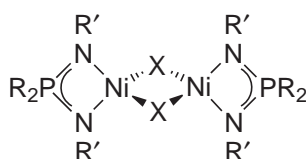

X = Cl, Br

(138b)

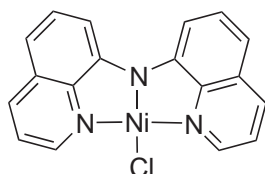

(139)

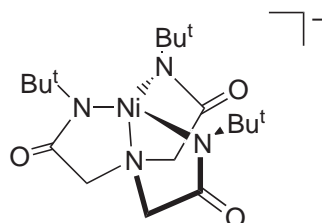

(140)

all Ni ions are six-coordinate, but with different coordination spheres.⁵¹² Two of the tren ligands act as bridges, being only tridentate with respect to the central Ni^{II} and binding the outer Ni^{II} via the pendant primary amine. The higher homologues of tren, ((143)–(145)), also form octahedral type (146) and (147) complexes.⁵¹³ Variation of the lengths of the ligand arms leads to different chelate ring sizes, which causes distinct distortions of the octahedral coordination environment, of the strengths of bonds to monodentate coligands, and induces a slight shift in the UV–visible spectra.

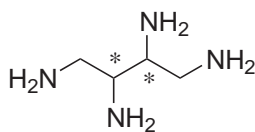

(141)

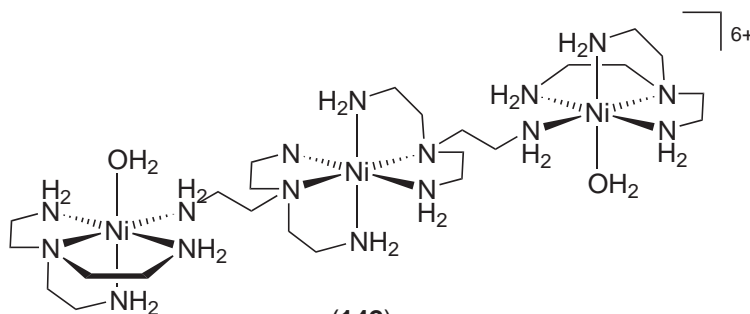

(142)

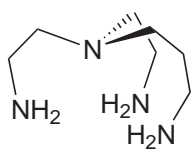

(143)

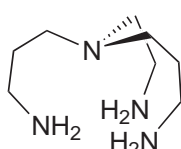

(144)

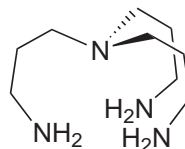

(145)

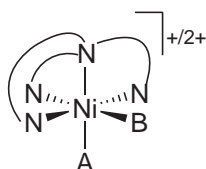
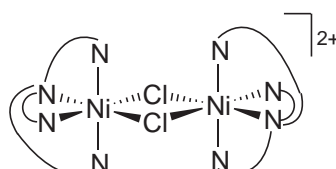
(146a) A = Cl, B = H₂O(146b) A = H₂O, B = Cl(146c) A = B = H₂O

(147)

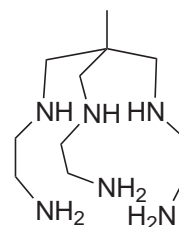

(148)

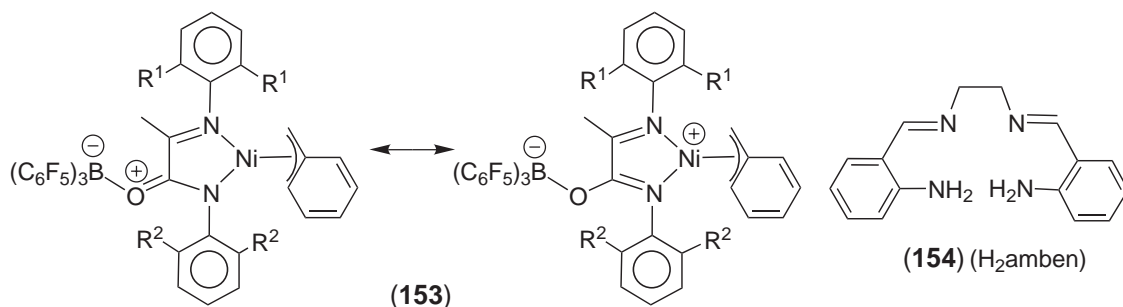

strongly dependent on the nature of X.⁵⁴⁴ The order or reactivity was found to be: $\text{ClO}_4^- < \text{Br}^- < \text{SCN}^- \ll \text{Cl}^-$. The slow substitution with $\text{X} = \text{ClO}_4^-$ takes days, while with $\text{X} = \text{Cl}^-$ it proceeds within minutes. According to the kinetic data for the system $[\text{Cu}(\text{amben})]/[\text{Ni}(\text{DMF})_6]^{2+}/\text{Cl}^-$ the overall process consists of a Ni- and Cl-dependent step, followed by two Ni- and Cl-independent consecutive steps. The first step can be described as a second-order reaction between $[\text{Cu}(\text{amben})]$ and a chloro species assumed to be distorted tetrahedral $[\text{NiCl}_2(\text{DMF})_2]$. This species initially reacts with the $\{\text{N}_2\}$ donor metalloligand $[\text{Cu}(\text{amben})]$ to form the binuclear intermediate $[\text{Cu}(\text{amben})\text{NiCl}_2]$ which subsequently rearranges in two first-order steps to form $[\text{Ni}(\text{amben})]$.

6.3.4.4 Complexes with chelating nitrogen ligands incorporating oximes and related functions

The oxime function is usually inserted close to another donor ensuring chelate formation, e.g., other donors like an oxime, amide, imine, or azo group. The insertion of an N-donor atom next to an oxime group results in efficient ligands for Ni^{II} ions. The arylazooximes with an aza function next to the oxime ($\text{H}[\mathbf{155}]$) form complexes $[\text{Ni}^{\text{II}}(\mathbf{155})_3]^-$ ($\mathbf{156}$; $\text{R} = \text{Me}$ or Ph).²⁶² One of the ligands may be easily displaced by 2,2'-bipyridine or related ligands giving the octahedral $[\text{Ni}(\mathbf{155})_2(\text{bipy})]$ complex. The crystal structure of $[\text{NET}_4][\text{Ni}(\mathbf{155})(\text{R}=\text{Ph})]$ shows that the $\{\text{NiN}_6\}$ coordination sphere (chelates are meridionally bound) is severely distorted from octahedral symmetry with $\text{Ni}-\text{N}_{\text{oxime}}$ bonds shorter than the $\text{Ni}-\text{N}_{\text{aza}}$ distances and a distinct *trans* effect displayed by the $\text{Ni}-\text{N}_{\text{oxime}}$ bond.

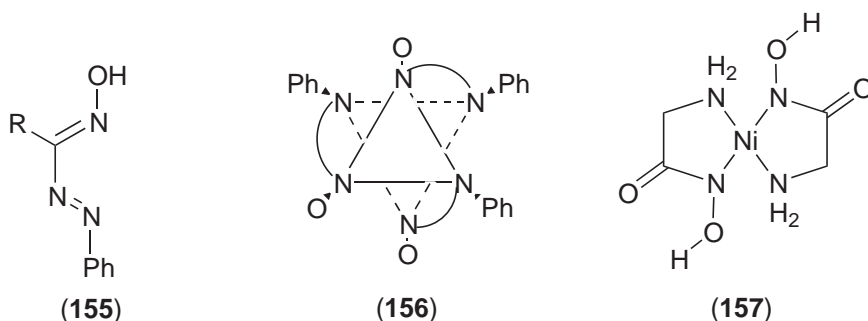

Bis(glycinohydroxamato)nickel(II) ($\mathbf{157}$) forms a square planar complex where the ligand behaves as an $\{\text{N}_2\}$ chelate.⁵⁴⁵ Ni^{II} complexes of imine oximes synthesized from corresponding alkyldione monoximes and amines show an unusual coordination. After almost 70 years the structure of the Pfeiffer complex (Figure 5) and the reaction leading to this structure was finally established.⁵⁴⁶

Amide N atoms next to an oxime moiety are strong donors and $\{\text{N}_{\text{oxime}};\text{N}_{\text{amide}}\}$ chelation usually results in square planar NiL_2 complexes.⁵⁴⁷ Two oxime groups accompanied by two amine, amide, imine, or other donors are also powerful ligands. Such tetradentate dioximes form planar complexes. Deprotonated 3,6,6,9-tetramethyl-4,8-diaza-3,8-undecadiene-2,10-dione dioxime forms with Ni^{II} a slightly distorted square planar complex ($\mathbf{158}$) with intramolecular hydrogen between the oxime oxygen atoms.⁵⁴⁸

A ring closing reaction involving coordinated amide groups is observed for ($\mathbf{159a}$), which forms ($\mathbf{159b}$) upon condensation with formaldehyde and methylamine.⁵⁴⁹

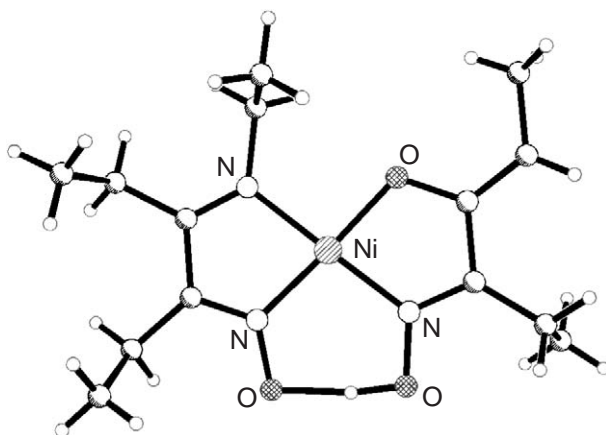
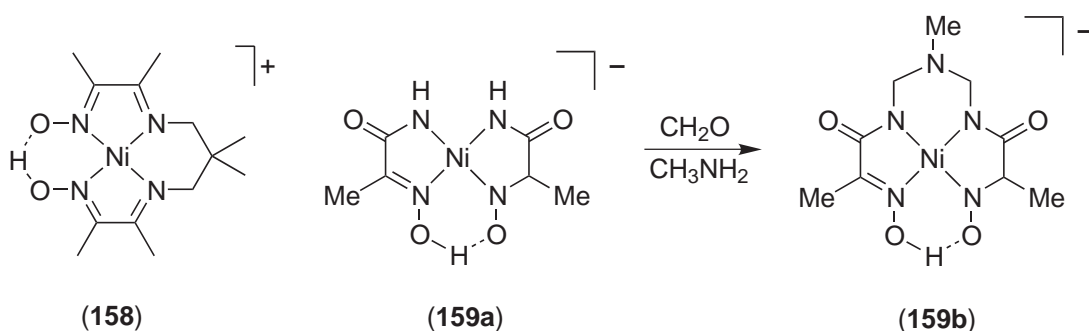

Figure 5 Crystal structure of Ni(hex)(eti).⁵⁴⁶



Various tetradentate amide and oxime open chain ligands exhibit very high efficacy in the coordination to Ni^{II} ions. *N,N'*-bis(2-hydroxyiminopropionyl)-1,2-diaminoethane (H₂pen) and *N,N'*-bis(2-hydroxyiminopropionyl)propane-1,3-diamine (H₂pap) form very stable square planar Ni^{II} complexes (NiH₂L) with very short hydrogen bonds between two oximic oxygen atoms (Figure 6).^{550–552} This short hydrogen bond closes the planar complex structure into a pseudo-macrocyclic environment. The NiH₂L complex is very stable also in solution and it is the first major species formed with Ni^{II} above pH 6. The structure of Li[Ni(H₂pen)]·4H₂O shows that the metal ion lies in the center of four N-donors of two deprotonated amides and two oxime groups. The coordination in [Ni(H₂pap)][−] is very similar to that of [Ni(H₂pen)][−]; however, in the former complex there are alternating five-, six-, five-membered rings, whereas in the [Ni(H₂pen)][−] species all three fused chelate rings are five membered. This leads to noticeable shortening of the Ni—N bonds. The Ni—N_{amide} bonds being within the 1.803–1.816 Å range are

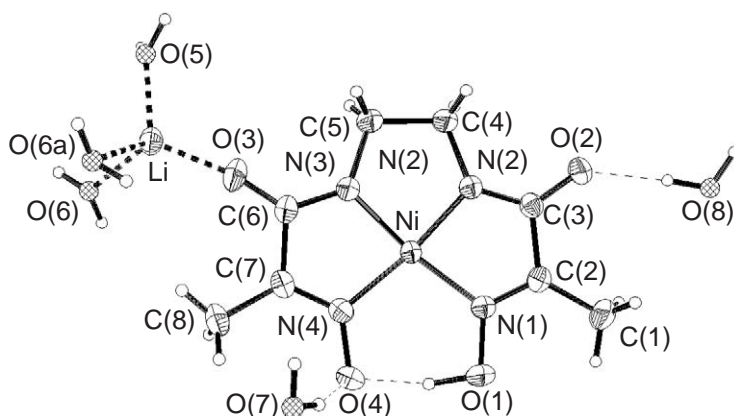

Figure 6 Structure and numbering scheme for the complex Li[Ni(H₂pen)]·4H₂O.

distinctly shorter than those found for other amides including macrocyclic complexes (average 1.85–1.87 Å). Very similar behavior is shown by dithia dioxime ligands. The $\{S_2N_2\}$ coordination in the square planar Ni^{II} complex is stabilized by the short effective hydrogen bond between two oxime oxygen atoms.⁵⁵³ A tetraoximic analogue of EDTA, ethylenedinitrilo-tetraacetamidooxime, which is potentially a six-coordinate ligand involves all four oxime nitrogen donors to coordinate the Ni^{II} together with two tertiary amine nitrogen donors.⁵⁵⁴

6.3.4.4.5 Complexes with chelating ligands incorporating N-heterocycles

N-heterocyclic compounds containing six-membered rings (pyridine and analogues) behave as excellent π -acceptors and in turn they provide a rather soft site for metal ion coordination. The π -excessive five-membered pyrazole is a poorer π -acceptor and a better π -donor and it acts as relatively hard donor site. Inclusion of six- and five-membered N-heterocycles like pyridine and pyrazole in one ligand system leads to very attractive coordination chemistry with variations of the electronic properties.⁵⁵⁵ The insertion of a spacer (e.g., methylene groups) between two heterocycles, which breaks any electronic communication, makes the coordination properties even more manifold.

Pyrazolate as a ligand can exhibit various coordination modes, *inter alia*, monodentate, *exo*-bidentate, and *endo*-bidentate. Several review articles have been published in the field.^{556–559} The use of pyrazole in the modeling of biological systems was also reviewed.^{560,561} The most common application of pyrazole ligands is to use its *exo*-bidentate coordination mode linking two metal centers that may be identical or different (compare Section 6.3.4.12.6). Polypyrazolylborates and related ligands are covered in the subsequent section.

The bidentate ligand (**160**) forms a dimeric compound $[Ni(\mathbf{160})Cl_2]_2$ incorporating two chloride bridges,⁵⁶² where both metal centers are in a distorted trigonal bipyramidal $\{N_2Cl_3\}$ environment. Two pyrazole rings are linked by a short bridge, e.g., borate in (**161**), which prevents coordination to one of the pyrazole N atoms. Hence, (**161**) acts as a bidentate ligand and is very effective in metal extraction.⁵⁶³ Substitution of the pyrazole rings by methyl groups may change distinctly the complex stability and selectivity in the metal extraction. The small Ni^{II} ion usually forms square planar complexes, but when both pyrazoles bear methyl substituents, steric hindrance causes the $[Ni(\mathbf{161})_2]$ species to be highly strained and less stable than complexes with larger metal ions. One pyrazole and one benzimidazole linked by a methylene group (**162**) forms $[Ni(\mathbf{162})_2(ClO_4)]^+$ with a chelating bidentate perchlorate.⁵⁶⁴ The complex can have a Λ configuration with the chelate rings in boat conformation α , or a Δ configuration with the chelate rings in β -conformation. This conformational flexibility in the coordination of Ni^{II} is proposed to have implications for asymmetric catalysis.⁵⁶⁵

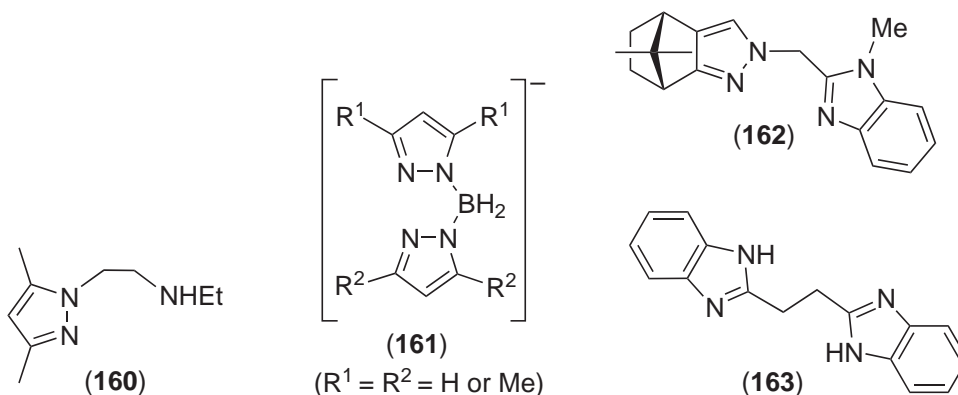

Bis(2-benzimidazolyl)ethane (**163**) forms mononuclear $[Ni(\mathbf{163})_2]^{2+}$ with the Ni^{II} ion surrounded by four N atoms in an almost perfect square planar geometry.⁵⁶⁶

The simple tris(benzimidazolato)nickel(II) complex has been known for a long time. However, it is still a very attractive unit to build cation-mediated 1-, 2-, and 3-D superstructures.^{567–569} The production of such molecular architectures by a one-pot molecular self-organization of the anionic building blocks $[Ni(Hbim)_3]^-$ (**164**) evolves from three basic factors: (i) the presence of three complementary binary hydrogen bonding sites, (ii) the occurrence of Δ and Λ optical isomers of the anionic nickel building blocks, and (iii) the identity of the counterions. Simplified self-organized superstructures are shown in (**164a**)–(**164d**).

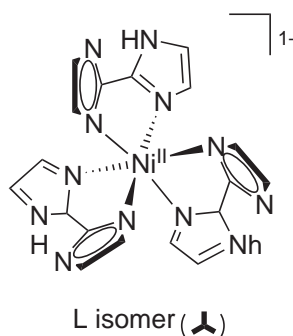
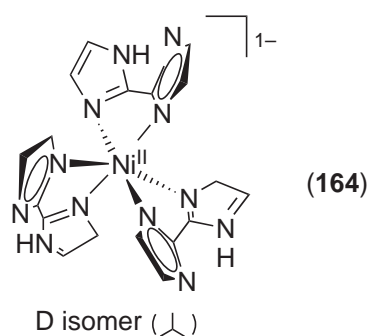

(164a) 0D dot

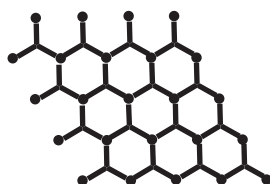

(164b) 1D zigzag ribbon

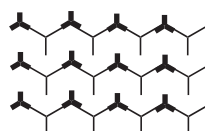

(164c) 2D honeycomb sheet

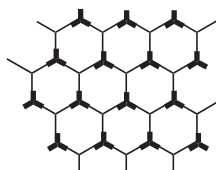

(164d) expanded 2D honeycomb sheet

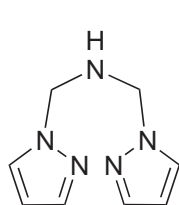
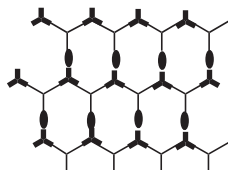

(165a)

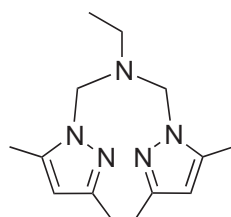

(165b)

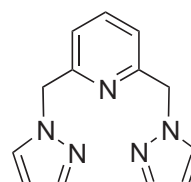

(166)

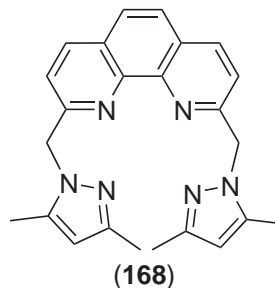
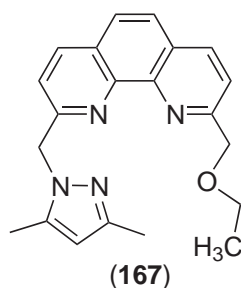

Bis(1-pyrazolylmethyl)amine (**165**) acts as a tridentate ligand that forms $[\text{Ni}(\mathbf{165a})_2]^{2+}$ with almost octahedral geometry and *fac* coordination of the ligands.⁵⁷⁰ A similar ligand with dimethyl-substituted pyrazoles (**165b**) forms $[\text{Ni}(\mathbf{165b})(\text{NO}_3)_2]$ with the metal ion surrounded by two pyrazoles and one tertiary amine N atom as well as three nitrate O atoms (one of the nitrates acts as a bidentate ligand).⁵⁷¹ Two pyrazoles combined with one pyridine (**166**) results in $[\text{Ni}(\mathbf{166})_2]^{2+}$, which is an octahedral complex. The Ni—N_{pyridine} bond is longer than

Ni—N_{pyrazole}.⁵⁷² Tridentate (**167**) forms five-coordinate [Ni(**167**)Cl₂] with trigonal bipyramidal geometry, while (**168**) forms octahedral [Ni(**168**)(H₂O)₂]Cl₂. The presence of the basic phenantroline allows the ligand to stabilize the Ni^I species as revealed by a quasi-reversible Ni^{II}/Ni^I wave at $E_{1/2} = -0.46$ V vs. AgCl/Ag⁺ (for [Ni(**167**)Cl₂]).⁵⁷³

The combination of imidazole and pyrazole units leads to multidentate ligands useful for biological modeling. Potentially pentadentate (**169**) forms a six-coordinate Ni^{II} complex with a distorted octahedral {N₄O₂} geometry.⁵⁷⁴ One of the ligand imidazole groups is not involved in the coordination and nitrate acts as bidentate ligand. A pyrazole moiety in Schiff base-type tetradentate N ligands may have a strong impact on the complex structure even if not directly bound to the metal ion. Increase of the polymethylene chain in *N,N'*-bis(5-aminopyrazol-4-ylmethylene)polymethylenediamine forces a gradual alteration of the configuration at the metal center from planar to tetrahedral.⁵⁷⁵ Ni^{II} complexes (**170**) with $n = 2$ or 3 are square planar both in the solid state and solution, whereas in the case of (**170f**) with $n = 4$ the complex is diamagnetic in the solid state and a rapid (on the NMR timescale) equilibrium between planar ($S = 0$) and tetrahedral ($S = 1$) forms is observed in chloroform solution. Strong tetrahedral distortion from planar metal configuration is also evident from the X-ray crystal structure of (**170f**).

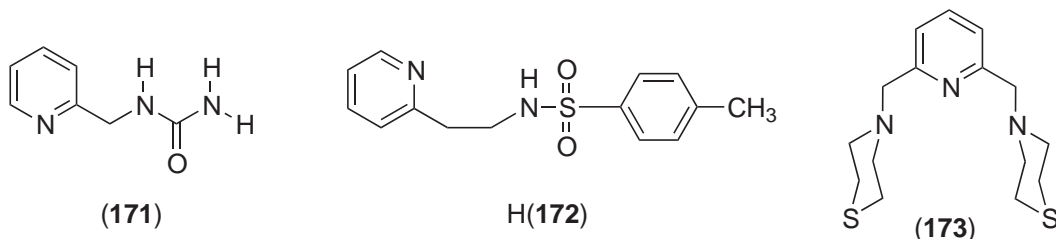
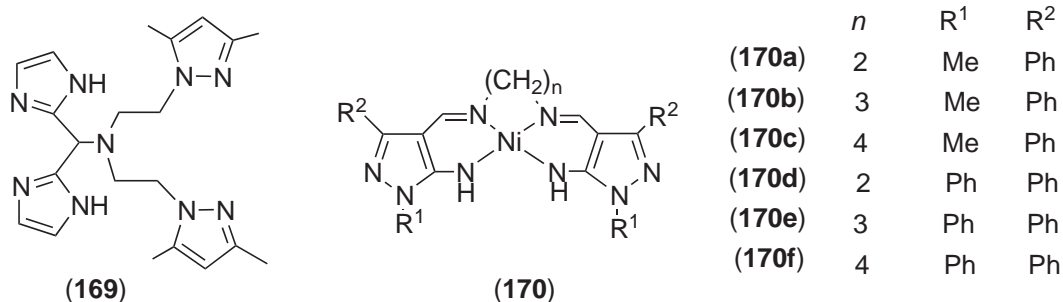

Pyridine, which has a softer N-donor atom than pyrazole, is one of the most prominent coordinating units for the Ni^{II} ion. It has been combined with a variety of other donor systems forming very specific metal complexes. In the case of pyridine-substituted urea (**171**) an involvement of the pyridine nitrogen in metal ion binding induces Ni^{II} ion coordination to the urea N atom.⁵⁷⁶ This N-coordination of urea is not enforced by the geometry of the ligand (in the related Zn^{II} complex the urea moiety exhibits the standard mode of binding via its oxygen donor). 4-Methyl-*N*-(pyridin-2-yl-ethyl)-benzenesulfonamide (H(**172**)) forms [Ni(**172**)₂] with the metal ion in a distorted square-planar environment defined by two pyridyl and two amide nitrogen atoms.⁵⁷⁷

Tridentate 2,6-bis(thiomorpholinomethyl)pyridine (**173**) forms only the 1:1 complex [Ni(**173**)(NO₃)₂] with Ni^{II}. However, the geometry around the metal center is octahedral due to coordination of two nitrates, one as a monodentate and the other as a bidentate ligand.⁵⁷⁸

Complexes with pyridine-2,6-diimine ligands, five-coordinate [NiX₂(**174**)] (X = Cl, Br) or six-coordinate [Ni(**174**)₂]X₂, were usually assumed to have innocent neutral ligands. The X-ray structure and spectroscopic characteristics of [Ni(**174**)₂](PF₆) confirm that the complex contains the neutral ligand ([**174**)⁰] and a divalent nickel ion.⁵⁷⁹ The cyclic voltamogram of this complex in CH₂Cl₂ shows three reversible one-electron-transfer processes at +1.19 V, -1.30 V, and -1.82 V (vs. Fc⁺/Fc), of which the first is a one-electron oxidation, while the other two correspond to two successive one-electron reductions. The spectroscopic data allow one to assign these processes as follows ([**174**)¹⁻ is a one-electron reduced radical form of [**174**)⁰): [Ni^{III}(**174**)₂]³⁺ ⇌ [Ni^{II}(**174**)₂]²⁺ ⇌ [Ni^I(**174**)₂]⁺ ⇌ [Ni^I(**174**)⁰(**174**)¹⁻]⁰.

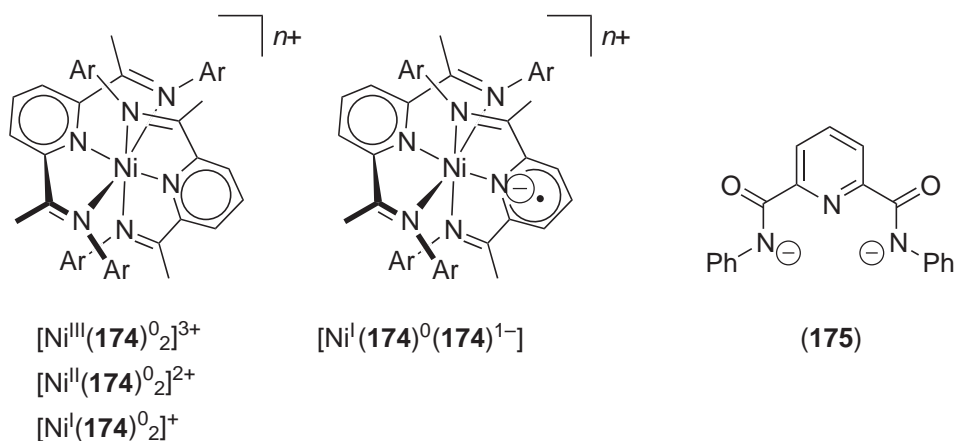

The addition of two amide nitrogen donors to a pyridine moiety in 2,6-bis(*N*-phenylcarbamoyl)pyridine ($H_2[175]$) allows stabilization of the higher oxidation states Ni^{III} and Ni^{IV} (see Section 6.3.3.3.1). In the Ni^{II} complex $[Et_4N]_2[Ni(175)_2] \cdot H_2O$, the metal ion is coordinated by four deprotonated amide nitrogens in the equatorial plane and two pyridine nitrogens in the axial positions.⁵⁸⁰ The arrangement of the ligands is meridional and the geometry of the $\{NiN_6\}$ polyhedron is distinctly compressed.

Ni^{II} complexes (176) of a tetradentate 2,2'-bipyridyl derivative feature unusual stabilities.⁵⁸¹ In the solid state, the complex contains a six-coordinate metal ion with bromide and water completing the coordination sphere. The low stability of the complex in aqueous solution results from the low ligand basicity and the unfavorable spacing of its donor groups as seen in the solid-state structure. Acyclic diamide-dipyridyl tetradentate ligands with two central amide groups form Ni^{II} complexes having the ability to cleave DNA in the presence of oxidants, as do Ni^{II} complexes with oligopeptides.⁵⁸² The same behavior is found for the pyrrolidine-based analogue (177). When its Ni^{II} complex is prepared in the presence of air, two amine groups undergo oxidative dehydrogenation.⁵⁸³ The $Ni^{III/II}$ reduction potentials of complexes with pyridyl- and pyrrolidine-based diamide ligands do not show any correlation with the ease of ligand oxidation.

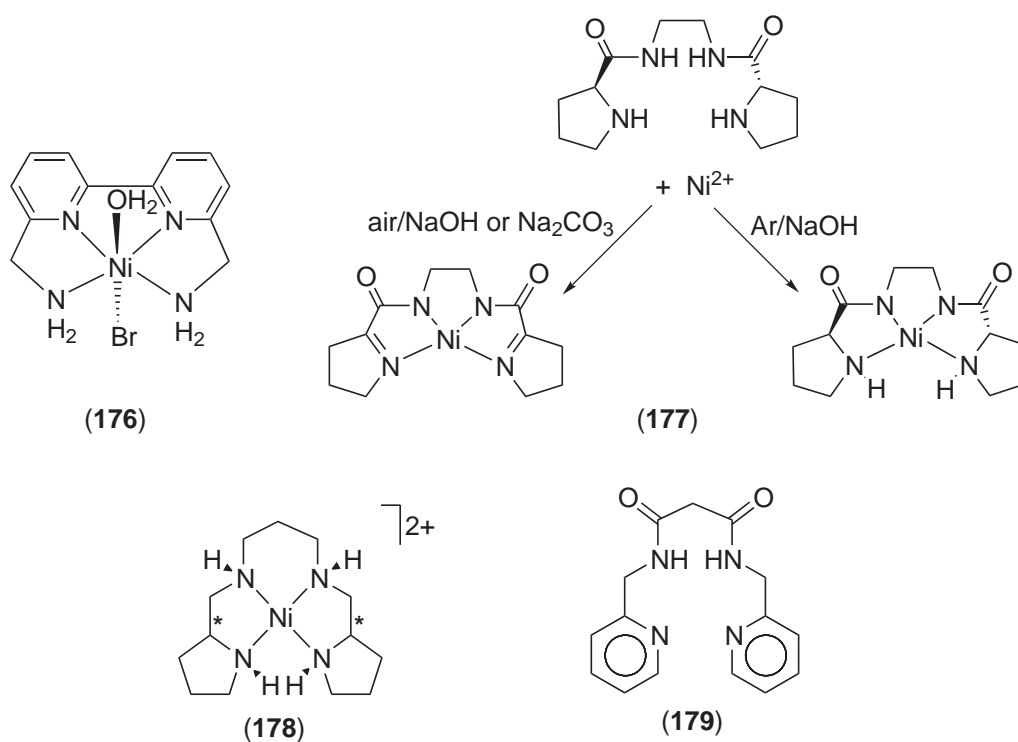

Racemic amino acids have been resolved via stereoselective coordination to the square planar chiral matrix complex (**178**).⁵⁸⁴ The bisamidobispyridyl ligand (**179**) forms a square planar Ni^{II} complex with considerable tetrahedral twist due to repulsion of the *ortho* protons of the pyridyl rings.⁵⁸⁵

The terpyridine (terpy) unit is widely used to design multidentate ligands which are attractive for, *inter alia*, supramolecular chemistry.^{586–588} The use of two covalently linked terpy moieties results in octahedral Ni^{II} monomeric complexes, but the length of the linker is critical for their stability. Complexes with (**180a,b**) are six-coordinate and relatively strain free, because the butane linker is optimal for complex stability.⁵⁸⁹ The structure of the [Ni(**180a**)]²⁺ cation is slightly bowed with the angle between the two mean terpyridine planes around 85°. For [Ni(**180b**)]²⁺ this angle is close to 89°.

Tris(2-pyridyl) tripod ligands which use nitrogen, phosphorus, arsenic, or carbon as central bridging atoms are very useful tridentate ligands both in Ni^{II} coordination and organometallic chemistry.⁵⁹⁰ Tripodal tris(2-pyridyl)amine (tpa, (**181a**)) forms centrosymmetric [Ni(**181a**)₂]²⁺.⁵⁹¹ Similar to a pyrazole tripod (*vide supra*), tripodal pyridine ligands induce a strong ligand field due to relatively short Ni–N distances. An angular overlap study indicates that pyridines are moderately strong σ -donors and weak π -donors. A comparison of the amine, methyl, and phosphine analogues shows negligible, if any, conjugation of the π -system across the bridgehead atom.

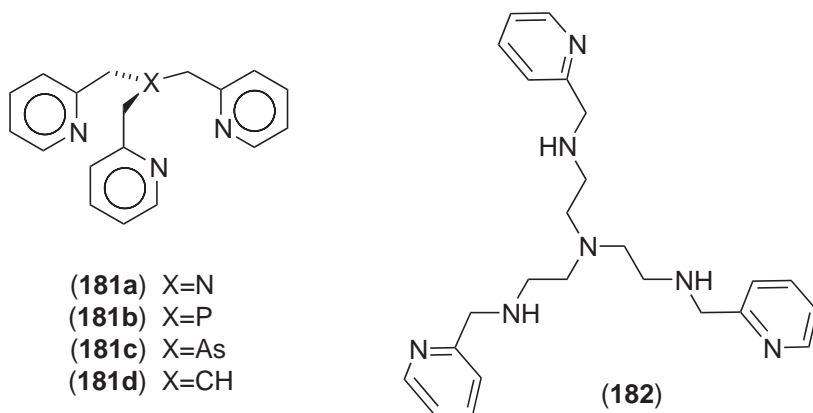
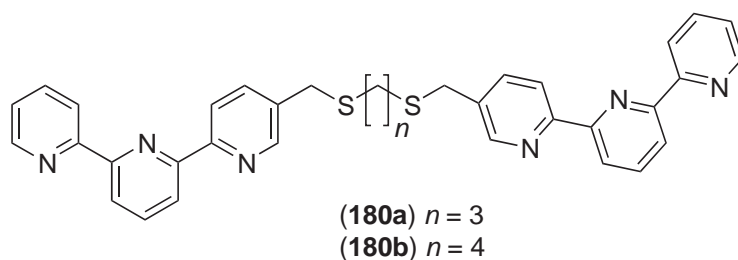

The potentially heptadentate tripod tris{2-[(2-pyridylmethyl)amino]ethyl}amine (**182**) does not show any particular effect on the electronic or steric properties of its Ni^{II} complex in the solid or solution phase, although it is playing a part in enforcing six-coordination on the Ni^{II} ion in the gas phase.⁵⁹² Such a type of tripod ligand has interesting chiral properties. The tris-imidazole-based ligand tris[2-((2-phenylimidazole-4-yl)methylidene)amino]ethyl]amine (H₃L) forms chiral [NiH₃L]X₂ complexes ((**183**); X = nitrate, acetate, or perchlorate). Each complex has an octahedral coordination environment for the metal ion, formed by six N atoms, and is either a Δ (clockwise) or a Λ (anticlockwise) enantiomorph, depending on the screw arrangement of the tripodal ligand around the nickel ion.⁵⁹³ CD spectra and crystal structures provide strong evidence for spontaneous resolution of the chiral molecules.

Ni^{II} complexes with open-chain pyrrolic ligands bear certain similarities to Ni-porphyrins (compare Section 6.3.4.11.3). Ni^{II} complexes of various differently substituted 2,2'-bidipyrrins (**184**) are diamagnetic, despite the tetrahedral deviation from square planar coordination geometry.^{594,595} The complexes are helical, and even the methyl terminated species are extremely stable towards racemization (no racemization after prolonged heating to >200 °C; *t*-butyl groups at the termini are sterically too demanding to give stable Ni^{II} complexes). In comparison to the

related porphyrinato-Ni^{II} complexes, complexes (**184**) have a much smaller HOMO-LUMO gap due to a significantly raised HOMO, which gives rise to a red shift of the longest-wavelength UV-visible absorption. Ni^{II} complexes of α,ω -dimethyltripyrrens (**185**) are paramagnetic and their coordination geometry can best be described as distorted trigonal bipyramidal with one equatorial ligand missing. This is enforced by the terminal methyl groups of the tripyrrolic ligand which shield the fourth site of a putative square around the metal ion and force the coligand above or below the {NiN₃} plane. A fifth ligand such as water can easily be accepted to give five-coordinate species.⁵⁹⁶

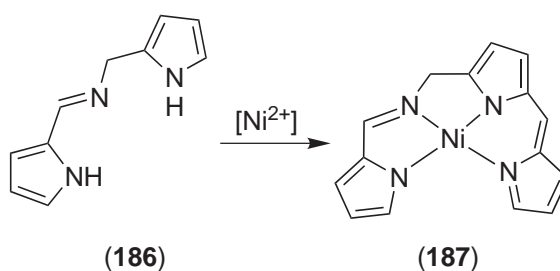
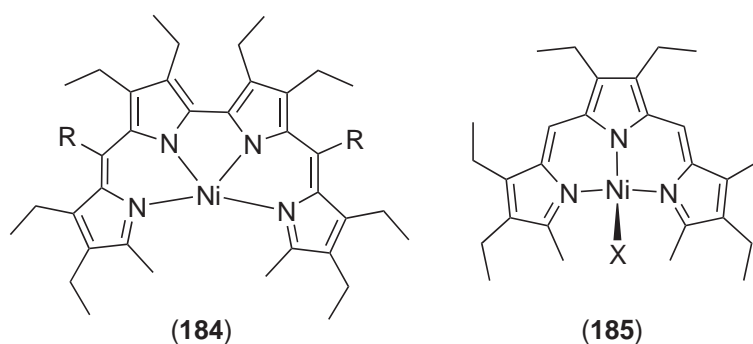
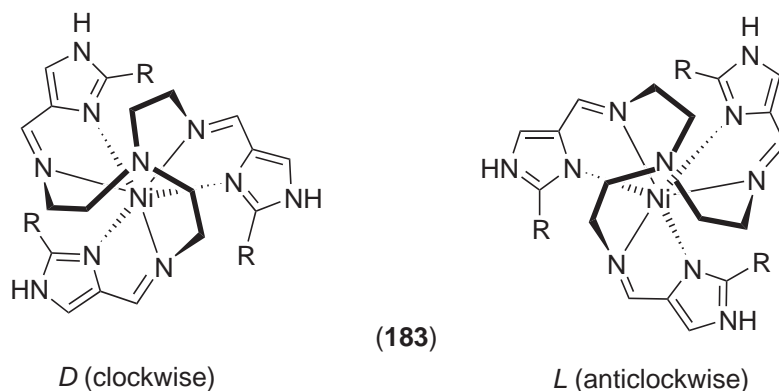

A square planar Ni^{II} complex (**187**) of a tripyrrolic tetradentate ligand was obtained unexpectedly from the reaction of (**186**) with Ni(OAc)₂.⁵⁹⁷ The reaction presumably proceeds via Ni-mediated partial cleavage of (**186**) to give 2-formylpyrrole and its subsequent condensation with a second equivalent of (**186**). The Ni^{II} complex of *meso*-phenyl-4,6-dipyrin (**188**) is severely distorted from square planar (angle between the planes of the two dipyrin ligands ~40 °C) but still diamagnetic.⁵⁹⁸

Optical spectra of the Ni^{II} complex (**189**) show close similarity to those of Ni-phtalocyanines in the low-energy spectral region where the first π - π^* transition (Q band) occurs.^{599,600} A reduction

of the Ni—N distance causes a red shift of the Q band, as deduced from a comparison of (189) with the related mixed-ligand compound (190) and its pyridine adduct [(190)·2py].⁶⁰⁰

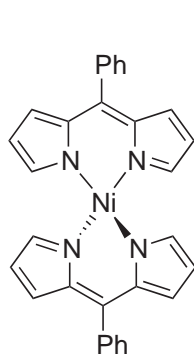

(188)

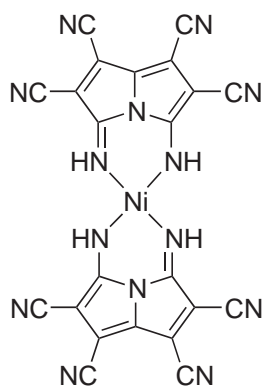

(189)

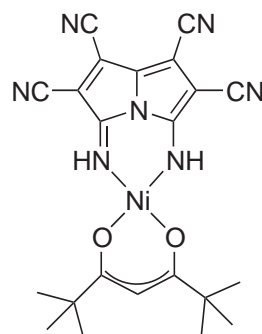

(190)

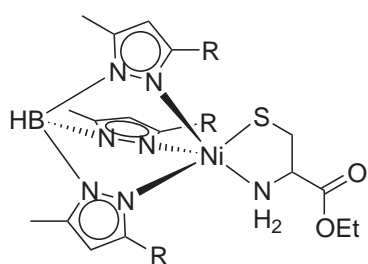

(191)

R = Ph, Me

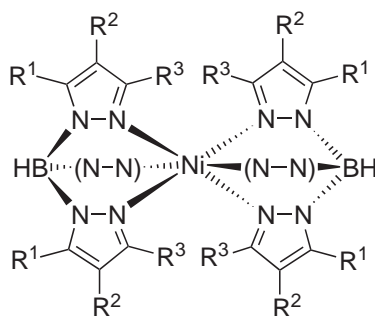

(192)

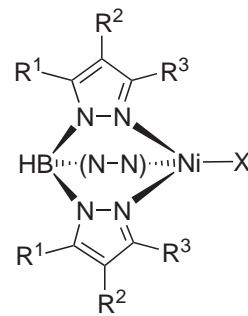

(193)

6.3.4.4.6 Complexes with polypyrazolylborates and related tripodal ligands

The family of poly(pyrazol-1-yl)borates has been widely used as supporting ligands in nickel coordination chemistry.^{556,557} Complex (191) is an example, where unusual cysteine coordination is achieved at a tris(pyrazolyl)borate/nickel(II) template.⁶⁰¹ (191) undergoes rapid reaction with molecular oxygen to presumably form a sulfinate.

Properties of nickel poly(pyrazol-1-yl)borate complexes such as solubility, coordination geometry, etc., can be controlled by appropriate substituent groups on the pyrazole rings, in particular in the 3- and 5-positions. Typical complexes are those of octahedral (C_{3v}) symmetry (192)^{602–604} and tetrahedral species (193). In the former case, two different tris(pyrazolyl)borate ligands may be involved to give heteroleptic compounds.^{602,603} Substituents in the 5-position mainly provide protection of the BH group. Only few representative examples are discussed here.

Even in the case of bulky substituents in the 3-position of the pyrazoles (e.g., in (194a)), octahedral complexes may be formed. However, while [Ni(194a)₂] is octahedral in the solid state, it is five-coordinate in the melt or in solution. Upon heating, [Ni(194a)₂] rearranges to the thermally very stable complex [{HB(3-neopentyl-pz)₂(5-neopentyl-pz)₂Ni}], in which one of the neopentyl groups has migrated from the 3- to the 5-position.⁶⁰⁴ This underscores the driving force toward octahedral structures in these compounds, even in the presence of steric bulk. The tendency for the stabilization of tetrahedral species (193) (with respect to conversion to (192)) increases with the hierarchy of steric hindrance as a function of the 3-R group: H < 2-thienyl < Me < Ph < Prⁱ < Bu^t.^{605,606} However, steric effects are not always straightforward: [Ni(194a)NCS] is monomeric while [Ni(194b)NCS]₂ is a dimer (with S-bridging),⁶⁰⁶ but [Ni(194a)₂] could be isolated while [Ni(194b)₂] could not. Ligands (194b–d) exhibit similar coordination chemistry, although complexes derived from the cyclohexyl-substituted ligands show greater stability.⁶⁰⁷ A distinction, however, is the reaction with oxalate, where either the simple

oxalate-bridged dinuclear species $[\text{Ni}(\mathbf{194b})_2(\text{C}_2\text{O}_4)]^{602}$ or the unusual complex $[\text{Ni}(\mathbf{194d})(3\text{-cyclohexyl-4-Br-pz})](\text{H})_2$ is formed.⁶⁰⁷

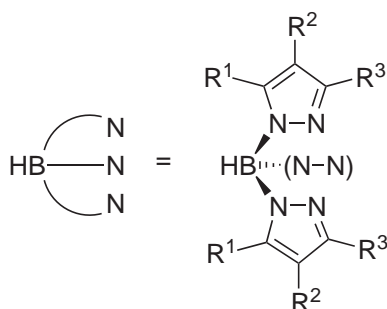

(194a) ($R^1 = R^2 = \text{H}$, $R^3 = \text{CH}_2^t\text{Bu}$)

(194b) ($R^1 = \text{H}$, $R^2 = \text{Br}$, $R^3 = i\text{Pr}$)

(194c) ($R^1 = R^2 = \text{H}$, $R^3 = \text{cyclohexyl}$)

(194d) ($R^1 = \text{H}$, $R^2 = \text{Br}$, $R^3 = \text{cyclohexyl}$)

(194e) ($R^1 = R^2 = \text{H}$, $R^3 = ^t\text{Bu}$)

(194f) ($R^1 = R^2 = \text{H}$, $R^3 = \text{Ph}$)

(194g) ($R^1 = R^2 = R^3 = \text{Me}$)

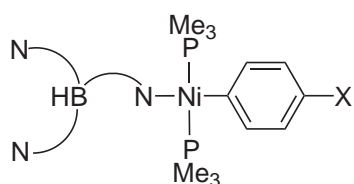

(195)

($X = \text{H}, \text{Me}, \text{OMe}$)

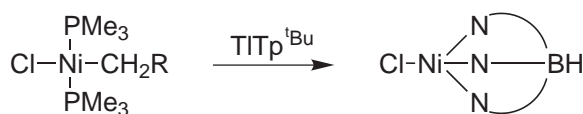

(196)

($R = \text{SiMe}_3, \text{CMe}_2\text{Ph}, \text{CN}, \text{CO}_2\text{Et}$)

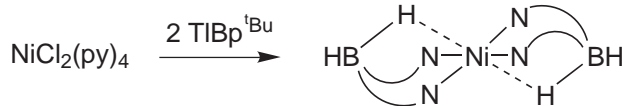
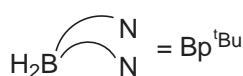
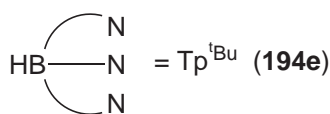

(197)

Very bulky (194e) coordinates monohapto in the Ni^{II} complex (195), both in solution and in the solid state.⁶⁰⁸ Upon reaction of (194e) with *trans*- $[\text{Ni}(\text{CH}_2\text{R})\text{Cl}(\text{PMe}_3)_2]$, however, (196) is formed in low yields.⁶⁰⁹ (196) is also accessible directly from NiCl_2 and (194e).^{610,611} Treatment of (194e) with $[\text{NiCl}_2(\text{py})_4]$ gave the homoleptic complex (197).⁶⁰⁹ In contrast to other complexes $[\text{Ni}\{\text{H}_2\text{B}(3\text{-R-5-R}'\text{-pz})\}_2]$ which are usually orange and square planar (hence diamagnetic),⁶¹² (197) is pale blue and paramagnetic ($\mu_{\text{eff}} = 2.9 \mu_{\text{B}}$). The X-ray crystal structure reveals that the square planar NiN_4 arrangement is complemented by two *trans* $\text{Ni}\cdots\text{H}-\text{B}$ interactions.

The dinuclear hydroxo-bridged Ni^{II} complex (198) fixes atmospheric CO_2 to give the μ -carbonato species (199).⁶¹³ A similar coordination mode of carbonate is also seen with ligand (194c).⁶⁰⁷ Upon treatment with 1 N NaOH, the carbonato complex (199) is converted back to the hydroxo complex. When $[\text{Ni}(\mathbf{194g})(\text{OH})_2]$ was reacted with H_2O_2 at low temperatures, the bis(μ -oxo)nickel(III) complex (200) could be isolated and structurally characterized.^{181,182} Both $[\text{Ni}(\mathbf{194g})(\text{OH})_2]$ and (200) contain five-coordinate Ni ions with a slightly distorted square pyramidal geometry. (200) decomposes within 1 h at room temperature via oxidation of the methyl substituents at the (194g) ligand, with H-atom abstraction being the rate-determining step. In the presence of excess H_2O_2 , products (201) and (202) are formed, depending on the ligand employed.^{182,614}

In square planar (203), the ligand (194f) acts as a bidentate. Despite the presence of the potentially coordinating third pyrazole group, (203) is an active catalyst for the alternating copolymerization of CO and ethylene.⁶¹⁵ Similar activity is displayed by complex (204), indicating that neither the borane H atom nor the noncoordinating pyrazole ring are essential for the catalysis.⁶¹⁶

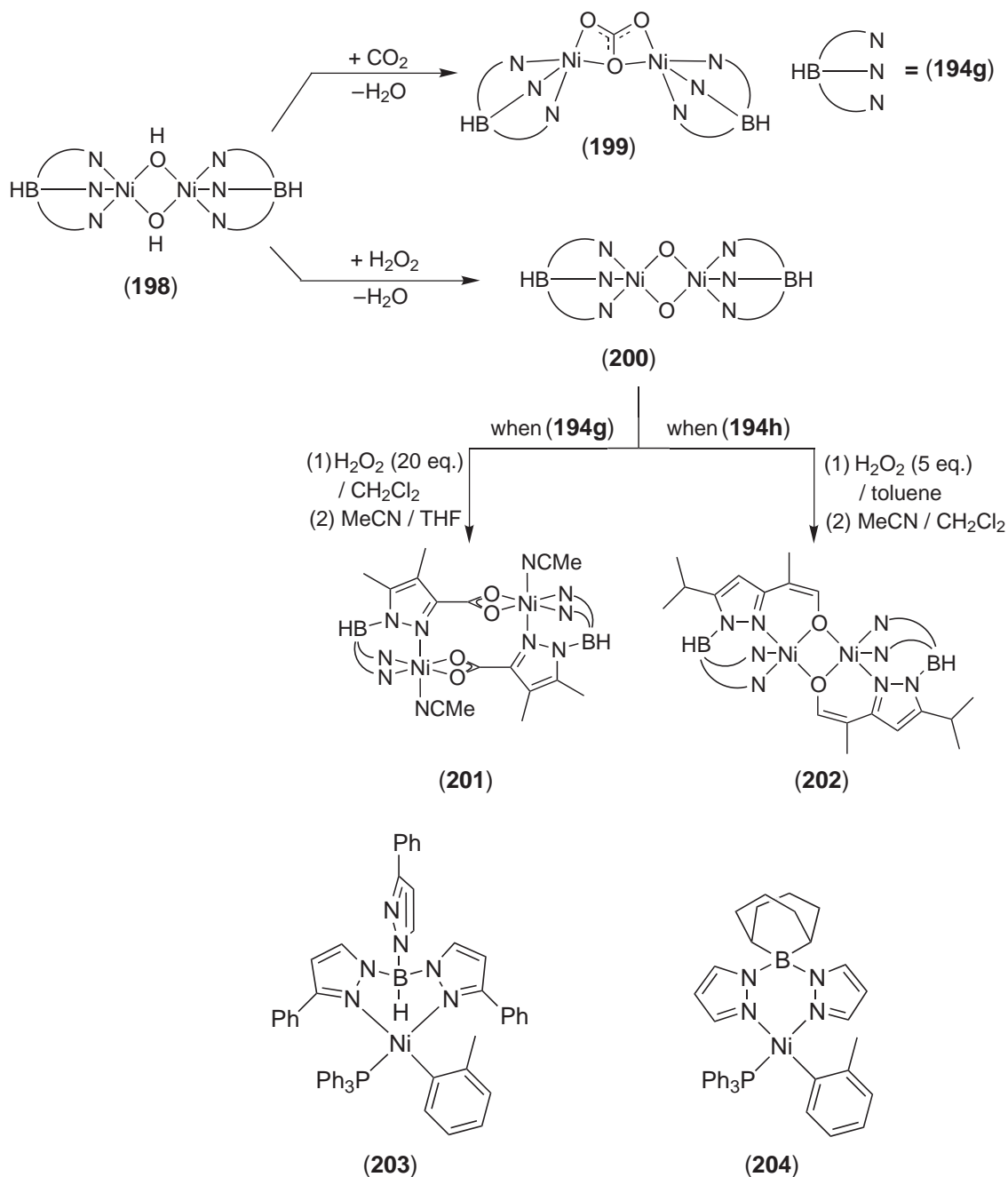

Tris(3-methyl-5-carboxyethylpyrazol-1-yl)borate forms the Ni^{II} complex (205) with three water molecules completing the octahedral geometry (Figure 7). The ester groups of the tripod ligand act as H-bond acceptors and stabilize the triaquated species, which is a structural model for enzymes of the vicinal oxygen chelate superfamily.⁶¹⁷ (2-Hydroxy-phenyl)bis(pyrazolyl)methanes act as tripod ligands.⁶¹⁸ For the unsubstituted ligand (206), the absence of steric bulk on the pyrazoles allows two ligands to coordinate to one metal ion in a tridentate fashion with the two phenoxy groups in *trans* position to each other. 3,5-Dimethyl substitution does not produce much bulk, but besides the [Ni(206)₂] species a dinuclear complex [Ni(206)₂NiCl₂] is also formed. Introduction of 3-isopropyl substituents prevents formation of the NiL₂ complex due to steric reasons, and oligonuclear species are formed instead.

The coordination mode of bis(imidazolyl)(pyrazolyl)borates towards Ni^{II} depends on the steric congestion around the boron center caused by substituents in the pyrazol 5-position. Complexes (207) or (208) have been obtained upon reaction with Ni(NO₃)₂.⁶¹⁹ The tripod ligand

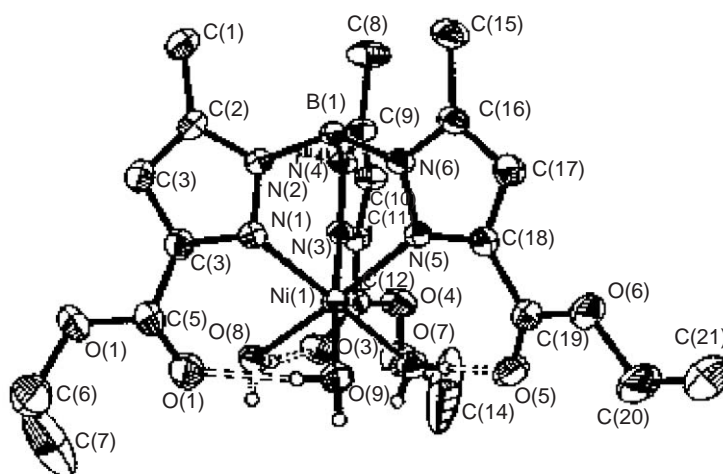
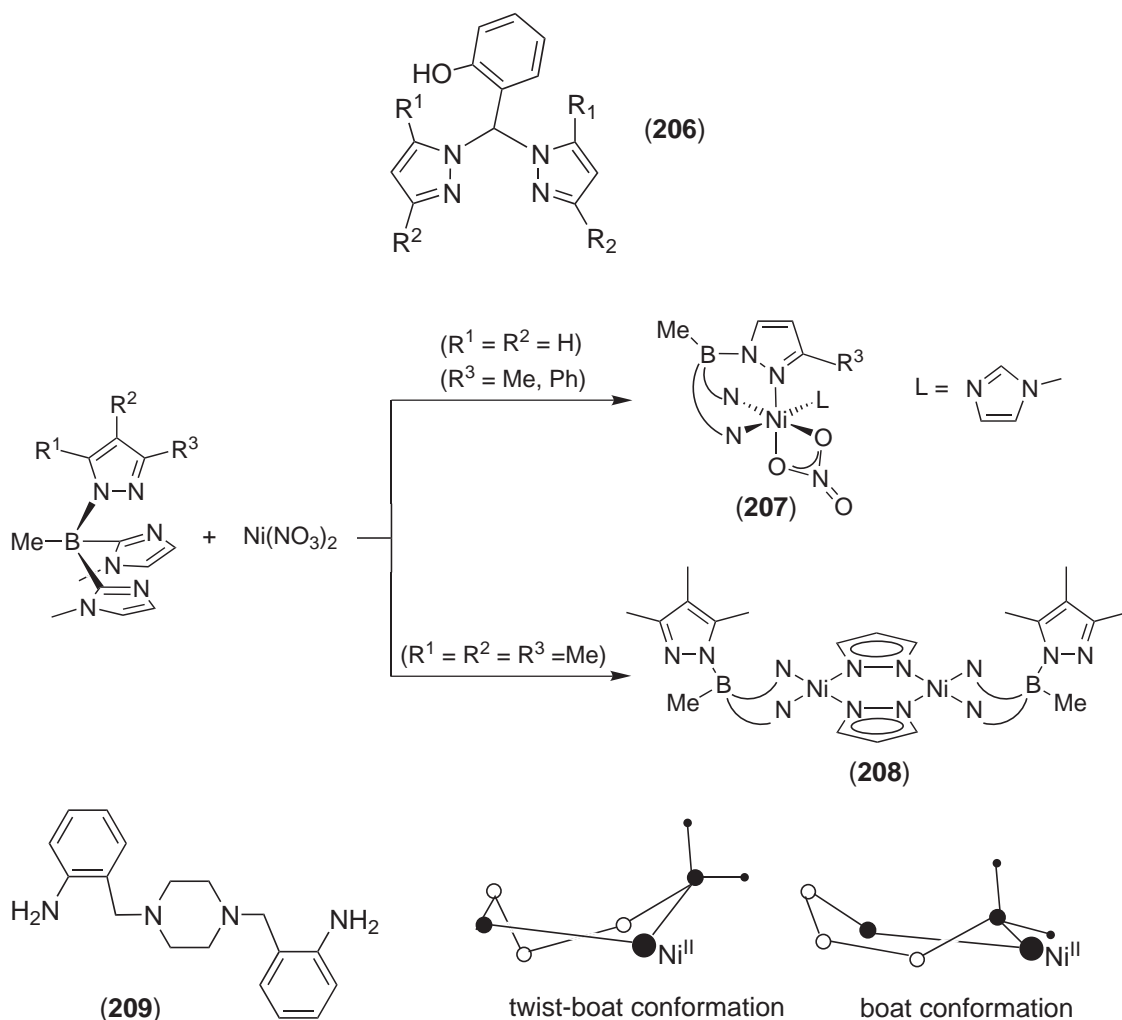
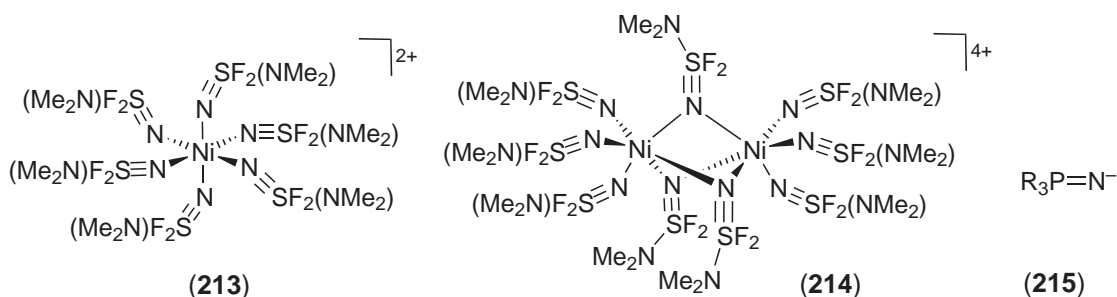
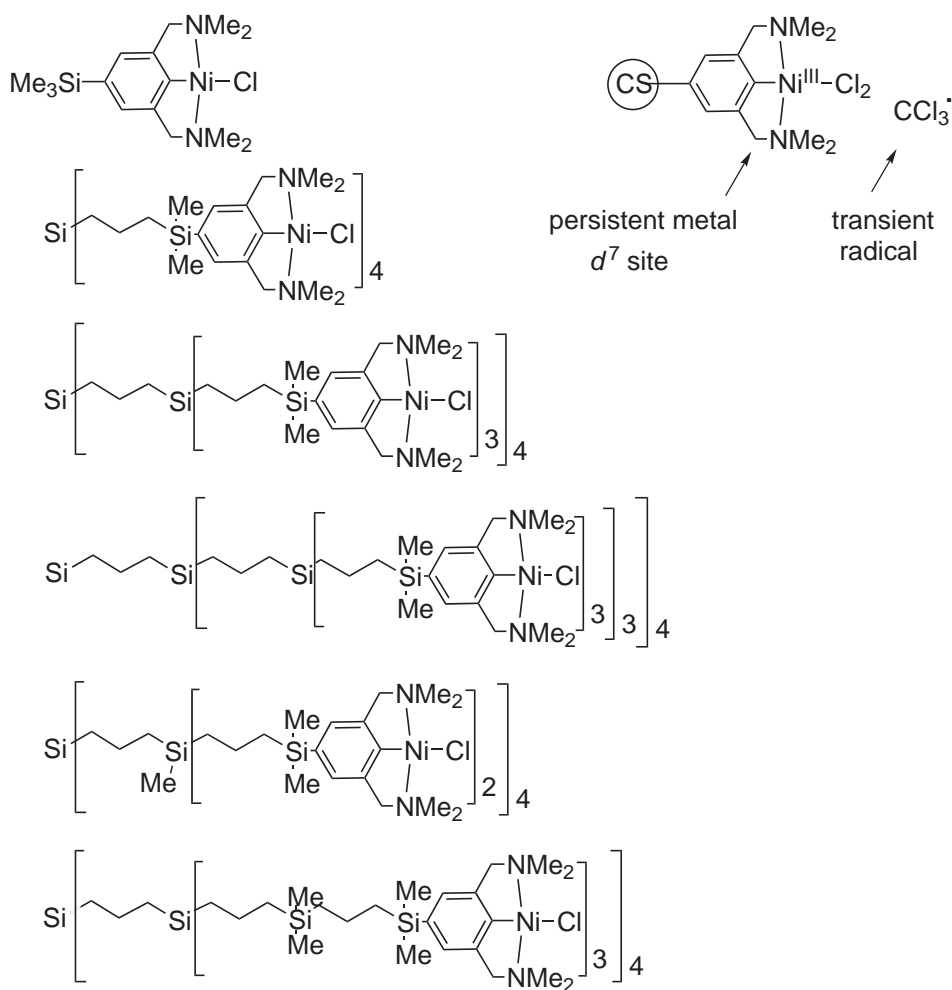

Figure 7 Molecular structure of (205)⁶¹⁷ (reproduced by permission of The Royal Society of Chemistry).

tris-(pyrazol-1-yl)methane forms $[\text{Ni}\{(\text{pz})_3\text{CH}_2\}_2](\text{NO}_3)_2$ which has an octahedral geometry with slight trigonal distortion.⁶²⁰ The pyrazole group acts as a moderately strong σ -donor and a weak out-of-plane π -donor. The tripod ligand produces a relatively strong ligand field, consistent with rather short Ni—N bond lengths (2.072–2.084 Å).





[(dppm)₂MCl₂] are ionic for M = Pd, Pt with two phosphines bound as {P,P} chelates, while it is nonionic for M = Ni. It was assumed that in the nickel complex two phosphines are bound as monodentate ligands because of the four-membered ring strain. The X-ray structure has shown, however, that the complex is five-coordinate with both monodentate and bidentate dppm ligands and two chlorides completing the coordination.⁶³⁷

[NiBr₂(PETPh₂)₂] has pseudotetrahedral coordination⁶³⁸ while [Ni(N₃)₂(PET₃)₂] has a *trans*-planar geometry;⁶³⁹ charge-transfer photolysis of the latter gives dimeric [{Ni(N₃)₂(PET₃)₂]₂. In the square planar Ni^{II} complex [Ni(*cis*-dppen)Cl₂] (*cis*-dppen = *cis*-bis(diphenylphosphino)ethene), a slight tetrahedral distortion caused by crystal packing effects is observed.⁶⁴⁰ The *cis*-dicyanide

complex $[\text{Ni}(\text{cis-dppen})(\text{CN})_2]$ has a similar structure, but comparison with the respective Pd^{II} and Pt^{II} complexes indicates that $\text{C}-\text{H}\cdots\text{Ni}$ repulsive contacts may also lead to small deviations from coplanarity.⁶⁴¹ The unsaturated nature of (dppen) gives rise to π -bonding interactions with the Ni—ligand bonds, which causes a very high stability of the *cis*-dicyanide complex. It is interesting to note that removal of coordinated chloride in $[\text{Ni}(\text{cis-dppen})\text{Cl}_2]$ by AgBF_4 followed by subsequent coordination of bis-(diphenylphosphino)amine (dppam) gives the five-coordinate complex $[\text{Ni}(\text{cis-ddpen})(\text{dppam})\text{Cl}](\text{BF}_4)$.

The unsymmetrical triphosphine ligand $\text{Ph}_2\text{P}(\text{CH}_2)_3\text{PPh}(\text{CH}_2)_2\text{PPh}_2$ is a simple analogue of the well-known bidentate ligands $\text{Ph}_2\text{P}(\text{CH}_2)_n\text{PPh}_2$ ($n=2, 3, 4, \dots$). It is able to establish tridentate coordination to the Ni^{II} site of a square planar complex. Chiral tridentate phosphines $\text{R}_2\text{P}(\text{CH}_2)_3\text{PPh}(\text{CH}_2)_2\text{PPh}_2$ ($\text{R}=\text{C}_6\text{H}_5, p\text{-ClC}_6\text{H}_4, p\text{-FC}_6\text{H}_4$) form a series of diamagnetic $[\text{NiLX}]\text{X}$ complexes. In the solid state the complex with $\text{X}=\text{I}$ exhibits five-coordination with only a slight distortion of the square pyramid.⁶⁴² However, the Ni—I bond lengths reveal that the second apical iodide is only weakly bound to the nickel ion, which explains the square planar geometry found in solution.

The neopentane-based triphos ligands $\text{RC}(\text{CH}_2\text{PPh}_2)_3$ (**216**) are prominent scaffolds in Ni coordination chemistry, in particular for low-valent Ni^0 and Ni^{I} . These ligands can also be functionalized at the backbone R substituent, e.g., in $\{[\text{PhCH}_2\text{C}(\text{CH}_2\text{PPh}_2)_3]\text{NiCl}\}$.⁶⁴³ Treatment of $[\text{Ni}(\text{H}_2\text{O})_6]^{2+}$ with triphos initially gives red-brown (**217**), which upon addition of further $[\text{Ni}(\text{H}_2\text{O})_6]^{2+}$ yields the hydroxo-bridged dimeric (**218**). The dangling P atoms of the latter can be oxidized by polysulfide to give the $\text{P}=\text{S}$ species.⁶⁴⁴ An all-phosphorus environment for Ni^{II} is found the crystallographically characterized (**219**) which features a cyclic P_3 unit.^{645,646} $\text{Pt}(\text{PPh}_3)_2$ inserts into one of the P—P bonds of (**219**) to give $[(\text{triphos})\text{Ni}(\text{P}_3)\text{Pt}(\text{PPh}_3)_2]$.⁶⁴⁷

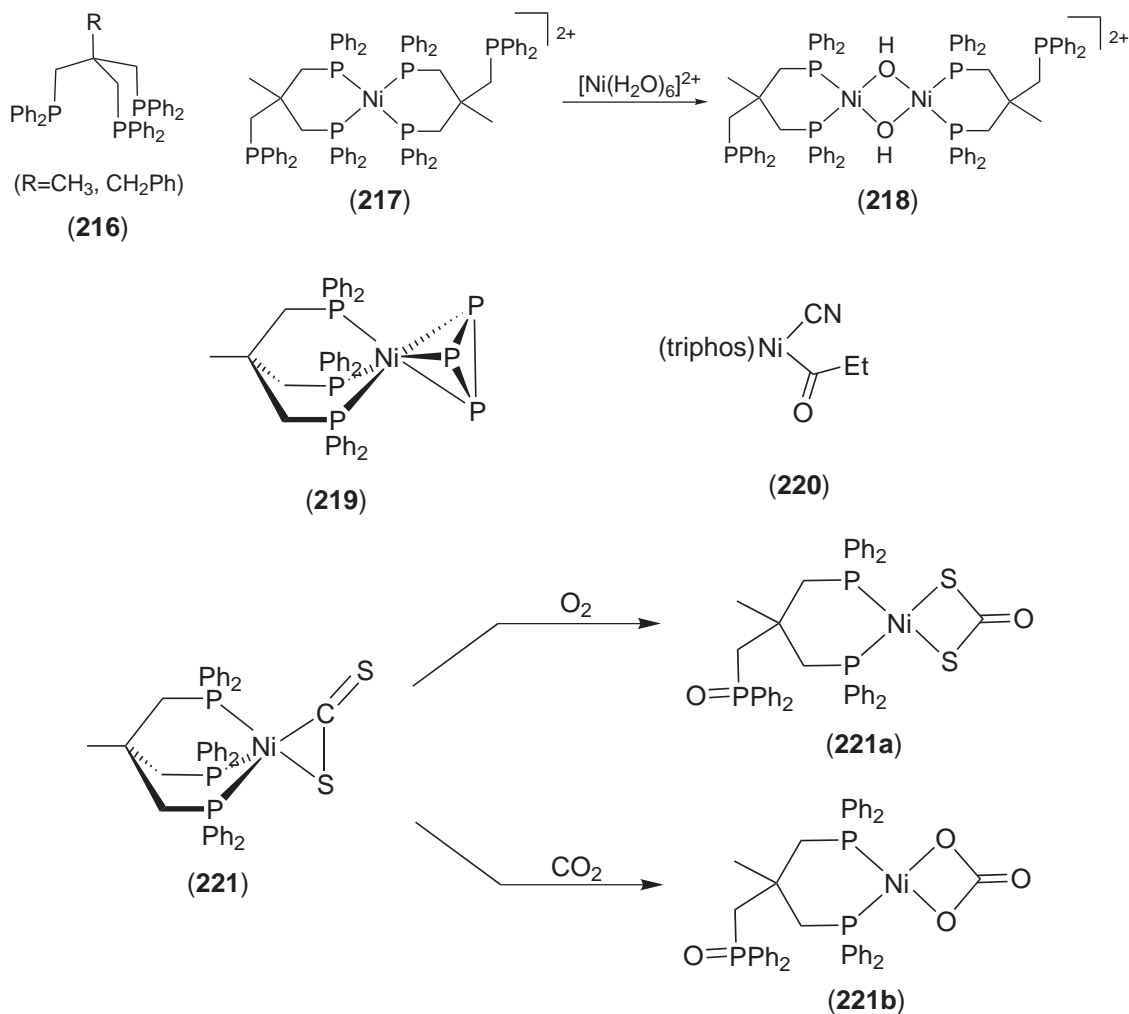

The (triphos)Ni⁰ template reacts with ethyl cyanofornate to give (220).⁶⁴⁸ The MO description and reactivity of the CS₂ complex (221) has been studied in some detail.⁶⁴⁹ Treatment with O₂ gives the dithiocarbonate compound (221a),⁶⁵⁰ while bubbling of CO₂ through a solution of (221) yields the carbonato complex (221b).⁶⁵¹ In both cases, one of the phosphine arms has been oxidized and is found dangling.

Reaction of [(triphos)Ni(S₂CS)] with Ni(BF₄)₂ and NaBPh₄ yields the dinuclear complex [(triphos)Ni(μ-CS₃)Ni(triphos)](BPh₄)₂.⁶⁵²

Thermolysis of 1-phenyl-3,4-dimethylphosphole in alcoholic solvents in the presence of NiCl₂ leads to the synthesis of the racemic biphospholene complex (222).^{653,654} Upon reaction of the bromo derivative with AgBF₄, the meso and racemic diastereomers of (223) are formed, which can be separated by fractional crystallization.⁶⁵⁵ In both (222) and (223) the coordination sphere is slightly distorted from square planar.

Metal-phosphoranide complexes have been known for many years.⁶⁵⁶ The use of LiBu to deprotonate spirobicyclic phosphorane followed by the reaction of the lithiated species with [NiCl₂(PMe₃)₂] gives *trans*-(PMe₃)₂{(C₄H₆O₃)₂P-P}NiCl (224), which is a square planar species with *trans*-PMe₃ ligands.⁶⁵⁷ The large steric demands of the phosphoranide ligand result in some angular distortion seen by bending of the phosphine ligands toward the chlorine.

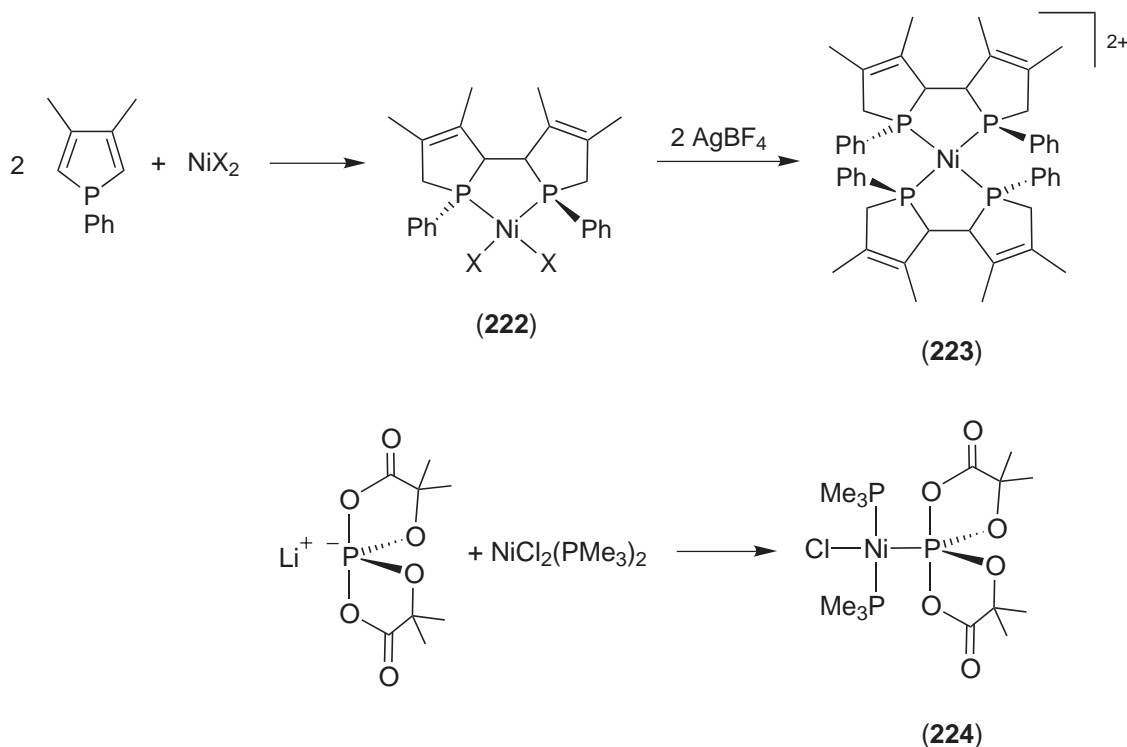

6.3.4.5.2 Complexes with phosphido and phosphinidene ligands

There are few well-characterized terminal phosphido complexes of nickel Ni^{II}. (225) and (226) have been obtained according to Equation (5).⁶⁵⁸ The Ni—P bond length shortens considerably upon going from Ni^I to Ni^{II}, which is accompanied by planarization at P as required for in-plane Ni—P π-bonding. Deprotonation of (226) gives the bright green phosphinidene complex (227) ($\delta^{31}\text{P} = 970$ ppm). In (227), the Ni is distorted from planarity, the Ni—P bond length is similar to those in (225) and (226), and the Ni—P—Ar moiety is significantly bent (130.8° at P).

An unusual complex is (228), which forms upon reaction of [NiCl₂(PMe₃)₂] with K₂(Bu^tP)₂.⁶⁵⁹ Different mechanisms have been proposed for its formation, generally involving diphosphene Ni⁰ intermediates.⁶⁶⁰

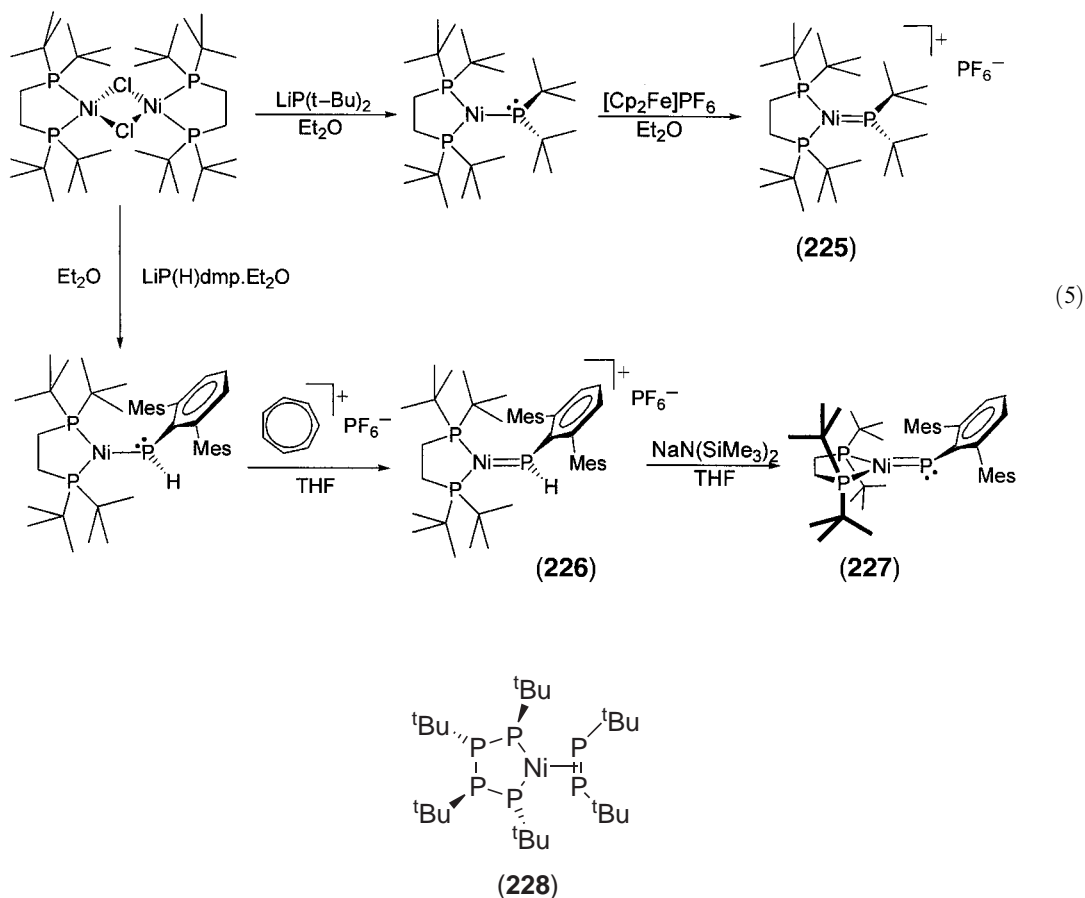

6.3.4.6.3 Complexes with mixed donor atoms involving phosphorus

Ni^{II} complexes with monodentate phosphines are countless. P(CH₂OH)Ph₂ is found in complex **(229a)** which forms upon reaction of Na₂[Ni(CN)₄] with PPh₂ and formaldehyde. One of the Ni—P bonds in **(229a)** is extremely long (2.400 Å), and **(229a)** readily dissociates one phosphine to give **(229b)**.⁶⁶¹

Hemilabile ligands containing a strongly coordinating donor center and one weakly binding donor center can be used to protect an active site metal center until it is required to effect a transformation of a substrate during a catalytically operating process. Polydentate ligands containing pairs of P and O or S donor atoms meet these requirements.^{662–664} In Ni chemistry, hemilabile {P,O} ligands are prominent with a tertiary phosphorus atom, which is responsible for effective binding to the metal center, and a ketonic, carboxylic, oxidic, or alcoholic oxygen atom (or O atoms incorporated into ether moieties, both open chain and cyclic). These latter donors form only weak Ni—O bonds, which can be cleaved reversibly.⁶⁶⁵ The earlier reviews devoted to the general chemistry of {P,O} ligands described most of the major achievements in the field.^{662,666} A set of Ni^{II} complexes with various diastereoisomers of the P-containing macrocycle **(230)** has shown such flexibility of the Ni—O interactions.⁶⁶⁷

In square planar Ni^{II} complexes [Ni(Ph)**(231)**(PPh₃)] and *cis*-[Ni**(231)**₂], the bond lengths indicate considerable electron delocalization in the five-membered NiPCCO chelate rings.⁶⁶⁸ The reaction of 3-diphenylphosphino-1,1,1-trifluoro-trifluoromethyl-2-propanol **(232)** with [Ni(cod)₂] (cod = 1,5-cyclooctadiene) gives an active system for the formation of higher olefins from ethene. The reaction of [Ni(cod)₂] with **(232)** in the presence of tricyclohexylphosphane results in complex **(233)**, which has a square planar geometry.⁶⁶⁹ The structure of the latter complex supports a nickel hydride mechanism in ethene oligomerization. Treatment of [Ni(η⁵-C₅Ph₅)X(CO)] complexes (X = I, Br) with phosphine-β-ketophosphorus ylide gives the {P,O} complex **(234)**. This complex is a rare example of a keto-stabilized ylide nickel complex derived from the nucleophilicity of the oxygen atom.⁶⁷⁰

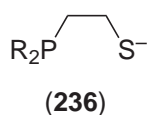
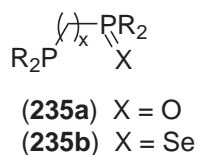
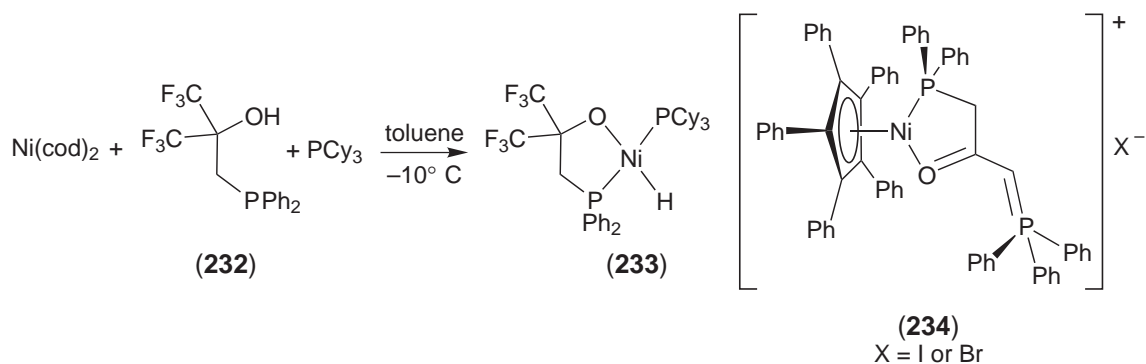
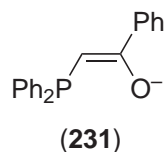
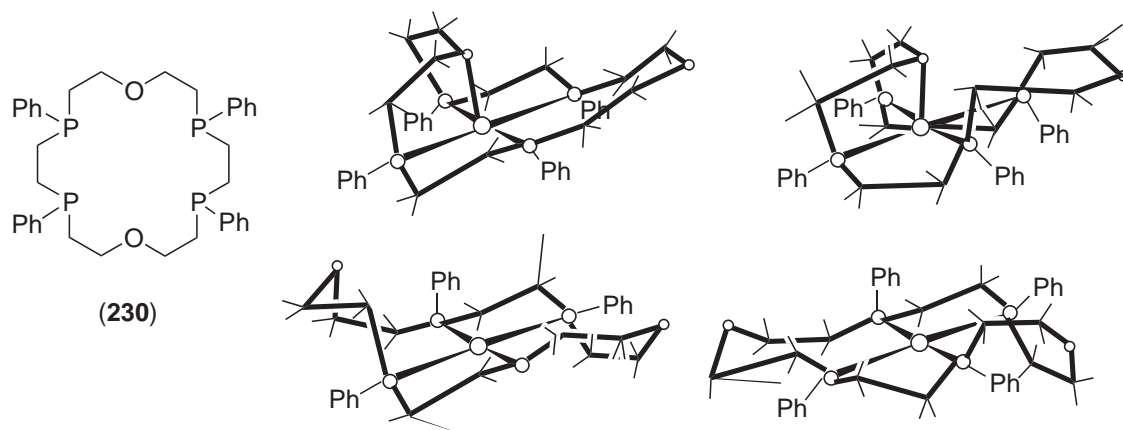
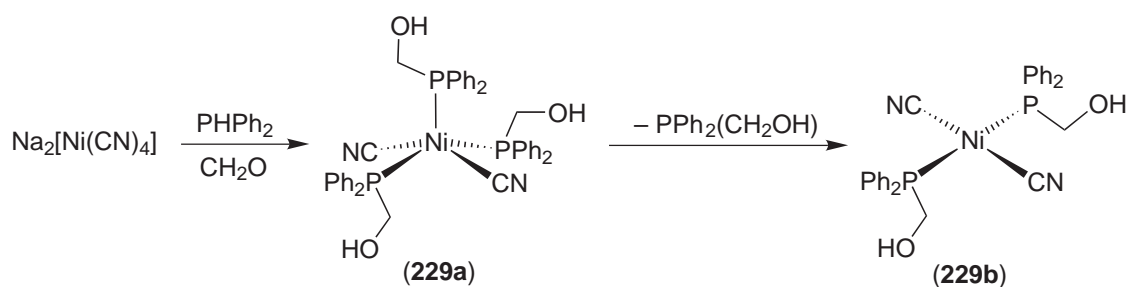

Ligands like diphosphine monoxides $\text{Ph}_2\text{P}(\text{CH}_2)_n\text{P}(\text{O})\text{Ph}_2$, ((235a); $n=1-3$) and $p\text{Tol}_2\text{P}(\text{CH}_2)_n\text{P}(\text{O})p\text{Tol}_2$ consist of a soft phosphino group and hard phosphoryl group. With nickel they form

cationic species with {P,O} chelation. Although X-ray structures are not available, the complexes seem to be monomeric species.⁶⁷¹ Biphosphine monoxides have been proven to behave as functionalized phosphines showing hemilabile behavior.⁶⁷² Se-containing $\text{Ph}_2\text{PCH}_2\text{P}(\text{Se})\text{Ph}_2$ (**235b**) behaves very similarly to its O analog. It coordinates through the {P,Se} donor set forming $[\text{Ni}(\text{235b})_2]\text{Cl}_2 \cdot 2\text{EtOH}$ with square planar geometry.⁶⁷³

Ligands combining P- and S-donor atoms offer rich coordination chemistry since both P and S are excellent donors for a variety of metal ions, including Ni. Five main types of {P,S} ligands are usually distinguished: phosphino-thiols containing phosphine and thiol groups, phosphino-thioformamides, phosphino-dithioformates, diphosphine-monosulfides, and phosphino-thioethers. The coordination abilities of these ligands have been reviewed.⁶⁶³

The coordination chemistry of phosphino-thiols and phosphino-thioethers towards nickel has been studied rather extensively. Phosphino-thiols (**236**) often give thiolate-bridged complexes like $[\text{Ni}(\text{Ph}_2\text{PCH}_2\text{CH}_2\text{S})_2\text{Ni}(\text{Ph}_2\text{PCH}_2\text{CH}_2\text{S})]^+$ and $[\{\text{Ni}(\text{Et}_2\text{PCH}_2\text{CH}_2\text{S})_2\}_2\text{Ni}]^{2+}$.⁶⁷⁴ The oligomerization reaction involves the isomerization of the original monomeric complex from the *trans*- to the *cis*-form as is also seen in the case of $[\text{Ni}(\text{MePhPCH}_2\text{CH}_2\text{S})_2]$.⁶⁷⁵ The formation of monomeric and dimeric complexes with $\text{Ph}_2\text{PCH}_2\text{CH}_2\text{S}^-$ is also likely.^{305,676}

P-donor ligands are prominent spectator ligands that enable transformations at {NiP_x} templates. When simple Ni^{II} salts are treated with thiols, different products are obtained depending on the bulkiness and basicity of the thiol ligand (compare Section 6.3.4.7). The presence of phosphines may induce the formation of monomeric complexes with mixed {P,S} coordination relevant to catalytic or biological sites. The complex $[\text{NiBr}_2(\text{dippe})]$ (dippe = 1,2-bis(diisopropylphosphino)ethane) reacts with benzene- and polyfluorobenzene-thiolates yielding square planar complexes $[\text{Ni}(\text{SR})_2(\text{dippe})]$ (R = C₆F₅, C₆F₄H, C₆H₄F, or Ph).⁶⁷⁷ These compounds further react with CNBu^t yielding *cis*- $[\text{Ni}(\text{SR})(\text{CNBu}^t)(\text{dippe})](\text{BPh}_4)$, but they do not react with CO under the same conditions. The diphosphino complex also reacts with bidentate dithiocarbamate inducing its degradation and giving a square planar complex with dithiocarbonate $[\text{Ni}(\text{S}_2\text{CO})(\text{dippe})]$. Diphosphino complexes with bidentate dithiolates may be easily obtained starting from the corresponding bis(hydrosulfido) complexes $[\text{Ni}(\text{dppe})(\text{SH})_2]$ and the α -bromoketones (heterocycle-C(O)CH₂Br) (dppe = 1,2-bis(diphenyldiphosphino)ethane).⁶⁷⁸ The resulting complexes $[\text{Ni}(\text{dppe})(\text{S}_2\text{C}_2\text{-heterocycle})\text{H}]$ have slightly distorted square planar geometries around nickel and the metallo-1,2-dithiolate is $\sim 6^\circ$ from being coplanar with the heterocycle. In the monomeric $[\text{Ni}(\text{dppp})(\text{Se}_2\text{C}_2(\text{CN})_2)]$ complex (dppp = 1,3-bis(diphenylphosphino)propane), the square planar geometry around the metal ion is formed by two bidentate ligands.⁶⁷⁹

New fluorinated azaheterocycles have been synthesized via C—F activation of fluorinated precursors by Ni.⁶⁸⁰ The stepwise reaction of $[\text{Ni}(\text{cod})_2]$ with PET_3 and 2,4,6-trifluoropyrimidine in hexane results in the fast and regioselective formation of the C—F activation product (**237**).⁶⁸¹ Addition of $\text{Et}_3\text{N} \cdot 3\text{HF}$ to (**237**) gives bifluoride complex (**237a**). Treatment with CsOH converts (**237a**) into (**237**) and (**237b**). Treatment of (**237**) or (**237a**) with the base in the presence of excess of 2,4,6-trifluoropyrimidine in THF results solely in (**237b**). Reaction of the latter with HCl liberates the oxygenated heterocycle. This set of reactions represents an interesting example of Ni-assisted C—F bond activation.

Several other methods for activation of C—F bonds with Ni–phosphine complexes have been reported.^{682,683,2546,2577} Treatment of *trans*- $[\text{NiF}(2\text{-C}_5\text{NF}_4)(\text{PET}_3)_2]$ (C_5NF_4 = tetrafluoropyridyl) with HCl effects the formation of air-stable *trans*- $[\text{NiCl}(2\text{-C}_5\text{NF}_4)(\text{PET}_3)_2]$. Reaction of this complex with an excess of HCl slowly gives 2,3,4,5-tetrafluoropyridine. The latter compound instantly reacts with $[\text{Ni}(\text{cod})(\text{PET}_3)_2]$ to form $[\text{NiF}(2\text{-C}_5\text{NF}_3\text{H})(\text{PET}_3)_2]$ via a C—F activation process.⁶⁸⁴ Treatment of $[\text{Ni}(\text{cod})_2]$ with trifluoroiodoethene or 1,1-dibromodifluoroethene in the presence of PET_3 results in the formation of *trans*- $[\text{NiI}(\text{CF}=\text{CF}_2)(\text{PET}_3)_2]$ (**238a**) and *trans*- $[\text{NiBr}(\text{CBr}=\text{CF}_2)(\text{PET}_3)_2]$ (**239**), respectively.⁶⁸⁵ Reaction of (**238a**) with NaBAR'_4 ($\text{Ar}' = 3,5\text{-C}_6\text{H}_3(\text{CF}_3)_2$) and acetonitrile gives complex (**238b**), treatment of (**238a**) with NaBAR'_4 in the presence of CO results in (**238c**) (which is stable in CH_2Cl_2), and the reaction of (**238a**) with BAR'_4 and Bu^tNC yields complex (**238d**). The highly electrophilic properties of the vinyl ligand cause that upon treatment of complex (**238d**) with PET_3 and NaBAR'_4 the dicationic phosphinoethyl complex *trans*- $[\text{Ni}\{\text{CF}=\text{CF}(\text{PET}_3)\}(\text{CNBu}^t)(\text{PET}_3)_2][\text{BAR}'_4]_2$ (**240**) is formed which features a phosphonioethenyl ligand bound to nickel.

A combination of P- and N- donors is another useful approach to potentially reactive (and catalytically active) Ni species. Similar to O- donors, N is a hard donor capable of stabilizing metal ions in higher oxidation states, whereas the soft donor P is best suited to stabilize medium or low oxidation states. A neutral bidentate {P,N} ligand combining a hard dimethylamino and a soft phosphine donor in *N,N'*-dimethyl-2-(diphenylphosphino)aniline (**241**) affords the neutral trigonal bipyramidal and the

cationic square planar Ni^{II} complexes $[\text{NiCl}_2(\text{PMe}_2\text{Ph})(\mathbf{241})]$ and $[\text{NiCl}(\text{PMe}_2\text{Ph})(\mathbf{241})]\text{PF}_6$, respectively.⁶⁸⁶ The latter complex is an effective cocatalyst in propylene oligomerization.

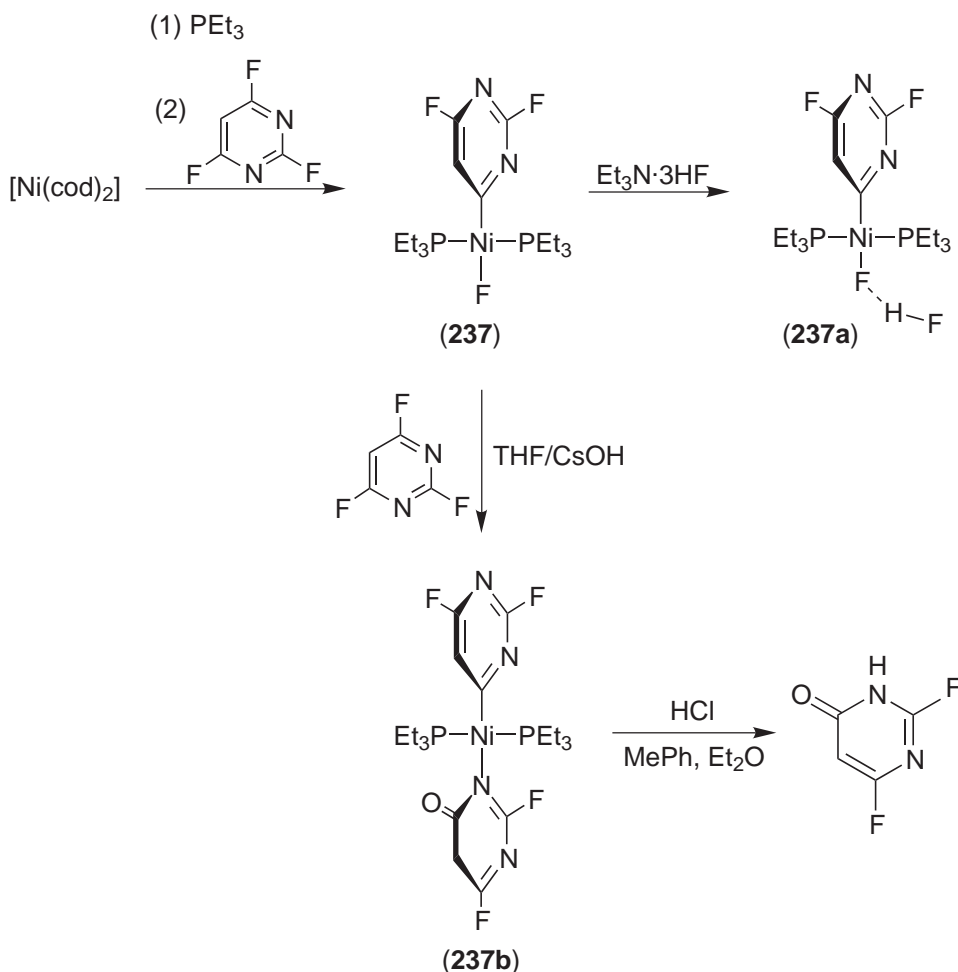

Complexes $[\text{Ni}(\mathbf{242a})_2](\text{BF}_4)_2$ and $[\text{Ni}(\mathbf{242b})_2](\text{BF}_4)_2 \cdot \text{MeCN}$ with the imidazolylphosphine ligands adopt square planar structures with different configurations. In the former complex the two P atoms are in *cis*-position, whereas in the latter complex they are *trans* to each other.⁶⁸⁷ The complex $[\text{Ni}(\mathbf{242a})\text{Cl}_2]$ has a five-coordinate dimeric structure with chlorides bridging two Ni ions in the solid state and a monomeric square planar geometry $[\text{Ni}(\mathbf{242a})(\text{solv})_2]^{2+}$ in aqueous and methanolic solutions. In the case of $[\text{Ni}(\mathbf{242b})\text{Cl}_2]$, a planar structure is present both in the solid state as well as in solution. Steric bulk and the electronic nature of the substituents on the P atom have distinct influence on the stereochemistry of $[\text{Ni}\{\text{P},\text{N}\}_2]^{2+}$ -type complexes. It is also evident that imidazolylphosphine ligands have better donor abilities than related and well-known pyridylphosphines (**243**).⁶⁸⁸

Various phosphino oxazoline ligands were designed, and they can also be optimized via high-throughput catalyst screening for certain applications. In (**244**), a near square planar environment with two nitrogen atoms in a *cis* position relative to each other is observed.⁶⁸⁹

Chiral ligand self-recognition phenomena are well described for transition metals and diphosphine ligands.^{690,691} Phosphinoaryl oxazoline ligands form two complexes (**245a**) and (**245b**).⁶⁹² Reaction of the paramagnetic complex (**245a**) ($\text{R}^1 = \text{CH}_2\text{Pr}^i$) with two equivalents of AgO_3SCF_3 in the presence of one further equivalent of the ligand yields a bright orange diamagnetic complex $[(4S)(4'S)]$ -(**246**). Two arrangements T and C of the $\{\text{P},\text{N}\}$ ligands are possible for the square planar geometry. The latter is favored, since two π -accepting P centers are *trans* to the σ -donating N donors. The C arrangement was indeed found both in the solid state as well as in solution. The homochiral complex $[(4S)(4'S)]$ -(**246**) is strongly preferred over the heterochiral $[(4R)(4'S)]$ species due to a fitting of the two $\{\text{P},\text{N}\}$ ligands around the nickel center that is reminiscent of an intramolecular embrace. (**247**) is an example of a Ni^{II} complex with a chiral $\{\text{P}_2\text{N}_2\}$ Schiff base ligand.⁶⁹³

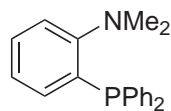
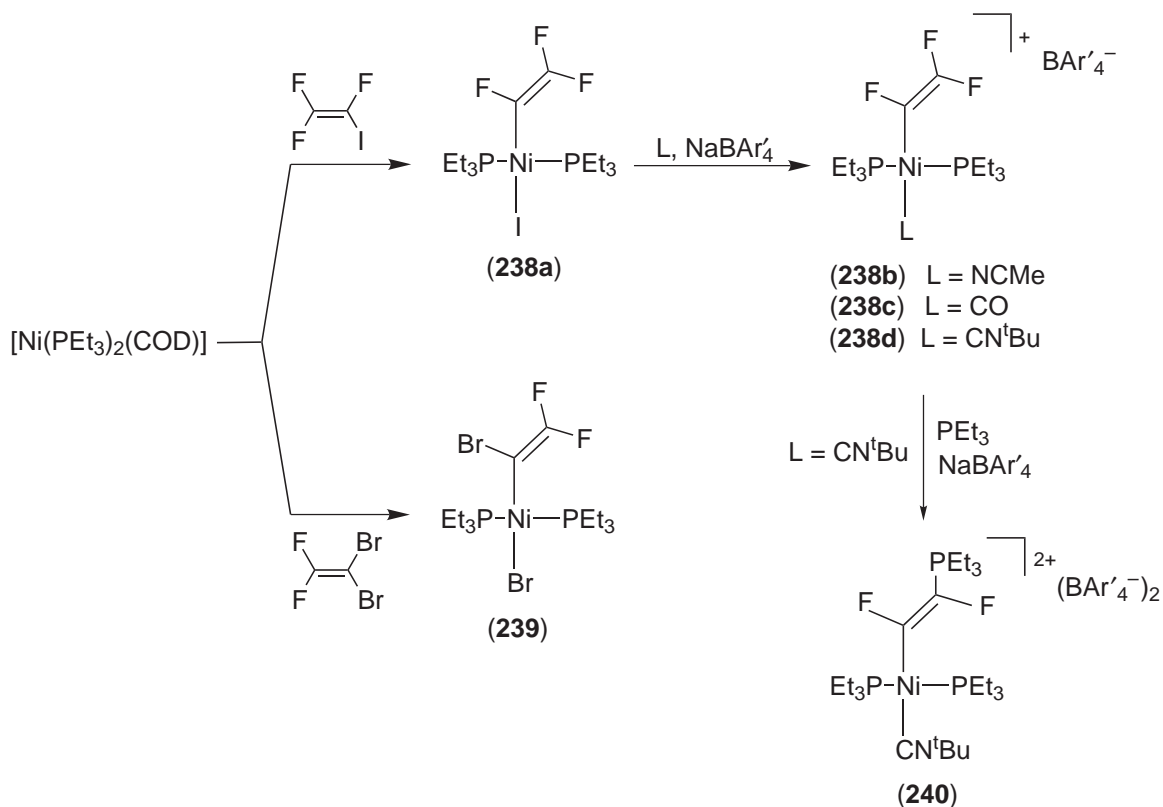

(241)

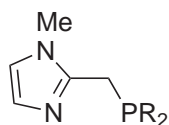

(242a) R = Ph

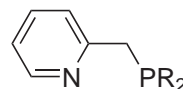
(242b) R = ⁱPr

(243)

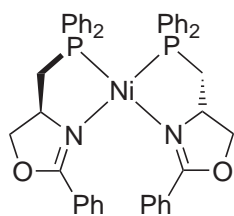

(244)

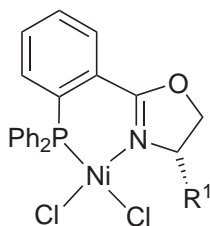

(245a)

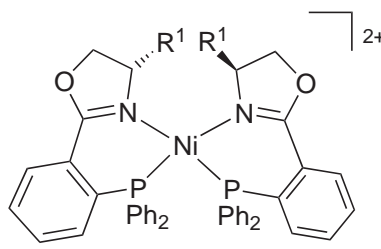

(245b)

The oxidative addition of α -ketophosphorus ylides $\text{Ph}_3\text{P}=\text{CR}'\text{C}(=\text{O})\text{R}''$ to Ni^0 in the presence of a two-electron donor phosphine ligand leads to square planar complexes containing both a $\text{Ni}-\text{C}$ σ -bond and a bidentate, three-electron donor $\{\text{P},\text{O}\}$ chelating ligand, e.g., $[\text{NiPh}(\mathbf{231})(\text{PPh}_3)]$.⁶⁹⁴ This and related complexes are convenient precursors for the active species responsible for the catalytic oligomerization of ethylene into olefins (Shell higher olefin process, SHOP). The α -iminophosphorus ylide $\text{Ph}_3\text{P}=\text{CHC}(=\text{NPh})\text{Ph}$ ($\mathbf{248}$) reacts with $[\text{Ni}(\text{cod})_2]$ to produce the square planar complex ($\mathbf{249}$) in which the tertiary phosphine is not bound to the Ni^{II} ,⁶⁹⁵ but instead an intact ylide molecule is bound via the α -imino nitrogen. In the presence of PMe_3 , PMe_2Ph , or PMePh_2 the complexes ($\mathbf{250a-c}$) were obtained.

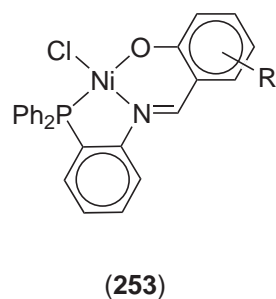
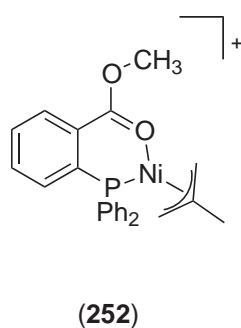
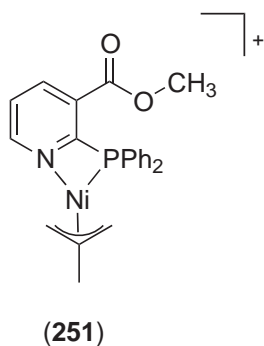
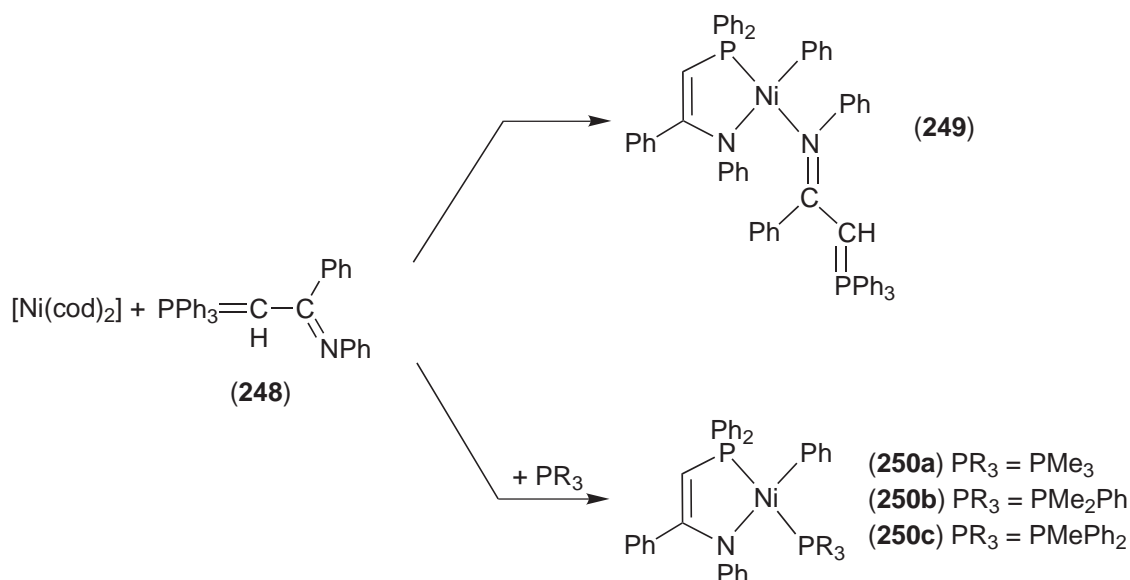
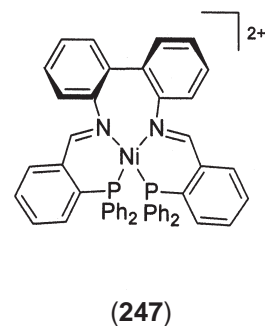
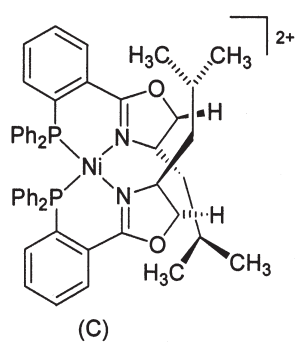
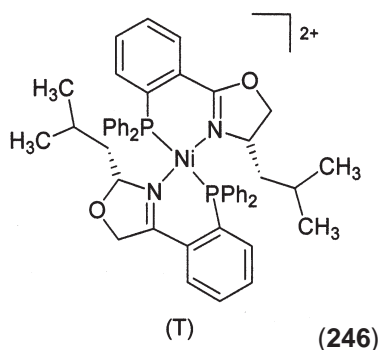

The coordination modes found in Ni^{II} complexes with 2-(diphenylphosphino)nicotinic acid and its methyl ester and 2-(diphenylphosphino)benzoic acid and its methyl ester are surprising.⁶⁹⁶ The complex with the benzoic acid derivative shows the expected {P,O} coordination with a six-membered chelate ring (252), while the nicotinic acid analogue forms a four-membered chelate ring with {P,N} binding (251).

Various mixed tridentate ligands with {P,N,O/S/N} donor sets have been explored in Ni^{II} chemistry. For example, condensation of 2-(diphenylphosphino)aniline with substituted (5-chloro-, 5-nitro-, 5-bromo-, 5-methoxy-, and 3-methoxy-) salicylaldehydes yields (253).⁶⁹⁷ The deprotonated ligand coordinates through its {P,N,O} donor set in a square planar geometry with some distortion, which is probably due to the bulk of the phosphine group and to the bite angle of the {P,N} chelate.

Triphos-derived tridentate ligands with mixed donor sets have been developed and subsequently used in Ni coordination chemistry. Nickel(II) complexes include dinuclear compounds (**254**) and (**255**) with $\{P_2S\}$ and $\{P_2O\}$ ligands, respectively.⁶⁹⁸

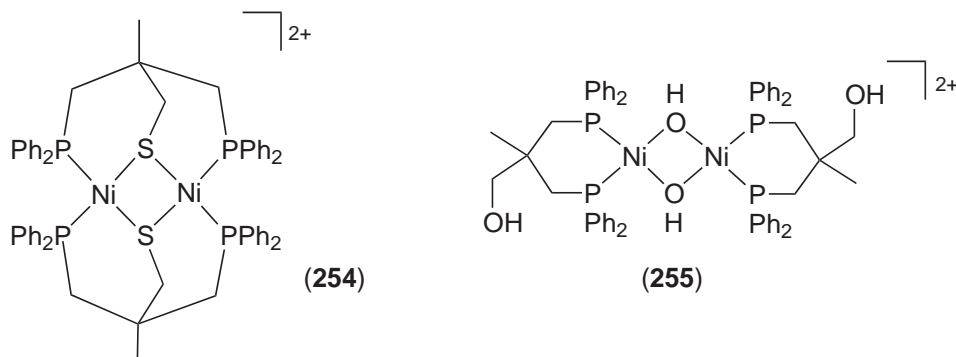

6.3.4.5.4 Complexes with ligands containing arsenic and antimony

Multidentate arsine ligands stabilize a wide range of oxidation states and coordination geometries for nickel.⁶³⁶ 1,2-Bis(dimethylarsino)tetrafluorobenzene, *o*-C₆F₄(AsMe₂)₂ (**257b**), forms high-spin tetragonal Ni^{II} complexes [Ni(**257b**)₂X₂] (X = Cl or Br), which remain six-coordinate in nonpolar solvents, while in the case of [Ni(**257b**)₂]₂ the nickel environment is square planar and diamagnetic.⁶⁹⁹ The Ni^{III} bromide complex *trans*-[Ni(**257b**)₂Br₂]BF₄ consists of a tetragonal cation with *d*(Ni—Br) = 2.543 and *d*(Ni—As) = 2.336 Å. However, EXAFS data have shown that the Ni^{II} complex with nonfluorinated benzene, [Ni(**257b**)₂]Br₂, is square planar. The octahedral geometry for this type of ligands is rather unusual, but is reminiscent of [Ni{*o*-C₆F₄(PMe₂)₂}₂Cl₂] for which both planar and octahedral forms are known.⁷⁰⁰ The diarsine is a strongly coordinating ligand capable of stabilizing high oxidation states of nickel including Ni^{III} and Ni^{IV} (compare Section 6.3.3.4).^{701,702}

Some Ni complexes containing arsenic donors or hybrid arsine–phosphine ligands were shown to exhibit unusual intra- and intermolecular dynamic behavior in solution.⁷⁰³ NMR studies have shown that two five-coordinate Ni^{II} complexes containing either the tridentate (**256a**) or (**256b**) and the bidentate (**257**) undergo a rapid intramolecular donor-site exchange process in square pyramidal complexes.⁷⁰⁴ Complex [Ni(**256a**)(**257a**)](ClO₄)₂ adopts an unsymmetrical square pyramidal geometry with a mean basal Ni—As distance of 2.285 Å and an apical Ni—As distance of 2.400 Å. The complex [Ni(**256b**)(**257a**)](ClO₄)₂ adopts a similar structure. There are two different mechanisms of ligand exchange dynamics. The low-energy donor-site process (i) shows a rapid exchange between square pyramidal enantiomers as one of the AsMe₂ groups of (**257a**) oscillates between the equivalent sites through the pseudotrigonal pyramidal transition state, while in the high-energy donor-site process (ii) both groups of (**257a**) spin over the three positions of a facial site on the complexes.

The reaction of square pyramidal [Ni(**256a**)₂]²⁺ with either free (**257a**) or square planar [Ni(**257a**)₂]²⁺ yields five-coordinate [Ni(**256a**)(**257a**)]²⁺. In both reactions the ternary complex formation involves the detachment of (**256a**) from [Ni(**256a**)₂]²⁺, which is the slow rate-determining process (*t*_{1/2} = 105 min), followed by a rapid ligand reorganization.⁷⁰⁵

There are two structurally distinct conformers of [Ni(fdma)₂Br₂] (fdma = 1,1'-bis(dimethylarsino)ferrocene). The geometry around Ni^{II} in both forms is a tetragonally compressed octahedron. In one conformer the ferrocene moieties are parallel, while in the other they are approximately at right angles to each other (Figure 8).⁷⁰⁶ Both conformers show staggered arrangements of the ferrocenyl rings and the Ni—As distances are rather long (2.588 Å).

[(C₃H₅)Ni(EPh₃)₂](PF₆) (E = P, As, Sb) are active catalysts for olefin oligomerization. The stibine species is the most active in the 1,4-polymerization of butadiene.^{707,708}

6.3.4.6 Complexes with Oxygen Donor Ligands

6.3.4.6.1 Complexes with monodentate oxygen ligands and carboxylates

The geometry and bond distances of the [Ni(H₂O)₆]²⁺ cation were thoroughly discussed.⁷⁰⁹ As expected from ligand field theories, the metal—OH₂ bond reaches its minimum for Ni^{II} ions, which

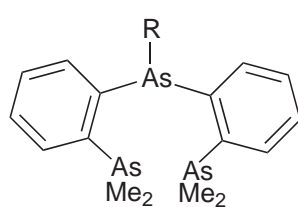

(256a) R = Me

(256b) R = Ph

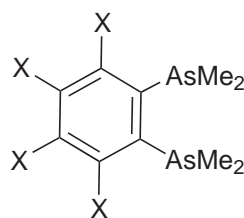

(257a) R = H

(257b) R = F

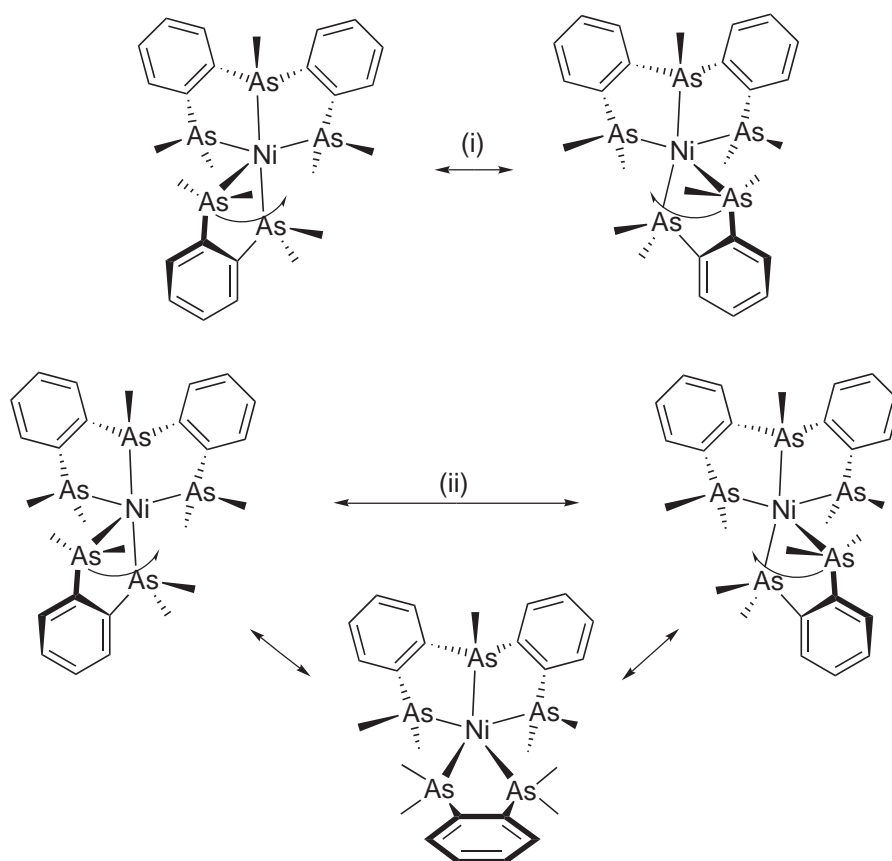

is usually located in the center of symmetry in a distorted octahedron. The set of the hydrogen bonds formed between water molecules of the aquaion and the other ions (cations and anions present in the crystal) may form specific layers depending on their hydrophilic and hydrophobic character.⁷¹⁰⁻⁷¹³ The mean Ni—O distance of the $[\text{Ni}(\text{H}_2\text{O})_6]^{2+}$ cation is about 2.055 Å in both solid state and solution.⁷¹⁴

The specific structure of $[(\text{H}_2\text{O})_5\text{Ni}(\text{py})]^{2+}$ was observed in the complexes with the second-sphere coordination of calix[4]arene sulfonate.⁷¹⁵ There are two different $[(\text{H}_2\text{O})_5\text{Ni}(\text{py})]^{2+}$ cations in the complex assembly. In one the hydrophobic pyridine ring is buried in the hydrophobic cavity of the calixarene with the depth of penetration into the calixarene cavity being 4.3 Å (Figure 9). The second independent $[(\text{H}_2\text{O})_5\text{Ni}(\text{py})]^{2+}$ cation is intercalated into the calixarene bilayer.

N,N-dimethylformamide binds Ni^{II} ion monodentately forming an octahedral cation.⁷¹⁶⁻⁷¹⁸ The hexakis(*N,N*-dimethylformamide-*O*)nickel(II) complex is a useful starting reagent for the synthesis of various Ni^{II} complexes. Hexakis(dimethylsulfoxide)nickel(II) chloride or bromide with an octahedral $[\text{Ni}(\text{Me}_2\text{SO})_6]^{2+}$ cation precipitates from a concentrated DMSO solution of the respective NiX_2 salt ($\text{X} = \text{Cl}, \text{Br}$).⁷¹⁹ The Ni—O distance in $[\text{Ni}(\text{Me}_2\text{SO})_6]^{2+}$ is about 2.08 Å.⁷²⁰⁻⁷²² The 1,1,3,3-tetramethylurea solvated Ni^{II} ion is reported to be five-coordinated in

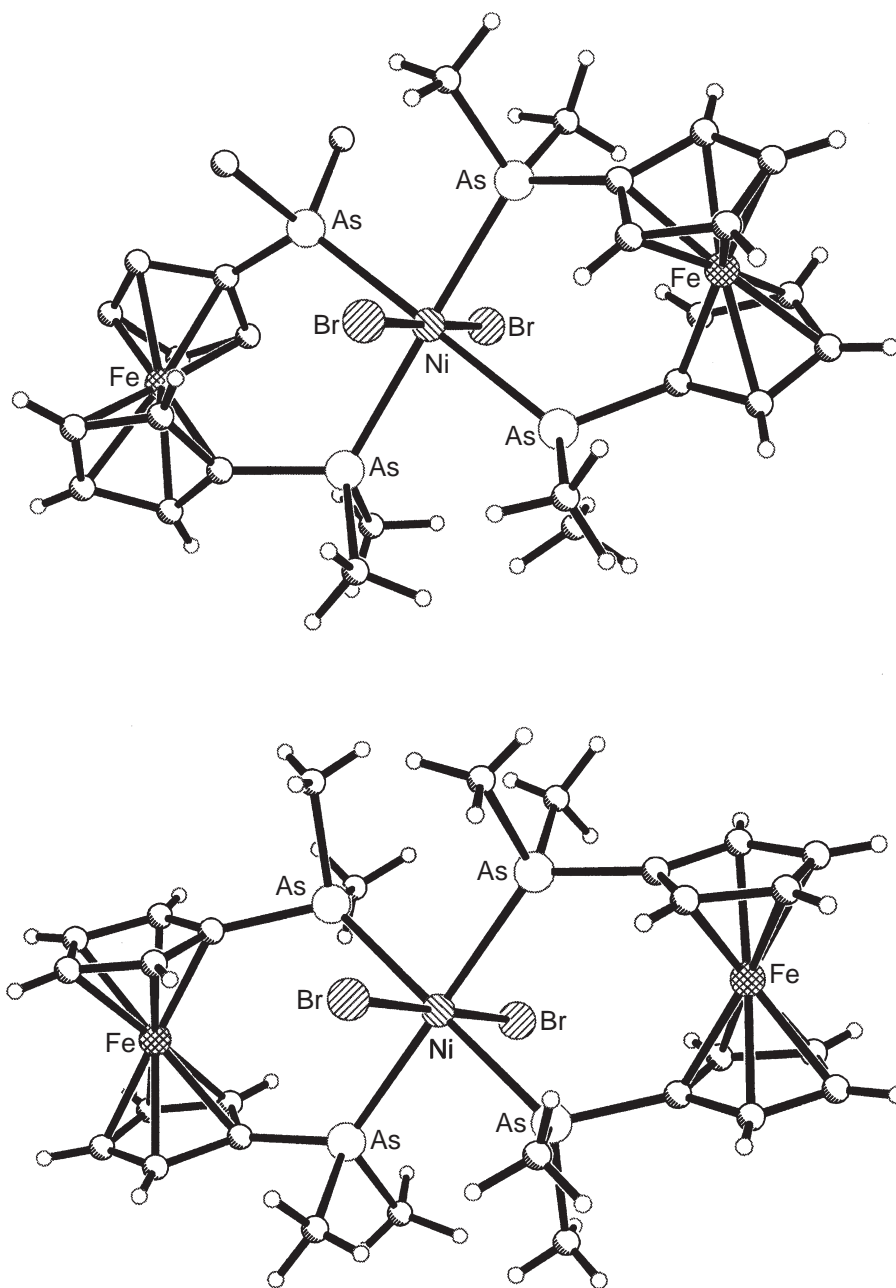

Figure 8 Planar and centrosymmetric “stepped” conformer of $\text{Ni}(\text{fdma})_2\text{Br}_2$.⁷⁰⁶

solution with $d(\text{Ni}-\text{O}) = 2.00(1) \text{ \AA}$ according to EXAFS.⁷²³ For these O-donor solvent complexes, coordination numbers lower than six are generally ascribed to steric restrictions.

In general, monodentate coordination through O is not a very effective binding mode in the case of Ni^{II} . In many cases, however, the presence of hydrogen bonding networks may lead to interesting tertiary structures in the solid state. Squarate complexes were initially expected to be good materials for semiconductivity or magnetism studies. However, due to poor metal–ligand orbital overlap they do not exhibit the desired properties.^{724–728}

In the complex of Ni^{II} with methoxycyclobutenedionate, $[\text{Ni}(\text{CH}_3\text{OC}_4\text{O}_3)_2(\text{H}_2\text{O})_4]$, the metal ion is six-coordinate with two 1-methoxycyclobutenedionate(–1) ligands, the methoxy substituent being oriented *cis* with respect to the ligating oxygen (Figure 10). The remaining sites are filled by water molecules, and monomers are linked by $\text{O}-\text{H}\cdots\text{O}$ hydrogen bonds to form arrays of stepped tapes.⁷²⁸ The methoxy substituent, which has lone pairs that can move into

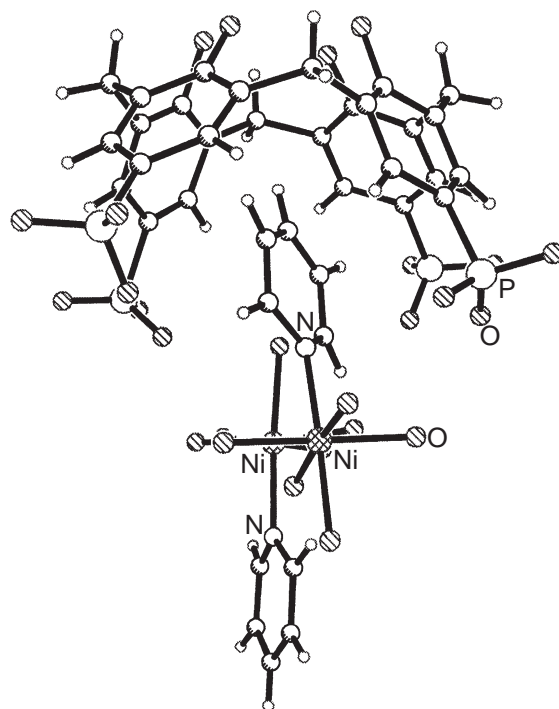

Figure 9 Complex assembly of $[(\text{H}_2\text{O})_5\text{Ni}(\text{py})]^{2+}$ and calix[4]arene sulfonate.⁷¹⁵

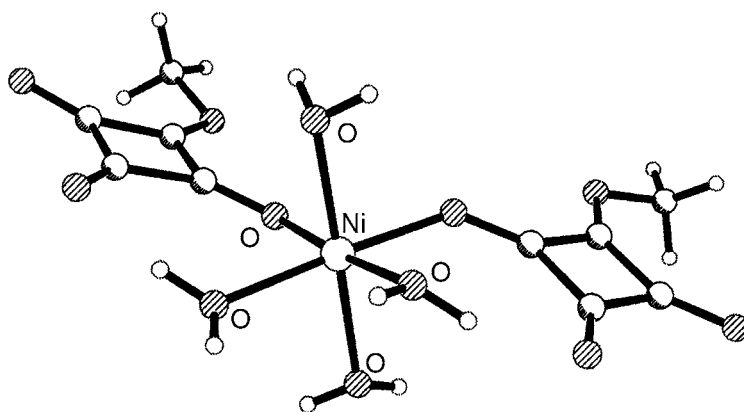
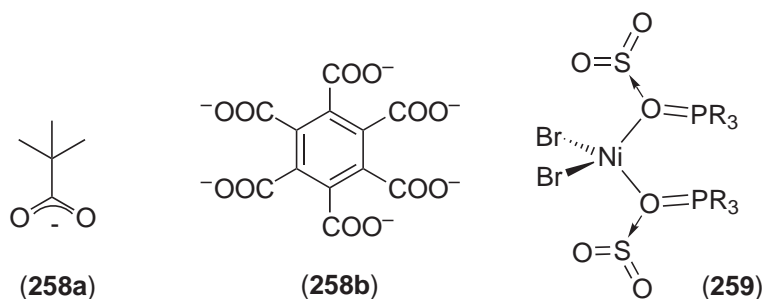

Figure 10 Molecular structure of $[\text{Ni}(\text{CH}_3\text{OC}_4\text{O}_3)_2(\text{H}_2\text{O})_4]$.⁷²⁸

the ring, apparently causes an increase in the amount of delocalization. Thus, proper ring substituents may be used to synthesize metal–squarate complexes with desired solid-state structure and properties through formation of extensive three-dimensional (3D) hydrogen bond networks.⁷²⁷

Ni^{II} complexes with carboxylates are numerous and no comprehensive list can be given here. For example, the Ni^{II} coordination chemistry of trimethylacetate (pivaloate, **(258a)**) has been covered in a review.⁷²⁹ Quite often, the bridging ability of the carboxylate group is taken advantage of for the assembly of polynuclear cluster and supramolecules where, *inter alia*, magnetic properties are of particular interest (compare also Section 6.3.4.13.3). Perspectives in this regard are offered by the use of polycarboxylates like, for example, benzenehexacarboxylic acid (mellitic acid, **(258b)**). This forms a 2D coordination polymer $[\text{Ni}_4(\mathbf{258b})(\text{OH})_2(\text{H}_2\text{O})_6]$ (incorporating dimer motifs of pseudo-octahedral $\{\text{NiO}_6\}$ linked through $\mu_3\text{-OH}$) via a hydrothermal synthesis.⁷³⁰



Monodentate coordination of carboxylate in monomeric species is rather rare although well understood. The monomeric complexes usually formed have a very effective hydrogen bond system, especially when water is the additional ligand as it is seen in the tetraaquabis(maleato)-nickel(II) complex.⁷³¹ Neutron diffraction clearly shows the presence of a three-centered bifurcated donor hydrogen bond and reveals that the hydrogen network reduces the complex symmetry from O_h to C_i . Substituted benzoate often acts as a monodentate ligand coordinated through a single carboxylate-O to complete the coordination sphere of six-coordinate Ni^{II} complexes chelated by two molecules of, for example, 1,3-diaminopropane.^{732,733}

Bis(trialkylphosphine oxide) complexes $[NiBr_2(O=PR_3)_2]$ reversibly bind SO_2 to give species formulated as (259).⁷³⁴

6.3.4.6.2 Complexes with β -diketones and related ligands

Acetylacetonate (acac) and a variety of its derivatives have one of the most examined coordination chemistry among the chelate systems.^{735,736} The parent acac may be substituted at various sites. Its methyl groups can be fluorinated, and the hexafluoroacetylacetonate ligand forms a stable octahedral complex having two co-ligands bound in *cis* positions.⁷³⁷ The substitution of the methyl groups in the trimer $[Ni(acac)_2]_3$ by sterically more bulky groups results in the formation of a monomeric species containing square planar Ni^{II} .

The dibenzoylmethanate (DBM) ligand forms with Ni^{II} three polymorphic forms (light green, brown, and green).⁷³⁸ The light green polymorph is metastable, and after recrystallization the brown stable polymorph is formed which is a square planar diamagnetic $[Ni(DBM)_2]$ species. When heated, the brown form transforms to a green form, which is trimeric $[Ni_3(DBM)_6]$ consisting of linear Ni_3 clusters and a Ni—Ni distance of 2.81 Å. Benzene stabilizes the trimeric structure at room temperature, forming the $[Ni_3(DBM)_6] \cdot 2(\text{benzene})$ inclusion compound. $[Ni(DBM)_2]$ may accept two pyridine-type molecules in the axial positions. The resulting $[Ni(py)_2(DBM)_2]$ complex has *trans* configuration and forms supramolecular structures.⁷³⁹

In the presence of diamines, the square planar Ni^{II} -bis(β -ketoenolate) unit forms ternary complexes with nearly octahedral geometry and *trans* configuration of two monodentately bound diamines (e.g., 1,2-diaminobenzene)⁷⁴⁰ or with *cis* configuration of the chelating amines (e.g., 1,2-ethanediamine)⁷⁴¹ and two 1,3-diphenyl-1,3-propanedione molecules. The monomer–trimer isomerism can be also controlled by substitution at the C(3) position of the ligand. Such 3-substituted pentane-2,4-dione derivatives (260)⁷⁴² form monomeric square planar NiL_2 complexes (261). These dissolve readily in ethanol to give octahedral adducts (261a).⁷⁴³ In the case of (260c), small amounts of green crystals were also formed and identified as the trimer $[Ni(260c)_2]_3$. Thus, the presence of electron-donating substituents in the 3-position of the pentane-2,4-dionato group favors the formation of the monomeric species, while in the presence of the electron-withdrawing phenyl group, both monomeric and trimeric complexes are possible.

Carbonylnitronate ligands $O_2NCHC(O)R^-$ form complexes similar to those of β -dicarbonyl ligands. The reaction of a Ni^{II} salt with benzoylnitromethane or alkyl nitroacetate gives, in the presence of a deprotonating agent, complexes in which the monoanion of the nitro derivative is coordinated to the metal center. When 1,8-bis(dimethylamino)naphthalene (DMAN) is used as the deprotonating agent, $(DMANH)[Ni(O_2NCHC(O)R)_3]$ is obtained.⁷⁴⁴ In the case of $R = Ph$, the benzoylnitronate ligand is coordinated to Ni^{II} through its keto and one nitro oxygen (262).

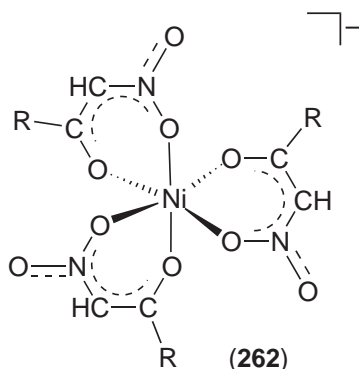
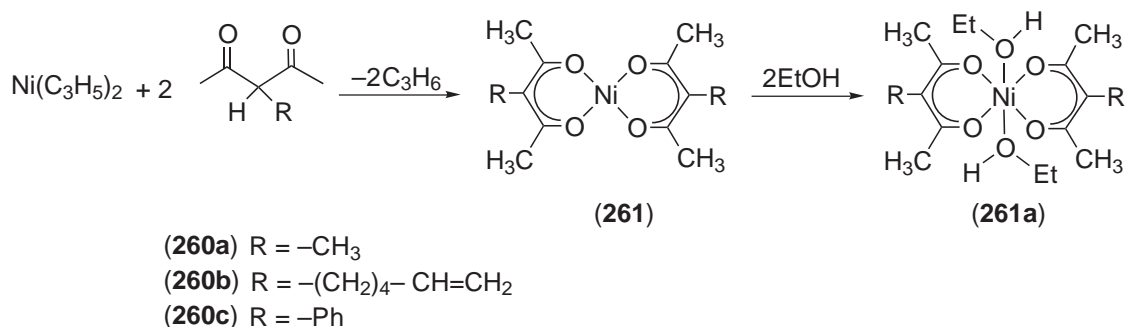

The reactions of Ni^{II} with acac-type ligands are complicated by the fact that β -diketones HL are subject to keto/enol tautomerism. The keto tautomer HK is in equilibrium with the enol from HE and both tautomers can dissociate to form the enolate E⁻, so that the given metal can react with HK, HE, or E⁻.⁷⁴⁵ The β -diketone 3-(*N*-acetylamido)pentane-2,4-dione (Hamac) is highly soluble in water and strongly enolized ([enol]/[ketone] = 2.4). Kinetic studies have shown that the enol tautomer HE and the enolate E⁻ are the reactive species to form [Ni(amac)]⁺, with second-order rate constant $k_E > k_{HE}$. The kinetic data further suggest that formation of the first Ni—O bond is rate controlling and the acidity of the bound water is rate affecting.⁷⁴⁶

6.3.4.6.3 Complexes with deprotonated hydroxamic acids, catechols, and related ligands

Hydroxamic acids, RC(O)N(R')OH, are important ligands especially when acting as siderophores for Fe^{III}⁷⁴⁷ or inhibitors for enzymes.^{748–750} The stability constants of Ni^{II} complexes of hydroxamic acid and derivatives thereof as well as the speciation in aqueous solution have been studied in great detail.^{751–756} Although the hydroxamate ligand usually behaves as a bidentate ligand, it may also coordinate as a monodentate and bridging unit. The monodentate coordination is enforced if adjacent coordination sites are blocked, e.g., by porphyrins.⁷⁵⁷ For coordination of hydroxamates via their N atoms see Section 6.3.4.4.4. Purely bidentate O-coordination was found in the ternary complex with the macrocyclic [12]aneN₃ ligand.⁷⁵⁸ Upon addition of acetohydroxamic acid (HAh) to a solution of [Ni([12]-aneN₃-mc2)(μ -OH)]₂(PF₆)₂ ([12]ane N₃-mc2 = 2,4,4,9-tetramethyl-1,5,9-triazacyclododec-1-ene), the complex [Ni([12]aneN₃-mc2)(Ah)]PF₆ is obtained with pentacoordinate nickel (263). The hydroxamate oxygen atoms occupy two basal coordination sites. The Ni—O distances are shorter than those found for octahedral dinuclear complexes.⁷⁵⁹ Bidentate and bridging modes can occur simultaneously in polynuclear complexes. The reaction of 2-(dimethylamino)phenylhydroxamic acid with NiSO₄ gives a heptanuclear complex, in which the hydroxamate moiety exhibits a variety of binding modes including the bidentate and bridging coordination.⁷⁶⁰ In some metallacrowns the binding modes are even more spectacular showing the involvement of all hydroxamate donor atoms including the N atom.⁷⁶¹

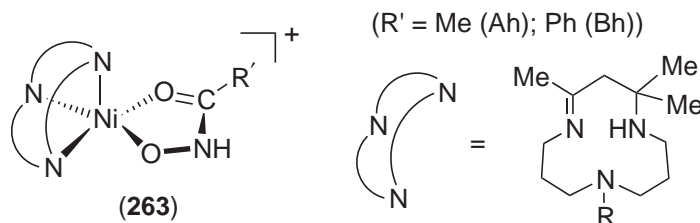

Another family of bidentate O-donor ligands are the 3-acytetramic acids.⁷⁶² Catechol complexes were reviewed in detail.⁷⁶³ Although binary Ni^{II} catecholate compounds have been known for a long time, many studies explaining details of their electronic properties were published only recently.⁷⁶⁴ Ni(OAc)₂ and catechol form two types of complexes depending on the crystallization rate: the paramagnetic six-coordinate Na₂[Ni(cat)₂(H₂O)₂] and diamagnetic square planar Na₂[Ni(cat)₂] or Na₂[Ni(cat)₂]·2DMF. Dissolution of the paramagnetic complex in hot DMSO generates the planar complex by removing water from the coordination sphere. In the paramagnetic species the nickel ion is located in a slightly distorted octahedral environment composed of two symmetry-equivalent catechol ligands in the equatorial plane and two axial water molecules. The bond lengths of the two catechol O atoms are identical for both ligands, with $d(\text{Ni}-\text{O}_{\text{cat}}) = 2.043 \text{ \AA}$ and 2.045 \AA . The Ni—O_{water} bond is longer, at 2.162 \AA . In the planar complex Na₂[Ni(cat)₂]·2DMF, the metal center is coordinated in a slightly distorted square planar fashion by two catecholates with distances $d(\text{Ni}-\text{O}_{\text{cat}}) = 1.858 \text{ \AA}$ and 1.868 \AA . Both paramagnetic and diamagnetic complexes are very sensitive toward oxidation. The oxidation of Ni-catechol complexes is a major reason for difficulties in their unambiguous assignment in the earlier work. The use of bis(catechol) ligands such as *N,N'*-bis(2,3-dihydroxybenzoyl)-1,7-diazaheptane (5-LICAM) gives monomeric Ni^{II} complexes. The yellow diamagnetic Ni^{II} complex with 5-LICAM (264) incorporates a square planar Ni^{II} bis(catecholate) entity (Figure 11).⁷⁶⁵

A variety of ternary complexes containing catecholate moieties are known. For example, in a trimeric Ni^{II} core the catecholate serves as a bidentate ligand to one Ni^{II} and also as a bridge between the two podal and the unique axial metal.⁷⁶⁶

Due to their magnetic properties, complexes of Ni^{II} with semiquinone- and quinone-type ligands have been studied more intensively than catecholates. [Ni(3,6-DBSQ)₂] ((265a); 3,6-DBSQ = 3,6-di-*t*-butyl-1,2-benzosemiquinone) and [Ni(3,5-DBSQ)₂] ((265b); 3,5-DBSQ = 3,6-di-*t*-butyl-1,2-benzosemiquinone) are monomeric square planar complexes.^{767,768} The metal core is diamagnetic, while in [Ni(3,6-DBSQ)₂] two SQ ligands are antiferromagnetically coupled with the value of $J(\text{SQ}-\text{SQ}) = -39.1 \text{ cm}^{-1}$. The mixed ligand complex [Ni(3,6-DBBQ)(3,6-DBSQ)₂] is octahedral with high-spin Ni^{II} ($S = 1$) and two paramagnetic SQ ligands. There is only little temperature dependence of the magnetic moment from $4.57 \mu_{\text{B}}$ at room temperature to $4.38 \mu_{\text{B}}$ at 5 K. Thus, the exchange interactions between the SQ moieties strongly depend on the complex structure and accompanying ligands.^{769,770} Quinone and semiquinone ligands are distinguishable by their bond lengths, with average Ni—O distances of 1.999 \AA for SQ and 2.125 \AA for Q oxygens.

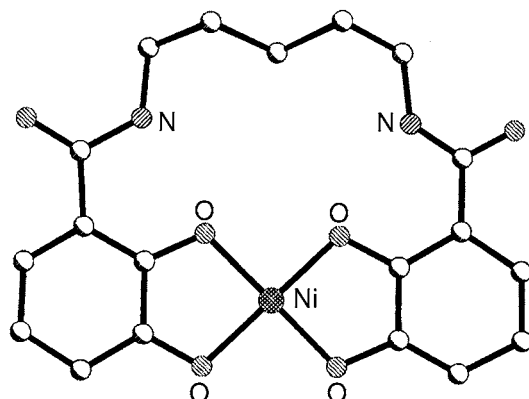
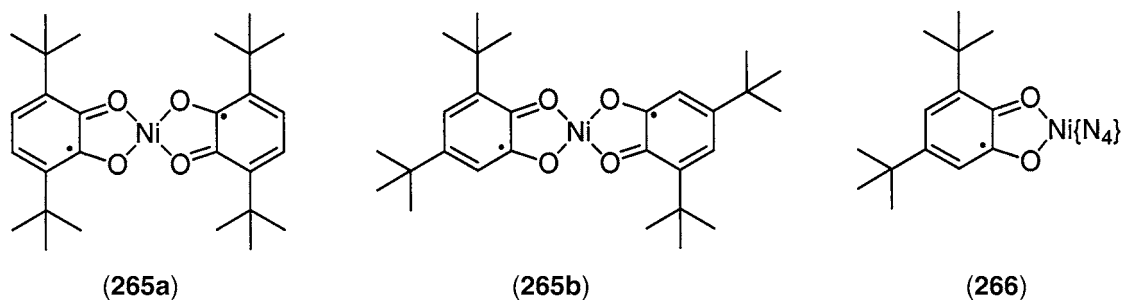

Figure 11 Molecular structure of (264).⁷⁶⁵



The ferromagnetic coupling between the Ni^{II} ion ($S=1$) and the SQ ($S=1/2$) in (266) ($\{N_4\}$ = *dl*-5,7,7,12,14,14-hexamethyl-1,4,8,11-tetraazacyclotetradecane) is so strong that no evidence of population of the excited doublet state is observed at room temperature.⁷⁷¹ [$\{N_3\}$ Ni(TCSQ)(TCQ)] (TCQ = tetrachloroquinone, TCSQ = tetrachlorosemiquinone) exhibits an effective magnetic moment of $2.97\mu_B$ and is formulated as a Ni^I species ferromagnetically coupled to the TCSQ based on the bond lengths of the dioxolene moieties, although a Ni^{II} description cannot be completely ruled out.⁷⁷²

6.3.4.6.4 Complexes with miscellaneous oxygen ligands

Croconate, the monocyclic aromatic oxocarbon dianion $[C_5O_5]^{2-}$, is an analogue of squarate (*vide supra*) and may act as a bidentate ligand forming octahedral complexes like $Na_2[Ni(C_5O_5)_2 \cdot (H_2O)_2] \cdot 4H_2O$ (267).⁷⁷³ In this case the nickel atom is located at the inversion center and is surrounded by six oxygen atoms of which four are croconate O atoms and two are from water molecules. Sodium acts as an interconnecting cation to build up a 3D framework.

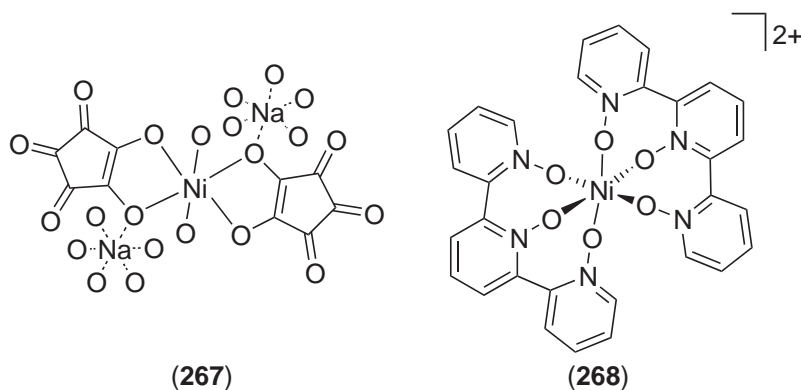

Tridentate oxygen ligands usually form $[NiL_2]$ complexes having pseudo-octahedral geometry. Terpyridine 1,1',1''-trioxide (terpyO₃) gives monomeric $[Ni(terpyO_3)_2]^{2+}$ (268), which features a six-coordinate Ni center in a slightly distorted octahedron with typical Ni—O bond lengths (2.047–2.064 Å). The seven-membered chelate rings produce an unstrained structure that contains the ligand in facial coordination mode rather than the meridional arrangement typical for the parent terpyridine ligand.⁷⁷⁴ DFT calculations, which agree well with the X-ray structure, show that no stable meridional arrangement can be constructed for this ligand without one metal–oxygen bond being cleaved. Terpyridine 1,1'-dioxide (terpyO₂) forms $[Ni(terpyO_2)_2](ClO_4)_2$ with the Ni^{II} center in an octahedral geometry and the two terpyridyl units in *mer* arrangement. The structure of the terpyridine monooxide complex is also meridional.

The oxydiacetate ligand ($oda = ^-O_2C-CH_2-O-CH_2-CO_2^-$) is mainly acknowledged for its capacity to form bridges, which results in polymeric structures as described for polycarboxylates. It may also form, however, monomeric complexes with Ni^{II} featuring tridentate coordination.⁷⁷⁵ In all complexes obtained, $[Ni(oda)(H_2O)_3] \cdot 1.5H_2O$, $[Ni(oda)phen](H_2O)] \cdot 1.5H_2O$, and $[Ni(oda)(terpy)] \cdot 2H_2O$, oxydiacetate acts as a tridentate ligand being hinged in the first complex and almost planar in the other two. The hydrogen bond network is very extensive in the solid state leading to a very intricate packing scheme. Other multicarboxylate ligands with monodentate

coordination usually serve as a bridge to form oligomeric or polymeric structures like it is found for $[\text{Ni}(\text{H}_2\text{O})_5(\mu\text{-C}_6\text{H}_2(\text{COO})_4)\text{Ni}(\text{H}_2\text{O})_5] \cdot 6\text{H}_2\text{O}$.⁷⁷⁶

Kläui's tripodal metalloligand $\text{L}^{\text{OMe}} = (\eta^5\text{-C}_5\text{H}_5)\text{Co}[\text{P}(=\text{O})(\text{OMe})_2]_3$ has been used for the synthesis of an octahedral Ni^{II} complex (**269**).⁷⁷⁷ Before crystallization from acetone, the dinuclear adduct $[\text{Ni}(\mu\text{-L}^{\text{OMe}})_2(\mu\text{-NO}_3)_2\text{Ni}(\text{NO}_3)]$ was isolated. The labile acetone ligand in (**269**) is easily replaced by various P- and N-donor ligands.

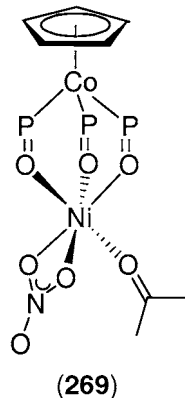

6.3.4.7 Complexes with Sulfur-, Selenium-, and Tellurium-containing Ligands

6.3.4.7.1 Complexes with sulfido and monodentate thiol ligands

Ni coordination compounds bearing SH^- , S^{2-} , S_2^{2-} , and H_2S are attractive targets as models for biological Ni/S systems. Further, nickel sulfides are of interest as promoters in hydrotreating catalysts, and nickel complexes can be employed in desulfurization reactions.⁷⁷⁸ The latter desulfurizations are believed to proceed via intermediate terminal sulfido species. Evidence for the existence of a terminal Ni^{II} sulfido complex comes from the reaction depicted in Equation (6), where kinetic data are consistent with a unimolecular rate determining step involving the loss of benzene from (**270**) and formation of a terminal sulfido intermediate (**271**) to finally yield the bridged sulfido dimer (**272**) (which has a bent Ni_2S_2 core).⁷⁷⁹ (**271**) can be trapped by nitrones.

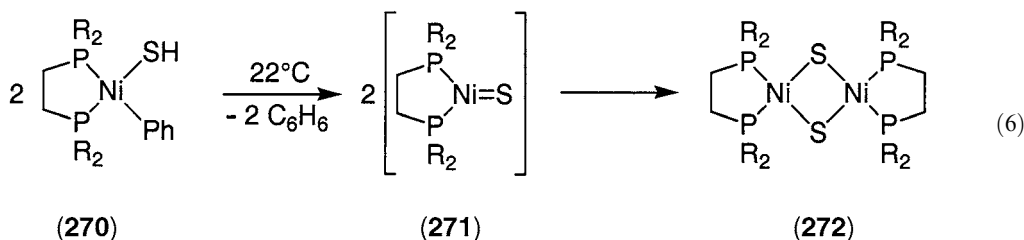

Complexes containing ligands such as SH^- , S^{2-} , S_2^{2-} , and H_2S usually tend to form the binary sulfides or to form oligonuclear S-bridged species. However, mononuclear Ni^{II} complexes with terminal SH ligands can be obtained by the proper choice of spectator ligands, and some selected examples are given here. Reaction of $[\text{Ni}(\text{cyclam})](\text{ClO}_4)_2$ with KSH gives $[\{\text{Ni}(\mu\text{-SH})_2(\text{cyclam})\}_2][\text{Ni}(\text{SH})_2(\text{cyclam})](\text{ClO}_4)_2$, which contains a mononuclear *trans*- $\text{Ni}(\text{SH})_2$ unit (**273**) and a dinuclear cationic $\text{Ni}_2(\mu\text{-SH})_2$ fragment (**274**).⁷⁸⁰ Treatment of $[\text{Ni}(\text{cyclam})](\text{ClO}_4)_2$ with K_2S_2 instead of KSH gives (**275**).⁷⁸¹ A *cis*- $\text{Ni}(\text{SH})_2$ moiety is found in (**276**), which is a valuable starting material for the synthesis of various S-bridged nickel complexes. A tetradentate bridging S_2^{2-} ligand is found in the tetranuclear Ni^{II} complex (**277**).⁷⁸² The mercaptodithiotrinickel complex $[\text{Ni}_3(\mu_3\text{-S})_2(\text{SH})(\text{PEt}_3)_5]^+$ is a product of the reaction of H_2S and PEt_3 with $[\text{Ni}(\text{C}_2\text{H}_4)(\text{PPh}_3)_2]$.⁷⁸³

Two general classes of mononuclear $[\text{Ni}(\text{SR})_4]^{2-}$ complexes are known, those containing monodentate thiolates^{784,785} which adopt a flattened tetrahedral geometry in the solid state with Ni—S bond distances of 2.26–2.33 Å and S—Ni—S angles in the range 88–125°. In contrast, mononuclear $[\text{Ni}\{\text{S}\}_2]^{2-}$ complexes of chelating thiolates like ethane-1,2-dithiolate and analogues are diamagnetic and show square planar geometries. The latter complexes are discussed in the subsequent section.

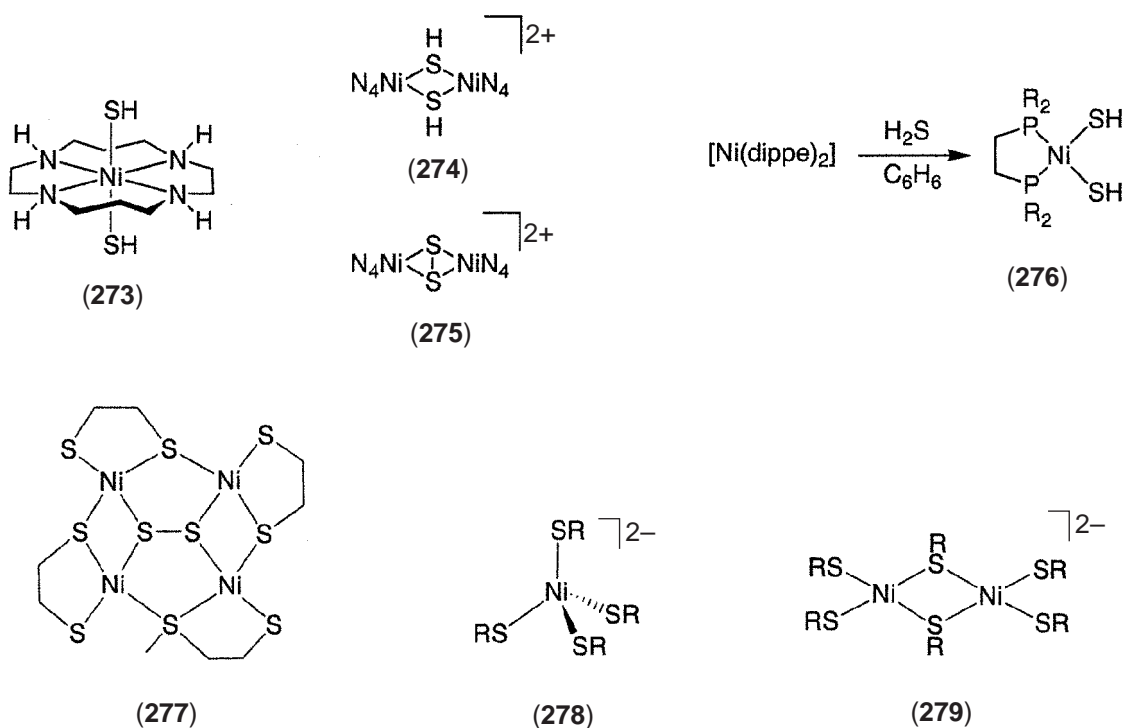

Nickel(II) complexes with monodentate thiolate ligands are unstable towards oligomerization or polymerization and autoredox decomposition reactions. Therefore the synthesis requires strictly oxygen-free conditions. A careful choice of solvent and the use of excess of thiolate prevent the precipitation of insoluble polymers. In this context some new syntheses have been reported which start usually from alkali thiolates and a Ni^{II} salt (e.g., (NEt₄)₂[NiCl₄]). The resulting [Ni(SR)₄]²⁻ anions (278) have a tetragonally distorted tetrahedral coordination geometry which could be shown by means of several X-ray structures of (NEt₄)₂[Ni(SR)₄] complexes (R = Bu^t,⁷⁸⁶ C₆H₅,^{787,788} *p*-ClC₆H₄,⁷⁸⁹ *p*-PhC₆H₄⁷⁹⁰). The dissociation sequence of nickel complexes with arene thiolate ligands was studied in DMSO by spectrophotometric methods. Dissociation was found to proceed through generation of the diamagnetic species [Ni(SR)₃(DMSO)]⁻ and [Ni(SR)₂(DMSO)₂].⁷⁹¹

In addition, the structures of various dimeric,⁷⁸⁶ trimeric,⁷⁹²⁻⁷⁹⁴ and oligomeric thiolate nickel complexes are known, in some cases with additional sulphido bridges. Among them are toroidal Ni^{II} thiolates [Ni(SR)₂]₄ containing S-bridged Ni tetragons,⁷⁹⁵⁻⁷⁹⁸ [Ni(SR)₂]₅ containing S-bridged Ni pentagons,^{796,799,800} various examples of [Ni(SR)₂]₆ hexagons,⁸⁰¹⁻⁸⁰⁷ a [Ni(SR)₂]₈ octagon (R = CH₂CO₂Et),⁸⁰⁸ as well as [Ni(SPh)₂]₉ and [Ni(SPh)₂]₁₁ containing unique 9- and 11-membered ring systems, respectively.⁸⁰⁹ In general, square planar geometries about the nickel centers are predominant. For example, the reaction of [Ni(Me₆tren)Cl]Cl with *p*-ClC₆H₄S⁻ (L) affords the salt [Ni(Me₆tren)Cl]₂[(L)₂Ni(μ-L)₂Ni(L)₂], the anion (279) showing a square planar geometry around each Ni^{II}.⁸¹⁰ For some species with bulky ligands, however, a tetrahedral geometry is found.^{786,801} In many cases the oligonuclear Ni^{II}-thiolato complexes can be reversibly oxidized to give compounds with broken Ni oxidation states.⁸¹¹ Oligomeric complexes with manifold different structures have been discovered including rings and clusters, where the electronic structures and the binding modes are of particular interest. For the pentanuclear star-like complex [Ni₅(μ₅-S)(μ₂-SBu^t)]⁻⁸¹² the MO diagram has been calculated.⁸¹³

By oxidative addition of aryl sulphides to low-valent nickel complexes, a C—S bond cleavage occurs to form Ni^{II} thiolate complexes. For example, exposure of diaryl sulphides to [(Bu^t₃P)₃Ni⁰] leads to oxidative addition, with nickel inserting into the C—S bond (280).⁸¹⁴

Similarly, exchange between the Ar and Ar' groups in [Ni(Ar)(SAr')(PET₃)₂] occurs via reversible reductive elimination and oxidative addition involving C—S bond formation and cleavage at the nickel center to give a mixture of [Ni(Ar')(SAr)(PET₃)₂] and [Ni(Ar)(SAr')(PET₃)₂].⁸¹⁵

The reaction of thiolate ligands with [Ni(terpy)Cl₂] in MeOH or MeCN affords different products depending on the basicity and bulk of the thiolate ligand employed. Thus, the reaction with PhSH yields the thiolate bridged dimer [Ni(terpy)(SPh)₂]₂·6CH₃OH (281), reaction with C₆F₅SH yields the

solvated monomer $[\text{Ni}(\text{terpy})(\text{SC}_6\text{F}_5)_2(\text{CH}_3\text{CN})] \cdot 3\text{CH}_3\text{CN}$ (**282**), while the reaction with 2,4,6- $(\text{Pr}^i)_3\text{C}_6\text{F}_2\text{SH}$ yields the pentacoordinate complex $[\text{Ni}(\text{terpy})(S\text{-}2,4,6\text{-}(\text{Pr}^i)_3\text{C}_6\text{F}_2)_2]$ (**283**).⁸¹⁶

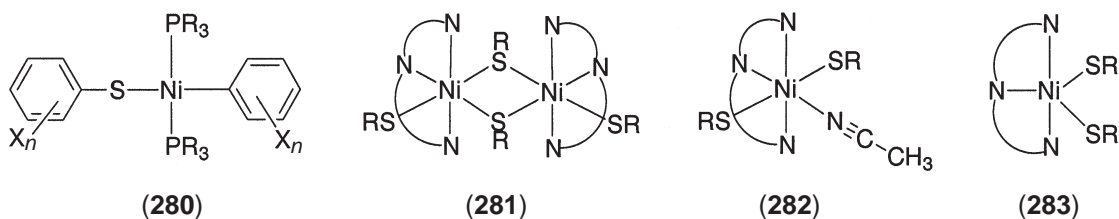

Complexes (**284**) can be protonated at the sulfur to give $[(\mathbf{284})\text{H}]^+$.⁸¹⁷ Kinetic evidence suggests a simple equilibrium reaction for $\text{R} = \text{Ph}$, but more complicated kinetics for $\text{R} = \text{Et}$. In the latter case, the data are indicative of two coupled equilibria in which the initial protonation of the thiolate is followed by a unimolecular equilibrium reaction that is assumed to involve formation of an $\eta^2\text{-EtS-H}$ ligand. Presumably, the more strongly *s*-donating EtS ligand makes the P_3Ni fragment sufficiently electron rich and hence the basicities of the S and the Ni become similar. This observation is relevant with respect to nickel-based hydrogenases.

6.3.4.7.2 Complexes with dithiol ligands

(**285**)–(**289**) are typical dithiol ligands forming dithiolate nickel complexes with five-membered chelate rings. The basic ligand is ethane-1,2-dithiolate (edt^{2-}) (**285**), which forms complexes of the composition $[\text{Ni}(\mathbf{285})_2]^{2-}$ and $[\text{Ni}_2(\mathbf{285})_3]^{2-}$. Crystal and molecular structures of both compounds (as the NEt_4^+ , Ph_4P^+ , or Ph_3MeP^+ salt) have been determined, revealing a square planar geometry around the nickel center,^{197,787,818,819} and complexes of higher nuclearity have also been obtained.^{782,820} Also characterized crystallographically are the Ni^{II} complexes with (**287**) ($(\text{Et}_4\text{N})_2[\mathbf{290a}]$)^{821,822} and (**288**) ($(\text{PPh}_4)_2[\mathbf{290b}]$).¹⁹⁶

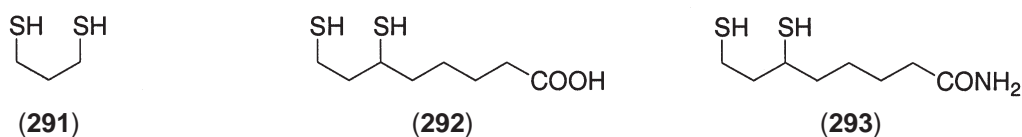
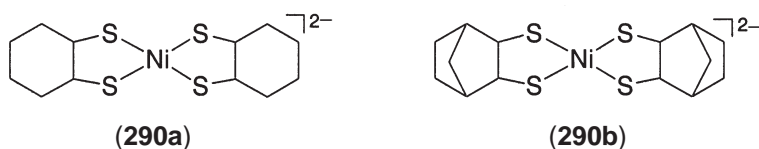
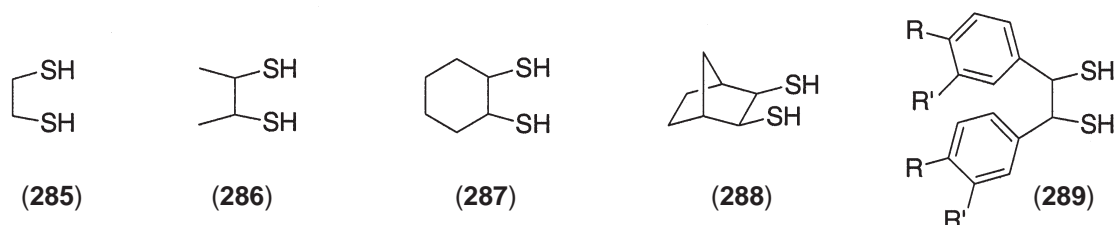
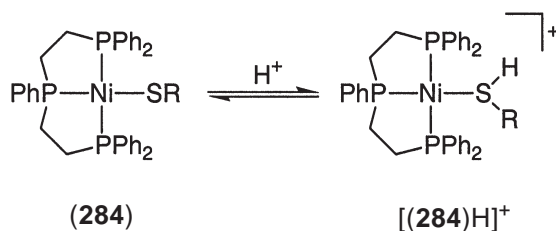

The K-edge spectra of $[\text{Ni}(\mathbf{287})_2]^{2-}$ and $[\text{Ni}(\text{edt})_2]^{2-}$ are remarkably similar to each other and to those of natural hydrogenases.¹⁹⁶ Some complexes with ligand (**289**) ($\text{R} = \text{NMe}_2$, $\text{R}' = \text{H, Me, NMe}_2$) have been characterized using electronic and near infrared spectroscopy.⁸²³ Complex $[\text{Ni}(\mathbf{289})_2]^{2-}$ served to study phase transformation behavior by microscopy and DSC.⁸²⁴

1,3-Propanedithiol (**291**) forms hexanuclear $[\text{Ni}_6(\mathbf{291})_7]^{2-}$ which can be viewed as composed of two $[\text{Ni}_3(\mathbf{291})_4]^{2-}$ subunits sharing a common ligand.⁸²⁰ A study has been carried out on the thermodynamic characteristics of the formation of Ni^{II} complexes with 2,3-mercaptopropanesulphonate. The stability constants for both 1:1 and 1:2 complexes have been determined.⁸²⁵ Dithiolate complexes with six-membered chelate rings are formed in the reaction of Ni^{II} with the ligands (**292**) (lipoic acid) and (**293**), the complexes having been characterized by potentiometric and spectroscopic methods.⁸²⁶

Seven-membered chelate rings are formed with biphenyl-2,2'-dithiolate and *o*-xylenedithiol (**294**). The latter gives trinuclear Ni^{II} complexes $[\text{Ni}_3(\mu_3\text{-S})(\mathbf{294})_3]^{2-}$ and $[\text{Ni}_3(\mathbf{294})_4]^{2-}$.^{827,828} The Ni^{II} is in a square planar $\{\text{NiS}_4\}$ environment, as it is in complex (**295a**). In the absence of excess ligand the mononuclear (**295a**) readily loses one ligand to form the dinuclear complex (**295b**). Oxidation by air causes complex decomposition instead of oxidation at the thiole ligand or oxidation to Ni^{III} .⁸²⁹

Upon reaction of Na_2edt with NiCl_2 and PPh_3 in methanol, C—S bond cleavage occurs and the mixed ligand complex $[\text{Ni}(\text{PPh}_3)(\text{tpt})]$ (**296**) is formed. The crystal and molecular structure of this complex revealed a distorted square planar geometry for the nickel atom with tpt functioning as a tridentate ligand, and the fourth coordination site occupied by the phosphine ligand.⁸³⁰

A number of structures with S-rich dianion ligands have been determined (**297–299**).^{831,832} For example, (**297**) can be synthesized by the reaction of $[\text{Ni}(\text{CN})_4]^{2-}$ with polysulfide.⁸³³ Upon further reaction with CS_2 or substituted acetylenes it forms perthiocarbonato and dithiolene complexes, respectively.

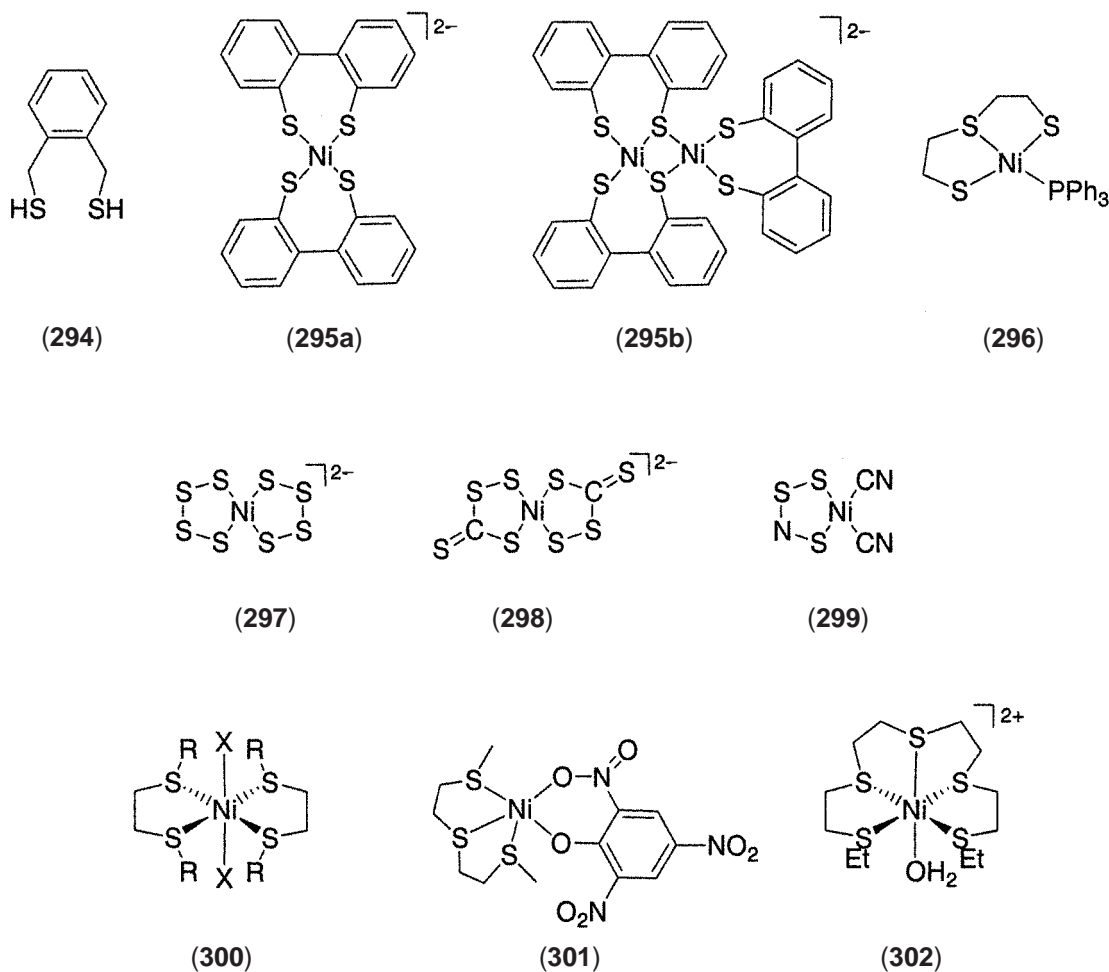

6.3.4.7.3 Complexes with thioether and mixed thioether/thiol ligands

Monodentate thioether ligands are relatively poor ligands towards Ni^{II}. However, several Ni^{II} complexes with polydentate thioether ligands are known, where the coordination capability is enhanced by chelation. In particular, complexes with macrocyclic thioether ligands, which are discussed in Sections 6.3.4.10.1(iii) and 6.3.4.10.3, are very stable.

(300)–(302) are selected Ni^{II} complexes with di-, tri-, and polydentate thioether ligands. Three type (300) Ni^{II} complexes with the bidentate ligands 1,2-bis(methylthio)ethane and 1,2-bis(ethylthio)ethane have been characterized by X-ray crystallography. Octahedral complexes are formed with the thioether ligands coordinating in a bidentate manner and two additional ligands (X = Br, SCN) in *trans*-position.⁸³⁴ The reaction of a Ni^{II} salt with 3,6,9,12,15-pentathiaheptadecane affords a nearly perfect octahedral complex (302) with an additional water ligand.⁸³⁵ An attempt to restrict the flexibility of the polythioether ligands without making use of macrocyclic ligands lead to the syntheses of complexes with ligand (303) and related ligands in which one donor is part of a thiane or a thiepane unit. The resulting Ni^{II} complexes show an octahedral coordination geometry. The S donors of the side arms form a NiS₄ plane, and the S-donor of the heterocycle coordinates in the axial position. In addition, one ClO₄[−] ion or one water molecule occupies the sixth position.⁸³⁶

Ligands that provide a face-capping S₃ donor set comparable to trithiacyclononane (ttcn) are tetrakis((methylthio)methyl)borate (304a) and phenyl(tris((methylthio)methyl)borate) (304b). These ligands are more easily accessible than ttcn but show a comparable coordination behavior by forming complexes of the type [L₂Ni].^{837,838} They particularly stabilize Ni^{II}, but also higher oxidation states. Oxygenation of the Ni^I complex (304c)Ni(CO) leads to O₂ activation and O—O bond rupture with formation of a bi(μ-oxo)nickel(III) complex.¹⁸⁴ Attempted alkylation of [NiCl(304c)] with Me₂Mg or MeLi results in production of [Ni(κ²-(304c))(η²-CH₂SBu^t)] (308).⁸³⁹ The reaction presumably proceeds via reduction of the starting complex and subsequent loss of the borato ligand, which then alkylates another [NiCl(304c)]. In contrast to other Ni-alkyl complexes, (308) does not react with CO. (304d) forms a square planar homoleptic Ni^{II} complex [Ni(304d)₂], while with the more bulky ligand (304e) B—C bond rupture takes place and the organometallic derivative [Ni(304e)(η²-CH₂SBu^t)] with a structure analogous to (308) is yielded.⁸⁴⁰

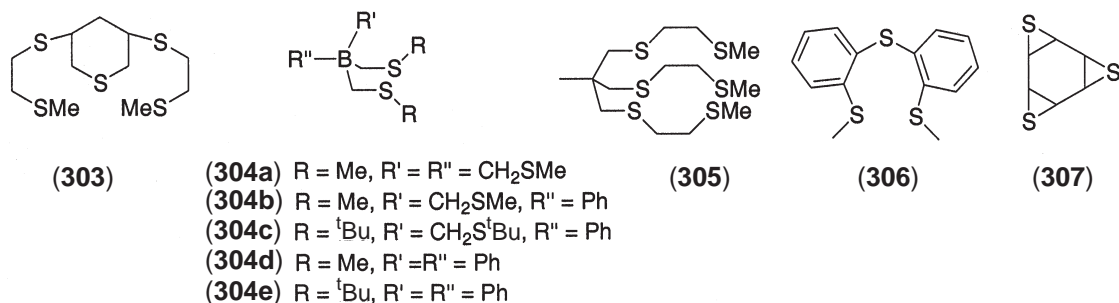

In complexes with ligand (305), hexacoordination of the nickel center is imposed.⁸⁴¹ Benzene trisulfide (BTS) (307) forms with Ni^{II} the octahedral complex [Ni(BTS)₂](BF₄)₂, BTS coordinating in a facial manner. A comparison of this system with other complexes containing thioether ligands was made, and BTS was shown to generate the strongest ligand field of any of the thioether ligands examined. This was ascribed to its rigid endodentate conformation.⁸⁴²

Another class of ligands is those with mixed thioether–thiolate donors. (309)–(311) are shown as a selection of Ni^{II} complexes of this class characterized by X-ray crystallography.^{843,844}

Ligands (312)–(319) are usually synthesized by template reaction between [Ni(C₆H₄S₂)₂]^{2−} and the corresponding dibromide linker, e.g., (BrCH₂CH₂)₂S. Even chiral ligands such as (318) (R' = Me, HO(CH₂)₉, PhCH₂) can be obtained.⁸⁴⁵ The ligands can be displaced for complexation to other metals by treatment with aqueous HCl. Depending on the linker, the corresponding Ni^{II} complexes adopt various coordination geometries (Table 3) examined by crystallographic and spectroscopic methods.^{846–850} For example, the Ni^{II} complex of (312) is the first five-coordinate Ni^{II} complex with all-sulfur coordination.

Table 3 Ni^{II} complexes of ligands (312)–(319).

Ligand	R	Complex type	Coordination number
(312)	–(CH ₂ CH ₂ S) _n CH ₂ CH ₂ – (n = 2)	[NiL]	4
(313)	–CH ₂ CH ₂ OCH ₂ CH ₂ –	[NiL] ₂	4
(314)	–CH ₂ CH ₂ SCH ₂ CH ₂ –	[NiL]	5
(315)	–CH ₂ CH ₂ NHCH ₂ CH ₂ –	[NiL] ₂	6
(316)	–CH ₂ CH ₂ CH ₂ –	[NiL]	4
(317)	–CH ₂ CH ₂ CH ₂ CH ₂ –	[NiL] ₂	4
(318)		[NiL]	4
(319)		[NiL]	4

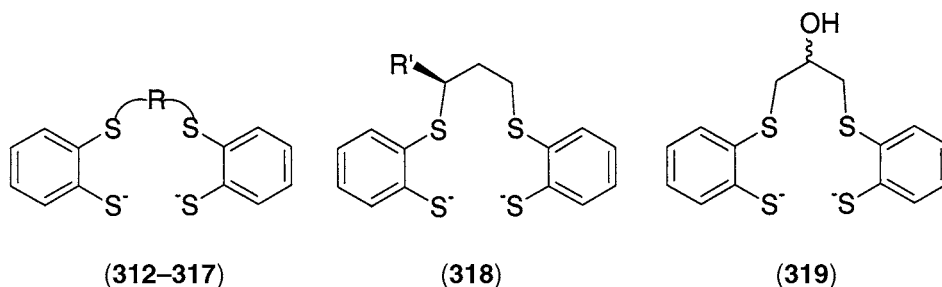
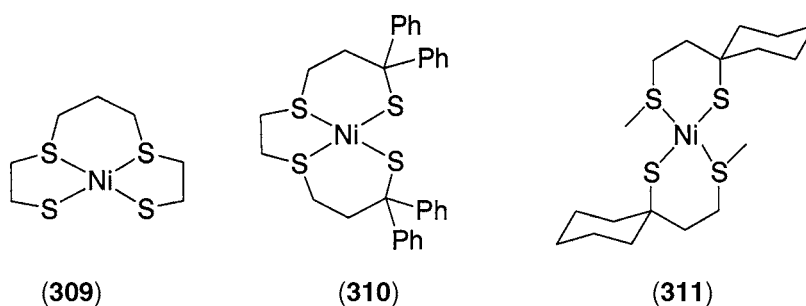
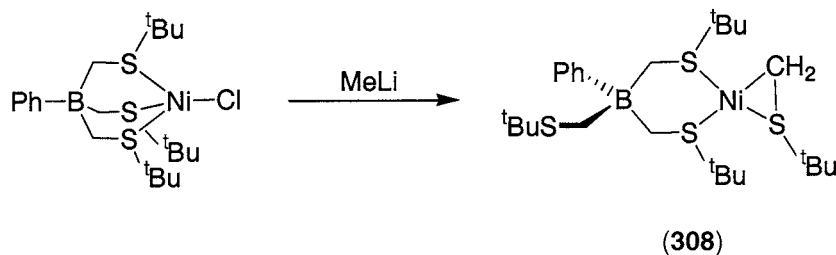

Nickel complexes of this group are of interest in biomimetic work. By means of ligand (320) the complete reaction cycle of acetyl CoA synthase could be executed (Scheme 2). Ligand (320) can also be synthesized by a template reaction. Upon reduction of the Ni^{II} complex (321) with Na/Hg, the ligand backbone is cleaved, resulting in a thermally stable trinuclear Ni^{II} alkyl thiolato complex (322).

Treatment of (322) with donor ligands L (L = Py, thf, PMe₃) affords the corresponding mononuclear complexes (323). Subsequent stoichiometric reaction with CO ultimately leads to formation of the cyclic thioester (325) and Ni(CO)₄. By reaction of (323c) with CO the intermediate Ni^{II} acyl thiolato complex (324) could be intercepted and fully characterized. The original complex (321) can be regenerated by reaction of Ni(CO)₄ with ligand (320). Hence, the reaction cycle that comprises the CODH sequence [Ni] → [Ni-alkyl] → [Ni-acyl] → [Ni] + thioester is closed.⁸⁵¹

In order to obtain suitable precursors of Ni^{II} complexes [LNiX]ⁿ⁻ that model the reactive sites of hydrogenases and CO dehydrogenases, compounds with the ligand L = bis(2-mercaptophenyl)sulfide were synthesized (X = SR⁻, PR₃, Cl⁻, N₃⁻). All these complexes (326) exhibit a distorted tetrahedral coordination geometry.^{852,853}

With $X = \text{HNPPr}_3$ the new phosphorane imine complex (**326a**) was obtained. Spectroscopic and structural data indicate that the HNPPr_3 ligand favors an ylidic structure.⁸⁵⁴

The exchange reaction of LNiHNPPr_3 (**326a**) with D_2 at 10 bar gave LNiDNPPr_3 and HD. This reaction can be followed by ^2H NMR spectroscopy. Similarly the exchange reaction of (**326a**) with D_2O gave LNiDNPPr_3 and HDO. These findings suggest a D_2 heterolysis caused by the concerted attack of the Ni^{II} center and the thiolate donor. Following Scheme 3 an exchange of H and D occurs, resulting in the formation of HD.⁸⁵⁵

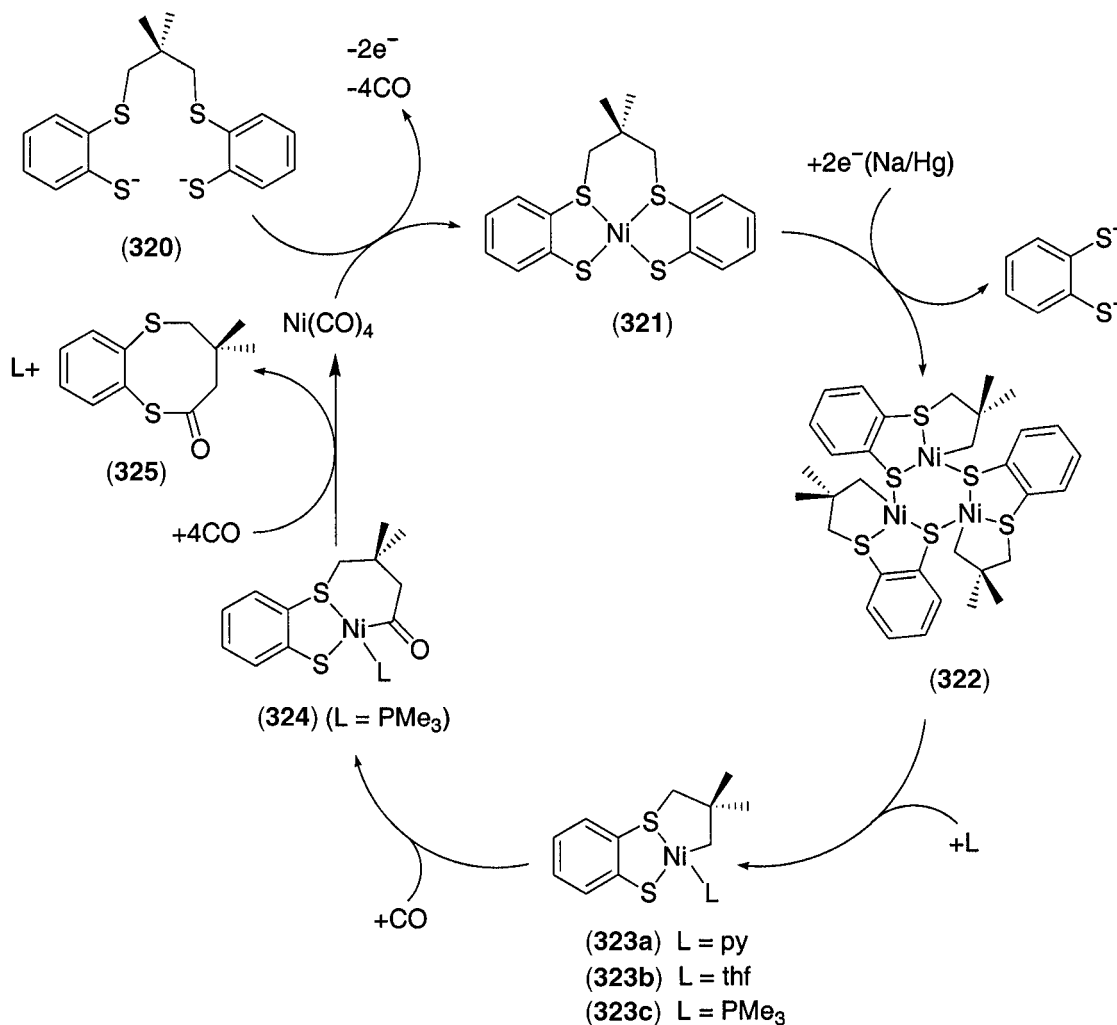

Scheme 2

The type (**326**) azido and amido complexes $\text{NBu}_4[\{\text{S}_3\}\text{NiN}_3]$ and $\text{NBu}_4[\{\text{S}_3\}\text{Ni}\{\text{N}(\text{SiMe}_3)_2\}]$ were found to react with CO, CO_2 , and SO_2 under very mild conditions at temperatures down to -50°C . Depending on the oxidation state of the N-donor ligands, addition or partial to complete desoxygenation of the oxides take place. The reaction between $\text{NBu}_4[\{\text{S}_3\}\text{NiN}_3]$ and CO gives $\text{NBu}_4[\{\text{S}_3\}\text{Ni}(\text{NCO})]$. The reaction between $\text{NBu}_4[\{\text{S}_3\}\text{Ni}\{\text{N}(\text{SiMe}_3)_2\}]$ and CO, CO_2 , and SO_2 affords selectively the complexes $\text{NBu}_4[\{\text{S}_3\}\text{NiX}]$ with $X = \text{CN}^-$, NCO^- , NSO^- . The silyl groups act as oxygen scavengers. Mechanisms are suggested which have in common the formation of reactive five-coordinate $\text{NBu}_4[\text{LNiXX}']$ intermediates. In these reactions highly activated X and X' react with each other.⁸⁵⁶

The oxidation of nickel-bound thiolate by dioxygen has been explored for complexes of multi-dentate ligands including $\text{S}(\text{CH}_2\text{CH}_2\text{S}^-)_2$.⁸⁵⁷ Reaction of the dithiole with $\text{Ni}(\text{OAc})_2$ gives the thiolate bridged dimer $[\text{Ni}\{\text{S}(\text{CH}_2\text{CH}_2\text{S}^-)_2\}_2]$. Reaction of this with $(\text{Et}_4\text{N})\text{CN}$ gives planar $\text{Et}_4\text{N}[\text{Ni}\{\text{S}(\text{CH}_2\text{CH}_2\text{S}^-)_2\}\text{CN}]$ (**327**), the crystal structure of which shows a highly distorted square

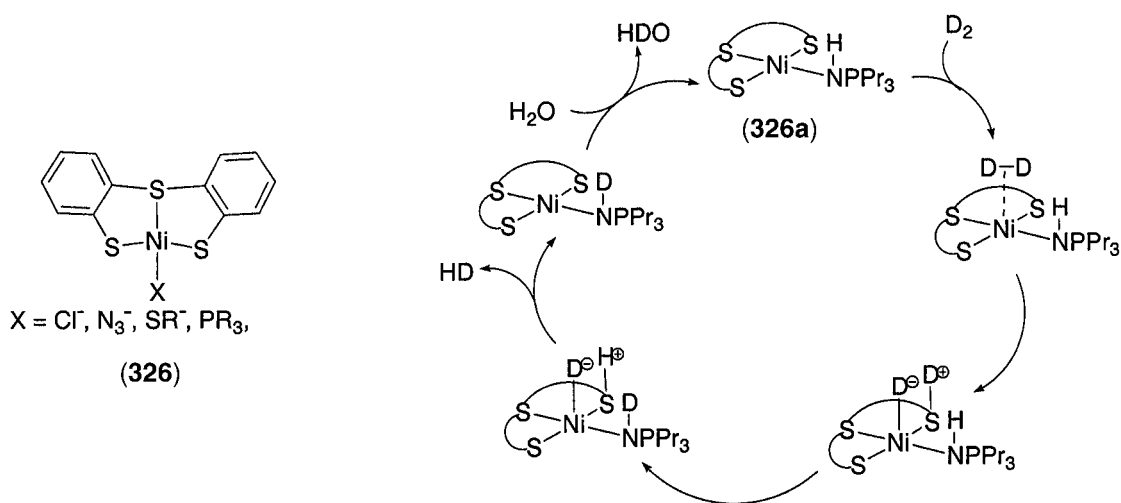

planar arrangement with *trans*-thiolates. (327) reacts with dioxygen to form a planar complex (328) of a mixed thiolate–sulfinate ligand. Isotopic labeling studies show that the two sulfinate atoms in each molecule derive mainly from a single O₂ molecule.

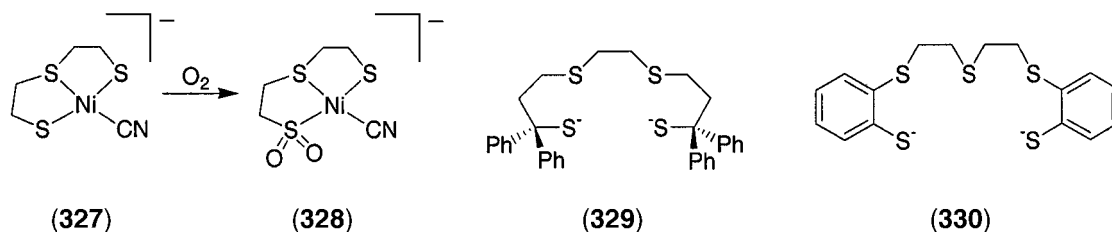

The ligand (329) affords with Ni^{II} the dark violet square planar complex [Ni(329)].^{858,859} Cyclic voltammetry shows that [Ni(329)] undergoes one-electron reduction at -1.33 V, which shifts to more positive potentials and becomes irreversible in the presence of CO. This together with IR spectroscopic data suggests that the corresponding Ni^{II} complex binds CO. Moreover the complex is catalytic for CO₂ reduction. Thus, the complex mimics two of the suggested reactions of the nickel site in [NiFe] CODH.

A nickel-promoted C–S bond cleavage has been reported,⁸⁶⁰ which occurs when solutions of the Ni^I complex of (330) are electrogenerated. The product was identified by cyclic voltammetry and spectroscopy as [Ni(C₆H₄S₂)₂]²⁻. EPR and NMR evidence suggests a one-electron mechanism, involving reduction to a 19-electron Ni^I species, electron transfer, and concomitant C–S bond cleavage, extrusion of ethylene followed by a further one-electron reduction and extrusion of ethylene sulfide.

The olive green precursor to the S-rich [Ni(S₂CPh)(S₃CPh)], originally thought to be [Ni^{IV}S(S₂CPh)₂], has been identified as [Ni(S₂CPh)₃]⁻ and crystallographically characterized as the [K(2,2,2-crypt)]⁺ salt.⁸⁶¹

6.3.4.7.4 Complexes with dithiophosphates and related ligands

With dithiophosphate ligands (also called phosphorodithioates), Ni^{II} forms complexes of the general formula [Ni{S₂P(OR)₂}]₂ with the bidentate ligands forming four-membered chelate rings. The {NiS₄} core has a square planar structure as confirmed by three crystal structures of this complex type with R = Prⁱ,⁸⁶² cyclohexyl,⁸⁶³ and the cyclic ligands with R–R = biphenyl and dimethylethylene.⁸⁶⁴ In addition, a number of adduct complexes with N-donors have been characterized structurally (Table 4). In the case of monodentate amine ligands, the square planar

Table 4 Bis(dithiophosphate)nickel(II) complexes with N-donor ligands

Complex	R	N-donor ligand X	References
L ₂ NiX (331)	Bu ⁿ	a (bipy)	865
L ₂ NiX ₂ (332)	Bu ⁿ	b (imid)	866
[LNiX ₂]L (333)	Bu ⁿ	c (phen)	867
[LNiX ₄]L (334)	C ₆ H ₁₁ (cyclohexyl)	n-BuNH ₂	868
L ₂ NiX ₂ (335)	C ₆ H ₁₁ (cyclohexyl)	PhCH ₂ NH ₂	869
L ₂ NiX ₂ (336)	Bu ⁿ	d	870
L ₂ NiX ₂ (337)	Et	e	871
L ₂ NiX ₂ (338)	Et	f (mepy)	872
L ₂ NiX ₂ (339)	Et	g	873
L ₂ NiX ₂ (340)	Bu ⁿ	e	874
[L ₂ NiX] _n (341)	Bu ⁿ	h (4,4'-bipy)	875
L ₂ NiX (342)	4-Methyl-pentyl	i	876
L ₂ NiX (343)	Tolyl	c (phen)	877
L ₂ NiX ₂ (344)	Pr ⁱ	j	878

{NiS₄} core is conserved giving *trans* octahedral complexes, while with bidentate amines *cis* octahedral complexes are obtained. Linear bidentate amines can result in a 1D chain like in compound (341) where 4,4'-bipyridine molecules bridge the square planar units.

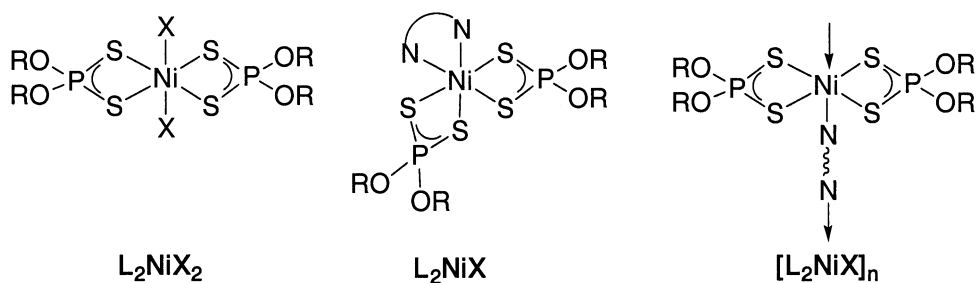

In compounds (333) and (336) the amines substitute one of the dithiophosphate ligands to form a {NiN₄S₂} core with the second dithiophosphate ligand serving as a counterion. Coordination number 5 is rare, but is found for complex (345) where one of thiophosphates switched to a monodentate coordination,⁸⁷⁹ and in compound (346) where only one additional phosphine adduct coordinates to Ni.⁸⁸⁰

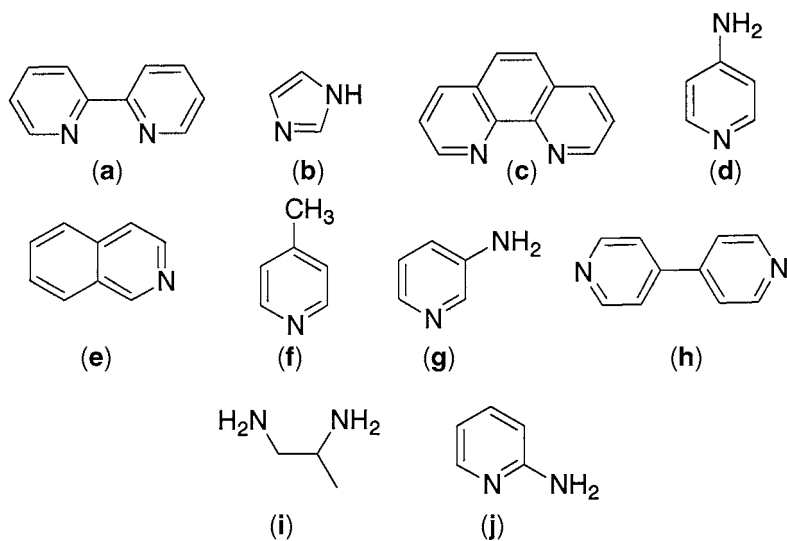

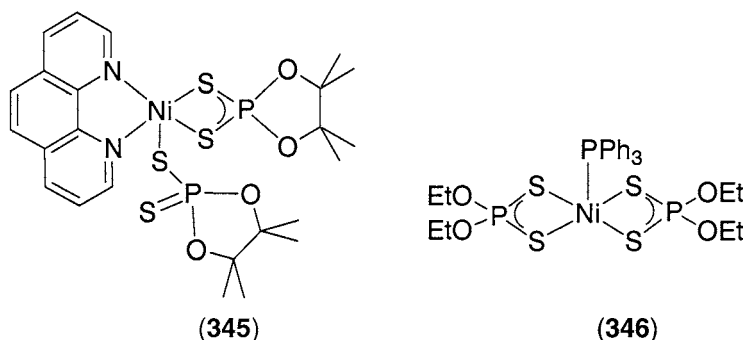

Stability constants of dithiophosphate nickel complexes have been determined by potentiometric and spectrophotometric measurements.⁸⁸¹ A number of binary and mixed ligand Ni complexes of dialkyl dithiophosphate and ammoniummethyl dithiophosphate were studied with respect to their thermal decomposition reactions by TG and DSC techniques in nitrogen and oxygen atmospheres.⁸⁸² The activation energies for the thermal decomposition were determined thermogravimetrically using different approaches to analyze the data.^{883–885} The thermogravimetric and vapor pressure studies of a number of $[\text{NiL}_2]$ complexes reveal that only for $\text{R} = \text{Et}$ the thermal stability is high enough to allow gas chromatography of these compounds.⁸⁸⁶ N-donor adduct complexes are unstable towards the loss of the N-donor upon heating.^{887,888} Nickel complexes of dithiophosphates are not stable towards hydrolysis.⁸⁸⁹ Hydrolysis can be followed by ^{31}P NMR spectroscopy.⁸⁹⁰ The complex dissociation of bis(O,O'-dipropyl dithiophosphato) Ni^{II} in ethanol–water mixtures can be utilized for spectrophotometric detection of the alcohol content of alcoholic drinks.⁸⁹¹

Various physicochemical methods have been used to investigate structural features and properties of the dithiophosphate Ni^{II} complexes,^{892–894} among them IR, ^1H NMR, ^{31}P NMR, EPR, ENDOR,⁸⁹⁵ electronic spectroscopy,⁸⁹⁶ spectrophotometry,⁸⁹⁷ magnetochemical studies, as well as cyclic voltammetry and coulometry.⁸⁹⁸ The oscillator strength for the $d-d$ transitions in planar $[\text{ML}_2]$ complexes of D_{2h} symmetry were calculated within the framework of the vibronic mechanism and the AOM. General expressions were used to interpret the intensities and polarization of the $d-d$ bands in the bis(diethyldithiophosphato) Ni^{II} spectra.⁸⁹⁹ A theoretical *ab initio* (pseudopotential valence only) and UV–PE (He I and He II) spectroscopic examination of $[\text{M}(\text{S}_2\text{P}\{\text{OEt}\}_2)_2]$ complexes ($\text{M} = \text{Ni}, \text{Pd}, \text{Pt}$) has been reported. The conclusions of this study are that the metal-based orbitals are more tightly bound in Ni than in Pd or Pt complexes. Ni ionization energies obtained by the Tamm–Dancoff method deviate from Koopman's theorem. The dominant nickel–ligand interaction is of σ -character, the d_{xz} and d_{yz} orbitals being almost nonbonding.⁹⁰⁰

Complexes with the enantiomeric ligands cyclo-O,O'-(*R,R*)- or (*S,S*)-1,2-dimethylethylene dithiophosphate were synthesized and characterized via UV–visible and CD-spectroscopy and by an X-ray crystal structure, the results of which were correlated. The absence of an intrinsic configurational chirality on the metal results in CD-spectra due only to the less intense chirality induced on the Ni^{II} electronic $d-d$ transitions by the ligands outer ring conformations and absolute configuration on the C_2 and C_3 atoms of the two chelating ligands.⁸⁶⁴

A huge number of Ni^{II} thiophosphate complexes and their adducts with nitrogen bases like pyridine, picoline, bipyridine, phenanthroline, or isochinoline have been prepared and characterized by spectroscopic methods.^{894,901–903} For example, ^{14}N NMR was used to measure the pyridine exchange in a series of pyridine adducts.⁹⁰⁴ The relationship between the intrinsic Lewis acidity of the Ni^{II} center in the parent complex, as measured by equilibrium constants for bis(pyridine) adduct formation, and the lability of pyridine in the adducts were explored. In another investigation, the interaction of NiL_2 with several pyridine-type adducts was studied via relative isotropic ^1H NMR spectroscopic shift studies.⁹⁰⁵ The adduct formation has been examined thermodynamically by spectrophotometric methods, and formation constants and reaction enthalpies and entropies were measured.⁹⁰⁶ For some N-adduct complex structures deviating from the above mentioned ones were suggested from electronic and IR spectra.^{876,907} Good agreement between electronic spectra of a number of complexes and calculated values using the ASED-MO method was observed.⁹⁰⁸

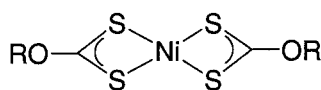

(354)

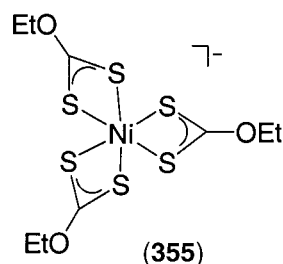

(355)

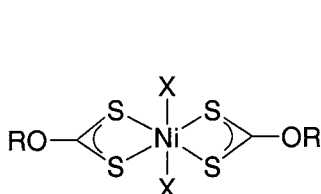
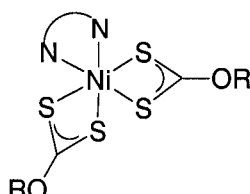
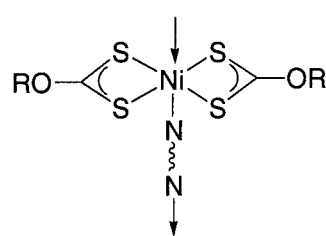
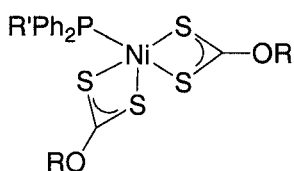
 L_2NiX_2
(356)

 L_2NiX
(357)

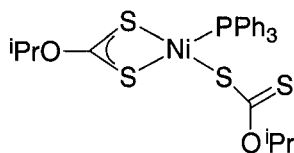
 $[L_2NiX]_n$
(358)

(359a) $R' = Ph, R = Et$
(359b) $R' = Me, R = Cy$

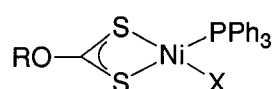

(360)



(361a) $R = Amyl, X = Br$
(361b) $R = iPr, X = Cl$

Analogous to the dithiophosphate complexes, *cis* octahedral complexes are formed with bidentate ligands like phenanthroline, 2,2'-bipyridine, or tmeda and *trans* octahedral complexes are formed with monodentate ligands like pyridine and its derivatives. Some examples are mentioned with linear bidentate ligands like 4,4'-bipyridine, which build up 1D chains by bridging the $[NiL_2]$ molecules.⁹²⁶⁻⁹³³

With P-donors a variety of different structures are formed. Two complexes (359a,b) with a five-coordinate square pyramidal geometry and one S-donor in the apical position are reported.^{934,935} In a related complex (360) the nickel center reveals a distorted square planar geometry, because one xanthate ligand switched to a monodentate coordination mode.⁹³⁶ By reaction of $[NiL_2]$ complexes with $Ph_2P(CH_2)_2P(Ph)(CH_2)_2PPh_2$, compound (362) is formed, which consists of a five-coordinate cation and a hexacoordinate anion.⁹³⁷

In (362), the cation is distorted trigonal pyramidal with the axial positions occupied by one S atom and the central P atom of the $\{P_3\}$ ligand. In the anion the nickel center is bonded to six S-donors of three xanthate ligands. Upon reaction with dppe an approximately square planar $\{NiS_2P_2\}$ complex results.⁹³⁸ A similar coordination geometry is found for the two complexes (361a,b).^{939,940}

The bis(xanthate) Ni^{II} complexes and their adduct complexes have been characterized by various physicochemical methods like NMR, IR, and UV.^{941,942} Electrochemical investigations of $[Ni(S_2COEt)_2]$ revealed two irreversible oxidation peaks at 0.35 V and 0.80 V (referenced to the Ag/Ag^+ electrode). The CV of $[(EtOCS_2)_3Ni]^-$ displays one reversible (-0.15 V) and two irreversible (0.35 V and 0.80 V) oxidation peaks.^{943,944} The low-temperature EPR spectra of the oxidatively electrolyzed solution of $[NiL_3]^-$ indicates the presence of $[Ni^{III}L_3]$, which disproportionates to $[NiL_2]$ and the dimer of the oxidized ligand, $EtOC(S)SS(S)COEt$. The corresponding chemical oxidations were achieved with iodine. Xanthate Ni^{II} complexes are of interest as liquid crystals, and as additives in lubricating oils or in polymers as antioxidants.

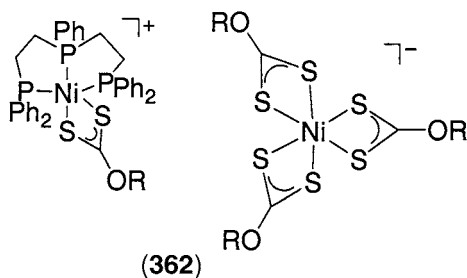

R, R' = CH₂CH₂OH (363a)

R = C(O)CH₃; R' = CH₂Ph (363b)

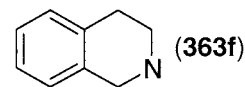
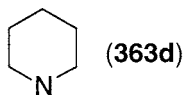
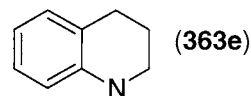
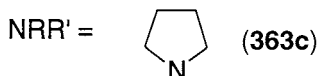
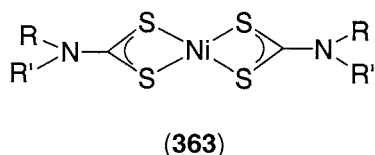

6.3.4.7.6 Complexes with dithiocarbamate and related ligands

Quite a number of Ni^{II} complexes with dithiocarbamate ligands have been characterized structurally. These complexes have the general formula [Ni(S₂CNRR')₂] with the carbamates being unsubstituted (R, R' = H), N-monosubstituted (R = alkyl, aryl; R' = H), or N,N-disubstituted (R, R' = alkyl, aryl).⁹⁴⁵ As the carbamates coordinate bidentately through the S-donors, a square planar coordination geometry with four-membered chelate rings is found. The Ni—S bond lengths are in the range 2.19–2.22 Å.

The substituents R and R' may even bear further functional groups like in (363a)⁹⁴⁶ and (363b)⁹⁴⁷ or be part of a cyclic system like in (363c)⁹⁴⁸ and (363d).⁹⁴⁹ Similar complexes (363e) and (363f) have been made using tetrahydroquinoline dithiocarbamate and tetrahydroisoquinoline dithiocarbamate.⁹⁵⁰ A convenient synthetic route to the preparation of carbodithioato derivatives of weak N nucleophiles has been reported: N-alkyldithiocarbamate ligands, when bidentately coordinated to Ni^{II}, were found to undergo facile electrophilic substitution reactions with a diversity of electrophiles, yielding novel carbodithioato derivatives of weak N bases, not available by other synthetic methods.^{951,952} Furthermore, complexes with dithiocarbamate ligands containing electrophiles [Ni(S₂CN(E)R)] (E = electrophile, e.g., CONHPh, COOEt, PhSO₂; R = Me, n-butyl, Ph, PhCH₂) have been prepared and characterized by spectroscopic methods.⁹⁵³

Analytical techniques that have been applied to study the carbamate complexes are, *inter alia*, electronic,⁹⁵⁴ IR, resonance Raman, NMR, UV, and XPS^{955–958} spectroscopy. An interesting development is a correlation of the shifts in the infrared spectra with those observed for atomic core levels in the X-ray photoelectron spectra.⁹⁵⁹ ⁵⁹Ni and ⁶²Ni isotopic labeling has been applied in an infrared study carried out on a variety of heterocyclic dithiocarbamate nickel complexes. Assignment of the Ni–ligand vibrational modes revealed that the Ni—S bond strength is practically independent of the substituent in the heterocycle.⁹⁶⁰

A comparative study of the electronic structures of N,N-diethyldithiocarbamate and pyrrole-N-carbodithioate has been undertaken.⁹⁶¹ The enthalpy of formation of [Ni(S₂CNMe₂)₂] (–146.1 ± 10.9 kJ mol^{–1}) has been measured.⁹⁶² The square planar dithiocarbamate complexes can be oxidized to the corresponding five-coordinate Ni^{III} dithiocarbamate complexes [Ni(S₂CNR₂)₂X] (X = I, Br, ClO₄) using Br₂, I₂, or (NO)ClO₄.^{963,964}

A number of mixed ligand complexes have been reported. In many cases the square planar coordination geometry is conserved in complexes [NiLQ] (Q = xanthates, aldoximes, dimethylglyoxim,^{954,965} Schiff bases derived from L,⁹⁶⁶ or phosphines).^{957,967–970} Comparison of a dithiocarbamate complex (364) with PPh₃ ligands and the corresponding complex (365) with the chelating phosphine dppe revealed that both complexes have planar {NiS₂P₂} chromophores,

but dppe forces the Ni—S distances to be symmetrical (2.200 Å and 2.204 Å), while PPh₃ induces asymmetry (2.227 Å and 2.198 Å).^{971,972} On the contrary the phen adduct of [Ni(S₂CNEt₂)₂] is the first example of the addition of a chelating diamine to form an octahedral complex [Ni(dto)(phen)] (367).⁹⁷³

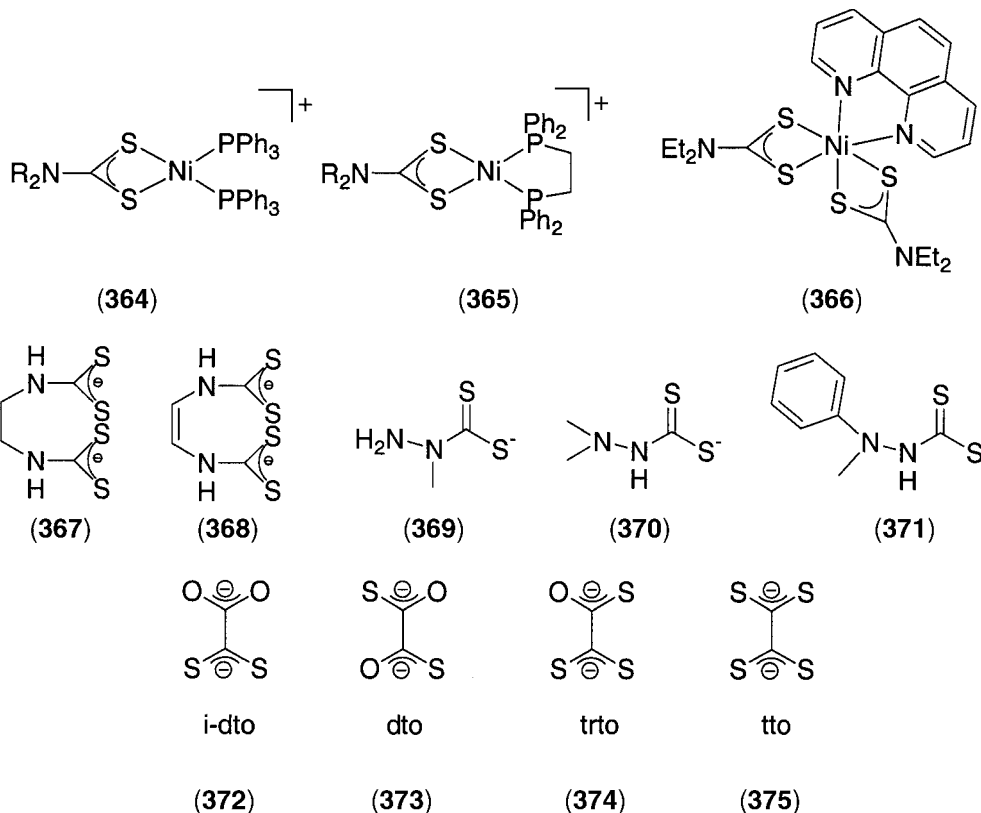

The reactivity of (367) and (368) towards phosphine complexes of Ni^{II} has been investigated. Depending on the nature of the phosphine and the dithiocarbamate used, different complexes were obtained.⁹⁷⁴ The stability constants for the Ni^{II} complexes of (369), (370), and (371) have been determined in aqueous solution. Both 1:1 and 1:2 complexes were observed.⁹⁷⁵

6.3.4.7.7 Complexes with thiooxalate and related ligands

Considering the four thiooxalates 1,1-dithiooxalate (i-dto), 1,2-dithiooxalate (dto), trithiooxalate (trto), and tetrathiooxalate (tto), dto is by far the most prominent in Ni^{II} coordination chemistry.⁹⁷⁶

Dto coordinates to Ni^{II} in a bidentate manner via its sulfur donors, resulting in square planar dianion complexes [Ni(dto)₂]²⁻. The nickel chelate with dto is much more stable than that with oxalate. However, the remaining dto oxygens tend to coordinate to further metal ions (e.g., the counterions) to yield definite multinuclear arrangements. In complexes with organic “onium” cations (e.g., anilinium,⁹⁷⁷ pyridinium,^{978–980} pyrazinium,⁹⁸¹ ethylenediammonium,⁹⁸² arsonium,⁹⁸³ or phosphonium⁹⁸⁴) this interaction is lacking. Nevertheless the crystal structures of these compounds reveal that the ions are associated through H bonds, the motif depending on the nature of the cation. Supramolecular interactions lead to a 3D character.⁹⁸⁵ The spectroscopic properties of the dto–nickel complexes are well examined and a comprehensive summary is given in a review.⁹⁷⁸

6.3.4.7.8 Complexes with dithioketones and related ligands

Dithioacetylacetonate (sacsac) forms square planar complexes with Ni^{II}, the chelate rings being six membered. A comparative IR, ¹H NMR, and ¹³C NMR study of nickel complexes with sacsac

and the derivatives acac, nacac, and sacac has been carried out.⁹⁸⁶ An electrochemical study of $[\text{Ni}(\text{sacsac})_2]$ (**376**) revealed a one-electron quasi-reversible reduction at -1.54 V and an irreversible four-electron oxidation at $+0.64$ V. The product of the reduction reacts with H_2O , CO , CO_2 , CH_3I , and $\text{C}_{12}\text{H}_{25}\text{SH}$.⁹⁸⁷ Addition of N-donors L to $[\text{Ni}(\text{sacsac})_2]$ leads to five-coordinate complexes $[\text{Ni}(\text{sacsac})_2\text{L}]$ (L = variously substituted pyridines or anilines).^{988,989}

Nickel ketoenolates are active catalysts in olefin polymerization. The reactions are promoted by phosphines as coligands. Complexes $[\text{Ni}(\text{sacsac})\text{X}(\text{PR}_3)]$ (R = Ph, Me, Et, cyclohexyl; X = Cl, Br),⁹⁹⁰ $[\text{Ni}(\text{sacac})\text{Cl}(\text{PR}_3)]$ (**377**; R = Et, Buⁿ) and $[\text{Ni}(\text{sacsac})\text{Ph}_2\text{P}(\text{CH}_2)_n\text{PPh}_2]\text{BPh}_4$ ^{991,992} ($n=1,2$) have been reported, which disproportionate to some extent in solution. The crystal structure of $[\text{Ni}(\text{sacac})\text{Cl}(\text{PEt}_3)]$ (**377**) shows square planar geometry of the Ni^{II} ion with P *trans* to O and S *trans* to Cl. Changing the phosphine ligand affects the activity and selectivity of the oligomerization reaction, while changing sacac for saacs increases catalyst activity.^{993,994} Crystal structures of mixed ligand complexes (**378a**) and (**378b**) with derivatives of sacsac and diisopropylthiocarbamate have been reported.^{995,996}

Also, the structure of the Ni^{II} complex (**379**) with the related ligand dimethyltetrathiomalonate has been determined.⁹⁹⁷ The geometry at the nickel center is approximately square planar with an inversion center. (**379**) shows reversible redox properties.⁹⁹⁸ Oxidation with I_2 affords 1,3-bis(methylthio)-1,2-dithiolium triiodide.

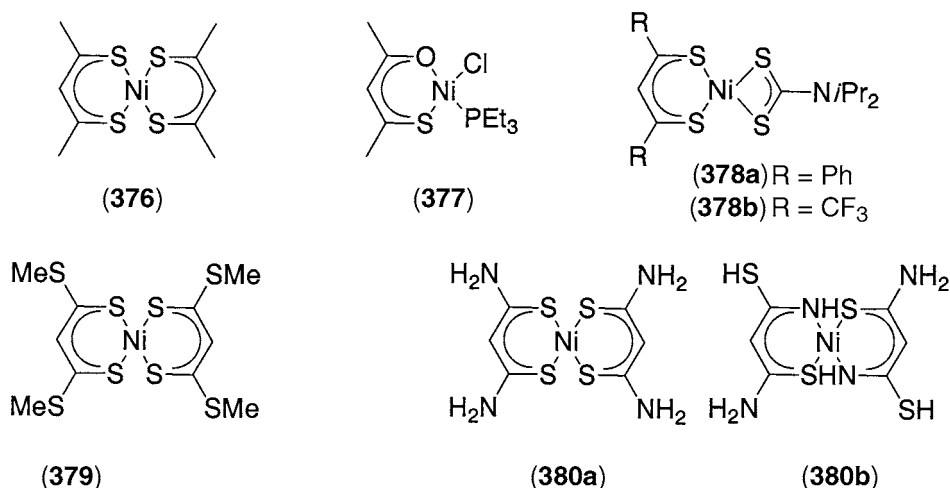

A related ligand is dithiomalonamid, which is able to form two different coordination isomers (**380a**) and (**380b**) with Ni^{II} .⁹⁹⁹ One X-ray structure of the diphenyl derivative has been determined. In this case the ligand coordinates via the S-donors, so that a square planar $\{\text{NiS}_4\}$ arrangement results. NMR spectra confirm that the structure is maintained in solution.¹⁰⁰⁰

6.3.4.7.9 Complexes with thiourea and related ligands

Thiourea and substituted thioureas coordinate as monodentate ligands to Ni^{II} to give either square planar $[\text{NiL}_4]$ or octahedral complexes $[\text{NiL}_4\text{X}_2]$ in most cases. Some of these complexes with parent thiourea (**381**), imidazolidene-2-thione (**382**),¹⁰⁰¹ and 1-methylimidazoline-2-thione¹⁰⁰² have been characterized by X-ray crystal structure. Solely for the complexes $[\text{NiL}_2\text{Cl}_2]$ (L = (**383**))¹⁰⁰³ and $[\text{NiL}_2\text{X}_2]$ (L = phenyl-thiourea; X = CN^- , SCN^-)^{1004,1005} a high-spin tetrahedral coordination geometry is proposed.

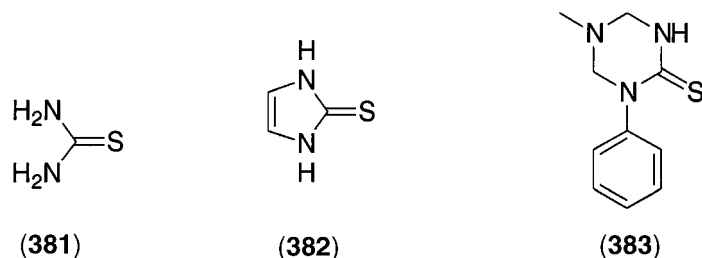

Another exception is $[\text{NiL}_3(\text{NCS})\text{X}]_2$ ($\text{L} = \text{thiourea}, o\text{-tolylthiourea}$; $\text{X} = \text{Cl}^-, \text{NO}_3^-$), which is a dinuclear complex with thiocyanato bridges.¹⁰⁰⁶ Numerous complexes with substituted thiourea have been synthesized^{1007–1009} and characterized by spectroscopic or thermogravimetric methods. IR and Raman spectroscopy are excellent tools for proving coordination via the S-donor. For a series of $[\text{NiL}_4\text{Cl}_2]$ complexes the thermal degradation has been investigated, indicating two different decomposition mechanisms via intermediates $[\text{NiLCl}_2]$ or $[\text{NiLCl}]$ to give NiS as the final product. The respective mechanism depends on the structure of the thiourea ligand.¹⁰¹⁰

A theoretical study employing the discrete variational $\text{X}\alpha$ implementation of Hartree–Fock–Slater theory has been carried out for $[\text{Ni}(\text{thiourea})_4\text{Cl}_2]$. This accounts better for experimental data (optical spectra, magnetic properties, and charge density distribution) than crystal or ligand field theories and supports the existence of considerable covalency in the metal–ligand bonding.¹⁰¹¹ The dependence of the spin state of *trans*- $[\text{NiL}_4\text{X}_2]$ ($\text{L} = \text{diethyl-thiourea}$; $\text{X} = \text{Cl}, \text{Br}, \text{I}$) on pressure has been studied. High pressure shifts the singlet–triplet equilibrium observed for these complexes in favor for the triplet. This is consistent with pressure forcing the axial ligands closer to the nickel ion.¹⁰¹²

N,N'-diphenylthiourea (H_2L) has been reacted with Ni^{II} to give the neutral complex $[\text{Ni}(\text{HL})_2]$, which has been characterized using spectroscopic and thermogravimetric analysis. In addition, the stability constants for $[\text{Ni}(\text{HL})]^+$ and $[\text{Ni}(\text{HL})_2]$ have been determined spectrophotometrically.¹⁰¹³

Various thiourea ligands have been used in the synthesis of mixed ligand complexes. A series of complexes $[\text{NiQ}_2\text{L}_2]$ ($\text{HQ} = \text{ethylacetoacetate}$, $\text{L} = \text{thiourea}, \text{allyl-}, \text{benzoyl-}, \text{methyl-}, \text{diphenylthiourea}$) have been prepared. The complexes are all paramagnetic ($\mu = 3.02\text{--}3.27\mu_{\text{B}}$) and have been assigned *trans*-octahedral structures.¹⁰¹⁴

6.3.4.7.10 Complexes with dithiolene ligands

Bis-1,2-dithiolene complexes have been widely studied due to their physical properties and their projected applications in the areas of conducting and magnetic materials, dyes, nonlinear optics, catalysis, and others. These applications arise from a combination of functional properties, specific geometries, and intermolecular interactions. A large number of new dithiolene ligands and resultant complexes have been prepared with the aim to vary and optimize the molecular properties and to prepare novel and improved materials. This interest, fired by the discovery of phenomena such as superconductivity and ferromagnetism in metal dithiolene salts, has resulted in the search for new analogues with better properties. A selection of frequently employed dithiolene ligands is given below.

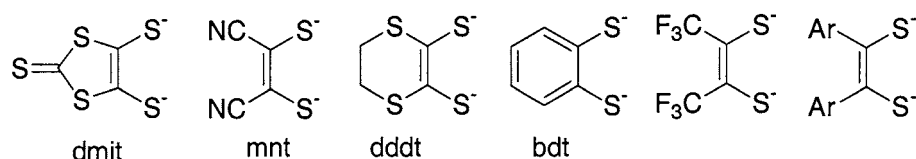

Several reviews presenting various aspects of dithiolene chemistry have appeared over the years,^{1015–1026} so that this summary will only focus on some selected findings. Also, the photodissociations of Ni dithiolene complexes, which lead to long-lived Ni complex radicals, have been reviewed.¹⁰²⁷ Since many studies in the field of Ni–dithiolene chemistry deal with different oxidation states of the metal, this chapter will also cover much work related to Ni^{III} and Ni^{IV} .

The most characteristic feature of nickel dithiolene complexes is the existence of an electron transfer series whose members are interrelated by reversible one-electron steps. Three members I–III of the series, I and III being diamagnetic and II having an $S = 1/2$ ground state, are preparatively accessible: $[\text{Ni}(\text{S}_2\text{C}_2\text{R}_2)_2]^{2-}$ (I) \leftrightarrow $[\text{Ni}(\text{S}_2\text{C}_2\text{R}_2)_2]^{1-}$ (II) \leftrightarrow $[\text{Ni}(\text{S}_2\text{C}_2\text{R}_2)_2]$ (III).

The well-known ambiguities in limiting descriptions of metal and ligand oxidation states are summarized below.

While the structural and electronic properties of the dianions are consistent with the indicated Ni^{II} -enedithiolate description, two and four formulations are conceivable for the monoanion and the neutral complex, respectively. For the latter, one is a ligand diradical whose spins are antiferromagnetically coupled, consistent with diamagnetism. Numerous members of the series have been isolated and/or generated in solution by chemical or electrochemical reactions. Because redox potentials are markedly dependent on the nature of the R substituent, certain members of a given series have not been isolated in substance.

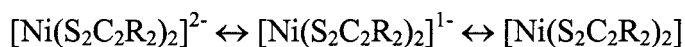

I

II

III

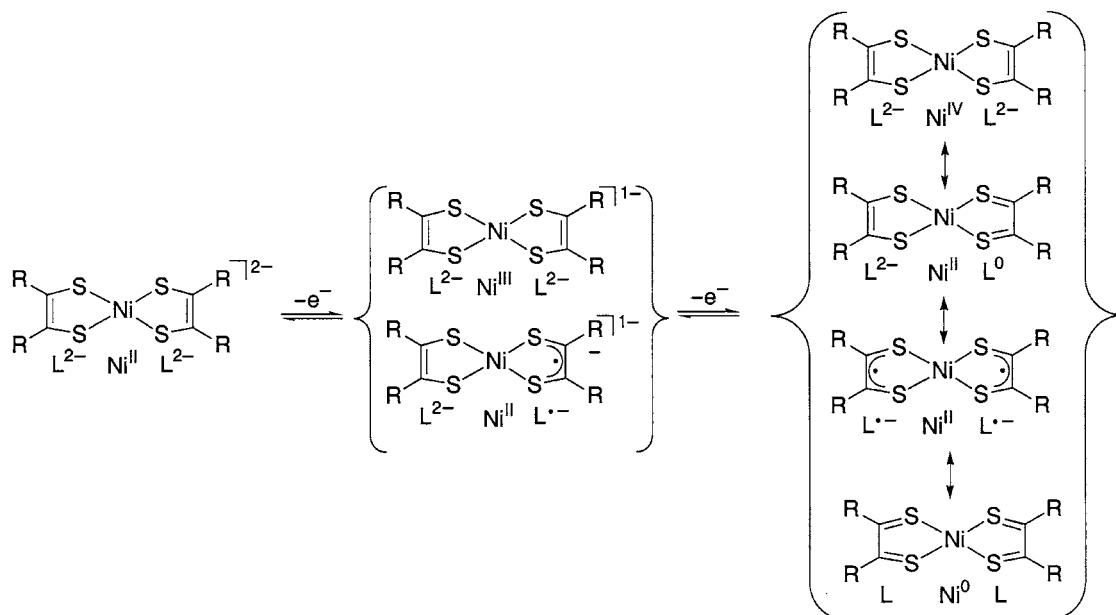
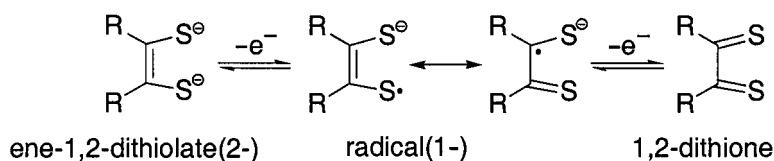

There are few examples of complexes where all three oxidation states have been isolated. Two examples, $[\text{Ni}(\text{S}_2\text{C}_2(\text{CF}_3)_2)_2]^{0,1-,2-}$ and $[\text{Ni}(\text{S}_2\text{C}_2\text{Ph}_2)_2]^{0,1-,2-}$, had already been realized in the 1960s. For the two newer examples, $[\text{Ni}(\text{S}_2\text{C}_2\text{Ph}_2)_2]^{0,1-,2-}$ (**384**)¹⁰²⁸ and $[\text{Ni}(3,5\text{-Bu}_2\text{bdt})_2]^{0,1-,2-}$ (**385**)¹⁹⁰, even X-ray structures of all three oxidation states are available. All members of the series show planar structures, the $d(\text{Ni}-\text{S})$ and $d(\text{C}-\text{S})$ bond lengths increase, the $d(\text{C}-\text{C})$ bond lengths decrease. For (**384**), DFT calculations reveal that the electroactive orbital is highly delocalized, and electron transfer reactions are largely ligand-based events. The isolation of the three species (**385**) confirms that ligands derived from 1,2-benzenedithiolate(2-) behave as normal 1,2-dithiolate ligands. Here the X-ray structures show a different trend: $d(\text{Ni}-\text{S})$ and $d(\text{C}-\text{S})$ decreasing and $d(\text{C}-\text{C})$ almost retaining its value. Together with XPS and EPR investigations this has led to the suggestion that the oxidation concerns electrons which reside in orbitals having $\{\text{NiS}_4\}$ character (compare also Section 6.3.3.6).

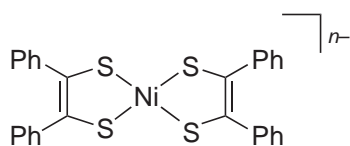
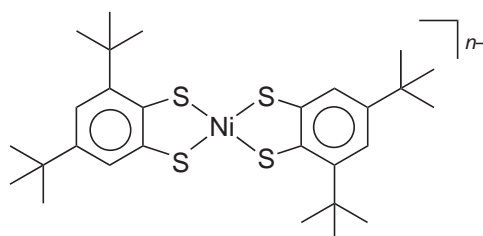
**(384)** $n = 0, 1, 2$ **(385)** $n = 0, 1, 2$

An enormous amount of research has gone into the synthesis and characterization of dmit ligand complexes and related selenium and oxygen isologues. Interest centers on the isolation of

metallic or even superconducting materials, which owe these properties to extensive intermolecular $S\cdots S$ or $Se\cdots Se$ interactions.

The discovery of the first molecular superconductor containing a transition metal complex, $TTF[Ni(dmit)_2]_2$ (**386**), initiated a significant effort into the search for more of these fascinating materials.¹⁰²⁹

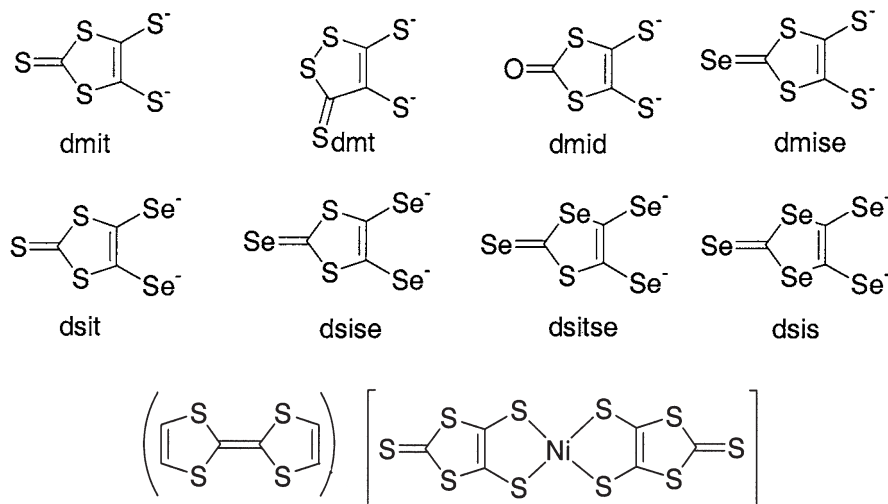

(**386**)

Since then seven further superconducting (at low temperatures and/or under high pressures) dmit-based complexes with Ni or Pd as metal, synthesized via electrocrystallization, have become known. The donor-acceptor complex α -(EDT-TTF)[Ni(dmit)₂]₂ is the first ambient pressure superconductor with $T_c = 1.3$ K.²⁵⁷⁸

The electrocrystallization and characterization of a novel molecular metal which displays both electronic and ionic conduction has been reported. The complex $Li_{0.6}(15\text{-crown-5-ether})[Ni(dmit)_2] \cdot H_2O$ is composed of stacks of [Ni(dmit)₂] units which provide pathways for electronic conduction. The stacks are separated by parallel stacks of 15-crown-5-ether moieties in a channel-like formation which facilitates ion conduction. The salt has a room temperature conductivity of 240 Scm^{-1} . Temperature-dependent magnetic susceptibility and NMR measurements were used to prove the existence of Li^+ movement within the crown ether channels.¹⁰³⁰

Concerning molecule-based magnets, the first spin-ladder was synthesized: $(p\text{-EPYNN})[Ni(dmit)_2]$ ($p\text{-EPYNN} = p\text{-N-ethylpyridinium } \alpha\text{-nitronyl nitroxide}$). Within the crystal lattice, the radical cation $p\text{-EPYNN}$ units are arranged in 1D chains with ferromagnetic interactions. The chains of [Ni(dmit)₂] moieties in the ladder formation exhibit coexistent antiferromagnetic interactions.^{1031,1032}

A much smaller amount of work has been done with nickel complexes of dmt ligands since they are more difficult to crystallize. Some complexes have been assembled combining [Ni(dmt)₂] with viologen-based cations for applications in electrical conductivity and dioxygen activation.¹⁰³³⁻¹⁰³⁵

Nickel complexes with the dmid ligand are also less recognized in research. A conductivity as high as 10^{-2} Scm^{-1} was reached with $(Et_4N)_{0.17}[Ni(dmid)_2]$.¹⁰³⁶ $(Bu_4N)_x[Ni(dmid)_2]$ complexes have been studied by XPS and for applications in electrical switching and memory devices.^{1037,1038}

The aim of substituting the S by a Se substituent in dmise is to increase dimensionality in the crystal lattice in order to enhance the electrical properties.^{1039,1040} In 1993, the first molecular conductors based on dmise, α - and β -(Me₄N)[Ni(dmise)₂]₂, were reported. The two structures show differences in molecular packing; both exhibit many short intermolecular $S\cdots S$ interactions, and the α structure also has some very short $Se\cdots Se$ distances. The β -phase showed the higher room temperature conductivity of 10 Scm^{-1} (bandgap: $E_g = 0.08 \text{ eV}$ (α), 0.05 eV (β)).¹⁰⁴¹ For dsise, the first nickel complexes were reported in 1993 and $(Me_4N)[Ni(dsise)_2]$, a semiconductor, has the highest room temperature conductivity of 12 Scm^{-1} .^{1042,1043}

1,2-Dithiolene complexes with the maleonitridedithiolate (mnt) ligand form highly delocalized systems and are widespread in studies of conducting and magnetic materials. The electronic properties have been extensively studied with various computational methods including Hückel and extended Hückel approaches to identify the nature of the orbitals involved in intramolecular and intermolecular interactions. These structural properties allow the complexes to interact in the solid state via short stacking $S\cdots S$ and short interstack $S\cdots S$ contacts.¹⁰⁴⁴⁻¹⁰⁴⁸

In $(\text{NH}_4)[\text{Ni}(\text{mnt})_2] \cdot \text{H}_2\text{O}$ ferromagnetic ordering was found below 4.5 K. This material consists of side-by-side stacks of planar $[\text{Ni}(\text{mnt})_2]^-$ complexes forming 2D sheets that are separated by a network of ammonium cations and H_2O . The stacks show an equidistant arrangement of the anions, which prevents the dimerization to a singlet ground state, observed in other salts. The Curie temperature increases markedly with pressure until ferromagnetic order abruptly disappears at 6.8 kbar, indicating that the magnetic coupling is very sensitive to intermolecular separation.^{1049,1050}

The charge transfer salt $(\text{BDNT})_2[\text{Ni}(\text{mnt})_2]$ (BDNT = 4,9-bis(1,3-benzodithiol-2-ylidene)-4,9-dihydronaphtho[2,3-c]1,2,5-thiadiazole) also shows ferromagnetic interaction with $J = 3.4$ K, which was concluded to arise from the $[\text{Ni}(\text{mnt})_2]^-$ component on the basis of EPR evidence. In the absence of structural data, however, further understanding of this behavior could not be obtained. The anion was shown to be monoanionic, hence the valence of BDNT is +0.5.¹⁰⁵¹

4,5-Dicyanobenzene-1,2-dithiolate (dcbdt) forms the Ni^{II} complex (387) and the respective Ni^{III} and partially oxidized $\text{Ni}^{\text{III/IV}}$ salts. The paramagnetic Ni^{III} compound is dimerized and its magnetic susceptibility reveals very strong antiferromagnetic coupling.¹⁰⁵²

With reference to the exceptional properties of $\text{Li}_{0.6}(\text{15-crown-5-ether})[\text{Ni}(\text{dmit})_2] \cdot \text{H}_2\text{O}$ some mnt complexes with crown ether complexes of alkali metals as counterions have been reported.¹⁰⁵³⁻¹⁰⁵⁵ $(\text{NBu}_4)_2[\text{Ni}(\text{mnt})_2\text{-Cu}_4\text{I}_4]$ shows a very unusual structure. The $[\text{Ni}(\text{mnt})_2]$ moiety supports a novel eight-membered Cu_4I_4 ring via two cyano groups, four of which coordinate to two copper ions in neighboring molecules, resulting in the formation of a unique doubly-bridged 1D chain structure.¹⁰⁵⁶ $(\text{DT-TTF})_2[\text{Ni}(\text{mnt})_2]$ shows high room temperature electrical conductivities (40 S cm^{-1}). Observation of a single line in the EPR spectra, which increases dramatically in width as the conductivity increases with temperature, is evidence for the presence of two magnetic subsystems which interact in the salt with paramagnetic $[\text{Ni}(\text{mnt})_2]^-$ ions.^{1057,1058}

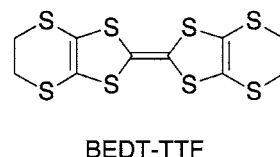
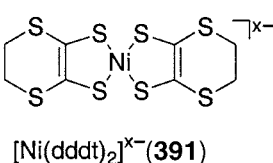
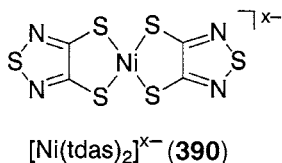
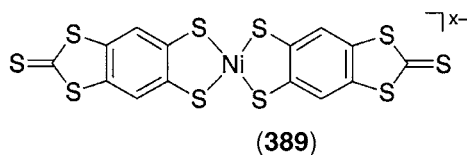
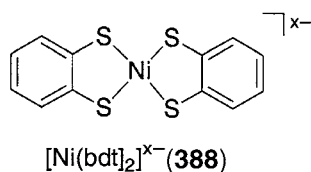
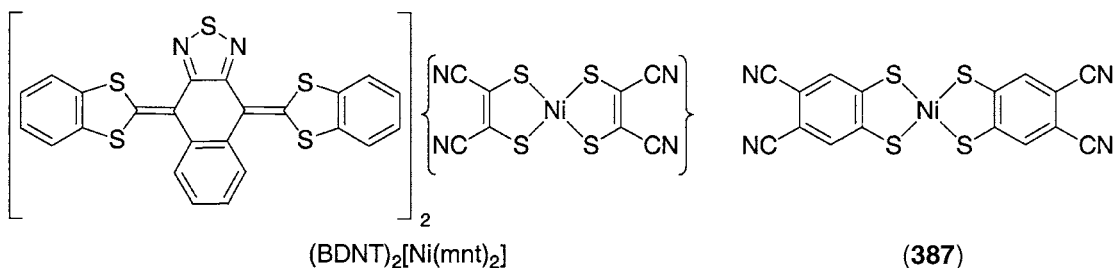

Complexes with the bdt ligand are less recognized, but some type (388) complexes with ligands derived from bdt have shown interesting properties. $(\text{NEt}_4)_x[\text{Ni}(\text{S}_2\text{C}_6\text{H}_3\text{CH}_3)_2]$ ($x = 2, 1$) has been studied for its electrochemical and spectroscopic properties.¹⁰⁵⁹

Complex (389) can be considered as a dmit analogue, in which the aromatic ring replaces the $\text{C}=\text{C}$ bond. The complex was isolated as $(\text{NBu}_4)_x[\text{NiL}_2]$ ($x = 2, 1, 0.29$). The latter nonintegral salt, prepared by electrocrystallization, shows metallic conductivity down to 20 K. The magnetic properties of the 1:1 salt with radical metal complexes revealed Curie-Weiss behavior with a weak antiferromagnetic interaction.^{1060,1061} In (389), the difference between the first and the second reduction potential is larger than for $[\text{Ni}(\text{dmit})_2]^{x-}$.

The salt $(\text{TTF})_2[\text{Ni}(\text{tdas})_2]$ (**390**) was obtained by electrocrystallization with a room temperature conductivity of 0.1 S cm^{-1} . This indicates the potential of these complexes as components of conducting materials. Some tdas complexes have been characterized by X-ray crystal structure.^{1062–1064}

A range of multisulfur 1,2-dithiolene complexes of nickel has been prepared, in which the 1,2-dithiolene moiety has been extended by incorporation of heterorings, e.g., in dddd (**391**). The research motivation had its origin in the similarity to BEDT-TTF, the organic electron donor known to have the largest number of superconducting organic salts and those with the highest T_c . Nickel complexes with the dddt ligand have been synthesized with a range of counterions with the charge on the complex ranging between dianionic, monoanionic, and neutral. But the dddt complexes are exceptional as they can be electrochemically oxidized to mixed-valence cationic complexes. The redox chemistry of $(\text{R}_4\text{N})[\text{Ni}(\text{dddtt})_2]$ has been studied using microelectrode techniques.^{1065,1066} Besides a quasi-reversible one-electron reduction ($E \approx -0.7 \text{ V}$) and oxidation ($E \approx 0.0 \text{ V}$), a further irreversible oxidation ($E_{\text{pa}} \approx +0.9 \text{ V}$) was observed, assigned to the formation of $[\text{Ni}(\text{dddtt})_2]_3(\text{BF}_4)_2$. The mechanism involves one-electron oxidation to $[\text{NiL}_2]^+$ followed by fast chemical processes leading either to the formation of the solid mixed valence complex, or to decomposition. $[\text{Ni}(\text{dddtt})_2]_3(\text{HSO}_4)_2$ and its isostructural analogue, $(\text{BEDT-TTF})_3(\text{HSO}_4)_2$, are both metallic at room temperature and exhibit insulator transitions at 25 K and 130 K, respectively.^{1067–1069} $[\text{Ni}(\text{dddtt})_2]_3[\text{AuBr}_2]_2$ also shows metallic behavior down to at least 1.3 K.^{1070,1071} Despite nickel dddt complexes and the organic salts being structurally related, there are differences in material properties, caused by differences in the frontier orbitals. Thus, the influence of a much smaller HOMO/LUMO separation in the nickel complexes than in the organic analogues and the influence of these orbitals on the dimensionality of the salt play a key role in the conducting properties. $[\text{Ni}(\text{dddtt})_2][\text{FeCl}_4]$ shows 3D behavior of its magnetic susceptibility despite the isolated chain or sheet arrangement of the magnetic anions.¹⁰⁷² This is regarded as a consequence of the coexistence of exchange paths involving the halides on the Fe and the π -electrons on the donor molecules. The complex shows an antiferromagnetic transition around liquid helium temperature if $[\text{FeCl}_4]^-$ is adopted as a counteranion, and the transition temperature is also affected by substitution of the central metal atom. $[\text{Ni}(\text{dddtt})_2]_x[\text{Ni}(\text{dmit})_2]_y$ is an example for a salt where both anion and cation consists of a nickel dithiolene complex.¹⁰⁷³

Some other ligands of the dddt family which are less recognized in research are depicted below. Examples in the literature have often been prepared for other applications such as optical materials. Especially on electrochemical and structural details much work has been done.^{1074–1080}

The complex $\text{Ni}[(\text{S}_2\text{C}_2(\text{CF}_3)_2)_2]$ (**392**) is able to bind light olefins selectively and reversibly.¹⁰⁸¹ According to Scheme 4, the reaction of olefins with (**392**) can be controlled electrochemically, where the oxidation state-dependent binding and release of olefins is fast on the electrochemical timescale. Olefin binding is supposed to occur via the ligand S-donors.

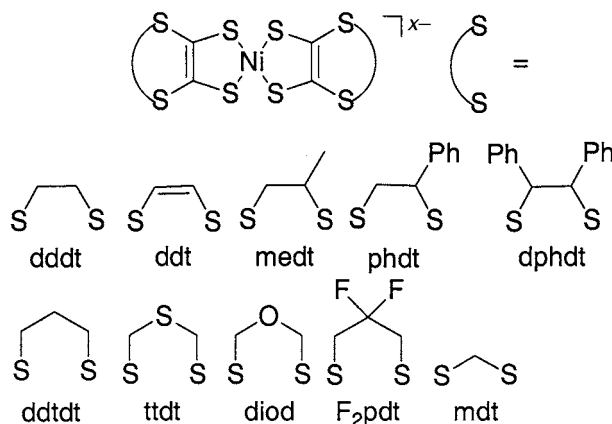

This sequence has been proposed as a novel approach to olefin separation and purification. However, there is disagreement about the reversibility of the reaction because it has been shown that irreversible reduction to the dianionic complex occurs through an ECE process.¹⁰⁸² A convenient new route to 1,2-enedithiolate complexes of Ni has been reported, which starts from the bis(hydrosulfido) complex $[\text{Ni}(\text{dppe})(\text{SH})_2]$ and various α -bromoketones (heterocycle- $\text{C}(\text{O})\text{CH}_2\text{Br}$).⁶⁷⁸

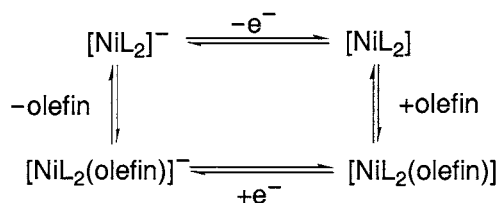
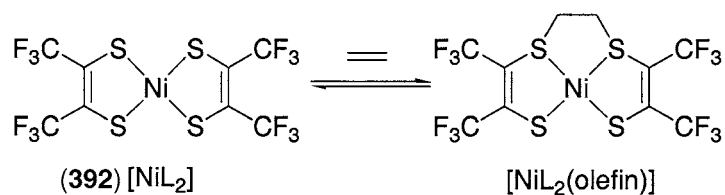

Scheme 4

6.3.4.7.11 Complexes with selenium- and tellurium-containing ligands

Nickel–selenium coordination compounds have received attention in recent years, because a unique Ni–selenocysteine interaction was revealed in the active site of [FeNiSe]-hydrogenases.^{1083,1084} Of particular interest in this regard are mixed CO/selenolate complexes. Distorted square planar (393) was prepared from [CpNi(CO)]₂, PhSeSePh, and [Fe(CO)₃(SePh)₃]⁻ and provides the first example of CO bound to a square planar Ni^{II} center in thiolate/selenolate environment.^{1085,1086} Upon addition of RSSR, species of the series [Ni(CO)(SR)_n(SePh)_{3-n}]⁻ are formed. $\nu(\text{CO})$ ranges from 2,023 cm⁻¹ to 2,043 cm⁻¹ and is regarded as a spectroscopic reference for the CO binding site in [NiFeSe] hydrogenases.

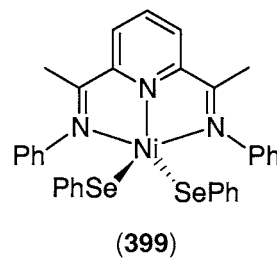
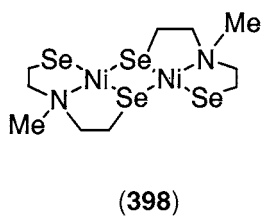
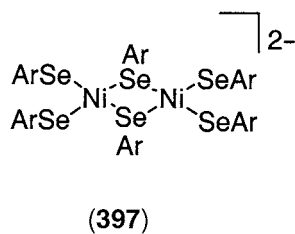
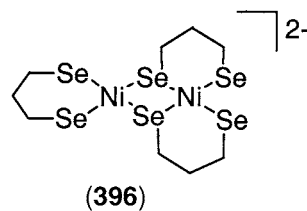
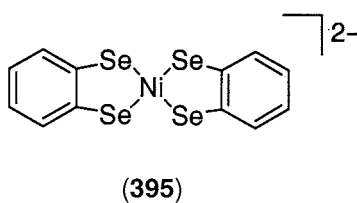
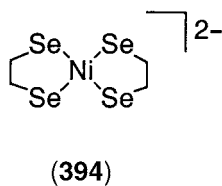
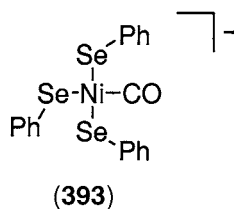

In (393), the average Ni—Se distance is 231.7(2) pm.¹⁰⁸⁵ Simple tetrahedral $[\text{Ni}(\text{SePh})_4]^{2-}$ has been prepared by reaction of $\text{NiCl}_2 \cdot 4\text{H}_2\text{O}$ with LiSePh .^{1087,1088} An excess of selenolate has to be used to prevent formation of $[\text{Ni}(\text{SePh})_2]_8$. The PPh_4^+ salt is stable in air for several hours. Its average Ni—Se bond lengths (240.1(3) pm) are longer than in the homoleptic square planar systems.

Mono- and dinuclear Ni^{II} selenolates include four-coordinate (square planar) (394),¹⁰⁸⁹ (395),¹⁰⁹⁰ $[\text{Ni}(\text{dmp})(\text{SeAr})_2]$ (Ar = 2,4,6- $\text{Me}_3\text{C}_6\text{H}_2\text{Se}$),¹⁰⁹¹ (396),¹⁰⁸⁸ (397),¹⁰⁸⁸ and (398)^{1092,1093}, and five-coordinate (399).⁸⁶ $[\text{Ni}(\text{terpy})(\text{SePh})_2]_2$,¹⁰⁹¹ $[\text{Ni}(\text{dmp})(\text{SePh})_2]_2$,¹⁰⁹¹ and $[\text{Ni}(\text{terpy})(\text{SeAr})_2]$ (Ar = 2,4,6- $\text{Me}_3\text{C}_6\text{H}_2\text{Se}$).⁸⁶ In general, most Ni^{II} alkaneselenolates are very sensitive to air. (394) is oxygen sensitive and decomposes in polar solvents. Its average Ni—Se bond lengths of 230.5(3) pm are interpreted in terms of a higher covalency of the Ni—Se bond compared to the Ni—S bond.¹⁰⁸⁹ The oxidized forms of (395) and (398) (one unpaired electron) have been investigated in detail by EPR spectroscopy.^{1090,1093} One-electron oxidation of (398) gives a radical anion, which exhibits EPR spectra consistent with a $S=1/2$ system. The g -values are similar to those of the analogous S-donor complex ($g_x=2.23$, $g_y=2.14$, $g_z=2.05$), but the observation of ^{77}Se hyperfine coupling ($A_z=129\text{G}$) indicates that the SOMO is largely Se in character.¹⁰⁹³ Tri- and tetranuclear homoleptic Ni^{II} selenolato complexes like (400) and $[\text{Ni}_4(\text{SePr}^1)_8]$ have been structurally characterized.¹⁰⁹⁴ They are isostructural with the corresponding thiolato complexes.

Selenium analogues of dithiolene complexes like (401) are attracting attention as components of conducting materials.¹⁰⁹⁵ The first and second redox potentials of (401) (converting between the dianion and the neutral state) are about 0.1 V higher than those of the sulfur derivative, suggesting that Se lowers the electron-donating ability. Further, (401) shows an irreversible oxidation wave leading to the radical cation.

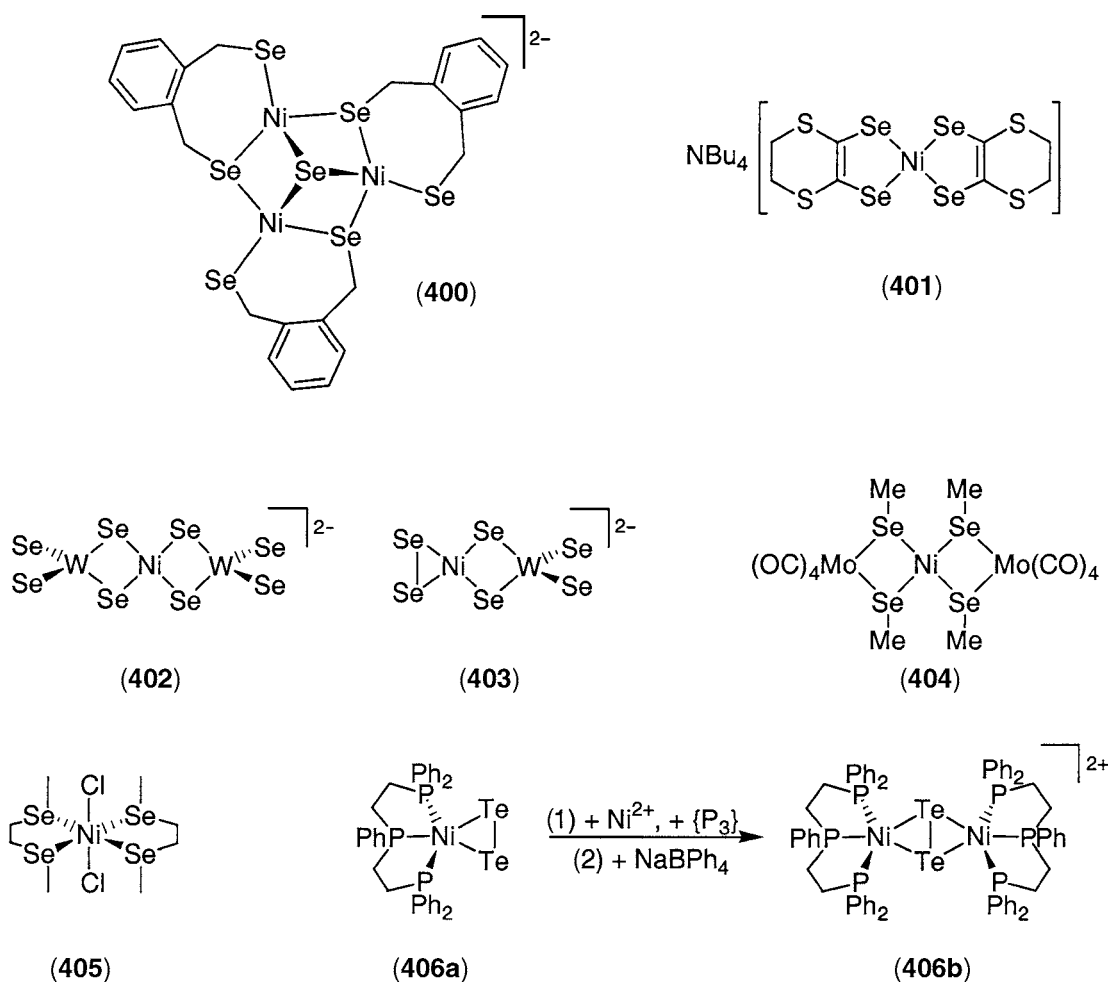

Distorted square planar $\{\text{NiSe}_4\}$ cores are observed in mixed-metal selenides, e.g., (402). The $[\text{Ni}(\text{WSe}_4)_2]^{2-}$ anion is analogous to $[\text{Ni}(\text{WS}_4)_2]^{2-}$.¹⁰⁹⁶ Using slightly different reaction conditions,

(403) was obtained, which contains a side-on Se_2 ligand.¹⁰⁹⁷ The Ni—Se bridge distances are much shorter in the latter compound, because there is no Se atom directly *trans* to these bridges. Trinuclear (404) was obtained from the reaction of Ni^{II} salts with the chelating metalloligand $\text{cis}[\text{Mn}(\text{CO})_4(\text{SeMe})_2]^-$ and features Ni—Se distances of 233.1(1) pm.¹⁰⁹⁸

Few thoroughly characterized Ni^{II} selenoether complexes have been reported, and most of them contain macrocyclic Se-containing ligands (see Section 6.3.4.10). Reaction of $\text{MeSeCH}_2\text{CH}_2\text{SeMe}$ with NiCl_2 gives (405) with two chelating diselenoethers and *trans*-chlorides.¹⁰⁹⁹ The related bromo and iodo complexes have also been prepared and analyzed by nickel K-edge EXAFS. The Ni—Se bond lengths are in the range 252–257 pm, which is 5–10 pm longer than Ni—S bonds in Ni^{II} thioethers.

Reaction of $[\text{Ni}^{\text{II}}\{\text{P}_3\}]$ scaffolds (where $\{\text{P}_3\}$ is a tridentate phosphine ligand) with a solution of polytelluride gives complexes (406a) with a side-on bound Te_2^{2-} moiety, which can be reacted with further $[\text{Ni}^{\text{II}}\{\text{P}_3\}]$ to give dinuclear (406b).¹¹⁰⁰ Ni^{II} complexes with telluroethers and telluroates are very scarce.¹¹⁰¹ Type (407) and (408) telluroate complexes have been reported from the reaction of $[(\text{dppe})\text{NiCl}_2]$ with NaTeAr and characterized spectroscopically.¹¹⁰² Te coordination has been invoked in Ni^{II} complexes of ligand (409),¹¹⁰³ and simple telluroethers like Me_2Te and Et_2Te are assumed to bind to bis(chlorosulfato)nickel(II) to give compounds $[\text{Ni}(\text{SO}_3\text{Cl})(\text{R}_2\text{Te})_2]$.^{1104,1105} Spectral data are more consistent with six-coordinate Ni^{II} in (410).¹¹⁰⁶

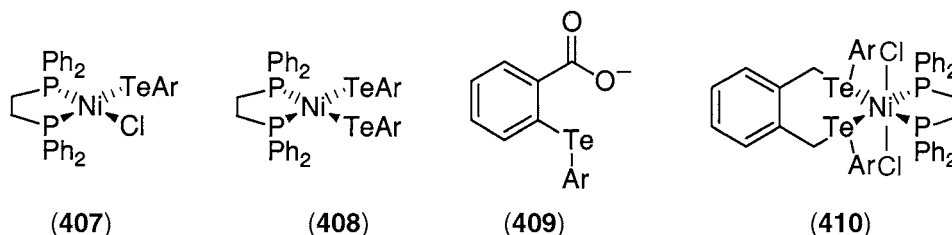

6.3.4.8 Halide Complexes

Ni^{II} forms weak complexes with fluoride ions in aqueous solution ($\log K_1 = 1.32$),¹¹⁰⁷ while Ni^{II} complexes with the other halide ions are extremely weak ($\log K_1 < -0.8$).^{1108,1109} The degree of complex formation in a concentrated aqueous solution of Ni^{II} chloride seems to increase with increasing temperature.¹¹¹⁰ In general, the complex formation of the Ni^{II} halide system is expected to be stronger in aprotic nonaqueous solvents than in water,¹¹¹¹ mainly due to the weaker solvation of halide ions in such solvents.¹¹¹² Significant complex formation between Ni^{II} and chloride is reported in methanol ($\log K_1 = 2.82$),¹¹¹³ in dimethyl sulfoxide ($\log K_1 = 1.51\text{--}2.7$, depending on ionic medium and strength),^{1114–1116} and in *N,N*-dimethylformamide ($\log K_1 = 2.85\text{--}3.14$).^{1117,1118} *N,N*-Dimethylacetamide is the only solvent where complex formation between Ni^{II} and bromide ions has been reported ($\log K_1 = 2.57$).¹¹¹⁹

Tetrafluoronickelate(II) complexes were synthesized with various cations from aqueous media by treatment of $[\text{Ni}(\text{acac})_2(\text{H}_2\text{O})_2]$ with HF and MF.¹¹²⁰ Experimental and theoretical studies were performed for the $\text{K}_2[\text{NiF}_4]$ complex.¹¹²¹ Core-level and valence-band X-ray angle-integrated photoemission data were analyzed by a CI impurity cluster model. Comparison of local *d* functional band calculations with angle-resolved photoemission data shows significant discrepancies, indicating that electron correlation effects are important. Two crystal modifications of $(\text{NH}_4)[\text{NiF}_3]$ were found.¹¹²² The low-temperature modification is cubic and crystallizes in the CaTiO_3 type of structure. The high-temperature structure is hexagonal and the compound crystallizes in the hexagonal BaTiO_3 type of structure.

Theoretical calculations based on the CNDO method were performed in order to understand the T_d/D_{4h} equilibrium of the tetrafluoro and tetrabromo complexes. The ability to form the square planar complexes decreases monotonically in the first row transition metal series: $\text{Mn}^{\text{II}} > \text{Fe}^{\text{II}} > \text{Co}^{\text{II}} > \text{Ni}^{\text{II}} > \text{Cu}^{\text{II}}$.¹¹²³ The same ability decreases in the series: $\text{F}^- > \text{Cl}^- > \text{Br}^-$. A dipole moment covalency polarizability correlation ligand field model was used to analyze experimental optical and magnetic properties for a set of $[\text{Ni}^{\text{II}}\text{X}_6]^{4-}$ clusters.¹¹²⁴ Using this model and a parametrization *d*-orbital theory, the theoretical absorption spectra of various $[\text{NiX}_6]^{4-}$ clusters were calculated without any fitting parameters. Good agreement was obtained for absorption spectra, EPR parameters, and magnetic susceptibility. MS- X_α calculations performed on various spin orbital configurations of $[\text{NiCl}_4]^{2-}$ were used to assign its ligand field

spectrum and XPS spectrum.¹¹²⁵ The calculated ligand field spectrum is in reasonably good agreement with observations. The calculated XPS spectrum suggested that part of the observed spectrum comes from satellite features and that multiplet splitting of ligand field states cannot represent the spectrum.

Complexation equilibria between Ni^{II} and Cl⁻ were studied in MeCN by spectrophotometry and calorimetry at 25 °C. Formation of [Ni^{II}Cl_{*n*}]^{(2-*n*)+} (*n* = 1–4) species was suggested and the various formation constants, enthalpies, and entropies were determined.¹¹²⁶ Individual electronic spectra of the complexes were obtained for both charge transfer (CT) bands (230–350 nm) and *d*–*d* transition bands (320–840 nm). Thermal analysis of pyridinium tetrachloronickelate(II) has shown that this complex is green and tetrahedral in the anhydrous state but yellow and octahedral when aquated.¹¹²⁷ It undergoes dehydrohalogenation upon heating in the solid state to yield [NiCl₂py₂]. An attempt was made to track the changes in the Jahn–Teller active vibrational modes of some pseudotetrahedral [MCl₄]²⁻ ions.¹¹²⁸ The IR and Raman spectra of powdered (Et₄N)₂[MCl₄] (M = Ni, Cu, Zn) and of Cu- and Ni-doped (Et₄N)₂[ZnCl₄] were recorded both at room temperature and at 77 K, 100 K, and 170 K. Room temperature spectra show that for [NiCl₄]²⁻ and [CuCl₄]²⁻ the Jahn–Teller distortions are dynamically averaged, if present at all. The low-temperature spectra, however, show splittings that are indicative of a low-symmetry field, suggesting that at 77 K both complex anions are vibronically stabilized in a static C_{2v} field. Room temperature IR and Raman and low-temperature (100 K and 77 K) IR spectra of R₂[MCl₄] have been recorded in the 4,000–50 cm⁻¹ frequency range.¹¹²⁹ The metal ions Zn^{II}, Ni^{II}, and Cu^{II} form a series of increasing ionic radius, while the counterions Bu₄N⁺, Et₄N⁺, Cs⁺, and Rb⁺ reflect the order of decreasing bulkiness. According to the IR and Raman spectra, the [ML₄]²⁻ units are distorted tetrahedrons, the distortion increasing with the size of the counterion. Additional splittings due to the vibronic coupling (Jahn–Teller coupling) were observed for the Cu^{II} and Ni^{II} compounds.

While for larger halide ions (X = Cl, Br, I) tetrahedral [NiX₄]²⁻ anions are usually found, (piperidinium)₂[NiCl₄] adopts an unusual catena-poly[nickel-tri-*μ*-chloro(1-)] chloride structure (similar to a distorted CsNiCl₃ type), in which face-sharing [NiCl₆]⁴⁻ octahedra, separated from one another by two crystallographically independent piperidinium cations and an isolated chloride anion, form a 1D chain.¹¹³⁰ In (ET)[NiCl₄]·H₂O (ET = bis(ethylenedithio)tetrathiofulvalene), where the [NiCl₄]²⁻ anions are sandwiched between lamellas of ET cations, the [NiCl₄]²⁻ unit is not tetrahedral but distorted square planar.¹¹³¹ The solid-state synthesis of thermochromic [(C₂H₅)₂NH₂]₂[NiCl₄] was described as a useful procedure for a classroom demonstration to show the effect of ligand field splitting on color and the strength effect of hydrogen bonding in a solid crystal on the configuration of a complex.¹¹³²

The chloride ligands in [NiCl₄]²⁻ ions in the interlayers of a Mg–Al hydrotalcite-like clay (NiCl-HT) are completely exchanged by bromide upon treatment with alkyl bromide in the liquid phase.¹¹³³ The solvent exerts a very strong effect on the reactivity of interlamellar Cl⁻ anions in NiCl-HT towards butyl bromide. Thus, all the interstitial Cl⁻ anions of the interlayer [NiCl₄]²⁻ ions appear as butyl chloride after 15 min in DMF, while in decane or toluene only 52% and 41% of interstitial Cl⁻, respectively, were found in the organic phase after 15 min. The use of butanol as a solvent results in complete inhibition of the reaction. [NiCl₄]²⁻ complex anions in NiCl-HT are isomorphically transformed into tetrahedral [NiBr₄]²⁻ by halide exchange with BuBr in DMF.

Br, Cl, and P ligand K-edge absorption EXAFS was used to evaluate the bond angles in nickel halide and halo phosphine complexes.¹¹³⁴ Particularly good results were obtained for [NiBr₂(dppe)]. Ligand K-edge X-ray absorption spectroscopy was used to investigate the metal–ligand bonding in the series of tetrahedral [MCl₄]^{*n*-} complexes including the nickel one.¹¹³⁵ The intensity of the pre-edge feature in these spectra reflects excited state multiplet effects, intermediate-strength ligand field excited state mixing, and ligand–metal covalency in the partially occupied *d*-orbital-derived MOs of each complex. A methodology which relates covalency to pre-edge intensity for *d*^{10-*n*} hole systems was developed. Application of this methodology to the experimental data provided quantitative information about the covalency of the ligand–metal bond. An analysis of the pre-edge and edge energies allowed the relative energy of the metal *d*-manifold as well as the charge on each chloride ligand to be quantified. The metal centers with the deepest *d*-manifold energies (closest to the ligand 3*p* orbital energy) are involved in the strongest ligand–metal bonding interactions and exhibit the largest metal *d*-derived orbital covalency.

Li₂[NiBr₄] in THF regioselectively cleaves epoxides to give bromohydrins in high yield.¹¹³⁶ The Br atom is predominantly found at the less-hindered carbon.

The layered double hydroxide (LDH) $\text{Al}_2\text{Li}(\text{OH})_6[\text{NiCl}_4]_{1/2}$ was synthesized by anion exchange of $\text{Al}_2\text{Li}(\text{OH})_6(\text{NO}_3)$, and the structure of $[\text{NiCl}_4]^{2-}$ in the interlayers was studied.¹¹³⁷ The LDH has a hexagonal cell with an interlayer distance of 2.9 Å, which is too narrow for the usual tetrahedral $[\text{NiCl}_4]^{2-}$ structure. However, from EXAFS measurements it is concluded that the first neighbor Ni—Cl distances in the LDH are 2.10 Å, which is compatible with four-fold coordination.

The electronic structure of *trans*- $[\text{NiCl}_2(\text{H}_2\text{O})_4]\cdot 2\text{H}_2\text{O}$ has been investigated in detail, both by calculations and by absorption and luminescence spectroscopy.¹¹³⁸

6.3.4.9 Mononuclear Complexes with Open-chain Ligands Containing Mixed Donor Atoms

6.3.4.9.1 Complexes with mixed {N,O} ligands

(i) Complexes of Schiff base and related ligands

Schiff base complexes have been studied intensively. They are of interest as stereochemical and electrochemical models for biological sites and because of their catalytic activities. Earlier work has been exhaustively reviewed,^{1139–1142} and the basic bidentate and tridentate coordination modes of Schiff base ligands have been well described. However, there are still new applications of bidentate Schiff bases evolving, since their syntheses are straightforward and peripheral groups can easily be altered. For example, transition metal–bischelates are widely used in thermotropic liquid crystals (metallomesogens). Ni^{II} complexes such as (411) form enantiotropic nematic phases over the temperature range 158–230 °C (melting points) and 160–253 °C (clearing points).¹¹⁴³

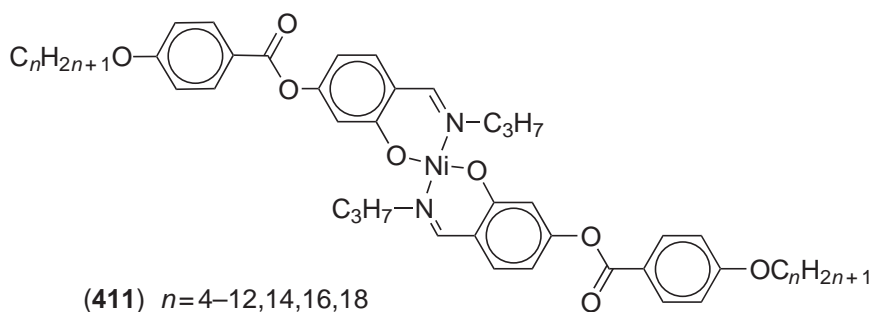

Earlier studies had shown that bidentate Schiff base ligands with bulky substituents and tetradentate ligands containing biphenyl or naphthyl moieties exhibit an endothermic spin equilibrium process. The preference of the low-spin state ($S=0$) is strong for the four-coordinate chelates, but bulky substituents may shift it towards the paramagnetic state ($S=1$). While such behavior is not observed for tetradentate ligands with aliphatic linkages, the incorporation of pyrazole in the $\{\text{N}_2\text{O}_2\}$ Schiff base may induce spin-equilibrium processes if the proper length of the linker is used.¹¹⁴⁴ Complexes (412) with $n=2$ or 3 form four-coordinate complexes in nondonor solvents. The complexes with $n=2$ are fully diamagnetic, but a spin equilibrium process $S=0 \leftrightarrow S=1$ is observed for $n=3$, and the complexes have a flattened tetrahedral geometry in the latter case. The four-coordinate Ni^{II} ions may increase their coordination number by coordinating solvent molecules like pyridine or DMSO in the axial positions, thereby enlarging the distances to equatorially bound donor atoms.

The use of imidazole or pyrazine containing asymmetric $\{\text{N}_3\text{O}\}$ Schiff bases (413a) and (413c) allows one to form monomeric complexes with square planar geometry around the Ni^{II} ions and a “rear-side” bridging system involving the unbound N atom of the heterocycle.¹¹⁴⁵ These monomeric complexes may use their unbound heterocyclic N atom to form dinuclear species (413b) and (413d), respectively.

The coordination in $[\text{bis}(4\text{-isopropyliminomethyl})1,3\text{-diphenylpyrazol-5-ylaminato}]\text{Ni}^{\text{II}}$ is pseudo-tetrahedral, the angle between the N—Ni—NH and NH'—Ni—N' planes being 93.8° and the Ni—N(imine) bond lengths being 1.999 Å and 2.003 Å. This is significantly longer than the Ni—N(amine) bond lengths of 1.919 Å. Similar effects are observed in other pyrazole containing Ni^{II} -Schiff base complexes.¹¹⁴⁶

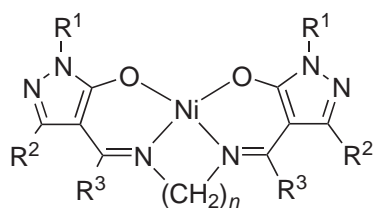

(412)

	<i>n</i>	R ¹	R ²	R ³
(412a)	3	Ph	Ph	Ph
(412b)	3	Ph	Ph	<i>p</i> -ClC ₆ H ₄
(412c)	3	Ph	Me	Ph
(412d)	3	Ph	Me	<i>p</i> -MeC ₆ H ₄
(412e)	2	Ph	Me	Ph
(412f)	2	Me	Ph	Ph
(412g*)	2	Ph	Me	H

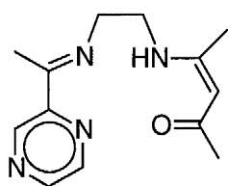
*The chain is CH(Me)CH₂

(413a)

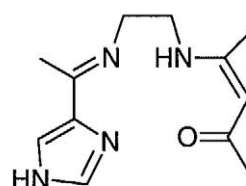

(413c)

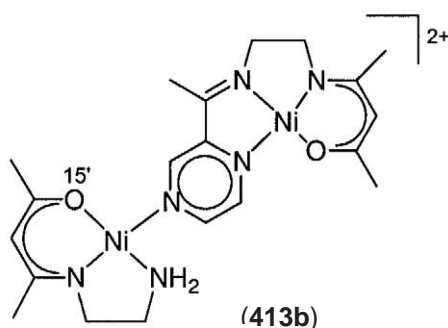

(413b)

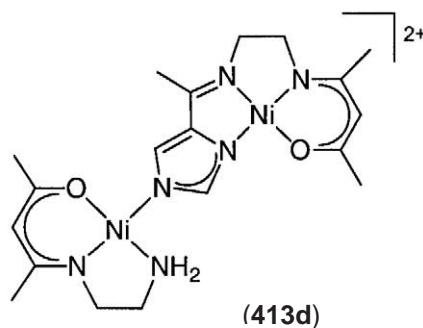

(413d)

Chiral Schiff base complexes can act as catalysts of enantioselective reactions, e.g., for the oxidation of hydrocarbons.^{1147,1148} Studies on chiral Ni^{II} complexes with {N₂O₂} Schiff bases derived from (1*R*,2*R*)- and (1*S*,2*S*)-1,2-diaminocyclohexane (**414**) have shown that substituents with high electron-withdrawing ability stabilize the lower oxidation state and promote the addition of axial ligands.¹¹⁴⁹ The reduction potential of the planar complexes correlates with the ability to bind axial ligands (log β₂). Parent *N,N'*-(1*R*,2*R*)-(-)-1,2-cyclohexanebis(2-hydroxyacetophenonylideneiminato)nickel(II) ((**414**) with R¹ = R² = H) has an umbrella-type geometry with the dihedral angle between the planes defined by the two acetophenonylideneimine moieties of 43.5°. The Ni atom is in a distorted square planar environment.¹¹⁵⁰ The distortion is more pronounced than in the salicylaldehyde analogue and it is caused by the interactions between the methyl group and methane, methylene, and phenyl hydrogens. The steric demands of the bulky groups are often the main cause of tetrahedral distortion in this type of complex.^{1151,1152} {N₄} Schiff base complexes with very bulky tosyl groups (**415**) are square planar even in coordinating solvents, although the solid-state structure shows distinct tetrahedral distortion.¹¹⁵³ Ni^{II} salicylaldiminato complexes¹¹⁵⁴ with bulky substituents at the ketimine-N (type (**416**) complexes) are active catalyst for olefin polymerization¹¹⁵⁵ and may even tolerate heteroatoms¹¹⁵⁶ or perform polymerization in water.¹¹⁵⁷ Functional groups such as 2-pyridyl or diphenylphosphino can be attached to Ni-salen type complexes (**417**).^{1158,1159} For Ni^{II} Schiff base complexes involving P-donors see Section 6.3.4.6.3.

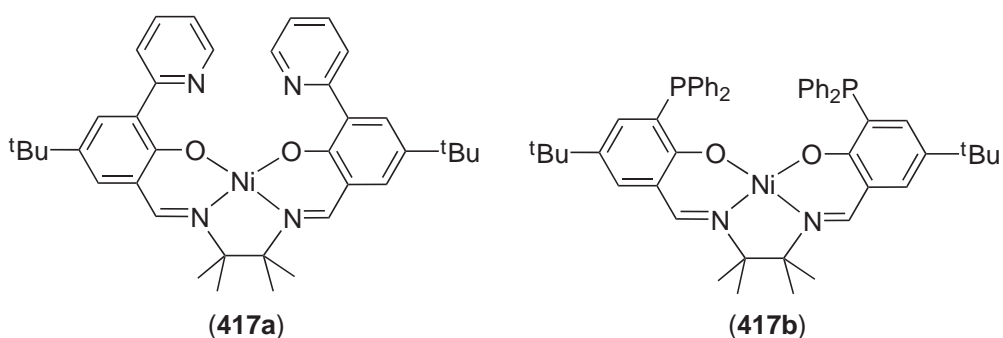
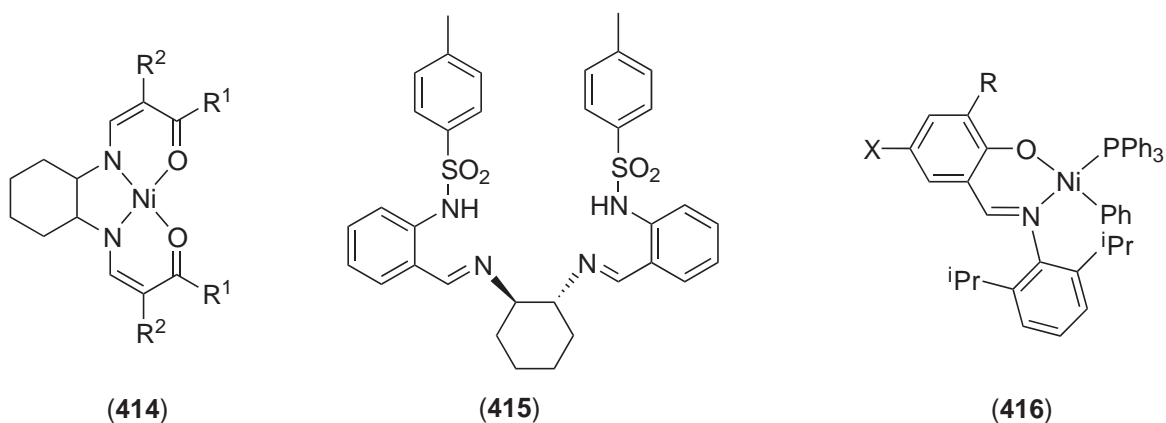

The solubility properties of Ni^{II} salen complexes can be varied by appropriate substituents. A choice of ligands containing *t*-butyl or methyl(triphenylphosphonium chloride) substituents at the aromatic rings (Figure 12) provides a series of Ni^{II} complexes with solubility adjustable for most commonly used solvents including water.¹¹⁶⁰

Ligand substitution in salicylaldimine [NiA₂] complexes has been studied in detail.¹¹⁶¹ Substitution in chiral [NiA₂] species by chiral salen-type tetradentate H₂B ligands in acetone proceeds according to Equation (7):

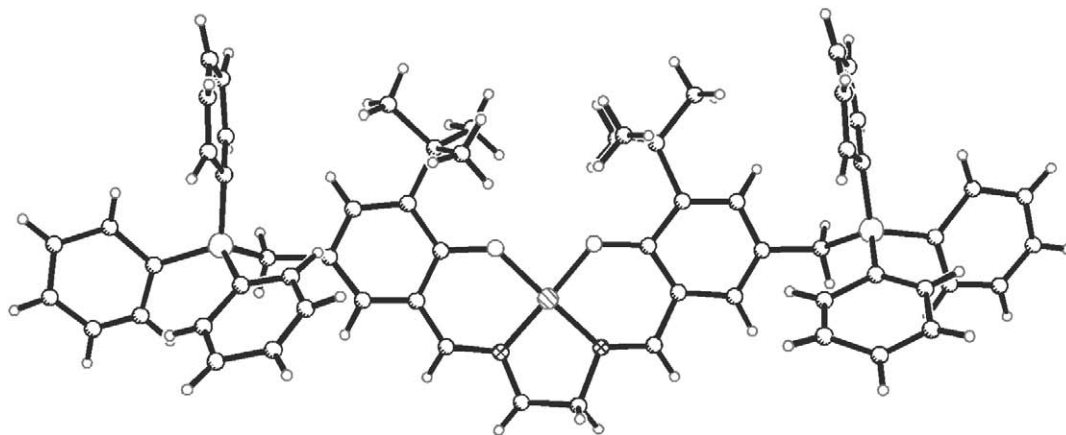
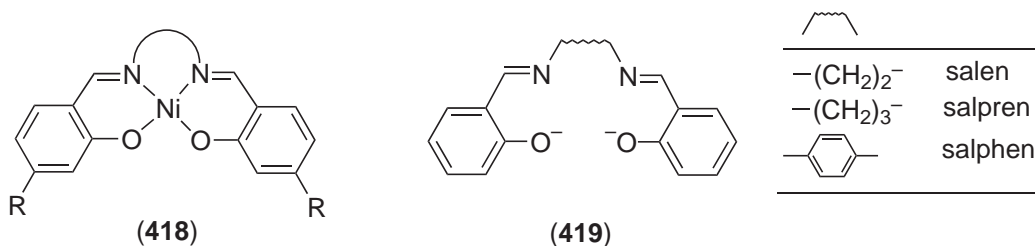

Figure 12 Crystal structure of *N,N'*-bis{3-*t*-butyl-5-[(triphenylphosphonium)methyl]salicylidene}-1,2-ethanediamine chloride with Ni^{II} ions.¹¹⁶⁰

The substitution process is second order according to Equation (8). The substitution reaction (7) is an associatively controlled process consisting of three distinguishable steps: fast adduct formation $\{\text{NiA}_2, \text{H}_2\text{B}\}$ followed by rate-controlling loss of the first bidentate ligand HA and the loss of the second bidentate ligand with first order rate constant making the overall reaction a second-order process.^{1162,1163} Ligand substitution is subject to chiral discrimination. The ratio of the second rate constants, $k_{\text{fast}}/k_{\text{slow}}$, with k_{fast} being the rate constant for the faster reacting pair of enantiomers, lies in the range 1.0–3.0, depending on the nature of the *N*-alkyl groups in NiA_2 and the organic groups attached to the ethylene bridge in H_2B ligands.¹¹⁶⁴ The rate discrimination factor of 3.0 obtained for $\text{NiA}_2 = \text{bis}[\text{N-dehydrodiethyl-salicylaldiminato}]\text{nickel(II)}$ reacting with the *R*- and *S*-enantiomer of $\text{H}_2\text{B} = \text{N,N}'\text{-disalicylidene-1,2-diamino-4-methylpentane}$ appears to be the highest stereoselectivity reported for any ligand substitution in Ni^{II} complexes.

$$\text{rate} = k \times [\text{NiA}_2] \times [\text{H}_2\text{B}] \quad (8)$$

Nickel(II) bis(salicylaldiminato) complexes are promising nonlinear optical systems.¹¹⁶⁵ A series of ligands obtained by condensation of appropriate salicylaldehydes with diamines form complexes with Ni^{II} (e.g., (418)), and general structures have been determined.¹¹⁶⁶ Thermal analysis, linear optical spectroscopy and second-order NLO response, sampled by the electric field-induced second-harmonic generation technique in combination with a quantum chemical analysis have shown a relationships between electronic structure and NLO properties of this class of inorganic NLO chromophores.¹¹⁶⁷ Solution-phase hyperpolarizability values deduced from electric field-induced second-harmonic generation experiments are high. Similar behavior is found for the chiral 1,2-diaminocyclohexane derivatives.¹¹⁶⁸



The high structural and synthetic versatility of the Schiff base complexes provides a possibility to design host systems without functionalization procedure. Even relatively simple $\text{Ni}^{\text{II}} \{\text{N}_2\text{O}_2\}$ Schiff base complexes (419) are able to incorporate Ni^{II} both in the solid state and solution.¹¹⁶⁹ In $[\{\text{Ni}(\text{salen})\}_2\text{Ba}(\text{ClO}_4)_2(\text{thf})]$ and $[\{\text{Ni}(\text{salen})\}_2\text{Ni}(\text{H}_2\text{O})_2](\text{ClO}_4)_2$, two $[\text{Ni}(\text{salen})]$ units act as bidentate O-donor ligands. In the Ni—Ni adduct, the central Ni^{II} ion is coordinated by two $[\text{Ni}(\text{salen})]$ units in a distorted octahedral geometry including two water molecules (Figure 13).

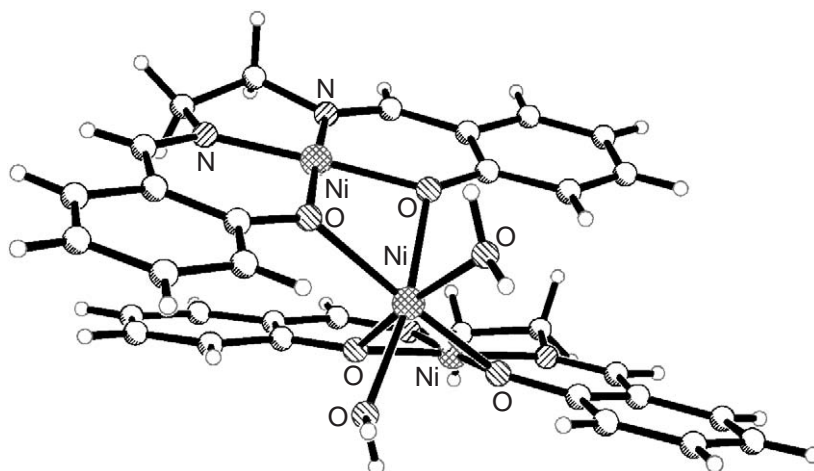
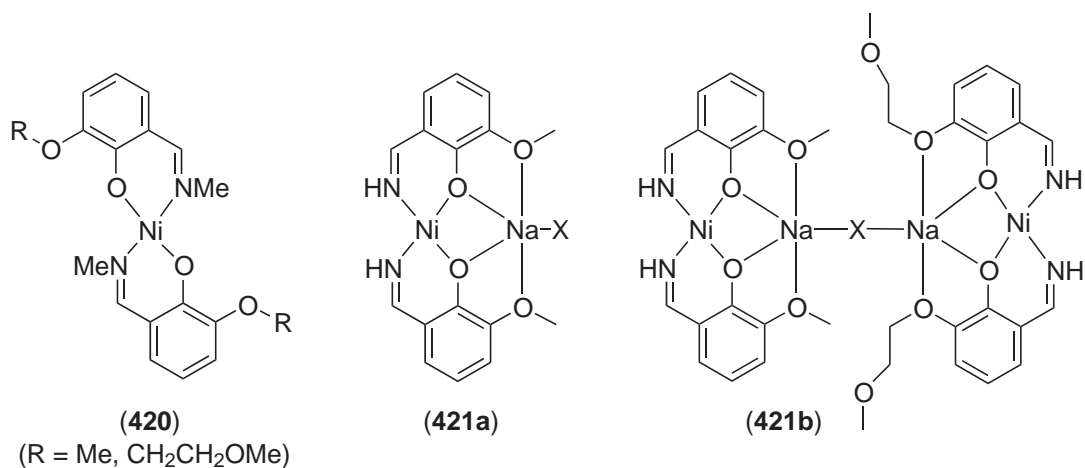

Figure 13 Molecular structure of the cation $[\{\text{Ni}(\text{salen})\}_2\text{Ni}(\text{H}_2\text{O})_2]^{2+}$.

Schiff base ligands may be enriched by pendent arms bearing a potentially chelating site.^{1170–1172} Insertion of a simple oxime function allows one to form oligonuclear structures with interesting magnetic properties.¹¹⁷³ Polyether side arms are suitable to associate alkali metal cations with the Ni^{II} Schiff base unit. Addition of sodium picrate to [NiL₂] (**420**; L = 3-methoxy-*N*-methylsalicylaldiminato) results in paramagnetic species [NiL₂NaX]₂ (X = picrate ion), which display cage structures with two side arms bound to Na⁺.^{1174,1175} Diamagnetic complexes are obtained from the reaction of Na⁺ with 3-methoxysalicylaldiminato and 3-(2-methoxyethoxy)salicylaldiminato Ni^{II} complexes (**421a,b**).^{1176,1177} The monometallic type (**420**) precursors react with Na⁺ yielding mono- or bimetallic species with *cis*-{NiN₂O₂} chromophores and the alkali cation accommodated in the ether-like outer cavity. In the presence of barium ions the precursor complexes change their configurations from *trans* to *cis* to offer a polyoxygen coordination site for the Ba²⁺ ion in [(NiL₂)₂Ba (ClO₄)]⁺.¹¹⁷⁸



Crown ethers may also be used to functionalize salicylideneimine complexes.¹¹⁷⁹ The crown ether-functionalized tetra-*t*-butyl-salicylideneimines are useful in studies on the selective complexation and transport of cations (e.g., Na⁺ and K⁺). 4,5-Bis(3,5-di-*t*-butylsalicylideneimino)benzo-18-crown-6 coordinates Ni^{II} via the Schiff base {N₂O₂} donor system and K⁺ or Cs⁺ at the crown site.¹¹⁸⁰ These Ni-alkali metal complexes are able to transport amino acids from acidic aqueous solution to pure water.

The presence of N-donors in pendent arms makes Schiff base ligands very effective for the formation of bimetallic complexes with two Ni^{II} ions. Dinuclear complexes of compartmental Schiff base ligands are covered in Section 6.3.4.12.

{N,O} ligands with *sp*³ N atoms are more flexible than those with *sp*² N-donors. Examples of mixed {N,O} ligands with *sp*³ N-donor and terminal alcoholate include chiral bidentate {N,O},¹¹⁸¹ {N,O₂} tridentate,¹¹⁸² and {N,O₃} tetradentate ligands.¹¹⁸³ The {N₂,O₂} tetradentate ligand (**422**) coordinates Ni^{II} to yield blue [Ni(**422**)(NCS)₂]·H₂O·2EtOH,¹¹⁸⁴ where the neutral tetradentate ligand adopts a *cis*-α geometry with mutually *cis* N-bound thiocyanate moieties. The configuration around Ni^{II} is Λ with *R* configuration at the stereogenic N atoms. The absolute configuration of the complexes formed (Δ or Λ) depends on the metal ion involved.

Covalent modification of nucleic acids with metal complexes can be used for, *inter alia*, probing nucleic acid structure, understanding DNA reactivity, regulating gene expression, or chromosome modification triggering apoptosis. Ni^{II} complexes are well suited for covalent modification of DNA as the Ni^{II/III} couple often lies close to the redox potential of the substrate ligand. Water-soluble Ni(salen)-type complexes (**432**) are able to form covalent bonds to nucleic acids, which occurs almost exclusively at guanine residues.¹¹⁸⁵

Ni(salen)-DNA adduct formation is closely related to that formed by the Ni(peptide) systems, although there are different mechanisms proposed for both types of complexes. In the case of Ni(salen), the addition of a phenol radical to the guanine heterocycle and formation of a covalent bond to guanine C8 (Equation (9)) is suggested.

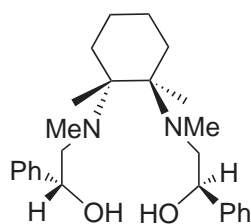

(422)

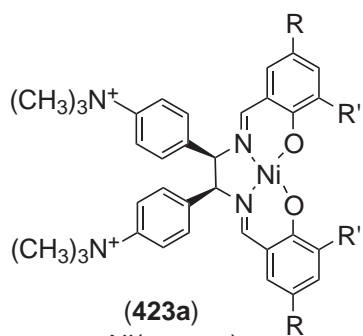
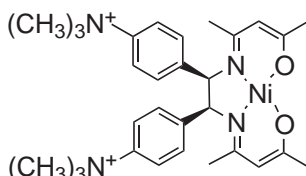
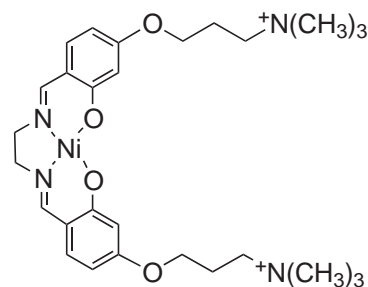
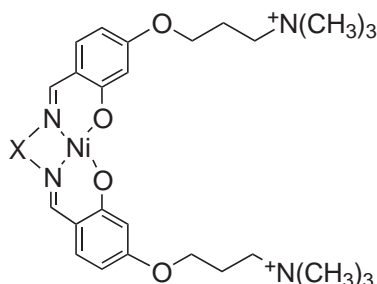
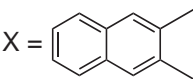
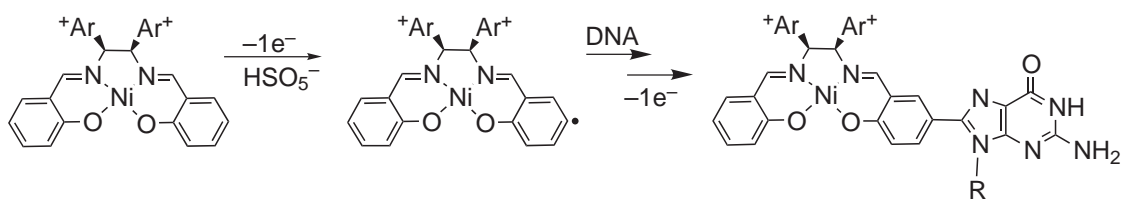
(423a)
Ni(tmapes)(423b)
Ni(tmep-acac)(423c)
Ni(espa)X =  (423d), Ni(phespa)X =  (423e), Ni(naspa)

(9)

[Ni(salen)] complexes may interact with nucleic acids in different modes as well as with different chemical consequences.^{1186,1187}

(ii) {N,O} edta-type and related polydentate chelating agents

The factors affecting stabilities of edta-type chelating agents have been comprehensively discussed.¹¹⁸⁸ Spin-labeled edta ligands (**424a,b**) have been prepared, and the large difference in the EPR spectra of the free ligands and the Ni^{II} complexes indicates a substantial exchange contribution to the interaction in the case of (**424a**), which is attenuated for (**424b**).¹¹⁸⁹

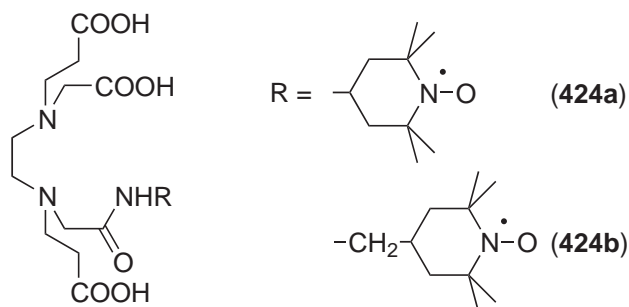

Bonding angles exhibited by metal complexes with edta are distinctly strained, which is seen by the significant deviation from regular values.¹¹⁹⁰ The Ni^{II} complex with edta forms a dinuclear $[\text{Ni}_2(\text{edta})(\text{H}_2\text{O})_4] \cdot 2\text{H}_2\text{O}$ species with two different subunits: the primary Ni^{II} center is hexacoordinated by the edta ligand (Figure 14). Constraints exerted by the ligand result in a highly distorted octahedron with deviation angles O—Ni—O up to 22.7° . The largest deviations are observed in the coordination plane of the ethylenediamine ring. The second Ni^{II} is in less distorted environment, since it is surrounded by four water molecules and two bridging carboxylates. These two subunits form alternating Ni(edta)—Ni(H₂O)₄ infinite zigzag chains hold together by H bonds and van der Waals interactions between O atoms of the remaining free carboxylates and water molecules. The magnetic properties can be described by a Heisenberg or Ising exchange model with a coupling of $J \sim -8.3 \text{ K}$.

Due to the steric constraints of the ligand, the partially protonated H₂cdta binds as a pentadentate ligand in $[\text{Ni}(\text{H}_2\text{cdta})(\text{H}_2\text{O})]$ where a water molecules completes the octahedral coordination sphere.^{1191,1192}

Edta-type ligands with longer diamine or carboxylate chains are likely to function as hexadentate ligands towards larger metal ions by forming less strained structures.¹¹⁹³ A symmetrical edta-type ligand, eddarp (ethylenediamine-*N,N'*-diacetate-*N,N'*-di-3-propionate) can form three geometrical isomers for hexadentate coordination: *trans*(O₅), *trans*(O₅O₆), and *trans*(O₆).¹¹⁹⁴ Because of strain in the equatorial plane, the Ba[Ni(eddarp)]·6H₂O complex adopts a *trans*(O₅) configuration. The strain analysis for the complexes with edta and its analogues for various metal ions indicates that expanding of the diamine ring or the equatorial glycine rings lowers the octahedral strain. The impact of the steric strain on the instability of the in-equatorial acetate coordination is also seen in the Ni^{II} complexes with eddarp.¹¹⁹⁵ The hexadentate complex with propionate rings in equatorial

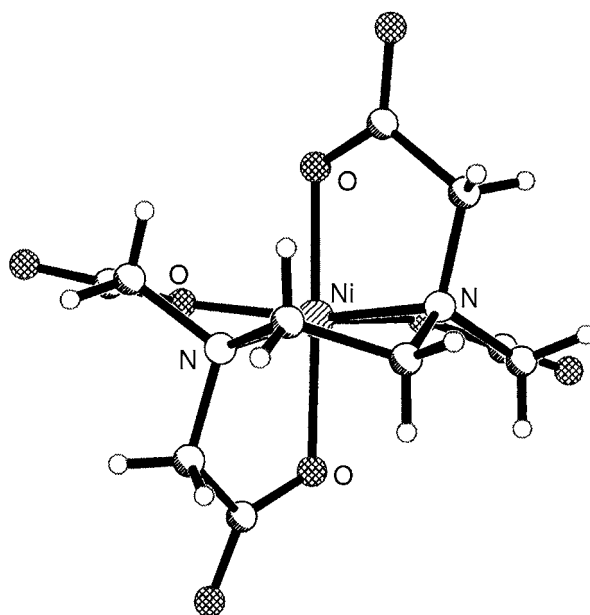
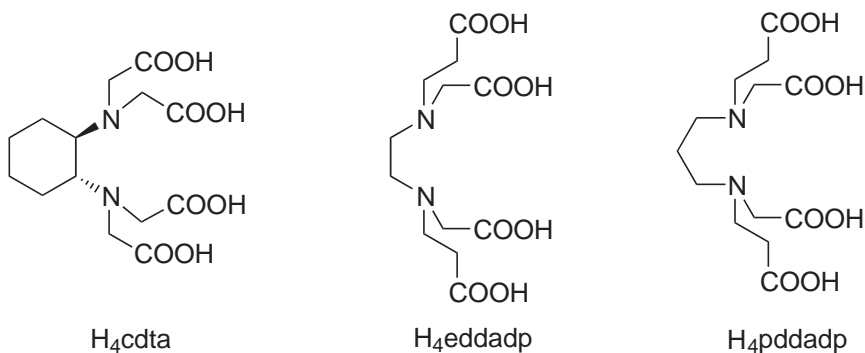
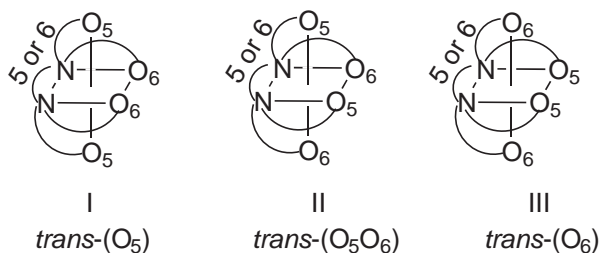

Figure 14 Molecular structure of the $[\text{Ni}(\text{edta})]^{2-}$ subunit in $[\text{Ni}_2(\text{edta})(\text{H}_2\text{O})_4] \cdot 2\text{H}_2\text{O}$.

positions converts into a pentadentate species at high temperature. This conversion involves removal of one of the out-of-plane acetates, suggesting that acetate coordination is not stronger than that of propionate.



In general, increasing the number of methylene groups in the diamine part (e.g., in H_4pddap) decreases the stability constant of the $[\text{NiL}]$ species, as does substitution of an acetic group by a 3-propionic group.¹¹⁹⁶



m-Phenyldiamine- and pyridine-2,6-diamine- N,N',N' -tetraacetic acid form dinuclear complexes (**425a–c**), both in solution and in the solid state.^{1197,1198} The pyridine-N is not bonded to the metal.

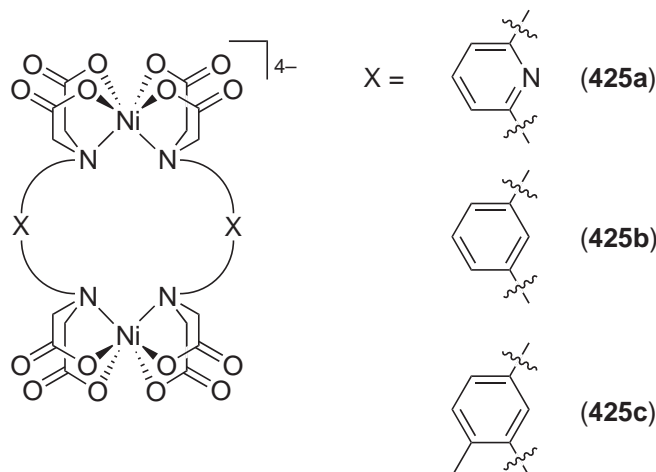

Simple tetradentate ligands $\text{HOOCCH}_2\text{NH}(\text{CH}_2)_n\text{NHCH}_2\text{COOH}$ (**426**) in which two glycine building blocks are connected by a methylene chain have been employed in Ni^{II} coordination chemistry. 1,4-Diaminobutane- N,N' -diacetic acid forms a seven-membered chelate ring showing a negative chelate effect in octahedral Ni^{II} complexes $[\text{NiL}]$ and $[\text{NiL}_2]^{2-}$.¹¹⁹⁹ For the Ni^{II} complexes of 1,2-diaminoethane- N,N' -di-3-propionate (eddp) and 1,3-diaminopropane- N,N' -diacetate (1,3-pdda), only one (*uns-cis*) geometric isomer was found to dominate, confirming that six-membered chelate rings have a profound effect on the distribution of geometrical isomers. Two water molecules complete the octahedral environment in $[\text{Ni}(1,3\text{-pdda})(\text{H}_2\text{O})_2]$.¹²⁰⁰ Ni^{II} complexes of the 1,4-diazacycloheptane-based ligands dachdR are octahedral $[\text{Ni}(\text{dachdH})(\text{H}_2\text{O})_2]$, square

planar [Ni(dachdMe)], [Ni(dachdEt)], and [Ni(dachdPr)], or five-coordinate [Ni(dachdH)py], depending on the R substituent and the solvent.^{1201,1202} The chiral (*all-R*)-1,2-bis(2-aza-3-carboxy-bicyclo[3.3.0]octan-2-yl)ethane (H₂baboc) has been prepared from a nonrecyclable industrial waste material.^{1203,1204} It can be regarded as a new chiral analog of edda (ethylenedinitrilodiacetate) and forms the enantiomerically pure helical Ni^{II} complex [Ni(baboc)(H₂O)]·H₂O (**427**).¹²⁰⁵ This complex is pentacoordinated with a square pyramidal geometry. Comparison with the octahedral [Ni(edda)(H₂O)₂]·H₂O complex¹²⁰⁶ reveals that the steric influence of the chiral bicyclic system is responsible for the square pyramidal structure.

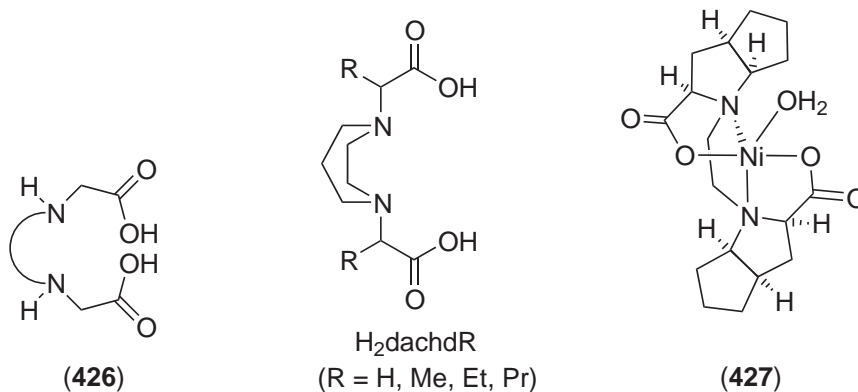

Nitrilotriacetate (nta³⁻) is a powerful tetradentate chelating agent with $\log \beta_{\text{NiL}} = 11.53$.¹²⁰⁷ The successive substitution of carboxylate by phosphonate group results in three ligands N(CH₂CO₂H)_{3-r}(CH₂PO₃)_r with $r = 0-3$.^{1208,1209} The high p*K* values for deprotonation of these ligands give rise to many protonated species. The stability of the NiL complex with the fully deprotonated ligand is highest for $r = 1$ and lowest for the pure phosphonate analogue ($r = 3$). α -Aminoalkylphosphinic acids differ from their carboxylate analogues quite remarkably. The phosphinate O atom is more difficult to protonate both in the free acid and in its metal complexes.^{1210,1211} This causes certain azaphosphinate complexes to be resistant to proton mediated dissociation. The lower basicity of the O- and N-donors results in lower stability constants with respect to the carboxylate analogues. The insertion of alkyl or aryl substituents at P allows one to control the complex lipophilicity¹²¹² and makes phosphorus a stereogenic center when its O atom is bound to the metal ion.¹²¹³ With acyclic tetradentate ligands incorporating two N-donors and two alkyl or aryl phosphinate donors (**428**), Ni^{II} forms equimolar complexes with significant phosphinate ligation.¹²¹⁴ The stability sequence is reverse to the Irving–Williams series since the stability of the Ni^{II} complexes is distinctly higher than those of the Cu^{II} species.

(iii) Complexes with miscellaneous {N,O} ligands

In contrast to many other *N,N'*-substituted oxamides which usually give diamagnetic square planar Ni^{II} species, paramagnetic Ni^{II} complexes such as [Ni₂(glyox)(H₂O)₆] can be obtained from the glycine-derived H₄glyox (**429**).¹²¹⁵ Relatively strong antiferromagnetic coupling ($J = -12.5 \text{ cm}^{-1}$) is observed for [Ni₂(glyox)(H₂O)₆]. Square planar Ni^{II} complexes of oxamides such as (**430**) are useful for catalyzing the aerobic epoxidation of olefins.¹²¹⁶

Diamagnetic square planar (**431**) contains two *o*-semiquinonato-type radical ligands with a singlet ground state due to strong antiferromagnetic coupling. Its electronic structure is best described as a singlet diradical.^{192,1217}

6.3.4.9.2 Complexes with mixed {N,S} ligands

(i) Thiosemicarbazide, thiosemicarbazones, and related ligands

A great number of nickel complexes with thiosemicarbazide (**432**) and thiosemicarbazone (**433**) ligands and their substituted derivatives have been examined. Thiosemicarbazone chemistry is

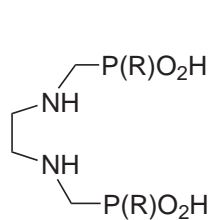

L¹ R = Me
L² R = Ph

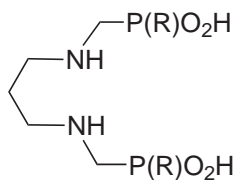

L³ R = Me
L⁴ R = Ph

(428)

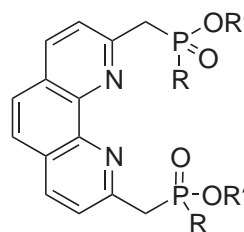

L^{5a} R = Me, R' = Et
L^{5b} R = Me, R' = H
L^{6a} R = Ph, R' = Et
L^{6b} R = Ph, R' = H
L^{7a} R = CH₂Ph, R' = Et
L^{7b} R = CH₂Ph, R' = H

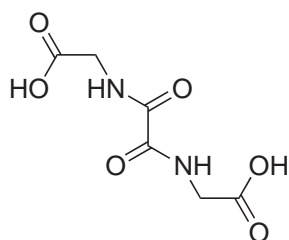

(429)
H₄glyox

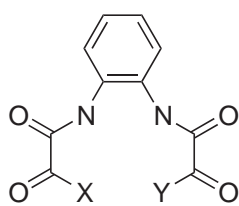

(430)
(X, Y = OH, NMe₂)

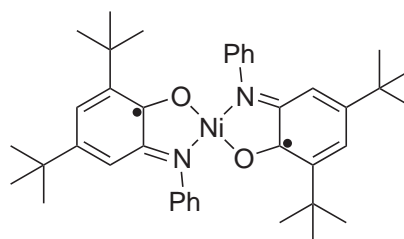

(431)

partly inspired by the belief that coordination to metal ions may improve the anticancer, antiviral, fungicidal, and bactericidal potential of thiosemicarbazones.^{1218,1219}

The interaction of thiosemicarbazide with Ni^{II} has been studied in solution and in the solid state, and the properties and stereochemistry of two isomeric forms, α and β , of [Ni(432)₃]I₂ have been reported. The crystal structure of the β -form reveals that Ni is octahedrally coordinated by three molecules of (432) through their S and hydrazine N atoms.¹²²⁰

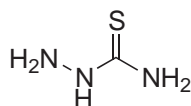

(432)

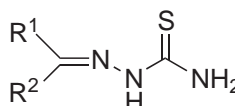

(433)

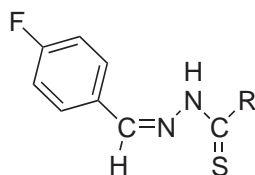

(434)

R = NH₂t
NHMe
NHAllyl
NHPh
NMe₂
NHPhMe

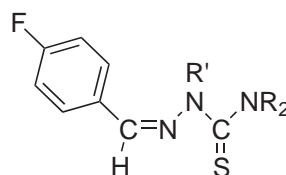

(435)

R = H, H; R' = H
R = H, Me; R' = H
R = H, Allyl; R' = H
R = H, Ph; R' = H
R = H, MePh; R' = H
R = H, Me, R' = Me
R = Me, Me; R' = H

The basic thiosemicarbazone ligands coordinate in a {N,S} bidentate manner, generally via the azomethine N-donor and the thione or deprotonated amidothione group. Designating the ligands as HL, this usually results in square planar complexes [NiL₂],¹²²¹⁻¹²²⁷ [Ni(HL)₂]X₂,^{1222,1228}

$[\text{Ni}(\text{HL})\text{X}_2]$,¹²²² or $[\text{NiLX}]$ ^{1222,1229} as well as octahedral complexes $[\text{Ni}(\text{HL})_2\text{X}_2]$,^{1222,1230–1232} The square planar $[\text{NiL}_2]$ is the common and most widely encountered type, while tetrahedral complexes are very rare.^{1233,1234}

Ni^{II} complexes of thiosemicarbazones derived from *p*-fluorobenzaldehyde and differently substituted thiosemicarbazides (**434**, **435**) are square planar $[\text{NiL}_2]$ species with the S and hydrazine-N atoms in *trans* position to each other and a slight tetrahedral distortion in some cases.^{1235,1236}

5-Methyl-2-furfural thiosemicarbazone forms three types of Ni^{II} complexes. Two square planar species with *trans* configuration, $[\text{NiL}_2]$ and $[\text{NiL}_2]\cdot 2\text{DMF}$, and a pseudo-octahedral $[\text{NiL}_2\text{X}_2]$ ($\text{X} = \text{Cl}^-$, Br^-).¹²³⁷ Likewise, the $[\text{NiL}_2]$ complex of thiophene-2-carbaldehyde thiosemicarbazone is a square planar species with *trans* configuration.¹²³⁸ Simple theoretical calculations suggest a correlation between the biological activity of the metal complex and its LUMO energy level. The incorporation of the bulky vitamin K_3 into the thiosemicarbazone structure seems to favor the formation of an octahedral nickel complex in ethanol solution.¹²³⁹ Biological tests show that metal ion coordination indeed increases the antibacterial activities of the ligands.

Tri- or tetradentate ligands can be obtained by attaching functional groups to the thiosemicarbazone scaffold. Tridentate ligands often possess an $\{\text{N}_2\text{S}\}$ donor set, generating a broad range of coordination geometries, including square planar, octahedral, and trigonal bipyramidal complexes.^{1240–1246} (**436**)–(**439**) are depicted as examples. In many cases, the lack of solubility of these complexes strongly reduces the possibility of *in vivo* testing.

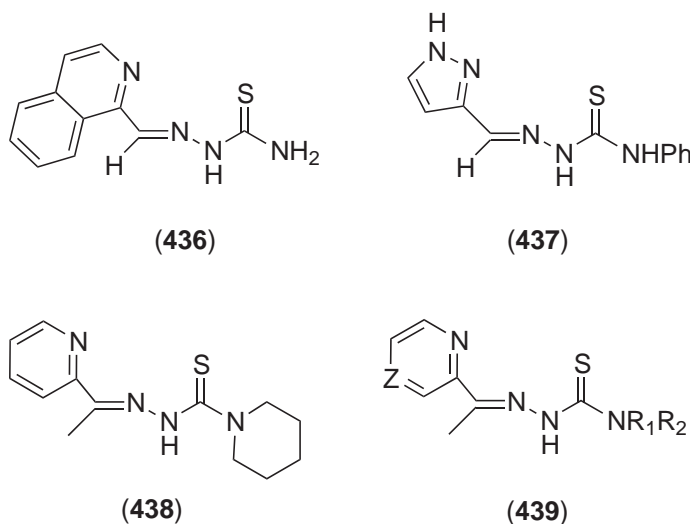

Complexes $[\text{NiL}_2]$ with ligand (**439**) (HL) are less fungicidal than the free ligand,¹²⁴⁷ but it has been shown that with more sterically demanding groups R_1 and R_2 the fungitoxicity of the free ligands HL increases. With NiX_2 in hot EtOH, complexes $[\text{NiLX}]$ ($\text{X} = \text{Cl}$, Br ; $\text{Z} = \text{CH}$; $\text{R}_1, \text{R}_2 = (\text{CH}_2)_5, (\text{CH}_2)_6$) can be obtained, which have comparable fungitoxicity to the free ligands.^{1248,1249} Attachment of an additional donor at the ligand ($\text{Z} = \text{CH}$; $\text{R}_1 = \text{H}$, Me ; $\text{R}_2 = (\text{CH}_2)_n$ (2-pyridyl), $n = 1, 2$) leads to complexes of the type $[\text{Ni}(\text{HL})\text{X}_2]$. IR spectroscopic data suggest thione-S coordination, but the additional pyridine ring is apparently not involved in coordination.¹²⁵⁰

Thiosemicarbazones attached to an amide moiety rather than an aldehyde or ketone moiety show better solubility. For example, the Ni^{II} complex with 2-pyridineformamide N(4)-methylthiosemicarbazone is square planar with $\{\text{N}, \text{N}, \text{S}\}$ ligand coordination.¹²⁵¹ The coordination sphere is completed by an O-bound acetate coligand.

Tridentate thiosemicarbazones with $\{\text{N}, \text{S}, \text{O}\}$ donor set form $[\text{NiL}_2]$ complexes with pseudo-octahedral geometry around the Ni^{II} ion.^{1252,1253} Both acenaphthenequinone thiosemicarbazone (**440**) and isatin- β -thiosemicarbazone (**441**) coordinate as monodeprotonated ligands in a meridional fashion. The Ni—O bonds are unusually long and distinctly larger than the sum of covalent Pauling radii. The complex $[\text{Ni}(\text{442})]$ catalyzes H_2/D^+ exchange and is thus considered as a model complex for Ni-containing hydrogenases.¹²⁵⁴ The 1:1 complex $[\text{Ni}(\text{442})]^+$ is formulated as an O-bridged dimer.¹²⁵⁵

Bis(thiosemicarbazones) generally behave as dianionic, tetradentate $\{\text{N}_2\text{S}_2\}$ ligands that form planar $[\text{NiL}]$ complexes (with loss of two protons upon coordination) or planar $[\text{NiL}]\text{X}$ (with loss of

only one proton).^{1256–1262,1269} (**443**) and (**444**) are depicted as examples. The same coordination mode is found for mixed bis(N(4)-substituted thiosemicarbazones) (**445**).¹²⁶³ The Ni—S bonds are significantly longer (~ 2.145 Å) than the Ni—N (~ 1.849 Å) bonds, and hence the coordination geometry around the Ni^{II} ion is trapezoidal.

Ligand (**446**) (resulting from the condensation of benzil and thiosemicarbazide) forms planar {NiN₄} complexes^{1264,1265} even in strongly coordinating DMSO, but the solvent may partially substitute the bis(thiosemicarbazones) ligand. Template condensation of the appropriate mole ratios of Ni^{II}, benzil, and thiosemicarbazide gives a neutral macrocyclic species formulated as octahedral (**447**).¹²⁶⁶

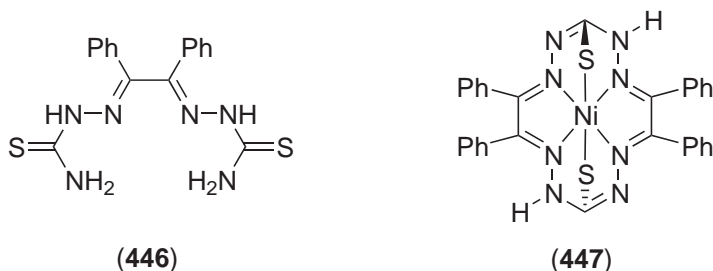
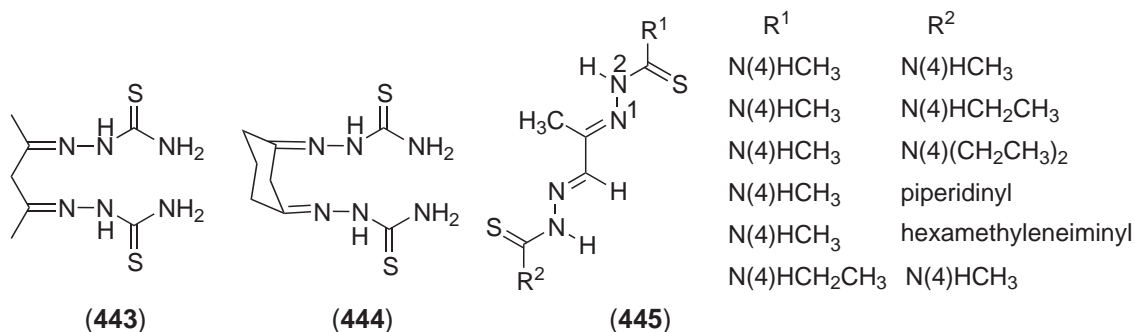
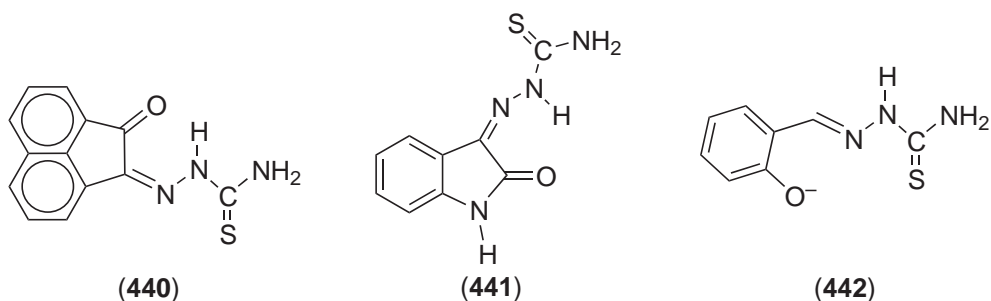

Bis(semicarbazones) with {N₂O₂} donor set form six-coordinate complexes with distorted octahedral geometry. The well-studied (potentially pentadentate) 2,6-diacetylpyridine bis(semicarbazone) (H₂daps, **448**) forms two type of crystals containing the same complex [Ni(Hdaps)₂].¹²⁶⁷ The ligands are coordinated through their pyridine and the imine N atoms and the O atom of one arm.

(H₂L**449**) is formally related to the tridentate thiosemicarbazone, but it coordinates either bidentate, (in [Ni(HL)₂]) or tridentate (in [NiL]₂).¹²⁶⁸ In contrast, (**450**) (R = Me, Ph; R' = Me, Bz) coordinates tridentate, building square planar complexes [NiLX] with one, and octahedral complexes [NiL₂] with two equivalents of the ligand.¹²⁷⁰

Thiocarbohydrazone ligands (**451**) bind bidentate through the hydrazine and thionic group.¹²⁷¹ Bis[phenyl(2-pyridyl)methanone] thiocarbazone (**451a**) is a useful ligand in preparing compounds with specific magnetic properties.¹²⁷² In the conformationally rigid tetrameric structure [NiHL]₄⁴⁺ (**452**) each metal center is octahedrally coordinated by the S atoms, the thiocarbazone N atoms and the pyridine N atoms from two different ligand molecules. These two ligands are bound to

Ni^{II} in a meridional fashion with pairs of S- and pyridine N atoms in *cis* positions, while the thiocarbonyl N atoms are *trans* to each other as it is usually found in the related octahedral complexes with thiosemicarbazones.^{1273,1274}

The neutral ligand DtdtzH₂ (**453**) can be deprotonated to yield hexadentate Dtdtz²⁻ and forms pseudo-octahedral Ni^{II} complexes¹²⁷⁵ such as $[\text{Ni}(\text{DtdtzH}_2)](\text{ClO}_4)_2$ and $[\text{Ni}(\text{Dtdtz})]$. The Ni ion has a {S₄N₂} surrounding with a *cis*-S₂ (thioether), *cis*-S₂ (thione), and *trans*-N₂ arrangement. Deprotonation of DtdtzH₂ in $[\text{Ni}(\text{Dtdtz})]$ results in an increase of thiolate character, and the average C—S (thione) bond length increases by 0.04 Å while the average N—N bond length decreases by 0.03 Å. One consequence of this is the relative facility of oxidation of $[\text{Ni}(\text{Dtdtz})]$ to the Ni^{III} species at +0.24 V vs. SCE.

The reaction between S₄N₄ and Ni^{II} has been investigated in DMSO. Reaction was found to proceed very slowly, but after several days, the nickel complex $[\text{Ni}(\text{S}_2\text{N}_2\text{H}_2)_2]$ was formed and acidification of the solution was observed. ¹H and ¹⁵N NMR studies revealed that the protonated form of the complex $[\text{Ni}(\text{S}_2\text{N}_2\text{H}_2)(\text{S}_2\text{N}_2\text{H})]^+$ exists in solution. These studies also confirmed bidentate coordination of the ligand S=N—S—NH₂, where the additional proton is bound at the NH group.¹²⁷⁶

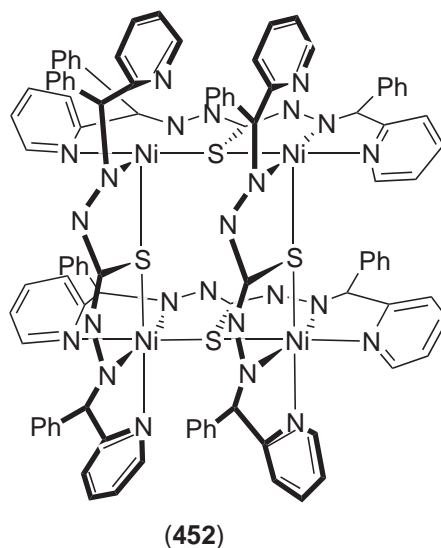
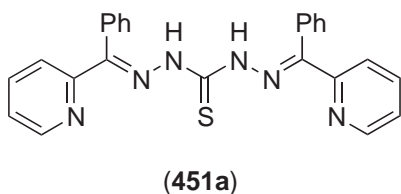
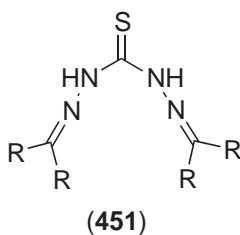
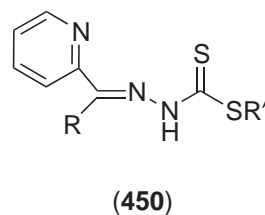
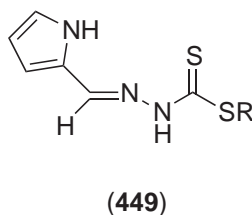
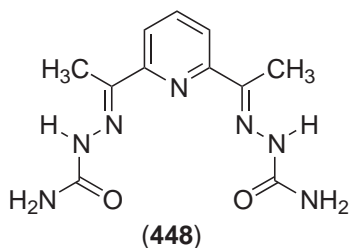

(ii) Complexes with mixed amine/thiolate ligands

The crystal and molecular structure of the Ni^{II} complex of the simplest amino-thiolate ligand 2-mercaptoethylamine (aet) (**454**) has been determined and shows that the complex, contrary to earlier belief, has a *trans* configuration.¹²⁷⁷

The reaction of (**454**) with metal salts results in multinuclear arrangements. For example the reaction of (**454**) with Pd^{2+} in water in the presence of Br^- gave the S-bridged hexanuclear $[\text{Pd}_2\{(\text{454})_2\}_4]\text{Br}_4$. The structure consists of four *cis*-(**454**) units bridging two square planar Pd^{II} moieties in a turnstile arrangement. Treatment of $[\text{Pd}(\text{aet})_2]$ with Ni^{II} gave a mixture of products $[\text{Pd}_2\{(\text{454})_2\}_{4-x}\{\text{Pd}(\text{aet})_2\}_x]\text{Br}_4$ ($x = 0-4$), showing that the ligand transfer from Pd^{II} to Ni^{II} occurs under these conditions.¹²⁷⁸ With $[\text{CoCl}_2(\text{en})_2]^+$, however, (**454**) reacts in water to give an S-bridged complex $[\text{Ni}\{\text{Co}(\text{aet})_2(\text{en})\}_2]^{4+}$, indicating that aet has transferred from Ni^{II} to

Co^{III}.¹²⁷⁹ In these reactions the Ni^{II} center normally retains its square planar geometry, but the reaction with [PtCl₂(bipy)] results in a pseudo-octahedral complex [(H₂O)₂Ni(aet)₂]Pt(bipy)]²⁺. Reaction with bipy gives [(bipy)Ni(aet)₂]Pt(bipy)]²⁺.¹²⁸⁰

In coherence with the question how thiolate-sulfur modification influences the redox properties of sulfur-rich metalloenzymes such as [NiFe]hydrogenase and CO dehydrogenase, the examination of S-oxygenation of nickel thiolates is studied intensively. Prominent systems are *cis*-dithiolate[1,5-bis(2-mercaptoethyl)-1,5-diazacyclooctanato]nickel(II) (**455a**) and *cis*-dithiolate[1,5-bis(2-mercapto-2-methylpropyl)-1,5-diazacyclooctanato]nickel(II) (**455b**).¹²⁸¹ A series of metal bound S-oxygenates of these systems could be prepared by reaction with ground state O₂, excited state ¹Δ O₂, or H₂O₂. The compounds are fully characterized, including molecular structures from X-ray crystallography in most cases. All oxygenates are S-bound and maintain the square planar geometry of the parent dithiolates.

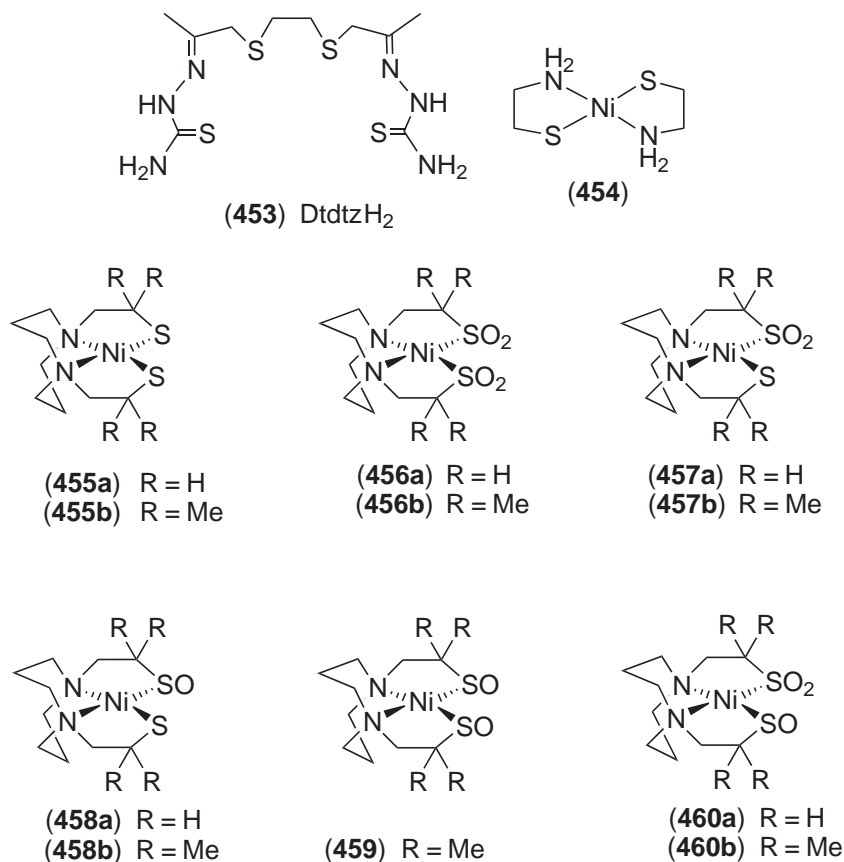

By reaction of (**455a**) with ground state O₂, a mixture of (**456a**) and (**457a**) is generated (Scheme 5), but surprisingly (**457a**) could not be reacted with further O₂ to yield (**456a**) (for this transformation H₂O₂ or singlet O₂ is needed).¹²⁸² Using MALDI mass spectra and ¹⁶O₂/¹⁸O₂ mixtures, it could be shown that both O atoms of the resulting sulfones originate from different O₂ molecules, indicating a cross-site addition of molecular O₂ in the production of the bis(sulfinate) complex (**456a**).^{1283,1284}

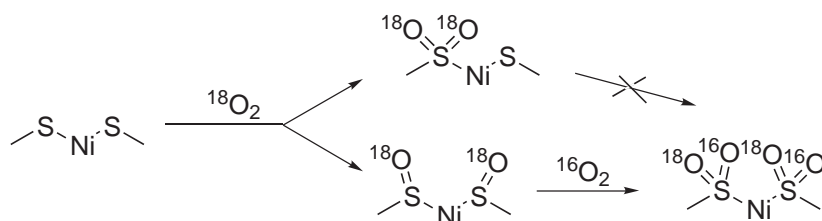

This result suggests the intermediacy of a bis(sulfoxide) rather than mono(sulfone) in the production of (456a), consistent with the lack of reactivity of isolated (457a). With (459) a bis(sulfoxide) could be isolated. A series of further experiments, including reactions with singlet O_2 , have been done to gain mechanistic information. Another question involved in this work is whether O_2 is bound by the nickel center or if the oxygenations are ligand based. In this context a ligand-based SO_2 -adduct complex could be isolated.¹²⁸⁵ The S-based reactivity is consistent with *ab initio* calculations which show the HOMO for a square planar nickel dithiolate complex analogous to (455a) to lie on the thiolate sulfur. Calculated electrostatic potentials confirm that the thiolates are the most nucleophilic sites in the complex.¹²⁸⁶ However, some participation of the nickel centers in the oxygenation reactions could not be fully excluded. It was verified that the Ni^I oxidation state is stabilized upon conversion of the thiolates to thioethers, to RSO_x by oxygenation, and upon interaction with metal cations. In contrast, the Ni^{III} oxidation state is destabilized in the cationic thioether derivatives, but gains stability when those derivatives contain additional ligating sites leading to $N_2S_2O_2$ octahedral complexes.^{1287,1288} A ligand (461) with a modified backbone framework, which is more easily accessible, has been reported.¹²⁸⁹

Complex (462) reacts with a large excess of H_2O_2 to the fully oxygenated bis(sulfonato) complex (463).^{1290,1291} With only little excess of H_2O_2 or O_2 , a mixture of (463) and the mono(sulfone) complex (464) is formed. This complex is the only intermediate in the oxygenation reaction that could be isolated, and it is shown to be further reactive towards O_2 to yield the fully oxidized product (463) (Equation (10)).¹²⁹²

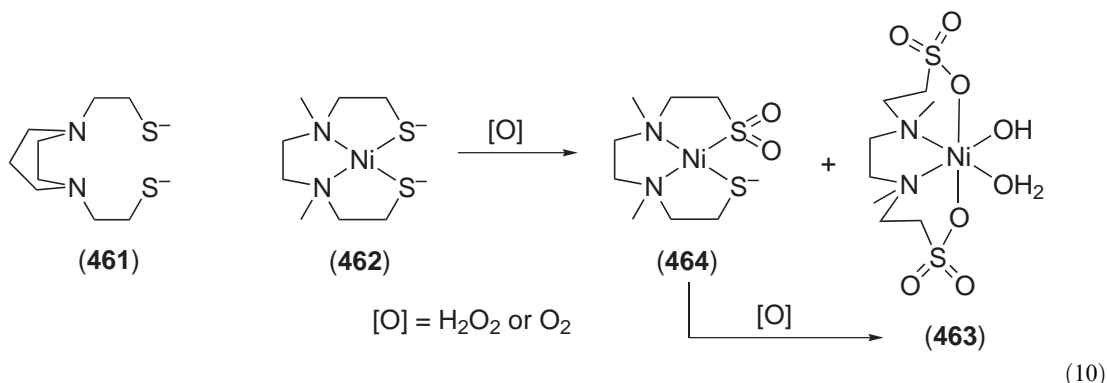

For a better understanding of the reactivity observed for (462), DFT calculations have been undertaken, which show a possible reaction path toward the fully oxidized product (463). The difference in products between (462) and (455a) has been ascribed to an enlarged barrier of (455a) to form octahedral complexes, but from DFT results there is no obvious reason explaining the different reactivity. For the reaction path, the results are consistent with a switch in reactivity of O_2 with (462), following the first (electrophilic) addition of O_2 to the (nucleophilic) thiolate sulfur of (464). It is suggested that the resultant electrophilicity of the $Ni-SO_2R$ bond site elicits the nucleophilic reactivity character of O_2 , and provides a path for a four-centered peroxy intermediate or transition state. This results in subsequent and irreversible oxygenation steps. Such cooperativity or cascading dioxygen addition reactivity leads to the fully oxidized product (463).

Ligands of the type $RN[(CH_2)_2SH]_2$ ($R = \text{alkyl, aryl, } (CH_2)_2SH, (CH_2)_2SR$) form dimeric S-bridged complexes (465) with Ni^{II} . In the case of tripodal ligands the third arm rests uncoordinated.¹²⁹³⁻¹²⁹⁶

Treatment with additional ligands like CN^- leads to monomeric complexes. Reaction of dimeric bis{[μ -(2-mercaptoethyl)(2-mercaptoethyl)methylaminato]nickel(II)} with either O_2 or H_2O_2 leads to the formation of a dimeric product, bis{[μ -(2-sulfinatoethyl)(2-mercaptoethyl)methylaminato(2-)]nickel(II)}. The reaction is first order in $[Ni]$ and proceeds at a very slow rate at $40^\circ C$ ($t_{1/2} = 7.8$ days; $k = 1.0 \times 10^{-6} s^{-1}$) under 1 atm of O_2 .¹²⁹⁷ Also the monomeric species can be oxidized to the mono(sulfones).¹²⁹⁸⁻¹³⁰² These *trans*-dithiolates do not undergo successive O_2 addition to yield the bis(sulfone) like in (455a), which demonstrates the deactivation of the thiolate by the *trans*-sulfone.¹³⁰³

Ni^{II} complexes of various amine/thiophenolate ligands have been investigated (for Ni complexes of *ortho*-aminothiophenol see Section 6.3.4.9.2(iv)). Thiophenolate is expected to exhibit decreased bridging tendency compared to aliphatic thiolates, but complexes (466) and (467) still consist of two pseudo-octahedral NiL fragments bridged via thiolate donors. In contrast to the parent complex (466), the thiolate and thioether donors in (467) coordinate *cis* to the Ni center

forming *meso* fragments. In contrast to (466), (467) readily dissociates in solution to give the mononuclear species. With PMe_3 , the adduct $[\text{NiL}(\text{PMe}_3)]$ is yielded, while reaction with I_2 gave the Ni^{III} complex $[\text{Ni}(\text{L})\text{I}]$.¹³⁰⁴

Complex $[\text{Ni}(\mathbf{468})]$ is formed with Ni^{II} salts and the amine-thiolate ligand, or by reduction of the corresponding Schiff base complex with NaBH_4 . $[\text{Ni}(\mathbf{468})]$ is easily deprotonated to form the dianionic complex, which is subsequently oxidized to the monoanion. On the other hand, the dianionic complex reacts with CH_3I to form the fourfold methylated octahedral complex (469).¹³⁰⁵ Since without preceding deprotonation only the S-donors are methylated, the complex with twofold amine methylation must be synthesized via protection and subsequent deprotection of the S-donors.¹³⁰⁶

By reaction of $[\text{Ni}(\mathbf{468})]$ with DMSO or formic acid, the nickel thiolate carbene complex (470) was formed in small amounts. In preparative amounts (470) could be obtained in a one-pot reaction of ligand $\text{H}_2(\mathbf{468})$, NiCl_2 , and $\text{CH}(\text{OEt})_3$. First a dinuclear complex is formed which can be cleaved by reaction with nucleophiles like pyridine or PR_3 . X-ray structures of these PR_3 adducts reveal that the metal centers are coordinated by two sulfur, one phosphorus, and one C(carbene) donor in a distorted plane.^{1307,1308} Even HNPPR_3 and HNSPPH_2 ligands can be introduced, X-ray structures indicating an ylidic structure.¹³⁰⁹ Ligand (471) reacts with Ni^{II} to presumably give octahedral $[\text{Ni}(\mathbf{471})_2]$.¹³¹⁰

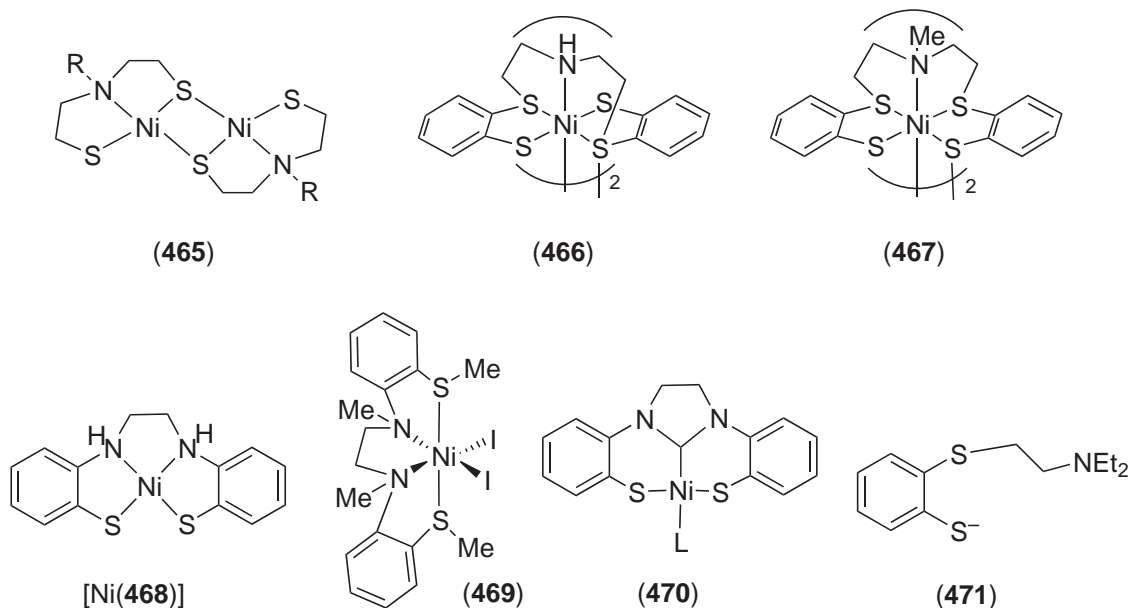

Complexes of type (472) are monomeric and square planar or tetrahedral, depending on the size of the R substituent (substituents other than Et at the ligand backbone have also been tested).^{347,1311–1313} While (472d) is purely tetrahedral both in the solid state and in solution, (472a) and (472b) are almost entirely planar at room temperature. X-ray crystallography confirmed a planar structure for (473a) and a distorted tetrahedral structure for (473b).¹³¹³ Many of these systems exhibit planar \rightleftharpoons tetrahedral equilibria in solution, the latter prevailing with larger R and increasing temperature. ³¹P NMR spectroscopy has been a useful tool for investigating these equilibria. Both ΔH and ΔS values are positive, indicating that the tetrahedral form is entropically favored.

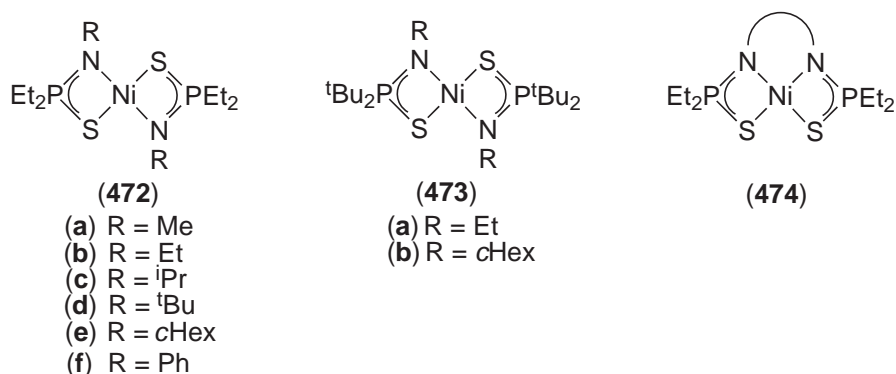

Similar equilibria planar \rightleftharpoons tetrahedral have been observed for Ni^{II} complexes (**474**) featuring tetradentate bis(thiophosphonic amidato) ligands with various spacers.¹³¹⁴ (**472a**) inserts CS₂ to give a *P,P*-diethylthiophosphorylmethylthiocarbamate complex with a {NiS₄} chromophore.¹³¹⁵

(iii) Complexes with mixed amine/thioether ligands

Tripodal ligands N[(CH₂)₂SR]₃ form complexes (**475**) in which all three thioethers are coordinated (Scheme 6). For example with R = Prⁱ octahedral dimeric complexes {[NiLCl]₂}(BPh₄)₂, (**475a**), and with R = Bu^t distorted trigonal bipyramidal complexes (**475b**) are formed. With MeMgCl both species react to give (**476**), which has been characterized crystallographically and by ¹H NMR spectroscopy. These complexes insert CO to give acyl complexes, although for R = Bu^t the complex is only stable under a CO atmosphere. Upon reaction with NaBH₄, (**475**) affords a stable hydride (**478**) (δ_H = -37.8 ppm) which in turn reacts reversibly with ethylene to give [Ni^I{NS₃}CH₂CH₃]BPh₄.^{1316,1317} In addition, (**478**) leads to a [Ni^I{NS₃}(CO)] complex that is covered in Section 6.3.5.4.

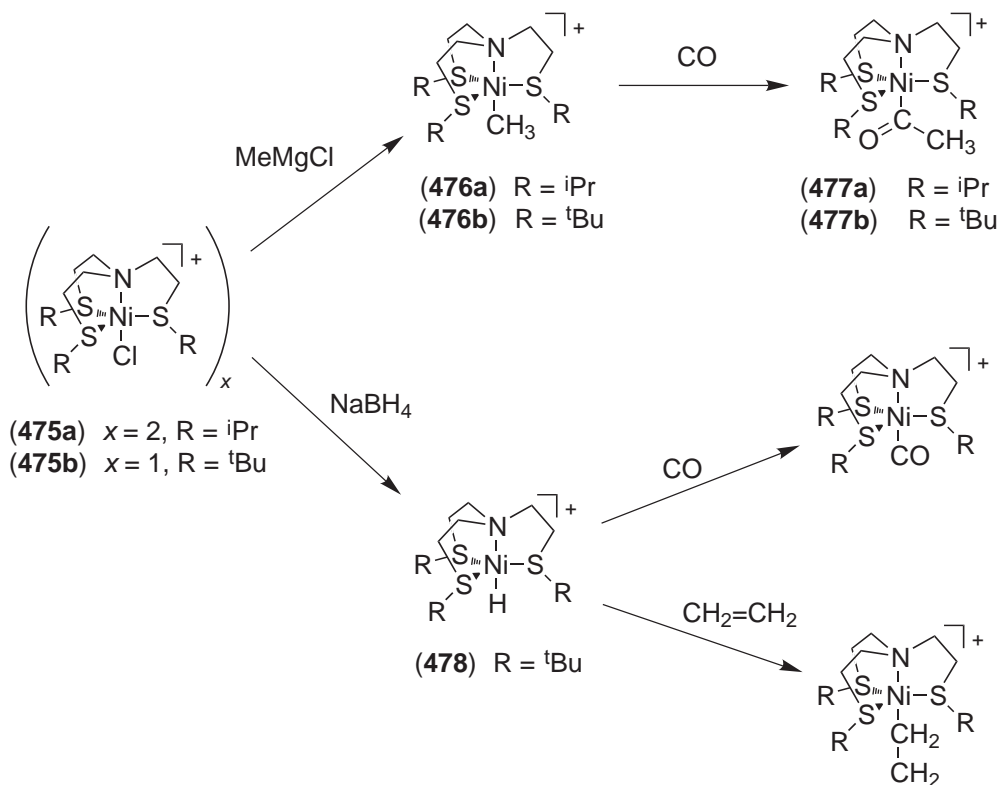

Scheme 6

The synthesis, X-ray crystal structures, and electronic spectra of [NiL(ClO₄)]ClO₄ (**479**) (L = tris{[2-(2-aminophenyl)thio]ethyl}amine) and [NiL'](ClO₄)₂ (**480**) (L' = tris{[2-(2-aminoethyl)thio]ethyl}amine) have been reported.¹³¹⁸ In (**479**) the Ni atom is bound equatorially to two S and two N atoms from two arms of the tripodal ligand while the two axial positions are occupied by the bridgehead nitrogen and an oxygen from a perchlorate. In (**480**), all three arms of the ligand are bound to the Ni providing a distorted-octahedral {S₃N₃} donor set.

(**481**) coordinates to Ni^{II} in a bidentate fashion via the imidazole N atom and the thioether S atom. The thiourea S atom does not take part in coordination.¹³¹⁹

(**482**) and (**483**) function as tridentate {N₂S} ligands forming complexes of the type [NiL₂]X₂(H₂O)_{*n*} (X = Cl, NO₃, BF₄) and [NiLCl₂(H₂O)].¹³²⁰ The {N₂S₂} ligand (**484**) coordinates tetradentate to Ni^{II} and forms octahedral complexes of the type [NiLX₂].¹³²¹

A number of further thioether-imidazole ligands with {NS}, {N₂S}, {N₂S₂}, and {N₄S₂} donor set have been characterized by X-ray crystallography, and they show a comparable coordination behavior.^{1322–1328}

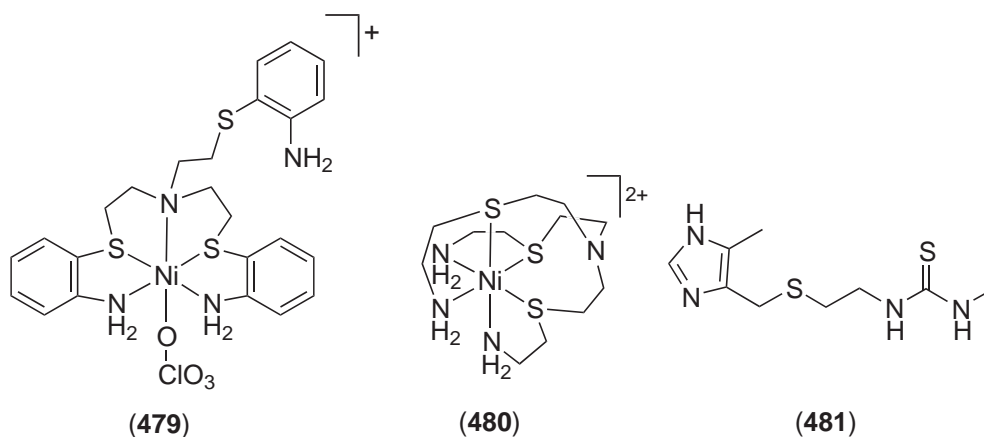

A series of related pyridine-thioether ligands (**485**) have also been studied. All the ligands gave pseudo-octahedral monomeric complexes, with solvent molecules completing the coordination sphere where required.¹³²⁹⁻¹³³¹ Ligand (**486a**) is suggested to function as a tridentate ligand forming $[\text{Ni}(\mathbf{486a})\text{Cl}_2]\cdot\text{H}_2\text{O}$,¹³³² and tridentate binding has been confirmed for complexes $[\text{Ni}(\mathbf{486b})\text{X}_2]$ and $[\text{Ni}(\mathbf{486c})\text{X}_2]$ ($\text{X} = \text{halide}$).¹³³³ Formation of either monomeric pentacoordinate species $[\text{NiLX}_2]$ or dimeric X -bridged hexacoordinate species $[\text{NiLX}_2]_2$ depends on the steric bulk of the ligand and the choice of halide ion. X-ray crystal structures reveal that (**487**) functions as a tridentate ($[\text{NiL}_2]^{2+}$) and (**488**) and (**489**) as pentadentate ligands ($[\text{NiLX}]\text{X}$).^{1334,1335}

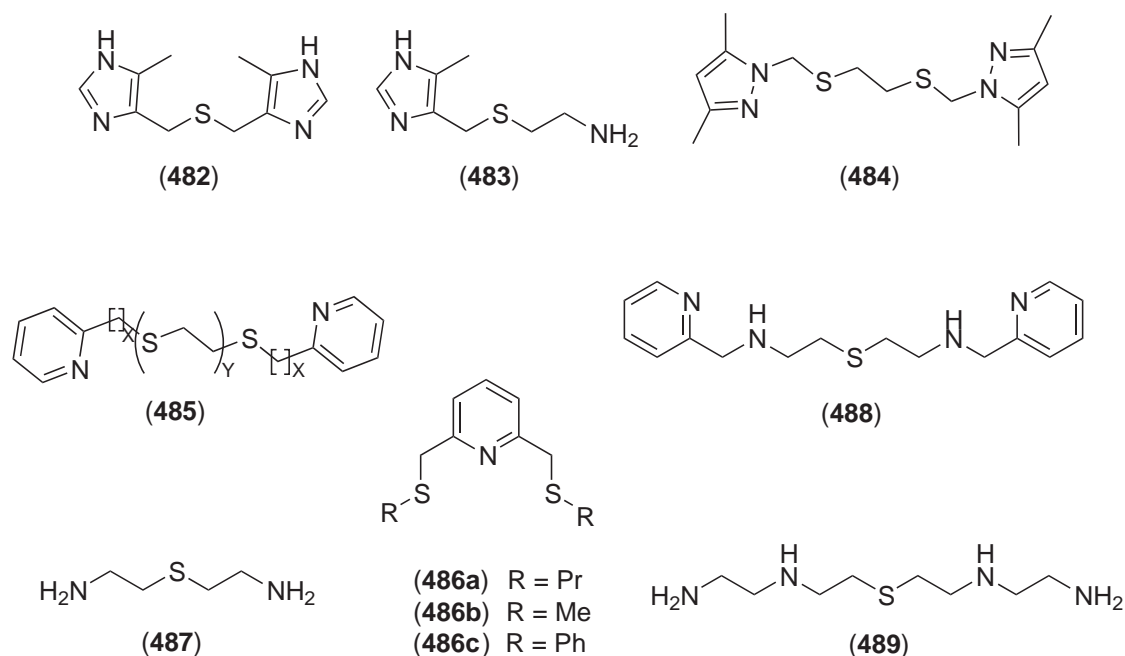

The cryptands (**490**) coordinate by three sulfur and three nitrogen donors only, forming distorted octahedral Ni^{II} complexes.¹³³⁶

By a template reaction of 2-aminothiophenol, NaOEt, 1,2-(BrCH_2)₂C₆H₄, and $[\text{Ni}(\text{ClO}_4)_2]\cdot 6\text{H}_2\text{O}$, complex $[\text{Ni}(\mathbf{491})\text{Br}_2]$ could be obtained. Interestingly, this complex could not be made from preformed (**491**) and Ni^{II} salts.¹³³⁷

Optically active amine-thioether ligands (**492**) have been investigated in nickel-catalyzed asymmetric cross-coupling reactions of Grignard reagents.¹³³⁸

(**493**) and (**494**) bear both thioether and thiolate donors besides potential N donors.^{1339,1340} For the Ni^{II} complex of (**493**), spectroscopic data favor an octahedral geometry with four S- and two N-donors. In the case of (**494**), spectroscopic data are also consistent with a pseudo-octahedral geometry, but X-ray data showed two distinct environments, i.e., square planar and square pyramidal geometry.

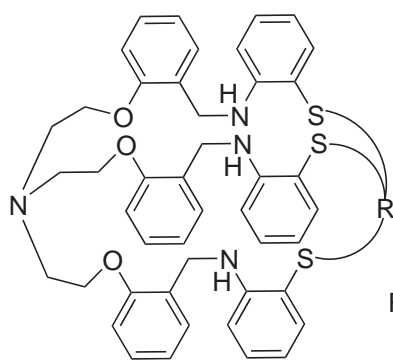

(490)

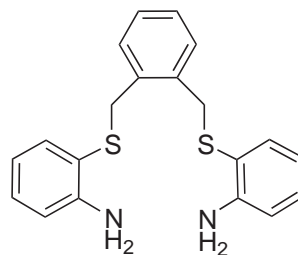
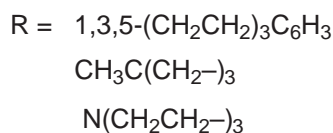

(491)

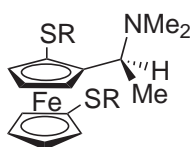

(492)

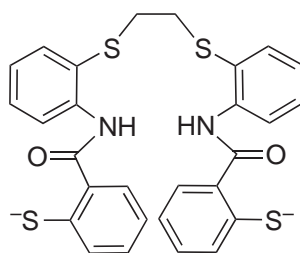

(493)

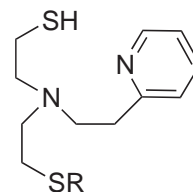

(494)

(iv) Complexes with mixed imine/thiolate and imine/thioether ligands

Schiff bases containing {N/S} donor groups are usually considered as interesting models for the Ni^{II} binding sites in enzymes. The biological significance of the nickel–cysteine sulfur interaction and the accessibility of several oxidation states of the metal ion in catalysis—either in bioinorganic systems or in metalloorganic chemistry—make S-donors very attractive also in Schiff base coordination chemistry.

A template synthesis employing Ni(OAc)₂, 2,5-dihydroxy-2,5-dimethyl-1,4-dithiane, and 3,3'-iminobis(propylamine) gave the water-soluble five-coordinate complex [Ni(495)], the crystal structure of which shows trigonal bipyramidal coordination of Ni^{II} with the central amine and terminal thiolates in plane and the two imino nitrogens in axial positions. Solvatochromism of the complex is interpreted in terms of S⋯H bonding, which may be of relevance to the catalytic cycle in hydrogenases.¹³⁴¹

2-Phenylbenzothiazoline gives complex (496a) upon reaction with Ni^{II}. (496a) undergoes C—C bond formation even at room temperature and yields complex (496b), which contains a non-innocent ligand with two chiral centres. The crystal structures of both complexes reveal a square planar environment around the Ni^{II} ions.^{1342,1343} The substitution of the phenyl group with two 3,5-di-*t*-butyl-4-hydroxyphenyl groups makes the carbon–carbon bond formation impossible even at high temperatures.¹³⁴⁴

2,4-Di-*t*-butyl-6-aminothiophenol gives complex (497) under strictly anaerobic conditions. In the presence of air, deep blue-violet solutions are obtained from which mixtures of solid deep blue-black *cis/trans*-(498) can be isolated.¹³⁴⁵ For the square planar Ni complex, the *cis-trans* isomerization rate is fast. (498) is best described as a singlet diradical due to strong antiferromagnetic coupling of the benzosemiquinonate π-radicals.^{192,1345}

Methyl-2-amino-1-cyclopentenedithiocarboxylate coordinates to Ni^{II} in a bidentate manner through the thioketone sulfur and the imine nitrogen atom, resulting in (499) with *trans* planar coordination geometry.¹³⁴⁶ Alkyl substituents (e.g., Me, Et, Prⁿ, Prⁱ, Buⁿ) on the imine N atoms drive the coordination stereochemistry from planar to tetrahedral.¹³⁴⁷ Systematic distortion from square planar to tetrahedral was also observed as the number of methylene groups is increased in the tetradentate {N₂S₂} ligands (500).^{1348–1350} For *n* = 3, the complex is effectively tetrahedral in

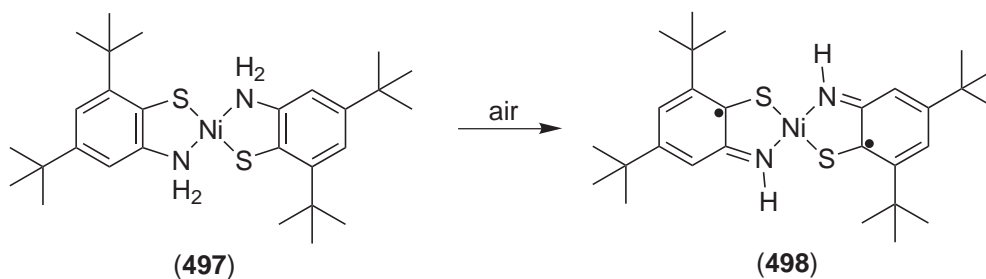
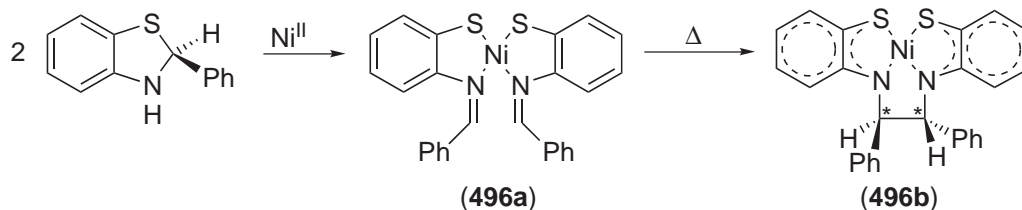
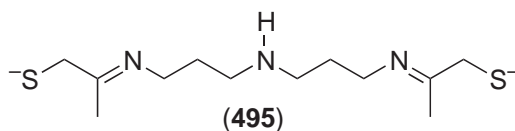

the solid ($\mu_{\text{eff}} = 3.2\mu_{\text{B}}$), but in solution only 2–3% is in the high-spin form as assessed by ^1H NMR contact shift measurements. A similar study with similar conclusions has also been carried out for Ni^{II} complexes of ligand **(501)**^{1351–1353} and related systems with $\{\text{N}_2\text{O}_2\}$ and $\{\text{N}_2(\text{NH})_2\}$ donor sets. A study on the whole series of tetradentate Schiff base Ni^{II} complexes **(502)** with $\{\text{N}_2(\text{NH})_2\}$ and $\{\text{N}_2\text{S}_2\}$ Schiff base ligands revealed that the $\{\text{N}_2(\text{NH})_2\}$ complexes are fully diamagnetic for

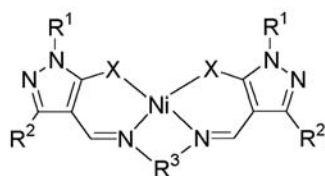
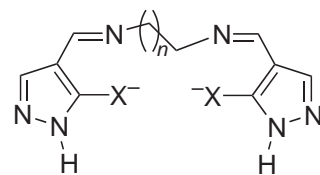
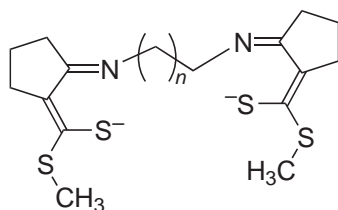
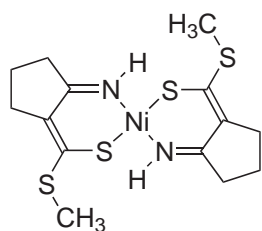

$X = \text{NH}, \text{S}$ or O

$R^1, R^2 = \text{Ph}$ or Me

$R^3 = -(\text{CH}_2)_3-, -\text{CHMeCH}_2\text{CHMe}-, -(\text{CH}_2)_2-$ or $-\text{CHMeCH}_2-$

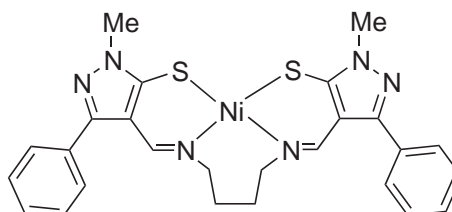
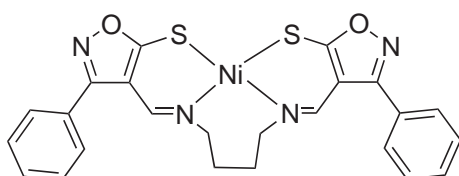

$n = 2$ and 3, while in the case of $\{N_2S_2\}$ donors the complexes are diamagnetic only for $n = 2$.¹³⁵² The ligand field parameters derived from the electronic spectra as well as cyclic voltammetry have shown that the low-spin character ($S = 0$) is emphasized in both $\{N_2(NH)_2\}$ and $\{N_2S_2\}$ Ni^{II} complexes when compared with the corresponding $\{N_2O_2\}$ species.

Incorporation of isoxazole instead of pyrazole has similar affects. Ni^{II} complexes with Schiff bases having pyrazole or isoxazole subunits and linkers with $n = 4$ (**503**, **504**) form a flattened tetrahedron with the dihedral angle (for the pyrazole derivative) between two N—Ni—S planes being 12.7° .¹³⁵⁴ In solution a spin equilibrium and racemization process $\Delta \rightleftharpoons \Lambda$ is observed.

Nickel(II) complexes of (**505**) exhibit spin equilibria in solution.¹³⁵⁵ With the bidentate analogues (**506**), complexes $[Ni(\mathbf{506})_2]$ have been isolated.¹³⁵⁶ When $R_1 = Ph$, the complex is tetrahedral in solution. It has a temperature independent magnetic moment of $2.75\mu_B$. When $R_1 = Me$, the complex exhibits square planar–tetrahedral equilibrium in solution. Both are, however, diamagnetic in the solid state.

A detailed study involving racemization kinetics and spin states of a series of nine related complexes (**507**) has been undertaken.¹³⁵⁷ In an X-ray crystallographic study of a series of complexes ($R_1 = Pr^i$, $R_2 = Me$, $R_3 = H$, $R_4 = Me, Ph, Bu^t$) all complexes were found to possess pseudotetrahedral geometry.¹³⁵⁸

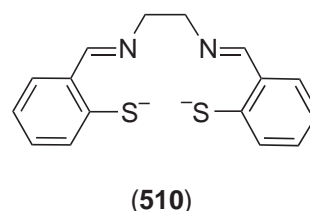
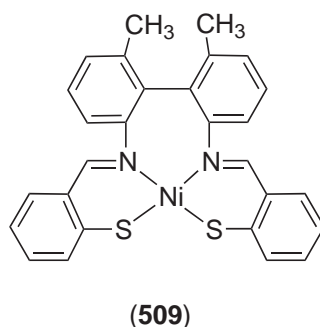
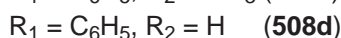
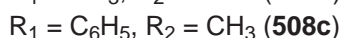
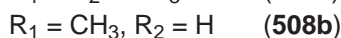
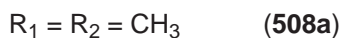
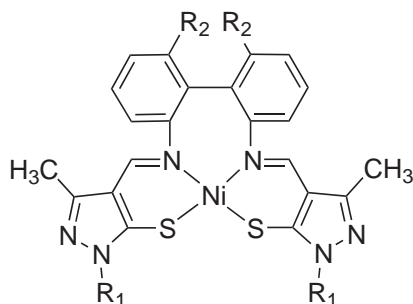
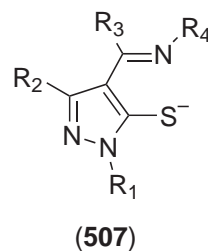
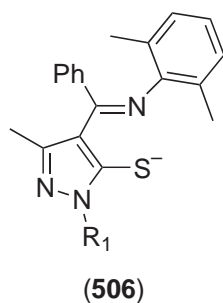
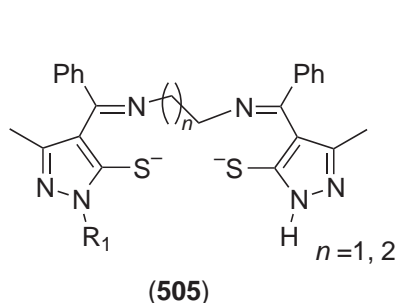

Complexes (**508a**) and (**508b**) are paramagnetic with magnetic moments characteristic for distorted tetrahedral structures with relatively large zfs ($D = 36\text{ cm}^{-1}$ and 53 cm^{-1} , respectively), whereas complexes (**508c**) and (**508d**) are diamagnetic.¹³⁵⁹ The solid-state structure of (**508a**) confirms the distorted tetrahedral geometry, while (**508d**) and the related complex (**509**) are much closer to square planar. The respective dihedral angles between the planes defined by the N—Ni—S and N'—Ni—S' atoms are 77.4° and 35.7° for (**508a**) and (**508d**). In chloroform solution all complexes (**508**) show a $^1A_{1g} \leftrightarrow ^3T_1$ spin equilibrium with equilibrium constants $K_{eq}(N_{HS}/N_{LS})$ in the range of 0.456–0.080. Surprisingly, the nature of the substituents on the pyrazolyl rings has a stronger influence on the spin state than the nature of the substituents on the biphenyl moiety.

In thiosalen-type complexes the Ni^{II} ion usually has a four-coordinate square planar geometry.^{1360,1361} Complex $[Ni(\mathbf{510})]$ shows a quasi-reversible reduction at -1.36 V and an irreversible

oxidation at +1.00 V.^{1362,1363} When the ethylene bridge is replaced by a phenylene bridge, again square planar complexes are isolated.¹³⁶⁰ Alkylation of the S atom results in distinct changes in the binding ability, since Ni^{II} complexes of such thioether ligands adopt an almost ideal octahedral geometry with two additional *trans* ligands (**511**; X = Cl, Br).^{1364,1365} Both complexes (**511**) and (**512**) are paramagnetic. (**511a**) and (**511b**) are soluble and stable in noncoordinating solvents (CH₂Cl₂, CHCl₃), but dissociate in DMSO and other strongly coordinating solvents. In contrast, complexes (**512a**) and (**512b**) are stable in coordinating solvents, while (**512c**) is unstable and complex (**513**) crystallizes from a solution of (**512c**) in EtOH. In the case of longer dodecyl chains at the S atoms (**511b**), the S atoms have opposite relative configurations {*R,S*}, while with hexyl substituents the configuration at S is the same. The longer alkyl chains are fully extended in the all-*trans* conformation with resultant hydrophobic interactions and a bilayer packing in the crystals.

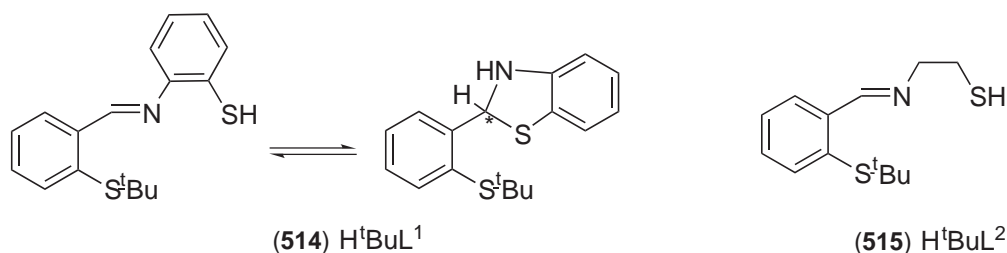
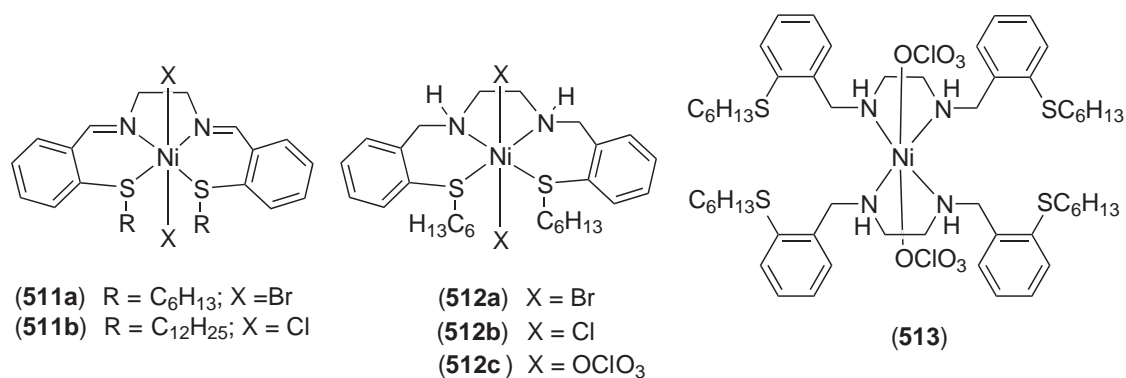

Potentially tridentate benzothiazolidine {NS₂} ligands (**514**) form mononuclear or dinuclear Ni^{II} complexes, depending on the anion used.¹³⁶⁶ Upon reaction with Ni(OAc)₂, HBu^tL¹ forms a monomeric complex [Ni(Bu^tL¹)₂], which is a square planar species with slight distortion towards tetrahedral geometry. With other Ni^{II} salts it gives a dimeric, S-bridged complex [Ni(L¹)₂] after loss of the *t*-butyl protecting group. The same coordination mode is found for (**515**) (Figure 15).

Complex (**516**) was prepared according to Equation (11). The dangling formyl groups can be used for further derivatization (e.g., (**517**) shown in Figure 16), and (**516**) serves as a valuable starting material for the synthesis of macrocyclic dinuclear species (compare Section 6.3.4.12).¹³⁶⁷

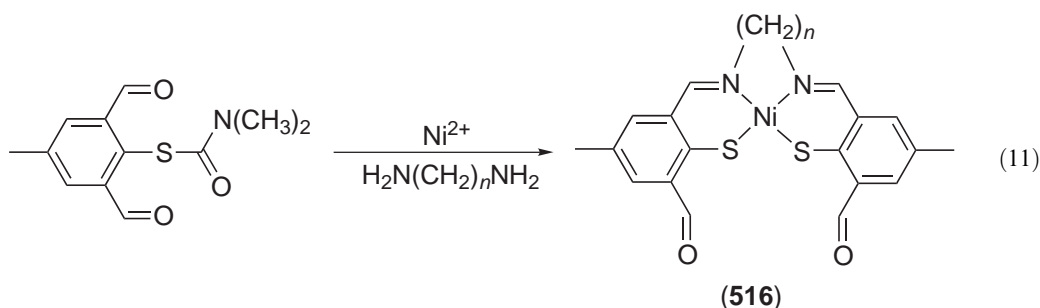

The reaction of 2,2'-dithiodibenzaldehyde with Ni^{II} complexes containing coordinated primary amines results in Schiff base condensation and cleavage of the disulfide bond to form a chelating

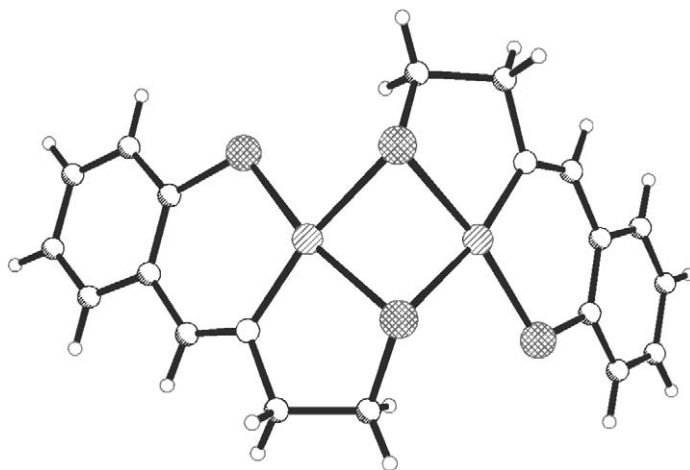

Figure 15 Molecular structure of $[\text{Ni}(\text{L}^2)]_2$ ($\text{HBu}^1\text{L}^2 = (515)$).

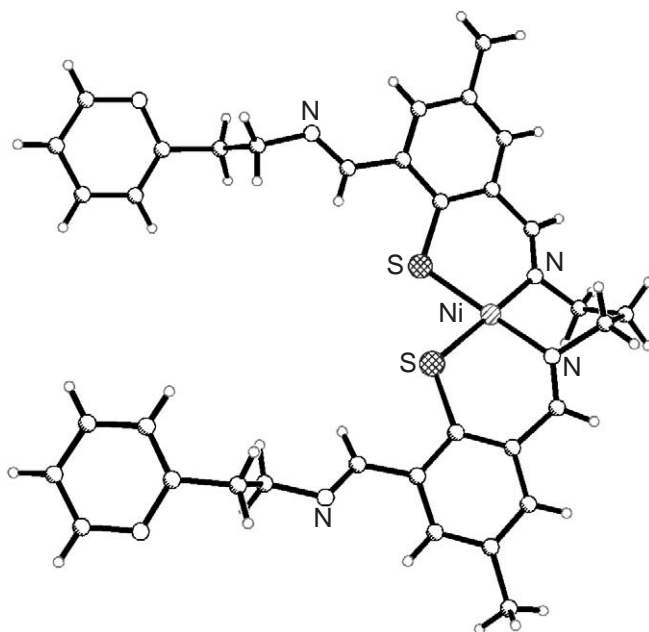
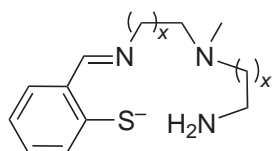

Figure 16 Molecular structure of (517).

{N/S} ligand.^{1363,1368} The method was used to synthesize Ni^{II} complexes with varying {N/S} donor sets, including complexes $[\text{Ni}(518\text{a})]\text{BPh}_4$ and $[\text{Ni}(518\text{b})]\text{BPh}_4$ with tetradentate {N₃S} Schiff base coordination. Although both complexes have similar planar structures, the complex with (518b) is significantly more distorted towards tetrahedral, because the six-membered chelate rings must deviate from planarity to assume boat or chair conformations. With (519), polymeric octahedral complexes are formed, the ligand coordinating via pyrrolyl, sulfide, and imine donors.¹³⁶⁹ Cimetidine (520), when reacted with NiX_2 ($\text{X} = \text{BF}_4, \text{NO}_3$), yielded complexes $[\text{Ni}(520)_2]\text{X}_2$. The complexes were assigned pseudo-octahedral stereochemistry with a {NiN₂N₂*S₂} chromophore.¹³⁷⁰

A number of differently substituted *N*-(thiocarbamoyl)benzamidines (521) ($\text{R} = \text{Et}, \text{Bu}$; $\text{NR}_2 = \text{morpholino}$) have been complexed with Ni^{II} . The ligands function in a bidentate manner, coordinating via the primary amine N and thione S atoms.¹³⁷¹

Quinazoline-2-thione-4-one (522) and its 3-phenyl derivative coordinate to Ni^{II} after deprotonation via the S and the N1 donor resulting in a square planar complex.¹³⁷² The related 2-isopropylquinoline-8-thiolate (523) forms a distorted tetrahedral complex.¹³⁷³ For deprotonated 2-thiocarbamyl-thiazoline ($\text{HL} = (524)$) the octahedral complex $[\text{NiL}(\text{H}_2\text{O})_4]^+$ is favored over the square planar $[\text{NiL}_2]$ complex.¹³⁷⁴



(518)
x = 1 (a), x = 2 (b)

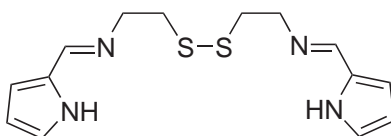

(519)

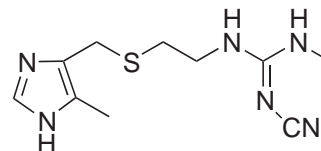

(520)

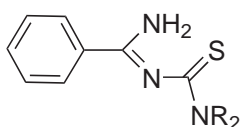

(521)

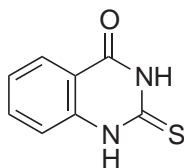

(522)

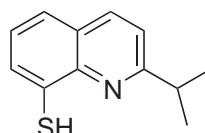

(523)

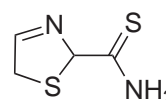

(524)

Ligand (525) forms with Ni^{II} a square planar complex with coordination through the S and the N4 atoms.¹³⁷⁵ In work aimed at the imitation of the low potentials observed for certain [FeNi]-hydrogenases, the complex (Et₄N)₂[Ni(526)₂] has been prepared. Its structure is tetragonally distorted octahedral with an essentially planar NiS₄ fragment and a *mer* configuration. The oxidation of this complex with I₂ in MeOH affords [Ni^{III}(526)₂]⁻, in which the geometry observed for Ni^{II} is preserved. Cyclic voltammetry of the Ni^{II} complex shows a reversible oxidation at -0.085 V (SCE) and the EPR spectrum of the ⁶¹Ni-enriched Ni^{III} species has been obtained (compare Section 6.3.3.9.2).¹³⁷⁶

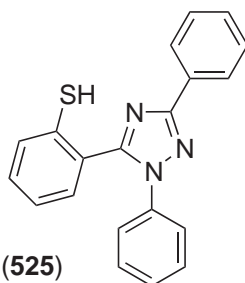

(525)

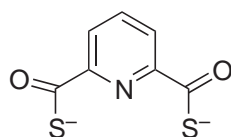

(526)

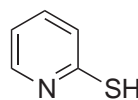

(527)

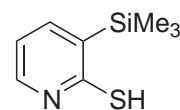

(528)

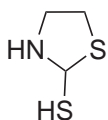

(529)

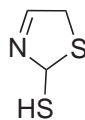

(530)

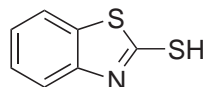

(531)

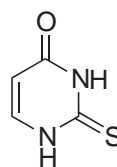

(532)

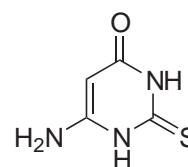

(533)

The electrochemical oxidation of a nickel electrode in a solution of pyridine-2-thione (HL = (527)) in MeCN gives polymeric, six-coordinate [NiL₂]_n. In the presence of py, bpy, or phen, the monomeric complexes [NiL₂X₂] (X₂ = py₂, bpy, phen) are formed. The structure of [NiL₂(bpy)]·0.5bpy reveals a distorted octahedral geometry, with the S-donors axial and the four N-donors roughly in a plane. Structural and spectroscopic data indicate that deprotonated (527) coordinates essentially as the 2-C₅H₅NS⁻ tautomer.¹³⁷⁷ With pyridine-2-thiol and pyrimidine-2-thiole [NiL₃]⁻ anions have been characterized structurally.¹³⁷⁸ Ligand (528) functions as a bidentate {NS} donor resulting in planar Ni^{II} complexes.¹³⁷⁹ The sacrificial anode method has also been used to prepare this complex. With bpy or phen planar or octahedral complexes resulting in solution with (528) chelating in the thiolate form.¹³⁸⁰ For other mercapto-pyridine derivatives similar results have been found.¹³⁸¹⁻¹³⁸⁴

[NiL₂] complexes with ligands (529) and (530) have been synthesized using electrochemical methods. In the presence of further donors they form octahedral complexes.¹³⁸⁵ Ligand (531)

forms $[\text{NiL}_2]$ complexes with Ni^{II} . With phen or bpy as coligands, magnetic and spectroscopic data of the resulting complexes again suggest planar or octahedral coordination of {NS} chelates.^{1386,1387} Four-membered {NS} coordination is also present in the octahedral complexes $(\text{Et}_4\text{N})[\text{NiL}_3]$ (HL = (531), (532), (533)).¹³⁸⁸

The neutral ligand (534) acts as a bidentate {NS} donor with all-*trans* coordination in $[\text{Ni}(534)_2(\text{H}_2\text{O})_2](\text{ClO}_4)_2$. With NiX_2 , polymeric octahedral $[\text{Ni}(534)_2\text{X}_2]$ (X = Cl, Br) and $[\text{Ni}(534)_2\text{X}_2(\text{H}_2\text{O})_2]$ (X = Br) have been characterized, with the ligand acting as a monodentate N-donor. A second isomer of $[\text{Ni}(534)_2\text{Br}_2]$ can be isolated with bidentate {NS} coordination. Hence ligand (534) functions either as a monodentate N-donor or as a bidentate ligand depending on the nature of the counter ion and the conditions employed.¹³⁸⁹

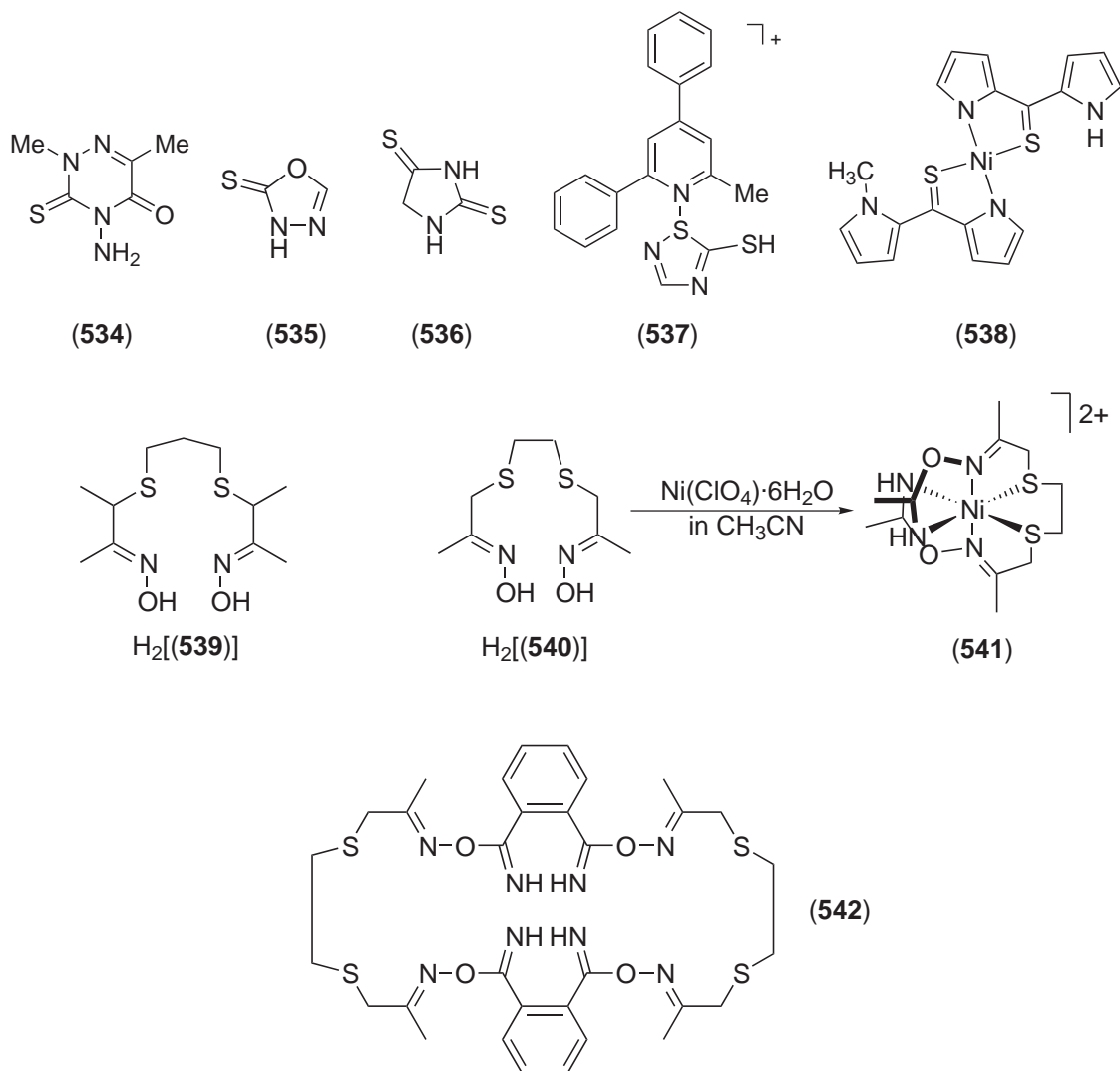

Complexation of (535) and (536) with Ni^{II} yielded complexes of the type $[\text{NiL}_2]$. The complexes were found to be diamagnetic, with the ligands binding in a monobasic {NS} bidentate fashion.¹³⁹⁰ $[\text{Ni}(537\text{H}_{-1})_2(\text{ClO}_4)_2]$ has been prepared and characterized using chemical analysis, thermogravimetric, magnetic and a variety of spectroscopic techniques.¹³⁹¹ A number of further thiadiazole ligands have been examined, confirming {NS} bonding.¹³⁹² 2-Pyrrolylthiones form square planar $[\text{NiL}_2]$ complexes such as (538), similar to the related 2-thioacetylpyrrole and 2-thiobenzoylpyrrole.¹³⁹³

The mixed dithioether/dioxime ligand $\text{H}_2[539]$ gives a planar Ni^{II} complex $[\text{Ni}(\text{H}[539])]\text{ClO}_4$.¹³⁹⁴ In contrast, upon reaction of $\text{Ni}(\text{ClO}_4)_2 \cdot 6\text{H}_2\text{O}$ with $\text{H}_2[540]$ the octahedral complex (541) is formed by Ni-mediated coupling of the dioxime with two moles of MeCN.¹³⁹⁵ If $\text{H}_2[540]$ is coupled with *o*-phthalonitrile in the presence of Ni^{II} , a dinuclear complex of (542) is obtained.¹³⁹⁶

6.3.4.9.3 Complexes with mixed {N,O,S} ligands

Mixed {N,S,O} donor sets are useful to compare the coordination ability and the structural consequences of various donor sets and to induce a variety of structural properties. The solid-state structures of [Ni(pyzs)]BF₄, [Ni(pyrs)]BF₄ and [Ni(pyzo)]BF₄ containing dissymmetric tetradentate ligands with {N₂S₂} (**543**) and {N₂SO} (**544**) donor sets are square planar.¹³⁹⁷ The phenolate-based complexes are essentially planar in nitromethane, but distorted octahedral in methanol, while thiophenolate-containing complexes remain square planar in both solvents.

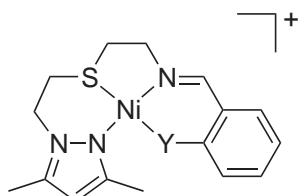

(543)

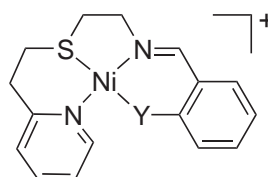

(544)

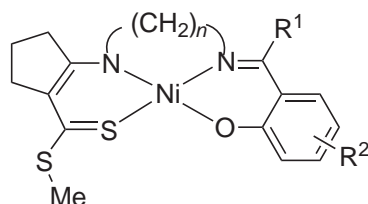

	$\underline{R^1}$	$\underline{R^2}$	$\underline{n = 2}$	$\underline{n = 3}$
(545a)	H	H	[Ni(cdsalen)]	[Ni(cdsalpd)]
(545b)	Me	H	[Ni(cdMesalen)]	[Ni(cdMesalpd)]
(545c)	H	3'-MeO	[Ni(cdMeOsalen)]	[Ni(cdOsalpd)]
(545d)	Me	5'-Me	[Ni(cdMe ₂ salen)]	[Ni(cdMe ₂ salpd)]
(545e)	H	4',6'-(MeO)	[Ni{cd(MeO) ₂ salen}]	[Ni{cd(MeO) ₂ salpd}]
(545f)	Me	5'-MeO	[Ni(cdMeMeOsalen)]	[Ni(cdMeMeOsaldpd)]
(545g)	H	3',5'-Cl ₂	[Ni(cdCl ₂ salen)]	[Ni(cdCl ₂ salpd)]

The Ni^{II} complexes (**545**) with tetradentate {N,N',O,S} Schiff base ligands have a tetrahedrally distorted square planar geometry which is retained even in strongly coordinating solvents.¹³⁹⁸ Increasing the bulkiness of the ligand substituents does not induce significant changes in the complex structure. In most cases the reduction of Ni^{II} complexes to Ni^I does not change the coordination number, although in some cases six-coordinate species are formed.

Tridentate {NOS} ligands (**546a**) and (**546b**) give thiolato-bridged dinuclear and trinuclear Ni^{II} complexes, respectively.¹³⁹⁹ In dinuclear (**547**) incorporating a salicylaldehyde thiosemicarbazone ligand, it is the phenolato-O that forms the bridges. The latter complex mediates silane alcoholysis and has been exploited as a model for the D₂/H⁺ exchange reaction of hydrogenases.¹²⁵⁵ N,N'-disubstituted dithioxamides form dinuclear species (**548**) with antiferromagnetic coupling very similar to the corresponding oxamides ($J = -13 \text{ cm}^{-1}$).¹⁴⁰⁰

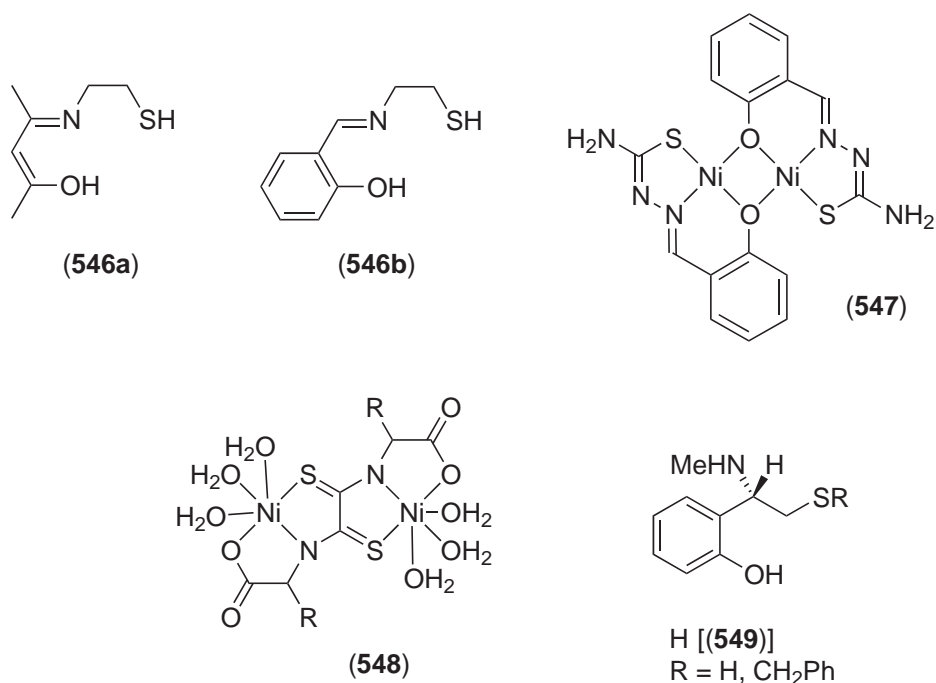

Chiral **(549)** can act as a tripodal {NOS} ligand, and a hexacoordinate Ni^{II} species [Ni(**(549)**)₂] forms for R = CH₂Ph.¹⁴⁰¹ However, the thioether ligand is labile, and square planar [Ni(κ -N,*O*-**(549)**)₂] may also be present depending on the conditions. The protonated ligand gives octahedral [Ni(κ -N,*S*-H(**(549)**))₂Cl₂]. Using the related ligand with R = H, a trinuclear cluster [Ni₃S(κ -N,*S*-H(**(549)**))₃] consisting of three N,*S*-bound ligands and a central sulfide was isolated.¹⁴⁰²

The tripodal ligand **(550)** with {N₂OS} donor set reacts with Ni(OAc)₂·4H₂O or Ni(ClO₄)₂·6H₂O to give multinuclear Ni^{II} complexes (Scheme 7).

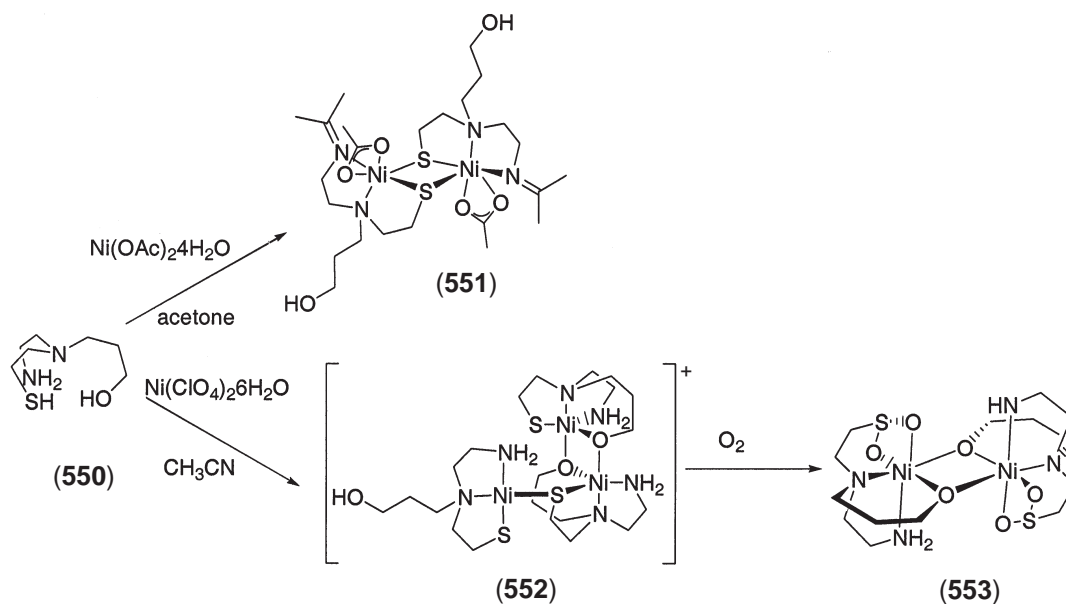

Scheme 7

When Ni(OAc)₂·4H₂O is employed, a dimeric complex **(551)** with a coordinated Schiff base forms, because the amine donor reacts with the solvent acetone. With Ni(ClO₄)₂·6H₂O, a trinuclear complex **(552)** is obtained which is readily oxidized upon exposure to air or by aqueous

H₂O₂ to yield the corresponding sulfinate complex (**553**). In the latter, the sulfinato group is O,O-bound—a very unusual coordination mode for Ni^{II} sulfinate complexes.¹⁴⁰³

6.3.4.10 Complexes with Macrocyclic Ligands

Nickel complexes of macrocyclic ligands—in particular aza-type macrocycles—have received much attention, and an immense number of publications has appeared in the field. This is, among other aspects, due to the stabilization of uncommon oxidation states (high-valent nickel Ni^{III} and Ni^{IV}, and low-valent nickel Ni^I) by particular macrocycles and the use of such complexes in catalytic reactions, e.g., olefin epoxidation as well as electrochemical reduction of alkyl halides and carbon dioxide. Further impetus comes from the occurrence of a Ni-containing macrocyclic tetrapyrrol-derived cofactor (called F₄₃₀) in the active site of the enzyme S-methyl coenzyme M reductase, which catalyzes the final step in methane generation by several methanogenic organisms. This enzyme is assumed to contain Ni^{II} in its resting state and Ni^I in the active form. Several reviews on macrocyclic chemistry have appeared,^{1404,1405} including an excellent review that specifically focuses on the macrocyclic chemistry of nickel.⁹¹

Square planar Ni^{II} complexes are most stable with 14-membered macrocyclic ligands, the prototype of which is [14]aneN₄ (cyclam). Hence, Ni^{II} complexes with cyclam-based ligands that form 6-5-6-5-membered chelate rings with the metal ion are particularly manifold. Also, Ni^{II} complexes of the small macrocycle [9]aneN₃ (tacn) and its heteroanalogues are being studied intensively. Since in this case the nickel ion cannot be accommodated within the cavity of the macrocyclic ligand, the chemistry of such complexes is somewhat distinct and will be covered in a separate section. The even smaller cyclic ligand 1,5-diazacyclooctane (daco), often referred to as a mesocycle, has been investigated in Ni^{II} coordination chemistry. The structures of [Ni(daco)₂]₂Br₂ (**554a**) and [Ni(daco)₂]₂Br₂ (**554b**) revealed boat/chair conformations with the ligands either related by a center of symmetry or by a mirror plane. Calculations confirmed that form (**554a**) has thermodynamic stability, while (**554b**) has chemical stability.¹⁴⁰⁶

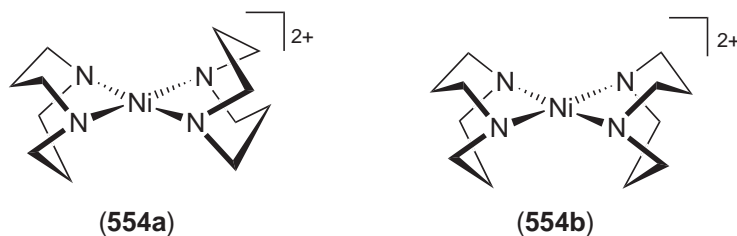

Daco-derived ligands, in particular derivatives alkylated with ethylene sulfide to provide pendent mercaptoethyl groups, have been used in model compounds for the active site of Ni^{II}-containing hydrogenases.^{1407–1409}

6.3.4.10.1 Complexes with 1,4,7-triazacyclononane-type ligands

Largely due to the favorable ligating properties of the tridentate 1,4,7-triazacyclononane ligand ([9]aneN₃, tacn), numerous nickel complexes with tacn and derivatives thereof have been studied. Different to the larger macrocycles like [14]aneN₄, where the metal ion often resides within the macrocycle cavity, the small tacn ligand coordinates facially in octahedral complexes. Tacn-based complexes are particularly prominent in bioinorganic model chemistry (although this is less valid for nickel compared to other metal ions, e.g., iron or copper) and usually exhibit high stability constants.¹⁴⁰⁴ Of growing interest in tacn coordination chemistry is the appending of side arms bearing additional donor atoms, thereby increasing the number of coordination sites filled upon nickel binding to the macrocycle.

(i) Sandwich complexes with tacn ligands

The sandwich complex [Ni(tacn)₂]²⁺ (**555**) is known as a kinetically inert, thermodynamically stable system. Functionalized tacn ligands with “innocent” alkyl substituents like, for

example, methyl or isopropyl, at all N atoms are not able to form sandwich complexes, which has been attributed to steric interaction between the bulky substituents.¹⁴⁰⁴ Asymmetrically functionalized Bztacn with only a single benzyl substituent, however, forms a sandwich complex with the benzyl amine donors occupying adjacent sites at the metal center (*syn* isomer), which—contrary to initial expectation—appears to be the sterically less hindered isomer.¹⁴¹⁰

A number of bis(tacn) ligands, composed of pairs of covalently linked tacn macrocycles, can form similar structures, provided the linker group between the sandwiching macrocycles is sufficiently flexible (e.g., (556)).^{1411–1413} In particular, several Ni^{II} complexes of poly(tacn) derivatives with a central benzene have been studied, where the Ni is sandwiched between pairs of tacn macrocycles when these are attached to the *ortho* positions of the aromatic spacer group (e.g., (557)).^{1412,1413}

[NiL₂]²⁺-type sandwich complexes of tacn ligands bearing one or three pendent alkyne arms (L = *N,N',N''*-tris(3-prop-1-yne)-1,4,7-triazacyclononane or *N*-(4-but-2-yne)-1,4,7-triazacyclononane) have been synthesized.¹⁴¹⁴ Contrary to expectation, the alkyne groups did not show any reactivity towards organometallic reagents like Co₂(CO)₈. The Ni^{II} complex of a chiral tacn-type ligand (558) with a cyclohexane ring fused to macrocycle framework (L = chttacn) has also been reported.¹⁴¹⁵

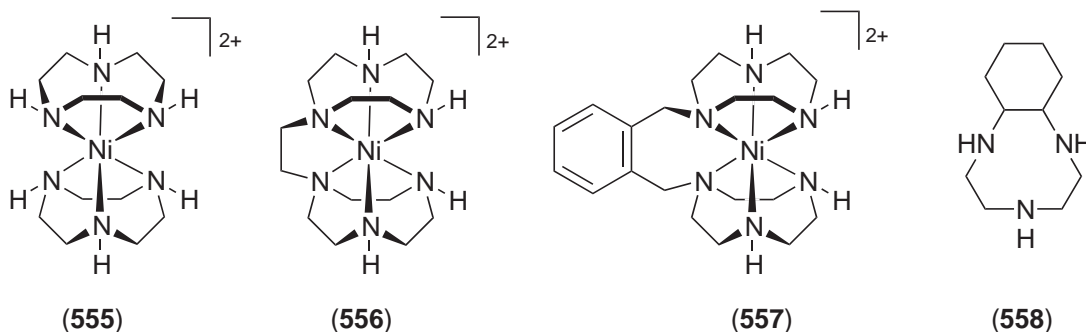

Electronic spectral data for selected tacn sandwich complexes of Ni^{II} are collected in Table 5. Three common maxima of octahedral Ni^{II} predominantly arise from spin-allowed transitions ³A_{2g} → ³T_{2g} (1,000–800 nm), ³A_{2g} → ³T_{1g}(F) (550–500 nm), and ³A_{2g} → ³T_{1g}(P) (300–400 nm). A detailed spectroscopic and ligand field analysis of the parent complex has been performed using the AOM.¹⁴¹⁶ The band envelope of the low-energy transition, which is asymmetric or has a shoulder, has to be attributed to symmetry splitting and spin-orbit coupling within the ³T_{2g} state, or a close approach of the ¹E_{2g} state such that the spin-forbidden ³A_{2g} → ¹E_{2g} transition gains intensity through spin-orbit coupling with the ³T_{2g} state. The contributions of these effects may differ in each individual case, where for parent [Ni(tacn)₂]²⁺ the double-humped band shape is largely the result of two relatively narrow bands corresponding to transitions to spin-orbit levels which contain significant spin singlet character. The best fit ligand field parameters are e_σ(N) = 4340, B = 840, C = 2830, and ζ = 500 cm⁻¹.¹⁴¹⁶

The high ligand field splitting value of [Ni(tacn)₂]²⁺ is due to this complex having the minimum possible cage size for Ni^{II}, and it has been assumed that the metal–ligand distances would be shorter were it not for the nonbonded repulsive interactions between pairs of methylene groups on

Table 5 Electronic spectral data for selected tacn sandwich complexes of Ni^{II}.

	λ _{max} (nm)	10Dq(cm ⁻¹)	References
[Ni(tacn) ₂] ²⁺	308, 505, 800, 870 (sh)	12,500	1416
[Ni(bztacn) ₂] ²⁺	390, 532, 840, 961	11,900	1410
[Ni(chttacn) ₂] ²⁺	290, 508, 812, 880	12,300	1415
[NiL ^{eth}] ^{2+ a}	366, 522, 849, 924	11,780	1411
[NiL ^{ox}] ^{2+ b}	347, 359, 538, 625 (sh), 840 (sh), 917	11,900	1413

^a L^{eth} = 1,2-bis(1,4,7-triazacyclon-1-yl)ethane. ^b L^{ox} = 1,2-bis(1,4,7-triazacyclon-1-ylmethyl)benzene.

adjacent rings.¹⁴¹⁷ The $10Dq$ value for the chiral derivative $[\text{Ni}(\text{chtacn})_2]^{2+}$ is slightly lower than for the parent complex, presumably due to the donor strength difference between secondary and tertiary amines as well as steric reasons that originate from the bulk of the cyclohexane rings fused to the macrocycle.¹⁴¹⁵ The latter effect is much more pronounced in the case of $[\text{Ni}(\text{bztacn})_2]^{2+}$, where the benzyl substituents prevent the N-donors from approaching the optimum Ni—N distance of 2.08 Å (Ni—Nbz distances of 2.251 Å and 2.262 Å), resulting in a much weaker ligand field.¹⁴¹⁵

(ii) Complexes of tacn-based ligands with pendent donor side arms

Nickel(II) complexes of tacn ligands with pendent donor arms have received considerable attention. One, two, or three N atoms of the macrocycle can be functionalized, leaving two, one, or no remaining coordination sites at the octahedrally coordinated metal ion (general types (559), (560), and (561)). For synthetic reasons, type (561) complexes are by far the most numerous. These systems comprise, *inter alia*, tacn ligands with three 3-aminopropyl (taptacn),¹⁴¹⁸ imidazol-2-ylmethyl (timtacn),^{1419,1420} 2-pyridylmethyl (tpmtacn),^{97,1421} pyrazol-3-ylmethyl (tpz3mtacn),¹⁴²² pyrazol-1-ylmethyl (tpz1mtacn),¹⁴²⁰ 2-hydroxy-3-methylbutyl (thmbtacn),^{1423,1424} acetate (tacnta),¹⁴²⁵ or ethylacetate (tacntea)¹⁴²⁶ pendent arms. In the case of 1,4,7-triazacyclononane-*N,N',N''*-tris(2-ethanesulfonate) (tacntes), the crystal structure reveals that one of the side arms remains uncoordinated with one water bound to the Ni ion.¹⁴²⁶

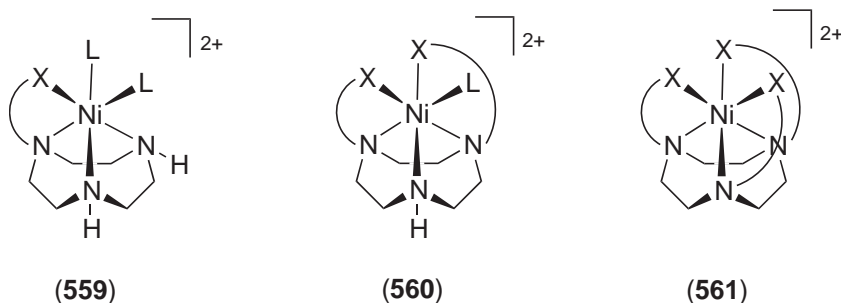

The pseudo-octahedral $\{\text{NiN}_6\}$ core in type (561) complexes usually features a twist angle, e.g., 23.4° in $[\text{Ni}(\text{tpmtacn})]^{2+}$.⁹⁷ Since the five-membered chelate rings of the coordinated tacn are not planar but adopt either the $\lambda\lambda\lambda$ or $\delta\delta\delta$ conformation for each set of chelate rings, the coordinated base fragment is chiral and the pendent arms may attach themselves in a clockwise or anticlockwise fashion for a given arrangement of the base fragment.

The kinetics and mechanism of complex formation has been studied in great detail for $[\text{Ni}(\text{tacnta})]^-$: in the pH range 4.4–6.8, Ni^{2+} and the ligand species Htacnta^{2-} equilibrate rapidly ($K=13 \text{ M}^{-1}$) to form an intermediate $[\text{Ni}(\text{Htacnta})]$ which is subject to protonation ($\text{p}K_{\text{H}}=5.77 \pm 0.04$). Spectral properties suggest that this is a monoacetato species with partial N coordination. In a second (first-order) rate-controlling step ($k_{\text{H}}=154 \pm 15 \text{ s}^{-1}$) that is accompanied by proton release, the N_3O_3 coordination of the Ni is completed.¹⁴²⁷ When crystallized from nitric acid, $[\text{Ni}(\text{tacnta})]^-$ forms as the hydronium salt, indicating extreme stability.¹⁴²⁵ This is in contrast to comparable complexes (such as EDTA complexes) where any acid protonates a carboxylate which is then left uncoordinated. The structure of $[\text{Ni}(\text{tacnta})]^-$ displays very short Ni—N bond lengths of 2.04 Å which are not the result of compression, but rather the very efficient packing of the tacnta ligand around small metal ions. Consequently, the $10Dq$ values for $[\text{Ni}(\text{tacnta})]^-$ (Table 6) are higher than for other complexes of Ni^{II} with an N_3O_3 donor set, attributed to the donor strength of the tertiary N as well as to the highly favorable steric arrangement.¹⁴²⁵

Multipole analysis with high-resolution X-ray data for $[\text{Ni}(\text{thmbtacn})]^{2+}$ was carried out to determine the electron configuration in the C_3 symmetry-adapted orbitals of the Ni ion, confirming a higher occupancy of the crystal field-stabilized t_{2g} orbitals relative to the destabilized e_g orbitals. This is interpreted in terms of a predominantly ionic metal–ligand interaction.¹⁴²⁴

For $[\text{Ni}(\text{taptacn})]^{2+}$, electronic spectra confirm that the inner coordination sphere remains intact in CH_3CN or CH_3NO_2 solution. In aqueous acidic media, however, ready dissociation

Table 6 Electronic spectral data for selected Ni^{II} complexes of donor-substituted tacn ligands.

	$\lambda_{\max}(\text{nm})$	$10Dq(\text{cm}^{-1})$	References
$[\text{Ni}(\text{taptacn})]^{2+}$	340, 538, 815, 860	12,270	1418
$[\text{Ni}(\text{tpz3mtacn})]^{2+}$	340, 530, 810, 880 (sh)	12,350	1422
$[\text{Ni}(\text{tpmtacn})]^{2+}$	515, 810, 886	12,350	97
$[\text{Ni}(\text{tpz1mtacn})]^{2+}$	350, 535, 815, 880	12,270	1420
$[\text{Ni}(\text{tacnta})]^{-}$		10,820	1425
$[\text{Ni}(\text{tacn})(\text{H}_2\text{O})_3]^{2+}$		10,400	1428
$[\text{Ni}(\text{taphtacn})]^{2+ \text{ a}}$	326 (sh), 521, 811, 869 (sh)	12,330	1429
$[\text{Ni}(\text{tabtacn})]^{2+ \text{ b}}$	240, 270 (sh), 918	10,900	1430

^a taphtacn = 1,4,7-tris(2-aminophenyl)-1,4,7-triazacyclononane. ^b tabtacn = 1,4,7-tris(2-aminobenzyl)-1,4,7-triazacyclononane.

and protonation of the primary amines is observed with successive $\text{p}K_{\text{a}}$ values of 4.18 ± 0.05 , 4.91 ± 0.01 , and 5.64 ± 0.02 for the tri-, di-, and monoprotonated species.¹⁴¹⁸ $10Dq$ values for tacn ligands with three pendent N-donor side arms are indicative of a quite strong ligand field (Table 6).

Ni^{II} complexes of tacn ligands with three 2-aminophenyl groups attached to the tacn scaffold either directly or via a methylene group have been reported.^{1429,1430} In the former case the more rigid ligand enforces a stronger metal–ligand interaction according to the $10Dq$ values. Hexadentate tabtacn forms a stable complex with a distorted octahedral (C_3 -symmetric) $\{\text{NiN}_6\}$ chromophore (Figure 17).¹⁴³⁰ The potentials for the $[\text{LNi}]^{3+/2+}$ couple are generally more negative for complexes containing the pure σ -donor tacn than those of a ligand containing three tertiary amine donors and pendent π -acceptor ligands that stabilize the +2 oxidation state, e.g., by ~ 400 mV for tpmtacn bearing three pyridine N atoms.⁹⁷

Upon recrystallization, $[\text{Ni}(\text{tpz1mtacn})]^{2+}$ affords $[\text{Ni}(\text{L})(\text{MeCN})]^{2+}$ (L = 1,4-bis(pyrazol-1-ylmethyl)-1,4,7-triazacyclononane) via a N-dealkylation reaction and loss of a pendent arm.¹⁴²⁰ More rational routes to Ni complexes of tacn ligands with only one or two pendent arms have been developed.^{1431,1432} In $[\text{Ni}(\text{L})(\text{X})_n]^{x-}$ (e.g., L = 1-(3-aminopropyl)-1,4,7-triazacyclononane ($n=2$) or 1-(1-methylimidazol-2-ylmethyl)-1,4,7-triazacyclononane ($n=2$) or 1,4-bis(1-methylimidazol-2-ylmethyl)-1,4,7-triazacyclononane ($n=1$), the coordination sphere is completed by additional ligands that bind either terminal ($\text{X} = \text{Cl}^-$, H_2O) or bridge two metal ions ($\text{X} = \text{N}_3^-$, OH^- , oxalate). The Ni^{II} complex of 1,4-bis(2-pyridylmethyl)-1,4,7-triazacyclononane has been shown to be extremely inert to ligand dissociation in aqueous solution.¹⁴³³ In (562), the tacn ligand provides a single bidentate arm.¹⁴³⁴

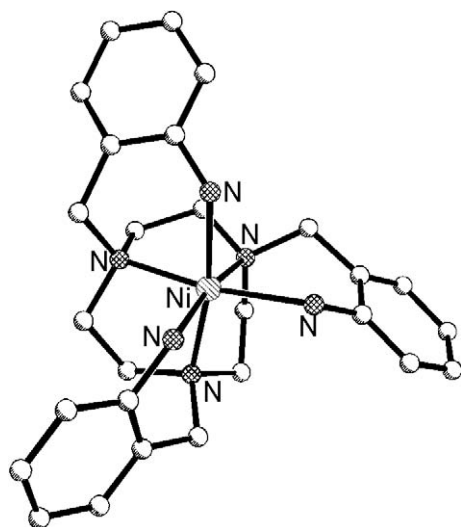
**Figure 17** Molecular structure of $[\text{Ni}(\text{tabtacn})]^{2+}$.¹⁴³⁰

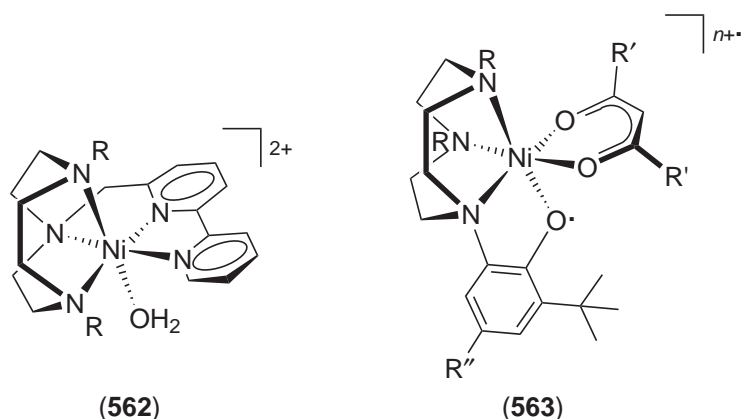

While permutation of the Irving–Williams order was found for the Cu^{2+} and Ni^{2+} complexes of parent tacn,¹⁴³⁵ $\text{L} = 1,4,7$ -triazacyclononane-1-acetic acid follows the conventional stability order $\text{Ni}^{2+} < \text{Cu}^{2+}$ with $\log K_{\text{NiL}} = 17.85(3)$.¹⁴³⁶ The carboxylate group of the side chain prevents formation of the bis(ligand) species $[\text{ML}_2]$. The Ni^{II} complex of an asymmetric tacn ligand bearing two 1-methylimidazol-2-ylmethyl and one carboxymethyl pendent arm has been structurally characterized and reported to be remarkably stable in water even in the presence of a large excess of CN^- (changes in the electronic spectrum are only observed after 20 days).¹⁴³⁷

A combination of hard and soft donor atoms is found in Ni^{II} complexes of the tetradentate tacn ligand with a diphenylphosphanylpropyl pendent arm.¹⁴³⁸ Side arm moieties may also be susceptible to oxidation, and nickel complexes of such ligands have been thoroughly investigated in order to distinguish metal-centered vs. ligand-centered redox processes. Ni complexes of phenolate-pendent arm ligands derived from tacn form very stable phenolato complexes in the presence of acac coligands (**563**). Upon electrochemical one-electron oxidation, spectral and magnetic features are characteristic of phenoxyl radical formation and ferromagnetic coupling to the high-spin Ni^{II} to give an $S = 3/2$ ground state.¹⁴³⁹

(iii) Complexes of heteroanalogous tacn-type ligands

Nickel(II) complexes of various heteroanalogues of the tridentate tacn ligand ($[\text{9}] \text{aneN}_3$) have been reported, where one, two, or all three N-donor atoms of the macrocycle are replaced by S, O, or combinations thereof. Such moieties have also been incorporated in bicyclic ligand systems that form complexes with Ni^{II} .¹⁴⁴⁰

Most prominent are Ni complexes of the all-thia analogue of tacn, $[\text{9}] \text{aneS}_3$. A simple laboratory experiment for the synthesis of $[\text{Ni}([\text{9}] \text{aneS}_3)_2](\text{BF}_4)_2$ has been described.¹⁴⁴¹ In this complex the metal atom is in a slightly distorted octahedral environment of S atoms provided by the facially coordinating $[\text{9}] \text{aneS}_3$.^{1442,1443} The mixed-ligand complex $[\text{Ni}([\text{9}] \text{aneN}_3)([\text{9}] \text{aneS}_3)]^{2+}$ (**564**) allows for a direct comparison of the two cyclononane ligands. It has been prepared in a controlled fashion via the solvento complex $[\text{Ni}([\text{9}] \text{aneN}_3)(\text{H}_2\text{O})_3]^{2+}$.¹⁴⁴⁴ While the Ni–N distances are comparable to those of $[\text{Ni}([\text{9}] \text{aneN}_3)_2]^{2+}$, the Ni–S bond lengths are slightly longer than those in $[\text{Ni}([\text{9}] \text{aneS}_3)_2]^{2+}$. The natural differences of the Ni–N and Ni–S distances impose a trigonal distortion, and unlike the homoleptic counterparts a trigonal twist of 3.5° is observed.

A Ni^{II} complex of a C-substituted 1,4,7-trithiacyclononane ligand has been mentioned.¹⁴⁴⁵ Also, a number of five-coordinate Ni^{II} complexes of $[\text{9}] \text{aneS}_3$ with diphosphane coligands have been structurally characterized (e.g., (**565**)).^{1446,1447} A very particular case is the Ni^{II} complex of the highly rigid crown trithioether benzene trisulfide, bts (**566**), for which a sandwich structure has been proposed.^{1448,1449} A $10Dq$ value of $13,020 \text{ cm}^{-1}$ has been determined, indicating a very strong ligand field. However, the complex decomposes within hours in the solid state and must be stored at low temperature under exclusion of light and air.¹⁴⁴⁹

The molecular structure of the complex $[\text{Ni}([\text{9}] \text{aneN}_2\text{S})_2]^{2+}$ reveals a center of symmetry, i.e., the sulfurs are placed *trans* to each other, which leads to a coordination geometry that is

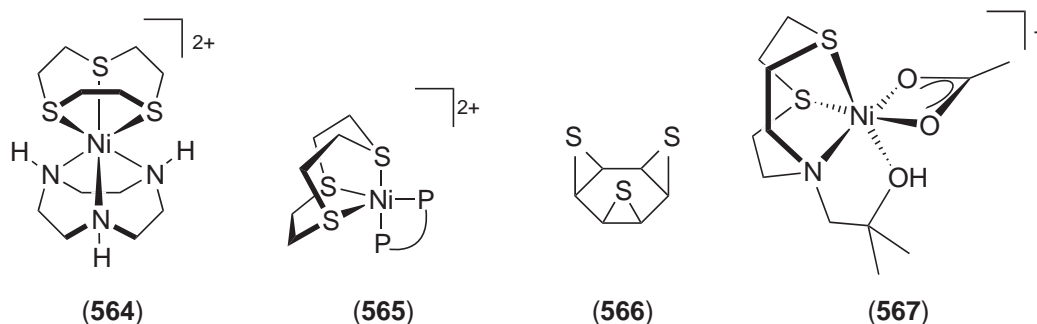

considerably distorted from octahedral.^{1450,1451} A similar geometry was found for $[\text{Ni}(\text{[9]aneN}_2\text{O})_2]^{2+}$.¹⁴⁵² If a single sulfoxide group is introduced into the macrocycle, coordination through the sulfoxide-O is observed, with the O atoms again occupying *trans* positions at the octahedral metal ion.^{1453,1454} Ni—N distances are shorter for $[\text{Ni}(\text{[9]aneN}_2\text{SO})_2]^{2+}$ than for $[\text{Ni}(\text{[9]aneN}_2\text{S})_2]^{2+}$. The Ni^{II} sandwich complex $[\text{Ni}(\text{[9]aneNS}_2)_2]^{2+}$ likewise features a center of inversion. Its Ni—N bond lengths are similar to those of $[\text{Ni}(\text{[9]aneN}_2\text{S})_2]^{2+}$ and $[\text{Ni}(\text{[9]aneN}_3)_2]^{2+}$, but Ni—S distances are distinctly longer than in the symmetric $[\text{Ni}(\text{[9]aneS}_3)_2]^{2+}$ system. The *trans* diastereomer is assumed to be present for $[\text{Ni}(\text{[9]aneS}_2\text{O})_2]^{2+}$ as well.¹⁴⁵⁵ A [9]aneNS₂ type ligand bearing a pendent alcohol substituent acts as a tetradentate ligand in (567),¹⁴⁵⁶ and the Ni^{II} complex of a pentadentate ligand bearing pyridyl side arms at the N atoms of [9]aneN₂S has also been reported.¹⁴⁵⁷

[9]aneS₃ exerts a stronger ligand field than does [9]aneN₃ (tacn). It has been argued that this is due to the fact that [9]aneS₃ can coordinate in a very low-strain manner. For mixed donor ligands such as [9]aneN₂S the great differences in Ni—N and Ni—S bond lengths lead to a mismatch upon coordination to the metal ion, and the resulting steric strain lowers the ligand field strength.¹⁴⁵⁸ The 10Dq value for [9]aneNS₂ lies in-between those for [9]aneN₂S and [9]aneS₃, while the value for [9]aneOS₂ is the lowest in the series (Table 7). The values for the Racah parameters *B* usually decrease upon gradual replacement of the harder secondary nitrogen donors with by the softer thioether donors, consistent with the more covalent nature of the Ni—S bond.¹⁴⁵⁹

Since small metal ions like Ni²⁺ fit best into the [9]aneX₃ macrocycles, the macrocyclic effect is particularly large for Ni²⁺.¹⁴⁵⁸ *E*_{1/2} values for the Ni^{II}/Ni^{III} redox couple indicate that the relative stability of the trivalent complex decreases along the series [9]aneN₃ > [9]aneN₂S > [9]aneNS₂ > [9]aneS₃ > [9]aneN₂O, which is assumed to be controlled by the strength of the metal–ligand interactions.¹⁰¹ Spectroscopic data confirm that these oxidations are metal-centered.¹⁰³

Table 7 Formation constants of Ni²⁺ complexes of [9]aneX₃ type macrocycles and spectral and Ni^{II}/Ni^{III} redox properties of $[(\text{[9]aneX}_3)_2\text{Ni}]^{2+}$.

	<i>E</i> _{1/2} ^a	log <i>K</i> ₁	log <i>K</i> ₂	λ _{max} (nm)	10Dq (cm ⁻¹)	References
[9]aneN ₃	+0.558	16.24	14.2	310, 500, 800, 870	12,350	
[9]aneN ₂ S	+0.785	10.82	9.95	520, 850, 952 (sh)	11,770	101,1451
[9]aneN ₂ O	+1.084	8.49	7.27		11,600	101,1460
[9]aneNS ₂	+0.887			297, 524, 840, 1035	11,930	1459
[9]anePS ₂	+0.27					306
[9]aneS ₃	+0.97			325, 527, 784	12,760	103,1443
[9]aneOS ₂				568, 872	11,470	1455
$[\text{Ni}(\text{[9]aneN}_3)(\text{[9]aneS}_3)]^{2+}$	+0.86			325 (sh), 543, 590 (sh), 817	12,240	1444

^a *E*_{1/2} in V vs. FeCp₂⁺/FeCp₂ in MeCN for the Ni²⁺/Ni³⁺ couple.

6.3.4.10.2 Complexes with larger macrocyclic nitrogen ligands

(i) Synthesis

Ni^{II} macrocyclic complexes can be prepared following two general procedures: either via complexation reactions between presynthesized macrocyclic ligands and the metal ion in solution, or by metal ion-directed template condensation reactions.⁹¹ For Ni^{II} , the latter approach has been pursued more often than with other metal ions, since Ni^{II} does not impede ligand-forming reactions by redox processes or hydrolysis, and most Ni^{II} complexes are insensitive to moisture and oxygen. While complexation reactions offer the advantage that the macrocyclic ligand may be isolated and purified prior to the synthesis of the complex, the template synthesis often yields the desired product in one-pot reactions and generally provides selective routes to new ligand complexes in high yields.⁹¹

C-functionalization of azamacrocycles is in general more difficult to achieve than N-functionalization. The latter has been developed to an extent that macrocycles carrying side chains with various ligating groups are accessible, and Ni^{II} complexes can be prepared with high selectivity and predisposition for high thermodynamic and kinetic stability.

(a) *Synthesis via template condensations.* The synthesis of Ni^{II} macrocyclic complexes via the simple and convenient route of template condensation reactions is often carried out by heating amines and formaldehyde in the presence of the metal ion. In the cyclization reaction, formaldehyde links two *cis*-coordinated amine moieties to give methylenediamine (N—CH₂—N) linkages. While the nitrogen atoms of methylenediamine linkages of secondary nitrogens show a strong tendency to become tertiary upon cyclization,^{1461–1467} the secondary nitrogens of methylenediamine linkages can be stabilized when coordinated to the metal ion. Hence, ligands containing methylenediamine linkages with secondary nitrogens are stable as long as they exist as part of metal complexes.

Hexaaza macrocyclic ligand complexes like (568) and (569) with various different alkyl groups at the uncoordinated bridgehead nitrogen atoms have been synthesized by template condensation of ethylenediamine, formaldehyde, and primary alkylamine in the presence of NiCl_2 in MeOH according to Equation (12). In the complexes, the Ni^{II} ions are found in square planar geometry with the tertiary bridgehead nitrogens noncoordinating.^{1464,1468} Similarly, the Ni^{II} complexes of type (570) pentaaza macrocyclic ligands have been prepared by employing 3,7-diazanonane-1,9-diamine (2,3,2-tet), formaldehyde, and a primary amine as described in Equation (13).¹⁴⁶⁹ Nitroalkanes have also been utilized in place of the primary amine to give, for example, the square planar Ni^{II} complex of (571) from the reaction of $\text{Ni}(\text{en})_3^{2+}$, formaldehyde, and nitroethane.^{1470,1471} Subsequent reduction of the nitro functions gives Ni^{II} complexes of *trans*-6,13-diamino-6,13-dimethyl-1,24,8,11-tetraazacyclotetradecane.¹⁴⁷²

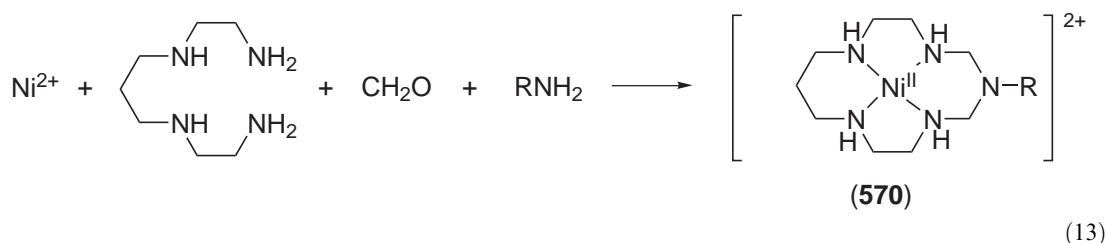
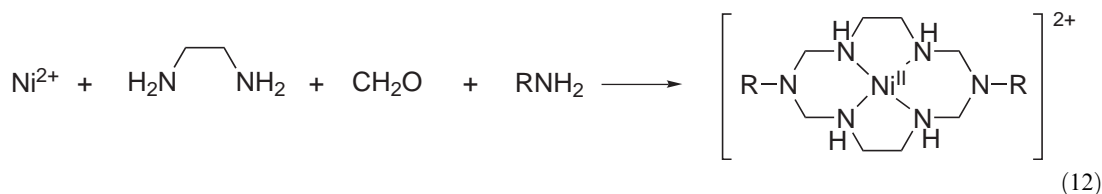

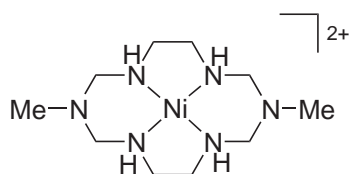

(568)

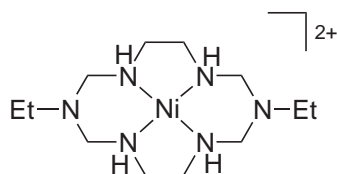

(569)

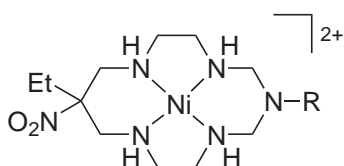

(571)

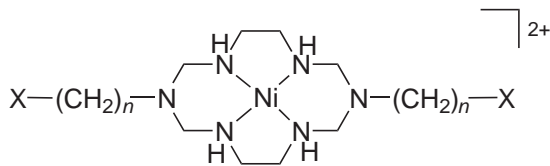

(572a) X = OH, n = 2

(572b) X = OH, n = 3

(572c) X = CN, n = 2

(572d) X = CN, n = 5

A wide variation of functional groups can be attached to the macrocyclic ligands by variations of the methods shown in Equations (12) and (13), e.g., by using carboxamide or sulfonamide instead of the primary amine. In the case of pendent pyridine units, these may react with $[\text{Pt}^{\text{II}}\text{Cl}_4]^{2-}$ and $\text{cis-}[\text{Ru}^{\text{II}}(\text{bipy})_2\text{Cl}_2]$ in a 2:1 ratio to give supercomplexes $\text{cis-}[(\text{Ni}^{\text{II}}\text{L})_2\text{Pt}^{\text{II}}\text{Cl}_2](\text{PtCl}_4)(\text{ClO}_4)_2$ and $\text{cis-}[(\text{Ni}^{\text{II}}\text{L})_2\text{Ru}^{\text{II}}(\text{bipy})_2](\text{ClO}_4)_6$, respectively.^{1473,1474} Other complexes with functional groups linked to the azacyclam ligand have also been synthesized by a similar reaction giving, for example, pendent ferrocene,¹⁴⁷⁵ OH, and CN groups.¹⁴⁷⁶ These complexes are square planar in solutions, where the pendent hydroxyl groups in $[\text{572a}]^{2+}$ and $[\text{572b}]^{2+}$ do not coordinate to the Ni^{II} ion in water at $\text{pH} \leq 13.0$ and ionic strength 1.0 M (NaClO_4). However, while many of these complexes remain square planar in the solid state with the functional side arms dangling, in $[\text{572c}](\text{BF}_4)_2$, the complex containing a $-\text{CH}_2\text{CH}_2-\text{CN}$ functional group, both CN coordinate intermolecularly to form a coordination polymer with an octahedral geometry around the metal. A 1D polymeric structure in the solid state has also been observed for derivatives of [15]aneN₄ with pendent primary amine or carboxylate arms.¹⁴⁷⁷

Ni^{II} complexes of various polyaza polycyclic ligands, e.g., (573)–(576), have been synthesized by heating formaldehyde and appropriate amines at reflux in the presence of NiCl_2 in methanol solutions and then precipitating with LiClO_4 or $\text{CF}_3\text{SO}_3\text{Li}$ as summarized in Equations (14)–(17).^{1463,1465,1467,1478} The yields of these condensation reactions are generally high (50–90%), and all ligands contain methylenediamine linkages in which nitrogen atoms are either tertiary or coordinated secondary groups. The complexes contain football-shaped tetraazabicyclononane moieties or uncommon 1,3-diazacyclopentane and 1,3-diazacyclohexane subring moieties in the hexaaza macrocyclic framework. Even though such ligands contain more than four nitrogen atoms, only the central four N-donors act as a tetradentate scaffold in the square planar Ni^{II} complexes. These complexes are extremely stable and decompose only very slightly even in highly acidic media. Again, nitroethane can be used instead of the primary amine to give, for example, the Ni^{II} complex of the hexaaza macrotricyclic ligand (577):¹⁴⁷⁹

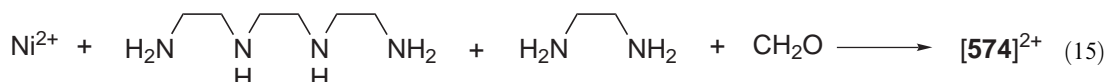

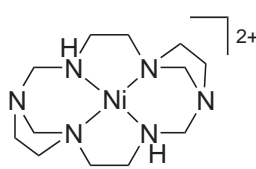
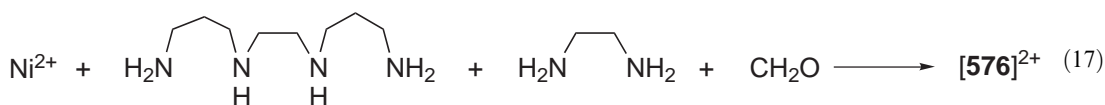

(573)

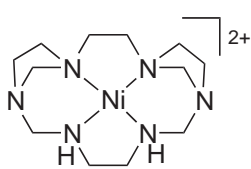

(574)

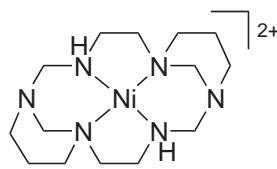

(575)

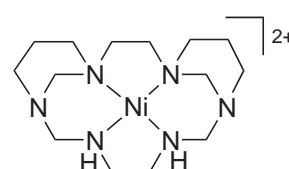

(576)

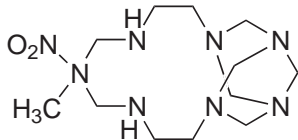

(577)

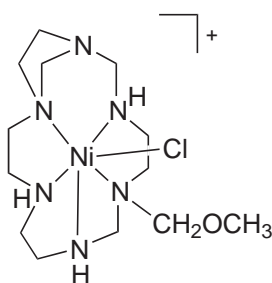

(578)

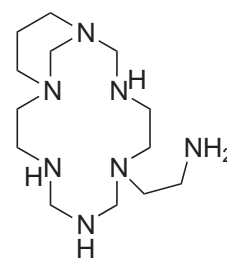

(579)

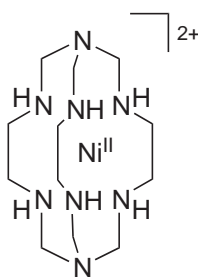

(580)

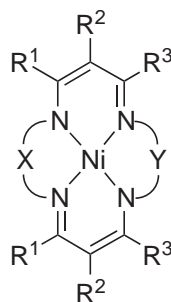

(581)

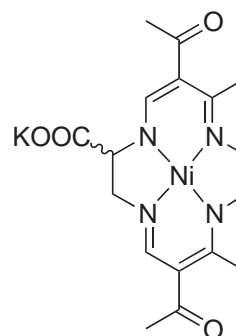

(582)

Octahedral coordination of Ni^{II} can be observed with macrobicyclic ligands. In (578), the hexaaza macrocyclic ligand serves as a pentadentate ligand, forming a six-coordinate species with an axial Cl^- ligand. The complex includes an uncommon four-membered chelate ring and the methoxy methyl pendent chain.¹⁴⁶⁶ A similar situation has been observed for the Ni^{II} complex of (579)—in this case the pendent amine arm fills the sixth coordination site.¹⁴⁸⁰

The encapsulated Ni^{II} complex (580) was obtained from the reaction of $[\text{Ni}(\text{en})_3]^{2+}$, formaldehyde, and ammonia, similarly to Equation (14). The yield was low (ca. 1%), probably because the Ni^{II} ion is a labile metal ion.¹⁴⁶¹ The complex was extraordinarily stable against ligand substitution with donors such as NCS^- , Me_2SO , H_2O , or MeCN . The electronic spectrum of the complex is similar to that of $[\text{Ni}(\text{en})_3]^{2+}$, but the ligand field strength of the complex was slightly stronger than that of $[\text{Ni}(\text{en})_3]^{2+}$ because of the tris(methylene)amino caps.

Other template reactions involving Ni^{II} take advantage of Schiff base formation or related reactions. In continuation of extensive work following the initial publication by Jäger in 1964, numerous Ni^{II} complexes of tetraaza[14]annulenes and related $[\text{N}_4]$ Jäger-type macrocycles (**581**) have been prepared by template condensation between diamines and 1,3-dicarbonyl compounds in the presence of the metal ion.¹⁴⁸¹ A modified stepwise synthesis with final base-initiated formation of the ring-closing azomethine bond has been reported,¹⁴⁸² and intermediates in the template synthesis of Ni^{II} dibenzotetraaza[14]annulenes have been isolated.¹⁴⁸³ Chiral groups have been introduced by means of enantiomerically pure building blocks, e.g., in the Ni^{II} complex of a 15-membered carboxylato-substituted macrocycle (**582**). This complex is acid sensitive and undergoes facile oxidative decarboxylation to generate the corresponding hydroxy-substituted species in a disproportionation reaction.¹⁴⁸⁴ A Ni^{II} complex of the sterically congested tetraaza[14]annulene derivative 5,7,12,14-tetraphenyldibenzo[*b,i*]-1,4,8,1-terazacyclotetradecinate (TPTAA) has been prepared in a template synthesis via microwave heating, albeit in low yields.¹⁴⁸⁵

The square planar Ni^{II} complex (**583**) was prepared from the template reaction of 3,3'-(ethylene bis(iminomethylidene)bis(2,4-pentanedionato)nickel(II) with 1,3-diamino-2-propanol (Equation (18)). The uncoordinated $-\text{OH}$ group reacted smoothly with acylating agents, resulting in $-\text{COPh}$ and $-\text{COCH}_3$ side arms.¹⁴⁸⁶

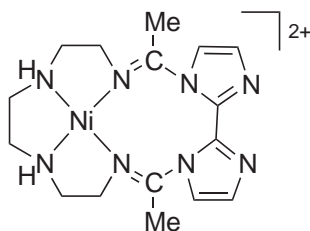
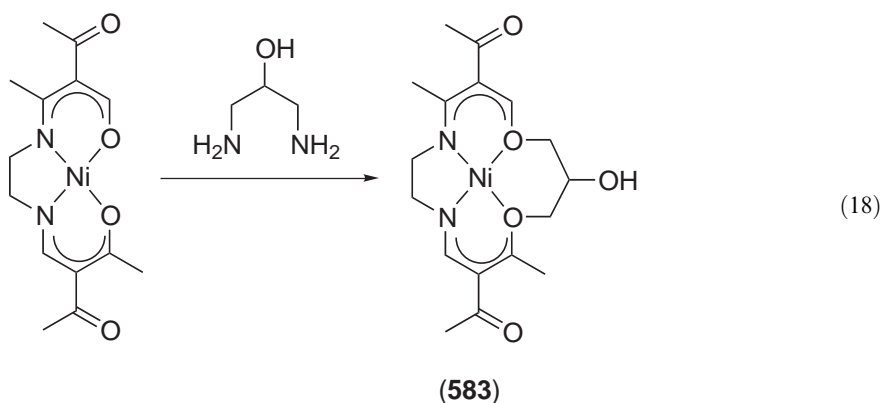

(584)

The Ni^{II} complex of a 16-membered macrocycle, 2,7-dimethyl-3,6-(1,1'-(2,2'-biimidazole)-1,3,6,8,11,14-hexaazacyclohexadeca-1,7-diene (**584**), was synthesized by condensation of a Ni^{II} -triethylenetetramine precursor complex and 1,1'-diacetyl-2,2'-bisimidazole.¹⁴⁸⁷ It forms a square planar geometry with iodide or perchlorate anions, but an octahedral structure in the presence of chloro or bromo coligands. Template syntheses have also been applied for the synthesis of Ni^{II} complexes of large ring tetraazamacrocycles having 18-, 20-, 22-, 24-, 26-, 28-, or 34-membered rings.¹⁴⁸⁸

(b) *Synthesis of Ni^{II} macrocyclic complexes from free ligands.* This strategy allows one to design and presynthesize a wide variety of macrocyclic ligands and is often used for systems with pendent functional groups (in particular for cyclam derivatives) or ligands with other building blocks, e.g., pyridine, in the macrocyclic framework. After insertion of nickel, the functional groups may affect the properties of the macrocyclic complexes through coordination to the metal ion.

Strategies for selective partial alkylation of cyclam have been developed and Ni^{II} complexes of the variously substituted ligands prepared.¹⁴⁸⁹ In a series of tetra-*N*-alkylated cyclams, Ni^{II} incorporation was only observed for smaller substituents such as Me, Et, and Pr, while no

complexes were formed with sterically demanding substituents like Pr^i , PhCH_2 , or $2\text{-MeC}_6\text{H}_4\text{CH}_2$. Depending on the sterical hindrance of the *N*-substituents, the complexes are either square planar or pentacoordinate in solution, since an axial water molecule can bind in the case of the ligand with four small methyl substituents.¹⁴⁹⁰

Side chains with functional groups such as amine, hydroxyl, amide, carboxylic, and nitrile moieties have been attached to the *N*-donor atoms of azamacrocycles.^{1491–1497} Upon Ni^{II} complexation by these ligands, the side arms may or may not bind to the metal. For example, the cyclam derivative with four nitrile pendent chains (**585**) was prepared directly by heating cyclam in acrylonitrile.¹⁴⁹⁴ Its Ni^{II} complex has a square planar geometry without coordination of any of its nitrile groups to the metal ion. However, the corresponding ligand with four amide functions yielded an octahedral and a five-coordinate complex in which two and one of the pendent amide groups, respectively, are bonded to the Ni^{II} ion. Side arm coordination to the Ni^{II} was observed in cyclam derivatives with methylthioethyl groups, whereas no coordination was observed for a methoxyethyl substituent.¹⁴⁹⁸ The Ni^{II} complex of (**586**) is six-coordinate with the pendent arm donors in the apical positions.¹⁴⁹⁹ Also, both isomeric forms of bis(pyridylmethyl)cyclam (i.e., the 1,11- and 1,8-isomers) give six-coordinate complexes with the pyridyl groups bound to the metal.¹⁵⁰⁰

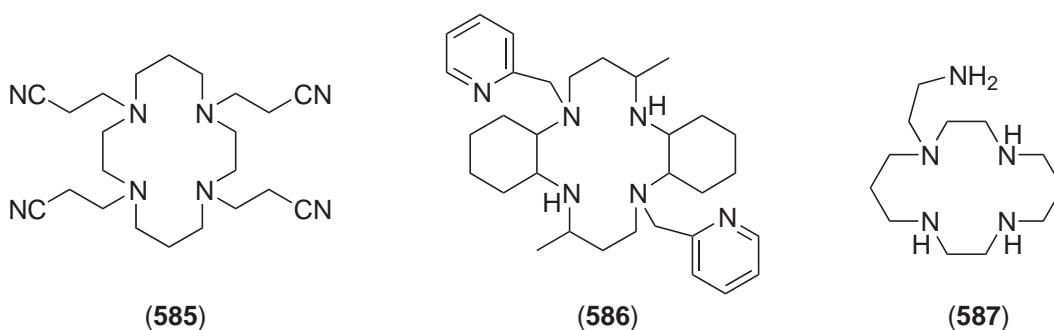

N-(aminoethyl)cyclam (**587**) was prepared from the reaction between tritosylated cyclam and tosylaziridine. In the Ni^{II} complexes of the ligand, the amine group of the side chain displayed acidity-dependent coordination behavior. At $\text{pH} > 2.8$ the side arm apically bound to Ni^{II} ion to form a blue high-spin complex $[\text{Ni}(\mathbf{587})]^{2+}$, but at $\text{pH} < 2.8$ the amine of the side chain became protonated and formed $[\text{Ni}^{\text{II}}(\mathbf{587H})]^{3+}$ as a mixture of a blue high-spin form and a yellow low-spin form.¹⁵⁰¹

In the Ni^{II} complex $[\text{Ni}(\mathbf{588})]_2$ containing the small 12-membered tetraaza macrocycle (**588**) with four pendent pyrazole groups, the ligand wraps around the metal ion in an unusual fashion. It forms a distorted octahedral structure with two pendent arms of the ligand being coordinated, where the four amine nitrogens span two contiguous faces of the distorted octahedron about the nickel atom and the pyrazole nitrogens occupy the remaining pair of *cis* positions.¹⁵⁰² A similar situation has been observed in the case of tetrakis(2-pyridylmethyl)cyclen, where two of the appended pyridine donors occupy *cis*-positions of the octahedral coordination environment.¹⁵⁰³

Ni^{II} complexes of ligands containing pyridine in the macrocyclic framework with a single pyrrolidinyl pendent arm (**589a**) and (**589b**) have been prepared.¹⁵⁰⁴ In $[\text{Ni}(\mathbf{589b})(\text{ClO}_3)](\text{ClO}_4)$, octahedral coordination is set up by four nitrogens of the macrocycle, the pendent pyridine, and a ClO_4^- ion. The macrocyclic ligand occupies the corners of a square pyramid with the pendent group at the apical position.

The pendent-arm macrocycles (**590a**) and (**590b**) have been synthesized by the reaction of $[\text{Ni}(\text{DMSO})_n](\text{ClO}_4)_2$ and the unsubstituted ligands with aqueous NaOH in EtOH , followed by the addition of 2-chloromethylpyridine or 1-(hydroxymethyl)pyrazole under nitrogen. The resulting Ni^{II} complexes are of six-coordinate with the macrocycle adopting a folded conformation and the two pendent 2-pyridylmethyl arms occupying *cis*-coordination sites.¹⁵⁰⁵

The 12-membered macrocyclic triamine bearing a phenol pendent (**591**) was synthesized by one-pot annealation from coumarin and 1,7-diamino-4-azaheptane. Upon coordination to Ni^{II} , the pendent phenol readily dissociates its proton at acidic pH and becomes a strong fourth donor.¹⁵⁰⁶

A cyclam derivative with an amine pendent donor attached at the bridgehead carbon atom was presynthesized from diethylaminomalonic acid and 1,9-diamino-3,7-diazanonane in refluxing MeOH , followed by $\text{BH}_3\text{-THF}$ reduction.¹⁵⁰⁷ It acts as a pentadentate ligand at pH 8.5 and forms a six-coordinate complex (**592**) with a water molecule sitting at the remaining axial site.

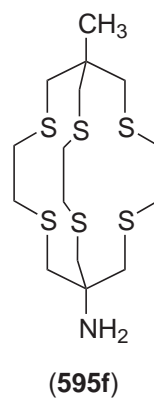
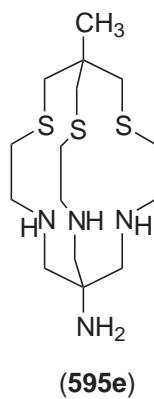
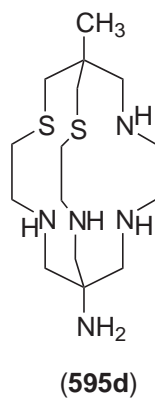
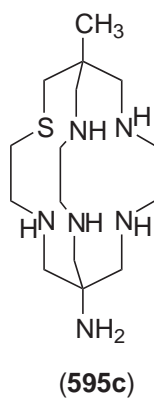
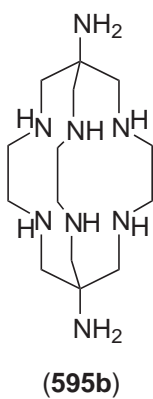
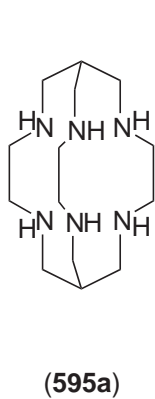
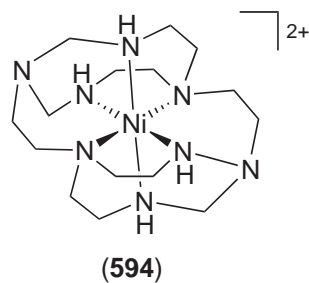
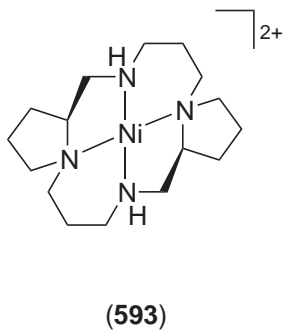
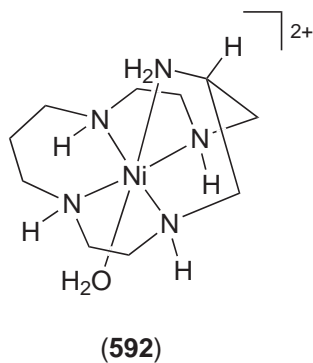
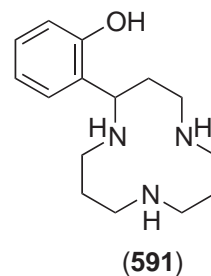
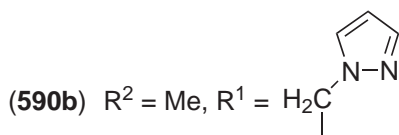
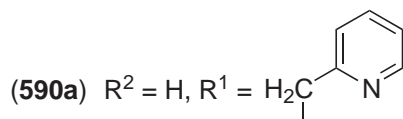
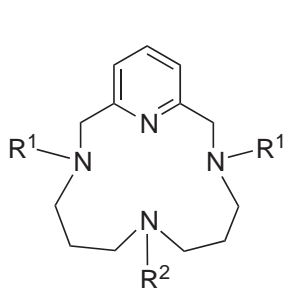
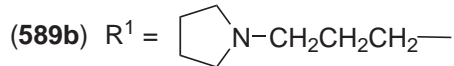
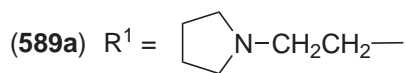
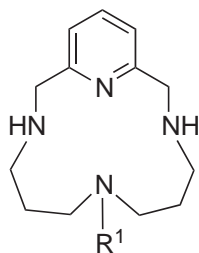
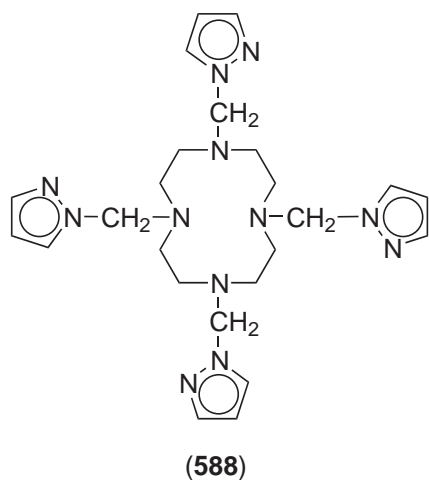

Enantiomerically pure cyclam-type ligands derived from L-proline have been prepared via multistep procedures and shown to form complexes of Ni^{II}, e.g., (593).¹⁵⁰⁸ The Ni^{II} ion in (594) is encapsulated by a face-to-face bis(macrocyclic) ligand that forms upon treatment of [Ni(tren)₂]²⁺ with formaldehyde.¹⁵⁰⁹

Sexadentate sarcophagine-type ligands (595) form particularly stable complexes with Ni^{II}. The Ni^{II} complexes of parent sarcophagine (sar, (595a)), [Ni(sar)](ClO₄)₂,¹⁵¹⁰ as well as the 1,8-diammonio complexes [Ni(595b)]^{157,1511} have been studied in detail. [Ni(sar)](ClO₄)₂ has been proposed as a magnetic susceptibility standard. It follows the Curie–Weiss law above 10 K to room temperature (2.94 μ_B), and the value of the axial anisotropy is $D = +1.400 \text{ cm}^{-1}$ with $g_{\perp} = 2.143(1)$ and $g_{\parallel} = 2.125(1)$.¹⁵¹⁰

The encapsulating ligand with N₄S₂ donors (AMN₄S₂sar, (595d)) was prepared, and it coordinates to Ni^{II} to give an octahedral complex.¹⁵¹² It has been pointed out that the whole set of Ni^{II} complexes of (595a–f) provides a useful series to study the influence of spin-orbit mixing and differential nephelauxetic effects on the electronic spectra, since the N/S ratio can be systematically altered without significantly affecting the macrocyclic backbone structure.¹⁵¹³ It has been found that the spin-forbidden ${}^3A_{2g} \rightarrow {}^1E_{1g}$ and ${}^3A_{2g} \rightarrow {}^1A_{1g}$ transitions undergo a dramatic shift to lower energy as the number of S-donors is increased.

(c) *Synthesis via modification of presynthesized Ni^{II} macrocyclic units.* The most important modification of presynthesized Ni^{II} macrocyclic complexes is *N*-alkylation, which may also be used to link two or more macrocyclic units by a spacer group. *N*-methylated macrocyclic Ni^{II} complexes are often prepared by the deprotonation of secondary amines already bound to the metal ion with pulverized KOH in Me₂SO or MeCN media, followed by alkylation with CH₃I. For example, bis-*N*-alkylated complexes of (596) and (597), as well as the tetramethylated Ni^{II} cyclam derivatives (598) (Ni^{II}TMC), have been synthesized by this route.^{1494,1514} While the bis-*N*-alkylated Ni^{II} complexes (596) and (597) were stable against ligand dissociation in acidic aqueous solution, other *N*-alkylated complexes may be dealkylated when heated in aqueous solutions.^{1494,1514} Selective partial alkylation of cyclam–nickel complexes has also been reported.¹⁵¹⁵

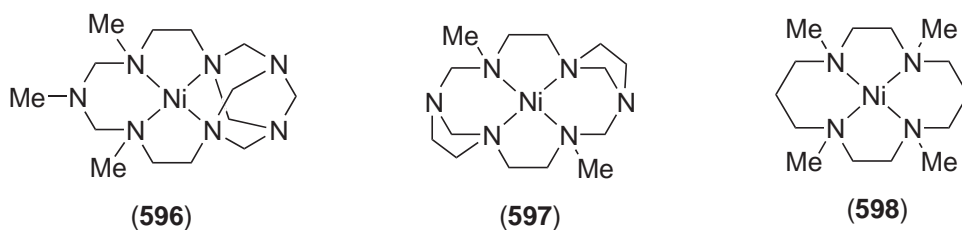

Nickel(II) complexes of type (599) unsaturated 14-membered tetrazamacrocycles react with the anion of nitromethane under basic conditions to give the 5-nitromethyl derivatives (600), and the square planar diperchlorates (601) upon treatment with HClO₄ (Equation (19)):¹⁵¹⁶

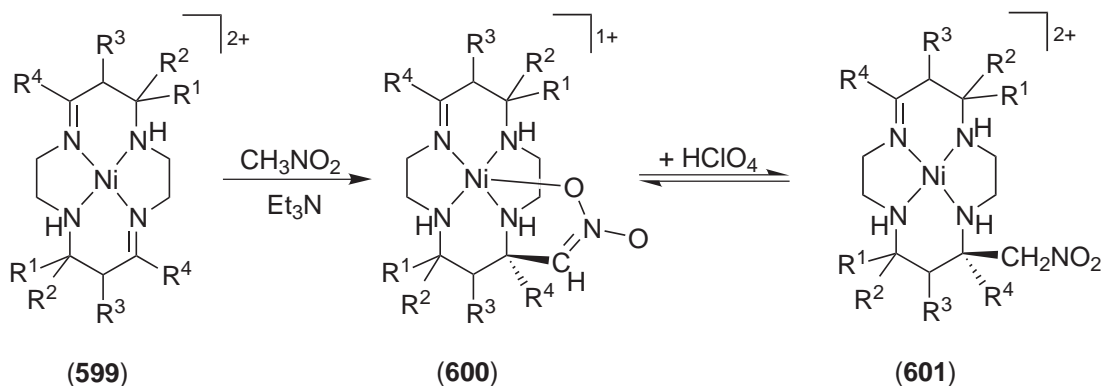

(19)

Some Ni^{II} complexes of polyaza macrocyclic ligands containing coordinated secondary amino groups can be chemically oxidized to give complexes with a higher degree of unsaturation in the ligand.^{1517,1518} Oxidation of (602) with concentrated HNO₃ gives (603) or (604) selectively,

depending on the reaction conditions (Equation (20)). The Ni^{III} species of the saturated ligand is a first intermediate in each case causing subsequent metal ion-assisted oxidative dehydrogenation of the ligand.

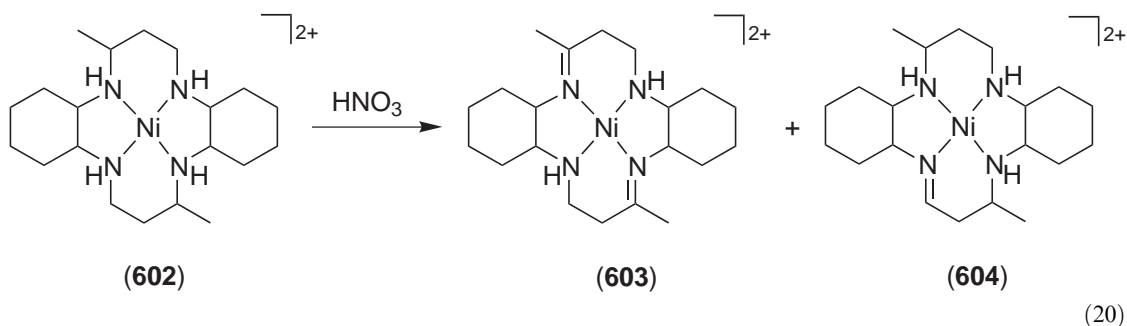

Nickel(II) complexes of tetraaza[14]annulenes, in particular of the much-studied 5,7,12,14-tetramethyldibenzo[b,i]-1,4,8,1-tetraazacyclotetradecinate (TMTAA, (605)), have been modified in various ways. Lithiation of a methyl group followed by the addition of an electrophile gives extension of the methyl substituent,¹⁵¹⁹ and selective alkylations in the periphery of 16-membered cyclidene complexes have been reported.¹⁵²⁰ Substitution at the γ, γ' positions has been extensively researched, because the *meso* positions of the ring are known to be highly reactive. Macrocyclic modification at these positions usually involves reaction with acid chlorides^{1521–1533} or benzylic bromides.¹⁵³⁴ For example, Ni^{II} dibenzotetraaza[14]annulene complexes have been equipped with chiral ester-type substituents bearing menthyl, bornyl, and quininyl groups.¹⁵³³

Reaction of [Ni(TMTAA)] with acid in the presence of AlCl₃ gives complex (606) that features two isolated diimine units in the six-membered chelate rings (Equation (21)),¹⁵³⁵ while hydrogenation of [Ni(TMTAA)] leads to fully saturated cyclam macrocycles (607) (Equation (22)).¹⁵³⁶

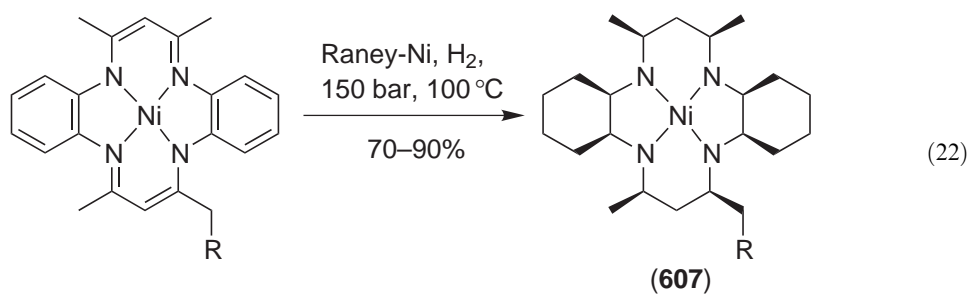
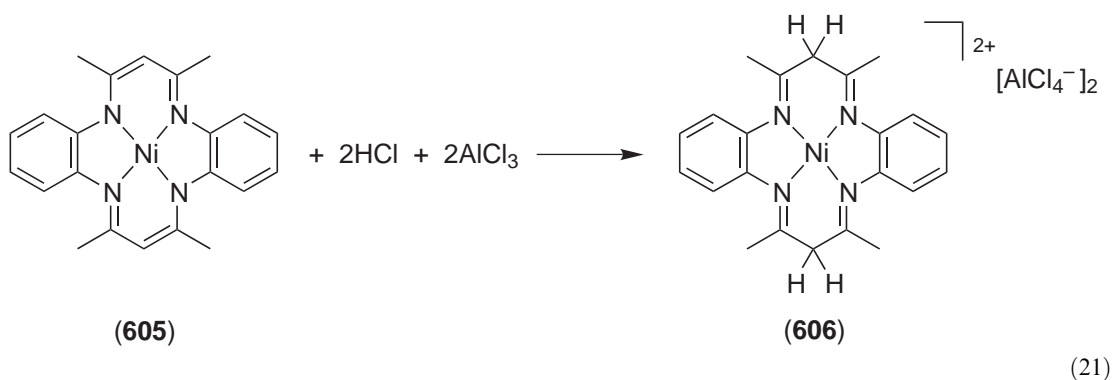

(ii) Structures and spectroscopic properties

The Ni—N bond distances, N—N bite distances, and N—M—N bite angles of Ni^{II} macrocyclic complexes depend on the coordination number of the metal ion and the type of macrocycle. These

structural parameters also influence the electronic spectra and the electrochemical data.⁹¹ In general, Ni—N bond distances of square planar complexes are shorter than those of the octahedral complexes due the absence of electrons in the $d_{x^2-y^2}$ orbital. Furthermore, as the Ni—N bond distance increases, the value of λ_{\max} for the square planar Ni^{II} complex shifts to the longer wavelength. In addition, Ni^{II} \rightarrow Ni^I electrochemical reduction of the complexes becomes easier and Ni^{II} \rightarrow Ni^{III} electrochemical oxidation becomes more difficult as the Ni—N bond distances increase.

Square planar Ni^{II} complexes with saturated macrocyclic ligands usually have Ni—N bond distances ranging from 1.90 Å to 1.95 Å, depending on the type of ligand. The Ni—N bond distances increase when square planar Ni^{II} complexes bind axial ligands to form octahedral species.⁹¹

A 14-membered tetraaza macrocyclic complex may exist in one of five possible configurations I–V based on the stereochemistry of the donor nitrogens.^{1537,1538} Most of the known square planar complexes of azamacrocyclic ligand have the *R,R,S,S* configuration, which is thermodynamically the most stable. In this form, the H atoms at the N atoms of each six-membered chelate rings are on the same side of the macrocycle plane, but on the opposite side with respect to the H atoms of the other six-membered ring. In the case of the *R,S,R,S* complex, the asymmetric *gauche* conformation in the five-membered chelate rings exerts significant strain on the ligand structure and leads to isomerization to the more stable *R,R,S,S* configuration. For example, in H₂O/MeCN media, (*R,S,R,S*)-[Ni(**576**)]²⁺ isomerizes to (*R,R,S,S*)-[Ni(**576**)]²⁺ via axial coordination of water followed by Ni—N(*t*) bond cleavage assisted by water acting as a general acid.¹⁵⁷⁰ The first-order rate constant is $k_{\text{obs}} = 4.16 \times 10^{-5} \text{ s}^{-1}$ and is independent of pH and buffer concentration, but increases with increasing water contents. The activation parameters are $\Delta H^\ddagger = 33 \pm 1 \text{ kcal mol}^{-1}$ and $\Delta S^\ddagger = 24 \text{ cal K}^{-1} \text{ mol}^{-1}$ at 25 °C. Reverse isomerization from the *R,R,S,S* to the *R,S,R,S* configuration is also possible. In this process, a strongly coordinating solvent¹⁵³⁹ or pendent donor group induces the configurational change of the macrocycle.¹⁵⁰⁷

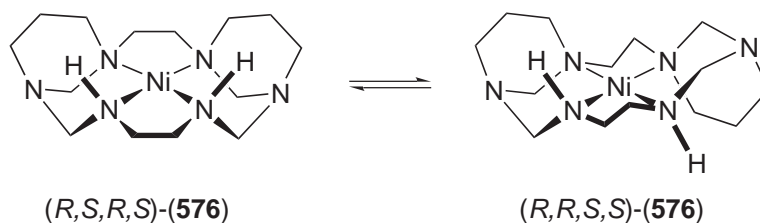

A detailed structural analysis of all Ni complexes of 14-membered tetraazamacrocycles listed in the CSD was performed in 1998, and all compounds were grouped according to their macrocycle configuration by means of cluster analysis.¹⁵⁴⁰ Nickel(II) low-spin complexes have Ni—N distances of less than 2.02 Å, while high-spin complexes have distances of greater than 2.05 Å. The most stable configuration of the ligand is the *R,R,S,S*-(*trans*-III) configuration, but the *trans*-I configuration becomes more stable relative to the *trans*-III configuration in going from octahedral to square planar Ni^{II} complexes.¹⁵⁴¹ However, the addition and specific location of substituents on the macrocyclic backbone can change the identity of the lowest energy configuration. For example, for *C-rac* Ni^{II} complexes of 5,5,7,12,12,14-hexamethyl-cyclam all octahedral species were found in the *cis*-V configuration, while for the *C-meso* form the *trans*-III configuration was lower in energy.¹⁵⁴⁰ Unexpected *cis*-II and *cis*-V arrangements were found for the Ni^{II} complex of cyclam bearing two methyl substituents and one coordinating 2-ethane sulfonic acid group at the N atoms.¹⁵⁴²

In the case of the smaller macrocycle [13]aneN₄, six configurational isomers exist for [Ni([13]aneN₄)]²⁺ due to the orientation of the N—H protons above or below the plane of the macrocycle. X-ray crystallography and NMR spectroscopy, respectively, revealed that the *R,S,R,S*-[Ni([13]aneN₄)]²⁺ form (*trans*-II) is the preferred one both in aqueous solution and in the solid state.¹⁵⁴³

Fourteen-membered ring ligands of the cyclam type have “natural” hole sizes which lie between the ideal ones for low- and high-spin Ni^{II}. Hence these ligands can accommodate either type of Ni^{II} ion, depending on whether coordinating or noncoordinating anions are present. Benzoannulation may drastically alter the flexibility of the macrocyclic ligand scaffold, and comparative studies of the Ni^{II} complexation by, *inter alia*, (**608**)–(**610**), displaying different patterns of dibenzo substitution have been performed.^{140,1544} The complex [Ni(**608**)](BF₄)₂ has a planar coordination geometry, while [Ni(**608**)(NCS)₂] has a *trans*-pseudo-octahedral geometry with the

Ni^{II} in axial sites. For the six-coordinate high-spin complex there is a considerable expansion of the N_4 donor cavity to accommodate the larger metal ion.¹⁴⁰ The related **(610)** gives a folded ligand conformation in $[\text{Ni}(\mathbf{610})(\text{H}_2\text{O})_2]^{2+}$ with the water ligands in *cis* positions.¹⁵⁴⁴ A folded macrocycle ligand for the parent $[\text{Ni}(\text{cyclam})]^{2+}$ fragment is observed in, for example, *cis*- $[\text{Ni}(\text{cyclam})(\text{H}_2\text{O})_2]\text{Cl}_2$ ¹⁵³⁷ and $(\mu\text{-C}_2\text{O}_4)[\text{Ni}(\text{cyclam})]_2(\text{NO}_3)_2$.¹⁵⁴⁵ The Ni^{II} complex of a cyclam derivative carrying eight methyl groups and a single hydroxyethyl side arm adopts an unusual distorted trigonal bipyramidal coordination geometry with the O atom of the donor arm in an equatorial position.¹⁵⁴⁶ Tetrakis(diphenylphosphinomethyl)cyclam forms a five-coordinate high-spin complex $[\text{NiLCl}]^{2+}$ with a Cl ligand in apical position and all phosphino side arms dangling.¹⁵⁴⁷ The Ni^{II} complexes of *cis*- and *trans*-6,13-dimethyl-1,4,8,11-tetraazacyclotetradecane-6,13-diamine (*cis*- and *trans*-diammac, **(611)** and **(612)**) as well as the Ni^{II} complex **(613)** of *a*-6,13-bis(2-pyridinyl)-1,4,8,11-tetraazacyclotetradecane (*a*-pypymac) feature hexacoordinate metal ions in with the macrocyclic ligands coordinating as a sexidentate.^{1548–1550}

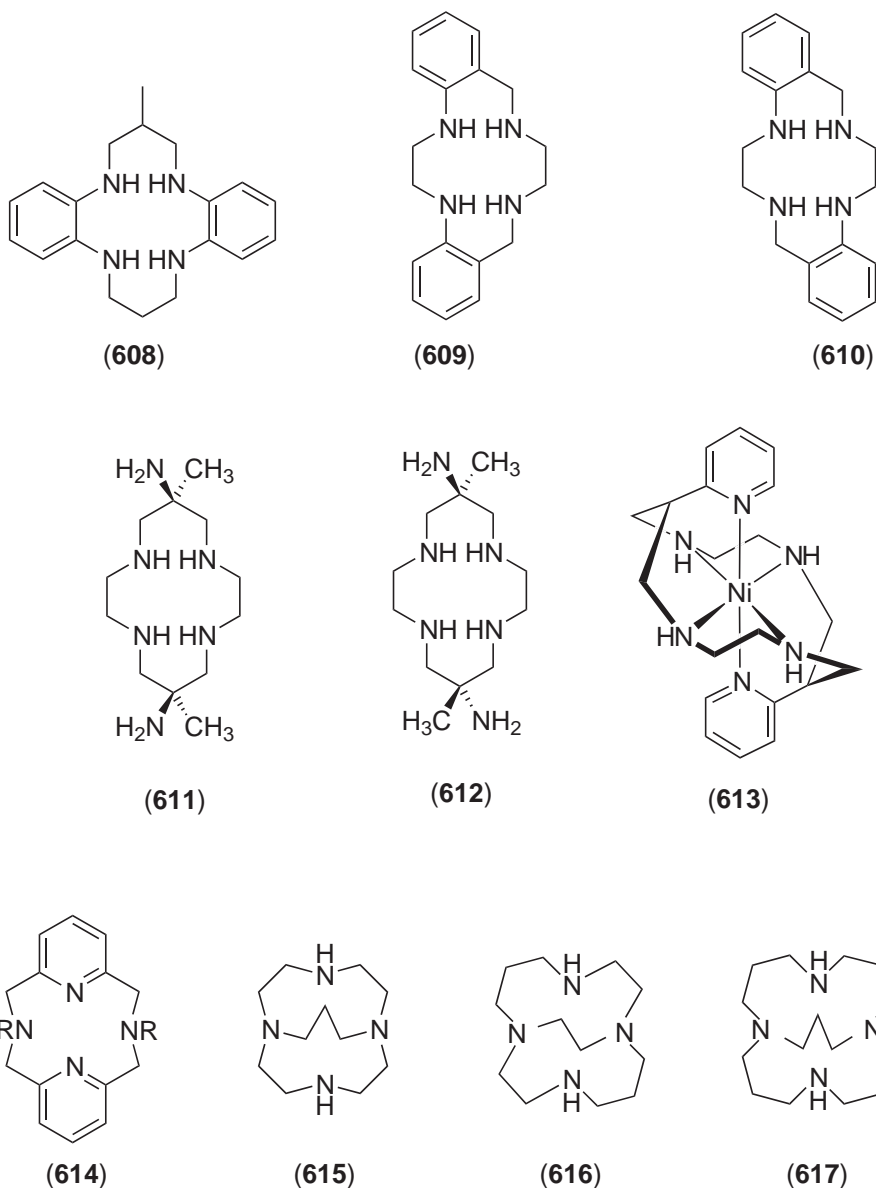

While *cis*-octahedral Ni^{II} complexes of cyclam are known to spontaneously isomerize in aqueous solution to the *trans*-octahedral isomer,¹⁵⁵¹ such spontaneous isomerization does not occur for the Ni^{II} complex of [12]ane N_4 because the hole in the smaller 12-membered ring does not allow for four unconstrained Ni—N coplanar bonds. However, accommodation of square

planar nickel ions may be enforced in the flexible [12]aneN₄ type scaffold.¹⁵⁵² In contrast, increased rigidity is introduced by the pyridine rings in the related 2,11-diaza[3,3](2,6)pyridinophane ligands (**614**). These have a decisive tendency to form distorted *cis*-octahedral geometries in their Ni^{II} complexes, which is confirmed by the crystal structure of [Ni(**614**)(H₂O)Cl]Cl.¹⁵⁵³ The macrocyclic ligand adopts a *syn* boat–boat conformation in the latter complex. The same effect is obtained if two nonadjacent N atoms in the [12]aneN₄ macrocyclic skeleton are connected by an alkylene chain to give, for example, the structurally reinforced bowl tetraamines [2⁴3¹]adamanzane (**615**) or [2³3²]adamanzane (**616**). In their Ni^{II} complexes, the ligand coordinates the metal in a cleft and two *cis* coordination sites of the distorted octahedral environment are available for coligand binding.^{1554,1555} Ni^{II} complexes of the larger [3⁵]adamanzane (**617**) are predominantly five-coordinate, with the half life for dissociation of [Ni(**617**)Cl]⁺ amounting to 14–15 months in 5 M HCl solution.¹⁵⁵⁶

The large 16-membered tetraazamacrocyclic [16]aneN₄ adopts the lowest energy form in the complex [Ni([16]aneN₄)]²⁺ with all four six-membered chelate rings in chair conformations and the N-bound H atoms alternating above and below the coordination plane.¹⁵⁵⁷ The analogous Ni^{II} complex of [15]aneN₄ exhibits a strong tendency to transform to an octahedral species with ClO₄⁻ anions bound to the axial sites. In this complex, the three six-membered chelate rings adopt chair/twist/chair conformations.¹⁵⁵⁷

A comparative study of the effect of macrocyclic and chelate ring size on the structures of Ni^{II} complexes with dibenzo tetrazamacrocycles (**618**) incorporating 14- to 17-membered rings has been performed.¹⁵⁵⁸ All complexes [Ni(**618**)X₂] (X = Cl, NCS, NO₃) have *trans*-octahedral geometries with the macrocycle blocking the equatorial plane. While the planarity of the N₄ donor set is maintained, the distortion to a trapezoidal arrangement of the donors increases as the length of the methylene bridge between the benzyl N atoms is increased. In the case of Ni^{II} complexes of the tropocoronands (**619**) it has been reported that increasing the length of both alkyl linkages induces a gradual distortion of the coordination geometry from square planar to near tetrahedral.¹⁵⁵⁹

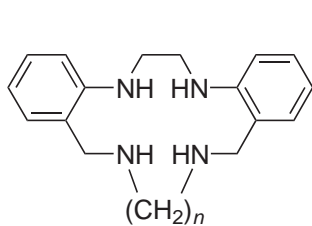
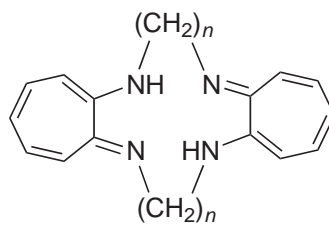
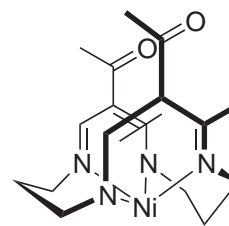
**(618)****(619)****(620)**

The solid-state structures of the Jäger-type macrocycles vary widely with ring size.¹⁵⁶⁰ Ni^{II} complexes of the 14-membered rings are planar, the 15-membered rings adopt one of two possible geometries (either “saddle shaped” or *Z*-configuration), while the 16-membered rings are in general saddle shaped (e.g., (**620**), due to the conformations adopted by the two saturated six-membered chelate rings), with few exceptions.¹⁵⁶¹ The low-energy absorption (~500–600 nm) of Ni^{II} dibenzotetraaza[14]annulene complexes, which has been assigned to a LMCT transition,¹⁵⁶² depends on the degree of saddle-shaped distortion and exhibits a bathochromic shift upon substitution of the macrocycle.¹⁵⁶³ While the Ni–ligand interaction is dominated by σ -bonding, this shift has been assigned to Ni–ligand π -contributions.^{1564,1565}

The UV–visible spectrophotometric properties of Ni^{II} macrocyclic complexes are affected by the substituents, the degree of unsaturation, the cavity size, and the chelate ring sequences of the macrocyclic ring (Table 8).^{1473,1566} In addition, the presence of tertiary amine donors and the size of the subring moieties fused to the macrocyclic framework may alter such properties. In general, introduction of tertiary amine donors in the Ni^{II} macrocyclic complexes results in a decrease in the ligand field strength, thus causing the maximum absorption to shift to longer wavelengths. For the macrotricyclic complexes with fused subring moieties such as (**573**)–(**576**), the ligand field strength is shown to decrease as the size of the subring increases.⁹¹

Square planar Ni^{II} macrocyclic complexes are typically yellow, red, or brown in color and absorb around 400–500 nm, depending on the ligand structure. The octahedral Ni^{II} complexes absorb at 500–600 nm.

Table 8 Electronic absorption spectra and electrochemical data for Ni^{II} macrocyclic complexes.

Complex	λ_{\max} (ϵ) (nm (M ⁻¹ cm ⁻¹))	$E_{\text{ox}}^{\text{a,b}}$ Ni ^{II} /Ni ^{III}	$E_{\text{red}}^{\text{a,b}}$ Ni ^{II} /Ni ^I	References
<i>Square planar complexes</i>				
(568)	449 (56) ^c	+0.93	-1.55	1464
(569)	449 (64) ^c	+0.90	-1.47	1464
(571) (R = Me)	450 ^d			1469
(572a)	448 (82), ^c 446 (56) ^d	+0.94(q)	-1.47 (qr)	1476
(572b)	449 (77), ^c 445 (56) ^d			1476
(572c)	445 (27), ^d 451 (39) ^f			1476
(572d)	449 (63), ^c 445 (57) ^d			1476
[Ni([14]aneN ₄)] ²⁺	445 ^d	+0.91	-1.46	1567
[Ni(Me ₄ [14]aneN ₄)] ²⁺	394 (95), 512 (82), 650 (33) ^j			1490,1568
[Ni(Me ₆ [14]aneN ₄)] ^{2+g}		+1.11	-1.33	1567
[Ni(Me ₂ [13]aneN ₄)] ^{2+g}	428 (145)			1569
(621)	438 (83), ^c 442 (80) ^e	+1.32	-1.39	1463
(622)	425 (209) ^d	> +1.53	-1.38 (r)	1478
(573)	447 (80), ^c 449 (78) ^e	+1.50 (i)	-1.28	1465,1467
(574)	456 (89), ^c 459 (80) ^e	+1.43 (i)	-1.25	1467
(575)	465 (95), ^c 471 (41) ^e	+1.34	-1.20 (qr)	1465,1467
<i>R,R,S,S</i> -(576)	471 (90), ^c 480 (28) ^e	+1.25	-1.14	1467
<i>R,S,R,S</i> -(576)	489 (116), ^c 496 (106) ^e	+1.39	-1.01	1570
(623)	460 (130)			1571
[Ni(623a)] ²⁺ⁱ	459(70) ^d	+0.70	-0.63(i)	1572
[Ni(623b)] ²⁺ⁱ	496(108) ^d	+0.64	-0.76	1572
<i>Octahedral complexes</i>				
(578)	554 (15), 363 (23) ^f			1466
(580)	510 (8), 316 (11) ³			1461
[Ni(611)] ²⁺	883, 809, 516, 490, 323 ^d			1548
[Ni(612)] ²⁺	887, 799, 772, 487, 313 ^d			1548
[Ni(586)] ^{2+ h}	524(8), 262(558) ^d	-0.06 (qr)	-1.40	1499
[Ni(Et ₄ [14]aneN ₄)] ²⁺	544(258)			1490
[Ni(Et ₂ Me ₂ [14]aneN ₄)] ²⁺	530(186)			1490
[Ni(Pr ₂ Me ₂ [14]aneN ₄)] ²⁺	531(216)			1490

^a Measured in acetonitrile solutions, 0.1 M (Buⁿ)₄NClO₄, volts vs. SCE. ^b i=irreversible; qr=quasi-reversible. ^c Measured in MeNO₂. ^d Measured in H₂O. ^e Measured in MeCN. ^f Measured in Me₂SO. ^g Abbreviations: Me₆[14]aneN₄=5,5,7,12,12,14-hexamethyl-1,4,8,11-tetraazacyclotetradecane; Me₂[13]aneN₄=8,10-dimethyl-1,4,7,11-tetraazacyclotridecane. ^h vs. Ag/AgCl. ⁱ vs. Ag/Ag⁺. ^j Present in two forms, square planar (512 nm) and square pyramidal (394 nm and 650 nm).

The presence of two extra uncoordinated tertiary nitrogens at the bridgehead position of type (568)–(570) complexes does not affect the ligand field strength of the complexes, and variation of alkyl groups and the types of the pendent functional groups at the bridgehead nitrogen atoms only slightly affects the spectra of the complexes.^{1464,1468,1473,1476}

In contrast, subrings fused to the macrocyclic framework may have a significant influence on the spectral properties. For example, Ni^{II} complexes (621) and (622) absorb at significantly shorter wavelengths than the complexes of the usual 14-membered tetraaza macrocycles and exhibit unusually strong ligand field strength, which has been attributed to the short N–N bite distances of the six-membered chelate ring involving the tetraazabicyclononane (“football”)

moieties.^{1464,1478} These N—N bite distances are similar to the values typical for five-membered chelate ring, and the macrocycles in (621) and (622) are thus rather similar to a [13]aneN₄ and a [12]aneN₄, respectively.

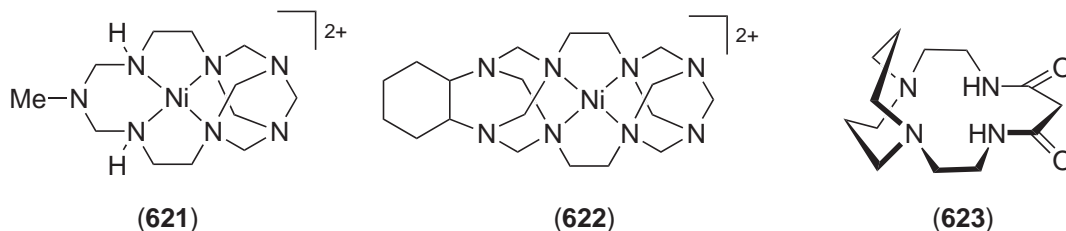

For the macrotricyclic complexes (573)–(576), which retain the same 14-membered macrocyclic framework, the size of the subring moieties slightly affects the spectroscopic properties of the complexes.^{1465,1467} There is a qualitative relationship between Ni—N bond distances and λ_{\max} values. As the Ni—N bond distance increases, the λ_{\max} value increases.⁹¹

The constraints imposed by the additional trimethylene strap in the macrocyclic diamide complex of (623) causes the Ni^{II} ion to be pushed out of the N₄ plane and results in a lower ligand field strength than in the Ni^{II} complex of the corresponding monocyclic dioxocyclam ligand.¹⁵⁷¹

The introduction of *N*-alkyl substituents to the secondary N atoms of cyclam and its derivatives, e.g., to the secondary N atoms of (573) and (621), results in the shift of λ_{\max} values to 10–20 nm longer wavelengths, indicating a decrease in the ligand field strength upon *N*-alkylation.^{1514,1567,1573–1575} This is attributed to the steric effect of the *N*-alkyl groups and the longer Ni—N bond distances of the complexes. In the cases of partly *N*-alkylated tetraazamacrocycles, the effect is much less significant than in fully alkylated species. Effects of *C*-alkyl groups are comparatively weak or negligible, but properties of macrocyclic compounds containing both *N*- and *C*-alkyl groups may be effected significantly by the *C*-substituents.^{1576–1578} For example, the wavelengths for the *d*–*d* transitions for complexes of (625a,b) are very longer than those of related di-*N*-alkylated 14-membered tetraazamacrocycles due to the very long Ni—N distances (1.992 Å).

The spectrum of the octahedral Ni^{II} complex (580) with a hexaaza macrobicyclic ligand is similar to that of [Ni(en)₃]²⁺, but the ligand field strength of the complex is increased slightly by the capping of the [Ni(en)₃]²⁺ moiety with two tris(methylene)amino groups.¹⁴⁶¹

The absorption maximum λ_{\max} and the extinction coefficient of macrocyclic Ni^{II} complexes are affected by the configuration of the ligand.^{1570,1579} For example, the maximum absorption band of (*R,S,R,S*)-[Ni(567)]²⁺ appears at ~20 nm longer wavelengths than that of the *R,R,S,S* isomer. In addition, the value of the extinction coefficient in the visible region for the *R,S,R,S* complex is greater than that for the *R,R,S,S* isomer. Similar observations have also been made with other macrocyclic complexes^{1579,1580} and have been attributed to steric strain in the case of the *R,S,R,S* complex, which is evident from the fact that the metal ion locates out of the coordination plane and the five-membered chelate rings display an asymmetric *gauche* conformation. The result is a poor overlap between the Ni^{II} ion and the nitrogen orbitals, and hence a weaker ligand field strength.

(iii) Electrochemical properties⁹¹

Electrochemical properties of the Ni^{II} macrocyclic complexes are related to the cavity size, the unsaturation, the degree of functionalization, and the subring moieties fused to the macrocycles.^{1467,1514,1581,1582}

For Ni^{II} complexes of monocyclic ligands (e.g., (568)), oxidation to Ni^{III} usually occurs at +0.90 V to +0.93 V and reduction to Ni^I at –1.46 to –1.55 V vs. SCE. However, in the macropolycyclic ligand complexes (573)–(576) as well as (621) and (622), the oxidation and reduction processes are observed at +1.25 V to +1.60 V and at –0.94 V to –1.40 V vs. SCE, respectively. Electrochemical oxidation of the Ni^{II} species is obviously easier for the complexes of monocyclic ligands, whereas electrochemical reduction to Ni^I is easier for the macropolycyclic complexes. These anodic shifts in both oxidation and reduction potentials for Ni^{II} macropolycyclic complexes may in part be attributed to the tertiary nitrogen donors of the ligands.

The redox properties of complexes with hexaaza monocyclic ligands (e.g., (568)–(570)) are similar to those of the cyclam complex, indicating that the electrochemical properties of the complexes are only slightly affected by the presence of uncoordinated tertiary nitrogen atoms,

length of the pendent chain, and the type of the functional group appended at the bridgehead nitrogen.^{1476,1567} However, the redox potentials of the Ni^{II} complexes of type (570) derivatives containing carboxamide or sulfonamide functional groups are reported to be influenced by the nature of the functional group. In particular, the amide fragment controls the reduction potential for the Ni^{III}/Ni^{II} and Ni^{II}/Ni^I redox couples, which may be attributed to the π interaction between the nickel ion and the amido group.¹⁵⁸³

Attachment of pendent noncoordinating donor groups at the cyclam N atoms may affect significantly the electronic spectra and redox properties of the Ni^{II} complexes. For example, the presence of the *N*-quinolinemethyl groups in (624b) makes the oxidation of Ni^{II} to Ni^{III} easier and reduction to Ni^I more difficult compared to (624a), which has been attributed to the steric crowding caused by the noncoordinating substituents.¹⁵⁷² In (626) and (627), crown ethers 15-crown-5 and 18-crown-6, respectively, have been attached to the type (621) Ni^{II} macrocyclic complex. The reduction potentials in the presence of alkali ions shift to the positive direction in the order Li⁺ > Na⁺ > K⁺ and K⁺ > Na⁺ > Li⁺, respectively,¹⁵⁸⁴ in accordance with the expected affinity of the alkali ions for the crown ether moieties. Ni^{II} complexation in a macrocycle host may also effect the redox properties of pendent groups: the Ni^{II} complex of the ferrocene-bridged cyclam derivative (628) features a rather short Fe—Ni distance (3.85 Å), and the redox potential of the Fe^{II}/Fe^{III} couple is shifted by +380 mV with respect to the Ni-devoid system.¹⁵⁸⁵

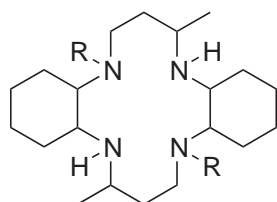

(624a) R = H

(624b) R = 2-(chloromethyl)quinoline

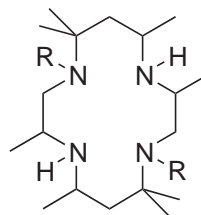
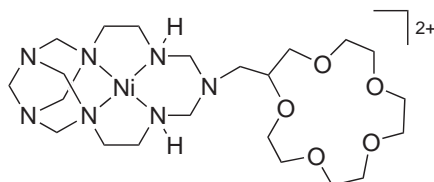
(625a) R = CH₂CH=CH₂(625b) R = CH₂CH₂CH₃

(626)

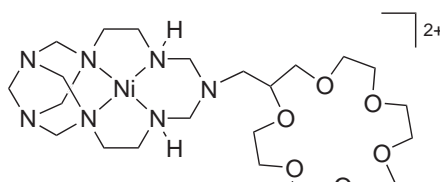

(627)

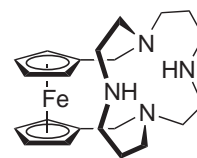

(628)

In general, the introduction of *N*-alkyl substituents to the secondary amine donors of the macrocycle results in anodic shifts in both oxidation and reduction potentials of the complexes relative to the parent ligand systems, i.e., *N*-alkylation makes the attainment of the Ni^I state easier and the Ni^{III} state more difficult. The extent of anodic shifts depends on the number of alkyl groups introduced to the ligand.^{1514,1567} Such stabilization of Ni^I species by *N*-alkylation is ascribed to solvation and stereochemical effects.^{1575,1586} *N*-ethyl groups have greater inductive effects than *N*-methyl groups and yield less anodic shift in both oxidation and reduction potentials.¹⁵¹⁴ This anodic shift of redox potentials may be attributed to weaker Ni—N interactions in the *N*-alkylated complexes, because the weaker Ni—N interaction for the tertiary amine results in the stabilization of antibonding σ -orbitals of the Ni^{II} complex, thus making it more favorable to add an electron, but less favorable to remove an electron.⁹¹

The configuration of the macrocyclic ligand also affects the electrochemical properties of Ni^{II} complexes.^{1570,1574} For example, the oxidation and reduction potentials of (*R,S,R,S*)-[Ni(576)]²⁺ are shifted by +0.14 V and +0.13 V, respectively, compared with those of the *R,R,S,S* isomer. Similar trends are also observed for a series of *R,S,R,S* and *R,R,S,S* isomers of *N*-methylated cyclam derivatives.^{1587,1588} These anodic shifts of the redox potentials for the *R,S,R,S*-Ni^{II} complexes indicate that the complex is more difficult to oxidize to Ni^{III} but easier to reduce to Ni^I, compared with the *R,R,S,S* complex. The effect may be related to the reduced ligand field strength of the *R,S,R,S* complex, which stabilizes the antibonding σ -orbitals and thus makes addition of an electron more favorable while removal of an electron is less favorable.

The redox behavior of Ni^{II} tetraazaannulene complexes can be tuned by the appropriate choice of substituents bound to the ligand scaffold.¹⁵⁸⁹ It is interesting to note that in a series of Jäger-type Ni^{II} complexes, both the type (629) and type (630) systems give reversible oxidation, while (631) does not.¹⁵⁹⁰

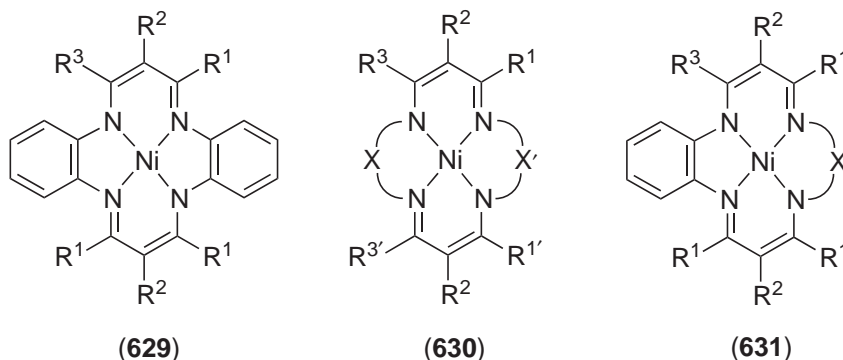

(iv) Equilibrium between square planar and octahedral species⁹¹

It is well established that some macrocyclic Ni^{II} complexes may exist as equilibrium mixtures of the yellow, diamagnetic, square planar [Ni(L)]²⁺ and blue (or violet), paramagnetic, octahedral [Ni(L)(S)₂]²⁺ species in coordinating solvents (S) such as water, acetonitrile, or Me₂SO.^{1464,1467,1469,1473,1476,1583,1591,1592} Interconversion between these two forms depends on the ligand structure and reflects a balance between endothermic solvent coordination and exothermic Ni—N bond lengthening in octahedral species.⁹¹ In water, the equilibrium constant *K* of Equation (23) is reduced when either the concentration of supporting electrolyte (e.g., NaClO₄) or the temperature is increased. Existence of the equilibrium is indicated by the absorption coefficients at λ_{max} measured in water for [Ni(L)]²⁺, which are smaller than those measured in a noncoordinating solvent such as nitromethane or acetone.

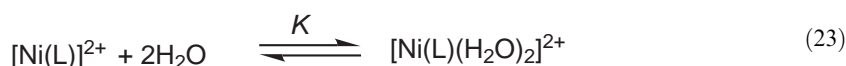

The Ni^{II} cyclam complex, as well as Ni^{II} complexes such as (568) and (570) featuring hexaaza and pentaaza macrocyclic ligands display a low-spin square planar and high-spin octahedral complex interconversion in aqueous solution.^{1464,1469,1473,1583} However, complexes (568) and (569) favor formation of the high-spin form upon addition of acid, which is in contrast to the cyclam complex. The protonation of tertiary nitrogen atoms at the bridgehead position facilitates the axial coordination of anion or water because of hydrogen bonding between them.^{1469,1593}

[Ni(cyclam)]²⁺ gives smaller coordination equilibrium constants than the open chain analogue, [Ni(2,3,2-tet)]²⁺. A comparative study of donor solvent coordination to Ni^{II} complexes of 2,3,2-tet, cyclam, the smaller [12]aneN₄, and [14]aneS₄ has been performed.¹⁵⁹⁴

Thermodynamic data of Equation (23) for selected Ni^{II} macrocyclic complexes are summarized in Table 9. The exothermic nature of the processes reflects the increase in coordination number and the formation of two axial bonds, while the negative Δ*S*^o reflects the increase in order due to the binding of two water molecules. The more flexible the macrocyclic ligands the larger the *K* values, since the octahedral species have longer Ni—N bond distances than the square planar species and thus require the ligand scaffold to adapt to this situation. For example, the formation constants of octahedral species for [575]²⁺ and [576]²⁺ are ca. 10 times greater than those for [573]²⁺ and [574]²⁺ at room temperature, and they are comparable to those of the complexes of the more flexible monocyclic ligands Me₂[14]aneN₆ and Et₂[14]aneN₆.¹⁴⁶⁷ The complexes (575) and (576), which have larger macrocyclic holes than (573) and (574), are obviously better suited to accommodate the larger octahedral Ni^{II} ions.

Both the −Δ*H*^o and −Δ*S*^o values are quite large for the Ni^{II} complex (633) bearing a pendent hydroxyethyl arm.¹⁵⁹⁵ If this complex is treated with a bidentate ligand that binds exclusively in a *cis* fashion, coordination forces the macrocycle to fold out of the plane to give a so-called *cis* folded product. Thermodynamic data for the binding of ethylenediamine to give (635)

Table 9 Equilibrium thermodynamic data for Equation (23).^a

Complex	K , 25 °C	$-\Delta H^\circ$ (kJ mol ⁻¹)	$-\Delta S^\circ$ (kJ mol ⁻¹ K ⁻¹)	References
(568)	0.17 ^d , 0.44 ^b	36 ^d , 17 ^b	136 ^d , 64 ^b	1464
(569)	0.23 ^d , 0.36 ^b	19 ^d , 10 ^b	75 ^d , 43 ^b	1464
(573)	0.0511, 0.0538 ^b	24.5, 21.4 ^b	106, 96.2 ^b	1467
(574)	0.0398, 0.0707 ^b	31.57, 12.9 ^b	132, 65.4 ^b	1467
(575)	0.772 ^b	20.9 ^b	72.4 ^b	1467
(576)	0.297, 0.646 ^b	34.1, 24.6 ^b	124, 86.1 ^b	1467
(633)	0.167 ^b	55 ^b	198 ^b	1595
(632a)	0.16	-36.4	-138	1596
(632b)	2.0	-17.5	-53.5	1596
[Ni(Me ₂ [14]aneN ₄)] ²⁺	2.5			1597

^a $I=0.07$ M NaClO₄ and $T=25$ °C unless otherwise specified. ^b Measured in pure water. ^c Data cannot be measured in $I=0.07$ M NaClO₄ because of insolubility of the complex. ^d $I=0.1$ M NaClO₄.

are: $K(25\text{ °C})=4.17 \times 10^2 \text{ l mol}^{-1}$ ($\log K=2.62$), $\Delta H^\circ = -38.5 \pm \text{kJ mol}^{-1}$, and $\Delta S^\circ = -79 \pm 5 \text{ J K}^{-1} \text{ mol}^{-1}$. The presence of the pendent 2-hydroxyethyl arm apparently does not have a significant influence, since a similar value $\log K=2.56$ has been reported for the corresponding equilibrium involving the planar form of [Ni(cyclam)]²⁺.¹⁵⁹⁸

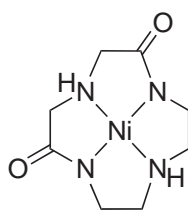

(632a)

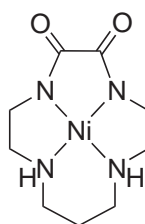

(632b)

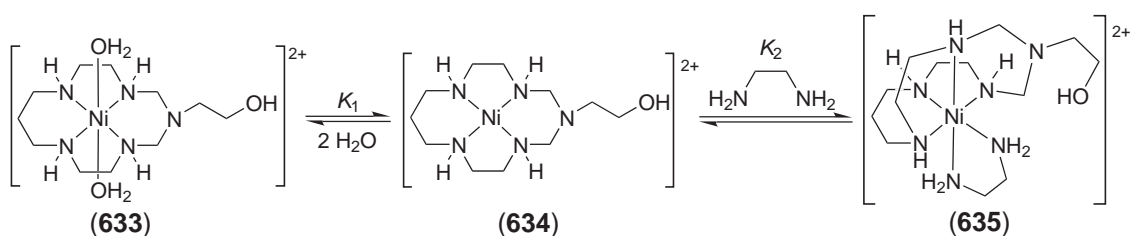

On the basis of spectral data it has been concluded that for macrocycles that do not coordinate Ni^{II} in a planar fashion, steric factors influence the ligand field strength more than the size of the macrocycle.^{1599,1600} Ni^{II} complexes of the small [12]aneN₄ type ligands, which usually adopt *cis*-octahedral geometries when six-coordinate, show an equilibrium between the five-coordinate [Ni(R₄[12]aneN₄)(H₂O)]²⁺ and the almost planar [Ni(R₄[12]aneN₄)]²⁺ complex in solution (Equation 24; Table 10). The equilibrium is dominated by the solvation properties of the R groups, i.e., the larger (and less polar) the R groups, the larger the K , ΔS and ΔH values for the dissociation equilibrium.

Ni^{II} complexes of reinforced macrocyclic ligands such as (636a–c) are square planar and show no tendency to axially coordinate a solvent molecule (or a N₃⁻ ion), because the rigid ligand cannot adapt to the larger high-spin Ni^{II} ion.¹⁶⁰⁴

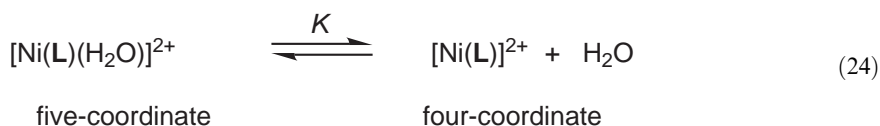
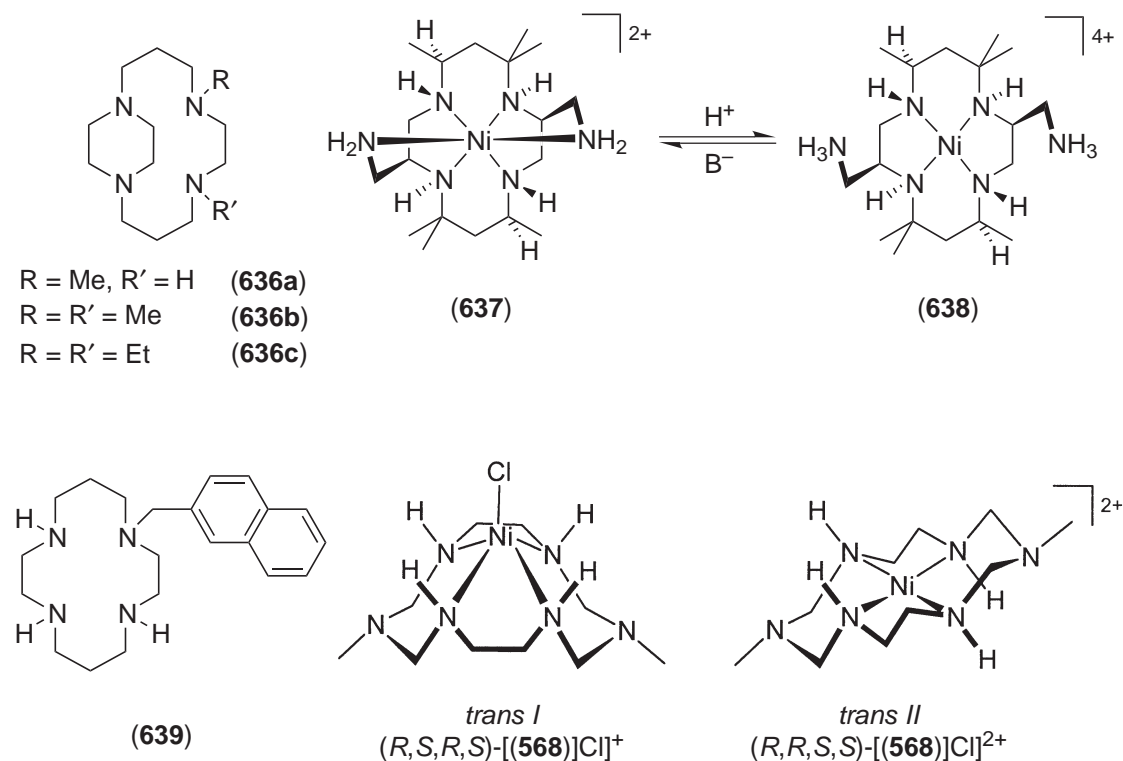

Table 10 Equilibrium thermodynamic data for Equation (24).^a

<i>L</i>	<i>K</i> , 25 °C	$-\Delta H^\circ$ (kJ mol ⁻¹)	$-\Delta S^\circ$ (kJ mol ⁻¹ K ⁻¹)	References
[12]ane N ₄	0.0033, 0.003 ^b	5.77, 5.66 ^b	8.05, 7.39 ^b	1601
Me ₄ [12]ane N ₄	0.87, 0.95 ^b	1.44, 1.73 ^b	4.61, 5.66 ^b	1599, 1602
(PhCH ₂) ₄ [12]aneN ₄	20.8	8.6	34.9	1599
[13]aneN ₄	6.9	7.5	30	1603

^a *I* = 0.1 M NaClO₄ and *T* = 25 °C unless otherwise specified. ^b Measured in pure water.



Azamacrocyclic complexes with pendent donor side arms may show an internal pH-dependent equilibrium between the uncoordinated and chelated forms of the substituent. When a pendent amine group is protonated, the diamagnetic, square planar Ni^{II} complexes are formed. At higher pH values, however, deprotonation and coordination of the amine group leads to paramagnetic, octahedral complexes. This change in Ni configuration is often accompanied by change of the macrocycle conformation. For example, in the octahedral cyclam diammine complex (637) the macrocycle adopts a folded conformation, while protonation of the amino groups gives a planar macrocycle in the square planar complex (638).¹⁶⁰⁵ Such protonation equilibria also give rise to a pH-dependent electrochemical behavior of the Ni^{II} complexes with pendent amino groups,^{1606–1609} and the change in color associated with this process has been proposed as a probe in analytical applications. Even in cases where the pendent amine arms of tetraazamacrocycles are not involved in direct coordination, their deprotonation may increase the concentration of the octahedral species [NiL(H₂O)₂]²⁺ in solution.¹⁶¹⁰

The high-spin/low-spin interconversion in a Ni^{II} complex of the cyclam derivative (639) bearing a luminescent naphthalene substituent has been used as a fluorescent molecular thermometer.¹⁶¹¹ The Ni^{II} tends to quench fluorescence of the proximate naphthalene subunit, but the two spin states exert a different influence on the emission properties. Emission is temperature dependent, since the high spin → low spin conversion is endothermic, i.e., a temperature increase favors formation of the low-spin form.

solution, it forms a 1:1 dioxygen adduct (**641**)–O₂, which is formulated as Ni^{III}–O₂[–] based on the EPR spectral data. The magnetic moment of the O₂ adduct is 2.83μ_B, which is interpreted in terms of weak magnetic coupling of Ni^{III} with the superoxide. The O₂ uptake reaction is first order with respect to both [O₂] and (**641**) in aqueous solutions, and a second-order rate constant of 1.7 × 10² M^{–1} s^{–1} at 35 °C has been determined. The O₂ complexation constant *K* is 1.9 × 10⁴ M^{–1} at 35 °C.¹⁶¹⁷ The dioxygen adducts react with added substrates such as benzene, toluene, and anisole to produce hydroxylated products of organic substrates, except with nitrobenzene, which suggests that the activated O₂ species has an electrophilic character.¹⁶¹⁷ However, in the absence of substrates the O₂ complexes also undergo facile irreversible degradation in aqueous solutions and result in the hydroxylated derivatives of the corresponding ligands being formed in good yield.^{1616,1618}

Some nickel complexes of type (**641**) are capable of mediating O₂-dependent DNA cleavage.¹⁶¹⁹ In the case of R = F, reaction with O₂ leads to ligand oxidation to give (**642**).^{155,1620} α-Hydroxylation of glycine in peptides is a biologically important reaction performed by the copper-containing enzyme peptidylglycine α-amidating monooxygenase (PAM). Selective α-hydroxylation was observed for the Ni^{II} complexes of cyclic tetrapeptides (**643**), giving (**644**) and (**645**) in a stepwise process.¹⁶²¹ ¹⁸O₂ labeling confirms that the hydroxo O atom comes from aerial dioxygen. The reaction presumably proceeds via formation of a Ni^{III} superoxide, H atom abstraction and a glycy radical intermediate.

(b) *DNA modification.* Various Ni^{II} complexes promote oxidative modification of DNA in the presence of oxidants and effect strand scission subsequent to alkaline treatment. In particular, complexes with neutral tetraazamacrocyclic cyclam and cyclam-like ligands are known to enhance the reactivity of Ni^{II} in promoting DNA oxidation using KHSO₅.^{1622–1624} Reaction occurs specifically at solvent-exposed guanines. These reactions depend strongly on the nature of the metal complex, and several features have been found to be essential for efficient DNA oxidation: (i) square planar rather than octahedral coordination, (ii) positively charged complexes with neutral rather than anionic ligands, and (iii) relatively high *E*_{1/2} values for Ni^{II}/Ni^{III} oxidation. The 14-membered macrocycles with pyridine or imine N-donors are more efficient complexes for such a reaction. A high degree of unsaturation in the ring leads to conformational rigidity, which may be detrimental to the formation of key intermediates bound to DNA. Accordingly the complex (**646**) was found to be a very effective catalyst for the DNA oxidation. A mechanism in which the square planar Ni^{II} complex is oxidized to a square pyramidal or octahedral Ni^{III} complex possessing labile axial sites to bind to N7 of guanine has been proposed.^{1625,1626} Evidence for such recognition has been obtained by a diagnostic ability of some Ni^{II} macrocyclic complexes to convert poly(dG-dC) from a B- to a Z-helix.¹⁶²⁷ Further, ¹H NMR monitoring of the interaction between the complexes and 5'-GMP is characteristic of coordination of guanine-N7 to the Ni ion, and ¹H and ³¹P NMR spectra of DNA containing a single, isolated extrahelical guanine are consistent with selective binding of Ni to N7 of this unique base.¹⁶²⁸ Despite this mode of binding, however, the specificity of guanine oxidation reflects native DNA conformations that are independent of Ni.¹⁶²⁷ It should be noted that Ni^{II} macrocyclic complexes have also been reported to cleave RNA at specific uridine residues.¹⁶²⁹

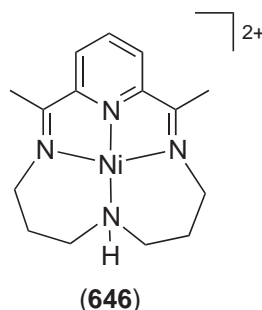

(c) *Electrocatalytic reduction of CO₂.* A number of Ni^{II} complexes show catalytic activity for the electrocatalytic reduction of CO₂ in water, which has been proposed to involve intermediate formation of Ni^I species. A pulse radiolysis study of the CO₂ reduction by [Ni^I(cyclam)]⁺ in aqueous solution revealed that it proceeds via the reduction of [Ni^I(cyclam)(CO₂)]⁺ or [Ni^I(cyclam)H]⁺ adducts by [Ni^I(cyclam)]⁺.¹⁶³⁰ CO and formate are usually produced by this way. The selectivity of the process is highly important in order to obtain a useful electrocatalyst in

the electroreduction of CO_2 : since many electrochemical systems available for reducing CO_2 require the presence of water, the reduction of molecular hydrogen is always a competing reaction that needs to be avoided. The Ni^{II} complexes of 14-membered tetraaza macrocyclic ligands, $[\text{Ni}(\text{cyclam})]^{2+}$, (647)–(649) show catalytic activity in H_2O or aqueous MeCN. The total mole-for-mole yields of CO and H_2 are around 1 in most cases. The $[\text{Ni}(\text{cyclam})]^{2+}$ complex is a very effective and selective catalyst for the electrochemical reduction of CO_2 to CO relative to the reduction of water to H_2 in aqueous solution when it is adsorbed onto mercury. The CO/H_2 product ratio is >100 for $[\text{Ni}(\text{cyclam})]\text{Cl}_2$.¹⁶³¹ It is suggested that the greater selectivity for the electroreduction of CO_2 compared with water is related to the size of the macrocyclic ligand and the presence of $\text{N}-\text{H}$ groups in $[\text{Ni}(\text{cyclam})]\text{Cl}_2$. The complexes $[\text{Ni}(\text{cyclam})]^{2+}$ and $[\text{Ni}_2(\text{649})]^{4+}$ display analogous properties with respect to CO_2 , leading to CO formation in water but HCOO^- in addition to CO in low-water-content DMF.^{1631–1636}

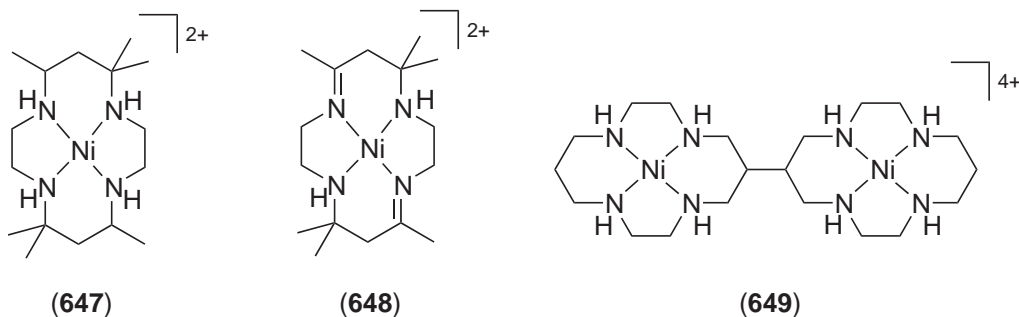

A Ni^{II} complex of a cyclam derivative with protonated amine pendant also catalyzes the electrochemical reduction of CO_2 to CO efficiently.¹⁵⁰⁷

The Ni^{II} complex (568) has been reported to show a high activity for the electrocatalytic reduction of CO_2 to CO when a rotating copper disk electrode is used.¹⁶³⁷ In addition, water-soluble type (570) Ni^{II} -azacyclam complexes, where R = carboxamide or sulfonamide, either aliphatic or aromatic, are found to be active in the electrocatalytic reduction of CO_2 at a mercury cathode. The efficiency is comparable to that of $[\text{Ni}(\text{cyclam})]^{2+}$.¹⁴⁷⁴ The complex of an azacyclam derivative with a 2-hydroxyethyl pendent arm ((570) with $\text{R} = \text{CH}_2\text{CH}_2\text{OH}$) showed less H_2 evolution than $[\text{Ni}(\text{cyclam})]^{2+}$.¹⁶³⁸ In a series of dinuclear Ni^{II} complexes of pentaaza macrocycles with methylene bridges of varying lengths, the catalytic currents for the dinuclear species are comparable to those of mononuclear analogues. This is possibly the result of less effective absorption on the electrode due to ligand steric interactions.¹⁶³⁹

Different isomeric forms of Ni^{II} macrocyclic complexes may behave differently in the CO_2 reduction, and subtle structural differences may be an important factor.¹⁶⁴⁰ The complexes $C\text{-}R,R,S,S\text{-}(650)(\text{ClO}_4)_2$ and $C\text{-}meso\text{-}(651)(\text{ClO}_4)_2$ have been shown to be better catalysts than $[\text{Ni}(\text{cyclam})]^{2+}$ in terms of larger catalytic currents and more positive potentials in aqueous solution using a hanging mercury electrode. However, $R,S,S,R\text{-}(650)$ does not show good catalytic activity. In the latter case, the axial methyl group may sterically hinder effective adsorption of the complex onto Hg , and may also hinder CO_2 binding to the complex.¹⁶⁴¹

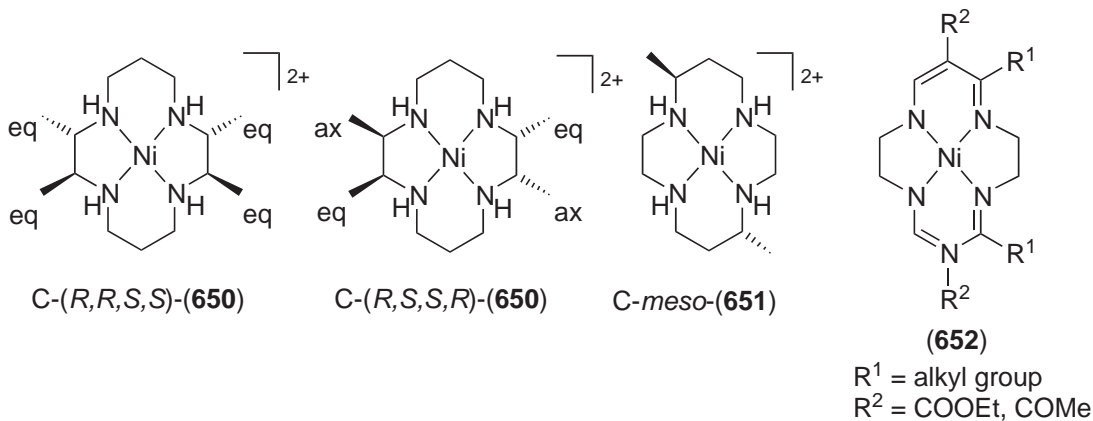

Different to the charge-positive cyclam-type systems, neutral Ni^{II} complexes (**652**) with Jäger-type ligands are remarkably selective and persistent homogeneous catalysts for the electrochemical reduction of CO₂ to oxalate.¹⁶⁴²

(d) *Photoreduction of CO₂*. Some Ni^{II} macrocyclic complexes mediate electron transfer and produce CO during the photochemical reduction of CO₂. Compared to the electrochemical reduction of CO₂ with [Ni(cyclam)]²⁺, however, photochemical reduction of CO₂ using a photosensitizer, a sacrificial electron donor, and [Ni(cyclam)]²⁺ as the catalyst has been only moderately successful. Enhanced catalytic activity has been observed for a bismacrocyclic dinuclear Ni^{II} complex.¹⁶⁴³

Ru^{II}/Ni^{II} heteronuclear complexes such as (**653**), in which a photosensitizer [Ru(bpy)₃]²⁺ or [Ru(phen)₃]²⁺ is covalently attached to the Ni^{II}-cyclam complex, have been synthesized in order to improve the efficiency of electron transfer from the photoexcited photosensitizer to the catalytic site.^{1644–1646} However, these complexes did not perform particularly well, either due to unfavorable configuration of the Ni^{II}-cyclam subunit and the resulting steric hindrance or due to short lifetime of the excited states of the Ru photosensitizer moieties. A stable catalytic system has been prepared by immobilizing macrocyclic Ni^{II} complexes and [Ru(bipy)₃]²⁺ in a nafion membrane.¹⁶⁴⁷

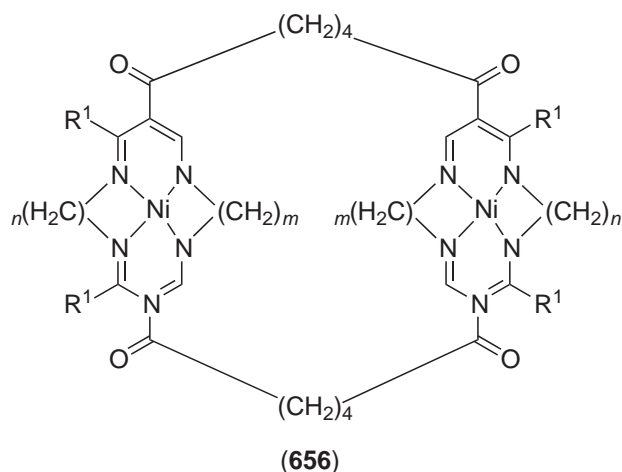
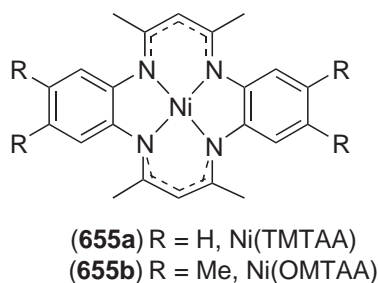
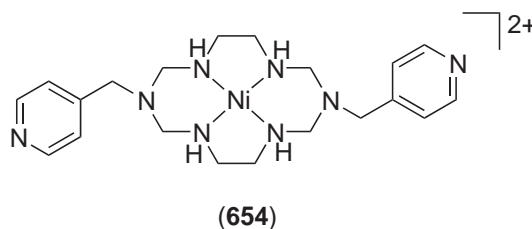
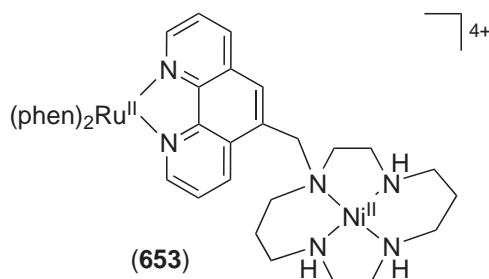

(e) *Supramolecular assemblies*. Ni^{II} macrocyclic complexes are frequently used as building blocks for the construction of 1D, 2D, and 3D supramolecular coordination networks. In general this involves reaction of the Ni^{II} complex with an oligofunctional linker, e.g., with the dianions of oxalic acid,^{1648,1649} terephthalic acid,¹⁶⁵⁰ 1,4-benzenedicarboxylic acid,¹⁶⁵¹ 2,5-pyridinedicarboxylic acid,^{1651,1652} etc. or with the trianions of 1,3,5-benzenetricarboxylic acid,^{1651,1653,1654} and *cis,cis*-1,3,5-cyclohexanetricarboxylic acid.¹⁶⁵⁵ [Ni(*rac*-Me₆[14]aneN₄)]²⁺ forms a dinuclear complex with the dianion of 2,5-pyridinedicarboxylic acid as a bridging ligand.¹⁶⁵² One Ni atom is coordinated to the O atom of the 2-carboxylic group and to the pyridine-N atom (forming a five-membered chelate ring), while the second Ni is bound to both O atoms of the 5-carboxylic group (forming a four-membered chelate ring). Hydrogen bonding involving macrocyclic NH groups, both 2- and 5-carboxylic groups, perchlorate anions, and water molecules gives a supramolecular network in the solid state.¹⁶⁵² Likewise, in cases where 1D polymeric chains or 2D layers result, these are often linked via H bonding interactions to give rise to 3D networks in the crystals. Inclusion studies have been carried out for host solids that are built from Ni^{II} complexes with tetra- and hexa-azamacrocyclic ligands and 1,3,5-benzenetricarboxylate. In order to enforce H bonding patterns and π - π stacking interactions for the construction of more robust 3D open frameworks, the Ni^{II}

macrocyclic complex (**654**) bearing pyridyl pendent groups has been employed as a metal-based building block.^{1655,1656}

Nickel(II) complexes of saddle-shaped tetramethyldibenzotetraaza[14]annulene ligands (**655a,b**) are versatile receptors for a range of globular molecules. 1:1 complexes with the fullerenes C₆₀ and C₇₀ are known, in which the Ni^{II} complex acts as a divergent receptor in the solid state.^{1657,1658} For smaller globular molecules such as 1,2-dicarba-*closo*-dodecaborane(12), P₄S₃, and cyclo-S₈, the [Ni(tmtaa)] complex associates through aromatic faces into dimers and these dimers then act as divergent homotopic receptors with a 1:2 ratio of guest:host species.^{1659,1660} [(H₂O)₂∩([18]crown6)] has been confined in a disk-shaped cavity lined with six [Ni(tmtaa)] dimers,¹⁶⁶¹ and ternary super-complexes of Ni^{II} dibenzotetraaza[14]annulene complexes with [Co(C₂B₉H₁₁)₂]⁻ and [M∩[2.2.2]cryptate]⁺ (M = Na, K)¹⁶⁶² as well as with C₆₀ and CS₂ have been discovered.¹⁶⁶³

Acceptor guest molecules such as quinone, TCNQ, or toluene can be accommodated in the flexible cavity of face-to-face bismacrocylic Ni^{II} complexes (**656**). The host-guest interactions decrease the energy gap between the LUMO of the organic acceptors and the HOMO of the complex donors.¹⁶⁶⁴

(f) *Molecular switches of fluorescence*. Manifold molecular systems have been developed in which a Ni macrocyclic complex (in most cases of the cyclam type) is connected to a fluorogenic fragment. Through intramolecular signal transduction, fluorescence is switched on and off by an external stimulus, e.g., by a pH change (**657**)¹⁶⁶⁵ or a change of redox potential (**658**).¹⁶⁶⁶ An alternative strategy uses the redox-driven intramolecular translocation of anionic ligands between two different transition metal centers in a two-component complex, one of which usually is a Ni-cyclam moiety.¹⁶⁶⁷ This application of Ni macrocyclic chemistry has been thoroughly reviewed.¹⁶⁶⁸⁻¹⁶⁷¹

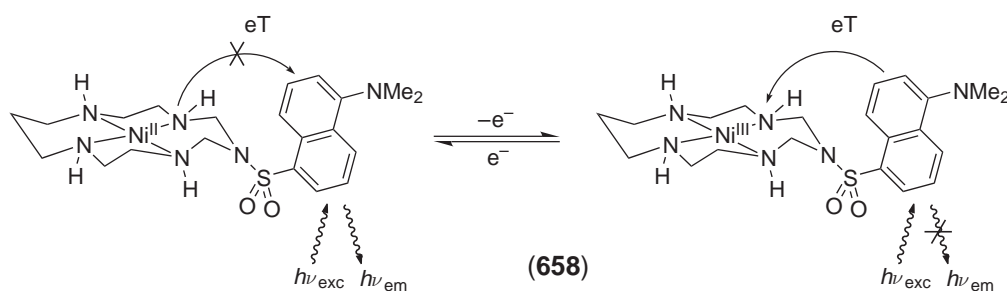
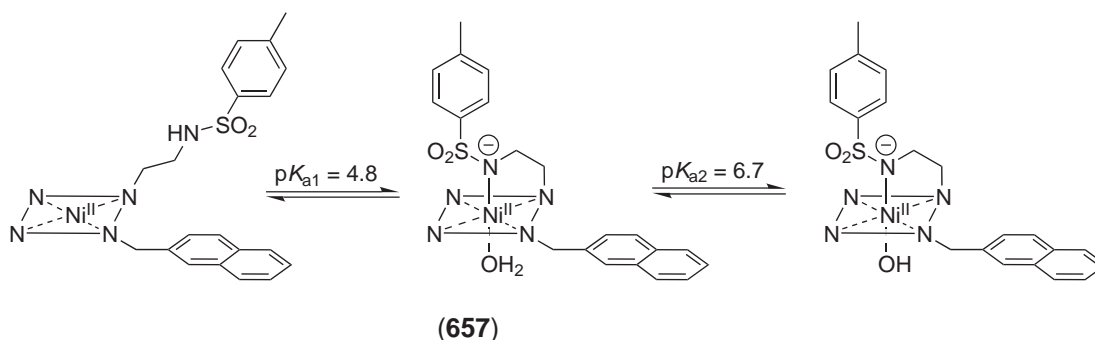

6.3.4.10.3 Complexes with larger macrocycles containing mixed donor atoms

Various Ni^{II} macrocyclic complexes with donor atoms other than nitrogen have been reported, including macrocyclic ligands with mixed donor atoms. Reviews covering parts of the field have appeared.¹⁶⁷²⁻¹⁶⁷⁴ In particular, macrocyclic Ni-thioether systems are the subject of intense interest, which is stimulated, *inter alia*, by the biological importance of redox-active Ni in sulfur-rich environments.¹⁶⁷⁵ In general, thioether coordination stabilizes lower spin and oxidation states. Ligand field splittings are roughly comparable with those of amine systems, but with a considerably greater nephelauxetic effect.

Ni^{II} complexes with tri-, tetra-, penta-, and hexa-thia crowns have been studied.¹⁶⁷⁵⁻¹⁶⁸³ It has been shown that peripheral macrocycle modifications may lead to substantial improvements in Ni^{II} complexation: *gem*-dimethyl substituents at the [14]ansS₄ macrocycle (e.g., (**659**), (**660**))

enhance its Ni^{II} binding strength (by ΔG° of complexation of ca. $-1.1 \text{ kcal mol}^{-1}$ per *gem*-dimethyl pair),^{1678,1679} as do both *cis*- and *trans*-fused cyclohexyl rings (**661**, **662**).¹⁶⁷⁶

The formation and dissociation kinetics of Ni^{II} complexes of various [14]aneS₄ derivatives has been investigated. The rate-determining step is the chelate ring closure, i.e., the second bond formation (in contrast to acyclic thioether systems), and subsequent conformational reorganization is rapid. The latter behavior differs from that of the corresponding macrocyclic tetraamines, because any donor atom inversion associated with conformational changes is easily accomplished by thioether sulfurs, but requires deprotonation of coordinated amines.¹⁶⁷⁷

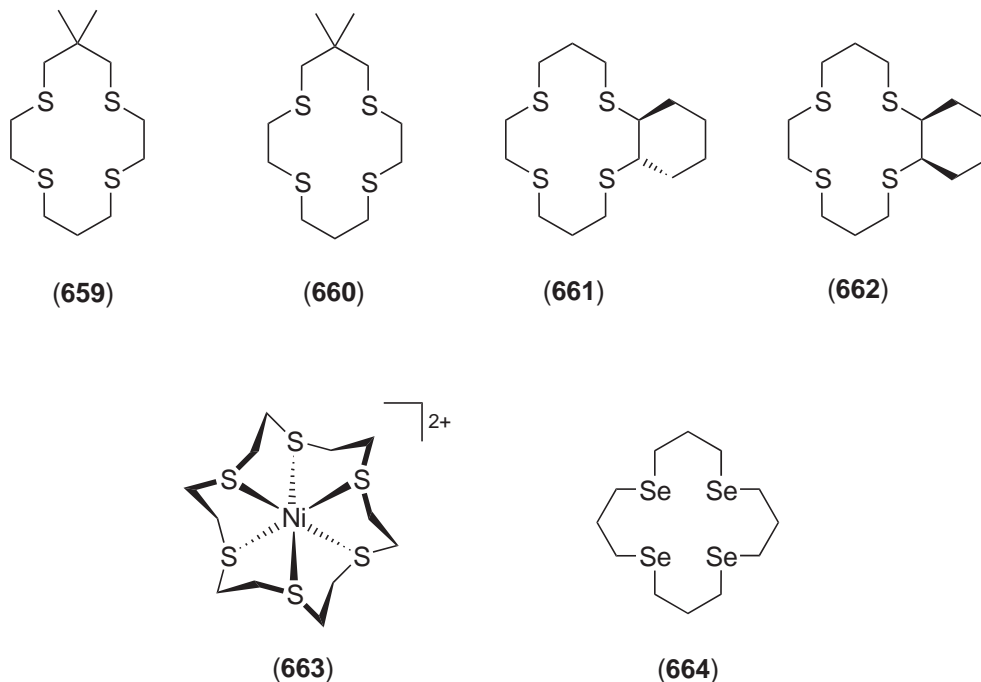

In contrast to [14]aneS₄, which can enforce fourfold thioether coordination to give a low-spin square planar Ni^{II} complex, each of the thiocrown complexes [Ni([18]aneS₆)]²⁺, [Ni([24]aneS₆)]²⁺, and [Ni([12]aneS₃)]²⁺ comprise a near-octahedral NiS₆ coordination sphere with the crown thioethers wrapped around the high-spin Ni^{II} ion (e.g., **(663)**).^{1680,1681} Since [Ni([12]aneS₃)]²⁺ undergoes a substantial conformational change upon complexation (in contrast to [Ni([9]aneS₃)]²⁺), [Ni([12]aneS₃)]²⁺ decomposes immediately on contact with water (as does [Ni([24]aneS₆)]²⁺). Ligand field splittings for [Ni([18]aneS₆)]²⁺ and [Ni([9]aneS₃)]²⁺ exceed those of [Ni([24]aneS₆)]²⁺ and [Ni([12]aneS₃)]²⁺ by $\sim 10\%$.¹⁶⁸⁰ In the absence of coordinating anions the complexation of Ni^{II} by [12]aneS₄ and [16]aneS₄ leads to octahedral complexes [NiL(sol)₂]²⁺ (sol = MeCN, H₂O).¹⁶⁸³ In the presence of anions such as chloride, however, dichloro-bridged dimeric cations exhibiting edge-sharing bioctahedral structures are formed, with the macrocyclic ligands coordinating in a *cis*-fashion around the metal ion. A similar structure is observed for [Ni([14]aneS₄)Cl]₂⁺.¹⁶⁸² Reaction of NiX₂ (X = Cl, Br, I) with the macrocyclic selenoether [16]aneSe₄ (**664**) afforded octahedral complexes *trans*-[NiX₂([16]aneSe₄)], whose structures were deduced via Ni *K*-edge EXAFS. A ligand field analysis of the UV-visible spectra of analogous [NiX₂([16]aneY₄)] complexes showed that the ligand fields decrease in the order Y₄ = N₄ > S₄ > Se₄.¹⁶⁸⁴

Ni^{II} complexes of mixed P₂S₂,¹⁶⁸⁵ P₂O₂,¹⁶⁸⁶ P₂N₂,¹⁶⁸⁶ and PNS₂¹⁶⁸⁷ macrocyclic ligands have been investigated, as well as Ni^{II} complexes of pyridine-derived N₃O₂ systems.¹⁶⁸⁸ A comparative study of the 1:1 (metal/ligand) complex stabilities of 14- and 16-membered *cis*- and *trans*-dibenzo-substituted type (**665**) and (**666**) macrocycles incorporating *trans*-N₂O₂, -N₂S₂ and -N₄ donor sets towards, *inter alia*, Ni^{II} has been carried out,¹⁶⁸⁹ as well as a similar study for a series of dibenzo-substituted macrocyclic ligands incorporating N₂O₂, N₄O₂, N₂O₃, N₃O₃, and N₂O₄ mixed-donor sets.¹⁶⁹⁰ Ni^{II} complexes with pendent pyridylmethyl side arms at the N atoms of type (**665**) and (**666**) N₂S₂ ligands show distorted octahedral structures with *cis*-orientation of chemically identical donor atoms.^{1691,1692} Ni^{II} complexes of the N₂S₃ crown (**667**) incorporating a 1,10-phenanthroline unit are six-coordinate with five sites occupied by the macrocyclic ligand and one additional anionic or neutral coligand.¹⁶⁹³

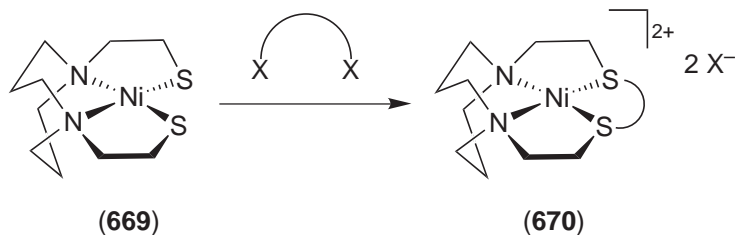
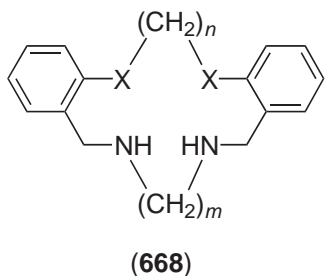
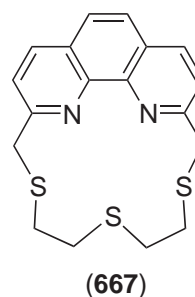
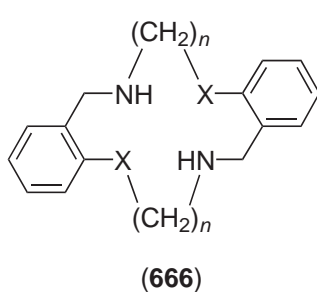
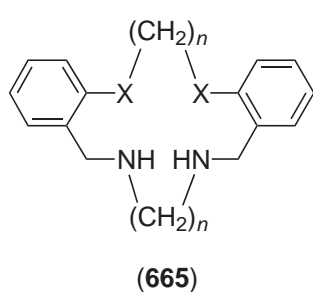

X = O, NH, S; $n = 2, 3$; $m = 2-4$

The size of bonding cavities available to, *inter alia*, Ni^{II} has been specified for a series of type (668) macrocycles.¹⁶⁹⁴ The “bonding cavity” radii are found to increase by ~ 0.05 Å for each additional atom in the inner great ring, while changing the donor atom type has a relatively small influence. Along the N₂O₂ donor series, stabilities of the Ni^{II} complexes reach a maximum at the 16-membered ring complex with both the 15- and 16-membered compounds being considerably more stable than the 14-membered system.

cis-Dithiolate complexes of Ni^{II} diamine derivatives are known to template the synthesis of N/thioether macrocycles, and this has been extensively exploited for the sterically constrained (*N,N'*-bis(2-mercaptoethyl)-1,5-diazacyclooctane)nickel(II) (669) to give type (670) complexes,¹⁶⁹⁵⁻¹⁶⁹⁸ and also for the 1,4-diazacycloheptane analogue.¹⁶⁹⁹ Upon template reaction with dihaloalkanes that are functionalized with heteroatom donors, Ni^{II} complexes of pentadentate N₂S₂X macrocyclic ligands are accessible. With X = NH, O, these form six-coordinate complexes in the solid state, e.g., [NiLCl]⁺ (671). In solution, they undergo an equilibrium between (671) and four-coordinate (672), equally well for X = NH and O.¹⁶⁹⁸ The systematic enlargement and increasing flexibility of the macrocyclic N₂S₂ cavity ((673) → (674) → (675)) correlates with electrochemical properties. Due to the decrease in the energy of the $d_{x^2-y^2}$ orbital and decreasing field strength concomitant with increasing ring size, the Ni^{II}/Ni^I couple becomes more accessible along the series, while the Ni^{III} state is stabilized by the smaller cavities.¹⁷⁰⁰ Some data relating to Ni^{II} complexes of N₂S₂ macrocycles are summarized in Table 11.

Table 11 Electronic absorption spectra (in water) and electrochemical data (in CH₃CN) for Ni^{II} complexes of N₂S₂ macrocycles.

Complex	$\lambda_{\max}(\epsilon)$ (nm (M ⁻¹ cm ⁻¹))	E_{ox}^{a} Ni ^{II} /Ni ^{III}	$E_{\text{red}}^{\text{a}}$ Ni ^{II} /Ni ^I	References
[673]Br ₂	458 (213)	+1.15	-0.76	1700
[674]Br ₂	454 (133)	+1.17	-0.59	1700
[675]Br ₂	480 (179)	+1.27	-0.43	1700
[Me ₄ (672)]I ₂	465 (102), 584 (98)		-0.45	1698
[671]I	470 (166)		-0.63	1698

^a Referenced to NHE.

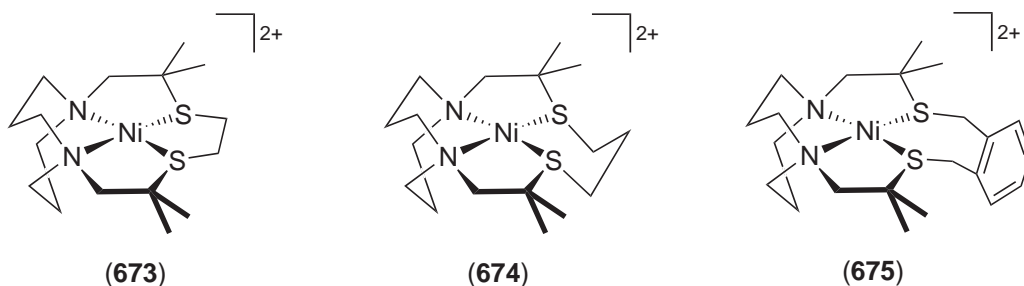
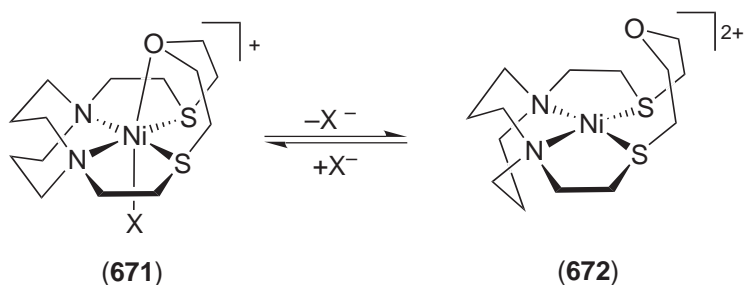

An unusual template reaction leads to the Ni^{II} complex of a tetrabenzo-N₂S₂ macrocyclic ligand (676) via C—Cl bond cleavage and C—S bond formation according to Equation (25).¹⁷⁰¹

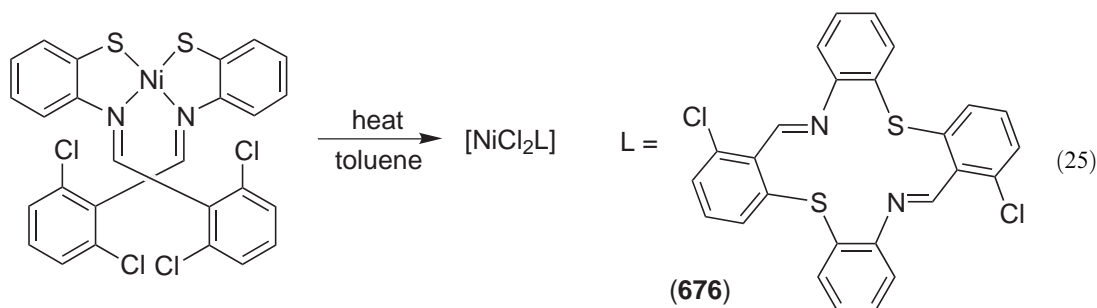

6.3.4.11 Complexes with Bioligands

Nickel is now recognized as an essential element for bacteria, plants, animals, and humans. The biological role of nickel in enzymatic catalysis comprises various systems including urease, which has been known for almost 30 years. The basic role of nickel for CO dehydrogenase/acetyl-coenzyme A synthase, methyl-coenzyme M reductase, [NiFe] hydrogenases, and nickel superoxide dismutase are examples of biological involvement of nickel. Nickel is also a toxic element for living organisms and a well-established carcinogen. Selected biologically relevant complexes are discussed in the following.

6.3.4.11.1 Complexes with amino acids and amino acid derivatives

(i) Complexes with α -amino acids

Natural α -amino acids provide a moderately effective {N,O} chelating donor set derived from carboxylate and amino groups, respectively. Several side-chain donor atoms may also be involved in metal ion coordination, especially those of Cys (thiol sulfur) and His (imidazole nitrogen(s)). (Abbreviations for amino acid residues are those recommended by IUPAC-IUB.¹⁷⁰²)

The major studies on Ni^{II} amino acids were performed in the 1980s and review articles^{1703,1704} have covered most of the important results. α -Amino acids form with Ni^{II} two distinct complex species, [NiL] and [NiL₂]. The first (K_1) and the second (K_2) stability constant logarithms for complexes of simple {N,O} chelating amino acids are in the range 5–6 for log K_1 and 4–5 for log K_2 . The side chains may be involved in the interaction with Ni^{II} leading to partly closed structures.¹⁷⁰³ However, only the β -carboxylate of Asp, the thiol-S of Cys, and the imidazole-N of His are involved so much that the stabilities of the respective complexes are distinctly higher. The log K_1 values of 7.15 for Asp, 8.66 for His, and 8.7 for Cys clearly indicate tridentate coordination of these amino acids. While the bis-His complex of Ni^{II} is pseudo-octahedral, the [NiL₂] complexes of Cys or its analogue *D*-penicillamine are square planar with very efficient {N,S} chelation.^{1705,1706} Such {N,S} coordination is also likely in the five-coordinate Ni^{II}-cysteine complex with tridentate tris(3,5-disubstituted pyrazolyl)borate.¹⁷⁰⁷ Stability constants for ternary complexes [NiABH₂], [NiABH], and [NiAB] with L-cysteine and L-cysteic acid (A), and DL-2,3-diaminopropionic acid, DL-2,4-diaminobutyric acid, or DL-ornithine (B) have been determined by titration methods.¹⁷⁰⁸

Ni^{II} coordination to simple amino acids in confined environments has attracted interest. The formation of a binary metalocyclodextrin is possible through binding of a metal ion by a functionalized cyclodextrin.¹⁷⁰⁹ Subsequent formation of a ternary metalocyclodextrin through the binding of a substrate, e.g., an amino acid, can take place. The metalocyclodextrin annulus partly encapsulates the amino acid, which also interacts with the adjacent metal ion, resembling a Michaelis complex. A study on the formation of metallo-6^A-((bis(2-aminoethyl)amino)ethyl)amino)-6^A-deoxy- β -cyclodextrins and their complexes with tryptophan has shown that Ni^{II} coordinated to such functionalized cyclodextrin is able to bind Trp orders of magnitude more efficiently than in simple binary systems (677).¹⁷¹⁰

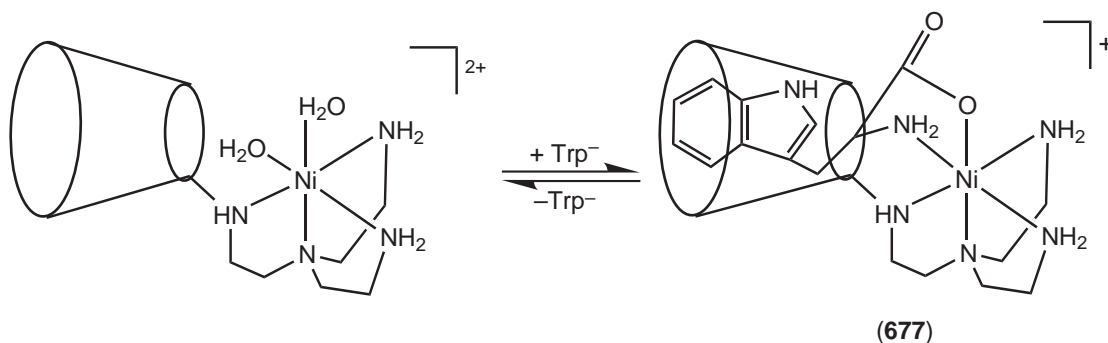

Interaction of Ni^{II} ions with amino acids is also important for asymmetric synthesis of amino acids. A convenient large-scale asymmetric synthesis of enantiometrically pure *trans*-cinnamylglycine and α -alanine via reaction of cinnamyl halides with Ni^{II} complexes of a chiral Schiff base of glycine and alanine has been elaborated.¹⁷¹¹ Similar procedures have been applied to other amino acids as well.¹⁷¹²

(ii) Complexes with hydroxamic and oximic analogues of α -amino acids

Modification of a weakly coordinating amino acid carboxylate into a hydroxamic group changes dramatically the binding ability towards Ni^{II} ions.¹⁷¹³ For Ni^{II}, the {N,N} chelation possible in the amino-hydroxamic ligands is more efficient than {N,O} coordination occurring in the simple amino acid complexes. While the {N,O} coordination results in octahedral or pseudo-octahedral complexes, {N,N} chelation may lead to planar complexes in which the {N,N} binding mode is especially favored. This conclusion has been widely confirmed, both in the solid state^{1714–1716} as well as in solutions studies.^{1717–1721} The {N,N} binding mode exhibited by aminohydroxamic acids is also much more effective than the {O,O} chelation offered by simple alkylhydroxamic systems.¹⁷¹⁴ In the latter case the O-only chelation leads to formation of poorly soluble octahedral complexes.

In aqueous solution, depending on pH, α -aminohydroxamic acids having no competing donor system in a side chain (like glycinehydroxamic acid or alaninehydroxamic acid, H₂L) form different complex species with Ni^{II} ions. The major complexes are the {NiL}, and [NiL(HL)]⁻

species with {N,N} donors involved. While the NiL complex is octahedral, the bis(ligand) complexes have square planar geometry. In the NiL₂ species ligands are in *trans* position to each other,^{1716,1722} while in the [NiL(HL)]⁻ complex they change to a *cis* geometry¹⁷¹⁵ due to the strong interligand hydrogen bond (678).

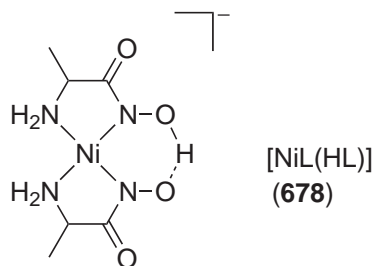

Oxime derivatives of amino acids (and their amides) are more efficient ligands than the parent amino acids. Oximes of amino acid amides are particularly good ligands for Ni^{II} ions forming {N₄} complexes with specific *cis* coordination of two amide ligands stabilized by a hydrogen bond between the two oximic O atoms (Figure 18).¹⁷²³

Simultaneous modification of amino carboxylate groups into oximic and hydroxamic functions results in very powerful N-coordinating ligands for Ni^{II} ion. The stability of the NiL₂ complex is much higher than that of the respective amino acid or its oximic or hydroxamic analogue.¹⁷²⁴ Two hydrogen bonds stabilize very effectively the pseudomacrocyclic complex (Figure 19). Similar coordination behavior is observed for the dihydroxamic acid derived from oxalic acid (Figure 20).¹⁷²⁵

6.3.4.11.2 Complexes with peptides

(i) Complexes with peptides bearing noncoordinating side chains

The coordination abilities of peptide ligands have been the subject of several reviews.^{1726–1729} Peptides are very effective and specific ligands for Ni^{II} ions since they contain a variety of potential donor centers. The most important binding sites for Ni^{II} is usually the N-terminal nitrogen (679A), derived from a primary NH₂ group or secondary NH in the case of proline. The C-terminal carboxylate (679B) and carbonyl (679C) O atoms are also potential donors, although for Ni^{II} ion they are usually less effective than the nitrogen donors. Ni^{II} can promote ionization of the amide nitrogen of the peptide linkage (679D) to form a very stable Ni^{II}—amide bond. Thus,

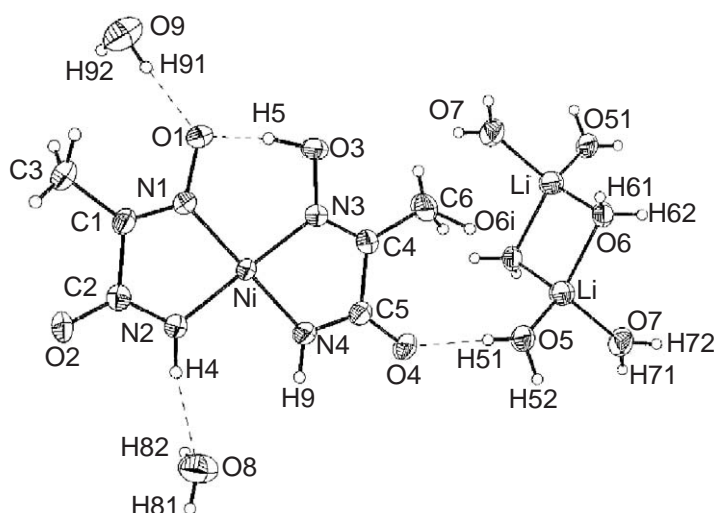

Figure 18 Crystal structure of Li[NiL(HL)] complex (H₂L = 2-hydroxyiminopropanamide).

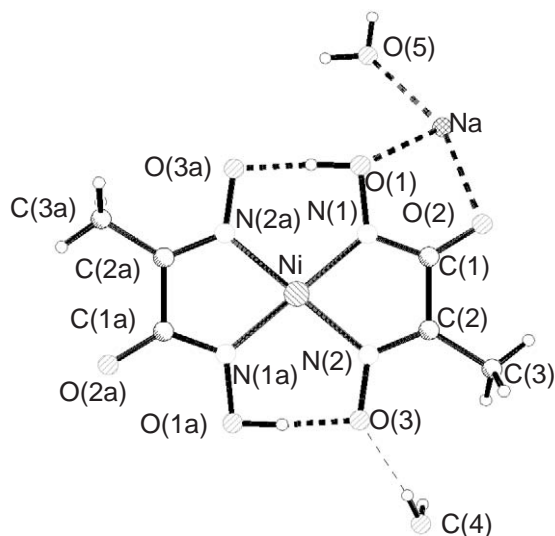

Figure 19 Crystal structure of $\text{Na}_2[\text{NiL}_2] \cdot 4\text{H}_2\text{O}$ complex ($\text{H}_2\text{L} = 2\text{-(hydroxyimino)propanohydroxamic acid}$).

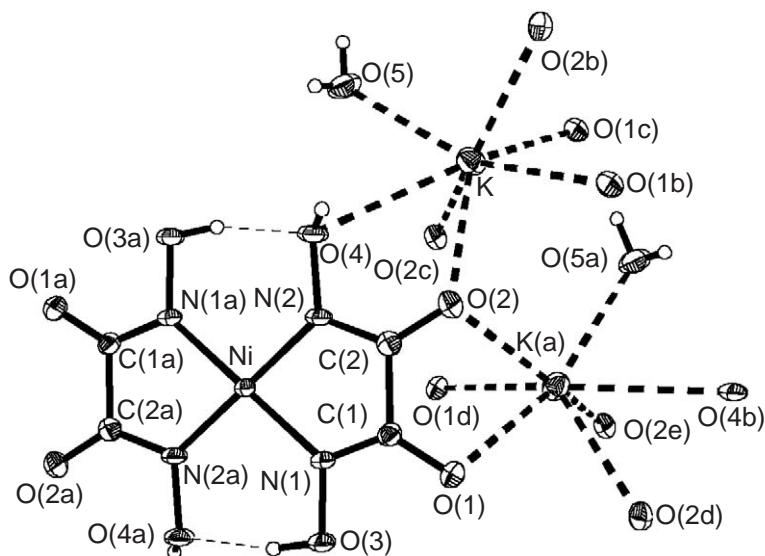
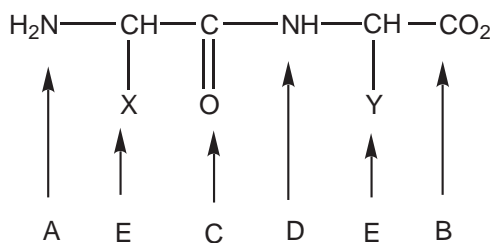
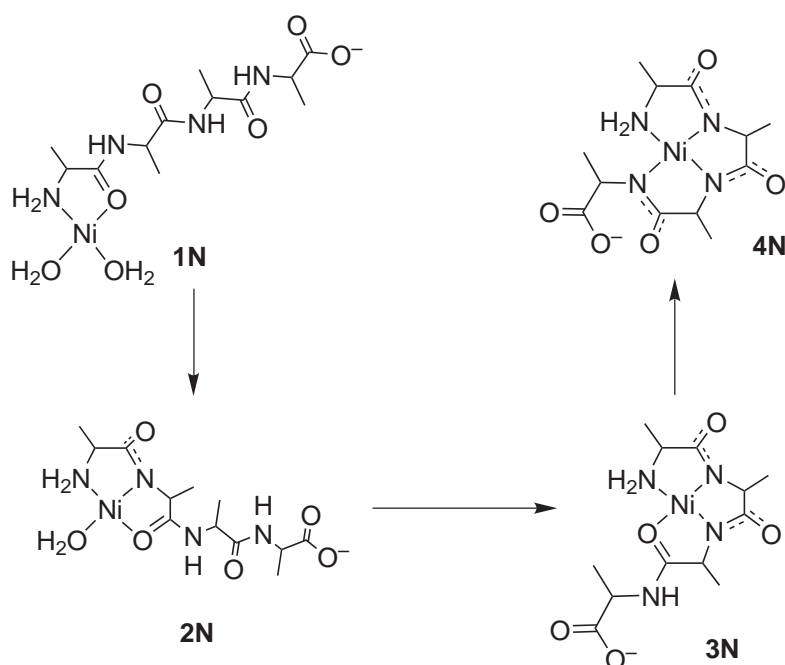

Figure 20 Crystal structure of $\text{K}_2[\text{Ni(oxha)}_2] \cdot 2\text{H}_2\text{O}$.

in the case of simple oligopeptides with noncoordinating side chains, complex formation with Ni^{II} starts at the N-terminal amino nitrogen and proceeds as shown in [Scheme 8](#).^{1726–1729} A characteristic feature of Ni^{II} –peptide systems is the cooperative deprotonation of the amide N atoms resulting in the transition from an octahedral (1 N) to a square planar (4 N) complex.¹⁷²⁶





Scheme 8

(ii) Complexes with peptides containing side-chain donor systems

In addition to the backbone donor system the amino acid residues can contain a variety of donor centers (**679E**). The most important of these are the imidazole N atoms of His, the S atom of Cys, and to some extent the β -carboxylate O atom of Asp. Other side chain donors like the O atoms of Ser and phenolic O atoms of Tyr or amino N atoms of Lys are of minor importance for coordination of Ni^{II} ions. Also, thioether S-donors of Met play only a minor role in the interactions with Ni^{II} ions.¹⁷³⁰

The β -carboxylate group of the Asp residue is not a favored donor for Ni^{II} ions. It may stabilize, however, the complexes formed between the metal ion and simple oligopeptides, particularly when present as the N-terminal residue.¹⁷³¹ In the latter case, Ni^{II} coordinates to the N-terminal amino group (1 N species, Scheme 8) and the β -carboxylate closes the six-membered chelate ring. This binding mode stabilizes considerably the 1 N (NiL) species by a factor of up to 2 log units. The side chain of glutamic acid with its γ -carboxylate has a much smaller effect than Asp on the binding ability of peptides towards metal ions.

(iii) Complexes with peptides containing histidine

The Histidine residue with its imidazole side chain is one of the most effective ligation sites in metallopeptides. The His residue provides two N-donors and a six-membered chelate ring for coordination. Although the N-terminal amino-N usually initiates the Ni^{II} ion coordination to the peptide chain, an imidazole of His residue present in a peptide sequence may also act as a primary anchoring site for Ni^{II} . The competition between the terminal amino and the imidazole N donors to coordinate to Ni^{II} strongly depends on the position of His in the peptide chain.^{1732,1733} Simple peptides with His in the N-terminal position bind Ni^{II} differently from ordinary peptides. The histamine-like $\{\text{NH}_2, \text{N}_{\text{im}}\}$ chelate of the His-1 residue is so efficient that it wins competition with the amide bonds and only pseudo-octahedral NiL and NiL_2 complexes are formed.^{1734,1735}

The insertion of histidine in position two of the peptide chain results in the simultaneous binding of the N-terminal amine, the imidazole, and the intervening amide-N to the Ni^{II} ion. The major complex $[\text{NiH}_{-1}\text{L}]^+$ with $\{\text{NH}_2, \text{N}_{\text{am}}^-, \text{N}_{\text{im}}\}$ binding mode is pseudo-octahedral and in

aqueous solution it dominates in the pH range 6–10.^{1734,1736,1737} The most characteristic feature of the short peptides having His-2 residues is the formation of the very stable diamagnetic tetrameric $\text{Ni}_4\text{H}_8\text{L}_4$ complex with square-planar Ni^{II} ions bridged by imidazole rings (Scheme 9).^{1736,1737}

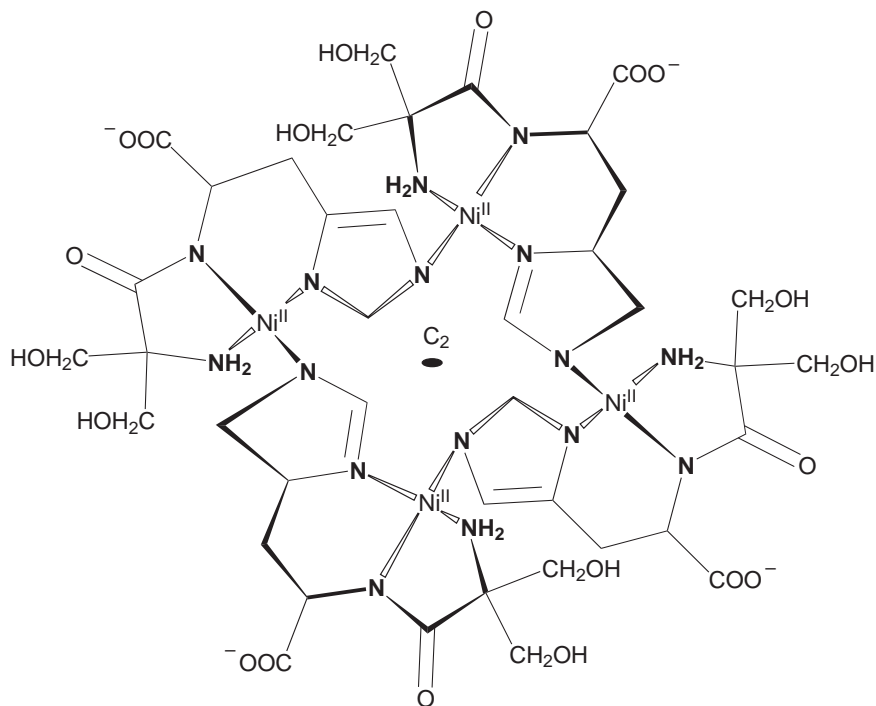

Scheme 9 Tetrameric $\text{Ni}_4\text{H}_8\text{L}_4$ complex with square-planar Ni^{II} ions.^{1736,1737}

Coordination of the imidazole-N of His to Ni^{II} is most effective when His is located in the third position in the peptide chain. This position allows for the simultaneous formation of three fused chelate rings, involving a $\{\text{NH}_2, \text{N}^{\text{am}}, \text{N}^{\text{am}}, \text{N}^{\text{im}}\}$ donor set (680) and saturating all available coordination sites in the planar (4N) Ni^{II} ion. The Xaa-Yaa-His- sequence corresponds to the N-terminal binding site for Ni^{II} in human serum albumin (Asp-Ala-His) and it is one of the most effective peptide chelating agents for Cu^{II} and Ni^{II} ions.^{1738–1742} The albumin-like sequence has been studied extensively and numerous findings confirmed the coordination mode shown in (680), including the X-ray structure obtained for the Ni^{II} complex with glycylglycyl- α -hydroxy-D-L-histamine.¹⁷⁴³ Although the short peptides may not be reliable models of thermodynamic and kinetic properties of the N-terminal metal binding site in serum albumin, the available data allow to evaluate the impact of the Xaa-Yaa-dipeptide sequence on the stabilities of the Ni^{II} complexes with Xaa-Yaa-His.

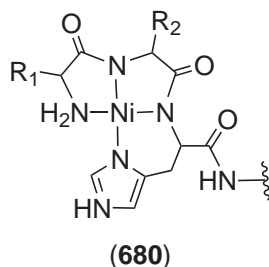

The N-terminal peptide fragment of des-angiotensinogen Val-Ile-His-Asn contains two strongly hydrophobic amino acid residues on the N-terminal site of His-3. The potentiometric data have shown that the NiH_2L complex with this albumin-like sequence is more than two orders of magnitude more stable than the respective complex with Gly-Gly-His.¹⁷⁴⁴ The NMR-based molecular structure has shown that the side chains of Val-1 and Ile-2 form a well-ordered hydrophobic fence (Figure 21) shielding one side of the coordination plane from the bulk of

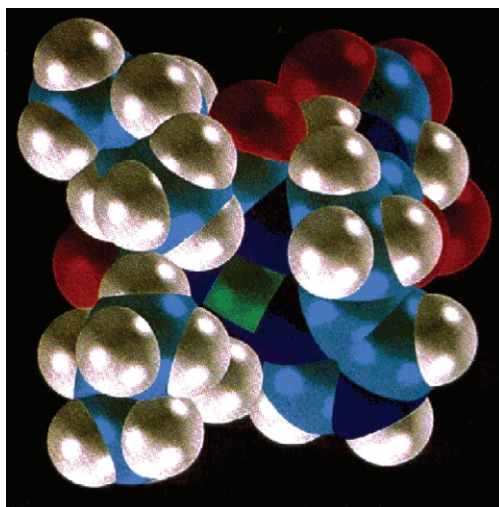

Figure 21 Space-filling model of the structure with the lowest overall energy showing the amino acid side chains hindering axial approach to Ni^{II} . Color code: C, light blue; H, white; N, dark blue; O, red; Ni^{II} , green.¹⁷⁴⁵

the solution. The stability of the Ni^{II} -peptide complex depends on the rate of dissociation, and in the case of the Xaa-Yaa-His complex dissociation of nickel requires attack of water or H^+ on the bound amide-N. Thus, the protection of the metal-amide bonds by the hydrophobic fence increases the complex stability. The acidic properties of the N atoms of the residues involved in the Xaa-Yaa-His sequence may play a crucial role in the binding ability of the albumin-like peptides as well.¹⁷⁴⁵

The unusual binding ability of the albumin-like peptides may be also critical for Ni^{II} ion binding by larger peptides. The human protamine HP2, which is a small basic protein providing compact DNA binding in vertebrate sperm, has the albumin-like N-terminal sequence Arg-Thr-His. This sequence binds to Ni^{II} much more effectively than simple albumin-like peptides,¹⁷⁴⁶ which indicates that HP2 is a likely target for toxic Ni^{II} ions. The Ni^{II} ion coordinated to the N-terminal tripeptide unit of HP2 induces very a specific secondary structure in the N-terminal pentadecapeptide of human protein.¹⁷⁴⁷ A striking double-loop conformation was found, exhibiting the interactions of the aromatic ring of Tyr-8 residue with the Ni^{II} coordination site at Arg-1, Thr-2, and His-3 (Figure 22). The resulting conformation could be critical for a possible physiological function of the N terminus of HP2 as a metal binding site.

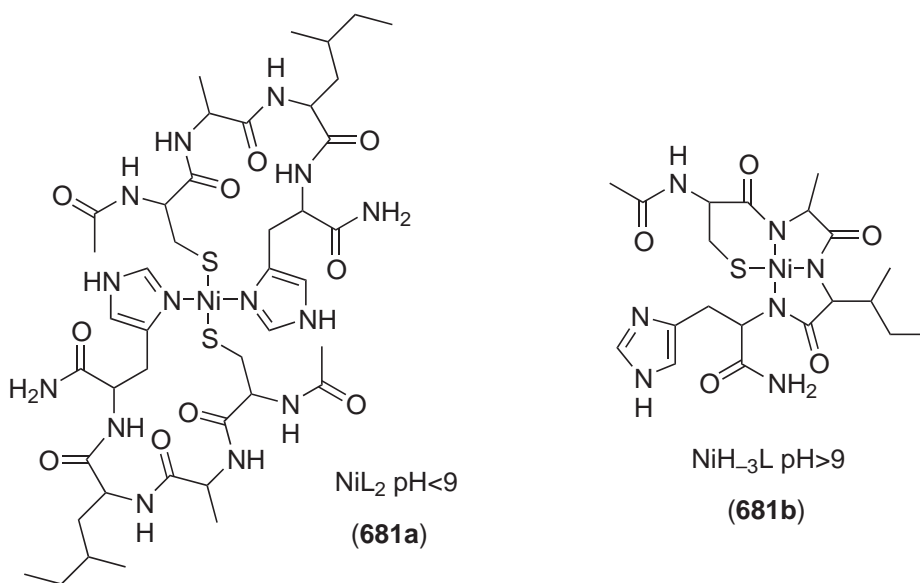

Figure 22 Positioning of the Tyr⁸ phenol ring (colored stick structures) relative to the Ni^{II} (purple sphere) and its chelate ring (ball-and-stick structure). The lowest-energy representatives of conformational families 1-3 are shown in blue, green, and yellow, respectively. The phenol oxygen is a red sphere.¹⁷⁴⁷

Ni^{II} complexes with Xaa-Yaa-His peptides are sensitive to oxygen species including dioxygen itself. The yellow solution containing Ni^{II} and Gly-Gly-His left for 48 h at ambient temperature gave rise to crystals which according to the X-ray structure contain the decarboxylation product Ni^{II} (Glycyl-Glycyl- α -hydroxy-D,L-histamine).¹⁷⁴³ The ability of Ni^{II} complexes to catalyze such oxidation reactions is often used to cleave specifically DNA.^{1748,1749} Nickel peptide complexes with His-3 have also been used for very specific DNA cleavage by attachment to DNA recognition groups, e.g., a zinc-finger DNA binding domain^{1750,1751} or a peptide nucleic acid (PNA) oligomer.^{1752,1753} The strong equatorial ligand donors in the planar Ni^{II} complexes are essential for a mechanism that involves Ni^{III} as an intermediate.

When His is inserted in position 4 or further away from the N terminus, coordination equilibria become much more complicated and the binding ability is usually lower than that of albumin-like sequences. With respect to the molecular mechanisms of nickel carcinogenesis, much effort was undertaken to understand Ni^{II} binding to short and long fragments of many proteins associated with chromatin or proteins related to metal detoxification. Some histone proteins containing one or more His residues are potential binding sites for Ni^{II} ion. For the N-terminal tail of the histone H4 it was shown that H4 is a relatively good binding site for metal ions at the His residue and that coordinated Ni^{II} stabilizes a bent structure around the metal ion binding site.¹⁷⁵⁴ Lack of the N-terminal amino-N anchoring site makes His-18 the only primary ligation site and the formed complexes are relatively stable, thus making H4 a relevant metal ion binding site to be considered in the mechanism of nickel carcinogenicity.

Much more effective ligation for Ni^{II} ions was found in histone H3 containing the Cys-Ala-Ile-His sequence. The presence of two powerful donor systems (Cys and His) leads to formation of a planar Ni^{II} complex at physiological pH involving both side chain donors. Proposed structures are (681a) and (681b).¹⁷⁵⁵ Such complexes are formed with a short tetrapeptide fragment as well as with the whole histone (H3-H4) core tetramer *in vitro*.¹⁷⁵⁶ The binding constant obtained for the histone tetramer is relatively high (log K of 4.26–5.26, depending on the extent of protein aggregation). Complexes (681) facilitate the oxidation of 2'-deoxyguanosine in the presence of H_2O_2 and are a reasonable model for the oxidative concept of nickel-induced carcinogenicity.¹⁷⁵⁷ Ni^{II} also binds effectively the histone H2A at the -Thr-Glu-Ser-His-His-Lys- sequence forming an octahedral complex involving two imidazoles of the His residues.^{1758,1759} The octahedral complex has similar stability to that found in the H3 histone, but it does not act as an oxidative catalyst. Nickel(II) ion binding to the H2A site, however, results in the hydrolysis of the Glu-Ser amide bond, with formation of the planar complex with the Ser-His-His-Lys- motif, which may then act as an oxidative catalyst.¹⁷⁵⁷ The coordination mode in the latter complex is characteristic for the albumin-like peptides. The presence of several His residues in the peptide sequence may influence the metal binding equilibria. However, the most effective position His-3 predominates (see the case of HP2 protein, *vide supra*). The same phenomenon is observed for the pNiXa-1 peptide: His-Arg-His-Arg-His-Glu-Gln-Gln-Gly-His-His-Asp-Ser-Ala-Lys-His-Gly-His.¹⁷⁶⁰



Proposed structure of different complexes formed by Ni^{II} with $\text{CH}_3\text{CO-Cys-Ala-Ile-His-NH}_2$ ¹⁷⁵⁵

His residues in the peptide sequence are fundamental for Ni^{II} ion interactions with peptides. When the His residue is relatively distant from the N terminus, it may compete as a primary ligation site with the N-terminal amino nitrogen. However, even the higher number of His residues inserted inside the peptide sequence may be not able to compete with the albumin-like N terminus, unless the specific peptide structure is established.

(iv) *Complexes with peptides containing cystein*

Cysteinyl-S is the other powerful donor site for Ni^{II} ions. The binding abilities and the coordination equilibria in Ni^{II}-peptide systems depend strongly on the position of Cys residues in the peptide sequence. The Ni^{II} binding to peptides containing Cys in the N-terminal position (Cys-Xaa-Yaa-) is similar to that observed for the Ni^{II}-Cys system.^{1761,1762} Solely the Cys residue is involved in the direct metal ion binding via its {NH₂,S⁻} donor set. The stability constants are lower for the peptide systems due to steric effects and because the trimeric species (682) (which is characteristic for the Ni^{II}-Cys system) is only a minor species in the case of peptide ligands.

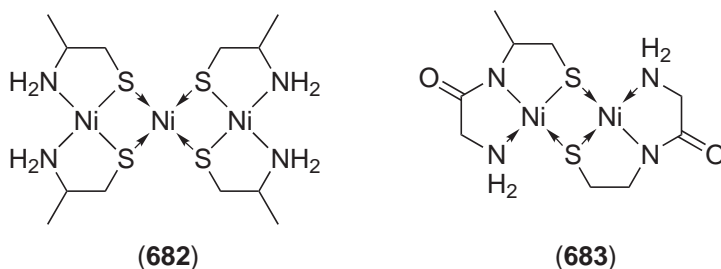

The Xaa-Cys sequence binds Ni^{II} ion via its {NH₂,N⁻,S⁻} donor set forming square planar complexes. The dimeric species [NiH₋₂L]₂ is a major complex above pH 6, it is very stable and sulfur acts as a bridging unit (683). When Cys was inserted into the albumin-like sequence Xaa-Cys-His,¹⁷⁶³ Ni^{II} binds to the {NH₂,2xN⁻_{am},N_{im}} donor set as in a typical Xaa-Yaa-His peptide. However, the complex obtained in the absence of air is a paramagnetic species, suggesting the involvement of a thiol donor in the apical coordination in an intramolecular fashion (684a) or via formation of a dimeric species (684b). In the presence of air the complex becomes diamagnetic due to oxidation to a disulfide-bridged dimer (684c).

Insertion of a thioamide (ψ [CSNH]) bond into a peptide backbone with noncoordinating side chains increases distinctly the coordination ability of the peptide toward Ni^{II}. The thioamide sulfur is a much more potent donor than the carbonyl-O and it is a basic donor for Ni^{II} ion coordination around physiological pH.¹⁷⁶⁴

6.3.4.11.3 *Complexes with porphyrins and related ligands*

A handbook on inorganic and coordination chemistry of porphyrins has been published.¹⁷⁶⁵ Factor F₄₃₀ is the nickel-hydrocorphinoid group of the enzyme methyl coenzyme M reductase.^{47,48} The mystery of this particular metalloprotein is one of the major reasons for the development of Ni^{II}-porphyrin coordination chemistry, although not the only one.

Porphyrins are ideal ligands to form planar complexes with Ni^{II} ions. However, the small size of the low-spin Ni^{II} ion leads to short Ni-N bonds in the equatorial plane of the macrocycle. A number of structures determined for a variety of Ni^{II}-porphyrin complexes have shown that the problem of the short Ni-N bonds is solved by changes in the porphyrin core conformation.¹⁷⁶⁶ Three major core structures are usually observed for Ni^{II}-porphyrin complexes: a ruffled, a planar, and a saddled conformation. There is no simple relation between the core conformation and the Ni-N bond length. The structure of a simple unsubstituted (porphinato)Ni^{II} complex has a planar core both in solution and in the solid state.¹⁷⁶⁷ However, complexes with porphyrins with only slightly more bulky substituents like 2,3,7,8,12,13,17,18-octaethylporphyrin (OEP)¹⁷⁶⁸⁻¹⁷⁷⁰ or protoporphyrin IX¹⁷⁷¹ exist at least in two conformations in solution (planar and nonplanar). Ni(OEP) crystallizes in two planar forms and one ruffled tetragonal form. Besides the small size of the Ni^{II} ion, bulky substituents also result in nonplanar conformations that relieve steric

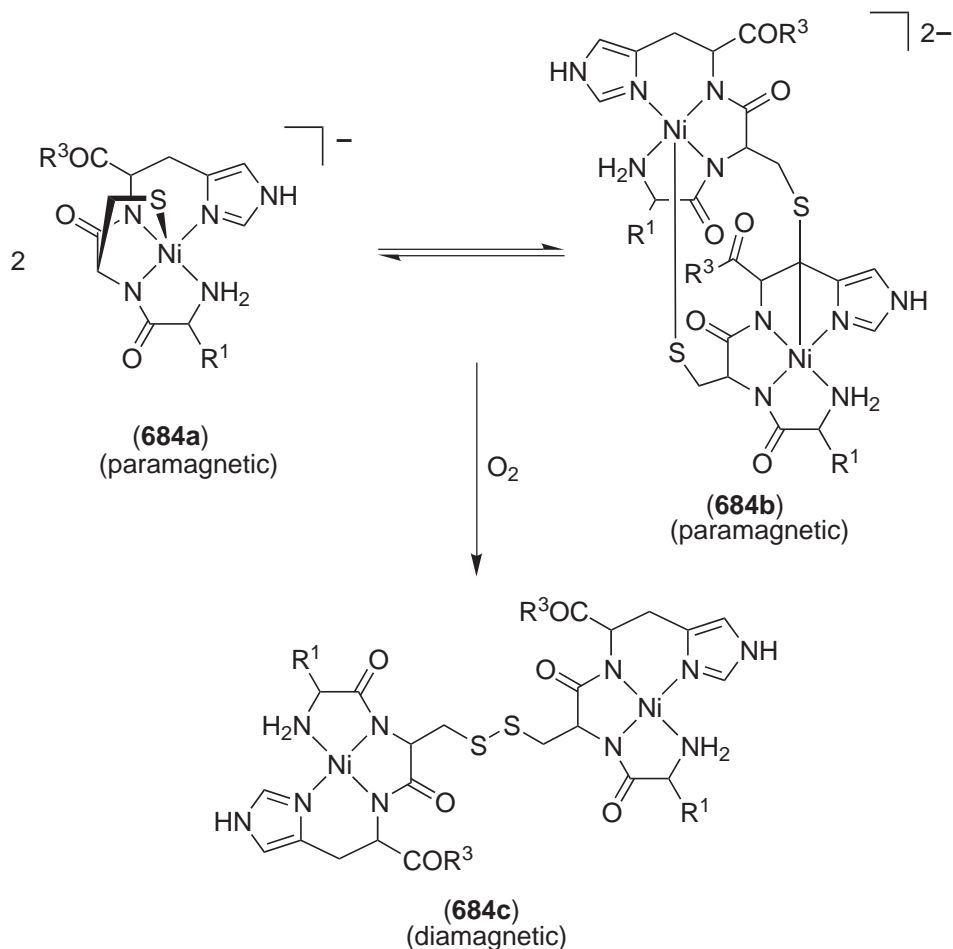

crowding at the periphery of the macrocycle.¹⁷⁷² Crystallographic studies have shown that in the series of substituted tetraphenylporphyrins¹⁷⁷³ the macrocycle distortion increases gradually in the order TPP < DETPP < tTETPP < cTETPP < HETPP < OETPP. Metal-free porphyrins with more bulky substituents usually assume a nonplanar saddle-shaped conformation, while a ruffled conformation can be induced by small metal ions. Coordination of these porphyrins with Ni^{II} only in one case, Ni^{II}tTETPP, resulted in a highly nonplanar ruffled conformation, while Ni^{II}DETPP, Ni^{II}cTETPP, and Ni^{II}HETPP exhibit a saddle-distorted conformation of the macrocycle¹⁷⁷³ (Figure 23). The complex of another highly substituted porphyrin, 5,10,15,20-tetrabutyl-2,3,7,8,12,13,17,18-octaethylporphyrin, has a significantly distorted ruffled-shaped core conformation (Figure 24) with very short average Ni—N bond distances in the crystal (1.873 Å) and in solution (1.87 Å according to EXAFS data).¹⁷⁷⁴

A detailed analysis of Ni^{II} complexes with *meso*-substituted porphyrins bearing zero, one, two, or four *t*-butyl groups revealed that both the out-of-plane and in-plane distortion depend on the perturbation symmetry of the peripheral substituents (number and position of substituents), and their orientation.¹⁷⁷⁵ These results have implications for understanding the role of nonplanar distortions in the function of metalloproteins containing nonplanar porphyrins.¹⁷⁷⁶

Meso-tetracyclohexylporphyrin contains four nonplanar electron donating bulky *meso* substituents, causing distinct steric crowding at the porphyrin periphery.¹⁷⁷⁷ Its Ni^{II} complex has a ruffled conformation of the core with the shortest Ni—N distances being 1.881–1.897 Å. The electron donating effect of the cyclohexyl groups is seen in the redox properties of the porphyrin in the complex. It is easier to oxidize and harder to reduce than in the case of its tetraphenylporphyrins congeners.

Polar substituents have been attached to the porphyrin core in order to achieve water-solubility. (685) has been synthesized by reaction of the Ni^{II} complex of tetrakis(pentafluorophenyl)porphyrin with dimethylammonium hydrochloride in DMF, followed by methylation with methyl trifluoromethanesulfonate (triflate) in trimethyl phosphate.¹⁷⁷⁸ The triflate and chloride salts are

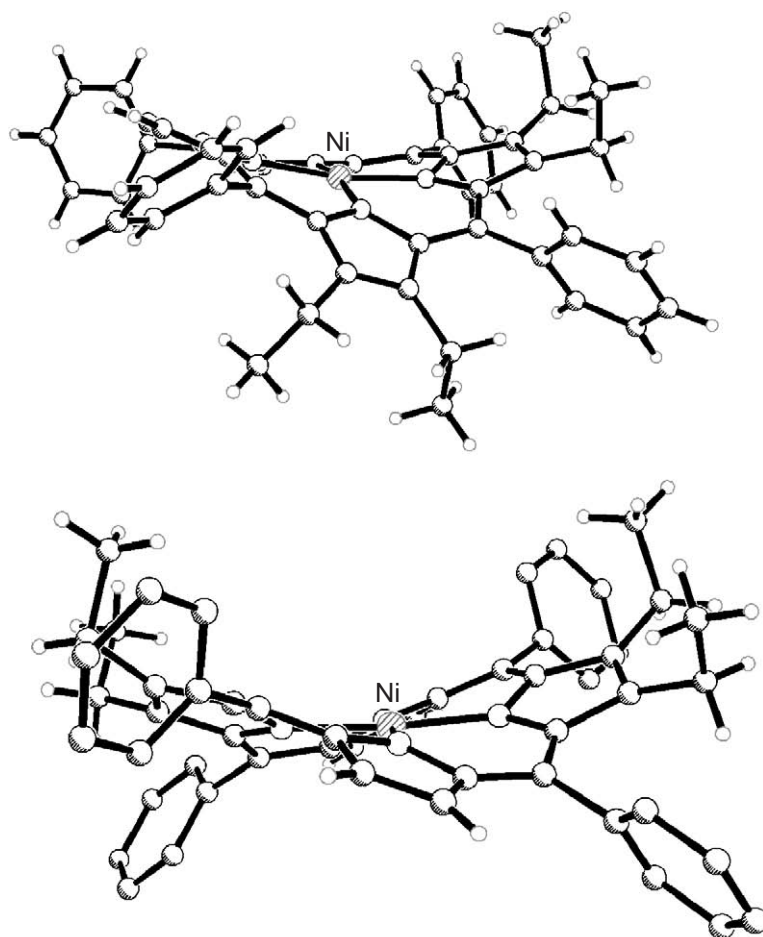

Figure 23 Side views of the molecular structures of one of the two independent molecules in the structures of Ni^{II}tTETPP (top) and Ni^{II}cTETPP (bottom).¹⁷⁷³

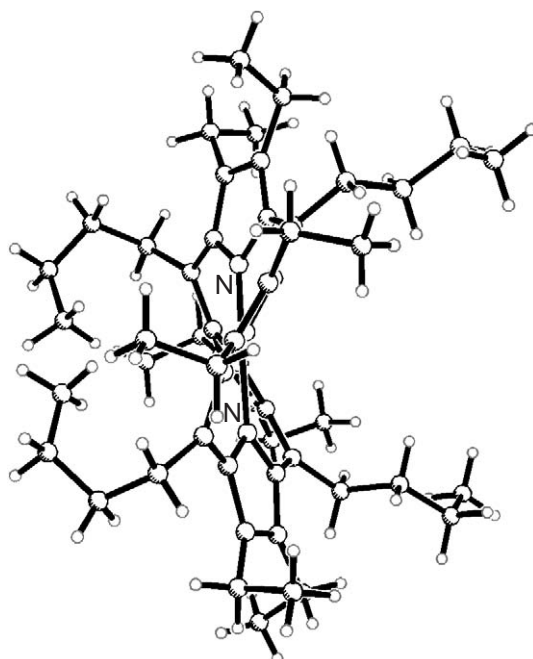
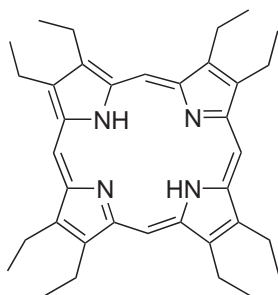
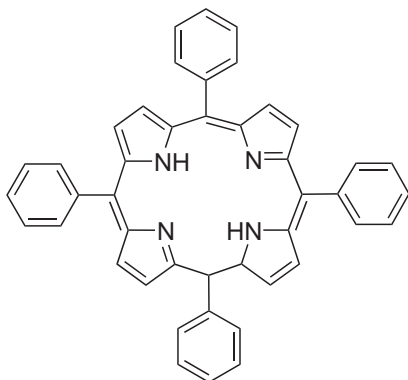
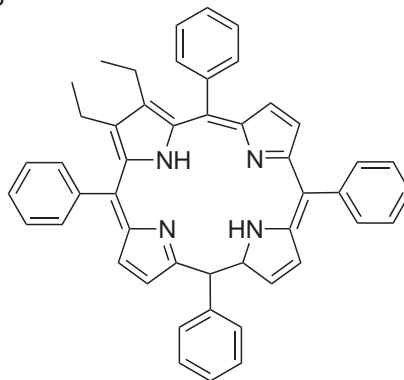
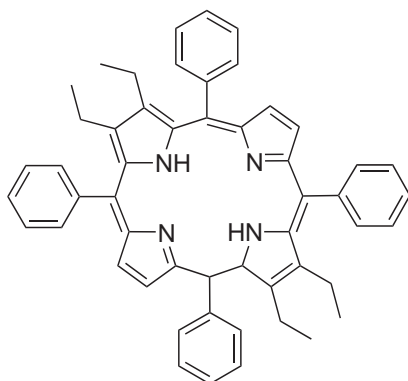
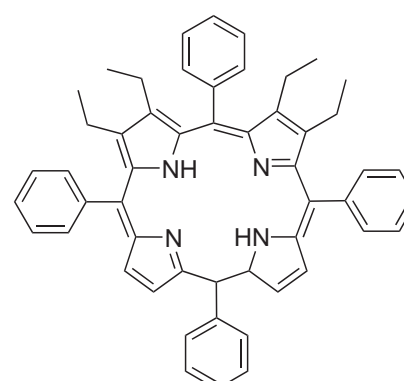
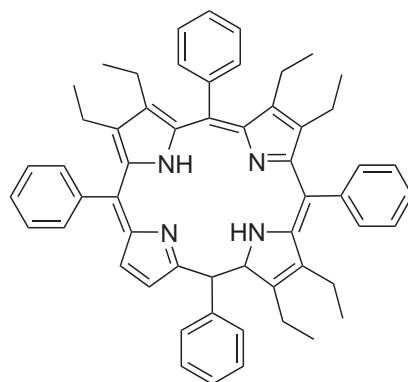
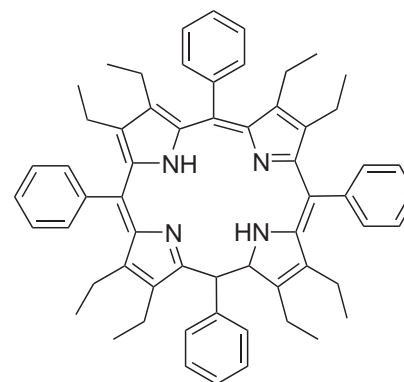
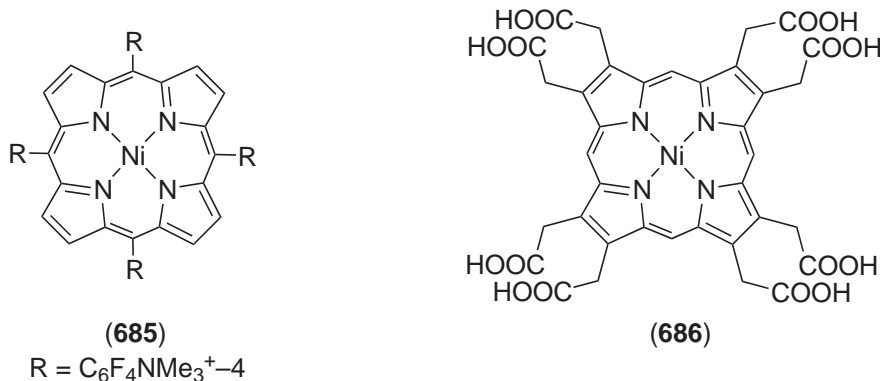

Figure 24 Side view of the molecular structure of NiTBuOEP in the crystal.¹⁷⁷⁴

H₂OEPH₂TPPH₂DETTPH₂tTETPPH₂cTETPPH₂HTETPPH₂OETPP

water soluble. The fluorine substituents reduce the tendency to aggregation and adsorption to electrode surfaces often found for water-soluble porphyrins. **(686)** also is water soluble, and several esters of **(686)** have been studied.¹⁷⁷⁹ These latter complexes are highly nonplanar as indicated by resonance Raman and NMR spectroscopic experiments. Consistent with this, EXAFS measurements show short Ni—N bond lengths in the range 1.92(2)–1.89(2) Å. Unlike [Ni(uroporphyrin)], which undergoes aggregation in low pH (<3) or high ionic strength media, complexes **(686)** remain unassociated, probably because of the degree of distortion from planarity.



Crystallographic work on a Ni^{II} complex of the *N*-oxide dianion of OEP has revealed direct coordination of the O-donor (Figure 25).¹⁷⁸⁰

In general, the combined effect of the small Ni^{II} ion and substituents larger than H atoms is required to shift the conformational equilibrium toward a nonplanar structure. Binding a ligand in the axial position raises the coordination number and the effective size of the metal ion, which becomes paramagnetic. Only nitrogenous bases are observed to form six-coordinate species.¹⁷⁸¹ However, the occurrence of six-coordinate, pseudo-octahedral Ni^{II} inserted in a tetrapyrrole ring is rare. Work on Ni^{II} complexes with tetraphenyl-porphyrins bearing β -pyrrole electron-withdrawing substituents¹⁷⁸² has shown that expansion of the porphyrin core takes place when the saddle-shaped and slightly ruffled low-spin [Ni^{II}(TPP(Br)₄(CN)₄)] (2,3,12,13-tetrabromo-7,8,17,18-tetracyano-5,10,15,20-tetraphenylporphyrin) complex binds two pyridines. (Ni—N)_{av} bond distances increase from 1.929 Å [Ni—N(Br)] and 1.911 Å [Ni—N(CN)] to 2.073 Å and 2.040 Å, respectively. This expansion is accompanied by a significant decrease of the saddle distortion and a clear increase of

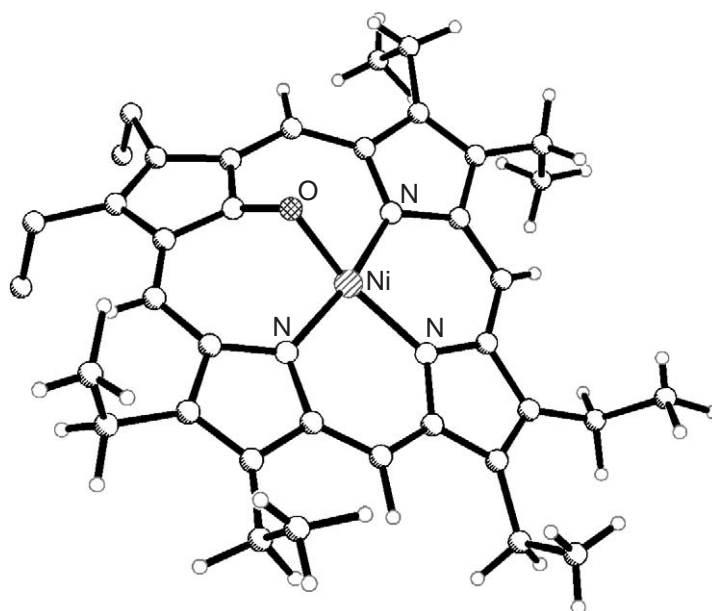
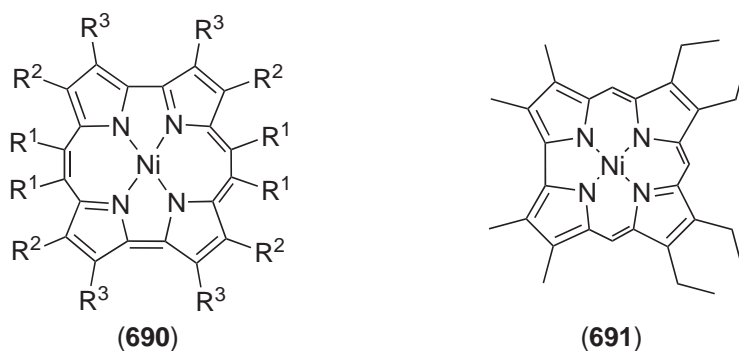
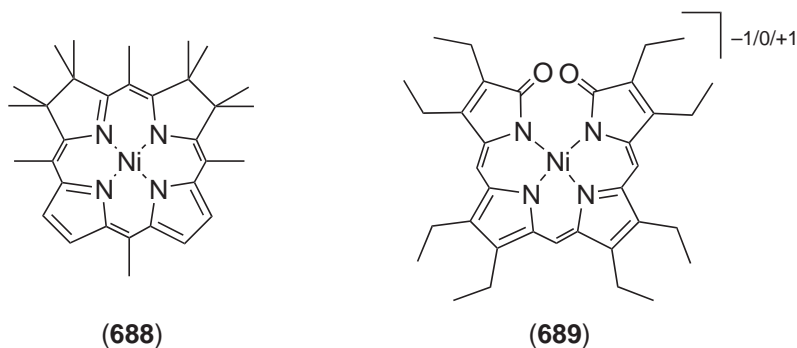
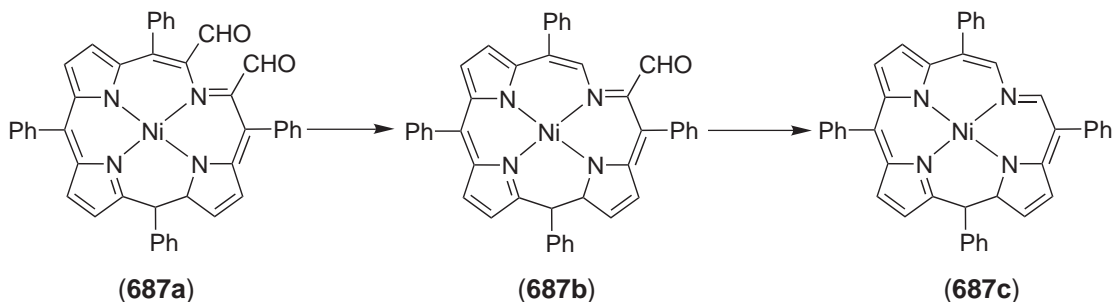

Figure 25 Predominant form of the Ni^{II} complex of octaethylporphyrin *N*-oxide.¹⁷⁸⁰

the ruffling of the porphyrin present in $[\text{Ni}(\text{TPP}(\text{Br})_4(\text{CN})_4)(\text{py})_2]$. The macrocycle present in $[\text{Ni}(\text{TPP}(\text{CN})_4)(1\text{-MeIm})_2]$ displays a waved conformation and it is only slightly nonplanar.

Cleavage of one peripheral β, β' -double bond in $[\text{NiTPP}]$ gives the secochlorinato complex (**687a**), a metallochlorin-like pigment.¹⁷⁸³ Stepwise decarbonylation yields (**687b**) and the *meso*-tetraphenylchlorophinato complex (**687c**).¹⁷⁸⁴ Both (**687a**) and (**687c**) exist in severely ruffled conformations. While more rigid ligands such as homoporphyrins are unable to increase their cavity size for accommodating the larger Ni^{I} ion (and hence favor ligand-centered reduction), one-electron reduction of the more flexible secochlorin and chlorophin complexes gives Ni^{I} species.¹⁷⁸⁵

The complex with the reduced porphyrin derivative 5,10,15,20-tetramethylisobacteriochlorin, $[\text{Ni}(\text{TMiBC})]$ (**688**), has an S_4 -ruffled conformation and a bond length pattern indicative of a reduction of aromaticity, both of which are more pronounced than those found for the corresponding porphyrin and chlorin complexes.¹⁷⁸⁶



Oxidation of heme goes through the biliverdin species. Octaethylbiliverdin can exist in coordinated form as the fully reduced trianion $(\text{OEB})^{3-}$, as the two-electron-oxidized monoanion $(\text{OEB}_{\text{ox}})^-$, or as the one-electron-oxidized radical $(\text{OEB}\cdot)^{2-}$. Nickel forms complexes with all three moieties, $[\text{Ni}^{\text{II}}(\text{OEB})]^n$ with $n = +1, 0,$ and -1 (**689**).¹⁷⁸⁷ The most highly oxidized species $[\text{Ni}(\text{OEB}_{\text{ox}})]\text{I}_3$ could be crystallized. The structure shows a helical coordination of the linear tetrapyrrole ligand around nickel with Ni—N distances of 1.867 Å and 1.879 Å.

Complexes (**690**) undergo two one-electron reversible reductions and two oxidations, all of which appeared ligand centered. Thus, these ligands behave electrochemically much like

bacteriochlorins; smaller potential differences between the first oxidation and reduction waves are found than for porphyrins.¹⁷⁸⁸ A type (690) complex with $R_1 = R_2 = R_3 = \text{Me}$ on electrooxidation gave a partially oxidized material $[\mathbf{690}]_{2.5}(\text{BF}_4)_2 \cdot \text{C}_{10}\text{H}_7\text{Cl}$, characterized crystallographically.¹⁷⁸⁹ It has a columnar arrangement of stacked metallomacrocycles. The intermolecular spacing ($<3.4 \text{ \AA}$) suggested π -overlap, and ESR spectroscopic measurements showed the oxidation to be ligand centered. The material has an intermolecular charge transfer band at ca. $3,000 \text{ cm}^{-1}$. Similarly, chemical oxidation of (690) ($R_1 = R_2 = \text{H}$, $R_3 = \text{Pr}$) with iodine afforded $[(\mathbf{690})\text{I}]_{1.67}$.¹⁷⁹⁰ This complex consisted of $[\mathbf{690}]^{0.33+}$ cations packed in a slipped stack along the b -axis, and surrounded by disordered chains of iodine, identified as I_5^- by Raman spectroscopy. Again, the oxidation was identified as ligand based.

The Ni-complex of corrole (octaalkyl derivative (691)) is a $S = 1/2$ low-spin Ni^{II} species with a ligand-centered π -cation radical.^{291,292}

6.3.4.11.4 Complexes with core-modified heteroanalogues of porphyrins

Metalloporphyrin reactivity and catalytic properties can also be controlled by modifications of the porphyrin core. Ni coordination chemistry of core-modified porphyrins has been reviewed.^{1791,1792} Several X-ray structures of four-, five-, and six-coordinate Ni^{II} complexes with oxa-, thia-, and dioxatetraarylporphyrins are known.

The Ni^{II} complex with 5,20-di-(p -tolyl)-10,15-bisphenyl-21-oxaporphyrin, $[\text{Ni}(\text{ODTDPP})\text{Cl}]$, exhibits a saddle-shaped conformation of the oxaporphyrin macrocycle.¹⁷⁹³ The Ni—N bond distances are close to those of the related thiaporphyrin complex. The furan ring is planar and binds to Ni^{II} ion in the η^1 fashion (Figure 26). Similarly, in the structure of $[\text{Ni}^{\text{I}}(\text{ODTDPP})]$ the metal is located in the furan plane, which binds Ni^{I} in the η^1 fashion through its oxygen donor, and the core conformation is saddle shaped.

In the related Ni^{II} complex with tetraphenyl-21-thiaporphyrin, $[\text{Ni}(\text{STPP})\text{Cl}]$, the metal ion is found in approximately square pyramidal geometry with an apical Cl, and the thiophene ring is bent from the STPP ligand core and coordinates through a pyramidal S.^{1794,1795} The reduction product $[\text{Ni}^{\text{I}}(\text{STPP})]$ binds various nitrogenous bases and SO_2 to give paramagnetic five-coordinate species,¹⁷⁹⁶ and the structure of the diphenyldi- p -tolyl-21-thiaporphyrinato derivative, $[\text{Ni}^{\text{I}}(\text{SDPDTP})]$, was determined. Again, the thiophene ring is topped 52.3° out of the N3 plane with pyramidal coordination of the thiophene-S.¹⁷⁹⁷ $[\text{Ni}^{\text{II}}(\text{SDPDTP})\text{Cl}]$ reacts with the Grignard reagent PhMgX to give a paramagnetic (s -phenyl)nickel(II) derivative with a Ni-bound phenyl group.¹⁷⁹⁸ Spectroscopic properties of the Ni^{II} complex of 5,20-di-(p -tolyl)-10,15-bisphenyl-21-selenaporphyrin, $[\text{Ni}^{\text{II}}(\text{SeDPDTP})\text{Cl}]$, are very similar to those of the S-analogue, and hence a similar structure with side-on bound Se is proposed.¹⁷⁹⁹

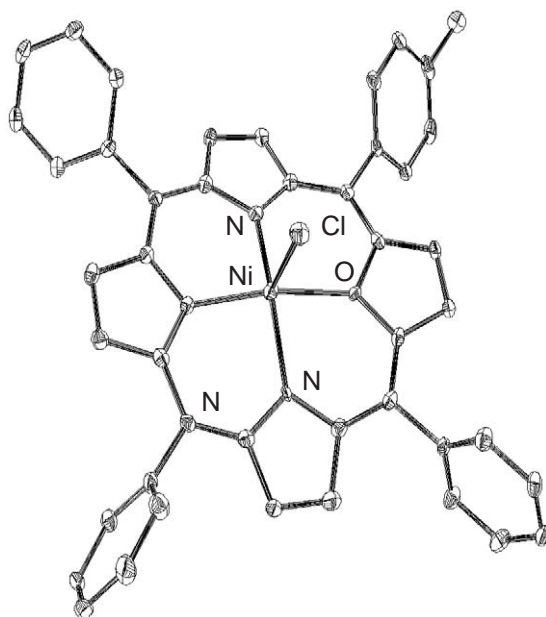
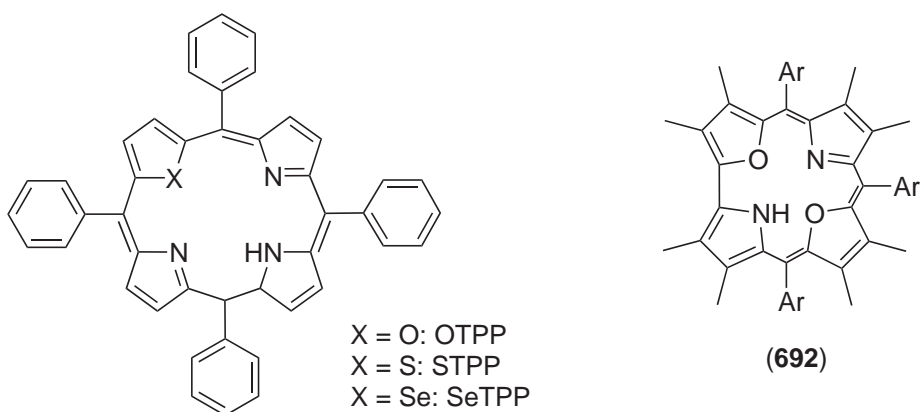

Figure 26 Molecular structure of $[(\text{ODTDPP})\text{Ni}^{\text{II}}\text{Cl}]$.¹⁷⁹³

The Ni^{II} complex of 5,10,15-triaryl-21,23-dioxacorrole (**692**), [Ni(21,23-O₂Cor)Cl], is a high-spin Ni^{II} species,¹⁸⁰⁰ in contrast to diamagnetic Ni^{II} oxacorrole.¹⁸⁰¹



Replacement of a pyrrol-N by a methine-C, e.g., in the inverted porphyrins, imposes formation of a Ni—C bond, which was demonstrated for [Ni^{II}(CTTP)] (Figure 27, CTTP = 2-aza-5,10,15,20-tetra(*p*-tolyl)-21-carbaporphyrin) and [Ni^{II}(2-NCH₃CTPP)] (2-NCH₃CTPP = 2-aza-2-methyl-5,10,15,20-tetraphenyl-21-carbaporphyrin) complexes.^{1802,1803} The coordination core geometry is essentially planar, although some ruffling is observed for tetraphenyl-carbaporphyrin complexes.¹⁷⁹¹

In the complex of calix[4]phyrin (**693**) with an inward-pointing carbon atom, the Ni^{II} ion is located in the middle of the core and the molecule shows a ruffled structure.¹⁸⁰⁴ The higher structural flexibility of the complex formed with this type of ligands could be attractive for studies of their organometallic and redox chemistry. Nickel(II) azuliporphyrin (**694**) retains a cross-conjugated borderline aromatic structure, as judged by UV-visible and NMR spectroscopy as well as X-ray crystallography.¹⁸⁰⁵

Meso substitution of porphyrines to give tetraazaporphyrines, so-called porphyrazines, modulates the electronic character of the macrocycle. While porphyrazines have received considerably less attention than porphyrines over many years, this has changed due to the development of efficient syntheses of soluble derivatives.^{1806–1809} Also, various porphyrazines (and phthalocyanines) with peripheral groups for metal ion coordination have been prepared and used for the construction of multimetallic complexes.¹⁸⁰⁶ Ni porphyrazines (**695**) typically show absorptions spectra with a strong Q band at around 615 nm.

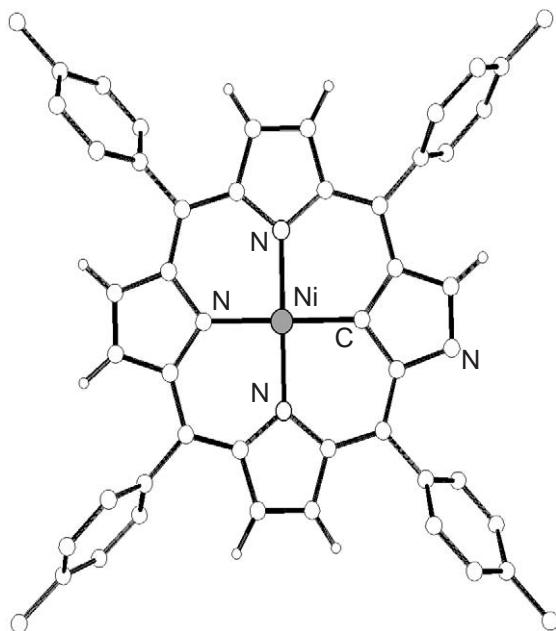
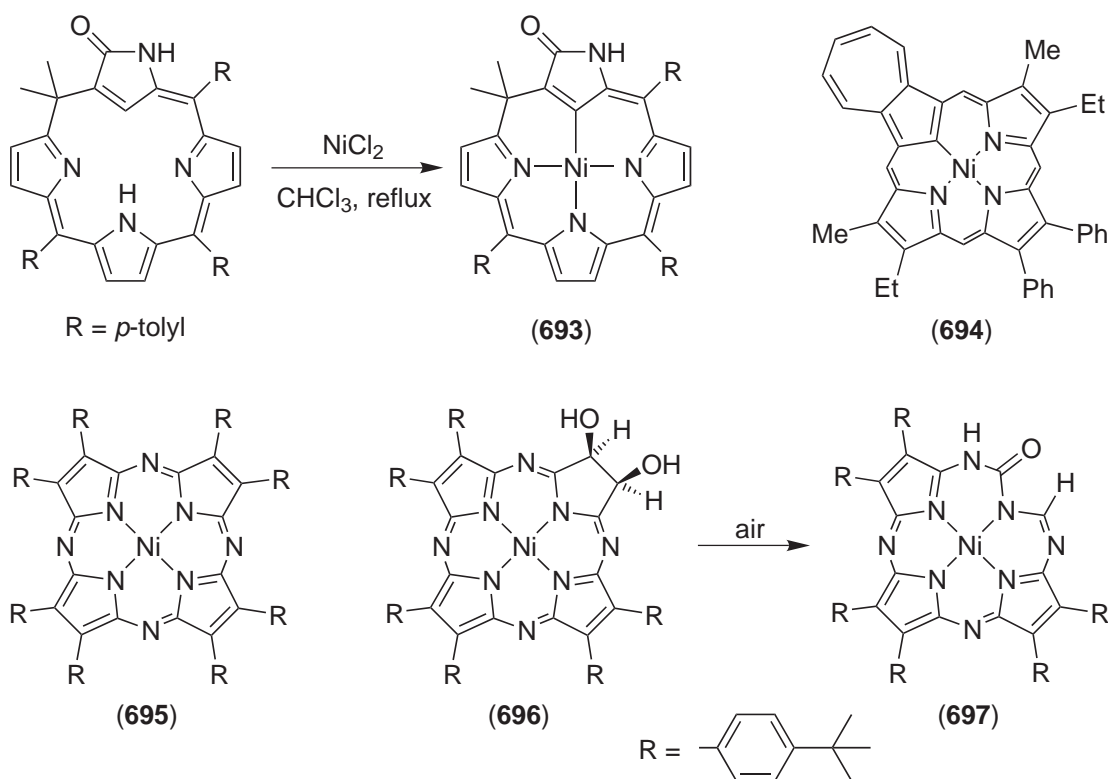

Figure 27 Molecular structure of [Ni^{II}(CTTP)].



The Ni complex of *cis*-dihydroxylated porphyrazine (**696**) gives (**697**) upon reaction with air.¹⁸¹⁰ The decaptation reaction is assumed to result from Ni-mediated air oxidation of the *cis*-diol unit and subsequent loss of CO₂.

6.3.4.11.5 Complexes with carbohydrates

The chemistry of Ni^{II} complexes with carbohydrates is of potential importance in inorganic and bioinorganic chemistry, although the details, e.g., about the stereochemistry, of the complexes are largely unexplored due to the difficulties in isolating particular complexes.^{1811–1815} Aminocarbohydrates are much more efficient ligands for metal ions due to an anchoring role of the amino-N. Simple aminocarbohydrates coordinate to Ni^{II} ion via an {N,O} donor set and the complexes formed are moderately stable.^{1816,1817} The use of good chelating agents like ethane-1,2-diamine (en) as an anchor to 1-deoxy-D-galactitol¹⁸¹⁸ leads to more stable complexes, although the involvement of the deprotonated sugar hydroxyl-O in Ni^{II} coordination takes place above pH 10. The complexes of Ni^{II} with ligands derived from *N*-glycoside derivatives have been reviewed.¹⁸¹⁹

Reactions of [Ni(tren)(H₂O)₂]X₂ (tren = tris(2-aminoethyl)amine; X = Cl, Br, SO₄) with mannose-type aldoses, having a 2,3-*cis* configuration resulted in {bis(N-aldosyl-2-aminoethyl)(2-aminoethyl)-amine}Ni^{II} complexes, [Ni(*N,N'*-(aldosyl)₂-tren)]X₂ (aldosyl = D-mannosyl or L-rhamnosyl).^{1820,1821} The ligand binds hexadentate with {N₄O₂} coordination, where the tren unit acts as a tetradentate chelate and the two O atoms are in *cis*-arrangement (Figure 28). The octahedron around Ni is considerably distorted with *trans* and *cis* angles of 153.9° and 76.6°, respectively. Both sugar moieties adopt the stable β-⁴C₁-pyranose form and bind to the nickel through the glycosidic N and the O atom of the C-2 hydroxyl group. D-Mannosyl and L-rhamnosyl derivatives form complexes which are almost exact enantiomeric forms compared to each other. The reaction with D-glucose, D-glucosamine, and D-galactosamine having 2,3-*trans* configuration results in the formation of monosugar complexes [Ni(N-(aldosyl)-tren)(H₂O)₂]Cl₂, while the reaction of tris(*N*-aldosyl-2-aminoethyl)amine with Ni^{II} gives the tris(sugar) complexes, [Ni(*N,N',N''*-(aldosyl)₃-tren)]X₂ (aldosyl = D-mannosyl, L-rhamnosyl, D-glucosyl, maltosyl, and melibiosyl). In tris(L-Rha), Ni^{II} is only bound to four N-donors of tren while two additional binding sites are occupied by a bidentate sulfate anion. The sugar moieties are anchored to the metal only via their glycosidic N atom, but all hydroxyl groups are noncoordinating.

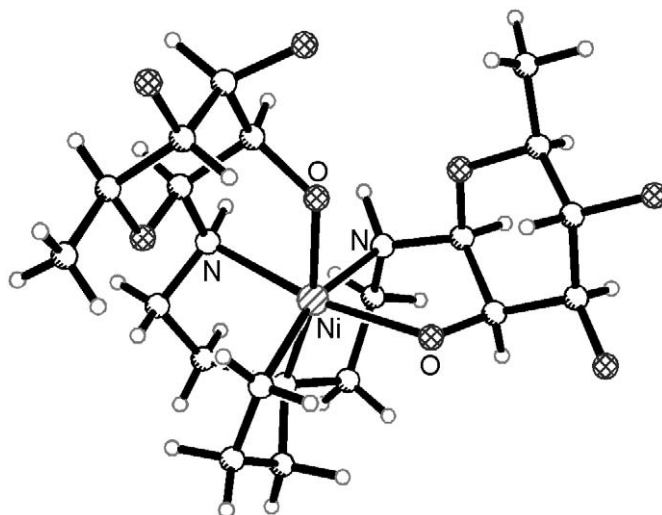

Figure 28 X-ray structure of $[\text{Ni}(\text{N},\text{N}'\text{-(L-Rha)}_2\text{tren})]^{2+}$.

Reaction of $[\text{Ni}(\text{tn})_3]\text{X}_2$ ($\text{tn} = 1,3\text{-diaminopropane}$) with aldopentoses gives mononuclear Ni^{II} complexes $[\text{Ni}(\text{aldose-tn})_2]\text{X}_2$ [$\Delta\text{-C}_2\text{-tn} = 1\text{-}(N\text{-aldosyl})\text{-amino-3-aminopropane}$, aldose = D-xylose, D-lyxose, D-ribose, and D-arabinose].¹⁸²² $[\text{Ni}(\text{D-Ara-tn})_2]\text{Br}_2 \cdot 2\text{H}_2\text{O}$ contains a Ni^{II} ion ligated by two tridentate ligands, 1-amino-3-(*N*-D-arabinosyl)propane. These are coordinated to Ni through their primary amino and *N*-glycosidic N atoms and the C-2 hydroxy group of the sugar moiety in a meridional mode, resulting in a $\Delta\text{-C}_2$ -helical configuration around the metal center. The sugar rings adopt an unusual $\alpha\text{-C}_4$ chair conformation and the sugar chelate ring conformation is δ .

The differentiation of diastereomeric Ni^{II} *N*-glycoside complexes is possible with the use of tandem mass spectrometry.^{1823,1824}

6.3.4.11.6 Complexes with nucleosides, nucleotides, and related ligands

Earlier reviews^{1825,1826} have discussed interactions of Ni^{II} ions with subunits of nucleic acids. Ni^{II} is not very effective in its interactions with nucleosides and nucleotides. Ni^{II} coordinates to N-donors of the nucleic bases and it may form macrochelates bridging phosphate and a nucleic base. The most effective binding donor is N_7 of purines, found in Ni^{II} complexes with guanosine and inosine 5'-monophosphates. Several structures have shown a monodentate metal binding to purine nucleotides via N_7 (Figure 29).^{1827,1828} However, potentiometric, NMR, and calorimetric studies on the interactions of Ni^{II} strongly suggest the formation of a macrocyclic chelate between N_7 and the phosphate moiety.^{1829–1831} The stacking interactions between the purine base rings can also influence the stability of the complexes formed. Ni^{II} ions have some effect on the phosphate hydrolysis in nucleotides, thus corroborating coordination to the phosphate group.¹⁸³²

The antiviral nucleotide analogue 9-[2-(phosphonomethoxy)ethyl]-2,6-diaminopurine also uses its N_7 as a major binding site and forms a N_7 -phosphonate macrochelate (698).¹⁸³³ Another antiviral analogue of 2'-deoxyguanosine, acyclovir (9-[(2-hydroxyethoxy)-methyl]guanine) forms with Ni^{II} a bis-complex with two N_7 coordinated in *trans* position to each other.¹⁸³⁴

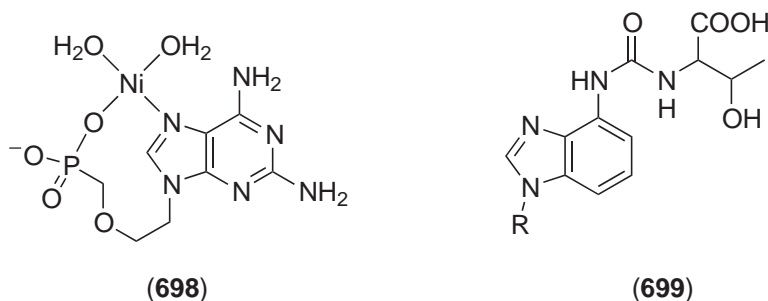

(698)

(699)

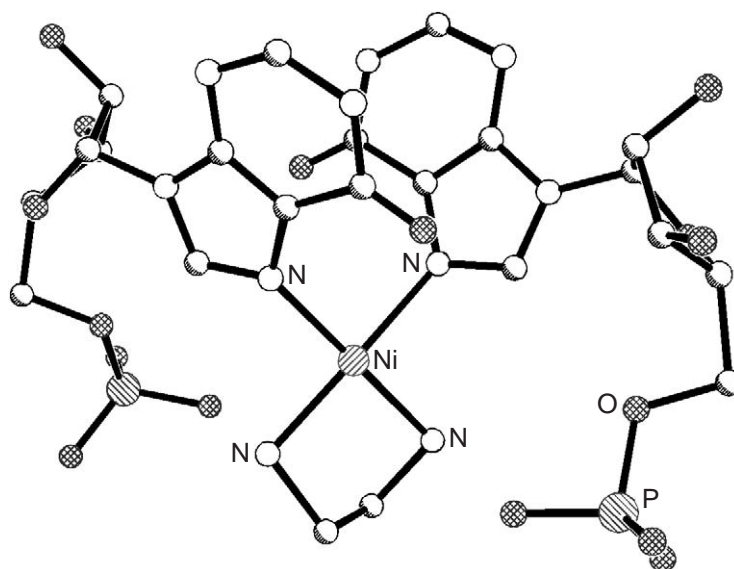

Figure 29 Molecular structure of the complex $[\text{Ni}(\text{5'GMMPH})_2(\text{en})(\text{H}_2\text{O})_2]$.

Regular pyrimidines are less effective ligands for Ni^{II} ions. They may use, *inter alia*, their $\text{C}=\text{O}$ donor to yield monodentate coordination.¹⁸³⁵ Insertion of a sulfur atom into a pyrimidine moiety increases considerably its binding ability.¹⁸³⁶ Thiolation of uridine at C(2) or C(4) results in formation of a quite effective $\{\text{S},\text{N}_3\}$ four-membered chelate in the complexes with Ni^{II} . Thiolation of purine at C(6) increases the stability constant by 3.5 orders of magnitude.

Hypermodified nucleosides that contain an attached amino acid at C(6) are important in the biochemistry of RNAs. The Ni^{II} complex with N-[(9- β -D-ribofuranosylpurin-6-yl)-carbamoyl]-threonine (**699**) forms a very stable complex involving N(1) of the purine ring, the amide-N and the carboxylate of the attached threonine as donors.¹⁸³⁷

Chiral peptide nucleic acids (cPNAs) are synthetic analogues of DNA in which the natural phosphate-deoxyribose backbone is replaced by a peptide chain (**700**). Although both the peptide backbone chain and the nucleobases resting in the side chains are able to coordinate to Ni^{II} ions, the oligopeptide donor system dominates metal ion coordination (Figure 30).^{1838,1839} Nucleobases which do not interact directly with the metal ion can stabilize very effectively the complexes formed by means of hydrogen bonds and the stacking interactions present within the complex molecule.

6.3.4.11.7 Ligands for biomimetic and related nickel complexes

For the known nickel sites in biological systems, four-coordinate square planar, five-coordinate, and six-coordinate octahedral geometries are found.^{1840–1846} In general, the flexible coordination geometry of nickel causes its coordination properties in metallo-biomolecules to be critically influenced by the protein structure.

Biomimetic chemistry of nickel was extensively reviewed.^{1847,1848} Elaborate complexes have been developed in order to model structural and spectroscopic properties as well as the catalytic function of the biological sites. Biomimetic systems for urease are described in Section 6.3.4.12.7, and model systems for $[\text{Ni},\text{Fe}]$ -hydrogenases are collected in Section 6.3.4.12.5.

Each catalytic center of methyl coenzyme M reductase, (MCR), contains a yellow chromophore factor F_{430} .⁴⁸ The structure of $\text{Ni}-\text{F}_{430}$ determined by the crystallographic analysis and the proposed mechanism of MCR is shown in Scheme 10.⁴⁷

This cofactor is a rare, highly saturated Ni-containing porphinoic system called “corphin,” meaning a hybrid of corrinoid and porphinoic tetrapyrrolic macrocycle. It is a most reduced

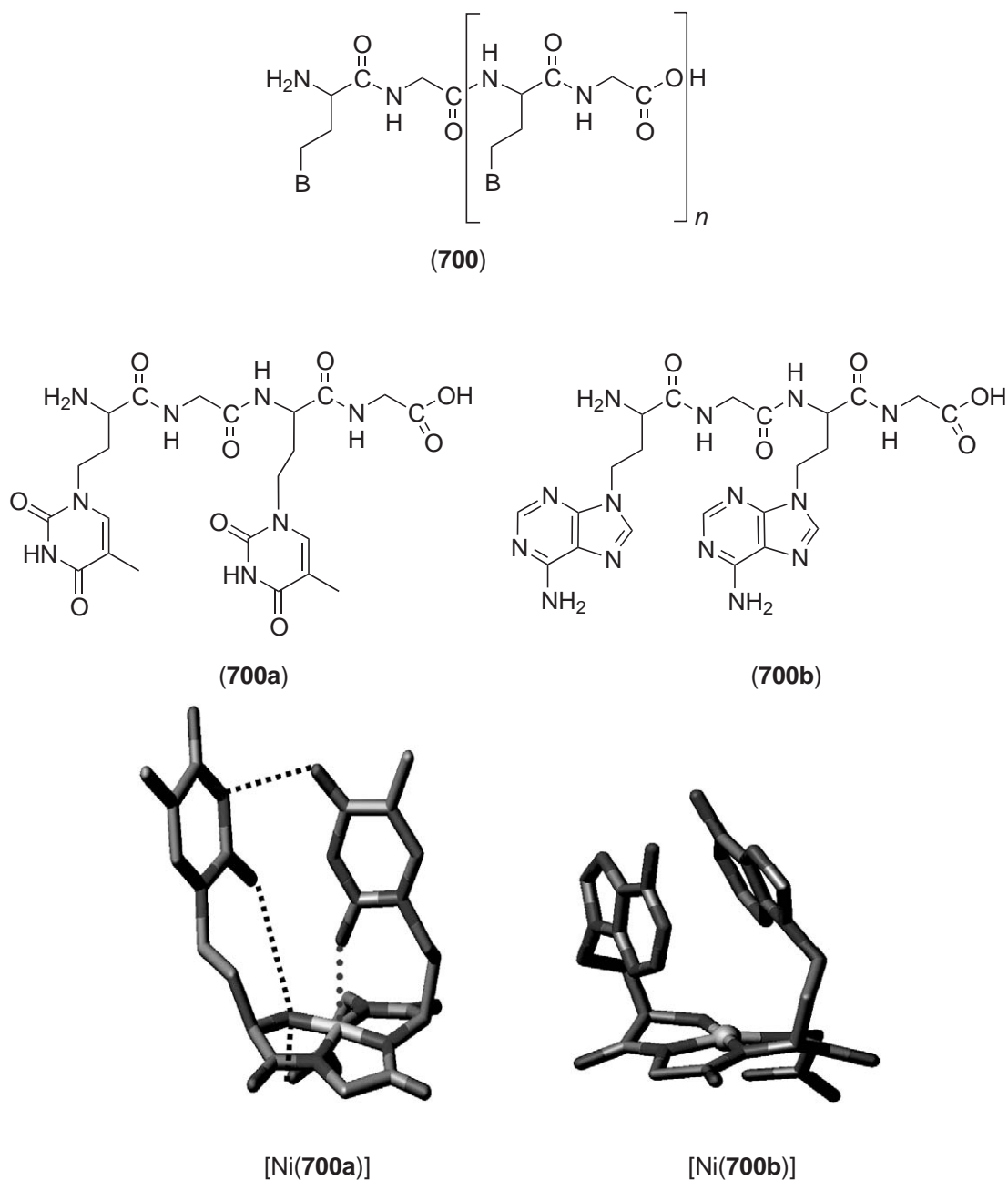
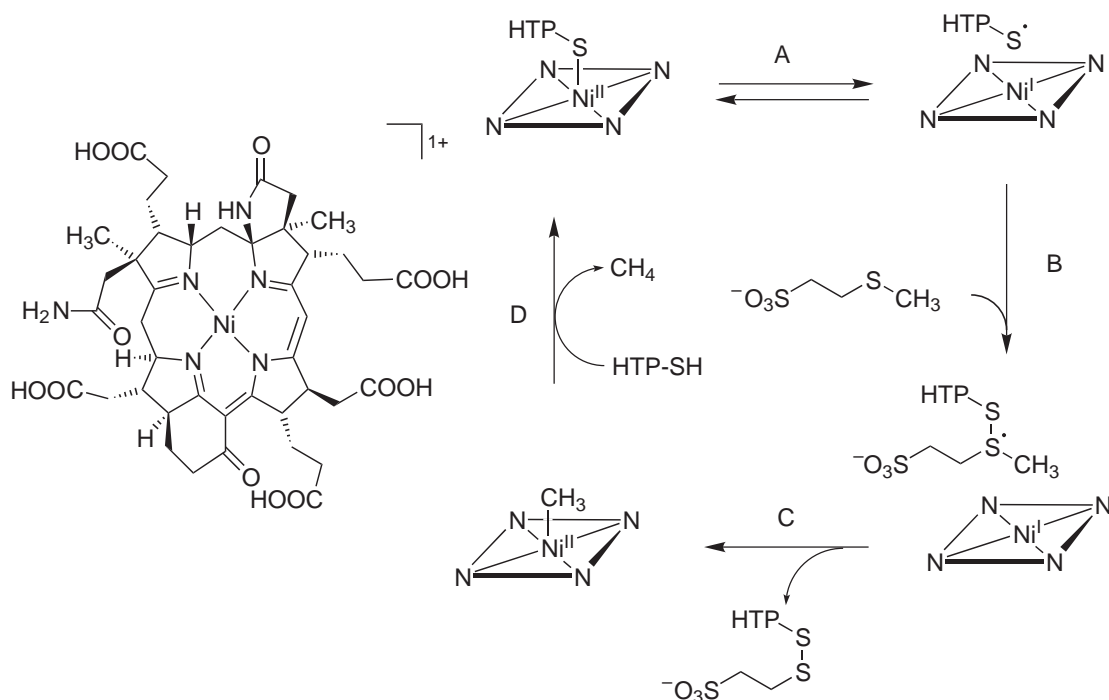

Figure 30 Proposed structure of complexes Ni(II)-dThy ([Ni(700a)]) and Ni(II)-dAdy ([Ni(700b)]).

tetrapyrrole found in biological systems, having only five double bonds within the cycle. Macrocyclic ligands including porphyrins have been used to model the site in methyl-coenzyme-M reductase, and porphyrins seem to be natural models for the nickel- F_{430} site in methyl coenzyme-M reductase (MCR). However, the involvement of Ni^I in MCR has led to considerable interest in the chemistry of Ni^I with F_{430} and isobacteriochlorins, the only tetrapyrrolic ligands that afford isolable Ni^I species when reduced.^{1849,1850} The reduction of Ni^{II} porphyrin systems very often results in the formation of a ligand-based radical rather than in metal-based reduction. Some useful models, both electrochemically as well as functionally, are the Ni complexes with cyclam-derived macrocyclic tetraaza ligands (701)–(703); compare Section 6.3.4.10).^{1851,1852} The complexes were found to be homogeneous catalysts for the

dehalogenation of cyclohexyl bromide by sodium borohydride with the effectiveness depending on the solvent and the structure of the complex. None of these complexes, however, cleaves methyl CoM to methane.



Scheme 10

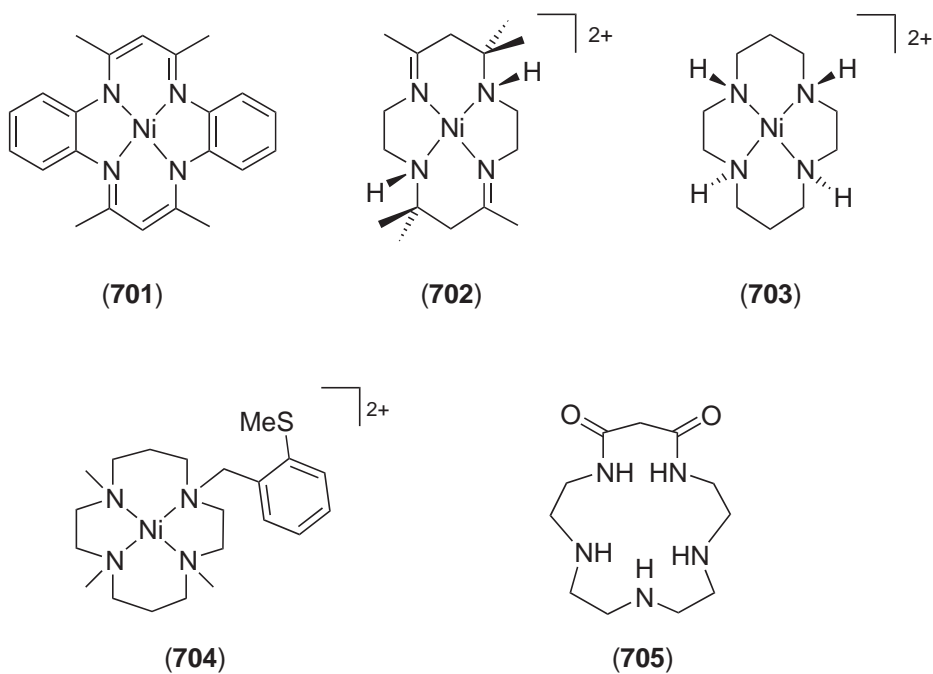

The cyclam-based complex (**704**) bearing a methylthio pendent arm has been proposed as a model for F_{430} .¹⁸⁵³ While participation of the thioether group in Ni coordination is observed neither in solution nor in the solid state, the Ni^{II} species is reversibly reduced to Ni^I around -0.7 V vs. SCE, followed by thioether bond cleavage and formation of a thiol group at more negative potentials. Reduction of (**704**) with Na/Hg in DMF produces small amounts of methane. In contrast to some initial reports,^{1854,1855} the Ni^{II} complex of (**705**) is not capable to effect C—S bond cleavage of Me-CoM.¹⁸⁵⁶

It has been demonstrated that the MCR enzyme is active only if the metal center of coenzyme F_{430} is in the Ni^I form.¹⁸⁵⁷ The natural substrate Me-CoM or simple methyl thioethers, however, do not react with $Ni^I F_{430}$, which has led to the proposal of a catalytic mechanism in which the addition of a thiyl radical to the S atom of the thioether giving a sulfuranyl radical intermediate is the central step (Scheme 10).^{266,1858} Such reactivity has been reproduced with the model substrate (**706**), which forms a square planar Ni^{II} complex (**707**). Upon irradiation (i.e., generation of a Ni^I /thiyl radical pair by excitation of the LMCT band), formation of the spirodisulfide (**708**) and methane is observed (Scheme 11).¹⁸⁵⁹ In order to model individual species involved in the catalytic cycle depicted in Scheme 10, pentacoordinate thiophenolate complexes of $[Ni^{II}(tmc)]^{2+}$ (tmc = tetramethylcyclam)¹⁹⁶⁷ and paramagnetic Ni^{II} -methyl derivatives of $[Ni^{II}(tmc)]^{2+}$ have been prepared and characterized.^{1860–1862}

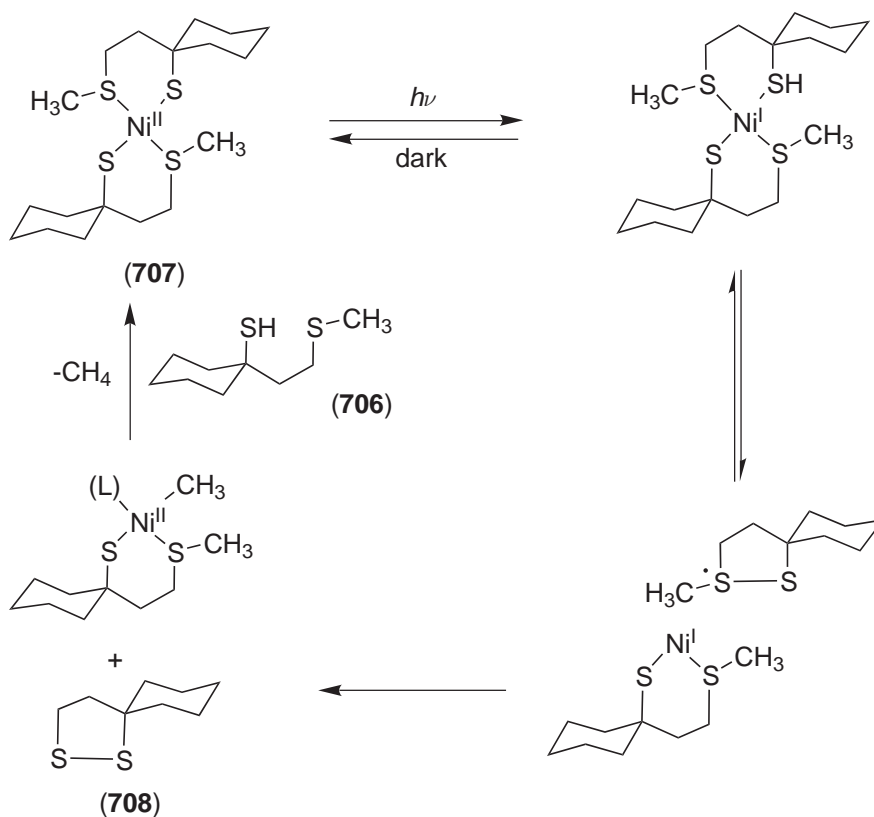

Scheme 11

6.3.4.12 Di- and Oligonuclear Ni^{II} Complexes with Compartmental Dinucleating Ligands

Due to the interest in electronic and magnetic metal–metal interactions as well as due to the occurrence of multimetallic sites in the active centers of various enzymes, di- and oligonuclear complexes of compartmental ligands are receiving increasing attention. Various types of multifunctional ligands have been designed and employed in order to preorganize the metal ions.

6.3.4.12.1 Complexes with bis(macrocyclic) ligands

The covalent linkage of multiple macrocyclic moieties has proven to be an effective method for arranging two or more Ni ions in close proximity and in specific spatial arrangement. Preorganization can be tuned by the characteristics of the spacer fragment between the macrocycles, e.g., by its rigidity and size and by the orientation it imposes on the coordination subunits. In $[\text{Ni}_2(\mathbf{709})(\text{ClO}_4)_4]$ the two Ni^{II} ions are each located in one cyclam subunit at a distance of 6.829 Å.¹⁸⁶³ The cylindrical macrotricyclic topology enforces a face-to-face conformation of the two cyclam rings, and inclusion of substrate molecules in the cavity is expected. Likewise, in the dinuclear bismacrocylic complex (**710**) the two cyclam rings are arranged in a face-to-face manner, and ligands such as $\text{X} = \text{Cl}^-$, Br^- , or CO_3^{2-} adopt a bridging position. The chloro-bridged dinickel(II) complex features a pseudo-1D Ni—Cl alternate linear chain structure in the solid state and exhibits antiferromagnetic exchange coupling between the two Ni^{II} ions.¹⁸⁶⁴ By the reaction of the Ni^{II} complex (**711**) with isophthaloyl dichloride the dinuclear Ni^{II} complex (**712**) is obtained in which the two coordination planes are almost coplanar with the metal ions being 12.8 Å apart (Equation (26)).¹⁸⁶⁵

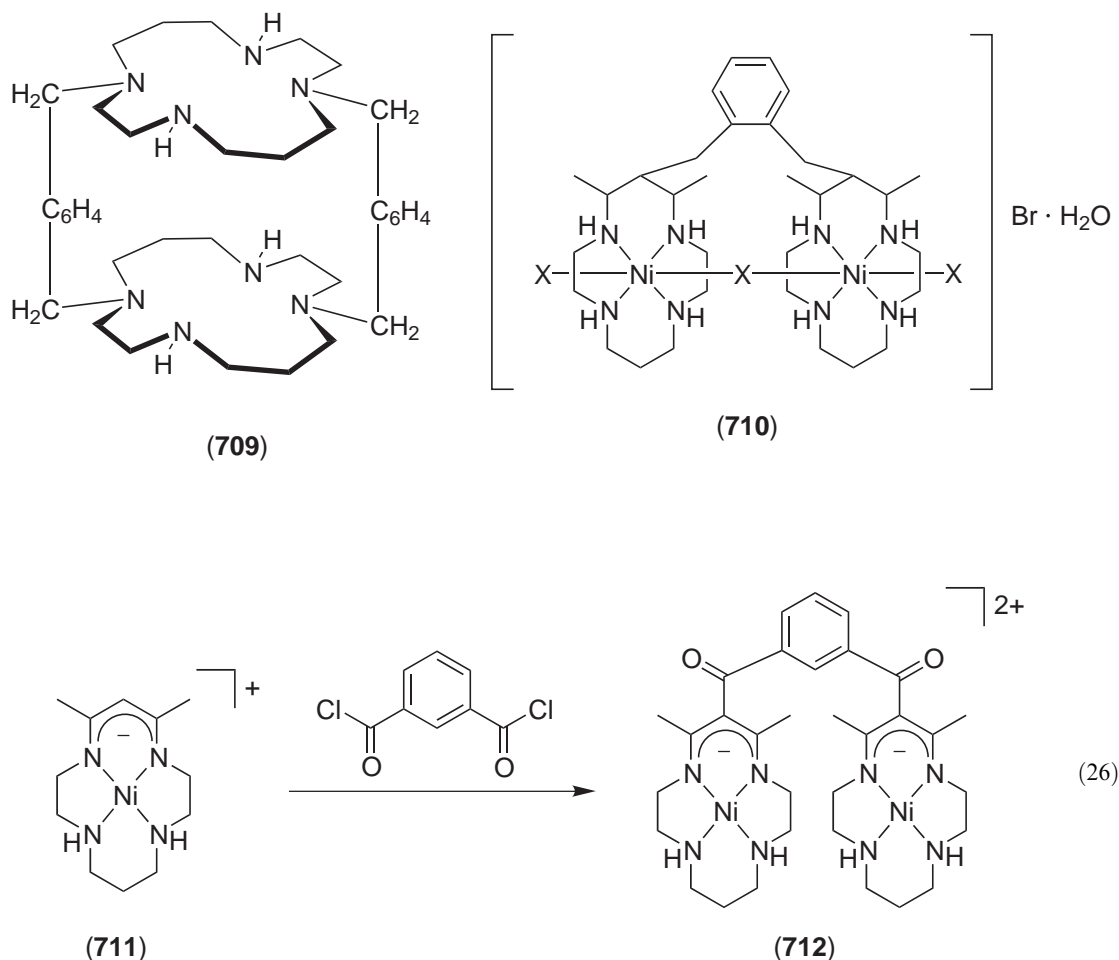

With a tetramacrocyclic ligand derived from four 1,4,7-triazacyclononane units that are attached to a central benzene ring, each two of the TACN subunits may sandwich one metal ion. Dinuclear, trinuclear, and tetranuclear Ni^{II} complexes (**713**)–(**715**) have been shown to form, depending on the stoichiometry and reaction conditions.¹⁸⁶⁶

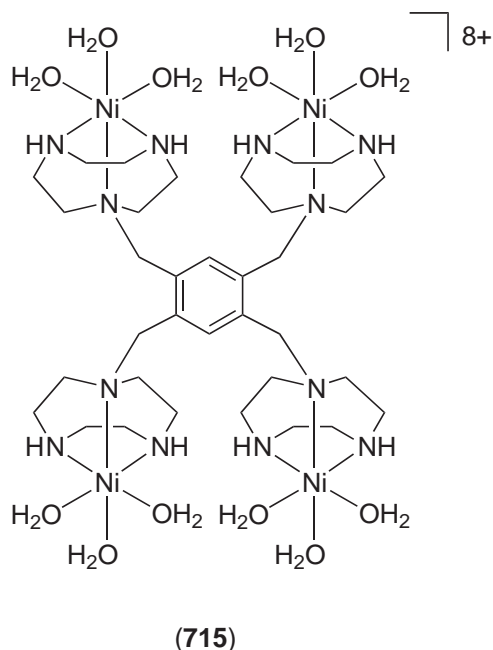
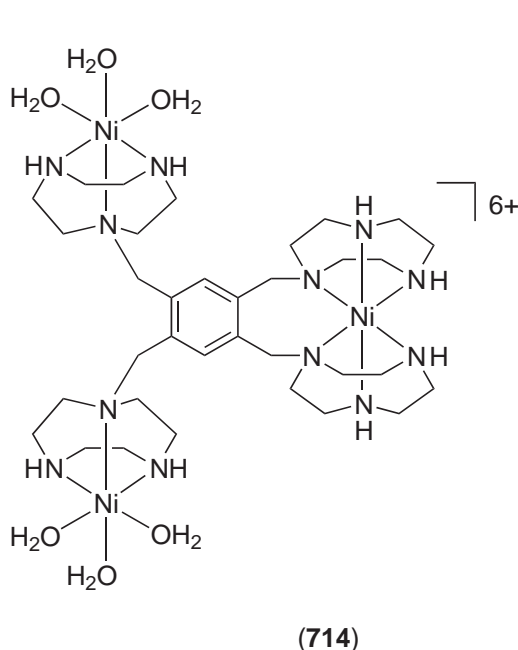
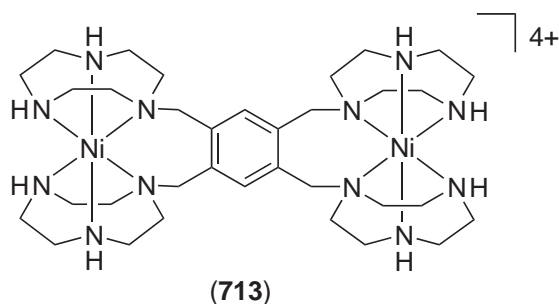

Template condensation reactions of the nickel(II) complex of 3,7-bis(2-aminoethyl)-1,3,5,7-tetraazabicyclo[3.3.1]nonane with formaldehyde and the appropriate primary diamines such as ethylenediamine, 1,4-butanediamine, and *p*-xylenediamine yield dinickel(II) complexes of bis-heptaazamacrocyclic ligands (716)–(718). Similarly, the dinuclear Ni^{II} complexes (719) and (720) were prepared by using [Ni(2,3,2-tet)](ClO₄)₂, formaldehyde, and NH₂–(CH₂)_{*n*}–NH₂ (*n* = 2, 3, 4, 5, 6, 10) or melamine, respectively.

The electrochemical data indicate that each Ni^{II} ion is independent in all these cases, without interaction between the adjacent Ni^{II} centers.^{1867–1871} Despite the absence of any electronic coupling, such dinuclear complexes with two Ni^{II} macrocyclic subunits in close proximity may show cooperative effects, e.g., in the binding of anionic guest molecules. In the case of (720), much higher association constants with sulfate have been observed, as compared to the related mononuclear melamine-substituted azacyclam complex. Stabilization of the sulfate adduct has been ascribed to H bonding between the sulfate coordinated to one Ni^{II} and a water molecule axially coordinated to the adjacent Ni^{II}. In the presence of sulfate, two single-electron Ni^{II}/Ni^{III} redox steps are observed.¹⁸⁷⁰

In (721) and (722), the two Ni^{II} macrocyclic fragments are directly bridged by a short C–C linkage. The dimethylcyclam coordination subunits in (721) may adopt different conformations, with steric repulsion between the 1,3-diaxial methyl substituents being of major importance.^{1872,1873} (722) has a folded structure with a torsion angle Ni–C_{bridgehead}–C_{bridgehead}–Ni of 55° in the solid state, which corresponds to the lowest energy conformation according to molecular mechanics calculations.¹⁸⁷⁴

The denticity of the ligand compartments in bis(macrocyclic) Ni^{II} complexes can be increased by adding donor substituents to the macrocycles. For example, type (723) dinickel(II) complexes

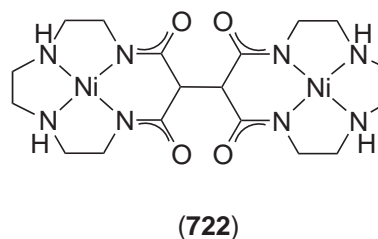
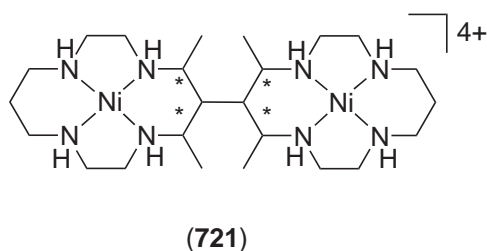
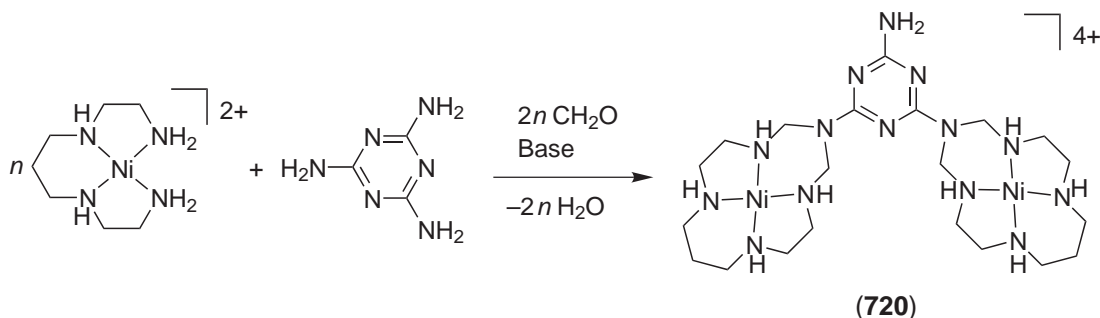
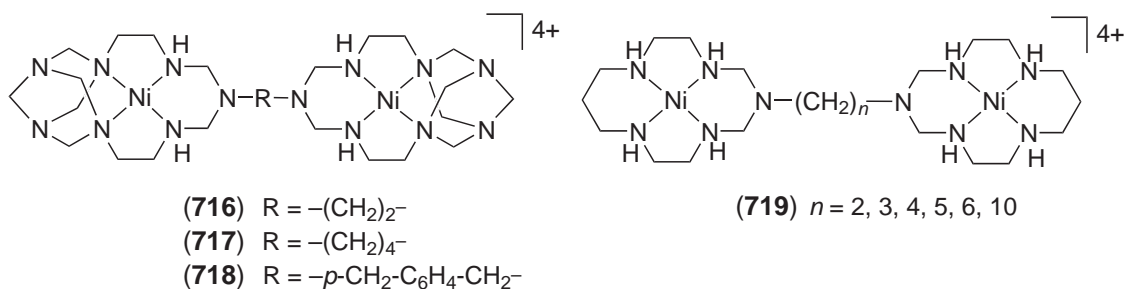

of bis(pentadentate) TACN-derived ligands with various spacers have been investigated. Electrochemical potentials for the $\text{Ni}^{\text{II}}/\text{Ni}^{\text{III}}$ couple decrease with the length of alkyl group linking the two coordination compartments, indicating that an increase in $\text{Ni} \cdots \text{Ni}$ separation leads to a decrease in electrostatic repulsion in the oxidized state. Splitting of the oxidation waves due to separate one-electron oxidation steps has only been observed in the case of (723a) and (723e).¹⁸⁷⁵

Pyrazolato-bridged bis(tacn) ligands and their dinickel complexes are mentioned in Sections 6.3.4.12.6 and 6.3.4.12.7.

6.3.4.12.2 Di- and oligonuclear complexes with open-chain alkoxy- or phenolato-based dinucleating ligands

Alkoxide or phenolate moieties are the most prominent bridging groups and are frequently incorporated in dinucleating ligand systems employed in nickel coordination chemistry. Compartmental ligands may be of the side-off (724a) or the end-off type (724b), or of the macrocyclic type (724c).¹⁸⁷⁶ Nickel complexes of the latter are described separately in the subsequent section.

Generic type (724d) dinickel(II) complexes built around an aliphatic μ -alkoxy fragment have been prepared with various combinations of X and Y donor groups and exogeneous coligands Z. *N,N'*-bridging diazine and diazole coligands Z (e.g., pyrazolate or phthalazine) have proven particularly suited. Some representative examples of ligands for the construction of type (724d) dinickel(II) complexes are discussed below.^{1877–1880}

In most cases the Ni^{II} ions are low spin and in square planar coordination environment. Dinickel(II) complexes $[\text{Ni}_2\text{L}(\text{pyrazolate})]$ of dinucleating ligands like (725) and dinickel complexes such as (726) feature two nearly reversible electrode processes at very negative potential,

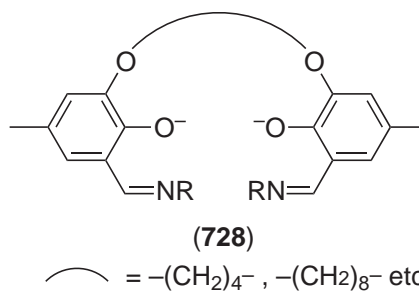
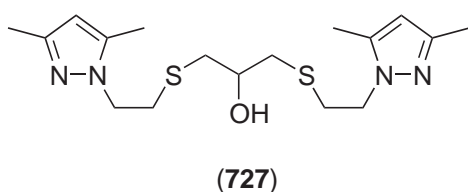
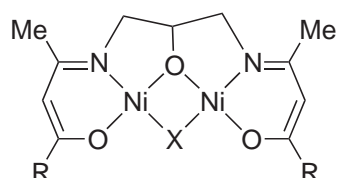
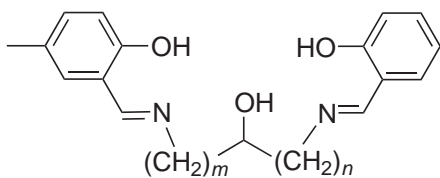
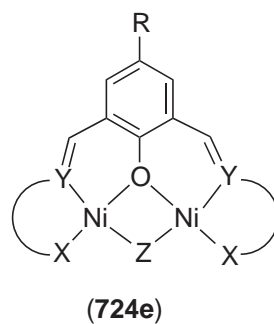
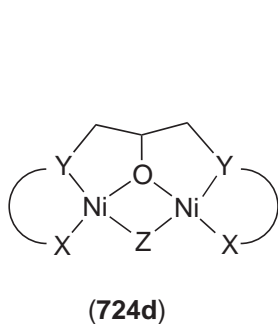
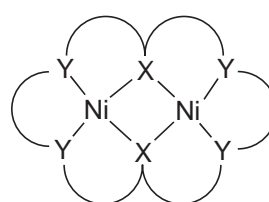
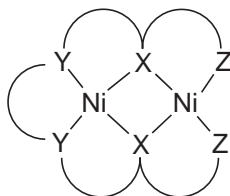
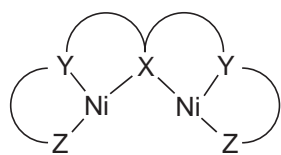
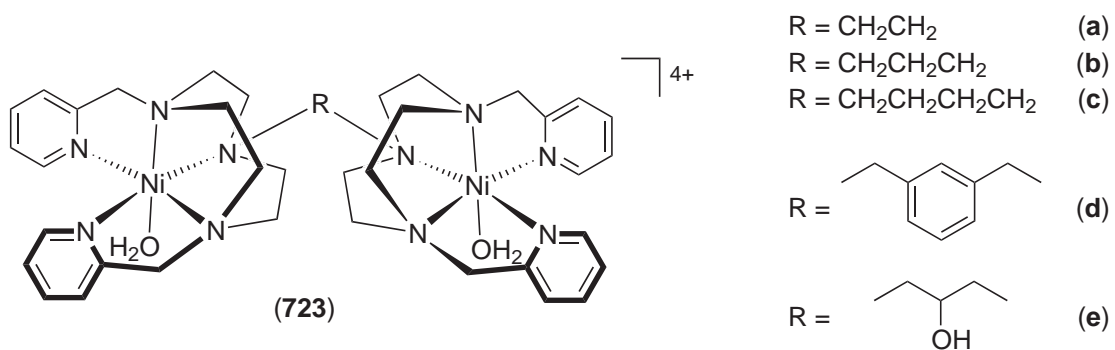

corresponding to the formation of $\text{Ni}^{\text{I}}\text{Ni}^{\text{II}}$ and $\text{Ni}^{\text{I}}\text{Ni}^{\text{I}}$ species.¹⁸⁸¹ The reaction of pentadentate (727) with NiCl_2 , however, gives trinuclear $[\text{Ni}_3(727)(\text{EtOH})\text{Cl}_5]$ with three distorted octahedral chromophores as well as dinuclear $[\text{Ni}_2(727)\text{Cl}_3]$ with two distorted trigonal bipyramidal chromophores.¹⁸⁸⁰ The trinuclear species can be regarded as being formed out of the dinuclear compound onto which an additional NiCl_2 unit is stuck, concomitant with some conformational changes of the ligand. NiBr_2 only forms the dinuclear species, presumably because of steric effects. If the alkoxide bridging group is omitted, e.g., in (728), complexes of the type $[\text{Ni}_2\text{L}_2]$ form, which for $\text{L}=(728)$ have a double-stranded helix structure with the Ni^{II} ions in square planar environment, both in solution and in the solid state.¹⁸⁸²

Various dinickel(II) complexes related to (724d) but with a phenolate bridging moiety, type (724e), have been investigated. To illustrate the great variety, (729) and (730) are depicted as examples.^{1883,1884}

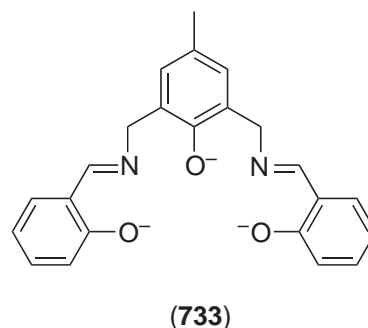
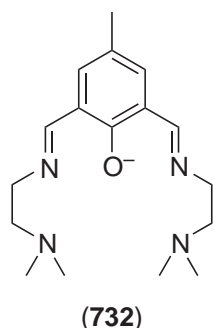
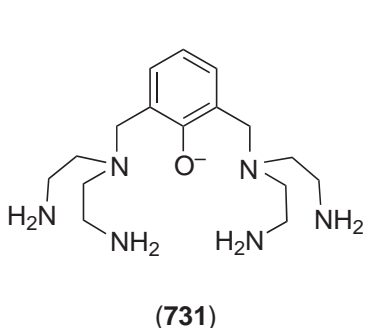
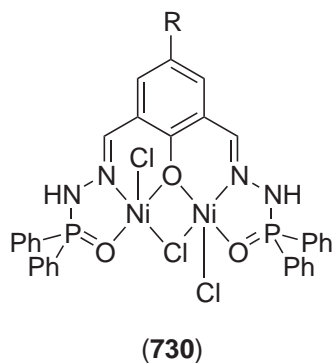
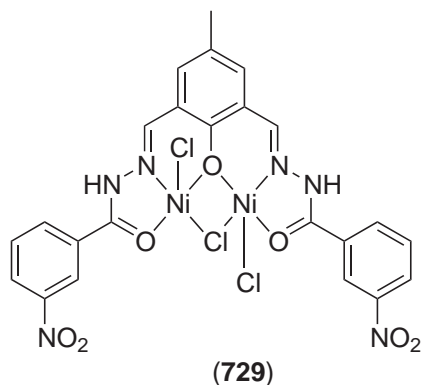

The flexible ligand (731) forms stable dinickel(II) complexes both in solution and in the solid state. The crystal structure of $[\text{Ni}_2(731)\text{Cl}_3]$ reveals the bridging phenolato-O, a secondary Cl bridge, and two terminal Cl ligands, i.e., six-coordinate metal ions.¹⁸⁸⁵

The reaction of (732) with NiCl_2 gives $[\text{Ni}_2(732)(\mu\text{-Cl})\text{Cl}_2(\text{H}_2\text{O})_2]$ with two high-spin six-coordinate metal ions, which are coupled ferromagnetically.¹⁸⁸⁶ In contrast, $[\text{Ni}_2(733)(\text{pz})(\text{Hpz})(\text{MeOH})]$ with a N,N' -bridging exogenous pyrazolate is a mixed-spin species, since one Ni ion features a square planar coordination environment and the adjacent Ni is six-coordinate due to the binding of a MeOH and an additional pyrazole in the axial positions.¹⁸⁸⁷ A second complex, $[\text{Ni}_4(733)_2(\text{pz})_2(\text{MeOH})]$, has been isolated with the same ligand. In the solid state, it adopts a zigzag tetranuclear structure, in which two mixed-spin building blocks are associated with two phenoxy bridges and one methanol bridge.

In (734), replacement of the phenolate group by a thiophenolate, i.e., replacement of the endogenous O by its homologue S, leads to significant differences in the solution and redox properties. The bulky *t*-butyl substituents induce good solubility and allow for physical studies in a range of solvents, including nonpolar ones.¹⁸⁸⁸ Both systems are reduced in two steps separated by several hundreds millivolts, indicating strong electronic interaction and stabilization of the mixed-valent form. However, while reduction is almost solvent-independent for (734a), (734b) exists as a mixture of solvated species in coordinating solvents, which strongly influences the redox properties. Overall, the sulfur dinuclear complex is harder to oxidize than the oxygen analogue.¹⁸⁸⁸

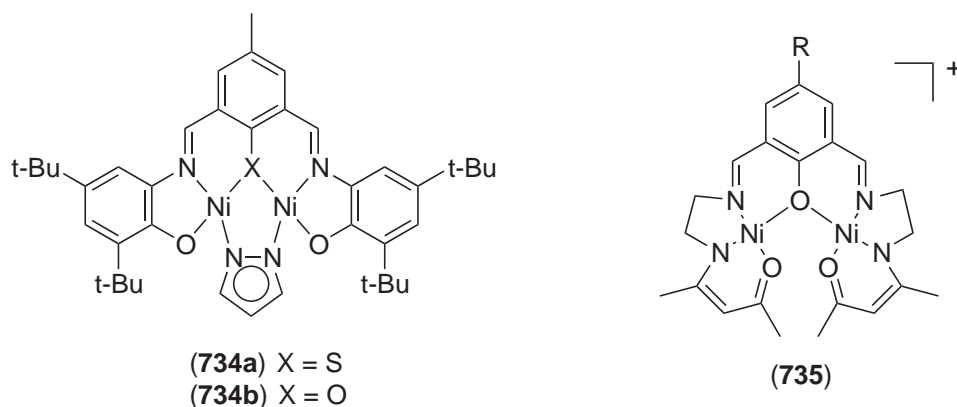

A twisted bifurcated shape is observed for the dinickel(II) complex of a bis(tetradentate) compartmental type (**724e**) ligand, (**735**).¹⁸⁸⁹ (**735**) is diamagnetic with both Ni^{II} being four-coordinate. NMR studies indicate C_2 symmetry of the bimetallic arrangement, which is confirmed by the crystal structure. Due to steric congestion, the two subunits of the complex (i.e., the two ketoenamine portions) cannot be coplanar, resulting in a twist of the two coordination planes against each other and a bifurcated overall shape. Racemization appears prohibited without breaking of metal–ligand bonds.

Attempts have been made to exploit the intrinsic C_2 symmetry of the phenolate-based dinickel core in enantioselective catalytic reactions. Therefore, enantiomerically pure C_2 -symmetric ligands such as (**736a**) and the corresponding dinickel systems (**736b**) have been prepared (Equation (27)),¹⁸⁹⁰ and (**736b**) was tested in the epoxidation of unfunctionalized alkenes with sodium hypochlorite as the oxidant. The catalytic reaction was found to be highly pH dependent with an optimum at a pH of 9. While the complex is catalytically active, significant enantioselectivity was not achieved.

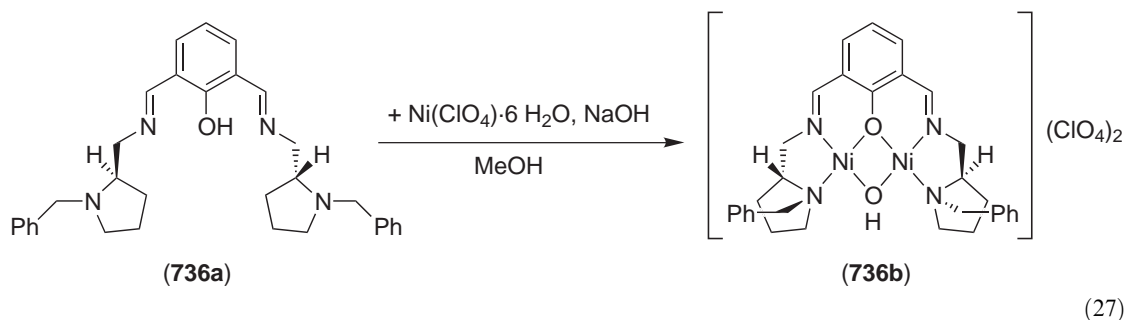

Acyclic side-off dinucleating systems with nonequivalent binding sites are relatively scarce in nickel coordination chemistry. Stepwise metallation of (**737**) first gives mononuclear (**738**) and then dinuclear (**739**), where the first Ni^{II} occupies the salen-type N_2O_2 inner binding site and the second Ni^{II} binds to the pyridyl groups in the outer site.¹⁸⁹¹ As revealed by an X-ray crystal structure, the former exhibits a square planar coordination geometry while the latter is ligated by two additional ethanol solvent molecules in axial positions. Because of the stepwise synthetic procedure (Equation (28)), heterobimetallic Ni^{II}/Cu^{II} complexes can also be obtained.

Unsymmetric compartmental ligands that allow for the controlled synthesis of unsymmetric Ni₂ or heterobimetallic NiM complexes have received particular attention.^{1876,1892} A wide range of such ligands derived particularly from 2-hydroxy-3-hydroxymethyl-5-methylbenzaldehyde and 2-hydroxy-3-hydroxymethyl-bromo-benzaldehyde has now been prepared and used for Ni complexation. These ligands have monopodal iminic pendent arms and either mono- or dipodal aminic pendent arms and the terminal donors of the pendent arms can be provided by pyridine, imidazole, and tertiary amino groups.^{1893–1897} Complexes are usually prepared by reaction of the requisite Ni^{II} salts with the preformed ligand.

The reaction of Ni^{II} perchlorate with (**740a**) gave the complex (**741**), in which the imine bond of the proligand had undergone hydrolysis. In the resulting dimeric Ni₂ structure with a Ni ··· Ni distance of 3.088 Å, both metal ions are in octahedral coordination environment. When (**740b**) was used,

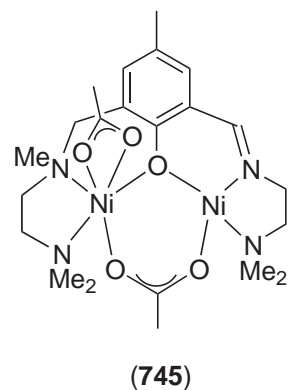
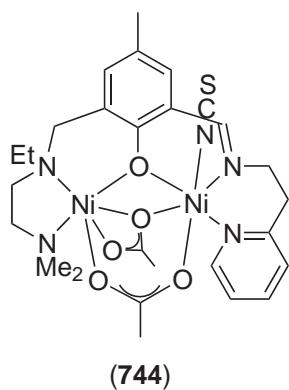
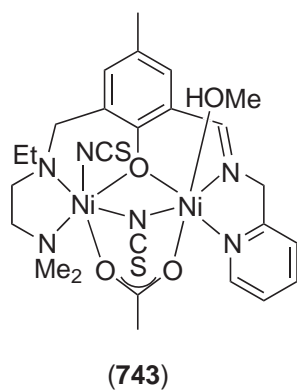
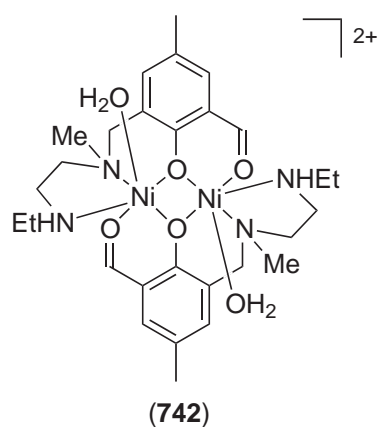
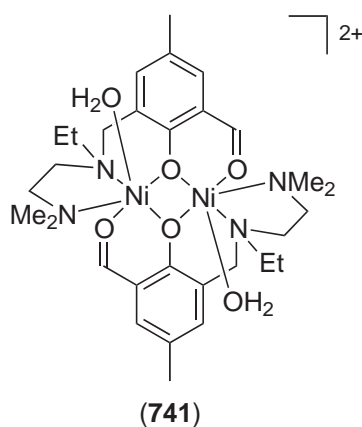
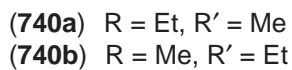
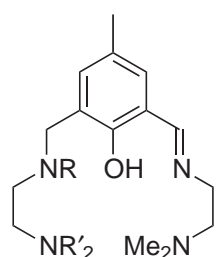
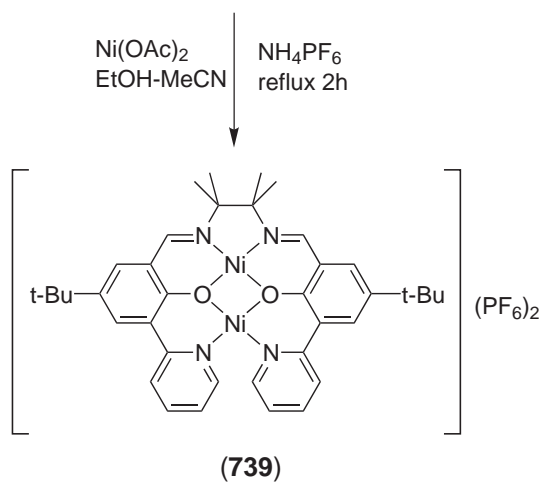
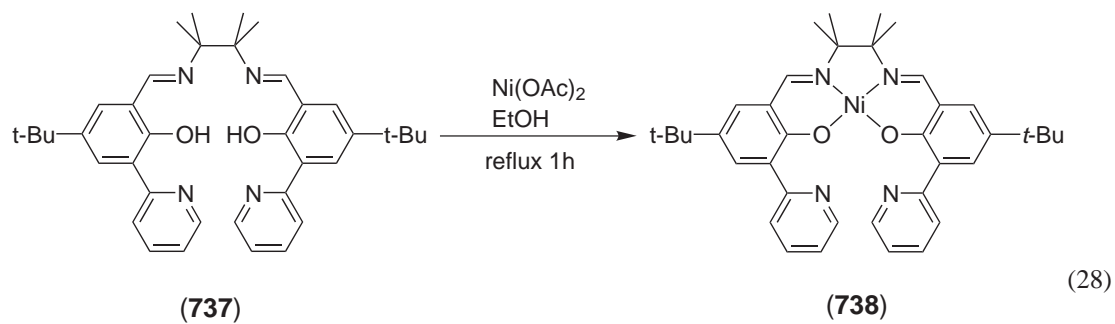

surprisingly complex (**742**) was obtained, i.e., both hydrolytic cleavage of the pendent imine function and loss of a C_2H_4 moiety from the terminal NEt_2 group had occurred. While loss of C_2H_4 has been suggested to proceed via a Hofmann elimination reaction, the ethylene which would be produced by this reaction has not been detected. For cleavage of the iminic pendent arm, the presence of both weakly coordinating anions (ClO_4^- , BF_4^-) and Ni^{II} cations appears to be required.¹⁸⁹⁸

Strategies to control the binding mode of acetate to Ni_2 complexes of unsymmetrical compartmental proligands have been developed. The formation of a *syn-syn* bidentate acetate bridge is assumed to be a key feature, and complexes such as (**743**)^{1894,1895,1897} (with a *syn-syn* bidentate acetate bridge augmented by a bridging N-bonded thiocyanate anion), (**744**)¹⁸⁹⁷ (which has the *syn-syn* bidentate acetate bridge augmented by a $\mu^2-\eta^1, \eta^2$ acetate anion), and (**745**) (in which one acetate is chelated to the Ni atom in the aminic compartment with bridging between the two Ni atoms being provided by the cresolato-O atom of and a *syn-syn* bidentate acetate)¹⁸⁹⁵ have been obtained by subtle variations of the ligand scaffold and careful addition of the thiocyanate coligand. The synthetic procedure uses the same reaction conditions for all of the above products and it has been concluded that the presence of five-membered chelating rings derived from the iminic pendent arms gives rise to *syn-syn* bidentate acetate bridging whereas the introduction of a six-membered chelating ring at the iminic binding generates a monodentate bridging acetate.¹⁸⁹⁷

An unsymmetrical ligand capable of providing adjacent N_2O and N_3O donor compartments gives complex (**746**) that features a donor asymmetric Ni_2 core with two six-coordinate metal ions due to the binding of an additional methanol solvent molecule.¹⁸⁹⁴ Incorporation of the solvating atom into the pendent arms, i.e., increasing the donor capacity of the arm by an additional O atom afforded (**747**), in which the thermal alcohol is coordinated. In the presence of added thiocyanate ion, however, neither an additional terminal amine nor the terminal alcohol are coordinated, e.g., in (**748**), reflecting the comparative bond strengths of the putative donor groups.¹⁸⁹⁹ The two isothiocyanate anions in (**748**) are *trans* to each other and the isothiocyanato bridge is unsymmetric with $Ni-N$ distances of 2.73 Å and 2.04 Å.

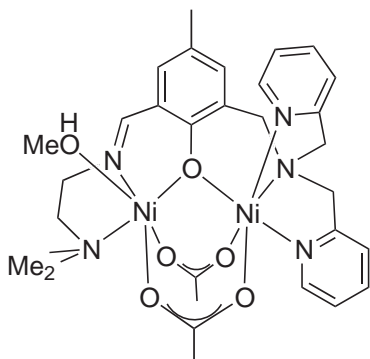

(746)

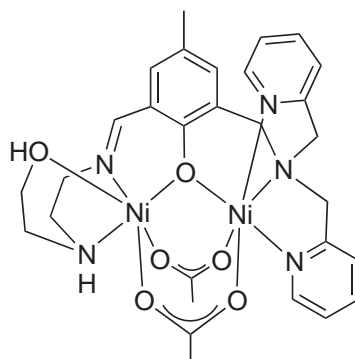

(747)

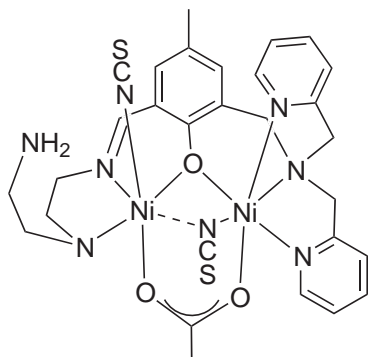

(748)

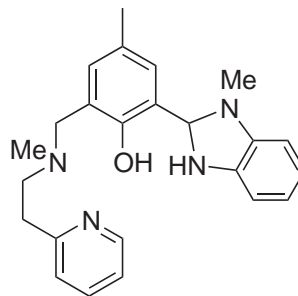

(749)

The unsymmetric phenolato-derived ligand (**749**) bearing a tridentate N_2O donor set and a bidentate NO donor set has produced a trinuclear Ni^{II} complex that incorporates two unusual

tridentate acetate bridges in a $\mu^3\text{-}\eta^2,\eta^1$ bridging mode, and the dihydrobenzimidazole ring system present in (749) has been oxidized to a benzimidazole ring system.¹⁹⁰⁰

6.3.4.12.3 Di- and oligonuclear complexes with compartmental macrocycles incorporating O bridges

Macrocyclic Schiff base compartmental ligands (750) (Robson-type ligands) derived from the [2 + 2] condensation of a 2,6-diformyl- or 2,6-diketo-substituted phenol and a diamine are very prominent in dinuclear Ni coordination chemistry.^{1901–1903} Particular interest lies in magnetic exchange interactions between the adjacent metal ions as well as in bioinorganic chemistry, where such dinuclear complexes have been proposed as synthetic analogues for bimetallosites.

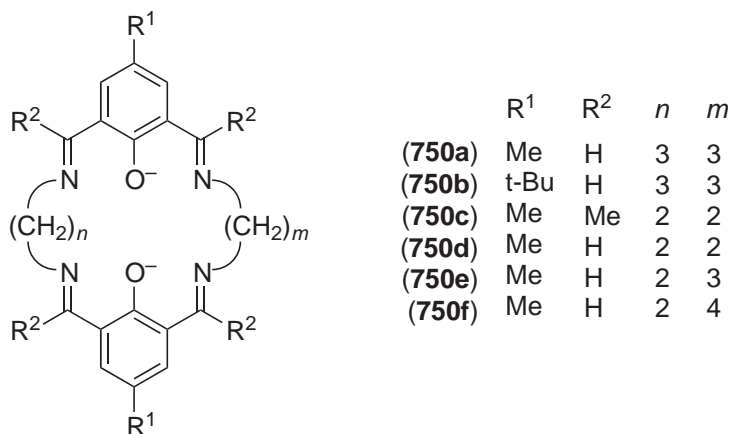

The stereochemistry and the spin state of the Ni ion in the resulting complexes can be controlled by the ring size of the macrocycle. A larger cavity size (C₃ linkers) results in a weaker ligand field and Ni^{II} will adopt an octahedral geometry. For example, in [Ni₂(750a)(NCMe)₄]²⁺ both metal ions bind MeCN ligands in the axial positions.¹⁹⁰³ Six-coordination can also be achieved by the assembly of two dinuclear units to give tetranuclear complexes with a central Ni₄O₄ cubane-type core.¹⁹⁰⁴ In contrast, [Ni₂(750c)]²⁺ and [Ni₂(750d)]²⁺ where the ligand incorporates C₂ linkers show square planar Ni^{II} centers and are diamagnetic.^{1902,1905} Ligands (750c) and (750d) with reduced cavity size can accommodate only the small Cu^{II} and Ni^{II} ions because the “salen” (*N,N'*-ethylenedisalicylaldimine)-like entity embedded in the macrocyclic framework has little flexibility compared with salen itself. Disymmetric ligands with two different lateral spacers ((750e,f)) give mixed-spin (*S*₁ = 0, *S*₂ = 1) dinickel(II) complexes, while in strongly coordinating solvents the high-spin state (*S*₁ = *S*₂ = 1) is found for these systems, and even for [Ni₂(750d)]²⁺.¹⁹⁰⁵ Symmetric (750a) can form heterodinuclear complexes like [PdNi(750a)(MeCN)]²⁺, which was prepared in a stepwise fashion by reaction Pd^{II} acetate with the mononuclear Ni^{II} complex of the macrocycle. The Ni ion is six-coordinate with MeCN ligands in the axial position.¹⁹⁰⁶

Similar observations have been made for type (751) ligands with saturation of the azomethine linkages, but the saturation has significant effects on various physicochemical properties of the dinuclear complexes.¹⁹⁰⁷ In [Ni₂(751c)(MeOH)₂(ClO₄)₂], each metal ion bears one methanol and one perchlorate ligand in the axial positions,¹⁹⁰⁸ and four axial water molecules are found in [Ni₂(751c)(H₂O)₄]²⁺.¹⁹⁰⁹ In the presence of pyridine, the latter transforms into the square pyramidal complex [Ni₂(751c)(py)₂]²⁺. Likewise, various N-donor ligands such as NH₃, imidazole, pyridine, pyrazine, etc., can be attached, and equilibrium constants for the replacement of axially bound methanol solvent molecules by these bases have been determined.¹⁹¹⁰ Pyrazolate appears to act as an additional bridging ligand.¹⁹¹⁰ Stepwise two-electron reduction and two-electron oxidation is observed electrochemically for [Ni₂(751c)(MeOH)₂(ClO₄)₂].¹⁹⁰⁸ In general, reduction to the Ni^INi^{II} and Ni^INi^I species occurs at significantly higher potentials for complexes of type (750) ligands compared to type (751) ligands.¹⁹⁰⁵ Apparently, the reduced state is stabilized by the C=N groups. In the presence of acetate, complexes [Ni₂(L)(OAc)₂] (L = (751a), (751c), (751d), (751e)) have been isolated.¹⁹⁰⁷ The structure of [Ni₂(751a)(OAc)₂] shows that the macrocycle adopts a folded conformation and the acetate binds as a chelating bidentate ligand.¹⁹⁰⁷ However,

in $[\text{Ni}_2(\mathbf{751c})(\mu\text{-OAc})(\text{H}_2\text{O})_2]^+$ the acetate bridges the two Ni ions, as do amino acids like glycine in $[\text{Ni}_2(\mathbf{751c})(\mu\text{-O}_2\text{CCH}_2\text{NH}_3)(\text{H}_2\text{O})_2]^{2+}$ (and similarly for β -alanine and glycylglycine).¹⁹¹¹ The disymmetric ligand (**751b**) with different hole sizes forms a mixed-spin ($S_1 = 0$, $S_2 = 1$) complex $[\text{Ni}_2(\mathbf{751b})(\text{H}_2\text{O})_2]^{2+}$, where two axial water molecules are bound to the high-spin ion nested in the larger cavity.¹⁹⁰⁹

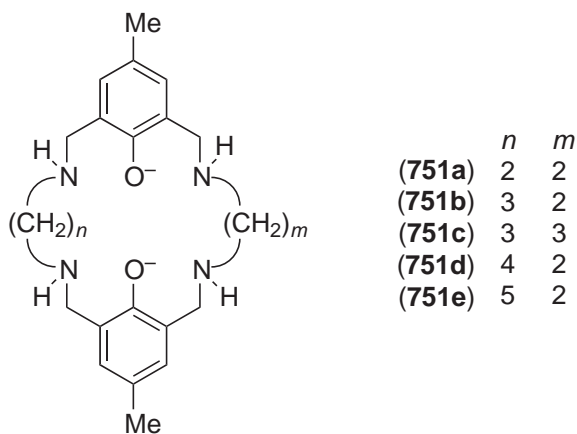

Additional coordinating side arms can be attached to the aminic N atoms of type (**751**) ligands. Picolyl pendent arms at one compartment give one hexadentate site and one tetradentate site (**752**). Two Ni ions can be inserted in a stepwise process to first give $[\text{Ni}(\mathbf{752})]$ with a six-coordinate metal ion (which can be protonated at the azomethine N atoms to give $[\text{Ni}(\mathbf{752})\text{H}_2]^{2+}$) and the dinuclear $[\text{Ni}_2(\mathbf{752})]^{2+}$ with one six-coordinate and one four-coordinate Ni^{II} .¹⁹¹² (**752**) and related systems are also capable of forming heterodinuclear NiM complexes ($M = \text{Zn}, \text{Co}$, etc.). The Ni ion usually resides in the open site, either square planar or five-coordinate with an additional Cl ligand.¹⁹¹³ A different strategy to increase denticity of the ligand is the use of spacers with additional donor atoms, e.g., (**753**).^{1914,1915} Both dinickel complexes $[\text{Ni}_2(\mathbf{753})]^{2+}$ and $[\text{Ni}_2(\mathbf{753})(\text{H}_2\text{O})_2]^{2+}$ have been structurally characterized. In the former, the Ni ions are in square pyramidal N_3O_2 environment and the macrocycle adopts a twisted configuration, while in the latter the Ni are six-coordinate due to two additional water ligands. Attachment of additional N-donors in (**754**) gives rise to two hexadentate coordination sites, and a dinickel(II) complex with six-coordinate metal ions and the pendent arms approaching from opposite sides of the macrocycle is proposed.¹⁹¹⁶

If the spacer contains potentially bridging alcohol groups, the nuclearity of the complexes depends on the spacer length. $\text{H}_4(\mathbf{755a})$ may accommodate four metal ions in its tetraanionic form. For example, the heterotetranuclear macrocyclic unit $[\text{Cu}_2\text{Ni}_2(\mathbf{755a})\text{O}(\text{OAc})]^+$ is prepared from the dicopper precursor without scrambling of the metal ions. It contains a central O atom, an acetate spanning the two Ni ions, and the Ni and Cu ions, respectively, in an alkoxide-bridged side-by-side geometry.^{1917,1918} The analogous thiophenolate-based ligand (**755b**) gives a tetranickel complex with five different bridging groups (thiophenolato-S, alkoxo-O, μ -1,1 acetato, μ -1,3 acetato, and a central μ_4 -OH).¹⁹¹⁹ In the case of shorter spacers, the alcohol groups remain noncoordinating, e.g., in type (**756**) complexes.¹⁹²⁰ In the latter, the two Ni^{II} ions are six-coordinate with anions and/or water molecules in the axial positions.

Considerable work has concentrated on the controlled synthesis of heterobimetallic NiM complexes of disymmetric Robson-type macrocycles.^{1903,1921} (**757**) forms both $\text{Cu}^{\text{II}}\text{Ni}^{\text{II}}$ and $\text{Mn}^{\text{II}}\text{Ni}^{\text{II}}$ complexes. In $[\text{CuNi}(\mathbf{757})(\text{H}_2\text{O})(\text{DMF})]^{2+}$,¹⁹²² the Cu^{II} resides in the N_2O_2 site with the ethylene lateral chain and assumes a planar geometry. The Ni^{II} , in the N_2O_2 site bonded by the tetramethylene chain, acquires a pseudo-octahedral geometry by further interaction with DMF and water oxygen atoms at the axial sites. A very strong antiferromagnetic interaction operates between the metal ions ($J = -90 \text{ cm}^{-1}$ based on $-2J S_{\text{Cu}} S_{\text{Ni}}$). The electronic structure of the spin-doublet ground state was studied by means of EPR spectroscopy, and the recognition of a four-line hyperfine structure due to Cu ($I_{\text{Cu}} = 3/2$) and the relationships $g_{\perp} > g_{\parallel}$ and $A_{\psi} = -(1/3) A_{\text{Cu}}$ (A_{Cu} is the hyperfine coupling constant for the analogous CuZn complex)^{1923,1924} demonstrated that one unpaired electron of the spin-coupled complex exists in the molecular orbital of d_{z^2} character comprising $d_{z^2}(\text{Cu})$ and $d_{z^2}(\text{Ni})$ and is delocalized over the CuNi dinuclear core. The dinuclear $\text{Ni}^{\text{II}}\text{Mn}^{\text{II}}$ complex $[\text{NiMn}(\mathbf{757})(\text{DMF})_2]^{2+}$ has the Ni^{II} in the N_2O_2 site with the ethylene

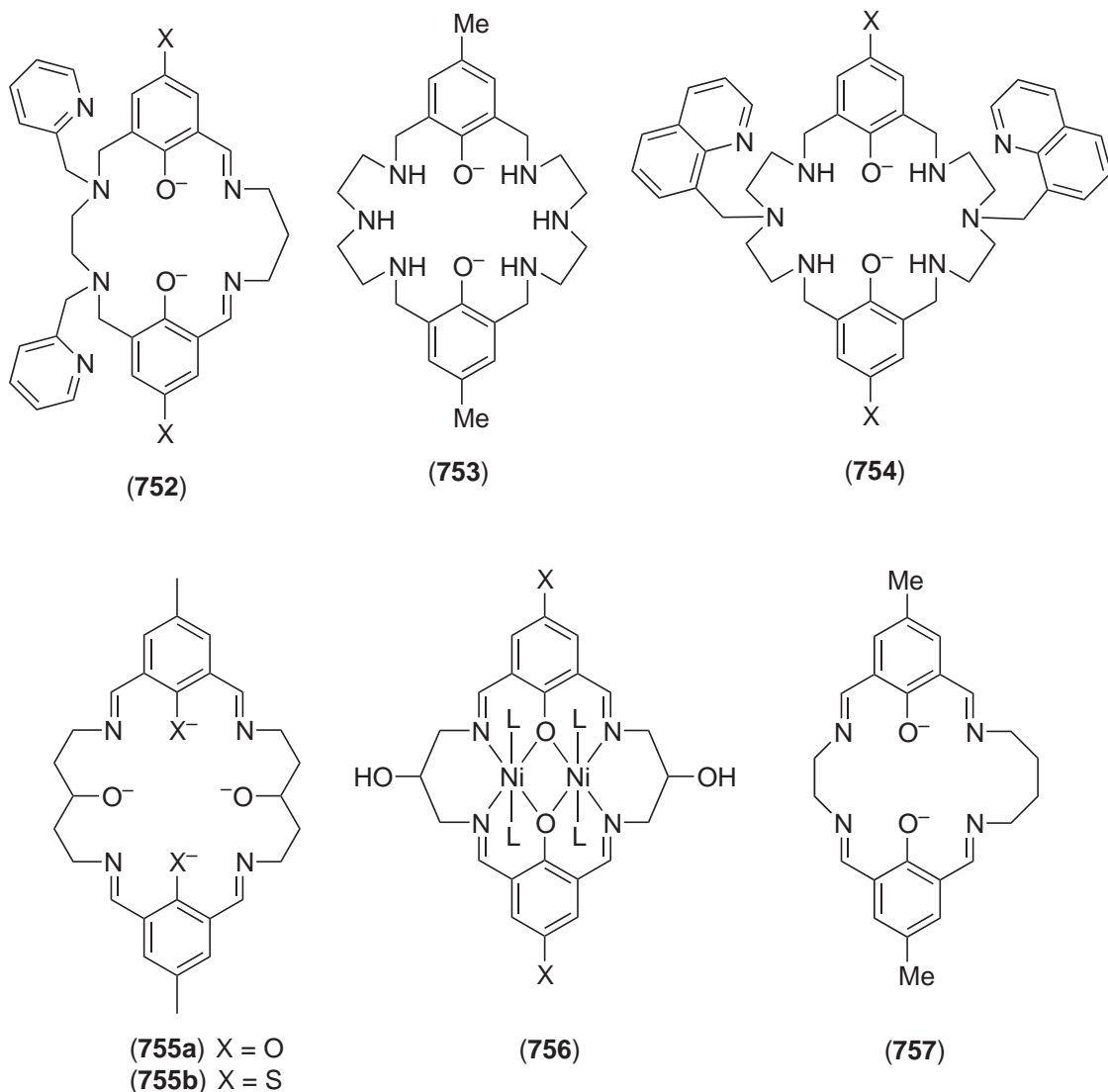

lateral chain and the Mn^{II} in the N_2O_2 site derived from the tetramethylene lateral chain.¹⁹²⁵ The Ni^{II} has a planar geometry and is diamagnetic. Cyclic voltammetry indicates that the $\text{Ni}^{\text{II}}\text{Mn}^{\text{II}}$ complex is reversibly reduced to a $\text{Ni}^{\text{I}}\text{Mn}^{\text{II}}$ species (near -0.1 V vs. SCE) and oxidized to $\text{Ni}^{\text{II}}\text{Mn}^{\text{III}}$ species (near $+1.5\text{ V}$). The deeply green-colored $\text{Ni}^{\text{I}}\text{Mn}^{\text{II}}$ complex was generated *in situ* by controlled potential reduction and shows three visible bands of significant intensity at 570 nm, 640 nm, and 800 nm. These bands are attributable to $d-d$ transitions of planar Ni^{I} .¹⁹²⁶

Further distinction of the metal binding sites is achieved by an additional amine N atom within one lateral chain to provide a four-coordinate and a potential five-coordinate site. A series of $\text{Ni}^{\text{II}}\text{M}^{\text{II}}$ ($\text{M} = \text{Mn}, \text{Fe}, \text{Co}, \text{Ni}, \text{Cu}, \text{Zn}$) complexes of (758) have been obtained which contain planar Ni^{II} .¹⁹²⁷ A macrocyclic ligand with an additional alkoxy group is able to coordinate simultaneously Ni^{II} and various Ln^{III} ions ($\text{Ln} = \text{La}, \text{Ce}, \text{Pr}, \text{Nd}, \text{Sm}, \text{Eu}$). Both in solution and in the solid state, three Cl coligands are bound to the lanthanide ions in $[(759)\text{Cl}_3]$.¹⁹²⁸ Ni complexes of unsymmetrical compartmental macrocycles having $\text{N}(\text{amine})_2\text{O}_2$ and $\text{N}(\text{imine})_2\text{O}_2$ metal binding sites are still limited. $[\text{Cu}(760)]$ reacts with NiCl_2 to form dinuclear $[\text{CuNiCl}_2(760)]$.¹⁹²⁹

(751b) reacts with $\text{VO}(\text{acac})_2$ to give a mixture of oxovanadium(IV) and -(V) complexes.¹⁹³⁰ This mixture reacts with Ni^{II} perchlorate to afford three complexes $[(\text{V}^{\text{IV}}\text{O})(751\text{b})\text{Ni}(\text{H}_2\text{O})_2]^{2+}$, $[\text{Ni}(751\text{b})(\text{V}^{\text{IV}}\text{O})]^{2+}$, and $[(\text{V}^{\text{IV}}\text{O})(751\text{b})\text{Ni}(\text{H}_2\text{O})]\{(\text{V}^{\text{V}}\text{O}_2)(\text{H}751\text{b})\}^{2+}$. Related oxovanadium(IV)-nickel(II) complexes of symmetrical macrocyclic ligands have also been prepared.¹⁹³¹

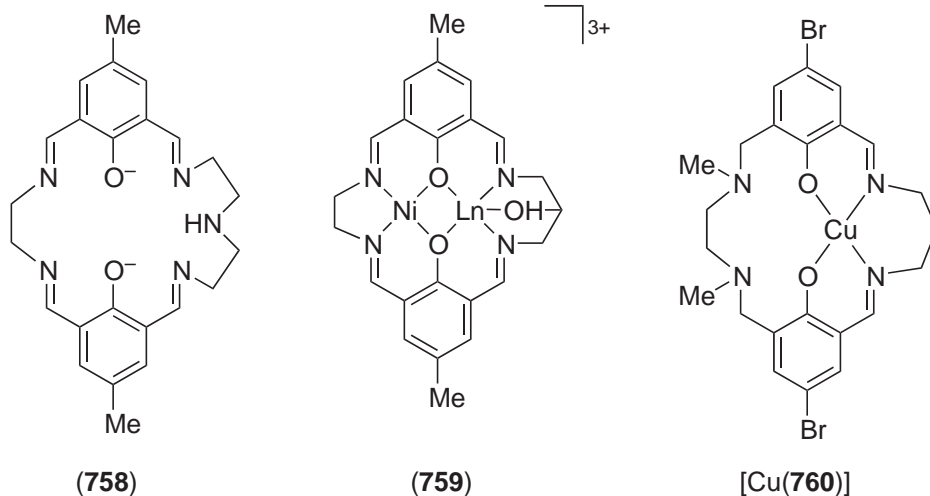

Instead of the aliphatic spacers of the Robson-type ligands, other groups have been used to link the two bis(imino)phenolato subunits and such ligands have been employed in Ni coordination chemistry. Tetraanionic (**761**) forms neutral complexes $[\text{Ni}_2(\text{761})]$ with diamagnetic square planar metal ions, which are resistant to hexacoordination even in strongly coordinating γ -picoline.¹⁹³² Pseudomacrocyclic structures are observed in dicationic (**762**), where the two dioxime ligands are connected via strong hydrogen bonds. Type (**762**) complexes can be doubly deprotonated at the dioxime units to give neutral dinickel complexes with hexacoordinate metal ions due to coligands in the axial positions (the complex with pyridine has been structurally characterized).^{1932,1933}

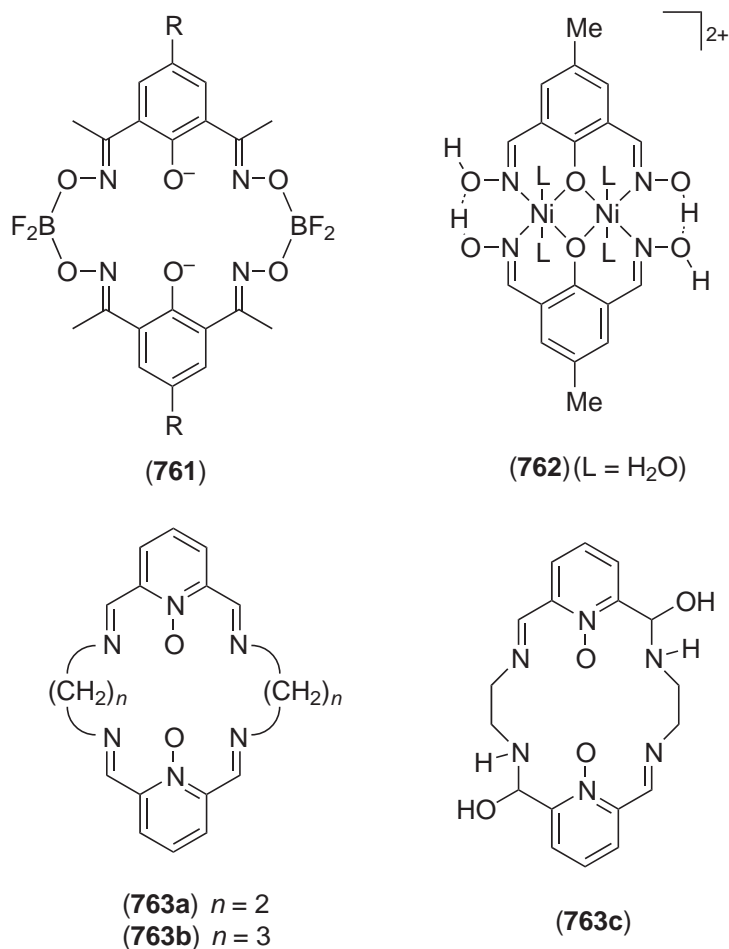

Pyridine-*N*-oxide-derived ligands (**763**) are neutral analogues of the Robson-type systems and may also form dinuclear Ni complexes. Attempts to prepare $[\text{Ni}_2(\mathbf{763a})]^{4+}$ by treating (**763a**) with nickel nitrate, however, yielded $[\text{Ni}_2(\mathbf{763c})(\text{H}_2\text{O})_4](\text{NO}_3)_4$ due to partial solvolysis of two Schiff base groups. It shows a nonplanar stepped structure where *cis* coordination sites of the hexa-coordinate metal ions are occupied by water.¹⁹³⁴ The Ni^{II} ions are coupled antiferromagnetically ($J = -15.5 \text{ cm}^{-1}$).

The expanded pyridine-modified macrocycle (**764**) is able to accommodate four Ni^{II} ions in a dimer-of-dimer arrangement.¹⁹³⁵ Molecular-sized chiral cavities are present in dinickel calixsalen complexes (**765**). These have been proposed as hosts for guests molecules, and inclusion of MeCN has been found in the solid state.¹⁹³⁶ Multidentate macrocycles incorporating only a single phenolate bridging unit are also capable of forming dinickel complexes, given the macrocycle size is large enough as in (**766**).¹⁹³⁷ They strongly prefer coligands that form a secondary bridge between the metal ions (Cl in (**766**)).

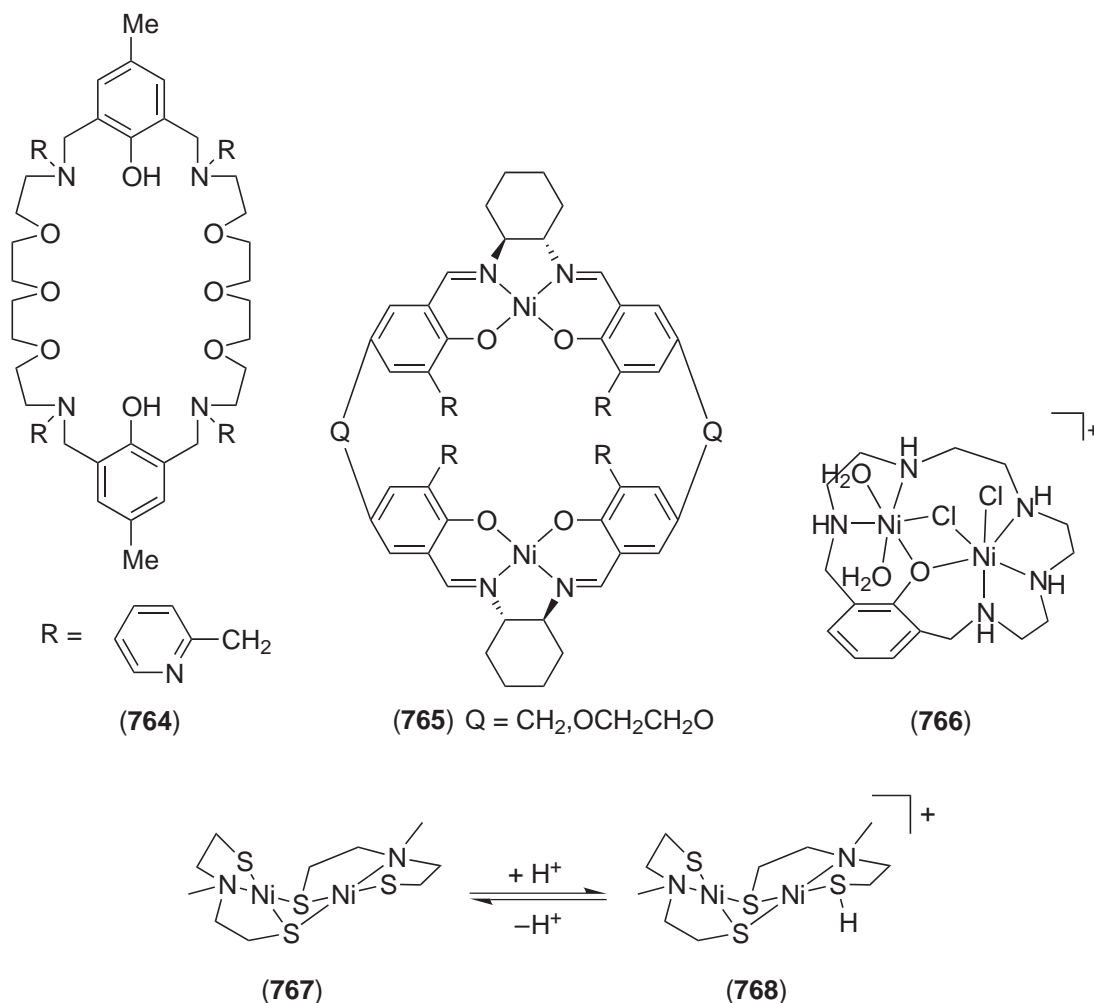

6.3.4.12.4 Di- and oligonuclear complexes with thiolate-based dinucleating ligands

Thiolates exhibit a strong tendency to bridge Ni^{II} ions (as well as other metal ions), but often the reaction between the metal ion and a thiolate ligand is difficult to control and the formation of higher aggregates and polymers is observed. Control of the product nuclearity can be achieved, *inter alia*, by appropriate fine-tuning of the ligand scaffold, e.g., by steric bulk or by incorporating the thiolate donor within a macrocyclic framework.¹⁹³⁸ Another difficulty is the propensity of Ni-bound thiolates to undergo oxidation, e.g., to sulphenates or sulphinates.¹⁹⁵² The noninnocence of Ni-bound thiolate adds to the interest in such systems. Besides their redox activity, Ni-bound

thiolates may also become protonated, which is of relevance to the reactivity of the Ni/Fe hydrogenase active site. For example, the dinuclear Ni^{II} thiolate complex (**767**)¹⁹⁹ is reversibly protonated at a single terminal thiolate-S by upon addition of [H(OEt)₂]₂{B[3,5-(CF₃)C₆H₃]₄} to give (**768**).²⁰⁰ An analogous complex that features a benzylated thiolate ligand has been structurally characterized. Upon reaction with iodine, mononuclear Ni^{II} complexes of linear tetradentate {N₂S₂} diaminodithiolate ligands are oxidatively coupled to give dinuclear complexes of macrocyclic bis(disulfide)tetramines (**769**),¹⁹³⁹ which are easily demetallated.

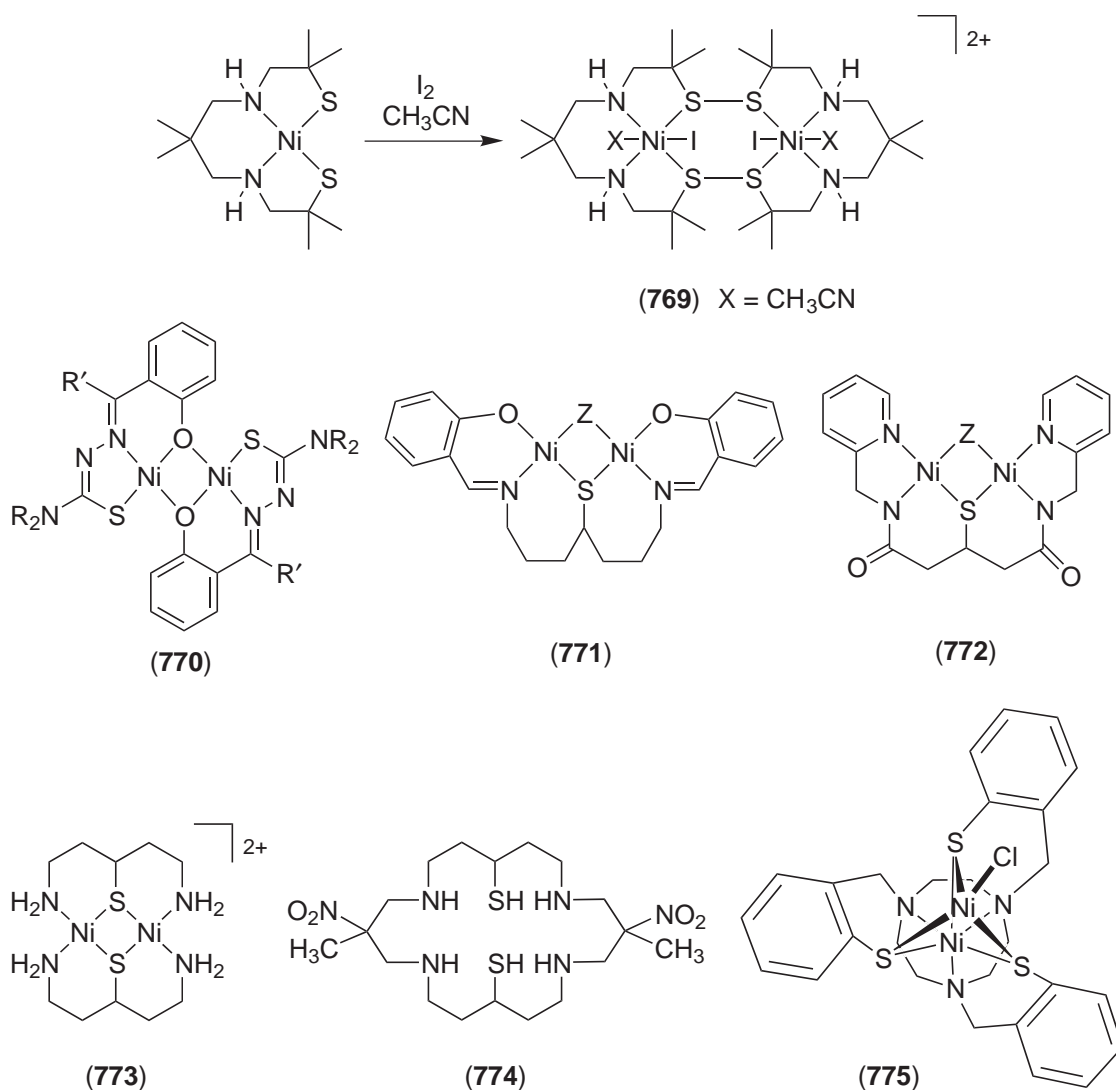

Deprotonated thioamides, which bind in the imino thiolate form (RN=CR-S⁻), exhibit a very low bridging tendency due to their lower S-basicity. If incorporated in a chelate scaffold with phenolate-O, it is the latter which forms the bridge, e.g., in (**770**).^{1940,1941}

Ni^{II} complexes of dinucleating ligands containing an endogenous aliphatic thiolate bridging group and iminic or aminic side arms, e.g., (**771**) and (**772**), can accommodate three-atom bridges (e.g., carboxylates), two-atom bridges (e.g., pyrazolate), or one-atom bridges (provided they are large enough, e.g., iodide) at the Z site.^{1942,1943} Complex (**773**) which contains two Ni^{II} ions in a square planar N₂S₂ coordination environment (even in aqueous solution)¹⁹⁴⁴ can serve as a starting material for the preparation of macrocyclic bis(thiolato) bridged dinickel complexes via template reactions. Reaction of (**773**) with formaldehyde and nitroethane in basic methanol gives a diamagnetic dinickel(II) complex of (**774**) with two essentially planar *cis*-{NiN₂S₂} chromophores. One O atom of each nitro groups interacts axially with the respective Ni ion at quite long distances (2.89 Å).¹⁹⁴⁵

Even better control of the nuclearity is achieved with aromatic thiolate donors such as thiophenolates, because these are less electron rich.¹⁹³⁸ A hexadentate, triazacyclononane-derived ligand with 4-*t*-butyl-2-mercaptobenzyl pendent arms forms homo- and heterodinuclear Ni complexes.¹⁹⁴⁶ In the Ni₂ complex (**775**) one metal ion is six-coordinate with a *fac*-N₃S₃ donor set and the other is four-coordinate in a S₃Cl environment, both Ni^{II} being high spin and strongly antiferromagnetically coupled ($J = -135 \text{ cm}^{-1}$) due to the face-sharing octahedral/tetrahedral arrangement.

Tridentate 4-*t*-butyl-2,6-di(aminomethyl)thiophenolate forms dinickel(II) complex (**776**) in a controlled fashion, and the {N₂Ni(μ-SR)₂NiN₂} core structure is also retained in solution.¹⁹⁴⁷ (**776**) readily adds another equivalent of the ligand to afford (**777**) containing two face-sharing octahedral {NiN₃S₃} subunits.¹⁹⁴⁸ (**777**) shows a rich electrochemistry and can be chemically oxidized by iodine to a robust Ni^{II}Ni^{III} species, which has been structurally characterized. The mixed-valent Ni^{II}Ni^{III} compound is valence-trapped and has a $S = 3/2$ ground state below ~80 K. Upon going from (**776**) to (**777**), the Ni^{III} state becomes more easily accessible.¹⁹⁴⁸ Similar chemistry has been observed for the corresponding amine-selenophenolate complexes.^{1947,1948} Linking two of the terminal amine groups in (**776**) leads to (**778**), in which the hexadentate chelating ligand allows for the axial binding of coligands to the central {N₂Ni(μ-SR)₂NiN₂} core because of its weaker ligand field.¹⁹⁵⁰ Binding of anions (e.g., thiocyanate) to (**778**) occurs selectively at the axial trans positions of the Ni^{II} ion in the closed compartment, i.e., where the secondary N atoms exert a slightly weaker ligand field. The resulting complex (**779**) features adjacent octahedral *cis*-{NiN₄S₂} and planar *cis*-{NiN₂S₂} sites. Binding of thiocyanate is accompanied by an unexpected inversion of configuration at both secondary N-donor atoms. Both (**778**) and (**779**) undergo two successive reductions, assigned to formation of the Ni^{II}Ni^I and Ni^INi^I species.¹⁹⁵⁰ An axial coordination site can be occupied intramolecularly by an additional NH donor of a slightly modified septadentate ligand.¹⁹⁵¹ In (**780**), the remaining position trans to this NH is the reactive site where solvent molecules and anionic coligands L such as thiocyanate and chloride can bind.

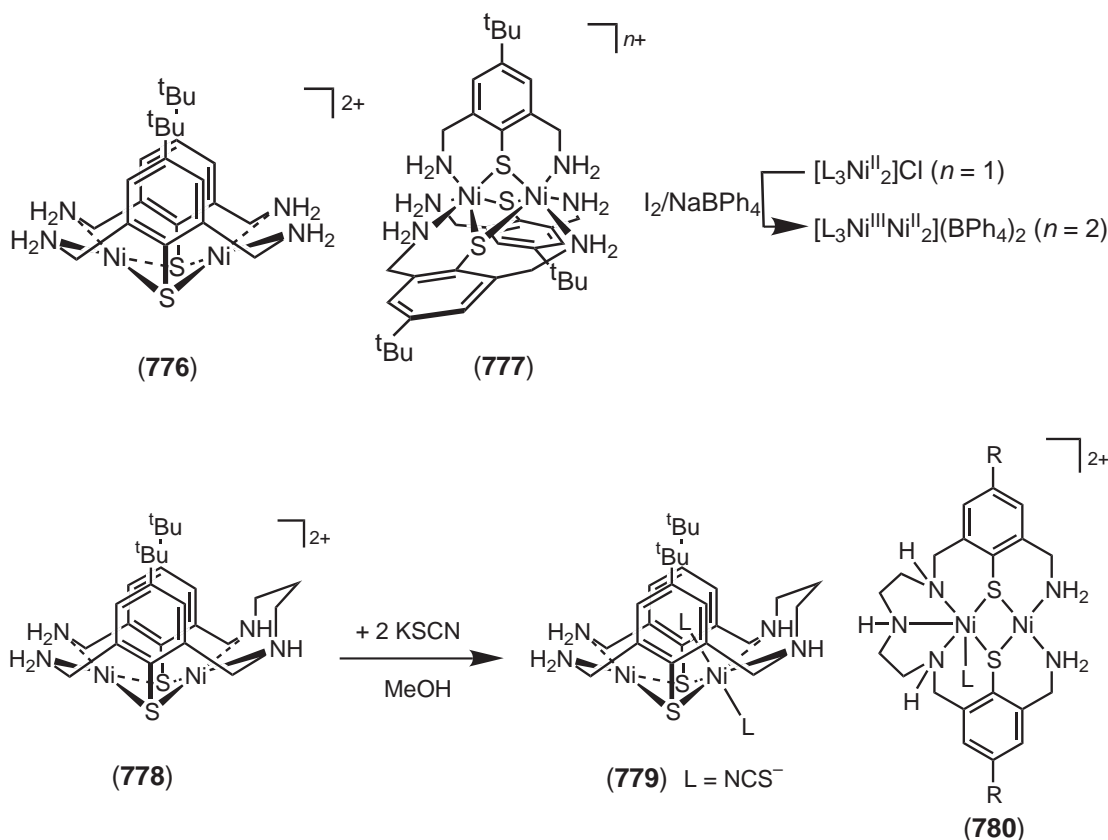

Dinickel(II) complexes of general type (**781**) macrocycles have been studied in detail since the early 1990s.¹⁹⁵²⁻¹⁹⁵⁵ (**782**) is the most prominent scaffold employed, and the structures of its dinickel(II) complexes show the anticipated differences from the analogous phenolate complexes.^{1946,1954,1956,1957} In particular, the thiophenolate complex [Ni₂(**782**)]²⁺ is bowed in dramatic contrast to the flat

structures of the phenolate analogues, i.e., the S atoms adopt a pyramidal geometry whereas the oxygen atoms are trigonal. Furthermore, the nickel atoms in the phenolate complexes are in octahedral environment (and hence high spin) whereas in the thiophenolate complex the nickel atoms are in a square planar environment (and hence low spin). $[\text{Ni}_2(\mathbf{782})]^{2+}$ features a rich redox chemistry with four one-electron processes observed, and the two reversible reduction processes (-1.46 V, -1.01 V vs. 0.01 M AgNO_3/Ag in MeCN solution) as well as the two oxidation processes ($+0.63$ V, $+1.07$ V; the first process is reversible, while the second is quasi-reversible) occur more readily than in the analogous phenolate complex (-1.40 V, $+1.05$ V, $+1.26$ V).¹⁹⁵⁴ The oxidation waves are sensitive to axial coordination by solvent molecules, as is expected for the formation of Ni^{III} . The mixed valent $\text{Ni}^{\text{II}}\text{Ni}^{\text{III}}$ thiophenolate complex has been isolated but is unstable even in the solid state.¹⁹⁵³ An unusual trinickel(II) complex, $[\text{Ni}_3(\mathbf{783})_2]^{2+}$ was obtained from incomplete template cyclisation and acetal formation in ethanolic solvents. It incorporates one central high-spin Ni^{II} ion and two square-planar low-spin Ni^{II} ions within each acyclic ligand.

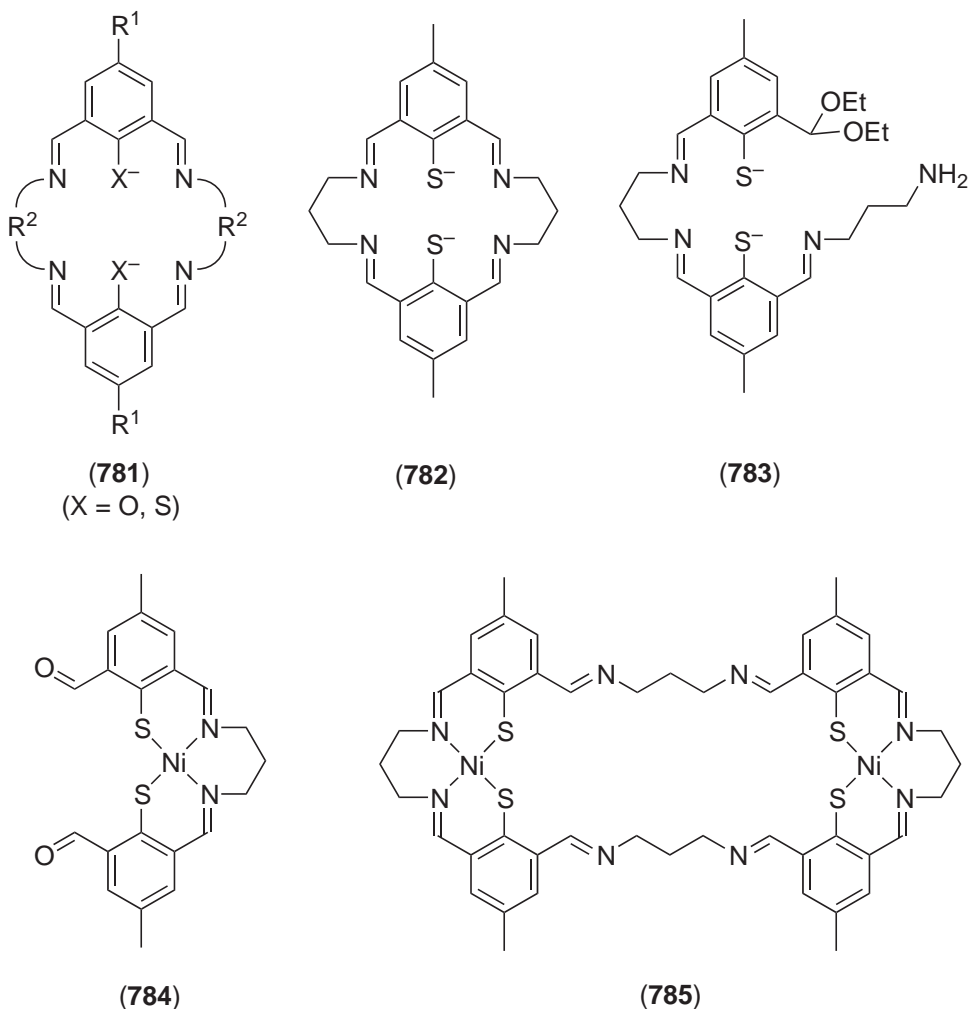

By judicious choice of reaction conditions an acyclic Ni^{II} complex (**784**) could be isolated, which serves as a valuable starting material for the preparation of unsymmetrical and mixed metal complexes by subsequent reaction with various amines. Also, a symmetrical Schiff base macrocycle of larger size has been obtained as a minor byproduct upon condensation of (**784**) with 1,3-diaminopropane. The resulting Ni^{II} complex (**785**) is again bimetallic, although room to bind four metal ions is in principle available.¹³⁶⁷

Enlargement of the metal binding cavity was expected to favor high-spin nickel centers in thiophenolate macrocycles.¹⁹⁵³ Complex (**786**) incorporating 1,4-diaminobutane linkages is still diamagnetic in the solid state but exhibits a greater tetrahedral distortion away from square planar than is the case for the analogous $[\text{Ni}_2(\mathbf{782})]^{2+}$. Consistent with this, (**786**) exhibits an

increased tendency to coordinate solvent molecules in the axial sites. When reacted with NaSCN, both systems form complexes with two thiocyanate ions on just one of the two nickel ions, even if four equivalents of NaSCN are used. It is assumed that the charge-neutral nature of the product complex is important for the course of this reaction, since it leads to reduced solubility and consequent crystallization from the reaction mixture.^{1958–1960} [(786)(NCS)₂] thus contains juxtaposed high and low-spin Ni^{II} ions despite the provision of potentially equivalent macrocycle binding sites. Metal–ligand bonds for the high-spin Ni ions are typically about 0.15–0.20 Å longer than those for the low-spin nickel ions.^{1961–1963}

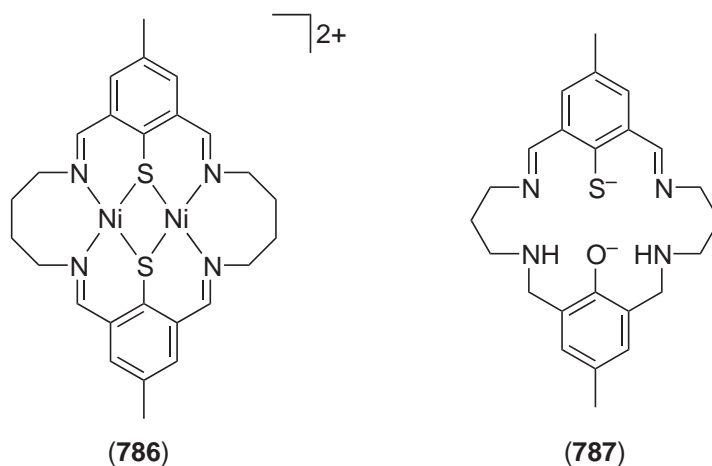

Several examples of dinickel(II) complexes of Schiff base macrocycles with mixed phenolate/thiophenolate bridging units have been reported.^{1960,1964,1965} Again, [Ni₂(787)(MeCN)₂]²⁺ has Ni^{II} ions in differing spin states,¹⁹⁶⁵ despite the provision of two potentially equivalent macrocycle binding sites. One nickel ion is in a square planar environment whilst the other is octahedrally coordinated due to axial binding of two acetonitrile solvent molecules. The replacement of one thiophenolate diimine moiety of (782) by a phenolate diamine moiety in (787) leads to a significant reduction of the ligand field strength of the resulting macrocycle, since in the absence of coordinating counterions the dinickel(II) complexes of (782) are diamagnetic. In the presence of NaSCN, the dinickel(II) complex of (787) produces an example in which both Ni^{II} centers are six-coordinate and high spin. Similar to the complexes of (782) just two thiocyanate ions are incorporated (even when four equivalents are used), forming a neutral complex which precipitates from solution. In this case, however, rather than both anions binding to the same nickel ion,¹⁹⁵³ one thiocyanate binds to each of the two Ni ions, as is also seen for the phenolate amine analogue.¹⁹⁵⁹ One of the two metal ions coordinates an additional DMF solvent molecule to give [Ni₂(787)(NCS)₂(DMF)]. Both Ni^{II} ions are established to be high-spin by examination of the structural information,¹⁹⁶⁶ and this was confirmed by a magnetic moment determination.^{1960,1964} This is a rare example of a high-spin square pyramidal thiolate-coordinated Ni^{II} ion.¹⁹⁶⁷ In the case of the pure amine phenolate macrocycle, the axial binding ability of dinickel(II) complexes gives a delicate balance between high-spin square pyramidal and high-spin octahedral geometries, which depends on the choice of axial ligand.^{1962,1968–1970} The phenolate ligand has insufficient ligand field strength to induce spin pairing, but reducing the ring size of the phenolate macrocycle (e.g., by replacing one propylene lateral unit by an ethylene lateral unit) does result in the observation of square planar (diamagnetic) nickel ions in the smaller compartment.¹⁹⁶² The redox potentials for [Ni₂(787)(MeCN)₂] in MeCN at –1.50(irrev.) V, –1.23(quasir.) V, +0.65(irrev.) V, and +1.00(rev.) V vs. 0.01 M AgNO₃|Ag do not simply fall in between those obtained for the dinickel(II) complexes of the corresponding bis(thiophenolato) and bis(phenolato) bridged species, and in particular the reductions, which are expected to be more sensitive to changes to the macrocyclic donors, are quite different.¹⁹⁶⁴

The Ni^{II} templated (2 + 2) condensation of 2,6-diformly-4-methyl-thiophenol with 1,5-diaminopentan-3-ol gives a tetranuclear complex with a combination of thiophenolate and alkoxide bridging.¹⁹⁷¹ The large Schiff base macrocycle provides two bridging thiophenolate and alkoxy moieties, and encircles four Ni^{II} ions with a central μ₄-OH[–] group. There are five different bridging groups, and all four Ni^{II} ions have different coordination environments, largely due to the mixture of acetate ions and acetic acid molecules which differentiate the two faces of the

planar Ni_4 array. The Ni^{II} ions in this complex are six-coordinate and high spin, as was observed in the tetraphenolate analogues.^{1960,1964,1972-1974}

Whereas most of the complexes described above can be electrochemically reduced or oxidized, no structurally characterized examples of metal-centered redox products are known and reported examples of isolated redox products are few. These include the one-electron oxidation product of $[\text{Ni}_2^{\text{II}}(\mathbf{782})]^{2+}$, the black complex $[\text{Ni}_2(\mathbf{782})\text{Ce}(\text{NO}_3)_6]$, in which the oxidation is believed to be primarily metal centered, and the macrocyclic ligand oxidation product obtained in low yields from the oxidation of $[\text{Ni}_2^{\text{II}}(\mathbf{786})]^{2+}$ with iodine.^{1953,1955,1964}

In general, the amine analogues of Schiff base macrocycles are more robust than the parent Schiff bases. The dinickel(II) complex (**788**) of a tetraamine thiophenolate Schiff base macrocycle was prepared by sodium borohydride reduction of the appropriate Schiff base macrocyclic complex.¹⁹⁷⁵ Despite the acid workup, the Ni^{II} ions remain bound and in the +2 oxidation state, possibly due to the experiment being carried out in air. As for $[\text{Ni}_2(\mathbf{782})]^{2+}$ the macrocycle is bowed and the Ni^{II} ions are in square planar coordination environments. However, in this case the greater flexibility of the amine bonds allows formation of a bowl structure with the "walls" provided by the phenyl rings and the alkyl lateral chains, thus distinguishing the two faces of the macrocyclic complex. Electrochemical experiments show that (**788**) is harder to reduce than the Schiff base counterpart ($-1.86(\text{quasirev.}) \text{ V}$ and $-1.18(\text{rev.}) \text{ V}$ vs. $0.01 \text{ M AgNO}_3/\text{Ag}$, in MeCN).^{1953,1975} Contrary to what is expected from comparison with related mononuclear Ni^{II} thiophenolate species,¹⁹⁷⁶⁻¹⁹⁷⁸ potentials for the two oxidation processes occur at the same values as those observed for the imine analogue ($+0.69(\text{rev.}) \text{ V}$ and $+1.10(\text{quasirev.}) \text{ V}$).^{1953,1975}

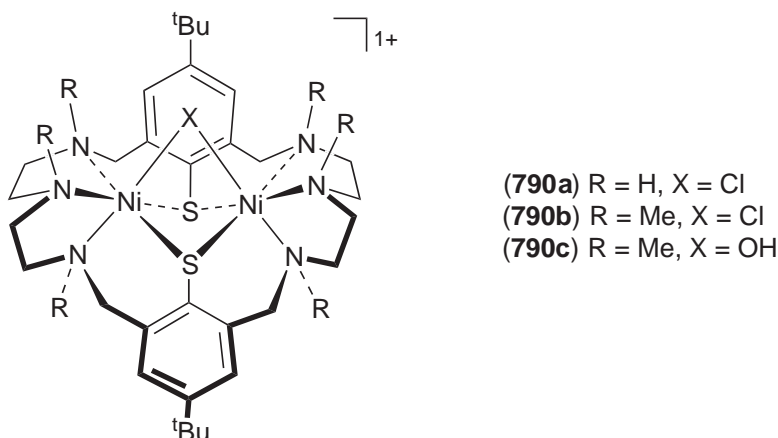
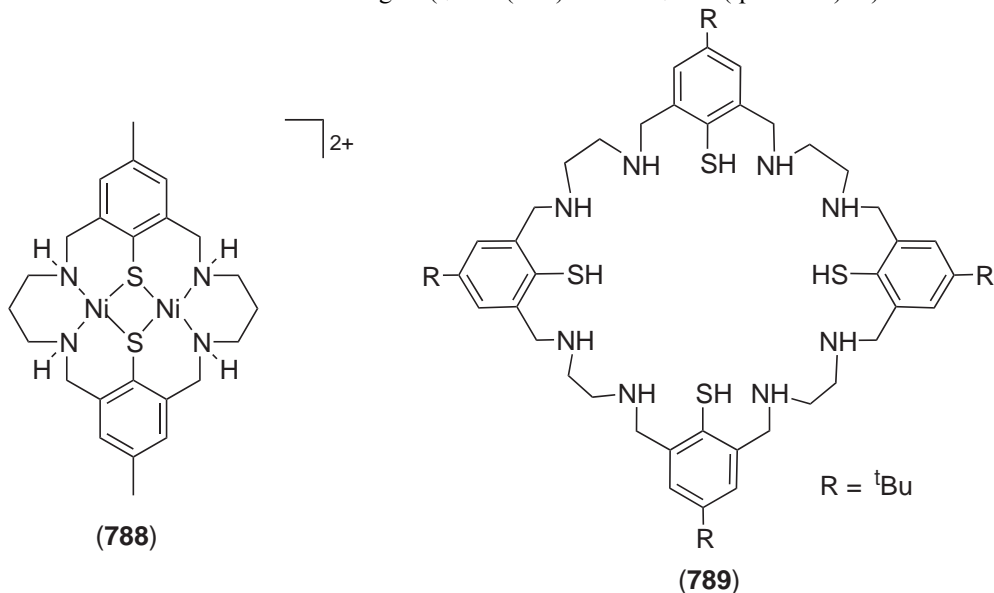

Three Ni^{II} complexes have been produced from the large, metal-free amine macrocycle (789)·8HCl by neutralizing *in situ* with NEt₃ and adding an appropriate amount of a suitable Ni^{II} salt. A purple, diamagnetic, neutral dinickel(II) complex and a tetranickel(II) perchlorate complex were prepared.¹⁹⁷⁹ The latter complex was converted to the neutral thiocyanate salt and structurally characterized.¹⁹⁷⁹ It features a mixture of square planar (low-spin) and octahedral (high-spin) Ni^{II} ions and seems to link together two independent dinickel complexes, because pairs of thiophenolate-S form doubly bridged pairs of Ni centers rather than connecting all of the nickel centers together. The two octahedral centers have bound two thiocyanate ions in *cis* positions.¹⁹⁷⁹ A related tetranickel(II) complex of a 40-membered macrocyclic octaamine-thiophenolate ligand has also been reported.¹⁹⁸⁰

Face-sharing bioctahedral dinickel complexes (790) with a central [N₃Ni(μ-SR)₂(μ-X)NiN₃] core featuring coordinatively unsaturated Ni ions are formed from a macrocyclic amine thiophenolate ligand.¹⁹⁸¹ Permethylation drastically facilitates substitution at the X position, possibly due to the more hydrophobic microenvironment. While (790b) readily reacts with NBu₄OH to give (790c), complex (790a) was found to be unreactive. All three complexes undergo two successive electrochemical one-electron oxidations assigned to formation of the Ni^{II}Ni^{III} and Ni^{III}Ni^{III} species, but the latter is not stable on the timescale of the cyclovoltammetric experiment, in contrast to related coordinatively saturated Ni amine-thiolate complexes. Differences of the redox potentials for (790a–c) follow the trend expected from the ligand field strength.¹⁹⁸¹ (790c) reacts with CO₂ in MeOH to give the methylcarbonato bridged complex, presumably via an intermediate hydrogencarbonato species.¹⁹⁸² While primary alcohols show this CO₂ fixation reaction, secondary or tertiary alcohols do not, which is ascribed to the restricted space within the hydrophobic binding pocket.

Bis(benzenedithiolate) ligands with an appropriate spacer between the benzenedithiolate donors form dinuclear Ni^{II} complexes (791) and (792), in which the square planar NiS₄ subunits are linked in a double-stranded fashion by the carbon backbone and they adopt a coplanar arrangement in a stair-like manner.¹⁹³ In both cases, Ni^{II}₂ and Ni^{III}₂ have been isolated. Electrochemical redox transformation shows a single two-electron wave, indicating that no strong intramolecular interaction of the metal ions exists. Reduction is more difficult and less reversible for (792) with the shorter spacer unit, because the electron-donating alkyl bridge creates a more electron-rich environment.

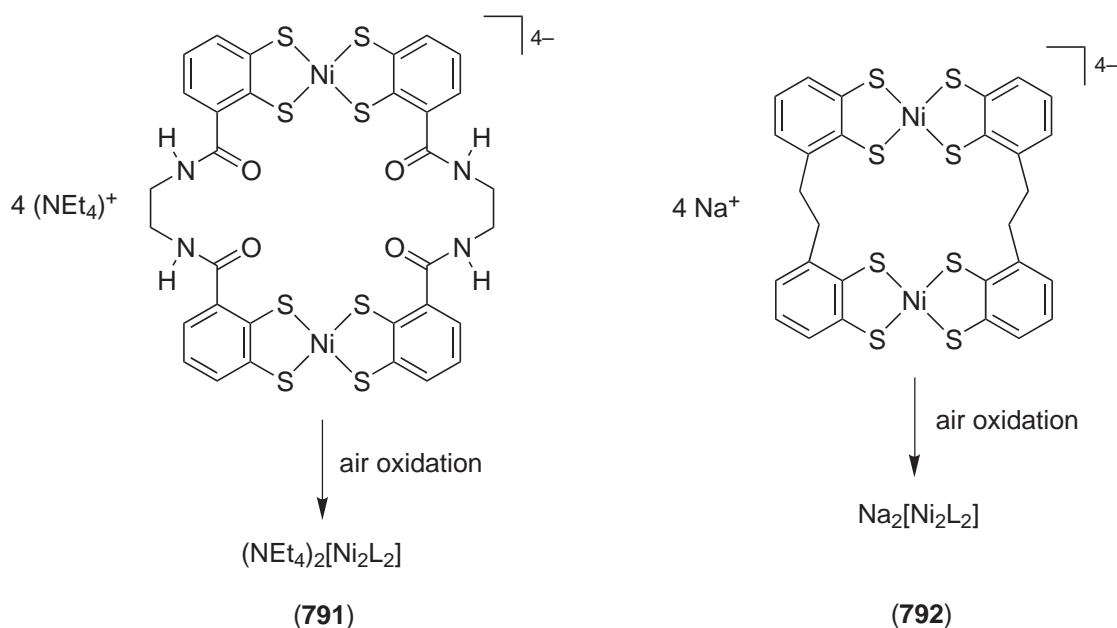

6.3.4.12.5 Heterobimetallic Ni/Fe complexes as model systems for the Ni/Fe hydrogenase and CO-dehydrogenase/acetyl CoA synthase active sites

Thiolate-bridged dinickel complexes and, in particular, heterobimetallic Ni/Fe complexes have attracted much interest as model systems for the hydrogenase enzymes. A review covering this

field of biomimetic Ni coordination chemistry has appeared.¹⁹⁸³ An important synthetic route to thiolate-bridged heterobimetallic complexes is the addition of a solution of a metal complex with labile ligands to a mononuclear metal thiolate complex, although the high tendency of metal thiolate complexes to aggregate and to form homometallic clusters is an often encountered obstacle to this strategy. In order to control the cluster-forming process, the thiolates of the mononuclear thiolate precursor are often incorporated within a polychelate ligand that wraps around the metal center. The chelate effect then prevents dissociation of the thiolate-containing ligand and directs subsequent reactions with metal salt and complex reagents towards the terminal thiolate donors. Mixed NiFe complexes have most commonly been obtained via reaction of a Ni^{II} thiolate complex with a labile Fe species, giving a range of synthetic models for the NiFe hydrogenase active site.

Reaction of the Ni^{II} thiolate species [Ni(L)] (L = *N,N'*-diethyl-*N,N'*-bis(2-mercaptoethyl)-1,3-propanediamine) with the tetraiodo cluster anion [Fe₄S₄I₄]²⁻ yields [Ni(L)(Fe₄S₄I₂)(L)Ni] (793).¹⁹⁸⁴ It incorporates a dithiolate bridge between Ni and Fe centers with a Ni—Fe distance of 2.827(1) Å and exhibits a quasi-reversible oxidation wave at $E_{1/2} = +0.15$ V (vs. SCE). The corresponding monosubstituted cluster anion [Ni(L)Fe₄S₄I₃]⁻ (794) was also reported.¹⁹⁸⁵

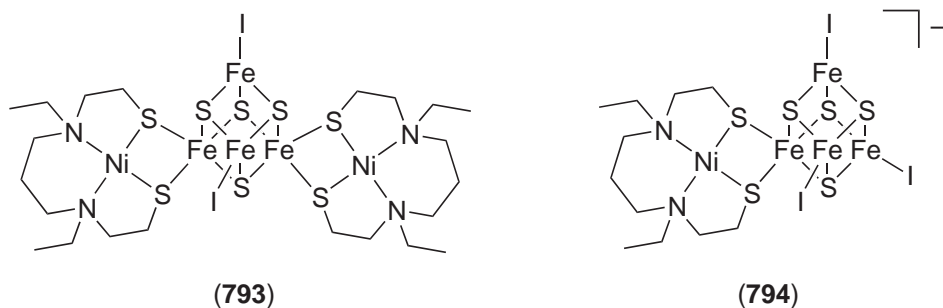

The same Ni^{II} thiolato building block and the respective methyl derivative have also been utilized in various other reactions with Fe^{II} complexes. Treatment with [Fe(H₂O)₆](ClO₄)₂ gave [Ni(L)₃Fe](ClO₄)₂ (795), the single-crystal X-ray structure of which confirms the formation of a Ni₃Fe cluster with mono- and dithiolato bridges.^{1986,1987} It contains a central high-spin Fe^{II} surrounded by five thiolate donors, which form bridges to three square planar Ni^{II} centers. The remaining sixth thiolate is at a nonbonding distance of 3.197(8) Å, while the Ni^{II} centers have retained their square planar arrangements. The Ni—Fe distances in (795) are 2.976(4) Å, 3.123(3) Å, and 3.269(4) Å. A further Ni—Fe complex derived from [Ni(L)] was obtained from the reaction with [Fe(CO)₂(NO)₂] to give [Ni(L)Fe(NO)₂] (796).¹⁹⁸⁸ It shows the Ni^{II} ion in a square planar N₂S₂ environment with the Fe center in a distorted tetrahedral coordination environment ligated by two bridging thiolates and two terminal NO ligands. As the NO groups are bound in a linear fashion, they may be regarded as formally 3e⁻ donors. The oxidation state at Fe can therefore be assigned as -2 with the complex having an overall 18-electron configuration. The Ni—Fe distance is relatively short at 2.797(1) Å with the Ni—S—Fe angles somewhat acute at 76.11(4)°, similar to the angles of 74° observed in the NiFe hydrogenase active site.¹⁹⁸⁹ (796) exhibits a quasi-reversible oxidation at $E_{1/2} = -0.12$ V (vs. SCE) assigned to the Fe(-2/-1) couple on the basis that oxidation of [Ni(L)] does not occur below +0.86 V (vs. SCE).

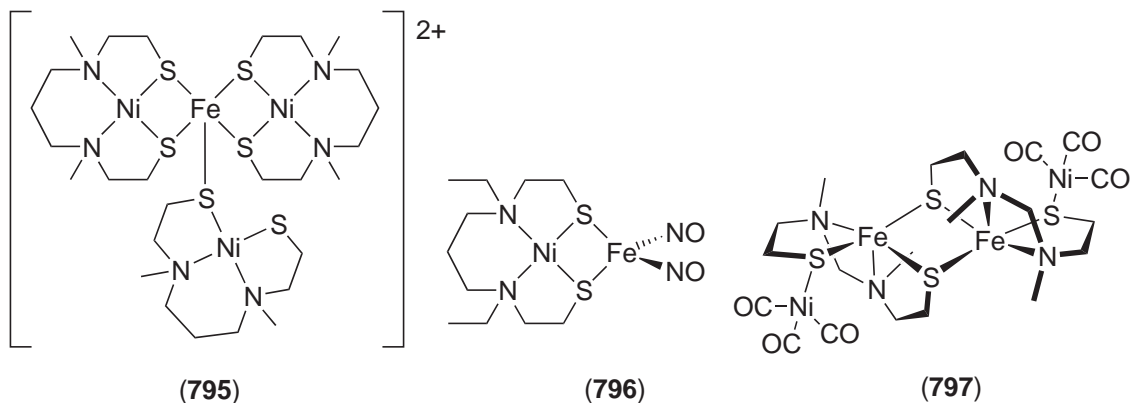

In a related approach, reaction of $[\text{Ni}(\text{dsdm})]$ ($\text{H}_2\text{dsdm} = N,N'$ -dimethyl- N,N' -bis(2-sulfanylethyl)ethylenediamine)) with $\text{K}[\text{HFe}(\text{CO})_4]$ gave $[\text{Fe}(\text{dsdm})\text{Ni}(\text{CO})_3]_2$ (**797**).¹⁹⁹⁰ In this case, however, reshuffling of the ligands and of the metal oxidation states occurred, since the product consists of a $\text{Ni}(0)\text{--Fe}^{\text{II}}\text{--Fe}^{\text{II}}\text{--Ni}(0)$ core, with one thiolate from each dsdm ligand bridging the two Fe^{II} centers and the remaining thiolates bridging the Fe^{II} and $\text{Ni}(\text{CO})_3$ moieties. The $\text{Ni}\text{--Fe}$ distance in (**797**) is relatively long at 3.899(1) Å.

A number of thiolate-bridged NiFe systems have been reported to result from $(\text{H}_2\text{L}')\text{--}(\text{L}' = N,N'$ -bis(2-mercaptoethyl)-1,5-diazacyclooctane), which reacts with Ni^{II} to first yield $[\text{Ni}(\text{L}')]_2$ as a suitable precursor complex. This has subsequently been treated with a variety of Fe^{II} compounds.^{1991–1993} For example, reaction with anhydrous FeCl_2 gives $[\text{Ni}(\text{L}')\text{FeCl}(\mu\text{-Cl}_2)\text{ClFe}(\text{L}')\text{Ni}]$ (**798**),¹⁹⁹³ in which the Ni^{II} and Fe^{II} ions have square planar and pseudo-square pyramidal geometries, respectively, and lie 3.100(1) Å apart. The thiolate donors and the bridging Cl ligands provide the basal plane to the square pyramid at Fe^{II} , with the terminal Cl occupying the axial site to give a planar $\text{Fe}_2(\mu\text{-Cl})_2$ core. (**798**) shows a reversible reduction at $E_{1/2} = -0.64$ V assigned to a $\text{Ni}^{\text{II}}/\text{Ni}^{\text{I}}$ couple, and an irreversible reduction at $E_{\text{pc}} = -1.53$ V (vs. NHE). The reaction of $[\text{Ni}(\text{L}')]_2$ with $[\text{Fe}_2(\text{CO})_9]$ leads to $[\text{Ni}(\text{L}')\text{Fe}(\text{CO})_4]$ (**799**).¹⁹⁹² In this case the Ni and Fe centers remain in their original oxidation states of +2 and 0, respectively, and the $\text{Fe}(\text{CO})_4$ fragment is simply bound to $[\text{Ni}(\text{L}')]_2$ via a single thiolate bridge at a large $\text{Ni}\text{--Fe}$ distance of 3.76(1) Å. (**799**) was one of the early examples that confirmed the ability of Ni-coordinated thiolates to bind to $\text{Fe}\text{--}(\text{CO})$ fragments with some control over stoichiometry. Upon oxidation, (**799**) forms $[\text{Ni}(\text{L}')\text{Fe}(\text{CO})_2(\text{L}')\text{Ni}](\text{BF}_4)_2$ (**800**) in which Fe^0 has been oxidized to Fe^{II} .¹⁹⁹² The Fe^{II} ion in (**800**) links two $\text{Ni}(\text{L}')$ units each through two thiolate bridges. The Ni ions remain in the Ni^{II} formal oxidation state in a square planar N_2S_2 donor set, and the $\text{Ni}\text{--S}$ distances do not change significantly while the $\text{Ni}\text{--Fe}$ distance decreases from 3.76(1) Å in (**799**) to 3.088 Å in (**800**), which is accompanied by a decrease in the $\text{Ni}\text{--S}\text{--Fe}$ angle from 89.3(4)° to 76.99(7)°.

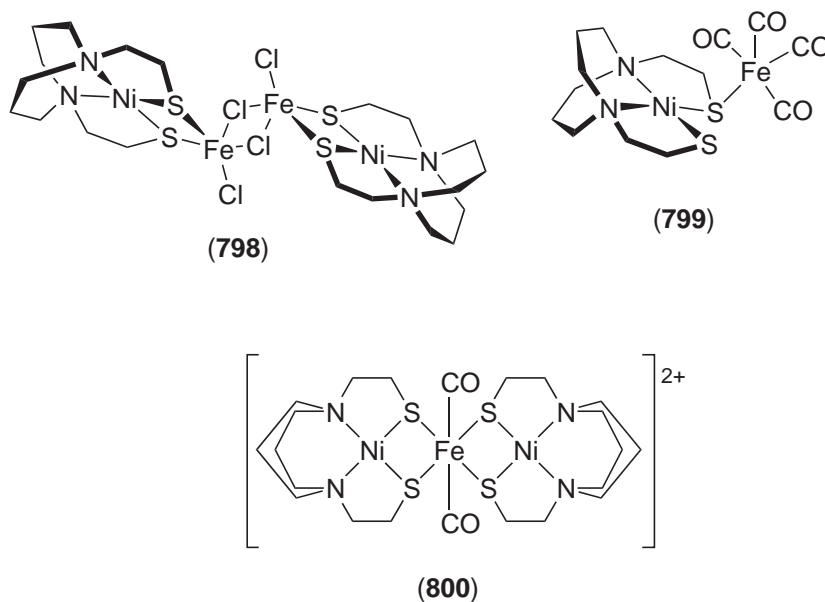

Reaction of pentadentate $(\text{H}_2\text{L}'')$ ($\text{L}'' = N,N'$ -dimethyl- N,N' -bis(2-mercaptoethyl)-bis(aminoethyl)sulphide) with Ni^{II} forms $[\text{Ni}(\text{L}'')]_2$. When treated with $[\text{FeCp}(\text{CO})_2\text{I}]$, this Ni^{II} thiolate complex gives rise to $[\text{Ni}(\text{L}'')\text{FeCpI}]$ (**801**), which is related to the reduced form of the NiFe hydrogenase enzyme.¹⁹⁹⁴ In (**801**), the thioether donor occupies the apical position of a square pyramidal coordination geometry, and the $\text{Ni}\text{--S}$ (thioether) bond (2.283(6) Å) is shorter than the $\text{Ni}\text{--S}$ (thiolate bridge) distances (2.308(6) Å and 2.315(6) Å). The $\text{Ni}(\mu\text{-S})_2\text{Fe}$ core exhibits a very acute $\text{Ni}\text{--S}\text{--Fe}$ bridging angle of 58–59° (compared with 74° in $[\text{NiFe}]$ hydrogenase from *D. gigas*),^{1989,1995} which brings the two metal ions within close proximity (2.54 Å, i.e., similar to the value of 2.5–2.6 Å observed for the $\text{Ni}\text{--Fe}$ distance in the $\text{Ni}\text{--SI}$ form of the enzyme.^{1996–1998}

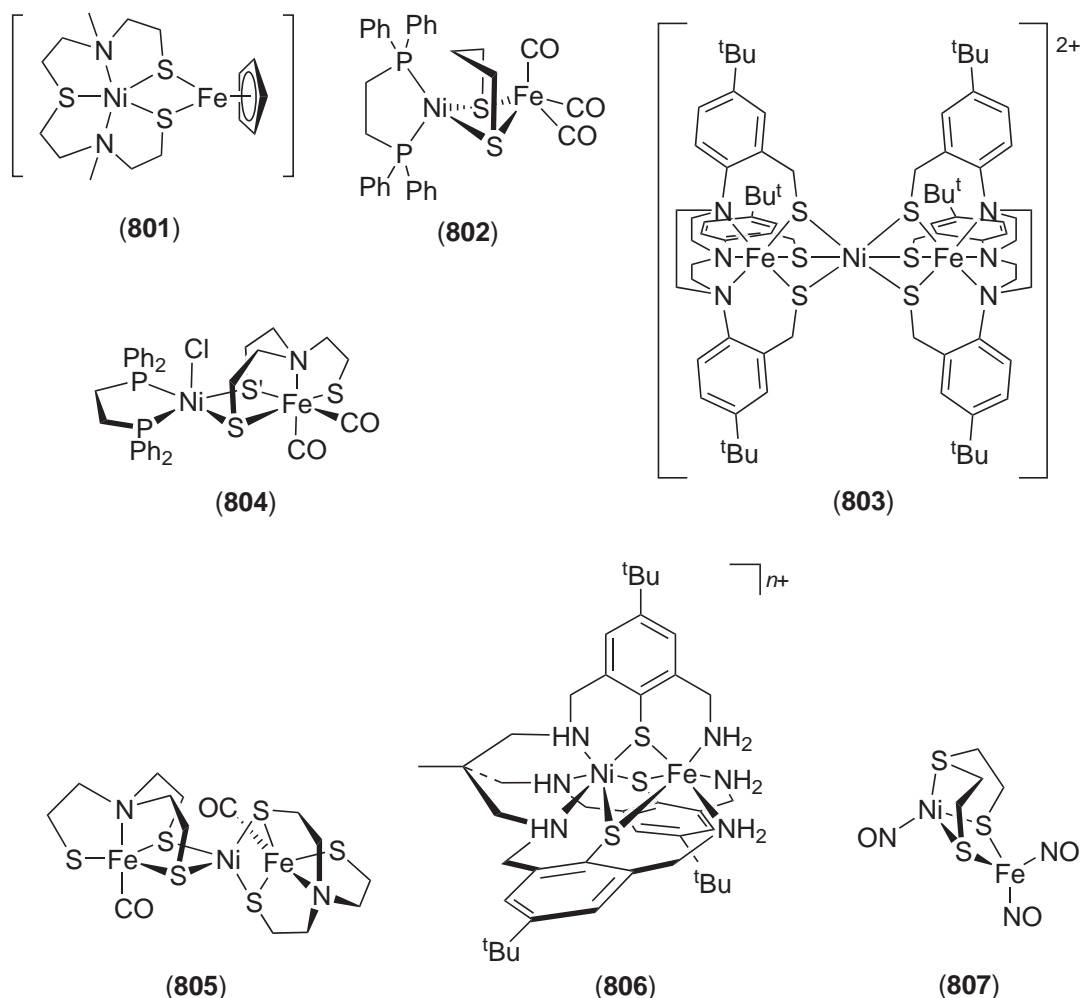

Instead of terminal N-donor ligands at the Ni center, soft phosphines have frequently been employed since these are better models for the soft cysteine sulfurs of the enzyme. For example, addition of $[\text{Fe}_3(\text{CO})_{12}]$ to $[(\text{dppe})\text{Ni}(\text{pdt})]$ (dppe = ethane-1,2-diphenylphosphine, pdt = 1,3-propanedithiolate)¹⁹⁹⁹ gives the neutral heterobimetallic complex $[(\text{dppe})\text{Ni}(\text{pdt})\text{Fe}(\text{CO})_3]$ (**802**).¹⁹⁹⁴ It should be noted that a bridging derivative of 1,3-propanedithiolate is relevant in the active site of [Fe]-only hydrogenase.^{2000,2001} In (**802**), the Ni coordination sphere has a distorted tetrahedral arrangement and the angle between the Ni–S1–S2 and Fe–S1–S2 planes of 80.3° compares with an angle of 81° in the enzyme.^{1989,1995,2002}

In a reverse methodology, construction of thiolate-bridged Ni–Fe cores starts from a chelating thiolate ligand already bound to Fe and subsequent reaction of with a source of Ni^{II} . A set of four redox-related complexes $[\text{Fe}(\text{L})\text{Ni}(\text{L})\text{Fe}]^{+/2+/3+/4+}$ ($\text{L}^{3-} = 1,4,7\text{-tris}(4\text{-}t\text{-butyl-2-mercaptobenzyl})\text{-}1,4,7\text{-triazacyclononane}$) was prepared using this approach.^{2003–2005} Reaction of the mononuclear species $[\text{Fe}(\text{L})]^{2005}$ with $\text{NiCl}_2 \cdot 6\text{H}_2\text{O}$ and subsequent metathesis yields $[\text{Fe}(\text{L})\text{Ni}(\text{L})\text{Fe}](\text{PF}_6)_2$ (**803**), the crystal structure of which confirms the three face-sharing thiolate bridged octahedra with two terminal Fe^{III} ions and a central Ni^{II} ion. (**803**) exhibits three reversible redox processes, two reversible oxidations and a reversible reduction at $E_{1/2} = +0.69\text{ V}$, -0.02 V , and -0.90 V (vs. Fc/Fc^+). It was concluded, however, that any assignment of the formal metal oxidation states to individual centers via a localized charge model was inappropriate, because the one-electron oxidations and reductions affected all the three metal ions simultaneously.²⁰⁰⁵ It was confirmed that the Fe ions remained equivalent in all four compounds, consistent with some computational studies of the active site of [NiFe] hydrogenase from *D. gigas*.^{2006,2007} According to these studies, redox chemistry of the active site involves the cluster as a whole, but the Fe remains in the same redox state throughout.

Several bis(thiolato) bridged NiFe complexes have been prepared by the reaction of $[\text{Fe}(\text{L})(\text{CO})]^- (\text{L}^{3-} = \text{N}(\text{CH}_2\text{CH}_2\text{S})_3^{3-})$ and appropriate Ni^{II} species. For example, treatment with $[\text{dppeNiCl}_2]$ under CO gave $[\{\text{Fe}(\text{L})(\text{CO})_2\text{-S,S'}\}\text{NiCl}(\text{dppe})]$ (**804**) where the Ni^{II} is found in a distorted square pyramidal geometry with two bridging thiolate moieties occupying two *cis* positions in the basal plane.^{2008,2009} The remainder of the coordination sphere comprises a dppe molecule in the basal plane and a Cl^- ion at the axial position. (**804**) was the first literature example of a model complex featuring a bis-thiolate bridged heterodinuclear Ni—Fe center with CO at the Fe^{II} . When the reaction was performed under nitrogen, the monocarbonyl rather than the dicarbonyl complex was formed. The CO ligands may also be replaced by a single NO.²⁰¹⁰ Reaction of $[\text{Fe}(\text{L})(\text{CO})]^-$ with the DMSO solvate of NiCl_2 gave a trinuclear FeNiFe complex (**805**) in which the central Ni^{II} ion resides in an almost regular tetrahedral thiolate environment.²⁰⁰⁹ Complex (**810**) resulted from the reaction of dinuclear (**808**) with labile (**809**).²⁰¹¹ Its bridging Ni—S distances (2.230–2.241 Å) are distinctly longer than the terminal Ni—S distances (2.14–2.25 Å), but the latter are typical for diamagnetic four-coordinate Ni^{II} thiolate species. The $[\text{Ni}(\text{SR})_2]$ fragment withdraws electron density from the Fe center of the $[\text{Fe}(\text{CO})\text{L}_2(\text{SR})_2]$ core, thus causing a blue-shift of the $\nu(\text{CO})$ frequency.

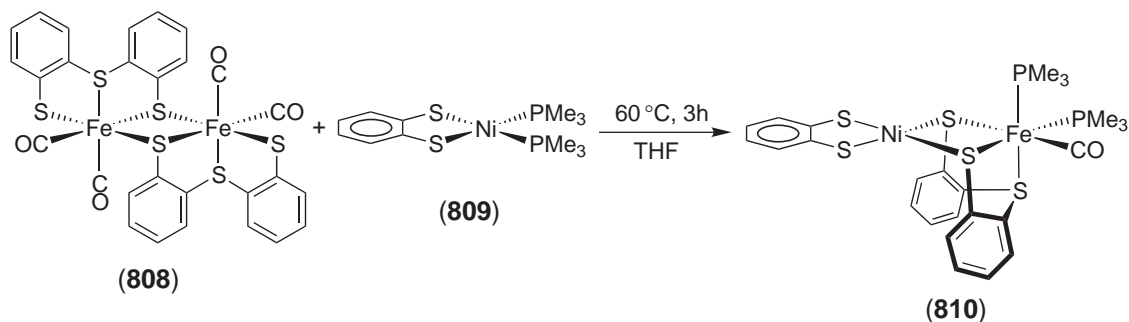

A particularly elaborate strategy for obtaining NiFe heterobimetallic complexes uses preorganized dinucleating ligand scaffolds, e.g., for the synthesis of complex (**806**) which is based on a compartmental mixed amine thiophenolate ligand that enforces triple thiolate bridging.^{2012,2013} (**806**) was prepared by sequential addition of NiCl_2 and FeCl_2 to a solution of the ligand. The synthesis does not formally involve the formation of the Ni^{II} complex as a direct precursor, but presumably this occurs *in situ*. (**806**), like the related compounds (**803**),^{2003–2005} has interesting electrochemical properties. It shows a reversible oxidation at $E_{1/2} = +0.45$ V and a reversible reduction at $E_{1/2} = -0.43$ vs. SCE, and these redox states were characterized as: $[\text{Ni}^{\text{III}}(\text{L})\text{Fe}^{\text{III}}]^{3+} \Leftrightarrow [\text{Ni}^{\text{II}}(\text{L})\text{Fe}^{\text{III}}]^{2+} \Leftrightarrow [\text{Ni}^{\text{II}}(\text{L})\text{Fe}^{\text{II}}]^+$.

Dinuclear Ni^{II} complexes can also serve as precursors for the synthesis of heterobimetallic NiFe systems. Thus, treatment of $[\text{Ni}(\mu\text{-SCH}_2\text{CH}_2\text{SCH}_2\text{CH}_2\text{S})_2]$ with $[\text{Fe}(\text{NO})_2(\text{SePh})_2]^-$ in the presence of NaNO_2 yields (**807**),²⁰¹⁴ illustrating that a monometallic fragment with terminal thiolates is not a prerequisite for forming NiFe complexes (mononuclear fragments may well be generated from the dinickel starting material in solution, however). In (**807**) the Ni is presumably reduced to Ni^0 and is found in a distorted tetrahedral arrangement with S(thioether)—Ni—S(thiolate) angles of ca. 90° . The very acute Fe—S—Ni angle gives rise to a Ni—Fe distance of 2.8 Å, which is similar to the characteristics of the oxidized form of the NiFe active site of *D. gigas* hydrogenase.

In view of the X-ray crystallographic findings for the Ni/Fe active site of carbon monoxide dehydrogenase (CODH),^{41,42} which showed the Ni to be part of an $[\text{Ni—Fe—S}]$ cluster, the single example of a synthetic NiFe_3S_4 cubane-type cluster (**812**) is of particular interest.²⁰¹⁵ Examples for larger mixed Ni/Fe/S clusters include $[\text{Fe}_3\text{Ni}_5\text{S}_6\text{I}_8]^{4-}$.²⁰¹⁶ Previous to the X-ray crystal structure of CODH, it was believed that the Ni is not part of the Fe/S cluster but is attached to it via a bridging thiolate (from cysteine). Hence, attempts have been made to prepare CODH model systems with the $\text{Ni}(\mu\text{-SR})[\text{Fe}_4\text{S}_4]$ motif. Prominent examples are compounds (**793**), (**811**), and (**813**), in which two Ni^{II} are covalently bound to an Fe_4S_4 core via bridging thiolates. The Ni coordination geometry remains nearly unchanged with respect to the mononuclear Ni precursor complexes.^{1984,2017}

Mononuclear Ni complexes have been investigated as functional models for individual steps of the reactions mediated by the CODH/acetyl coenzyme A synthase.^{2018–2020} These are mentioned in the respective sections on mononuclear Ni complexes. The dinuclear type (**770**) complexes are

active catalysts for CO oxidation in aqueous medium with electron transfer to methylviologen and production of CO₂.²⁰²¹ The proposed mechanism involves CO interaction with the Ni^{II} and subsequent nucleophilic attack by water, followed by decarboxylation of the Ni-COO⁻ intermediate by the methylviologen.

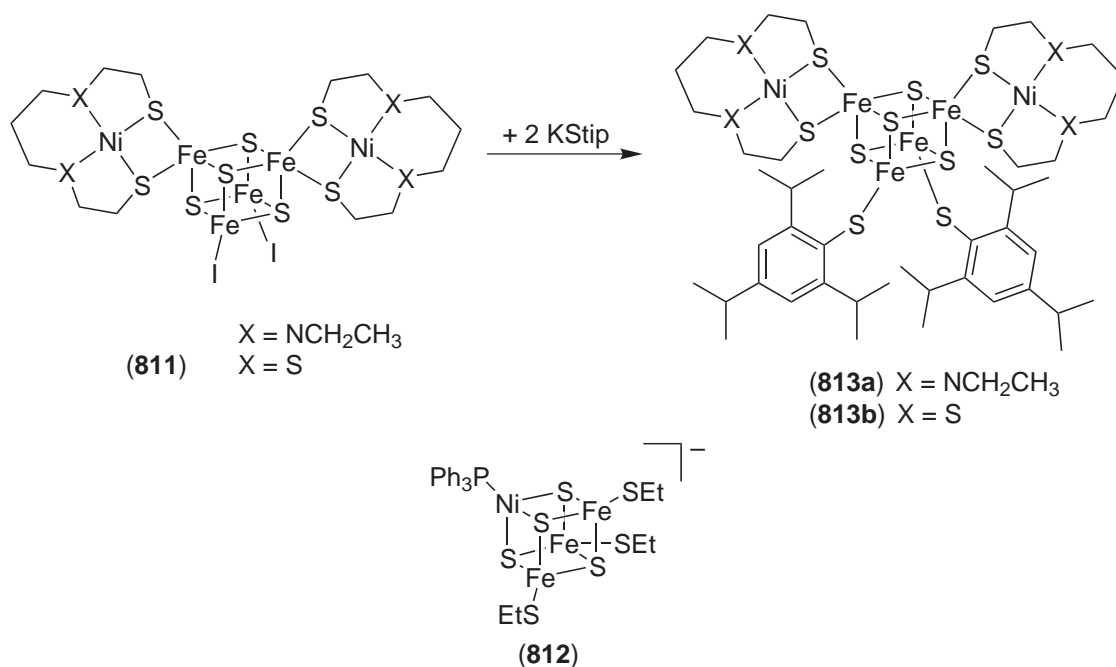

6.3.4.12.6 Di- and oligonuclear complexes with dinucleating ligands incorporating diazine, diazole, and triazenido bridging units

The N—N groups of diazoles and related compounds (e.g., pyrazolate, triazolate) as well as the N—N group of diazines (like pyridazine, phtalazine) are very useful bridging units in Ni^{II} coordination chemistry. Such dinuclear complexes have been studied, *inter alia*, with respect to magnetic and electronic exchange interactions as well as cooperative substrate activations. Some what related dinucleating ligands are those based on a naphthyridine unit. The intrinsic C₂ symmetry of the naphthyridine-based dinickel core (e.g., (814b)) has been exploited in enantioselective catalytic reactions.²⁰²²

While attempts to prepare binary Ni^{II} pyrazolates by reacting pure metal with molten pyrazoles were largely unsuccessful, air-stable polymeric compounds of composition [Ni(4-Xpz)₂]_x (X = H, Cl) as well as the corresponding 3,5-dimethylpyrazole derivatives [Ni(4-Xdmpz)₂]_x were obtained by the reaction of nickelocene with the appropriate pyrazole.²⁰²³ Extended-chain double pyrazolate-bridged structures are assumed in all cases, but spectroscopic and magnetic data indicate a planar {NiN₄} chromophore in 4-Xpz ligands vs. a tetrahedral {NiN₄} chromophore in the case of the more bulky 4-Xdmpz compounds. Pyrazolate-bridged dinickel systems may also be obtained from mononuclear precursors by thermal transformation. For example, bis(3,5-dimethylpyrazole-1-carbodithioato)nickel(II) (815) undergoes a facile irreversible decomposition to give the dimeric complex (816).²⁰²⁴

Dinickel complexes (817), which contain both bridging and terminal pyrazolate ligands, have allowed the detection of different types of dynamic processes, namely *N,N'* metal shift, rotation of the terminal ligand, and bridging-terminal intermolecular pyrazolate exchange.²⁰²⁵ Spin saturation transfer experiments reveal a slow motion of the terminal pyrazolate ligand that consists of a combination of *N,N'*-metallotropic shift and rotation around the Ni—N bond, but exchange of the bridging and terminal pyrazolate ligands was only detected as a very slow process in cross experiments with different pyrazolate ligands. In contrast, (817)·HBr displays dynamic NMR spectra due to rapidly interconverting isomers in solution.

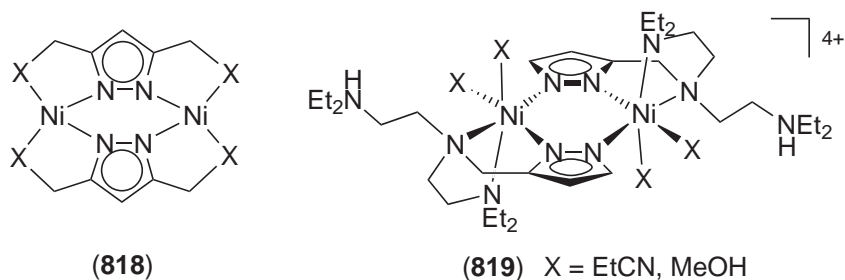
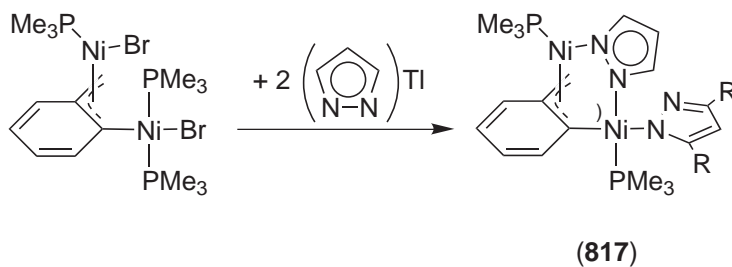
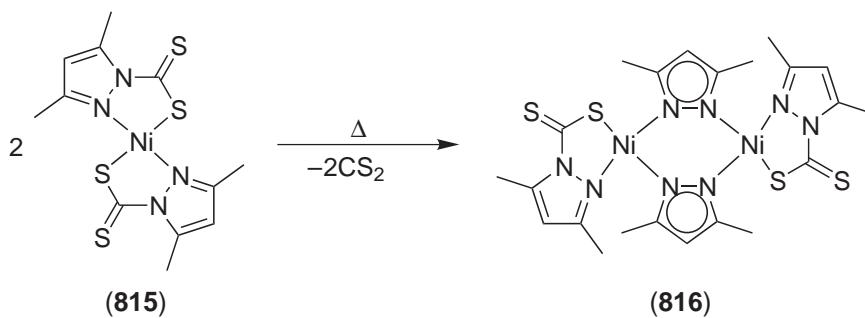
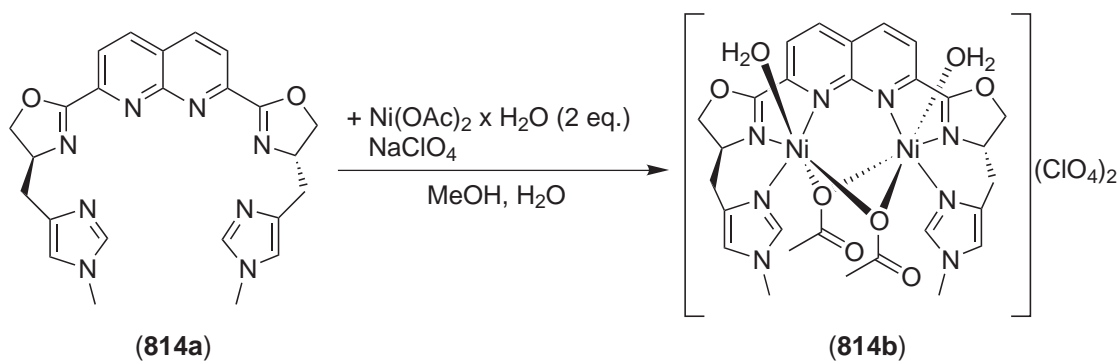

Chelating side arms have been attached to the 3- and 5-positions of the dinucleating pyrazole, in order to control the nuclearity and the characteristics of pyrazole-bridged dinickel species. Bis(pyrazolato)-bridged dinickel(II) complexes of general type (818) are formed with 3,5-bis(2'-pyridyl)pyrazole²⁰²⁶ and pyrazole-3,5-dicarboxylic acid.²⁰²⁷ In the former case, a complex with two octahedral Ni^{II} ions due to coordination of methanol solvent molecules in the axial positions has been structurally characterized.²⁰²⁶ Bis(pyrazolato)-bridged dinickel systems may also form with ligands carrying a single chelate side arm. In this case, open coordination sites remain for solvent (or other coligand) binding, e.g., in (819).²⁰²⁸

Type (820) dinickel complexes offer the opportunity of substrate binding within the bimetallic pocket, and highly preorganized complexes of this type have also been employed as model systems for the urease metalloenzyme (see Section 6.3.4.12.7). The Ni—Ni separation in type (820) complexes can be

controlled by changing the lengths of the chelating side arms in the 3- and 5-positions of the heterocycle. For example, in **(821)** with longer side arms (i.e., six-membered outer chelate rings) the Ni···Ni distance is around 3.6 Å and an OH bridge is found within the bimetallic pocket. In contrast, the shorter side arms (i.e., five-membered outer chelate rings) in **(822)** pull the two Ni^{II} back and apart, thus enforcing a larger Ni···Ni distance of around 4.4 Å which prevents the small OH group from spanning the metal ions. Instead, an additional water molecule is incorporated to give an intramolecular (H₃O₂)⁻ unit with a short O—H—O hydrogen bridge.^{422,2028} A (H₃O₂)⁻ group can also span four Ni^{II} ions, as has been shown in tetranickel complexes with phtalazine- or phenolate-derived dinucleating ligands (type **(823)** and **(824)**, respectively).^{2029,2079}

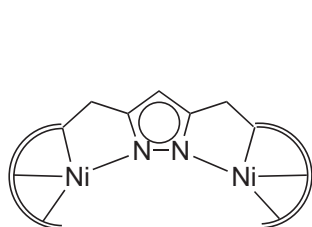
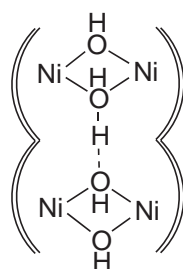
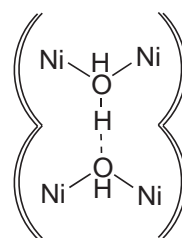
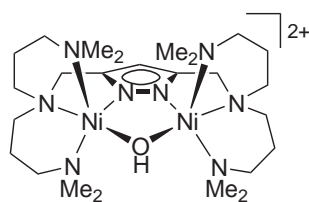
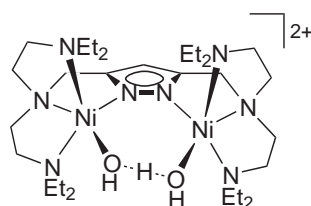
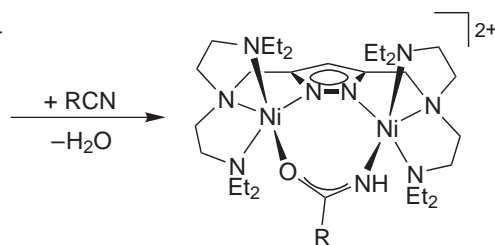
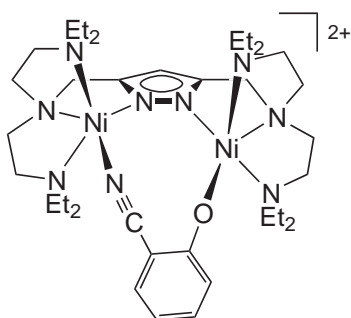
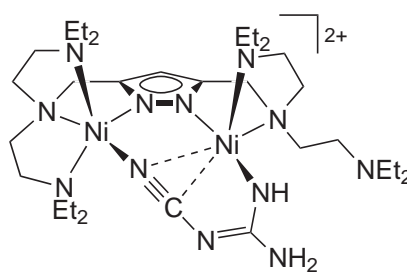
**(820)****(823)****(824)****(821)****(822)****(825)**
(R = Me, C₂H₃, Ph)**(826)****(827)**

The H₃O₂ function in **(822)** is hydrolytically active and is capable of, *inter alia*, nitrile hydration to give complexes **(825)** with N,O-bridging amidato groups.⁴²² Replacement of the additional water by the end-on bound nitrile is assumed as a first step in this reaction, which is corroborated by the structural characterization of **(826)**.²⁰³⁰ The particular geometric constraints in **(822)** can also give rise to unusual binding modes within the bimetallic pocket, e.g., a unique cyanoguanidine coordination with enforced side-on π -interaction of the C \equiv N group with a high-spin Ni^{II} site **(827)**.²⁰³⁰

In the case of macrocyclic tacn side arms, stability constants of type **(820)** dinickel complexes are considerably higher and six-coordination can be achieved due to the binding of additional coligands, either at both Ni^{II} (in **(828)**)²⁰³¹ or at only one of them (in **(829)**).²⁰⁸²

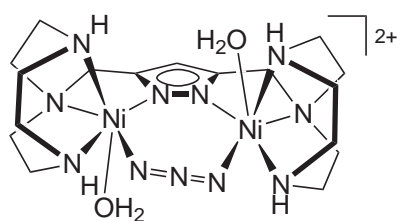
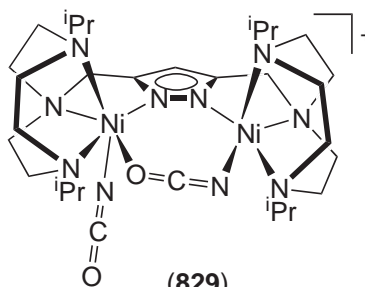
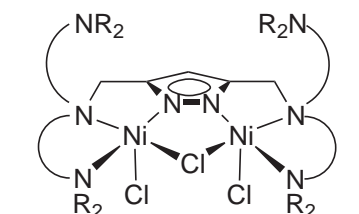
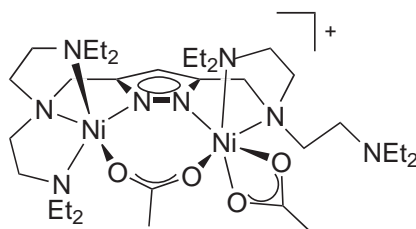
**(828)****(829)****(830)****(831)**

With open-chain chelate arms at the heterocycle, however, coordination of additional coligands may be accompanied by detachment of some ligand side arms, e.g., in **(830)** or **(831)**.^{422,2032,2072}

A pyrazole ligand bearing Schiff base chelate arms with bulky substituents forms a hexanuclear Ni^{II} cage complex **(832)** that incorporates an interstitial μ_6 -Cl atom (Figure 31). The cage structure is opened up in the presence of coordinating solvents to give, *inter alia*, **(833)** (from ethanol).²⁰³³

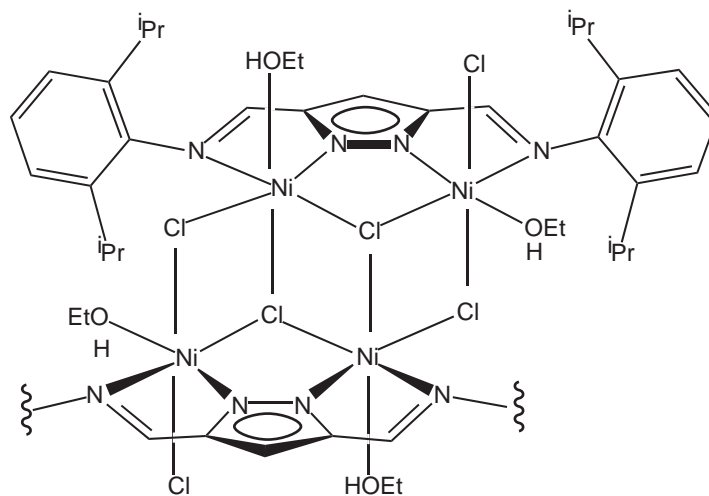
**(833)**

Unsymmetrical compartmental pyrazole ligands with different chelating side arms in the 3- and 5-positions have been developed for the controlled synthesis of unsymmetric dinickel(II)

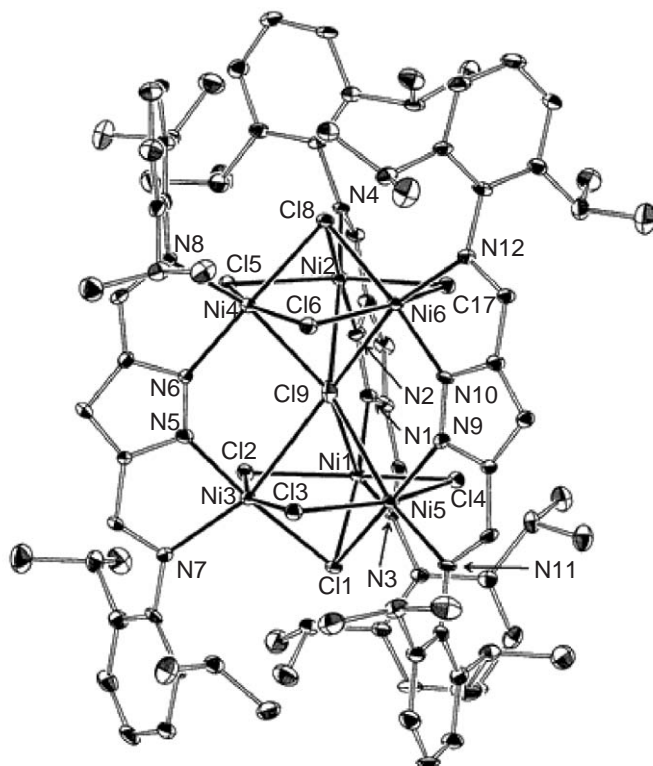
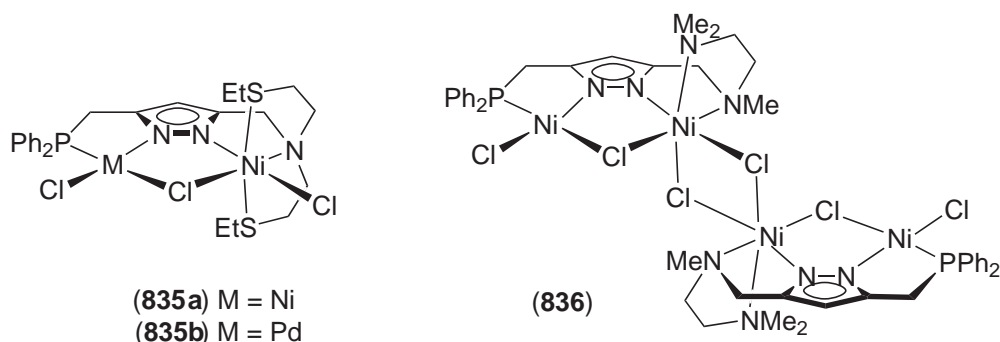
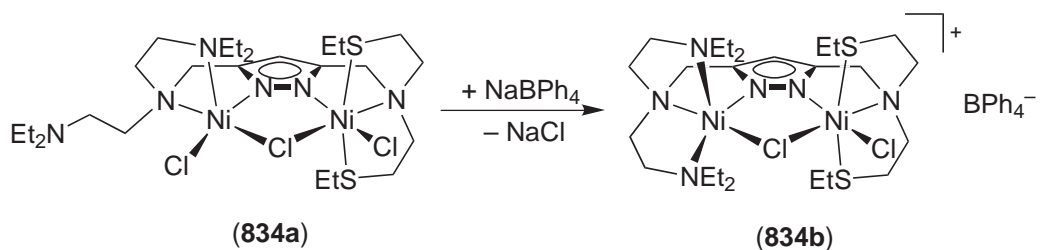

Figure 31 Hexanuclear Ni^{II} cage complex (**832**) with an interstitial μ_6 -Cl atom²⁰³³ (reproduced by permission of the Royal Society of Chemistry).

complexes or heterobimetallic NiPd compounds, e.g., (**834**)–(**836**).^{2034,2035} (**835a**) and (**836**) are mixed-spin systems with one tetracoordinate low-spin and one hexacoordinate high-spin Ni^{II} per pyrazolate-based bimetallic unit. Structural, spectroscopic, and electrochemical characteristics of these systems reveal that the coordination subunits are only moderately coupled with regard to conformational and electronic aspects.²⁰³⁵



Dinickel(II) complexes of dinucleating 1,2,4-triazole- and pyridazine-based ligands have mainly been studied with respect to magnetic exchange interactions. With 1,2,4-triazole, Ni^{II} forms oligomeric and polymeric coordination compounds. Using 3,5-dialkyl substituted triazoles and thiocyanate as a coligand, trimeric species could be isolated and characterized crystallographically.²⁰³⁶ Subsequently, a series of di- and trinuclear triazole-based Ni^{II} complexes have been characterized and their magnetic properties investigated,^{2037–2041} and related complexes have also been obtained with 2,5-diamino-1,3,4-thiadiazole.²⁰⁴² Triply triazolato-bridged systems show anti-ferromagnetic coupling with J ranging from -10 cm^{-1} to -20 cm^{-1} (Table 12). In the case of two triazole or thiadiazole bridges and an exogenous coligand, the exchange was found to be ferromagnetic with NCS⁻ but antiferromagnetic with OH⁻.

3-(Pyridin-2-yl)-1,2,4-triazole and 4-amino-3,5-bis(pyridin-2-yl)-1,2,4-triazole give compounds (837) and (838), respectively, with solvent or chloride coligands filling the remaining sites of the distorted octahedral environment.^{2043,2044} A similar constitution is indicated by FAB mass spectrometry for Ni^{II} complexes of (839).²⁰⁴⁵ Weak to moderate antiferromagnetic coupling is observed in these cases. 4-Amino-3,5-bis(hydroxymethyl)-1,2,4-triazole (840), however, forms a tetranuclear complex with a Ni₄O₄ cubane cluster where three ligands are singly deprotonated and one ligand is doubly deprotonated. The latter bridges two Ni₄O₄ entities to give dumbbell-like pairs of clusters. Hexacoordination of each Ni^{II} ion is completed by a thiocyanate anion.²⁰⁴⁶ The nature of the magnetic exchange is overall antiferromagnetic.

Table 12 Magnetic exchange parameter in triply triazolato-bridged Ni^{II} complexes.

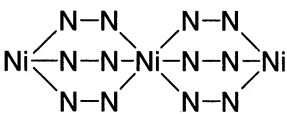
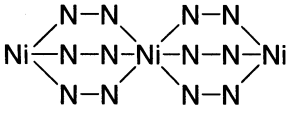
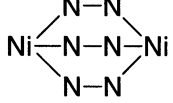
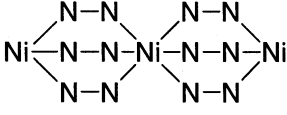
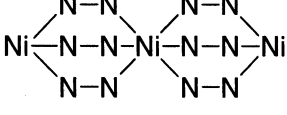
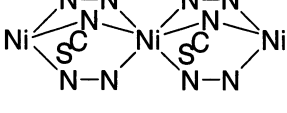
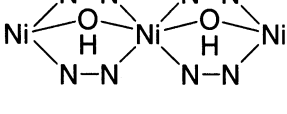
Compound	Bonding scheme	J/cm^{-1}
$[\text{Ni}_3(\text{L}^4)_6(\text{H}_2\text{O})_6]^{6+}$		-18.8
$[\text{Ni}_3(\text{L}^5)_8(\text{NCS})_4]^{2+}$		-20
$[\text{Ni}_2(\text{L}^6)_4(\text{NSC})_4(\text{H}_2\text{O})]$		-17.4
$[\text{Ni}_3(\text{L}^7)_{12}]^{6+}$		-14
$[\text{Ni}_3(\text{L}^3)_6(\text{NCS})_6]$		-10
$[\text{Ni}_3(\text{L}^2)_6(\text{NCS})_6]$		+20
$[\text{Ni}_3(\text{L}^1)_4(\text{NCS})_4(\text{OH})_2(\text{OH}_2)_2]$		-10

$\text{L}^4 = 4$ -Ethyl-, $\text{L}^5 = 4$ -*tert*-butyl, $\text{L}^6 = 4$ -allyl-, $\text{L}^7 = 4$ -*tert*-butyl-3-methyl-1, 2, 4-triazole.

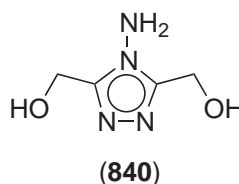
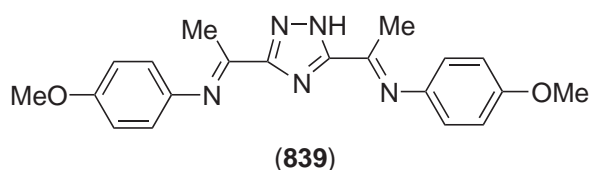
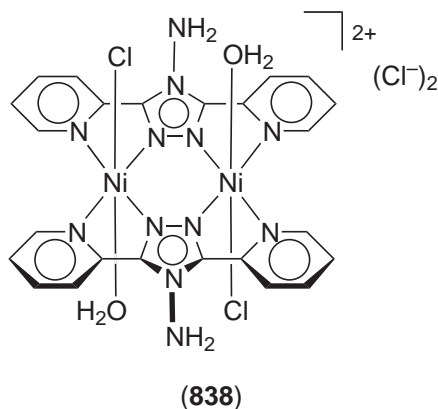
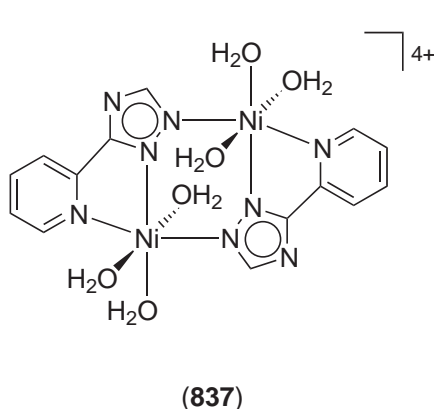

The Ni^{II} complex of bis(pyridazine)carboxamide can act as a bidentate ligands towards other metal ions, e.g., in **(841)**.^{2047–2049} 3,6-Bis(2-pyridyl)pyridazine (dppn, **(842)**) forms a tetranickel complex [Ni₄(μ-OH)₂(μ-dppn)₄(μ-H₂O)₂]⁶⁺ with two central H₃O₂ units spanning the four metal ions. Each Ni atom is six-coordinate with distorted octahedral {N₄O₂} geometry.²⁰⁵⁰ 3,6-Dicarboxylatopyridazine (**(843)**) and 3,6-bis(1'-pyrazolyl)pyridazine (**(844)**) give the typical doubly bridged [Ni₂L₂(H₂O)₄] complexes with water in the axial positions. The magnetic coupling constant *J* (for the Hamiltonian $H = -2JS_1S_2$) is around -15 cm^{-1} .^{2051,2052} If longer and oligodentate chelate arms are attached to the pyridazine or phtalazine heterocycle, preorganized bimetallic systems such as **(845)** can be obtained.^{2053–2055} Dinickel(II) complexes of phtalazine-derived compartmental ligands have been investigated as model systems for the urease metalloenzyme (see below).^{2079–2081}

3,6-Bis(2-pyridyl)-1,2,4,5-tetrazine (bptz, **(846)**) can act as a dinucleating ligand towards Ni^{II}.²⁰⁵⁶ From the reaction of [Ni(MeCN)₆]²⁺ with bptz, tetranuclear squares [Ni₄(bptz)₄(MeCN)₈]⁸⁺ or metallapentagons [Ni₅(bptz)₅(MeCN)₁₀]¹⁰⁺ have been isolated, depending on the choice of the templating counteranion (ClO₄⁻ or BF₄⁻ vs. SbF₆⁻).^{2057,2058}

In contrast to diazine heterocycles, ligands based on a N—N single bond derived from hydrazine have rarely been used as bridging scaffolds in Ni chemistry. Ligands **(847a–c)** contain a flexible diazine unit and terminal pyridine and pyrazine residues, respectively. **(847a)** forms a spiral-like dinickel(II) complex, in which three ligands wrap themselves around the six-coordinate metal ions. The diazine N atoms act as bridging groups, and the pyridine-N ligate to the remaining coordination sites.²⁰⁵⁹ The magnetic moment is close to the value expected for uncoupled Ni^{II} centers. **(847b)** and **(847c)** form tetranuclear compounds [Ni₄(L)₄(H₂O)₄]⁴⁺, where the Ni ions are linked solely by alkoxo O atoms to form a square [Ni₄(μ₂-O)₄] array and are coupled antiferromagnetically.²⁰⁶⁰

The single N atom of pyridine can also bridge two Ni^{II} ions. Pentadentate ligands **(848a)** and **(848b)** in their twofold deprotonated form give helical dinickel complexes, in which the metal ions are bridged by the two pyridine-N and are ligated by two donor atoms of one chelate arm of each ligand, featuring overall six-coordination.^{2061,2062}

Triazenido ligands can exhibit various coordination modes, and they can also act as a bridge spanning two Ni^{II} ions. A representative example is complex **(849)**, where three 1,2-bis(phenyl-triazenido)benzene ligands encapsulate a Ni(μ-OH)₂Ni core.²⁰⁶³

6.3.4.12.7 Model complexes for the urease active site

Urease is an exceptional metallohydrolase that contains two proximate Ni^{II} ions within its active site.^{24,25} It efficiently catalyzes the hydrolysis of urea to finally give carbon dioxide and two moles

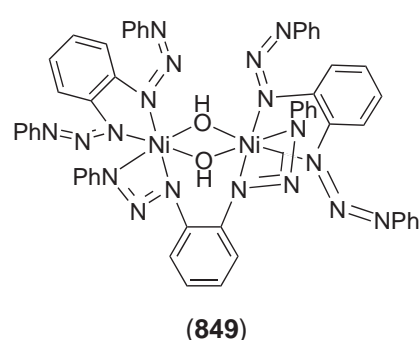
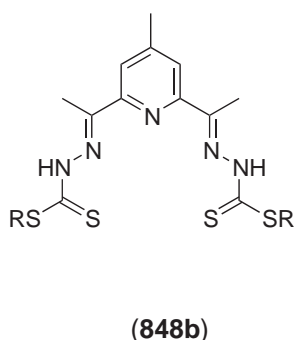
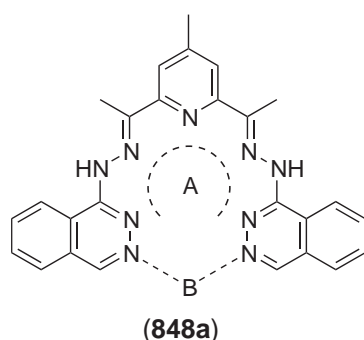
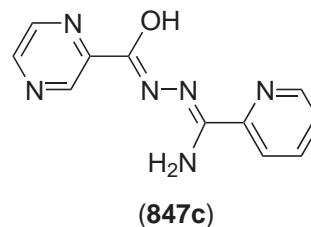
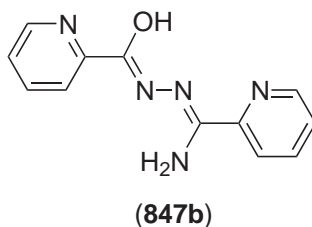
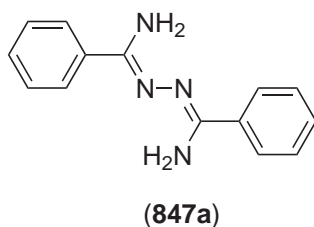
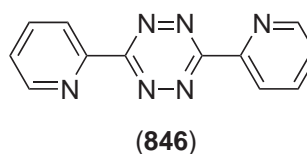
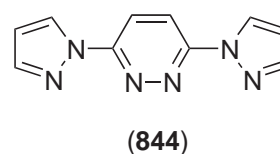
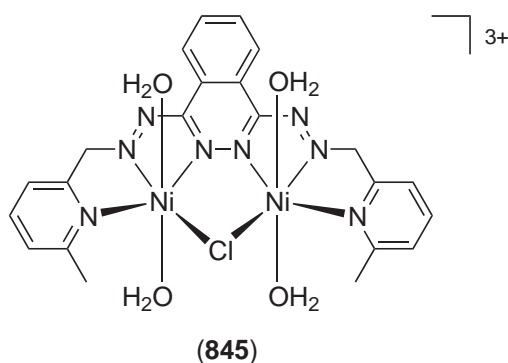
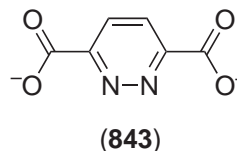
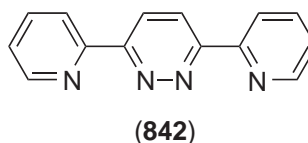
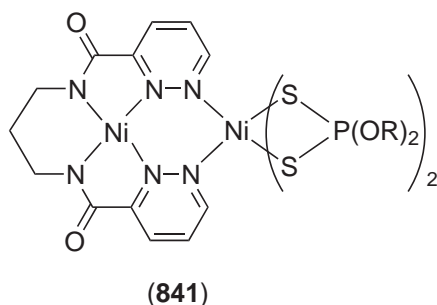

of ammonia. Due to the exceptional stability of urea and the importance of urea degradation for environmental, agricultural and medical sciences, the urease enzyme and its mode of action has received much attention. Since the first X-ray crystal structure of microbial urease was published in 1995,²³ accumulating crystallographic evidence has meanwhile provided a detailed picture of the enzyme active site and a solid background for an understanding of its mechanism of catalysis.^{26,27} The initially proposed mechanism of urease activity assumes that urea is activated by coordination to one Ni^{II} ion in conjunction with extensive hydrogen bonding within the active

site pocket of the protein and is subsequently attacked by a nucleophilic hydroxide terminally bound to the opposite Ni^{II}.²⁰⁶⁴ The resulting carbamate then decomposes further to produce carbonic acid and another molecule of ammonia (Scheme 12, left-hand sequence). Based on the crystal structures of urease inhibited by either phosphate or diamidophosphate, as well as on the basis of model calculations, an alternative mechanism has been proposed and the sequence of events outlined in the right-hand part of Scheme 12 now seems most probable.^{28,29} It implies that urea first coordinates to one nickel ion through its carbonyl oxygen atom, followed by a transition towards a bridging binding mode and concomitant nucleophilic attack by the bridging hydroxide. However, details of this process are still under debate, and cyanate has also been proposed as a possible intermediate in the urease mechanism.²⁰⁶⁵

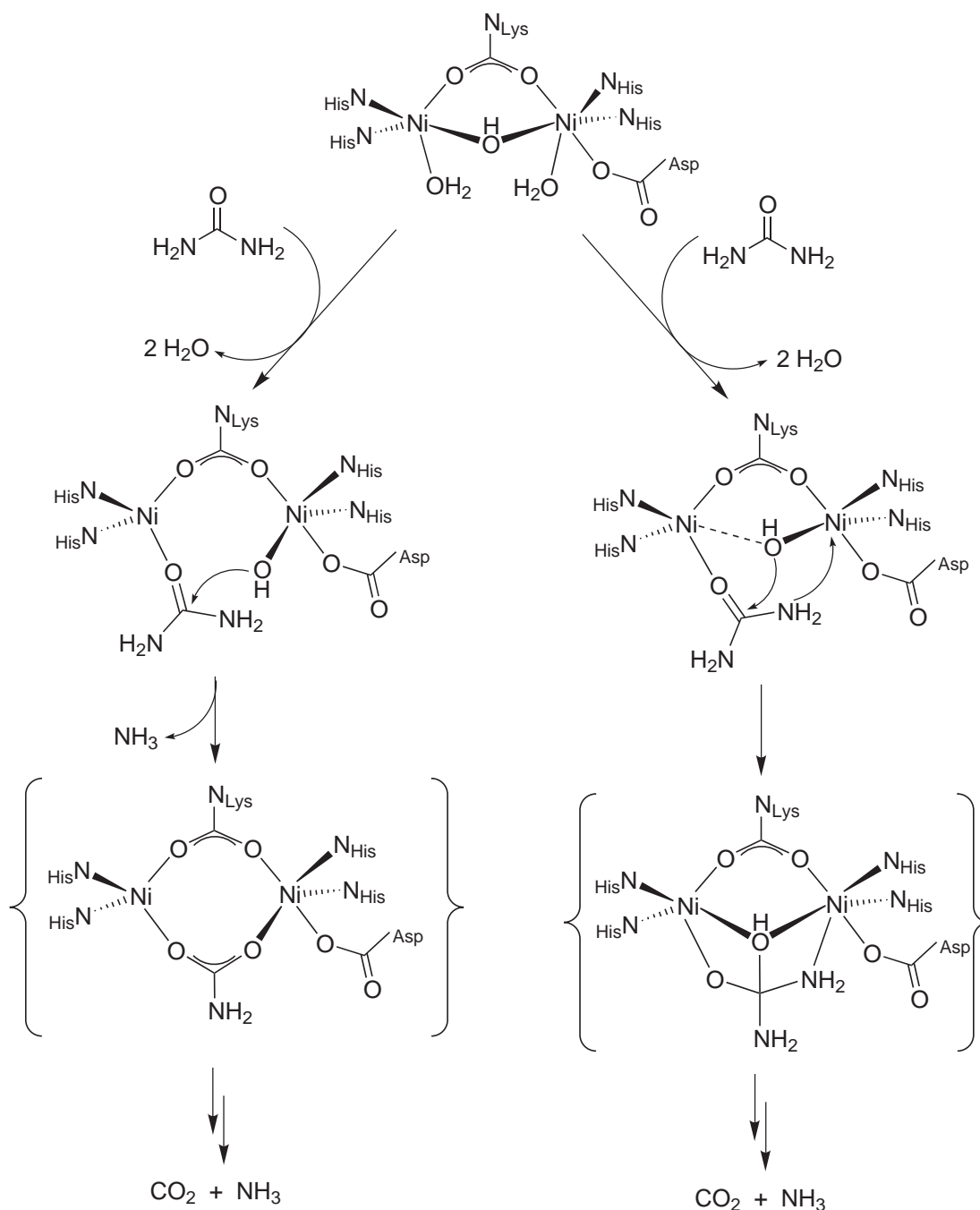

Scheme 12

As a consequence, the design and investigation of dinuclear Ni^{II} model complexes that mimic characteristics of the urease active site and that are capable of binding and degrading urea continues to be of particular interest. Among the specific active site structural features of urease are the nonsymmetric N/O-rich coordination environment with a Ni—Ni distance of around 3.5 Å, the bridging carbamate (often modeled by a bridging carboxylate), and the presence of a hydrolytically active Ni-bound hydroxide or water. The ability to bind urea is a prerequisite for urease-like activity, and different urea binding modes have been observed in synthetic model compounds.

In order to provide a dinucleating scaffold for proper orientation of two proximate Ni^{II} ions, compartmental ligands based on bridging alkoxide, phenolate, pyrazolate, or phthalazine units have been employed.^{422,2066–2082} Selected examples are discussed below.

In (850)²⁰⁶⁶, (851),²⁰⁶⁹ and (852)²⁰⁷⁶ the two nickel ions are additionally spanned by carboxylate bridges, whereas (853)²⁰⁷², (854)²⁰⁸³, (855)⁴²², (856),⁴²² and (858)²⁰⁷⁹ feature bridging hydroxide,

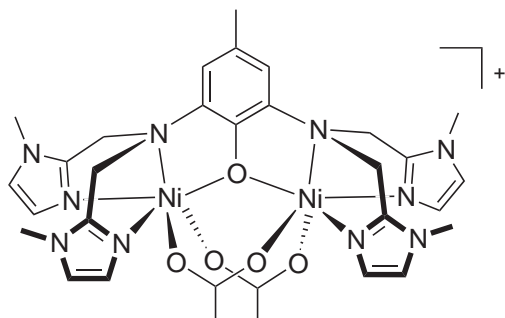

(850)

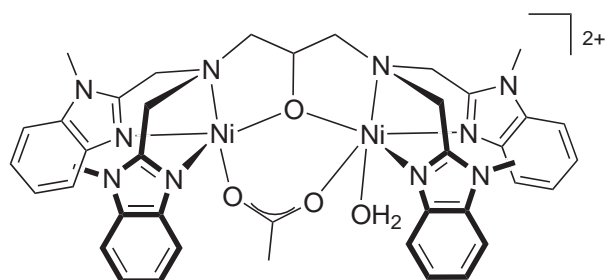

(851)

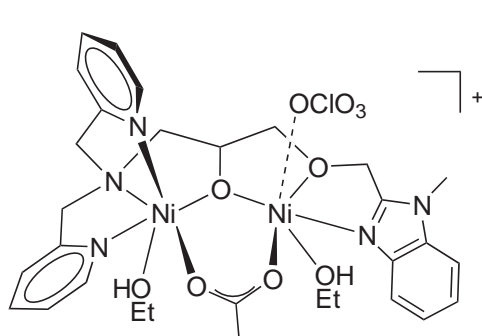

(852)

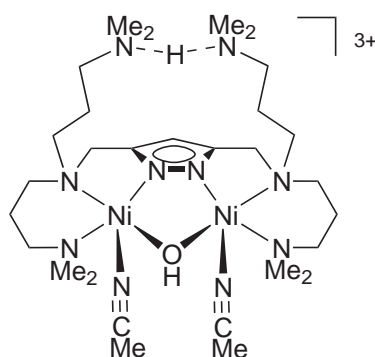

(853)

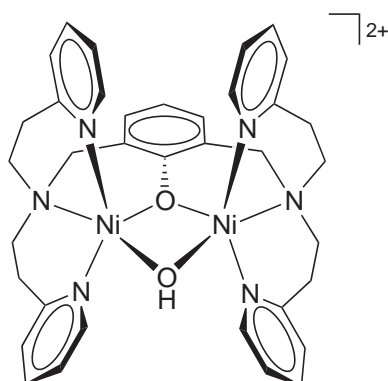

(854)

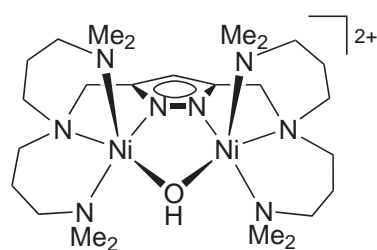

(855)

water, or H_3O_2 moieties. In some cases (e.g., **(852)**²⁰⁷⁶, the bimetallic scaffolds are nonsymmetric due to the different coordination compartments of the dinucleating ligand. **(853)**²⁰⁷² provides additional N functional groups in proximity to the bimetallic core—during complex formation, these basic amine functions pick up a proton to give the Ni-bound hydroxide, which resembles essential characteristics of the protein surrounding in the urease active site. Several compounds have readily accessible coordination sites available for substrate binding: e.g., the acetonitrile ligands in **(853)** are easily replaced by DMF or N-bound thiocyanate.²⁰⁷² A dinickel(II) complex of a tetrakis(benzimidazolyl) substituted 2-hydroxy-1,3-diaminopropane ligand (similar to the ligand in **(851)**) was found to readily absorb CO_2 in methanol solution to give a monomethyl carbonato bridged species.²⁰⁸⁴

Complex **(854)** has been tested in the catalysis of bis(p-nitrophenyl)phosphate hydrolysis. A plot of the rate constant vs. pH showed a sigmoid curve with an inflection point at a pH close to the $\text{p}K_{\text{a}}$ of the Ni-coordinated water (~ 8.5), which is consistent with the metal-bound hydroxide acting as the nucleophile.²⁰⁸³ **(856)** is capable of nitrile hydration to give complexes with N,O-bridging amidato groups **(857)**,⁴²² and complex **(858)** effects the hydrolytic cleavage of picolinamide in ethanol to give **(859)**.²⁰⁷⁹ The latter is proposed to occur by the bridging hydroxide, which is suitably arranged for nucleophilic attack.

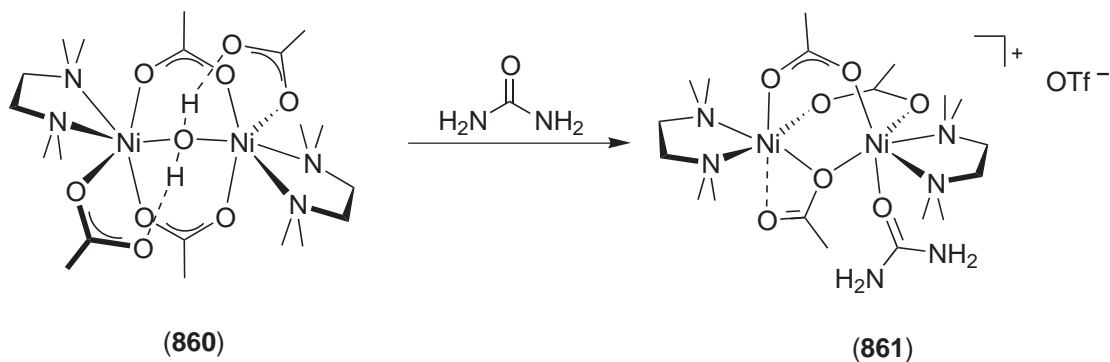
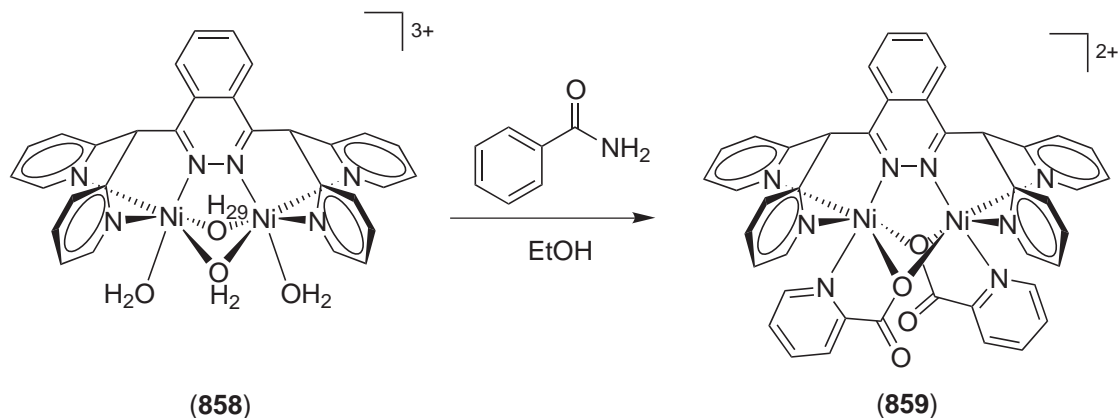
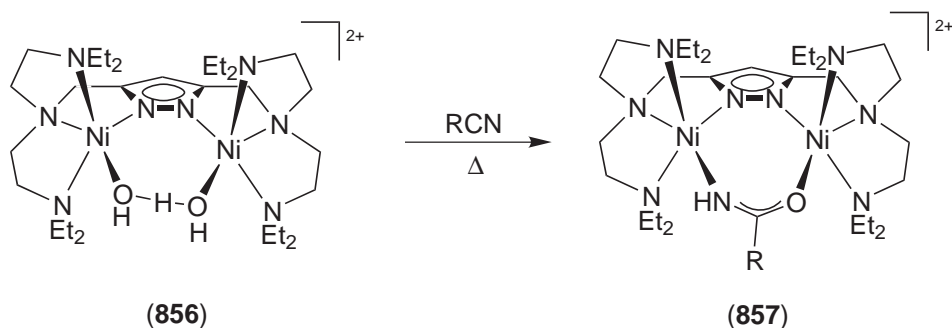

Complex **(860)**²⁰⁸⁵ containing a (μ -aqua)bis(μ -carboxylato) core reacts with urea to provide the first example of urea coordination to a dinickel(II) site.²⁰⁶⁷ In the resulting **(861)**, the urea molecule binds through its carbonyl-O to one of the Ni^{II} ions, which is the most commonly observed coordination mode.

Urea bound with η^1 -O has also been found in the (μ -alkoxide)(μ -carboxylato) complex **(862)**,²⁰⁷⁰ in the phenolate-bridged species **(863)**,²⁰⁷¹ in several pyrazolate-based dinickel(II) compounds with additional carboxylate bridges and either symmetric **(864, 865)** or nonsymmetric **(866)** cores,²⁰⁷² and in the phthalazine-derived complex **(867)**.²⁰⁸⁰ In the latter two cases, species with *N*-substituted urea have also been structurally characterized,^{2072,2081} as well as a phthalazine-based dinickel complex with S-bound thiourea.²⁰⁸¹ Whereas **(865)** provides additional terminal sites for solvent coordination,²⁰⁷² **(867)** incorporates both a μ -aqua and a μ -hydroxide group.²⁰⁸¹ In **(864)**, **(865)**, and **(866)**, the urea is additionally tied up with the bimetallic core by H bonding between the urea NH and the O atoms of the bridging acetate,²⁰⁷² while type **(867)** complexes feature urea H bonding interactions with the bridging

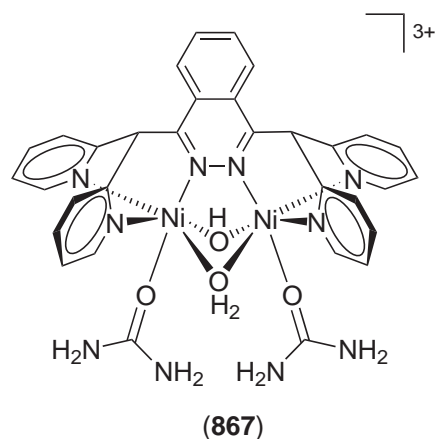
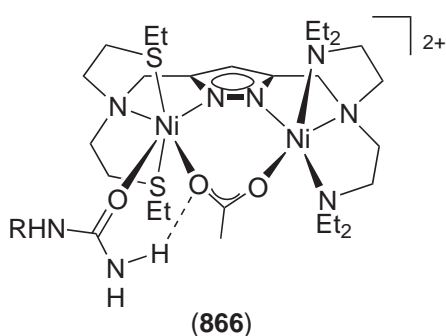
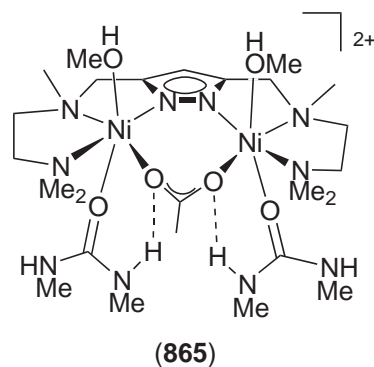
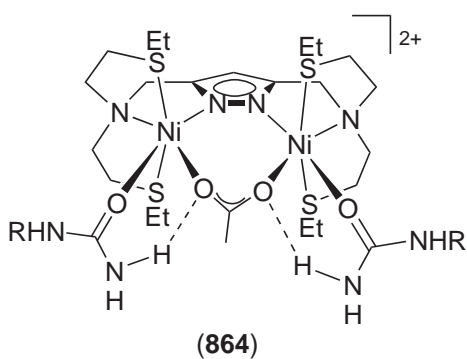
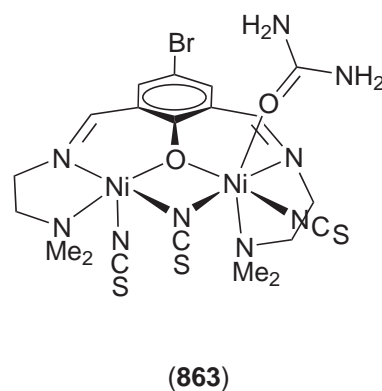
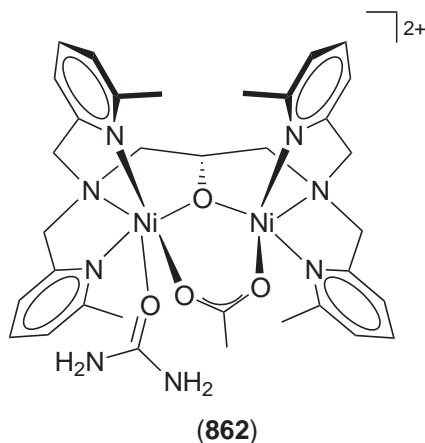

hydroxide.^{2080,2081} All Ni^{II} ions with η^1 -O-bound urea are usually six-coordinate. The urea C—O bond lengths generally do not change appreciably upon coordination, indicating very little polarization of the substrate.

Complex (868) is a unique example where urea forms a single-atom bridge between the proximate metal ions through its carbonyl-O atom.²⁰⁸⁰ An N,O-bridging coordination of (deprotonated) urea occurs in (869),²⁰⁷⁴ which forms in an equilibrium reaction between the active H₃O₂-bridged species (856) and the substrate ($K_1 = 4.3 \pm 0.4$ M in acetone, 2.7 ± 0.5 M in MeCN).²⁰⁸⁶ Kinetic studies by stopped-flow methods provided insight into the process of urea bridge incorporation: it was shown to follow a rate nonlinear in urea concentration, indicating that two urea molecules are involved. A detailed kinetic scheme has been derived.²⁰⁸⁶ Starting from the related H₃O₂-bridged dinickel complex (870) with tacn side arms attached to the pyrazolate, not only parent urea but also *N*-substituted urea derivatives could be incorporated in the N,O-bridging position.²⁰⁸²

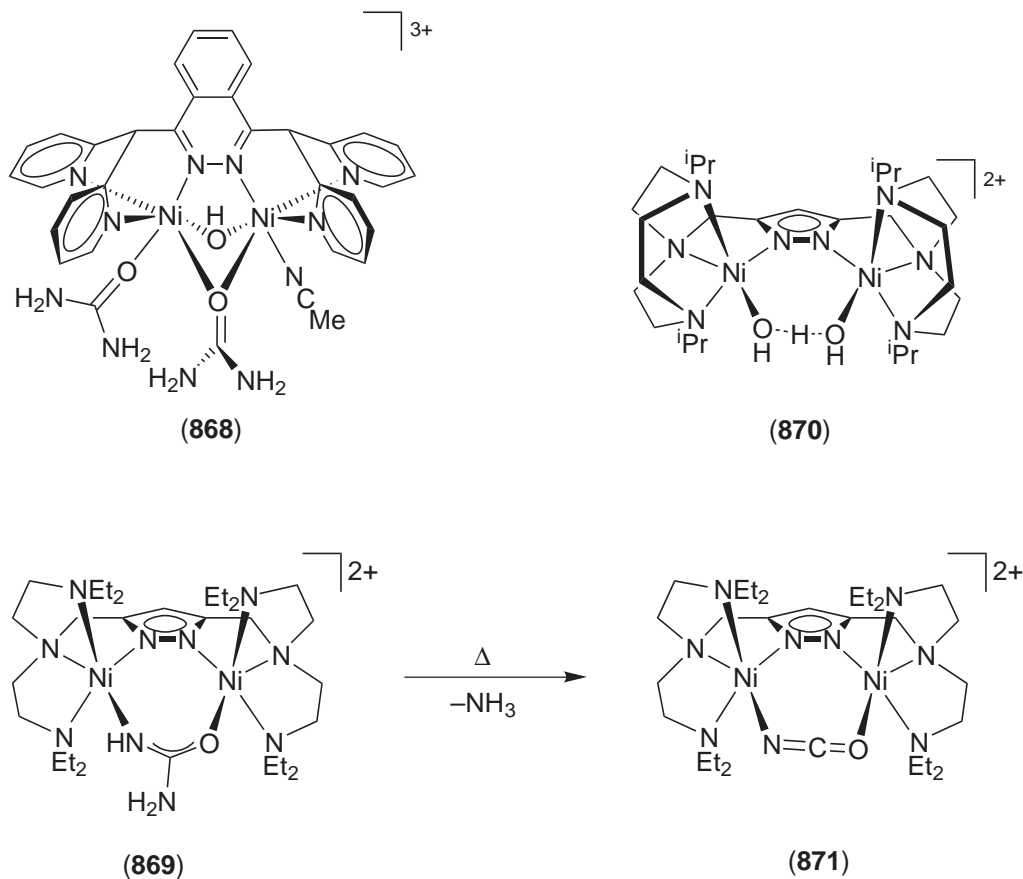

An unprecedented μ_3 - κ N: κ N': κ O triply bridging coordination mode of deprotonated urea has been observed in the tetranuclear Ni^{II} complex (872), which assembles from two pyrazolate-based bimetallic entities.²⁰⁷⁷ In (872), the presence of two terminal four-coordinate low-spin Ni^{II} and two central six-coordinate high-spin Ni^{II} leads to a mixed-spin situation, while results from UV-visible spectroscopy and magnetic measurements in solution suggest the coordination of additional solvent ligands to the outer metal ions at low temperature.²⁰⁷⁷

While dinickel(II) complexes with bound urea in various coordination modes are known, very few systems mediate the hydrolytic degradation of the substrate. Ethanolysis of urea in a slow catalytic reaction (4 equivalents of ethyl carbamate after 12 h at 80 °C) has been reported for (862).²⁰⁷⁰ Compound (865) produces 2.2 equivalents of ethyl carbamate after 6 days at 80 °C.²⁰⁷⁸ Several complexes that promote the elimination of ammonia from coordinated urea to yield metal-bound cyanate are known. A series of dinuclear Ni^{II} complexes of the nonsymmetric ligand (873) react with urea in refluxing ethanol solution to give dinickel products with N-bridging cyanate.²⁰⁷⁵ Heating of (869) gives rise to ammonia extrusion from the N,O-bridging ureate and formation of the cyanate-bridged complex (871).⁴²²

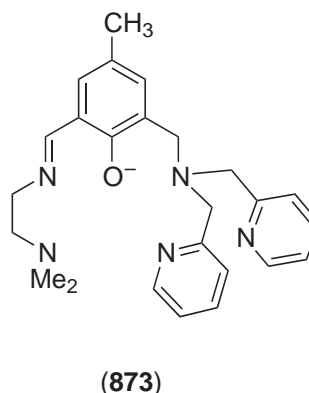
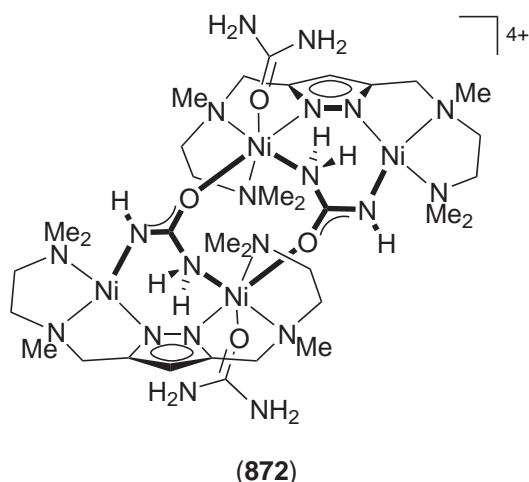

Both complexes (867) and (868) promote the hydrolysis of urea in a two-step process.²⁰⁸⁰ Heating of (867) or (868) in acetonitrile solution produced ammonia with kinetic first-order dependence on complex concentration and an observed rate constant of $(7.7 \pm 0.5) \times 10^{-4} \text{ h}^{-1}$ to yield a cyanate complex as the reaction product. When the reaction was carried out in 50% aqueous acetonitrile solution, ammonia was produced at the same rate but without buildup of the cyanate-containing product, suggesting that the latter is hydrolyzed in the presence of water. The hydrolysis rate was also first order in water, indicating that it occurred by attack of an external water on the coordinated cyanate.²⁰⁸⁰

In an analogous reaction, urea substrates having alkyl substituents at only one of the N atoms undergo alkylamine elimination to form a dinickel cyanate complex.²⁰⁸¹ In contrast, no reaction was observed for *N,N'*-dialkylated substrates.

The results of most model studies for Ni-mediated urea degradation reported to date are consistent with a cyanate intermediate. While this differs from the most likely mechanism of urease activity as deduced from protein crystallography, there is still no definitive evidence ruling out a transient Ni-bound cyanate intermediate for the enzyme.

Crystal structures of dinickel complexes with O,O-bridging and O,N-bridging (O-methylated) carbamate have been reported.^{2074,2082} (874) produces one equivalent of ammonia upon heating in methanol/water solution.²⁰⁸²

Acetohydroxamic acid (AHA) is known as a potent inhibitor of urease, and the crystal structure of the AHA-inhibited enzyme has been reported^{2087,2088} (as well as structural details with other inhibitors such as β -mercaptoethanol²⁰⁸⁹ and phenylphosphorodiamidate).²⁸ The structure of the AHA-inhibited active site reveals the binding mode of the AHA inhibitor with its hydroxamate-O symmetrically bridging both metal ions and the carbonyl-O chelating to one of the Ni^{II}. Such AHA coordination has been closely modeled in (875) and (876), which are readily prepared from the reaction of (860) and (861) with AHA.²⁰⁹⁰ A similar situation is observed in the complex with salicylhydroxamic acid (877).²⁰⁹¹ Compound (878) containing a deprotonated bridging *N*-hydroxyglutarimide was obtained in an unusual hydroxylamine elimination and cyclization reaction upon reaction of (860) with glutarodihydroxamic acid.²⁰⁹² Finally, it should be noted that four distinct hydroxamate binding modes have been observed in a heptanuclear Ni^{II} complex with 2-(dimethyl amino)phenylhydroxamic acid (2-dmAphaH), $[\text{Ni}_7(2\text{-dmAphaH})_2(2\text{-dmApha})_8(\text{H}_2\text{O})_2]\text{SO}_4 \cdot 15\text{H}_2\text{O}$.²⁰⁹³

6.3.4.12.8 Chain complexes with oligo(pyridylamido) ligands

Linear multinuclear metal complexes are attracting attention in the context of molecular electronics due to their projected use as molecular wires. Oligo(pyridyl)amido ligands are efficient scaffolds for lining up several Ni^{II} ions like a string. The first structurally characterized trinickel complex of this type, $[\text{Ni}_3(\text{dpa})_4\text{Cl}_2]$ (dpa = bis(2-pyridyl)amide), showed a nearly linear Ni₃ unit with Ni—Ni distances of around 244 pm.²⁰⁹⁴ Penta-, hepta-, and nonanuclear systems have

meanwhile been described, where the oligo(pyridyl)amido ligand coordinates in an all-*syn* form.^{2095–2099} An example is the heptanickel(II) complex (879) (Figure 32).²⁰⁹⁹

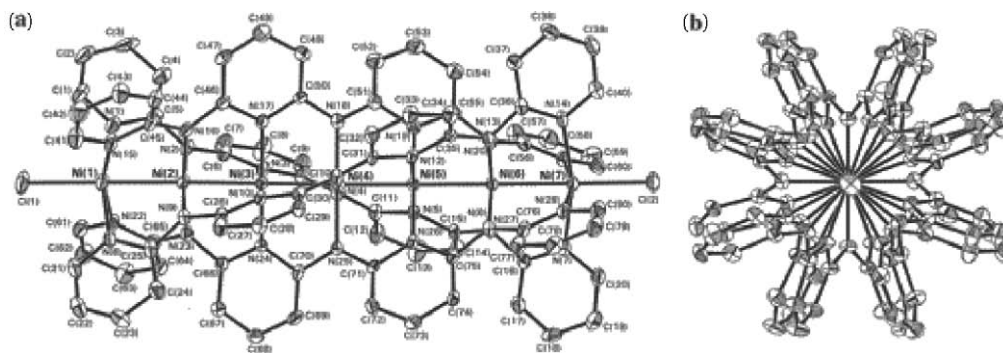
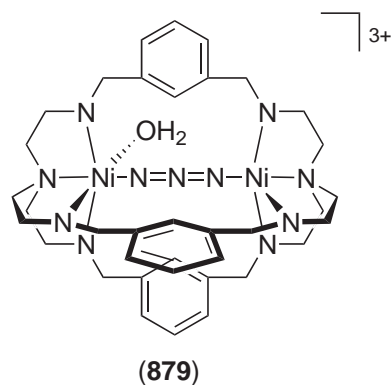
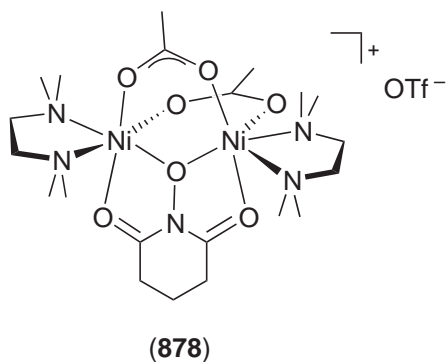
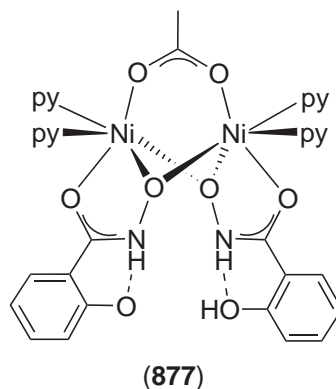
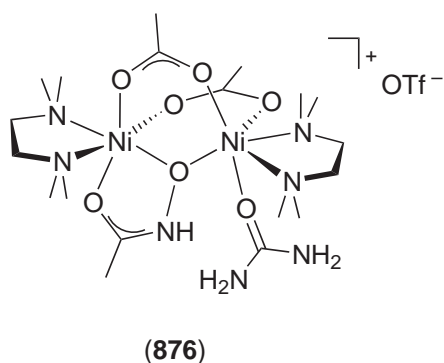
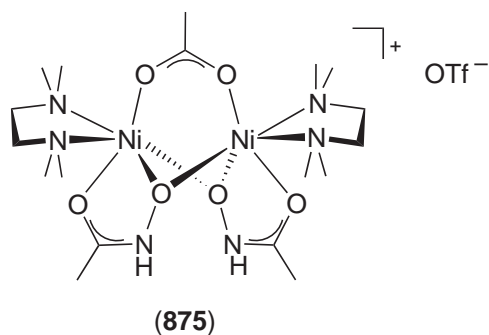
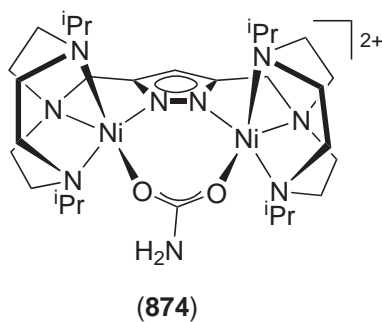

Figure 32 Molecular structure of the heptanickel complex (879). (reprinted with permission from ref. 2099; © 1999, American Chemical Society).

In these multinuclear Ni^{II} complexes, all the internal nickel ions are in a low-spin state, whereas the two external nickel ions are in a high-spin state. The antiferromagnetic coupling constants decrease in the order -99 cm^{-1} , -8.3 cm^{-1} , -3.8 cm^{-1} , and -1.7 cm^{-1} for the tri-, penta, hepta-, and nonanickel dichloride complexes. In their neutral forms there are no metal–metal bonds. Upon abstraction of the terminal chlorides and one-electron oxidation, however, the Ni–Ni distances shorten significantly, indicating formation of partial Ni–Ni bonds. Magnetic data for [Ni₃(dpa)₄(PF₆)₃] are consistent with one unpaired electron and delocalized Ni–Ni bonding.²¹⁰⁰ Coupling constants in the one-electron oxidized unsymmetrical pentanickel complexes [Ni₅-(tpda)₄(H₂O)(BF₄)](BF₄)₂ and [Ni₅(tpda)₄(SO₃CF₃)₂](SO₃CF₃) are estimated to be -555 cm^{-1} and -318 cm^{-1} , respectively, i.e., much higher than in the neutral form.²¹⁰¹

6.3.4.13 Magnetic Properties of Polynuclear Complexes

High-spin Ni^{II} has received increasing attention in the field of molecular magnetism. Since the energy barrier to reorientation of magnetization for a metal cluster is related to the spin (S) of the ground state and the zfs (D) of that spin, high-spin systems with large magnetic anisotropy are required. Nickel(II) has been proposed as a promising candidate in this respect, due to the possibility of achieving ferromagnetic exchange and the large single-ion zfs. Consequently, the first single-molecule magnets based on Ni^{II} centers have been discovered, a Ni₁₂ cluster based on 6-chloro-2-pyridonate and acetate ligands and a Ni₂₁ cluster with citrate and hydroxide.^{60,61,2102} The former ($S=12$ ground state) is the highest spin molecule to show quantum tunneling of magnetization.

6.3.4.13.1 Complexes with bridging azido ligands

In the field of molecular magnetism the flexidentate azido ligand plays a prominent role, since it mediates different kinds of magnetic coupling depending on its various modes of coordination. For Ni^{II}, many polynuclear complexes with azido bridging ligands have been discovered, which feature a great variety of different architectures. An excellent review has appeared.²¹⁰³ Related pseudohalides like thiocyanate, selenocyanate, etc., have also been used, although the structural variety is much less diverse in those cases. Coordination chemistry of the latter systems is covered in Section 6.3.4.3.2.

The Ni^{II}–azido compounds are best divided according to their dimensionality: discrete molecules and 1D, 2D, and 3D systems. When acting as a bridging ligand, the N₃[−] anion usually adopts the μ -1,3 (end-to-end, EE) or the μ -1,1 (end-on, EO) binding mode,^{2103–2105} although few examples of triply (μ ₃-1,1,3 and μ ₃-1,1,1) and quadruply (μ ₄-1,1,1,1 and μ ₄-1,1,3,3) bridging azide have been reported. Magnetostructural correlations for the two major binding modes of the azido ligand have emerged: systems with μ -1,3 azido bridges usually exhibit antiferromagnetic coupling while μ -1,3 coordination entails ferromagnetic coupling. For very large Ni(μ -1,3-N₃)Ni bond angles, however, the magnetic coupling may be reversed. In addition to the angle β measuring the linearity of the Ni–NNN–Ni skeleton, two dihedral angles are often discussed for magnetostructural correlations: δ (the dihedral angle between the plane defined for the six N azido atoms and the N1–M–N3' plane) is commonly considered for complexes with double EE azido bridges and τ (the dihedral angle between the mean planes M–N1–N2–N3 and N1–N2–N3–M) for complexes with single EE azido bridges.²¹⁰³

For magnetostructural correlation, intimate knowledge of the molecular structure is a prerequisite, and hence the following discussion is mainly restricted to compounds characterized by X-ray crystallography. J -values are given with respect to the $H = -J_{ij}S_iS_j$ Hamiltonian (reported values have been adapted for cases where the $H = -2J_{ij}S_iS_j$ Hamiltonian has been used in the literature).

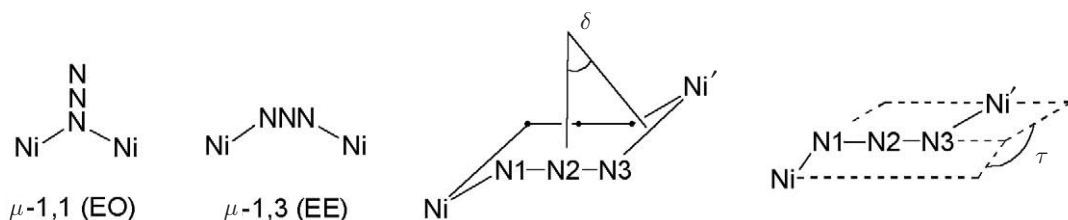

(i) Dinuclear complexes

(a) *With μ -1,3-azido ligands.* Compounds with only one azido bridge, with two azido bridges, or with three azido bridges have been structurally characterized. Systems with only one μ -1,3 azido bridging ligand comprise (i) $[\text{Ni}_2(\text{N}_3)_2(\text{Me}_4\text{cyclam})_2(\mu\text{-N}_3)]\text{I}$ (Me_4cyclam = 1,4,8,11-tetra-methyl-1,4,8,11-tetraazacyclotetradecane) reported earlier^{2106,2107} with octahedral coordination of the Ni^{II} ions and two terminal azido ligands in *trans* position with regard to the bridge, (ii) $[\text{Ni}_2(\text{trenpy})_2(\mu\text{-N}_3)](\text{ClO}_4)_3$ ²¹⁰⁸ with a pentadentate capping ligand (*trenpy* = *N,N*-bis(2-aminoethyl)-*N'*-2-(pyridylmethyl)ethane-1,2-diamine), (iii) $[\text{Ni}_2(\text{L})(\mu\text{-N}_3)](\text{N}_3)(\text{ClO}_4)_2$, and (iv) $[\text{Ni}_2(\text{L})(\text{H}_2\text{O})(\mu\text{-N}_3)](\text{CF}_3\text{SO}_3)_3$ (**879**) where L is a cryptate host.^{2109,2110} While the Ni-(μ -1,3- N_3)-Ni central unit is nonlinear in the first two complexes (as is also the case in the 1D systems with only one azido bridging ligand in μ -1,3 coordination mode), the geometrical constraints imposed by the rigid dimetallic cryptate induce a rather unusual quasi-linearity (Ni—N—N angles close to 165°) in the latter two complexes.

Table 13 collects the main structural data and the exchange coupling parameter J . $[\text{Ni}_2(\text{L})(\text{H}_2\text{O})(\mu\text{-N}_3)](\text{CF}_3\text{SO}_3)_2$ is a rare example with ferromagnetic coupling mediated by the EE azido bridges.^{2109,2110} This has been ascribed to both the linearity of the azide bridge and the pentacoordination of one of the Ni^{II} ions. DFT calculations predict weak antiferromagnetic coupling for compounds only slightly distorted from linearity (β up to 30°), and a dramatic enhancement of the antiferromagnetism at larger β -values. A single case with only one end-to-end azido bridging ligand and also a pyrazole bridge has been reported, though no magnetic data are given.²¹¹²

Numerous dinuclear complexes with two μ -1,3 azido bridging ligands have been reported. Bi-, tri-, or tetradentate amine ligands are commonly used as capping ligands, while in some cases additional terminal azido ligands are present. In general, the counteranion is a nonligating anion such as ClO_4^- , PF_6^- , or $\text{B}(\text{C}_6\text{H}_5)_4^-$. In most cases, the two azido ligands of the $[\text{Ni}_2(\mu\text{-N}_3)_2]^{2+}$ core are coplanar like in (**880**). $[\text{Ni}_2(\text{L}')_2(\text{N}_3)_2(\mu\text{-N}_3)_2]$ ((**881**); L' = 1,4,7-trimethyl-1,4,7-triazacyclononane)²¹¹³ and $[\text{Ni}_2(\text{bispicen})_2(\mu\text{-N}_3)_2](\text{ClO}_4)_2$ (*bispicen* = *N,N'*-bis(2-pyridylmethyl)ethylene-diamine)²¹¹⁴ are exceptions, with the two azido bridging ligands crossing each other. The main structural data and the exchange coupling parameter, J , are listed in Table 14.

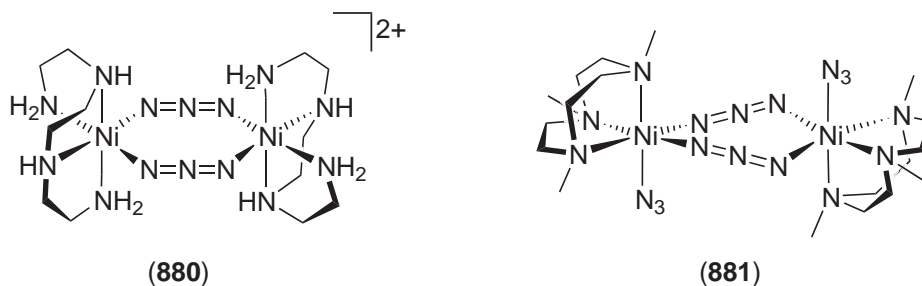

Both extended Hückel and DFT calculation have been carried out in order to rationalize the observed trends. According to the magnetochemical theories,^{2120,2121} the antiferromagnetic contribution to the exchange coupling J_{AF} is proportional to the squared energy difference ($\varepsilon_1 - \varepsilon_2$), where ($\varepsilon_1 - \varepsilon_2$) represents each of the gaps created between the symmetric and antisymmetric

Table 13 Structural and magnetic parameters for dimers with the $[\text{Ni}(\mu\text{-1,3-}\text{N}_3)\text{Ni}]$ unit: Ni—N bond distances (Å), Ni—N—N and τ angles ($^\circ$), J in cm^{-1} .^a

	Ni—N	Ni—N—N	τ	J	References
$[\text{Ni}_2(\text{trenpy})_2(\mu\text{-N}_3)](\text{ClO}_4)_3$	2.133	131.6	180	−26.8	2108
$[\text{Ni}_2(\text{dmptacn})_2(\mu\text{-N}_3)](\text{ClO}_4)_3$				−42.5	2108
$[\text{Ni}_2(\text{Me}_4\text{cyclam})_2(\text{N}_3)_2(\mu\text{-N}_3)_3]\text{I}$	2.15	142	180	−17.0	2106
$[\text{Ni}_2(\text{Metpa})_2(\text{N}_3)_2(\mu\text{-N}_3)](\text{ClO}_4)$	2.117	139.1	180	−20.5	2111
$[\text{Ni}_2(\text{L})(\mu\text{-N}_3)](\text{N}_3)(\text{ClO}_4)_2$	1.998, 2.032	169.9, 164.7			2109
$[\text{Ni}_2(\text{L})(\text{H}_2\text{O})(\mu\text{-N}_3)](\text{CF}_3\text{SO}_3)_3$ (879)	2.037, 1.998	165.8, 157.6		+11.8	2110

^a *Trenpy* = *N,N*-bis(2-aminoethyl)-*N'*-2-(pyridylmethyl)ethane-1,2-diamine; *dmptacn* = 1,4-bis(2-pyridylmethyl)-1,4,7-triazacyclononane; *Me*₄*cyclam* = 1,4,8,11-tetramethyl-1,4,8,11-tetraazacyclotetradecane; *Metpa* = tris(6-methyl-2-pyridylmethyl)amine; L = cryptate host).

Table 14 Structural and magnetic parameters for dimers with the $[\text{Ni}(\mu\text{-}1,3\text{-N}_3)_2\text{Ni}]$ unit: Ni—N bond distances (Å), Ni—N—N and δ angles ($^\circ$), J in cm^{-1} .^a

	Ni—N	Ni—N—N	δ	J	References
$[\text{Ni}_2(\text{en})_4(\mu\text{-N}_3)_2](\text{PF}_6)_2$	2.181, 2.183	121.3, 119.3	45.0	−4.6	2115
$[\text{Ni}_2(1,3\text{-tn})_4(\mu\text{-N}_3)_2](\text{BPh}_4)_2$	2.167, 2.144	127.7, 139.0	3.0	−114.5	2115
$[\text{Ni}_2(\text{L})_2(\text{N}_3)_2(\mu\text{-N}_3)_2]$	2.167, 2.135	124.4, 138.4	6.8	−90.0	2116
$[\text{Ni}_2(\text{L}')_2(\text{N}_3)_2(\mu\text{-N}_3)_2]$ (881)	2.111, 2.118	124.5, 128.2	^b	−36.4	2113
$[\text{Ni}_2(\text{tren})_2(\mu\text{-N}_3)_2](\text{BPh}_4)_2$	2.069, 2.195	123.3, 135.7	20.7	−35	2106
$[\text{Ni}_2(222\text{-tet})_2(\mu\text{-N}_3)_2](\text{BPh}_4)_2$ (880)(BPh_4) ₂	2.103, 2.155	128.5, 129.9	22.4	−83.6	2117
$[\text{Ni}_2(\text{aep})_4(\mu\text{-N}_3)_2](\text{PF}_6)_2$	2.180, 2.128	126.7, 123.8	34.6	−29.1	2118
$[\text{Ni}_2(\text{D,L-hm cyclam})_2(\mu\text{-N}_3)_2](\text{ClO}_4)_2$	2.141, 2.098	141.6, 127.4	3.3	−113.0	2119
$[\text{Ni}_2(\text{D,L-hm cyclam})_2(\mu\text{-N}_3)_2](\text{PF}_6)_2$	2.128, 2.143	124.3, 142.2	11.5	−75.1	2119
$[\text{Ni}_2(\text{bispcien})_2(\mu\text{-N}_3)_2](\text{ClO}_4)_2$			^b	−56.2	2114

^a L = 1,5,9-triazacyclododecane; L' = 1,4,7-trimethyl-1,4,7-triazacyclononane; tren = 2,2', 2''-triaminotriethylamine; 222-tet = triethylenetriethylenetetramine; aep = aminoethylpyridine; hm cyclam = 5,5,7,12,12,14-hexamethylcyclotetradecane; bispcien = *N,N'*-bis(2-pyridylmethyl)ethylenediamine. ^b In this case the azide bridges of the $[\text{Ni}_2(\mu\text{-N}_3)_2]^{2+}$ moiety (N_3)₂ are not coplanar.

combinations of the Ni^{II} magnetic orbitals ($z^2 \pm z^2$ and $x^2 - y^2 \pm x^2 - y^2$). The main factor determining the J -value is the $[\text{Ni}-(\mu\text{-N}_3)_2\text{-Ni}]$ dihedral angle δ , i.e., the more planar the structure (dihedral angle δ close to 0°), the more antiferromagnetic is the coupling.²¹¹⁵

A single dinuclear complex has been reported with three EE azido bridges, i.e., with a $[\text{Ni}(\mu\text{-}1,3\text{-N}_3)_3\text{Ni}]$ central core: $[\text{Ni}_2(\text{L}')_2(\mu\text{-}1,3\text{-N}_3)_3](\text{ClO}_4)$ (**882**).^{2113,2116} The Ni—N—N angles lie between 115.6° and 119.2° (average value = 118.1°), and the J -value is -67.9 cm^{-1} .

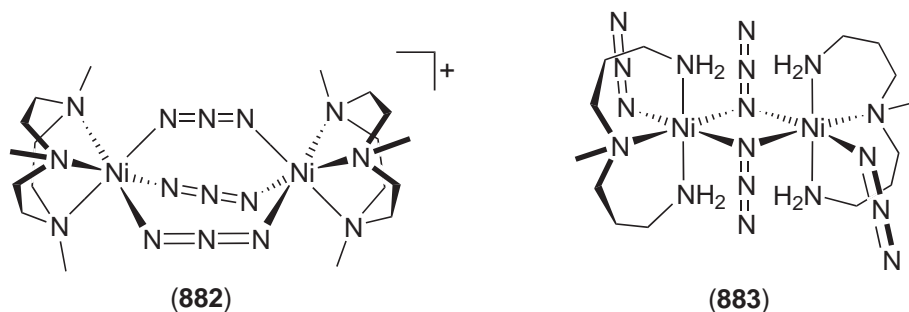

(b) With $\mu\text{-}1,1$ -azido ligands. Complexes with $\mu\text{-}1,1$ -azido ligands show ferromagnetic coupling, as indicated above. While most compounds have two azido bridges with a $[\text{Ni}(\mu\text{-}1,1\text{-N}_3)_2\text{Ni}]^{2+}$ core structure, few examples with three azido bridges have also been reported. Most of the former compounds show a planar $[\text{Ni}-(\text{N}_3)_2\text{-Ni}]$ unit with an inversion center. The coordination of the Ni^{II} ions is generally completed by di-, tri-, or tetradentate amine capping ligands. Weakly coordinating counteranions such as ClO_4^- or PF_6^- are usually employed, and azido terminal ligands may be present in some cases. Complexes (**883**) and (**884**) are depicted as representative examples. The main structural data and the exchange coupling parameter, J , are collected in Table 15.

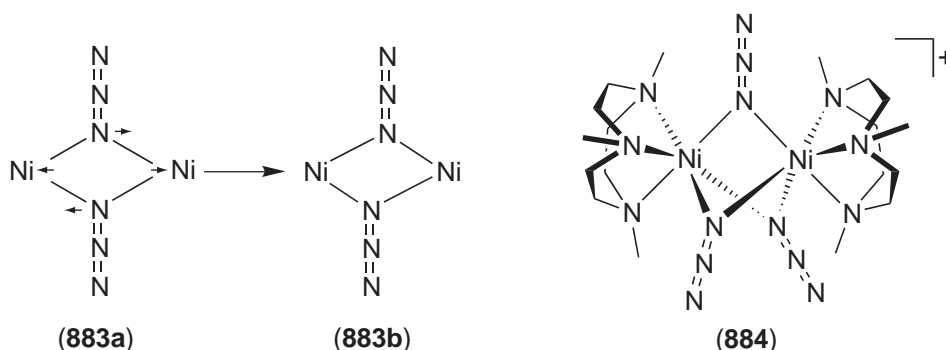

Table 15 Structural and magnetic parameters for dimers with the $[\text{Ni}(\mu\text{-}1,1\text{-N}_3)_2\text{Ni}]$ unit: Ni—N bond distances (Å), Ni—N—Ni angles θ ($^\circ$), J in cm^{-1} .^a

	Ni—N	θ	Ni—(N ₃) ₂ —Ni inv. center	J	References
$[\text{Ni}_2(\text{en})_4(\mu\text{-N}_3)_2](\text{ClO}_4)_2$	2.144, 2.123	104.3	Yes	+43.7	2113
$[\text{Ni}_2(\text{terpy})_2(\text{N}_3)_2(\mu\text{-N}_3)_2]\cdot 2\text{H}_2\text{O}$	2.198, 2.038	101.3	Yes	+40.2	2122–2124
$[\text{Ni}_2(\text{terpy})_2(\text{N}_3)_2(\mu\text{-N}_3)_2]\cdot \text{H}_2\text{O}$	2.184, 2.039	101.6	Yes	+45.6	2126
$[\text{Ni}_2(\text{terpy})_2(\text{N}_3)(\text{H}_2\text{O})(\mu\text{-N}_3)_2]\text{ClO}_4$	2.069, 2.172, 2.114, 2.060	103	No	+27.2	2123
$[\text{Ni}_2(\text{terpy})_2(\mu\text{-N}_3)_2(\text{N}_3)(\text{H}_2\text{O})](\text{ClO}_4)(\text{H}_2\text{O})$	2.069, 2.175, 2.119, 2.068	102.5, 100.6	No	+27.2	2124
$[\text{Ni}_2(\text{pepci})_2(\text{N}_3)_2(\mu\text{-N}_3)_2]\cdot 2\text{H}_2\text{O}$	2.107, 2.163, 2.109, 2.128	102.2, 101.0	No	+72.6	2126
$[\text{Ni}_2(\text{Me}_3[12]\text{N}_3)_2(\mu\text{-N}_3)_2](\text{ClO}_4)_2$	2.092, 2.067	103.8	Yes	+43.9	2127
$[\text{Ni}_2(232\text{-tet})_2(\mu\text{-N}_3)_2](\text{ClO}_4)_2$	2.166	104.9	Yes	+33.8	2127
$[\text{Ni}_2(\text{Medpt})_2(\text{N}_3)_2(\mu\text{-N}_3)_2]$ (883)	2.207, 2.197	104.0	Yes	+46.7	2128, 2129
$[\text{Ni}_2(232\text{-tet})_2(\mu\text{-N}_3)_2](\text{PF}_6)_2$	2.177, 2.183	104.6	Yes	+34.3	2130

^a Pepci = *N'*-(2-pyridin-2-ylethyl)pyridine-2-carbaldimide; Me₃[12]N₃ = 2,4,4-trimethyl-1,5,9-triazacyclododec-1-ene; 232-tet = *N,N'*-bis(2-aminoethyl)-1,3-propanediamine; Medpt = methyl-bis(3-aminopropyl)amine.

All Ni₂ dinuclear complexes have Ni—N—Ni angles in the narrow range 101–105° and exhibit ferromagnetic coupling with J -values between +27 cm^{-1} and +73 cm^{-1} . It should be noted though, that due to the *zfs* effects manifest at low temperatures the magnitude of J should be treated with care in the ferromagnetic case.

A hysteresis cycle in the molar susceptibility measurements has been observed for $[\text{Ni}_2(\text{Medpt})_2(\text{N}_3)_2(\mu\text{-N}_3)_2]$ (**883**). This has been ascribed to a phase transition caused by an asymmetrization process of the rhombus-like centrosymmetric $[\text{Ni}(\text{N}_3)_2\text{Ni}]$ core that occurs with falling temperature. The asymmetrization transition can be explained in terms of a second-order Jahn–Teller distortion, taking into account the local symmetry of the dinuclear $[\text{Ni}(\text{N}_3)_2\text{Ni}]$ entity (D_{2h} , rhombic symmetry) before the arrangement.²¹²⁸

Only two complexes with three azido bridging ligands have been reported: $[\text{Ni}_2\text{L}'_2(\mu\text{-N}_3)_3]\text{ClO}_4$ ($\text{L}' = 1,4,7\text{-trimethyl-}1,4,7\text{-triazacyclononane}$)²¹¹³ (**884**) and $[\text{Ni}_2(\text{L})_2(\mu\text{-N}_3)_3]\text{ClO}_4$ ($\text{L} = (N,N'\text{-dimethyl-}1,4,7\text{-triazacyclononane})\text{calix}[4]\text{arene}$).²¹³¹ While the geometry of the triple bridge is similar in both complexes, the average Ni—N—Ni angles of 85.9° and 86.2° are much smaller than in the doubly bridged systems and the Ni···Ni distances are considerably shorter (2.896 Å and 2.852 Å, respectively). Both complexes show ferromagnetic coupling ($J = +30.7 \text{ cm}^{-1}$ and +17.2 cm^{-1} , respectively).

DFT calculations have been carried out in order to explain the exchange interactions in EO azido-bridged Ni^{II} complexes.²¹³² There is a clear correlation between the calculated exchange coupling constant and the Ni—N—Ni bridging angle θ (analogous to that of the hydroxo-bridged species), but the interaction is predicted to be ferromagnetic for all the range of θ angles explored. A maximum is expected at $\theta \approx 104^\circ$ for the $\text{Ni}(\mu\text{-}1,1\text{-N}_3)_2\text{Ni}$ core and at $\theta \approx 95^\circ$ for the $\text{Ni}(\mu\text{-}1,1\text{-N}_3)_3\text{Ni}$ core. Also, the Ni—N bond distance is seen to have a strong influence on the value of the coupling constant, while the out-of-plane displacement τ of the azido bridge only has a negligible influence. Positive spin density has been calculated at the bridging N atom, indicating a pre-dominant spin delocalization mechanism.

Ab initio DDCI2 (difference-dedicated configuration interaction) calculations seem to provide accurate estimations of the magnetic exchange coupling constants, as demonstrated for the doubly azido-bridged nickel(II) dimer $[\text{Ni}_2(\text{terpy})_2(\mu\text{-}1,1\text{-N}_3)_2]^{2+}$.²¹³³

(ii) Trinuclear, tetranuclear, and high nuclearity complexes

$[\text{Ni}_3(2,2,2\text{-tet})_3(\mu\text{-N}_3)_3](\text{PF}_6)_3$ and its perchlorate analogue have been suggested as trinuclear complexes with an irregular triangle structure.²¹¹⁷ While a crystal structure is lacking, EXAFS and XANES spectra support the occurrence of azido-bridged trinuclear nickel(II) compounds with Ni···Ni separations of 5.16 Å and 5.12 Å, respectively. Two J parameters had to be

introduced in order to fit the magnetic data. The values $J_{1,2} = -72 \text{ cm}^{-1}$ and -60.3 cm^{-1} and $J_3 = -36 \text{ cm}^{-1}$ and -29 cm^{-1} , respectively, are in agreement with the assumed EE coordination mode for the azido bridging ligand.

Tetranuclear Ni^{II} complexes with EO azido bridging ligand have been reported both with open frame and cubane-like structures. In $[\text{Ni}_4(2\text{-oxo-1,3-diaminopropane})_2(2\text{-hydroxo-1,3-diaminopropane})_2(\mu\text{-1,1-N}_3)_4](\text{ClO}_4)_2$ (**885**) the four Ni^{II} atoms are in a distorted octahedral environment and are related by an S_4 symmetry axis forming a quasi-perfect square. The Ni^{II} ions are bridged by an oxygen atom of the amine ligand (OHpn and Opn) and an EO azide bridge, yielding ferromagnetic coupling with $J = +21.3 \text{ cm}^{-1}$. Magnetization measurements are indicative of an $S = 4$ spin ground state.

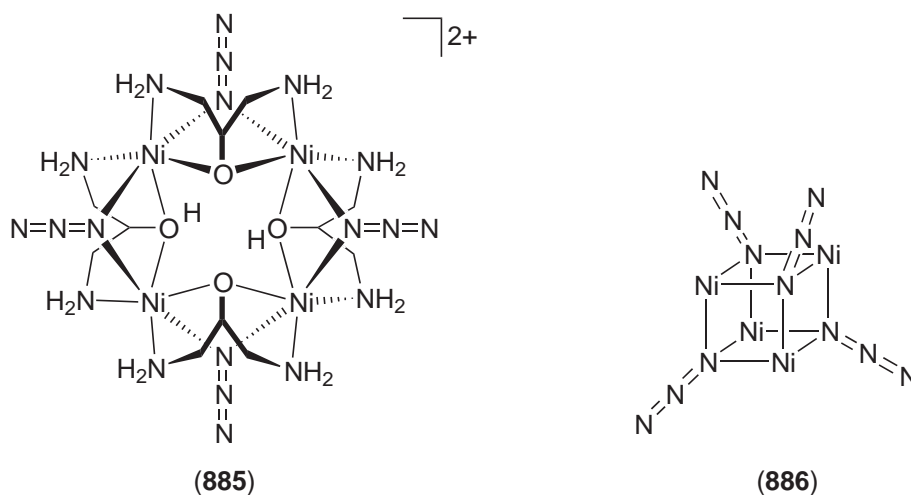

Few Ni_4 complexes with a cubane-like structure and four triply bridging $\mu_3\text{-1,1,1-N}_3$ ligands symmetrically bound to three Ni^{II} ions have been discovered (**886**),^{2135,2136} but magnetic data are only reported in the case of $[\text{Ni}_4(\text{dmb})_4(\text{EtOH})_4(\mu_3\text{-1,1,1-N}_3)_4]$ (dbm = dibenzoylmethane).^{2135,2136} Its magnetic behavior was well reproduced by a model with a single $J = +11.9 \text{ cm}^{-1}$.

Centrosymmetric tetranuclear units have been obtained with tridentate ligands resulting from the solvolysis of dpk (dpk = di-2-pyridylketone).^{2137,2138} The Ni^{II} ions are bridged by both $\mu\text{-oxo}$ and $\mu_3\text{-oxo}$ from the dpk derivative and $\mu\text{-1,1}$ azido ligands, to give a face-share dicubane-like coordination core with two missing vertices. The magnetic properties of the two species $[\text{Ni}_4(\text{dpkOH})_2(\text{dpkOMe})_2(\mu\text{-N}_3)_2(\text{H}_2\text{O})_2](\text{ClO}_4)_2 \cdot 2\text{H}_2\text{O}$ ²¹³⁷ and $[\text{Ni}_4(\text{dpkOH})_4(\mu\text{-N}_3)_2(\text{N}_3)_2] \cdot 2\text{H}_2\text{O}$ ²¹³⁸ are characteristic of intramolecular ferromagnetic coupling and have been modeled with $J_1 = +18.0 \text{ cm}^{-1}$, $J_2 = +16.3 \text{ cm}^{-1}$, $J_3 = +27.1 \text{ cm}^{-1}$, $J_4 = -1.6 \text{ cm}^{-1}$ and $J_1 = +18.8 \text{ cm}^{-1}$, $J_2 = +6.9 \text{ cm}^{-1}$, $J_3 = +1.3 \text{ cm}^{-1}$, $J_4 = +0.2 \text{ cm}^{-1}$, respectively.

A very unusual nonanuclear cage compound $[\text{Ni}_9(\mu_4\text{-1,1,1,1-N}_3)_2(\text{O}_2\text{CMe})_8(\text{dpkO})_4]$ has been obtained from the reaction of NaN_3 with the similar complex containing OH^- instead of N_3^- .²¹³⁹ It features two azide ligands in the extremely rare $\mu_4\text{-1,1,1,1}$ binding mode. Magnetic measurements reveal moderate ferromagnetic coupling and an $S = 9$ ground state.

Preorganized bimetallic building blocks have been used for the assembly of tetranuclear Ni^{II} complexes. In (**888**), the metal ions of each Ni_2 subunit are spanned by two thiophenolate-S and by a μ -pyridazine.²¹⁴⁰ Magnetic data for the related dinuclear complex (**887b**) show intramolecular ferromagnetic exchange with $J = +23.0 \text{ cm}^{-1}$. Crosslinking of two such Ni_2 units (**887a**) by EE azido bridges in (**888**) gives an $S = 4$ ground state, i.e., coupling between the Ni_2 constituents is also ferromagnetic, which is rationalized on the basis of the dihedral $\text{Ni-N}_3\text{-Ni}$ torsion angle of 76.4° . Analysis of the magnetic susceptibility data for X gives $J_1 = +12.9 \text{ cm}^{-1}$ and $J_2 = +7.2 \text{ cm}^{-1}$, where J_1 represents the exchange interaction in the dinuclear subunit and J_2 describes the interaction via the azido linkages.

Tetranuclear Ni^{II} complexes (**889**), (**890a**), and (**890b**) with unusual $\mu_3\text{-1,1,3}$ and $\mu_4\text{-1,1,3,3}$ azide binding modes have been obtained from discrete pyrazolate-based dinuclear building blocks.²¹⁴¹ (**890a**) and (**890b**) represent the only known examples of such EE/EO μ_4 coordination of azide in molecular compounds.

Finally it should be noted that a great variety of complexes may arise from the combination of different metals and different bridges. The trinuclear complex $\text{Mn}(\text{N}_3)_4[\text{Ni}(\text{en})_2(\text{NO}_2)_2]$ is given as an example here: the metal ions in the linear $\text{Ni}-\text{M}-\text{Ni}$ sequence are linked by both EO azide and $\mu\text{-NO}_2^-$ to give an $S=9/2$ triad state.²¹⁴²

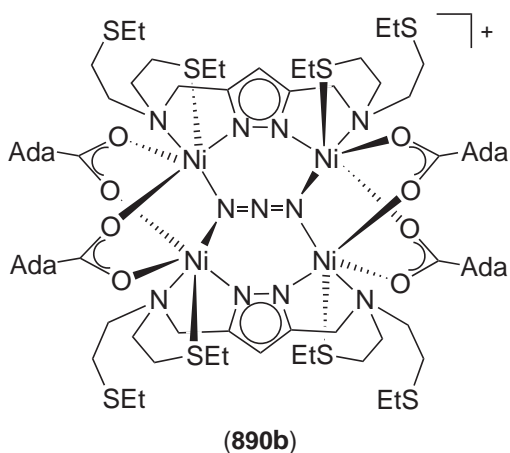
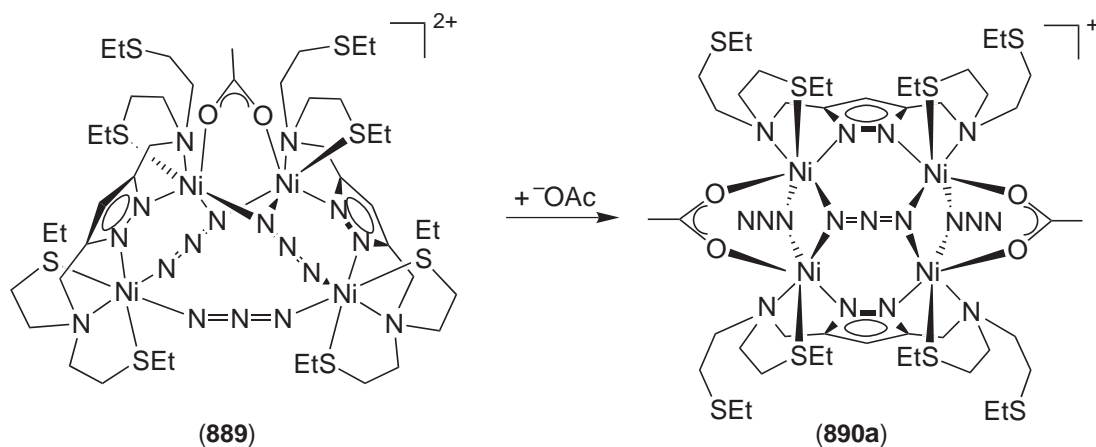
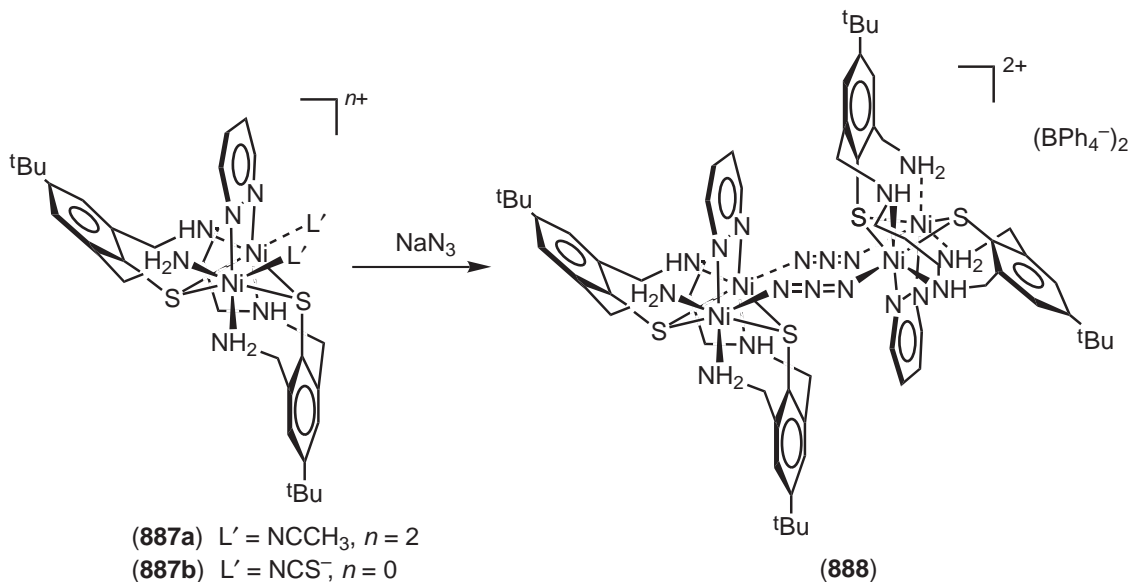

(iii) One-dimensional uniform systems

For these types of 1D systems only Ni^{II} compounds with a single 1,3-azido bridging ligand have been reported. Depending on the position of the two adjacent azido bridging ligands at each Ni^{II} ion, two different types of 1D system—*trans*-(**891a**) or *cis*-(**891b**)—can be distinguished. The hexacoordination of each Ni^{II} ion is usually completed by chelating nitrogen ligands. The main structural data and the exchange coupling parameter J are given in Table 16 for *trans*-complexes and in Table 17 for *cis*-complexes.

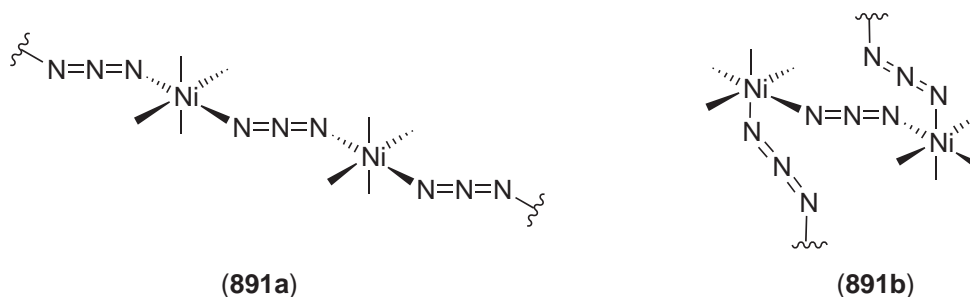

In a 1D chain where the Ni^{II} ions are bridged by one μ -1,3 azido ligand, two different azido bridges may be present in the chain with the Ni^{II} ions related by an inversion center located at the

Table 16 Structural and magnetic parameters for 1D *trans*-[Ni(μ -1,3-N₃)Ni] systems: angles Ni—N—N and dihedral angles τ (°); J in cm⁻¹.^a

	Ni—N—N	τ	J	References
[Ni(tmd) ₂ (μ -N ₃) _n](PF ₆) _n	126.1	180	-55.8 (-70.6) ^b	2143
[Ni(2,2-mettn) ₂ (μ -N ₃) _n](PF ₆) _n	136.5	180	-19.4 (-41.4) ^b	2143
[Ni(cyclam) ₂ (μ -N ₃) _n](ClO ₄) _n	140.7, 128.2	166.9	-39.2	2144
[Ni([15]aneN ₄)(μ -N ₃) _n](PF ₆) _n				2145
[Ni(232-tet) ₂ (μ -N ₃) _n](ClO ₄) _n	134.6, 124.1	142.4	-26.9	2146
[Ni(323-tet) ₂ (μ -N ₃) _n](ClO ₄) _n	135.8, 119.8	169.3	-62.7	2146
[Ni(macro) ₂ (μ -N ₃) _n](ClO ₄) _n	115.6, 116.8	175.7	-97.8	2147
[Ni(cth) ₂ (μ -N ₃) _n](ClO ₄) _n ^c	(A) 128.5, 130.7; (B) 131.4	150.5, 146.2	-41.1, -36.4	2148
[Ni(<i>N</i> -Eten) ₂ (μ -N ₃) _n](PF ₆) _n	123.4, 134.8	140.1	-13.6	2149
[{Ni(5-Mepz) ₄ (μ -N ₃) _n }(ClO ₄) _n · <i>n</i> H ₂ O]	128.4, 146.1	75.7	+6.9	2150,2151

^a 2,2-Mettn = 2,2-dimethyl-1,3-diaminepropane; 232-tet = *N,N'*-bis(2-aminoethyl)-1,3-propanediamine; 3,2,3-tet = *N,N'*-bis(aminopropyl)-1,3-ethanediamine; macro = 2,3-dimethyl-1,4,8,11-tetraazacyclotetradeca-1,3-diene; cth = *meso*-5,7,7,12,14,14-hexamethyl-1,4,8,11-tetraazacyclotetradecane; *N*-Eten = *N*-ethylethylenediamine; 5-Mepz = 5-methylpyrazole. ^b Different values at low and high temperature due to a phase transition. ^c Two structurally distinct 1D chains in the crystal lattice, indicated by (A) and (B).

Table 17 Structural and magnetic parameters for 1D *cis*-[Ni(μ -1,3-N₃)Ni] systems: angles Ni—N—N and dihedral angles τ (°); J in cm⁻¹.^a

	Ni—N—N	τ	J	References
[Ni(333-tet) ₂ (μ -N ₃) _n](PF ₆) _n	151.8, 151.3	142.8	-18.5	2156
[Ni(2-methyl) ₂ (μ -N ₃) _n](ClO ₄) _n	131.8, 125.9	125.9	-16.8	2152,2153
[Ni(2-methyl) ₂ (μ -N ₃) _n](PF ₆) _n	135.0, 122.6	146.8	-3.2	2152
[Ni(bipy) ₂ (μ -N ₃) _n](ClO ₄) _n	123.7, 120.1; 126.6, 121.3	133.9, 138.9	-33.0	2155
[Ni(bipy) ₂ (μ -N ₃) _n](PF ₆) _n	122.6, 122.6; 120.6, 127.4	134.9, 138.0	-22.4	2155
[Ni(aep) ₂ (μ -N ₃) _n](ClO ₄) _n	127.8, 126.2	122.4	<-1	2118
[Ni(L)(μ -N ₃)(N ₃) _n]	133.4, 124.5	106.8	+13.5	2154

^a 333-Tet = *N,N'*-bis(3-aminopropyl)-1,3-propanediamine; 2-methyl = 1,2-diamino-2-methylpropane; aep = 2-(aminoethyl-pyridine); L = tridentate Schiff base from pyridine-2-aldehyde and *N,N,N',N'*-tetramethylpropane-1,3-diamine.

central N of each azido bridge. Such compounds have a structurally and magnetically alternating chain and are discussed in the following section. Two different Ni^{II} ions may be present, located at an inversion center. In this case, all azido bridges are equivalent and the chain is structurally alternating but magnetically uniform, e.g., in *trans*-[Ni(*N*-Eten)₂(μ-N₃)_n](PF₆)_n, which is included here.

Extended Hückel calculations were performed on dimeric fragments in order to derive magneto-structural correlations for both kinds of complexes, *trans* and *cis*.^{2155,2156} Since bond distances are similar in all the complexes reported, the wide range of bond angles (Ni—N—N angles and dihedral Ni—N₃—Ni torsion) must play a significant role in the superexchange interaction between the nickel atoms. According to the MO calculations, for a *trans* chain (where the *d*₂ orbitals are oriented in the chain direction and are operative in the exchange pathway) the maximum coupling is expected for Ni—N—N angles of 108° while for larger values the antiferromagnetic interaction must decrease. At around 164° an accidentally orthogonal valley is found. It is assumed that the main interactions occur through the π pathway using the non-bonding MO of the azido ligand, while the σ pathway is poorly operative. For all Ni—N—N angles the maximum coupling can be expected for a torsion value of 180°, decreasing gradually thereafter as the torsion angles decrease. However, the magnitude of this effect is lower than the effect of the bond angle.

In the *cis* complexes, the torsion angle is usually smaller than that in *trans* complexes (Tables 16 and 17), leading to decreased antiferromagnetic coupling. In this case, the chains are helical and the compactness of this helix is a further factor that needs to be considered: the more compact the helicoidal structure, the greater the antiferromagnetic coupling.

While most 1D chain compounds with EE azido bridges show global antiferromagnetic coupling, there are a few exceptions. In *trans*-[Ni(5-Mepz)₄(μ-N₃)_n](ClO₄)_n·*n*H₂O,²¹⁵⁰ the torsion angle of the azido bridge (75.5°) is in the range where the antiferromagnetic contribution is minimized to favor ferromagnetic coupling. This compound shows spin canting caused by perturbation of ferromagnetism and zfs. Dehydration enhances the magnetic interactions to afford a soft magnet with *T*_c = 2.3 K and a coercive field of 20 G.²¹⁵¹ *cis*-[Ni(L)(μ-N₃)(N₃)_n] (L = tridentate Schiff base from pyridine-2-aldehyde and *N,N,N',N',2,2*-tetramethylpropane-1,3-diamine) was reported to exhibit metamagnetic behavior,²¹⁵⁴ which was ascribed to the combination of the large Ni—N—N angles deviating from 108°, the small torsion angle, and the axial–equatorial binding mode of the azide.

Uniform 1D systems obtained from *S* = 1 ions like Ni^{II} are of particular interest with respect to the experimental investigation of the so-called Haldane's gap, i.e., a quantic gap created between the ground state (*S* = 0) and the first excited state of a chain where the local *S*-value is an integer.^{2157–2162}

(iv) One-dimensional alternating systems

(l) *With only μ-1,1-azido ligands.* Some complexes of this type with general formula [Ni(L)(μ-N₃)₂]_n have been reported for Ni^{II},^{2149,2163} where L is a bidentate nitrogen ligand like ethylenediamine, 1,3-diaminopropane, and *N*-ethylethylenediamine. Although all neighboring Ni^{II} ions are linked by two EO azide bridges, the chains are structurally and magnetically alternating. For example, in [Ni(*N*-Eten)(μ-N₃)₂]_n the Ni^{II} ions are alternatively related by an inversion center or by a twofold axis. One of the Ni–N–Ni–N rings is planar, the other is not.

As can be expected from the EO coordination mode of the azido ligand, all these complexes show ferromagnetic coupling. The field dependence of the magnetization in the low temperature region has been interpreted as indicative of metamagnetic behavior.

While the first two complexes in Table 18 were analyzed with a single *J* parameter employing a model derived for a uniform ferromagnetic 1D system, a general formula for an isotropic ferromagnetic *S* = 1 Heisenberg chain has been developed and gives *J*₁ = +57.3 cm⁻¹ and *J*₂ = +29.0 cm⁻¹ for [Ni(*N*-Eten)(μ-N₃)₂]_n.²¹⁴⁹

(m) *With only μ-1,3-azido ligands.* For these compounds, alternation in the chain may be achieved either by different geometries in adjacent EE azido bridges (type A) or by consecutive single and double μ-1,3 azido linkages (type B). Examples for both types have been reported (Table 19). An equation for the analysis of magnetic susceptibility data of the antiferromagnetic alternating Heisenberg chain with local *S* = 1 has been developed by Borrás-Almenar *et al.*²¹⁶⁴ by following the Bonner–Fisher procedure.

Table 18 Structural and magnetic parameters for 1D $[\text{Ni}(\mu\text{-}1,1\text{-N}_3)_2\text{Ni}]$ systems.^a

	<i>Ni—N—Ni</i>		<i>J</i>	<i>D</i>	References
	<i>Unit A</i>	<i>Unit B</i>			
$[\text{Ni}(\text{en})(\mu\text{-N}_3)_2]_n$	103	100.9	+35.6 ^b	6.3	2163
	95.2	100.9	+23.8 ^b	0	
	103				
	101				
$[\text{Ni}(\text{tn})(\mu\text{-N}_3)_2]_n$	108.1	100.1	+3502 ^b	4.4	2163
	105.0	101.4	+3908 ^b	0	
$[\text{Ni}(N\text{-Eten})(\mu\text{-N}_3)_2]_n$	103.3		+57.3		2149
	100.3		+29.0		

^a Ni—N—N angles (°); *J* in cm^{-1} ; en = ethylenediamine; tn = 1,3-diaminopropane; *N*-Eten = *N*-ethylethylenediamine). ^b Analyzed with a single average *J* parameter using a formula for a uniform ferromagnetic chain; the first *J*-value is found by assuming *D* ≠ 0, the second one by assuming *D* = 0.

Table 19 Structural and magnetic parameters for alternating 1D $[\text{Ni}(\mu\text{-}1,3\text{-N}_3)\text{Ni}]$ systems: angles Ni—N—N and dihedral angles τ (°); *J* in cm^{-1} .^a

	<i>Ni—N—N</i>	<i>Type</i>	τ	<i>J, J'</i>	References
$[\text{Ni}(333\text{-tet})(\mu\text{-N}_3)]\text{ClO}_4$	123.6, 142.4	A	180	−80.7, −37.4	2156,2165,2166
$[\text{Ni}(N\text{-Eten})_2(\mu\text{-N}_3)]_n(\text{ClO}_4)_n$	134.8, 143.7	A	180	−68.4, −37.8	2149
$[\text{Ni}_2(\text{dpt})_2(\mu\text{-N}_3)(\mu\text{-N}_3)_2]_n(\text{ClO}_4)_n$ (892)	128.2/124.4,	B	57.4, 180	−41.4, −84.6	2167,2168
	119.2				
$[\text{Ni}_2\text{L}(\mu\text{-N}_3)(\mu\text{-N}_3)_2]_n$	122.5–131.3,	B	76.8/42.4, 47.7		2169
	114.9/116.4				

^a 333-tet = *N,N'*-bis(3-aminopropyl)-1,3-propanediamine; *N*-Eten = *N*-ethylethylenediamine; dpt = bis(3-aminopropyl)amine; L = 3,5-bis[*N*-2-dimethylamino)ethyl-*N*-methyl]aminomethyl]pyrazolate.

Type A: This has been found in $[\text{Ni}(333\text{-tet})(\mu\text{-N}_3)]_n\text{ClO}_4$ (333-tet = *N,N'*-bis(3-aminopropyl)-1,3-propanediamine)²¹⁵⁶ and $[\text{Ni}(N\text{-Eten})_2(\mu\text{-N}_3)]_n(\text{ClO}_4)_n$ (*N*-Eten = *N*-ethylethylenediamine).²¹⁴⁹ In both cases, the Ni^{II} ions are related by an inversion center located at the central nitrogen of each azido bridge, which produces a structurally and magnetically alternating antiferromagnetic chain. Using the Borrás-Almenar expression, the values $J = -80.7 \text{ cm}^{-1}$, $J' = -37.4 \text{ cm}^{-1}$ (alternation parameter $J'/J = \alpha = 0.46$) were derived for $[\text{Ni}(333\text{-tet})(\mu\text{-N}_3)]\text{ClO}_4$, and $J = -68.4 \text{ cm}^{-1}$, $J' = -37.8 \text{ cm}^{-1}$ ($\alpha = 0.55$) for $[\text{Ni}(N\text{-Eten})_2(\mu\text{-N}_3)]_n(\text{ClO}_4)_n$. As expected from the individual Ni—N—N angles of the alternating chain (123.6°/142.4° and 134.8°/143.7°, respectively), two very different values of *J* were obtained in both cases. The greater experimental *J*-value has been assigned to the bridge of 123.6°/134.8° (closer to 108–110° for which the maximum susceptibility is expected) and the smaller value to the greater angle (142.4°/143.7°). The alternance parameter α is close to the theoretical ratio between the gaps calculated by extended Hückel methods. $[\text{Ni}(333\text{-tet})(\mu\text{-N}_3)]\text{ClO}_4$ has been extensively studied as a model of the gapless point of the Affleck–Haldane conjecture.^{2165,2166}

Type B: Both double and unsupported single azido bridges have been observed in $[(\text{Ni}_2(\text{dpt})_2(\mu\text{-N}_3)(\mu\text{-N}_3)_2)]_n(\text{ClO}_4)_n$ (**892**); dpt = bis(3-aminopropyl)amine).^{2167,2168} In the Ni—(N₃)₂—Ni fragment, the azido ligands are not coplanar but cross each other. By using the Borrás-Almenar equation,²¹⁶⁴ the following values were determined: $J = -84.6 \text{ cm}^{-1}$, $J' = -41.4 \text{ cm}^{-1}$ ($\alpha = 0.49$). Considering its very small Ni—N—N angle of 119.2°, the greater value can be assigned to the single bridge.

An alternative strategy to obtain 1D alternating chains in a more rational manner is the linkage of distinct and well-defined bimetallic building blocks, giving a 1D coordination polymer with inherent alternation in the chain structure. This approach has been followed in the case of $[\text{Ni}_2\text{L}(\mu\text{-N}_3)(\mu\text{-N}_3)_2]_n$ (**893**); L = bis(tridentate) pyrazolate ligand) as well as the related $[\text{Ni}_2\text{L}(\mu\text{-Cl})(\mu\text{-Cl})_2]_n$.^{2169,2579} In its dinuclear constituents the Ni^{II} ions are spanned by the pyrazolate and an EE azido bridge (the EE mode being induced by the chelating side arms that enforce a rather large metal–metal separation), and these bimetallic units are linked by double EE bridges.²¹⁶⁹

Magnetic susceptibility data indicate overall antiferromagnetic coupling, but an unusual feature at low temperature awaits a more detailed study.

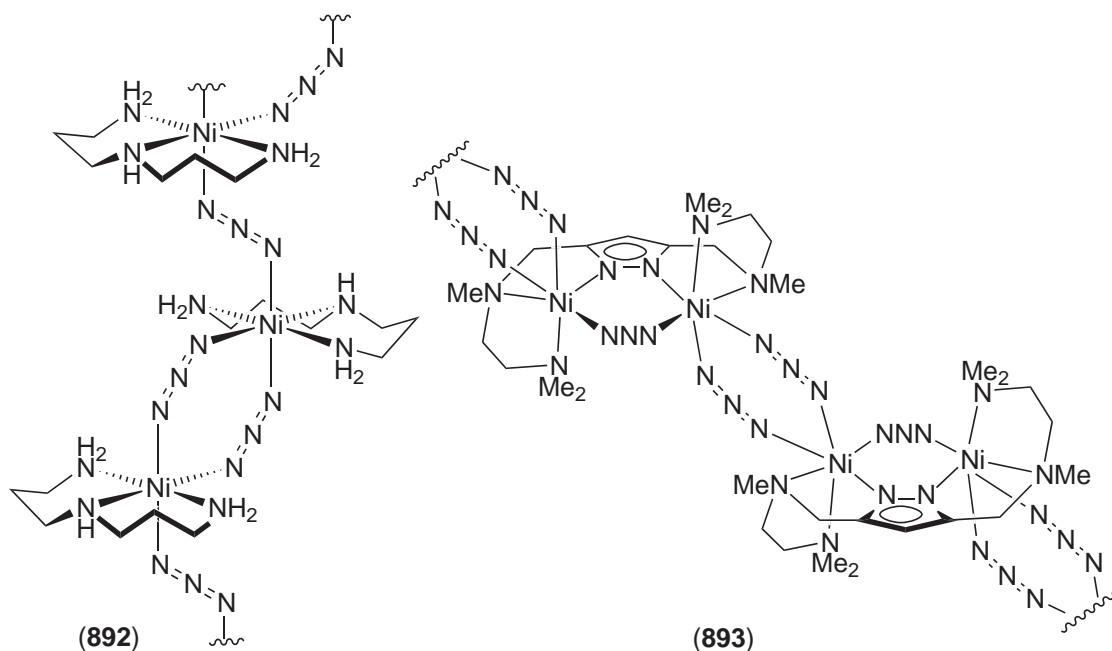

(n) With μ -1,3- and μ -1,1-azido bridges. Within this series of complexes, not only the alternating ferromagnetic-antiferromagnetic sequence (F-AF) resulting from an EO-EE azido bridge alternation has been observed, but also more complicated alternations like, for example, F-F-AF. Usually, the magnetic data have been interpreted and fitted by numerical extrapolations of $S = 1$ rings of finite length, assuming an isotropic Heisenberg system with quantic spin $S = 1$.²¹⁷⁰⁻²¹⁷² Some structural and magnetic parameters for these alternating chain compounds are collected in Table 20.

Antiferromagnetic coupling along $\text{Ni}(\mu$ -1,3- N_3) $_2\text{Ni}$ linkages follows the common trend, i.e., the higher the δ angle the lower the J -value. A distinct topology with alternating double EO and single EE bridges has been reported for $[\text{Ni}_2(\text{Medien})(\mu$ -1,1- N_3) $_2(\mu$ -1,3- $\text{N}_3)]_n$.²¹⁷³ A sequence with one end-to-end and three end-on bridges in alternation has been reported for $[\text{Ni}_2(\text{tmeda})_2(\mu$ -1,1- N_3) $_3(\mu$ -1,3- $\text{N}_3)]_n$ (894),²¹⁷⁴ which exhibits very small Ni-N-Ni angles for the azido ligands in EO mode (average value 84.2°). Different fitting procedures have been tested: either with the Borrás-Almenar formula²¹⁶⁴ for an antiferromagnetic alternating $S = 1$ chain or with the standard formula for a dinuclear Ni^{II} unit, assuming that J_{EO} is zero in the latter case. The parameters $J_1 = -31.8 \text{ cm}^{-1}$, $J_2 = -6.9 \text{ cm}^{-1}$ are obtained for the alternating chain, while the second approach gives $J = -29.3 \text{ cm}^{-1}$. Either way, antiferromagnetic coupling is present in both parts of the chain.

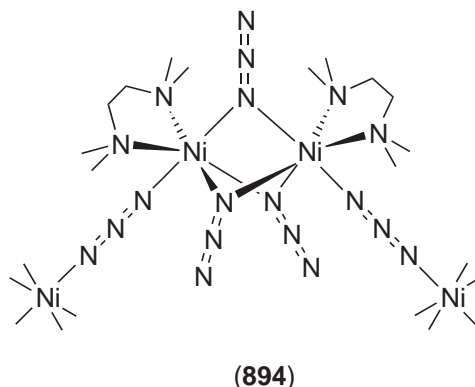
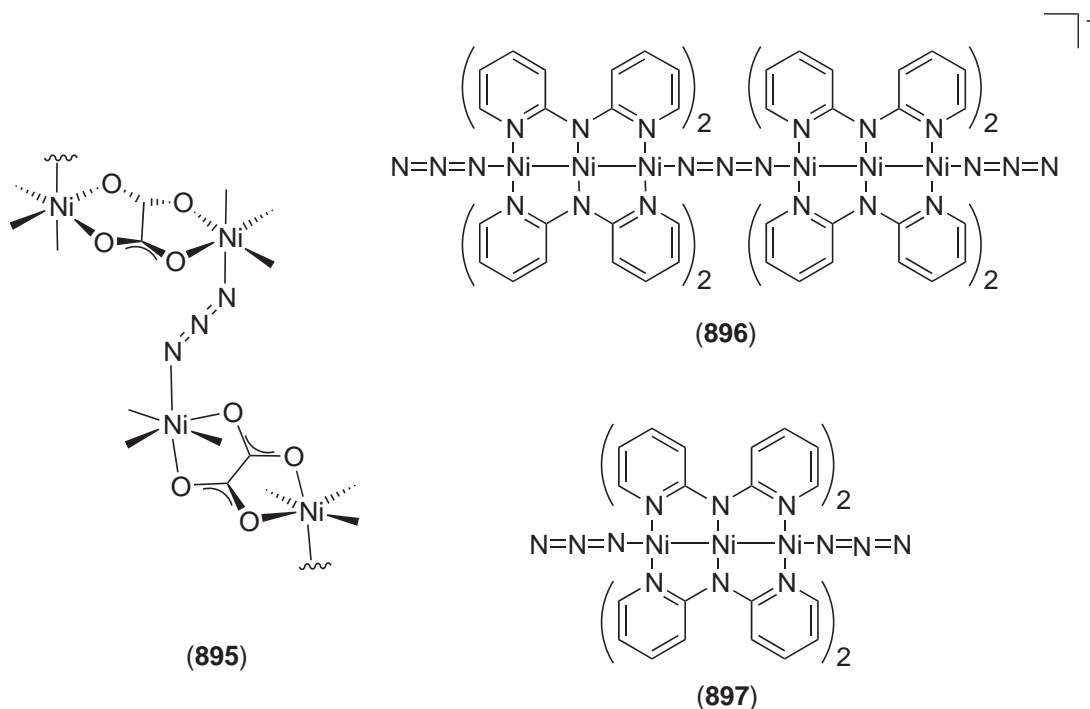

Table 20 Structural and magnetic parameters for F-AF 1D systems with both μ -1,3-N₃ and μ -1,1-N₃ bridges.^a

	Type	Ni—N—N	Ni—N—Ni	δ	τ	J, J', J''	References
[Ni(bipy)(μ -N ₃) ₂] _n	F-AF	118.2, 129.9	101.5	35.2		+26, -2.6	2172,2175
[Ni(phen)(μ -N ₃) ₂] _n	F-AF	117.0, 128.3	100.5	39.0		+28.1, -4.8	2176
[Ni(N,N'-dmen)(μ -N ₃) ₂] _n	F-AF	121.1, 139.4	98.2	~0		+77, -187.1	2177,2178
[Ni(aep)(μ -N ₃) ₂] _n	F-AF	125.6, 124.4, 121.6, 117.9	98.7			+73, -28.5	2177,2178
[Ni ₂ (Medien) ₂ (μ -N ₃) ₂ (μ -N ₃)ClO ₄	F-AF	138.1, 125.7	100.8, 98.9		162.8	-34.7, +38.2	2173
[Ni(N,N,N',N'-Me ₃ en)(μ -N ₃) ₂] _n	F-AF	129.6, 129.9	100.5	9.6		+99, -132	2179
[Ni(N,N,N'-dmen)(μ -N ₃) ₂] _n	F-F-F-AF	130.9, 132.9	100.5, 101.2, 102.9	8.4		-120, +20, +37	2170,2171
[Ni ₂ (tmeda) ₂ (μ -N ₃) ₃ (μ -N ₃)] _n (894)	AF-AF	138	85.2, 84.3, 83.2		0	-31.8, -6.9 (-29.3) ^b	2174

^a Ni—N—N angles and δ and τ angles for the Ni-(μ -1,3-N₃)-Ni linkages, Ni—N—Ni angles for the Ni-(μ -1,1-N₃)-Ni subunit ($^\circ$), J in cm⁻¹. N,N'-dmen = N,N'-dimethylethylenediamine; aep = 2-aminoethylpyridine; Medien = Methyl-diethylenetriamine; N,N,N',N'-Me₃en = N,N,N',N'-trimethylethylenediamine; N,N'-dmen = N,N'-dimethylethylenediamine; tmeda = N,N,N',N'-tetramethylethylenediamine. ^b Using a different model, see text.

(o) *Combination of μ -1,1-azido bridges with other linkages in alternating chains.* A straightforward strategy to obtain alternating chains is the use of different types of bridging ligands. This approach has been followed for the synthesis of $[\text{Ni}_2(\text{dpt})_2(\mu\text{-ox})(\mu\text{-N}_3)]_n(\text{PF}_6)_n$ (and its Medpt derivative) in which oxalato and azido bridges alternate (**895**).^{2180,2181} The oxalato group is coordinated in the common bis-bidentate mode, and the azido ligand is coordinated in an asymmetric EE mode with $\text{Ni}-\text{N}-\text{N} = 120.1^\circ$ and 119.41° and a very large torsion angle along the $\text{Ni}-\text{N}_3-\text{Ni}$ group (102.1°). $J_1 = -27.4\text{ cm}^{-1}$, $J_2 = -2.7\text{ cm}^{-1}$ ($\alpha = 0.1$) have been obtained by means of the Borrás-Almenar equation.²¹⁶⁴ Since the J parameter is found in the range -30 cm^{-1} to -39 cm^{-1} for all Ni-oxalato systems reported, assignment of the two J -values is evident. The low value for J_2 is presumably due to the very high torsion angle of the $\text{Ni}-\text{N}_3-\text{Ni}$ entity.



An unusual 1D alternating chain compound (**896**) consists of trinickel(II) units $[\text{Ni}_3(\text{dba})_4]^{2+}$ ($\text{dba} = \text{di}(\alpha\text{-pyridyl})\text{amide}$) that are linked by EE azido bridges.²¹⁸² Within the N_3 entity, the two terminal Ni^{II} are high spin ($S = 1$) while the central Ni^{II} is low spin ($S = 0$). Thus, the $S = 1$ ions in the 1D structure are alternately bridged by the $S = 0$ anions and by μ -1,3-azido. Magnetic data reveal overall antiferromagnetic behavior and are fitted by a dimer model to give results similar to those for the related dinuclear complex (**897**).²¹⁸²

(v) *Two-dimensional systems*

The anionic substructure of the salt $\text{Cs}_2[\text{Ni}(\text{N}_3)_4] \cdot \text{H}_2\text{O}$ ²¹⁸³ consists of a 2D structure formed by $\text{Ni}(\text{N}_3)_6$ octahedra connected via four EE azido groups placed in a distorted plane, but no magnetic data have been reported.

The compound $[\text{Ni}(2,2\text{-mettn})(\mu\text{-N}_3)]_n$ ($2,2\text{-mettn} = 2,2\text{-dimethyl-propanediamine}$) forms a 2D layer system with ferro-antiferromagnetic alternation, in which each azido ligand coordinates three Ni^{II} ions in a μ_3 -1,1,3 mode.^{2184,2185} The sheets are linked by hydrogen and van der Waals forces. This system shows a spin canting phenomenon at unexpectedly high temperatures (close to 50 K). A metamagnetic 2D compound $[\text{Ni}(N,N\text{-Et}_2\text{-N}'\text{-Meen})(\mu\text{-N}_3)_2]_n$ ($N,N\text{-Et}_2\text{-N}'\text{-Meen} = N,N\text{-diethyl-N}'\text{-methylethylenediamine}$) has been reported, where dinuclear nickel units with double EO azido bridges are further linked to four equivalent entities by means of single EE azido bridges.²¹⁸⁶ Magnetic data reveal intralayer ferromagnetic interactions and interlayer antiferromagnetic interactions.

The structure of $[\text{Ni}(\text{bpa})(\text{N}_3)_2]_n$ ($\text{bpa} = 1,2\text{-bis}(4\text{-pyridyl})\text{ethane}$) is deduced from the X-ray analysis of the isomorphous Mn compound. Its 2D sheet arrangement is composed of chains of

octahedrally coordinated metal ions bridged by double μ -1,3 azido linkages that are connected through bpa ligands.²¹⁸⁷ Magnetic data for the Ni^{II} system are characteristic of strong overall antiferromagnetic exchange, and treatment as a uniform linear $S=1$ chain (assuming that coupling through the bpa ligands is negligible) gives $J = -80 \text{ cm}^{-1}$. Quite similar, the structure of $[\text{Ni}(4,4'\text{-bipy})(\text{N}_3)_2]_n$ is proposed to consist of chains of Ni^{II} ions that are alternately bridged by double EO/mixed EO–EE/mixed EO–EE azido linkages, where the chains are connected by 4,4'-bipyridine to give a 2D sheet structure.²¹⁸⁸

6.3.4.13.2 Cyanide-based oligo- and polynuclear complexes

Stimulated by the favorable and tunable magnetic properties of 3D bimetallic assemblies of the Prussian blue type derived from $[\text{M}(\text{CN})_6]^{3-}$ ($\text{M} = \text{Cr}^{\text{III}}, \text{Fe}^{\text{III}}$), oligonuclear and polymeric compounds of cyanometallate building blocks are receiving great attention. Ni^{II} can be involved either as the diamagnetic $[\text{Ni}(\text{CN})_4]^{2-}$ anion acting as a bridge between paramagnetic metal ions, or as coordinatively unsaturated paramagnetic (high-spin) $[\text{NiL}_x]^{m+}$ entities that are bound to the N atoms of (dia- or paramagnetic) cyanide complexes, e.g., of hexacyanometallate building blocks $[\text{M}(\text{CN})_6]^{3-}$ ($\text{M} = \text{Fe}, \text{Cr}, \text{Mn}$). Examples for the type $[\text{NiL}]_3[\text{M}(\text{CN})_6]_2$ where L is a tetraza macrocycle with *trans* oriented accessible coordination sites are particularly manifold.^{2189–2195} Honeycomb-like structures are formed if the $[\text{NiL}]$ groups connect with three cyanide groups in a *fac* arrangement at the M ion, whereas a brick-wall structure results if the $[\text{NiL}]$ groups bind in a *mer* arrangement.^{2194,2195} Assembly reactions between $[(\text{Me}_3\text{tacn})\text{Mo}(\text{CN})_3]$ and $[(\text{cyclam})\text{Ni}(\text{H}_2\text{O})_2]^{2+}$ affords linear trinuclear $[(\text{Me}_3\text{tacn})_2(\text{cyclam})\text{NiMo}_2(\text{CN})_6]^{2+}$ with ferromagnetic coupling ($J = +17.0 \text{ cm}^{-1}$ to $+17.6 \text{ cm}^{-1}$ depending on the counterion) and an $S=4$ ground state.²¹⁹⁵ Depending on the stoichiometry of the reaction, $[(\text{Me}_3\text{tacn})_2(\text{cyclam})_3(\text{H}_2\text{O})_2\text{Ni}_3\text{Mo}_2(\text{CN})_6]^{6+}$ with a zigzag structure and 1D $[(\text{Me}_3\text{tacn})(\text{cyclam})\text{NiMo}(\text{CN})_3]^{2+}$ has also been obtained. Again, the magnetic behavior indicates ferromagnetic coupling.²¹⁹⁶ Reaction of $[(\text{Me}_3\text{tacn})\text{Mo}(\text{CN})_3]$ with $[\text{Ni}(\text{H}_2\text{O})_6]^{2+}$, however, produces face-centered cubic $[(\text{Me}_3\text{tacn})_8\text{Mo}_8\text{Ni}_6(\text{CN})_{24}]^{12+}$ involving cyanide linkage isomerization and formation of low-spin $[\text{Ni}(\text{CN})_4]^{2-}$ constituents. The related giant 24-metal cluster $[(\text{Me}_3\text{tacn})_{12}\text{Cr}_{12}\text{Ni}_{12}(\text{CN})_{48}]^{12+}$ with 12 *trans*-coordinated $[\text{Ni}(\text{CN})_4]^{2-}$ units has been reported to result from the reaction of $[(\text{Me}_3\text{tacn})\text{Cr}(\text{CN})_3]$, NiI_2 , and KCN.²¹⁹⁷ While antiferromagnetic coupling is often operative via diamagnetic $[\text{Ni}(\text{CN})_4]^{2-}$,²¹⁹⁸ some 1D complexes $[\text{NiL}][\text{Ni}(\text{CN})_4]$ (where L is a tetraaza macrocycle) show ferromagnetic interactions.²¹⁹⁹ Other paramagnetic ions partially coordinated with amine ligands can also be bridged by $[\text{Ni}(\text{CN})_4]^{2-}$ to give molecular, 1D, 2D, and 3D structures, e.g., 1D polymeric $[\text{Cu}(\text{L})\text{Ni}(\text{CN})_4]$ with weak antiferromagnetic interactions, where L is a di- or tridentate amine ligand.²²⁰⁰ The 2D coordination polymer $[\text{Fe}(\text{py})_2\text{Ni}(\text{CN})_4]$ consists of 2D extended cyanide sheets constructed by the alternate linkage between square planar Ni^{II} (C-bound) and octahedral Fe^{II} (N-bound) through cyano bridges, with the py ligands in *trans* positions at the Fe atoms.²²⁰¹ It undergoes a cooperative spin crossover transition between 210 K and 170 K. Using pyrazine (pz) instead of pyridine, the related 3D coordination spin crossover polymer $[\text{Fe}(\text{pz})\text{Ni}(\text{CN})_4]$ showing a significantly wider hysteresis loop was obtained.²²⁰²

6.3.4.13.3 Oligonuclear and polymeric complexes with other bridging ligands

Architectures of known oligo- and polynuclear Ni^{II} complexes are manifold, and only selected classes of compounds and selected examples can be mentioned.

The oxalate dianion is a very powerful magnetic exchange mediator. Various complexes of general type (898) with oxalate acting as a bis(bidentate) bridging ligand have been reported, in most cases with di-, tri-, or tetradentate amine capping ligands (e.g., (899), (900)) and, *inter alia*, $\{\text{N}_4\text{O}_2\}$,^{2203–2212} $\{\text{N}_3\text{O}_3\}$,^{2206,2213–2216} $\{\text{N}_2\text{O}_4\}$,^{2205,2217} or $\{\text{O}_6\}$ coordination environment of the distorted octahedral Ni^{II} ions. Antiferromagnetic exchange is usually found, with coupling constants J in the range -10 cm^{-1} to -20 cm^{-1} (based on the Hamiltonian $H = -2JS_1S_2$). In general, replacement of O by N atoms in the capping ligands is accompanied by an increase of the antiferromagnetic coupling. For example, $J = -11 \text{ cm}^{-1}$ has been reported for (901),²²¹⁷ whereas type (900) systems exhibit values of $J = -17 \text{ cm}^{-1}$ to -20 cm^{-1} .^{2215,2217} In the mixed oxalate/tetracyanonickelate bridged complex (902), the magnetic exchange ($J = -15.6 \text{ cm}^{-1}$) probably

also hold for other types of phenoxo-, alkoxo-, or hydroxo-bridged dinickel(II) systems: the magnetic coupling becomes less antiferromagnetic as the Ni—O—Ni angles diminish.^{2237,2238}

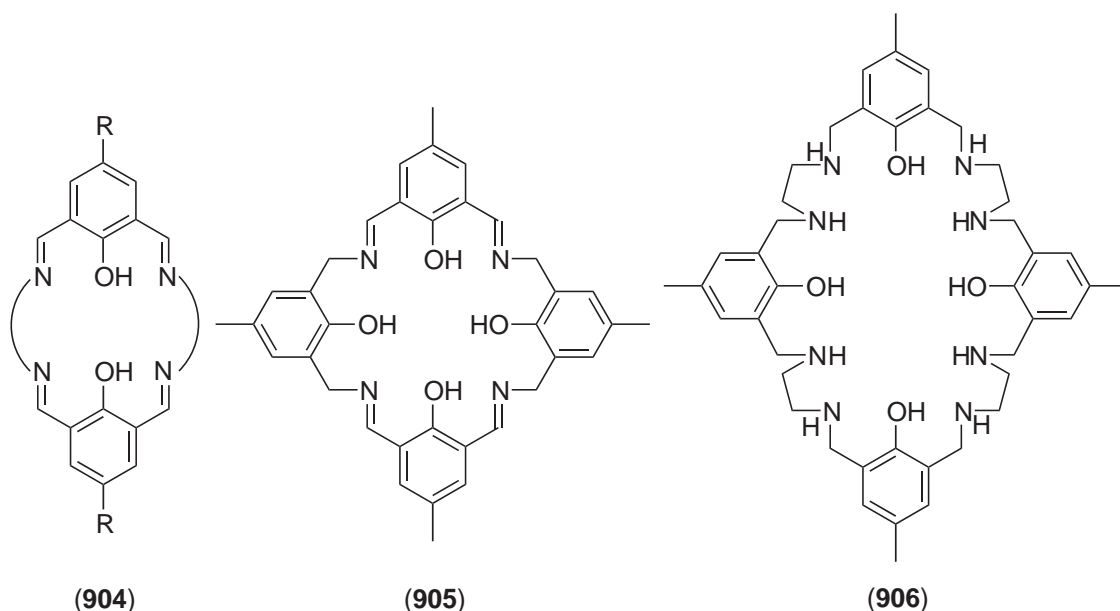

Large macrocycles like **(905)** and **(906)** form square- or rectangle-like tetranuclear Ni^{II}₄ complexes which may encircle a μ_4 -OH **(905)**²²³⁹ or μ_3 -OH group **(906)**.^{2240,2241} The former system behaves as an essentially noninteracting pair of Ni₂ units within which there is antiferromagnetic coupling. The coupled pairs are probably those involving the dialdehyde-derived phenoxo bridges, because these subunits are almost planar.²²³⁹ Imidazolate-bridged and 8-hydroxyquinoline-based cyclic Ni₄ complexes as well as a [2 × 2]-grid structure have been reported and magnetically analyzed.^{2242–2244} Other topologies of magnetically coupled Ni₄ species include a tetrameric Ni^{II} chair **(907)**²²⁴⁵ as well as a Ni₄ complex with planar triangular shape **(908)** (Figure 33).²²⁴⁶ **(907)** shows antiferromagnetic internal coupling but ferromagnetic spin alignment, because the large Ni—O(H)—Ni angles between the inner and outer Ni ions are the determining feature, which by setting the larger $-2J$ value drive the two central spins parallel. Global magnetic coupling in **(908)** is ferromagnetic.

Several examples of tetranuclear Ni^{II} complexes with a Ni₄O₄ cubane core and μ_3 -OR⁻ or μ_3 -OH⁻ at the four corners have been described **(909)**.^{2247–2256} In most cases, the Ni₄O₄ skeleton is not a regular cube, but has different sets of faces. The dominant parameter in the magnetostructural correlation is the averaged Ni—O—Ni angle of each cubane face. Ferromagnetic coupling is observed when this angle is close to orthogonality, while Ni—O—Ni angles in the vicinity of and larger than 99° lead to antiferromagnetic interaction.²²⁵⁷ Depending on the symmetry of the individual cubane, different J models have been used to analyze the magnetic data of such systems.

Reaction of [Ni(acac)₂(H₂O)₂] with benzotriazolone (bta; or a derivative thereof) gives a pentanuclear compound [Ni₅(OH)(bta)₅(acac)₄(H₂O)₄].^{2258,2259} Its structure is composed of a tetrahedral arrangement of four six-coordinate Ni^{II} ions centered on the fifth, and the complex exhibits antiferromagnetic coupling with an intermediate spin [$S = 0, S = 1$] ground state.²²⁵⁹ The ground

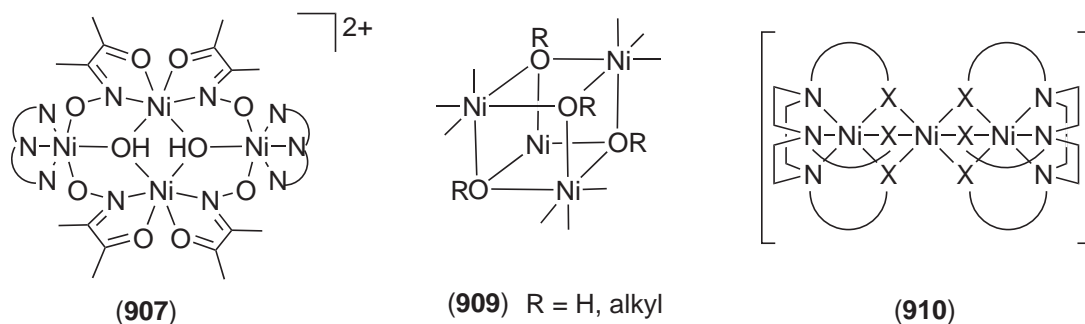

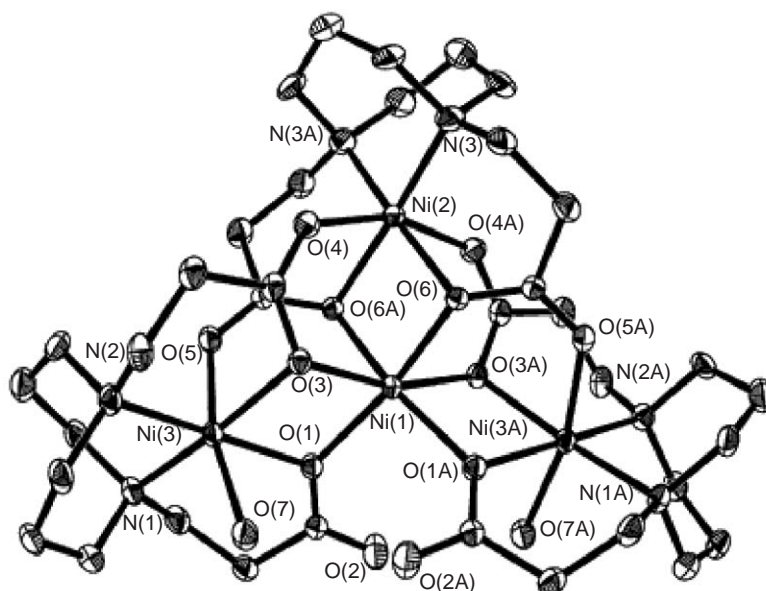
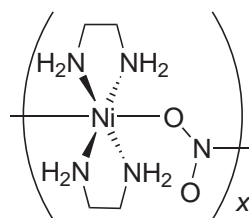

Figure 33 Structure of the $[\text{Ni}_4\text{L}_3(\text{H}_2\text{O})_2]^{2+}$ cation (**908**) ($\text{H}_2\text{L}=\text{bis}(3\text{-propionyloxy})\text{-}4,5\text{-diazacyclotane}$).²²⁴⁶ Reproduced by permission of The Royal Society of Chemistry.

state increases with the cluster symmetry, since a totally symmetric related Ni_5 species has a $[S = 1, S = 2]$ ground state.²²⁶⁰ Further, a nonanuclear Ni_9 complex could be obtained with the same type of ligands, where two regular tetrahedra (like in the Ni_5 complexes) share a common vertex. This compound features an intermediate spin $[S = 2, S = 3]$ ground state.²²⁶⁰

Type (**910**) Ni_3 complexes (as well as analogous heterotrinnuclear species involving Ni^{II}) form with 1,4,7-tris(4-*t*-butyl-2-mercaptobenzyl)-1,4,7-triazacyclononane ($\text{X} = \text{S}$) and 1,4,7-tris(3,5-dimethyl-2-hydroxybenzyl)-1,4,7-triazacyclononane ($\text{X} = \text{O}$).²²⁶¹ The central Ni^{II} is connected to the outer ones via six thiolate or phenolate bridging pendent arms, respectively. Magnetic data indicate that the thiolate complex has an $S = 1$ ground state whereas in the phenolate complex it is $S = 3$. This is a consequence of the smaller $\text{Ni}-\text{S}-\text{Ni}$ angle which cancels the orthogonality of the magnetic orbitals and provides an antiferromagnetic coupling pathway through overlap between filled $3s$ sulfur orbitals and the half-filled e_g set of Ni^{II} .²²⁶¹ In some different Ni_3 complexes incorporating both phenolato and acetate bridges, the $\text{Ni}-\text{O}-\text{Ni}$ angle is much larger than 90° (as required for orthogonality) and antiferromagnetic coupling is observed.^{2262,2263} A variety of linear heterotrinnuclear and heterotetranuclear complexes incorporating Ni^{II} have been developed by proper design of the ligand scaffold and their magnetic properties investigated.^{2264–2266}

One-dimensional Ni^{II} chains are attracting interest in connection with the Haldane conjecture.^{2267,2268} Theoretical models for the exchange alternation and single-ion anisotropy in the antiferromagnetic Heisenberg $S = 1$ chain have been developed.²²⁷¹ Prominent examples of such compounds is the alternating chain system $\{[\text{Ni}_2(\text{edta})(\text{H}_2\text{O})_4] \cdot 2\text{H}_2\text{O}\}_x$,^{2269–2271} and in particular the thoroughly studied $[\text{Ni}(\text{en})_2(\text{NO}_2)](\text{ClO}_4)$ (**911**), often abbreviated as NENP.^{2272–2274} For the latter system, magnetic measurements allowed an estimate of 13 cm^{-1} for the Haldane gap.²²⁷⁴ Using different anions, a dimerized Ni^{II} chain with nitro-nitrito bridges could be obtained, which also has an energy gap between the singlet ground state and low-lying excited states.²²⁷⁵ Several kinds of 1D Ni^{II} -nitrito systems of the type $\{[\text{NiL}(\mu\text{-NO}_2)]_n(\text{ClO}_4)_n$ have been



(**911**)

characterized in this connection, where L is a noncyclic tetraamine ligand,²²⁷⁶ and another type of carboxylate-bridged Ni^{II} chain is known with diethylenetriamine-N'-acetic acid.²²⁷⁷

The complex $[\text{Ni}_3(\text{fum})_2(\mu_3\text{-OH})_2(\text{H}_2\text{O})_4]_n \cdot (2\text{H}_2\text{O})_n$ (fum = fumarate) has a 3D structure formed by chains of fused Ni^{II} octahedral units and behaves as a 3D ferrimagnet.²²⁷⁸

6.3.4.13.4 Complexes with nitronyl nitroxide and verdazyl radical ligands

Complexes with radical ligands, e.g., nitronyl nitroxides (NITs, (912)) and imino nitroxides (IMs, (913)), have been actively pursued for the design of molecular based ferromagnets, since direct magnetic exchange is possible.²²⁷⁹ NITs are poor O-donors towards transition metals, and hence electron-withdrawing coligands such as hexafluoroacetylacetonato (hfac) have to be used in Ni^{II} complexes of simple NITs. Magnetic properties of $[\text{Ni}(\text{hfac})_2(\mathbf{912})_2]$ indicate weak to strong antiferromagnetic coupling between the Ni^{II} and the radicals.^{2280–2282} Auxiliary donor substituents at the NIT moiety enhance the coordination ability, and various NIT chelate ligands (in particular with pyridyl groups) have been employed in Ni chemistry. (914) binds via the pyridyl-N without involvement of the NIT O atom.^{2283,2284} Magnetic data of $[\text{Ni}(\text{hfac})_2(\mathbf{914})_2]$ and $[\text{Ni}(\mathbf{914})_4\text{Cl}_2]$ show antiferromagnetic coupling of about -10 cm^{-1} .²²⁸³ NITs and IMs with 2-pyridyl groups have been used most often, since (915) can act as a N,O-bidentate chelate ligand.^{2285–2291} The Ni^{II} complex of a related NIT-triazole ligand (916) has also been reported.²²⁹² NITmepy (915b) and IMmepy (917) form Ni^{II} complexes with ferromagnetic interactions.²²⁹³ The introduction of a methyl group at the *o*-position of the pyridyl ring (915b) can result in a coordination number lower than OC-6. For example, IMmepy forms $[\text{NiCl}_2(\mathbf{917})]$, which is a dimer with pentacoordinate Ni^{II} ions bridged by two chlorides with a large Ni–Ni distance (3.5808 Å). Upon use of the slim thiocyanate, however, a six-coordinate complex *cis*(NCS)-*trans*(py)- $[\text{Ni}(\text{NCS})_2(\text{IMmepy})_2]$ is formed. This complex shows distinctly longer Ni–N_{py} bonds and nonplanarity between the pyridine and the imino nitroxide planes due to the steric requirements of the hexacoordination.²²⁹³ Pyridyl-based NIT diradicals that have been studied in their Ni^{II} complexes are, *inter alia*, (918)²²⁹⁴ and the tetradentate bipyridine derivative in (919). Complex (919) exhibits an unusually large Ni^{II}–nitroxide ferromagnetic interaction ($+39.6\text{ cm}^{-1}$)^{2295,2296} which arises from the near-coplanarity between the π -conjugated radical plane and the equatorial plane of the *trans*-diaqua- $\{\text{Ni}\{(\text{N}_2\text{O}_2)\}(\text{H}_2\text{O})_2\}$ octahedron. Deviation from this geometry results in an antiferromagnetic component.

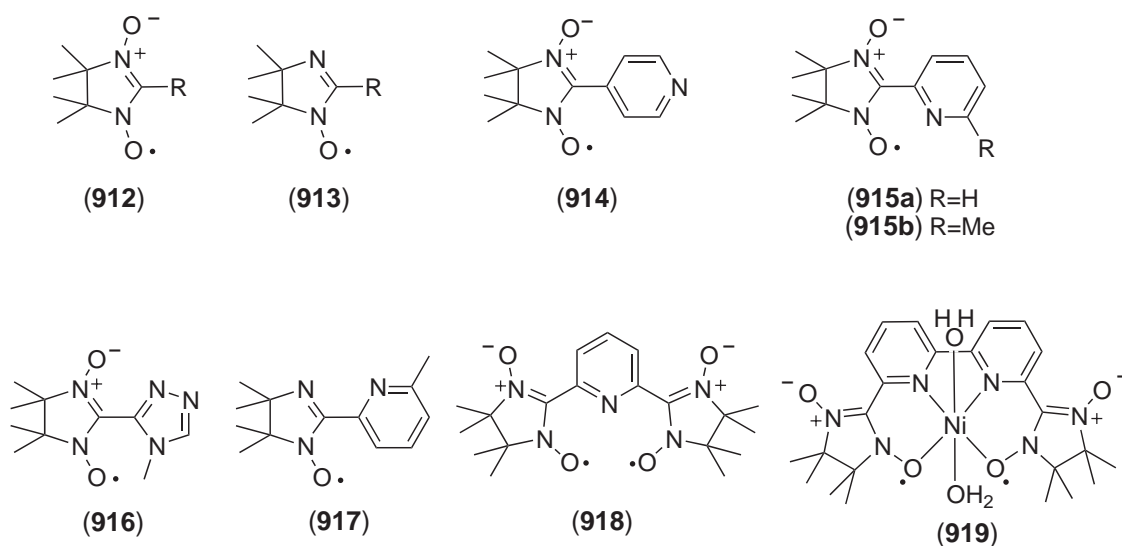

The carboxyphenyl-substituted ligand (920) forms a ladder-type polymeric structure where the nickel is coordinated simultaneously by carboxylate-O, NIT-O, and water.²²⁹⁷ Binding to the NIT substituent can be enhanced by appropriate chelate sites, e.g., in (921).²²⁹⁸ Complex (921) shows weak ferromagnetic coupling via the diamagnetic Ni^{II}. The spin-labeled dioxime 2,2,5,5-tetramethyl-1-oxylpyrrolidine-3,4-dione dioxime (H₂L) forms with Ni^{II} a planar complex $[\text{Ni}(\text{HL})_2]$ (922) with an intramolecular hydrogen bond between the oximic oxygens.²²⁹⁹ In the solid state the

square planar environment of the metal is completed to distorted octahedral by the O atom of the N—O groups of a neighboring molecule. This leads to formation of a parquet-like layered polymer structure in the solid. The Ni—O distance is, however, long (2.953 Å) and the Ni^{II} ion remains low spin. The layered polymer structure is responsible for the formation of exchange clusters >N—O· · ·Ni· · ·O—N< with effective interactions between the magnetic orbitals of the nitroxyl groups via the diamagnetic metal ions.

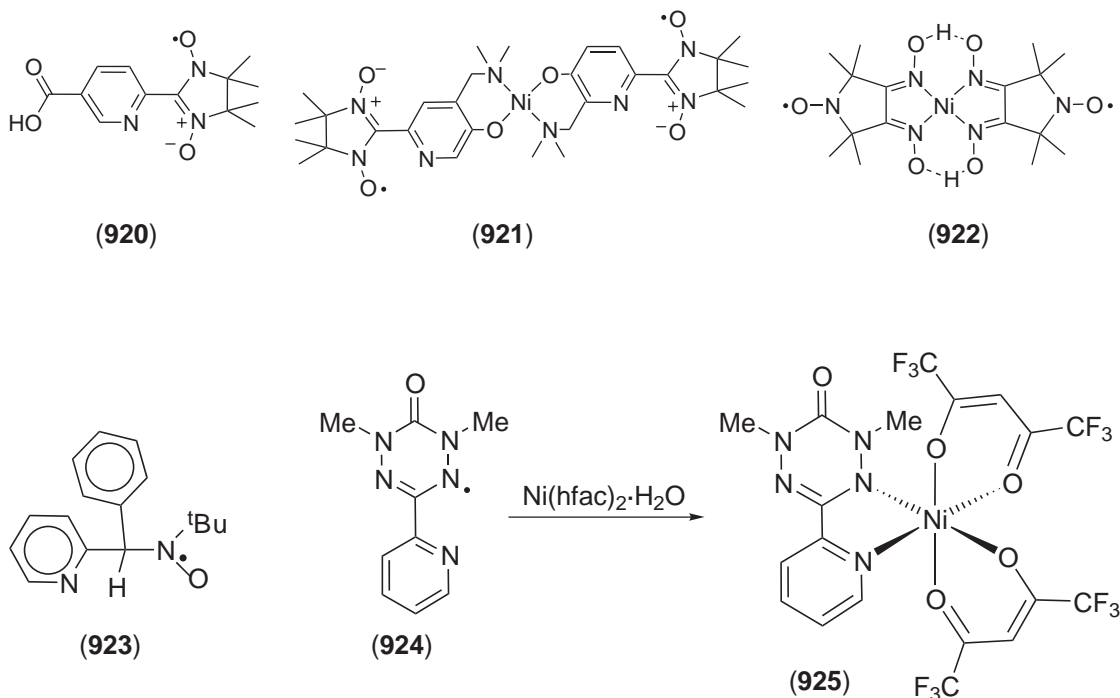

The presence of β -hydrogen in the nitroxide radical may lead to disproportionation reactions. In spin-trapping experiments, *N-t*-butyl- α -phenyl nitroxide yields rather unstable spin adducts. This type of radical can be stabilized by coordination to Ni^{II}. The Ni^{II} complex with *N*-oxy-*N-t*-butyl-(2-pyridyl)phenylmethanamine (**923**) reveals a distorted octahedral geometry with antiferromagnetic interactions between the unpaired electrons of the metal ion and the radical spins.²³⁰⁰

Verdazyl radicals have been proposed as attractive alternatives to NITs, because they offer several potential donor atoms. The first verdazyl radical complexes of open-shell ions were reported in 2000. Electron-withdrawing hfac ancillary ligands and chelate assistance by a pyridyl substituent have been used to prepare (**925**) from (**924**). The verdazyl–Ni^{II} coupling is strong and ferromagnetic ($J = +120 \text{ cm}^{-1}$ as a lower limit), which is explained by orthogonality of the magnetic orbitals.²³⁰¹ The dinuclear complex (**927**) is accessible from the pyrimidine–verdazyl ligand (**926**). It has an $S = 5/2$ ground state due to strong Ni^{II}–verdazyl ferromagnetic coupling ($J = +110 \text{ cm}^{-1}$).²³⁰² Other verdazyl ligands employed in Ni^{II} coordination chemistry are tridentate (**928**) (which gives $[\text{Ni}(\mathbf{928})_2]^{2+}$) and water-soluble (**929**) (which gives $[\text{Ni}(\mathbf{929})_2\text{H}_2\text{O}]_2$).²³⁰⁴

6.3.4.14 Miscellaneous Complexes of Nickel(II)

6.3.4.14.1 Complexes with silyl and silylene ligands

Quite a number of silylnickel and silylenenickel compounds have been reported, and only a few can be cited here.^{2305–2309} Bis(silyl)nickel complexes have been implicated as important intermediates in Ni-catalyzed double silylation of various organic substrates. Using an *o*-bis(dimethylsilyl)carborane ligand, complex (**930**) could be isolated and structurally characterized.²³¹⁰ Its unusual thermal stability is attributed to the advantageous steric and electronic properties of the carboranyl unit. (**930**) undergoes

subsequent double silylation reactions with unsaturated organic substrates. **(931)** is another example of a bis(silyl)nickel(II) complex.³¹⁵

Reaction of the 1-silacyclopropene **(932)** with $[\text{Ni}(\text{PEt}_3)_4]$ gives nickelasilabutene **(933)**.²³¹¹

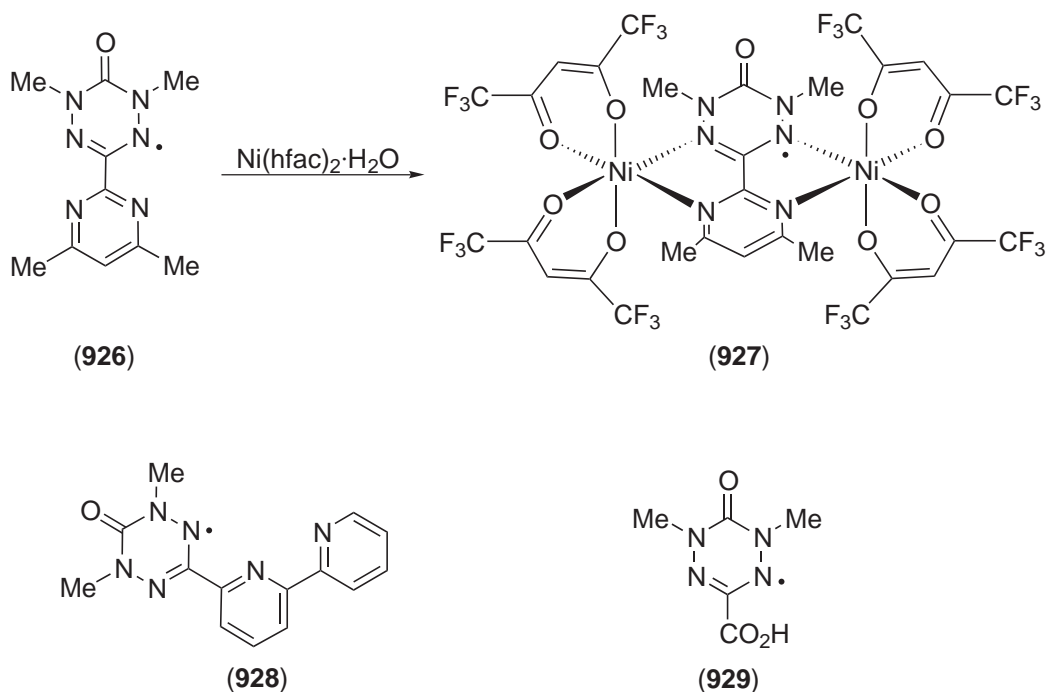

6.3.4.14.2 Hydride complexes

Ni hydrides have been implicated as reactive species in various organometallic transformations and catalytic processes, e.g., ethene oligomerization by **(934)**.²³¹² Giving the importance of Ni hydrides in industrial and possibly enzymatic processes, only few examples will be mentioned here in order to indicate the scope: *inter alia*, stereoselective cyclization of a 1,3-diene and the carbonyl group in a chain is mediated by a Ni^{II} hydride complex generated from $[\text{Ni}(\text{acac})_2]$ and DIBAL-H in the presence of PPh_3 ,²³¹³ and silane alcoholysis is catalyzed by a Ni^{II} complex with {N,O,S} coordination.¹²⁵⁵ Ethylene dimerization by $[\text{Ni}(\text{acac})\text{H}]$ ²³¹⁴ and oxidative addition of H_2 to Ni^{II} complexes such as $[\text{NiCl}_2(\text{PH}_3)_2]$ to give the formal Ni^{IV} complex $[\text{NiH}_2\text{Cl}_2(\text{PH}_3)_2]$ have been studied by DFT and *ab initio* methods, respectively.²³¹⁵

Square planar Ni^{II} hydride complexes $\text{trans}[\text{NiH}(\text{X})(\text{PCy}_3)_2]$ (**935**) are conveniently accessible by addition of HX to the dinitrogen complex $[(\text{PCy}_3)_2\text{Ni}-\text{NN}-\text{Ni}(\text{PCy}_3)_2]$, and subsequent substitution of X gives rise to manifold derivatives such as $\text{trans}[\text{NiH}(\text{CH}_3)(\text{PCy}_3)_2]$ and $\text{trans}[\text{NiH}(\text{Ph})(\text{PCy}_3)_2]$.²³¹⁶ The *trans* influence of the X ligand on the Ni—H bond has been investigated, using the IR-derived $\nu(\text{Ni}-\text{H})$ stretching frequencies and the ^1H NMR chemical shifts.²³¹⁷ CO_2 and MeI were used as chemical probes: derivatives with a stronger Ni—H bond (S- and O-donors) show no reactivity while the C-bond derivatives exhibit CO_2 insertion at the hydride. While $\text{trans}[\text{NiH}(\text{CH}_3)(\text{PCy}_3)_2]$ gives the hydridonickel formate complex $\text{trans}[\text{NiH}(\text{HCO}_2)(\text{PCy}_3)_2]$, $\text{trans}[\text{NiH}(\text{Ph})(\text{PCy}_3)_2]$ simply gives $\text{trans}[\text{Ni}(\text{HCO}_2)(\text{Ph})(\text{PCy}_3)_2]$.²³¹⁸ In the C-donor derivatives, the Ni—H bond is reactive towards MeI via H-atom abstraction by methyl radicals. With CCl_4 and CHBr_3 , $\text{trans}[\text{NiH}(\text{Cl})(\text{PCy}_3)_2]$ reacts to give $[\text{NiCl}_3(\text{PCy}_3)]^-$ and $[\text{NiBr}_3(\text{PCy}_3)]^-$, respectively.²³¹⁹

Complexes $[\text{Ni}(\text{H})(\text{diphosphine})_2]^+$ can be prepared by two ways, either by reaction of $[\text{Ni}^{\text{II}}(\text{diphosphine})_2]^{2+}$ with H_2 in the presence of base, or by reaction of $[\text{Ni}^0(\text{diphosphine})_2]$ with NH_4^+ . A linear free energy relationship exists between the half-wave potentials of the $\text{Ni}^{\text{I}}/\text{Ni}^{\text{II}}$ couples of different $[\text{Ni}(\text{diphosphine})_2]$ complexes and the hydride donor ability of the corresponding $[\text{Ni}(\text{H})(\text{diphosphine})_2]^+$.²³²⁰ Several methods have been used to determine those hydride

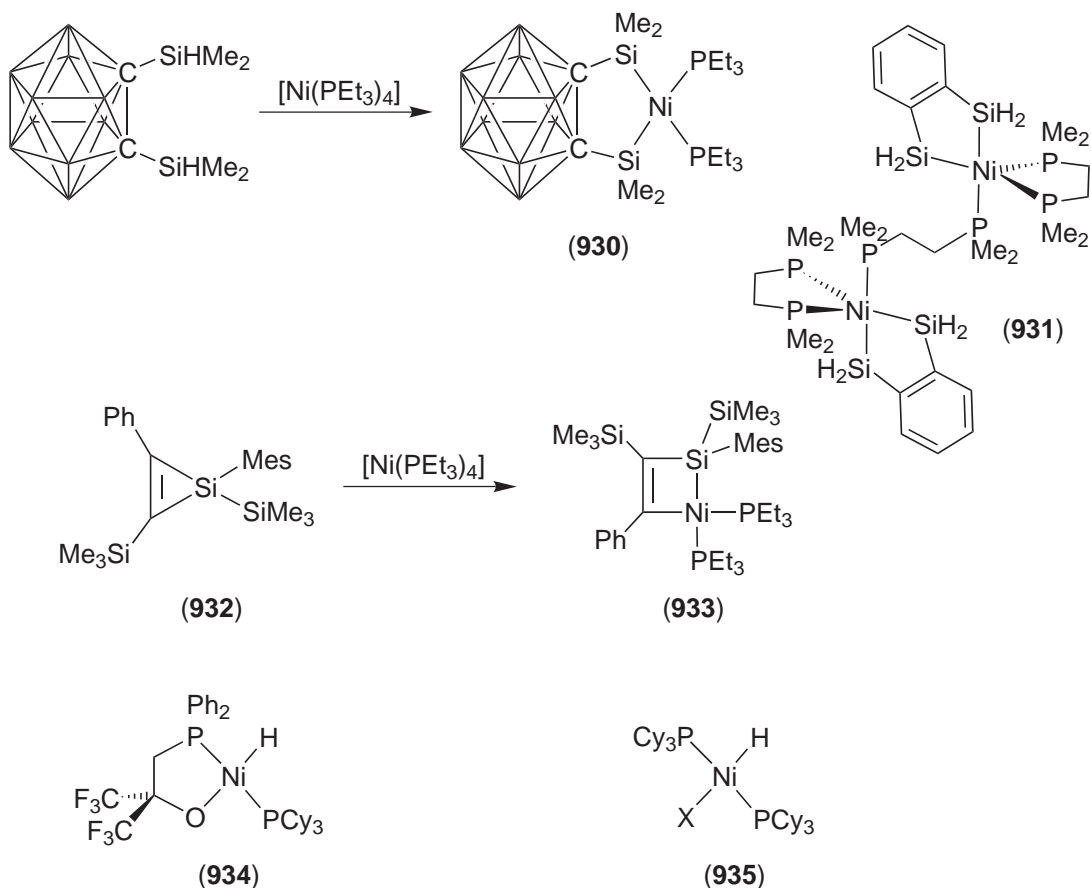

donor abilities, which is useful for understanding the differences in the reactivity of $[\text{Ni}(\text{diphosphine})_2]^{2+}$ towards H_2 .²³²¹

6.3.5 COMPLEXES OF NICKEL(I)

6.3.5.1 Introduction

Similar to the high-valent Ni story, significant impetus for the interest in low-valent Ni chemistry stems from the involvement of Ni^{I} species in bioinorganic processes, predominantly from the unique Ni^{I} state of the active form of coenzyme F_{430} of methylcoenzyme M reductase (MCR) and the possible relevance of Ni^{I} in $[\text{Ni},\text{Fe}]$ hydrogenase. This also contributes to the particular prominence of nitrogen- and sulfur-based ligand systems in studies on Ni^{I} complexes. However, not every ligand environment can support Ni^{I} , and in many cases Ni^0 is produced directly upon reduction of Ni^{II} compounds. Hence, most Ni^{I} species with simple N and O ligands are thermodynamically and kinetically unstable with respect to disproportionation into Ni^0 and Ni^{II} . Stabilization of Ni^{I} is more easily achieved by soft donor ligation (C, P, As, S donor atoms) or by a macrocyclic environment. The redox chemistry of nickel has been reviewed.⁶³

6.3.5.2 Complexes with Nitrogen Donor Ligands

6.3.5.2.1 Complexes with macrocyclic nitrogen donor ligands

Similar to porphyrin systems, Ni^{I} complexes with macrocyclic $\{\text{N}_4\}$ ligands (in particular of the cyclam type) have been considered particularly instructive with respect to the chemistry of the active site of methyl coenzyme M reductase. In most cases, Ni^{I} species are produced by

reduction of the corresponding Ni^{II} complexes. Electrochemical properties of the Ni^{II} macrocyclic complexes are related to the cavity size, the unsaturation, the degree of functionalization, and the subring moieties fused to the macrocycles. These aspects are also covered in the sections dealing with Ni^{II}, and the reader should refer to [Section 6.3.4.10.2\(iii\)](#) for additional information.

Electrochemical reduction has been used to great extent in the synthesis of Ni^I macrocyclic complexes. For example, the divalent nickel complexes of cyclam (**936**), tetramethylcyclam (**937**), *meso*-5,7,7,12,14,14-hexamethyl-1,4,8,11-tetraazacyclotetradecane (**938**), and decamethylcyclam (**939**) were reduced to their corresponding Ni^I complexes in aqueous solution.²³²² Redox potentials for the Ni^{II}/Ni^I couple are -1.58 V, -1.15 V, -1.42 V, and -0.98 V (vs. SCE), respectively, indicating that the major effect is the strength of the Ni–L interaction, in agreement with the clear correlation between the redox potentials and $10\Delta g$ values determined spectrophotometrically. The effects of *N*-methylation on the Ni^{II}/Ni^I couples and on the properties of the Ni^I complex in solution have been studied for a large series of tetraazamacrocyclic cyclam analogues.²³²³ The positive shift in redox potential observed on methylation is largely a consequence of the decrease in solvation energy of the Ni^{II} complex. However, the lifetime of the Ni^I complex is not linearly related to the redox potential. Methyl substituents bound to the N atoms of cyclam slow down the ligand loss reaction in water.²³²² Disulfides react with [Ni(**937**)]⁺ by oxidative addition to give [Ni(**937**)(SR)]⁺.¹⁹⁶⁷

R,S,R,S-[Ni(**937**)]⁺ reacts with a series of alkyl halides in aqueous alkaline solution to form alkylnickel(II) complexes of the type [RNi(**937**)]⁺. Kinetic data indicate that the reaction occurs in two steps, the first being a one-electron transfer from [Ni(**937**)]⁺ to RX (X = halide), yielding an alkyl radical R. The second step involves rapid capture of the alkyl radical by [Ni(**937**)]⁺.²³²⁴ [Ni(**937**)]⁺ has also been reacted with a number of variously disubstituted alkanes, including 1,4-dihaloalkanes,²³²⁵ 1,5-dihaloalkanes,²³²⁶ 1,2-disubstituted alkanes, 1,3-disubstituted alkanes, 1,4-disubstituted alkanes, 1,5-disubstituted alkanes, and 1,6-disubstituted alkanes.²³²⁷ Reaction products ranged from ethylene to cyclopentane depending on the disubstituted alkane employed. Further, Ni^I macrocycle complexes have been used as electron transfer catalysts in the radical cyclization of halogeno ethers. When the Ni^I macrocycle complexes were generated electrochemically from their corresponding Ni^{II} complexes, enhanced catalytic activity relative to those generated by reduction with Zn or Mn metal was observed.²³²⁸

The effect of steric crowding on the rates of reaction of the Ni^I tetraaza macrocycle complex [Ni(dmc)]⁺ with organic halides and hydroperoxides has also been examined. Reaction with this complex was found to be about 104 times slower than with the corresponding [Ni(tmc)]⁺ complex.²³²⁹

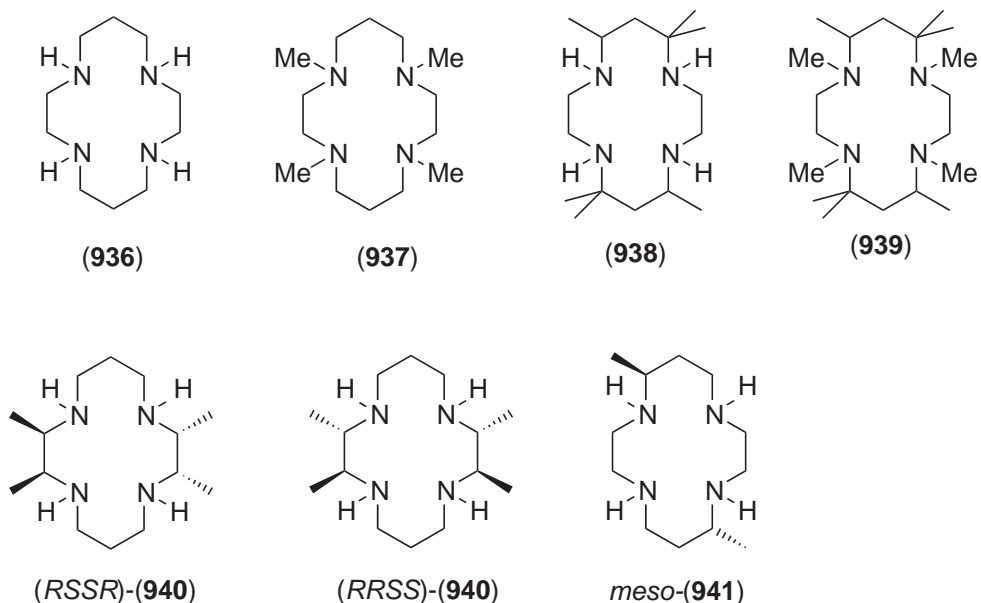

The Ni^I complexes may exist in different isomeric forms, and the form obtained may depend upon whether pulse radiolysis or electroreduction are employed to synthesize them.²³²³ Usually, isomeric integrity of tmc nickel complexes is not maintained upon going from Ni^{II} to Ni^I:

chemical reduction (Na/Hg) of either Ni^{II} isomer (*R,R,S,S* or *R,S,R,S*) resulted in production of both Ni^I isomers.^{1967,2324} *R,R,S,S*-[Ni(**937**)](OTf)·NaOTf has been structurally characterized.¹⁹⁶⁷ The {N₄} environment is rigorously planar, but two sets of distinct Ni—N distances are observed (2.120(5) Å and 2.095(5) Å), which is a common phenomenon in square planar Ni^I (and Ni^{II}) complexes. Upon reduction, the average Ni—N distance has increased by 0.12 Å to accommodate the larger Ni^I ion. Comparison of [Ni^{II}(*R,S,S,R*-(**940**))] ²⁺ with [Ni^I(*R,S,S,R*-(**940**))] ⁺ shows a lengthening of the Ni—N bonds from 1.948–1.969 Å in the Ni^{II} complex to 2.053–2.083 Å in the Ni^I analogue because of the placing of an extra electron in the *d_{x²-y²}* orbital and reduction of ligand field strength, but distortion of the macrocycle core is not observed.²³³⁰

The X-ray crystal structure of *meso*-[Ni^I(**942a**)] ⁺ reveals a distorted square planar environment with Ni—N bonds that are 0.128 Å (Ni—N_{amine}) and 0.077 Å (Ni—N_{imine}) longer than for the *meso*-[Ni^{II}(**942a**)] ²⁺ complex due to the extra electron in the *d_{x²-y²}* orbital. Similar values have been deduced from EXAFS data both for [Ni^I(**942a**)] ⁺ and [Ni^I(**942b**)] ⁺, while for [Ni^{II}(**943a**)] ⁺ the reduction is ligand centered to give a π anion radical.²³³¹ EXAFS data on the CO adducts of [Ni^I(**942a**)] ⁺ and [Ni^I(**942b**)] ⁺ clearly showed pentacoordination with the presence of a short Ni—C bond (1.78–1.80 Å), which is accompanied by a dramatic increase of the Ni—N distances and further distortion of the macrocycle. Coordination of CO to the π anion radical [Ni^{II}(**943a**)] ⁺ likewise gives [Ni^I(**943a**)(CO)] ⁺, which involves substantial displacement of the metal ion out of the {N₄} plane. The latter reaction provides an alternative route toward Ni^I formation.²³³¹

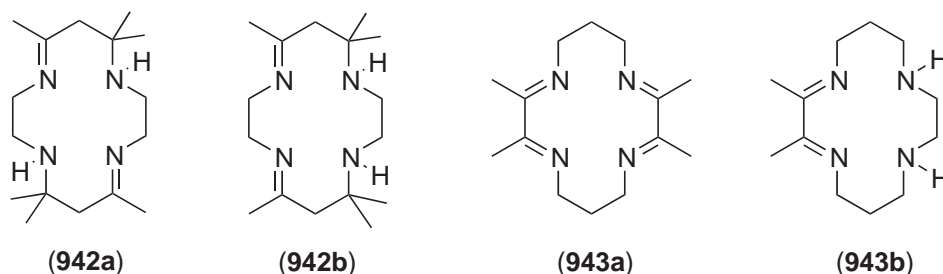

Binding constants and $\nu(\text{CO})$ for various Ni^I–CO complexes were determined; representative examples are collected in Table 21. Generally, the CO binding ability is related to the electron donating ability of the ligand and to steric effects. CO stretching frequencies decrease and CO binding constants increase as [NiL] ⁺ becomes a more powerful reductant. [Ni(**937**)] ⁺ is an exception, and its stronger binding of CO has been attributed to the macrocycle conformation that protects the bound CO in the cavity of the four methyl groups.²³³¹

Ni^I complexes (**944**)–(**950**) with various different saturated polyaza macrotricyclic ligands having noncoordinated nitrogen atoms in the ligand framework have been prepared by reduction of the Ni^{II} complexes with Na/Hg in acetonitrile. The crystal and molecular structures of (**948**), (**946**), and (**945**) were determined.^{1582,2333} Both complexes were found to have essentially square

Table 21 Carbon monoxide binding constants^a and carbonyl vibrational frequencies in CH₃CN at 25 °C.

Compound	$E_{1/2}$ (V vs. SCE)	K_{CO} (M ⁻¹)	ν_{CO} (cm ⁻¹)	References
[Ni(943a)] ⁺	-0.498	$(1.3 \pm 0.3) \times 10^2$	2012	2331
<i>C-RSRS</i> -[Ni(937)] ⁺	-0.837	$(1.2 \pm 0.4) \times 10^5$	1967	1538
[Ni(942a)] ⁺	-1.215	$(5.6 \pm 1.5) \times 10^4$	1962	2331
[Ni(942b)] ⁺	-1.234	$(1.8 \pm 0.4) \times 10^4$	1961	2331
[Ni(943b)] ⁺	-0.823	$(3.7 \pm 0.8) \times 10^2$	1977	2331
[Ni(938)] ⁺	-1.243	$(4.0 \pm 1.5) \times 10^4$	1956	2331
<i>C-RRSS</i> -[Ni(940)] ⁺	-1.430	$(9.0 \pm 2.0) \times 10^4$	1939	1538
[Ni(941)] ⁺	-1.445	$(1.8 \pm 0.4) \times 10^5$	1956	1538
[Ni(936)] ⁺	-1.445	$(2.8 \pm 0.6) \times 10^5$	1955	2331
<i>RRSS</i> -[Ni(945)] ⁺	-1.22	1.6×10^4		2332
<i>RRSS</i> -[Ni(946)] ⁺	-1.08	1.9×10^3		2332
<i>RRSS</i> -[Ni(947)] ⁺	-1.11	1.9×10^3		2332

^a For *C-RSRS*-[Ni(**943a**)] ⁺, K_{CO} is defined by the following reaction: Ni^{II}(TIM) ⁺ + CO \rightleftharpoons Ni^ITIM–CO ⁺. The first reduction is ligand centered.

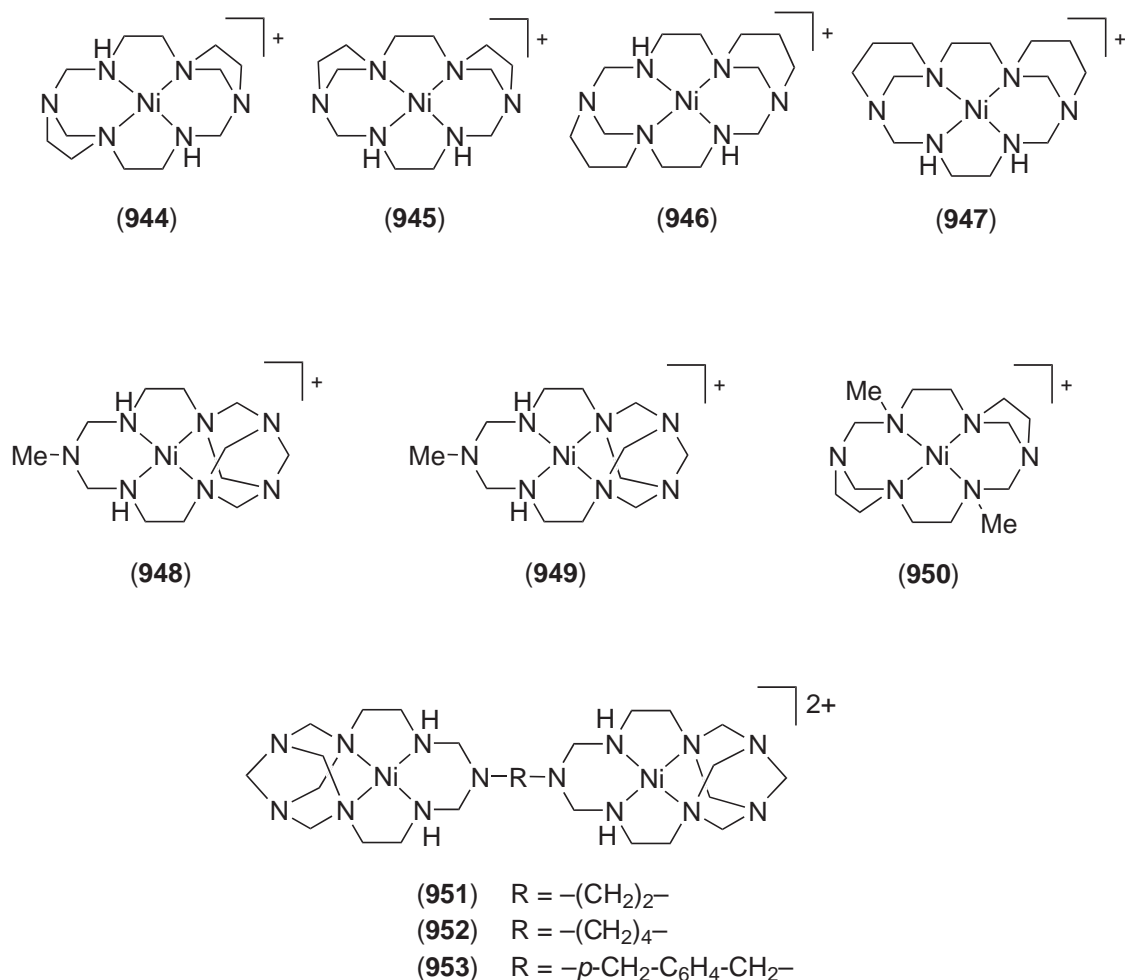

planar coordination geometry, although some square pyramidal (**948**) or tetrahedral (**945**, **946**) distortion was discernible. Usually, there are two sets of Ni—N bond distances, e.g., three at 1.978(3) (av.) Å and one at 1.878(4) Å in the case of (**946**), without any noticeable expansion of the macrocyclic hole.²³³³

A square pyramidal Ni^I complex, $R,S,R,S\text{-}[\text{Ni}(\mathbf{945})(\text{NHC}(\text{OH})\text{CH}_3)]^+$ has been obtained by the reduction of $R,R,S,S\text{-}[\text{Ni}(\mathbf{945})]^{2+}$ with Na/Hg in MeCN under a N₂ atmosphere.²³³⁴ In the formation of the complex, the solvent MeCN was hydrated to acetamide and coordinated to the Ni^I ion in the iminol form. All Ni—N bonds are significantly longer than those of the square planar Ni^I complex $R,R,S,S\text{-}[\text{Ni}(\mathbf{945})]^+$.

EPR spectra of the dinickel(I) complexes (**951**)–(**953**) with bis(macrocyclic) ligands show that the two metals behave independently.¹⁸⁶⁷

Irradiation of solutions of $[\text{Ni}(\text{L})]^{2+}$ and 0.01 M HCO₂Na (L = (**939**), (**947**)) with γ -rays or 3 MeV electrons afforded $[\text{Ni}(\text{L})]^+$.²³³⁵ Injection of methyl coenzyme M (MeSCH₂CH₂SO₃[−]) gave methane, blank experiments without the Ni complexes did not.

Reaction of $[\text{CH}_3\text{Co}(\text{dmgBF}_2)_2\text{L}]$ (dmgBF₂ = (difluoroboryl)dimethylglyoximate, L = py, PEt₃) with two equivalents of $[\text{Ni}(\mathbf{937})]^+$ gave $[\text{Co}(\text{dmgBF}_2)_2\text{L}]^-$, $[\text{Ni}(\mathbf{937})]^{2+}$, and $[\text{Ni}(\mathbf{937})\text{CH}_3]^+$ in 80% yield.¹⁸⁶² The overall transformation provides a model for the transfer of a CH₃ group from methylcobalamin to the Ni-containing enzyme CO dehydrogenase during acetyl CoA synthesis. $R,R,S,S\text{-}[\text{Ni}(\mathbf{937})\text{CH}_3](\text{BAR}'_4)$ (BAR'₄ = B(3,5-(CF₃)₂C₆H₄)₄[−]) was characterized by X-ray diffraction. The products and stoichiometry of the reaction are consistent with a three-step mechanism initiated by electron transfer from $[\text{Ni}(\text{tmc})]^+$ to $[\text{CH}_3\text{Co}(\text{dmgBF}_2)_2\text{L}]^-$. The second step is rapid CH₃—Co bond homolysis yielding $[\text{Co}(\text{dmgBF}_2)_2\text{L}]^-$ and CH₃, and then the CH₃ radical is captured by the second equivalent of $[\text{Ni}(\mathbf{937})]^+$, yielding $[\text{Ni}(\mathbf{937})\text{CH}_3]^+$.

The fact that Ni^{II} tetraamine macrocycle complexes catalyze CO₂ electroreduction, even in aqueous solution (compare Section 6.3.4.10.2(v)), encouraged detailed studies of the interaction of

CO₂ with the reduced Ni^I species. *Inter alia*, cyclic voltammetry has been used to measure the binding constant for complexation of CO₂ by various electrogenerated Ni^I tetraazamacrocyclic complexes.²³³⁶ Complexes [Ni(L)]⁺ (L = conjugated diimine or tetraimine macrocycle, or sterically hindered tetraamine macrocycle) do not bind CO₂ strongly. Interestingly, the complex which binds CO₂ most strongly is that with parent cyclam (936); [Ni(cyclam)]²⁺ is the most effective catalyst for CO₂ electroreduction. The mechanism of the latter reaction has been studied in aqueous solution at mercury electrodes, using electrochemical techniques,¹⁶³⁵ and the thermodynamics and kinetics of CO₂ and H⁺ binding to [Ni(cyclam)]⁺ in aqueous solution have been explored.²³³⁷ Reduction of [Ni(cyclam)]²⁺ by hydrogen atoms proceeds by an inner-sphere mechanism ($k = 5 \pm 2 \times 10^9 \text{ M}^{-1} \text{ s}^{-1}$) to give [Ni(H)(cyclam)]²⁺, which decomposes to [Ni(cyclam)]⁺ and H⁺ ($k = 6.3 \pm 0.7 \times 10^5 \text{ s}^{-1}$). Reduction by CO₂⁻ is also inner-sphere ($k = 6.7 \pm 0.2 \times 10^9 \text{ M}^{-1} \text{ s}^{-1}$); the intermediate [Ni(CO₂)(cyclam)]⁺ decomposes to [Ni(cyclam)]⁺ and CO₂ ($k = 2.0 \pm 0.2 \times 10^6 \text{ s}^{-1}$). The equilibrium constant for CO₂ dissociation is 0.062 M; this compares with a pK_a of 1.8 for the hydride complex, and suggests why [Ni(cyclam)]²⁺ is selective as a catalyst for CO₂ electroreduction even in aqueous solution at pH 4.

6.3.5.2.2 Complexes with nonmacrocylic nitrogen donor ligands

Since most Ni^I species with simple N-donor ligands are prone to disproportionation into Ni⁰ and Ni^{II}, relatively few Ni^I complexes with nonmacrocylic N-donor ligands have been reported. Formation of Ni^I species is in most cases proposed on the basis of electrochemical data, although ligand-centered redox processes have to be considered. The ligands usually contain imine donor atoms or aromatic N-heterocycles, which because of their π-acceptor ability favor stabilization of lower oxidation states.

Ni^{II} complexes with aminopyridine ligands (954)–(956) can be reversibly reduced to relatively stable EPR-active Ni^I complexes in solution.²³³⁸ The EPR spectrum of the more flexible [Ni(954)]²⁺ is rhombic with $g_{\perp} > g_{\parallel}$ ($g_x = 2.239$ and $g_y = 2.199$, $g_{\parallel} = 2.025$) indicative of a (d_{z^2})¹ ground state in trigonal bipyramidal coordination geometry, while the EPR spectrum of the methylated [Ni(955)]²⁺ is characteristic of a ($d_{x^2-y^2}$)¹ ground state with $g_{\parallel} > g_{\perp}$ ($g_{\parallel} = 2.324$, $g_{\perp} = 2.079$), suggesting a square planar environment. Dissociation of one of the ethylpyridine arms in the latter case is corroborated by the identical spectra of [Ni(955)]²⁺ and [Ni(956)]²⁺. The half-wave Ni^{II}/Ni^I potentials increase in the series [Ni(954)]²⁺ (−1.01 V) < [Ni(955)]²⁺ (−0.91 V) < [Ni(956)]²⁺ (−0.83 V; all vs. SCE), showing that *N*-methylation stabilizes the lower oxidation state.^{1575,2338}

The Ni^I complex with the ligand 1,2-bis(pyridine-2-carboxamido)benzene (H₂bphen), generated by reduction with Na amalgam of the homologous Ni^{II} complex, was studied by EPR and electronic spectroscopy.²³³⁹ Analysis of the spectroscopic data revealed that the complex exhibits low covalency in the σ in-plane bonding and high covalency in the out-of-plane π bonds, which has enabled the assignment of the electronic bands at 13,500 cm⁻¹ and 19,600 cm⁻¹ of [Ni^I(bphen)]⁻ (957). This may have implications for the spectral characterization of cofactor F₄₃₀.

Catenane ligands such as (958) strongly stabilize Ni^I with respect to Ni^{II} because of the overwhelming preference of this ligand for tetrahedral coordination.^{2340,2341} The Ni^I complex could be generated by constant potential electrolysis of [Ni(958)]²⁺ at −0.45 V in CH₃CN and, furthermore, a second reversible one-electron transfer (assigned to Ni^I/Ni⁰) was found at −1.325 V. Crystal structures of both the Ni^{II} and Ni^I complexes have been obtained.²³⁴¹ The orange Ni^{II} complex is very distorted four-coordinate, with the Ni^{II} ion lying almost in a plane surrounded by three of the four N atoms (mean Ni—N distance = 2.01(4) Å), which may in part be due to the maximizing of π–π interactions in the ligands. However, the Ni^I ion is at the center of a tetrahedral coordination sphere (mean Ni—N distance = 1.98(2) Å) and π–π stacking interactions are no longer significant.

Nickel complexes of bpy and related ligands are active electrocatalysts for CO₂ reduction. [Ni(terpy)₂]²⁺ undergoes two successive one-electron reductions at −1.20 V and −1.38 V in DMF.²³⁴² In the presence of CO₂, the cathodic peak current for the first process is enhanced greatly. Electrodes modified with films of poly-[Ni(4'-vinylterpy)₂](PF₆)₂ (grown by repetitive cyclic voltammetry between 0.00 V and −1.70 V of a solution of the complex in CH₃CN) were also active for CO₂ electroreduction in DMF, and, unlike the complex in solution, for O₂ reduction in water. Interestingly, both two-electron O₂ reduction (giving H₂O₂) and four-electron reduction to H₂O occurred.

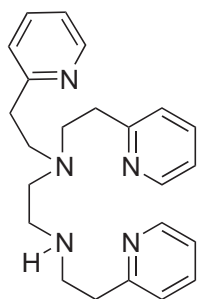

(954)

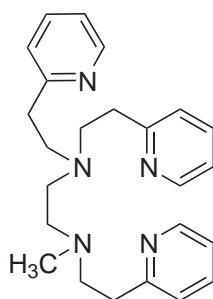

(955)

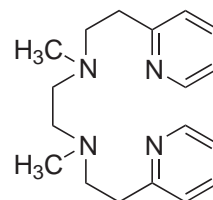

(956)

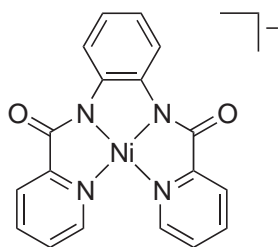

(957)

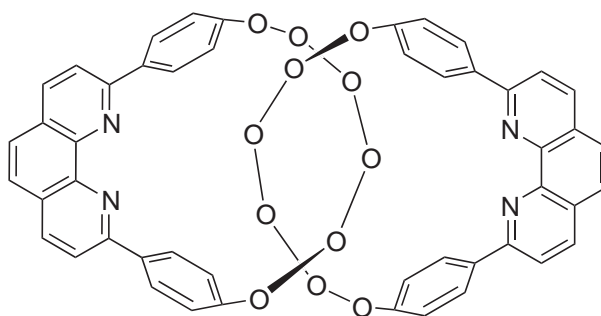

(958)

Like several other systems, Ni complexes of (954) and (955) show high catalytic activity in the electroreduction of 1,2-*trans*-dibromocyclohexane into cyclohexene.²³³⁸

For a terminal amido complex of Ni^I, see Section 6.3.5.4 ((964) in Scheme 13).

6.3.5.2.3 Complexes with porphyrins and related ligands

The redox properties of Ni^{II} porphyrins have been extensively studied and a detailed review of their electrochemistry in nonaqueous media has appeared.²³⁴³ Nickel porphyrins are typically reduced in two one-electron transfer steps, although some Ni^{II} porphyrins with highly electron-withdrawing groups can be reduced by a total of three electrons.²³⁴⁴ In most cases, the initial oxidations and reductions involve the porphyrin π -system, but examples where the first electron is added to the central metal ion to give a Ni^I species^{2345–2347} are well documented. The study of Ni^I with porphyrin-type {N₄} ligands (and their reduced analogues) receives major impetus from the interest in the active site of methyl coenzyme M reductase (compare Section 6.3.4.11.7). The pentamethyl ester of coenzyme F₄₃₀ has been reversibly reduced from the Ni^{II} form to the Ni^I form, and UV–visible spectra (characteristic absorption maxima at 380 nm and 750 nm) as well as quasi-axial EPR spectra indicate that the Ni^I complex is approximately square planar with the unpaired electron in an orbital of $d_{x^2-y^2}$ character.²³⁴⁸

Major factors that determine the Ni^{II}/Ni^I redox properties are the core size, the flexibility of the macrocycle, and the electronic properties of substituents.²³⁴⁹ Molecular mechanics has been used to examine the effect of macrocyclic reduction on the core–hole size of porphyrins and applied to the nickel–tetrapyrrole F₄₃₀ cofactor.²³⁵⁰ Macrocyclic reduction at the two methin protons provides the F₄₃₀ macrocycle with the flexibility necessary to accommodate both high-spin (six-coordinate) and low-spin (square planar four-coordinate) Ni^{II}. However, the relative inability to ruffle due to the steric effect of peripheral substituents implies that the {N₄} core of F₄₃₀ cannot contract sufficiently to coordinate optimally a low-spin Ni^{II} ion, which appears to be a key factor for stabilization of the larger Ni^I and high-spin Ni^{II}.²³⁵¹

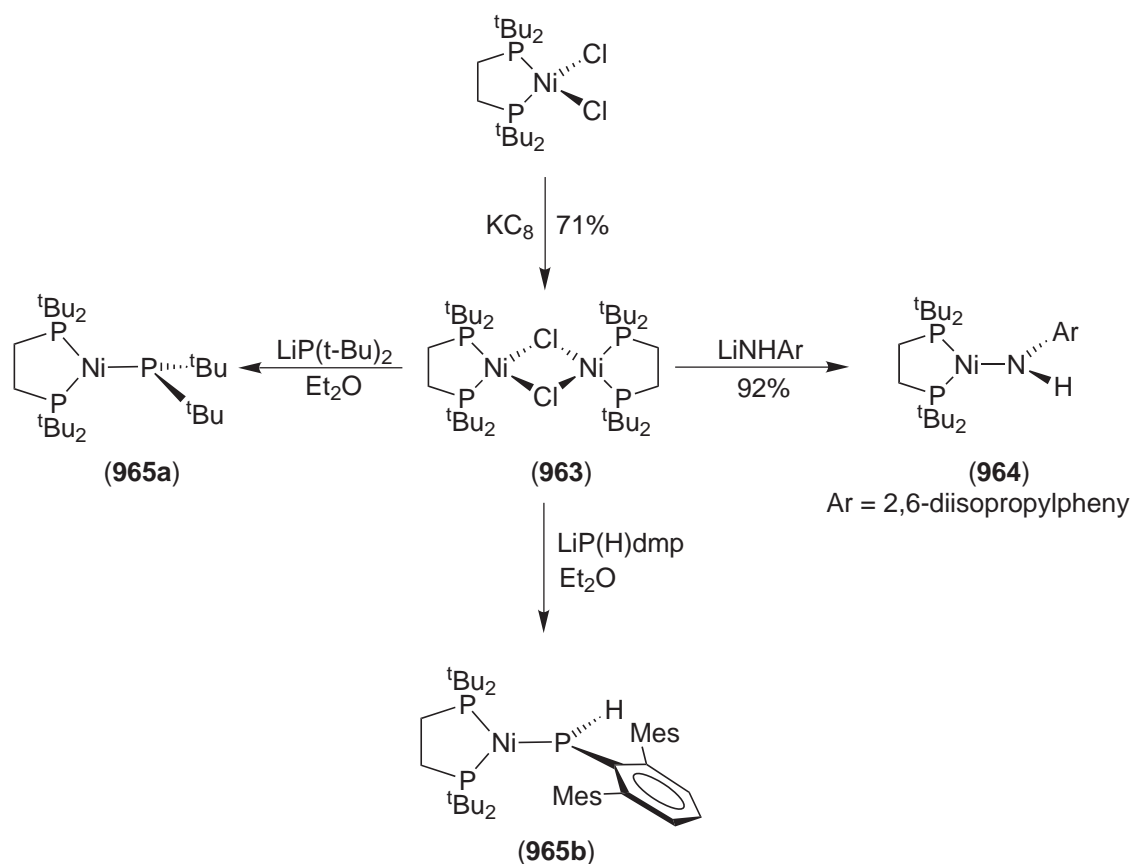

Scheme 13

The relationship between half-wave potential, the site of electron transfer, and the catalytic activity of a given [(porphyrin)Ni][−] complex towards CH₃I reduction has been investigated for various Ni^{II} porphyrin compounds. For example, five out of seven electrogenerated complexes, [(porphyrin)Ni][−], reacted catalytically with CH₃I under an applied potential, suggesting the presence of Ni^I in the singly reduced species.²³⁴⁶

Complexes of isobacteriochlorins are frequently used as F₄₃₀ mimics because they, too, can be reduced to isolable Ni^I complexes,^{2352,2353} reduction leads to nickel hexahydroporphyrin complexes. [Ni^I(oeibc)] has been studied as a model for the active site of F₄₃₀ using EPR and ENDOR spectroscopy; bond lengths and spectroscopic data were correlated.²³⁵⁴ The stability of [Ni^I(oeibc)] is greatest in polar solvents. With weak acids such as water, alcohols, and thiols it affords H₂ with an apparent stoichiometry of 2:1 Ni^I:H₂.²³⁵⁵ The reactions of [Ni^I(959)][−] with alkyl and aryl halides have been studied, and the organic products resulted from reduction or dehydrohalogenation;²³⁵⁶ alkene formation was favored by polar solvents, and isomerization of alkenes occurred during reaction. This implies the intermediacy of Ni—H and Ni—R species in the reactions. Detailed vibrational studies have been reported.²³⁵⁷ Although the Ni^I complex of (959) is very resistant to further reduction, in the presence of proton donors reduction of the macrocycle ring occurs,²³⁵³ affording initially the Ni^I complex of (960), the first complex of this precorrin to be identified.

Reduction of both nickel porphyrins and thiaporphyrins to Ni^I species has been studied by EPR and ²H NMR spectroscopy.^{1796,2358} The Ni^I complex of 5,10,15,20-tetraphenyl-21-thiaporphyrin has been isolated and characterized. Reaction of this complex with sulfur dioxide produced a paramagnetic five-coordinated Ni^I—SO₂ adduct, while reaction with nitrogenous base ligands (amines, pyridines, imidazoles) yielded five- and six-coordinate complexes. In addition, the crystal structure of Ni^I diphenyldi-*p*-tolyl-21-thiaporphyrin has been determined. The coordination geometry about the nickel center is essentially square planar with extremely short Ni—N and Ni—S bonds (Ni—N = 2.015(2) Å, 2.014(12) Å, and 1.910(14) Å and Ni—S = 2.143(6) Å).²³⁵⁹

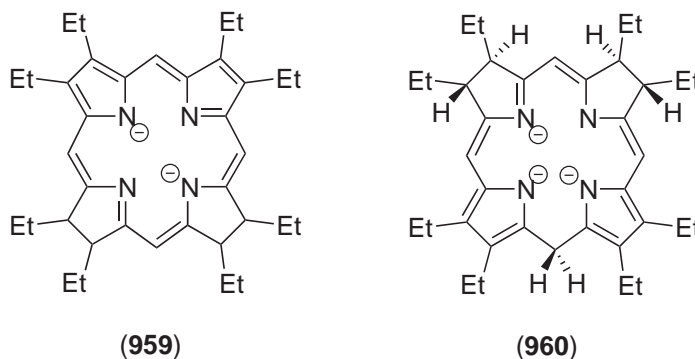

6.3.6.3 Complexes with Phosphines and Arsines

Complexes with phosphines (and arsines) are particularly prominent in Ni^I chemistry. For [NiCl(PPh₃)₂] (**961**) previous studies have reported that the formally 15-electron species oligomerizes in the solid state. However, crystallographic analyses have revealed no short intermolecular interactions, but a distorted trigonal planar geometry with a contracted P—Ni—P angle of 111.52(2)° (thf solvated)²³⁶⁰ and 114.94(2)° (unsolvated).²³⁶¹ The angular distortion most probably arise from a first-order Jahn–Teller effect which, for a *d*⁹ complex, is expected to destabilize the ML₃ structure from *D*_{3h} to *C*_{2v}. Both tricoordinate heteroleptic complexes [Ni(PR₃)₂L]⁺ (R = Ph, Prⁱ, Cy; L = OEt₂, CO) and tetracoordinate complexes [Ni(PR₃)_{4-n}L_n]⁺ (L = P(OR')₃, CO) have been investigated in detail by EPR spectroscopy, which allowed the determination of the consequences of the Jahn–Teller distortion of the *d*⁹ species and vibronic effects.^{2362,2363} [NiCl(PPh₃)₃] (**962**) has a distorted tetrahedral geometry.²³⁶⁴

Nickel complexes of the type [Ni(L)₂]²⁺ (L = dppm, dppe, dppv, dppb, dppp), [Ni(L)(L')]²⁺ (L = dppe, dppp, dppb; L' = dppm, dppp), and [Ni(dppm)₂(CH₃CN)]²⁺ have been prepared and characterized. The half-wave potentials for the Ni^{II}/Ni^I couple were found to become more positive as the bite size of the diphosphine was increased. X-ray crystal structural studies of [Ni(dppm)₂](BF₄)₂ and [Ni(dppb)₂](BF₄)₂ revealed that increasing the bite size results in larger tetrahedral distortion. The most stable Ni^I complex, [Ni(dppp)₂](PF₆), could be isolated and characterized.²³⁶⁵ The relative stability and interchangeability of the various oxidation states for nickel complexed to 1,2-bis(dialkylphosphino)benzene (alkyl = Me, Et, Prⁱ, Prⁿ) depends on the ligand: the reduction potentials and electrochemical reversibilities are highly sensitive to the substituents at P, with potentials for electrooxidation being shifted to more positive potentials as the bulk of the alkyl substituent is increased.²³⁶⁶ The complexes [Ni(L)₂]²⁺ and [Ni(L)₂X]⁺ (L = dppv, dppb, *o*-C₆H₄(PPh₂)(PMePh), *o*-C₆H₄(PPh₂)(PBuPh); X = Cl, Br) have been prepared and characterized.²³⁶⁷ For [Ni(L)₂]²⁺, two successive one-electron metal-based reductions are observed. [Ni(L)₂X]²⁺ loses halide upon reduction to give the stable [Ni(L)₂]⁺. The Ni^I/Ni^{II} potentials vary according to the nature of the chelate bridge (no link < ethene < ethane < *o*-phenylene), and additional effects are observed due to changes of the substituents at P.

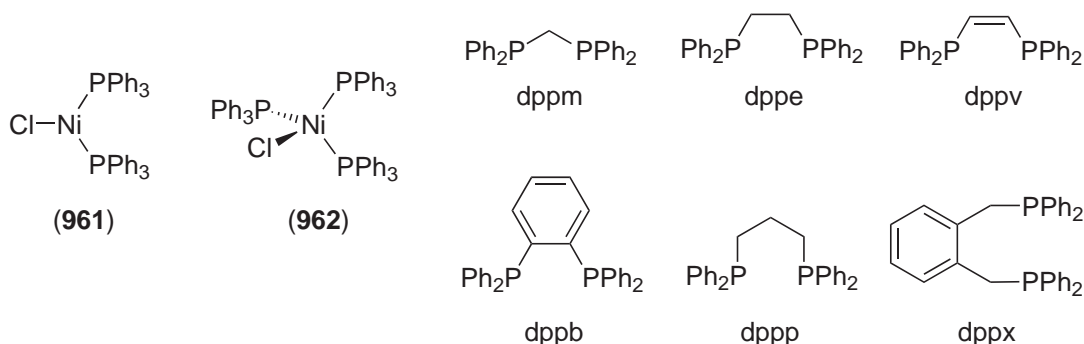

Reduction of Ni^{II} chloride complexes [NiCl₂(L)] (L = various diphosphinomethanes, -ethanes, and -propanes) with, for example, potassium naphthalenide in THF gives the corresponding Ni^I chlorides [NiCl(L)].²³⁶⁸ By treatment of (963) with LiNHAr, a terminal amido complex of Ni^I (964) was prepared (Scheme 13).²³⁶⁹ It contains planar three-coordinate nickel and a planar amido ligand with $d(\text{Ni}-\text{N}) = 1.881(2) \text{ \AA}$. The {P,Ni,P} and {C,N,H} planes are orthogonal with a 91° dihedral angle.

Nickel(I) phosphido complexes (965a) and (965b) have been obtained from (963) according to Scheme 13. The Ni atom in paramagnetic (965a) is planar (like in the respective Ni^{II} complex, compare Section 6.3.4.5.2), and the phosphido-P is substantially pyramidalized with $d(\text{Ni}-\text{P}) = 2.2077(12) \text{ \AA}$ (the Ni—P(diphosphane) bond lengths are 2.2169(12) Å and 2.2351(12) Å).²³⁷⁰ In the related phosphido complex [(Cy₂PCH₂CH₂PCy₂)NiP(SiMe₃)₂] (966) the Ni—P distances for the diphosphine ligand are slightly shorter (2.192(2) Å, 2.202(2) Å) than the Ni—P bond for the phosphido ligand (2.225(2) Å).²³⁷¹

Various type (967) dinuclear complexes with phosphido bridges have been prepared, usually by reduction of [(R₃P)₂NiX₂] with, for example, sodium.^{2372–2375} The terminal phosphines can be exchanged by other phosphines or by CO, yielding (968) and (969) in the latter case.^{2373,2374} Diphenylphosphide Ni^I complexes have also been prepared electrochemically.²³⁷⁶

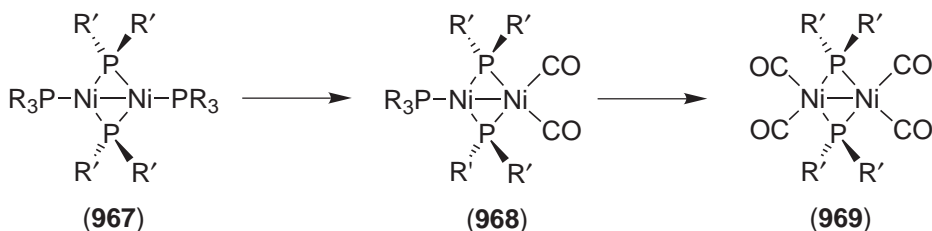
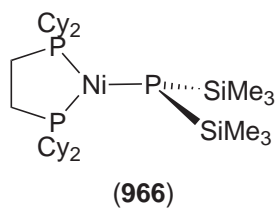

A typical synthetic scheme is shown in Scheme 14.²³⁷⁷ [(Dcpm)NiCl₂] (dcpm = bis(dicyclohexyl(dicyclohexylphosphino)methane)) is reduced with Bu₃SnH in toluene at room temperature to form the air sensitive “A-frame” (971). The Ni—Ni bond distance for (971) is 2.904(3) Å, which indicates a lack of any Ni—Ni metal bonding. (972) is formed by the reaction of (970) and excess LiH, and (971) is an intermediate in the synthesis of the bridging phosphido Ni^I complex. The Ni—Ni bond distance in (972) is 2.3910(8) Å, corresponding to a single Ni—Ni metal bond. Ni—Ni distances in “A-frame” complexes with bridging hydrides ((971) and type (973)) as well as bridging phosphido ligands are collected in Table 22.

An “A-frame” structure has also been found for [Ni₂Cl₂(μ-SO)(μ-dppm)₂], which forms upon oxidative addition of SOCl₂ to a Ni⁰ complex.²³⁸⁴ Type (974a) complexes with nonequivalent metal centers have been formulated as mixed oxidation state systems with a coordinative Ni—Ni bond involving donation of an electron pair from a tetrahedral Ni⁰ to a T-shaped Ni^{II} center. However, these complexes are fluxional and easy interconversion between (974a) and (974b) is observed. (974a) is prepared by reaction of the Ni⁰ complex [Ni₂(CO)₂(μ-dppm)₂] with the Ni^{II} complex [NiCl₂(dppm)₂].²³⁸⁵

Tripod-like tetradentate polytertiary phosphines or closely related ligands such as tris(2-diphenylphosphinoethyl)amine (NP₃), tris(2-diphenylphosphinoethyl)phosphine (PP₃), and tris(2-diphenylarsenoethyl)amine (NAS₃) have been shown to be suitable for the stabilization of Ni^I.^{2386,2387} The Ni^I complex is usually obtained by oxidation of a suitable Ni⁰ precursor. The crystal structure of (975) reveals a trigonal bipyramidal configuration with the As atoms occupying the equatorial positions. Compound (976) (similar to the related NP₃ compound) exhibits an unusual trigonal pyramidal geometry in which the nickel atom is solely coordinated to the four P atoms of the ligand.^{2386,2388} In solution, however, electrochemical measurements indicate that a trigonal

bipyramidal structure with an elongated Ni—I bond can also have a finite lifetime.²³⁸⁷ Electrons are accepted successively in the Ni—I σ^* MO upon exceeding the d^8 configuration, and structural trends in the complete series of complexes $[(NP_3)Ni^{II}]^+$, $[(NP_3)Ni^I]^+$, and $[(NP_3)Ni^0]$ have been investigated in detail.²³⁸⁷ (976) reacts readily with chlorinated solvents and disproportionates in acetonitrile to give $[(PP_3)Ni(NCMe)]^{2+}$ and $[Ni_2(PP_3)_2]$.²³⁸⁹

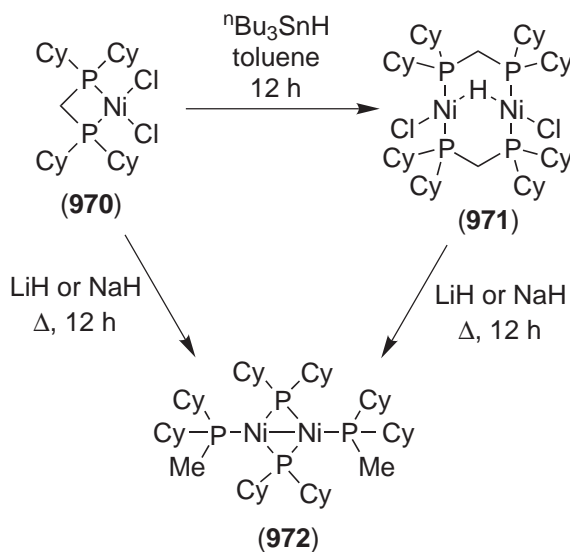

Scheme 14

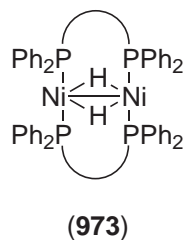
Table 22 Ni—Ni bond lengths for selected nickel compounds.^a

Compound	$d(Ni-Ni)(\text{\AA})$	References
$[Ni_2(dcpm)_2Cl_2(\mu-H)]$	2.904(3)	2378
$\{[Ni(dippe)]_2(\mu H)_2\}[BPh_4]$	2.316(5) ^b	2379
$[Ni_2(dcpp)_2(\mu-H)_2]$	2.441(1) ^b	2380
$[Ni_2(dipp)_2(\mu-H)_2]$	2.438(1) ^b	2381
$[Ni_2(\mu-Bu^t_2P)(PMe_3)_2]$	2.375(3) ^b	2382
$[Ni(\mu-(Bu^t)(H)P)(PMe_3)_2]_2$	2.559(2) ^b	2383
$[Ni_2(\mu-PCy_2)_2(PCy_2Me)_2]$	2.3910(8) ^b	2377

^a dcpm = bis(dicyclohexylphosphino)methane; dppm = bis(diphenylphosphino)methane; dcpp = (bis(dicyclohexylphosphino) propane); dippe = bis(diisopropylphosphino)ethane; dipp = bis(diisopropylphosphino) propane. ^b Indicates actual Ni—Ni bonds.

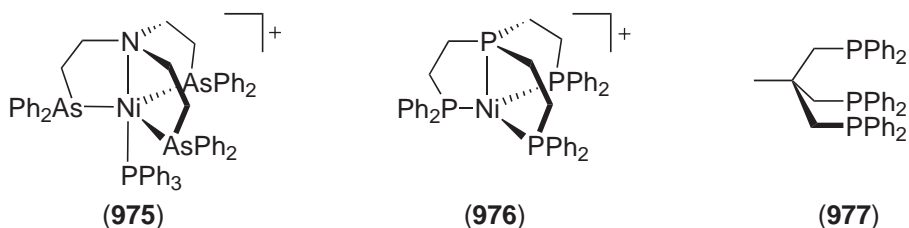
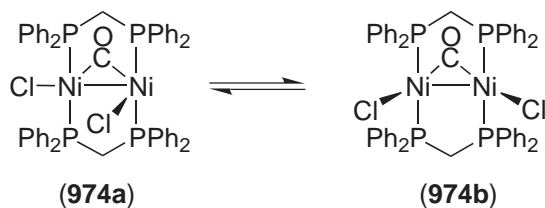

It is well-known that the tridentate triphos (**977**) (P_3) readily stabilizes Ni^I , and P_3 has become one of the most preferred ligands in low-valent nickel chemistry. Structural reorganizations concomitant with $Ni^{II} \rightarrow Ni^I$ reduction in $[(P_3)Ni]^{+/0}$ have been revealed by X-ray crystallography: there is a 0.13 Å elongation of the Ni—I bond upon reduction (2.414(4) Å vs. 2.546(2) Å), while the Ni—P bond lengths become slightly shorter in the uncharged species.²³⁹⁰ The additional electron occupies a metal d_{π} orbital that is involved in antibonding interactions with the iodine p_{π} orbitals.

Only a few further examples of Ni^I complexes with the P_3 ligand scaffold will be mentioned here. Reduction of the dithiocarbamate complex $[(triphos)Ni(S_2CNET_2)]BPh_4$ with $Na[BH_4]$ yields $[(triphos)Ni(SH)]$ which has a distorted tetrahedral structure and a room temperature magnetic moment of $2.11 \mu_B$ corresponding to a doublet ground state.²³⁹¹ In addition, the related compound $[(triphos)Ni(\mu-S_2)-Ni(triphos)]ClO_4$ is a novel nickel dimer bridged by two sulfur atoms. The Ni_2S_2 bridging framework is planar, with a Ni—Ni distance of 3.865(1) Å, while a formal oxidation of +1/+2 has been assigned.²³⁹²

Five-coordinate Ni^{II} arsine complexes of the ligands (**978**)–(**980**) of formulas $[Ni(L_3)(L_2)]^{2+}$ – (L_3 = tridentate (**980**), L_2 = bidentate (**978**), (**979**)) and $[Ni(L_3)_2]^{2+}$ (the latter are also five-coordinate

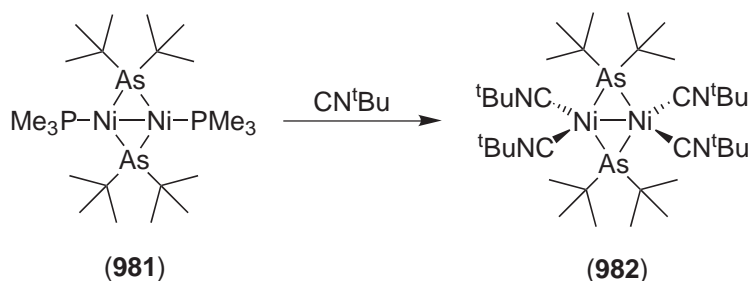
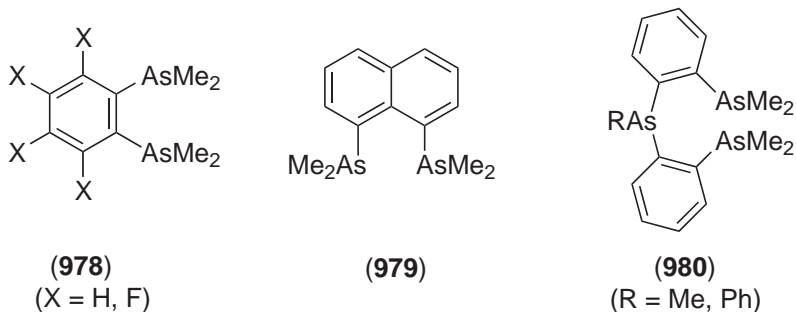

with a single “dangling” AsMe_2 group) have been studied electrochemically, and extensive Ni-centered redox chemistry was observed.^{2393,2394} The arsine donor sets stabilize (on the voltametric timescale) all Ni oxidation states from 0 to +4: all complexes showed two oxidations and two reductions in CV experiments in CH_3CN . The reductions are assigned to $\text{Ni}^{\text{I}}/\text{Ni}^{\text{II}}$ and $\text{Ni}^0/\text{Ni}^{\text{I}}$ couples. Thus the relative stability of the five-coordinate Ni^{I} complexes with these ligands makes an interesting contrast with $[\text{Ni}(\text{diars})]^{2+}$ which is reduced to Ni^0 in a single two-electron process.

The arsenido-bridged complex (**981**) (which is similar to the phosphido-bridged species (**967**), $\text{R}' = \text{Bu}^t$) can be obtained from the reaction of $[(\text{Me}_3\text{P})_2\text{NiCl}_2]$ with LiAsMe_2 .²³⁹⁵ It reacts with CNBu^t to give (**982**). Both contain a planar centrosymmetric Ni_2As_2 core with Ni—Ni bond lengths of 2.429(1) Å and 2.693(2) Å, respectively.

6.3.5.4 Complexes with Sulfur- and Selenium-containing Ligands

The interest in low-valent Ni complexes in S-rich environments has been stimulated by the presence of Ni in $[\text{Ni},\text{Fe}]$ hydrogenase and CODH. While thiolate ligation usually favors higher oxidation states, thioethers stabilize Ni^{I} and Ni^0 . In most cases, however, Ni^{I} ions of an $\{\text{NiS}_4\}$ chromophore are unstable with respect to disproportionation. The cyclic voltammogram of square planar (**983**) with homoleptic thioether coordination exhibits a quasi-reversible wave at -0.42 V (vs. NHE), which on the basis of the rhombic EPR spectrum ($g_1 = 2.27$, $g_2 = 2.11$, and $g_3 = 2.03$) of the chemically reduced species (Na/Hg) is assigned to metal-centered reduction.⁸³⁸

Reaction of (**984**) with MeLi in the presence of donor ligands such as CO or PMe_3 traps the Ni^{I} species (**985**), which could be characterized by X-ray crystallography.⁸³⁹ Oxygenation of a related Ni^{I} complex $\{\text{S}_3\}\text{Ni}(\text{CO})$ leads to O_2 activation and O—O bond rupture with formation of a bis(μ -oxo)nickel(III) complex.^{184,185}

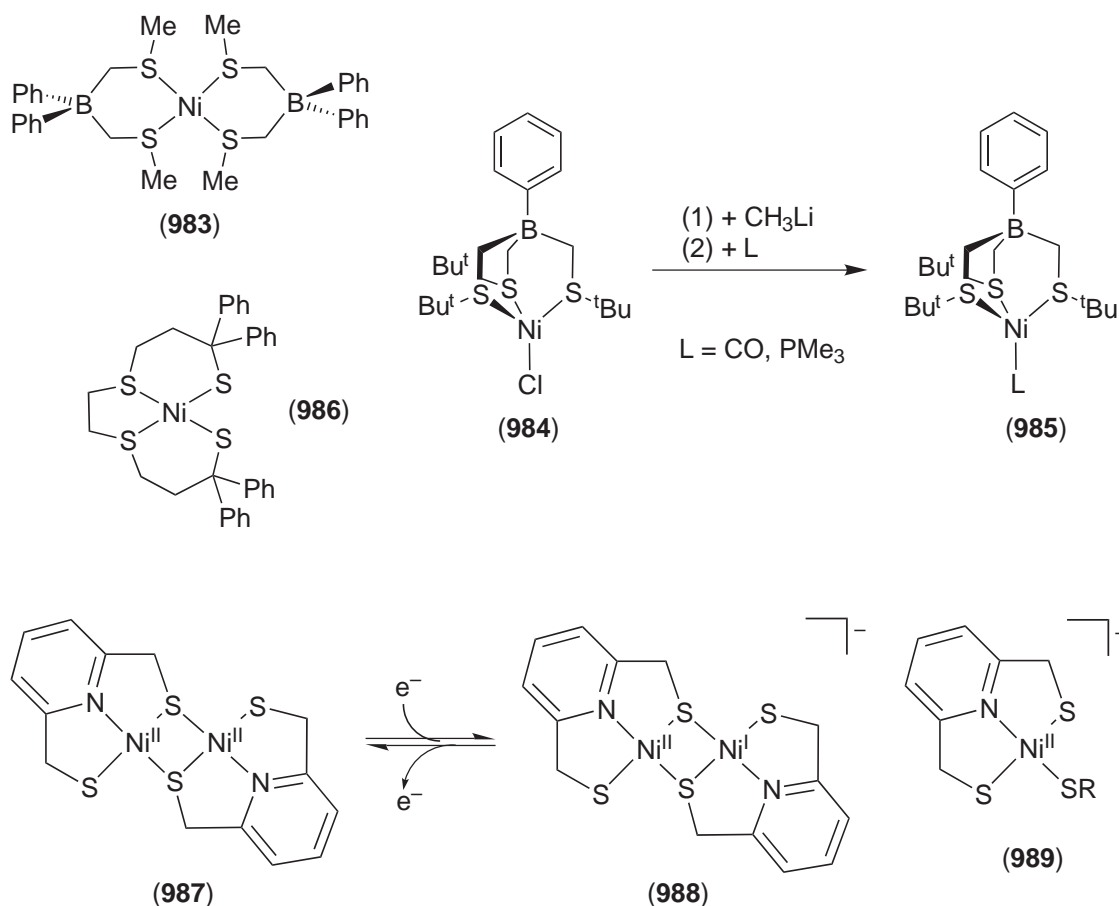

(986) gives a reversible $\text{Ni}^{\text{II}}/\text{Ni}^{\text{I}}$ redox wave, but reversibility is lost under a CO atmosphere. Upon chemical reduction, CO increases the stability of the reduced species and a $\text{Ni}^{\text{I}}\text{-CO}$ compound was observed by IR spectroscopy.⁸⁴³

The “reduced” cluster $\text{Ni}_8\text{S}(\text{SBU}^{\text{I}})_9^-$ has six Ni atoms in a trigonal prism, with the other two capping trigonal faces.⁷⁹⁷

The dinickel(II) complex (987) has been electrochemically reduced at $E_{1/2} = -1.21$ V (vs. SCE) to form the mixed-valence $\text{Ni}^{\text{I}}\text{Ni}^{\text{II}}$ complex (988), which could then be cleaved with RSSR to afford (989).²³⁹⁶

Square planar $\{\text{N}_2\text{S}_2\}\text{Ni}^{\text{II}}$ complexes (990a–f) show reversible $\text{Ni}^{\text{II}}/\text{Ni}^{\text{I}}$ couples, and the Ni^{I} species prepared chemically have been characterized by EPR spectroscopy (axial signal with $g_{\parallel} > g_{\perp}$, indicative of a $(d_{x^2-y^2})^1$ ground state).²³⁹⁷ In CH_3CN , each substitution of a thioether for a thiolate donor gives a 700 mV positive shift in the $\text{Ni}^{\text{II}}/\text{Ni}^{\text{I}}$ potential, and each substitution of a sulfinate for a thiolate gives a 300 mV positive shift. Thus, the Ni^{I} complex is most readily accessed (-0.482 V vs. NHE) for (990c) and least for (990a), and the ability to stabilize Ni^{I} increases in the order $\text{SR}^- < \text{SO}_2\text{R}^- < \text{SR}_2$.

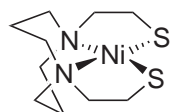

(990a)

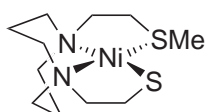

(990b)

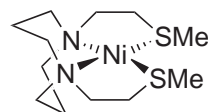

(990c)

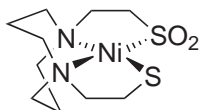

(990d)

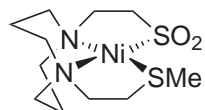

(990e)

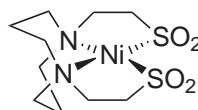

(990f)

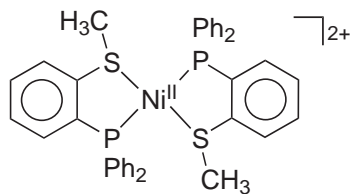

(991)

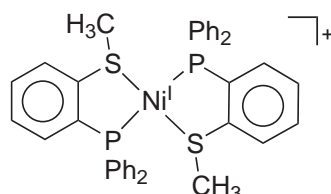
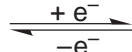

(992)

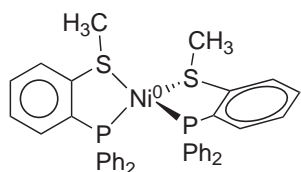

(994)

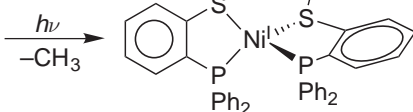

(993)

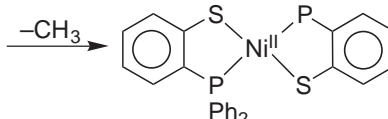

(995)

The cyclic voltammogram of (991) in MeCN shows two redox events assigned to $\text{Ni}^{\text{II/I}}$ and $\text{Ni}^{\text{I/0}}$, and chemical reduction of (991) with Cp_2Co provided a Ni^{I} species (992) characterized at 100 K by an axial EPR signal with $g_x = g_y = 2.10$ and $g_z = 1.96$. Hyperfine spectral features resulting from coupling to two ^{31}P nuclei suggest a retention of substantially square planar geometry. In contrast, the isotropic character of the EPR signal of (993) presumed to be the first product of the photochemical demethylation of (994) ultimately yielding the doubly demethylated complex (995) suggests the intervening thioether/thiolate Ni^{I} species to be pseudotetrahedral.²³⁹⁸ It is concluded

that delocalization of the odd electron is favored for the dithioether ligand environment, whereas electron/thiolate ligand repulsion encourages tetrahedral character.

The Ni^I complex (**996**) has been structurally characterized. It displays an axial EPR spectrum and an intense $\nu(\text{CO})$ band at $2,026\text{ cm}^{-1}$.^{1316,1317}

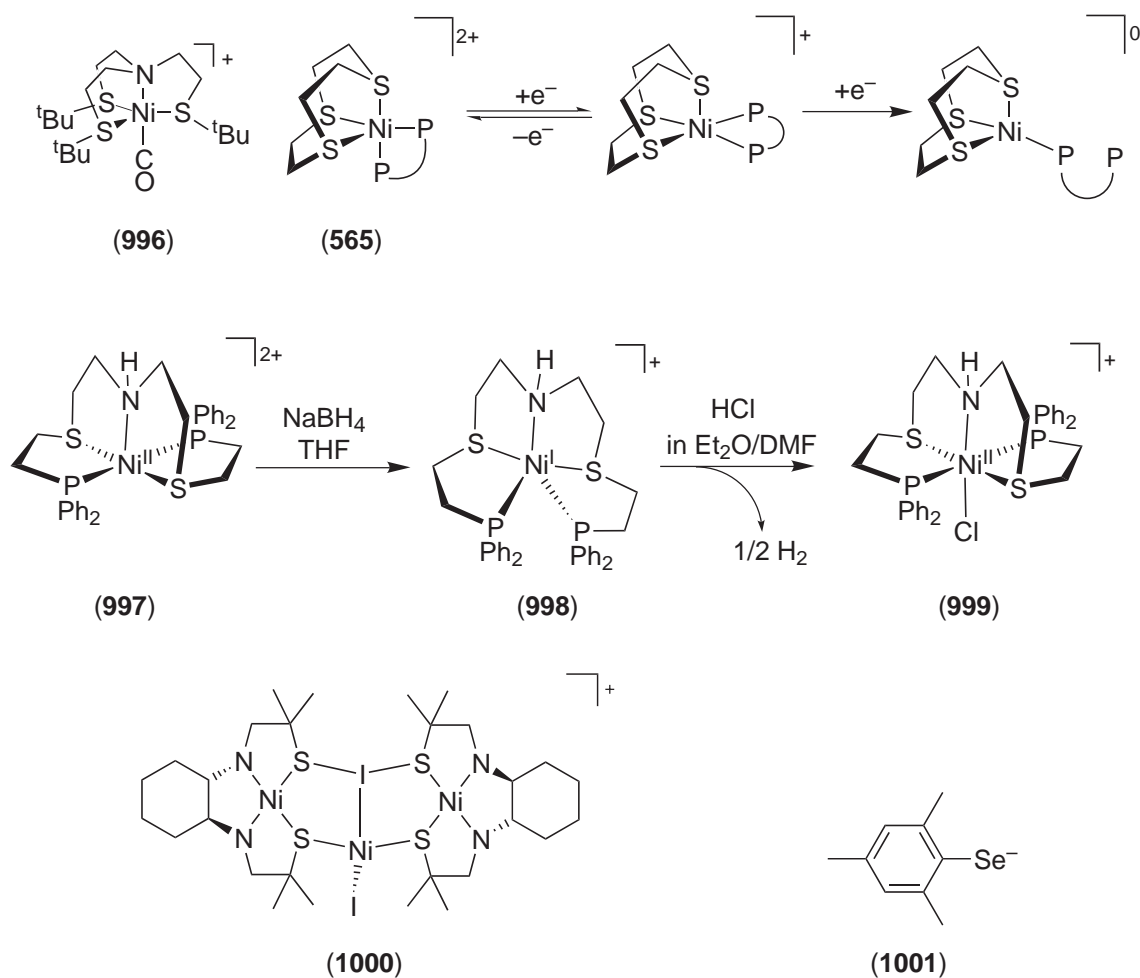

Upon reduction of (**565**), the stereochemistry is proposed to change from trigonal bipyramidal (Ni^{II}) to square pyramidal (Ni^I) and tetrahedral (Ni⁰).¹⁴⁴⁶

(**997**) can be reduced to the Ni^I species (**998**) with NaBH_4 . Both complexes have been structurally characterized by X-ray diffraction, and (**998**) was demonstrated to be an authentic Ni^I complex.²³⁹⁹ Upon reduction, the P—Ni—N angles expand, while the P—Ni—P angle contracts, and overall structural changes are in the direction of trigonal bipyramidal coordination with the S atoms positioned axially. While the Ni—N and Ni—P distances are nearly constant, the Ni—S bond lengths increase significantly (by $0.24\text{--}0.25\text{ \AA}$) due to the $(d_{z^2})^1$ ground state. Upon protonation of the Ni^I complex, Ni-mediated formation of H_2 has been observed according to the stoichiometry $\text{Ni}^{\text{I}} + \text{H}^+ \rightarrow \text{Ni}^{\text{II}} + 1/2 \text{ H}_2$, and the kinetics of this process has been investigated. The overall reaction (**998**) + $\text{HCl} \rightarrow$ (**999**) + $1/2 \text{ H}_2$ proceeds by two parallel pathways dependent on chloride concentration, but the common initial step is protonation of Ni^I.

Based on charge balance requirements, a mixed-valent Ni^{II}₂Ni^I formulation with a central Ni²⁺ group has been proposed for the trinuclear complex (**1000**).²⁴⁰⁰

[Ni(terpy)(**1001**)₂] is reduced by aqueous dithionate to a Ni^I complex, which displays reversible CO binding, and also reacts with H^- .²⁴⁰¹

Various Ni/chalcogenide/phosphane clusters are known, which are formally mixed-valent Ni^{II}/Ni^I species. Examples include $[\text{Ni}_8\text{S}_6(\text{PPh}_3)_6\text{Cl}_2]$ and $[\text{Ni}_8\text{S}_5(\text{PPh}_3)_7]$,²⁴⁰² $[\text{Ni}_{23}\text{Se}_{12}(\text{PET}_3)_{13}]$,²⁴⁰³ $[\text{Ni}_{34}\text{Se}_{22}(\text{PPh}_3)_{10}]$,²⁴⁰⁴ $[\text{Ni}_{20}\text{Se}_{12}(\text{SeMe})_{10}]^{2-}$,²⁴⁰⁵ $[\text{Ni}_9\text{Te}_6(\text{PET}_3)_8]$, and $[\text{Ni}_{20}\text{Te}_{18}(\text{PET}_3)_{12}]$.²⁴⁰⁶

6.3.5.5 Miscellaneous Complexes of Nickel(I)

A set of Ni^I complexes (**1002**) of tetradentate Schiff base ligands with NN'OS donor environment were prepared from the corresponding Ni^{II} complexes and studied by spectroscopic and electrochemical techniques.²⁴⁰⁷ By comparison with related complexes with salen-type ligands, it was found that values of $E_{1/2}$ for the Ni^{II}/Ni^I couple increase by ~ 0.07 V in the order Ni{N₂O₂} < Ni{NN'OS} < Ni{N₂S₂}, and tetrahedral distortion is an important factor in the relative stabilization of the Ni^I species. EPR data show that the Ni^I complexes (**1002**) are typically four-coordinate, although in the case of a trimethylene bridge formation of six-coordinate Ni^I complexes is observed. Ni^I complexes (**1003**) are obtained either electrochemically or chemically from the corresponding Ni^{II} species, and reduction potentials were found to be strongly dependent on the degree of tetrahedral distortion of the latter. EPR data show that the *g*-values are very sensitive both to the coordination sphere and to the extent of tetrahedral distortion.²⁴⁰⁸

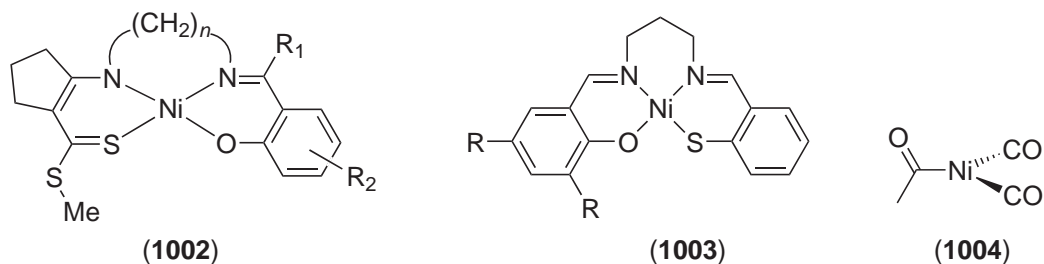

{N₃}Ni(TCSQ)(TCQ) (TCQ = tetrachloroquinone, TCSQ = tetrachlorosemiquinone) exhibits strong ferromagnetic Ni^I semiquinone coupling and the effective magnetic moment is 2.97 μ_B . However, a Ni^{II} description cannot be completely ruled out.⁷⁷²

Sequential bond dissociation energies have been determined for [Ni(CO)_x]⁺ ($x = 1-4$), [Ni(N₂)_x]⁺ ($x = 1-4$), and [Ni(NO)_x]⁺ ($x = 1-3$) by collision-induced dissociation in a guided ion beam tandem mass spectrometer.²⁴⁰⁹ The trend in bond energies for loss of a ligand is sketched in Figure 33, which can be understood in terms of σ -donor and π -acceptor capabilities of the ligands and the number of electrons donated by each ligand.

Guided ion beam tandem mass spectrometry has also been employed to study the reaction of Ni⁺ with CS₂ and COS.²⁴¹⁰ The ground state ion Ni⁺ undergoes endothermic reaction to form NiS⁺ in both cases, as well as NiCS⁺ and NiCO⁺, respectively. Threshold values for the reactions and bond dissociation energies for the products have been determined.

The *d*⁹ species (OC)₂NiCHO has been prepared by the reaction of H atoms with Ni(CO)₄ in a krypton matrix at 77 K. The complex is not thermally interconvertible with its isomer, HNi(CO)₃, and EPR spectroscopy reveals that components in the *xy* plane of the principal *g*-values $g_{zz} = 2.0024(2)$ and $g_{xx} = g_{yy} = 2.0207(2)$ split at 4 K. Hence, structure (**1004**) was proposed.²⁴¹¹ The oxides KNa₂[NiO₂] and K₃[NiO₂] contain Ni^I with virtually linear coordination.²⁴¹²

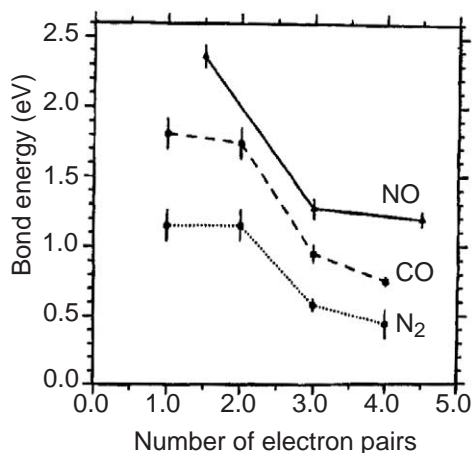

Figure 34 Trend in bond energies for loss of a ligand from [Ni(CO)_x]⁺ ($x = 1-4$), [Ni(N₂)_x]⁺ ($x = 1-4$), and [Ni(NO)_x]⁺ ($x = 1-3$) (reprinted with permission from ref. 2409; © 1995, American Chemical Society).

6.3.6 COMPLEXES OF NICKEL(0)

Detailed procedures for the synthesis of various often used $[\text{Ni}^0\text{L}_4]$ complexes (L = phosphines, arsines, stibines, alkyl isocyanides) and $[\text{Ni}^0\text{L}'_2]$ complexes (L' = bipyridine, phenantroline, diphosphines, diarsines) have been compiled.²⁴¹³

6.3.6.1 Carbonyl and Nitrosyl Complexes

6.3.6.1.1 Carbonyl complexes

An accurate solid-state structure is reported for $\text{Ni}(\text{CO})_4$, which is tetrahedral with $d(\text{Ni}-\text{C}) = 1.817 \text{ \AA}$.²⁴¹⁴ The luminescence spectrum of $\text{Ni}(\text{CO})_4$ following photolysis with an XeCl laser is strong enough to be visually detected. A three-step mechanism is advanced: luminescence is primarily from the $\text{Ni}(\text{CO})_3$ fragment with its smaller HOMO–LUMO gap resulting in visible emission.²⁴¹⁵ Calculation of the sequential Ni–CO binding energies for the series $\text{Ni}(\text{CO})_x$ ($x = 1-4$) yields $125.4 \text{ kJ mol}^{-1}$, $121.2 \text{ kJ mol}^{-1}$, $150.4 \text{ kJ mol}^{-1}$, and $100.32 \text{ kJ mol}^{-1}$, which is in good agreement with experimental results.²⁴¹⁶ Di-*t*-butoxytin(II) and bis(trimethylsiloxy)tin(II) react with $\text{Ni}(\text{CO})_4$, yielding the disubstituted complexes $[\text{Ni}(\text{CO})_3\text{Sn}(\text{OCMe}_3)_2]_2$ and $[\text{Ni}(\text{CO})_3\text{Sn}(\text{OSiMe}_3)_2]_2$, respectively.²⁴¹⁷

Although $\text{Ni}(\text{CO})_4$ was discovered many years ago, no neutral $\text{Ni}_2(\text{CO})_x$ compound has ever been synthesized in macroscopic amounts. However, several communications report ionic species such as $[\text{Ni}_2(\text{CO})_8]^+$, $[\text{Ni}_2(\text{CO})_7]^-$, and $[\text{Ni}_2(\text{CO})_6]^+$, where structures with one or two bridging carbonyls are proposed.²⁴¹⁸ Plausible structures for neutral $\text{Ni}_2(\text{CO})_x$ ($x = 5, 6, 7$) have been investigated by theoretical methods, and decomposition temperatures well below room temperature have been predicted.^{2419,2420} Tetra-, penta-, and hexanuclear nickel carbonyl clusters have been investigated by means of molecular orbital theory. It is found that the neutral forms are more stable than the corresponding anionic forms but the anionic forms gain in stability as the nuclearity rises.²⁴²¹ Nickel carbonyl cluster anions are manifold, and structural systematics have been reviewed.^{2422,2423} An example includes the anion $[\text{Ni}_9(\text{CO})_{16}]^{2-}$ with a close-packed two-layer metal core.²⁴²⁴

Neutral dinuclear nickel carbonyl units can be stabilized by the replacement of four carbonyl groups in $\text{Ni}_2(\text{CO})_7$ with small-bite bidentate ditertiary phosphine ligands to give (diphos)₂- $\text{Ni}_2(\text{CO})_2(\mu\text{-CO})$ derivatives. Some binuclear nickel carbonyls of this type which have been isolated and structurally characterized^{2425–2427} are **(1005)** and **(1006)**. The complexes $[\text{Ni}(\text{CO})_2(\eta^1\text{-dppm})_2]$, $[\text{Ni}_2(\mu\text{-dppm})_2(\mu\text{-CO})(\text{CO})_2]$, and $[\text{Ni}_2(\mu\text{-dppm})_2(\text{CO})_4]$ have all been isolated by minor modifications of the same synthetic procedure, i.e., BH_4^- reduction of a solution of NiCl_2 and dppm in MeOH under CO.²⁴²⁸ The different species are interconvertible in solution, and reaction of CO with $[\text{Ni}(\text{CO})_2(\eta^1\text{-dppm})_2]$ gives $[\text{Ni}(\text{CO})_3(\eta^1\text{-dppm})]$. In general, the Ni–Ni bond distances in the structurally characterized (diphos)₂ $\text{Ni}_2(\text{CO})_2(\mu\text{-CO})$ derivatives fall in a rather wide range, 2.53–2.69 Å, which in general is lower than the 2.73 Å Ni–Ni bond distance calculated for the parent μ -carbonylhexacarbonyldinickel. The stabilization of $\text{Ni}_2(\text{CO})_7$ by such phosphine substitution of carbonyl ligands is typical in metal carbonyl chemistry and arises from an increase in the electron density on the nickel atoms by replacement of CO groups with the weaker acceptor phosphine ligands.

A convenient synthetic route to the Ni⁰ cradle complex $[\text{Ni}_2(\mu\text{-CO})(\text{CO})_2(\text{PPh}_2\text{CH}_2\text{PPh}_2)_2]$ **(1006)** has been reported, which involves the simultaneous reaction of $\text{Ni}(\text{COD})_2$ with CO and dppm.²⁴²⁹ Also, $[\text{Ni}(\text{CO})_2\{\text{HC}(\text{PPh}_2)_3\}]$ has been used to prepare the Ni⁰ dimer **(1006)**. The crystal structure of **(1006)** has been determined, showing approximate tetrahedral geometry about each of the Ni atoms, with an unusual *cis* arrangement of the two bridging dppm ligands, one bridging CO ligand and two terminal CO ligands.²⁴²⁵

6.3.6.1.2 Nitrosyl complexes

The oxidation state of the metal in $\{\text{Ni}(\text{NO})\}^x$ species often is not obvious at first sight, since the nitrosyl group may be considered as a cationic NO^+ , a neutral paramagnetic NO, or an anionic NO^- ligand. A common criterion to distinguish between the limiting descriptions is the geometry of the complex and of the triatomic Ni–N–O moiety: in tetracoordinate $\{\text{Ni}(\text{NO})\}^{10}$ complexes, square planar geometry with a strongly bent N–N–O group (120°) indicates a NO^- formulation,

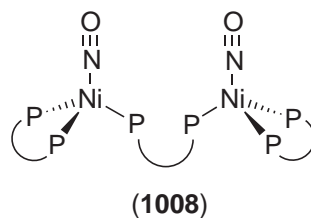
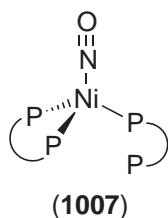
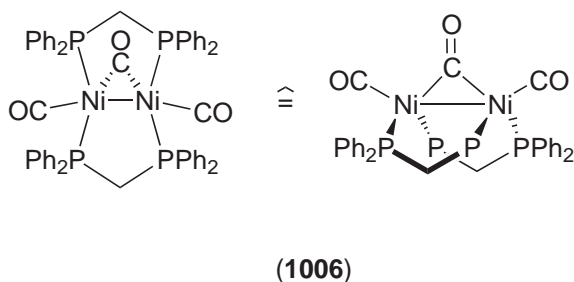
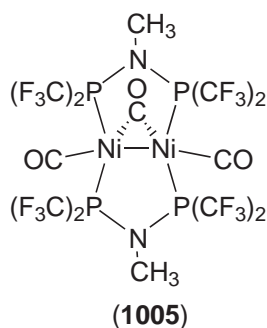

while a tetrahedral geometry with a linear Ni—N—O is assumed characteristic for NO⁺. In many cases, however, an intermediate situation is observed. For example, [Ni(NO)(PMe₃)₃]⁺ is tetrahedral and belongs to the NO⁺ type with an Ni—N—O angle of 175.4(5)[°],²⁴³⁰ while the metal ion in [Ni(NO)(NO₂)(dppe)]₂ is found in a distorted tetrahedral environment with an Ni—N—O angle of 153.4(8)[°].²⁴³¹ No simple correlation can be drawn between the $\nu(\text{NO})$ stretch and the NO coordination mode. Most Ni⁰ nitrosyl complexes have phosphine coligands, and some examples with diphosphines involve mononuclear (1007) and dinuclear (1008).²⁴³² In the case of [NiX(NO){1,2-C₆H₄(PMePh)₂}], configurational stability of the complexes has been investigated.²⁴³³

Parent NiNO and Ni(NO)₂ have been prepared by cocondensation of Ni and NO in solid argon and investigated by IR spectroscopy in combination with DFT calculations.^{2434–2437} Two different isomeric forms have been evidenced for the dinitrosyl, Ni(η^1 -NO)₂ and Ni(η^2 -NO)₂, differing by their coordination modes and electronic structure.²⁴³⁶

6.3.6.2 Complexes with CO₂, CS₂, and related ligands—Electroreduction of CO₂

In neat low-temperature CO₂ matrices, CO₂ is side-on coordinated to Ni atoms and the binding energy is weak (18 kcal mol⁻¹).^{2438,2439} The calculated OCO angle is 145[°], which is quite a large value compared to those of other CO₂ complexes. In dinitrogen matrices, the binding of CO₂ is enhanced due to formation of [Ni(N₂)_n(CO₂)] (*n* = 1, 2).²⁴³⁷

The key role played by diverse nickel complexes in the development of CO₂ coordination chemistry and CO₂ electroreduction catalysts has been highlighted,²⁴⁴⁰ and several reviews discussing CO₂ electroreduction and photoreduction are available.^{2441–2445}

The Aresta complex [Ni(CO₂)(PCy₃)₂] has been investigated further. ³¹P and ¹³C NMR in the solid state and in solution have been used to determine a direct correlation of the modes of bonding of CO₂ in [Ni(CO₂)(PCy₃)₂]. It was found that, in solution at 173 K, CO₂ is η^2 -CO bonded to nickel, and that the ³¹P and ¹³C chemical shifts were almost identical to the values found in the solid state. In solution, however, a dynamic process averages the two P atoms at room temperature via an intramolecular motion.²⁴⁴⁶ In addition, vibrational studies and CAS-SCF calculations on [Ni(CO₂)(PCy₃)₂] have been reported.²⁴⁴⁷ FTIR and Raman spectra could be assigned with the aid of ¹³CO₂ and C¹⁸O₂ labeling, normal coordinate analysis, and NMR data. It is suggested that the fluxional behavior, and the fact that two C—O stretches (1,150 cm⁻¹, 1093 cm⁻¹) are seen, can best be explained by the existence of an unstable end-on Ni(η^1 -CO₂) isomer in both the solid state and solution.

The stability of Ni—CO₂ complexes is related to the basicity of ancillary phosphines and to the P—Ni—P bond angle. For example, it was calculated that the total energy for the complex

$[\text{Ni}(\text{PH}_3)_2(\text{CO}_2)]$ is a function of the P—Ni—P angle, being the most favorable when this angle is 120° .²⁴⁴⁸ $\text{Ni}(\text{dppe})$ does not interact with CO_2 , which is ascribed to the insufficient basicity of the diphosphine. In contrast, the more basic chelating diphosphines $\text{Cy}_2\text{P}-(\text{CH}_2)_n-\text{PCy}_2$ do react with CO_2 and afford CO_2/Ni^0 adducts for $n = 2, 3, 4$. They show the characteristic strong IR absorption at around 1740 cm^{-1} for bound CO_2 and a doublet at $162\text{--}165\text{ ppm}$ in the ^{13}C NMR. The complex in which the P—Ni—P angle is about 90° ($n = 2$) is unstable and cannot be isolated owing to rapid disproportionation.²⁴⁴⁹

Upon reaction of complexes $[\text{Ni}(\text{PR}_3)_2(\text{CO}_2)]$ with O_2 , Ni^{II} peroxocarbonate species (**1009**) are formed.^{2448,2450} In the case of $[\text{Ni}(\text{PCy}_3)_2(\text{CO}_2)]$, a detailed study using labeled $^{13}\text{CO}_2$, C^{18}O_2 , and $^{18}\text{O}_2$ has revealed details of the mechanism of this reaction.²⁴⁴⁹ It implies initial CO_2 decoordination, followed by O_2 coordination and subsequent CO_2 insertion into the O—O bond of the intermediate $[\text{Ni}(\text{PCy}_3)_2(\text{O}_2)]$.

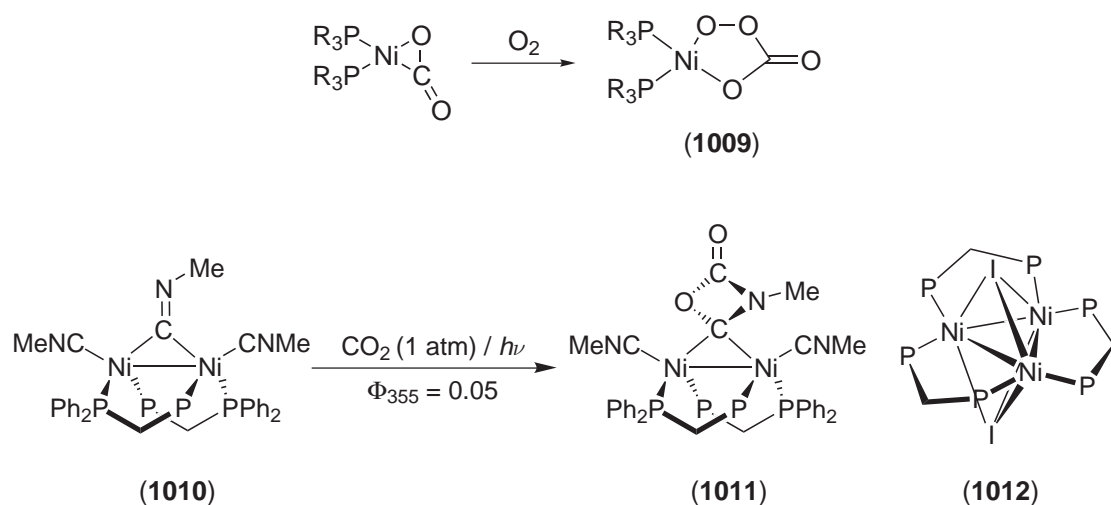

Photochemical activation of CO_2 has been achieved using the long-lived ligand-centered charge-transfer excited state of the binuclear Ni^0 complex $[\text{Ni}_2(\mu\text{-CNMe})(\text{CNMe})_2(\text{PPh}_2\text{CH}_2\text{PPh}_2)_2]$ (**1010**). Through bimolecular association of CO_2 to the excited state (**1010**), complex (**1011**) is formed.^{2451,2452} The association of CO_2 with (**1010**) results in its activation towards O-atom transfer reactions. Prolonged exposure to CO_2 results in the formation of $[\text{Ni}_2(\mu\text{-CO})(\text{CO})_2(\text{PPh}_2\text{CH}_2\text{PPh}_2)_2]$ (**1006**).^{2453,2454}

Upon reaction of (**1010**) with NiI_2 , trinuclear $[\text{Ni}_3(\mu_3\text{-I})_2(\text{dppe})_3]$ (**1012**) is formed. The latter can also be obtained directly from $[\text{Ni}(\text{cod})_2]$, NiI_2 and dppe . (**1012**) photoreduces carbon dioxide to its radical anion, which can be trapped by cyclohexene.²⁴⁵⁵

The reaction between $[\text{Ni}(\text{cod})_2]$, CO_2 , and benzaldehyde-*N*-furfurylideneimine (L) in 1,4-dioxane or THF gave a 24-membered organometallic macrocycle $[(\text{L})\text{Ni}(\text{—CH}(\text{R}_1)\text{—N}(\text{R}_2)\text{—COO—})_6(\text{solvent})_n]$ ($\text{R}_1 = \text{Ph}$, $\text{R}_2 = \text{furfurylidene}$, $\text{solvent} = 1,4\text{-dioxane}$ or THF).^{2456,2457} According to the X-ray analyses, six monomeric nickelacyclic units are connected through six $\text{Ni}\text{—}\mu_2\text{—OCO—Ni}$ bridges in these macrocycles, with cavity diameters of around 9.3 \AA . The complexes isomerize in benzene to form dimeric $[(\text{L})\text{Ni}(\text{—CH}(\text{R}_1)\text{—N}(\text{R}_2)\text{—COO—})_2(\text{solvent})_n]$ (**1013**), and they react with PPh_3 to give tetranuclear species. The macrocycle partially eliminates CO_2 above 20° , followed by elimination of half of the monodentately coordinated Schiff base ligands to form a planar tetrameric complex (**1014**). This is a reversible process.

The reaction of $\text{Ni}(\text{CNAr})_4$ (**1015**; $\text{Ar} = 2,6\text{-Me}_2\text{C}_6\text{H}_3$) with carbon dioxide in the presence of Li^+ leads to the formation of $\text{Ni}(\text{CO})_2(\text{CNAr})_2$ (**1016**) and the arylisocyanate ArNCO (Equation (29)).^{2458,2459} Complex $[\text{Ni}(\text{CNMe})_4]$ reacts similarly with carbon dioxide in the presence of Li^+ to produce $[\text{Ni}(\text{CO})_2(\text{CNMe})_2]$. ^{13}C -labeling studies indicate that the carbonyl ligands of $\text{Ni}(\text{CO})_2(\text{CNR})_2$ are produced by multiple bond metatheses between CO_2 and CNR ($\text{R} = 2,6\text{-Me}_2\text{C}_6\text{H}_3$, Me), not by deoxygenation of CO_2 . Hence, the reaction of (**1015**) with $^{13}\text{CO}_2$ gave $\text{Ni}(\text{CO})_2(\text{CNAr})_2$ and $\text{ArN}=\text{C}^{13}\text{=O}$. The reaction of $\text{Ni}(\text{C}^{13}\text{CNMe})_4$ with CO_2 gave $\text{Ni}(\text{C}^{13}\text{CO})_2(\text{CNMe})_2$. The reactions are catalytic and first order in $[\text{Li}^+]$ over the range $[\text{Li}^+]/[\text{1015}]$:

0.01–40. Kinetic studies indicate that the rate of reaction of **(1015)** with CO₂ is first order in [CO₂]. The reaction order in **(1015)** is complex. At high [Li⁺] and high [CO₂], the reaction rate is second order in **(1015)** but the rate saturates and becomes nearly independent of **(1015)** at low [Li⁺] and low [CO₂].

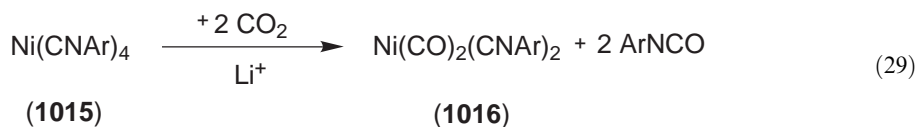
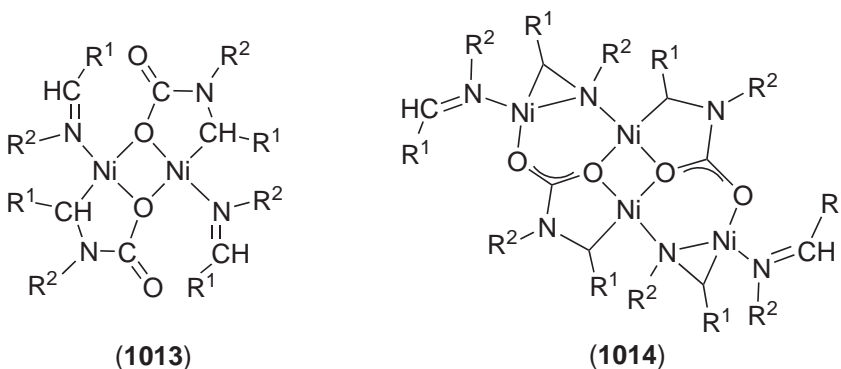

The reactions of carbon dichalcogenides other than CO₂ with Ni⁰ have also been studied quite intensively.^{2460,2461} *Inter alia*, Ni polymeric complexes with metallic properties have been prepared using CS₂ as the starting material.²⁴⁶² Some further impetus was given by the observation that CS₂ can mimic the binding of CO to the CODH enzyme active site, although CS₂ itself does not undergo oxidation/reduction and does not appear to bind to center C (the site of CO oxidation and CO₂ reduction).²⁴⁶³

Several classes of discrete Ni/CS₂ compounds have been prepared, usually by reaction of CS₂ with Ni⁰ phosphine complexes. Reactions of CS₂, CO₂, and COS with Ni⁰ complexes have been reviewed.²⁴⁴⁰ Compounds of varying stoichiometry have been obtained, depending on the phosphine used:

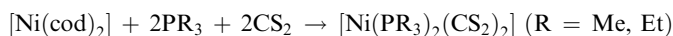
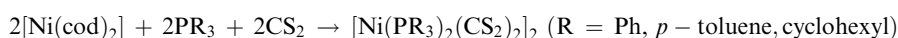

A single-crystal X-ray analysis of the triphenylphosphine complex [Ni(PPh₃)(CS₂)₂] has revealed that the complex has the binuclear structure **(1017)**.²⁴⁶⁰ The complex [Ni(PMe₃)₂(CS₂)₂] displays NiPSCS coordination **(1018)** and is severely distorted from square planar. Of interest is the fact that the SC(S)SC(PMe₃)S linkage can be formally described as a condensation product of two molecules of CS₂ with one molecule of PMe₃.²⁴⁶⁴

The decisive factor for reaction to occur has been shown to be the HOMO energy of the complex, relative to the LUMO energy of the potential ligand. For example, [Ni(bipy)(cod)] reacts with SeCS, CS₂, and SCO, whereas [Ni(PPh₃)₂(C₂H₄)] only reacts with CS₂, and not SCO. Generally the carbon dichalcogenides are bonded side-on (η^2), and it is always the most electronegative heteroatom of the asymmetric ligands SeCS and SCO which does not interact with the central metal atom.²⁴⁶⁵ Reactions of the CS₂ complex **(1019)** are described in Section 6.3.4.5.1.^{648–650}

When laser-ablated Ni atoms were reacted with CS₂ during cocondensation in excess argon, the C-bonded Ni(η^1 -CS₂) and side-on bonded Ni(η^2 -CS)₂ complexes were formed on annealing, whereas the inserted SNiCS was formed on photolysis. All species were characterized by IR spectroscopy and DFT calculations.²⁴⁶⁶ The reaction of low-valent [Ni(CO)_x]⁻ ($x = 2, 3$) with CS₂ has been studied by FT-ICR spectroscopy.²⁴⁶⁷

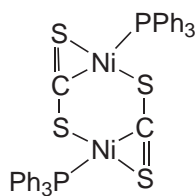

(1017)

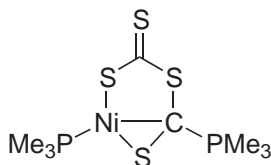

(1018)

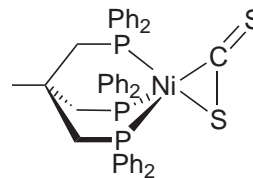

(1019)

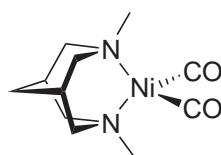

(1020)

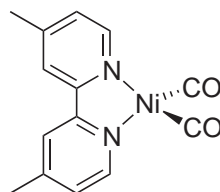

(1021)

6.3.6.3 Complexes with Nitrogen-containing Ligands

Aliphatic amines, which are hard bases, are unfavorable for coordination to soft Ni^0 . If the principles of ligand preorganization and donor prepositioning are applied, however, (diamine) Ni^0 complexes are accessible, which has been demonstrated for complex (1020) with a rigid N,N' -dimethyl-3,7-diazabicyclo[3.3.1]nonane ligand.²⁴⁶⁸

Bis(bipyridyl)nickel(0) has been prepared by metal-vapor methods and electrochemical data were obtained for it. In these low-valence states, a significant proportion of the electron density lies on the bipy ligand.²⁴⁶⁹ Also, the crystal and molecular structure of 4,6-dimethyl-2,2'-dipyridyldicarbonylnickel(0) (1021) has been determined. The coordination geometry about Ni is tetrahedral.²⁴⁷⁰

In a series of studies of the spectroscopy and photochemistry of nickel(0)- α -diimine complexes, the structural differences among the complexes NiL_2 and $\text{Ni}(\text{CO})_2\text{L}$ ($\text{L} = \alpha$ -diimine) have been examined by means of molecular orbital calculations and electronic absorption Raman resonance studies.^{2471,2472} Summing up earlier work, the noninnocence of α -diimine ligands with a flat $-\text{N}=\text{C}-\text{C}=\text{N}-$ skeleton in low-valent Ni chemistry and the course of substitution reactions of Ni^0 complexes with 1,4-diaza-1,3-dienes or α,α' -bipyridine have been reviewed.²⁴⁷³

6.3.6.4 Complexes with Dinitrogen and Dioxygen

The new dinitrogen complex $[\text{Ni}(\text{CO})_3\text{N}_2]$ can be generated in a pressure cell by UV photolysis of tetracarbonylnickel in liquid krypton, doped with N_2 at 114 K. The decomposition of this complex was followed over the temperature range 122–127 K and a value of the $\text{Ni}-\text{N}_2$ bond dissociation energy estimated at 10 kcal mol^{-1} .²⁴⁷⁴

Various theoretical studies on the coordination of N_2 (and related molecules) to Ni^0 compounds have been carried out. These include *ab initio* calculations on $\text{Ni}(\text{N}_2)$ and $\text{Ni}(\text{N}_2)_4$ (in comparison with $[\text{Ni}(\text{CO})_4]$),²⁴⁷⁵ on $[\text{Ni}(\text{PH}_3)(\text{N}_2)]$,²⁴⁷⁶ on $[\text{Ni}(\text{PH}_3)_2(\text{N}_2)]$,^{2477,2478} on the series of complexes $[\text{Ni}(\text{PH}_3)_2(\text{N}_2)]$, $[\text{Ni}(\text{PH}_3)_2(\text{NCH}_2)]$, and $[\text{Ni}(\text{PH}_3)_2(\text{N}_2\text{H}_3)]$,²⁴⁷⁹ as well as *ab initio* calculations (MP2 and CCSD(T) level) on $[\text{Ni}(\text{CO})_2(\text{N}_2)]$.²⁴⁸⁰ Also, the bonding between $[\text{Ni}(\text{PH}_3)_2]$ and O_2 has been analyzed by quasi-relativistic DFT calculations.²⁴⁸¹

$[\text{Ni}(\text{PCy}_3)_2(\text{O}_2)]$ is proposed as a reactive intermediate in the reaction of $[\text{Ni}(\text{PCy}_3)_2(\text{CO}_2)]$ with dioxygen to give the peroxocarbonate complex $[\text{Ni}(\text{PCy}_3)_2(\text{CO}_4)]$ (see Section 6.3.6.2).²⁴⁴⁹

6.3.6.5 Complexes with Phosphines, Arsines, and Stibines

Phosphorus is the most common donor atom in Ni⁰ chemistry. Likewise, As- and Sb-based ligands are well suited for stabilizing low-valent Ni⁰. Ni⁰ phosphine chemistry is extensive, and the general synthetic approaches have been summarized previously.

6.3.6.5.1 Complexes with mono- and oligodentate phosphines and phosphido ligands

Tetrakisphosphine complexes of Ni⁰ are usually prepared either from labile Ni⁰ precursors (such as [Ni(cod)₂] or [Ni(CO)₂(cod)]) or by reduction of an appropriate Ni^{II} complex in the presence of phosphine. Despite the large number of homoleptic Ni–phosphine complexes NiL₄, however, relatively few X-ray crystal structures are known. Some examples are collected in Table 23. Typical Ni⁰–P distances are in the range 2.14–2.21 Å. [Ni(PMePh₂)₄] was obtained serendipitously upon treatment of [NiBr(NPMe₃)₃]₄ with LiCCPh.

Crystals of the first homoleptic Ni⁰–trialkylphosphine complex to be analyzed by X-ray crystallography, [Ni(PEt₃)₄], were obtained serendipitously on recrystallizing the product of reaction between [NiCl₂(PEt₃)₂] and lithium 2-bis(trimethylsilyl)methylpyridine.²⁴⁸² In all cases, for NiL₄ phosphine complexes there are distortions from overall tetrahedral geometry caused by the steric requirements of the ligands.

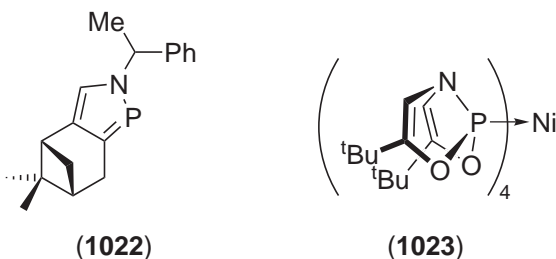

Several complexes [Ni(PPh₃)₃(η¹-NCR)] (R = PhCH₂, 2-MeC₆H₄, Me₃Si) have been synthesized, and the crystal structure of one example (R = Me₃Si) obtained.²⁴⁸⁷ Again, the overall geometry is distorted tetrahedral. The reaction of [Ni(PPh₃)₄] with CH₂Br₂ in the presence of Zn followed by carbonylation gives the η²-(C,C) ketene complex [Ni(CH₂=C=O)(PPh₃)₂] (1024a). This complex can be considered as a model for homogeneous CO reduction.²⁴⁸⁸ From qualitative MO arguments and EH model calculations, however, η²-(C,O) bonding of a ketene ligand in bis(phosphane)nickel(0) complexes is suggested to be preferred over η²-(C,C) coordin-

Table 23 X-ray crystallographic results for homoleptic Ni⁰L₄ phosphine complexes.

Complex	Geometry	<i>d</i> (Ni–P)(Å)	References
[Ni(PEt ₃) ₄]	Distorted tetrahedral (<i>C</i> _{2v}); P–Ni–P angles ranging from 102.4(2)° to 111.6(1)°	2.210(1), 2.151(1)	2482
[Ni(PH ₂ Mes) ₄]	Distorted tetrahedral; P–Ni–P angles ranging from 106.9(3)° to 111.3(2)°	2.140(8)–2.158(7)	2483
[Ni(PMePh ₂) ₄]	Distorted tetrahedral; P–Ni–P angles ranging from 103.35(4)° to 122.40(4)°	2.193(1)–2.206(1)	
[Ni(PPh ₂ NHPh) ₄]	Compressed tetrahedron; P–Ni–P angles ranging from 104.89(4)° to 117.21(4)°	2.175(1)–2.183(1)	2484
[Ni(1022) ₄]	Distorted tetrahedron; P–Ni–P angles ranging from 103.1(1)° to 117.4(1)°	2.143(1), 2.146(1)	2485
(1023)	Tetrahedral; P–Ni–P angles 109.5°	2.093	2486

ation, and increasing relative stability of η^2 -(C,O) bonding is predicted with decreasing P—Ni—P angle.²⁴⁸⁹ Hence, complex **(1024b)** with a small diphosphine bite angle shows the latter coordination mode.²⁴⁸⁹

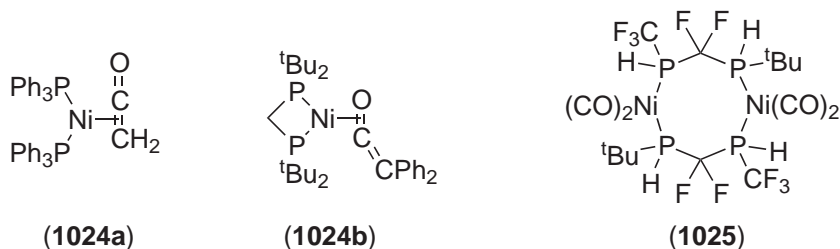

Examples of new Ni⁰ complexes with bulky diphosphine ligands prepared by reduction of [Ni(L-L)X₂] (X = Cl, Br) include [Ni(L-L)] and [Ni(L-L)(toluene)] (L-L = 1,2-bis(dicyclohexylphosphino)ethane (dcpe); 1,3-bis(dicyclohexylphosphino)propane (dcp); 1,4-bis(dicyclohexylphosphino)butane (dcpb)), as well as Ni₂(dcpe)₃, Ni₂(dcpb)₃, Ni(dcpe)₂, and Ni(depe)₂ (depe = 1,2-bis(diethylphosphino)ethane). The electronic spectra of these complexes have been investigated.²⁴⁹⁰ The reaction of [NiCl₂(L-L)] (L-L = dppe, dppp) with NaOR gives [Ni(L-L)₂], Ni(OR)₂, and aldehyde or acetone in a 1:1:1 ratio (R = Me, Et, Prⁱ), as well as NaCl.²⁴⁹¹ When L-L = dcpe, the product is [Ni₂(dcpe)₃] or (with additional diphosphine present) [Ni(dcpe)₂]. Under CO, the corresponding complexes [Ni(CO)₂(L-L)] are formed in high yield. An unusual route to [Ni⁰L₄] and [Ni⁰(L-L)₂] phosphine complexes is the CT excitation of Ni^{II} azido compounds [Ni(N₃)₂L₂] and [Ni(N₃)₂(L-L)], respectively, according to Equation (30).²⁴⁹² Formation of the Ni⁰ products **(1026)** goes via reactive nitren intermediates, which has been corroborated by trapping experiments. The trifluoromethyl-1,3-diphosphane Bu^t(H)PCF₂P(H)CF₃ reacts with Ni(CO)₄ to give dinuclear **(1025)**.²⁴⁹³

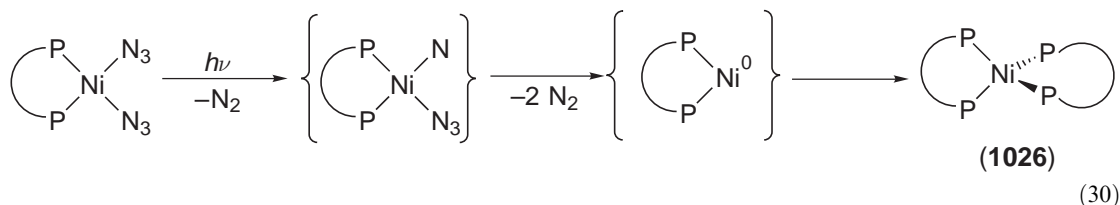

X-ray crystallographic data for homoleptic [Ni⁰(L-L)₂] diphosphine complexes with a {NiP₄} core are collected in Table 24.

The organometallic diphosphine ligand **(1031)** forms Ni⁰ complexes [Ni(**1031**)₂] and [Ni(**1031**)(CO)₂].²⁴⁹⁸ [Ni(**1031**)₂] shows a reversible two-electron oxidation at -0.70 V (Cr-centered according to EPR), followed by a reversible process at -0.52 V and a quasi-reversible process at -0.16 V. The latter are assumed to be Ni based.

Upon reaction with various Ni⁰ precursors, the rigid *cis*-1,2-bis(diphenylphosphino)ethane gives mononuclear **(1032a)** or polymeric **(1032b)**, depending on the stoichiometry.²⁴⁹⁹ NiL₂

Table 24 X-ray crystallographic data for homoleptic Ni⁰(L-L)₂ diphosphine complexes.

Complex	Geometry	<i>d</i> (Ni—P)(Å)	References
[Ni(1027) ₂]	Distorted tetrahedral	2.152(3)–2.177(3)	2494
[Ni(1028) ₂]	Distorted tetrahedral; P—Ni—P angles ranging from 102.76(9)° to 112.2(1)°	2.201(4)–2.208(3)	2495
[Ni(1029) ₂]	Strongly distorted tetrahedral; P—Ni—P angles ranging from 92.4(1)° to 123.0(1)°	2.187(2)–2.210(3)	2496
[Ni(1030) ₂]	Distorted tetrahedral; P—Ni—P angles ranging from 103.4(1)° to 114.4(1)°	2.136(1), 2.140(1)	2497
[Ni(1031) ₂]	Distorted tetrahedral; P—Ni—P angles ranging from 103.0(1)° to 116.9(1)°	2.146(1), 2.151(1)	2498

fragments can be inserted into the P—P bond of 1,2,3,4-tetraphenyl-1,2-dihydro-1,2-diphosphete, and two limiting descriptions are possible for the resulting product: either a nickeldiphospholene (**1033a**) with square planar metal ion and a formal +2 oxidation state of Ni, or a 1,4-phosphadiene (**1033b**) complex with tetrahedral Ni⁰.²⁵⁰⁰ Both forms exist depending on the coligands, and isomerization has been observed in some cases. The X-ray crystal structure of the species with a dppe coligand reveals a situation intermediate between square planar and tetrahedral (LNiL/PNiP interplane angle 38°). A single-crystal X-ray determination of the reaction product of Ni(CO)₄ with the small-bite didentate ligand 1,2-bis(dimethylphosphino)-methane has revealed a dimeric structure, [μ-(CH₃)₂PCH₂P(CH₃)₂]₂Ni₂(CO)₄, for what was previously assumed to be the monomeric complex [(CH₃)₂PCH₂P(CH₃)₂Ni(CO)₂]. The coordination geometry about the two Ni atoms is essentially tetrahedral with a nonbonded Ni—Ni distance of 4.39 Å.²⁵⁰¹

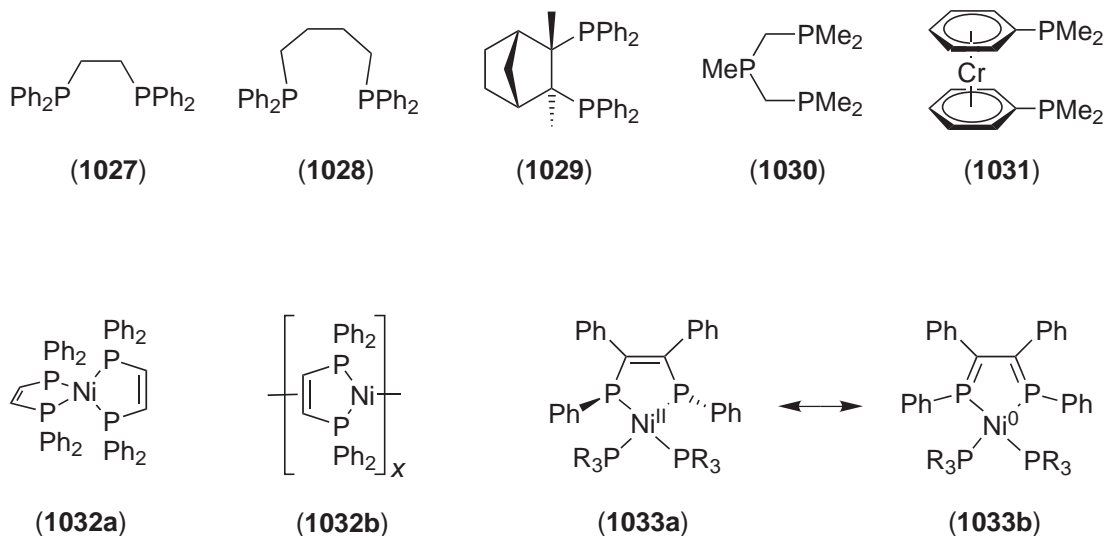

The coordinatively unsaturated [Ni(PPh₃)₃] (**1034**) has trigonal planar Ni,²⁵⁰² the structure showing some close approach of three *ortho*-phenyl H atoms to the central Ni (2.74–3.09 Å) with implications for *ortho*-metallation.

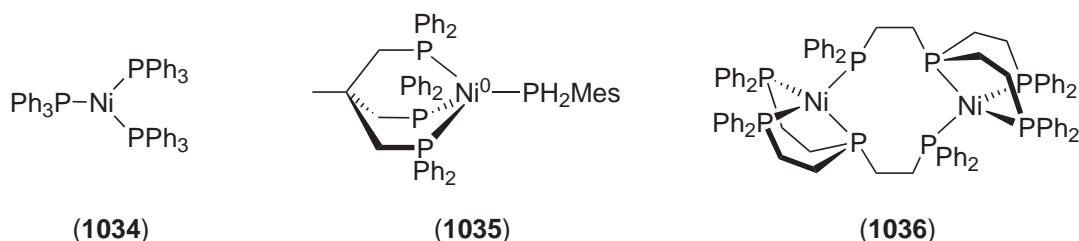

The particular ability of the tris(2-diphenylphosphinomethyl)ethane (P₃) and related tripod-like tetradentate tris(2-diphenylphosphinoethyl)phosphine (PP₃), tris(2-diphenylphosphinoethyl)amine (NP₃) and tris(2-diphenylarsenoethyl)amine (NAS₃) to stabilize low-valent Ni species has already been outlined in previous sections (e.g., Section 6.3.6.3). Some further examples in Ni⁰ chemistry are given here. Complex (**1035**) is obtained from the reaction of [Ni(PH₂Mes)₄] with P₃, and its structure has been established by X-ray crystallography.²⁴⁸² It is concluded that the coordination properties of P₃ are dominated by its relatively small cone angle and that the basicity of P₃ is comparable to that of the monodentate tertiary phosphines. The electrochemistry of [Ni(PP₃)X]⁺ (X = Cl, Br, I, MeCN) has been studied in CH₃CN and CH₂Cl₂,^{171,2388} revealing that the cations undergo reduction to the Ni⁰ complexes [Ni(PP₃)X]⁻. For X = Br and I, this is followed by loss of X⁻ and formation of a PP₃-bridged Ni⁰ dimer (**1036**). In CH₃CN, [Ni(PP₃)I]⁻ also undergoes iodide displacement by solvent.

$[\text{Ni}(\text{NP}_3)]$ reacts with CS_2 to initially give (1037), which forms (1038) upon subsequent methylation by MeOSO_2F (Equation (31)).²⁵⁰³

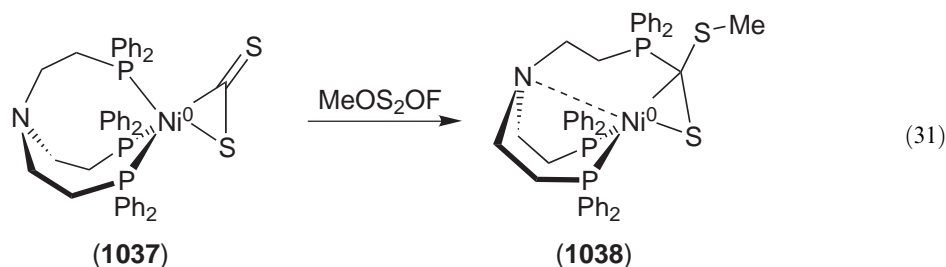

Nickel(0) complexes with water-soluble phosphines have attracted interest in the context of homogeneous catalysis. A comprehensive study of the coordination chemistry of tris(sodium-*m*-sulfonatophenyl)phosphine (1039) has appeared.²⁵⁰⁴ The complexes $[\text{Ni}(\text{CO})_2(\mathbf{1039})_2] \cdot 6\text{H}_2\text{O}$ have been made by reaction of (1039) with $\text{Ni}(\text{CO})_4$ under phase-transfer conditions, and the homoleptic $[\text{Ni}(\mathbf{1039})_3] \cdot 9\text{H}_2\text{O}$ has been made from Ni^0 precursors and (1039) under phase-transfer conditions, or from NiCl_2 , (1039), and BH_4^- in water. A related complex $[\text{Ni}(\text{CO})_2(\mathbf{1040})_2]$ with the bidentate ligand (1040) has also been studied.²⁵⁰⁵

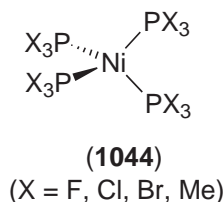
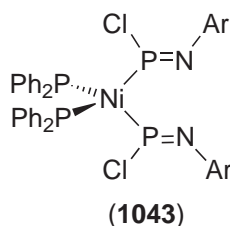
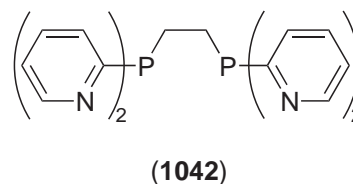
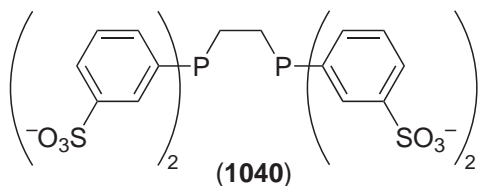
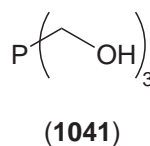
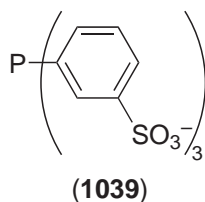

$[\text{Ni}^0\{\text{P}(\text{CH}_2\text{OH})_3\}_4]$ has been prepared by the reaction of $\text{P}(\text{CH}_2\text{OH})_3$ (1041) with $[\text{Ni}(\text{cod})_2]$ in toluene and is assumed to be tetrahedral. It is similar to its PMe_3 and PET_3 analogues in many respects, with the main differences being enhanced water solubility, increased stability of the low oxidation state, and high coordination number.²⁵⁰⁶ With the same intention to increase water solubility, complexes $[\text{Ni}(\text{CO})_2\text{L}_2]$ and $[\text{NiL}_4]$ with 2-pyridylphosphine ligands ($\text{L} = \text{PPh}_{3-n}\text{py}_n$) as well as with the chelating ligand (1042) have been prepared.²⁵⁰⁷

Chloro(2,4,6-tri-*t*-butylphenylimino)phosphine, $\text{Cl}-\text{P}=\text{NAr}$ ($\text{Ar} = 2,4,6\text{-Bu}^t_3\text{C}_6\text{H}_2$), has been reacted with a variety of Ni^0 complexes, yielding σ -complexes of P-functionalized iminophosphines.²⁵⁰⁸ The structure of $[\text{Ni}(\text{PEt}_3)_2(\text{Cl}-\text{P}=\text{NAr})_2]$ ($\text{Ar} = 2,4,6\text{-Bu}^t_3\text{C}_6\text{H}_2$; (1043)) has been obtained; the complex is almost perfectly tetrahedral with the chloroiminophosphine η^1 -bonded as a consequence of its carbene-like frontier orbitals.²⁵⁰⁹

Bis(η^3 -allyl)nickel(0) and bis(η^5 -pentadienyl)iron(II) have been used as starting materials in the preparation of $[\text{Ni}(\text{PF}_3)_4]$ and $[\text{Ni}(\text{PF}_2\text{H})_4]$.²⁵¹⁰ The electronic structure of the fluorophosphine complex $[\text{Ni}(\text{PF}_3)_4]$ has been investigated by various spectroscopic and theoretical methods.^{2511–2515} *Inter alia*, a theoretical treatment by the multiple scattering X_α method showed that π back donation is of the same magnitude as in $[\text{Ni}(\text{CO})_4]$.²⁵¹⁶ Photoelectron spectra of $[\text{Ni}(\text{PF}_3)_4]$ have been measured using synchrotron radiation. Unexpectedly, this formally d^{10} complex shows $p-d$ resonance between 70 eV and 100 eV,²⁵¹⁷ which is attributed to covalent mixing of d character into unoccupied molecular orbitals. Force constant calculations have been carried out for $[\text{Ni}(\text{PBr}_3)_4]$ using simple valence force field with interaction constants. The force constant values were compared for the coordinated and free ligand, and also with $k(\text{Ni}-\text{P})$ stretching in the series of molecules $[\text{Ni}(\text{PX}_3)_4]$ ($X = \text{F}, \text{Cl}, \text{Me}$). It was found that the $k(\text{Ni}-\text{P})$ stretching force constant was lowest for $[\text{Ni}(\text{PBr}_3)_4]$ in the series (1044).²⁵¹⁸

Protonation of a number of Ni^0 phosphine complexes has been carried out using $\text{H}_2\text{C}(\text{SO}_2\text{CF}_3)_2$. The resultant complex cations $[\text{L}_3\text{NiH}]^+$ ($\text{L} = \text{Ph}_3\text{P}, \text{Ph}_2\text{PMe}, \text{Et}_3\text{P}$) were isolated as their $\text{HC}(\text{SO}_2\text{CF}_3)_2^-$ salts. However, protonation of $[\text{Ni}\{\text{P}(\text{OEt})_3\}_4]$ was found to yield $[(\text{EtO})_3\text{P}\}_4\text{NiH}][\text{HC}(\text{SO}_2\text{CF}_3)_2]$. In addition, the compounds $[(\text{Et}_3\text{P})_3\text{NiH}][\text{HC}(\text{SO}_2\text{CF}_3)_2]$ and $[(\text{Ph}_3\text{P})_3\text{NiH}][\text{HC}(\text{SO}_2\text{CF}_3)_2]$ were found to be stereochemically nonrigid in CH_2Cl_2 solution.²⁵¹⁹

It has been shown that some phosphine or phosphite Ni^0 complexes have long-lived emissive excited states at room temperature and possess photochemical reactivity towards organic substrates.²⁵²⁰

An improved method for the preparation of $[\text{Ni}(\text{CO})_2(\text{PR}_3)_2]$ has been reported. The preparation involves reaction of the dithiocarbamate, $[\text{Ni}(\text{S}_2\text{COEt})_2]$, with the relevant phosphine PR_3 . Yields of up to 50% have been recorded.²⁵²¹ Infrared carbonyl stretching frequencies of the newly characterized difluorophosphine-coupled $[\text{Ni}(\text{CO})_3(\text{PF}_2\text{H})]$ and $[\text{Ni}(\text{CO})_2(\text{PF}_2\text{H})_2]$ indicate that the bonding capabilities of this particular phosphine are intermediate between PH_3 and PF_3 .²⁵²² New bis(dialkylamino)phosphine Ni^0 complexes of the type $[\text{Ni}(\text{CO})_3\text{L}]$ ($\text{L} = \text{Me}_2\text{NPF}_2, (\text{Me}_2\text{N})_2\text{PF}, \text{CH}_3\text{NCH}_2\text{CH}_2\text{N}(\text{CH}_3)\text{PF}, (\text{Me}_2\text{N})_2\text{PH}, \text{CH}_3\text{NCH}_2\text{CH}_2\text{N}(\text{CH}_3)\text{PH}$) have been prepared in good yield and characterized spectroscopically.²⁵²³

A selection of the extensive bimetallic Ni carbonyl phosphido chemistry is given in the following. Toluene solutions of $[\text{Ni}(\text{CO})_2(\text{PPh}_3)_2]$ react with excess K metal to give the $[\text{Ni}_2(\text{CO})_4(\mu\text{-PPh}_2)_2]^{2-}$ ion (1045) which contains two tetrahedral Ni centers fused along a common edge.²⁵²⁴ Each Ni achieves an 18-electron configuration without the formation of a Ni—Ni bond ($d(\text{Ni}-\text{Ni}) = 3.397(1) \text{ \AA}$) in contrast to the two-electron oxidation product $\text{Ni}_2(\text{CO})_4(\mu\text{-PPh}_2)_2$ ($d(\text{Ni}-\text{Ni}) = 2.510(2) \text{ \AA}$).

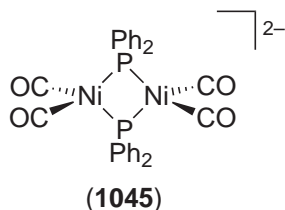

6.3.6.5.2 Complexes with diphosphenes, phosphabenzene, biphosphinine, and other unsaturated phosphorus donor ligands

The orange, air-stable, homoleptic tetrakis(η^1 -phosphabenzene)nickel (1046) is tetrahedral (point symmetry S_4) and can be obtained from phosphabenzene and $[\text{Ni}(\text{cod})_2]$.²⁵²⁵ It features a short Ni—P bond length of 2.1274(5) \AA with considerable Ni \rightarrow P π -backbonding and a $\nu(\text{Ni}-\text{P})$ stretch at 168 cm^{-1} . In solution, partial dissociation of one phosphabenzene ligand is observed. 2-Diphenylphosphino-3-methylphosphinine forms with $[\text{Ni}(\text{cod})_2]$ in the presence of the CO the dinuclear complex (1047) with a W-frame structure.²⁵²⁶

2,2'-Biphosphinines, the P analogues of bipyridine, are particularly suited as ligands for reduced metal species (reduction of biphosphinines is much easier than of bipyridine). Complexes $[\text{Ni}(\mathbf{1048})_2]$ and $[\text{Ni}(\mathbf{1048})\text{L}_2]$ ($\text{L} = \text{PPh}_3$, etc.) have been prepared by several procedures (from 2,2'-biphosphinine and $[\text{NiCl}_2(\text{dppe})]$ or from $[\text{NiCl}_2(\text{PPh}_3)_2]$ in the presence of excess Zn powder to afford $[\text{Ni}(\mathbf{1048})\text{L}_2]$, or with NiBr_2 under the same conditions to afford $[\text{Ni}(\mathbf{1048})_2]$, or from the biphosphinine dianion and the respective $\text{Ni}^{\text{II}}\text{X}_2$ precursor) and are stable to air (in contrast to $[\text{Ni}(\text{bipy})_2]$).^{2527,2528} $[\text{Ni}(\mathbf{1048})_2]$ has a distorted tetrahedral structure with Ni—P bond lengths (2.141–2.149(1) \AA) that are significantly longer than those for (1046).²⁵²⁶ Electrochemistry shows

reaction with $[\text{Ni}(\text{cod})_2]$, the same phosphacetyne gives (**1057a**) with a 1,3-diphosphacyclobutadiene and a side-on π ligand,²⁵⁴¹ and with $\text{Ni}(\text{CO})_4$ it gives (**1057b**).²⁵⁷⁵

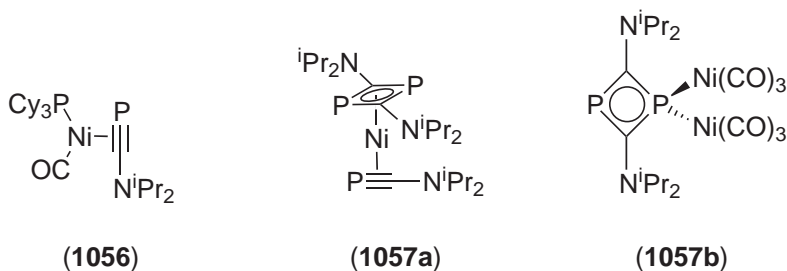
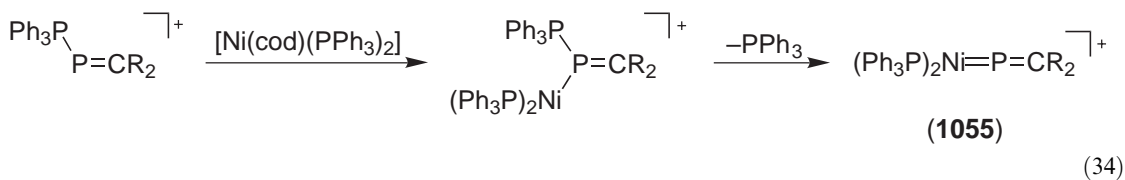
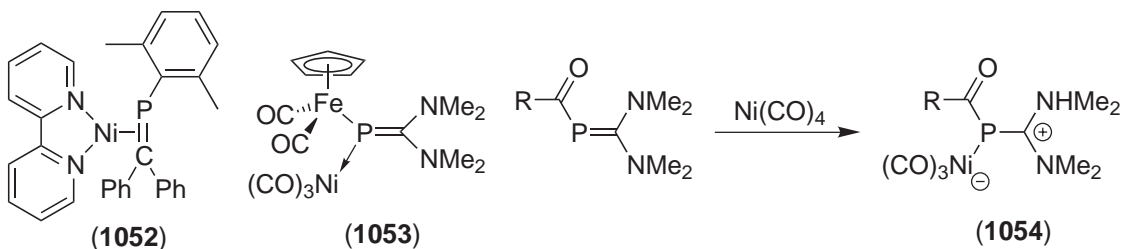

The diphosphene $(2,4,6\text{-Bu}^t_3\text{C}_6\text{H}_2)_2\text{P}_2$ reacts with $\text{Ni}(\text{CO})_4$ to give (**1058**), the first Ni^0 complex with a η^1 -diphosphene.²⁵⁴² Only one $\text{Ni}(\text{CO})_3$ moiety attaches, even if the diphosphene is treated with an excess of $\text{Ni}(\text{CO})_4$. $[\text{Ni}(\text{PET}_3)_2(\eta^2\text{-Me}_3\text{SiPPSiMe}_3)]$, the crystal structure of which has been determined,²⁵⁴³ shows the diphosphene ligand coordinated in the more common η^2 mode. $(\text{CF}_3\text{P})_4$ and $(\text{CF}_3\text{P})_5$ have been reacted with a number of zerovalent tertiary phosphine nickel complexes. Generally $\eta^2\text{-CF}_3\text{PPCF}_3$ complexes of the formula $[\text{L}_2\text{Ni}(\text{CF}_3\text{PPCF}_3)]$ were obtained, which were characterized by NMR spectroscopy and single-crystal X-ray methods.²⁵⁴⁴ Various synthetic routes are meanwhile available for the synthesis of Ni^0 diphosphene complexes.^{2370,2545,2546} Some approaches are collected in Equation (35).

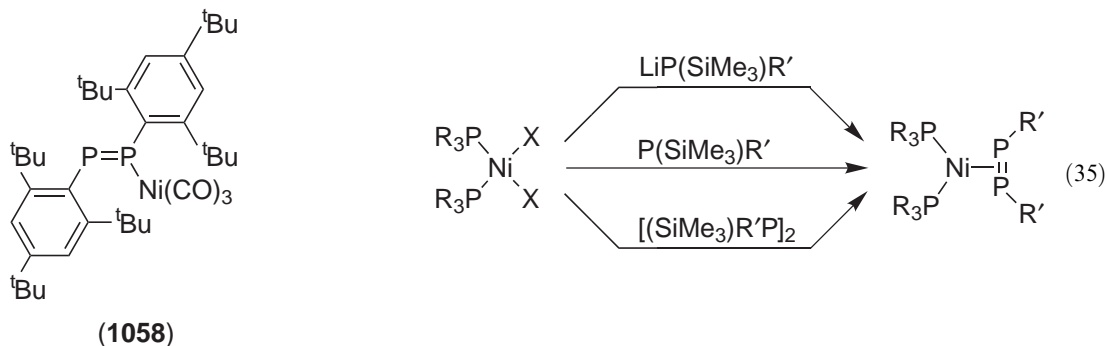

An unusual diphosphene complex of Ni^0 is (**1059**), which forms upon reaction of $[\text{NiCl}_2(\text{PET}_3)_2]$ with two equivalents of $\text{Na}[\text{cyclo}-(\text{P}_5\text{tBu}_4)]$.²⁵⁴⁷ The $\text{P}=\text{P}$ bond in (**1059**) (2.1183(11) Å) is clearly

shorter than all other P—P bonds in the P₅ ring, and the Ni atom is surrounded by four P atoms in an almost square planar fashion.

By slight modification of the synthetic procedure outlined in Equation (35), a P₂ unit side-on bound to two Ni⁰ complex fragments can be obtained according to Equation (36) (**1060**). X-ray crystallography shows a butterfly structure with $d(\text{P}\equiv\text{P}) = 2.121(6) \text{ \AA}$.²⁵⁴⁸

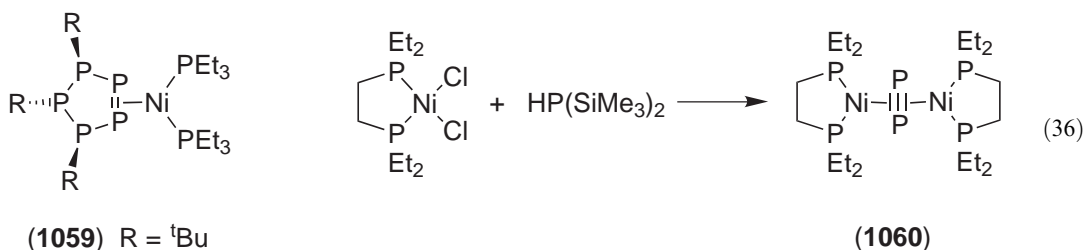

6.3.6.6.3 Complexes with miscellaneous phosphorus donor ligands

Diamagnetic [Ni(PBu^t)₆] (**1061**) has been prepared simply by reaction of NiCl₂ with P(SiMe₃)₃ and (PBu^t)₃, while the reaction of (PBu^t)₃ with [Ni(CO)₄] affords [Ni₅(PBu^t)₆(CO)₆]. The crystal and molecular structures of both complexes have been determined, and (**1061**) features a Ni at the center of a near-planar hexagon of PBu^t moieties.²⁵⁴⁹ It can be regarded as an isomer of (**228**) (see Section 6.3.4.5.2). The electronic structure of this unique complex (**1061**) has been discussed and investigated theoretically.^{2550,2551} The system could be regarded as essentially a 16-electron Ni⁰ species, with three of the six P—P σ -bonds interacting with the central Ni atom.

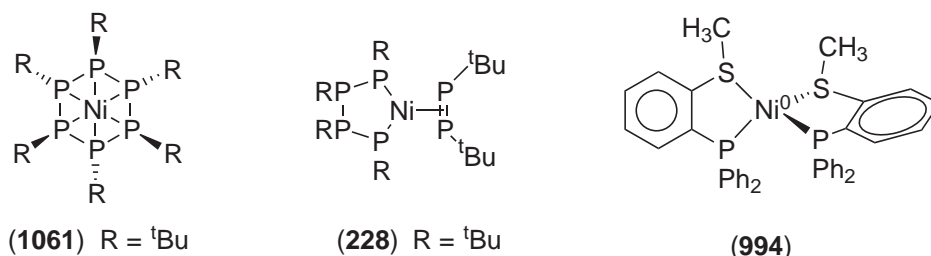

Reactions of the tetrahedral Ni⁰ complex (**994**) have already been discussed in Section 6.3.5.4.²³⁹⁷ A nickel carbonyl cation (**1062**) containing a cyclophosphonium ligand has been assembled through a hydride abstraction reaction according to Equation (37).²⁵⁵²

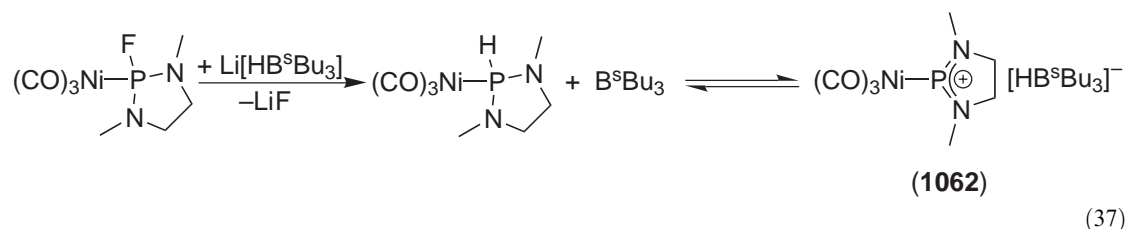

6.3.6.5.4 Complexes with arsenic and antimony donor ligands

In most studies of Ni complexes with As or Sb donor ligands, the complete range of redox states is covered. Therefore, the reader should also refer to the examples given in the respective sections for Ni^{II} and Ni^I.

Reactions of tetracarbonylnickel with SbCl₃ proceed to the monosubstituted stage only. A complete vibrational assignment has been made for [Ni(CO)₃(SbCl₃)] under C_{3v} symmetry.²⁵⁵³

The reaction of $[\text{Ni}_6(\text{CO})_{12}]^{2-}$ with SbCl_3 affords the large clusters $[\text{Ni}_{13}\text{Sb}_2(\text{CO})_{24}]^{n-}$ ($n=2,3,4$).²⁵⁵⁴ They can formally be regarded as exotic bidentate stibine ligands, $[\text{Ni}_{11}\text{Sb}_2(\text{CO})_{18}]^{n-}$ (nickel-centered icosahedra, one antimony atom capping each Ni_5 plane) bridging two $[\text{Ni}(\text{CO})_3]$ fragments.

Complexes **(1063)** have been obtained by the reaction of $\text{Ni}(\text{CO})_4$ with monomeric Lewis base-stabilized aluminum pnictines $[\text{dmap-AlMe}_2\text{-E}(\text{SiMe}_3)_2]$ ($\text{E} = \text{P}, \text{As}, \text{Sb}$).²⁵⁵⁵

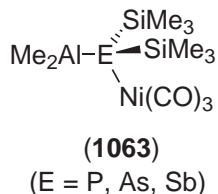

6.3.6.6 Miscellaneous Complexes of Nickel(0)

A general strategy for the synthesis of complexes $[\text{NiL}_3(\text{SO}_2)]$ ($\text{L} =$ monodentate phosphane), $[\text{NiL}_2(\text{SO}_2)_2]$ ($\text{L}_2 =$ two monodentate phosphanes or a bidentate N-donor ligand), and $[\text{NiL}_2(\text{SO}_2)]$ ($\text{L} =$ bidentate phosphane) has been worked out.^{2556–2558} Upon oxidation with dioxygen, sulfato complexes are formed.²⁵⁵⁷ The SO_2 ligand may coordinate in η^1 -pyramidal, η^1 -planar, or η^2 -S,O side-on mode, which depends on the coligands.²⁵⁵⁹ Various theoretical studies have been carried out to see if the bonding options differed significantly in energy, and various different and partially counteracting influences have been identified.^{2559–2562} In complexes of the type $[\text{NiL}_3(\text{SO}_2)]$, coligands L with higher basicity favor the η^1 -pyramidal coordination mode of SO_2 , while steric repulsion acts against the bent structure.²⁵⁶¹ Selected Ni^0 complexes with SO_2 that have been structurally characterized include four-coordinate **(1064)** and three-coordinate **(1065)**, both with η^1 -pyramidal SO_2 ligand.^{2563,2564}

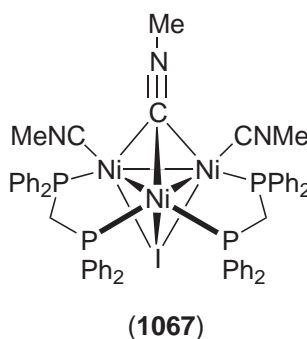
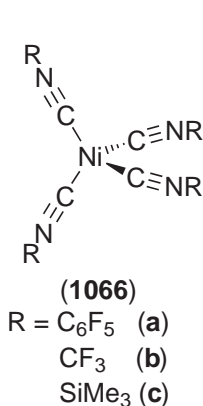
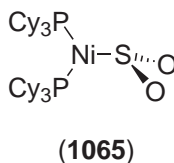
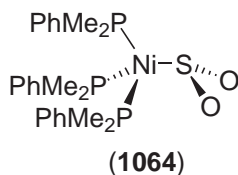

Some new homoleptic isocyanide complexes **(1066)** are collected here, which include fluorinated^{2565,2566} and silylated ones.²⁵⁶⁷ For the reaction of $[\text{Ni}(\text{CNR})_4]$ with CO_2 see Section 6.3.6.2. A triangulo Ni_3 cluster featuring a μ^3 - η^1 -isocyanide ligand has been reported **(1067)**.²⁵⁶⁸ The $\nu(\text{CN})$ band of the μ^3 - η^1 -isocyanide ligand appears at 1943 cm^{-1} , which is relatively high. When the precursor to this complex, $[\text{Ni}_2(\mu\text{-CNMe})(\text{CNMe})_2(\text{dppe})_2]$, is treated with HgCl_2 , a spirocyclic Ni_4Hg cluster is formed, in which a central Hg^{2+} ion is surrounded by four Ni atoms.²⁵⁶⁹

26. Ciurli, S.; Benini, S.; Rypniewski, W. R.; Wilson, K. S.; Miletti, S.; Mangani, S. *Coord. Chem. Rev.* **1999**, *190–192*, 331–335.
27. Benini, S.; Rypniewski, W. R.; Wilson, K. S.; Miletti, S.; Ciurli, S.; Mangani, S. *Structure* **1999**, *7*, 205–216.
28. Benini, S.; Rypniewski, W. R.; Wilson, K. S.; Ciurli, S.; Mangani, S. *J. Biol. Inorg. Chem.* **2001**, *6*, 778–790.
29. Musiani, F.; Arnolfi, E.; Casadio, R.; Ciurli, S. *J. Biol. Inorg. Chem.* **2001**, *6*, 300–314.
30. Clugston, S. L.; Barnard, J. F. J.; Kinach, R.; Miedema, D.; Ruman, R.; Daub, E.; Honek, J. F. *Biochemistry* **1998**, *37*, 8754–8763.
31. Davidson, G.; Clugston, S. L.; Honek, J. F.; Maroney, M. J. *Inorg. Chem.* **2000**, *39*, 2962–2963.
32. He, M. M.; Clugston, S. L.; Honek, J. F.; Matthews, B. W. *Biochemistry* **2000**, *39*, 8719–8727.
33. Thauer, R. K. *Science* **2001**, *293*, 1264–1265.
34. Choudhury, S. B.; Lee, J.-W.; Davidson, G.; Yim, Y.-I.; Bose, K.; Sharma, M. L.; Kang, S.-O.; Cabelli, D. E.; Maroney, M. J. *Biochemistry* **1999**, *38*, 3744–3752.
35. Frey, M. *Struct. Bonding* **1998**, *90*, 97–126.
36. Garcin, E.; Vernede, X.; Hatchikian, E. C.; Volbeda, A.; Frey, M.; Fontecilla-Camps, J. C. *Structure Fold. Des.* **1999**, *7*, 557–566.
37. Volbeda, A.; Charon, M. H.; Piras, C.; Hatchikian, E. C.; Frey, M.; Fontecilla-Camps, J. C. *Nature* **1995**, *373*, 580–587.
38. Higuchi, Y.; Ogata, H.; Miki, K.; Yasuoka, N.; Yagi, T. *Structure Fold. Des.* **1999**, *7*, 549–556.
39. Rousset, M.; Montet, Y.; Guigliarelli, B.; Forget, N.; Asso, M.; Bertrand, P.; Fontecilla-Camps, J. C.; Hatchikian, E. C. *Proc. Natl. Acad. Sci. USA* **1998**, *95*, 11625–11630.
40. Lindahl, P. A. *Biochemistry* **2002**, *41*, 2097–2105.
41. Dobbek, H.; Svetlichnyi, V.; Gremer, L.; Huber, R.; Meyer, O. *Science* **2001**, *293*, 1281–1285.
42. Drennan, C. L.; Heo, J.; Sintchak, M. D.; Schreiter, E.; Ludden, P. W. *Proc. Natl. Acad. Sci. USA* **2001**, *98*, 11973–11978.
43. Doukov, T. I.; Iverson, T. M.; Seravalli, J.; Ragsdale, S. W.; Drennan, C. L. *Science* **2002**, *298*, 567–568.
44. Peters, J. W. *Science* **2002**, *298*, 552–553.
45. Kumar, M.; Qiu, D.; Spiro, T. G.; Ragsdale, S. W. *Science* **1995**, *270*, 628–629.
46. Thauer, R. K. *Microbiology* **1998**, *144*, 2377–2406.
47. Ermler, U.; Grabarse, W.; Shima, S.; Goubeaud, M.; Thauer, R. K. *Science* **1997**, *278*, 1457–1462.
48. Telser, J. *Struct. Bonding* **1998**, *91*, 31–63.
49. Ghosh, A.; Wondimagegn, T.; Ryeng, H. *Curr. Opin. Chem. Biol.* **2001**, *5*, 744–750.
50. Telser, J.; Horng, Y.-C.; Becker, D. F.; Hoffman, B. M.; Ragsdale, S. W. *J. Am. Chem. Soc.* **2000**, *122*, 182–183.
51. Telser, J.; Davydov, R.; Horng, Y.-C.; Ragsdale, S. W.; Hoffman, B. M. *J. Am. Chem. Soc.* **2001**, *123*, 5853–5860.
52. Mehrotra, R. C.; Singh, A. *J. Indian Chem. Soc.* **1993**, *70*, 885–892.
53. Bosman, A. W.; Schenning, A. P. H. J.; Janssen, R. A. J.; Meijer, E. W. *Chem. Ber. /Recl.* **1997**, *130*, 725–728.
54. Jarzabinska, A.; Pietraszkiewicz, M.; Renata, B. *Mater. Sci. Eng. C* **2001**, *C18*, 61–64.
55. Forster, P. M.; Cheetham, A. K. *Angew. Chem., Int. Ed.* **2002**, *41*, 457–459; *Angew. Chem.* **2002**, *114*, 475–477.
56. Guillou, N.; Gao, Q. M.; Forster, P. M.; Chang, J. S.; Park, S. E.; Férey, G.; Cheetham, A. K. *Angew. Chem.* **2001**, *113*, 2913–2916; *Angew. Chem. Int. Ed. Engl.* **2001**, *40*, 2831–2834.
57. Nassiopoulou, A. G.; Zianni, X. *Microelectronics, Microsystems and Nanotechnology*, Proceedings of the Conference, Athens, Greece, 2000; World Sci, Singapore, 2001; pp 57–60.
58. Gonzalez, E. M.; Villegas, J. E.; Jaque, D.; Navarro, E.; Vicent, J. L. *Vacuum* **2002**, *67*, 693–698.
59. Ochsenbein, S.; Murrie, M.; Rusanov, E.; Stoekli-Evans, H.; Sekine, C.; Güdel, H. U. *Inorg. Chem.* **2002**, *41*, 5133–5140.
60. Cadiou, C.; Murrie, M.; Paulsen, C.; Villar, V.; Wernsdorfer, W.; Winpenny, R. E. P. *Chem. Commun.* **2001**, 2666–2667.
61. Andres, H.; Basler, R.; Blake, A. J.; Cadiou, C.; Chaboussant, G.; Grant, C. M.; Güdel, H.-U.; Murrie, M.; Parsons, S.; Paulsen, C.; Semadini, F.; Villar, V.; Wernsdorfer, W.; Winpenny, R. E. P. *Chem. Eur. J.* **2002**, *8*, 4867–4876.
62. Brezina, F.; Pastorek, R. *Chem. Listy* **1994**, *88*, 760–765; *Chem. Abstr.* **1995**, *122*, 94–973.
63. Lappin, A. G.; McAuley, A. *Adv. Inorg. Chem.* **1988**, *32*, 241–295.
64. Bhattacharaya, S.; Saha, B.; Dutta, A.; Banerjee, P. *Coord. Chem. Rev.* **1998**, *170*, 47–73.
65. Pappenhagen, P. R.; Margerum, D. W. *J. Am. Chem. Soc.* **1985**, *107*, 4576–4577.
66. Beach, M. W.; Margerum, D. W. *Inorg. Chem.* **1990**, *29*, 1225–1232.
67. Wang, Y. L.; Beach, M. W.; Pappenhagen, T. L.; Margerum, D. W. *Inorg. Chem.* **1988**, *27*, 4464–4472.
68. Lee, H.-L.; McCracken, J. *J. Phys. Chem.* **1994**, *98*, 12861–12870.
69. McCracken, J.; Friedenber, S. *J. Phys. Chem.* **1994**, *98*, 467–473.
70. Pinho, D.; Gomes, P.; Freire, C.; de Castro, B. *Eur. J. Inorg. Chem.* **2001**, 1483–1493.
71. Evans, J.; Levason, W.; Perry, R. J. *J. Chem. Soc., Dalton Trans.* **1990**, 3691–3695.
72. Cooper, D. A.; Higgins, S. F.; Levason, W. *J. Chem. Soc., Dalton Trans.* **1983**, 2131–2133.
73. Ozawa, Y.; Toriumi, K. *Chem. Lett.* **1995**, 257–258.
74. Ikeda, R.; Tamura, T.; Yamashita, M. *Chem. Phys. Lett.* **1990**, *173*, 466–470.
75. Evans, J.; Gauntlett, J. T.; Levason, W. *Inorg. Chem.* **1988**, *27*, 4521–4523.
76. Yamashita, M.; Murase, I.; Ikemoto, I.; Ito, T. *Chem. Lett.* **1985**, *8*, 1133–1136.
77. Yamashita, M.; Murase, I. *Inorg. Chim. Acta* **1985**, *97*, L43–L44.
78. Yamashita, M.; Tsuruta, E.; Inoue, K.; Oyama, M.; Toriumi, K. *Inorg. Chem.* **1993**, *32*, 363–365.
79. Evans, J.; Levason, W.; Perry, R. J. *J. Chem. Soc., Dalton Trans.* **1992**, 1497–1501.
80. Yamashita, M.; Manabe, T.; Inoue, K.; Kawashima, T.; Okamoto, H.; Kitagawa, H.; Mitani, T.; Toriumi, K.; Miyamae, H.; Ikeda, R. *Inorg. Chem.* **1999**, *38*, 1894–1899.
81. Yamashita, M.; Manabe, T.; Kawashima, T.; Okamoto, H.; Kitagawa, H. *Coord. Chem. Rev.* **1999**, *190–192*, 309–330.
82. Boeyens, J. C. A.; Oosthuizen, E. L. *J. Crystallogr. Spec. Res.* **1990**, *20*, 617–619.
83. Szalda, D. J.; Macartney, D. H.; Sutin, N. *Inorg. Chem.* **1984**, *23*, 3473–3479.

84. Wieghardt, K.; Walz, W.; Nuber, B.; Weiss, J.; Ozarowski, A.; Stratemeier, H.; Reinen, D. *Inorg. Chem.* **1986**, *25*, 1650–1654.
85. Chlistunoff, J. B.; Bard, A. J. *Inorg. Chem.* **1992**, *31*, 4582–4587.
86. Marganian, C. A.; Vazir, H.; Baidya, N.; Olmstead, M. M.; Mascharak, P. K. *J. Am. Chem. Soc.* **1995**, *117*, 1584–1594.
87. Kumar Patra, A.; Mukherjee, R. *Inorg. Chem.* **1999**, *38*, 1388–1393.
88. Freire, C.; de Castro, B. *Polyhedron* **1998**, *17*, 4227–4235.
89. Lampeka, Ya. D.; Rosokha, S. V.; Yatsimirskii, K. B. *Dokl. Akad. Nauk SSSR* **1990**, *315*, 617–620.
90. Gavriush, S. P.; Lampeka, Ya. D. *Russ. J. Inorg. Chem. (Engl. Transl.)* **1996**, *41*, 1255–1258.
91. Suh, M. P. *Adv. Inorg. Chem.* **1997**, *44*, 93–146.
92. Fabbriizzi, L. *Comments Inorg. Chem.* **1985**, *4*, 33–53.
93. Larin, G. M. *Russ. Khim. Zh.* **1996**, *40*, 74–85; *Chem. Abstr.* **1997**, *127*, 10338.
94. McAuley, A.; Norman, P. R. *Isr. J. Chem.* **1985**, *25*, 106–111.
95. Wieghardt, K.; Schmidt, W.; Herrmann, W.; Küpers, H. *Inorg. Chem.* **1983**, *22*, 2953–2956.
96. McAuley, A.; Xu, C. *Inorg. Chem.* **1988**, *27*, 1204–1209.
97. Wieghardt, K.; Schoeffmann, E.; Nuber, B.; Weiss, J. *Inorg. Chem.* **1986**, *25*, 4877–4883.
98. van der Merwe, M. J.; Boeyens, J. C. A.; Hancock, R. D. *Inorg. Chem.* **1983**, *22*, 3489–3490.
99. van der Merwe, M. J.; Boeyens, J. C. A.; Hancock, R. D. *Inorg. Chem.* **1985**, *24*, 1208–1213.
100. Boeyens, J. C. A.; van der Merwe, M. J. *Inorg. Chem.* **1997**, *36*, 3779–3780.
101. Fabbriizzi, L.; Proserpio, D. M. *J. Chem. Soc., Dalton Trans.* **1989**, 229–232.
102. McAuley, A.; Subramanian, S. *Inorg. Chem.* **1990**, *29*, 2830–2837.
103. Blake, A. J.; Gould, R. O.; Halcrow, M. A.; Holder, A. J.; Hyde, T. I.; Schröder, M. *J. Chem. Soc., Dalton Trans.* **1992**, 3427–3431.
104. Buttafava, A.; Fabbriizzi, L.; Perotti, A.; Poggi, A.; Poli, G.; Seghi, B. *Inorg. Chem.* **1986**, *25*, 1456–1461.
105. Benko, J.; Vollárová, O.; Alshehri, S.; Burgess, J.; Haines, R. I. *Transition Met. Chem.* **1993**, *18*, 551–554.
106. Haines, R. I.; Butt, L.; Park, M. K.; Wheeler, D. *Can. J. Chem.* **1993**, *71*, 976–982.
107. Crawford, P. W.; Schultz, F. A. *Inorg. Chem.* **1994**, *33*, 4344–4350.
108. Fabbriizzi, L.; Mariani, M.; Seghi, B.; Zanchi, F. *Inorg. Chem.* **1989**, *28*, 3362–3366.
109. Gao, Y. D.; Lipkowitz, K. B.; Schultz, F. A. *J. Am. Chem. Soc.* **1995**, *117*, 11932–11938.
110. McAuley, A.; Norman, P. R.; Olubuyide, O. *Inorg. Chem.* **1984**, *23*, 1938–1943.
111. Hung, M.-L.; Stanbury, D. M. *Inorg. Chem.* **1994**, *33*, 4062–4069.
112. Koshino, N.; Funahashi, S.; Takagi, H. D. *J. Chem. Soc., Dalton Trans.* **1997**, 4175–4180.
113. DeMaine, M. M.; Stanbury, D. M. *Inorg. Chem.* **1991**, *30*, 2104–2109.
114. Sonnberger, B.; Huhn, P.; Wasserburger, A.; Wasgestian, F. *Inorg. Chim. Acta* **1992**, *196*, 65–71.
115. Fairbank, M. G.; McAuley, A.; Norman, P. R.; Olubuyide, O. *Can. J. Chem.* **1985**, *63*, 2983–2989.
116. Fabbriizzi, L.; Cohen, H.; Meyerstein, D. *J. Chem. Soc., Dalton Trans.* **1983**, 2125–2126.
117. Bernhard, P. V.; Lawrance, G. A.; Sangster, D. F. *Inorg. Chem.* **1988**, *27*, 4055–4049.
118. Kimura, E.; Koike, T.; Machida, R.; Nagai, R.; Kodama, M. *Inorg. Chem.* **1984**, *23*, 4181–4188.
119. Fabbriizzi, L.; Kaden, T. A.; Perotti, A.; Seghi, B.; Siegfried, L. *Inorg. Chem.* **1986**, *25*, 321–327.
120. Fabbriizzi, L.; Licchelli, M.; Perotti, A.; Poggi, A.; Soresi, S. *Isr. J. Chem.* **1985**, *25*, 112–117.
121. Bu, X. H.; An, D. L.; Zhu, Z. A.; Chen, Y. T.; Shionoya, M.; Kimura, E. *Polyhedron* **1996**, *16*, 179–185.
122. Gavriush, S. P.; Lampeka, Y. D. *J. Coord. Chem.* **1996**, *38*, 295–303.
123. Bu, X. H.; An, D. L.; Cao, X. C.; Chen, Y. T.; Shionoya, M.; Kimura, E. *Polyhedron* **1996**, *15*, 161–163.
124. Collins, T. J.; Kostka, K. L.; Uffelman, E. S.; Weinberger, T. L. *Inorg. Chem.* **1991**, *30*, 4204–4210.
125. Collins, T. J.; Nichols, T. R.; Uffelman, E. S. *J. Am. Chem. Soc.* **1991**, *113*, 4708–4709.
126. Wieghardt, K.; Walz, W.; Nuber, B.; Weiss, J.; Ozarowski, A.; Stratemeier, H.; Reinen, D. *Inorg. Chem.* **1986**, *25*, 1650–1654.
127. McAuley, A.; Palmer, T.; Whitcombe, T. W. *Can. J. Chem.* **1993**, *71*, 1792–1799.
128. Yamashita, M.; Toriumi, K.; Ito, T. *Acta Cryst.* **1985**, *C41*, 1607–1609.
129. Yamashita, M.; Miyame, H. *Inorg. Chim. Acta* **1989**, *156*, 71–75.
130. McAuley, A.; Subramanian, S. *Inorg. Chem.* **1991**, *30*, 371–378.
131. Miyame, H.; Yamachi, K.; Yamashita, M. *J. Chem. Soc., Dalton Trans.* **1991**, 2921–2923.
132. Machida, R.; Kimura, E.; Kushi, Y. *Inorg. Chem.* **1986**, *25*, 3461–3466.
133. Kobiro, K.; Nakayama, A.; Hiro, T.; Suiva, M.; Kakiuchi, K.; Tobe, Y.; Odaira, Y. *Chem. Lett.* **1990**, 1979–1982.
134. Suh, M. P.; Lee, E. Y.; Shim, B. Y. *Inorg. Chim. Acta* **1998**, *269*, 337–341.
135. McAuley, A.; Subramanian, S. *Inorg. Chem.* **1991**, *30*, 371–378.
136. Suh, M. P.; Kang, S. G.; Goedken, V. L.; Park, S. H. *Inorg. Chem.* **1991**, *30*, 365–370.
137. Kimura, E.; Koike, T.; Uenishi, K.; Davidson, R. B. *J. Chem. Soc., Chem. Commun.* **1986**, 1110–1111.
138. Calligaris, M.; Carugo, O.; Crippa, G.; De Santis, G.; Di Casa, M.; Fabbriizzi, L.; Poggi, A.; Seghi, B. *Inorg. Chem.* **1990**, *29*, 2964–2970.
139. Jubran, N.; Meyerstein, D.; Koresh, K.; Cohen, H. *J. Chem. Soc., Dalton Trans.* **1986**, 2509–2513.
140. Adam, K. R.; Antolovich, M.; Brigden, L. G.; Leong, A. J.; Lindoy, L. F.; Baillie, P. J.; Uppal, D. K.; McPartlin, M.; Shah, B.; Proserpio, D.; Fabbriizzi, L.; Tasker, P. A. *J. Chem. Soc., Dalton Trans.* **1991**, 2493–2501.
141. Kimura, E.; Shionoya, M.; Okamoto, M.; Nada, H. *J. Am. Chem. Soc.* **1988**, *110*, 3679–3680.
142. De Santis, G.; Fabbriizzi, L.; Poggi, A.; Taglietti, A. *Inorg. Chem.* **1994**, *33*, 134–139.
143. Golub, G.; Zilbermann, I.; Cohen, H.; Meyerstein, D. *Supramol. Chem.* **1996**, *6*, 275–279.
144. Taraszewska, J.; Roslonek, G. *Supramol. Chem.* **1997**, *8*, 369–377.
145. Zilbermann, I.; Golub, G.; Cohen, H.; Meyerstein, D. *J. Chem. Soc., Dalton Trans.* **1997**, 141–143.
146. Fairbank, M. G.; McAuley, A. *Inorg. Chem.* **1986**, *25*, 1233–1238.
147. McAuley, A.; Olubuyide, O.; Spencer, L.; West, P. R. *Inorg. Chem.* **1984**, *23*, 2594–2599.
148. Macartney, D. H.; McAuley, A.; Olubuyide, O. A. *Inorg. Chem.* **1985**, *24*, 307–312.
149. Fairbank, M. G.; McAuley, A. *Inorg. Chem.* **1987**, *26*, 2844–2848.
150. Yao, Q.; Bakak, A.; Espenson, J. H. *Inorg. Chem.* **1993**, *32*, 1488–1492.

151. Linn, D. E.; Ramage, S. D.; Grutsch, J. L. *Int. J. Chem. Kinetics* **1993**, *25*, 489–507.
152. van Eldik, R.; Cohen, H.; Meshulam, A.; Meyerstein, D. *Inorg. Chem.* **1990**, *29*, 4156–4158.
153. Sauer, A.; Cohen, H.; Meyerstein, D. *Inorg. Chem.* **1988**, *23*, 4578–4581.
154. Kelley, D. G.; Marchaj, A.; Bakac, A.; Espenson, J. H. *J. Am. Chem. Soc.* **1991**, *113*, 7583–7587.
155. Kimura, E.; Machida, R.; Kodama, M. *J. Am. Chem. Soc.* **1984**, *106*, 5497–5505.
156. Nam, W.; Baek, S. J.; Lee, K. A.; Ahn, B. T.; Muller, J. G.; Burrows, C. J.; Valentine, J. S. *Inorg. Chem.* **1996**, *35*, 6632–6633.
157. Clark, I. J.; Creaser, I. I.; Engelhardt, L. M.; Harrowfield, J. M.; Krausz, E. R.; Moran, G. M.; Sargeson, A. M.; White, Aust. *J. Chem.* **1993**, *46*, 111–126.
158. Bailey, C. L.; Bereman, R. D.; Rillema, D. P.; Nowak, R. *Inorg. Chem.* **1984**, *23*, 3956–3960.
159. Jäger, E.-G.; Keutel, H.; Rudolph, M.; Krebs, B.; Wiesemann, F. *Chem. Ber.* **1995**, *128*, 503–514.
160. Gray, L. R.; Higgins, S. J.; Levason, W.; Webster, M. *J. Chem. Soc., Dalton Trans.* **1984**, 459–467.
161. Godfrey, S. M.; Kelly, D. G.; Mackie, A. G.; MacRory, P. P.; McAuliffe, C. A.; Pritchard, R. G.; Watson, S. M. *J. Chem. Soc., Chem. Commun.* **1991**, 1447–1449.
162. Brickleband, N.; Godfrey, S. M.; McAuliffe, C. A.; Pritchard, R. G. *J. Chem. Soc., Dalton Trans.* **1996**, 157–160.
163. Godfrey, S. M.; Lane, H. P.; McAuliffe, C. A.; Pritchard, R. G. *J. Chem. Soc., Dalton Trans.* **1993**, 1599–1604.
164. Godfrey, S. M.; McAuliffe, C. A.; Pritchard, R. G. *J. Chem. Soc., Dalton Trans.* **1993**, 2875–2881.
165. Corker, J. M.; Evans, J.; Levason, W.; Spicer, M. D.; Andrews, P. *Inorg. Chem.* **1991**, *30*, 331–334.
166. Chandler, D. J.; Jones, R. A.; Whittlesey, B. R. *J. Coord. Chem.* **1987**, *16*, 19–24.
167. Levason, W.; Preece, S. R. *Inorg. Chem.* **1995**, *34*, 1626–1628.
168. Hanton, L. R.; Evans, J.; Levason, W.; Perry, R. J.; Webster, M. *J. Chem. Soc., Dalton Trans.* **1991**, 2039–2044.
169. Chandramouli, G. V. R.; Manoharan, P. T. *Inorg. Chem.* **1987**, *26*, 3291–3293.
170. Mahadevan, C.; Seshasayee, M.; Ramakrishna, B. L.; Manoharan, P. T. *Acta Crystallogr.* **1985**, *C41*, 38–40.
171. Whyte, T.; Casey, A. T.; Williams, G. A. *Inorg. Chem.* **1995**, *34*, 2781–2787.
172. Higgins, S. J.; Levason, W.; Feiters, M. C.; Steel, A. T. *J. Chem. Soc., Dalton Trans.* **1986**, 317–322.
173. Steel, A. T.; Feiters, M. C.; Garner, C. D.; Hasnain, S. S.; Levason, W.; Higgins, S. J. *J. Chem. Soc., Chem. Commun.* **1985**, 484–485.
174. Downard, A. J.; Hanton, L. R.; McMorran, D. A.; Paul, R. L. *Inorg. Chem.* **1993**, *32*, 6028–6033.
175. Dunbar, K. R.; Sun, J.-S.; Quillevère, A. *Inorg. Chem.* **1994**, *33*, 3598–3600.
176. Bhattacharya, S.; Mukherjee, R.; Chakravorty, C. *Inorg. Chem.* **1986**, *25*, 3448–3452.
177. Dunne, S. J.; Burns, R. C.; Lawrance, G. A. *Aust. J. Chem.* **1992**, *45*, 1943–1952.
178. Straatemeier, H.; Hitchman, M. A.; Kepert, D. L.; Skelton, B. W.; Sugars, K. E.; White, A. H. *J. Chem. Soc., Dalton Trans.* **1992**, 3035–3039.
179. Demourgues, A.; Gautier, L.; Chadwich, A. V.; Delmas, C. *Nucl. Instrum. Methods Phys. Res. B* **1997**, *133*, 39–44; *Chem. Abstr.* **1998**, *128*, 135677.
180. Eremenko, I. L.; Golubnichaya, M. A.; Nefedov, S. E.; Sidorov, A. A.; Golovaneva, I. F.; Burkov, V. I.; Elert, O. G.; Novotortsev, V. M.; Eremenko, T.; Sousa, A.; Bermejo, M. R. *Russ. Chem. Bull.* **1998**, *47*, 704–718; *Chem. Abstr.* **1998**, *129*, 156109.
181. Hikichi, S.; Yoshizawa, M.; Sasakura, Y.; Akita, M.; Moro-oka, Y. *J. Am. Chem. Soc.* **1998**, *120*, 10567–10568.
182. Hikichi, S.; Yoshizawa, M.; Sasakura, Y.; Komatsuzaki, H.; Moro-oka, Y.; Akita, M. *Chem. Eur. J.* **2001**, *7*, 5012–5028.
183. Shiren, K.; Ogo, S.; Fujinami, S.; Hayashi, H.; Suzuki, M.; Uehara, A.; Watanabe, Y.; Morka, Y. *J. Am. Chem. Soc.* **2000**, *122*, 254–262.
184. Mandimutsira, B. S.; Yamarik, J. L.; Brunold, T. C.; Gu, W.; Cramer, S. P.; Riordan, C. G. *J. Am. Chem. Soc.* **2001**, *123*, 9194–9195.
185. Schenker, R.; Mandimutsira, B. S.; Riordan, C. G.; Brunold, T. C. *J. Am. Chem. Soc.* **2002**, *124*, 13842–13855.
186. Bag, B.; Mondal, N.; Rosair, G.; Mitra, S. *Chem. Commun.* **2000**, 1729–1730.
187. Zvereva, G. A.; Larin, G. M. *Zh. Neorg. Khim.* **1992**, *37*, 147–153.
188. Sawyer, D. T.; Srivatsa, G. S.; Bodini, M. E.; Schaefer, W. P.; Wing, R. M. *J. Am. Chem. Soc.* **1986**, *108*, 936–942.
189. Harbron, S. K.; Higgins, S. J.; Hope, E. G.; Kemmitt, T.; Levason, W. *Inorg. Chim. Acta* **1987**, *130*, 43–47.
190. Sellmann, D.; Binder, H.; Häußinger, D.; Heinemann, F. W.; Sutter, J. *Inorg. Chim. Acta* **2000**, *300–302*, 829–836.
191. Baidya, N.; Olmstead, M. M.; Mascharak, P. K. *J. Am. Chem. Soc.* **1992**, *114*, 9666–9668.
192. Bachler, V.; Olbrich, G.; Neese, F.; Wieghardt, K. *Inorg. Chem.* **2002**, *41*, 4179–4193.
193. Huynh, H. V.; Schulze-Isfort, C.; Seidel, W. W.; Lügger, T.; Fröhlich, R.; Kataeva, O.; Hahn, F. E. *Chem. Eur. J.* **2002**, *8*, 1327–1335.
194. Baidya, N.; Mascharak, P. K.; Stephan, D. W.; Campagno, C. F. *Inorg. Chem.* **1990**, *177*, 233–238.
195. Fox, S.; Wang, Y.; Silver, A.; Millar, M. *J. Am. Chem. Soc.* **1990**, *112*, 3218–3220.
196. Yamamura, T.; Arai, H.; Kurihara, H.; Nakamura, N.; Kuroda, R. *Chem. Lett.* **1990**, 1975–1978.
197. Baidya, N.; Mascharak, P. K.; Stephan, D. W.; Campagno, C. F. *Inorg. Chim. Acta* **1990**, *177*, 233–238.
198. Mukhopadhyay, S.; Ray, D. *J. Chem. Soc., Dalton Trans.* **1993**, 1159–1162.
199. Choudhury, S. B.; Pressler, M. A.; Mirza, S. A.; Day, R. O.; Maroney, M. J. *Inorg. Chem.* **1994**, *33*, 4831–4839.
200. Allan, C. B.; Davidson, G.; Choudhury, S. B.; Gu, Z.; Bose, K.; Day, R. O.; Maroney, M. J. *Inorg. Chem.* **1998**, *37*, 4166–4167.
201. Blake, A. J.; Gould, R. O.; Halcrow, M. A.; Holder, A. J.; Hyde, T. I.; Schroeder, M. *J. Chem. Soc., Dalton Trans.* **1992**, 3427–3431.
202. McAuley, A.; Subramanian, S.; Zaworotko, M. J.; Atencio, R. *Inorg. Chem.* **1998**, *37*, 4607–4610.
203. Krueger, T.; Krebs, B.; Henkel, G. *Angew. Chem.* **1992**, *104*, 71–72; *Angew. Chem. Int. Ed. Engl.* **1992**, *31*, 55–56.
204. Vance, C. T.; Bereman, R. D. *Inorg. Chim. Acta* **1988**, *149*, 229–234.
205. Welch, J. H.; Bereman, R. D.; Singh, P.; Haase, D.; Hatfield, W. E.; Kirk, M. L. *Inorg. Chim. Acta* **1989**, *162*, 89–96.
206. Vance, C. T.; Bereman, R. D.; Bordner, J.; Hatfield, W. E.; Helms, J. H. *Inorg. Chem.* **1985**, *24*, 2905–2910.
207. Kuppusamy, P.; Manoharan, P. T.; Mahadevan, C.; Seshasayee, M. *J. Cryst. Spectrosc. Res.* **1985**, *15*, 359–376.
208. Cornelissen, J. P.; Creighton, E. J.; de Graaff, R. A. G.; Haasnoot, J. G.; Reedijk, J. *Inorg. Chim. Acta* **1991**, *185*, 97–102.
209. Reefman, D.; Cornelissen, J. G.; de Graaff, R. A. G.; Haasnoot, J. G.; Reedijk, J. *Inorg. Chem.* **1991**, *30*, 4928–4931.

210. Geiser, U.; Tytko, S. F.; Allen, T. J.; Wang, H. H.; Kini, A. M.; Williams, J. M. *Acta Crystallogr.* **1991**, *C47*, 1164–1167.
211. Underhill, A. E.; Clemenson, P. I.; Clark, R. A. *Pure & Appl. Chem.* **1989**, *61*, 953–957.
212. Nishihara, S.; Akutagawa, T.; Hasegawa, T.; Nakamura, T. *Chem. Commun.* **2002**, 408–409.
213. Bigoli, F.; Curreli, S.; Deplano, P.; Leoni, L.; Mercuri, M. L.; Pellinghelli, M. A.; Serpe, A.; Trogu, E. F. *J. Chem. Soc., Dalton Trans.* **2002**, 1985–1991.
214. Xie, J.; Ren, X.; Gao, S.; Meng, Q. *Chem. Lett.* **2002**, 576–577.
215. Xie, J.; Ren, X.; Song, Y.; Zou, Y.; Meng, Q. *J. Chem. Soc., Dalton Trans.* **2002**, 2868–2872.
216. Kobayashi, N.; Toshio, N.; Inabe, T. *Mol. Cryst. Liq. Cryst. Sci. Technol. A* **2002**, *376*, 233–238.
217. Ren, X.; Meng, Q.; Song, Y.; Lu, C.; Hu, C.; Chen, X. *Inorg. Chem.* **2002**, *41*, 5685–5692.
218. Kena, C. L.; Miller, D. O.; Pickup, P. G. *J. Mater. Chem.* **2002**, *12*, 2949–2956.
219. Kobayashi, A.; Suzuki, W. *Mol. Cryst. Liq. Cryst. Sci. Technol. A* **2002**, *380*, 37–43.
220. Aonuma, S.; Casellas, H.; De Bonneval, B. G.; Faulmann, C.; Malfant, I.; Cassoux, P.; Hosokoshi, Y.; Inoue, K. *Mol. Cryst. Liq. Cryst. Sci. Technol. A* **2002**, *380*, 263–268.
221. Ren, X.; Meng, Q.; Song, Y.; Hu, C.; Lu, C.; Chen, X.; Xue, Z. *Inorg. Chem.* **2002**, *41*, 5931–5933.
222. Yaman, S. O.; Onal, A. M.; Isci, H. *Z. Naturforsch. B* **2001**, *56*, 202–208.
223. Manhas, B. S.; Kalia, S. B. *Synth. React. Inorg. Metal Org. Chem.* **1998**, *28*, 1221–1233.
224. Verma, B. C.; Kalia, S. B.; Manhas, B. S. *Ind. J. Chem. A* **1997**, *36A*, 160–163.
225. Bond, A. M.; Colton, R.; D'Agostino, A.; Harvey, J.; Traeger, J. C. *Inorg. Chem.* **1993**, *32*, 3952–3956.
226. Pastorek, R.; Brezina, F.; Krausova, D. *Z. Chem.* **1990**, *30*, 70–71.
227. Brezina, F.; Pastorek, R.; Subcikova, M.; Sindelar, Z. *Czech. Conf. Coord. Chem.* **1989**, *12*, 65–68.
228. Pastorek, R.; Brezina, F.; Sindelar, Z. *Z. Fur Chemie* **1988**, *28*, 223–224.
229. Manhas, B. S.; Kaur, M. P.; Kaur, K.; Verman, B. C.; Kalia, S. B. *Synth. React. Inorg. Metal Org. Chem.* **1999**, *29*, 1009–1021.
230. Baral, M.; Kanungo, B. K.; Pradham, B. *Ind. J. Chem. A* **1988**, *27A*, 66–67.
231. Chen, W.; Li, H.; Zhong, Z.-J.; Zhang, K.; You, X.-Z. *Acta Crystallogr.* **1996**, *C52*, 3030–3033.
232. Oyaizu, K.; Yamamoto, K.; Ishii, Y.; Tsuchida, E. *Chem. Eur. J.* **1999**, *5*, 3193–3201.
233. Morozov, V. I.; Luchkina, S. A.; Il'yasov, A. V. *Koord. Khim.* **1984**, *10*, 1094–1096.
234. Plyusnin, V. F.; Grivin, V. P.; Larionov, S. V. *Coord. Chem. Rev.* **1997**, *159*, 121–133.
235. Collison, D.; Garner, C. D.; McGrath, C. M.; Mosselmans, J. F. W.; Pidcock, E.; Roper, M. D.; Searle, B. G.; Seddon, J. M. W.; Sinn, E.; Young, N. A. *J. Chem. Soc., Dalton Trans.* **1998**, 4179–4186.
236. Choudhury, S. B.; Ray, D.; Chakravorty, A. *Inorg. Chem.* **1990**, *29*, 4603–4611.
237. Dag, O.; Yaman, S. O.; Onal, A. M.; Isci, H. *J. Chem. Soc., Dalton Trans.* **2001**, 2819–2824.
238. Choudhury, S. B.; Chakravorty, A. *Inorg. Chem.* **1992**, *31*, 1055–1058.
239. McConnachie, J. M.; Ansari, M. A.; Ibers, J. A. *J. Am. Chem. Soc.* **1991**, *113*, 7078–7079.
240. McConnachie, J. M.; Ansari, M. A.; Ibers, J. A. *Inorg. Chim. Acta* **1992**, *198-200*, 85–93.
241. Jesih, A.; Lutar, K.; Leban, I.; Zemva, B. *Eur. J. Solid State Inorg. Chem.* **1991**, *28*, 829–840.
242. Lucier, G. M.; Shen, C.; Elder, S. H.; Bartlett, N. *Inorg. Chem.* **1998**, *37*, 3829–3834.
243. Zemva, B.; Lutar, K.; Jesih, A.; Casteel, W. J., Jr.; Bartlett, N. *J. Chem. Soc., Chem. Commun.* **1989**, 346–347.
244. Zemva, B.; Lutar, K.; Chacon, L.; Fele-Beuermann, M.; Allman, J.; Shen, C.; Bartlett, N. *J. Am. Chem. Soc.* **1995**, *117*, 10025–10034.
245. Zemva, B.; Chacon, L.; Lutar, K.; Shen, C.; Allman, J.; Bartlett, N. *J. Fluorine Chem.* **1995**, *71*, 195–196.
246. Hector, A. L.; Hope, E. G.; Levason, W.; Weller, M. T. *Z. Anorg. Allg. Chem.* **1998**, *624*, 1982–1988.
247. Tramšek, M.; Žemva, B. *Acta Chim. Slov.* **2002**, *49*, 209–220.
248. Lucier, G.; Shen, C.; Casteel, W. J.; Chacon, L.; Bartlett, N. *J. Fluorine Chem.* **1995**, *72*, 157–163.
249. Bartlett, N.; Chambers, R. D.; Roche, A. J.; Spink, R. C. H.; Chacoón, L.; Whalen, M. *Chem. Commun.* **1996**, 1049–1050.
250. Margerum, D. W. *Pure Appl. Chem.* **1983**, *55*, 23–34.
251. Owens, D. G.; Philipps, D. A.; Czarnecki, J. J.; Raycheba, J. M. T.; Margerum, D. W. *Inorg. Chem.* **1984**, *23*, 1345–1353.
252. Jacobs, S. A.; Margerum, D. W. *Inorg. Chem.* **1984**, *23*, 1195–1201.
253. Anliker, S. L.; Beach, M. W.; Lee, H. D.; Margerum, D. W. *Inorg. Chem.* **1988**, *27*, 3809–3818.
254. Wang, J.-F.; Kumar, K.; Margerum, D. W. *Inorg. Chem.* **1989**, *28*, 3481–3484.
255. Schadler, S. E.; Sharp, C.; Lappin, A. G. *Inorg. Chem.* **1992**, *31*, 51–57.
256. Kirvan, G. E.; Margerum, D. W. *Inorg. Chem.* **1985**, *24*, 3245–3253.
257. Subak, E. J.; Loyola, V. M.; Margerum, D. W. *Inorg. Chem.* **1985**, *24*, 4350–4356.
258. Pappenhagen, T. L.; Kennedy, W. R.; Bowers, C. P.; Margerum, D. W. *Inorg. Chem.* **1985**, *24*, 4356–4362.
259. Lappin, A. G.; Martone, D. P.; Osvath, P. *Inorg. Chem.* **1985**, *24*, 4187–4191.
260. Bhattacharya, S.; Ali, M.; Gangopadhyay, S.; Banerjee, P. *J. Chem. Soc., Dalton Trans.* **1994**, 3733–3738.
261. Martone, D. P.; Osvath, P.; Lappin, A. G. *Inorg. Chem.* **1987**, *26*, 3094–3100.
262. Karmakar, S.; Choudhury, S. B.; Ganguly, S.; Chakravorty, A. *J. Chem. Soc., Dalton Trans.* **1997**, 585–590.
263. Ray, D.; Chakravorty, A. *Inorg. Chem.* **1988**, *27*, 3292–3297.
264. Krüger, H.-J.; Holm, R. H. *J. Am. Chem. Soc.* **1990**, *112*, 2955–2963.
265. Mandal, S.; Gould, E. S. *Inorg. Chem.* **1995**, *34*, 3993–3997.
266. Ghosh, A.; Steene, E. *J. Biol. Inorg. Chem.* **2001**, *6*, 739–752.
267. Jaun, B. *Helv. Chim. Acta* **1990**, *73*, 2209–2217.
268. Renner, M. W.; Fajer, J. *J. Biol. Inorg. Chem.* **2001**, *6*, 823–830.
269. Wondimagegn, T.; Ghosh, A. *J. Am. Chem. Soc.* **2001**, *123*, 1543–1544.
270. Kadish, K. M.; Van Caemelbecke, E.; Royal, G. In *The Porphyrin Handbook*; Kadish, K. M., Smith, K. M., Guillard, R., Eds.; Academic Press: Boston, MA, 2000, Vol. 8, 1–114.
271. Ghosh, A.; Steene, E. *J. Biol. Inorg. Chem.* **2001**, *6*, 739–752.
272. Kadish, K. M.; Van Caemelbecke, E.; Boulas, P.; D'Souza, F.; Vogel, E.; Kisters, M.; Medforth, C. J.; Smith, K. M. *Inorg. Chem.* **1993**, *32*, 4177–4178.

273. Seth, J.; Palaniappan, V.; Bocian, D. F. *Inorg. Chem.* **1995**, *34*, 2201–2206.
274. Connick, P. A.; Macor, K. A. *Inorg. Chem.* **1991**, *30*, 4654–4663.
275. Connick, P. A.; Haller, K. J.; Macor, K. A. *Inorg. Chem.* **1993**, *32*, 3256–3264.
276. Song, H.; Orosz, R. C.; Reed, C. A.; Scheidt, W. R. *Inorg. Chem.* **1990**, *29*, 4274–4282.
277. Kim, D.; Miller, L. A.; Spiro, T. G. *Inorg. Chem.* **1986**, *25*, 2468–2470.
278. Nahor, G. S.; Neta, P.; Hambright, P.; Robinson, L. R. *J. Phys. Chem.* **1991**, *95*, 4415–4418.
279. Guldi, D. M.; Kumar, M.; Neta, N.; Hambright, P. *J. Phys. Chem.* **1992**, *96*, 9576–9581.
280. Chang, D.; Malinksi, T.; Ulman, A.; Kadish, K. M. *Inorg. Chem.* **1984**, *23*, 817–824.
281. Tsurumaki, H.; Watanabe, Y.; Morishima, I. *Inorg. Chem.* **1994**, *33*, 4186–4188.
282. Renner, M. W.; Furenlid, L. R.; Barkigia, K. M.; Forman, A.; Shim, H.-K.; Simpson, D. J.; Smith, K. M.; Fajer, J. J. *Am. Chem. Soc.* **1991**, *113*, 6891–6898.
283. Barkigia, K. M.; Renner, M. W.; Furenlid, L. R.; Medforth, C. J.; Smith, K. M.; Fajer, I. *J. Am. Chem. Soc.* **1993**, *115*, 3627–3635.
284. Drain, C. M.; Gentemann, S.; Roberts, J. A.; Nelson, N. Y.; Medforth, C. J.; Jia, S.; Simpson, M. C.; Smith, K. M.; Fajer, I.; Shelnut, J. A.; Holten, D. *J. Am. Chem. Soc.* **1998**, *120*, 3781–3791.
285. Lin, C.-Y.; Hu, S.; Rush, T.; Spiro, T. G. *J. Am. Chem. Soc.* **1996**, *118*, 9452–9453.
286. Renner, M. W.; Barkigia, K. M.; Melamed, D.; Smith, K. M.; Fajer, J. *Inorg. Chem.* **1996**, *35*, 5120–5121.
287. Balch, A. L.; Noll, B. C.; Phillips, S. L.; Reid, S. M.; Zovinka, E. P. *Inorg. Chem.* **1993**, *32*, 4730–4736.
288. Ghosh, A.; Wondimagen, T.; Gonzalez, E.; Halvorsen, I. *J. Inorg. Biochem.* **2000**, *78*, 79–82.
289. Kadish, K. M.; Sazou, D.; Maiya, G. B.; Han, B. C.; Liu, Y. M.; Saoiabi, A.; Ferhat, M.; Guillard, R. *Inorg. Chem.* **1989**, *13*, 2542–2547.
290. Chmielewski, P. J.; Latos-Grazynski, L. *Inorg. Chem.* **1997**, *36*, 840–845.
291. Will, S.; Lex, J.; Vogel, E.; Schmickler, H.; Gisselbrecht, J.-P.; Hauptmann, C.; Bernard, M.; Gross, M. *Angew. Chem.* **1997**, *109*, 367–371; *Angew. Chem., Int. Ed. Engl.* **1997**, *36*, 357–361.
292. Ghosh, A.; Wondimagen, T.; Parusel, A. B. *J. Am. Chem. Soc.* **2000**, *122*, 5100–5104.
293. Goldsby, K. A.; Blaho, J. K.; Hoferkamp, L. A. *Polyhedron* **1989**, *8*, 113–115.
294. De Casto, B.; Freire, C.; Pereira, E. *J. Chem. Soc., Dalton Trans.* **1994**, 571–576.
295. De Casto, B.; Freire, C. *Inorg. Chem.* **1990**, *29*, 5113–5119.
296. Freire, C.; de Castro, B. *Polyhedron* **1998**, *17*, 4227–4235.
297. Ray, D.; Pal, S.; Chakravorty, A. *Inorg. Chem.* **1986**, *25*, 2674–2676.
298. Krüger, H.-J.; Peng, G.; Holm, R. H. *Inorg. Chem.* **1991**, *30*, 734–742.
299. Krüger, H.-J.; Holm, R. H. *Inorg. Chem.* **1987**, *26*, 3645–3647.
300. Hanss, J.; Krüger, H.-J. *Angew. Chem., Int. Ed.* **1998**, *37*, 360–363; *Angew. Chem.* **1998**, *110*, 366–369.
301. Pramanik, K.; Karmaker, S.; Choudhury, S. B.; Chakravorty, A. *Inorg. Chem.* **1997**, *36*, 3562–3564.
302. Tripathi, A.; Syal, R. K.; Bharadwaj, P. K. *Polyhedron* **1999**, *18*, 2229–2232.
303. Choudhery, S. B.; Ray, D.; Chakravorty, A. *Inorg. Chem.* **1991**, *30*, 4354–4360.
304. Köckerling, M.; Henkel, G. *Chem. Ber.* **1993**, *126*, 951–953.
305. James, T., J.; Smith D. M.; Holm, R. H. *Inorg. Chem.* **1994**, *33*, 4869–4877.
306. Smith, R. J.; Powell, A. K.; Barnard, N.; Dilworth, J. R.; Blower, P. J. *J. Chem. Soc., Chem. Commun.* **1993**, 54–56.
307. Franolic, J. D.; Wang, W. Y.; Millar, M. *J. Am. Chem. Soc.* **1992**, *114*, 6587–6588.
308. Grove, D. M.; van Koten, G.; Zoet, R.; Murrall, N. W.; Welch, A. J. *J. Am. Chem. Soc.* **1983**, *105*, 1379–1380.
309. Grove, D. M.; van Koten, G.; Mul, P.; Zoet, R.; van der Linden, J. G. M.; Legters, J.; Schimtz, J. E. J.; Murrall, N. W.; Welch, A. J. *Inorg. Chem.* **1988**, *27*, 2466–2473.
310. Alonso, P. J.; Falvello, L. R.; Forniés, J.; Martín, A.; Menjón, B.; Rodríguez, G. *Chem. Commun.* **1997**, 503–504.
311. Klein, H.-F.; Bickelhaupt, A.; Jung, T.; Cordier, G. *Organometallics* **1994**, *13*, 2557–2559.
312. Klein, H.-F.; Bickelhaupt, A.; Lemke, M.; Sun, H.; Brand, A.; Jung, T.; Röhr, C.; Flörke, U.; Haupt, H.-J. *Organometallics* **1997**, *16*, 668–676.
313. Klein, H. F.; Bickelhaupt, A.; Lemke, M.; Jung, T.; Röhr, C. *Chem. Lett.* **1995**, 467–468.
314. Klein, H.-F.; Li, X.; Sun, H.; Beck, R.; Flörke, U.; Haupt, H.-J. *Inorg. Chim. Acta* **2000**, *298*, 63–69.
315. Shimada, S.; Rao, M. L. N.; Tanaka, M. *Organometallics* **1999**, *18*, 291–293.
316. Chen, W.; Shimada, S.; Tanaka, M. *Science* **2002**, *295*, 308–310.
317. Sherer, E. C.; Kinsinger, C. R.; Kormos, B. L.; Thompson, J. D.; Cramer, C. J. *Angew. Chem., Int. Ed.* **2002**, *41*, 1953–1956; *Angew. Chem.* **2002**, *114*, 2033–2036.
318. Aullón, G.; Lledós, A.; Alvarez, S. *Angew. Chem., Int. Ed.* **2002**, *41*, 1956–1959; *Angew. Chem.* **2002**, *114*, 2036–2039.
319. Shimada, S.; Rao, M. L. N.; Hayashi, T.; Tanaka, M. *Angew. Chem., Int. Ed.* **2001**, *40*, 213–216; *Angew. Chem.* **2001**, *113*, 219–222.
320. Kester, J. G.; Keller, D.; Huffman, J. C.; Benefiel, M. A.; Geiger, W. E.; Atwood, C.; Siedle, A. R.; Korba, G. A.; Todd, L. J. *Inorg. Chem.* **1994**, *33*, 5438–5442.
321. Orpen, A. G.; Brammer, L.; Allen, F. H.; Kennard, O.; Watson, D. C.; Taylor, R. *J. Chem. Soc., Dalton Trans.* **1989**, S1–S83.
322. See, R. F.; Kruse, R. A.; Strub, W. M. *Inorg. Chem.* **1998**, *37*, 5369–5375.
323. Jóna, E. *J. Therm. Anal.* **1988**, *34*, 1053–1072.
324. Uhlig, E. *Curr. Trends Coord. Chem.* **1995**, *15*, 43–48.
325. Frömmel, T.; Peters, W.; Wunderlich, H.; Kuchen, W. *Angew. Chem.* **1992**, *104*, 632–633; *Angew. Chem., Int. Ed. Engl.* **1992**, *31*, 612–613.
326. Frömmel, T.; Peters, W.; Wunderlich, H.; Kuchen, W. *Angew. Chem.* **1993**, *105*, 926–928; *Angew. Chem., Int. Ed. Engl.* **1993**, *32*, 907–909.
327. Brück, A.; Englert, U.; Kuchen, W.; Peters, W. *Chem. Ber.* **1996**, *129*, 551–555.
328. Mink, H.-J.; Schmidtke, H.-H. *Chem. Phys. Lett.* **1984**, *231*, 235–240.
329. Mink, H.-J.; Schmidtke, H.-H. *Chem. Phys. Lett.* **1995**, *247*, 310–312.
330. Bridgeman, A. J.; Gerloch, M. *Chem. Phys. Lett.* **1995**, *247*, 304–309.
331. Mink, H.-J.; Schmidtke, H.-H. *Chem. Phys. Lett.* **1996**, *256*, 663–668.
332. Schäfer, C. E. *Inorg. Chim. Acta* **1995**, *240*, 581–592.

333. Deeth, R. J.; Kemp, C. M. *J. Chem. Soc., Dalton Trans.* **1992**, 2013–2017.
334. Lever, A. B. P.; Walker, I. M.; McCarthy, P. J.; Mertes, K. B.; Jircitano, A.; Sheldon, R. *Inorg. Chem.* **1983**, *22*, 2252–2258.
335. Deeth, R. J.; Gerloch, M. *Inorg. Chem.* **1987**, *26*, 2582–2585.
336. Bussière, G.; Reber, C. *J. Am. Chem. Soc.* **1998**, *120*, 6306–6315.
337. Triest, M.; Bussière, G.; Bélisle, H.; Reber, C. *J. Chem. Educ.* **2000**, *77*, 670.
338. Abernathy, S. M.; Sharp, R. R. *J. Phys. Chem. A* **1997**, *101*, 3692–3698.
339. Larsson, T.; Westlund, P.-O.; Kowalewski, J.; Koenig, S. H. *J. Chem. Phys.* **1994**, *101*, 1116–1128.
340. Svoboda, J.; Nilsson, T.; Kowalewski, J.; Westlund, P.-O.; Larsson, P. T. *J. Magn. Reson., Ser. A* **1996**, *121*, 108–113.
341. McGarvey, B. R. *Inorg. Chem.* **1995**, *34*, 6000–6007.
342. Dei, A. *Inorg. Chim. Acta* **1982**, *65*, L9–L12.
343. Pacholska, E.; Chmielewski, P. J.; Latos-Grazynski, L. *Inorg. Chim. Acta* **1998**, *273*, 184–190.
344. Robert, J. M.; Evilia, R. F. *Inorg. Chem.* **1987**, *26*, 2857–2861.
345. Basato, M.; Favero, G.; Veronese, A. C.; Grassi, A. *Inorg. Chem.* **1993**, *32*, 763–768.
346. Kessenikh, A. V.; Ataev, A.; Plakhtin, B. N.; Fedotov, M. A. *Khim. Fiz.* **1993**, *12*, 1687–1696.
347. Peters, W.; Fuchs, M.; Sicius, H.; Kuchen, W. *Angew. Chem. Int. Ed.* **1985**, *24*, 231–232; *Angew. Chem.* **1985**, *97*, 217–218.
348. Holz, R. C.; Evdokimov, E. A.; Gobena, F. T. *Inorg. Chem.* **1996**, *35*, 3808–3814.
349. Luchinat, C.; Steuernagel, S.; Turano, P. *Inorg. Chem.* **1990**, *29*, 4351–4353.
350. Clementi, V.; Luchinat, C. *Acc. Chem. Res.* **1998**, *31*, 351–361.
351. Owens, C.; Drago, R. S.; Bertini, I.; Luchinat, C.; Banci, L. *J. Am. Chem. Soc.* **1986**, *108*, 3298–3303.
352. Belle, C.; Bougault, C.; Averbuch, M.-T.; Durif, A.; Pierre, J.-L.; Latour, J.-M.; Le Pape, L. *J. Am. Chem. Soc.* **2001**, *123*, 8053–8066.
353. Barra, A.-L.; Brunel, L.-C.; Gatteschi, D.; Pardi, L.; Sessoli, R. *Acc. Chem. Res.* **1998**, *31*, 460–466.
354. Krzystek, J.; Park, J.-H.; Meisel, M. W.; Hitchman, M. A.; Stratemeier, H.; Brunel, L.-C.; Telsler, J. *Inorg. Chem.* **2002**, *41*, 4478–4487.
355. Van Dam, P. J.; Klaassen, A. A. K.; Reijerse, E. J.; Hagen, W. R. *J. Magn. Reson.* **1998**, *130*, 140–144.
356. Pardi, L. A.; Hassan, A. K.; Hulsbergen, F. B.; Reedijk, J.; Spek, A. L.; Brunel, L.-C. *Inorg. Chem.* **2000**, *39*, 159–164.
357. Collison, D.; Helliwell, M.; Jones, V. M.; Mabbs, F. E.; McInnes, E. J. L.; Riedi, P. C.; Smith, G. M.; Pritchard, R. G.; Cross, W. I. *J. Chem. Soc., Faraday Trans.* **1998**, *94*, 3019–3025.
358. Maroney, M. J.; Gu, Z.; Choudhury, S. B.; Allan, C. B. *Metal Ions in Biology and Medicine*, Proceedings of the International Symposium; 1996; Libbey Eurotext, Montrouge/Fr. 1996, pp. 21–23.
359. Mansour, A. N.; Melendres, C. A.; Pankuch, M.; Brizzolara, R. A. *J. Electrochem. Soc.* **1994**, *141*, L69–L71.
360. Hector, A. L.; Hope, E. G.; Levason, W.; Weller, M. T. *Z. Anorg. Allg. Chem.* **1998**, *624*, 1982–1988.
361. Colpas, G. J.; Maroney, M. J.; Bagyinka, C.; Kumar, M.; Willies, W. S.; Suib, S. L.; Baidya, N.; Mascharak, P. K. *Inorg. Chem.* **1991**, *30*, 920–928.
362. Nivorozhkin, A. L.; Segal, B. M.; Masgrave, K. B.; Kates, S. A.; Hedman, B.; Hodgson, K. O.; Holm, R. H. *Inorg. Chem.* **2000**, *39*, 2306–2313.
363. Musgrave, K. B.; Laplaza, C. E.; Holm, R. H.; Hedman, B.; Hodgson, K. O. *J. Am. Chem. Soc.* **2002**, *124*, 3083–3092.
364. Baidya, N.; Olmstead, M. M.; Whitehead, J. P.; Bagyinka, C.; Maroney, M. J.; Mascharak, P. K. *Inorg. Chem.* **1992**, *31*, 3612–3619.
365. Colpas, G. J.; Maroney, M. J.; Bagyinka, C.; Kumar, M.; Willis, W. S.; Suib, S. L.; Mascharak, P. K.; Baidya, N. *Inorg. Chem.* **1991**, *30*, 920–928.
366. Glaser, T.; Kesting, F.; Beissel, T.; Bill, E.; Weyhermüller, T.; Meyer-Klaucke, W.; Wieghardt, K. *Inorg. Chem.* **1999**, *38*, 722–732.
367. Davies, M. K.; Levason, W.; Reid, G. *J. Chem. Soc., Dalton Trans.* **1998**, 2185–2190.
368. Higgins, S. J.; Levason, W.; Feiters, M. C.; Steel, A. T. *J. Chem. Soc., Dalton Trans.* **1986**, 317–322.
369. Evans, J.; Gauntlett, J. T.; Levason, W. *Inorg. Chem.* **1988**, *27*, 4521–4523.
370. Evans, J.; Levason, W.; Perry, R. J. *Inorg. Chem.* **1990**, 3691–3695.
371. Levason, W.; Preece, S. R. *Inorg. Chem.* **1995**, *34*, 1626–1628.
372. Van der Gaauw, A.; Wilkin, O. M.; Young, N. A. *J. Chem. Soc., Dalton Trans* **1999**, 2405–2406.
373. Wang, H.; Ge, P.; Riordan, C. G.; Brooker, S.; Woome, C. G.; Collins, T.; Melendres, C. A.; Graudejus, O.; Bartlett, N.; Cramer, S. P. *J. Phys. Chem. B* **1988**, *102*, 8343–8346.
374. Jansen, N.; Walcher, D.; Gütllich, P.; Gäussinger, D.; Hannebauer, B.; Kniep, R.; Lutar, K.; Schmidt, P. C.; Sellmann, D. *Nuovo Cimento, della Societa Italiana di Fisica, D: Condens. Matter Atom. Mol. Chem. Phys. Fluids Plas. Biophys.* **1996**, *18D*, 231–235.
375. Hancock, R. D. *Progr. Inorg. Chem.* **1989**, *37*, 187–291.
376. Deeth, R. J. *Struct. Bonding* **1995**, *82*, 1–42.
377. Comba, P. *NATO Sci. Ser. E* **1999**, *360*, 87–100.
378. Comba, P. *NATO Sci. Ser. E* **1999**, *360*, 71–86.
379. Comba, P.; Hambley, T. W. *Molecular Modeling of Inorganic Compounds*; VCH: Weinheim, Germany, 1995.
380. Csiki, C.; Norenberg, K. M.; Shoemaker, C. M.; Zimmer, M. *NATO ASI Ser.3* **1997**, *41*, 105–129.
381. Comba, P. *Coord. Chem. Rev.* **1999**, *185-186*, 81–98.
382. Hancock, R. D. *Acc. Chem. Res.* **1990**, *23*, 253–257.
383. Comba, P. *Fundam. Principles Mol. Modeling* **1996**, 167–187.
384. Bernhardt, P. V.; Comba, P. *Inorg. Chem.* **1993**, *32*, 2798–2803.
385. Deeth, R. J.; Munslow, I. J.; Paget, V. J. *NATO ASI Ser.3* **1997**, *41*, 77–103.
386. Martell, A. E.; Hancock, R. D.; Motekaitis, R. J. *Coord. Chem. Rev.* **1994**, *133*, 39–65.
387. Hancock, R. D.; Dobson, S. M.; Evers, A.; Wade, P.; Ngwenya, M. P.; Boeyens, J. C. A.; Wainwright, K. P. *J. Am. Chem. Soc.* **1988**, *110*, 2788–2794.
388. Adam, K. R.; Antolovich, M.; Brigden, L. G.; Lindoy, L. F. *J. Am. Chem. Soc.* **1991**, *113*, 3346–3351.

389. Hancock, R. D.; Dobson, S. M.; Evers, A.; Ngwenya, M. P.; Wade, P. W.; Boeyens, J. C. A.; Wainwright, K. P. *J. Am. Chem. Soc.* **1988**, *110*, 2788–2794.
390. Bernhardt, P. V.; Comba, P. *Inorg. Chem.* **1992**, *31*, 2638–2644.
391. Adam, K. R.; Atkinson, I. M.; Antolovich, M.; Brigden, L. G.; Lindoy, L. F. *J. Mol. Struct.* **1994**, *323*, 223–231.
392. Comba, P.; Hambley, T. W.; Ströhle, M. *Helv. Chim. Acta* **1995**, *78*, 2042–2047.
393. Bernhardt, P. V.; Comba, P.; Gyr, T.; Várnagy, K. *Inorg. Chem.* **1992**, *31*, 1220–1223.
394. Norenberg, K. M.; Shoemaker, C. M.; Zimmer, M. *J. Chem. Soc., Dalton Trans.* **1997**, 1521–1526.
395. DaCruz, F.; Zimmer, M. *Inorg. Chem.* **1998**, *37*, 366–368.
396. Hambley, T. W. *Inorg. Chem.* **1998**, *37*, 3767–3774.
397. Munk, V. P.; Cham, S. T.; Fenton, R. R.; Hocking, R. K.; Hambley, T. W. *Aust. J. Chem.* **2002**, *55*, 523–529.
398. Adam, K. R.; Atkinson, I. M.; Lindoy, L. F. *J. Mol. Struct.* **1996**, *384*, 183–190.
399. Adam, K. R.; Atkinson, I. M.; Lindoy, L. F. *Inorg. Chem.* **1997**, *36*, 480–481.
400. Shao, L.; Zhang, L.; Zhou, M.; Qin, Q. *Organometallics* **2001**, *20*, 1137–1143.
401. Beattie, I. R.; Jones, P. J.; Young, N. A. *J. Am. Chem. Soc.* **1992**, *114*, 6146–6152.
402. Forníés, J.; Martín, A.; Martín, L. F.; Menjón, B.; Kalamarides, H. A.; Rhodes, L. F.; Day, C. S.; Day, V. W. *Chem. Eur. J.* **2002**, *8*, 4925–4934.
403. Ptasiwicz-Bak, H.; Lovsson, I.; McIntyre, G. J. *Acta Cryst. B* **1998**, *B54*, 600–612.
404. Sano, M.; Kashiwagi, H.; Yamatera, H. *Bull. Chem. Soc. Jpn.* **1982**, *55*, 750–753.
405. Banciu, A. C. *Revue Roumaine de Chimie* **2000**, *44*, 889–894.
406. Mantz, Y. A.; Musselman, R. L. *Inorg. Chem.* **2002**, *41*, 5770–5777.
407. Mason, W. R. *Inorg. Chem.* **1989**, *28*, 2487–2489.
408. Pleskiewicz, J. C.; Billo, E. J. *Inorg. Chim. Acta* **1985**, *99*, 149–155.
409. Beach, M. W.; Margerum, D. W. *Inorg. Chem.* **1990**, *29*, 1225–1232.
410. Berseth, P. A.; Sokol, J. J.; Shores, M. P.; Heinrich, J. L. K.; Long, J. R. *J. Am. Chem. Soc.* **2000**, *122*, 9655–9662.
411. Sokol, J. J.; Shores, M. P.; Long, J. R. *Angew. Chem.* **2001**, *113*, 242–245; *Angew. Chem., Int. Ed. Engl.* **2001**, *40*, 236–239.
412. Lancaster, S. J.; Walker, D. A.; Thornton-Pett, M.; Bochmann, M. *J. Chem. Soc., Chem. Commun.* **1999**, 1533–1534.
413. Meyer, F.; Winter, R. F.; Kaifer, E. *Inorg. Chem.* **2001**, *40*, 4597–4603.
414. Mang, T. S.; McGinnis, C.; Liebow, C.; Nseyo, U. O.; Crean, D. H.; Dougherty, T. J. *Cancer* **1993**, *71*, 269.
415. Ponikvar, W.; Mayer, P.; Piotrowski, H.; Swoboda, P.; Oetker, C.-J.; Beck, W. *Z. Anorg. Allg. Chem.* **2002**, *628*, 15–19.
416. Korybut-Daszkiewicz, B.; Mrozinski, J. *Pol. Bull. Pol. Acad. Sci. Chem.* **1985**, *33*, 411–419.
417. Soldatov, D. V.; Dyadin, Y. A.; Lipkowski, J.; Suwinska, K. *Mendelev Commun.* **1997**, 100–102.
418. Nour, El M.; Rady, A. H. *Transition Met. Chem.* **1991**, *16*, 400–401.
419. Cortes, R.; Arriortua, M. I.; Rojo, T.; Beltran, D.; Debaerdemaeker, T. *Transition Met. Chem.* **1986**, *11*, 238–239.
420. Escuer, A.; Vicente, R.; El Fallah, M. S.; Solans, X.; Font-Bardia, M. *J. Chem. Soc., Dalton Trans.* **1996**, 1013–1019.
421. Escuer, A.; Vicente, R.; Ribas, J.; El Fallah, M. S.; Solans, X.; Font-Bardia, M. *Inorg. Chim. Acta* **1994**, *216*, 5–7.
422. Meyer, F.; Kaifer, E.; Kircher, P.; Heinze, K.; Pritzkow, H. *Chem. Eur. J.* **1999**, *5*, 1617–1630.
423. Liu, J.; Meyers, E. A.; Cowan, J. A.; Shore, S. G. *J. Chem. Soc., Chem. Commun.* **1998**, 2043–2044.
424. Freire, E.; Baggio, S.; Suescun, L.; Baggio, R. *Acta Cryst. C* **2001**, *C57*, 905–908.
425. Pickardt, J.; Roleke, D. *Z. Kristallogr. New Cryst. Struct.* **1997**, *212*, 156.
426. Mukherjee, A. K.; Mukherjee, M.; Ray, S.; Ghosh, A.; Chaudhuri, N. R. *J. Chem. Soc., Dalton Trans.* **1990**, 2347–2350.
427. De, G.; Chaudhuri, N. R. *Transition Met. Chem.* **1985**, *10*, 476–479.
428. Pariya, C.; Ghosh, A.; Chaudhuri, N. R.; Ghosh, S.; Mukherjee, M.; Mukherjee, A. K. *Polyhedron* **1996**, *15*, 1643–1650.
429. Trofimenko, S.; Calabrese, J. C.; Kochi, J. K.; Wolowiec, S.; Hulsbergen, F. B.; Reedijk, J. *Inorg. Chem.* **1992**, *31*, 3943–3950.
430. Fabretti, A. C.; Malavasi, W.; Gatteschi, D.; Sessoli, R. *J. Chem. Soc., Dalton Trans.* **1991**, 2331–2334.
431. Jamnicky, M.; Jona, E. *Inorg. Chim. Acta* **1984**, *88*, 1–6.
432. Sarma, K. P.; Poddar, R. K. *Transition Met. Chem.* **1984**, *9*, 135–138.
433. DeFotis, G. C.; Dell, K. D.; Krovich, D. J.; Brubaker, W. W. *J. Appl. Phys.* **1993**, *73*, 5386–5388.
434. Koide, M.; Ishiguro, S.-I. *J. Chem. Soc., Faraday Trans.* **1995**, *91*, 2313–2317.
435. Pilarczyk, M.; Grzybowski, W.; Klinszorn, L. *J. Chem. Soc., Faraday Trans. 1* **1989**, *85*, 3395–3402.
436. Bjerrum, J. *Acta Chem. Scand., Ser. A* **1988**, *A42*, 721–723.
437. Chiumia, G. C.; Craig, D. C.; Phillips, D. J.; Rae, A. D.; Kaifi, F. M. *Z. Inorg. Chim. Acta* **1999**, *285*, 297–300.
438. Vicente, R.; Escuer, A.; Solans, X.; Font-Bardia, M. *Inorg. Chim. Acta* **1996**, *248*, 59–65.
439. Hoffman, D. W.; Wood, J. S. *Cryst. Struct. Commun.* **1982**, *11*, 691–694.
440. Hanotier, J.; De Radzitsky, P. *Inclusion Comp.* **1984**, *1*, 105–134.
441. Moore, M. H.; Nassimbeni, L. R.; Niven, M. L. *Inorg. Chim. Acta* **1987**, *131*, 45–52.
442. Sekiya, R.; Nishikiori, S.-I. *J. Chem. Soc., Chem. Commun.* **2001**, 2612–2613.
443. Shi, J. M.; Shu, C. Y.; Yu, W. T.; Sun, K. J.; Wu, C. J.; Lu, J. J. *Pol. J. Chem.* **2001**, *75*, 1067–1071.
444. Cortés, R.; Ruiz de Larramendi, J. I.; Lezama, L.; Rojo, T.; Urtiaga, K.; Arriortua, M. I. *J. Chem. Soc., Dalton Trans.* **1992**, 2723–2728.
445. Liu, J.-C.; Song, Y.; Zhuang, J.-Z.; You, X.-Z.; Huang, X.-Y.; Huang, Z.-X. *Jiegou Huaxue* **2000**, *19*, 81–85.
446. Cano, J.; De Munno, G.; Lloret, F.; Julve, M. *Inorg. Chem.* **2000**, *39*, 1611–1614.
447. Monfort, M.; Bastos, C.; Diaz, C.; Ribas, J.; Solans, X. *Inorg. Chim. Acta* **1994**, *218*, 185–188.
448. Escuer, A.; Kumar, S. B.; Mautner, F.; Vicente, R. *Inorg. Chim. Acta* **1998**, *269*, 313–316.
449. Zurowska, B.; Mrozinski, J.; Julve, M.; Lloret, F.; Maslejova, A.; Sawka-Dobrowolska, W. *Inorg. Chem.* **2002**, *41*, 1771–1777.
450. Maji, T. K.; Laskar, I. R.; Mostafa, G.; Welch, A. J.; Mukherjee, P. S.; Chaudhuri, N. R. *Polyhedron* **2001**, *20*, 651–655.
451. Monfort, M.; Ribas, J.; Solans, X. *Inorg. Chem.* **1994**, *33*, 4271–4276.

452. Zurowska, B.; Mrozinski, J.; Julve, M.; Lloret, F.; Maslejova, A.; Sawka-Dobrowolska, W. *Inorg. Chem.* **2002**, *41*, 1771–1777.
453. Maji, T. K.; Mostafa, G.; Mukherjee, P. S.; Mondal, A.; Welch, A. J.; Okamoto, K.-I.; Chaudhuri, N. R. *Polyhedron* **2000**, *19*, 1903–1907.
454. Escuer, A.; El Fallah, M. S.; Kumar, S. B.; Mautner, F.; Vicente, R. *Polyhedron* **1998**, *18*, 377–381.
455. Vicente, R.; Escuer, A.; Ribas, J.; Solans, X.; Font-Bardia, M. *Inorg. Chem.* **1993**, *32*, 6117–6118.
456. Rojo, T.; Cortes, R.; Lezama, L.; Arriortua, M. I.; Urriaga, K.; Villeneuve, G. *J. Chem. Soc., Dalton Trans.* **1991**, 1779–1783.
457. Bridgeman, A. J.; Wilkin, O. M.; Young, N. A. *Inorg. Chem. Commun.* **2000**, *3*, 681–684.
458. Dev, S.; Ramli, E.; Rauffuss, T. B.; Wilson, S. R. *Inorg. Chem.* **1991**, *30*, 2514–2519.
459. Koman, M.; Jona, E.; Mašleyová, A. *Acta Crystallogr.* **1991**, *C47*, 1206–1208.
460. Bachman, R. E.; Whitmire, K. H.; Mandal, S.; Bharadway, P. K. *Acta Crystallogr.* **1992**, *C48*, 1836–1837.
461. Ďurčanská, E.; Koman, M.; Jamnický, M. *Acta Crystallogr.* **1991**, *47*, 1191–1193.
462. Alzuet, G.; Ferrer, S.; Borrás, J.; Solans, X.; Font-Bardia, M. *Inorg. Chim. Acta* **1993**, *203*, 257–261.
463. Ferrer, S.; Borrás, J.; Miratvilles, C.; Fuertes, A. *Inorg. Chem.* **1989**, *28*, 160–163.
464. Tenten, A.; Jacobs, H. *J. Less Common Met.* **1991**, *170*, 145–159.
465. Tenten, A.; Jacobs, H. *Z. Anorg. Allg. Chem.* **1991**, *604*, 113–126.
466. Tenten, A.; Jacobs, H. *J. Alloys Comp.* **1991**, *177*, 193–217.
467. Bartlett, R. A.; Chen, H.; Power, P. P. *Angew. Chem., Int. Ed. Engl.* **1989**, *28*, 316; *Angew. Chem.* **1989**, *101*, 325–327.
468. Mindiola, D. J.; Hillhouse, G. L. *J. Am. Chem. Soc.* **2001**, *123*, 4623–4624.
469. Mindiola, D. J.; Hillhouse, G. L. *Chem. Commun.* **2002**, 1840–1841.
470. Garcia-Granda, S.; Gómez-Beltrán, F. *Acta Crystallogr.* **1984**, *C40*, 949–951.
471. Garcia-Granda, S.; Beurskens, P. T.; Behm, H. J. J.; Gómez-Beltrán, F. *Acta Crystallogr.* **1987**, *C43*, 236–238.
472. Garcia-Granda, S.; Díaz, M. R.; Gómez-Beltrán, F. *Acta Crystallogr.* **1990**, *C46*, 598–600.
473. Ihara, Y.; Fukuda, Y.; Sone, K. *Inorg. Chem.* **1987**, *26*, 3745–3750.
474. Koner, S.; Chaudhuri, N. R. *Thermochim. Acta* **1991**, *180*, 177–184.
475. Pariya, C.; Ghosh, S.; Ghosh, A.; Mukherjee, M.; Mukherjee, A. K.; Chaudhuri, N. R. *J. Chem. Soc., Dalton Trans.* **1995**, 337–342.
476. Koner, S.; Ghosh, A.; Chaudhuri, N. R. *J. Chem. Soc., Dalton Trans.* **1990**, 1563–1567.
477. Linert, W.; Taha, A. *J. Chem. Soc., Dalton Trans.* **1994**, 1091–1095.
478. Marchetti, F.; Tanturli, R.; Pertici, P.; Rosini, C. *Inorg. Chim. Acta* **1999**, *294*, 28–34.
479. Garcia-Granda, S.; Díaz, M. R.; Gómez-Beltrán, F. *Acta Crystallogr.* **1991**, *C47*, 181–182.
480. Garcia-Granda, S.; Díaz, M. R.; Gómez-Beltrán, F. *Acta Crystallogr.* **1990**, *C46*, 993–995.
481. Gerard, K. J.; Morgan, J.; Steel, P. J.; House, D. A. *Inorg. Chim. Acta* **1997**, *260*, 27–34.
482. Hataya, K.; Yanagihara, R.; Osanai, S.; Yoshikawa, S. *J. Chem. Soc., Chem. Commun.* **1991**, 1246–1247.
483. Barker, J.; Kilner, M. *Coord. Chem. Rev.* **1994**, *133*, 219–300.
484. Cotton, F. A.; Matonic, J. H.; Murillo, C. A. *Inorg. Chem.* **1996**, *35*, 498–503.
485. Edelman, F. T. *Coord. Chem. Rev.* **1994**, *137*, 403–481.
486. Walther, D.; Gebhardt, P.; Fischer, R.; Kreher, U.; Görls, H. *Inorg. Chim. Acta* **1998**, *281*, 181–189.
487. Wedler, M.; Knösel, F.; Noltemeyer, M. N.; Edelman, F. T.; Behrens, U. *J. Organomet. Chem.* **1990**, *388*, 21–45.
488. Krytov, S. V.; Nazarenko, A. Y.; Smith, M. B.; Rybak-Akimova, E. V. *Chem. Commun.* **2001**, 1174–1175.
489. Döhler, T.; Görls, H.; Walther, D. *Chem. Commun.* **2000**, 945–946.
490. Walther, D.; Stollenz, M.; Böttcher, L.; Görls, H. *Z. Anorg. Allg. Chem.* **2001**, *627*, 1560–1570.
491. Mukherjee, M.; Mukherjee, A. K.; Pariya, C.; Chaudhuri, N. R. *Acta Crystallogr.* **1995**, *C51*, 1543–1545.
492. Hynes, R. C.; Willis, C. J.; Vittal, J. J. *Acta Crystallogr.* **1996**, *C52*, 1879–1881.
493. Brorson, M.; Damhus, T.; Schaffer, C. *Inorg. Chem.* **1983**, *22*, 1569–1573.
494. Mukherjee, A. K.; Koner, S.; Ghosh, A.; Chaudhuri, N. R.; Mukherjee, M.; Welch, A. J. *J. Chem. Soc., Dalton Trans.* **1994**, 2367–2371.
495. von Zelewsky, A. *Stereochemistry of Coordination Compounds* **1996**, Wiley: Chichester, UK.
496. Rodriguez, V.; Gutiérrez-Zorrilla, J. M.; Vitoria, P.; Luque, A.; Román, P.; Martínez-Ripoll, M. *Inorg. Chim. Acta* **1999**, *290*, 57–63.
497. Hancock, R. D.; Ngwenya, M. P.; Evers, A.; Wade, P. W.; Boeyens, J. C. A.; Dobson, S. M. *Inorg. Chem.* **1990**, *29*, 264–270.
498. Tapper, A. E.; Billo, E. J. *Inorg. Chim. Acta* **1993**, *210*, 71–75.
499. Wen, R.; Bernal, I.; Somoza, F.; Li, W.; Fronczek, F. R. *Inorg. Chim. Acta* **1998**, *282*, 96–109.
500. Wen, R.; Bernal, I.; Fronczek, F. R. *Inorg. Chim. Acta* **1999**, *292*, 149–156.
501. Hegetschweiler, K.; Gramlich, V.; Ghisletta, M.; Samaras, H. *Inorg. Chem.* **1992**, *31*, 2341–2346.
502. Weber, M.; Kuppert, D.; Hegetschweiler, K.; Gramlich, V. *Inorg. Chem.* **1999**, *38*, 859–868.
503. Hegetschweiler, K.; Finn, R. C.; Rarig, R. S., Jr.; Sander, J.; Steinhauser, S.; Wörle, M.; Zubieta, J. *Inorg. Chim. Acta* **2002**, *337*, 39–47.
504. Pauly, J. W.; Sander, J.; Kuppert, D.; Winter, M.; Reiss, G. J.; Zürcher, F.; Hoffmann, R.; Fässler, T. F.; Hegetschweiler, K. *Chem. Eur. J.* **2000**, *6*, 2830–2846.
505. Boese, R.; Düppmann, M.; Kuchen, W.; Peters, W. *Z. Anorg. Allg. Chem.* **1998**, *624*, 837–845.
506. Fenske, D.; Maczek, B.; Maczek, K. *Z. Anorg. Allg. Chem.* **1997**, *623*, 1113–1120.
507. Peters, J. C.; Harkins, S. B.; Brown, S. D.; Day, M. W. *Inorg. Chem.* **2001**, *40*, 5083–5091.
508. Mealli, C.; Ghilardi, C. A.; Orlandini, A. *Coord. Chem. Rev.* **1992**, *120*, 361–387.
509. Ray, M.; Yap, G. P. A.; Rheingold, A. L.; Borovik, A. S. *J. Chem. Soc., Chem. Commun.* **1995**, 1777–1778.
510. Ray, M.; Hammes, B. S.; Yap, G. P. A.; Rheingold, A. L.; Borovik, A. S. *Inorg. Chem.* **1998**, *37*, 1527–1532.
511. Zimmer, A.; Kuppert, D.; Weyhermüller, T.; Müller, I.; Hegetschweiler, K. *Chem. Eur. J.* **2001**, *7*, 917–931.
512. Masters, M. V.; Bernhardt, P. V.; Gahan, L. R.; Moubaraki, B.; Murray, K. S.; Berry, K. J. *J. Chem. Soc., Dalton Trans.* **1999**, 2323–2328.
513. Ochs, C.; Hahn, F. E.; Lügger, T. *Eur. J. Inorg. Chem.* **2001**, 1279–1285.
514. McAuley, A.; Subramanian, S.; Whitcomb, T. W. *J. Chem. Soc., Dalton Trans.* **1993**, 2209–2214.

515. Johnson, L. K.; Killian, C. M.; Brookhart, M. *J. Am. Chem. Soc.* **1995**, *117*, 6414–6415.
516. Killian, C. M.; Tempel, D. J.; Johnson, L. K.; Brookhart, M. *J. Am. Chem. Soc.* **1996**, *118*, 11664–11665.
517. Feldman, J.; McLain, S. J.; Parthasarathy, A.; Marshall, W. J.; Calabrese, J. C.; Arthur, S. D. *Organometallics* **1997**, *16*, 1514–1516.
518. Killian, C. M.; Johnson, L. K.; Brookhart, M. *Organometallics* **1997**, *16*, 2005–2007.
519. Svejda, S. A.; Brookhart, M. *Organometallics* **1999**, *18*, 65–74.
520. Mecking, S. *Coord. Chem. Rev.* **2000**, *203*, 325–351.
521. Musaev, D. G.; Fröse, R. D. J.; Svensson, M.; Morokuma, K. *J. Am. Chem. Soc.* **1997**, *119*, 367–374.
522. Deng, L.; Margl, P.; Ziegler, T. *J. Am. Chem. Soc.* **1997**, *119*, 1094–1100.
523. Fröse, R. D. J.; Musaev, D. G.; Morokuma, K. *J. Am. Chem. Soc.* **1998**, *120*, 1581–1587.
524. Woo, T. K.; Blöchl, P. E.; Ziegler, T. *J. Phys. Chem. A* **2000**, *104*, 121–129.
525. Michalak, A.; Ziegler, T. *Organometallics* **2001**, *20*, 1521–1532.
526. Tomita, T.; Takahama, T.; Sugimoto, M.; Sakaki, S. *Organometallics* **2002**, *21*, 4138–4146.
527. Svejda, S. A.; Johnson, L. K.; Brookhart, M. *J. Am. Chem. Soc.* **1999**, *121*, 10634–10635.
528. Huff, R. L.; Svejda, S. A.; Tempel, D. J.; Leatherman, M. D.; Johnson, L. K.; Brookhart, M. *Polym. Prepr. (Am. Chem. Soc., Div. Polym. Chem.)* **2000**, *41*, 401–402.
529. Simon, L. C.; Williams, C. P.; Soares, J. B. P.; De Souza, R. F. *J. Mol. Catal. A* **2001**, *165*, 55–66.
530. Pappalardo, D.; Muszoe, M.; Pellicchia, C. *Macromol. Rapid Commun.* **1997**, *18*, 1017–1023.
531. Schleis, T.; Spaniol, T. P.; Okuda, J.; Heinemann, J.; Mulhaupt, R. *J. Organomet. Chem.* **1998**, *569*, 159–167.
532. Preishuber-Pflugl, P.; Brookhart, M. *Macromolecules* **2002**, *35*, 6074–6076.
533. Held, A.; Bauers, F. M.; Mecking, S. *J. Chem. Soc., Chem. Commun.* **2000**, 301–302.
534. Bauers, F. M.; Mecking, S. *Angew. Chem.* **2001**, *113*, 3112–3115; *Angew. Chem., Int. Ed.* **2001**, *40*, 3020–3022.
535. Laine, T. V.; Klinga, M.; Leskela, M. *Eur. J. Inorg. Chem.* **1999**, 959–964.
536. Laine, T. V.; Lappalainen, K.; Liimatta, J.; Aitola, E.; Lofgren, B.; Leskela, M. *Macromol. Rapid Commun.* **1999**, *20*, 487–491.
537. Schröder, D. L.; Keim, W.; Zuideveld, M. A.; Mecking, S. *Macromolecules* **2002**, *35*, 6071–6073.
538. Schmid, M.; Eberhardt, R.; Kukral, J.; Rieger, B. *Z. Naturforsch. B* **2002**, *57*, 1141–1146.
539. Li, F.; Yap, G. P. A.; Scott, S. L.; Woo, S. I. *Trans. Met. Chem.* **2001**, *26*, 271–275.
540. Liimatta, J. O.; Lofgren, B.; Miettinen, M.; Ahlgren, M.; Haukka, M.; Pakkanen, T. T. *J. Polym. Sci. A* **2001**, *39*, 1426–1434.
541. Schmid, M.; Eberhardt, R.; Klinga, M.; Leskela, M.; Rieger, B. *Organometallics* **2001**, *20*, 2321–2330.
542. Lee, B. Y.; Bazan, G. C.; Vela, J.; Komon, Z. J. A.; Bu, X. *J. Am. Chem. Soc.* **2001**, *123*, 5352–5353.
543. Brewer, G.; Jasinski, J.; Mahany, W.; May, L.; Prytkov, S. *Inorg. Chim. Acta* **1995**, *232*, 283–187.
544. Busse, S.; Elais, H.; Fisher, J.; Poggemann, M.; Wannowius, K. J.; Boca, R. *Inorg. Chem.* **1998**, *37*, 3999–4005.
545. Pakkanen, T. T.; Pakkanen, T. A.; Smolander, K.; Brown, D. A.; Glass, W. K.; Roche, A. L. *J. Mol. Struct.* **1987**, *162*, 313–320.
546. Martin, J. D.; Abboud, K. A.; Dahmen, K.-H. *Inorg. Chem.* **1998**, *37*, 5811–5815.
547. Sliva, T. Yu.; Duda, A. M.; Glowiak, T.; Fritsky, I. O.; Amirkhanov, V. M.; Mokhir, A. A.; Kozlowski, H. *J. Chem. Soc., Dalton Trans.* **1997**, 273–276.
548. Lu, T.-H.; Tseng, F.; Luh, H.; Chung, C.-S. *Acta Crystallogr.* **1993**, *C49*, 666–668.
549. Fritsky, I. O. *J. Chem. Soc., Dalton Trans.* **1999**, 825–826.
550. Duda, A. M. M.; Karaczyn, A.; Kozlowski, H.; Fritsky, I. O.; Glowiak, T.; Prisyazhnaya, E. V.; Sliva, T. Yu.; Swiatek-Kozlowska, J. *J. Chem. Soc., Dalton Trans.* **1997**, 3853–3859.
551. Fritsky, I. O.; Kozlowski, H.; Prisyazhnaya, E. V.; Rzaczyńska, Z.; Karaczy, A.; Sliva, T. Yu.; Glowiak, T. *J. Chem. Soc., Dalton Trans.* **1998**, 3629–3633.
552. Fritsky, I. O. *J. Chem. Soc., Dalton Trans.* **1999**, 825–826.
553. Pavlishchuk, V. V.; Addison, A. W.; Butcher, R. J.; Kanters, R. P. *Inorg. Chem.* **1994**, *33*, 397–399.
554. Pearse, G. A., Jr.; Pflugger, C. R. *Inorg. Chim. Acta* **1994**, *227*, 171–174.
555. Constable, E. C.; Steel, P. J. *Coord. Chem. Rev.* **1989**, *93*, 205–223.
556. Trofimenko, S. *Prog. Inorg. Chem.* **1986**, *34*, 115–117.
557. Trofimenko, S. *Chem. Rev.* **1993**, *93*, 943–980.
558. La Monica, G.; Ardizzoia, G. A. *Prog. Inorg. Chem.* **1997**, *46*, 151–238.
559. Mukherjee, R. *Coord. Chem. Rev.* **2000**, *203*, 151–218.
560. Bouwman, E.; Driessen, W. L.; Reedijk, J. *Coord. Chem. Rev.* **1990**, *1014*, 143–172.
561. Mani, F. *Coord. Chem. Rev.* **1992**, *120*, 325–359.
562. Driessen, W. L.; de Vos, R. M.; Etz, A.; Reedijk, J. *Inorg. Chim. Acta* **1995**, *235*, 127–133.
563. Kokusen, H.; Sohrin, Y.; Matsui, M.; Hata, Y.; Hasegawa, H. *J. Chem. Soc., Dalton Trans.* **1996**, 195–201.
564. House, D. A.; Steel, P. J.; Watson, A. A. *J. Chem. Soc., Chem. Commun.* **1987**, 1575–1576.
565. Watson, A. A.; House, D. A.; Steel, P. J. *Aust. J. Chem.* **1995**, *48*, 1549–1572.
566. van Albada, G. A.; Smeets, W. J. J.; Veldman, N.; Spek, A. L.; Reedijk, J. *Inorg. Chim. Acta* **1999**, *290*, 105–112.
567. Tadokoro, M.; Isobe, K.; Uekusa, H.; Ohashi, Y.; Toyoda, J.; Tashiro, K.; Nakasuiji, K. *Angew. Chem.* **1999**, *111*, 102–106; *Angew. Chem., Int. Ed. Engl.* **1999**, *38*, 95–98.
568. Tadokoro, M.; Nakasuiji, K. *Coord. Chem. Rev.* **2000**, *198*, 205–218.
569. Tadokoro, M.; Shiomi, T.; Isobe, K.; Nakasuiji, K. *Inorg. Chem.* **2001**, *40*, 5476–5478.
570. Spek, A. L.; Duisenberg, A. J. M.; Driessen, W. L.; Wiesmeijer, W. G. R. *Acta Crystallogr.* **1988**, *C44*, 623–626.
571. Schnhoven, J. W. F. M.; Griessen, W. L.; Reedijk, J.; Verschoor, G. C. *J. Chem. Soc., Dalton Trans.* **1984**, 1053–1058.
572. Watson, A. A.; House, D. A.; Steel, P. J. *Inorg. Chim. Acta* **1987**, *130*, 167–176.
573. Masood, Md. A.; Hodgson, D. J. *Inorg. Chem.* **1994**, *33*, 3038–3042.
574. Tabbi, G.; Driessen, W. L.; Reedijk, J.; Veldman, N.; Spek, A. L. *Inorg. Chim. Acta* **1999**, *288*, 239–243.
575. Nivorozhkin, A. L.; Toftlund, H.; Jørgensen, P. L.; Nivorozhkin, L. E. *J. Chem. Soc., Dalton Trans.* **1996**, 1215–1221.
576. Maslak, P.; Szczepanski, J. J.; Parvez, M. *J. Am. Chem. Soc.* **1991**, *113*, 1062–1063.

577. Durán, M. L.; García-Vázquez, J. A.; Romero, J.; Castiñeiras, A.; Sousa, A.; Garnovskii, A. D.; Garnovskii, D. A. *Polyhedron* **1997**, *16*, 1707–1711.
578. Li, Y.; Lai, Y.-H.; Mok, K. F.; Drew, M. G. B. *Inorg. Chim. Acta* **1998**, *279*, 221–225.
579. de Bruin, B.; Bill, E.; Bothe, E.; Weyhermüller, Wieghardt K. *Inorg. Chem.* **2000**, *39*, 2936–2947.
580. Patra, A. K.; Mukherjee, R. *Inorg. Chem.* **1999**, *38*, 1388–1393.
581. Wang, Z.; Reibenspies, J.; Motekaitis, R. J.; Martell, A. E. *J. Chem. Soc., Dalton Trans.* **1995**, 1511–1518.
582. Fenton, R. R.; Stephens, F. S.; Vagg, R. S. *J. Coord. Chem.* **1991**, *23*, 291–311.
583. Weeks, C. L.; Turner, P.; Fenton, R. R.; Lay, P. A. *J. Chem. Soc., Dalton Trans.* **2002**, 931–940.
584. Bernhardt, P. V.; Comba, P.; Hambley, T. W.; Sóvágó, I.; Várnagy, K. *J. Chem. Soc., Dalton Trans.* **1993**, 2023–2026.
585. Comba, P.; Goll, W.; Nuber, B.; Várnagy, K. *Eur. J. Inorg. Chem.* **1998**, 2041–2049.
586. Cargill Thomson, A. M. W. *Coord. Chem. Rev.* **1997**, *160*, 1–52.
587. Hasenknopf, B.; Lehn, J. M. *Helv. Chim. Acta* **1996**, *79*, 1643–1650.
588. Goodman, M. S.; Jubian, V.; Hamilton, A. D. *Tetrahedron Lett.* **1995**, *36*, 2551–2554.
589. Priimov, G. U.; Moore, P.; Maritim, Ph.K.; Butalanyi, P. K.; Alcock, N. W. *J. Chem. Soc., Dalton Trans.* **2000**, 445–449.
590. Szczepura, L. F.; Withman, L. M.; Takeuchi, K. J. *Coord. Chem. Rev.* **1998**, *174*, 5–32.
591. Astley, T.; Hitchman, M. A.; Keene, F. R.; Tiekink, E. R. T. *J. Chem. Soc., Dalton Trans.* **1996**, 1845–1851.
592. Hartman, J. R.; Vachet, R. W.; Callahan, J. H. *Inorg. Chim. Acta* **2000**, *297*, 79–87.
593. Katsuki, I.; Matsumoto, N.; Kojima, M. *Inorg. Chem.* **2000**, *39*, 3350–3354.
594. Bröring, M.; Brandt, C. D.; Lex, J.; Humpf, H.-U.; Bley-Esrich, J.; Gisselbrecht, J.-P. *Eur. J. Inorg. Chem.* **2001**, 2549–2556.
595. Bröring, M.; Brandt, C. D. *Monatsh. Chem.* **2002**, *133*, 623–630.
596. Bröring, M.; Prikhodovski, S.; Brandt, C. D. *J. Chem. Soc., Dalton Trans.* **2002**, 4213–4218.
597. Brückner, C.; Mar, E. K.; Rettig, S. J.; Dolphin, D. *Chem. Ber.* **1996**, *129*, 1195–1198.
598. Brückner, C.; Karunaratne, V.; Rettig, S. J.; Dolphin, D. *Can. J. Chem.* **1996**, *74*, 2182–2193.
599. Bonamico, M.; Fares, V.; Flamini, A.; Poli, N. *Inorg. Chem.* **1991**, *30*, 3081–3087.
600. Flamini, A.; Fares, V.; Pifferi, A. *Eur. J. Inorg. Chem.* **2000**, 523–536.
601. Desrochers, P. J.; Cutts, R. W.; Rice, P. K.; Golden, M. L.; Graham, J. B.; Barclay, T. M.; Cordes, A. W. *Inorg. Chem.* **1999**, *38*, 5690–5694.
602. Calabrese, J. C.; Domaille, P. J.; Thompson, J. S.; Trofimenko, S. *Inorg. Chem.* **1990**, *29*, 4429–4437.
603. Olson, M. D.; Rettig, S. J.; Storr, A.; Trotter, J.; Trofimenko, S. *Acta Crystallogr.* **1991**, *C47*, 1544–1546.
604. Calabrese, J. C.; Trofimenko, S. *Inorg. Chem.* **1992**, *31*, 4810–4814.
605. Calabrese, J. C.; Domaille, P. J.; Trofimenko, S.; Long, G. J. *Inorg. Chem.* **1991**, *30*, 2795–2801.
606. Trofimenko, S.; Calabrese, J. C.; Kochi, J. K.; Wolowiec, S.; Hulsbergen, F. B.; Reedijk, J. *Inorg. Chem.* **1992**, *31*, 3943–3950.
607. Trofimenko, S.; Rheingold, A. L.; Liable Sands, L. M. *Inorg. Chem.* **2002**, *41*, 1889–1896.
608. Gutiérrez, E.; Hudson, S. A.; Monge, A.; Nicosio, M. C.; Paneque, M.; Carmona, E. *J. Chem. Soc., Dalton Trans.* **1992**, 2651–2652.
609. Belderrain, T. R.; Paneque, M.; Carmona, E.; Gutiérrez-Puebla, E.; Monge, M. A.; Ruiz-Valero, C. *Inorg. Chem.* **2002**, *41*, 425–428.
610. Trofimenko, S.; Calabrese, J. C.; Thompson, J. S. *Inorg. Chem.* **1987**, *26*, 1507–1514.
611. Gorrell, I. B.; Parkin, G. *Inorg. Chem.* **1990**, *29*, 2452–2456.
612. Kokusen, H.; Sohrin, Y.; Matsui, M.; Hata, Y.; Hasegawa, H. *J. Chem. Soc., Dalton Trans.* **1996**, 195–201.
613. Kitajima, N.; Hikichi, S.; Tanaka, M.; Moro-oka, Y. *J. Am. Chem. Soc.* **1993**, *115*, 5496–5508.
614. Hikichi, S.; Yoshizawa, M.; Sasakura, Y.; Komatsuzaki, H.; Akita, M.; Moro-oka, Y. *Chem. Lett.* **1999**, 979–980.
615. Domhöver, B.; Kläui, W.; Kremer-Aach, A.; Bell, R.; Mootz, D. *Angew. Chem., Int. Ed.* **1998**, *37*, 3050–3051; *Angew. Chem.* **1998**, *110*, 3218–3220.
616. Kläui, W.; Turkowski, B.; Rheinwald, G.; Lang, H. *Eur. J. Inorg. Chem.* **2002**, 205–209.
617. Hammes, B. S.; Carrano, M. W.; Carrano, C. J. *J. Chem. Soc., Dalton Trans.* **2001**, 1448–1451.
618. Higgs, T. C.; Carrano, C. J. *Inorg. Chem.* **1997**, *36*, 298–306.
619. Fujita, K.; Hikichi, S.; Akita, M.; Moro-oka, Y. *J. Chem. Soc., Dalton Trans.* **2000**, 117–119.
620. Astley, T.; Gulbis, J. M.; Hitchman, M. A.; Tiekink, E. R. T. *J. Chem. Soc., Dalton Trans.* **1993**, 509–515.
621. Yam, V. W.-W.; Lo, K. K.-W. *Coord. Chem. Rev.* **1999**, *184*, 157–240.
622. Jandeleit, B.; Schaefer, D. J.; Powers, T. S.; Turner, H. W.; Weinberg, W. H. *Angew. Chem.* **1999**, *111*, 2648–89; *Angew. Chem., Int. Ed.* **1999**, *38*, 2494–2532.
623. Niklas, N.; Wolf, S.; Liehr, G.; Anson, C. E.; Powell, A. K.; Alsfasser, R. *Inorg. Chim. Acta* **2001**, *314*, 126–132.
624. Yamaguchi, K.; Koshino, S.; Akagi, F.; Suzuki, M.; Uehara, A.; Suzuki, S. *J. Am. Chem. Soc.* **1997**, 5752–5753.
625. Sigman, D. S.; Mazumder, A.; Perrin, D. M. *Chem. Rev.* **1993**, *93*, 2295–2316.
626. Arounagiri, S.; Maiya, B. G. *Inorg. Chem.* **1996**, *35*, 4267–4270.
627. Schlager, O.; Wiegardt, K.; Rufinska, A.; Nuber, B. *J. Chem. Soc., Dalton Trans.* **1996**, 1659–1668.
628. Ceder, R. M.; Muller, G.; Ordinas, M.; Maestro, M. A.; Mahia, J.; Bardia, M. F.; Solans, X. *J. Chem. Soc., Dalton Trans.* **2001**, 977–985.
629. Gossage, R. A.; van de Kuil, L. A.; van Koten, G. *Acc. Chem. Res.* **1998**, *31*, 423–431.
630. Kleij, A. W.; Gossage, R. A.; Jastrzebski, J. T. B. H.; Boersma, J.; van Koten, G. *Angew. Chem.* **2000**, *112*, 179–181; *Angew. Chem. Int. Ed.* **2000**, *39*, 176–178.
631. Behrens, I.; Petersen, J.; Lork, E.; Watson, P. G.; Mews, R. *Angew. Chem., Int. Ed. Engl.* **1997**, *36*, 1878–1879; *Angew. Chem.* **1997**, *109*, 1951–1953.
632. Dehnicke, K.; Krieger, M.; Massa, W. *Coord. Chem. Rev.* **1999**, *182*, 19.
633. Krieger, M.; Gould, R. O.; Pebler, J.; Dehnicke, K. *Z. Anorg. Allg. Chem.* **1998**, *624*, 781.
634. Krieger, M.; Gould, R. O.; Harms, K.; Greiner, A.; Dehnicke, K. *Z. Anorg. Allg. Chem.* **2001**, *627*, 747–754.
635. Mast, C.; Krieger, M.; Dehnicke, K.; Greiner, A. *Macromol. Rap. Commun.* **1999**, *20*, 232.
636. Sacconi, L.; Mani, F.; Bencini, A. In *Comprehensive Coordination Chemistry*; Wilkinson, G., Gillard, R. D., McCleverty, J. A., Eds.; Pergamon: Oxford, UK, 1987; Vol. 5, Chapter 50.

637. Manojlovic-Muir, L.; Mirza, H. A.; Sadiq, N.; Puddephatt, R. J. *Inorg. Chem.* **1993**, *32*, 117–119.
638. Mam, J. O.; Alfredsson, V.; Svensson, G.; Albertsson, J. *Acta Crystallogr.* **1992**, *C48*, 406–408.
639. Becalska, A.; Batchelor, R. J.; Einstein, F. W. B.; Hill, R. H.; Plamer, B. J. *Inorg. Chem.* **1992**, *31*, 3118–3123.
640. Oberhauser, W.; Bachmann, C.; Stampfl, T.; Haid, R.; Brüggeler, P. *Polyhedron* **1997**, *16*, 2827–2835.
641. Oberhauser, W.; Bachmann, C.; Stampfl, T.; Haid, R.; Langes, C.; Rieder, A. Brüggeler P. *Polyhedron* **1998**, *17*, 3211–3220.
642. Dyer, G.; Roscoe, J. *Inorg. Chem.* **1996**, *35*, 4098–4102.
643. Janssen, B. C.; Sernau, V.; Huttner, G.; Asam, A.; Walter, O.; Büchner, M.; Zsolnai, L. *Chem. Ber.* **1995**, *128*, 63–70.
644. Ghilardi, C. A.; Innocenti, P.; Midollini, S.; Orlandini, A. *J. Chem. Soc., Dalton Trans.* **1988**, 1063–1066.
645. Di Vaira, M.; Sacconi, L.; Stoppioni, P. *J. Organomet. Chem.* **1983**, *250*, 183–195.
646. Di Vaira, M.; Peruzzini, M.; Stoppioni, P. *Acta Crystallogr.* **1983**, *C39*, 1210–1211.
647. Di Vaira, M.; Stoppioni, P. *Polyhedron* **1994**, *13*, 3045–3051.
648. Bianchini, C.; Masi, D.; Meli, A.; Sabat, M. *Organometallics* **1986**, *5*, 1670–1675.
649. Bianchini, C.; Masi, D.; Mealli, C.; Meli, A. *Inorg. Chem.* **1984**, *23*, 2838–2844.
650. Bianchini, C.; Ghilardi, C. A.; Meli, A.; Orlandini, A. *J. Organomet. Chem.* **1985**, *286*, 259–270.
651. Bianchini, C.; Mealli, C.; Meli, A.; Sabat, M. *Inorg. Chem.* **1984**, *23*, 2732–2734.
652. Bianchini, C.; Innocenti, P.; Meli, A. *J. Chem. Soc., Dalton Trans.* **1983**, 1777–1781.
653. Mercier, F.; Mathey, F.; Fischer, J.; Nelson, J. H. *J. Am. Chem. Soc.* **1984**, *106*, 425–426.
654. Mercier, F.; Mathey, F.; Fischer, J.; Nelson, J. H. *Inorg. Chem.* **1985**, *24*, 4141–4149.
655. Solujic, L.; Milosavljevic, E. B.; Nelson, J. H.; Fischer, J. *Inorg. Chem.* **1994**, *33*, 5654–5658.
656. Jeanneaux, F.; Grand, A.; Riess, J. G. *J. Am. Chem. Soc.* **1981**, *103*, 4272–4273.
657. Faw, R.; Montgomery, C. D.; Rettig, S. J.; Shumer, B. *Inorg. Chem.* **1998**, *37*, 4136–4138.
658. Melenkivitz, R.; Mindiola, D. J.; Hillhouse, G. L. *J. Am. Chem. Soc.* **2002**, *124*, 3846–3847.
659. Jones, R. A.; Seeberger, M. H.; Whittlesey, B. R. *J. Am. Chem. Soc.* **1985**, *107*, 6424.
660. Phillips, I. G.; Ball, R. G.; Cavell, R. G. *Inorg. Chem.* **1992**, *31*, 1633–1641.
661. Hope, H.; Olmstead, M. M.; Power, P. P.; Viggiano, M. *Inorg. Chem.* **1984**, *23*, 326–330.
662. Bader, A.; Lindner, E. *Coord. Chem. Rev.* **1991**, *108*, 27–110.
663. Dilworth, J. R.; Wheatley, N. *Coord. Chem. Rev.* **2000**, *199*, 89–158.
664. Slone, C. S.; Weinberger, D. A.; Mirkin, C. A. *Prog. Inorg. Chem.* **1999**, *48*, 233–350.
665. Horner, L.; Simons, G. *Z. Naturforsch.* **1984**, Teil B, *39*, 497–503.
666. Keim, W. *Angew. Chem.* **1990**, *102*, 251–260; *Angew. Chem., Int. Ed. Engl.* **1990**, *29*, 235–244.
667. Ciampolini, M.; Dapporto, P.; Nardi, N.; Zanobini, F. *Inorg. Chem.* **1983**, *22*, 13–17.
668. Qichen, H.; Minzhi, X.; Yanlong, Q.; Weihua, X. *J. Organomet. Chem.* **1985**, *287*, 419–426.
669. Müller, U.; Keim, W.; Krüger, C.; Betz, P. *Angew. Chem.* **1989**, *101*, 1066–1067; *Angew. Chem., Int. Ed. Engl.* **1989**, *28*, 1011–1012.
670. Soulivong, D.; Wieser, C.; Marcellin, M.; Matt, D.; Harriman, A.; Toupet, L. *J. Chem. Soc., Dalton Trans.* **1997**, 2257–2262.
671. Brassat, I.; Englert, U.; Keim, W.; Keitel, D. P.; Killat, S.; Suranna, G.-P.; Wang, R. *Inorg. Chim. Acta* **1998**, *280*, 150–162.
672. Wegman, R. W.; Abatjoglou, A. G.; Harrison, A. M. *J. Chem. Soc., Chem. Commun.* **1987**, 1891–1892.
673. Cauzzi, D.; Graiff, C.; Lanfranchi, M.; Priedieri, G.; Tiripicchio, A. *Inorg. Chim. Acta* **1998**, *273*, 320–325.
674. Pfeiffer, E.; Pasquier, M. L.; Marty, W. *Helv. Chim. Acta* **1984**, *67*, 654–663.
675. Leung, P. H.; Martin, J. W. L.; Wild, S. B. *Inorg. Chem.* **1986**, *25*, 3396–3400.
676. Hsiao, Y.-M.; Chojnacki, S. S.; Hinton, P.; Reibenspies, J. H.; Darensbourg, M. Y. *Organometallics* **1993**, *12*, 870–875.
677. Tenorio, M. J.; Puerta, M. C.; Valerga, P. *J. Chem. Soc., Dalton Trans.* **1996**, 1935–1939.
678. Kaiwar, S. P.; Hsu, J. K.; Liable-Sands, L. M.; Rheingold, A. L.; Pilato, R. S. *Inorg. Chem.* **1997**, *36*, 4234–4240.
679. McLauchlan, C. C.; Ibers, J. A. *Inorg. Chem.* **2000**, *39*, 1046–1048.
680. Braun, T.; Perutz, R. N. *Chem. Commun.* **2002**, 2749–2757.
681. Braun, T.; Foxon, S. P.; Perutz, R. N.; Walton, P. H. *Angew. Chem.* **1999**, *111*, 3543–3545; *Angew. Chem., Int. Ed. Engl.* **1999**, *38*, 3326–3329.
682. Cronin, L.; Higgitt, C. L.; Karch, R.; Perutz, R. N. *Organometallics* **1997**, *16*, 4920–4928.
683. Braun, T.; Cronin, L.; Higgitt, C. L.; McGraely, J. E.; Perutz, R. N.; Reihold, M. *New J. Angew. Chem.* **2001**, *25*, 19–21; *Angew. Chem., Int. Ed. Engl.* **1999**, *38*, 3326–3329.
684. Archibald, S. J.; Braun, T.; Gaunt, J. A.; Hobson, J. E.; Perutz, R. N. *J. Chem. Soc., Dalton Trans.* **2000**, 2013–2018.
685. Braun, T.; Blöcker, B.; Schorlemer, V.; Neumann, B.; Stammeler, A.; Stammeler, H.-G. *J. Chem. Soc., Dalton Trans.* **2002**, 2213–2218.
686. Crociani, L.; Refosco, F.; Tisato, F.; Gatto, S.; Corain, B. *Inorg. Chim. Acta* **1996**, *249*, 131–133.
687. Jalil, M. A.; Fujinami, S.; Senda, H.; Nishikawa, H. *J. Chem. Soc., Dalton Trans.* **1999**, 1655–1661.
688. Newkome, G. R. *Chem. Rev.* **1993**, *93*, 2067–2089.
689. Porte, A. M.; Reibenspies, J.; Burgess, K. *J. Am. Chem. Soc.* **1998**, *120*, 9180–9187.
690. Cotton, F. A.; Kang, S.-J. *Inorg. Chim. Acta* **1993**, *209*, 23–27.
691. Faller, J. W.; Mazzieri, M. R.; Nguyen, J. T.; Parr, J.; Tokunaga, M. *Pure Appl. Chem.* **1994**, *66*, 1463–1469.
692. Bray, K. L.; Butts, C. P.; Lloyd-Jones, G. C.; Murray, M. J. *J. Chem. Soc., Dalton Trans.* **1998**, 1421–1422.
693. Ligtenbarg, A. G. J.; van den Beuken, E. K.; Meetsma, A.; Veldman, N.; Smeets, W. J. J.; Spek, A. L.; Feringa, B. L. *J. Chem. Soc., Dalton Trans.* **1998**, 263–270.
694. Keim, W. *J. Mol. Catal.* **1989**, *52*, 19–25.
695. Braunstein, P.; Pietsch, J.; Chauvin, Y.; Mercier, S.; Saussine, L.; DeCian, A.; Fisher, J. *J. Chem. Soc., Dalton Trans.* **1996**, 3571–3574.
696. Bonnet, M. C.; Dahan, F.; Ecke, A.; Keim, W.; Schulz, R. P.; Tkachenko, I. *J. Chem. Soc., Chem. Commun.* **1994**, 615–616.
697. Parr, J.; Slavin, A. M. *Z. Inorg. Chim. Acta* **2000**, *303*, 116–120.

698. Reinhard, G.; Soltek, R.; Huttner, G.; Barth, A.; Walter, O.; Zsolnai, L. *Chem. Ber.* **1996**, *129*, 97–108.
699. Hanton, L. R.; Evans, J.; Levason, W.; Perry, R. J.; Webster, M. *J. Chem. Soc., Dalton Trans.* **1991**, 2039–2044.
700. Higgins, S. J.; Levason, W. *Inorg. Chem.* **1985**, *24*, 1105–1107.
701. Levason, W. *Comments Inorg. Chem.* **1990**, *9*, 331–361.
702. Higgins, S. J.; Levason, W.; Feiters, M. C.; Steel, A. T. *J. Chem. Soc., Dalton Trans.* **1986**, 317–322.
703. Salem, G.; Wild, S. B. *Inorg. Chem.* **1984**, *23*, 2655–2663.
704. Fitzpatrick, M. G.; Hanton, L. R.; McMorran, D. A. *Inorg. Chem.* **1995**, *34*, 4821–4827.
705. Buckingham, D. A.; Clark, C. R.; Hanton, L. R.; McMorran, D. A. *J. Chem. Soc., Dalton Trans.* **1997**, 1165–1167.
706. Fitzpatrick, M. G.; Hanton, L. R.; Simpson, J. *Inorg. Chim. Acta* **1996**, *244*, 131–136.
707. Balbolov, E.; Mitkova, M.; Kurtev, K.; Gehrke, J. P.; Taube, R. *J. Organomet. Chem.* **1988**, *352*, 247–256.
708. Taube, R.; Gehrke, J. P.; Schmidt, U. *J. Organomet. Chem.* **1985**, *292*, 287–296.
709. Cotton, F. A.; Daniels, L. M.; Murillo, C. A.; Queseda, J. F. *Inorg. Chem.* **1993**, *32*, 4861–4867.
710. Groh, S. E.; Riggs, P. J.; Baldacchini, C. J.; Rheingold, A. L. *Inorg. Chim. Acta* **1990**, *174*, 17–20.
711. Halasyamani, P.; Willis, M. J.; Stern, C. L.; Poeppelmeier, K. R. *Inorg. Chim. Acta* **1995**, *240*, 109–115.
712. Henderson, W.; Nicholson, B. K. *Acta Crystallogr.* **1995**, *C51*, 37–40.
713. Berraho, M.; R'Kha, C.; Vegas, A.; Rafiq, M. *Acta Crystallogr.* **1992**, *C48*, 1350–1352.
714. Kristiansson, O.; Persson, I.; Bobicz, D.; Xu, D. *Inorg. Chim. Acta* **2003**, *344*, 15–27; and references therein.
715. Atwood, J. L.; Orr, G. W.; Hamada, F.; Vincent, R. L.; Bott, S. G.; Robinson, K. D. *J. Am. Chem. Soc.* **1991**, *113*, 2760–2761.
716. McKee, V.; Metcalfe, T.; Wikaira, J. *Acta Crystallogr.* **1996**, *C52*, 1139–1141.
717. Li, W.-S.; Blake, A. J.; Champness, N. R.; Schröder, M.; Bruce, D. W. *Acta Crystallogr.* **1998**, *C54*, 349–351.
718. McLauchlan, C. C.; Robowski, S. D.; Ibers, J. A. *Inorg. Chem.* **2001**, *40*, 1372–1375.
719. Bobicz, D.; Kristiansson, O.; Persson, I. *J. Chem. Soc., Dalton Trans.* **2002**, 4201–4205.
720. Long, D. L.; Hu, H.-M.; Chen, J.-T.; Huang, J.-S. *Acta Cryst.* **1999**, *C55*, 339.
721. Kalugin, O. N.; Ashok, K. A. *Phys. Chem. Chem. Phys.* **2000**, *2*, 11.
722. Reibenspies, J. H.; Kim, J. S. *Z. Krist.* **1996**, *211*, 418.
723. Inada, Y.; Sugimoto, K.-I.; Ozutsumi, K.; Funahashi, S. *Inorg. Chem.* **1994**, *33*, 1875.
724. Castro, I.; Calatayud, M. L.; Sletten, J.; Julve, M. *J. Chem. Soc., Dalton Trans.* **1997**, 811–817.
725. Gutschke, S. O. H.; Molinier, M.; Powell, A. K.; Wood, P. T. *Angew. Chem., Int. Ed. Engl.* **1997**, *36*, 991–992.
726. Alleyne, B. D.; Hall, L. A.; Hosein, H.-A.; Jaggernauth, H.; White, A. J. P.; Williams, D. J. *J. Chem. Soc.* **1998**, 33845–3850.
727. Alleyne, B. D.; Hosein, H.-A.; Jaggernauth, H.; Hall, L. A.; White, A. J. P.; Williams, D. J. *Inorg. Chem.* **1999**, *38*, 2416–2421.
728. Hosein, H.-A.; Jaggernauth, H.; Alleyne, B. D.; Hall, L. A.; White, A. J. P.; Williams, D. J. *Inorg. Chem.* **1999**, 3716–3720.
729. Eremenko, I. L.; Nefedov, S. E.; Sidorov, A. A.; Moiseev, I. I. *Russ. Chem. Bull.* **1999**, *48*, 405–416.
730. Kumagai, H.; Oka, Y.; Akita-Tanaka, M.; Inoue, K. *Inorg. Chim. Acta* **2002**, *332*, 176–180.
731. Sequeira, A.; Rajagopal, H.; Gupta, M. P.; Vanhouteghem, F.; Lenstra, A. T. H.; Geise, H. J. *Acta Crystallogr.* **1992**, *C48*, 1192–1197.
732. Sundberg, M. R.; Sillanpää, R.; Jokela, J. *Inorg. Chim. Acta* **1996**, *248*, 1–7.
733. Sundberg, M. R.; Tylli, H.; Matikainen, J.; Böök, T.; Ugglä, R.; Valkeapää, M. *Inorg. Chim. Acta* **1997**, *266*, 47–53.
734. Godfrey, S. M.; McAuliffe, C. A.; Ranger, G. C.; Kelly, D. G. *J. Chem. Soc., Dalton Trans.* **1993**, 2809–2815.
735. Kawaguchi, S. *Coord. Chem. Rev.* **1986**, *70*, 51–84.
736. Thorton, D. A. *Coord. Chem. Rev.* **1990**, *104*, 173–249.
737. Romero, R. R.; Cervantes-Lee, F.; Porter, L. C. *Acta Crystallogr.* **1992**, *C48*, 993–995.
738. Soldatov, D. V.; Henegouwen, A. T.; Enright, G. D.; Ratcliffe, C. I.; Ripmeester, J. A. *Inorg. Chem.* **2001**, *40*, 1626–1636.
739. Soldatov, D. V.; Enright, G. D.; Ripmeester, J. A. *Supramol. Chem.* **1999**, *11*, 35–47.
740. Hotz, R. P.; Purrington, S. T.; Singh, P.; Bereman, R. D.; Sinn, E. *Inorg. Chim. Acta* **1987**, *130*, 195–201.
741. Jircitano, A. J.; Henry, R. F.; Hammond, R. R. *Acta Crystallogr.* **1990**, *C46*, 1799–1802.
742. Döhring, A.; Goddard, R.; Jolly, P. W.; Krüger, C.; Polyakov, V. R. *Inorg. Chem.* **1997**, *36*, 177–183.
743. Polyakov, V. R.; Czerwinski, M. *Inorg. Chem.* **2001**, *40*, 4798–4802.
744. Basato, M.; Detomi, N.; Meneghetti, M.; Valle, G.; Veronese, A. C. *Inorg. Chim. Acta* **1999**, *285*, 18–24.
745. Hynes, M. J. *Rev. Inorg. Chem.* **1990**, *11*, 21–78.
746. Hirsch, J.; Paulus, H.; Elias, H. *Inorg. Chem.* **1996**, *35*, 2343–2351.
747. Crumbliss, A. L. *Coord. Chem. Rev.* **1990**, *105*, 155–179.
748. Tam, S. S. C.; Lee, D. H. S.; Wang, E. Y.; Munroe, D. G.; Lau, C. Y. *J. Biol. Chem.* **1995**, *270*, 13948–13955.
749. Stemmler, A. J.; Kampf, J. W.; Kirk, M. L.; Pecoraro, V. L. *J. Am. Chem. Soc.* **1995**, *117*, 6368–6369.
750. Botos, I.; Scapozza, L.; Zhang, D.; Liotta, L. A.; Meyer, E. F. *Proc. Natl. Acad. Sci. USA* **1996**, *93*, 2749–2754.
751. Sun, Y.; Martell, A. E.; Motekaitis, R. J. *Inorg. Chem.* **1985**, *24*, 4343–4350.
752. Hutchinson, B.; Sample, S.; Thompson, L.; Olbricht, S.; Crowder, J.; Hurley, D.; Eversdyk, D.; Jett, D.; Bostick, J. *Inorg. Chim. Acta* **1983**, *74*, 29–38.
753. Parekh, P. C.; Manon, S. K.; Agrawal, Y. K. *J. Chem. Soc., Perkin Trans. 2* **1989**, 1117–1123.
754. Farkas, E.; Enyedy, E. A.; Micera, G.; Garribba, E. *Polyhedron* **2000**, *19*, 1727–1736.
755. Swiatek-Kozłowska, J.; Fritsky, I. O.; Dobosz, A.; Karaczyn, A.; Dudarenko, N. M.; Sliva, T. Y.; Gumienka-Kontecka, E.; Jerzykiewicz, L. *J. Chem. Soc., Dalton Trans.* **2000**, 4064–4068.
756. Amelie, S. M.; Grazina, R.; Pinto, M.; Farkas, E. *Inorg. Chim. Acta* **2001**, *321*, 42–48.
757. Cheng, L.; Khan, M. A.; Powell, D. R.; Taylor, R. W.; Richter-Addo, G. B. *Chem. Commun.* **1999**, 1941–1942.
758. Santana, M. D.; Garcia, G.; Pérez, J.; Molins, E.; López, G. *Inorg. Chem.* **2001**, *40*, 5701–5703.
759. Arnold, M.; Brown, D. A.; Deeg, O.; Errington, W.; Haase, W.; Herlihy, K.; Kemp, T. J.; Nimir, H.; Werner, R. *Inorg. Chem.* **1998**, *37*, 2920–2925.
760. Gaynor, D.; Starikova, Z. A.; Ostrovsky, S.; Haase, W.; Nolan, K. B. *Chem. Commun.* **2002**, 506–507.

761. Psoomas, G.; Stemmler, A. J. M.; Dendrinou-Samara, C.; Bodwin, J. J.; Schneider, M.; Alexiou, M.; Kampf, J.; Kesissoglou, D. P.; Pecoraro, V. L. *Inorg. Chem.* **2001**, *40*, 1562–1570.
762. Royles, B. J. L. *Chem. Rev.* **1995**, *95*, 1981–2001.
763. Pierpont, C. G.; Lange, C. W. *Prog. Inorg. Chem.* **1994**, *41*, 331–442.
764. Brückner, C.; Caulder, D. L.; Raymond, K. N. *Inorg. Chem.* **1998**, *37*, 6759–6764.
765. Huang, S.-P.; Franz, K. J.; Olmstead, M. M.; Fish, R. H. *Inorg. Chem.* **1995**, *34*, 2820–2825.
766. Reynolds, R. A. III; Yu, W. O.; Dunham, W. R.; Coucouvanis, D. *Inorg. Chem.* **1996**, *35*, 2721–2722.
767. Abakumov, G. A.; Cherkasov, V. K.; Bubnov, M. P.; Ellert, O. G.; Rakitin, Y. V.; Zakharov, L. N.; Struchkov, Y. T.; Saf'yanov, Y. N. *Izv. Akad. Nauk SSSR, Ser. Khim.* **1992**, *41*, 1813–1818.
768. Lange, C. W.; Pirpont, C. G. *Inorg. Chim. Acta* **1997**, *263*, 219–224.
769. Lange, C. W.; Conklin, B. J. M.; Pierpont, C. G. *Inorg. Chem.* **1994**, *33*, 1276–1283.
770. Benelli, C.; Die, A.; Gatteschi, D.; Pardi, L. *Inorg. Chem.* **1989**, *28*, 1476–1480.
771. Benelli, C.; Die, A.; Gatteschi, D.; Pardi, L. *Inorg. Chem.* **1988**, *27*, 2831–2836.
772. Benelli, C.; Die, A.; Gatteschi, D.; Pardi, L. *J. Am. Chem. Soc.* **1988**, *110*, 6897–6898.
773. Wang, C.-C.; Yang, C.-H.; Lee, G.-H. *Inorg. Chem.* **2002**, *41*, 1015–1018.
774. Amoroso, A. J.; Burrows, M. W.; Dickinson, A. A.; Jones, C.; Willock, D. J.; Wong, W.-T. *J. Chem. Soc., Dalton Trans.* **2001**, 225–227.
775. Baggio, R.; Garland, M. T.; Pereg, M. *Inorg. Chim. Acta* **2000**, *310*, 103–109.
776. Rochon, F. D.; Massarweh, G. *Inorg. Chim. Acta* **2000**, *304*, 190–198.
777. Akita, M.; Ma, D.; Hikichi, S.; Moro-oka, Y. *J. Chem. Soc., Dalton Trans.* **1999**, 987–996.
778. Vivic, D. A.; Jones, W. D. *J. Am. Chem. Soc.* **1997**, *119*, 10855–10856.
779. Vivic, D. A.; Jones, W. D. *J. Am. Chem. Soc.* **1999**, *121*, 4070–4071.
780. Pleus, R. J.; Waden, H.; Saak, W.; Haase, D.; Pohl, S. *J. Chem. Soc., Dalton Trans.* **1999**, 2601–2610.
781. Vivic, D. A.; Jones, W. D. *J. Am. Chem. Soc.* **1999**, *121*, 7606–7617.
782. Tremel, W.; Krebs, B.; Henkel, G. *J. Chem. Soc., Chem. Commun.* **1986**, 1527–1529.
783. Ghilardi, C. A.; Midollini, S.; Orlandini, A.; Battistoni, C.; Mattogno, G. *J. Chem. Soc., Dalton Trans.* **1984**, 939–942.
784. Blower, P. J.; Dilworth, J. R. *Coord. Chem. Rev.* **1987**, *76*, 121–185.
785. Wilk, A.; Hitchman, M. A.; Massa, W.; Reinen, D. *Inorg. Chem.* **1993**, *32*, 2483–2490.
786. Müller, A.; Henkel, G. *Z. Naturforsch.* **1995**, *50B*, 1464–1468.
787. Yamamura, T.; Miyamae, H.; Katayama, Y.; Sasaki, Y. *Chem. Lett.* **1985**, *3*, 269–272.
788. Rheingold, A. L.; Beall, K. S.; Riggs, P. J.; Groh, S. E. *Acta Cryst.* **1993**, *49C*, 542–543.
789. Rosenfield, S. G.; Armstrong, W. H.; Mascharak, P. K. *Inorg. Chem.* **1986**, *25*, 3014–3018.
790. Silver, A.; Koch, S. A.; Millar, M. *Inorg. Chim. Acta* **1993**, *205*, 9–14.
791. Yamamura, T.; Arai, H. *Bull. Chem. Soc. Jpn.* **1992**, *65*, 1799–1806.
792. Matsumoto, K.; Nakanishi, I.; Nakano, H.; Ooi, S. *Polyhedron* **1996**, *15*, 4501–4505.
793. Matsumoto, K.; Nakano, H.; Ooi, S. *Chem. Lett.* **1988**, 823–826.
794. Rosenfield, S. G.; Wong, M. L. Y.; Stephan, D. W.; Mascharak, P. K. *Inorg. Chem.* **1987**, *26*, 4119–4122.
795. Gaete, W.; Ros, J.; Solans, X.; Font-Altaba, M.; Brianoso, J. L. *Inorg. Chem.* **1984**, *23*, 39–43.
796. Kriege, M.; Henkel, G. *Z. Naturforsch. B* **1987**, *42*, 1121–1128.
797. Krüger, T.; Krebs, B.; Henkel, G. *Angew. Chem., Int. Ed.* **1989**, *28*, 61–62.
798. Kockerling, M.; Henkel, G. *Inorg. Chem. Commun.* **2000**, *3*, 117–119.
799. Mahmoudkhani, A. H.; Langer, V. *Inorg. Chim. Acta* **1999**, *294*, 83–86.
800. Koo, B. K.; Block, E.; Kang, H.; Liu, S.; Zubietta, J. *Polyhedron* **1988**, *7*, 1397–1399.
801. Mahmoudkhani, A. H.; Langer, V. *Polyhedron* **1999**, *18*, 3407–3410.
802. Capdevila, M.; Gonzalez-Duarte, P.; Sola, J.; Foces-Foces, C.; Hernandez, C. F.; Martinez-Ripoll, M. *Polyhedron* **1989**, *8*, 1253–1259.
803. Yamamura, T. *Bull. Chem. Soc. Jpn.* **1988**, *61*, 1975–1978.
804. Wark, T. A.; Stephan, D. W. *Organometallics* **1989**, *8*, 2836–2843.
805. Schulbert, K.; Mattes, R. *Z. Naturforsch. B* **1994**, *49*, 770–772.
806. Feld, H.; Leute, A.; Rading, D.; Benninghoven, A.; Henkel, G.; Krüger, T.; Krebs, B. *Z. Naturforsch. B* **1992**, *47*, 929–936.
807. Barrera, H.; Bayon, J. C.; Suades, J.; Germain, C.; Declercq, J. P. *Polyhedron* **1984**, *3*, 969–975.
808. Dance, I. G.; Scudder, M. I.; Secomb, R. *Inorg. Chem.* **1985**, *24*, 1201–1208.
809. Ivanov, S. A.; Kozee, M. A.; Merrill, W. A.; Agarwal, S.; Dahl, L. F. *J. Chem. Soc., Dalton Trans.* **2002**, 4105–4115.
810. Colpas, G. J.; Kumar, M.; Day, R. O.; Maroney, M. J. *Inorg. Chem.* **1990**, *29*, 4779–4788.
811. Krüger, T.; Krebs, B.; Henkel, G. *Angew. Chem., Int. Ed. Engl.* **1992**, *31*, 55–56.
812. Müller, A.; Henkel, G. *Chem. Commun.* **1996**, 1005–1006.
813. Cheung, F.-W.; Lin, Z. *Angew. Chem., Int. Ed. Engl.* **1997**, *36*, 1847–1849.
814. Wenkert, E.; Shepard, M. E.; McPhail, A. T. *Chem. Commun.* **1986**, 1390–1391.
815. Osakada, K.; Maeda, M.; Nakamura Y.; Yamamoto, T.; Yamamoto, A. *Chem. Commun.* **1986**, 442–443.
816. Baidya, N.; Olmstead, M.; Mascharak, P. K. *Inorg. Chem.* **1991**, *30*, 929–937.
817. Clegg, W.; Henderson, R. A. *Inorg. Chem.* **2002**, *41*, 1128–1135.
818. Yamamura, T.; Kurihara, H.; Nakamura, N.; Kuroda, R.; Asakura, K. *Chem. Lett.* **1990**, 101–104.
819. Snyder, B. S.; Rao, C. P.; Holm, R. H. *Aust. J. Chem.* **1986**, *39*, 963–974.
820. Tremel, W.; Kriege, M.; Krebs, B.; Henkel, G. *Inorg. Chem.* **1988**, *27*, 3886–3895.
821. Fox, S.; Wang, Y.; Silver, A.; Millar, M. *J. Am. Chem. Soc.* **1990**, *112*, 3218–3220.
822. Kockerling, M.; Henkel, G. *Inorg. Chem. Commun.* **2000**, *3*, 117–119.
823. Tabushi, I.; Yamamura, K.; Nonoguchi, H. *Chem. Lett.* **1987**, 1373–1376.
824. Ohta, K.; Hasebe, H.; Ema, H.; Fujimoto, T.; Yamamoto, I. *Chem. Commun.* **1989**, 1610–1611.
825. Kamysbaev, D. K.; Utegulov, R. N.; Ospanov, K. K. *Koord. Khim.* **1992**, *18*, 156–159.
826. Bonomi, F.; Pagani, S.; Cariati, F.; Pozzi, A.; Crisponi, G.; Cristiani, F.; Diaz, A.; Zannoni, R. *Inorg. Chim. Acta* **1992**, *192*, 237–242.

827. Tremel, W.; Krebs, B.; Henkel, G. *Inorg. Chim. Acta* **1983**, *80*, L31–L32.
828. Tremel, W.; Krebs, B.; Henkel, G. *Angew. Chem.* **1984**, *96*, 604–605.
829. Erkizia, E.; Conry, R. R. *Inorg. Chem.* **2000**, *39*, 1674–1679.
830. Cao, R.; Lei, X.; Huang, Z.; Hong, M.; Liu, H. *J. Coord. Chem.* **1992**, *25*, 165–169.
831. Coucouvanis, D.; Patil, P. R.; Kanatzidis, M. G.; Detering, B.; Baenzinger, N. C. *Inorg. Chem.* **1985**, *24*, 24–31.
832. Weiß, J. Z. *Anorg. Allg. Chem.* **1985**, *521*, 44–56.
833. Udpa, K. N.; Sarkar, S. *Polyhedron* **1987**, *6*, 627–631.
834. Köckerling, M.; Henkel, G. *Z. Naturforsch.* **1996**, *51B*, 178–186.
835. Lucas, C. R.; Liu, S. *J. Chem. Soc., Dalton Trans.* **1994**, 185–190.
836. Desper, J. M.; Gellman, S. H. *Angew. Chem., Int. Ed. Engl.* **1994**, *33*, 319–322.
837. Ohrenberg, C.; Ge, P.; Schebler, P.; Riordan, C. G.; Yap, G. P. A.; Rheingold, A. L. *Inorg. Chem.* **1996**, *35*, 749–754.
838. Ge, P.; Riordan, C. G.; Yap, G. P. A.; Rheingold, A. L. *Inorg. Chem.* **1996**, *35*, 5408–5409.
839. Schebler, P. J.; Mandimutsira, B. S.; Riordan, C. G.; Liable-Sands, L. M.; Incarvito, C. D.; Rheingold, A. L. *J. Am. Chem. Soc.* **2001**, *123*, 331–332.
840. Ge, P.; Rheingold, A. L.; Riordan, C. G. *Inorg. Chem.* **2002**, *41*, 1383–1390.
841. Thorne, C. M.; Rawle, S. C.; Admans, G. A.; Cooper, S. R. *Inorg. Chem.* **1986**, *25*, 3850–3851.
842. Grant, G. J.; Grant, C. D.; Setzer, W. N. *Inorg. Chem.* **1991**, *30*, 353–355.
843. Yamamura, T.; Arai, H.; Nakamura, N.; Miyamae, H. *Chem. Lett.* **1990**, 2121–2124.
844. Yamamura, T.; Sakurai, S.; Arai, H.; Miyamae, H. *Chem. Commun.* **1993**, 1656–1658.
845. Sellmann, D.; Bail, P.; Knoch, F.; Moll, M. *Chem. Ber.* **1995**, *128*, 653–663.
846. Sellmann, D.; Fünfgelder, S.; Pöhlmann, G.; Knoch, F.; Moll, M. *Inorg. Chem.* **1990**, *29*, 4772–4778.
847. Sellmann, D.; Bail, P.; Knoch, F.; Moll, M. *Inorg. Chim. Acta* **1995**, *237*, 137–141.
848. Sellmann, D.; Schillinger, H.; Knoch, F. *Z. Naturforsch.* **1992**, *47B*, 645–655.
849. Sellmann, D.; Fünfgelder, S.; Knoch, F. *Z. Naturforsch.* **1991**, *46B*, 1593–1600.
850. Sellmann, D.; Fünfgelder, S.; Knoch, F.; Moll, M. *Z. Naturforsch.* **1991**, *46B*, 1601–1608.
851. Sellmann, D.; Häussinger, D.; Knoch, F.; Moll, M. *J. Am. Chem. Soc.* **1996**, *118*, 5368–5374.
852. Sellmann, D.; Geipel, F.; Heinemann, F. W. *Eur. J. Inorg. Chem.* **2000**, 271–279.
853. Sellmann, D.; Häußinger, D.; Heinemann, F. W. *Eur. J. Inorg. Chem.* **1999**, 1715–1725.
854. Sellmann, D.; Geipel, F.; Heinemann, F. W. *Eur. J. Inorg. Chem.* **2000**, 59–63.
855. Sellmann, D.; Geipel, F.; Moll, M. *Angew. Chem. Int. Ed.* **2000**, *39*, 561–563.
856. Sellmann, D.; Geipel, F.; Heinemann, F. W. *Chem. Eur. J.* **2000**, *6*, 4279–4284.
857. Mirza, S. A.; Pressler, M. A.; Kumar, M.; Day, R. O.; Maroney, M. J. *Inorg. Chem.* **1993**, *32*, 977–987.
858. Yamamura, T.; Sakurai, S.; Arai, H.; Miyamae, H. *J. Chem. Commun.* **1993**, 1656–1658.
859. Yamamura, T.; Watanabe, H.; Niino, Y.; Fujisawa, K.; Morooka, Y. *Inorg. Chim. Acta* **1997**, *263*, 415–420.
860. Cha, M.; Shoner, S. C.; Kovacs, J. A. *Inorg. Chem.* **1993**, *32*, 1860–1863.
861. Fackler, J. P., Jr.; Del Niera, P. R.; Campana, C.; Trzcinska-Bancroft, B. *J. Am. Chem. Soc.* **1984**, *106*, 7883–7886.
862. Hoskins, B. F.; Tiekink, E. R. T. *Acta Crystallogr.* **1985**, *C41*, 322–324.
863. Lin, C.; Liu, S.; Xu, Z.; Lin, J.; You, X. *Jiegou Huaxue* **1987**, *6*, 186–188.
864. Benedetti, M.; Biscarini, P.; Foresti E.; Sabatino, P.; Kuroda, R. *Enantiomer* **1999**, *4*, 57–61.
865. You, X.; Xu, Z.; Yu, Y.; Liu, S.; Lin, C. *Jiegou Huaxue* **1986**, *5*, 154–158.
866. Huang, J.; Yu, Y.; Xu, Z.; You, X. *Acta Crystallogr.* **1990**, *C46*, 991–993.
867. Yu, Y.; Zhu, D.; Liu, S.; Lin, C.; Xu, Z.; Gou, S.; You, X. *Jiegou Huaxue* **1990**, *9*, 73–79.
868. Lin, J.; Xu, Z.; You, X.; Yu, Y.; Zhu, D.; Liu, S.; Lin, C. *Jiegou Huaxue* **1990**, *9*, 201–210.
869. You, X.; Xu, Z.; Xu, X.; Lin, J.; Yu, Y.; Lin, C.; Liu, S. *Chin. Sci. Bull.* **1992**, *37*, 657–661.
870. You, X.-Z.; Xiong, R.; Dong, J.-X.; Huang, X.-Y. *Polyhedron* **1994**, *13*, 2763–2766.
871. Huang, X.-Y.; Xiong, R.-G.; Dong, J.-X.; You, X.-Z. *Acta Crystallogr.* **1995**, *C51*, 598–600.
872. Song, B.-L.; Xiong, R.-G.; You, X.-Z.; Huang, X.-Y. *Acta Crystallogr.* **1995**, *C51*, 2258–2259.
873. Huang, X.-Y.; Xiong, R.-G.; You, X.-Z. *Acta Crystallogr.* **1995**, *C51*, 2261–2263.
874. Xiong, R.-G.; You, X.-Z.; Huang, X.-Y. *Acta Crystallogr.* **1995**, *C51*, 2263–2265.
875. Xiong, R.-G.; Yu, Z.; Zuo, J.-L.; You, X.-Z.; Huang, X.-Y. *Spectrosc. Lett.* **1997**, *30*, 403–413.
876. Machala, V.; Travnicek, Z.; Sindelar, Z.; Kvitek, L.; Marek J. *Transition Met. Chem.* **2000**, *25*, 715–719.
877. Hao, Q.; Fun, H. K.; Chantrapromma, S.; Razak, I. A.; Jian, F.; Yang, X.; Lu, L.; Wang, X. *Acta Crystallogr.* **2001**, *C57*, 717–718.
878. Hao, Q.; Jian, F.; Wang, X.; Razak, I. A.; Shanmuga Sundara Raj, S.; Fun, H. K. *Acta Crystallogr.* **2001**, *C57*, 160–161.
879. Bhasin, C. P.; Bohra, R.; Srivastava, G.; Mehrotra, R. C.; Hitchcock, P. B. *Inorg. Chim. Acta* **1989**, *164*, 11–16.
880. Liu, S.; Lin, C.; Yu, Y.; Zhu, D.; Xu, Z.; Gou, S.; You, X. *Acta Crystallogr.* **1991**, *C47*, 43–45.
881. Gorodkiewicz, E. Figaszewski Z. *Chem. Analityczna* **1998**, *43*, 445–455.
882. Aly, A. A. M.; Al-Quirashi, M. A. *Bull. Faculty Sci.* **1999**, *28*, 9–20.
883. Howell, B. A.; Sastry, B. B. S. *Thermochim. Acta* **1999**, *340-341*, 311–314.
884. Howell, B. A.; Sastry, B. B. S. *Polym. Mater. Sci. Eng.* **1996**, *74*, 276–277.
885. Aly, A. A. M. *Transition Met. Chem.* **1991**, *16*, 249–251.
886. Gemmler-Colos, V.; Neeb, R. *Fresenius' Z. Anal. Chem.* **1982**, *311*, 496–498.
887. Mukherjee, R. N.; Vijaya, V. S.; Gogoi, P. K. *Thermochim. Acta* **1982**, *57*, 387–389.
888. Lu, Z.; Chen, S.; Yu, Y.; Sun, J.; Xiang, S. *J. Therm. Anal. Cal.* **1999**, *55*, 197–203.
889. Toropova, V. F.; Garifiyanov, A. R.; Panfilova, I. E.; Sara'eva, N. I.; Cherkasov, R. A. *Zh. Obshch. Khim.* **1984**, *54*, 2200–2203.
890. Burn, A. J.; Dewan, S. K.; Gosney, I.; McKendrick, K. G.; Warrens, C. P.; Wastle, J. P.; Watson, C. W. *J. Chem. Soc., Perkin Trans.* **1994**, 373–379.
891. Sasaki, Y.; Tagashira, S.; Muratami, Y.; Yoshiko, K. S. *Anal. Sci.* **1993**, *9*, 483–486.
892. Dzhanibekov, N. F.; Medzhidov, A. A.; Akhamedzade, D. A.; Markova, E. I.; Novruzov, O. N. *Koord. Khim.* **1986**, *12*, 679–684.
893. Dzhanibekov, N. F.; Markova, M. Kh.; Gui'shani, Dzh.G. *Russ. J. Coord. Chem.* **1996**, *22*, 56–59.

894. Bhasin, C. P.; Srivastava, G.; Mehrotra, R. C. *Inorg. Chim. Acta* **1987**, *128*, 69–74.
895. Iliev, V.; Alexiev, V. *Spectrochim. Acta* **1995**, *A51*, 969–977.
896. Atanasov, M. A.; Nikolov, G. S. *Inorg. Chim. Acta* **1983**, *68*, 15–23.
897. Hayashi, K.; Sasaki, Y.; Tagashira, S.; Nakashima, M. *Anal. Sci.* **1985**, *1*, 51–54.
898. Losada, J.; Moran, M.; Muro, C. *Transition Met. Chem.* **1989**, *14*, 127–130.
899. Atanasov, M. A.; Nikolov, G. S. *J. Mol. Struct.* **1984**, *114*, 65–68.
900. Ciliberto, E.; DeBella, S.; Fragale, I.; Granozzi, G.; Burton, N. A.; Hillier, I. H.; Kendrick, J.; Guest, M. F. *J. Chem. Soc., Dalton Trans.* **1990**, 849.
901. Bhasin, C. P.; Srivastava, G.; Mehrotra, R. C. *Inorg. Chim. Acta* **1983**, *77*, L131–L134.
902. Aly, A. A. M.; El-Meligy, M. S.; Zidan, A. S. A.; El-Shabasy, M. *Synth. React. Inorg. Met. Org. Chem.* **1987**, *17*, 257–274.
903. Bhasin, C. P.; Srivastava, G.; Mehrotra, R. C. *Indian J. Chem.* **1987**, *A26*, 834–837.
904. Sachinidis, J.; Grant, M. W. *Aust. J. Chem.* **1983**, *36*, 2019–2030.
905. Mukherjee, R. N.; Shankar, S.; Mascarenhas, D. L. *Bull. Chem. Soc. Jpn.* **1986**, *59*, 3239–3242.
906. Ishiguro, S.; Suzuki, H.; You, X.; Yu, Y.; Saito, K. *Inorg. Chim. Acta* **1991**, *180*, 111–115.
907. Haiduc, I.; Micu-Semeniuc, R.; Silaghi-Dumitrescu, L. *Synth. React. Inorg. Met. Org. Chem.* **1993**, *23*, 1629–1643.
908. Al-Qurashi, M. A. *Int. J. Chem.* **1997**, *8*, 19–25.
909. Aly, A. A. M.; El-Shahawy, A. S.; El-Zohry, M.; Mohamed, A. A. *Bull. Soc. Chim. Fr.* **1988**, 930–932.
910. Aly, A. A. M.; Hassan, A. M. A.; Soliman, E. M.; El-Shabasy, M. *Indian J. Chem.* **1990**, *A29*, 811–814.
911. Yordanov, N. D. *Polyhedron* **1990**, *9*, 2597–2602.
912. Arca, M.; Cornia, A.; Devillanova, F. A.; Fabretti, A. C.; Isaia, F.; Lippolis, V.; Verani, G. *Inorg. Chim. Acta* **1997**, *262*, 81–84.
913. Aragoni, M. C.; Arca, M.; Demartin, F.; Devillanova, F. A.; Graiff, C.; Isaia, F.; Lippolis, V.; Tiripiccio, A.; Verani, G. *J. Chem. Soc., Dalton Trans.* **2001**, 2671–2677.
914. Diemert, K.; Haas, P.; Kuchen, W. Z. *Inorg. Allg. Chem.* **1982**, *492*, 148–156.
915. Dogar, F.; Silaghi-Dumitrescu, L.; Grecu, R.; Haiduc, I. *Rev. Roum. Chim.* **1986**, *31*, 79–83.
916. Aragoni, M. C.; Arca, M.; Demartin, F.; Devillanova, F. A.; Graiff, C.; Isaia, F.; Lippolis, V.; Tiripiccio, A.; Verani, G. *Eur. J. Inorg. Chem.* **2000**, 2239–2244.
917. Cavell, R. G.; Creed, B.; Gelmini, L.; Law, D. J.; McDonald, R.; Sanger, A. R.; Somogyvari, A. *Inorg. Chem.* **1998**, *37*, 757–763.
918. Sayettat, J.; Bull, L. M.; Gabriel, J.-C. P.; Jobic, S.; Camerel, F.; Marie, A.-M.; Fourmigué, M.; Batail, P.; Brec, R.; Inglebert, R.-L. *Angew. Chem., Int. Ed.* **1998**, *37*, 1711–1714.
919. Hoskins, B. F.; Tiekink, E. R. T.; Winter, G. Z. *Kristallogr.* **1995**, *172*, 257–261.
920. Cox, M. J.; Tiekink, E. R. T. *Z. Kristallogr.* **1996**, *111*, 111–113.
921. Cox, M. J.; Tiekink, E. R. T. *Z. Kristallogr.* **1997**, *121*, 350–350.
922. Cox, M. J.; Tiekink, E. R. T. *Z. Kristallogr.* **1999**, *214*, 242–250.
923. Edwards, A. J.; Hoskins, B. F.; Winter, G. *Aust. J. Chem.* **1986**, *39*, 1983–1991.
924. Abrahams, B. F.; Hoskins, B. F.; Tiekink, E. R. T.; Edward, R. T.; Winter, George. *Aust. J. Chem.* **1988**, *41*, 1117–1122.
925. Choudhury, S. B.; Ray, D.; Chakravorty, A. *Inorg. Chem.* **1990**, *29*, 4603–4611.
926. Travnicek, Z.; Walla, J.; Kvitek, L.; Sindelar, Z.; Biler, M. *Transition Met. Chem.* **1999**, *24*, 633–637.
927. Travnicek, Z.; Pastorek, S.; Sindelar, Z.; Marek, J. *J. Coord. Chem.* **1998**, *44*, 193–204.
928. Xiong, R.-G.; Yu, Z.; Liu, C.-M.; You, X.-Z. *Polyhedron* **1997**, *16*, 2667–2671.
929. Xiong, R.-G.; Liu, C.-M.; Zuo, J.-L.; Li, H.-Z.; You, X.-Z.; Fun, H.-K.; Sivakumar, K. *Polyhedron* **1997**, *16*, 2315–2319.
930. Travnicek, Z.; Pastorek, R.; Sindelar, Z.; Kamenicek, J.; Marek, J. *Polyhedron* **1996**, *15*, 2975–2981.
931. Travnicek, Z.; Pastorek, R.; Sindelar, Z.; Klicka, R.; Marek, J. *Polyhedron* **1995**, *14*, 3627–3633.
932. Travnicek, Z.; Pastorek, R.; Sindelar, Z.; Marek, J. *Transition Met. Chem.* **1995**, *20*, 67–71.
933. Gable, R. W.; Hoskins, B. F.; Winter, G. *Inorg. Chim. Acta* **1985**, *96*, 151–159.
934. Hussain, Md. F.; Bansal, R. K.; Puri, B. K.; Satake, M. *India. Analyst.* **1985**, *110*, 1131–1136.
935. Ballester, L.; Gutierrez-Alonso, A.; Perpignan, M. F.; Gutierrez-Puebla, E.; Ruiz-Valero, C. *Polyhedron* **1990**, *9*, 1341–1343.
936. Travnicek, Z.; Pastorek, R.; Sindelar, Z.; Kasperek, F.; Marek, J. *Polyhedron* **1997**, *16*, 2573–2579.
937. Ballester, L.; Gutierrez A.; Perpignan, M. F.; Ruiz-Valero, C. *Polyhedron* **1996**, *15*, 1103–1112.
938. Travnicek, Z.; Pastorek, R.; Sindelar, Z.; Klicka, R.; Marek, J. *Transition Met. Chem.* **1996**, *21*, 81–84.
939. Travnicek, Z.; Malon, M.; Sindelar, Z.; Marek, J. *Transition Met. Chem.* **1999**, *24*, 156–159.
940. Pastorek, R.; Travnicek, Z.; Sindelar, Z.; Klicka, R.; Brezina, F.; Marek, J. *Polyhedron* **1995**, *14*, 1615–1620.
941. Ballester, L.; Perpignan, M. F. *J. Chem. Edu.* **1988**, *65*, 362–364.
942. Aly, A. A. M.; El-Meligy, M. S.; Zidan, A. S. A.; El-Shabasi, M. *Synth. React. Inorg. Met. Org. Chem.* **1987**, *17*, 257–274.
943. Dag, O.; Onal, A. M.; Isci, H. *Environment* **1997**, *26*, 579–590.
944. Dag, O.; Yaman, S. O.; Onal, A. M.; Isci, H. *J. Chem. Soc., Dalton Trans.* **2001**, *19*, 2819–2824.
945. Sevaraju, R.; Panchanatheswaran, K.; Thiruvalluvar, A.; Parthasarathi, V. *Acta Crystallogr.* **1995**, *C51*, 606–608.
946. Ramalingam, K.; Radha, K.; Aravamudan, G.; Mahadevan, C.; Subramanyam, C.; Seshasayee, M. *Acta Crystallogr.* **1984**, *C40*, 1838–1839.
947. Christidis, P. C. *Acta Crystallogr.* **1986**, *C42*, 781–783.
948. Engelhardt, L. M.; Patrick, J. M.; White, A. H. *Aust. J. Chem.* **1985**, *38*, 1413–1416.
949. Radha, A.; Seshasayee, M.; Aravamudan, G. *Acta Crystallogr.* **1988**, *C40*, 1378–1381.
950. Garg, B. S.; Garg, R. K.; Reddy, M. J. *Transition Met. Chem.* **1995**, *20*, 97–99.
951. Hadjikostas, C. C.; Katsoulos, G. A.; Sigalas, M. P.; Tsipis, C. A. *Polyhedron* **1989**, *8*, 2637–2639.
952. Hadjikostas, C. C.; Katsoulos, G. A.; Sigalas, M. P.; Tsipis, C. A. *Can. J. Chem.* **1989**, *67*, 902–909.
953. Hadjikostas, C. C.; Katsoulos, G. A.; Sigalas, M. P.; Tsipis, C. A. *Inorg. Chim. Acta* **1989**, *163*, 173–176.
954. Rajendiran, N.; Ramalingam, K.; Thiruneelakandan, R. *Indian J. Chem.* **2001**, *40A*, 1101–1103.

955. Furlani, C.; Polzonetti, G.; Preti, C.; Tosi, G. *Gazz. Chim. Ital.* **1983**, *113*, 609–613.
956. Payne, R.; Magee, R. J.; Liesegang, J. *J. Electron Spectrosc. Relat. Phenom.* **1985**, *35*, 113–130.
957. Thirunelakandan, R.; Ramalingam, K.; Manohar, A.; Bocelli, G.; Righi, L. *Z. Anorg. Allg. Chem.* **2002**, *628*, 685–689.
958. Mazalov, L. N.; Parygina, G. K.; Fomin, E. S.; Bausk, N. V.; Erenburg, S. B.; Zemskova, S. M.; Larionov, S. V. *J. Struct. Chem.* **1998**, *39*, 923–927.
959. Liesegang, J.; Lee, A. R. *J. Electron Spectrosc. Relat. Phenom.* **1985**, *35*, 101–111.
960. Desseyne, H. O.; Fabretti, A. C.; Forghieri, F.; Preti, C. *Spectrochim. Acta* **1985**, *41A*, 1105–1108.
961. Anderson, W. P.; Baird, D. M. *Inorg. Chem.* **1988**, *27*, 3240–3242.
962. Ribeiro da Silva, M. A. V.; Reis, A. M. M. V.; Faria, R. I. M. C. P. *J. Chem. Thermodyn.* **1995**, *27*, 1365–1372.
963. Pastorek, R.; Brezina, F.; Sindelar, Z. *Z. Chem.* **1988**, *28*, 223–224.
964. Pastorek, R.; Brezina, F.; Lackova, L.; Kamenicek, J. *Z. Chem.* **1990**, *30*, 452–454.
965. Aggarwal, R. C.; Bala, R.; Prasad, R. L. *Spectrochim. Acta* **1986**, *42A*, 725–728.
966. Manoussakis, G. E.; Bolos, C. A. *Inorg. Chim. Acta* **1985**, *108*, 215–220.
967. Manohar, A.; Ramalingam, K.; Thirunelakandan, R.; Bocelli, G.; Righi, L. *Z. Anorg. Allg. Chem.* **2001**, *627*, 1103–1108.
968. Pastorek, R.; Travnické, Z.; Ptosek, P.; Sindelar, Z.; Brezina, F.; Marek, J. *J. Coord. Chem.* **1998**, *44*, 247–255.
969. Tenorio, M.; Jimenez, P.; Puerta, M. C.; Valerla, P. *J. Chem. Soc., Dalton Trans.* **1996**, 1935–1939.
970. Venkatachalam, V.; Ramalingam, K.; Mak, T. C. W.; Bao-Cheng, L. *Polyhedron* **1996**, *15*, 1295–1301.
971. Venkatachalam, V.; Ramalingam, K.; Bocelli, G.; Cantoni, A. *Inorg. Chim. Acta* **1997**, *257*, 49–58.
972. Ramalingam, K.; Aravamudan, G.; Seshasayee, M. *Inorg. Chim. Acta* **1987**, *128*, 231–237.
973. Emmenegger, F. P. *Inorg. Chem.* **1989**, *28*, 2210–2214.
974. Gutierrez Alonso, A. G.; Ballester Reventos, L. B. *J. Chem. Doc., Dalton Trans.* **1988**, 537–539.
975. Izquierdo, A.; Guasch, J.; Rius, F. X. *Polyhedron* **1985**, *4*, 897–889.
976. Dietzsch, W.; Strauch, P.; Hoyer, E. *Coord. Chem. Rev.* **1992**, *121*, 43–130.
977. Roman, P.; Beitia, J. I.; Luque, A.; Guzman-Miralles, C. *Polyhedron* **1996**, *15*, 1071–1077.
978. Roman, P.; Bao, C.; Gutierrez-Zorilla, J. M.; Vegas, A. *J. Crystallogr. Spectrosc. Res.* **1988**, *18*, 207–217.
979. Roman, P.; Luque, A.; Beitia, J. I.; Guzman-Miralles, C. *Polyhedron* **1992**, *11*, 1883–1890.
980. Roman, P.; Beitia, J. I.; Luque, A.; Aranzabe, A. *Polyhedron* **1993**, *12*, 1345–1352.
981. Enjalbert, R.; Gleizes, A.; Trombe, J. C.; Gutierrez-Campo, M. L.; Roman, P. *J. Mol. Struct.* **1985**, *131*, 1–10.
982. Trombe, J. C.; Gleizes, A.; Galy, J. C. *R. Acad. Sci., Ser. 2* **1985**, *300*, 5–8.
983. Roman, P.; Luque, A.; Gutierrez-Zorilla, J. M.; Beitia, J. I.; Martinez-Ripoll, M. *Z. Kristallogr.* **1992**, *198*, 213–225.
984. Roman, P.; Beitia, J. I.; Luque, A.; Guzman-Miralles, C. *Polyhedron* **1995**, *14*, 1091–1096.
985. Benedix, R.; Hofbauer, M.; Mobius, M.; Knoch, F. *Inorg. Chim. Acta* **1997**, *262*, 177–185.
986. Bennett, A. M. A.; Foulds, G. A.; Thornton, D. A. *Polyhedron* **1989**, *8*, 2305–2311.
987. Lay, P. A.; Masters, A. F.; Wasiowych, C. D. *Aust. J. Chem.* **1995**, *48*, 835–849.
988. Sachar, R.; Paul, Y. *Chem. Environ. Res.* **2000**, *9*, 163–167.
989. Sachar, R.; Paul, Y. *Ultra Scientist Phys. Sci.* **2000**, *12*, 81–85.
990. Cavell, K. J.; Hay, D. G.; Masters, A. F.; Williams, G. A. *Aust. J. Chem.* **1985**, *38*, 369.
991. Cavell, K. J.; Masters, A. F. *Aust. J. Chem.* **1986**, *39*, 1129–1134.
992. Boyd, P. D. W.; Richard, C. E. F. *Acta Crystallogr.* **2000**, *56C*, 416–418.
993. Foulds, G. A.; Bennett, A. M. A.; Thornton, D. A.; Brown, S. J.; Clutterbuck, L. M.; Hinton, C.; Humphreys, G. B.; Masters, A. F. *Polyhedron* **1992**, *11*, 1285–1293.
994. Foulds, G. A.; Bennett, A. M. A.; Niven, M. L.; Thornton, D. A.; Cavell, K. J.; Desjardins, S.; Peacock, E. J. *J. Mol. Catal.* **1994**, *87*, 117–136.
995. Anderson, I. H.; Blake, A. J.; Heath, G. A. *Acta Crystallogr.* **1993**, *49C*, 87–89.
996. Anderson, I. H.; Blake, A. J.; Heath, G. A. *Acta Crystallogr.* **1989**, *45C*, 1430–1431.
997. Srdanov, G.; Jacobson, R. H.; Wudl, F. *Acta Crystallogr.* **1990**, *46C*, 590–593.
998. Singh, H. B.; Jacobson, R. H.; Hinkelmann, K.; Srdanov, G.; Wudl, F. *Inorg. Chem.* **1989**, *28*, 4221–4225.
999. Pal, T.; Ganguly, A.; Pal, A. *J. Indian Chem. Soc.* **1988**, *65*, 655–657.
1000. Battaglia, L. P.; Bonamartini, C. A.; Marzotto, A.; Menabue, L.; Pellicani, G. C. *J. Crystallogr. Spectrosc. Res.* **1988**, *18*, 101–112.
1001. Raper, E.; Jordan, B. M.; Creighton, J. R. *Thermochim. Acta* **1983**, *65*, 135.
1002. Oughtred, R. E.; Raper, E. S.; Nowell, I. W. *Inorg. Chim. Acta* **1984**, *84*, L5–L18.
1003. Zakharova, O. S.; Dobрева, D. D.; Ignatova, L. A.; Kravchenko, V. V.; Petrov, I. K. *Koord. Khim.* **1984**, *10*, 1182–1186.
1004. Kryvlyuk, L. N.; Semenishin, D. I. *Vestn. L'vov Politekh. Inst.* **1982**, *163*, 8–10.
1005. Kryvlyuk, L. N.; Badik, V. S.; Krupa, I. G. *Vestn. L'vov Politekh. Inst.* **1985**, *191*, 9–10.
1006. Tembe, G. L.; Adi, M. B.; Murty, A. S. R. *Indian J. Chem.* **1983**, *22A*, 618–619.
1007. Uhlig, E.; Doering, M. *Proc. Conf. Coord. Chem.* **1985**, *10*, 421–426.
1008. Hussain, M. S.; Chakraborty, S. C.; Tembe, G. L.; Murty, A. S. R. *Indian J. Chem.* **1986**, *25A*, 737–740.
1009. Aly, A. A. M.; El-Shahawy, A. S.; El-Zohry, M.; Mohamed, A. A. *Bull. Soc. Chim. Fr.* **1988**, *6*, 930–932.
1010. Attard, M. P. B.; Hill, J. O.; Magee, R. J.; Prakash, S.; Sastri, M. N. *Aust. J. Therm. Anal.* **1986**, *31*, 407–420.
1011. Christos, G. A.; Figgis, B. N.; Reynolds, P. A. *J. Chem. Soc., Dalton Trans.* **1990**, 2947–2951.
1012. Bray, K. L.; Drickamer, H. G. *J. Phys. Chem.* **1990**, *94*, 7037–7040.
1013. Koksharova, T. V.; Prisyazhnyuk, A. I. *Zh. Neorg. Khim.* **1984**, *29*, 3085–3087.
1014. Arora, O. P.; Sankhla, D. S.; Misra, S. N. *Egypt. J. Chem.* **1983**, *25*, 17–21.
1015. Cassoux, P.; Valade, L.; Kobayashi, H.; Kobayashi, A.; Clark, R. A.; Underhill, A. E. *Coord. Chem. Rev.* **1991**, *110*, 115–160.
1016. Cassoux, P.; Valade, L. In *Inorganic Materials*; Bruce, D. W., O'Hare, D., Eds.; Wiley: Chichester, 1997; Chapter 1.
1017. Cassoux, P. *Coord. Chem. Rev.* **1999**, *185-186*, 213–232.
1018. Akutagawa, T.; Nakamura, T. *Coord. Chem. Rev.* **2000**, *198*, 297–311.
1019. Olk, R.-M.; Olk, B.; Dietzsch, W.; Kirmse, R.; Hoyer, E. *Coord. Chem. Rev.* **1992**, *117*, 99–131.

1020. Pullen, A. E.; Olk, R.-M. *Coord. Chem. Rev.* **1999**, *188*, 211–262.
1021. Candell, E. *Coord. Chem. Rev.* **1999**, *185-186*, 629–651.
1022. Clemenson, P. I. *Coord. Chem. Rev.* **1990**, *106*, 171–203.
1023. Müller-Westhof, U. T.; Vance, B. *Comprehensive Coordination Chemistry*; Pergamon: Oxford, UK, 1987; Chapter 16, 5.
1024. Deplano, P.; Mercuri, M. L.; Pintus, G.; Trogu, E. F. *Comm. Inorg. Chem.* **2001**, *6*, 353–374.
1025. Ouahab, L. *Coord. Chem. Rev.* **1998**, *178-180*, 1501–1531.
1026. Robertson, N.; Cronon, L. *Coord. Chem. Rev.* **2002**, *227*, 93–127.
1027. Sugimori, A. *Coord. Chem. Rev.* **1997**, *159*, 397–406.
1028. Lim, B. S.; Formitchev, D. V.; Holm, R. H. *Inorg. Chem.* **2001**, *40*, 4257–4262.
1029. Bousseau, M.; Valade, L.; Legros, J. P.; Cassoux, P.; Garbouskas, M.; Interrante, L. V. *J. Am. Chem. Soc.* **1986**, *108*, 1908–1916.
1030. Nakamura, T.; Akutagawa, T.; Honda, K.; Underhill, A. E.; Coomber, A. T.; Friend, R. H. *Nature* **1998**, *394*, 159–162.
1031. Imai, H.; Inabe, T.; Otsuka, T.; Okuno, T.; Awaga, K. *Phys. Rev.* **1996**, *54B*, R6838–R6840.
1032. Imai, H.; Inabe, T.; Otsuka, T.; Okuno, T.; Awaga, K. *Synth. Met.* **1997**, *85*, 1705–1706.
1033. Kisch, H. *Coord. Chem. Rev.* **1997**, *159*, 385–396.
1034. Nunn, I.; Eisen, B.; Benedix, R.; Kisch, H. *Inorg. Chem.* **1994**, *33*, 5079–5085.
1035. Kisch, H.; Nüsslein, F.; Znn, I. Z. *Anorg. Allg. Chem.* **1991**, *600*, 67–71.
1036. Sun, S.; Zhang, B.; Wu, P.; Zhu, D. *J. Chem. Soc., Dalton Trans.* **1997**, 1455.
1037. Liu, S.-G.; Wu, P.-J.; Liu, Y. Q.; Zhu, D.-B. *Mol. Cryst. Liq. Cryst. Sci. Technol.* **1996**, *275A*, 211–223.
1038. Liu, S.-G.; Liu, Y. Q.; Zhu, D.-B. *Mol. Cryst. Liq. Cryst. Sci. Technol.* **1996**, *281A*, 229.
1039. Naito, T.; Sato, A.; Kawano, K.; Tateno, A.; Kobayashi, H.; Kobayashi, A. *J. Chem. Soc., Chem. Commun.* **1995**, 351–352.
1040. Sato, A.; Kobayashi, H.; Naito, T.; Sakai, F.; Kobayashi, A. *Inorg. Chem.* **1997**, *36*, 5262–5269.
1041. Cornelissen, J. P.; Pomarede, B.; Spek, A. L.; Reefman, D.; Haasnoot, J. P.; Reedijk, J. *Inorg. Chem.* **1993**, *32*, 3720–3726.
1042. Olk, R.-M.; Hoyer, R.; Faulmann, C.; Cassoux, P. *Synth. Met.* **1993**, *56*, 2453–2458.
1043. Olk, R.-M.; Kirmse, R.; Hoyer, R.; Faulmann, C.; Cassoux, P. *Z. Anorg. Allg. Chem.* **1994**, *620*, 90–100.
1044. Cai, S. H.; Chen, Z.; Sun, F. X.; Gao, X. C.; Lu, S. F. *Acta Chim. Sin.* **1998**, *56*, 1117–1122.
1045. Ihlo, L.; Bottcher, R.; Olk, R. M.; Kirmse, R. *Inorg. Chim. Acta* **1998**, *281*, 160–164.
1046. Huyett, J. E.; Choudhury, S. B.; Eichhorn, D. M.; Bryngelson, P. A.; Maroney, M. J.; Hoffman, B. M. *Inorg. Chem.* **1998**, *37*, 1361–1367.
1047. Jones, M. T.; Jansen, S. *Physica* **1986**, *143B*, 515–517.
1048. Veiros, L. F.; Morgado, J. *Mol. Cryst. Liq. Cryst.* **1999**, *333A*, 259–268.
1049. Clemenson, P. I.; Underhill, A. E.; Hursthouse, M. B.; Short, R. L. *J. Chem. Soc., Dalton Trans.* **1988**, 1689–1691.
1050. Coomber, A. T.; Beljonne, D.; Friend, R. H.; Bredas, J. L.; Charlton, A.; Robertson, N.; Underhill, A. E.; Kurmoo, M.; Day, P. *Nature* **1996**, *380*, 144–146.
1051. Uruichi, M.; Yakushi, K.; Yamashita, Y.; Qin, J. *Mat. Chem.* **1998**, *8*, 141–146.
1052. Simão, D.; Alves, H.; Belo, D.; Rabaca, S.; Lopes, E. B.; Santos, I. C.; Gama, V.; Duarte, M. T.; Henriques, R. T.; Novais, H.; Almeida, M. *Eur. J. Inorg. Chem.* **2001**, 3119–3126.
1053. Robertson, N.; Roehrs, S.; Akutagawa, T.; Nakamura, T.; Underhill, A. E. *J. Chem. Res.* **1999**, *1*, 54–55.
1054. Long, D. L.; Cui, H. M.; Hu, C. P.; Chen, J. T.; Ji, Z. P.; Zhang, Y. D.; Huang, J. S. *Inorg. Chim. Acta* **1999**, *293*, 89–94.
1055. Long, D. L.; Cui, Y.; Chen, J. T.; Cheng, W. D.; Huang, J. S. *Polyhedron* **1998**, *17*, 3969–3975.
1056. Sugimoto, K.; Kuroda-Sowa, T.; Maekawa, M.; Munakata, M. *Chem. Commun.* **1999**, 455–456.
1057. Ribera, E.; Rovira, C.; Veciana, J.; Tarres, J.; Canadell, E.; Rousseau, R.; Molins, E.; Mas, M.; Schoeffel, J. P.; Pouget, J. P.; Morgado, J.; Gam, V.; Henriques, R. T.; Almeida, M. *Synth. Met.* **1999**, *102*, 1743–1746.
1058. Arcon, D.; Lappas, A.; Margadonna, S.; Prassides, K.; Ribera, E.; Veciana, J.; Rovira, C.; Henriques, R. T.; Almeida, M. *Phys. Rev.* **1999**, *60B*, 4191–4194.
1059. Sawyer, D. T.; Srivatsa, G. S.; Bodini, M. E.; Schaefer, W. P.; Wing, R. M. *J. Am. Chem. Soc.* **1986**, *108*, 936–942.
1060. Noh, D.-Y.; Mizuno, M.; Choy, J.-H. *Inorg. Chim. Acta* **1994**, *216*, 147–153.
1061. Larsen, J.; Bechgaard, K. *J. Org. Chem.* **1987**, *52*, 3285–3288.
1062. Hawkins, I.; Underhill, A. E. *J. Chem. Soc., Chem. Commun.* **1990**, 1593–1594.
1063. Dyachenko, O. A.; Konovalikhin, S. V.; Kotov, A. I.; Shilov, G. V.; Yagubskii, E. B.; Faulmann, C.; Cassoux, P. *J. Chem. Soc., Chem. Commun.* **1993**, 508–510.
1064. Schenk, S.; Hawkins, I.; Wilkes, S. B.; Underhill, A. E.; Kobayashi, H.; Kobayashi, A. *J. Chem. Soc., Chem. Commun.* **1993**, 1648–1649.
1065. Faulmann, C.; Errami, A.; Legros, J. P.; Cassoux, P.; Yagubskii, E. B.; Kotov, A. I. *Synth. Met.* **1993**, *56*, 2057–2062.
1066. Faulmann, C.; Cassoux, P.; Yagubskii, E. B.; Vetskhina, L. V. *New J. Chem.* **1993**, *17*, 385–391.
1067. Yagubskii, E. B.; Kotov, A. I.; Khomenko, A. G.; Buravov, L. I.; Schegolev, A. I.; Shibaeva, R. P. *Synth. Met.* **1992**, *46*, 255–259.
1068. Doublet, L. M.; Canadell, E.; Pouget, J. P.; Shibaeva, R. P. *J. Phys.* **1994**, *14*, 1439–1450.
1069. Merzhanov, V. A.; Hits, D. A.; Yagubskii, E. B.; Doublet, M. L.; Canadell, E. *Synth. Met.* **1995**, *71*, 1867–1868.
1070. Kushch, L. A.; Gritsenko, V. V.; Buravov, L. I.; Khomenko, A. G.; Shilov, G. V.; Dyachenko, O. A.; Merzhanov, V. A.; Yagubskii, E. B.; Rousseau, R.; Canadell, E. *J. Mater. Chem.* **1995**, *5*, 1633–1638.
1071. Yagubskii, E. B.; Kushch, L. A.; Gritsenko, V. V.; Dyachenko, O. A.; Buravov, L. I.; Khomenko, A. G. *Synth. Met.* **1995**, *70*, 1039–1041.
1072. Miyazaki, A.; Enomoto, M.; Enoki, T.; Saito, G. *Mol. Cryst. Liq. Cryst.* **1997**, *A305*, 425–434.
1073. Faulmann, C.; Errami, A.; Donnadieu, B.; Malfant, I.; Legros, J. P.; Cassoux, P.; Rovira, C.; Canadell, E. *Inorg. Chem.* **1996**, *35*, 3856–3873.
1074. Zuo, J.-L.; You, F.; You, X.-Z.; Fun, H.-K. *Polyhedron* **1997**, *16*, 1465–1469.

1075. Noh, J.-L.; Lee, H.-J.; Hong, J.-K.; Underhill, A. E. *Tetrahedron Lett.* **1996**, *37*, 7603–7606.
1076. Lee, H.-J.; Noh, D.-Y. *Polyhedron* **2000**, *19*, 425–429.
1077. Veldhuizen, Y. S. J.; Veldman, N.; Spek, A. L.; Cassoux, P.; Carlier, R.; Mulder, M. J. J.; Haasnoot, J. G.; Reedijk, J. *J. Chem. Soc., Dalton Trans.* **1998**, 2989–2994.
1078. Bereman, R. D.; Lu, H. *Inorg. Chim. Acta* **1993**, *204*, 53–61.
1079. Dautel, O. J.; Fourmigue, M. *Inorg. Chem.* **2001**, *40*, 2083–2087.
1080. Kisch, H.; Eisen, B.; Dinnebier, R.; Shankland, David W. I. F.; Knoch, F. *Chem. Eur. J.* **2001**, *7*, 738–748.
1081. Wang, K.; Stiefel, E. I. *Science* **2001**, *291*, 106–109.
1082. Geiger, W. E. *Inorg. Chem.* **2002**, *41*, 136–139.
1083. Lian, W.-F. *Huaxue* **1996**, *54*, 81–84.
1084. Garcin, E.; Vernede, X.; Hatchikian, E. C.; Volbeda, A.; Frey, M.; Fontecilla-Camps, J. C. *Structure* **1999**, *7*, 557–566.
1085. Liaw, W.-F.; Horng, Y.-C.; Ou, D.-S.; Ching, C.-Y.; Lee, G.-H.; Peng, S.-M. *J. Am. Chem. Soc.* **1997**, *119*, 9299–9300.
1086. Liaw, W.-F.; Chen, C.-H.; Lee, C.-M.; Lee, G.-H.; Peng, S.-M. *J. Chem. Soc., Dalton Trans.* **2001**, 138–143.
1087. McConnachie, J. M.; Ibers, J. A. *Inorg. Chem.* **1991**, *30*, 1770–1773.
1088. Goldman, C. M.; Olmstead, M. M.; Mascharak, P. K. *Inorg. Chem.* **1996**, *35*, 2752–2757.
1089. Marganian, C. A.; Baidya, N.; Olmstead, M. M.; Mascharak, P. K. *Inorg. Chem.* **1992**, *31*, 2992–2994.
1090. Sandman, D. J.; Allen, G. W.; Acampora, L. A.; Stark, J. C.; Jansen, S.; Jones, M. T.; Ashwell, G. J.; Foxman, B. M. *Inorg. Chem.* **1987**, *26*, 1664–1669.
1091. Baidya, N.; Noll, B. C.; Olmstead, M. M.; Mascharak, P. K. *Inorg. Chem.* **1992**, *31*, 2999–3000.
1092. Choudhury, S. B.; Allan, C. B.; Maroney, M. J. *Inorg. Synth.* **1998**, *32*, 98–107.
1093. Choudhury, S. B.; Pressler, M. A.; Mirza, S. A.; Day, R. O.; Maroney, M. J. *Inorg. Chem.* **1994**, *33*, 4831–4839.
1094. Müller, A.; Henkel, G. *Z. Naturforsch. B* **1997**, *52*, 1501–1509.
1095. Fujiwara, H.; Arai, E.; Kobayashi, H. *J. Chem. Soc., Chem. Commun.* **1997**, 837–838.
1096. Müller, A.; Bögge, H.; Krickemeyer, E.; Henkel, G.; Krebs, B. *Z. Naturforsch. B* **1982**, *37*, 1014–1019.
1097. Ansari, Mohammad, A.; Chau, C.-N.; Mahler, C. H.; Ibers, J. A. *Inorg. Chem.* **1989**, *28*, 650–654.
1098. Liaw, W.-F.; Chou, S.-Y.; Jung, S. -J.; Lee, G.-H.; Peng, S.-M. *Inorg. Chim. Acta* **1999**, *286*, 155–159.
1099. Davies, M. K.; Levason, W.; Reid, G. *J. Chem. Soc., Dalton Trans.* **1998**, 2185–2189.
1100. Di Vaira, M.; Peruzzini, M.; Stoppioni, P. *Angew. Chem., Int. Ed. Engl.* **1987**, *26*, 916; *Angew. Chem.* **1987**, *99*, 955–956.
1101. Levason, W.; Orchard, S. D.; Reid, G. *Coord. Chem. Rev.* **2002**, *225*, 159–199.
1102. Gupta, S. K.; Jain, R.; Sira, P. K. *Transition Met. Chem.* **1994**, *19*, 518–520.
1103. Al-Salim, N. I.; McWhinnie, W. R. *Inorg. Chim. Acta* **1989**, *155*, 213–216.
1104. Shakir, M.; Firdaus, F.; Hameed, P. S.; Kumar, D. *Synth. React. Inorg. Met. Org. Chem.* **1992**, *22*, 1087–1096.
1105. Shakir, M.; Kumar, D.; Siddiqui, Z. A. *Transition Met. Chem.* **1991**, *16*, 149–151.
1106. Gupta, S. K.; Parihar, J.; Tripathi, S. K. *Transition Met. Chem.* **1998**, *23*, 253–256.
1107. Solomon, L. R.; Bond, A. M.; Bixler, J. W.; Hallenbeck, D. R.; Logsdon, K. M. *Inorg. Chem.* **1983**, *22*, 1644–1648.
1108. Libus, Z.; Tialowska, H. *J. Solution Chem.* **1975**, *4*, 1011–1022.
1109. Libus, Z.; Kowaleska, G. *Polish J. Chem.* **1978**, *52*, 709–714.
1110. Waizumi, K.; Kouda, T.; Taino, A.; Fukushima, X.; Ohtaki, H. *J. Solution Chem.* **1999**, *28*, 83–100.
1111. Grzybkowski, W. *Polyhedron* **1990**, *9*, 2257–2261, and references therein.
1112. Inerowicz, H. D.; Wei, L.; Persson, I. *J. Chem. Soc., Faraday Trans.* **1994**, *90*, 2223–2234.
1113. Doe, H.; Kitagawa, T. *Inorg. Chem.* **1982**, *21*, 2272–2276.
1114. Libus, W.; Pastewski, R. *J. Solution Chem.* **1988**, *17*, 59–65.
1115. Suzuki, H.; Ishiguro, S.; Ohtaki, H. *J. Chem. Soc., Faraday Trans. I* **1990**, *86*, 2179–2185.
1116. Dickert, F.; Hoffmann, H. *Ber. Bunsenges. Phys. Chem.* **1971**, *75*, 1320–1323.
1117. Grzybkowski, W.; Pilarczyk, M. *J. Chem. Soc., Faraday Trans I* **1986**, *82*, 1745–1753.
1118. Ishiguro, S.; Ozutsumi, K.; Ohtaki, H. *Bull. Chem. Soc. Jpn.* **1987**, *60*, 531–538.
1119. Strzelecki, H.; Pastewski, R. *Bull. Pol. Acad. Chem.* **1987**, *35*, 31–39.
1120. Chaudhuri, M. K.; Ghosh, S. K.; Hiese, Z. *J. Chem. Soc., Dalton Trans.* **1984**, 1763–1764.
1121. Sangalietti, L.; Parmigiani, F.; Ratler, E.; Shen, Z.-X.; Chemelli, C.; Jepsen, O. *Phys. Rev. B* **1994**, *50*, 17854–17866.
1122. Plitzko, Plitzko; Strecker, M.; Meyer, G. *Z. Kristallogr.* **1997**, *212*, 3–4.
1123. Pelikan, P.; Liska, M. *Czech. Collect. Chem. Commun.* **1984**, *49*, 2837–2856.
1124. Zhao, M.; Du, M.; Sen, G. *J. Phys. C* **1987**, *20*, 5557–5571.
1125. Hades, R. G. *J. Chem. Soc.* **1984**, *81*, 4018–4022.
1126. Suzuki, H.; Ishiguro, S. *Bull. Chem. Soc. Jap.* **1993**, *66*, 83–88.
1127. Bhattachagharaya, R.; Ghosh, A. *J. Chem. Res.* **2001**, 332–333.
1128. Trendafilova, N.; Nikolov, G. S.; Kellner, R.; Mikosch, H.; Bauer, G.; Bogatchev, G. *Chem. Phys.* **1990**, *147*, 377–387.
1129. Trendafilova, N.; Nikolov, G. S.; Kellner, R.; Bauer, G. *Vibr. Spectrosc.* **1994**, *6*, 351–362.
1130. Bond, M. R.; Willett, R. D. *Acta Crystallogr.* **1993**, *C49*, 668–671.
1131. Fitzmaurice, J. C.; Slawin, A. M. Z.; Williams, D. J.; Woollins, J. D. *J. Chem. Soc., Chem. Commun.* **1993**, 1479–1481.
1132. Chen, Ch.; Zhou, Z.; Zhou, Y.; Du Diangyan, *J. Chem. Educ.* **2000**, *77*, 1206–1207.
1133. Lopez-Salinas, E.; Tomita, N.; Mitsui, T.; Suzuki, E.; Ono, Y. *J. Mol. Catal.* **1993**, *81*, 397–405.
1134. Corker, M.; Evans, J.; Leach, H.; Levason, W. *J. Chem. Soc., Chem. Commun.* **1989**, 181–183.
1135. Shadle, S. E.; Hedman, B.; Hodgson, K. O.; Solomon, E. I. *J. Am. Chem. Soc.* **1995**, *117*, 2259–2272.
1136. Dawe, R. D.; Milinski, T. F.; Tuner, J. V. *Tetrahedron Lett.* **1984**, *25*, 2061–2064.
1137. Okada, K.; Matsushita, F.; Hayashi, S. *Clay Minerale* **1997**, *32*, 299–305.
1138. Bussiere, G.; Beaulac, R.; Cardinal-David, B.; Reber, C. *Coord. Chem. Rev.* **2001**, *219–221*, 509–543.
1139. Costamagna, J.; Vargas, J.; Lattore, R.; Alvarado, A.; Mena, G. *Coord. Chem. Rev.* **1992**, *119*, 67–88.
1140. Garnovskii, A. D.; Nivorozhkin, A. L.; Minkin, V. I. *Coord. Chem. Rev.* **1993**, *126*, 1–69.

1141. Calligaris, M.; Randacio, L. In *Comprehensive Coordination Chemistry*; Wilkinson, G., Ed., Pergamon: London, 1987; Vol. 2, Chapter, 20. 1, p 715.
1142. Yamada, S. *Coord. Chem. Rev.* **1999**, 190–192, 537–555.
1143. Hoshino, N.; Kodama, A.; Shibuya, T.; Matsunaga, Y.; Miyajima, S. *Inorg. Chem.* **1991**, 30, 3091–3096.
1144. la Cour, A.; Findeisen, M.; Hazell, R.; Hennig, L.; Olsen, C. E.; Simonsen, O. *J. Chem. Soc., Dalton Trans.* **1996**, 3437–3447.
1145. Fernández-García, M. I.; Fernández-Fernández, B.; Fondo, M.; García-Deibe, A. M.; Gómez-Fórneas, E.; Bermejo, M. R.; Sanmartín, J.; González, A. M. *Inorg. Chim. Acta* **2000**, 304, 144–149.
1146. Toftlund, H.; Novorozhkin, A. L.; la Cour, A.; Adhikari, B.; Murray, K. S.; Fallon, G. D.; Novorozhkin, L. E. *Inorg. Chim. Acta* **1995**, 228, 237–241.
1147. Jacobsen, E. N. Ojima, I., Ed., *Catalytic Asymmetric Synthesis* **1993**, 159–202. VCH: New York.
1148. Canali, L.; Sherrington, D. C. *Chem. Soc. Rev.* **1999**, 28, 85–93.
1149. Jäger, E.-G.; Schuhmann, K.; Görls, H. *Inorg. Chim. Acta* **1997**, 255, 295–305.
1150. Szlyk, E.; Wojtczak, A.; Larsen, E.; Surdykowski, A.; Nauman, J. *Inorg. Chim. Acta* **1999**, 293, 239–244.
1151. Bernardo, K.; Leppard, S.; Robert, A.; Commenges, G.; Dahan, F.; Meunier, B. *Inorg. Chem.* **1996**, 35, 387–396.
1152. Wojtczak, A.; Szlyk, E.; Jaskolski, M.; Larsen, E. *Acta Chem. Scand.* **1997**, 51, 274–278.
1153. Vázquez, M.; Bermejo, M. R.; Sanmartín, J.; García-Deibe, A. M.; Lodeiro, C.; Mahia, J. *J. Chem. Soc., Dalton Trans.* **2002**, 870–877.
1154. Klein, H.-F.; Bickelhaupt, A. *Inorg. Chim. Acta* **1996**, 248, 111–114.
1155. Wang, C.; Friedrich, S.; Younkin, T. R.; Li, R. T.; Grubbs, R. H.; Bansleben, D. A.; Day, M. W. *Organometallics* **1998**, 17, 3149–3151.
1156. Younkin, T. R.; Connor, E. F.; Henderson, J. I.; Friedrich, S. K.; Grubbs, R. H.; Bansleben, D. A. *Science* **2000**, 287, 460–462.
1157. Bauers, F. M.; Mecking, S. *Macromolecules* **2001**, 34, 1165–1171.
1158. Lam, F.; Xu, J. X.; Chan, K. S. *J. Org. Chem.* **1996**, 61, 8414–8418.
1159. Lam, F.; Wang, R.-J.; Mak, T. C.; Chan, K. S. *J. Chem. Soc., Chem. Commun.* **1994**, 2439–2440.
1160. Haikarainen, A.; Sipilä, Pietikäinen P.; Pajunen, A.; Mutikainen, I. *J. Chem. Soc., Dalton Trans.* **2001**, 991–995.
1161. Schumann, M.; Elias, H. *Inorg. Chem.* **1985**, 24, 3187–3192.
1162. Warmuth, R.; Elais, H. *Inorg. Chem.* **1991**, 30, 5027–5032.
1163. Hoss, H.; Elias, H. *Inorg. Chem.* **1993**, 32, 317–323.
1164. Haus, A.; Raidt, M.; Link, T. A.; Elias, H. *Inorg. Chem.* **2000**, 39, 5111–5117.
1165. Di Bella, S.; Fragalà, I.; Ledoux, I.; Diaz-Garcia, M. A.; Lacroix, P. G.; Marks, T. J. *Chem. Mater.* **1994**, 6, 881–883.
1166. Gaetani Manfredotti, A.; Guastini, C. *Acta Crystallogr.* **1983**, C39, 863–865.
1167. Di Bella, S.; Fragalà, I.; Ledoux, I.; Diaz-Garcia, M. A.; Marks, T. J. *J. Am. Chem. Soc.* **1997**, 119, 9550–9557.
1168. Lenoble, G.; Lacroix, P. G.; Daran, J. C.; Di Bella, S.; Nakatani, K. *Inorg. Chem.* **1998**, 37, 2158–2165.
1169. Carbonaro, L.; Isola, M.; La Pegna, P.; Senatore, L.; Marchetti, F. *Inorg. Chem.* **1999**, 38, 5519–5525.
1170. Guerriero, P.; Tamburini, S.; Vigato, P. A. *Coord. Chem. Rev.* **1995**, 139, 17–243.
1171. Costes, J. P.; Laurent, J. P.; Chabert, P.; Commenges, G.; Dahan, F. *Inorg. Chem.* **1997**, 36, 656–660.
1172. Lehn, J. M. *Angew. Chem., Int. Ed. Engl.* **1990**, 29, 1304–1319.
1173. Costes, J. P.; Dahan, F.; Dupuis, A.; Laurent, J. P. *J. Chem. Soc., Dalton Trans.* **1998**, 1307–1314.
1174. Schall, O. F.; Robinson, K.; Atwood, J. L.; Gokel, G. W. *J. Am. Chem. Soc.* **1993**, 115, 5962–5969.
1175. Schall, O. F.; Robinson, K.; Atwood, J. L.; Gokel, G. W. *J. Am. Chem. Soc.* **1991**, 113, 7434–7436.
1176. Costes, J. P.; Dahan, F.; Laurent, J. P. *Inorg. Chem.* **1994**, 33, 2738–2742.
1177. Costes, J. P.; Dahan, F.; Laurent, J. P. *Inorg. Chem.* **1995**, 34, 3102–3104.
1178. Costes, J. P.; Laurent, J. P.; Chabert, P.; Commenges, G.; Dahan, F. *Inorg. Chem.* **1997**, 36, 656–660.
1179. Gok, Y.; Degirmencioglu, I.; Karabocek, S. *Synth. React. Inorg. Met. Org. Chem.* **1997**, 27, 331–345.
1180. Rosa, D. T.; Coucouvanis, D. *Inorg. Chem.* **1998**, 37, 2328–2329.
1181. Soai, K.; Niwa, S. *Chem. Rev.* **1992**, 92, 833–856.
1182. Barbaro, P.; Belderrain, T. R.; Bianchini, C.; Scapaci, G.; Masi, D. *Inorg. Chem.* **1996**, 35, 3362–3368.
1183. Nugent, W. A.; Harlow, R. L. *J. Am. Chem. Soc.* **1994**, 116, 6142–6148.
1184. Cross, R. J.; Farrugia, L. J.; Newman, P. D.; Peacock, R. D.; Stirling, D. *Inorg. Chem.* **1999**, 38, 1186–1192.
1185. Muller, J. G.; Kayser, L. A.; Paikoff, S. J.; Duarte, V.; Tang, N.; Perez, R. J.; Rokita, S. E.; Burrows, C. J. *Coord. Chem. Rev.* **1999**, 185–186, 761–774.
1186. Routier, S.; Bernier, J.-L.; Cateau, J.-P.; Bailly, C. *Bioorg. Med. Chem. Lett.* **1997**, 7, 63–66.
1187. Mandal, S. S.; Kumar, N. V.; Varshney, U.; Bhattacharya, S. *J. Inorg. Biochem.* **1996**, 63, 265–272.
1188. Martell, A. E.; Hancock, R. D.; Motekaiakis, R. J. *Coord. Chem. Rev.* **1994**, 133, 39–65.
1189. More, K. M.; Eaton, G. R.; Eaton, S. S. *Inorg. Chem.* **1986**, 25, 2638–2646.
1190. Coronado, E.; Drillon, M.; Fuertes, A.; Beltran, D.; Mosset, A.; Galy, J. *J. Am. Chem. Soc.* **1986**, 108, 900–905.
1191. Martín-Ramos, J. D.; Tercero-Moreno, J. M.; Matilla-Hernández, A.; Niclós-Gutiérrez, J.; Busnot, A.; Ferrer, S. *Polyhedron* **1996**, 17, 439–446.
1192. Flippova, T. V.; Poznyak, A. L.; Polynova, T. N.; Porai-Koshits, M. A. *Russ. J. Coord. Chem. (Transl. Koord. Khim.)* **1996**, 22, 50–55.
1193. Douglas, B. E.; Radanovic, D. J. *Coord. Chem. Rev.* **1993**, 128, 139–165.
1194. Radanovic, D. J.; Ianelli, S.; Pelosi, G.; Matovic, Z. D.; Tasic-Stojanovic, S.; Douglas, B. E. *Inorg. Chim. Acta* **1998**, 278, 66–75.
1195. Frank, T.; Evilia, R. F. *Inorg. Chim. Acta* **1990**, 171, 107–113.
1196. Djurdjevic, P.; Radanovic, D. J.; Cvijovic, M.; Dimitrijevic, M.; Veselinovic, D. *Polyhedron* **1992**, 11, 197–204.
1197. Mederos, A.; Gili, P.; Dominguez, S.; Benitez, A.; Soledad Palacios, M.; Hernández-Padilla, M.; Martín-Zarza, P.; Rodríguez, M. L.; Ruiz-Pérez, C.; Lahoz, F. J.; Oro, L. A.; Brito, F.; Arrieta, J. M.; Vlasi, M.; Germain, P. *J. Chem. Soc., Dalton Trans.* **1990**, 1477–1491.
1198. Domínguez, S.; Mederos, A.; Gili, P.; Rancel, A.; Rivero, A. E.; Brito, F.; Lloret, F.; Solans, X.; Ruíz-Pérez, C.; Rodríguez, M. L.; Brito, I. *Inorg. Chim. Acta* **1997**, 255, 367–380.

1199. Anderegg, G.; Kholeif, S. *Inorg. Chim. Acta* **1997**, *258*, 47–51.
1200. Radanovic, D. J.; Matovic, V. C.; Matovic, Z. D.; Battaglia, L. P.; Pelizzi, G.; Ponticelli, G. *Inorg. Chim. Acta* **1995**, *237*, 151–157.
1201. Fukuda, Y.; Miyamae, H.; Yamagata, K.; Sone, K. *Chem. Lett.* **1984**, 1309–1312.
1202. Fukuda, Y.; Yamagata, K.; Kaden, T. A. *Bull. Chem. Soc. Jpn.* **1987**, *60*, 3569–3574.
1203. Wassmann, S.; Wilken, J.; Martens, J. *Tetrahedron: Asymmetry* **1999**, *10*, 4437–4445.
1204. Kossensjans, M.; Soeberdt, M.; Wallbaum, S.; Harms, K.; Martens, J.; Aurich, H. G. *J. Chem. Soc., Perkin Trans. I* **1999**, 2353–2365.
1205. Pennemann, H.; Wassmann, S.; Wilken, J.; Gröger, H.; Wallbaum, S.; Kossensjans, M.; Haase, D.; Saak, W.; Pohl, S.; Martens, J. *J. Chem. Soc., Dalton Trans.* **2000**, 2467–2470.
1206. Wen, R.; Bernal, I.; Somoza, F.; Li, W.; Fronczek, F. R. *Inorg. Chim. Acta* **1998**, *282*, 96–109.
1207. Motekaitis, R. J.; Martell, A. E. *J. Coord. Chem.* **1994**, *31*, 67–78.
1208. Sawada, K.; Araki, T.; Suzuki, T.; Doi, K. *Inorg. Chem.* **1989**, *28*, 2687–2688.
1209. Sawada, K.; Duan, W.; Ono, M.; Satoh, K. *J. Chem. Soc., Dalton Trans.* **2000**, 919–924.
1210. Bazakas, K.; Lukes, I. *J. Chem. Soc., Dalton Trans.* **1995**, 1133–1137.
1211. Lukes, I.; Bazakas, K.; Hermann, P.; Vojtisek, P. *J. Chem. Soc., Dalton Trans.* **1992**, 939–944.
1212. Cole, E.; Copley, R. C. B.; Howard, J. A. K.; Parker, D.; Ferguson, G.; Gallagher, J. F.; Kaitner, B.; Harrison, A.; Royle, L. *J. Chem. Soc., Dalton Trans.* **1994**, 1619–1629.
1213. Aime, S.; Botta, M.; Senanayake, K.; Parker, D.; Howard, J. A. K.; Williams, J. A. G.; Batsanov, A. *Inorg. Chem.* **1994**, *33*, 4696–4706.
1214. Bates, G. B.; Cole, E.; Parker, D.; Katakya, R. *J. Chem. Soc., Dalton Trans.* **1996**, 2693–2698.
1215. Lloret, F.; Sletten, J.; Ruiz, R.; Julve, M.; Faus, J.; Verdaguer, M. *Inorg. Chem.* **1992**, *31*, 778–784.
1216. Fernández, I.; Pedro, J. R.; Roselló, A. L.; Ruiz, R.; Ottenwälder, X.; Journaux, Y. *Tetrahedron Lett.* **1998**, *39*, 2869–2872.
1217. Chaudhuri, P.; Verani, C. N.; Bill, E.; Bothe, E.; Weyhermüller, T.; Wieghardt, K. *J. Am. Chem. Soc.* **2001**, *123*, 2213–2223.
1218. West, D. X.; Padhye, S. B.; Sonawane, P. B. *Struct. Bonding* **1991**, *76*, 1–50.
1219. West, D. X.; Liberta, A. E.; Padhye, S. B.; Chikate, R. C.; Sonawane, B. P.; Kumbhar, A. S.; Yerande, R. G. *Coord. Chem. Rev.* **1993**, *123*, 47–71.
1220. Sirota, A.; Dunaj-Jurco, M.; Jorik, V.; Jona, E. *Proc. Conf. Coord. Chem.* **1985**, *10*, 351–356.
1221. Chandra, S.; Sharma, K. K. *Synth. React. Inorg. Met. Org. Chem.* **1993**, *13*, 559.
1222. Mukkanti, K.; Pandeya, K. B.; Singh, R. P. *Indian J. Chem.* **1982**, *21A*, 641–644.
1223. Mostafa, M. M.; Shallaby, A. A.; El-Asmy, A. A. *Indian J. Chem. Soc.* **1983**, *LX*, 109–111.
1224. Ghelase, I.; Negoiu, D. *Rev. Roum. de Chim.* **1983**, *28*, 463–470.
1225. Negoiu, D.; Ghelase, I. *Rev. Roum. de Chim.* **1983**, *28*, 355–364.
1226. Chandra, S.; Singh, R. *Spectrochim. Acta* **1985**, *41A*, 1109–1112.
1227. Valdes-Martinez, J.; Toscano, R. A.; Cea-Olivares, R. *Acta Crystallogr.* **1991**, *47C*, 2666–2668.
1228. Chandra, S.; Sharma, K. K. *Synth. React. Inorg. Met. Org. Chem.* **1984**, *14*, 969–980.
1229. West, D. X.; Scovill, J. P.; Silverton, J. V.; Bavoso, A. *Transition Met. Chem.* **1986**, *11*, 123–131.
1230. Thimmaiah, K. N.; Chandrappa, G. T.; Lloyd, W. D.; Parkanyi, C. *Transition Met. Chem.* **1985**, *10*, 299–302.
1231. Thimmaiah, K. N.; Lloyd, W. D.; Chandrappa, G. T. *Inorg. Chim. Acta* **1985**, *106*, 81–83.
1232. Kumar, N. R. S.; Nethaji, M.; Patil, K. C. *Acta Crystallogr.* **1991**, *47C*, 2052–2054.
1233. El-Asmy, A. A.; Mostafa, M. M. *Polyhedron* **1983**, *7*, 591–593.
1234. Gupta, R. P.; Srivastava, A. K. *Synth. React. Inorg. Met. Org. Chem.* **1985**, *15*, 117–128.
1235. Ferrari, M. B.; Capacchi, S.; Reffo, G.; Pelosi, G.; Tarasconi, P.; Albertini, R.; Pinelli, S.; Lunghi, P. *J. Inorg. Biochem.* **2000**, *81*, 89–97.
1236. Ferrari, M. B.; Capacchi, S.; Bisceglie, F.; Pelosi, G.; Tarasconi, P. *Inorg. Chim. Acta* **2001**, *312*, 81–87.
1237. Jouad, E. M.; Larcher, G.; Allain, M.; Riou, A.; Bouet, G. M.; Khan, M. A.; Thanh, X. D. *J. Inorg. Biochem.* **2001**, *86*, 565–571.
1238. Garcia-Tojal, J.; Pizarro, J. L.; García-Orad, A.; Pérez-Sanz, A. R.; Ugalde, M.; Díaz, A. A.; Serra, J. L.; Arriortua, M. I.; Rojo, T. *J. Inorg. Biochem.* **2001**, *86*, 627–633.
1239. Li, Q.; Tang, H.; Li, Y.; Wang, M.; Wang, L.-F.; Xia, C.-G. *J. Inorg. Biochem.* **2000**, *78*, 167–174.
1240. Mohan, M.; Mohan, M. *Synth. React. Inorg. Met. Org. Chem.* **1982**, *12*, 761–784.
1241. Bhoon, Y. K.; Scovill, J. P.; Klayman, D. L. *Indian J. Chem.* **1983**, *22A*, 267–269.
1242. Mostafa, M. M.; El-Asmy, A. A.; Ibrahim, G. M. *Transition Met. Chem.* **1983**, *8*, 54–56.
1243. Mohan, M.; Sharman, P.; Jha, N. K. *Inorg. Chim. Acta* **1985**, *106*, 117–121.
1244. Mohan, M.; Sharman, P.; Jha, N. K. *Inorg. Chim. Acta* **1985**, *106*, 197–201.
1245. West, D. X.; Ooms, C. E.; Saleda, J. S.; Gebremedhin, H.; Liberta, A. E. *Transition Met. Chem.* **1994**, *19*, 553–558.
1246. West, D. X.; Ertem, G.; Makeever, R. M.; Scovill, J. P.; Klayman, D. L. *Transition Met. Chem.* **1985**, *10*, 41–45.
1247. West, D. X.; Lockwood, M. A.; Castineiras, A.; Liberta, A. E. *Polyhedron* **1993**, *12*, 1887–1893.
1248. West, D. X.; Gebremedhin, H.; Butcher, R. J.; Jasinski, J. P.; Liberta, A. E. *Polyhedron* **1993**, *12*, 2489–2497.
1249. West, D. X.; Lockwood, M. A.; Liberta, A. E.; Chen, X.; Willett, R. D. *Transition Met. Chem.* **1993**, *18*, 221–227.
1250. West, D. X.; Whyte, A. C.; Sharif, F. D.; Gebremedhin, H.; Liberta, A. E. *Transition Met. Chem.* **1993**, *18*, 238–242.
1251. West, D. X.; Swearingen, J. K.; Valdés-Martínez, J.; Hernández-Ortega, S.; El-Sawaf, A. K.; van Meurs, F.; Castineiras, A.; Garcia, I.; Bermejo, E. *Polyhedron* **1999**, *18*, 2919–2929.
1252. Rodriguez-Argüelles, M. C.; Ferrari, M. B.; Fava, G. G.; Pelizzi, C.; Pelosi, G.; Albertini, R.; Bonati, A.; Dall'Aglio, P. P.; Lunghi, P.; Pinelli, S. *J. Inorg. Biochem.* **1997**, *66*, 7–17.
1253. Rodriguez-Argüelles, M. C.; Sánchez, A.; Ferrari, M. B.; Fava, G. G.; Pelizzi, C.; Pelosi, G.; Albertini, R.; Lunghi, P.; Pinelli, S. *J. Inorg. Biochem.* **1999**, *73*, 7–15.
1254. Zimmer, M.; Schulte, G.; Luo, X.-L.; Crabtree, R. H. *Angew. Chem., Int. Ed. Engl.* **1991**, *30*, 193–195.
1255. Barber, D. E.; Lu, Z.; Richardson, T.; Crabtree, R. H. *Inorg. Chem.* **1992**, *31*, 4709–4711.

1256. West, D. X.; Ives, J. S.; Bain, G. A.; Liberta, A. E.; Valdés-Martínez, J.; Ebert, K. H.; Hernández-Ortega, S. *Polyhedron* **1997**, *16*, 1895–1905.
1257. Castiñeiras, A.; Bermejo, E.; West, D. X.; Ackerman, L. J.; Valdés-Martínez, J.; Hernández-Ortega, S. *Polyhedron* **1999**, *18*, 1463–1469.
1258. Castiñeiras, A.; Bermejo, E.; West, D. X.; El-Sawaf, A. K.; Swearingen, J. K. *Polyhedron* **1998**, *17*, 2751–2757.
1259. Iskander, M. F.; El-Sayed, L.; El-Toukhy, A.; Chehata, A. K. *Inorg. Chim. Acta* **1986**, *123*, 19–25.
1260. Arion, V. B.; Gerbeleu, N. V.; Indrichan, K. M. *Zh. Neorg. Khim.* **1985**, *30*, 126–131.
1261. Reddy, K. H.; Reddy, D. V. *Indian J. Chem.* **1985**, *24A*, 154–155.
1262. Rodríguez-Argüelles, M. C.; Battaglia, L. P.; Ferrari, M. B.; Fava, G. G.; Pelizzi, C.; Pelosi, G. *J. Chem. Soc., Dalton Trans.* **1995**, 2297–2303.
1263. Ackerman, L. J.; Fanwick, P. E.; Green, M. A.; John, E.; Running, W. E.; Swearingen, J. K.; Webb, J. W.; West, D. X. *Polyhedron* **1999**, *18*, 2759–2767.
1264. Arquero, A.; Mendiola, M. A.; Souza, P.; Sevilla, M. T. *Polyhedron* **1996**, *15*, 1657–1665.
1265. Cañadas, M.; López-Torres, E.; Martínez-Arias, A.; Mendiola, M. A.; Sevilla, M. T. *Polyhedron* **2000**, *19*, 2059–2068.
1266. Krishna, A.; Reddy, K. H.; Reddy, D. V. *Inorg. Chim. Acta* **1990**, *173*, 13–18.
1267. Carcelli, M.; Ianelli, S.; Pelagatti, P.; Pelizzi, G. *Inorg. Chim. Acta* **1999**, *292*, 121–126.
1268. Ali, M. A.; Fernando, K. R.; Palit, D.; Nazimuddin, M. *Transition Met. Chem.* **1995**, *20*, 19–22.
1269. Leovac, V. M.; Češljević, V. I.; Argay, G.; Kālmān, A.; Ribār, B. *J. Coord. Chem.* **1995**, *34*, 357–364.
1270. Hossain, M. E.; Begum, J.; Nurul Alam, M.; Nazimuddin, M.; Akbar Ali, M. *Transition Met. Chem.* **1993**, *18*, 497–500.
1271. Dobrov, A. A.; Gerbeleu, N. V. *Zhur. Neorg. Khim.* **1983**, *28*, 1764–1769.
1272. Cheng, H.; Chun-ying, D.; Chen-jie, F.; Yong-jiang, L.; Qing-jin, M. *J. Chem. Soc., Dalton Trans.* **2000**, 1207–1212.
1273. Ferrari, M. B.; Fava, G. G.; Pelosi, G.; Rodríguez-Argüelles, M. C.; Tarasconi, P. *J. Chem. Soc., Dalton Trans.* **1995**, 3035–3040.
1274. Ainscough, E. W.; Brodie, A. M.; Ranford, J. D.; Waters, J. *J. Chem. Soc., Dalton Trans.* **1991**, 2125–2131.
1275. Pavlishchuk, V. V.; Kolotilov, S. V.; Addison, A. W.; Butcher, R. J.; Sinn, E. *J. Chem. Soc., Dalton Trans.* **2000**, 335–341.
1276. Calatayud, M. L.; Ramirez, J. A.; Faus, J. *J. Chem. Soc., Dalton Trans.* **1991**, 2995–3001.
1277. Suades, J.; Solans, X.; Font-Altaba, M. *Polyhedron* **1984**, *3*, 1227–1231.
1278. Konno, T.; Yonenobu, K.; Hidaka, J.; Okamoto, K. *Inorg. Chem.* **1994**, *33*, 861–864.
1279. Konno, T.; Hidaka, J.; Okamoto, K. *Bull. Chem. Soc. Jpn.* **1995**, *68*, 1353–1359.
1280. Konno, T.; Yoshinari, Y.; Okamoto, K. *Chem. Lett.* **1995**, 989–990.
1281. Grapperhaus, C. A.; Darensbourg, M. Y. *Acc. Chem. Res.* **1998**, *31*, 451–459, and references therein.
1282. Darensbourg, M. Y.; Tuntulani, T.; Reibenspies, J. H. *Inorg. Chem.* **1995**, *34*, 6287–6294.
1283. Farmer, P. J.; Solouki, T.; Mills, D. K.; Soma, T.; Russell, D. H.; Reibenspies, J. H.; Darensbourg, M. Y. *J. Am. Chem. Soc.* **1992**, *114*, 4601–4605.
1284. Farmer, P. J.; Solouki, T.; Soma, T.; Russell, D. H.; Darensbourg, M. Y. *Inorg. Chem.* **1993**, *32*, 4171–4172.
1285. Darensbourg, M. Y.; Tuntulani, T.; Reibenspies, J. H. *Inorg. Chem.* **1994**, *33*, 611–613.
1286. Maroney, M. J.; Choudhury, S. B.; Bryngelson, P. A.; Mirza, S. A.; Sherrod, M. J. *Inorg. Chem.* **1996**, *35*, 1073–1076.
1287. Musie, G.; Farmer, P. J.; Tuntulani, T.; Reibenspies, J. H.; Darensbourg, M. Y. *Inorg. Chem.* **1996**, *35*, 2176–2183.
1288. Smee, J. J.; Goodman, D. C.; Reibenspies, J. H.; Darensbourg, M. Y. *Eur. J. Inorg. Chem.* **1999**, *3*, 539–546.
1289. Smee, J. J.; Miller, M. L.; Grapperhaus, C. A.; Reibenspies, J. H.; Darensbourg, M. Y. *Inorg. Chem.* **2001**, *40*, 3601–3605.
1290. Colpas, G. J.; Kumar, M.; Day, R. O.; Maroney, M. J. *Inorg. Chem.* **1990**, *29*, 4779–4788.
1291. Henderson, R. K.; Bouwman, E.; Spek, A. L.; Reedijk, J. *Inorg. Chem.* **1997**, *36*, 4616–4617.
1292. Kaasjager, V. E.; Bouwman, E.; Gorter, S.; Reedijk, J.; Grapperhaus, C. A.; Reibenspies, J. H.; Smee, J. J.; Darensbourg, M. Y.; Derecskei-Kovacs, A.; Thomson, L. M. *Inorg. Chem.* **2002**, *41*, 1837–1844.
1293. Davies, S. C.; Evans, D. J.; Hughes, D. L.; Longhurst, S. *Acta Crystallogr.* **1999**, *55C*, 1436–1438.
1294. Cornman, C. R.; Jantzi, K. L.; Wirgau, J. I.; Stauffer, T. C.; Kampf, J. W.; Boyle, P. D. *Inorg. Chem.* **1998**, *37*, 5851–5855.
1295. Allan, C. B.; Davidson, G.; Choudhury, S. B.; Gu, Z.; Bose, K.; Day, R. O.; Maroney, M. J. *Inorg. Chem.* **1998**, *37*, 4166–4167.
1296. Handa, M.; Mikuriya, M.; Okawa, H.; Kida, S. *Chem. Lett.* **1988**, *9*, 1555–1558.
1297. Mirza, S. A.; Day, R. O.; Maroney, M. J. *Inorg. Chem.* **1996**, *35*, 1992–1995.
1298. Choudhury, S. B.; Allan, C. B.; Maroney, M. J. *Inorg. Synth.* **1998**, *32*, 98–107.
1299. Choudhury, S. B.; Pressler, M. A.; Mirza, S. A.; Day, R. O.; Maroney, M. J. *Inorg. Chem.* **1994**, *33*, 4831–4839.
1300. Mirza, S. A.; Pressler, M. A.; Kumar, M.; Day, R. O.; Maroney, M. J. *Inorg. Chem.* **1993**, *32*, 977–987.
1301. Colpas, G. J.; Kumar, M.; Day, R. O.; Maroney, M. J. *Inorg. Chem.* **1990**, *29*, 4779–4788.
1302. Kumar, M.; Colpas, G. J.; Day, R. O.; Maroney, M. J. *J. Am. Chem. Soc.* **1989**, *111*, 8323–8325.
1303. Maroney, M. J.; Choudhury, S. B.; Bryngelson, P. A.; Mirza, S. A.; Sherrod, M. J. *Inorg. Chem.* **1996**, *35*, 1073–1076.
1304. Sellmann, D.; Hofmann, T.; Knoch, F. *Z. Naturforsch.* **1994**, *49b*, 821–826.
1305. Sellmann, D.; Prechtel, W.; Knoch, F.; Moll, M. *Z. Naturforsch.* **1992**, *47b*, 1411–1423.
1306. Sellmann, D.; Ruf, R.; Knoch, F.; Moll, M. *Z. Naturforsch.* **1995**, *50b*, 791–801.
1307. Sellmann, D.; Prechtel, W.; Knoch, F.; Moll, M. *Inorg. Chem.* **1993**, *32*, 538–546.
1308. Sellmann, D.; Prechel, W.; Knoch, F.; Moll, M. *Organometallics* **1992**, *11*, 2346–2348.
1309. Sellmann, D.; Prechtel, F.; Heinemann, F. W. *Z. Anorg. Allg. Chem.* **2001**, *627*, 1034–1038.
1310. Sellmann, D.; Häußinger, D.; Heinemann, F. W. *Eur. J. Inorg. Chem.* **1999**, 1715–1725.
1311. Fuchs, M.; Kuchen, W.; Peters, W. *Chem. Ber.* **1986**, *119*, 1569–1580.
1312. Deeg, A.; Kuchen, W.; Langsch, D.; Mootz, D.; Peters, W.; Wunderlich, H. *Z. Anorg. Allg. Chem.* **1991**, *606*, 119–132.

1313. Kuchen, W.; Wunderlich, H. *Acta Crystallogr.* **2000**, C56, 1296–1297.
1314. Kuchen, W.; Peters, W.; Sünkeler, M.; Wiskemann, R.; Wunderlich, H. *Z. Anorg. Allg. Chem.* **1998**, 624, 1956–1964.
1315. Kuchen, W.; Fuchs, M.; Keck, H.; Wunderlich, H. *Z. Kristallogr.* **1988**, 183, 123–127.
1316. Stavropoulos, P.; Muettterties, M. C.; Carrie, M.; Holm, R. H. *J. Am. Chem. Soc.* **1991**, 113, 8485–8492.
1317. Stavropoulos, P.; Carrie, M.; Muettterties, M. C.; Holm, R. H. *J. Am. Chem. Soc.* **1990**, 112, 5385–5387.
1318. Raganathan, K. G.; Bharadwaj, P. K. *J. Chem. Soc., Dalton Trans.* **1992**, 2417–2422.
1319. Martinez, M. A.; Legros, J. P.; Soto, L.; Sancho, A. *Polyhedron* **1991**, 10, 1031–1036.
1320. Verweij, P. D.; Sital, S.; Bouwman, E.; Driessen, W. L.; Reedijk, J.; Wood, J. S. *Inorg. Chim. Acta* **1991**, 182, 187–195.
1321. Haanstra, W. G.; Driessen, W. L.; Reedijk, J.; Fröhlich, R.; Krebs, B. *Inorg. Chim. Acta* **1991**, 185, 175–180.
1322. Spek, A. L.; Duisenberg, A. J. M.; Bouwman, E.; Driessen, W. L.; Reedijk, J. *Acta Crystallogr.* **1988**, 44C, 1569–1572.
1323. Bouwman, E.; Wood, J. S.; Day, R.; ten Hove, J. C.; Driessen, W. L.; Reedijk, J. *Acta Crystallogr.* **1988**, C44, 644–646.
1324. Bouwman, E.; ten Hove, J. C.; Driessen, W. L.; Reedijk, J. *Polyhedron* **1988**, 7, 2591–2595.
1325. van Rijn, J.; Bouwman, E.; Empfield, J. R.; Driessen, W. L.; Reedijk, J. *Polyhedron* **1989**, 8, 1965–1970.
1326. Bouwman, E.; Westheide, C. E.; Driessen, W. L.; Reedijk, J. *Inorg. Chim. Acta* **1989**, 166, 291–299.
1327. Paap, F.; Driessen, W. L.; Reedijk, J.; Spek, A. L. *Inorg. Chim. Acta* **1988**, 150, 57–64.
1328. van Diepen, M. G. W.; de Graaff, R. A. G.; Hulsbergen, F. B.; Reedijk, J. *Inorg. Chim. Acta* **1989**, 162, 271–275.
1329. Bermejo, E.; Castineiras, A.; Dominguez, R.; Strähle, J.; Hiller, W. *Acta Crystallogr.* **1993**, 49C, 1919–1920.
1330. Bermejo, E.; Castineiras, A.; Dominguez, R.; Strähle, J.; Hiller, W. *Acta Crystallogr.* **1993**, 49C, 324–326.
1331. Adhikary, B.; Liu, S.; Lucas, C. R. *Inorg. Chem.* **1993**, 32, 5957–5962.
1332. Teixidor, F.; Escriche, L.; Casabo, J.; Molins, E.; Miravittles, *Inorg. Chem.* **1986**, 26, 4060–4062.
1333. Ball, R. J.; Genge, A. R. J.; Radford, A. L.; Skelton, B. W.; Tolhurst, V.-A.; White, A. H. *J. Chem. Soc., Dalton Trans.* **2001**, 2807–2812.
1334. Hart, S. M.; Boeyens, J. C. A.; Hancock, R. D. *Inorg. Chem.* **1983**, 22, 982–986.
1335. Kuma, H.; Yamada, S.; Murase, I. *Synth. React. Inorg. Met. Org. Chem.* **1982**, 12, 785–792.
1336. Ghosh, P.; Shukla, R.; Chand, D. K.; Bharadwaj, *Tetrahedron* **1995**, 51, 3265–3270.
1337. Pal, S.; Poddar, S. N.; Mukherjee, G. *Transition Met. Chem.* **1994**, 19, 449–52.
1338. Naiini, A. A.; Lai, C.-K.; Ward, D. L.; Brubaker, C. H. *J. Organomet. Chem.* **1990**, 390, 73–90.
1339. Shukla, R.; Mandal, S.; Bharadwaj, P. K. *Polyhedron* **1993**, 12, 83–88.
1340. Mikuriya, M.; Handa, M.; Shigematsu, S.; Funaki, S.; Fujii, T.; Okawa, H.; Koshiba, T.; Terauchi, H. *Bull. Chem. Soc. Jpn.* **1993**, 66, 1104–1110.
1341. Shoner, S. C.; Olmstead, M. M.; Kovacs, J. A. *Inorg. Chem.* **1994**, 33, 7–8.
1342. Kawamoto, T.; Kushi, Y. *Chem. Lett.* **1992**, 893–896.
1343. Kawamoto, T.; Kuma, H.; Kushi, Y. *Bull. Chem. Soc. Jpn.* **1997**, 70, 1599–1606.
1344. Kawamoto, T.; Kushi, Y. *J. Chem. Soc., Dalton Trans.* **2000**, 3022–3026.
1345. Herebian, D.; Bothe, E.; Bill, E.; Weyhermüller, T.; Wieghardt, K. *J. Am. Chem. Soc.* **2001**, 123, 10012–10023.
1346. Martin, E. M.; Bereman, R. D.; Reibenspies, J. *Inorg. Chim. Acta* **1992**, 191, 171–177.
1347. Martin, E. M.; Bereman, R. D. *Inorg. Chim. Acta* **1991**, 188, 233–242.
1348. Martin, E. M.; Bereman, R. D. *Inorg. Chim. Acta* **1991**, 188, 221–231.
1349. Martin, E. M.; Bereman, R. D.; Singh, P. *Inorg. Chem.* **1991**, 30, 957–962.
1350. Martin, E. M.; Bereman, R. D.; Dorfman, J. *Inorg. Chim. Acta* **1990**, 176, 247–254.
1351. Nivorozhkin, A. L.; Konstantinovskii, L. E.; Nivorozhkin, L. E.; Minkin, V. I.; Takhirov, T. G.; Dyachenko, O. A.; Tagiev, D. V. *Izv. Akad. Nauk. SSR, Ser. Khim.* **1990**, 327–335.
1352. Adhikhari, B.; Anderson, O. P.; la Cour, A.; Hazell, R.; Miller, S. M.; Olsen, C. E.; Toftlund, H. *J. Chem. Soc., Dalton Trans.* **1997**, 4539–4548.
1353. la Cour, A.; Findeisen, M.; Hansen, K.; Hazell, R.; Hennig, L.; Olsen, C. E.; Pedersen, L.; Simonsen, O. *J. Chem. Soc., Dalton Trans.* **1997**, 12, 2045–2057.
1354. la Cour, ; Findeisen, M.; Hazell, A.; Hazell, R.; Zdobinsky, G. *J. Chem. Soc., Dalton Trans.* **1997**, 121–128.
1355. Henning, L.; Kirmse, R.; Hammerich, O.; Larsen, S.; Frydendahl, H.; Toftlund, H.; Becher, J. *Inorg. Chim. Acta* **1995**, 234, 67–74.
1356. Toftlund, H.; Nivorozhkin, A. L.; LaCour A.; Adhikary, B.; Murray, K. S.; Fallon, G. D.; Nivorozhkin, L. E. *Inorg. Chim. Acta* **1995**, 228, 237–241.
1357. La Cour, A.; Adhikhari, B.; Toftlund, H.; Hazell, A. *Inorg. Chim. Acta* **1992**, 202, 145–156.
1358. Nivorozhkin, A. L.; Nivorozhkin, L. E.; Minkin, V. I.; Takhirov, T. G.; Diachenko, O. A. *Polyhedron* **1991**, 10, 179–185.
1359. Frydendahl, H.; Toftlund, H.; Becher, J.; Dutton, J. C.; Murray, K. S.; Taylor, L. F.; Anderson, O. P.; Tiekink, E. R. T. *Inorg. Chem.* **1995**, 34, 4467–4476.
1360. Smeets, W. J. J.; Spek, A. L.; Henderson, R. K.; Bouwman, E.; Reedijk, J. *Acta Crystallogr.* **1997**, C53, 1564–1566.
1361. Henderson, R. K.; Bouwman, E.; Reedijk, J.; Powell, A. K. *Acta Crystallogr.* **1996**, C51, 2696–2698.
1362. Yamamura, T.; Tadokoro, M.; Tanaka, K.; Kuroda, R. *Bull. Chem. Soc. Jpn.* **1993**, 66, 1984–1990.
1363. Goswami, N.; Eichhorn, D. M. *Inorg. Chim. Acta* **2000**, 303, 271–276.
1364. Bohle, D. S.; Goodson, P. A.; Jaeger, D. A.; Zafar, A. *Inorg. Chim. Acta* **2001**, 312, 210–214.
1365. Bohle, D. S.; Zafar, A.; Goodson, P. A.; Jaeger, D. A. *Inorg. Chem.* **2000**, 39, 712–718.
1366. Bouwman, E.; Henderson, R. K.; Powell, A. K.; Reedijk, J.; Smeets, W. J. J.; Spek, A. L.; Veldman, N.; Wocadlo, S. *J. Chem. Soc., Dalton Trans.* **1998**, 3495–3499.
1367. Christensen, A.; Jensen, H. S.; McKee, V.; McKenzie, C. J.; Munch, M. *Inorg. Chem.* **1997**, 36, 6080–6085.
1368. Goswami, N.; Eichhorn, D. M. *Inorg. Chem.* **1999**, 38, 4329–4333.
1369. Castro, J.; Romero, J.; Garcia-Vazquez, J. A.; Duran, M. L.; Castineiras, A.; Sousa, A.; Fenton, D. E. *J. Chem. Soc., Dalton Trans.* **1990**, 3255–3258.
1370. Abadia, A.; Sancho, A.; Soto, L.; Borrás, J. *Transition Met. Chem.* **1986**, 11, 8–11.

1371. Hartung, J.; Weber, G.; Beyer, L.; Szargan, R. *Z. Anorg. Allg. Chem.* **1985**, *523*, 153–160.
1372. Dave, L. D.; Mathew, C.; Oommen, V. *Indian J. Chem.* **1983**, *22A*, 420–421.
1373. Pecs, L.; Ozols, J.; Fundamenskii, V. S.; Sturis, A. P. *Zhur. Strukt. Khim.* **1982**, *23*, 114–118.
1374. Friese, M.; Dietze, F.; Szargan, R.; Hoyer, E.; Kibbel, H. U. *Z. Chem.* **1982**, *22*, 455–456.
1375. Garnovskii, A. D.; Korzhavina, O. B.; Ryabukhin, Y. I. *Koord. Khim.* **1986**, *12*, 853–854.
1376. Krüger, H.-J.; Holm, R. H. *J. Am. Chem. Soc.* **1990**, *112*, 2955–2963.
1377. Castro, R.; Duran, M. L.; Garcia-Vazquez, J. A.; Romero, J.; Sousa, A.; Castineiras, A.; Hiller, W.; Strähle, J. *J. Chem. Soc., Dalton Trans.* **1990**, 531–534.
1378. Rosenfield, S. G.; Berends, H. P.; Gelmini, L.; Stephan, D. W.; Mascharak, P. K. *Inorg. Chem.* **1987**, *26*, 2792–2797.
1379. Block, E.; Ofori-Okai, G.; Kang, H.; Zubieta, J. *Inorg. Chim. Acta* **1991**, *188*, 7–13.
1380. Castro, R.; Garcia-Vaquez, J. A.; Romero, J.; Sousa, A.; Castineiras, A.; Hiller, W.; Strähle, J. *Inorg. Chim. Acta* **1993**, *211*, 47–53.
1381. Castro, R.; Garcia-Vaquez, J. A.; Romero, J.; Sousa, A.; Pritchard, R.; McAuliffe, C. A. *J. Chem. Soc., Dalton Trans.* **1994**, 1115–1120.
1382. Khalifa, M. A.; Hassan, A. M. A. *Transition Met. Chem.* **1994**, *19*, 28–30.
1383. Garcia-Vaquez, J. A.; Romero, J.; Sousa-Pedrares, A.; Louro, M. L.; Sousa, A.; Zubieta, J. *J. Chem. Soc., Dalton Trans.* **2000**, *4*, 559–567.
1384. Perez-Lourido, P.; Garcia-Vazquez, J. A.; Romero, J.; Louro, M. S.; Sousa, A.; Zubieta, J. *Inorg. Chim. Acta* **1998**, *271*, 1–8.
1385. Ballester, L.; Gutierrez, A.; Perpignan, M. F.; Rico, T.; Gutierrez-Puebla, Monge A. *Polyhedron* **1994**, *13*, 2277–2283.
1386. Castro, R.; Garcia-Vaquez, J. A.; Romero, J.; Sousa, A.; McAuliffe, C. A.; Pritchard, R. *Polyhedron* **1993**, *12*, 2241–2247.
1387. Aly, A. A. M.; Zidan, A. S. A.; El-Said, A. I. *J. Therm. Anal.* **1991**, *37*, 627–636.
1388. Raper, E. S.; Britton, A. M.; Clegg, W. *J. Chem. Soc., Dalton Trans.* **1990**, 3341–3345.
1389. Lopez, G.; Sanchez, G.; Garcia, G.; Perez, E.; Casato, J.; Molins, E.; Miravittles, C. *Inorg. Chim. Acta* **1990**, *178*, 213–220.
1390. Srivastava, R. S.; Srivastava, R. R.; Bhargava, H. N. *Bull. Chim. Soc. Fr.* **1991**, *128*, 671–676.
1391. Supuran, C. T.; Cimpoesu, F.; Manole, G.; Brezeanu, M. *Rev. Roum. Chim.* **1992**, *37*, 959–964.
1392. Umapathy, P.; Budhkar, A. P. *Synth. React. Inorg. Met. Org. Chem.* **1986**, *16*, 1289–1304.
1393. Brückner, C.; Rettig, S. J.; Dolphin, D. *Inorg. Chem.* **2000**, *39*, 6100–6106.
1394. Pavlishchuk, V. V.; Addison, A. W.; Butcher, R. J.; Kanters, R. P. F. *Inorg. Chem.* **1994**, *33*, 397–399.
1395. Pavlishchuk, V. V.; Kolotilov, S. V.; Addison, A. W.; Prushan, M. J.; Butcher, R. J.; Thompson, L. K. *Inorg. Chem.* **1999**, *38*, 1759–1766.
1396. Pavlishchuk, V. V.; Kolotilov, S. V.; Addison, A. W.; Prushan, M. J.; Butcher, R. J.; Thompson, L. K. *Chem. Commun.* **2002**, 468–469.
1397. Kaasjager, V. E.; Puglisi, L.; Bouwman, E.; Driessen, W. L.; Reedijk, J. *Inorg. Chim. Acta* **2000**, *310*, 183–190.
1398. Tereira, E.; Gomes, L.; de Castro, B. *J. Chem. Soc., Dalton Trans.* **1998**, 629–636.
1399. Kaasjager, V. E.; van den Broeke, J.; Henderson, R. K.; Smeets, W. J. J.; Spek, A. L.; Driessen, W. L.; Bouwman, E.; Reedijk, J. *Inorg. Chim. Acta* **2001**, *316*, 99–104.
1400. Castiñeiras, A.; Vidal, M. C. F.; Romero, J.; Sáez, R.; Matilla, A.; Niclós, J.; Tercero, J. M. *Z. Anorg. Allg. Chem.* **2001**, *627*, 1553–1559.
1401. Berkessel, A.; Bats, J. W.; Bolte, M.; Neumann, T.; Seidel, L. *Chem. Ber. /Recueil* **1997**, *130*, 891–897.
1402. Berkessel, A.; Bats, J. W.; Hüber, M.; Haase, W.; Neumann, T.; Seidel, L. *Chem. Ber.* **1995**, *128*, 125–129.
1403. Ochs, C.; Hahn, F. E.; Fröhlich, R. *Chem. Eur. J.* **2000**, *6*, 2193–2199.
1404. Chaudhuri, P.; Wieghardt, K. *Prog. Inorg. Chem.* **1987**, *35*, 329–436.
1405. Lindoy, L. F. *The Chemistry of Macrocyclic Ligand Complexes*; Cambridge University Press: Cambridge, UK, 1989.
1406. Du, M.; Bu, X.-H.; Wang, G.-C.; Guo, Y.-M.; Zhang, R.-H. *Inorg. Chim. Acta* **2001**, *320*, 190–197.
1407. Farmer, P. J.; Reibenspies, J. H.; Lindahl, P. A.; Darensbourg, M. Y. *J. Am. Chem. Soc.* **1993**, *115*, 4665–4674.
1408. Musie, G.; Farmer, P. J.; Tuntulani, T.; Reibenspies, J. H.; Darensbourg, M. Y. *Inorg. Chem.* **1996**, *35*, 2176–2183.
1409. Grapperhaus, C. A.; Darensbourg, M. Y. *Acc. Chem. Res.* **1998**, *31*, 451–459, and references therein.
1410. Blake, A. J.; Fallis, I. A.; Parsons, S.; Ross, S. A.; Schröder, M. *J. Chem. Soc., Dalton Trans.* **1996**, 525–532.
1411. Wieghardt, K.; Tolksdorf, I.; Herrmann, W. *Inorg. Chem.* **1985**, *24*, 1230–1235.
1412. Graham, B.; Fallon, G. D.; Hearn, M. T. W.; Hockless, D. C. R.; Lazarev, G.; Spiccia, L. *Inorg. Chem.* **1997**, *36*, 6366–6373.
1413. Graham, B.; Spiccia, L.; Bond, A. M.; Hearn, M. T. W.; Kepert, C. M. *J. Chem. Soc., Dalton Trans.* **2001**, 2232–2238.
1414. Ellis, D.; Farrugia, L. J.; Peacock, R. D. *Polyhedron* **1999**, *18*, 1229–1234.
1415. Golding, S. W.; Hambley, T. W.; Lawrance, G. A.; Luther, S. M.; Maeder, M.; Turner, P. *J. Chem. Soc., Dalton Trans.* **1999**, 1975–1980.
1416. Stranger, R.; Wallis, S. C.; Gahan, L. R.; Kennard, C. H. L.; Byriel, K. A. *J. Chem. Soc., Dalton Trans.* **1992**, 2971–2976.
1417. Thoen, V. J.; Boeyens, J. C. A.; McDougall, G. J.; Hancock, R. D. *J. Am. Chem. Soc.* **1984**, *106*, 3198–3207.
1418. Bushnell, G. W.; Fortier, D. G.; McAuley, A. *Inorg. Chem.* **1988**, *27*, 2626–2634.
1419. Di Vaira, M.; Mani, F.; Stoppioni, P. *J. Chem. Soc., Chem. Commun.* **1989**, 126–127.
1420. De Martino, N. G.; Di Vaira, M.; Mani, F.; Mazzi, S.; Stoppioni, P. *J. Chem. Soc., Dalton Trans.* **1992**, 361–365.
1421. Koikawa, M.; Jensen, K. B.; Matushima, H.; Tokii, T.; Toftlund, H. *J. Chem. Soc., Dalton Trans.* **1998**, 1085–1086.
1422. Di Vaira, M.; Mani, F.; Stoppioni, P. *J. Chem. Soc., Dalton Trans.* **1994**, 3739–3743.
1423. Fallis, I. A.; Farrugia, L. J.; Macdonald, N. M.; Peacock, R. D. *J. Chem. Soc., Dalton Trans.* **1993**, 2759–2763.
1424. Smith, G. T.; Howard, J. A. K. *J. Chem. Soc., Chem. Commun.* **1996**, 525–526.
1425. Van der Mewe, M. J.; Boeyens, J. C. A.; Hancock, R. D. *Inorg. Chem.* **1985**, *24*, 1208–1213.
1426. Wieghardt, K.; Bossek, U.; Guttman, M.; Weiss, J. *Z. Naturforsch. B* **1983**, *38B*, 81–89.
1427. Groess, S.; Elias, H. *Inorg. Chim. Acta* **1996**, *251*, 347–354.

1428. Zompa, L. J. *Inorg. Chem.* **1978**, *17*, 2531–2536.
1429. Fallis, I. A.; Farley, R. D.; Malik, K. M. A.; Murphy, D. M.; Smith, H. J. *J. Chem. Soc., Dalton Trans.* **2000**, 3632–3639.
1430. Schlager, O.; Wiegardt, K.; Nuber, B. *Inorg. Chem.* **1995**, *34*, 6449–6455.
1431. Fortier, D. B.; McAuley, A. *J. Chem. Soc., Dalton Trans.* **1991**, 101–109.
1432. Di Vaira, M.; Mani, F.; Stoppioni, P. *Inorg. Chim. Acta* **2000**, *303*, 61–69.
1433. Lyon, J. M.; Gunther, E. J. *Coord. Chem.* **1995**, *34*, 13–22.
1434. Alcock, N. W.; McLaren, F.; Moore, P.; Pike, G. A.; Roe, S. M. *J. Chem. Soc., Chem. Commun.* **1989**, 629–632.
1435. Yang, R.; Zompa, L. J. *Inorg. Chem.* **1976**, *15*, 1499–1502.
1436. Cai, H. Z.; Kaden, T. A. *Helv. Chim. Acta* **1993**, *76*, 557–562.
1437. Di Vaira, M.; Mani, F.; Stoppioni, P. *Inorg. Chim. Acta* **1998**, *273*, 151–159.
1438. Ellis, D.; Farrugia, L. J.; Lovatt, P. A.; Peacock, R. D. *Eur. J. Inorg. Chem.* **2000**, 1489–1493.
1439. Muller, J.; Kikuchi, A.; Bill, E.; Weyhermuller, T.; Hildebrandt, P.; Oud-Moussa, L.; Wiegardt, K. *Inorg. Chim. Acta* **2000**, *297*, 265–277.
1440. McAuley, A.; Fortier, D. G.; Macartney, D. H.; Whitcombe, T. W.; Xu, C. *J. Chem. Soc., Dalton Trans.* **1994**, 2071–2079.
1441. Grant, G. J.; Mauldin, P. L.; Setzer, W. N. *J. Chem. Educ.* **1991**, *68*, 605–607.
1442. Seltzer, W. N.; Ogle, C. A.; Wilson, G. S.; Glass, R. S. *Inorg. Chem.* **1983**, *22*, 266–271.
1443. Wiegardt, K.; Kueppers, H. J.; Weiss, J. *Inorg. Chem.* **1985**, *24*, 3067–3071.
1444. McAuley, A.; Subramanian, S.; Zaworotko, M. J.; Atencio, R. *Inorg. Chem.* **1998**, *37*, 4607–4610.
1445. Smith, R. J.; Admans, G. D.; Richardson, A. P.; Kueppers, H. J.; Blower, P. J. *J. Chem. Soc., Chem. Commun.* **1991**, 475–476.
1446. Blake, A. J.; Gould, R. O.; Halcrow, M. A.; Schröder, M. *J. Chem. Soc., Dalton Trans.* **1993**, 2909–2920.
1447. Blake, A. J.; Halcrow, M. A.; Schröder, M. *Z. Kristallogr.* **1993**, *205*, 295–299.
1448. Kagabu, S.; Kaiser, C.; Keller, R.; Becker, P. G.; Mueller, K. H.; Knothe, L.; Rihs, G.; Prinzbach, H. *Chem. Ber.* **1988**, *121*, 741–756.
1449. Grant, G. J.; Grant, C. D.; Setzer, W. N. *Inorg. Chem.* **1991**, *30*, 353–355.
1450. Nonoyama, M.; Ishida, T. *Transition Met. Chem.* **1984**, *9*, 367–371.
1451. Hart, S. M.; Boeyens, J. C. A.; Michael, J. P.; Hancock, R. D. *J. Chem. Soc., Dalton Trans.* **1983**, 1691–1606.
1452. Boeyens, J. C. A.; Hancock, R. D.; Thom, V. J. *J. Crystallogr. Spectrosc. Res.* **1984**, *14*, 261–268.
1453. Nonoyama, M.; Nonoyama, K. *Transition Met. Chem.* **1985**, *10*, 382–384.
1454. Loewe, A.; Mattes, R.; Wasielewski, K. *Z. Anorg. Allg. Chem.* **1993**, *619*, 905–911.
1455. Grant, G. J.; Jones, M. W.; Loveday, K. D.; VanDerveer, D. G.; Pennington, W. T.; Eagle, C. T.; Mehne, L. F. *Inorg. Chim. Acta* **2000**, *300-302*, 250–263.
1456. Blake, A. J.; Danks, J. P.; Fallis, I. A.; Harrison, A.; Li, W.-S.; Parsons, S.; Ross, S. A.; Whittaker, G.; Schröder, M. *J. Chem. Soc., Dalton Trans.* **1998**, 3969–3976.
1457. Wasielewski, K.; Mattes, R. *Z. Anorg. Allg. Chem.* **1993**, *619*, 158–162.
1458. Hancock, R. D.; Dobson, S. M.; Boeyens, J. C. A. *Inorg. Chim. Acta* **1987**, *133*, 221–231.
1459. McAuley, A.; Subramanian, S. *Inorg. Chem.* **1990**, *29*, 2830–2837.
1460. Hart, S. M.; Boeyens, J. C. A.; Hancock, R. D. *Inorg. Chem.* **1983**, *22*, 982–986.
1461. Suh, M. P.; Shin, W.; Kim, D.; Kim, S. *Inorg. Chem.* **1984**, *23*, 618–620.
1462. Suh, M. P.; Kim, D. *Inorg. Chem.* **1985**, *24*, 3712–3714.
1463. Suh, M. P.; Shin, W.; Kim, H.; Koo, C. H. *Inorg. Chem.* **1987**, *26*, 1846–1852.
1464. Suh, M. P.; Kang, S.-G. *Inorg. Chem.* **1988**, *27*, 2544–2546.
1465. Suh, M. P.; Shin, W.; Kang, S.-G.; Lah, M. S.; Chung, T. M. *Inorg. Chem.* **1989**, *28*, 1602–1605.
1466. Suh, M. P.; Choi, J. W.; Kang, S.-G.; Shin, W. C. *Inorg. Chem.* **1989**, *28*, 1763–1765.
1467. Suh, M. P.; Kang, S. G.; Goedken, V. L.; Park, S. H. *Inorg. Chem.* **1991**, *30*, 365–370.
1468. Jung, S. K.; Kang, S. G.; Suh, M. P. *Kor. Chem. Soc.* **1989**, *10*, 362–366.
1469. Fabbrizzi, L.; Lanfredi, A. M. M.; Pallavicini, P.; Perotti, A.; Taglietti, A.; Ugozzoli, F. *J. Chem. Soc., Dalton Trans.* **1991**, 3263–3269.
1470. Boucher, H. A.; Lawrance, G. A.; Lay, P. A.; Sargeson, A. M.; Bond, A. M.; Sangster, D. F.; Sullivan, J. C. *J. Am. Chem. Soc.* **1983**, *105*, 4652–4661.
1471. Kang, S.-G.; Choi, J.-S.; Kim, S.-J. *Bull. Korean Chem. Soc.* **1995**, *16*, 518–523.
1472. Curtis, N. F.; Gainsford, G. J.; Siriwardena, A.; Weatherburn, D. C. *Aust. J. Chem.* **1993**, *46*, 755–786.
1473. De Blas, A.; De Santis, G.; Fabbrizzi, L.; Licchelli, M.; Lanfredi, A. M. M.; Pallavicini, P.; Poggi, A.; Ugozzoli, A. *Inorg. Chem.* **1993**, *32*, 106–113.
1474. Abba, F.; De Santis, G.; Fabbrizzi, L.; Licchelli, M.; Lanfredi, A. M. M.; Pallavicini, P.; Poggi, A.; Ugozzoli, F. *Inorg. Chem.* **1994**, *33*, 1366–1375.
1475. De Santis, G.; Fabbrizzi, L.; Licchelli, M.; Mangano, C.; Pallavicini, P.; Poggi, A. *Inorg. Chem.* **1993**, *32*, 854–860.
1476. Suh, M. P.; Shim, B. Y.; Yoon, T. S. *Inorg. Chem.* **1984**, *33*, 5509–5514.
1477. Hambley, T. W.; Lawrance, G. A.; Maeder, M.; Wilkes, E. N. *Inorg. Chim. Acta* **1996**, *246*, 65–71.
1478. Suh, M. P.; Kim, I. S.; Cho, S.-J.; Shin, W. *J. Chem. Soc., Dalton Trans.* **1994**, 2765–2769.
1479. Bernhardt, P. V.; Curtis, L. S.; Curtis, N. F.; Lawrance, G. A.; Skelton, B. W.; White, A. H. *Aust. J. Chem.* **1989**, *42*, 797–811.
1480. Kang, S.-G.; Ryu, K.; Jung, S.-K.; Jeong, J. H. *Inorg. Chim. Acta* **2001**, *317*, 314–319.
1481. Cutler, A. R.; Alleyne, C. S.; Dolphin, D. *Inorg. Chem.* **1985**, *24*, 2276–2281.
1482. Jäger, E. G.; Seidel, D. *Z. Chem.* **1983**, *23*, 261–262.
1483. Cutler, A. R.; Alleyne, C. S.; Dolphin, D. *Inorg. Chem.* **1985**, *24*, 2281–2286.
1484. Cameron, J. H.; Clarke, C. A.; Harvey, H. B.; McCullough, K. J.; Rudolf, P. A. *J. Chem. Soc., Dalton Trans.* **1996**, 1513–1518.
1485. Hayes, J. W. II; Taylor, C. J.; Hotz, R. P. *J. Chem. Educ.* **1996**, *73*, 991–992.
1486. Stephenson, N. A.; Tweedy, H. E.; Busch, D. H. *Inorg. Chem.* **1989**, *28*, 4376–4379.
1487. Kandil, S. S.; Collier, H. L. *Inorg. Chem.* **1988**, *27*, 4542–4546.

1488. Prasad, R. N.; Sharma, S. J. *Serb. Chem. Soc.* **1996**, *61*, 25–30.
1489. Comparone, A.; Kaden, T. A. *Helv. Chim. Acta* **1998**, *81*, 1765–1772.
1490. Oberholzer, M. R.; Neuburger, M.; Zehnder, M.; Kaden, T. A. *Helv. Chim. Acta* **1995**, *78*, 505–513.
1491. Hay, R. W.; Pujari, M. P.; Moodie, W. T.; Craig, S.; Richens, D. T.; Perotti, A.; Ungaretti, L. *J. Chem. Soc., Dalton Trans.* **1987**, 2605–2613.
1492. Barefield, E. K.; Foster, K. A.; Freeman, G. M.; Hodges, K. D. *Inorg. Chem.* **1986**, *25*, 4663–4668.
1493. Tschudin, D.; Basak, A.; Kaden, T. A. *Helv. Chim. Acta* **1988**, *71*, 100–106.
1494. Freeman, G. M.; Barefield, E. K.; Van Derveer, D. G. *Inorg. Chem.* **1984**, *23*, 3092–3103.
1495. Kang, S.-G.; Ryu, K.; Song, J. *Polyhedron* **1999**, *18*, 2193–2199.
1496. Choi, K.-Y.; Lee, H.-H.; Park, B. B.; Kim, J. H.; Kim, J.; Kim, M.-W.; Ryu, J.-W.; Suh, M.; Suh, I.-H. *Polyhedron* **2001**, *20*, 2003–2009.
1497. Kang, S.-G.; Kim, M.-S.; Choi, J.-S.; Whang, D.; Kim, K. *J. Chem. Soc., Dalton Trans.* **1995**, 363–366.
1498. Schmid, C. L.; Neuburger, M.; Zehnder, M.; Kaden, T. A.; Bujino, K.; Bilewicz, R. *Helv. Chim. Acta* **1997**, *80*, 241–252.
1499. Choi, K.-Y.; Chun, K.-M.; Suh, I.-H. *Polyhedron* **1999**, *18*, 2811–2820.
1500. Batsanov, A. S.; Goeta, A. E.; Howard, J. A. K.; Maffeo, D.; Puschmann, H.; Gareth Williams, J. A. *Polyhedron* **2001**, *20*, 981–986.
1501. Pallavicini, P. S.; Perotti, A.; Poggi, A.; Seghi, B.; Fabbrizzi, L. *J. Am. Chem. Soc.* **1987**, *109*, 5139–5144.
1502. De Martino Norante, G.; Di Vaira, M.; Mani, F.; Mazzi, S.; Stoppioni, P. *Inorg. Chem.* **1990**, *29*, 2822–2829.
1503. Bu, X.-H.; Cao, X.-C.; Chen, W.; Zhang, R.-H.; Thomas, C. *Polyhedron* **1997**, *17*, 289–293.
1504. Alcock, N. W.; Balakrishnan, K. P.; Moore, P.; Omar, H. A. A. *J. Chem. Soc., Dalton Trans.* **1987**, 545–550.
1505. Balakrishnan, K. P.; Omar, H. A. A.; Moore, P.; Alcock, N. W.; Pike, G. A. *J. Chem. Soc., Dalton Trans.* **1990**, 2965–2969.
1506. Kimura, E.; Yamaoka, M.; Morioka, M.; Koike, T. *Inorg. Chem.* **1986**, *25*, 3883–3886.
1507. Kimura, E.; Haruta, M.; Koike, T.; Shionoya, M.; Takenouchi, K.; Iitaka, Y. *Inorg. Chem.* **1993**, *32*, 2779–2784.
1508. Achmatowicz, M.; Jurczak, J. *Tetrahedron Lett.* **2000**, *41*, 5967–5970.
1509. Kang, S.-G.; Ryu, K.; Suh, M. P.; Jeong, J. H. *Inorg. Chem.* **1997**, *36*, 2478–2481.
1510. Mrozinski, J.; Skorupa, A.; Pochaba, A.; Dromzée, Y.; Verdaguer, M.; Goovaerts, E.; Varcammen, H.; Korybut-Daszkiewicz, B. *J. Mol. Struct.* **2001**, *559*, 107–118.
1511. Engelhardt, L. M.; Harrowfield, J. M.; Sargeson, A. M.; White, A. H. *Aust. J. Chem.* **1993**, *46*, 127–133.
1512. Donlevy, T. M.; Gahan, L. R.; Stranger, R.; Kennedy, S. E.; Byriel, K. A.; Kennard, C. H. *Inorg. Chem.* **1993**, *32*, 6023–6027.
1513. Stranger, R.; McMahon, K. L.; Gahan, L. R.; Bruce, J. I.; Hambley, T. W. *Inorg. Chem.* **1997**, *36*, 3466–3475.
1514. Suh, M. P.; Kim, M. J.; Kim, H. K.; Oh, K. Y. *Bull. Kor. Chem. Soc.* **1992**, *13*, 80–83.
1515. Kang, S.-G.; Kim, M.-S.; Whang, D.; Kim, K. *Inorg. Chim. Acta* **1998**, *279*, 238–242.
1516. Hay, R. W.; Tarafder, M.; Tofazzal, H.; Korybut-Daszkiewicz, B. *Transition Met. Chem.* **1998**, *23*, 165–167.
1517. Kang, S.-G.; Kim, S.-J.; Ryu, K. *Bull. Korean Chem. Soc.* **1996**, *17*, 83–85.
1518. Kang, S.-G.; Kim, S.-J.; Kwak, C.-H.; Kim, J. J. *J. Chem. Soc., Dalton Trans.* **1996**, 2809–2813.
1519. König, B.; Pelka, M.; Zieg, P. G. J.; Dix, I. *J. Chem. Soc., Chem. Commun.* **1996**, 471–472.
1520. Cameron, J. H.; Scott, E. L. *J. Chem. Soc., Dalton Trans.* **1995**, 1029–1034.
1521. Sakata, K.; Hashimoto, M.; Hamada, T.; Matsuno, S. *Polyhedron* **1996**, *15*, 967–972.
1522. Tsai, Y.-H.; Sun, Y.-L.; Lin, C.-C.; Kuo, C.-Y. *Polyhedron* **1997**, *16*, 2599–2604.
1523. Sakata, K.; Itoh, M. *J. Heterocycl. Chem.* **1992**, *29*, 921–926.
1524. Sakata, K.; Shimoda, M.; Hashimoto, M. *J. Heterocycl. Chem.* **1996**, *33*, 1593–1598.
1525. Sakata, K.; Koyanagi, K.; Hashimoto, M. *J. Heterocycl. Chem.* **1995**, *32*, 329–333.
1526. Eilmes, J. *Polyhedron* **1987**, *6*, 423–425.
1527. Eilmes, J. *Polyhedron* **1988**, *7*, 2197–2200.
1528. Eilmes, J. *Polyhedron* **1989**, *8*, 1243–1246.
1529. Eilmes, J.; Ptaszek, M.; Zielinska, K. *Polyhedron* **2001**, *20*, 143–149.
1530. Eilmes, J.; Michalski, O.; Wozniak, K. *Inorg. Chim. Acta* **2001**, *317*, 103.
1531. Hardie, M. J.; Malic, N.; Nichols, P. J.; Raston, C. L. *Tetrahedron Lett.* **2001**, *42*, 8075–8079.
1532. Eilmes, J.; Ptaszek, M.; Wozniak, K. *Polyhedron* **2002**, *21*, 7–17.
1533. Eilmes, J.; Michalski, O.; Wozniak, K. *Inorg. Chim. Acta* **2001**, *317*, 103–113.
1534. Sakata, K.; Hashimoto, M.; Hamada, T.; Matsuno, S. *Polyhedron* **1996**, *15*, 967–972.
1535. Tsai, Y.-H.; Lin, C.-C. *Chem. Lett.* **1996**, 101–102.
1536. König, B.; Pelka, M.; Möller, O.; Dix, I.; Jones, P. G. *Chem. Ber. /Recl.* **1997**, *130*, 521–527.
1537. Barefield, E. K.; Bianchi, A.; Billo, E. J.; Connolly, P. J.; Paoletti, P.; Summers, J. S.; Van Derveer, D. G. *Inorg. Chem.* **1986**, *25*, 4197–4202.
1538. Szalda, D. J.; Fujita, E.; Sanzenbacher, R.; Paulus, H.; Elias, H. *Inorg. Chem.* **1994**, *35*, 5855–5863.
1539. Moore, P.; Sachinidis, J.; Willey, G. R. *J. Chem. Soc., Chem. Commun.* **1983**, 522–523.
1540. Donnelly, M. A.; Zimmer, M. *Inorg. Chem.* **1999**, *38*, 1650–1658.
1541. Connolly, P. J.; Billo, E. J. *Inorg. Chem.* **1987**, *26*, 3224–3226.
1542. Schmid, C.; Neuburger, M.; Zehnder, M.; Kaden, T. A. *Polyhedron* **1998**, *17*, 4065–4070.
1543. Billo, E. J.; Connolly, P. J.; Sardella, D. J.; Jasinski, J. P.; Butcher, R. J. *Inorg. Chim. Acta* **1995**, *230*, 19–28.
1544. Feldhaus, R.; Köppe, J.; Mattes, R. Z. *Naturforsch. B* **1996**, *51*, 869–878.
1545. Battaglia, L. P.; Bianchi, A.; Bonamartini Corradi, A.; Garcia-España, E.; Micheloni, M.; Julve, M. *Inorg. Chem.* **1988**, *27*, 4171–4179.
1546. Kang, S.-G.; Song, J.; Jeong, J. H. *Inorg. Chim. Acta* **2000**, *310*, 196–202.
1547. Planinic, P.; Matkovic-Calogovic, D.; Meider, H. *J. Chem. Soc., Dalton Trans.* **1997**, 3445–3451.
1548. Bernhardt, P. V.; Comba, P.; Hambley, T. W. *Inorg. Chem.* **1993**, *32*, 2804–2809.
1549. Comba, P.; Luther, S. M.; Maas, O.; Pritzkow, H.; Vielfort, A. *Inorg. Chem.* **2001**, *40*, 2335–2345.
1550. Curtis, N. F.; Gainsford, G. J.; Hambley, T. W.; Lawrance, G. A.; Morgan, K. R.; Siriwardena, A. *J. Chem. Soc., Chem. Commun.* **1987**, 295–297.

1551. Billo, E. J. *Inorg. Chem.* **1984**, *23*, 236–238.
1552. Coates, J. H.; Hadi, D. A.; Hambley, T. W.; Lincoln, S. F.; Rodgers, J. R. *Cryst. Struct. Commun.* **1982**, *11*, 815–820.
1553. Krüger, H.-J. *Chem. Ber.* **1995**, *128*, 531–539.
1554. Sanzenbacher, R.; Sotofte, I.; Springborg, J. *Acta Chem. Scand.* **1999**, *53*, 457–464.
1555. Weisman, G. R.; Wong, E. H.; Hill, D. C.; Rogers, M. E.; Reed, D. P.; Calabrese, J. C. *J. Chem. Soc., Chem. Commun.* **1996**, 947–948.
1556. Broge, L.; Pretzmann, U.; Jensen, N.; Sotofte, I.; Olsen, C. E.; Springborg, J. *Inorg. Chem.* **2001**, *40*, 2323–2334.
1557. Chen, L.; Cotton, F. A. *J. Mol. Struct.* **1998**, *470*, 161–166.
1558. Atkinson, I. M.; Baillie, P. J.; Choi, N.; Fabbri, L.; Lindoy, L. F.; McPartlin, M.; Tasker, P. A. *J. Chem. Soc., Dalton Trans.* **1996**, 3045–3051.
1559. Imajo, S.; Nakanishi, K.; Roberts, M.; Lippard, S. J.; Nozoe, T. *J. Am. Chem. Soc.* **1993**, *105*, 2071–2073.
1560. Alcock, N. W.; Lin, W.-K.; Jircitano, A.; Mokren, J. D.; Corfield, P. W. R.; Johnson, G.; Novotnak, G.; Cairns, C.; Busch, D. H. *Inorg. Chem.* **1987**, *26*, 440–452.
1561. Cameron, J. H.; Nicol, D. P.; Rosair, G. M. *J. Chem. Soc., Chem. Commun.* **1998**, 1595–1596.
1562. Snopok, B. A.; Lampeka, Y. D. *Opt. Spektrosk.* **1993**, *75*, 321–328.
1563. Schumann, H. *Z. Naturforsch. B: Chem. Sci.* **1996**, *51*, 989–998.
1564. Rosa, A.; Ricciardi, G.; Lelj, F.; Chizhov, Y. *Chem. Phys.* **1992**, *161*, 127–140.
1565. Casarin, M.; Ciliberto, E.; Di Bella, S.; Gulino, A.; Fragalà, I.; Marks, T. J. *Inorg. Chem.* **1992**, *31*, 2835–2842.
1566. Jubran, N.; Cohen, H.; Meyerstein, D. *Isr. J. Chem.* **1985**, *25*, 118–121.
1567. Ciampolini, M.; Fabbri, L.; Licchelli, M.; Perotti, A.; Pezzini, F.; Poggi, A. *Inorg. Chem.* **1986**, *25*, 4131–4135.
1568. Micheloni, M.; Paoletti, P.; Bürki, S.; Kaden, A. *Helv. Chim. Acta* **1982**, *65*, 587–594.
1569. Holtmann, M. S.; Cummings, S. C. *Inorg. Chem.* **1976**, *15*, 660–665.
1570. Lee, D.; Suh, M. P.; Lee, J. W.; Shin, W. *J. Chem. Soc., Dalton Trans.* **1997**, 577–584.
1571. Chin, M.; Wone, D.; Nguyen, Q.; Nathan, L. C.; Wagenknecht, P. S. *Inorg. Chim. Acta* **1999**, *292*, 254–259.
1572. Choi, K.-Y.; Suh, I. H. *Inorg. Chim. Acta* **2000**, *299*, 128–133.
1573. Sabatini, L.; Fabbri, L. *Inorg. Chem.* **1979**, *18*, 438–444.
1574. Barefield, E. K.; Freeman, G. M.; Van Derveer, D. G. *Inorg. Chem.* **1986**, *25*, 552–558.
1575. Jubran, N.; Ginzburg, G. G.; Cohen, H.; Koresh, Y.; Meyerstein, D. *Inorg. Chem.* **1985**, *24*, 251–258.
1576. Kang, S.-G.; Song, J.; Whang, D.; Kim, K. *Bull. Korean Chem. Soc.* **2000**, *21*, 1106–1110.
1577. Kang, S.-G.; Kim, M.-S.; Whang, D.; Kim, K. *Inorg. Chim. Acta* **1998**, *279*, 238–242.
1578. Kang, S.-G.; Ryu, K.; Kim, J. *Bull. Korean Chem. Soc.* **2002**, *23*, 81–85.
1579. Hancock, R. D.; Ngwenya, M. P.; Wade, P. W.; Boeyens, J. A.; Dobson, S. M. *Inorg. Chim. Acta* **1989**, *164*, 73–84.
1580. Iwamoto, E.; Yokoyama, T.; Yamasaki, S.; Yabe, T.; Kumamaru, T.; Yamamoto, Y. *J. Chem. Soc., Dalton Trans.* **1988**, 1935–1941.
1581. Lovocchio, F. V.; Gore, E. S.; Busch, D. H. *J. Am. Chem. Soc.* **1974**, *96*, 3109–3118.
1582. Suh, M. P.; Kim, H. K.; Kim, M. J.; Oh, K. Y. *Inorg. Chem.* **1992**, *31*, 3620–3625.
1583. Abba, F.; Santis, G. D.; Fabbri, L.; Licchelli, M.; Lanfredi, A. M. M.; Pallavicini, P.; Poggi, A.; Ugozzoli, F. *Inorg. Chem.* **1994**, *33*, 1366–1375.
1584. Kwak, C.-H.; Nam, H.; Moon, J.-M.; Jeon, I. C.; Choi, Y. K. *Polyhedron* **1999**, *18*, 2597–2603.
1585. Plenio, H.; Aberle, C. *J. Chem. Soc., Chem. Commun.* **1998**, 2697–2698.
1586. Golub, G.; Cohen, H.; Meyerstein, D. *J. Chem. Soc., Chem. Commun.* **1992**, 397–398.
1587. Crick, I. S.; Gable, R. W.; Hoskins, B. F.; Tregloan, P. A. *Inorg. Chim. Acta* **1986**, *111*, 35–38.
1588. Hambley, T. W. *J. Chem. Soc., Dalton Trans.* **1986**, 565–569.
1589. Bailey, C. L.; Bereman, R. D.; Rillema, D. P.; Nowak, R. *Inorg. Chem.* **1984**, *23*, 3956–3960.
1590. Jäger, E.-G.; Keutel, H.; Rudolph, M.; Krebs, B.; Wiesemann, F. *Chem. Ber.* **1995**, *128*, 503–514.
1591. Bernhardt, P. V.; Harrowfield, J. M.; Hockless, D. C. R.; Sargeson, A. M. *Inorg. Chem.* **1994**, *33*, 5659–5670.
1592. Szalda, D. J.; Fujita, E.; Sanzenbacher, R.; Paulus, H.; Elias, H. *Inorg. Chem.* **1994**, *33*, 5855–5863.
1593. Kim, S.-J.; Choi, J.-S.; Kang, S.-G.; Kim, C.-S.; Suh, M. P. *Bull. Kor. Chem. Soc.* **1995**, *16*, 217–221.
1594. Yokoyama, T.; Kitagawa, H.; Iwasawa, H.-A.; Zenki, M. *Inorg. Chim. Acta* **1996**, *253*, 1–6.
1595. Cromie, T. J.; Hay, R. W.; Lightfoot, P.; Richens, D. T.; Crayston, J. A. *Polyhedron* **2001**, *20*, 307–312.
1596. Hay, R. W.; Bembi, R.; Sommerville, W. *Inorg. Chim. Acta* **1982**, *59*, 147–153.
1597. Fairbank, M. G.; McAuley, A. *Inorg. Chem.* **1987**, *26*, 2844–2848.
1598. Billo, E. J. *Inorg. Chem.* **1984**, *23*, 2223–2227.
1599. Luo, F.; Webb, R. L.; Kelly, C.; Mino, M. L.; Woodworth, B.; Blinn, E. L. *Inorg. Chim. Acta* **1995**, *234*, 75–85.
1600. Bencini, A.; Bianchi, A.; Garcia-Espana, E.; Jeannin, Y.; Julve, M.; Marcelino, V.; Philoche-Levisalles, M. *Inorg. Chem.* **1990**, *29*, 963–970.
1601. Coates, J. H.; Hadi, D. A.; Lincoln, S. F.; Dodgen, H. W.; Hunt, J. P. *Inorg. Chem.* **1981**, *20*, 707–711.
1602. Coates, J. H.; Hadi, D. A.; Lincoln, S. F. *Aust. J. Chem.* **1982**, *35*, 903–909.
1603. Fabbri, L. *J. Chem. Soc., Dalton Trans.* **1979**, 1857–1861.
1604. Kowallick, R.; Neuburger, M.; Zehnder, M.; Kaden, T. A. *Helv. Chim. Acta* **1997**, *80*, 948–959.
1605. Korybut-Daszkiewicz, B.; Gluzinski, P.; Krajewski, J.; Kemme, A.; Mishnev, A. *Eur. J. Inorg. Chem.* **1999**, 263–268.
1606. Korybut-Daszkiewicz, B.; Taraszewska, J.; Kamiński, B. *Eur. J. Inorg. Chem.* **2001**, 645–649.
1607. Pallavicini, P. S.; Perotti, A.; Poggi, A.; Seghi, B.; Fabbri, L. *J. Am. Chem. Soc.* **1987**, *109*, 5139–5144.
1608. Taraszewska, J.; Roslonek, G.; Korybut-Daszkiewicz, B. *J. Electroanal. Chem.* **1991**, *297*, 245–255.
1609. Kimura, E.; Haruta, M.; Koike, T.; Shionoya, M.; Takenouchi, K.; Iitaka, Y. *Inorg. Chem.* **1993**, *32*, 2779–2784.
1610. Kang, S.-G.; Ryu, K.; Jung, S.-K.; Kim, J. *Inorg. Chim. Acta* **1999**, *293*, 140–146.
1611. Engeser, M.; Fabbri, L.; Licchelli, M.; Sacchi, D. *J. Chem. Soc., Chem. Commun.* **1999**, 1191–1192.
1612. Bang, H.; Lee, E. J.; Lee, E. Y.; Suh, J.; Suh, M. P. *Inorg. Chim. Acta* **2000**, *308*, 150–154.
1613. Olivero, S.; Franco, D.; Clinet, J.-C.; Dunach, E. *Coll. Czech. Chem. Commun.* **2000**, *65*, 844–861.
1614. Lee, D.; Bang, H.; Suh, M. P. *J. Mol. Catal. A* **2000**, *151*, 71–78.
1615. McAuley, A.; Xu, C. *Inorg. Chem.* **1992**, *31*, 5549–5554.
1616. Chen, D.; Martell, A. E. *J. Am. Chem. Soc.* **1990**, *112*, 9411–9412.

1617. Kimura, E.; Machida, R. *J. Chem. Soc., Chem. Commun.* **1984**, 499–500.
1618. Chen, D.; Motekaitis, R. J.; Martell, A. E. *Inorg. Chem.* **1991**, *30*, 1396–1402.
1619. Cheng, C.-C.; Rokita, S. E.; Burrows, C. J. *Angew. Chem., Int. Ed. Engl.* **1993**, *32*, 277–278.
1620. Cheng, C.-C.; Gulia, J.; Rokita, S. E.; Burrows, C. J. *J. Mol. Cat. A* **1996**, *113*, 379–391.
1621. Haas, K.; Dialer, H.; Piotrowski, H.; Schapp, J.; Beck, W. *Angew. Chem., Int. Ed.* **2002**, *41*, 1879–1881.
1622. Muller, J. G.; Chen, X.; Dadiz, A. C.; Rokita, S. E.; Burrows, C. J. *Pure Appl. Chem.* **1993**, *65*, 545–550.
1623. Burrows, C. J.; Rokita, S. E. *Acc. Chem. Res.* **1994**, *27*, 295–301.
1624. McLachlan, G. A.; Muller, J. G.; Rokita, S. E.; Burrows, C. J. *Inorg. Chim. Acta* **1996**, *251*, 193–199.
1625. Chen, X.; Rokita, S. E.; Burrows, C. J. *J. Am. Chem. Soc.* **1991**, *113*, 5884–5886.
1626. Müller, J. G.; Chen, X.; Dadiz, A. C.; Rokita, S. E.; Burrows, C. J. *J. Am. Chem. Soc.* **1992**, *114*, 6407–6411.
1627. Shih, H.-C.; Tang, N.; Burrows, C. J.; Rokita, S. E. *J. Am. Chem. Soc.* **1998**, *120*, 3284–3288.
1628. Shih, H.-C.; Burrows, C. J.; Rokita, S. E. *Biochemistry* **1999**, *38*, 15034–15042.
1629. Hickerson, R. P.; Watkins-Sims, C. D.; Burrows, C. J.; Atkins, J. F.; Gesteland, R. F.; Felden, B. *J. Mol. Biol.* **1998**, *279*, 577–587.
1630. Kelly, C. A.; Blinn, E. L.; Camaioni, N.; D'Angelantonio, M.; Mulazzani, Q. G. *Inorg. Chem.* **1999**, *38*, 1579–1584.
1631. Beley, M.; Collin, J. P.; Ruppert, R.; Sauvage, J.-P. *J. Am. Chem. Soc.* **1986**, *108*, 7461–7467.
1632. Fischer, B.; Eisenberg, R. *J. Am. Chem. Soc.* **1980**, *102*, 7361–7363.
1633. Beley, M.; Collin, J.-P.; Ruppert, R.; Sauvage, J.-P. *J. Chem. Soc., Chem. Commun.* **1984**, 1315–1316.
1634. Collin, J.-P.; Jouaiti, A.; Sauvage, J.-P. *Inorg. Chem.* **1988**, *27*, 1986–1990.
1635. Fujihara, H.; Hirata, Y.; Suga, K. *J. Electroanal. Chem.* **1990**, *292*, 199–215.
1636. Taniguchi, I. In *Modern Aspects of Modern Electrochemistry*; Bockris, J. O'M., White, R. E., Conway, B. E., Eds.; Plenum Press: New York, 1989; Vol. 20, pp 327–400.
1637. Smith, C. I.; Crayston, J. A.; Hay, R. W. *J. Chem. Soc., Dalton Trans.* **1993**, 3267–3269.
1638. Hay, R. W.; Crayston, J. A.; Cromie, T. J.; Lightfoot, P.; De Alwis, C. L. *Polyhedron* **1997**, *16*, 3557–3563.
1639. De Alwis, C.; Crayston, J. A.; Cromie, T.; Eisenblatter, T.; Hay, R. W.; Lampeka, Ya.D.; Tsybal, L. V. *Electrochim. Acta* **2000**, *45*, 2061–2074.
1640. Bujno, K.; Bilewicz, R.; Siegfried, L.; Kaden, T. A. *J. Electroanal. Chem.* **1996**, *407*, 131–140.
1641. Fujita, E.; Haff, J.; Sanzenbacher, R.; Elias, H. *Inorg. Chem.* **1994**, *33*, 4627–4628.
1642. Rudolph, M.; Dautz, S.; Jäger, E.-G. *J. Am. Chem. Soc.* **2000**, *122*, 10821–10830.
1643. Mochizuki, K.; Manaka, S.; Takeda, I.; Kondo, T. *Inorg. Chem.* **1996**, *35*, 5132–5136.
1644. Kimura, E.; Bu, X.; Shionoya, M.; Wada, S.; Marujama, S. *Inorg. Chem.* **1992**, *31*, 4542–4546.
1645. Kimura, E.; Mitsuhiko, S.; Okazaki, Y. *Inorg. Chem.* **1994**, *33*, 770–778.
1646. Fujita, E.; Brunswig, B. S.; Ogata, T.; Yanagida, S. *Coord. Chem. Rev.* **1994**, *132*, 195–200.
1647. Ramaraj, R.; Premkumar, J. R. *Curr. Sci.* **2000**, *79*, 884–886.
1648. Taraszewska, J.; Tsybal, L. V.; Lampeka, Y. D. *Supramol. Chem.* **1999**, *10*, 287–295.
1649. Kim, J. C.; Cho, J.; Lough, A. J. *Inorg. Chim. Acta* **2001**, *317*, 252–258.
1650. Choi, H. J.; Suh, M. P. *Inorg. Chem.* **1999**, *38*, 6309–6312.
1651. Choi, K.-Y.; Moon Chun, K.; Suh, I.-H. *Polyhedron* **2001**, *20*, 57–65.
1652. Basiuk, E. V.; Basiuk, V. V.; Gomez-Lara, J.; Toscano, R. A. *J. Incl. Phenom. Macrocycl. Chem.* **2000**, *38*, 45–56.
1653. Choi, H. J.; Suh, M. P. *J. Am. Chem. Soc.* **1998**, *120*, 10622–10628.
1654. Choi, H. J.; Lee, T. S.; Suh, M. P. *J. Incl. Phenom. Macrocycl. Chem.* **2001**, *41*, 155–162.
1655. Min, K. S.; Suh, M. P. *Chem. Eur. J.* **2001**, *7*, 303–313.
1656. Min, K. S.; Suh, M. P. *Eur. J. Inorg. Chem.* **2001**, 449–455.
1657. Croucher, P. D.; Marshall, J. M. E.; Nichols, P. J.; Raston, C. L. *J. Chem. Soc., Chem. Commun.* **1999**, 193–194.
1658. Croucher, P. D.; Nichols, P. J.; Raston, C. L. *J. Chem. Soc., Dalton Trans.* **1999**, 279–284.
1659. Andrews, P. C.; Atwood, J. L.; Barbour, L. J.; Nichols, P. J.; Raston, C. L. *Chem. Eur. J.* **1998**, *4*, 1384–1387.
1660. Andrews, P. C.; Croucher, P. D.; Atwood, J. L.; Barbour, L. J.; Nichols, P. J.; Smith, N. O.; Skelton, B. W.; White, A. H.; Raston, C. L. *J. Chem. Soc., Dalton Trans.* **1999**, 2927–2932.
1661. Raston, C. L.; Nichols, P. J.; Baranyai, K. *Angew. Chem., Int. Ed.* **2000**, *39*, 1842–1845.
1662. Hardie, M. J.; Malic, N.; Raston, C. L.; Roberts, B. A. *J. Chem. Soc., Chem. Commun.* **2001**, 865–866.
1663. Soldatov, D. V.; Diamente, P. R.; Ratcliffe, C. I.; Ripmeester, J. A. *Inorg. Chem.* **2001**, *40*, 5660–5667.
1664. Bilewicz, R.; Wieckowska, A.; Korybut-Daszkiewicz, B.; Olszwska, A.; Feeder, N.; Wozniak, K. *J. Chem. Phys. B* **2000**, *104*, 11430–11434.
1665. Fabbri, L.; Foti, F.; Licchelli, M.; Poggi, A. *Inorg. Chem.* **2002**, *41*, 4612–4614.
1666. De Santis, G.; Fabbri, L.; Licchelli, M.; Sardone, N.; Velders, A. H. *Chem. Eur. J.* **1996**, *2*, 1243–1250.
1667. Fabbri, L.; Gatti, F.; Pallavicini, P.; Zambiarbi, E. *Chem. Eur. J.* **1999**, *5*, 682–690.
1668. Amendola, V.; Fabbri, L.; Licchelli, M.; Mangano, C.; Pallavicini, P.; Parodi, L.; Poggi, A. *Coord. Chem. Rev.* **1999**, *190–192*, 649–669.
1669. Fabbri, L.; Licchelli, M.; Pallavicini, P. *Acc. Chem. Res.* **1999**, *32*, 846–853.
1670. Amendola, V.; Di Casa, M.; Fabbri, L.; Licchelli, M.; Mangano, C.; Pallavicini, P.; Poggi, A. *J. Incl. Phen. Macrocycl. Chem.* **2001**, *41*, 13–18.
1671. Amendola, V.; Fabbri, L.; Licchelli, M.; Pallavicini, P.; Sacchi, D. *Chemistry at the Beginning of the Third Millennium: Molecular Design, Supramolecules, Nanotechnology and Beyond*, Proceedings of the German–Italian Meeting of Coimbra Group Universities; Fabbri, L., Poggi, A., Eds.; Springer-Verlag: Berlin, 2000; pp 207–226.
1672. Lindoy, L. F. *Cation Binding Macrocycles* **1990**, 599–629.
1673. Danks, J. P.; Champness, N. R.; Schröder, M. *Coord. Chem. Rev.* **1998**, *174*, 417–468.
1674. Reid, G.; Schröder, M. *Chem. Soc. Rev.* **1990**, *19*, 239–269.
1675. Blake, A. J.; Schröder, M. *Adv. Inorg. Chem.* **1990**, *35*, 1–80.
1676. Desper, J. M.; Vyvyan, J. R.; Mayer, M. J.; Ochrymowycz, L. A.; Gellman, S. H. *Inorg. Chem.* **1993**, *32*, 381–382.
1677. Kulatilleke, C. P.; Goldie, S. N.; Heeg, M. J.; Ochrymowycz, L. A.; Rorabacher, D. B. *Inorg. Chem.* **2000**, *39*, 1444–1453.
1678. Desper, J. M.; Gellman, S. H. *J. Am. Chem. Soc.* **1990**, *112*, 6732–6734.
1679. Desper, J. M.; Gellman, S. H.; Wolf, R. E., Jr.; Cooper, S. R. *J. Am. Chem. Soc.* **1991**, *113*, 8663–8670.

1680. Cooper, S. R.; Rawle, S. C.; Hartman, J. A. R.; Hintsä, E. J.; Admans, G. A. *Inorg. Chem.* **1988**, *27*, 1209–1214.
1681. Rawle, S. C.; Hartman, J. R.; Watkin, D. J.; Cooper, S. R. *J. Chem. Soc., Chem. Commun.* **1986**, 1083–1084.
1682. Blake, A. J.; Halcrow, M. A.; Schröder, M. *J. Chem. Soc., Dalton Trans.* **1994**, 1463–1470.
1683. Blake, A. J.; Halcrow, M. A.; Schröder, M. *J. Chem. Soc., Dalton Trans.* **1992**, 2803–2808.
1684. Davies, M. K.; Levason, W.; Reid, G. *J. Chem. Soc., Dalton Trans.* **1998**, 2185–2189.
1685. Munoz, J. A.; Escriche, L.; Casabo, J.; Kivekaes, R. *Inorg. Chem.* **1997**, *36*, 947–949.
1686. Widhalm, M.; Wimmer, P.; Klitschar, G. *J. Organomet. Chem.* **1996**, *523*, 167–178.
1687. Escriche, L.; Munoz, J. A.; Rosell, J.; Kivekaes, R.; Sillanpää, R.; Casabo, J. *Inorg. Chem.* **1998**, *37*, 4807–4813.
1688. Valencia, L.; Adams, H.; Bastida, R.; de Blas, A.; Fenton, D. E.; Macias, A.; Rodriguez-Blas, T. *Inorg. Chim. Acta* **2000**, *300–302*, 234–242.
1689. Leong, A. J.; Lindoy, L. F.; Hockless, D. C. R.; Swiegers, G. F.; Wild, S. B. *Inorg. Chim. Acta* **1996**, *246*, 371–377.
1690. Davis, C. A.; Duckworth, P. A.; Leong, A. J.; Lindoy, L. F.; Bashall, A.; McPartlin, M. *Inorg. Chim. Acta* **1998**, *273*, 372–378.
1691. Funkemeier, D.; Mattes, R. *J. Chem. Soc., Dalton Trans.* **1993**, 1313–1319.
1692. Ehlers, N.; Mattes, R. *Inorg. Chim. Acta* **1995**, *236*, 203–207.
1693. Blake, A. J.; Casabò, J.; Devillanova, F. A.; Escriche, L.; Garau, A.; Isaia, F.; Lippolis, V.; Kivekas, R.; Muns, V.; Schröder, M.; Sillanpää, R.; Verani, G. *J. Chem. Soc., Dalton Trans.* **1999**, 1085–1092.
1694. Henrich, K.; Lindoy, L. F.; McPartlin, M.; Tasker, P. A.; Wood, M. P. *J. Am. Chem. Soc.* **1984**, *106*, 1641–1645.
1695. Darensbourg, M. Y.; Font, I.; Pala, M.; Reibenspies, J. H. *J. Coord. Chem.* **1994**, *32*, 39–49.
1696. Darensbourg, M. Y.; Font, I.; Mills, D. K.; Pala, M.; Reibenspies, J. H. *Inorg. Chem.* **1992**, *31*, 4965–4971.
1697. Goodman, D. C.; Buonoma, R. Z.; Farmer, P. J.; Reibenspies, J. H.; Darensbourg, M. Y. *Inorg. Chem.* **1996**, *35*, 4029–4037.
1698. Goodman, D. C.; Reibenspies, J. H.; Goswami, N.; Jurisson, S.; Darensbourg, M. Y. *J. Am. Chem. Soc.* **1997**, *119*, 4955–4963.
1699. Smee, J. J.; Miller, M. L.; Grapperhaus, C. A.; Reibenspies, J. H.; Darensbourg, M. Y. *Inorg. Chem.* **2001**, *40*, 3601–3605.
1700. Musie, G.; Reibenspies, J. H.; Darensbourg, M. Y. *Inorg. Chem.* **1998**, *37*, 302–310.
1701. Kawamoto, T.; Kuma, H.; Kushi, Y. *J. Chem. Soc., Chem. Commun.* **1996**, 2121–2122.
1702. Joint Commission on Biochemical Nomenclature. *Pure Appl. Chem.* **1984**, *56*, 595–624.
1703. Martin, R. B. In *Metal Ions in Biological Systems*; Sigel, H., Ed., Marcel Dekker: New York, 1988; Vol. 23, pp 123–164.
1704. Kiss, T. In *Biocoordination Chemistry: Coordination Equilibria in Biologically Active Systems*; Burger, K., Ed., Ellis Horwood: Chichester, UK, 1990; pp 56–134.
1705. Baidya, N.; Ndreu, D.; Olmstead, M. M.; Mascharak, P. K. *Inorg. Chem.* **1991**, *30*, 2448–2451.
1706. Baidya, N.; Olmstead, M. M.; Mascharak, P. K. *Inorg. Chem.* **1991**, *30*, 3967–3969.
1707. Desrochers, P. J.; Cutts, R. W.; Rice, Ph.K.; Golden, M. L.; Graham, J. B.; Barclay, T. M.; Cordes, A. W. *Inorg. Chem.* **1999**, *38*, 5690–5694.
1708. Nair, M. S.; Arasu, P. T.; Pallai, M. S.; Natarajan, C. *Transition Met. Chem.* **1995**, *20*, 132–135.
1709. Rizzarelli, E.; Vecchio, G. *Coord. Chem. Rev.* **1999**, *188*, 343–364.
1710. Haskard, C. A.; Easton, Ch.J.; May, B. L.; Lincoln, S. F. *Inorg. Chem.* **1996**, *35*, 1059–1064.
1711. Qiu, W.; Soloshonok, V. A.; Cai, Ch.; Tang, X.; Hruby, V. J. *Tetrahedron* **2000**, *56*, 2577–2582.
1712. Belokon, Y. N.; Sagyan, A. S.; Djangaryan, S. A.; Bakmutov, V. I.; Vitt, S. V.; Batsanov, A. S.; Struchkov, Y. T.; Belikov, V. M. *J. Chem. Soc. Perkin Trans. 1* **1990**, 2301–2310.
1713. Kurzak, B.; Kozłowski, H.; Farkas, E. *Coord. Chem. Rev.* **1992**, *114*, 169–200.
1714. Brown, D. A.; Roche, A. L. *Inorg. Chem.* **1983**, *22*, 2199–2202.
1715. Julien-Pouzol, M.; Jaulmes, S.; Laruelle, P.; Carvalho, S.; Paniago, E. B. *Acta Crystallogr.* **1985**, *C41*, 712–715.
1716. Brown, D. A.; Glass, W. K.; Roche, A. L. *J. Mol. Struct.* **1987**, *162*, 313–320.
1717. Leporati, E. *J. Chem. Soc., Dalton Trans.* **1986**, 2587–2592.
1718. Leporati, E. *J. Chem. Soc., Dalton Trans.* **1988**, 421–426.
1719. Paniago, E. B.; Carvalho, S. *Inorg. Chim. Acta* **1987**, *136*, 159–163.
1720. Farkas, E.; Szöke, J.; Kiss, T.; Kozłowski, H.; Bal, W. *J. Chem. Soc., Dalton Trans.* **1989**, 2247–2251.
1721. Kurzak, B.; Bal, W.; Kozłowski, H. *J. Inorg. Biochem.* **1990**, *38*, 9–16.
1722. Glowiak, T.; Kurzak, B. *J. Crystallogr. Spectrosc. Res.* **1992**, *22*, 341–348.
1723. Sliva, T. Yu.; Kowalik-Jankowska, T.; Amrkanov, V. M.; Glowiak, T.; Onindo, Ch. O.; Fritsky, I. O.; Kozłowski, H. *J. Inorg. Biochem.* **1997**, *65*, 287–294.
1724. Dobosz, A.; Dudarenko, N. M.; Fritsky, I. O.; Glowiak, T.; Karaczyn, A.; Kozłowski, H.; Sliva, T. Yu.; Swiatek-Kozłowska, J. *J. Chem. Soc., Dalton Trans.* **1999**, 743–749.
1725. Swiatek-Kozłowska, J.; Fritsky, I. O.; Dobosz, A.; Karaczyn, A.; Dudarenko, N. M.; Sliva, T. Yu.; Gumienna-Kontecka, E.; Jerzykiewicz, L. *J. Chem. Soc., Dalton Trans.* **2000**, 4064–4068.
1726. Sigel, H.; Martin, R. B. *Chem. Rev.* **1982**, *82*, 385–426.
1727. Sovago, I. In *Biocoordination Chemistry: Coordination Equilibria in Biologically Active Systems*; Burger, K., Ed.; Ellis Horwood: Chichester, UK, 1990; pp 135–184.
1728. Pettit, L. D.; Gregor, J. E.; Kozłowski, H. In *Perspectives on Bioinorganic Chemistry*; Hay, R. W., Dilworth, J. R., Nolan, K. B., Eds.; JAI Press: London, 1991; pp 1–41.
1729. Kozłowski, H.; Bal, W.; Dyba, M.; Kowalik-Jankowska, T. *Coord. Chem. Rev.* **1999**, *184*, 319–346.
1730. Várnagy, K.; Bóka, B.; Sóvágó, I.; Sanna, D.; Marras, P.; Micera, G. *Inorg. Chim. Acta* **1998**, *275–276*, 440–446.
1731. Kozłowski, H.; Lebkiri, A.; Onindo, Ch. O.; Pettit, L. D.; Galey, J.-F. *Polyhedron* **1995**, *14*, 211–218.
1732. Pettit, L. D.; Pyburn, S.; Kozłowski, H.; Decock-Le-Reverend, Liman F. *J. Chem. Soc., Dalton Trans.* **1989**, 1471–1475.
1733. Bal, W.; Kozłowski, H.; Robbins, R.; Pettit, L. D. *Inorg. Chim. Acta* **1995**, *231*, 7–12.
1734. Farkas, E.; Sóvágó, I.; Gergely, A. *J. Chem. Soc., Dalton Trans.* **1983**, 1545–1551.
1735. Sóvágó, I.; Petocz, G. *J. Chem. Soc., Dalton Trans.* **1987**, 1717–1720.

1736. Gajda, T.; Henry, B.; Delpuech, J. J. *Inorg. Chem.* **1995**, *34*, 2455–2460.
1737. Mlynarz, P.; Kowalik-Jankowska, T.; Stasiak, M.; Leplawy, M. T.; Kozlowski, H. *J. Chem. Soc., Dalton Trans.* **1999**, 3673–3677.
1738. Glennon, J. D.; Sarkar, B. *Biochem. J.* **1982**, *203*, 15–23.
1739. Laussac, J. P.; Sarkar, B. *Biochemistry* **1984**, *23*, 2832–2838.
1740. Sadler, P. J.; Tucker, A.; Viles, J. H. *Eur. J. Biochem.* **1994**, *220*, 193–200.
1741. Harford, C.; Sarkar, B. *Acc. Chem. Res.* **1997**, *30*, 123–130.
1742. Zhang, Yi Akilesh S.; Wilcox, D. E. *Inorg. Chem.* **2000**, *39*, 3057–3064.
1743. Bal, W.; Djuran, M. I.; Margerum, D. W.; Gray, E. T.; Mazid, M. A.; Tom, R. T.; Nieboer, E.; Sadler, P. J. *J. Chem. Soc., Chem. Commun.* **1994**, 1889–1890.
1744. Bal, W.; Chmurny, G. N.; Hilton, B. D.; Sadler, P. J.; Tucker, A. *J. Am. Chem. Soc.* **1996**, *118*, 4727–4728.
1745. Mlynarz, P.; Valensin, D.; Kociolek, K.; Zabrocki, J.; Olejnik, J.; Kozlowski, H. *New J. Chem.* **2002**, *26*, 264–268.
1746. Bal, W.; Jezowska-Bojczuk, M.; Kasprzak, K. S. *Chem. Res. Toxicol.* **1997**, *10*, 906–914.
1747. Bal, W.; Wojcik, J.; Maciejczyk, M.; Grochowski, P.; Kasprzak, K. S. *Chem. Res. Toxicol.* **2000**, *13*, 823–830.
1748. Lepentisiotis, V.; Domagala, J.; Grgic, I.; van Eldik, R.; Muller, J. G.; Burrows, C. J. *Inorg. Chem.* **1999**, *38*, 3500–3505.
1749. Muller, J. G.; Hickerson, R. P.; Perez, R. J.; Burrows, C. J. *J. Am. Chem. Soc.* **1997**, *119*, 1501–1506.
1750. Mack, D. P.; Dervan, P. B. *J. Am. Chem. Soc.* **1990**, *112*, 4604–4606.
1751. Mack, D. P.; Dervan, P. B. *Biochemistry* **1992**, *31*, 9399–9405.
1752. Nagaoka, M.; Hagihara, M.; Kuwahara, J.; Sugiura, Y. *J. Am. Chem. Soc.* **1994**, *116*, 4085–4086.
1753. Harford, C.; Narindrasorasak, S.; Sarkar, B. *Biochemistry* **1996**, *35*, 4271–4278.
1754. Zorrodo, M. A.; Peanna, M.; Kowalik-Jankowska, T.; Kozlowski, H.; Costa, M. *J. Chem. Soc., Dalton Trans.* **2002**, 458–465.
1755. Bal, W.; Lukszo, J.; Jezowska-Bojczuk, M.; Kasprzak, K. S. *Chem. Res. Toxicol.* **1995**, *8*, 683–692.
1756. Bal, W.; Karanza, V.; Moudrianakis, E. N.; Kasprzak, K. S. *Arch. Biochem. Biophys.* **1999**, *364*, 161–166.
1757. Bal, W.; Kasprzak, K. S. *Toxicol. Lett.* **2002**, *127*, 55–62.
1758. Bal, W.; Lukszo, Bialkowski K.; Kasprzak, K. S. *Chem. Res. Toxicol.* **1998**, *11*, 1014–1023.
1759. Bal, W.; Liang, R.; Lukszo, J.; Lee, S. H.; Dizdaroglu, M.; Kasprzak, K. S. *Chem. Res. Toxicol.* **2000**, *13*, 616–624.
1760. Sunderman, F. W.; Jr., Varghese, A. H.; Kroftova, O. S.; Grbac-Ivankovic, S.; Kotyza, J.; Datta, A. K.; Davis, M.; Bal, W.; Kasprzak, K. S. *Mol. Reprod. Dev.* **1996**, *44*, 507–524.
1761. Kozlowski, H.; Decock Le-Reverend, B.; Ficheux, D.; Loucheux, C.; Sóvágó, I. *J. Inorg. Biochem.* **1987**, *29*, 187–197.
1762. Cherifí, K.; Decock Le-Reverend, B.; Varnagy, K.; Kiss, T.; Sóvágó, I.; Loucheux, C.; Kozlowski, H. *J. Inorg. Biochem.* **1990**, *38*, 69–80.
1763. Ross, S. A.; Burrows, C. J. *Inorg. Chem.* **1998**, *37*, 5358–5363.
1764. Kowalik-Jankowska, T.; Jasonowski, M.; Lankiewicz, L.; Kozlowski, H. *J. Inorg. Biochem.* **1997**, *66*, 45–49.
1765. Kadisch, K. M.; Smith, K. M.; Guillard, R., Eds.; *The Porphyrin Handbook*; Academic Press: New York, **2000**; Vol. 3.
1766. Scheidt, W. R. *The Porphyrin Handbook*; Kadisch, K. M.; Smith, K. M.; Guillard, R., Eds.; Academic Press: New York, **2000**; pp 50–112.
1767. Jentzen, W.; Turowska-Tyrk, I.; Scheidt, W. R.; Shelnutt, J. A. *Inorg. Chem.* **1996**, *35*, 3559–3567.
1768. Alden, R. G.; Crawford, B. A.; Doolen, R.; Ondrias, M. R.; Shelnutt, J. A. *J. Am. Chem. Soc.* **1989**, *111*, 2070–2072.
1769. Anderson, K. K.; Hobbs, J. D.; Luo, L.; Stanley, K. D.; Quirke, J. M. E.; Shelnutt, J. A. *J. Am. Chem. Soc.* **1993**, *115*, 12346–12352.
1770. Jentzen, W.; Dreybrodt, W.; Schweitzer-Stenner, R. *Biophys. J.* **1993**, *64*, A155.
1771. Alden, R. G.; Ondrias, M. R.; Shelnutt, J. A. *J. Am. Chem. Soc.* **1990**, *112*, 691–697.
1772. Barkigia, K. M.; Renner, M. W.; Furenlid, L. R.; Medforth, C. J.; Smith, K. M.; Fajer, J. *J. Am. Chem. Soc.* **1993**, *115*, 3627–3635.
1773. Senge, M. O.; Kalisch, W. W. *Inorg. Chem.* **1997**, *36*, 6103–6116.
1774. Senge, M. O.; Renner, M. W.; Kalisch, W. W.; Fajer, J. *J. Chem. Soc., Dalton Trans.* **2000**, 381–385.
1775. Song, X.-Z.; Jentzen, W.; Jaquinod, L.; Khoury, R. G.; Medforth, C. J.; Jia, S.-L.; Smith, K. M.; Shelnutt, *Inorg. Chem.* **1998**, *37*, 2117–2128.
1776. Jentzen, W.; Simpson, M. C.; Hobbs, J. D.; Song, X.; Ema, T.; Nelson, N. Y.; Medforth, C. J.; Smith, K. M.; Veyrat, M.; Mazzanti, M.; Ramasseul, R.; Marchon, J.-C.; Takeuchi, T.; Goddard, III W. A.; Shelnutt, J. A. *J. Am. Chem. Soc.* **1995**, *117*, 11085–11097.
1777. Veyrat, M.; Ramasseul, R.; Turowska-Tyrk, I.; Scheidt, W. R.; Autret, M.; Kadish, K. M.; Marchon, J.-C. *Inorg. Chem.* **1999**, *38*, 1772–1779.
1778. La, T.; Richards, R.; Miskelly, G. M. *Inorg. Chem.* **1994**, *33*, 3159–3163.
1779. Miura, M.; Majumder, S. A.; Hobbs, J. D.; Renner, M. W.; Furenlid, L. R.; Shelnutt, J. A. *Inorg. Chem.* **1994**, *33*, 6078–6085.
1780. Balch, A. L.; Chan, Y.-W.; Olmstead, M. M. *J. Am. Chem. Soc.* **1985**, *107*, 6510–6514.
1781. Sanders, J. K.; Bampos, N.; Clyde-Watson, Z.; Darling, S. L.; Hawley, J. C.; Kim, H.-J.; Mak, C. C.; Webb, S. J. In *The Porphyrin Handbook*; Kadisch, K. M., Smith, K. M., Guillard, R., Eds.; Academic Press: New York, **2000**; pp 1–48.
1782. Duval, H.; Bulach, V.; Fischer, J.; Weiss, R. *Inorg. Chem.* **1999**, *38*, 5495–5501.
1783. Brückner, C.; Rettig, S. J.; Dolphin, D. *J. Org. Chem.* **1998**, *63*, 2094–2098.
1784. Brückner, C.; Sternberg, E. D.; MacAlpine, J. K.; Rettig, S. J.; Dolphin, D. *J. Am. Chem. Soc.* **1999**, *121*, 2609–2610.
1785. Campbell, C. J.; Rusling, J. F.; Brückner, C. *J. Am. Chem. Soc.* **2000**, *122*, 6679–6685.
1786. Suh, M. P.; Swepston, P. N.; Ibers, J. A. *J. Am. Chem. Soc.* **1984**, *106*, 5164–5171.
1787. Lord, P. A.; Olmstead, M. M.; Balch, A. L. *Inorg. Chem.* **2000**, *39*, 1128–1134.
1788. Bernard, C.; Gisselbrecht, J. P.; Gross, M.; Vogel, E.; Lausmann, M. *Inorg. Chem.* **1994**, *33*, 2393–2401.
1789. Barbe, J.-M.; Richard, P.; Aukauloo, M. A.; Lecomte, C.; Petit, P.; Guillard, R. *J. Chem. Soc., Chem. Commun.* **1994**, 2757–2758.

1790. Miller, D. C.; Bollinger, J. C.; Hoffman, B. M.; Ibers, J. A. *Inorg. Chem.* **1994**, *33*, 3354–3357.
1791. Latos-Grazynski, L. *In The Porphyrin Handbook*; Kadisch, K. M., Smith, K. M., Guillard, R., Eds.; Academic Press: New York, 2000; pp 361–416.
1792. Latos-Grazynski, L.; Chmielewski, P. J. *New J. Chem.* **1997**, *21*, 691–700.
1793. Chmielewski, P. J.; Latos-Grazynski, L.; Olmstead, M. M.; Balch, A. L. *Chem. Eur. J.* **1997**, *3*, 268–278.
1794. Latos-Grazynski, L.; Lisowski, J.; Olmstead, M. M.; Balch, A. L. *Inorg. Chem.* **1989**, *28*, 1183–1188.
1795. Lisowski, J.; Latos-Grazynski, L.; Sztrenberg, L. *Inorg. Chem.* **1992**, *31*, 1933–1940.
1796. Chmielewski, P.; Grzeszczuk, M.; Latos-Grazynski, L.; Lisowski, J. *Inorg. Chem.* **1989**, *28*, 3546–3552.
1797. Latos-Grazynski, L.; Olmstead, M. M.; Balch, A. L. *Inorg. Chem.* **1989**, *28*, 4065–4066.
1798. Chmielewski, P. J.; Latos-Grazynski, L. *Inorg. Chem.* **1992**, *31*, 5231–5235.
1799. Latos-Grazynski, L.; Pacholska, E.; Chmielewski, P. J.; Olmstead, M. M.; Balch, A. L. *Inorg. Chem.* **1996**, *35*, 566–573.
1800. Pawlicki, M.; Latos-Grazynski, L.; Sztrenberg, L. *J. Org. Chem.* **2002**, *67*, 5644–5653.
1801. Sridevi, B.; Narayanan, S. J.; Chandrashekar, T. K.; English, U.; Ruhlandt-Senge, K. *Chem. Eur. J.* **2000**, *6*, 2554–2563.
1802. Chmielewski, P. J.; Latos-Grazynski, L.; Rachelwicz, K.; Glowiak, T. *Angew. Chem., Int. Ed. Engl.* **1994**, *33*, 779–781.
1803. Chmielewski, P. J.; Latos-Grazynski, L. *J. Chem. Soc. Perkin Trans. 2* **1995**, 503–509.
1804. Furuta, H.; Ishizuka, T.; Osuka, A.; Uwatoko, Y.; Ishikawa, Y. *Angew. Chem., Int. Ed.* **2001**, *40*, 2323–2325.
1805. Graham, S. R.; Ferrence, G. M.; Lash, T. D. *Chem. Commun.* **2002**, 894–895.
1806. Andersen, K.; Anderson, M.; Anderson, O. P.; Baum, S.; Baumann, T. F.; Beall, L. S.; Broderick, W. E.; Cook, A. S.; Eichhorn, D. M.; Goldberg, D.; Hope, H.; Jarrell, W.; Lange, S. J.; McCubbin, Q. J.; Mani, N. S.; Miller, T.; Garrido Montalban, A.; Rodriguez-Morgade, M. S.; Lee, S.; Nie, H.; Olmstead, M. M.; Sabat, M.; Sibert, J. W.; Stern, C.; White, A. J. P.; Williams, D. B. G.; Williams, D. J.; Barrett, A. G. M.; Hoffman, B. M. *J. Heterocyclic Chem.* **1998**, *35*, 1013–1042.
1807. Baumann, T. F.; Barrett, A. G. M.; Hoffman, B. M. *Inorg. Chem.* **1997**, *36*, 5661–5665.
1808. Angeloni, S.; Bauer, E. M.; Ercolani, C.; Popkova, I. A.; Stuzhin, P. A. *J. Porphyrins Phthalocyanines* **2001**, *5*, 881–888.
1809. Koca, A.; Sahin, M.; Gul, A.; Uslu, R. Z. *Monatsh. Chemie* **2002**, *133*, 1135–1145.
1810. Nie, H.; Stern, C. L.; Barrett, A. G. M.; Hoffman, B. M. *Chem. Commun.* **1999**, 703–704.
1811. Whitfield, D. M.; Stojkowski, S.; Sarkar, B. *Coord. Chem. Rev.* **1993**, *122*, 171–225.
1812. Yano, S.; Otsuka, K. In *Metal Ions in Biological Systems*; Sigel, A.; Sigel, H., Eds.; Marcel Dekker: New York, 1996; p 27.
1813. Micera, G.; Kozlowski, H. In *Handbook of Metal-Ligand Interactions in Biological Fluids. Bioinorganic Chemistry*; Berthon, G., Ed.; Marcel Dekker: New York, 1995; Vol. I, Part 3, Chapter 2, pp 707–716.
1814. Kozlowski, H.; Jezowska-Bojczuk, M. Berthon, G., Ed., *Handbook of Metal-Ligand Interactions in Biological fluids. Bioinorganic Chemistry* **1995**, *1*, 679–685. Marcel Dekker: New York Part 3, Chapter 2.
1815. Gyuresik, B.; Nagy, L. *Coord. Chem. Rev.* **2000**, *203*, 81–149.
1816. Lerivrey, J.; Dubois, B.; Decock, P.; Micera, G.; Urbanska, J.; Kozlowski, H. *Inorg. Chim. Acta* **1986**, *125*, 187–190.
1817. Radomska, B.; Kozlowski, H.; Decock, P.; Dubois, B.; Micera, G. *J. Inorg. Biochem.* **1988**, *33*, 153–159.
1818. Gyuresik, B.; Gajda, T.; Jancsó, A.; Lammers, R.; Nagy, L. *J. Chem. Soc., Dalton Trans.* **1997**, 2125–2130.
1819. Yano, S. *Coord. Chem. Rev.* **1988**, *92*, 113–156.
1820. Tanase, T.; Doi, M.; Nouchi, R.; Kato, M.; Sato, Y.; Ishida, K.; Kobayashi, K.; Sakurai, T.; Yamamoto, Y.; Yano, S. *Inorg. Chem.* **1996**, *35*, 4848–4857.
1821. Yano, S.; Doi, M.; Kato, M.; Okura, I.; Nagano, T.; Yamamoto, Y.; Tanase, T. *Inorg. Chim. Acta* **1996**, *249*, 1–3.
1822. Tanase, T.; Yasuda, Y.; Onaka, T.; Yano, S. *J. Chem. Soc., Dalton Trans.* **1998**, 345–352.
1823. Smith, G.; Leary, J. A. *J. Am. Chem. Soc.* **1996**, *118*, 3293–3295.
1824. Smith, G.; Leary, J. A. *J. Am. Chem. Soc.* **1998**, *120*, 13046–13056.
1825. Martin, R. B. In *Metal Ions in Biological Systems*; Sigel, H., Ed.; Marcel Dekker: New York, 1988; Vol. 23, pp 315–330.
1826. Swiatek, J. *J. Coord. Chem.* **1994**, *33*, 191–217.
1827. Begum, N. S.; Poojary, M. D.; Manohar, H. *J. Chem. Soc., Dalton Trans.* **1988**, 1303–1307.
1828. Fiol, J. J.; Terrón, A.; Calafat, A.; Moreno, V.; Aguiló, M.; Solans, X. *J. Inorg. Biochem.* **1989**, *35*, 191–214.
1829. Sigel, H.; Massoud, S. S.; Corfú, N. A. *J. Am. Chem. Soc.* **1994**, *116*, 2958–2971.
1830. Sigel, H. *Chem. Soc. Rev.* **1993**, *22*, 255–267.
1831. Herrero, L. A.; Fiol, J. J.; Mas, F.; Cerdà, V.; Terrón, A. *Inorg. Chem. Soc.* **1996**, *35*, 3786–3791.
1832. Sigel, H. *Coord. Chem. Rev.* **1990**, *100*, 453–539.
1833. Blindauer, C. A.; Sjästad, T. I.; Holý, Sletten E.; Sigel, H. *J. Chem. Soc., Dalton Trans.* **1999**, 3661–3671.
1834. Garcia-Raso, A.; Fiol, J. J.; Badenas, F.; Cons, R.; Terrón, A.; Quiros, M. *J. Chem. Soc., Dalton Trans.* **1999**, 167–173.
1835. Fiol, J. J.; Garcia-Raso, A.; Terrón, A.; Mata, I.; Molins, E. *Inorg. Chim. Acta* **1997**, *262*, 85–89.
1836. Kowalik-Jankowska, T.; Varnagy, K.; Swiatek-Kozlowska, J.; Jon, A.; Sovago, I.; Sochacka, E.; Malkiewicz, A.; Spychala, J.; Kozlowski, H. *J. Inorg. Biochem.* **1997**, *65*, 257–262.
1837. Várnagy, K.; Jezowska-Bojczuk, M.; Swiatek, J.; Kozlowski, H.; Sóvágó, I.; Adamiak, R. W. *J. Inorg. Biochem.* **1990**, *40*, 357–363.
1838. Brasun, J.; Ciapetti, Kozlowski, H.; Oldziej, S.; Taddei, M.; Valensin, D.; Valensin, G.; Gaggeli, N. *J. Chem. Soc., Dalton Trans.* **2000**, 2639–2644.
1839. Brasun, J.; Oldziej, S.; Taddei, M.; Kozlowski, H. *J. Inorg. Biochem.* **2001**, *85*, 79–87.
1840. Lancaster, J. R., Ed. *The Bioinorganic Chemistry of Nickel*; VCH: New York, 1988.
1841. Cammack, R. *Adv. Inorg. Chem.* **1988**, *32*, 297–302.
1842. van Elp, J.; Peng, G.; Searle, B. G.; Mitra-Kirtley, S.; Huang, Y.-H.; Johnson, M. K.; Zhou, Z. H.; Adams, M. W. W.; Maroney, M. J.; Cramer, S. P. *J. Am. Chem. Soc.* **1994**, *116*, 1918–1923.

1843. Ciurli, S.; Mangani, S. In *Handbook on Metalloproteins*; Bertini, I., Sigel A., Sigel H., Eds.; Marcel Dekker: New York, 2001; Chapter 14, pp 669–707.
1844. Maroney, M. J.; Davidson, G.; Allan, C. B. *Struct. Bonding* **1998**, *92*, 1–64.
1845. Fontecilla-Camps, *Struct. Bonding* **1998**, *91*, 1–30.
1846. Maroney, M. J. *Curr. Opin. Chem. Biol.* **1999**, *3*, 188–199.
1847. Halcrow, M. A.; Christou, G. *Chem. Rev.* **1994**, *94*, 2421–2481.
1848. Marr, A. C.; Spencer, D. J. E.; Schröder, M. *Coord. Chem. Rev.* **2001**, *219–221*, 1055–1074.
1849. Stolzenberg, A. M.; Stershic, M. T. *J. Am. Chem. Soc.* **1988**, *110*, 6391–6402.
1850. Renner, M. W.; Furenlid, L. R.; Barkigia, K. M.; Forman, A.; Shim, H. K.; Simpson, D. J.; Smith, K. M.; Fajer, J. *J. Am. Chem. Soc.* **1991**, *113*, 6891–6898.
1851. Zhang, Z.; Petersen, J. L.; Stolzenberg, A. M. *Inorg. Chem.* **1996**, *35*, 4649–4655.
1852. Stolzenberg, A. M.; Zhang, Z. *Inorg. Chem.* **1997**, *36*, 593–600.
1853. Schmid, C. L.; Kempf, C.; Taubert, A.; Neuburger, M.; Zehnder, M.; Kaden, T. A. *Helv. Chim. Acta* **1996**, *79*, 1011–1020.
1854. Drain, C. M.; Sable, D. B.; Corden, B. B. *Inorg. Chem.* **1988**, *27*, 2396–2398.
1855. Drain, C. M.; Sable, D. B.; Corden, B. B. *Inorg. Chem.* **1990**, *29*, 1428–1433.
1856. Zhang, Z.; Peterson, J. L.; Stolzenberg, A. M. *Inorg. Chem.* **1996**, *35*, 4649–4655.
1857. Goubeau, M.; Schreiner, G.; Thauer, R. K. *Eur. J. Biochem.* **1997**, *243*, 110–114.
1858. Berkessel, A. *Bioorg. Chem.* **1991**, *19*, 101–115.
1859. Signor, L.; Knappe, C.; Hug, R.; Schweizer, B.; Pfaltz, A.; Jaun, B. *Chem. Eur. J.* **2000**, *6*, 3508–3516.
1860. Lin, S.-K.; Jaun, B. *Helv. Chim. Acta* **1991**, *74*, 1725–1738.
1861. D'Aniello, J. M. J.; Barefield, E. K. *J. Am. Chem. Soc.* **1976**, *98*, 1610–1611.
1862. Riordan, C. G.; Ram, M. S.; Yap, G. P. A.; Liable-Sands, L.; Rheingold, A. L.; Marchaj, A.; Norton, J. R. *J. Am. Chem. Soc.* **1997**, *119*, 1648–1655.
1863. Lachkar, M.; Guillard, R.; Atmani, A.; De Cian, A.; Fischer, J.; Weiss, R. *Inorg. Chem.* **1998**, *37*, 1575–1584.
1864. Kajiwara, T.; Yamaguchi, T.; Kido, S.; Kawabata, S.; Kuroda, R.; Ito, T. *Inorg. Chem.* **1993**, *32*, 4990–4991.
1865. Matsumoto, N.; Koikawa, M.; Baba, N.; Okawa, H. *Bull. Chem. Soc. Jpn.* **1992**, *65*, 258–261.
1866. Graham, B.; Grannas, M. J.; Hearn, M. T.; Kepert, C. M.; Spiccia, L.; Skelton, B. W.; White, A. H. *Inorg. Chem.* **2000**, *39*, 1092–1099.
1867. Suh, M. P.; Kim, S. K. *Inorg. Chem.* **1993**, *32*, 3562–3564.
1868. Rosokha, S. V.; Lampeka, Y. D. *J. Chem. Soc., Chem. Commun.* **1991**, 1077–1079.
1869. Rosokha, S. V.; Lampeka, Y. D.; Maloshtan, I. M. *J. Chem. Soc., Dalton Trans.* **1993**, 631–636.
1870. Comba, P.; Lampeka, Y. D.; Nazarenko, A. Y.; Prikhod'ko, A. I.; Pritzkow, H.; Taraszewska, J. *Eur. J. Inorg. Chem.* **2002**, 1871–1882.
1871. Tsybal, L. V.; Lampeka, Y. D.; Taraszewska, J. *Polyhedron* **2001**, *20*, 1837–1844.
1872. Mochizuki, K. *Chem. Lett.* **1997**, 1257–1258.
1873. Mochizuki, K.; Manaka, S.; Takeda, I.; Kondo, T. *Inorg. Chem.* **1996**, *35*, 5132–5136, and references therein.
1874. Comba, P.; Gavriš, S. P.; Hay, R. W.; Hilfenhaus, P.; Lampeka, Y. D.; Lightfoot, P.; Peters, A. *Inorg. Chem.* **1999**, *38*, 1416–1421.
1875. Brudenell, S. J.; Spiccia, L.; Bond, A. M.; Mahon, P. C.; Hockless, D. C. R. *J. Chem. Soc., Dalton Trans.* **1998**, 3919–3926.
1876. Fenton, D. E. *Inorg. Chem. Commun.*, **2002**, *5*, 537–547.
1877. Elmali, A.; Kavlakoglu, E.; Elerman, Y. Z. *Naturforsch. B* **2001**, *56*, 1315–1318.
1878. Chunmin, L.; Kanehisa, N.; Miyagi, Y.; Nakao, Y.; Takamizawa, S.; Moro, W.; Kai, Y. *Bull. Chem. Soc. Jpn.* **1997**, *70*, 2429–2436.
1879. Mikuriya, M.; Sasaki, T.; Anjiki, A.; Ikenoue, S.; Tokii, T. *Bull. Chem. Soc. Jpn.* **1992**, *65*, 334–339.
1880. Bouwman, E.; Evans, P.; Kooijman, H.; Reedijk, J.; Spek, A. L. *J. Chem. Soc., Chem. Commun.* **1993**, 1746–1748.
1881. Mazurek, W.; Bond, A. M.; O'Connor, M. J.; Wedd, A. G. *Inorg. Chem.* **1986**, *25*, 906–915.
1882. Isola, M.; Liuzzo, V.; Marchetti, F.; Raffaelli, A. *Eur. J. Inorg. Chem.* **2002**, 1588–1590.
1883. Kogan, V. A.; Popov, L. D.; Lukov, V. V.; Starikov, A. G. *Zh. Neorg. Khim.* **1994**, *39*, 1676–1679.
1884. Epifantsev, A. P.; Kogan, V. A.; Lukov, V. V. *Zh. Neorg. Khim.* **1992**, *37*, 2215–2222.
1885. Dapporto, P.; Formica, M.; Fusi, V.; Micheloni, M.; Paoli, P.; Pontellini, R.; Rossi, P. *Inorg. Chem.* **2000**, *39*, 4663–4665.
1886. Quijano, E. R.; Stevens, E. D.; O'Connor, C. J. *Inorg. Chim. Acta* **1990**, *177*, 267–275.
1887. Mikuriya, M.; Nakadera, K.; Kotera, T. *Bull. Chem. Soc. Jpn.* **1996**, *69*, 399–405.
1888. Bond, A. M.; Haga, M.; Creece, I. S.; Robson, R.; Wilson, J. C. *Inorg. Chem.* **1988**, *27*, 712–721.
1889. Kwiatkowski, M.; Kwiatkowski, E.; Olechnowicz, A. *J. Chem. Soc., Dalton Trans.* **1990**, 3063–3069.
1890. Rispens, M. R.; Gelling, O. J.; de Vries, A. H. M.; Meetsma, A.; Van Bolhuis, F.; Feringa, B. L. *Tetrahedron* **1996**, *52*, 3521–3546.
1891. Lam, F.; Wang, R.-J.; Mak, T. C. W.; Chan, K. S. *J. Chem. Soc., Chem. Commun.* **1994**, 2439–2440.
1892. Fenton, D. E.; Okawa, H. *Chem. Ber. /Recueil* **1997**, *130*, 433–442, and references therein.
1893. Adams, H.; Fenton, D. E.; Haque, S. R.; Heath, S. L.; Ohba, M.; Okawa, H.; Spey, S. E. *J. Chem. Soc., Dalton Trans.* **2000**, 1849–1856.
1894. Uozumi, S.; Furutachi, H.; Ohba, M.; Okawa, H.; Fenton, D. E.; Shindo, K.; Murata, S.; Kitko, D. J. *Inorg. Chem.* **1998**, *37*, 6281–6287.
1895. Koga, T.; Furutachi, H.; Nakamura, T.; Fukita, N.; Ohba, M.; Takahashi, K.; Okawa, H. *Inorg. Chem.* **1998**, *37*, 989–996.
1896. Adams, H.; Fenton, D. E.; Haque, S. R.; Heath, S. L.; Ohba, M.; Okawa, H.; Spey, S. E. *J. Chem. Soc., Dalton Trans.* **2000**, 1849–1856.
1897. Adams, H.; Clunas, S.; Fenton, D. E.; Spey, S. E. *J. Chem. Soc., Dalton Trans.* **2002**, 441–448.
1898. Adams, H.; Clunas, S.; Fenton, D. E. *Inorg. Chem. Commun.* **2001**, *4*, 667–670.
1899. Adams, H.; Fenton, D. E.; McHugh, P. E.; Potter, T. J. *Inorg. Chim. Acta* **2000**, *331*, 117–122.
1900. Adams, H.; Clunas, S.; Fenton, D. E.; Gregson, T. J.; McHugh, P. E.; Spey, S. E. *Inorg. Chem. Commun.* **2002**, *5*, 211–214.

1901. Fenton, D. E. *Pure Appl. Chem.* **1986**, *58*, 1437–1444.
1902. Atkins, A. J.; Blake, D.; Blake, A. J.; Marin-Becerra, A.; Parsons, S.; Ruiz-Ramirez, L.; Schröder, M. *J. Chem. Soc., Chem. Commun.* **1996**, 457–464.
1903. Okawa, H.; Furutachi, H.; Fenton, D. E. *Coord. Chem. Rev.* **1998**, *174*, 51–75.
1904. Atkins, A. J.; Blake, A. J.; Schröder, M. *J. Chem. Soc., Chem. Commun.* **1993**, 1662–1665.
1905. Okawa, H.; Aratake, Y.; Motoda, K.-I.; Ohba, M.; Sakiyama, H.; Matsumoto, N. *Supramol. Chem.* **1996**, *6*, 293–302.
1906. Starynowicz, P.; Lisowski, J. *J. Chem. Soc., Chem. Commun.* **1999**, 769–770.
1907. Aratake, Y.; Ohba, M.; Sakiyama, H.; Tadokoro, M.; Matsumoto, N.; Okawa, H. *Inorg. Chim. Acta* **1993**, *212*, 183–190.
1908. Das, R.; Nag, K. *Inorg. Chem.* **1991**, *30*, 2831–2833.
1909. Nanda, K. K.; Das, R.; Venkatsubramanian, K.; Paul, P.; Nag, K. *J. Chem. Soc., Dalton Trans.* **1993**, 2515–2520.
1910. Nanda, K. K.; Das, R.; Newlands, M. J.; Hynes, R.; Gabe, E. J.; Nag, K. *J. Chem. Soc., Dalton Trans.* **1992**, 897–901.
1911. Das, R.; Nanda, K. K.; Venkatsubramanian, K.; Paul, P.; Nag, K. *J. Chem. Soc., Dalton Trans.* **1992**, 1253–1257.
1912. Rybak-Akimova, E. V.; Alcock, N. W.; Busch, D. H. *Inorg. Chem.* **1998**, *37*, 1563–1574.
1913. Golchoubian, H.; Waltz, W. L.; Quail, J. W. *Can. J. Chem.* **1999**, *77*, 37–56.
1914. Yan, W.-F.; Ma, C.-Q.; Wu, J.-G.; Zhang, W.-X.; Jiang, D.-H. *Inorg. Chim. Acta* **1999**, *287*, 212–217.
1915. Kong, D.; Martell, A. E.; Motekaitis, R. J.; Reibenspies, J. H. *Inorg. Chim. Acta* **2001**, *317*, 243–251.
1916. Qian, M.; Zeng, Q.; Gou, S. *Synth. React. Inorg. Met. Org. Chem.* **2000**, *30*, 637–647.
1917. Kruger, P. E.; Launay, F.; McKee, V. *J. Chem. Soc., Chem. Commun.* **1999**, 639–640.
1918. Cromie, S.; Launay, F.; McKee, V. *J. Chem. Soc., Chem. Commun.* **2001**, 1918–1919.
1919. Kruger, P. E.; McKee, V. *J. Chem. Soc., Chem. Commun.* **1997**, 1341–1342.
1920. Downard, A. J.; McKee, V.; Tandon, S. S. *Inorg. Chim. Acta* **1990**, *173*, 181–190.
1921. Blake, A. B.; Sinn, E.; Yavari, A.; Moubaraki, B.; Murray, K. S. *Inorg. Chim. Acta* **1995**, *229*, 281–290.
1922. Aono, T.; Wada, H.; Aratake, Y.; Matsumoto, N.; Okawa, H.; Matsuda, Y. *J. Chem. Soc., Dalton Trans.* **1996**, 25–29.
1923. Chao, C. C. *J. Magn. Reson.* **1973**, *10*, 1–6.
1924. Scaringe, R. P.; Hodgson, D.; Hatfield, W. E. *Mol. Phys.* **1978**, *35*, 701–713.
1925. Wada, H.; Aono, T.; Motoda, K.; Ohba, M.; Matsumoto, N.; Okawa, H. *Inorg. Chim. Acta* **1996**, *246*, 13–21.
1926. Suh, M. P.; Kim, H. K.; Kim, M. J.; Oh, K. Y. *Inorg. Chem.* **1992**, *31*, 3620–3625.
1927. Nishio, J.; Okawa, H.; Ohtsuka, S.; Tomono, M. *Inorg. Chim. Acta* **1994**, *218*, 27–32.
1928. Lisowski, J.; Starynowicz, P. *Inorg. Chem.* **1999**, *38*, 1351–1355.
1929. Yonemura, M.; Ohba, M.; Takahashi, K.; Okawa, H.; Fenton, D. E. *Inorg. Chim. Acta* **1998**, *283*, 72–79.
1930. Nanda, K. K.; Mohanta, S.; Ghosh, S.; Mukherjee, M.; Helliwell, M.; Nag, K. *Inorg. Chem.* **1995**, *34*, 2861–2869.
1931. Mohanta, S.; Nanda, K. K.; Ghosh, S.; Mukherjee, M.; Helliwell, M.; Nag, K. *J. Chem. Soc., Dalton Trans.* **1996**, 4233–4238.
1932. Nanda, K. K.; Addison, A. W.; Paterson, N.; Sinn, E.; Thompson, L. K.; Sakaguchi, U. *Inorg. Chem.* **1998**, *37*, 1028–1036.
1933. Black, D.; Blake, A. J.; Dancey, K. P.; Harrison, A.; McPartlin, M.; Parsons, S.; Tasker, P. A.; Whittaker, G.; Schröder, M. *J. Chem. Soc., Dalton Trans.* **1998**, 3953–3960.
1934. Mohanta, S.; Baitalik, S.; Dutta, S. K.; Adhikary, B. *Polyhedron* **1998**, *17*, 2669–2677.
1935. Asato, E.; Furutachi, H.; Tamanaha, C.; Matsudaira, H.; Ohba, M.; Okawa, H.; Mikuriya, M. *Chem. Lett.* **1999**, 647–648.
1936. Li, Z.; Jablonksi, C. *Inorg. Chem.* **2000**, *39*, 2456–2461.
1937. Dapporto, P.; Formica, M.; Fusi, V.; Micheloni, M.; Paoli, P.; Pontellini, R.; Romani, P.; Rossi, P. *Inorg. Chem.* **2000**, *39*, 2156–2163.
1938. Brooker, S. *Coord. Chem. Rev.* **2001**, *222*, 33–56.
1939. Fox, S.; Stibrany, R. T.; Potenza, J. A.; Knapp, S.; Schugar, H. J. *Inorg. Chem.* **2000**, *39*, 4950–4961.
1940. Lu, Z.; White, C.; Rheingold, A. L.; Crabtree, R. H. *Inorg. Chem.* **1993**, *32*, 3991–3994.
1941. West, D. X.; Yang, Y.; Klein, T. L.; Goldberg, K. I.; Liberta, A. E.; Valdes-Martinez, J.; Hernandez-Ortega, S. *Polyhedron* **1995**, *14*, 3051–3060.
1942. Iliopoulos, P.; Fallon, G. D.; Murray, K. S. *J. Chem. Soc., Dalton Trans.* **1988**, 1823–1826.
1943. McKenzie, C. J.; Robson, R. *Inorg. Chem.* **1987**, *26*, 3615–3621.
1944. Murase, I.; Ueno, S.; Kida, S. *Bull. Chem. Soc. Jpn.* **1983**, *56*, 2748–2751.
1945. Lawrance, G. A.; Maeder, M.; Manning, T. M.; O'Leary, M. A.; Skelton, B.; White, A. H. *J. Chem. Soc., Dalton Trans.* **1990**, 2491–2495.
1946. Beissel, T.; Glaser, T.; Kesting, F.; Wieghardt, K.; Nuber, B. *Inorg. Chem.* **1996**, *35*, 3936–3947.
1947. Kersting, B. *Eur. J. Inorg. Chem.* **1998**, 1071–1077.
1948. Kersting, B.; Siebert, D. *Inorg. Chem.* **1998**, *37*, 3820–3828.
1949. Kersting, B.; Siebert, D. *Eur. J. Inorg. Chem.* **1999**, 189–193.
1950. Kersting, B.; Steinfeld, G.; Hausmann, J. *Eur. J. Inorg. Chem.* **1999**, 179–187.
1951. Kersting, B. *Eur. J. Inorg. Chem.* **1999**, 2157–2166.
1952. Atkins, A. J.; Blake, A. J.; Schröder, M. *J. Chem. Soc., Chem. Commun.* **1993**, 1662–1665.
1953. Brooker, S.; Croucher, P. D.; Davidson, T. C.; Dunbar, G. S.; Beck, C. U.; Subramanian, S. *Eur. J. Inorg. Chem.* **2000**, 169–179.
1954. Brooker, S.; Croucher, P. D.; Roxburgh, F. M. *J. Chem. Soc., Dalton Trans.* **1996**, 3031–3037.
1955. Brooker, S.; Caygill, G. B.; Croucher, P. D.; Davidson, T. C.; Clive, D. L. J.; Magnuson, S. R.; Cramer, S. P.; Ralston, C. Y. *J. Chem. Soc., Dalton Trans.* **2000**, 3113–3121.
1956. Atkins, A. J.; Black, D.; Blake, A. J.; Marin-Becerra, A.; Parsons, S.; Ruiz-Ramirez, L.; Schröder, M. *J. Chem. Soc., Chem. Commun.* **1996**, 457–464.
1957. Downard, A. J.; McKee, V.; Tandon, S. S. *Inorg. Chim. Acta* **1990**, 181–190.
1958. Kersting, B.; Steinfeld, G.; Hausmann, J. *Eur. J. Inorg. Chem.* **1999**, 179–187.

1959. Nanda, K. K.; Das, R.; Thompson, L. K.; Venkatsubramanian, K.; Paul, P.; Nag, K. *Inorg. Chem.* **1994**, *33*, 1188–1193.
1960. Brooker, S.; Croucher, P. D. *J. Chem. Soc., Chem. Commun.* **1997**, 459–460.
1961. Glick, M. D.; Lintvedt, R. L.; Anderson, T. J.; Mack, J. L. *Inorg. Chem.* **1976**, *15*, 2258–2262.
1962. Nanda, K. K.; Das, R.; Venkatsubramanian, K.; Paul, P. Nag, K. *J. Chem. Soc., Dalton Trans.* **1993**, 2515–2520.
1963. Suh, M. P. *Adv. Inorg. Chem.* **1997**, *44*, 93–146.
1964. Brooker, S.; Croucher, P. D. *Polyhedron* **2000**, *19*, 1887–1894.
1965. Brooker, S.; Croucher, P. D. *J. Chem. Soc., Chem. Commun.* **1995**, 2075–2076.
1966. Orioli, P. L. *Coord. Chem. Rev.* **1971**, *6*, 285–308.
1967. Ram, M. S.; Riordan, C. G.; Ostrander, R.; Rheingold, A. L. *Inorg. Chem.* **1995**, *34*, 5884–5892.
1968. Das, R.; Nag, K. *Inorg. Chem.* **1991**, *30*, 2831–2833.
1969. Nanda, K. K.; Das, R.; Newlands, M. J.; Hynes, R.; Gabe, E. J.; Nag, K. *J. Chem. Soc., Dalton Trans.* **1992**, 897–901.
1970. Nanda, K. K.; Thompson, L. K.; Bridson, J. N.; Nag, K. *J. Chem. Soc., Chem. Commun.* **1994**, 1337–1338.
1971. Krüger, P. E.; McKee, V. *J. Chem. Soc., Chem. Commun.* **1997**, 1341–1342.
1972. Bell, M.; Edwards, A. J.; Hoskins, B. F.; Kachab, E. H.; Robson, R. *J. Chem. Soc., Chem. Commun.* **1987**, 1852–1854.
1973. Bell, M.; Edwards, A. J.; Hoskins, B. F.; Kachab, E. H.; Robson, R. *J. Am. Chem. Soc.* **1989**, 3603–3610.
1974. Edwards, A. J.; Hoskins, B. F.; Kachab, E. H.; Markiewicz, A.; Murray, K. S.; Robson, R. *Inorg. Chem.* **1992**, *31*, 3585–3591.
1975. Brooker, S.; Croucher, P. D.; Davidson T. C.; Dunbar, G. S.; McQuillan, A. J.; Jameson, G. B. *J. Chem. Soc., Chem. Commun.* **1998**, 2131–2132.
1976. Yamamura, T.; Tadokoro, M.; Kuroda, R. *Bull. Chem. Soc. Jpn.* **1983**, 1984–1990.
1977. Yamamura, T.; Tadokoro, M.; Tanaka, K.; Kuroda, R. *Bull. Chem. Soc. Jpn.* **1993**, *66*, 1984–1990.
1978. Frydendahl, H.; Toftlund, H.; Becher, J.; Dutton, J. C.; Murray, K. S.; Taylor, L. F.; Anderson, O. P.; Tiekink, E. R. T. *Inorg. Chem.* **1995**, *17*, 4467–4476.
1979. Kersting, B.; Steinfeld, G.; Fritz, T.; Hausmann, J. *Eur. J. Inorg. Chem.* **1999**, 2167–2172.
1980. Kersting, B. *Z. Naturforsch.* **2000**, *55b*, 961–965.
1981. Kersting, B.; Steinfeld, G. *Chem. Commun.* **2001**, 1376–1377.
1982. Kersting, B. *Angew. Chem., Int. Ed.* **2001**, *40*, 3987–3990.
1983. Marr, A. C.; Spencer, D. J. E.; Schröder, M. *Coord. Chem. Rev.* **2001**, 219–221, 1055–1074.
1984. Osterloh, F.; Saak, W.; Haase, D.; Pohl, S. *J. Chem. Soc., Chem. Commun.* **1996**, 777–778.
1985. Saak, W.; Pohl, S. *Z. Naturforsch.* **1985**, *40b*, 1105–1112.
1986. Colpas, G. J.; Kumar, M.; Day, R. O.; Maroney, M. J. *Inorg. Chem.* **1990**, *29*, 4779–4788.
1987. Colpas, G. J.; Day, R. O.; Maroney, M. J. *Inorg. Chem.* **1992**, *31*, 5053–5055.
1988. Osterloh, F.; Saak, W.; Haase, D.; Pohl, S. *J. Chem. Soc., Chem. Commun.* **1997**, 979–980.
1989. Volbeda, A.; Garcin, E.; Piras, C.; De Lacey, A. L.; Fernandez, V. M.; Hatchikian, E. C.; Frey, M.; Fontecilla-Camps, J. C. *J. Am. Chem. Soc.* **1996**, *118*, 12989–12996.
1990. Bouwman, E.; Henderson, R. K.; Spek, A. L.; Reedijk, J. *Eur. J. Inorg. Chem.* **1999**, 217–219.
1991. Mills, D. K.; Hsiao, Y. M.; Farmer, P. J.; Atnip, E. V.; Reibenspies, J. H.; Darensbourg, M. Y. *J. Am. Chem. Soc.* **1991**, *113*, 1421–1423.
1992. Lai, C. H.; Reibenspies, J. H.; Darensbourg, M. Y. *Angew. Chem., Int. Ed. Engl.* **1996**, *35*, 2390–2393.
1993. Mills, D. K.; Reibenspies, J. H.; Darensbourg, M. Y. *Inorg. Chem.* **1990**, *29*, 4364–4366.
1994. Spencer, D. J. E.; Blake, A. J.; Cooke, P. A.; Schröder, M. *J. Inorg. Biochem.* **1999**, *74*, 303.
1995. Volbeda, A.; Charon, M.-H.; Piras, C.; Hatchikian, E. C.; Frey, M.; Fontecilla-Camps, J. C. *Nature* **1995**, *373*, 580–587.
1996. Davidson, G.; Choudhury, S. B.; Gu, Z.; Bose, K.; Roseboom, W.; Albracht, S. P. J.; Maroney, M. J. *Biochemistry* **2000**, *39*, 7468–7479.
1997. Garcin, E.; Vernede, X.; Hatchikian, E. C.; Volbeda, A.; Frey, M.; Fontecilla-Camps, J. C. *Struct. Folding Des.* **1999**, *5*, 557–566.
1998. Wang, H.; Ralston, C. Y.; Patil, D. S.; Jones, R. M.; Gu, W.; Verhagen, M.; Adams, M.; Ge, P.; Riordan, C.; Marganian, C. A.; Mascharak, P.; Kovacs, J.; Miller, C. G.; Collins, T. J.; Brooker, S.; Croucher, P. D.; Wang, K.; Stiefel, E. I.; Cramer, S. P. *J. Am. Chem. Soc.* **2000**, *122*, 10544–10552, and references therein.
1999. Schmidt, M.; Hoffmann, G. G. *J. Organomet. Chem.* **1977**, *124*, C5–C8.
2000. Nicolet, Y.; Piras, C.; Legrand, P.; Hatchikian, C. E.; Fontecilla-Camps, J. C. *Structure* **1999**, *7*, 13–23.
2001. Peters, J. W.; Lanzilotta, W. N.; Lemon, B. J.; Seefeldt, L. C. *Science* **1998**, *282*, 1853–1858.
2002. Fontecilla-Camps, J. C. *J. Biol. Inorg. Chem.* **1996**, *1*, 91–98, and references therein.
2003. Glaser, T.; Kesting, F.; Beissel, T.; Bill, E.; Weyhermüller, T.; Meyer-Klaucke, W.; Wieghardt, K. *Inorg. Chem.* **1999**, *38*, 722–732.
2004. Glaser, T.; Beissel, T.; Bill, E.; Weyhermüller, T.; Schünemann, V.; Meyer-Klaucke, W.; Trautwein, A. X.; Wieghardt, K. *J. Am. Chem. Soc.* **1999**, *121*, 2193–2208.
2005. Beissel, T.; Bürger, K. S.; Voigt, G.; Wieghardt, K.; Butzlaff, C.; Trautwein, A. X. *Inorg. Chem.* **1993**, *32*, 124–126.
2006. De Gioia, L.; Fantucci, P.; Guigliarelli, B.; Bertrand, P. *Inorg. Chem.* **1999**, *38*, 2658–2662.
2007. Amara, P.; Volbeda, A.; Fontecilla-Camps, J. C.; Field, M. J. *J. Am. Chem. Soc.* **1999**, *121*, 4468–4477.
2008. Davies, S. C.; Evans, D. J.; Hughes, D. L.; Longhurst, S.; Sanders, J. R. *J. Chem. Soc., Chem. Commun.* **1999**, 1935–1936.
2009. Smith, M. C.; Longhurst, S.; Barclay, J. E.; Cramer, S. P.; Davies, S. C.; Hughes, D. L.; Gu, W.-W.; Evans, D. J. *J. Chem. Soc., Dalton Trans.* **2001**, 1387–1388.
2010. Smith, M. C.; Barclay, J. E.; Cramer, S. P.; Davies, S. C.; Gu, W.-W.; Hughes, D. L.; Longhurst, S.; Evans, D. J. *J. Chem. Soc., Dalton Trans.* **2002**, 2641–2647.
2011. Sellmann, D.; Geipel, F.; Lauderbach, F.; Heinemann, F. W. *Angew. Chem., Int. Ed.* **2002**, *41*, 632–634.
2012. Kersting, B.; Siebert, D.; Volkmer, D.; Kolm, M. J.; Janiak, C. *Inorg. Chem.* **1999**, *38*, 3871–3882.
2013. Steinfeld, G.; Kersting, B. *J. Chem. Soc., Chem. Commun.* **2000**, 205–206.

2014. Liaw, W. F.; Chiang, C. Y.; Lee, G. H.; Peng, S. M.; Lai, C. H.; Darensbourg, M. Y. *Inorg. Chem.* **2000**, 480–484.
2015. Ciurli, S.; Yu, S.-B.; Holm, R. H. K.; Srivastava, K. K. P.; Münck, E. *J. Am. Chem. Soc.* **1990**, 112, 8169–8171.
2016. Saak, W.; Pohl, S. *Angew. Chem.* **1991**, 103, 869–870; *Angew. Chem. Int. Ed. Engl.* **1991**, 30, 881–883.
2017. Osterloh, F.; Saak, W.; Pohl, S. *J. Am. Chem. Soc.* **1997**, 119, 5648–5656.
2018. Stavropoulos, P.; Carrié, M.; Muettterties, M. C.; Holm, R. H. *J. Am. Chem. Soc.* **1990**, 112, 5385–5387.
2019. Stavropoulos, P.; Muettterties, M. C.; Carrié, M.; Holm, R. H. *J. Am. Chem. Soc.* **1991**, 113, 8485–8492.
2020. Tommasi, I.; Aresta, M.; Giannoccaro, P.; Quaranta, E.; Fragale, C. *Inorg. Chim. Acta* **1998**, 272, 38–42.
2021. Lu, Z.; Crabtree, R. H. *J. Am. Chem. Soc.* **1995**, 117, 3994–3998.
2022. Fahrni, C. J.; Pfaltz, A.; Neuburger, M.; Zehnder, M. *Helv. Chim. Acta* **1998**, 81, 507–524.
2023. Storr, A.; Summers, D. A.; Thompson, R. C. *Can. J. Chem.* **1998**, 76, 1130–1137.
2024. Mukhopadhyay, S.; Mukhopadhyay, U.; Mak, T. C. W.; Ray, D. *Inorg. Chem.* **2001**, 40, 1057–1059.
2025. Cămpora, J.; López, J. A.; Maya, C. M.; Palma, P.; Carmona, E.; Ruiz, C. *Organometallics* **2000**, 19, 2707–2715.
2026. Casabó, J.; Pons, J.; Siddiqi, K. S. *J. Chem. Soc., Dalton Trans.* **1989**, 1401–1403.
2027. Bayoñ, J. C.; Esteban, P.; Net, G.; Rasmussen, P. G.; Baker, K. N.; Hahn, C. W.; Gumz, M. M. *Inorg. Chem.* **1991**, 30, 2572–2574.
2028. Siegfried, L.; Kaden, T. A.; Meyer, F.; Kircher, P.; Pritzkow, H. *J. Chem. Soc., Dalton Trans.* **2001**, 2310–2315.
2029. Adams, H.; Clunas, S.; Fenton, D. E. *J. Chem. Soc., Chem. Commun.* **2002**, 418–419.
2030. Meyer, F.; Hyla-Kryspin, I.; Kaifer, E.; Kircher, P. *Eur. J. Inorg. Chem.* **2000**, 771–781.
2031. Weller, H.; Siegfried, L.; Neuburger, M.; Zehnder, M.; Kaden, T. A. *Helv. Chim. Acta* **1997**, 80, 2315–2328.
2032. Buchler, S.; Meyer, F.; Jacobi, A.; Kircher, P.; Zsolnai, L. *Z. Naturforsch.* **1999**, 54b, 1295–1306.
2033. Röder, J. C.; Meyer, F.; Pritzkow, H. *Chem. Commun.* **2001**, 2176–2177.
2034. Konrad, M.; Meyer, F.; Heinze, K.; Zsolnai, L. *J. Chem. Soc., Dalton Trans.* **1998**, 199–205.
2035. Konrad, M.; Wuthe, S.; Meyer, F.; Kaifer, E. *Eur. J. Inorg. Chem.* **2001**, 2233–2240.
2036. Van Albada, G. A.; De Graaff, R. A. G.; Haasnoot, J. G.; Reedijk, J. *Inorg. Chem.* **1984**, 23, 1404–1408.
2037. Antolini, L.; Fabretti, A. C.; Gatteschi, D.; Giusti, A.; Sessoli, R. *Inorg. Chem.* **1990**, 29, 143–145.
2038. Vos, G.; Haasnoot, J. G.; Verschoor, G. C.; Reedijk, J.; Schaminee, P. E. L. *Inorg. Chim. Acta* **1985**, 105, 31–39.
2039. Groeneveld, L. R.; Le Febre, R. A.; De Graaff, R. A. G.; Haasnoot, J. G.; Vos, G.; Reedijk, J. *Inorg. Chim. Acta* **1985**, 102, 69–82.
2040. Vos, G.; Haasnoot, J. G.; Verschoor, G. C.; Reedijk, J. *Inorg. Chim. Acta* **1985**, 102, 187–198.
2041. Vreugdenhil, W.; Haasnoot, J. G.; Schoondergang, M. F. J.; Reedijk, J. *Inorg. Chim. Acta* **1987**, 130, 235–242.
2042. Fabretti, A. C.; Lalavasi, W.; Gatteschi, D.; Sessoli, R. *J. Chem. Soc., Dalton Trans.* **1991**, 2331–2334.
2043. Van Koningsbruggen, P. J.; Gluth, M. W.; Ksenofontov, V.; Walcher, D.; Schollmeyer, D.; Levchenko, G.; Gütlich, P. *Inorg. Chim. Acta* **1998**, 273, 54–61.
2044. Keij, F. S.; De Graaff, R. A. G.; Haasnoot, J. G.; Reedijk, J. *J. Chem. Soc., Dalton Trans.* **1984**, 2093–2097.
2045. Cabezón, B.; Sastre, A.; Torres, T.; Schäfer, W.; Borrás-Almenar, J. J.; Coronado, E. *J. Chem. Soc., Dalton Trans.* **1995**, 2305–2310.
2046. Vreugdenhil, W.; Haasnoot, J. G.; Reedijk, J.; Spek, A. L. *Inorg. Chim. Acta* **1987**, 129, 205–216.
2047. Miah, M. D. A. A.; Phillips, D. J. *Inorg. Chim. Acta* **1989**, 165, 23–24.
2048. Miah, M. D. A. A.; Phillips, D. J. *Inorg. Chim. Acta* **1993**, 214, 181–183.
2049. Miah, M. D. A. A.; Phillips, D. J.; Rae, A. D. *Inorg. Chim. Acta* **1992**, 201, 191–196.
2050. Sung, N.-D.; Yun, K.-S.; Kim, T.-Y.; Choi, K.-Y.; Suh, M.; Kim, J.-G.; Suh, I.-H.; Chin, J. *Inorg. Chem. Commun.* **2001**, 4, 377–380.
2051. Rosenber, L.; Thompson, L. K.; Gabe, E. J.; Lee, F. L. *J. Chem. Soc., Dalton Trans.* **1986**, 625–631.
2052. Escuer, A.; Vicente, R.; Mernari, B.; El Gueddi, A.; Pierrot, M. *Inorg. Chem.* **1997**, 36, 2511–2516.
2053. Bullock, G.; Cook, A.; Foster, A.; Rosenberg, L.; Thompson, L. K. *Inorg. Chim. Acta* **1985**, 103, 207–215.
2054. Wen, T.; Thompson, L. K.; Lee, F. L.; Gabe, E. J. *Inorg. Chem.* **1988**, 27, 4190–4196.
2055. Thompson, L. K.; Matthews, C. J.; Zhao, L.; Wilson, C.; Leech, M. A.; Howard, J. A. K. *J. Chem. Soc., Dalton Trans.* **2001**, 2258–2262.
2056. Jaradat, Q.; Barqawi, K.; Akasheh, T. S. *Inorg. Chim. Acta* **1986**, 116, 63–73.
2057. Campos-Fernández, C. S.; Clérac, R.; Dunbar, K. R. *Angew. Chem., Int. Ed.* **1999**, 38, 3477–3479; *Angew. Chem.* **1999**, 111, 3685–3688.
2058. Campos-Fernández, C. S.; Clérac, R.; Koomen, J. M.; Russell, D. H.; Dunbar, K. R. *J. Am. Chem. Soc.* **2001**, 123, 773–774.
2059. Xu, Z.; Thompson, L. K.; Miller, D. O.; Clase, H. J.; Howard, J. A. K.; Goeta, A. E. *Inorg. Chem.* **1998**, 37, 3620–3627.
2060. Matthews, C. J.; Avery, K.; Xu, Z.; Thompson, L. K.; Zhao, L.; Miller, D. O.; Biradha, K.; Poirier, K.; Zaworotko, M. J.; Wilson, C.; Goeta, A. E.; Howard, J. A. K. *Inorg. Chem.* **1999**, 38, 5266–5276.
2061. Paolucci, G.; Stelluto, S.; Sitran, S.; Ajò, D.; Benetollo, F.; Polo, A. *Inorg. Chim. Acta* **1992**, 193, 57–75.
2062. Ali, M. D. A.; Mirza, A. H.; Butcher, R. J.; Tarafder, M. T. H.; Ali, M. A. *Inorg. Chim. Acta* **2001**, 320, 1–6.
2063. Hörner, M.; Fenner, H.; Hiller, W.; Beck, J. *Z. Naturforsch. B* **1988**, 43, 1174–1178.
2064. Dixon, N. E.; Riddles, P. W.; Gazzola, C.; Blakeley, R. L.; Zerner, B. *Can. J. Biochem.* **1980**, 58, 1335–1344.
2065. Roecker, L.; Akande, J.; Nelson Elam, L.; Gauga, I.; Helton, B. W.; Prewitt, M. C.; Sargeson, A. M.; Swango, J. H.; Willis, A. C.; Xin, T.; Xu, J. *Inorg. Chem.* **1999**, 38, 1269–1275.
2066. Buchanan, R. M.; Mashuta, M. S.; Oberhausen, K. J.; Richardson, J. F. *J. Am. Chem. Soc.* **1989**, 111, 4497–4498.
2067. Wages, H. E.; Taft, K. L.; Lippard, S. J. *Inorg. Chem.* **1993**, 32, 4985–4987.
2068. Volkmer, D.; Hörstmann, A.; Griesar, K.; Haase, W.; Krebs, B. *Inorg. Chem.* **1996**, 35, 1132–1135.
2069. Volkmer, D.; Hommerich, B.; Griesar, K.; Haase, W.; Krebs, B. *Inorg. Chem.* **1996**, 35, 3792–3803.
2070. Yamaguchi, K.; Koshino, S.; Akagi, F.; Suzuki, M.; Uehara, A.; Suzuki, S. *J. Am. Chem. Soc.* **1997**, 119, 5752–5753.
2071. Koga, T.; Furutachi, H.; Nakamura, T.; Fukita, N.; Ohba, M.; Takahashi, K.; Okawa, H. *Inorg. Chem.* **1998**, 37, 989–996.
2072. Meyer, F.; Jacobi, A.; Nuber, B.; Rutsch, P.; Zsolnai, L. *Inorg. Chem.* **1998**, 37, 1213–1218.

2073. Hosokawa, Y.; Yamane, H.; Nakao, Y.; Matsumoto, K.; Takamizawa, S.; Mori, W.; Suzuki, S.; Kimoto, H. *Inorg. Chim. Acta* **1998**, *283*, 118–123.
2074. Meyer, F.; Pritzkow, H. *Chem. Commun.* **1998**, 1555–1556.
2075. Uozumi, S.; Furutachi, H.; Ohba, M.; Okawa, H.; Fenton, D. E.; Shindo, K.; Murata, S.; Kitko, D. J. *Inorg. Chem.* **1998**, *37*, 6281–6287.
2076. Hommerich, B.; Schwöppe, H.; Volkmer, D.; Krebs, B. *Z. Anorg. Allg. Chem.* **1999**, *625*, 75–82.
2077. Meyer, F.; Konrad, M.; Kaifer, E. *Eur. J. Inorg. Chem.* **1999**, 1851–1854.
2078. Konrad, M.; Meyer, F.; Jacobi, A.; Kircher, P.; Rutsch, P.; Zsolnai, L. *Inorg. Chem.* **1999**, *38*, 4559–4566.
2079. Barrios, A. M.; Lippard, S. J. *J. Am. Chem. Soc.* **1999**, *121*, 11751–11757.
2080. Barrios, A. M.; Lippard, S. J. *J. Am. Chem. Soc.* **2000**, *122*, 9172–9177.
2081. Barrios, A. M.; Lippard, S. J. *Inorg. Chem.* **2001**, *40*, 1250–1255.
2082. Buchler, S.; Meyer, F.; Kaifer, E.; Pritzkow, H. *Inorg. Chim. Acta* **2002**, *337*, 371–386.
2083. Gultneh, Y.; Khan, A. R.; Ahvazi, B.; Butcher, R. J. *Polyhedron* **1998**, *17*, 3351–3360.
2084. Hosokawa, Y.; Yamane, H.; Nakao, Y.; Matsumoto, K.; Takamizawa, S.; Mori, W.; Suzuki, S. *Chem. Lett.* **1997**, 891–892.
2085. Turpeinen, U.; Hämäläinen, R. *Polyhedron* **1987**, *6*, 1603–1610.
2086. Kryatov, S. V.; Rybak-Akimova, E. V. H.; Meyer, F.; Pritzknow, H. *Eur. J. Inorg. Chem.* **2003**, 1581–1590.
2087. Pearson, M. A.; Overbye Michel, L.; Hausinger, R. P.; Karplus, P. A. *Biochemistry* **1997**, *36*, 8164–8172.
2088. Benini, S.; Rypniewski, W. R.; Wilson, K. S.; Miletti, S.; Ciurli, S.; Mangani, S. *J. Biol. Inorg. Chem.* **2000**, *5*, 110–118.
2089. Benini, S.; Rypniewski, W. R.; Wilson, K. S.; Ciurli, S.; Mangani, S. *J. Biol. Inorg. Chem.* **1998**, *3*, 268–273.
2090. Arnold, M.; Brown, D. A.; Deeg, O.; Errington, W.; Haase, W.; Herlihy, K.; Kemp, T. J.; Nimir, H.; Werner, R. *Inorg. Chem.* **1998**, *37*, 2920–2925.
2091. Stemmler, A. J.; Kampf, J. W.; Kirk, M. L.; Pecoraro, V. L. *J. Am. Chem. Soc.* **1995**, *117*, 6368–6369.
2092. Brown, D. A.; Cuffe, L. P.; Deeg, O.; Errington, W.; Fitzpatrick, N. J.; Glass, W. K.; Herlihy, K.; Kemp, T. J.; Nimir, H. *Chem. Commun.* **1998**, 2433–2434.
2093. Gaynor, D.; Starikova, Z. A.; Ostrovsky, S.; Haase, W.; Nolan, K. B. *Chem. Commun.* **2002**, 506–507.
2094. Aduldecha, S.; Hathaway, B. *J. Chem. Soc., Dalton Trans.* **1991**, 993–998.
2095. Shieh, S.-J.; Chou, C.-C.; Lee, G.-H.; Wang, C.-C.; Peng, S.-M. *Angew. Chem., Int. Ed. Engl.* **1997**, *36*, 56; *Angew. Chem.* **1997**, *109*, 57–59.
2096. Wang, C.-C.; Lo, W.-C.; Chou, C.-C.; Lee, G.-H.; Chen, J.-M.; Peng, S.-M. *Inorg. Chem.* **1998**, *37*, 4059–4065.
2097. Clérac, R.; Cotton, F. A.; Dunbar, K. R.; Murillo, C. A.; Pascual, I.; Wang, X. *Inorg. Chem.* **1999**, *38*, 2655–2657.
2098. Lai, S.-Y.; Wang, C.-C.; Chen, Y.-H.; Lee, C.-C.; Liu, Y.-H.; Peng, S.-M. *J. Chin. Chem. Soc.* **1999**, *46*, 477–485.
2099. Lai, S.-Y.; Lin, T.-W.; Chen, Y.-H.; Wang, C.-C.; Lee, G.-H.; Yang, M.-h.; Leung, M.-k.; Peng, S.-M. *J. Am. Chem. Soc.* **1999**, *121*, 250–251.
2100. Berry, J. F.; Cotton, F. A.; Daniels, L. M.; Murillo, C. A. *J. Am. Chem. Soc.* **2002**, *124*, 3212–3213.
2101. Yeh, C.-Y.; Chian, Y.-L.; Lee, G.-H.; Peng, S.-M. *Inorg. Chem.* **2002**, *41*, 4096–4098.
2102. Ochsenbein, S.; Murrie, M.; Rusanov, E.; Stoeckli-Evans, H.; Sekine, C.; Güdel, H. U. *Inorg. Chem.* **2002**, *41*, 5133–5140.
2103. Ribas, J.; Escuer, A.; Monfort, M.; Vicente, R.; Cortés, R.; Lezama, L.; Rojo, T. *Coord. Chem. Rev.* **1999**, *193–195*, 1027–1068.
2104. Ribas, J.; Monfort, M.; Diaz, C.; Escuer, A.; Vicente, R.; Salah El Fallah, M.; Solans, X.; Font-Bardia, M. *Adv. Mater. Res.* **1994**, *1–2*, 573–580.
2105. Thompson, L. K.; Tandon, S. S. *Comments Inorg. Chem.* **1996**, *18*, 125–144.
2106. Pierpont, C. G.; Hendrickson, D. N.; Duggan, D. M.; Wagner, F.; Barefield, E. K. *Inorg. Chem.* **1975**, *14*, 604–610.
2107. Wagner, F.; Mocella, M. T.; D’Aniello, M. J. J.; Wang, A. H. J.; Barefield, E. K. *J. Am. Chem. Soc.* **1974**, *96*, 2625–2627.
2108. McLachlan, G. A.; Fallon, G. D.; Martin, R. L.; Moubaraki, B.; Murray, K. S.; Spiccia, L. *Inorg. Chem.* **1994**, *33*, 4663–4668.
2109. Fabbrizzi, L.; Pallavicini, P.; Parodi, L.; Perotti, A.; Sardone, N.; Taglietti, A. *Inorg. Chim. Acta* **1996**, *244*, 7–9.
2110. Escuer, A.; Harding, C. J.; Dussart, Y.; Nelson, J.; McKee, V.; Vicente, R. *J. Chem. Soc., Dalton Trans.* **1999**, 223–228.
2111. Zhang, Z.-H.; Bu, X.-H.; Ma, Z.-H.; Bu, W.-M.; Tang, Y.; Zaho, Q.-H. *Polyhedron* **2000**, *19*, 1559–1566.
2112. Weller, H.; Siegfried, L.; Neuburger, M.; Zehnder, M.; Kaden, T. A. *Helv. Chim. Acta* **1997**, *80*, 2315–2328.
2113. Chaudhuri, P.; Weyhermüller, T.; Bill, E.; Wieghardt, K. *Inorg. Chim. Acta* **1996**, *252*, 195–202.
2114. Gao, E.-Q.; Liao, D.-Z.; Jiang, Z.-H.; Yan, S.-P.; Zhang, S.-F. *Huaxue Xuebao* **2001**, *59*, 1294–1298.
2115. Ribas, J.; Monfort, M.; Diaz, C.; Bastos, C.; Solans, X. *Inorg. Chem.* **1993**, *32*, 3557–3561.
2116. Chaudhuri, P.; Guttman, M.; Ventur, D.; Wieghardt, K.; Nuber, B.; Weiss, J. *J. Chem. Soc., Chem. Commun.* **1985**, 1618–1620.
2117. Escuer, A.; Castro, I.; Mautner, F. A.; El Fallah, M. S.; Vicente, R. *Inorg. Chem.* **1997**, *36*, 4633–4640.
2118. Ribas, J.; Monfort, M.; Gosh, B. K.; Cortés, R.; Solans, X.; Font-Bardia, M. *Inorg. Chem.* **1996**, *35*, 864–868.
2119. Escuer, A. M.; Vicente, R.; El Fallah, M. S.; Solans, X.; Font-Bardia, M. *Inorg. Chim. Acta* **1998**, *278*, 43–50.
2120. Hay, P. J.; Thibeault, J. C.; Hoffmann, R. *J. Am. Chem. Soc.* **1975**, *97*, 4884–4899.
2121. Fabrizi de Biani, F.; Rui, E.; Cano, J.; Novoa, J. J.; Alvarez, S. *Inorg. Chem.* **2000**, *39*, 3221–3229.
2122. Arriortua, M. I.; Cortés, R.; Lezama, L.; Rojo, T.; Solans, X.; Font-Bardia, M. *Inorg. Chim. Acta* **1990**, *174*, 263–269.
2123. Rojo, T.; Lezama, L.; Cortés, R.; Mesa, J. L.; Arriortua, M. I. *J. Magn. Magn. Mater.* **1990**, *83*, 519–521.
2124. Cortés, R.; Lezama, L.; Rojo, T.; Urriaga, M. K.; Arriortua, M. I. *IEEE Trans. Magn.* **1994**, *30*, 4728–4730.
2125. Barandika, G. M.; Cortés, R.; Lezama, L.; Urriaga, M. K.; Arriortua, M. I.; Rojo, T. *J. Chem. Soc., Dalton Trans.* **1999**, 2971–2976.
2126. Cortés, R.; Larramendi, J. I. R.; Lezama, L.; Rojo, T.; Urriaga, M. K.; Arriortua, M. I. *J. Chem. Soc., Dalton Trans.* **1992**, 2723–2728.

2127. Vicente, R.; Escuer, A.; Ribas, J.; El Fallah, M. S.; Solans, X.; Font-Bardia, M. *Inorg. Chem.* **1993**, *32*, 1920–1924.
2128. Escuer, A.; Vicente, R.; Ribas, J.; Solans, X. *Inorg. Chem.* **1995**, *34*, 1793–1798.
2129. Escuer, A.; Vicente, R.; Ribas, J. *J. Magn. Magn. Mater.* **1992**, *110*, 181–184.
2130. Escuer, A.; Vicente, R.; El Fallah, M. S.; Solans, X.; Font-Bardia, M. *Inorg. Chim. Acta* **1996**, *247*, 85–91.
2131. Beer, P. D.; Drew, M. G. B.; Leeson, P. B.; Lyssenko, K.; Ogden, M. I. *J. Chem. Soc., Chem. Commun.* **1995**, 929–930.
2132. Ruiz, E.; Cano, J.; Alvarez, S.; Alemany, P. *J. Am. Chem. Soc.* **1998**, *120*, 11122–11129.
2133. Castell, O.; Caballol, R.; Garcá, V. M.; Handrick, K. *Inorg. Chem.* **1996**, *35*, 1609–1615.
2134. Ribas, R.; Monfort, M.; Costa, R.; Solans, X. *Inorg. Chem.* **1993**, *32*, 695–699.
2135. Halcrow, M. A.; Huffman, J. C.; Christou, G. *Angew. Chem., Int. Ed. Engl.* **1995**, *34*, 889–891.
2136. Halcrow, M. A.; Sun, J.-S.; Huffman, J. C.; Christou, C. *Inorg. Chem.* **1995**, *34*, 4167–4177.
2137. Serna, Z. E.; Lezama, L.; Urriaga, M. K.; Arriortua, M. I.; Barandika, M. G.; Cortés, R.; Rojo, T. *Angew. Chem., Int. Ed.* **2000**, *39*, 344–347; *Angew. Chem.* **2000**, *112*, 352–355.
2138. Serna, Z. E.; Barandika, M. G.; Cortés, R.; Urriaga, M. K.; Barberis, G. E.; Rojo, T. *J. Chem. Soc., Dalton Trans.* **2000**, 29–34.
2139. Papaefstathiou, G. S.; Escuer, A.; Vicente, R.; Font-Bardia, M.; Solans, X.; Perlepes, S. P. *Chem. Commun.* **2001**, 2414–2415.
2140. Kersting, B.; Steinfeld, G.; Siebert, D. *Chem. Eur. J.* **2001**, *7*, 4253–4258.
2141. Meyer, F.; Kaifer, E.; Pritzkow, H. *Chem. Commun.* **2003**, 774–775.
2142. Rajendiran, T. M.; Mathonière, C.; Stéphane, G.; Ouahab, L.; Khan, O. *Inorg. Chem.* **1998**, *37*, 2651–2654.
2143. Monfort, M.; Ribas, J.; Solans, X.; Font-Bardia, M. *Inorg. Chem.* **1996**, *35*, 7633–7638.
2144. Escuer, A.; Vicente, R.; Ribas, J.; El Fallah, M. S.; Solans, X. *Inorg. Chem.* **1993**, *32*, 1033–1035.
2145. Yu, Y.; Honda, Z.; Katsumata, K.; Ohishi, T.; Manabe, T.; Yamashita, M. *Mol. Cryst. Liq. Cryst.* **1996**, *286*, 121–126.
2146. Escuer, A.; Vicente, R.; Ribas, J.; El Fallah, M. S.; Solans, X.; Font-Bardia, M. *Inorg. Chem.* **1993**, *32*, 3727–3732.
2147. Vicente, R.; Escuer, A.; Ribas, J.; El Fallah, M. S.; Solans, X.; Font-Bardia, M. *Inorg. Chem.* **1995**, *34*, 1278–1281.
2148. Escuer, A.; Vicente, R.; El Fallah, M. S.; Ribas, J.; Solans, X.; Font-Bardia, M. *J. Chem. Soc., Dalton Trans.* **1993**, 2975–2976.
2149. Monfort, M.; Resino, I.; El Fallah, M. S.; Ribas, J.; Solans, X.; Font-Bardia, M.; Stoeckli-Evans, H. *Chem. Eur. J.* **2001**, *7*, 280–287.
2150. Hong, C. S.; Do, Y. *Angew. Chem., Int. Ed.* **1999**, *38*, 193–195; *Angew. Chem.* **1999**, *111*, 153–155.
2151. Hong, C. S.; Koo, J.; S, S.-K.; Lee, Y. S.; Kim, Y.-S.; Do, Y. *Chem. Eur. J.* **2001**, *7*, 4243–4252.
2152. Ribas, J.; Monfort, M.; Diaz, C.; Bastos, C.; Mer, C.; Solans, X. *Inorg. Chem.* **1995**, *34*, 4986–4990.
2153. Ward, B. H.; Granroth, G. E.; Talham, D. R.; Meisel, M. W. *J. Magn. Magn. Mater.* **1998**, *177–178*, 661–662.
2154. Mukherjee, P. S.; Dalai, S.; Zangrando, E.; Lloret, F.; Chaudhuri, N. R. *Chem. Commun.* **2001**, 1444–1445.
2155. Cortés, R.; Urriaga, K.; Lezama, L.; Pizarro, J. L.; Goñi, A.; Arriortua, M. I.; Rojo, T. *Inorg. Chem.* **1994**, *33*, 4009–4015.
2156. Escuer, A.; Vicente, R.; Ribas, J.; El Fallah, M. S.; Solans, X.; Font-Bardia, M. *Inorg. Chem.* **1994**, *33*, 1842–1847.
2157. Chou, L. K.; Talham, D. R.; Kim, W. W.; Signore, P. J. C.; Meisel, M. W. *Physica B* **1994**, *194*, 313–314.
2158. Takeuchi, T.; Hori, H.; Date, M.; Yosida, T.; Katsumata, K.; Renard, J. P.; Gadet, V.; Verdaguer, M. *J. Magn. Magn. Mater.* **1992**, *104*, 813–814.
2159. Takeuchi, T.; Yosida, T.; Inoue, K.; Yamashita, M.; Kumada, T.; Kindo, K.; Merah, S.; Verdaguer, M.; Renard, J. P. *J. Magn. Magn. Mater.* **1995**, *140*, 1633–1634.
2160. Tomohiko, I.; Yamashita, M.; Hara, H.; Aizawa, N.; Matsuzaka, H.; Ikemoto, I. *Mol. Cryst. Liq. Cryst. Sci. Technol. A* **2000**, *342*, 309–318.
2161. Yamashita, M.; Inoue, K.; Ohishi, T.; Miyamae, H.; Takeuchi, T.; Yosida, T. *Synth. Met.* **1995**, *71*, 1961–1964.
2162. Yamashita, M.; Ishii, T.; Matsuzaka, H. *Coord. Chem. Rev.* **2000**, *198*, 347–366.
2163. Ribas, J.; Monfort, M.; Diaz, C.; Bastos, C.; Solans, X. *Inorg. Chem.* **1994**, *33*, 484–489.
2164. Borrás-Almenar, J. J.; Coronado, E.; Curély, J.; Georges, R. *Inorg. Chem.* **1995**, *34*, 2699–2704.
2165. Hagiwara, M.; Narumi, Y.; Kindo, K.; Kohno, M.; Nakano, H.; Sato, R.; Takahashi, M. *Phys. Rev. Lett.* **1998**, *80*, 1312–1315.
2166. Kohno, M.; Takahashi, M.; Hagiwara, M. *Phys. Rev. B* **1998**, *57*, 1046–1051.
2167. Vicente, R.; Escuer, A.; Ribas, J.; Solans, X. *Inorg. Chem.* **1992**, *31*, 1726–1728.
2168. Vicente, R.; Escuer, A. *Polyhedron* **1995**, *14*, 2133–2138.
2169. Meyer, F.; Pritzkow, H. *Inorg. Chem. Commun.* **2001**, *4*, 305–307.
2170. Ribas, J.; Monfort, M.; Resino, I.; Solans, X.; Rabu, P.; Maingot, F.; Drillon, M. *Angew. Chem., Int. Ed. Engl.* **1996**, *35*, 2520–2522.
2171. Esposito, F.; Kamieniarz, G. *Phys. Rev. B* **1998**, *57*, 7431–7433.
2172. Borrás-Almenar, J. J.; Clemente-Juan, J. M.; Coronado, E.; Llorde, E. *Chem. Phys. Lett.* **1997**, *275*, 79–84.
2173. Escuer, A.; Vicente, R.; El Fallah, M. S.; Kumar, S. B.; Mautner, F. A.; Gatteschi, D. *J. Chem. Soc., Dalton Trans.* **1998**, 3905–3910.
2174. Ribas, J.; Monfort, M.; Gosh, K. B.; Solans, X. *Angew. Chem., Int. Ed. Engl.* **1994**, *33*, 2087–2089.
2175. Viau, G.; Lombardi, M. G.; De Munno, G.; Julve, M.; Lloret, F.; Faus, J.; Caneschi, A.; Clemente-Juan, J. M. *J. Chem. Soc., Chem. Commun.* **1997**, 1195–1196.
2176. Li, L.; Liao, D.; Jiang, Z.; Yan, S. *Polyhedron* **2000**, *19*, 1575–1578.
2177. Ribas, J.; Monfort, M.; Gosh, K. B.; Solans, X.; Font-Bardia, M. *J. Chem. Soc., Chem. Commun.* **1995**, 2375–2376.
2178. Monfort, M.; Resino, I.; Ribas, J.; Rabu, P.; Drillon, M. *Inorg. Chem.* **2000**, *39*, 2572–2576.
2179. Monfort, M.; Resino, I.; Ribas, J.; Solans, X.; Font-Bardia, M. *New. J. Chem.* **2001**, *25*, 1577–1582.
2180. Escuer, A.; Vicente, R.; Solans, X.; Font-Bardia, M. *Inorg. Chem.* **1994**, *33*, 6007–6011.
2181. Nakano, H.; Hagiwara, M.; Chihara, T.; Takahashi, M. *J. Phys. Soc. Jpn.* **1997**, *66*, 2997–3000.
2182. Peng, C.-H.; Wang, C.-C.; Lee, H.-C.; Lo, W.-C.; Lee, G.-H.; Peng, S.-M. *J. Chin. Chem. Soc.* **2001**, *48*, 987–996.
2183. Maier, H. E.; Kirschner, H.; Paulus, H. *Z. Kristallogr.* **1981**, *157*, 277–289.
2184. Monfort, M.; Ribas, J.; Solans, X. *J. Chem. Soc., Chem. Commun.* **1993**, 350–351.
2185. Ribas, J.; Monfort, M.; Solans, X.; Drillon, M. *Inorg. Chem.* **1994**, *33*, 742–745.

2186. Monfort, M.; Resino, I.; Ribas, J.; Stoeckli-Evans, H. *Angew. Chem., Int. Ed.* **2000**, *39*, 191–193; *Angew. Chem.* **2000**, *112*, 197–199.
2187. Hernández, M. L.; Barandika, M. G.; Urriaga, M. K.; Cortés, R.; Lezama, L.; Arriortua, M. I. *J. Chem. Soc., Dalton Trans.* **2000**, 79–84.
2188. Martín, S.; Barandika, M. G.; Lezama, L.; Pizarro, J. L.; Serna, Z. E.; Larramendi, J. I. R.; Arriortua, M. I.; Rojo, T.; Cortés, R. *Inorg. Chem.* **2001**, *40*, 4109–4115.
2189. Ferlay, S.; Mallah, T.; Vaissermann, J.; Bartolome, F.; Veillet, P.; Verdaguer, M. *J. Chem. Soc., Chem. Commun.* **1996**, 2481–2482.
2190. Colacio, E.; Dominguez-Vera, J. M.; Ghazi, M.; Kivekas, R.; Lloret, F.; Moreno, J. M.; Stoeckli-Evans, H. *J. Chem. Soc., Chem. Commun.* **1999**, 987–988.
2191. Nowicka, B.; Hagiwara, M.; Wakatsuki, Y.; Kisch, H. *Bull. Chem. Soc. Jpn.* **1999**, *72*, 441–445.
2192. Kou, H.-Z.; Gao, S.; Bu, W.-M.; Liao, D.-Z.; Ma, B.-Q.; Jiang, Z.-H.; Yan, S.-P.; Fan, Y.-G.; Wang, G.-L. *J. Chem. Soc., Dalton Trans.* **1999**, 2477–2480.
2193. Kou, H.-Z.; Gao, S.; Ma, B.-Q.; Liao, D.-Z. *J. Chem. Soc., Chem. Commun.* **2000**, 713–714.
2194. Kou, H.-Z.; Gao, S.; Ma, B.-Q.; Liao, D.-Z. *J. Chem. Soc., Chem. Commun.* **2000**, 1309–1310.
2195. Mallah, T.; Marvilliers, A.; Riviere, E. *Phil. Trans. R. Soc. Lond. A* **1999**, *357*, 3139–3158.
2196. Shores, M. P.; Sokol, J. J.; Long, J. R. *J. Am. Chem. Soc.* **2002**, *124*, 2279–2292.
2197. Sokol, J. J.; Shores, M. P.; Long, J. R. *Inorg. Chem.* **2002**, *41*, 3052–3054.
2198. Zhan, S.-Z.; Guo, D.; Zhang, X.-Y.; Du, C.-X.; Zhu, Y.; Yang, R.-N. *Inorg. Chim. Acta* **2000**, *298*, 57–62.
2199. Kuo, H.-Z.; Si, S.-F.; Gao, S.; Liao, D.-Z.; Jiang, Z.-H.; Yan, S.-P.; Fan, Y.-G.; Wang, G.-L. *Eur. J. Inorg. Chem.* **2002**, 699–702.
2200. Smekal, Z.; Cisarova, I.; Mrozinski, J. *Polyhedron* **2001**, *20*, 3301–3306.
2201. Kitazawa, T.; Gomi, Y.; Takahashi, M.; Takeda, M.; Enomoto, M.; Miyazaki, A.; Enoki, T. *J. Mater. Chem.* **1996**, *6*, 119–121.
2202. Niel, V.; Martinez-Agudo, J. M.; Muñoz, M. C.; Gaspar, A. B.; Real, J. A. *Inorg. Chem.* **2001**, *40*, 3838–3839.
2203. Castro, I.; Calatayud, M. L.; Sletten, J.; Lloret, F.; Julve, M. *J. Chem. Soc., Dalton Trans.* **1997**, 811–817.
2204. Muga, I.; Gutierrez-Zorrilla, J. M.; Vitoria, P.; Luque, A.; Insausti, M.; Roman, P.; Lloret, F. *Eur. J. Inorg. Chem.* **2000**, 2541–2547.
2205. Brezina, F.; Smekal, Z.; Travnicek, Z.; Sindelar, Z.; Pastorek, R.; Marek, J. *Polyhedron* **1997**, *16*, 1331–1336.
2206. Smekal, Z.; Travnicek, Z.; Nadvornik, M.; Sindelar, Z.; Klicka, R.; Marek, J. *Collect. Czech. Chem. Commun.* **1998**, *63*, 783–792.
2207. Escuer, A.; Vicente, R.; El Fallah, M. S.; Jaud, J. *Inorg. Chim. Acta* **1995**, *232*, 151–156.
2208. Bencini, A.; Bianchi, A.; Garcia-Espana, E.; Jeannin, Y.; Julve, M.; Marcelino, V.; Philoche-Levisalles, M. *Inorg. Chem.* **1990**, *29*, 963–970.
2209. Ribas, J.; Monfort, M.; Diaza, C.; Solans, X. *An. Quim., Ser. B* **1988**, *84*, 186–193.
2210. Battaglia, L. P.; Bianchi, A.; Bonamartini Corrida, A.; Garcia-Espana, E.; Micheloni, M.; Julve, M. *Inorg. Chem.* **1988**, *27*, 4174–4179.
2211. Xiang, H.; Lu, T.-B.; Chen, S.; Mao, Z.-W.; Feng, X.-L.; Yu, K.-B. *Polyhedron* **2001**, *20*, 313–319.
2212. Lampeka, Y. D.; Lightfoot, P.; Maloshtan, I. M.; Mrozinski, J.; Skorupa, A. *Theor. Exp. Chem. (Translation of Teoreticheskaya i Eksperimental'naya Khimiya)* **2002**, *37*, 247–251.
2213. Wen, R.; Bernal, I.; Massoud, S. S.; Thalji, R. K.; Billodeaux, D. R.; Fronczek, F. R. *Inorg. Chim. Acta* **1999**, *295*, 91–105.
2214. Smekal, Z.; Travnicek, Z.; Lloret, F.; Marek, J. *Polyhedron* **1999**, *18*, 2787–2793.
2215. Escuer, A.; Vicente, R.; Ribas, J.; Jaud, J.; Raynaud, B. *Inorg. Chim. Acta* **1994**, *216*, 139–145.
2216. Bencini, A.; Bianchi, A.; Paoli, P.; Garcia-Espana, E.; Julve, M.; Marcelino, V. *J. Chem. Soc., Dalton Trans.* **1990**, 2213–2217.
2217. Roman, P.; Guzman-Miralles, C.; Luque, A.; Beitia, J. I.; Cano, J.; Lloret, F.; Julve, M.; Alvarez, S. *Inorg. Chem.* **1996**, *35*, 3741–3751.
2218. Muga, I.; Gutierrez-Zorrilla, J. M.; Luque, A.; Roman, P.; Lloret, F. *Inorg. Chem.* **1997**, *36*, 743–745.
2219. Taraszewska, J.; Tsybal, L. V.; Lampeka, Y. D. *Supramol. Chem.* **1999**, *10*, 287–295.
2220. Oshio, H.; Kikuchi, T.; Kikuchi, K.; Ito, T. *Mol. Cryst. Liq. Cryst. Sci. Technol. A* **1997**, *305*, 239–247.
2221. Oshio, H.; Okamoto, H.; Kikuchi, T.; Ito, T. *Inorg. Chem.* **1997**, *36*, 3201–3203.
2222. Choi, K.-Y.; Suh, I.-H. *J. Chem. Cryst.* **1998**, *28*, 867–870.
2223. Choi, K.-Y.; Ryu, H.; Suh, I.-H. *Inorg. Chim. Acta* **2000**, *299*, 268–276.
2224. Clemente-Juan, J. M.; Coronado, E.; Galán-Mascarós, J. R.; Gómez-García, C. J. *Inorg. Chem.* **1999**, *38*, 55–63.
2225. Clemente-Juan, J. M.; Andres, H. P.; Borrás-Almenar, J. J.; Coronado, E.; Güdel, H. U.; Aebersold, M.; Kearly, G.; Büttner, H.; Zolliker, M. *J. Am. Chem. Soc.* **1999**, *121*, 10021–10027.
2226. Mikuriya, M.; Murase, I.; Asato, E.; Kida, S. *Chem. Lett.* **1989**, 497–500.
2227. Rawle, S. C.; Harding, C. J.; Moore, P.; Alcock, N. W. *J. Chem. Soc., Chem. Commun.* **1992**, 1701–1703.
2228. Kempe, R.; Sieler, J.; Walther, D.; Reinhold, J.; Rommel, K. Z. *Anorg. Allg. Chem.* **1993**, *619*, 1105–1110.
2229. Yamada, K.; Hori, K.; Fukuda, Y. *Acta Crystallogr.* **1993**, *C49*, 445–448.
2230. Kitajima, N.; Hikichi, S.; Tanaka, M.; Morooka, Y. *J. Am. Chem. Soc.* **1993**, *115*, 5496–5508.
2231. Escuer, A.; Vicente, R.; Kumar, S. B.; Solans, X.; Font-Bardia, M.; Caneschi, A. *Inorg. Chem.* **1996**, *35*, 3094–3098.
2232. Escuer, A.; Vicente, R.; Kumar, S. B.; Solans, X.; Font-Bardia, M. *J. Chem. Soc., Dalton Trans.* **1997**, 403–407.
2233. Escuer, A.; Vicente, R.; Kumar, S. B.; Mautner, F. A. *J. Chem. Soc., Dalton Trans.* **1998**, 3473–3477.
2234. Murrie, M.; Stoeckli-Evans, H.; Güdel, H. U. *Angew. Chem., Int. Ed.* **2001**, *40*, 1960–1962.
2235. Nanda, K. K.; Thompson, L. K.; Bridson, J. N.; Nag, K. *J. Chem. Soc., Chem. Commun.* **1994**, 1337–1338.
2236. Nanda, K. K.; Das, R.; Thompson, L. K.; Venkatsubramanian, K.; Paul, P.; Nag, K. *Inorg. Chem.* **1994**, *33*, 1188–1193.
2237. Chaudhuri, P.; Küppers, H.-J.; Wieghardt, K. *J. Chem. Soc., Dalton Trans.* **1988**, 1367–1370.
2238. Bu, X.-H.; Du, M.; Zhang, L.; Liao, D.-Z.; Tang, J.-K.; Zhang, R.-H.; Shionoya, M. *J. Chem. Soc., Dalton Trans.* **2001**, 593–598.

2239. Edwards, A. J.; Hoskins, B. F.; Kachab, E. H.; Markiewicz, A.; Murray, K. S.; Robson, R. *Inorg. Chem.* **1992**, *31*, 3585–3591.
2240. Nanda, K. K.; Venkatsubramanian, K.; Majumdar, D.; Nag, K. *Inorg. Chem.* **1994**, *33*, 1581–1582.
2241. Mohanta, S.; Nanda, K. K.; Werner, R.; Haase, W.; Mukherjee, A. K.; Dutta, S. K.; Nag, K. *Inorg. Chem.* **1997**, *36*, 4656–4664.
2242. Mimura, M.; Matsuo, T.; Matsumoto, N.; Takamizawa, S.; Mori, W.; Re, N. *Bull. Soc. Chem. Jpn.* **1998**, *71*, 1831–1837.
2243. Hu, H.; Fumiaki, K.; Yoshifumi, A.; Masaaki, H.; Masaaki, N. *Bull. Chem. Soc. Jpn.* **1991**, *64*, 2464–2469.
2244. Waldmann, O.; Hassmann, J.; Müller, P.; Volkmer, D.; Schubert, U. S.; Lehn, J.-M. *Phys. Rev. B* **1998**, *58*, 3277–3284.
2245. Pavlishchuk, V. V.; Kolotilov, S. V.; Addison, A. W.; Prushan, M. J.; Schollmeyer, D.; Thompson, L. K.; Goreshnik, E. A. *Angew. Chem., Int. Ed.* **2001**, *40*, 4734–4737; *Angew. Chem.* **2001**, *113*, 4870–4873.
2246. Du, M.; Bu, X.-H.; Guo, Y.-M.; Zhang, L.; Liao, D.-Z.; Ribas, J. *Chem. Commun.* **2002**, 1478–1479.
2247. Bizilj, K.; Hardin, S. G.; Hoskins, B. F.; Oliver, P. J.; Tiekink, E. R. T.; Winter, G. *Aust. J. Chem.* **1986**, *39*, 1035–1042.
2248. Ballester, L.; Coronado, E.; Gutiérrez, A.; Monge, A.; Perpinán, M. G.; Pinilla, E.; Rico, T. *Inorg. Chem.* **1992**, *31*, 2053–2056.
2249. Atkins, A. J.; Blake, J.; Schröder, M. *J. Chem. Soc., Chem. Commun.* **1993**, 1662–1665.
2250. Blake, A. J.; Brechin, E. K.; Codron, A.; Gould, R. O.; Grant, C. M.; Parsons, S.; Rawson, J. M.; Winpenny, R. E. P. *J. Chem. Soc., Chem. Commun.* **1995**, 1983–1985.
2251. Halcrow, M. A.; Sun, J.-S.; Huffman, J. C.; Christou, G. *Inorg. Chem.* **1995**, *34*, 4167–4177.
2252. El Fallah, M. S.; Rentschler, E.; Caneschi, A.; Gatteschi, D. *Inorg. Chim. Acta* **1996**, *247*, 231–235.
2253. Escuer, A.; Font-Bardia, M.; Kumar, S. B.; Solans, X.; Vicente, R. *Polyhedron* **1999**, *18*, 909–914.
2254. Tong, M. L.; Lee, H. K.; Zheng, S.-L.; Chen, X.-M. *Chem. Lett.* **1999**, 1087–1088.
2255. Clemente-Juan, J. M.; Chansou, B.; Donnadiou, B.; Tuchagues, J.-P. *Inorg. Chem.* **2000**, *39*, 5515–5519.
2256. Tong, M.-L.; Zheng, S.-L.; Shi, J.-X.; Tong, Y.-X.; Lee, H. K.; Chen, X.-M. *J. Chem. Soc., Dalton Trans.* **2002**, 1727–1734.
2257. Boyd, P. D. W.; Martin, R. L.; Schwarzenbach, G. *Aust. J. Chem.* **1988**, *41*, 1449–56.
2258. Balakbassis, E. G.; Diamantopoulou, E.; Perlepes, S. P.; Raptopoulou, C. P.; Tangoulis, V.; Terzis, A.; Zafirooulos, T. F. *J. Chem. Soc., Chem. Commun.* **1995**, 1347–1348.
2259. Tangoulis, V.; Raptopoulou, C. P.; Terzis, A. *Inorg. Chem.* **1998**, *37*, 3142–3153.
2260. Tangoulis, V.; Diamantopoulou, E.; Bakalbassis, E. G.; Raptopoulou, C. P.; Terzis, A.; Perlepes, S. P. *Mol. Cryst. Liq. Cryst. Sci. Technol. A* **1999**, *335*, 1175–1184.
2261. Beissel, T.; Birkelbach, F.; Bill, E.; Glaser, T.; Kesting, F.; Krebs, C.; Weyhermüller, T.; Wieghardt, K.; Butzlaff, C.; Trautwein, A. X. *J. Am. Chem. Soc.* **1996**, *118*, 12376–12390.
2262. Kavlakoglu, E.; Elamlı, A.; Elerman, Y.; Werner, R.; Svoboda, I.; Fuess, H. *Z. Naturforsch.* **2001**, *56b*, 43–48.
2263. Elmali, A.; Elerman, Y.; Svoboda, I.; Fuess, H.; Griesar, K.; Haase, W. *Z. Naturforsch.* **1996**, *51b*, 665–670.
2264. Krebs, C.; Winter, M.; Weyhermüller, T.; Bill, E.; Wieghardt, K.; Chaudhuri, P. *J. Chem. Soc., Chem. Commun.* **1995**, 1913–1915.
2265. Verani, C. N.; Rentschler, E.; Weyhermüller, T.; Bill, E.; Chaudhuri, P. *J. Chem. Soc., Dalton Trans.* **2000**, 251–258.
2266. Verani, C. N.; Rentschler, E.; Weyhermüller, T.; Bill, E.; Chaudhuri, P. *J. Chem. Soc., Dalton Trans.* **2000**, 4263–4271.
2267. Haldane, F. D. M. *Phys. Lett.* **1983**, *93A*, 464.
2268. Haldane, F. D. M. *Phys. Rev. Lett.* **1983**, *50*, 1153.
2269. Escriva, E.; Fuentas, A.; Beltran, D. *Transition Met. Chem.* **1984**, *9*, 184–190.
2270. Coronado, E.; Drillon, M.; Fuentas, A.; Beltran, D.; Mosset, A.; Galy, J. *J. Am. Chem. Soc.* **1986**, *108*, 900–905.
2271. Borrás-Almenar, J. J.; Coronado, E.; Curely, J.; Georges, R. *Inorg. Chem.* **1995**, *34*, 2699–2704.
2272. Meyer, A.; Gleizes, A.; Girerd, J.-J.; Verdaguer, M.; Kahn, O. *Inorg. Chem.* **1982**, *21*, 1729–1739.
2273. Renard, J. P.; Verdaguer, M.; Regnault, L. P.; Erkelens, W. A. C.; Rossat-Mignod, J.; Ribas, J.; Stirling, W. G.; Vettier, C. *J. Appl. Phys.* **1988**, *63*, 3538–3542.
2274. Katsumata, K.; Hori, H.; Takeuchi, T.; Date, M.; Yamagishi, A.; Renard, J. P. *Phys. Rev. Lett.* **1989**, *63*, 86–88.
2275. Rajendiran, T. M.; Kahn, O.; Golhen, S.; Ouahab, L.; Honda, Z.; Katsumata, K. *Inorg. Chem.* **1998**, *37*, 5693–5696.
2276. Escuer, A.; Vicente, R.; Solans, X. *J. Chem. Soc., Dalton Trans.* **1997**, 531–535.
2277. Mao, Z.; Fu, D.; Hang, Q.; Tang, W.; Yu, K. *J. Chem. Soc., Dalton Trans.* **1993**, 3169–3173.
2278. Konar, S.; Mukherjee, P. S.; Zangrando, E.; Lloret, F.; Chaudhuri, N. R. *Angew. Chem., Int. Ed.* **2002**, *41*, 1561–1563; *Angew. Chem.* **2002**, *114*, 1631–1633.
2279. Caneschi, A.; Gatteschi, D.; Rey, P. *Prog. Inorg. Chem.* **1991**, *39*, 331–429.
2280. Caneschi, A.; Gatteschi, D.; Laugier, J.; Rey, P.; Sessoli, P. *Inorg. Chem.* **1988**, *27*, 1553–1557.
2281. Caneschi, A.; Gatteschi, D.; Renard, J. P.; Rey, P.; Sessoli, R. *Inorg. Chem.* **1989**, *28*, 2940–2944.
2282. Zhang, L.; Li, S.-Q.; Meng, X.-J.; Liao, D.-Z.; Jiang, Z.-H.; Wang, G.-L.; Shen, P.-W.; Zhao, Q.-H. *Transition Met. Chem.* **1999**, *24*, 247–249.
2283. Caneschi, A.; Ferraro, F.; Gatteschi, D.; Rey, P.; Sessoli, R. *Inorg. Chem.* **1990**, *29*, 4217–4223.
2284. Wei, H.-H.; Wong, H.-Y.; Lee, G.-H.; Wang, Y. *J. Chin. Chem. Soc.* **1996**, *43*, 253–259.
2285. Luneau, D.; Risoan, G.; Rey, P.; Grand, A.; Caneschi, A.; Gatteschi, D.; Laugier, J. *Inorg. Chem.* **1993**, *32*, 5616–5622.
2286. Yamamoto, Y.; Suzuki, T.; Kaizaki, S. *J. Chem. Soc., Dalton Trans.* **2001**, 1566–1572.
2287. Yoshida, T.; Kanamori, K.; Takamaizawa, S.; Mori, W.; Kaizaki, S. *Chem. Lett.* **1997**, 603–604.
2288. Yoshida, T.; Kaizaki, S. *Inorg. Chem.* **1999**, *38*, 1054–1058.
2289. Yoshida, T.; Suzuki, T.; Kanamori, K.; Kaizaki, S. *Inorg. Chem.* **1999**, *38*, 1059–1068.
2290. Yoshida, T.; Suzuki, T.; Kaizaki, S. *Acta Crystallogr.* **2001**, *C57*, 1274–1276.
2291. Yamamoto, Y.; Yoshida, T.; Suzuki, T.; Kaizaki, S. *Inorg. Chim. Acta* **2001**, *325*, 187–192.
2292. Pei, Y.; Lang, A.; Bergerat, P.; Kahn, O.; Fettuouhi, M.; Quahab, L. *Inorg. Chem.* **1996**, *35*, 193–198.

2293. Yamamoto, Y.; Suzuki, T.; Kaizaki, S. *J. Chem. Soc., Dalton Trans.* **2001**, 2943–2950.
2294. Ziessel, R.; Ulrich, G.; Lawson, R. C.; Echegoyen, L. *J. Mater. Chem.* **1999**, *9*, 1435–1448.
2295. Romero, F. M.; Luneau, D.; Ziessel, R. *J. Chem. Soc., Chem. Commun.* **1998**, 551–552.
2296. Luneau, D.; Romero F. M.; Ziessel, R. *Inorg. Chem.* **1998**, *37*, 5078–5087.
2297. Schioedt, N. C.; Fabrizi de Biani, F.; Caneschi, A.; Gatteschi, D. *Inorg. Chim. Acta* **1996**, *248*, 139–146.
2298. Schatzschneider, U.; Weyhermüller, T.; Rentschler, E. *Eur. J. Inorg. Chem.* **2001**, 2569–2586.
2299. Ovcharenko, V. I.; Fokin, S. V.; Reznikov, V. A.; Ikorskii, V. N.; Romanenko, G. V.; Sedgeev, R. Z. *Inorg. Chem.* **1998**, *37*, 2104–2105.
2300. Villamena, F. A.; Dickman, M. H.; Crist, D. R. *Inorg. Chem.* **1998**, *37*, 1454–1457.
2301. Hicks, R. G.; Lemaire, M. T.; Thompson, L. K.; Barclay, T. M. *J. Am. Chem. Soc.* **2000**, *122*, 8077–8078.
2302. Barclay, T. M.; Hicks, R. G.; Lemaire, M. T.; Thompson, L. K. *Inorg. Chem.* **2001**, *40*, 5581–5584.
2303. Barclay, T. M.; Hicks, R. G.; Lemaire, M. T.; Thompson, L. K. *Chem. Commun.* **2000**, 2141–2142.
2304. Barclay, T. M.; Hicks, R. G.; Lemaire, M. T.; Thompson, L. K.; Xu, Z. *Chem. Commun.* **2002**, 1688–1689.
2305. Brezinski, M. M.; Schneider, J.; Radonovich, L. J.; Klabunde, K. J. *Inorg. Chem.* **1989**, *28*, 2414–2419.
2306. Denk, M.; Hayashi, R. K.; West, R. *J. Chem. Soc., Chem. Commun.* **1994**, 33–34.
2307. Nlate, S.; Herdtweck, E.; Fischer, R. A. *Angew. Chem.* **1996**, *108*, 1957–1959; *Angew. Chem., Int. Ed. Engl.* **1996**, *35*, 1861–1863.
2308. Kang, Y.; Lee, J.; Kong, Y. K.; Kang, S. O.; Ko, J. *Chem. Commun.* **1998**, 2343–2344.
2309. Gehrhus, B.; Hitchcock, P. B.; Lappert, M. F.; Maciejewski, H. *Organometallics* **1998**, *17*, 5599–5601.
2310. Kang, Y.; Lee, J.; Kong, Y. K.; Kang, S. O.; Ko, J. *Chem. Commun.* **1998**, 2343–2344.
2311. Ishikawa, M.; Ohshita, J.; Ito, Y.; Iyoda, J. *J. Am. Chem. Soc.* **1986**, *108*, 7417–7419.
2312. Müller, U.; Keim, W.; Krüger, C.; Betz, P. *Angew. Chem., Int. Ed. Engl.* **1989**, *28*, 1011; *Angew. Chem.* **1989**, *101*, 1066–1067.
2313. Sato, Y.; Takimoto, M.; Hayashi, K.; Katsuhara, T.; Tagaki, K.; Mori, M. *J. Am. Chem. Soc.* **1994**, *116*, 9771–9772.
2314. Fan, L.; Krzywicki, A.; Somogyvari, A.; Ziegler, T. *Inorg. Chem.* **1994**, *33*, 5287–5294.
2315. Zakharov, I. I.; Startsev, A. N.; Zhidomirov, G. M. *React. Kinet. Catal. Lett.* **1998**, *64*, 247–254.
2316. Osakada, K.; Hayashi, H.; Maeda, M.; Yamamoto, Y.; Yamamoto, A. *Chem. Lett.* **1986**, 597.
2317. Darensbourg, M. Y.; Ludwig, M.; Riordan, C. G. *Inorg. Chem.* **1989**, *28*, 1630–1634.
2318. Darensbourg, D. J.; Darensbourg, M. Y.; Goh, L. Y.; Ludvig, M.; Wiegreffe, P. *J. Am. Chem. Soc.* **1987**, *109*, 7539–7540.
2319. Uhlig, E.; Schneider, H. *Z. Chem.* **1990**, *30*, 72–73.
2320. Berning, D. E.; Miedaner, A.; Curtis, C. J.; Noll, B. C.; DuBois, M. C. R.; DuBois, D. L. *Organometallics* **2001**, *20*, 1832–1839.
2321. Curtis, C. J.; Miedaner, A.; Ellis, W. W.; DuBois, D. L. *J. Am. Chem. Soc.* **2002**, *124*, 1918–1925.
2322. Jubran, N.; Ginzberg, G.; Cohen, H.; Koresh, Y.; Meyerstein, D. *Inorg. Chem.* **1985**, *24*, 251–258.
2323. Zilbermann, I.; Winnik, M.; Sagiv, D.; Rotman, A.; Cohen, H.; Meyerstein, D. *Inorg. Chim. Acta* **1995**, *240*, 503–514.
2324. Bakac, A.; Espenson, J. H. *J. Am. Chem. Soc.* **1986**, *108*, 713–719.
2325. Espenson, J. H.; Ram, M. S.; Bakac, A. *J. Am. Chem. Soc.* **1987**, *109*, 6892–6893.
2326. Ram, M. S.; Bakac, A.; Espenson, J. H. *Inorg. Chem.* **1988**, *27*, 2011–2015.
2327. Ram, M. S.; Bakac, A.; Espenson, J. H. *Inorg. Chem.* **1988**, *27*, 4231–4235.
2328. Ozaki, S.; Matsushita, H.; Ohmori, H. *J. Chem. Soc., Chem. Commun.* **1992**, 1120–1122.
2329. Sadler, S.; Scott, S. L.; Bakac, A.; Espenson, J. H.; Ram, M. S. *Inorg. Chem.* **1989**, *28*, 3951–3954.
2330. Szalda, D. J.; Fujita, E.; Sanzenbacher, R.; Paulus, H.; Elias, H. *Inorg. Chem.* **1994**, *33*, 5855–5863.
2331. Furenlid, L. R.; Renner, M. W.; Szalda, D. J.; Fujita, E. *J. Am. Chem. Soc.* **1991**, *113*, 883–892.
2332. Jung, H. J.; Bang, H.; Suh, M. P. *Bull. Korean Chem. Soc.* **2001**, *22*, 523–526.
2333. Myunghyun, P. S.; Yeon, J. L.; Jong, W. J. *J. Chem. Soc., Dalton Trans.* **1995**, 1577–1581.
2334. Suh, M. P.; Oh, K. Y.; Lee, J. W.; Bae, J. *J. Am. Chem. Soc.* **1996**, *118*, 777–783.
2335. Zilbermann, I.; Golub, G.; Cohen, H.; Meyerstein, D. *Inorg. Chim. Acta* **1994**, *227*, 1–3.
2336. Schmidt, M. H.; Miskelly, G. M.; Lewis, N. S. *J. Am. Chem. Soc.* **1990**, *112*, 3420–3426.
2337. Kelly, C. A.; Mulazzani, Q. G.; Venturi, M.; Blinn, E. L.; Rodgers, M. A. J. *J. Am. Chem. Soc.* **1995**, *117*, 4911–4919.
2338. Kryatov, S. V.; Mohanraj, B. S.; Tarasov, V. V.; Kryatova, O. P.; Rybak-Akimova, E. V.; Nuthakki, B.; Rusling, J. F.; Staples, R. J.; Nazarenko, A. Y. *Inorg. Chem.* **2002**, *41*, 923–930.
2339. Valente, M.; Freire, C.; de Castro, B. *J. Chem. Soc., Dalton Trans.* **1998**, 1557–1562.
2340. Dietrich-Buchecker, C. O.; Kern, J.; Sauvage, J. P. *J. Chem. Soc., Chem. Commun.* **1985**, 760–762.
2341. Dietrich-Buchecker, C. O.; Guilhem, J.; Kern, J.-K.; Pascard, C.; Sauvage, J. P. *Inorg. Chem.* **1994**, *33*, 3498–3502.
2342. Arana, C.; Keshavarz, M.; Potts, K. T.; Abruña, H. D. *Inorg. Chim. Acta* **1994**, *225*, 285–295.
2343. Kadish, K. M.; Van Caemelbecke, E.; Royal, G.; Kadish, K. M.; Smith, K. M.; Guillard, R., Ed., *The Porphyrin Handbook* **2000**, *8*, 1–114. Academic Press: Boston, MA.
2344. Ozette, K.; Leduc, P.; Palacio, M.; Bartoli, J. F.; Barkigia, K. M.; Fajer, J.; Battioni, P.; Mansuy, D. *J. Am. Chem. Soc.* **1997**, *119*, 6442–6443.
2345. Kadish, K. M.; Franzen, M. M.; Han, B. C.; Araullo-McAdams, C.; Sazou, D. *J. Am. Chem. Soc.* **1991**, *113*, 512–517.
2346. Kadish, K. M.; Franzen, M. M.; Han, B. C.; Araullo-McAdams, C.; Sazou, D. *Inorg. Chem.* **1992**, *31*, 4399–4403.
2347. Lexa, D.; Momenteau, M.; Mispelter, J.; Savéant, J.-M. *Inorg. Chem.* **1989**, *28*, 30–35.
2348. Jaun, B.; Pfaltz, A. *J. Chem. Soc., Chem. Commun.* **1986**, 1327–1329.
2349. Kadish, K. M.; Lin, M.; Van Caemelbecke, E.; De Stefano, G.; Medforth, C. J.; Nurco, D. J.; Nelson, N. Y.; Krattinger, B.; Muzzi, C. M.; Jaquinod, L.; Xu, Y.; Shyr, D. C.; Smith, K. M.; Shelnutt, J. A. *Inorg. Chem.* **2002**, *41*, 6673–6687.
2350. Kaplan, W. A.; Suslick, K. S.; Scott, R. A. *J. Am. Chem. Soc.* **1991**, *113*, 9824–9827.
2351. Wondimagegn, T.; Ghosh, A. *J. Am. Chem. Soc.* **2000**, *122*, 6375–6381.
2352. Procyk, A. D.; Bocian, D. F. *Inorg. Chem.* **1993**, *32*, 366–367.

2353. Lahiri, G. K.; Stolzenberg, A. M. *Angew. Chem., Int. Ed. Engl.* **1993**, *32*, 429–432.
2354. Telsler, J.; Fann, Y.-C.; Renner, M. W.; Fajer, J.; Wang, S.; Zhang, H.; Scott, R. A.; Hoffman, B. M. *J. Am. Chem. Soc.* **1997**, *119*, 733–743.
2355. Lahiri, G. K.; Schussel, L. J.; Stolzenberg, A. M. *Inorg. Chem.* **1992**, *31*, 4991–5000.
2356. Lahiri, G. K.; Stolzenberg, A. M. *Inorg. Chem.* **1993**, *32*, 4409–4413.
2357. Hu, S.; Mukherjee, A.; Spiro, T. G. *J. Am. Chem. Soc.* **1993**, *115*, 12366–12377.
2358. Chmielewski, P. J.; Latos-Grazynski, L.; Pacholska, E. *Inorg. Chem.* **1993**, *33*, 1992–1999.
2359. Yamauchi, O.; Odani, A.; Kohzuma, T.; Masuda, H.; Toriumi, K.; Saito, K. *Inorg. Chem.* **1989**, *28*, 4065–4066.
2360. Ellis, D. D.; Spek, A. L. *Acta Crystallogr.* **2000**, *C56*, 1067–1070.
2361. Norman, N. C.; Orpen, A. G.; Quayle, M. J.; Whittell, G. R. *Acta Crystallogr.* **2002**, *C58*, m160–m161.
2362. Saraev, V. V.; Kraikovskii, P. B.; Lazarev, P. G.; Myagmarsuren, G.; Tkach, V. S.; Shmidt, F. K. *Russ. J. Coord. Chem.* **1996**, *22*, 615–621.
2363. Saraev, V. V.; Kraikovskii, P. B.; Lazarev, P. G.; Myagmarsuren, G.; Tkach, V. S.; Shmidt, F. K. *Russ. J. Coord. Chem.* **1996**, *22*, 608–614.
2364. Cassidy, J. M.; Whitmire, K. H. *Acta Crystallogr.* **1991**, *C47*, 2094–2098.
2365. Miedaner, A.; Haltiwanger, R. C.; DuBois, D. L. *Inorg. Chem.* **1991**, *30*, 417–427.
2366. Fox, M. A.; Chandler, D. A.; Kyba, E. P. *J. Coord. Chem.* **1992**, *25*, 1–19.
2367. Bowmaker, G. A.; Williams, J. P. *J. Chem. Soc., Dalton Trans.* **1994**, 1231–1236.
2368. Scott, F.; Krüger, C.; Betz, P. *J. Organomet. Chem.* **1990**, *387*, 113–121.
2369. Mindiola, D. J.; Hillhouse, G. L. *J. Am. Chem. Soc.* **2001**, *123*, 4623–4624.
2370. Melenkivitz, R.; Mindiola, D. J.; Hillhouse, G. L. *J. Am. Chem. Soc.* **2002**, *124*, 3846–3847.
2371. Schäfer, H.; Binder, D.; Deppisch, B.; Mattern, G. Z. *Anorg. Allg. Chem.* **1987**, *546*, 79–98.
2372. Deppisch, B.; Schäfer, H. Z. *Anorg. Allg. Chem.* **1982**, *490*, 129–135.
2373. Jones, R. A.; Norman, N. C.; Seeberger, M. H.; Atwood, J. L.; Hunter, W. E. *Organometallics* **1983**, *2*, 1629–1634.
2374. Jones, R. A.; Stuart, A. L.; Atwood, J. L.; Hunter, W. E. *Organometallics* **1983**, *2*, 1437–1441.
2375. Giannandrea, R.; Matrilli, P.; Nobile, C. F.; Englert, U. *J. Chem. Soc., Dalton Trans.* **1997**, 1355–1359.
2376. Annan, T. A.; Kumar, R.; Tuck, D. G. *J. Chem. Soc., Dalton Trans.* **1991**, 11–18.
2377. Kriley, C. E.; Woolley, C. J.; Krepps, M. K.; Popa, E. M.; Fanwick, P. E.; Rothwell, I. P. *Inorg. Chim. Acta* **2000**, *300-302*, 200–205.
2378. Kriley, C. E.; Woolley, C. J.; Krepps, M. K.; Popa, E. M.; Fanwick, P. E.; Rothwell, I. P. *Inorg. Chim. Acta* **2000**, *300-302*, 200–205.
2379. Tenorio, M. J.; Puerta, M. C.; Valerga, P. *J. Chem. Soc., Dalton Trans.* **1996**, 1305–1308.
2380. Barnett, B. L.; Krüger, C.; Tsay, Y.-H.; Summerville, R. H.; Hoffman, R. *Chem. Ber.* **1977**, *110*, 3900–3909.
2381. Fryzuk, M. D.; Clentsmith, G. K. B.; Leznoff, D. B.; Rettig, S. J.; Geib, S. J. *Inorg. Chim. Acta* **1997**, *265*, 169–177.
2382. Jones, R. A.; Stuart, A. L.; Atwood, J. L.; Hunter, W. E.; Rogers, R. D. *Organometallics* **1982**, *1*, 1721–1723.
2383. Jones, R. A.; Norman, N. C.; Seeberger, M. H.; Atwood, J. L.; Hunter, W. E. *Organometallics* **1983**, *2*, 1629–1634.
2384. Gong, J. K.; Fanwick, P. E.; Kubiak, C. P. *J. Chem. Soc., Chem. Commun.* **1990**, 1190–1191.
2385. Manojlovic-Muir, L.; Muir, K. W.; Davis, W. M.; Mirza, H. A.; Puddephatt, R. J. *Inorg. Chem.* **1992**, *31*, 904–909.
2386. Stoppioni, P.; Biliotti, A.; Morassi, R. *J. Organomet. Chem.* **1982**, *236*, 119–122.
2387. Ceconi, F.; Midollini, S.; Orlandini, O. *J. Chem. Soc., Dalton Trans.* **1983**, 2263–2268.
2388. Ghilardo, C. A.; Mealli, C.; Midollini, S.; Orlandini, A.; Proserpio, D. M.; Cinquantini, A.; Zanello, P. *Stuct. Chem.* **1990**, *1*, 441–454.
2389. DuBois, D. L.; Miedaner, A. *Inorg. Chem.* **1986**, *25*, 4642–4650.
2390. Zanello, P.; Cinquantini, A.; Ghilardi, C. A.; Midollini, S.; Moneti, S.; Orlandini, A.; Bencini, J. *J. Chem. Soc., Dalton Trans.* **1990**, 3761–3766.
2391. Biachini, C.; Mealli, C.; Meli, A.; Scapacci, G. *Organometallics* **1983**, *2*, 141–143.
2392. Mealli, C.; Midollini, S. *Inorg. Chem.* **1983**, *22*, 2785–2786.
2393. Downard, J.; Hanton, L. R.; Paul, R. L. *J. Chem. Soc., Chem. Comm.* **1992**, 235–237.
2394. Downard, A. J.; Hanton, L. R.; McMorrin, D. A.; Paul, R. L. *Inorg. Chem.* **1993**, *32*, 6028–6033.
2395. Jones, R. A.; Whittlesey, B. R. *Inorg. Chem.* **1986**, *25*, 852–856.
2396. Krüger, H.-J.; Holm, R. H. *Inorg. Chem.* **1989**, *28*, 1148–1155.
2397. Farmer, P. J.; Reibenspies, J. H.; Lindahl, P. A.; Darensbourg, M. Y. *J. Am. Chem. Soc.* **1993**, *115*, 4665–4674.
2398. Kim, J. S.; Reibenspies, J. H.; Darensbourg, M. Y. *J. Am. Chem. Soc.* **1996**, *118*, 4115–4123.
2399. James, T. L.; Cai, L.; Muetterties, M. C.; Holm, R. H. *Inorg. Chem.* **1996**, *35*, 4148–4161.
2400. Fox, S.; Stibrany, R. T.; Potenza, J. A.; Schugar, H. J. *Inorg. Chim. Acta* **2001**, *316*, 122–126.
2401. Marganian, C. A.; Vazir, H.; Baidya, N.; Olmstead, M. M.; Mascharak, P. K. *J. Am. Chem. Soc.* **1995**, *117*, 1584–1594.
2402. Fenske, D.; Hachgenei, J.; Ohmer, J. *Angew. Chem., Int. Ed. Engl.* **1985**, *24*, 706.
2403. Brennan, J. G.; Siegrist, T.; Kwon, Y.-U.; Stuczynski, S. M.; Steigerwald, M. L. *J. Am. Chem. Soc.* **1992**, *114*, 10334–10338.
2404. Fenske, D.; Ohmer, J.; Hachgenei, J. *Angew. Chem., Int. Ed. Engl.* **1985**, *24*, 993; *Angew. Chem.* **1985**, *97*, 993–995.
2405. Fenske, D.; Fischer, A. *Angew. Chem., Int. Ed. Engl.* **1995**, *34*, 307–309; *Angew. Chem.* **1995**, *107*, 340–342.
2406. Brennan, J. G.; Siegrist, T.; Stuczynski, S. M.; Steigerwald, M. L. *J. Am. Chem. Soc.* **1989**, *111*, 9240.
2407. Pereira, E.; Gomez, L.; De Castro, B. *J. Chem. Soc., Dalton Trans.* **1998**, 629–636.
2408. Gomes, L.; Pereira, E.; De Castro, B. *J. Chem. Soc., Dalton Trans.* **2000**, 1373–1379.
2409. Khan, F. A.; Steele, D. L.; Armentrout, P. B. *J. Phys. Chem.* **1995**, *99*, 7819–7828.
2410. Rue, C.; Armentrout, P. B.; Kretzschmar, I.; Schröder, D.; Schwarz, H. *J. Phys. Chem. A* **2002**, *106*, 9788–9797.
2411. Morton, J. R.; Preston, K. F. *Chem. Phys. Lett.* **1984**, *111*, 611–612.
2412. Lucier, G.; Münzenberg, J.; Casteel, W. J., Jr.; Bartlett, N. *Inorg. Chem.* **1995**, *34*, 2692–2698.
2413. Ittel, S. D. *Inorg. Synth.* **1990**, *28*, 98–104.
2414. Braga, D.; Grepioni, F.; Orpen, A. G. *Organometallics* **1993**, *12*, 1481–1483.
2415. Rosch, N.; Kotzian, M.; Schroder, H. J.; Rager, B.; Metev, S. *J. Am. Chem. Soc.* **1986**, *108*, 4238–4239.

2416. Blomberg, M. R. A.; Brandemark, U. B.; Siegbahn, P. E. M.; Wennerberg, J.; Bauschlicher, C. W. *J. Am. Chem. Soc.* **1988**, *110*, 6650–6655.
2417. Grenz, M.; Du Mont, W. *J. Organomet. Chem.* **1983**, *241*, C5–C8.
2418. Morton, J. R.; Preston, K. F. *Inorg. Chem.* **1985**, *24*, 3317–3319.
2419. Ignatyev, I. S.; Schaefer, H. F. III; King, R. B.; Brown, S. T. *J. Am. Chem. Soc.* **2000**, *122*, 1989–1994.
2420. Schäfer, H. F. III; King, R. B. *Pure Appl. Chem.* **2001**, *73*, 1059–1073.
2421. Fantucci, P.; Pacchioni, G.; Valenti, V. *Inorg. Chem.* **1984**, *23*, 247–53.
2422. Masters, A. F.; Meyer, J. T. *Polyhedron* **1995**, *14*, 339–365.
2423. Beattie, J. K.; Masters, A. F.; Meyer, J. T. *Polyhedron* **1995**, *14*, 829–868.
2424. Femino, C.; Iapalucci, M. C.; Longoni, G.; Svensson, P. H. *Inorg. Chim. Acta* **2002**, *330*, 111–117.
2425. Zhang, Z.-Z.; Wang, H.-K.; Wang, H.-G.; Wang, R.-J.; Zhao, W.-Y.; Yang, L.-M. *J. Organomet. Chem.* **1988**, *347*, 269–275.
2426. Osborn, J. A.; Stanley, G. G.; Bird, P. H. *J. Am. Chem. Soc.* **1988**, *110*, 2117–2122.
2427. See also: DeLaet, D. L.; Fanwick, P. E.; Kubiak, C. P. *J. Chem. Soc., Chem. Commun.* **1987**, 1412–1413.
2428. Trumpy, V. A.; Oriskovich, T. A.; Schreiner, S. *Inorg. Chim. Acta* **1993**, *205*, 149–152.
2429. Gong, J.-K.; Kubiak, C. P. *Inorg. Chim. Acta* **1989**, *162*, 19–21.
2430. Elbaze, G.; Dahan, F.; Dartiguenave, M.; Dartiguenave, Y. *Inorg. Chim. Acta* **1984**, *87*, 91–97.
2431. Kriege-Simondsen, J.; Feltham, R. D. *Inorg. Chim. Acta* **1983**, *71*, 185–194.
2432. Del Zotto, A.; Mezzetti, A.; Novrelli, V.; Rigo, P.; Lanfranchi, M.; Tiripicchio, A. *J. Chem. Soc., Dalton Trans.* **1990**, 1035–1042.
2433. Mokhlesur Rahman, A. F. M.; Salem, G.; Stephens, F. S.; Wild, S. B. *Inorg. Chem.* **1990**, *29*, 5225–5230.
2434. Krim, L.; Manceron, L.; Alikhani, M. E. *J. Phys. Chem. A* **1999**, *103*, 2592–2598.
2435. Krim, L.; Alikhani, M. E.; Manceron, L. *J. Phys. Chem. A* **2001**, *105*, 7812–7816.
2436. Zhou, M.; Andrews, L. *J. Phys. Chem. A* **2000**, *104*, 3915–3925.
2437. Alikhani, M. E.; Krim, L.; Manceron, L. *J. Phys. Chem. A* **2001**, *105*, 7817–7822.
2438. Galan, F.; Fouassier, M.; Tranquille, M.; Mascetti, J.; Papai, I. *J. Phys. Chem. A* **1997**, *101*, 2626–2633.
2439. Mascetti, J.; Galan, F.; Papai, I. *Coord. Chem. Rev.* **1999**, *190-192*, 557–576.
2440. Leitner, W. *Angew. Chem., Int. Ed. Engl.* **1994**, *33*, 173–174.
2441. Ibers, J. A. *Chem. Soc. Rev.* **1982**, *11*, 57–73.
2442. Fujita, E.; Bruntschwig, B. S. *Electron Transfer Chem.* **2001**, *4*, 88–126.
2443. Troupel, M.; Ocafrain, M.; Dolhem, E.; Folest, J.-C.; Barhdadi, R. *Can. J. Chem. Eng.* **1998**, *76*, 1013–1019.
2444. Mori, Y.; Szalda, D. J.; Bruntschwig, B. S.; Schwarz, H. A.; Fujita, E. *Adv. Chem. Ser.* **1998**, *254*, 279–292.
2445. Fujita, E.; Bruntschwig, B. S.; Ogata, T.; Yanagida, S. *Coord. Chem. Rev.* **1994**, *132*, 195–200.
2446. Aresta, M.; Gobetto, R.; Quaranta, E.; Tommasi, I. *Inorg. Chem.* **1992**, *31*, 4286–4290.
2447. Jegat, C.; Fouassier, M.; Tranquille, M.; Mascetti, J.; Tommasi, I.; Aresta, M.; Ingold, F.; Dedieu, A. *Inorg. Chem.* **1993**, *32*, 1279–1289.
2448. Mealli, C.; Hoffman, R.; Stockis, A. *Inorg. Chem.* **1984**, *23*, 56–65.
2449. Mastroiilli, P.; Moro, G.; Nobile, C. F.; Latronico, M. *Inorg. Chim. Acta* **1992**, *192*, 189–193.
2450. Aresta, M.; Tommasi, I.; Dibenedetto, A.; Fouassier, M.; Mascetti, J. *Inorg. Chim. Acta* **2002**, *330*, 63–71.
2451. Lemke, F. R.; DeLaet, D. L.; Gao, J.; Kubiak, C. P. *J. Am. Chem. Soc.* **1988**, *110*, 6906–6908.
2452. Ratliff, K. S.; DeLaet, D. L.; Gao, J.; Fanwick, P. E.; Kubiak, C. P. *Inorg. Chem.* **1990**, *29*, 4022–4027.
2453. DeLaet, D. L.; del Rosario, R.; Fanwick, P. E.; Kubiak, C. P. *J. Am. Chem. Soc.* **1987**, *109*, 754–758.
2454. DeLaet, D. L.; Fanwick, P. E.; Kubiak, C. P. *J. Chem. Soc., Chem. Commun.* **1987**, 1412–1413.
2455. Morgenstern, D. A.; Wittig, R. E.; Fanwick, P. E.; Kubiak, C. P. *J. Am. Chem. Soc.* **1993**, *115*, 6470–6471.
2456. Walther, D.; Fugger, C.; Schreer, H.; Kilian, R.; Gørls, H. *Chem. Eur. J.* **2001**, *7*, 5214–5221.
2457. Walther, D.; Kilian, R.; Schreer, H.; Gørls, H. *Z. Anorg. Allg. Chem.* **2002**, *628*, 851–862.
2458. Kim, W. Y.; Chang, J.-S.; Park, S.-E.; Ferrence, G.; Kubiak, C. P. *Chem. Lett.* **1998**, *10*, 1063–1064.
2459. Kim, W. Y.; Chang, J.-S.; Park, S.-E.; Kubiak, C. P. *Res. Chem. Intermed.* **1999**, *25*, 459–469.
2460. Bianchini, C.; Ghilardi, C. A.; Meli, A.; Midollini, S.; Orlandini, A. *J. Chem. Soc., Chem. Commun.* **1983**, 753–754.
2461. Maier, W. B.; Poliakov, M.; Simpson, M. B.; Turner, J. J. *Mol. Struct.* **1982**, *80*, 83–86.
2462. Keller, H. J.; Klutz, T.; Münstedt, H.; Renner, G.; Schweitzer, D. *Springer Ser. Solid-State Sci.* **1987**, *76*, 338–340.
2463. Kumar, M.; Lu, W.-P.; Ragsdale, S. W. *Biochemistry* **1994**, *33*, 9769–9777.
2464. Mason, M. G.; Swepston, P. N.; Ibers, J. A. *Inorg. Chem.* **1983**, *22*, 411–418.
2465. Poppitz, W.; Uhling, E. *Z. Anorg. Allg. Chem.* **1982**, *489*, 67–76.
2466. Zhou, M.; Andrews, L. *J. Phys. Chem. A* **2000**, *104*, 4394–4401.
2467. Gregor, I. K. *Inorg. Chim. Acta* **1990**, *176*, 19–22.
2468. Haack, K.-J.; Goddard, R.; Pörschke, K.-R. *J. Am. Chem. Soc.* **1997**, *119*, 7992–7999.
2469. Henne, B. J.; Bartak, D. E. *Inorg. Chem.* **1984**, *23*, 369–373.
2470. Sieler, J.; Tham, N.; Bendix, R.; Dinjus, E.; Walther, D. *Z. Anorg. Allg. Chem.* **1985**, *522*, 131–136.
2471. Servaas, P. C.; Stufkens, D. J.; Oskam, A. *Inorg. Chem.* **1989**, *28*, 1774–1780.
2472. Servaas, P. C.; Stufkens, D. J.; Oskam, A. *Inorg. Chem.* **1989**, *28*, 1780–1787.
2473. Uhlig, E. *Pure Appl. Chem.* **1988**, *60*, 1235–1240.
2474. Turner, J. J.; Simpson, M. B.; Poliakov, M.; Maier, W. B. *J. Am. Chem. Soc.* **1983**, *105*, 3898–3904.
2475. Bauschlicher, C. W., Jr.; Langhoff, S. R.; Barnes, L. A. *Chem. Phys.* **1980**, *129*, 432–437.
2476. Brage, M. *Theochem.* **1994**, *110*, 41–44.
2477. Rosi, M.; Sgamellotti, A.; Tarantelli, F.; Floriani, C. *NATO ASI Ser. C* **1989**, *277*, 85–94.
2478. Ciullo, G.; Rosi, M.; Sgamellotti, A.; Floriani, C. *Chem. Phys. Lett.* **1991**, *185*, 522–528.
2479. Rosi, M.; Sgamellotti, A.; Tarantelli, F.; Floriani, C.; Cederbaum, L. S. *J. Chem. Soc., Dalton Trans.* **1989**, 33–38.
2480. Ehlers, A. W.; Dapprich, S.; Vyboishchikov, S. F.; Frenking, G. *Organometallics* **1996**, *15*, 105–117.
2481. Li, J.; Schreckenbach, G.; Ziegler, T. *Inorg. Chem.* **1995**, *34*, 3245–3252.
2482. Hursthouse, M. B.; Izod, K. J.; Motevalli, M.; Thornton, P. *Polyhedron* **1994**, *13*, 151–3.
2483. Kourkine, I. V.; Maslennikov, S. V.; Ditchfield, R.; Glueck, D. S. *Inorg. Chem.* **1996**, *35*, 6708–6716.
2484. Kühn, O.; Junk, P. C.; Hey-Hawkins, E. *Z. Anorg. Allg. Chem.* **2000**, *626*, 1591–1594.

2485. Angermund, K.; Eckerle, A.; Monkiewicz, J.; Krüger, C.; Wilke, G. *Inorg. Chim. Acta* **1998**, *270*, 273–278.
2486. Arduengo, A. J. III; Rasika Dias, H. V.; Calabrese, J. C. *Phosphorus, Sulfur, and Silicon* **1994**, *87*, 1–10.
2487. Wilhelm, D.; Hoffmann, T.; Wenschuh, E.; Reck, G.; Winter, G. *Z. Anorg. Allg. Chem.* **1993**, *619*, 1801–1805.
2488. Miyashita, A.; Shitara, H.; Nohira, H. *J. Chem. Soc., Chem. Commun.* **1985**, 850–851.
2489. Hofmann, P.; Perez-Moya, L. A.; Steigelmann, O.; Riede, J. *Organometallics* **1992**, *11*, 1167–1176.
2490. Mastroiilli, P.; Moro, G.; Nobile, C. F.; Latronico, M. *Inorg. Chim. Acta* **1992**, *192*, 183–187.
2491. Sacco, A.; Mastroiilli, P. *J. Chem. Soc., Dalton Trans.* **1994**, 2761–2769.
2492. Hennig, H.; Hofbauer, K.; Handke, K.; Stich, R. *Angew. Chem., Int. Ed. Engl.* **1997**, *36*, 408–410; *Angew. Chem.* **1997**, *109*, 373–375.
2493. Grobe, J.; Großpietsch, T.; Le Van, D.; Krebs, B.; Läge, M. *Z. Naturforsch. B* **1993**, *48b*, 1203–1211.
2494. Hartung, H.; Baumeister, U.; Walther, B.; Maschmeier, M. *Z. Anorg. Allg. Chem.* **1989**, *578*, 177–184.
2495. Edwards, A. J.; Retboll, M.; Wenger, E. *Acta Cryst. E* **2002**, *58*, m375–m377.
2496. Brunner, H.; Vitulli, G.; Porzio, W.; Zocchi, W. *Inorg. Chim. Acta* **1985**, *96*, 67–75.
2497. Müller, G.; Karsch, H. H. *Acta Cryst. C* **1987**, *43*, 663–666.
2498. Elschenbroich, C.; Heikenfeld, G.; Wünsch, M.; Massa, W.; Baum, G. *Angew. Chem., Int. Ed. Engl.* **1988**, *27*, 414; *Angew. Chem.* **1988**, *100*, 397–399.
2499. Proft, B.; Pörschke, K.-R. *Z. Naturforsch. B* **1993**, *48b*, 919–927.
2500. Sillett, G.; Ricard, L.; Patois, C.; Mathey, F. *J. Am. Chem. Soc.* **1992**, *114*, 9453–9457.
2501. Poerschke, K. R.; Tsay, Y. H.; Krüger, C. *Inorg. Chem.* **1986**, *25*, 2097–2099.
2502. Dick, D. G.; Stephan, D. W.; Campana, C. F. *Can. J. Chem.* **1990**, *68*, 628–632.
2503. Bianchini, C.; Ghilardi, C. A.; Meli, A.; Orlandini, A. *J. Organomet. Chem.* **1984**, *270*, 251–263.
2504. Herrmann, W. A.; Kellner, J.; Riepl, H. *J. Organomet. Chem.* **1990**, *389*, 103–128.
2505. Bartik, T.; Bunn, B. B.; Bartik, B.; Hanson, B. E. *Inorg. Chem.* **1994**, *33*, 164–169.
2506. Ellis, J. W.; Harrison, K. N.; Hoye, P. A. T.; Orpen, A. G.; Pringle, P. G.; Smith, M. B. *Inorg. Chem.* **1992**, *31*, 3026–3033.
2507. Baird, I. R.; Smith, M. B.; James, B. R. *Inorg. Chim. Acta* **1995**, *235*, 291–297.
2508. Hein, J.; Niecke, E.; Meidine, M. F.; Trigo Passos, B. F.; Nixon, J. F. *J. Chem. Soc., Chem. Commun.* **1991**, 41–42.
2509. Niecke, E.; Nixon, J. F.; Wenderoth, P.; Trigo Passos, B. F.; Nieger, M. *J. Chem. Soc., Chem. Commun.* **1993**, 846–848.
2510. Severson, S. J.; Cymbaluk, T. H.; Ernst, R. D.; Higashi, J. M.; Parry, R. W. *Inorg. Chem.* **1983**, *22*, 3833–3834.
2511. Edwards, H. G. M. *J. Mol. Struct.* **1987**, *156*, 137–142.
2512. Bligh-Smith, R. M.; Edwards, H. G. M.; Fawcett, V. *Spectrochim. Acta A* **1987**, *43A*, 1069–1073.
2513. Braga, M. *Quimica Nova* **1988**, *11*, 71–75.
2514. Green, J. C.; Kaltsoyannis, N.; Sze, K. H.; MacDonald, M. A. *J. Chem. Soc., Dalton Trans.* **1991**, 2371–2375.
2515. Braga, M. *Theochem.* **1992**, *85*, 167–178.
2516. Braga, M. *Inorg. Chem.* **1985**, *24*, 2702–2706.
2517. Brennan, J. G.; Green, J. C.; Redfern, C. M.; MacDonald, M. A. *J. Chem. Soc., Dalton Trans.* **1990**, 1907–1913.
2518. Edwards, H. G. M.; Fawcett, V. *Inorg. Chim. Acta* **1992**, *197*, 89–93.
2519. Siedle, A. R.; Newmark, R. A.; Gleason, W. B. *Inorg. Chem.* **1991**, *30*, 2005–2009.
2520. Caspar, J. V. *J. Am. Chem. Soc.* **1985**, *107*, 6718–6719.
2521. Ballester, L.; Gutierrez-Alonso, A.; Perez-Serrano, S.; Perpinan, M. F. *Inorg. Chem.* **1991**, *30*, 2954–2955.
2522. Snow, S. S.; Parry, R. W. *Inorg. Chem.* **1987**, *26*, 1597–1601.
2523. Snow, S. S.; Jiang, D.; Parry, R. W. *Inorg. Chem.* **1985**, *24*, 1460–1463.
2524. Kesanli, B.; Gardnem, D. R.; Scott, B.; Eichhorn, B. W. *J. Chem. Soc., Dalton Trans.* **2000**, 1291–1296.
2525. Elschenbroich, C.; Nowotny, M.; Behrendt, A.; Massa, W.; Wocadlo, S. *Angew. Chem., Int. Ed. Engl.* **1992**, *31*, 1343–1345; *Angew. Chem.* **1992**, *104*, 1388–1390.
2526. Mézailles, N.; LeFloch, P.; Waschbüsch, K.; Ricard, L.; Mathey, F.; Kubiak, C. P. *J. Organomet. Chem.* **1997**, *541*, 277–283.
2527. LeFloch, P.; Ricard, L.; Mathey, F.; Jutand, A.; Amatore, C. *Inorg. Chem.* **1995**, *34*, 11–12.
2528. Rosa, P.; Ricard, L.; Mathey, F.; LeFloch, P. *Organometallics* **1999**, *18*, 3348–3352.
2529. Choua, S.; Sidorenkova, H.; Berclaz, T.; Geoffroy, M.; Rosa, P.; Mézailles, N.; Ricard, L.; Mathey, F.; LeFloch, P. *J. Am. Chem. Soc.* **2000**, *122*, 12227–12234.
2530. Cowley, A. H.; Jones, R. A.; Stewart, C. A.; Stuart, A. L.; Atwood, J. L.; Hunter, W. E.; Zhang, H.-M. *J. Am. Chem. Soc.* **1983**, *105*, 3737–3738.
2531. Cowley, A. H.; Jones, R. A.; Lasch, J. G.; Norman, N. C.; Stewart, C. A.; Stuart, A. L.; Atwood, J. L.; Hunter, W. E.; Zhang, H.-M. *J. Am. Chem. Soc.* **1984**, *106*, 7015–7020.
2532. Gudat, D.; Meidine, M. F.; Nixon, J. F.; Niecke, E. *J. Chem. Soc., Chem. Commun.* **1989**, 1206–1208.
2533. Spek, A. L.; Duisenberg, A. J. M. *Acta Crystallogr.* **1987**, *C43*, 1216–1218.
2534. Niecke, E.; Metternich, H.-J.; Nieger, M.; Gudat, D.; Wenderoth, P.; Malisch, W.; Hahner, C.; Reich, W. *Chem. Ber.* **1993**, *126*, 1299–1309.
2535. Weber, L.; Uthmann, S.; Stämmler, H.-G.; Neumann, B.; Schoeller, W. W.; Boese, R.; Bläser, D. *Eur. J. Inorg. Chem.* **1999**, 2369–2381.
2536. Van der Knaap, T. A.; Jenneskens, L. W.; Meeuwissen, H. J.; Bickelhaupt, F. *J. Organomet. Chem.* **1983**, *254*, C33–C36.
2537. Appel, R.; Casser, C.; Knoch, F. *J. Organomet. Chem.* **1985**, *293*, 213–217.
2538. Weber, L.; Kaminski, O.; Quasdorff, B.; Stämmler, H.-G.; Neumann, B. *J. Organomet. Chem.* **1997**, *529*, 329–341.
2539. David, G.; Niecke, E.; Nieger, M.; Radseck, J.; Schoeller, W. W. *J. Am. Chem. Soc.* **1994**, *116*, 2191–2192.
2540. Grobe, J.; LeVan, D.; Hegemann, M.; Krebs, B.; Läge, M. *Chem. Ber.* **1993**, *126*, 63–65.
2541. Grobe, J.; Le Van, D.; Immel, F.; Hegemann, M.; Krebs, B.; Läge, M. *Z. Anorg. Allg. Chem.* **1996**, *622*, 24–34.
2542. Cowley, A. H.; Kilduff, J. E.; Lasch, J. G.; Norman, N. C.; Pakulski, M.; Ando, F.; Wright, T. C. *J. Am. Chem. Soc.* **1983**, *105*, 7751–7752.
2543. Deppisch, B.; Schäfer, H. *Acta Crystallogr.* **1982**, *B38*, 748–752.
2544. Philipps, I. G.; Ball, R. G.; Cavel, R. G. *Inorg. Chem.* **1992**, *31*, 1633–1641.

2545. Schäfer, H.; Binder, D. *Z. Anorg. Allg. Chem.* **1987**, *546*, 55–78.
2546. Schäfer, H.; Binder, D. *Z. Anorg. Allg. Chem.* **1988**, *557*, 45–58.
2547. Schisler, A.; Lönnecke, P.; Hunair, U.; Ahlrichs, R.; Hey-Hawkins, E. *Angew. Chem., Int. Ed.* **2001**, *40*, 4217–4219; *Angew. Chem.* **2001**, *113*, 4345–4348.
2548. Schäfer, H.; Binder, D.; Fenske, D. *Angew. Chem., Int. Ed. Engl.* **1985**, *24*, 522; *Angew. Chem.* **1985**, *97*, 523–525.
2549. Ahlrichs, R.; Fenske, D.; Oesen, H.; Schneider, U. *Angew. Chem., Int. Ed. Engl.* **1992**, *31*, 323–326.
2550. Dehnicke, K. *Angew. Chem., Int. Ed. Engl.* **1992**, *31*, 424–425.
2551. Tang, H.; Hoffman, D. M.; Albright, T. A.; Deng, H.; Hoffmann, R. *Angew. Chem., Int. Ed. Engl.* **1993**, *32*, 1616–1618.
2552. Snow, S.; Jiang, D.-X.; Parry, R. W. *Inorg. Chem.* **1987**, *26*, 1629–1631.
2553. Edwards, H. G. M. *J. Chem. Soc., Dalton Trans.* **1987**, 681–682.
2554. Albano, V. G.; Demartin, F.; Iapalucci, M. C.; Longoni, G.; Sironi, A.; Zanotti, V. *J. Chem. Soc., Chem. Commun.* **1990**, 547–548.
2555. Thomas, F.; Schulz, S.; Nieger, M. *Organometallics* **2001**, *20*, 2405–2408.
2556. Wenschuh, E.; Walther, D. *Z. Chem.* **1984**, *24*, 385–386.
2557. Wenschuh, E. *Z. Chem.* **1986**, *26*, 212–213.
2558. Hoffmann, T.; Karabit, M.; Zdunneck, P.; Wenschuh, E. *Z. Chem.* **1988**, *28*, 415–416.
2559. Hoffmann, T.; Hoffmann, H.; Karabit, M.; Zdunneck, P.; Wenschuh, E. *Z. Anorg. Allg. Chem.* **1988**, *565*, 91–105.
2560. Bertholdt, U.; Wenschuh, E.; Reinhold, J. *Z. Anorg. Allg. Chem.* **1989**, *578*, 37–46.
2561. Reinhold, J.; Schüler, M.; Hoffmann, T.; Wenschuh, E. *Inorg. Chem.* **1992**, *31*, 559–562.
2562. Sakaki, S.; Sato, H.; Imai, Y.; Morokuma, K.; Ohkubo, K. *Inorg. Chem.* **1985**, *24*, 4538–4544.
2563. Sieler, J.; Peters, K.; Wenschuh, E. *Z. Anorg. Allg. Chem.* **1987**, *549*, 171–176.
2564. Hoffmann, T.; Ziemer, B.; Muegge, C.; Bertholdt, U.; Wenschuh, E.; Leibnitz, P. *Z. Anorg. Allg. Chem.* **1991**, *600*, 55–60.
2565. Lentz, D. *Chem. Ber.* **1985**, *118*, 560–563.
2566. Lentz, D.; Anibarro, M.; Preugschat, D.; Bertrand, G. *J. Fluorine Chem.* **1998**, *89*, 73–81.
2567. Bessler, E.; Barbosa, B. M. *Z. Naturforsch.* **1991**, *46b*, 490–494.
2568. Ratliff, K. S.; Broeker, G. K.; Fanwick, P. E.; Kubiak, C. P. *Angew. Chem., Int. Ed. Engl.* **1990**, *29*, 395–397; *Angew. Chem.* **1990**, *102*, 405–407.
2569. Gong, J.; Huang, J.; Fanwick, P. E.; Kubiak, C. P. *Angew. Chem.* **1990**, *102*, 407–408; *Angew. Chem., Int. Ed. Engl.* **1990**, *29*, 397–398.
2570. Veith, M.; Stahl, L.; Huch, V. *J. Chem. Soc., Chem. Commun.* **1990**, 359–361.
2571. Uhl, W.; Pohlmann, M.; Wartchow, R. *Angew. Chem.* **1998**, *110*, 1007–1008; *Angew. Chem., Int. Ed.* **1998**, *37*, 961–963.
2572. Uhl, W.; Benter, M.; Melle, S.; Saak, W.; Frenking, G.; Uddin, J. *Organometallics* **1999**, *18*, 3778–3780.
2573. Uddin, J.; Frenking, G. *J. Am. Chem. Soc.* **2001**, *123*, 1683–1693.
2574. Doerr, M.; Frenking, G. *Z. Anorg. Allg. Chem.* **2002**, *628*, 843–850.
2575. Grobe, J.; Levan, D.; Hegemann, M.; Krebs, B.; Läge, M. *Angew. Chem.* **1992**, *104*, 94–96; *Angew. Chem., Int. Ed. Engl.* **1992**, *31*, 95–96.
2576. Brann, T.; Perutz, R. N.; Sledak, M. I. *Chem. Commun.* **2001**, 2254–2255.
2577. Sladek, M. I.; Brann, T.; Newmann, B.; Stammler, H.-G. *J. Chem. Soc., Dalton Trans.* **2002**, 297–299.
2578. Tajima, H.; Luokuchi, M.; Kobayashi, A.; Sato, A.; Naisto, T.; Kobayashi, H.; Kuroda, H. *Synth. Met.* **1997**, *85*, 1585–1586.
2579. Meyer, F.; Ruschewitz, U.; Schober, P.; Antelmann, B.; Zsoluai, L. *J. Chem. Soc., Dalton Trans.* **1998**, 1181–1186.

6.4

Palladium

N. M. KOSTIĆ and L.-M. DUTCĂ
Iowa State University, Ames, IA, USA

6.4.1	INTRODUCTION	556
6.4.1.1	Scope	556
6.4.1.2	Previous Reviews	556
6.4.2	OXIDATION STATES ALLEGEDLY HIGHER THAN +4	558
6.4.3	PALLADIUM(IV)	559
6.4.3.1	Carbon	559
6.4.3.2	Phosphorus	559
6.4.3.3	Selenium	559
6.4.3.4	Polynuclear Compounds and Polymers	560
6.4.4	PALLADIUM(III)	560
6.4.4.1	Mononuclear	560
6.4.4.1.1	<i>Various donor atoms</i>	560
6.4.4.1.2	<i>Boron</i>	560
6.4.4.1.3	<i>Nitrogen</i>	560
6.4.4.1.4	<i>Sulfur</i>	561
6.4.4.1.5	<i>Halogens</i>	561
6.4.4.2	Polynuclear Compounds and Polymers	561
6.4.5	PALLADIUM(II)	562
6.4.5.1	Carbon	562
6.4.5.2	Silicon and Tin	566
6.4.5.3	Nitrogen	566
6.4.5.4	Phosphorus	575
6.4.5.5	Oxygen	576
6.4.5.6	Sulfur	579
6.4.5.7	Selenium and Tellurium	583
6.4.5.8	Halogens	584
6.4.5.9	Hydrogen	585
6.4.5.10	Mixed Donor Atoms	586
6.4.5.10.1	<i>Promoters and catalysts for hydrolysis and related reactions</i>	591
6.4.5.11	Five-coordinate Complexes	596
6.4.5.12	Polynuclear Compounds	597
6.4.5.12.1	<i>Supramolecular assemblies (see Chapters 7.7 and 7.8)</i>	613
6.4.6	PALLADIUM(I)	638
6.4.6.1	Carbon	638
6.4.6.2	Phosphorus	638
6.4.6.3	Hydrogen	638
6.4.6.4	Polynuclear Compounds and Polymers (see Chapter 7.6)	639
6.4.7	PALLADIUM(0)	643
6.4.7.1	Carbon	643
6.4.7.2	Nitrogen	643
6.4.7.3	Phosphorus	644
6.4.7.4	Hydrogen	645
6.4.7.5	Mixed Donor Atoms	646
6.4.7.6	Polynuclear Compounds	647
6.4.7.7	Nanoparticles	654

6.4.8 PALLADIUM IN NEGATIVE AND FRACTIONAL OXIDATION STATES	655
6.4.8.1 Phosphorus	655
6.4.8.2 Polynuclear Compounds and Polymers	656
6.4.9 REFERENCES	656

6.4.1 INTRODUCTION

6.4.1.1 Scope

In preparing this chapter, the authors surveyed a vast literature seeking studies with original findings, convincing explanations, and probable useful applications. Merely solid studies were downplayed, as their results are more or less predictable. Whenever possible, studies of palladium complexes were placed in their broader context, with minimal “dilution” of the content of this chapter.

Compounds containing multiple metal atoms, or mixed ligated atoms, or palladium atoms in different oxidation states, or more than one of these characteristics could be placed in different sections and subsections of the chapter, and so could reactions in which palladium-containing reactants and products differ greatly in properties. In very large clusters, which contain many metal atoms, oxidation states are nearly meaningless. In all of these cases, classification was made according to the feature of greatest interest or novelty. Certain “hot” areas of research, such as supramolecular assemblies, hydrolytic and similar reactions, and nanoparticles have subsections dedicated to them.

In view of an enormous number of publications on many diverse subjects, it was found both practical and prudent to rely on the supreme expertise of the authors of the source publications. While these sources were read critically, their authors’ statements were borrowed or adapted, but these sources are always cited unambiguously.

6.4.1.2 Previous Reviews

A review¹ presents various palladium complexes with chiral ligands containing sulfenyl, sulfinyl, sulfoxamine, and selenenyl groups. Organosulfur functionalities, such as sulfenyl and sulfinyl groups, can serve as coordinating elements in ligands in Pd-catalyzed reactions, and normally they function as good π -acceptors. High enantioselectivity was obtained with chiral oxazoline, amidine, and imine ligands. Sulfinyl functionality serves as a slightly weaker coordinating element compared with sulfenyl function.

A review² describes the structural investigations of the compounds containing the direct Si—Pd bonds.

A review³ with 57 references discusses the interaction of Pt^{II} and Pd^{II} with histidine and histidyl containing peptides. The coordinating behavior of histidyl containing peptides towards Pt^{II} and Pd^{II} depends on the histidyl position in the peptide sequence.

A review⁴ with 40 references covers reactions of palladium(II) and platinum(II) complexes as synthetic peptidases, i.e., reagents that promote and, in some cases, catalyze hydrolytic cleavage of amide groups (peptide bonds) in peptides and proteins. Topics include general principles of reactivity and experimental methods for studying them; selective binding of these metal complexes to peptides and subsequent cleavage of these peptides; cleavage of proteins by these methods; and prospects for future developments.

Two reviews^{5,6} with approximately 34 references discuss a coordination approach to three-dimensional assemblies via molecular paneling. Families of planar *exo*-multidentate organic ligands (molecular panels) assemble into large three-dimensional assemblies through metal-coordination. In particular, *cis*-protected square planar metals, (en)Pd²⁺ or (en)Pt²⁺ (en = ethylene-1,2-diamine), are very useful to panel the molecules. Metal-assembled cages, bowls, tubes, capsules, and polyhedra are efficiently constructed by this approach.

The quantum chemical studies of Pd and Pt molecular systems carried out since 1990 are reviewed⁷ with 482 references to complement earlier comprehensive reviews. Topics covered

include mononuclear systems, polynuclear systems, reactivity of Pd and Pt complexes, and catalytic cycles.

A review⁸ with more than 186 references discusses the synthesis of Rh and Pd complexes with optically active P,N-bidentate ligands and their applications in homogeneous asymmetric catalysis. The effect of the nature of the P,N-bidentate compounds on the structure of the metal complexes and on enantioselectivity in catalysis was examined. Allylic substitution, cross-coupling, hydroboration and hydrosilylation catalyzed by Rh or Pd complexes with optically active P,N-bidentate ligands are considered.

A review⁹ with more than 37 references includes an examination of symmetry groups and chirality conditions for C₆₀ and C₇₀ bonded to one or two metals in η^5 and/or η^6 fashion. Palladium and platinum η^2 complexes of C₆₀ and C₇₀ are described (novel synthesis, NMR spectra, electrochemistry) as well as first optically active organometallic fullerene derivatives.

A review¹⁰ with eight references describes the photochemical reactions of the binuclear palladium(0) complex [Pd₂(dppm)₃] (dppm = bis(diphenyl)phosphinomethane) with organic halides.

A review¹¹ with 123 references is given on amino acid bonding preferences in complexes of platinum and palladium. The preferences for a particular donor atom for Pd^{II} depends primarily on relative thermodynamic stabilities of the complexes formed. Sizes of potential chelate rings often play a crucial role in determining donor atom preferences.

A review¹² with 26 references of the biocoordination chemistry of Pd, Pt, and Ru and the discovery of a new type of immunomodulating activity of the Pd compounds is presented.

A review¹³ with 53 references of the transition-metal mediated supramolecular self-assembly is presented. Focus is on the self-assembly of macrocycles, catenanes, and cages from (en)Pd(NO₃)₂ and pyridine-based bridging ligands.

A review¹⁴ discusses palladium and the other noble metals forming a variety of complexes M(P)LL' with tetrapyrrole ligands.

A review¹⁵ with 90 references covers the coordination chemistry of palladium(0TO+4) reported in 1992.

A review¹⁶ with 89 references is given on the excited state properties of the low valent (0 and +1) bi- and trinuclear complexes of Pd and Pt. Physical characterization of the nature of the lowest energy excited states along with their photoinduced chemical reactivities toward oxidative additions is discussed.

A review¹⁷ with 25 references of five-coordination in palladium(II) and platinum(II) chemistry is presented. The complexes have invariably a trigonal bipyramidal geometry with the bidentate ligand and the alkene in the equatorial plane.

Two reviews^{18,19} with 20 references are presented. A series of Pd clusters containing from four to several hundred Pd atoms in the metal skeleton was prepared and characterized with structural data and by chemical properties including catalytic activity.

A review²⁰ with 101 references includes topics on coordination complexes of palladium and catalysis.

A review²¹ with 45 references has topics on syntheses, characterization, structures, bonding, and reactivity of palladium cluster compounds.

A review²² with 100 references, is given on the chemistry of coordinatively unsaturated tripalladium and triplatinum clusters and on the relation between this chemistry and that which occurs on a Pt surface during chemisorption and catalysis.

A review²³ with 1,160 references describes the chemistry of Pd and Pt complexes and cluster compounds, catalysis by Pd and Pt complexes, and nonstoichiometric binary and ternary compounds.

A review²⁴ with 15 references discusses the theoretical aspects of the coordination chemistry of palladium and platinum in relationship with their biological activity.

A review²⁵ with 20 references has information on the preparation and properties of such large clusters as Pd₅₆₁(phen)₃₆O₁₉₀₋₂₀₀ (phen = 1,10-phenanthroline).

A review²⁶ with 787 references on Pt and Pd salts and coordination compounds covering literature cited in *Chemical Abstracts*, Vol. 97 (issue 21) to Vol. 99 (issue 24) is presented.

A review²⁷ has 554 references, on palladium and platinum coordination compounds.

A review²⁸ describes compounds of the Pt-group metals including halide, oxide, sulfide, coordination compounds, organometallic compounds, and metal cluster compounds.

A review²⁹ with 59 references of the inorganic and coordination chemistry of palladium is presented.

6.4.2 OXIDATION STATES ALLEGEDLY HIGHER THAN +4

Chen *et al.*³⁰ synthesized two derivatives of an unprecedented trinuclear complex of palladium with ligands coordinated through silicon atoms. The qualitative discussion of bonding was based mostly on the crystallographic evidence, given below.

In Figure 1 the silicon atoms are considered parts of silyl ligands, and bonding of the central palladium atom to individual silicon atoms is emphasized. Because a silicon atom with only three substituents and an octet of valence electrons is nominally anionic, and because the compound as a whole is electroneutral, the central palladium atom appears to have the oxidation number VI. The authors noticed the relatively short Si3—Si6 and Si4—Si5 distances and acknowledged the alternative view of bonding, shown in Figure 2. They realized that this bonding mode, involving electron donation from two Si—Si σ -bonds and two silyl ligands to Pd^{II}, is also unprecedented. Still, the authors favored the former view of bonding and palladium(VI).

Aullon *et al.*³¹ starkly contrasted the alternative views of bonding, and consequently the different oxidation states of the central palladium atom. They reinterpreted the experimental results by Chen *et al.* analyzed their original quantum-chemical calculations, and convincingly chose the oxidation state II. Aullon *et al.*³¹ drew an apt analogy between the Si—Si single bond and the familiar H—H, Si—H, C—H, and other single bonds in saturated ligands, which are known to bond to transition-metal atoms in various complexes. They rightly stressed the

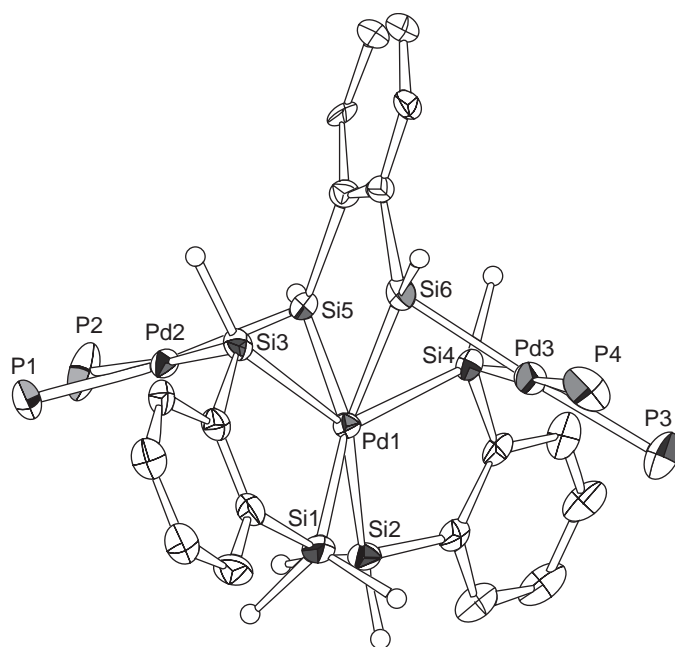

Figure 1 Trinuclear complex of palladium with ligands coordinated through silicon atoms.

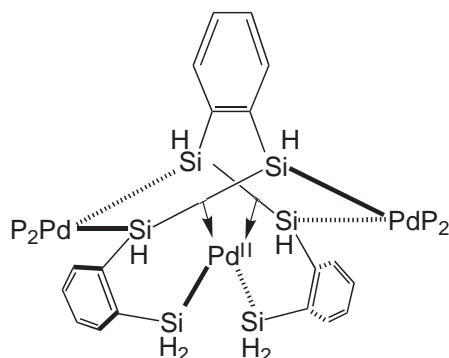

Figure 2 The alternative view of bonding for the trinuclear complex shown in Figure 1.

importance of the discovery by Chen *et al.* of the dihapto (η^2) coordination of disilane ligands to transition metals.

Sherer *et al.*³² carried out systematic DFT calculations (DFT = density functional calculations) on the compound in question and on pertinent simpler compounds. They optimized the geometric structures and compared the computed bond lengths and bond orders. These authors, too, chose the oxidation state II for the central palladium atom.

This controversy is settled.³³

6.4.3 PALLADIUM(IV)

6.4.3.1 Carbon

For the relatively new oxidation state IV for organopalladium chemistry,^{34,35} there appear to be only two reports of intramolecular coordination, and in these cases unstable species were detected for which ¹H-NMR spectra are consistent with presence of Pd^{IV}.^{36,37} Palladium(IV) complexes are usually synthesized from diorganopalladium(II) substrates via oxidative addition chemistry, and for organohalides this has been demonstrated to occur for C(*sp*³)—X bonds including benzyl halides^{38–42} and (halomethyl)naphthalenes.^{34,35,38} Appropriate choice of intramolecular coordination system and synthetic strategy, based on C(*sp*³)—Br oxidative addition to Pd^{II}, allowed the synthesis of stable Pd^{IV} complexes and the first structural analysis of an arylpalladium(IV) complex.⁴³ Synthesis and characterization of stable arylpalladium(IV) complexes indicates that species of this type are feasible as intermediates in organic synthesis, in particular where proposed for systems where the individual steps involving Pd^{IV} are supported by model reactions for these steps.⁴³ Representative examples of such syntheses and reports of model reactions for key steps include halogenation of azobenzenes,^{37,44,45} the synthesis of 2,6-dialkyl-substituted arenes and vinylarenes,^{34,35,41,42,46,47} and the acetoxylation of arenes.^{48–50}

6.4.3.2 Phosphorus

There are several palladium catalyzed processes for which the involvement of palladium(IV) intermediates has amply been demonstrated.⁵¹ There are reports of spectroscopic detection of unstable species [PdMe₃(bipy)(L)]⁺ (L = PPh₃, PMePh₂ or PMe₂Ph) formed in equilibrium with [PdIME₃(bipy)] and formation of [PdMe₃(bipy)(PPh₃)]⁺ (where bipy = 2,2-bipyridyl).⁵² Trimethylpalladium(IV) complexes containing one phosphine donor interaction are stabilized in the coordination geometry *fac*-[PdMe₃(N—N)(L)]⁺ (L = phosphine), and are sufficiently stable for isolation and structural analysis. Facile reductive elimination of ethane occurs in solution to form monomethylpalladium(II) complexes.⁵³

6.4.3.3 Selenium

Recent development of organopalladium(IV) chemistry has provided new perspectives in *d*⁶ chemistry.^{34,35,41,54–58} PdIME₃(bpy) undergoes facile decomposition at ambient temperature in solution allowing detailed mechanistic studies of reductive elimination at a *d*⁶ metal center.^{59,60} There is a report of thiolate or selenolate complexes in organopalladium(IV) chemistry. Such complexes are formed via oxidation of palladium(II) reagents by (ER)₂. Both (EPh)₂ (E = S, Se) and (O₂CPh)₂ were used as oxidants.⁴⁹ The results reported illustrate several new phenomena in organopalladium(IV) chemistry: isolation of stable dimethylpalladium(IV) complexes and selenolate complexes and detection of unstable thiolate complexes; formation of C···O, C···S, and C···Se bonds on decomposition; and structural studies allowing detailed comparisons between palladium(IV) and platinum(IV).⁴⁹ The low stability of organopalladium(IV) complexes renders them ideal candidates for studies of decomposition at *d*⁶ metal centers, and the dominance of C···C bond formation from triorganopalladium(IV) complexes is not reflected in diorganopalladium(IV) complexes in the presence of group 16 donor atoms (E) where C···E coupling becomes an important feature.⁴⁹ The observation of C···O coupling at palladium(IV) is relevant to the proposed catalytic role of palladium(IV) in the acetoxylation of arenes.^{48,50}

6.4.3.4 Polynuclear Compounds and Polymers

Low-dimensional compounds have attracted much attention because they show very interesting physical properties such as Peierls transition, spin-Peierls transition, neutral-ionic transition, charge density wave (CDW) states, spin density wave (SDW) states, and superconductivities, etc. Among these compounds, quasi-one-dimensional halogen-bridged mixed-valence compounds (hereafter abbreviated as MX chains) have been extensively investigated during the last 20 years of the twentieth century, because of their interesting physical properties. In most MX chains, due to the strong electron–phonon interaction, the bridging halogens are distorted from the midpoints between the neighboring two metal atoms, giving CDW states or $M^{II}-M^{IV}$ mixed-valence states ($\cdots M^{II}\cdots X-M^{IV}-X\cdots M^{II}\cdots$). Accordingly, the half-filled metallic band is split into the occupied valence band and the unoccupied conduction band with finite Peierls gaps. Therefore, these compounds belong to the class II of the Robin-Day classification for the mixed-valence complexes. These compounds are formulated as $[M^{II}(AA)_2][M^{IV}(AA)_2X_2]Y_4$ ($M^{II}-M^{IV} = Pd^{II}-Pd^{IV}, Pd^{II}-Pt^{IV}$; $X = Cl, Br, I$, and mixed halides; $AA =$ ethylenediamine (en), cyclohexanediamine (chxn), etc.; $Y = ClO_4, BF_4, X$, etc.). These MX chains have two characteristic points compared with the inorganic semiconductors and organic conjugated polymer as follows. The magnitudes of the band gaps or CDW strengths can be tuned by varying chemical factors such as M, X, AA, and Y. Moreover, the interchain interaction can be controlled by using the intra- and interchain hydrogen bond networks between amino hydrogens and counteranions. Synthesis and the physical properties of a series of $Ni_{1-x}Pd_x(chxn)_2Br_3$ compounds with various mixing ratios, have been reported.⁶¹ In the Ni–Pd mixed-metal compounds the electron correlation in Ni^{III} states (SDW) and the electron-phonon interaction in $Pd^{II}-Pd^{IV}$ mixed-valence states (CDW) compete with each other. As a result, the $Pd^{II}-Pd^{IV}$ mixed-valence states gradually approach the Pd^{III} state with the decrease of the Pd ratios influenced by the increase of the Ni^{III} states. This means that the electron–phonon interactions in the $Pd^{II}-Pd^{IV}$ mixed-valence states are weakened by the strong electron correlation in the Ni^{III} states. In other words, the CDW strengths of Pd sites can be tuned by competition between the electron–phonon interaction of the $Pd^{II}-Pd^{IV}$ states and the electron correlation of the Ni^{III} states in the Ni–Pd mixed-metal compounds $Ni_{1-x}Pd_x(chxn)_2Br_3$.⁶¹

6.4.4 PALLADIUM(III)

6.4.4.1 Mononuclear

6.4.4.1.1 Various donor atoms

Mononuclear palladium(III) complexes are relatively uncommon;⁶² the two most well-characterized examples are $[Pd([9]aneS_3)_2]^{3+}$ ($[9]aneS_3 = 1,4,7$ -trithiacyclononane)^{63,64} and $[Pd([9]aneN_3)_2]^{3+}$ ($[9]aneN_3 = 1,4,7$ -triazacyclononane),^{65,66} for which X-ray structures have been determined. Several others have been generated electrochemically or otherwise studied *in situ*, but not isolated, including $[Pd(B_9C_2H_{11})_2]^-$ ($B_9C_2H_{11}^{2-} = 7,8$ -dicarbollide),⁶⁷ $[Pd(B_9C_2Me_2H_9)_2]^{2-}$ ($= 7,8$ -dimethyl-7,8-dicarbollide),⁶⁸ $[Pd(mnt)_2]^-$ ($mnt =$ maleonitriledithiolate),⁶⁹ $[Pd(dmit)_2]^-$ ($dmit =$ isotrithionedithiolate),⁶⁹ $[Pd(xdt)_2]^-$ ($xdt = o$ -xylenedithiolate),⁶⁹ $[Pd([18]aneN_2S_4)]^{3+}$ ($[18]aneN_2S_4 = 1,4,10,13$ -tetrathia-7,16-diazacyclooctadecane),^{70,71} $[Pd([10]aneS_3)_2]^{3+}$ ($[10]aneS_3 = 1,4,7$ -trithiaclodecane),^{72,73} and $[Pd([9]aneNS_2)_2]^{3+}$ ($[9]aneNS_2 = 1,4$ -dithia-7-azacyclononane).⁷⁴

6.4.4.1.2 Boron

The *nido*-borane cage ligand $[B_{11}H_{11}]^{4-}$ can support unusually high formal oxidation states of transition metals. An attempt to synthesize the closo anion $[(PMe_2Ph)_2Pd^{II}(B_{11}H_{11})]^{2-}$ from $[B_{11}H_{11}]^{4-}$ and $(PMe_2Ph)_2PdBr_2$, instead led to the synthesis, isolation, and characterization of an air-stable Pd^{III} complex which incorporates a B_{11} borane cage ligand.⁷⁵

6.4.4.1.3 Nitrogen

In 1988 a powdered material believed to be $[PdL'_2](PF_6)_3$ ($L' = 1,4,7$ -triazacyclononane), which behaved electrochemically in accord with that formula, was prepared.⁷⁶

6.4.4.1.4 Sulfur

Only in 1987 was the compound $(\text{H}_3\text{O})[\text{PdL}_2](\text{ClO}_4)_4 \cdot 3\text{H}_2\text{O}$ ($\text{L} = 1,4,7\text{-trithiacyclononane}$) reported with a structure determination.⁷⁷ Since then there have been no others unambiguously established.

6.4.4.1.5 Halogens

The number of compounds of Pd^{III} that have been isolated and characterized is extremely limited. In the realm of aqueous chemistry there is no aqua ion nor any classical anionic complexes, PdX_6^{3-} ; the latter have been made only in the solid state under strenuous conditions.⁷⁸ There are no binary compounds (“ PdF_3 ” being a mixed Pd^{II} , Pd^{IV} compound).⁷⁹

6.4.4.2 Polynuclear Compounds and Polymers

Three reported attempts to make and isolate dinuclear Pd^{III} complexes were unsuccessful. In Cotton's laboratory⁸⁰ $\text{Pd}_2(\text{DTolF})_4$, $\text{DTolF}^- = [(p\text{-tolyl})\text{NC}(\text{H})\text{N}(p\text{-tolyl})]^-$, was oxidized to $[\text{Pd}_2(\text{DTolF})_4](\text{PF}_6)$ which was crystallographically characterized. In it, the Pd—Pd distance of 2.637(6) Å is little different from that, 2.622(3) Å, in the unoxidized starting material. No product containing a Pd_2^{6+} core could be isolated although a $\text{Pd}_2^{5+} \rightarrow \text{Pd}_2^{6+}$ oxidation wave was seen at +1.19 V, and the EPR spectrum of the Pd_2^{5+} compound was considered indicative of ligand rather than M_2 core oxidation. Contemporaneously, Bear and co-workers⁸¹ prepared the similar N,N' -diphenylbenzamidinate compound. They saw only one oxidation wave, but from their EPR spectrum they concluded that a genuine $\text{Pd}_2^{4+} \rightarrow \text{Pd}_2^{5+}$ oxidation had occurred. Finally, attempts were made⁸² to oxidize the $\text{Pd}_2(\text{pyt})_4$ ($\text{pyt}^- = 2\text{-thiopyridinate anion}$) molecule which appears to generate an unstable $\text{Pd}_2(\text{pyt})_4\text{X}_2$ species during cyclic voltammetry, but no Pd_2^{5+} or Pd_2^{6+} products were actually isolated. Recently, use of the binitrogen-donor ligand hpp (the anion of 1,3,4,6,7,8-hexahydro-2H-pyrimido[1,2-*a*]pyrimidine) has proven to be effective in stabilizing metal–metal bonds in paddlewheel complexes for several transition metals. The first single bond between two trivalent palladium atoms has been reported.⁸³ A reaction of Pd^{II} acetate with $\text{Li}(\text{hpp})$ in THF produces the orange complex $\text{Pd}_2(\text{hpp})_4$. Its cyclic voltammogram in CH_2Cl_2 showed a quasi-reversible oxidation at -0.12 V and an irreversible oxidation at $+0.82$ V, indicating that oxidation products obtained under these conditions are likely to be unstable. However, the two electron oxidation with $\text{PhI} \cdot \text{Cl}_2$ resulted in the formation of the dark complex $\text{Pd}_2(\text{hpp})_4\text{Cl}_2$. Reproducibly a small amount of $\text{Pd}_2(\text{hpp})_4\text{Cl}_2$ was obtained from several reactions, even when different temperatures, solvents, and oxidizing agents such as NOPF_6 and NOBF_4 were used. All invariably gave a mixture of products. Unfortunately, the only way to separate them was to hand-pick them. The presence of $\text{Pd}_2(\text{hpp})_4\text{Cl}_2$ was confirmed in each case by checking the cell dimensions by X-ray diffraction.⁸³ The structures of both centrosymmetric complexes, $\text{Pd}_2(\text{hpp})_4$ and $\text{Pd}_2(\text{hpp})_4\text{Cl}_2$, are very similar; only the latter is shown in Figure 3. In each complex the two palladium atoms are bridged by four hpp ligands, resulting in a paddlewheel-type structure. Additionally, two axial chloride ions are present in the latter. There is formally no metal–metal bond in the former although the intermetallic separation is quite short (2.555(1) Å). In similar complexes containing binitrogen-donor ligands, the Pd—Pd separations are comparable although slightly longer.⁸³ The unprecedented Pd—Pd bond distance of 2.391(2) Å found in $\text{Pd}_2(\text{hpp})_4\text{Cl}_2$ is 0.164 Å shorter than that in $\text{Pd}_2(\text{hpp})_4$ and 0.097 Å shorter than the shortest Pd—Pd distance ever reported for any type of complex (in this case a $\text{Pd}^{\text{I}}\text{—Pd}^{\text{I}}$ acetonitrile complex)⁸⁴. It is also worth noting that the Pd—Pd single bond distance in $\text{Pd}_2(\text{hpp})_4\text{Cl}_2$ is 0.36 Å shorter than the Pd—Pd distance in the metal itself. The magnitude of the shortening of the Pd—Pd distance provides strong evidence that the oxidation does occur in the dipalladium unit and that the electron-rich single bond configuration of $\sigma^2\pi^4\delta^2\delta^*\pi^*4$ can be appropriately assigned to the metal–metal interaction.⁸³ A high-level calculation of the electronic structure of the $\text{Pd}_2(\text{hpp})_4\text{Cl}_2$ molecule, in which the geometry was optimized, gave results in excellent agreement with experiment: Pd—Pd, 2.402 Å vs. 2.391 Å (obs) and for the torsion angle 22.6° vs. 24° (obs). The HOMO/LUMO gap is calculated to be 167 kcal mol⁻¹.⁸³

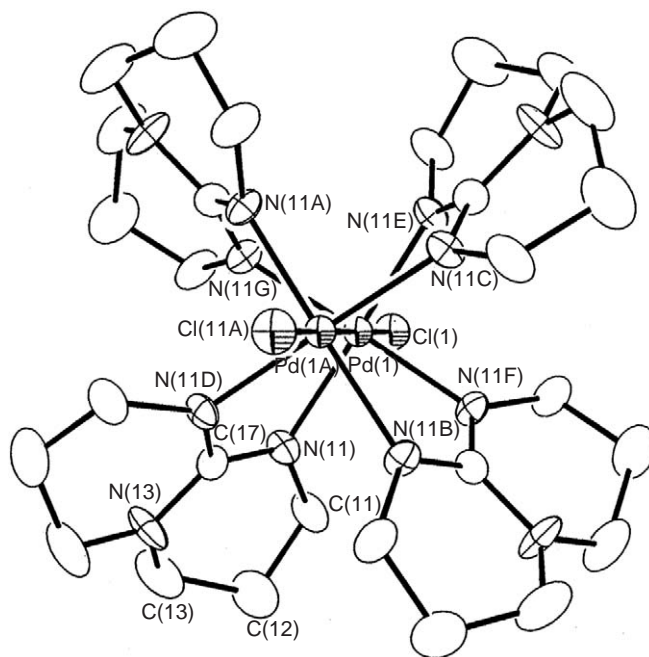

Figure 3 The structures of the centrosymmetric complex $\text{Pd}_2(\text{hpp})_4\text{Cl}_2$.

6.4.5 PALLADIUM(II)

6.4.5.1 Carbon

The cyanide exchange on $[\text{M}(\text{CN})_4]^{2-}$ with $\text{M} = \text{Pt}, \text{Pd},$ and Ni is a rare case in which mechanistic comparisons between $3d$, $4d$, and $5d$ transition-metal complexes. Surprisingly, the behavior of these metal square-planar centers leads to mechanistic diversity involving pentacoordinated species or transition states as well as protonated complexes. The reactivities of these species are strongly pH-dependent, covering 15 orders of magnitude in reaction rates.⁸⁵

A variety of palladium(II) complexes with porphyrins,⁸⁶ heteroporphyrins,⁸⁷ and doubly-N-confused porphyrins⁸⁸ have been isolated and characterized. Importantly, the palladium(II) ion is susceptible to phenyl coordination in a cyclopalladation process.^{89–91} Once the carbon donor is built into macrocyclic or pincer ligands, the palladium(II) ion forms robust organometallic compounds.^{92–94} Oxybenzporphyrin is conceptually derived from benzporphyrin, in which a benzene ring replaces one of the porphyrinic pyrroles leading to a structure devoid of macrocyclic aromaticity. A study of the synthesis and spectroscopic properties of oxybenzporphyrin complexes with Pd^{II} examined the effects of complexation and electrophile addition on the aromaticity of the ligand.⁹⁵

Intramolecular π – π aromatic stacking interactions are rare, especially within ligands of transition metal compounds for which electrostatic interactions are likely to dominate over weak dispersion effects. Chiral Pd complexes, shown in Figure 4, present three pairs of aromatic ring systems that adopt almost parallel, stacked configurations. In the full QM-calculated models (a) $\text{PdBr}(p\text{-CNC}_6\text{H}_4)(\{S\}\text{-MeO-Biphep})$; (b) $\text{PdBr}(\text{C}_6\text{F}_5)(\{S\}\text{-MeO-Biphep})$ potential aromatic π – π stacking interactions are indicated by arrows.

Combined quantum mechanics/molecular mechanics studies have demonstrated that π – π stacking interactions are important in determining the structural features of polyarene transition metal compounds such as the two d^8 Pd complexes.⁹⁶

Photorefractivity is a property exhibited by some materials in which the redistribution in space of photogenerated charges will induce a nonuniform electric space-charge field which can, in turn, affect the refractive index of the material. In a new material the active species is a highly efficient cyclopalladated molecule^{97,98} shown in Figure 5. The palladium-bonded azobenzene molecule is conformationally locked, and gratings derived from *cis*–*trans* isomerizations can be safely excluded.

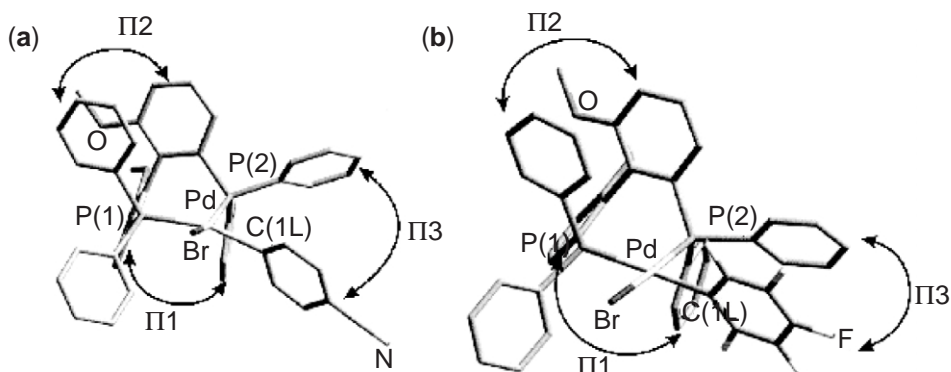

Figure 4 Chiral Pd complexes (a) PdBr(*p*-CNC₆H₄)(*S*)-MeO-Biphep); (b) PdBr(C₆F₅)(*S*)-MeO-Biphep). Potential aromatic π - π stacking interactions are indicated by arrows.

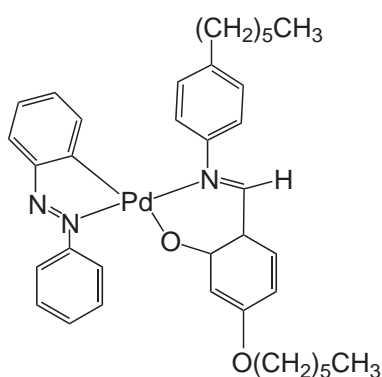

Figure 5 Palladium-bonded azobenzene molecule.

Lanthanides in combination with transition metals have been shown to have a positive effect in promoting heterogeneous catalytic reactions. The bimetallic Yb–Pd catalyst obtained from the precursor $\{(DMF)_{10}Yb_2[Pd(CN)_4]_3\}_\infty$ on a titania surface offers improved performance over a palladium-only catalyst for the reduction of NO by CH₄ in the presence of O₂.^{99,100} The structure, shown in Figure 6, consists of two inverted parallel zigzag chains that are connected through the lanthanide atoms by *trans*-bridging $[Pd(CN)_4]^{2-}$ anions.¹⁰¹

The synthesis and structural characterization of luminescent di- and tri-nuclear organopalladium complexes with rigid conjugated alkynyl–aryl bridges and preliminary experiments on the formation of the first generation metallodendrimer using the trinuclear complex as the backbone were reported.¹⁰²

Halo carbonyl complexes of palladium have been widely studied.^{103–108} For homoleptic typical carbonyls and highly reduced carbonylates, the square planar coordination geometry was unknown. All known tetracarbonyl species are invariably tetrahedral, including Pd(CO)₄ which exists in inert gas matrices only.¹⁰⁹ A new synthetic methodology, the use of various superacids as reaction media in carbonylation and solvolysis reactions, provides a viable pathway to a wide range of homoleptic metal carbonyl cations, among them many superelectrophilic cations, with ionic charges of +2 and +3. This approach has been applied to the reductive carbonylation of Pd[Pd(SO₃F)₆].^{110,111} The solvated cation $[Pd(CO)_4]^{2+}_{(solv)}$ forms initially in HSO₃F, but the fluorosulfate *cis*-Pd(CO)₂(SO₃F)₂ is eventually isolated.¹¹² The molecular structure of *cis*-Pd(CO)₂(SO₃F)₂ is known.¹¹³ In liquid SbF₅ in a CO atmosphere *cis*-Pd(CO)₂(SO₃F)₂ is easily converted to $[Pd(CO)_4][Sb_2F_{11}]_2$. The square planar coordination geometry of the cation is easily deduced from the vibrational spectra.¹¹⁴ Pd(CO)₄[Sb₂F₁₁]₂¹¹⁴ and the precursor *cis*-Pd(CO)₂(SO₃F)₂^{112,115} appear to be the only true cationic polycarbonyl derivatives of palladium(II),¹⁰⁵ with the possible exception of thermally unstable Pd(CO)₂R₂, R = C₆F₅, C₆Cl₅.¹¹⁶ An early claim of the synthesis of *cis*-Pd(CO)₂Cl₂¹¹⁷ has been repudiated,¹¹⁸ and the reported crystal structure and spectroscopic properties of “[Pd(μ -Cl)(CO)₂]₂”¹¹⁹ are evidently identical in all respects to those of well-known [Rh(μ -Cl)(CO)₂]₂.^{120,121} A detailed study¹²² reached the following goals: summarized

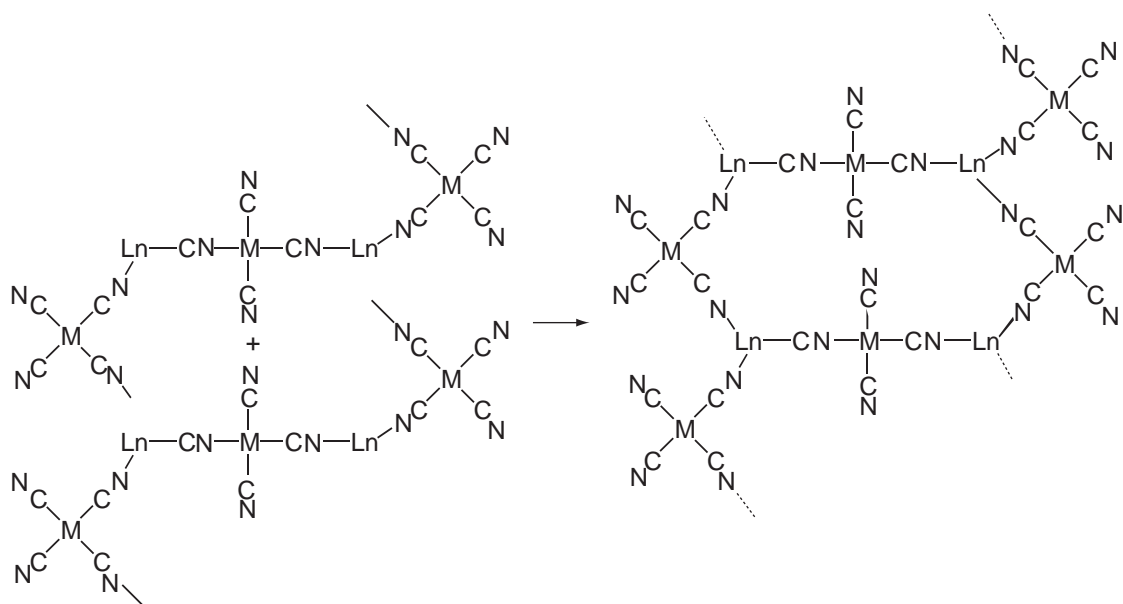

Figure 6 Bimetallic Yb–Pd catalyst obtained from the precursor $\{(\text{DMF})_{10}\text{Yb}_2[\text{Pd}(\text{CN})_4]_3\}_\infty$ on a titania surface and consisting of two inverted parallel zigzag chains that are connected through the lanthanide atoms by *trans*-bridging $[\text{Pd}(\text{CN})_4]^{2-}$ anions.

and evaluated a number of alternative synthetic routes to $[\text{Pd}(\text{CO})_4]^{2+}$,¹²³ investigated the thermal behavior of $[\text{Pd}(\text{CO})_4][\text{Sb}_2\text{F}_{11}]_2$, and reported the crystal, molecular and extended structure of $[\text{Pd}(\text{CO})_4][\text{Sb}_2\text{F}_{11}]_2$.¹²²

The photophysics and photoreactivity of coordinatively unsaturated platinum(II) complexes^{124–128} and their applications as luminescent sensors are areas of considerable interest in inorganic photochemistry. Rich and diverse low-energy excited states, including IL (intraligand: $\pi \rightarrow \pi^*$), MLCT (metal-to-ligand charge transfer) [$d\sigma^* \rightarrow p\sigma$], and $[d\sigma^* \rightarrow \pi^*]$ (or MMLCT, metal–metal-to-ligand charge transfer), have been observed. Relatively scant attention has been focused upon the luminescent characteristics of palladium(II) complexes. Nevertheless, such investigations have been dominated by cyclometalated derivatives,^{129–132} and reports comparing Pd^{II} and Pt^{II} analogues can yield information on electronic structures and excited states.^{91,133–136} The ability of cyclometalated Pd^{II} complexes to effect DNA cleavage has been described.^{137,138} Various aspects of luminescent cyclometalated Pt^{II} complexes bearing substituted 6-phenyl-2,2'-bipyridine ligands have been studied.^{139–143} The preparation, crystal structures, and spectroscopic behavior of mono- and binuclear cyclometalated Pd^{II} derivatives are presented. The correlation between Pd^{II} and Pt^{II} congeners has enabled evaluation of metal–metal and ligand–ligand interactions in these systems and offered insight into their excited-state properties.¹⁴⁴

Palladium(II) complexes containing orthometalated chiral amines such as those shown in Figure 7 are useful reagents:

- (i) for the resolution of chiral phosphines and arsines,
- (ii) for the determination of the optical purity of chiral phosphines by $^{31}\text{P}\{^1\text{H}\}$ -NMR spectroscopy, and
- (iii) as templates for the asymmetric syntheses of conformationally rigid bidentate ligands derived from metal-promoted intramolecular [4 + 2] Diels–Alder cycloadditions of 3,4-dimethyl-1-phenylphosphole (DMPP) with a variety of dienophilic ligands.

Complexes shown in Figure 7 undergo facile bridge-splitting reactions with a variety of two-electron donor ligands to give mononuclear species.¹⁴⁵

The preparation of helically well-ordered polymers with stable screw-sense, which is able to be transmitted to newly formed polymer main-chains effectively, is highly desired for the development of new methodology for the synthesis of optically active helical polymers. An aromatizing polymerization of 1,2-diisocyanobenzenes is promoted by methylpalladium(II) complexes, producing poly(quinoxaline-2,3-diyl)s.^{146–148} The polymerization proceeds with successive insertion of the two isocyno groups of the diisocyanobenzene to the carbon–palladium bond of

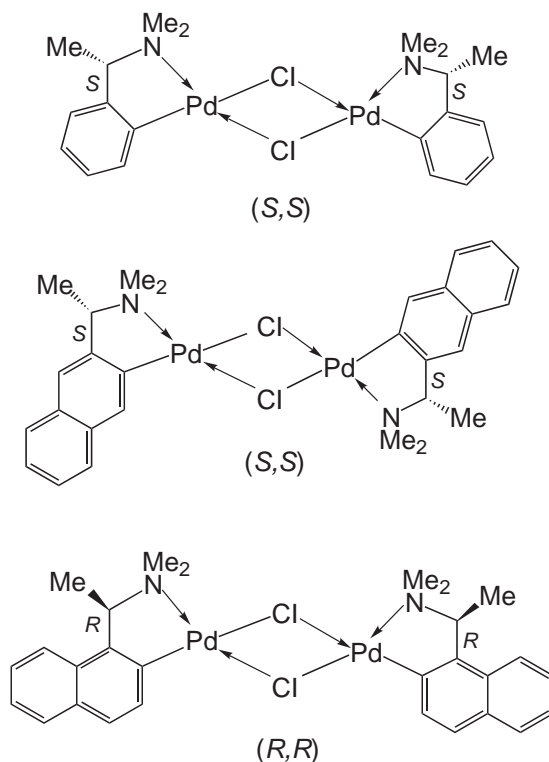

Figure 7 Palladium(II) complexes containing orthometalated chiral amines.

organopalladium complex to give 2-quinoxalinylpalladium complexes, whose carbon–palladium bond undergoes further successive insertion of the diisocyanobenzenes to provide the quinoxaline polymers. The poly(quinoxaline)s thus produced feature their rigid helical structures. The first attempt for the synthesis of optically active, helical poly(quinoxaline)s started with separation and isolation of two diastereomerically pure bromo[oligo(quinoxaliny)]palladium(II)-L*₂ (L* = di((S)-2-ethylbutyl)phenylphosphine) complexes, which were produced by the oligomerization of 3,6-di-*p*-tolyl-1,2-diisocyanobenzene with optically active *trans*-(bromo)methylpalladium(II)-L*₂.^{149–153} Right- and left-handed bromo(quinquequinoxaliny)palladium(II)-L*₂ thus prepared were subjected to ligand exchange reaction with a large excess of a chiral dimethylphenylphosphine. The enantiomerically pure right- and left-handed bromo(quinquequinoxaliny)palladium(II) bis(dimethylphenylphosphine) complexes isolated were used as catalysts for polymerization of 1,2-diisocyanobenzenes, providing right- and left-handed helical poly(quinoxaline-2,3-diyl)s after removal of the palladium moiety with methylmagnesium bromide. The asymmetric polymerization of 1,2-diisocyanobenzenes is promoted by optically active iodo(1,1'-binaphth-2-yl)palladium(II) complexes as initiators. The axial chirality of the binaphthyl group, which becomes far from the living palladium terminus with propagation of the polymerization, successfully induced high screw-sense selectivity to provide optically pure, helical poly(quinoxaline-2,3-diyl)s.¹⁵⁴ The choice of substituents on the binaphthyl groups was crucially important to attain the high screw-sense selectivity. The highly effective control of the helical sense by the 7'-methoxy-1,1'-binaphthyl group at the initiation terminal of the polymer may arise from highly diastereoselective formation of the (terquinoxaliny)palladium(II) intermediate, whose screw-sense was completely maintained for further propagation. The complete retention of the helical structure in the polymerization was demonstrated by the synthesis of optically pure polymers with varying molecular weights up to 100mer. The asymmetric polymerization has successfully been applied for the screw-sense selective synthesis of poly(quinoxaline-2,3-diyl)s having hydrophobic and/or hydrophilic side chains, by which the surface of the polymer is modifiable for new functional materials.¹⁵⁴

Square-planar *d*⁸ platinum complexes could perhaps be used as the chemically sensitive layer for a chemical sensor system. These complexes are robust and form colored solid-state materials that respond spectroscopically to a wide range of volatile organic compounds (VOCs); this process has been named vapochromism. The vapochromic shifts occur in the solid-state UV–vis,

NIR, and IR spectra of $[\text{Pt}(p\text{-CN-C}_6\text{H}_4\text{-C}_{10}\text{H}_{21})_4][\text{Pd}(\text{CN})_4]$.¹⁵⁵ These studies suggest that sorbed guest molecules capable of significant H-bonding interact with the cyanide ligands to produce shifts in the $\nu(\text{CN})$ stretching frequencies that also correlate with the UV-vis changes. The synthesis and X-ray powder diffraction studies of a series of hydrated and solvated $[\text{Pt}(\text{CN-iso-C}_3\text{H}_7)_4][\text{Pd}(\text{CN})_4]$ complex were reported.¹⁵⁶ These studies show that vapochromism is accompanied by large reversible increases in the unit cell dimensions perpendicular to the Pt-Pd direction. The large (50–90%) unit cell increases allow the reversible inclusion of solvent molecules. Significant H-bonding interactions are present between the guest molecules and the cyanide ligands of the tetracyanometalate anions.¹⁵⁶

6.4.5.2 Silicon and Tin

For trinuclear complexes that have a central Pd atom coordinated by six silyl groups, as shown in Figure 8, a highly unusual Pd^{VI} oxidation state has been assigned.³⁰ There are several reasons why the formulation of such a compound as a Pd^{II} center with two η^2 -coordinated Si-Si single bonds is strongly favored, rather than as a Pd^{VI} center with six-coordinate silyl groups.^{31–33} (see Section 6.4.2)

In a trinuclear complex two of the Pd atoms can be readily characterized as Pd^{II} centers but the nature of the third, central Pd atom is less clear.³⁰ While this Pd atom is considered as bonding directly to two Si atoms and further interacting with two Si-Si bonds, the interatomic distances from the X-ray crystal-structure data could also be interpreted to be consistent with an absence of Si-Si bonds and instead six Pd-Si bonds,³⁰ that is, the central metal would formally be Pd^{VI} . Both structures are without precedent in palladium coordination chemistry,^{157,158} although compounds of the type $[\text{PdF}_n]$ ($n = 2, 4, 6$),^{159–162} have been reported where the extreme electronegativity of fluorine is exploited for the generation of higher oxidation states.¹⁶³ Assigning the central metal to be Pd^{VI} is not warranted, unless such an assignment is permitted to encompass the ambiguity of multicenter, delocalized bonding.³² (see Section 6.4.2)

Complex (dippe = 1,2-bis(diisopropylphosphino)ethane) $\text{Pd}(\text{SiH}_2\text{Ph})_2$ is a very rare example^{164–168} of an isolated Pd^{II} *cis*-bis(silyl) complex.¹⁶⁹

A bis(stannyl)bis(phosphine)palladium complex has a twisted square planar structure and shows facile unimolecular twist-rotation.¹⁷⁰

6.4.5.3 Nitrogen

An analogue of 2,2'-bipyridine is capable of coordinating to *trans* metal binding sites. A ligand consisting of two 2-pyridyl moieties joined by a well-organized tether that orients the nitrogens at an appropriate distance affords exactly the required geometry.^{171–174}

In a tetraazaporphyrin selective oxidative cleavage of one or more of the pyrrole rings yields secoporphyrazines. The new ligands and metal complexes derived thereof are of potential interest in areas such as nonlinear optics, electron transfer, and photodynamic therapy. Bis(dimethylamino)porphyrazines are versatile since they can be converted not only to seco analogues but also to new solitaire complexes upon peripheral metalation. The synthesis of the first macrocycles containing both an oxidatively cleaved pyrrole ring and a peripherally coordinated metal species has been reported.¹⁷⁵ The peripheral complexation and the oxidative cleavage of one of the pyrrole rings have a profound effect on the electronic properties of the porphyrazines.¹⁷⁵

The incorporation of photoactive components into the molecular structure, which allows reversible switching of the output physical properties, such as light or redox potential, by an

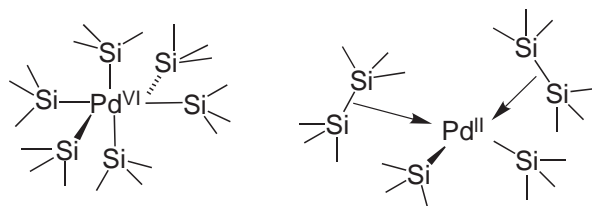

Figure 8 Trinuclear complexes that have a central Pd atom coordinated by six silyl groups.

external trigger, is promising in the development of molecular or supramolecular devices. The preparation and photochemistry of a series of self-assembly transition-metal-based macrocyclic compounds bridged by a photoisomerizable 4,4'-azopyridine or 1,2-bis(4-pyridyl)ethylene ligand was described.¹⁷⁶ The self-assembled Pd—Re and Pd tetranuclear squares can be photochemically converted to their corresponding dinuclear squares and thermally returned back to the tetranuclear squares.¹⁷⁶

One of the chief defects of the phosphorus based pyrazolyl (PZ) ligands appears to be the hydrolytic sensitivity of the P—N bond particularly after interaction of the ligand with transition metal ions. The interactions of $\text{PhP(O)}(3,5\text{-Me}_2\text{pz})_2$ and $\text{Ph}_2\text{P(O)}(3,5\text{-Me}_2\text{pz})_2$ with Pd^{II} salts accelerates the P—N bond hydrolysis.¹⁷⁷

Potentiometric and $^1\text{H-NMR}$ methods were combined in the studies of the interaction of $[\text{Pd}(\text{en})(\text{H}_2\text{O})_2]^{2+}$ and $[\text{Pd}(\text{pic})(\text{H}_2\text{O})_2]^{2+}$ (pic = 2-picolyamine) with monodentate ligands containing nitrogen or sulfur donor atoms. The ligands represent the side chain residues of nucleic acids and proteins.¹⁷⁸

Metals are well known to induce conformational changes upon binding ligand systems. Upon removal of the metal ion the ligand usually “forgets” and reverts to its conformationally flexible state. Remarkably, a bis(pyridine) ligand can retain its metal-induced conformation even in the absence of the metal ion. At room temperature the ligand adopts one of two conformations: *syn*- or *anti*-. On heating in the presence of $[\text{PdCl}_2(\text{PhCN})_2]$, the *syn*-isomer is preferred. On cooling this conformational preference is “locked-in” even on removal of the Pd^{II} ion (see Figure 9). The ligand can be programmed to adopt either a convergent *syn*-conformer that forms chelates or a divergent *anti*-conformer that forms coordination polymers.¹⁷⁹

The octaethylporphyrin (OEP) complex cocrystalline with C_{60} , namely $\text{Pd}^{\text{II}}(\text{OEP})\cdot\text{C}_{60}\cdot 1.5\text{C}_6\text{H}_6$ is one of the first examples of the *anti*-formed macrocyclic metal complexes of OEPs.^{180,181}

In the ligand 1,2-bis-(2-pyridylethynyl)benzene the pyridyl N atoms easily attain the appropriate separation for *trans*-chelation of metal cations. The 1:1 complex of the ligand with palladium(II) chloride has been structurally characterized.^{171,182}

The reactivity of a series of closely related substances can either be enhanced or inhibited depending on the type and extent of interaction with double-helical DNA. This was shown in a kinetic study of the substitution of ethylenediamine (en) or *N,N'*-dimethylethylenediamine (Me_2en) by thiourea in the palladium(II) complexes $[\text{Pd}(4,4'\text{-R}_2\text{bpy})(\text{en})](\text{PF}_6)_2$ ($\text{R} = \text{H}$ or Me), $[\text{Pd}(\text{en})_2](\text{PF}_6)_2$, and $[\text{Pd}(\text{Me}_2\text{en})_2](\text{PF}_6)_2$, in water and in the presence of calf thymus DNA.¹⁸³

“N-Confused porphyrin” (NCP) is a porphyrin isomer in which one of the pyrrolic rings is inverted. NCP can coordinate a metal in the porphyrin core by using the inner carbon and nitrogens. Owing to the outward pointing nitrogen, outer-N coordination is also conceivable. Two types of palladium-NCP complexes, inner-coordinated Pd^{II} -NCP and inner- and outer-N-coordinated, double-decker Pd complexes,¹⁸⁴ are reported (see Figure 10).⁸⁸ The latter Pd dimers are the first examples of the outer-N coordination in the NCP family.

Short peptides (fewer than 15 residues) are rarely helical in solution. A stable single α -helical turn in solution, a native pentapeptide, was constrained by a Pd^{II} clip to the shortest α -helix

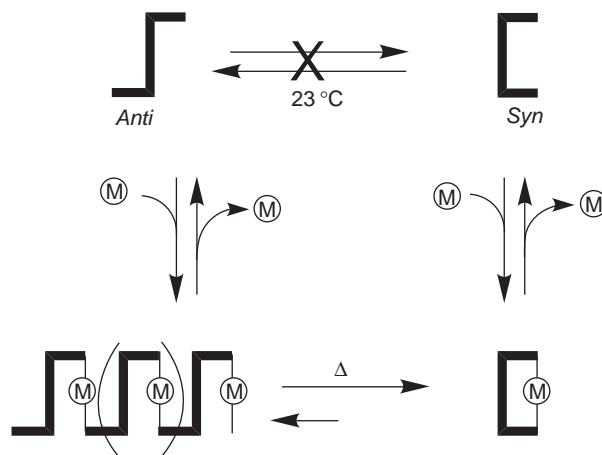

Figure 9 Retention of metal-induced conformation of a bis(pyridine) ligand by heating in the presence of $[\text{PdCl}_2(\text{PhCN})_2]$.

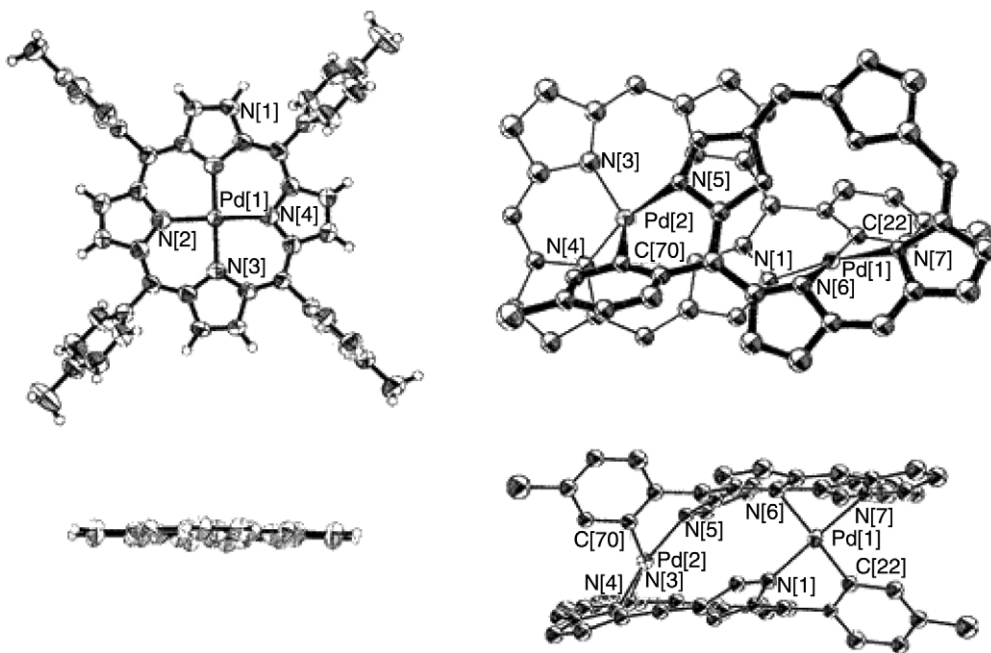

Figure 10 Two types of palladium-NCP complexes, inner-coordinated Pd^{II}-NCP and inner- and outer-N-coordinated, double-decker Pd complexes.

known, as shown in Figure 11.¹⁸⁵ This ion chelates two histidines (via N1 nitrogens) arranged at *i* and *i* + 4 positions, inducing α -helicity even in a pentapeptide.

Novel cationic methyl and neutral methyl, chloro Pd^{II} complexes have been synthesized with various functionalized imidazole ligands. For the first time, structurally characterized examples of this type of Pd complex could be obtained. The chelate ligand is shown to adopt a boat conformation. Inversion of the chelate ring was established by NMR spectroscopy. Depending on electronic and steric features of the ligand, the complexes can act as catalysts in the CO/ethylene as well as the Heck reaction.¹⁸⁶

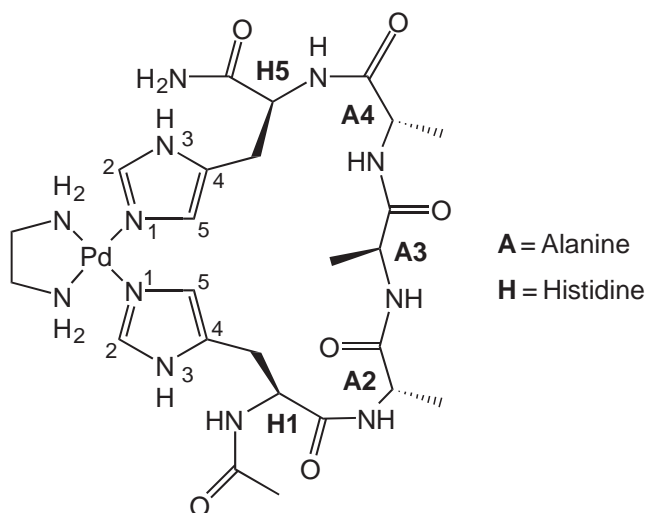

Figure 11 Pd^{II} chelates two histidines (via N1 nitrogens) arranged at *i* and *i* + 4 positions, inducing α -helicity even in a pentapeptide.

Certain azacrown-appended cholesterol derivatives can form unique vesicular or lamellar structures in the absence and the presence of metal salts in aqueous solution.^{187–190} These superstructures created from the azacrown-appended cholesterol derivatives are useful as a template for the transcription into the silica structure. Azacrown-appended cholesterol gelator creates the novel multilayered spherical structure in acetic acid, whereas this gelator results in the fluffy globular aggregates in the presence of Pd(NO₃)₂.¹⁹¹

AMTTO—a representative of 4-amino-6-alkyl-1,2,4-triazine-5-one—acts as a bidentate chelating ligand towards PdCl₂ in methanol/acetonitrile to give the air-stable palladacycle [(AMTTO)PdCl₂] \cdot MeOH.¹⁹² Its reactions with triphenylphosphane and sodium thiocyanate, led to the air-stable complexes [(AMTTO)Pd(PPh₃)Cl]Cl \cdot MeOH and [(AMTTO)Pd(SCN)₂] \cdot MeOH, respectively.¹⁹³ Another paper reports the halide exchange reactions with sodium bromide and sodium iodide, as well as the reactions of the bromine and iodine palladacycles with triphenylphosphane.¹⁹⁴

In order to anchor a metal ion firmly on a pyrazole derivative, polydentate ligands shown in Figure 12 can form stable chelates involving one soft ligating atom (P or S) and one pyrazole N, while leaving the other pyrazole N and its attached hydrogen available for donating a hydrogen bond or a proton to another ligand on the metal. In this study, a pyrazole substituent containing a ligating P or S atom must be attached to a carbon of the heterocycle. Four new ligands designed to form bidentate complexes using a soft donor atom and a pyrazole nitrogen have been synthesized and their corresponding *cis*-dichloropalladium(II) complexes prepared. In the solid state, the two palladium complexes with a pyrazole N—H group show intra- and intermolecular hydrogen bonding to the chloride ligands. The intramolecular distances between chloride and the NH proton are comparable to the closest intermolecular contacts found in the solid state structures. In contrast, isomeric complexes lacking an N—H group show no hydrogen bonding.¹⁹⁵

The self-assembled membrane (SAM) technique has been much used as an effective method to organize the molecules on the solid surface with well-ordered structure and thickness for interfacial optical studies. Palladium porphyrins show strong room-temperature phosphorescence with high quantum yield and long lifetime. Therefore these compounds have been widely utilized as oxygen-sensitive dyes. There was a report previously on optical oxygen sensing using an SAM of palladium tetrakis(4-carboxyphenyl)porphyrin (PdTCPP) on an alumina surface, but a more sensitive oxygen sensing system and stable and highly ordered films are desired. Highly organized SAMs can be obtained using compounds with long hydrocarbon chains. An optical oxygen-sensing technique was established using a self-assembled film of Pd porphyrin with long alkyl chain, PdPC10COOH, on an alumina plate.¹⁹⁶

Among luminescent dyes, palladium porphyrins display strong room-temperature phosphorescence with a high quantum yield and long lifetime. Therefore these compounds have been frequently utilized as oxygen-sensitive dyes. As palladium tetrakis(4-carboxyphenyl)porphyrin (PdTCPP) has a carboxyl group, a stable self-assembled PdTCPP film will be formed on an alumina surface. An optical oxygen sensor was prepared using PdTCPP self-assembled film on alumina plate. The film is highly sensitive to oxygen pressure and possesses good operational stability and a fast response.¹⁹⁷

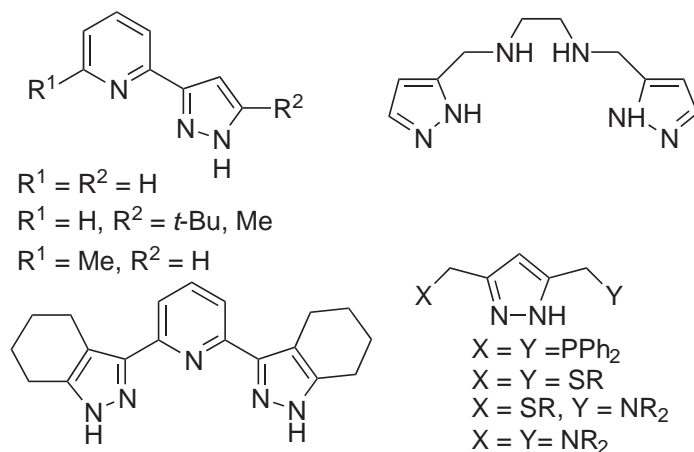

Figure 12 Polydentate ligands capable of anchoring a metal ion on a pyrazole derivative.

Traditionally, oxidations of alcohols are performed with stoichiometric amounts of inorganic oxidants, notably chromium(VI) reagents. These oxidants are not only relatively expensive, but they also generate copious amounts of heavy-metal waste. Moreover, the reactions are often performed in environmentally undesirable solvents, typically chlorinated hydrocarbons. In a constant search for cleaner (“greener”) technologies, there is a definite need for catalytic oxidations that use dioxygen (O_2) or hydrogen peroxide as the stoichiometric oxidant. These oxidants are atom efficient and produce water as the only by-product. Supported noble metals, such as palladium or platinum on carbon, are known to catalyze the aerobic oxidation of alcohols in an aqueous medium, but the method is generally limited to water-soluble substrates, such as carbohydrates.¹⁹⁸ Moreover, primary alcohols are oxidized to carboxylic acids, and one equivalent of base is required. An extremely effective aerobic oxidation of alcohols, both of activated and nonactivated hydroxyl groups, was performed in water with a soluble catalyst.¹⁹⁹ The latter is a water-soluble palladium complex of bathophenanthroline disulfonate (PhenS*), see Figure 13.

A wide range of both primary and secondary allylic, benzylic, and aliphatic alcohols can be oxidized with high conversions and selectivities. Mechanistic studies¹⁹⁹ of olefin oxidations with this catalyst showed that, under neutral conditions, the catalyst precursor is a dimeric palladium species with two bridging hydroxy ligands.²⁰⁰ Increasing the pH values up to pH ~10 yields a similar dimeric species with three bridging hydroxy ligands,²⁰¹ apparently without changing the rate equation. The addition of sodium acetate (NaOAc) further increases the reaction rate. The reaction may also be carried out at neutral pH at only marginally lower rates. Coordination of the alcohol to the metal center probably splits the dimeric precursor, see Scheme 1. Next, a base (B) abstracts a proton from the coordinated alcohol to form a palladium alcoholate species that subsequently undergoes β -hydride elimination to give the alkanone, water, and a zerovalent palladium species. Oxidation of the latter with O_2 gives a palladium peroxide. Reaction of this peroxide with one equivalent of zerovalent palladium yields the starting palladium dimer. Reoxidation of Pd^0 seems to be facilitated by NaOAc, which avoids the irreversible formation of a palladium mirror. A minimum of 1 mmole of NaOAc is recommended to avoid this palladium black formation.¹⁹⁹

Octaethylbilindione (H_3OEB) is a convenient model for the bile pigment biliverdin IX α . Key redox states of this ligand as observed in its complexes are shown in Figure 14. The redox behavior of the palladium complex of octaethylbilindione was examined in order to determine the generality of the redox behavior of this group of transition metal complexes.²⁰² A preliminary report on the novel tetrameric $Pd_4(OEB)_2$, which contains palladium(I) ions π -bonded to C=C bonds of the tetrapyrrole ligand, and of $Pd^{II}(OEB\cdot)$ has appeared.²⁰³

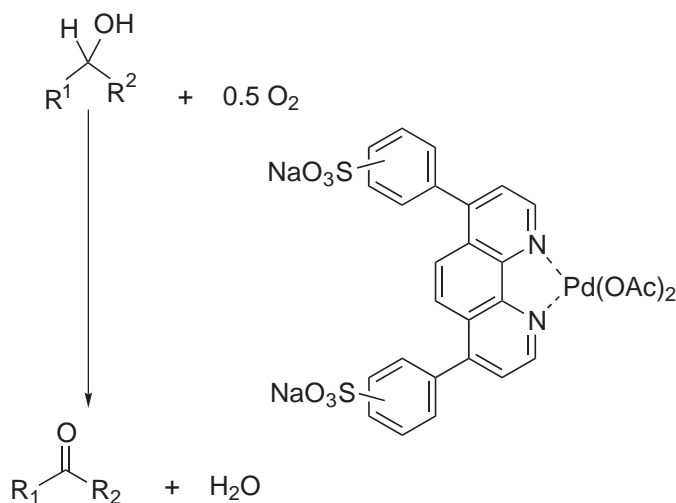
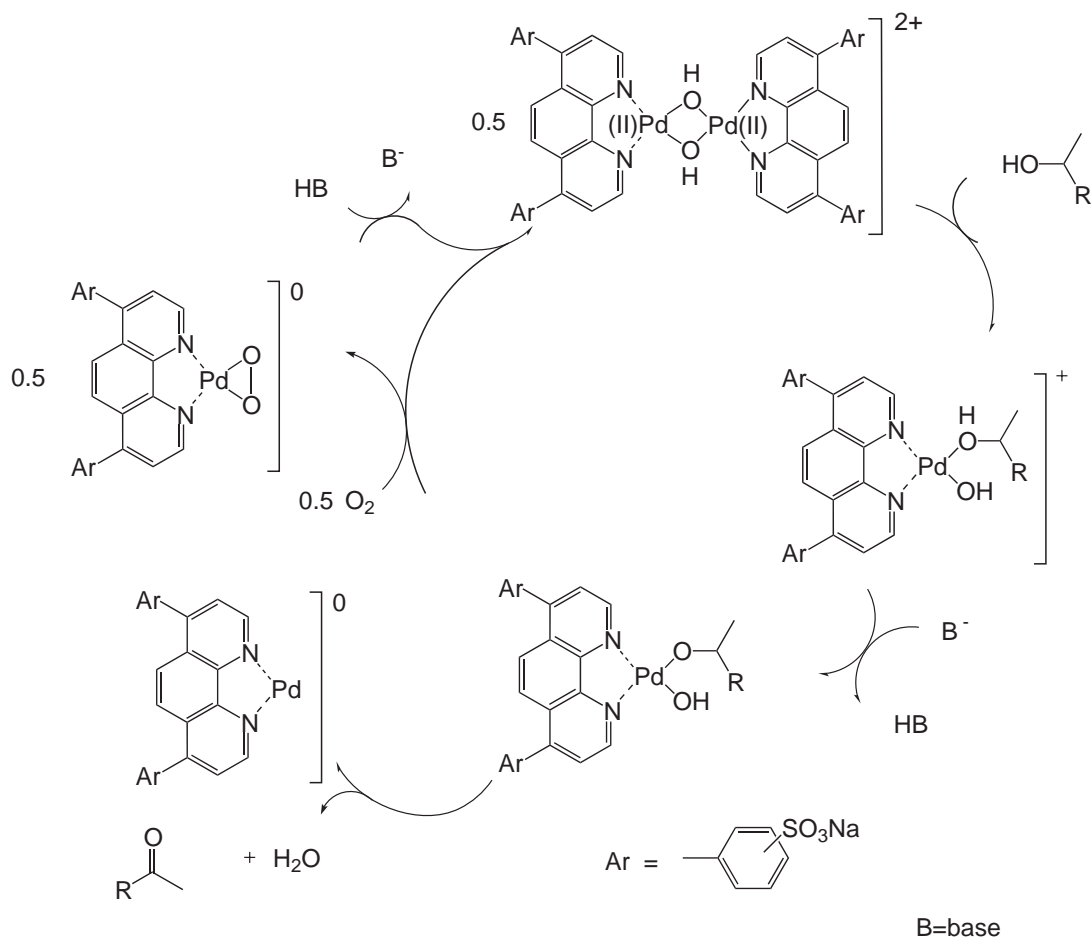

Figure 13 Aerobic oxidation of alcohols catalyzed by water-soluble PhenS*Pd(OAc)₂; R = alkyl, aryl.



Scheme 1

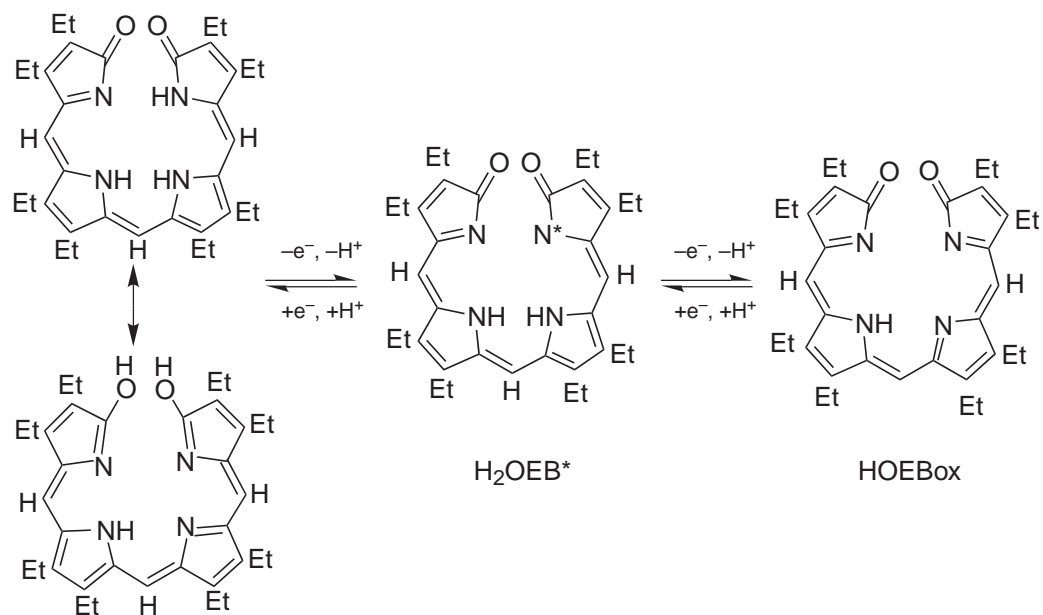
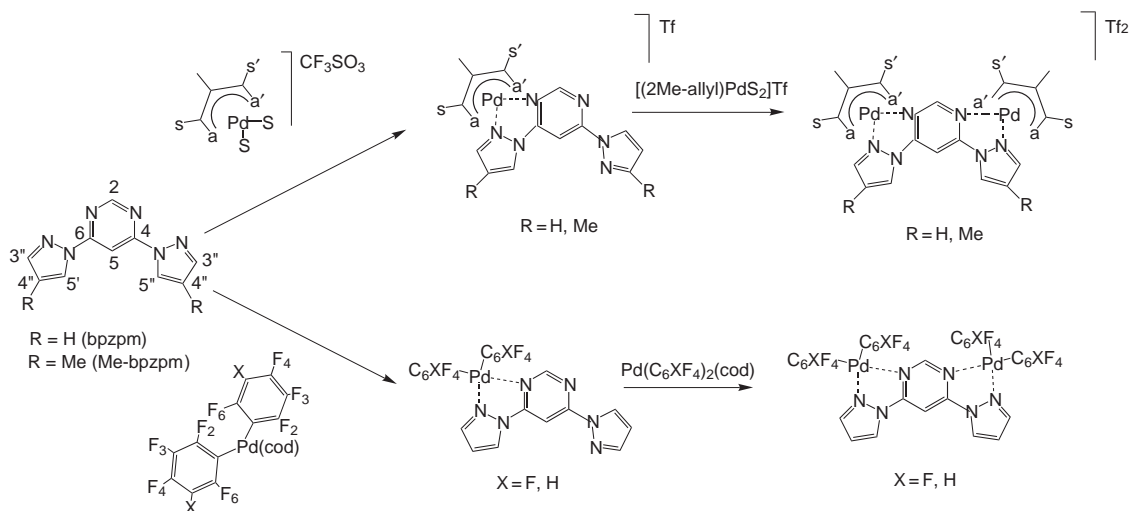

Figure 14 Redox behavior of octaethylbilindione.

The fluxional behavior of new palladium and platinum derivatives containing 2,4,6-tris(2-pyridyl)-1,3,5-triazine and 2,4,6-tris(2-pyridyl)pyrimidine ligands has been reported.^{204,205} An intramolecular mechanism based on a 1,4-metallotropic shift coupled to the metal hurdling along the coordination positions of the N-donor ligand has been proposed. There has been some controversy about the mechanism of the 1,4-metallotropic shift process, and both associative²⁰⁶ and dissociative²⁰⁷ pathways have been proposed. An elegant study with asymmetric terpyridine ligands coordinated to palladium and platinum fragments, showed that the 1,4-metallotropic shift pursues an associative mechanism where the role of the N atom in the central pyridine ring is essential.²⁰⁸ A study²⁰⁹ reported the synthesis and the dynamic behavior of new allylpalladium derivatives coordinated to pyrazolyltriazine ligands where the metallic group interchanges between the different coordination positions of the ligand. As in aforementioned examples,^{204,205} but with energy barriers low enough to observe several coalescences in the ¹H-NMR spectra, the authors measured two different free activation energies whose difference lies correctly with the expected strengths of the Pd—N bonds, which are necessarily broken in each step. This implies the existence of Pd—N bond rupture in the two processes. The N₅ atom of the triazine ring could assist the palladium group in the 1,4-metallotropic shift, making the process intramolecular. The role of the triazine central nitrogen atom, was evaluated with two similar ligands, 4,6-bis(pyrazol-1-yl)pyrimidine²¹⁰ (bpzpm) and 4,6-bis(4-methylpyrazol-1-yl)pyrimidine (Me-bpzpm) (see Scheme 2), that lack the N₅ atom, making impossible an intramolecular 1,4-metallotropic shift of the metal. Because these new ligands still possess two identical asymmetric chelating coordination sites, if the palladium fragments are able to jump from one position to the other, a different pathway must be involved.

Two processes have been detected in the complex: an intramolecular apparent allyl rotation and an intermolecular process of interconversion of the two pyrazolyl groups, with negative activation entropy, for which an associative mechanism is proposed. The existence of this latter process indicates that the presence of a nitrogen atom is not necessary in the 5-position of the central heterocycle of the ligands in order for an interconversion of the two pyrazolyl groups to take place. However, participation of a nitrogen atom in the 5-position cannot be excluded when it is present.²¹¹ Another goal of this study²¹¹ was to explore the possibility of synthesizing asymmetric dinuclear derivatives and to study the mutual influence of the two metallic groups through the ligand core. In this context different reactions have been performed with the bpzpm and Me-bpzpm ligands, with the metallic complex Pd(C₆F₅)₂(COD) or Pd(C₆HF₄)₂(COD) where COD = cyclooctadiene, and with the solvato [Pd(³-2-Me-C₃H₄)(S)₂]Tf(Tf = CF₃SO₃).



Scheme 2

Immobilized metal ion affinity chromatography (IMAC) is an important method for the separation of proteins having exposed histidine groups. Attachment of polyhistidine tails (His_n, where $n = 2-6$) fused to a desired peptide or protein has been developed to enhance its affinity to the IMAC column. A peptide Ser-Pro-His-His-Gly-Gly (SPHHGG) has been bioengineered to select for high-affinity binding to of Cu^{II}-IMAC columns.^{212,213} The diamagnetic, square-planar

[Pd^{II}(mida)] chelate (mida²⁻ = methyliminodiacetate) is used to approximate the distorted tetragonal Cu^{II}-IMAC sites in order to identify which amino acid groups or their side-chain donors of SPHHGG and HHHHHH become attached to the metal site.²¹⁴

Chemical cross-linking is a useful method to probe protein–protein interactions in solution. A significant advance in this area would be to design chemical cross-linking reagents that could be activated efficiently with visible light and which would then mediate protein cross-linking very rapidly. A molecule that could be photoexcited to a state capable of oxidizing tyrosine might mediate protein cross-linking with the assistance of a hydrogen atom-abstrating agent (see Scheme 3).

The literature on Pd^{II} porphyrin photochemistry suggests that these agents might be useful in this regard.^{215–217} To probe this point, glutathione S-transferase (GST), a native homodimer that can also associate into higher-order species, was photolyzed with visible light (>400 nm) in the presence of Pd^{II} 5,10,15,20-tetra(methylpyridinium)porphyrin (Pd^{II}TMPyP) and ammonium persulfate (APS), a good electron acceptor.²¹⁸ An approximately 50% yield of cross-linked products was produced after only a 10s irradiation using a 150 W xenon lamp and a 400 nm cutoff filter. Little or no cross-linking was observed when either light, APS, or Pd^{II} porphyrin was omitted from the solution or when free base porphyrin was substituted for the Pd^{II} derivative.²¹⁸ To probe the scope of this reaction, the Pd^{II} porphyrin/APS photomediated cross-linking of several proteins was examined.²¹⁸ A limitation of this reaction is the requirement for APS, which is cell-impermeable and can oxidize some cellular components directly. Therefore, it would be useful to find an APS substitute with more favorable properties. Co^{III} complexes are sometimes used to accept electrons from excited-state metal complexes. Unfortunately, much lower yields of cross-linked products were produced when Co^{III}(NH₃)₅Cl²⁺ was used in place of APS.²¹⁸

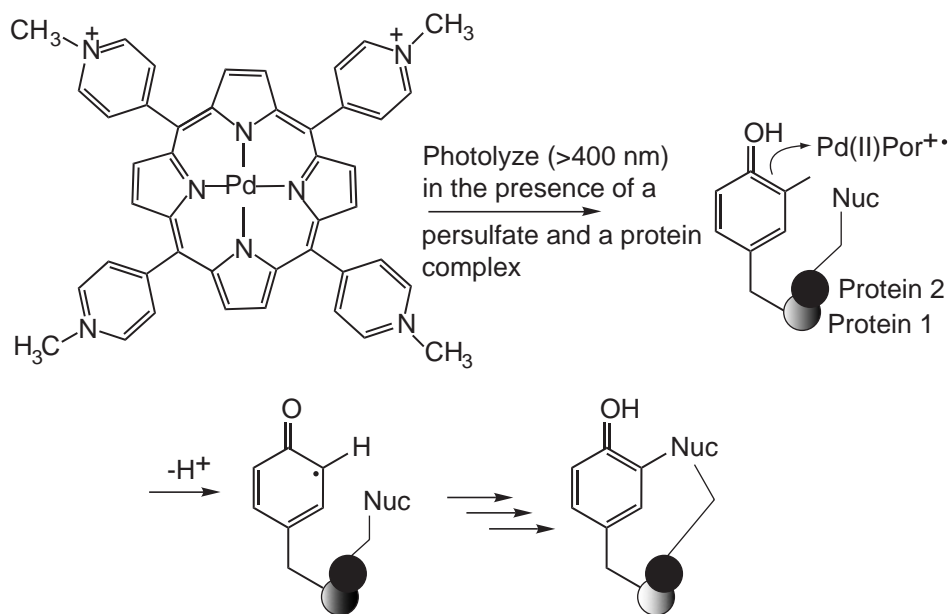

Scheme 3

Mono- and dinuclear 2,2':6',2''-terpyridine (terpy) complexes of Pt^{II} and Pd^{II} have been the subject of numerous studies, e.g., with regard to photophysical^{219–222} and electrochemical²²³ properties as well as substitution-mechanistic aspects.²²⁴ The mononuclear compounds have also been applied in biochemical and biochemistry related studies as DNA intercalators^{225–227} or metal probes for the histidine^{228–230} and arginine residues.²³¹ The interaction of [(terpy)PdCl] with model nucleobases such as 1-methylcytosine (Hmcyt) was studied.²³² Formation of mononuclear [(terpy)Pd(Hmcyt-N₃)]²⁺ as well as dinuclear {(terpy)Pd}₂(mcyt-N₃, N₄)³⁺ was clearly evident from potentiometric and proton NMR studies, but there was contradicting evidence as to the spatial orientation of the two metal entities in the dinuclear complex. Mono- and dinuclear (terpy)M^{II} (M = Pd, Pt) complexes containing the model nucleobase 1-methylcytosine have been prepared, X-ray structurally characterized and their solution behavior studied by spectroscopy.²³³ Evidence points to a stacked conformation rather than an *anti* orientation of the two (terpy)M entities, and

the visible spectrum is likewise in agreement with such a structure. The solid state structures further confirm that a stacked conformation is possible, in principle.²³³

Recently, variably substituted oligonitriles became available for the first time in monodisperse, well-defined form. Although these substances are isoelectronic with polyacetylenes (polyenes), their structural and electronic properties are entirely different. Of special interest is their behavior in complexation and redox reactions as well as their electrical conductivity and the NLO (non-linear optical) properties. The complexation ability of oligonitriles was studied using palladium(II) as the metal counterpart. Oligonitriles are expected to serve as potent polydentate ligands since each imine nitrogen atom is a potential σ donor. Furthermore, the numerous C=N bonds may give rise to π complexation. High molecular flexibility due to low barriers of rotation around the C–N single bonds is expected to facilitate complexation.²³⁴

The tetraazaporphyrin (porphyrazine) macrocycle is a structural template for rigid organization of the metal centers, with the potential to mediate electron transfer or magnetic exchange between metal ions. Peripherally functionalized porphyrazines are prepared by the template cyclization of maleonitrile derivatives and have the form $M[pz(\mathbf{A}_n;\mathbf{B}_{4-n})]$, where **A** and **B** symbolize functional groups fused directly to the β -positions of the pyrroles, and **M** represents a metal ion coordinated in the macrocyclic core. The peripheral **A** moieties generally involve heteroatoms (S, N, O) appended to the porphyrazine ring and can be designed to bind an exocyclic metal ion. The **B** groups can be designed to:

- (i) optimize the yields;
- (ii) introduce novel electronic, optical, or redox properties; or
- (iii) to confer a desired solubility.

In octakis(dimethylamino)porphyrazine^{235,236} the peripheral $(NMe_2)_2$ moiety is analogous to the metal-binding chelates tetramethylethylenediamine (tmen) and tetramethyl-*o*-phenylenediamine (tmopda). This new ligand will coordinate $PdCl_2$. The chlorine ligands were substituted by dithiolato ligands and the first stable heteroleptic bis(amine)dithiolene palladium(II) complex was synthesized and structurally characterized.²³⁷ As a step toward the synthesis of metal-linked multiporphyrazine arrays, the bis(palladium)(btt)-bridged porphyrazine dimers were assembled (btt=1,2,4,5-tetra(benzylthio)benzene).²³⁷ The heteroleptic palladium(II) complexes with electron rich dithiolene ligands were unstable toward disproportionation.²³⁷

Present methods for the cyclization of peptides generally require a completely protected peptide precursor, which is cyclized in solution or at a solid phase by using a coupling agent, as well as a strongly activated acyl component. A facile, metal-mediated synthesis of 12-, 14-, 16-, and 18-membered cyclic tetrapeptides or macrolactams is possible from readily accessible nonactivated dipeptide ester precursors. The reaction of Pd^{II} salts with two equivalents of dipeptide ester in methanol in the presence of NaOMe as base results in dianionic complexes, which can be isolated by precipitation with suitable cations (see Figure 15).²³⁸

The crucial step is the same as that assumed for the oligomerization of peptides at metal centers,^{239–241} namely the nucleophilic attack of a coordinated terminal amino group on the carbonyl group of the neighboring *trans*-coordinated dipeptide ester.²³⁸ The cyclic tetrapeptide is bound to the metal through the four deprotonated amide nitrogen atoms. The palladium center and the N atoms lie in a plane.²³⁸ Tetrapeptide ester can be employed instead of two dipeptide esters (see Figure 16).²³⁸ This synthesis of cyclotetrapeptides requires neither a protecting group nor an activated group or a coupling reagent. It can be performed as a one-pot process. High dilution of the reaction mixture is also not necessary (see Figure 16).²³⁸

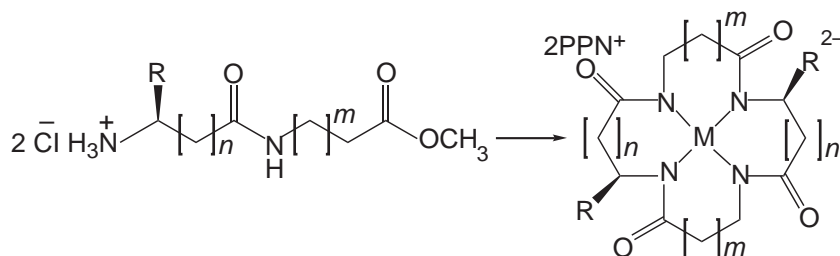

Figure 15 The reaction of Pd^{II} salts with two equivalents of dipeptide ester in methanol in the presence of NaOMe as base results in dianionic complexes, which can be isolated by precipitation with suitable cations.

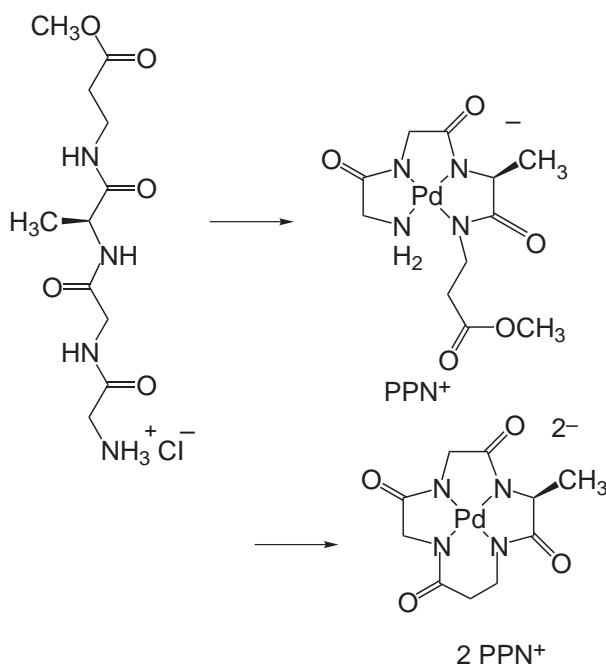

Figure 16 Synthesis of Pd^{II} cyclotetrapeptides.

6.4.6.4 Phosphorus

Several amphiphilic and water-soluble phosphine ligands have been reported with the aim of anchoring the metallic center to a surfactant molecule to obtain a microheterogeneous arrangement of the catalyst in the reaction media. A new water-soluble phosphine family with surfactant properties was synthesized; their complexing properties toward Pd^{II} and the aggregation properties of these ligands and their metallic complexes were studied.²⁴²

Calix[4]arenes possessing the P^{III} functionality are receiving considerable attention as the ligands of transition-metal complexes.²⁴³ Matt and co-workers reported the preparation of calix[4]arene propyl ether having *two* diphenylphosphino groups at distal positions.²⁴⁴ They studied its complexation with Pd^{II} and other transition metals to obtain the corresponding complexes with a *trans* configuration. A bis(diphenylphosphino)calix[4]arene ligand has the benzyl ether group²⁴⁵ at the lower rim, which fixes the cone conformation.²⁴⁵ Pt^{II} and Pd^{II} complexes bearing the bis(diphenylphosphino)calix[4]arene as a ligand involve *trans*-dinuclear and *cis*-mononuclear derivatives. Especially, the latter show unique fluxional behavior caused by two simultaneous motions.²⁴⁶

In-plane bis(dipolar) assemblies were synthesized by stereoselective coordination of P,N-chromophores on a *d*⁸-square-planar Pd-center.²⁴⁷ These are the first NLO-phores based on phosphole rings. *Trans*-effect offers a simple synthetic methodology for controlling the in-plane parallel arrangement of 1D-P,N-dipoles in a molecular assembly.

Phosphine ligands based on the ferrocene backbone are very efficient in many palladium-catalyzed reactions, e.g., cross-coupling reactions,²⁴⁸ Heck reaction,²⁴⁹ amination reaction,²⁵⁰ and enantioselective synthesis.²⁵¹ A particularly interesting example of an unusual coordination mode of the 1,1'-bis(diphenylphosphino)ferrocene (dppf) ligand has been reported. Dicationic palladium(II) complexes, such as [(dppf)Pd(PPh₃)]²⁺[BF₄⁻]₂, were shown to contain a palladium–iron bond.^{252,253} Palladium–iron bonds occur also in monocationic methyl and acylpalladium(II) complexes.²⁵⁴ A palladium–iron interaction is favored by bulky alkyl substituents on phosphorus and a lower electron density at palladium.

The first catalytic dihydroamination of a phosphalkyne was confirmed when the product diamminophosphine was formed, the complex *trans*-[PdCl₂{P(PrⁱNH)₂CH₂(Bu^t)₂}₂].²⁵⁵

Palladium complexes of inexpensive, easily synthesized bis(phosphinite) “PCP”-pincer ligands show good activity in the Suzuki coupling of deactivated and sterically hindered aryl bromides.²⁵⁶

The first heterodifunctional ligand derived from a tetradentate phosphine was made in a study concerning synthesis and characterization of *cis,trans,cis*-1,3-bis(diphenylphosphino)-2,4-bis(diphenylphosphinothioyl)cyclobutane and its complex with PdCl₂.²⁵⁷

Deprotonation of $[\text{Pd}(\text{dppe})(\text{Me})(\text{PH}_2\text{Mes}^*)][\text{BF}_4]$ ($\text{dppe} = \text{Ph}_2\text{PCH}_2\text{CH}_2\text{PPh}_2$, $\text{Mes}^* = 2,4,6\text{-}(\text{Bu}^t)_3\text{C}_6\text{H}_2$) gave $\text{Pd}(\text{dppe})(\text{Me})(\text{PHMes}^*)$, which underwent reductive elimination to give $\text{PH}(\text{Me})(\text{Mes}^*)$ and Pd^0 . Since this type of P—C bond-forming step is important in Pd-catalyzed cross-coupling reactions used for synthesis of tertiary phosphines, the authors have investigated its generality and mechanism. Several complexes $[\text{Pd}(\text{diphos})(\text{R})(\text{PR}'_2\text{H})]^+$ could be prepared by the reaction of $\text{Pd}(\text{diphos})(\text{R})(\text{X})$ ($\text{diphos} = \text{dppe}$ or dcpe ($\text{Cy}_2\text{PCH}_2\text{CH}_2\text{PCy}_2$, $\text{Cy} = \text{cyclo-C}_6\text{H}_{11}$); $\text{R} = \text{Me}$, Ph , Mes ($2,4,6\text{-Me}_3\text{C}_6\text{H}_2$); $\text{R}' = \text{Ph}$, Cy , Mes ; $\text{X} = \text{Cl}$, Br , I) with Ag^+ and secondary phosphines.²⁵⁸ However, attempts to extend these syntheses to complexes with diphosphines having different bite angles and/or steric bulk did not give analogous products.²⁵⁹

The susceptibility of phosphites to hydrolysis limits their application as ligands for homogeneous catalysis. The fused tricyclic monophosphites derived from calix[4]arenes^{260–262} form coordination complexes with palladium.²⁶³

Very little work has been devoted to cholesteryl-derived phosphines. The cholesteryl fragment offers many advantages in terms of chirality, liquid crystalline behavior, lipophilicity, optical and molecular recognition. Novel optically pure cholesteryl-phosphine ligands ($3\alpha\text{-PPh}_2\text{chol}$ and $3\beta\text{-PMe}_2\text{chol}$) have been synthesized and were shown to form stable and highly soluble Pd^{II} and Pt^{II} complexes; as revealed by an X-ray analysis, the $(\text{chol})\text{-P}\cdots\text{P}(\text{chol})$ fragment of the square planar $\text{trans-}[\text{PtI}_2(3\text{-}\beta\text{-PMe}_2\text{chol})_2]$ complex adopts a staggered arrangement (V-shape), see Figure 17.²⁶⁴

Cocrystals composed of two different neutral molecules are very rare and most can be classified as those which have two or more very similar molecules, often differing in a substituent on a ligand or by the presence of slightly different ligand such as replacement of one halide for another. The reaction of $[\text{Pd}(\text{cod})\text{Cl}_2]$ ($\text{cod} = \text{cycloocta-1,5-diene}$) with *rac*-diphenyl[2.2]paracyclophanylphosphine $\text{PPh}_2(\text{C}_{16}\text{H}_{15})$ affords $\text{trans-}[\text{Pd}\{\text{PPh}_2(\text{C}_{16}\text{H}_{15})\}_2\text{Cl}_2]$ and $[\text{Pd}\{\text{PPh}_2(\text{C}_{16}\text{H}_{15})\}_2\text{Cl}_2]_2$ in approximately equal yield which cocrystallize to form an unusual solid-state material.²⁶⁵ The crystal is composed of alternating layers of the two complexes intercalated with dichloromethane solvent molecules (see Figure 18).²⁶⁵

The transformation of carbon dioxide into useful chemical derivatives is an attractive goal in chemistry. Electroreduction of $\text{Pd}_2(\text{dppm})_2\text{Cl}_2$ and $\text{Pd}(\text{dppm})\text{Cl}_2$ ($\text{dppm} = \text{bis}(\text{diphenylphosphino})\text{-methane}$) in an aprotic medium under carbon dioxide produces $\text{Pd}_3(\mu_3\text{-CO})(\mu\text{-dppm})_3$.²⁶⁶

6.4.5.5 Oxygen

Cationic palladium(II) complexes are homogeneous catalysts for both intramolecular and intermolecular hydroamination reactions.²⁶⁷ Palladium species immobilized on silica can be prepared by the simple addition of alkyl- or hydroxopalladium(II) complexes to partially dehydroxylated silica. The silica-bound species are more stable than their molecular precursors and are efficient catalysts for the cyclization of aminoalkynes.²⁶⁸

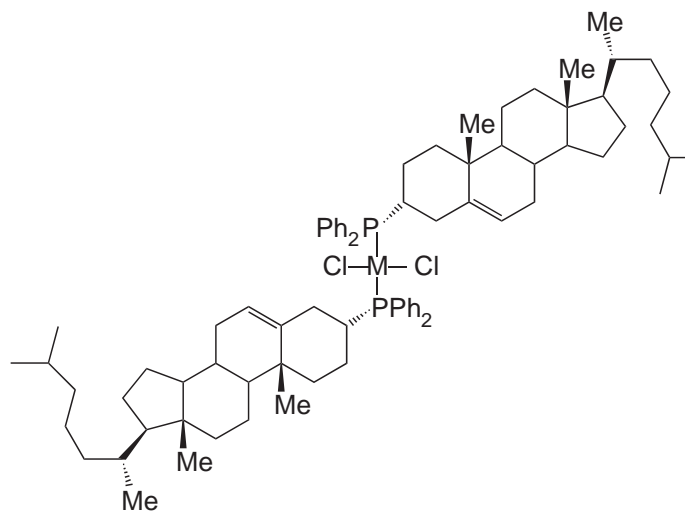

Figure 17 The $(\text{chol})\text{-P}\cdots\text{P}(\text{chol})$ fragment of the square planar $\text{trans-}[\text{PtI}_2(3\text{-}\beta\text{-PMe}_2\text{chol})_2]$ complex adopts a staggered arrangement (V-shape).

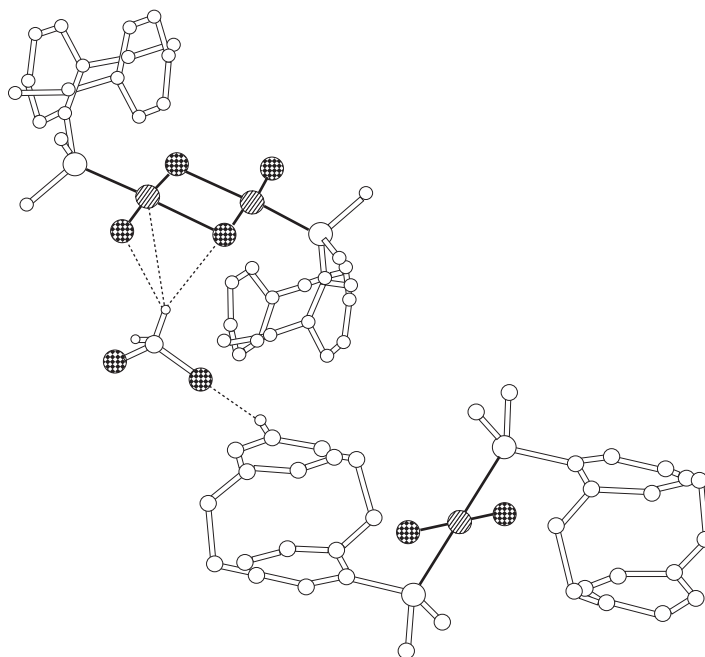

Figure 18 *trans*-[Pd{PPh₂(C₁₆H₁₅)₂Cl₂] and [Pd{PPh₂(C₁₆H₁₅)Cl₂]₂.

The majority of reported palladium hydroxo complexes are formed by the reaction of hydroxide with a metal–halide species by a simple metathesis reaction.²⁶⁹ Direct observation of protonation of a hydrocarbyl ligand (M–R) on a *d*⁸ square planar metal by water to form R–H and a M–OH species is extremely rare.^{270–274} However, this type of protonation reaction with water has been proposed as the product release step in catalytic reactions that involve *d*⁸ square planar hydroxo complexes.^{275,276} Preparation of a new potentially tridentate ligand, *o,o'*-Ph₂PC₆H₄C=NCH₂C₆H₄Br (PNC–Br), and a Pd^{II}–Br complex, (PNC)PdBr, of this new ligand were reported. Abstraction of a bromide ion from the complex with AgBF₄ in the presence of H₂O leads to protonation of the benzyl group of the PNC ligand, resulting in formation of a palladium bis- μ -hydroxo dimer, [(PN)Pd(μ -OH)]₂[BF₄]₂.²⁷⁷

Dehydrative condensation of transition metal hydroxo complexes is a versatile synthetic method, when the conjugated acid of the incoming ligand (H–A) is a protic compound. There are reports of the synthesis of two types of square-planar hydroxopalladium complexes, mononuclear [Tp^{iPr2,X}(L)Pd–OH] (X = H, Br) and dinuclear complexes [Tp^{iPr2}Pd(H₂O)(μ -OH)]₂(H₂O)PdTp^{iPr2}] (Tp^{iPr2} = hydrotris(3,5-diisopropylpyrazolyl)borate), and some dehydrative condensations of them.²⁷⁸

Gas-phase photolysis of metal-containing molecules readily causes photofragmentation to produce metal atoms and ions. More recently it has been shown by luminescence spectroscopy that photolysis of these molecules also readily produces diatomic metal-containing molecules in the gas phase. These discoveries have assisted in the elucidation of the photolytic decomposition pathways relevant to laser-assisted chemical vapor deposition (LCVD). Both desired fragments and undesirable fragments containing heteroatoms that contaminate the final films have been identified. The fluorinated acetylacetonate ligands (1,1,1,5,5,5-hexafluoro-2,4-pentanedionate = hfac) that were used in the latter studies provide good precursor volatility and allow for facile transport in the gas phase, but they may also result in fluorine and/or carbon contamination of the final deposit. The formation of diatomic metal fluorides can be easily eliminated by removing the fluorine substituents from the precursor, but the carbon that leads to metal carbide molecules cannot be so easily eliminated. Studies of the gas-phase photolysis of Pd(hfac)₂, showed that PdC⁺ is a common photoproduct over a wide range of irradiation wavelengths, but that the ratio of Pd⁺ to PdC⁺ is very sensitive to the wavelength. Changing the wavelength by a few angstroms can cause the formation of PdC⁺ to decrease below the detection limit. The photoproducts are monitored by using time-of-flight mass spectroscopy.²⁷⁹ The energy level diagram (Figure 19) illustrates the photochemical events leading to Pd⁺ and PdC⁺ formation.²⁷⁹ These types of wavelength dependence studies of chemical vapor deposition precursors are leading to a

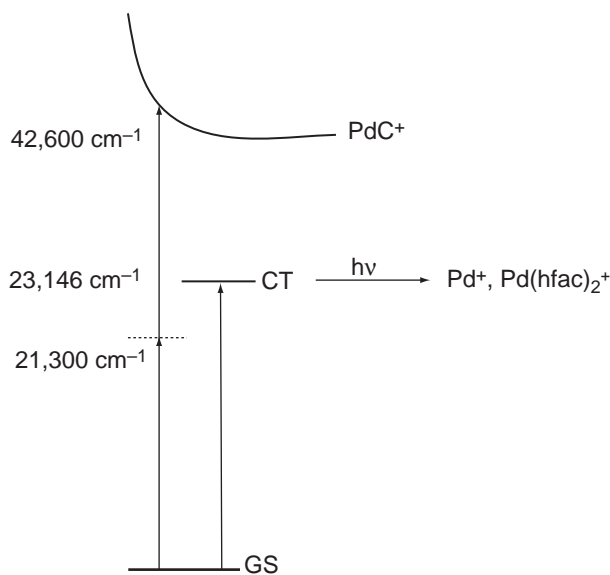

Figure 19 Energy level diagram illustrating the photochemical events leading to Pd^+ and PdC^+ formation.

fuller understanding of the gas-phase photochemical components of the LCVD process and may be helpful toward designing strategies for obtaining higher quality thin films.²⁷⁹

The coordination and catalytic chemistry of 1,1'-bis(diphenylphosphino) ferrocene (dppf) has been reviewed.^{280,281} It can be readily oxidized to its mono- and di-oxide (dppfO₂) forms. Interest in Pd^{II} -dppf chemistry stems from the rich catalytic activities shown by many dppf complexes of Pd^{II} .²⁸²⁻²⁸⁶ Some of these complexes are susceptible to oxidation in solution and the decomposition product is generally assumed to be chiefly free dppfO₂.²⁸⁷ There is a report of the isolation of a simple Pd^{II} -dppfO₂ complex with a rare mononuclear tetrahedral Pd^{II} center which, to our knowledge, has not previously been reported in the literature.²⁸⁸ It is well known that d^8 platinum metals overwhelmingly favour square planar structures and only Ni^{II} forms a significant number of tetrahedral complexes. The magnetic moment ($2.48 \mu_{\text{B}}$) is lower than that of a typical Ni^{II} tetrahedral complex (ca. $3.2 \mu_{\text{B}}$) but still consistent with paramagnetic Pd^{II} with two unpaired electrons. The cyclic voltammogram shows a reversible one-electron couple.²⁸⁸ Crystallographic analysis confirmed a mononuclear neutral complex with a chelating dppfO₂ and two terminal chlorides (see Figure 20). The near-ideal tetrahedral geometry at the Pd^{II} center is exemplified by the large intra- and inter-ligand angles (O1—Pd1—O2, Cl1—Pd1—Cl2 and O—Pd—Cl angles of $104.3(3)^\circ$, $120.4(2)^\circ$, and 107.8° (av.), respectively).²⁸⁸

Reaction control with transition metal catalysis is largely underdeveloped in the carbohydrate field. One of the most important reasons for the limited use of metal catalysis is the lack of knowledge of the bonding mode of carbohydrates towards transition metal ions. An aqueous solution of *cis*-[Pd(en)(OH)₂] is a versatile agent for the analysis of carbohydrate-metal interactions in alkaline aqueous media. In the presence of carbohydrate-based 1,2- and 1,3-diol groups, the hydroxo ligands of *cis*-[Pd(en)(OH)₂], are replaced by a dianionic diolato ligand. The ligating alkoxo O atoms are acceptors in hydrogen bonds, which are established as intramolecular bonds whenever possible. Pd-en is a coordinating solvent for polysaccharides, including cellulose, which is molecularly dispersed to give entirely metallated single strands.²⁸⁹

A columnar mesophase consisting of chiral molecules tilted with respect to the column axis can be ferroelectrically switched. The possibility of achieving ferroelectric switching in a columnar liquid crystal comes from the appearance of a macroscopic polarization perpendicular to the column axis. Ferroelectric columnar metallomesogens can be designed by taking advantage of the possibility of obtaining disklike molecules by means of metal complexation, for metal bis(1,3-diphenyl-1,3-propanedionates) bearing 10 peripheral tails.²⁹⁰ Two pentasubstituted 1,3-diphenylpropanedione ligands can be complexed to palladium(II), thus giving rise to a disklike core surrounded by 10 chiral tails derived from L-(−)-lactic acid. A combination of different characterization techniques—optical microscopy, differential scanning calorimetry, X-ray diffraction, circular dichroism, and dielectric spectroscopy—has allowed a rigorous analysis of the mesophase

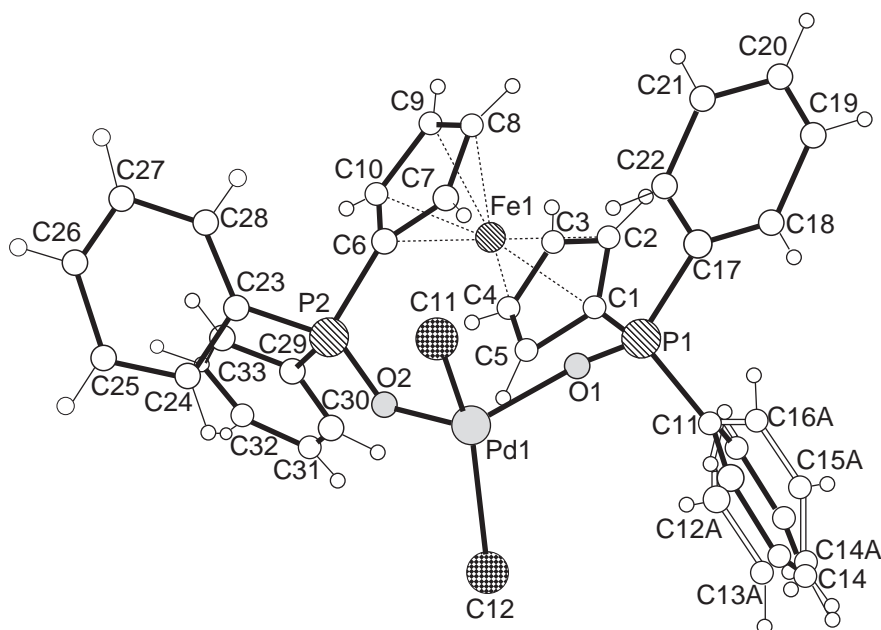

Figure 20 A mononuclear tetrahedral complex with a chelating dppfO2 and two terminal chlorides.

structure and the switching process of these compounds.²⁹⁰ A single mesophase is stable at room temperature. The mesophase has been identified as rectangular columnar by X-ray diffraction. Circular dichroism has demonstrated the existence of helical order within the column. By application of an alternating electric field, an electrooptic effect was observed. The response of the material to the field is in accordance with a strong tilting of the molecules with respect to the column axis.²⁹⁰

6.4.5.6 Sulfur

Hydrosulfido palladium complexes are rare. Only some terminal hydrosulfido compounds of the type $[\text{PdL}_2(\text{SH})_2]$ ($\text{L}_2 = 2 \text{ PPh}_3$, 2 PEt_3 , 2 PBu^i_3 , or diphos) (diphos = [1,2 bis(diphenylphosphino)ethane]),^{291–293} have been reported and no examples of bridging hydrosulfido ligands on palladium were known until recently. The μ -hydroxo complexes of palladium are excellent precursors in synthetic work.^{294–296} Their reactions with H_2S gas gives the first bridging hydrosulfido palladium complexes. The mononuclear hydrosulfido complexes $[\text{Pd}(\text{C}_6\text{F}_5)_2(\text{SH})(\text{PPh}_3)]^-$ prepared from the corresponding dimers by addition of PPh_3 in the molar ratio 1:2, can be used as metalloligands toward $\text{M}'(\text{PPh}_3)^+$ ($\text{M}' = \text{Ag}$ or Au), yielding heterobinuclear or heterotruclear complexes.²⁹⁷

Potentially coordinatively unsaturated dithiolene-metal complexes are rare,^{298–306} and 1:1 dithiolene-transition-metal complexes with no other ligands are, to our knowledge, unprecedented.³⁰⁷ The neutral complex $[\text{PdS}_2\text{C}_2(\text{COOMe})_2]_6$,³⁰⁸ is homoleptic containing one dithiolene unit for each palladium atom and no other ligands. Electrochemical reduction of the compound depicted in Figure 21 proceeds in four reversible steps.

As nucleobases can bind metal ions, base-pairing interactions can be used directly in their complexes. For the adenine–thymine (AT) pair, there are numerous possibilities for interactions which involve two hydrogen bonds. The thermodynamically favored arrangement is the Hoogsteen AT pattern, which involves A–N7. However, since this is also the preferred site for metal-ion binding, this pairing mode is often unavailable. The dithioether, shown in Figure 22, reacts with Pd^{II} to give cationic A–N3-bonded complex.³⁰⁹ The dithioether group and the A–N3 site coordinate to the metal ion. The molecular structure of the complex cation is presented in Figure 23. There is Hoogsteen base pairing between complex cations. Infinite base-paired chains are formed by translational symmetry. The crystal symmetry produces antiparallel alignment of neighboring chains. Further interactions between the nucleobases involve dimers of stacked AT

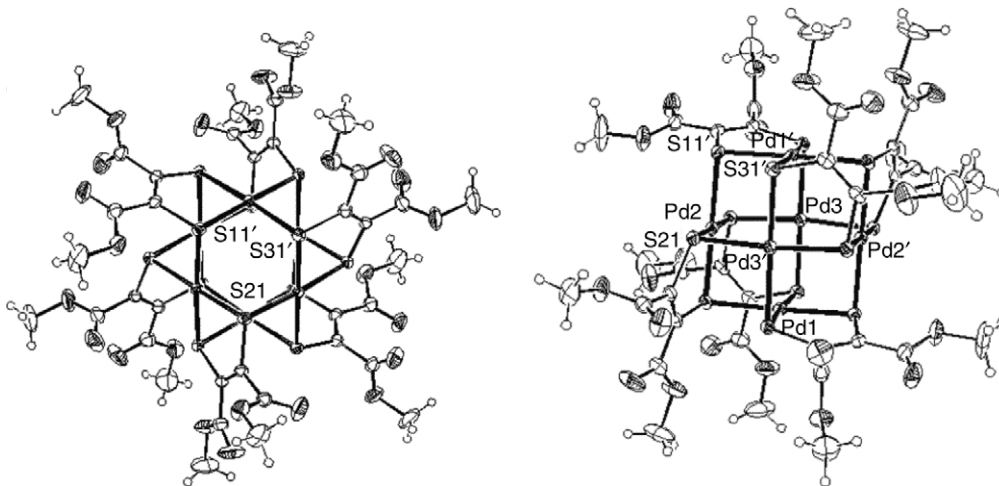

Figure 21 The neutral complex containing one dithiolene unit for each palladium atom and no other ligands.

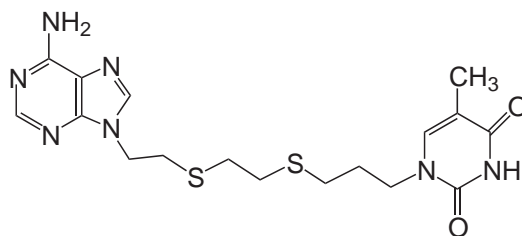

Figure 22 The dithioether that reacts with Pd^{II} to give cationic A-N3-bonded complex in Figure 23.

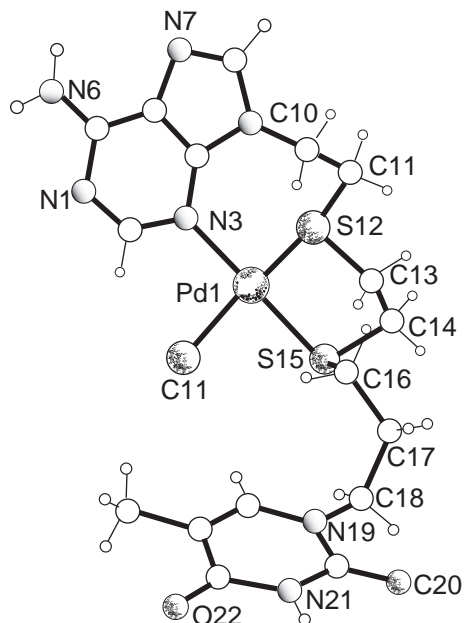

Figure 23 Molecular structure of the complex cation containing adenine and thymine.

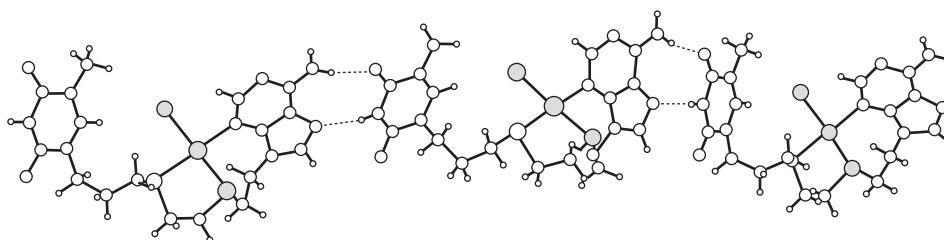

Figure 24 Interactions between the nucleobases involve dimers of stacked AT pairs that are slipped so as to form ATTA sequence.

pairs that are slipped so as to form ATTA sequence runs with typical separations for π - π stacking, as depicted in Figure 24. Evidently, controlling the metal ion nucleobase binding pattern by using a chelating group enables the synthesis of base-pairing complexes that assemble in a predictable arrangement.

Early/late heterobimetallics can be prepared from so-called metalloligands, in which a bifunctional ligand is coordinated to a transition metal. In a second step, a second transition metal is introduced. When the zirconocene metalloligand was treated with $[\text{PdCl}_2(\text{P}^n\text{Bu}_3)_2]$, the octanuclear $\text{Zr}^{\text{IV}}-\text{Pd}^{\text{II}}$ complex was formed unexpectedly, albeit in low yield (see Figure 25).³¹⁰ There is no Pd-Pd interaction [Pd1...Pd2 3.141(1) Å]. The cavity of the central 20-membered ring (Zr1—Pd1—Zr1a—Pd1a) is filled by the *n*-butyl groups of the phosphine ligands. Additionally, two 10-membered rings are formed by Zr_2 , Pd_2 , and the monodentate sulfidoacetato ligands. The formation of this unprecedented large ring-like molecule is apparently preferred over the formation of simple heterodinuclear complexes.

Palladium dimethylsilanedithiolato complex is a precursor for Ti-Pd and Ti-Pd₂ heterometallic complexes.³¹¹ The bis-silyl sulfides $(\text{R}_3\text{Si})_2\text{S}$ have been widely used to prepare a variety of metal sulfide clusters, because these reagents exploit the strength of the Si-O and Si-Cl bond to

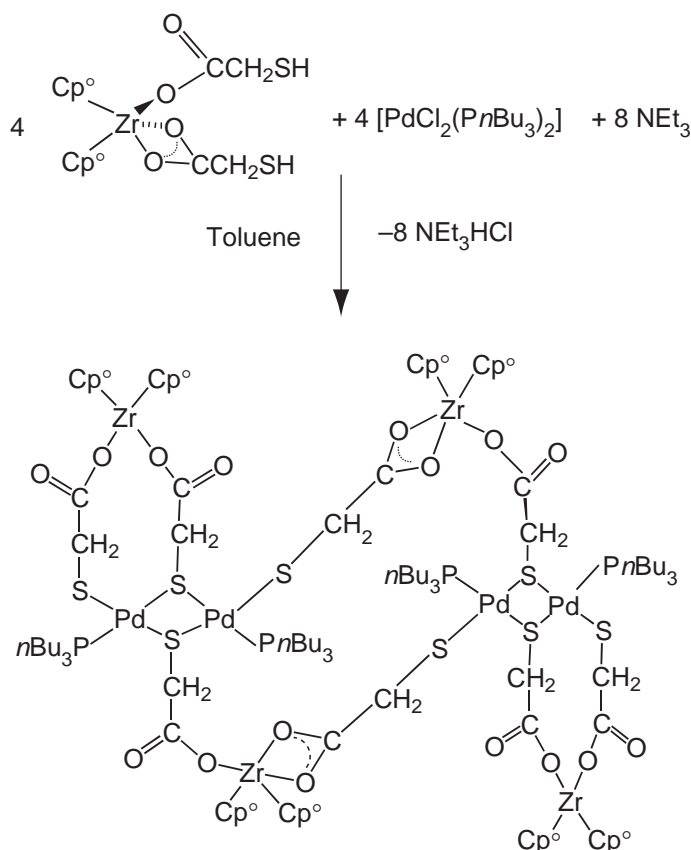

Figure 25 Formation of an octanuclear $\text{Zr}^{\text{IV}}-\text{Pd}^{\text{II}}$ complex.

replace a halide, alkoxide, acetate, or oxide with a sulfido ligand under very mild and controlled conditions. Therefore, a metal–silanethiolato complex (e.g., $M\text{—SSiR}_3$) would be expected to serve as a synthetic precursor for homo- and hetero-metallic sulfido clusters.^{312,313} The synthesis of a palladium dimethylsilanedithiolato complex and its cluster forming reactions with $(\text{C}_5\text{H}_5)\text{TiCl}_3$ and $\text{TiCl}_4(\text{THF})_2$ are shown in Figure 26.³¹¹

The formation of mesogenic materials from functionalized macrocyclic ligands is the subject of considerable current interest. On complexation to Pd^{II} , the macrocyclic ring becomes conformationally locked and acts as a rigid spacer which couples the terminal mesogenic groups together.³¹⁴ This demonstrated the ability of a metal ion to induce mesomorphism (liquid crystallinity) in non-mesomorphic ligands, and thus to define a sensing function for the ligands.

Pelletier and Reber³¹⁵ present new luminescence and low-energy excitation spectra of $\text{Pd}(\text{SCN})_4^{2-}$ in three different crystalline environments, $\text{K}_2\text{Pd}(\text{SCN})_4$, $[\text{K}(18\text{-crown-6})]_2\text{Pd}(\text{SCN})_4$, and $(2\text{-diethylammonium } N\text{-(2,6-dimethylphenyl)acetamide})_2\text{Pd}(\text{SCN})_4$, and analyze the vibronic structure of the luminescence spectra, their intensities, and lifetimes as a function of temperature. The spectroscopic results are compared to the HOMO and LUMO orbitals obtained from density functional calculations to qualitatively illustrate the importance of the bending modes in the vibronic structure of the luminescence spectra.

The best known dithiolenes are those derived from the dmit ligand ($\text{dmit} = \text{C}_3\text{S}_5^{2-}$, 1,3-dithiole-2-thione-4,5-dithiolate) with d^8 transition-metal ions^{316–325} because of their interesting electrical conduction properties. At present, several superconductors deriving from the dmit ligand, such as $\alpha\text{-TTF}[\text{Pd}(\text{dmit})_2]$,³²⁶ (TTF = tetrathiafulvalene) are known. Some neutral $[\text{Ni}(\text{S}_2\text{C}_2\text{R}, \text{R}')_2]$ dithiolenes could be used as Q-switching dyes for NIR-lasers because of their high photochemical stability and intense vis-NIR absorption.³²⁷ This absorption, attributed to a $\pi\text{—}\pi^*$ electronic transition between the HOMO and the LUMO, occurs at energy values depending on the nature of the R and R' substituents. For the simplest dithiolenes ($\text{R} = \text{R}' = \text{H}$, often reported as “parent dithiolenes”) this absorption was observed at 785 nm for $[\text{Pd}(\text{S}_2\text{C}_2\text{H}_2)_2]$.³²⁸ The more recently reported $[\text{Pd}(\text{Et}_2\text{timdt})_2]$ ³²⁹ shows the NIR absorption band at 1010 nm with a molar extinction coefficient of $70,000 \text{ M}^{-1} \text{ cm}^{-1}$. The wavelength and the high intensity of the NIR absorption band also propose this new class of dithiolenes as candidates for Q-switching the Nd:YAG laser (excitation wavelength 1,064 nm). To obtain dithiolenes characterized by the NIR absorption as close as possible to the excitation wavelength of the Nd:YAG laser, the authors have systematically varied either the central metal or the substituents R and R' in the $[\text{M}(\text{R}, \text{R}'\text{timdt})_2]$ dithiolenes unit. Therefore, dithiolenes with $\text{M} = \text{Pd}$ have been synthesized (see Scheme 4).³³⁰

The interaction of palladium(II) complexes with sulfur-containing peptides was studied by electrospray mass spectrometry.³³¹

Ferrocene compounds containing heteroelements are versatile building blocks for polynuclear complexes. They possess electrochemically active iron centers as well as unique cylindrical shapes. An example of ferrocene-substituted thiolato ligands is 1,1'-ferrocenedithiolate (S_2fc). Its complex with Pd(II) lacks a Pd–Fe bond.

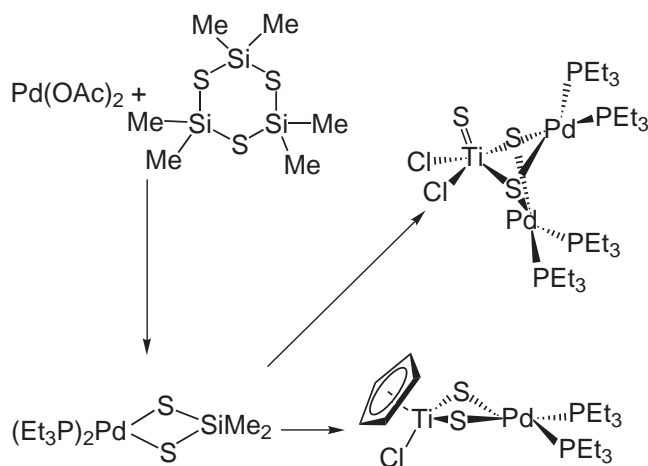
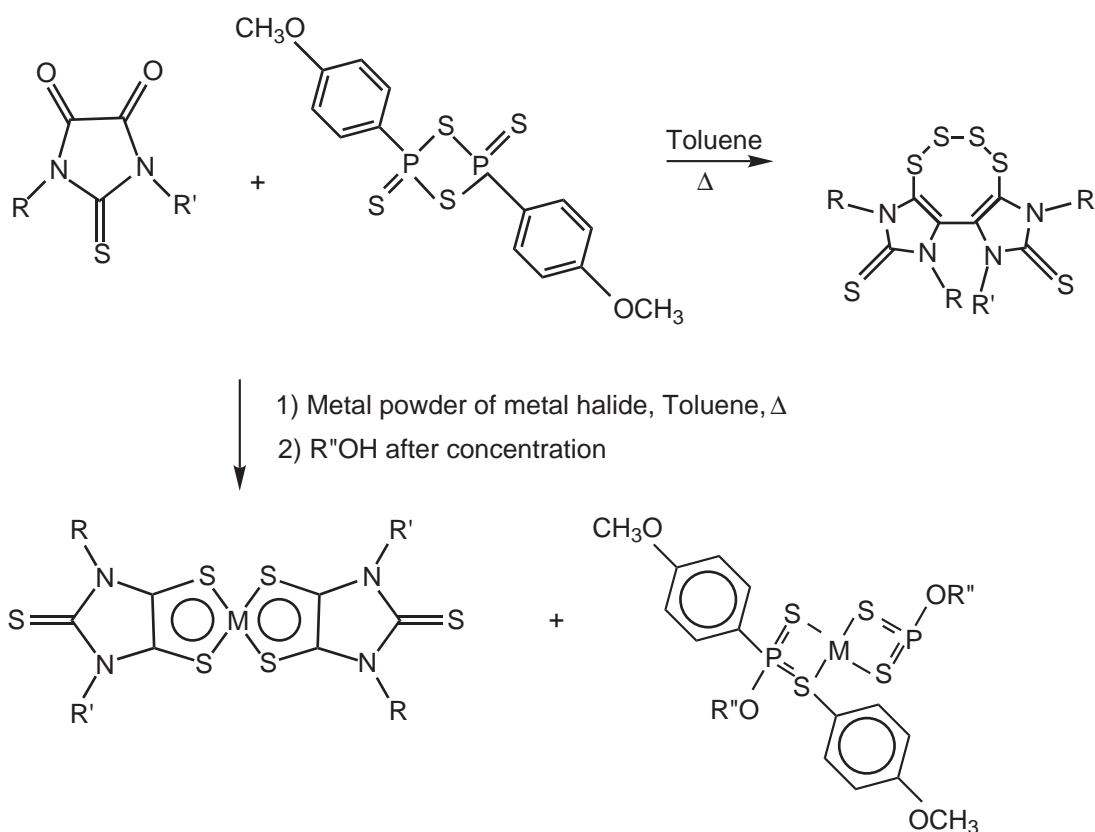

Figure 26 Synthesis of a palladium dimethylsilanedithiolato complex and its cluster forming reactions with $(\text{C}_5\text{H}_5)\text{TiCl}_3$ and $\text{TiCl}_4(\text{THF})_2$.



Scheme 4

Metal dithiolenes can exist in well defined oxidation states. The intense vis-NIR absorption is assigned to a $\pi \rightarrow \pi^*$ transition between HOMO and LUMO and depends on the nature of the substituents R¹ on the carbon atoms of the $[\text{S}_2\text{C}_2\text{R}^1_2]^{2-}$ moiety. Accepting substituents shift this absorption to lower energies. The aim is to prepare complexes of this class having the NIR absorption as close as possible to the Nd-YAG laser excitation energy. The first Pd complex belonging to this new class of dithiolenes, $[\text{Pd}(\text{Et}_2\text{timdt})_2]$, is fully characterized.³²⁹ In order to obtain mixed-valence compounds which might have interesting conducting properties, the authors treated it with diiodine in several molar ratios.³²⁹

6.4.5.7 Selenium and Tellurium

The preparation of transition metal complexes with organoselenide and -telluride ligands characteristically involves the oxidative addition of the organochalcogen compounds to low-valent transition metal centers most often resulting in the cleavage of the chalcogen-chalcogen bond and the formation of mono- or dinuclear complexes with anionic bridging or terminal RE^- (E = Se, Te) ligands, as shown in Figure 27.

It has, however, also been reported that the reaction of aryl ditellurides with Ni^0 , Pd^0 , and Pt^0 may result in the cleavage of the carbon-chalcogen bond.³³²⁻³³⁵ The oxidative addition of organochalcogen compounds to low-valent transition metal centers is considered a key step in homogeneous catalysis.³³⁶ Complex $[\text{Pd}_2(\text{SePh})_4(\text{PPh}_3)_2]$ forms from Ph_2Se_2 and $[\text{Pd}(\text{PPh}_3)_4]$ in benzene.³³⁷ Analogous dinuclear complexes in which two bridging RE^- (E = S, Se) ligands link two palladium centers together are exemplified by $[\text{Pd}_2(\text{C}_3\text{H}_5)_2\{\text{Ph}_2\text{P}(\text{O})\text{NP}(\text{Se})\text{Ph}_2\text{Se}\}_2] \cdot 2\text{CHCl}_3$,³³⁸ $[\text{Pd}_2\{\text{Se}_2\text{C}_8\text{H}_{12}\}_2(\text{PPh}_3)_2]$,³³⁹ and $[\text{Pd}_2\text{Cl}_2(\text{SeMe})_2\{\text{SeMe}(\text{C}_4\text{H}_2\text{O})\}_2\text{CMe}_2]$.³⁴⁰ The oxidative addition of bis(thienyl) diselenide to $[\text{Pd}(\text{PPh}_3)_4]$ results in the cleavage of the Se-Se bond. The main products in the reaction of $[\text{Pd}(\text{PPh}_3)_4]$ and Th_2Se_2 are dinuclear *cis*- and *trans*- $[\text{Pd}_2(\text{SeTh})_4(\text{PPh}_3)_2]$, which could be identified by ³¹P- and ⁷⁷Se-NMR spectroscopy.

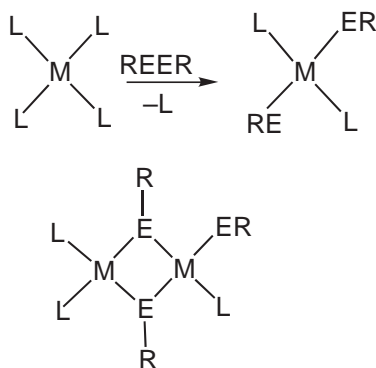

Figure 27 Oxidative addition of the organochalcogen compounds to low-valent transition metal centers most often resulting in the cleavage of the chalcogen–chalcogen bond and the formation of mono- or dinuclear complexes with anionic bridging or terminal RE^- ($E = Se, Te$) ligands.

Recrystallization afforded *trans*- $[Pd_2(SeTh)_4(PPh_3)_2]$, which could be characterized by X-ray crystallography. When the reaction is carried out in dichloromethane, a small amount of $[PdCl(Th)(PPh_3)_2]$ is formed. This implies that the solvent plays an active role in the reaction and that the cleavage of a C–Se bond may also occur during the oxidative addition.³⁴¹ The different behavior of analogous palladium and platinum complexes has been noted for the reactions of $[MCl_2(PhCN)_2]$ ($M = Pd, Pt$) with cyclohepteno-1,4-diselenin.^{339,342} The reaction with $[PdCl_2(PhCN)_2]$ is a simple ligand substitution reaction whereas with $[PtCl_2(PhCN)_2]$ an oxidative addition of a C–Se bond to a Pt^{II} center takes place with the formation of a dinuclear platinum(IV) complex.³⁴¹ The oxidative addition reactions involving aromatic ditellurides are significantly more complicated than those involving diselenides. They also depend on the choice of the aromatic substituent, and are sensitive to the choice of the solvent.³⁴¹

The complex bis(tetraphenylphosphonium)[bis(1,2-diselenosquarato)palladate(II)], $(Ph_4P)_2[Pd(dssq)_2]$, is the first coordination compound of the new ligand 1,2-diselenosquarate.³⁴³

6.4.5.8 Halogens

Neutral palladium(II) complexes containing carboxylic acid groups can give supramolecular structures through intermolecular hydrogen bonding, but in cationic complexes the desired hydrogen bonding between carboxylic acid groups did not occur because H-bonding of the carboxylic acid groups to the anions or to solvent molecules was generally preferred.^{344,345} Amides form stronger hydrogen bonds. Both neutral and cationic palladium(II) complexes containing carboxamide groups are readily prepared, and they self-assemble to form interesting supramolecular arrays. The neutral complex *trans*- $[PdCl_2(NC_5H_4-3-CONHMe)_2]$ forms an infinite two-dimensional sheet structure in the solid state. The sheets are further connected by weaker $Pd \cdots Cl$ bonds and $O \cdots H-O$ hydrogen bonds to form a three-dimensional network.³⁴⁶

For halide ligands, a coordination number of four (μ_4-X) is rare. Self-assembly of d^8 metal centers and halides around a pyramidal halide gives tetrapalladium complexes. In this unprecedented case the metallamacrocycle owes its formation to the halide acting as a template.³⁴⁷ The complexes $(PPN)[Pd_4(Fmes)_4]$ ($Fmes = 2,4,6$ -tris(trisfluoromethyl)phenyl) display fluxional behavior in solution in noncoordinating solvents.³⁴⁷

Only eight transition-metal species containing a terminal FHF (FHF = Fluorine-Hydrogen-Fluorine) ligand have been described in the literature. Of those, only six have been isolated in pure form and only four have been structurally characterized. A palladium bifluoride complex, $[(Ph_3P)_2Pd(Ph)(FHF)]$, has been studied by X-ray diffraction, IR, and VT (variable temperature), 1H -, ^{19}F -, and ^{31}P -NMR spectroscopy, and ^{19}F -NMR magnetization transfer.³⁴⁹ The Pd bifluoride is fluxional in solution at room temperature due to F/F interchange. When the latter is frozen at $-60^\circ C$, the structure in solution is similar to the solid-state X-ray structure. Although all structural and spectroscopic data point to $MF \cdots HF$ rather than $M \cdots FHF$ character, ^{19}F -NMR magnetization transfer experiments have demonstrated a minor contribution of HF dissociation to the exchange. The main process that governs F/F exchange is intramolecular ($\Delta H^\ddagger = 33.7 \pm 2.1 \text{ kJ mol}^{-1}$; $\Delta S^\ddagger = -56.1 \pm 9.6 \text{ J mol}^{-1} \text{ K}^{-1}$), which is proposed to occur via the

pentacoordinate intermediate $[(\text{Ph}_3\text{P})_2\text{Pd}(\text{Ph})(\eta^2\text{-FHF})]$. DFT calculations for two model Pd bifluoride complexes $[(\text{R}_3\text{P})_2\text{Pd}(\text{Me})(\text{FHF})]$ ($\text{R} = \text{H}, \text{Me}$) indicate virtually unrestricted rotation around the Pd-FHF bond.³⁴⁹

One way to investigate the effect of halide ions on the structure and reactivity of palladium(0) complexes in oxidative addition with aryl halides^{350–353} was to generate them by electrochemical reduction of $\text{PdX}_2(\text{PPh}_3)_2$ in the presence of various amounts of halides X^- ($\text{X} = \text{Cl},$ ^{350,351} $\text{Br},$ ³⁵¹ I ³⁵¹) in THF. Reinvestigation of this reaction led the authors to reject their first tentative hypothesis and to establish that reactions of halides X^- with $\text{PdX}_2(\text{PPh}_3)_2$ result in substitution of one phosphane ligand with formation of an anionic $\text{PdX}_3(\text{PPh}_3)^-$ species; this palladium(II) complex is more difficult to reduce. In other words, the two peaks represent the reduction of two different palladium(II) complexes. Halide ions can substitute a phosphane ligand in $\text{PdX}_2(\text{PPh}_3)_2$ complexes to afford anionic species $\text{PdX}_3(\text{PPh}_3)^-$ by an equilibrium. The phosphane substitution is easier for chloride ions which reveals the higher nucleophilic affinity of Cl^- for the palladium(II) center than that of Br^- or I^- . This can be understood as an interaction between “hard” Lewis acids and bases.³⁵⁴ Conversely, we have reported that the affinity of Cl^- for palladium(0) centers is less than that of Br^- or I^- which can be rationalized as an interaction between “soft” centers.³⁵¹ Those results are evidence of the ability of halide ions to coordinate both palladium(0) and palladium(II) complexes. The ligation of palladium(0) complexes by halide^{351–353} or acetate ions^{353,355} affects the mechanism of palladium-catalyzed reactions. Although palladium(II) dihalide complexes are less involved as promoters of catalytic reactions than palladium(0) complexes, arylpalladium(II) halide complexes are postulated to be crucial intermediates in palladium(0) catalyzed reactions involving aryl halides. Reactions of halide ions X'^- with $\text{ArPdX}(\text{PPh}_3)_2$ complexes do not result in a substitution of one phosphane ligand but rather substitution of the halide X^- to form neutral $\text{ArPdX}'(\text{PPh}_3)_2$ complexes.³⁵⁶ In fact, $\text{ArPdX}(\text{PPh}_3)_2$ complexes are not reactive intermediates in cross-coupling^{351,353} or Heck^{353,355} reactions, and the effect of chloride or acetate anions on the course of these reactions is to produce new anionic or neutral complexes such as $\text{ArPdX}(\text{Cl})(\text{PPh}_3)_2^-$, $\text{ArPdX}(\text{OAc})(\text{PPh}_3)_2^-$, $\text{ArPd}(\text{OAc})(\text{PPh}_3)_2$, where the two phosphane ligands remain attached to the palladium(II) center.³⁵⁴

6.4.5.9 Hydrogen

Rate constants for H_2 activation vary with Pd_n cluster size.³⁵⁷ This is in accord with theoretical studies, which have predicted that the minimum-energy structure is a side-bonded atom-molecule complex,^{7,358–364} but that Pd_2 can form a stable ring $(\text{PdH})_2$ species with no H—H bond.^{13,14} Evidence for naked metal- H_2 complexes in a krypton and xenon matrix study with Pd was interpreted in terms of both end- and side-bonded complexes;^{362,365} however, theoretical investigations find a stable minimum only for the side-bonded structure. The complete infrared spectrum of $\text{Pd}(\text{H}_2)$ in solid argon, is in very good agreement with the density functional theory (DFT) calculated vibrational spectrum. The novel bis- and tris- H_2 complexes, the related $\text{Pd-Pd}(\text{H}_2)$ complex, and the stable $(\text{PdH})_2$ reaction product containing dissociated dihydrogen are identified.³⁶⁶

Many palladium-catalyzed reactions are initiated by the reaction of a palladium(0) complex with an acidic derivative.³⁶⁷ The catalytic cycle is considered to be induced by a hydridopalladium complex. When the acidic derivatives are strong acids (e.g., HBF_4 , HCl , $\text{CF}_3\text{CO}_2\text{H}$, HOTs), the hydridopalladium formation may be regarded as the protonation of basic Pd^0 to afford complexes HPdL_3 ^{+368–374} or HPdL_2S^+ ,³⁷⁵ in which $\text{S} = \text{solvent}$ (see Equation (1)):

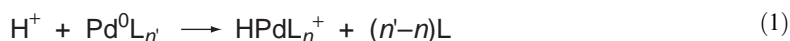

The palladium may then be considered as either Pd^0 ligated by a proton or as Pd^{II} ligated by a hydride,³⁷⁶ albeit that the very negative shift of the $^1\text{H-NMR}$ signal is more indicative of a hydride linked to a palladium(II) center. This is why this reaction is also considered as an oxidative addition.³⁷⁶ When weak carboxylic acids are involved (e.g., acetic acid, formic acid), the reaction is regarded as an oxidative addition, i.e., insertion of palladium(0) into the H—X bond (see Equation (2)):^{367,376}

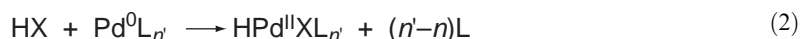

It is not clear whether the X anion remains ligated to the palladium(II) center. For example, for acetic acid, the palladium hydride was initially postulated as being $\text{HPd}(\text{OAc})\text{L}_n$,^{377,378} but more recently as HPdL_n^+ .³⁶⁷ To date, none of these complexes has been characterized.³⁶⁷ Oxidative addition of acetic acid or formic acid to a palladium(0) complex in DMF affords a cationic palladium hydride *trans*- $\text{HPd}(\text{PPh}_3)_2(\text{DMF})^+$, with an acetate or a formate counter-anion. Both reactions are reversible and involve an unfavorable equilibrium so that a large excess of acid is required for the quantitative formation of the palladium hydride complex.³⁷⁹ This allows us to conclude that the catalytic reactions initiated by reaction of palladium(0) and acetic acid (or formic acid) proceed via a cationic palladium hydride *trans*- $\text{HPd}(\text{PPh}_3)_2(\text{DMF})^+$, when they are performed in DMF.³⁷⁹

6.4.5.10 Mixed Donor Atoms

The palladium(II) chemistry of the tri-linked macrocycles of the type shown in Figure 28, parallels that of the related single ring macrocycles.³⁸⁰

There has been considerable interest in the study of multinuclear d^8 metal complexes with bridging sulfide ligands.³⁸¹ The first examples of *triangulo* palladium(II) are the complexes containing substituted 2,2'-bipyridine and triply bridging sulfide ligands, namely $[\text{Pd}_3(\text{diimine})_3(\mu_3\text{-S})_2][\text{ClO}_4]_2$.³⁸²

Carbon disulfide undergoes 1,3-dipolar cycloaddition to the coordinated azide in the cyclopalladated Pd^{II} complex.³⁸³

The authors synthesized three amino acid substituted calix[4]arenes and investigated their coordination reactions towards Pd^{II} using electrospray mass spectrometry.³⁸⁴

By linking metal-binding domains to estrogen through the 17 α -position, strong affinity for the estrogen receptor is achieved. The palladium(II) metallo-estrogen shows transport and subsequent binding affinity that is of the same order as estradiol itself. Despite their monocationic nature, the palladium(II) complexes have exhibited similar (and even enhanced) receptor binding affinities compared to their corresponding neutral free ligands.³⁸⁵

Many bis-chelate Pd^{II} complexes possessing a *cis*-arrangement of the phosphinoalkylsilyl ligands have been synthesized,³⁸⁶⁻³⁸⁹ but comparatively few *trans*-bis-chelates are known. The kinetic stability of *trans*-bis-chelates can be greatly enhanced by placing a bulky *o*-carborane unit in the ligand backbone.³⁹⁰

Hydrothermal synthesis using hard and soft acids and bases gave the metal hydroxide-based phases $\text{M}_3\text{Pd}_2(\text{OH})_2[\text{NC}_5\text{H}_3(\text{CO}_2)_2\text{-}2,4]_4(\text{H}_2\text{O})_4$ ($\text{M} = \text{Co}, \text{Ni}, \text{Zn}$).³⁹¹ A crystal structure is shown in Figure 29.

The C_2 -symmetric 1,1-binaphthyl unit and tetradentate Schiff bases (salen) constitute two of the most important types of chiral auxiliaries in metal-mediated asymmetric catalysis. Their "hybridized" forms, i.e., binaphthyl Schiff bases, have been developed. One palladium(II) tetradentate Schiff base complex, characterized by X-ray crystallography, contains N_3O rather than N_2O_2 chelating atoms.³⁹² These ligands, shown in Figure 30, favor the nonplanar N_2O_2 arrangement in binding metal ions.

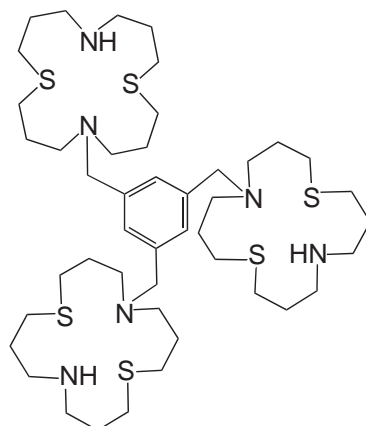

Figure 28 A tri-linked macrocycle of the type used in palladium(II) chemistry.

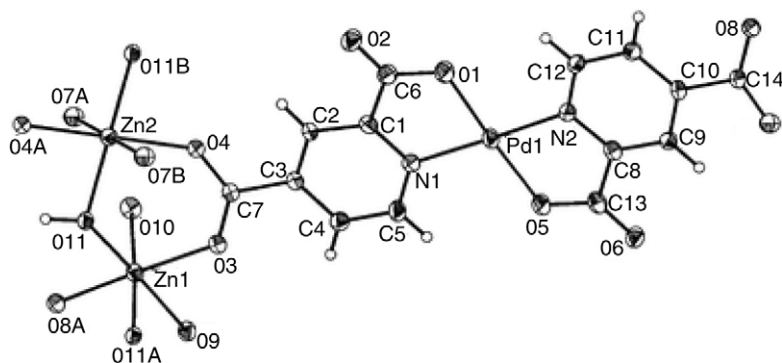

Figure 29 Crystal structure of the basic building block for $M_3Pd_2(OH)_2[NC_5H_3(CO_2)_{2-2,4}]_4(H_2O)_4$ ($M = Co, Ni, Zn$).

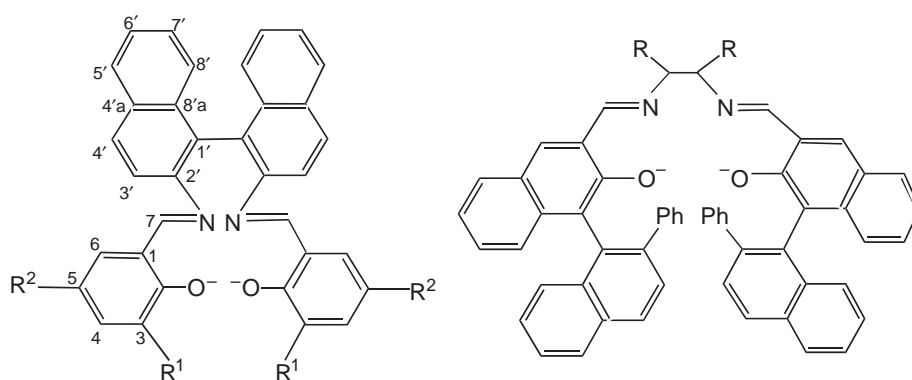

Figure 30 Schiff base binaphthyl ligands.

The synthesis, structure, and catalytic properties of a Pd^{II} complex with a partially hydrogenated ligand, shown in **Figure 31**, are described.³⁹³ This study provides the first asymmetric epoxidation of alkenes catalyzed by a palladium complex.³⁹³

In many reactions catalyzed by late transition metals, the precatalyst is stabilized by ligands having phosphorus donor atoms which are compatible with a wide variety of metal oxidation

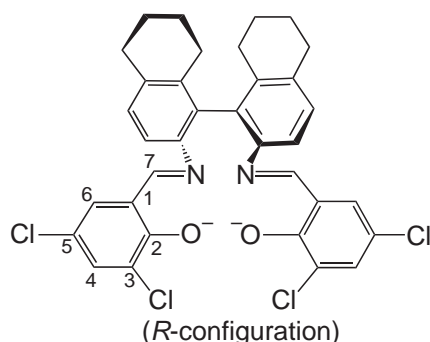
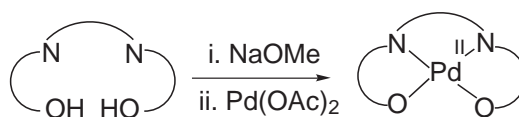

Figure 31 A Pd^{II} complex with a partially hydrogenated ligand acts as a catalyst for asymmetric epoxidation.

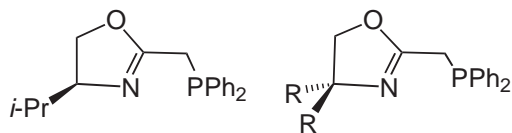
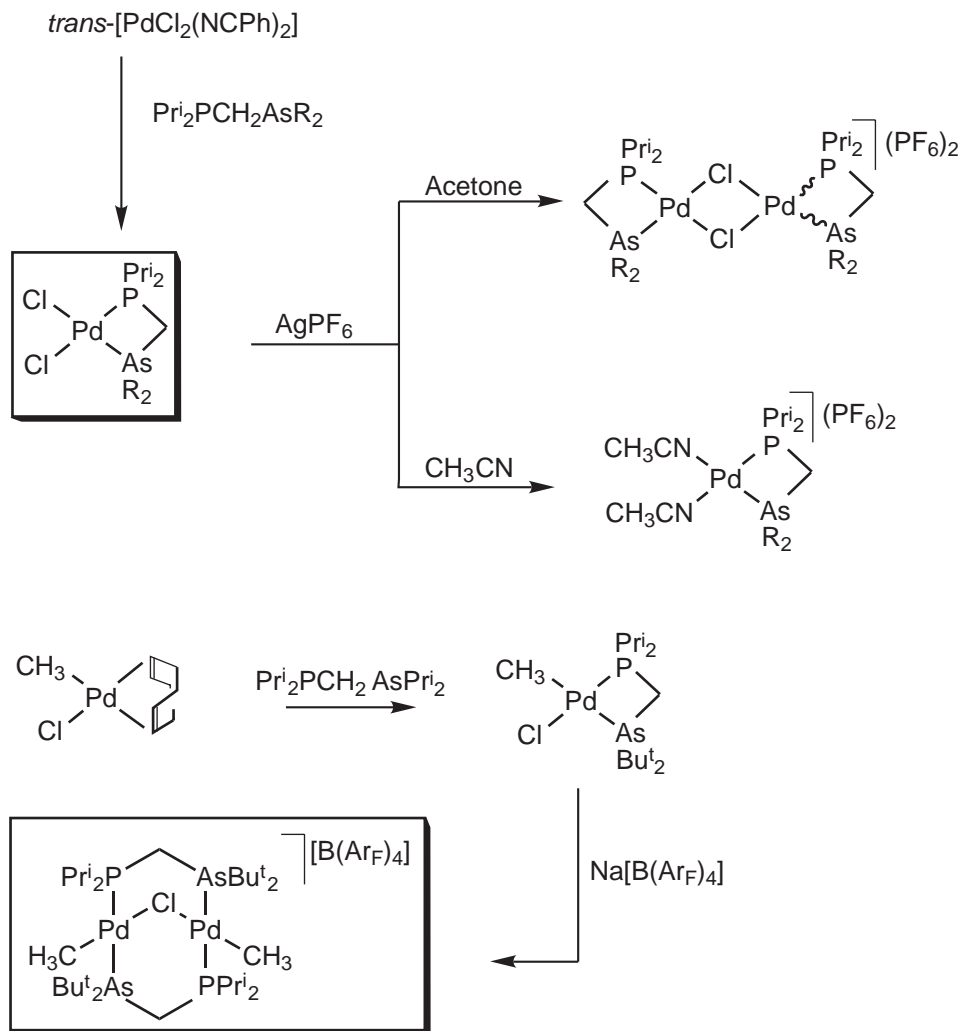

Figure 32 The first P,N-ligand shown in Figure 32 can form five-membered ring chelates, in allylic alkylation with Pd; the second is a chelating (phosphinomethyl)oxazoline P,N-type ligand, that catalyzes the copolymerization of ethylene/CO.

states and therefore with redox changes that may occur. Ligands which bear both phosphorus and nitrogen donors confer high reactivity and selectivity in some catalytic reactions. The first P,N ligand shown in Figure 32 can form five-membered ring chelates, in allylic alkylation with Pd.³⁹⁴ A study reports the synthesis and structure of Pd^{II} complexes containing chelating (phosphino-methyl)oxazoline P,N-type ligands, the second shown in Figure 32. These complexes catalyze the copolymerization of ethylene/CO.³⁹⁵

The new arsino(phosphino)methanes with bulky substituents at the two donor centers can behave both as chelating and bridging ligands toward palladium(II). Besides neutral and mono- as well as di-nuclear cationic compounds, in which these ligands are bonded in a chelating fashion, a di-nuclear complex of the A-frame type could also be generated (see Scheme 5).³⁹⁶



Scheme 5

An optical-microwave double resonance study¹³¹ of a metal–organic chelate compound Pd(2-thpy)₂ ((2-thpy)[−] = 2-thienylpyridinate) in the lowest excited triplet state demonstrated the complementary nature of time-resolved emission spectroscopy and phosphorescence microwave double-resonance spectroscopy. Interestingly, both methods^{131,397} can reveal a spin selectivity in the vibrational satellite lines of the emission spectrum. The complex Pd(qol)₂ (qol[−] = 8-quinolinolato-*N,O* = oxinate) is investigated by means of high-resolution and site-selective emission spectroscopy as well as by methods involving microwave double-resonance spectroscopy to develop a detailed understanding of the properties of the lowest excited states, presumably of the intraligand charge-transfer type.³⁹⁸

Phosphinothiolato chelate ligands place phosphorus and sulfur in a *cis* configuration, and this should imprint electronic asymmetry on the metal center to be transmitted to any *trans* groups. An important difference in bulk between coordinating atoms is also characteristic of this type of ligands. Asymmetry in size and electronic influence should be important to the stability of the key intermediates that control the stereochemistry of the products of interesting reactions that are thought to depend on two adjacent coordination sites, such as catalytic palladium mediated carbonylations. Furthermore, more recent reports point to the particular nature of catalytic carbonylation systems that incorporate thiolato ligands. Aminothiolo complexes of palladium with triphenylphosphine catalyze the conversion of styrene to 2-phenylpropionic acid in high yield and excellent regioselectivity.^{399,400} While these systems could only be acting with an *open* P,*S*-coordination, phosphinothiolato complexes could act with a *closed* P,*S*-coordination. Synthetic routes were found to hitherto unknown stable compounds containing palladium(II), the simple phosphinothiolato ligands 2-(diphenylphosphino)ethanethiol (HSCH₂CH₂PPh₂, Hdppet) and 3-(diphenylphosphino)propanethiol (HS(CH₂)₃PPh₂, Hdpppt), and also triphenylphosphine in an effort to contain the tendency of thiolato ligands to form bridged species.⁴⁰¹ Complexes of the type [PdCl(S-E)(PPh₃)] with E = P, contain the chelating dppet and dpppt ligands. Mononuclear complexes of this class with E = N are the aminothiolo-*S,N* complexes [PdCl(S-N)(PPh₃)], where S-N are the ligands derived from cysteamine, cysteine ethyl ester, and penicillamine methyl ester.³⁹⁹ Phosphinothiolato complexes of palladium have never been tested in any carbonylation reaction, and catalysis reports on open P,*S*-coordinated thiolato phosphine palladium systems are rare.⁴⁰² In phosphinothiolato complexes, the phosphorus side is bulkier, so that *trans* complexes are expected for the square planar coordination of *d*⁸ ions. Complexes of palladium with the ligand *o*-(diphenylphosphino)benzenethiolato, such as *trans*-[Pd(SC₆H₄PPh₂)₂] and [Pd₂I₂(SC₆H₄PPh₂-*P,μ-S*)₂], have been obtained from the corresponding thioether complexes.^{403–405} In a series of studies on the resolution of ligands with chirality at phosphorus involving metal complexation, a series of group 10 metal complexes with 2-(methylphenylphosphino)ethanethiol have been reported, including the palladium bischelat Pd(SC₂H₄PMePh)₂.^{406–409} Palladium complexes with a ferrocenyl phosphinothiolato ligand⁴¹⁰ and with a phosphacyclic thiolato ligand⁴¹¹ have been recently described. Curiously, the anion bis(ethane-1,2-dithiolato)palladate [Pd(edt)₂]^{2−}⁴¹² evolves into anionic [Pd₂(edt)₃]^{2−}. Structural diversity makes it difficult to predict the precise nature of dppet and dpppt palladium species of 1:1 stoichiometry.⁴⁰¹

The imidazole unit coordinates to transition-metal ions, such as palladium(II) and platinum(II), predominantly via one of its nitrogen atoms. In some rare cases, however, the cyclic unit may also coordinate as a carbene or an amidine ligand via its C² carbon atom.⁴¹³ Palladium complexes containing C-bound imidazole ligands are efficient catalysts for cross-coupling reactions.⁴¹⁴ There is a report of the palladium-template synthesis of the first imidazole-substituted tertiary phosphine bidentate ligand in which the C² carbon of the imidazole unit is involved in metal chelation.⁴¹⁵ An organopalladium-complex-promoted Diels–Alder reaction between 1-phenyl-3,4-dimethylphosphole and 1-vinylimidazole gave a novel imidazole-substituted phosphanorbornene bidentate ligand which coordinated to the palladium template via the C² carbon atom of the imidazole group and the bridgehead phosphorus donor atom (see Scheme 6).⁴¹⁵

The insertion of unsaturated molecules into metal–carbon bonds is a critically important step in many transition-metal catalyzed organic transformations. The difference in insertion propensity of carbon–carbon and carbon–nitrogen multiple bonds can be attributed to the coordination characteristics of the respective molecules. The difficulty in achieving σ to π isomerization may be the reason for the paucity of imine insertions. The synthesis of amides by the insertion of imines into palladium(II)-acyl bonds is the first direct observation of the insertion of imines into bonds between transition metals and carbon (see Scheme 7). The alternating copolymerization of imines with carbon monoxide (in which the insertion of the imine into palladium-acyl bonds would be the key step in the chain growth sequence), if successful, should constitute a new procedure for the synthesis of polypeptides (see Scheme 7).³⁴⁸

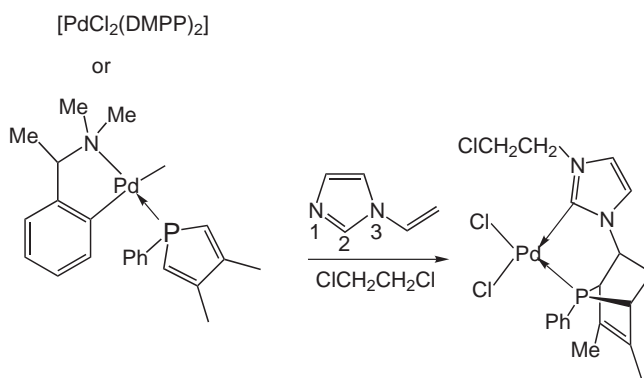

Scheme 6

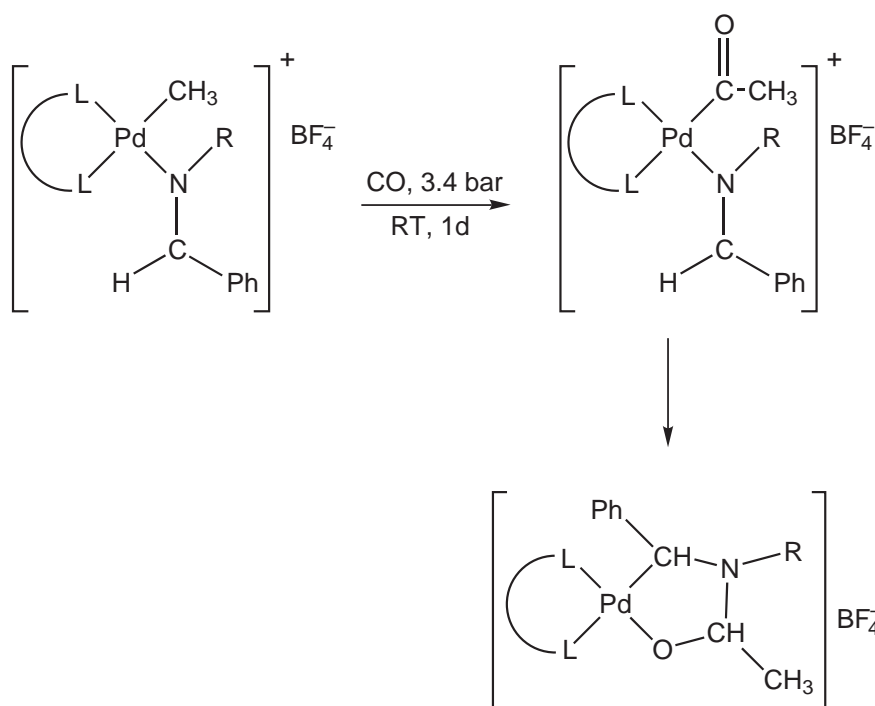

Scheme 7

Anionic, nonzeolitic inorganic supramolecular architectures are very rare, and the only examples known involve iodine-rich compounds.⁴¹⁶⁻⁴¹⁸ Reaction of the binuclear complex [Pd₂Cl₂([18]ane-N₂S₄)](PF₆)₂⁷⁰ with Buⁿ₄NI and I₂ in a 1:2:4 molar ratio in acetonitrile, followed by several days of slow evaporation of the solvent, affords black prismatic crystals in 90% yield. The asymmetric unit consists of one I₅⁻ and two I₃⁻ ions and one and a half binuclear [Pd₂Cl₂([18]aneN₂S₄)]²⁺ dications. The Pd^{II} ions are each coordinated to one N- and two S-donor atoms, and a Cl⁻ ligand completes the square-planar coordination. The two coordination planes lie parallel to each other but the overall binuclear dication adopts a stepped conformation in order to minimize steric interactions, see Figure 33.⁴¹⁹ The dications are linked pairwise by hydrogen bonds. The intracation Pd⋯Pd distances are 4.055(2) Å and 4.155(2) Å, while the Pd⋯Pd distances between adjacent cations are significantly shorter. The infinite chains of binuclear dications are embedded in a unique matrix of polyiodides whose fundamental units are one “L”-shaped I₅⁻ ion consisting of an asymmetric I₃⁻ ion interacting with a I₂ molecule and two slightly asymmetric I₃⁻ ions.⁴¹⁹ These results confirm the general principle of template

α -helix or a random coil, showed that the regioselectivity and the rate of cleavage are independent of the overall conformation.⁴²⁷ In this long substrate, the only cleaved site was the second peptide bond from the N-terminal side of one of the two histidine residues, that is, the second bond upstream from the anchor. Palladium(II) complexes proved remarkably effective in promoting fairly regioselective cleavage of cytochrome *c*,⁴²⁸ myoglobin,⁴²⁹ three albumins,⁴³⁰ and several other proteins. Because histidine and methionine residues have a combined average abundance in proteins of only 5.5%, the cleavage usually will give large fragments, convenient for sequencing and other biochemical applications. Upon removal of Pd^{II} ions by precipitation or chelation, the peptides (protein fragments) should remain pristine and can be used further. Simple and readily available Pd^{II} complexes act with unprecedented and useful regioselectivity in promoting the hydrolytic cleavage of peptides and proteins. In acidic aqueous solution, these reagents hydrolyze the peptide bond involving the amino group of the residue preceding the methionine or histidine side chain in the sequence, that is, the second peptide bond upstream of these anchoring residues (see Figure 34).⁴³¹ The ability of Pd^{II} complexes to cleave proteins at relatively few sites, with explicable selectivity, and with good yields bodes well for their growing use in biochemical and bioanalytical practice.

Kostić *et al.* showed that palladium(II) complexes spontaneously bind to the side chains of methionine and histidine residues and effect hydrolytic cleavage of short peptides with half-lives that range from several hours to several minutes.^{4,231,420–449} Because palladium(II) complexes are diamagnetic, kinetic experiments are easily done by ¹H-NMR spectroscopy. Because the cleavage reactions sometimes occur with turnover,^{424–426} the simple palladium(II) complexes that catalyze them can be considered primitive artificial peptidases. The successes in selective cleavage of cytochrome *c*,⁴²² myoglobin,⁴²⁹ and other proteins^{4,431} bode well for the general applicability of these new reagents in biochemistry and allied disciplines. A study showed for the first time that peptide bonds can be cleaved with commercially available salts of [PdCl₄]²⁻ anion; no chemical derivatization or modification of this simple complex is required. Aquation of this complex, however, causes a remarkable difference in reactivity; the complex [Pd(H₂O)₄]²⁺ cleaves peptides more rapidly and with different regioselectivity than its chloro precursor does. Experimental kinetics and theoretical molecular dynamics were combined to study how simple substitution of ancillary ligands affects hydrolytic cleavage of peptides by palladium(II) complexes and to determine the stereochemical basis for the regioselectivity of cleavage.⁴⁴⁴

Palladium(II) complexes, as cleavage agents, differ from the well known complexes of other transition metals because their attachment to substrates is achieved simply by mixing; the hydrolysis reactions have half-lives as short as 15 min, and the complexes are easily removed from the cleaved substrates. Longer peptides and proteins are readily cleaved by Pd^{II} complexes, but with a different regioselectivity.^{4,431} A better knowledge of the coordination chemistry of histidine-containing peptides with palladium(II) complexes is necessary for understanding the regioselectivity of peptide and protein cleavage promoted by such complexes. A paper reports an ¹H-NMR investigation of the hydrolysis reaction of a model histidine-containing dipeptide, *N*-acetylated L-histidylglycine, catalyzed by a series of palladium(II) complex cations of the type *cis*-[Pd(L)(H₂O)₂]²⁺ in which L is a chelating diamine ligand, which differ in the number of methyl groups at the nitrogen or carbon atom, or *S,N*-coordinated amino acid. The observed rates of reaction are explained in terms of steric hindrance of the chelating ligand on the palladium(II) complexes.⁴⁴⁷ The results of this study of dipeptides are not pertinent to study of cleavage of longer peptides and proteins by Pd^{II} complexes.

A monodentate palladium(II) complex *trans*-[Pd(py)₂(H₂O)₂]²⁺ hydrolyzes Met-Aa amide bonds with a rate comparable with that promoted by [Pd(H₂O)₃(OH)]⁺. Unlike [Pd(H₂O)₃(OH)]⁺, *trans*-[Pd(py)₂(H₂O)₂]²⁺ is relatively stable and easy to prepare. An *N,N,N',N'*-tetramethylethylenediamine hydrolyzes Met-Aa amide bonds with hydrolytic rate controlled by temed release. The action of the other two complexes, *cis*-[Pd(EDTA)Cl₂] (EDTA = ethylene diaminetetraacetic acid) and *cis*-1,2-bis(2-formylglycinebenzenesulfenyl)ethane Pd^{II} chloride differs from the action of similar complexes of *cis*-[Pd(en)Cl₂] and *cis*-[Pd(dtco-3-OH)Cl₂] (dtco-3-OH = 1,5-dithiacyclooctan-3-ol).⁴⁴⁸

A promising method for protein cleavage consists of spontaneous attachment, without tethering, of preformed Pd^{II} complexes to nucleophilic side chains, followed by cleavage of proximate amide bonds. To investigate possible effects of the secondary structure (conformation) on the cleavage promoted by palladium(II) complexes, Kostić *et al.* compared the reactivity of the same nonadecapeptide in predominantly α -helical and essentially random-coil conformations. This study indicates that cleavage is probably unaffected by the overall conformation of the substrate, at least in the polypeptide examined.⁴²⁷

Most of the palladium hydrolysis reagents used to date must be applied in aqueous solution. This requirement is incompatible with the cleavage of lipophilic peptides and proteins, which are insoluble or sparingly soluble in water. During the hydrolysis of methionine-containing dipeptides the most active mononuclear complexes, $[\text{Pd}(\text{OH}_2)_4]^{2+}$ and $\text{cis-}[\text{Pd}(\text{en})(\text{OH}_2)_2]^{2+}$, form dinuclear active species bridged by methionine side chains.^{421,449,450} An important advantage of dimerization is the possibility of cooperation between metals. These considerations suggested to Kostić *et al.* that polynuclear complexes should be good reagents for peptide hydrolysis. The thiolate-bridged complex $(\text{Me}_4\text{N})_2[\text{Pd}_2(\mu\text{-SPh})_2\text{Cl}_4]$, is expected to be stable in solution. The bridging thiolate ligands should not be displaced by methionine side chains or other donor groups in peptides and proteins. In addition, the *trans* effect of the thiolate sulfur atoms should allow for especially weak and potentially reversible binding of methionine to palladium(II). Indeed, this complex is an effective catalyst for rapid cleavage of methionine-containing dipeptides in nonaqueous solvents.

Selective cleavage of peptides and proteins is an important procedure in biochemistry and molecular biology. The half-life for the uncatalyzed hydrolysis of amide bonds is 350–500 years at room temperature and pH 4–8. Clearly, efficient methods of cleavage are needed. Despite their great catalytic power and selectivity to sequence, proteinases have some disadvantages. Peptides^{420,423,424,426} and proteins^{428,429} can be hydrolytically cleaved near histidine and methionine residues with several palladium(II) aqua complexes, often with catalytic turnover.

Kostić *et al.* reported that palladium(II) complexes bind to *N*-acetylated tryptophan-containing peptides AcTrp-Ala, AcTrp-Val, and AcTrp-ValOMe in acetone solution and regioselectively cleave them upon addition of an equivalent of water.⁴³⁶ Upon mixing of *N*-acetyl-L-tryptophanamide (AcTrp-NH₂) and $\text{cis-}[\text{Pd}(\text{en})(\text{sol})_2]^{2+}$ in acetone solution, the complex shown in Figure 35 appears.⁴³⁶ In the presence of the palladium(II) complexes and one equivalent of water in an acetone-*d*₆ solution, peptides are completely cleaved in less than a day. The active intermediates are complexes of the type shown in Figure 35. As Scheme 8 shows, the products are the *C*-terminal amino acid and palladium(II) complex of *N*-acetyl-L-tryptophan. Acetic acid is not detected. In control experiments with AcAla-Trp, which lacks a *C*-terminal amide bond adjacent to the tryptophanyl residue, neither amide bond is cleaved. Evidently, palladium(II) regioselectively cleaves on the *C*-terminal side of tryptophan, not on the *N*-terminal side. In aqueous solution coordination of the tryptophanyl residue to palladium(II) completely ceases, and the peptides do not hydrolyze.⁴³⁶

Absence of aqua ligands in the hydrolytically active complexes of the type shown in Figure 35 rules out the internal attack of a Pd^{II}-bound nucleophile at the amide carbon. Coordination of the amide oxygen renders the amide carbon more electrophilic and susceptible to external attack of solvent water, which causes the hydrolytic cleavage on the *C*-terminal side of tryptophan (see Scheme (8)). There is no cleavage on the *N*-terminal side, presumably because that amide bond is not activated by the palladium(II) atom.⁴³⁶ To our knowledge, this is the first report that coordination of the tryptophan side chain is followed by hydrolysis of a nearby peptide bond. Unlike methionine and histidine, which coordinate to palladium(II) in aqueous as well as acetone solutions,^{420,423,424,426} tryptophan coordinates only in acetone solution.⁴³⁶ Therefore, the overall selectivity of cleavage can be altered simply by changing the solvent or the concentration of the palladium(II) promoter. Cleavage will occur near histidine and methionine in aqueous solution, and near histidine, methionine, and tryptophan in acetone solution, if the promoter is present in excess. The fine selectivity, preference for the *C*-terminal over the *N*-terminal amide bond of tryptophan, is due to the stereochemistry of chelate rings. Further studies will show whether proteins and longer peptides are cleaved with the same regioselectivity. A prospect for cleaving hydrophobic or membrane-bound proteins in nonaqueous solutions, by palladium(II) complexes, has emerged.

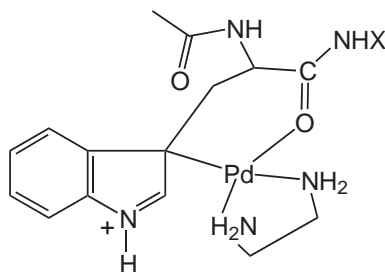
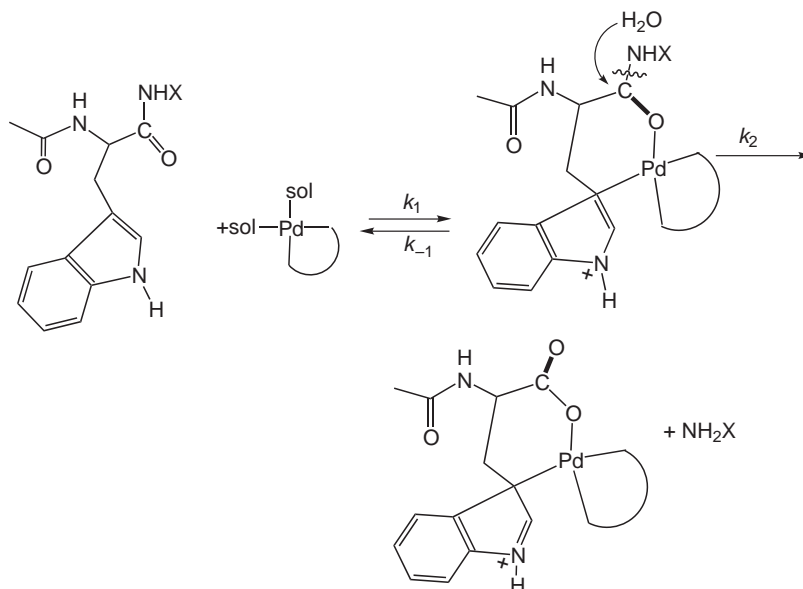

Figure 35 Complex formed by mixing *N*-acetyl-L-tryptophanamide (AcTrp-NH₂) and $\text{cis-}[\text{Pd}(\text{en})(\text{sol})_2]^{2+}$ in acetone solution.



Scheme 8

Kostić *et al.* discovered that Pd^{II} complexes, when attached to tryptophan residues, can rapidly cleave peptides in acetone solutions to which a stoichiometric amount of water is added, for hydrolysis.⁴³⁶ The indole tautomer in which a hydrogen has moved from the nitrogen to C(3) is named indolenine. Its palladium(II) complexes that are coordinated via the nitrogen atom have been characterized by X-ray crystallography and spectroscopic methods.⁴⁵¹ Binuclear dimeric complexes between palladium(II) and indole-3-acetate involve cyclopalladation.⁴⁵² Bidentate coordination to palladium(II) through the N(1) and the C(2) atoms occurs in binuclear complexes.⁴⁵³ Reactions of palladium(II) complexes with indole-3-acetamide and its derivatives produced new complexes of unusual structure. Various NMR, UV, IR, and mass spectral analyses have revealed bidentate coordination via the indole carbon C(3) and the amide oxygen.⁴³⁷

Selective cleavage of peptides and proteins is one of the most common and most important procedures in biochemistry. The extreme inertness of the amide bond makes this reaction interesting from the chemical point of view. Several proteolytic enzymes are used for cleavage, but application of enzymes is limited by their rather narrow requirements for temperature and pH. Therefore, new methods for selective hydrolysis of peptides and proteins are required. Kostić and coworkers have shown that palladium(II)^{420–424,432,438,440} aqua complexes are promising reagents for hydrolytic cleavage of peptides and proteins. These complexes bind to the heteroatom in the side-chain of methionine^{420–422,432,438,440} or histidine^{423,424,432,438,440} in dipeptides and promote cleavage of the amide bond involving the carboxylic group of this anchoring amino acid. This regioselectivity in the cleavage is clearly demonstrated in the reaction of *cis*-[Pd(en)(H₂O)₂]²⁺ with a series of MeCO His-X dipeptides, in which X is Gly, Ala, Leu, Ser, Thr, Tyr or Phe.⁴²⁴ In this reaction, the amide bond involving the carboxylic group of histidine is completely hydrolyzed at relatively mild and unrestrictive conditions (60 °C and 1.5 ≤ pH ≤ 2.5) in less than two days, while the amide bond involving the amino group of histidine is not cleaved. It was found that only catalyst monodentally bound to the N-3 atom of imidazole can effect this reaction; none of the other modes of coordination is effective.^{423,424} The reaction is unimolecular with respect to the palladium(II)–peptide complex. However, when the carboxylic group of histidine is free, as in MeCO-Gly-His, *cis*-[Pd(en)(H₂O)₂]²⁺ does not effect hydrolysis. Another study dealt with stoichiometric hydrolysis of inactivated amide bonds in histidine-containing peptides promoted by *cis*-[Pd(L-Ala-N,O)Cl₂][−] and *cis*-[Pd(L-Ala-N,O)(H₂O)₂]⁺ complexes (L-Ala is amino acid alanine coordinated via N and O atoms). There are interesting differences between the active form of the palladium(II) complex and the reagent that is initially added.⁴⁵⁴

The highly regioselective hydrolysis of tryptophan-containing peptides with the [Pd(en)]²⁺ (en = H₂NC₂H₄NH₂) complex has been reported by Kostić and co-workers.⁴³⁶ The hydrolysis does not proceed without the palladium(II) complex. However, when equimolar amounts of a

peptide and a palladium(II) complex are mixed in acetone solution at 50 °C with a stoichiometric amount of H₂O, the reaction is remarkably promoted and occurs selectively on the *N*-terminal side of the peptide, producing the *N*-terminal amino acid and the palladium(II) complex of *N*-acetyltryptophan, as shown in Scheme 9.

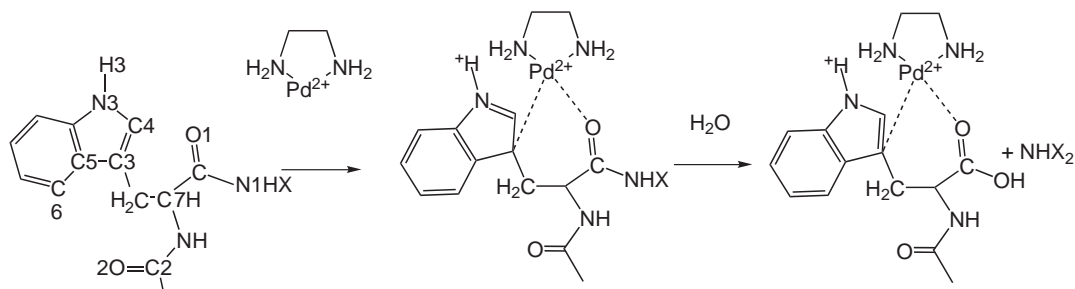

Scheme 9

The origin of the regioselectivity and the promotion effect of the palladium(II) complex [Pd(en)]²⁺ on the hydrolysis of a tryptophan-containing peptide was theoretically examined by means of the density functional method B3LYP using the model peptide *N*-formyltryptophanamide.⁴⁵⁵ The calculations confirmed the explanations by Kostić *et al.* The *N*-formyltryptophanamide easily binds to the [Pd(en)]²⁺ complex to form the stereochemically stable compound with the six-membered ring, where not only the carbonyl oxygen but also the indole carbon interact with the Pd atom, and its binding is kept during the hydrolysis reaction, to stabilize the energy surface and reduce the energy barrier. The positive charge of the *N*-terminal amide carbon is remarkably enhanced by the formation of *cis*-[Pd(en)C,*O*-FmTrp-NH₂]²⁺, and thereby, the water oxygen selectively attacks the *N*-terminal amide carbon and the electron is transferred from the water to the electron acceptor [Pd(en)]²⁺ complex along the O3(water)—C1—O1—Pd linkage. The largely positively charged water hydrogen migrates as a proton to the amide nitrogen to break the C—N bond of the amide. The good correlation found between the energy barrier and the strength of the electron donation of the ligand suggested that the ligand plays a key role in the reaction, and the less electron donative ligand is more efficient for the hydrolysis.⁴⁵⁵

Kostić *et al.* reported the use of various palladium(II) aqua complexes as catalysts for the hydration and alcoholysis of nitriles,^{435,456} decomposition of urea to carbon dioxide and ammonia, and alcoholysis of urea to ammonia and various carbamate esters.⁴⁵⁷ Labile aqua or other solvent ligands can be displaced by a substrate. In many cases, the coordinated substrate thus becomes activated toward nucleophilic addition of water or alcohols.

Hydrolysis of oximes catalyzed by transition-metal complexes has not been studied prior to a report by Kostić *et al.* They have reported kinetics of hydrolysis of acetoxime to acetone catalyzed by two palladium(II) complexes, identified active species in the hydrolysis reaction, proposed a reaction mechanism, and fully characterized a bis(acetoxime) complex that is relatively stable toward hydrolysis.⁴⁵⁸

Kostić *et al.* recently reported the use of various palladium(II) aqua complexes as catalysts for the hydration of nitriles.⁴⁵⁶ crossref:1.34 Reactivity of coordination These complexes, some of which are shown in Figure 36, also catalyze hydrolytic cleavage of peptides, decomposition of urea to carbon dioxide and ammonia, and alcoholysis of urea to ammonia and various carbamate esters.^{420–424, 427,429,456,457} Clearly, palladium(II) aqua complexes are versatile catalysts for hydrolytic reactions. Their catalytic properties arise from the presence of labile water or other solvent ligands which can be displaced by a substrate. In many cases the coordinated substrate becomes activated toward nucleophilic additions of water/hydroxide or alcohols. New palladium(II) complexes *cis*-[Pd(dtod)Cl₂] and *cis*-[Pd(dtod)(sol)₂]²⁺ contain the bidentate ligand 3,6-dithiaoctane-1,8-diol (dtod) and unidentate ligands, chloride anions, or the solvent (sol) molecules. The latter complex is an efficient catalyst for the hydration and methanolysis of nitriles, reactions shown in Equation (3).⁴³⁵

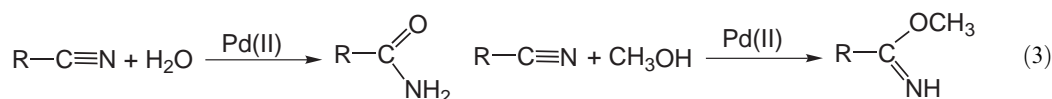

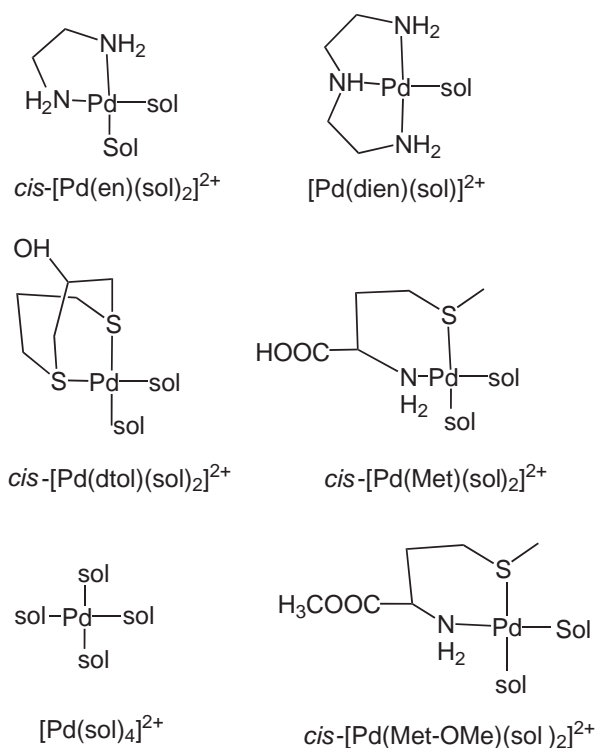

Figure 36 Complexes catalyzing hydrolytic cleavage of peptides, hydrolysis and alcoholysis of nitriles, decomposition of urea to carbon dioxide and ammonia, and alcoholysis of urea to ammonia and various carbamate esters.

The complex $cis-[Pd(dtod)(sol)_2]^{2+}$ also promotes the stoichiometric alcoholysis of urea by the hydroxyl groups within the ligand dtod.⁴³⁵

6.4.5.11 Five-coordinate Complexes

Five-coordinate complexes of Pd^{II} are so distinctive that they are grouped together and not classified according to the ligand atoms.

Palladium(II) coordination and organometallic compounds usually are square-planar; five- and six-coordinate species are less common.⁴⁵⁹ Cyclometalated palladium(II) complexes with mono- and diphosphine ligands invariably are square-planar.⁴⁶⁰ Tri- and tetradentate polyphosphine ligands are known to promote the formation of stable complexes with uncommon coordination numbers and geometries. The first pentacoordinated cyclometalated palladium(II) complex was prepared by reaction of a monodentate Schiff base cyclometalated derivative and the triphosphine (triphos), in which the coordination geometry of the palladium atom is a distorted trigonal bipyramid.⁴⁶¹ The reaction of four cyclometalated Pd^{II} complexes with triphos gives four new pentacoordinated species, three of which have been characterized by X-ray crystallography.⁴⁶²

The stereochemistry of divalent palladium is characterized by the square-planar arrangement in the majority of its coordination and organometallic compounds. Coordination number six has been reported for a few unusual complexes whose structures have been investigated, generally showing two weaker interactions on the metal atom.^{463,464} Five-coordinate Pd^{II} complexes have been more extensively investigated, probably due to the interest in clarifying the kinetic properties for substitution and exchange reactions for palladium complexes in solution and in biological systems.⁴⁶⁵ Treatment of cyclometalated halide-bridged palladium(II) dimer complexes with tertiary mono- and diphosphines, gave only four-coordinate compounds with a square-planar environment for the palladium atom.^{466–468} Polyphosphine ligands offer a number of special characteristics, among which are the formation of stable complexes with different oxidation states and coordination numbers and the stereoselective occupation of center of the coordination polyhedron.^{469–471} Five-coordinate cyclometalated palladium(II) compounds may be synthesized

with ligands such as tridentate phosphines that control the geometry and coordination number at the metal center. This is the first example of a “true” five-coordinate example of its kind, by formation of three five-membered rings at palladium: two comprising the triphos ligand and the palladacycle from the *C,N*-bonded organic ligand.⁴⁶¹

Palladium(II) pentacoordinate complexes^{472–474} are mechanistically and synthetically relevant in organometallic chemistry. Complexes of substituted phenanthrolines with pentacoordinate palladium halides⁴⁷⁵ and cyanide^{476,477} were studied. They can be synthesized either by treating a four-coordinate complex with an olefin^{478–480} or by oxidative addition of an alkyl halide to three-coordinate palladium(0) olefin complexes.⁴⁸¹ Steric hindrance of the *N–N'* chelating ligand is a demanding requirement for the stabilization of five-coordinate palladium complexes.⁴⁸² The reaction of palladium 1,10-phenanthroline bis(carbomethoxy) complex Pd(phen)(CO₂CH₃)₂, with HCl gave Pd(phen)Cl(CO₂CH₃). Surprisingly, the reaction with the nonconventional acid phenanthroline hexafluorophosphate gives the new five-coordinate complex [Pd(phen)₂(CO₂CH₃)](PF₆), whose structure is shown in Figure 37.⁴⁸³

6.4.5.12 Polynuclear Compounds

Metallodendrimers are emerging as efficient and recyclable catalysts in many chemical reactions.^{484–486} Generally, metal centers involved in chemical reactions are placed either at the periphery or within the dendrimers. When the active site is located at the core, the dendritic superstructure around it can provide a shielding which generates a microenvironment reminiscent of those found in biological systems.^{487,488} A series of dendritic pyridyl ligands, and the corresponding Pd^{II} complexes were synthesized.⁴⁸⁹ Mechanistic studies on the reactivity of the η^3 -allyl complexes containing such ligands toward amination with piperidine were reported.⁴⁹⁰

Dendrimers having nanoscopic dimensions can be molecularly dissolved. Thus, soluble dendrimers carrying a defined number of catalytic sites can be removed from homogeneous reaction mixtures by simple nanofiltration techniques. The combination of these properties makes them suitable to bridge the gap between homo- and heterogeneous catalysts. Moreover, the use of dendrimers instead of polymers for anchoring catalytic sites leads to well-defined nanosized species in which the number and location of the catalytic sites can be controlled. The synthesis of the compound depicted in Figure 38 and utilization of its aqua complexes as homogeneous catalysts for an aldol condensation reaction were presented.

Numerous dendrimers, which contain coordination sites on the outer surface, within the macrostructure throughout all layers, and at the inner core have been prepared. In contrast,

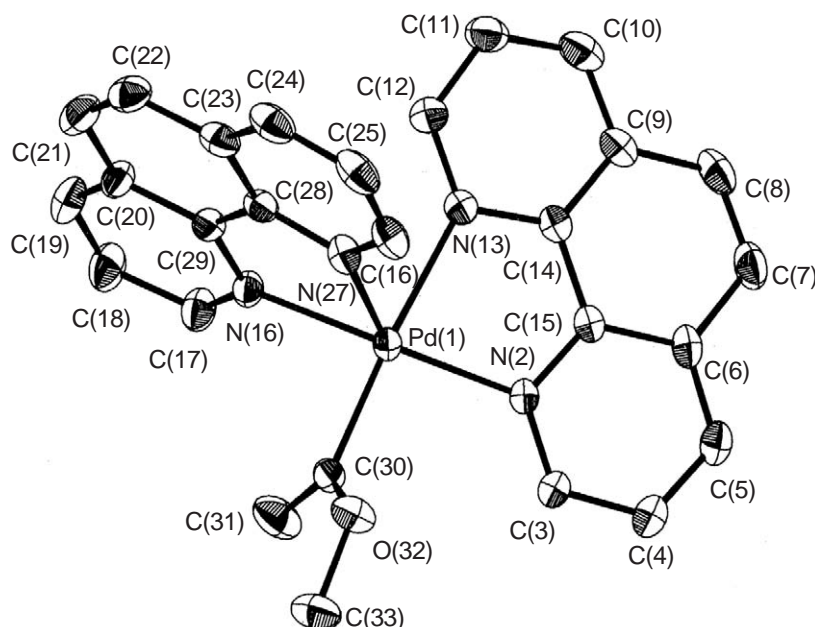

Figure 37 Structure of the five-coordinate complex [Pd(phen)₂(CO₂CH₃)](PF₆).

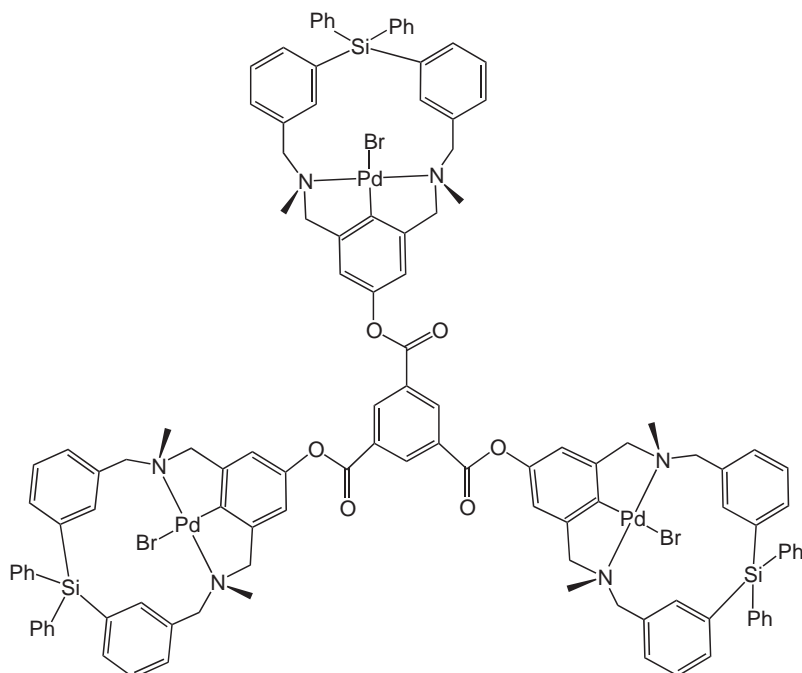

Figure 38 Pd dendrimer

except for scant coordination studies, very little has been done about the construction of dendrimers with specific coordination centers within the dendritic wedges and their reaction with metal substrates. In particular, only one report has yet appeared on the synthesis of dendrimers with a pyridine based skeleton incorporating a specific coordination site for platinum-group metals.⁴⁸⁹ The 2,6-di(thiomethyl)pyridine subunit, has been shown to form very stable Pd^{II} complexes.⁴⁹² The complexation of Pd^{II} with dendrons gives metallodendrons, shown in Figure 39.⁴⁸⁹

Dendrimers are attractive nanosize model compounds because of their globular architecture and their highly functionalized surface. These hyperbranched compounds are synthesized in a repetitive reaction sequence of nearly quantitative reactions. The synthetic route can either be divergent, starting from the nucleus toward the surface, or convergent, where “dendrons” or “wedges” are covalently linked to a polyfunctional nucleus. The number of metallodendrimers is still limited.^{493–506}

Metallodendrimers can have a metal in the core, in every generation, or only at the outside. A noncovalent, divergent synthesis toward nanosize metallodendrimers has been developed.^{507,508} The “controlled assembly” is based on the activation of the nucleus, containing three Pd–Cl pincer complexes, by removing the chloride ion with AgBF₄. Subsequent addition of three equivalents of nitrile-containing building blocks yields a first generation metallodendrimer by coordination of the nitrile ligands to the palladium centers. Using controlled assembly the authors were able to synthesize metallodendrimers up to generation five.⁵⁰⁸ With the combination of two

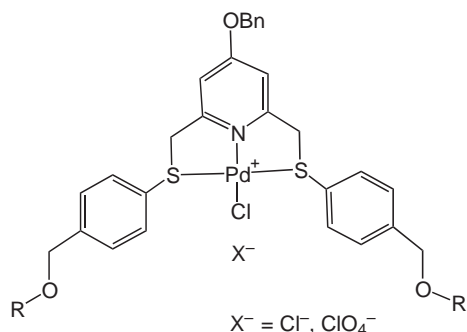

Figure 39 A Pd metallodendrimer.

different ligands one can construct metallodendrimers not only via a divergent but also via a convergent route.⁵⁰⁷ The combination of pyridine- with cyano-based building blocks allowed the assembly of dendrons up to the third generation. It has been possible to attach these dendrons to an activated nucleus. This is an example of the assembly of metallodendrimers via a convergent route.⁵⁰⁷

One of the main applications of dendrimers is in catalysis allowing easy recycling of the homogeneous catalyst by means of nanofiltration. Carbosilane dendrimers functionalized with diphenylphosphine groups at the periphery have been synthesized and characterized. Palladium complexes of these dendrimers have been used as catalysts in the allylic alkylation reaction. These dendrimeric catalysts can be used in a continuous process using a membrane reactor.⁵⁰⁹

Architectural control of transition metal-directed assembly to construct well-arranged metallo-macrocycles is one of the current research areas to create organized nanostructures for advanced materials.⁵¹⁰⁻⁵¹³

A conjugated homobimetallic palladium(II) complex (see Figure 40) was formed by one-pot oxidative complexation of 1,4-phenylenediamine with a palladium(II) complex bearing the tridentate ligand shown. In the absence of 1,4-phenylenediamine this palladium(II) complex undergoes controlled formation of a macrocyclic tetramer *via* removal of a labile solvent ligand, as shown in Figure 41.⁵¹⁴

It is possible to prepare coordination polymers not requiring the presence of counterions, if suitable negatively charged ligands (obtained from deprotonated stable polyazaheterocycles) are used with metal cations.⁵¹⁵ The synthesis of $M(im)_2$ species containing rigorously square-planar MN_4 systems, exploited the well-known tendency of group-10 metal ions (in their +2 oxidation state) to afford local D_{4h} symmetry. Hydrogen-bonded polymers of general $M(Him)_2(im)_2$ formula ($M = Pd, Pt$; $Him = imidazole$) were completely characterized.⁵¹⁶ The imidazole/imidazolate Pd and Pt derivatives sharing the same formula are not isostructural nor, obviously, isomorphous.

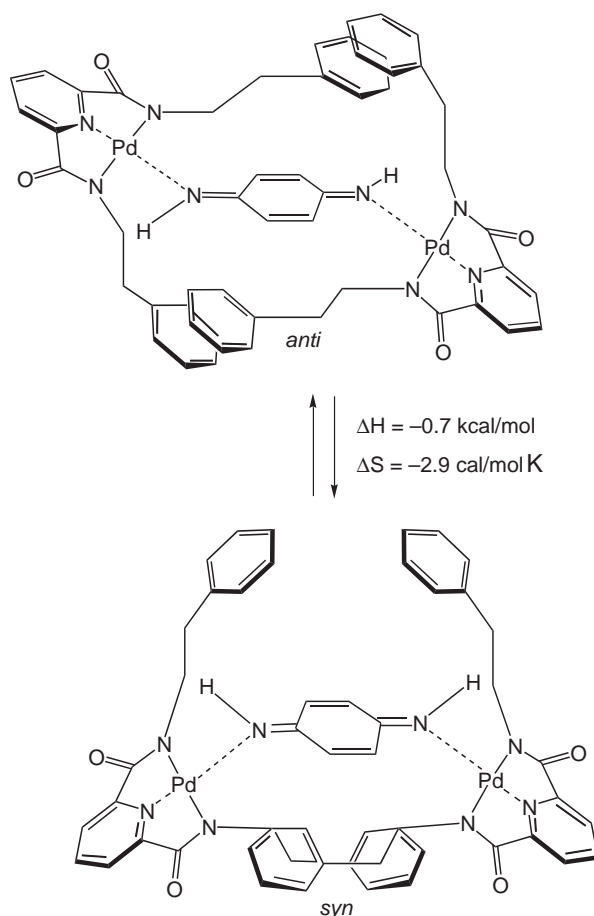

Figure 40 A conjugated homobimetallic palladium(II) complex, formed by one-pot oxidative complexation of 1,4-phenylenediamine with a palladium(II) complex bearing the tridentate ligand.

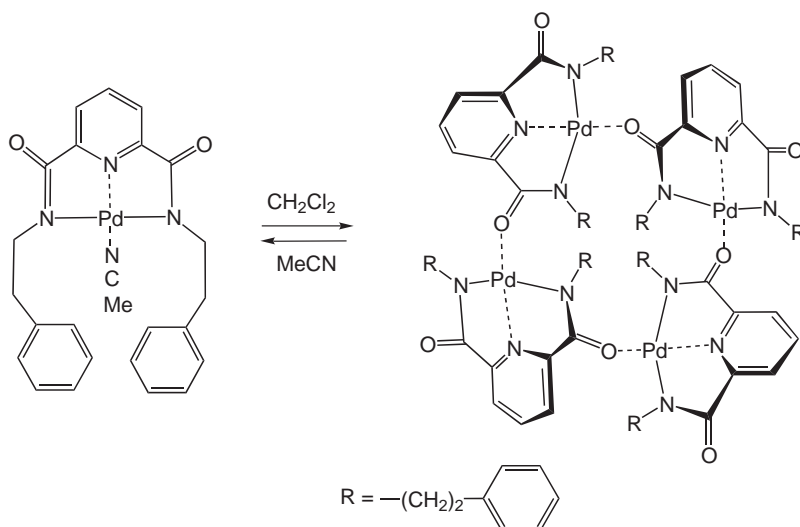

Figure 41 Controlled formation of a macrocyclic tetramer *via* removal of a labile solvent ligand.

Fullerenes are spontaneously attracted to porphyrins and metalloporphyrins. The palladium-linked *m*-pyridyl dimer (shown in Figure 42) has a high binding constant in solution. Addition of C_{60} or C_{70} to solutions of these palladium-linked bis-porphyrins gave complexes that were chromatographically distinct from their individual components. This indication of tight binding was also seen in MALDI mass spectra.⁵¹⁷

Covalently linked multiporphyrin arrays are interesting because of their unique photoelectronic properties and potential applications as mimics of light-harvesting systems in photosynthesis and as electron transfer moieties in molecular wires. Among these, fused oligoporphyrins sharing a common extended π -electron network are of particular interest. The electrochemical oxidation of the Pd^{II} complex gave a meso- β -linked diporphyrin.⁵¹⁸ The reaction mechanism involves the reaction of a radical cation with a neutral metalloporphyrin. Oxidation reactions of metalloporphyrins with a strong oxidant tris(4-bromophenyl)ammonium hexachloroantimonate (BAHA) facilitated the instantaneous generation of a porphyrin radical cation.⁵¹⁹ Doubly meso- β -linked diporphyrin products were obtained in the reaction of Pd^{II} -porphyrin with 1.2 equivalents of BAHA (see Figure 43). Their most notable feature is a red-shifted, intense Q-band. The oxidation

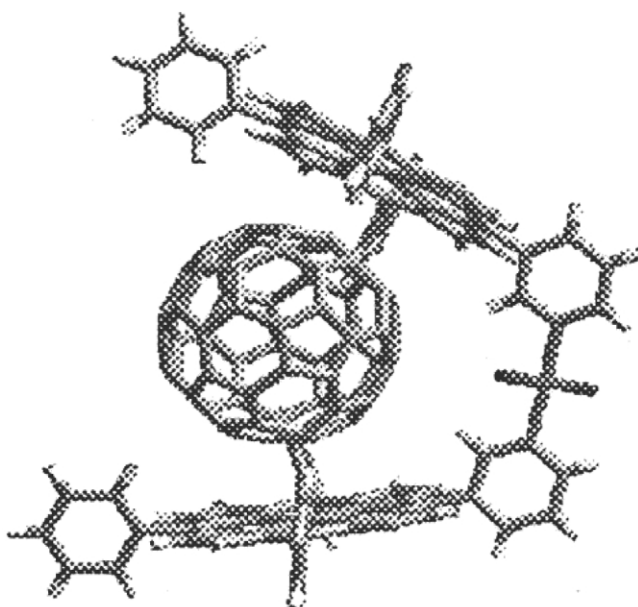

Figure 42 Palladium-linked *m*-pyridyl dimer- C_{60} complex.

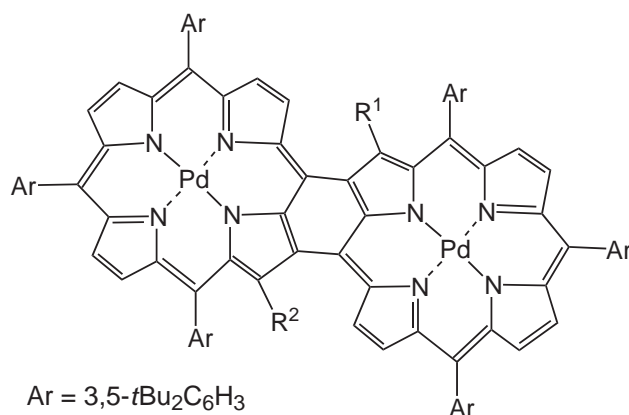

Figure 43 Doubly meso- β -linked diporphyrin products obtained in the reaction of Pd^{II}-porphyrin with 1.2 equivalents of BAHA.

of 5,10-diaryl- and 5,10,15-triaryl- Pd^{II}- porphyrins with BAHA constitutes a new, facile synthetic route to doubly meso- β -linked diporphyrins that exhibit unique optical and electrochemical properties stemming from their full π -conjugation. The lower oxidation potentials of the doubly meso- β -linked diporphyrins than that of the starting metalloporphyrin suggest an extension of this synthetic strategy to higher oligoporphyrins.⁵¹⁹

A new type of tweezer complex involving a rhenium–rhenium multiple bond enforces an unusual structure in a dipalladium(II) unit. The coordination of the P atoms of *cis*-Re₂(μ -O₂CC₆H₄-4-PPh₂)₂Cl₂(μ -dppm)₂ to a [Pd₂(μ -Cl)₂Cl₂] unit creates a Re₂Pd₂ assembly in *cis*-Re₂(μ -O₂CC₆H₄-4-PPh₂)₂Cl₂(μ -dppm)₂(Pd₂Cl₄) (shown in Figure 44).⁵²⁰

The structure of a non-hydrolyzed dimer, {*cis*-(2,2'-bipyridine)palladium(II)₂(μ -1,3-NO₃)₂}²⁺ is shown in Figure 45.⁵²¹ The dimerized *cis*-(2,2'-bipyridine)Pd^{II} units aggregate into a dimer-to-dimer linear conformation through direct metal–metal interaction⁵²² and π - π stacking.⁵²³ Notably, the dimer was first reported to be linked by double nitrate-bridges (μ -1,3-NO₃)₂ in a cofacial

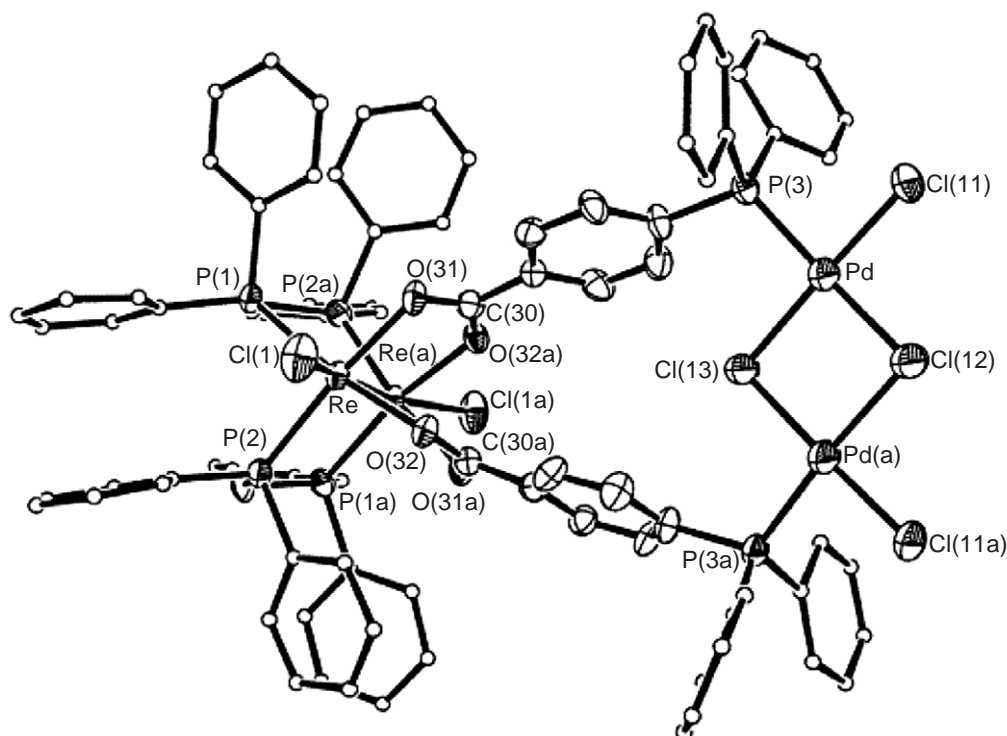

Figure 44 Structure of *cis*-Re₂(μ -O₂CC₆H₄-4-PPh₂)₂Cl₂(μ -dppm)₂(Pd₂Cl₄).

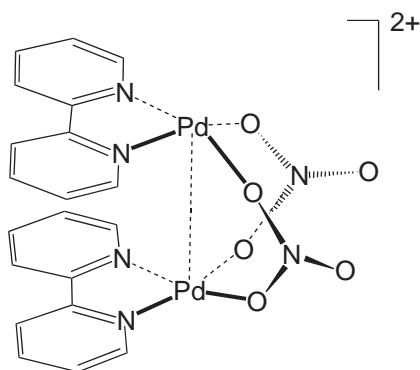

Figure 45 Structure of $\{cis-[(2,2\text{-bipyridine})\text{palladium(II)}]_2(\mu\text{-}1,3\text{-NO}_3)_2\}^{2+}$.

arrangement, similar to the amido- or carboxylato-bridged platinum blue-type dimeric or polymeric Pt and Pd complexes.^{524–527} It has been mentioned that there is a coordination mode of $(\mu\text{-}1,3\text{-NO}_3)_2$ bonded to two metals,⁵²⁸ which is scarcely seen in platinum group metals.^{524–529} The two dimers aggregate alternately along the linear chain consisting of the four Pd^{II} atoms with Pd···Pd distances of 2.848(3) Å (intradimer) and 3.117(3) Å (interdimer), showing quite strong metal–metal interactions.

Dithiolene complexes $\{[\text{Pd}(\text{PPh}_3)_2]_n\{\text{S}_2\text{C}=\text{CCHC}(\text{O})\text{R}\}\}$ are mononuclear or homodinuclear derivatives of ferrocenyl-substituted dithiolene ligands.⁵³⁰ 2,2-Diacetyl-1,1-ethylenedithiolato complexes of palladium can be used to prepare dinuclear PdAg and PdAu complexes.⁵³¹

In a polythiophene derivative conjugated chains are linked by Pd bridges in which the metal is σ -bonded to a C of the backbone.⁵³² Interesting materials are formed by electropolymerization of Pd^{II} complexes containing phosphinoterthiophene ligands exhibiting several different bonding modes.⁵³³ The largest degree of interaction between the dimethylterthienyl groups is seen in a complex where the metal is both P,C- and P,S-coordinated. The conductivity appears to involve a contribution from cross-metal delocalization.⁵³³

A dinuclear complex of Pd^{II} was obtained by the reactions of $[\text{Pd}(\text{bpm})(\text{H}_2\text{O})_2]^{2+}$ (bpm = bis(pyridine-2-yl)methane) with model nucleobases as constituents of DNA.⁵³⁴

In the homodinuclear complex $\{[\text{Pd}(\text{dppp})]_2(\mu\text{-biim})\}(\text{OTf})_2$ (dppp = bis(diphenylphosphino)propane, biim = 2,2'-biimidazole, OTf = OSO_2CF_3) a biim²⁻ ligand spans the two palladium(II) centers.⁵³⁵

Many metal-containing liquid crystals (metallomesogens) contain coordination compounds; there are fewer liquid crystals of the organometallic type. Among the latter, there are many dinuclear and mononuclear orthometallated complexes. The dinuclear complexes $[\text{Pd}(\mu\text{-X})\text{L}^n]_2$ permit one to induce thermotropic changes not only by modifying terminal alkyl or alkoxy chains in L^n ,^{536–539} but also by modifying the bridging system X, which can be bridging thiolates.^{540,541} Reactions of dinuclear compounds $[\text{Pd}(\mu\text{-OH})\text{L}^n]_2$ with protic substrates like amines, thiols, and carboxylic acids give other dinuclear complexes with double and mixed bridges: air stable amido–hydroxo, anilido–hydroxo, bis-amido, amido–thiolato, and amido–carboxylato complexes.⁵⁴² Noteworthy is the thermal stability of those with amido ligands containing β -hydrogens: the number of known dinuclear amido–bridged palladium complexes is limited^{296,543–554} and even fewer possess β -hydrogens,^{543,544,547} because there is a strong tendency for the late transition metal amido complexes to undergo β -hydrogen elimination, usually followed by decomposition.

A trinuclear system, whose structure was published,⁵⁵⁵ was formed in high yield by the cyclometalation of a 1,3-bis(alkylbenzimidazol-2-yl)benzene ligand, followed by the trimerization of the unit, which possesses a vacant coordination site on the palladium atom and a pendant noncoordinated benzimidazole moiety. The resulting product forms a cup-shaped trimer or tricorner, presented in Figure 46, that includes a molecule of acetonitrile in the crystal structure.⁵⁵⁶

Binuclear μ -hydroxo- μ -amido palladium(II) complexes of the type $\{[\text{Pd}(\text{C}_6\text{F}_5)(\text{PPh}_3)]_2(\mu\text{-OH})(\mu\text{-NHC}_6\text{H}_4\text{X-}p)\}$ have been prepared by reaction of $\{[\text{Pd}(\text{C}_6\text{F}_5)(\text{PPh}_3)(\mu\text{-OH})]_2\}$ with the corresponding aromatic amine, and the bis(amido) complexes $\{[\text{Pd}(\text{C}_6\text{F}_5)(\text{Bu}^t\text{NC})(\mu\text{-NHC}_6\text{H}_4\text{X-}p)]_2\}$ by the reaction of $\{[\text{Pd}(\text{C}_6\text{F}_5)(\text{Bu}^t\text{NC})(\mu\text{-Cl})]_2\}$ with $[\text{NBu}_4]\text{OH}$ and the arylamine (1:2:2 mol ratio).⁵⁵⁰ Although the reductive elimination chemistry of the mononuclear methyleneamido palladium complex $[(\text{DPPF})\text{Pd}(\text{C}_6\text{H}_4)\text{-Bu}^t(\text{N}=\text{CPh}_2)]$ (DPPF = (1,1'-diphenylphosphino)ferrocene), which contains one unsaturated nitrogen bound to palladium, has been reported,⁵⁵⁷

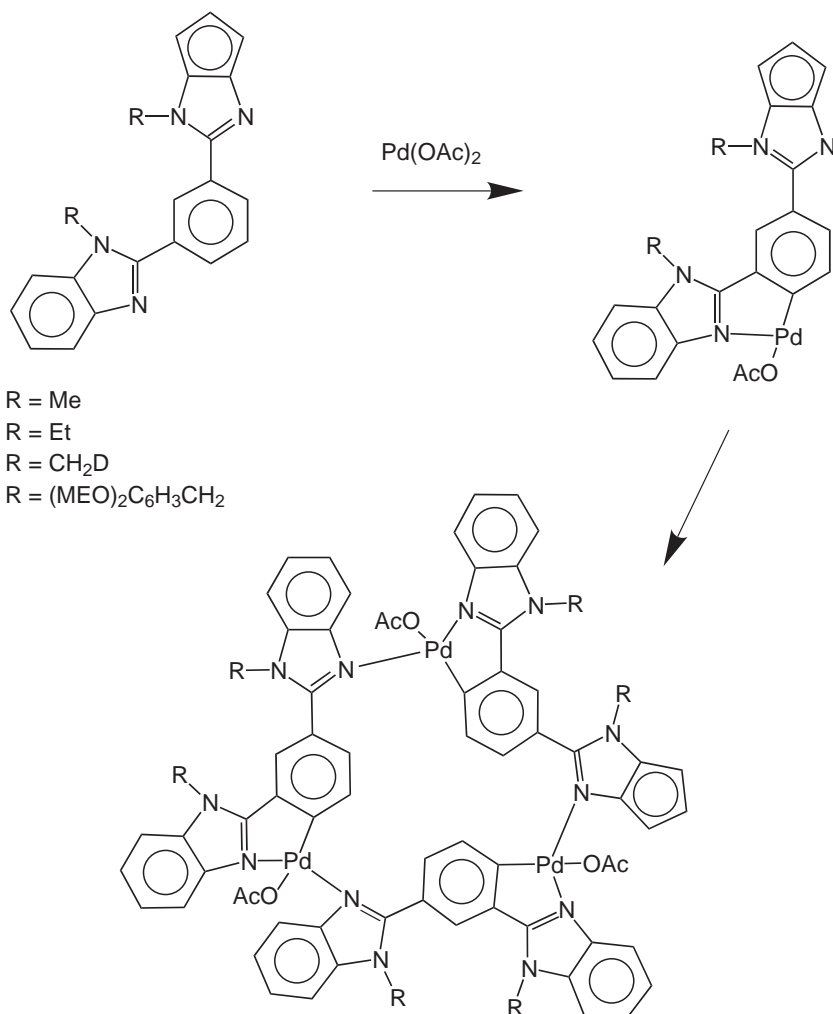

Figure 46 A trinuclear system, formed in high yield by the cyclometalation of a 1,3-bis(alkylbenzimidazol-2-yl)benzene ligand.

it could not be isolated. Little is known about methyleneamido (or azavinylidene)-bridged compounds. The first synthesis of a stable azavinylidene-bridged palladium complex, $[\{\text{Pd}(\text{C}_6\text{F}_5)(\text{Bu}^t\text{NC})(\mu\text{-N}=\text{CPh}_2)\}_2]$, and its structural elucidation by an X-ray diffraction analysis have been reported.⁵⁵⁸

Trifluorophosphane can behave as a μ_3 donor towards a triangular palladium core.^{559,560} The symmetrically bridging μ_2 -coordination mode has little precedent for tertiary ligands based on Group 15 atoms. The synthesis of a Pd^I dimer featuring a strongly bonded symmetrically bridging μ_2 -phosphole unit, which is the first example of this coordination mode for a tertiary phosphane, has been reported.⁵⁶¹

Dinuclear Pd^I complexes involving six two-electron donors arranged about the Pd–Pd bond are well-known,^{203,562} but the new complex, shown in Figure 47, exhibits two striking features: (i) In contrast to most Pd^I dimers,^{203,562,563} the Pd₂²⁺ core has an edge-bridged planar structure imposed by the topology of ligand; and (ii) the phosphorus atoms of both coordinated phospholes bridge almost symmetrically the Pd–Pd vector (Pd–P: 2.349(2) Å and 2.358(2) Å).⁵⁶¹

A possible way to achieve more robust coordination polymer frameworks is to put the powerfully stabilizing chelate effect to use in the bridging ligands. If appropriate donor centers are introduced into the three substituents on the CN₃ core, then it may be possible to chelate three metal centers strongly and symmetrically, in a roughly planar fashion, and providing a close metal–metal contact. Tris(2-hydroxybenzylidene)triaminoguanidine LH₅ is very easily made from triaminoguanidine and salicylaldehyde. Reaction of LH₆Cl with (Et₄N)₂[PdCl₄] in acetonitrile in

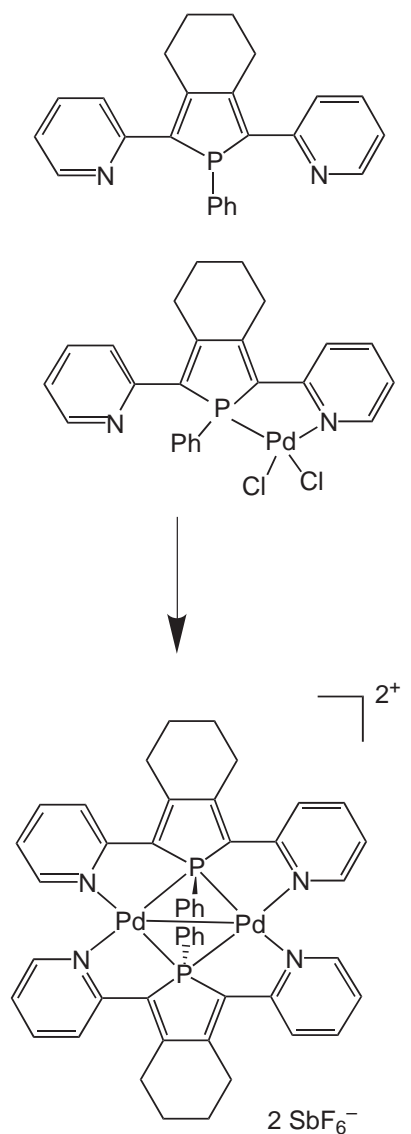

Figure 47 The new dinuclear Pd(I) complex.

the presence of Et_4NOH yielded dark red crystals of $(\text{Et}_4\text{N})_2[\text{LPd}_3\text{Cl}_3]\text{CH}_3\text{CN}$. The chiral propeller-like structure of the $[\text{LPd}_3\text{Cl}_3]^{2-}$ ion is shown in [Figure 48](#).⁵⁶⁴ The wide scope offered by these types of LM_3 species as 3-connecting building blocks in the construction of networks is immediately apparent. One possibility would be to substitute the Cl ligands in the LPd_3 system by appropriate bridging ligands linking one LM_3 unit to another.⁵⁶⁴

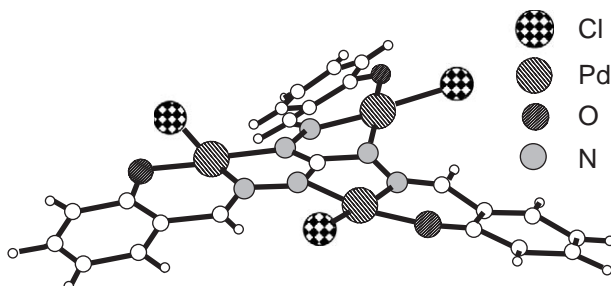

Figure 48 The chiral propeller-like structure of the $[\text{LPd}_3\text{Cl}_3]^{2-}$ ion.

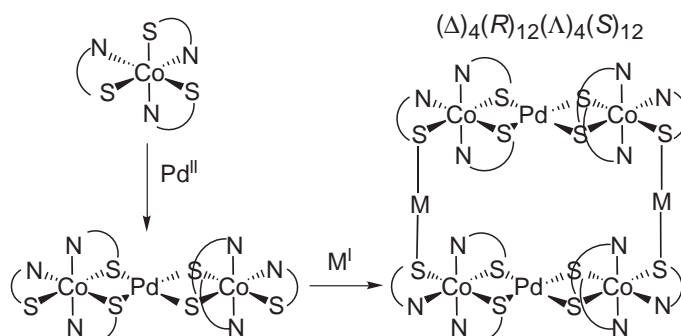

Figure 49 Cyclic sulfur-bridged octanuclear complexes $[M_2'\{Pd[Co(aet)_3]_2\}_2]^{6+}$.

Octahedral metal complexes assemble with simple thiolate ligands, such as 2-aminoethanethiolate (aet) and l-cysteinate (l-cys). The assembly of these types of complexes can be achieved by facile reactions with a variety of metal ions, M, which utilize the binding ability of a coordinated thiolato sulfur atom toward a second metal ion, M'. One way to do this is to introduce a four-coordinate metal ion, such as $M' = Pd^{II}$, Pt^{II} , at the center of the linear trinuclear structure in $[M'\{M(aet)_3\}_2]^{2+}$. The reaction of *fac*(S)-[Co(aet)₃] with $[PdCl_4]^{2-}$ in a 1:1 ratio produced a sulfur-bridged Co₂Pd₃ pentanuclear complex, $[Pd_2\{Pd(aet)_2\}\{Co(aet)_3\}_2]^{4+}$, in which all of the eight thiolato sulfur atoms from two *fac*(S)-[Co(aet)₃] and one *cis*(S)-[Pd(aet)₂] units are bound to two square-planar Pd^{II} ions.⁵⁶⁵ The corresponding 2:1 reaction under milder conditions gives the desired trinuclear complex $[Pd\{Co(aet)_3\}_2]^{2+}$, which readily reacts with Ag^I or Au^I as M' to afford cyclic sulfur-bridged octanuclear complexes $[M_2'\{Pd[Co(aet)_3]_2\}_2]^{6+}$ (see Figure 49). This is the first example of chiral metallacycles composed of three kinds of metal ions with different oxidation states and coordination geometries: octahedral Co^{III}, square-planar Pd^{II}, and linear Ag^I or Au^I ions.⁵⁶⁶ Synthesis, reactivity, and X-ray crystallographic characterization of mono-, di-, and tetranuclear palladium(II)-metalated species were reported.⁵⁶⁷

The compound $\{Pd[\mu_2-(C_6H_4)PPh_2]Br\}_4$ has $[(C_6H_4)PPh_2]^-$ anions bridging two palladium atoms in a tetranuclear structure. This tetranuclear frame was cleaved with phosphines to form mononuclear compounds.⁵⁶⁸ Intermediate products of the frame degradation were detected (see Figure 50).⁵⁶⁷

An example of the modified 7-azaindoyl ligands is the novel starburst molecule, 1,3,5-tris(7-azaindol-1-yl)benzene (tabH). The complex $[Pd_3(tab)_2Cl_4]$ has three Pd^{II} ions in two different environments.⁵⁶⁹ The tab ligand acts both as a chelating and a bridging ligand (see Figure 51).

Although two closed-shell metal cations with the same charge would normally be expected to repel each other, evidence has been obtained for an entire family of cation–cation interactions in d^{10} or s^2 systems.⁵⁷⁰ This attraction is now shown to originate from dispersion (van der Waals)

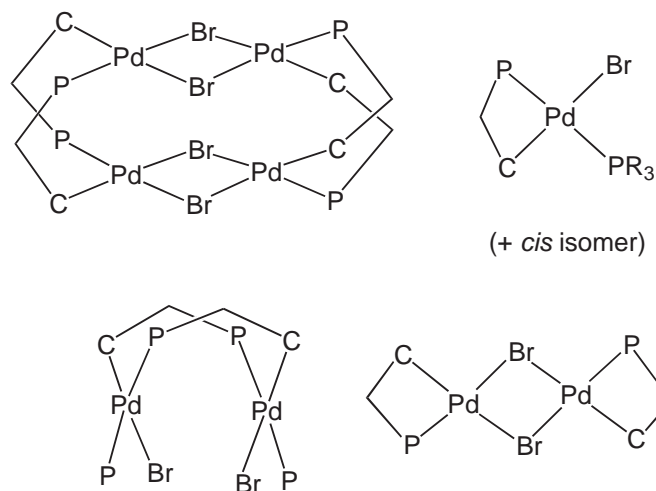

Figure 50 Intermediate products of the frame degradation of $\{Pd[\mu_2-(C_6H_4)PPh_2]Br\}_4$ after being cleaved with phosphines.

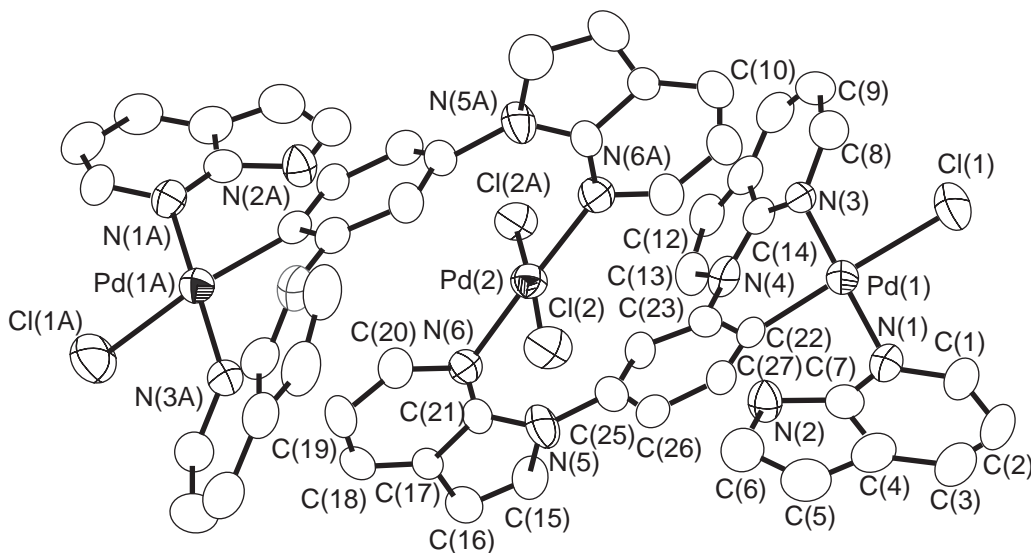

Figure 51 The complex $[\text{Pd}_3(\text{tab})_2\text{Cl}_4]$.

interactions. It is comparable in strength with typical hydrogen bonds, and it is especially strengthened by relativistic effects for heavy elements such as gold.^{571–573} Also, because of the large crystal-field splitting, d^8 ions are, in a sense, closed-shell atoms and can be involved in similar attractions. Regarding d^8-d^{10} systems, a number of structurally characterized complexes in which metalphilic attraction appears are known, but although heterometallic gold-palladium complexes have been characterized,⁵⁷⁴ no examples of $\text{Au}^I \cdots \text{Pd}^{II}$ interactions seem to have been reported before year 2000.⁵⁷⁵ The main contribution to the $\text{Pd}^{II}-\text{Au}^I$ attraction is dispersion. Charge-transfer type contributions are about half as important, but the two contributions $\text{Pd} \rightarrow \text{Au}$ and $\text{Au} \rightarrow \text{Pd}$ are energetically comparable.⁵⁷⁵

Dinuclear complexes with bridging phosphido, hydrido, and diphosphine ligands were formed via some interesting transformations, such as P–C bond formation, P–H bond activation, and conversion of a chelate diphosphine to one bridging two metal centers.²⁵⁹

The 2,2′-bipyrazine (2,2′-bpz) complexes $[\text{L}_2\text{Pd}(2,2′\text{-bpz-}N^1,N^1)]^{2+}$ in which ($\text{L}_2 = \text{en}$ and $\text{L} = \text{H}_2\text{O}$) represent useful angular units for the generation of larger cationic aggregates. There are two principal ways by which this can be achieved: (i) When additional metal ions M bind to the available N(4) positions of the chelating 2,2′-bpz ligand and cross-link to other cations, depending on the geometry of M' , flat triangles ($M' = \text{trans}(\text{NH}_3)_2\text{Pt}^{II}$),⁵⁷⁶ loop structures ($M' = \text{Ag}^+$), or hexanuclear vases ($M' = \text{enPd}^{II}$)⁵⁷⁷ can form. (ii) The aqua compound can likewise act as an angular unit upon substitution of the aqua ligands by other bridging ligands L . These may be small (OH^-) or large (4,4′-bpy) and may themselves be angular (OH^-) or linear units (4,4′-bpy). Of course, variations of these motifs are possible, e.g., upon use of $M'-L-M'$ fragments in (i) or $L-M'-L$ linear units in (ii). Finally there is, in principle, also the possibility of combining (i) and (ii) in such a way as to use as a cross-element in molecular architecture (option (iii) in Figure 52).⁵⁷⁸

Owing to the high affinity of palladium for sulfur, the palladium complexes with phosphine ligands readily react with organosulfur compounds^{579–587} to give very stable sulfide and thiolate complexes, which are probably responsible for the poisoning of palladium catalysts by organosulfur impurities in feedstocks. The palladium(II) complexes blending both phosphine and thiolate ligands have received attention only in the 1990s.^{136,588–590} A tetranuclear complex $[\text{Pd}_4(\mu_3\text{-Se})_2(\mu\text{-SCH}_2\text{Ph})_2(\mu\text{-dppm})_2\text{Cl}_2]$ is formed via the reaction of $[\text{Pd}_2(\mu\text{-dppm})_2\text{Cl}_2]$ with selenium powder in the presence of NaSCH_2Ph in DMF.⁵⁹¹ The features of this complex are its novel structure arising from the asymmetric coordination by phosphorus, selenium, sulfur, and chlorine atoms and its formation involving considerable rearrangement of the initial components. A study reports the condensation reactions of mononuclear palladium(II) complexes with mixed diphosphine and thiolate ligands, $[\text{Pd}(\text{dppp})(\text{SRS})]$ ($\text{SRS}^{2-} = \text{edt}^{2-}$ or propane-1,3-dithiolate), through oxidation of the ligands with oxygen or elemental Se, and the crystal structures of a series of polynuclear palladium complexes isolated from the condensation reactions along with their spectroscopic properties are presented.⁵⁹²

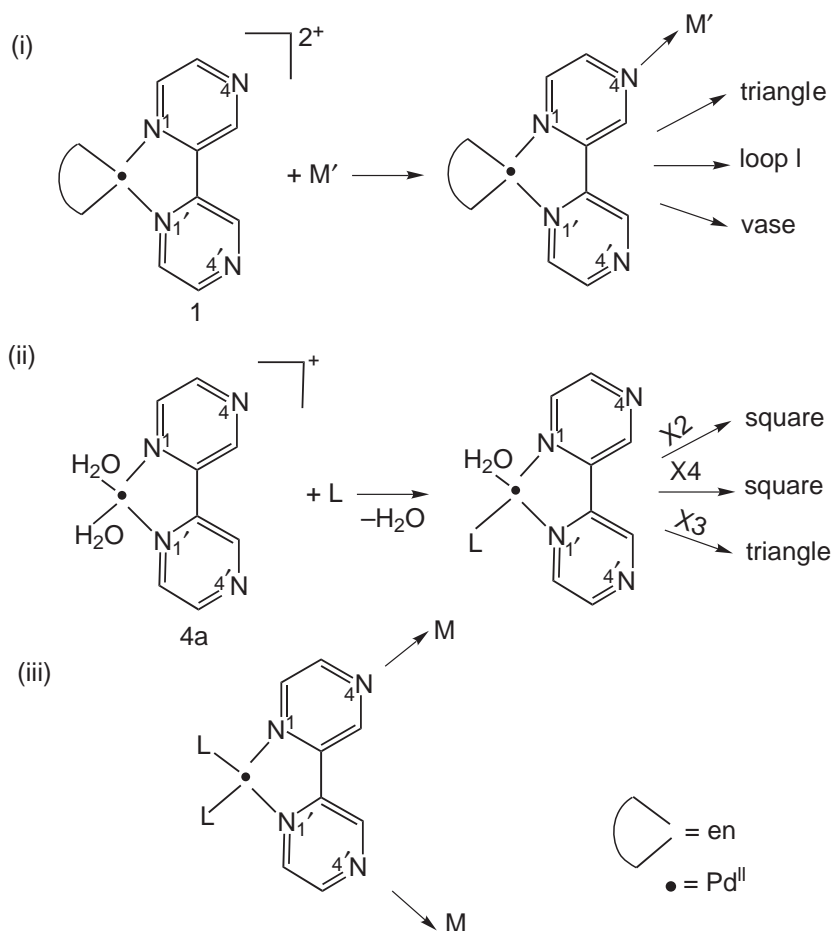

Figure 52 Use of the 2,2'-bipyrazine (2,2'-bpz) complexes $[L_2Pd(2,2'\text{-bpz-}N^1, N^{1'})]^{2+}$ in which ($L_2 = \text{en}$ and $L = H_2O$) as angular units for the generation of larger cationic aggregates.

Reactions of $PdCl_2(PhCN)_2$ with (*S*)-*N,N'*-bis[2-(diphenylphosphino)benzylidene]-2,2'-diimino-1,1'-binaphthylene and (*S,S'*)-*N,N'*-bis[2-(diphenylphosphino)benzylidene]-1,2-diimino-1,2-diphenylethane give unexpected results, as shown in [Scheme 10](#).⁵⁹³

Palladium(II) complexes possessing bidentate ligands are known to efficiently catalyze the copolymerization of olefins with carbon monoxide to form polyketones.^{594–596} Sulfur dioxide is an attractive monomer for catalytic copolymerizations with olefins since SO_2 , like CO, is known to undergo facile insertion reactions into a variety of transition metal-alkyl bonds. Indeed, Drent has patented alternating copolymerization of ethylene with SO_2 using various palladium(II) complexes.⁵⁹⁷ In 1998, Sen and coworkers also reported that $[(dppp)PdMe(NCMe)]BF_4$ was an effective catalyst for the copolymerization of SO_2 with ethylene, propylene, and cyclopentene.⁵⁹⁸ There is a report of the insertion reactions of SO_2 into Pd^{II} -methyl bonds and the attempted spectroscopic detection of the copolymerization of ethylene and SO_2 .⁵⁹⁹

The cationic 1,3-bis(diphenylphosphino)propane (dppp) palladium(II) complex (see [Figure 53](#)) can be prepared by the low temperature reaction of $(dppp)PdMe_2$ with $H(OEt_2)_2[Bar']_4$ [$Ar' = C_6H_3(CF_3)_2-3,5$].⁶⁰⁰ Reaction of this complex with an excess of SO_2 (~25 equivalents) at 193 K produces an unusual dinuclear complex, shown in [Figure 54](#).⁵⁹⁹ The eight-membered ring consists of a plane of palladium and oxygen atoms, with the sulfur atoms located above and below the plane. The six-membered rings formed by the dppp ligand are in the chair conformation.

The cyclooctapyrroles shown in [Figure 55](#) appear predestined to form binuclear metal complexes since the loop-shaped conformation of these macrocycles exhibits two structurally identical, helical N_4 cavities. Enantiomers of such complexes, which are presumably generally very stable towards racemization owing to the rigidity of the molecule imposed by the incorporation of the metal, are of interest as possible models for binuclear metalloenzymes and as potential catalysts in asymmetric synthesis. The first two ligands as well as their recently obtained palladium complexes⁶⁰¹ were

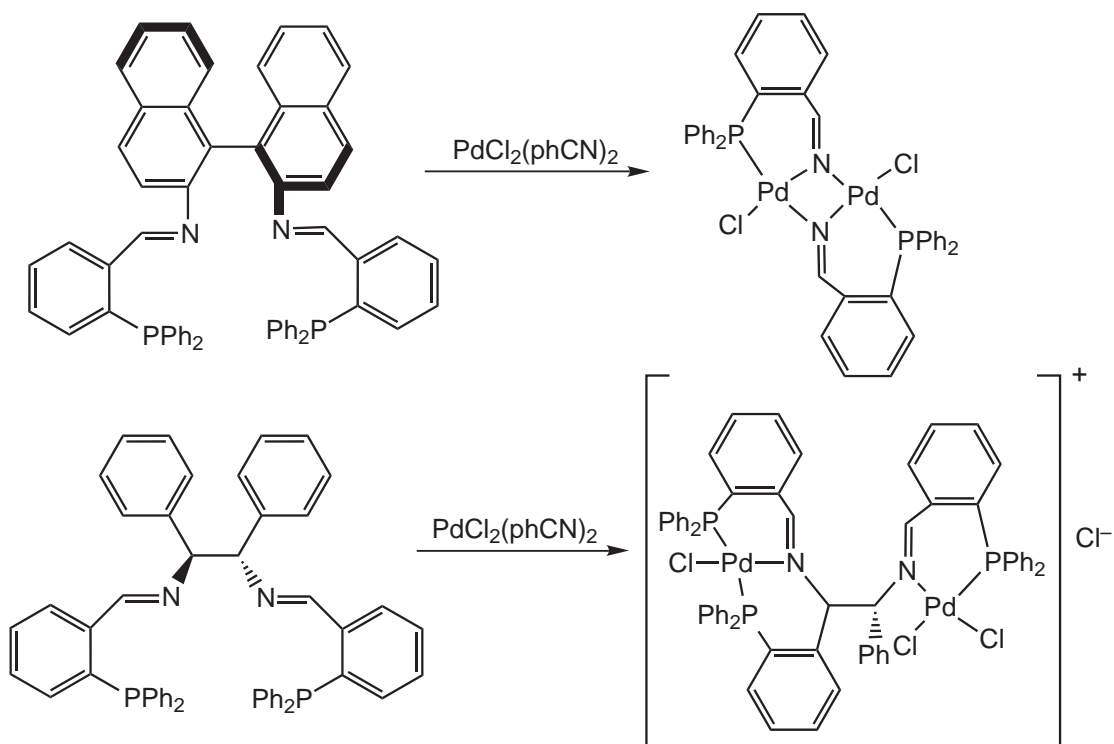

Scheme 10

investigated as examples to effect enantiomeric separation.⁶⁰¹ The molecular frameworks of the cyclooctapyrroles show the figure eight conformation previously derived from the NMR studies.⁶⁰¹ The ability of the first two cyclooctapyrroles shown, to form binuclear chelates was confirmed by the preparation of the homobinuclear palladium(II) complexes.

X-ray structure analysis shows that on incorporation of two Pd^{II} ions into the two N_4 cavities the molecular symmetry remains unaffected, but there are marked conformational changes in the ligand framework, as shown in Figure 56. The intramolecular separations of the metal centers are not conducive to significant intermetal interactions. Figure eight cyclooctapyrroles and—presumably in general—their binuclear metal complexes are amenable to preparative enantiomeric separation by chromatography on suitable phases (here a CDMPC (CDMPC = cellulose tris(3,5-dimethylphenyl-carbamate)) coated silica gel proved suitable). They hold promise for a symmetric catalysis.⁶⁰¹

Many examples are known of edge-sharing square planar bimetallic complexes formed by d^8 transition-metal centers. A recent report tentatively classified the structures of such complexes bridged with two X ligands ($\text{X} = \text{halogen anion}, \text{RO}^-, \text{RS}^-, \text{S}^{2-}, \text{or } \text{R}_2\text{P}^-$) into two possible groups, that is, flat and bent forms (see Figure 57).⁶⁰² Of these two structures, the bent form is of interest, particularly because axial orbitals of the two metals are in close proximity under the hinged planes and interact cooperatively with a substrate. Such an interaction is expected to play a significant role in binding a substrate to a bimetallic complex. A study reports the preparation and X-ray structure of unprecedented linked-bisphosphido dipalladium-(II) complexes with a

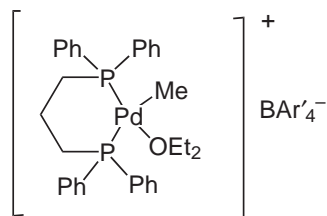

Figure 53 Cationic 1,3-bis(diphenylphosphino)propane (dppp) palladium(II) complex.

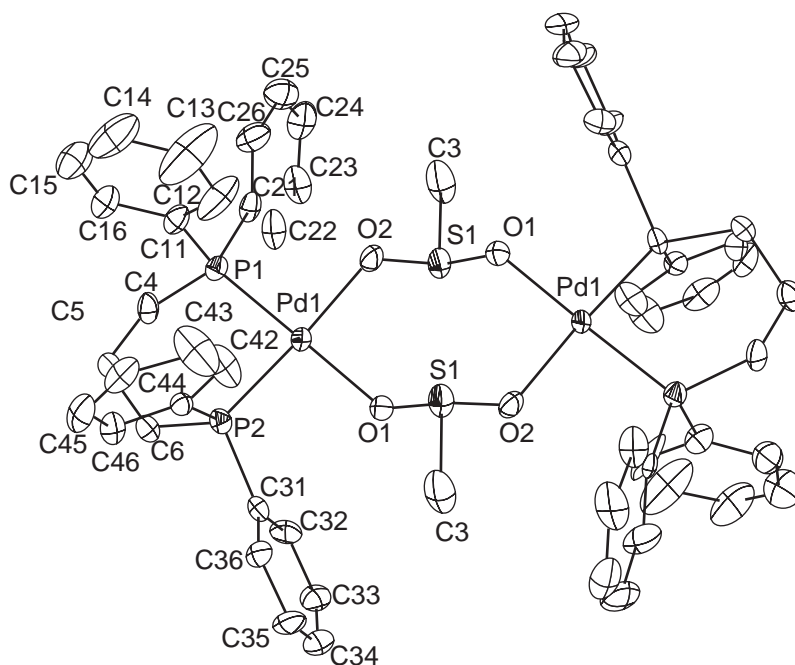

Figure 54 Product of the reaction of 1,3-bis(diphenylphosphino)propane (dppp) palladium(II) complex with an excess of SO_2 .

formula $[\text{Pd}_2(\mu\text{-RPCH}_2\text{CH}_2\text{PR})(\text{DPPE})_2]\text{Cl}_2$ ($\text{R} = \text{Me}$ and Ph), in which the linked-bisphosphido groups are employed as ligands to enforce them sterically to adopt a bent structure.⁶⁰³

Trinuclear clusters $[\text{Pd}_3(\mu_3\text{-E})_2(\text{L})_3]^{2+}$ ($\text{E} = \text{S}$, Se or Te ; $\text{L} =$ bis(diphenylphosphino)methane (dppm), 1,2-bis(diphenylphosphino)ethane (dppe), 1,3-bis(diphenylphosphino)propane (dppp) or 1,4-bis(diphenylphosphino)butane (dppb)) were made and studied by cyclic voltammetry. The extent of chemical reversibility of the reduction process clusters depends on the chelate ring size and varies in the order $\text{L} = \text{dppe} > \text{dppp} > \text{dppb} = \text{dppm}$ for the clusters. For the $[\text{Pd}_3(\mu_3\text{-E})_2(\text{dppe})_3]^{2+}$ clusters, the extent of reversibility improves in the order $\text{Te} > \text{Se} > \text{S}$. The ease of reduction follows the order $\text{Te} > \text{Se} > \text{S}$ regarding the chalcogenido ligands.^{604–606} The ligand 1,2-bis(diphenylarsino)ethane (dpae) was used to synthesize trinuclear $[\text{Pd}_3(\mu_3\text{-E})_2(\text{dpae})_3]^{2+}$ ($\text{E} = \text{S}$, Se or Te) clusters. The dpae ligand chelates to a metal ion through its two arsenic atoms. The synthesis and cyclic voltammetry and X-ray structure of $[\text{Pd}_3(\mu_3\text{-S})_2(\text{dpae})_3][\text{BPh}_4]_2$ are described.⁶⁰⁷

Metallacrown ethers are a class of molecular receptors with both crown ether- and transition metal-receptor sites. The metallacrown ether $[\text{PdCl}_2\{\text{PPh}_2\text{-(CH}_2\text{CH}_2\text{O)}_4\text{CH}_2\text{CH}_2\text{PPh}_2\text{-P,P'}\}]_m$,⁶⁰⁸ exhibits a unique mode of molecular recognition in which the metallacrown ether ring is expanded by the incorporation of a PdCl_2 moiety. The product of this reaction is the first reported example of a dimetallacrown ether, see [Scheme 11](#).⁶⁰⁹

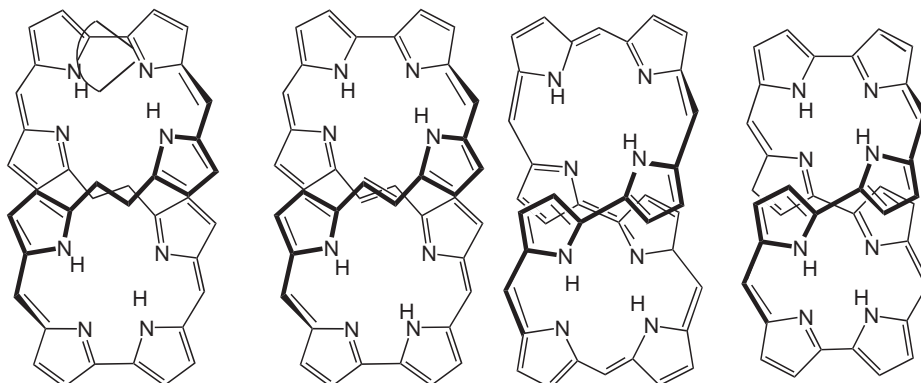

Figure 55 Cyclooctapyrroles.

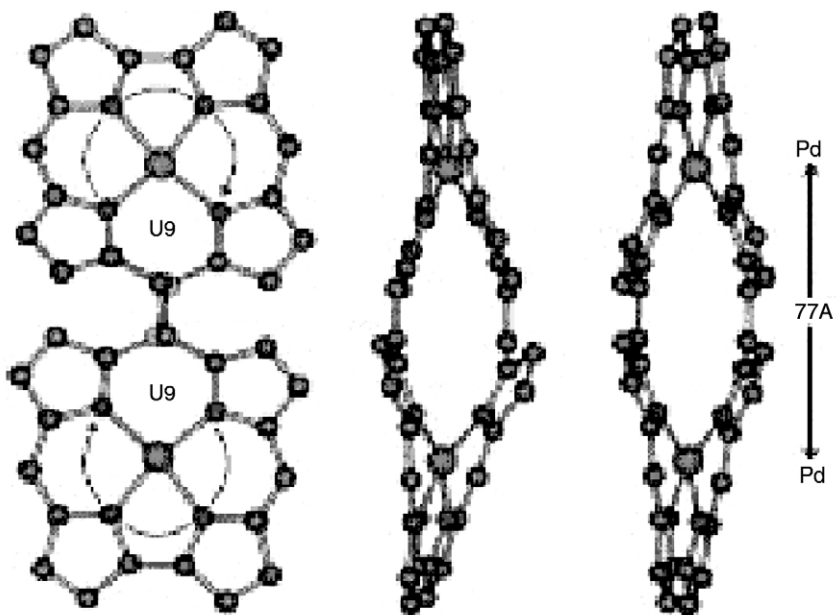

Figure 56 Conformational changes in the ligand framework of cyclooctapyrroles.

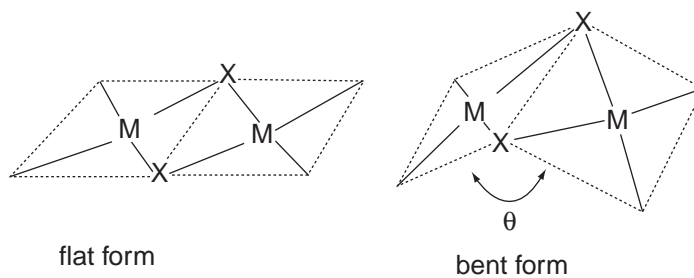
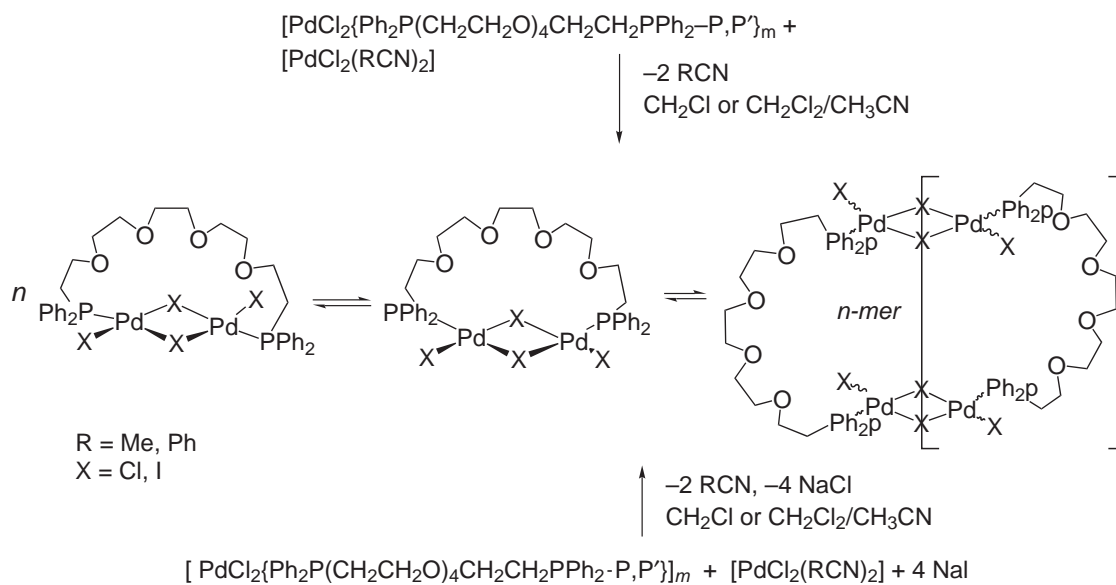

Figure 57 Flat and bent forms of edge-sharing square planar bimetallic complexes formed by d^8 transition-metal centers.



Scheme 11

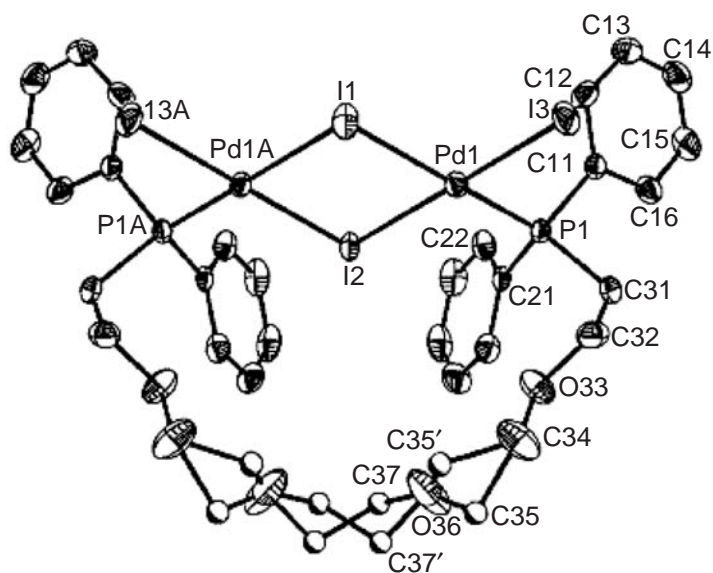

Figure 58 X-ray crystal structure of a dimetallacrown ether.

The X-ray crystal structure shown in **Figure 58** suggests that this dimetallacrown ether could have quite different receptor properties from those of the previously reported metallacrown ethers. The average cross-ring oxygen–oxygen distance (O33–O36A and O33A–O36, 5.27 Å), provides a measure of the ring size.⁶⁰⁹ A bifunctional molecule, such as CO, could easily coordinate to both the Pd and the alkali metal cation in the dimetallacrown ether.⁶⁰⁹

Syntheses and reactivities of noble metal–sulfur clusters are still poorly understood. The mixed-metal sulfido cluster containing a cubane-type $\text{PdMo}_3(\mu_3\text{-S})_4$ core is capable of catalyzing the stereo- and regioselective addition of alcohols⁶¹¹ or carboxylic acids⁶¹¹ to the alkynes with electron-withdrawing substituents as well as the intramolecular cyclization of alkynoic acids.⁶¹² Two versatile synthetic routes lead to metal sulfido clusters containing Pd. One involves the reactions of the hydrosulfido-bridged dinuclear complexes $[\text{Cp}^*\text{MCl}(\mu_2\text{-SH})_2\text{MCp}^*\text{Cl}]$ ($\text{Cp}^* = \eta^5\text{-C}_5\text{Me}_5$; $\text{M} = \text{Ru}, \text{Rh}, \text{Ir}$) with various metal complexes affording an enormous body of $\text{M}_2\text{M}'(\mu_3\text{-S})_2$ clusters,^{613,614} while the other is the incorporation of one or two noble metals into the dinuclear complexes $[\text{M}_2\text{S}_2(\mu_2\text{-S})_2(\text{S}_2\text{CNET}_2)_2]$ ($\text{M} = \text{Mo}, \text{W}$) affording the mixed-metal clusters with the $\text{M}_2\text{Pd}(\mu_2\text{-S})_4$ or $\text{Mo}_2\text{Pd}_2(\mu_3\text{-S})_4$ core.⁶¹⁵ Most of the metal–sulfido cluster cores have been constructed by the use of self-assembly systems, and the rational and reliable methods to form the desired metal–sulfur frameworks in satisfactory yields are still rare.⁶¹⁵

The ability to switch a molecular unit on and off is a key component of an efficient molecular device, since it allows modulation of the physical response of such a device by external physical or chemical triggers. A molecular device, based on a trinuclear metal complex, shown in **Figure 59**, functions as an electroswitchable-photoinduced-electron-transfer (ESPET) device.⁶¹⁶ Electrochemical switching of the redox state of a spacer intervening between a donor–acceptor pair can dictate the type of the observable charge separation and the lifetime of the resulting ion pair.⁶¹⁶

The insertion of an S or Se bridge into $[\text{Pd}_2(\mu\text{-dppm})_2\text{X}_2]$ ($\text{X} = \text{halogen}$) to give rise to complexes $[\text{Pd}_2(\mu\text{-E})(\mu\text{-dppm})_2\text{X}_2]$ ($\text{E} = \text{S}, \text{Se}$) with a change of the oxidation state of palladium from +1 to +2 has been reported,^{582,617,618} whilst reports on the palladium complexes with mixed thiolate and diphosphine ligands, especially those having a palladium formal oxidation state of +2 and containing both dppm and thiolate ligands, are very rare. A metal–thiolate–diphosphine

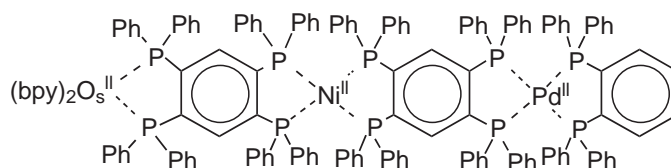
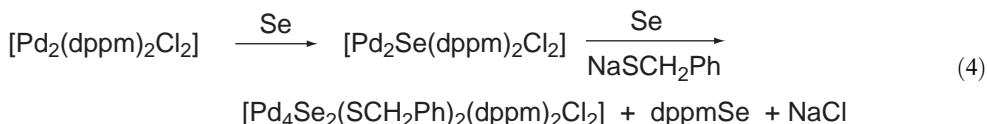

Figure 59 A trinuclear metal complex that functions as an electroswitchable-photoinduced-electron-transfer (ESPET) device.

complex $[\text{Pd}(\text{SR})_2(\text{dppx})]$ [$\text{dppx} = \text{Ph}_2\text{PCH}_2\text{PPh}_2, \text{Ph}_2\text{P}(\text{CH}_2)_2\text{PPh}_2$]^{619–621} is known. The oxidation of $[\text{Pd}_2(\text{dppm})_2\text{Cl}_2]$ with selenium in the presence of NaSCH_2Ph in DMF (see Equation (4)) gives rise to a novel polynuclear complex $[\text{Pd}_4(\mu_3\text{-Se})_2(\mu\text{-SCH}_2\text{Ph})_2(\mu\text{-dppm})_2\text{Cl}_2]$; all the palladium(II) atoms in the compound are tetracoordinated with distorted square-planar geometry, of which two are asymmetrically coordinated with selenium, sulfur, chlorine, and phosphorus atoms.⁵⁹¹



For heterobinuclear complexes which contain an early and a late transition metal and in which the metal centers can “communicate” with one another, interesting properties have been predicted, such as multifunctionality and cooperative effects. However, the problems encountered in the realization of the differing coordination chemical requirements of both metals in close proximity to one another are just as great as the expectations. There is a report on the synthesis and structure of heterobinuclear complexes in which interactions of palladium with a lanthanide (Nd) are possible.^{622–624} A decisive factor for this enlargement of the class of “early-late heterobimetallics” (ELHB) is a novel ligand system incorporating bisaminopyridinato (bis(Ap)) ligands.⁶²⁵ The Nd–Pd-alkyl complex is isolated as a light yellow powder. The molecular structure (see Figure 60) shows a planar coordination geometry, characteristic of Pd^{II} compounds, and a Nd–Pd distance of 3.0345(12) Å. The two metal centers are bridged by only one ligand.⁶²⁵ Decisive for the preparation as well as the stabilization of the heterobimetallic compound is that

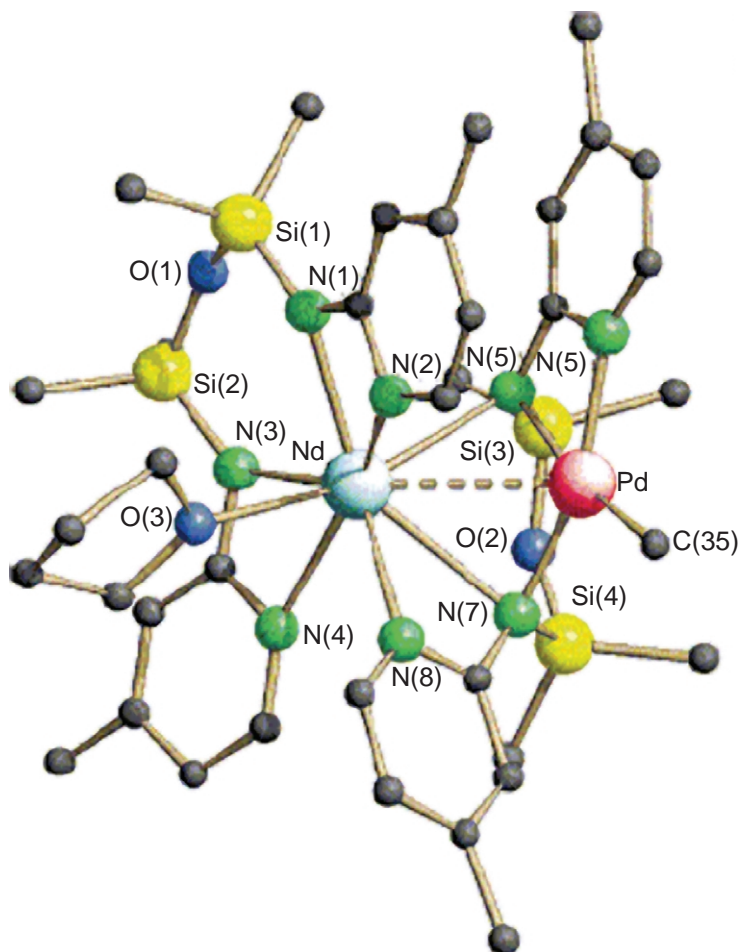

Figure 60 A novel complex incorporating bisaminopyridinato (bis(Ap)) ligands.

the lanthanide “ate” complexes react with chlorides of electron-rich transition metals, such as Pd by salt elimination and that bisaminopyridinato ligands can prevent the ligand transfer from early to late transition metals and thus the decomposition of the bimetallic complex. The flexible coordination mode of the bis(Ap) ligands allows a coordinative saturation of the lanthanide metal center, leaving two or three nitrogen donor groups for a square-planar coordination geometry at the late transition metal as well as an interaction between the two metals.⁶²⁵

6.4.5.12.1 Supramolecular assemblies (see Chapters 7.7 and 7.8)

A considerable variety of frequently predesigned molecular polygons and polyhedra have been established, and a methodology exists on how to combine angular and linear building blocks to generate a particular ensemble. As far as the smallest possible polygon, the triangle, is concerned, it should be formed most readily by combining three 60° angular fragments and three linear ones, see Figure 61.^{626–628}

However, a triangle with a 60° turning angle at the metal was unknown because of the impossibility of generating such an angle in a metal fragment of common coordination numbers. Virtually all molecular triangles, with metal entities at the corners display 80–90° angles. It is the flexibility of the organic ligand, shown in Figure 62 that in essence enables formation of the triangle.

Complex formation of enPt^{II} with 2,2'-bipyrazine (bpz) leads in a kinetically controlled reaction and in reasonable yield to a cyclic trimer of composition $[\{\text{enPt}(\text{bpz-N}4,\text{N}4')\}_3]^{6+}$. Due to the low barrier of rotation about the central C2—C2' bond of the bpz ligand and because of monodentate binding of each pyrazine half to the heavy metal, the molecular triangle is rather flexible.⁵⁷⁷ It has been crystallized in two distinctly different forms, with an all-*trans* orientation of the two pyrazine entities (C_2 molecular symmetry) and an all-*cis* arrangement of the pyrazine rings (approximately C_3 symmetry). The trimer in its all-*cis* form behaves as an efficient ligand toward additional metal electrophiles such as enPd^{II}, affording highly charged multinuclear species of different topologies, with vases, a paddle wheel, and a barrel crystallographically characterized.⁵⁷⁷ The building block $[\text{enPd}(\text{bpz-N}1,\text{N}1')]^{2+}$, is the starting material for another type of molecular triangles,⁵⁷⁶ containing metal ions at the corners and at the centers of the sides.

Self-assembled metallomacrocycles have attracted a great amount of attention because of their shape- and size-selective encapsulating properties, with potential applications in catalysis, sensing devices, molecular electronics, and small molecule transport. For example, *cis*-blocked, square-planar palladium(II) and platinum(II) complexes with bidentate or tridentate pyridine-based ligands have been used to prepare molecular boxes and cages that are soluble in either water or organic solvents.^{511,628–634} It is established that 4(3*H*)-pyrimidone is a versatile ligand, either in the neutral or deprotonated form. A neutral palladium(II) complex and cationic complexes with diphosphine ligands contain the neutral ligand while the cationic tripalladium complexes contain the deprotonated ligand acting as a bridging group. The Pd₃ complex can act as a host for anions.⁶³⁵

Construction of discrete and well-defined molecular architectures using organic ligands and metal ions through the self-assembly route has received much attention. A dinuclear Pd^{II} cage,⁶³⁶ includes a hexafluorophosphate ion inside the cavity. Self-assembly of a novel macrotricyclic cage

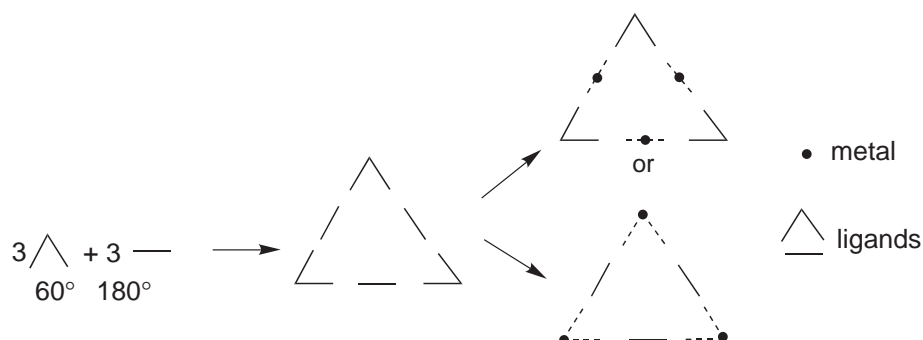

Figure 61 Formation of a triangle by combining three 60° angular fragments and three linear ones.

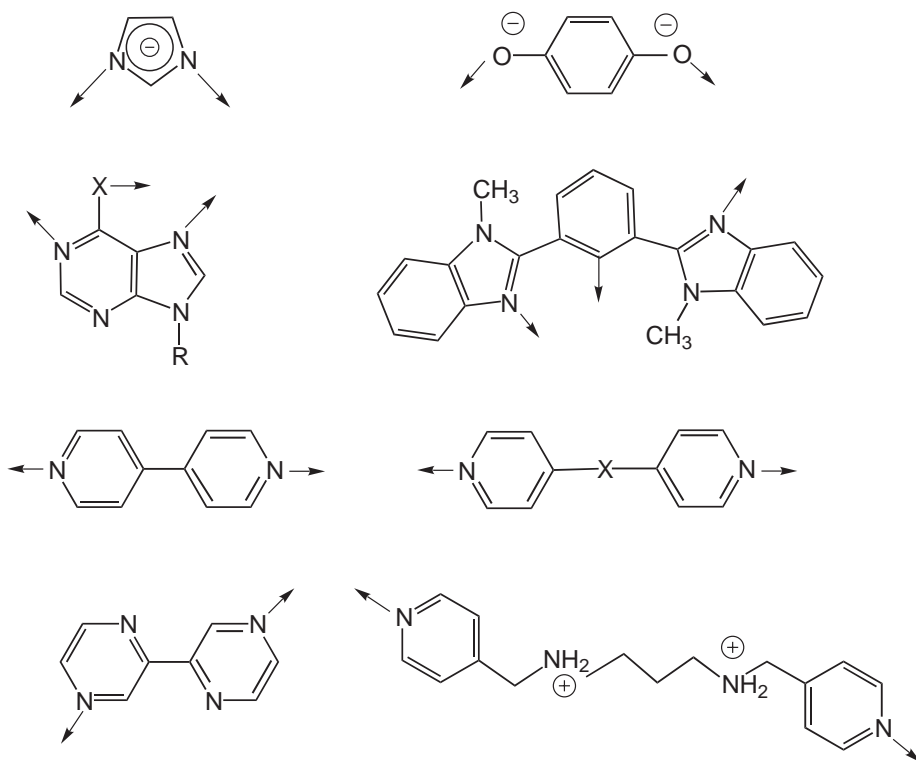

Figure 62 Flexible organic ligands.

molecule from the ligand and $\text{Pd}(\text{NO}_3)_2$, shown in Figure 63, was directly monitored using NMR spectroscopy.⁵¹³

Capsules are instantly formed by simple addition of two equivalents of $\text{Pd}(\text{dppp})(\text{OTf})_2$ (dppp = 1,3-bis(diphenylphosphino)propane) to acetone, CH_2Cl_2 or CHCl_3 solutions of resorcin [4]arene derivatives having four pyridine units as pendent groups, see Figure 64.⁶³⁷

One of the most successful approaches to the synthesis of metalla-supramolecular systems has been by templated self-assembly processes. Most of the templating agents used by synthetic chemists are either cationic or neutral species. Anions, on the other hand, have only fairly recently been successfully utilized as templates. The new metalla-macrocycles $[\text{Pd}_2\text{Ni}_2(\text{atu})_4(\text{PPh}_3)_4\text{X}]^{3+}$ (atu = deprotonated amidinothiourea, $\text{X} = \text{Cl}, \text{Br}, \text{I}$) have been prepared using anion templated syntheses. Only in the presence of each of these three halides are the metalla-macrocycles formed.⁶³⁸

Transition metal-directed self-assembly of macrocycles and cage compounds has received considerable attention lately, leading to more and more complex architectures.⁵¹¹ Numerous examples for square structures but considerably less for triangular structures are given in the literature.^{576,577,639–644} Equilibria between molecular squares and triangles have been reported.^{13,517,577,645–648} One of the most useful corner units is *cis*- $\text{dpppPd}^{\text{II}}$.⁶⁴⁹ These corners are reported to form almost exclusively molecular squares with linear diazaligands.^{646,650} Self-assembly of substituted diazadibenzoperylene bridging ligands with Pd^{II} -phosphane corners resulted in unexpected equilibria between molecular triangles and molecular squares. Owing to complex dynamics on the NMR time scale, identification and characterization of the species could only be accomplished by a combination of variable-temperature ^1H - and $^{31}\text{P}\{^1\text{H}\}$ -NMR spectroscopy and ESI-FTICR mass spectrometry.⁶⁵¹

Since the first self-assembly of a molecular square based on a labile Pd^{II} complex,⁶⁵² many self-assembly molecular squares utilizing Pd^{II} as corners have been reported.^{511,512} Strategies of self-assembly and “complexes as ligands” were combined in the preparation of the octanuclear molecular square $\{(\text{dppf})\text{Pd}[\mu\text{-(pyterpy)}_2\text{Ru}]\}_4(\text{PF}_6)_8(\text{OTf})_8$, where pyterpy is 4'-(4'''-pyridyl)-2,2':6',2'-terpyridine and dppf = 1,1'-bis(diphenylphosphino)ferrocene. The dimensions of this large square are about $21.8 \times 21.8 \text{ \AA}$, probably the largest reported in the literature to 2003. The complex exhibits multielectron redox processes, indicating negligible electronic communications between the individual chromophores. The observed photophysical properties are

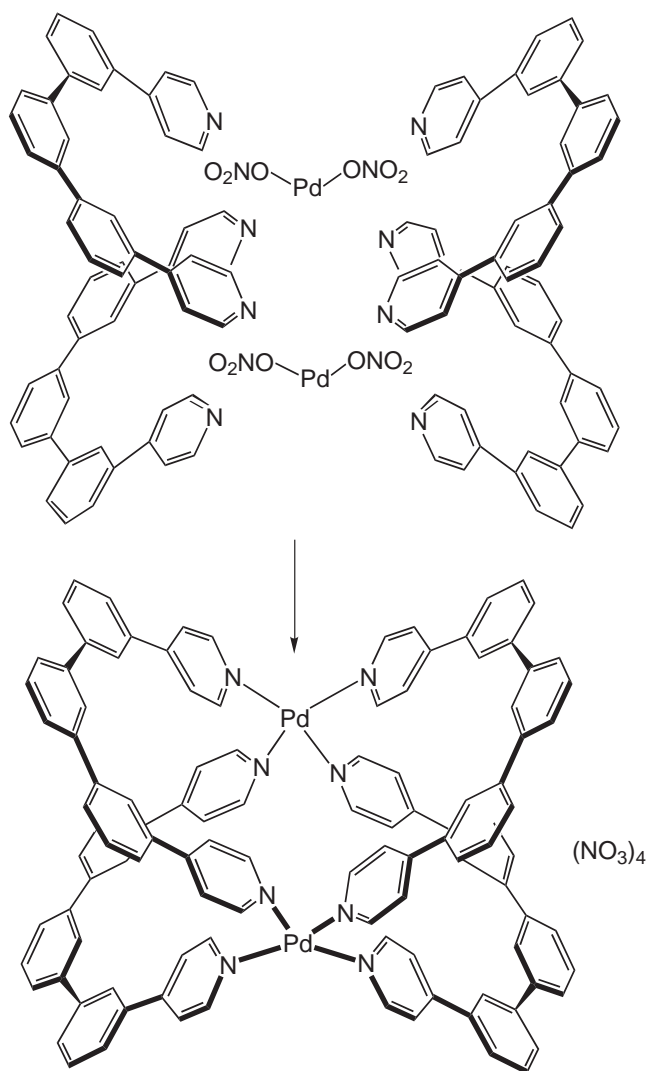

Figure 63 A dinuclear Pd^{II} cage.

dominated by the bridging metal–complex ligands with minimum influence from the corner chromophores.⁶⁵³

Two homooxalix[3]arenes dimerize with three Pd^{II}(Ph₂PCH₂CH₂CH₂PPh₂)·(OTf⁻)₂ into a molecular capsule,^{654,655} which can specifically include C₆₀ fullerene, the selectivity of C₆₀ fullerene versus C₇₀ fullerene being nearly “perfect.”^{655,656} A new molecular capsule is composed of two homooxalix[3]arene with 3-pyridyl substituents at the *para*-positions and three Pd^{II} complexes. According to computational studies and examination of CPK molecular models, this capsule should be “chirally” twisted into either a right-handed (*P*) or a left-handed (*M*) form because of the asymmetrical structural characteristic of the 3-pyridyl substituents, and the ratio should be controlled by “chiral” guest molecules included in the cavity.^{657–660} Indeed this molecular capsule has a chiral factor and the (*P*) versus (*M*) equilibrium is readily controlled by the inclusion of Pirkle’s reagent or chiral R*NH₃⁺ ions.⁶⁶¹

The method developed by Fujita^{662,663} and Stang^{626,627} has proved to be remarkably successful in that predictable supramolecular structures are formed in essentially quantitative yield under thermodynamic control (see Figure 65). It employs a square-planar complex of Pd²⁺ or Pt²⁺ bearing an inert bidentate ligand and easily displaceable ligands, L, in the remaining *cis*-disposed coordination sites. If a linear linker, such as 4,4′-dipyridyl is used, a quantitative yield of the square is slowly formed.⁶⁵² In a similar way, by using the Pd^{II} complex and the tripyridyl linker, the three-dimensional triangular structure is isolated.^{664,665}

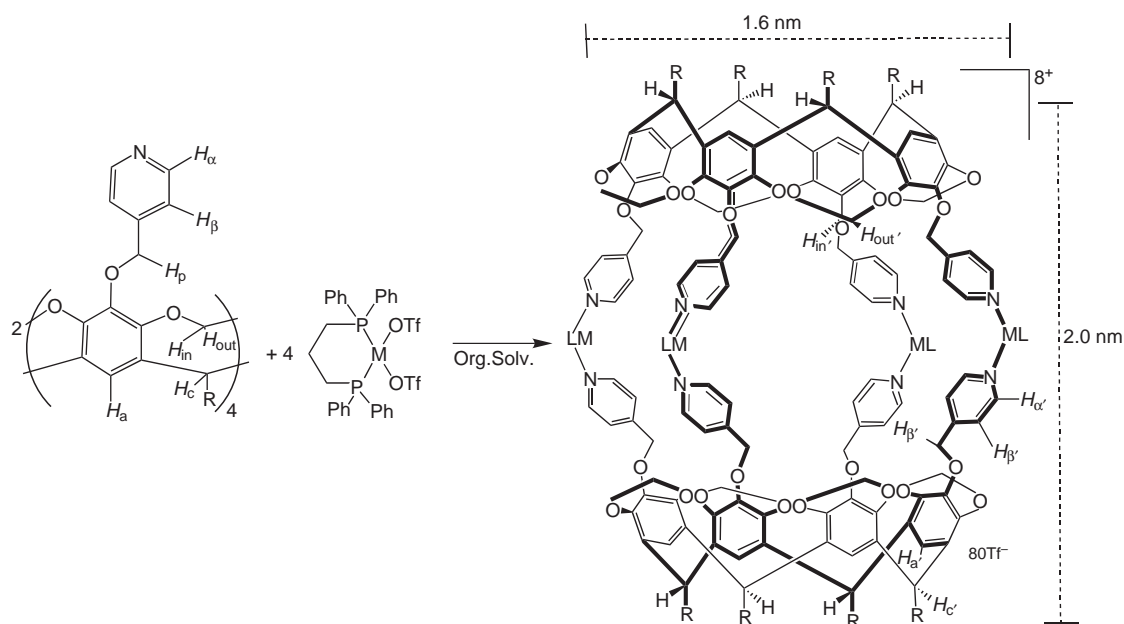

Figure 64 Synthesis of molecular capsules.

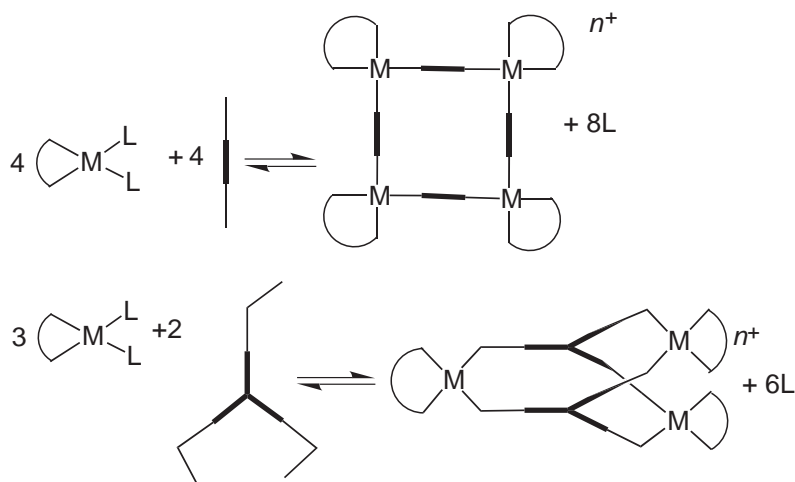

Figure 65 Preparation of supramolecular structures.

Many of the larger supramolecular structures have been shown to incarcerate multiple guest molecules.⁶⁶² Square planar d^8 transition metal complexes formed from planar aromatic ligands are known to form stacked crystal structures which have weak metal–metal bonding and attractive π – π -stacking.^{125,219,666–669} The metal–metal separations are about 3.5 Å which is similar to the separation between stacked aromatic molecules. Consequently, to provide a receptor for square planar d^8 complexes with planar aromatic ligands and also purely organic aromatic molecules, a spacer-chelator molecule is required which holds the chelators cofacially at a separation of about 7 Å. Two cofacial tridentate chelators bound to a square planar metal are shown in Figure 66.

Provided the unidentate ligand, L, is a good leaving group, addition of a linear linker should generate the molecular rectangle. Similarly, a triangular linker should generate a molecular triangle, and so on. Because complexes may carry charge, the cofacial disposition of the metals should allow for the incorporation of negatively charged ligands and complexes into the molecular clefts as illustrated in Figure 67. The synthesis of a spacer-terpyridyl chelator, the formation of molecular rectangles with Pd^{II}, and the stabilities of various guests in the cofacial molecular cleft have been reported.⁶⁷⁰

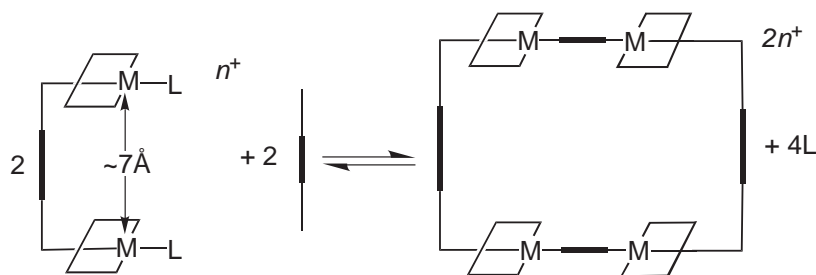

Figure 66 Two cofacial tridentate chelators bound to a square planar metal.

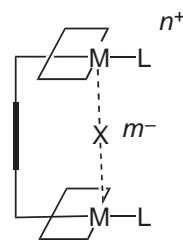

Figure 67 Cofacial disposition of the metals allowing for the incorporation of negatively charged ligands and complexes into the molecular clefts.

The simple combination of square-planar coordination geometry of Pd^{II} or Pt^{II} with pyridine-based ligands offers an efficient method for the self-assembly of nanometer-sized frameworks such as macrocycles, cages, catenanes, tubes, and capsules.^{511,663,671} To expand the structures of pyridyl-coordinated Pd^{II} complexes into more rigid and bigger coordination frameworks, one can replace a mono-coordinating 4-pyridyl group by a doubly ligating 3,5-bis(3-pyridyl)phenyl unit. According to this idea, 4,4'-bipyridine, which is the simplest pyridine-based bridging ligand, is modified into a tetradentate ligand. This ligand is expected to take a panel-like conformation and, on complexation with (en)Pd(NO₃)₂, assemble into large discrete box structures in analogy to the assembly of trinuclear and tetranuclear cyclic complexes from (en)Pd(NO₃)₂ and 4,4'-bipyridine.^{626,627,649,652,672–676} These expected box structures are efficiently formed in a *dynamic* fashion. Namely, the boxes are in equilibrium and smoothly interconvertible. Cold-spray ionization mass spectroscopy (CSI-MS)⁶⁷⁷ is very effective to study both kinetic and thermodynamic products in the assembly process shown in [Figure 68](#).⁶⁷⁸

The propeller-like [M(L-L)₃]^{±z} structural motif in supramolecular chemistry has been exploited to introduce chirality at both the local and global structural level in these assemblies. Evidence is presented to support the self-assembly of molecular hexagons of large dimension (>5 nm).⁶⁷⁹ Six inert, chiral transition metal complexes [(bpy)Ru(tpphz)₂]²⁺ or [(bpy)Os(tpphz)₂]²⁺ are joined by six labile Pd^{II} ions. The Ru₆Pd₆, Os₆Pd₆, and Ru₃Os₃Pd₆ structures (shown in [Figure 69](#)) form due to the torsional restraints imposed by the Ru or Os stereochemistry along with the entropic factors which favor rings systems over polymeric structures. The metals alternate in a Ru–Pd, Os–Pd, and Ru–Pd–Os–Pd fashion.⁶⁸⁰

A number of supramolecular aggregates of the cubic cluster Pd₆Cl₁₂ with methylated benzenes (i.e., durene and mesitylene), the fullerene C₆₀, and polynuclear aromatic hydrocarbons (i.e., naphthalene and 1,2:5,6-dibenzanthracene) can be isolated in crystalline form.^{681,682} Compounds of this type, which include Pd₆Cl₁₂·(durene), Pd₆Cl₁₂·1.5(naphthalene), Pd₆Cl₁₂·0.5C₆₀·1.5(benzene), and Pd₆Cl₁₂·0.5(1,2:5,6-dibenzanthracene)·0.5(benzene), consist of individual molecules of Pd₆Cl₁₂ and the flat aromatic molecules arranged in close, face-to-face proximity. These molecules are formed by simply mixing the appropriate hydrocarbon or fullerene (as a solution in benzene if it is not a liquid) with the labile complex, bis(benzonitrile)palladium(II) dichloride, and allowing the mixture to stand over a prolonged period. Eventually, deep red, air-stable crystals of the aggregates crystallize from solution. The Pd₆Cl₁₂ cluster itself is soluble in aromatic solvents. Spectroscopic studies on solutions of Pd₆Cl₁₂ in various methylated benzenes (i.e., mesitylene, xylene, and toluene) are consistent with charge-transfer interactions between the aromatic donors

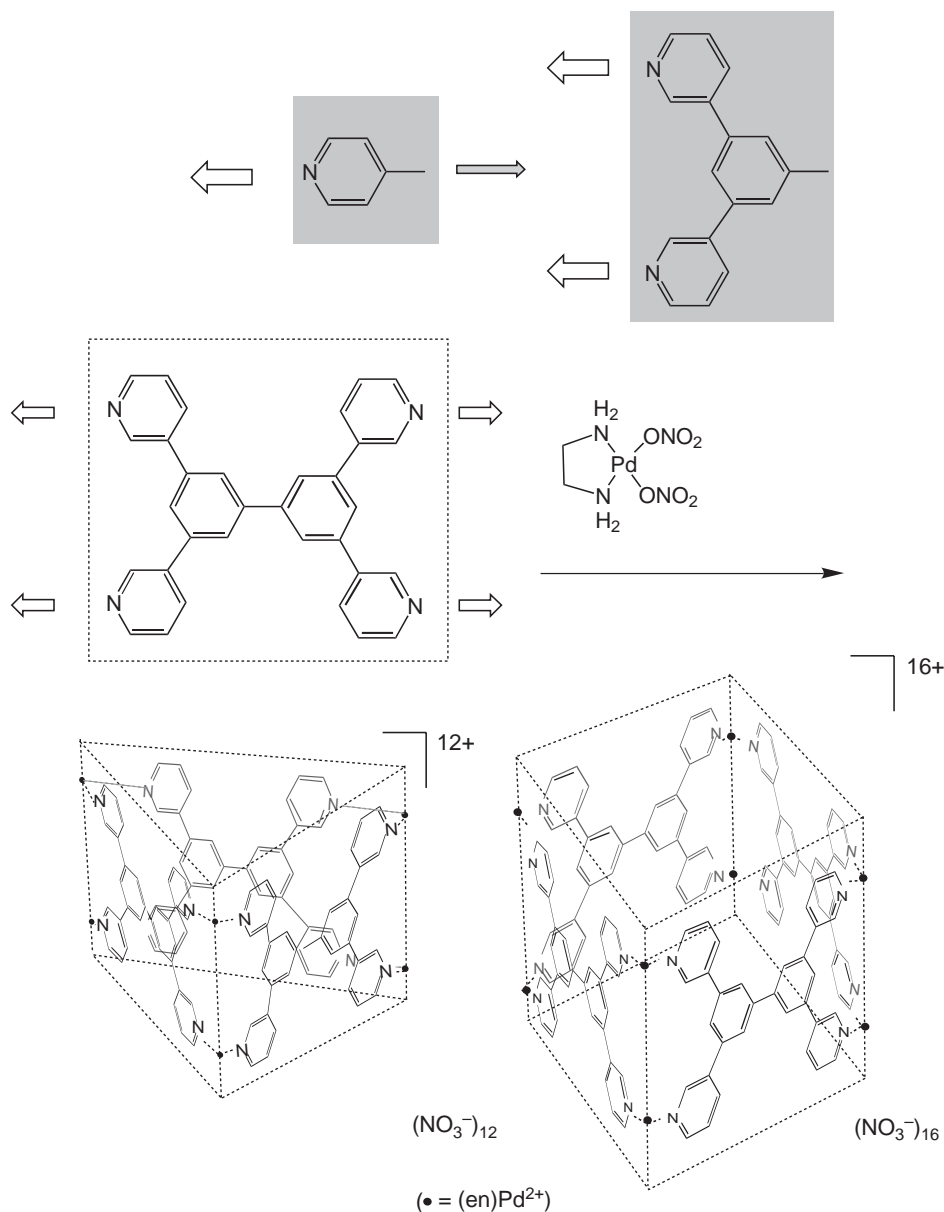

Figure 68 Self-assembly process of box structures.

and the palladium cluster. The new clusters $\text{Pd}_6\text{Br}_{12}$ and Pd_6I_{12} are made from the corresponding bis(benzonitrile)palladium(II) dihalides. Additionally, two new compounds contain the $\text{Pd}_6\text{Cl}_{12}$ cluster cocrystallized with its precursor, bis(benzonitrile)palladium(II) dichloride, and with a potential ligand, (*E*)-stilbene.⁶⁸³

A dynamic receptor library is an equilibrium mixture of several receptors from which the appropriate one is selected by an optimal guest. It is particularly important to study the dynamic features of guest-selected receptor formation from the library because the phenomenon is closely related to biological receptor systems. Shown in **Figure 70** is the guest-controlled assembly of Pd^{II} -linked cage-like receptors from a dynamic library generated from a Pd^{II} complex and two different tridentate ligands. The library contains two classes of receptors: homoleptic and heteroleptic. The homoleptic receptor contains two identical ligands and, hence, is termed a “self-recognized” receptor while the heteroleptic receptor contains two different ligands and is termed “hetero-recognized.” The equilibration between the receptors is very efficiently controlled by the addition of appropriate guests which selectively stabilize their optimal receptors.⁶⁸⁴

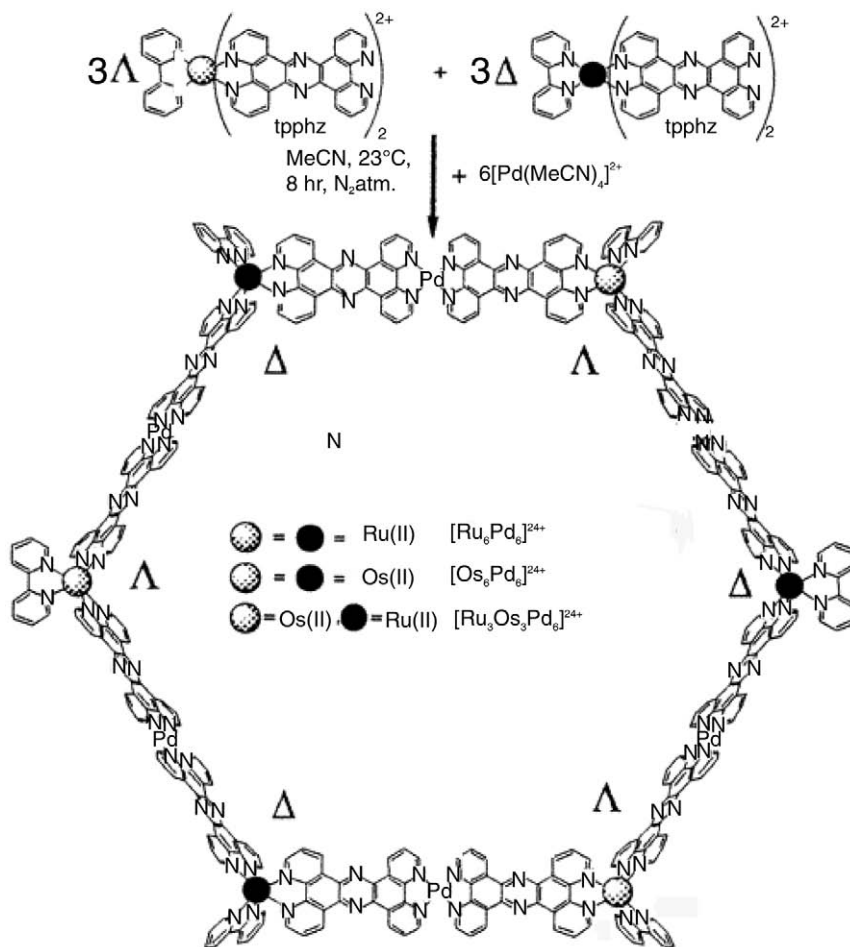

Figure 69 The molecular hexagons Ru₆Pd₆, Os₆Pd₆, and Ru₃Os₃Pd₆.

Triangular *exo*-polydentate ligands have been frequently employed for the metal-directed assembly of coordination polyhedra. By linking triangles at their corners or edges, a family of polyhedral structures can, in principle, be made. A triangular panel-like ligand was designed, with four donor sites on the two edges of the triangle (two donor sites on each edge); see the Figure 71. Having two-point binding sites on its two edges, this triangular unit is expected to assemble into edge-sharing polyhedral entity upon complexation with (en)Pd(NO₃)₂, which is a versatile 90° coordination unit for metal-directed assembly. Whereas previous triangular ligands all possess C₃ symmetry, this panel is C₂-symmetric and hence can be linked in two different ways: parallel and antiparallel links. Interestingly, these two options were perfectly controlled by the guests.⁶⁸⁵ A new study showed that some large guests induce the parallel link of the triangles leading to open cone (tetragonal pyramidal) structure, whereas antiparallel link is selected by some small tetrahedral guests giving closed tetrahedron structure, see Figure 71. Both assemblies have the same M₈L₄ composition and, therefore, constitute a dynamic receptor library^{646,657,658,664,686–692} from which each receptor is selected by its optimal guests.⁶⁹³ The structure of the lower right complex was finally determined by an X-ray crystallographic analysis.

Several complexes were derived from enPd^{II} and enPt^{II} entities and the 2-hydroxypyrimidine ligand. By making use of a combination of 120° and 90° bond angles provided by the 2-hydroxypyrimidine ligand and enPd metal entities, respectively, the direct synthesis of metallacalix[4]arenes by a self-assembly process is possible. These compounds are analogous to classic organic calix[4]arenes in both their structure and conformational dynamics. Despite the positive charge of these metallacalix[4]arenes, interactions with positively charged species are possible. Multiple H-bonding interactions between metallacalix[4]arenes and guest molecules are the driving force in the molecular recognition process.⁶³²

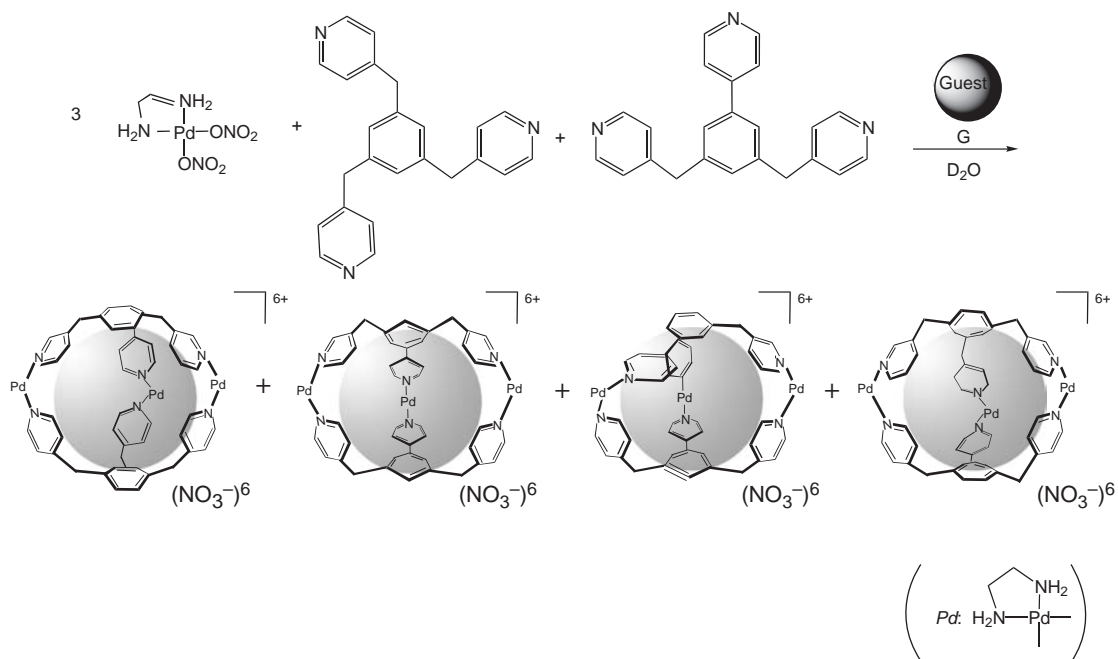

Figure 70 Guest-controlled assembly of Pd^{II}-linked cage-like receptors from a dynamic library generated from a Pd^{II} complex and two different tridentate ligands.

Cyclic frameworks of calixarenes associated with the presence of phenol oxygen atoms afford efficient complexing agents for metal ions, while their hydrophobic cavities allow the inclusion of guest molecules. Formation of analogous inorganic macrocycles, metallacalixarenes, can be achieved by combining 120° and 90° bond angles provided, respectively, by an appropriate ligand and a suitable metal entity.^{632,672,694} Other angle combinations lead to molecular triangles,^{576,643} squares,^{652,695} and other structures of higher complexity.^{696,697} Reaction of [(en)Pd(H₂O)₂]²⁺ with 4,6-dimethyl-2-hydroxypyrimidine (Hdmpymo) generates the cyclic species [(en)-Pd(dmpymo-*N*¹,*N*³)]₄⁴⁺, by a self-assembly process, shown in Figure 72.⁶⁹⁸ The presence of four exocyclic oxygen atoms of the pyrimidine moieties, suggested the possible coordination of additional metal atoms. Lanthanide metal ions were thought to be ideally suited in terms of both size and oxygen affinity. Addition of an excess of Gd(NO₃)₃·6H₂O to an aqueous solution of the tetramer affords {Gd(NO₃)₂(H₂O)[(en)Pd(dmpymo)]₄}⁵⁺ which has been structurally characterized and has been proved to be a metallacalix[4]arene of C_s symmetry, see Figure 73. The four Pd centers lie in a plane forming an almost perfect square with ca. 5.7 Å sides. The pyrimidine rings A, B and C, are not coplanar to the Pd₄ plane, which results in the formation of a molecular vase, see Figure 73.⁶⁹⁹

Self-assembly via dative bonding of bidentate nitrogen-containing ligands with transition metal complexes is a widely used methodology in supramolecular chemistry.^{627,699,700} Such systems as helicates,⁶³⁶ catenanes,⁷⁰¹ cylinders,⁷⁰² and other three-dimensional cage compounds⁶⁶³ have been prepared. Much progress has been made in the design of molecules that can act as host molecules for organic guests,^{663,703} and the physical basis of self-assembly macrocyclizations is the subject of current research.⁷⁰⁴ Over the past few years, the synthesis of diverse molecular squares and rectangles has been reported,^{663,705–709} but only a few publications show the design of parallelograms with other than 90° angles at the corners.^{710–712} The synthesis of new silicon-containing pyridine-based linker units with tetrahedral angles of 109° may allow the self-assembly of hitherto unknown silicon-containing supramolecular parallelograms. The larger atomic size of silicon compared to carbon is especially important for the synthesis of cyclic compounds and possible host–guest chemistry within the cavities of these molecules. Cationic dinuclear rhomboids have been isolated via modular self-assembly of silicon- and carbon-based tectons with *cis* square-planar palladium bistriflate complexes. The versatility of the coordination paradigm was shown by the use of diverse angular linkers to form similar rhomboid-like systems.⁷¹³ Entropy plays an important role in the formation of these macrocyclic systems, favoring the formation of the smallest cycle even though the hydration is thermodynamically disfavored. X-ray crystal structure analysis showed planar rhomboids with small internal cavities of approximately 10 Å × 8 Å.⁷¹³

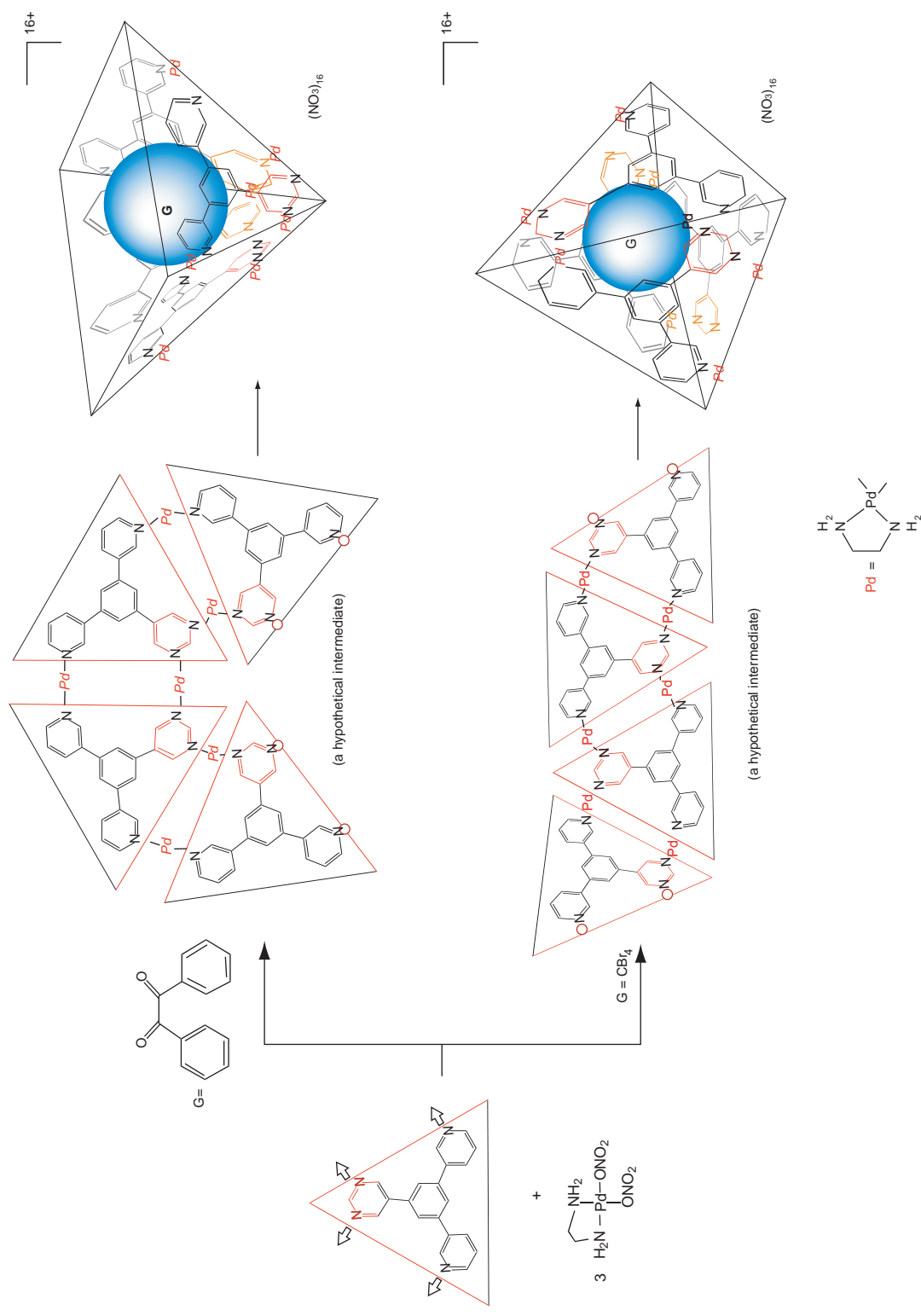

Figure 71 A triangular panel-like ligand, with four donor sites on the two edges of the triangle.

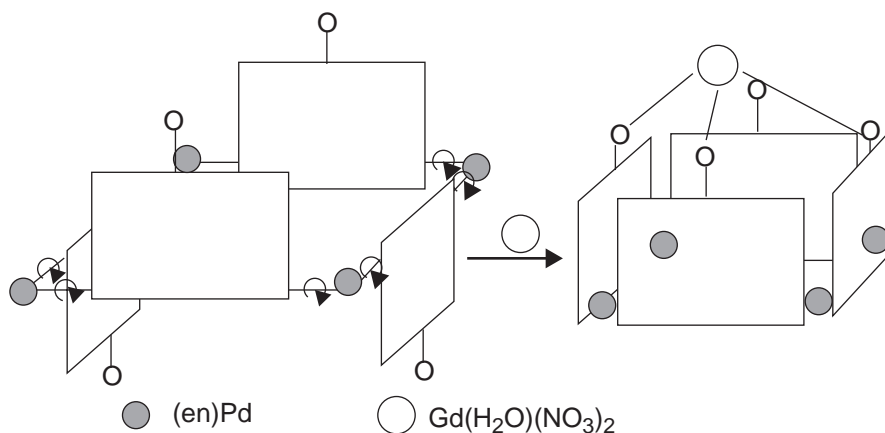

Figure 72 Generation of the cyclic species $[(en)\text{-Pd}(\text{dmpymo-}N^1, N^3)]_4^{4+}$, by a self-assembly process.

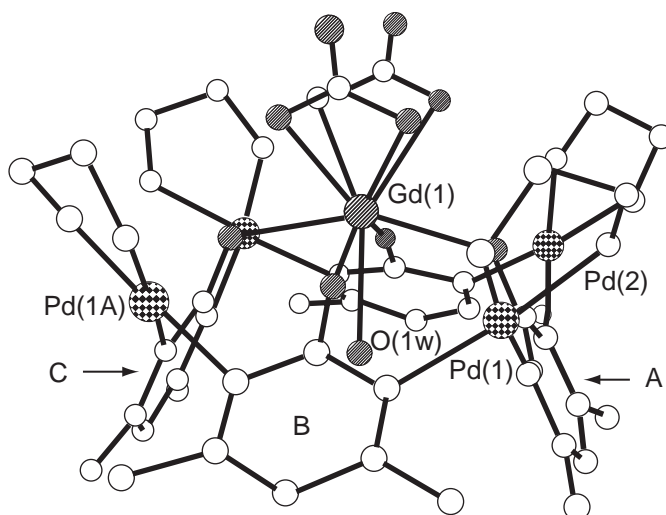

Figure 73 The structure of $\{\text{Gd}(\text{NO}_3)_2(\text{H}_2\text{O})[(\text{en})\text{Pd}(\text{dmpymo})]_4\}^{5+}$.

Biological receptors modulate the shape and size of their recognition sites to bind substrate molecules, generating numerous receptor structures from which the most suitable one is selected (or induced-fit) by their substrates. Modeling such a system is particularly important to develop a new receptor design wherein artificial receptors are constructed through a selection process by their own guests. In **Figure 74** Pd^{II}-linked cages, and some oligomeric compounds⁶⁵⁸ accessible from the same components are in equilibrium. From this thermodynamic mixture, each cage structure is selected upon the addition of appropriate guest molecules. The phenomenon described herein is a prototype for a “dynamic receptor library,” which represents one of the important goals in the field of molecular recognition.⁶⁵⁸ An asymmetric cage complex was selectively formed from a mixture of oligomeric compounds upon the addition of 1,3,5-benzenetricarboxylic acid.

The selective formation of a symmetrical host was induced by the addition of spherical guests such as CBrCl_3 and CBr_4 . Molecular modeling, refined by Cerius program, explains the origin of the selectivity in the formation of the two hosts shown in **Figure 75**. The host frameworks should be organized so that maximum hydrophobic interaction can be gained. Therefore, flat guests select the asymmetric host, whereas spherical guests prefer the symmetric host.⁶⁵⁸

Supermolecules consisting of interlinked ring-like molecules (catenanes)⁷¹⁴ are an interesting target for chemical synthesis both for their intrinsic interest as noncovalently bound but robust assemblies and because of the perspective they offer on materials chemistry.⁷¹⁵ Catenanes have been prepared by metal-ion templating^{716,717} and self-assembly through other noncovalent interactions. Fujita *et al.* report the synthesis of a catenane composed not of two interlocking rings but of two cages.⁶⁶⁵ This structure is prepared by metal-mediated self-assembly.^{662,665,718} The

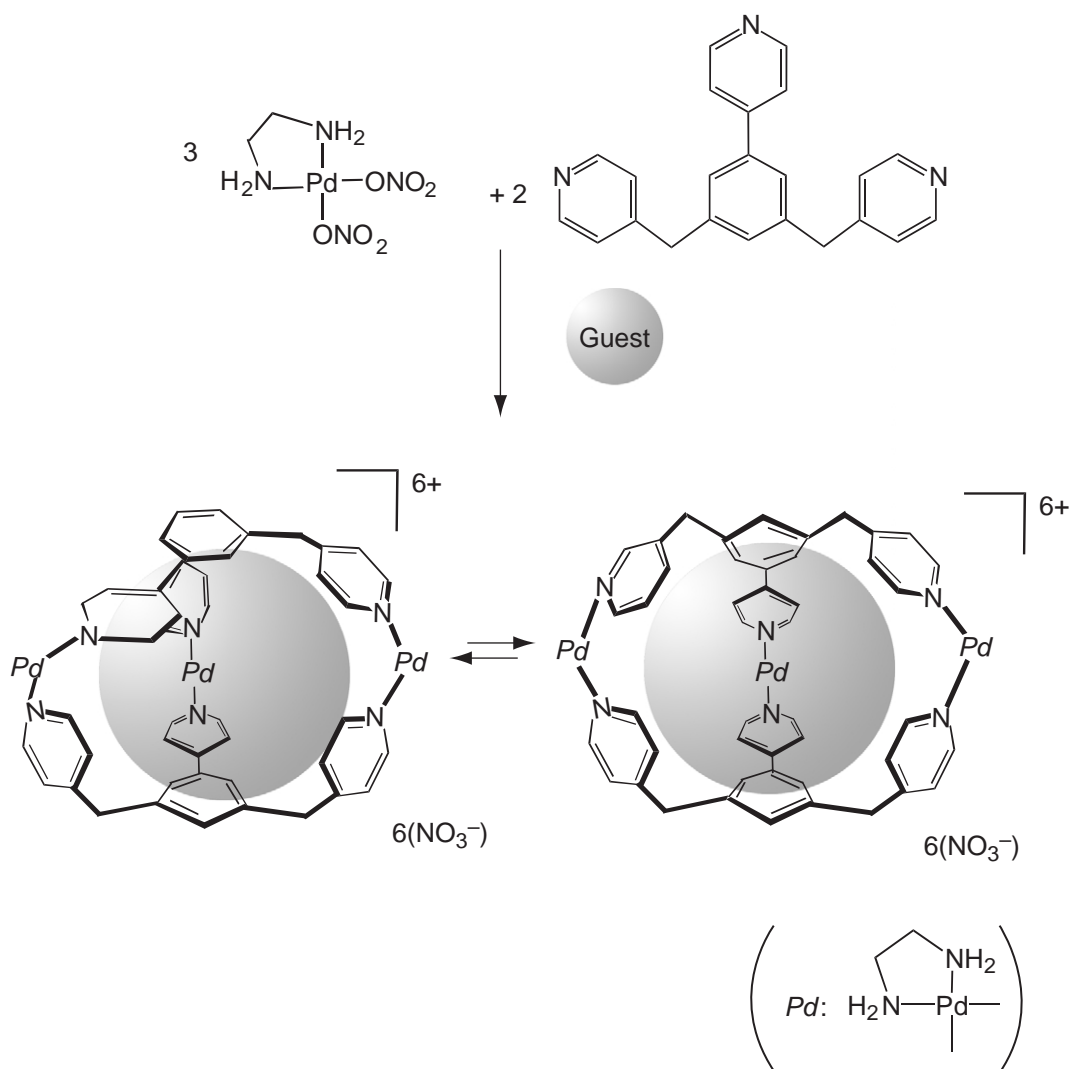

Figure 74 Pd^{II}-linked cages and some oligomeric compounds accessible from the same components are in equilibrium.

framework of each cage is assembled from five components: two tridentate ligands held together with three metal ions (see Figure 76). A cage-like complex is designed, in which the interplanar surface-to-surface distance between the “floor” and the “ceiling” is $\sim 3.5 \text{ \AA}$, an ideal distance for binding an aromatic ring. Because each cage framework can bind an aromatic ring, two cage units

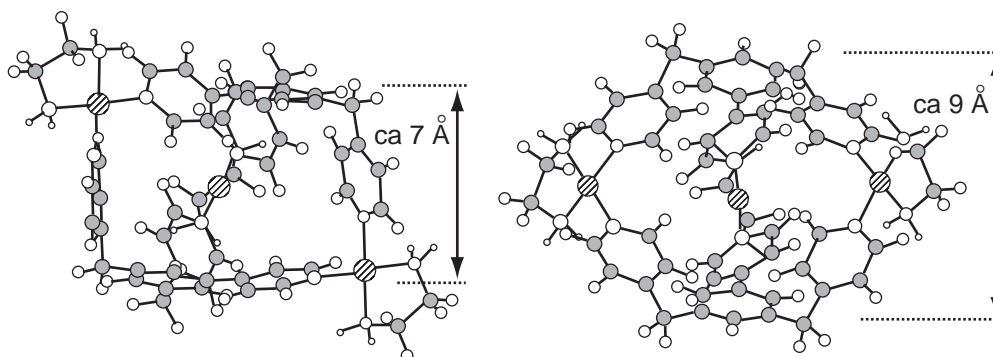

Figure 75 Selectivity in the formation of the two hosts. Flat guests select the asymmetric host, whereas spherical guests prefer the symmetric host.

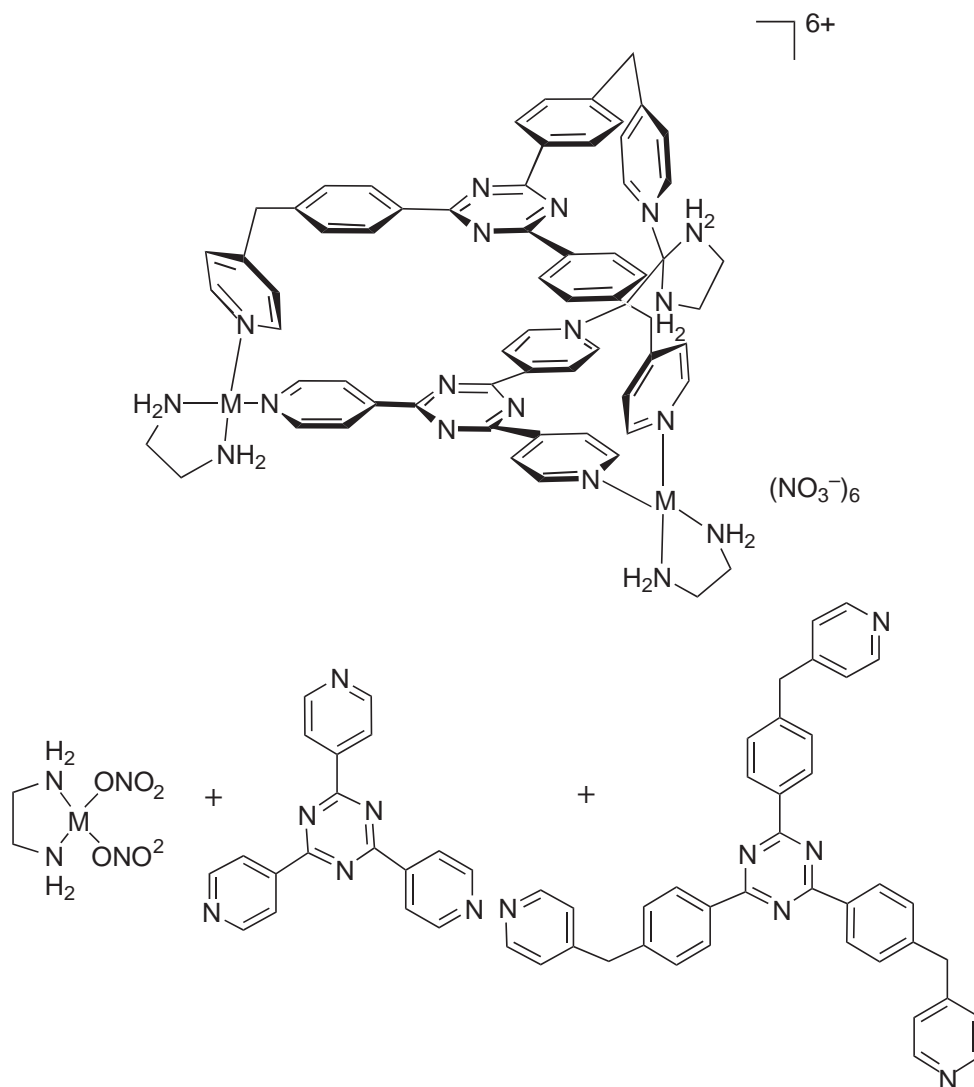

Figure 76 Framework of each cage is assembled from five components: two tridentate ligands held together with three metal ions.

will bind one another during their assembly process through the formation of a quadruple aromatic stack, giving rise to the ten-component interlocked supermolecule (see Figure 77).⁶⁶⁵

Rectangular molecular boxes with interplanar separation of $\sim 3.5 \text{ \AA}$ were shown to effectively self-assemble into catenated dimers.⁷¹⁹ X-ray crystallographic analysis shows that the catenane consists of two identical cage frameworks interlocking with each other. From the side view the efficient quadruple stacking of aromatic rings is observed. This stacking makes the interlocked structure the most stable of any possible structures.⁶⁶⁵ The interlocked cages are further stacked in an intermolecular fashion, leading to one-dimensional infinite stacking of triazine π -systems. The structure of the catenane in solution was determined by NMR studies. Both ^1H and ^{13}C NMR agree well with the structure.⁶⁶⁵ A striking observation is that two preformed Pd^{II} cage compounds are reorganized into the three-dimensionally interlocked catenane in high yield when they are mixed in an aqueous solution (see Figure 78). The $12+$ cage M_6L_4 type is a very stable cage compound which assembles from ten components. The $6+$ cage is also found to assemble from five components. These cage compounds were independently prepared in D_2O and then combined in 1:2 ratio so that the component ratio became 6:2:2. After the solution was allowed to stand at room temperature, all components were completely reorganized into an interlocked-cage catenane compound. At an elevated temperature (80°C), the reorganization was completed within 10 minutes.⁶⁶⁵

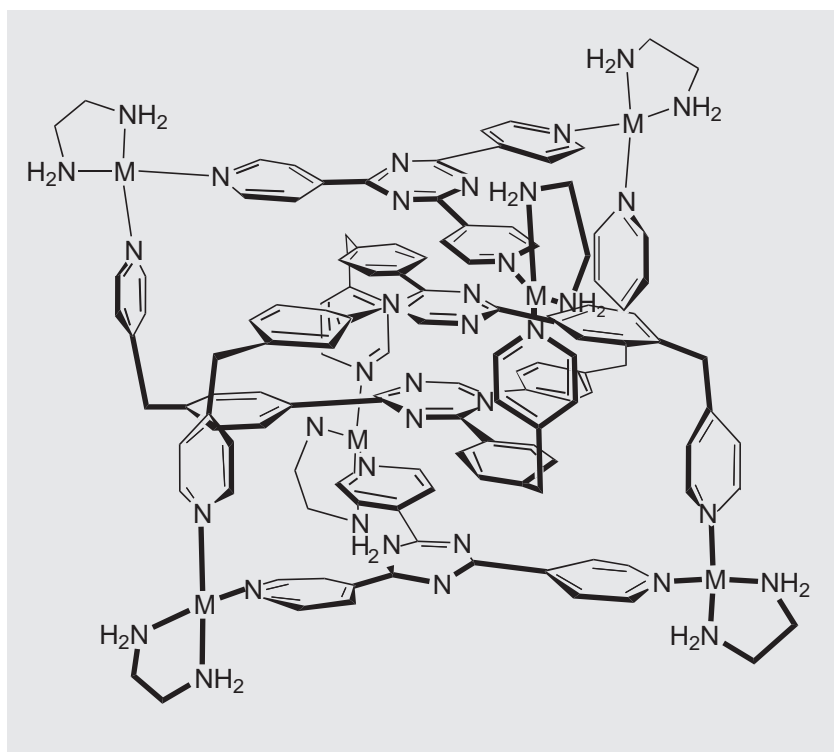

Figure 77 A ten-component interlocked supermolecule.

Molecular capsules consist of closed, hollow frameworks within which encapsulated molecules are isolated from interaction with external molecules. In this environment, otherwise reactive molecules can be stabilized. An *exo*-hexadentate ligand, 1,3,5-tris(3,5-pyrimidyl)benzene, is used as a triangular assembly unit. This ligand is an almost planar triangle and is expected to give edge-sharing polyhedra when its aromatic nitrogens are ligated at the *cis*-coordination site of a metal ion. A *cis*-protected palladium(II), $\text{Pd}(\text{NO}_3)_2(\text{en})$, provides a 90° coordination angle, and has been shown to be useful for constructing well-defined discrete structures on complexation with a variety of *exo*-polydentate ligands.^{13,652,720} Because the angles between the planes of tetra-, hexa-, and octahedra do not significantly deviate from 90° , the assembly of such a polyhedron was achieved on complexation of this ligand with Pd^{II} unit (see Figure 79).⁶³⁰ Of the several possibilities, the assembly of a molecular hexahedron trigonal bipyramidal actually occurred.⁶³⁰ The by-product formation was completely suppressed by employing a small excess amount of $\text{Pd}(\text{NO}_3)_2(\text{en})$. The crystal structure shown in Figure 80 clearly demonstrates that the assembly is a trigonal bipyramidal coordination capsule with the chemical formula $\text{C}_{144}\text{H}_{216}\text{N}_{108}\text{Pd}_{18}$, a molecular mass of 7,103 Da, and a dimension of $3 \times 2.5 \times 2.5 \text{ nm}$.⁶³⁰ Each equatorial corner of the hexahedron is made up by the assembly of four triangle units, where a $(\text{Pd}^{\text{II}}\text{-pym})_4$ cyclic framework gives a small “pinhole” ($2 \times 2 \text{ \AA}$). Through these holes, only small molecules such as water and molecular oxygen may pass, but ordinary organic molecules cannot enter or escape. Not even such a “pinhole” exists at the apical corners. The free volume inside the capsule, into which guests can be accommodated, is $\sim 900 \text{ \AA}^3$, implying that the complex can host large molecules such as buckminsterfullerene, C_{60} .⁶³⁰ The thermodynamic stability is explained by a strong positive cooperative effect of 36 $\text{Pd}^{\text{II}}\text{-pym}$ coordination bonds involved in the framework. The metal-linked dimer and trimer (see Figure 81) may be involved as intermediates in the assembly process, because these species were observed when the triangular ligand was titrated with Pd^{II} complex.

These results complement Fujita's previous synthesis of a corner-sharing octahedron assembling from an *exo*-tridentate ligand, 1,3,5-tris(4-pyridyl)triazine, and the same Pd^{II} complex.^{720,721} The framework of this octahedron complex has large windows and encloses large guest molecules (for example, as many as four carborane molecules) which can enter or exit through the openings. In contrast, the edge-sharing hexahedron complex has a closed shell structure, and it should be able to engage large molecules.⁶³⁰

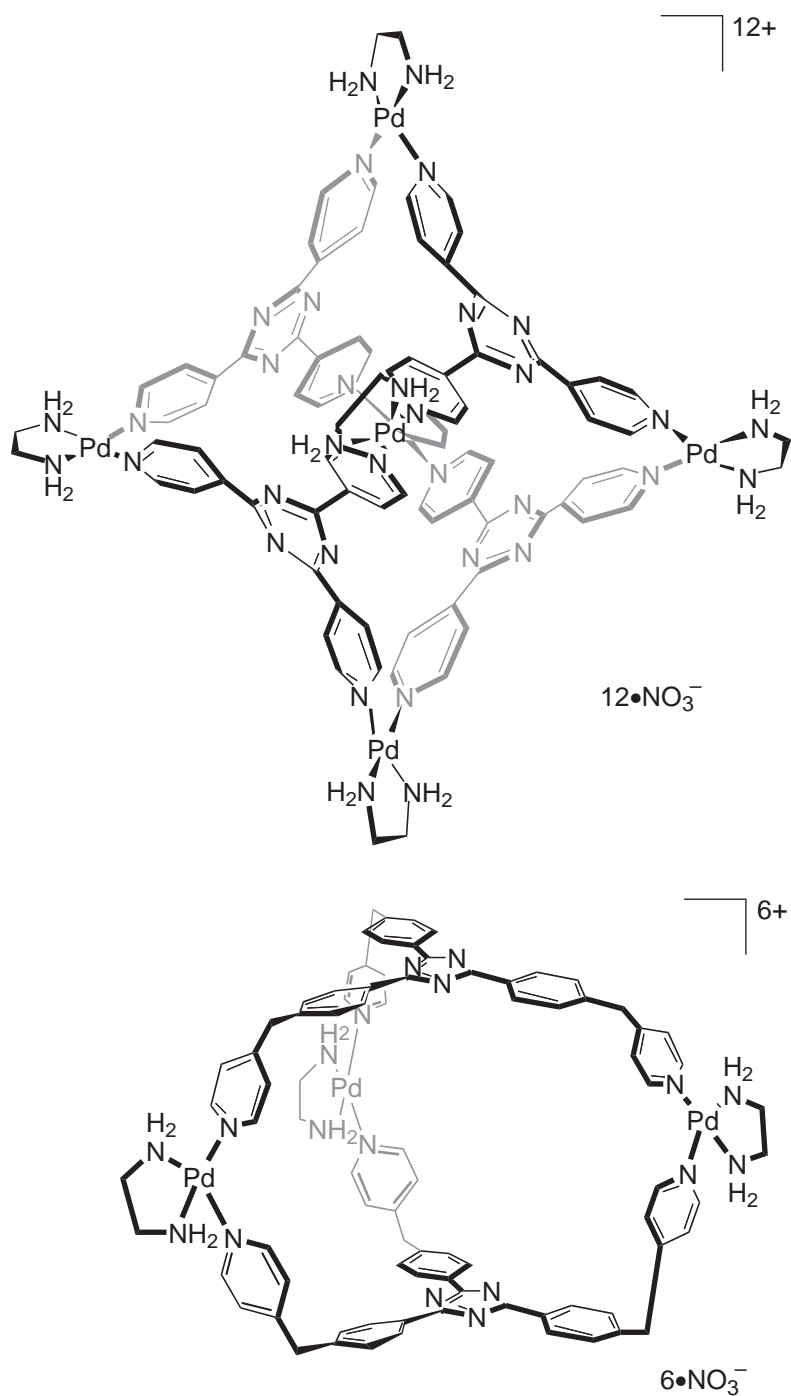

Figure 78 Two preformed Pd^{II} cage compounds that are reorganized into the three-dimensionally interlocked catenane in high yield when they are mixed in an aqueous solution.

Various molecular devices based on oligoporphyrins have recently been engineered and prepared. The porphyrin oligomers have been synthesized by either covalent attachment of the monomers or methods of self-assembly. Porphyrin arrays consisting of up to nine units have been reported.⁷²² Preparation of the porphyrin arrays in high yields and significant quantities is still problematic. One of the major obstacles for synthesizing porphyrin derivatives is low solubility.⁷²³ Macrocyclic assemblies, containing two or four porphyrin units, are readily obtained on a preparative scale via self-assembly with use of Pd^{II}- or Pt^{II}-containing auxiliary modules. The bispophine ligands coordinated to transition metals provide an enhanced solubility of

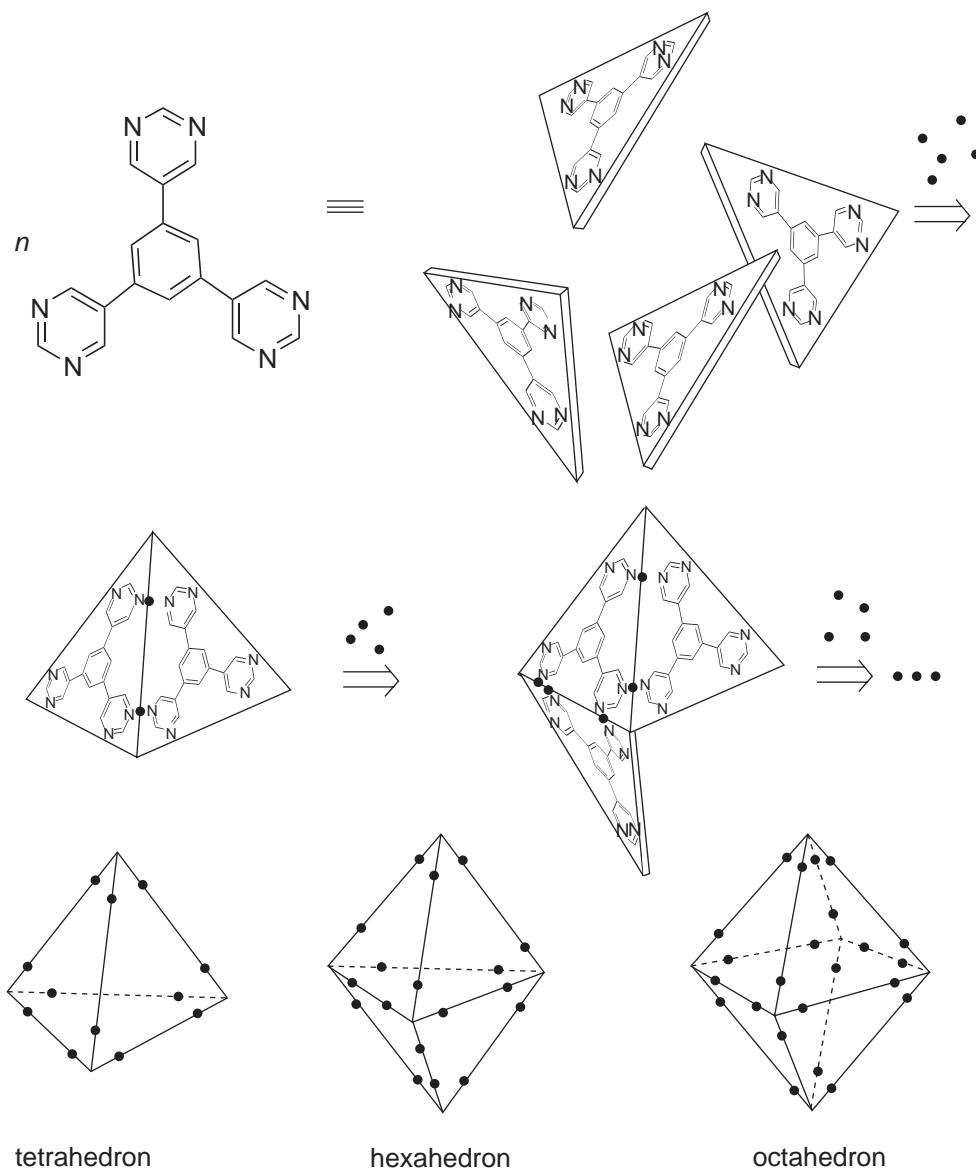

Figure 79 Assembly of a polyhedron achieved by complexation of 1,3,5-tris(3,5-pyrimidyl)benzene with $\text{Pd}(\text{en})^{2+}$ groups.

macrocycles. The porphyrin cores are not coplanar when used as parts of the linear modules in the tetramers.⁷²³ Chiral macrocycles are formed upon employment of the BINAP– Pd^{II} angular building block. The chiral tetramers have a puckered structure of D_2 symmetry at ambient temperature.⁷²³ The high solubility and ease of synthesis of self-assembled porphyrin macrocycles, based on Pt^{II} and Pd^{II} phosphine bistriflates, provides tetramers that are excellent ensembles for the study of porphyrin exciton coupling interactions and induced circular dichroism.⁷²³

Rapid progress in molecular enclathration chemistry has been partly the result of the development of the facile preparation of cage compounds by noncovalent synthesis exploiting hydrogen and coordination bonds.^{724–730} Transition metal-mediated self-assembly⁷²⁰ has recently allowed the highly effective construction of hollow, nanosized coordination cage (shown in Figure 82), which enclathrates large neutral guest molecules at a fixed position of the cavity in a 1:4 host-guest ratio.⁷²¹ Fujita *et al.* report the remarkable ability of the cage for the selective enclathration of “C-shaped” molecules such as *cis*-azobenzene and *cis*-stilbene derivatives. These guest molecules are enclathrated in the cavity through the “ship-in-a-bottle” formation of a hydrophobic dimer of the guest, (see Figure 83). The hydrophobic dimer of azobenzene derivative is considerably stabilized and does not undergo *cis*–*trans* isomerization.⁷³¹

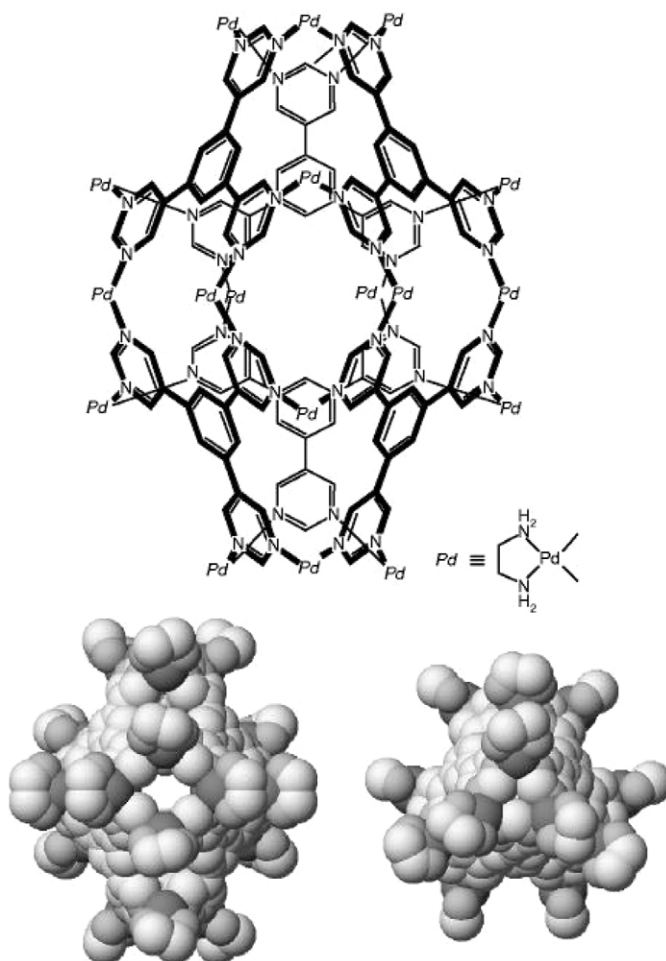

Figure 80 Trigonal bipyramidal coordination capsule with a chemical formula of $C_{144}H_{216}N_{108}Pd_{18}$, a molecular mass of 7,103 Da, and a dimension of $3 \times 2.5 \times 2.5$ nm.

Transition-metal-mediated self-assembly and metal–ligand interactions are becoming increasingly popular in the construction of a variety of nanoscale-sized entities. The basic appeal of this method is in its highly convergent synthetic protocol, the fast and facile formation of the final product, as such metal–donor ligand interactions are established very rapidly, and most importantly, the great versatility of this method, as a large number of nanostructures can be prepared via the combination of a relatively small number of building blocks.^{718,732} Among these assemblies, chiral structures (shown in Figure 84) occupy an important place, as they are the first examples of transition-metal-based discrete supramolecular assemblies with controlled stereochemistry. A first step in their study is the careful determination of rotational barriers and a detailed study of the fluxional behavior of various heteroaryl complexes of Pd^{II} and Pt^{II} bis(phosphanes), as they are directly responsible for the existence of different rotational isomers in these chiral assemblies.⁷³³

The interaction between chelated Pd^{II} triflates with various heteroaryl complexes results in the formation of diastereomeric, square-planar, cationic complexes. For reaction with $[Pd(R(+)-BINAP)[OTf]_2]$ (BINAP = 2,2'-Bis(Diphenylphosphino)-1,1'-Binaphthyl) and 2-bromo-5-methylpyridine the formation of a diastereoisomeric mixture of three rotamers and a complex with a single heteroaryl group is observed. Reaction of 3-methylisoquinoline with the above bis(triflates) also yielded similar results, whereas in the case of the more sterically demanding 2-methylquinoline, the mono(heteroaryl) complexes $[Pd(R(+)-BINAP)(2\text{-methylquinoline})][OTf]_2$ are observed exclusively. Steric effects of the substituents located in close proximity to the transition metal are responsible for such remarkable control of the stoichiometry of the products.⁷³³ The restricted rotation about the metal–nitrogen heteroaryl bond in the complex $[Pd(R(+)-BINAP)(3\text{-picoline})_2][OTf]_2$ was investigated by temperature-dependent 1H -NMR spectroscopy. The free energy of

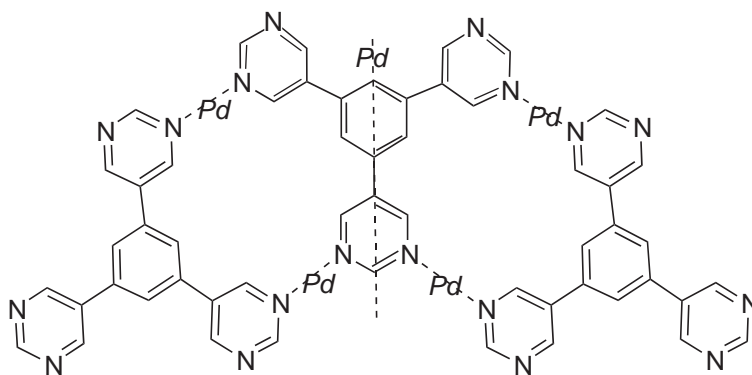
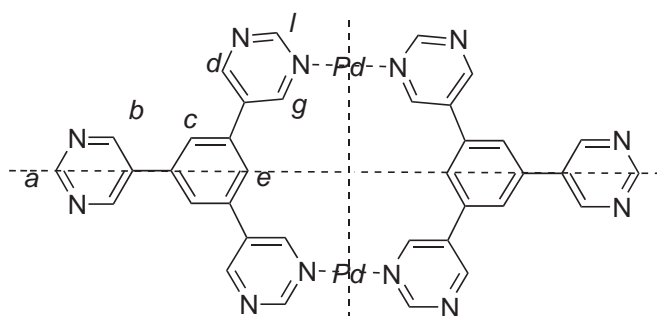

Figure 81 Metal-linked dimer and trimer.

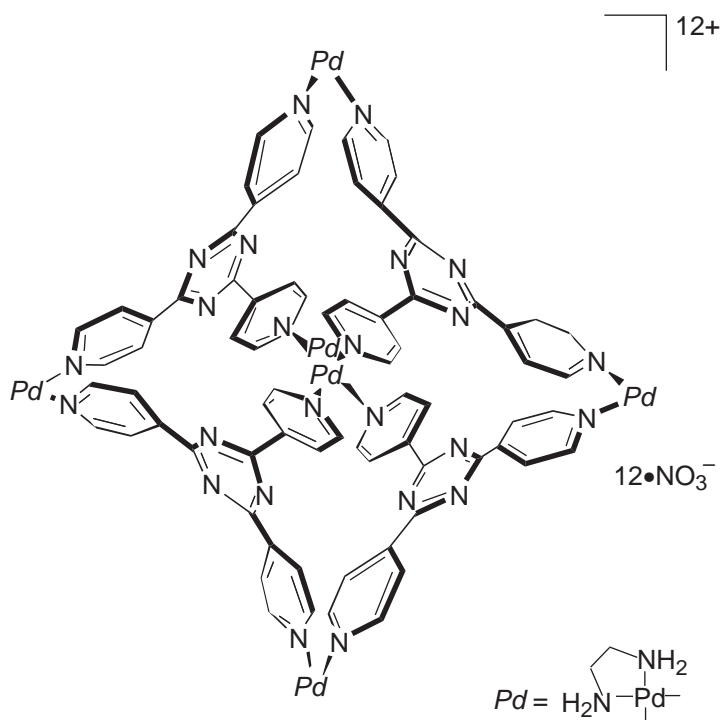

Figure 82 A hollow, nanosized coordination cage.

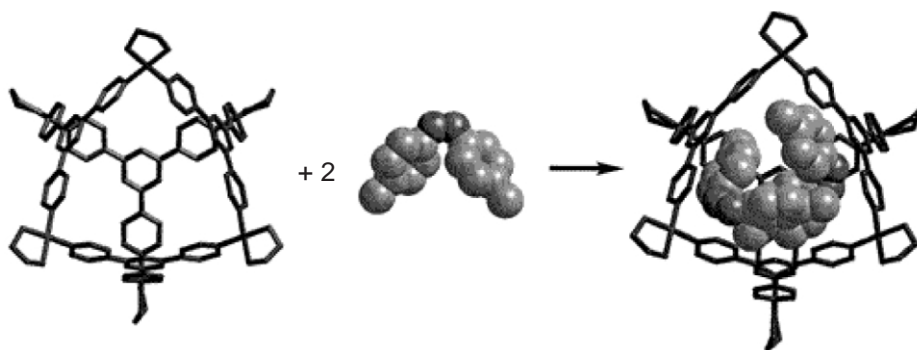

Figure 83 Guest molecules are enclathrated in the cavity through the “ship-in-a-bottle” formation of a hydrophobic dimer of the guest.

activation ΔG^\ddagger is $12 \pm 0.5 \text{ kcal mol}^{-1}$ for the Pd complex.⁷³³ *Ab initio* calculations (HF/lanl2dz) of model complex $[\text{dpe}]\text{Pd}(\text{HN}=\text{CH}_2)_2^{2+}$ (dpe = diphosphinoethylene) support the interpretation of experimental results.⁷³³ The rotation of the heteroaryl ligand is hindered, therefore making these assemblies stable to interconversion even at elevated temperatures. Since these assemblies are formed in near-quantitative yield, probably there are some additional factors that influence the formation and high thermodynamic stability of these macrocycles besides their conformational rigidity and the lability of the metal-heteroaryl bond. There are indirect indications that the degree of π -stacking between the phenyl ring of the bis(phosphane) (BINAP) and the coordinated heteroaryl plays an important role in the stabilization of these assemblies.⁷³³

Although single-, double- and triple-stranded helicates have been well documented,^{734–737} quadruply stranded helicates are rare. One type are pentanuclear metal complexes bridged by a pentadentate ligand.⁷³⁸ These species contain metal–metal bonds with terminal ancillary ligands on octahedral metal centers and, as such, can be classified as unsaturated helicates.⁷³⁴ It was predicted⁷³⁴ that the synthesis of a saturated quadruply stranded helicate might be achieved by employing a combination of square-planar metal centers with oligomonodentate bridging ligands. There is a report on the successful realization of this challenge, with the synthesis and X-ray crystal structure of a quadruply stranded helicate that encapsulates a hexafluorophosphate anion.⁶³⁶ Its synthesis is shown in Figure 85. The dimeric complexes contain PPh_3 or pyridine as ligand. Diffusion of diethylether into an acetonitrile solution of the pyridine complex containing ammonium hexafluorophosphate resulted in a reorganization of the components and the assembly of a helicate species, which deposited from the solution as a tetrakis(hexafluorophosphate) salt and as a bis(acetonitrile) solvate. The compound contains a full M_2L_4 helical cage that has each square-planar palladium atom coordinated to the four bridging ligands and within which resides a well-ordered PF_6^- ion (see Figure 86). External to the cage are three other PF_6^- anions and two acetonitrile solvate molecules. The dimensions of the cage are defined by the Pd \cdots Pd separation (8.8402(8) Å) and the distance between the centroids of the cofacial benzene rings (8.849(7) Å and 8.925(7) Å).⁶³⁶

A remarkable feature of the structure is the encapsulation of the hexafluorophosphate anion. In contrast to the many molecular hosts capable of recognizing and complexing cationic guests, the search for similar species capable of complexing anionic guests has proved considerably more difficult. Although PF_6^- ions normally act as noncoordinating anions, the encapsulated anion within cage makes weak contacts with the palladium centers (Pd1—F11 = 2.789(5) Å; Pd2—F12 = 2.911(5) Å). This structure is maintained in solution.⁶³⁶

A coordination cage, shown in Figure 87, with a diameter of approximately 2 nm was constructed through transition metal mediated self-assembly from six metal ions and four ligands.^{720,739,740} The remarkable ability of this complex to encapsulate large, neutral molecules was explored.⁷²¹ It encapsulated four molecules of *o*-carborane, an icosahedral carbon–boron cage molecule with a diameter of 8 Å. This large, neutral molecule is nonpolar and immiscible with water. However, when a hexane solution of it was stirred with a D_2O solution of the cage, four equivalents were rapidly transferred into the aqueous phase and the stoichiometric formation of the complex was observed. Adamantane was also encapsulated by the cage to form a 1:4 complex.⁷²¹ The cage and the two guests are shown in Figure 87. When 1- or 2-adamantanol was employed as a guest, the formation of a stable 1:4 complex was again observed. The interior of the host is highly hydrophobic and the guest molecule is located in the cage such that the hydroxyl group is pointed outward. Significant

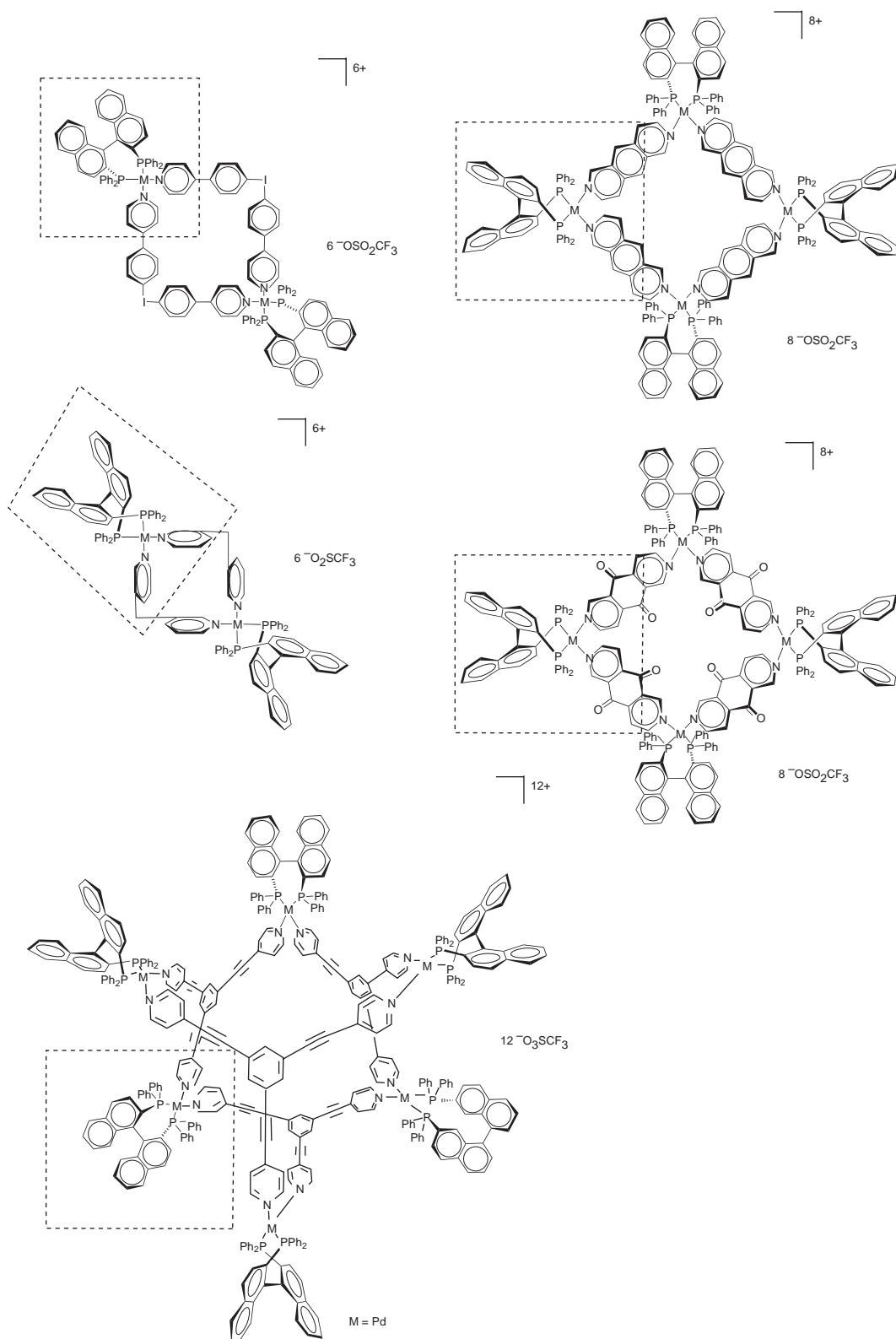

Figure 84 Chiral structures—the first examples of transition-metal-based discrete supramolecular assemblies with controlled stereochemistry.

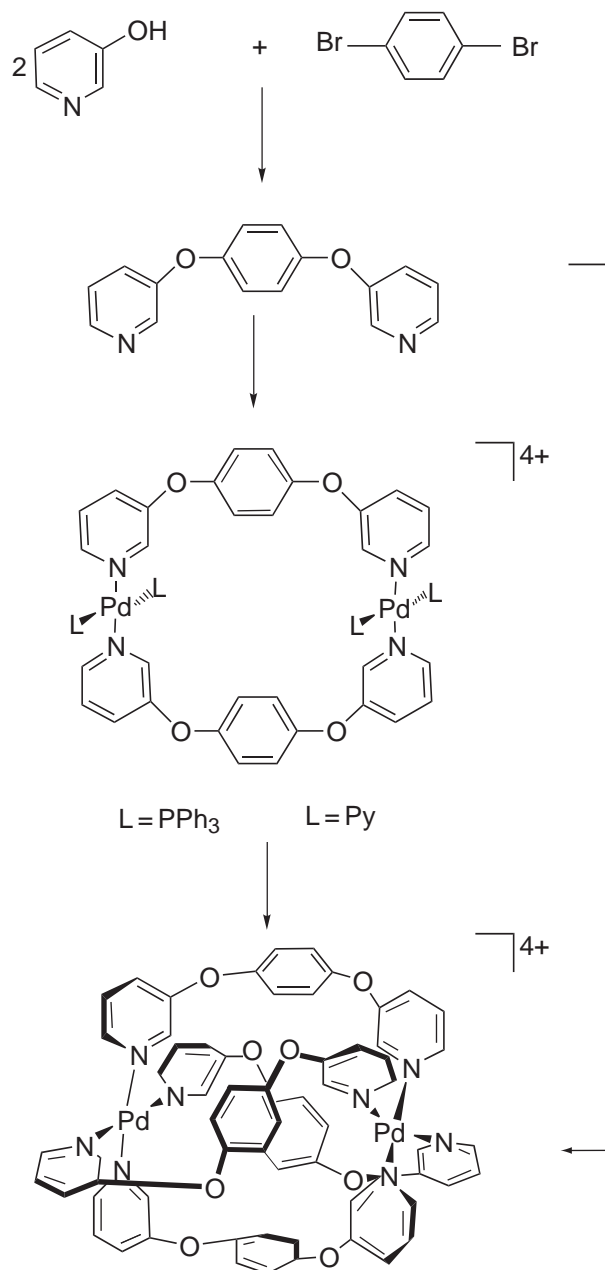

Figure 85 A quadruply stranded helicate that can encapsulate a hexafluorophosphate anion.

π -donor-acceptor interactions were observed when 1,3,5-trimethoxybenzene was employed as a guest.⁷²¹ The complexation is much faster when the guest molecules are smaller. Tri-*t*-butylbenzene, which is slightly larger than the portal of the cage, is very slowly encapsulated by the cage through thermally induced slippage at 80 °C. Once encapsulated, this oversized guest did not escape from the cavity within two hours at room temperature even when the solution was treated with an organic solvent.⁷²¹

Organic and organometallic polynitriles are polytopic organic ligands for the self-assembly of coordination polymers and supramolecular metal complexes. Transition metal complexes of arylisocyanides bearing nitrile groups in peripheral locations can be employed in a similar fashion.⁷⁴¹ The solid formed from *trans*-diiodobis(4-isocyanobenzonitrile)palladium and two equivalents of bis(hexafluoroacetylacetonate)copper, was found to possess a one-dimensional structure, which can be described as a string of 20-membered rings, each consisting of two I-Pd-CN-C₆H₄-CN subunits that are joined by copper bridges, whereby the palladium atoms are

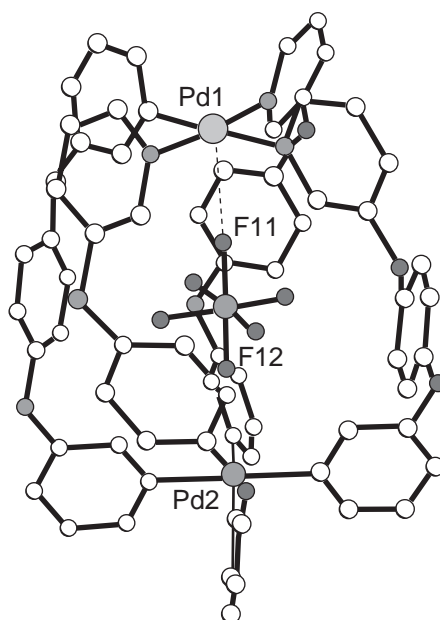

Figure 86 Compound containing a full M_2L_4 helical cage that has each square-planar palladium atom coordinated to the four bridging ligands and within which resides a well-ordered PF_6^- ion.

shared by adjacent rings. As a consequence of the linear nature of the $Pd-CN-C_6H_4-CN-$ portion within the rings, the copper-nitrile linkages are strongly bent.⁷⁴² The analogous solid, formed from *trans*-diiodobis(3-isocyanobenzonitrile)palladium and bis(hexafluoroacetylacetonate)copper, contains the same type of rings but with linear copper–nitrile linkages. The observation of end-on- and side-on-bonded nitrile ligands in the two isomeric coordination polymers suggests that metal–nitrile bonds may not generally be relied upon as rigid structural links in coordination polymers.⁷⁴²

In the synthesis of discrete ordered arrays of covalently linked porphyrins, there now seems to be a practical limit of about 10 macrocycles. To create ever larger arrays in reasonable yields, a supramolecular approach has been employed to design a variety of discrete porphyrin arrays. The largest designed discrete assemblies containing six or more components have been squares made up of four porphyrins assembled by four transition metal ions,^{743–746} and a rosette containing six porphyrins assembled by hydrogen bonding. A discrete supramolecular array of nine porphyrins has been made. Self-assembly is accomplished by coordination of exocyclic pyridyl groups on three different porphyrin derivatives to 12 palladium(II) dichloride units: Four different types of molecules self-assemble to a 21-membered array that is 25 nm² large.⁷²² These types of systems are expected to: further our understanding of photonic communication between chromophores mediated by noncovalent interactions; serve as guides for the formation of molecular channels or receptors; and be a foundation for the development of molecular photonic materials for use in nonlinear optics. The well-characterized photophysical behavior of these macrocycles provides a tool for the examination of the kinetics, mechanism, and thermodynamics of self-assembly. The nonameric arrays were designed by appropriate choice of *trans* coordination by the relatively labile square planar bis(benzonitrile)palladium(II) dichloride, the correct stoichiometries of the components, and the correct substitution patterns of three different porphyrins: one central X-shaped unit, four T-shaped units on the sides, and four L-shaped units in the corners (see Figure 88). The “molecular information” inherent in the individual molecules and the stoichiometry (12Pd, 1“X”, 4“L”, and 4“T”) favors the formation of the desired arrays, but the reversibility of pyridyl–palladium bond formation is also crucial for reaching what appears to be the thermodynamic product. Thus, the desired arrays are formed in approximately 90% yield at room temperature in less than 30 minutes.⁷²² There are three different porphyrins, so any combination of free base and metallo compounds may be used to make the supramolecular arrays. This results in arrays with metallo derivatives in predictable positions. Only the all-free base or all-zinc complexes are presented to avoid the kinetic and spectroscopic complications that arise from axial coordination by the pyridyl groups to other metalloporphyrins (homocoordination).⁷²²

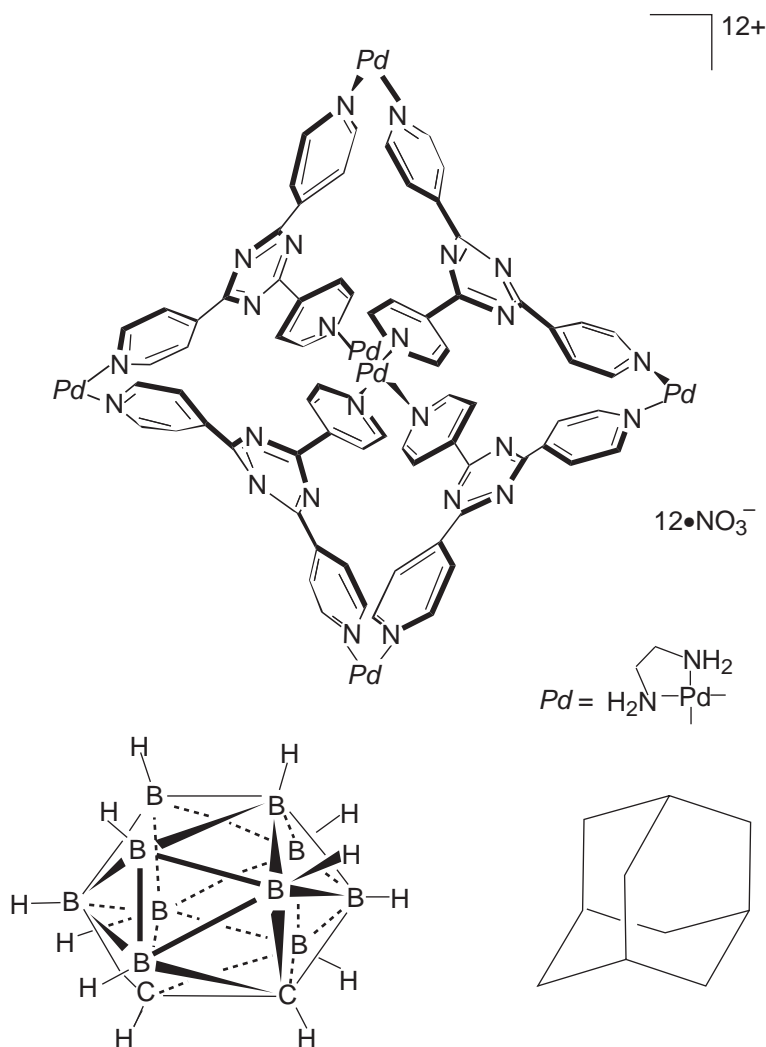

Figure 87 A host cage, constructed through transition metal mediated self-assembly from six metal ions and four ligands, and two guests.

Porphyrin tapes (see Figure 89) are made in a manner similar to that of the nonamers. For example, addition of two porphyrins (“O”) to two “I”-shaped porphyrins and two equivalents of $[\text{PdCl}_2(\text{NCPH})_2]$ results in the palladium-based tape as a mixture of the dimer, the trimer, and the tetramer in a ratio of about 3:8:2.⁷²² The substantial broadening, concomitant decrease in intensity, and red shift of the Soret band are typical for electronically coupled porphyrins. It is observed to a lesser extent for the Pd-mediated dimer and tetramer arrays and other squares.^{743–746} There is a consistent red shift of about 2 nm (and broadening) per porphyrin. The excited state lifetime for a mixture of porphyrins in toluene at room temperature is 12 ns, and that of the array is less than 1 ns.⁷²² The substantial additional quenching for the arrays is likely due to energy transfer from one porphyrin moiety to another, and to some π stacking of the nonamers.⁷²² The $^1\text{H-NMR}$ titrations exhibit similar trends as those observed for other porphyrin squares,^{743–746} namely, there is a highly characteristic shift in the pyridyl protons upon coordination of a metal ion.⁷²² Light-scattering results suggest that clusters with a radius of 5–7 nm are present in solution. Depending on solution conditions, deposition of nonameric arrays on polished glass substrates results in the formation of nanoparticle clusters. Characterization of the three-dimensional arrangement of these clusters by atomic force microscopy (AFM), shown in Figure 90, suggests that the nonameric arrays deposit as columnar structures on the glass surface, potentially as nanocrystals. The clusters range in height from 1.3 nm to 39 nm with over 75% between 4.5–6.5 nm, which is consistent with the light-scattering data.⁷²² Such sharp, clear images of the tip structure (shown in Figure 90) strongly suggest the nonamers deposit as stacks

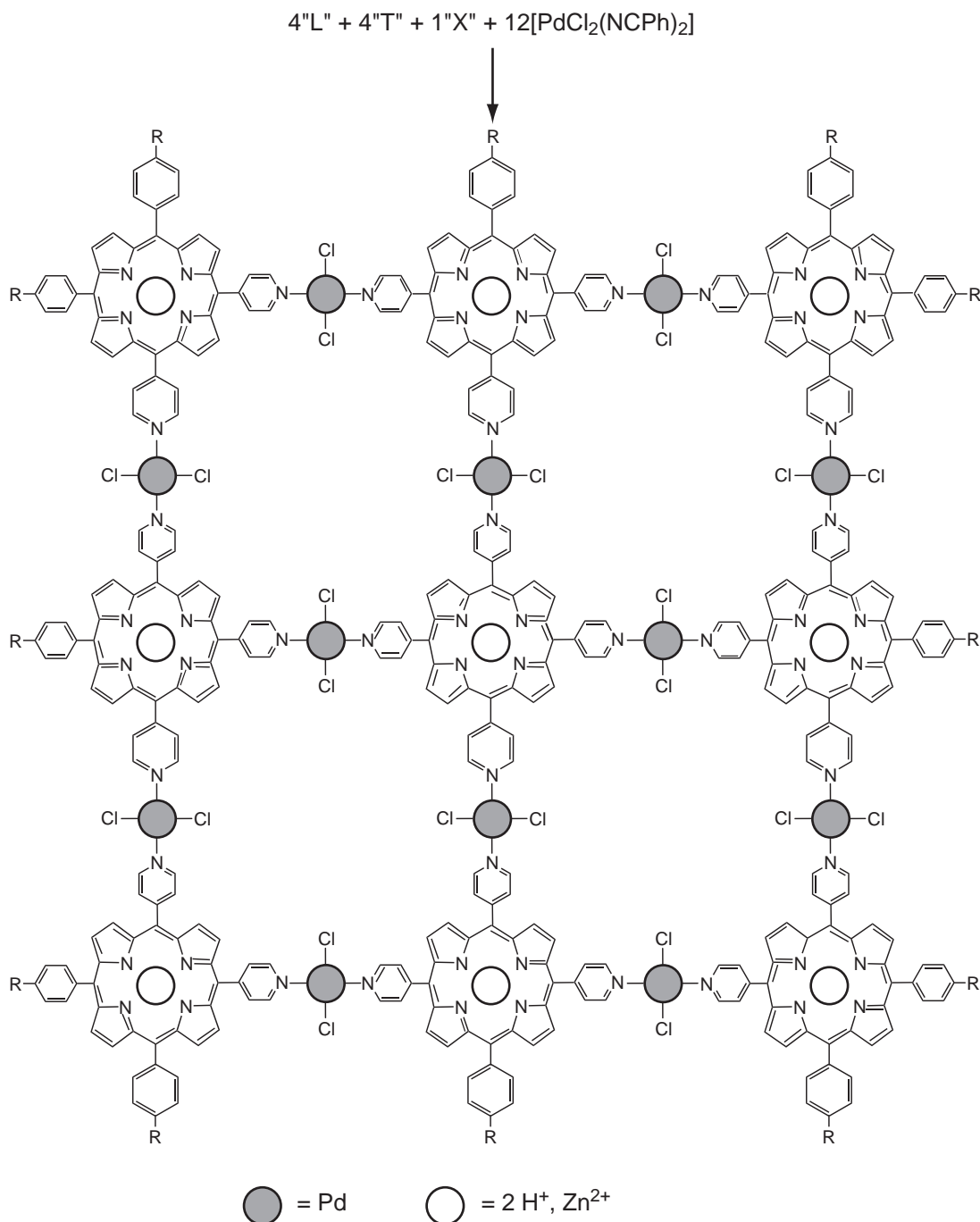

Figure 88 Nonameric arrays of porphyrins.

on the order of $5 \times 5 \times 5 \text{ nm}^3$. These arrangements are induced by a significant intermolecular π stacking energy per porphyrin face ($\sim 5 \text{ kcal mol}^{-1}$) depending on solvent and concentration. Other evidence for the formation of the arrays and tapes comes from a variety of methods: dynamic light scattering and size-exclusion chromatography; ESMS; and vapor phase osmometry.⁷²² The data taken together indicate formation of nonamer arrays that are about 25 nm^2 large, objects that are between discrete chemical species and polymeric materials. This work demonstrates that it is possible to design and self-assemble large, complex arrays of rigid dye molecules such as porphyrins by choosing the appropriate geometry of the building blocks and metal ions.⁷²²

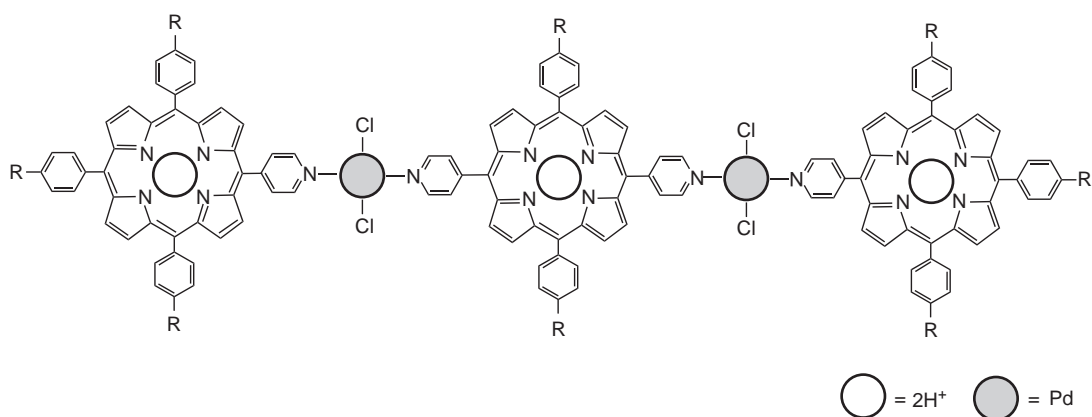

Figure 89 Porphyrin tapes.

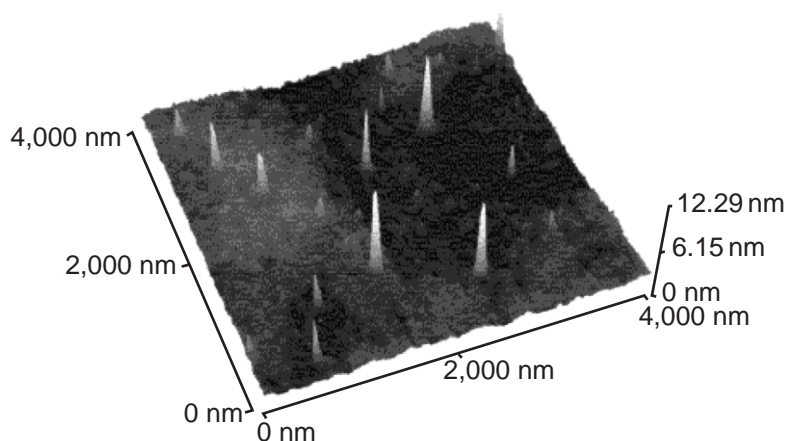

Figure 90 Characterization of the three-dimensional arrangement of porphyrin arrays by atomic force microscopy.

A number of chiral transition-metal-based infinite structures and smaller chiral systems, such as helices and helicates,^{747–760} have been reported. It is important to understand the function of chiral elements in supramolecular structures in an effort to unravel the intricacies of biological systems and the subtle functions respective chiral components introduce.⁷⁶¹ Bisphosphines such as 2,2'-bis(diphenylphosphino)-1,1'-binaphthyl (BINAP) and its derivatives have been most extensively utilized as chiral transition-metal-chelating reagents. The BINAP Pd^{II} and Pt^{II} bistriflate complexes⁷⁶² are fairly pliant and have been shown to be suitable building blocks for the preparation of chiral macrocyclic molecular squares.⁷⁶³ DIOP (2,3-*O*-isopropylidene-2,3-dihydroxy-1,4-bis(diphenylphosphino)-butane) is also widely used. Stang *et al.* reported the preparation of all transition metal and mixed Pt and Pd-iodonium, fully charged, cationic systems and the asymmetric induction resulting in these complexes using metal centers with chiral chelating ligands and helicity.^{763,764} A new chiral tetranuclear molecular Pt–Pd square was made using the simplest approach, that of a chiral chelating ligand, to access chirality. The resulting chiroptical properties of the chiral assemblies were studied. Optical rotation and CD spectra of the chiral starting material are reported; their set of intrinsic properties is being compared to those of the resulting macrocycles. The coordination of silver via π -interaction with the acetylenes is detected by CD, as well as the capture of neutral diheteroatomic aromatic guests by the resulting Lewis acid/base receptors.⁷⁶¹ NMR spectroscopy, circular dichroism (CD), and UV spectroscopy were used to observe tetramer formation, silver coordination, and guest inclusion. The DIOP moiety was most useful when used in conjunction with the achiral triethyl phosphine palladium bistriflate. However, the BINAP moiety allowed for the observation of larger Cotton effects,

which proved particularly useful for monitoring the formation of the chiral tetramers as well as the inclusion of neutral guests.⁷⁶¹

Rigid complexes can be synthesized in which the overall structure is dictated by a combination of the binding constraints of the ligand and the geometrical requirements of the metal ions. There is a report of the self-assembly of a rigid, cyclic structure that contains 4,7-phenanthroline and the linear organopalladium complex fragments, shown in Figure 91, as building blocks. Self-assembly of these complementary molecular building blocks with angular requirements of 60° and 180° results in a six-component $[3 + 3]$ cyclic array.⁶³⁹

In attempts to observe intermediates in the self-assembly process, experiments involving stepwise addition of metal to ligand and ligand to metal were monitored by $^1\text{H-NMR}$ spectroscopy. In no case were species other than the cyclic product and the component in excess observed. This is consistent with rapid formation of the thermodynamically favored cyclic product. An X-ray structural study confirmed the postulated hexanuclear structure (see Figure 92).⁶³⁹ 4,7-Phenanthroline is a simple, commercially available ligand that favors bridging over chelation and provides a rigid 60° corner for creating unique metal–ligand arrays. An advantage of employing the organopalladium complex fragments described here is the readily variable substituent on the sulfur atom, which allows the modification of the physical properties.⁶³⁹

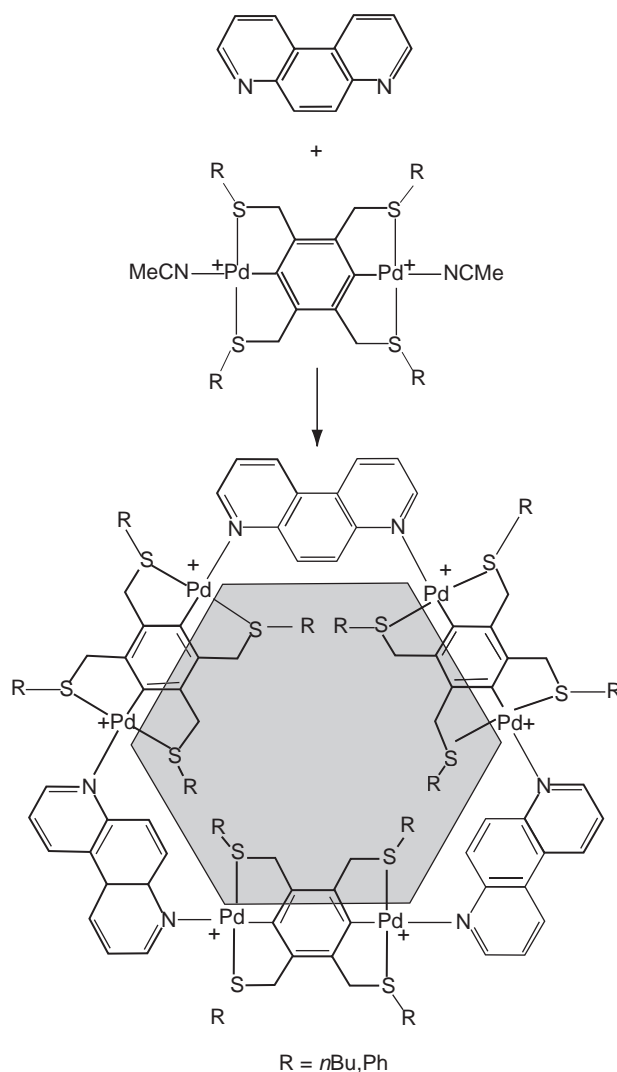

Figure 91 Rigid, cyclic structure that contains 4,7-phenanthroline and the linear organopalladium complex fragments.

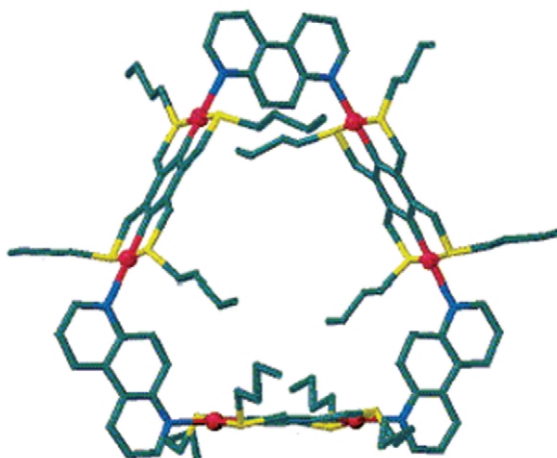

Figure 92 Hexanuclear structure of the [3 + 3] cyclic array.

6.4.6 PALLADIUM(I)

6.4.6.1 Carbon

Tetrapyrrole ligands, including porphyrins, porphyrinogens, and bilindiones, can coordinate metal ions in a π -fashion as well as in the usual σ -fashion through the nitrogen lone pairs. In $\text{Pd}_4(\text{OEB})_2$, a $[\text{Pd}_2]^{2+}$ unit is bound in π -fashion to olefinic sites that are exocyclic to pyrrole rings of the octaethylbilindione (H_3OEB) ligand.²⁰³ An unprecedented rearrangement of the framework of the bilindione occurs as a direct consequence of the π -coordination of the palladium. This complex, multistep process involves cleavage of the Pd–Pd and Pd–C bonds, oxidation of palladium, migration of the nitrogen atom from one carbon to another, and introduction of the oxygen atom via a hydrolytic process, not necessarily in this particular sequence.⁷⁶⁵

6.4.6.2 Phosphorus

Palladium triphenylphosphine complexes are important because of their numerous applications in organic synthesis and catalysis. A new binary palladium triphenylphosphine complex shows an unprecedented triphenylphosphine bonding mode.⁷⁶⁶ Yellow $[(\text{PPh}_3)_2\text{Pd}(\mu\text{-OH})_2](\text{BF}_4)_2$ ⁷⁶⁷ is only slightly soluble in CH_2Cl_2 but rapidly dissolves to give a red solution when ethanol is added. The $[\text{Pd}_3(\text{PPh}_3)_4]^{2+}$ cation consists of a $\text{Ph}_3\text{P}-\text{Pd}-\text{Pd}-\text{Pd}-\text{PPh}_3$ linear chain sandwiched by two head-to-tail $\text{Ph}_2\text{P}-\text{C}_6\text{H}_5$ groups each bonded through the P atom to one Pd atom and to two Pd atoms through a phenyl ring.⁷⁶⁸ Although PPh_3 has been observed to bridge two metal centers through the P atom and a Ph ring,^{769–777} a three-metal-center bridge is without precedent; see Figure 93.⁷⁶⁶

The arene rings bind to the Pd centers through four carbon atoms, bridging the two Pd atoms as $\mu\text{-}\eta^2\text{:}\eta^2\text{-diene}$ units. Arene bonding similar to that in the complex has been observed in Pd_2 complexes.^{778–780} Pd oxidation states in the chain may be described as $\text{Pd}^{\text{I}}-\text{Pd}^{\text{0}}-\text{Pd}^{\text{I}}$.⁷⁶⁶ The formation of this complex involves Pd^{II} reduction. The alcohol is the reducing agent and free PPh_3 is scavenged by air oxidation, thereby improving the yield of the new complex. The novel triphenylphosphine bridging to three metal centers is surprisingly robust and resists degradation at ambient temperatures. The low PPh_3/Pd ratio does, however, suggest that $[\text{Pd}_3(\text{PPh}_3)_4]^{2+}$ may be a useful precursor in stoichiometric and catalytic reactions.⁷⁶⁶

6.4.6.3 Hydrogen

Although a number of mono- and binuclear palladium hydrides have been successfully identified structurally and spectroscopically,^{375,781–786} very rare are the hydrido polynuclear Pd complexes that have been convincingly characterized. To our knowledge there is no X-ray structure of

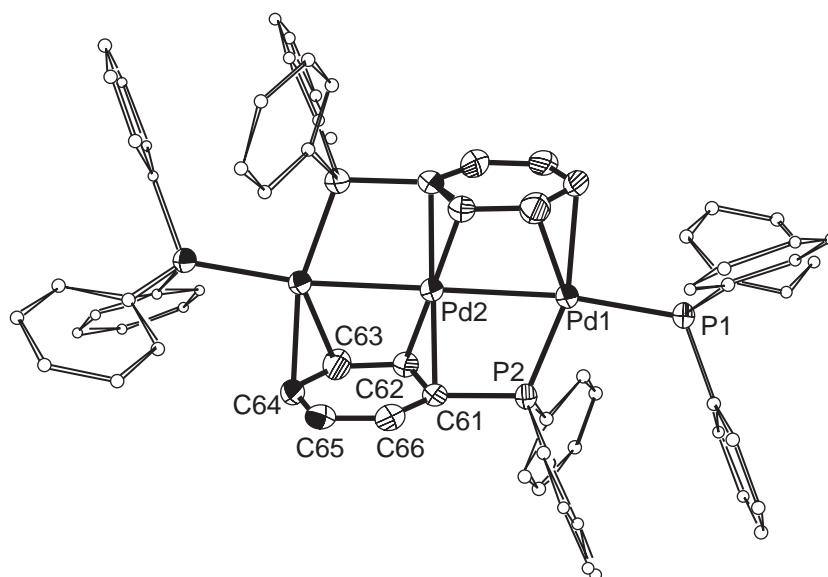

Figure 93 A three-metal-center bridge in $[\text{Pd}_3(\text{PPh}_3)_4]^{2+}$ ion.

$\text{Pd}_3(\text{H})_x$ or of hydride Pd_n ($n \geq 4$) complexes in the literature. Puddephatt *et al.*^{787,788} prepared the unstable compound $[\text{Pd}_3(\text{dppm})_3(\mu^3\text{-S})(\text{H})]\text{PF}_6$ which was characterized by NMR and IR and by comparison with the X-ray crystallographically characterized Pt analogue. Furthermore, attempts to prepare $[\text{Pd}_3(\text{dppm})_3(\mu^3\text{-H})]^+$ were unsuccessful. One group studied the reaction between $\text{Pd}_2(\text{dppm})_2\text{Cl}_2$ and NaBH_4 which produced putative “ $\text{Pd}_2(\text{dppm})_2(\text{H})_x$.”⁷⁸⁹ Another group reinvestigated the reaction between $\text{Pd}_2(\text{dppm})_2\text{X}_2$, where $\text{X} = \text{Cl}, \text{Br}, \text{or I}$, and NaBH_4 under the same experimental conditions. While no reaction is observed for the I derivative, they have obtained the same diamagnetic product according to color, spectra, and chemical behavior, except that both compounds contain halides (Cl or Br). They report the characterization of the first tetrapalladium hydride cluster, formulated as $[\text{Pd}_4(\text{dppm})_4(\text{H})_2]\text{X}_2$ ($\text{X} = \text{Cl}, \text{Br}$), along with some of its electrochemical properties in relation to electrocatalysis.⁷⁹⁰

6.4.6.4 Polynuclear Compounds and Polymers (see Chapter 7.6)

Homoleptic transition metal complexes containing weakly coordinated ligands have long been recognized as versatile sources of active catalysts or inorganic functional materials.^{791,792} For example, the combination of an electrophilic Pd^{II} complex $[\text{Pd}(\text{CH}_3\text{CN})_4][\text{BF}_4]_2$ ^{793,794} and appropriate auxiliary ligands has been frequently used as a pre-catalyst for olefin oligomerization, aromatic substitution, Wacker type oxidation, or alkyne hydroamination reaction.^{795–802} Preparation of the first homoleptic nitrile dipalladium(I) complex is shown in Figure 94.⁸⁰³

The dipalladium complex underwent facile ligand-substitution reaction with the Pd–Pd bond remaining *intact* under moderate conditions.⁸⁰³ The reaction with two equivalents of bidentate phosphine, dppm (diphenylphosphinomethane), in CD_3CN afforded a known complex $[\text{Pd}_2(\text{dppm})_2(\text{CH}_3\text{CN})_2][\text{BF}_4]_2$ ⁸⁰⁴ quantitatively. The reaction with two equivalents of 1,10-phenanthroline (phen) afforded $[\text{Pd}_2(\text{phen})_2(\text{CH}_3\text{CN})_2][\text{BF}_4]_2$.⁸⁰⁵

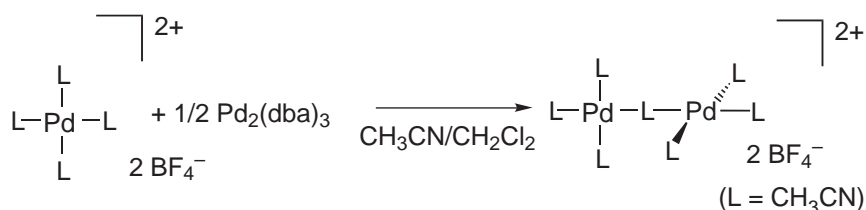

Figure 94 Preparation of the first homoleptic nitrile dipalladium(I) complex.

The design of efficient molecular catalysts for proton reduction to H_2 has recently become a subject of increasing interest.^{806–809} The identification and electrochemical characterization of a tetrapalladium dihydride cluster $[Pd_4(dppm)_4(H)_2](X)_2$ ($X^- = Cl^-, Br^-$) was reported.⁷⁹⁰ Because this cluster exhibits hydrides and an electrochemically reversible (two-electron) reduction system,⁷⁹⁰ one can hope for hydrogen evolution electrocatalysis. Another work⁸¹⁰ reports the first homogeneous electrocatalytic hydrogen evolution reaction induced by a cluster compound. Experimental results indicate that the intermediate is another polyhydride species, $Pd_4(dppm)_4(H)_3^+$, that is relatively stable. This study⁸¹⁰ also reports the one electron electrocatalytic decomposition of the formate ion to CO_2 and $1/2H_2$ by this same intermediate. The dihydrido cluster can be prepared chemically and electrochemically by various methods using the starting $Pd_2(dppm)_2Cl_2$ material. The dihydrido cluster is sensitive to nucleophiles such as Cl^- , Br^- , and CN^- , but the $[Pd_4(dppm)_4(H)_2](X)_2$ salts ($X^- = BF_4^-, PF_6^-, BPh_4^-$) proved to be particularly stable, even for weeks in solution. Its preparation in two general ways is shown in Figure 95: The first being the addition of “ H^+ ” to a chemically or electrochemically generated $Pd_2(dppm)_2$ species ($d^{10}-d^{10}$); and the second being the addition of “ H^- ” to $Pd_2(dppm)_2Cl_2$ (d^9-d^9).⁸¹⁰

The studies on palladium-phosphine complexes, especially those with diphosphine ligands, have mainly been focused on the complexes of palladium in lower oxidation state of 0 and +1,^{84,580,581,583,766,787,788,811–816} such as $[Pd_2(dppm)_2]^{2+}$, $[Pd_2(dppm)_3]$,⁸¹⁵ $[Pd_3(dppm)_3(\mu_3-S)H]PF_6$,^{787,788} $[Pd_4(dppm)_4(H)_2]X_2$,⁸¹⁴ and $\{[Pd(\mu-SC_6F_5)(\mu-dppm)Pd](\mu-SC_6F_5)\}_4$.⁸¹³

Until recently, only a few examples of clusters containing $[MSe_4]^{2-}$ units and non- d^{10} metal atoms were known.^{817,818} In order to obtain such a cluster, the reaction of palladium(I) complex $[Pd_2(\mu-dppm)_2Cl_2]$ ⁸¹⁹ with $[Et_4N]_2[WSe_4]$ in a CH_2Cl_2 –DMF mixture solvent was carried out. The neutral heterohexanuclear cluster $[(\mu_3-WSe_4)_2(Pd_2)_2(\mu-dppm)_2] \cdot 2DMF$ was formed by displacement of two chlorides and one dppm ligand in the complex, with two $[WSe_4]^{2-}$ groups coordinated to the two $[Pd_2(dppm)]^{2+}$ species, see Figure 96.⁸²⁰

In this reaction, the $[WSe_4]^{2-}$ anion is employed as a tridentate ligand and resembles a triseleno acid or four electron ligand, thus the synthesis entails the metathetical reactions of palladium chlorides and $[WSe_4]^{2-}$ anion. Moreover, perhaps more significantly, electrically neutral polynuclear heterometallic clusters with an open d -shell metal center appear to be promising precursors to new inorganic solids. The synthesis, structural characterization, and spectroscopic properties of the hexanuclear W–Se–Pd cluster $[(\mu_3-WSe_4)_2(Pd_2)_2(\mu-dppm)_2] \cdot 2DMF$ are presented, see Figure 97.⁸²⁰

The quadruply bonded dinuclear dimolybdenum(II) complex, $Mo_2(pyphos)_4$ (shown as the upper left structure in Figure 98(a)) (pyphos = 6-diphenylphosphino-2-pyridonate), binds two palladium(I) species at both of the axial positions of the Mo_2 core to form the metal–metal-bonded tetranuclear complex $Mo_2Pd_2Cl_2(pyphos)_4$ (shown as the middle structure in Figure 98(b)), which has two single Pd^I – Mo^{II} bonds and one triple Mo – Mo bond.^{821,822} This reaction involves the coordination of two Pd^{II} at the axial positions of the Mo_2 core to form $Mo_2Pd_2Cl_4$

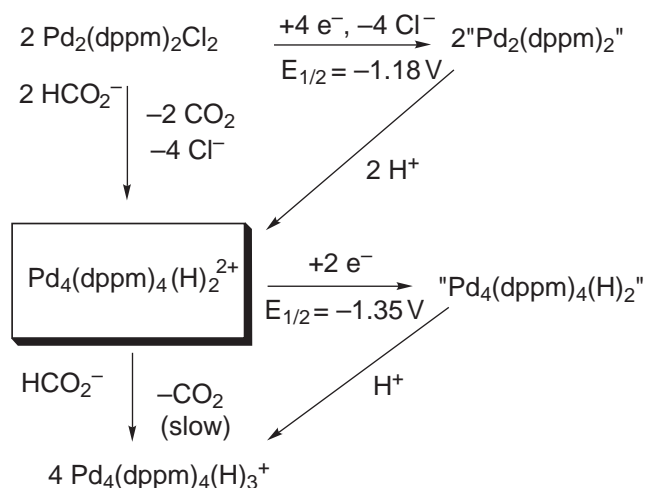

Figure 95 Preparation of $[Pd_4(dppm)_4(H)_2](X)_2$ salts ($X^- = BF_4^-, PF_6^-, BPh_4^-$) in two general ways.

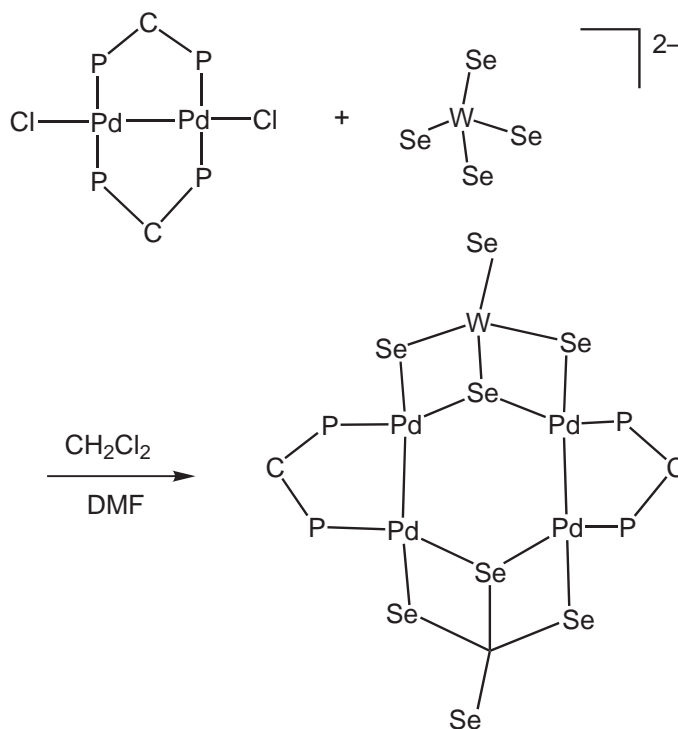

Figure 96 Preparation of neutral heterohexanuclear cluster $[(\mu_3\text{-WSe}_4)_2(\text{Pd}_2)_2(\mu\text{-dppm})_2]\cdot 2\text{DMF}$.

(pyphos)₄ (shown as the upper right structure in Figure 98(c)) and then the reduction of Pd^{II} to Pd^I as a result of the formation of Mo—Pd σ bonds.

Bis(diphenylphosphine)methane (dppm), as a constraining ligand, prefers to lock two metal atoms together in close proximity and favors unusual oxidation states; thus, most palladium complexes containing dppm are binuclear complexes doubly bridged by dppm and related ligands, such as $[\text{Pd}_2(\mu\text{-dppm})_2\text{X}_2]$ (X = halogen),^{579,580,583,823} and the oxidation state of palladium is mainly +1. Many studies have been carried out on the insertion of small molecules, such as CO, SO₂, RCN, etc., into the Pd—Pd bond in $[\text{Pd}_2(\mu\text{-dppm})_2\text{X}_2]$ to yield the so-called A-frame complexes with the maintenance of the oxidation state of palladium.^{824–827} In the octanuclear $\{[\text{Pd}(\mu\text{-SC}_6\text{F}_5)(\mu\text{-dppm})\text{Pd}](\mu\text{-SC}_6\text{F}_5)\}_4$, the oxidation state of palladium remains +1.^{828,829}

Up to a few years ago, a common viewpoint was that monodentate phosphines act exclusively as two-electron terminally bonded donors. The structure of $[\text{Pd}_2(\text{dppp})_2][\text{CF}_3\text{SO}_3]_2$ [dppp = 1,3-

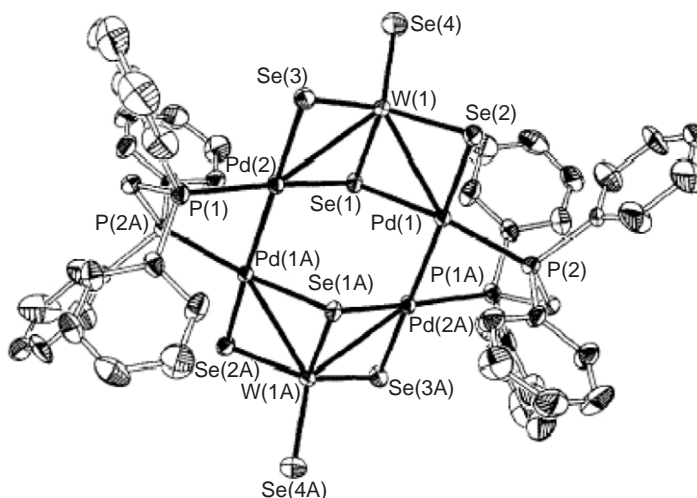

Figure 97 Hexanuclear cluster $[(\mu_3\text{-WSe}_4)_2(\text{Pd}_2)_2(\mu\text{-dppm})_2]\cdot 2\text{DMF}$.

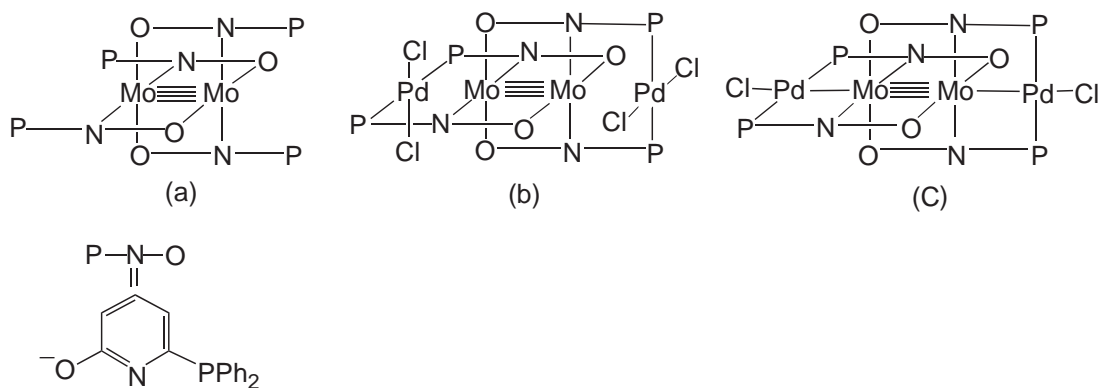

Figure 98 Quadruply bonded dinuclear dimolybdenum(II) complexes (a) $\text{Mo}_2(\text{pyphos})_4$, (b) $\text{Mo}_2\text{Pd}_2\text{Cl}_2(\text{pyphos})_4$, and (c) $\text{Mo}_2\text{Pd}_2\text{Cl}_4(\text{pyphos})_4$.

bis(diphenylphosphino)propane]⁷⁶⁸ contains a dinuclear palladium(I) cation, surviving thanks to a metal–metal bonding interaction, and two bridging phosphines. The cation can in fact be viewed as the dimer of the bent $(\text{dppp})\text{Pd}^+$ moiety; within each dppp molecule one phosphorus binds terminally one of the metals and the remaining one bridges the Pd–Pd bond, as shown in Figure 99.⁷⁶⁸

The complex $[\text{Pd}_2(\mu\text{-PBU}^t_2)(\mu\text{-PBU}^t_2\text{H})(\text{PBU}^t_2\text{H})_2]\text{BF}_4$ ⁸³⁰ contains a secondary phosphine as bridging ligand, see Figure 100. With respect to most of the bridges described above, which involve orbitals centered on single phosphorus atoms, the bridging secondary phosphine differs substantially because of the active role played by the P–H σ -bond. This furnishes two extra electrons, involved in an unprecedented Pd–H–P agostic interaction, to the dimetallic system. The PBU^t_2H molecule can therefore be formally considered as a four-electron donor, or, in other words, a bidentate ligand,⁸³⁰ as for example the bridging diphenylvinylphosphine in the cation $[\{\text{Pd}[\mu\text{-Ph}_2(\text{CH})][\text{CH}_2][\text{PPh}_2(\text{CH})][\text{CH}_2]\}_2]^{2+}$, shown in Figure 101.⁸³¹

The bridging PBU^t_2H molecule is not as tightly bonded as other bridging bidentate ligands. This can easily be confirmed by comparing the reactivities of monodentate phosphines.⁸³² The strength of the overall $\text{Pd}_2(m\text{-PBU}^t_2\text{H})$ interaction is greater than that of a terminal Pd– BU^t_2H bond.⁸³²

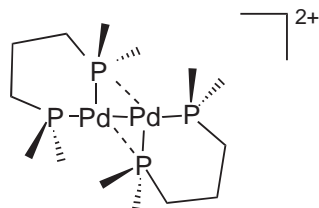

Figure 99 The structure of $[\text{Pd}_2(\text{dppp})_2][\text{CF}_3\text{SO}_3]_2$.

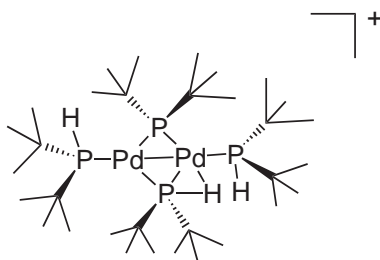

Figure 100 The structure of the complex $[\text{Pd}_2(\mu\text{-PBU}^t_2)(\mu\text{-PBU}^t_2\text{H})(\text{PBU}^t_2\text{H})_2]\text{BF}_4$, which contains a secondary phosphine as bridging ligand.

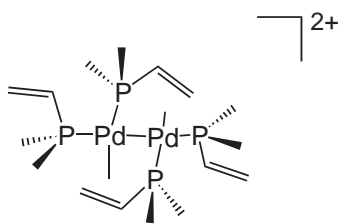

Figure 101 The cation $[\{\text{Pd}[\mu\text{-Ph}_2(\text{CH})\text{CH}_2]\}[\text{PPh}_2(\text{CH})\text{CH}_2]\}_2]^{2+}$.

6.4.7 PALLADIUM(0)

6.4.7.1 Carbon

Many research groups have employed Pd catalysis to prepare a variety of covalently-linked multiporphyrin arrays. Couplings of the Heck, Suzuki, Sonogashira, and Stille types, amongst others, have so far been used.^{833–841} In couplings of the *meso*-haloporphyrin using Pd⁰ and phosphines, an essential step is the oxidative addition to form a *meso*-η¹-palladioporphyrin.⁸³⁹ Synthesis and spectra of peripherally-palladated porphyrins have been reported.⁸⁴²

Isolated mononuclear Pd⁰-carbonyl complexes are rare. Examples include (Ph₃P)₃Pd(CO), which on reversible phosphine dissociation gives rise to (Ph₃P)₂Pd(CO), which itself has not been isolated,^{843,844} {N(C₂H₄PPh₂)₃}Pd(CO),⁸⁴⁵ and {MeC(CH₂PPh₂)₃}Pd(CO);⁸⁴⁶ the last compound has been structurally characterized. Matrix isolation techniques have allowed the spectroscopic characterization of the highly unstable homoleptic complexes Pd(CO)_n (*n* = 1–4).^{847–849} The dinuclear Pd⁰-carbonyl complexes {(bpy)Pd(μ-CO)}₂ and {(*o*-phen)Pd(μ-CO)}₂⁸⁵⁰ and trinuclear clusters L_nPd₃(CO)₃ (L = PPh₃; *n* = 3, 4; L = P^tBu₃, PPh^tBu₂; *n* = 3)⁸⁵¹ have been reported, but without structural data. The molecular structures of larger clusters such as (Ph₂MeP)₄Pd₄(μ₂-CO)₅,⁸⁵² (Buⁿ₃P)₄Pd₄(μ₂-CO)₆,⁸⁵³ (Me₃P)₇Pd₆(μ₃-CO)₄,⁸⁵⁴ and (Me₃P)₇Pd₇(μ₂-CO)₃(μ₃-CO)₄⁸⁵⁵ have, however, been established.⁸⁵⁶ Dinuclear Pd₂(μ-CO) bonding has been suggested for adsorption of CO on a Pd(100) surface,^{857,858} but interestingly no examples of dinuclear Pd⁰-monocarbonyl complexes were known until recently.⁸⁵⁹ The synthesis and properties of the novel mononuclear complexes (R₂PC₂H₄PR₂)Pd(CO)₂ (R = Prⁱ, Bu^t), with terminal CO ligands, and the dinuclear {(d¹bpe)Pd}₂(μ-CO), containing a single CO bridge were reported.⁸⁵⁹ It appears that for the Pd⁰-CO system the Pd₂(μ-CO) entity is strongly favored over other possible coordination modes (e.g., Pd-σ-CO and Pd₂(μ-CO)₂).⁸⁵⁹

There is a growing class of metal carbonyl compounds with unusually high ν(CO) values. These and other high ν(CO) values are due to greatly diminished π backbonding for late transition metal [M(CO)_n]^{m+} species. A ν(CO) value greater than 2,143 cm⁻¹ can occur for two distinguishable situations: (i) negligible or relatively minor M → CO π backbonding (i.e., nonclassical behavior) or (ii) π backbonding that is significant (i.e., classical behavior) but insufficient to lower ν(CO) below 2,143 cm⁻¹.⁸⁶⁰ There is computational evidence that the metal-carbon bonds in the *d*¹⁰ D_{∞h} species such as [Pd(CO)₂], are fundamentally different than the metal-carbon bonds in the isoelectronic, isoleptic, and isostructural species [Ag(CO)₂]⁺, [Zn(CO)₂]²⁺, [Cd(CO)₂]²⁺, and [Hg(CO)₂]²⁺.⁸⁶¹

6.4.7.2 Nitrogen

The simplest carbohydrates are easily available, chiral, and may afford both lipo- and hydro-soluble ligands^{862–867} depending on whether or not the hydroxyl groups are protected. There are new nitrogen chelates based on α-D-mannose and α-D-glucose, where the sugar residue was bound to the N-donor through the C6 atom. Their coordination properties were investigated by preparing lipo- and hydro-soluble complexes of Pd⁰ with general formula [Pd⁰(*N,N*-chelate)(olefin)]. A significant diastereoselectivity in the coordination of both dimethyl fumarate and fumarodinitrile (fdn) was obtained with ligands of the type shown in Figure 102.⁸⁶⁸

Improved *N,N*-ligands, shown in Figure 103, have a chiral carbon closer to the coordinating atoms, i.e., a linkage between the carbohydrate C1 carbon and the N donor. This feature enhances the ability of the ligands to induce enantioselective coordination of prochiral olefins.

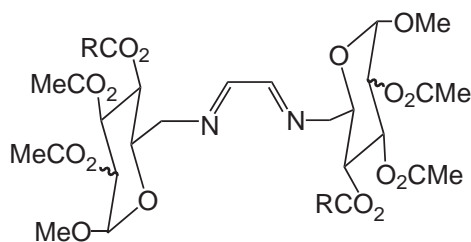

Figure 102 Chelating ligand that is derived from α -D-MANNOSE.

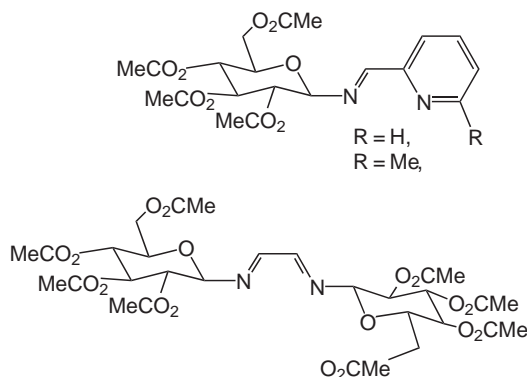

Figure 103 Improved N,N-ligands.

A new water soluble palladium(0) complex was also prepared. This compound and a previously reported related species were examined as catalysts in the hydrogenation of unsaturated nitriles in water. It was found that the pH of the solvent plays a crucial role in determining both yield and reaction course.⁸⁶⁹

6.4.7.3 Phosphorus

Determination of the rate constant of the oxidative addition of aryl halides with $\text{Pd}^0(\text{PPh}_3)_4$ or with the Pd^0 complexes generated from $\text{Pd}^0(\text{dba})_2$ and one equivalent of dppp shows that the oxidative addition is slower for *ortho*-substituted aryl halides than for the corresponding non-substituted or *meta*-substituted aryl halides.⁸⁷⁰

Sources of catalytically active palladium(0) typically arise from ligand dissociation from coordinatively more saturated Pd^0 complexes^{871–880} or from reduction of a Pd^{II} species.^{353,881} Another route to catalytically active (P–P)Pd fragments is the dissociation of the dinuclear complexes $[(\mu\text{-P–P})\text{Pd}]_2$.⁸⁸² Complexes $[(\mu\text{-dcpm})\text{Pd}]_2$ and $[(\mu\text{-dtbpm})\text{Pd}]_2$ were obtained from the reductive elimination of ethane from dimethylpalladium(II) complexes (dippm = bis(diisopropylphosphino)methane; dcpm = bis(dicyclohexylphosphino)methane; dtbpm = bis(di-*t*-butylphosphino)methane).⁸⁸³

During the 1990s the interest in the complexing properties of calixarenes shifted toward transition metal complexation. This shift has resulted in the synthesis of an appreciable number of phosphorus-containing calix[4]- and calix[6]arenes. Calix[4]arene diphosphite is shown in Figure 104. The ligand shows a tendency to form *cis*-coordinated complexes with palladium(II) in which it has an almost ideal bite angle of 94° . Furthermore it can stabilize palladium(0). The geometry of this complex is presumably a (distorted) tetrahedron. This complex is successful in palladium-catalyzed copolymerization of carbon monoxide and ethene.⁸⁸⁴

Tetracoordinate Pd^0 -phosphine complexes are widely used as catalysts in organic synthesis. Interesting among the several routes to these compounds is the formation of a Pd^0 complex in quantitative conversion via a redox transmetalation involving Pd^{II} and Pt^0 .⁸⁸⁵ In more traditional preparations, Pd^{II} -halide complexes are reduced to the corresponding bis(diphosphine) Pd^0 or tetrakis(phosphine) Pd^0 analogues in the presence of the phosphine or diphosphine. In the redox reaction shown in Equation (5) Pd^{II} bis-phosphine complexes are reduced to tetrakis(phosphine) Pd^0

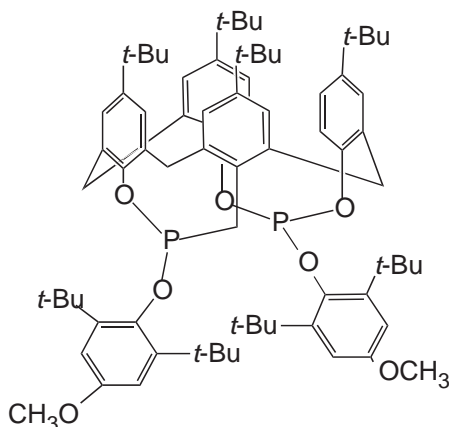
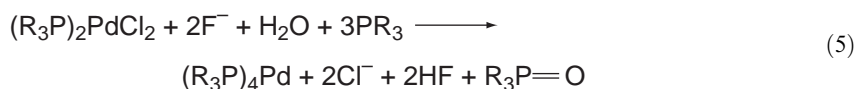

Figure 104 Calix[4]arene diphosphite.

complexes while part of the excess phosphine is oxidized to $R_3P=O$.⁸⁸⁷ This reaction is catalytic in fluoride in the presence of very strong nonionic bases:⁸⁸⁷



6.4.7.4 Hydrogen

The family of solid-state hydrides now comprises the members $Li_2(PdH_2)$, $Na_2(PdH_2)$, $NaBa(PdH_3)$, $Sr_2(PdH_4)$, and $Ba_2(PdH_4)$.^{888–891} Also these hydrides can be made fairly conveniently by hot sintering compacted powder mixtures of the binary alkali or alkaline earth hydrides with Pd in hydrogen. The existence of these complexes is interesting as such low oxidation states of the transition metal are usually associated with ligands having good electron-accepting properties. This conventional stabilization by “back-donation” to ligand orbitals is, however, not available in homoleptic hydrido complexes. Some of the hydrides show metallic electric conductivity, indicating that the cations are required to participate more in the bonding, beyond the role of a conventional undeformed cation. Thus it seems likely that a stabilization mechanism for these electron dense low formal oxidation states is to be found in the interaction of the hydrogen ligands with the cations surrounding the complexes. This could correspond to a somewhat indirect “back-bonding” mechanism where electron density from the *d*-orbitals of the transition metals are distributed to the cations via bonding with the hydrogen atoms. Such a mechanism could also be of interest for applications as it may offer a way to influence the stability of a complex and thus the hydrogen release pressure by manipulating the “electropositive matrix” surrounding the complexes. The stabilization of four palladium-hydrido complexes, a square-planar $[Pd^{II}H_4]^{2-}$, a linear $[Pd^0H_2]^{2-}$, a trigonal $[Pd^0H_3]^{3-}$, and a slightly distorted $[Pd^0H_4]^{4-}$, in the solid-state hydrides $K_2[Pd^{II}H_4]$, $Li_2[Pd^0H_2]$, $Na_2[Pd^0H_2]$, $NaBa[Pd^0H_3]$, and $Ba_2[Pd^0H_4]$ has been studied by investigating the palladium–hydrogen bond strength with inelastic neutron scattering and by performing self-consistent linear muffin-tin orbital calculations on the corresponding solid-state structures.⁸⁹² The capacity of the easily polarizable H^- ion for redistributing electron density has thus probably a somewhat neglected importance for complex chemistry in general, but the effect has not been elucidated until the work with homoleptic hydrido complexes.⁸⁹² In hydrides where the interactions between neighbors become so large that electrons become itinerant, we might further find new interesting electric phenomena relating conductivity with the crystal lattice modes.⁸⁹²

Metal hydrides containing transition metal (TM)–hydrogen complexes, with the transition metal in a formally low oxidation state, are of fundamental interest for clarifying how an electron-rich metal atom can be stabilized without access to the conventional mechanism for relieving the electron density by “back-donation” to suitable ligand orbitals. By reacting electro-positive alkali or alkaline earth metals (*s*-elements) with group 7, 8, 9, and 10 transition metals in

the presence of hydrogen, a large number of interesting ternary and quaternary complex transition metal hydrides have been synthesized. Although none of the transition metals form stable binary hydrides, except for palladium, the hydrides based on the hydrogen-rich TM complexes have a considerably higher storage capacity than the hydrogen storage alloys commercially available in the early twenty-first century. In the synthesis of these new hydrides, the electro-positive *s*-elements are supplying their valence electrons to allow for the formation of usually 18-electron homoleptic TM-hydrogen complexes. A small number of electron-dense Pd–H complexes have already been found, namely Li_2PdH_2 and Na_2PdH_2 .^{889,890} The flexibility inherent in the polarizable TM–H bond and lattice-induced effect seems to offer enough relief of the high electron density in the d^{10} state of the central atom, helping to stabilize a formal oxidation state that is usually found only with good electron-accepting ligands. Palladium seems to even favor such a low oxidation state, as it has been found with a formal oxidation state of zero in two complexes: a linear PdH_2 complex in Li_2PdH_2 and Na_2PdH_2 and a planar trigonal PdH_3 complex in NaBaPdH_3 .⁸⁹¹ For comparison, an assumedly more conventional square-planar $\text{Pd}^{\text{II}}\text{H}_4$ complex was synthesized in Na_2PdH_4 , but at an extreme 2,000 bar H_2 pressure.⁸⁹³ The addition of a third zerovalent-palladium hydrido complex in the series A_2PdH_2 , namely A_2PdH_4 ($\text{A} = \text{Sr}, \text{Ba}$),⁸⁹⁴ shows that hydrogen as a ligand can participate in the stabilization of such a formally low oxidation state, where one would only expect good electron accepting ligands to be involved. The large variation in hydrogen coordination numbers and geometries in response to the *s*-metal counter ion charge distribution implies that the unique chemical softness of H^- permits stabilization of a number of probably energetically similar structural configurations in these systems. It also indicates the need to consider the total metal lattice when explaining the stability of the different complexes.⁸⁹⁴

For the palladium hydrides, the formation of $[\text{Pd}^0\text{H}_2]$ complexes is favored over that of a more common square planar arrangement in $[\text{Pd}^{\text{II}}\text{H}_4]\cdot\text{Na}_2\text{PdH}_4$, containing the latter four-coordinated complex, has been synthesized but could only be obtained at an extreme 2 kbar H_2 pressure.⁸⁹³ K_2PdH_4 , containing the larger and more electropositive potassium ion, was synthesized at a more moderate pressure.⁸⁹⁵ Both hydrides are nonmetallic, and the Pd–H distances are short, 1.61 Å and 1.63 Å, respectively, indicating more covalent bonding than the longer Pd–H distances, 1.68 Å, in the metallic Li_2PdH_2 and Na_2PdH_2 hydrides. The quaternary hydride NaBaPdH_3 , contains unprecedented 16-electron $[\text{PdH}_3]$ complexes that contain formally zerovalent palladium with planar trigonal D_{3h} symmetry. The crystal structure was determined and refined from single-crystal X-ray diffraction data and was verified by a neutron powder diffraction experiment on a deuterated sample.⁸⁹⁶

6.4.7.5 Mixed Donor Atoms

Ligands with mixed donor atoms have been the subject of many studies. Particularly interesting are the hemilabile ligands, in which “soft” and “hard” donor atoms are combined to give flexible coordination modes. This behavior has been exploited to maximize the stability of a metal complex and has been implicated in a number of catalytic reactions. Although the coordination chemistry of phosphorus–nitrogen–phosphorus donors (PNP ligands) to transition metals has been widely reported, their application to catalysis is fairly recent, where in most cases the nitrogen is used either as a means of tethering the ligand to solid supports, and chiral or hydrophilic groups. As nitrogen is inherently a weaker donor toward later transition metals than phosphines, it is conceivable that the complex could isomerize between *cis* and *trans* configurations as the ligand alters between the bi- and terdentate modes (see Equation (6)). As this isomerization process does not necessarily entail a cleavage of the M–P bond, it is envisaged that ligand dissociation and decomposition during a catalytic reaction should be minimized:⁸⁹⁷

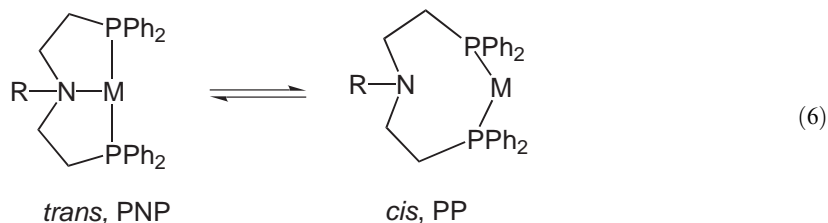

General routes for the synthesis of a number of PNP ligands of the general formula $R-N(CH_2CH_2PPh_2)_2$ ($R = \text{acyl, alkyl, aryl}$) have been developed. Their coordination chemistry with palladium has been explored and was found to be capable of PP-dimeric, PNP-monomeric, and PP-monomeric modes of coordination, depending on the substituents on palladium, as well as on the nature of the R group on the nitrogen donor. Different substitutions on nitrogen have an appreciable effect on the rates of the oxidative addition reaction on palladium(0).⁸⁹⁷

6.4.7.6 Polynuclear Compounds

Ruthenium–ruthenium bonds form adducts to the Lewis acid palladium grouping $Pd(PBu^t_3)$.⁸⁹⁸ The tripalladium complex $Ru_3(CO)_{12}[Pd(PBu^t_3)]_3$, shown in Figure 105, was obtained from the reaction of $Pd(PBu^t_3)_2$ with $Ru_3(CO)_{12}$. The compound consists of a central triruthenium triangle with three Ru–Ru bonds. Each Ru–Ru bond contains a bridging $Pd(PBu^t_3)$ grouping. Each palladium atom is bonded to two ruthenium atoms. The cluster of six metal atoms is not planar, but has a dish-like shape. The reaction of $Pd(PBu^t_3)_2$ with $Ru_6(CO)_{17}(C)$ yielded two isomers of the dipalladium complex $Ru_6(CO)_{17}(C)[Pd(PBu^t_3)]_2$. In one isomer the $Pd(PBu^t_3)$ groups bridge two edges of the Ru_6 octahedron; in the other isomer, one $Pd(PBu^t_3)$ group bridges an edge of the Ru_6 octahedron while the other $Pd(PBu^t_3)$ group serves as a triple bridge. The reaction of

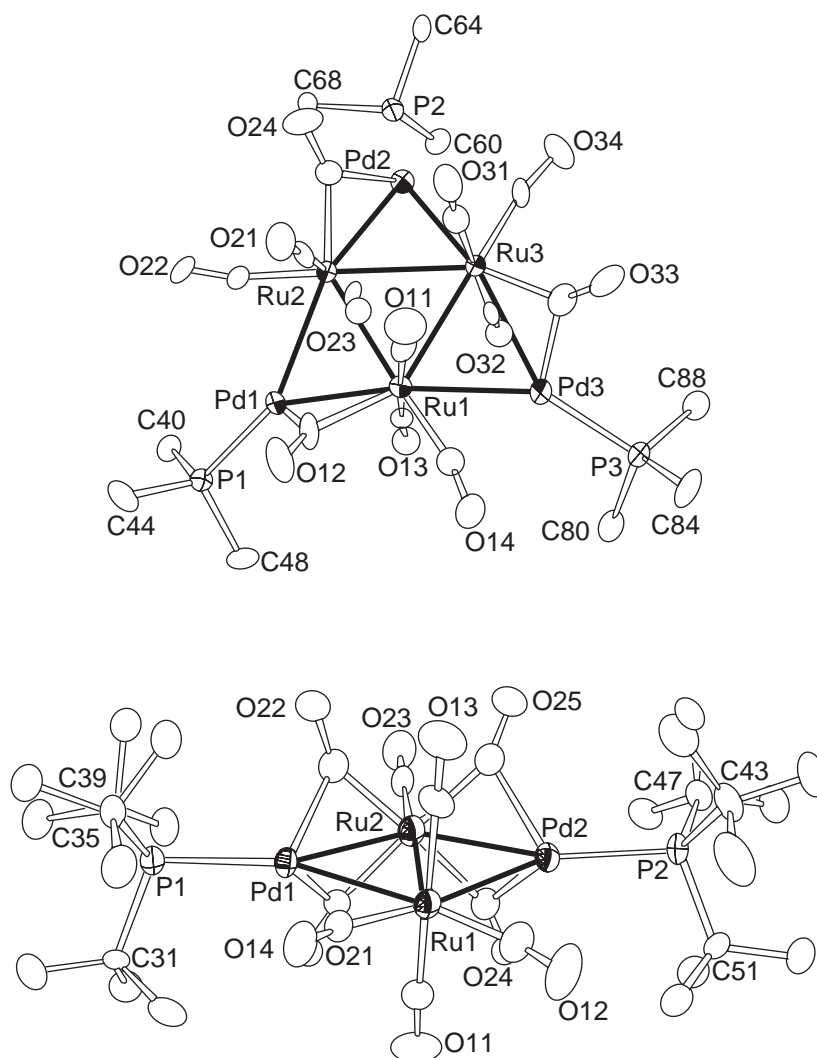

Figure 105 The structures of the complexes $Ru_3(CO)_{12}[Pd(PBu^t_3)]_3$ (above) and $Ru_2(CO)_9[Pd(PBu^t_3)]_2$ (below).

$\text{Ru}(\text{CO})_5$ with $\text{Pd}(\text{PBU}^t_3)_2$ gives $\text{Ru}_2(\text{CO})_9[\text{Pd}(\text{PBU}^t_3)]_2$, depicted in Figure 105, which can be viewed as a dipalladium adduct of the elusive compound $\text{Ru}_2(\text{CO})_9$.

There has been great interest in the preparation of bimetallic transition metal cluster complexes containing palladium.^{899–902} Bimetallic palladium–ruthenium clusters have been shown to be good precursors to supported bimetallic catalysts.^{903,904}

Since the first report on the synthesis and characterization of the $\text{Pd}_3(\text{dppm})_3(\text{CO})^{2+}$ cluster (dppm = bis(diphenylphosphino)methane), by Puddephatt *et al.*^{905,906} numerous and exhaustive works on its reactivity and properties have appeared.^{22,907,908} This cluster exhibits a triangular Pd_3 frame with three dppm-supported M–M single bonds. While one M_3 face is capped by a CO group (see Figure 106), the other one is unsaturated, giving rise to rich coordination chemistry.^{22,907–909} The dppm-phenyl groups form a cavity above this M_3 plane, limiting access to smaller substrates only.^{907,908} The binding of halide ions onto this Pd_3^{2+} species leads to very stable architectures,⁹⁰⁹ and the approximated binding constants indicate that the stability varies as $\text{I} \gg \text{Br} \gg \text{Cl}$.^{910–912}

This cationic cluster exhibits a two-electron-reduction process, and depending upon the counter anion or the solvent, this event can appear either as a single two-electron step or two one-electron peaks on the cyclic voltammogram. The two-electron transfer reaction, which can be discriminated into its one-electron individual steps, has been the topic of many studies.^{913,914} The electrochemically induced R–Br and R–I bond cleavage by the generated paramagnetic $\text{Pd}_3(\text{dppm})_3(\text{CO})^+$ intermediate cluster occurs by a pathway producing “R⁺” and “X[−]”.⁹¹⁵ One of the driving forces of this reactivity is the great affinity of the unsaturated Pd_3^{2+} center toward Br^- and I^- , leading to the final inorganic products $\text{Pd}_3(\text{dppm})_3(\text{CO})(\text{X})^+$ ($\text{X} = \text{Br}^-, \text{I}^-$).⁹¹⁶

Relatively few investigations involving palladium carbonyl clusters have been carried out, partly because palladium *per se* does not form stable, discrete homometallic carbonyl clusters at room temperature in either solid or solution states.^{114,917–922} Nevertheless, solution-phase palladium carbonyl complexes have been synthesized with other stabilizing ligands (e.g., phosphines),^{105,923} and carbon monoxide readily adsorbs on palladium surfaces.⁹²⁴ Moreover, gas-phase $[\text{Pd}_3(\text{CO})_n]^-$ anions ($n = 1–6$) have been generated and their binding energies determined via the collision-induced dissociation method.⁹²⁵

Many intriguing palladium carbonyl phosphine clusters have been prepared and their stereochemistry extensively investigated; however, the number of high-nuclearity homopalladium carbonyl clusters characterized by X-ray diffraction analysis is still limited: namely, $\text{Pd}_{10}(\text{CO})_{14}(\text{PBU}^n_3)_4$,⁹²⁶ $\text{Pd}_{10}(\text{CO})_{12}(\text{PBU}^n_3)_6$,⁹²⁷ $\text{Pd}_{12}(\text{CO})_{12}(\text{PBU}^n_3)_6$,⁹²⁸ $\text{Pd}_{16}(\text{CO})_{13}(\text{PET}_3)_9$,⁹²⁹ $\text{Pd}_{23}(\text{CO})_{22}(\text{PET}_3)_{10}$,⁹³⁰ $\text{Pd}_{23}(\text{CO})_{20}(\text{PET}_3)_8$,⁹³¹ $\text{Pd}_{34}(\text{CO})_{24}(\text{PET}_3)_{12}$,⁹³² and $\text{Pd}_{38}(\text{CO})_{28}(\text{PET}_3)_{12}$.^{932,933} Synthetic pathways to these large clusters usually involve the elimination of ligands from smaller palladium clusters thereby resulting in aggregation. The products of such reactions are unpredictable, and consequently X-ray crystallography is normally utilized to establish the composition as well as atomic arrangement.

High-nuclearity homopalladium carbonyl clusters $\text{Pd}_{16}(\text{CO})_{13}(\text{PMe}_3)_9$, $\text{Pd}_{35}(\text{CO})_{23}(\text{PMe}_3)_{15}$, $\text{Pd}_{39}(\text{CO})_{23}(\text{PMe}_3)_{16}$, and $\text{Pd}_{59}(\text{CO})_{32}(\text{PMe}_3)_{21}$ were obtained in moderate yields from a highly reproducible synthesis involving the initial preparation of a heterometallic Pd–Ni carbonyl cluster without phosphine ligand followed by its reaction with PMe_3 under acidic conditions.⁹³⁵

Nanosized $\text{Pd}_{145}(\text{CO})_x(\text{PET}_3)_{30}$ contains a capped three-shell 145-atom metal-core geometry of pseudo icosahedral symmetry. The pseudo- I_h metal core (see Figure 107) consists of a central Pd atom surrounded by 12 Pd atoms (shell 1), which in turn are encapsulated by 42 Pd atoms (shell 2), which in turn are encapsulated by 60 Pd atoms (shell 3). Thirty additional Pd atoms cap the 30 square polygons of the third-shell polyhedron with a triethylphosphane ligand attached to each capping Pd atom. It is currently presumed that 60 CO groups (crystal-disordered) edge-bridge the 30 capping Pd atoms with one-half of the square basal Pd atoms. The diameter of the entire Pd_{145}

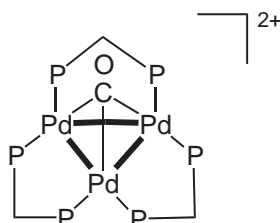

Figure 106 The complex ion $[\text{Pd}_3(\text{dppm})_3(\text{CO})]^{2+}$.

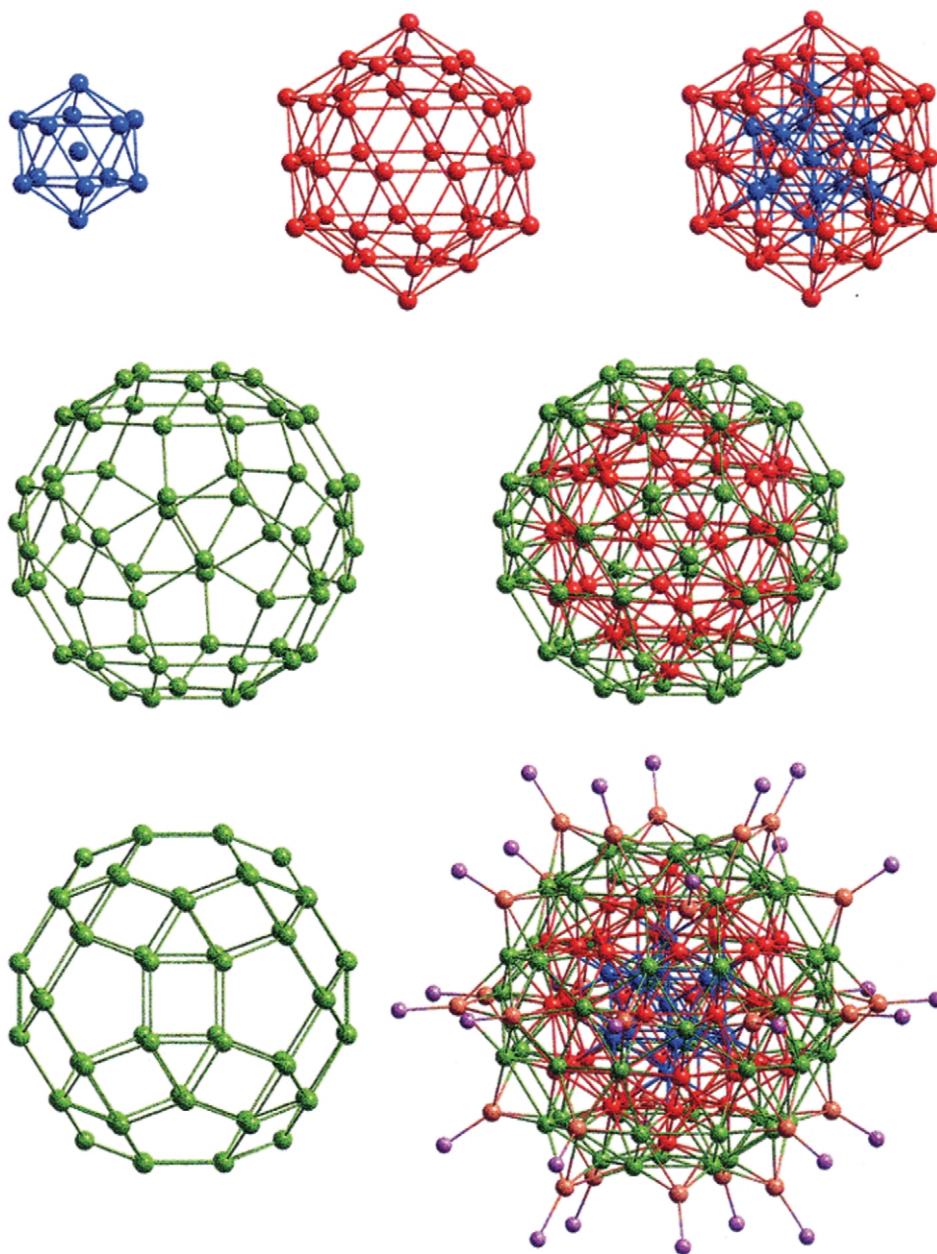

Figure 107 The pseudo- I_h metal core showing three shell layers and 145-atom metal-core geometry in $\text{Pd}_{145}(\text{CO})_x(\text{PEt}_3)_{30}$.

core of is 1.65 nm; the geometry of the centered three-shell Pd_{115} kernel (that is, without the 30 capping Pd atoms) is spheroidal.⁹³⁴

This remarkable Pd_{145} nanocluster, whose metal-core geometry was unambiguously characterized, was isolated from the reduction of a monomeric square-planar palladium precursor, $[\text{Pd}(\text{PEt}_3)_2\text{Cl}_2]$.⁹³⁴ A preliminary investigation has already indicated the existence of PMe_3 and PPh_3 analogues.⁹³⁴

Since the early 1980s a variety of high-nuclearity neutral homopalladium carbonyl phosphine clusters have been prepared and characterized from X-ray crystallography.^{926,927,930,932} Analyses of the stereochemistry and prominent bonding features of several of these clusters have been presented.^{21,936,937} Moreover, *N,O*-ligated palladium nanoclusters possessing idealized formulations based upon concentric closed-shell palladium cores have been reported, namely, five-shell Pd_{561} clusters^{25,938–940} and mixtures of seven-shell Pd_{1415} and eight-shell Pd_{2057} clusters.⁹⁴¹

Zero-valent Pd complexes in organic solutions (e.g., THF) decomposed under CO in the presence of PPh_3 to give novel PPh_3/CO -stabilized Pd particles which were studied by spectroscopic methods;⁹⁴² although the Pd particles were relatively unstable and were subject to size variations in solution, three distinct size-selected distributions were obtained with observed mean

diameters determined from TEM to correspond to idealized two-shell Pd₅₅, three-shell Pd₁₄₇, and five-shell Pd₅₆₁ cores.⁹⁴² The well-defined neutral cluster Pd₅₉(CO)₃₂(PMe₃) possesses the largest crystallographically determined metal-atom core with direct metal–metal bonding. Furthermore, it contains a nanosized metal core with 11 interior atoms. The ellipsoidal-shaped architecture of its Pd₅₉ core may be formally considered as a trigonal deformation of a spheroidal-like geometry.⁸⁵⁶ The new cluster was obtained in moderate yields (~40%) from a highly reproducible synthesis involving the initial preparation of a heterometallic Pd–Ni carbonyl cluster (without phosphine ligands) followed by its reaction with PMe₃ under acidic conditions. Although it was presumed that the latter reaction would result in PMe₃ substitution for CO ligands and/or other large Pd–Ni carbonyl clusters via phosphine stabilization, the reaction instead gave rise to several new high-nuclearity homopalladium clusters with Pd₅₉(CO)₃₂(PMe₃) as the major product.⁸⁵⁶ The trimethyl phosphine ligands are distributed about the metal core as six Pd(μ₃-CO)₂PMe₃, nine Pd(μ₂-CO)₂PMe₃, and six Pd(μ₃-CO)PMe₃ moieties. The ¹H-NMR measurements showed no detectable high-field signals characteristic of hydride-like atoms.⁸⁵⁶

An efficient synthesis of the dinuclear palladium(0) complexes has been devised.¹⁶⁹

The bonding interaction between closed-shell, heavy metal atoms or ions is gaining increasing attention.⁵⁷⁰ The complex [Pd(PPh₂py)₃Tl]⁺ (PPh₂py = diphenyl-2-pyridylphosphine) contains the first example of unsupported Pt⁰–Tl^I bond.⁹⁴³ *In situ* addition of Tl^I salts to some Pd⁰-catalyzed reactions is an efficient method for controlling the regioselectivity and rate of catalysis.^{944,945}

Catalano *et al.* reported the synthesis and characterization of a new series of Pd⁰-based metallocryptates that bind Tl^I ion in the absence of attractive ligand interactions through metallophilic connections. The cationic species have been characterized by a variety of methods and have considerable stability. From the solid-state structural data it is apparent that interaction of the metal atoms with one another is the dominant bonding interaction within the metallocryptate cavity. The characterization of complexes supports the concept of “metallophilic” behavior as a fundamental component of bonding in closed-shell systems. These materials may ultimately serve as prototypical systems for detection of closed-shell ions.⁹⁴⁶

Synthesis and characterization of the Pd⁰-based metallocryptates with exceptionally short Pd⁰–Pb^{II} interactions has been reported. This seems to be the first report of an unsupported Pd⁰–Pb^{II} bond.⁹⁴⁸ Further, these metallocryptands represent a new type of host complex that employ attractive metallophilic interactions for metal ion binding rather than Lewis acid–base interactions. The deep green–brown, air-stable [Pd₂(P₂phen)₃Pb](ClO₄)₂ [P₂phen = 2,9-bis(diphenylphosphino)-1,10-phenanthroline], shown in Equation (7), is easily synthesized in good yield in acetonitrile. The Pb^{II} can be replaced by addition of an excess of Tl^I ion:

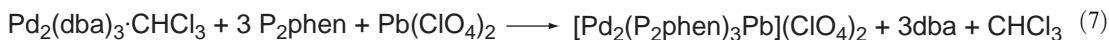

The Pb atom resides in the center of the D₃ symmetric cavity formed by the P₂phen ligands coordinated to the two trigonal Pd⁰ centers. The Pd(1)–Pb(1) and Pd(2)–Pb(1) separations are nearly identical, and a Pb center is nearly linearly bonded in Pd(1)–Pb(1)–Pd(2), indicating that the lone pair is stereochemically inactive (see Figure 108).

The attractive metal–metal interactions observed here can be rationalized by employing a qualitative MO diagram similar to that proposed by Balch *et al.*⁹⁴⁸ by combining the filled *d*_{z²} and empty *p*_z-orbitals on the transition metals with the filled Pb 6*s* and empty Pb 6*p*_z-orbitals. Mixing between levels stabilizes the filled orbitals relative to their unfilled counterparts leading to an attractive interaction between these metals.⁹⁴⁷ The compounds reported here are examples of a rapidly expanding class of easily synthesized inorganic host complexes that employ strong, closed-shell attractive interactions for metal ion binding. By eliminating ligand–ion interactions these metallocryptands provide a simple probe to the metal–metal bonding both in solution and in the solid state. Substitution of Pb^{II} for other heavy metal ions should provide numerous combinations of heavy metal interactions for further study.⁹⁴⁷

The Ph₂P(CS₂Me) ligand can transfer between [Pd(PPh₃)₄] and [W(CO)₅[PPh₂(CS₂Me)]], forming *anti*-[(Ph₃P)₂Pd[μ-η¹,η²-(CS₂Me)PPh₂]W(CO)₅] as an intermediate.⁹⁴⁹ Next, the existence of configurational isomers in complexes between [diphenyl(dithioalkoxycarbonyl)phosphine]tungsten(0) compounds and Pd(PPh₃)₄ was studied.⁹⁵⁰ PPh₂(CS₂R) acts as a bridging ligand through phosphorus σ-bonding and C=S π-bonding and forms *syn*- and *anti*-configurational dimetallic complexes. The diphenyl(dithiomethoxycarbonyl)phosphine transfer reaction between [Pd(PPh₃)₄] and [W(CO)₅[PPh₂(CS₂Me)]] forms [[(Ph₃P)Pd[μ-η¹,η²-(CS₂Me)PPh₂]]₂] as the ultimate product.

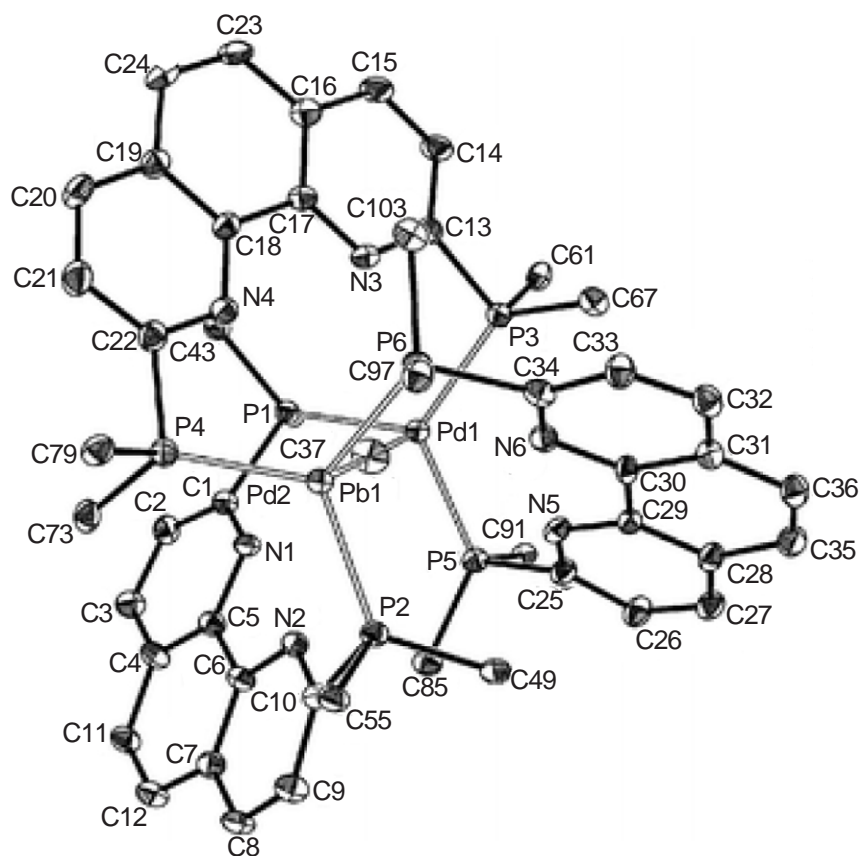

Figure 108 Structure of $[\text{Pd}_2(\text{P}_2\text{phen})_3\text{Pb}](\text{ClO}_4)_2$.

The reaction proceeds via a η^2 -coordination of the C=S fragment to Pd, giving *anti*- $[(\text{Ph}_3\text{P})_2\text{Pd}[\mu\text{-}\eta^1, \eta^2\text{-(CS}_2\text{Me)PPh}_2]\text{W}(\text{CO})_5]$ as an intermediate. Increased hindrance of the thioalkoxy groups exerts stereospecific control leading to the formation of *syn* configurational complexes. Useful $^{31}\text{P}\{^1\text{H}\}$ -NMR patterns are able to differentiate configurational compounds.⁹⁵⁰

The reactions of cluster anions with cation or halide of Group 10 transition metals give clusters comprising two different transition metals, for example, $[\text{Pd}_{33}\text{Ni}_9(\text{CO})_{41}(\text{PPh}_3)_6]^{4-}$ ⁹⁵¹ and $[\text{Fe}_6\text{Pd}_6(\text{CO})_{24}\text{H}]^{3-}$.⁹⁵² In these examples, considerable fragmentation and recombination of the original cluster component appear to be the important factors. The coupling of ruthenium carbide carbonyl clusters through palladium species gives high-nuclearity Ru/Pd mixed-metal complexes of “sandwich cluster” type structure. Treatment of the pentanuclear ruthenium carbido anion $[\text{Ru}_5\text{C}(\text{CO})_{14}]^{2-}$ (cation: $\text{PPN} = \text{N}(\text{PPh}_3)_2^+$) with two equivalents of $[\text{Pd}(\text{C}_3\text{H}_5)\text{Cl}]_2$ in THF at room temperature for 12 h gave dark red crystals of a neutral cluster with the composition $[\text{Pd}_8\text{Ru}_{10}\text{C}_2(\text{CO})_{27}(\text{C}_3\text{H}_5)_4]$ in 52% yield. The molecule has two pseudomirror planes.⁹⁰⁰ The Pd_8 core is flanked on each side by a squarepyramidal Ru_5 core (shown in Figure 109(a)). Refluxing $[\text{PPN}]_2[\text{Ru}_6\text{C}(\text{CO})_{16}]$ in CH_2Cl_2 with about one equivalent of $[\text{Pd}(\text{CH}_3\text{CN})_4][\text{BF}_4]_2$ for four hours under air and subsequent treatment with $\text{CH}_2\text{Cl}_2/\text{MeOH}$ resulted in crystals of $[\text{PPN}]_2[\text{Pd}_2\text{Ru}_{12}\text{C}_2(\text{CO})_{30}]$ (see Figure 109(b)) in 33% yield. Reaction of the same reactants in the same feeding ratio in THF at room temperature for 12 hours but under argon gave dark red crystals of the composition $[\text{PPN}]_2[\text{Pd}_4\text{Ru}_{12}\text{C}_2(\text{CO})_{32}]$, shown in Figure 109(c). The yield of this reaction was 34% based on the starting ruthenium complex and 68% based on the palladium cation used.⁹⁰⁰

In the second cluster, the two Ru_6 octahedra are linked through two palladium atoms. The third cluster contains two additional palladium atoms. The Pd_4 skeleton adopts the form of a bent square. The two Ru_6 octahedra have local structures similar to those in the second cluster, but their relative orientation is now twisted. Apparently, formation of these heterometallic cluster complexes does not result from a simple combination reaction between cationic and anionic complexes but is accompanied by partial redox reactions.⁹⁰⁰

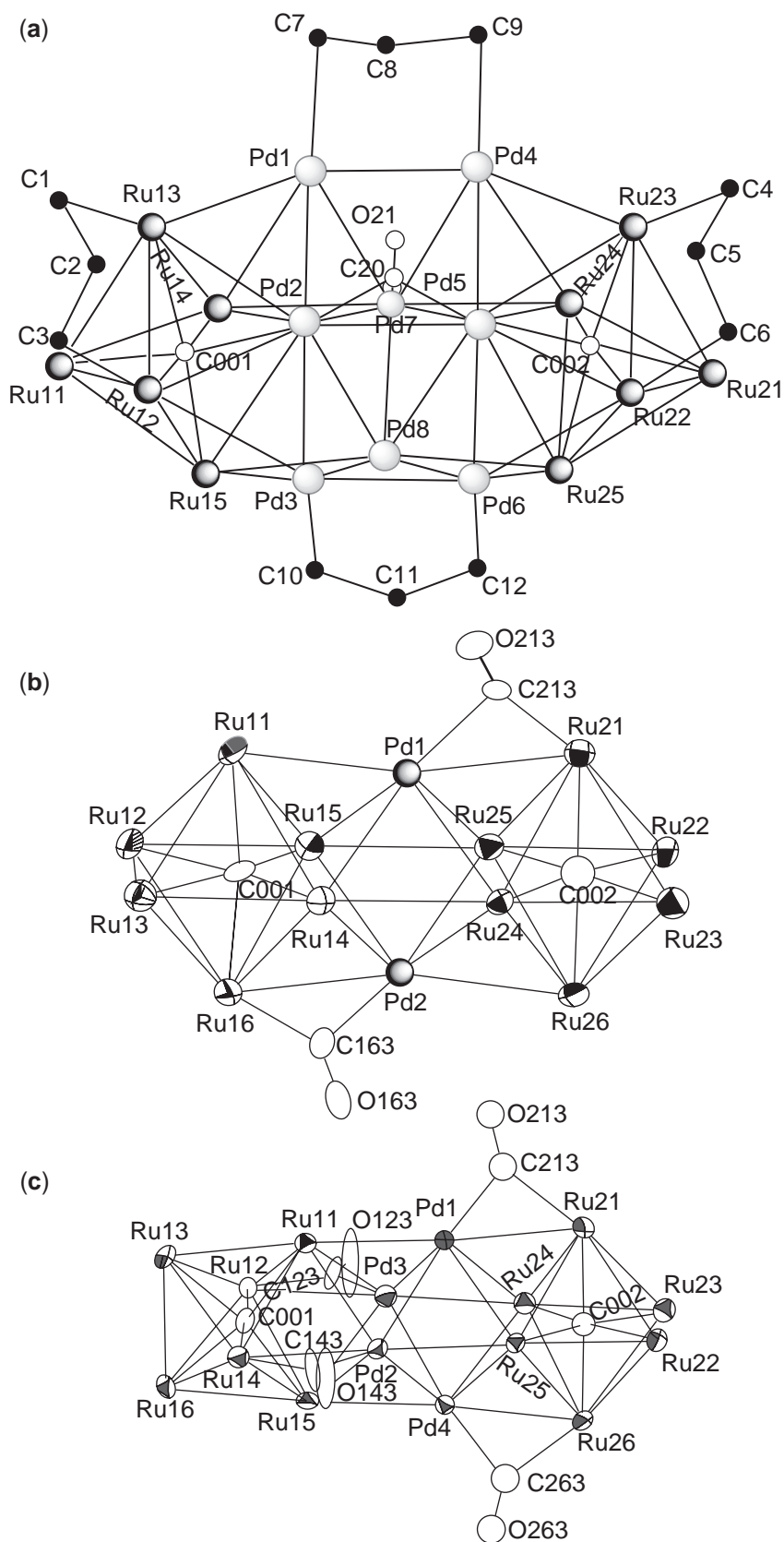

Figure 109 Structures of (a) $[\text{Pd}_8\text{Ru}_{10}\text{C}_2(\text{CO})_{27}(\text{C}_3\text{H}_5)_4]$; (b) $[\text{PPN}]_2[\text{Pd}_2\text{Ru}_{12}\text{C}_2(\text{CO})_{30}]$; and (c) $[\text{PPN}]_2[\text{Pd}_4\text{Ru}_{12}\text{C}_2(\text{CO})_{32}]$.

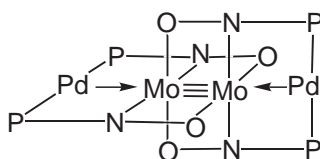

Figure 110 Tetrametal complex $\text{Mo}_2\text{Pd}_2(\text{pyphos})_4$.

The short-bite ligand bis(diphenylphosphinoamine) ($\text{Ph}_2\text{PNHPPH}_2$, dppa) has received attention for assembling metal centers in bi- or polynuclear metal complexes owing to both its isoelectronic relationship with the more popular bis(diphenylphosphinomethane) ligand ($\text{Ph}_2\text{PCH}_2\text{PPh}_2$, dppm) and the increased reactivity of its N—H group compared with that of the CH_2 unit in dppm.^{580,953–957} Thus, the greater acidity of the NH proton versus the CH_2 protons may facilitate subsequent functionalization reactions that would require too drastic conditions in the case of dppm. The synthesis of Co_2Pd and MoPd_2 mixed-metal clusters containing the dppa ligand⁹⁵⁸ was reported. Heterometallic triangular clusters containing two dppa ligands or dppa and dppm (mixed ligand sets) have been prepared by direct incorporation of the second diphosphine ligand.⁹⁵⁸

The tetrametal complex $\text{Mo}_2\text{Pd}_2(\text{pyphos})_4$ (pyphos = 6-diphenylphosphino-2-pyridonate), (see Figure 110), has a $\text{Pd}^0\text{—Mo}^{\text{II}}\text{—Mo}^{\text{II}}\text{—Pd}^0$ skeleton.⁹⁵⁹

The existence of a $\text{Pd}^0\text{—Mo}^{\text{II}}$ dative bond elongates the quadruple Mo₂ bond to some extent. This complex has two Pd^0 centers that can react with a variety of olefinic compounds, shown schematically in Figure 111; such reactions give $\text{Mo}_2\text{Pd}_2(\text{pyphos})_4(\text{L})_2$ [L = acrylonitrile, fumaronitrile, tetracyanoethylene] in moderate yields. Unlike the previous compounds which have a strictly *trans* arrangement of the P-donor atoms, the last compound has a *cis* arrangement and thus the four metals are not linear.⁹⁵⁹

The palladium(0) complex with dative $\text{Pd}^0\text{—Mo}^{\text{II}}$ bonds is very reactive toward oxidative addition reaction. Its treatment with dichloromethane at room temperature results in the formation of a palladium(II) complex, $\text{Mo}_2\text{Pd}_2\text{Cl}_2(\text{CH}_2\text{Cl})_2(\text{pyphos})_4$ (shown in Figure 112), which is a rare example of the oxidative addition of dichloromethane to a Pd^0 center, e.g., mononuclear Pd^0 complexes^{960,961} and a dinuclear Pd^0 complex, $\text{Pd}_2(\text{dpm})_3$ (dpm = bis(diphenylphosphino)methane).^{585,781} The metal atoms, Pd, Mo, Mo, and Pd, are aligned linearly. Each of the palladium atoms is coordinated to a chlorine atom and a chloromethyl group in square-planar geometry.⁹⁵⁹

The palladium(I) complex $[\text{Pd}_2(\mu\text{-dppm})_2\text{Cl}_2]$ is used to generate mixed-metal systems. Most investigations have been concerned with the formation of A-frame complexes via insertion of small molecules, e.g., CO, SO_2 , or RCN, into the M—M bond, or their reactivity towards nucleophilic metal reagents, such as carbonylmetalates.^{824–827} For example, the reaction of $[\text{Pd}_2(\mu\text{-dppm})_2\text{Cl}_2]$ with the dianion $[\text{Fe}(\text{CO})_4]^{2-}$ yielded the neutral heterotrinnuclear complex $[\text{Pd}_2\text{Fe}(\text{dppm})_2(\text{CO})_4]$ by displacement of the two chloride ligands and the insertion of the iron group into one of the Pd—P bonds. Two Fe—Pd bonds were formed in the process.⁸²⁷

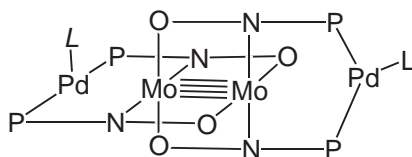

Figure 111 $\text{Mo}_2\text{Pd}_2(\text{pyphos})_4(\text{L})_2$ [L = acrylonitrile, fumaronitrile, tetracyanoethylene].

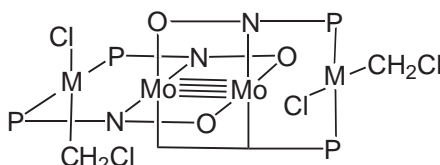

Figure 112 $\text{Mo}_2\text{Pd}_2\text{Cl}_2(\text{CH}_2\text{Cl})_2(\text{pyphos})_4$.

The reaction with $[\text{Mn}(\text{CO})_5]_2$ or $[\text{Co}(\text{CO})_4]_2$ also led to mixed-metal clusters.^{962,963} Osmium–palladium mixed-metal carbonyl clusters were made using the unsaturated cluster $[\text{Os}_3(\text{CO})_{10}(\mu\text{-H})_2]$ and the carbido cluster $[\text{Os}_5(\mu_5\text{-C})(\text{CO})_{15}]$.^{964–970} Treatment of $[\text{Os}_3(\text{CO})_{10}(\mu\text{-H})_2]$ with $[\text{Pd}_2(\mu\text{-dppm})_2\text{Cl}_2]$ afforded the novel high-nuclearity osmium–palladium mixed-metal carbonyl clusters $[\text{Os}_5\text{Pd}_6(\text{CO})_{13}(\mu\text{-CO})_5(\mu\text{-H})_2(\mu\text{-dppm})_2]$, $[\text{Os}_5\text{Pd}_6(\text{CO})_{13}(\mu\text{-CO})_6(\mu\text{-dppm})_2]$, and $[\text{Os}_4\text{Pd}_6(\text{CO})_8(\mu\text{-CO})_8(\mu\text{-dppm})_2]$ in low yields, while the reaction of $[\text{Os}_5(\mu_5\text{-C})(\text{CO})_{15}]$ with $[\text{Pd}_2(\mu\text{-dppm})_2\text{Cl}_2]$ afforded $[\text{Os}_5\text{Pd}_4(\mu_6\text{-C})(\text{CO})_{12}(\mu\text{-CO})_3(\mu\text{-dppm})_2]$ and $[\text{Os}_5(\mu_5\text{-C})(\text{CO})_{13}(\mu\text{-dppm})]$ in moderate yields.²⁸⁹ The electron counts found in these osmium–palladium clusters do not always agree with those predicted by skeletal electron counting rules. This may simply be ascribed to the ability of Pd to be satisfied with both 16- and 18-electron counts.²⁸⁹

6.4.7.7 Nanoparticles

Transition metal nanoparticles have attracted a great deal of attention in the 1990s.^{971–977} The method most generally used is the chemical or electrochemical reduction of a metal salt by a suitable reducing agent in the presence of stabilizers, which adsorb to the particle surface thus preventing agglomeration and controlling the particle size. Palladium nanoparticles were encapsulated in a dendrimer with a periphery featuring amino groups which interact with polyfluorinated carboxylic acids, the total architecture being soluble in perfluorinated phases.^{978,979} These architectures catalyze the hydrogenation of alkenes. 1,5-Bis(4,4'-bis(perfluorooctyl)-1,4-pentadien-3-one stabilizes palladium nanoparticles of 4–5 nanometers in diameter.⁹⁸⁰ These nanoparticles are active in Heck and Suzuki reactions. Other compounds highly loaded with fluorine possess the same property.⁹⁸¹ In all cases a solution of $\text{Na}_2[\text{Pd}_2\text{Cl}_6]$ was reduced in methanol at 60 °C.

Giant noncrystalline *N,O*-ligated nanosized palladium clusters possess idealized formulations based upon concentric closed-shell metal cores: namely, five-shell Pd_{561} clusters^{982–985} and mixtures of seven-shell Pd_{1415} and eight-shell Pd_{2057} clusters.⁹⁴¹ Zerovalent Pd complexes in organic solutions (e.g., THF) decompose under CO in the presence of PPh_3 to give PPh_3/CO -stabilized Pd nanosized particles that were investigated by spectroscopic methods; although the Pd particles were subject to size variations in solution, three distinct size-selected distributions were obtained with observed mean diameters determined from TEM indicating idealized two-shell Pd_{55} , three-shell Pd_{147} , and five-shell Pd_{561} cores.⁹⁴²

Metal nanowires have attracted much attention due to their potential magnetic, optical, electrical, and catalytic properties. The synthesis and characterization of novel necklace-shaped Pt–Pd nanowire in hybrid organic–inorganic mesoporous material was reported. The dry hybrid organic–inorganic mesoporous material was impregnated with an aqueous solution of $\text{H}_2\text{PtCl}_6 \cdot 6\text{H}_2\text{O}$ and H_2PdCl_4 . The unique magnetic property of the Pt–Pd nanowires is also reported.⁹⁸⁶

Nanoparticles modified with organic monolayers may exhibit combined properties from their inorganic nuclei and their organic surfaces. The surface attachment of cyclodextrins (CDs) to palladium nanoparticles that catalyze the hydrogenation of allylamine has been reported. As opposed to classical Pd catalytic materials, these novel nanocomposites are soluble in aqueous media and can be easily recovered by precipitation with ethanol.⁹⁸⁷ Solutions of PdCl_4^{2-} sodium salts in $\text{DMSO-H}_2\text{O}$ were readily reduced with BH_4^- in the presence of *per*-6-thio- β -cyclodextrin⁹⁸⁸ (see Figure 113), leading to the isolation of dark precipitates. IR spectra show conversion of the H–S bonds in HS- β -CD to metal–thiolate bonds as the CD host chemisorbs on the surface of the metal nanoparticles. ¹H-NMR spectroscopy also provides experimental evidence that supports the presence of cyclodextrin in the dark precipitates.⁹⁸⁷ TEM measurements verified

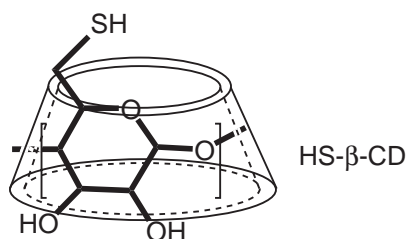

Figure 113 Structure of *per*-6-thio- β -cyclodextrin.

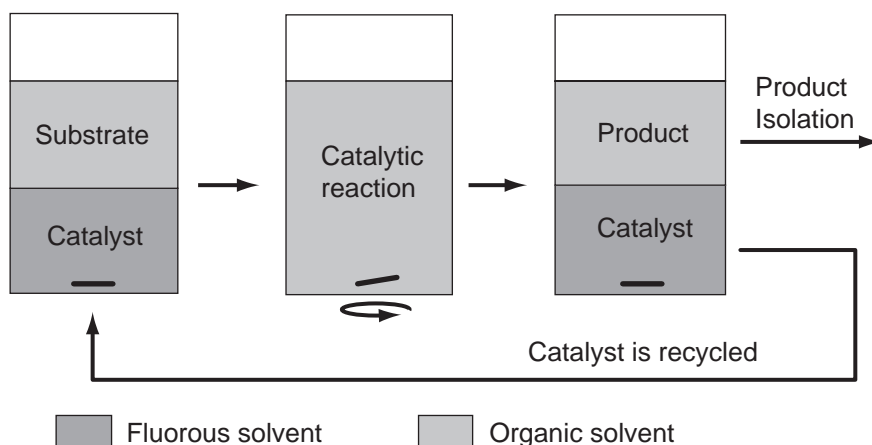

Figure 114 Biphasic catalysis in an organic/fluorous solvent system by Pd/dendrimer nanocomposites.

that these solid materials are composed of metal particles with dimensions in the nanometer range. The surface modified Pd colloidal particles reported in this work are active catalysts for the hydrogenation of allylamine in aqueous solution.⁹⁸⁷

The general approach to biphasic catalysis is illustrated in Figure 114.⁹⁸⁹ The system consists of organic and fluorous layers. The catalyst is selectively soluble in the fluorous phase, while the reactants are preferentially soluble in the organic solvent. Stirring, sonicating, and/or heating of the mixture leads to formation of a fine emulsion and partial homogenization, and the catalytic reaction proceeds at the interface between the two liquids. When the reaction is over, the liquid phases are separated, the product is isolated from the organic phase, and the catalyst-containing fluorous layer is recycled. Many fluorous phase-soluble catalysts have been reported in the literature, including some based on metal complexes. Preparation of fluorous phase-soluble metal nanoparticles, however, has not been reported, prior to the study in reference.⁹⁷⁸ Remarkably, the Pd/dendrimer nanocomposites are catalytically active in fluorous biphasic systems.⁹⁷⁸ These new catalysts can be used for hydrogenation of a range of unsaturated compounds, and also for isomerization of terminal alkenes. The reaction selectivity resembles that of colloidal, rather than bulk, Pd catalysts.⁹⁷⁸ The methodology is very simple to implement and the catalysts are easy to separate from the product and recycle. Taken together, these factors suggest that these materials are promising candidates for selective, environmentally friendly catalysis applications.⁹⁷⁸

6.4.8 PALLADIUM IN NEGATIVE AND FRACTIONAL OXIDATION STATES

6.4.8.1 Phosphorus

Balch *et al.*⁵⁶⁰ prepared the cluster $[\text{Pd}_3(\mu\text{-dppm})_3(\mu_3\text{-I})(\mu_3\text{-PF}_3)]\text{PF}_6$ [dppm = bis-(diphenylphosphino)methane] (shown in Figure 115), which contains a PF_3 molecule triply bridging a central triangular Pd_3 core. However, exceptions are not limited to PF_3 , an atypical phosphine often considered closer to carbon monoxide. For further examples, see the section on polynuclear Pd^{I} complexes.

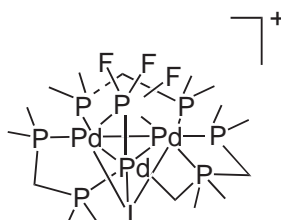

Figure 115 The cluster $[\text{Pd}_3(\mu\text{-dppm})_3(\mu_3\text{-I})(\mu_3\text{-PF}_3)]\text{PF}_6$ [dppm = bis-(diphenylphosphino)methane].

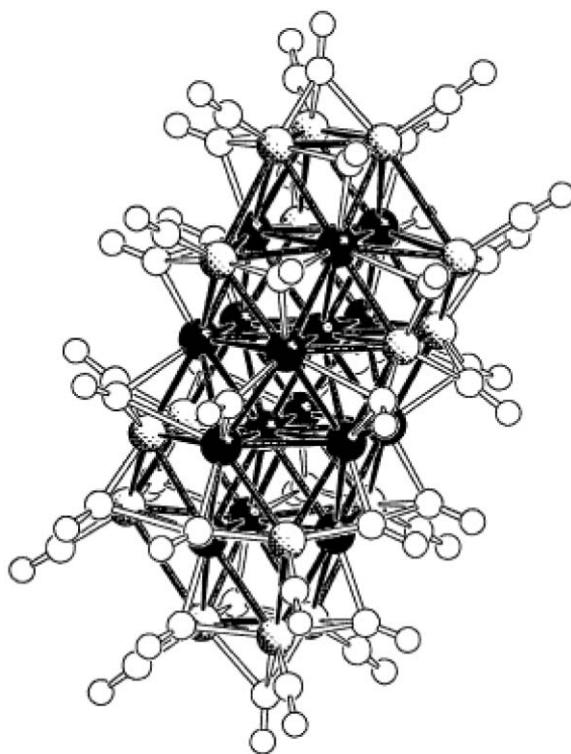

Figure 116 The structure of $[\text{Ni}_{16}\text{Pd}_{16}(\text{CO})_{40}]^{4-}$.

6.4.8.2 Polynuclear Compounds and Polymers

Recent collision-induced dissociation studies on the gas phase $[\text{Pd}_3(\text{CO})_6]^-$ cluster⁹²⁵ supplement other experimental observations,^{923,924,990–992} which seem to suggest the feasibility of derivatives. The synthesis of Ni–Pd homoleptic carbonyl bimetallic clusters (HCBCs) has been reported.⁹⁹³ So far, only the related phosphane substituted derivative $[\text{Ni}_9\text{Pd}_{33}(\text{CO})_{41}(\text{PPh}_3)_6]^{4-}$ ⁹⁵¹ and the trimetallic derivative $[\text{Au}_6\text{Ni}_6(\text{Pd}_{6-x}\text{Ni}_x)\text{Ni}_{20}(\text{CO})_{44}]^{6-}$ ⁹⁹⁴ have been reported. To our knowledge, the only Ni–Pd HCBC cited in the literature is the incompletely characterized $[\text{Ni}_{30-x}\text{Pd}_x(\text{CO})_y]^{4-}$ ($x \approx 16$, $y \approx 36$) species, which has been used as a precursor for the synthesis of the giant complex $[\text{Pd}_{59}(\text{CO})_{32}(\text{PMe}_3)_{21}]$.⁸⁵⁶ Investigation of the reaction of $[\text{Ni}_6(\text{CO})_{12}]^{2-}$ with Pd^{II} compounds in miscellaneous molar ratio and reaction solvents displayed the existence of wide series of Ni–Pd HCBCs. There is a report⁹⁹³ on the synthesis, chemical properties, and X-ray structural characterization of the tetranion $[\text{Ni}_{16}\text{Pd}_{16}(\text{CO})_{40}]^{4-}$, as well as preliminary details of the closely related hexaanion $[\text{Ni}_{26}\text{Pd}_{20}(\text{CO})_{54}]^{6-}$. The structure of $[\text{Ni}_{16}\text{Pd}_{16}(\text{CO})_{40}]^{4-}$ is shown in **Figure 116**. The black spheres represent the palladium atoms. The range of M–M bonds (Å) is: Ni–Ni 2.426(1)–2.473(1) Å, Ni–Pd 2.582(1)–2.825(1) Å, Pd–Pd 2.674(1)–2.930(1) Å. The Ni–Ni interlayer separations of the outer pair of layers are outside of the above range.⁹⁹³

6.4.9 REFERENCES

- Hiroi, K. Pd(O) and Pd(II) complexes containing sulfur and selenium ligands. In *Handbook of Organopalladium Chemistry for Organic Synthesis*; Negishi, E., Ed.; Wiley: Hoboken, NJ, 2002; Vol. 1, p 67.
- Lukevics, E.; Arsenyan, P.; Pudova, O. *Main Group Metal Chem.* **2002**, 25, 415.
- Tsiveriotis, P.; Malandrinou, G.; Hadjiliadis, N. *Rev. Inorg. Chem.* **2000**, 20, 305.
- Milović, N. M.; Kostić, N. M. *Met. Ion.Biol. Syst.* **2001**, 38, 145.
- Fujita, M.; Umemoto, K.; Yoshizawa, M.; Fujita, N.; Kusukawa, T.; Biradha, K. *Chem. Commun.* **2001**, 509.
- Fujita, M. *Struct. Bond.* **2000**, 96, 177.
- Dedieu, A. *Chem. Rev.* **2000**, 100, 543.
- Gavrilov, K. N.; Polosukhin, A. I. *Russian Chem. Rev.* **2000**, 69, 661.
- Sokolov, V. I. *Pure Appl. Chem.* **1998**, 70, 789.
- Tsubomura, T.; Sakai, K. *Coord. Chem. Rev.* **1998**, 171, 107.

11. Appleton, T. G. *Coord. Chem. Rev.* **1997**, *166*, 313.
12. Efimenko, I. A. *Russ. J. Coord. Chem.* **1998**, *24*, 265.
13. Fujita, M.; Ogura, K. *Bull. Chem. Soc. Jap.* **1996**, *69*, 1471.
14. Buchler, J. W.; Dreher, C.; Kuenzel, F. M. *Struct. Bond.* **1995**, *84*, 1.
15. Byers, P. K. *Coord. Chem. Rev.* **1995**, *138*, 195.
16. Harvey, P. D. *J. Cluster Sci.* **1993**, *4*, 377.
17. Maresca, L.; Natile, G. *Comments Inorg. Chem.* **1993**, *14*, 349.
18. Moiseev, I. I.; Vargaftik, M. N.; Zamaraev, K. I.; Kochubey, D. I. *Materials Research Society Symposium Proceedings*, **1992**, *272*, 139.
19. Vargaftik, M. N.; Moiseev, I. I.; Kochubei, D. I.; Zamaraev, K. I. *Faraday Discuss.* **1992**, *92*, 13.
20. Kakkar, A. K.; Khan, M. S. *Coord. Chem. Rev.* **1993**, *124*, 1.
21. Burrows, A. D.; Mingos, D. M. P. *Transition Met. Chem.* **1993**, *18*, 129.
22. Puddephatt, R. J.; Manojlovic-Muir, L.; Muir, K. W. *Polyhedron* **1990**, *9*, 2767.
23. Chaloner, P. A. *Coord. Chem. Rev.* **1990**, *101*, 1.
24. Zakhharova, I. A. *Rev. Roum. Chim.* **1989**, *34*, 1615.
25. Schmid, G. *Polyhedron* **1988**, *7*, 2321.
26. Chaloner, P. A. *Coord. Chem. Rev.* **1986**, *72*, 1.
27. Hartley, F. R. *Coord. Chem. Rev.* **1982**, *41*, 319.
28. Amundsen, A. R.; Stern, E. W. Platinum-group metals, compounds. In *Kirk-Othmer Encyclopedia Chem. Technol.*, 3rd ed.; Grayson, M., Eckroth, D., Eds.; Wiley: New York, 1982; Vol. 18, p 254.
29. Albéniz, A. C.; Espinet, P. In *Encyclopedia of Inorganic Chemistry*; King, R. B., Ed.; Wiley: New York, 1994; p 3010.
30. Chen, W.; Shimada, S.; Tanaka, M. *Science* **2002**, *295*, 308.
31. Aullon, G.; Lledos, A.; Alvarez, S. *Angew. Chem., Int. Ed. Engl.* **2002**, *41*, 1956.
32. Sherer, E. C.; Kinsinger, C. R.; Kormos, B. L.; Thompson, J. D.; Cramer, C. J. *Angew. Chem., Int. Ed. Engl.* **2002**, *41*, 1953.
33. Kostić, N. M. *Chem. Tracts-Inorg. Chem.* **2003**, *16*, 42.
34. Canty, A. J. Palladium-carbon σ -bonded complexes. In *Comprehensive Organometallic Chemistry II*; Puddephatt, R. J., Ed.; Pergamon: Oxford, U.K., 1995; Vol. 9, , pp 225–290.
35. Canty, A. J. *Acc. Chem. Res.* **1992**, *25*, 83.
36. Weinberg, E. L.; Hunter, B. K.; Baird, M. C. *J. Organomet. Chem.* **1982**, *240*, 95.
37. Alsters, P. L.; Engel, P. F.; Hogerheide, M. P.; Copijn, M.; Spek, A. L.; van Koten, G. *Organometallics* **1993**, *12*, 1831.
38. Byers, P. K.; Canty, A. J.; Skelton, B. W.; Traill, P. R.; Watson, A. A.; White, A. H. *Organometallics* **1990**, *9*, 3080.
39. Canty, A. J.; Jin, H.; Roberts, A. S.; Skelton, B. W.; Traill, P. R.; White, A. H. *Organometallics* **1995**, *14*, 199.
40. de Graaf, W.; Boersma, J.; van Koten, G. *Organometallics* **1990**, *9*, 1479.
41. Kruis, D.; Markies, B. A.; Canty, A. J.; Boersma, J.; van Koten, G. *J. Organomet. Chem.* **1997**, *532*, 235.
42. Markies, B. A.; Canty, A. J.; Boersma, J.; van Koten, G. *Organometallics* **1994**, *13*, 2053.
43. Canty, A. J.; Hoare, J. L.; Patel, J.; Pfeffer, M.; Skelton, B. W.; White, A. H. *Organometallics* **1999**, *18*, 2660.
44. Canty, A. J.; Jin, H.; Roberts, A. S.; Skelton, B. W.; White, A. H. *Organometallics* **1996**, *15*, 5713.
45. Fahey, D. R. *J. Organomet. Chem.* **1971**, *27*, 283.
46. Catellani, M.; Fagnola, M. C. *Angew. Chem.* **1994**, *106*, 2559.
47. Catellani, M.; Frignani, F.; Ragoni, A. *Angew. Chem., Int. Ed.* **1997**, *36*, 119.
48. Stock, L. M.; Tse, K.-T.; Vorvick, L. J.; Walstrum, S. A. *J. Org. Chem.* **1981**, *46*, 1759.
49. Canty, A. J.; Jin, H.; Skelton, B. W.; White, A. H. *Inorg. Chem.* **1998**, *37*, 3975.
50. Yoneyama, T.; Crabtree, R. H. *J. Mol. Catal. A*, **1996**, *108*, 35.
51. Canty, A. J. In *Handbook of Organopalladium Chemistry for Organic Synthesis*; Negishi, E.-I., Ed.; Wiley: New York, 2001; Vol. II.4.
52. Bayler, A.; Canty, A. J.; Skelton, B. W.; White, A. H. *J. Organomet. Chem.* **2000**, *595*, 296.
53. Bayler, A.; Canty, A. J.; Edwards, P. G.; Skelton, B. W.; White, A. H. *Dalton* **2000**, 3325.
54. Catellani, M.; Chiusoli, G. P. *Gazz. Chim. Ital.* **1993**, *123*, 1.
55. Kläui, W.; Glaum, M.; Wagner, T.; Bennett, M. A. *J. Organomet. Chem.* **1994**, *472*, 355.
56. van Asselt, R.; Rijnberg, E.; Elsevier, C. J. *Organometallics* **1994**, *13*, 706.
57. van Belzen, R.; Hoffmann, H.; J., E. C. *Angew. Chem., Int. Ed. Engl.* **1997**, *36*, 1743.
58. Byers, P. K.; Canty, A. J.; Skelton, B. W.; White, A. H. *Organometallics* **1990**, *9*, 826.
59. Byers, P. K.; Canty, A. J.; Crespo, M.; Puddephatt, R. J.; Scott, J. D. *Organometallics* **1988**, *7*, 136.
60. Dücker-Benfer, C.; van Eldik, R.; Canty, A. J. *Organometallics* **1994**, *13*, 2412.
61. Yamashita, M.; Ishii, T.; Matsuzaka, H.; Manabe, T.; Kawashima, T.; Okamoto, H.; Kitagawa, H.; Mitani, T.; Marumoto, K.; Kuroda, S.-I. *Inorg. Chem.* **1999**, *38*, 5124.
62. Greenwood, N. N.; Earnshaw, A. *Chemistry of the Elements*; Pergamon: Oxford, UK, 1984.
63. Black, A. J.; Holder, A. J.; Hyde, T. I.; Schroder, M. *J. Chem. Soc., Chem. Commun.* **1987**, 987.
64. Blake, A. J.; Holder, A. J.; Hyde, T. I.; Roberts, Y. V.; Lavery, A. J.; Schroder, M. *J. Organomet. Chem.* **1987**, *323*, 261.
65. Blake, A. J.; Gordon, L. M.; Holder, A. J.; Hyde, T. I.; Reid, G.; Schroder, M. *J. Chem. Soc., Chem. Commun.* **1988**, 1452.
66. McAuley, Q.; Whitcombe, T. W. *Inorg. Chem.* **1988**, *27*, 3090.
67. Warren, L. F., Jr.; Hawthorne, M. F. *J. Am. Chem. Soc.* **1968**, *90*, 4823.
68. Warren, L. F., Jr.; Hawthorne, M. F. *J. Am. Chem. Soc.* **1970**, *92*, 1157.
69. Kirmse, R.; Stach, J.; Dietzsch, W.; Steimecke, G.; Hoyer, E. *Inorg. Chem.* **1980**, *19*, 2679.
70. Blake, A. J.; Reid, G.; Schroder, M. *J. Chem. Soc., Dalton Trans.* **1990**, 3363.
71. Reid, G.; Blake, A. J.; Hyde, T. I.; Schroder, M. *J. Chem. Soc., Chem. Commun.* **1988**, 1397.
72. Grant, G. J.; Sanders, K. A.; Setzer, W. N.; VanDerveer, D. G. *Inorg. Chem.* **1991**, *30*, 4053.
73. Chandrasekhar, S.; McAuley, A. *Inorg. Chem.* **1992**, *31*, 2663.
74. Blake, A. J.; Crofts, R. D.; deGroot, B.; Schroder, M. *J. Chem. Soc., Dalton Trans.* **1993**, 485.
75. Jasper, S. A., Jr.; Huffman, J. C.; Todd, L. J. *Inorg. Chem.* **1998**, *37*, 6060.

76. McAuley, A.; Whitcombe, T. W. *Inorg. Chem.* **1988**, *27*, 3090.
77. Blake, A. J.; Holder, A. J.; Hyde, T. I.; Schröder, M. *J. Chem. Soc., Chem. Commun.* **1987**, 987.
78. Tressaud, A.; Khairoun, S.; Dance, J. M.; Hagenmuller, P. *Z. Anorg. Allg. Chem.* **1984**, *517*, 43.
79. Tressaud, A.; Wintenberger, M.; Bartlett, N.; Hagenmuller, P. *C. R. Acad. Sci.* **1976**, *282*, 1069.
80. Cotton, F. A.; Matusz, M.; Poli, R.; Feng, X. *J. Am. Chem. Soc.* **1988**, *110*, 1144.
81. Yao, C.-L.; He, L.-P.; Korp, J. D.; Bear, J. L. *Inorg. Chem.* **1988**, *27*, 4389.
82. Umakoshi, K.; Ichimura, A.; Kinoshita, I.; Ooi, S. *Inorg. Chem.* **1990**, *29*, 4005.
83. Cotton, F. A.; Gu, J.; Murillo, C. A.; Timmons, D. J. *J. Am. Chem. Soc.* **1998**, *120*, 13280.
84. Murahashi, T.; Otani, T.; Mochizuki, E.; Kai, Y.; Kurosawa, H. *J. Am. Chem. Soc.* **1998**, *20*, 4536.
85. Monlien, F. J.; Helm, L.; Abou-Hamdan, A.; Merbach, A. E. *Inorg. Chem.* **2002**, *41*, 1717.
86. Stolzenberg, A. M.; Schussel, L. J.; Summers, J. S.; Foxman, B. M.; Petersen, J. L. *Inorg. Chem.* **1992**, *31*, 1678.
87. Latos-Grazynski, L.; Lisowski, J.; Chmielewski, P.; Grzeszczuk, M.; Olmstead, M. M.; Balch, A. L. *Inorg. Chem.* **1994**, *33*, 192.
88. Furuta, H.; Kubo, N.; Maeda, H.; Ishizuka, T.; Osuka, A.; Nanami, H.; Ogawa, T. *Inorg. Chem.* **2000**, *39*, 5424.
89. Steenwinkel, P.; Gossage, R. A.; Grove, D. M.; van Koten, G. *Chem. Eur. J.* **1998**, *4*, 759.
90. Steenwinkel, P.; Gossage, R. A.; Maunula, T.; Grove, D. M.; van Koten, G. *Chem. Eur. J.* **1998**, *4*, 763.
91. Jolliet, P.; Gianini, M.; von Zelewsky, A.; Bernardinelli, G.; Stoeckli-Evans, H. *Inorg. Chem.* **1996**, *35*, 4833.
92. van der Boom, M.; Liou, S.-Y.; Ben-David, Y.; Shimon, L. J. W.; Milstein, D. *J. Am. Chem. Soc.* **1998**, *120*, 6531.
93. Giesbrecht, G. R.; Hanan, G. S.; Kickham, J. E.; Loeb, S. J. *Inorg. Chem.* **1992**, *31*, 3286.
94. Gossage, R. A.; van de Kuil, L. A.; van Koten, G. *Acc. Chem. Res.* **1998**, *31*, 423.
95. Stepien, M.; Latos-Grazynski, L.; Lash, T. D.; Sztterenber, L. *Inorg. Chem.* **2001**, *40*, 6892.
96. Magistrato, A.; Pregosin, P. S.; Albinati, A.; Rothlisberger, U. *Organometallics* **2001**, *20*, 4178.
97. Aiello, I.; Crispini, A.; Ghedini, M.; La Deda, M.; Barigelletti, F. *Inorg. Chim. Acta* **2000**, *308*, 121.
98. Aiello, I.; Dattilo, D.; Ghedini, M.; Golemme, A. *J. Am. Chem. Soc.* **2001**, *123*, 5598.
99. Rath, A.; Liu, J.; Shore, S. G.; Aceves, E.; Mitome, J.; Ozkan, U. *S. J. Mol. Catal. A: Chem.* **2001**, *165*, 103.
100. Knoepfel, D. W.; Liu, J.; Meyers, E. A.; Shore, S. G. *Inorg. Chem.* **1998**, *37*, 4828.
101. Liu, J.; Knoepfel, D. W.; Liu, S.; Meyers, E. A.; Shore, S. G. *Inorg. Chem.* **2001**, *40*, 2842.
102. Wing-Wah Yam, V.; Zhang, L.; Tao, C.-H.; Man-Chung Wong, K.; Cheung, K.-K. *J. Chem. Soc., Dalton Trans.* **2001**, 1111.
103. Tripathi, S. C.; Srivastava, S. C.; Mani, R. P.; Shrimal, A. K. *Inorg. Chim. Acta* **1976**, *17*, 257.
104. Vergaftik, M. N.; Stromnova, T. A.; Moiseev, I. I. *Russ. J. Inorg. Chem.* **1980**, *25*, 127.
105. Stromnova, T. A.; Moiseev, I. I. *Russ. Chem. Rev.* **1998**, *67*, 485.
106. Roundhill, M. Platinum. In *Comprehensive Coordination Chemistry*; Wilkinson, G.; Gillard, R. D.; McCleverty, J. A. Eds; Pergamon: Oxford, UK, 1987; Vol. 5, p 351.
107. Calderazzo, F. *J. Organomet. Chem.* **1990**, *400*, 303.
108. Calderazzo, F.; Belli Dell'Amico, D. *Pure Appl. Chem.* **1986**, *58*, 561.
109. Moskovits, M.; Ozin, G. A. *Cryochemistry*; Wiley: New York, 1976.
110. Lee, K. C.; Aubke, F. *Can. J. Chem.* **1977**, *55*, 2473.
111. Lee, K. C.; Aubke, F. *Can. J. Chem.* **1979**, *57*, 2058.
112. Hwang, G.; Wang, C.; Bodenbinder, M.; Willner, H.; Aubke, F. *J. Fluorine Chem.* **1994**, *66*, 159.
113. Wang, C.; Willner, H.; Bodenbinder, M.; Batchelor, R. J.; Einstein, F. W. B.; Aubke, F. *Inorg. Chem.* **1994**, *33*, 3521.
114. Hwang, G.; Wang, C.; Aubke, F.; Willner, H.; Bodenbinder, M. *Can. J. Chem.* **1993**, *71*, 1532.
115. Wang, C.; Bodenbinder, M.; Willner, H.; Rettig, S.; Trotter, J.; Aubke, F. *Inorg. Chem.* **1994**, *33*, 779.
116. Uson, R.; Fornies, J.; Tomas, M.; Menjon, B. *Organometallics* **1985**, *4*, 1912.
117. Fink, E. C. R. *Hebd. Seances Acad. Sci.* **1898**, *126*, 646.
118. Manchot, W.; König, J. *Chem. Ber.* **1926**, *59*, 883.
119. Soriano-Garcia, M.; Rosa, N.; Gomez-Lara, J.; Toscana, R. A. *Acta Crystallogr., Sect. C* **1987**, *43*, 1679.
120. Dahl, L. F.; Martell, C.; Wampler, D. L. *J. Am. Chem. Soc.* **1961**, *83*, 1761.
121. Yang, A. C.; Garland, C. W. *J. Phys. Chem.* **1957**, *61*, 1504.
122. Willner, H.; Bodenbinder, M.; Broechler, R.; Hwang, G.; Rettig, S. J.; Trotter, J.; von Ahsen, B.; Westphal, U.; Jonas, V.; Thiel, W.; Aubke, F. *J. Am. Chem. Soc.* **2001**, *123*, 588.
123. Wang, C.; Siu, S. C.; Hwang, G.; Bach, C.; Bley, B.; Bodenbinder, M.; Willner, H.; Aubke, F. *Can. J. Chem.* **1996**, *74*, 1952.
124. Roundhill, D. M.; Gray, H. B.; Che, C. M. *Acc. Chem. Res.* **1989**, *22*, 55.
125. Houlding, V. H.; Miskowski, V. M. *Coord. Chem. Rev.* **1991**, *111*, 145.
126. Sandrini, D.; Maestri, M.; Balzani, V.; Chassot, L.; von Zelewsky, A. *J. Am. Chem. Soc.* **1987**, *109*, 7720.
127. Kunkely, H.; Vogler, A. *J. Am. Chem. Soc.* **1990**, *112*, 5625.
128. Cummings, S. D.; Eisenberg, R. *J. Am. Chem. Soc.* **1996**, *118*, 1949.
129. Maestri, M.; Sandrini, D.; Balzani, V.; von Zelewsky, A.; Jolliet, P. *Helv. Chim. Acta* **1988**, *71*, 134.
130. Schwarz, R.; Gliemann, G.; Jolliet, P.; von Zelewsky, A. *Inorg. Chem.* **1989**, *28*, 742.
131. Glasbeek, M.; Sitters, R.; van Veldhoven, E.; von Zelewsky, A.; Humbs, W.; Yersin, H. *Inorg. Chem.* **1998**, *37*, 5159.
132. Garcia-Herbosa, G.; Muñoz, A.; Maestri, M. *J. Photochem. Photobiol. A: Chem.* **1994**, *83*, 165.
133. Maestri, M.; Cornioley-Deuschel, C.; von Zelewsky, A. *Coord. Chem. Rev.* **1991**, *111*, 117.
134. Maestri, M.; Sandrini, D.; Balzani, V.; von Zelewsky, A.; Cornioley-Deuschel, C.; Jolliet, P. *Helv. Chim. Acta* **1988**, *71*, 1053.
135. Barigelletti, F.; Sandrini, D.; Maestri, M.; Balzani, V.; von Zelewsky, A.; Chassot, L.; Jolliet, P.; Maeder, U. *Inorg. Chem.* **1988**, *27*, 3644.
136. Van Houten, K. A.; Heath, D. C.; Barringer, C. A.; Rheingold, A. L.; Pilato, R. S. *Inorg. Chem.* **1998**, *37*, 4647.
137. Newkome, G. R.; Onishi, M.; Puckett, W. E.; Deutsch, W. A. *J. Am. Chem. Soc.* **1980**, *102*, 4551.
138. Suggs, J. W.; Dube, M. J.; Nichols, M. *J. Chem. Soc., Chem Commun* **1993**, 307.
139. Lai, S. W.; Chan, M. C. W.; Cheung, T. C.; Peng, S. M.; Che, C. M. *Inorg. Chem.* **1999**, *38*, 4046.
140. Cheung, T. C.; Cheung, K. K.; Peng, S. M.; Che, C. M. *J. Chem. Soc., Dalton Trans.* **1996**, 1645.
141. Wong, K. H.; Chan, M. C. W.; Che, C. M. *Chem. Eur. J.* **1999**, *5*, 2845.

142. Lai, S. W.; Chan, M. C. W.; Cheung, K. K.; Che, C. M. *Organometallics* **1999**, *18*, 3327.
143. Tse, M. C.; Cheung, K. K.; Chan, M. C. W.; Che, C. M. *Chem. Commun.* **1998**, 2295.
144. Lai, S.-W.; Cheung, T.-C.; Chan, M. C. W.; Cheung, K.-K.; Peng, S.-M.; Che, C.-M. *Inorg. Chem.* **2000**, *39*, 255.
145. Guel, N.; Nelson, J. H. *Organometallics* **2000**, *19*, 91.
146. Ito, Y.; Ihara, E.; Murakami, M.; Shiro, M. *J. Am. Chem. Soc.* **1990**, *112*, 6446.
147. Ito, Y.; Ihara, E.; Uesaka, T.; Murakami, M. *Macromolecules* **1992**, *25*, 6711.
148. Ito, Y.; Ihara, E.; Murakami, M. *Polym. J.* **1992**, *24*, 297.
149. Ito, Y.; Ihara, E.; Murakami, M. *Angew. Chem., Int. Ed. Engl.* **1992**, *31*, 1509.
150. Ito, Y.; Ihara, E.; Murakami, M.; Sisido, M. *Macromolecules* **1992**, *25*, 6810.
151. Ito, Y.; Kojima, Y.; Murakami, M. *Tetrahedron Lett.* **1993**, *51*, 8279.
152. Ito, Y.; Kojima, Y.; Murakami, M.; Suginome, M. *Heterocycles* **1996**, *42*, 597.
153. Ito, Y.; Kojima, Y.; Murakami, M.; Suginome, M. *Bull. Chem. Soc. Jpn.* **1997**, *70*, 2801.
154. Ito, Y.; Miyake, T.; Hatano, S.; Shima, R.; Ohara, T.; Suginome, M. *J. Am. Chem. Soc.* **1998**, *120*, 11880.
155. Extrom, C. L.; Pomije, M. K.; Mann, K. R. *Chem. Mater.* **1998**, *10*, 942.
156. Buss, C. E.; Anderson, C. E.; Pomije, M. K.; Lutz, C. M.; Britton, D.; Mann, K. R. *J. Am. Chem. Soc.* **1998**, *120*, 7783.
157. Crabtree, R. H. *Science* **2002**, *295*, 288.
158. Crabtree, R. H. *The Organometallic Chemistry of the Transition Metals*; 3rd ed.; Wiley: New York, 2001.
159. Bartlett, N.; Maitland, R. *Acta Crystallogr.* **1958**, *11*, 747.
160. Wright, A. F.; Fender, B. E. F.; Bartlett, N.; Leary, K. *Inorg. Chem.* **1978**, *17*, 748.
161. Timakov, A. A.; Prusakov, V. N.; Drobyshevskii, Y. V. *Russ. J. Inorg. Chem. (Engl. Transl.)* **1982**, *27*, 1704.
162. Serezkhin, V. N.; Serezkhin, L. B.; Buslaev, Y. A. *Russ. J. Inorg. Chem. (Engl. Transl.)* **2000**, *45*, 1241.
163. Hargittai, M. *Chem. Rev.* **2000**, *100*, 2233.
164. Woo, T. K.; Pioda, G.; Rothlisberger, U.; Togni, A. *Organometallics* **2000**, *12*, 1655.
165. Suginome, M.; Kato, Y.; Takeda, N.; Oike, H.; Ito, Y. *Organometallics* **1998**, *17*, 495.
166. Murakami, M.; Yoshida, T.; Ito, Y. *Organometallics* **1994**, *13*, 2900.
167. Suginome, M.; Oike, H.; Shuff, P. H.; Ito, Y. *Organometallics* **1996**, *15*, 2170.
168. Pan, Y.; Mague, J. T.; Fink, M. J. *Organometallics* **1992**, *11*, 3495.
169. Reid, S. M.; Fink, M. J. *Organometallics* **2001**, *20*, 2959.
170. Tsuji, Y.; Obora, Y. *J. Organomet. Chem.* **2000**, *611*, 343.
171. Bosch, E.; Barnes, C. L. *Inorg. Chem.* **2001**, *40*, 3097.
172. Kawano, T.; Kuwana, J.; Shinomaru, T.; Du, C.-X.; Ueda, I. *Chem. Lett.* **2001**, 1230.
173. Fiscus, J. E.; Shotwell, S.; Layland, R. C.; Smith, M. D.; zur Loye, H.-C.; Bunz, U. H. F. *Chem. Commun.* **2001**, 2647.
174. Hu, Y.-Z.; Chamchoumis, C.; Grebowicz, J. S.; Thummel, R. P. *Inorg. Chem.* **2002**, *41*, 2296.
175. Sakellariou, E. G.; Montalban, A. G.; Meunier, H. G.; Rumbles, G.; Phillips, D.; Ostler, R. B.; Suhling, K.; Barrett, A. G. M.; Hoffman, B. M. *Inorg. Chem.* **2002**, *41*, 2182.
176. Sun, S.-S.; Anspach, J. A.; Lees, A. J. *Inorg. Chem.* **2002**, *41*, 1862.
177. Kingsley, S.; Vij, A.; Chandrasekhar, V. *Inorg. Chem.* **2001**, *40*, 6057.
178. Nagy, Z.; Sovago, I. *J. Chem. Soc., Dalton Trans.* **2001**, 2467.
179. Chong, Y. S.; Smith, M. D.; Shimizu, K. D. *J. Am. Chem. Soc.* **2001**, *123*, 7463.
180. Ishii, T.; Aizawa, N.; Yamashita, M.; Matsuzaka, H.; Kodama, T.; Kikuchi, K.; Ikemoto, I.; Iwasa, Y. *J. Chem. Soc., Dalton Trans.* **2000**, 4407.
181. Ishii, T.; Aizawa, N.; Kanehama, R.; Yamashita, M.; Matsuzaka, H.; Kodama, T.; Kikuchi, K.; Ikemoto, I. *Inorg. Chim. Acta* **2001**, *317*, 81.
182. Pilloni, G.; Longato, B.; Bandoli, G. *Inorg. Chim. Acta* **2000**, *298*, 251.
183. Cusumano, M.; Di Pietro, M. L.; Giannetto, A.; Messina, M. A.; Romano, F. *J. Am. Chem. Soc.* **2001**, *123*, 1914.
184. Buchler, J. W.; Cian, A. D.; Fischer, J.; Kihn-Botulinski, M.; Paulus, H.; Weiss, R. *J. Am. Chem. Soc.* **1986**, *108*, 3652.
185. Kelso, M. J.; Hoang, H. N.; Appleton, T. G.; Fairlie, D. P. *J. Am. Chem. Soc.* **2000**, *122*, 10488.
186. Done, M. C.; Ruther, T.; Cavell, K. J.; Kilner, M.; Peacock, E. J.; Braussaud, N.; Skelton, B. W.; White, A. *J. Organomet. Chem.* **2000**, *607*, 78.
187. Echegoyen, L. E.; Hernandez, J.; Kaifer, A. E.; Gokel, G. W.; Echegoyen, L. *J. Chem. Soc., Chem. Commun.* **1988**, 836.
188. Nakano, A.; Hernadez, J. C.; Dewall, S. L.; Wang, K.; Berger, D. R.; Gokel, G. W. *Supramol. Sci.* **1997**, *8*, 21.
189. Echegoyen, L. E.; Portugal, L.; Miller, S. R.; Hernandez, J. C.; Echegoyen, L.; Gokel, G. W. *Tetrahedron Lett.* **1988**, *29*, 4065.
190. Okahara, M.; Kuo, P. L.; Yamamura, S.; Ikeda, I. *J. Chem. Soc., Chem. Commun.* **1980**, 586.
191. Jung, J. H.; Ono, Y.; Sakurai, K.; Sano, M.; Shinkai, S. *J. Am. Chem. Soc.* **2000**, *122*, 8648.
192. Ghassemzadeh, M.; Aghapour, K.; Heravi, M. M.; Neumüller, B. *Z. Anorg. Allg. Chem.* **1998**, *624*, 1969.
193. Neumüller, B.; Heravi, M. M.; Ghassemzadeh, M. *Z. Anorg. Allg. Chem.* **1999**, *625*, 1908.
194. Ghassemzadeh, M.; Bolourtchian, M.; Chitsaz, S.; Neumüller, B.; Heravi, M. M. *Eur. J. Inorg. Chem.* **2000**, 1877.
195. Grotjahn, D. B.; Combs, D.; Van, S.; Aguirre, G.; Ortega, F. *Inorg. Chem.* **2000**, *39*, 2080.
196. Amao, Y.; Asai, K.; Miyakawa, K.; Okura, I. *J. Porphyrins Phthalocyanines* **2000**, *4*, 19.
197. Amao, Y.; Asai, K.; Okura, I. *J. Porphyrins Phthalocyanines* **2000**, *4*, 179.
198. Mallat, T.; Baiker, A. *Catal. Today* **1994**, *19*, 247.
199. ten Brink, G.-j.; Arends, I. W. C. E.; Sheldon, R. A. *Science (Washington, D. C.)* **2000**, *287*, 1636.
200. ten Brink, G. J.; Arends, I. W. C. E.; Papadogianakis, G.; Sheldon, R. A. *Appl. Catal. A* **2000**, *194–195*, 435.
201. Wimmer, S. W.; Castan, P.; Wimmer, F. L.; Johnson, N. P. *Inorg. Chim. Acta* **1988**, *142*, 13.
202. Lord, P. A.; Olmstead, M. M.; Balch, A. L. *Inorg. Chem.* **2000**, *39*, 1128.
203. Lord, P.; Olmstead, M. M.; Balch, A. L. *Angew. Chem., Int. Ed. Engl.* **1999**, *38*, 2761.
204. Gelling, A.; Olsen, M. D.; Orrell, K. G.; Osborne, G.; Sik, V. *Chem. Commun.* **1997**, 587.
205. Gelling, A.; Olsen, M. D.; Orrell, K. G.; Osborne, A. G.; Sik, V. *Inorg. Chim. Acta* **1997**, *264*, 257.

206. Abel, E. W.; Orrell, K. G.; Osborne, A. G.; Pain, H. M.; Sik, V.; Hursthouse, M. B.; Malik, K. M. A. *J. Chem. Soc., Dalton Trans.* **1994**, 3441.
207. Rotondo, E.; Giordano, G.; Minniti, D. *J. Chem. Soc., Dalton Trans.* **1996**, 253.
208. Abel, E. W.; Gelling, A.; Orrell, K. G.; Osborne, A. G.; Sik, V. *Chem. Commun.* **1996**, 2329.
209. Gómez-de la Torre, F.; de la Hoz, A.; Jalón, F. A.; Manzano, B. R.; Otero, A.; Rodríguez, A. M.; Rodríguez-Pérez, M. C.; Echevarría, A.; Elguero, J. *Inorg. Chem.* **1998**, *37*, 6606.
210. Ikeda, M.; Maruyama, K.; Nobuhara, Y.; Yamada, T.; Okabe, S. *Chem. Pharm. Bull.* **1997**, *45*, 549.
211. Gomez-de la Torre, F.; De la Hoz, A.; Jalón, F. A.; Manzano, B. R.; Rodríguez, A. M.; Elguero, J.; Martínez-Ripoll, M. *Inorg. Chem.* **2000**, *39*, 1152.
212. Goud, G. N.; Patwardhan, A. V.; Beckman, E. J.; Atai, M. M.; Koepsel, R. R. *Int. J. Biol. Chromatogr.* **1997**, *3*, 123.
213. Patwardhan, A. V.; Goud, G. N.; Koepsel, R. R.; Atai, M. M. *J. Chromatogr.* **1997**, *787*, 91.
214. Chen, Y.; Pasquini, R.; Atai, M.; Koepsel, R. R.; Kortess, R. A.; Shepherd, R. E. *Inorg. Chem.* **2000**, *39*, 1180.
215. Harriman, A.; Porter, G.; Walters, P. *Chem. Soc. Faraday Trans. 1* **1983**, *79*, 1335.
216. Aoudia, M.; Rodgers, M. A. J. *J. Am. Chem. Soc.* **1997**, *119*, 12859.
217. Kaschak, D. M.; Lean, J. T.; Waraksa, C. C.; Saupe, G. B.; Usami, H.; Mallouk, T. E. *J. Am. Chem. Soc.* **1999**, *121*, 3435.
218. Kim, K.; Fancy, D. A.; Carney, D.; Kodadek, T. *J. Am. Chem. Soc.* **1999**, *121*, 11896.
219. Bailey, J. A.; Miskowski, V. M.; Gray, H. B. *Inorg. Chem.* **1993**, *32*, 369.
220. Bailey, J. A.; Hill, M. G.; Marsh, R. E.; Miskowski, V. M.; Schaefer, W. P.; Gray, H. B. *Inorg. Chem.* **1995**, *34*, 4591.
221. Yip, H.-K.; Che, C.-M.; Zhou, Z.-Y.; Mak, T. C. W. *J. Chem. Soc., Chem. Commun.* **1992**, 1369.
222. Yip, H.-K.; Cheng, L.-K.; Cheung, K.-K.; Che, C.-M. *J. Chem. Soc., Dalton Trans.* **1993**, 2933.
223. Hill, M. G.; Bailey, J. A.; Miskowski, V. M.; Gray, H. B. *Inorg. Chem.* **1996**, *35*, 4585.
224. Mureinik, R. J.; Bidani, M. *Inorg. Chim. Acta* **1978**, *29*, 37.
225. Wang, A. H.-J.; Nathans, J.; van der Marel, G. A.; van Boom, J. H.; Rick, A. *Nature* **1978**, *276*, 471.
226. Jenette, K. W.; Gill, J. T.; Sadowick, J. A.; Lippard, S. J. *J. Am. Chem. Soc.* **1976**, *98*, 6159.
227. Arena, G.; Monsù Scolaro, L.; Pasternack, R. F.; Romeo, R. *Inorg. Chem.* **1995**, *34*, 2994.
228. Brothers II, H. M.; Kostić, N. M. *Inorg. Chem.* **1988**, *27*, 1761.
229. Brothers II, H. M.; Kostić, N. M. *Biochemistry* **1990**, *29*, 7468.
230. Appleton, T. G.; Pesch, F. J.; Wienken, M.; Menzer, S.; Lippert, B. *Inorg. Chem.* **1992**, *31*, 4410.
231. Ratilla, E. M. A.; Scott, B. K.; Moxness, M. S.; Kostić, N. M. *Inorg. Chem.* **1990**, *29*, 918.
232. Kiss, A.; Farkas, E.; Sóvágó, I.; Thormann, B.; Lippert, B. *J. Inorg. Biochem.* **1997**, *68*, 85.
233. Cosar, S.; Janik, M. B. L.; Flock, M.; Freisinger, E.; Farkas, E.; Lippert, B. *J. Chem. Soc., Dalton Trans.* **1999**, 2329.
234. Aust, N. C.; Beckmann, A.; Deters, R.; Kramer, R.; Terfloth, L.; Warzeska, S.; Wurthwein, E.-U. *Eur. J. Inorg. Chem.* **1999**, 1189.
235. Mani, N. S.; Beall, L. S.; Miller, T.; Anderson, O. P.; Hope, H.; Parkin, S. R.; Williams, D. J.; Barrett, A. G. M.; Hoffman, B. M. *J. Chem. Soc., Chem. Commun.* **1994**, 2095.
236. Eichhorn, D. M.; Yang, S.; Jarrell, W.; Baumann, T. F.; Beall, L. S.; White, A. J. P.; Williams, D. J.; Barrett, A. G. M.; Hoffman, B. M. *J. Chem. Soc., Chem. Commun.* **1995**, 1703.
237. Lange, S. J.; Nie, H.; Stern, C. L.; Barrett, A. G. M.; Hoffman, B. M. *Inorg. Chem.* **1998**, *37*, 6435.
238. Haas, K.; Ponikvar, W.; Noth, H.; Beck, W. *Angew. Chem., Int. Ed.* **1998**, *37*, 1086.
239. Wagatsuma, M.; Terashima, S.; Yamada, S. *Tetrahedron* **1973**, *29*, 1497.
240. Beck, W.; Krämer, R. *Angew. Chem., Int. Ed. Engl.* **1991**, *30*, 1467.
241. Krämer, R.; Maurus, M.; Polborn, K.; Sünkel, K.; Robl, C.; Beck, W. *Chem. Eur. J.* **1996**, *2*, 1518.
242. Valls, E.; Solsona, A.; Suades, J.; Mathieu, R.; Comelles, F.; Lopez-Iglesias, C. *Organometallics* **2002**, *21*, 2473.
243. Wieser, C.; Dielman, C. B.; Matt, D. *Coord. Chem. Rev.* **1997**, *165*, 93.
244. Wieser-Jeunesse, C.; Matt, D.; De Cian, A. *Angew. Chem., Int. Ed.* **1998**, *37*, 2861.
245. Iwamoto, K.; Araki, K.; Shinkai, S. *Tetrahedron* **1991**, *47*, 4325.
246. Takenaka, K.; Obora, Y.; Jiang, L. H.; Tsuji, Y. *Organometallics* **2002**, *21*, 1158.
247. Fave, C.; Hissler, M.; Senechal, K.; Ledoux, I.; Zyss, J.; Reau, R. *Chem. Commun.* **2002**, 1674.
248. Hayashi, T.; Konishi, M.; Kumada, M. *Tetrahedron Lett.* **1979**, *21*, 1871.
249. Boyes, A. L.; Butler, I. R.; Quayle, S. C. *Tetrahedron Lett.* **1998**, *39*, 7763.
250. Hamann, B. C.; Hartwig, J. F. *J. Am. Chem. Soc.* **1998**, *120*, 7369.
251. Nettekoven, U.; Kamer, P. C. J.; van Leeuwen, P. W. N. M.; Widhalm, M.; Spek, A. L.; Lutz, M. *J. Org. Chem.* **1999**, *64*, 3996.
252. Sato, M.; Shigeta, H.; Sekino, M.; Akabori, S. *J. Organomet. Chem.* **1993**, *458*, 199.
253. Sato, M.; Suzuki, K.; Asano, H.; Sekino, M.; Kawata, Y.; Habata, Y.; Akabori, S. *J. Organomet. Chem.* **1994**, *470*, 263.
254. Zuideveld, M. A.; Swennenhuis, B. H. G.; Kamer, P. C. J.; van Leeuwen, P. W. N. M. *J. Organomet. Chem.* **2001**, *637–639*, 805.
255. Cloke, F. G. N.; Hitchcock, P. B.; Nixon, J. F.; Wilson, D. J. *Chem. Commun.* **2000**, 2387.
256. Bedford, R. B.; Draper, S. M.; Noelle Scully, P.; Welch, S. L. *New J. Chem.* **2000**, *24*, 745.
257. Stampfl, T.; Haid, R.; Langes, C.; Oberhauser, W.; Bachmann, C.; Kopacka, H.; Ongania, K.-H.; Bruggeller, P. *Inorg. Chem. Commun.* **2000**, *3*, 387.
258. Wicht, D. K.; Kourkine, I. V.; Lew, B. M.; Nthenge, J. M.; Glueck, D. S. *J. Am. Chem. Soc.* **1997**, *119*, 5039.
259. Zhuravel, M. A.; Moncarz, J. R.; Glueck, D. S.; Lam, K.-C.; Rheingold, A. L. *Organometallics* **2000**, *19*, 3447.
260. Khasnis, D. V.; Burton, J. M.; McNeil, J. D.; Zhang, H.; Lattman, M. *Phosphorus Sulfur Silicon Relat. Elem.* **1993**, *75*, 253.
261. Khasnis, D. V.; Lattman, M. *J. Am. Chem. Soc.* **1990**, *112*, 9422.
262. Khasnis, D. V.; Burton, J. M.; Lattman, M.; Zhang, H. *J. Chem. Soc., Chem. Commun.* **1991**, 562.
263. Coble, C. J.; Ellis, D. D.; Orpen, A. G.; Pringle, P. G. *Dalton* **2000**, 1101.
264. Soulivong, D.; Matt, D.; Ziessel, R. *Chem. Commun.* **1999**, 393.

265. Dyer, P. W.; Dyson, P. J.; James, S. L.; Suman, P.; Dyer, P. W.; Davies, J. E.; Martin, C. M. *Chem. Commun.* **1998**, 1375.
266. Gauthron, I.; Mugnier, Y.; Hierso, K.; Harvey, P. D. *New J. Chem.* **1998**, 22, 237.
267. Müller, T. E.; Beller, M. *Chem. Rev.* **1998**, 98, 675.
268. Richmond, M. K.; Scott, S. L.; Alper, H. *J. Am. Chem. Soc.* **2001**, 123, 10521.
269. Bryndza, H. E.; Tam, W. *Chem. Rev.* **1988**, 88, 1163.
270. Deeming, A. J.; Johnson, B. F. G.; Lewis, J. *J. Chem. Soc., Dalton Trans.* **1973**, 1848.
271. Bennett, M. A.; Yoshida, T. *J. Am. Chem. Soc.* **1978**, 100, 1750.
272. Bennett, M. A.; Rokicki, A. *Aust. J. Chem.* **1985**, 38, 1307.
273. Paterniti, D. P.; Atwood, J. D. *Chem. Commun.* **1997**, 1665.
274. Paterniti, D. P.; Atwood, J. D. *Polyhedron* **1998**, 17, 1177.
275. Ganguly, S.; Roundhill, D. M. *J. Chem. Soc., Chem. Commun.* **1991**, 639.
276. Ganguly, S.; Roundhill, D. M. *Organometallics* **1993**, 12, 4825.
277. Getty, A. D.; Goldberg, K. I. *Organometallics* **2001**, 20, 2545.
278. Akita, M.; Miyaji, T.; Muroga, N.; Mock-Knoblauch, C.; Adam, W.; Hikichi, S.; Moro-oka, Y. *Inorg. Chem.* **2000**, 39, 2096.
279. Muraoka, P.; Byun, D.; Zink, J. I. *J. Am. Chem. Soc.* **2000**, 122, 1227.
280. Gan, K.-S.; Hor, T. S. A. 1,1'-Bis(diphenylphosphine) ferrocene. Coordination chemistry, organic synthesis, and catalysis. VCH: Weinheim, Germany. In *Ferrocenes-Homogeneous Catalysis, Organic Synthesis, Materials Science*; Togni, A., Hayashi, T., Eds., 1995, p 3.
281. Fong, S.-W. A.; Hor, T. S. A. *J. Cluster Sci.* **1998**, 9, 351.
282. Wei, B.; Li, S. H.; Lee, H. K.; Hor, T. S. A. *J. Mol. Catal. A: Chem.* **1997**, 126, L83.
283. Kobayashi, T.; Sakakura, T.; Tanaka, M. *Tetrahedron Lett.* **1985**, 26, 3463.
284. Hartwig, J. F. *Angew. Chem., Int. Ed.* **1998**, 37, 2090.
285. Hayashi, T.; Konishi, M.; Kobori, Y.; Kumada, M.; Higuchi, T.; Hirotsu, K. *J. Am. Chem. Soc.* **1984**, 106, 158.
286. Ghimlitz, L.; Rehahn, M.; Ballauff, M. *Polymer* **1993**, 34, 646.
287. Pilloni, G.; Longato, B.; Corain, B. *J. Organomet. Chem.* **1991**, 420, 57.
288. Yeo, J. S. L.; Vittal, J. J.; Hor, T. S. A. *Chem. Commun.* **1999**, 1477.
289. Ahlrichs, R.; Ballauff, M.; Eichkorn, K.; Hanemann, O.; Kettenbach, G.; Klufers, P. *Chem. Eur. J.* **1998**, 4, 835.
290. Barbera, J.; Iglesias, R.; Serrano, J. L.; Sierra, T.; de la Fuente, M. R.; Palacios, B.; Perez-Jubindo, M. A.; Vazquez, J. T. *J. Am. Chem. Soc.* **1998**, 120, 2908.
291. Schmidt, M.; Hoffmann, G. G.; Höller, R. *Inorg. Chim. Acta* **1979**, 32, L19.
292. Shaver, A.; Lai, R. D.; Bird, P.; Wickramasinghe, W. *Can. J. Chem.* **1985**, 63, 2555.
293. Ghillardi, C. A.; Midollini, S.; Nazzi, F.; Orlandini, A. *Transition Met. Chem.* **1983**, 8, 73.
294. Ruiz, J.; Martínez, M. T.; Vicente, C.; García, G.; López, G.; Chaloner, P. A.; Hitchcock, P. B. *Organometallics* **1993**, 12, 1594.
295. Ruiz, J.; Rodríguez, V.; López, G.; Chaloner, P. A.; Hitchcock, P. B. *Organometallics* **1996**, 15, 1662.
296. Ruiz, J.; Rodríguez, V.; López, G.; Casabó, J.; Molins, E.; Miravittles, C. *Organometallics* **1999**, 19, 1177.
297. Ruiz, J.; Rodríguez, V.; Vicente, C.; Martí, J. M.; Lopez, G.; Perez, J. *Inorg. Chem.* **2001**, 40, 5354.
298. Burns, R. P.; McAuliffe, C. A. *Adv. Inorg. Chem. Radiochem.* **1979**, 22, 303.
299. Eisenberg, R. *Prog. Inorg. Chem.* **1970**, 12, 295.
300. McCleverty, J. A. *Prog. Inorg. Chem.* **1968**, 10, 49.
301. Olson, D. C.; Mayweg, V. P.; Schrauzer, G. N. *J. Am. Chem. Soc.* **1966**, 88, 4876.
302. Schrauzer, G. N.; Mayweg, V. P. *J. Am. Chem. Soc.* **1965**, 87, 1483.
303. Davison, A.; Edelstein, N.; Holm, R. H.; Maki, A. H. *Inorg. Chem.* **1963**, 2, 1227.
304. McCleverty, J. A.; Atherton, N. M.; Locke, A. J.; Wharton, E. J.; Winscom, C. J. *J. Am. Chem. Soc.* **1967**, 89, 6082.
305. Balch, A. I. *Inorg. Chem.* **1967**, 6, 2158.
306. Schrauzer, G. N.; Mayweg, V. P.; Finck, H. W.; Heinrich, W. *J. Am. Chem. Soc.* **1966**, 88, 4604.
307. Bosch, B. E.; Eisenhauer, M.; Kersting, B.; Kirschbaum, K.; Krebs, B.; Giolando, D. M. *Inorg. Chem.* **1996**, 35, 6599.
308. Beswick, C. L.; Terroba, R.; Greaney, M. A.; Stiefel, E. I. *J. Am. Chem. Soc.* **2002**, 124, 9664.
309. Price, C.; Horrocks, B. R.; Mayeux, A.; Elsegood, M. R. J.; Clegg, W.; Houlton, A. *Angew. Chem., Int. Ed. Engl.* **2002**, 41, 1047.
310. Wenzel, B.; Loennecke, P.; Stender, M.; Hey-Hawkins, E. *J. Chem. Soc., Dalton Trans.* **2002**, 478.
311. Komuro, T.; Matsuo, T.; Kawaguchi, H.; Tatsumi, K. *Chem. Commun.* **2002**, 988.
312. Tran, D. T. T.; Taylor, N. J.; Corrigan, J. F. *Angew. Chem., Int. Ed.* **2000**, 39, 935.
313. Cai, L.; Holm, R. H. *J. Am. Chem. Soc.* **1994**, 116, 7177.
314. Richtzenhain, H.; Blake, A. J.; Bruce, D. W.; Fallis, I. A.; Li, W.-S.; Schroeder, M. *Chem. Commun.* **2001**, 2580.
315. Pelletier, Y.; Reber, C. *Inorg. Chem.* **2000**, 39, 4535.
316. Fujiwara, H.; Arai, E.; Kobayashi, H. *J. Chem. Soc., Chem. Commun.* **1997**, 837.
317. Steimecke, G.; Sieler, H. J.; Kirmse, R.; Hoyer, E. *Phosphorus Sulfur Silicon Relat. Elem.* **1979**, 7, 49.
318. Cassoux, P.; Valade, L.; Kobayashi, H.; Kobayashi, A.; Clark, R. A.; Underhill, A. E. *Coord. Chem. Rev.* **1991**, 110, 115.
319. Sun, S.; Wu, P.; Zhu, D.; Ma, Z.; Shi, N. *Inorg. Chim. Acta* **1998**, 268, 103.
320. Sato, A.; Kobayashi, H.; Naito, T.; Sakai, F.; Kobayashi, A. *Inorg. Chem.* **1997**, 36, 5262.
321. Kochurani, Singh, H. B.; Jasinski, J. P.; Paight, E. P.; Butcher, R. J. *Polyhedron* **1997**, 16, 3505.
322. Matsubayashi, G.; Natsuaki, K.; Nakano, M.; Tamura, H.; Arakow, R. *Inorg. Chim. Acta* **1997**, 262, 103.
323. Yeldhuizen, Y.; Veldman, N.; Lakin, M. T.; Spek, A. L.; Paulus, P. M.; Faulmann, C.; Haasnoot, J. G.; Maaskant, M. J. A.; Reedijk, J. *Inorg. Chim. Acta* **1996**, 245, 27.
324. Valade, L.; Legros, J.-P.; Bousseau, M.; Garbauskas, M.; Interrante, L. V. *J. Chem. Soc., Dalton Trans.* **1985**, 783.
325. Pomarède, B.; Garreau, B.; Malfant, I.; Valade, L.; Cassoux, P.; Legros, J.-P.; Audouard, A.; Brossard, L.; Ulmet, J. P.; Doublet, M. L.; Canadell, E. *Inorg. Chem.* **1994**, 33, 3401.

326. Brossard, L.; Hurdequint, L.; Ribault, M.; Valade, L.; Legros, J.-P.; Cassaux, P. *Synth. Met.* **1988**, *27*, B157.
327. Drexhage, K. H.; Mueller-Westerhoff, U. T. *IEEE Quantum Electron* **1972**, *QE-8*, 759.
328. Browall, K. W.; Interrante, L. V. *J. Coord. Chem.* **1973**, *3*, 27.
329. Arca, M.; Demartin, F.; Devillanova, F. A.; Garau, A.; Isaia, F.; Lelj, F.; Lippolis, V.; Pedraglio, S.; Verani, G. *J. Chem. Soc., Dalton Trans.* **1998**, 3731.
330. Aragoni, M. C.; Arca, M.; Demartin, F.; Devillanova, F. A.; Garau, A.; Isaia, F.; Lelj, F.; Lippolis, V.; Verani, G. *J. Am. Chem. Soc.* **1999**, *121*, 7098.
331. Luo, X.; Huang, W.; Mei, Y.; Zhou, S.; Zhu, L. *Inorg. Chem.* **1999**, *38*, 1474.
332. Han, L.-B.; Choi, N.; Tanaka, M. *J. Am. Chem. Soc.* **1997**, *119*, 1795.
333. Han, L.-B.; Shimada, S.; Tanaka, M. *J. Am. Chem. Soc.* **1997**, *119*, 8133.
334. Han, L.-B.; Tanaka, M. *Chem. Commun.* **1998**, 47.
335. Khanna, A.; Khandelwal, B. L.; Saxena, A. K.; Singh, T. P. *Polyhedron* **1995**, *14*, 2705.
336. Parrshall, G. W.; Ittel, S. D. *Homogeneous Catalysis*; Wiley: New York, 1992.
337. Fukukawa, S.-I.; Fujinami, T.; Sakai, S. *Chem. Lett.* **1990**, 927.
338. Bhattacharyya, P.; Slawin, A. M. Z.; Smith, M. B. *J. Chem. Commun. Dalton Trans.* **1998**, 2467.
339. Ford, S.; Khanna, P. K.; Morley, C. P.; Di Vaira, M. *J. Chem. Soc., Dalton Trans.* **1999**, 791.
340. Oilunkaniemi, R.; Laitinen, R. S.; Ahlgren, M. *Chem. Commun.* **1999**, 585.
341. Oilunkaniemi, R.; Laitinen, R. S.; Ahlgren, M. *J. Organomet. Chem.* **1999**, *587*, 200.
342. Bates, C. M.; Khanna, P. K.; Morley, C. P.; Di Vaira, M. *J. Chem. Soc. Chem. Commun.* **1997**, 913.
343. Drutkowski, U.; Wenzel, B.; Strauch, P. *Inorg. Chem. Commun.* **1998**, *1*, 449.
344. Qin, Z.; Jennings, M. C.; Puddephatt, R. J.; Muir, K. W. *Cryst. Eng. Commun.* **2000**, 11.
345. Qin, Z.; Jenkins, H. A.; Coles, S. J.; Muir, K. W.; Puddephatt, R. J. *Can. J. Chem.* **1999**, *77*, 155.
346. Qin, Z.; Jennings, M. C.; Puddephatt, R. J. *Inorg. Chem.* **2001**, *40*, 6220.
347. Bartolome, C.; De Blas, R.; Espinet, P.; Martin-Alvarez, J. M.; Villafane, F. *Angew. Chem., Int. Ed. Engl.* **2001**, *40*, 2521.
348. Kacker, S.; Kim, J. S.; Sen, A. *Angew. Chem., Int. Ed.* **1998**, *37*, 1251.
349. Roe, D. C.; Marshall, W. J.; Davidson, F.; Soper, P. D.; Grushin, V. V. *Organometallics* **2000**, *19*, 4575.
350. Amatore, C.; Azzabi, M.; Jutand, A. *J. Organomet. Chem.* **1989**, *363*, C41.
351. Amatore, C.; Azzabi, M.; Jutand, A. *J. Am. Chem. Soc.* **1991**, *113*, 1670.
352. Amatore, C.; Jutand, A.; Suarez, A. *J. Am. Chem. Soc.* **1993**, *115*, 9531.
353. Amatore, C.; Jutand, A. *J. Organomet. Chem.* **1999**, *576*, 254.
354. Amatore, C.; Jutand, A.; Mottier, L. *Eur. J. Inorg. Chem.* **1999**, 1081.
355. Amatore, C.; Carré, E.; Jutand, A.; M'Barki, M. A.; Meyer, G. *Organometallics* **1995**, *14*, 5605.
356. Pilon, M. C.; Grushin, V. V. *Organometallics* **1998**, *17*, 1774.
357. Fayet, P.; Kaldor, A.; Cox, D. M. *J. Chem. Phys.* **1990**, *92*, 254.
358. Low, J. J.; Goddard, W. A., III. *J. Am. Chem. Soc.* **1984**, *106*, 8321.
359. Balasubramanian, K.; Feng, P. Y.; Liao, M. Z. *J. Chem. Phys.* **1988**, *88*, 6955.
360. Chi, Q.; Musaev, D. G.; Morokuma, K. *J. Chem. Phys.* **1998**, *108*, 8418.
361. Backvall, J. E.; Bjorkman, E. E.; Petterson, L.; Siegbahn, P. E. M. *J. Am. Chem. Soc.* **1985**, *107*, 7265.
362. Jarque, C.; Novaro, O.; Ruiz, M. E.; Garcia-Prieto, J. *J. Am. Chem. Soc.* **1986**, *108*, 3507.
363. Bloomberg, M. R. A.; Siegbahn, P. E. M.; Svenson, M. *J. Phys. Chem.* **1992**, *96*, 5783.
364. Siegbahn, P. E. M. *Theor. Chim. Acta* **1994**, *81*, 441.
365. Ozin, G. A.; Garcia-Prieto, J. *J. Am. Chem. Soc.* **1986**, *108*, 3099.
366. Andrews, L.; Manceron, L.; Alikhani, M. E.; Wang, X. *J. Am. Chem. Soc.* **2000**, *122*, 11011.
367. Trost, B. M. *Chem. Eur. J.* **1998**, *4*, 2405.
368. Green, M. L. H.; Munakata, H. *J. Chem. Soc., Chem. Commun.* **1971**, 549.
369. Green, M. L. H.; Munakata, H. *J. Chem. Soc., Dalton Trans.* **1974**, 269.
370. Schunn, R. A. *Inorg. Chem.* **1976**, *15*, 208.
371. Meakin, P.; Schunn, R. A.; Jesson, J. P. *J. Am. Chem. Soc.* **1974**, *96*, 277.
372. Siedle, A. R.; Newmark, R. A.; Gleason, W. B. *Inorg. Chem.* **1991**, *30*, 2005.
373. Zudin, V. N.; Chinakov, V. D.; Nekipelov, V. M.; Likholobov, V. A.; Yermakov, Y. I. *J. Organomet. Chem.* **1985**, *289*, 425.
374. Verspui, G.; Moiseev, I. I.; Sheldon, R. A. *J. Organomet. Chem.* **1999**, *586*, 196.
375. Leoni, P.; Sommovigo, M.; Pasquali, M.; Midollini, S.; Braga, D.; Sabatino, P. *Organometallics* **1991**, *10*, 1038.
376. Grushin, V. V. *Chem. Rev.* **1996**, *96*, 2011.
377. Trost, B. M.; Romero, D. L.; Rise, F. *J. Am. Chem. Soc.* **1994**, *116*, 4268.
378. Trost, B. M.; Pfrengle, W.; Urabe, H.; Dumas, J. *Acc. Chem. Res.* **1990**, *23*, 34.
379. Amatore, C.; Jutand, A.; Meyer, G.; Carelli, I.; Chiarotto, I. *Eur. J. Inorg. Chem.* **2000**, 1855.
380. Atkinson, I. M.; Chartres, J. D.; Groth, A. M.; Lindoy, L. F.; Lowe, M. P.; Meehan, G. V.; Skelton, B. W.; White, A. H. *J. Chem. Soc., Dalton Trans.* **2001**, 2801.
381. Dance, I.; Fisher, K. *Prog. Inorg. Chem.* **1994**, *41*, 637.
382. Tzeng, B.-C.; Chan, S.-C.; Chan, M. C. W.; Che, C.-M.; Cheung, K.-K.; Peng, S.-M. *Inorg. Chem.* **2001**, *40*, 6699.
383. Santana, A. M.; Mauro, A. E.; Tonon de Almeida, E.; Vieira de Godoy Netto, A.; Klein, S. I.; Santos, R. H. D. A.; Zola, J. R. *J. Coord. Chem.* **2001**, *53*, 163.
384. He, W.; Liu, F.; Mei, Y.; Guo, Z.; Zhu, L. *New J. Chem.* **2001**, *25*, 1330.
385. Jackson, A.; Davis, J.; Pither, R. J.; Rodger, A.; Hannon, M. J. *Inorg. Chem.* **2001**, *40*, 3964.
386. Gossage, R. A.; McLennan, G. D.; Stobart, S. R. *Inorg. Chem.* **1996**, *35*, 1729.
387. Grundy, S. L.; Holmes-Smith, R. D.; Stobart, S. R.; Williams, M. A. *Inorg. Chem.* **1991**, *30*, 3333.
388. Holmes-Smith, R. D.; Stobart, S. R.; Cameron, T. S.; Jochem, K. *J. Chem. Soc., Chem. Commun.* **1981**, 937.
389. Schubert, U.; Muller, C. *J. Organomet. Chem.* **1989**, *373*, 165.
390. Lee, Y.-J.; Bae, J.-Y.; Kim, S.-J.; Ko, J.; Choi, M.-G.; Kang, S. O. *Organometallics* **2000**, *19*, 5546.
391. Gerrard, L. A.; Wood, P. T. *Chem. Commun.* **2000**, 2107.
392. Kratochvil, B.; Ondracek, J.; Maixner, J.; Macicek, J.; Haber, V. *Collect. Czech. Chem. Commun.* **1991**, *56*, 1900.

393. Zhou, X.-G.; Huang, J.-S.; Yu, X.-Q.; Zhou, Z.-Y.; Che, C.-M. *Dalton* **2000**, 1075.
394. Sprinz, J.; Helmchen, G. *Tetrahedron Lett.* **1993**, *34*, 1769.
395. Braunstein, P.; Fryzuk, M. D.; Le Dall, M.; Naud, F.; Rettig, S. J.; Speiser, F. *Dalton* **2000**, 1067.
396. Schmidt, U.; Ilg, K.; Werner, H. *Dalton* **2000**, 1005.
397. Schmidt, J.; Wiedenhofer, H.; von Zelewsky, A.; Yersin, H. *J. Phys. Chem.* **1995**, *99*, 226.
398. Yersin, H.; Donges, D.; Nagle, J. K.; Sitters, R.; Glasbeek, M. *Inorg. Chem.* **2000**, *39*, 770.
399. Real, J.; Pagès, M.; Polo, A.; Piniella, J. F.; Alvarez-Larena, A. *Chem. Commun.* **1999**, 277.
400. Kruis, D.; Ruiz, N.; Janssen, M. D.; Boersma, J.; Claver, C.; van Koten, G. *Inorg. Chem. Commun.* **1998**, *1*, 295.
401. Brugat, N.; Polo, A.; Alvarez-Larena, A.; Piniella, J. F.; Real, J. *Inorg. Chem.* **1999**, *38*, 4829.
402. Bayon, J. C.; Claver, C.; Masdeu-Bultó, A. M. *Coord. Chem. Rev.* **1999**, *193*, 73.
403. Benefiel, A.; Roundhill, D. M.; Fultz, W. C.; Rheingold, A. L. *Inorg. Chem.* **1984**, *23*, 3316.
404. Roundhill, D. M.; Roundhill, S. G. N.; Beaulieu, W. B.; Bagchi, U. *Inorg. Chem.* **1980**, *19*, 3365.
405. Roundhill, D. M.; Beaulieu, W. B.; Bagchi, U. *J. Am. Chem. Soc.* **1979**, *101*, 5428.
406. Martin, J. W. L.; Palmer, J. A. L.; Wild, S. B. *Inorg. Chem.* **1984**, *23*, 2664.
407. Chooi, S. Y. M.; Hor, T. S. A.; Leung, P.-H.; Mok, K. F. *Inorg. Chem.* **1992**, *31*, 1494.
408. Leung, P.-H.; Martin, J. W. L.; Wild, S. B. *Inorg. Chem.* **1986**, *25*, 3396.
409. Leung, P.-H.; Willis, A. C.; Wild, S. B. *Inorg. Chem.* **1992**, *31*, 1406.
410. Albinati, A.; Herrmann, J.; Pregosin, P. S. *Inorg. Chim. Acta* **1997**, *264*, 33.
411. Leung, P.-H.; Siah, S.-Y.; White, A. J. P.; Williams, D. J. *J. Chem. Soc., Dalton Trans.* **1998**, 893.
412. Snyder, B. S.; Rao, C. P.; Holm, R. H. *Aust. J. Chem.* **1986**, *39*, 963.
413. Cotton, F. A.; Wilkinson, G. *Advanced Inorganic Chemistry*; 5th ed.; Wiley: New York, 1988.
414. Herrmann, W. A.; Kocher, C. *Angew. Chem., Int. Ed. Engl.* **1997**, *36*, 2162.
415. Lang, H.; Vittal, J. J.; Leung, P.-H. *J. Chem. Soc., Dalton Trans.* **1998**, 2109.
416. Tebbe, K.-F.; Buchem, R. *Angew. Chem., Int. Ed. Engl.* **1997**, *37*, 1345.
417. Tebbe, K.-F.; Farida, T. Z. *Naturforsch. B* **1995**, *50*, 1685.
418. Tebbe, K.-F.; Gilles, T. Z. *Anorg. Allg. Chem.* **1996**, *622*, 138.
419. Blake, A. J.; Gould, R. O.; Li, W.-S.; Lippolis, V.; Parsons, S.; Radek, C.; Schroder, M. *Angew. Chem., Int. Ed. Engl.* **1998**, *37*, 293.
420. Zhu, L.; Kostić, N. M. *Inorg. Chem.* **1992**, *31*, 3994.
421. Zhu, L.; Kostić, N. M. *J. Am. Chem. Soc.* **1993**, *115*, 4566.
422. Zhu, L.; Kostić, N. M. *Inorg. Chim. Acta* **1994**, *217*, 21.
423. Parac, T. N.; Kostić, N. M. *J. Am. Chem. Soc.* **1996**, *118*, 5946.
424. Parac, T. N.; Kostić, N. M. *J. Am. Chem. Soc.* **1996**, *118*, 51.
425. Chen, X.; Zhu, L.; You, X.; Kostić, N. M. *J. Biol. Inorg. Chem.* **1998**, *3*, 1.
426. Karet, G. B.; Kostić, N. M. *Inorg. Chem.* **1998**, *37*, 1021.
427. Parac, T. N.; Kostić, N. M. *Inorg. Chem.* **1998**, *37*, 2141.
428. Zhu, L.; Qin, L.; Parac, T. N.; Kostić, N. M. *J. Am. Chem. Soc.* **1994**, *116*, 5218.
429. Zhu, L.; Bakhtiar, R.; Kostić, N. M. *J. Biol. Inorg. Chem.* **1998**, *3*, 383.
430. Zhu, L.; Kostić, N. M. *Inorg. Chim. Acta* **2002**, *339*, 104.
431. Milović, N. M.; Kostić, N. M. *J. Am. Chem. Soc.* **2002**, *124*, 4759.
432. Chen, X.; Zhu, L.; Yan, H.; You, X.; Kostić, N. M. *J. Chem. Soc., Dalton Trans.* **1996**, 2653.
433. Chen, X. H.; Zhu, L. G.; Kostić, N. M. *Chin. Chem. Lett.* **1996**, *7*, 127.
434. Johnson, T. W.; Kostić, N. M. Steric effect on the rate of hydrolysis by Pd(II) complexes of the C-terminal amide bond in a series of dipeptides Ac-Met-AA, American Chemical Society, Washington, D. C. In *Book of Abstracts*, 212th ACS National Meeting, Orlando, FL, August 25–29, 1996.
435. Kaminskaia, N. V.; Guzei, I. A.; Kostić, N. M. *J. Chem. Soc., Dalton Trans.* **1998**, 3879.
436. Kaminskaia, N. V.; Johnson, T. W.; Kostić, N. M. *J. Am. Chem. Soc.* **1999**, *121*, 8663.
437. Kaminskaia, N. V.; Ullmann, G. M.; Fulton, D. B.; Kostić, N. M. *Inorg. Chem.* **2000**, *39*, 5004.
438. Korneeva, E. N.; Ovchinnikov, M. V.; Kostić, N. M. *Inorg. Chim. Acta* **1996**, *243*, 9.
439. Kostić, N. M. Catalysis of selective cleavage of peptides and proteins with palladium(II) complexes, American Chemical Society, Washington, D. C. In *Book of Abstracts*, 212th ACS National Meeting, Orlando, FL, August 25–29, 1996.
440. Milinković, S. U.; Parac, T. N.; Djuran, M. I.; Kostić, N. M. *J. Chem. Soc., Dalton Trans.* **1997**, 2771.
441. Milović, N. M.; Kostić, N. M. *Inorg. Chem.* **2002**, *41*, 7053.
442. Milović, N. M.; Kostić, N. M. *J. Am. Chem. Soc.* **2003**, *125*, 781.
443. Parac, T. N.; Kostić, N. M. *J. Serb. Chem. Soc.* **1997**, *62*, 847.
444. Parac, T. N.; Ullmann, G. M.; Kostić, N. M. *J. Am. Chem. Soc.* **1999**, *121*, 3127.
445. Zhu, L.; Kostić, N. M. *Organometallics* **1988**, *7*, 665.
446. Burgeson, I. E.; Kostić, N. M. *Inorg. Chem.* **1991**, *30*, 4299.
447. Djuran, M. I.; Milinković, S. U. *Polyhedron* **2000**, *19*, 959.
448. Chen, X.; Luo, X.; Song, Y.; Zhou, S.; Zhu, L. *Polyhedron* **1998**, *17*, 2271.
449. Zhu, L.; Qin, L.; Parac, T. N.; Kostić, N. M. *J. Am. Chem. Soc.* **1994**, *116*, 8.
450. Zhu, L.; Kostić, N. M. *J. Am. Chem. Soc.* **1993**, *115*, 6.
451. Yamauchi, O.; Takani, M.; Toyoda, K.; Masuda, H. *Inorg. Chem.* **1990**, *29*, 1856.
452. Takani, M.; Masuda, H.; Yamauchi, O. *Inorg. Chim. Acta* **1995**, *235*, 367.
453. Robson, R. *Inorg. Chim. Acta* **1982**, *57*, 71.
454. Djuran, M. I.; Milinković, S. U. *Polyhedron* **1999**, *18*, 3611.
455. Matsubara, T.; Hirao, K. *Organometallics* **2001**, *20*, 5056.
456. Kaminskaia, N. V.; Kostić, N. M. *J. Chem. Soc., Dalton Trans.* **1996**, 3677.
457. Kaminskaia, N. V.; Kostić, N. M. *Inorg. Chem.* **1998**, *37*, 4302.
458. Kaminskaia, N. V.; Kostić, N. M. *J. Chem. Soc., Dalton Trans.* **2001**, 1083.
459. Dixon, K. R.; Dixon, A. C. Palladium Complexes with Carbonyl, Isocyanide and Carbene Ligands, In *Comprehensive Organometallic Chemistry II: A review of the literature 1982–1994*; Puddephatt, R. J. Ed., Elsevier, **1995**, Vol. 9, p 193.

460. Vila, J. M.; Gayoso, M.; Pereira, M. T.; Suárez, A.; Fernández, J. J.; Ortigueira, J. M.; Fernández, A.; López-Torres, M. *Trends Organomet. Chem.* **1997**, *2*, 21.
461. Vila, J. M.; Pereira, M. T.; Ortigueira, J. M.; Fernández, J. J.; Fernández, A.; López-Torres, M.; Adams, H. *Organometallics* **1999**, *18*, 5484.
462. Lopez-Torres, M.; Fernandez, A.; Fernandez, J. J.; Suarez, A.; Pereira, M. T.; Ortigueira, J. M.; Vila, J. M.; Adams, H. *Inorg. Chem.* **2001**, *40*, 4583.
463. Wiedhardt, K.; Küppers, H. J.; Raabe, E.; Krüger, C. *Angew. Chem., Int. Ed. Engl.* **1986**, *25*, 1101.
464. Byers, P. K.; Cauty, A. J.; Skelton, B. W.; Traill, P. R.; Watson, A. A.; White, A. H. *Organometallics* **1992**, *11*, 3085.
465. Wilkins, R. G. Substitution Reactions. In *Kinetics and Mechanism of Reactions of Transition Metals*, 2nd ed.; VCH: Weinheim, Germany, 1991; Chapter 4.
466. Vila, J. M.; Pereira, M. T.; Ortigueira, J. M.; López-Torres, M.; Castiñeiras, A.; Lata, D.; Fernández, J. J.; Fernández, A. *J. Organomet. Chem.* **1998**, *556*, 31.
467. Vila, J. M.; Gayoso, M.; López-Torres, M.; Fernández, J. J.; Fernández, A.; Ortigueira, J. M.; Bailey, N. A.; H., A. *J. Organomet. Chem.* **1996**, *511*, 129.
468. Vila, J. M.; Gayoso, M.; Pereira, M. T.; Ortigueira, J. M.; López-Torres, M.; Castiñeiras, A.; Suárez, A.; Fernández, J. J.; Fernández, A. *J. Organomet. Chem.* **1997**, *547*, 297.
469. Levason, W., Phosphine complexes of transition metals in Chem. Organophosphorous Compd. Hartley, F. R., Eds. Wiley: Chichester, **1990**, p 567.
470. Mayer, H. A.; Kaska, W. C. *Chem. Rev.* **1994**, *94*, 1239.
471. Cotton, F. A.; Hong, B. *Prog. Inorg. Chem.* **1992**, *40*, 179.
472. Fanizzi, F. P.; Natile, G.; Lanfranchi, M.; Tiripicchio, A.; Laschi, F.; Zanello, P. *Inorg. Chem.* **1996**, *35*, 3173.
473. Albano, V. G.; Castellari, C.; De Felice, V.; Panunzi, A.; Ruffo, F. *Organometallics* **1996**, *15*, 4012.
474. Fanizzi, F. P.; Intini, F. P.; Maresca, L.; Natile, G.; Lanfranchi, M.; Tiripicchio, A.; Pacchioni, G. *J. Chem. Soc., Chem. Commun.* **1992**, 333.
475. Plowman, R. A.; Power, L. F. *J. Aust. Chem.* **1971**, *24*, 303.
476. Plowman, R. A.; Power, L. F. *J. Aust. Chem.* **1971**, *24*, 309.
477. Gillard, R. D.; Kane-Maguire, L. A. P.; Williams, P. A. *Transition Met. Chem.* **1977**, *2*, 55.
478. Fanizzi, F. P.; Intini, F. P.; Maresca, L.; Natile, G.; Lanfranchi, M.; Tiripicchio, A. *J. Chem. Soc., Dalton Trans.* **1991**, 1007.
479. Albano, V. G.; Castellari, C.; Cucciolito, M. E.; Panunzi, A.; Vitagliano, G. *Organometallics* **1990**, *9*, 1269.
480. De Renzi, A.; Morelli, G.; Panunzi, A.; Vitagliano, A. *Gazz. Chim. Ital.* **1987**, *117*, 445.
481. Cucciolito, M. E.; Panunzi, A.; Ruffo, F.; De Felice, V. *Gazz. Chim. Ital.* **1989**, *119*, 461.
482. De Felice, V.; Albano, V. G.; Castellari, C.; Cucciolito, M. E.; Panunzi, A.; De Renzi, G. *J. Organomet. Chem.* **1993**, *403*, 269.
483. Garrone, R.; Romano, A. M.; Santi, R.; Millini, R. *Organometallics* **1998**, *17*, 4519.
484. Astruc, D.; Chardac, F. *Chem. Rev.* **2001**, *101*, 2991.
485. Twyman, L. J.; King, A. S. H.; Martin, I. K. *Chem. Soc. Rev.* **2002**, *31*, 69.
486. Oosterom, G. E.; Reek, J. N. H.; Kamer, P. C. J.; van Leeuwen, P. *Angew. Chem., Int. Ed.* **2001**, *40*, 1828.
487. Slawin, A. M. Z.; Smith, M. B.; Woollins, J. D. *Polyhedron* **1998**, *17*, 4465.
488. Hetch, S.; Fréchet, J. M. J. *Angew. Chem., Int. Ed.* **2001**, *40*, 74.
489. Chessa, G.; Scrivanti, A.; Canovese, L.; Visentin, F.; Uguagliati, P. *Chem. Commun.* **1999**, 959.
490. Canovese, L.; Chessa, G.; Santo, C.; Visentin, F.; Uguagliati, P. *Organometallics* **2002**, *21*, 4342.
491. Rodriguez, G.; Lutz, M.; Spek, A. L.; Van Koten, G. *Chem. Eur. J.* **2002**, *8*, 45.
492. Canovese, L.; Chessa, G.; Marangoni, G.; Pitteri, B.; Visentin, F.; Uguagliati, P. *Inorg. Chim. Acta* **1991**, *186*, 79.
493. Balzani, V.; Campagna, S.; Denti, G.; Juris, A.; Serroni, S.; Venturi, M. *Acc. Chem. Res.* **1998**, *31*, 26.
494. Frey, H.; Lach, C.; Lorenz, K. *Adv. Mater.* **1998**, *10*, 279.
495. Gorman, C. *Adv. Mater.* **1998**, *10*, 295.
496. Serroni, S.; Denti, G.; Campagna, S.; Juris, A.; Ciano, M.; Balzani, V. *Angew. Chem., Int. Ed. Engl.* **1992**, *31*, 1493.
497. Campagna, S.; Denti, G.; Serroni, S.; Juris, A.; Venturi, M.; Ricevuto, V.; Balzani, V. *Chem. Eur. J.* **1995**, *1*, 211.
498. Serroni, S.; Juris, A.; Venturi, M.; Campagna, S.; Resino, I. R.; Denti, G.; Credi, A.; Balzani, V. *Mater. Chem.* **1997**, *7*, 1227.
499. Achar, S.; Puddephatt, R. J. *Angew. Chem., Int. Ed. Engl.* **1994**, *33*, 847.
500. Constable, E. C. *Chem. Commun.* **1997**, 1073.
501. Constable, E. C.; Harverson, P.; Oberholzer, M. *Chem. Commun.* **1996**, 1821.
502. Newkome, G. R.; He, E. J. *Mater. Chem.* **1997**, *7*, 1237.
503. Newkome, G. R.; Gross, J.; Moorefield, C. N.; Woosley, B. D. *Chem. Commun.* **1997**, 515.
504. Achar, S.; Immoos, C. E.; Hill, M. G.; Catalano, V. J. *Inorg. Chem.* **1997**, *36*, 2314.
505. Ohshiro, N.; Kiyotake, F.; Onitsuka, K.; Takahashi, S. *Chem. Lett.* **1996**, 871.
506. Miedaner, A.; Curtis, C. J.; Barkley, R. M.; DuBois, D. L. *Inorg. Chem.* **1994**, *33*, 5482.
507. Huck, W. T. S.; Prins, L. J.; Fokkens, R. H.; Nibbering, N. M. M.; van Veggel, F. C. J. M.; Reinhoudt, D. N. *J. Am. Chem. Soc.* **1998**, *120*, 6240.
508. Huck, W. T. S.; Hulst, R.; Timmerman, P.; van Veggel, F. C. J. M.; Reinhoudt, D. N. *Angew. Chem., Int. Ed. Engl.* **1997**, *36*, 1006.
509. de Groot, D.; de Wilde, J. C.; van Haaren, R. J.; Reek, J. N. H.; Kamer, P. C. J.; van Leeuwen, P. W. N. M.; Eggeling, E. B.; Vogt, D.; Kooijman, H.; Spek, A. L.; van der Made, A. W. *Chem. Commun.* **1999**, 1623.
510. Slone, R. V.; Benkstein, K. D.; Bélanger, S.; Hupp, J. T.; Guzei, Rheingold, A. L. *Coord. Chem. Rev.* **1998**, *171*, 221.
511. Leininger, S.; Olenyuk, B.; Stang, P. J. *Chem. Rev.* **2000**, *100*, 853.
512. Swiegers, G. F.; Malefetse, T. J. *Chem. Rev.* **2000**, *100*, 3483.
513. Chand, D. K.; Biradha, K.; Fujita, M. *Chem. Commun.* **2001**, 1652.
514. Moriuchi, T.; Kamikawa, M.; Bandoh, S.; Hirao, T. *Chem. Commun.* **2002**, 1476.
515. Rettig, S. J.; Sanchez, V.; Storr, A.; Thompson, R. C.; Trotter, J. J. *Chem. Soc., Dalton Trans.* **2000**, 3931.
516. Masciocchi, N.; Ardizzoia, G. A.; LaMonica, G.; Maspero, A.; Galli, S.; Sironi, A. *Inorg. Chem.* **2001**, *40*, 6983.
517. Sun, D.; Tham, F. S.; Reed, C. A.; Chaker, L.; Burgess, M.; Boyd, P. D. W. *J. Am. Chem. Soc.* **2000**, *122*, 10704.

518. Ogawa, T.; Nishimoto, Y.; Yoshida, N.; Ono, N.; Osuka, A. *Angew. Chem., Int. Ed.* **1999**, *38*, 176.
519. Tsuda, A.; Nakano, A.; Furuta, H.; Yamochi, H.; Osuka, A. *Angew. Chem., Int. Ed.* **2000**, *39*, 558.
520. Kuang, S.-M.; Fanwick, P. E.; Walton, R. A. *Inorg. Chem.* **2002**, *41*, 1036.
521. Yu, S.-Y.; Fujita, M.; Yamaguchi, K. *J. Chem. Soc., Dalton Trans.* **2001**, 3415.
522. Chen, C.-T.; Suslick, K. S. *Coord. Chem. Rev.* **1993**, *128*, 293.
523. Janiak, C. *J. Chem. Soc., Dalton Trans.* **2000**, 3885.
524. Matsumoto, K.; Sakai, K. *Adv. Inorg. Chem.* **2000**, *49*, 375.
525. Hartley, F. R. *The Chemistry of Platinum and Palladium* **1973**, Applied Science Publishers: London.
526. Micklitz, W.; Sheldrick, W. S.; Lippert, B. *Inorg. Chem.* **1990**, *29*, 211.
527. Oskui, B.; Sheldrick, W. S. *Eur. J. Inorg. Chem.* **1999**, 1325.
528. Yang, L.-W.; Liu, S.; Rettig, S. J.; Orvig, C. *Inorg. Chem.* **1995**, *34*, 4921.
529. Cotton, F. A.; Walton, R. A. *Multiple Bonds between Metal Atoms*; Oxford University Press: Oxford, UK, 1993.
530. Buchweitz, J.; Gompper, R.; Polborn, K.; Robl, C.; Sailer, M.-T.; Weigand, W. *Chem. Ber.* **1996**, *127*, 23.
531. Vicente, J.; Chicote, M. T.; Huertas, S.; Jones, P. G.; Fischer, A. K. *Inorg. Chem.* **2001**, *40*, 6193.
532. Clot, O.; Wolf, M. O.; Patrick, B. O. *J. Am. Chem. Soc.* **2000**, *122*, 10456.
533. Clot, O.; Wolf, M. O.; Patrick, B. O. *J. Am. Chem. Soc.* **2001**, *124*, 9963.
534. Mock, C.; Puscasu, I.; Rauterkus, M. J.; Tallen, G.; Wolff, J. E. A.; Krebs, B. *Inorg. Chim. Acta* **2001**, *319*, 109.
535. Maiboroda, A.; Rheinwald, G.; Lang, H. *Inorg. Chem. Commun.* **2001**, *4*, 381.
536. Baena, M. J.; Buey, J.; Espinet, P.; Kitzerow, H. S.; Heppke, G. *Angew. Chem.* **1993**, *105*, 1238.
537. Baena, M. J.; Barbera, J.; Espinet, P.; Ezcurra, A.; Ros, M. B.; Serrano, J. L. *J. Am. Chem. Soc.* **1994**, *116*, 1899.
538. Ros, M. B.; Ruiz, N.; Serrano, J. L. *Liq. Cryst.* **1991**, *9*, 77.
539. Marcos, M.; Ros, M. B.; Serrano, J. L. *Liq. Cryst.* **1988**, *8*, 1129.
540. Buey, J.; Espinet, P. G.; Diez, A.; García-Granda, S.; Pérez-Carreño, E. *Eur. J. Inorg. Chem.* **1998**, 1235.
541. Baena, M. J.; Espinet, P.; Ros, M. B.; Serrano, J. L.; Ezcurra, A. *Angew. Chem.* **1993**, *105*, 1260.
542. Diez, L.; Espinet, P.; Miguel, J. A. *J. Chem. Soc., Dalton Trans.* **2001**, 1189.
543. Driver, M. S.; Hartwig, J. F. *J. Am. Chem. Soc.* **1996**, *118*, 4206.
544. Driver, M. S.; Hartwig, J. F. *Organometallics* **1997**, *16*, 5706.
545. Driver, M. S.; Hartwig, J. F. *J. Am. Chem. Soc.* **1995**, *117*, 4708.
546. Driver, M. S.; Hartwig, J. F. *J. Am. Chem. Soc.* **1997**, *119*, 8232.
547. Alonso, E.; Fornies, J.; Fortuño, C.; Tomás, M. *J. Chem. Soc., Dalton Trans.* **1995**, 3777.
548. Okeya, S.; Yoshimatsu, H.; Nakamura, Y.; Kawaguchi, S. *Bull. Chem. Soc. Jpn.* **1982**, *55*, 483.
549. Lee, S. W.; Trogler, W. C. *Inorg. Chem.* **1990**, *29*, 1099.
550. Ruiz, J.; Martínez, M. T.; Vicente, C.; García, G.; López, G.; Chaloner, P. A.; Hitchcock, P. B. *Organometallics* **1993**, *12*, 4321.
551. Ruiz, J.; Cutillas, N.; Torregrosa, J.; García, G.; López, G.; Chaloner, P. A.; Hitchcock, P. B.; Harrinson, R. M. *J. Chem. Soc., Dalton Trans.* **1994**, 2353.
552. Villanueva, L. A.; Abboud, K. A.; Boncella, J. M. *Organometallics* **1994**, *13*, 3291.
553. Cuevas, J. V.; García-Herboza, G.; Muñoz, A.; García-Granda, S.; Miguel, D. *Organometallics* **1997**, *16*, 2220.
554. Ragaini, F.; Cenini, S.; Demartin, F. *J. Chem. Soc., Dalton Trans.* **1997**, 2855.
555. Rüttimann, S.; Bernardinelli, G.; Williams, A. F. *Angew. Chem., Int. Ed. Engl.* **1993**, *32*, 392.
556. Carina, R. F.; Williams, A. F.; Bernardinelli, G. *Inorg. Chem.* **2001**, *40*, 1826.
557. Mann, G.; Hartwig, J. F.; Driver, M. S.; Fernández-Rivas, C. *J. Am. Chem. Soc.* **1998**, *120*, 827.
558. Ruiz, J.; Rodríguez, V.; Cutillas, N.; Florenciano, F.; Perez, J.; Lopez, G. *Inorg. Chem. Commun.* **2001**, *4*, 23.
559. Balch, A. L.; Davis, B. J.; Olmstead, M. M. *Inorg. Chem.* **1993**, *32*, 3937.
560. Balch, A. L.; Davis, B. J.; Olmstead, M. M. *J. Am. Chem. Soc.* **1990**, *112*, 8592.
561. Sauthier, M.; Le Guennic, B.; Deborde, V.; Toupet, L.; Halet, J.-F.; Reau, R. *Angew. Chem., Int. Ed.* **2001**, *40*, 228.
562. Marahashi, T.; Otani, T.; Mochizuki, E.; Kai, Y.; Kurosawa, H. *J. Am. Chem. Soc.* **1998**, *120*, 4536.
563. Balch, A. L. *Comments Inorg. Chem.* **1984**, *3*, 51.
564. Muller, I. M.; Robson, R. *Angew. Chem., Int. Ed.* **2000**, *39*, 4357.
565. Okamoto, K.; Sasaki, C.; Yamada, Y.; Konno, T. *Bull. Chem. Soc. Jpn.* **1999**, *72*, 1685.
566. Konno, T.; Chikamoto, Y.; Okamoto, K.-I.; Yamaguchi, T.; Ito, T.; Hirotsu, M. *Angew. Chem., Int. Ed. Engl.* **2000**, *39*, 4098.
567. Estevan, F.; Garcia-Bernabe, A.; Lahuerta, P.; Sanau, M.; Ubeda, M. A.; Ramirez de Arellano, M. C. *Inorg. Chem.* **2000**, *39*, 5964.
568. Aarif, A. M.; Estevan, F.; Garcia-Bernabé, A.; Lahuerta, P.; Sanaú, M.; Ubeda, M. A. *Inorg. Chem.* **1997**, *36*, 6472.
569. Wu, Q.; Hook, A.; Wang, S. *Angew. Chem., Int. Ed.* **2000**, *39*, 3933.
570. Pyykkö, P. *Chem. Rev.* **1997**, *97*, 597.
571. Pyykkö, P.; Li, J. *Inorg. Chem.* **1993**, *32*, 2630.
572. Pyykkö, P.; Li, J. *Chem. Phys. Lett.* **1992**, *197*, 586.
573. Pyykkö, P.; Zhao, Y.-F. *Angew. Chem., Int. Ed. Engl.* **1991**, *30*, 604.
574. Chiffey, A. F.; Evans, J.; Levason, W.; Webster, M. *Polyhedron* **1996**, *15*, 591.
575. Crespo, O.; Laguna, A.; Fernandez, E. J.; Lopez-de-Luzuriaga, J. M.; Jones, P. G.; Teichert, M.; Monge, M.; Pyykkö, P.; Runeberg, N.; Schuetz, M.; Werner, H.-J. *Inorg. Chem.* **2000**, *39*, 4786.
576. Schnebeck, R.-D.; Freisinger, E.; Lippert, B. *Chem. Commun.* **1999**, 675.
577. Schnebeck, R.-D.; Freisinger, E.; Glahe, F.; Lippert, B. *J. Am. Chem. Soc.* **2000**, *122*, 1381.
578. Schnebeck, R.-D.; Freisinger, E.; Lippert, B. *Eur. J. Inorg. Chem.* **2000**, 1193.
579. Balch, A. L. Binuclear, phosphine-bridged complexes: progress and prospects. Pignoler, L. H. Ed.; Homogenous Catal. Met. Phosphine Complex. **1983**, *167*, Plenum: New York, 1983.
580. Puddephatt, R. *J. Chem. Soc. Rev.* **1983**, *12*, 99.
581. Chaudret, B.; Delavaux, B.; Poilblanc, R. *Coord. Chem. Rev.* **1988**, *86*, 191.
582. Balch, A. L.; Benner, L. S.; Olmstead, M. M. *Inorg. Chem.* **1979**, *18*, 2996.
583. Russel, M. J. H.; Barnard, C. F. J., Eds.; Pergamon: Oxford, UK, 1987; Vol. 5.
584. Hunt, C. T.; Balch, A. L. *Inorg. Chem.* **1981**, *20*, 2267.

585. Balch, A. L.; Hunt, C. T.; Lee, C.-L.; Olmstead, M. M.; Farr, J. P. *J. Am. Chem. Soc.* **1981**, *103*, 3764.
586. Okeya, S.; Kameda, H.; Kawashima, H.; Shimomura, H.; Nishioka, T.; Isobe, K. *Chem. Lett.* **1995**, 501.
587. Ebner, M.; Otto, H.; Werner, H. *Angew. Chem., Int. Ed. Engl.* **1985**, *24*, 518.
588. Reger, D. L.; Collins, J. E. *Inorg. Chem.* **1995**, *34*, 2473.
589. Kaiwar, S. P.; Hsu, J. K.; Liable-Sands, L. M.; Rheingold, A. L.; Pilato, R. S. *Inorg. Chem.* **1997**, *36*, 4234.
590. Capdevila, M.; Clegg, W.; Gonzalez-Duarte, P.; Harris, B.; Mira, L.; Sola, J.; Taylor, I. C. *J. Chem. Soc., Chem. Commun.* **1992**, 2817.
591. Cao, R.; Su, W.; Hong, M.; Zhang, W.; Lu, J.; Wong, W.-T. *Chem. Commun.* **1998**, 2083.
592. Su, W.; Cao, R.; Hong, M.; Wu, D.; Lu, J. *Dalton* **2000**, 1527.
593. Wong, W.-K.; Zhang, L.-L.; Chen, Y.; Wong, W.-Y.; Wong, W.-T.; Xue, F.; Mak, T. C. W. *Dalton* **2000**, 1397.
594. Sen, A. *Adv. Polym. Sci.* **1986**, *73/74*, 125.
595. Drent, E.; van Broekhoven, J. A. M.; Doyle, M. J. *J. Organomet. Chem.* **1991**, *417*, 235.
596. Rix, F. C.; Brookhart, M.; White, P. S. *J. Am. Chem. Soc.* **1996**, *118*, 4746.
597. Drent, E. U. S. Catalytic process for preparing polymers of sulfur dioxide and olefins. Patent 4,808,697, 19890228.
598. Wojcinski, L. M.; Boyer, M. T.; Sen, A. *Inorg. Chim. Acta* **1998**, *270*, 8.
599. Gates, D. P.; White, P. S.; Brookhart, M. *Chem. Commun.* **2000**, 47.
600. Brookhart, M.; Grant, B.; Volpe, A. F. *Organometallics* **1992**, *11*, 3920.
601. Werner, A.; Michels, M.; Zander, L.; Lex, J.; Vogel, E. *Angew. Chem., Int. Ed.* **1999**, *38*, 3650.
602. Aullón, G.; Ujaque, G.; Lledós, A.; Alvarez, S.; Alemany, P. *Inorg. Chem.* **1998**, *37*, 804.
603. Mizuta, T.; Aoki, S.; Nakayama, K.; Miyoshi, K. *Inorg. Chem.* **1999**, *38*, 4361.
604. Matsumoto, K.; Saiga, N.; Tanaka, S.; Ooi, S. *J. Chem. Soc., Dalton Trans.* **1991**, 1265.
605. Matsumoto, K.; Ikuzawa, M.; Kamikubo, M.; Ooi, S. *Inorg. Chim. Acta* **1994**, *217*, 129.
606. Matsumoto, K.; Takahashi, K.; Ikuzawa, M.; Kimoto, H.; Okeya, S. *Inorg. Chim. Acta* **1998**, *281*, 174.
607. Matsumoto, K.; Takahashi, K.; Hada, S.; Nakao, Y. *Polyhedron* **1999**, *18*, 1811.
608. Smith, D. C., Jr.; Gray, G. M. *Inorg. Chem.* **1998**, *37*, 1791.
609. Smith, D. C., Jr.; Lake, C. H.; Gray, G. M. *Chem. Commun.* **1998**, 2771.
610. Murata, T.; Mizobe, Y.; Gao, H.; Ishii, Y.; Wakabayashi, T.; Nakano, F.; Tanase, T.; Yano, S.; Hidai, M.; Echizen, I.; Nanikawa, H.; Motomura, S. *J. Am. Chem. Soc.* **1994**, *116*, 3389.
611. Wakabayashi, T.; Ishii, Y.; Murata, T.; Mizobe, Y.; Hidai, M. *Tetrahedron Lett.* **1995**, *36*, 5585.
612. Wakabayashi, T.; Ishii, Y.; Ishikawa, K.; Hidai, M. *Angew. Chem., Int. Ed. Engl.* **1996**, *35*, 2123.
613. Hashizume, K.; Mizobe, Y.; Hidai, M. *Organometallics* **1996**, *15*, 3303.
614. Tang, Z.; Nomura, Y.; Ishii, Y.; Mizobe, Y.; Hidai, M. *Organometallics* **1997**, *16*, 151.
615. Ikada, T.; Kuwata, S.; Mizobe, Y.; Hidai, M. *Inorg. Chem.* **1998**, *37*, 5793.
616. Zahavy, E.; Fox, M. A. *Chem.-Eur. J.* **1998**, *4*, 1647.
617. Besenyi, G.; Párkányi, L.; Simándi, L. I.; James, B. R. *Inorg. Chem.* **1995**, *34*, 6118.
618. Besenyi, G.; Lee, C. L.; Gulinski, J.; Retting, S. J.; James, B. R.; Nelson, D. A.; Lilga, M. A. *Inorg. Chem.* **1987**, *26*, 3622.
619. Su, W. P.; Cao, R.; Hong, M. C.; Zhou, Z. Y.; Xue, F.; Liu, H. Q.; Mak, T. C. W. *Polyhedron* **1997**, *16*, 2531.
620. Su, W. P.; Hong, M. C.; Zhou, Z. Y.; Xue, F.; Liu, H. Q.; Mak, T. C. W. *Acta Crystallogr., Sect. C* **1996**, *52*, 2691.
621. Su, W. P.; Hong, M. C.; Cao, R.; Liu, H. Q. *Acta Crystallogr., Sect. C* **1997**, *53*, 66.
622. Lindoy, L. F.; Lip, H. C.; Louie, H. W.; Drew, M. G. B.; Hudson, M. J. *J. Chem. Soc., Chem. Commun.* **1977**, 778.
623. Burns, C. J.; Andersen, R. A. *J. Am. Chem. Soc.* **1987**, *109*, 915.
624. Schwartz, D. J.; Ball, G. E.; Andersen, R. A. *J. Am. Chem. Soc.* **1995**, *117*, 6027.
625. Spannenberg, A.; Oberthur, M.; Noss, H.; Tillack, A.; Arndt, P.; Kempe, R. *Angew. Chem., Int. Ed. Engl.* **1998**, *37*, 2079.
626. Stang, P. J. *Chem. Eur. J.* **1998**, *4*, 19.
627. Stang, P. J.; Olenyuk, B. *Acc. Chem. Res.* **1997**, *30*, 502.
628. Olenyuk, B.; Whiteford, J. A.; Fechtenkotter, A.; Stang, P. J. *Nature* **1999**, *398*, 796.
629. Fujita, N.; Biradha, K.; Fujita, M.; Sakamoto, S.; Yamaguchi, K. *Angew. Chem., Int. Ed. Engl.* **2001**, *40*, 1718.
630. Takeda, N.; Umemoto, K.; Yamaguchi, K.; Fujita, M. *Nature* **1999**, *398*, 794.
631. Navarro, J. A. R.; Lippert, B. *Coord. Chem. Rev.* **1999**, *185-186*, 653.
632. Navarro, J. A. R.; Freisinger, E.; Lippert, B. *Inorg. Chem.* **2000**, *39*, 2301.
633. Holliday, B. J.; Mirkin, C. A. *Angew. Chem., Int. Ed.* **2001**, *40*, 2022.
634. Eisenberg, A. H.; Dixon, F. M.; Mirkin, C. A.; Stern, C. L.; Incarvito, C. D.; Rheingold, A. L. *Organometallics* **2001**, *20*, 2052.
635. Qin, Z.; Jennings, M. C.; Puddephatt, R. J. *Inorg. Chem.* **2002**, *41*, 3967.
636. McMorrán, D. A.; Steel, J. *Angew. Chem., Int. Ed.* **1998**, *37*, 3295.
637. Park, S. J.; Hong, J.-I. *Chem. Commun.* **2001**, 1554.
638. Cheng, S.-T.; Doxiadi, E.; Vilar, R.; White, A. J. P.; Williams, D. J. *J. Chem. Soc., Dalton Trans.* **2001**, 2239.
639. Hall, J. R.; Loeb, S. J.; Shimizu, G. K. H.; Yap, G. P. A. *Angew. Chem., Int. Ed.* **1998**, *37*, 121.
640. Thompson, A.; Rettig, S. J.; Dolphin, D. *Chem. Commun.* **1999**, 631.
641. Haberer, T.; Warchhold, M.; Nöth, H.; Severin, K. *Angew. Chem., Int. Ed.* **1999**, *38*, 3225.
642. Lai, S.-W.; Chan, M. C.-W.; Peng, S.-M.; Che, C.-M. *Angew. Chem., Int. Ed.* **1999**, *38*, 669.
643. Schnebeck, R.-D.; Randaccio, L.; Zangrando, E.; Lippert, B. *Angew. Chem., Int. Ed. Engl.* **1998**, *37*, 119.
644. Barbera, J.; Elduque, A.; Gimenez, R.; Oro, L. A.; Serrano, J. L. *Angew. Chem., Int. Ed.* **1996**, *35*, 2832.
645. Fujita, M.; Ogura, K. *Coord. Chem. Rev.* **1996**, *148*, 249.
646. Lee, S. B.; Hwang, S.; Chung, D. S.; Yun, H.; Hong, J.-I. *Tetrahedron Lett.* **1998**, *39*, 873.
647. Sun, S.-S.; Lees, A. J. *Inorg. Chem.* **1999**, *38*, 4181.
648. McQuillan, F. S.; Berridge, T. E.; Chen, H.; Hamor, T. A.; Jones, C. J. *Inorg. Chem.* **1998**, *37*, 4959.
649. Stang, P. J.; Cao, D. H. *J. Am. Chem. Soc.* **1994**, *116*, 4981.
650. Stang, P. J.; Cao, D. H.; Saito, S.; Arif, A. M. *J. Am. Chem. Soc.* **1995**, *117*, 6273.
651. Sautter, A.; Schmid, D. G.; Jung, G.; Wuerthner, F. *J. Am. Chem. Soc.* **2001**, *123*, 5424.
652. Fujita, M.; Yazaki, J.; Ogura, K. *J. Am. Chem. Soc.* **1990**, *112*, 5645.

653. Sun, S.-S.; Lees, A. J. *Inorg. Chem.* **2001**, *40*, 3154.
654. Ikeda, A.; Yoshimura, M.; Tani, F.; Naruta, Y.; Shinkai, S. *Chem. Lett.* **1998**, 587.
655. Ikeda, A.; Yoshimura, M.; Udzu, H.; Fukuhara, C.; Shinkai, S. *J. Am. Chem. Soc.* **1999**, *121*, 4296.
656. Ikeda, A.; Udzu, H.; Yoshimura, M.; Shinkai, S. *Tetrahedron* **2000**, *56*, 1825.
657. Rivera, J. M.; Martin, T.; Rebek, J., Jr. *Science* **1998**, *279*, 1021.
658. Hiraoka, S.; Fujita, M. *J. Am. Chem. Soc.* **1999**, *121*, 10239.
659. Castellano, R. K.; Nuckolls, C.; Rebek, J., Jr. *J. Am. Chem. Soc.* **1999**, *121*, 11156.
660. Rivera, J. M.; Craig, S. L.; Martin, T.; Rebek, J., Jr. *Angew. Chem., Int. Ed.* **2000**, *39*, 2130.
661. Ikeda, A.; Udzu, H.; Zhong, Z.; Shinkai, S.; Sakamoto, S.; Yamaguchi, K. *J. Am. Chem. Soc.* **2001**, *123*, 3872.
662. Fujita, M. *Acc. Chem. Res.* **1999**, *32*, 53.
663. Fujita, M. *Chem. Soc. Rev.* **1998**, *27*, 417.
664. Fujita, M.; Nagao, S.; Ogura, K. *J. Am. Chem. Soc.* **1995**, *117*, 1649.
665. Fujita, M.; Fujita, N.; Ogura, K.; Yamaguchi, K. *Nature* **1999**, *400*, 52.
666. Connick, W. B.; Henling, L. M.; Marsh, R. E.; Gray, H. B. *Inorg. Chem.* **1996**, *35*, 6261.
667. Connick, W. B.; Marsh, R. E.; Schaefer, W. P.; Gray, H. B. *Inorg. Chem.* **1997**, *36*, 913.
668. Rice, S. F.; Miskowski, V. M.; Gray, H. B. *Inorg. Chem.* **1988**, *27*, 4704.
669. Hegmans, A.; Zangrando, E.; Freisinger, E.; Pichierri, F.; Randaccio, L.; Mealli, C.; Gerdan, M.; Trautwien, A. X.; Lippert, B. *Chem. Eur. J.* **1999**, *5*, 3010.
670. Sommer, R. D.; Rheingold, A. L.; Goshe, A. J.; Bosnich, B. *J. Am. Chem. Soc.* **2001**, *123*, 3940.
671. Biradha, K.; Fujita, M. *Adv. Supramolecular Chem.* **2000**, *6*, 1.
672. Rauter, H.; Mutikainen, I.; Blomberg, M.; Lock, C. J. L.; OmarOchoa, P.; Freisinger, E.; Randaccio, L.; Chiarparin, E.; Lippert, B. *Angew. Chem., Int. Ed. Engl.* **1997**, *36*, 1269.
673. Hanan, G. S.; Volkmer, D.; Schubert, U. S.; Lehn, J.-M.; Baum, G.; Fenske, D. *Angew. Chem., Int. Ed. Engl.* **1997**, *36*, 1843.
674. Duan, C.-Y.; Liu, Z.-H.; You, X.-Z.; Xue, F.; Mak, T. C. W. *Chem. Commun.* **1997**, 381.
675. Cotton, F. A.; Daniels, L. M.; Lin, C.; Murillo, C. A. *J. Am. Chem. Soc.* **1999**, *121*, 4538.
676. Bu, X.-H.; Morishita, H.; Tanaka, K.; Biradha, K.; Furusho, S.; Shionoya, M. *Chem. Commun.* **2000**, 971.
677. Sakamoto, S.; Fujita, M.; Kim, K.; Yamaguchi, K. *Tetrahedron* **2000**, *56*, 955.
678. Yamanoi, Y.; Sakamoto, Y.; Kusukawa, T.; Fujita, M.; Sakamoto, S.; Yamaguchi, K. *J. Am. Chem. Soc.* **2001**, *123*, 980.
679. Bolger, J.; Gourdon, A.; Ishow, E.; Launay, J.-P. *J. Chem. Soc., Chem. Commun.* **1995**, 1799.
680. Ali, M. M.; MacDonnell, F. M. *J. Am. Chem. Soc.* **2000**, *122*, 11527.
681. Olmstead, M. M.; Ginwalla, A. S.; Noll, B. C.; Tinti, D. S.; Balch, A. L. *J. Am. Chem. Soc.* **1996**, *118*, 7737.
682. Olmstead, M. M.; Wei, P.-P.; Balch, A. L. *Chem. Eur. J.* **1999**, *5*, 3136.
683. Olmstead, M. M.; Wei, P.-P.; Ginwalla, A. S.; Balch, A. L. *Inorg. Chem.* **2000**, *39*, 4555.
684. Hiraoka, S.; Kubota, Y.; Fujita, M. *Chem. Commun.* **2000**, 1509.
685. Scherer, M.; Caulder, D. L.; Johnson, D. J.; Raymond, K. N. *Angew. Chem., Int. Ed.* **1999**, *38*, 1588.
686. Hasenknopf, B.; Lehn, J.-M.; Boumediene, N.; Dupont-Gervais, A.; Dorsserler, A. V.; Kneisel, B.; Fenske, D. *J. Am. Chem. Soc.* **1997**, *119*, 10956.
687. Hasenknopf, B.; Lehn, J.-M.; Baum, G.; Fenske, D. *Proc. Natl. Acad. Sci. U.S.A.* **1996**, *93*, 1397.
688. Hasenknopf, B.; Lehn, J.-M.; Baum, G.; Kneisel, B. O.; Fenske, D. *Angew. Chem., Int. Ed. Engl.* **1996**, *35*, 1838.
689. Rowan, S. J.; Sanders, J. K. M. *J. Chem. Soc., Perkin Trans. 1* **1997**, 1407.
690. Calama, M. C.; Timmerman, P.; Reinhoudt, D. N. *Angew. Chem., Int. Ed.* **2000**, *39*, 755.
691. Rivera, J. M.; Martin, T.; Rebek, J., Jr. *J. Am. Chem. Soc.* **1998**, *120*, 819.
692. Hof, F.; Nuckolls, C.; Rebek, J., Jr. *J. Am. Chem. Soc.* **2000**, *122*, 4251.
693. Umamoto, K.; Yamaguchi, K.; Fujita, M. *J. Am. Chem. Soc.* **2000**, *122*, 7150.
694. Rauter, H.; Hillgeris, E. C.; Erxleben, A.; Lippert, B. *J. Am. Chem. Soc.* **1994**, *116*, 616.
695. Lüth, M. S.; Freisinger, E.; Glahé, F.; Lippert, B. *Inorg. Chem.* **1998**, *37*, 5044.
696. Stemmler, A. J.; Kampf, J. W.; Kirk, M. L.; Atasi, B. H.; Pecoraro, V. L. *Inorg. Chem.* **1999**, *38*, 2807.
697. Johnson, D. W.; Xu, J.; Saalfrank, R. W.; Raymond, K. N. *Angew. Chem., Int. Ed.* **1999**, *38*, 3058.
698. Navarro, J. A. R.; Salas, J. M. *Chem. Commun.* **2000**, 235.
699. Olenyuk, B.; Fechtenkötter, A.; Stang, P. J. *J. Chem. Soc., Dalton Trans.* **1998**, 1707.
700. Caulder, D. L.; Raymond, K. N. *J. Chem. Soc., Dalton Trans.* **1999**, 1185.
701. Fujita, M. *Acc. Chem. Res.* **1998**, *32*, 53.
702. Baxter, P. N. W.; Lehn, J.-M.; Baum, G.; Fenske, D. *Chem. Eur. J.* **1999**, *5*, 102.
703. Ruttimann, S.; Bernadelli, G.; Williams, A. F. *Angew. Chem., Int. Ed. Engl.* **1993**, *32*, 392.
704. Ercolani, G. *J. Phys. Chem. B* **1998**, *102*, 5699.
705. Jeong, K.-S.; Cho, Y. L.; Song, J. U.; Chang, H.-Y.; Choi, M.-G. *J. Am. Chem. Soc.* **1998**, *120*, 10982.
706. Constable, E. C.; Schofield, E. *J. Chem. Soc., Chem. Commun.* **1998**, 403.
707. Duhme, A.-K.; Davies, S. C.; Hughes, D. L. *Inorg. Chem.* **1998**, *37*, 5380.
708. Woessner, S. M.; Helms, J. B.; Shen, Y.; Sullivan, B. P. *Inorg. Chem.* **1998**, *37*, 5406.
709. Benkstein, K. D.; Hupp, J. T.; Stern, C. L. *J. Am. Chem. Soc.* **1998**, *120*, 12982.
710. Fujita, M.; Aoyagi, M.; Ogura, K. *Inorg. Chim. Acta* **1996**, *246*, 53.
711. Habicher, T.; Nierengarten, J.-F.; Gramlich, V.; Diederich, F. *Angew. Chem., Int. Ed. Engl.* **1998**, *37*, 1916.
712. Hartshorn, C. M.; Steel, P. J. *Inorg. Chem.* **1996**, *35*, 6902.
713. Schmitz, M.; Leininger, S.; Fan, J.; Arif, A. M.; Stang, P. J. *Organometallics* **1999**, *18*, 4817.
714. Wasserman, E. *J. Am. Chem. Soc.* **1960**, *82*, 4433.
715. Amabilino, D. B.; Stoddart, J. F. *Chem. Rev.* **1995**, *95*, 2725.
716. Sauvage, J.-P.; Dietrich-Buchecker, C. O.; Chambron, J.-C. Transition metals as assembling and templating species: synthesis of catenanes and molecular knots. In *Comprehensive Supramolecular Chemistry*; Sauvage, J.-P.; Hosseini, M.W., Ed., Publisher: Elsevier, Oxford, UK 1996; Vol. 2, p 43.
717. Dietrich-Buchecker, C. O.; Sauvage, J.-P.; Kintzinger, J.-P. *Tetrahedr. Lett.* **1983**, *24*, 5095.
718. Baxter, P. N. W. Metal ion directed assembly of complex molecular architectures and nanostructures. In *Comprehensive Supramolecular Chemistry*; Sauvage, J.-P.; Hosseini, M. W., Eds.; Pergamon: Oxford, UK, 1996; Vol. 9, pp 165–211.

719. Fujita, M.; Aoyagi, M.; Ibukuro, F.; Ogura, K.; Yamaguchi, K. In *J. Am. Chem. Soc.*, 1998; Vol. 120, pp 611.
720. Fujita, M.; Oguro, D.; Miyazawa, M.; Oka, H.; Yamaguchi, K.; Ogura, K. *Nature* **1995**, 378, 469.
721. Kusakawa, T.; Fujita, M. *Angew. Chem., Int. Ed.* **1998**, 37, 3142.
722. Drain, C. M.; Nifiatis, F.; Vasenko, A.; Batteas, J. D. *Angew. Chem., Int. Ed. Engl.* **1998**, 37, 2344.
723. Fan, J.; Whiteford, J. A.; Olenyuk, B.; Levin, M. D.; Stang, P. J.; Fleischer, E. B. *J. Am. Chem. Soc.* **1999**, 121, 2741.
724. Saalfrank, R. W.; Stark, A.; Peters, K.; Schnering, H. G. *Angew. Chem., Int. Ed. Engl.* **1988**, 27.
725. Baxter, P.; Lehn, J.-M.; DeCian, A.; Fischer, J. *Angew. Chem., Int. Ed. Engl.* **1993**, 32, 69.
726. Mann, S.; Huttner, G.; Zsolnai, L.; Heinze, K. *Angew. Chem., Int. Ed. Engl.* **1996**, 35, 2808.
727. Baisel, T.; Powers, R. E.; Raymond, K. N. *Angew. Chem., Int. Ed. Engl.* **1996**, 35, 1084.
728. Jacopozzi, P.; Dalcanele, E. *Angew. Chem., Int. Ed. Engl.* **1997**, 36, 613.
729. Hartshorn, C. M.; Steel, P. J. *J. Chem. Soc., Chem. Commun.* **1997**, 541.
730. Parac, T. N.; Caulder, D. L.; Raymond, K. N. *J. Am. Chem. Soc.* **1998**, 120, 8003.
731. Kusakawa, T.; Fujita, M. *J. Am. Chem. Soc.* **1999**, 121, 1397.
732. Chambron, J.-C.; Dietrich-Buchecker, C.; Sauvage, J.-P. Transition metals as assembling and templating species: synthesis of catenanes and molecular knots. In *Comprehensive Supramolecular Chemistry*; Lehn, J.-M., Atwood, J. L., Davis, J. E. D., MacNicol, D. D., Vögtle, F., Eds., Pergamon: Oxford, UK 1996; Vol. 9, pp 43–83.
733. Fuss, M.; Siehl, H.-U.; Olenyuk, B.; Stang, P. J. *Organometallics* **1999**, 18, 758.
734. Piguët, C.; Bernardinelli, G.; Hopfgartner, G. *Chem. Rev.* **1997**, 97, 2005.
735. Constable, E. C. Polynuclear transition metal helicates; In *Comprehensive Supramolecular Chemistry*, Lehn, J.-M. Sauvage, J.-P., Hosseini, M. W. Eds., Pergamon: Oxford, UK 1996; Vol. 9, pp 213–252.
736. Williams, A. *Chem. Eur. J.* **1997**, 3, 15.
737. Rowan, A. E.; Nolte, R. J. M. *Angew. Chem., Int. Ed.* **1998**, 37, 63.
738. Shieh, S.-J.; Chou, C.-C.; Lee, G.-H.; Wang, C.-C.; Peng, S.-M. *Angew. Chem., Int. Ed. Engl.* **1997**, 36, 56.
739. Stang, P. J.; Olenyuk, B.; Muddiman, D. C.; Smith, R. D. *Organometallics* **1997**, 119, 3094.
740. Ibukuro, F.; Kusakawa, T.; Fujita, M. *J. Am. Chem. Soc.* **1998**, 120, 8561.
741. Mao, L.-F.; Mayr, A. *Inorg. Chem.* **1996**, 35, 3183.
742. Mayr, A.; Mao, L.-F. *Inorg. Chem.* **1998**, 37, 5776.
743. Yuan, H.; Thomas, L.; Woo, L. K. *Inorg. Chem.* **1996**, 35, 2808.
744. Drain, C. M.; Lehn, J.-M. *J. Chem. Soc., Chem. Commun.* **1994**, 2313.
745. Stang, P. J.; Fan, J.; Olenyuk, B. *Chem. Commun.* **1997**, 1453.
746. Slone, R. V.; Hupp, J. T. *Inorg. Chem.* **1997**, 36, 5422.
747. Lehn, J.-M.; Sauvage, J. P.; Simon, J.; Ziessel, R.; Piccinni-Leopardi, C.; Germain, G.; Declercq, J. P.; Van Meerssche, M. *Nouv. J. Chim.* **1983**, 7, 413.
748. Ohata, N.; Masuda, H.; Yamauchi, O. *Angew. Chem., Int. Ed. Engl.* **1996**, 35, 531.
749. Bell, T. W.; Jousselin, H. *Nature* **1994**, 367, 441.
750. Carboniere, L. J.; Bernardinelli, G.; Piguët, C.; Sargeson, A. M.; Williams, A. F. *J. Chem. Soc., Chem. Commun.* **1994**, 1419.
751. Piguët, C.; Bunzli, J. C. G.; Bernardinelli, G.; Hopfgartner, G.; Williams, A. F. *J. Am. Chem. Soc.* **1993**, 115, 8197.
752. Potts, K. T.; Keshavarz-K. M.; Tham, F. S.; Abruna, H. D.; Arana, C. R. *Inorg. Chem.* **1993**, 32, 4422.
753. Potts, K. T.; Keshavarz-K. M.; Tham, F. S.; Gheysen Raiford, K. A.; Arana, C. R.; Abruna, H. D. *Inorg. Chem.* **1993**, 32, 5477.
754. Constable, E. C.; Walker, J. V. *J. Chem. Soc., Chem. Commun.* **1992**, 884.
755. Zarges, W.; Hall, J.; Lehn, J.-M.; Bolm, C. *Helv. Chim. Acta* **1991**, 74, 1843.
756. Constable, E. C.; Ward, M. D.; Tocher, D. A. *J. Am. Chem. Soc.* **1990**, 112, 1256.
757. Koert, U.; Harding, M. M.; Lehn, J.-M. *Nature* **1990**, 346, 339.
758. Garrett, T. M.; Koert, U.; Lehn, J.-M.; Rigault, A.; Meyer, D.; Fischer, J. *J. Chem. Soc., Chem. Commun.* **1990**, 557.
759. Lehn, J.-M.; Rigault, A. *Angew. Chem., Int. Ed. Engl.* **1988**, 27, 1095.
760. Lehn, J.-M.; Rigault, A.; Siegel, J.; Harrowfield, J.; Chevrier, B.; Moras, D. *Proc. Natl. Acad. Sci. U.S.A.* **1987**, 84, 2565.
761. Mueller, C.; Whiteford, J. A.; Stang, P. J. *J. Am. Chem. Soc.* **1998**, 120, 9827.
762. Stang, P. J.; Olenyuk, B.; Arif, A. M. *Organometallics* **1995**, 14, 5281.
763. Olenyuk, B.; Whiteford, J. A.; Stang, P. J. *J. Am. Chem. Soc.* **1996**, 118, 8221.
764. Stang, P. J.; Olenyuk, B. *Angew. Chem., Int. Ed. Engl.* **1996**, 35, 732.
765. Lord, P. A.; Noll, B. C.; Olmstead, M. M.; Balch, A. L. *J. Am. Chem. Soc.* **2001**, 123, 10554.
766. Kannan, S.; James, A. T.; Sharp, P. R. *J. Am. Chem. Soc.* **1998**, 120, 215.
767. Bushnell, G. W.; Dixon, K. R.; Hunter, R. G.; McFarland, J. J. *Can. J. Chem.* **1972**, 50, 3694.
768. Budzelaar, P. H.; van Leeuwen, P. W. N. M.; Roobeck, C. F. *Organometallics* **1992**, 11, 23.
769. Robertson, G. B.; Whimp, P. O. *J. Organomet. Chem.* **1973**, 60, C11.
770. Alyea, E. C.; Ferguson, G.; Somogyvari, A. *Organometallics* **1983**, 2, 668.
771. Luck, R.; Morris, R. H.; Sawyer, J. F. *Organometallics* **1984**, 3, 1009.
772. Elschenbroich, C.; Heikenfeld, G.; Wunsch, M.; Massa, W.; Gr., B. *Angew. Chem., Int. Ed. Engl.* **1988**, 27, 414.
773. Cotton, F. A.; Luck, R. L.; Morris, R. H. *Organometallics* **1989**, 8, 1282.
774. Cotton, F. A.; Kibala, P. A.; Shang, M.; Wojtczak, W. A. *Organometallics* **1991**, 10, 2626.
775. Cotton, F. A.; Wojtczak, W. A. *Inorg. Chim. Acta* **1994**, 217, 187.
776. Singewald, E. T.; Mirkin, C. A.; Stern, C. L. *Angew. Chem., Int. Ed. Engl.* **1995**, 34, 1624.
777. Elschenbroich, C.; Isenburg, T.; Behrendt, A.; Frenzen, G.; Harms, K. *J. Organomet. Chem.* **1995**, 501, 129.
778. Allegra, G.; Casagrande, G. T.; Immirzi, A.; Porri, L.; Vitulli, G. *J. Am. Chem. Soc.* **1970**, 92, 289.
779. Dupont, J.; Pfeiffer, M.; Rotteveel, M. A.; De Cian, A.; Fischer, J. *Organometallics* **1989**, 8, 1116.
780. Balch, A. L.; Boehm, J. R.; Hope, H.; Olmstead, M. M. *J. Am. Chem. Soc.* **1976**, 98, 7431.
781. Young, S. J.; Kellenberger, B.; Reibenspies, J. H.; Himmel, S. E.; Manning, M.; Anderson, O. P.; Stille, J. K. *J. Am. Chem. Soc.* **1988**, 110, 5744.
782. Braga, D.; Sabatino, P.; Di Bugno, C.; Leoni, P.; Pasquali, M. *J. Organomet. Chem.* **1987**, 334, C46.
783. Di Bugno, C.; Pasqual, M.; Leoni, P.; Sabatino, P.; Braga, D. *Inorg. Chem.* **1989**, 28, 1390.

784. Fryzuk, M. D.; Lloyd, B. R.; Clentsmith, G. K. B.; Rettig, S. J. *J. Am. Chem. Soc.* **1991**, *113*, 4332.
785. Fryzuk, M. D.; Lloyd, B. R.; Clentsmith, G. K. B.; Rettig, S. J. *J. Am. Chem. Soc.* **1994**, *116*, 3804.
786. Portnoy, M.; Frolow, F.; Milstein, D. *Organometallics* **1991**, *10*, 3960.
787. Jennings, M. C.; Payne, N. C.; Puddephatt, R. J. *J. Chem. Soc., Chem. Commun.* **1986**, 1809.
788. Jennings, M. C.; Payne, N. C.; Puddephatt, R. J. *Inorg. Chem.* **1987**, *26*, 3776.
789. Kirss, R. U.; Eisenberg, R. *Inorg. Chem.* **1989**, *28*, 3372.
790. Gauthron, I.; Gagnon, J.; Zhang, T.; Rivard, D.; Lucas, D.; Mugnier, Y.; Harvey, P. D. *Inorg. Chem.* **1998**, *37*, 1112.
791. Davies, J. A.; Hockensmith, M.; Kukushkin, V. Y.; Kukushkin, Y. N., Homoleptic Solvento-Complexes: Starting Materials for Preparative Coordination Chemistry, in *Synthetic Coordination Chemistry: Principles and Practice*; World Scientific: River Edge, NJ, **1996**, p 95.
792. Buschmann, W. E.; Miller, J. S. *Chem. Eur. J.* **1998**, *4*, 1731.
793. Schramm, R. F.; Wayland, B. B. *Chem. Commun.* **1968**, 898.
794. Thomas, R. R.; Sen, A. *Inorg. Synth.* **1990**, *28*, 63.
795. Trost, B. M.; Godleski, S. A.; Genêt, J. P. *J. Am. Chem. Soc.* **1978**, *78*, 3930.
796. Lai, T.-W.; Sen, A. *Organometallics* **1984**, *3*, 866.
797. Sen, A.; Lai, T.-W. *Organometallics* **1982**, *1*, 415.
798. Sen, A. *Acc. Chem. Res.* **1988**, *21*, 421.
799. Hegedus, L. S.; Mulhern, T. A.; Asada, H. *J. Am. Chem. Soc.* **1986**, *108*, 6224.
800. Jiang, Z.; Sen, A. *Organometallics* **1993**, *12*, 1406.
801. Oi, S.; Kashiwagi, K.; Inoue, Y. *Tetrahedron Lett.* **1998**, *39*, 6253.
802. Uozumi, Y.; Kato, K.; Hayashi, T. *J. Org. Chem.* **1998**, *63*, 5071.
803. Murahashi, T.; Nagai, T.; Okuno, T.; Matsutani, T.; Kurosawa, H. *Chem. Commun.* **2000**, 1689.
804. Miedaner, A.; Du Bois, D. L. *Inorg. Chem.* **1988**, *27*, 2479.
805. Tanase, T.; Ukaji, H.; Yamamoto, Y. *J. Chem. Soc., Dalton Trans.* **1996**, 3059.
806. Bhughun, I.; Lexa, D.; Savéant, J. M. *J. Am. Chem. Soc.* **1996**, *118*, 3982.
807. Collman, J. P.; Ha, Y.; Wagenknecht, P. S.; Lopez, M.-A.; Guilard, R. J. *J. Am. Chem. Soc.* **1993**, *115*, 9080.
808. Collman, J. P.; Ha, Y.; Wagenknecht, P. S.; Lewis, N. S. *J. Am. Chem. Soc.* **1992**, *114*, 5665.
809. Grass, V.; Lexa, D.; Savéant, J. M. *J. Am. Chem. Soc.* **1997**, *119*, 7526.
810. Meilleur, D.; Rivard, D.; Harvey, P. D.; Gauthron, I.; Lucas, D.; Mugnier, Y. *Inorg. Chem.* **2000**, *39*, 2909.
811. Braunstein, P.; Luke, M. A.; Tiripicchio, A.; Camellini, M. T. *Angew. Chem., Int. Ed. Engl.* **1987**, *26*, 768.
812. Usón, R.; Furniés, J.; Falvello, L. R.; Usón, M. A.; Usón, I.; Herrero, S. *Inorg. Chem.* **1993**, *32*, 1066.
813. Usón, R.; Furniés, J.; Sanz, J. F.; Usón, M. A.; Usón, I.; Herrero, S. *Inorg. Chem.* **1997**, *36*, 1912.
814. Gauthron, I.; Gagnon, J.; Zhang, T.; Rivard, D.; Lucas, D.; Mugnier, Y.; Harvey, P. D. *Inorg. Chem.* **1998**, *37*, 1112.
815. Kiess, R. V.; Eisenberg, R. *Inorg. Chem.* **1989**, *28*, 3372.
816. Reetz, M. T.; Bohres, E.; Goddard, R.; Holthausen, M. C.; Thiel, W. *Chem. Eur. J.* **1999**, *5*, 2101.
817. Greaney, M. A.; Coyle, C. L.; Pilato, R. S.; Stiefel, E. I. *Inorg. Chim. Acta* **1991**, *189*, 81.
818. Ansari, M. A.; Chau, C.-N.; Mahler, C. H.; Ibers, J. A. *Inorg. Chem.* **1989**, *28*, 960.
819. Benner, L. S.; Balch, A. L. *J. Am. Chem. Soc.* **1978**, *100*, 6099.
820. Zhang, Q.-F.; Shanmuga Sundara Raj, S.; Hong, M.-C.; Cao, R.; Fun, H.-K.; Xin, X.-Q. *Inorg. Chem. Commun.* **1999**, *2*, 272.
821. Mashima, K.; Nakano, H.; Nakamura, A. *J. Am. Chem. Soc.* **1993**, *115*, 11632.
822. Mashima, K.; Nakano, H.; Nakamura, A. *J. Am. Chem. Soc.* **1996**, *118*, 9083.
823. Poilblanc, R. *Coord. Chem. Rev.* **1988**, *86*, 191.
824. Braunstein, P.; Jud, J.-M.; Dusausou, Y.; Fisher, J. *Organometallics* **1983**, *2*, 180.
825. Braunstein, P.; Jud, J.-M.; Dusausou, Y.; Fisher, J. *J. Chem. Soc., Chem. Commun.* **1983**, 5.
826. Gressel, M. C.; Moulding, R. P.; Seddon, K. R. *J. Organomet. Chem.* **1983**, *253*, C52.
827. Braunstein, P.; Kervennal, J.; Richert, J.-L. *Angew. Chem., Int. Ed. Engl.* **1985**, *24*, 768.
828. Usón, R.; Furniés, J.; Fernandez, S.; Usón, M. A.; Usón, I.; Herrero, S. *Inorg. Chem.* **1997**, *36*, 1912.
829. Usón, R.; Furniés, J.; Falvello, L. R.; Usón, I.; Herrero, S. *Inorg. Chem.* **1993**, *32*, 1066.
830. Leoni, P.; Pasquali, M.; Sommovigo, M.; Laschi, F.; Zanello, P.; Albinati, A.; Lianza, F.; Pregosin, P. S.; Rüegger, H. *Organometallics* **1993**, *12*, 1713.
831. Wilson, W. L.; Nelson, J. H.; Alcock, N. W. *Organometallics* **1990**, *9*, 1699.
832. Leoni, P.; Pieri, G.; Pasquali, M. *J. Chem. Soc., Dalton Trans.* **1998**, 657.
833. Arnold, D. P.; Bott, R. C.; Eldridge, H.; Elms, F.; Smith, G.; Zojaji, M. *Aust. J. Chem.* **1997**, *50*, 495.
834. Boyle, R. W.; Johnson, C. K.; Dolphin, D. *J. Chem. Soc., Chem. Commun.* **1995**, 527.
835. Gauler, R.; Risch, N. *Eur. J. Org. Chem.* **1998**, 1193.
836. Strachan, J. P.; Gentemann, S.; Seth, J.; Kalsbeck, W. A.; Lindsey, J. S.; Holten, D.; Bocian, D. C. *Inorg. Chem.* **1998**, *37*, 1191.
837. Wagner, R. W.; Johnson, T. E.; Li, F.; Lindsey, J. S. *J. Org. Chem.* **1995**, *60*, 5266.
838. Chan, K. S.; Zhou, X.; Au, M. T.; Tam, C. Y. *Tetrahedron* **1995**, *51*, 3129.
839. DiMagno, S. G.; Lin, V. S.-Y.; Therien, M. J. *J. Org. Chem.* **1993**, *58*, 5983.
840. Lin, V. S.-Y.; DiMagno, S. G.; Therien, M. J. *Science* **1994**, *264*, 1105.
841. DiMagno, S. G.; Lin, V. S.-Y.; Therien, M. J. *J. Am. Chem. Soc.* **1993**, *115*, 2513.
842. Arnold, D. P.; Healy, P. C.; Hodgson, M. J.; Williams, M. L. *J. Organomet. Chem.* **2000**, *607*, 41.
843. Kudo, K.; Hidai, M.; Uchida, Y. *J. Organomet. Chem.* **1971**, *31*, 393.
844. Misono, A.; Uchida, Y.; Hidai, M.; Kudo, K. *J. Organomet. Chem.* **1969**, *20*, 7.
845. Ceconfi, F.; Ghilardi, C. A.; Midollini, S.; Moneti, S.; Orlandini, A.; Scapacci, G. *J. Chem. Soc., Dalton Trans.* **1989**, 211.
846. Grévin, J.; Kalck, P.; Daran, J. C.; Vaissermann, J.; Bianchini, C. *Inorg. Chem.* **1993**, *32*, 4965.
847. Huber, H.; Kündig, P.; Moskovits, M.; Ozin, G. A. *Nature, Phys. Sci.* **1972**, *235*, 98.
848. Darling, J. H.; Ogden, J. S. *Inorg. Chem.* **1972**, *11*, 666.
849. Darling, J. H.; Ogden, J. S. *J. Chem. Soc., Dalton Trans.* **1973**, 1079.

850. Burianová, J.; Burianec, Z. *Collect. Czech. Chem. Commun.* **1963**, *28*, 2138.
851. Yoshida, T.; Otsuka, S. *J. Am. Chem. Soc.* **1977**, *99*, 2134.
852. Dubrawski, J.; Krieger-Simonsen, J. C.; Feltham, R. D. *J. Am. Chem. Soc.* **1980**, *102*, 2089.
853. Mednikov, E. G.; Eremenko, N. K.; Mikhailov, V. A.; Gubin, S. P.; Slovokhotov, Y. L.; Struchkov, Y. T. *J. Chem. Soc., Chem. Commun.* **1981**, 989.
854. Klein, H.-F.; Mager, M.; Flörke, U.; Haupt, H.-J. *Organometallics* **1992**, *11*, 3915.
855. Goddard, R.; Jolly, P. W.; Krüger, C.; Schick, K.-P.; Wilke, G. *Organometallics* **1982**, *1*, 1709.
856. Tran, N. T.; Kawano, M.; Powell, D. R.; Dahl, L. F. *J. Am. Chem. Soc.* **1998**, *120*, 10986.
857. Ortega, A.; Hoffmann, F. M.; Bradshaw, A. M. *Surf. Sci.* **1982**, *119*, 79.
858. Behm, R. J.; Christmann, K.; Ertl, G.; Van Hove, M. A. *J. Chem. Phys.* **1980**, *73*, 2984.
859. Trebbe, R.; Goddard, R.; Rufinska, A.; Seevogel, K.; Poerschke, K.-R. *Organometallics* **1999**, *18*, 2466.
860. Strauss, S. H. *Chemtracts: Inorg. Chem.* **1997**, *10*, 77.
861. Lupinetti, A. J.; Frenking, G.; Strauss, S. H. *Angew. Chem., Int. Ed. Engl.* **1998**, *37*, 2113.
862. Shin, S.; RajanBabu, T. V. *Org. Lett.* **1999**, *1*, 1299.
863. Shi, J. C.; Zheng, Y.; Wu, D. X.; Huang, X. Y.; Liu, Q. T.; Kang, B. S. *Inorg. Chim. Acta* **1999**, *290*, 121.
864. Yano, S.; Inoue, S.; Yasuda, Y.; Tanase, T.; Mikata, Y.; Kakuchi, T.; Tsubomura, T.; Yamasaki, M.; Kinoshita, I.; Doe, M. *J. Chem. Soc., Dalton Trans.* **1999**, 1851.
865. Yonehara, K.; Hashizume, T.; More, K.; Ohe, K.; Uemura, S. *Chem. Commun.* **1999**, 415.
866. Tschöerner, M.; Trabesinger, G.; Albinati, A.; Pregosin, P. S. *Organometallics* **1997**, *16*, 3447.
867. RajanBabu, T. V.; Casalnuovo, A. L.; Ayers, T. A. Ligand tuning in asymmetric catalysis: hydrocyanation and hydrogenation reactions. In *Advances in Catalytic Processes*; Doyle, M. P., Ed., Jai Press: London, 1997; Vol. 2, p 1.
868. Whitesell, J. K. *Chem. Rev.* **1989**, *89*, 1581.
869. Borriello, C.; Ferrara, M. L.; Orabona, I.; Panunzi, A.; Ruffo, F. *Dalton* **2000**, 2545.
870. Alami, M.; Amatore, C.; Bensalem, S.; Choukchou-Brahim, A.; Jutand, A. *Eur. J. Inorg. Chem.* **2001**, 2675.
871. Hartwig, J. F. *Angew. Chem., Int. Ed.* **1998**, *37*, 2046.
872. Amatore, C.; Jutand, A. *Coord. Chem. Rev.* **1998**, *178–180*, 511.
873. Grushin, V.; Bensimon, C.; Alper, H. *Organometallics* **1995**, *14*, 3295.
874. Grushin, V.; Alper, H. *Organometallics* **1993**, *12*, 1890.
875. Hartwig, J. F.; Paul, F. *J. Am. Chem. Soc.* **1995**, *117*, 5373.
876. Paul, F.; Patt, J.; Hartwig, J. F. *J. Am. Chem. Soc.* **1994**, *116*, 5969.
877. Paul, F.; Patt, J.; Hartwig, J. F. *Organometallics* **1995**, *14*, 3030.
878. Hartwig, J. F. *Synlett* **1997**, 329.
879. Wolfe, J. P.; Singer, R. A.; Yang, B. H.; Buchwald, S. L. *J. Am. Chem. Soc.* **1999**, *121*, 1.
880. Krause, J.; Cestari, G.; Haack, K. J.; Seevogel, K.; Storm, W.; Pörschke, K. R. *J. Am. Chem. Soc.* **1999**, *121*, 9807.
881. Amatore, C.; Jutand, A. *Acc. Chem. Res.* **2000**, *33*, 314.
882. Pan, Y.; Mague, J. T.; Fink, M. J. *J. Am. Chem. Soc.* **1993**, *115*, 3842.
883. Reid, S. M.; Mague, J. T.; Fink, M. J. *J. Am. Chem. Soc.* **2001**, *123*, 4081.
884. Parlevliet, F. J.; Zuideveld, M. A.; Kiener, C.; Kooijman, H.; Spek, A. L.; Kamer, P. C. J.; van Leeuwen, P. W. N. *Organometallics* **1999**, *18*, 3394.
885. Ogoshi, S.; Kurosawa, H. *Organometallics* **1993**, *12*, 2869.
886. Mason, M. R.; Verkade, J. G. *Organometallics* **1992**, *11*, 2212.
887. McLaughlin, P. A.; Verkade, J. G. *Organometallics* **1998**, *17*, 5937.
888. Olofsson-Mårtensson, M.; Kritikos, M.; Noréus, D. *J. Am. Chem. Soc.* **1999**, *121*, 10908.
889. Kadir, K.; Noréus, D. *Z. Z. Phys. Chem. N.F.* **1989**, *163*, 231.
890. Noréus, D.; Törnroos, K. W.; Börje, A.; Szabó, T.; Bronger, W.; Spittank, H.; Auffermann, G.; Müller, P. *J. Less Common Met.* **1988**, *139*, 233.
891. Olofsson, M.; Kritikos, M.; Noréus, D. *Inorg. Chem.* **1998**, *37*, 2900.
892. Olofsson-Mårtensson, M.; Haeussermann, U.; Tomkinson, J.; Noreus, D. *J. Am. Chem. Soc.* **2000**, *122*, 6960.
893. Bronger, W.; Auffermann, G. *J. Alloys Compd.* **1995**, *228*, 119.
894. Olofsson-Mårtensson, M.; Kritikos, M.; Noreus, D. *J. Am. Chem. Soc.* **1999**, *121*, 10908.
895. Kadir, K.; Kritikos, M.; Noréus, D.; Andresen, A. F. *J. Less-Common Met.* **1991**, *172–174*, 36.
896. Olofsson, M.; Kritikos, M.; Noreus, D. *Inorg. Chem.* **1998**, *37*, 2900.
897. Hii, K. K.; Thornton-Pett, M.; Jutand, A.; Tooze, R. P. *Organometallics* **1999**, *18*, 1887.
898. Adams, R. D.; Captain, B.; Fu, W.; Smith, M. D. *J. Am. Chem. Soc.* **2002**, *124*, 5628.
899. Lee, S.-M.; Wong, W.-T. *J. Cluster Sci.* **1998**, *9*, 417.
900. Nakajima, T.; Ishiguro, A.; Wakatsuki, Y. *Angew. Chem., Int. Ed.* **2000**, *39*, 1131.
901. Brivio, E.; Ceriotti, A.; Pergola, R. D.; Garlaschelli, L.; Demartin, F.; Manassero, M.; Sansoni, M.; Zanello, P.; Laschi, F.; Heaton, B. T. *J. Chem. Soc., Dalton Trans.* **1994**, 3237.
902. Kuwata, S.; Mizobe, Y.; Hidai, M. *J. Am. Chem. Soc.* **1993**, *115*, 8499.
903. Hermans, S.; Raja, R.; Thomas, J. M.; Johnson, B. F. G.; Sankar, G.; Gleeson, D. *Angew. Chem., Int. Ed.* **2001**, *40*, 1211.
904. Raja, R.; Sankar, G.; Hermans, S.; Shephard, D. S.; Bromley, S.; Thomas, J. M.; Johnson, B. F. G. *Chem. Commun.* **1999**, 1571.
905. Manojlovic-Muir, L. J.; Muir, K. W.; Lloyd, B. R.; Puddephatt, R. J. *J. Chem. Soc., Chem. Commun.* **1983**, 1336.
906. Lloyd, B. R.; Puddephatt, R. J. *Inorg. Chim. Acta* **1984**, *90*, L77.
907. Harvey, P. D.; Crozet, M.; Aye, K. T. *Can. J. Chem.* **1995**, *73*, 123.
908. Harvey, P. D.; Hubig, S.; Ziegler, T. *Inorg. Chem.* **1994**, *33*, 3700.
909. Manojlovic-Muir, L.; Muir, K. W.; Lloyd, B. R.; Puddephatt, R. J. *J. Chem. Soc., Chem. Commun.* **1985**, 536.
910. Harvey, P. D.; Provencher, R.; Gagnon, J.; Zhang, T.; Fortin, D.; Hierso, K.; Drouin, M.; Socol, S. M. *Can. J. Chem.* **1996**, *74*, 2268.
911. Zhang, T.; Drouin, M.; Harvey, P. D. *Chem. Commun.* **1996**, 877.
912. Harvey, P. D.; Hierso, K.; Braunstein, P.; Morise, X. *Inorg. Chim. Acta* **1996**, *250*, 337.
913. Gauthron, I.; Mugnier, Y.; Hierso, K.; Harvey, P. D. *Can. J. Chem.* **1997**, *75*, 1182.

914. Pierce, D. T.; Geiger, W. E. *J. Am. Chem. Soc.* **1992**, *114*, 6063.
915. Brevet, D.; Lucas, D.; Cattey, H.; Lemaître, F.; Mugnier, Y.; Harvey, P. D. *J. Am. Chem. Soc.* **2001**, *123*, 4340.
916. Lemaître, F.; Brevet, D.; Lucas, D.; Vallat, A.; Mugnier, Y.; Harvey, P. D. *Inorganic Chemistry* **2002**, *41*, 2368.
917. Longoni, G.; Iapalucci, M. C. Clusters in ligand shells. Low-valent organometallic clusters. In *Clusters and Colloids: From Theory to Applications*; Schmid, G., Ed., VCH: New York, 1994; p 91.
918. Ceriotti, A.; Pergola, R. D.; Garlaschelli, L. *Physics and Chemistry of Metal Cluster Compounds*; Kluwer Academic: The Netherlands, 1994.
919. Weber, L. *Angew. Chem., Int. Ed. Engl.* **1994**, *33*, 1077.
920. Aubke, F.; Wang, C. *Coord. Chem. Rev.* **1994**, *137*, 483.
921. Strauss, S. H. *J. Chem. Soc., Dalton Trans.* **2000**, 1.
922. Goldman, A. S.; Krogh-Jespersen, K. *J. Am. Chem. Soc.* **1996**, *118*, 12159.
923. Dixon, K. R.; Dixon, A. C. Palladium complexes with carbonyl, isocyanide and carbene ligands. In *Comprehensive Organometallic Chemistry II*; Puddephatt, R. J., Ed., Pergamon: Oxford, UK, 1995; Vol. 9, pp 193–223.
924. Yeo, Y. Y.; Vattuone, L.; King, D. A. *J. Chem. Phys.* **1997**, *106*, 1990.
925. Spasov, V. A.; Ervin, K. M. *J. Chem. Phys.* **1998**, *109*, 5344.
926. Mednikov, E. G.; Eremenko, N. K.; Slovokhotov, Y. L.; Struchkov, Y. T.; Gubin, S. P. *J. Organomet. Chem.* **1983**, *258*, 247.
927. Mednikov, E. G.; Eremenko, N. K.; Gubin, S. P.; Slovokhotov, Y. L.; Struchkov, Y. A. *J. Organomet. Chem.* **1982**, *239*, 401.
928. Mednikov, E. G.; Struchkov, Y. T.; Slovokhotov, Y. L. *J. Organomet. Chem.* **1998**, *566*, 15.
929. Mednikov, E. G.; Slovokhotov, Y. L.; Struchkov, Y. T. *Metalloorg. Khim.* **1991**, *4*, 123.
930. Mednikov, E. G.; Eremenko, N. K.; Slovokhotov, Y. T.; Struchkov, Y. T. *J. Organomet. Chem.* **1986**, *301*, C35.
931. Mednikov, E. G. *Izvestiya Akademii Nauk, Seriya Khimicheskaya* **1993**, 1299.
932. Mednikov, E. G.; Kanteeva, N. I. *Izvestiya Akademii Nauk, Seriya Khimicheskaya* **1995**, 167.
933. Mednikov, E. G.; Eremenko, N. K.; Slovokhotov, Y. L.; Struchkov, Y. T. *J. Chem. Soc., Chem. Commun.* **1987**, 218.
934. Tran, N. T.; Powell, D. R.; Dahl, L. F. *Angew. Chem., Int. Ed. Engl.* **2000**, *39*, 4121.
935. Tran, N. T.; Kawano, M.; Dahl, L. F. *J. Chem. Soc., Dalton Trans.* **2001**, 2731.
936. Eremenko, N. K.; Gubin, S. P. *Pure Appl. Chem.* **1990**, *62*, 1179.
937. King, R. B. *Gazz. Chim. Ital.* **1992**, *122*, 383.
938. Moiseev, I. I.; Vargaftik, M. N.; Volkov, V. V.; Tsirkov, G. A.; Cherkashina, N. V.; Novotortsev, V. M.; Ellert, O. G.; Petrunenko, I. A.; Chuvilin, A. L.; Kvit, A. V. *Mendeleev Commun.* **1995**, 87.
939. Schmid, G. *Chem. Rev.* **1992**, *92*, 1709.
940. Schmid, G. In *Physics and Chemistry of Metal Cluster Compounds*; de Jongh, L. J., Ed., Kluwer: Dordrecht, The Netherlands, 1994, p 107.
941. Schmid, G.; Harms, M.; Malm, J.-O.; Bovin, J.-O.; van Ruitenbeck, J.; Zandbergen, H. W.; Fu, W. T. *J. Am. Chem. Soc.* **1993**, *115*, 2046.
942. Amiens, C.; de Caro, D.; Chaudret, B.; Bradley, J. S.; Mazel, R.; Roucau, C. *J. Am. Chem. Soc.* **1993**, *115*, 11638.
943. Catalano, V. J.; Bennett, B. L.; Muratidis, S.; Noll, B. C. *J. Am. Chem. Soc.* **2001**, *123*, 173.
944. Grigg, R.; Sridharan, V. *Tetrahedron Lett.* **1993**, *34*, 7471.
945. Grigg, R.; Kennewell, P.; Teasdale, A. J. *Tetrahedron Lett.* **1992**, *33*, 7789.
946. Catalano, V. J.; Bennett, B. L.; Yson, R. L.; Noll, B. C. *J. Am. Chem. Soc.* **2000**, *122*, 10056.
947. Catalano, V. J.; Bennett, B. L.; Noll, B. C. *Chem. Commun.* **2000**, 1413.
948. Balch, A. L.; Catalano, V. J.; Chatfield, M. A.; Nagle, J. K.; Olmstead, M. M.; Reedy, P. E., Jr. *J. Am. Chem. Soc.* **1991**, *113*, 1252.
949. Yih, K.-H.; Lin, Y.-C.; Cheng, M.-C.; Wang, Y. *J. Chem. Soc., Dalton Trans.* **1994**, 474, C34.
950. Yih, K.-H.; Lee, G.-H.; Wang, Y. *Inorg. Chem.* **2000**, *39*, 2445.
951. Kawano, M.; Bacon, J. W.; Campana, C. F.; Dahl, L. F. *J. Am. Chem. Soc.* **1996**, *118*, 7869.
952. Longoni, G.; Massero, M.; Sansoni, M. *J. Am. Chem. Soc.* **1980**, *102*, 3242.
953. Mague, J. T. *J. Cluster Sci.* **1995**, *6*, 217.
954. Bachert, I.; Braunstein, P.; Hasselbring, R. *New. J. Chem.* **1996**, *20*, 993.
955. Bhattacharyya, P.; Woollins, J. D. *Polyhedron* **1995**, *14*, 3367.
956. Balakrishna, M. S.; Sreenivasa Reddy, Y.; Krishnamurthy, S. S.; Nixon, J. F.; Burckett St. Laurent, J. C. T. R. *Coord. Chem. Rev.* **1994**, *129*, 1.
957. Knorr, M.; Hallauer, E.; Huch, V.; Veith, M.; Braunstein, P. *Organometallics* **1996**, *15*, 3868.
958. Bachert, I.; Bartussek, I.; Braunstein, P.; Guillon, E.; Rose, J.; Kickelbick, G. *J. Organomet. Chem.* **1999**, *588*, 143.
959. Mashima, K.; Fukumoto, A.; Nakano, H.; Kaneda, Y.; Tani, K.; Nakamura, A. *J. Am. Chem. Soc.* **1998**, *120*, 12151.
960. Huser, M.; Youinou, M.-T.; Osborn, J. A. *Angew. Chem., Int. Ed. Engl.* **1989**, *28*, 1386.
961. Leoni, P. *Organometallics* **1993**, *12*, 2432.
962. Braunstein, P.; de Meric de Bellefon, C.; Ries, M.; Fischer, J.; Bouaoud, S.-E.; Grandjean, D. *Inorg. Chem.* **1988**, *27*, 1327.
963. Braunstein, P.; de Meric de Bellefon, C.; Ries, M. *Organometallics* **1988**, *7*, 332.
964. Chan, S.; Wong, W.-T. *J. Chem. Soc., Dalton Trans.* **1994**, 1605.
965. Chan, S.; Wong, W.-T. *J. Chem. Soc., Dalton Trans.* **1995**, 3987.
966. Chan, S.; Lee, S.-M.; Lin, Z.; Wong, W.-T. *J. Organomet. Chem.* **1996**, *510*, 219.
967. Hui, J. W.-S.; Wong, W.-T. *J. Chem. Soc., Dalton Trans.* **1996**, 2887.
968. Hui, J. W.-S.; Wong, W.-T. *J. Chem. Soc., Dalton Trans.* **1997**, 1515.
969. Hui, J. W.-S.; Wong, W.-T. *J. Chem. Soc., Dalton Trans.* **1997**, 2445.
970. Hui, J. W.-S.; Wong, W.-T. *Chem. Commun.* **1997**, 2009.
971. Aiken, J. D.; Finke, R. G. *J. Mol. Catal. A* **1999**, *145*, 1.
972. Bradley, J. S. *Clusters and Colloids, From Theory to Applications*; VCH: Weinheim, Germany, 1994.
973. Edwards, P. P.; Johnston, R. L.; Rao, C. N. R. *Metal Clusters in Chemistry*; Wiley-VCH: Weinheim, Germany, 1998.
974. Fendler, J. H. *Nanoparticles and Nanostructured Films, Preparation, Characterization and Applications*; Wiley-VCH: Weinheim, Germany, 1998.

975. Lewis, L. N. *Chem. Rev.* **1993**, *93*, 2693.
976. Rao, C. N. R.; Kulkarni, G. U.; Thomas, P. J.; Edwards, P. P. *Chem. Soc. Rev.* **2000**, *29*, 27.
977. Reetz, M. T.; Winter, M.; Breinbauer, R.; Thurn-Albrecht, T.; Vogel, W. *Chem. Eur. J.* **2001**, *7*, 1084.
978. Chechik, V.; Crooks, R. M. *J. Am. Chem. Soc.* **2000**, *122*, 1243.
979. Crooks, R. M.; Zhao, M.; Su, L.; Chechik, V.; Yeung, L. K. *Acc. Chem. Res.* **2001**, *34*, 181.
980. Moreno-Manas, M.; Pleixats, R.; Villarroya, S. *Organometallics* **2001**, *20*, 4524.
981. Moreno-Manas, M.; Roser, P.; Villarroya, S. *Chem. Commun.* **2002**, 60.
982. Moiseev, I. I.; Vargaftik, M. N. Catalysis with palladium clusters. In *Catalysis by Di- and Polynuclear Metal Cluster Complexes*; Adams, R. D.; Cotton, F. A. Eds. Wiley VCH: New York, 1998, p 395.
983. Stromnova, T. A.; Moiseev, I. I. *Russ. J. Coord. Chem.* **1998**, *24*, 227.
984. Vargaftik, M. N.; Zagorodnikov, V. P.; Stolyarov, I. P.; Moiseev, I. I.; Likholobov, V. A.; Kochubey, D. I.; Chuvilin, A. L.; Zaikovskiy, V. I.; Zamaraev, K. I.; Timofeeva, G. I. *J. Chem. Soc., Chem. Comm.* **1985**, 937.
985. Schmid, G. Ligand-stabilized Giant Metal Clusters and Colloids. In *Physics and Chemistry of Materials with Low-Dimensional Structures*, Kluwer Academics: The Netherlands, Longh, J. L. 1994; Vol. 18, pp 107.
986. Fukuoka, A.; Sakamoto, Y.; Guan, S.; Inagaki, S.; Sugimoto, N.; Fukushima, Y.; Hirahara, K.; Iijima, S.; Ichikawa, M. *J. Am. Chem. Soc.* **2001**, *123*, 3373.
987. Alvarez, J.; Liu, J.; Roman, E.; Kaifer, A. E. *Chem. Commun.* **2000**, 1151.
988. Rojas, M. T.; Königer, R.; Stoddart, J. F.; Kaifer, A. E. *J. Am. Chem. Soc.* **1995**, *117*, 336.
989. de Wolf, E.; van Koten, G.; Deelman, B.-J. *Chem. Soc. Rev.* **1999**, *28*, 37.
990. Kundig, E. P.; McIntosh, D.; Moskovits, M.; Ozun, G. A. *J. Am. Chem. Soc.* **1976**, *98*, 7324.
991. Libuda, J.; Sandell, A.; Baumer, M.; Freund, H.-J. *Chem. Phys. Lett.* **1995**, *240*, 429.
992. Sheu, L.-L.; Knozinger, H.; Sachtler, W. M. H. *J. Am. Chem. Soc.* **1989**, *111*, 8125.
993. Femoni, C.; Iapalucci, M. C.; Longoni, G.; Svensson, P. H.; Wolowska, J. *Angew. Chem., Int. Ed. Engl.* **2000**, *39*, 1635.
994. Tran, N. T.; Kawano, M.; Powell, D. R.; Hayashi, R. K.; Campana, C. F.; Dahl, L. F. *J. Am. Chem. Soc.* **1999**, *121*, 5945.

6.5

Platinum

L. M. RENDINA and T. W. HAMBLEY
University of Sydney, NSW 2006, Australia

6.5.1	INTRODUCTION	674
6.5.2	PLATINUM(0)	674
6.5.2.1	Platinum(0) Complexes with Phosphorus Donor Ligands	674
6.5.2.1.1	<i>Synthesis</i>	674
6.5.2.1.2	<i>Platinum(0) dimers</i>	675
6.5.2.1.3	<i>Platinum(0) trimers</i>	675
6.5.2.1.4	<i>Hydrides</i>	676
6.5.2.1.5	<i>Unusual platinum(0) complexes</i>	676
6.5.2.1.6	<i>Unusual phosphine ligands</i>	677
6.5.2.1.7	<i>Oxidative addition reactions of platinum(0) complexes</i>	678
6.5.2.1.8	<i>Addition reactions of silanes</i>	679
6.5.2.1.9	<i>Other reactions</i>	681
6.5.2.1.10	<i>Reactions with chalcogens</i>	681
6.5.2.2	Platinum(0) Interactions with Other Metals	682
6.5.2.3	Spectroscopy	682
6.5.2.3.1	<i>Other platinum(0) complexes</i>	682
6.5.3	PLATINUM(I)	682
6.5.3.1	Unsupported Dimers	683
6.5.3.1.1	<i>Preparations</i>	683
6.5.3.1.2	<i>Reactions</i>	684
6.5.3.2	Hydride Complexes	684
6.5.3.2.1	<i>Structures</i>	684
6.5.3.2.2	<i>Reactions</i>	684
6.5.3.3	Phosphine-bridged Dimers	684
6.5.3.3.1	<i>Preparation of phosphine-bridged dimers</i>	685
6.5.3.3.2	<i>Reactions of phosphine-bridged dimers</i>	686
6.5.3.4	Dimers Bridged by Unsymmetric Ligands	687
6.5.3.5	Dimers Bridged by Monodentate Ligands	687
6.5.3.6	Phosphido-bridged Dimers	688
6.5.3.7	Electrochemical Reduction and Linear Chain Complexes	688
6.5.4	PLATINUM(II)	688
6.5.4.1	Platinum(II) Complexes with Carbonyl and Silicon-donor Ligands	688
6.5.4.1.1	<i>Carbonyl ligands</i>	688
6.5.4.1.2	<i>Si-Donor ligands</i>	689
6.5.4.2	Platinum(II) Complexes with Nitrogen-donor Ligands	690
6.5.4.2.1	<i>Ammine and alkylamine ligands</i>	690
6.5.4.2.2	<i>Amide ligands</i>	695
6.5.4.2.3	<i>Amido, imido, and nitrido ligands</i>	696
6.5.4.2.4	<i>Nitroso ligands</i>	698
6.5.4.2.5	<i>Heterocyclic N-donor ligands</i>	698
6.5.4.2.6	<i>Macrocyclic N-donor ligands</i>	703
6.5.4.2.7	<i>Amino acid and peptide ligands</i>	704
6.5.4.3	Platinum(II) Complexes with Phosphorus-, Arsenic-, and Antimony-donor Ligands	706
6.5.4.3.1	<i>Mono-, bi-, and tridentate P-donor ligands</i>	706
6.5.4.3.2	<i>Macrocyclic P-donor ligands</i>	709
6.5.4.3.3	<i>As- and Sb-donor ligands</i>	709
6.5.4.4	Platinum(II) Complexes with Oxygen-donor Ligands	709
6.5.4.4.1	<i>Aqua, hydroxo, and oxo ligands</i>	709
6.5.4.4.2	<i>Peroxo ligands</i>	711

6.5.4.4.3	Alcohol, alkoxo, and ether ligands	711
6.5.4.4.4	Carboxylato and carbonato ligands	714
6.5.4.5	Platinum(II) Complexes with Sulfur- and Selenium-donor Ligands	715
6.5.4.5.1	S_n and Se_n ligands	715
6.5.4.5.2	Sulfoxide, thiourea, and thiolato ligands	716
6.5.4.5.3	Macrocyclic <i>S</i> -donor ligands	717
6.5.4.6	Platinum(II) Complexes with Hydrido and Dihydrogen Ligands	718
6.5.4.6.1	Hydrido ligands	718
6.5.4.6.2	Dihydrogen ligands	720
6.5.4.7	Platinum(II) Complexes with Mixed Donor-atom Ligands	720
6.5.4.7.1	Bidentate <i>NO</i> and <i>OS</i> ligands	720
6.5.4.7.2	Bidentate <i>PO</i> , <i>PS</i> , and <i>PN</i> ligands	721
6.5.5	PLATINUM(III)	722
6.5.5.1	Monomeric Platinum(III)	723
6.5.5.2	Unbridged Dimers	723
6.5.5.3	O,O-Bridged Dimers	723
6.5.5.3.1	Sulfate and hydrogenphosphate-bridged dimers	723
6.5.5.3.2	Pyrophosphito-bridged dimers	724
6.5.5.3.3	Acetato-bridged dimers	724
6.5.5.4	N,S and S,S-bridged Dimers	724
6.5.5.5	N,O-bridged Dimers	725
6.5.6	PLATINUM(IV)	725
6.5.6.1	Five-coordinate Platinum(IV) Complexes	725
6.5.6.2	Group IV Complexes	726
6.5.6.3	Group V Complexes	726
6.5.6.4	Group VI Complexes	727
6.5.6.5	Am(m)ine Complexes	727
6.5.6.6	Amino Acid and Peptide Complexes	728
6.5.6.7	Nucleobase Complexes	728
6.5.6.8	Macrocyclic and Macrobicyclic Complexes	728
6.5.6.9	Porphyrin Complexes	729
6.5.6.10	Reactions of Coordinated Ligands	730
6.5.6.11	Ligand Exchange Reactions	730
6.5.6.12	Kinetics and Mechanism of Platinum(IV) Reduction	731
6.5.6.13	Novel Mechanisms of Platinum(II) Oxidation to Platinum(IV)	732
6.5.6.14	Hydride Complexes	732
6.5.7	MIXED OXIDATION AND MIXED METAL COMPLEXES	732
6.5.7.1	Platinum(0)/Platinum(I)	732
6.5.7.2	Platinum Blues	733
6.5.7.3	Linear Chain Complexes	733
6.5.7.4	Mixed Metal Systems	734
6.5.7.5	Mixed Oxidation State Clusters	735
6.5.7.6	Mixed Metal Clusters	735
6.5.8	REFERENCES	736

6.5.1 INTRODUCTION

The coordination chemistry of platinum is a massive field and a thorough survey of its coordination chemistry in a limited number of pages was simply impossible. Instead, what we have attempted to do is provide a flavor of this enormous range of chemistry.

6.5.2 PLATINUM(0)

The chemistry of platinum(0) is overwhelmingly dominated by phosphine complexes with the general formula $[Pt(PR_3)_n]$ ($n = 2-4$). These complexes undergo various types of oxidative addition reactions, activating a wide variety of bonds. The stability of the complexes depends on the steric bulk of the phosphine ligand with the bulkier ligands stabilizing the lower coordination numbers.

6.5.2.1 Platinum(0) Complexes with Phosphorus Donor Ligands

6.5.2.1.1 Synthesis

A variety of methods have been reported for synthesizing platinum(0) tertiary phosphine complexes and a range of standard methods have been described in a series of reports in

Inorganic Syntheses.¹⁻⁵ In addition, a number of novel methods have been reported for preparing such complexes, particularly those that are more unstable and cannot be prepared by the standard methods. For example, in contrast to bulkier analogues, the two-coordinate, 14-electron complex $[\text{Pt}(\text{PPh}_3)_2]$ is not stable, but can be prepared by bulk reductive electrolysis of *cis*- $[\text{PtCl}_2(\text{PPh}_3)_2]$.⁶ The ethyl analogue $[\text{Pt}(\text{PEt}_3)_2]$ can also be produced by electrolysis.⁷ These complexes are too reactive to be isolated, but they can be trapped by reaction with O_2 , HCl ,^{8,9} MeI , PhCOCl , or alkynes.⁷ $[\text{Pt}(\text{PEt}_3)_2]$ can also be prepared photochemically by UV irradiation of $[\text{Pt}(\text{C}_2\text{O}_4)(\text{PEt}_3)_2]$ via reductive elimination of oxalate as CO_2 .^{8,9} The generation of $[\text{Pt}(\text{PPh}_3)_2]$ under phase transfer conditions (benzene/60% KOH -18-crown-6) has been reported,¹⁰ and its subsequent reaction with a variety of ligands ranging from CO , phosphines, and alkenes gives products in high yield.

6.5.2.1.2 Platinum(0) dimers

The characterization and crystal structure of the dimer $[\text{Pt}_2(\mu\text{-dppm})_3]$ (dppm = bis(diphenylphosphino)methane), first reported as a deep red complex in 1978, was described by Manojlović-Muir *et al.* in 1986.¹¹ The structure, the first of its type, is made up of two parallel and almost eclipsed trigonal-planar platinum moieties bridged by three diphosphine ligands. The $\text{Pt}\cdots\text{Pt}$ separation is 3.0225(3) Å, too long to be considered a bond.¹¹ $[\text{Pt}_2(\mu\text{-dppm})_3]$ catalyzes the hydrogenation/reduction of carbon dioxide with dimethylamine to give dimethylformamide¹² (Equation (1)) and the reverse reaction.¹³



The characterization of two other types of novel platinum(0) dimer was reported at about the same time. Reaction of $[\text{Pt}(\text{PPh}_3)_3]$ with a bidentate diphosphine produced either $[\text{Pt}_2(\mu\text{-R}_2\text{PCH}_2\text{PR}_3)_3(\text{PPh}_3)]$ (R = Me or Et) or $[\text{Pt}_2(\mu\text{-R}_2\text{PCH}_2\text{PR}_3)_3(\text{PPh}_3)_2]$ (R = Ph or OEt).¹⁴ Both structures can be thought of as deriving from the $[\text{Pt}_2(\mu\text{-dppm})_3]$ dimer by the addition of a PPh_3 to one or both platinum centers. Thus, one has one three-coordinate and one four-coordinate platinum and the other two four-coordinate platinum atoms (1).

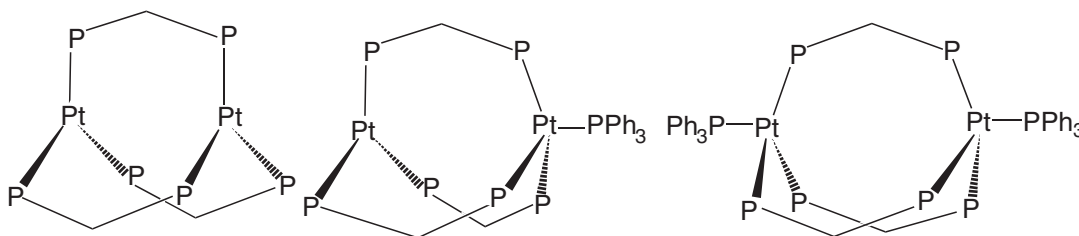

(1)

6.5.2.1.3 Platinum(0) trimers

Numerous examples of 42-electron trinuclear platinum(0) clusters of the type $[\text{Pt}_3(\mu\text{-L}^2)_3\text{L}^1_3]$ (2) have been reported,^{15,16} including recent examples with polyaromatic phosphine ligands incorporating naphthyl groups.¹⁷ However, there have been few studies of their properties and reactions. Their electronic spectra are dominated by metal-to-ligand charge transfer (MLCT) transitions.¹⁸ The terminal ligands in $[\text{Pt}_3(\mu\text{-CO})_3\text{L}_3]$ (L = bulky phosphine) undergo facile ligand exchange on a time scale of seconds to minutes.¹⁹ Scrambling of the carbonyl ligands also occurs, but on a time scale of hours. Reaction with CS_2 , OCS , and SO_2 results in fragmentation to dimeric species such as $[\text{Pt}_2(\mu\text{-CS}_2)_2(\text{phosphine})_2]$.¹⁹ Reaction of $[\text{Pt}_3(\mu\text{-CO})_3(\text{PCy}_3)_3]$ with 3 or 5 mole-equivalents of 2,6-xylylisocyanide results in displacement of two or three of the bridging carbonyl ligands and one or two of the terminal phosphine ligands to give $[\text{Pt}_3(\mu\text{-CO})(\mu\text{-CNC}_8\text{H}_9)_2(\text{CNC}_8\text{H}_9)(\text{PCy}_3)_2]$ and $[\text{Pt}_3(\mu\text{-CNC}_8\text{H}_9)_2(\text{CNC}_8\text{H}_9)_2(\text{PCy}_3)]$.²⁰

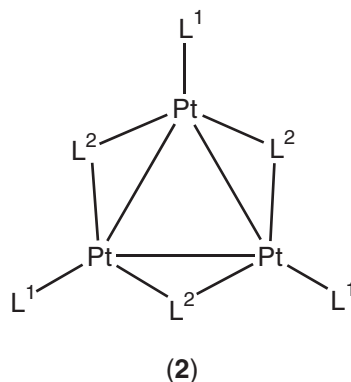

Reaction of $[\text{Pt}_3(\mu\text{-SO}_2)_3\{\text{P}(\text{Cy})_3\}_3]$ with 2,6-xylyl isocyanide results in displacement of one or at most two of the SO_2 ligands by the isocyanide.²¹ Similarly, carbon monoxide usually only partially displaces the SO_2 , but the addition of trimethylamine *N*-oxide (Me_3NO) facilitates the substitution leading to formation of $[\text{Pt}_3(\mu\text{-CO})_3\{\text{P}(\text{Cy})_3\}_3]$.²² Me_3NO also facilitates substitution of one SO_2 ligand by halides and azide.²²

The propensity of $[\text{Pt}_3(\mu\text{-CO})_3(\text{CO})_3]$ clusters to oligomerize into chains of the type $[\text{Pt}_3(\mu\text{-CO})_3(\text{CO})_3]_n^{2-}$ ($n=2-6, 10$) has been analyzed and the need for the additional two electrons is discussed in terms of the electronic structure of the oligomers.²³

6.5.2.1.4 Hydrides

The $[\text{Pt}(\text{PR}_3)_n]$ ($n=2-4$) complexes are quite basic and will react with protic acids, generally yielding platinum(II) hydride complexes. For example, $[\text{Pt}(\text{PR}_3)_2]$ ($\text{R}_3 = (\text{Bu}^t)_3$ and $(\text{Bu}^t)_2\text{Ph}$) react with the ammonium cation to give platinum(II) complexes *trans*- $[\text{PtH}(\text{NH}_3)(\text{PR}_3)_2]\text{X}$ ($\text{X} = \text{PF}_6^-$ or ClO_4^-).²⁴ Protonation of the dimeric platinum(0) complexes $[\text{Pt}_2(\mu\text{-R}_2\text{PCH}_2\text{PR}_2)_3(\text{PPh}_3)_n]$ ($n=0$, $\text{R} = \text{Ph}$ or Et ; $n=1$, $\text{R} = \text{Me}$; $n=2$, $\text{R} = \text{EtO}$) gives rise to the dimeric platinum(I) species $[\text{Pt}_2\text{H}(\eta^1\text{-dppm})(\mu\text{-dppm})_2]$ when R is phenyl and different structural forms of the dimeric platinum(II) complexes $[\text{Pt}_2\text{H}_2(\mu\text{-R}_2\text{PCH}_2\text{PR}_2)_2]$ when R is one of the smaller groups, Me , Et , or EtO .²⁵ Reaction of $[\text{Pt}(\text{Cy}_2\text{P}(\text{CH}_2)_n\text{PCy}_2)]$ ($n=2-4$) with hydrogen gives rise to complexes $[\text{PtH}_2(\text{Cy}_2\text{P}(\text{CH}_2)_n\text{PCy}_2)]$ that can be described as either *cis* platinum(II) dihydrides or platinum(0) η^2 -dihydrogen complexes.²⁶ Interchange of the hydrogen atom positions and the ready loss of dihydrogen on heating are consistent with a dynamic process involving an exchange between these two alternatives. The dihydrides give rise to bridged platinum(I) species $[\text{Pt}(\mu\text{-H}_2)(\text{Cy}_2\text{P}(\text{CH}_2)_n\text{PCy}_2)]$ on standing.²⁶

Protonation of $[\text{Pt}(\text{PR}_3)_3]$ complexes is known to be reversible because they have been used to activate H_2O for hydrogen–deuterium exchange. However, it has recently been shown that the protonation state and oxidation state can be readily controlled by adjusting the pH.²⁷ Thus, adding acid to a solution of the platinum(0) complex $[\text{Pt}(\text{TPPTS})_3]$ ($\text{TPPTS} = \text{P}(m\text{-C}_6\text{H}_4\text{SO}_3\text{Na})_3$) gives the platinum(II) hydride $[\text{PtH}(\text{TPPTS})_3]$, and addition of base results in reversion to the platinum(0) complex. These reactions are slow indicating a substantial activation barrier, perhaps due to the energy needed to convert from the tetrahedral platinum(0) to the square-planar platinum(II).²⁷ A novel platinum(0)–platinum(II) hydride (4) has been reported to result from the reversible decomposition of the platinum(II) hydride (3) (Scheme 1).²⁸ (R_P)-phenylphosphinate adds to $[\text{Pt}(\text{PEt}_3)_4]$ to give the platinum(II) hydride $[\text{PtH}\{\text{P}(=\text{O})\text{Ph}(\text{OR})\}_2(\text{PEt}_3)_2]$ with retention of the configuration at the phosphorus.²⁹

6.5.2.1.5 Unusual platinum(0) complexes

The first monometallic anionic platinum(0) complex, $[\text{Pt}(\text{Me}_2\text{NCS}_2)(\text{PEt}_3)]^-$ was prepared *in situ* by hydrogen abstraction from the platinum(II) hydride, $[\text{PtH}(\text{Me}_2\text{NCS}_2)(\text{PEt}_3)]$.³⁰ This complex has not been isolated, but it has been trapped by reaction with Ph_3SnCl , MeI , and I_2 giving a range of platinum(II) complexes.³⁰

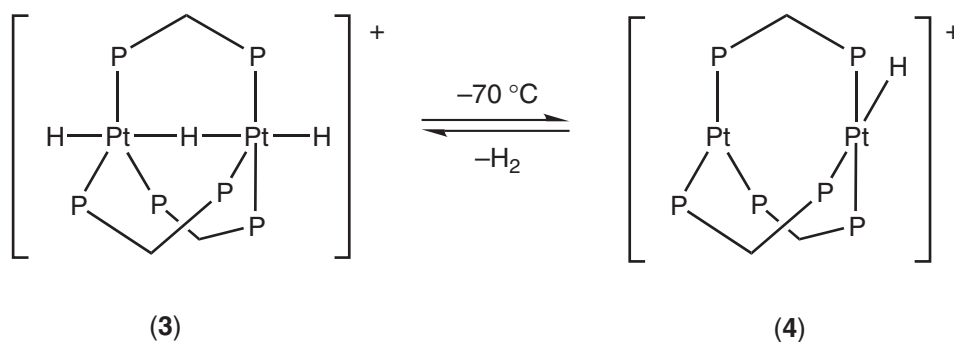

Scheme 1

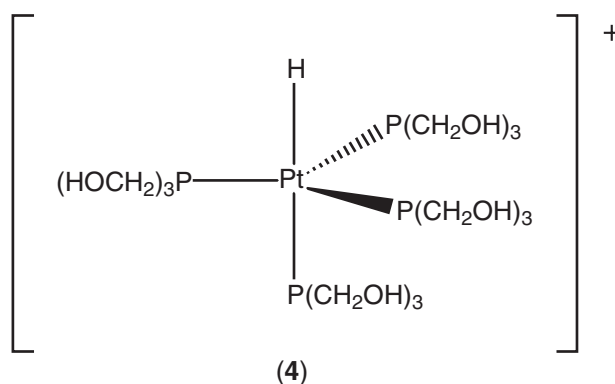

The first platinum complex of buckminsterfullerene (C_{60}) was prepared by reacting the ethene complex $[\text{Pt}(\eta^2\text{-C}_2\text{H}_4)(\text{PPh}_3)_2]$ with C_{60} in toluene solution yielding black crystals of $[\text{Pt}(\eta^2\text{-C}_{60})(\text{PPh}_3)_2]$ in 2 hours.³¹ Reaction of $[\text{Pt}(\text{PEt}_3)_4]$ with C_{60} in benzene yielded the hexasubstituted complex $[\{\text{Pt}(\text{PEt}_3)_2\}_6(\eta^2\text{-C}_{60})]$.³² Reaction of $[\text{Pt}(\eta^2\text{-C}_2\text{H}_4)(\text{PPh}_3)_2]$ with C_{70} in benzene in appropriate ratios yielded mono-, di-, tri-, and tetra-substituted complexes, but higher levels of substitution could not be achieved.³³ In all complexes, the bonding between the platinum and the fullerene is very similar to that in platinum(0) ethene complexes. Coordination to platinum shifts the reduction potentials of the C_{60} to more negative potentials and the reduction is accompanied by loss of the diphosphineplatinum(0) moieties.³⁴ More recently, a platinum moiety with a chelating diphosphine ligand has been coordinated to C_{60} by first reacting the fullerene with $[\text{Pt}(\text{COD})_2]$, giving $[\text{PtC}_{60}]$ in quantitative yield, and then reacting this species with the diphosphine.³⁵ $[\text{PtC}_{60}]$ had been reported previously, obtained by reaction of the fullerene with $[\text{Pt}(\text{dba})_2]$ ($\text{dba} = 1,5\text{-diphenylpenta-1,4-dien-3-one}$).³⁶

Platinum(0) complexes of monodentate and bidentate dendrimer–phosphine ligands were prepared by reaction with $[\text{PtCl}_2(\text{COD})]$ ($\text{COD} = \text{cyclooctadienes}$) followed by borohydride reduction.³⁷ The monodentate ligands gave $[\text{PtL}_3]$ complexes and the bidentate $[\text{Pt}(\text{L-L})_2]$. The former complexes readily underwent oxidative addition reactions indicating that the metal centers remained accessible in the dendrimeric structure. Molecular modeling of these complexes revealed nanoscale structures with approximate diameters of 4.4 nm.³⁷

Tri-*n*-butylphosphite, tri-*n*-butylarsine, and tri-*n*-butylstibine complexes of platinum(0) have been prepared by the reaction of the ligand with $[\text{Pt}(\text{COD})_2]$ or, in the case of the phosphite, by reaction with $[\text{Pt}(\text{PPh}_3)_4]$.³⁸ All form four-coordinate complexes when 4 mole-equivalents of ligand are used, but when 2 or 3 mole-equivalents of the phosphite ligand are used, mixtures of three- and four-coordinate complexes are observed.³⁸

The first reported example of an η^2 -bonded nitroso ligand was in the complex $[\text{Pt}(\text{PPh}_3)_2(\text{PhNO})]$.³⁹

6.5.2.1.6 Unusual phosphine ligands

The effectiveness of platinum(0) complexes of phosphines as catalysts has led to the synthesis of a wide variety of complexes with phosphines that confer solubility in a range of solvents or have

unusual electronic properties. Water-soluble complexes are of particular interest because of their potential as immobilized homogeneous catalysts. Tris(hydroxymethyl)phosphine forms a water soluble platinum(0) complex, $[\text{Pt}\{\text{P}(\text{CH}_2\text{OH})_3\}_4]$, which is a catalyst for the addition of PH_3 to formaldehyde.^{40,41} In aqueous solution $[\text{Pt}\{\text{P}(\text{CH}_2\text{OH})_3\}_4]$ exists in an equilibrium with a five-coordinate platinum(II) hydride (**4**). $[\text{Pt}\{\text{P}(\text{CH}_2\text{OH})_3\}_4]$ can be formed by the reaction of these reagents with $\text{K}_2[\text{PtCl}_4]$ or $\text{Na}_2[\text{PtCl}_6]$ in a self-replicating reaction.⁴⁰ A similar example of self-replication has been reported for the synthesis of tris(cyanoethyl)phosphine (tcep) from PH_3 and $\text{CH}_2=\text{CHCN}$, catalyzed by $[\text{Pt}(\text{tcep})_3]$.⁴² The platinum complex is a more effective catalyst for this process than are either the nickel or palladium analogues.

The replacement of one or all of the phenyl groups in triphenylphosphine with pyridine confers water solubility on the platinum(0) complexes, but has interesting effects on their properties.⁴³ For instance, the trispyridylphosphine ligand forms the tetrakis complex $[\text{Pt}(\text{Ppy}_3)_4]$, but not the analogous tris complex. The reverse reaction is observed for the pyridyldiphenylphosphine ligand with only $[\text{Pt}(\text{PPh}_2\text{py})_3]$ observed.⁴³ Both complexes undergo oxidative addition with MeI , but only the latter reacts with gaseous HCl .⁴³

Phosphite complexes of platinum(0) have received substantially less attention than have phosphine complexes.⁴⁴ $[\text{Pt}\{\text{P}(\text{OC}_6\text{H}_4\text{OMe}-2)_3\}_3]$ can be prepared by reduction of the $[\text{PtCl}_2\{\text{P}(\text{OC}_6\text{H}_4\text{OMe}-2)_3\}_2]$ complex in the presence of the phosphite or by the reaction of the phosphite with tris(η^2 -norbornene)platinum(II).⁴⁴ Alkene complexes of bis(phosphite)platinum(II) can be prepared in a similar manner to the analogous phosphine complexes.⁴⁴

6.5.2.1.7 Oxidative addition reactions of platinum(0) complexes

Platinum(0) phosphine complexes undergo a variety of oxidative addition reactions with compounds containing Group 14 elements. These reactions are of widespread interest because similar processes are probably involved in the catalysis by platinum complexes of reactions such as the hydrosilylation of alkenes and the disilylation of dienes and alkenes.

(i) Tellurides

Silyl, germyl, and stanyl tellurides, (RTeMMe_3) , react readily with $[\text{Pt}(\text{PETe}_3)_3]$ in hexane at 25°C to give *trans*- $[\text{Pt}(\text{RTe})(\text{MMe}_3)(\text{PETe}_3)_2]$ ($\text{M} = \text{Si}, \text{Ge}, \text{Sn}$; $\text{R} = \text{Ph}, 4\text{-biphenyl}, \text{Bu}, \text{Me}_3\text{Sn}$).⁴⁵ A slower reaction was observed for the selenide (PhSeTMS), but no reaction was observed with the analogous sulfide.⁴⁵

(ii) M—M ($M = \text{Si}, \text{Ge}, \text{Sn}$)

$[\text{Pt}(\text{PETe}_3)_3]$ cleaves the Si—Si bond in the halosilanes, $\text{XMe}_2\text{Si—SiMe}_2\text{Y}$ ($\text{X}, \text{Y} = \text{F}, \text{Cl}, \text{Me}; \text{Br}, \text{Me}$), yielding *cis*- $[\text{Pt}(\text{XMe}_2\text{Si})(\text{YMe}_2\text{Si})(\text{PETe}_3)_2]$ whereas $\text{IMe}_2\text{Si—TMS}$ oxidatively adds at the Si—I bond to give *trans*- $[\text{PtI}(\text{TMS—SiMe}_2)(\text{PETe}_3)_2]$.⁴⁶ The 1,2-dihydrosilane, $\text{HMe}_2\text{Si—SiMe}_2\text{H}$ similarly reacts with $[\text{Pt}(\text{PETe}_3)_3]$ to give *cis*- $[\text{Pt}(\text{HMe}_2\text{Si})_2(\text{PETe}_3)_2]$ as well as oligosilanes.⁴⁷ $\text{HMe}_2\text{Si—TMS}$ and TMS—TMS gave oligomeric species, but no silicon bonded Pt complexes.⁴⁷ The products of these reactions are probably the catalytically active intermediates in the addition of Si—Si bonds to unsaturated complexes.⁴⁸ Pham and West reported that platinum(0) diphosphines reacted with 1,2-dihydrosilanes to give disilene platinum complexes.^{49,50}

The Ge—Ge bond in $\text{ClMe}_2\text{Ge—GeMe}_2\text{Cl}$ oxidatively adds to $[\text{Pt}(\text{PETe}_3)_3]$ to give *cis*- and *trans*- $[\text{Pt}(\text{ClMe}_2\text{Ge})_2(\text{PETe}_3)_2]$.⁵¹ Similarly, the organodistannane $\text{Me}_3\text{Sn—SnMe}_3$ reacts with $[\text{Pt}(\text{PR}_3)_4]$ to give *cis*- and *trans*- $[\text{Pt}(\text{Me}_3\text{Sn})_2(\text{PR}_3)_2]$, $\text{R}_3 = \text{Ph}_3, p\text{-Tol}_3, \text{Ph}_2\text{Me}$.⁵² The crystal structure of the complex with $\text{R}_3 = p\text{-Tol}_3$ reveals a highly twisted square-planar structure with the *cis* geometry, presumably brought about by the steric bulk of the ligands.⁵²

The trimeric platinum(0) complex $[\text{Pt}_3(\text{CNBu}^t)_6]$ undergoes a double oxidative addition reaction with 2,2-bis(disilanyl)dithiane to give tetrakis(organosilyl)bis(*t*-butylisocyanide)platinum(IV) complexes.⁵³ The Si—Ge bonds in bis(silylgermyl)dithiane are also cleaved by $[\text{Pt}_3(\text{CNBu}^t)_6]$ giving analogous platinum(IV) complexes with Pt—Si and Pt—Ge bonds.⁵³

(iii) $\text{Si}=\text{Si}$

Disilenes are generally unstable with respect to polymerization. However, if very bulky groups are attached to the silicon atoms then they can be obtained as stable compounds.⁵⁴ Such disilenes react with *in situ* generated $[\text{Pt}(\text{PR}_3)_2]$ to give disilene complexes analogous to alkene complexes.⁵⁰

(iv) $M-X$ ($M = \text{Si}, \text{Ge}, \text{Sn}, X = \text{halide}$)

Early attempts at the oxidative addition of $\text{Si}-X$ bonds to transition-metal complexes failed, but Tanaka and co-workers showed that when $X = \text{Br}$ or I , the reactions are quite facile.^{55,56} For instance, $\text{TMS}-\text{Br}$ reacts with $[\text{Pt}(\text{PEt}_3)_3]$ in benzene solution at 90°C to give *trans*- $[\text{PtBr}(\text{TMS})(\text{PEt}_3)_2]$.⁵⁵ However, there is no reaction with $[\text{Pt}(\text{PPh}_3)_4]$ nor do chlorosilanes react. In general, the order of reactivity for the silanes TMSX were $X = \text{Cl}$ (no reaction) $\ll \text{Br} < \text{I}$ and for the platinum complexes $[\text{Pt}(\text{PPh}_3)_4]$, $[\text{Pt}(\text{dppe})_2]$ (no reaction) $\ll [\text{Pt}(\text{PMe}_2\text{Ph})_4] < [\text{Pt}(\text{PMe}_3)_4] < [\text{Pt}(\text{PEt}_3)_3]$.⁵⁶ As mentioned above (Section 6.5.2.1.7(ii)), cleavage of the $\text{Si}-\text{I}$ bond is favored over cleavage of the $\text{Si}-\text{Si}$ bond.⁴⁶ In contrast, the $\text{Ge}-\text{Cl}$ bond in Me_2GeCl_2 is cleaved by $[\text{Pt}(\text{PEt}_3)_3]$ to give *trans*- $[\text{PtCl}(\text{ClMe}_2\text{Ge})(\text{PEt}_3)_2]$.⁵¹

In alcohols, $[\text{Pt}(\text{PPh}_3)_4]$ undergoes a double oxidative addition reaction with $\text{SnCl}_2 \cdot 2\text{H}_2\text{O}$ to give the octahedral platinum(IV) complex $[\text{PtCl}(\text{H})(\text{OEt})(\text{SnCl}_3)(\text{PPh}_3)_2]$.⁵⁷ When $\text{SnCl}_4 \cdot 5\text{H}_2\text{O}$ is used, a similar product, believed to be a different isomer, is observed. Similar reactions are also observed in 1-propanol and 1-butanol, but in isopropanol the product is a binuclear nonhydrido complex $[\text{PtCl}(\text{OPr}^i)(\text{SnCl}_3)_2(\text{PPh}_3)_2]$ with bridging chloro ligands.⁵⁷

6.5.2.1.8 Addition reactions of silanes

Many catalytic reactions involve the activation of $\text{Si}-\text{H}$ bonds and consequently the reaction of silanes with platinum(0) has been studied extensively. The reactions of hydrosilanes with transition-metal complexes, including platinum, has been extensively reviewed by Corey and Braddock-Wilking.⁵⁸

(i) SiRH_3

1,2-Disilylbenzene reacts with $[\text{Pt}(\text{PEt}_3)_3]$ to give a tetrakis(silyl)platinum(IV) complex (**5a**), which when reacted with additional amounts of $[\text{Pt}(\text{PEt}_3)_3]$, gave a novel platinum(II)/platinum(IV) complex (**5b**).⁵⁹ $[\text{Pt}(\text{PEt}_3)_3]$ reacts with SiArH_3 ($\text{Ar} = \text{Ph}$, mesityl, *p*-toluene) in a 2:1 ratio to give the dimeric complex shown in (**6**) and in a 1:3 ratio to give monomeric *cis*- $[\text{Pt}(\text{SiH}_2\text{Ar})_2]$ -

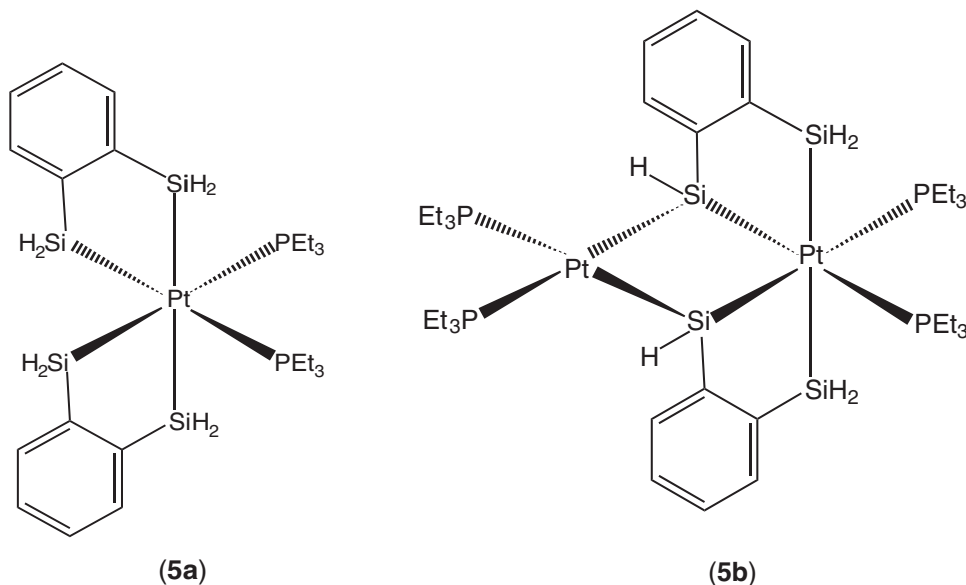

$(\text{PEt}_3)_2$.⁶⁰ When $[\text{Pt}(\text{PEt}_3)_3]$ or $[\text{Pt}(\text{PPr}_3)_3]$ reacts with the bulkier silane $\text{Si}(n\text{-hexyl})\text{H}_3$, two dimeric products are observed, one with a short $\text{Si}\cdots\text{Si}$ contact analogous to that shown in (6) and the other with a short $\text{Pt}\cdots\text{Pt}$ contact (7).⁶¹

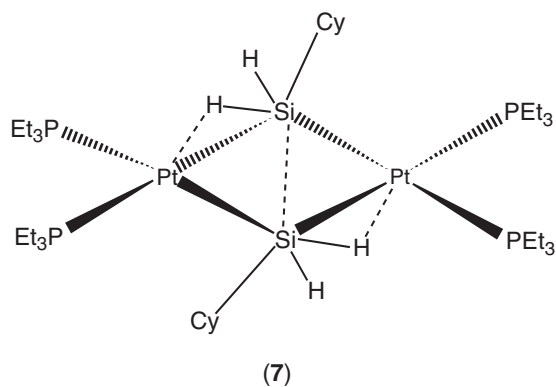
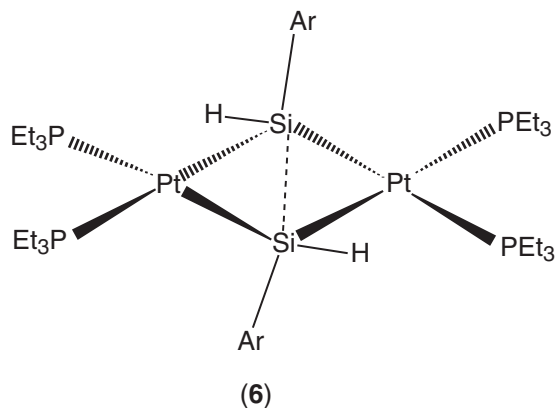

(ii) SiR_2H_2

Reaction of SiAr_2H_2 ($\text{Ar} = \text{Ph}$ or $p\text{-C}_6\text{H}_4\text{F}$) with $[\text{Pt}(\text{PEt}_3)_4]$ yields $\text{cis-}[\text{Pt}(\text{SiH}_2\text{Ar})_2(\text{PEt}_3)_2]$ in contrast to reaction with $\text{cis-}[\text{PtEt}_2(\text{PMe}_3)_2]$, which yields the unstable *trans* isomer.⁶²

The dimeric complex $[\text{Pt}_2(\mu\text{-CO})(\text{CO})_2(\mu\text{-dppm})_2]$ reacts with the secondary silanes SiMe_2H_2 , SiEt_2H_2 , SiPh_2H_2 , and SiMePhH_2 to give complexes of the type $[\text{Pt}_2(\mu\text{-SiR}_2)(\text{CO})_2(\mu\text{-dppm})_2]$ (8).⁶³

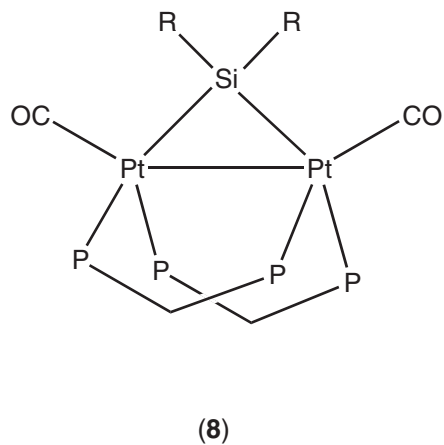

(iii) SiR_3H

There are relatively few examples of the reaction of platinum(0) with tertiary silanes. A novel example is the reaction of $[\text{Pt}(\text{PEt}_3)_4]$ with the rhodium complex $[\text{RhCl}(\text{H})(\text{SiAr}_3)(\text{P}(\text{Pr}^i)_3)_2]$, which results in silane transfer to give the platinum(II) complex $\text{cis-}[\text{PtH}(\text{SiAr}_3)(\text{P}(\text{Pr}^i)_3)_2]$.⁶⁴

6.5.2.1.9 Other reactions

The alkenylphosphine oxide $\text{Ph}_2\text{P}(\text{O})\text{H}$ reacts with $[\text{Pt}(\text{PEt}_3)_3]$ at room temperature to give $\text{cis-}[\text{PtH}(\text{P}(\text{O})\text{Ph}_2)(\text{P}(\text{OH})\text{Ph}_2)(\text{PEt}_3)]$ (**9**), the crystal structure of which reveals a novel intramolecular hydrogen bond.⁶⁵

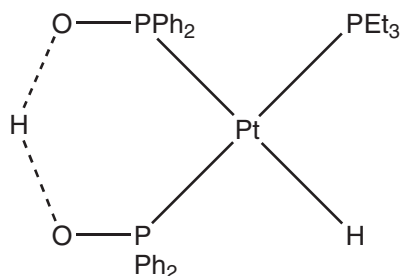

(9)

The complex, $[\text{Pt}(\text{np}_3)(\text{PPh}_3)]$ ($\text{np}_3 = \text{N}(\text{CH}_2\text{CH}_2\text{PPh}_2)_3$) with a tripodal ligand, dechlorinates ClPtEt_2 , undergoing oxidative addition to give a five-coordinate platinum(II) complex $[\text{Pt}(\text{PEt}_2)(\text{np}_3)]^+$.⁶⁶ The PEt_2 ligand in this complex can be protonated by HCl or methylated with methyl iodide to give $[\text{Pt}(\text{PHEt}_2)(\text{np}_3)]^{2+}$ or $[\text{Pt}(\text{PMeEt}_2)(\text{np}_3)]^{2+}$, respectively.⁶⁶

The bis(β -diketone) 2,2,4,4-tetraacetyl-1,3-diselenetane reacts with $[\text{Pt}(\text{PPh}_3)_4]$, undergoing cleavage of the Se—Se bond to give the platinum(II) complex $[\text{Pt}(2,4\text{-pentanedione-3-selenolate})(\text{PPh}_3)_2]$.⁶⁷ $[\text{Pt}(\text{PEt}_3)_3]$ and $[\text{Pt}(\text{PEt}_3)_4]$ insert into the Te—C bond of Ph_2Te to give $\text{trans-}[\text{PtPh}(\text{PhTe})(\text{PEt}_3)_2]$.⁶⁸ When mixed tellurides, $\text{R}^1\text{—Te—R}^2$, are used, mixtures of complexes are obtained with either R^1 or R^2 bound directly to the platinum.⁶⁸

6.5.2.1.10 Reactions with chalcogens

Elemental sulfur reacts with $[\text{Pt}(\text{PPh}_3)_4]$ in ratios of three to six to give mixtures of $[\text{Pt}_2(\mu\text{-S})_2(\text{PPh}_3)_4]$ (**10a**) and $[\text{PtS}_4(\text{PPh}_3)_2]$ (**10b**).⁶⁹ The former complex is alkylated at one bridging sulfido ligand by dichloromethane and chloroform to give $[\text{Pt}_2(\mu\text{-S})(\mu\text{-SR})(\text{PPh}_3)_4]$, $\text{R} = \text{CH}_2\text{Cl}$ and CHCl_2 , respectively.⁶⁹

Sulfur dioxide and carbon disulfide react with bis(bulky phosphine)platinum complexes to give monomeric trigonal planar $[\text{Pt}(\text{PR}_3)_2(\text{SO}_2)]$ and trimeric complexes such as $[\text{Pt}_3(\mu\text{-SO}_2)(\text{PR}_3)_2]$ and $[\text{Pt}_3(\mu\text{-CS}_2)(\text{PR}_3)_2]$ where $\text{R} = \text{Cy}$ or Bu^t .^{70,71}

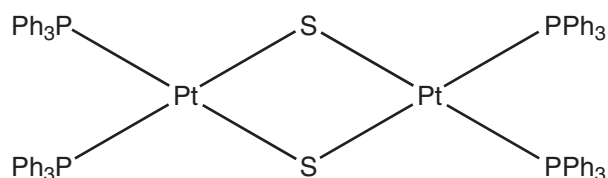

(10a)

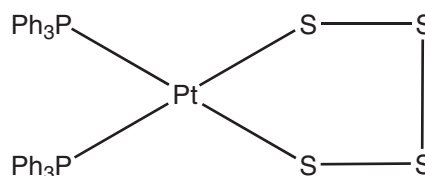

(10b)

6.5.2.2 Platinum(0) Interactions with Other Metals

There are many examples of platinum(II) interacting with metals such as lead(II) or thallium(I) but few where the same metals interact with platinum(0). Catalano *et al.* have reported a series of metallocryptands such as the one shown in **(11)** that act as hosts for thallium(I)⁷² and lead(II).⁷³ They have also reported an unsupported thallium(I) interaction with the platinum in [Pt(PR₃)₃] (R = Ph or R₃ = Ph₂py).⁷⁴ The Pt···Tl separations in the cryptands (2.791–2.795 Å) are slightly shorter than those in the unsupported complexes (2.865–2.889 Å).^{72,74}

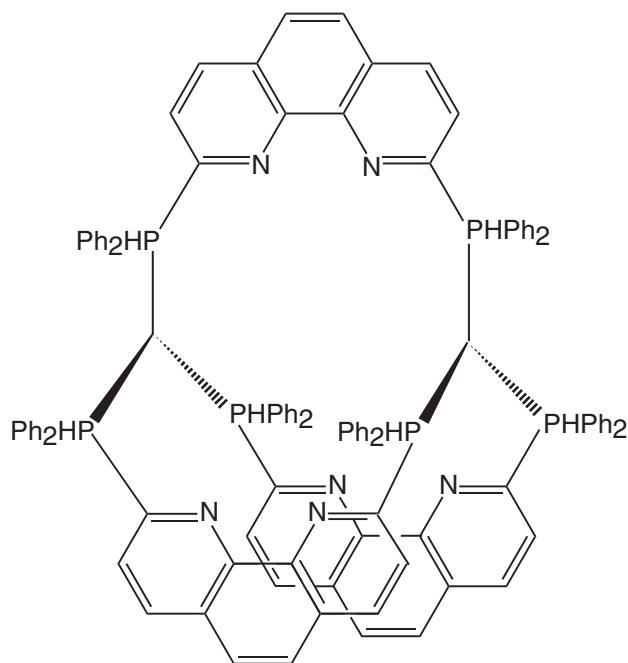

(11)

6.5.2.3 Spectroscopy

The electronic absorption and MCD spectra of [Pt(P(Bu^t)₃)₂] can be explained in terms of $5d \rightarrow 1\pi_u$ MLCT transitions.^{75,76} The $5d_z$ orbital is not strongly involved in the $P \rightarrow M$ σ bonding. There is some $M \rightarrow P$ back bonding in these systems, but it does not add a lot to the stabilization. Thus, there is minimal $5d$ orbital involvement in the bonding and it mostly involves the $6s$ and $6p_z$ orbitals.^{75,76}

The electronic absorption and emission bands of [Pt₂(dppm)₂] are attributable to $d \rightarrow p\pi$ bonding.⁷⁷ The Pt–Pt stretching vibrations in the resonance Raman spectra are indicative of weak Pt–Pt bonds with a metal–metal separation of 3.024 Å and a force constant of 0.6 mdyne Å⁻¹.

6.5.2.3.1 Other platinum(0) complexes

Bis(amido)-germylene and -stannylene react with [Pt(COD)₂] to give the platinum(0) complexes [Pt(M{NTMS}₂)₂], M = Ge or Sn.⁷⁸ The stannylene complex has a trigonal-planar structure with Pt–Sn bond lengths of 2.47–2.50 Å.⁷⁹

6.5.3 PLATINUM(I)

The chemistry of platinum(I) is overwhelmingly dominated by the formation of Pt–Pt bonded dimers. In addition, there are mixed oxidation state clusters and these are dealt with in Section 6.5.6.

6.5.3.1 Unsupported Dimers

The great majority of platinum(I) complexes are binuclear with monofunctional or bifunctional bridging groups. However, there is also a series of unsupported dimers with the general structure shown in (12). These are generally stabilized by phosphine, carbonyl, and isocyanide ligands.¹⁷ Dimeric hydride complexes can have terminal or bridging hydrides and these are discussed above in Section 6.5.2.1.4.

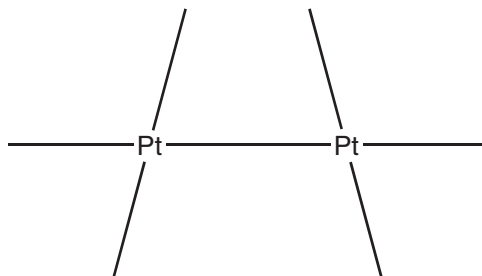

(12)

6.5.3.1.1 Preparations

Among the simplest of the unsupported dimers are the anions $[\text{Pt}_2\text{X}_4(\text{CO})_2]^{2-}$ ($\text{X} = \text{Cl}^-, \text{Br}^-, \text{I}^-$). A high yielding method for preparing these complexes involves reaction of $[\text{PtX}_3(\text{CO})]^-$ with controlled amounts of formic acid and NPr^i_3 in THF.⁸⁰ NMR studies revealed intramolecular exchange of CO and X, probably via a mechanism involving CO bridging. Asymmetrically bridging carbonyls have been reported in the structure of $[\text{Pt}_2\text{Br}_2(\mu\text{-CO})(\text{PPh}_3)_3]$, derived from $[\text{Pt}_2\text{Br}_4(\text{CO})_2]^{2-}$ by reaction with PPh_3 ⁸¹ and in the structure of the chloro analogue.⁸²

The neutral dimer $[\text{Pt}_2\text{Cl}_2(\text{RNC})_4]$, $\text{R} = 2,4\text{-Bu}^t\text{-6-MeC}_6\text{H}_2$, or $2,4,6\text{-Bu}^t\text{-C}_6\text{H}_2$, has been prepared both by electrochemical reduction of *cis*- $[\text{PtCl}_2(\text{RNC})_2]$ and by its reaction with zerovalent $[\text{Pt}_3(\text{RNC})_6]$.^{83,84} A similar reaction between divalent *cis*- $[\text{Pt}(\text{C}_6\text{X}_5)_2\text{L}_2]$ ($\text{X} = \text{F}$, $\text{L} = \text{CO}$, $p = \text{MeC}_6\text{H}_4\text{NC}$, $\text{C}_6\text{H}_{11}\text{NC}$, or Bu^tNC ; $\text{X} = \text{Cl}$, $\text{L} = \text{CO}$ or $p\text{-MeC}_6\text{H}_4\text{NC}$) and zerovalent $[\text{Pt}(\eta^2\text{-C}_2\text{H}_4)(\text{PPh}_3)_2]$ produced the platinum(I) complexes $[\text{Pt}_2(\text{C}_6\text{X}_5)_2\text{L}_2(\text{PPh}_3)_2]$.⁸⁵ Controlled potential electrolysis of $[\text{Pt}(2,6\text{-Me}_2\text{C}_6\text{H}_3\text{NC})_4]$ gives dimeric $[\text{Pt}_2(2,6\text{-Me}_2\text{C}_6\text{H}_3\text{NC})_6]$ ⁸⁶ and electrolysis of $[\text{Pt}(\text{diphos})(\text{RNC})_2](\text{PF}_6)_2$ (diphos = $\text{Ph}_2\text{P}(\text{CH}_2)_n\text{-PPh}_2$ ($n = 2\text{-}4$) or $\text{Bu}^t_2\text{P}(\text{CH}_2)_n\text{-P}^t\text{Bu}^t_2$, $\text{R} = 2,6\text{-dimethylphenyl}$ or $2,4,6\text{-trimethylphenyl}$) gives dinuclear $[\text{Pt}_2(\text{diphos})_2(\text{RNC})_2](\text{PF}_6)_2$ (13).^{87,88} Electrochemical reduction of $[\text{Pt}(\text{RNC})_4]^{2+}$ ($\text{R} = 2,6\text{-Me}_2\text{C}_6\text{H}_3$, or $2,4\text{-Bu}^t\text{-6-MeC}_6\text{H}_2$) and $[\text{Pt}(\text{RNC})_2(\text{dppm})]^{2+}$ ($\text{R} = 2,6\text{-Me}_2\text{C}_6\text{H}_3$) gives the cationic dimer $[\text{Pt}_2(\text{RNC})_6]^{2+}$ along with trimeric and mixed metal complexes.⁸⁹

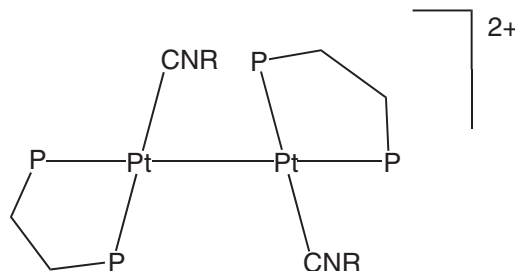

(13)

Chemical reduction of $[\text{PtCl}_2(\text{COD})]$ using LiBHET_3 in the presence of CO and a phosphine yields $[\text{Pt}_2\text{Cl}_2(\text{CO})_2(\text{PR}_3)_2]$ ($\text{PR}_3 = \text{PNpPh}_2$ and PFc_2Ph ; $\text{Np} = \text{naphthyl}$, $\text{Fc} = \text{ferrocenyl}$).¹⁷ The triflate complexes $[\text{Pt}(\text{SO}_3\text{CF}_3)_2(\text{PP})]$ ($\text{PP} = \text{dppm}$ or dppe ; $\text{dppe} = 1,2\text{-bis}(\text{diphenylphosphino})\text{ethane}$) are reduced in the presence of CO to give $[\text{Pt}_2(\text{CO})_2(\mu\text{-dppm})_2]^{2+}$ or $[\text{Pt}_2(\text{CO})_2(\text{dppe})_2]^{2+}$.⁹⁰ Reaction of $[\text{Pt}_3(\text{CO})_3(\text{P-Bu}^t_2\text{Ph}_3)]$ with HCl at -50°C initially results in

the formation of platinum(II) complexes, but these slowly convert to the dimeric platinum(I) complex $[\text{Pt}_2\text{Cl}_2(\text{CO})_2(\text{P-Bu}^t_2\text{Ph})_2]$.⁹¹

The first homoleptic, dinuclear platinum(I) carbonyl complex $[\text{Pt}_2(\text{CO})_6]^{2+}$ has been prepared by dissolving PtO_2 in concentrated sulfuric acid under a CO atmosphere.^{92,93} The structure is rigid on the NMR time scale at room temperature. DFT studies suggested a staggered structure for the dimer.^{92,93}

6.5.3.1.2 Reactions

The hexakis(methyl isocyanide) dimers, $[\text{Pt}_2(\text{CNMe})_6]$, undergo photolytic cleavage of the Pt—Pt bond to give 15-electron radicals, $\text{Pt}(\text{CNMe})_3$.⁹⁴ Mixtures of platinum and palladium dimers give rise to heteronuclear complexes under photolytic conditions. Mixtures of normal and deuterium-labeled methyl isocyanide complexes reveal that the metal–ligand bonds undergo thermal redistribution.⁹⁴

6.5.3.2 Hydride Complexes

6.5.3.2.1 Structures

The hydride complexes of platinum(I) fall naturally between the supported and unsupported dimers because they range from one to the other. On going from nickel to platinum, there is a decreasing tendency for hydride ligands to bridge,⁹⁵ although there are examples of both bridging and terminal hydrides. *bis*Dihydride diphosphine platinum(II) complexes have a tendency to decompose to give dimeric platinum(I) complexes. For example, $[\text{Pt}(\mu\text{-H})(\text{C}_y_2\text{P}(\text{CH}_2)_n\text{PC}_y_2)]_2$ ($n=2\text{--}4$) is formed from the *cis*-dihydride on standing.²⁶ It is also formed by reaction of the ethylene complex with hydrogen gas.²⁶ A similar complex, $[\text{Pt}(\mu\text{-H})(\text{dppe})]_2$ is obtained by reacting $[\text{PtCl}_2(\text{dppe})]$ with LiBEt_3H , a reaction that proceeds via the *cis*-dihydride.⁹⁶ $[\text{Pt}(\mu\text{-H})(\text{dppe})]_2$ is a strong base and reacts with protic solvents such as methanol to give the hydride bridged platinum(II) complex $([\text{PtH}(\text{dppe})(\mu\text{-H})_2\text{Pt}(\text{dppe})]^+)$.⁹⁶ Schwartz and Anderson similarly found that the *cis*-dihydrides $[\text{PtH}_2(\text{PP})]$ ($\text{PP} = \text{Pr}^i_2\text{P}(\text{CH}_2)_2\text{PPr}^i_2$, $\text{C}_y_2\text{P}(\text{CH}_2)_2\text{PC}_y_2$, or $\text{Bu}^t_2\text{P}(\text{CH}_2)_2\text{PBU}^t_2$) formed dimeric platinum(I) complexes in solution and established that the hydrides are terminal rather than bridging.⁹⁵ Fryzuk *et al.* also found terminal hydrides in the closely related complex $[\text{PtH}(\text{PP})]_2$ ($\text{PP} = \text{Pr}^i_2\text{P}(\text{CH}_2)_3\text{PPr}^i_2$).⁹⁷ In contrast, Bennett and Roddick reported that the hydrides in $[\text{PtH}(\text{dfep})]_2$ are bridging and the Pt—Pt distances (2.7–2.8 Å) are more consistent with this description than those in the complexes mentioned above (2.5–2.6 Å).⁹⁸

6.5.3.2.2 Reactions

The A-frame hydride $[\text{Pt}_2\text{H}_2(\mu\text{-H})(\mu\text{-dppm})_2]$ undergoes reductive elimination of H_2 in the presence of tertiary phosphine ligands, L, to give the platinum(I) dimer, $[\text{Pt}_2\text{HL}(\mu\text{-dppm})_2]$. Hill and Puddephatt have shown that this occurs via the intermediate $[\text{Pt}_2\text{H}_2(\mu\text{-H})\text{L}(\mu\text{-dppm})_2]$ (**14**).⁹⁹ Carbon monoxide reacts rapidly and reversibly with $[\text{PtH}(\mu\text{-PP})_2\text{Pt}(\text{CO})]^+$, $\text{PP} = \text{R}_2\text{P-CH}_2\text{-PR}_2$, $\text{R} = \text{Et}$ or Ph , to give $[\text{PtH}(\mu\text{-PP})_2\text{Pt}(\text{CO})_2]^+$ and $[\text{PtH}(\text{CO})(\mu\text{-PP})_2\text{Pt}(\text{CO})_2]^+$, the first reported mixed valence, platinum(0)–platinum(II) complexes.¹⁰⁰

6.5.3.3 Phosphine-bridged Dimers

Phosphine-bridged dimers form the largest group of platinum(I) complexes. The most efficient bridging phosphines are those with a single central atom, $\text{R}_2\text{P-CH}_2\text{-PR}_2$ and the tendencies of these and longer chain phosphines are exemplified by the reactions of $[\text{Pt}(\text{triflate})_2(\text{PP})]$ ($\text{PP} = \text{Ph}_2\text{P-(CH}_2)_n\text{-PPh}_2$, $n=1$ or 2) with carbon monoxide. When $n=2$, the product is the unbridged complex, (**15a**), and when $n=1$ it is the bridged complex, (**15b**).

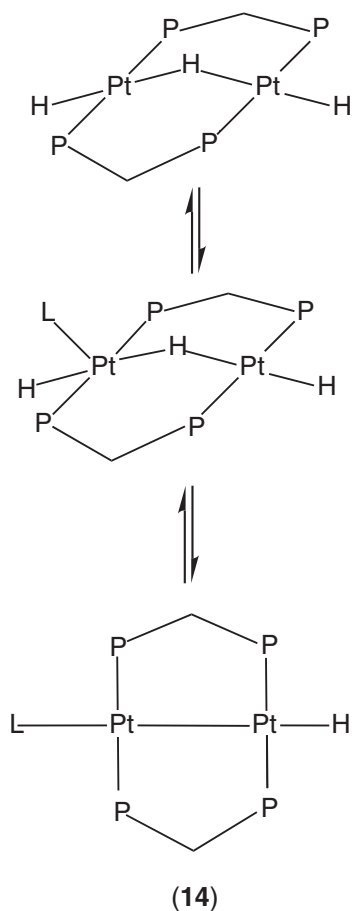

6.5.3.3.1 Preparation of phosphine-bridged dimers

The asymmetric platinum(I) dimer $[\text{Pt}_2\text{Cl}(\text{PPh}_3)(\mu\text{-dppm})_2]^+$ is the only product of the reaction of $[\text{Pt}_2\text{Cl}_2(\mu\text{-dppm})_2]$ with PPh_3 in relatively nonpolar solvents.¹⁰¹ Only in more polar solvents such as methanol are both chloro ligands replaced by the phosphine and the product, $[\text{Pt}_2(\text{PPh}_3)_2(\mu\text{-dppm})_2]^{2+}$, reacts with halides (Cl^- , Br^- , I^-) in dichloromethane to give the asymmetric dimer.¹⁰¹ An intermediate in these processes is the complex shown in (16), which has both bridging and chelating dppm ligands. The X-ray crystal structure of the PF_6^- salt of the asymmetric dimer reveals that the PPh_3 coordinated platinum is tetrahedrally distorted as a result of steric clashes between the phosphine ligands.¹⁰²

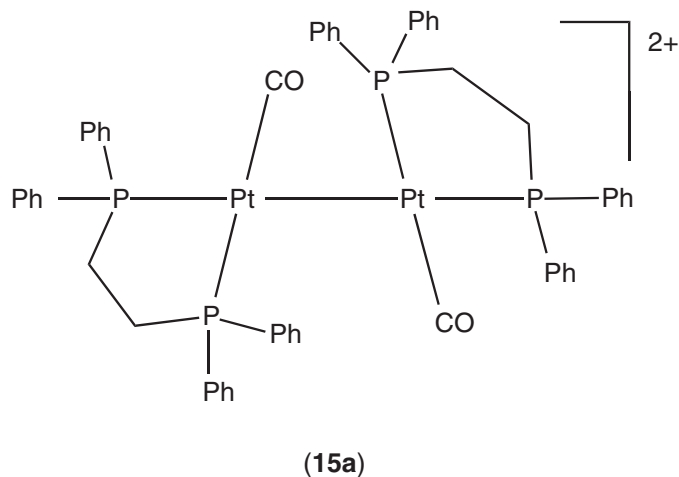

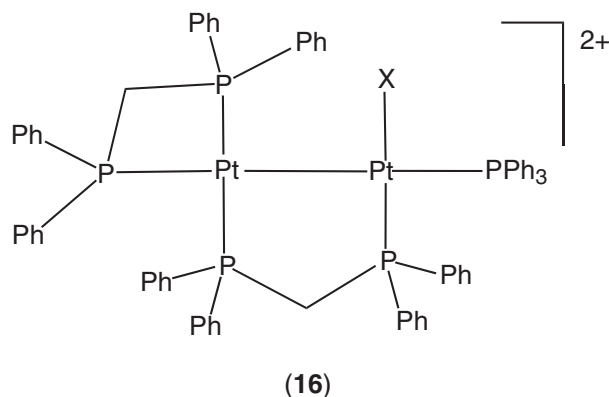
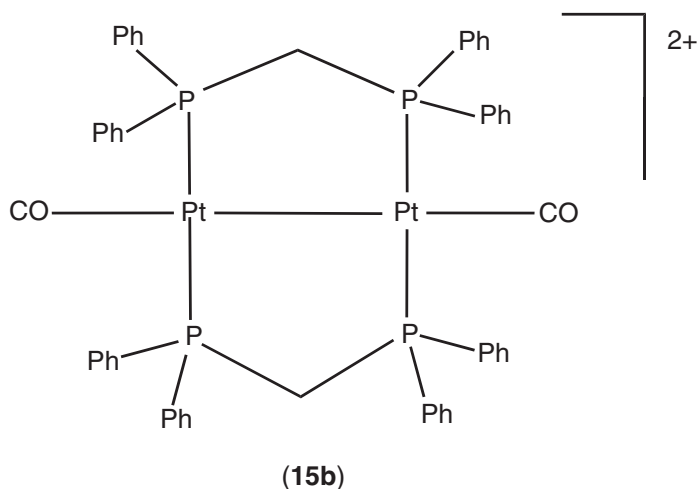

A mixed palladium/platinum dimer, $[\text{PtX}(\mu\text{-dppm})_2\text{Pd}(\text{C}_6\text{F}_5)]$ ($\text{X} = \text{Cl}, \text{Br}, \text{or } \text{C}_6\text{F}_5$) has been prepared by the reaction of $[\text{PdX}(\text{C}_6\text{F}_5)(\eta^1\text{-dppm})_2]$ with $[\text{Pt}(\text{COD})_2]$ or $[\text{Pt}(\text{PPh}_3)_4]$.¹⁰³

6.5.3.3.2 Reactions of phosphine-bridged dimers

Bridged phosphine complexes of the type $[\text{Pt}_2\text{X}_2(\mu\text{-dppm})_2]$ undergo reactions with a variety of substrates to give either the A-frame complexes $[\text{Pt}_2\text{X}_2(\mu\text{-Y})(\mu\text{-dppm})_2]^{n+}$, and/or the substituted platinum(I) dimers, $[\text{Pt}_2\text{XY}(\mu\text{-dppm})_2]^{n+}$ and $[\text{Pt}_2\text{Y}_2(\mu\text{-dppm})_2]^{n+}$, depending on the nature and proportion of the substrate used. Isocyanides in particular, give rise to a range of products. For instance, $[\text{Pt}_2\text{X}_2(\mu\text{-dppm})_2]$ ($\text{X} = \text{Cl}$ or I) reacts with *p*-tolylisocyanide (CNR) to give $[\text{Pt}_2\text{X}_2(\mu\text{-CNR})(\mu\text{-dppm})_2]$, $[\text{Pt}_2\text{X}(\text{CNR})(\mu\text{-dppm})_2]^{n+}$, and $[\text{Pt}_2(\text{CNR})_2(\mu\text{-dppm})_2]^{2+}$.¹⁰⁴ Reaction of $[\text{Pt}_2\text{Cl}_2(\mu\text{-dppm})_2]$ with NO^+ gives the stable cationic A-frame complex $[\text{Pt}_2\text{Cl}_2(\mu\text{-NO})(\mu\text{-dppm})_2]^+$.¹⁰⁵ Similar reactions are observed for the bromo and iodo complexes. $[\text{Pt}_2(\text{PPh}_3)_2(\mu\text{-dppm})_2]^{2+}$ reacts with CH_2N_2 , CO , S , and SO_2 in dichloromethane to give $[\text{Pt}_2(\text{PPh}_3)_2(\mu\text{-Y})(\mu\text{-dppm})_2]^{2+}$ ($\text{Y} = \text{CH}_2, \text{CO}, \text{S}, \text{and } \text{SO}_2$).¹⁰⁶ The reaction has pseudo first-order kinetics that are consistent with pre-association between the reactants or with formation of a common intermediate, probably one with a dangling dppm ligand.¹⁰⁶ The reaction of $[\text{Pt}_2\text{Cl}_2(\mu\text{-dppm})_2]$ with S_8 is second-order, whereas that with SO_2 involves pre-association of the reactants.¹⁰⁷ When the chloro ligands are replaced by uncharged ligands such as pyridine, NH_3 or CO , the reactions are much slower.¹⁰⁷ The chloro ligand in the unsymmetrical complex $[\text{PtCl}(\mu\text{-dppm})_2\text{Pt}(\text{C}_6\text{F}_5)]$ can be replaced by Br^- , SCN^- , PPh_3 , AsPh_3 , pyridine, or CO to give platinum(I) dimers.¹⁰⁸ Other agents such as alkynes, SO_2 , $[\text{N}_2\text{C}_6\text{H}_4\text{Me-}p]^+$, and H^+ insert in the

Pt—Pt bond to give A-frame complexes.¹⁰⁸ The related mixed-metal complex $[\text{PtCl}(\mu\text{-dppm})_2\text{Pd}(\text{C}_6\text{F}_5)]$ also reacts with R_2N^+ , SO_2 , and alkynes to give A-frame complexes.

Both chloro ligands of $[\text{Pt}_2\text{Cl}_2(\mu\text{-dppm})_2]$ are replaced by quinoline, 1-methylimidazole, and 4-*t*-butylpyridine, but only one is replaced by 2,4,6-trimethylpyridine.¹⁰⁹ All of these platinum(I) dimers and $[\text{Pt}_2(\text{PPh}_3)_2(\mu\text{-dppm})_2]$ display solid-state luminescence at room temperature and long emission lifetimes at 77 K.¹⁰⁹

The $[\text{Pt}_2\text{L}^1\text{L}^2(\mu\text{-dppm})_2]$ series of complexes has been used to study the trans influence of the ligands L^1 and L^2 on both the Pt—Pt bond and on each other. Platinum(195)—³¹P NMR coupling constants are influenced by the ligands and correlate with the Pt—P bond lengths in both platinum(I) dimers and platinum(II) complexes.¹¹⁰ The Pt—Pt bond exerts *cis* and *trans* influences similar to those of a hydride ligand and the *cis* and *trans* coupling constants can be used to estimate the Pt—Pt bond length.¹¹⁰ The ¹H and ³¹P NMR spectra reveal that the ligands L^1 and L^2 primarily influence the Pt—Pt bond, but ligands that exert a very strong *trans* influence can also affect each other.¹¹¹ Two-dimensional ³¹P COSY (Correlation Spectroscopy) spectroscopy can be used to determine the sign and magnitude of ² $J_{\text{Pt-P}}$ coupling constants that were unobtainable in complex spectra.¹¹²

6.5.3.4 Dimers Bridged by Unsymmetric Ligands

There is a range of complexes, analogous to the diphosphine-bridged dimers, in which one arm of the diphosphine is replaced by a nonphosphine donor. These complexes can exist as head-to-head (HH) or head-to-tail (HT) isomers as illustrated in (17) for the most widely studied group, where the bridging ligands are either 2-diphenyl- or 2-dimethyl-phosphinopyridine. The HT isomer is obtained only in the reactions of $[\text{Pt}(\text{Ph}_2\text{Ppy})_2\text{Cl}_2]$ with either $[\text{Pd}_2(\text{dba})_3]\cdot\text{CHCl}_3$ or $[\text{Pt}(\text{dba})_3]$ to give $[\text{PtPdCl}_2(\mu\text{-Ph}_2\text{Ppy})_2]$ and $[\text{Pt}_2\text{Cl}_2(\mu\text{-Ph}_2\text{Ppy})_2]$, respectively.¹¹³ In contrast, reaction of the iodo equivalent gives the HH isomer which undergoes isomerization on heating, the difference arising because $[\text{Pt}(\text{Ph}_2\text{Ppy})_2\text{Cl}_2]$ exists as the *cis* isomer in solution whereas $[\text{Pt}(\text{Ph}_2\text{Ppy})_2\text{I}_2]$ exists as the *trans* isomer.¹¹³ Similar conproportionation reactions involving the less bulky 2-dimethylphosphinopyridine ligand and Cl^- , Br^- , or I^- also give the HH isomer followed by isomerization to the HT isomer.¹¹⁴ The structures of these complexes and those of the diphenyl analogue were confirmed by X-ray crystallography,¹¹⁵ and revealed Pt—Pt bonds ranging from 2.56 Å to 2.59 Å, significantly shorter than those found in diphosphine bridged complexes.

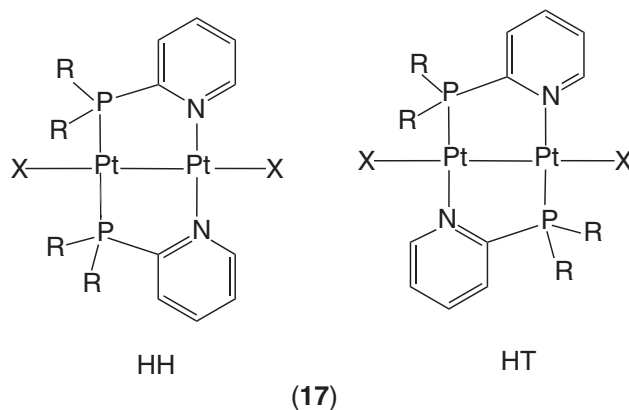

The diarsine and arsine/phosphine analogues of dppm have been used to prepare bridged diplatinum(I) complexes, in both cases with terminal chloro ligands.^{116,117} Both complexes react with carbon monoxide to produce carbonyl-bridged species. The mixed thio/phosphine ligand $\text{Ph}_2\text{PCH}_2\text{SMe}$ (PS) also forms a diplatinum(I) complex by conproportionation of its dichloroplatinum(II) complex with $[\text{Pt}(\text{dba})_2]$.¹¹⁸ This dimer reacts with carbon monoxide to produce an unsupported dimer $[\text{PtCl}(\text{PS})(\text{CO})]_2$ with the thioether arm of the $\text{Ph}_2\text{PCH}_2\text{SMe}$ unbound.

6.5.3.5 Dimers Bridged by Monodentate Ligands

A number of complexes with carbonyl and hydride bridges have been discussed above and phosphido bridges are discussed below. The most common of the other bridges are sulfur and

selenium, either in elemental form or as SR^- or CSR^- . For example, $[\text{Pt}(\text{CSE})(\text{dppe})]$ ($\text{E} = \text{S}$ or Se) reacts with $[\text{Pt}(\text{PPh}_3)_4]$ to give $[\text{Pt}_2(\mu\text{-E})(\text{dppe})(\text{PPh}_3)\text{CS}]$ as a result of cleavage of CS_2 or CSSe .¹¹⁹ Addition of dppe or dpmb ($\text{dpmb} = \text{Ph}_2\text{PCH}_2\text{-}o\text{-C}_6\text{H}_4\text{-CH}_2\text{PPh}_2$) results in reformation of the CSE to give the bridged complex $[\text{Pt}_2(\eta^2\text{-EC}=\text{S})(\text{diphos})_2]$ ($\text{diphos} = \text{dppe}$ or dpmb , $\text{E} = \text{S}$ or Se).¹¹⁹ A similar cleavage of CS_2 occurs on reaction of $[\text{Pt}(\eta^2\text{-CS}_2)(\text{dppe})]$ with $[\text{Pt}(\eta^2\text{-C}_2\text{H}_4)(\text{PPh}_3)_2]$ to give $[\text{Pt}_2(\mu\text{-S})(\text{dppe})(\text{PPh}_3)\text{CS}]$.¹²⁰

6.5.3.6 Phosphido-bridged Dimers

The trinuclear clusters $[\text{Pt}_3(\mu\text{-X})(\mu\text{-PPh}_2)_2(\text{PPh}_3)_3]^{n+}$ ($\text{X} = \text{H}, \text{Cl}, \text{S}, \text{SR}, \text{PPh}_2$) react with dpmp to give a dinuclear cation, $[\text{Pt}_2(\mu\text{-PPh}_2)(\mu\text{-dpmp})(\text{PPh}_3)_2]^+$, with bridging phosphido and dpmp ligands.¹²¹ Unlike its palladium analogue, the platinum(II) dihydride, $[\text{Pt}(\mu\text{-PBU}^t_2)(\text{H})(\text{PBU}^t_2\text{H})_2]_2$, does not undergo elimination of molecular hydrogen to give a platinum(I) dimer.¹²² However, oxidant-induced hydride abstraction gives $[\text{Pt}_2(\mu\text{-PBU}^t_2)_2(\text{H})(\text{PBU}^t_2\text{H})_2]^+$ and this can be deprotonated with a strong base to give $[\text{Pt}(\mu\text{-PBU}^t_2)(\text{PBU}^t_2\text{H})_2]$.¹²² This complex reacts with CO , resulting in displacement of one of the phosphines to give the monocarbonyl complex, $[\text{Pt}_2(\mu\text{-PBU}^t_2)_2(\text{PBU}^t_2\text{H})(\text{CO})]$.¹²² Thermally initiated degradation of a variety of platinum(0) complexes such as $[\text{Pt}(\text{PPh}_3)_2(\text{C}_2\text{H}_4)]$, $[\text{Pt}(\text{PPh}_3)_4]$ or $[\text{Pt}(\text{PPh}_3)_2(\text{alkyne})]$ in toluene gives a platinum(I) dimer with bridging phosphido and deprotonated triphenylphosphine $[\text{Pt}_2(\mu\text{-C}_6\text{H}_4(\text{PPh}_2)(\mu\text{-PPh}_2)(\text{PPh}_3)_2]$ (**18**).¹²³ Reaction of *cis*- $[\text{Pt}(\text{C}_6\text{F}_5)_2(\text{PPh}_2\text{H})_2]$, $[\text{Pt}(\text{norbornene})_3]$, and PPh_3 in a 1:1:1 ratio results in platinum(II) dimers, but in 1:1:2 ratio results in the phosphido bridged platinum(I) dimer $[\text{Pt}(\text{C}_6\text{F}_5)(\text{PPh}_3)(\mu\text{-PPh}_2)\text{Pt}(\text{PPh}_3)_2]$.¹²⁴

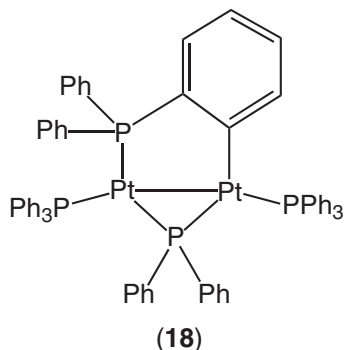

6.5.3.7 Electrochemical Reduction and Linear Chain Complexes

The reduction of $[\text{Pt}(\text{bipy})_2]^{2+}$ in water by metallic iron or at a platinum electrode gives monomeric $[\text{Pt}(\text{bipy})_2]\text{NO}_3 \cdot 2\text{H}_2\text{O}$ that forms as black-green needles.¹²⁵ The needles have a relatively high electrical conductivity and a $\text{Pt} \cdots \text{Pt}$ separation of $3.563(1) \text{ \AA}$.¹²⁵ In contrast, reduction in aprotic solvents such as DMF or DMSO results in the formation of dimeric $[\text{Pt}_2(\text{bipy})_2(\mu\text{-bipy})]^{2+}$ ($\text{bipy} = 2,2'\text{-bipyridine}$) with a $\text{Pt} \cdots \text{Pt}$ separation of $2.527, 2(5) \text{ \AA}$.¹²⁶

6.5.4 PLATINUM(II)

6.5.4.1 Platinum(II) Complexes with Carbonyl and Silicon-donor Ligands

6.5.4.1.1 Carbonyl ligands

Platinum(II)-carbonyl complexes have a long history. Indeed, chloro derivatives such as *cis*- $[\text{PtCl}_2(\text{CO})_2]$ were among the first transition metal carbonyl complexes to be prepared. Novel high-yielding, preparative routes to *cis*- $[\text{PtCl}_2(\text{CO})_2]$ have been described, in addition to its X-ray structure.¹²⁷ Methods of synthesis have included the reaction of $[\text{NBu}_4]_2[\text{PtCl}_4]$ with 1 atm of CO in CH_2Cl_2 solution at room temperature in the presence of AlCl_3 , which is added to the solution in order to scavenge free chloride. Another method involves the reaction of PtI_2 with 1 atm of CO

cyclopentylamine) with an excess of AgNO_3 .¹³⁸ Pt–Pt bridge cleavage and subsequent hydrolysis followed by the addition of chloride affords $[\text{PtCl}_3(\text{amine})]^-$ in reasonable-to-high yields.

The preparation of the first phosphodiester complexes of platinum(II), in particular those containing the diphenylphosphato ligand, has been reported.¹³⁹ Treatment of $[\text{PtCl}_2(\text{en})]$ with Ag_2O in DMF with two equivalents of diphenylphosphate gives $[\text{Pt}(\text{dpp})_2(\text{en})]$ (**26**); dpp = diphenylphosphato, en = ethylene-1,2-diamine), the first example of a bis(phosphodiester) complex of platinum(II). The complex is stable as a monomer, and it does not undergo dimerization or oligomerization reactions.

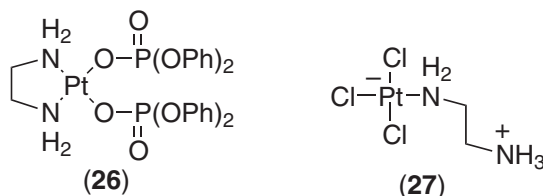

The reaction of $[\text{PtCl}(\text{Me}_2\text{S})(\text{en})]\text{Cl}$ with concentrated HCl results in the formation of the zwitterionic complex $[\text{PtCl}_3(\text{enH})]$ (**27**), where the en no longer acts as a chelating ligand owing to protonation of one of the amine groups.¹⁴⁰ The X-ray structure of the complex confirms the unusual coordination mode of the en ligand.

Bulk electrochemical reduction of the platinum(IV) complex of the tridentate ligand 1,1,1-tris(aminomethyl)ethane(tame), $[\text{Pt}(\text{tame})_2]^{4+}$, leads to the quantitative formation of $[\text{Pt}(\text{tame})_2]^{2+}$ (**28**), in which one of the amine donor groups in tame remains noncoordinated.¹⁴¹ The X-ray structure of the diprotonated complex $[\text{Pt}(\text{Htame})_2]^{4+}$, as its tetrachlorozincate(II) salt, is also reported.

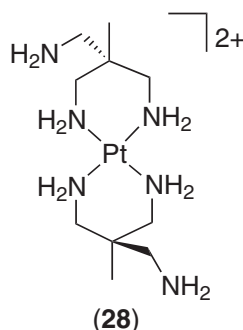

The synthesis and neutron diffraction study of the double-salt complex $[\text{NPr}^n_4]_2[\text{PtCl}_4] \cdot \text{cis}[\text{PtCl}_2(\text{NH}_2\text{Me})_2]$ at 20 K has been reported.^{142,143} The molecular structure of the complex shows strong $\text{N}-\text{H}\cdots\text{Pt}$ and $\text{N}-\text{H}\cdots\text{Cl}$ hydrogen bonds that link the two platinum(II) complexes. The structure confirms that transition metal centers can act as H-bond acceptors, and that a new three-center, four-electron hydrogen bridge model best describes the $\text{N}-\text{H}\cdots\text{Pt}$ interaction.

The detailed photophysics have been reported for the 1:1 supramolecular complex of $[\text{Pt}(\text{NH}_3)_2(\text{bipy})]^{2+}$ and a cylindrical macrocyclic receptor comprising of two [18]- N_2O_4 moieties linked to two 2,6-dimethylnaphthalene bridges.¹⁴⁴ The adduct is stabilized by the formation of an extensive network of H-bonds between the *O*-atoms of the macrocycles and the H-atoms of the ammine ligands. The electron-deficient bipy ligand and electron-rich naphthalene moieties also undergo $\pi-\pi$ stacking interactions, allowing for facile charge-transfer interactions to occur.¹⁴⁵

One of the most active research areas in bio-inorganic chemistry at the present time is the study of di- and trinuclear platinum complexes as potential anticancer drugs and as probes of DNA structure and function. Notably, a series of dinuclear complexes based on cisplatin and the corresponding *trans* isomer, linked by variable-length primary amines, have been studied in great detail by Farrell and co-workers.¹⁴⁶ The general formula of the complexes is $[\{\text{PtCl}_m(\text{NH}_3)_{3-m}\}-\mu\text{-H}_2\text{N}-\text{R}-\text{NH}_2-\{\text{PtCl}_n(\text{NH}_3)_{3-n}\}]^{(2-m)+(2-n)+}$ (m and $n = 0-3$; R = linear or substituted aliphatic group). Spermine- and spermidine-bridged complexes have also been studied.^{147,148}

The preparation of the dinuclear complexes is readily achieved by taking advantage of the well-established *trans* effect in square-planar complexes. For example, the treatment of two equivalents

of $[\text{PtCl}_3(\text{NH}_3)]^-$ with 1,4-diaminobutane leads to the formation of the dinuclear species *cis*- $[\{\text{PtCl}_2(\text{NH}_3)_2\}_2\{\mu\text{-H}_2\text{N}(\text{CH}_2)_4\text{NH}_2\}]$ (**29**), in which the diaminoalkane acts as bridging bidentate ligand.¹⁴⁹ Tetraamine complexes of the type $[\{\text{Pt}(\text{NH}_3)_3\}_2\{\mu\text{-H}_2\text{N-R-NH}_2\}]^{4+}$ (**30**) can be prepared by the reaction of *cis*- $[\{\text{PtCl}_2(\text{NH}_3)_2\}_2\{\mu\text{-H}_2\text{N-R-NH}_2\}]$ with aqueous ammonia. Another class of tetraamine complexes is prepared by the reaction of *cis*- $[\text{PtCl}_2(\text{NH}_3)_2]$ with the diaminoalkane to afford the doubly bridged species *cis*- $[\{\text{Pt}(\text{NH}_3)_2\}_2\{\mu\text{-H}_2\text{N-R-NH}_2\}_2]^{4+}$ (**31**). Further reaction of this species with aqueous HCl (6 M) affords *trans*- $[\{\text{PtCl}_2(\text{NH}_3)_2\}_2\{\mu\text{-H}_2\text{N-R-NH}_2\}]$ (**32**). The mononuclear species *trans*- $[\text{PtCl}_2(\text{NH}_3)\{\text{H}_2\text{N-R-NH}_3\}]^+$ (**33**), containing a dangling protonated amine, is also formed in the reaction mixture.¹⁵⁰ This species has proved to be very useful in the synthesis of the mixed *cis-trans* species $[\{\text{cis-PtCl}_2(\text{NH}_3)\}_2\{\mu\text{-H}_2\text{N-R-NH}_2\}\{\text{trans-PtCl}_2(\text{NH}_3)\}]$ (**34**) upon reaction with $[\text{PtCl}_3(\text{NH}_3)]^-$.¹⁵¹ The dinuclear trichloro species including $[\{\text{trans-PtCl}(\text{NH}_3)_2\}_2\{\mu\text{-NH}_2\text{-R-NH}_2\}\{\text{cis-PtCl}_2(\text{NH}_3)\}]^+$ (**35**) and $[\{\text{cis-PtCl}(\text{NH}_3)_2\}_2\{\mu\text{-NH}_2\text{-R-NH}_2\}\{\text{cis-PtCl}_2(\text{NH}_3)\}]^+$ (**36**) have also been reported,¹⁵² as have related structural types,^{153,154} including the first examples of platinum(II)-amine complexes containing a carborane (dicarba-*closo*-dodecaborane(12)) ligand (**37**) and (**38**).¹⁵⁵

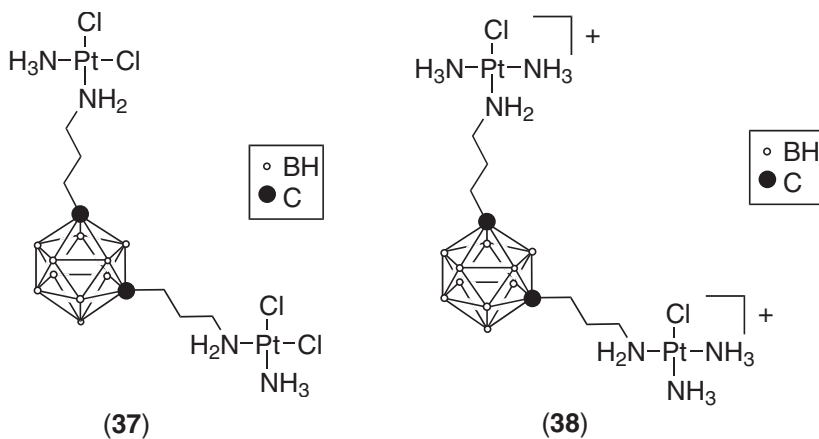
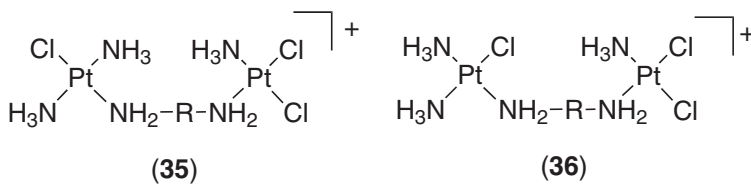
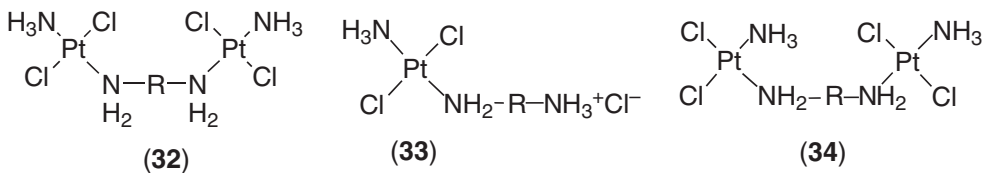
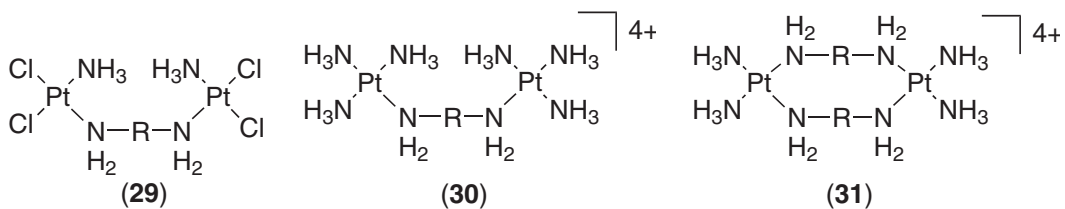

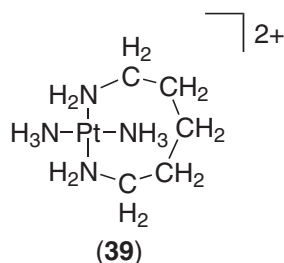

Farrell has noted that the types of products formed in the reaction of two equivalents of *trans*-[PtCl₂(NH₃)₂] with diaminoalkanes of the type NH₂(CH₂)_nNH₂ (*n* = 2–8) depend on the polymethylene chain length.¹⁵⁶ For example, the use of amines with *n* = 2–4 affords the dinuclear complexes [*trans*-[PtCl(NH₃)₂]₂{μ-NH₂(CH₂)_nNH₂}]²⁺, even when the chelating en ligand is used. In contrast, when *n* = 5, the amine acts as a *trans*-chelating bidentate ligand and the resulting complex has the formulation *trans*-[Pt(NH₃)₂{NH₂(CH₂)₅NH₂}]²⁺ (39). With longer chain length amines (*n* = 6–8), mixtures of products were observed, but the desired dinuclear complexes can be prepared in high yield and purity by the use of the labile species *trans*-[PtCl(dmef)(NH₃)₂]⁺ instead of the corresponding dichloro precursor.

The chemistry of dinuclear platinum(II) species linked by bridging diaminoalkane ligands can also be extended to related trinuclear species.¹⁵⁷ In general, the synthesis of a suitable mononuclear precursor complex containing two monoprotected amine ligands (by means of an amine hydrochloride salt, or a suitable blocking agent such as *t*-butoxycarbonyl that is readily removed by the addition of strong acid) is used as a source for further reactions with two equivalents of an appropriate platinum(II) complex in the presence of base. For example, the trinuclear species [*cis*-PtCl₂(NH₃)₂]₂{μ-*cis*-PtCl₂(NH₂-R-NH₂)₂} (40) can be prepared in three steps. First, treatment of [PtCl₄]²⁻ with two equivalents of a BOC-monoprotected diaminoalkane ligand affords *cis*-[PtCl₂{NH₂-R-NH(BOC)}₂]. Second, treatment of the *cis*-dichloro species with concentrated HCl affords the deprotected complex *cis*-[PtCl₂(NH₂-R-NH₃)₂]²⁺. Finally, the triplatinum species is prepared by the reaction of the BOC deprotected *cis*-dichloro intermediate with two equivalents of [PtCl₃(NH₃)]⁻ in the presence of base. More complicated complexes with two inequivalent coordination spheres can also be prepared as follows. First, treatment of *cis*-[PtCl₂(NH₃)₂] with two equivalents of a BOC-monoprotected diaminoalkane ligand affords *cis*-[Pt(NH₃)₂{NH₂-R-NH(BOC)}₂]²⁺. Second, treatment of the *cis*-dichloro species with concentrated HCl affords the deprotected complex *cis*-[Pt(NH₃)₂(NH₂-R-NH₃)₂]⁴⁺. Finally, the triplatinum species [*cis*-PtCl₂(NH₃)(μ-NH₂-R-NH₂)₂]{*cis*-Pt(NH₃)₂}²⁺ (41) can be prepared by treatment of *cis*-[Pt(NH₃)₂(NH₂-R-NH₃)₂]⁴⁺ with two equivalents of [PtCl₃(NH₃)]⁻ in the presence of base.

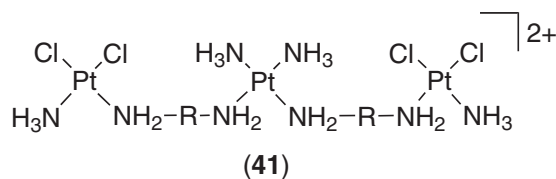
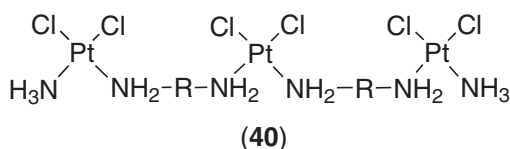

A comprehensive series of mono- and dinuclear iodoplatinum(II) complexes [PtI(dien)]⁺ and [{PtI(dien)}₂(μ-CH₂)_n] (42) (dien = parent or substituted diethylenetriamine; *n* = 2–9), respectively, have been synthesized as potential probes of nucleic acid structure.¹⁵⁸ Both chiral and achiral species were prepared. In general, the complexes are synthesized by the reaction of *trans*-[PtI₂(DMSO)₂] with the dien ligand in DMF solution.

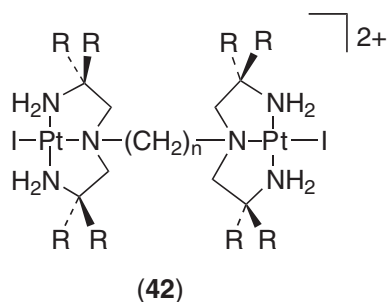

The synthesis and DNA-binding properties of a $[\text{PtCl}_2(\text{en})]$ complex tethered to an intercalating acridine orange (3,6-bis(dimethylamino)acridine) via a polymethylene chain ($n = 3$ or 6 ; **(43)**) have been reported.^{159,160} The solution aggregation behavior of these complexes was also studied in great detail. Both complexes are capable of binding to calf-thymus DNA, as determined by UV-visible spectroscopy. The hexamethylene-tethered complex is also capable of unwinding and rewinding supercoiled plasmid DNA. However, it does not shorten the DNA helix like its parent complex $[\text{PtCl}_2(\text{en})]$, probably due to the inhibition of the platinum binding mode that is responsible for the shortening effect by the nearby intercalator. Upon irradiation with a visible-light source, photonic nicking of the DNA was observed.¹⁵⁹

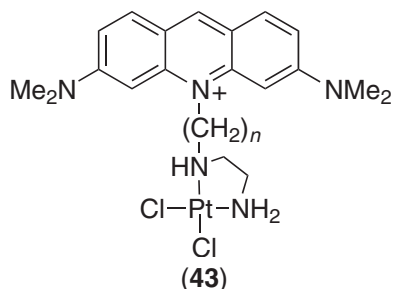

Chloroplatinum(II) complexes linked to DNA intercalators such as proflavine (3,6-diaminoacridine, dac) and 3,6-bis(dimethylamino)acridine (AO) may lead to enhanced DNA interactions when compared to cisplatin and other platinum drugs. Such complexes can be prepared by the direct reaction of the electrophilic coordinated alkene in $[\text{PtCl}(\text{C}_2\text{H}_4)(\text{tmen})]^+$ ($\text{tmen} = N,N,N',N'$ -tetramethylethane-1,2-diamine) with the endocyclic N -atom or the exocyclic amino groups of the acridine.¹⁶¹ The endocyclic N -atom of AO is involved in the reaction with the platinum(II) complex to afford the mononuclear species $[\text{PtCl}\{\text{CH}_2\text{CH}_2\text{-AO}\}(\text{tmen})]^+$ (**(44)**), in which the platinum(II) moiety is linked to the AO via an ethylene chain; the product structure was confirmed by means of X-ray diffraction. In the case of proflavine, the two exocyclic amino groups react with $[\text{PtCl}(\text{C}_2\text{H}_4)(\text{tmen})]$ to afford the dinuclear platinum(II) species $[\{\text{PtCl}(\text{tmen})\}_2\{\text{CH}_2\text{CH}_2\text{NH-C}_{13}\text{H}_7\text{NH-NHCH}_2\text{CH}_2\}]^+$ (**(45)**).

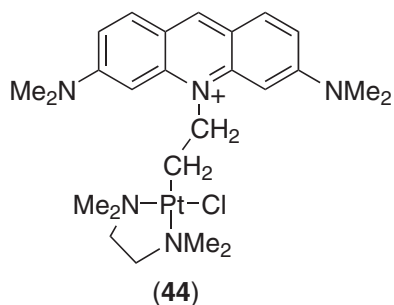

Hambley and co-workers have reported the synthesis, DNA cross-linking, and *in vitro* anti-cancer properties of a platinum(II) complex that was designed to bind the macromolecule in an interstrand rather than intrastrand manner,¹⁶² the latter being the dominant mode of DNA-binding by platinum anticancer drugs such as cisplatin. The complex $[\text{PtCl}_2(\text{hpip})]$ (**(46)**;

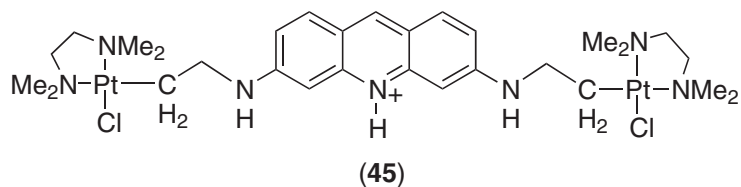

hpip = homopiperazine) was shown to cross-link linearized plasmid DNA in a bifunctional manner. Indeed, at low Pt/DNA nucleotide ratios, the complex was found to be equally effective at forming interstrand cross-links when compared to *cis*platin, but at higher Pt/DNA ratios *cis*platin was found to be more effective. Furthermore, the complex proved to form very few intrastrand cross-links, but monofunctional adducts were clearly dominant, accounting for over 90% of the total DNA interactions. Studies of the interaction of [PtCl₂(hPIP)] with a d(GpG) dinucleotide have also been reported.¹⁶³

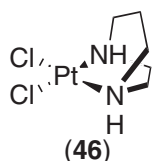

6.5.4.2.2 Amide ligands

The coordination modes of acetamide and formamide toward platinum(II) complexes containing diethylenetriamine have been reported.¹⁶⁴ The complexes were prepared by treatment of the labile aqua species [Pt(OH₂)(dien)]²⁺ with the amide in acetone solution. In both cases, two linkage isomers were isolated, in which the amides are *O*- or *N*-bonded to the metal center. The latter was found to exist in solution as the iminol [Pt{NHC(OH)R}(dien)]²⁺ (R = H, Me) (47) form instead of the tautomeric amide [Pt{NH₂COR}(dien)]²⁺ (48) and, furthermore, it adopted only a *cis* geometry with respect to the C—N bond, which possesses restricted rotation. The *O*-bonded isomers are the kinetic products, and very slowly (*t*_{1/2} = ca. 30 h at 293 K) convert to the thermodynamically favored *N*-bonded species in an intramolecular manner. Alternatively, base-catalyzed hydrolysis of the acetonitrile complex [Pt(MeCN)(dien)]²⁺ in water leads to the *N*-bonded acetamide complex [Pt(NHCOMe)(dien)]⁺, which can be protonated by strong Brønsted acids such as CF₃SO₃H to afford the iminol species [Pt{NHC(OH)Me}(dien)]²⁺. The free-energy difference between the two isomeric forms was determined to be 8.3 kJ mol⁻¹ in all cases. In a related study, the coordination chemistry of 1,1-dimethylurea in platinum(II)-dien complexes was also explored.¹⁶⁵ Once again, both *O*- and *N*-bound linkage isomers were isolated and characterized, with the latter being slightly thermodynamically favored (*K*_{eq(N-isomer/O-isomer)} ~ 3). Interestingly, in the *N*-bound complex, the 1,1-dimethylurea exists in the amide rather than iminol tautomeric form.

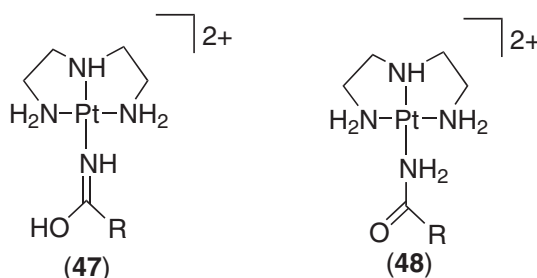

In a study of the hydrolysis of platinum(II)-nitrile complexes to afford the corresponding amides, the first well-characterized examples of platinum(II) complexes that dimerize spontaneously to form weakly bonded Pt–Pt dimers with an unsupported intermetallic bond have been described.¹⁶⁶ For example, treatment of *cis*-[PtCl₂(NCBu^t)₂] with excess KOH affords the amide species *cis*-[PtCl₂{HN=C(OH)Bu^t}₂], which exists as a dimer (49) both in solution and in the solid state, with a Pt–Pt bond length of 3.165(1) Å, as determined by X-ray crystallography. Four

p-NO₂C₆H₄; L₂ = 1,3-bis(diphenylphosphino)propane (dppp), R = Ph, *p*-tolyl) affords the mixed hydroxo-amido species [Pt₂(μ-OH)(μ-NHR)(L₂)₂]²⁺. In some cases, the di-μ-amido complexes of the type [Pt₂(μ-NHR)₂(L₂)₂]²⁺ are obtained (R = H, L₂ = dppm, dppe, dppp, 2PMe₂Ph; R = Ph, *p*-tolyl, L₂ = dppm, dppe; R = NH₂, L₂ = dppm, dppp, dppb). When the mixed hydroxo-amido species [Pt₂(μ-OH)(μ-NHR)(L₂)₂]²⁺ (**55**) are treated with strong bases such as LiNPr₂, deprotonation of the bridging hydroxo group occurs exclusively to afford the mixed oxo-amido species of the type [Pt₂(μ-O)(μ-NHR)(L₂)₂]⁺ (**56**), and deprotonation of the amido ligand is never observed. In the [Pt₂(μ-NHR)₂(dppm)₂]²⁺ (**57**) complexes, however, deprotonation of the dppm methylene group occurs with LiN(TMS)₂ to give complexes of the type [Pt₂(μ-NHR)₂(dppm-H)₂]; R = H, NH₂, Ph, *p*-tolyl) (**58**); the di-μ-hydrazido complex was crystallized as the [Li(THF)₂] adduct, in which the Li⁺ ion is strongly associated with the two hydrazido NH₂ groups. In another study, Sharp and co-workers have reported several other examples of related μ-hydrazidodiplatinum(II) derivatives.¹⁷⁷ Finally, treatment of the di-μ-amido species of the type [Pt₂(μ-NHR)₂(dppm-H)₂] (R = H, Ph, *p*-tolyl) with strong bases such as MeLi results in the deprotonation of the amido ligands to afford the di-μ-imido complexes [Pt₂(μ-NR)₂(dppm-H)₂]²⁻ (**59**).¹⁷⁶

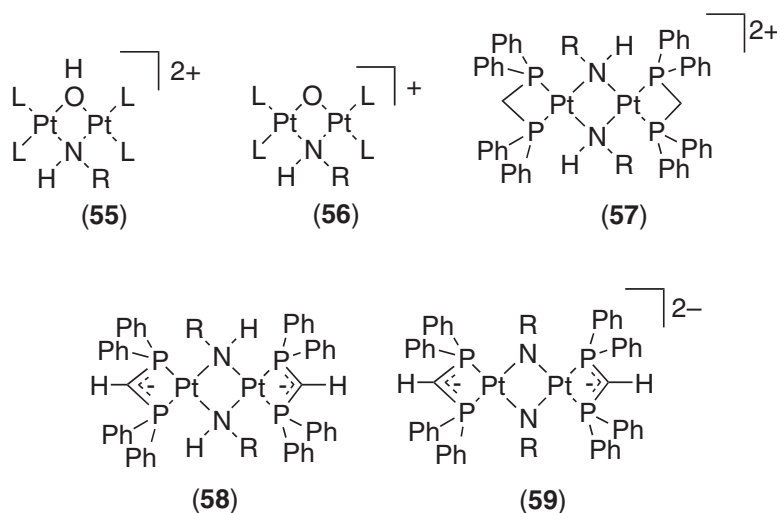

The phenylamidoplatinum(II) complex *trans*-[PtH(NHPh)(PEt₃)₂] can be obtained by the reaction of *trans*-[PtH(NO₃)(PEt₃)₂] with NaNHPh in C₆H₆/THF solution.¹⁷⁸ In the solid state, the complex is unstable and decomposes within a matter of hours at room temperature, but in solution it is stable for indefinite periods at ambient temperatures. Despite its instability in the solid state, the X-ray structure of the complex was determined at -100 °C. Addition of CO or PEt₃ to the complex results in the rapid formation of the platinum(0) species [Pt(CO)₂(PEt₃)₂] or [Pt(PEt₃)₄], respectively, by the reductive elimination of aniline. Treatment of the complex with H₂ gives [PtH₂(PEt₃)₂] and aniline. The reaction of *trans*-[PtH(NHPh)(PEt₃)₂] with acrylonitrile generates the hydrido(alkyl) species *trans*-[PtH{C(CN)CH₂NHPh}(PEt₃)₂], formed by regioselective insertion of the activated alkene into the Pt—N bond, thus modeling one of the key steps that would be required in a catalytic cycle for alkene amination.^{178,179} Other electrophilic substrates such as CO₂, COS, and PhNCO also insert into the Pt—N bond, with no insertion into the Pt—H bond ever observed. In a related reaction, *trans*-[PtH(OPh)(PEt₃)₂] is prepared by the reaction of *trans*-[PtH(NO₃)(PEt₃)₂] with NaOPh in C₆H₆/MeOH solution.¹⁷⁸ Its reactivity toward electrophilic substrates, for example, is similar to that of the amido analogue, although the reactions occur much more rapidly. The relative strength of the Pt—O bond vs. the Pt—N bond appears to govern the reactivity of the complexes.

Numerous sulfur nitrido derivatives of platinum(II) have been reported. Treatment of (TMSN)₂S with the platinum(0) complex [Pt(C₂H₄)(PPh₃)₂] affords *cis*-[Pt(NSN-TMS)₂(PPh₃)₂] by oxidative addition, the first example of a metal complex containing the RNSN⁻ ligand.¹⁸⁰ X-ray crystallography confirms that the ligand is σ-bonded to the platinum(II) center via the terminal N-atom. Disulfur dinitrido derivatives of platinum(II) have been prepared by the reaction of Na(S₃N₃) with [PtCl₂L₂] (L = PMe₃, PMe₂Ph, PMePh₂, PPh₃, PEt₃, PPrⁿ₃, PBuⁿ₃; L₂ = dppe) to afford complexes of the type [Pt(S₂N₂)L₂].¹⁸¹ The molecular structure of [Pt(S₂N₂)(PMe₃)₂] was confirmed by X-ray crystallography. In a related study, treatment of *cis*-[PtCl₂(PMe₃)₂] with

$[\text{Me}_2\text{Sn}(\text{S}_2\text{N}_2)]_2$ and NH_4PF_6 in CH_2Cl_2 solution affords the *N*-protonated metallacycle $[\text{Pt}(\text{S}_2\text{N}_2\text{H})(\text{PMe}_3)_2]\text{PF}_6$ and Me_2SnCl_2 .¹⁸² Another method of preparation involves protonation of disulfur dinitride complexes with strong acids. For example, treatment of $[\text{Pt}(\text{S}_2\text{N}_2)(\text{PMe}_2\text{Ph})_2]$ with HBF_4 affords $[\text{Pt}(\text{S}_2\text{N}_2\text{H})(\text{PMe}_2\text{Ph})_2]\text{BF}_4$. Treatment of $[\text{Pt}(\text{S}_2\text{N}_2\text{H})\text{L}_2]^+$ ($\text{L} = \text{PMe}_2\text{Ph}$, PMe_3 , PPt^n) with Br_2 gives the platinum(IV) complex *trans*- $[\text{PtBr}_2(\text{S}_2\text{N}_2\text{H})\text{L}_2]^+$, which rapidly undergoes isomerization to the corresponding *cis* isomer, followed by an unusual reductive elimination reaction to give $[\text{PtBr}(\text{S}_2\text{N}_2\text{H})\text{L}]$. The analogous iodo complex $[\text{PtI}(\text{S}_2\text{N}_2\text{H})(\text{PMe}_2\text{Ph})]$ can be prepared by the reaction of $[\text{Pt}(\text{S}_2\text{N}_2\text{H})(\text{PMe}_2\text{Ph})_2]^+$ with I_2 .¹⁸³ The first example of a six-membered PtS_2N_3 metallacycle was prepared by the reaction of $[\text{PtCl}_2(\text{PMe}_2\text{Ph})_2]$ with $\text{S}_4\text{N}_4\text{O}_2$ in liquid ammonia to afford $[\text{Pt}\{\text{S}_2\text{N}_3(\text{SO}_2)(\text{NH}_2)\}(\text{PMe}_2\text{Ph})_2]$.¹⁸⁴ The X-ray structure of the product was also reported, confirming the puckered nature of the PtS_2N_3 ring. The complex *trans*- $[\text{Pt}(\text{NSO})_2(\text{PPh}_3)_2]$ can be obtained by the reaction of the platinum(0) species $[\text{Pt}(\text{C}_2\text{H}_4)(\text{PPh}_3)_2]$ with $\text{Hg}(\text{NSO})_2$.¹⁸⁵

6.5.4.2.4 Nitroso ligands

The platinum(0) complex $[\text{Pt}(\text{PhNO})(\text{PPh}_3)_2]$ reacts with CO_2 to afford the metallacyclic nitroso species $[\text{Pt}\{\text{ON}(\text{Ph})\text{C}(\text{O})\text{O}\}(\text{PPh}_3)_2]$ (**60**), the first example of insertion of CO_2 into a Pt—N bond.¹⁸⁶ Other unsaturated carbon compounds such as CS_2 and electrophilic alkenes and alkynes react similarly. The diradical perfluoro-*N,N'*-dimethylethane-1,2-bis(amino-oxyl) reacts readily by oxidative addition to the platinum(0) precursor $\text{Pt}(\text{PPh}_3)_4$ to afford the corresponding platinum(II)–nitroso complex containing a seven-membered chelate ring (**61**). The resulting complex is stable in air for several days at room temperature.¹⁸⁷

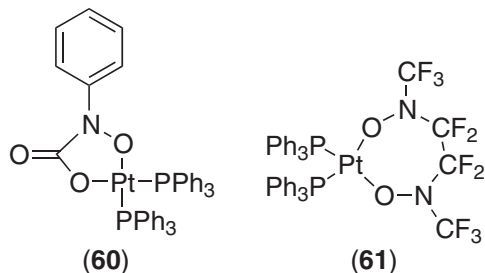

A dinuclear platinum(II) species containing three distinct linkage isomers of nitrosobenzene can be prepared by the treatment of $[\text{PtH}_2(\text{PMe}_3)_2]$ with a large excess of nitrobenzene to afford black crystals of $[\text{Pt}_2(\text{PhNO})_3(\text{PMe}_3)_3]$ (**62**) in low yield.¹⁸⁸ The X-ray structure of the product shows that the two platinum(II) centers and two bridging, dianionic nitroso groups are arranged in a puckered five-membered ring, with one of the nitroso ligands bridging the two metal centers in an unusual η^2 -manner and the other ligand bridging via the *N*-atom only. The third nitroso group acts as an uncharged *N*-donor ligand to one of the platinum atoms, formed by displacing one of the PMe_3 ligands.

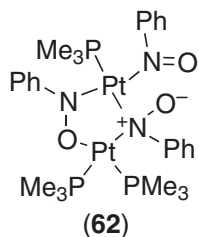

6.5.4.2.5 Heterocyclic *N*-donor ligands

Nitrogen heterocycles have a strong affinity for platinum(II), and complexes of these ligands, particularly pyridine and related diimines such as bipy, are ubiquitous.^{189,190} The favorable electronic (strong σ -donor/weak π -acceptor) and steric properties of such ligands lead to the

formation of many distinct classes of stable complexes, with many of these exhibiting strong luminescence owing to favorable MLCT processes.¹⁹¹

The cationic ligand 1'-methyl-2,4'-bipyridinium (mbpy) ion reacts with $[\text{PtCl}_4]^{2-}$ to afford the zwitterionic complex $[\text{PtCl}_3(\text{mbpy})]$ (**63**) in which the mbpy ligand is coordinated to the metal center in a monodentate manner via the N-1 atom.¹⁹² Refluxing the complex in water for several hours yields the cyclometallated species $[\text{PtCl}_2(\text{mbpy})]$, in which the platinum(II) center is coordinated to the pyridyl N-1 and C-5' atoms of the chelating mbpy ligand.

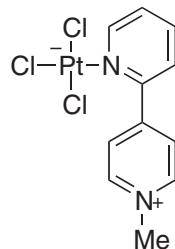

(63)

The orange–yellow complex $[\text{Pt}(\text{CN})_2(5,5'\text{-Me}_2\text{bipy})]$ is intensely luminescent in MeCN solution ($\lambda_{\text{emission}} = 502 \text{ nm}$, with a lifetime (τ_0) of $6.3 \mu\text{s}$) at room temperature.¹⁹³ The excited triplet state arising from a $\pi\text{-}\pi^*$ transition is a potent one-electron oxidizing agent and also a useful reductant, with numerous substrates such as alkyl iodides being able to quench the excited state. The intense solution and solid-state emission properties of related diimineplatinum(II) complexes of the type $[\text{PtL}_2(5,6\text{-Me}_2\text{phen})]$ ¹⁹⁴ and $[\text{Pt}(\text{CN})_2(\text{NN})]$ (NN = 4,4'-dimethyl-2,2'-bipyridine; bipy; 1,10-phenanthroline),¹⁹⁵ respectively, have also been reported.

Herber and co-workers¹⁹⁸ have described the detailed FT-IR, UV–visible and EXAFS study into the origin of the polychromism of $[\text{PtCl}_2(\text{bipy})]$ which is known to exist in both red and yellow crystalline forms.^{196,197} The predominant difference between the two modifications is the considerable differences in the stacking interactions of the monomers in the solid state.¹⁹⁸ Temperature-dependent X-ray diffraction and emission spectroscopy studies of the red form have also been reported.¹⁹⁹ The related complexes $[\text{Pt}(\text{CSN})_2(\text{bipy})]$ ²⁰⁰ and $[\text{Pt}(\text{CSN})_2(4,4'\text{-Me}_2\text{bipy})]$ ²⁰¹ were also studied. Both complexes display linkage isomerism where the thiocyanato ligand is coordinated to the metal center by either the S- or N-atom. Interestingly, the mixed linkage isomer $[\text{Pt}(\text{SCN})(\text{NCS})(4,4'\text{-Me}_2\text{bipy})]$ can be isolated by the careful heating of solid $[\text{Pt}(\text{SCN})_2(4,4'\text{-Me}_2\text{bipy})]$ under vacuum.

Langmuir-Blodgett films of luminescent platinum(II) complexes such as $[\text{Pt}(\text{dppe})(5,6\text{-Me}_2\text{phen})]^{2+}$ (**64**; phen = 1,10-phenanthroline) are of great interest.²⁰² Both monolayer and multilayer films can be prepared and manipulated on a water surface when the complexes are mixed with stearic acid in either a 1:1 or 1:2 ratio. The pressure–area isotherms of the films have been analyzed, and the monolayer-transferred films were studied by means of scanning tunneling microscopy. Luminescent Langmuir-Blodgett films of the amphiphilic complex $[\text{PtCIL}]^+$ (L = 2,6-bis(1-octadecylbenzimidazol-2-yl)pyridine) have also been reported.²⁰³

Platinum(II) complexes of the type $[\text{PtI}_2(2,9\text{-Me}_2\text{phen})\text{L}]$; L = C_2H_4 , CO, PPh_3 , ONPh can be prepared by the facile addition of L to $[\text{PtI}_2(2,9\text{-Me}_2\text{phen})]$.^{204,205} The X-ray structure for each of the complexes was determined. In the case of strong π -accepting ligands such as CO, the ground-state geometry of the complex is close to five-coordinate, but in the case of ONPh and PPh_3 , the rigid 2,9-Me₂phen ligand becomes monodentate and the complex is four-coordinate. *Ab initio* Hartree-Fock SCF MO calculations were performed in order to rationalize this behavior. In later work, the synthesis and detailed dynamic behavior of complexes of the type *cis*- and *trans*- $[\text{PtX}_2(2,9\text{-Me}_2\text{phen})(\text{PPh}_3)]$, *trans*- $[\text{PtX}(2,9\text{-Me}_2\text{phen})(\text{PPh}_3)_2]^+$, and *trans*- $[\text{PtX}(2,9\text{-Me}_2\text{phen})(\text{PBU}^n_3)_2]^+$ (X = Cl, Br, I), where the Me₂phen ligand acts as a monodentate ligand, were also reported.²⁰⁶

A series of diastereomeric platinum(II) complexes of the type *cis*- $[\text{PtL}_2\text{Y}_2]^{2+}$ (L = 3-bromopyridine, quinoline, isoquinoline; Y = PEt_3 , $\text{Y}_2 = \text{dppp}$, (*R*)-(+)-2,2'-bis(diphenylphosphino)-1,1'-binaphthyl (*R*-(+)-binap)) have been prepared by the reaction of *cis*- $[\text{PtY}_2(\text{OTf})_2]$ (OTf = trifluoromethanesulfonate) with two equivalents of the N-donor ligand.²⁰⁷ Related complexes have also been studied, for example when L = pyridine.²⁰⁸ Restricted rotation about the Pt–N bonds in many of the complexes is usually detected by NMR spectroscopy, with only $[\text{Pt}(\text{dppp})(\text{isoquinoline})_2]^{2+}$ (**65**) exhibiting dynamic behavior at ambient temperatures. The PEt_3

complexes are found to restrict the rotation of the N-donor ligand to the greatest extent, with the quinoline complexes undergoing the slowest interconversion. The X-ray structure of $[\text{Pt}(\text{dppp})(\text{quinoline})_2](\text{OTf})_2$ (**66**) and its ^{31}P NMR solution spectrum confirm that the complex exists in the *syn* conformation. In contrast, the major rotamer of $[\text{Pt}\{(R)\text{-}(+)\text{-binap}\}(\text{isoquinoline})_2]$ (**67**) exists in one of the two *anti* (C_2 -symmetrical) forms.²⁰⁷ In a related study, the Pt—N rotational barriers in complexes of the type $[\text{Pt}\{R\text{-}(+)\text{-binap}\}L_2]^{2+}$ ($L = 3\text{-picoline}, 2\text{-bromo-5-methylpyridine}, 2\text{-methylquinoline}, 3\text{-methylisoquinoline}$) were determined by means of variable-temperature NMR spectroscopy.²⁰⁹

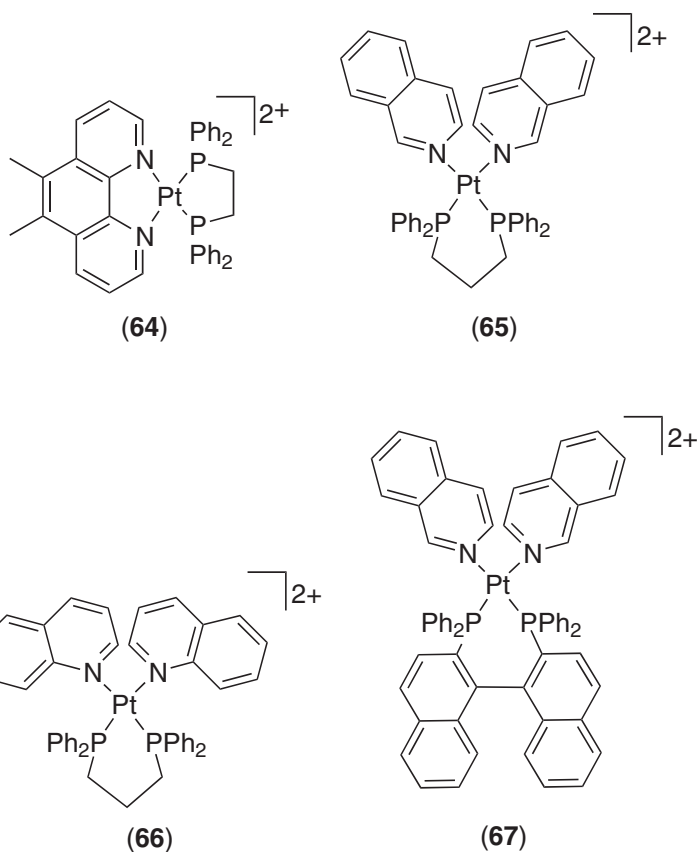

Platinum(II) complexes of 1-methyluracil, 9-ethylguanine, 9-methyladenine, and several other nucleobase derivatives have been reviewed extensively,^{210,211} and the following examples serve to highlight this rich and diverse area of coordination chemistry. The molecular structure of *cis*- $[\text{Pt}(\text{NH}_3)_2(1\text{-MeU})_2]\cdot 4\text{H}_2\text{O}$ has been determined by X-ray diffraction, confirming the coordination of 1-MeU to the metal center via N-3 of the pyrimidine base.²¹² The reaction of $[\text{Pt}(\text{NH}_3)_3(\text{H}_2\text{O})]^{2+}$ with 9-EtGH affords three products, the mononuclear species $[\text{Pt}(\text{NH}_3)_3(9\text{-EtGH})]^{2+}$ (**68**) where the platinum(II) center is bonded to N-7, the dinuclear species $[\text{Pt}(\text{NH}_3)_3(9\text{-EtG})\text{-Pt}(\text{NH}_3)_3]^{3+}$ (**69**) where one platinum(II) center is bonded to N-7, and the other bonded to (deprotonated) N-1 and, finally, the trinuclear species $[\{\text{Pt}(\text{NH}_3)_3\}_3(9\text{-EtG})]^{5+}$ (**70**) where the sites of platination occur at (deprotonated) N-1, N-3, and N-7.²¹³ The triplatinated species is the first example of a guanine complex containing three metal centers. The synthesis and structure of a dinuclear platinum(II) derivative of 9-EtG bridged by pyrazolate (pz), *cis*- $[\{\text{Pt}(\text{NH}_3)_2(9\text{-EtG})\}_2(\mu\text{-pz})]^{3+}$ (**71**), has been reported.²¹⁴ The unusual but facile intramolecular migration of *trans*-diammineplatinum(II) from the endocyclic N-1 (or N-7) site to the exocyclic NH_2 group in 9-MeA has been demonstrated.^{215,216} A platinum(II) derivative of 3',5'-diacetylthymidine ($\text{Ac}_2(\text{dT})$) has been prepared by the treatment of *cis*- $[\text{PtCl}_2(\text{dppf})]$ ($\text{dppf} = 1,1'\text{-bis}(\text{diphenylphosphino})\text{ferrocene-}P^1, P^2$) with $\text{Ac}_2(\text{dT})$ in dimethylsulfoxide or *N,N*-DMF solution to rapidly afford the species *cis*- $[\text{PtL}\{\text{Ac}_2(\text{dT})\}(\text{dppf})]$ ($L = \text{DMSO}, \text{DMF}$). The $\text{Ac}_2(\text{dT})$ ligand is coordinated to the platinum(II) center via the (deprotonated) N-3 atom of thymidine.²¹⁷

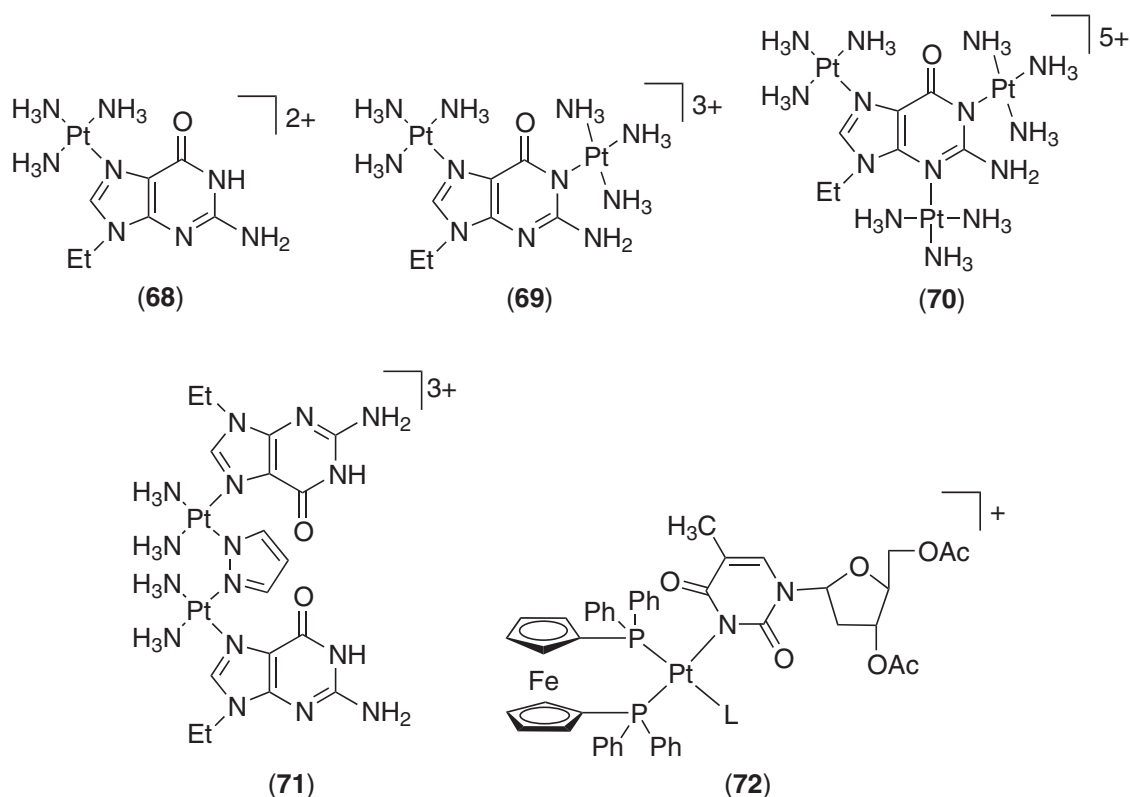

Farrell and Skov have reported the synthesis and properties of the two- and five-substituted nitroimidazole complexes *cis*- and *trans*-[PtCl₂(NH₃)(ImNO₂)], which may be useful as potential radiosensitizers and hypoxic cytotoxins.^{218,219} Treatment of [PtCl₃(NH₃)]⁻ with one equivalent of the nitroimidazole derivatives etanidazole, misonidazole, and metronidazole affords the *cis* isomers. Heating the complexes for several hours leads to the formation of the corresponding *trans* isomers when misonidazole or metronidazole is used. The X-ray structure of *cis*-[PtCl₂(NH₃)(etanidazole)] (73) and the reduction potentials of all new complexes were also determined. Interestingly, the reduction potential of all nitroimidazole ligands increased by 0.15–0.25 V upon coordination to the metal. The complexes have also been shown to bind to DNA.²¹⁸

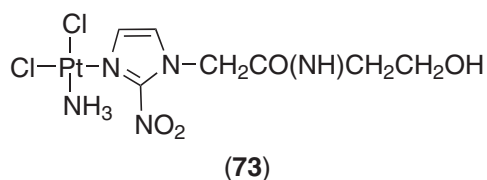

The preparation and DNA-binding properties of platinum(II) complexes of the type [Pt(bipy)(*n*-R-py)]²⁺ (R = CN, Cl, H, Ph, Me, NH₂; *n* = 2–4), prepared by the reaction of excess pyridine with [PtCl₂(bipy)], have been reported.²²⁰ The related [Pt(Ph₂bipy)(4-R-py)]²⁺ complexes were also studied.²²¹

The synthesis and X-ray structure of a platinum(II) complex containing the well-known antiviral nucleoside acyclovir (9-(2-hydroxyethoxymethyl)guanine, acv) have been described.²²² Treatment of acyclovir with [PtCl(DMSO)(en)]⁺ results in the formation of [Pt(en)(acv)₂]²⁺ (74), whereby two acv molecules are coordinated to the platinum(II) center via their N-7 atoms. The related complex *cis*-[PtCl(NH₃)₂(acv)]⁺ (75) has also been reported.²²³

Numerous examples of nucleophilic attack on coordinated nitrile ligands are found in the literature, particularly when the transition metal is platinum(II).²²⁴ The nucleophilic attack of two equivalents of ClCH₂CH₂O⁻ on the electrophilic nitrile carbon atoms of both nitrile ligands in *cis*- or *trans*-[PtCl₂(RCN)₂] (R = Et, Prⁿ, Prⁱ, Bu^t, *p*-CF₃C₆H₄, *p*- and *o*-MeC₆H₄) affords the corresponding Δ²-1,3-oxazoline complexes ((76) and (77), respectively), in which the heterocycle acts as a

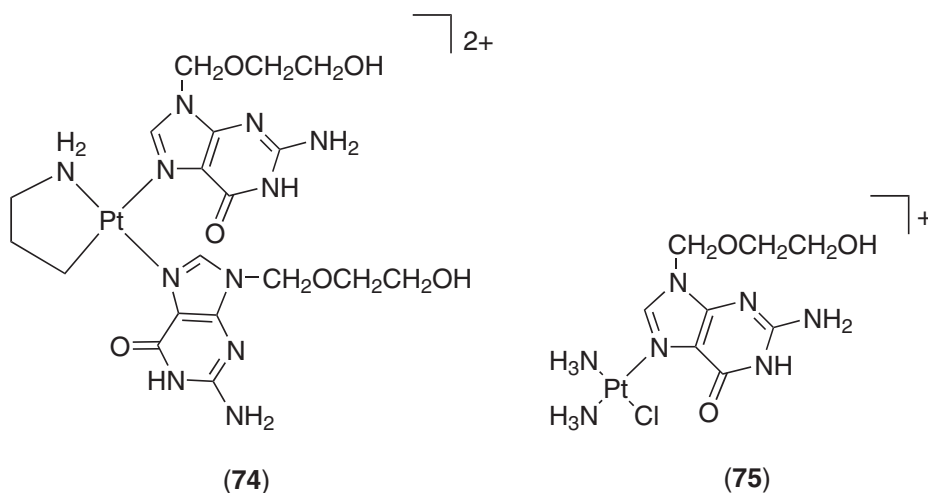

N-donor ligand. The reaction appears to proceed via an acyclic iminoplatinum(II) intermediate that undergoes a subsequent intramolecular cyclization. Some mechanistic aspects of this versatile reaction have been elucidated.^{225,226} Δ^4 -1,2,4-oxadiazolines have been prepared by the [2+3] cycloaddition of various nitrones to coordinated benzonitrile in *cis*-[PtCl₂(DMSO)(PhCN)] precursors.^{227,228} Racemic and chiral [PtCl₂(PhMeSO)(PhCN)] complexes have also been used in order to introduce a degree of stereoselectivity into the reaction, resulting in the first enantioselective synthesis of Δ^4 -1,2,4-oxadiazolines, which can be liberated from the complexes by the addition of excess ethane-1,2-diamine.

Liquid–crystalline complexes (metallomesogens) containing platinum(II) are new types of materials that have been the subject of several studies. These have largely included complexes of the type *trans*-[PtX₂L₂] (X = Cl, L = cyanobiphenyls,²²⁹ X = Cl, carboxylate, L = 4-alkoxy-4′stilbazoles;²³⁰ X = Cl, L = 2,4-, 3,4-, or 3,5-dialkoxy stilbazoles, 2,3,4-, 2,4,5-, or 3,4,5-trialkoxy stilbazoles).^{231,232} Their liquid–crystalline properties have also been reported.

The first examples of transition metal complexes containing 4,9-dichloroquino[7,8-*h*]quinoline, also known as a “proton sponge”, have been described.²³³ Treatment of Zeise’s dimer, [Pt₂(C₂H₄)₂Cl₄], with 4,9-dichloroquino[7,8-*h*]quinoline (dcqq) in CH₂Cl₂ solution leads to the formation of [PtCl₂(dcqq)] (78). The X-ray structure of the complex reveals a highly distorted aromatic system, with the platinum atom lying 1.43 Å out of an idealized square plane.

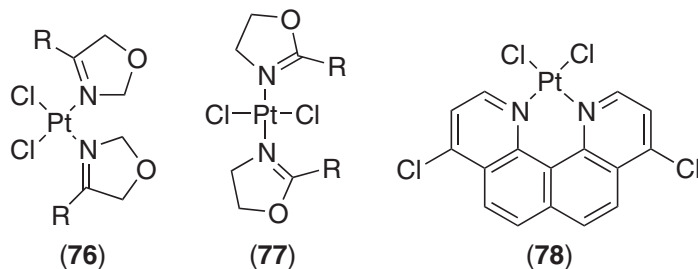

Fujita *et al.* have reported the synthesis of a remarkable “molecular lock” comprising of two dinuclear platinum(II) complexes that form a mechanically interlocked [2]-catenane structure.²³⁴ Heating the monomeric platinum(II) species (79) in highly polar media such as a concentrated aqueous solution of NaNO₃ (5 M) results in the cleavage of at least one of the Pt–N bonds, and a subsequent equilibrium results between the monomer and catenated dimer, with the self-assembly of the latter favored under these conditions. Cooling and crystallization from the solution allowed the [2]-catenane species to be isolated, the structure of which was confirmed by X-ray diffraction. The mechanically interlocked species was stable to 100 °C in aqueous solution. This example is only one of several that have highlighted the great versatility of the Pt–N bond in the construction of nanomolecular polygons and polyhedra by self-assembly, an area that has been reviewed extensively.^{235–249} Furthermore, supramolecular coordination chemistry is comprehensively reviewed in Volume 6 of *Comprehensive Coordination Chemistry II*. Two major classes of precursor platinum(II) complexes containing labile ligands have been utilized in these studies, namely the mononuclear complexes

[Pt(en)(NO₃)₂] and [Pt(OTf)₂L₂] (L = mono- or 1/2 bidentate tertiary phosphine) or dinuclear complexes of the type [Pt₂(OTf)₂(μ-σ-aryl)L₂] (L = monodentate tertiary phosphine; σ-aryl = 4,4'-biphenyl, *p*-terphenyl, 4,4'-benzophenone, etc.); other structural motifs employing platinum(II) have also been reported.²⁵⁰ The addition of bridging, multidentate N-donor ligands of various shapes and sizes to the labile complexes in a suitable solvent system has afforded several classes of discrete, platinum(II)-containing polygons, polyhedra, and catenanes.

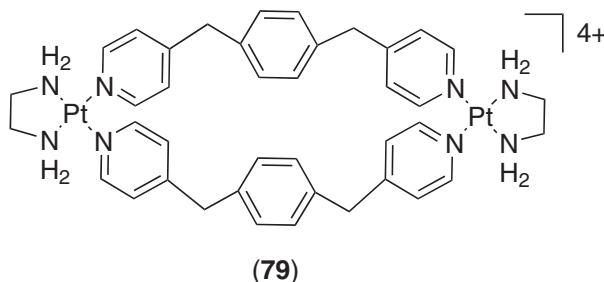

6.5.4.2.6 Macrocyclic N-donor ligands

The first structurally characterized example of a platinum(II) derivative containing a saturated tetraamine macrocycle, 6,13-dimethyl-1,4,8,11-tetraazacyclotetradecane-6,13-diamine has been reported (**80**).²⁵¹ The species crystallizes as the colorless tetra-cationic complex from dilute HClO₄ solution by slow evaporation, where the two pendant primary amines are protonated. Other macrocyclic tetraamine complexes including [Pt([14]aneN₄)]Cl₂ have also been described.²⁵²

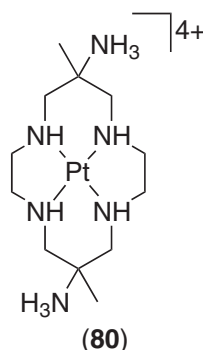

A lipophilic dioxocyclam derivative has proved to be very efficient at the selective extraction of platinum(II) from complexes such as *cis*-[PtCl₂(NH₃)₂] or [PtCl₄]²⁻ at pH > 3.²⁵³ Addition of the reducing agent S₂O₃²⁻ to the solution assists with metal complexation, possibly by reductive weakening of the Pt—X bond prior to complexation by the macrocycle. Indeed, the absence of a reducing agent leads to very little complexation. The macrocycle can also selectively remove platinum(II) from a mixture of metal ions including copper(II) and nickel(II). The method described in this work may have potential applicability in chelation therapy and in analytical and mineralogical systems. The first X-ray structures of dioxocyclam- and 6-methyldioxocyclam-platinum(II) complexes (**81**) and (**82**), respectively) have also been reported.²⁵⁴

The reaction of *trans*-[PtCl₂(NH₃)(PEt₃)] with the aza-crown ethers [12]aneNO₃, [15]aneNO₄, and [18]aneNO₅ in CHCl₃ solution has been reported.²⁵⁵ Substitution of the ammine ligand by the secondary amine of the crown ether ensues to give complexes of the type *trans*-[PtCl₂(aza-crown)(PEt₃)]. When the 4,13-diaza[18]crown-6 ether [18]aneN₂O₄ is used, a dinuclear complex [{"PtCl₂(PEt₃)}₂([18]aneN₂O₄)] (**83**) is obtained. If equimolar amounts of *trans*-[PtCl₂(NH₃)(PEt₃)] and *trans*-[PtCl₂([18]aneNO₅)(PEt₃)] are allowed to crystallize from CHCl₃ solution then yellow crystals of the second-sphere adduct *trans*-[PtCl₂(NH₃)(PEt₃)]·[PtCl₂([18]aneNO₅)(PEt₃)] (**84**) are formed, the first example of a metalloreceptor in which *both* the host and guest are transition metal complexes. X-ray analysis of the adduct reveals extensive H-bonding interactions of the ammine ligand in the *trans*-[PtCl₂(NH₃)(PEt₃)] guest with the crown ether O-atoms in the *trans*-[PtCl₂([18]aneNO₅)(PEt₃)] host. The same authors have also reported that the dicationic tetrakis(*n*-butylnicotinamide)platinum(II) species is a useful receptor for oxoanions such as nitrate.²⁵⁶

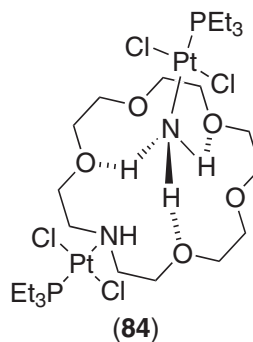
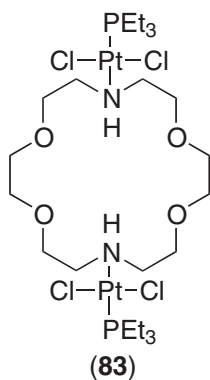
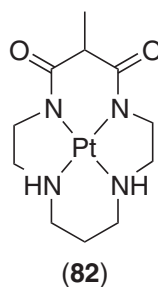
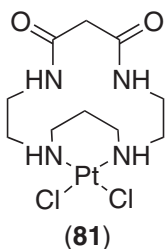

Platinum(II) derivatives of the mono- and trimacrocyclic N_2S_2 -donor ligands based upon 1,9-dithia-5,13-diazacyclohexadecane have been reported.²⁵⁷ Treatment of the ligands with *cis*- $[PtCl_2(PhCN)_2]$ in MeCN solution under reflux conditions afforded the mono- and trinuclear complexes ((85) and (86), respectively) in good yield.

6.5.4.2.7 Amino acid and peptide ligands

The interaction of platinum(II) complexes with various amino acids and simple peptides is relevant to understanding the biological fate of platinum anticancer agents such as *cis*platin, and this area has been reviewed extensively.^{258–261}

Treatment of the simplest amino acid glycine, with *cis*- $[Pt(NH_3)_2(H_2O)_2]^{2+}$ in aqueous solution affords *cis*- $[Pt(NH_3)_2(O-glyH)(H_2O)]^{2+}$ (87), in which the glycine is coordinated to the metal center via the *O*-atom only.²⁶² The product subsequently converts to the thermodynamically

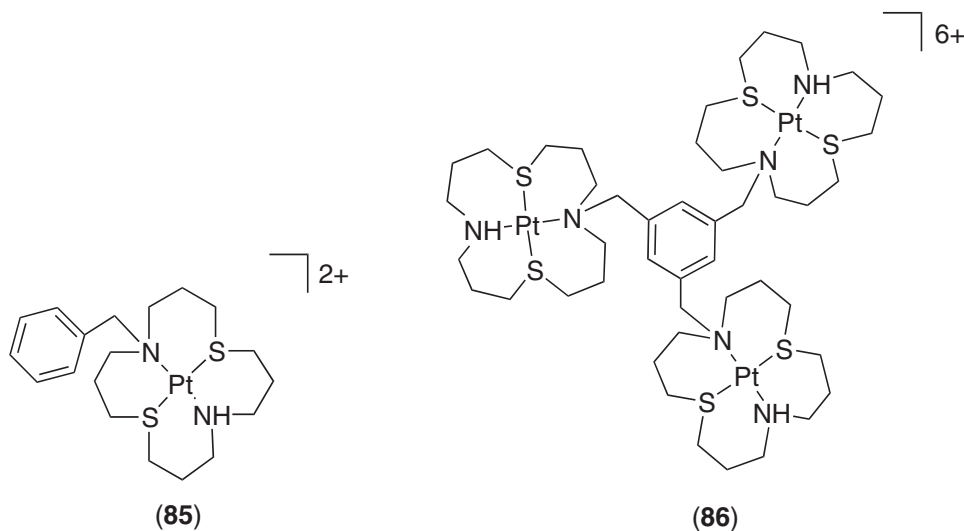

avored chelate complex $[\text{Pt}(\text{NH}_3)_2(N,O\text{-gly})]^+$ (**88**). The slow rate of the ring closure reaction is considerably enhanced if base is added to the solution in order to deprotonate the ammonium group of the glycine. Alternatively, gentle heating of the solution enhances the rate of ring closure also. Similar reactions were also observed with *N*-acetylglycine.²⁶³ In a related study, treatment of *cis*- $[\text{Pt}(\text{NH}_3)_2(\text{H}_2\text{O})_2]^{2+}$ with L-methionine and *S*-methyl-L-cysteine at pH = 5 affords the chelate complexes $[\text{Pt}(\text{NH}_3)_2(N,S\text{-met})]^+$ (**89**) and $[\text{Pt}(\text{NH}_3)_2(N,S\text{-mecys})]^+$ (**90**), respectively, as slowly interconverting diastereomers owing to the different configurations about the sulfur atom.²⁶⁴ At low pH values (≤ 0.5), the first product that is formed in the reaction with *S*-methyl-L-cysteine is the *O*-bonded chelate complex $[\text{Pt}(\text{NH}_3)_2(O,S\text{-mecysH})]^{2+}$ (**91**), which is slowly converted to the thermodynamically preferred *N,S*-chelate species (**92**). A similar type of reaction occurs with L-methionine, but *cis*- $[\text{Pt}(\text{NH}_3)_2(S\text{-metH})]^{2+}$ (**93**) is also formed in competition with *cis*- $[\text{Pt}(\text{NH}_3)_2(O,S\text{-metH})]^{2+}$ (**94**). Loss of ammonia occurs in all complexes upon standing, most probably due to the strong *trans*-effect of the S-donor ligand. In another study involving the reaction of *cis*- $[\text{Pt}(\text{NH}_3)_2(\text{H}_2\text{O})_2]^{2+}$ with the thiol-containing amino acids *N*-acetyl-L-cysteine, D,L-homocysteine and the peptide glutathione, a dinuclear complex containing a four-membered Pt_2S_2 ring is formed, with slow loss of ammonia from the complexes again being observed.²⁶⁵ L-Cysteine affords a related complex in addition to two minor components, *cis*- $[\text{Pt}(\text{NH}_3)_2\{(\text{SCH}_2\text{CH}(\text{NH}_3)(\text{CO}_2\text{H})_2\}_2]^{2+}$ and $[\text{Pt}(\text{NH}_3)_2(N,S\text{-cysH})]^+$. Finally, the use of D-penicillamine at low pH (< 0.5) leads to the initial formation of a dinuclear platinum(II) species $[\{\text{Pt}(\text{NH}_3)_2\}_2(\text{penH})]^{3+}$ in which it appears that the two metal centers are bridged by both the sulfur atom and the carboxylato group. Within a few hours at room temperature, the complex converts to a new isomeric species in which the two metal centers are still bridged by the sulfur atom, but the D-penicillamine amino group is coordinated to one of the platinum(II) centers, and the carboxylato group is bound to the other metal center.

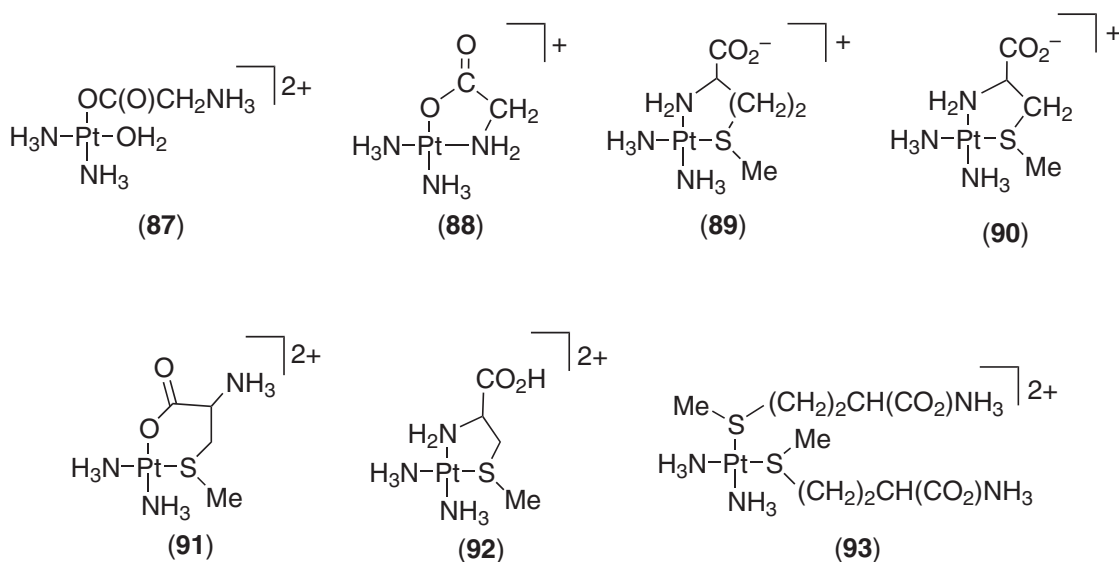

The use of luminescent complexes such as $[\text{PtCl}(\text{terpy})]^+$ (terpy = 2,2':6',2''-terpyridine) and its derivatives as reporter probes for biomolecules is now well-established.^{266,267} As part of a number of studies involving the labeling of specific protein sites with metal complexes,²⁶⁸⁻²⁷¹ Kostic and co-workers have investigated the reactions of $[\text{PtCl}(\text{terpy})]^+$ with arginine, guanidine, *N*-acetylarginine, canavanine, and methylguanidine.²⁷² The platinum(II) precursor reacts with ArgH, CanH, and MeGua to afford the yellow, mononuclear species of the type $[\text{PtL}(\text{terpy})]^{2+}$ (L = ArgH, CanH, and MeGua, respectively). In these reactions, a red dinuclear species $[\{\text{Pt}(\text{terpy})\}_2\text{L}]^{4+}$ was also formed, and the two species were readily separated from each other by means of cation-exchange chromatography. In the mononuclear complexes, the guanidine ligand coordinates to the metal center by means of the trigonal imino-type N atom. In contrast, the guanidine ligand bridges two metal centers in the dinuclear complexes via the amino- and imino-type N-atoms. The X-ray structure of $[\{\text{Pt}(\text{terpy})\}_2(\text{Can})]^{4+}$ (**95**) confirms the unusual bonding mode of the guanidine ligand.

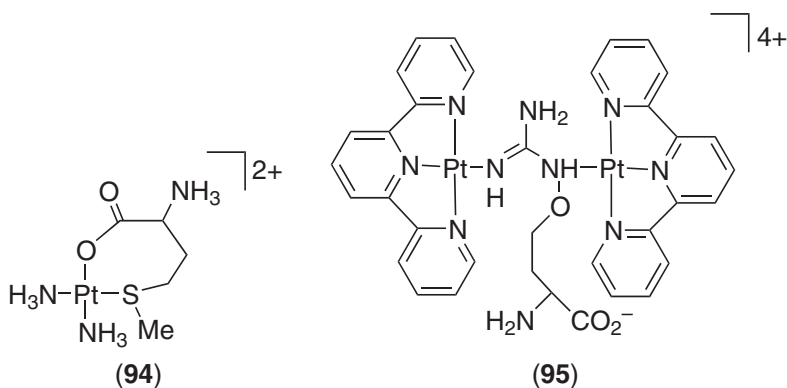

The ^1H , ^{13}C , and ^{195}Pt NMR and CD spectroscopic characterization of platinum(II) complexes containing the triglycine (trg) peptide has been reported. Treatment of triglycine with $[\text{PtCl}_4]^{2-}$ in aqueous solution ($\text{pH} = 6-7$) affords three distinct 1:1 peptide complexes, namely $[\text{PtCl}(\text{trg})]^{2-}$ (**96**), $[\text{Pt}(\text{trg})]^-$ (**97**), and $[\text{Pt}(\text{OH})(\text{trg})]^{2-}$ (**98**) with the chloro species present in greatest abundance (ca. 70% of total platinum). In all cases, two deprotonated *N*-peptide ligands are arranged in a *cis* geometry.²⁷³

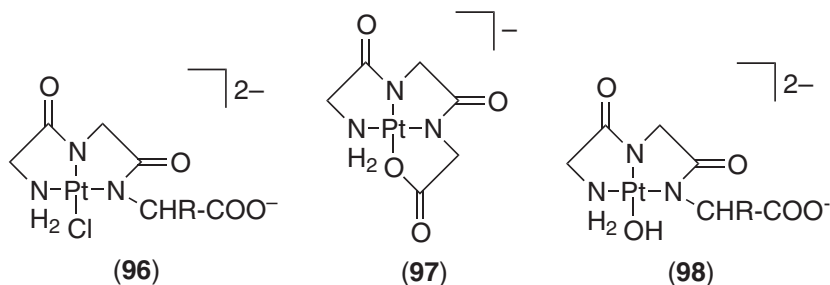

6.5.4.3 Platinum(II) Complexes with Phosphorus-, Arsenic-, and Antimony-donor Ligands

6.5.4.3.1 Mono-, bi-, and tridentate *P*-donor ligands

Studies of the conductivity behavior of $[\text{Pt}(\text{dppm})_2]\text{X}_2$ ($\text{X} = \text{Cl}, \text{Br}, \text{I}, \text{PF}_6, \text{BF}_4$) in solution have been reported.²⁷⁴ Both conductivity and NMR studies of the halide complexes are consistent with the five-coordinate adduct $[\text{Pt}(\text{dppm})_2\text{X}]^+$ being present in chlorinated hydrocarbon and ethanenitrile solutions.

The various factors that influence the formation of *cis* and *trans* complexes of platinum(II) containing long-chain diphosphine ligands of the type $\text{Ph}_2\text{P}(\text{CH}_2)_n\text{PPh}_2$ ($n = 2, 6-12, 16$) have been investigated.²⁷⁵ The formation of individual isomers appears to be highly dependent on the nature of the precursor complex. In the case of $[\text{PtCl}_4]^{2-}$, the *cis* isomer is formed exclusively, whereas the *trans* isomer is formed when $\text{K}[\text{PtCl}_3(\text{C}_2\text{H}_4)] \cdot \text{H}_2\text{O}$ (Zeise's salt) is employed in the synthesis. The thermodynamically more stable *cis* isomer is formed if a strong *trans*-labilizing ligand is not present in the precursor complex. Indeed, the *trans* isomer is readily converted to the *cis* form by the application of heat or the addition of excess phosphine ligand to the solution. The presence of bulky R groups on the phosphorus atoms is not a necessary criterion for the formation of the *trans* isomer. For the *cis* complexes, a dimeric form whereby the two phosphine ligands bridge two platinum(II) centers, is generally preferred over the monomeric, chelated species. A related study involving the 1,8-bis(diphenylphosphino)-3,6-dioxaoctane ligand involved parallel syntheses to those described above, with *cis*- $[\text{Pt}(\text{dpdo})\text{Cl}_2]$ (dpdo = 1,8-bis(diphenylphosphino)-3,6-dioxaoctane) prepared from $[\text{PtCl}_4]^{2-}$ and the corresponding *trans* isomer (**99**) prepared from Zeise's salt.²⁷⁶

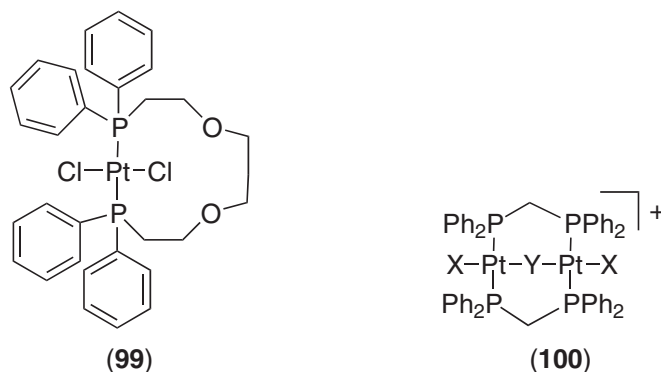

The mechanism of “A”-frame inversion for dinuclear platinum(II) complexes of the type $[\text{Pt}_2(\mu\text{-Y})\text{X}_2(\mu\text{-dppm})_2]^+$ ($\text{Y} = \text{H}, \text{Cl}, \text{SMe}, \text{PPh}_2$; $\text{X} = \text{H}, \text{Cl}, \text{Me}$) (**100**) has been studied in great detail.²⁷⁷ All of the complexes that undergo an inversion process on the NMR time scale possess a bridging hydrido ligand or are capable of rapidly isomerizing to a complex possessing a bridging hydride. The key step in the process appears to involve an intermediate with a linear $\text{Pt}\text{--}\text{H}\text{--}\text{Pt}$ group. An elucidation of the mechanism and reaction energetics for the ligand-induced reductive elimination of H_2 from the parent “A”-frame species $[\text{Pt}_2(\mu\text{-H})\text{H}_2(\mu\text{-dppm})_2]^+$ by various tertiary phosphines to afford a species containing a $\text{Pt}\text{--}\text{Pt}$ bond has also been reported.⁹⁹ In this process, the key intermediate $[\text{Pt}_2\text{L}(\mu\text{-H})\text{H}_2(\mu\text{-dppm})_2]^+$ (L = tertiary phosphine) is formed, and is followed by intramolecular loss of H_2 .

The reactions of the dinuclear platinum(I) species $[\text{Pt}_2(\text{PPh}_3)_2(\mu\text{-dppm})_2]^{2+}$ with CH_2N_2 , CO , SO_2 , and S_8 to afford the corresponding “A”-frame complexes of the type $[\text{Pt}_2(\text{PPh}_3)_2(\mu\text{-Y})(\mu\text{-dppm})_2]^{2+}$ ($\text{Y} = \text{CH}_2, \text{CO}, \text{SO}_2$, and S , respectively) (**101**) have been described.¹⁰⁶ The results of comprehensive kinetic experiments are consistent with the unimolecular formation of a common intermediate possessing a dangling dppm ligand, which is then attacked by the inserting reagent to form the final product.

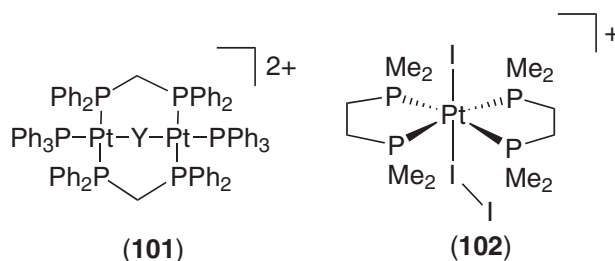

An extremely rare example of a six-coordinate platinum(II) complex has been prepared by the reaction of $[\text{Pt}(\text{dmpe})_2]^{2+}$ with three equivalents of I_2 in $\text{H}_2\text{O}/\text{EtOH}$ solution which affords black crystals of $[\text{PtI}(\text{dmpe})_2(\kappa\text{-I}_2)]\text{I}_3$ (**102**). X-ray crystallography reveals a neutral I_2 ligand that is coordinated to the metal center through one of the iodine atoms.²⁷⁸ XPS (X-ray photoelectron spectroscopy) measurements are consistent with the platinum center having a +2 oxidation state.

The coordination chemistry of tertiary phosphine-functionalized calix[4]arenes have been described.²⁷⁹ Treatment of a bis(diphenylphosphino) or bis(dimethylphosphino) derivative of calix[4]arene with $[\text{PtCl}_2(\text{COD})]$ leads to the formation of the corresponding dichloroplatinum(II) complex. The related diplatinum(II) species has also been reported with the tetrafunctionalized calix[4]arene.²⁸⁰ The mononuclear derivative is susceptible to oligomerization if the two free phosphine ligands are not oxidized or complexed to another metal center such as gold(I).²⁷⁹ The platinum(II) coordination chemistry of a mono-²⁸¹ and diphosphite²⁸² derived calix[*n*]arene ($n = 4$ and 6 , respectively) has also been described.

The first examples of platinum(II) complexes of the steroid 5-cholestene have been reported.²⁸³ Treatment of two equivalents of 5-cholestene-3*n*-diphenylphosphine ($n = \alpha$) or -dimethylphosphine ($n = \beta$) with $[\text{PtCl}_2(\text{PhCN})_2]$ or $[\text{PtCl}_2(\text{SEt}_2)_2]$, respectively, affords the corresponding *trans*-dichloroplatinum(II) derivatives (**103**) in high yield.

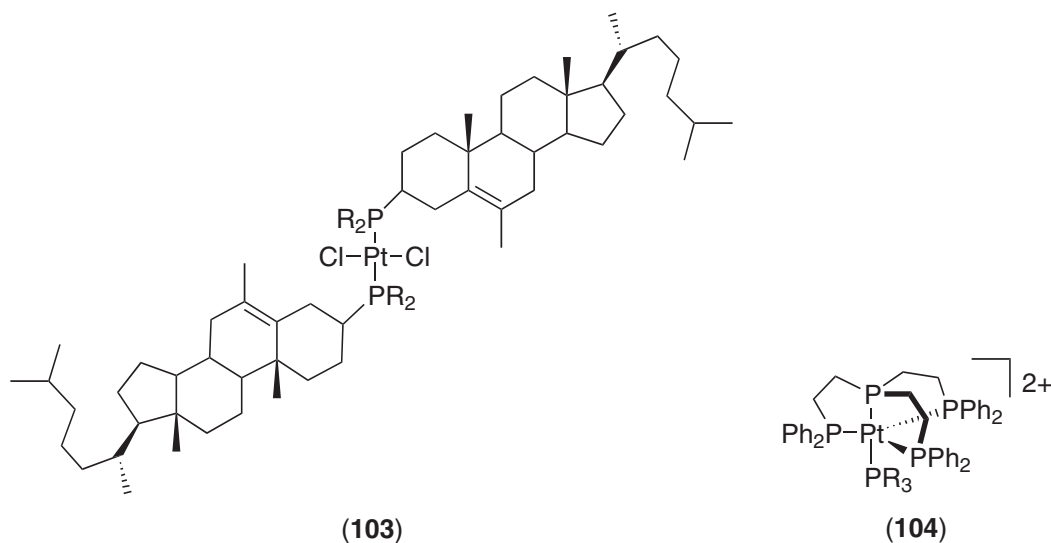

The first examples of five-coordinate platinum(II) complexes of the type $[\text{Pt}(\text{PR}_3)\text{L}]^{2+}$ ($\text{L} = \text{tris}(2\text{-}(\text{diphenylphosphino})\text{ethyl})\text{phosphine}$; $\text{R} = \text{Et}, \text{OMe}, \text{OEt}$) (**104**) containing only P-donor atoms have been prepared by the reaction of $[\text{PtClL}]^+$ with an appropriate monodentate tertiary phosphine or phosphite ligand.²⁸⁴ Triaryl phosphines and phosphites do not react with the precursor complex, even at elevated temperatures, most probably due to the considerable steric interactions that would occur upon the approach of the P-donor ligand to the platinum(II) center.

A study of sequential Arbuzov-type demethylation reactions of the platinum(II)–phosphite complex $[\text{Pt}\{\text{P}(\text{OMe})_3\}_4]^{2+}$, in which the phosphite ligands are converted to phosphonates, has been described.²⁸⁵ Many of the products of the reaction were characterized by NMR spectroscopy and X-ray crystallography.²⁸⁶ The X-ray structures are the first reported for trialkylphosphite complexes of platinum(II).

A rare example of the resolution of a planar-chiral platinum(II) complex has been described.²⁸⁷ Treatment of the ligand with $[\text{PtCl}_2(\text{COD})]$ in CH_2Cl_2 solution affords the *meso* complex $[\text{PtCl}_2(\text{achiraphos})]$ (*achiraphos* = (R^*, S^*) -2,3-bis(diphenylphosphino)butane) (**105**) in high yield. The addition of one equivalent of Ag^+ to remove one of the two enantiotopic chloro ligands, followed by the addition of the homochiral resolving ligand *R*-diphenylmethylphosphine (*R*-PMenPh₂) and NH_4PF_6 affords the diastereomeric complexes $[\text{PtCl}(\text{R-PMenPh}_2)(\text{achiraphos})]\text{PF}_6$ in which the monodentate phosphine ligand is located *trans* to the diphenylphosphino group attached to either the *R* or *S* carbon atom of the chelating *achiraphos*. The homochiral epimer in which the *R*-PMenPh₂ ligand is bonded *trans* to the diphenylphosphino group attached to the *S* carbon atom of the *achiraphos* ligand is crystallized from the concentrated mother liquor containing a mixture of the two epimers. X-ray crystallography confirmed the structure of the planar-chiral complex.

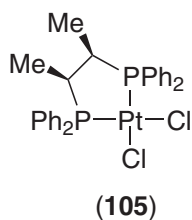

A variable-temperature ^{19}F NMR spectroscopic study of pentafluorophenylphosphine complexes of the type *trans*- $[\text{PtCl}_2(\text{PEt}_3)\text{L}]$ ($\text{L} = \text{P}(\text{C}_6\text{F}_5)_3, \text{PPh}(\text{C}_6\text{F}_5)_2, \text{PPH}_2(\text{C}_6\text{F}_5)$) has been reported.²⁸⁸ Hindered rotation occurs about the P—C₆F₅ bonds in *trans*- $[\text{PtCl}_2(\text{PEt}_3)\{\text{P}(\text{C}_6\text{F}_5)_3\}]$, but no such phenomena were observed in the other complexes.

6.5.4.3.2 Macrocyclic P-donor ligands

The synthesis and X-ray structure of the platinum(II) derivative of a tetradentate macrocycle $\text{Me}_4[14]\text{aneP}_4$ has been described.²⁸⁹ The ligand is the phosphorus analogue of tetramethylcyclam, and it was prepared by means of a template reaction employing $[\text{Pt}(\text{MeHPCH}_2\text{CH}_2\text{PHMe})_2]^{2+}$ and 1,3-dibromopropane in the presence of a weak base. The resulting complex $[\text{Pt}(\text{Me}_4[14]\text{aneP}_4)]^{2+}$ (**106**), with a *trans* III (*RRSS*) configuration of the four asymmetric P-atoms, was obtained in low yield.

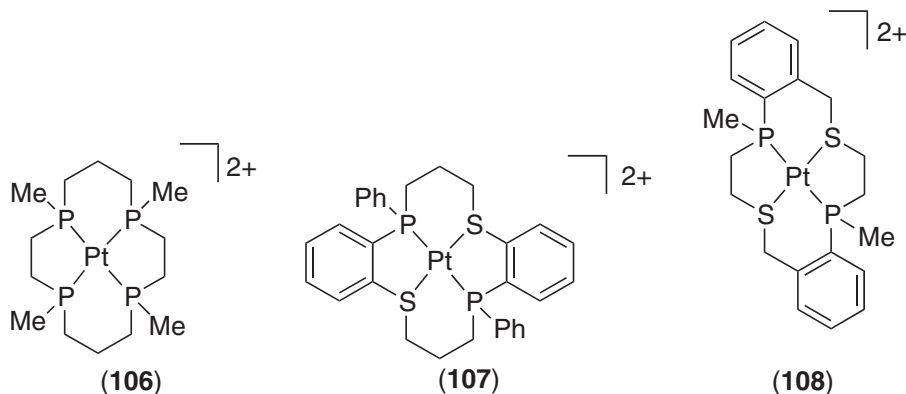

The platinum(II) derivative of a 14-membered P_2S_2 -macrocyclic containing the 1-thio-2-(phenylphosphino)benzene moiety (**107**) has been described.²⁹⁰ X-ray crystallography confirms the square-planar geometry of the coordination sphere, with the Pt—S and Pt—P bond lengths being almost identical. The low-yielding metal-templated preparation of another 14-membered *trans*- P_2S_2 macrocycle has also been described.²⁹¹ Both the R^*,R^* and R^*,S^* forms of the macrocycle were isolated by the reaction of (\pm) -(2-thioethyl)(2-methoxybenzyl)methylphosphine with $[\text{PtCl}_4]^{2-}$ in the presence of base, followed by fractional crystallization of the mixture of *cis* and *trans* diastereomers, to afford *trans*- $[\text{Pt}(\text{tmbmp})_2]$ ($\text{tmbmpH} = (\pm)$ -(2-thioethyl)(2-methoxybenzyl)methylphosphine) as lemon-yellow crystals. Treatment of the complex with BBr_3 allowed cyclization at sulfur to occur and thus generate the desired macrocyclic complex (**108**).

6.5.4.3.3 As- and Sb-donor ligands

In the first examples of terminal arsenido derivatives of platinum, treatment of $[\text{Pt}\{\text{N}(\text{CH}_2\text{CH}_2\text{PPh}_2)_3\}(\text{PPh}_3)]$ with one equivalent of R_2AsX ($\text{R} = \text{Me}$, $\text{X} = \text{I}$; $\text{R} = \text{Ph}$, $\text{X} = \text{Cl}$) in $\text{C}_6\text{H}_6/\text{EtOH}$ solution affords the species $[\text{Pt}\{\text{N}(\text{CH}_2\text{CH}_2\text{PPh}_2)_3\}\text{AsR}_2]^{+}$ (**109**) in high yield. X-ray diffraction studies of the $\text{R} = \text{Ph}$ derivative confirm that the platinum(II) center is five-coordinate.²⁹²

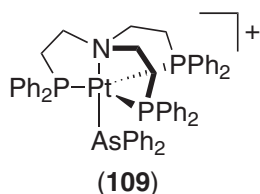

Wendt and co-workers have reported the synthesis of platinum(II) complexes of the type $[\text{PtI}_3(\text{EPh}_3)]^{-}$ ($\text{E} = \text{P}$, Sb , As).^{293,294} A systematic mechanistic study demonstrated that the *trans* effect for the Group 15 ligands follows the order $\text{Ph}_3\text{Sb} > \text{Ph}_3\text{P} > \text{Ph}_3\text{As}$. From X-ray data, the *trans* influence of the ligands is found to follow the order $\text{Ph}_3\text{P} \geq \text{Ph}_3\text{As} > \text{Ph}_3\text{Sb}$.

6.5.4.4 Platinum(II) Complexes with Oxygen-donor Ligands

6.5.4.4.1 Aqua, hydroxo, and oxo ligands

The reactions of the $[\text{Pt}(\text{H}_2\text{O})_4]^{2+}$ ion with various anionic (A^{m-}) ligands have been studied by means of ^{195}Pt NMR spectroscopy.²⁹⁵ The formation of complexes of the type

$[\text{PtA}_n(\text{H}_2\text{O})_{4-n}]^{(2-mn)+}$ was reported for Cl^- ($n=1-4$), ONO_2^- ($n=1-3$), OSO_3^{2-} ($n=1, 2$), OPO_3H_2^- ($n=1-4$), OH^- ($n=4$), and MeCO_2^- ($n=1$). No evidence of a reaction with the weakly coordinating ClO_4^- was observed.

The original synthesis²⁹⁶ of $[\text{Pt}(\text{H}_2\text{O})(\text{PET}_3)_3](\text{PF}_6)_2$ has been improved by the reaction of equimolar amounts of $[\text{PtCl}_2(\text{PET}_3)_2]$ and Ag_2SO_4 to afford $[\text{Pt}(\text{SO}_4)(\text{PET}_3)_2]$.²⁹⁷ The addition of one equivalent of triethylphosphine to the sulfato complex in dilute H_2SO_4 solution results in the quantitative formation of $[\text{Pt}(\text{H}_2\text{O})(\text{PET}_3)_3]^{2+}$. FAB-MS evidence is consistent with the proposed structure of the complex. The labile aqua ligand can be displaced by a variety of other ligands, e.g., chloride, nitrate, perchlorate, acetate, and tertiary phosphines.²⁹⁶ Furthermore, fluoride ion is abstracted from hexafluorophosphate in acetone solution to afford $[\text{PtF}(\text{PET}_3)_3]^+$, a rare example of a fluoroplatinum(II) species.

The aqua-sulfato complex $[\text{Pt}(\text{SO}_4)(\text{H}_2\text{O})(\text{dmen})]$ ($\text{dmen} = N,N'$ -dimethylethane-1,2-diamine) has been prepared by the reaction of $[\text{PtI}_2(\text{dmen})]$ with Ag_2SO_4 in aqueous solution.²⁹⁸ The complex is the first example of a platinum(II) species containing a monodentate sulfato ligand, as determined by X-ray diffraction. In a related study, treatment of $[\text{PtCl}_2(\text{en})]$ with AgNO_3 in aqueous solution, followed by adjustment of the pH of the solution to 5.8 by the addition of 1 M NaOH affords crystals of the unusual tetranuclear complex *cyclo*- $[\text{Pt}_4(\mu\text{-OH})_4(\text{en})_4](\text{NO}_3)_4$ (**110**), the structure of which was confirmed by X-crystallography.²⁹⁹

The yellow-orange, di- μ -hydroxo species $[(\text{NN})\text{Pt}(\mu\text{-OH})_2\text{Pt}(\text{NN})]^{2+}$ ($\text{NN} = \text{bipy}$ or phen) ((**111**) and (**112**), respectively) can either be prepared by the reaction of $[\text{PtCl}_2(\text{NN})]$ with AgNO_3 in aqueous solution, or by the reaction of $[\text{PtI}_2(\text{NN})]$ with AgNO_3 in acetone, followed by dissolution of the resulting nitrate species $[\text{Pt}(\text{NO}_3)_2(\text{NN})]$ in water.³⁰⁰ Treatment of the dinuclear products with one equivalent of hydroxide ion affords the stable, deep-red tri- μ -hydroxo species $[(\text{NN})\text{Pt}(\mu\text{-OH})_3\text{Pt}(\text{NN})]^+$ ((**113**) and (**114**)). Alternatively, the reaction of $[\text{Pt}(\text{OH})_2(\text{NN})]$ with HX ($\text{X} = \text{ClO}_4, \text{NO}_3$) affords $[(\text{NN})\text{Pt}(\mu\text{-OH})_3\text{Pt}(\text{NN})]^+$, $[(\text{NN})\text{Pt}(\mu\text{-OH})_2\text{Pt}(\text{NN})]^{2+}$, and $[\text{Pt}(\text{NO}_3)_2(\text{NN})]$ at pH 8, 4, and 1, respectively.

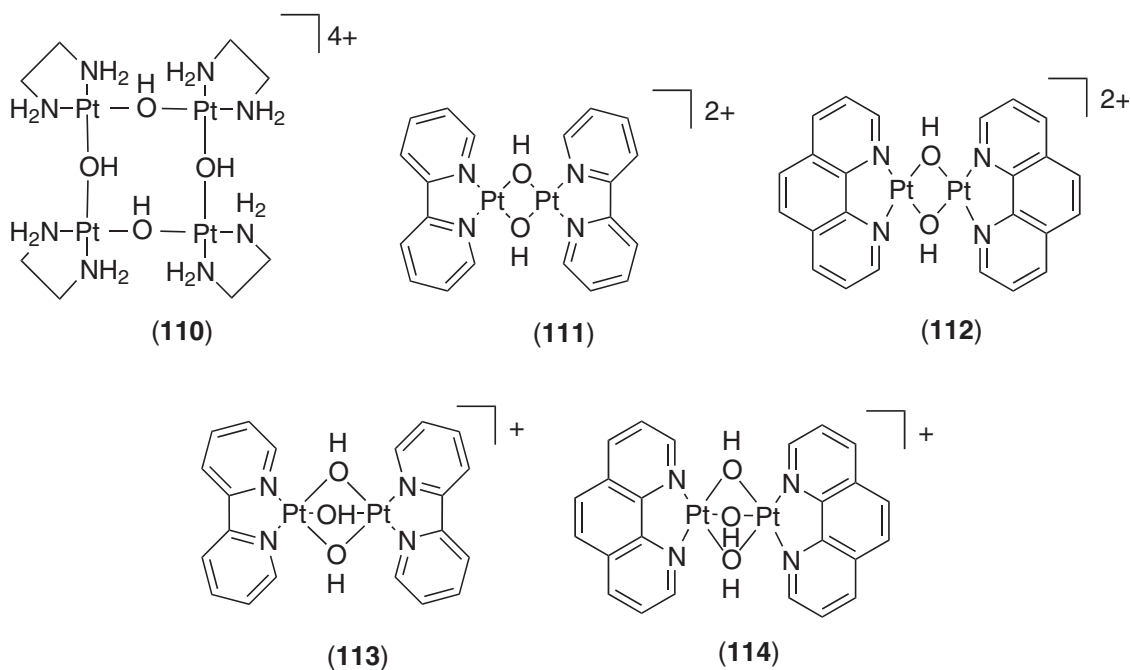

Platinum(II)-oxo intermediates have been implicated in the reactions of bis(alkoxo) and carbonato complexes with ligands such as CO and tertiary phosphines,³⁰¹ but there are few examples of stable platinum(II)-oxo species in the literature. Sharp and co-workers have reported the synthesis and characterization of several diplatinum(II)-hydroxo and -oxo complexes.³⁰²⁻³⁰⁴ Treatment of $[\text{PtCl}_2\text{L}_2]$ ($\text{L}_2 = \text{dppm}, \text{dppe}, \text{dppp}, \text{dppb}, 2\text{PMe}_2\text{Ph}, 4,4'\text{-Bu}^t_2\text{bipy}$) with AgBF_4 in the presence of small amounts of water affords $[\text{Pt}_2(\mu\text{-OH})_2(\text{L}_2)_2]^{2+}$; the analogous $[\text{Pt}_2(\mu\text{-OH})_2(\text{PMe}_3)_4]^{2+}$ species has also been reported.³⁰⁵ Most of the reactions are sensitive to the nature of the solvent and the amount of water present. Addition of excess $\text{LiN}(\text{TMS})_2$ to $[\text{Pt}_2(\mu\text{-OH})_2(\text{L}_2)_2]^{2+}$ leads to the deprotonation of the bridging hydroxo groups to afford the corresponding di- μ -oxo species. In all cases, the platinum(II)-oxo complexes are strongly basic.

The triphenylphosphine derivative $[\text{Pt}_2(\mu\text{-O})_2(\text{PPh}_3)_4]$ crystallizes with one equivalent of LiBF_4 , in which the lithium ion of a LiBF_4 ion pair is strongly associated with both of the μ -oxo groups. The *dppe*, *dppp*, *dppb*, and Bu^t_2bipy complexes react similarly, but the resulting di- μ -oxo species crystallize with two equivalents of LiBF_4 . In the case of PMePh_2 , the deprotonation reaction is more complicated, as the initially formed $[\text{Pt}_2(\mu\text{-O})_2(\text{PMePh}_2)_2]\cdot\text{LiBF}_4$ undergoes further reaction to afford the trinuclear di- μ_3 -oxo species $[\text{Pt}_3(\mu_3\text{-O})_2(\text{PMePh}_2)_6]^{2+}$. Interestingly, treatment of $\text{LiN}(\text{TMS})_2$ with the *dppm* complex $[\text{Pt}_2(\mu\text{-OH})_2(\text{dppm})_2]^{2+}$ results in the deprotonation of the *dppm* methylene groups rather than the hydroxo ligands to afford $[\text{Pt}_2(\mu\text{-OH})_2(\text{dppm-H})_2]$. Further deprotonation occurs in THF solution to afford the anionic di- μ -oxo species $[\text{Pt}_2(\mu\text{-O})_2(\text{dppm-H})_2][\text{Li}(\text{THF})_2]_2$.

6.5.4.4.2 Peroxo ligands

The preparation, characterization, and reactivity of novel platinum(II) complexes containing hydroperoxo and alkylperoxo ligands, $[\text{PtR}^1(\text{OOR}^2)_2\text{L}_2]$ (L = monodentate phosphine, L_2 = bidentate phosphine; $\text{R}^1 = \text{CF}_3, \text{CH}_2\text{CF}_3, \text{CH}_2\text{CN}$; $\text{R}^2 = \text{H}, \text{Bu}^t$) have been reported.³⁰⁶ The complexes have been prepared by a condensation reaction of the corresponding hydroxo precursors $[\text{PtR}^1(\text{OH})\text{L}_2]$ with $\text{R}^2\text{O}_2\text{H}$. The complexes are capable of acting as effective *O*-atom transfer reagents toward compounds such as CO , PPh_3 , and NO . In related work, complexes of the type *trans*- $[\text{PtR}(\text{OO-Bu}^t)_2\text{L}_2]$ (L = mono- or bidentate tertiary phosphine; $\text{R} = \text{CF}_3, \text{Ph-}o\text{-CN}, \text{Ph}$) have been prepared by a similar condensation route to that described above, and the X-ray structure of *trans*- $[\text{PtPh}(\text{OO-Bu}^t)(\text{PPh}_3)_2]$ (**115**) was reported. Most of the complexes are capable of stoichiometrically oxidizing 1-octene to 2-octanone under anhydrous conditions.³⁰⁷ Interestingly, related complexes with a *cis* geometry and those with the hydroperoxo ligand are found to be incapable of the oxidation reaction. The epoxidation of 1-octene takes place in the presence of H_2O_2 and catalytic amounts of $[\text{PtR}(\text{OH})\text{L}_2]$ when L_2 = bidentate tertiary phosphine; the formation of the catalytically active hydroperoxo species $[\text{PtR}(\text{OOH})\text{L}]$ was inferred.^{308,309} Further kinetic studies of this reaction suggest a bimetallic mechanism in which the hydroperoxo complex interacts with a platinum(II)-alkene intermediate in the *O*-atom transfer step.³¹⁰

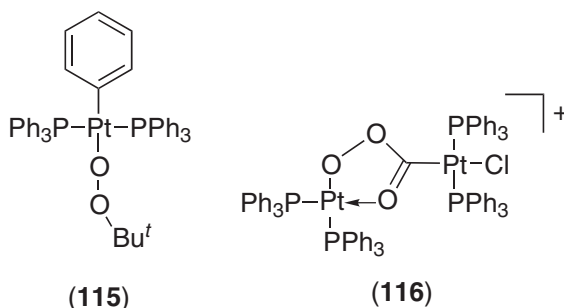

A rare example of the activation of O_2 and CO by platinum involves the treatment of the nucleophilic dioxygen species $[\text{Pt}(\text{O}_2)(\text{PPh}_3)_2]$ with the electrophilic carbonyl ligand in $[\text{PtCl}(\text{CO})(\text{PPh}_3)_2]^+$ to afford a dinuclear cycloperoxycarbonyl adduct (**116**) in high yield.³¹¹

6.5.4.4.3 Alcohol, alkoxo, and ether ligands

There are several studies describing the synthesis of stable alcohol, alkoxo, and ether complexes of platinum(II) that have the *O*-donor functionality incorporated into a phosphine ligand. The reaction of $\text{Ph}_2\text{PCH}_2\text{CMe}_2\text{OH}$ with $[\text{PtCl}_2(\text{COD})]$ or Zeise's salt forms the *cis* and *trans* isomers of $[\text{PtCl}_2\{\text{Ph}_2\text{PCH}_2\text{CMe}_2\text{OH}\}_2]$, respectively, which can be readily interconverted.³¹² The bis(alkoxo) chelate complex *cis*- $[\text{Pt}\{\text{Ph}_2\text{PCH}_2\text{CMe}_2\text{O}\}_2]$ (**117**) is formed upon the addition of a base such as NEt_3 or NaOH to the *cis*-dichloro species. Alternatively, treatment of the *trans*-dichloro species with NEt_3 affords the species *trans*- $[\text{Pt}\{\text{Ph}_2\text{PCH}_2\text{CMe}_2\text{O}\}\{\text{Ph}_2\text{PCH}_2\text{CMe}_2\text{OH}\}]$ (**118**), possessing one chelated alkoxo ligand and one dangling alcohol group; its conversion to the bis(alkoxo) chelate species is realized by the addition of NaOH in refluxing ethanol solution. A number of stable platinum(II)-alcohol intermediates were also characterized in this work, and

the X-ray structure of the bis(alkoxo) chelate complex was determined. In a related study, the chelate-stabilized primary and secondary alcohol and alkoxo complexes containing the less bulky ligands $\text{Ph}_2\text{PCH}_2\text{CHROH}$ ($\text{R} = \text{H}$ or Me) were also studied.³¹³

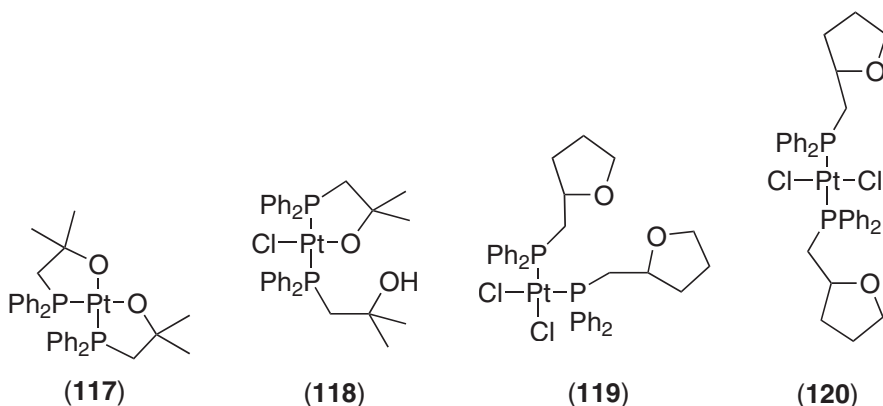

Treatment of the tetrahydrofuran phosphine ligand, $\text{PPh}_2\text{CH}_2\text{C}_4\text{H}_7\text{O}$, with $[\text{PtCl}_2(\text{NCBu}^t)_2]$ in acetone solution affords *cis*- and *trans*- $[\text{PtCl}_2(\text{PPh}_2\text{CH}_2\text{C}_4\text{H}_7\text{O})_2]$ ((119) and (120), respectively).³¹⁴ Subsequent treatment of the *cis* isomer with KPF_6 in MeCN solution yields the chelate-stabilized THF complex *cis*- $[\text{PtCl}(\text{PPh}_2\text{CH}_2\text{C}_4\text{H}_7\text{O})_2]\text{PF}_6$ (121), containing one pendant THF group and one THF group coordinated to the metal center through the *O*-atom. If AgClO_4 is used instead of KPF_6 , then the bischelated THF product $[\text{Pt}(\text{PPh}_2\text{CH}_2\text{C}_4\text{H}_7\text{O})_2](\text{ClO}_4)_2$ (122) is formed instead. The X-ray structure of the monochelate complex *cis*- $[\text{PtCl}(\text{PPh}_2\text{CH}_2\text{C}_4\text{H}_7\text{O})_2]\text{PF}_6$ is consistent with its solution NMR structure, with no evidence of fluxionality observed in solution. From this and earlier data, the *trans* influence of neutral *O*-donor ligands was deduced to follow the order: alcohols > THF > alkyl ethers.³¹⁴ From ^{31}P NMR data, the *trans* influence of alkoxo ligands was found to follow the order: $3^\circ > 2^\circ > 1^\circ$, even through the relative differences are quite small.³¹³ The isolation of air- and moisture-stable platinum(II)-alkoxo complexes supports the notion that the observed instability of several types of alkoxo complexes is probably the result of kinetic phenomena rather than inherently weak $\text{Pt}-\text{O}$ bonds.¹⁷¹

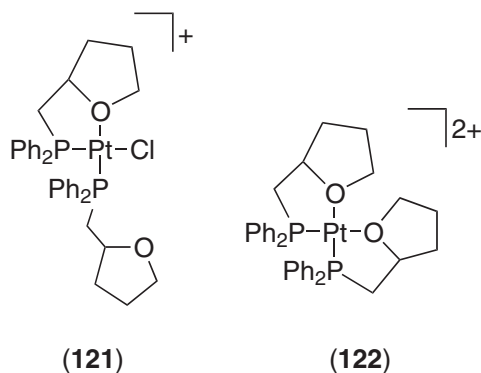

The use of a chiral platinum(II) auxiliary for the discrimination of the terminal hydroxy groups of glycerol in diastereomeric *O,O*-glycerolato chelate complexes has been described.³¹⁵ Treatment of $(R^*, R^*)-(\pm)-[\text{Pt}(\text{OMe})_2\{1,2-\text{C}_6\text{H}_4(\text{PMePh}_2)_2\}]$ with glycerol in $\text{C}_6\text{H}_6/\text{MeOH}$ solution affords a 3:2 equilibrium mixture of $[(R^*, R^*), (R^*)]-$ and $[(R^*, R^*), (S^*)]-(\pm)-[\text{PtOCH}_2\text{CH}(\text{O})\text{CH}_2\text{OH}\{1,2-\text{C}_6\text{H}_4(\text{PMePh}_2)_2\}]$ ((123) and (124)), respectively. The product $[(R^*, R^*), (R^*)]-(\pm)-[\text{PtOCH}_2\text{CH}(\text{O})\text{CH}_2\text{OH}\{1,2-\text{C}_6\text{H}_4(\text{PMePh}_2)_2\}] \cdot 2\text{MeOH}$ crystallizes from CD_2Cl_2 solution as an (externally) H-bonded centrosymmetric dimer consisting of asymmetric monomers of opposite helicity.

Well-characterized transition metal complexes of vitamin C (ascorbic acid) are rare, and a select number of these exhibit anticancer properties. Hollis *et al.* have described the first examples to be fully characterized by X-ray crystallography.³¹⁶ Treatment of $[\text{Pt}(\text{H}_2\text{O})_2\text{L}_2]^{2+}$ ($\text{L} = \text{NH}_3, \text{MeNH}_2$; $\text{L}_2 = \text{en}, 1,2\text{-chxn}$) with ascorbic acid gives either the mono- or bisascorbate species of the type *cis*- $[\text{PtL}_2(\text{C}^2, \text{O}^5\text{-ascorbate})]$ (e.g., (125)) or *cis*- $[\text{PtL}_2(\text{C}^2\text{-ascorbate})(\text{O}^3\text{-ascorbate})]$, respectively. Interestingly, in both types of complexes, platinum(II) forms a bond with the C-2 atom of ascorbic

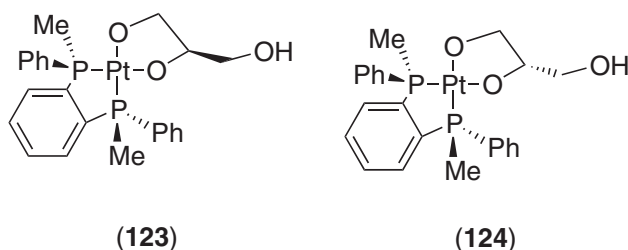

acid. NMR studies³¹⁷ of the solution chemistry of these complexes and the reaction chemistry of the chelate complexes in the presence of various protic acids have also been reported.³¹⁸ The phosphorus-containing chelate analogues $[\text{Pt}(\text{Asc-}O^2, O^3)\text{L}_2]$ ($\text{L}_2 = \text{dppm}, \text{dppe}, \text{dppp}$) have also been described.³¹⁹ The reaction of $[\text{Pt}(\text{H}_2\text{O})_2\text{L}_2]^{2+}$ ($\text{L}_2 = \text{en}, \text{dmen}, \text{tmen}$) with sodium ascorbate (AscH), results in the formation of mixtures containing ascorbate bound to platinum in several distinct modes.³¹⁹ The first involves monodentate coordination of one or two ascorbate ligands to the metal center via the O-3 atom to afford $[\text{Pt}(\text{HAsc-}O^3)(\text{H}_2\text{O})\text{L}_2]^+$ or $[\text{Pt}(\text{HAsc-}O^3)_2\text{L}_2]$, respectively. The ascorbate is also found to coordinate via the C-2 atom to give the mixed complex $[\text{Pt}(\text{HAsc-}O^3)(\text{HAsc-C}^2)\text{L}_2]$. Finally, the ascorbate can act as a chelating ligand to afford $[\text{Pt}(\text{Asc-}O^2, O^3)\text{L}_2]$ and $[\text{Pt}(\text{Asc-C}^2, O^5)\text{L}_2]$; the structure of the latter ($\text{L}_2 = \text{en}$) was determined by X-ray diffraction. In all cases, the O-bound complexes are formed first and then slowly re-arrange to the C-bound ligand, with the relative rates of conversion dependent upon the degree of methyl substitution of the N-donor ligand. Indeed, the re-arrangement process was not observed for the bulky tmen ligand, in accordance with previous work.³²⁰

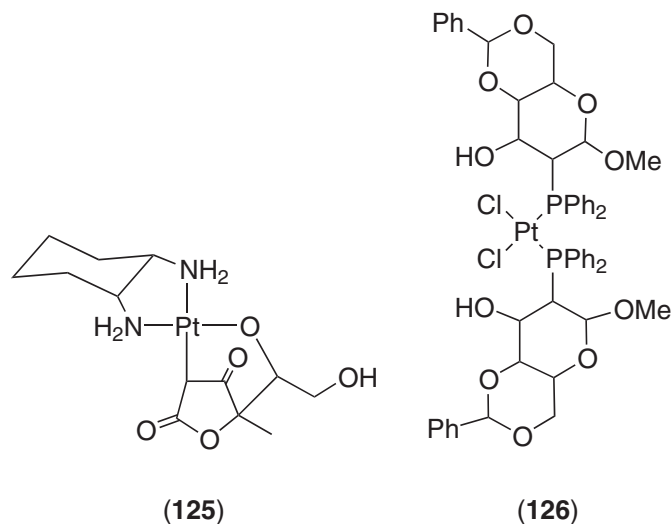

Carbohydrate derivatives of tertiary phosphine ligands have been prepared as new types of chiral ligands for transition metals such as platinum(II).³²¹ Treatment of $[\text{PtCl}_2(\text{COD})]$ with methyl-4,6-*O*-benzylidene-2-deoxy-2-(diphenylphosphino)- α -D-altropyranoside affords $[\text{PtCl}_2(2\text{-Hmbpa})_2]$ ((126); 2-Hmbpa = methyl-4,6-*O*-benzylidene-2-deoxy-2-(diphenylphosphino)- α -D-altropyranoside).³²² In the presence of NEt_3 , *cis*- $[\text{PtCl}_2(2\text{-Hmbpa})(2\text{-mbpa})]$ (127) is formed, in which two phosphine ligands and one deprotonated 3-OH group of the sugar moiety are coordinated to the platinum(II) center. Addition of NaOMe generates the *P,O*-chelated, bis(alkoxo) species *cis*- $[\text{Pt}(2\text{-mbpa})_2]$ (128), the structure of which was determined by X-ray crystallography. Finally, the 4,6-*O*-benzylidene groups can be removed from the sugar moieties by the addition of 5% HClO_4 solution to afford *cis*- $[\text{Pt}(2\text{-mpa})_2]$ (129) (mpa = methyl-2-deoxy-2-(diphenylphosphino)- α -D-altropyranoside).

The reaction of $[\text{Pt}(\text{CO})_3(\text{dppp})]$ with a modest excess of vicinal diols in CH_2Cl_2 solution affords the corresponding $[\text{Pt}(\alpha, \beta\text{-diolato})(\text{dppp})]$ species under equilibrium conditions, a reaction that is readily reversed by the addition of dry ice to the product. The reaction with triols such as glycerol and alditol carbohydrates also affords the corresponding diolato species, with the reaction exhibiting excellent equilibrium regioselectivities for a number of isomers, of which the γ , δ -*threo* diols are the most favored.

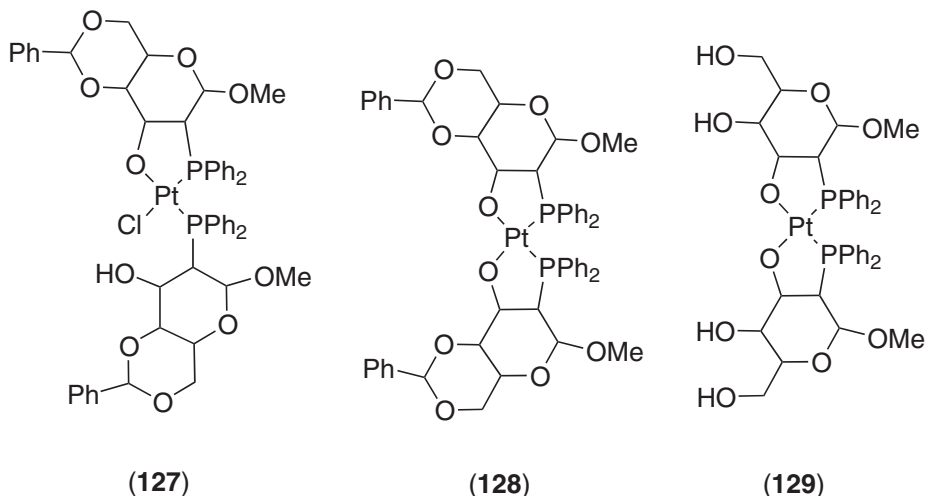

6.5.4.4.4 Carboxylato and carbonato ligands

A remarkably versatile synthesis of symmetrical and nonsymmetrical dicarboxylatoplatinum(II) complexes of the type $[\text{Pt}(\text{O}_2\text{CRCO}_2)\text{L}^1\text{L}^2]$ ($\text{R} = \text{CH}_2$, cyclobutyl; L^1 and $\text{L}^2 =$ same or different amine) that allows one to systematically vary the nature of the amine ligands in a facile manner has been described.³²³ This method greatly expands the number of potential third-generation platinum anticancer drugs that can be prepared and studied. In general, the method utilizes the dimethylsulfoxide precursor complexes $[\text{Pt}(\text{O}_2\text{CRCO}_2)(\text{DMSO})_2]$, which are readily prepared from *cis*- $[\text{PtCl}_2(\text{DMSO})_2]$ and the disilver salt of a dicarboxylic acid, e.g., malonic acid. If this precursor is treated with two equivalents of amine at 100°C in aqueous solution, then the symmetrical complexes $[\text{Pt}(\text{O}_2\text{CRCO}_2)\text{L}_2]$ are prepared in high yields. Alternatively, the reaction of $[\text{Pt}(\text{O}_2\text{CRCO}_2)(\text{DMSO})_2]$ with one equivalent of amine at 40°C in water affords the monosulfoxide complex $[\text{Pt}(\text{O}_2\text{CRCO}_2)(\text{DMSO})\text{L}^1]$. When this intermediate is treated with an equivalent of a different amine ligand L^2 at 100°C , then the unsymmetrical mixed-amine complex $[\text{Pt}(\text{O}_2\text{CRCO}_2)\text{L}^1\text{L}^2]$ is conveniently generated in good yield.

The first example of a stable geminal enediol derivative of a carboxylic acid, isolated as its platinum(II) complex, has been reported.³²⁴ Treatment of $[\text{Pt}(\text{OH}_2)_2(\text{en})]^{2+}$ with *N,N*-bis(phosphonomethyl)aminoacetic acid yields zwitterionic $[\text{Pt}(\text{bpmaa})(\text{en})]$ ($\text{bpmaaH} = \text{N,N}$ -bis(phosphonomethyl)aminoacetic acid), which upon crystallization from water (pH 1) affords the corresponding enol tautomer (130), as determined by X-ray crystallography and IR spectroscopy.

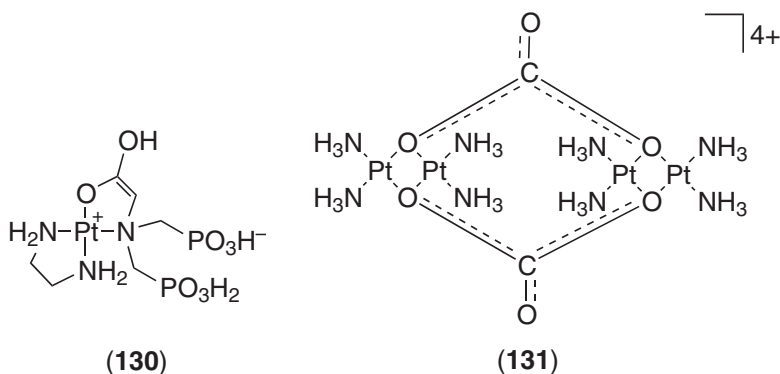

Stein and co-workers have reported the structure of an unusual tetranuclear platinum(II) complex possessing both ammine and carbonato ligands.³²⁵ During a study of the reaction of cisplatin with Ag^+ , followed by the addition of 2'-deoxyuridine to afford "platinum blue"-like products from aqueous solution (pH < 2), a colorless minor product was isolated from the reaction mixture. X-ray crystallography confirmed that the product was a *cyclo* tetra-cation

consisting of four *cis*-diammineplatinum(II) units bridged by two μ_4 -carbonato ligands, [$\{cis\text{-Pt}(\text{NH}_3)_2\}_4\{\mu_4\text{-CO}_3\}_2\}^{4+}$ (**131**). The source of the carbonato ligand was probably adventitious CO_2 present in the original reaction mixture that was used to prepare the blue complexes.

New reproducible syntheses of platinum(II) carbonato complexes of the type $[\text{Pt}(\text{CO}_3)\text{L}_2]$ (L = mono- or bidentate tertiary phosphine) involve the reaction of Ag_2CO_3 with $[\text{PtCl}_2\text{L}_2]$ in water-saturated CH_2Cl_2 solution.³²⁶ Other methods of preparation include the conversion of the dichloroplatinum(II) complexes to the corresponding bis(alkoxo)- or bis(phenoxo)-platinum(II) species, followed by hydrolysis in the presence of CO_2 .

6.5.4.5 Platinum(II) Complexes with Sulfur- and Selenium-donor Ligands

6.5.4.5.1 S_n and Se_n ligands

The first X-ray and molecular structure of a metallacyclic platinum(II) complex containing a chelating S_4^{2-} ligand, $[\text{Pt}(\text{S}_4)(\text{PPh}_3)_2]$ (**132**), has been reported.³²⁷ The complex can be prepared by treating the platinum(IV) species $[\text{Pt}(\text{S}_5)_3]^{2-}$ with an excess of PPh_3 . The X-ray structure of the complex shows some notable features that are not apparent in other MS_4 ($\text{M} = \text{Mo}, \text{W}$) species, notably the absence of alternating S—S bond lengths and the asymmetric puckering of the PtS_4 ring, with one of the sulfur atoms lying significantly out of the plane of the remaining PtS_3 atoms.

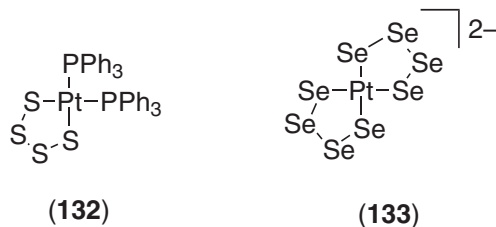

The $[\text{Pt}(\text{Se}_4)_2]^{2-}$ complex (**133**) has been prepared by the reduction of the platinum(IV) species $[\text{Pt}(\text{Se}_4)_3]^{2-}$ with excess borohydride.³²⁸ The X-ray structure of the complex shows that each of the five-membered rings adopts a half-chair conformation, with the platinum coordination sphere exhibiting slight distortion from a square-planar geometry.³²⁹

The first examples of mononuclear disulfur and diselenium complexes of platinum have been described.³³⁰ Reduction of the sterically hindered complex *trans*- $[\text{PtCl}_2(\text{PMe}_2\text{Ar})_2]$ ($\text{Ar} = 2,4,6$ -tris[bis(trimethylsilyl)methyl]phenyl, 2,6-bis[bis(trimethylsilyl)-methyl]-4-[tris(trimethylsilyl) methyl]-phenyl) with lithium naphthalide in THF solution affords the platinum(0) species $[\text{Pt}(\text{PMe}_2\text{Ar})_2]$. Oxidative addition of elemental sulfur or selenium yields the dichalcogenatoplatinum(II) complexes of the type $[\text{PtE}_2(\text{PMe}_2\text{Ar})_2]$ ($\text{E} = \text{S}, \text{Se}$) containing a unique PtE_2 ring system. The complexes are stable to air in the solid state, but slowly decompose in solution after several days at room temperature.

The luminescent, dinuclear platinum(II) species $[\text{Pt}_2(\mu\text{-S})_2(\text{dppy})_4]$ (**134**) can be prepared by treating $[\text{PtCl}_2(\text{dppy})_2]$ with NaSH in the presence of NEt_3 under anaerobic conditions.³³¹ When the complex is dissolved in CH_2Cl_2 solution, pale-yellow crystals of $[\text{Pt}(\text{S}_2\text{CH}_2)(\text{dppy})_2]$ (**135**) are formed, the first example of a four-membered, saturated dithiolato platinacycle.

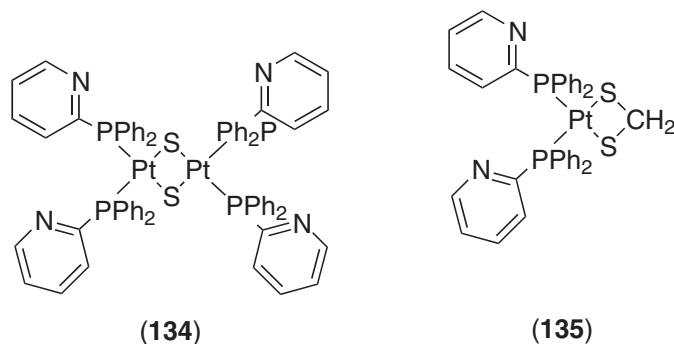

Treatment of $[\text{PtCl}_2\text{L}_2]$ ($\text{L}_2 = 4,4'\text{-Bu}_2\text{bipy}$, $4,4'\text{-dmc}_2\text{bipy} = 4,4'\text{-dimethylcarboxylate-2,2'}$ -bipyridine [dmc_2bipy], dppm) with Na_2S affords novel trinuclear platinum(II) complexes of the type $\text{cyclo-}[\text{Pt}_3\text{L}_2(\mu_3\text{-S})_2]^{2+}$, with a triply bridging sulfido ligand.³³² The solid-state luminescence properties of the complexes and the X-ray structure of the Bu_2bipy complex have also been determined.

6.5.4.5.2 Sulfoxide, thiourea, and thiolato ligands

Numerous sulfoxide complexes of the type $\text{trans-}[\text{PtCl}(\text{R}^1\text{R}^2\text{SO})\text{L}_2]^+$ ($\text{L} = \text{NH}_3$, pyridine, picoline; $\text{R}^1 = \text{R}^2 = \text{Me}$; $\text{R}^1 = \text{Me}$, $\text{R}^2 = \text{Ph}$; $\text{R}^1 = \text{Me}$, $\text{R}^2 = \text{benzyl}$) and $[\text{PtCl}(\text{R}^1\text{R}^2\text{SO})(\text{NN})]^+$ ($\text{NN} = \text{cyclohexane-1,2-diamine}$ [$1,2\text{-chxn}$], $1,1\text{-bis(aminomethyl)cyclohexane}$ [damch]; $\text{R}^1 = \text{R}^2 = \text{Me}$, Ph , benzyl ; $\text{R}^1 = \text{Me}$, $\text{R}^2 = \text{Ph}$; $\text{R}^1 = \text{Me}$, $\text{R}^2 = \text{benzyl}$) have been reported.^{333,334} The preparation of the chelate complexes $[\text{PtCl}(\text{R}^1\text{R}^2\text{SO})(\text{NN})]^+$ is best accomplished by the addition of $[\text{PtCl}_2(\text{NN})]$ to $\text{R}^1\text{R}^2\text{SO}$.³³⁴ The preparation of $\text{trans-}[\text{PtCl}(\text{R}^1\text{R}^2\text{SO})\text{L}_2]^+$ involves the treatment of $\text{trans-}[\text{PtCl}_2\text{L}_2]$ with Ag^+ in the presence of $\text{R}^1\text{R}^2\text{SO}$.³³³

The synthesis of mono- and dinuclear complexes containing thiourea derivatives have been described.³³⁵ Treatment of $[\text{PtCl}_2(\text{en})]$ or $[\text{PtCl}_2(1,2\text{-chxn})]$ with one equivalent of Ag^+ in DMF solution, followed by the addition of 1,1,3,3-tetramethylthiourea (tmtu) affords $[\text{PtCl}(\text{en})(\text{tmtu})]^+$ (**136**) and $[\text{PtCl}(1,2\text{-chxn})(\text{tmtu})]^+$ (**137**), respectively, in which the tmtu ligand acts as a S-donor ligand. Dinuclear platinum(II) species containing the novel, bridging-bidentate thiourea derivatives $\text{C}_2\text{H}_4(\text{NMeCSNMe}_2)_2$ and $\text{C}_6\text{H}_{12}(\text{NMeCSNMe}_2)_2$ can also be prepared in a similar manner.

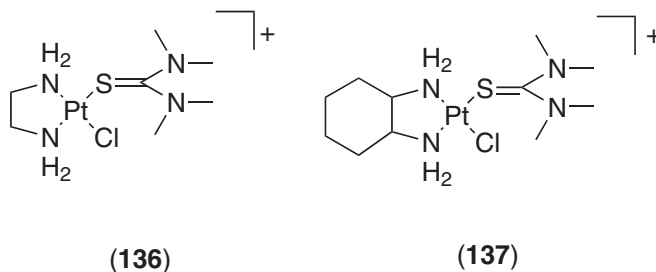

There are numerous examples of platinum(II)-dithiolato complexes that exhibit remarkable luminescence properties. Eisenberg and co-workers have reported a novel class of maleonitriledithiolato complexes of the type $[\text{PtL}_2(\text{mnt})]$ ($\text{L} = \text{P}(\text{OEt})_3$ and $\text{P}(\text{OPh})_3$; $\text{L}_2 = \text{COD}$ and dppm ; $\text{mnt} = \text{maleodinitriledithiolate}$) that exhibit luminescence in the solid-state and in rigid glasses at low temperature, with highly structured emission and excitation spectra.³³⁶ The solvent and temperature dependence of the emission process for a series of related $[\text{Pt}(\text{NN})(\text{SS})]$ ($\text{NN} = 4,4'\text{-dimethyl-2,2'}$ -bipyridine, $4,7\text{-diphenyl-1,10-phenanthroline}$; $\text{SS} = 1\text{-(ethoxycarbonyl)-1-cyanoethylene-2,2-dithiolate}$ [ecda], $1\text{-(}t\text{-butoxycarbonyl)-1-cyanoethylene-2,2-dithiolate}$) complexes was also reported.³³⁷ Strong luminescence and solvatochromism were also observed at room temperature for related diimine complexes possessing a variety of chelating dithiocarbamate or dithiolato ligands,^{338,339} and the luminescence properties of such complexes have been reviewed.^{191,340} The analogous complexes $[\text{PtL}_2(\text{SS})]$ ($\text{L}_2 = \text{mono- or bidentate tertiary phosphine ligands}$; $\text{SS} = \text{mnt}$, ecda) have also been studied, with strong emissions being observed in the solid state and in rigid media at low temperature, with emission lifetimes for the latter being in the microsecond range.³⁴¹ The photooxidation reactions of $[\text{Pt}(\text{bdt})(\text{bipy})]$ ($\text{bdt} = 1,2\text{-benzenedithiolate}$; (**138**)) have been reported.³⁴² The complex reacts with O_2 in the presence of light to form the mono- and disulfinated products $[\text{Pt}(\text{bdtO}_2)(\text{bipy})]$ (**139**) and $[\text{Pt}(\text{bdtO}_4)(\text{bipy})]$ (**140**), respectively. The oxidant is likely to be photogenerated singlet O_2 . The photochemically stable platinum(II)-diimine complexes $[\text{Pt}(\text{dip})(1\text{-S-C}_2\text{B}_{10}\text{H}_{11})_2]$ and $[\text{Pt}(\text{dip})(1,2\text{-S}_2\text{-C}_2\text{B}_{10}\text{H}_{10})_2]$ ($\text{dip} = 4,1\text{-diphenyl-1,10-phenanthroline}$) containing the 1-thiolato-1,2-carborane and 1,2-dithiolato-1,2-carborane ligands, respectively, exhibit remarkable photoluminescence and excited-state oxidation characteristics.³⁴³ The preparation of the orange $[\text{Pt}(\text{pyridine-4-thiolato})_2(\text{Bu}_2\text{bipy})]$ with two free pyridyl groups for further coordination to transition metals allows for the study of supramolecular materials containing a highly luminescent chromophore.³⁴⁴

The donor-acceptor complex $(\text{TTF})[\text{Pt}(\text{dmit})_2]_3$ ($\text{dmit} = 4,5\text{-dimercapto-1,3-dithiol-2-thione}$) and its Group 10 congeners have been reported, and their electrical conductivities have been

examined.³⁴⁵ The platinum(II) complex is semi-conducting in the 100–300 K temperature range. Its X-ray structure shows aggregates of monomers and dimers (connected by a Pt–Pt bond) alternately stacked in columns, with an adjacent layer of TTF molecules. In related work, the electrochemical synthesis and characterization of a salt comprising of the bis(ethylenedithio)-tetrathiafulvalene (bedt-ttf⁺) radical cation and the bis(dithiosquarato)platinate(II) (bis(3,4-dithio-1,2-cyclobutenedione)platinate(II)) complex has been described. Black hexagonal crystals of [bedt-ttf⁺]₂[Pt(S₂C₄O₂)₂] consist of bedt-ttf⁺ dimers and complex anions alternating along one axis of the unit cell.³⁴⁶

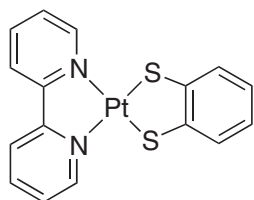

(138)

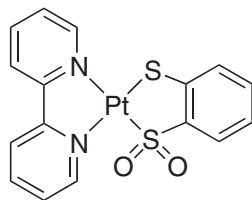

(139)

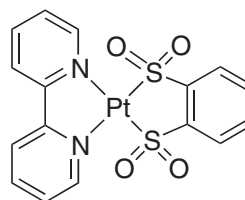

(140)

An unusual hexanuclear complex of platinum(II) has been isolated from the reaction of [PtBr₂(en)] with 2-aminoethanethiol under basic conditions.³⁴⁷ The product [Pt₆(SCH₂CH₂NH₂)₈][Br₄·6H₂O] was characterized fully by X-ray crystallography. The structure of the tetra-cation comprises of a central, eight-membered Pt₄S₄ ring fused onto two outer, six-membered Pt₃S₃ rings. The mechanism of product formation was not studied, but clearly it is very complicated.

The cyclic thiolato complex [Pt{SCH₂C(O)CH₂}(PPh₃)₂] readily reacts with electrophiles such as alkyl halides to afford the platinum(II)-thioether complexes [Pt{RSCH₂C(O)CH₂}X(PPh₃)₂] (R = Me, X = I; R = Et, X = Br; R = PhCH₂, X = Cl) (**141**) and [RPPH₃]X rather than the products of oxidative addition to the platinum(II) center.³⁴⁸ The reaction appears to proceed via the unstable cationic intermediate [Pt{RSCH₂C(O)CH₂}(PPh₃)₂]⁺X⁻ (**142**), as determined by ³¹P NMR spectroscopy.

The first examples of DNA metallointercalators containing a 1,2- or 1,7-carborane thiolato ligand have been reported.³⁴⁹ For example, treatment of [Pt(OTf)(terpy)]⁺ (terpy = 2,2':6',2''-terpyridine) with 1-HSCH₂-1,2-C₂B₁₀H₁₁ leads to the formation of [Pt(1-SCH₂-1,2-C₂B₁₀H₁₁)(terpy)]⁺ (**143**). The DNA-binding properties of several complexes have also been described.

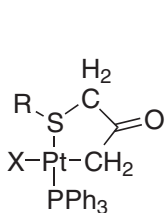

(141)

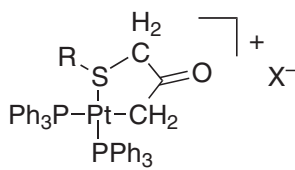

(142)

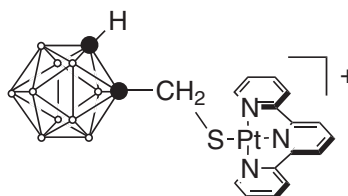

(143)



6.5.4.5.3 Macrocyclic S-donor ligands

The synthesis, X-ray structure, NMR, and UV-visible spectroscopy, and electrochemistry of a macrocyclic platinum(II) complex containing the tetradentate 1,4,7,10-tetrathiacyclodecane ligand, [12]aneS₄ (**144**) have been reported.³⁵⁰ Related complexes including [Pt([13]aneS₄)]²⁺ and [Pt([16]aneS₄)]²⁺ have also been prepared, and molecular mechanics calculations complemented

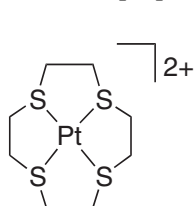

(144)

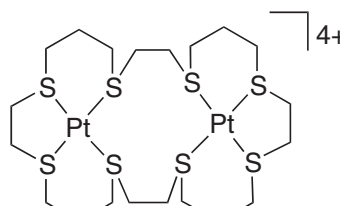

(145)

the study. The related complexes $[\text{Pt}([\text{14}] \text{aneS}_4)]^{2+}$ and $[\text{Pt}([\text{15}] \text{aneS}_4)]^{2+}$ have been reported elsewhere.²⁵² Schröder and co-workers have independently reported the synthesis and electrochemistry of a series of $[\text{Pt}([n] \text{aneS}_4)]^{2+}$ ($n=12, 14, 16$) complexes.³⁵¹ The dinuclear species $[\text{Pt}_2([\text{28}] \text{aneS}_8)]^{4+}$ (**145**) was also prepared and characterized.

The macrocyclic thioethers 1,4,7-trithiacyclononane and 1,4,7-trithiacyclodecane form complexes of the type $[\text{Pt}([n] \text{aneS}_3)\text{L}_2]^{2+}$ ($n=9$ or 10 ; $\text{L} = \text{PPh}_3$; $\text{L}_2 = \text{dppm}, \text{dppe}, \text{dppp}, 1,4\text{-bis}(\text{diphenylphosphino})\text{butane}, 1,5\text{-bis}(\text{diphenylphosphino})\text{pentane}, 1,2\text{-bis}(\text{diphenylphosphino})\text{benzene}, \text{cis-}1,2\text{-bis}(\text{diphenylphosphino})\text{ethene}$), e.g., $[\text{Pt}([\text{9}] \text{aneS}_3)(\text{dppe})]^{2+}$ (**146**).^{352,353} All complexes were shown to possess a *cis* arrangement of the S_2 and P_2 donor atoms, with only two of the three S-atoms in the macrocycle coordinated to the platinum(II) center. In contrast, when diimine ligands are used in place of the chelating tertiary phosphines, five-coordinate platinum(II) complexes are formed. For example, the synthesis, NMR, and X-ray study of $[\text{Pt}([\text{9}] \text{aneS}_3)(\text{phen})]^{2+}$ ($\text{phen} = 1,10\text{-phenanthroline}$; **147**) has been described.³⁵⁴ The X-ray structure confirms the distorted square-pyramidal geometry of the complex, with the phen ligand and two of the three S atoms of the [9]aneS₃ ligand occupying the square plane; the remaining S atom is located at the apical position of the square-pyramid. Variable-temperature NMR spectroscopy demonstrates that the complex is fluxional, with the macrocyclic ligand undergoing rapid, intramolecular 1,4-metallatropic shifts.

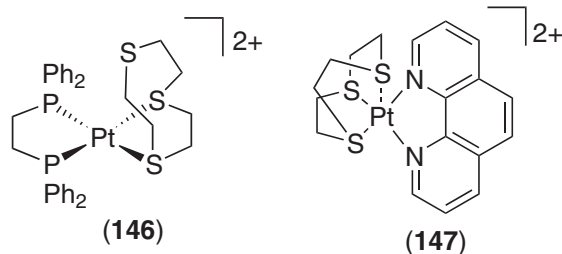

Treatment of $[\text{PtCl}_4]^{2-}$ with the macrocyclic oxathiaethers 1-oxa-4,7-dithiacyclononane ($[\text{9}] \text{aneS}_2\text{O}$) and 1,10-dioxa-4,7,13,16-tetrathiacyclooctadecane ($[\text{18}] \text{aneS}_4\text{O}_2$) results in the formation of $[\text{Pt}([\text{9}] \text{aneS}_2\text{O})]^{2+}$ and $[\text{Pt}([\text{18}] \text{aneS}_4\text{O}_2)]^{2+}$, respectively.³⁵⁵ The X-ray structures of the hexafluorophosphate salts were also reported, confirming the square-planar geometry of the PtS_4 unit.

6.5.4.6 Platinum(II) Complexes with Hydrido and Dihydrogen Ligands

6.5.4.6.1 Hydrido ligands

The stable dihydridoplatinum(II) complexes *cis*- and *trans*- $[\text{PtH}_2(\text{PR}_3)_2]$ ($\text{R} = \text{Me}, \text{Et}$) have been isolated and characterized.³⁵⁶ Their preparation involves the formal oxidative addition of dihydrogen gas to the platinum(0) precursor $[\text{Pt}(\text{C}_2\text{H}_4)(\text{PR}_3)_2]$ at room temperature to afford an equilibrium mixture of the two isomeric products, the position of which is dependent upon a number of factors. For example, the ratio of *cis*:*trans* isomers depends upon the nature of the solvent and the phosphine ligand. When the trimethylphosphine ligand is used, the conversion of the *trans* to the *cis* isomer in toluene and acetone solution occurs with $K_{\text{eq}} = 0.3$ and $2.2 \text{ mol}^{-1} \text{ dm}^3$ at 298 K, respectively, reflecting the greater degree of solvation of the *cis* isomer in acetone solution owing to its greater dipole moment. Furthermore, the value of K_{eq} is approximately one order of magnitude smaller when the bulkier triethylphosphine ligand is present in the complex. Under certain conditions, analytically pure *trans*- $[\text{PtH}_2(\text{PET}_3)_2]$ can be isolated as unstable, off-white crystals. However, the complex is indefinitely stable both as a solid and in solution under an atmosphere of dihydrogen at ambient temperatures. A detailed study of the kinetics of *cis*-*trans* isomerization and reductive elimination of H_2 in $[\text{PtH}_2(\text{PMe}_3)_2]$ has also been reported.³⁵⁷

When a toluene solution of $[\text{PtH}_2(\text{PET}_3)_2]$ is exposed to a CO_2 atmosphere (1 atm), an equilibrium mixture ($K_{\text{eq}} = 2 \text{ atm}^{-1}$ at 298 K) containing both the corresponding formate species *trans*- $[\text{PtH}(\text{O}_2\text{CH})(\text{PET}_3)_2]$ and the precursor complex is formed.³⁵⁸ In polar solvents such as acetonitrile or acetone, the cationic diplatinum(II) species $[\text{Pt}_2(\mu\text{-H})_2(\text{H})(\text{PET}_3)_4]^+$ (**148**) and free formate ion are formed rapidly and quantitatively. The reaction appears to be completely reversible as bubbling H_2 gas through a solution of the dinuclear complex regenerates the $[\text{PtH}_2(\text{PET}_3)_2]$ with loss of CO_2 . In a related study, UV-irradiation of the oxalato complex $[\text{Pt}(\text{ox})(\text{PET}_3)_2]$

(ox = oxalate) in MeCN solution under 1 atm of H₂ affords [Pt₂(μ-H)₂H(PEt₃)₄]⁺ with the liberation of CO₂.³⁵⁹ Another transient species formed when [PtH₂(PEt₃)₂] was treated with formic acid or CO₂ in acetone solution, and it was identified to be the isomeric dinuclear species [Pt₂(μ-H)H₂(PEt₃)₄]⁺ (**149**). The same complex can be prepared exclusively by UV-irradiation of [Pt(ox)(PEt₃)₂] in MeOH solution at 298 K to afford *trans*-[PtH(OMe)(PEt₃)₂],⁸ which converts to [Pt₂(μ-H)H₂(PEt₃)₄]⁺; slow isomerization to the thermodynamically favored [Pt₂(μ-H)₂H(PEt₃)₄]⁺ occurs upon heating. Alternatively, the addition of small amounts of pyridine or iodide ion to [Pt₂(μ-H)H₂(PEt₃)₄]⁺ catalyzes the isomerization reaction.³⁵⁹

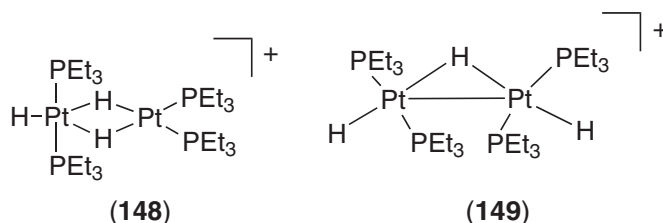

The highly reactive mono- and dihydrido platinum(II) complexes *trans*-[PtClH(PMe₃)₂] and *cis*/*trans*-[PtH₂(PMe₃)₂] can be prepared by the reaction of *cis*-[PtCl₂(PMe₃)₂] with one and two equivalents, respectively, of sodium naphthalide in THF solution under a H₂ atmosphere.³⁶⁰ The source of hydride in these reactions is H₂, as confirmed by deuterium-labeling studies, with sodium naphthalide acting only as an electron-transfer reagent. The X-ray structures of *trans*-[PtClH(PMe₃)₂] and *trans*-[PtH₂(PMe₃)₂] (as its naphthalene adduct) were also reported. The latter complex is extremely unstable, losing H₂ under a N₂ atmosphere, but crystals of the complex are indefinitely stable under a H₂ atmosphere at room temperature. In solution, [PtH₂(PMe₃)₂] exists as an equilibrium mixture of *trans* and *cis* isomers with the latter favored in polar solvents owing to its higher dipole moment. The energetics of the *cis*–*trans* isomerization process were also reported.

A series of *cis*-dihydridoplatinum complexes of the type [PtH₂{Cy₂P(CH₂)_nPCy₂}] (*n* = 2–4) have been prepared by the exposure of the platinum(0) species [PtCy₂P(CH₂)_nPCy₂] or [Pt(C₂H₄)₂{Cy₂P(CH₂)_nPCy₂}] to a pressurized H₂ atmosphere.²⁶ NMR studies in C₆D₆ solution provide strong evidence of a dynamic process involving *cis*-dihydride to η²-dihydrogen exchange, i.e., involving platinum(II) and platinum(0), respectively.

Five-coordinate hydrido complexes of platinum(II) containing the tetradentate tertiary phosphine ligand 1,1,4,7,10,10-hexaphenyl-1,4,7,10-tetraphosphadecane have been reported (**150**).³⁶¹ Both chiral and *meso* derivatives of the flexible phosphine ligand were used, and a number of coordination geometries were observed that appeared to depend upon the nature of the counterion. Five-coordinate hydridoplatinum(II) complexes containing the bidentate tertiary phosphine ligands dmpe and 1,2-bis(diethylphosphino)ethane (depe) have also been reported.³⁶² Treatment of [Pt(dmpe)₂]²⁺ or [Pt(depe)₂]²⁺ with NaBH₄ on alumina affords [PtH(dmpe)₂]⁺ or [PtH(depe)₂]⁺, respectively, in good yields. The depe complex can also be generated electrochemically. Other five-coordinate hydridoplatinum(II) complexes have also been reported, including [PtH(PP₃)]⁺ (PP₃ = tris(2-(diphenylphosphino)ethyl)phosphine)³⁶³ and [PtHL(PP₂)]⁺ (PP₂ = bis(2-(diphenylphosphino)ethyl)phenylphosphine; L = PPh₃, PBU₃, PPh₂H, PCy₂H, dppm).³⁶⁴

The synthesis, characterization, and the relative thermodynamic hydricities of hydridoplatinum(II) species-containing bidentate phosphine ligands [PtHL₂]⁺ (L₂ = dppe, depe, dmpe, 1,3-bis(dimethylphosphino)propane [dmpp]) have been determined, with the best hydride donor found to be [PtH(dmpe)₂]⁺.³⁶⁵

Dinuclear hydridoplatinum(II) species containing secondary phosphine ligands, *cis*-[Pt₂H₂(PHBu^t₂)₂(μ-H)(μ-PBu^t₂)] (**151**) and *trans*-[PtH(PHBu^t₂)(μ-PBu^t₂)₂] (**152**), have been prepared by the reaction of *trans*-[PtCl₂(PHBu^t₂)₂] with NaBH₄ in THF solution under reflux conditions.³⁶⁶ If the reaction is conducted in the presence of free PHBu^t₂, then *cis*-[Pt₂H₂(PHBu^t₂)₂(μ-H)(μ-PBu^t₂)] is selectively formed in high yield.

The protonation of the *cis*-dihydridomethylplatinum(IV) derivative of hydridotris(3,5-dimethylpyrazolyl)borate, [Pt(H)₂Me(Tp')]⁺ (Tp' = hydridotris(3,5-dimethylpyrazolyl)borate), with [H(OEt₂)₂][BAr^t₄] (BAr^t₄ = tetrakis(3,5-trifluoromethylphenyl)borate) occurs in the presence of MeCN at –78 °C to afford the platinum(II) species [PtH(MeCN)(Tp'+H)]⁺ (**153**) containing a bidentate Tp' ligand that is protonated at the nitrogen atom of the free pyrazolyl ring.³⁶⁷ When suitable donor ligands are absent from solution, the red–purple, dinuclear species [Pt₂(μ-H)₂(Tp'+H)₂]²⁺ (**154**) is formed instead, again with the protonated Tp' acting as a bidentate ligand. The latter is a rare example of a dinuclear μ-hydridoplatinum species that is stabilized by N-donor ligands.

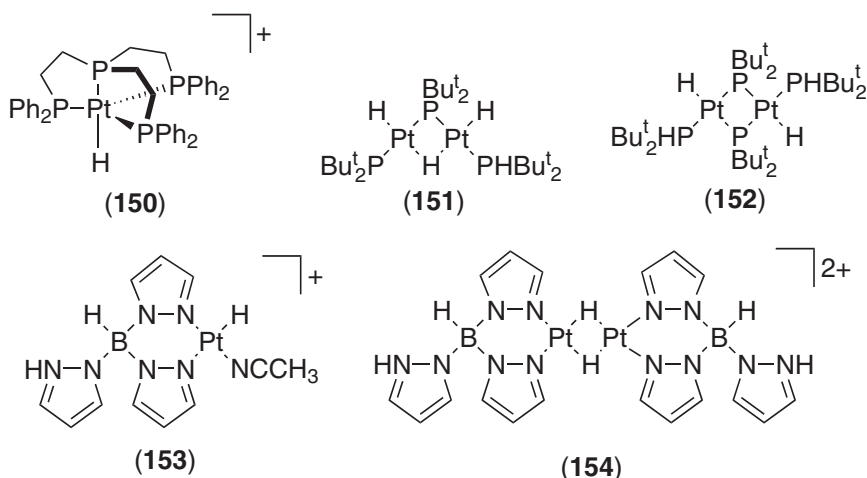

Protonation of $[\text{Pt}(\text{SO}_2)(\text{PPr}^i_3)_2]$ with $[\text{H}(\text{OEt}_2)_2]\text{BAR}^f_4$ in diethyl ether solution affords the labile hydrido species $\text{trans-}[\text{PtH}(\text{OEt}_2)(\text{PPr}^i_3)_2]^+$ in high yield.³⁶⁸ The addition of alkyl and aryl halocarbon (RX_n) compounds to the complex leads to the formation of isolable, air-stable complexes of the type $\text{trans-}[\text{PtH}(\eta^1\text{-XRX}_{n-1})(\text{PPr}^i_3)_2]^+$ ($\text{R} = \text{CH}_2$, $\text{X} = \text{Cl}$, $n = 2$; $\text{R} = \text{Ph}$, $\text{X} = \text{Br}$ or I , $n = 1$), in which the halogen acts as a donor atom to the platinum(II) center. The halocarbon ligands are readily displaced by donor solvents such as THF to afford $\text{trans-}[\text{PtH}(\text{THF})(\text{PPr}^i_3)_2]^+$.

6.5.4.6.2 Dihydrogen ligands

The first example of a platinum(II)–dihydrogen complex, $[\text{PtH}(\eta^2\text{-H}_2)(\text{PBu}^t_3)_2]^+$ (**157**), has been prepared by the protonation of $\text{trans-}[\text{Pt}(\text{H})_2(\text{PBu}^t_3)_2]$ with $\text{CF}_3\text{SO}_3\text{H}$ or, alternatively, by the reaction of $[\text{PtH}(\text{PBu}^t_3)_2]^+$ with H_2 .³⁶⁹ Deuteration experiments and NMR spectroscopy confirm the formulation of the product as a dihydrogen complex. Hydrogen-2 NMR studies reveal both Pt–D and Pt(DH) resonances for the deuterated complex, including the first report of a metal–H₂ spin–spin interaction. Other NMR experiments confirm that no intramolecular scrambling of the H/H₂ ligands occurs on the NMR time-scale. *Ab initio* calculations complemented this work. The preparation of the related complex $\text{trans-}[\text{PtH}(\eta^2\text{-H}_2)(\text{PPr}^i_3)_2]^+$ has also been described.³⁶⁸

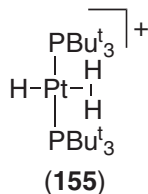

Protonation of complexes of the type $\text{trans-}[\text{Pt}(\text{H})\text{X}(\text{PCy}_3)_2]$ ($\text{X} = \text{SiH}_3$, H , Me , Ph , Cl , Br , I , CN , CF_3SO_3) and $\text{trans-}[\text{Pt}(\text{H})\text{L}(\text{PCy}_3)_2](\text{BAR}^f_4)$ ($\text{L} = \text{CO}$, 4-picoline) using strong acids such as $[\text{H}(\text{OEt}_2)_2][\text{BAR}^f_4]$ at low temperatures results in the three reaction outcomes depending on the site of proton attack, i.e., the hydrido ligand, the ligand located *trans* to the hydrido ligand, or the metal center.³⁷⁰ All of the complexes that form the unstable dihydrogen adduct, $\text{trans-}[\text{Pt}(\text{H}_2)\text{X}(\text{PCy}_3)_2]$, have a strong σ -donor ligand located *trans* to the hydrido ligand, i.e., $\text{X} = \text{H}$, Me , and Ph . The enhanced basicity of the *trans* hydrido ligand appears to make it more amenable to protonation.

6.5.4.7 Platinum(II) Complexes with Mixed Donor-atom Ligands

6.5.4.7.1 Bidentate NO and OS ligands

Platinum-195 NMR spectroscopy has been used to probe the reversible and intramolecular HH to HT isomerization of the α -pyridonato-bridged diplatinum(II) complex $[\text{Pt}_2(\text{en})_2\text{L}_2]^{2+}$

(L = α -pyridonate, C₅H₄NO⁻).³⁷¹ At 312 K and pH 6.5, the kinetic parameters for the isomerization process were determined to be $k_f = 7.4(2) \times 10^{-5} \text{ s}^{-1}$, $k_r = 13.9(2) \times 10^{-5} \text{ s}^{-1}$, and $K_{\text{eq}} = 0.53$. The values of ΔH^\ddagger (114(5) kJ mol⁻¹) and ΔS^\ddagger (40(10) J mol⁻¹ K⁻¹) were determined by means of an Eyring plot. The mechanistic data are consistent with cleavage of the α -pyridonato Pt—N bond during the isomerization process.

5-Aminoorotic acid can exhibit up to three coordination modes with platinum(II).³⁷² Treatment of [PtCl₂(COD)] with two equivalents of PPh₃ and an excess of 5-aminoorotic acid in the presence of Ag⁺ affords two isomers of [Pt(aoaH₂)(PPh₃)₂] ((**156**) and (**157**)), where 5-aminoorotic acid acts as a dianionic bidentate ligand. Only one isomer is formed when dppe was used instead of PPh₃. Further reaction of complex (**157**) with NaBF₄ results in the formation of the dinuclear species [Pt₂(aoaH)(PPh₃)₄]⁺ (aoaH₄ = 5-aminoorotic acid; (**158**)), in which the 5-aminoorotic acid acts as a trianionic ligand. The presence of several H-bonding groups on the periphery of the complexes leads to various supramolecular structures being formed in the solid state, with dimers and cyclic tetramers elucidated by X-ray crystallography.

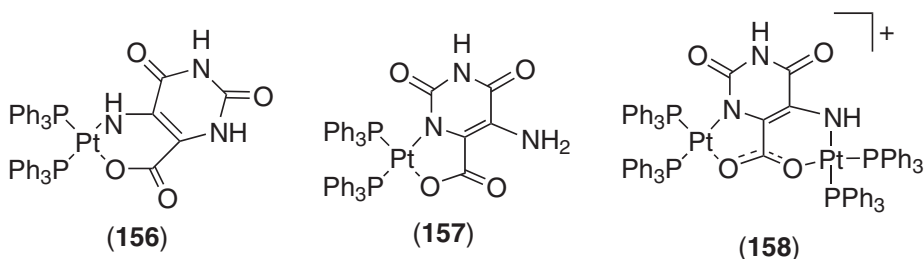

The preparation and characterization of diastereomeric *N*-iminodiacetato platinum(II) complexes of (*R,S*)- and (*R,R*)-1,2-chxn have been reported,³⁷³ where the substituted iminodiacetylato ligand is bonded to the metal center in a tridentate manner (**159**). One arm of the ligand forms a stable five-membered *N,O*-chelate, and the remaining carboxylate group interacts with the positively charged metal center to form a zwitterionic species. Unequal proportions of the diastereomers are formed in solution.

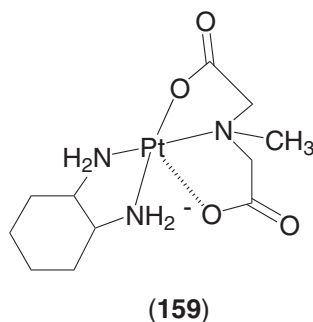

Treatment of the bischelating ligands 3,3,3',3'-tetra(Bu¹)-1,1'-terephthaloylbis(thiourea) ({H₂L¹}₂) or 3,3,3',3'-tetraethyl-1,1'-isophthaloylbis(thiourea) ({H₂L²}₂) with [PtCl₄]²⁻ results in the formation of the tri- or dinuclear metallacyclic species, *cis*-[Pt(L¹-*S,O*)]₃ (**160**) or *cis*-[Pt(L²-*S,O*)]₂ (**161**), respectively.³⁷⁴ The stoichiometry of the reaction appears to depend upon the relative positions of the chelating *S,O* moieties around the arene ring.

A series of mixed-ligand thiosalicylato complexes of the type [PtL(PPh₃)Y₂] (Y₂ = thiosalicylate; L = pyridine, 4-methylpyridine, picolinic acid hydrazide, imidazole) have been prepared by the reaction of [PtCl₂(COD)] with PPh₃, thiosalicylic acid, and *N*-donor ligand in MeOH solution.³⁷⁵ The X-ray structure of the pyridine derivative (**162**) was determined, the first example of where a platinum atom is coordinated to a N, O, P, and S donor atom set.

6.5.4.7.2 Bidentate PO, PS, and PN ligands

Treatment of [PtX₂(COD)] (X = Cl, I) with the unsymmetrical ligands Ph₂P(CH₂)_{*n*}R (*n* = 2, R = OMe, NMe₂, SMe; *n* = 3, R = NMe₂) leads to the formation of the chelate complexes

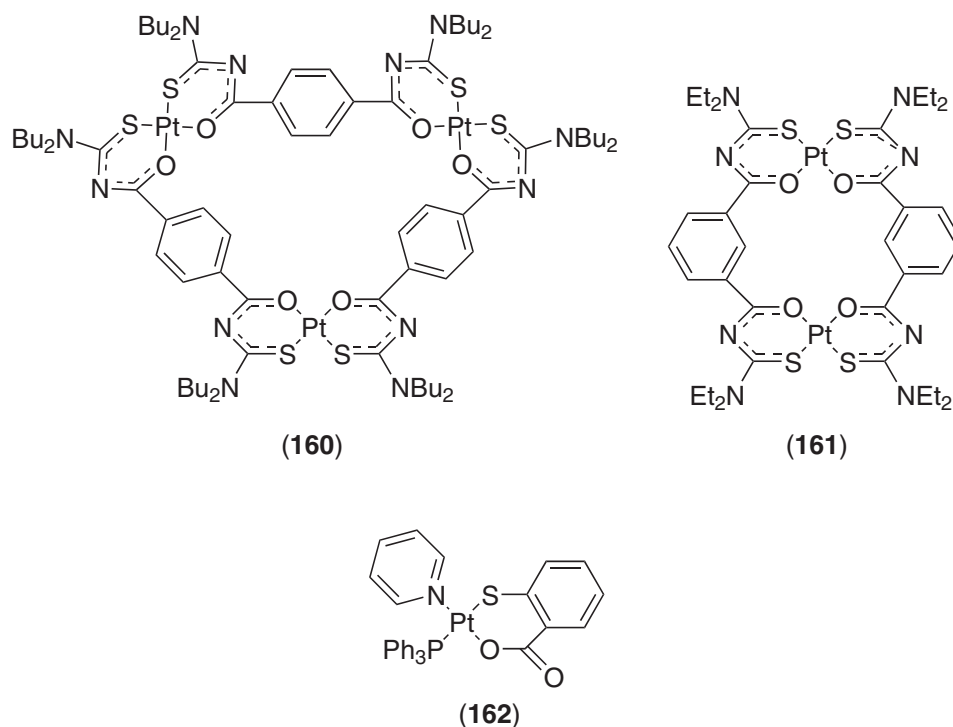

$[\text{PtX}\{\text{Ph}_2\text{P}(\text{CH}_2)_n\text{R}\}_2]^+$ and $[\text{Pt}\{\text{Ph}_2\text{P}(\text{CH}_2)_n\text{R}\}_2]^{2+}$, a process that is dependent upon the nature of the nonphosphorus donor atom and on the size of the chelate ring that is formed.³⁷⁶ Halide abstraction by the use of one or two equivalents of Ag^+ is required for the formation of the chelated species in the case of $\text{R} = \text{OMe}$ and NMe_2 ($n = 3$), otherwise the nonchelated complex *cis*- $[\text{PtX}_2\{\text{Ph}_2\text{P}(\text{CH}_2)_n\text{R}\}_2]$ is formed exclusively. In contrast, when $\text{Ph}_2\text{P}(\text{CH}_2)_2\text{NMe}_2$ is added to $[\text{PtCl}_2(\text{COD})]$, the chelate complex $[\text{PtCl}\{\text{Ph}_2\text{P}(\text{CH}_2)_2\text{NMe}_2\}_2]^+$ is formed in the absence of Ag^+ , indicating the stability of the final complex is determined by the “bite” of the chelating ligand with the sufficiently nucleophilic NMe_2 group. When one equivalent of $\text{Ph}_2\text{P}(\text{CH}_2)_2\text{SMe}$ is used, the chelate complex $[\text{PtX}_2\{\text{Ph}_2\text{P}(\text{CH}_2)_2\text{SMe}\}]$ is formed, but the addition of a second equivalent of ligand gives a mixture of products, and the involvement of ion-paired species has been inferred.

Sadler and co-workers have prepared a series of bischelated aminophosphine complexes of the type $[\text{Pt}(\text{R}^1\text{R}^2\text{N}(\text{CH}_2)_n\text{PPh}_2)_2]^{2+}$ ($n = 2, 3$; R^1 and $\text{R}^2 = \text{H}, \text{Me}, \text{Bz}, \text{Cy}$) (163).³⁷⁷ The N-donor atoms of the chelate can become dissociated from the metal center and thus generate up to two vacant coordination sites that can allow rapid reaction of the complex with potential biological ligands such as nucleobases. This process is influenced by a number of factors, including the nature of the R^1 and R^2 groups, pH, chloride ion concentration, and even the value of n . The ring-opening process was observed both in the solid state³⁷⁷ and in solution.³⁷⁸

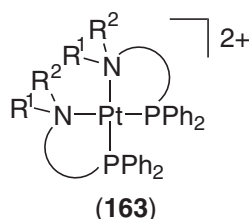

6.5.5 PLATINUM(III)

Platinum(III) complexes are remarkably rare and most examples date from less than 30 years ago. The great majority are dimeric species with only a few authenticated stable monomers reported. Most of the dimers are bridged by bidentate ligands and are almost exclusively doubly or quadruply bridged, the latter giving rise to the classic “lantern” structure.

6.5.5.1 Monomeric Platinum(III)

The first example of an isolated monomeric platinum(III) complex was reported by Uson *et al.* in 1984.³⁷⁹ $[\text{NBu}_4][\text{Pt}(\text{C}_6\text{Cl}_5)_4]$ was obtained by oxidation of $[\text{NBu}_4]_2[\text{Pt}(\text{C}_6\text{Cl}_5)_4]$ with halogens or TiCl_3 and was characterized by X-ray crystallographic, spectroscopic, and magnetic methods. The Pt—C bond lengths are indistinguishable in the platinum(III) 2.086(14) Å and platinum(II) 2.094(8) Å oxidation states.

Bond *et al.* showed that electrochemical oxidation of $[\text{Pt}(\eta^1\text{-S}_2\text{CNEt}_2)(\eta^3\text{-P}_2\text{P}')^+]$ ($\text{P}_2\text{P}' = \text{Ph}_2\text{P}(\text{CH}_2)_2\text{P}(\text{Ph})(\text{CH}_2)_2\text{Ph}_2$) gives the moderately stable platinum(III) complex $[\text{Pt}(\eta^1\text{-S}_2\text{CNEt}_2)(\eta^3\text{-P}_2\text{P}')^+]^{2+}$.³⁸⁰ ESR spectroscopy was used to confirm the presence of paramagnetic platinum(III) and it was suggested that bulky ligands are needed to stabilize monomeric platinum(III).³⁸⁰

Caseric and co-workers have reported that $[\text{Pt}(\text{NH}_2\text{Octyl})_4][\text{Pt}(\text{mnt})_2]$ can be oxidized with iodine to give $[\text{Pt}(\text{NH}_2\text{Octyl})_4][\text{Pt}(\text{mnt})_2]$ in which the anion $[\text{Pt}(\text{mnt})_2]^{2-}$ has platinum in the formal oxidation state III.³⁸¹ There has been some debate about whether mnt should be described as a dinegative dithiolate or a neutral dithioketone, but its structure is more consistent with the former. Thus, the description of the metal as platinum(III) is sound, though the additional positive charge is probably distributed throughout the complex.

Monomeric platinum(III) complexes have been observed frequently as transient species in electrochemical or pulse radiolysis studies and they are proposed as an intermediates in reductive elimination and oxidative addition reactions of platinum(IV) and platinum(II) respectively.^{382–388}

6.5.5.2 Unbridged Dimers

The first unbridged platinum(III) dimer, $[\text{PtCl}_3\{\text{(Z)-HN}=\text{C}(\text{OH})\text{Bu}^1\}_2]_2$, was reported by Natile and co-workers in 1991³⁸⁹ and arose from the oxidation of *cis*- $[\text{PtCl}_2\{\text{(Z)-HN}=\text{C}(\text{OH})\text{Bu}^1\}_2]$ with chlorine. The Pt—Cl bonds *trans* to the Pt—Pt bond are 2.458(2) Å long, significantly longer than those in the equatorial planes (2.306(3), 2.328(3) Å), consistent with the metal–metal bond exerting a strong *trans* influence. Prolonged exposure of the platinum(III) complex to chlorine yields the platinum(IV) complex *cis*- $[\text{PtCl}_4\{\text{(Z)-HN}=\text{C}(\text{OH})\text{Bu}^1\}_2]$.

Soon after, Heath and co-workers reported an unsupported dimer with α -dioximato ligands ($[\text{PtCl}_2(\text{C}_8\text{doH})_2]$ (C_8doH is shown in (164)) obtained by controlled oxidation of $[\text{Pt}(\text{C}_8\text{doH})_2]$ with either PhICl_2 or *p*- $\text{ClC}_6\text{H}_4\text{ICl}_2$.³⁹⁰ Addition of further oxidant produced the platinum(IV) complex $[\text{PtCl}_2(\text{C}_8\text{doH})_2]$. The Pt—Pt bond length (2.696,4(5) Å)³⁹⁰ is similar to that observed in the first reported example, 2.694(1) Å³⁸⁹ indicating that this is a normal value for an unsupported $\text{Pt}^{\text{III}}\text{—Pt}^{\text{III}}$ bond. The Pt—Cl bond length (2.386(2) Å) is shorter than the axial Pt—Cl bond length in $[\text{PtCl}_3\{\text{(Z)-HN}=\text{C}(\text{OH})\text{Bu}^1\}_2]_2$, suggesting that steric strain contributes to the latter, but consistent with a strong *trans* influence from the Pt—Pt bond. The same group obtained an unsupported dimer, $[\text{Pt}_2\text{Cl}_2(\text{acac})_4]$ (*acac* = acetylacetonate), by oxidation of $[\text{Pt}(\text{acac})_2]$ with chlorine.³⁹¹

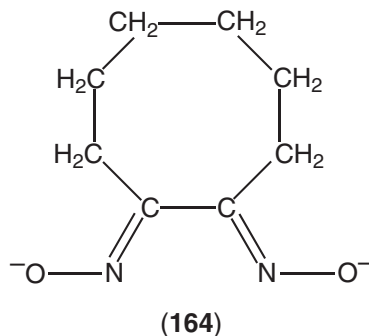

6.5.5.3 O,O-Bridged Dimers

6.5.5.3.1 Sulfate and hydrogenphosphate-bridged dimers

The sulfate bridged dimer $\text{K}_2[\text{Pt}_2(\text{SO}_4)_4(\text{H}_2\text{O})_2]$ was among the first platinum(III) compounds prepared and the analogous hydrogenphosphate bridged complexes $[\text{Pt}_2(\text{HPO}_4)_4(\text{L})_2]^{2+}$ are

equally well known.³⁹² The structures of a number of these complexes have been determined as a variety of salts and with a variety of ligands (L) in the axial sites.^{393–396} As with other dimeric systems, the Pt—Pt bond exerts a significant *trans* influence on the axial ligand and vice versa. Appleton and co-workers have examined the ¹⁹⁵Pt, ¹⁵N, and ¹³C NMR spectra of sulfate- and phosphate-bridged dimers, showing that the *J*(Pt—Pt) coupling constants decrease with increasing *trans* influence of the axial ligands.³⁹⁷ They concluded from these and other observations that both Pt atoms undergo rehybridization when the axial ligand on one of the metals is replaced.³⁹⁷ They also used ¹⁹⁵Pt NMR spectroscopy to follow the reactions of sulfate- and hydrogen phosphate-bridged complexes with halides.³⁹⁸ Stranger *et al.* have assigned the electronic spectroscopy of such complexes, assigning the intense UV band at about 45,000 cm⁻¹ to predominantly SO₄ or HPO₄ → σ*(PtO_b) LMCT transitions.³⁹⁹

6.5.5.3.2 Pyrophosphito-bridged dimers

The pyrophosphito-bridged dimers, [Pt₂(pop)₄XY]ⁿ⁻ (pop = P₂O₅H₂²⁻; **(165)**), form one of the largest and most widely studied groups of platinum(III) dimers. Crystal structures have been determined for a wide variety of complexes including X = Y = Cl, Br, I, NO₂, MeCN, SCN, imidazole, and SEt₂, and X = Me, Y = I.^{400–406} The *trans* influence of these axial ligands follows the usual trend with the Pt—Pt bond lengths ranging from 2.676 Å to 2.782 Å, the shortest being for X = Y = MeCN and the longest being for the complex with X = Me, Y = I. The UV–Vis, IR, and Raman spectra also reflect the *trans* influences of the axial ligands.^{404,407,408} The rates of aquation and substitution at the axial ligand sites have been studied and been found to be suggestive of an interchange mechanism.^{409,410}

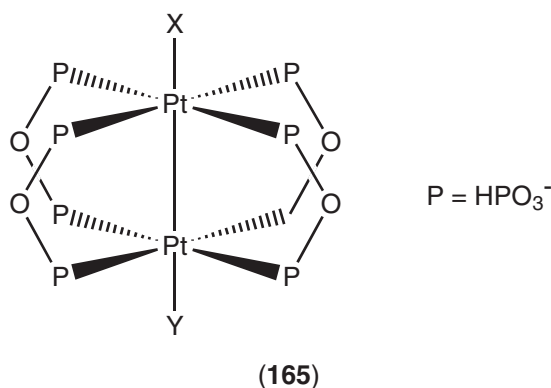

6.5.5.3.3 Acetato-bridged dimers

Bisacetato-bridged platinum(III) dimers have been known of for many years, but surprisingly, the first “lantern-shaped” tetrakis-acetatodiplatinum(III) complex was only reported in 1992. [Pt₂(μ-CH₂CO₂-O,O′)₄(H₂O)₂]²⁺ was obtained from a solution of K₂[Pt(NO₂)₄] in a mixture of glacial acetic acid and perchloric acid.^{411,412} The Pt—Pt bond in this complex is remarkably short at 2.390(2) Å.^{411,413} In aqueous solution one of the acetate ligands is rapidly lost.^{411,413} The electronic structure of [Pt₂(μ-CH₂CO₂-O,O′)₄(H₂O)₂]²⁺ has been analyzed using Xα-SW MO calculations and indicates a Pt—Pt single bond.⁴¹⁴

6.5.5.4 N,S and S,S-bridged Dimers

Goodgame and co-workers have described a series of dinuclear platinum(III) complexes with four bridging pyrimidine-2-thione or 2-thiouracil ligands [Pt₂(pyrmS)₄XY] (pyrmS = pyrimidine-2-thione).^{415–417} Somewhat unusually, these were first prepared by direct reaction between the ligand and [PtI₄]²⁻,^{415,416} but were also prepared by reduction of the platinum(IV) precursor [PtCl₆]²⁻.⁴¹⁷ Structures were determined for pyrmS, X = Y = Cl, I; X = Cl, Br, Y = pyrimidine-2-thione, and pyrmS = 2-thiouracil, X = Y = I.^{415–417} The Pt—Pt bond lengths range from 2.518(1) Å in the dichloro complex to 2.554(1) Å in the complex with mixed bromo and pyrimidine-2-thione ligands

in the axial positions. Similar complexes with bridging pyridine-2-thiol and 4-methylpyridine-2-thiol ligands were obtained by Ooi and co-workers by reacting these ligands with *cis*-[PtCl₂(NH₃)₂] and *cis*-[PtCl₂(MeCN)₂], respectively, and then stirring the bridged platinum(II) products in chloroform.⁴¹⁸ The complexes were obtained with axial chloro ligands and these were readily substituted with other halides or thiocyanate. The structure of the dichloro complex [Pt₂Cl₂(pyt)₄] (pyt = pyridine-2-thiol) revealed a Pt—Pt bond length of 2.532(1) Å.⁴¹⁸ In all structures in these series, the coordination geometry about the platinum(III) centers is *cis*-N₂S₂.⁴¹⁵⁻⁴¹⁸

There are very few example of S,S-bridged dimers, though tetrakis(dithiocarboxylato)platinum(III) dimers were reported before their carboxylato analogues. [Pt₂I₂(R₂CS₂)₄], R = Me, PhCH₂ or Me₂CH, were obtained by iodine oxidation of dimeric platinum(II) complexes.^{419,420} The Pt—Pt bond lengths in the latter two compounds are 2.598(1) Å and 2.578(1) Å respectively,⁴²⁰ substantially longer than that in the acetate analogue.

6.5.5.5 N,O-bridged Dimers

Modern platinum blue chemistry arose serendipitously from the study of the interaction between cisplatin and pyrimidines. The anticancer activity of these platinum blues, coupled with their often intractable nature led Lippard and co-workers to study the analogous α -pyridone (α -pyr) complexes and in the process they found a convenient route to dinuclear platinum(II) complexes.⁴²¹⁻⁴²⁴ Nitric acid and nitrous acid oxidation of the platinum(II) dimer [Pt₂(α -pyr)₂(NH₃)₄]²⁺ gave the nitrate and nitrite capped complexes [Pt₂XY(α -pyr)₂(NH₃)₄]²⁺, X = Y = NO₃⁻ or NO₂⁻, respectively.⁴²¹ In the presence of halide anions, these axial ligands are replaced.⁴²³ Oxidation of the *cis*-diamminepyridone blue with nitric acid gave a HH dimer with X = NO₃⁻, Y = H₂O (166).⁴²² Nitric acid oxidation of the platinum(II) dimer in which the ammine ligands had been replaced by en also gave a HH dimer with X = NO₃⁻, Y = NO₂⁻.⁴²⁴ Matsumoto *et al.* report similar syntheses of the ammine analogues of these complexes.^{425,426} The HH dimers were found to be more reactive than the HT.⁴²⁴

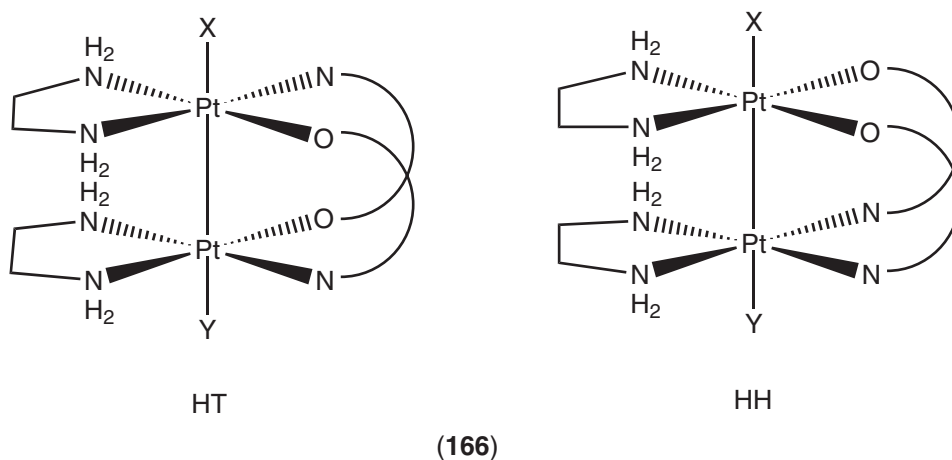

Lippert and co-workers have reported a similar series of N,O-bridged platinum(III) dimers in which the bridging ligands are the pyrimidines, 1-methyluracil, 1-methylthymine, or 1-ethylthymine. Chemical oxidation of dimeric platinum(II) complexes gave [Pt₂XY(L)₂(NH₃)₄]²⁺, X, Y = NO₃⁻, NO₂⁻, H₂O, Cl⁻, or Br⁻, L = 1-MeU, 1-MeT, 1-EtT.⁴²⁷⁻⁴³⁰ They too found that the HT dimers are more stable than the HH.⁴³⁰

6.5.6 PLATINUM(IV)

6.5.6.1 Five-coordinate Platinum(IV) Complexes

Five-coordinate or 16-electron platinum(IV) complexes have been avidly sought for many years because of their relevance as intermediates in catalytic processes. However, the first two structurally

characterized five-coordinate platinum(IV) complexes have only recently been described.⁴³¹ One of these, $[\text{PtMe}_3\{(\text{NArCMe})_2\text{CH}\}]$ ($\text{Ar} = 2,6\text{-Pr}^i_2\text{C}_6\text{H}_3$),⁴³² is an organometallic complex and hence beyond the scope of this review. The other, $[\text{PtH}_2(\text{SiEt}_3)(\text{Tp}'\text{+H})]^+$, was prepared both by protonation of one of the arms of the Tp' ligand in the six-coordinate platinum(IV) complex $[\text{PtH}_2(\text{SiEt}_3)(\text{Tp}')]^+$ or by treatment of the platinum(II) intermediate $[\text{PtH}(\text{solvent})(\text{Tp}'\text{+H})]^+$ with SiEt_3H .⁴³¹ The structure of this complex was not unequivocally established because the hydride ligands could not be located. However, the combination of the structure with the NMR data is sufficient to provide strong evidence for a five-coordinate platinum(IV) complex, stabilized by the strong *trans*-influence of the silyl ligand and the bulkiness of the Tp' ligand.

6.5.6.2 Group IV Complexes

Si—Si and Si—Ge bonds oxidatively add to platinum(0) to give platinum(II) silyl complexes as described in Section 6.5.2.1.7(iii), and 2,2-bis(disilanyl)dithiane double-oxidatively adds to $[\text{Pt}_3(\text{CNBu}^t)_6]$ to give the platinum(IV) complex shown in (167a).⁵³ The related 2,2-bis(silylgermyl)dithiane produces a mixture of germyl- and silylgermyl-platinum(IV) complexes shown in (167b) and (167c).⁵³

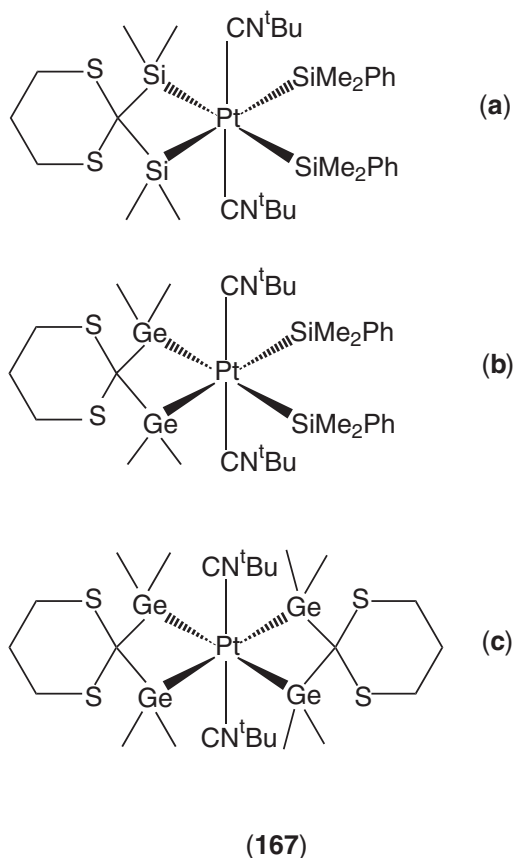

6.5.6.3 Group V Complexes

There are numerous platinum(IV) complexes with nitrogen donors, most of which have been prepared as potential anticancer drugs or in the study of the reactions of such drugs. These compounds are described below in Section 6.5.6.5.

Platinum(IV) complexes of phosphine and arsine ligands formed by oxidation with chlorine or bromine are well known. Chloro complexes such as *cis*- $[\text{PtCl}_2(\text{PET}_3)_4]^{2+}$ can be generated by electrolysis of the platinum(II) complex *cis*- $[\text{PtCl}_2(\text{PET}_3)_2]$.⁴³³ Similar platinum(IV) complexes

have been studied by ^{195}Pt NMR spectroscopy.⁴³⁴ In contrast, analogous iodo complexes are less well known and reaction with iodine frequently yields platinum(II) polyiodides, platinum(IV) polyiodides or mixed valence complexes. However, oxidation of $[\text{Pt}(\text{L-L})_2\text{I}_2]$, ($\text{L-L} = \text{dmpe}$ or $o\text{-C}_6\text{H}_4(\text{AsMe}_2)_2$) with concentrated nitric acid gives the platinum(IV) complex $[\text{Pt}(\text{L-L})_2\text{I}_2](\text{NO}_3)_2$.⁴³⁵

Platinum(II) and platinum(IV) complexes have been prepared using the constrained diphosphine ligands, 1,2-bis(diphenylphosphino)ethyne, and *cis*- and *trans*-1,2-bis(diphenylphosphino)ethene.^{412,436,437} The ethyne and *trans*-ethene ligands are unable to form chelate rings and act as bridging ligands in dinuclear platinum complexes.^{437,438} However, the *cis*-ethene ligand can form a chelate and produces mononuclear complexes of the type $[\text{PtCl}_2(\text{P}=\text{P})_2]^{2+}$.⁴³⁶

6.5.6.4 Group VI Complexes

Platinum(IV) complexes with six oxygen donors are rare but $\text{K}_6\text{Na}_2[\text{Pt}(\text{OH})_2(\text{HTeO}_6)_2] \cdot 12\text{H}_2\text{O}$ with chelating tellurato ligands and axial hydroxo ligands was obtained by reaction of $\text{K}_2[\text{PtCl}_6]$ with telluric acid in KOH.⁴³⁹ The axial and equatorial Pt—O bond lengths are indistinguishable.⁴³⁹

Oxidative addition of the disulfide like salt $[\{\text{SC}(\text{NMe}_2)_2\}_2]\text{Cl}_2 \cdot 2\text{H}_2\text{O}$ to am(m)inechloroplatinum(II) complexes gives rise to platinum(IV) complexes with thiourea and chloro ligands added in *trans* positions.⁴⁴⁰ For example, oxidation of $[\text{PtCl}_3(\text{NH}_3)]^-$ gives *cis*- $[\text{PtCl}_4(\text{NH}_3)(\text{tmtu})]$. Oxidation of *trans*- $[\text{PtCl}_2(\text{NH}_3)_2]$ and $[\text{PtCl}(\text{dien})]^+$ gives similar complexes, but they undergo light dependent isomerizations to *fac* and *trans*, *mer* configurations.⁴⁴⁰ *cis*- $[\text{PtCl}_2(\text{dmimt})_2]$ (*dmimt* = 1,3-dimethylimidazoline-2-thione) undergoes a similar *trans* addition of *dmimt* and chloro ligands, evidently as a result of spontaneous aerial oxidation.⁴⁴¹ Tetrasulfurtetranitride (S_4N_4) reacts with $[\text{PtCl}_2(\text{PMe}_2\text{Ph})_2]$ to give a platinum(IV) complex with the S_4N_4 coordinated as a tridentate via two sulfur donors and one nitrogen donor.⁴⁴² Refluxing in chloroform results in isomerization such that the coordination is via one sulfur donor and two nitrogen donors.⁴⁴³ Similarly, $\text{S}_2\text{N}_2\text{H}$ forms a bidentate complex with platinum(II) $[\text{Pt}(\text{S}_2\text{N}_2\text{H})(\text{PR}_3)_2]^+$ which is oxidized by bromine to the platinum(IV) complex *trans*- $[\text{PtBr}_2(\text{S}_2\text{N}_2\text{H})(\text{PR}_3)_2]^+$.¹⁸³ This latter complex undergoes isomerization at room temperature to give the *cis* complex.¹⁸³ Ammonium polysulfide reacts directly with $[\text{PtCl}_6]^{2-}$ to give the optically active $(\text{NH}_4)_2[\text{Pt}(\text{S}_5)_3] \cdot 2\text{H}_2\text{O}$ which reacts with concentrated hydrochloric acid to give a complex that was formulated as $(\text{NH}_4)_2[\text{PtS}_{17}] \cdot 2\text{H}_2\text{O}$.⁴⁴⁴

Chlorine or bromine oxidation of $[\text{Pt}([\text{16}] \text{aneSe}_4)]^{2+}$ gives the platinum(IV) complexes, *trans*- $[\text{Pt}([\text{16}] \text{aneSe}_4)\text{X}_2]^{2+}$ ($\text{X} = \text{Cl}$ or Br) with Pt—Se bond lengths of 2.496 Å to 2.502 Å.⁴⁴² Similarly, halogen oxidation of $[\text{PtX}_2(\text{L-L})]$ ($\text{X} = \text{Cl}$ or Br , $\text{L-L} = o\text{-C}_6\text{H}_4(\text{SeMe}_2)_2$) gives the platinum(IV) complexes $[\text{PtX}_4(\text{L-L})]$ with Pt—Se bond lengths of 2.432 Å to 2.441 Å.⁴⁴⁵ The novel cage compound $\text{P}_3\text{Se}_4\text{C}_3\text{Bu}^t_3$ undergoes a surprising reaction with $[\text{PtCl}_2(\text{PMe}_3)]_2$, oxidatively adding to the metal via cleavage of the Se—Se bond to give a facially coordinated tridentate ligand with three selenium donors in the platinum(IV) complex $[\text{PtCl}_2(\text{PMe}_3)(\text{P}_3\text{Se}_4\text{C}_3\text{Bu}^t_3)]$ (**168**).⁴⁴⁶

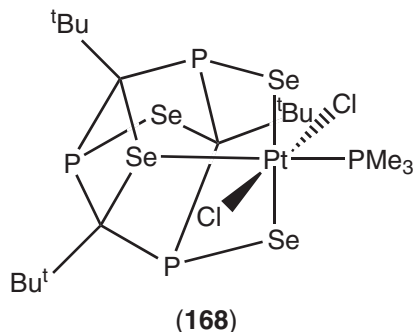

6.5.6.5 Am(m)ine Complexes

Platinum(IV) complexes have been known to be anticancer active since the original studies in this area by Rosenberg.⁴⁴⁷ Consequently numerous platinum(IV) complexes have been prepared for biological testing. Until recently, the great bulk of these were *trans*-dihydroxo complexes prepared

by peroxide oxidation of platinum(II) or *trans*-dihalo complexes prepared by halogen oxidation or by haloacid treatment of the dihydroxo complexes. However, workers at Johnson Matthey extended the range of complexes available greatly by developing new reactions of the *trans*-dihydroxo complexes.^{448,449} In particular, they showed that the hydroxo ligands react with anhydrides to give *trans*-dicarboxylato complexes.^{448,449} Many of these new complexes have demonstrated excellent antitumor activity⁴³⁷ and one, *cis,trans, cis*-[PtCl₂(COOMe)₂(cyclohexylamine)(NH₃)] (JM216), underwent extensive clinical trials as an orally administered anticancer agent.⁴⁵⁰ Other groups have produced related compounds and characterized them crystallographically, establishing that the Pt—O bond lengths to the axial carboxylates are similar to those to hydroxide ligands.^{451–454} Beck and co-workers showed that acyl chlorides also react with the hydroxo ligands to produce similar compounds.⁴⁵⁵ Sohn and co-workers have prepared a large set of complexes with axial and equatorial hydroxo ligands and reacted these with anhydrides to produce di-, tri- and tetracarboxylatoplatinum(IV) complexes.^{456–460} The same group has shown that the axial hydroxo ligands react with trimethylsilylchloride to give SiOMe₃[−] bound in these positions.⁴⁶¹ Oxidation of platinum(II) in methanol has been shown to lead to mixed *trans*-methoxo, hydroxoplatinum(IV) complexes and subsequent boiling in methanol leads to the *trans*-dimethoxo complexes.⁴⁶² Peroxide oxidation of dihydroxo bridged platinum(II) complexes yields the equivalent hydroxo bridged platinum(IV) dimers with axial hydroxo ligands.⁴⁶³

6.5.6.6 Amino Acid and Peptide Complexes

There are remarkably few platinum(IV) complexes of amino acids and peptides but a number have emerged in recent years. Early attempts to produce glycylglycine complexes of platinum(IV) by hydrogen peroxide oxidation of the platinum(II) complex *trans*-[PtCl₂(glycylglycine)₂] resulted in hydrolysis of the peptide and formation of the amino acid complex *trans,trans*-[PtCl₂(gly)₂] with the glycine ligands coordinated via the amine and carboxylate groups.⁴⁶⁴ Direct reaction of the platinum(IV) precursor Na₂[PtCl₆] with glycine yielded *cis*-[PtCl₂(gly)₂] whereas reaction of glycine or D-alanine with the crown ether salt [Na(18-crown-6)]₂[PtCl₆]·3H₂O gives the anionic complexes [PtCl₄(gly)][−] and [PtCl₄(D-ala)][−].⁴⁶⁵ When the latter reactions mixtures are exposed to light from a halogen lamp the neutral complexes [PtCl₄(glyH)₂] and [PtCl₄(D-alaH)] are obtained instead.^{465,466} Addition of dipeptides to solutions of KI and H₂[PtCl₆] yielded anionic complexes with tridentate and bidentate dipeptide ligands: K[Pt(dipep)Cl₃] and K[Pt(dipepH)Cl₄] (dipep = glycylglycine, glycyl-L-alanine, L-alanyl-glycine and L-alanyl-L-alanine).⁴⁶⁷ The same group prepared complexes of the type [PtCl(dipep)(OH)₂][−] and [PtCl₂(Hdipep)(OH)₂][−] (dipep as above) by hydrogen peroxide oxidation of the platinum(II) complexes.⁴⁶⁸ Halogen oxidation of [PtX₂L₂] (X = Cl, Br; L = glyOEt, glygly-OEt) generated the platinum(IV) complexes [PtX₄L₂].⁴⁶⁹

6.5.6.7 Nucleobase Complexes

A range of platinum(IV) nucleobases complexes have been prepared by the oxidation of platinum(II) complexes with nucleobases already bound. For example, Lippert and co-workers have reported a uracil complex obtained by chlorine oxidation,⁴⁷⁰ guanine and adenine complexes by hydrogen peroxide oxidation,^{471,472} and a 1-methylthymine complex by gold(III) oxidation.⁴⁷³ Hydrogen peroxide oxidation of a platinum(II) complex of 1-methylcytosine gave the expected *trans*-dihydroxoplatinum(IV) complex which was stable under strongly acidic conditions.⁴⁷⁴ However, at higher pH values ring closure occurred with displacement of the hydroxo ligands to give *N*₃,*N*₄-bound 1-methylcytosine ligands which formed four-membered chelate rings (**169**).⁴⁷⁴ Other workers reported a similar complex of 1-methylcytosine and suggested on the basis of spectroscopic evidence that following ring closure, the Pt–N₃ bond was displaced by a water ligand.⁴⁷⁵

6.5.6.8 Macrocyclic and Macrobicyclic Complexes

Halogen oxidation of platinum(II) complexes of macrocyclic ligands generally gives rise to *trans*-dihalo platinum(IV) complexes. In a case reported by Lawrance and co-workers, this occurred but pendant amine groups of the ligand were also completely chlorinated to give dichloroamino groups.⁴⁷⁶

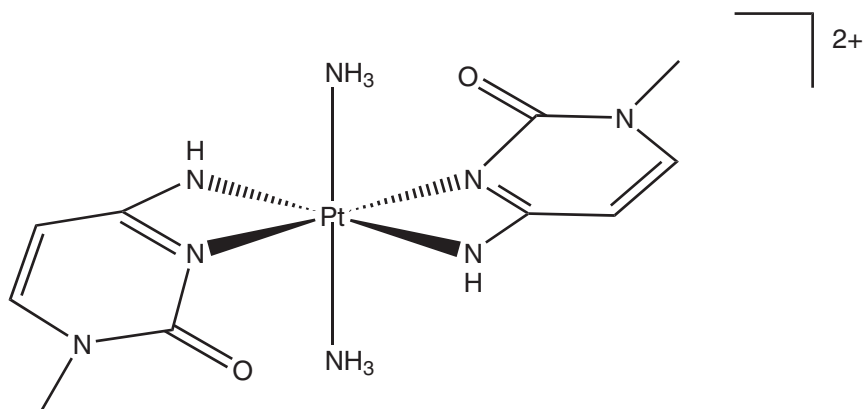

(169)

Sargeson and co-workers have reported the use of $[\text{Pt}(\text{en})_3]^{4+}$ in template reactions to produce the platinum(IV) complexes of the macrobicyclic ligands sep and $(\text{NO}_2)_2\text{sar}$ (**170**).⁴⁷⁷ These reactions are analogous to those that occur around cobalt(III). However, in contrast to the $[\text{Co}((\text{NO}_2)_2\text{sar})]^{3+}$ system, reduction of the pendant dinitro groups did not yield amines, but hydroxyamine groups.⁴⁷⁸

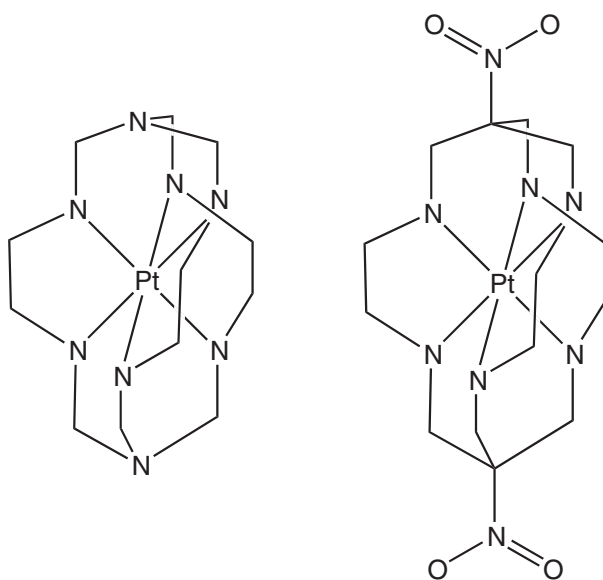

(170)

6.5.6.9 Porphyrin Complexes

The first reported porphyrin complexes of platinum(IV) date from 1980 and were obtained by hydrogen peroxide oxidation of platinum(II) porphyrin complexes in an acidic medium (HCl).⁴⁷⁹ Since then oxidation of platinum(II) complexes of other porphyrins has been achieved by the same method,⁴⁸⁰ and by chlorine,⁴⁸¹ or bromine⁴⁸² oxidation. Reaction with iodine did not lead to oxidation and treatment of platinum(IV) porphyrin complexes with iodide resulted in reduction to platinum(II).

The Soret, α and β bands in the visible spectra of platinum(IV) porphyrin complexes occur at longer wavelengths than their platinum(II) analogues,⁴⁸² ^1H NMR resonances are all shifted downfield,⁴⁸² the ^{13}C resonances of the α carbons are shifted upfield, and the ^1H - ^{195}Pt and ^{13}C - ^{195}Pt coupling constants are reduced.⁴⁸⁰ Whereas excitation of platinum(II) porphyrin complexes

by 35 ps flashes at 355 nm and 532 nm persists for more than 10 ns, that of the platinum(IV) complexes decays with a time constant of about 45 ps, an effect that has been attributed to a low-lying ring-to-metal charge transfer state.⁴⁸³

6.5.6.10 Reactions of Coordinated Ligands

Ligands coordinated to platinum(IV) undergo a variety of reactions. For example, Freeman has reported the nitrosation of ethane-1,2-diamine to *N,N'*-dinitroso-ethane-1,2-diamine by reaction of $[\text{PtCl}_2(\text{bipy})(\text{en})]^{2+}$ with KNO_2 .⁴⁸⁴ Oxidation of *cis*- and *trans*- $[\text{PtCl}_2(\text{Me}_2\text{C}=\text{NOH})_2]$ with chlorine results in the expected *trans*-dichloroplatinum(IV) complexes.⁴⁸⁵ The *trans* isomer is stable but the *cis* undergoes a novel coupling of the oxime ligands to give the complex shown in (171).⁴⁸⁵ Sargeson and co-workers have shown that template formation of macrobicyclic ligands, developed firstly on cobalt(III), can also be achieved on platinum(IV).¹⁴¹ The most extensively studied reactions are those of coordinated organonitriles. Kukushkin and Pombeiro have reported an extensive series of studies of the reactions of complexes of the type *trans*- $[\text{PtCl}_4(\text{RCN})_2]$ (R = Me, Et, CH_2Ph , Ph). Reaction with ketoximes, aldioximes, dialkylhydroxyamines, *vic*-dioximes, or chloro- and amidooximes results in iminoacylation,^{486–489} reaction with alcohols produces imino ester ligands,⁴⁹⁰ and reaction with water generates nitriles.⁴⁹¹

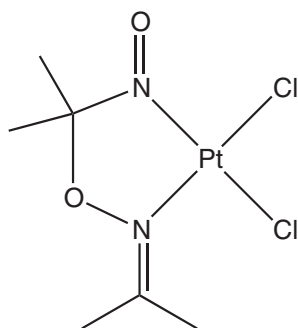

(171)

An important class of reactions are those involving the axial hydroxo ligands of platinum(IV) complexes, typically obtained by hydrogen peroxide oxidation. For example, reaction of $[\text{Pt}(\text{NH}_3)_5(\text{OH})]^{3+}$ with SO_2 or HSO_3^- results in the formation of the sulfito complex $[\text{Pt}(\text{NH}_3)_5(\text{OSO}_2)]^{2+}$.⁴⁹² This reaction is believed to occur by direct attack on the coordinated hydroxide rather than displacement of this ligand. Reactions with carboxylate anhydrides and acyl halides to produce bound carboxylates described above in Section 6.5.6.5 similarly take place by attack on the coordinated hydroxide.^{447,448,455} Multidentate ligands with unbound carboxylate and alcohol arms undergo reactions with axial hydroxides resulting in ring closure,^{493–496} although it is not known in this case whether the reaction occurs via displacement of, or attack on, the hydroxide.

6.5.6.11 Ligand Exchange Reactions

Platinum(IV) complexes are highly inert and therefore undergo unassisted ligand-exchange reactions only very slowly. The presence of even trace amounts of platinum(II) can dramatically increase the rate of such reactions as a result of ligand-bridging mechanisms as proposed by Pearson and co-workers.⁴⁹⁷ Ligand exchange can also be accelerated by reductive-elimination-oxidative-addition (REOA) processes and ligand-assisted mechanisms, the former occurring via a platinum(II) intermediate and the latter via a X–X–Pt bridge labilizing the *trans* ligand.⁴⁹⁸

The interest in platinum(IV) complexes as anticancer agents has increased the interest in the reactions of platinum(IV), particularly those with reducing agents (Section 6.5.6.12) and those with nucleobases. A number of groups have demonstrated that platinum(IV) complexes can

undergo slow ligand exchange reactions with nucleobases such as 9-methylxanthine, 9-methylhypoxanthine, and guanosine-5'-monophosphate.⁴⁹⁹⁻⁵⁰⁴ These reactions have half-lives of the order of a few days, but the presence of 10% of the corresponding platinum(II) complex increases the rate of reaction with 9-methylxanthine by 30-fold.⁵⁰⁰ It has been argued that as a result of such reactions it is possible that platinum(IV) complexes are themselves anticancer active and do not require reduction to platinum(II). However, the slowness of the unassisted reactions and the low likelihood of platinum(II) catalysis in high dilution biological environments suggests that significant biological effects are unlikely. Choi and co-workers have shown that the readily reduced platinum(IV) complex [PtCl₄(1,2-chxn)] oxidizes guanine to 8-oxoguanine.^{505,506} The 8-oxoguanine ligand can be displaced from the platinum center by an excess of guanine.^{505,506}

Dunham and Abbott have studied ligand exchange in *cis*- and *trans*-[Pt(ox)₂(H₂O)₂] and shown that it occurs too slowly to be involved in the formation of metal-metal bonded polymers.⁵⁰⁷ They also observed a *trans* to *cis* isomerization that occurred without ligand exchange and proposed a Bailar or Ray-Dutt twist process.⁵⁰⁷

The reaction of platinum(IV) complexes with ascorbate results in very slow reduction and for [PtCl₂(OH)₂(*N,N*-dmen)], in the formation of the oxalate complex [Pt(C₂O₄)Cl(OH)(*N,N*-dmen)].⁵⁰⁸

6.5.6.12 Kinetics and Mechanism of Platinum(IV) Reduction

The anticancer activity of platinum(IV) complexes, and the belief that reduction is needed to initiate this activity, had generated substantial interest in the rates and mechanism of reduction by biologically relevant reductants such as thiols, ascorbic acid, and methionine. Reduction of platinum(IV) to platinum(II) usually proceeds as a single two-electron step and is usually first-order with respect to both platinum(IV) and reductant concentrations.

Studies of the reduction of the tetracyanoplatinum(IV) complexes *trans*-[Pt(CN)₄X₂]²⁻ (X = Cl or Br) by SCN⁻, S₂O₃²⁻, CN⁻, and SO₃²⁻ led to the conclusion that the mechanism involved X⁺ transfer to the reducing agents.^{509,510} Elding and co-workers have undertaken extensive studies of the same complexes as models for anticancer active complexes.⁵¹¹⁻⁵¹³ Reduction by thiols occurs with a [RSH]:[Pt^{IV}] stoichiometry of 2:1, is first order with respect to each reactant and yields RSSR and [Pt(CN)₄]²⁻.⁵¹¹ A halide-bridged electron transfer was postulated with both RSH and RS⁻ contributing, though the latter being far more reactive.⁵¹¹ Oxidation by methionine, though occurring with a 1:1 stoichiometry, was via a similar mechanism.⁵¹² It was suggested that reduction by methionine may be competitive with reduction by thiols, particularly in acidic conditions.⁵¹² Reduction by the platinum(II) complexes [Pt(NH₃)₄]²⁺ and [Pt(en)₂]²⁺ also occurred via halide bridged mechanisms.⁵¹³ The same group have studied the reduction of *trans,trans,trans*-[PtCl₂(OH)₂(*c*-C₆H₁₁NH₂)(NH₃)] by thiols, finding similar reaction mechanisms to those suggested for the tetracyano complexes.⁵¹⁴ Others have similarly proposed outer-sphere activated complexes in the reduction of hexachloro and ammine/chloro complexes by ascorbic acid and hydroxyamine and a variety of α -hydroxy acids,^{515,516} but in the case of reduction by Sn^{II} and Fe^{II} have suggested an inner sphere mechanism.⁵¹⁵ Sadler and co-workers have shown that iodoplatinum(IV) complexes react with thiols more rapidly than expected, and substantially more rapidly than chloro analogues.⁵¹⁷ For example, *cis,trans*-[PtI₂(OH)₂(en)] reacts with the cysteine of albumin giving a sulfenic acid derivative.⁵¹⁷

The platinum(II) catalyzed reduction of *cis,cis,trans*-diaminedihalodihydroxoplatinum(IV) complexes by ascorbate has been reported to proceed via a long-lived platinum(IV)-ascorbate radical.⁵¹⁸ Ascorbate reduction of complexes with halides in the axial sites has been reported to proceed via reductive attack on one of these halides.⁵¹⁹ This group also showed that reduction by Asc²⁻ occurred seven orders of magnitude more rapidly than reduction by HAsc⁻ and that H₂Asc is unreactive.⁵¹⁹ Reduction by thiols and methionine is strongly dependent on pH because of a similar variation in reactivity of the protonated and unprotonated forms of the reductants.^{505,514}

The reduction potentials of platinum(IV) complexes have been shown to depend most on the nature of the axial ligands; those with axial chloro ligands are most readily reduced, those with axial carboxylato ligands are intermediate and those with axial hydroxo ligands are the most difficult to reduce.^{452,520,521} Choi *et al.* have shown that the rates of reduction follow the same trends.⁵²² The rates of reduction of diaminetetrachloro- or tetraaminedichloro-platinum(IV) complexes has been shown to depend on the steric bulk of the amine ligands, with bulkier substituents promoting reduction.^{523,524}

6.5.6.13 Novel Mechanisms of Platinum(II) Oxidation to Platinum(IV)

Platinum(II) oxidation to platinum(IV) usually occurs via oxidative addition of oxidants such as the halogens and hydrogen peroxide. Aerial oxidation is rare, but has recently been reported for platinum(II) complexes with one or two tridentate ligands that position additional coordinating groups above and below the coordination plane. For example, complexes of the tridentate [9]aneN₃ are oxidized by molecular oxygen to platinum(IV).^{525,526} In one case, a novel peroxo intermediate was obtained and crystallographically characterized.⁵²⁶ The deprotonated amide ligand *N,N,N',N'*-tetra(*N*-methylacetamide)ethane-1,2-diamine similarly facilitates aerial oxidation of platinum(II) to platinum(IV).⁵²⁷

6.5.6.14 Hydride Complexes

Platinum(IV) hydrides are relatively rare, with monohydride, dihydrides, and only recently trihydrides being reported as reviewed by Puddephatt.⁵²⁸ The tripodal ligands triphos and Tp' allow the formation of a stable trihydrides.^{529,530} [PtCl₂(triphos-*P,P'*)] reacts with sodium borohydride to give the trihydride [PtH₃(triphos)].⁵²⁹ [Pt(H)(Me)₂(Tp')] reacts with Et₃SiH to give the dihydride [Pt(H)₂(SiEt₃)(Tp')] which in turn reacts with methanol to give the trihydride [Pt(H)₃(Tp')].⁵³⁰ A salt like hexahydride complex complex K₂[PtH₆] has been prepared by the reaction of potassium hydride and platinum sponge under high-pressure conditions and has been characterized by X-ray powder diffractometry.⁵³¹

6.5.7 MIXED OXIDATION AND MIXED METAL COMPLEXES

Platinum is unusual in the extraordinary variety of mixed-valence compounds that it forms. Many of these have novel spectroscopic, electronic, and structural properties.

6.5.7.1 Platinum(0)/Platinum(I)

Reaction of the platinum(0) complex, [Pt(C₂H₄)(PPh₃)₂], with either of the platinum(II) complexes, [PtCl₂(PPh₃)₂] or [Pt(CN-xylyl)₄]²⁺, yields the linear trinuclear cluster [Pt₃(PPh₃)₂(CN-xylyl)₆]²⁺ (**172**) with an average oxidation state of 2/3.⁵³² The same complex was obtained by controlled potential electrolysis of [Pt(CN-xylyl)₄]²⁺, giving [Pt₃(CN-xylyl)₈]²⁺, followed by reaction with PPh₃.⁸⁶ Reaction of [Pt₃(CN-xylyl)₈]²⁺ with dppm gave the A-frame complex [Pt₃(dppm)₂(CN-xylyl)₄]²⁺ (**173**), a complex that could also be obtained by reaction of [Pt₂(dppm)₂(CN-xylyl)₂]²⁺ with Hg[Pt₃(CN-xylyl)₆]₂.⁸⁶

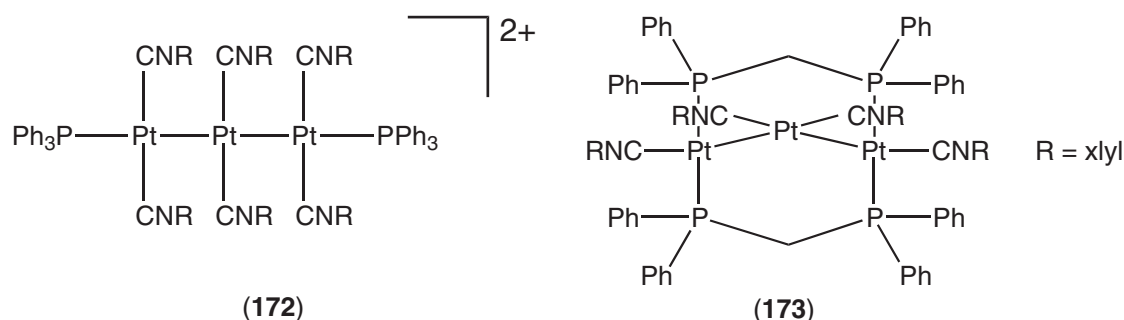

Clusters of platinum atoms are of interest as models for the adsorption of species onto the surface of metallic platinum. Models for terminal and two-fold (μ_2) binding are plentiful, but are rare for three-fold (μ_3) binding. However, the preparation of [Pt₃(μ_3 -CO)(μ -dppm)₃]²⁺ (**174**) by reaction of [Pt(O₂CCF₃)₂(dppm)₃] with CO, provides a carbonyl bridging three Pt atoms as model for this type of binding.⁵³³ The Pt—Pt bond lengths range from 2.613 Å to 2.650 Å,⁵³³ similar to those in the linear (2.639 Å) and A-frame (2.593 Å) complexes described above.^{86,532} This complex undergoes a variety of reactions and these have been reviewed extensively by Puddephatt *et al.*⁵³⁴

For example, it adds one or two carbonyls to give $[\text{Pt}_3(\mu_3\text{-CO})(\text{CO})(\mu\text{-dppm})_3]^{2+}$ and $[\text{Pt}_3(\mu\text{-CO})(\text{CO})_2(\mu\text{-dppm})_3]^{2+}$, respectively.⁵³⁵ In contrast, the halide bridged complex does not add carbonyl even though the halide is only weakly bound.⁵³⁵ It also adds one isocyanide ligand to give the intermediate $[\text{Pt}_3(\mu\text{-CO})(\text{CNMe})(\mu\text{-dppm})_3]^{2+}$ and a second resulting in displacement of the carbonyl to give $[\text{Pt}_3(\text{CNMe})_2(\mu\text{-dppm})_3]^{2+}$.⁵³⁶ Other reactions include those with hydride, halides, SnX_3^- , and phosphines.⁵³⁴

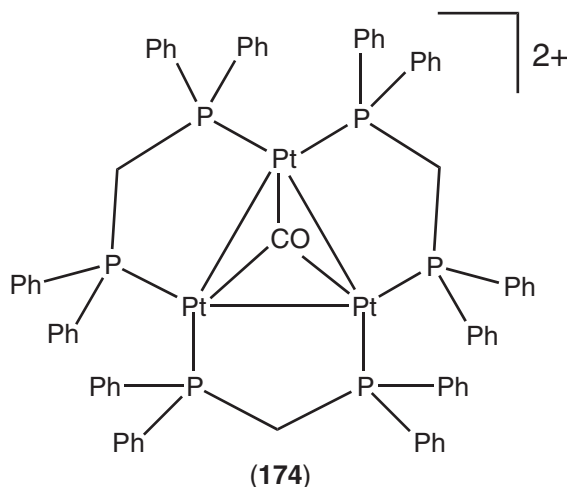

All of these trinuclear clusters are 42e and this is the most common electron count. However, a 46e cluster, $[\text{Pt}_3(\mu\text{-CO})(\mu\text{-dppm})_4]^{2+}$ has been obtained by reacting $[\text{Pt}_3(\mu\text{-dppm})_3(\text{PPh}_3)]$ with CO.⁵³⁷ The Pt—Pt bond lengths (2.620–2.648 Å) are remarkably similar to those in the 42e clusters.⁵³⁷

Mixed palladium/platinum analogues of these trinuclear clusters have also been reported. The first of these, $[\text{PtPd}_2\text{Cl}(\text{PPh}_2)_2(\text{PPh}_3)_3]^+$, was prepared by the reaction of $[\text{PdCl}(\text{PPh}_3)_3]^+$ with $[\text{PtCl}(\text{PPh}_3)_3]^+$.⁵³⁸

6.5.7.2 Platinum Blues

The compounds known as the “platinum blues” are in fact a series of compounds with colors ranging from violet through blue and green to tan or dark red and have average oxidation states ranging from 2.18 to 2.5.⁵³⁹ Their structures and activities have been reviewed thoroughly by Matsumoto and Sakai⁵³⁹ and here we limit our comments to the general principles. Although the discovery of the platinum blues dates from nearly 100 years ago, the recent interest arose from their incidental discovery in the study of the reactions of cisplatin with pyrimidines and the subsequent discovery of the anticancer activity of these new platinum blues.⁵³⁹ The difficulty in characterizing these compounds led the study of α -pyridonates by Lippard and co-workers and the first structural characterizations of the platinum blues as tetrameric systems.^{539,539a} Since then a variety of systems have been structurally characterized including octameric complexes, the first of which was $[\text{Pt}_8(\text{NH}_3)_{16}(\text{C}_2\text{H}_4\text{NO})_8]^{10+}$ with an average oxidation state of 2.25.⁵⁴⁰ The relationship between geometric parameters and the average platinum oxidation state has been examined in detail in a recent study by Sakai *et al.*⁵⁴¹

6.5.7.3 Linear Chain Complexes

The localized-valence halogen-bridged platinum(II)/platinum(IV) complexes (175) are of interest because of their highly anisotropic electrical and optical properties. The complexes are characterized by broad and intense intervalence bands in their electronic spectra.⁵⁴² Partial oxidation of $[\text{PtCl}(\text{dien})]\text{Cl}$ with iodine yields the mixed valence species $[\text{PtI}(\text{dien})][\text{PtI}_3(\text{dien})]\text{I}_2$,⁵⁴³ but when 4Me-dien is used, the mixed valence compound is only obtained if it is trapped quickly, before isomerization of the meridional platinum(IV) complex to a facial form.⁵⁴⁴ Although these species nominally have localized valences, the extent of delocalization increases as the bridging halide

goes from chloride to bromide to iodide.⁵⁴⁵ This trend has been attributed to the decrease in electronegativity and a consequent decrease in the effective atomic charge on the platinum(IV) center. When mixtures of chloride and bromide are used, the anions are essentially distributed randomly along the chains.⁵⁴⁶

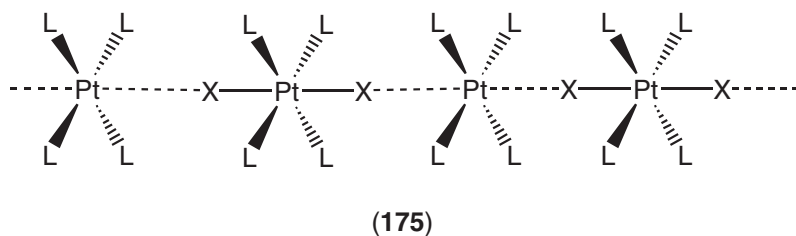

Partial oxidation of $[\text{Pt}_2(\text{pop})_4]^{4-}$ with halogen (X_2 , $\text{X} = \text{Cl}, \text{Br}, \text{I}$) leads to the formation of $\text{K}_4[\text{Pt}_2\text{X}(\text{pop})_4] \cdot n\text{H}_2\text{O}$.⁵⁴⁷ The structure of the bromide revealed linear PtPtBrPtPtBr chains with equal Pt—Br distances, consistent with a fully delocalized platinum(2.5) system (spin density wave state, SDW).⁵⁴⁷ Clark and co-workers, on the basis of spectroscopic data on these and related complexes, suggested that the Pt—X bond lengths are not equal and that the chains consist of platinum(II) and platinum(III) complexes.^{548,549} The crystal structure of the chloride revealed different Pt—Cl distances, consistent with the spectroscopic evidence.⁵⁵⁰ The difference between the bromide and chloride systems was subsequently confirmed by low temperature crystal structures though both can be described as having charge density wave (CDW) states.⁵⁵¹ These complexes exhibit the electronic spectra of the oxidized and reduced forms and have an intervalence charge-transfer band.⁵⁵² The effects of pressure on the spectra of these complexes were attributed to increased orbital overlap on increased ligand field interactions.⁵⁵² Yamashita *et al.* have recently shown that the iodide analogue exists in either the SDW or CDW state depending on the counterion present and on the temperature.⁵⁵³ The related complex $[\text{Pt}_2\text{I}(\text{dta})_4]$ ($\text{dta} = \text{MeCS}_2^-$) exhibits semiconducting behavior below 300 K, attributed to a $|\text{IPt}^{2+}\text{—Pt}^{3+}\text{—IPt}^{2+}\text{—Pt}^{3+}\text{—I}|$ state, and a metallic phase above this temperature attributed to a $|\text{—IPt}^{2.5+}\text{—Pt}^{2.5+}\text{—IPt}^{2.5+}\text{—Pt}^{2.5+}\text{—I}|$ state.^{554,555}

6.5.7.4 Mixed Metal Systems

Halide bridged nickel(II)/platinum(IV) and palladium(II)/platinum(IV) complexes with one-dimensional linear-chain structures have been studied extensively.^{556–559} These are analogous to the linear-chain platinum(II)/platinum(IV) systems described in Section 6.5.7.3 and have similar broad and intense intervalence bands.^{556–559} However, they have weaker metal–metal interactions resulting in more localized valences than the all platinum analogues.^{556–559}

The first copper(II)/platinum(IV) analogue, $[\text{Cu}(\text{en})_2][\text{PtX}_2(\text{en})_2](\text{ClO}_4)_4$ ($\text{X} = \text{Cl}, \text{Br}$) was reported by Oshio *et al.* and they reported that these compounds too had an intense intervalence band.⁵⁶⁰ Clark *et al.* questioned this and showed that the intense colors were due to the presence of a proportion of the platinum(II)/platinum(IV) compound and that they were more accurately formulated as $[\text{Cu}_x\text{Pt}_{1-x}(\text{en})_2][\text{PtX}_2(\text{en})_2](\text{ClO}_4)_4$.⁵⁶¹ When $x = 1$, the compounds are pale in color, are not dichroic and there is no resonance enhancement of the ClPtCl stretching mode.⁵⁶¹ Subsequently, a method was reported for preparing stoichiometric $[\text{Cu}(1,2\text{-chxn})_2][\text{PtX}_2(1,2\text{-chxn})_2]\text{X}_4$ ($\text{X} = \text{Cl}, \text{Br}$) in high purity allowing more complete studies of the properties of these mixed metal species.⁵⁶²

Trimeric cyanide bridged iron(II)/platinum(IV) complexes of the type $[(\text{CN})_5\text{Fe}(\mu\text{-CN})\text{-PtL}_4(\mu\text{-NC})\text{-Fe}(\text{CN})_5]^{4-}$ ($\text{L}_4 = (\text{en})_2$ or $(\text{NH}_3)_4$) have been described by Bocarsly and co-workers.^{563,564} These complexes have intervalence charge transfer bands in the visible region and are novel because they undergo two-electron charge transfer following irradiation into these bands resulting in the formation of $[\text{PtL}_4]^{2+}$ and two equivalents of $[\text{Fe}(\text{CN})_6]^{3-}$.^{563,565,566} A dimeric analogue $[(\text{NH}_3)_5\text{PtL}_4(\mu\text{-NC})\text{-Fe}(\text{CN})_5] \cdot 6\text{H}_2\text{O}$, has been prepared and exhibits similar spectroscopy and electrochemistry to the trimeric complexes.⁵⁶⁷ Polymeric and oligomeric analogues have been prepared from $[(\text{CN})_5\text{Fe}(\mu\text{-CN})\text{-Pt}(\text{NH}_3)_4]$ units, the growth of which is controlled by the oxidation state of the iron center.⁵⁶⁸ Related molybdenum species, $[(\text{CN})_7\text{Mo}(\mu\text{-CN})\text{-PtL}_4$

$(\mu\text{-NC})\text{-Mo}(\text{CN})_7]^{4-}$ ($\text{L}_4 = (\text{en})_2$ or $(\text{NH}_3)_4$), have been reported recently,⁵⁶⁹ as has a thallium complex, $[(\text{CN})_5\text{PtTl}(\text{CN})]^-$.⁵⁷⁰ All of these complexes are of interest for the storage and conversion of solar energy and for the construction of molecular wires.

6.5.7.5 Mixed Oxidation State Clusters

Platinum forms a wide variety of clusters and these are of interest as models for metallic platinum surfaces and catalysis on such surfaces. Many of these clusters are based on stacked triangles^{23,571} or bicapped pentagonal prisms.⁵⁷¹ Many smaller clusters are also derived from triplatinum building blocks.¹⁶

Only large clusters usually adopt the face-centered cubic structure of metallic platinum. A novel cuboctahedral cluster $[\text{Pt}_{15}\text{H}_x(\text{CO})_8(\text{PBU}^t_3)_6]$ has been reported by Spencer *et al.*⁵⁷² and the first octahedral cluster $[\text{Pt}_6(\text{CO})_6(\mu\text{-dppm})_3]^{2+}$ was only reported recently.⁵⁷³

Large platinum carbonyl clusters have been investigated as models for the adsorption of carbon monoxide on platinum surfaces and on platinum electrodes. An issue is how large the clusters must be before they adopt the properties of the bulk metal. Teo *et al.* have investigated the magnetic properties of the clusters $[\text{Pt}_6(\text{CO})_{12}]^{2+}$, $[\text{Pt}_9(\text{CO})_{18}]^{2+}$, $[\text{Pt}_{19}(\text{CO})_{22}]^{2+}$, and $[\text{Pt}_{38}(\text{CO})_{44}\text{H}_x]^{2+}$ and found that they have properties very similar to those of small crystallites.⁵⁷⁴ Dahl and co-workers have investigated the vibrational spectroscopy of seven redox forms of the cluster $[\text{Pt}_{24}(\text{CO})_{30}]^n$ ($n = 0$ to -6) as models for CO adsorption on platinum electrodes and observed that the frequency of the CO vibration decreased almost linearly with n .⁵⁷⁵ The same group has investigated the similar cluster $[\text{Pt}_{26}(\text{CO})_{32}]^{2-}$ using ^{252}Cf -plasma desorption mass spectrometry.⁵⁷⁶

6.5.7.6 Mixed Metal Clusters

There is an enormous variety of mixed metal clusters, the great majority of which are organo-metallic and, therefore, beyond the scope of this review. Werner-type examples generally have combinations of phosphine, carbonyl, and hydride ligands and have the platinum in low or zero oxidation states. For example, complexes of the type $[\text{M}(\text{CO})_4(\mu\text{-PPh}_2)(\mu\text{-H})\text{Pt}(\text{PR}_3)_2]$ have been reported for $\text{M} = \text{Cr}$, Mo , and W and for $\text{R} = \text{Et}$.⁵⁷⁷ $[\text{Pt}(\text{C}_2\text{H}_4)(\text{PPh}_3)_2]$ adds one PtPPh_3 unit to $[\text{Re}_2(\mu\text{-H})_2(\text{CO})_8]$ to give three isomeric forms of $[\text{Re}_2\text{Pt}(\mu\text{-H})_2(\text{CO})_8(\text{PPh}_3)_2]$ ⁵⁷⁸ and adds up to three PtPPh_3 units to $[\text{Re}_2(\text{CO})_{10}]$ to give $[\text{Re}_2\text{Pt}_n(\mu\text{-CO})_{2n}(\text{CO})_{10-2n}(\text{PPh}_3)_2]$ ($n = 2, 3$).⁵⁷⁹ $[\text{Re}_2(\mu\text{-H})(\text{CO})_8]$ reacts with $[\text{Pt}(\text{COD})_2]$ to give the bow tie geometry $[\text{Re}_4\text{Pt}(\mu\text{-H})_6(\text{CO})_{16}]$ which can be deprotonated in base,⁵⁸⁰ and the same group has reported rhenium/platinum clusters with phosphine and carbonyl ligands.

Many mixed metal clusters are derived from triplatinum units and these have been reviewed extensively by Imhof and Venanzi.¹⁶ As an example, gold forms a variety of cluster compounds with platinum including $[\text{Pt}_3\text{Au}(\mu\text{-CO})_3\{\text{P}(\text{Cy})_3\}_4]^+$ which reacts with sulfur dioxide to give SO_2 -bridged species.⁵⁸¹ Higher nuclearity clusters involving gold and copper have been reported more recently including complexes of the type $[\text{Pt}(\text{AuPPh}_3)_8(\text{CuCl})]^{2+}$, $[\text{Pt}(\text{CO})(\text{AuPPh}_3)_8(\text{CuCl})]^{2+}$, $[\text{Pt}(\text{CO})(\text{AuPPh}_3)_7(\text{CuCl})_2]^+$, $[\text{Pt}(\text{CO})(\text{Ag})_2(\text{AuPPh}_3)_7]^{3+}$,⁵⁸² $[\text{PtAg}(\text{AuPPh}_3)_8]^{3+}$, $[\text{Pt}(\text{CO})\text{Ag}(\text{AuPPh}_3)_8]^{3+}$,⁵⁸³ $[\text{Pt}(\text{PPh}_3)(\text{AuPPh}_3)_6(\text{Cu}_4\text{Cl}_3\text{PPh}_3)]^+$, and $[\text{Pt}(\text{PPh}_3)(\text{AuPPh}_3)_6(\text{Cu}_4\text{I}_3)]^+$.⁵⁸⁴

Very high nuclearity clusters have been widely sought. For example, the series of complexes $[\text{Ni}_{38}\text{Pt}_6(\text{CO})_{48}\text{H}_{6-n}]^{n-}$ ($n = 4, 5$) have been investigated as molecular models for bimetallic "cherry" crystallites.⁵⁸⁵ There has been a recent report of the binding of platinum to the $\text{E}_9^{3-/4-}$ Zintl ions ($\text{E} = \text{Ge}$, Sn , or Pb).⁵⁸⁶ $[\text{Pt}(\text{PPh}_3)_4]$ reacts with K_4Sn_9 to yield $[\text{Sn}_9\text{Pt}_2(\text{PPh}_3)]^{2-}$.⁵⁸⁶

ACKNOWLEDGMENTS

LMR wishes to thank Dr Daniela Caiazza for her assistance with the illustrations, and Ms Shanti Thavaneswaran for her assistance with the collection of reference material. TWH wishes to thank Ms Clare Underwood for assistance with the collection and collation of reference material.

6.5.8 REFERENCES

1. Meier, M.; Basolo, F. *Inorg. Synth.* **1990**, *28*, 104–107.
2. Yoshida, T.; Otsuka, S. *Inorg. Synth.* **1990**, *28*, 113–119.
3. Yoshida, T.; Matsuda, T.; Otsuka, S. *Inorg. Synth.* **1990**, *28*, 119–121.
4. Yoshida, T.; Matsuda, T.; Otsuka, S. *Inorg. Synth.* **1990**, *28*, 122–123.
5. Ugo, R.; Cariati, F.; La Monica, G. *Inorg. Synth.* **1990**, *28*, 123–126.
6. Davies, J. A.; Eagle, C. T.; Otis, D. E.; Venkataraman, U. *Organometallics* **1986**, *5*, 1264–1266.
7. Davies, J. A.; Eagle, C. T.; Otis, D. E.; Venkataraman, U. *Organometallics* **1989**, *8*, 1080–1088.
8. Paonessa, R. S.; Trogler, W. C. *Organometallics* **1982**, *1*, 768–770.
9. Paonessa, R. S.; Prignano, A. L.; Trogler, W. C. *Organometallics* **1985**, *4*, 647–657.
10. Grushin, V. V.; Akhrem, I. S.; Vol'pin, M. E. *J. Organomet. Chem.* **1989**, *371*, 403–419.
11. Manojlović-Muir, L.; Muir, K. W.; Grossel, M. C.; Brown, M. P.; Nelson, C. D.; Yavari, A.; Kallas, E.; Moulding, R. P.; Seddon, K. R. *J. Chem. Soc., Dalton Trans.* **1986**, 1955–1963.
12. Schreiner, S.; Yu, J. Y.; Vaska, L. *J. Chem. Soc., Chem. Commun.* **1988**, 602–603.
13. Yu, J. Y.; Schreiner, S.; Vaska, L. *Inorg. Chim. Acta* **1990**, *170*, 145–147.
14. Ling, S. S. M.; Jobe, I. R.; McLennan, A. J.; Manojlović-Muir, L.; Muir, K. W.; Puddephatt, R. J. *J. Chem. Soc., Chem. Commun.* **1985**, 566–567.
15. Hartley, F. R. Platinum. In *Comprehensive Organometallic Chemistry*; Wilkinson, G., Stone, F. G. A., Abel, E. W., Eds.; Platinum: Pergamon Press: Oxford, 1982, Vol. 6, p 471–762.
16. Imhof, D.; Venanzi, L. M. *Chem. Soc. Rev.* **1994**, *23*, 185–193.
17. Muller, T. E.; Ingold, F.; Menzer, S.; Mingos, D. P. M.; Williams, D. J. *J. Organomet. Chem.* **1997**, *528*, 163–178.
18. Jaw, H. R. C.; Mason, W. R. *Inorg. Chem.* **1990**, *29*, 3452–3455.
19. Browning, C. S.; Farrar, D. H.; Gukathasan, R. R.; Morris, S. A. *Organometallics* **1985**, *4*, 1750–1754.
20. Briant, C. E.; Gilmour, D. I.; Mingos, D. P. M.; Wardle, R. W. M. *J. Chem. Soc., Dalton Trans.* **1985**, 1693–1698.
21. Mingos, D. M. P.; Williams, I. D.; Watson, M. J. *J. Chem. Soc., Dalton Trans.* **1988**, 1509–1516.
22. Bott, S. G.; Hallam, M. F.; Ezomo, O. J.; Mingos, D. M. P.; Williams, I. D. *J. Chem. Soc., Dalton Trans.* **1988**, 1461–1466.
23. Underwood, D. J.; Hoffman, R.; Tatsumi, K.; Nakamura, A.; Yamamoto, Y. *J. Am. Chem. Soc.* **1985**, *107*, 5968–5980.
24. Goel, R. G.; Srivastava, R. C. *J. Organomet. Chem.* **1983**, *244*, 303–310.
25. Manojlović-Muir, L.; Jobe, I. R.; Ling, S. S. M.; McLennan, A. J.; Puddephatt, R. J. *J. Chem. Soc., Chem. Commun.* **1985**, 1725–1726.
26. Clark, H. C.; Hampden Smith, M. J. *J. Am. Chem. Soc.* **1986**, *108*, 3829–3830.
27. Helfer, D. S.; Atwood, J. D. *Organometallics* **2002**, *21*, 250–252.
28. Bartlett, K. L.; Goldberg, K. I.; Borden, W. T. *J. Am. Chem. Soc.* **2000**, *122*, 1456–1465.
29. Han, L.-B.; Zhao, C.-Q.; Onozawa, S.-Y.; Goto, M.; Tanaka, M. *J. Am. Chem. Soc.* **2002**, *124*, 3842–3843.
30. Reger, D. L.; Ding, Y. *Organometallics* **1994**, *13*, 1047–1048.
31. Fagan, P. J.; Calabrese, J. C.; Malone, B. *Science* **1991**, *252*, 1160–1161.
32. Fagan, P. J.; Calabrese, J. C.; Malone, B. *J. Am. Chem. Soc.* **1991**, *113*, 9408–9409.
33. Balch, A. L.; Hao, L.; Olmstead, M. M. *Angew. Chem., Int. Ed. Engl.* **1996**, *35*, 188–190.
34. Lerke, S. A.; Parkinson, B. A.; Evans, D. H.; Fagan, P. J. *J. Am. Chem. Soc.* **1992**, *114*, 7807–7813.
35. Van Wijnkoop, M.; Medine, M. F.; Avent, A. G.; Darwish, A. D.; Kroto, H. W.; Taylor, R.; Walton, D. R. M. *J. Chem. Soc., Dalton Trans.* **1997**, 675–677.
36. Nagashima, H.; Kato, Y.; Yamaguchi, H.; Kimura, E.; Kawanashi, T.; Kato, M.; Saito, Y.; Haga, M.; Itoh, K. *Chem. Lett.* **1994**, 1207–1210.
37. Balaji, B. S.; Obora, Y.; Ohara, D.; Koide, S.; Tsuji, Y. *Organometallics* **2001**, *20*, 5342–5350.
38. Goldsworthy, D. H.; Hartley, F. R.; Marshall, G. L.; Murray, S. G. *Inorg. Chem.* **1985**, *24*, 2849–2853.
39. Pizzotti, M.; Porta, F.; Cenini, S.; Demartin, F.; Masciocchi, N. *J. Organomet. Chem.* **1987**, *330*, 265–278.
40. Harrison, K. N.; Hoye, P. A. T.; Orpen, A. G.; Pringle, P. G.; Smith, M. B. *J. Chem. Soc., Chem. Commun.* **1989**, 1096–1097.
41. Ellis, J. W.; Harrison, K. N.; Hoye, P. A. T.; Orpen, A. G.; Pringle, P. G.; Smith, M. B. *Inorg. Chem.* **1992**, *31*, 3026–3033.
42. Costa, E.; Pringle, P. G.; Smith, M. B.; Worboys, K. *J. Chem. Soc., Dalton Trans.* **1997**, 4277–4282.
43. Xie, Y.; James, B. R. *J. Organomet. Chem.* **1991**, *417*, 277–288.
44. Baker, M. J.; Harrison, K. N.; Orpen, A. G.; Pringle, P. G.; Shaw, G. *J. Chem. Soc., Dalton Trans.* **1992**, 2607–2614.
45. Han, L.-B.; Shimada, S.; Tanaka, M. *J. Am. Chem. Soc.* **1997**, *119*, 8133–8134.
46. Yamashita, H.; Kobayashi, T.; Hayashi, T.; Tanaka, M. *Chem. Lett.* **1990**, 1447–1450.
47. Yamashita, H.; Tanaka, M.; Goto, M. *Organometallics* **1992**, *11*, 3227–3232.
48. Sharma, H. K.; Pannell, K. H. *Chem. Rev.* **1995**, *95*, 1351–1374.
49. Pham, E. K.; West, R. *J. Am. Chem. Soc.* **1989**, *111*, 7667–7668.
50. Pham, E. K.; West, R. *Organometallics* **1990**, *9*, 1517–1523.
51. Yamashita, H.; Kobayashi, T.; Tanaka, M. *Organometallics* **1992**, *11*, 2330–2333.
52. Obora, Y.; Tsuji, Y.; Nishiyama, K.; Ebihara, M.; Kawamura, T. *J. Am. Chem. Soc.* **1996**, *118*, 10922–10923.
53. Suginome, M.; Hideaki, O.; Shuff, P.H.; Ito, Y. *J. Organomet. Chem.* **1996**, *521*, 405–408.
54. West, R. *Angew. Chem., Int. Ed. Engl.* **1987**, *26*, 1201–1302.
55. Yamashita, H.; Hayashi, T.; Toshi-aki, K.; Tanaka, M.; Goto, M. *J. Am. Chem. Soc.* **1988**, *110*, 4417–4418.
56. Yamashita, H.; Tanaka, M.; Goto, M. *Organometallics* **1997**, *16*, 4696–4704.
57. Akl, N. S.; Tayim, H. A. *J. Organomet. Chem.* **1985**, *297*, 371–374.
58. Corey, J. Y.; Braddock-Wilking, J. *Chem. Rev.* **1999**, *99*, 175–292.
59. Shimada, S.; Tanaka, M.; Honda, K. *J. Am. Chem. Soc.* **1995**, *117*, 8289–8290.
60. Heyn, R. H.; Tilley, T. D. *J. Am. Chem. Soc.* **1992**, *114*, 1917–1919.

61. Sanow, L. M.; Chai, M.; McConville, D. B.; Galat, K. J.; Simons, R. S.; Rinaldi, P. L.; Youngs, W. J.; Tessier, C. A. *Organometallics* **2000**, *19*, 192–205.
62. Kim, Y.-J.; Park, J.-I.; Lee, S.-C. *Organometallics* **1999**, *18*, 1349–1352.
63. Brittingham, K. A.; Gallaher, T. N.; Schreiner, S. *Organometallics* **1995**, *14*, 1070–1072.
64. Koizumi, T.; Osakada, K.; Yamamoto, T. *Organometallics* **1997**, *16*, 6014–6016.
65. Han, L.-B.; Choi, N.; Tanaka, M. *Organometallics* **1996**, *15*, 3259–3261.
66. Ceconi, F.; Ghilardi, C. A.; Midollini, S.; Moneti, S.; Orlandini, A.; Scapacci, G. *Inorg. Chim. Acta* **1991**, *189*, 105–110.
67. Yamazaki, S. *Chem. Lett.* **1991**, 1299–1302.
68. Han, L.-B.; Choi, N.; Tanaka, M. *J. Am. Chem. Soc.* **1997**, *119*, 1795–1796.
69. Gukathasan, R. R.; Morris, R. H.; Walker, A. *Can. J. Chem.* **1983**, *61*, 2490–2492.
70. Ritchey, J. M.; Moody, D. C.; Ryan, R. R. *Inorg. Chem.* **1983**, *22*, 2276–2280.
71. Ritchey, J. M.; Moody, D. C. *Inorg. Chim. Acta* **1983**, *74*, 271–274.
72. Catalano, V. J.; Bennett, B. L.; Yson, R. L.; Noll, B. C. *J. Am. Chem. Soc.* **2000**, *122*, 10056–10062.
73. Catalano, V. J.; Bennett, B. L.; Noll, B. C. *J. Chem. Soc., Chem. Commun.* **2000**, 1413–1414.
74. Catalano, V. J.; Bennett, B. L.; Muratidis, S.; Noll, B. C. *J. Am. Chem. Soc.* **2001**, *123*, 173–174.
75. Jaw, H. R. C.; Mason, W. R. *Inorg. Chem.* **1989**, *28*, 4370–4373.
76. Mason, W. R. *Inorg. Chem.* **2001**, *40*, 6316–6319.
77. Harvey, P. D.; Gray, H. B. *J. Am. Chem. Soc.* **1988**, *110*, 2145–2147.
78. Hitchcock, P. B.; Lappert, M. F.; Misra, M. C. *J. Chem. Soc., Chem. Commun.* **1985**, 863–864.
79. Al-Allaf, T. A. K.; Eaborn, C.; Hitchcock, P. B.; Lappert, M. F.; Pidcock, A. *J. Chem. Soc., Chem. Commun.* **1985**, 548–550.
80. Boag, N. M.; Goggin, P. L.; Goodfellow, R. J.; Herbert, I. R. *J. Chem. Soc., Dalton Trans.* **1983**, 1101–1107.
81. Goodfellow, R. J.; Herbert, I. R.; Orpen, A. G. *J. Chem. Soc., Chem. Commun.* **1983**, 1386–1388.
82. Bender, R.; Braunstein, P.; Tiripicchio, A.; Tiripicchio Camellini, M. *J. Chem. Soc., Chem. Commun.* **1984**, 42–43.
83. Yamamoto, Y.; Takahashi, K.; Yamazaki, H. *Chem. Lett.* **1985**, 201–204.
84. Yamamoto, Y.; Takahashi, K.; Matsuda, T.; Yamazaki, H. *J. Chem. Soc., Dalton Trans.* **1987**, 1833–1837.
85. Uson, R.; Fornies, J.; Espinet, P.; Fortunato, C.; Tomas, M.; Welch, A. J. *J. Chem. Soc., Dalton Trans.* **1989**, 1583–1587.
86. Yamamoto, Y.; Takahashi, K.; Yamazaki, H. *J. Am. Chem. Soc.* **1986**, *108*, 2458–2459.
87. Tanase, T.; Kudo, Y.; Ohno, M.; Kobayashi, K.; Yamamoto, Y. *Nature* **1990**, *344*, 526–528.
88. Tanase, T.; Ukaji, U.; Kudo, Y.; Ohno, M.; Kobayashi, K.; Yamamoto, Y. *Organometallics* **1994**, *13*, 1374–1389.
89. Yamamoto, Y.; Yamazaki, H. *Organometallics* **1993**, *12*, 933–939.
90. Fallis, S.; Anderson, G. K. *J. Organomet. Chem.* **1994**, *474*, 223–228.
91. Couture, C.; Farrar, D. H.; Fisher, D. S.; Gukathasan, R. R. *Organometallics* **1987**, *6*, 532–536.
92. Xu, Q.; Souma, Y.; Heaton, B. T.; Jacob, C.; Kanamori, K. *Angew. Chem., Int. Ed. Engl.* **2000**, *39*, 208–209.
93. Xu, Q.; Heaton, B. T.; Jacob, C.; Mogi, K.; Ichihashi, Y.; Souma, Y.; Kanamori, K.; Eguchi, T. *J. Am. Chem. Soc.* **2000**, *122*, 6862–6870.
94. Reinking, M. K. K.; Marc, L.; Cutler, Ann, R.; Kubiak, Clifford, P. *J. Am. Chem. Soc.* **1985**, *107*, 3517–3524.
95. Schwartz, D. J.; Andersen, R. A. *J. Am. Chem. Soc.* **1995**, *117*, 4014–4025.
96. Carmichael, D.; Hitchcock, P. B.; Nixon, J. F.; Pidcock, A. *J. Chem. Soc., Chem. Commun.* **1988**, 1554–1556.
97. Fryzuk, M. D.; Clentsmith, G. K. B.; Leznoff, D. B.; Rettig, S. J.; Geib, S. J. *Inorg. Chim. Acta* **1997**, *265*, 169–177.
98. Bennett, B. L.; Roddick, D. M. *Inorg. Chem.* **1996**, *35*, 4703–4707.
99. Hill, R. H.; Puddephatt, R. J. *J. Am. Chem. Soc.* **1983**, *105*, 5797–5804.
100. McLennan, A. J.; Puddephatt, R. J. *Organometallics* **1986**, *5*, 811–813.
101. Blau, R. J.; Espenson, J. H. *J. Am. Chem. Soc.* **1986**, *108*, 1962–1969.
102. Blau, R. J.; Espenson, J. H.; Kim, S.; Jacobson, R. A. *Inorg. Chem.* **1986**, *25*, 757–763.
103. Fornies, J.; Martinez, F.; Navarro, R.; Redondo, A.; Tomas, M.; Welch, A. J. *J. Organomet. Chem.* **1986**, *316*, 351–366.
104. Grundy, K. R.; Robertson, K. N. *Organometallics* **1983**, *2*, 1736–1742.
105. Neve, F.; Ghedini, M.; Tiripicchio, A.; Ugozzoli, F. *Organometallics* **1992**, *11*, 795–801.
106. Muralidharan, S.; Espenson, J. H. *J. Am. Chem. Soc.* **1984**, *106*, 8104–8109.
107. Muralidharan, S.; Espenson, J. H.; Ross, S. A. *Inorg. Chem.* **1986**, *25*, 2557–2562.
108. Uson, R.; Fornies, J.; Espinet, P.; Fortunato, C. *J. Chem. Soc., Dalton Trans.* **1986**, 1849–1855.
109. Yip, H.-K.; Che, C.-M.; Peng, S.-M. *J. Chem. Soc., Dalton Trans.* **1993**, 179–187.
110. Blau, R. J.; Espenson, J. H. *Inorg. Chem.* **1986**, *25*, 878–880.
111. Ling, S. S. M.; Puddephatt, R. J. *Polyhedron* **1986**, *5*, 1423–1427.
112. Krevor, J. V. Z.; Simonis, U.; Karson, A.; Castro, C.; Aliakbar, M. *Inorg. Chem.* **1992**, *31*, 312–317.
113. Farr, J. P.; Wood, F. E.; Balch, A. L. *Inorg. Chem.* **1983**, *22*, 3387–3393.
114. Suzuki, T.; Fujita, J. *Bull. Chem. Soc. Jpn.* **1992**, *65*, 1016–1025.
115. Suzuki, T.; Iitaka, N.; Kurachi, S.; Kita, M.; Kashiwabara, K.; Ohba, S.; Fujita, J. *Bull. Chem. Soc. Jpn.* **1992**, *65*, 1817–1824.
116. Balch, A. L.; Guimerans, R. R.; Linehan, J.; Wood, F. E. *Inorg. Chem.* **1985**, *24*, 2021–2026.
117. Jacobsen, G. B.; Shaw, B. L. *J. Chem. Soc., Chem. Commun.* **1985**, 692–693.
118. Hallam, M. F.; Luke, M. A.; Mingos, M. P.; Williams, I. D. *J. Organomet. Chem.* **1987**, *325*, 271–283.
119. Ebner, M.; Otto, H.; Werner, H. *Angew. Chem., Int. Ed. Engl.* **1985**, *24*, 518–519.
120. Ma, E.; Semelhago, G.; Walker, A.; Farrar, D. H.; Gukathasan, R. R. *J. Chem. Soc., Dalton Trans.* **1985**, 2595–2601.
121. Hadj-Bagheri, N.; Browning, J.; Dehghan, K.; Dixon, K. R.; Meanwell, N. J.; Vefghi, R. *J. Organomet. Chem.* **1990**, *396*, C47–C52.
122. Leoni, P.; Chiaradonna, G.; Pasquali, M.; Marchetti, F. *Inorg. Chem.* **1999**, *38*, 253–259.
123. Bennett, M. A.; Berry, D. E.; Dirnberger, T.; Hockless, D. C. R.; Wenger, E. *J. Chem. Soc., Dalton Trans.* **1998**, 2367–2371.
124. Alonso, E.; Fornies, J.; Fortunato, C.; Martin, A.; Orpen, A. G. *Organometallics* **2001**, *20*, 850–859.

125. Palmans, R.; MacQueen, D. B.; Pierpont, C. G.; Frank, A. J. *J. Am. Chem. Soc.* **1996**, *118*, 12647–12653.
126. Brown, A. R.; Guo, Z.; Mosselmans, F. W. J.; Parsons, S.; Schroeder, M.; Yellowlees, L. J. *J. Am. Chem. Soc.* **1998**, *120*, 8805–8811.
127. Bagnoli, F.; Dell'Amico, D. B.; Calderazzo, F.; Englert, U.; Marchetti, F.; Herberich, G. E.; Pasqualetti, N.; Ramello, S. *J. Chem. Soc., Dalton Trans.* **1996**, *23*, 4317–4318.
128. Houliis, J. F.; Roddick, D. M. *J. Am. Chem. Soc.* **1998**, *120*, 11020–11021.
129. Hwang, G.; Wang, C.; Bodenbinder, M.; Willner, H.; Aubke, F. *J. Fluorine Chem.* **1994**, *66*, 159–166.
130. von Ahsen, B.; Bach, C.; Pernice, H.; Willner, H.; Aubke, F. *J. Fluorine Chem.* **2000**, *102*, 243–252.
131. Hwang, G.; Bodenbinder, M.; Willner, H.; Aubke, F. *Inorg. Chem.* **1993**, *32*, 4667–4669.
132. Willner, H.; Bodenbinder, M.; Bröchler, R.; Hwang, G.; Rettig, S. J.; Trotter, J.; von Ahsen, B.; Westphal, U.; Jonas, V.; Thiel, W.; Aubke, F. *J. Am. Chem. Soc.* **2001**, *123*, 588–602.
133. Simons, R. S.; Sanow, L. M.; Galat, K. J.; Tessier, C. A.; Youngs, W. J. *Organometallics* **2000**, *19*, 3994–3996.
134. Feldman, J. D.; Mitchell, G. P.; Nolte, J.-O.; Tilley, T. D. *J. Am. Chem. Soc.* **1998**, *120*, 11184–11185.
135. Michalczuk, M. J.; Recatto, C. A.; Calabrese, J. C.; Fink, M. J. *J. Am. Chem. Soc.* **1992**, *114*, 7955–7957.
136. Phan, E. K.; West, R. J. *J. Am. Chem. Soc.* **1989**, *111*, 7667–7668.
137. Appleton, T. G.; Bailey, A. J.; Barnham, K. J.; Hall, J. R. *Inorg. Chem.* **1992**, *31*, 3077–3082.
138. Rochon, F. D.; Melanson, R.; Doyon, M. *Inorg. Chem.* **1987**, *26*, 3065–3068.
139. Battle, A. R.; Plattis, J. A.; Hambley, T. W.; Deacon, G. B. *J. Chem. Soc., Dalton Trans.* **2002**, 1898–1902.
140. Natile, G.; Fanizzi, F. P.; Maresca, L.; Manotti-Lanfredi, A. M.; Tiripicchio, A. *J. Chem. Soc., Dalton Trans.* **1985**, 1057–1059.
141. Brown, K. N.; Hockless, D. C. R.; Sargeson, A. M. *J. Chem. Soc., Dalton Trans.* **1999**, 2171–2176.
142. Brammer, L.; Charnock, J. M.; Goggin, P. L.; Goodfellow, R. J.; Koetzle, T. F.; Orpen, A. G. *J. Chem. Soc., Chem. Commun.* **1987**, 443–445.
143. Brammer, L.; Charnock, J. M.; Goggin, P. L.; Goodfellow, R. J.; Orpen, A. G.; Koetzle, T. F. *J. Chem. Soc., Dalton Trans.* **1991**, 1789–1798.
144. Colquhoun, H. M.; Stoddart, J. F.; Williams, D. J. *Angew. Chem., Int. Ed.* **1986**, *25*, 487–507.
145. Ballardini, R.; Gandolfi, M. T.; Prodi, L.; Ciano, M.; Balzani, V.; Kohnke, F. H.; Shariari-Zavareh, H.; Spencer, N.; Stoddart, J. F. *J. Am. Chem. Soc.* **1989**, *111*, 7072–7078.
146. Farrell, N. *Comments Inorg. Chem.* **1995**, *16*, 373–389.
147. Hegmans, A.; Qu, Y.; Kelland, L. R.; Roberts, J. D.; Farrell, N. *Inorg. Chem.* **2001**, *40*, 6108–6114.
148. Rauter, H.; Di Domenico, R.; Menta, E.; Oliva, A.; Qu, Y.; Farrell, N. *Inorg. Chem.* **1997**, *36*, 3919–3927.
149. Farrell, N. P.; De Almeida, S. G.; Skov, K. A. *J. Am. Chem. Soc.* **1988**, *110*, 5018–5019.
150. Farrell, N.; Qu, Y. *Inorg. Chem.* **1989**, *28*, 3416–3420.
151. Farrell, N.; Qu, Y.; Hacker, M. P. *J. Med. Chem.* **1990**, *33*, 2179–2184.
152. Qu, Y.; Rauter, H.; Fontes, A. P. S.; Bandarage, R.; Kelland, L. R.; Farrell, N. *J. Med. Chem.* **2000**, *43*, 3189–3192.
153. Schumann, E.; Altman, J.; Karaghiosoff, K.; Beck, W. *Inorg. Chem.* **1995**, *34*, 2316–2322.
154. Kortés, R. A.; Geib, S. J.; Lin, F.; Shepherd, R. E. *Inorg. Chem.* **1999**, *38*, 5045–5052.
155. Woodhouse, S. L.; Rendina, L. M. *Chem. Commun.* **2001**, 2464–2465.
156. Qu, Y.; Farrell, N. *Inorg. Chem.* **1992**, *31*, 930–932.
157. Qu, Y.; Appleton, T. G.; Hoeschele, J. D.; Farrell, N. *Inorg. Chem.* **1993**, *32*, 2591–2593.
158. Alul, R.; Cleaver, M. B.; Taylor, J. S.; Cleaver, M. B.; Taylor, J. S. *Inorg. Chem.* **1992**, *31*, 3636–3646.
159. Bowler, B. E.; Hollis, L. S.; Lippard, S. J. *J. Am. Chem. Soc.* **1984**, *106*, 6102–6104.
160. Bowler, B. E.; Ahmed, K. J.; Sundquist, W. I.; Hollis, L. S.; Whang, E. E.; Lippard, S. J. *J. Am. Chem. Soc.* **1989**, *111*, 1299–1306.
161. Ceci, E.; Cini, R.; Karaulov, A.; Hursthouse, M. B.; Maresca, L.; Natile, G. *J. Chem. Soc., Dalton Trans.* **1993**, 2491–2497.
162. Ling, E. C. H.; Allen, G. W.; Hambley, T. W. *J. Am. Chem. Soc.* **1994**, *116*, 2673–2674.
163. Hambley, T. W.; Ling, E. C. H.; Messerle, B. A. *Inorg. Chem.* **1996**, *35*, 4663–4668.
164. Woon, T. C.; Fairlie, D. P. *Inorg. Chem.* **1992**, *31*, 4069–4074.
165. Woon, T. C.; Wickramasinghe, W. A.; Fairlie, D. P. *Inorg. Chem.* **1993**, *32*, 2190–2194.
166. Cini, R.; Fanizzi, F. P.; Intini, F. P.; Maresca, L.; Natile, G. *J. Am. Chem. Soc.* **1993**, *115*, 5123–5131.
167. Novoa, J. J.; Aullon, G.; Alemany, P.; Alvarez, S. *J. Am. Chem. Soc.* **1995**, *117*, 7169–7171.
168. Cini, R.; Intini, F. P.; Natile, G.; Pacifico, C. *J. Chem. Soc., Dalton Trans.* **1994**, 3753–3758.
169. Rochon, F. D.; Melanson, R.; Doyon, M.; Butler, I. S. *Inorg. Chem.* **1994**, *33*, 4485–4493.
170. Fryzuk, M. D.; Montgomery, C. D. *Coord. Chem. Rev.* **1989**, *95*, 1–40.
171. Bryndza, H. E.; Tam, W. *Chem. Rev.* **1988**, *88*, 1163–1188.
172. Park, S.; Roundhill, D. M.; Rheingold, A. L. *Inorg. Chem.* **1987**, *26*, 3972–3974.
173. Park, S.; Rheingold, A. L.; Roundhill, D. M. *Organometallics* **1991**, *10*, 615–623.
174. O'Mahoney, C. A.; Parkin, I. P.; Williams, D. J.; Woollins, J. D. *Polyhedron* **1989**, *8*, 1979–1981.
175. Alcock, N. W.; Bergamini, P.; Kemp, T. J.; Pringle, P. G.; Sostero, S.; Traverso, O. *Inorg. Chem.* **1991**, *30*, 1594–1598.
176. Li, J. J.; Li, W.; James, A. J.; Holbert, T.; Sharp, T. P.; Sharp, P. R. *Inorg. Chem.* **1999**, *38*, 1563–1572.
177. Xia, A.; Sharp, P. R. *Inorg. Chem.* **2001**, *40*, 4016–4021.
178. Cowan, R. L.; Trogler, W. C. *J. Am. Chem. Soc.* **1989**, *111*, 4750–4761.
179. Cowan, R. L.; Trogler, W. C. *Organometallics* **1987**, *6*, 2451–2453.
180. Walker, N. P. C.; Hursthouse, M. B.; Warrens, C. P.; Woollins, J. D. *J. Chem. Soc., Chem. Commun.* **1985**, 227–228.
181. Bates, P. A.; Hursthouse, M. B.; Kelly, P. F.; Woollins, J. D. *J. Chem. Soc., Dalton Trans.* **1986**, 2367–2370.
182. Jones, R.; Kelly, P. F.; Warrens, C. P.; Williams, D. J.; Woollins, J. D. *J. Chem. Soc., Chem. Commun.* **1986**, 711–713.
183. Jones, R.; Kelly, P. F.; Williams, D. J.; Woollins, J. D. *J. Chem. Soc., Dalton Trans.* **1988**, 1569–1576.
184. Parkin, I. P.; Slawin, A. M. Z.; Williams, D. J.; Woollins, J. D. *J. Chem. Soc., Chem. Commun.* **1989**, 58–59.
185. Short, R.; Hursthouse, M. B.; Purcell, T. G.; Woollins, J. D. *J. Chem. Soc., Chem. Commun.* **1987**, 407–408.
186. Bellon, P. L.; Cenini, S.; Demartin, F.; Pizzotti, M.; Porta, F. *J. Chem. Soc., Chem. Commun.* **1982**, 265–266.

187. Booth, B. L.; Haszeldine, R. N.; Holmes, R. G. *J. Chem. Soc., Dalton Trans.* **1982**, 671–672.
188. Packett, D. L.; Trogler, W. C.; Rheingold, A. L. *Inorg. Chem.* **1987**, *26*, 4308–4309.
189. Banerjee, P. *Coord. Chem. Rev.* **1999**, *190–192*, 19–28.
190. Sliwa, W.; Deska, M. *Coll. Czech. Chem. Commun.* **1999**, *64*, 435–458.
191. Hissler, M.; McGarrah, J. E.; Connick, W. B.; Geiger, D. K.; Cummings, S. D.; Eisenberg, R. *Coord. Chem. Rev.* **2000**, *208*, 115–137.
192. Castan, P.; Dahan, F.; Wimmer, S.; Wimmer, F. L. *J. Chem. Soc., Dalton Trans.* **1990**, *10*, 2971–2977.
193. Che, C. M.; Wan, K. T.; He, L. Y.; Poon, C. K.; Yam, V. W. W. *J. Chem. Soc., Chem. Commun.* **1989**, 943–944.
194. Wan, K. T.; Che, C. M. *J. Chem. Soc., Chem. Commun.* **1990**, *2*, 140–142.
195. Che, C. M.; He, L. Y.; Poon, C. K.; Mak, T. C. W. *Inorg. Chem.* **1989**, *28*, 3081–3083.
196. Miskowski, V. M.; Houlding, V. H. *Inorg. Chem.* **1989**, *28*, 1529–1533.
197. Houlding, V. H.; Miskowski, V. M. *Coord. Chem. Rev.* **1991**, *111*, 145–152.
198. Herber, R. H.; Croft, M.; Coyer, M. J.; Bilash, B.; Sahiner, A. *Inorg. Chem.* **1994**, *33*, 2422–2426.
199. Connick, W. B.; Lanfranchi, L. M.; Marsh, R. E.; Gray, H. B. *Inorg. Chem.* **1996**, *35*, 6261–6265.
200. Coyer, M. J.; Croft, M.; Chen, J.; Herber, R. H. *Inorg. Chem.* **1992**, *31*, 1752–1757.
201. Coyer, M. J.; Herber, R. H.; Chen, J.; Croft, M.; Szu, S. P. *Inorg. Chem.* **1994**, *33*, 716–721.
202. Samha, H.; Martinez, T.; De Armond, M. K. *Langmuir* **1992**, *8*, 2001–2004.
203. Wang, K.; Haga, M.; Monjushiro, H.; Akiba, M.; Sasaki, Y. *Inorg. Chem.* **2000**, *39*, 4022–4028.
204. Fanizzi, F. P.; Maresca, L.; Natile, G.; Lanfranchi, M.; Tiripicchio, A.; Pacchioni, G. *J. Chem. Soc., Chem. Commun.* **1992**, 333–335.
205. Maresca, L.; Natile, G. *Comments Inorg. Chem.* **1993**, *14*, 349–366.
206. Fanizzi, F. P.; Lanfranchi, M.; Natile, G.; Tiripicchio, A. *Inorg. Chem.* **1994**, *33*, 3331–3339.
207. Stang, P. J.; Olenyuk, B.; Arif, A. M. *Organometallics* **1995**, *14*, 5281–5289.
208. Xu, X.; James, S. L.; Mingos, D. M. P.; White, A. J. P.; Williams, D. J. *J. Chem. Soc., Dalton Trans.* **2000**, 3783–3790.
209. Fuss, M.; Siehl, H.; Olenyuk, B.; Stang, P. J. *Organometallics* **1999**, *18*, 758–769.
210. Zangrando, E.; Pichierri, F.; Randaccio, L.; Lippert, B. *Coord. Chem. Rev.* **1996**, *156*, 275–332.
211. Navarro, J. A. R.; Lippert, B. *Coord. Chem. Rev.* **1999**, *185–186*, 653–667.
212. Neugebauer, D.; Lippert, B. *J. Am. Chem. Soc.* **1982**, *104*, 6596–6601.
213. Raudaschl-Sieber, G.; Schoellhorn, H.; Thewalt, U.; Lippert, B. *J. Am. Chem. Soc.* **1985**, *107*, 3591–3595.
214. Komeda, S.; Ohishi, H.; Yamane, H.; Harikawa, M.; Sakaguchi, K.; Chikuma, M. *J. Chem. Soc., Dalton Trans.* **1999**, 2959–2962.
215. Arpalahti, J.; Klika, K. D. *Eur. J. Inorg. Chem.* **1999**, 1199–1201.
216. Viljanen, J.; Klika, K. D.; Sillanpaa, R.; Arpalahti, J. *Inorg. Chem.* **1999**, *38*, 4924–4925.
217. Longato, B.; Pilloni, G.; Bonora, G. M.; Corain, B. *J. Chem. Soc., Chem. Commun.* **1986**, 1478–1479.
218. Farrell, N.; Skov, K. A. *J. Chem. Soc., Chem. Commun.* **1987**, 1043–1044.
219. Rochon, F. D.; Kong, P. C.; Melanson, R.; Skov, K. A.; Farrell, N. *Inorg. Chem.* **1991**, *30*, 4531–4535.
220. Cusumano, M.; Di Pietro, M. L.; Giannetto, A. *Chem. Commun.* **1996**, 2527–2528.
221. Cusumano, M.; Di Pietro, M. L.; Giannetto, A.; Nicolo, F.; Rotondo, E. *Inorg. Chem.* **1998**, *37*, 563–568.
222. Grabner, S.; Plavec, J.; Bukovec, N.; Di Leo, D.; Cini, R.; Natile, G. *J. Chem. Soc., Dalton Trans.* **1998**, 1447–1451.
223. Cavallo, L.; Cini, R.; Kobe, J.; Marzilli, L. G.; Natile, G. *J. Chem. Soc., Dalton Trans.* **1991**, 1867–1873.
224. Belluco, U.; Michelin, R. A.; Ros, R.; Bertani, R.; Facchin, G.; Mozzon, M.; Zanotto, L. *Inorg. Chim. Acta* **1992**, *198–200*, 883–897.
225. Michelin, R. A.; Bertani, R.; Mozzon, M.; Bombieri, G.; Benetollo, F.; Angelici, R. J. *J. Chem. Soc., Dalton Trans.* **1993**, 959–966.
226. Michelin, R. A.; Bertani, R.; Mozzon, M.; Bombieri, G.; Benetollo, F.; Angelici, R. J. *Organometallics* **1991**, *10*, 1751–1757.
227. Wagner, G.; Haukka, M. *J. Chem. Soc., Dalton Trans.* **2001**, 2690–2697.
228. Wagner, G.; Haukka, M.; Frausto da Silva, J. J. R.; Pombeiro, A. J. L.; Kukushkin, V. Y. *Inorg. Chem.* **2001**, *40*, 264–271.
229. Bruce, D. W.; Lalinde, E.; Styring, P.; Dunmur, D. A.; Maitlis, P. M. *J. Chem. Soc., Chem. Commun.* **1986**, 581–582.
230. Price, D. J.; Richardson, T.; Bruce, D. W. *J. Chem. Soc., Chem. Commun.* **1995**, 1911–1912.
231. Donnio, B.; Bruce, D. W. *J. Chem. Soc., Dalton Trans.* **1997**, 2445–2755.
232. Mongin, C.; Donnio, B.; Bruce, D. W. *J. Am. Chem. Soc.* **2001**, *123*, 8426–8427.
233. Wustefeld, H.-U.; Kaska, W. C.; Schuth, F.; Stucky, G. D.; Xianhui, B.; Krebs, B. *Angew. Chem., Int. Ed.* **2001**, *40*, 3182–3184.
234. Fujita, M.; Ibukuro, F.; Yamaguchi, K.; Ogura, K. *J. Am. Chem. Soc.* **1995**, *117*, 4175–4176.
235. Sun, W.-Y.; Yoshizawa, M.; Kusukawa, T.; Fujita, M. *Curr. Opin. Chem. Biol.* **2002**, *6*, 757–764.
236. Fujita, M.; Umemoto, K.; Yoshizawa, M.; Fujita, N.; Kusukawa, T.; Biradha, K. *Chem. Commun.* **2001**, 509–518.
237. Biradha, K.; Fujita, M. *Adv. Supramol. Chem.* **2000**, *6*, 1–39.
238. Fujita, M. Transition metal-incorporating catenanes. In *Molecular Catenanes, Rotaxanes and Knots*; Sauvage, J.-P., Dietrich-Buchecker, C., Eds.; Wiley-VCH Verlag: Weinheim, Germany, 1999, pp 57–76.
239. Fujita, M. *Polym. Mater. Sci. Eng.* **1990**, *80*, 27–28.
240. Fujita, M. *Chem. Soc. Rev.* **1998**, *27*, 417–425.
241. Fujita, M. *Acc. Chem. Res.* **1999**, *32*, 53–61.
242. Fujita, N.; Ogura, K. *Supramol. Sci.* **1996**, *3*, 37–44.
243. Fujita, M. Self-assembled macrocycles, cages and catenanes containing transition metals in their backbones. In *Comprehensive Supramolecular Chemistry*; Sauvage, J.-P., Hosseini, M. W., Eds.; Elsevier: Oxford, 1996, Vol. 9, pp 253–282.
244. Fujita, M.; Ogura, K. *Coord. Chem. Rev.* **1996**, *148*, 249–264.
245. Seidel, S. R.; Stang, P. J. *Acc. Chem. Res.* **2002**, *35*, 972–983.
246. Leininger, S.; Olenyuk, B.; Stang, P. J. *Chem. Rev.* **2000**, *100*, 853–907.

247. Stang, P. J.; Olenyuk, B. Transition-metal-mediated self assembly of discrete manoscopic species with well-defined structures and shapes. In *Handbook of Nanostructured Materials and Nanotechnology*; Nalwa, H. S., Ed.; Academic Press: San Diego, 2000, Vol. 5, 167–224.
248. Olenyuk, B.; Fechtenkotter, A.; Stang, P. J. *J. Chem. Soc., Dalton Trans.* **1998**, 1707–1728.
249. Stang, P. J.; Olenyuk, B. *Acc. Chem. Res.* **1997**, *30*, 502–518.
250. Qin, Z.; Jennings, M. C.; Puddephatt, R. J. *Inorg. Chem., Chem. Commun.* **2001**, *40*, 6220–6228.
251. Bernhardt, P. V.; Lawrance, G. A.; Patalinghug, W. C.; Skelton, B. W.; White, A. H.; Curtis, N. F.; Siriwardena, A. *J. Chem. Soc., Dalton Trans.* **1990**, *9*, 2853–2858.
252. Waknine, D.; Heeg, M. J.; Endicott, J. F.; Ochrymowycz, L. A. *Inorg. Chem.* **1991**, *30*, 3691–3700.
253. Kimura, E.; Lin, Y.; Machida, R.; Zenda, H. *J. Chem. Soc., Chem. Commun.* **1986**, *13*, 1020–1022.
254. Kimura, E.; Korenari, S.; Shionoya, M.; Shiro, M. *Chem. Commun.* **1988**, *17*, 1166–1168.
255. Cameron, B. R.; Corrent, S. S.; Loeb, S. J. *Angew. Chem., Int. Ed.* **1996**, *34*, 2689–2691.
256. Bondy, C. R.; Gale, P. A.; Loeb, S. J. *Chem. Commun.* **2001**, 729–730.
257. Atkinson, I. M.; Chartres, J. D.; Groth, A. M.; Lindoy, L. F.; Lowe, M. P.; Meehan, G. V.; Skelton, B. W.; White, A. H. *J. Chem. Soc., Dalton Trans.* **2001**, 2801–2806.
258. Appleton, T. G. *Coord. Chem. Rev.* **1997**, *166*, 313–359.
259. Iakovovidis, A.; Hadjiliadis, N. *Coord. Chem. Rev.* **1994**, *135–136*, 17–63.
260. Tsvieriotis, P.; Hadjiliadis, N. *Coord. Chem. Rev.* **1999**, *190–192*, 171–184.
261. Lempers, E. L. M.; Reedijk, J. *Adv. Inorg. Chem.* **1991**, *37*, 175–217.
262. Appleton, T. G.; Hall, J. R. *J. Chem. Soc., Chem. Commun.* **1983**, 911–913.
263. Appleton, T. G.; Hall, J. R.; Prenzler, P. D. *Inorg. Chem.* **1989**, *28*, 815–819.
264. Appleton, T. G.; Connor, J. W.; Hall, J. R. *Inorg. Chem.* **1988**, *27*, 130–137.
265. Appleton, T. G.; Connor, J. W.; Hall, J. R.; Prenzler, P. D. *Inorg. Chem.* **1989**, *28*, 2030–2037.
266. McMillin, D. R.; Moore, J. J. *Coord. Chem. Rev.* **2002**, *229*, 113–121.
267. Crites Tears, D. K.; McMillin, D. R. *Coord. Chem. Rev.* **2001**, *211*, 195–205.
268. Ratilla, E. M. A.; Brothers, H. M.; Kostic, N. M. *J. Am. Chem. Soc.* **1987**, *109*, 4592–4599.
269. Peerey, L. M.; Kostic, N. M. *Inorg. Chem.* **1987**, *26*, 2079–2083.
270. Ratilla, E. M. A.; Kostic, N. M. *J. Am. Chem. Soc.* **1988**, *110*, 4427–4428.
271. Brothers, H. M.; Kostic, N. M. *Inorg. Chem.* **1988**, *27*, 1761–1767.
272. Ratilla, E. M. A.; Scott, B. K.; Moxness, M. S.; Kostic, N. M. *Inorg. Chem.* **1990**, *29*, 918–926.
273. Kirvan, G. E.; Margerum, D. W. *Inorg. Chem.* **1985**, *24*, 3017–3021.
274. Gossel, M. C.; Moulding, R. P.; Seddon, K. R.; Walker, F. J. *J. Chem. Soc., Dalton Trans.* **1987**, 705–708.
275. Hill, W. E.; Minahan, D. M. A.; Taylor, J. G.; McAuliffe, C. A. *J. Am. Chem. Soc.* **1982**, *104*, 6001–6005.
276. Hill, W. E.; Taylor, J. G.; Falshaw, C. P.; King, T. J.; Beagley, B.; Tonge, D. M.; Pritchard, R. G.; McAuliffe, C. A. *J. Chem. Soc., Dalton Trans.* **1986**, 2289–2295.
277. Puddephatt, R. J.; Azam, K. A.; Hill, R. H.; Brown, M. P.; Nelson, C. D.; Moulding, R. P.; Seddon, K. R.; Gossel, M. C. *J. Am. Chem. Soc.* **1983**, *105*, 5642–5646.
278. Makiura, R.; Nagasawa, I.; Kimura, N.; Ishimaru, S.; Kitagawa, H.; Ikeda, R. *Chem. Commun.* **2001**, 1642–1643.
279. Dieleman, C. B.; Marsol, C.; Matt, D.; Kyritsakas, N.; Harriman, A.; Kintzinger, J. *J. Chem. Soc., Dalton Trans.* **1999**, 4139–4148.
280. Stolmar, M.; Floriani, C.; Chiesi-Villa, A.; Rizzoli, C. *Inorg. Chem.* **1997**, *36*, 1694–1701.
281. Copley, C. J.; Ellis, D. D.; Orpen, A. G.; Pringle, P. G. *J. Chem. Soc., Dalton Trans.* **2000**, 1101–1107.
282. Parlevliet, F. J.; Olivier, A.; de Lange, W. G. J.; Kamer, P. C. J.; Kooijman, H.; Spek, A. L.; van Leeuwen, P. W. N. M. *Chem. Commun.* **1996**, 583–584.
283. Soulivong, D.; Matt, D.; Ziessel, R. *Chem. Commun.* **1999**, 393–394.
284. Brueggeller, P. *Inorg. Chem.* **1987**, *26*, 4125–4127.
285. Bao, Q. B.; Brill, T. B. *Inorg. Chem.* **1987**, *26*, 3447–3452.
286. Bao, Q. B.; Geib, S. J.; Rheingold, A. L.; Brill, T. B. *Inorg. Chem.* **1987**, *26*, 3453–3458.
287. Gugger, P.; Limmer, S. O.; Watson, A. A.; Willis, A. C.; Wild, S. B. *Inorg. Chem.* **1993**, *32*, 5692–5696.
288. Atherton, M. J.; Fawcett, J.; Holloway, J. H.; Hope, E. G.; Russell, D. R.; Saunders, G. C. *J. Chem. Soc., Dalton Trans.* **1997**, 2217–2220.
289. Mizuta, T.; Okano, A.; Sasaki, T.; Nakazawa, H.; Miyoshi, K. *Inorg. Chem.* **1997**, *36*, 200–203.
290. Kyba, E. P.; Clubb, C. N.; Larson, S. B.; Schueler, V. J.; Davis, R. E. *J. Am. Chem. Soc.* **1985**, *107*, 2141–2148.
291. Jones, T. L.; Willis, A. C.; Wild, S. B. *Inorg. Chem.* **1992**, *31*, 1411–1416.
292. Cecconi, F.; Ghilardi, C. A.; Midollini, S.; Moneti, S.; Orlandini, A.; Scapacci, G. *J. Chem. Soc., Chem. Commun.* **1990**, 1583–1584.
293. Kuznik, N.; Wendt, O. F. *J. Chem. Soc., Dalton Trans.* **2002**, 3074–3078.
294. Wendt, O. F.; Elding, L. I. *J. Chem. Soc., Dalton Trans.* **1997**, 4725–4731.
295. Appleton, T. G.; Hall, J. R.; Ralph, S. F.; Thompson, C. S. M. *Inorg. Chem.* **1984**, *23*, 3521–3525.
296. Bruce, D. W.; Jones, R. F.; Cole-Hamilton, D. J. *J. Chem. Soc., Dalton Trans.* **1984**, 2249–2253.
297. Preston, S. A.; Cole-Hamilton, D. J. *J. Chem. Soc., Dalton Trans.* **1986**, 1055.
298. Rochon, F. D.; Melanson, R. *Inorg. Chem.* **1987**, *26*, 989–992.
299. Rochon, F. D.; Morneau, A.; Melanson, R. *Inorg. Chem.* **1988**, *27*, 10–13.
300. Wimmer, S.; Castan, P.; Wimmer, F. L.; Johnson, N. P. *J. Chem. Soc., Dalton Trans.* **1989**, 403–412.
301. Andrews, M. A.; Gould, G. L.; Voss, E. J. *Inorg. Chem.* **1996**, *35*, 5740–5742.
302. Li, J. J.; Li, W.; Sharp, P. R. *Inorg. Chem.* **1996**, *35*, 604–613.
303. Sharp, P. R.; Li, J. J. *Inorg. Chem.* **1994**, *33*, 183–184.
304. Li, W.; Barnes, C. L.; Sharp, P. R. *J. Chem. Soc., Chem. Commun.* **1990**, 1634–1636.
305. Trovó, G.; Bandoli, G.; Casellato, U.; Corain, B.; Nicolini, M.; Longato, B. *Inorg. Chem.* **1990**, *29*, 4616–4621.
306. Strukul, G.; Ros, R.; Michelin, R. A. *Inorg. Chem.* **1982**, *21*, 495–500.
307. Strukul, G.; Michelin, R. A.; Orbell, J. D.; Randaccio, L. *Inorg. Chem.* **1983**, *22*, 3706–3713.
308. Strukul, G.; Michelin, R. A. *J. Am. Chem. Soc.* **1985**, *107*, 7563–7569.
309. Strukul, G.; Michelin, R. A. *J. Chem. Soc., Chem. Commun.* **1984**, 1538–1539.

310. Zanardo, A.; Pinna, F.; Michelin, R. A.; Strukul, G. *Inorg. Chem.* **1988**, *27*, 1966–1973.
311. Kubota, M.; Rosenberg, F. S.; Sailor, M. J. *J. Am. Chem. Soc.* **1985**, *107*, 4558–4559.
312. Alcock, N. W.; Platt, A. W. G.; Pringle, P. G. *J. Chem. Soc., Dalton Trans.* **1987**, 2273–2280.
313. Alcock, N. W.; Platt, A. W. G.; Pringle, P. G. *J. Chem. Soc., Dalton Trans.* **1989**, 139–143.
314. Alcock, N. W.; Platt, A. W. G.; Pringle, P. G. *J. Chem. Soc., Dalton Trans.* **1989**, 2069–2072.
315. Appelt, A.; Willis, A. C.; Wild, S. B. *J. Chem. Soc., Chem. Commun.* **1988**, 938–940.
316. Hollis, L. S.; Amundsen, A. R.; Stern, E. W. *J. Am. Chem. Soc.* **1985**, *107*, 274–276.
317. Hollis, L. S.; Stern, E. W.; Amundsen, A. R.; Miller, A. V.; Doran, S. L. *J. Am. Chem. Soc.* **1987**, *109*, 3596–3602.
318. Hollis, L. S.; Stern, E. W. *Inorg. Chem.* **1988**, *27*, 2826–2831.
319. Arendse, M. J.; Anderson, G. K.; Rath, N. P. *Inorg. Chem.* **1998**, *38*, 5864–5869.
320. Yuge, H.; Miyamoto, T. K. *Chem. Lett.* **1996**, 375–376.
321. Steinborn, D.; Junicke, H. *Chem. Rev.* **2000**, *100*, 4283–4317.
322. Shi, J.; Yueng, C.; Wu, D.; Liu, Q.; Kang, B. *Organometallics* **1999**, *18*, 3796–3801.
323. Bitha, P.; Morton, G. O.; Dunne, T. S.; Delos Santos, E. F.; Lin, Y. I.; Boone, S. R.; Haltiwanger, R. C.; Pierpont, C. G. *Inorg. Chem.* **1990**, *29*, 645–652.
324. Galanski, M.; Keppler, B. K.; Nuber, B. *Angew. Chem., Int. Ed. Engl.* **1995**, *34*, 1103–1104.
325. Mahtani, H. K.; Chang, S. C.; Ruble, J. R.; Black, I. N. L.; Stein, P. B. *Inorg. Chem.* **1993**, *32*, 4976–4978.
326. Andrews, M. A.; Gould, G. L.; Klooster, W. T.; Koenig, K. S.; Voss, E. J. *Inorg. Chem.* **1996**, *35*, 5478–5483.
327. Dudis, D.; Fackler, J. P. *Inorg. Chem.* **1982**, *21*, 3577–3578.
328. Ansari, M. A.; Mahler, C. H.; Chorghade, G. S.; Lu, Y.-J.; Ibers, J. A. *Inorg. Chem.* **1990**, *29*, 3832–3839.
329. McConnachie, J. M.; Ansari, M. A.; Ibers, J. A. *Inorg. Chem.* **1993**, *32*, 3250–3255.
330. Nagata, K.; Takeda, N.; Tokitoh, N. *Angew. Chem., Int. Ed.* **2002**, *41*, 136–138.
331. Yam, V. W.; Yeung, P. K.; Cheung, K. *J. Chem. Soc., Chem. Commun.* **1995**, 267–269.
332. Tzeng, B.-C.; Chan, S.-C.; Chan, M. C. W.; Che, C.-M.; Cheung, K.-K.; Peng, S.-M. *Inorg. Chem.* **2001**, *40*, 6699–6704.
333. Fontes, A. P. S.; Oskarsson, A.; Loeqvist, K.; Farrell, N. *Inorg. Chem.* **2001**, *40*, 1745–1750.
334. Farrell, N.; Kiley, D. M.; Schmidt, W.; Hacker, M. P. *Inorg. Chem.* **1990**, *29*, 397–403.
335. Bierbach, U.; Hambley, T. W.; Farrell, N. *Inorg. Chem.* **1998**, *37*, 708–716.
336. Johnson, C. E.; Eisenberg, R.; Evans, T. R.; Burberry, M. S. *J. Am. Chem. Soc.* **1983**, *105*, 1795–1802.
337. Zuleta, J. A.; Bevilacqua, J. M.; Rehm, J. M.; Eisenberg, R. *Inorg. Chem.* **1992**, *32*, 1332–1337.
338. Bevilacqua, J. M.; Eisenberg, R. *Inorg. Chem.* **1994**, *33*, 2913–2923.
339. Cummings, S. D.; Eisenberg, R. *J. Am. Chem. Soc.* **1996**, *118*, 1949–1960.
340. Fleeman, W. L.; Connick, W. B. *Comments Inorg. Chem.* **2002**, *23*, 205–230.
341. Bevilacqua, J. M.; Zuleta, J. A.; Eisenberg, R. *Inorg. Chem.* **1994**, *33*, 258–266.
342. Connick, W. B.; Gray, H. B. *J. Am. Chem. Soc.* **1997**, *119*, 11620–11627.
343. Base, K.; Grinstaff, M. W. *Inorg. Chem.* **1998**, *37*, 1432–1433.
344. Paw, W.; Lachicotte, R. J.; Eisenberg, R. *Inorg. Chem.* **1998**, *37*, 4139–4141.
345. Bousseau, M.; Valade, L.; Legros, J. P.; Cassoux, P.; Garbaskas, M.; Interrante, L. V. *J. Am. Chem. Soc.* **1986**, *108*, 1908–1916.
346. Bellitto, C.; Bonamico, M.; Fares, V.; Serino, P. *Inorg. Chem.* **1996**, *35*, 4070–4072.
347. Gibson, D.; Lippard, S. J. *Inorg. Chem.* **1986**, *25*, 219–222.
348. Henderson, W.; Nicholson, B. K.; Kemmitt, R. D. W. *J. Chem. Soc., Dalton Trans.* **1994**, 2489–2495.
349. Todd, J. A.; Rendina, L. M. *Inorg. Chem.* **2002**, *41*, 3331–3333.
350. Watzky, M. A.; Wankine, D.; Heeg, M. J.; Endicott, J. F.; Ochrymowycz, L. A. *Inorg. Chem.* **1993**, *32*, 4882–4888.
351. Blake, A. J.; Holder, A. J.; Reid, G.; Schroeder, M. J. *J. Chem. Soc., Dalton Trans.* **1994**, *5*, 627–631.
352. Grant, G. J.; Poullaos, I. M.; Galas, D. F.; VanDerveer, D. G.; Zubkowski, J. D.; Valente, E. J. *Inorg. Chem.* **2001**, *40*, 564–567.
353. Grant, G. J.; Galas, D. F.; Poullaos, I. M.; Carter, S. M.; VanDerveer, D. G. *J. Chem. Soc., Dalton Trans.* **2002**, 2973–2980.
354. Nikol, H.; Buergi, H.; Hardcastle, K. I.; Gray, H. B. *Inorg. Chem.* **1995**, *34*, 6319–6322.
355. Grant, G. J.; Galas, D. F.; Jones, M. W.; Loveday, K. D.; Pennington, W. T.; Schimek, G. L.; Eagle, C. T.; VanDerveer, D. G. *Inorg. Chem.* **1998**, *37*, 5299–5305.
356. Paonessa, R. S.; Trogler, W. C. *J. Am. Chem. Soc.* **1982**, *104*, 1138–1140.
357. Packett, D. L.; Trogler, W. C. *Inorg. Chem.* **1988**, *27*, 1768–1775.
358. Paonessa, R. S.; Trogler, W. C. *J. Am. Chem. Soc.* **1982**, *104*, 3529–3530.
359. Paonessa, R. S.; Trogler, W. C. *Inorg. Chem.* **1983**, *22*, 1038–1048.
360. Packett, D. L.; Jensen, C. M.; Cowan, R. L.; Strouse, C. E.; Trogler, W. C. *Inorg. Chem.* **1985**, *24*, 3578–3583.
361. Brüggeller, P. *Inorg. Chem.* **1990**, *29*, 1742–1750.
362. Miedaner, A.; DuBois, D. L.; Curtis, C. J.; Haltiwanger, R. C. *Organometallics* **1993**, *12*, 299–303.
363. Brüggeller, P. *Inorg. Chim. Acta* **1987**, *129*, L27–L28.
364. Handler, A.; Peringer, P.; Müller, E. P. *J. Organomet. Chem.* **1991**, *412*, 451–456.
365. Berning, D. E.; Noll, B. C.; DuBois, D. L. *J. Am. Chem. Soc.* **1998**, *121*, 11432–11447.
366. Mastroianni, P.; Palma, M.; Fanizzi, F. P.; Nobile, C. F. *J. Chem. Soc., Dalton Trans.* **2000**, 4272–4276.
367. Reinartz, S.; Baik, M.-U.; White, P. S.; Brookhart, M.; Templeton, J. L. *Inorg. Chem.* **2001**, *40*, 4726–4732.
368. Butts, M. D.; Scott, B. L.; Kubas, G. J. *J. Am. Chem. Soc.* **1996**, *118*, 11831–11843.
369. Gusev, D. G.; Notheis, J. U.; Rambo, J. R.; Hauger, B. E.; Eisenstein, O.; Caulton, K. G. *J. Am. Chem. Soc.* **1994**, *116*, 7409–7410.
370. Stahl, S. S.; Labinger, J. A.; Bercaw, J. E. *Inorg. Chem.* **1998**, *37*, 2422–2431.
371. O'Halloran, T. V.; Lippard, S. J. *Inorg. Chem.* **1989**, *28*, 1289–1295.
372. Burrows, A. D.; Mingos, D. M. P.; White, A. J. P.; Williams, D. J. *J. Chem. Soc., Dalton Trans.* **1996**, 3805–3812.
373. Hoeschele, J. D.; Farrell, N.; Turner, W. R.; Rithner, C. D. *Inorg. Chem.* **1988**, *27*, 4106–4113.
374. Koch, K. R.; Bourne, S. A.; Coetzee, A.; Miller, J. *J. Chem. Soc., Dalton Trans.* **1999**, 3157–3161.
375. Henderson, W.; McCaffrey, L. J.; Nicholson, B. K. *J. Chem. Soc., Dalton Trans.* **2000**, 2753–2760.

376. Anderson, G. K.; Kumar, R. *Inorg. Chem.* **1984**, *23*, 4064–4068.
377. Habtemariam, A.; Watchman, B.; Potter, B. S.; Palmer, R.; Parsons, S.; Parkin, A.; Sadler, P. J. *J. Chem. Soc., Dalton Trans.* **2001**, 1306–1318.
378. Habtemariam, A.; Parkinson, J. A.; Margiotta, N.; Hambley, T. W.; Parsons, S.; Sadler, P. J. *J. Chem. Soc., Dalton Trans.* **2001**, 362–372.
379. Uson, R.; Fornies, J.; Tomas, M.; Menjon, B.; Suenkel, K.; Bau, R. *J. Chem. Soc., Chem. Commun.* **1984**, 751–752.
380. Bond, A. M.; Colton, R.; Fiedler, D. A.; Kevekordes, J. E.; Tedesco, V.; Mann, T. F. *Inorg. Chem.* **1994**, *33*, 5761–5766.
381. Bremi, J.; d'Agostino, E.; Gramlich, V.; Caseri, W.; Smith, P. *Inorg. Chim. Acta* **2002**, *335*, 15–20.
382. Khan, H. M.; Waltz, W. L.; Lilie, J.; Woods, R. J. *Inorg. Chem.* **1982**, *21*, 1489–1497.
383. Drougge, L.; Elding, L. I. *Inorg. Chem.* **1988**, *27*, 795–798.
384. Waltz, W. L.; Lilie, J.; Goursot, A.; Chermette, H. *Inorg. Chem.* **1989**, *28*, 2247–2256.
385. Bothe, E.; Broszkiewicz, R. K. *Inorg. Chem.* **1989**, *28*, 2988–2991.
386. Geoffroy, M.; Bernardinelli, G.; Castan, P.; Chermette, H.; Deguenon, D.; Nour, S.; Weber, J.; Wermeille, M. *Inorg. Chem.* **1992**, *31*, 5056–5060.
387. Klein, A.; Hausen, H.-D.; Kaim, W. *J. Organomet. Chem.* **1992**, *440*, 207–217.
388. Waltz, W. L.; Lilie, J.; Chandrasekhar, S.; Woo, D.; Brown, K. *Inorg. Chem.* **1996**, *35*, 124–130.
389. Cini, R.; Fanizzi, F. P.; Intini, F. P.; Natile, G. *J. Am. Chem. Soc.* **1991**, *113*, 7805–7806.
390. Baxter, L. A. M.; Heath, G. A.; Raptis, R. G.; Willis, A. C. *J. Am. Chem. Soc.* **1992**, *114*, 6944–6946.
391. Prenzler, P. D.; Heath, G. A.; Lee, S. B.; Raptis, R. G. *J. Chem. Soc., Chem. Commun.* **1996**, 2271–2272.
392. Woollins, J. D.; Kelly, P. F. *Coord. Chem. Rev.* **1985**, *65*, 115–140.
393. Cotton, F. A.; Falvello, L. R.; Han, S. *Inorg. Chem.* **1982**, *21*, 1709–1710.
394. Conder, H. L.; Cotton, F. A.; Falvello, L. R.; Han, S.; Walton, R. A. *Inorg. Chem.* **1983**, *22*, 1887–1891.
395. Cotton, F. A.; Falvello, L. R.; Han, S. *Inorg. Chem.* **1982**, *21*, 2889–2891.
396. Bancroft, D. P.; Cotton, F. A.; Falvello, L. R.; Han, S.; Schwotzer, W. *Inorg. Chim. Acta* **1984**, *87*, 147–153.
397. Appleton, T. G.; Hall, J. R.; Neale, D. W. *Inorg. Chim. Acta* **1985**, *104*, 19–31.
398. Appleton, T. G.; Hall, J. R.; Neale, D. W.; Ralph, S. F. *Inorg. Chim. Acta* **1983**, *77*, L149–L151.
399. Stranger, R.; Nissen, S. C.; Mathieson, M. T.; Appleton, T. G. *Inorg. Chem.* **1997**, *36*, 937–939.
400. Che, C. M.; Schaefer, W. P.; Gray, H. B.; Dickson, M. K.; Stein, P. B.; Roundhill, D. M. *J. Am. Chem. Soc.* **1982**, *104*, 4253–4255.
401. Alexander, K. A.; Bryan, S. A.; Fronczek, F. R.; Fultz, W. C.; Rheingold, A. L.; Roundhill, D. M.; Stein, P.; Watkins, S. F. *Inorg. Chem.* **1985**, *24*, 2803–2808.
402. Hedden, D.; Roundhill, D. M.; Walkinshaw, M. D. *Inorg. Chem.* **1985**, *24*, 3146–3150.
403. Che, C. M.; Mak, T. C. W.; Miskowski, V. M.; Gray, H. B. *J. Am. Chem. Soc.* **1986**, *108*, 7840–7841.
404. Che, C. M.; Lee, W. M.; Mak, T. C. W.; Gray, H. B. *J. Am. Chem. Soc.* **1986**, *108*, 4446–4451.
405. Che, C. M.; Cheng, M. C.; Wang, Y.; Gray, H. B. *Inorg. Chim. Acta* **1992**, *191*, 7–9.
406. Che, C. M.; Mak, T. C. W.; Gray, H. B. *Inorg. Chem.* **1984**, *23*, 4386–4388.
407. Stein, P.; Dickson, M. K.; Roundhill, D. M. *J. Am. Chem. Soc.* **1983**, *105*, 3489–3494.
408. Stiegman, A. E.; Miskowski, V. M.; Gray, H. B. *J. Am. Chem. Soc.* **1986**, *108*, 2781–2782.
409. El-Mehdawi, R.; Bryan, S. A.; Roundhill, D. M. *J. Am. Chem. Soc.* **1985**, *107*, 6282–6286.
410. Che, C. M.; Lo, C. F.; Lau, T. C.; Poon, C. K.; Gray, H. B. *Inorg. Chem.* **1989**, *28*, 3270–3272.
411. Appleton, T. G.; Byriel, K. A.; Hall, J. R.; Kennard, C. H. L.; Mathieson, M. T. *J. Am. Chem. Soc.* **1992**, *114*, 7305–7307.
412. Appleton, T. G.; Barnham, K. J.; Byriel, K. A.; Hall, J. R.; Kennard, C. H. L.; Mathieson, M. T.; Penman, K. G. *Inorg. Chem.* **1995**, *34*, 6040–6052.
413. Appleton, T. G.; Byriel, K. A.; Garrett, J. M.; Hall, J. R.; Kennard, C. H. L.; Mathieson, M. T.; Stranger, R. *Inorg. Chem.* **1995**, *34*, 5646–5655.
414. Stranger, R.; Medley, G. A.; McGrady, J. E.; Garrett, J. M.; Appleton, T. G.; Heath, G. A. *Inorg. Chem.* **1996**, *35*, 2268–2275.
415. Goodgame, D. M. L.; Rollins, R. W.; Skapski, A. C. *Inorg. Chim. Acta* **1984**, *83*, L11–L12.
416. Goodgame, D. M. L.; Rollins, R. W.; Slawin, A. M. Z.; Williams, D. J.; Zard, P. W. *Inorg. Chim. Acta* **1986**, *120*, 91–101.
417. Goodgame, D. M. L.; Slawin, A. M. Z.; Williams, D. J.; Zard, P. W. *Inorg. Chim. Acta* **1988**, *148*, 5–6.
418. Umakoshi, K.; Kinoshita, I.; Ichimura, A.; Ooi, S. *Inorg. Chem.* **1987**, *26*, 3551–3556.
419. Bellitto, C.; Flamini, A.; Gastaldi, L.; Scaramuzza, L. *Inorg. Chem.* **1983**, *22*, 444–449.
420. Bellitto, C.; Bonamico, M.; Dessy, G.; Fares, V.; Flamini, A. *J. Chem. Soc., Dalton Trans.* **1986**, 595–601.
421. Hollis, L. S.; Lippard, S. J. *Inorg. Chem.* **1982**, *21*, 2116–2117.
422. Hollis, L. S.; Lippard, S. J. *Inorg. Chem.* **1983**, *22*, 2605–2614.
423. Hollis, L. S.; Roberts, M. M.; Lippard, S. J. *Inorg. Chem.* **1983**, *22*, 3637–3644.
424. O'Halloran, T. V.; Roberts, M. M.; Lippard, S. J. *Inorg. Chem.* **1986**, *25*, 957–964.
425. Matsumoto, K.; Harashima, K. *Inorg. Chem.* **1991**, *30*, 3032–3034.
426. Abe, T.; Moriyama, H.; Matsumoto, K. *Chem. Lett.* **1989**, 1857–1860.
427. Lippert, B.; Schoellhorn, H.; Thewalt, U. *Inorg. Chem.* **1986**, *25*, 407–408.
428. Schoellhorn, H.; Eisenmann, P.; Thewalt, U.; Lippert, B. *Inorg. Chem.* **1986**, *25*, 3384–3391.
429. Lippert, B. *New J. Chem.* **1988**, *12*, 715–720.
430. Peilert, M.; Weissbach, S.; Freisinger, E.; Korsunsky, V. I.; Lippert, B. *Inorg. Chim. Acta* **1997**, *265*, 187–195.
431. Reinartz, S.; White, P. S.; Brookhart, M.; Templeton, J. L. *J. Am. Chem. Soc.* **2001**, *123*, 6425–6426.
432. Fekl, U.; Goldberg, K. I. *J. Am. Chem. Soc.* **2002**, *124*, 6804–6805.
433. Chen, L.; Davies, J. A.; Staples, R. *Inorg. Chim. Acta* **1989**, *163*, 11–18.
434. Hope, E. G.; Levason, W.; Powell, N. A. *Inorg. Chim. Acta* **1986**, *115*, 187–192.
435. Hanton, L. R.; Levason, W.; Powell, N. A. *Inorg. Chim. Acta* **1989**, *160*, 205–208.
436. Oberhauser, W.; Bachmann, C.; Stampfl, T.; Haid, R.; Langes, C.; Rieder, A.; Brüggeller, P. *Inorg. Chim. Acta* **1998**, *274*, 143–154.

437. Kelland, L. R.; Murrer, B. A.; Abel, G.; Giandomenico, C. M.; Mistry, P.; Harrap, K. R. *Cancer Res.* **1992**, *52*, 822–828.
438. Oberhauser, W.; Bachmann, C.; Stampfl, T.; Brueggeller, P. *Inorg. Chim. Acta* **1997**, *256*, 223–234.
439. Levason, W.; Spicer, M. D.; Webster, M. *Inorg. Chem.* **1991**, *30*, 967–971.
440. Bierbach, U.; Hambley, T. W.; Roberts, J. D.; Farrell, N. *Inorg. Chem.* **1996**, *35*, 4865–4872.
441. Butler, L. M.; Creighton, J. R.; Raper, E. S.; Tomlinson, W. R. *Inorg. Chim. Acta* **1986**, *112*, L3–L4.
442. Hursthouse, M. B.; Motevalli, M.; Kelly, P. F.; Woollins, J. D. *Polyhedron* **1989**, *8*, 997–998.
443. Kelley, P. F.; Sheppard, R. N.; Woollins, J. D. *Polyhedron* **1992**, *11*, 2605–2609.
444. Gillard, R. D.; Wimmer, F. L.; Richards, J. P. G. *J. Chem. Soc., Dalton Trans.* **1985**, 253–258.
445. Hope, E. G.; Levason, W.; Webster, M.; Murray, S. G. *J. Chem. Soc., Dalton Trans.* **1986**, 1003–1009.
446. Hitchcock, P. B.; Nixon, J. F.; Sakarya, N. *J. Chem. Soc., Chem. Commun.* **2000**, 1745–1746.
447. Rosenberg, B.; Camp, L. V.; Trosko, J. E.; Mansour, V. H. *Nature* **1969**, *222*, 385–386.
448. Giandomenico, C. M.; Abrams, M. J.; Murrer, B. A.; Vollano, J. F.; Harrap, K. R.; Goddard, P. M.; Kelland, L. R.; Morgan, S. E. Synthesis and reactions of a new class of orally active platinum(IV) antitumor complexes. In *Platinum and Other Metal Coordination Compounds in Cancer Chemotherapy*; Howell, S. B., Ed.; Plenum Press: New York 1991, pp 93–100.
449. Giandomenico, C. M.; Abrams, M. J.; Murrer, B. A.; Vollano, J. F.; Rheinheimer, M. I.; Wyer, S. B.; Bossard, G. E.; Higgins, J. D. *Inorg. Chem.* **1995**, *34*, 1015–1021.
450. Kelland, L. R. *Exp Opin Invest Drugs* **2000**, *9*, 1373–1382.
451. Deng, Y.; Khokhar, A. R. *Inorg. Chim. Acta* **1993**, *204*, 35–38.
452. Ellis, L. T.; Er, H. M.; Hambley, T. W. *Aust. J. Chem.* **1995**, *48*, 793–806.
453. Deacon, G. B.; Lawrenz, E. T.; Hambley, T. W.; Rainone, S.; Webster, L. K. *J. Organomet. Chem.* **1995**, *493*, 205–213.
454. Shamsuddin, S.; van Hal, J. W.; Stark, J. L.; Whitmire, K. H.; Khokhar, A. R. *Inorg. Chem.* **1997**, *36*, 5969–5971.
455. Miller, B.; Altman, J.; Beck, W. *Inorg. Chim. Acta* **1997**, *264*, 101–108.
456. Jung, C. S.; Lee, S. S.; Jung, O.-S.; Sohn, Y. S. *Polyhedron* **1996**, *15*, 1677–1683.
457. Lee, E. J.; Jun, M.-J.; Lee, S. S.; Sohn, Y. S. *Polyhedron* **1997**, *16*, 2421–2428.
458. Kim, K. M.; Lee, Y.-A.; Lee, S. S.; Sohn, Y. S. *Inorg. Chim. Acta* **1999**, *292*, 52–56.
459. Song, R.; Kim, K. M.; Lee, S. S.; Sohn, Y. S. *Inorg. Chem.* **2000**, *39*, 3567–3571.
460. Song, R.; Kim, K. M.; Sohn, Y. S. *Inorg. Chim. Acta* **2002**, *338*, 89–93.
461. Kim, K. M.; Sohn, Y. S. *Inorg. Chem.* **1998**, *37*, 6109–6112.
462. Lee, Y.-A.; Jung, O.-S. *Bull. Chem. Soc. Jpn.* **2002**, *75*, 1533–1537.
463. Al-Baker, S.; Vollano, J. F.; Dabrowiak, J. C. *J. Am. Chem. Soc.* **1986**, *108*, 5643–5644.
464. Davies, H. O.; Brown, D. A.; Yanovsky, A. I.; Nolan, K. B. *Inorg. Chim. Acta* **1995**, *237*, 71–77.
465. Steinborn, D.; Junicke, H.; Heinemann, F. W. *Inorg. Chim. Acta* **1997**, *256*, 87–92.
466. Steinborn, D.; Gravenhorst, O.; Junicke, H.; Heinemann, F. W. *Z. Naturforsch.* **1998**, *53B*, 581–586.
467. Watabe, M.; Kai, M.; Asanuma, S.; Yoshikane, M.; Horiuchi, A.; Ogasawara, A.; Watanabe, T.; Mikami, T.; Matsumoto, T. *Inorg. Chem.* **2001**, *40*, 1496–1500.
468. Watabe, M.; Kobayashi, T.; Kawahashi, T.; Hino, A.; Watanabe, T.; Mikami, T.; Matsumoto, T.; Suzuki, M. *J. Inorg. Biochem.* **1999**, *73*, 1–5.
469. Bissinger, H.; Beck, W. *Z. Naturforsch.* **1985**, *40B*, 507–511.
470. Mueller, G.; Riede, J.; Beyerle-Pfner, R.; Lippert, B. *J. Am. Chem. Soc.* **1984**, *106*, 7999–8001.
471. Schwarz, F.; Lippert, B.; Schoellhorn, H.; Thewalt, U. *Inorg. Chim. Acta* **1990**, *176*, 113–121.
472. Frommer, G.; Preut, H.; Lippert, B. *Inorg. Chim. Acta* **1992**, *193*, 111–117.
473. Renn, O.; Lippert, B.; Albinati, A.; Lianza, F. *Inorg. Chim. Acta* **1993**, *211*, 177–182.
474. Schoellhorn, H.; Beyerle-Pfner, R.; Thewalt, U.; Lippert, B. *J. Am. Chem. Soc.* **1986**, *108*, 3680–3688.
475. Iakovidis, A.; Hadjiliadis, N. *Inorg. Chim. Acta* **1993**, *207*, 127–129.
476. Bernhardt, P. V.; Lawrance, G. A.; Hambley, T. W. *Inorg. Chem.* **1992**, *31*, 631–634.
477. Boucher, H. A.; Lawrance, G. A.; Lay, P. A.; Sargeson, A. M.; Bond, A. M.; Sangster, D. F.; Sullivan, J. C. *J. Am. Chem. Soc.* **1983**, *105*, 4652–4661.
478. Hagen, K. S.; Lay, P. A.; Sargeson, A. M. *Inorg. Chem.* **1988**, *27*, 3424–3426.
479. Buchler, J. W.; Lay, K.-L.; Stoppa, H. *Z. Naturforsch.* **1980**, *35B*, 433–438.
480. Milgrom, L. R.; Zuurbier, R. J.; Gascoyne, J. M.; Thompson, D.; Moore, B. C. *Polyhedron* **1994**, *13*, 209–214.
481. Mink, L. M.; Neitzel, M. L.; Bellomy, L. M.; Falvo, R. E.; Boggess, R. K.; Trainum, B. T.; Yeaman, P. *Polyhedron* **1997**, *16*, 2809–2817.
482. Mink, L. M.; Voce, J. W.; Ingersoll, J. E.; Nguyen, V. T.; Boggess, R. K.; Washburn, H.; Grove, D. I. *Polyhedron* **2000**, *19*, 1057–1062.
483. Kim, D.; Holten, D.; Gouterman, M.; Buchler, J. W. *J. Am. Chem. Soc.* **1984**, *106*, 4015–4017.
484. Freeman, W. A. *J. Am. Chem. Soc.* **1983**, *105*, 2725–2729.
485. Kukushkin, V. Y.; Bel'skii, V. K.; Aleksandrova, E. A.; Kononov, V. E.; Kirakosyan, G. A. *Inorg. Chem.* **1992**, *31*, 3836–3840.
486. Kukushkin, V. Y.; Pakhomova, T. B.; Kukushkin, Y. N.; Herrmann, R.; Wagner, G.; Pombeiro, A. J. L. *Inorg. Chem.* **1998**, *37*, 6511–6517.
487. Wagner, G.; Pombeiro, A. J. L.; Kukushkin, Y. N.; Pakhomova, T. B.; Ryabov, A. D.; Kukushkin, V. Y. *Inorg. Chim. Acta* **1999**, *292*, 272–275.
488. Kukushkin, V. Y.; Pakhomova, T. B.; Bokach, N. A.; Wagner, G.; Kuznetsov, M. L.; Galanski, M.; Pombeiro, A. J. L. *Inorg. Chem.* **2000**, *39*, 216–225.
489. Garnovskii, D. A.; Guedes da Silva, M. F. C.; Pakhomova, T. B.; Wagner, G.; Duarte, M. T.; Frausto da Silva, J. J. R.; Pombeiro, A. J. L.; Kukushkin, V. Y. *Inorg. Chim. Acta* **2000**, *300–302*, 499–504.
490. Bokach, N. A.; Kukushkin, V. Y.; Kuznetsov, M. L.; Garnovskii, D. A.; Natile, G.; Pombeiro, A. J. L. *Inorg. Chem.* **2002**, *41*, 2041–2053.
491. Luzyanin, K. V.; Haukka, M.; Bokach, N. A.; Kuznetsov, M. L.; Kukushkin, V. Y.; Pombeiro, A. J. L. *J. Chem. Soc., Dalton Trans.* **2002**, 1882–1887.

492. Koshy, K. C.; Harris, G. M. *Inorg. Chem.* **1983**, *22*, 2947–2953.
493. Appleton, T. G.; Hall, J. R.; Williams, M. A. *Inorg. Chim. Acta* **1982**, *61*, 51–56.
494. Kuroda, R.; Neidle, S.; Ismail, I. M.; Sadler, P. J. *J. Chem. Soc., Dalton Trans.* **1983**, 823–825.
495. Davies, M. S.; Wong, P. N.; Hambley, T. W. *J. Inorg. Biochem.* **2002**, *91*, 205–211.
496. Jolley, J. N.; Yanovsky, A. I.; Kelland, L. R.; Nolan, K. B. *J. Inorg. Biochem.* **2001**, *83*, 91–100.
497. Basolo, F.; Morris, M. L.; Pearson, R. G. *Discuss. Faraday Soc.* **1960**, *29*, 80–91.
498. Drougge, L.; Elding, L. I. *Inorg. Chim. Acta* **1986**, *121*, 175–183.
499. Roat, R. M.; Yolles, S.; Rheingold, A. L. *Inorg. Chem.* **1986**, *25*, 3102–3105.
500. Roat, R. M.; Jerardi, M. J.; Kopay, C. B.; Heath, D. C.; Clark, J. A.; Demars, J. A.; Weaver, J. M.; Bezemer, E.; Reedijk, J. *J. Chem. Soc., Dalton Trans.* **1997**, 3615–3621.
501. Talman, E. G.; Bruening, W.; Reedijk, J.; Spek, A. L.; Veldman, N. *Inorg. Chem.* **1997**, *36*, 854–861.
502. Talman, E. G.; Kidani, Y.; Mohrmann, L.; Reedijk, J. *Inorg. Chim. Acta* **1998**, *283*, 251–255.
503. Choi, S.; Mahalingaiah, S.; Delaney, S.; Neale, N. R.; Masood, S. *Inorg. Chem.* **1999**, *38*, 1800–1805.
504. Galanski, M.; Keppeler, B. K. *Inorg. Chim. Acta* **2000**, *300–302*, 783–789.
505. Chen, L.; Lee, P. F.; Ranford, J. D.; Vittal, J. J.; Wong, S. Y. *J. Chem. Soc., Dalton Trans.* **1999**, 1209–1212.
506. Choi, S.; Orbai, L.; Padgett, E. J.; Delaney, S.; Hakemian, A. S. *Inorg. Chem.* **2001**, *40*, 5481–5482.
507. Dunham, S. U.; Abbott, E. H. *Inorg. Chim. Acta* **2000**, *297*, 72–78.
508. Arendse, M. J.; Anderson, G. K.; Majola, R. N.; Rath, N. P. *Inorg. Chim. Acta* **2002**, *340*, 65–69.
509. Chandayot, P.; Fanchiang, Y. T. *Inorg. Chem.* **1985**, *24*, 3532–3534.
510. Chandayot, P.; Fanchiang, Y. T. *Inorg. Chem.* **1985**, *24*, 3535–3537.
511. Shi, T.; Berglund, J.; Elding, L. I. *Inorg. Chem.* **1996**, *35*, 3498–3503.
512. Shi, T.; Berglund, J.; Elding, L. I. *J. Chem. Soc., Dalton Trans.* **1997**, 2073–2077.
513. Shi, T.; Elding, L. I. *Inorg. Chim. Acta* **1998**, *282*, 55–60.
514. Lemma, K.; Shi, T.; Elding, L. I. *Inorg. Chem.* **2000**, *39*, 1728–1734.
515. Hindmarsh, K.; House, D. A.; van Eldik, R. *Inorg. Chim. Acta* **1998**, *278*, 32–42.
516. Pal, B.; Gupta, K. K. S. *Bull. Chem. Soc. Jpn.* **2000**, *73*, 553–560.
517. Kratochwil, N. A.; Ivanov, A. I.; Patriarca, M.; Parkinson, J. A.; Gouldsworthy, A. M.; Murdoch, P. d. S.; Sadler, P. J. *J. Am. Chem. Soc.* **1999**, *121*, 8193–8203.
518. Bose, R. N.; Weaver, E. L. *J. Chem. Soc., Dalton Trans.* **1997**, 1797–1799.
519. Lemma, K.; House, D. A.; Retta, N.; Elding, L. I. *Inorg. Chim. Acta* **2002**, *331*, 98–108.
520. Hambley, T. W.; Battle, A. R.; Deacon, G. B.; Lawrenz, E. T.; Fallon, G. D.; Gatehouse, B. M.; Webster, L. K.; Rainone, S. J. *Inorg. Biochem.* **1999**, *77*, 3–12.
521. Battle, A. R.; Deacon, G. B.; Dolman, R. C.; Hambley, T. W. *Aust. J. Chem.* **2002**, *55*, 699–704.
522. Choi, S.; Filotto, C.; Bisanzo, M.; Delaney, S.; Lagasee, D.; Whitworth, J. L.; Jusko, A.; Li, C.; Wood, N. A.; Willingham, J.; Schwenker, A.; Spaulding, K. *Inorg. Chem.* **1998**, *37*, 2500–2504.
523. Peloso, A. *Polyhedron* **1991**, *10*, 2191–2201.
524. Peloso, A. *Polyhedron* **1992**, *11*, 2187–2193.
525. Wieghardt, K.; Koeppen, M.; Swiridoff, W.; Weiss, J. *J. Chem. Soc., Dalton Trans.* **1983**, 1869–1872.
526. Davies, M. S.; Hambley, T. W. *Inorg. Chem.* **1998**, *37*, 5408–5409.
527. Campbell, C. J.; Castineiras, A.; Nolan, K. B. *Inorg. Chim. Acta* **1996**, *245*, 257–263.
528. Puddephatt, R. J. *Coord. Chem. Rev.* **2001**, *219–221*, 157–185.
529. Peter, M.; Wachtler, H.; Ellmerer-Mueller, E.; Ongania, K.-H.; Wurst, K.; Peringer, P. *J. Organomet. Chem.* **1997**, *542*, 227–233.
530. Reinartz, S.; White, P. S.; Brookhart, M.; Templeton, J. L. *Organometallics* **2000**, *19*, 3748–3750.
531. Bronger, W.; Auffermann, G. *Angew. Chem., Int. Ed. Engl.* **1994**, *33*, 1112–1114.
532. Briant, C. E.; Gilmour, D. I.; Mingos, D. M. P. *J. Organomet. Chem.* **1986**, *308*, 381–392.
533. Ferguson, G.; Lloyd, B. R.; Puddephatt, R. J. *Organometallics* **1986**, *5*, 344–358.
534. Puddephatt, R. J.; Manojlović-Muir, L.; Muir, K. W. *Polyhedron* **1990**, *9*, 2676–2802.
535. Lloyd, B. R.; Bradford, A.; Puddephatt, R. J. *Organometallics* **1987**, *6*, 424–427.
536. Puddephatt, R. J.; Rashidi, M.; Vittal, J. J. *J. Chem. Soc., Dalton Trans.* **1991**, 2835–2843.
537. Ling, S. S. M.; Hadj-Bagheri, N.; Manojlović-Muir, L.; Muir, K. W.; Puddephatt, R. J. *Inorg. Chem.* **1987**, *26*, 231–235.
538. Berry, D. E.; Bushnell, G. W.; Dixon, K. R.; Moroney, P. M.; Wan, C. *Inorg. Chem.* **1985**, *24*, 2625–2634.
539. Matsumoto, K.; Sakai, K. *Adv. Inorg. Chem.* **2000**, *49*, 375–427.
- 539a. Barton, J. K.; Rabinowitz, H. N.; Szalda, D. J.; Liooard, S. J.; *J. Am. Chem. Soc.* **1977**, *99*, 2827–2829.
540. Sakai, K.; Matsumoto, K. *J. Am. Chem. Soc.* **1989**, *111*, 3074–3075.
541. Sakai, K.; Tanaka, Y.; Tsuchiya, Y.; Hirata, K.; Tsubomura, T.; Iijima, S.; Bhattacharjee, A. *J. Am. Chem. Soc.* **1998**, *120*, 8366–8379.
542. Clark, R. J. H.; Croud, V. B.; Khokhar, A. R. *Inorg. Chem.* **1987**, *26*, 3284–3290.
543. Clark, R. J. H.; Kurmoo, M.; Galas, A. M. R.; Hursthouse, M. B. *J. Chem. Soc., Dalton Trans.* **1983**, 1583–1586.
544. Fanizzi, F. P.; Natile, G.; Lanfranchi, M.; Tiripicchio, A.; Clark, R. J. H.; Michael, D. J. *J. Chem. Soc., Dalton Trans.* **1989**, 1689–1696.
545. Austin, E. J. W.; Barrie, P. J.; Clark, R. J. H. *Inorg. Chem.* **1992**, *31*, 4281–4285.
546. Austin, E. J. W.; Barrie, P. J.; Clark, R. J. H. *Inorg. Chem.* **1995**, *34*, 3859–3863.
547. Che, C. M.; Herbstein, F. H.; Schaefer, W. P.; Marsh, R. E.; Gray, H. B. *J. Am. Chem. Soc.* **1983**, *105*, 4604–4607.
548. Clark, R. J. H.; Kurmoo, M. *J. Chem. Soc., Dalton Trans.* **1985**, 579–585.
549. Kurmoo, M.; Clark, R. J. H. *Inorg. Chem.* **1985**, *24*, 4420–4425.
550. Clark, R. J. H.; Kurmoo, M.; Dawes, H. M.; Hursthouse, M. B. *Inorg. Chem.* **1986**, *25*, 409–412.
551. Butler, L. G.; Zietlow, M. H.; Che, C. M.; Schaefer, W. P.; Sridhar, S.; Grunthaner, P. J.; Swanson, B. I.; Clark, R. J. H.; Gray, H. B. *J. Am. Chem. Soc.* **1988**, *110*, 1155–1162.
552. Stroud, M. A.; Drickamer, H. G.; Zietlow, M. H.; Gray, H. B.; Swanson, B. I. *J. Am. Chem. Soc.* **1989**, *111*, 66–72.
553. Yamashita, M.; Miya, S.; Kawashima, T.; Manabe, T.; Sonoyama, T.; Kitagawa, H.; Mitani, T.; Okamoto, H.; Ikeda, R. *J. Am. Chem. Soc.* **1999**, *121*, 2321–2322.

554. Kitagawa, H.; Onodera, N.; Sonoyama, T.; Yamamoto, M.; Fukawa, T.; Mitani, T.; Seto, M.; Maeda, Y. *J. Am. Chem. Soc.* **1999**, *121*, 10068–10080.
555. Kitagawa, H.; Mitani, T. *Coord. Chem. Rev.* **1999**, *190–192*, 1169–1184.
556. Yamashita, M.; Murase, I.; Ito, T.; Wada, Y.; Mitani, T.; Ikemoto, I. *Bull. Chem. Soc. Jpn.* **1985**, *58*, 2336–2339.
557. Clark, R. J. H.; Croud, V. B. *Inorg. Chem.* **1985**, *24*, 588–592.
558. Clark, R. J. H.; Croud, V. B. *Inorg. Chem.* **1986**, *25*, 1751–1756.
559. Clark, R. J. H.; Croud, V. B.; Wills, R. J. *Inorg. Chem.* **1988**, *27*, 2096–2101.
560. Oshio, H.; Toriumi, K.; Bandow, S.; Miyagawa, K.; Kurita, S. *J. Chem. Soc., Dalton Trans.* **1990**, 1013–1017.
561. Clark, R. J. H.; Michael, D. J.; Yamashita, M. *J. Chem. Soc., Dalton Trans.* **1991**, 3447–3450.
562. Kawashima, T.; Takai, K.; Aso, H.; Manabe, T.; Takizawa, K.; Kachi-Terajima, C.; Ishii, T.; Miyasaka, H.; Matsuzaka, H.; Yamashita, M.; Okamoto, H.; Kitagawa, H.; Shiro, M.; Toriumi, K. *Inorg. Chem.* **2001**, *40*, 6651–6655.
563. Zhou, M.; Pfennig, B. W.; Steiger, J.; Van Engen, D.; Bocarsly, A. B. *Inorg. Chem.* **1990**, *29*, 2456–2460.
564. Wu, Y.; Cohan, C.; Bocarsly, A. B. *Inorg. Chim. Acta* **1994**, *226*, 251–258.
565. Pfennig, B. W.; Bocarsly, A. B. *J. Phys. Chem.* **1992**, *96*, 226–233.
566. Pfennig, B. W.; Bocarsly, A. B. *Coord. Chem. Rev.* **1991**, *111*, 91–96.
567. Pfennig, B. W.; Lockard, J. V.; Cohen, J. L.; Watson, D. F.; Ho, D. M.; Bocarsly, A. B. *Inorg. Chem.* **1999**, *38*, 2941–2946.
568. Chang, C.; Ludwig, D.; Bocarsly, A. *Inorg. Chem.* **1998**, *37*, 5467–5473.
569. Podgajny, R.; Dromzee, Y.; Kruczala, K.; Sieklucka, B. *Polyhedron* **2001**, *20*, 685–694.
570. Berg, K. E.; Glaser, J.; Read, M. C.; Toth, I. *J. Am. Chem. Soc.* **1995**, *117*, 7550–7551.
571. Clark, H. C.; Jain, V. K. *Coord. Chem. Rev.* **1984**, *55*, 151–204.
572. Howard, J. A. K.; Spencer, J. L.; Turner, D. G. *J. Chem. Soc., Dalton Trans.* **1987**, 259–262.
573. Hao, L.; Spivak, G. J.; Xiao, J.; Vittal, J. J.; Puddephatt, R. J. *J. Am. Chem. Soc.* **1995**, *117*, 7011–7012.
574. Teo, B. K.; DiSalvo, F. J.; Waszczak, J. V.; Longoni, G.; Ceriotti, A. *Inorg. Chem.* **1986**, *25*, 2262–2265.
575. Lewis, G. J.; Roth, J. D.; Montag, R. A.; Safford, L. K.; Gao, X.; Chang, S. C.; Dahl, L. F.; Weaver, M. J. *J. Am. Chem. Soc.* **1990**, *112*, 2831–2832.
576. McNeal, C. J.; Hughes, J. M.; Lewis, G. J.; Dahl, L. F. *J. Am. Chem. Soc.* **1991**, *113*, 372–373.
577. Powell, J.; Gregg, M. R.; Sawyer, J. F. *J. Chem. Soc., Chem. Commun.* **1984**, 1149–1150.
578. Beringhelli, T.; Ceriotti, A.; D'Alfonso, G.; Della Pergola, R.; Ciani, G.; Moret, M.; Sironi, A. *Organometallics* **1990**, *9*, 1053–1059.
579. Ciani, G.; Moret, M.; Sironi, A.; Beringhelli, T.; D'Alfonso, G.; Della Pergola, R. *J. Chem. Soc., Chem. Commun.* **1990**, 1668–1670.
580. Ciani, G.; Moret, M.; Sironi, A.; Antognazza, P.; Beringhelli, T.; D'Alfonso, G.; Della Pergola, R.; Minoja, A. *J. Chem. Soc., Chem. Commun.* **1991**, 1255–1257.
581. Mingos, D. M. P.; Wardle, R. W. M. *J. Chem. Soc., Dalton Trans.* **1986**, 73–80.
582. Schoondergang, M. F. J.; Bour, J. J.; Schlebos, P. P. J.; Vermeer, A. W. P.; Bosman, W. P.; Smits, J. M. M.; Beurskens, P. T.; Steggerda, J. J. *Inorg. Chem.* **1991**, *30*, 4704–4709.
583. Kanters, R. P. F.; Schlebos, P. P. J.; Bour, J. J.; Bosman, W. P.; Smits, J. M. M.; Beurskens, P. T.; Steggerda, J. J. *Inorg. Chem.* **1990**, *29*, 324–328.
584. Kappen, T. G. M. M.; Schlebos, P. P. J.; Bour, J. J.; Bosman, W. P.; Smits, J. M. M.; Beurskens, P. T.; Steggerda, J. J. *J. Am. Chem. Soc.* **1995**, *117*, 8327–8334.
585. Ceriotti, A.; Demartin, F.; Longoni, G.; Manassero, M.; Marchionna, M.; Piva, G.; Sansoni, M. *Angew. Chem., Int. Ed. Engl.* **1985**, *24*, 697–698.
586. Kesanli, B.; Fettingner, J.; Gardner, D. R.; Eichhorn, B. *J. Am. Chem. Soc.* **2002**, *124*, 4779–4786.

6.6

Copper

R. MUKHERJEE

Indian Institute of Technology, Kanpur, India

6.6.1	INTRODUCTION: PURPOSE AND SCOPE	747
6.6.2	COORDINATION COMPOUNDS OF COPPER(III)	748
6.6.2.1	Amine Ligands	748
6.6.2.2	Pyridine-based Ligand	748
6.6.2.3	Deprotonated Amide Ligands	749
6.6.2.4	Thiol Ligand	750
6.6.2.5	Macrocyclic Ligands	750
6.6.3	COORDINATION COMPOUNDS OF COPPER(II)	752
6.6.3.1	Nitrogen Donor Ligands	752
6.6.3.1.1	<i>Polydentate aliphatic amine ligands</i>	752
6.6.3.1.2	<i>Heterocyclic nitrogen donor ligands</i>	752
6.6.3.2	Oxygen Donor Ligands	800
6.6.3.2.1	<i>Phenol-based ligands</i>	800
6.6.3.2.2	<i>Alcohol-based ligands</i>	817
6.6.3.3	Sulfur Donor Ligands	826
6.6.3.3.1	<i>Thiol and thioether-containing ligands</i>	826
6.6.3.4	Amide Ligands	827
6.6.3.5	Macrocyclic Ligands	840
6.6.3.6	Ligand-bridged Systems	854
6.6.3.6.1	<i>Carbonate ligands</i>	854
6.6.3.6.2	<i>Other bridged systems</i>	857
6.6.4	COORDINATION COMPOUNDS OF COPPER(I)	869
6.6.4.1	Carbon Donor Ligands	869
6.6.4.2	Nitrogen Donor Ligands	872
6.6.4.2.1	<i>Polydentate aliphatic amine ligands</i>	874
6.6.4.2.2	<i>Heterocyclic nitrogen donor ligands</i>	874
6.6.4.3	Phosphorus Donor Ligands	890
6.6.4.4	Oxygen Donor Ligands	891
6.6.4.5	Sulfur Donor Ligands	895
6.6.4.5.1	<i>Thiol- and thioether-containing ligands</i>	895
6.6.4.6	Macrocyclic Ligands/Cryptands	896
6.6.5	REFERENCES	900

6.6.1 INTRODUCTION: PURPOSE AND SCOPE

The chapter on copper in the first edition of *Comprehensive Coordination Chemistry (CCC)*, published in 1987,¹ presented a contemporary overview of the field. Since then there has been an explosion of growth in the coordination chemistry of copper in both the nonbiological and biological areas. As part of an ongoing series, this article attempts to provide an overview of the major developments in the field since 1982, allowing a certain degree of overlap in order to preserve continuity.

The properties of metal-coordinated compounds, whether in classical inorganic coordination complexes, in organometallic compounds, or in bioinorganic model compounds, are determined in large measure by the nature of ligands bound to the metal ion. Focus is therefore placed on the design of chelating ligands whose metal-binding sites differ in the nature of the donor atom. The purpose of this

article is to update the progress made (i) in the design of chelating ligands, and (ii) in the development of systematic coordination chemistry of copper thereof. A large amount of structural data for coordination complexes of copper with various ligand types has been accumulated, giving rise to an opportunity to look into their structural varieties in a systematic manner. This chapter addresses at the appropriate point the importance and relevance of coordination chemistry in the context of bioinorganic chemistry. It is worth mentioning here that the coordination chemistry of metal ions, including copper, in the biosphere and geosphere is covered in Volume 8.

The material included in this chapter has been organized by oxidation state, with further subdivision into ligand donor type, and was obtained from reports published in primary research journals. The article will cover coordination complexes of copper in three oxidation states: Cu^{III} , Cu^{II} , and Cu^{I} . The sections dealing with specific ligand donor types cut across several structural types. In view of the all-inclusive nature of the previous review of *CCC*(1987), no effort will be made here to present a comprehensive account. Instead, specific cases will be chosen for discussion because they exemplify important concepts concerning the relationship of ligand structure to metal complex properties.

This chapter deals mainly with structural aspects of compounds; magnetic behavior of ligand-bridged dinuclear/polynuclear copper(II) centers has also been emphasized. Only those structures that exist as discrete molecules, as opposed to a polymeric network extending throughout the crystal lattice, will be considered. Specifically excluded are kinetic and mechanistic work and work related to stability constants, as is purely magnetic work, except where some direct relationship to coordination chemistry is involved. The present review also does not cover categorically multinuclear copper cluster compounds, neither does it attempt to explore organometallic compounds involving copper, extensive supramolecular networks, and work of an essentially catalytic nature.

Understandably, every reference cannot be cited and selection has had to be severely limited. Priority is given mainly to work since about the mid-1980s, but frequent references to reviews are provided in the text, both to those which are mainly comprehensive listings of papers and to those which deal critically with a particular topic leading back into earlier work. Whenever possible, references have been chosen with the latter feature in mind, particularly where several reports on one topic have appeared at about the same time. It is suggested that readers take note of two review articles from the late 1990s on copper.^{2,3} Owing to limitations of space the references given here are to the more frequently cited journals and review journals, and preference has been given to those published in English before October 2001. In order to illustrate more clearly how each ligand molecule is coordinated to the copper center(s), a diagrammatic representation of the structures has been made.

6.6.2 COORDINATION COMPOUNDS OF COPPER(III)

6.6.2.1 Amine Ligands

The activation of molecular oxygen by copper plays a central role in synthetically useful stoichiometric and catalytic oxidative conversions of organic molecules and in biological systems.⁴⁻²⁶

In 1996 Stack and co-workers reported an unusual 3:1 (copper: O_2 stoichiometry) reaction between a mononuclear copper(I) complex of a *N*-permethylated (1*R*,2*R*)-cyclohexanediamine ligand with dioxygen. The end product of this reaction, stable at only low temperatures (X-ray structure at -40°C) is a discrete, mixed-valence trinuclear copper cluster (**1**), with two Cu^{II} and a Cu^{III} center (Cu–Cu: 2.641 and 2.704 Å).²⁷ Its spectroscopic and magnetic behavior were also investigated in detail. The relevance of this synthetic complex to the reduction of O_2 at the trinuclear active sites of multicopper oxidases⁴⁻⁸ was discussed. Once formed, it exhibits moderate thermal stability, decomposed by a non-first-order process in about 3 h at -10°C . In the presence of trace water, the major isolated product was the bis(μ -hydroxo)dicopper(II) dimer (**2**).

Continuing their efforts with similar ligands, they prepared a thermally sensitive crystal of a bis(μ -oxo)dicopper(III) compound (**3**).²⁸ Average Cu–O bond distance and Cu–Cu distance are 1.806 Å and 2.743 Å, respectively. Spectroscopic and kinetic parameters for this compound were also investigated. They also studied the reactivity properties of the copper–dioxygen complexes.²⁵

6.6.2.2 Pyridine-based Ligand

In a major breakthrough, Suzuki and co-workers²⁹ demonstrated that a tetradentate ligand produced the bis(μ -oxo)dicopper(III) complex (**4**) (each copper ion has a square planar structure,

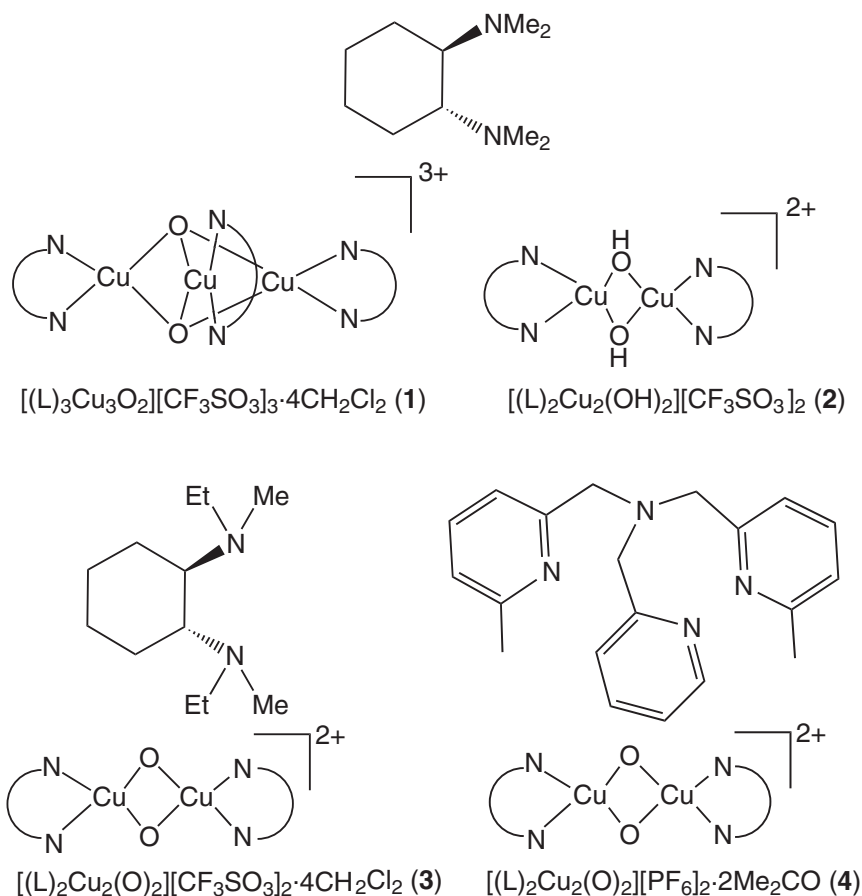

composed of a N_2O_2 donor set with two 6-methyl-2-pyridylmethyl sidearms which interact weakly with each copper ion in the axial positions; Cu–Cu: 2.758 Å), that can be reversibly converted to the copper(I) species (Section 6.6.4.2.2 (iv)) at $-80^\circ C$ in CH_2Cl_2 by the bubbling through of N_2 . Absorption spectral and resonance Raman studies were also done. They structurally characterized the corresponding bis(μ -hydroxo)dicopper(II) complex $[(L)Cu(OH)]_2[ClO_4]_2$ (Cu–Cu: 2.9368 Å) as well.

6.6.2.3 Deprotonated Amide Ligands

Amide groups are well known to offer two potential binding sites for metal-ion complexation (O vs. N-coordination).³⁰ For neutral amides complexation occurs generally at the oxygen atom, which is the most basic site. Amide deprotonation makes the nitrogen more basic than the oxygen atom, and complexation at nitrogen can be observed. The crystal structure of the complexes presented in this section and those presented in Section 6.6.3.4 are in agreement with these results.

Interest in copper compounds of the rare III oxidation state has mounted substantially since about 1980. Quite a few copper(III)-compatible ligand environments have been discovered. Collins *et al.*³¹ designed a series of polyanionic chelating (PAC) ligands containing *N*-amido and oxido donors to demonstrate that this family of ligands is a source for stabilizing the copper(III) state. The structure of complex (5) revealed a square-planar environment for the metal center. The Cu– N_{amido} bond distances are 1.813(4) Å and 1.804(4) Å, very similar to those found for the copper(III) tripeptide complex of tri- α -aminoisobutyric acid (1.801(4) Å and 1.804(5) Å).^{31,32} As a further matter of general interest, the Cu^{III}/Cu^{II} couple provides an excellent analytical tool for assessing the relative donor capacities of ligand complements. The property that Cu^{III}/Cu^{II} couples have of being highly sensitive to ligand environments has been exploited to assess the relative donor properties of a series of ligands containing *N*-amido, phenolato, and

alkoxido donors. The possible noninnocence of these ligands that contain aromatic groups was considered, and an approach for determining the best formal oxidation-state assignments for the metal centers in potentially ambiguous cases was introduced.

Using a deprotonated hydroxyiminoamide ligand, Krüger and co-workers³³ structurally characterized a discrete copper(III) compound (**6**). The square-planar structure is retained even in solution. Absorption and redox properties of this complex were also investigated.

In 2000 Hofmann and co-workers³⁴ demonstrated that their copper(I) ethylene complex (Section 6.6.4.1) could be oxidized by O₂ irreversibly, yielding a bis(μ -oxo)dicopper(III) complex (**7**). The anionic iminophosphanamide ligand [Bu^t₂P(NSiMe₃)₂]⁻ is highly basic and, because the small N–Cu–N bite angle of the neutral copper(I) complex leads to increased Lewis acidity of the copper center, provides better back-bonding capability, therefore stabilizing the copper(III) oxidation state.

6.6.2.4 Thiol Ligand

Krüger and co-workers³⁵ were successful in stabilizing remarkably a discrete copper(III) complex (**8**) containing aliphatic thiolate as the supporting ligand. They established the point that thiolate ligands can lower Cu^{III}/Cu^{II} redox potential. A very interesting paramagnetic copper(III) complex containing an octahedral CuS₆ coordination polyhedron was synthesized by Wieghardt and co-workers.³⁶ They first synthesized and structurally characterized a copper(II) complex, [(L)Co^{III}Cu^ICo^{III}(L)][PF₆]₂ (Section 6.6.3.5) (L is the hexadentate macrocyclic trianion 1,4,7-tris(4-*tert*-butyl-2-sulfidobenzyl)-1,4,7-triazacyclononane). One-electron oxidation of this compound yielded [(L)Co^{III}Cu^{III}Co^{III}(L)] [ClO₄]₃·2Me₂CO. EXAFS (extended X-ray absorption spectroscopy) clearly established the copper(III) state in this complex. Temperature-dependent magnetism and EPR spectral parameters established the *S* = 1 ground state of the copper(III) center. It is worth mentioning here the inherent problem associated with thiol oxidation³⁷ by copper(II) (Section 6.6.3.3.1).

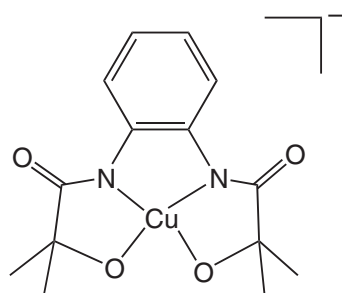

[PPh₄][Cu(L)]·2H₂O (**5**)

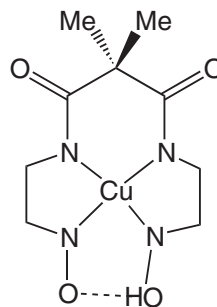

[Cu(HL)] (**6**)

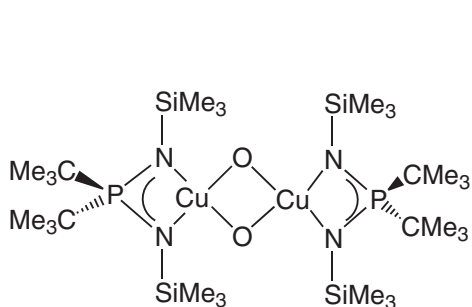

[(L)₂Cu₂(O)₂] (**7**)

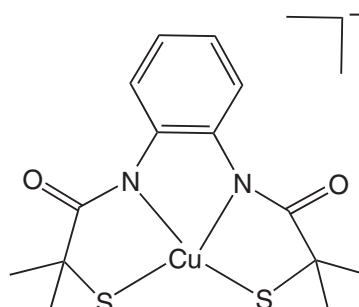

[Ph₄P][Cu(L)] (**8**)

6.6.2.5 Macrocyclic Ligands

Tolman and co-workers discovered a novel phenomenon: that when the copper(I) complex of 1,4,7-triisopropyl-triazacyclononane³⁸ is oxygenated at -78°C there exists an equilibrium

between the two oxygenated species $[\text{Cu}^{\text{II}}_2(\mu\text{-}\eta^2\text{:}\eta^2\text{-O}_2)]^{2+}$ (side-on peroxodicopper(II)) and $[\text{Cu}^{\text{III}}_2(\mu\text{-O})_2]^{2+}$ [bis(μ -oxo)dicopper(III)], depending on the solvent chosen, with CH_2Cl_2 favoring the former species and THF favoring the latter.³⁹ They structurally characterized the bis(μ -oxo)dicopper(III) compound (**9**), supported by tribenzyl-substituted ligand. They investigated absorption and resonance Raman features of such species and also carried out kinetic studies. The core geometry is contracted, compared to those of the bis(μ -hydroxo)dicopper(II) compounds that result from decomposition of the bis(μ -oxo) complexes upon warming.⁴⁰ Structural analyses of the decomposition products (complexes **(10)**–**(12)**) showed that they arise from N-dealkylation of the original capping macrocycles. Using a sterically hindered dinucleating bis(triazacyclononane) ligand they characterized one more bis(μ -oxo)dicopper(III) compound⁴¹ (**13**), and investigated how supporting ligand topology influences the structure and reactivity of copper–dioxygen complexes.^{21,22,24}

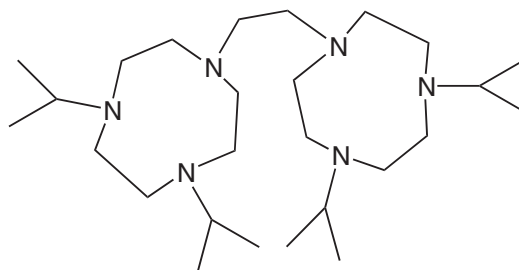
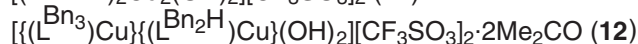
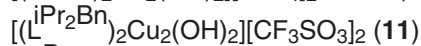
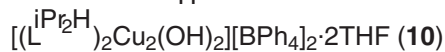
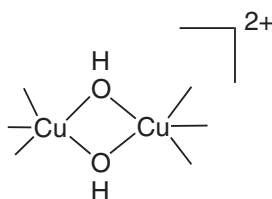
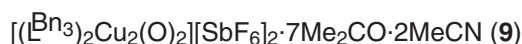
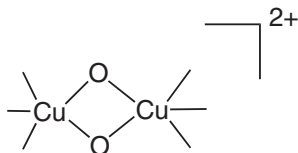
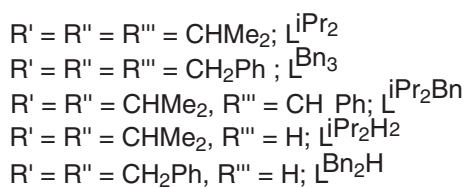
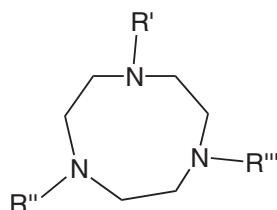

6.6.3 COORDINATION COMPOUNDS OF COPPER(II)

6.6.3.1 Nitrogen Donor Ligands

6.6.3.1.1 Polydentate aliphatic amine ligands

In the case of cytochrome c oxidases^{42–44} (which catalyze the reduction of dioxygen to water, the final step in aerobic metabolism), a binuclear iron–copper assembly is the site of dioxygen binding and subsequent reduction. As a part of providing synthetic examples for heme Fe^{III}-bridging ligand–Cu^{II} systems for this enzyme, Holm and co-workers^{45–49} structurally characterized an extensive series of monomeric copper(II) (as well as copper(I); Section 6.6.4.2.1) complexes of tetradentate ligands (Figure 1 and Table 1). These ligands coordinate in a tripodal manner, enforcing trigonal bipyramidal geometry at the metal; each arm of the ligand forms a puckered, five-membered chelate ring, with the ring conformations synchronized to impart an axial C₃ twist to the bound ligand. By use of these ligands, (distorted) trigonal bipyramidal (TBP) and tetragonal pyramidal (TP) arrangements, respectively, were stabilized with attendant axial and equatorial coordination. In many places throughout this chapter the geometry of a five-coordinate species has been defined in terms of a structural index parameter τ ($\tau = 0$ for square-pyramidal/tetragonal-pyramidal, and $\tau = 1$ for trigonal-bipyramidal geometries).⁵⁰

As a part of their ongoing investigations into the reaction of dioxygen with copper(I) complexes to identify copper–superoxo/peroxo intermediate species, Schindler and co-workers^{51–53} have also provided examples of a number of mononuclear copper(II) complexes (Table 1) (as well as copper(I); Section 6.6.4.2.1).

Comba and co-workers described a simple and efficient method for the determination of solution structures of weakly coupled binuclear copper(II) complexes.⁵⁴ The technique involves the combination of molecular mechanics^{55,56} and EPR spectroscopy. From this standpoint they reported the structure of the complex (29). Using an acyclic tertiary tetraamine ligand, Bernhardt reported⁵⁷ crystal structure of the complex (30), along with its redox properties.

6.6.3.1.2 Heterocyclic nitrogen donor ligands

In the blue, Type I copper proteins plastocyanin and azurin, the active-site structure comprises the trigonal array [CuN₂S] of two histidine ligands and one cysteine ligand about the copper,

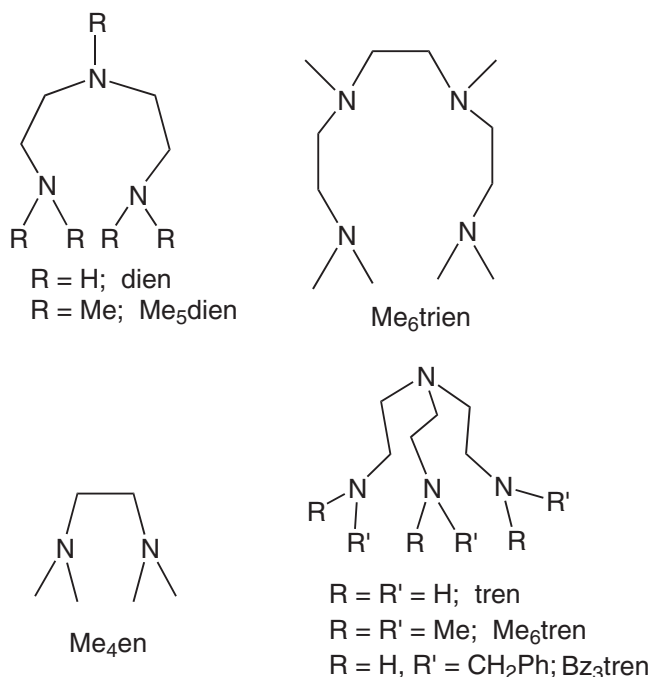
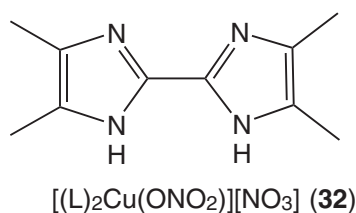
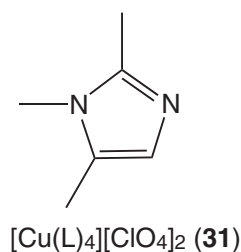
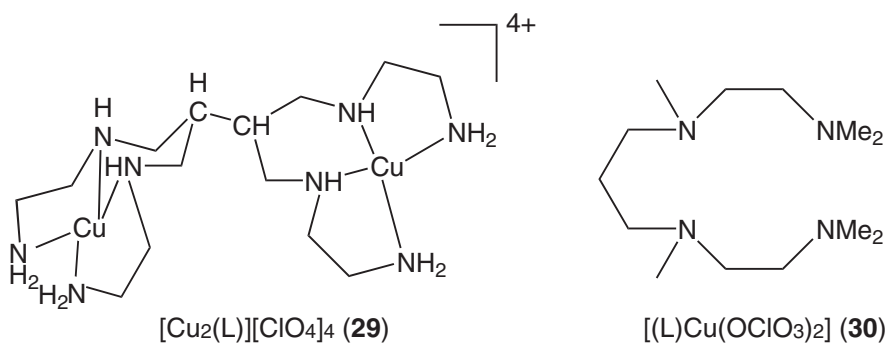
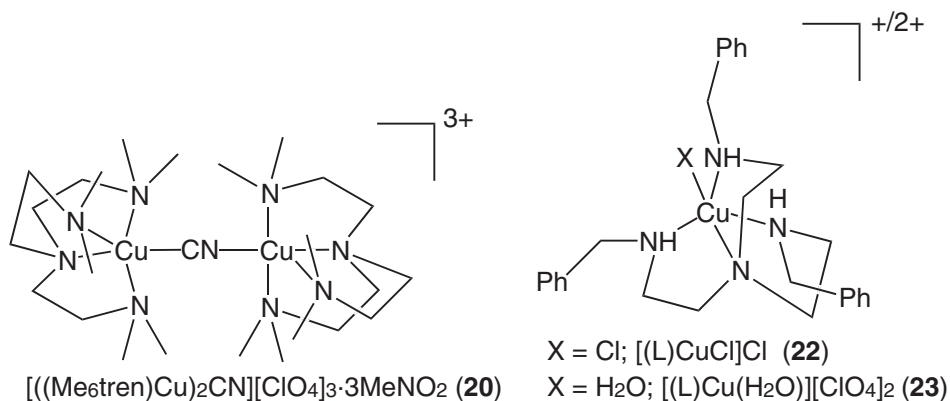

Figure 1 Monomeric copper complexes of tetradentate ligands.

Table 1 Stereochemistries of copper(II) complexes of aliphatic tripodal ligands.

Complex	Geometry	τ	References
$[(\text{tren})\text{Cu}(\text{MeCN})][\text{CF}_3\text{SO}_3]_2$ (14)	TBP	1.01	45
$[(\text{Me}_6\text{tren})\text{Cu}(\text{OH}_2)][\text{ClO}_4]_2$ (15)	TBP	0.965	46
$[(\text{Me}_6\text{tren})\text{Cu}(\text{OH})][\text{ClO}_4] \cdot \text{H}_2\text{O}$ (16)	TBP	0.94	46,47
$[(\text{Me}_6\text{tren})\text{Cu}(\text{MeCN})][\text{CF}_3\text{SO}_3]_2$ (17)	TBP	0.968	45
$[(\text{Me}_6\text{tren})\text{Cu}(\text{OSO}_2\text{CF}_3)][\text{CF}_3\text{SO}_3]$ (18)	TBP	0.90	45
$[(\text{Me}_6\text{tren})\text{Cu}(\text{CN})][\text{ClO}_4]$ (19)	TBP	1.02	48
$[(\text{Cu}(\text{Me}_6\text{tren}))_2(\text{CN})][\text{ClO}_4]_3 \cdot 3\text{MeNO}_2$ (20)	TBP	1.02	45
$[(\text{Me}_6\text{tren})\text{CuCl}][\text{ClO}_4]$ (21)			51
$[(\text{Bz}_3\text{tren})\text{CuCl}]\text{Cl}$ (22)	TBP	0.968	52
$[(\text{Bz}_3\text{tren})\text{Cu}(\text{H}_2\text{O})][\text{ClO}_4]_2$ (23)	TBP	0.968	52
$[(\text{Me}_5\text{dien})\text{Cu}(\text{OH}_2)(\text{OCMe}_2)][\text{ClO}_4]_2 \cdot \text{H}_2\text{O}$ (24)	TP	0.22	49
$[(\text{Me}_5\text{dien})\text{Cu}(\text{MeCN})_2][\text{BF}_4]_2$ (25)	TP	0.33	45
$[(\text{Me}_5\text{dien})\text{Cu}(\text{OSO}_2\text{CF}_3)_2]$ (26)	TP	0.21	45
$[(\text{Me}_6\text{trien})\text{CuCl}][\text{ClO}_4]$ (27)	TP	0.21	53
$[\text{Cu}(\text{Me}_4\text{en})_2(\text{OH})_2][\text{ClO}_4]_2$ (28) (structural type: 2)			53



together with a weak axial methionine interaction.^{4,5,8,19,58–60} This coordination geometry is largely retained in the oxidized and reduced forms of these proteins. Furthermore, in both forms the active-site geometry is considerably removed from the normally preferred geometries of Cu^{II}(tetragonal/square planar) and Cu^I(tetrahedral). Investigations of the coordination chemistry of copper(II) with chelating ligands incorporating pyridine, pyrazole, imidazole, and benzimidazole continue to be stimulated by interest in developing models for copper proteins, and in understanding the factors which give rise to the relationship between the coordination geometry and the nature of the donor atoms and redox potentials.^{37,61,62}

(i) *Imidazole-containing ligands*

Imidazole is a ubiquitous ligand for copper in proteins, as the coordinating side-chain of the amino-acid histidine. The presence of imidazole ligation has been confirmed crystallographically in several proteins and enzymes having mono-, bi-, and trinuclear copper centers.⁵⁸ The ubiquity of copper–imidazole bonding in copper-containing biomolecules has stimulated the synthesis and characterization of many imidazole-based ligands, where imidazole is present solely as, or as a part of, multidentate ligands and their copper complexes, in order to relate the spectroscopic properties of low-molecular-weight complexes to the natural systems. The complexes considered in this section are compiled in Table 2.

Nearly tetrahedral Cu^I/Cu^{II} model complexes that are well defined, approximately isostructural, and that contain biologically relevant ligation can be used to probe important questions about the active sites of copper metalloproteins that embody this structural feature. Schugar and co-workers characterized complexes (31)–(34) and studied their absorption and EPR spectral properties.^{63–66} Using a sterically demanding bidentate ligand, both Cu^I (Section 6.6.4.2.2(i)) and Cu^{II} complexes were prepared. X-ray structural analyses of compound (34)

Table 2 Stereochemistries of copper(II) complexes of imidazole-based chelating ligands.

Compound No.	Geometry	τ	References
(31)	Square planar		63
(32)	SP	0.24	64
(33)	Square planar		65
(34)	Distorted tetrahedral		66
(35)	Square planar		67
(36)	Distorted tetrahedral		68
(37)	SP	0.25	69
(38)	Distorted octahedra		69
(39)	Distorted TBP	0.85	70
(40)	Distorted TBP	0.94	70
(41)	Distorted TBP	0.93	71
(42)	Distorted TBP	0.89	71
(43,44)	DSP		73,74
(45)	TBP	0.96	77
(46)	SP	0.15	77
(47)	TBP	0.65	77
(48)	TBP	0.92,0.87	78
(49)	TBP	0.84 (Zn,0.91)	78
(50)	DSP	0.53,0.51	78
(51)	Distorted octahedral		65
(52)	TBP	0.99	79
(53)	TBP	0.76	79
(54)	DSP	0.46	79
(55)	Compressed TBP		80
(56)	Compressed octahedral		81
(57)	Compressed TBP		81
(58)	Elongated octahedral		80
(59)	Elongated octahedral		80
(60)	SP	0.05	82
(61)	SP	0.04	83

revealed a pseudotetrahedral $\text{CuN}(\text{imH})_4$ chromophore, with approximate D_{2d} point symmetry. The ligand exerts an unprecedented degree of geometric control of the coordination spheres for complexes of this type. The $\text{CuN}_2/\text{CuN}'_2$ dihedral angle is close to the ideal tetrahedral angle of 90° . Geometric constraints within the nine-membered chelate rings cause intraligand N–Cu–N angles to exceed the tetrahedral value, flattening (D_{2d}) the otherwise tetrahedral CuN_4 units; additional ligand-field effects result in a larger angle. Electrochemical measurements for the $[\text{CuL}_2]^{2+}/[\text{CuL}_2]^+$ couple in MeCN revealed a reversible redox reaction at a fairly positive potential. Using Cu^{I} and Cu^{II} complexes, as their BF_4^- salts of the *N*-methyl derivative of the ligand present in complex (34), the electron self-exchange rate in MeCN was determined by ^1H NMR techniques.⁶⁶ Garner and co-workers synthesized a series of sterically hindered imidazole proligands and investigated their copper coordination chemistry. Complex (35) is an example.⁶⁷ Electrochemical and EPR spectroscopic studies have also been done. The new diimidazole ligand was also synthesized by them and was shown to form a four-coordinate bis(diimidazole) Cu^{II} complex (36), as well as a Cu^{I} complex (Section 6.6.4.2.2(i)). The structural analysis revealed that the N–Cu–N angles are constrained by (i) the bite angle of the ligand to $94 \pm 2^\circ$; and (ii) the interligand steric interactions, which lead to the dihedral angle of the interligand planes of 68.2° . The steric bulk of the ligand, through interligand interactions between the phenyl groups substituted at the 4-positions of the imidazole rings, prevents the adoption of square-planar geometry. The dihedral angles observed for both structures reveal that in each case the CuN_4 geometry is intermediate between tetrahedral and square planar. The X-band EPR spectrum for the powdered complex is typical of an approximately D_2 CuN_4 center

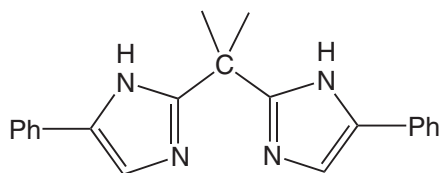

$[\text{Cu}(\text{L})_2][\text{ClO}_4]_2 \cdot 4\text{MeOH}$ (33)

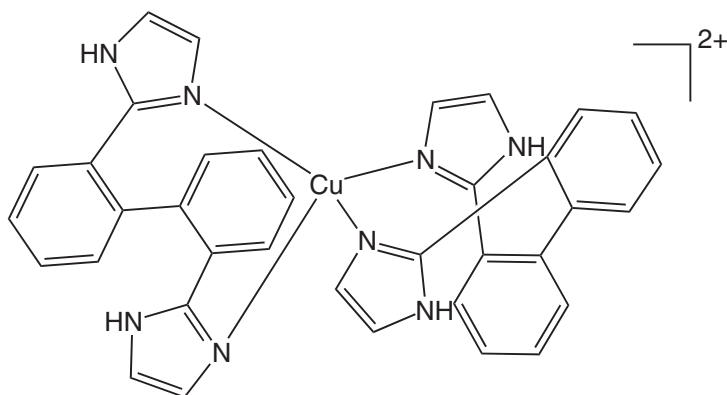

$[\text{Cu}(\text{L})_2][\text{ClO}_4]_2$ (34)

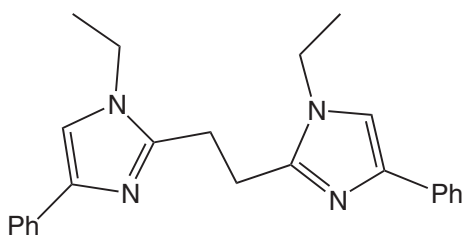

$[\text{Cu}(\text{L})_2][\text{BF}_4]_2$ (35)

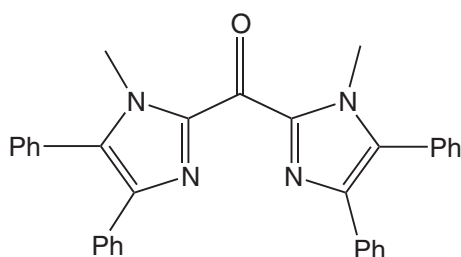

$[\text{Cu}(\text{L})_2][\text{BF}_4]_2 \cdot \text{CH}_2\text{Cl}_2$ (36)

possessing a d_{xy} ground state. Charge-transfer bands dominate the UV-vis spectra, and the complex is intensely colored. The EPR and electronic spectra indicate that the complex has a very similar structure in the solid state and in solution. The redox properties were also examined. In MeCN, electron self-exchange rate was also determined.⁶⁸ Using a variety of tridentate and tetradentate ligands with mixed donor sets (amine-imidazole, imidazole-pyridine), a number of mononuclear complexes (37)–(42) have been studied.^{69–71} EPR spectroscopic and cyclic voltammetric studies of these complexes were also made. Hydrogen bonding between bromide and the imidazole-NH atoms in compound (37) tie the individual molecules into an infinite two-dimensional network.⁶⁹ The structure of complex (38) reveals that the two nitrite anions are oriented differently, with one NO_2^- ion acting as a monodentate ligand and the other as (pseudo)didentate (one O atom behaving as semi-coordinate).⁶⁹ The potential of complexes (37) and (38) as active-site analogues of copper nitrite reductases (reduction of nitrite, to produce nitric oxide)⁷² has also been studied. Interestingly, the alcoholic O atom of the Schiff base ligand is not coordinated in complex (43)/(44).^{73,74}

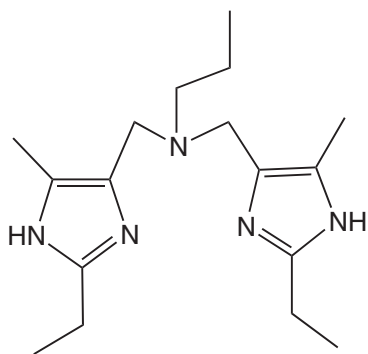

$[(\text{L})\text{CuBr}_2]$ (37)

$[(\text{L})\text{Cu}(\text{ONO})_2]$ (38)

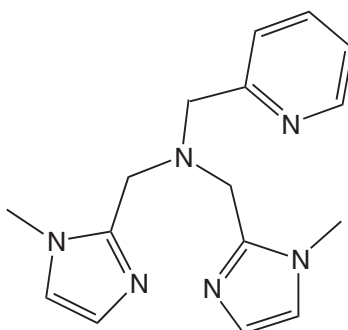

$[(\text{L})\text{CuCl}][\text{PF}_6] \cdot \text{MeCN}$ (39)

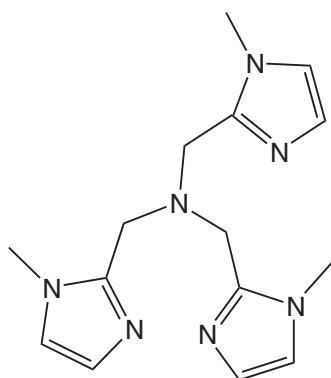

$[(\text{L})\text{CuCl}][\text{PF}_6]$ (40)

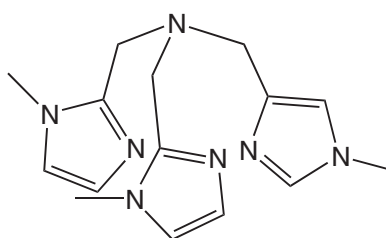

$[(\text{L})\text{CuCl}][\text{PF}_6]$ (41)

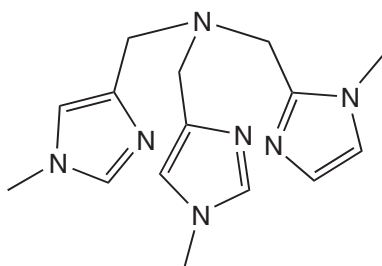

$[(\text{L})\text{CuCl}][\text{PF}_6]$ (42)

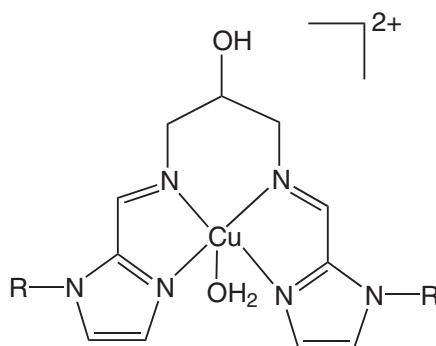

R = H; $[(\text{L})\text{Cu}(\text{H}_2\text{O})][\text{ClO}_4]_2$ (43)

R = Me; $[(\text{L})\text{Cu}(\text{H}_2\text{O})][\text{ClO}_4]_2$ (44)

Copper–zinc superoxide dismutase (SOD) contains an imidazolate-bridged $\text{Cu}^{\text{II}}\text{--Zn}^{\text{II}}$ heterodinuclear metal center in its active site.^{4,8,19,75,76} The copper ion is coordinated to four imidazole N atoms of histidine residues and a solvent (water) in distorted square-pyramidal geometry, while the zinc ion, located at a distance of 6.2 Å from the copper ion, is coordinated to a carboxylato O atom of an aspartic acid residue and three imidazole N atoms of histidine residues in a distorted tetrahedral structure. New dinucleating ligands having two metal-binding sites bridged by an imidazole binding have been designed and synthesized as model ligands for copper–zinc SOD by Fukuzumi and co-workers.^{77,78} The corresponding mononucleating ligand has also been synthesized for comparison (complexes (45)–(47)).⁷⁷ The copper ions in the imidazolate-bridged $\text{Cu}^{\text{II}}\text{--Cu}^{\text{II}}$ homodinuclear complexes ((48) and (50)) and $\text{Cu}^{\text{II}}\text{--Zn}^{\text{II}}$ heterodinuclear complex (49) have pentacoordinate geometries.⁷⁸ The coordination site occupied by a solvent can be susceptible to ligand substitution, providing a binding site for substrate superoxide. Magnetic measurements of complexes (48) and (50) have shown an antiferromagnetic (AF) exchange interaction with a coupling constant of $2J$ (singlet–triplet energy gap) = -73.4 cm^{-1} and -145.9 cm^{-1} , respectively. The $\text{Cu}^{\text{II}}\text{--Zn}^{\text{II}}$ distance of 6.197(2) Å agrees well with that of native enzyme. The EPR spectrum of complex (49) showed a signal which is characteristic of mononuclear trigonal-bipyramidal Cu^{II} complexes. The cyclic voltammetric behavior of these complexes was investigated in detail. The complexes catalyzed the dismutation of superoxide at biological pH; the SOD activity increased in the order (50) < (48) < (49). These monomeric, homodinuclear, and heterodinuclear complexes react with H_2O_2 in the presence of a base at -80°C yielding hydroperoxo Cu^{II} species (absorption and resonance Raman studies). The EPR spectral behavior of such species was also investigated.

From the standpoint of modeling Type I copper proteins,^{4,5,59,60} a variety of imidazole-based ligands containing thioether sulfurs and imidazole groups have been synthesized.^{61,62} The structures and spectroscopic properties of their copper(II) complexes (51)–(53) and (55)–(60) were investigated.^{65,79–82} To characterize apical copper(II)–thioether bonding, the complex (51) was

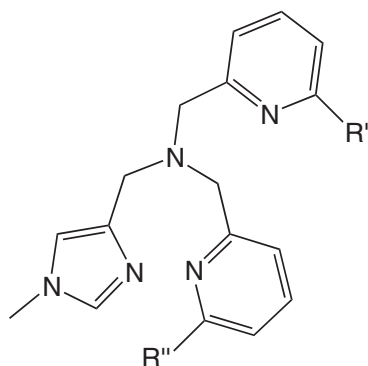

$\text{R}' = \text{R}'' = \text{H}$; $[(\text{L})\text{Cu}(\text{MeCN})][\text{ClO}_4]_2 \cdot \text{MeCN}$ (45)

$\text{R}' = \text{H}$, $\text{R}'' = \text{Me}$; $[(\text{L})\text{Cu}(\text{MeCN})][\text{ClO}_4]_2$ (46)

$\text{R}' = \text{R}'' = \text{Me}$; $[(\text{L})\text{Cu}(\text{MeCN})][\text{ClO}_4]_2$ (47)

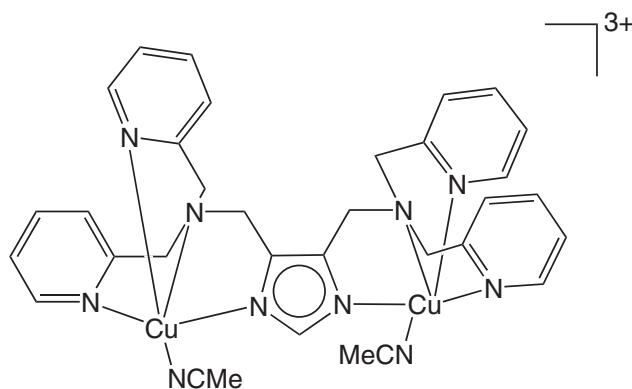

$[(\text{L})\text{Cu}_2(\text{MeCN})_2][\text{ClO}_4]_3 \cdot \text{MeCN} \cdot 3\text{H}_2\text{O}$ (48)

$[(\text{L})\text{CuZn}(\text{MeCN})_2][\text{ClO}_4]_3 \cdot 2\text{MeCN}$ (49)

investigated, to reveal discrete Cu^{II} monomers having tetragonal N_4S_2 ligand donor sets with equatorial CuN_4 and axial CuS_2 coordination.⁶⁵ Electronic and EPR spectral studies were also done. The compound (**54**) has a Cu_2Cl_2 core with bis(μ -chloro) bridges. The Cu–Cu separation is 3.552 Å.⁷⁹ All these compounds were characterized further by EPR and absorption spectroscopy.

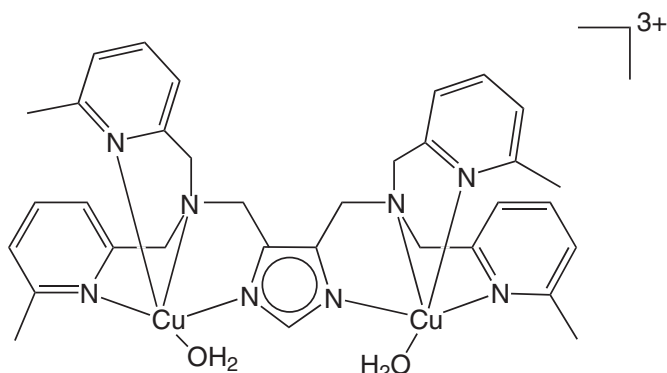

$[(\text{L})\text{Cu}_2(\text{H}_2\text{O})_2][\text{ClO}_4]_3 \cdot 4\text{H}_2\text{O}$ (**50**)

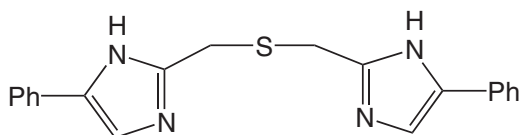

$[\text{Cu}(\text{L})_2][\text{ClO}_4]_2 \cdot 5\text{MeOH}$ (**51**)

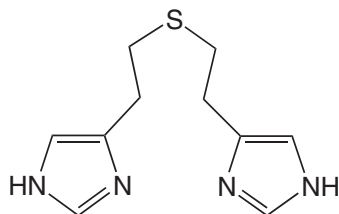

$[(\text{L})\text{CuCl}_2]$ (**52**)
 $[(\text{L})\text{Cu}(\text{NCS})_2]$ (**53**)

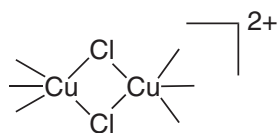

$[(\text{L})\text{CuCl}]_2[\text{ClO}_4]_2$ (**54**)

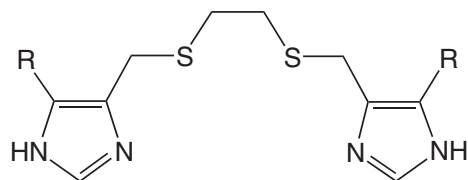

R = H; $[(\text{L})\text{CuCl}][\text{BF}_4]$ (**55**)
R = Me; $[(\text{L})\text{CuCl}_2]$ (**56**)
R = Me; $[(\text{L})\text{CuCl}]\text{Cl} \cdot 2\text{H}_2\text{O}$ (**57**)
R = Me; $[(\text{L})\text{CuCl}(\text{FBF}_3)]$ (**58**)
R = Me; $[(\text{L})\text{Cu}(\text{NCS})(\text{ONO}_2)]$ (**59**)

Using a new tripodal ligand, Sorrell and co-workers synthesized compound (**61**).⁸³ The dioxygen reactivity of the pseudotetrahedral complex of this ligand of composition $[(\text{L})\text{Cu}(\text{MeCN})][\text{BF}_4]$ (not structurally characterized) was examined. In MeOH at -78°C , the thermal decomposition of the side-on peroxodicopper(II) adduct in the presence of water yields a bis(hydroxide)-bridged

dicopper(II) dimer (not structurally characterized), $[(L)Cu(OH)]_2[BF_4]_2$, which further reacts with atmospheric CO_2 to produce a carbonato-bridged compound (**62**).

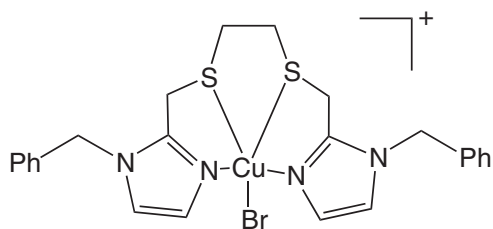

$[(L)CuBr]Br.xsolvent$ (**60**)

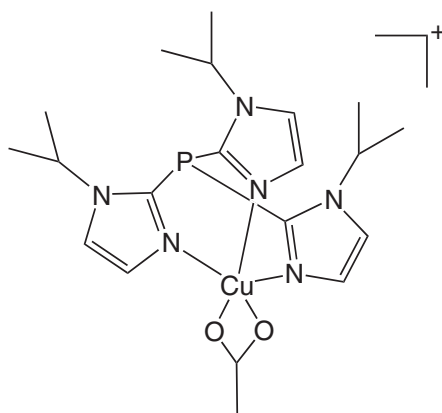

$[(L)Cu(O_2CMe)][BF_4]$ (**61**)

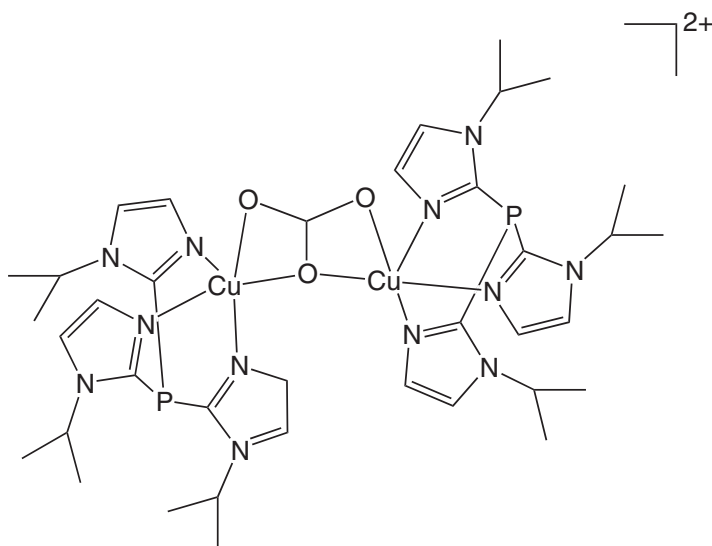

$[(L)Cu]_2(OCO_2)[BF_4]_2$ (**62**)

Dopamine β -hydroxylase ($D\beta H$) is a copper-containing glycoprotein that hydroxylates dopamine at the benzylic position to norepinephrine.⁸⁴ During the attempted crystallization of the bis(hydroxide)-bridged dicopper(II) dimer, a side product was subsequently isolated (complex **63**), revealing intramolecular hydroxylation at a formally benzylic position of the tris(imidazolyl)phosphine ligand.⁸⁵ The copper(II) center has an axially compressed TBP structure.

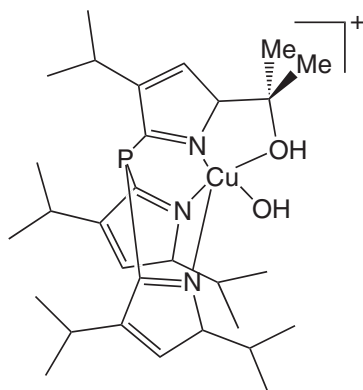

$[(L)Cu(OH)][BF_4] \cdot 1.625CH_2Cl_2$ (**63**)

A dinucleating ligand containing imidazoles and pyrazoles was designed and synthesized.⁸⁶ The synthesis and characterization of the copper(II) complexes were described, with the study aimed at modeling the active site of copper–zinc superoxide dismutase (SOD).^{4,8,19,75,76} Both non-imidazolato-bridged complex (**64**) (Cu–Cu distance: 6.104(1) Å) and imidazolato-bridged complex (**65**) (Cu–Cu distance: 5.566(1) Å) were obtained. Both structures show two copper centers in two different coordination environments: a distorted square pyramid ($\tau = 0.13$ for the imidazole-bridged complex, and $\tau = 0.12$ for the non-imidazole-bridged complex) and a distorted tetrahedron. Temperature-dependent magnetic susceptibility study of complex (**65**) shows AF behavior with $2J = -96 \text{ cm}^{-1}$. From pH-dependent EPR and electronic spectra, this complex has been demonstrated to be stable over quite a wide pH range, including the physiological pH values. A low concentration of complex (**65**) catalyzes the dismutation of superoxide at physiological pH.

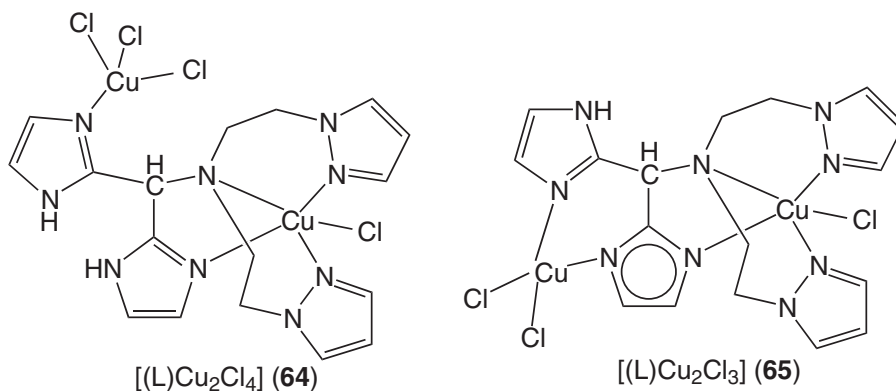

$[(L)Cu_2Cl_4]$ (**64**)

$[(L)Cu_2Cl_3]$ (**65**)

(ii) Benzimidazole-containing ligands

The incorporation of benzimidazole, in addition to mimicking the imidazole donor function, would result in distortions in coordination geometries, owing to its steric bulk. From this standpoint a number of complexes have been reported (Table 3).^{87–89}

From the standpoint of modeling copper nitrite reductases⁷² using benzimidazole-containing chelating ligands, Casella and co-workers⁹⁰ synthesized a number of mononuclear copper complexes; quite a few of them had nitrite bound ligands. The copper(I) complexes exhibited such activity and reacted rapidly with NO_2^- in the presence of stoichiometric amounts of acid to give NO and the corresponding copper(II) complexes. Under the same conditions, the reactions between the copper(I) complexes and NO^+ yielded the same amount of NO, indicating that protonation and dehydration of bound nitrite are faster than its reduction.

Table 3 Stereochemistries of copper(II) complexes of benzimidazole-based chelating ligands.

Compound No.	Geometry	τ	References
(66)	Distorted tetrahedral		87
(67)	Distorted tetrahedral		87
(68)	Distorted tetrahedral		87
(69)	Distorted tetrahedral		87
(70)	Elongated octahedral		88
(71)	Square planar		89
(72/73) ^a	Distorted SP (DSP)		90
(74)	DSP	0.27	90
(75)	Compressed TBP		90
(76) ^b	Four-coordinate		90
(77) ^{b,c}	Four-coordinate		90
(78)	Distorted TBP and SP		92
(79)	Distorted square planar		93
(80)	DSP		94
(81)	DSP	0.46	95
(82)	DSP	0.41	96
(83)	Distorted TBP		96
(84)	DSP		97
(85)	DSP		97
(86)	DSP	0.48	50
(87)	Pseudo octahedral		98
(88)	Pseudo octahedral		98
(89)	DSP	0.49	99
(90)	DSP	0.49	99
(91)	DSP	0.38	99
(92)	Square planar		100

^a ClO_4^- and BF_4^- salt, respectively; τ 0.13. ^b In between square planar and tetrahedral. ^c As NO_2^- bite angle is very small it is like that of (76).

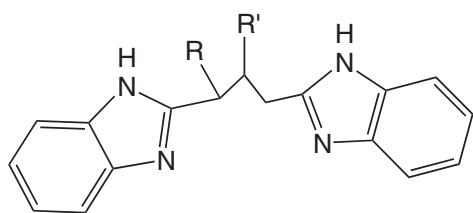

- R = Me, R' = H; $[(\text{L})\text{CuCl}_2]$ (66)
 R = Me, R' = H; $[(\text{L})\text{CuBr}_2]$ (67)
 R = H, R' = Me; $[(\text{L})\text{CuCl}_2]$ (68)
 R = H, R' = Me; $[(\text{L})\text{CuBr}_2]$ (69)

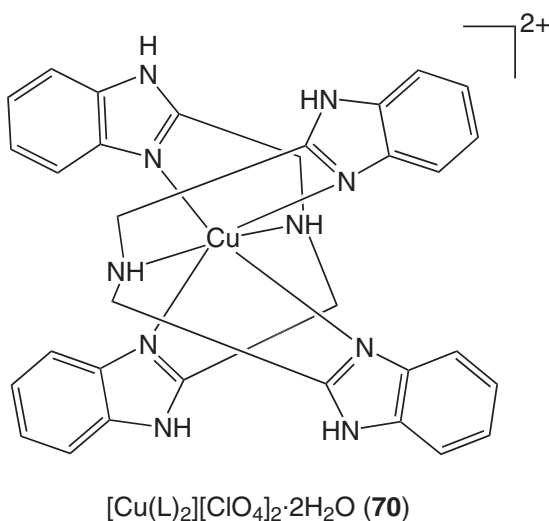

Hemocyanin and tyrosinase are dinuclear copper-containing proteins that bind or activate dioxygen.^{4,5,7-26} Hemocyanin functions as a dioxygen carrier, and tyrosinase, as a monooxygenase, which hydroxylates monophenols (tyrosine) and further oxidizes the *o*-diphenol to an *o*-quinone. The ubiquitous plant enzyme catechol oxidases,⁹¹ in contrast to tyrosinases, catalyze exclusively the oxidation of catechols to the corresponding *o*-quinone by molecular oxygen, without acting on monophenols. The resulting highly reactive quinones autopolymerize to form brown polyphenolic catechol melanins, a process thought to protect the damaged plant from pathogens or insects. In the course of their investigations on functional modeling of tyrosinase

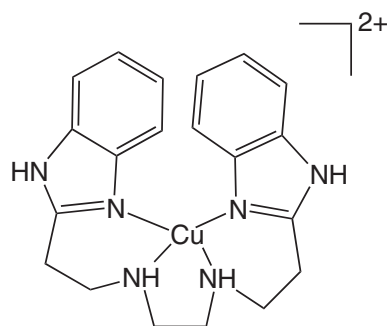
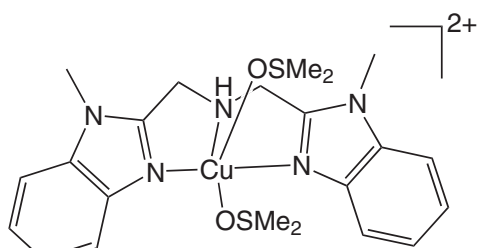
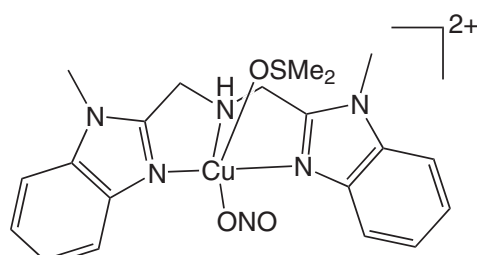
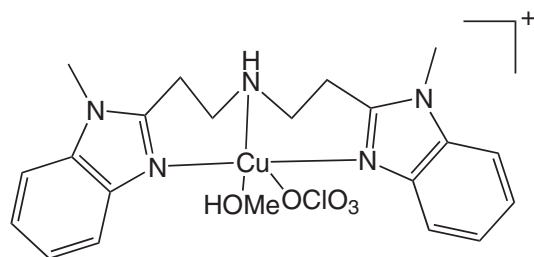
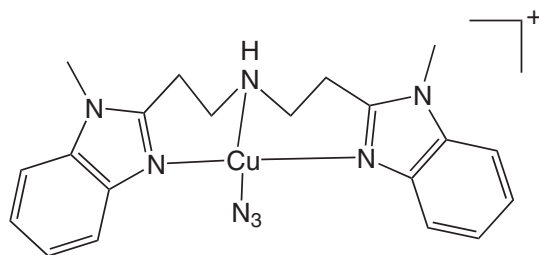
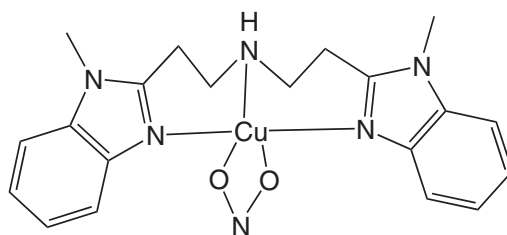
[Cu(L)]Br₂·2H₂O (**71**)[(L)Cu(OSMe₂)₂][ClO₄]₂ (**72**)[(L)Cu(OSMe₂)₂][BF₄]₂ (**73**)[(L)Cu(OSMe₂)(ONO)][ClO₄] (**74**)[(L)Cu(MeOH)(OCIO₃)][ClO₄] (**75**)[(L)Cu(N₃)][ClO₄] (**76**)[(L)Cu(ONO)][ClO₄]·MeCN (**77**)

and catechol oxidase, Casella and co-workers synthesized dinuclear complexes (**78**) (Cu–Cu: 8.02 Å)⁹² and (**79**) (Cu–Cu: 2.988 Å).⁹³ Voltammetric experiments on (**78**) revealed a 230 mV higher redox potential for the CuN₃(H₂O)₂ center than for the CuN₅ center. The complexes exhibit good catecholase activity. Using a tetraamino-tetrabenzimidazole ligand,⁹⁴ the structure of a dinuclear copper(II) complex (**80**) with a protonated piperazine ring has been solved. It is catalytically active in the air oxidation of di-*tert*-butylcatechol.

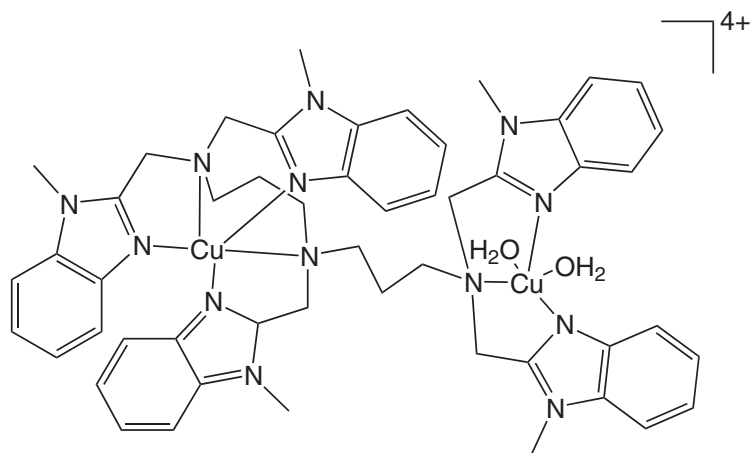
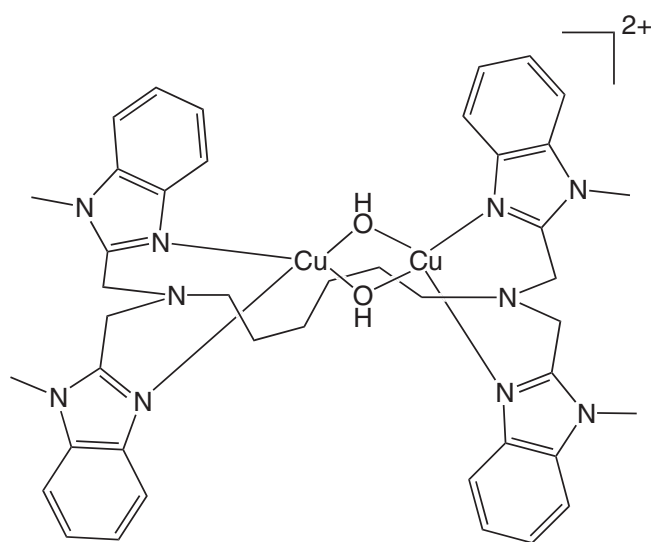
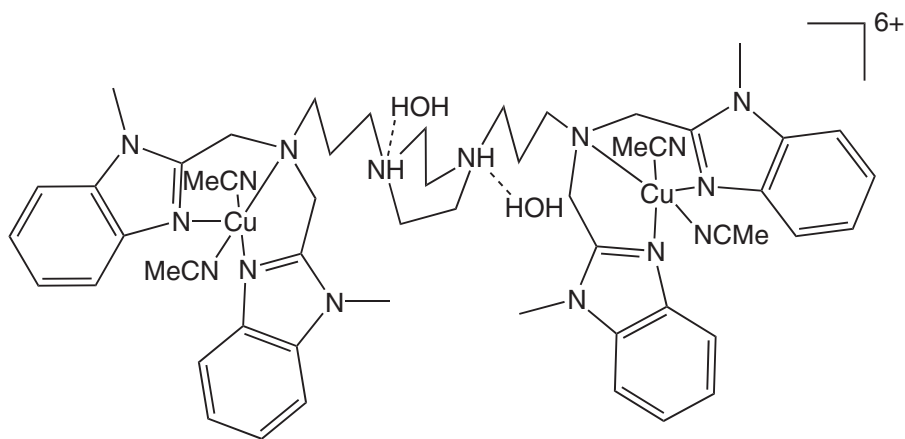
 $[(L)Cu_2(H_2O)_2][ClO_4]_4$ (**78**)

 $[(L)Cu(OH)_2][PF_6]_2$ (**79**)

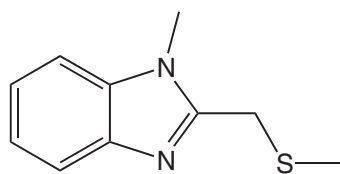
 $[(LH_2)Cu_2(MeCN)_4][ClO_4]_6 \cdot 2H_2O \cdot 3MeCN$ (**80**)

During the last two decades a large number of chelate ligands comprising heterocyclic N-donor, thiolate, and/or thioether S-donor centers have been studied,^{37,61,62} in connection with attempts to mimic the structure, spectroscopy, and redox behavior of “Type I” copper centers in “blue” copper proteins.^{4,5,8,19,59–61} Using a mixed benzimidazole/thioether bidentate ligand, Kaim and co-workers⁹⁵ synthesized a copper(I) (Section 6.6.4.2.2(ii)) and a copper(II) complex (**81**). Using bridged bis(benzimidazole)–thioether-containing ligands capable of providing N₂S donor sets, two distinct environments have been found in the crystal structures of (**82**) and (**83**).⁹⁶ As a part of their sustained efforts to model “Type I” copper centers, using two tridentate ligands, Addison and co-workers⁹⁷ recently investigated two compounds (**84**) and (**85**). Using a linear quadridentate N₂S₂ donor ligand, Addison *et al.* reported the structure of complex (**86**).⁵⁰ Along the same lines, Reedijk and co-workers⁹⁸ investigated the coordination chemistry of complexes (**87**) and (**88**), and Palaniandavar and co-workers^{99,100} prepared a number of copper(I) (Section 6.6.4.2.2(ii)) and copper(II) complexes (**89**)–(**92**) with bis(benzimidazole)–thioether-containing ligands.

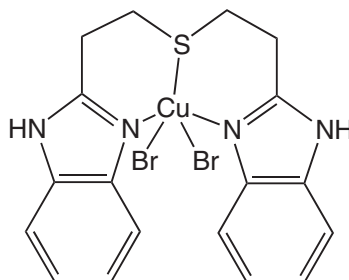

$[(L)_2Cu(OCIO_3)][ClO_4] \cdot 0.5MeOH$ (**81**)



$[(L)CuBr_2]$ (**82**)

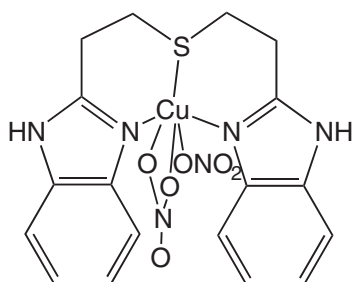

$[(L)Cu(ONO_2)(ONO_2)] \cdot MeOH$ (**83**)

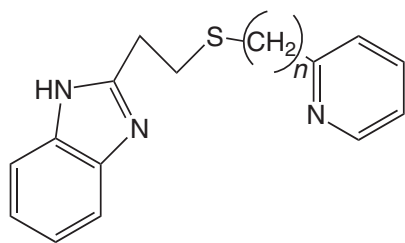

$n = 1; [(L)Cu][CF_3SO_3]_2 \cdot 0.5toluene \cdot H_2O$ (**84**)

$n = 2; [(L)Cu][CF_3SO_3]_2 \cdot 2H_2O$ (**85**)

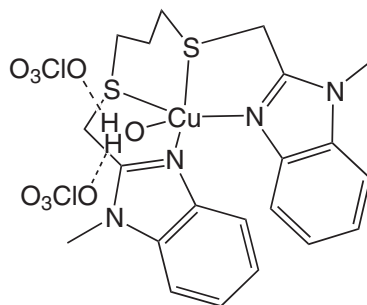

$[(L)Cu(H_2O)(OCIO_3)_2]$ (**86**)

The synthesis and coordination chemistry of an asymmetric multidentate ligand designed for modeling coordination-number asymmetry at metal sites in binuclear metalloproteins were reported.¹⁰¹ A dinuclear copper complex of this ligand demonstrates proof-of-concept for inducing coordinative unsaturation at one metal of the binuclear pair, and subsequent reaction with N₃⁻ illustrates site-directed reactivity. The copper ion in mononuclear complex (**93**) is present in distorted square-pyramidal geometry ($\tau = 0.43$). The hydroxo oxygen of the ligand does not participate in metal coordination. On the other hand, a structural analysis of the

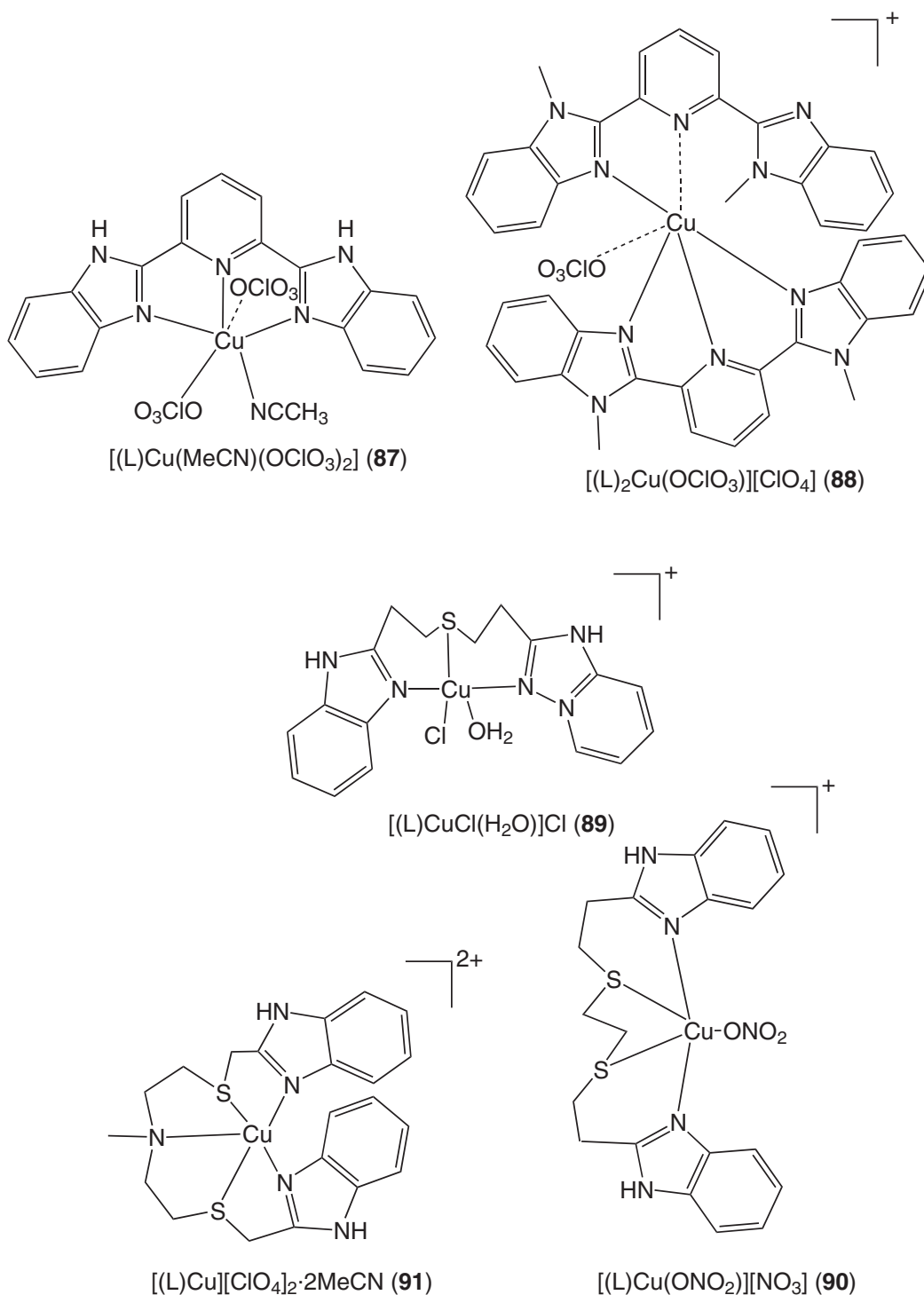

binuclear complex (**94**) reveals that as a result of the inherent asymmetry of the ligand, one copper ion has distorted trigonal-bipyramidal ($\tau=0.83$) geometry, while the other copper ion has distorted square-planar geometry. The potential for site-directed reactivity at a square-planar site was demonstrated by adding 0.5 equivalent of N_3^- ion to the binuclear copper complex in MeCN. The structure of the resulting azido-bridged complex (**95**) shows that the two copper ions within the binuclear unit are still coordinated by the ligand nitrogens, the acetate, and the ligand alkoxy oxygen.

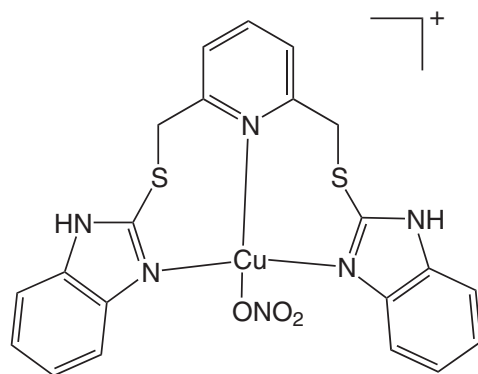

$[(L)Cu(ONO_2)][NO_3]$ (**92**)

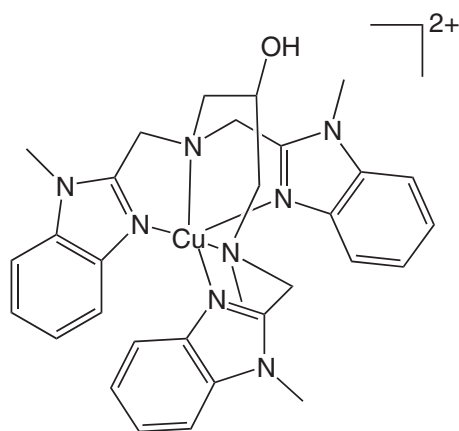

$[(L)Cu][ClO_4]_2 \cdot MeCN$ (**93**)

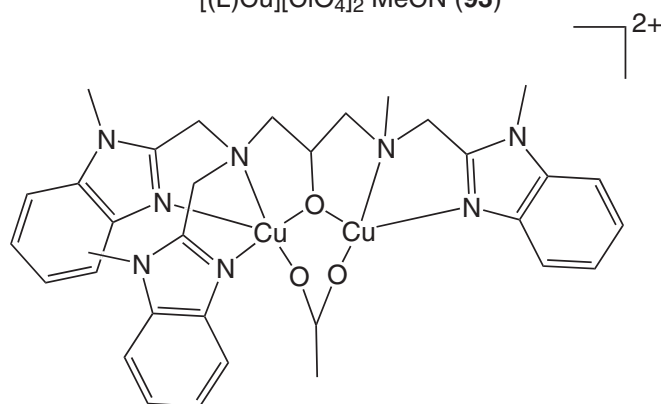

$[(L)Cu_2(O_2CMe)][ClO_4]_2 \cdot 2H_2O$ (**94**)

Müller *et al.*¹⁰² designed a new dinucleating ligand which allows for the “tuning” of the metal–metal distance, to provide a tentative coordination chemical modeling of hemocyanin and tyrosinase. The complex (**96**) of the unrestricted ligand presents an open conformation with discrete (4 + 2) copper coordination environments. The two halves of the ligand are rotated out of the *cis*-coplanar conformation by 116.6°, resulting in a relatively long Cu–Cu distance of 6.16 Å. Two oxygenation products of the dicopper(I) complex of a restricted ligand, which best approaches the geometry of a “Type III” site, were isolated. One is a tetranuclear copper(II) cluster (**97**), best described as a symmetric Cu₄O₄ eight-membered ring (Cu–Cu distances of 3.05 Å, 3.50 Å, and 6.30 Å). The other one is a dicopper(I) complex (Section 6.6.4.2.2(ii)).

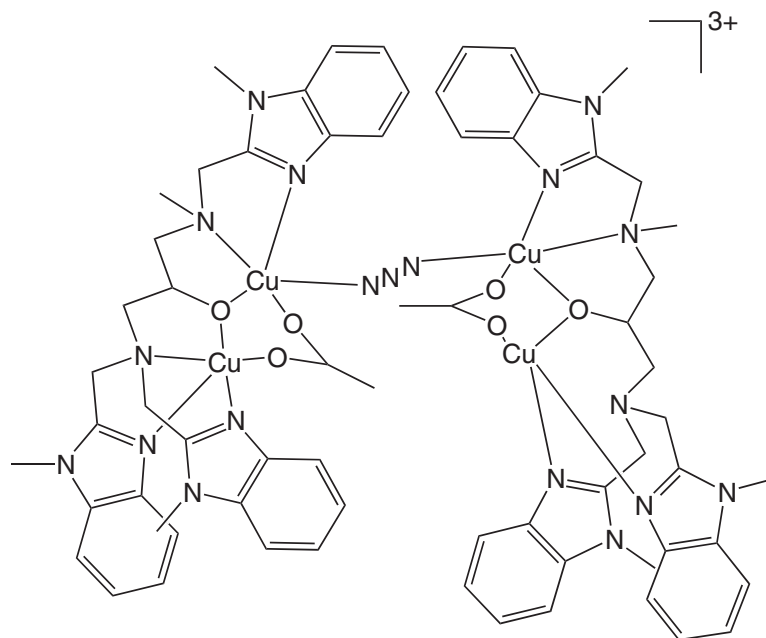

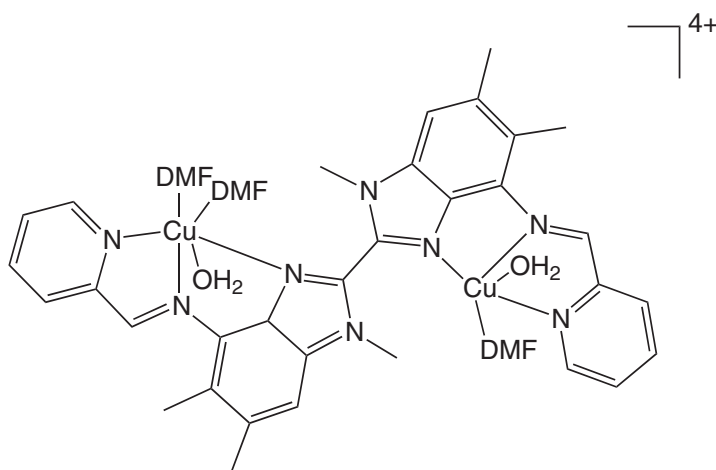
$$[\{(L)Cu_2(O_2CMe)_2(N_3)[ClO_4]_3 \cdot 8.5H_2O\} \quad (95)$$

$$[(L)Cu_2(DMF)_3(H_2O)_2][CF_3SO_3]_4 \quad (96)$$

(iii) Pyrazole-containing ligands

A wide range of pyrazole-containing chelating ligands^{103–107} have been designed, and their copper compounds have been studied as models for copper proteins.^{18–20,62,105,106} Among them, tris(pyrazol-1-yl)borate or “scorpionate” ligands by Trofimenko and co-workers^{103,104} have become increasingly important in the development of biomimetic coordination chemistry, with three histidine-like donors that can hold three *cis* sites fixed while leaving other coordination sites open. Notable successes include the work of Kitajima *et al.* with the hindered ligand hydrotris(3,5-diisopropyl-pyrazol-1-yl)borate in the syntheses of biomimetic copper(I) (Section 6.6.4.2.2(iii)), and copper(II) complexes. Kitajima *et al.* reported¹⁰⁸ the structure of complex (98), revealing an elongated rhombic octahedron with a CuN₆ chromophore. Very interestingly, Trofimenko *et al.* reported the structure of complex (99) (distorted tetrahedral). This is the first instance of a scorpionate free acid, acting as ligand.¹⁰⁹ Although this complex decomposed when

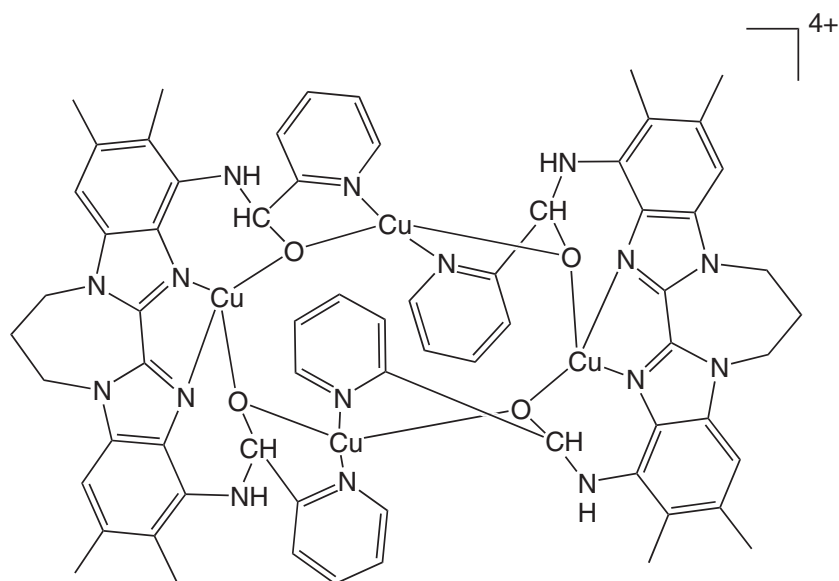

$$[\{H_2(L)O_2\}_2Cu_4][ClO_4]_4 \text{ (97)}$$

chromatographed, it reacted cleanly with aqueous $NaHCO_3$ solution to yield the carbonato-bridged dicopper(II) complex $[\{Cu(L)\}_2(OCO_2)]$ (**100**) (the core is similar to complex (**62**); Cu–Cu distance 4.058 Å). In 2001, structures of two new complexes (**101**) ($\tau = 0.34$) and (**102**) ($\tau = 0.30$) were reported.¹¹⁰

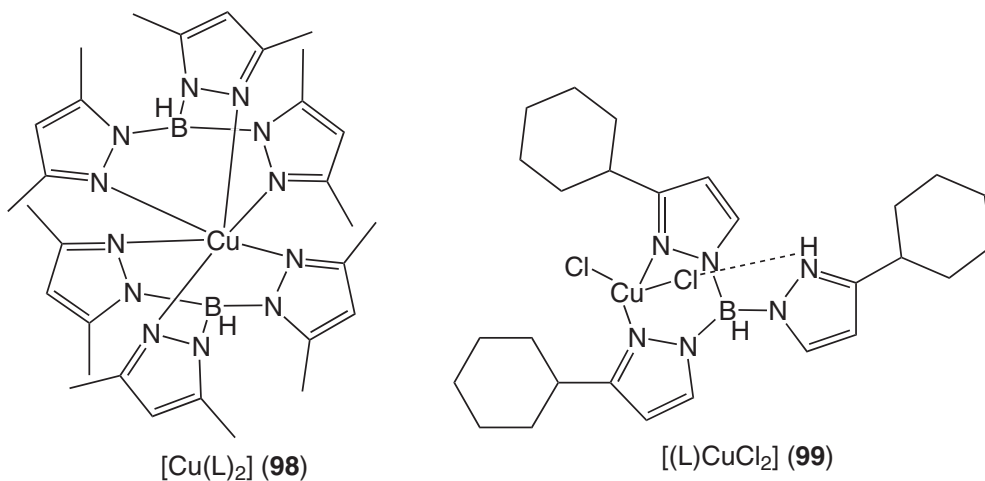

$$[Cu(L)_2] \text{ (98)}$$

$$[(L)CuCl_2] \text{ (99)}$$

From the standpoint of modeling copper–dioxygen chemistry of relevance to Hc/Tyr, Murray *et al.* reported in 2001¹¹¹ the results of their investigation of the reactivity towards dioxygen for two copper(I) complexes of the ligand tris(pyrazolyl)methane. One copper(I) complex was slowly oxidized in CH_2Cl_2 to form a bis-ligand complex (**103**). For the other complex, reversible oxygenation occurred in CH_2Cl_2 solution at $\sim 7^\circ C$ to yield a side-on peroxo complex (structural type (**108**); see below). Thermal decomposition of this species generated a strongly antiferromagnetically coupled di- μ -hydroxo bridged complex (**104**) (structural type: (**10**) to (**12**)).

In their pursuit of modeling “Type I” copper proteins, Kitajima *et al.* reported¹¹² a rare, tetrahedrally coordinated complex (**105**), which displayed an EPR spectrum consistent with the presence of the unpaired electron in the d_z^2 orbital.¹ They also isolated a square-pyramidal DMF adduct (complex (**106**)). They were successful in providing structural proof of a copper(II) complex (trigonal pyramidal) with $C_6F_5S^-$ -coordinated complex (**107**), with CuN_3S chromophore.¹¹³ The X-ray analysis (poor data set) of a closely similar complex with Ph_3CS^- as the

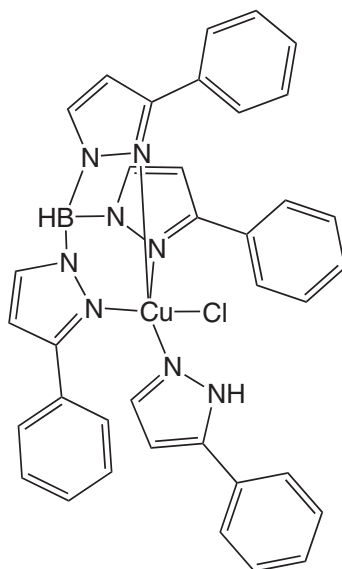
 $[(L)CuCl(L')Cl]$ (**101**)

 $[(L)CuCl(L')(NCS)]$ (**102**)

L' = 5-phenylpyrazole

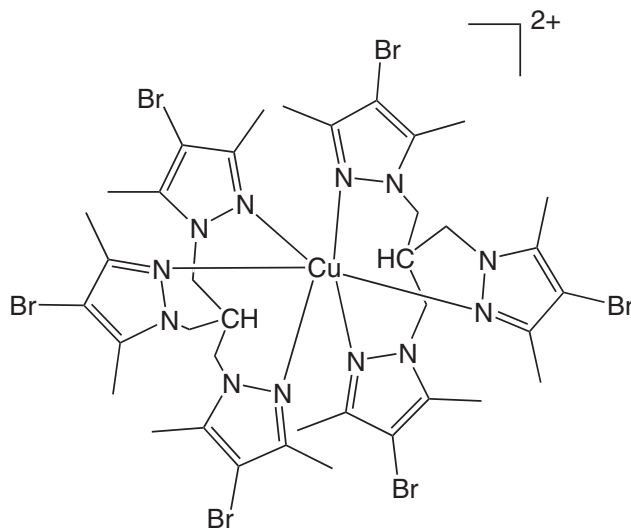

 $[Cu(L)_2][PF_6]_2 \cdot 2CH_2Cl_2$ (**103**)

thiolate ligand was also achieved. Tolman and co-workers characterized the first three-coordinate complexes of Cu^{II} (**107a**) and (**107b**), including a close structural analogue of the trigonal 'Type I' copper protein active sites.¹¹⁴

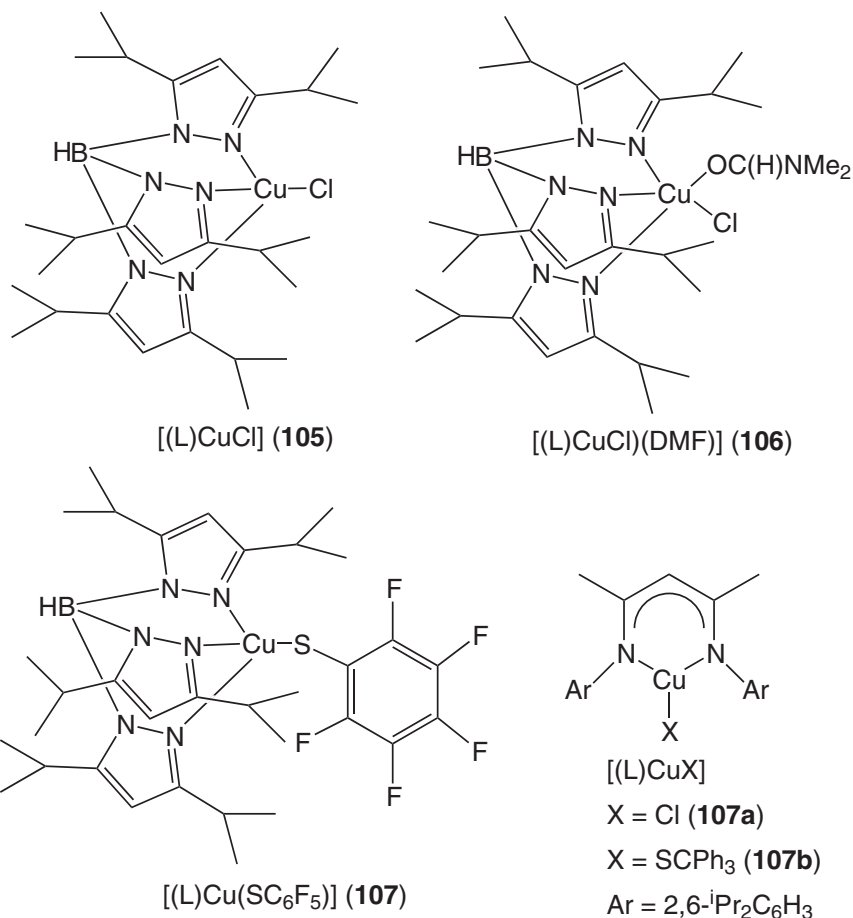
During the course of modeling copper–dioxygen chemistry, Kitajima *et al.* reported the synthesis of a μ -peroxo dinuclear complex with a 3,5-dimethyl-substituted tris(pyrazolyl)borate ligand, which showed remarkable physicochemical similarities to oxy-Hc and oxy-Tyr. Using a 3,5-di-isopropyl-substituted terminal ligand, they provided the first structural proof of the existence of μ - η^2 : η^2 peroxo dicopper(II) core (**108**) (copper geometry: distorted square pyramidal; Cu–Cu: 3.560 Å),^{115,116} and reported detailed characterization properties, which eventually led to the structural characterization of oxy-Hc.¹¹⁷ They were successful in preparing a similar core with a 3,5-di-phenyl-substituted ligand.¹¹⁶ They also synthesized and thoroughly characterized

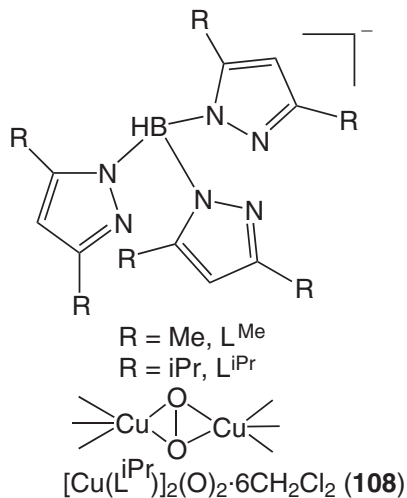

di- μ -hydroxo bridged complexes (**109**) (Cu–Cu: 2.937 Å)^{115,118} and (**110**) (Cu–Cu: 3.059 Å).¹¹⁹ The importance of $\mu\text{-}\eta^2\text{:}\eta^2$ peroxide was highlighted.¹²⁰ In this endeavor they characterized a number of very interesting complexes: (**111**)¹¹⁸, two carbonato-bridged complexes [(**112**), Cu–Cu: 4.044 Å,^{121,122} and (**113**), Cu–Cu: 4.140 Å¹¹⁹], an alkylperoxo complex (**114**),¹²³ and a μ -hydroxo-/ μ -azido-bridged complex (**115**) (Cu–Cu: 3.713 Å).¹²⁴ Kitajima and co-workers were also successful in providing the first example of a side-on superoxocopper(II) complex (**116**).¹²⁵



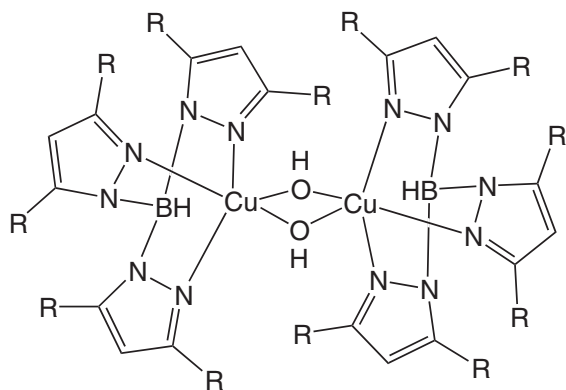

R = *i*Pr, $[(L)Cu(OH)]_2 \cdot 1.5CH_2Cl_2$ (**109**)
 R = Me, $[(L)Cu(OH)]_2 \cdot 2C_6H_6$ (**110**)

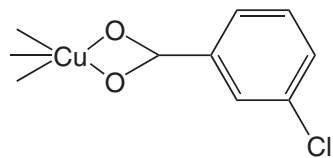

$[(L^{iPr})Cu(m\text{-Cl-benzoate})]$ (**111**)

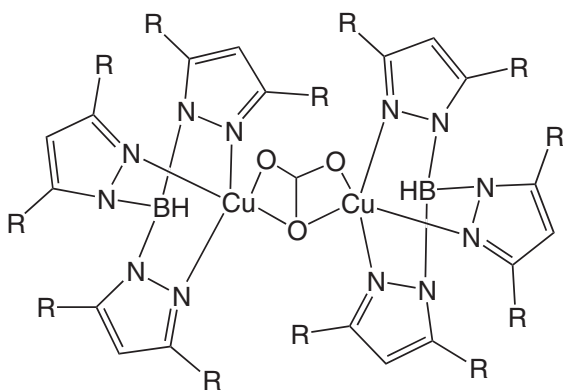

R = *i*Pr, $[Cu(L)]_2(OCO_2) \cdot 2MeCN$ (**112**)
 R = Me, $[Cu(L)]_2(OCO_2)$ (**113**)

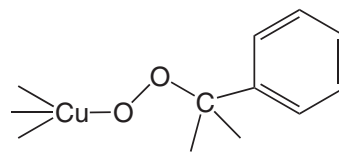

$[(L^{iPr})Cu(OOCMe_2Ph)]$ (**114**)

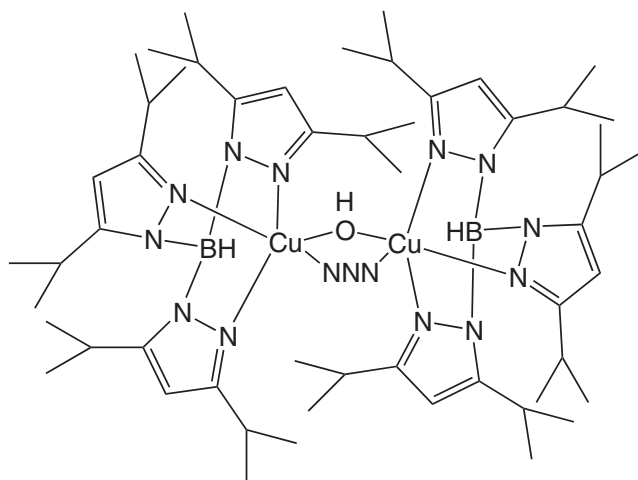

$[(L^{iPr})Cu]_2(OH)(N_3)$ (**115**)

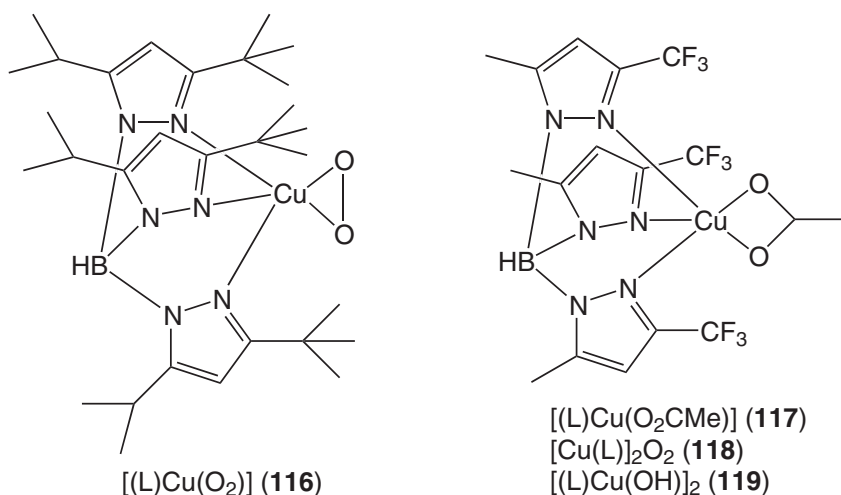

Using a fluorinated tris(pyrazolyl)borate ligand, Gorun and co-workers¹²⁶ synthesized a complex (**117**) ($\tau=0.06$). This group very successfully isolated and structurally characterized a dinuclear oxygenated complex, revealing that the crystal contains about 80% $\mu\text{-}\eta^2\text{:}\eta^2$ peroxo complex (**118**) (structural type: **(108)**) and 20% bis(μ -hydroxo) complex, (**119**) (structural type: **(109)**/**(110)**).¹²⁷

From the viewpoint of modeling nitrite reductases,⁷² Tolman and co-workers provided a number of structurally characterized complexes: (**120**) ($\tau=0.73$),¹²⁸ (**121**) (tetrahedral),¹²⁸ and (**122**) (approximately tetrahedral).^{128,129} Detailed structure and bonding aspects of coordinated NO were investigated, and its relevance to biology and heterogeneous catalysis was discussed.¹³⁰ In an elegant manner, they modeled N_2O generation by copper proteins and heterogeneous catalysts, through reductive disproportionation of Cu–NO species. To prove the reaction sequence, they isolated a nitrite-bound square-pyramidal complex (**123**).¹³¹

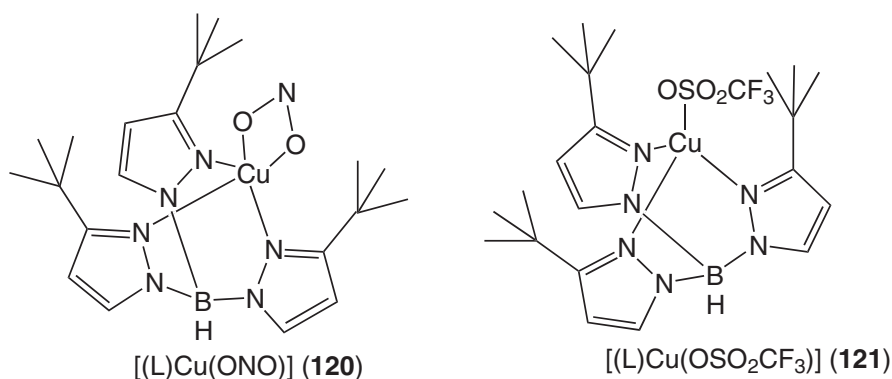

As a part of designing new, pyrazole-based ligands and exploring their copper coordination chemistry, Reedijk and co-workers synthesized two new complexes (**124**) (distorted octahedral) and (**125**) (tetrahedral), with two didentate bispyrazole ligands having an aliphatic spacer.¹³² Along the same lines, Pons *et al.* synthesized phenyl/pyridyl/pyrazole-based ligands and investigated their copper coordination chemistry: (**126**) (distorted square planar).¹³³ A large number of pyrazole-containing, nonplanar chelating ligands with additional donor sites (aliphatic amine, pyridyl groups, etc.) have been synthesized¹⁰⁷ to have a variable copper stereochemistry. A few representative examples with tridentate ligands include: (**127**) ($\tau=0.40$),¹³⁴ (**128**) ($\tau=0.12$),¹³⁵ (**129**) ($\tau=0.10$),¹³⁶ (**130**) (distorted tetrahedral) and (**131**) (distorted tetrahedral),¹³⁷ (**132**) ($\tau=0.54$),¹³⁸ (**133**) ($\tau=0.35$), and (**134**) ($\tau=0.18$).¹³⁹ Using two tridentate ligands, Feiters and co-workers have structurally characterized six copper(II) complexes (**(135)**–**(140)**)¹⁴⁰ with variable molecular structure and, as a consequence, varying electronic environment. The purpose of this

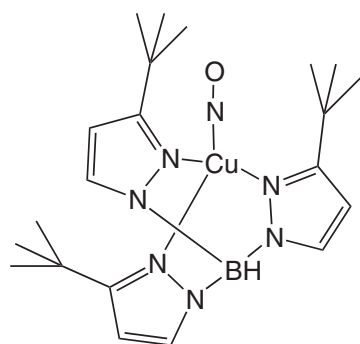
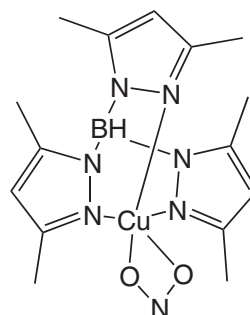
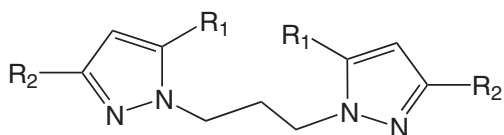
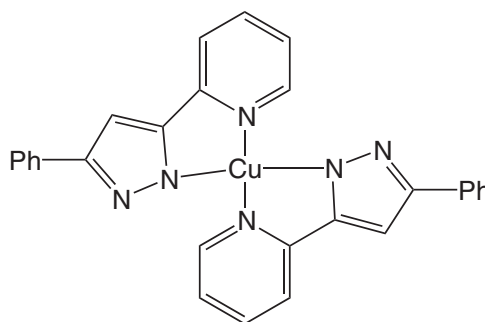
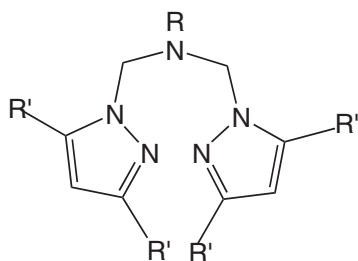
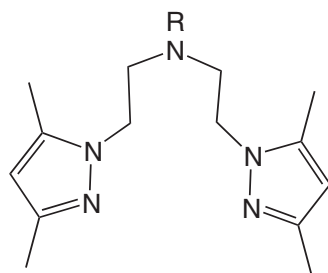
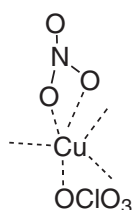
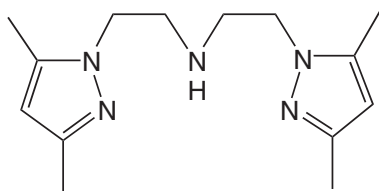
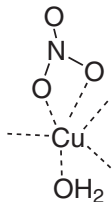
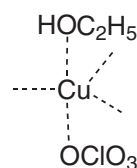
[(L)Cu(NO)]·0.5mesitylene (**122**)[(L)Cu(ONO)] (**123**)R₁ = Me; R₂ = H; [(L)Cu(ONO₂)₂] (**124**)R₁ = R₂ = Me; [(L)CuCl₂] (**125**)[Cu(L)₂] (**126**)R = Ph, R' = Me; [(L)CuBr₂] (**127**)R = Et, R' = H; [(L)CuBr₂] (**128**)R = CH₂Ph, R' = H; [(L)CuCl₂] (**129**)R = H, [(L)CuCl₂][CuCl₄] (**130**)[(L)CuCl][BF₄] (**131**)[(L)Cu(H₂O)₂][CF₃SO₃]₂ (**132**)R = Et, [(L)CuCl₂].EtOH (**133**)[(L)Cu(ONO₂)(H₂O)][NO₃] (**134**)[(L)Cu(ONO₂)₂] (**135**)[(L)Cu(ONO₂)] [NO₃] (**136**)[(L)Cu(C₂H₅OH)(OCIO₃)] [ClO₄] (**137**)

investigation was to elucidate the factors that control the geometry, redox behavior, and reactivity properties of copper(I) complexes with dioxygen. Using tetradentate ligands, Driessen and co-workers characterized five complexes with variable geometry: **(141)** (distorted octahedral),¹⁴¹ **(142)** (square planar) and **(143)** (square planar),¹⁴² **(144)** ($\tau=0.65$),¹⁴³ and **(145)** (distorted square planar).¹⁴⁴

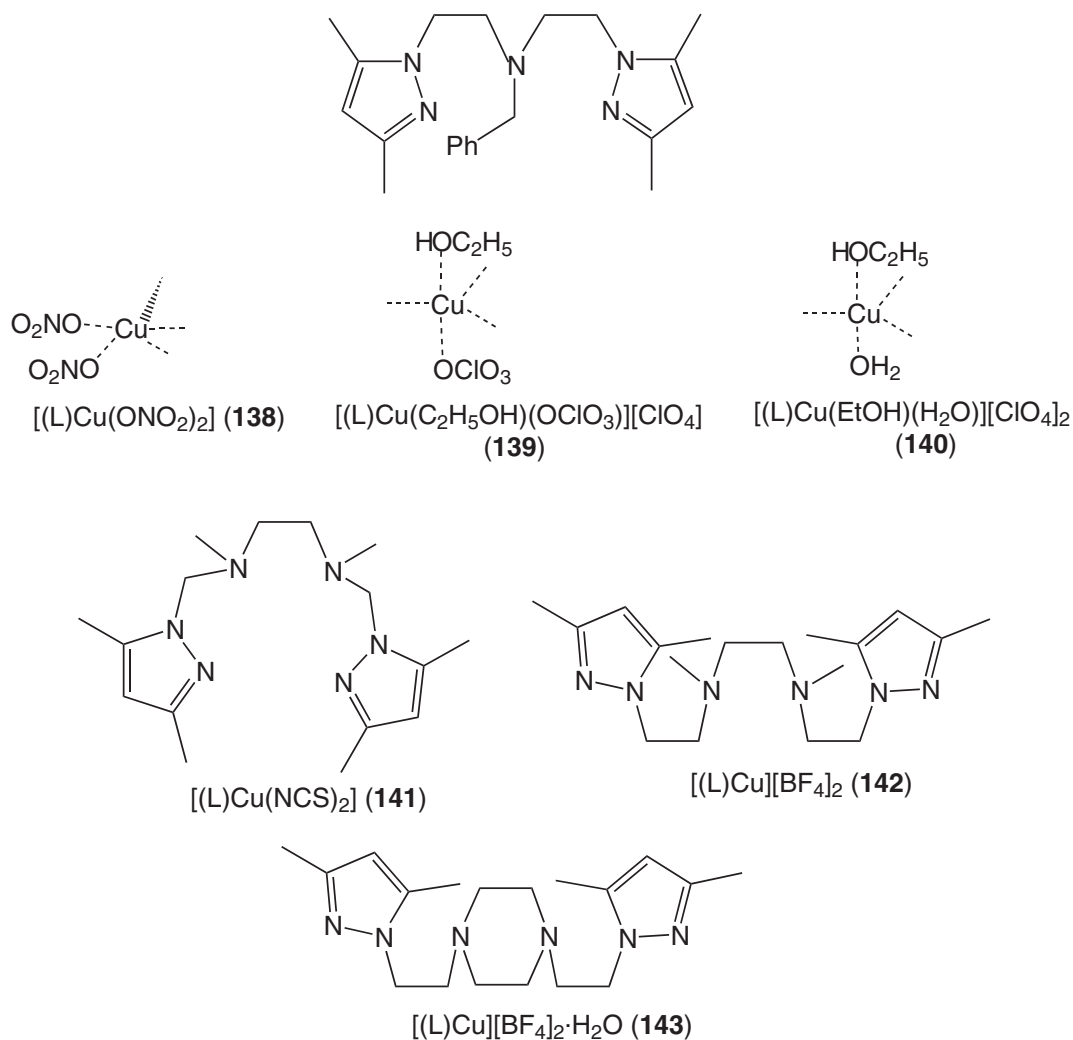

In 2000 Meyer and co-workers reported a novel example of unusual μ_4 -peroxo coordination (complex **(146)**), as well as of a structurally analogous complex in which the O–O linkage is formally cleaved and replaced by two OH units (**(147)**), while at the same time the overall tetra-nuclear framework is fully conserved.¹⁴⁵

Using a tripodal ligand, Driessen and co-workers characterized a complex with CuN_4O coordination (**(148)**), ($\tau=0.465$).¹⁴⁶ Using a sterically hindered analogue of this tripod, Sorrell *et al.* prepared a complex with a CuN_4O chromophore (complex **(149)**).¹⁴⁷ The higher Cu^{II}/Cu^I redox potential value for the methyl derivative relative to unsubstituted ligand was explained as due to “environment” effects. Colbran and co-workers designed a bulkier ligand and characterized three copper(II) complexes [**(150)** ($\tau=0.06$), **(151)** ($\tau=0.16$), and **(152)** ($\tau=0.17$)].¹⁴⁸ A *o*-xylyl-based ligand gave two complexes: a monomeric **(153)** (strongly distorted tetrahedral) and a dimeric **(154)** ($\tau=0.11$; Cu–Cu: 3.480 Å).¹⁴⁹ When 1,3,5-tris(pyrazol-1-ylmethyl)benzene was used as ligand, complex **(155)** was obtained.¹⁵⁰ Using the bidentate ligand 2-(3,5-dimethylpyrazol-1-ylmethyl)pyridine, Mukherjee and co-workers characterized a nitrite-bound complex (**(156)**) ($\tau=0.13$).¹⁵¹ Using a chiral tridentate ligand of similar class, complex **(157)** ($\tau=0.13$) was reported.¹⁵² Using the combination of a tridentate and a bidentate ligand, Mukherjee and

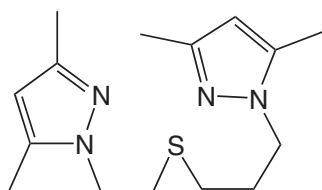
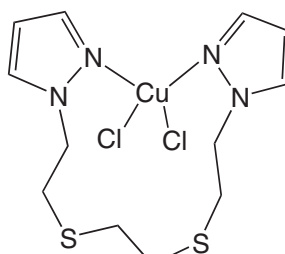
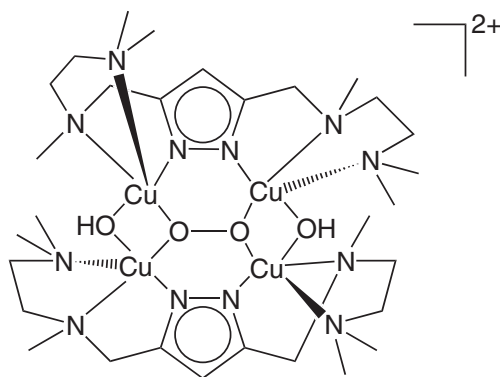
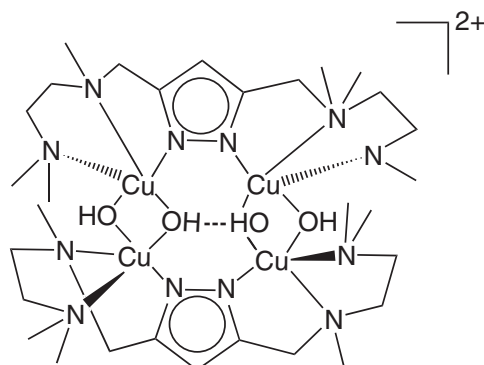
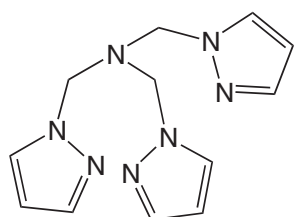
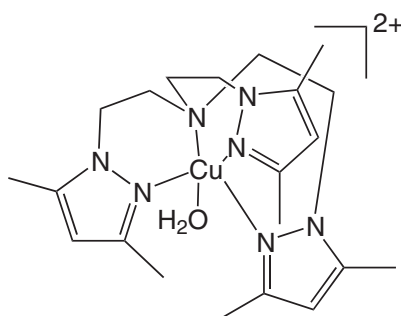
 $[(L)Cu(H_2O)][BF_4]_2$ (**144**)

 $[(L)CuCl_2]$ (**145**)

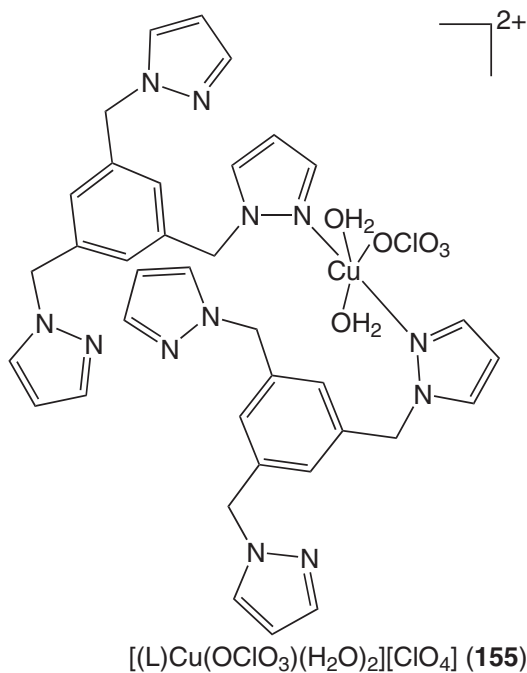
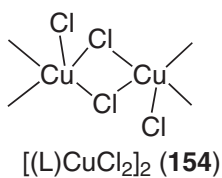
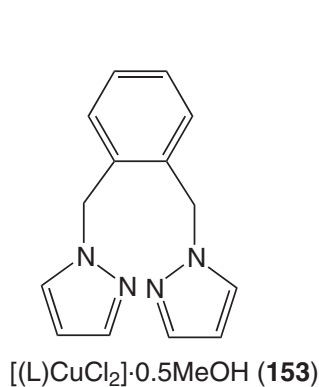
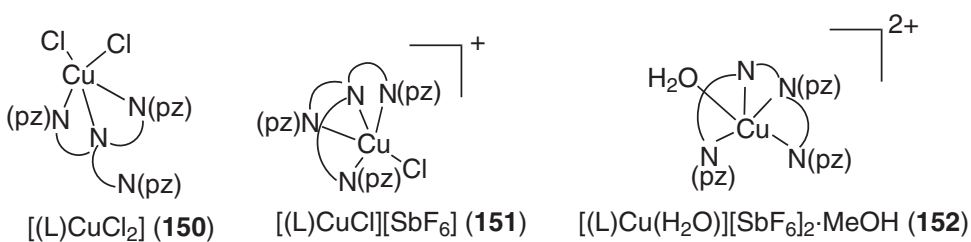
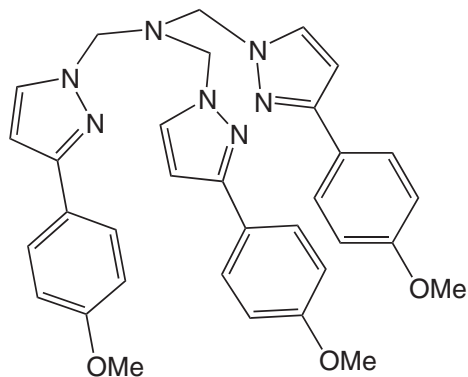
 $[(L)_2Cu_4(O_2)(OH)_2][PF_6]_2$ (**146**)

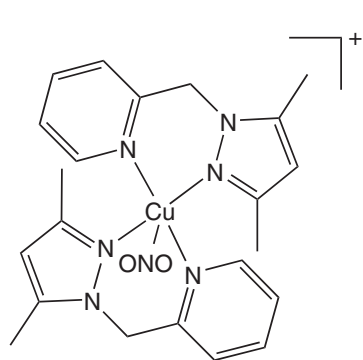
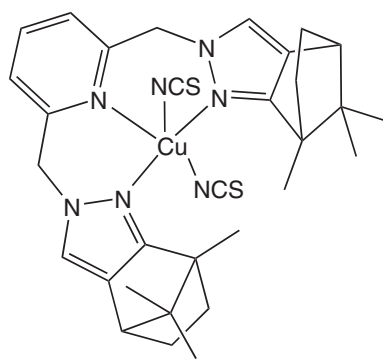
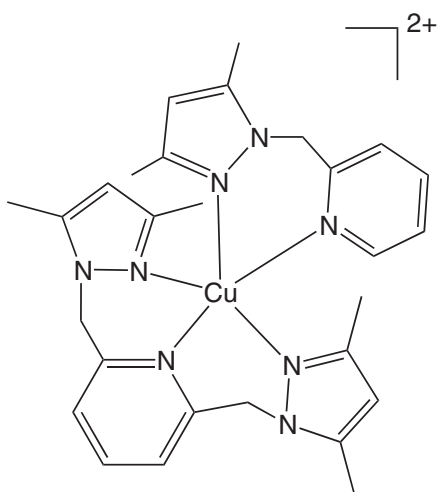
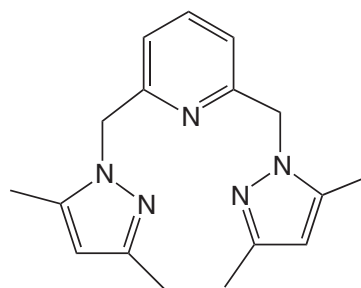
 $[(L)_2Cu_4(OH)_4][PF_6]_2$ (**147**)

 $[(L)Cu(ONO_2)][NO_3]$ (**148**)

 $[(L)Cu(H_2O)][BF_4]_2$ (**149**)

co-workers reported complex **(158)** ($\tau = 0.14$).¹⁵³ Using the tridentate ligand 2,6-(3,5-dimethylpyrazol-1-ylmethyl)pyridine, six anion-bound complexes of predominantly square-pyramidal geometry [**(159)** ($\tau = 0.16$),¹⁵⁴ **(160)** ($\tau = 0.14$),¹⁵⁴ **(161)** ($\tau = 0.26$),¹⁵⁵ **(162)** ($\tau = 0.10$),¹⁵⁴ **(163)** ($\tau = 0.37$),¹⁵⁶ and **(164)** ($\tau = 0.29$)¹⁵⁶] were reported. An unsymmetrical ligand afforded the tetragonally distorted CuN_6 complex **(165)**.¹⁵⁷





 $[(L)_2Cu(ONO)][ClO_4]$ (156)

 $[(L)Cu(NCS)]$ (157)

 $[(L)Cu(L')][ClO_4]_2$ (158)

 $[(L)CuCl_2]$ (159)

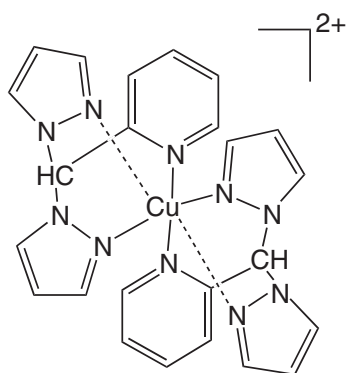
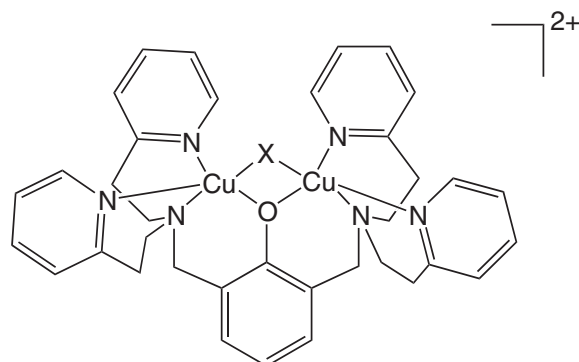
 $[(L)CuBr_2]$ (160)

 $[(L)Cu(NCS)_2]$ (161)

 $[(L)Cu(ONO)_2]$ (162)

 $[(L)Cu(N_3)_2]$ (163)

 $[(L)Cu(ONO)(ClO_3)]$ (164)

 $[Cu(L)_2][NO_3]_2$ (165)

 $X = OH; [(L)Cu_2(OMe)][PF_6]_2$ (166)

 $X = OMe; [(L)Cu_2(OH)][PF_6]_2 \cdot MeOH$ (167)

 $X = OMe; [(L)Cu_2(OMe)][BPh_4]_2$ (168)

 $X = Cl; [(L)Cu_2Cl][BPh_4]_2 \cdot Me_2CO$ (169)

 $X = Br; [(L)Cu_2Br][PF_6]_2 \cdot 0.5CH_2Cl_2$ (170)

(iv) Pyridine-containing ligands

Karlin and co-workers were the first to demonstrate the binding and activation of molecular oxygen with dinuclear copper complexes of *m*-xylyl-bridged bis-2-(2-pyridyl)ethylamine ligands.^{4,9-17} This result attracted a large number of inorganic chemists to model tyrosinase activity. Reaction of O₂ with a dinuclear copper(I) compound resulted in hydroxylation of the ligand (C—H → C—OH) to produce the dinuclear copper(II) complex (**166**) (Cu—Cu: 3.121 Å)¹⁵⁸ and (**167**) (Cu—Cu: 3.082 Å).¹⁵⁹ Using the endogenous bridge (phenolate), they varied the exogenous bridge and characterized complexes (**168**) (Cu—Cu: 3.128 Å), (**169**) (Cu—Cu: 3.265 Å), and (**170**) (Cu—Cu: 3.348 Å).¹⁶⁰ This gave them a unique opportunity to study their magnetostructural properties. During this endeavor they reported a mononuclear azido complex (**171**),¹⁶¹ as well as a dinuclear complex (**172**) (Cu—Cu: 3.185 Å).^{161,162} As part of ongoing investigations of copper(I) dioxygen reactivity, they modified their original ligand system and demonstrated the feasibility of such aromatic-ring-hydroxylation reactions in a quite general manner: (**173**) (Cu—Cu: 3.108 Å)¹⁶³ and (**174**) (Cu—Cu: 3.091 Å).¹⁶⁴ They proposed a mechanism of aromatic hydroxylation by demonstrating novel 1,2-methyl migrations and the NIH shift in copper chemistry.¹⁶⁵ During the course of their systematic investigations to pinpoint the ligand's conformational aspects necessary to bring about such reactions, they provided many more examples: (**175**) (Cu—Cu: 3.060 Å),¹⁶⁶ (**176**) (Cu—Cu: 3.037 Å),¹⁶⁷ (**177**) (Cu—Cu: 3.6517 Å), and (**178**) (Cu—Cu: 3.7413 Å).¹⁶⁸ The hydrolysis reaction of complex (**178**) with DMF, to generate complex (**177**), provides an example of the stoichiometric hydrolysis of an unactivated secondary amide under mild conditions.

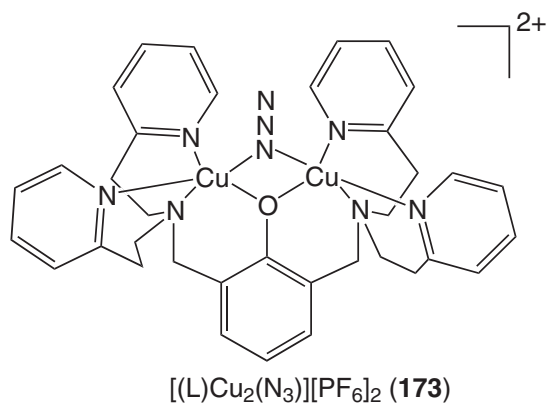
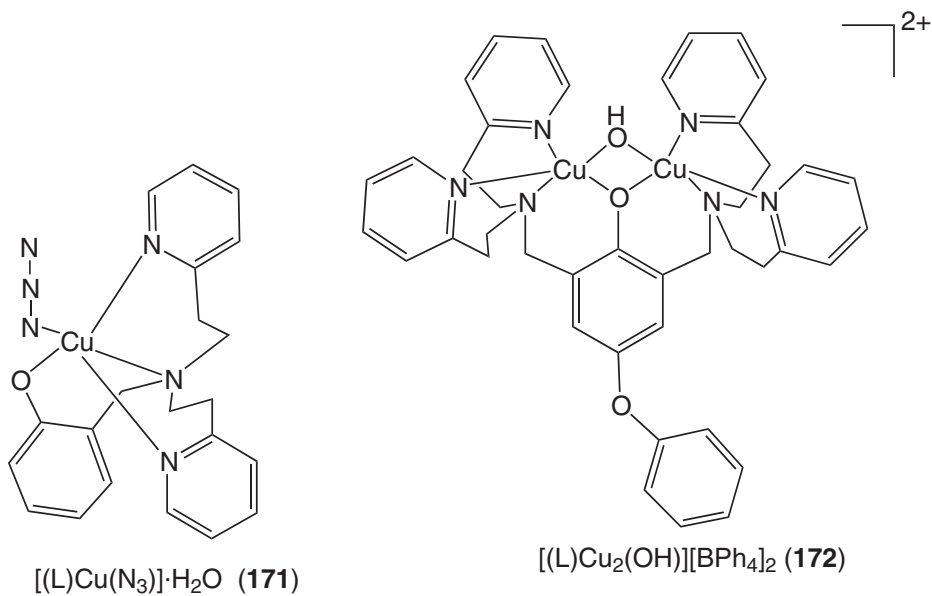

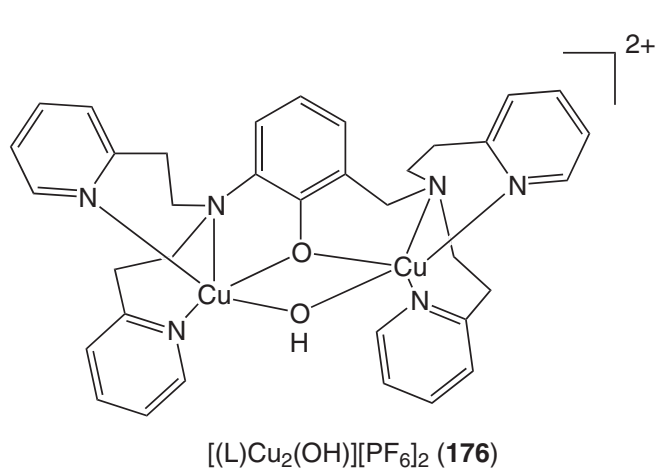
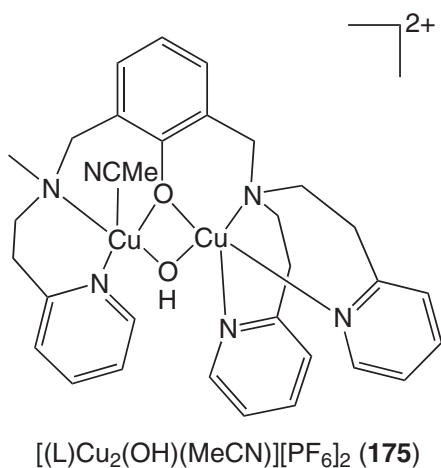
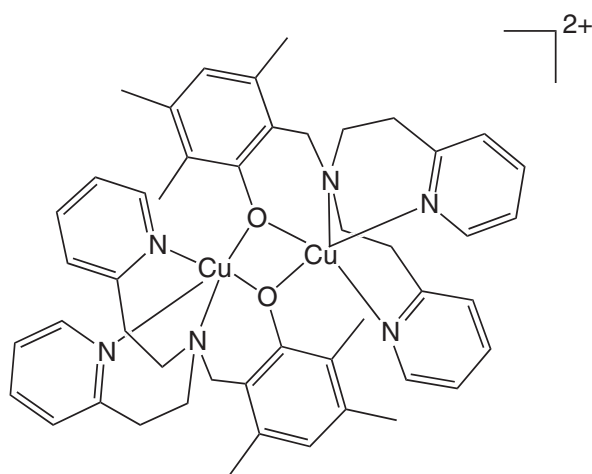
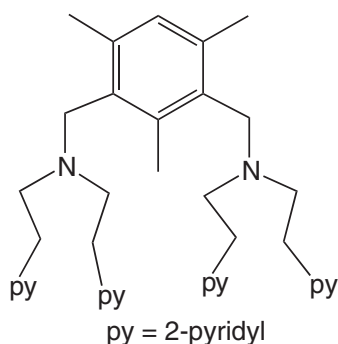

Inspired by the results of aromatic-ring hydroxylation from the laboratory of Karlin and co-workers, a few groups provided further examples of such reactivity, including some structurally characterized complexes of modified *m*-xylyl-based pyridine-donor ligands (Schiff base and non-Schiff base acyclic ligands), as well as aliphatic amine donor ligands: (**179**) (Cu–Cu: 2.990 Å),¹⁶⁹ (**180**) (Cu–Cu: 3.015 Å),¹⁷⁰ and (**181**) (Cu–Cu: 2.999 Å).^{171,172} A *m*-xylyl-based ligand system that was used by Mukherjee and co-workers in the formation of complex (**181**) also resulted in the isolation of a bis(μ -hydroxo)dicopper(II) complex (**182**) (Cu–Cu: 3.004 Å).^{171,172} Casella and co-workers demonstrated that when their dicopper(I) complex

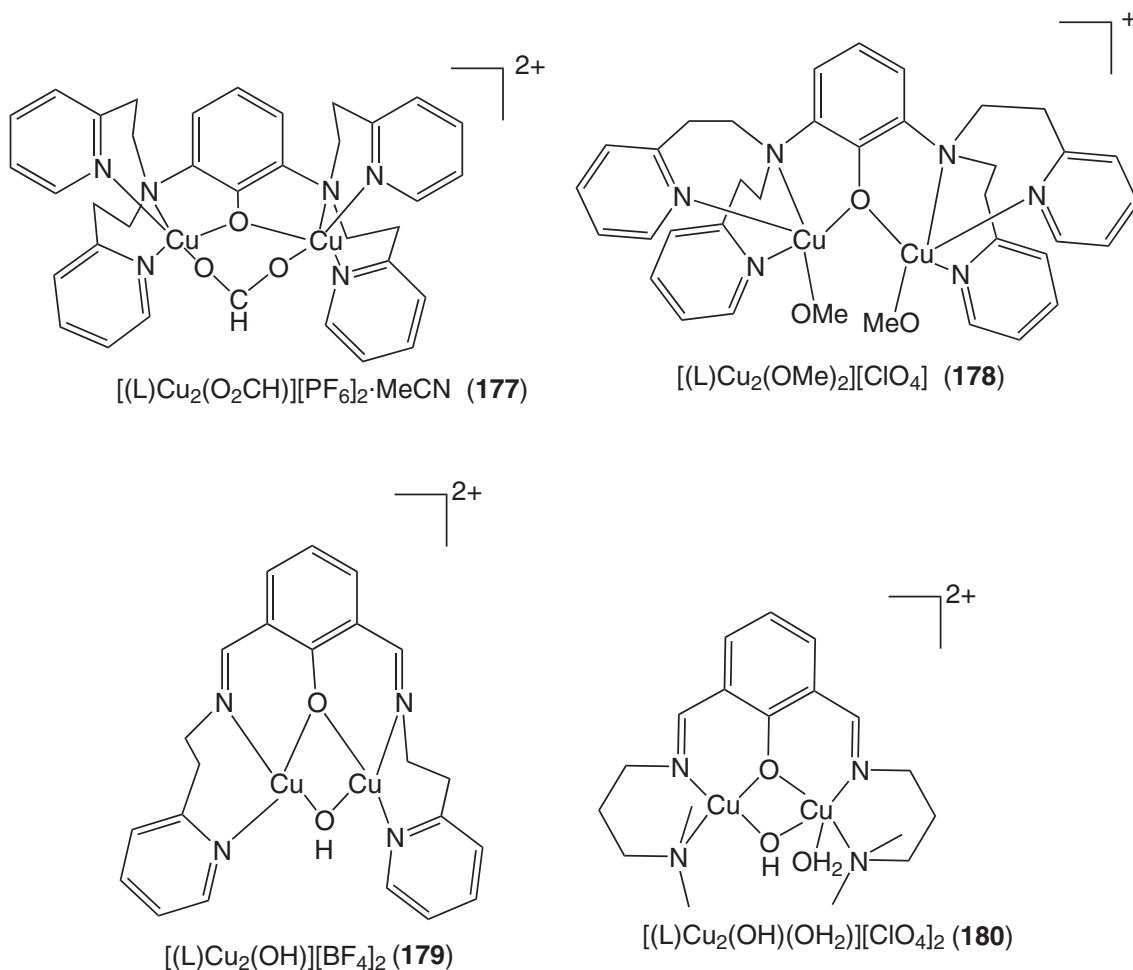

reacted with dioxygen, a partial aromatic hydroxylation of the ligand occurred. Definitive evidence of the monooxygenase activity resulted from the structure of the hydroxylated dicarbonyl product (compound **(183)**).¹⁷³ Fenton, Schindler, and their co-workers also provided examples of intramolecular ligand hydroxylation and conducted mechanistic studies on their Schiff base systems: **(184)** (Cu–Cu: 3.0294 Å) and **(185)** (Cu–Cu: 3.0309 Å).¹⁷⁴ In all these aromatic-ring hydroxylation studies copper(I) complexes of designed ligands react with molecular oxygen, which becomes activated and transfers one O atom to the ring (electrophilic attack of the peroxo-copper(II) intermediate); the other O atom ends up as hydroxide ion and is coordinated to the resulting dicopper(II) center.^{175–177}

During the course of this investigation Solomon *et al.* have thoroughly investigated spectroscopic properties, electronic structural properties, and kinetic aspects of these systems.^{7,12,14,16} Karlin and co-workers provided examples of the (acylperoxy)dicopper complex **(186)** (Cu–Cu: 3.197 Å)¹⁷⁸ and the catecholato-bound complex **(187)** (Cu–Cu: 3.248 Å).¹⁷⁹ Reaction of a phenoxo-bridged dicopper(I) complex (Section 6.6.4.2.2(iv)) with $NOPF_6$ resulted in the addition of a nitrosyl ligand to the dinuclear center to give complex **(188)** (Cu–Cu: 3.08 Å).¹⁸⁰ This compound has relevance to nitrite reductase model studies.⁷² Using various xylyl-based ligands, many compounds have been characterized with different nuclearities: **(189)** (Cu–Cu: 5.873 Å),¹⁸¹ **(190)** (Cu–Cu: 7.520 Å),¹⁸¹ **(191)** (Cu–Cu: 11.71 Å),¹⁸² **(192)** (it has, however, a mesityl-based ligand) (Cu–Cu distances: 3.106 Å, 3.119 Å, 7.458 Å, and 7.777 Å),¹⁸³ and **(193)** (it has, however, a tripodal ligand) (Cu–Cu distances: 5.834 Å, 6.239 Å, and 8.774 Å).¹⁸⁴ Using a mesityl-based new ligand, Kim and co-workers characterized a trinuclear mixed-valent compound **(194)**, due to oxidation of a copper(I) compound (Section 6.6.4.2.2(iv)).¹⁸⁵

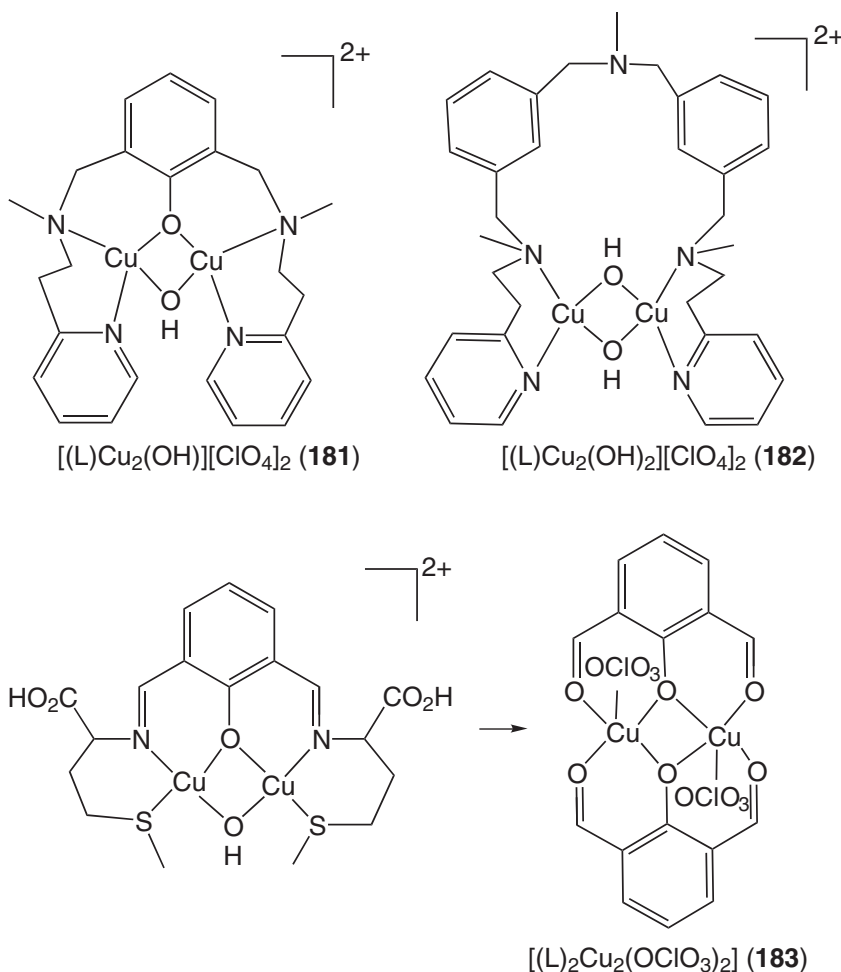

Using a designed ligand, Itoh, Fukuzumi, and their co-workers provided a well-characterized functional model of D β H:⁸⁴ a mononuclear precursor complex (**195**) and a ligand hydroxylated complex (**196**).^{186,187} This report inspired many groups to investigate aliphatic hydroxylation reactions. Réglér and co-workers have contributed substantially to providing suitable functional models of this enzyme. During the course of their investigation they characterized the complexes: (**197**) and (**198**),¹⁸⁸ (**199**),¹⁸⁹ and (**200**).¹⁹⁰ Using a copper(I) complex (Section 6.6.4.2.2(iv)) of a designed ligand, Tolman and co-workers demonstrated that the bis(μ -oxo)dicopper(III) species is capable of hydroxylating aromatic rings.¹⁹¹ This work invited a re-examination of the mechanism of aromatic-ring hydroxylation reactions of relevance to tyrosinase activity.¹⁹²

To investigate copper coordination chemistry with the bidentate, non-planar di-pyridylmethane ligand, complexes (**201**) (monomeric) and (**202**) (dimeric; structural type: (**154**))¹⁹³ and—using a sterically hindered variety of this ligand—complex (**203**)¹⁹⁴ were characterized. To study the basic chemistry of relevance to the active site of phenylalanine hydroxylase,¹³ which effects the hydroxylation of phenylalanine to give tyrosine, Karlin and co-workers structurally characterized complexes (**204**)¹⁹⁵ and (**205**).¹⁹⁶ Using a tridentate ligand, Karlin and co-workers characterized a solid of composition $\{[Cu(L)]_2O_2\}[BArF]_2$ (**206**). In contrast to the crystal structure, which shows an “intermediate” Cu_2O_2 core (Cu–Cu: 3.45 Å), spectroscopic studies (EXAFS and resonance Raman) revealed that it is a mixture of primarily side-on peroxo (core structure: (**108**)) and 5–20% of bis(μ -oxo) (core structure: (**4**)).¹⁹⁷ The dioxygen adduct is most stable as a cold solution in CH_2Cl_2 , but decomposes on warming to generate a bis(μ -hydroxo)dicopper(II) complex (**207**) (Cu–Cu: 3.012 Å).¹⁹⁸ Using a closely similar tridentate ligand, they reported a chloro-bridged complex (**208**).¹⁹⁹ To address a fundamental question of structural ambiguity (hydroxide or fluoride bridges?), Holm and co-workers reported the structure of (**209**) (Cu–Cu: 3.137 Å)²⁰⁰ of

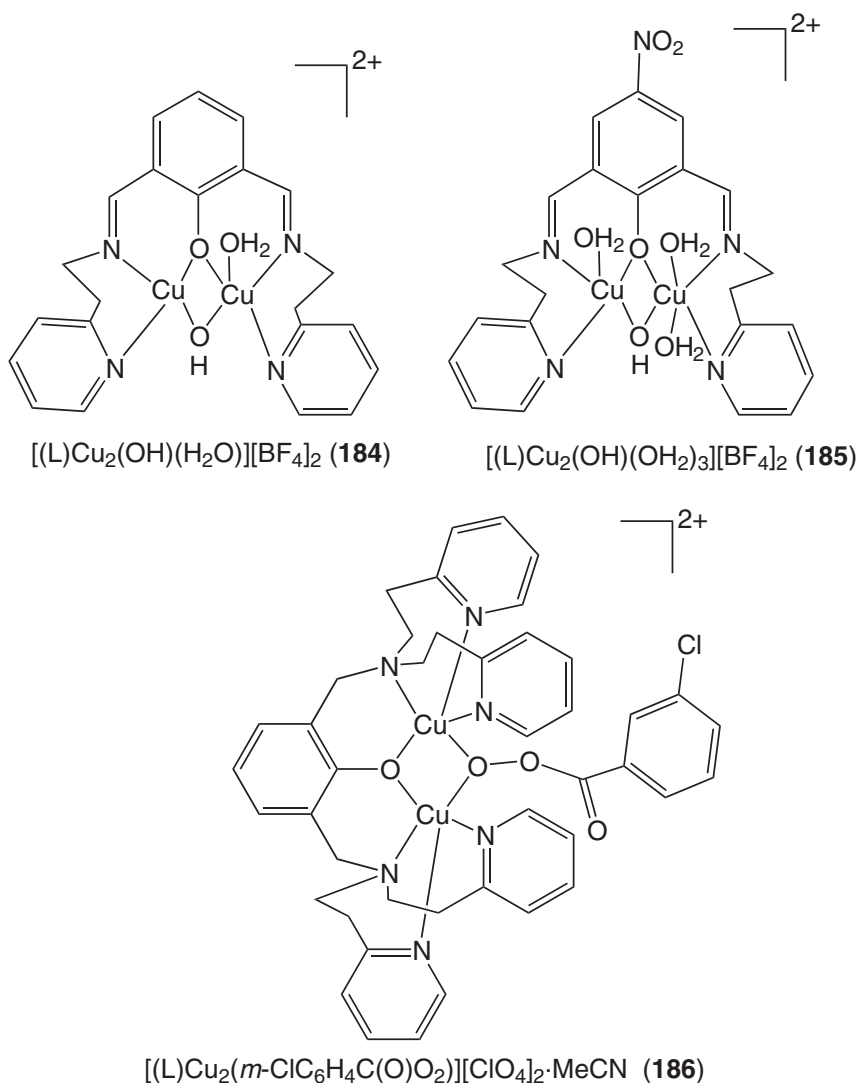

a previously reported complex of Karlin *et al.*²⁰¹ During the course of their investigation they observed a novel ligand oxygenation reaction (complex **(210)**; Cu–Cu: 3.011 Å), which had a resemblance to that catalyzed by DβH.⁸⁴

Using a well-known tridentate ligand, dipicolylamine, Addison and co-workers reported their novel observation: two different coordination geometries (**(211)** and **(212)**; $\tau = 0.38$) in the same unit cell of $[Cu(L)_2][BF_4]_2$.²⁰² Palaniandavar *et al.* reported the structural pathways of complex **(213)** ($\tau = 0.33$): an example of the uncommon “see-saw” stereochemistry.²⁰³ Using a bridged ligand system with aliphatic spacer, Karlin *et al.* reported the structure of the product **(214)** (Cu–Cu: 3.070 Å) from oxidation of a dicopper(I) complex.²⁰⁴ Using a designed ligand, Karlin and co-workers demonstrated catalytic oxygenation and oxo-transfer to a ketone, by characterizing a μ -1,3-bridged gem-diolate unsymmetrical dicopper(II) complex **(215)** (Cu–Cu: 5.583 Å).²⁰⁵

Using a strapped tridentate ligand, Kodera *et al.* reported the structure of complex **(216)** (Cu–Cu: 2.989 Å) and studied the oxidation of various phenols with H_2O_2 catalyzed by the triflate salt of this compound.²⁰⁶ In a major breakthrough, this group reported reversible O_2 binding of a room-temperature-stable μ - η^2 : η^2 peroxo dicopper(II) complex **(217)** (structural core:**(108)**; stereochemistry at the copper center: square pyramidal; Cu–Cu: 3.477 Å).²⁰⁷ Interestingly, the Cu–Cu distance is slightly longer than that of complex **(108)**; however, the O–O bond length, 1.485 Å, of this complex is slightly longer than the 1.412 Å of **(108)**. They reasoned that the observed result is attained owing to the large distortion of the Cu_2O_2 core.

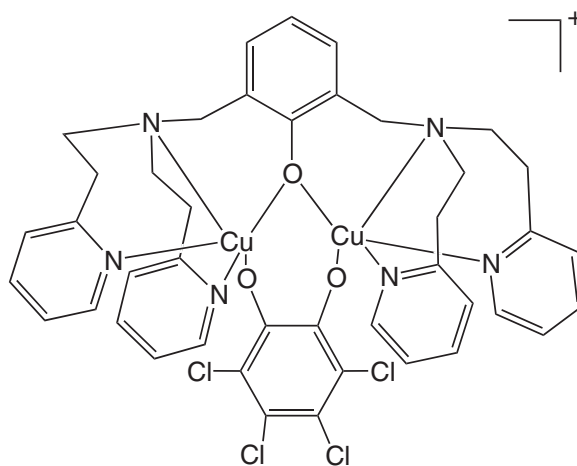
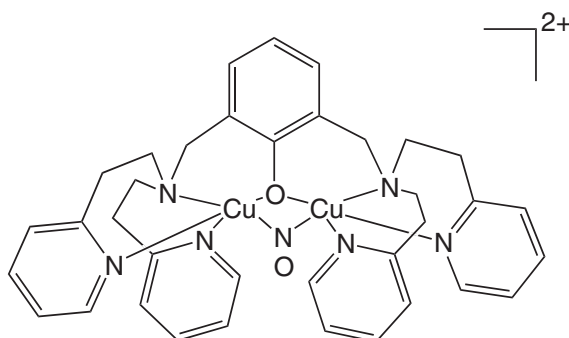
 $[(L)Cu_2(L')][PF_6]$ (**187**)

 $[(L)Cu_2(NO)][PF_6] \cdot 2CH_2Cl_2$ (**188**)

To better understand copper–dioxygen coordination chemistry with varying ligand type, Karlin and co-workers synthesized and investigated spectroscopic and redox properties of many complexes: (**218**) ($\tau = 1.005$) and (**219**) ($\tau = 0.19$),²⁰⁸ (**220**) ($\tau = 0.50$),²⁰⁹ (**221**) ($\tau = 0.19$) and (**222**) ($\tau = 0.06$),²¹⁰ (**223**) ($\tau = 0.91$) and (**224**) (Cu–Cu: 3.444 Å).²¹¹ In a major breakthrough, this group provided the first structurally characterized (-90°C) example of a trans-(μ -1,2-peroxo)dicopper(II) complex (**225**) (Cu–Cu: 4.359 Å),^{212,213} supported by two tripodal ligands. The system exhibited reversible binding of dioxygen.

To provide a model for nitrite reductases⁷² Karlin and co-workers characterized a nitrite-bound complex (**226**) ($\tau = 0.05$).²¹⁴ In an endeavor to model nitrite reductase activity, Tanaka and co-workers prepared a few mononuclear complexes: (**227**) ($\tau = 0.74$)²¹⁵ (**228**) ($\tau = 0.82$),²¹⁶ (**229**) ($\tau = 0.97$),²¹⁷ (**230**) ($\tau = 0.16$),²¹⁷ (**231**) ($\tau = 0.07$),²¹⁷ and (**232**) ($\tau = 0.43$ and $\tau = 0.53$)²¹⁷ and studied the electrochemical reduction of NO_2^- . As a part of their activity on modeling heme–copper terminal oxidases, Holm and co-workers prepared complex (**233**) ($\tau = 0.96$).²¹⁸ Using a sterically hindered tris(pyridylmethyl)amine, Canary *et al.* prepared a complex (**234**) ($\tau = 1.00$), studied its redox behavior, and discussed various factors that may contribute to the difference (higher potential for the new complex) in the redox potential of a Cu^{II}/Cu^I couple between substituted and unsubstituted ligands.²¹⁹

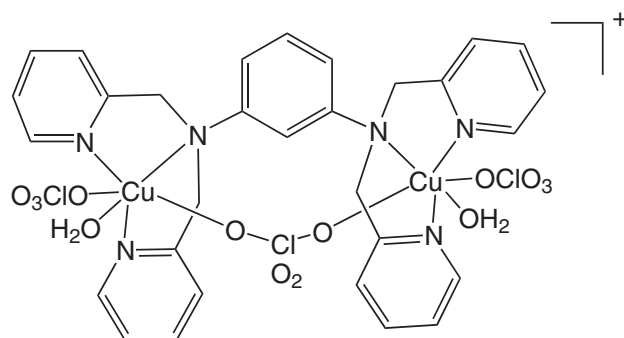
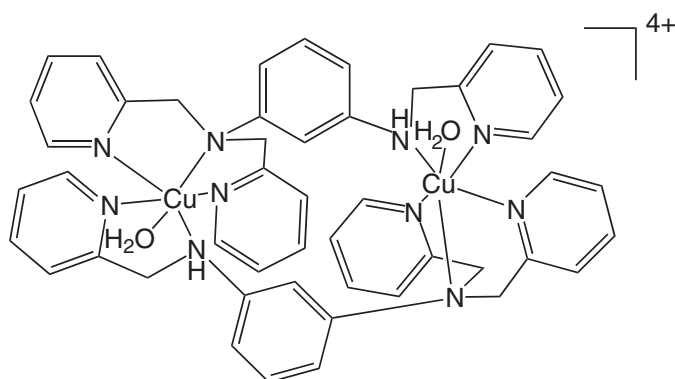
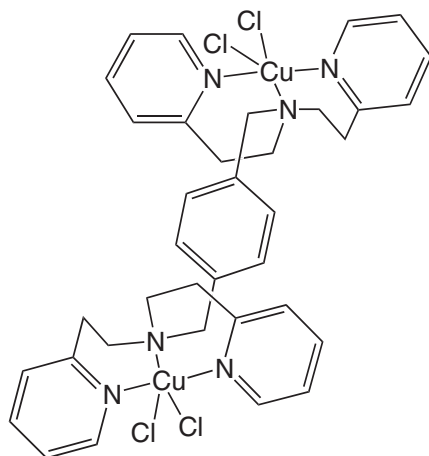
As a part of their work on copper(I)-dioxygen chemistry, Schindler and co-workers²²⁰ synthesized copper(I) (Section 6.6.4.2.2(iv)) and copper(II) complexes ((**235**): $\tau = 0.12$, and (**236**): $\tau = 0.08$) of a few tetradentate ligands, varying in their flexibility due to the presence of different chelate ring-forming arms, and studied their redox properties. Karlin and co-workers observed a

 $[(L)Cu_2(H_2O)_2(OCIO_3)_3][ClO_4] \cdot 4H_2O$ (**189**)

 $[Cu_2(L)_2(H_2O)_2][ClO_4]_4 \cdot 2H_2O$ (**190**)

 $[(L)Cu_2Cl_4] \cdot 2H_2O$ (**191**)

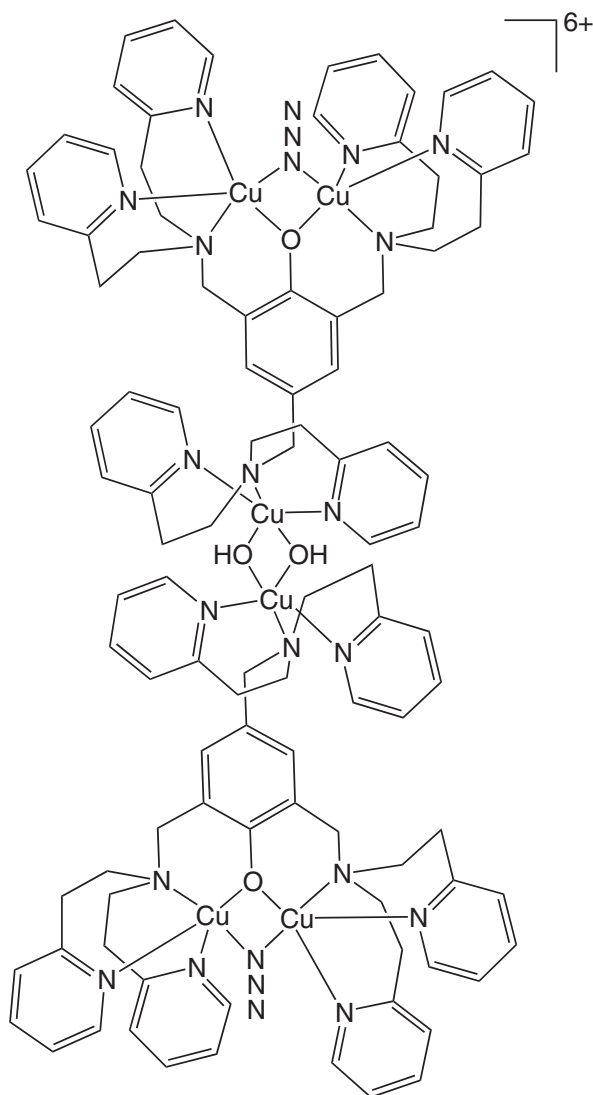
reaction between a dicopper(I) complex with dioxygen/ CO_2 which resulted in the formation of a carbonato-bridged complex (**237**) (Cu–Cu: 5.375 Å).²²¹

Complexes with ligands bearing alkylpyridine pendant arms attached to an ethylenediamine framework were prepared, and their spectral and redox properties were studied: (**238**), (**239**), and (**240**) ($\tau = 0.10$).²²²



$[\{(L)Cu_3(OH)(N_3)\}]_2[PF_6]_6 \cdot 4MeCN$ (**192**)

In an elegant approach, Comba and co-workers initiated molecular-mechanics-based models that allow the rational design of ligand systems which are able to stabilize copper–dioxygen compounds. As a part of this investigation, complexes (**241**) ($\tau = 0.12$),²²³ (**242**) ($\tau = 0.31$),²²⁴ and (**243**) ($\tau = 0.85$)²²⁴ were synthesized and the reactivity of copper(I) complexes (Section 6.6.4.2.2(iv)) with dioxygen was investigated.

Using two pentadentate ligands derived from tris(2-pyridylethyl)amine, Spiccia and co-workers reported complexes (**244**) ($\tau = 0.17$) and (**245**) ($\tau = 0.45$).²²⁵ Scheidt and co-workers reported structures of two five-coordinate complexes, copper(I) (Section 6.6.4.2.2(iv)) and copper(II) (**246**) of the same ligand, and studied their electron-transfer kinetics.²²⁶ To confirm the synthesis of a novel unsymmetrical geometrical isomer, the complex (**247**) ($\tau = 0.51$) was structurally characterized.²²⁷ Using a potentially hexadentate ligand, complex (**248**) ($\tau = 0.10$) was reported.²²⁸ Using a 2,2'-dipyridylamine-based ligand, complex (**249**) was reported.²²⁹ Mixed amine/pyridine tridentates exhibiting facial coordination are rare, so using a tridentate di-2-pyridylmethanamine ligand, complex (**250**) with CuN_6 coordination was characterized and its redox property investigated.²³⁰ Along a similar line of thought, complex (**251**) was characterized.^{231,232} Stack and co-workers²³³ developed an efficient modular protocol for synthesizing a series of facial-capping

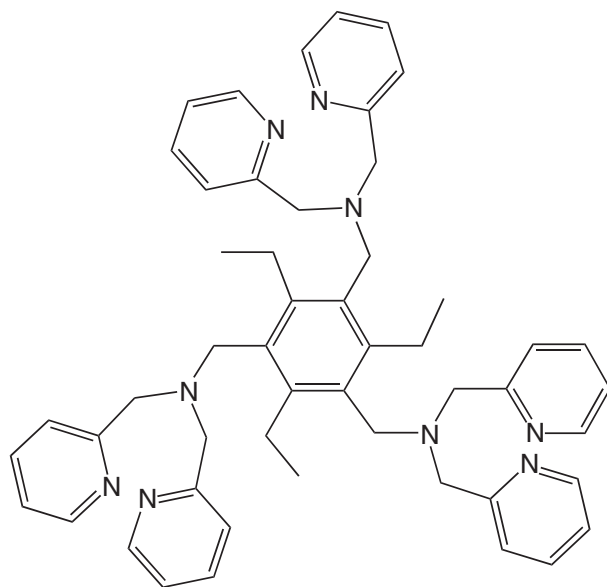
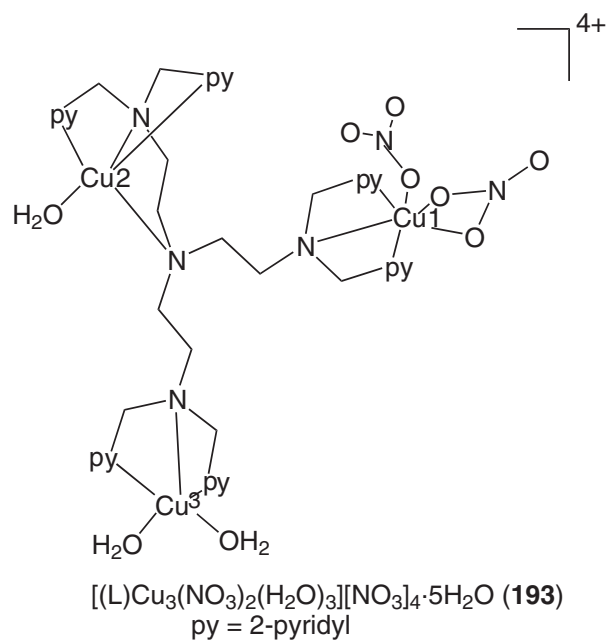

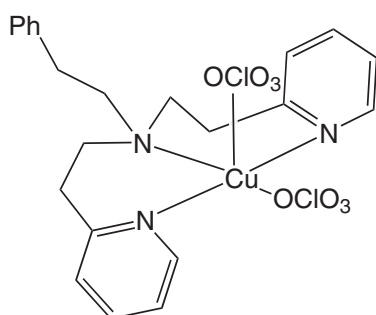
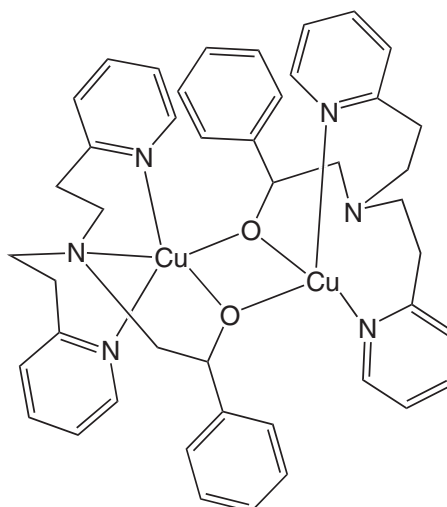
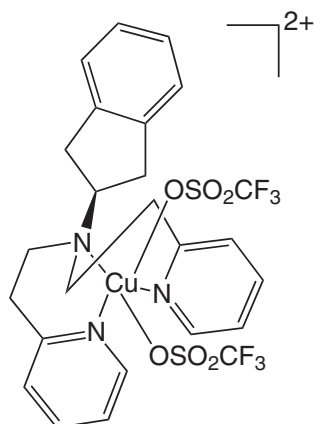
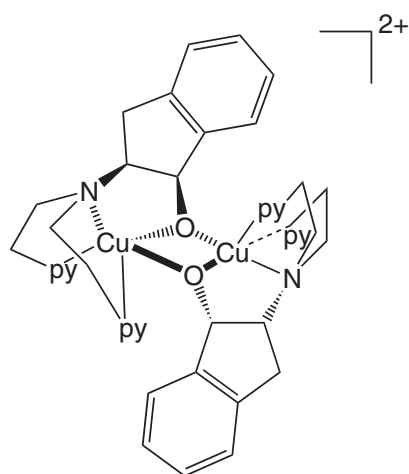
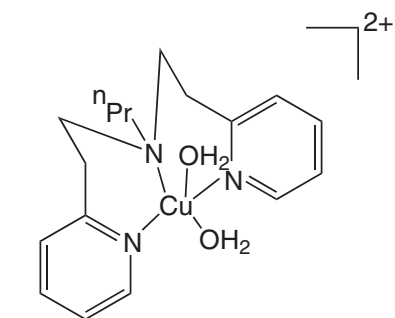
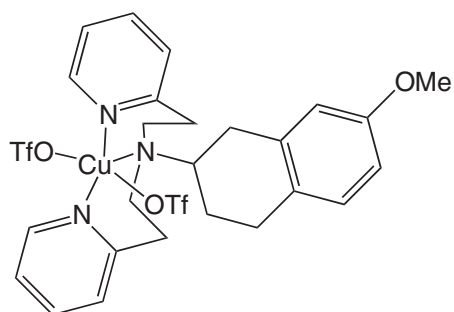

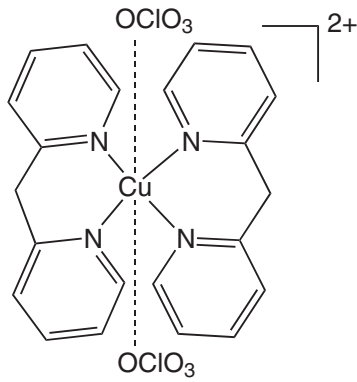
 $[(L)Cu(OCIO_3)_2]$ (**195**)

 $[Cu_2(L)_2][ClO_4]_2 \cdot 1.5CH_2Cl_2$ (**196**)

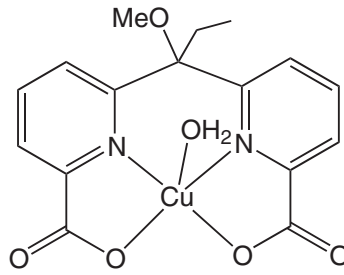
 $[(L)Cu(OSO_2CF_3)_2]$ (**197**)

 $[Cu_2(L)_2][CF_3SO_3]_2$ (**198**)
 py = 2-pyridyl

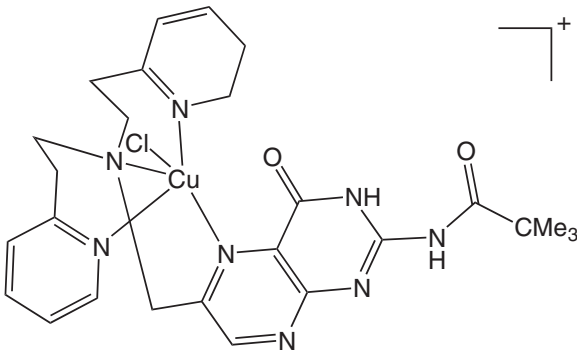
 $[(L)Cu(OH_2)_2][CF_3SO_3]_2$ (**199**)

 $[(L)Cu(OTf)_2]$ (**200**)



$[(L)_2Cu(OCIO_3)_2]$ (**201**)
 $[(L)CuCl_2]_2$ (**202**)



$[(L)Cu(H_2O)] \cdot 3H_2O$ (**203**)



$[(L)CuCl][PF_6][NaPF_6] \cdot 3MeCN$ (**204**)

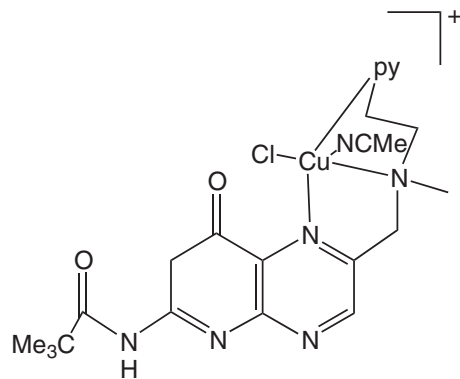

$[(L)CuCl(MeCN)][PF_6]$ (**205**)
 py = 2-pyridyl

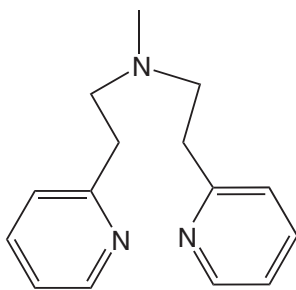

$[(L)_2Cu_2(O)_2][BARF]_2$ (**206**)
 $[(L)_2Cu_2(OH)_2][ClO_4]_2$ (**207**)

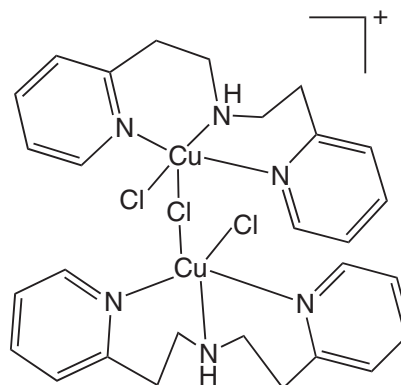

$[(L)_2Cu_2Cl_3][PF_6]$ (**208**)

tris-pyridyl ligands. This group of ligands allowed systematic variations of the steric demands at the periphery of the ligand. This ligand series generated bis-chelate complexes ((**252**)–(**255**)), with the copper(II) ligated in a tetragonally distorted octahedral coordination environment. For the ligand present in (**255**), the complex—due to its moisture sensitivity—gave a monoligated tris-aqua complex (**256**). Using a new ligand, tris(2-pyridyl)methylamine, Durrant and co-workers

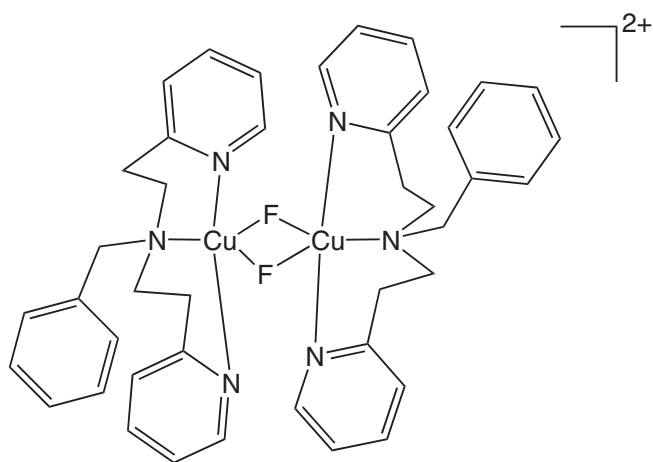
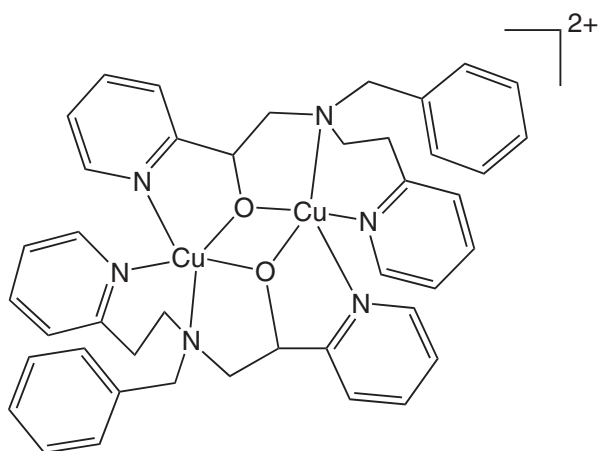
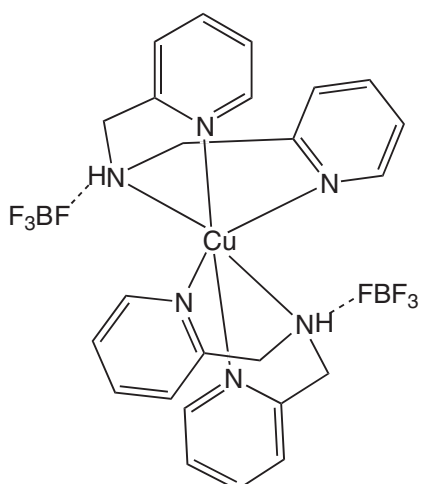
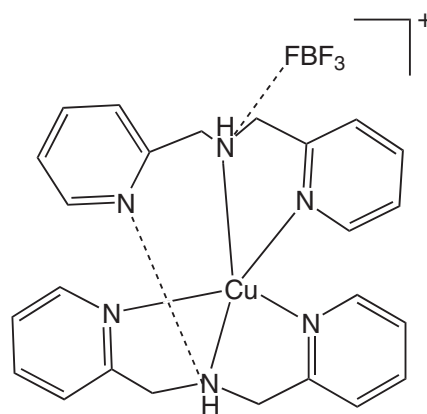

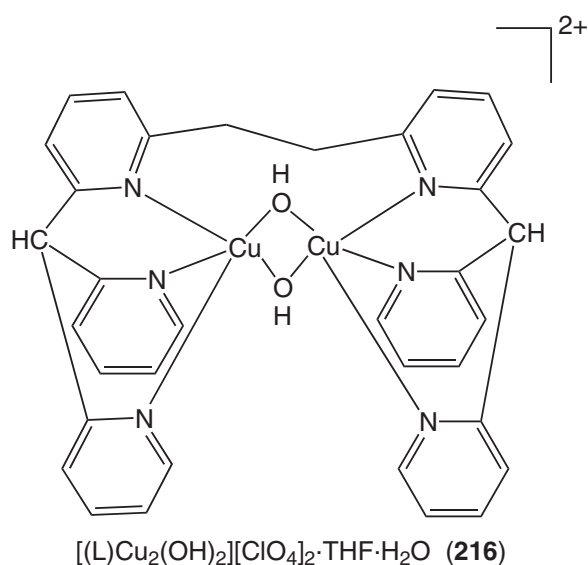
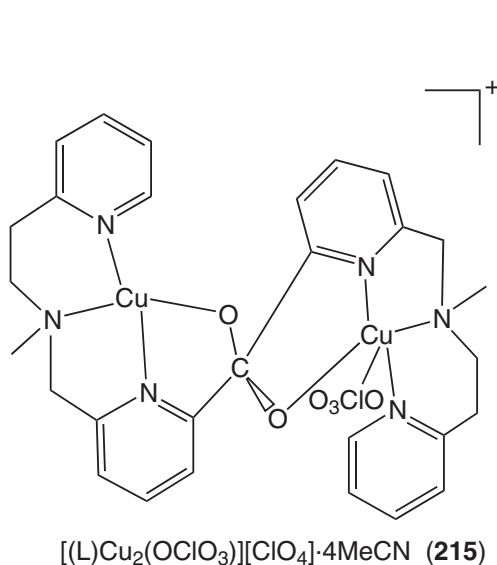
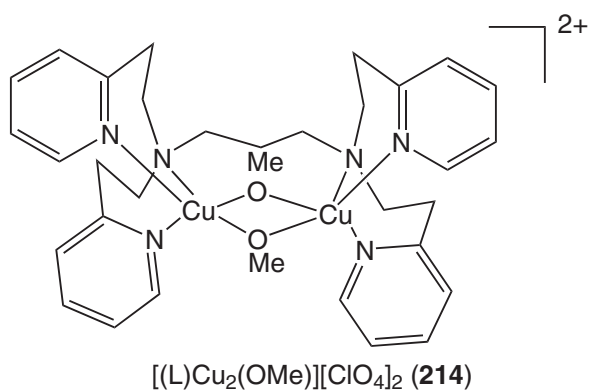
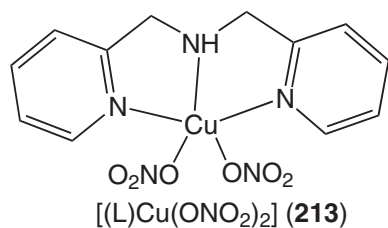
 $[(L)_2Cu_2F_2][PF_6]_2$ (**209**)

 $[Cu_2(L)_2][ClO_4]_2$ (**210**)

 $[Cu(L)_2][BF_4]_2$ (**211**)

 $[Cu(L)_2][BF_4]_2$ (**212**)

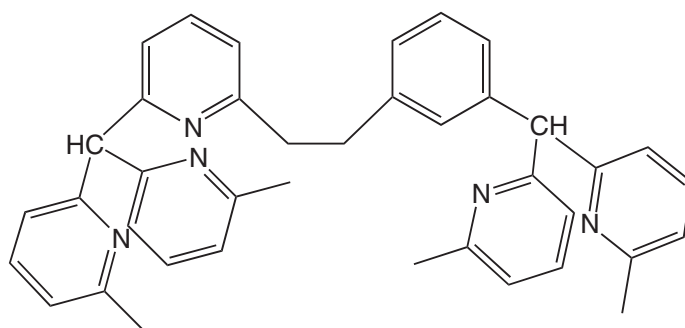
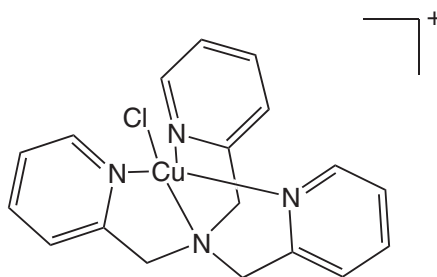
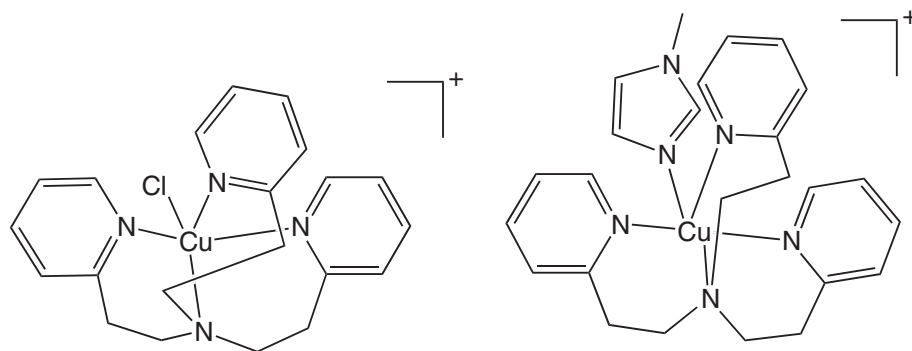

characterized²³⁴ a six-coordinate CuN_6 complex (**257**); one pyridyl arm from each ligand remained non-coordinated. Two sterically hindered tris-pyridylmethane ligands were designed by Kodera *et al.* Using an unsubstituted ligand, they prepared complex (**258**) ($\tau = 0.15$). Under aerobic conditions, the ligands reacted with CuX_2 ($X = Cl$ or Br), became oxygenated at the methane position, and characterized a mononuclear complex (**259**) ($\tau = 0.05$) and four triangular copper(II) complexes ((**260**) is a prototypical example; $\tau = 0.57$, $Cu-Cu$: 3.302 Å; weakly antiferromagnetically coupled).²³⁵

(v) Bipyridine-containing ligands

To impose a coordination environment around copper, Müller *et al.* reported structures of a copper(I) (Section 6.6.4.2.2(v)) as well as a copper(II) complex (**261**) ($\tau = 0.73$) with their designed ligand, and studied their spectral and redox properties.²³⁶ Using nonplanar tetradentate ligands, complexes (**262**) (square planar),²³⁷ (**263**) ($\tau = 0.66$),²³⁸ and (**264**) (square pyramidal)²³⁹ were characterized. Using various 2,2'-bipyridine-based ligands, dinuclear (noninteracting) complexes (**265**) ($Cu-Cu$: 7.718 Å),²⁴⁰ (**266**) ($Cu-Cu$: 5.81 Å),²⁴¹ and (**267**) ($Cu-Cu$: 8.020 Å)²⁴¹ were characterized. In complex (**265**) each copper atom is bound to three N atoms of the ligand and to one O atom of the sulfato group, giving square-planar coordination. However, the structure is disordered, with some of the copper atoms being hydrated. Using a μ -hydroxo-/ μ -aqua-/ μ -acetato-bridged dicopper(II) complex (Section 6.6.3.6.2), Chakravarty and co-workers demonstrated²⁴² ascorbate oxidation, leading to the formation of a catalytically active oxalate-bridged dicopper(II) complex (**268**). This chemistry has relevance to D β H.⁸⁴

 $[(L)Cu_2O_2][PF_6]_2 \cdot 3CH_2Cl_2$ (**217**)

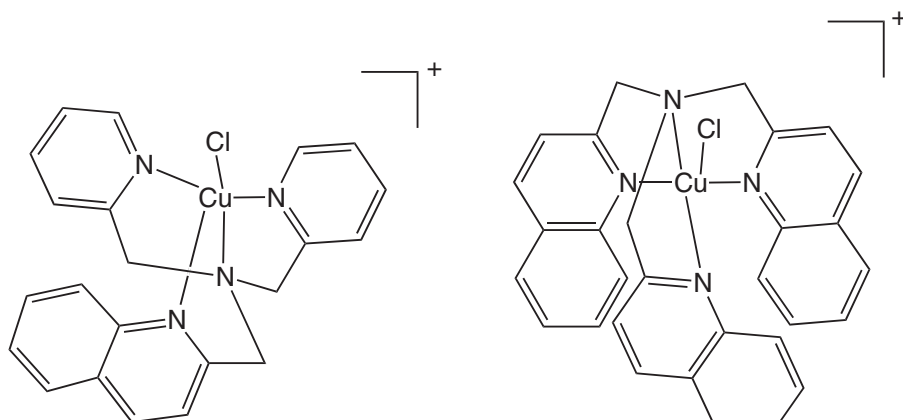
 $[(L)CuCl][PF_6]$ (**218**)

 $[(L)CuCl][PF_6]$ (**219**)

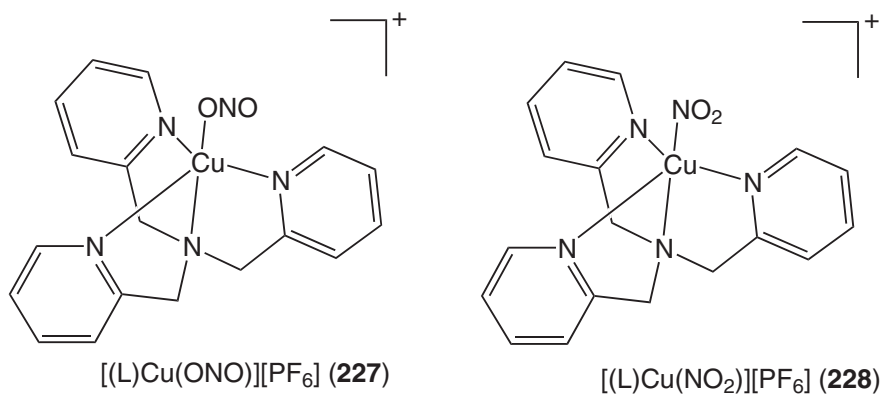
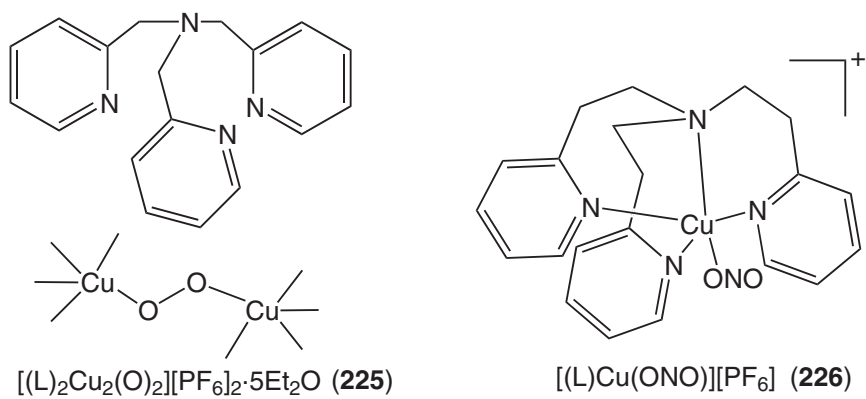
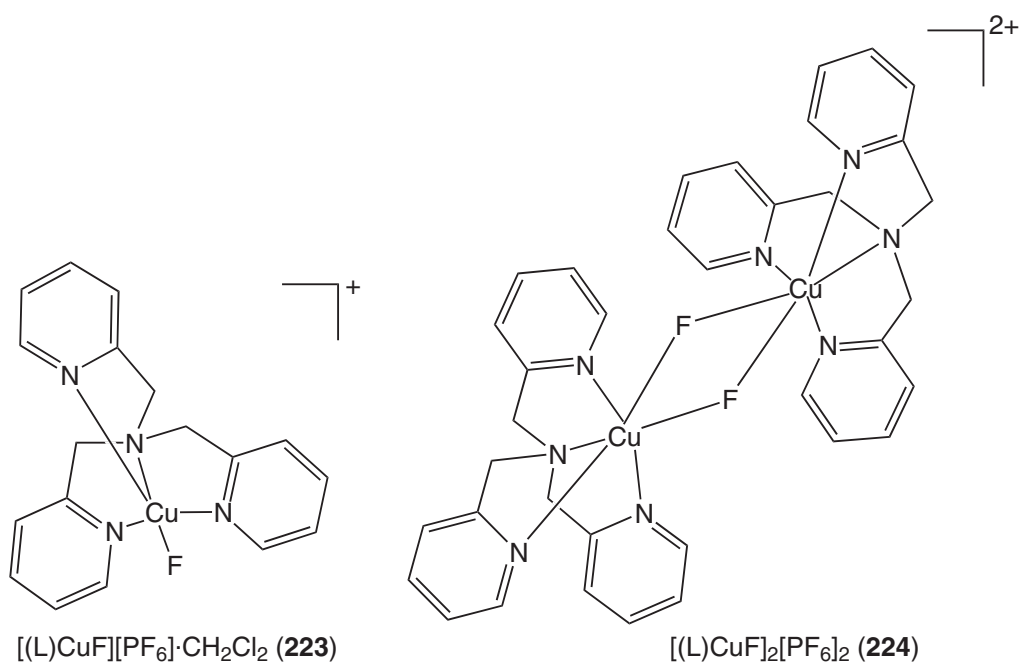
 $[(L)Cu(L')][BPh_4]$ (**220**)
 L' = 1-Melm

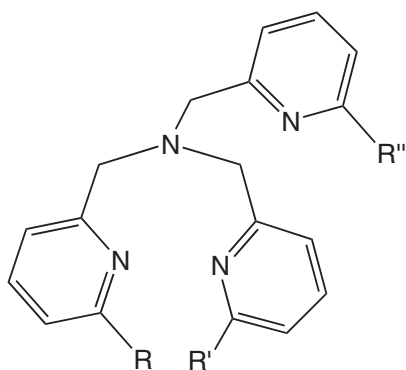
 $[(L)CuCl][PF_6] \cdot 0.5Et_2O$ (**221**)

 $[(L)CuCl][PF_6] \cdot MeCN \cdot 0.5Et_2O$ (**222**)



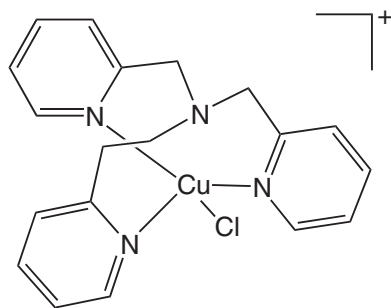

- $R = R' = R'' = H$; $[(L)Cu(H_2O)][ClO_4]_2$ (**229**)
 $R = R' = H$, $R'' = Me$; $[(L)CuCl][ClO_4]$ (**230**)
 $R = R' = Me$, $R'' = H$; $[(L)Cu(H_2O)][ClO_4]_2$ (**231**)
 $R = R' = R'' = Me$; $[(L)CuCl][(L)CuCl_2][ClO_4]$ (**232**)
 $R = R' = R'' = H$; $[(L)Cu(MeCN)][ClO_4]_2 \cdot MeCN$ (**233**)
 $R = R' = R'' = Ph$; $[(L)Cu(MeCN)][ClO_4]_2$ (**234**)



$[(L)CuCl][ClO_4] \cdot H_2O$ (**235**)

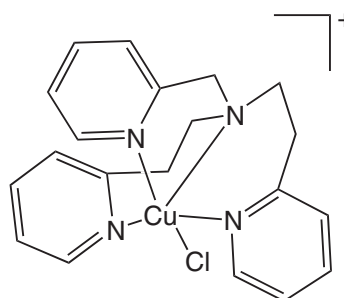

$[(L)CuCl][ClO_4]$ (**236**)

In a continuation of their earlier work,¹ Hathaway and co-workers investigated crystal structures, electronic properties, and structural pathways for a series of five-coordinate complexes with two 1,10-phenanthroline (phen) ligands and axial ligands: $[(phen)_2CuCl]Y$ [$Y = BF_4^- \cdot 0.5H_2O$ (**269**), PF_6^- (**270**), $CF_3SO_3^- \cdot H_2O$ (**271**) or BPh_4^- (**272**)],²⁴³ $[(phen)_2Cu(H_2O)][Y]_2$ [$Y = CF_3SO_3^-$ (**273**) or ClO_4^- (**274**)],²⁴⁴ and $[(phen)_2CuBr]Y$ [$Y = Br^- \cdot H_2O$ (**275**), ClO_4^- (**276**), $NO_3^- \cdot H_2O$ (**277**), PF_6^- (**278**), and BPh_4^- (**279**)].²⁴⁵

A series of copper(II) complexes with ring-substituted phen-ligands have been synthesized and their molecular structural and electronic structural properties have been investigated.²⁴⁶ Each structure ((**280**): $\tau = 0.72$, (**281**): $\tau = 0.81$, (**282**): $\tau = 0.88$, (**283**): $\tau = 0.83$, and (**284**): $\tau = 0.68$) is characterized by a distorted trigonal-bipyramidal arrangement of ligands around copper.

In an effort to investigate the kinetics of nitrite reductase activity,⁷² Ford and co-workers²⁴⁷ investigated NO reduction with complex (**285**). Using a phen-/pyrazole-based ligand, Hodgson and co-workers²⁴⁸ characterized the complex (**286**) ($\tau = 0.30$) and studied its redox property. Interestingly, the first alumina-supported syntheses of chiral bipyridines and of a chiral C_2 -symmetric terpyridine were conducted under microwave irradiation. The structure of complex (**287**) ($\tau = 0.58$) proved the claim.²⁴⁹

(vi) Other heterocycle-containing ligands

Using a triazole-/pyrimidine-containing hybrid ligand, terminally coordinated in a thiocyanate-bridged copper(II) dimer, Haasnoot *et al.* reported²⁵⁰ the structure of the β isomer of complex (**288**), revealing that the Cu–SCN distance is relatively short compared to other Cu–SCN

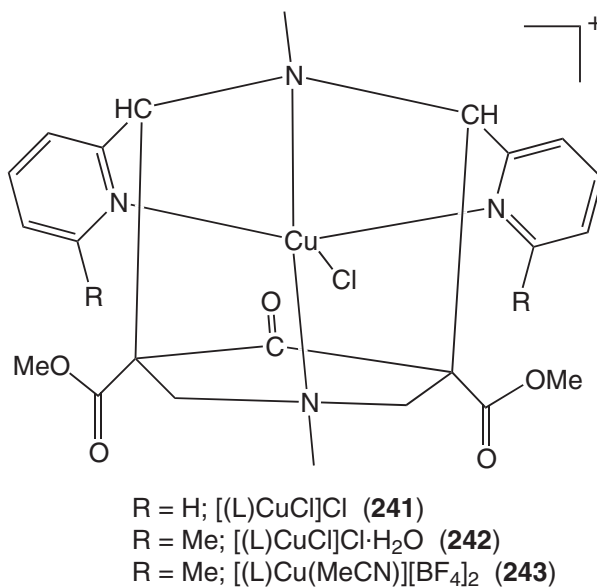
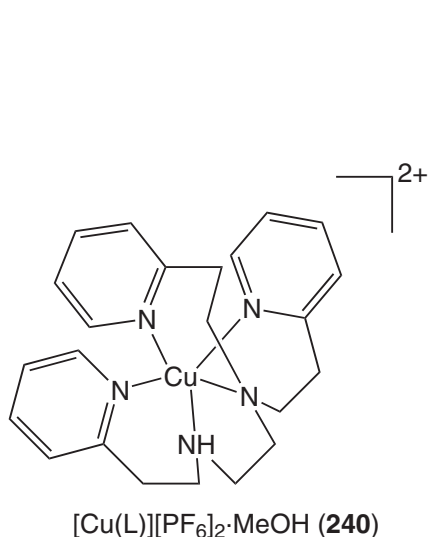
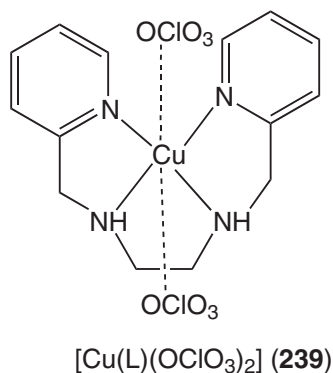
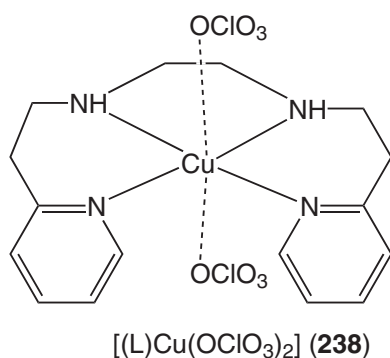
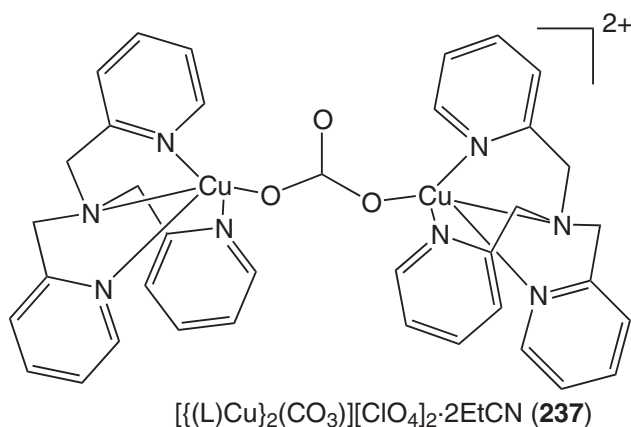

distances. This originates from the fact that in this compound the Cu—SCN bond is in an equatorial position, which is uncommon for copper(II)–thiocyanate complexes.²⁵¹

Oshio *et al.* reported²⁵² the structures of two dicopper(II) complexes (**289**) ($\tau = 0.72$) and (**290**) ($\tau = 0.44$) supported by a pyrazine-bridged ligand and differing only in solvent of crystallization.

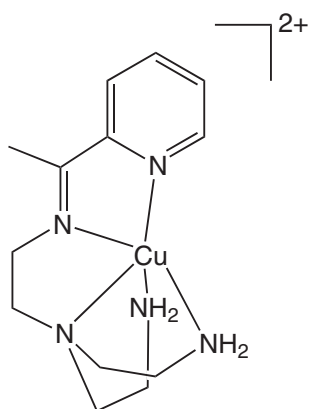
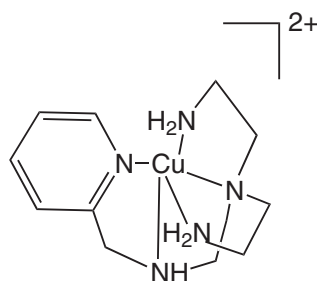
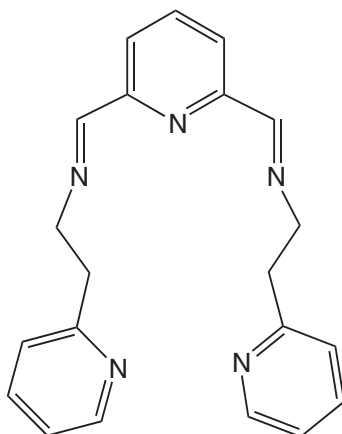
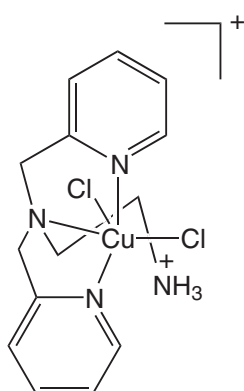
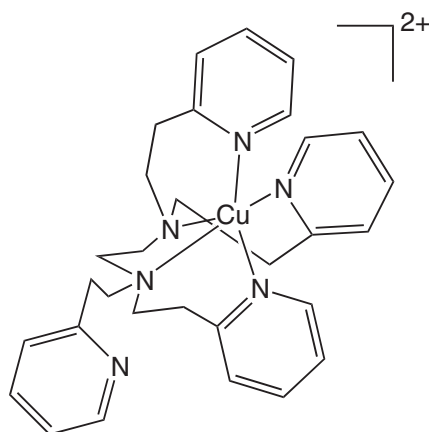
[Cu(L)][ClO₄]₂ (**244**)[Cu(L)][ClO₄]₂ (**245**)[Cu(L)][BF₄]₂ (**246**)[(L)CuCl₂][ClO₄] (**247**)[(L)Cu][PF₆]₂ · 1.5Me₂CO (**248**)

They also investigated the redox properties in detail. With a ligand varying in chelate ring size, they reported the complex (**291**) ($\tau = 0.07$) and demonstrated that increased chelate ring size is the dominant factor in determining the stability of copper(I) relative to copper(II). A more flexible (six-membered chelate ring formation) ligand is capable of modifying the coordination structure

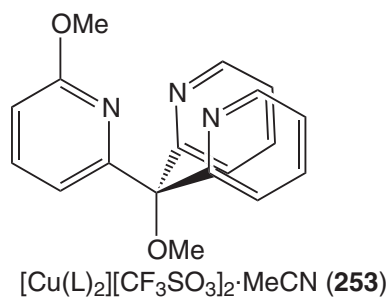
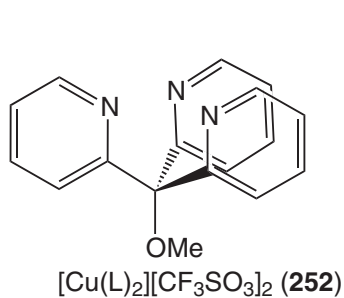
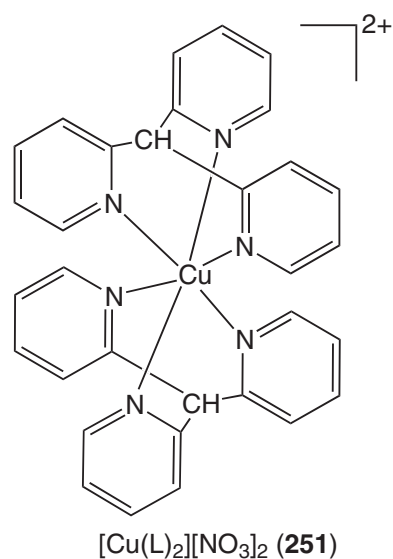
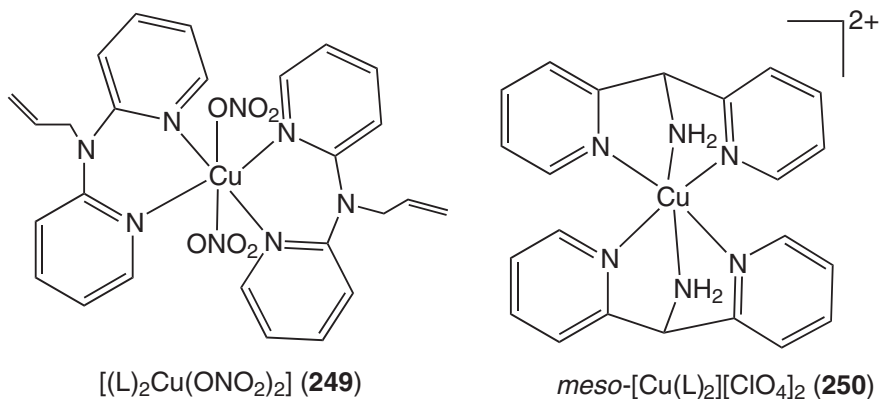

as the copper is reduced, and therefore is reduced more easily than a five-membered chelate ring-forming ligand.²⁵³

The study of exchange interactions between transition-metal ions and copper(II) in particular has been an active field of research (Section 6.6.3.6).^{254–256} In this context, Verdaguer and co-workers investigated complexes (292) and (293), supported by flexible 2,2'-bipyrimidine.²⁵⁷

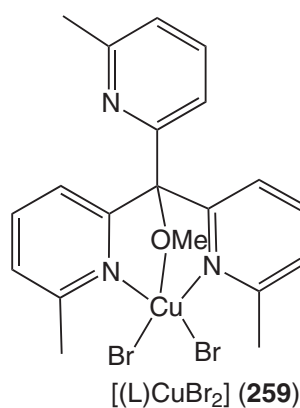
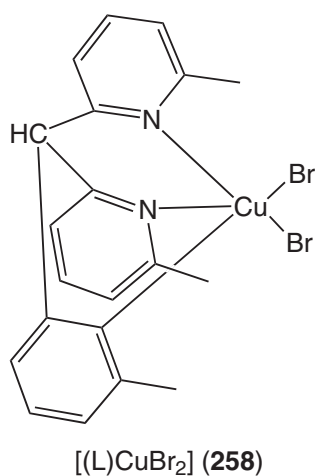
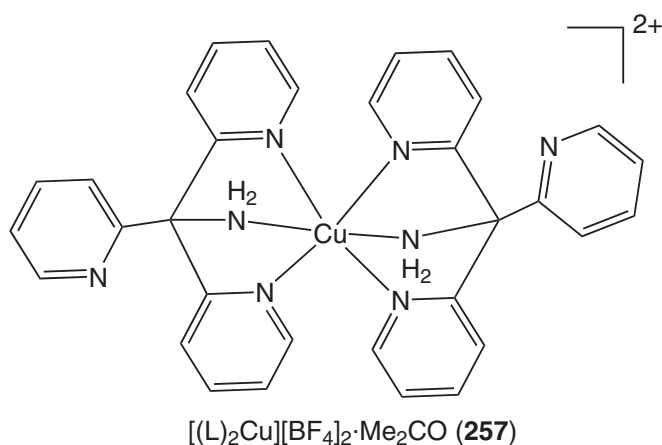
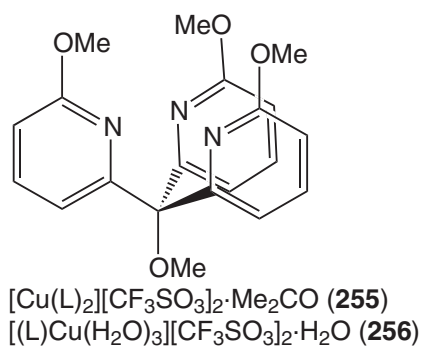
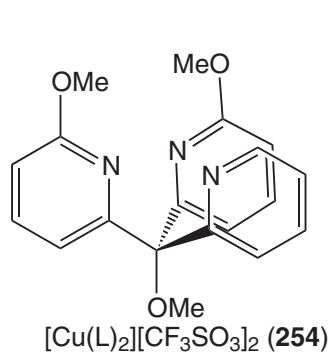

Using another pyridyl-/triazole-containing hybrid ligand, Müller and co-workers²⁵⁸ reported the structure of a complex (**294**), with flattened tetrahedral geometry at the copper center. They compared structural differences with a copper(I) compound (Section 6.6.4.2.2(vi)). Along similar lines of thought, complex (**295**), supported by a pyridyl/triazine hybrid ligand, was investigated.²⁵⁹

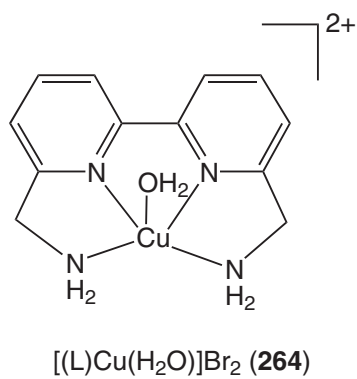
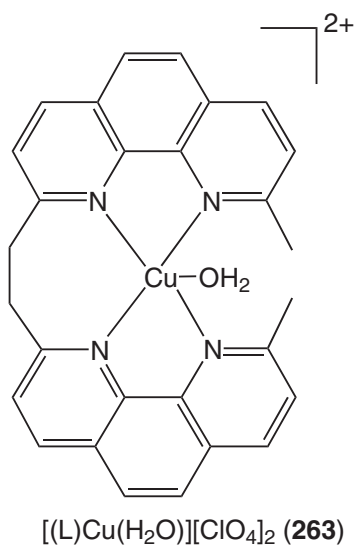
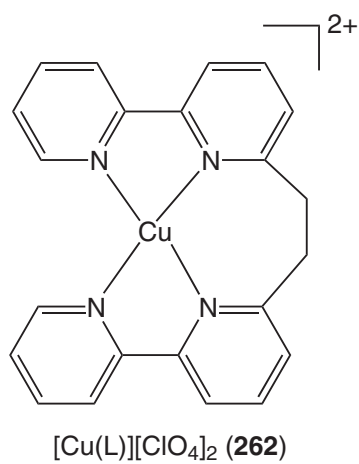
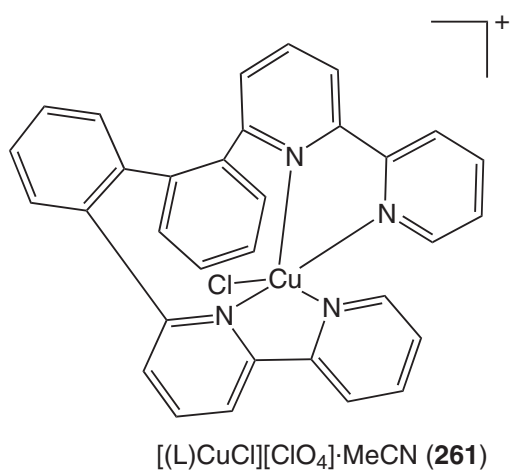
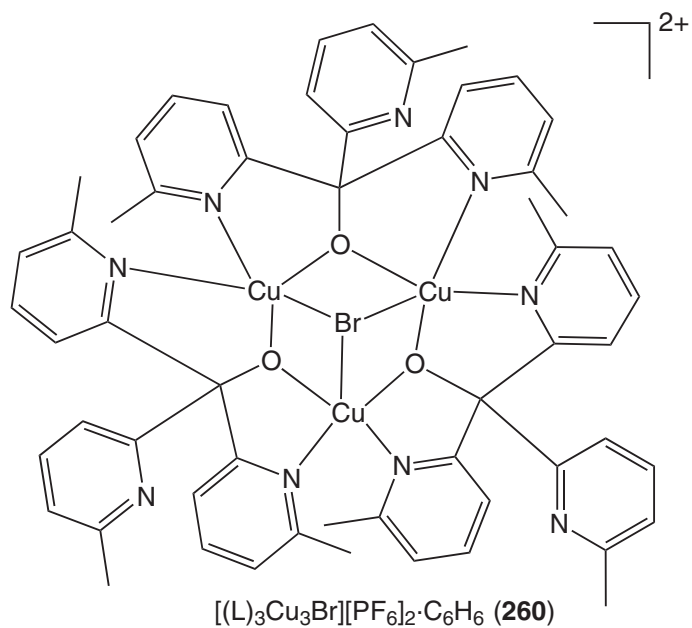

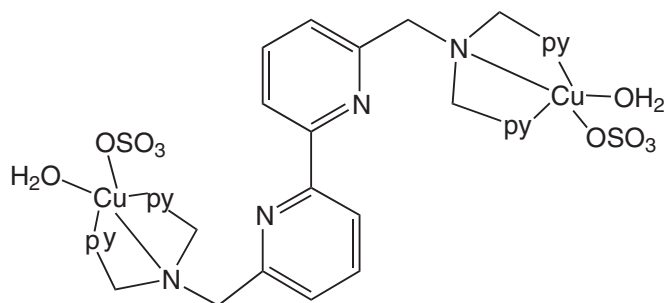

$[(L)Cu_2(SO_4)_2]_{0.68(1)} [(L)Cu_2(SO_4)_2(H_2O)_2]_{0.32(1)} \cdot 6.64(2)H_2O$ (**265**)
 py = 2-pyridyl

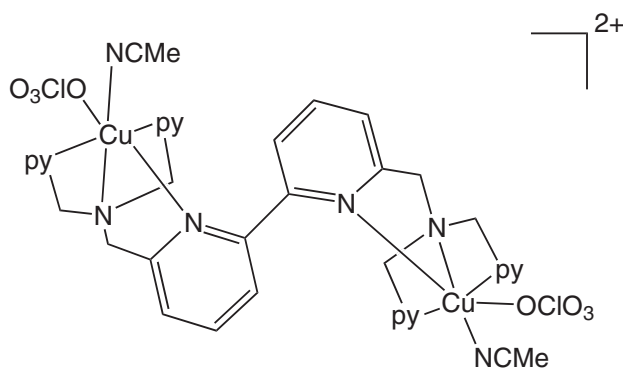

$[(L)Cu_2(MeCN)_2(OCIO_3)_2][ClO_4]_2 \cdot 6MeCN \cdot 4H_2O$ (**266**)
 py = 2-pyridyl

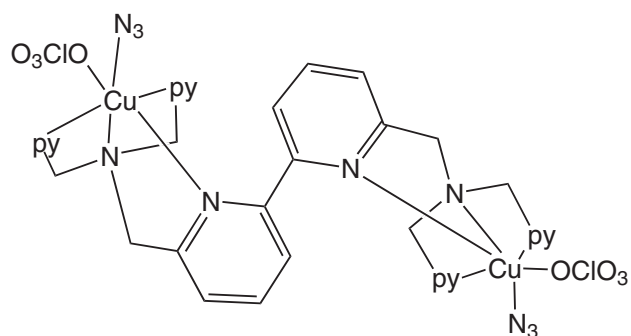

$[(L)Cu_2(N_3)_2(OCIO_3)_2]$ (**267**)
 py = 2-pyridyl

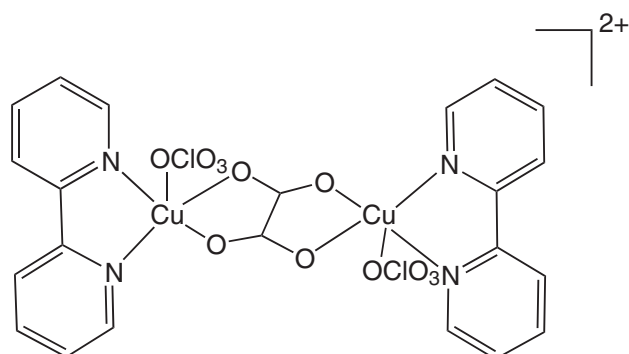

$[(bpy)_2Cu_2(ox)][PF_6]_2$ (**268**)

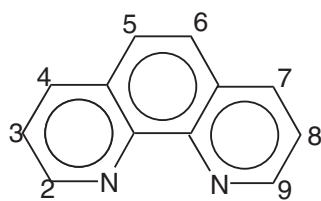

Position		Abbreviation
5	6	
NO ₂	H	5-NO ₂ -phen
Cl	H	5-Cl-phen
H	H	phen
Me	H	5-Me-phen
Me	Me	5, 6-Me ₂ -phen

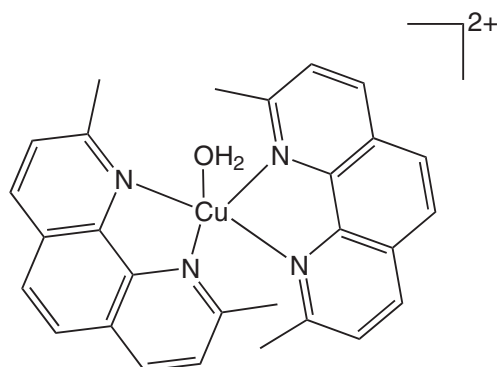
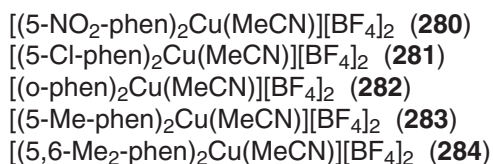

$[(\text{L})\text{Cu}(\text{H}_2\text{O})][\text{CF}_3\text{SO}_3]_2$ (**285**)

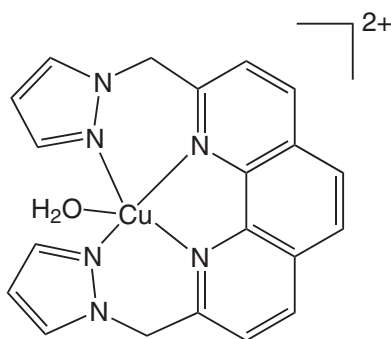

$[(\text{L})\text{Cu}(\text{H}_2\text{O})][\text{ClO}_4]_2$ (**286**)

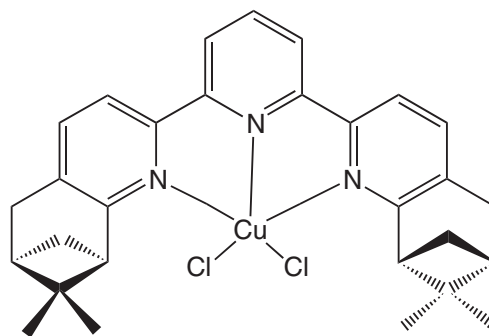

$[(\text{L})\text{CuCl}_2]$ (**287**)

6.6.3.2 Oxygen Donor Ligands

6.6.3.2.1 Phenol-based ligands

Copper(II) complexes with phenoxo ligands have attracted great interest, in order to develop basic coordination chemistry for their possible use as models for tyrosinase activity (dimeric complexes) and fungal enzyme galactose oxidase (GO) (monomeric complexes). The latter enzyme catalyzes the two-electron oxidation of primary alcohols with dioxygen to yield aldehyde and

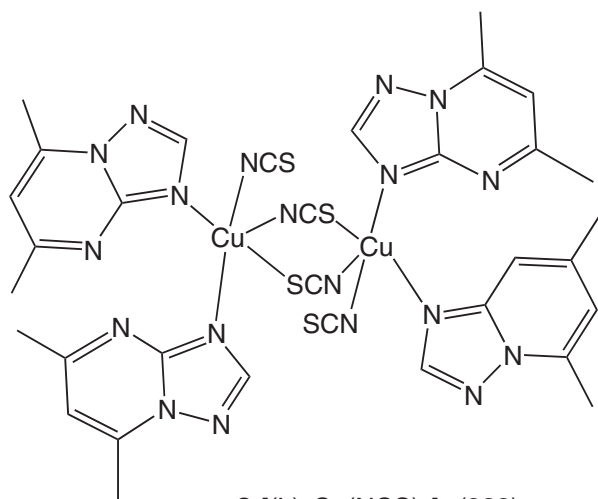

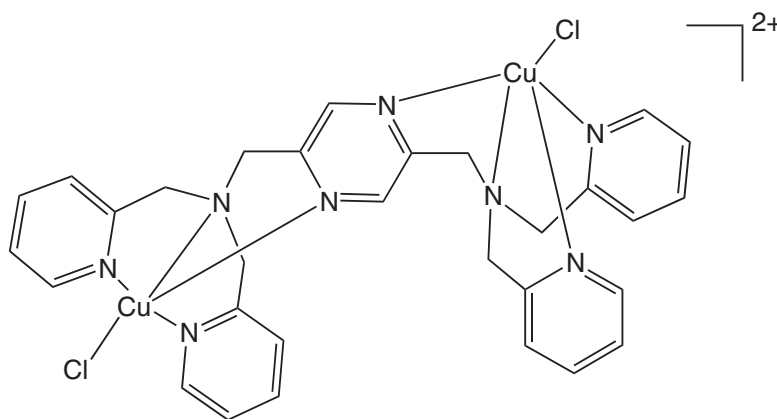
$$\text{B-}[(\text{L})_2\text{Cu}(\text{NCS})_2]_2 \text{ (288)}$$

$$[(\text{L})\text{Cu}_2\text{Cl}_2][\text{ClO}_4]_2 \cdot 2\text{MeOH} \text{ (289)}$$

$$[(\text{L})\text{Cu}_2\text{Cl}_2][\text{ClO}_4]_2 \text{ (290)}$$

hydrogen peroxide.^{260–262} In the tyrosinase–cresolase activity, a monophenol binds to the axial position of one of the two copper centers of the oxy-site prior to catalytic activation. In the galactose oxidase in resting form, the copper(II) ion is square pyramidal, weakly bonded to a tyrosinate in the axial position and to another tyrosinate, two histidine residues, and a water (pH 7) or an acetate (from buffer, pH 4.5) ligand in the equatorial sites. Evidence has been provided for the same type of active site in glyoxal oxidase, which catalyzes the oxidation of aldehydes to carboxylic acids.²⁶² Quite a few excellent reviews are available on phenoxo-bridged dicopper(II) systems.^{175–177,263,264}

Sorrell *et al.* provided a number of structurally characterized examples of dimeric complexes of pyrazole-phenol-based ligands: **(296)** (one Cu square pyramidal and the other distorted TBP; Cu–Cu: 3.054 Å; $2J = -420 \text{ cm}^{-1}$),²⁶⁵ **(297)** (one Cu square pyramidal and the other distorted TBP; Cu–Cu: 3.562 Å; $2J = \sim 0$)²⁶⁶ and **(298)** (both Cu tetragonal; Cu–Cu: 3.765 Å; $2J = -1,800 \text{ cm}^{-1}$).²⁶⁶ Using a tridentate, mixed-functionality ligand, Carrano and co-workers²⁶⁷ characterized three complexes **(299)** (mononuclear: no phenol coordination), **(300)** (mononuclear: one phenol coordinates, the other does not; Cu–Cu: 3.000 Å), and **(301)** (dinuclear, with one four-coordinate and the other five-coordinate; one phenol coordinate in a bridging mode, the other does not coordinate). Nag and co-workers reported²⁶⁸ the structure of a dinuclear system **(302)**, comprising of acetylacetonate and a pyrazole-phenol-based ligand (both Cu square planar; Cu–Cu: 3.03 Å; $2J = -110 \text{ cm}^{-1}$). Structure and reactivity of novel tetrahedral phenoxo copper(II) complexes

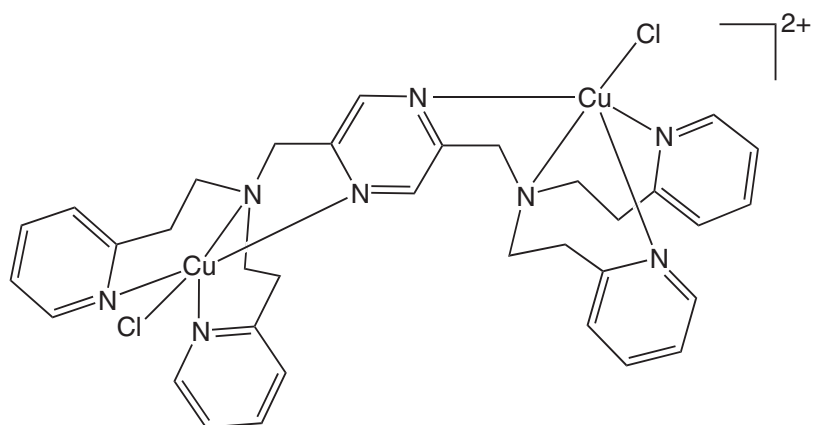
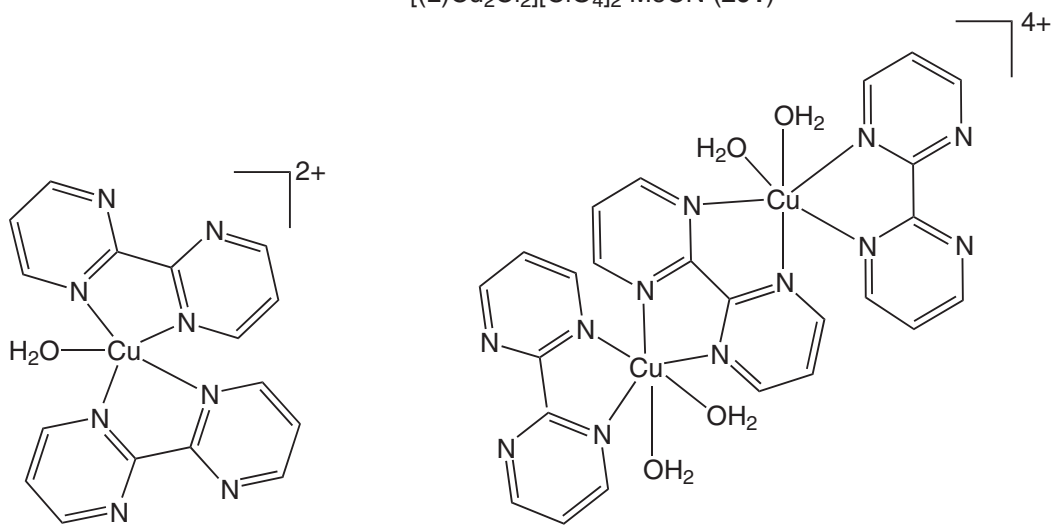

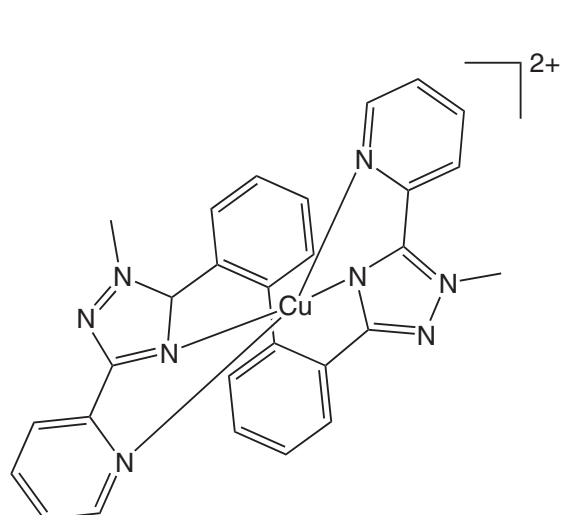
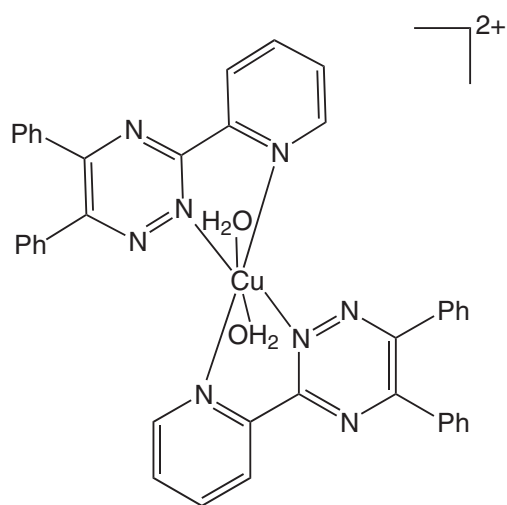
 $[(L)Cu_2Cl_2][ClO_4]_2 \cdot MeCN$ (**291**)

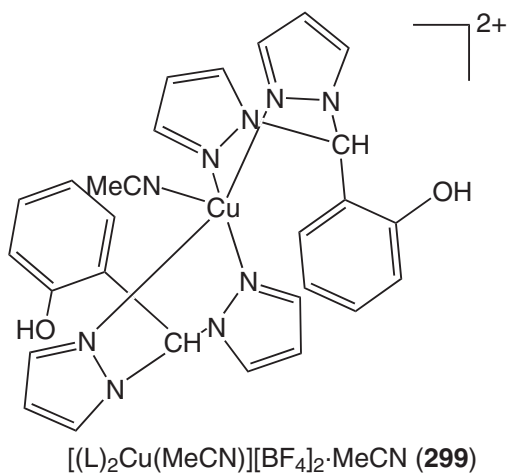
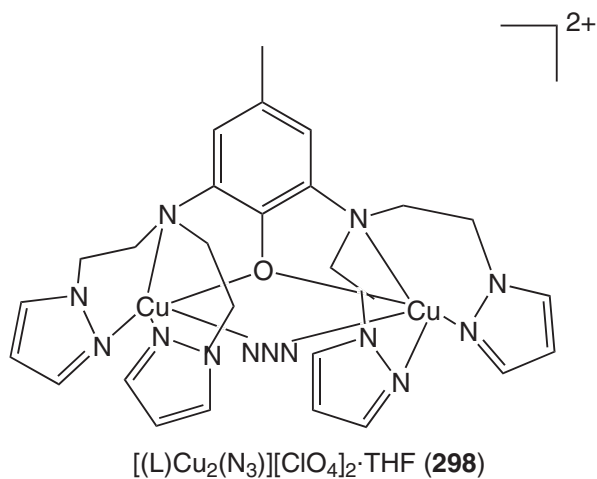
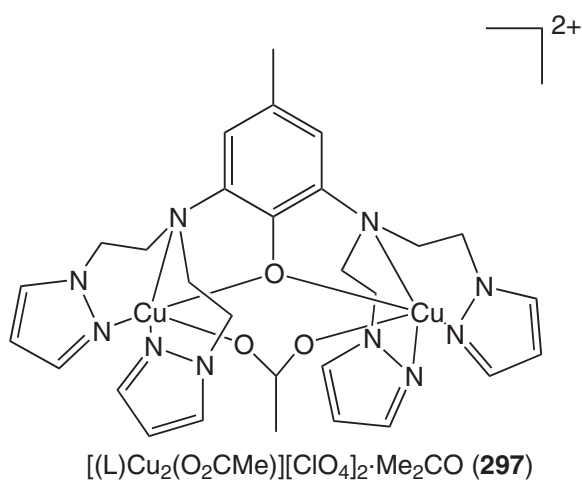
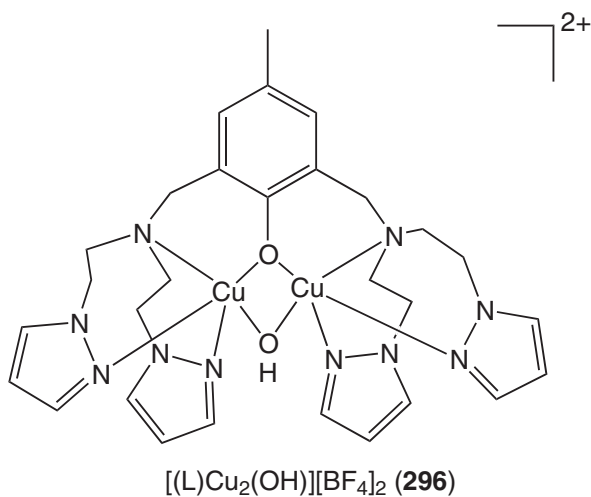
 $[(L)_2Cu(H_2O)][ClO_4]_2 \cdot 2H_2O$ (**292**)

 $[(L)_3Cu(H_2O)_4][ClO_4]_4$ (**293**)

 $[Cu(L)][ClO_4]_2 \cdot MeCN$ (**294**)

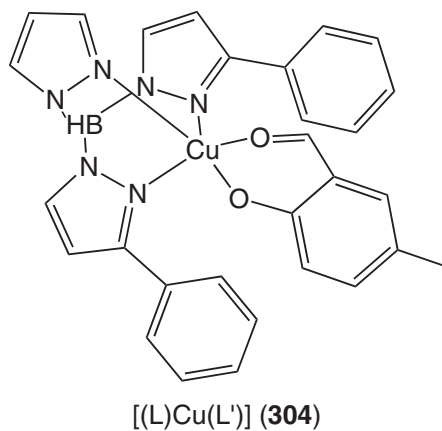
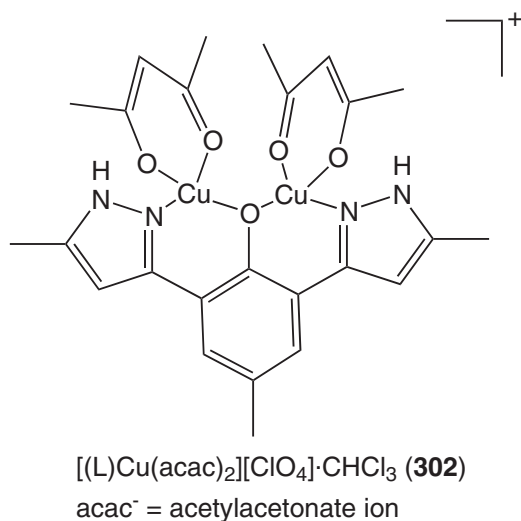
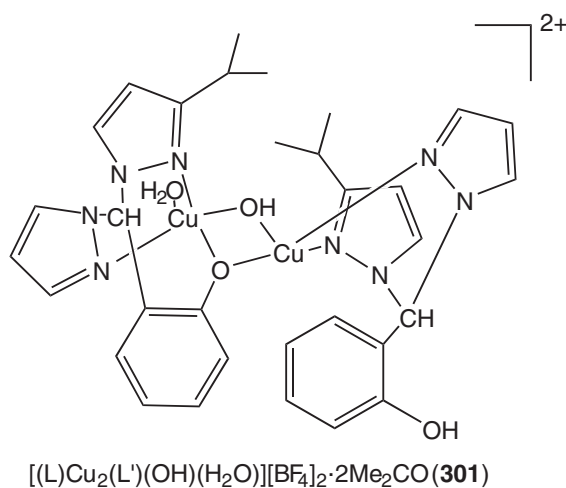
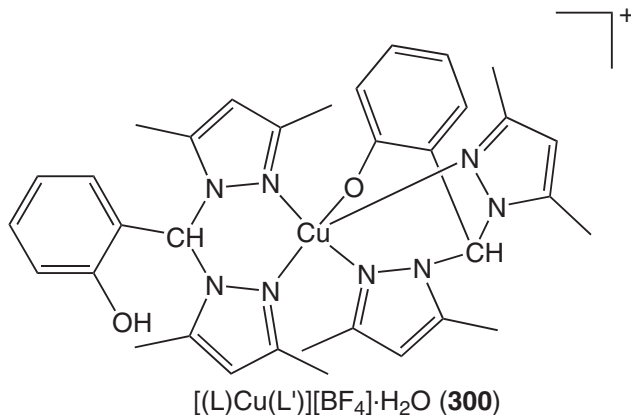
 $[(L)_2Cu(H_2O)_2][ClO_4]_2$ (**295**)

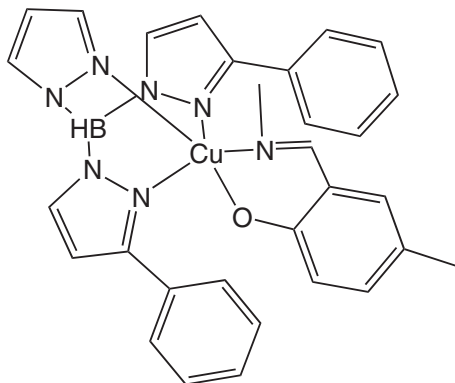
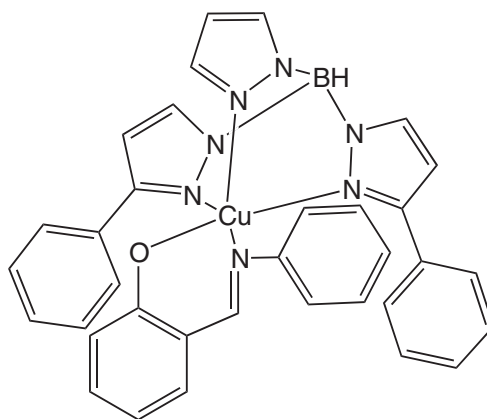
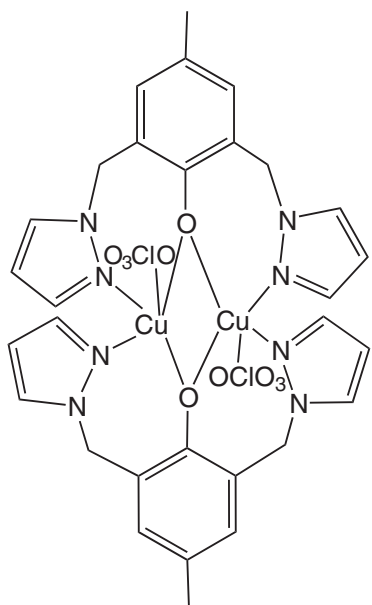
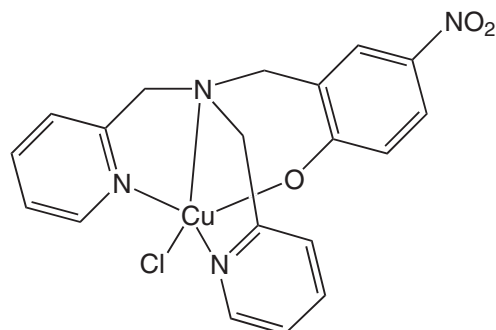
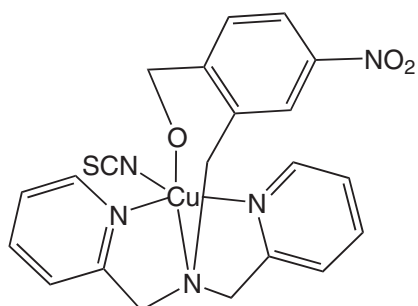
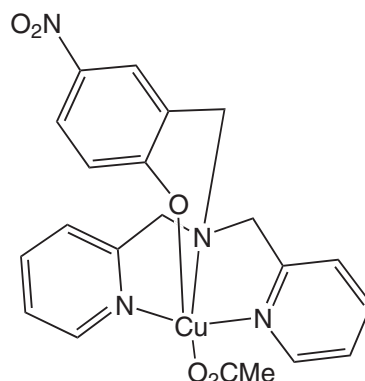

were reported²⁶⁹ by Fujisawa *et al.* as models for the reaction intermediates of the tyrosinase-catalyzed oxidation of phenols. A representative complex $[\{HB(3,5\text{-}^iPr_2pz)_3\}-Cu(OC_6H_4\text{-}4\text{-}F)]$ (**303**) was structurally characterized. Halcrow *et al.*²⁷⁰ were able to stabilize, in solution, an antiferromagnetically coupled copper(II)-phenoxy radical species of relevance to

GO.^{260–262} During this investigation they characterized three complexes: **(304)** ($\tau=0.08$), **(305)** ($\tau=0.38$), and **(306)** ($\tau=0.30$) (they structurally characterized a closely related copper(II) system ($\tau=0.07$)),²⁷¹ that when oxidized by one-electron showed absorption spectral features similar to that of the active form of GO). Using a dinucleating phenolate-based ligand with terminal pyrazole groups, Mukherjee and co-workers reported complex **(307)** ($\tau=0.06$; Cu–Cu: 3.0983 Å; $2J=-1204\text{ cm}^{-1}$).²⁷² Palaniandavar reported an axially coordinated phenolate ligand in the complex **(308)** ($\tau=0.16$), which has structural relevance to GO.^{273,274} They also reported complexes

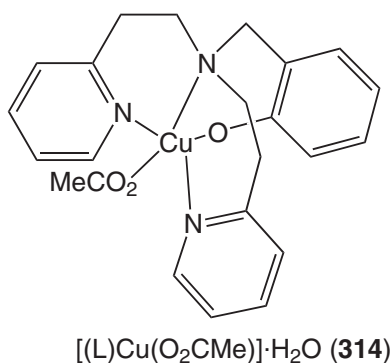
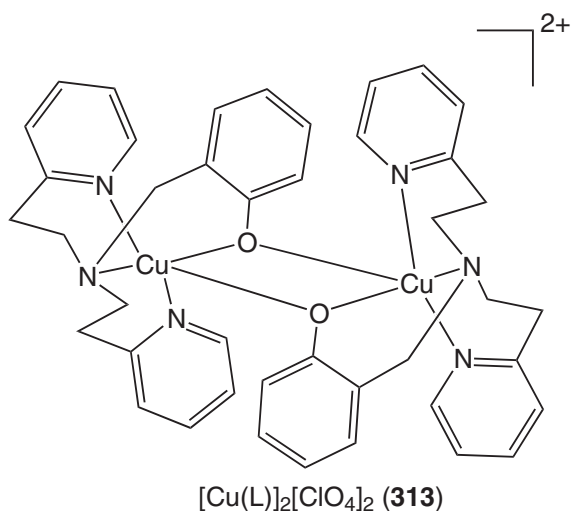
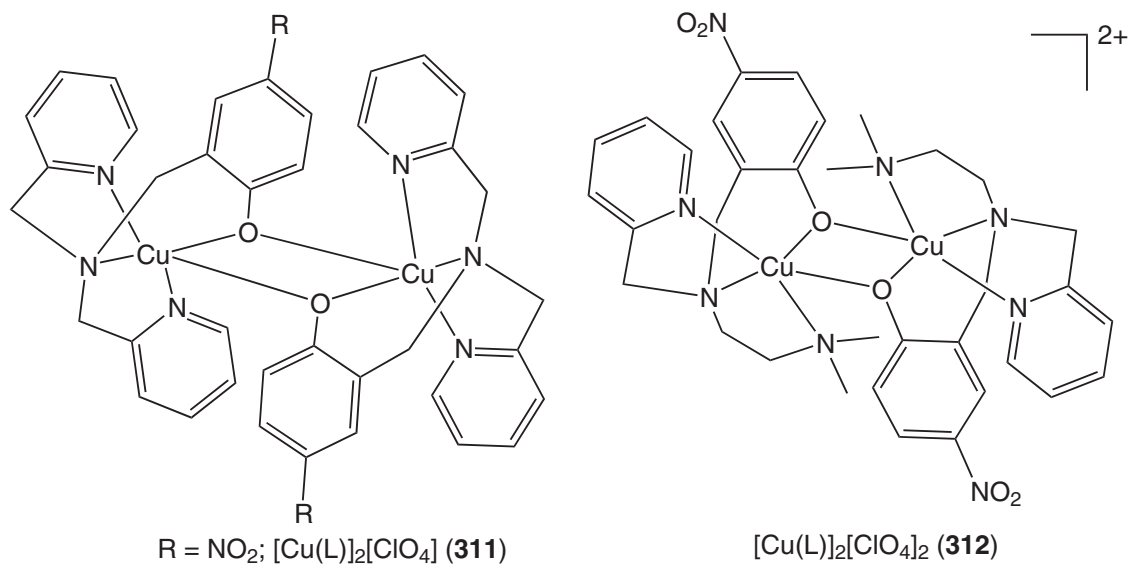

 $[(L)Cu(L'')]$ (305)

 $[(L)Cu(L''')]$ (306)

 $\{[Cu(L)](ClO_4)\}_2$ (307)

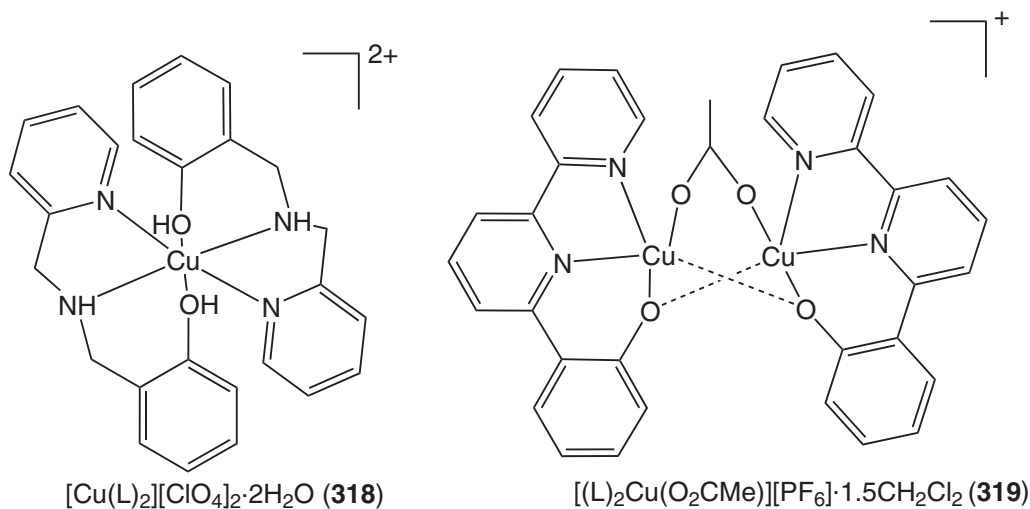
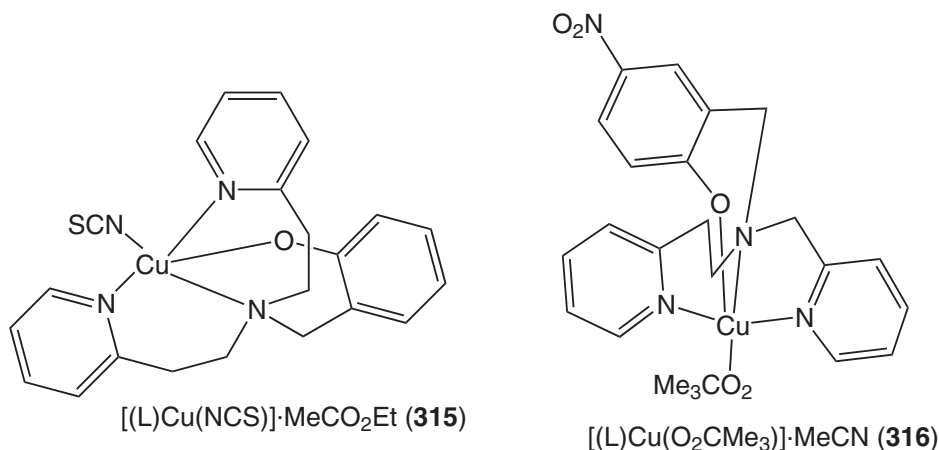
 $[(L)CuCl]$ (308)

 $[(L)Cu(NCS)] \cdot NH_4SCN$ (309)

 $[Cu(L)(O_2CMe)] \cdot MeOH \cdot p\text{-xylene}$ (310)



(**309**) ($\tau=0.24$),²⁷⁵ (**310**) ($\tau=0.29$),²⁷⁶ (**311**) (Cu–Cu: 3.09 Å),²⁷⁵ and (**312**) ($\tau=0.55$, Cu–Cu: 3.24 Å).²⁷⁶ In an independent effort, Fenton and co-workers investigated a series of interesting complexes: (**313**) ($\tau=0.17$; $2J=-660\text{ cm}^{-1}$),²⁷⁷ (**314**) ($\tau=0.08$),²⁷⁸ (**315**) ($\tau=0.11$),²⁷⁸ (**316**) (square pyramidal),²⁷⁹ and (**317**) (this has a similar structure to that of complex (**311**), with a water molecule as solvent of crystallization and without the NO₂ substituent in the ligand; $\tau=0.31$,



Cu–Cu: 3.153 Å).²⁷⁹ They also structurally characterized a complex similar to complex (**310**) ($\tau = 0.17$), with a water molecule as solvent of crystallization and without the NO₂ substituent in the ligand.²⁷⁹ Neves *et al.*²⁸⁰ reported an interesting structure (complex (**318**)) in which the two phenol oxygen atoms remain protonated and coordinate to copper in an axial fashion.

To explore the coordination abilities of mixed phenol-bpy/phen/terpy polydentate chelating ligands, Ward *et al.* investigated complexes (**319**) (Cu–Cu: 3.050 Å; moderate AF coupling),^{281,282} (**320**) (moderate AF coupling),²⁸³ and (**321**) (Cu–Cu: 3.324 Å; weak AF coupling).²⁸⁴

In a major breakthrough, Stack and co-workers reported^{285,286} biomimetic functional models of GO that catalytically oxidize benzylic and allylic alcohols to aldehydes with O₂ under mild conditions. They demonstrated that modest structural mimicry is sufficient to transfer an unusual, ligand-based radical mechanism to a simple chemical system (complex (**322**)). Krüger very nicely highlighted this work.²⁸⁷ Chaudhuri, Wiegardt, and their co-workers were successful in bringing structural models of GO to homogeneous catalysis and reported structures of a few very interesting complexes: (**323**),²⁸⁸ (**324**),²⁸⁹ and (**325**).²⁹⁰ They thoroughly investigated their electronic structural properties.²⁶² Garner and co-workers²⁹¹ also reported their success story in preparing phenoxyl radical complexes of copper(II): (**326**) and (**327**). Structural and spectroscopic models for GO have also been provided from the groups of Whittaker (complex (**328**); $\tau = 0.47/0.42$, Cu–Cu: 3.05 Å),²⁹² Itoh (complexes (**329**): $\tau = 0.35/0.06$, Cu–Cu: 3.16 Å, and (**330**): $\tau = 0.33/0.20$, Cu–Cu: 3.14 Å),²⁹³ and Hahn (complex (**331a**) $\tau = 0.20/0.10$, Cu–Cu: 3.2729 Å).²⁹⁴ Pierpont and Ruf provided a simple model for the GO and reported²⁹⁵ structures of two copper(II) complexes: a linear arrangement of three Cu^{II} ions (complex (**331b**); at the center of the molecule, a planar

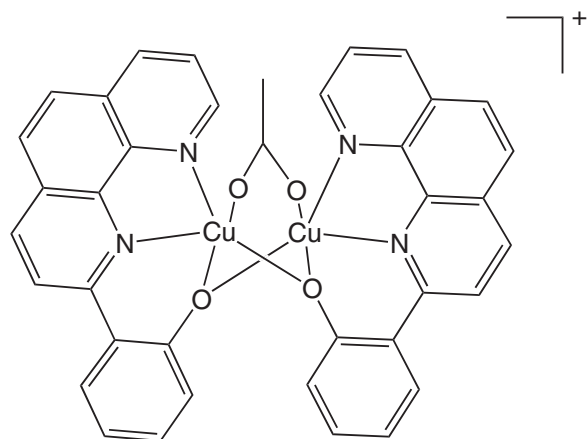

$[(L)_2Cu_2(O_2CMe)][PF_6]$ (**320**)

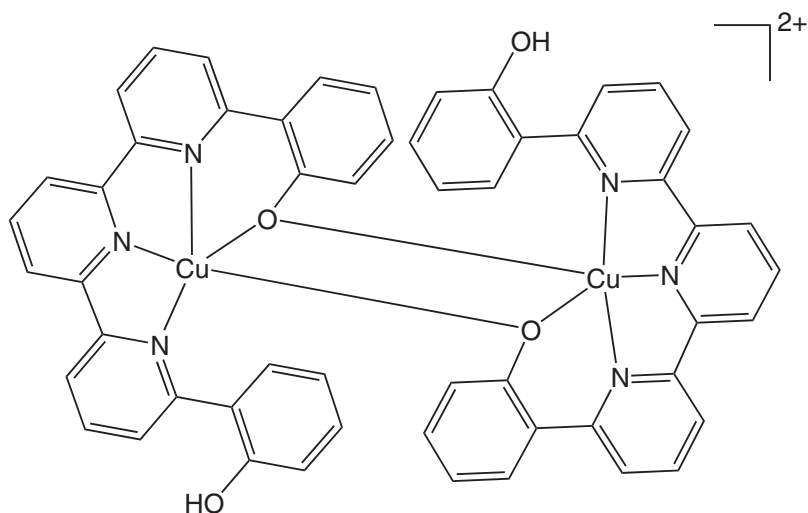

$[(L)Cu_2][PF_6]_2 \cdot 5MeCN$ (**321**)

$[Cu(OMe)_4]^{2-}$ anion is bridged to outer square-pyramidal $\{Cu(L)\}^+$ cations) and a mononuclear square-pyramidal complex (**331c**).

As a part of their activity on magnetic and electrochemical studies on dinuclear copper(II) complexes, Fenton and co-workers reported complex (**332**) (Cu–Cu: 2.957 Å; $2J = -493 \text{ cm}^{-1}$).²⁹⁶ It should be mentioned here that the magnetic properties of copper pairs are satisfactorily accounted for by considering the symmetry of the magnetic orbitals of the two interacting metallic fragments. Direct electronic communication is necessary for antiferromagnetic interaction, and so the overlap between metal magnetic orbitals (Cu–O–Cu bridge angle, Cu–Cu distance, displacement of Cu atoms from the coordination plane, etc.) and the highest occupied orbital(s) of the intervening atom(s) is the major determining factor for antiferromagnetic (AF) coupling (singlet–triplet gap ($2J$) is expressed in cm^{-1} ; the value is negative for AF coupled systems and positive for ferromagnetic (F) coupled systems).^{254–256,297–299}

In dinuclear transition-metal bio-sites the metal ions are often found in chemically or geometrically distinct environments.^{101,264} For example, the unsymmetrical nature of the dicopper site in Hc is demonstrated in the X-ray crystal structure of deoxyHc,⁵⁸ and sequence homology studies on tyrosinases have shown that whilst one of the copper sites has been highly conserved throughout evolution, the structure of the second copper site has been quite variable. Inspired by this fact, the design of unsymmetric dinucleating ligands came into being. From this background many interesting dicopper(II) systems were reported: (**333**) (one Cu is square pyramidal and the other one distorted TBP; Cu–Cu: 3.24 Å; $2J = -42 \text{ cm}^{-1}$),^{300,301} (**334**) (it is however,

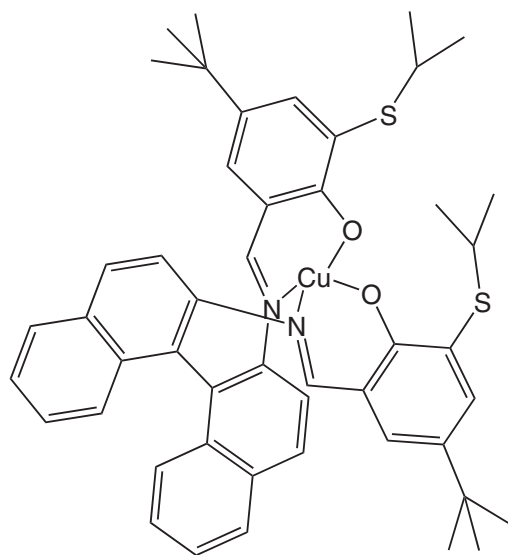

[Cu(L)] (322)

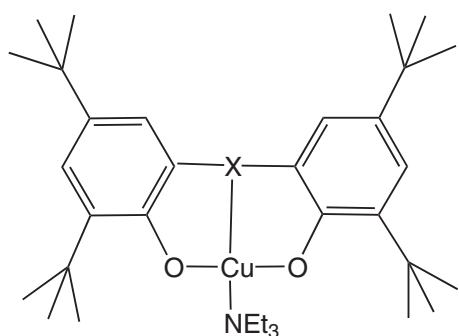
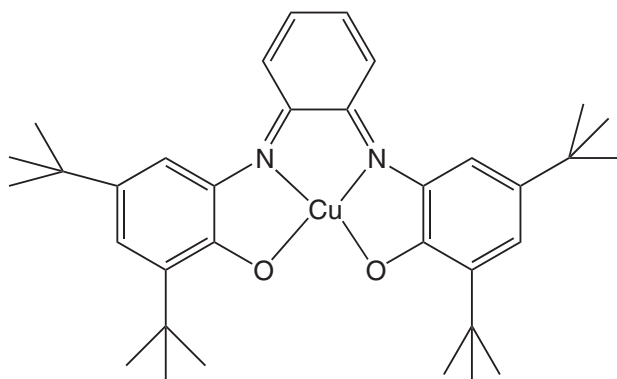
X = N; [Cu(L)(NEt₃)] (323)X = S; [Cu(L)(NEt₃)] (324)

[(L)Cu(MeCN)] (325)

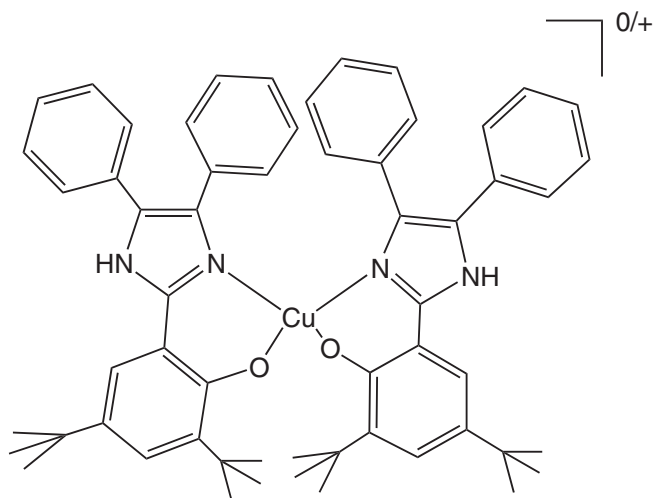
[Cu(L)₂]·4DMF (326)[Cu(L)₂][BF₄]·2CH₂Cl₂ (327)

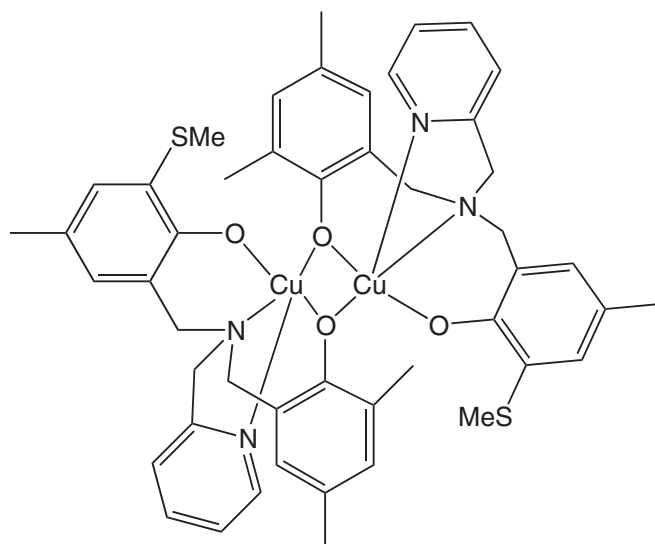

$[\text{Cu}_2(\text{L})_2] \cdot 2\text{MeCN}$ (**328**)

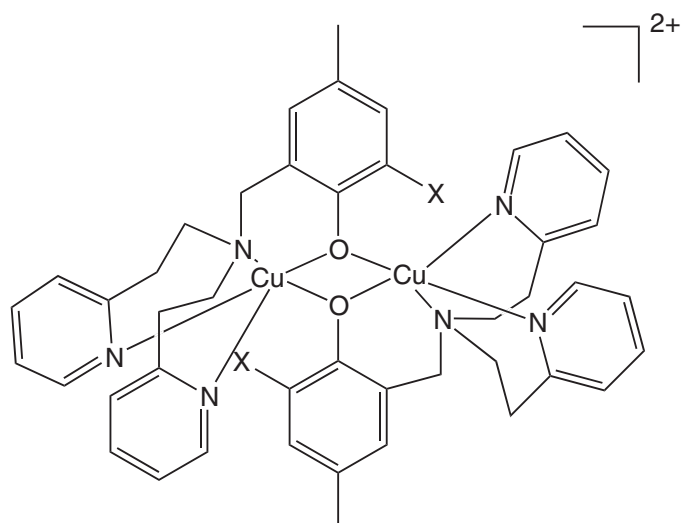

X = H; $[\text{Cu}_2(\text{L})_2][\text{PF}_6]_2$ (**329**)

X = SMe; $[\text{Cu}_2(\text{L})_2][\text{PF}_6]_2 \cdot 2\text{MeCN}$ (**330**)

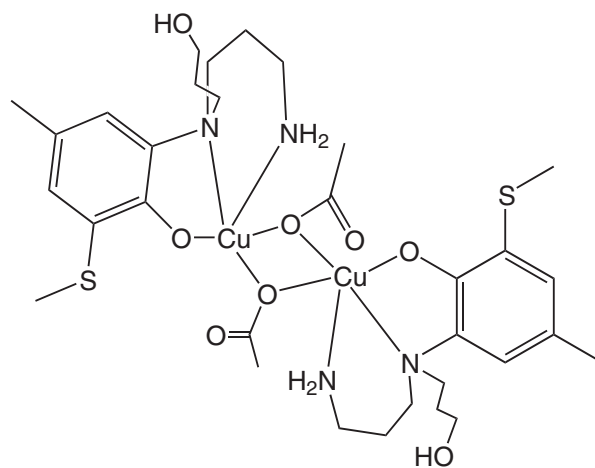

$\{[(\text{L})\text{Cu}(\text{O}_2\text{CMe})_2]\}_2 \cdot 2\text{MeCN}$ (**331a**)

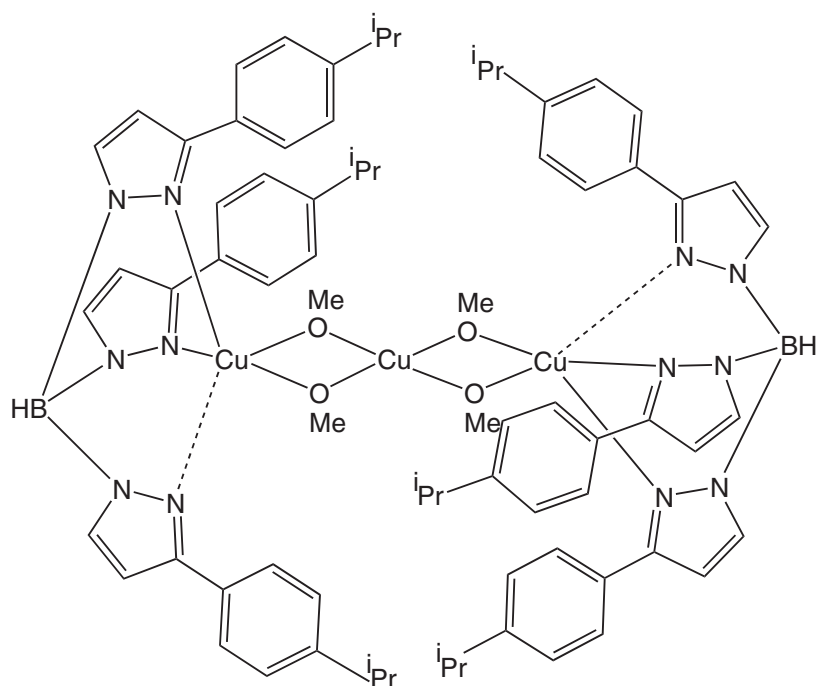

[[L]Cu(OMe)₂]₂Cu (331b)

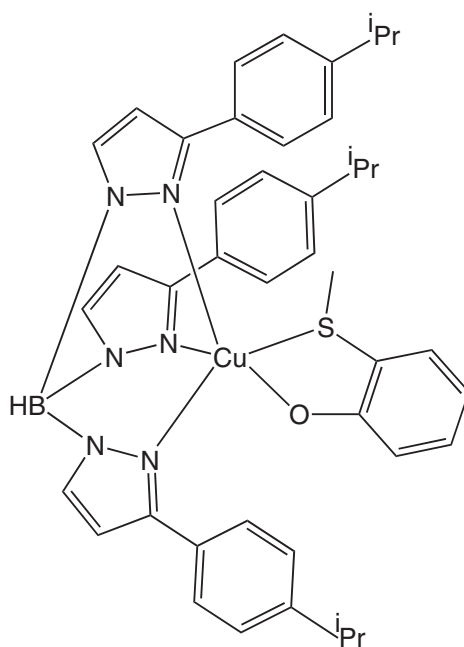

[[L]Cu(L')] (331c)

monomeric),³⁰² (335) ($\tau=0.03/0.74$; Cu–Cu: 2.938 Å; $2J=-85\text{ cm}^{-1}$),³⁰³ (336) ($\tau=0.05/0.34$; Cu–Cu: 3.221 Å; no magnetic interaction),³⁰⁴ (337) ($\tau=0.03/0.13$; Cu–Cu: 2.9596 Å; $2J=-430\text{ cm}^{-1}$),³⁰⁴ (338) (square pyramidal; Cu–Cu: 3.297 Å; $2J=-126\text{ cm}^{-1}$),³⁰⁵ and (339) (irregular square pyramid; Cu–Cu: 3.0107 Å).³⁰⁶ As a part of their direct involvement in tyrosinase modeling, Feringa *et al.* reported complexes (340) ($\tau=0.02/0.09$; Cu–Cu: 2.991 Å)³⁰⁷ and (341) ($\tau=0.03/0.13$; Cu–Cu: 3.0293 Å; $2J=-15\text{ cm}^{-1}$).³⁰⁸

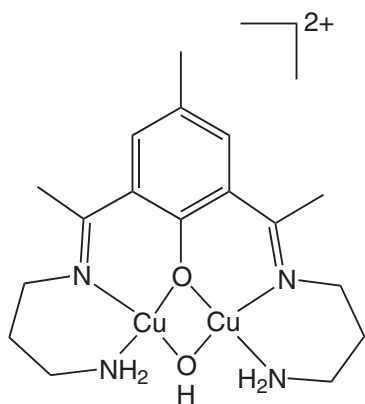

$[(L)Cu_2(OH)][ClO_4]_2 \cdot H_2O$ (**332**)

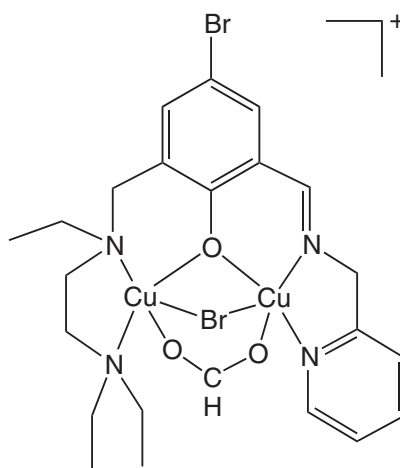

$[(L)Cu_2(L)(Br)(HCO_2)]_2[Cu_2Br_4]$ (**333**)

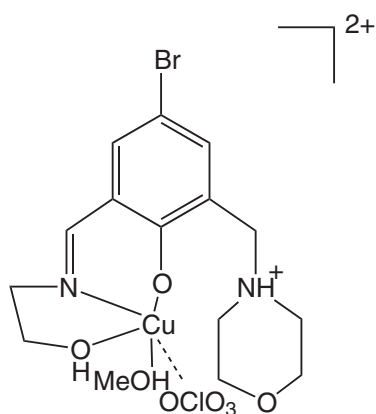

$[Cu(H_2L)][ClO_4]_2 \cdot H_2O \cdot MeOH$ (**334**)

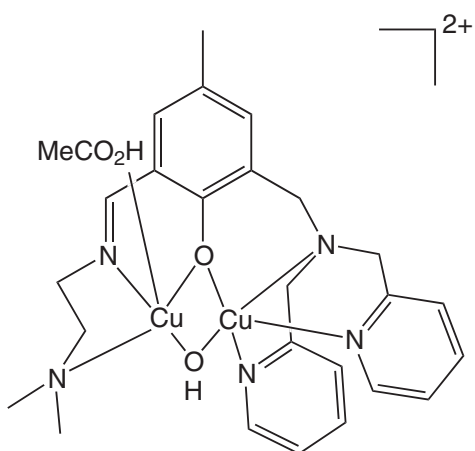

$[Cu_2(L)(OH)][ClO_4]_2 \cdot MeCO_2H$ (**335**)

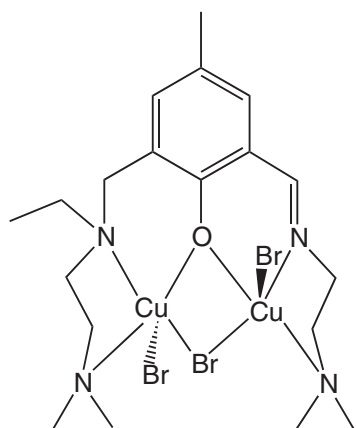

$[(L)Cu_2Br_3]$ (**336**)

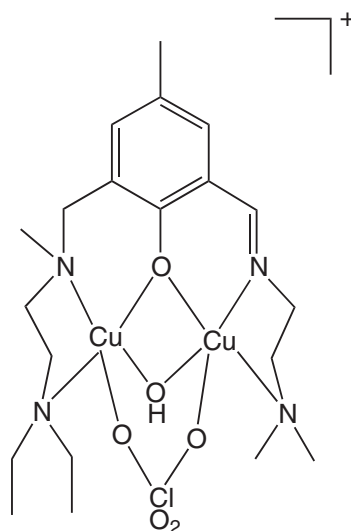

$[(L)Cu_2(OH)(OCIO_3)][ClO_4]$ (**337**)

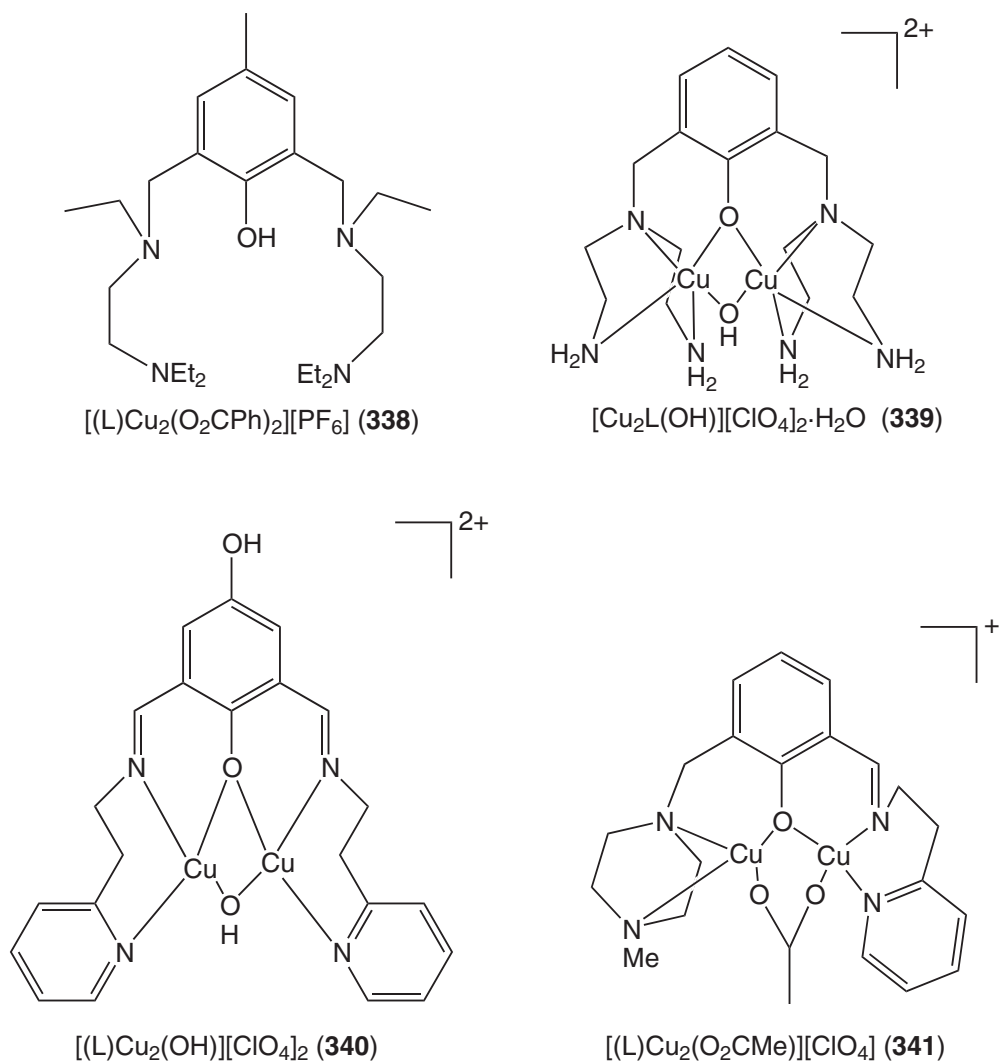

Kahn and co-workers and Murray and co-workers carried out pioneering magnetostructural correlations work in phenolato-bridged dicopper(II) systems: (**342**) (Cu–Cu: 2.993 Å; $2J = -161 \text{ cm}^{-1}$),³⁰⁹ (**343**) (Cu–Cu: 2.977 Å; $2J = 43 \text{ cm}^{-1}$),³⁰⁹ (**344**) (square-pyramidal; Cu–Cu: 2.872 Å; weak ferromagnetic coupling),³¹⁰ (**345**) (distorted SP; Cu–Cu: 3.263 Å; $2J = -72 \text{ cm}^{-1}$),³¹⁰ (**346**) (Cu–Cu: 3.603 Å; $2J = -244 \text{ cm}^{-1}$),³¹⁰ and (**347**) (Cu–Cu: 3.655 Å; $2J = -280 \text{ cm}^{-1}$).³¹⁰ Many workers investigated similar systems and studied their chemistry as well: (**348**) (distorted SP; Cu–Cu: 3.265 Å; $2J = -93 \text{ cm}^{-1}$),³¹¹ (**349**) (distorted SP; Cu–Cu: 3.030 Å; $2J = -299 \text{ cm}^{-1}$),³¹² (**350**) (distorted square planar and SP; Cu–Cu: 2.9708 Å; $2J = -113 \text{ cm}^{-1}$; ^1H NMR studies were also done),³¹³ (**351a**) (SP and distorted TBP; Cu–Cu: 3.011 Å; ^1H NMR studies were also done),³¹⁴ (**351b**) (sixfold coordination and distorted tetragonal pyramid with the water molecule as its apex; Cu–Cu: 3.014 Å; dimeric units linked by perchlorate groups to one-dimensional infinite chains along the *c*-axis),³¹⁵ (**352**) (distorted SP; Cu–Cu: 4.090 Å),³¹⁶ (**353**) (distorted TBP; Cu–Cu: 3.026 Å; $2J = -94 \text{ cm}^{-1}$),³¹⁶ (**354**) (distorted SP; Cu–Cu: 3.785 Å; $2J = 4.2 \text{ cm}^{-1}$),^{317,318} (**355**) (distorted five-coordinate geometry; Cu–Cu: 3.348 Å; uncoupled; EPR active (rhombic spectrum) both at room temperature and at 77 K),³¹⁹ (**356**) (SP; Cu–Cu: 3.549 Å; $2J = -80 \text{ cm}^{-1}$),³²⁰ (**357**) (SP; Cu–Cu: 4.128 Å; uncoupled),³²⁰ (**358**) (SP; Cu–Cu: 3.020 Å; $2J = -675 \text{ cm}^{-1}$),³²⁰ (**359**) (Cu–Cu: 2.924 Å),³²¹ (**360**) (TBP; Cu–Cu: 2.989 Å),³²² (using the ligand present in complex (**360**), Torelli *et al.* reported pH-controlled change of the copper(II) coordination; they structurally characterized three complexes: μ -phenoxo-/ μ -hydroxo-bridged: Cu–Cu 2.96 Å; diaqua- μ -phenoxo-bridged: Cu–Cu 4.32 Å; and an unusual unbridged

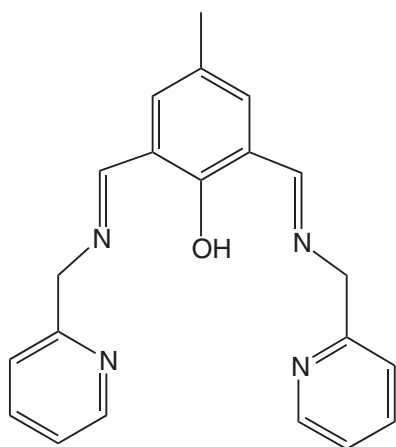

[(L)Cu₂(N₃)](ClO₄)₂ (**342**)
[(L)Cu₂(OCN)](ClO₄)₂ (**343**)

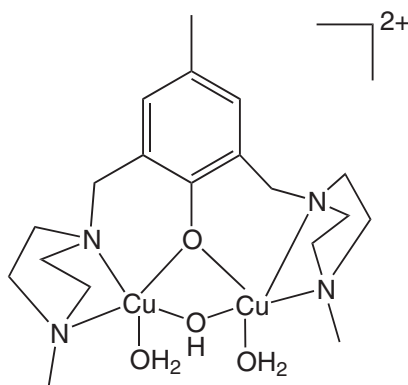

[(L)Cu₂(OH)(H₂O)₂](ClO₄)₂·H₂O (**344**)

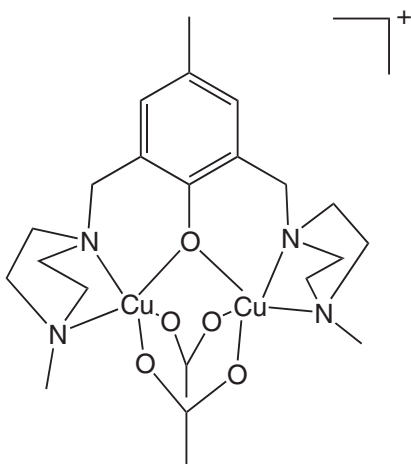

[(L)Cu₂(O₂CMe)₂](ClO₄)₂·3H₂O (**345**)

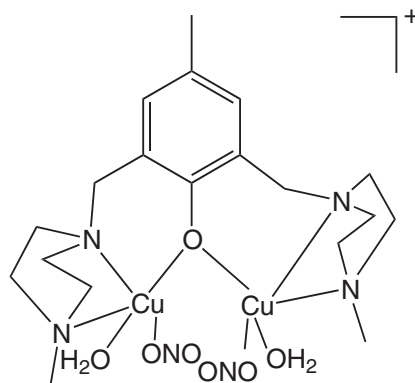

[(L)Cu₂(ONO)₂(H₂O)₂](ClO₄)₂·H₂O (**346**)

dimeric complex; and they carried out temperature-dependent magnetic and redox studies. The μ -phenoxo/ μ -hydroxo-bridged complex exhibited catecholase activity),³²³ (**361**) (distorted SP and distorted TBP; Cu–Cu: 3.255 Å; $2J = -443 \text{ cm}^{-1}$),³²⁴ (**362**) (distorted SP; Cu–Cu: 2.994 Å; $2J = -809 \text{ cm}^{-1}$),³²⁴ (**363**) (distorted TBP; Cu–Cu: 3.131 Å; $2J = -388 \text{ cm}^{-1}$),³²⁴ and (**364**) (distorted SP; Cu–Cu: 3.726 Å; uncoupled).³²⁵

Krebs and co-workers synthesized a series of dinuclear copper(II) complexes as models for catechol oxidase:⁹¹ (**365**) (distorted SP; Cu–Cu: 2.902 Å), (**366**) (distorted five-coordinate geometry; Cu–Cu: 3.002 Å), (**367**) (distorted SP; Cu–Cu: 2.995 Å), (**368**) (distorted five-coordinate geometry; Cu–Cu: 2.938 Å), and (**369**) (distorted SP; Cu–Cu: 2.874 Å). These complexes were characterized by spectroscopic and electrochemical methods. From kinetic analysis, a catalytic order for catecholase activity (aerial oxidation of 3,5-di-*tert*-butylcatechol) was obtained.³²⁶

In a major development, this group³²⁷ reported a thermally stable peroxocopper(II) complex (**370**) (Cu–Cu: 2.994 and 3.030 Å; $2J = -510 \text{ cm}^{-1}$). An interesting tetranuclear oxo-bridged complex (**371**) (Cu–Cu: 2.749 Å and 2.862 Å; $2J = -720 \text{ cm}^{-1}$)³²⁸ was also reported. For both these systems, detailed spectroscopic investigation was carried out. Investigations in MeOH solution provided evidence that the latter complex (oxo-bridged) can be converted into the former, peroxo-bridged complex. They also provided examples of oxo-bridged copper tetrameric complexes: (**372**) (all coppers have TBP geometry; by copper pairing, two of the Cu–Cu distances (average 3.000 Å) are significantly shorter than the other four (average 3.193 Å)), and (**373**) (with the corresponding distances: 2.992 Å and 3.216 Å, respectively).³²⁹ They also analyzed, in detail, their magnetic behavior.

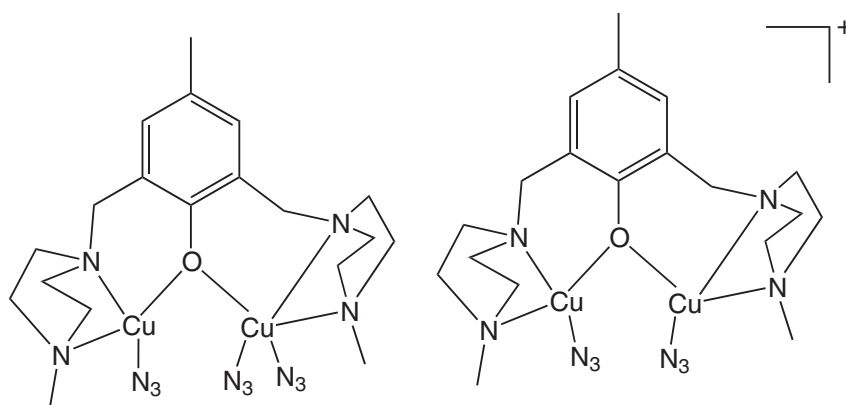

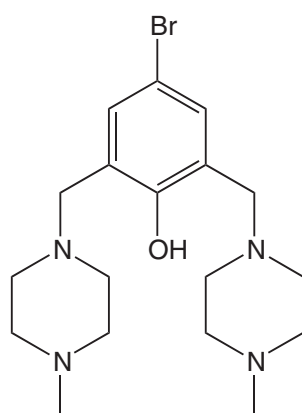
$$[(L)Cu_2(N_3)_3][(L)Cu_2(N_3)_2][ClO_4] \cdot 2H_2O \text{ (347)}$$

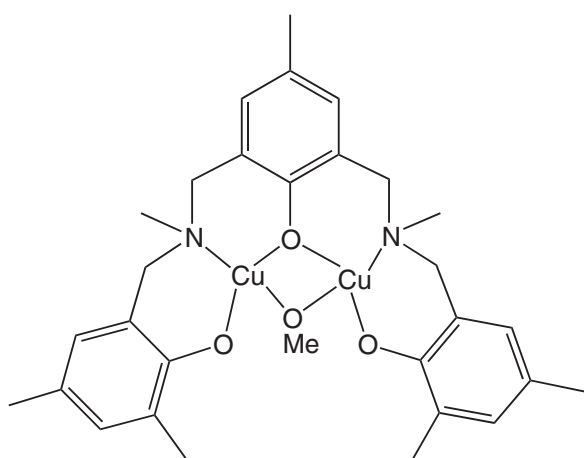
$$[(L)Cu_2(O_2CMe)_2][ClO_4]_2 \cdot H_2O \text{ (348)}$$

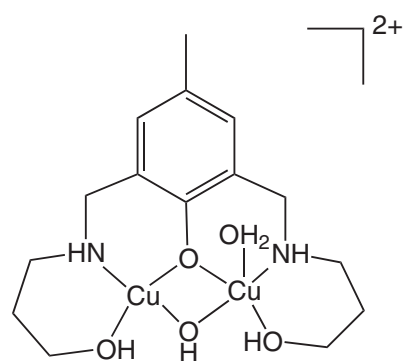
$$[(L)Cu_2(OMe)] \cdot MeOH \text{ (349)}$$

$$[(L)Cu_2(OH)(H_2O)][ClO_4]_2 \cdot H_2O \text{ (350)}$$

Using 2,6-diformyl-4-methylphenol dioxime, Tasker, Schröder, and their co-workers conducted a magnetostructural study on complex (374) (pseudo macrocyclic structure; Cu–Cu: 2.994 Å; $2J = -904 \text{ cm}^{-1}$).³³⁰ Using 2-hydroxy-5-nitro-benzaldehyde benzoylhydrazone as ligand, complex (375) (Cu–Cu: 3.041 Å; $2J = -372 \text{ cm}^{-1}$) was reported.³³¹ Using 3-formylsalicylic acid oxime Okawa and co-workers reported complex (376) (square-planar and SP geometry; Cu–Cu: 2.961 Å).³³²

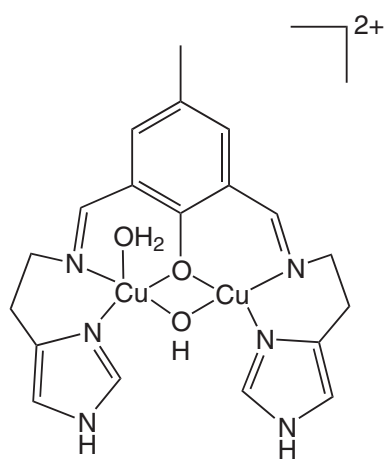
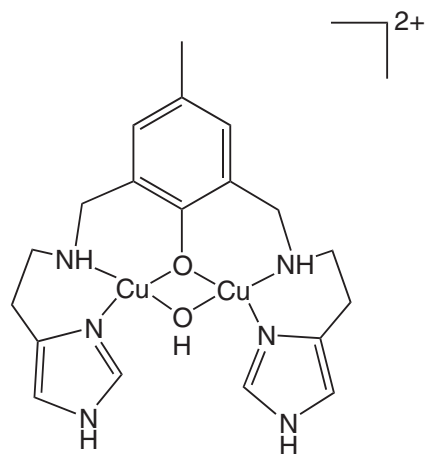
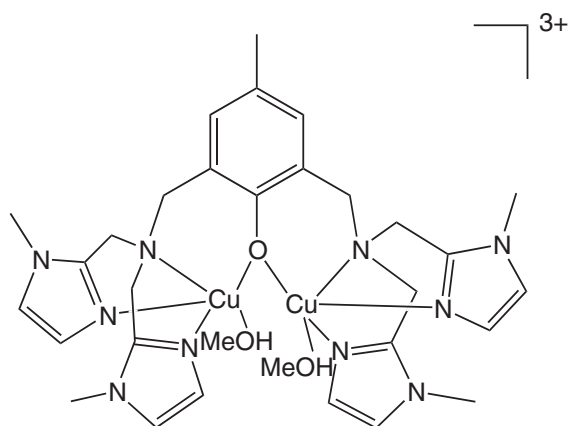
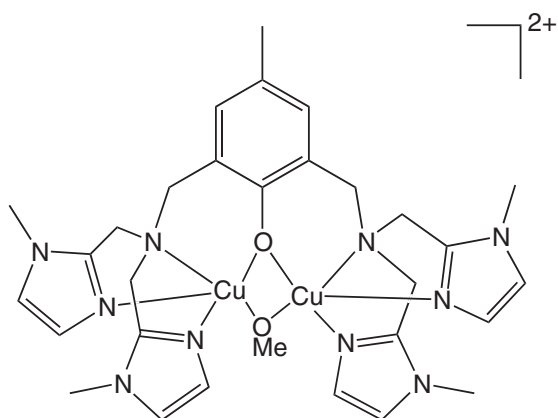
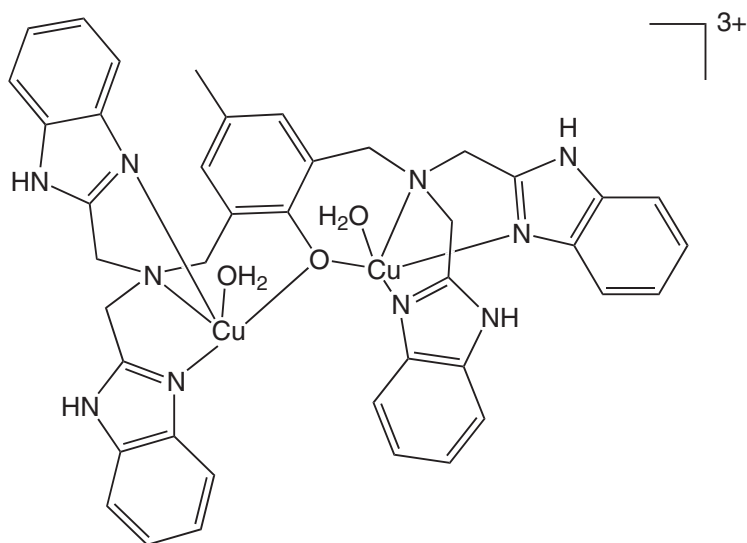

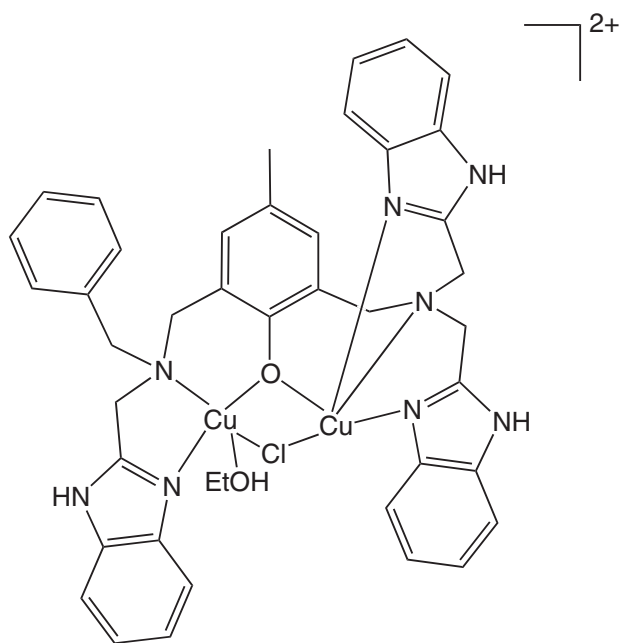
 $[(L)Cu_2(OH)(H_2O)][ClO_4]_2$ (**351a**)

 $[Cu_2(L)(OH)][ClO_4]_2 \cdot 1.5H_2O$ (**351b**)

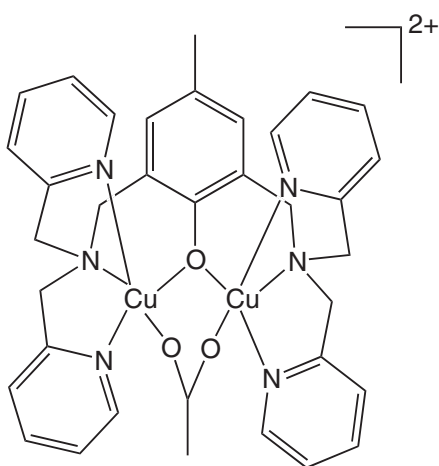
 $[(L)Cu_2(MeOH)_2][ClO_4]_3$ (**352**)

 $[(L)Cu_2(OMe)][ClO_4]_2 \cdot 2MeOH$ (**353**)

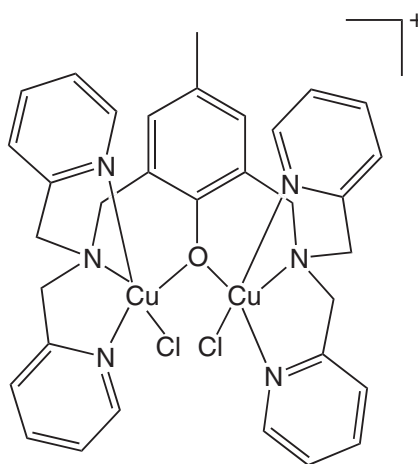
 $[(L)Cu_2(H_2O)_2][ClO_4]_3 \cdot 3H_2O$ (**354**)



$[(L)Cu_2(Cl)(EtOH)][ClO_4]_2 \cdot 4H_2O \cdot EtOH$ (**355**)



$[(L)Cu_2(MeCO_2)][PF_6]_2$ (**356**)



$[(L)Cu_2Cl_2][ClO_4]$ (**357**)

Partial hydrolysis of a potentially heptadentate Schiff-base tripodal ligand derived from tris-(2-aminoethyl)amine and 2-hydroxyacetophenone, induced by copper(II) salts, was reported and the final copper(II) complex (**377**) was characterized.³³³ Using salicylaldehyde as a co-ligand, with a copper(II) complex (**378**), catalytic epoxidation was demonstrated.³³⁴

6.6.3.2.2 Alcohol-based ligands

As a part of their efforts to model dinuclear copper active sites, Reed and co-workers reported, using alkoxo-based dinucleating ligands, a few very interesting systems from the viewpoint of magnetostructural correlations: (**379**) (TBP; Cu–Cu: 3.325 Å; $2J = -278 \text{ cm}^{-1}$), (**380**) (TBP; Cu–Cu: 3.459 Å; $2J = 24 \text{ cm}^{-1}$) and (**381**) (SP; Cu–Cu: 3.615 Å; diamagnetic).^{335–337} They used the concept of ‘ligand orbital complementarity’ to explain the magnetic properties of these

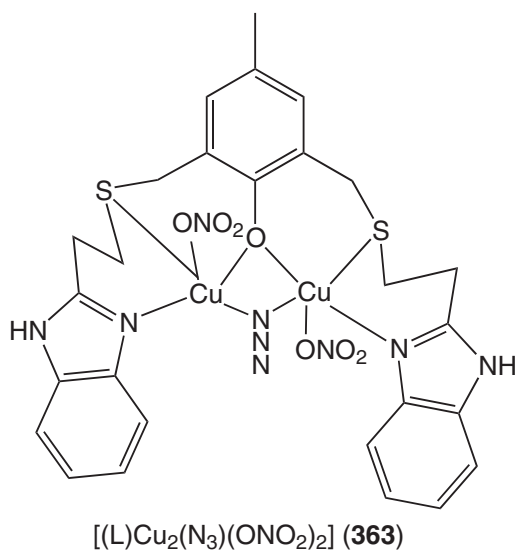
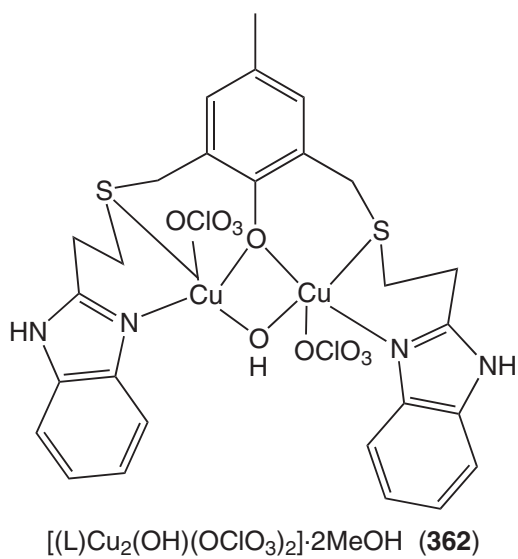
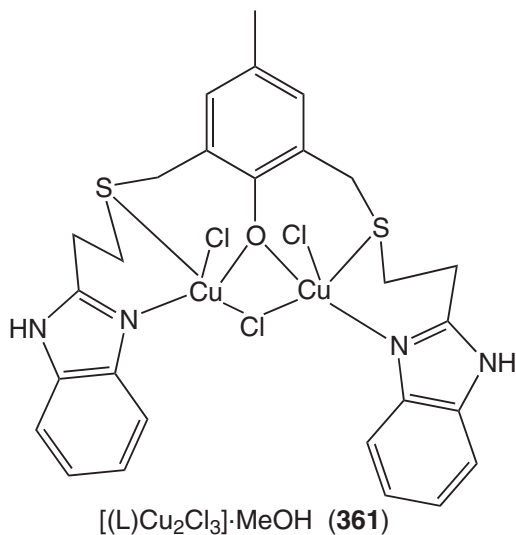
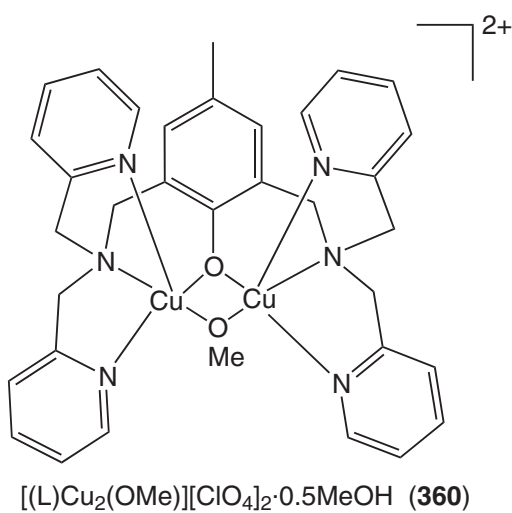
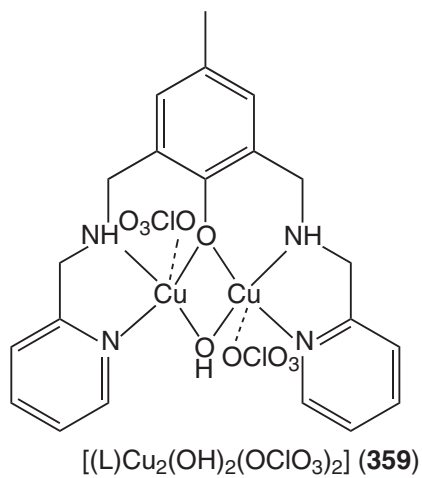
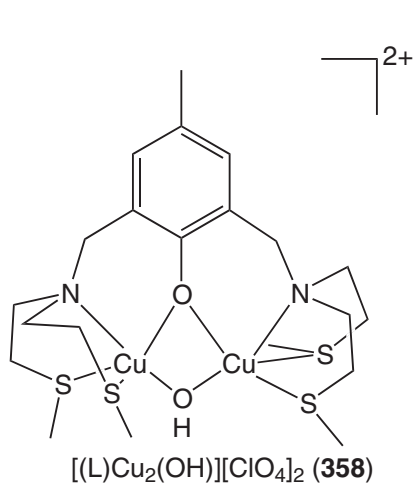

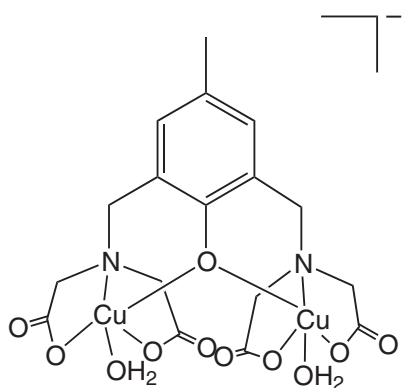
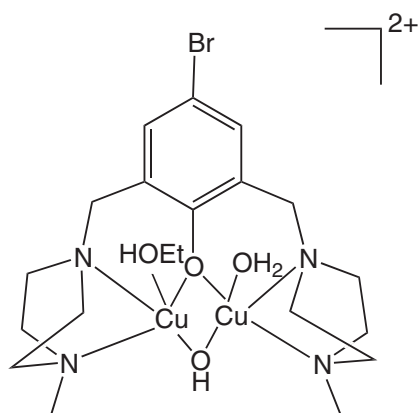
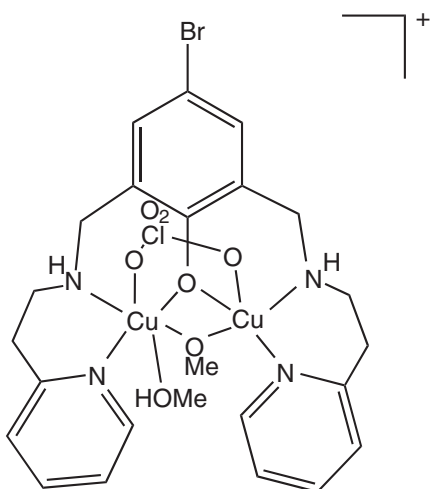
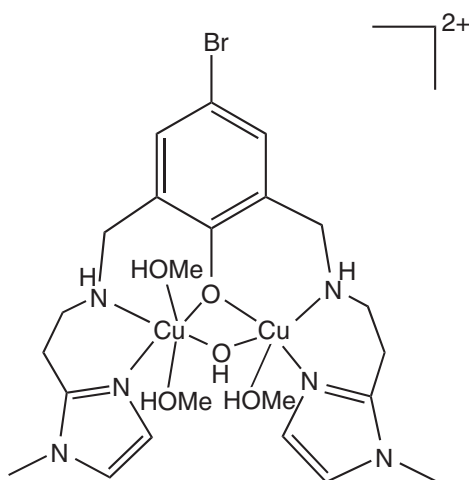
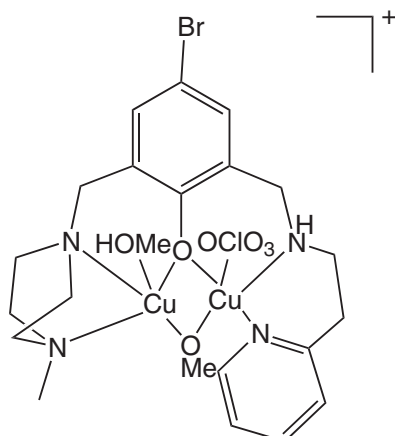
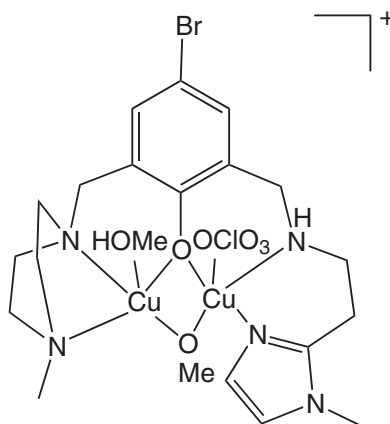

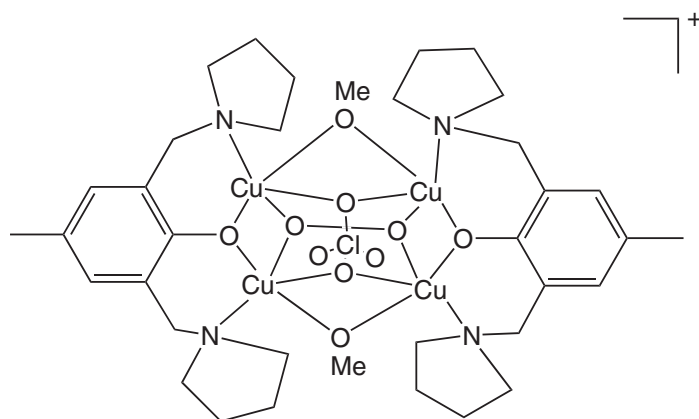
 $[(L)Cu_2(H_2O)_2] \cdot H \cdot 4H_2O$ (**364**)

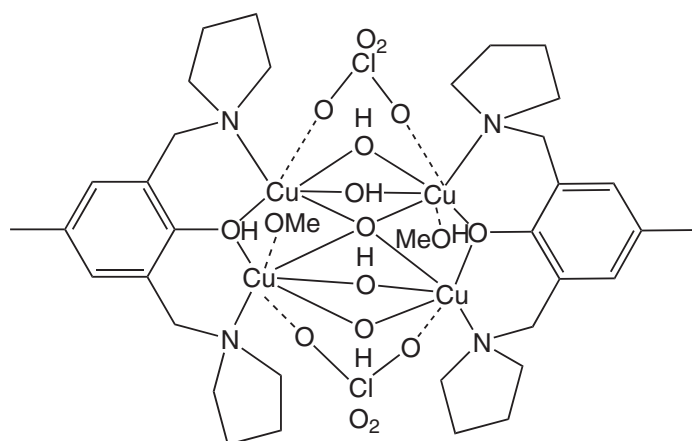
 $[(L)Cu_2(OH)(OH_2)(EtOH)] [ClO_4]_2 \cdot H_2O$ (**365**)

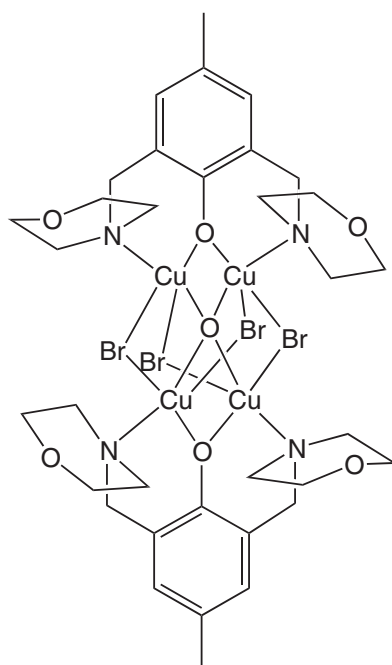
 $[(L)Cu_2(OMe)(MeOH)(O_2ClO_2)] [ClO_4]$ (**366**)

 $[(L)Cu_2(OH)(MeOH)_2] [BF_4]_2$ (**367**)

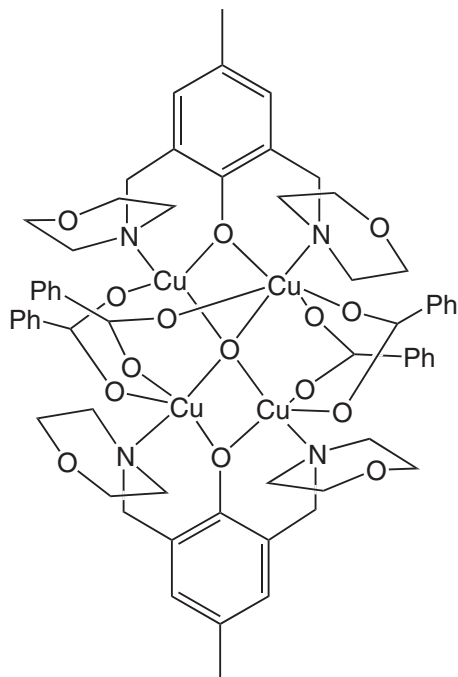
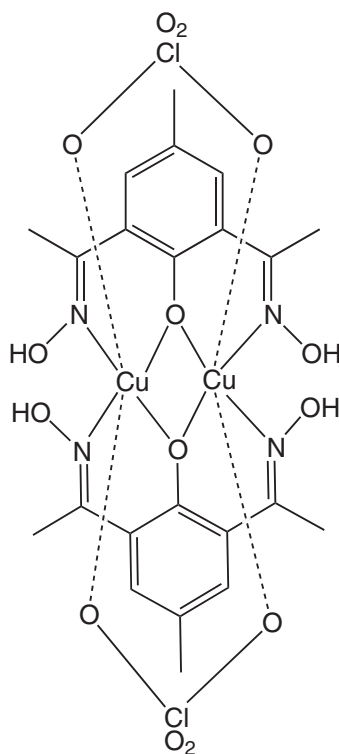
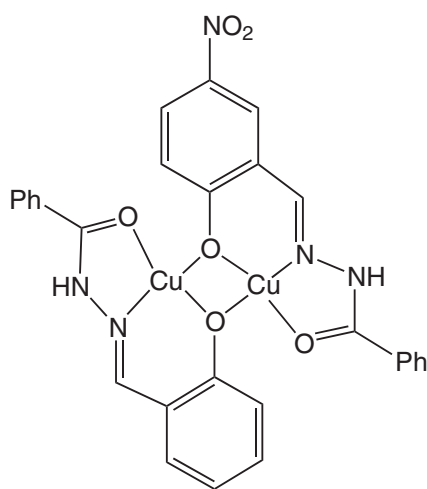
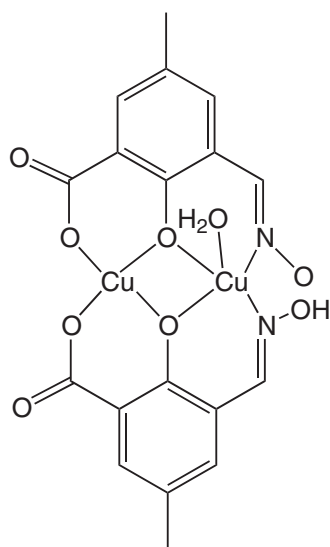
 $[(L)Cu_2(OMe)(MeOH)(OCIO_3)] [ClO_4]$ (**368**)

 $[(L)Cu_2(OMe)(MeOH)(OCIO_3)] [ClO_4]$ (**369**)



$$[(L)_2Cu_4(O_2)(OMe)_2(O_2ClO_2)][ClO_4] \cdot MeOH \text{ (370)}$$

$$[(L)_2Cu_4(O)(OH)_2(MeOH)_2(OCIO_3)_2] \text{ (371)}$$

$$[(L)_2Cu_4OBr_4] \cdot 2MeOH \text{ (372)}$$

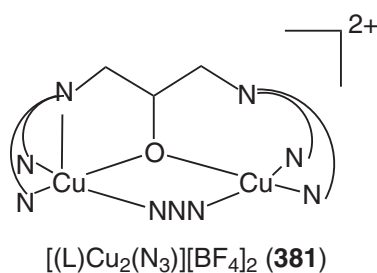
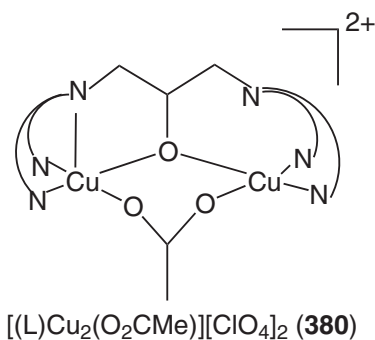
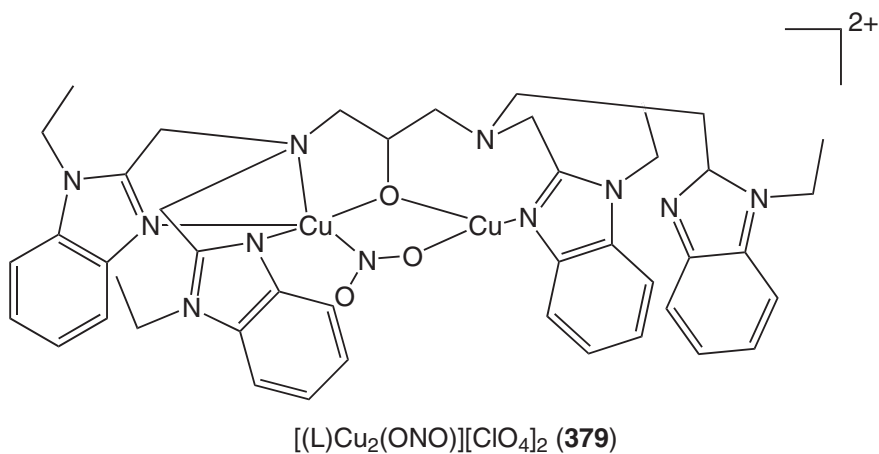
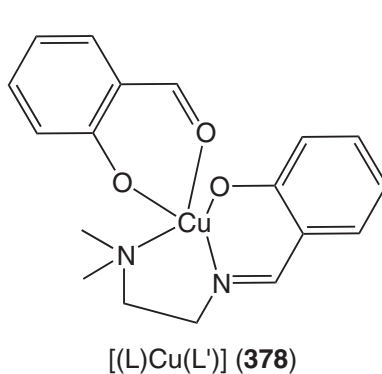
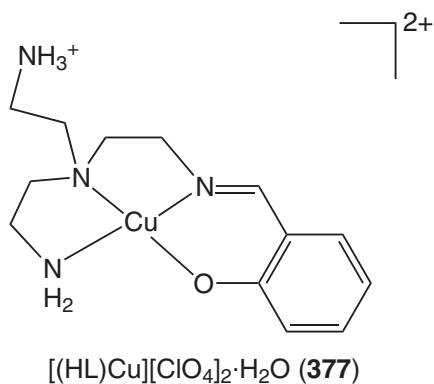

 $[(L)_2Cu_4O(O_2CPh)_2] \cdot H_2O$ (373)

 $[(H_2L)_2Cu_2(OClO_3)_2]$ (374)

 $[(L)_2Cu_2(H_2O)_2]$ (375)

 $Na[(HL)(L)Cu_2(H_2O)]$ (376)

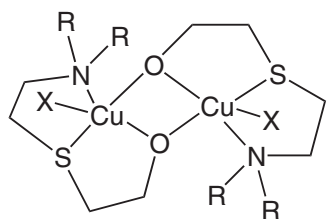
complexes, despite their very close structural similarity. By independently applying the same concept, Kida *et al.*³³⁸ also contributed to magnetostructural correlation studies: complexes (382) (distorted SP; Cu–Cu: 3.0463 Å; $2J = -745 \text{ cm}^{-1}$) and (383) (distorted SP; Cu–Cu: 2.998 Å). Mazurek *et al.*^{339,340} conducted similar studies: complexes (384) (SP; Cu–Cu: 2.928 Å; $2J = -284 \text{ cm}^{-1}$) and (385) (planar coordination; Cu–Cu: 3.359 Å; $2J = -240 \text{ cm}^{-1}$). Buchanan, Hendrickson and their co-workers reported complex (386) (planar coordination; Cu–Cu: 3.349 Å; $2J = -545.6 \text{ cm}^{-1}$).³⁴¹ Nishida *et al.* also contributed to magnetostructural correlation work by reporting a large number of systematically varied complexes: (387) (planar coordination; Cu–Cu: 3.502 Å; $2J = -165 \text{ cm}^{-1}$), (388) (planar coordination; Cu–Cu: 3.495 Å; $2J = -170 \text{ cm}^{-1}$), (389) (planar coordination;



Cu–Cu: 3.482 Å; $2J = -160 \text{ cm}^{-1}$), (**390**) (planar coordination; Cu–Cu: 3.129 Å; uncoupled), and (**391**) (planar coordination; Cu–Cu: 3.644 Å; $2J = -635 \text{ cm}^{-1}$);^{342–344} (**392**) (planar coordination; Cu–Cu: 3.502 Å; $2J = -95 \text{ cm}^{-1}$), (**393**) (planar coordination; Cu–Cu: 3.502 Å; $2J = -165 \text{ cm}^{-1}$), (**394**) (planar coordination; Cu–Cu: 3.495 Å; $2J = -170 \text{ cm}^{-1}$), (**395**) (planar coordination; Cu–Cu: 3.482 Å; $2J = -160 \text{ cm}^{-1}$) and (**396**) (planar coordination; Cu–Cu: 3.644 Å; $2J = -635 \text{ cm}^{-1}$);³⁴⁵ (**397**) (planar coordination; Cu–Cu: 3.401 Å; $2J = -595 \text{ cm}^{-1}$; a complex almost identical to (**385**) but without water of crystallization was reported: planar coordination; Cu–Cu: 3.349 Å; $2J = -310 \text{ cm}^{-1}$).³⁴⁶ From this standpoint, two more complexes (**398**) (distorted SP; Cu–Cu: 3.320 Å; $2J = -260 \text{ cm}^{-1}$) and (**399**) (distorted TBP; Cu–Cu: 3.359 Å; $2J = 32.8 \text{ cm}^{-1}$) were reported.³⁴⁷ Differences in the magnetic behavior of the two copper centers were rationalized using the “ligand orbital complementary” concept.

Kodera and co-workers demonstrated³⁴⁸ that complex (**400**) (distorted TBP; Cu–Cu: 2.926 Å; $2J = -148 \text{ cm}^{-1}$; they also characterized a closely similar ethoxy-bridged complex with two molecules of MeCN) catalyzes the quantitative oxidation of 2,4-di-*tert*-butylphenol to 3,3',5,5'-tetra-*tert*-butyl-2,2'-dihydroxybiphenyl with H_2O_2 . Krebs and co-workers provided models for the



R = n-Bu: [(L)CuCl]₂ (**382**)

R = n-Bu: [(L)CuBr]₂ (**383**)

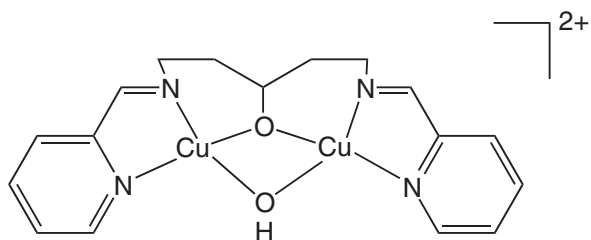

[(L)Cu₂(OH)][ClO₄]₂·2H₂O (**384**)

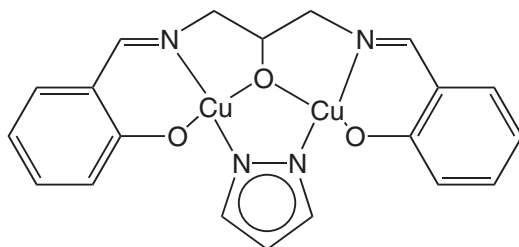

[(L)Cu₂(pz)]·H₂O (**385**)

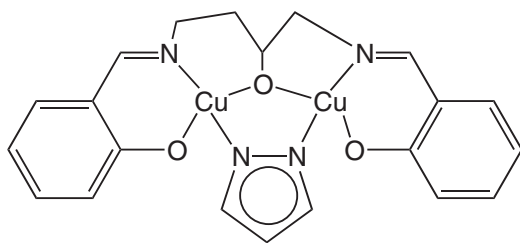

[(L)Cu₂(pz)] (**386**)

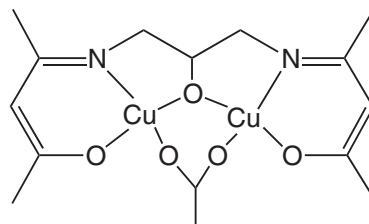

[(L)Cu₂(O₂CMe)]·H₂O (**387**)

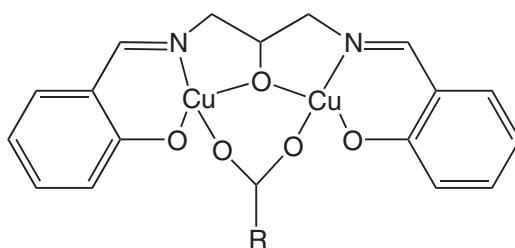

R = Me: [(L)Cu₂(O₂CMe)]·MeOH (**388**)

R = Ph: [(L)Cu₂(O₂CPh)]·H₂O (**389**)

catechol oxidases:⁹¹ complexes (**401**) (distorted square planar; Cu–Cu: 3.033 Å; $2J = -1020 \text{ cm}^{-1}$) and (**402**) (one of the two copper atoms is coordinated by the O atom of the disordered MeOH: one Cu has a distorted square planar and the other a distorted SP geometry; Cu–Cu: 3.017 Å; $2J = -630 \text{ cm}^{-1}$).³⁴⁹ The latter complex was able to oxidize 3,5-di-*tert*-butylcatechol (3,5-DTBC) to the corresponding quinone. Reedijk and co-workers reported³⁵⁰ complex (**403**) (distorted square planar coordination; Cu–Cu: 2.9896 Å; $2J = -773 \text{ cm}^{-1}$), and demonstrated that the compound is catalytically active in the oxidative coupling of 2,6-dimethylphenol and leads to a high selectivity in poly(1,4-ethylene ether) over the unwanted side product. Using a potential dinucleating ligand, Malachowski *et al.* reported³⁵¹ a mononuclear complex (**404**), which showed catalytic properties towards the aerial oxidation of 3,5-DTBC.

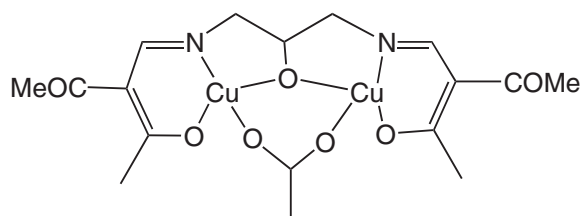
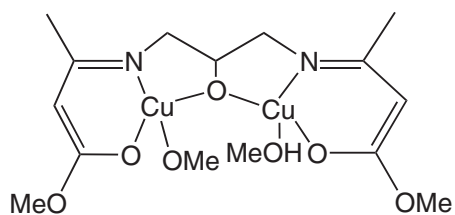
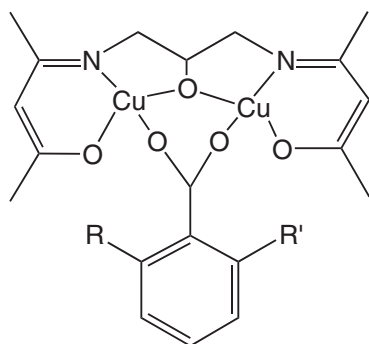
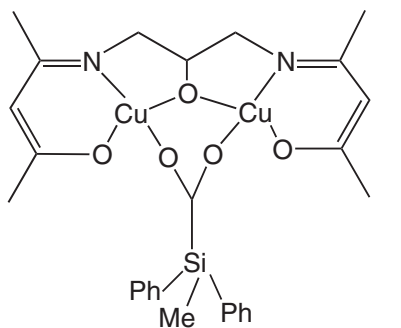
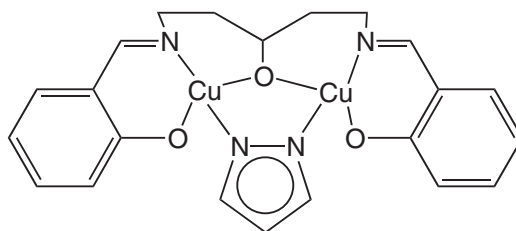
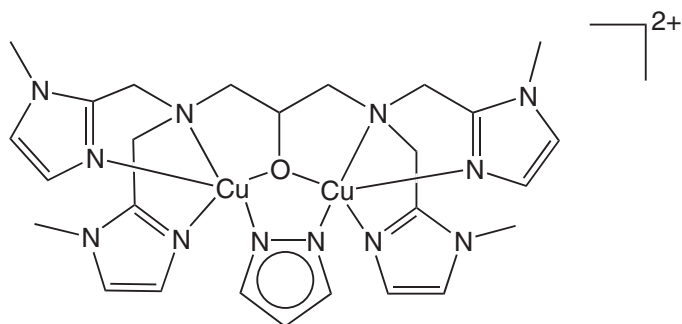
[(L)Cu₂(O₂CMe)] (**390**)[(L)Cu₂(OMe)(MeOH)] (**391**)R = R' = H: [(L)Cu₂(PhCO₂)] (**392**)R = H, R' = Me: [(L)Cu₂(2-Me-PhCO₂)]·0.5MeOH (**393**)R = R' = Me: [(L)Cu₂(2,6-Me₂-PhCO₂)] (**394**)R = R' = Cl: [(L)Cu₂(2,6-Cl₂-PhCO₂)]·0.7DMF (**395**)[(L)Cu₂(Ph₂MeSiCO₂)] (**396**)[(L)Cu₂(pz)] (**397**)[(L)Cu₂(pz)][ClO₄]₂·2MeCN (**398**)

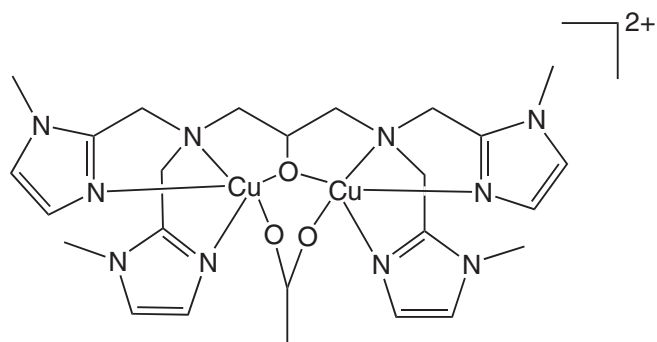
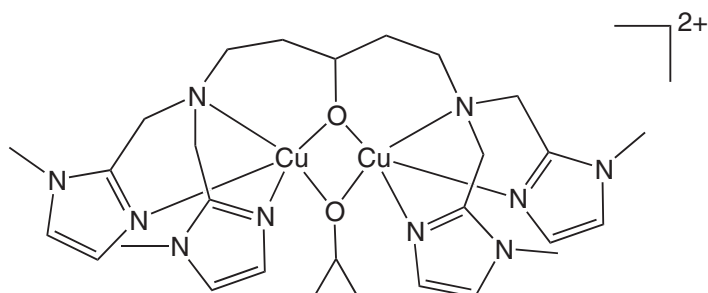
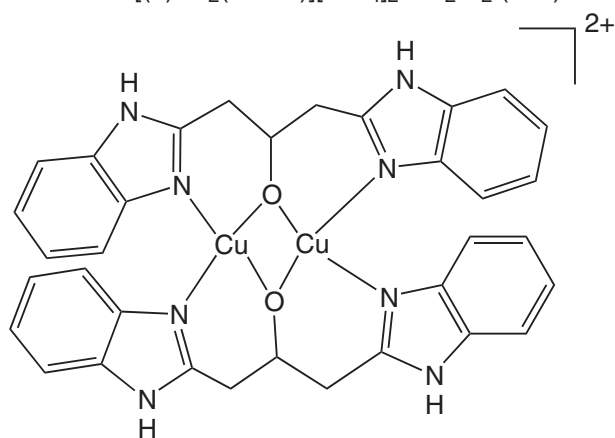
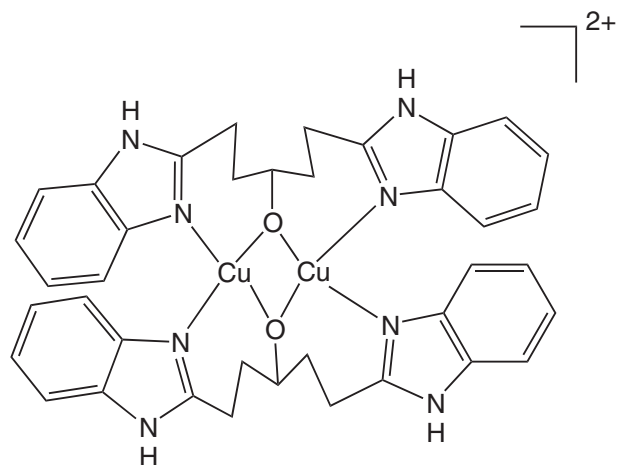
 $[(L)Cu_2(O_2CMe)][ClO_4]_2 \cdot MeCN$ (**399**)

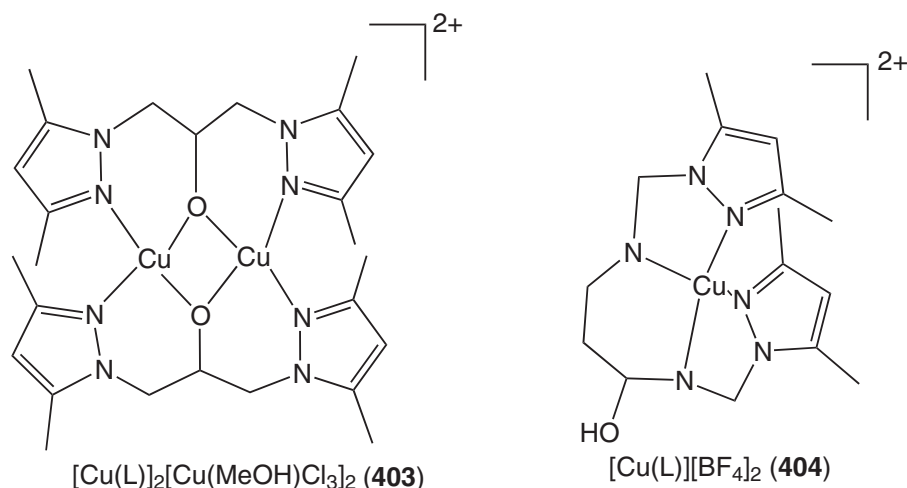
 $[(L)Cu_2(2-PrO)][ClO_4]_2 \cdot CH_2Cl_2$ (**400**)

 $[Cu_2(L)_2][ClO_4]_2 \cdot 2MeOH$ (**401**)

 $[Cu_2(L)_2][ClO_4]_2 \cdot 3MeOH$ (**402**)



As a part of their continued activity in the modeling of Hc and/or Tyr, Karlin *et al.* reported complex (**405**) (Cu–Cu: 2.995 Å).³⁵² The same group demonstrated the hydrolysis of unactivated esters and MeCN hydration by a hydroxo-dicopper(II) complex (**406**) (Cu–Cu: 3.685 and 5.192 Å).³⁵³ Mukherjee and co-workers reported an endogenous alkoxide and an exogenous pyrazolate bridged dicopper(II) complex (**407**) ($\tau=0.07/0.24$; Cu–Cu: 3.377 Å; $2J=-550\text{ cm}^{-1}$).³⁵⁴ Neves *et al.* reported³⁵⁵ a very interesting complex (**408**), in which each copper(II) center has a phenol group coordinated axially without deprotonation. It is worth mentioning here that a mononuclear copper(II)–phenol complex was reported by Masuda *et al.*³⁵⁶ This might have implications for substrate binding at the active site of tyrosinase. Krebs reported³⁵⁷ complex (**409**) (distorted SP; Cu–Cu: 3.382 Å). This complex exhibits catecholase activity; however, the activity is low. Hahn and co-workers reported complex (**410**) ($\tau=0.18$; Cu–Cu: 3.001 Å).²⁹⁴ Magnetostructural correlations and catecholase-like activities were reported with complexes (**411**) (distorted square planar; Cu–Cu: 2.8067 Å; $2J=81\text{ cm}^{-1}$), (**412**) (distorted square planar; Cu–Cu: 2.8690 Å; $2J=25\text{ cm}^{-1}$), (**413**) (distorted square planar; Cu–Cu: 2.9279 Å; $2J=-42\text{ cm}^{-1}$) and (**414**) (distorted square planar; Cu–Cu: 2.975 Å; $2J=-86\text{ cm}^{-1}$).³⁵⁸

6.6.3.3 Sulfur Donor Ligands

6.6.3.3.1 Thiol and thioether-containing ligands

Reaction of a Cu^{II} salt with a thiol is known to lead to a redox decomposition ($\text{Cu}^{\text{II}} + \text{RSH} \rightarrow \text{Cu}^{\text{I}} + \text{RSSR}$).³⁷ Therefore, the number of structurally characterized copper(II)–thiolate complexes will definitely be less. The structure of the first stable Cu^{II} complex (**415**) (CuN_2S_2 coordination), that incorporates deprotonated thiol ligation, was reported by Schugar and co-workers in 1986.³⁵⁹ They conducted spectroscopic studies as well. Kitajima and co-workers reported¹¹³ a CuN_3S system (complex (**107**); Section 6.6.3.1.2(iii)). Using a nonmacrocyclic ligands, Krüger and co-workers reported³⁵ complex $[\text{Et}_4\text{N}]_2[\text{Cu}(\text{L})]\cdot\text{H}_2\text{O}$ (**416**) (structural type: (8)), again with CuN_2S_2 coordination.

A few thioether-ligated copper(II) complexes have been reported, however (cf. Section 6.6.3.1.2): (**417**) (essentially square planar),³⁶⁰ (**418**) (two crystalline forms: one TBP and other SP),³⁶¹ (**419**) (SP),³⁶² (**420**) (SP),³⁶² (**421**) (TBP),³⁶² (**422**) (SP),³⁶³ (**423**) (SP),³⁶³ (**424**) (two independent complexes: SP and octahedral),³⁶⁴ (**425**) (TBP).³⁶⁴ In the complexes (**420**) and (**421**), EPR spectra revealed that the interaction between the unpaired electron and the nuclear spin of the halogen atom is dependent on the character of the ligand present. For (**424**) and (**425**), spectral and redox properties were also investigated. Rorabacher *et al.*³⁶⁵ nicely demonstrated the influence of coordination geometry upon $\text{Cu}^{\text{II}}/\text{Cu}^{\text{I}}$ redox potentials, and reported structures of complexes (**426**) and (**427**). Both the Cu^{I} (Section 6.6.4.5.1) and Cu^{II} complexes have virtual C_{3v} symmetry.

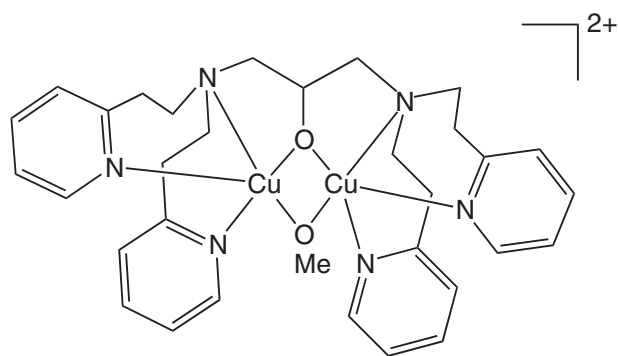

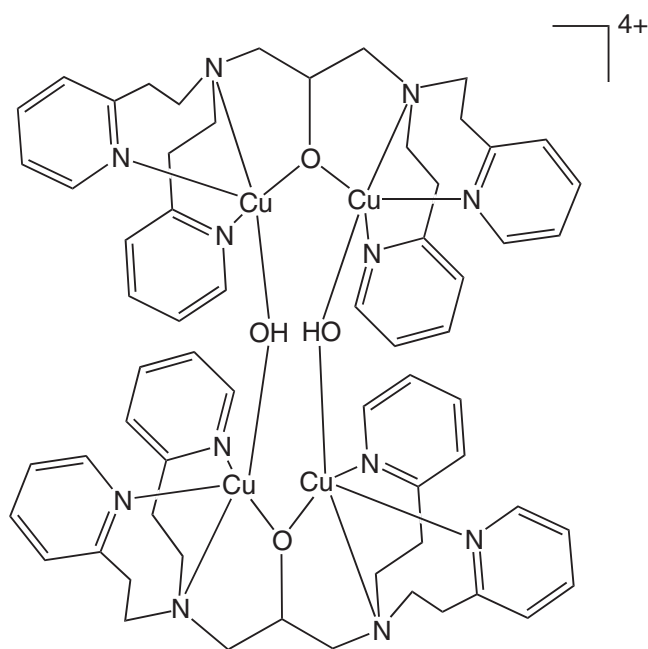
$$[(L)Cu_2(OMe)][PF_6]_2 \cdot MeOH \quad (405)$$

$$[(L)_2Cu_4(OH)_2][ClO_4]_4 \cdot 9MeCN \cdot Et_2O \quad (406)$$

As part of their activity to provide models for the Cu_B center of $D\beta H$,⁸⁴ Réglier and co-workers³⁶⁶ reported the structure of complex (428) (SP). An oxidation of the sulfide ligand was observed when this complex reacted with H_2O_2 . Kodera *et al.* spectroscopically demonstrated³⁶⁷ stabilization of the hydroperoxo-copper(II) species, which is a key intermediate in O_2 activation by $D\beta H$,⁸⁴ when complex (429) ($\tau = 0.39$; also structurally characterized a di-hydroxo-bridged complex $[(L)Cu(OH)]_2[ClO_4]_2 \cdot 2MeCN \cdot H_2O$) was reacted with H_2O_2 at $-40^\circ C$. Chakravarty and co-workers³⁶⁸ provided a structural model for this enzyme: complex (430). Interestingly, the complex is catalytically active in the oxidation of ascorbic acid by dioxygen mediated by a copper(I) species.

6.6.3.4 Amide Ligands

In their pursuit of determining solution structures of dinuclear copper complexes as carried out for complex (29) (Section 6.6.3.1.1), Comba reported complex (431) ($\tau = 0.02$; Cu–Cu: 6.9 \AA , comparable with the values of 7.2 \AA predicted by molecular mechanics calculations and 6.7 \AA obtained from the simulated EPR spectrum).⁵⁴ They reported³⁶⁹ complexes (432) (square planar) and (433) (Cu–Cu: 3.35 \AA) as well. As part of studying magnetic properties of mono-, di-, and

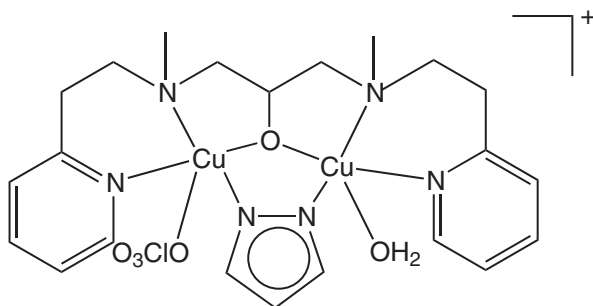
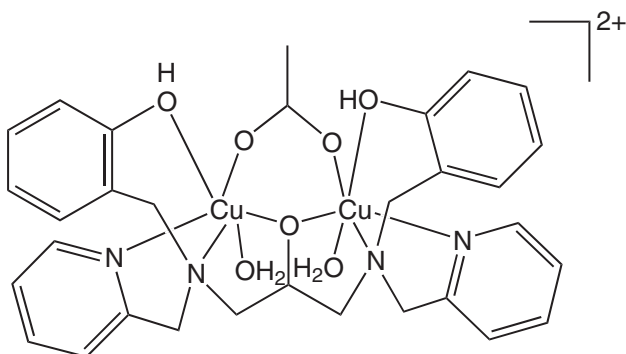
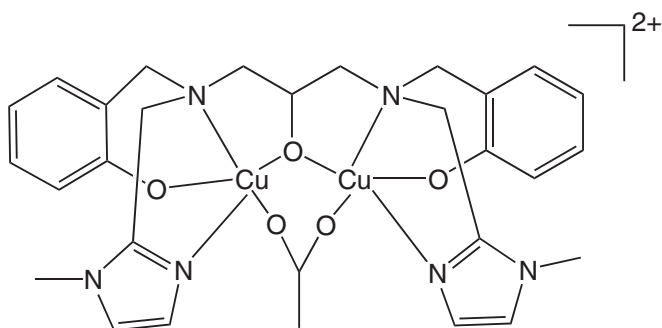
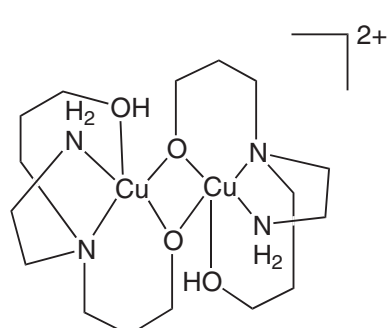
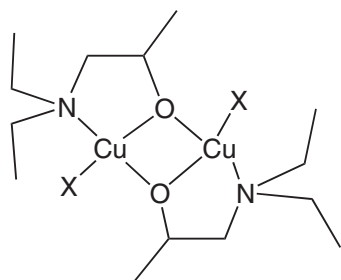
 $[(L)Cu_2(pz)(OCIO_3)(H_2O)][ClO_4] \cdot H_2O$ (**407**)

 $[(L)Cu_2(O_2CMe)(OH_2)]Cl_2 \cdot 2H_2O$ (**408**)

 $[(L)Cu_2(O_2CMe)][ClO_4]_2 \cdot 2MeOH$ (**409**)

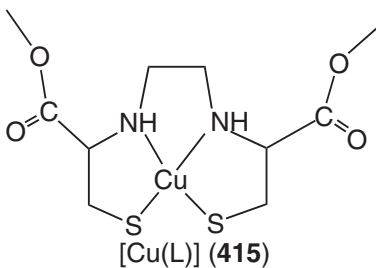
 $[Cu(L)]_2[PF_6]_2$ (**410**)

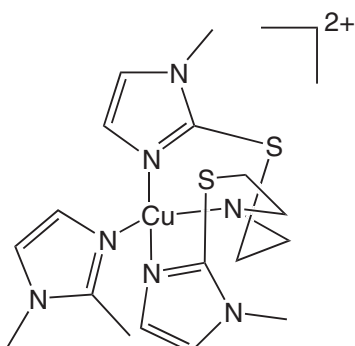
 $[(L)_2Cu_2(X)_2]$
 $X = N_3^-$; (**411**)

 $X = NCO^-$; (**412**)

 $X = ONO^-$; (**413**)

 $X = NCS^-$; (**414**)

 $[Cu(L)]$ (**415**)

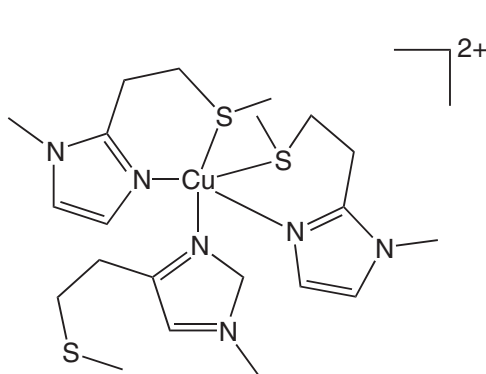
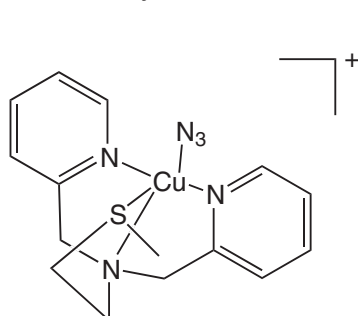
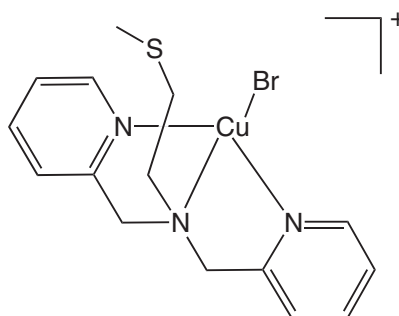
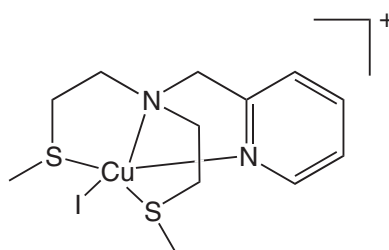
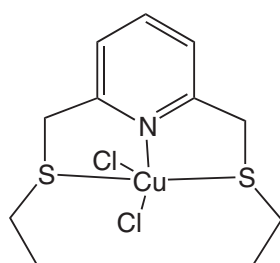
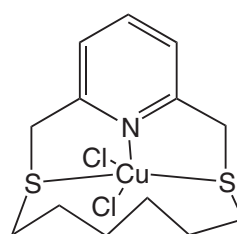

 $[(L)Cu(L')][PF_6]_2 \cdot 0.5Me_2CO$ (417)

L' = 1,2-dimethylimidazole

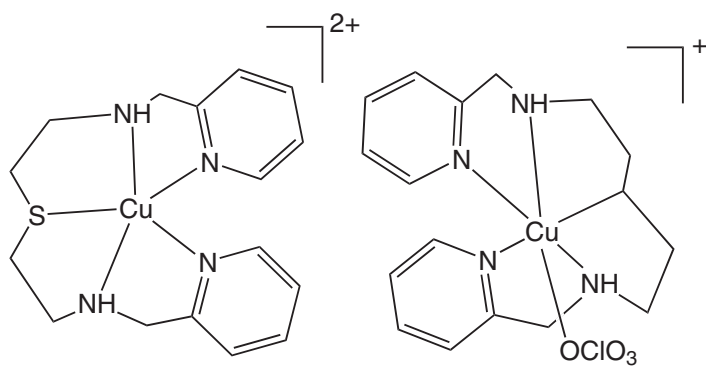
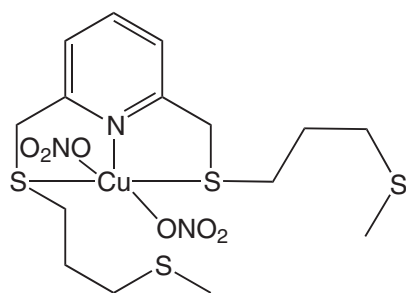
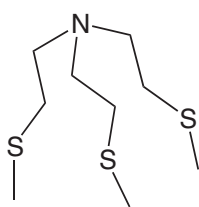
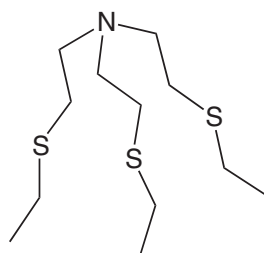
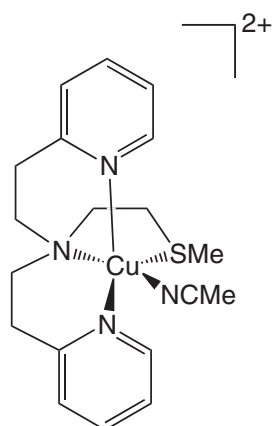
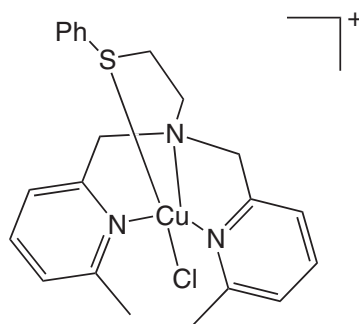
 $[Cu(L)_3][BF_4]_2$ (418)

 $[(L)Cu(N_3)][ClO_4]$ (419)

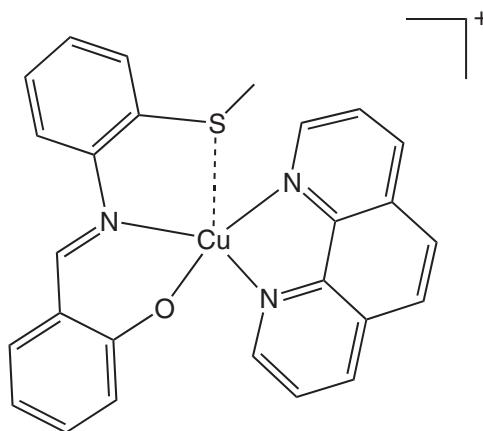
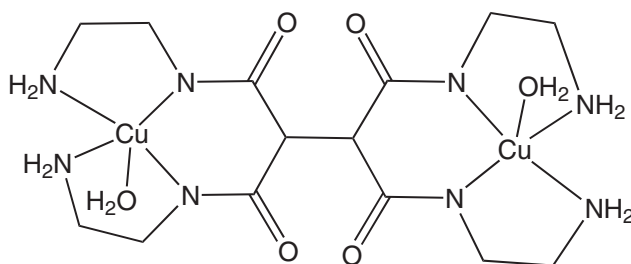
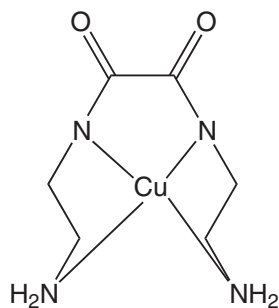
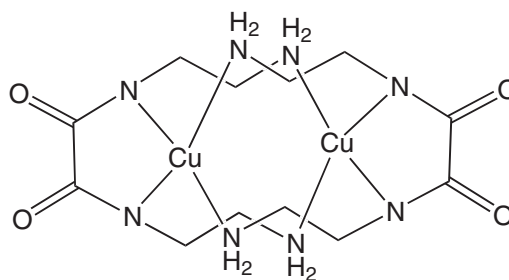
 $[(L)CuBr][ClO_4]$ (420)

 $[(L)CuI][ClO_4]$ (421)

 $[(L)CuCl_2]$ (422)

 $[(L)CuCl_2]$ (423)

trinuclear copper(II) complexes, Costes *et al.*³⁷⁰ reported complex (434) (tetrahedrally distorted square planar). Interestingly, the sodium atoms and the water molecules play an important part in stabilizing the structure, since they are simultaneously bonded to atoms belonging to different unit cells. In their pursuit of stabilizing copper(III) Julve, Journaux, and their co-workers^{371,372} reported primarily square-planar complexes (435)–(437a). To demonstrate oxidations of C–H and O–H bonds by isolated copper(III) complexes, Mayer and co-workers reported the structure of copper(II)

 $[\text{Cu}(\text{L})][(\text{L})\text{Cu}(\text{OCIO}_3)][\text{ClO}_4]_3$ (424)

 $[(\text{L})\text{Cu}(\text{ONO}_2)_2]$ (425)

 $[(\text{L})\text{CuBr}][\text{ClO}_4]$ (426)

 $[(\text{L})\text{CuCl}][\text{ClO}_4]$ (427)

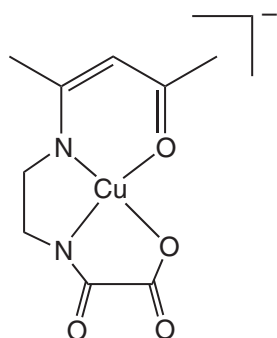
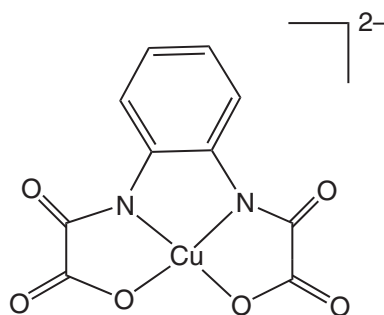
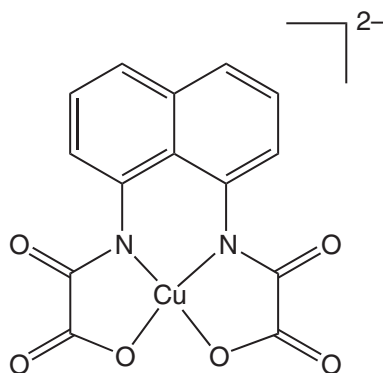
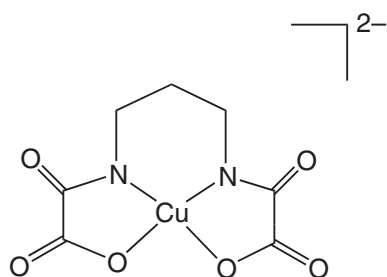
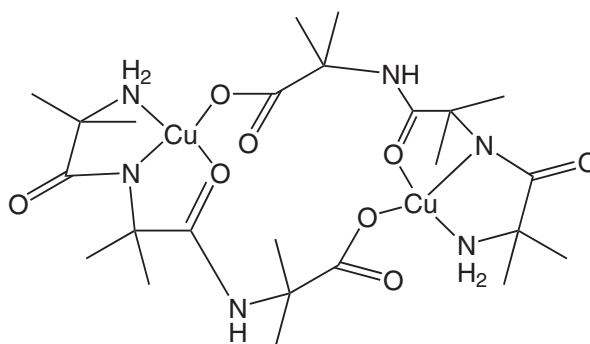
 $[\text{Cu}(\text{L})][\text{ClO}_4]_2 \cdot \text{MeCN}$ (428)

 $[(\text{L})\text{CuCl}][\text{ClO}_4]$ (429)

[(L)Cu(phen)][ClO₄] (**430**)[(L)Cu₂(H₂O)]·9H₂O (**431**)[Cu(L)]·2H₂O (**432**)[Cu(L)]₂·6H₂O (**433**)

complex (**437b**).³⁷³ The redox properties were also investigated. Krüger and co-workers reported³³ square-planar copper(II) complexes [Et₄N][Cu(L)] (**438**) (cf. complex (**6**)) and (**439**). The spectroscopic and redox properties were studied in detail.

As part of a synthetic analogue approach to metallobleomycins (a family of glycopeptide antibiotics, which in the presence of metal ions like Fe²⁺ and Cu²⁺ and molecular oxygen become activated and subsequently cleave double-stranded DNA),^{374–376} a large number of copper(II) complexes of deprotonated peptide ligands resembling fragments of the metal-chelating sections of bleomycins have been synthesized by Mascharak and co-workers.^{377–383} In these studies they not only characterized mononuclear and dinuclear complexes with variable stereochemistry ((**440**) to (**457**); complex (**440**) (Cu–Cu: 3.542 Å);³⁷⁷ complex (**448**) (Cu–Cu: 3.2235 Å);³⁸¹ complex (**449**) (Cu–Cu: 3.0943 Å);³⁸¹ complex (**451**) (Cu–Cu: 5.3433 Å);³⁸² complexes [(L)Cu(py)(H₂O)] (**453**), [(L)Cu(bpy)] (bpy = 2,2'-bipyridine) (**454**), [(L)Cu(Me₂bpy)]·NaClO₄·MeCN (Me₂bpy = 6,6'-dimethyl-2,2'-dipyridyl) (**455**), and [(L)Cu(Me₂phen)]·NaClO₄·1.2MeCN·0.4C₆H₅Me (Me₂phen = 2,9-dimethyl-1,10-phenanthroline); (**457**) has a similar structure to that of (**456**)), but also

Na[(L)Cu(H₂O)]·0.33H₂O (**434**)[Ph₄P]₂[Cu(L)] (**435**)[Bu₄N][Cu(L)] (**436**)[Ph₄P]₂[Cu(L)]·2H₂O (**437a**)[Cu(H₂L)]₂ (**437b**)

investigated in a systematic manner their spectral and redox properties. In some cases they did DNA nicking experiments to examine the potential of the complexes as a functional model of the bleomycins. Along similar lines, Kimura and co-workers reported^{384,385} complexes (**458**)–(**460**). From the same perspective, Shepherd *et al.*³⁸⁶ characterized complex (**461**) and also studied DNA nicking experiments. Réglie and co-workers achieved^{387,388} hydroxylation of aliphatic C–H bonds by copper(I) complexes and dioxygen (modeling of DβH⁸⁴) and characterized a number of copper(I) complexes ((**462**)–(**466**)) with amide O coordination. Using a bidentate, deprotonated pyridinecarboxamide ligand, Mukherjee and co-workers reported a tetrahedrally distorted CuN₄ complex (**467**).³⁸⁹ It was neatly demonstrated from cyclic voltammetric experiments that for the Cu^{II}/Cu^I couple, an anodic shift of 0.6–0.7 V could be observed by merely changing the copper stereochemistry from square planar to distorted tetrahedral. Using a substituted variety of this ligand, this group reported a copper(II) complex (**468**) with a TBP geometry ($\tau = 0.69$).³⁹⁰ Spectroscopic and redox properties were studied in detail. Using a tridentate pyridinecarboxamido ligand, Mukherjee

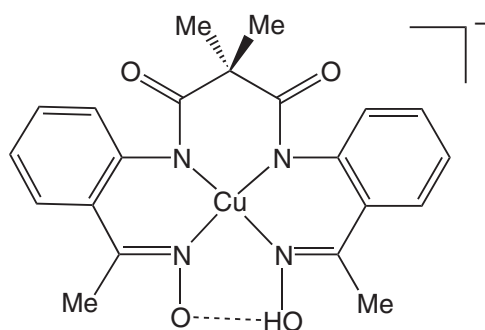
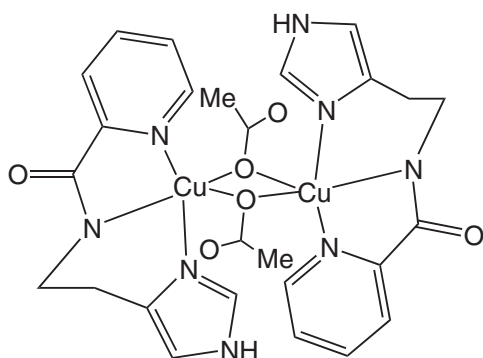
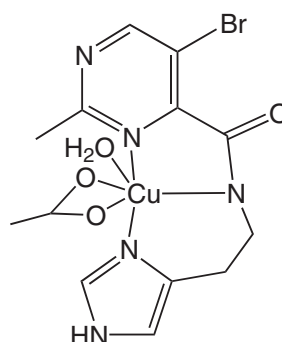
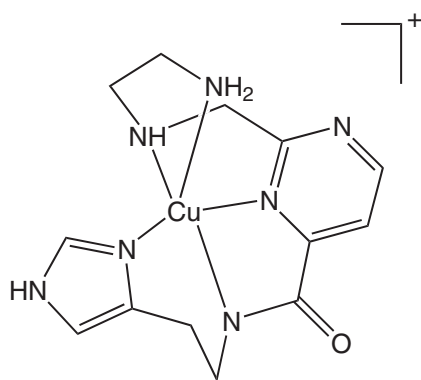
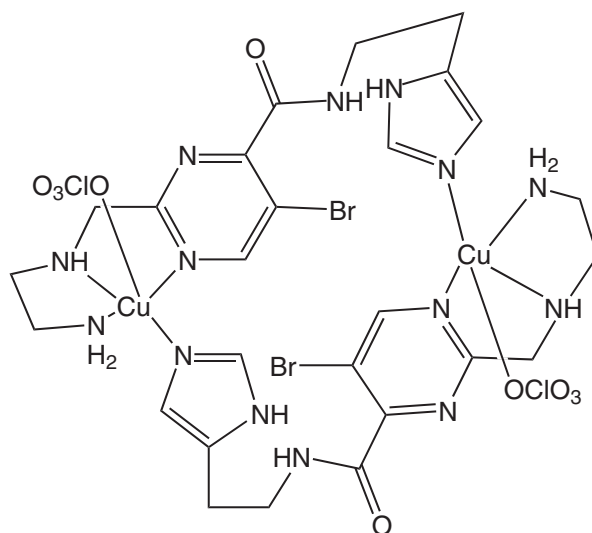
[Et₄N][Cu(L)] (439)[(L)Cu(MeCO₂)₂]₂·1.46H₂O (440)[(L)Cu(MeCO₂)(H₂O)] (441)[(L)Cu][ClO₄]·0.5H₂O·0.5MeOH (442)[{Cu(HL)}(OCIO₃)₂]₂·2H₂O (443)

and co-workers reported two singly hydroxo-bridged dicopper(II) complexes (**469**) (distorted square planar; Cu–Cu: 3.437 Å; Cu–OH–Cu angle: 131.6°; $2J = -334 \text{ cm}^{-1}$) and (**470**) (distorted square planar; Cu–Cu: 3.370 Å; Cu–OH–Cu angle: 126.6°; $2J = -296 \text{ cm}^{-1}$).³⁹¹ In each molecule in their crystal lattices, sodium or potassium ions are tetrahedrally coordinated by four amido oxygen atoms from four different dimeric units. Using a similar tridentate ligand with additional coordination groups, Borovik and co-workers, in their target of assembling supramolecular structures in crystal lattices, reported complex (**471**).³⁹² Kajikawa *et al.* reported an interesting complex (**472**) (the structure of a closely similar complex of composition $[(L)CuCl_2]_2SO_4 \cdot 8H_2O$ was also reported).^{393,394}

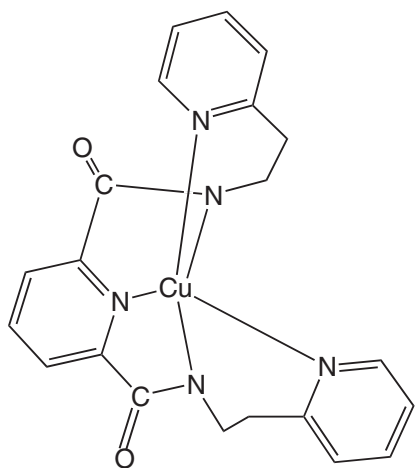

[Cu(L)] (444)

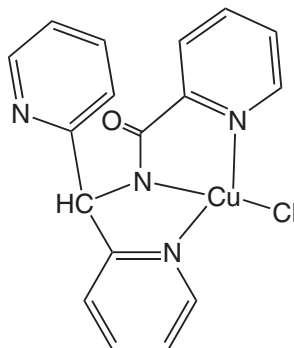

[(L)CuCl] (445)

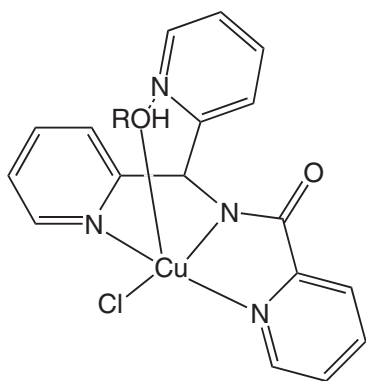

R = Me; [(L)CuCl(MeOH)] (446)

R = Et; [(L)CuCl(EtOH)] (447)

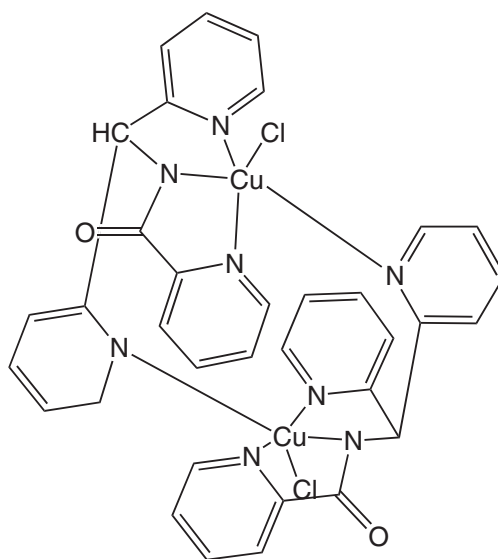
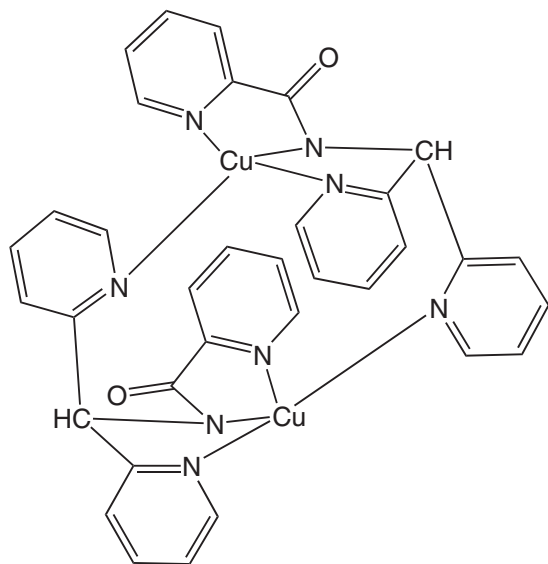
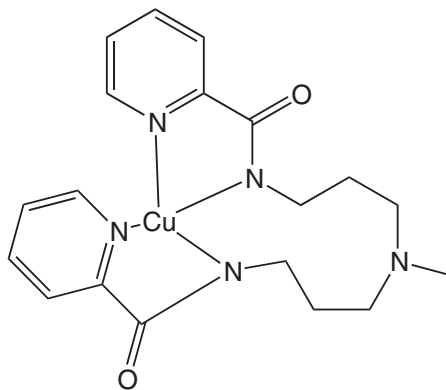
[(L)CuCl]₂·8H₂O (448)[Cu(L)]₂·[ClO₄]₂·MeCN·H₂O (449)

[Cu(L)] (450)

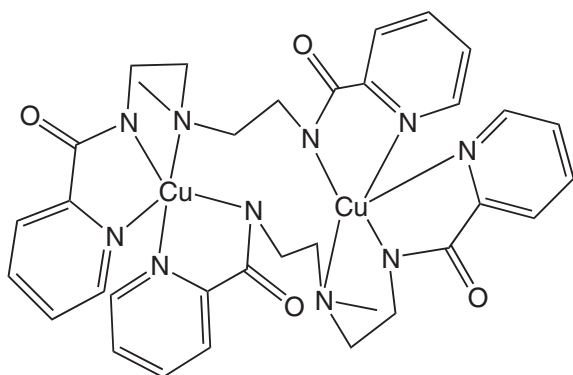
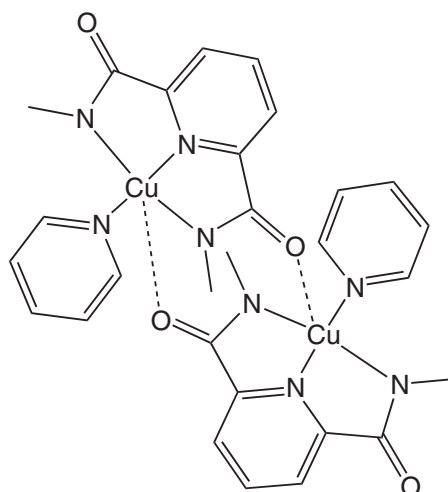
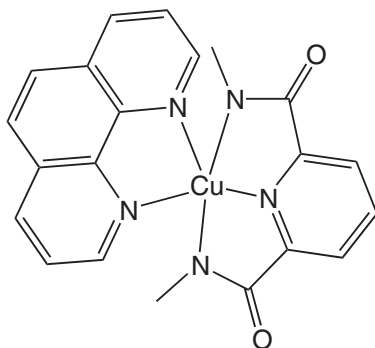
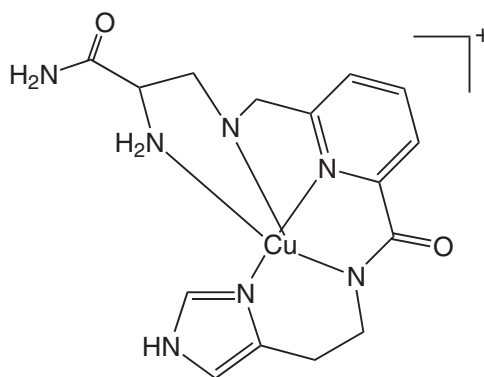
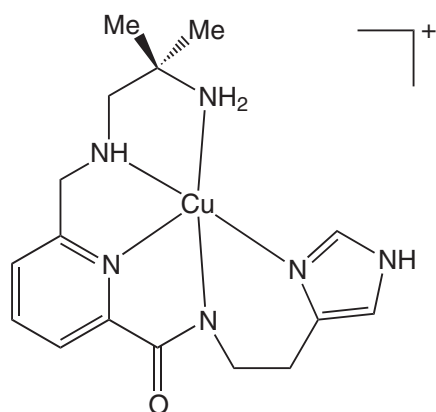
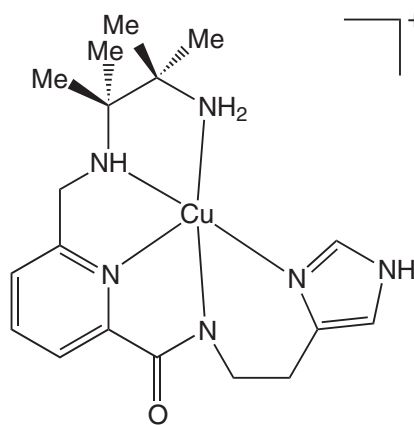
[Cu₂(L)₂]·H₂O (451)[(L)Cu(py)]₂ (452)[(L)Cu(σ-phen)]·NaClO₄·1.5MeCN (456)[Cu(L)][ClO₄]·H₂O (458)[(L)Cu][ClO₄] (459)[(L)Cu][BF₄] (460)

In order to construct new types of binding and activating models of dioxygen molecules, Jitsukawa, Masuda and their co-workers have synthesized a novel group of tripodal tetradentate ligands and successfully utilized them in the formation of mononuclear copper(II) complexes with novel structural features (complexes (473)–(488)).^{395–403} This group of ligands has four

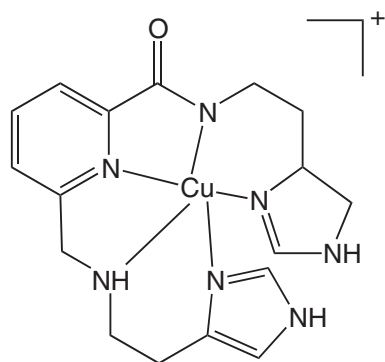
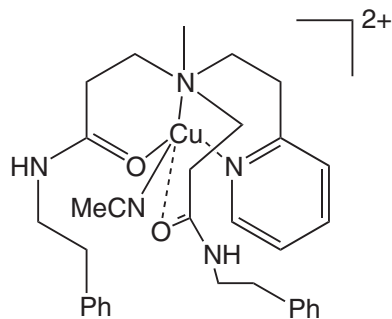
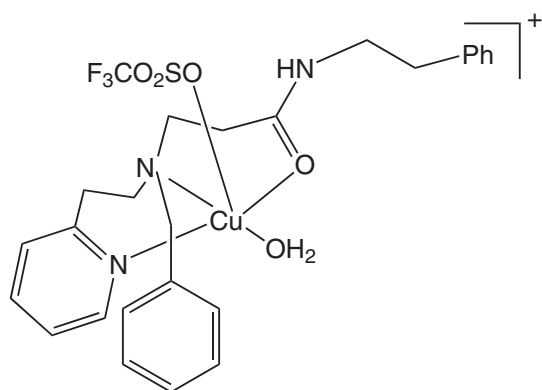
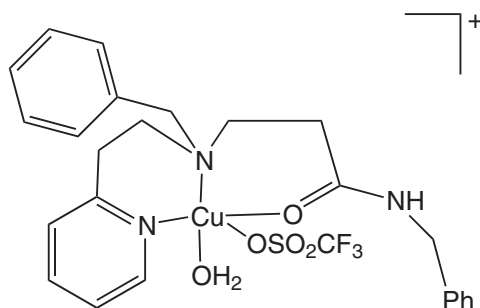
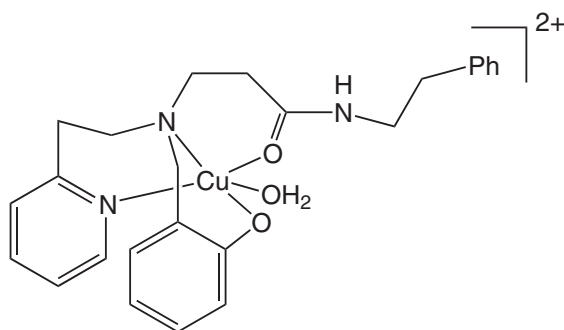
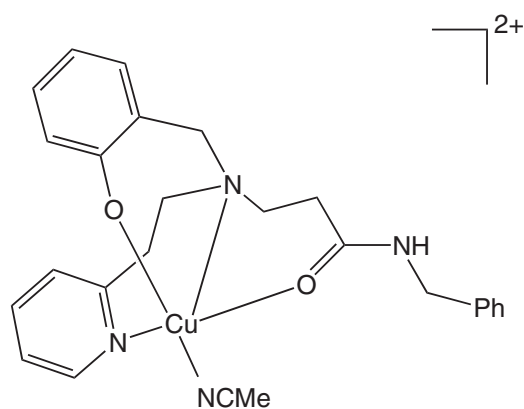
 $[\text{Cu}(\text{L})][\text{ClO}_4] \cdot 1.61\text{H}_2\text{O}$ (**461**)

 $[(\text{L})\text{Cu}(\text{MeCN})][\text{ClO}_4]_2$ (**462**)

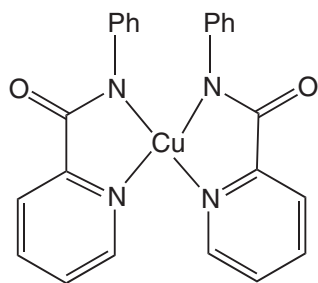
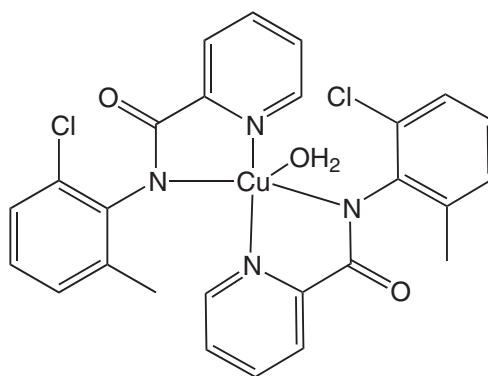
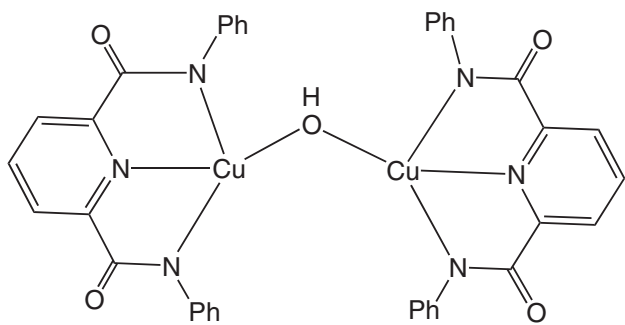
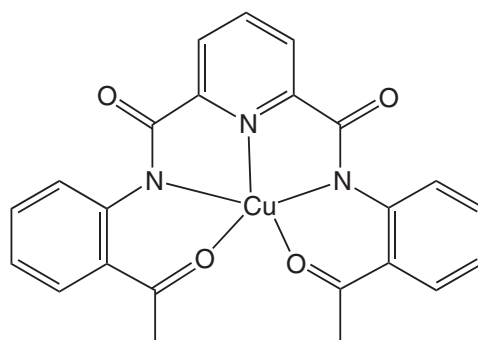
 $[(\text{L})\text{Cu}(\text{H}_2\text{O})(\text{OSO}_2\text{CF}_3)][\text{CF}_3\text{SO}_3]$ (**463**)

 $[(\text{L})\text{Cu}(\text{H}_2\text{O})(\text{OSO}_2\text{CF}_3)][\text{CF}_3\text{SO}_3] \cdot \text{H}_2\text{O}$ (**464**)

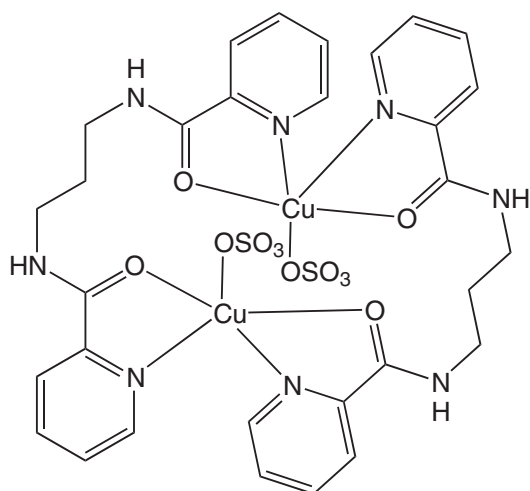
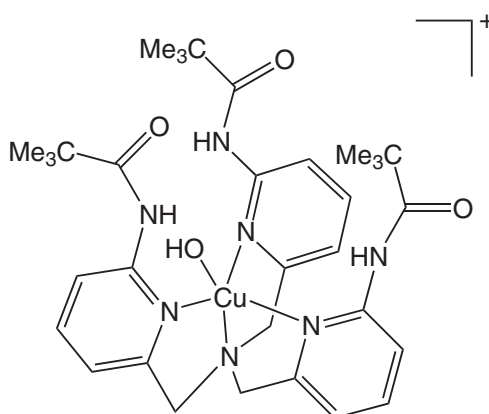
 $[(\text{L})\text{Cu}(\text{H}_2\text{O})][\text{CF}_3\text{SO}_3]_2$ (**465**)

 $[(\text{L})\text{Cu}(\text{MeCN})][\text{CF}_3\text{SO}_3]_2$ (**466**)

characteristic functional groups, i.e., four coordination sites for metal ions, two/three NH groups for hydrogen bonds to fix a small molecule such as dioxygen, two/three hydrophobic *tert*-butyl groups to protect the small bound molecule and to prevent dimerization of coordinated metal centers, and electron-withdrawing pivaloylamino groups to stabilize the copper(I) state. These complexes (TBP geometry) have also been characterized by electronic absorption, EPR and NMR spectral, and cyclic voltammetry. The structure of complex (**473**) was originally wrongly reported,³⁹⁵ which was pinpointed by Tolman and co-workers³⁹⁶ and eventually realized by this

[Cu(L)₂] (467)[(L)₂Cu(H₂O)].H₂O (468)Na[(L)₂Cu₂(OH)].2H₂O (469)K[(L)₂Cu₂(OH)].2H₂O (470)

[Cu(L)].0.5toluene (471)

[(L)Cu(OSO₃)]₂.13H₂O (472)[(L)Cu(OH)][ClO₄] (473)

group as well.³⁹⁷ Complexes [(L)CuCl][ClO₄] (474), [(L)Cu(OH)].2H₂O.Me₂CO (476), [(L)Cu(N₃)] [ClO₄].H₂O (482), [(L)Cu(OH)][PF₆].H₂O (483) and [(L)Cu₂Cl₄].2MeOH (488) have structures similar to complexes (473), (477) (however, in the place of amide oxygen coordination there is hydroxide ion coordination), (481) (however, now uncoordinated pyridine is coordinated;

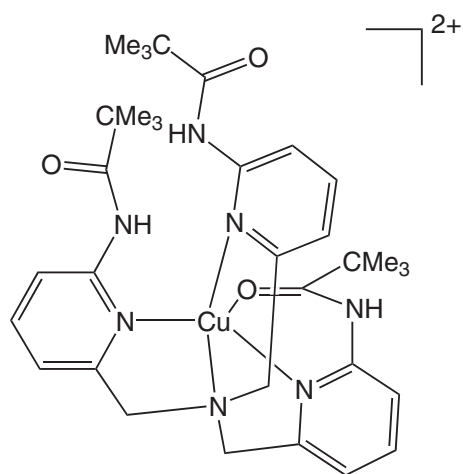
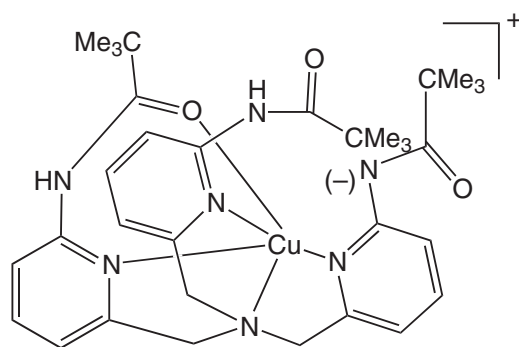
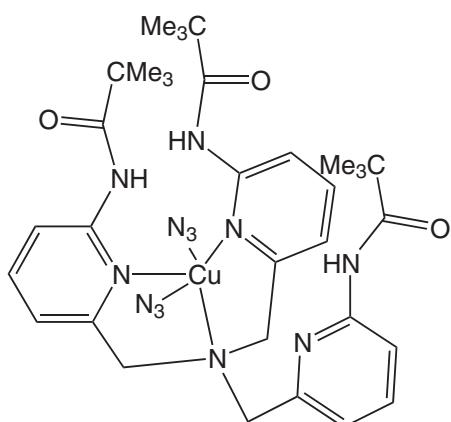
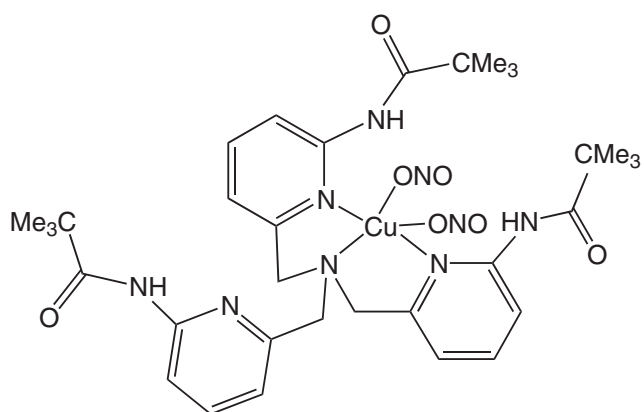
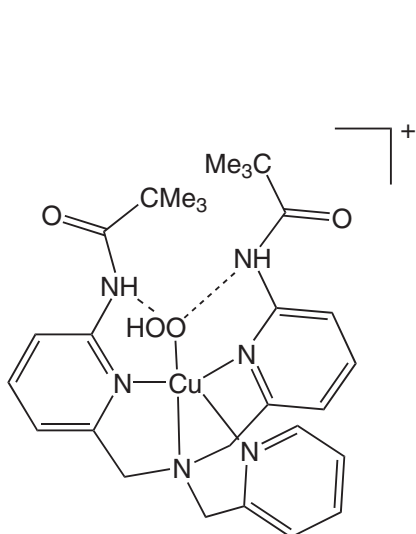
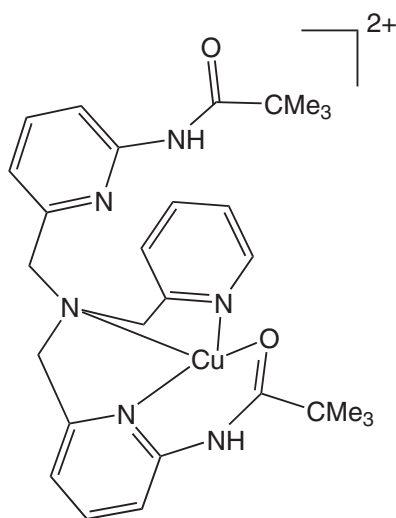
[Cu(L)][ClO₄]₂·2H₂O·MeOH (475)[Cu(L)][BPh₄] (477)[(L)Cu(N₃)₂]·2H₂O (478)[(L)Cu(ONO)₂] (479)[(L)Cu(OOH)][ClO₄] (480)[Cu(L)][ClO₄]₂ (481)

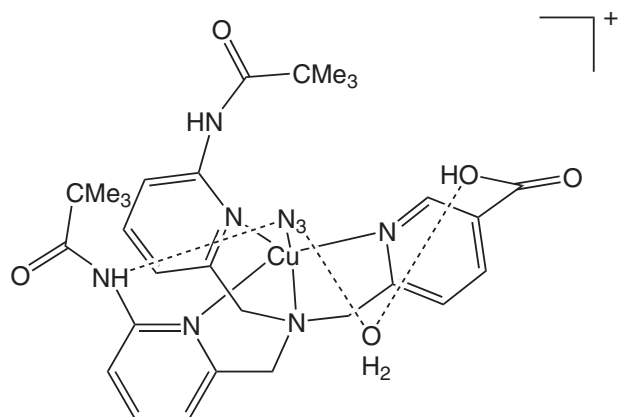

[(L)Cu(N₃)] [ClO₄] · 4.5H₂O (**484**)

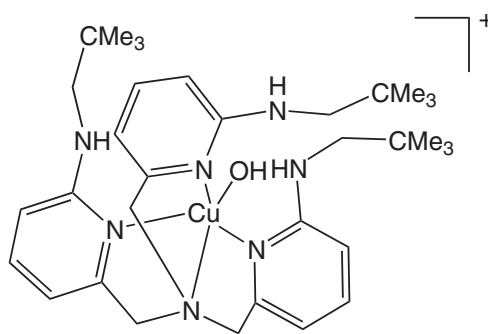

[(L)Cu(OH)] [ClO₄] (**485**)

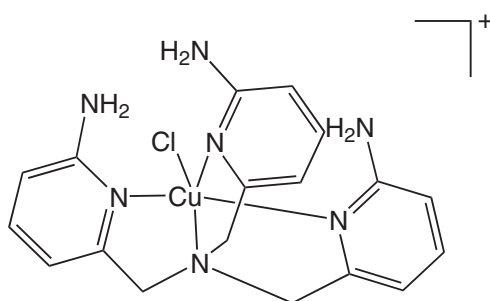

[(L)CuCl] [ClO₄] (**486**)

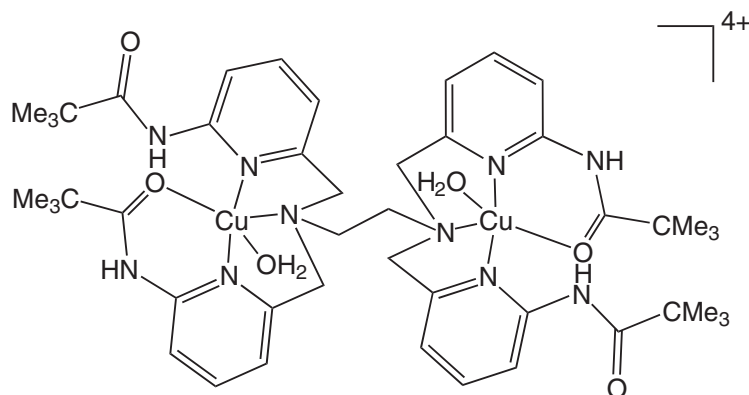

[(L)Cu₂(H₂O)₂] [ClO₄]₄ · 3MeCN · 2H₂O (**487**)

amide oxygen is no longer coordinated; and the azide ion is coordinated), (**481**) (however, now uncoordinated pyridine is coordinated; amide oxygen is no longer coordinated; hydroxide ion is coordinated) and (**487**) (however, the amide oxygen is no longer coordinated and each Cu atom has two chloride ions), respectively.

Using the pyrazinecarboxamide ligand, complexes (**489**) and (**490**) were reported.⁴⁰⁴ Using a tridentate ligand, complex (**491**) was reported.⁴⁰⁵ In this complex the crystal packing is achieved by intermolecular hydrogen bonding. Mathur and co-workers reported⁴⁰⁶ the structure of a complex (**492**) ($\tau = 0.59$) and demonstrated its catechol oxidase activity.⁹¹ The two complexes (**493**) ($\tau = 0.33$) and (**494**) ($\tau = 0.55$) were reported⁴⁰⁷ and their spectroscopic and redox properties investigated.

The concept of "ligand complex" was nicely demonstrated in the structures of complexes (**495**) (Cu–Cu: 3.1172 Å; $2J = -164 \text{ cm}^{-1}$)⁴⁰⁸ and (**496**) (Cu–Cu: 3.097 Å, 4.984 Å, and 5.108 Å).⁴⁰⁹ For both the complexes, spectroscopic and redox properties were also studied.

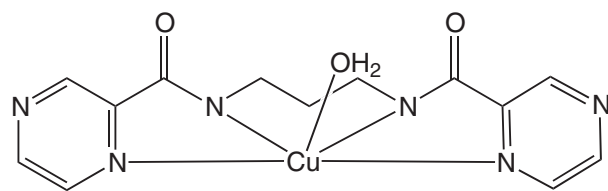
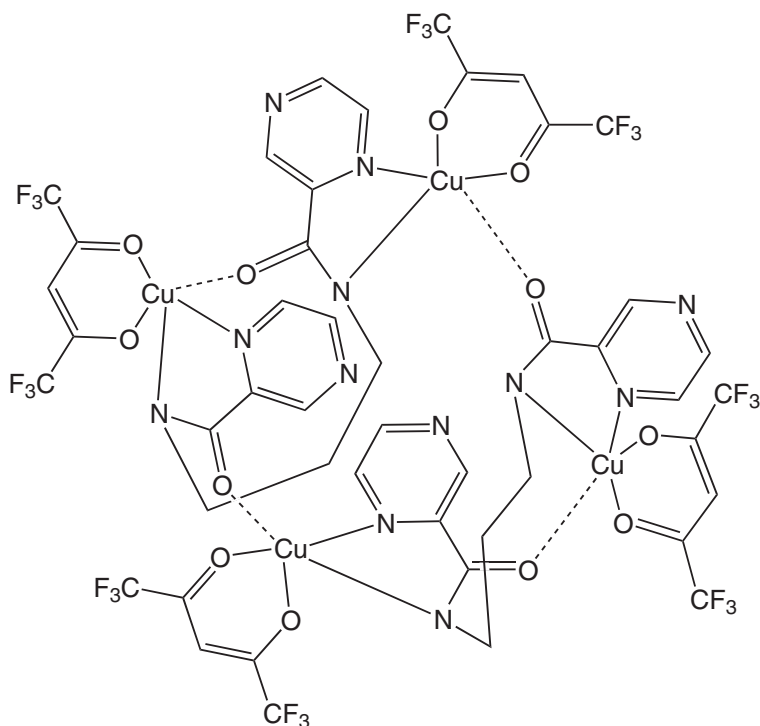
 $[(L)Cu(H_2O)] \cdot 3H_2O$ (489)

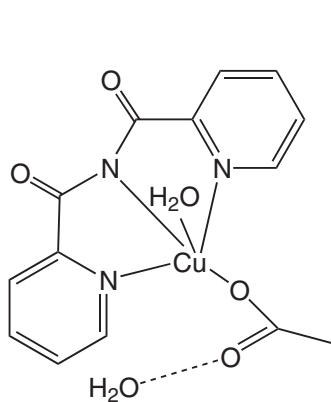
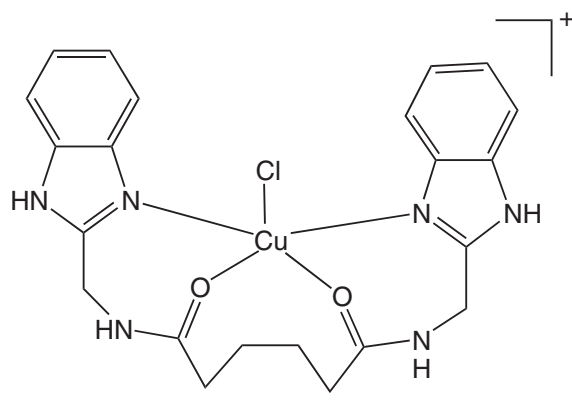
 $[(L)Cu(L')_2Cu]_2$ (490)

 L' = hexafluoroacac⁻

 $[(L)Cu((O_2CMe)(H_2O))] \cdot H_2O$ (491)

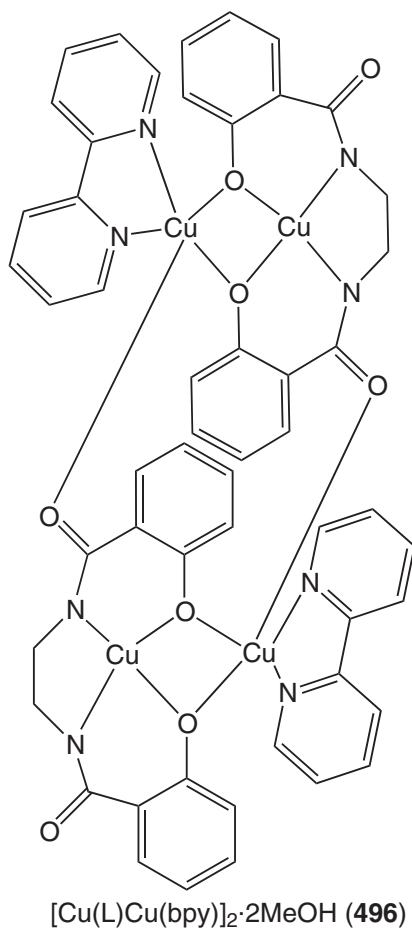
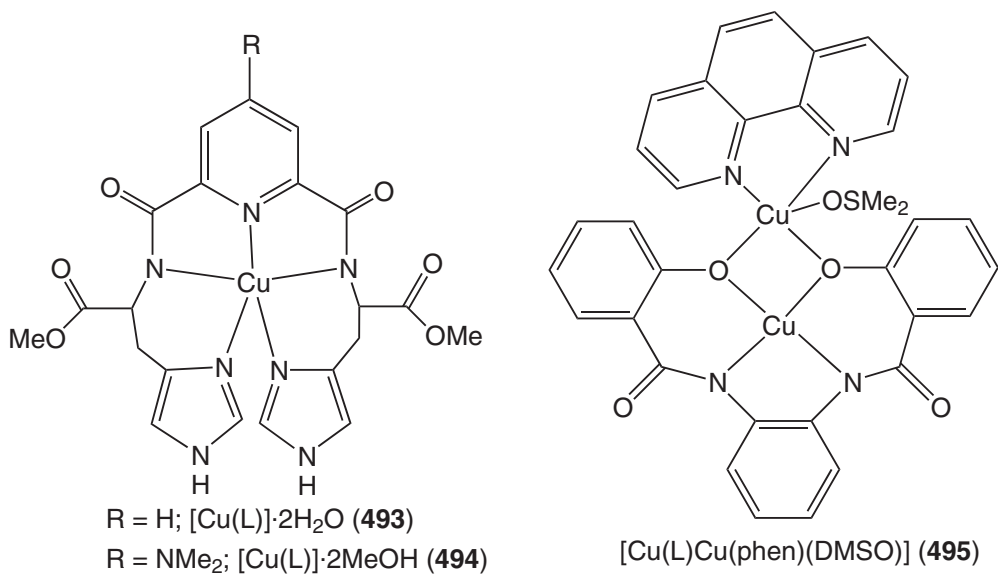
 $[(L)CuCl]Cl \cdot H_2O \cdot MeOH$ (492)

6.6.3.5 Macrocyclic Ligands

It is to be mentioned here that the coordination chemistry of macrocyclic ligands is covered in Volume 7. Therefore only selected systems having some direct relevance to the bioinorganic chemistry of copper will be discussed. Readers are recommended to consult review articles.^{2,3}



In their pursuit of modeling substrate adduct to the reduced active site of nitrite reductases, Tolman *et al.* thoroughly characterized^{410–412} complexes (**497**) (nitrite-bridged, mixed-valent complex), $[(i\text{-}Pr_3\text{TACN})Cu(O_2CMe)_2]$ (**498**), $[(i\text{-}Pr_3\text{TACN})Cu(OSO_2CF_3)(H_2O)][CF_3SO_3]$ (**499**) and demonstrated associated chemistry. Synthesis and characterization of a copper complex of

$[\text{Et}_2\text{N}(\text{N}_2\text{O}_2)]^-$ (**500**), stabilized with respect to NO release in aqueous solution, was also documented. During this endeavor, complex $[(i\text{-Pr}_3\text{TACN})\text{Cu}(\text{O}_2\text{CMe})]$ (bidentate acetate coordination) (**501**) and a carbonato-bridged complex (**502**) were characterized.⁴¹³

From their continued activity from the standpoint of dioxygen activation by copper(I) complexes of relevance to Hc/Tyr modeling, Tolman's group demonstrated an unusual ligand oxidation by a $(\mu\text{-}\eta^2\text{:}\eta^2\text{-peroxo})$ dicopper(II) species and structurally characterized a complex (**503**) (Cu–Cu: 3.0392 Å),⁴¹⁴ via the intermediacy of a novel bis(μ -alkylperoxo)dicopper intermediate. To investigate the reactivity of peroxo- and bis(μ -oxo)dicopper complexes with catechols, this group characterized a catechol-bound complex (**504**), as well as a semiquinone-bound complex (**505**).⁴¹⁵ With the goal of understanding how the nature of the tridentate macrocyclic supporting ligand influences the relative stability of isomeric $(\mu\text{-}\eta^2\text{:}\eta^2\text{-peroxo- and bis}(\mu\text{-oxo})$ dicopper complexes, a comparative study of the O_2 reactivity of Cu^{I} compounds supported by the 10- and 12-membered macrocycles was made by Tolman, Alvarez, and their co-workers.⁴¹⁶ In addition to structurally characterizing Cu^{I} complexes (cf. Section 6.6.4.6), they characterized a dihydroxo-bridged dicopper(II) complex (**506**) (structural type: **(10)**), a carbonato-bridged complex (**507**) (structural type: **(112)**), and a new peroxo-dicopper(II) complex (**508**) (structural type: **(108)**).⁴¹⁶ As a part of their activity on modeling GO,^{260–262} they characterized complexes (**509**) to (**514**).^{417,418} In an attempt to answer why the active form of GO possesses a diamagnetic ground state, Wieghardt and co-workers characterized complex (**515**).⁴¹⁹ In 2001, Halfen *et al.* demonstrated enhanced reactivity of copper catalysts for olefin aziridination and characterized the

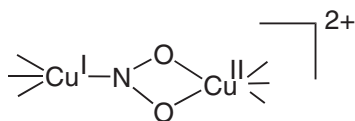

$[(i\text{-Pr}_3\text{TACN})\text{Cu}(\text{ONO}_2)\text{Cu}(i\text{-Pr}_3\text{TACN})][\text{PF}_6]_2$ (**497**)

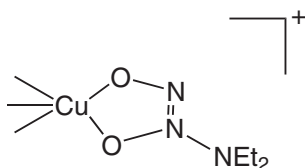

$[(i\text{-Pr}_3\text{TACN})\text{Cu}\{\text{Et}_2\text{N}(\text{N}_2\text{O}_2)\}][\text{CF}_3\text{SO}_3]$ (**500**)

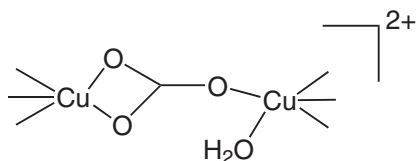

$[(i\text{-Pr}_3\text{TACN})_2\text{Cu}_2(\text{OCO}_2)(\text{H}_2\text{O})][\text{CF}_3\text{SO}_3]_2$ (**502**)

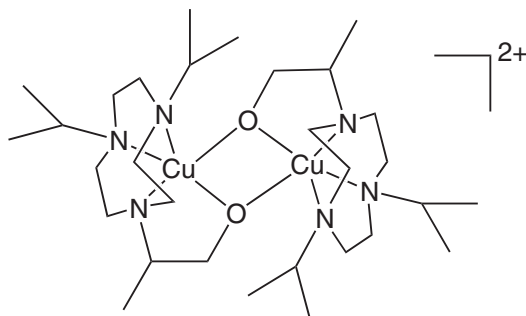

$[\text{Cu}_2(\text{L}_2)][\text{BPh}_4]_2 \cdot 2\text{MeCN} \cdot \text{DMF}$ (**503**)

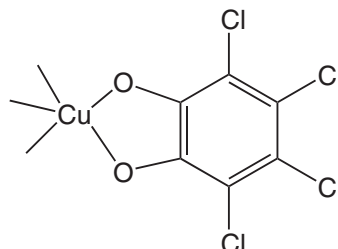

$[(\text{Bn}_3\text{TACN})\text{Cu}(\text{Cl}_4\text{cat})] \cdot \text{MeCN}$ (**504**)

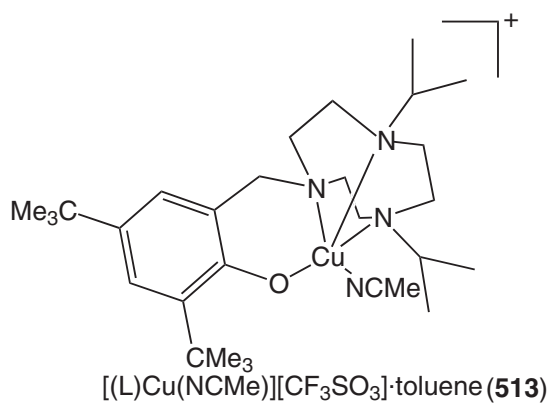
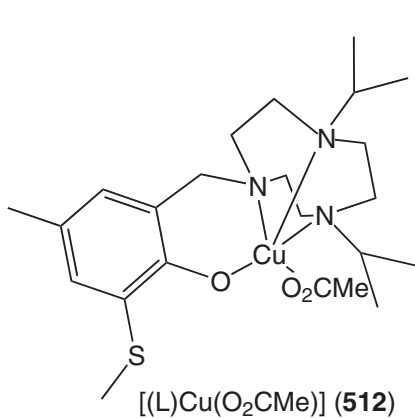
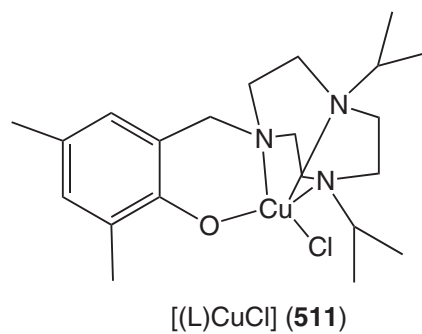
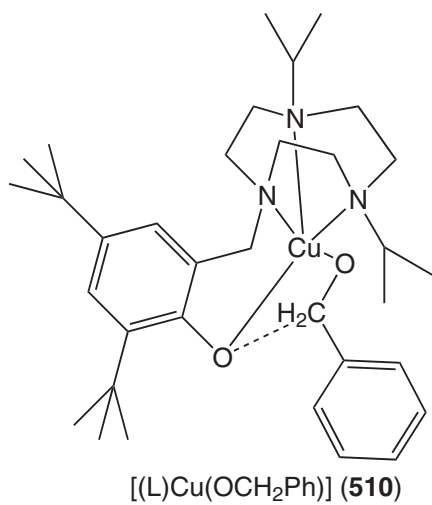
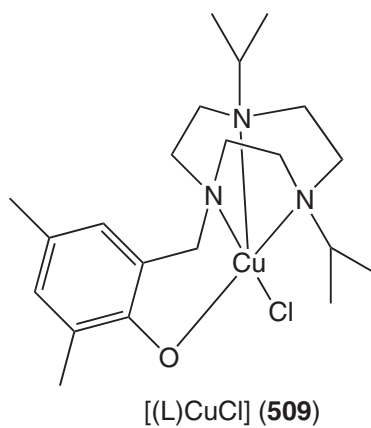
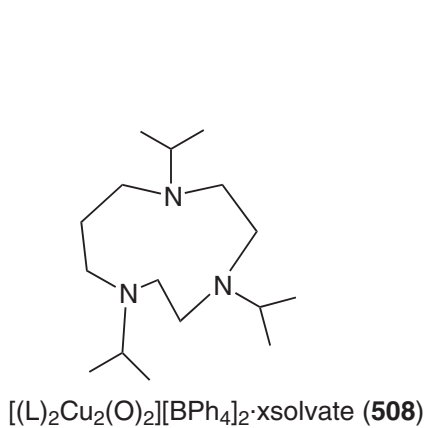
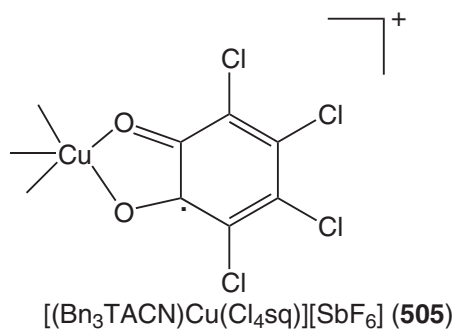

mononuclear complex (**516**) and a dichloro-bridged complex $[(L)CuCl]_2[PF_6]_2$ (**517**) (structural type: (**54**)).⁴²⁰

Chaudhuri *et al.* reported two novel isomeric tautomeric bridging complexes (**518**) (Cu–Cu: 2.97 Å; Cu–OH–Cu angle: 100.1°; $2J = -90\text{ cm}^{-1}$) and (**519**) (Cu–Cu: 3.03 Å; Cu–O–Cu angle: 88.6°; $2J = 74\text{ cm}^{-1}$).⁴²¹ Using complex (**520**), static and dynamic Jahn–Teller distortions in the CuN_6 polyhedron were nicely demonstrated.⁴²² Using a functionalized TACN ligand, Wieghardt and co-workers characterized complex (**521**) (distorted SP).⁴²³ Using a 3-*tert*-butyl-substituted variety of phenol-appended ligand, they structurally characterized complex $[Cu(H_2L)][ClO_4]$ (**522**) (distorted SP; out of three phenol groups one remained uncoordinated, one coordinated as phenolate, and one as phenol).⁴²³ Chaudhuri *et al.* characterized a spin-frustrated, imidazolate-bridged trinuclear copper(II) complex (**523**).⁴²⁴ Wieghardt and co-workers also characterized complexes (**524**)⁴²⁵ and (**525**) (cf. Section 6.6.2.4).³⁶ As part of their activity (see below), Spiccia and co-workers reported complex (**526**).⁴²⁶

Selective derivatization of parent TACN⁴²⁷ and particularly syntheses of a large number of linked-TACN^{428,429} resulted in the isolation of interesting complexes: (**527**) (the solid-state structure of this complex also contains an aggregate of $[Na(BF_4)_2]^-$ units which form a polymeric

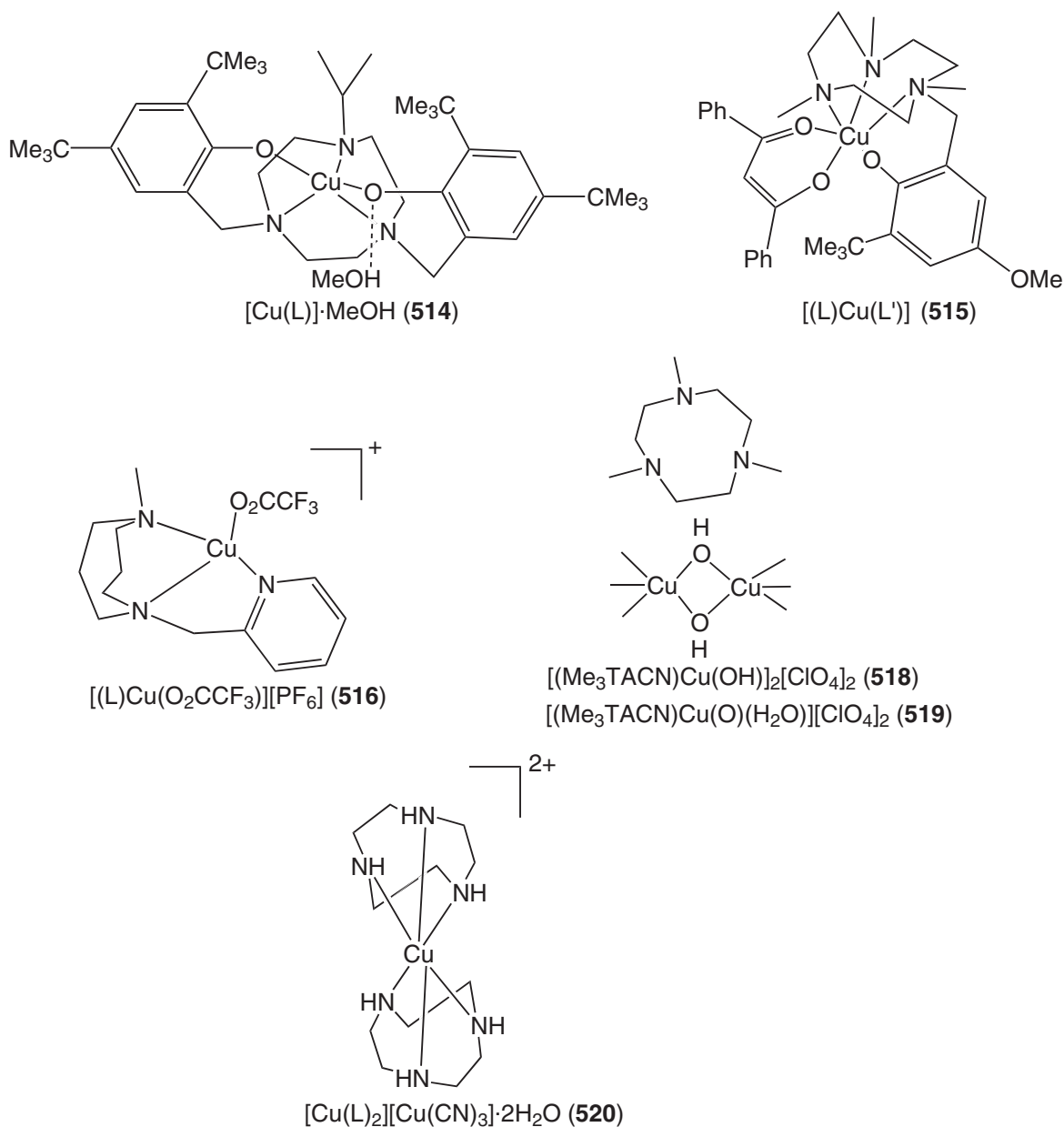

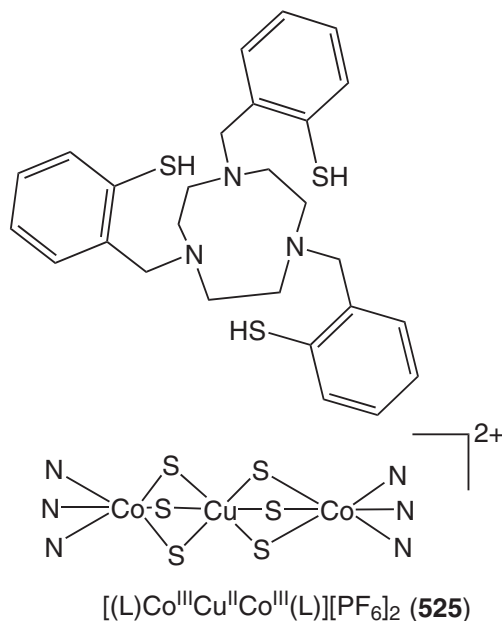
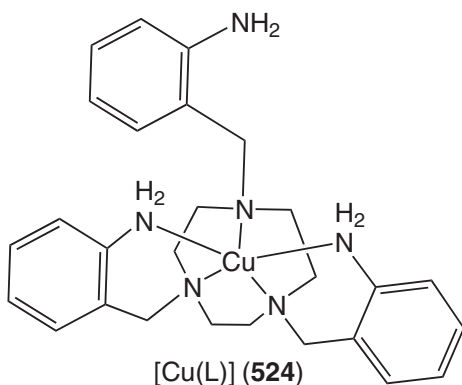
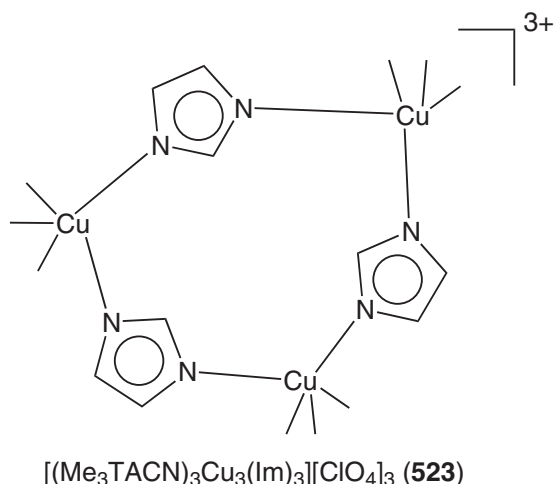
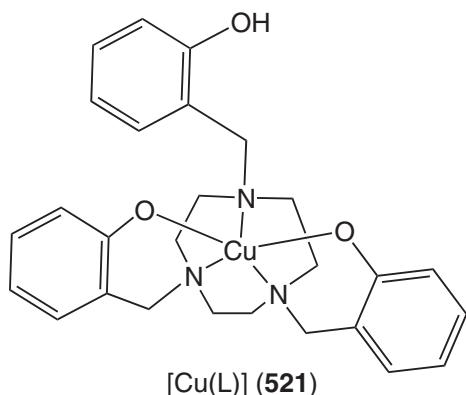

chain structure);⁴²⁷ (528);⁴²⁷ (529) (pseudo-square pyramidal; Cu–Cu: 2.947 Å; Cu–OH–Cu angle: 99.6°; $2J = -318 \text{ cm}^{-1}$);⁴³⁰ (530) ($\tau = 0.05/0.07$; Cu–Cu: 2.940 Å; $2J = -54 \text{ cm}^{-1}$);⁴³¹ (531) ($\tau = 0.0/0.06$; Cu–Cu: 2.962 Å; $2J = -538 \text{ cm}^{-1}$);⁴³¹ and (532) ($\tau = 0.07$; Cu–Cu: 3.006 Å; $2J = 188 \text{ cm}^{-1}$).⁴³¹ Using 1,3,5-tris(1,4,7-triazacyclonon-1-ylmethyl)benzene, Spiccia *et al.* structurally characterized⁴³² complex $\{(L)Cu_3(\mu\text{-OH})(\mu_3\text{-HPO}_4)(\text{H}_2\text{O})\}[\text{PF}_6]_3 \cdot 3\text{H}_2\text{O}\}_n$ (533), the polymeric lattice of which contains trinuclear copper(II) sites with structural similarities to laccase and ascorbate oxidase.^{4-7,433} These trinuclear sites consist of two ‘Type III’ copper(II) centers, at a separation of 3.557 Å, linked by a hydroxo bridge and two phosphate oxygens; while another phosphate oxygen links these two centers to the further removed ‘Type II’ copper(II) center, establishing separations of 4.561 Å and 5.474 Å. The molecule has an $S = 1/2$ molecular ground state arising from antiferromagnetic coupling. The biological existence of trinuclear metal centers has been highlighted by Fenton and Okawa.⁴³³

From structural studies (complex (534) and Section 6.6.4.6) on both the oxidation states, Addison and co-workers nicely provided evidence of the role of ligand framework conformability in Cu^{II}/Cu^I redox potentials.⁴³⁴ Using a very rigid bis-bispidine tetraazamacrocyclic which is highly preorganized for coordination to copper(II) (complex (535)), Comba and co-workers provided evidence⁴³⁵ that this ligand induces extremely high ligand fields for the copper(II) center. Using pyrazole-based macrocyclic ligands, Driessen and co-workers characterized complexes (536)

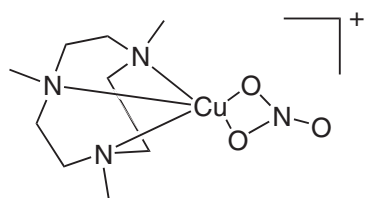
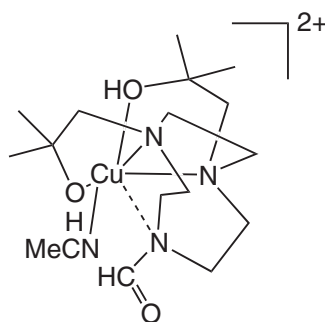
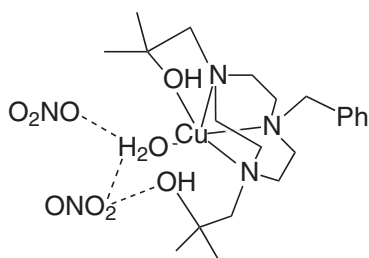
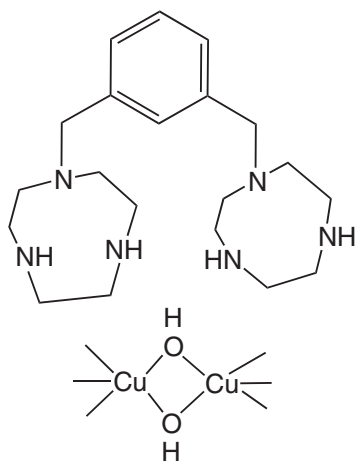
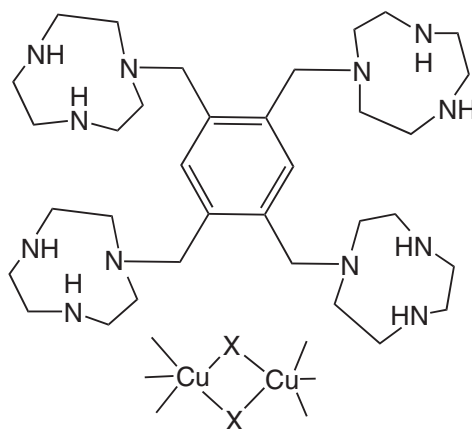
[(L)Cu(O₂NO)][ClO₄] (526)Na[(L)Cu(MeCN)][BF₄]₂[NO₃] (527)[(L)Cu(H₂O)][NO₃]₂ (528)[(L)Cu₂(OH)₂][BPh₄]₂ (529)X = OH; [(L)Cu₄(OH)₄][ClO₄]₄ (530)X = OH; [(L)Cu₄(OMe)₄][ClO₄]₄·HClO₄·2/3MeOH (531)X = OH; [(L)Cu₄(N₃)₄][PF₆]₄·4H₂O·6MeCN (532)

(SP; Cu–Cu: 7.14 Å,⁴³⁶ (537) ($\tau = 0.20$; Cu–Cu: 8.668 Å,⁴³⁷ and (538) ($\tau = 0.25$; Cu–Cu: 6.814 Å).⁴³⁷ The complex (539) ($\tau = 0.17$; Cu–Cu: 7.24 Å) catalyzes the oxidative polymerization of 2,6-dimethylphenol.⁴³⁸ Using an imidazolato-bridged dicopper(II) complex (540) (square planar N₄ environment for each copper with axial positions occupied by a water molecule on one Cu and two weakly bound triflates on the other Cu; Cu–Cu: 5.92 Å) of a macrocyclic Schiff base ligand, Burrows and co-workers provided a model for a hydrolytic enzyme (hydrolysis of *p*-nitrophenyl acetate). EPR and magnetic measurements in the solid state showed antiferromagnetic coupling between the metal ions. Interestingly, electrochemical studies indicated a single, quasi-reversible, two-electron reduction of Cu^{II} at $E_{1/2} = -0.435$ V vs. SCE (saturated calomel electrode).⁴³⁹ Two imidazolate-bridged complexes Cu^{II}Cu^{II}((541): $2J = -88$ cm⁻¹; Cu–Cu: 5.95 Å) and Cu^{II}Zn^{II}((542); Cu–Zn: 5.93 Å) of a macrobicyclic ligand (cryptand) were also synthesized and their redox properties investigated. All the results indicated that these complexes act as good models for SOD.⁴⁴⁰

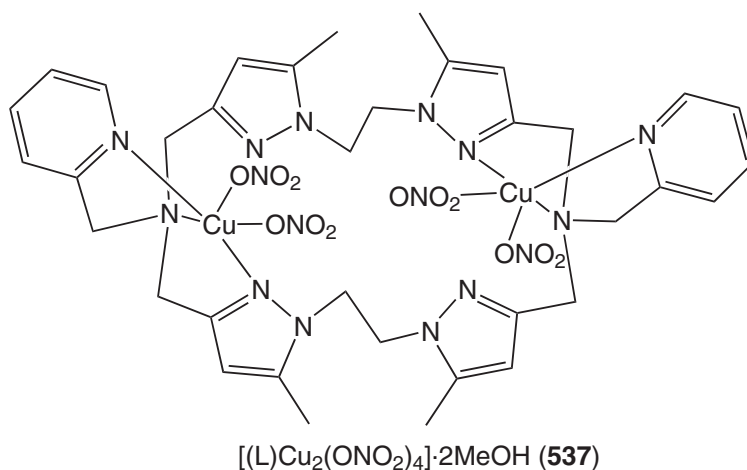
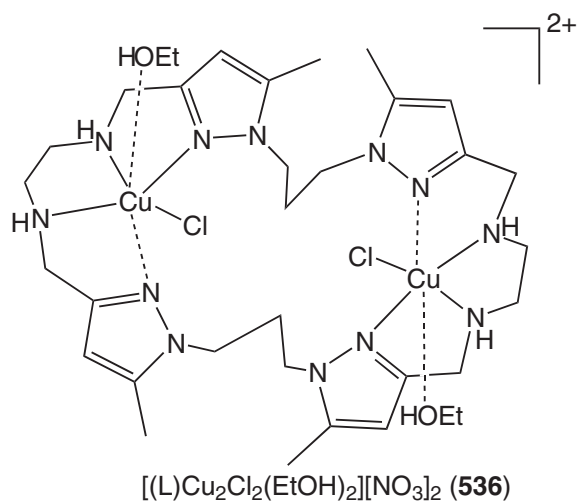
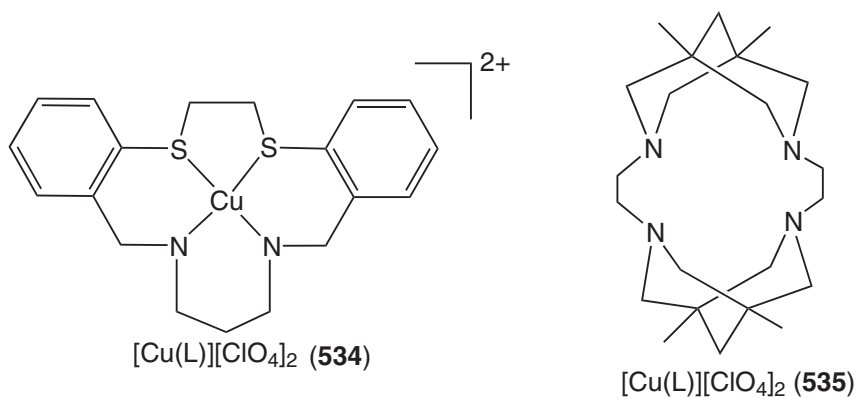

From the standpoint of modeling Hc/Tyr oxygenation of a copper(I) complex of a binucleating macrocyclic Schiff base ligand, Martell and co-workers reported a bridged dicopper(II) complex (**543**) (distorted square planar; Cu–Cu: 2.958 Å).⁴⁴¹ Along the same line of thought, using a macrobicyclic cryptand, this group reported complex (**544**) (the bridging CO_3^{2-} ion was taken up from atmospheric CO_2).⁴⁴²

Comba *et al.* reported structural properties (in the solid state and in solution) and molecular modeling studies on a dicopper(II) complex (**545**) (SP) of a macrocyclic amide ligand.⁴⁴³ In 1993

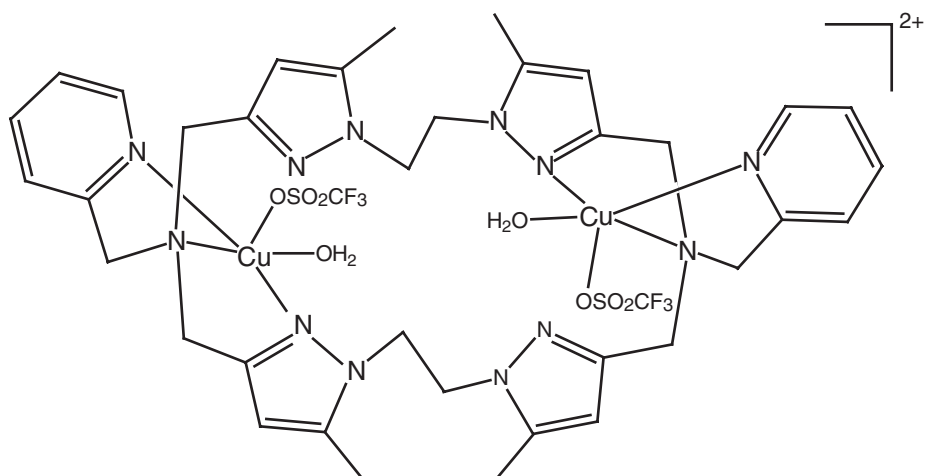

$[(L)Cu_2(OSO_2CF_3)_2(H_2O)_2][CF_3SO_3]_2 \cdot 2MeOH$ (538)

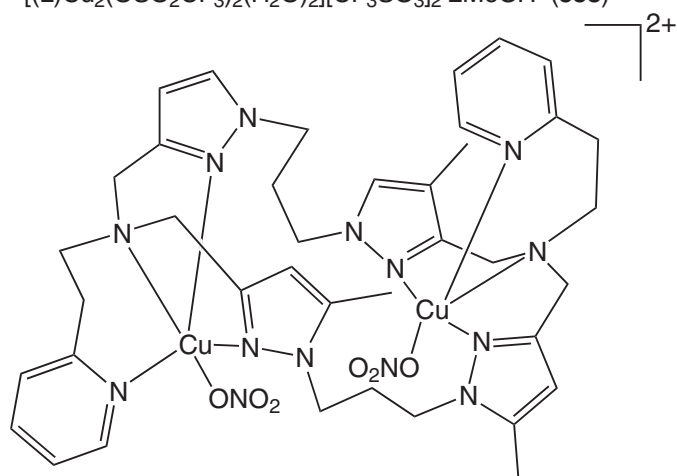

$[(L)Cu_2(ONO_2)_2][NO_3]_2 \cdot 7H_2O$ (539)

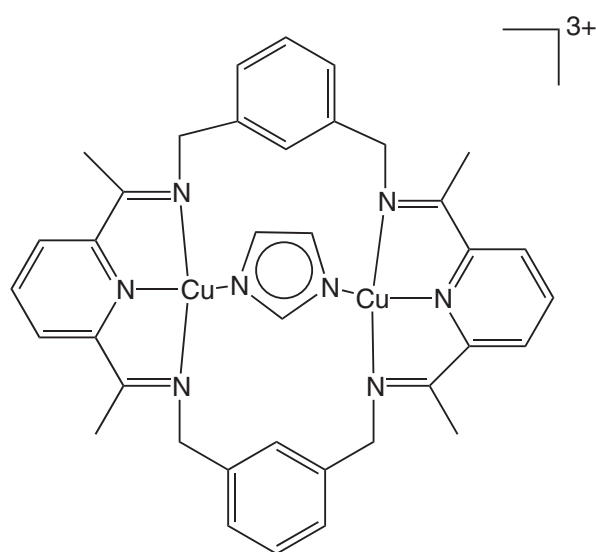

$[(L)Cu_2(Im)][CF_3SO_3]_3 \cdot H_2O$ (540)

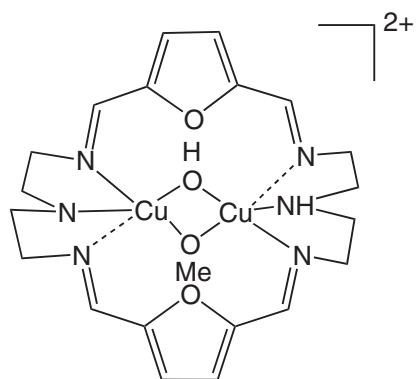
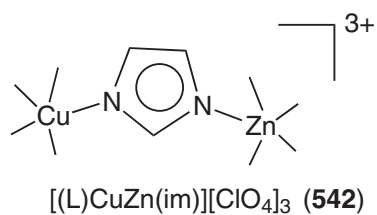
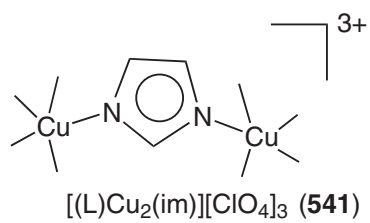
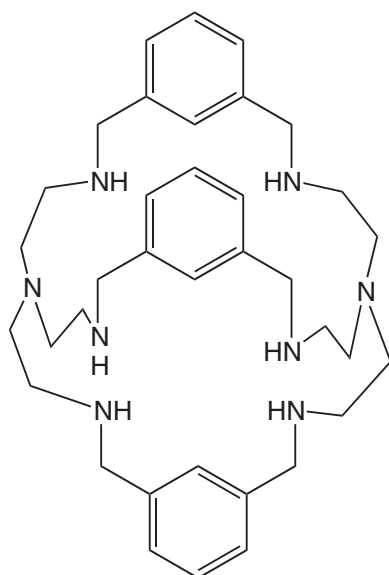

$[(L)Cu_2(OH)(OMe)][ClO_4]_2$ (543)

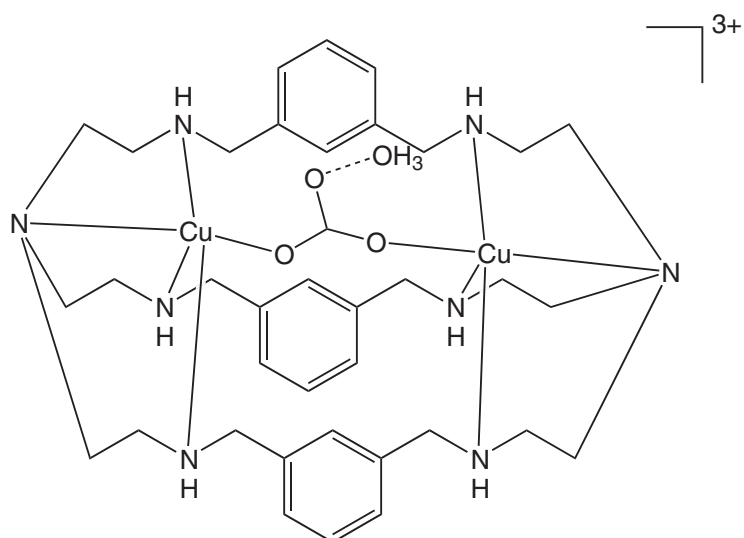

$[(L)Cu_2(OCO_2)(H_3O)]Br_3 \cdot 3H_2O$ (544)

Fenton and co-workers reported⁴⁴⁴ the first-generation model for the trinuclear copper site in ascorbate oxidase^{4-7,433} by reporting the complex (546) (a single Cu^{II} atom 4.9 and 5.9 Å distant from a pair of Cu^{II} atoms that are 3.6 Å apart and hydroxy-bridged). A study of the magnetic properties shows that the trinuclear copper(II) can be regarded as a mononuclear site, non-interacting with a moderately coupled copper pair ($2J = -202 \text{ cm}^{-1}$). As a part of their activity in the coordination chemistry with cryptand ligands, Fenton and co-workers reported⁴⁴⁵ the structure of the complex (547) (distorted TBP; Cu–Cu: 4.6 Å).

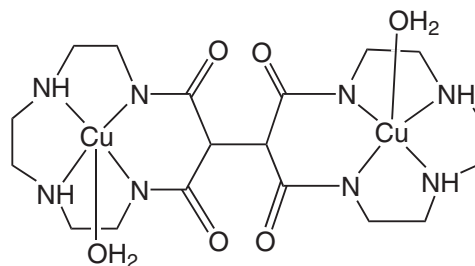

$[(L)Cu_2(H_2O)_2] \cdot 12H_2O$ (545)

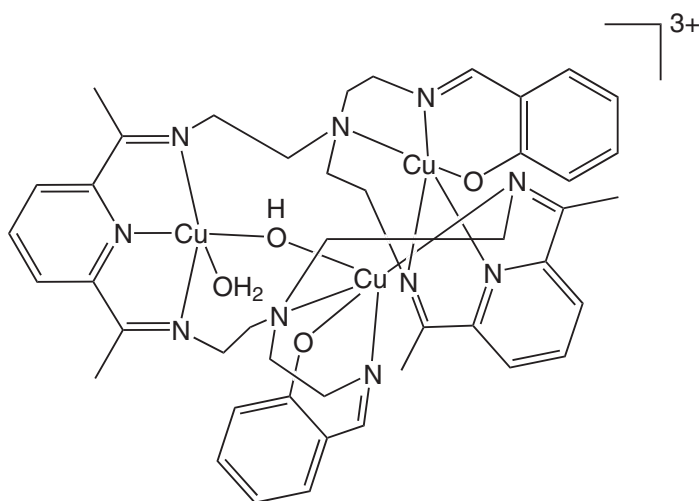

$[(L)Cu_3(OH)][ClO_4]_3 \cdot 2H_2O$ (546)

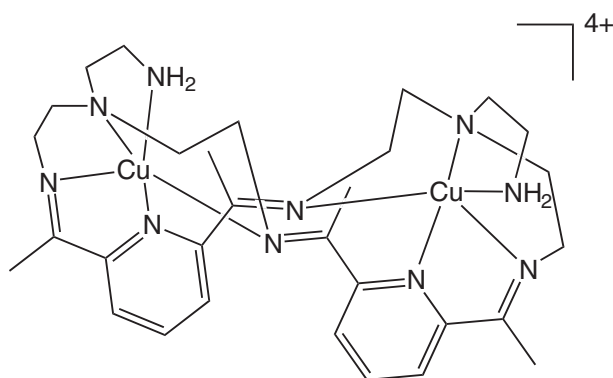

$[Cu_2(L)][BF_4]_4 \cdot 0.33MeCN \cdot 0.25H_2O$ (547)

To gain insight into electron-transfer kinetics of copper(II/I) complexes of macrocyclic thioethers,^{446,447} Rorabacher and co-workers reported^{448,449} structures of five complexes (complexes (548)–(552)).

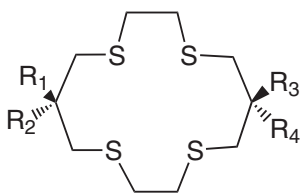

$R_1 = R_3 = \text{OH}; R_2 = R_4 = \text{H}$: *syn*

$R_1 = R_4 = \text{OH}; R_2 = R_3 = \text{H}$: *anti*

$[(L\text{-}syn)\text{Cu}(\text{ONO}_2)][\text{NO}_3]$ (**548**)

$[\text{Cu}(L\text{-}anti)][\text{ClO}_4]_2$ (**549**)

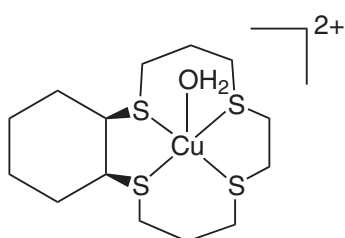

$[(L)\text{Cu}(\text{H}_2\text{O})][\text{ClO}_4]_2$ (**550**)

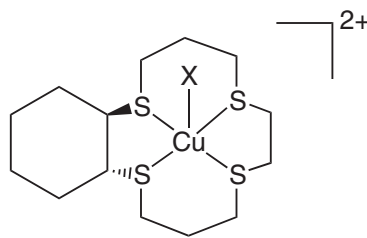

$X = \text{H}_2\text{O}; [\text{Cu}(\text{H}_2\text{O})][\text{ClO}_4]_2$ (**551**)

$X = \text{Cl}; [\text{Cu}(\text{H}_2\text{O})] \cdot 1/2\text{CuCl}_4 \cdot \text{H}_2\text{O}$ (**552**)

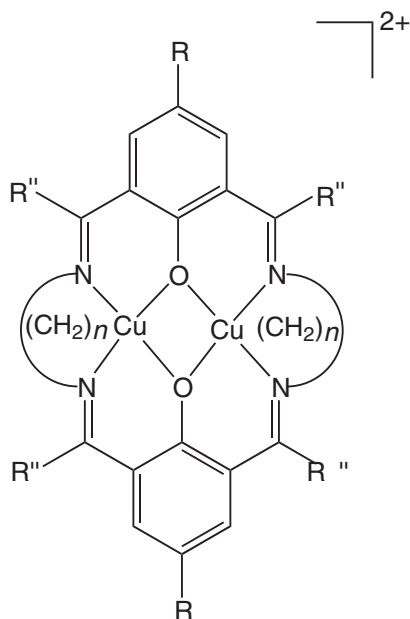

$R' : n = 3, R'' = \text{H}; [(L)\text{Cu}_2(\text{H}_2\text{O})_2]\text{F}_2 \cdot 2\text{MeOH}$ (**553**)

$R' : n = 4, R'' = \text{H}; [(L)\text{Cu}_2\text{Cl}_2][(L)\text{Cu}_2(\text{H}_2\text{O})_2]\text{Cl} \cdot [\text{ClO}_4] \cdot 5.5\text{H}_2\text{O}$ (**554**)

$R' : n = 2, R'' = \text{Me}; [(L)\text{Cu}_2(\text{H}_2\text{O})_2][\text{BF}_4]_2$ (**555**)

From the standpoint of magnetostructural correlations in bis(μ_2 -phenoxide)-bridged macrocyclic dinuclear copper(II) complexes,⁴⁵⁰ Thompson *et al.* reported complexes (**553**) (SP; Cu–Cu: 3.1184 Å; Cu–O–Cu 103.65°; $2J = -784 \text{ cm}^{-1}$), (**554**) ($\tau = 0.34/0.41$, Cu–Cu: 3.115 Å; distorted SP, Cu–Cu: 3.102 Å; Cu–O–Cu 102.4°, 107.5°, 102.9°, 106.1°; $2J = -801 \text{ cm}^{-1}$) and (**555**) (SP; Cu–Cu: 2.997 Å; Cu–O–Cu 98.8°; $2J = -689 \text{ cm}^{-1}$).⁴⁵¹ Nolte and co-workers reported^{452,453} a dihydroxo-bridged complex (**556**) (one of the coppers is pentacoordinated and the other is hexacoordinated; Cu–Cu: 3.542/3.778 Å).⁴⁵² Two molecules are linked by hydroxo ligands, forming a tetranuclear

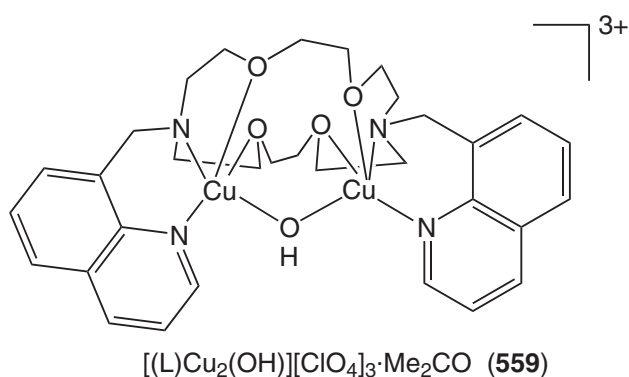
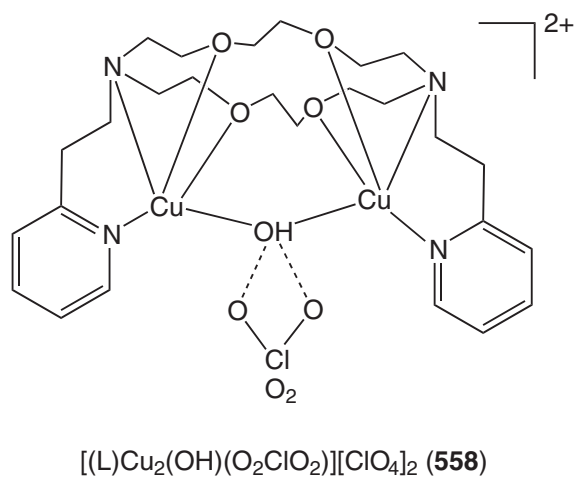
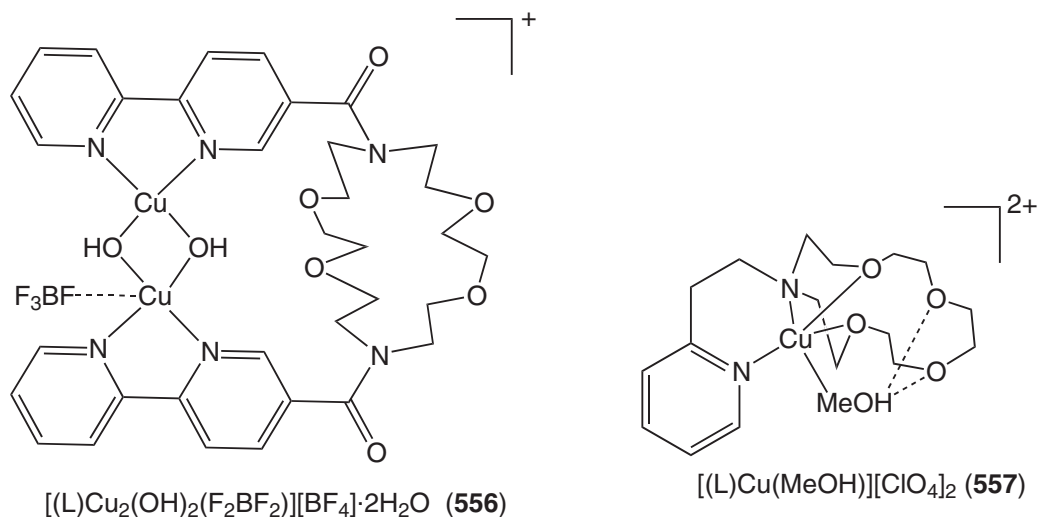

complex. Magnetic susceptibility and EPR measurements suggested that it has a triplet ground state ($2J = 16 \text{ cm}^{-1}$). This group also reported a mononuclear complex (**557**) ($\tau = 0.51$) and a dinuclear complex (**558**) ($\tau = 0.62$; Cu–Cu: 3.4592 Å).⁴⁵³ Wang *et al.* reported the first bridged dicopper(II) complex (**559**) (distorted SP; Cu–Cu: 3.526 Å) of a bibrachial lariat ether.⁴⁵⁴ As a part of their activity on heteroditopic cryptand chemistry,⁴⁵⁵ Bharadwaj and co-workers provided an example of the imposition of distorted geometry (complex **560**).⁴⁵⁶ In this complex the O atom of the water molecule is strongly bonded to the Cu^{II} ion, while its H atoms are H-bonded to

the nearest benzene rings. Using a group of diazamacrocyclic ligands, Bu *et al.* reported three complexes: **(561)** ($\tau = 0.02$), **(562)** ($\tau = 0.30$; Cu–Cu: 3.494 Å; $2J = 1.16 \text{ cm}^{-1}$), **(563a)** ($\tau = 0.30$; Cu–Cu: 3.0324 Å; $2J = -574 \text{ cm}^{-1}$),⁴⁵⁷ **(563b)** ($\tau = 0.38$), **(563c)** ($\tau = 0.29$), and **(563d)** ($\tau = 0.34$; Cu–Cu: 3.396 Å; $2J = 2.24 \text{ cm}^{-1}$).⁴⁵⁸

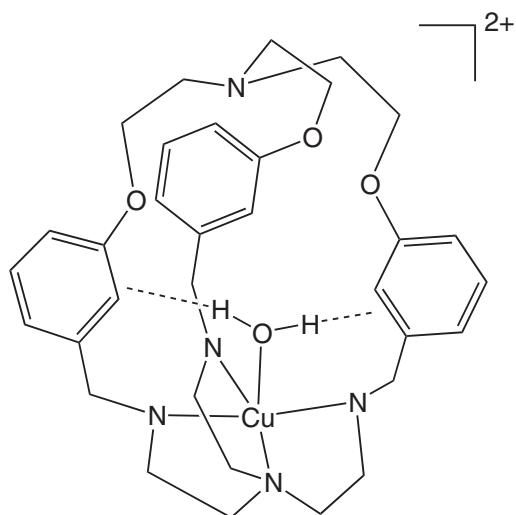

$[(L)Cu(H_2O)][picrate]_2 \cdot H_2O$ (**560**)

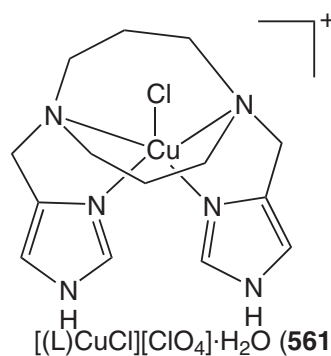

$[(L)CuCl][ClO_4] \cdot H_2O$ (**561**)

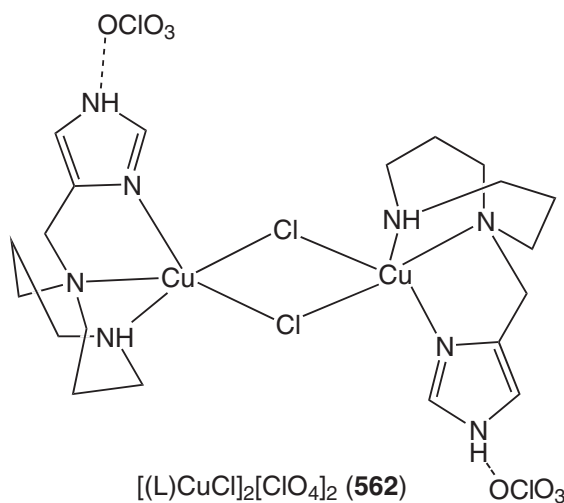

$[(L)CuCl]_2[ClO_4]_2$ (**562**)

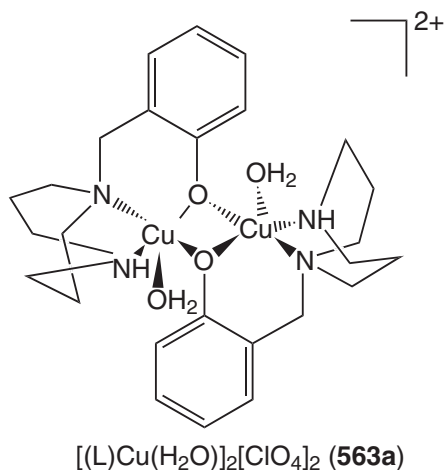

$[(L)Cu(H_2O)]_2[ClO_4]_2$ (**563a**)

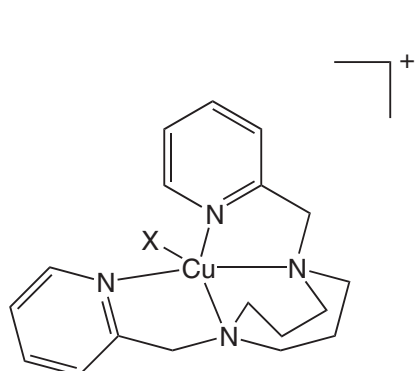

X = Cl: $[(L)CuCl][ClO_4]$ (**563b**)

X = N₃: $[(L)Cu(N_3)][ClO_4]$ (**563c**)

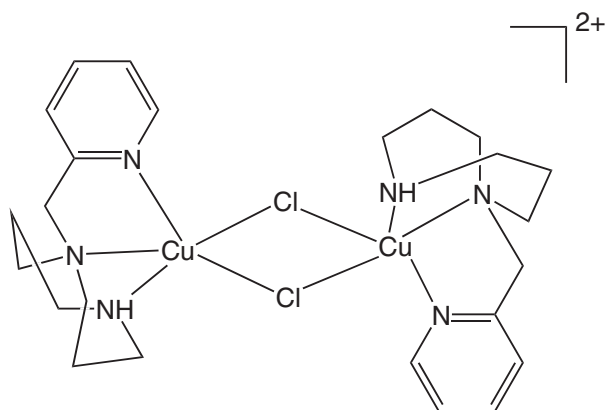

$[(L)CuCl]_2[ClO_4]_2$ (**563d**)

6.6.3.6 Ligand-bridged Systems

Dinuclear and multinuclear transition-metal complexes comprising two or more metal centers bridged by multidentate ligands have been the subject of an enormous amount of work, particularly in the latter years of the twentieth century. Such complexes can exhibit metal-metal interactions, such as energy or electron transfer, magnetic coupling, and intervalence transfer. These interactions are mediated by the bridging ligand. Such compounds are used to model important bioinorganic systems. It is to be mentioned here that the coordination chemistry of such systems is covered in Volume 7. Therefore only selected systems having some relevance to the bioinorganic chemistry of copper will be discussed. Readers are suggested to consult review articles.^{2,3,459-461}

6.6.3.6.1 Carbonate ligands

Studies on di- and trinuclear metal complexes bridged by carbonate or hydrogencarbonate are mainly noted from three areas: (i) fixation and activation of CO₂ from the viewpoint of environmental protection;⁴⁶²⁻⁴⁶⁴ (ii) functional models for zinc-containing carbonic anhydrase (Volume 8); and (iii) the relationship between the bridging modes of carbonate and magnetic properties.

From this background, many carbonato-bridged polynuclear compounds of varying nuclearity, with many different terminal ligands (Figure 2), have been reported: [(Et₄dien)₂Cu₂(H₂O)(OCO₂)] [ClO₄]₂·H₂O (**564**)⁴⁶⁵ (TBP; Cu-Cu: 5.233 Å; 2*J* = -17.8 cm⁻¹); [Cu(EtMe₄dien)₂Cu₂(H₂O)₂(OCO₂)] [ClO₄]₂·2H₂O (**565**)⁴⁶⁵ [SP; hydrogen bonds form a tetranuclear copper(II) unit; Cu-Cu: 5.937 Å; 2*J* = -125.5 cm⁻¹]; [(Cu(petdien))₂(OCO₂)] [ClO₄]₂ (**566**)⁴⁶⁶ (TBP; Cu-Cu: 4.601 (structure at 294 K) and 4.494 (structure at 92 K) Å; 2*J* = -215 cm⁻¹); [(bapma)₃Cu₃(OCIO₃)₃(OCO₂)] [ClO₄]₄ (**567**)⁴⁶⁷ (SP; Cu-Cu: 4.87 Å; 3*J* = 12.6 cm⁻¹); [(bapa)₄Cu₄Br₂(OCO₂)] Br₄ (**568**)⁴⁶⁸ (μ₄-carbonate ligand disordered; 2*J* = -275 cm⁻¹, -8 cm⁻¹, -57 cm⁻¹, and -31 cm⁻¹); [(bapma)₄-Cu₄Cl₂(OCO₂)] Cl₄·12H₂O (**569**)⁴⁶⁸ (μ₄-carbonate ligand disordered; 2*J* = -390 cm⁻¹, 22 cm⁻¹, -10 cm⁻¹,

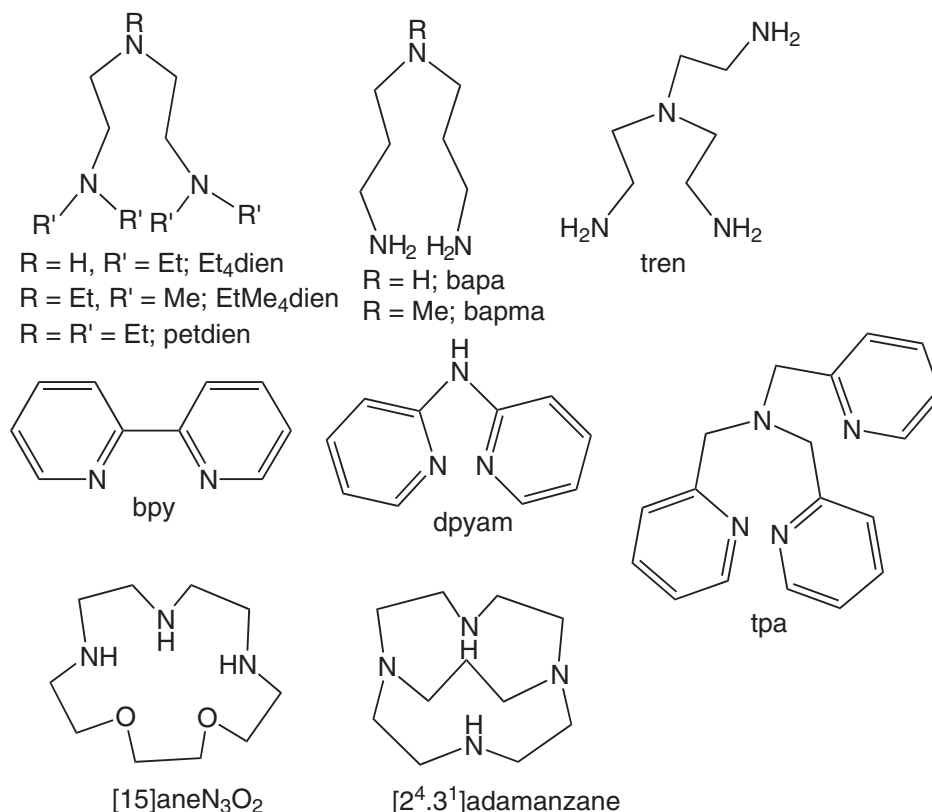
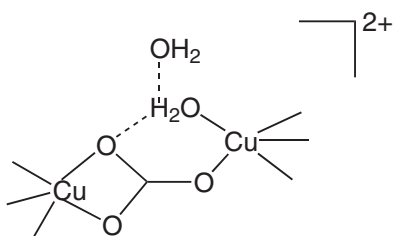
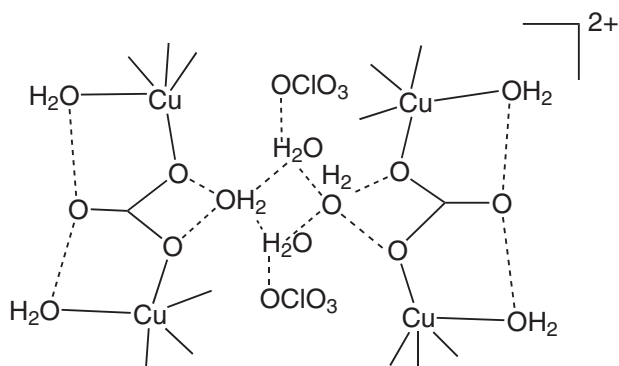

Figure 2 Carbonato-bridged polynuclear compounds of varying nuclearity with different terminal ligands.



$[(\text{Et}_4\text{dien})_2\text{Cu}_2(\text{H}_2\text{O})(\text{OCO}_2)][\text{ClO}_4]_2 \cdot \text{H}_2\text{O}$ (**564**)



$[(\text{EtMe}_4\text{dien})_2\text{Cu}_2(\text{OCO}_2)(\text{H}_2\text{O})_2][\text{ClO}_4]_2 \cdot 2\text{H}_2\text{O}$ (**565**)

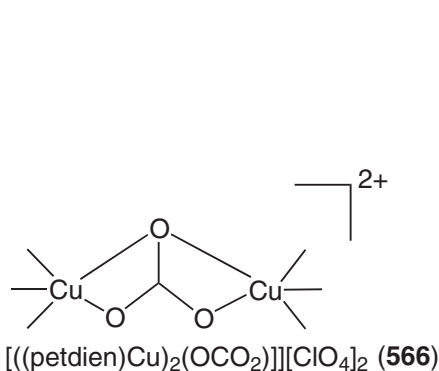

$[(\text{petdien})\text{Cu}_2(\text{OCO}_2)][\text{ClO}_4]_2$ (**566**)

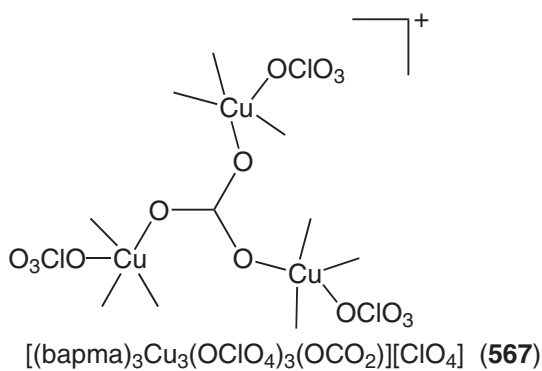

$[(\text{bapma})_3\text{Cu}_3(\text{OCIO}_4)_3(\text{OCO}_2)][\text{ClO}_4]$ (**567**)

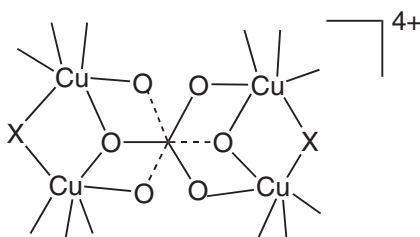

X = Cl, $[(\text{bapa})_4\text{Cu}_4\text{Br}_2(\text{OCO}_2)]\text{Br}_4$ (**568**)

X = Br, $[(\text{bapma})_4\text{Cu}_4\text{Cl}_2(\text{OCO}_2)]\text{Cl}_4$ (**569**)

and -26 cm^{-1}); $[(\text{Cu}(\text{tren}))_3(\text{OCO}_2)][\text{ClO}_4]_4 \cdot \text{H}_2\text{O}$ (**570**)⁴⁶⁹ (TBP); $[\text{bpy}]_4\text{Cu}_2(\text{OCO}_2)[\text{PF}_6]_2 \cdot 2\text{DMF}$ (**571**)⁴⁷⁰ (SP; Cu–Cu: 5.16 Å; $2J = -140.4\text{ cm}^{-1}$); $[(\text{bpy})_{10}\text{Cu}_6(\text{OH})_2(\text{OCO}_2)_2][\text{ClO}_4]_6 \cdot 4\text{H}_2\text{O}$ (**572**)⁴⁷⁰ ($\tau = 0.41, 0.23, 0.05$; Cu–Cu (hydroxo bridge): 2.845 Å; $S = 3$ ground state); $[(\text{bpy})_6\text{Cu}_3(\text{OCO}_2)][\text{BF}_4]_4 \cdot 2\text{H}_2\text{O} \cdot \text{EtOH}$ (**573**) (structural type: (**570**); distorted SP; Cu–Cu: 4.64 Å, 4.72 Å, and 5.00 Å; $3J = 10.6\text{ cm}^{-1}$).⁴⁷¹ It is worth mentioning here that van Eldik and co-workers reported⁴⁷² two

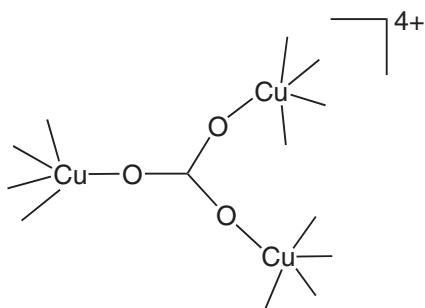

$[(\text{tren})_3\text{Cu}_3(\text{OCO}_2)][\text{ClO}_4]_4 \cdot \text{H}_2\text{O}$ (**570**)

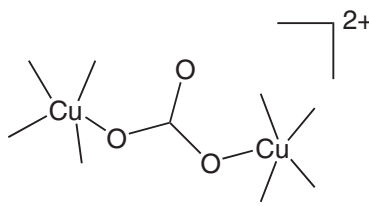

$[(\text{bpy})_4\text{Cu}_2(\text{OCO}_2)][\text{PF}_6]_2 \cdot 2\text{DMF}$ (**571**)

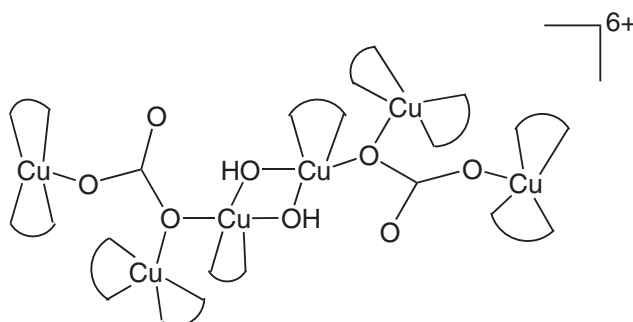

$[(\text{bpy})_{10}\text{Cu}_6(\text{OCO}_2)_2(\text{OH})_2][\text{ClO}_4]_6 \cdot 4\text{H}_2\text{O}$ (**572**)

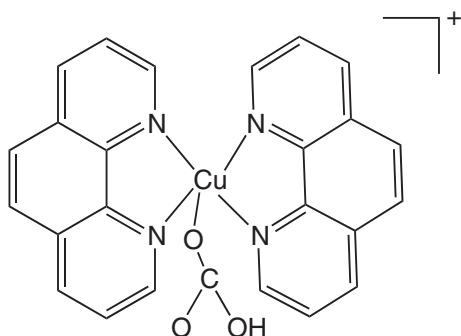

$[(\text{phen})_2\text{Cu}(\text{OCO}_2\text{H})][\text{ClO}_4]$ (**574**)

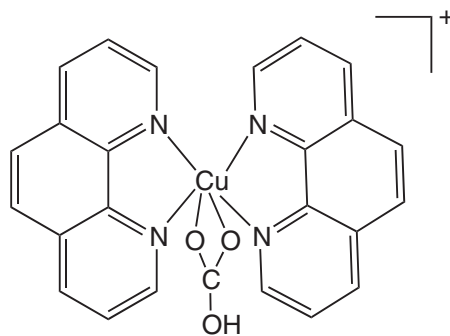

$[(\text{phen})_2\text{Cu}(\text{O}_2\text{COH})][\text{ClO}_4]$ (**575**)

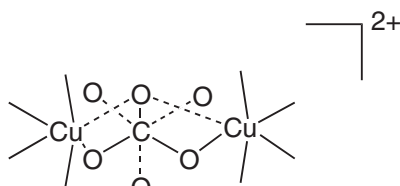

$[(\text{dpyam})_4\text{Cu}_2(\text{OCO}_2)][\text{ClO}_4]_2 \cdot 4\text{H}_2\text{O}$ (**576**)

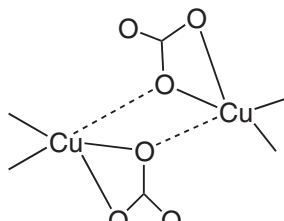

$[(\text{dpyam})_2\text{Cu}_2(\text{OCO}_2)_2] \cdot \text{H}_2\text{O}$ (**577**)

very interesting mononuclear, bicarbonate-bound (both monodentate and bidentate) complexes ((**574**) and (**575**)). Youngme *et al.* reported two carbonate-bridged complexes [(**576**) ($\tau = 0.13, 0.30$; Cu–Cu: 5.555 Å; $2J = -90.4 \text{ cm}^{-1}$) and (**577**) ($\tau = 0.20, 0.22$; Cu–Cu: 3.247 Å; $2J = -9.9 \text{ cm}^{-1}$)].⁴⁷³ Many such complexes have been reported: $[(\text{Cu}(\text{tpa}))_3(\text{OCO}_2)][\text{ClO}_4]_4$ ((**578**), structural type: (**570**); TBP;

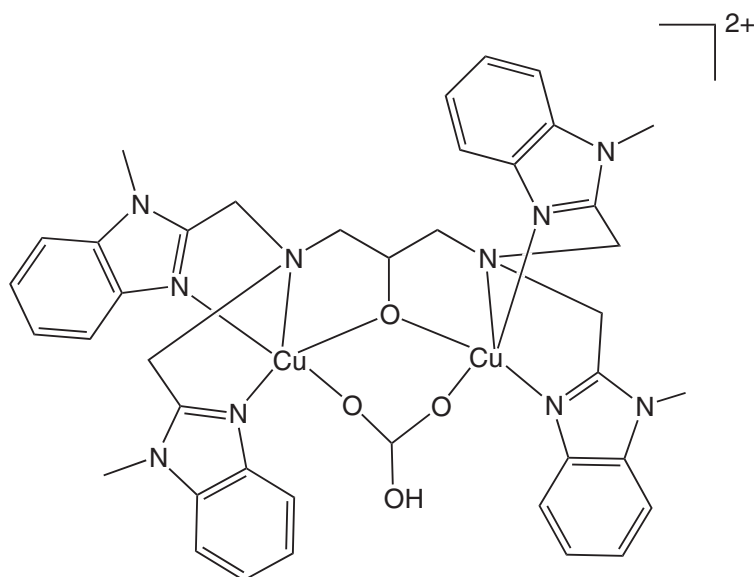

[(L)Cu₂(O₂COH)][BF₄]₂·5H₂O (**579**)

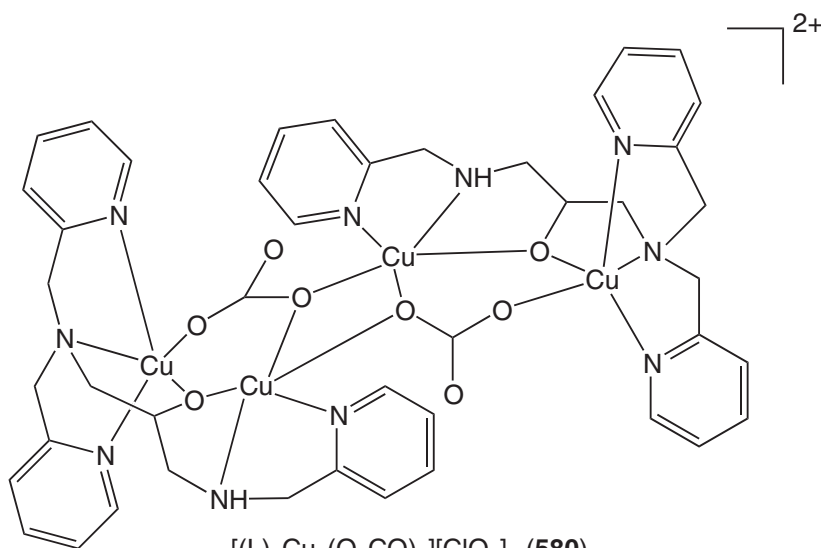

[(L)₂Cu₄(O₂CO)₂][ClO₄]₂ (**580**)

Cu–Cu: 4.91, 4.96, and 5.06 Å; $3J = -1.19 \text{ cm}^{-1}$),⁴⁷⁴ (**579**) (distorted SP; Cu–Cu: 3.440 Å; $2J = 36.3 \text{ cm}^{-1}$),⁴⁷⁵ (**580**) (distorted SP; Cu–Cu: 3.446 Å; $2J = -90.4 \text{ cm}^{-1}$; exhibits reversible CO₂ fixation).⁴⁷⁶ Using macrocyclic terminal ligands (Figure 2), complexes [$\{\text{Cu}(\text{L})\}_3(\text{OCO}_2)\text{]-}[\text{ClO}_4]_4$ (L = [15]aneN₃O₂) (**581**) ($\tau = 0.19$; $3J = 8.2 \text{ cm}^{-1}$),^{477,478} [$\{\text{Cu}(\text{L})\}_3(\text{OCO}_2)\text{]ClO}_4]_4$ (L = [2⁴.3¹]adamanzane) (**582**) ($\tau = 0.57$; Cu–Cu: 4.64, 4.72, and 5.00 Å; $3J = 17.2 \text{ cm}^{-1}$),⁴⁷⁹ and (**583**) (elongated octahedral; Cu–Cu: 3.240 and 4.601 Å)⁴⁸⁰ ((**581**)–(**583**); structural type: (**570**)) were reported. Using a natural cyclic peptide, complex (**584**) (distorted SP; Cu–Cu: 4.43 Å; $2J = 1.6 \text{ cm}^{-1}$) was thoroughly characterized.⁴⁸¹

6.6.3.6.2 Other bridged systems

Lippard and co-workers synthesized⁴⁸² a hexaimidazole ligand to encapsulate two copper ions in a biomimetic environment, and reported a very interesting dicopper(II) complex (**585**) (D_{2d}

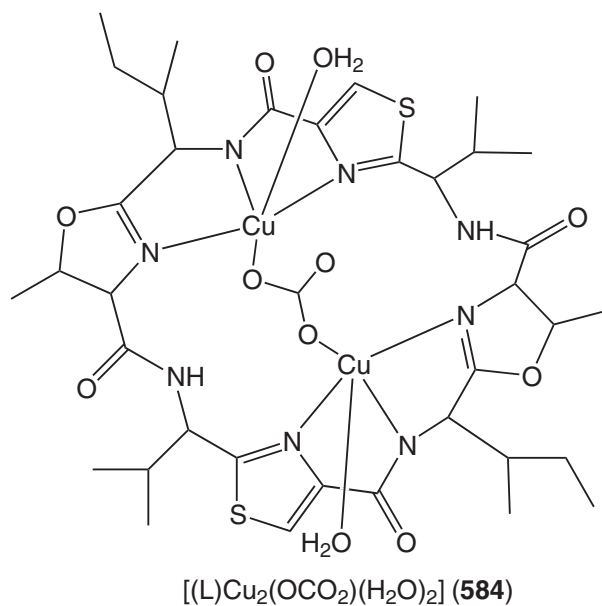
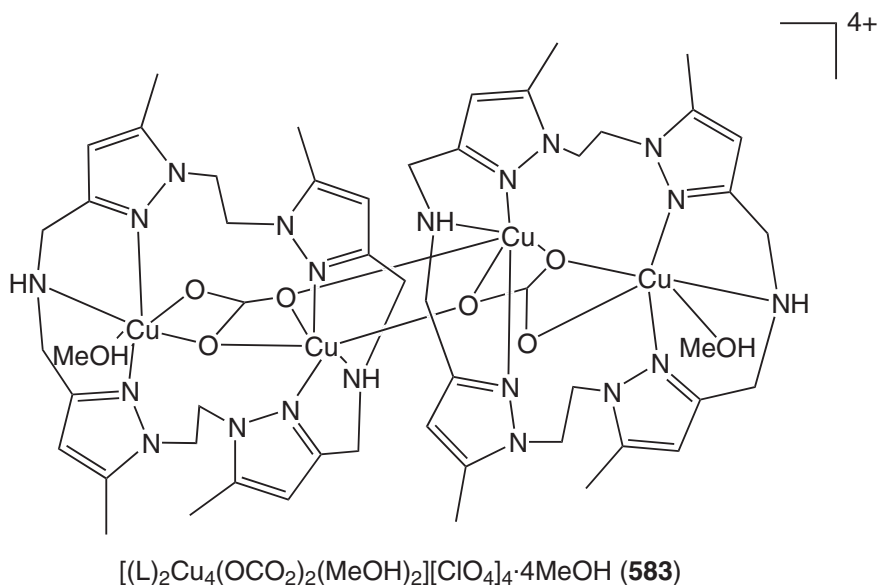

distorted square planar; dihedral angle between the best least-squares planes through the two copper coordination spheres is 62.5°). The most interesting feature of this structure is that a methanol solvent molecule, used to grow crystals, is inserted into the cavity defined by the bis(imidazolyl)benzene linker. Solid-state, temperature-dependent (6–300 K) measurements revealed the presence of a weak ferromagnetic coupling ($2J = +2.6(2) \text{ cm}^{-1}$) in this compound. EPR spectral properties were also studied. Comba and co-workers reported⁴⁸³ structural models of substrate-bound catechol oxidase⁹¹ (complexes **(586)**–**(589)**). The compound with a bridging catecholate was shown to be catalytically the most active.

From the viewpoint of molecular magnetism,^{484,485} Julve *et al.* reported⁴⁸⁶ complex **(590)** (elongated tetragonal octahedral; Cu–Cu: 3.435 Å; $2J = -374 \text{ cm}^{-1}$). Escuer *et al.* demonstrated the versatility of the cyanato ligand by doing magnetostructural studies on dimeric complexes: $[(Et_5dien)Cu(NCO)][ClO_4]$ (**(591)**) (square planar), **(592)** (axially elongated SP; Cu–Cu: 5.397 Å; $2J = 0.5 \text{ cm}^{-1}$), and **(593)** ($\tau = 0.27$; Cu–Cu: 3.216 Å; $2J = -4.6 \text{ cm}^{-1}$).⁴⁸⁷ Continuing with their activity, this group also investigated complexes **(594)** (axially elongated SP; Cu–Cu: 6.89 Å; $2J = -7.5 \text{ cm}^{-1}$), **(595)** (distorted SP; Cu–Cu: 7.569 Å; $2J = -28 \text{ cm}^{-1}$) and **(596)** (axially elongated

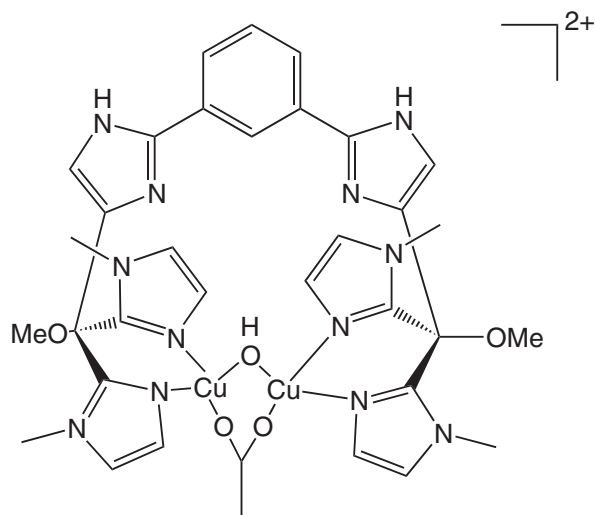

$[(L)Cu_2(OH)(O_2CMe)][ClO_4]_2 \cdot 1.5THF \cdot MeOH$ (**585**)

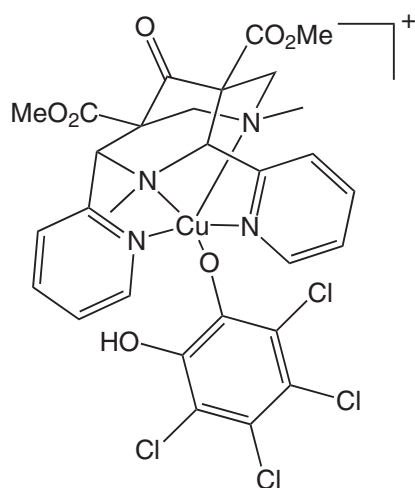

$[(L)Cu(tccH)][ClO_4]$ (**586**)
(H_2tcc = tetrachlorocatechol)

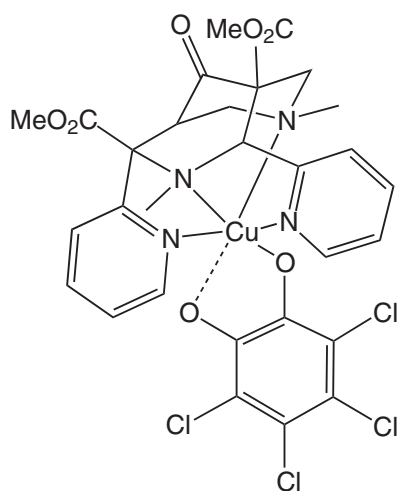

$[(L)Cu(tcc)]$ (**587**)
(H_2tcc = tetrachlorocatechol)

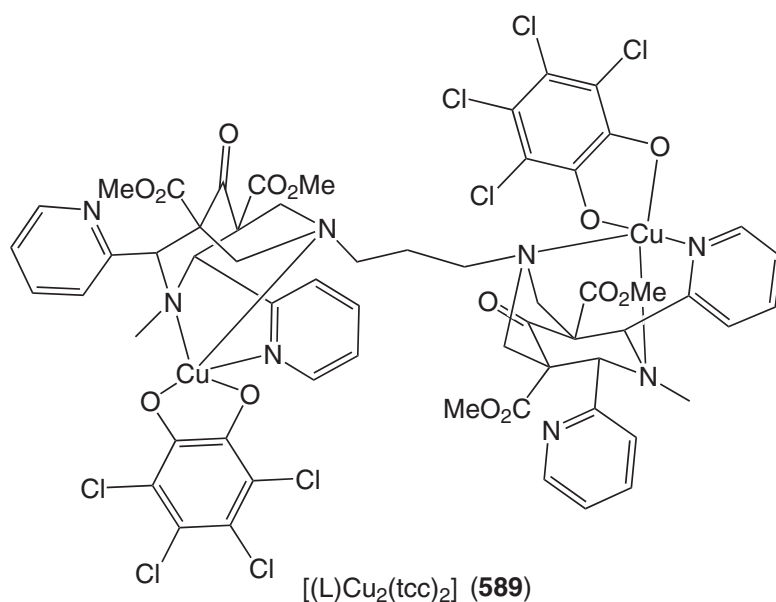
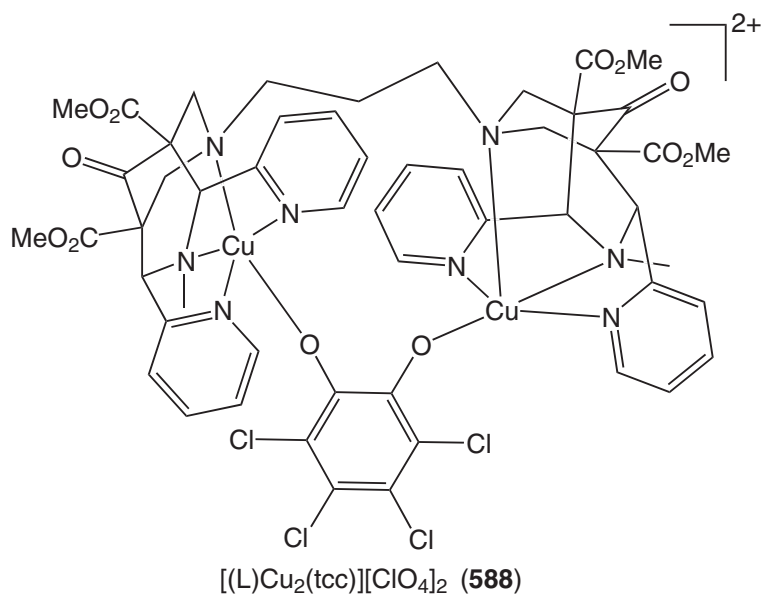

SP; Cu–Cu: 5.289 Å; $2J = -3.6 \text{ cm}^{-1}$).⁴⁸⁸ Spiccia and co-workers studied a mononuclear complex [(tpa)Cu(CN)][ClO₄]·0.5H₂O (Figure 2) ((**597**); TBP), as well as two cyanide-bridged complexes [(**598**) (TBP; Cu–Cu: 5.084 Å; $2J = -106.4 \text{ cm}^{-1}$) and (**599**) (TBP; Cu–Cu: 4.982 Å; $2J = -174.2 \text{ cm}^{-1}$)].⁴⁸⁹ McCleverty, Ward, and co-workers reported structural, magnetic, and EPR spectroscopic properties of tetranuclear grid-like copper(II) complexes with pyrazolate bridges:⁴⁹⁰ (**600**) (SP; Cu–Cu: 3.963 and 4.080 Å), (**601**) (MeOH is coordinated like DMF in complex (**600**): SP, Cu–Cu: 3.939 and 3.984 Å) and (**602**) (SP; Cu–Cu: 3.216 Å).⁴⁹¹ Tokii and co-workers investigated magnetostructural studies on bis-(μ -pyrazolato)-bridged dicopper(II) complexes: (**603**)–(**606**) (distorted TBP); (**607**) (distorted square bipyramidal). They structurally characterized a complex [(bpy)₂Cu₂(4-Mepz)₂(H₂O)₂][NO₃]₂ as well, having a structure closely similar to that of (**607**). Magnetic susceptibility data conform to $2J$ values in the range -143 to -268 cm^{-1} .⁴⁹² Chou *et al.* reported three pyrazolato-bridged complexes (**608**)–(**610**). In these complexes with additional bridges, redox and magnetic studies were also performed.⁴⁹³ Pons *et al.* provided example (complex (**611**))⁴⁹⁴ of an unexpected chlorination of a pyrazole ligand during crystallization of a mononuclear precursor. McKenzie and co-workers reported⁴⁹⁵

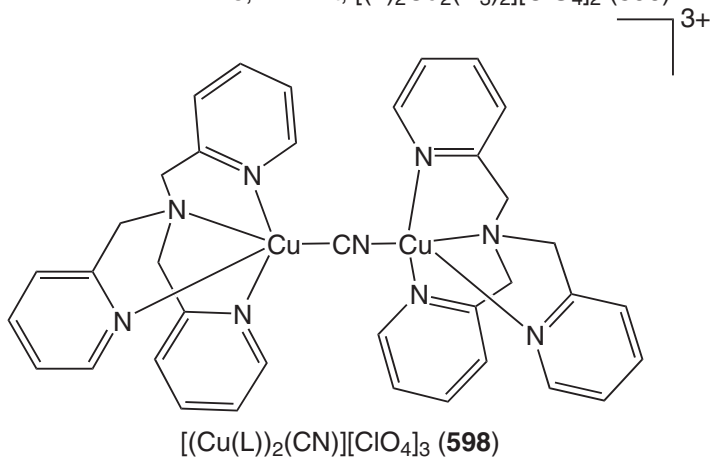
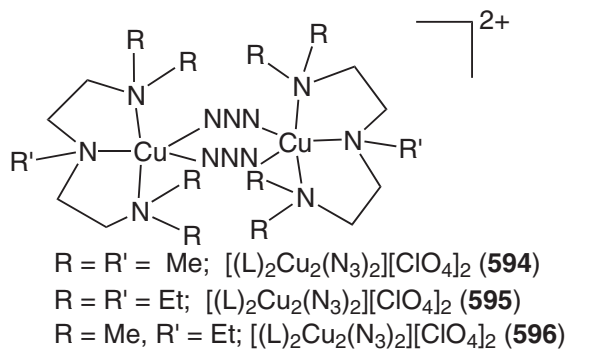
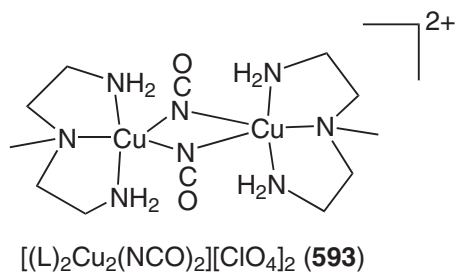
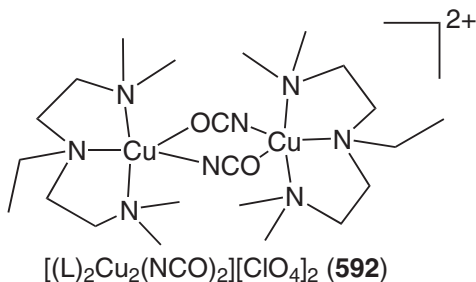
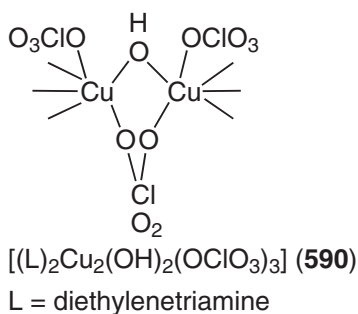

a *p*-phenylenediamine-bridged complex (**612**) (SP; weak antiferromagnetic coupling). Spodine *et al.* reported⁴⁹⁶ a monohydroxo-bridged complex (**613**) (SP; Cu–Cu: 3.663 Å; $2J = -360\text{ cm}^{-1}$). Reedijk and co-workers reported two interesting dihydroxo-bridged complexes (**614**) (distorted tetragonal; Cu–O–Cu: 99.3°; Cu–Cu: 2.9414 Å; $2J = -68.1\text{ cm}^{-1}$)⁴⁹⁷ and (**615**) (distorted octahedral; Cu–O–Cu: 94.5°; Cu–Cu: 2.8383 Å; $2J = 148\text{ cm}^{-1}$).⁴⁹⁸

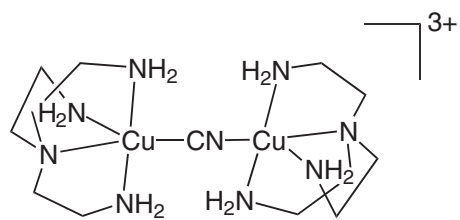
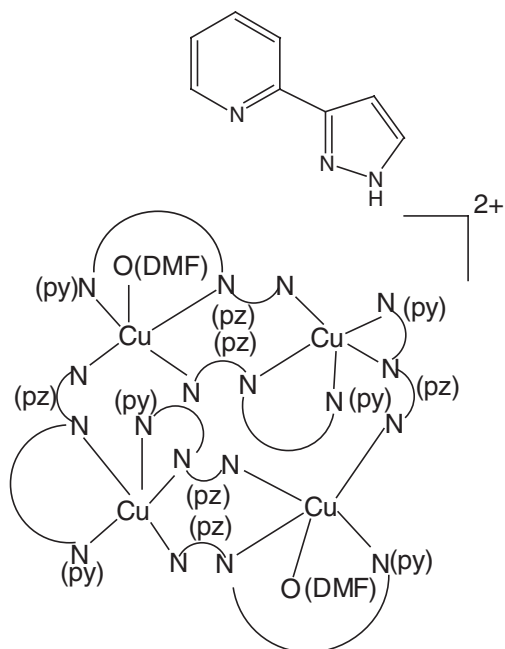
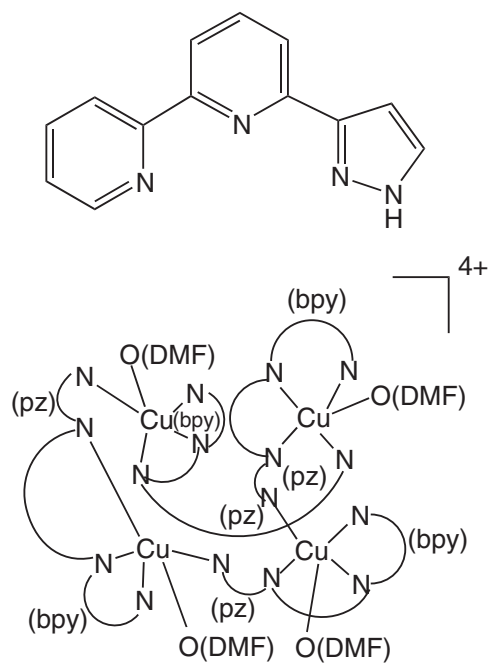
 $[(\text{Cu}(\text{L}))_2(\text{CN})][\text{ClO}_4]_3 \cdot \text{DMF} \cdot 0.5\text{H}_2\text{O}$ (**599**)

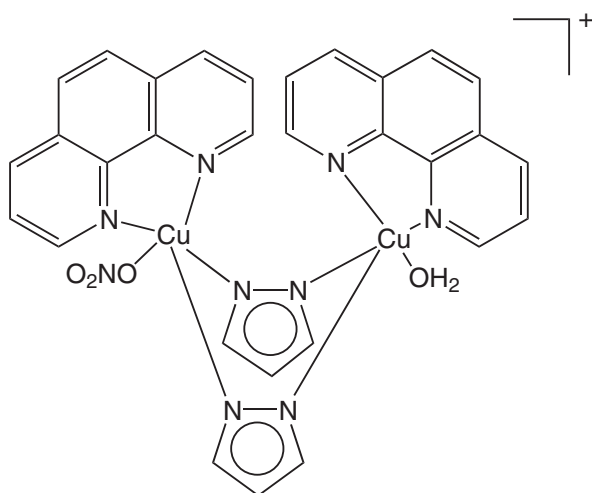
 $[(\text{L})_6\text{Cu}_4(\text{DMF})_2][\text{PF}_6]_2 \cdot 2\text{DMF}$ (**600**)

 $[(\text{L})_4\text{Cu}_4(\text{DMF})_4][\text{PF}_6]_4$ (**602**)

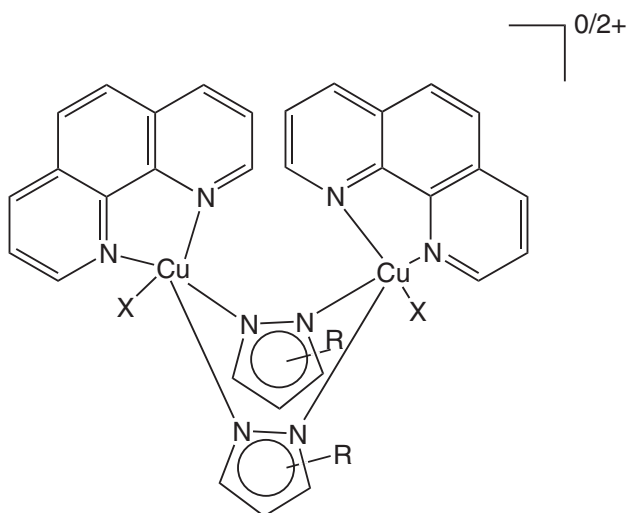

$[(L)_2Cu_2(pz)_2(ONO_2)(H_2O)][NO_3]$ (**603**)



R = H, X = ONO₂: $[(L)_2Cu_2(pz)_2(ONO_2)_2]$ (**604**)

X = ONO₂, R = 4-Cl: $[(L)_2Cu_2(4-Clpz)_2(ONO_2)_2] \cdot 2MeOH$ (**605**)

X = ONO₂, R = 4-Br: $[(L)_2Cu_2(4-Brpz)_2(ONO_2)_2] \cdot 2MeOH$ (**606**)

X = H₂O, R = 4-Me: $[(L)_2Cu_2(4-Mepz)_2(H_2O)_2][NO_3]_2$ (**607**)

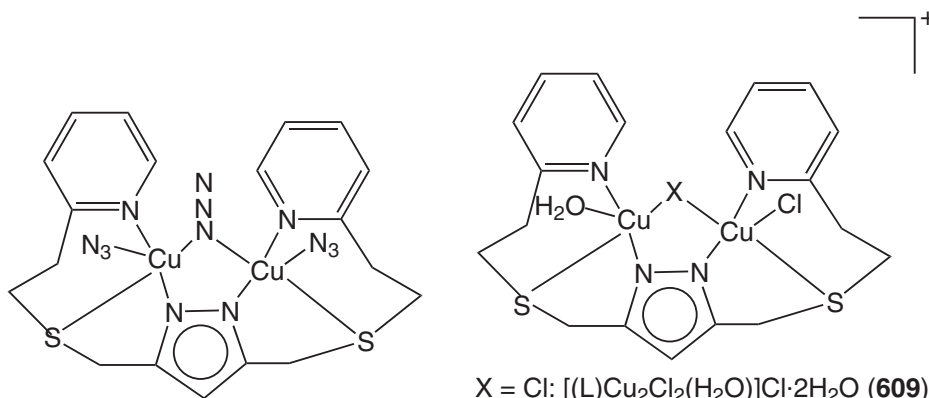

$[(L)Cu_2(N_3)_3]$ (**608**)

X = Cl: $[(L)Cu_2Cl_2(H_2O)]Cl \cdot 2H_2O$ (**609**)

X = Br: $[(L)Cu_2Br_2(H_2O)]Br \cdot 2H_2O$ (**610**)

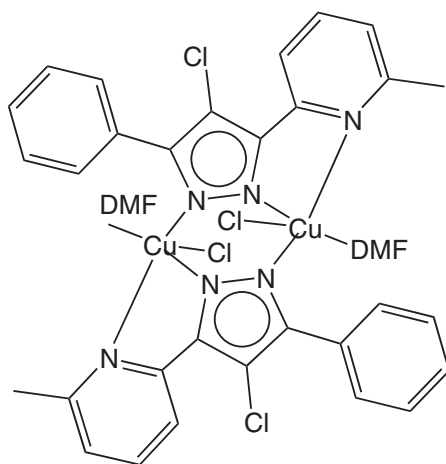
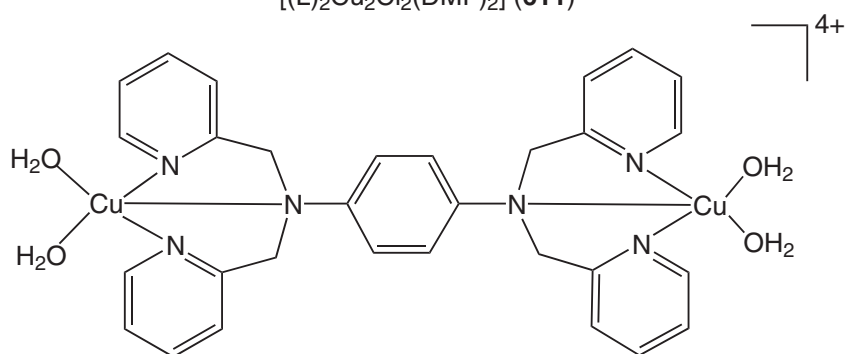
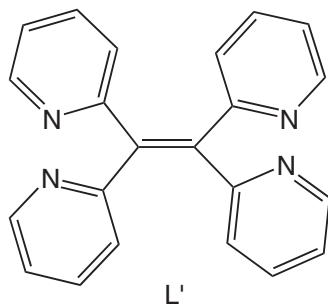
 $[(L)_2Cu_2Cl_2(DMF)_2]$ (611)

 $[(L)Cu_2(H_2O)_4][S_2O_6]_2 \cdot MeOH$ (612)

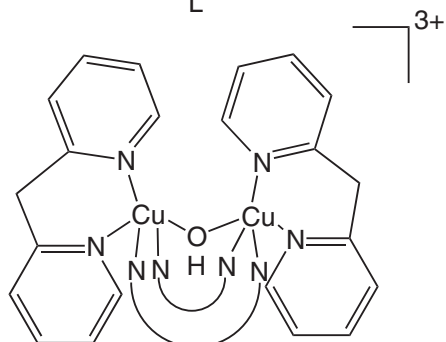
L'

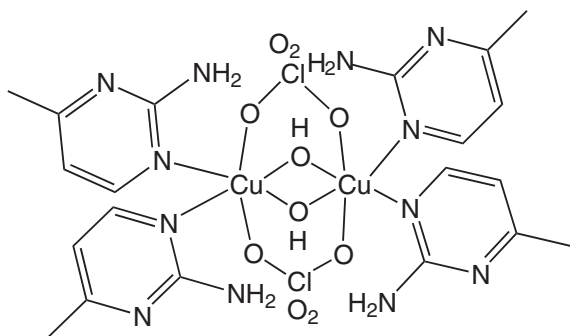
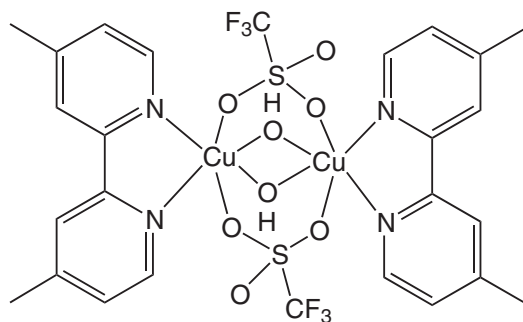

 $[(L)Cu_2(OH)(L')][ClO_4]_3 \cdot 2H_2O$ (613)



 $[(L)_4Cu_2(OH)_2(OCIO_3)_2]$ (**614**)

 $[(L)Cu(OH)(CF_3SO_3)]_2$ (**615**)

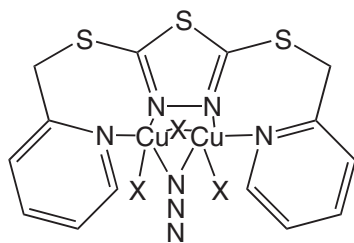
Thompson and co-workers systematically studied^{499,500} magnetostructural correlations with many interesting azido-bridged complexes, with endogenous equatorial diazine bridge exhibiting both ferromagnetic and antiferromagnetic coupling between the Cu^{II} centers. A few representative examples are complexes (**616**)–(**624**). Axial sites at both coppers involve a disordered array of partial waters and partial chloride ions (complex (**624a**)). From these studies they demonstrated that the μ_2 -1,1-azido bridge can propagate antiferromagnetic coupling if the bridge angle is large enough, and that the critical angle for accidental orthogonality (ferromagnetic coupling) for the azido bridge is $\approx 108.5^\circ$.

From the viewpoint of molecular-based magnetic materials,^{484,485} Ray Chaudhuri and co-workers reported the end-to-end azide-bridged complex (**625**).⁵⁰¹ Manoharan and co-workers systematically investigated molecular and electronic structural aspects of azido-bridged complexes (**626**) (distorted SP; Cu–Cu: 5.632 Å), (**627**) (contrary to (**626**), in this complex each copper has a weak perchlorate O coordination; Cu–Cu: 5.410 Å) and $[(dpt)Cu(\mu-N_3)]_2[ClO_4]_2$ (**628**) (structural type: (**593**)); dpt = dipropylenetriamine (Figure 2); Cu–Cu: 3.416 Å).⁵⁰² Akagi *et al.* reported a linear trinuclear copper(II) complex (**629**), bridged by oximate and azido groups (elongated octahedral; Cu(central)–Cu(terminal): 3.4008 Å; $2J = -532\text{ cm}^{-1}$).⁵⁰³

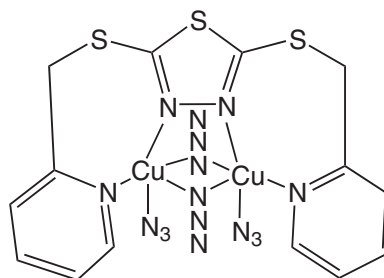
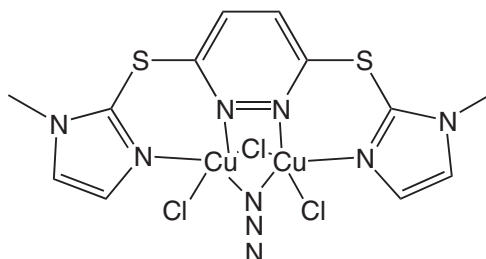
Christou, Hendrickson, and co-workers reported triply bridged, ferromagnetically coupled dicopper(II) complexes (**630**) and (**631**).^{504–506} Perlepes *et al.* reported alkoxo-/carboxylato-bridged complexes (**632**) and (**633**).⁵⁰⁶ Using hydroxo-/carboxylato-bridged dicopper(II) complexes, Chakravarty and co-workers investigated magnetostructural correlations; complexes (**634**) and (**635**)

 $X = Cl: [(L)Cu_2(N_3)Cl_3] \cdot MeCN$ (**616**)

 $X = Br: [(L)Cu_2(N_3)Br_3] \cdot MeCN$ (**617**)

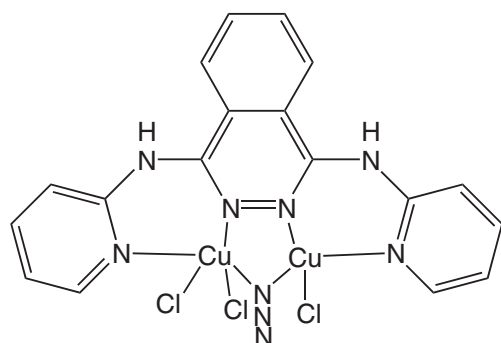
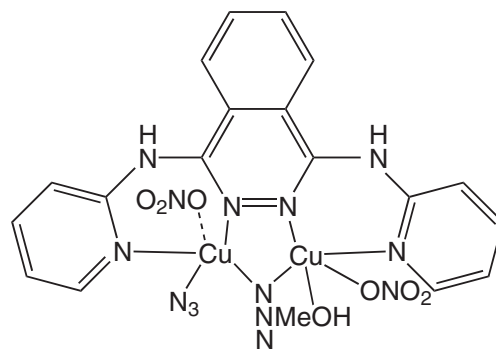
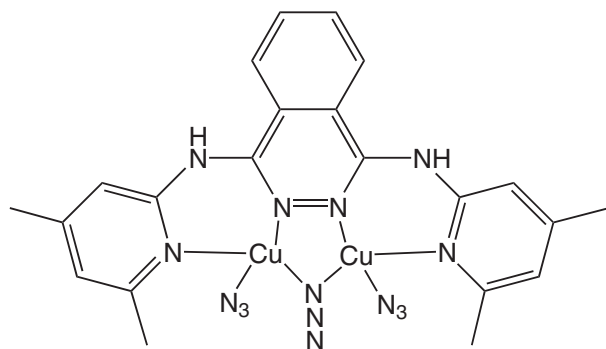
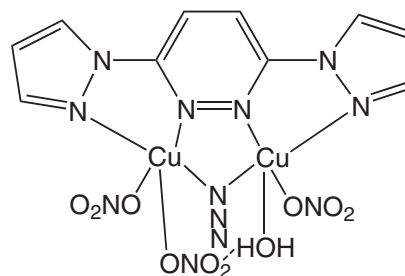
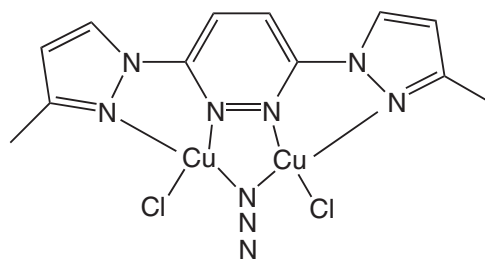
 $[(L)Cu_2(N_3)_4]$ (**618**)

 $[(L)Cu_2(N_3)Cl_3] \cdot 0.5MeOH$ (**619**)

 $[(L)Cu_2(N_3)Cl_3] \cdot CH_2Cl_2$ (**620**)

 $[(L)Cu_2(N_3)_2(ONO_2)(MeOH)][NO_3] \cdot MeOH$ (**621**)

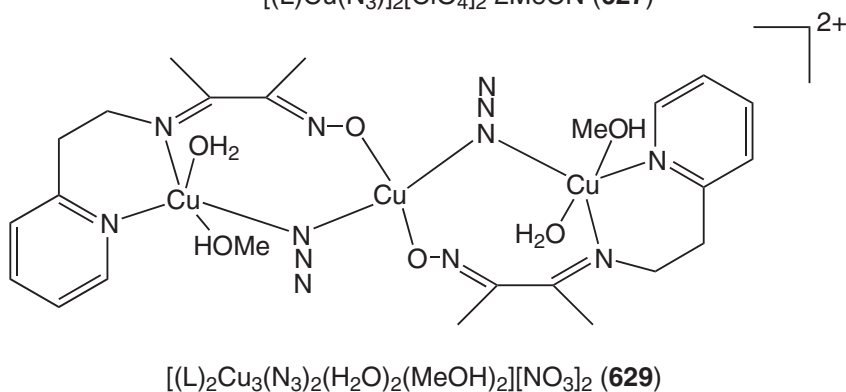
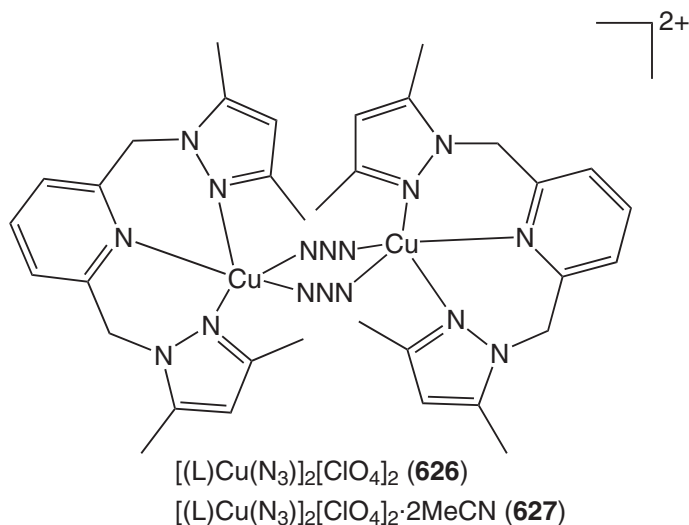
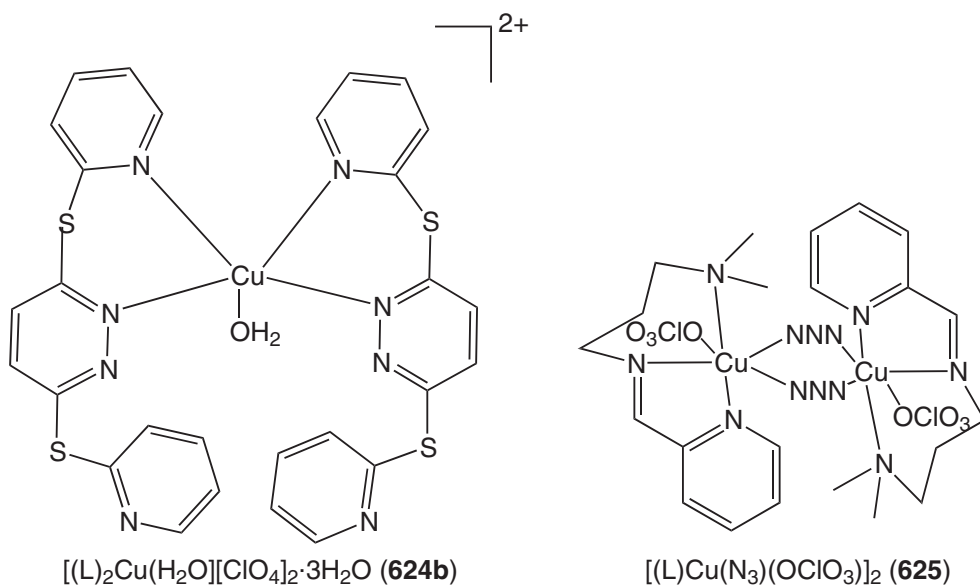
 $[(L)Cu_2(N_3)_3] \cdot 0.33H_2O$ (**622**)

 $[(L)Cu_2(N_3)(ONO_2)_3(H_2O)_{1.6}]$ (**623**)

 $[(L)Cu_2(N_3)Cl_3(H_2O)_{1.5}]$ (**624a**)

represent prototypical examples.⁵⁰⁷ Tokii *et al.* studied closely similar complexes, (**636**) and (**637**).⁵⁰⁸ Using a single-pot reaction, Walton and co-workers reported a complex (**638**) (SP; Cu–Cu: 3.491 Å; $2J = -152.1 \text{ cm}^{-1}$) of a *m*-xylyl-based Schiff base ligand.⁵⁰⁹

To address the role of the apical donor in the decomposition of copper(II) benzoate under the DOW-phenol process, Comba and co-workers reported complex (**639**).⁵¹⁰ Ruiz, Journaux, and co-workers demonstrated⁵¹¹ ferromagnetic coupling through spin polarization in a dinuclear copper(II) metallacyclophane complex (**640**). Actually, the structure affords an intricate two-dimensional network. Sletten and co-workers reported weak, antiferromagnetically coupled dicopper(II) complexes (**641**) and (**642**), with thiocyanato bridges.⁵¹² Rodríguez *et al.* reported a chloro-bridged dimer (**643**) with an unusual structure (distorted SP; the two pyramids share a base-to-apex edge, with the basal planes being perpendicular) and ferromagnetic coupling.⁵¹³

Using a macrocyclic ligand, an interesting μ -chloro- and μ -hydroxo-bridged complex (**644**) (TBP; Cu–Cu: 3.223 Å) was reported.⁵¹⁴ Wiegardt, Chaudhuri, and co-workers reported a very weakly antiferromagnetically coupled complex (**645**), with two chloro bridges and a carboxylato bridge. Applying magnetostructural concepts, they rationalized their result.⁵¹⁵ They investigated



exchange coupling across multiple-atom bridges (complex (**646**) (SP; Cu–Cu: 7.679 Å; $2J = -24.6 \text{ cm}^{-1}$)),⁵¹⁶ as well as intramolecular long-range exchange coupling in dinuclear copper(II) complexes with Cu–Cu separations greater than 10 Å (complexes (**647**)–(**651**)).⁵¹⁷ The latter studies demonstrated that intramolecular antiferromagnetic exchange coupling of considerable magnitude is possible, provided that the effective magnetic orbitals are favorably aligned.

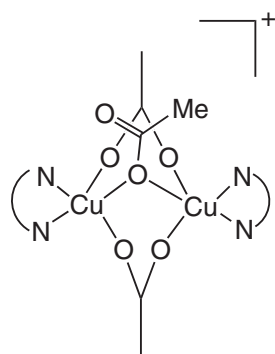

$[(bpy)_2Cu_2(O_2CMe)_2][ClO_4]$ (**630**)

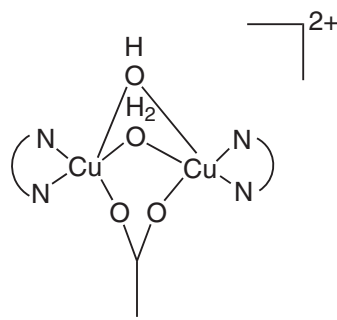

$[(bpy)_2Cu_2(H_2O)(OH)(O_2CMe)][ClO_4]_2$ (**631**)

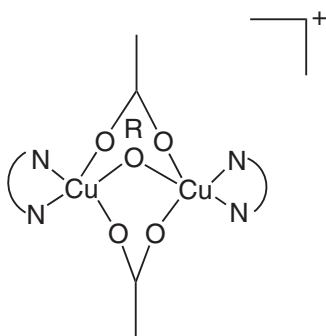

R = OMe: $[(bpy)_2Cu_2(OMe)(O_2CMe)_2][PF_6]$ (**632**)

R = OEt: $[(bpy)_2Cu_2(OEt)(O_2CMe)_2][PF_6]$ (**633**)

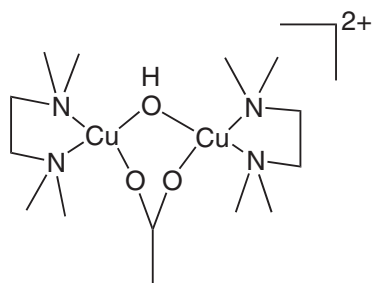

$[(L)_2Cu_2(OH)(O_2CMe)][ClO_4]_2$ (**634**)

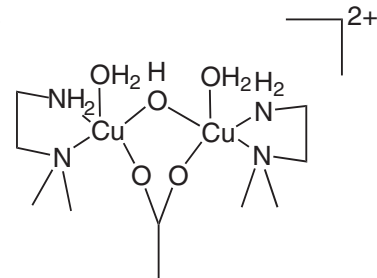
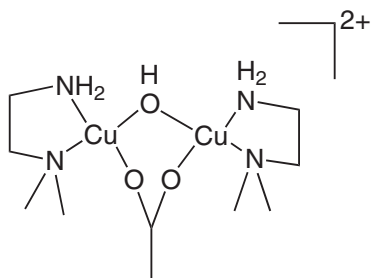

$[(L)_2Cu_2(OH)(O_2CMe)][ClO_4][(L)_2Cu_2(OH)_2(O_2CMe)(H_2O)_2][ClO_4]_2 \cdot 2NaClO_4$ (**635**)

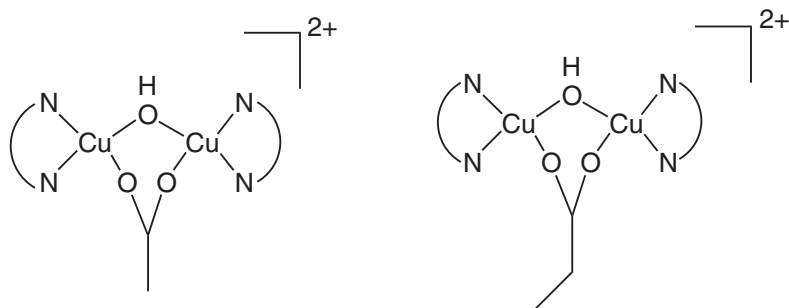
 $[(L)_2Cu_2(OH)(O_2CMe)][NO_3]_2 \cdot H_2O$ (**636**)

L = 1,10-phenanthroline

 $[(L)_2Cu_2(OH)(O_2CEt)][NO_3]_2 \cdot H_2O$ (**637**)

L = 1,10-phenanthroline

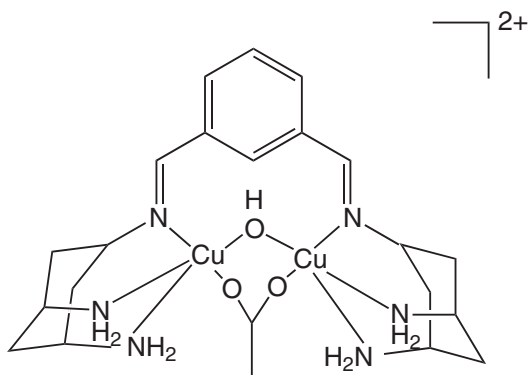
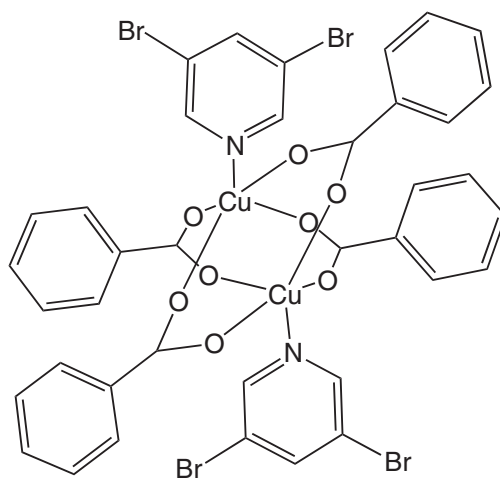

 $[(L)Cu_2(OH)(O_2CMe)][BF_4]_2 \cdot H_2O$ (**638**)

 $[(L)_2Cu_2(O_2CPh)_4(3,5-Br_2\text{-pyridine})_2]$ (**639**)

6.6.4 COORDINATION COMPOUNDS OF COPPER(I)

6.6.4.1 Carbon Donor Ligands

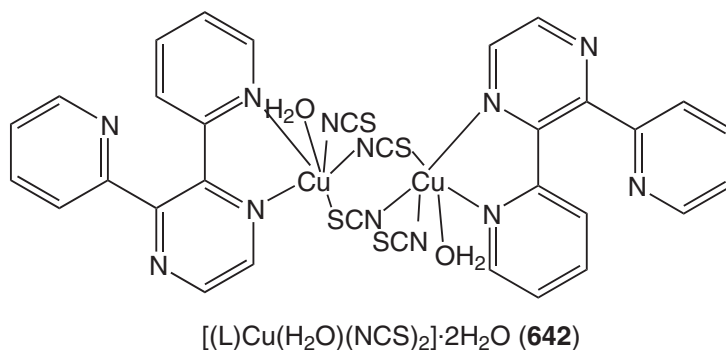
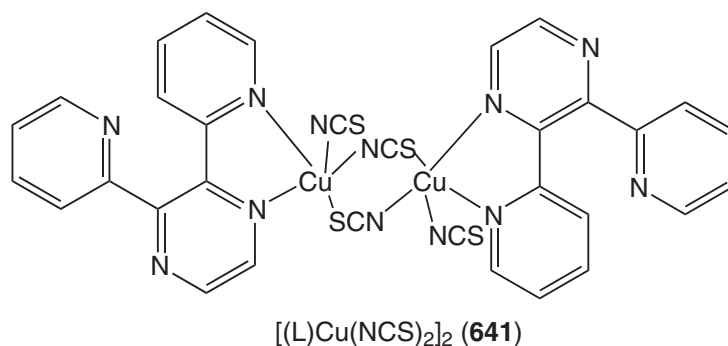
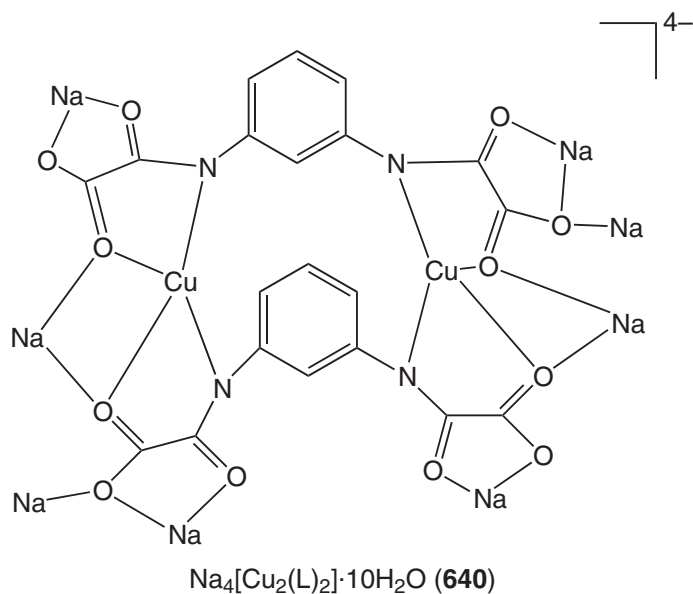
Copper–olefin bonding is of both practical and theoretical interest in view of the catalytic activity of copper(I) toward olefin activation and its role in biological systems.

Munakata *et al.* determined the molecular structures of the complexes (**652**) (quasi-tetrahedral) and (**653**) (distorted tetrahedron) and determined the nature of the bonding.⁵¹⁸ Warren and



co-workers reported⁵¹⁹ two thermally stable neutral β -diketiminato copper(I) olefin complexes (654) and (655), and with the same ligand a bis-hydroxo-copper(II) dimer $[(\text{L})\text{Cu}(\text{OH})_2]_2$ (complex (656); structural type: (2)). The dimer results from the reaction of the Cu^{I} ethylene complex with O_2 via the proposed intermediacy of a $\text{Cu}^{\text{III}}_2\text{O}_2$ species (structure (4)). With the ligand that is present in complex (7), Hofmann and co-workers reported⁵²⁰ a remarkably stable copper(I) ethylene complex (657), which catalyzes cyclopropanation of styrene with α -carbonyl diazoalkanes at room temperature. They also structurally characterized an analogous norbornene complex. Arnold *et al.* demonstrated⁵²¹ the incorporation of an alkoxide functional group into an N-heterocyclic carbene ligand. Using this anionic chelating ligand, they reported the first non-macrocyclic, square-planar Cu^{I} centers (complex (658)). It should be mentioned here that these strong σ -donor ligands can significantly increase the reactivity of many homogeneous catalysts.

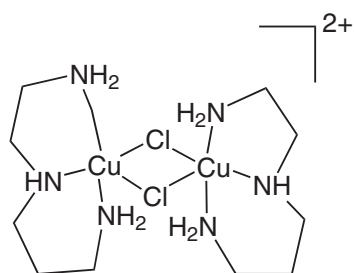
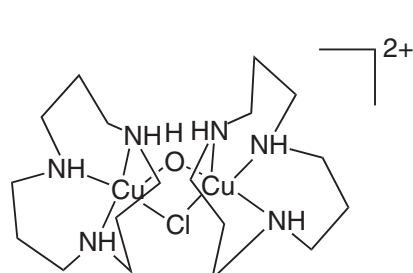
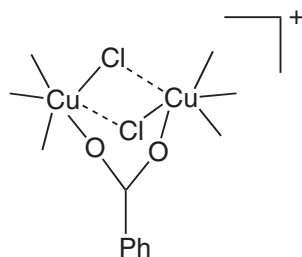
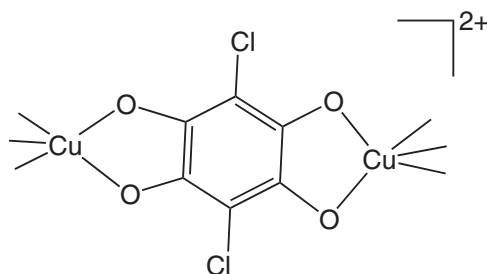

 $[(L)Cu(Cl)]_2 \cdot Cl_2$ (**643**)

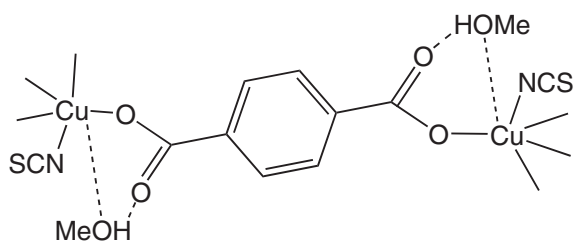
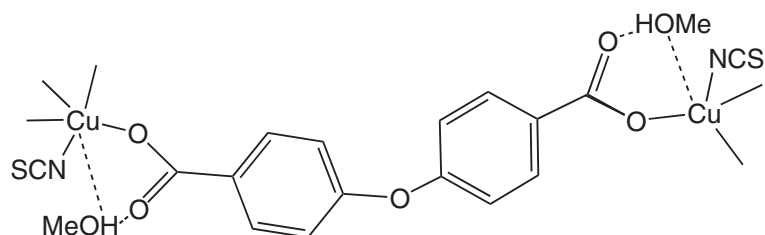
 $[(L)_2Cu_2(OH)(Cl)][ClO_4]_2$ (**644**)

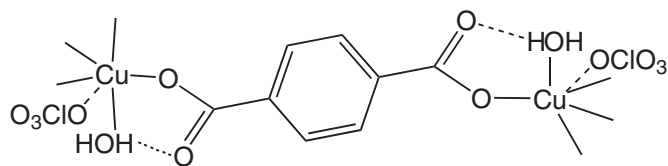
 $[(Me_3TACN)CuCl]_2(O_2CPh)[ClO_4]$ (**645**)

 $[(Me_3TACN)_2Cu_2(L)][ClO_4]_2$ (**646**)

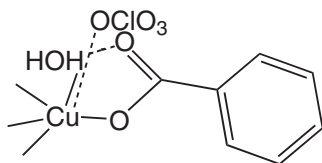
L' = chloranilate dianion



 $[(Me_3TACN)Cu(NCS)]_2(tetraphthalato) \cdot 2MeOH$ (**647**)

 $[(Me_3TACN)Cu(NCS)]_2(4,4'-oxybisbenzoato) \cdot 2MeOH$ (**648**)



$[\{(Me_3TACN)Cu(H_2O)\}_2(\text{terephthalato})][ClO_4]_2$ (**649**)

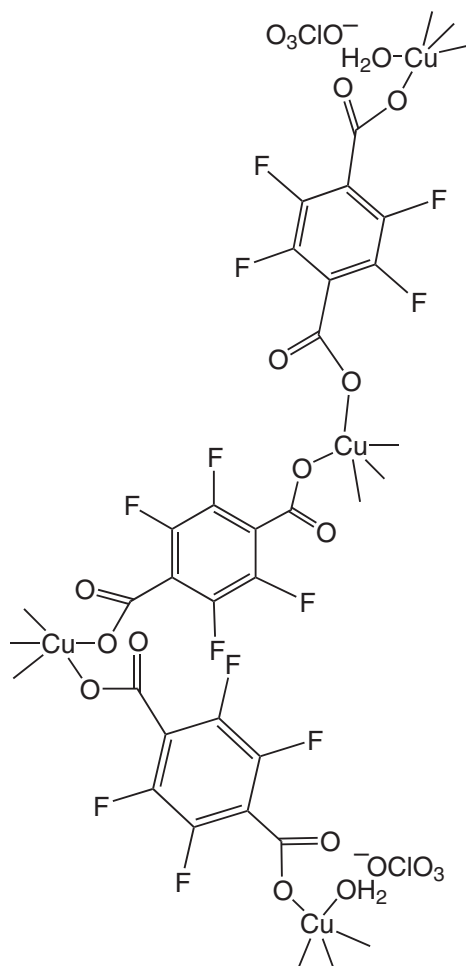

$[(Me_3TACN)Cu(H_2O)(\text{benzoato})][ClO_4]$ (**650**)



$[(L)_4Cu_4(H_2O)_2(F_4\text{-terephthalato})_3][ClO_4]_2 \cdot 6H_2O$ (**651**)

6.6.4.2 Nitrogen Donor Ligands

Copper proteins present interesting problems of structure for the copper(I) oxidation state. They are difficult to probe in detail, and what we do know of them suggests they are rarely regular or predictable.⁵⁸ In plastocyanin the copper(I) coordination sphere is made up of three strongly

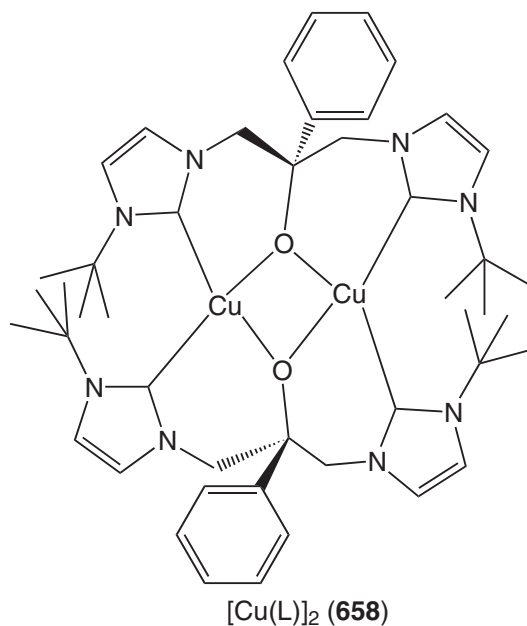
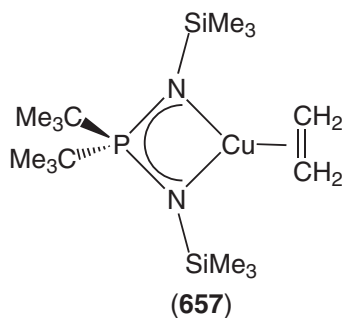
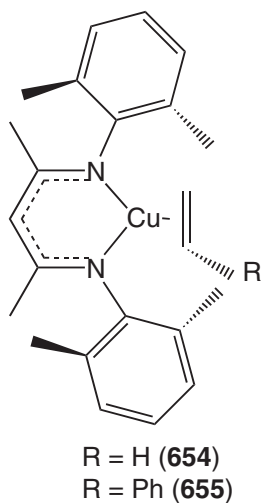
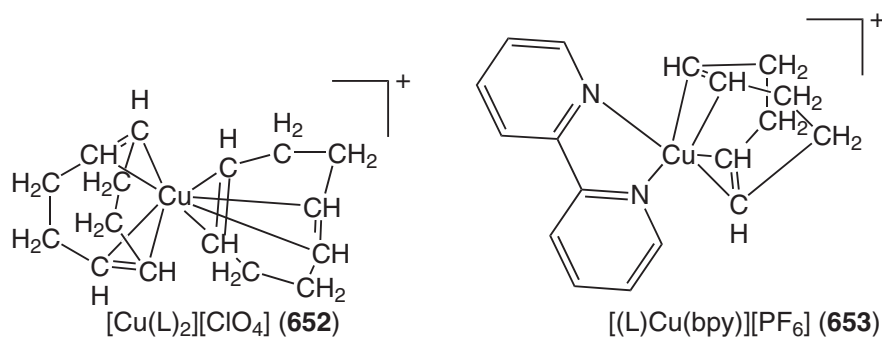

binding ligands (two histidines and one cysteine) and a weak interaction at 2.9 Å with methionine. The stereochemistry is sufficiently far from ideality that describing it in terms of a distorted tetrahedron that is tending toward an elongated trigonal pyramid has a rather limited utility.

6.6.4.2.1 Polydentate aliphatic amine ligands

A list of structurally characterized copper(I) complexes of tripodal aliphatic amines is provided in Table 4 (cf. Section 6.6.3.1.1 for corresponding mononuclear or dinuclear copper(II) complexes). Copper(II) complexes $[(L)CuCl]Cl$ (**664**) and $[(L)Cu(MeCN)][ClO_4]_2$ (**665**) with the ligand that is present in complex (**662**) were also structurally characterized.⁵²²

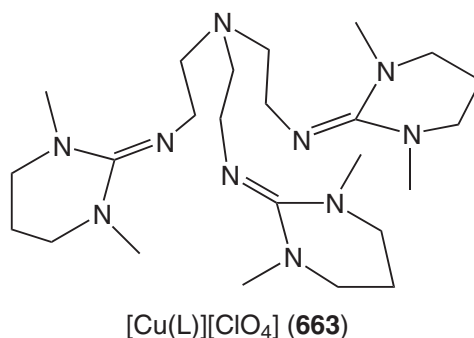
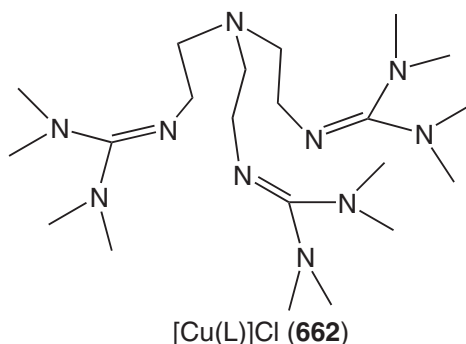

6.6.4.2.2 Heterocyclic nitrogen donor ligands

(i) Imidazole-containing ligands

Sorrell *et al.* reported the complex (**668**) (distorted trigonal; Cu–Cu, 3.139 Å).⁵²³ Schugar and co-workers reported complex (**669**) (pseudotetrahedral; corresponding copper(II) complex, structural type: (**34**)).⁶⁶ Garner and co-workers reported complex (**670**), intermediate between tetrahedral and square planar; (corresponding copper(II) complex, structural type: (**36**)).⁶⁸ Sorrell *et al.* reported complex (**671**) (T-shape) and investigated its oxygenation behavior.⁵²⁴ Along similar lines, Kurtz *et al.* reported complex (**672**). Moreover, they were successful in isolating and characterizing a side-on copper(II)-peroxo complex.⁵²⁵ Riordan and co-workers designed two cavitand-based imidazolyl ligands and reported their copper(I) complexes: (**673**) (trigonal planar) and (**674**) (trigonal planar).⁵²⁶

Table 4 Stereochemistries of copper(I) complexes of aliphatic tripodal ligands.

Complex/Complex no.	Geometry	References
$[(Me_3dien)Cu(MeCN)][ClO_4]$ (659)	Irregular	49
$[(L)_2Cu_2(CN)][ClO_4]$ (660) (L as that in complex (206))	Distorted tetrahedral	218
$[(L)_2Cu_2(CN)][ClO_4]$ (661) (L as that in complex (218))	Distorted tetrahedral	218
(662) ^a	Trigonal pyramidal	522
(663) ^a	Trigonal pyramidal	522
$[(L)Cu(OCIO_3)]$ (666); (L as that in complex (21))	Trigonal pyramidal	51
$[Cu(L)][CuCl_2]$ (667); (L as that in complex (27))	Distorted tetrahedral	53

^a Ligand structures are presented in this article.

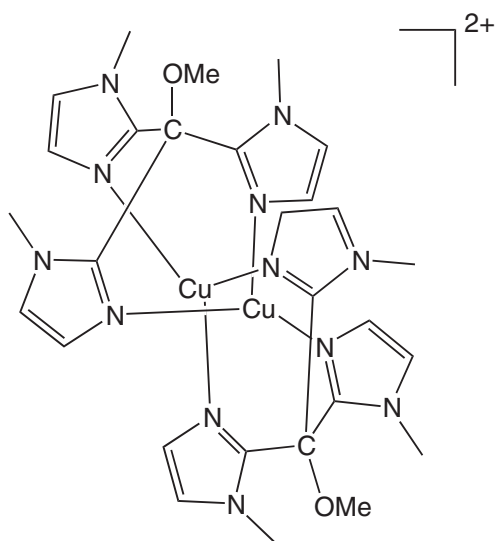
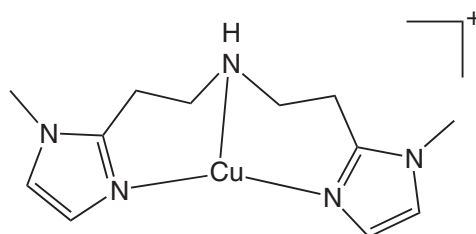
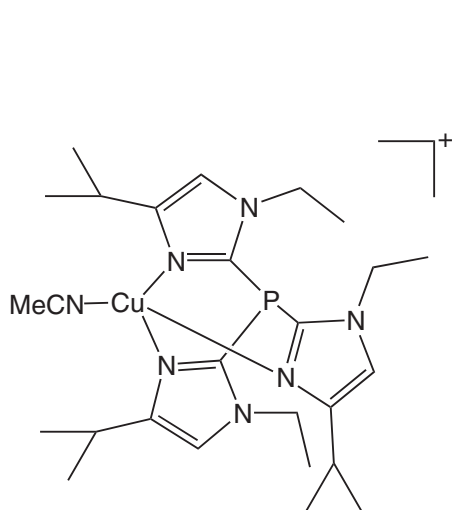
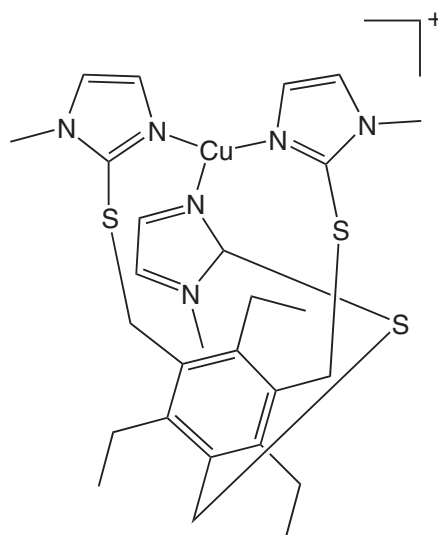
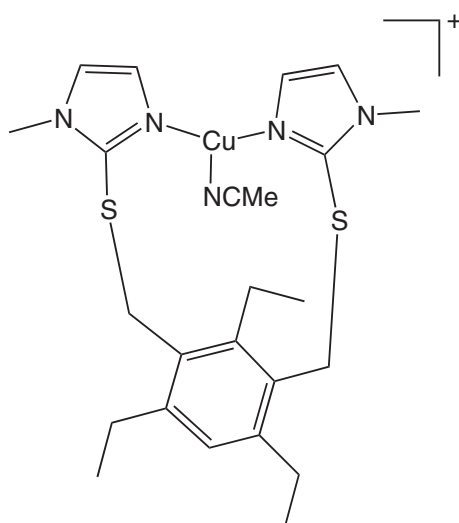
 $[\text{Cu}(\text{L})_2][\text{BF}_4]_2$ (**668**)

 $[\text{Cu}(\text{L})][\text{BF}_4]$ (**671**)

 $[(\text{L})\text{Cu}(\text{MeCN})][\text{PF}_6]$ (**672**)

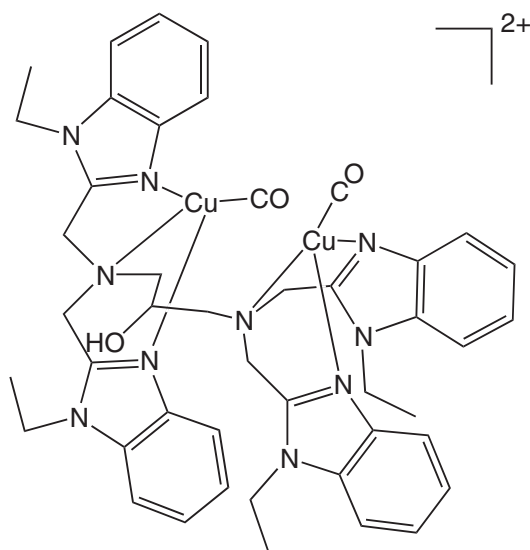
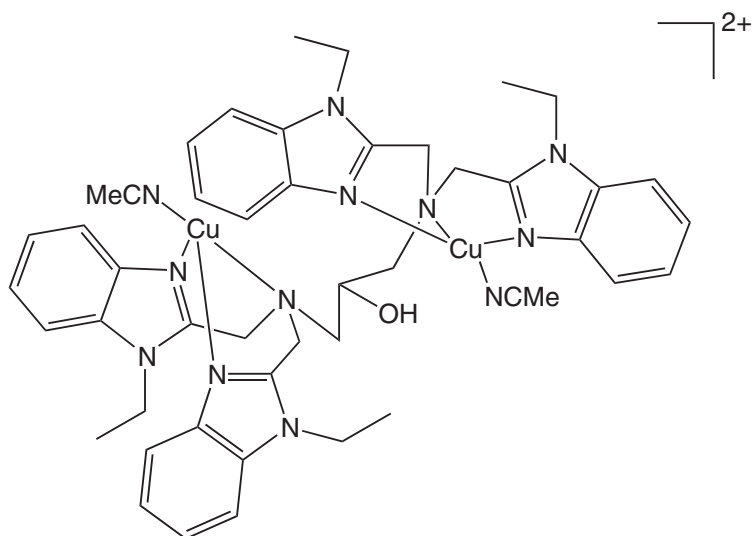
 $[\text{Cu}(\text{L})][\text{BF}_4]$ (**673**)

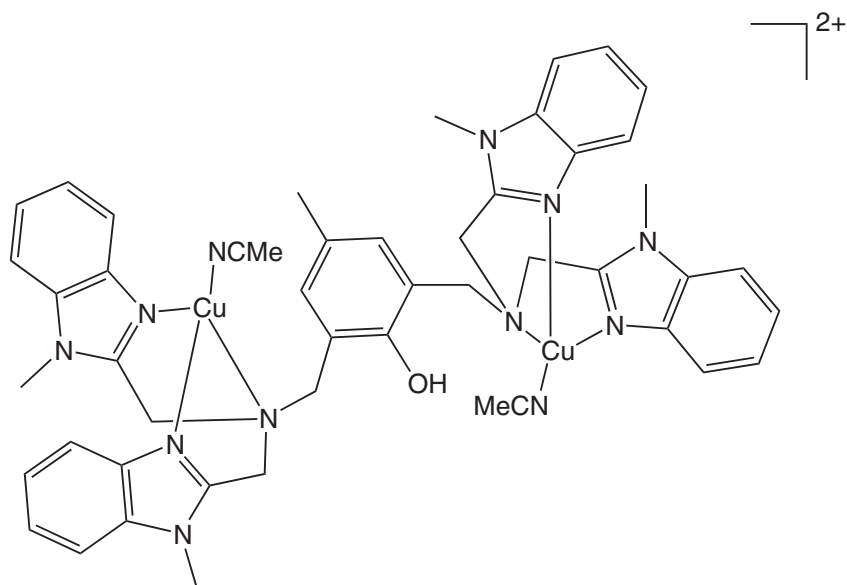
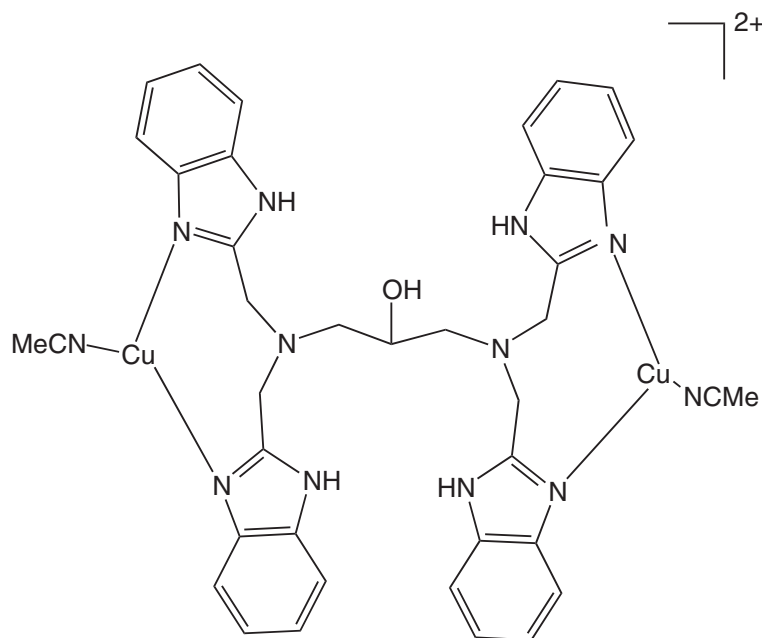
 $[(\text{L})\text{Cu}(\text{MeCN})][\text{BF}_4]$ (**674**)

(ii) Benzimidazole-containing ligands

Using benzimidazole ligands, Reed and co-workers provided examples of variable coordination number and distorted geometries: **(675)** (distorted trigonal pyramid; Cu–Cu: 5.35 Å), **(676)** (distorted trigonal pyramid), **(677)** (trigonal pyramid; Cu–Cu: 7.99 Å) and **(678)** (trigonal planar; Cu–Cu: 12.46 Å).⁵²⁷ With a bidentate imidazole/thioether ligand, Kaim and co-workers reported a copper(I) complex $[(L)Cu(PPh_3)_2][BF_4]$ (**679**) (corresponding copper(II) complex, structural type: **(81)**).⁹⁵ Palaniandavar *et al.* also provided examples of trigonal planar copper(I) complexes (corresponding copper(II) complex: structural type **(92)**): $[Cu(L)][NO_3]$ (**680**) and $[Cu(L)Cl]$ (**681**).¹⁰⁰ Using a potentially tridentate benzimidazolylpyridine ligand, Williams *et al.* reported an unusual double-helical copper(I) complex **(682)** (linearly coordinated by benzimidazoles, with a slight distortion toward a tetrahedral structure resulting from the weak interaction with the pyridines).⁵²⁸ Müller *et al.* reported a dinuclear copper(I) complex **(683)** (distorted tetrahedral; Cu–Cu: 4.59 Å), resulting from the oxygenation of a dicopper(I) complex (cf. **(96)** and **(97)**).¹⁰²

 $[(L)Cu_2(CO)_2][CF_3SO_3]_2$ (**675**)

 $[(L)Cu_2(MeCN)_2][CF_3SO_3]_2$ (**676**)

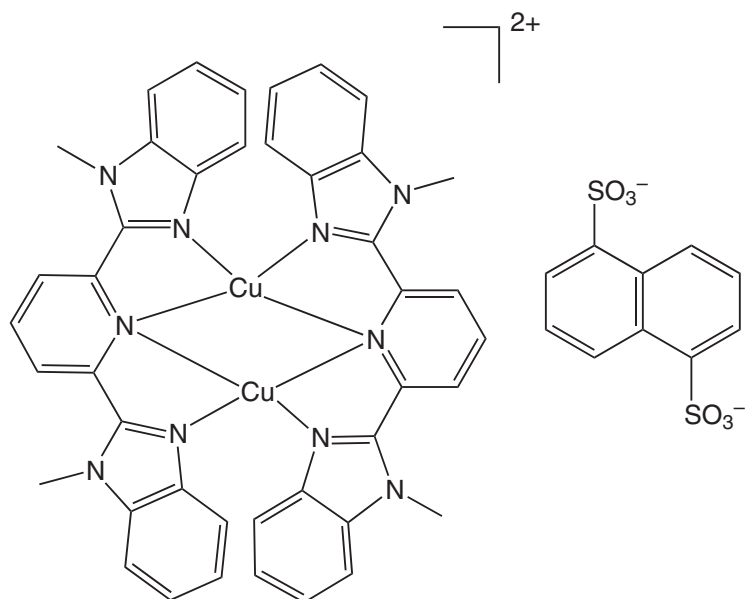

 $[(L)Cu_2(MeCN)_2][CF_3SO_3]_2$ (**677**)

 $[(L)Cu_2(MeCN)_2][ClO_4]_2 \cdot 1/3Et_2O$ (**678**)

(iii) Pyrazole-containing ligands

From the standpoint of mimicking Hc/Tyr activity using substituted hydrotris(pyrazolyl)borates as capping ligands, Kitajima *et al.* reported distorted tetrahedral complexes (**684**)¹¹⁸ and (**685**).¹¹⁵ In order to provide a structural/functional model of nitrite reductases⁷² Tolman *et al.* thoroughly characterized quite a few substrate-bound copper(I) complexes: (**686**) (linear; Cu–Cu: 3.284 Å),¹²⁹ (**687**) (distorted trigonal planar; Cu–Cu: 2.544 Å)⁵²⁹ and (**688**) (highly distorted geometry).⁵²⁹ Gorun and co-workers demonstrated⁵³⁰ reversible binding of dioxygen (copper(II)–peroxy species) at ambient conditions with the complex (**689**).

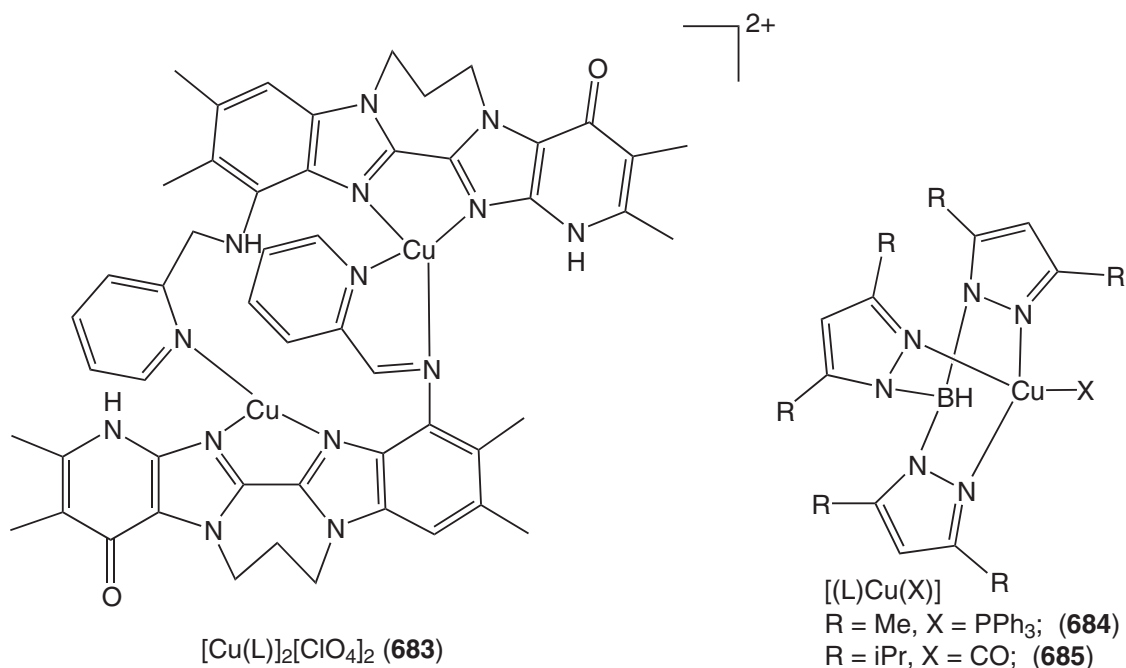

$[(L)_2Cu_2](\text{naphthalene-1,5-disulfonate})$ (**682**)



$[Cu(L)]_2[ClO_4]_2$ (**683**)

$[(L)Cu(X)]$
 R = Me, X = PPh₃; (**684**)
 R = iPr, X = CO; (**685**)

With pyrazole-based chelating ligands, Sorrell and co-workers structurally characterized monomeric as well as dimeric copper(I) complexes: monomeric (**690**) (distorted trigonal pyramid)¹⁴⁷ and (**691**) (T-shaped structure);⁵³¹ and dimeric (**692**) (linear; Cu–Cu: 6.350 Å)⁵³² and (**693**) (T-shaped; Cu–Cu: 5.100 Å).⁵³³ This group also investigated the redox properties of these complexes. Using a similar kind of ligand, Driessen and co-workers reported structures of copper(I) complexes (**694**) (distorted trigonal pyramid),⁵³⁴ (**695**) (distorted tetrahedral; Cu–Cu: 2.9511 Å) and (**696**) (distorted tetrahedral).⁵³⁵ Using a sterically hindered tris(pyrazolylmethyl)amine ligand, Colbran and co-workers reported complex (**697**) (ligand as that in complexes ((**150**)–(**152**)) (trigonal pyramid).¹⁴⁸ Using a tridentate pyrazolylmethylpyridine ligand, Manoharan and co-workers characterized the complexes (**698**) (distorted tetrahedron) and (**699**).⁵³⁶ Using the ligand present in the complex (**129**), a dicopper(I) complex (**700**) (Cu–Cu: 3.028 Å) with Cu₂I₂ unit was reported.¹³⁶

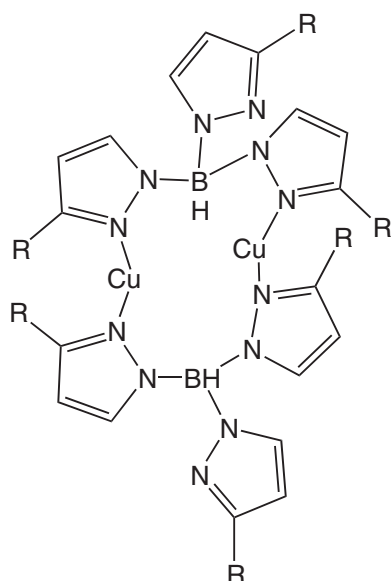
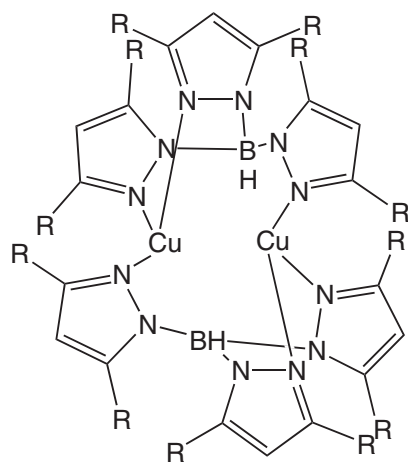
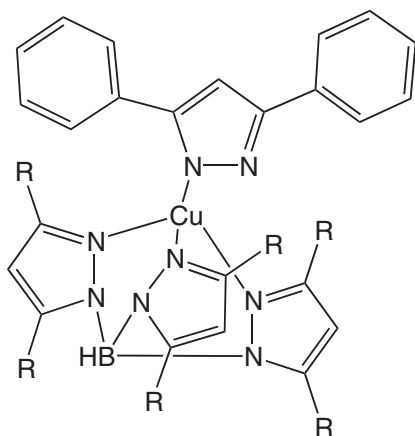
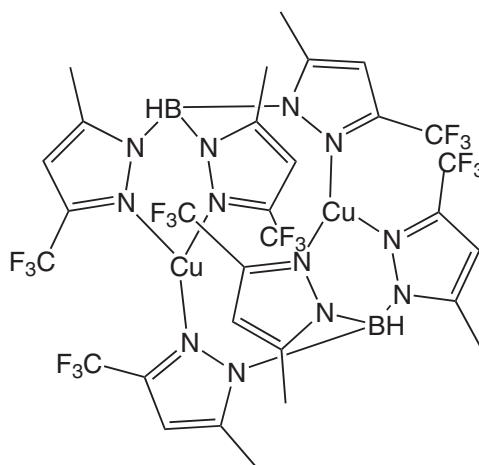
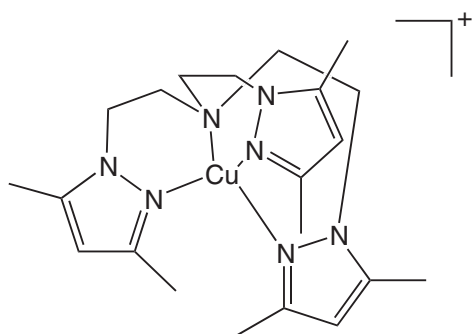
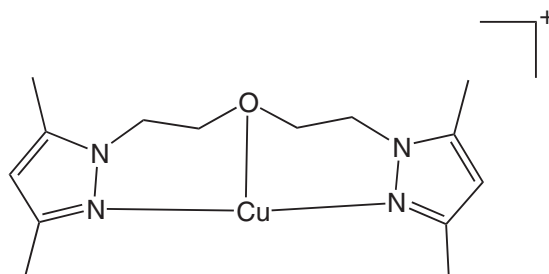
R = ^tBu; [Cu(L)]₂·Et₂O (686)R = Ph; [Cu(L)]₂·2CH₂Cl₂ (687)[(L)Cu(3,5-Ph₂pz)]·CH₂Cl₂ (688)[Cu(L)]₂ (689)[Cu(L)][BF₄] (690)[Cu(L)][BF₄] (691)

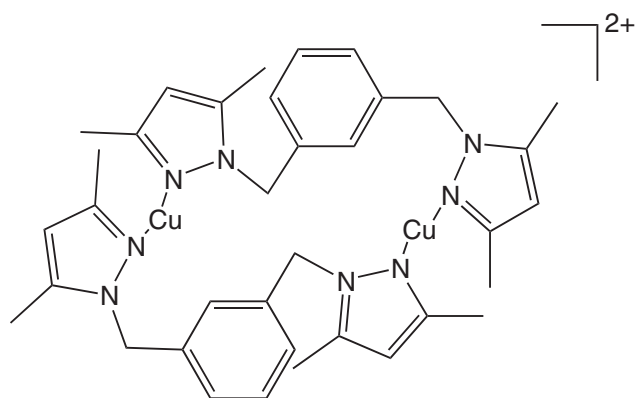
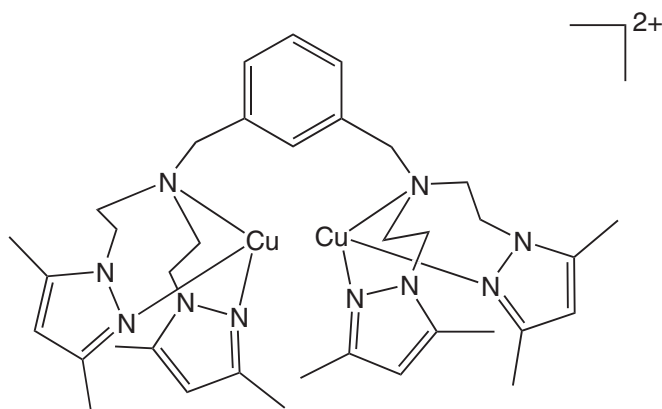
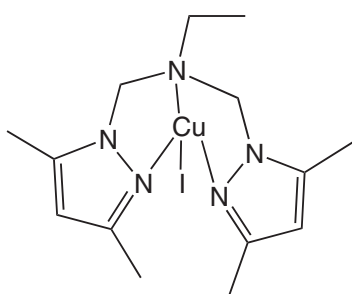
[Cu(L)]₂[BF₄]₂ (692)[Cu₂(L)][BF₄]₂ (693)

[(L)Cu] (694)

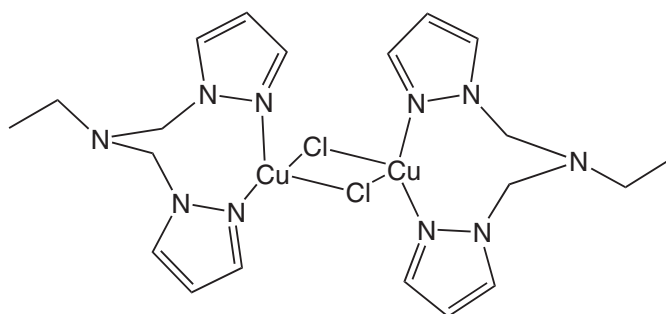
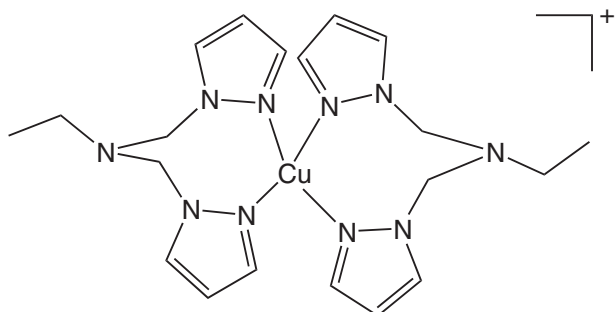
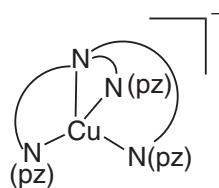
[(L)CuCl]₂ (695)[Cu(L)₂][CF₃SO₃] (696)

[Cu(L)][CuCl] (697)

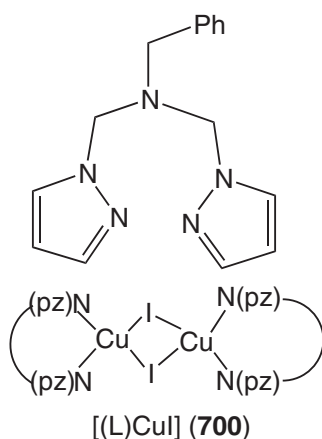
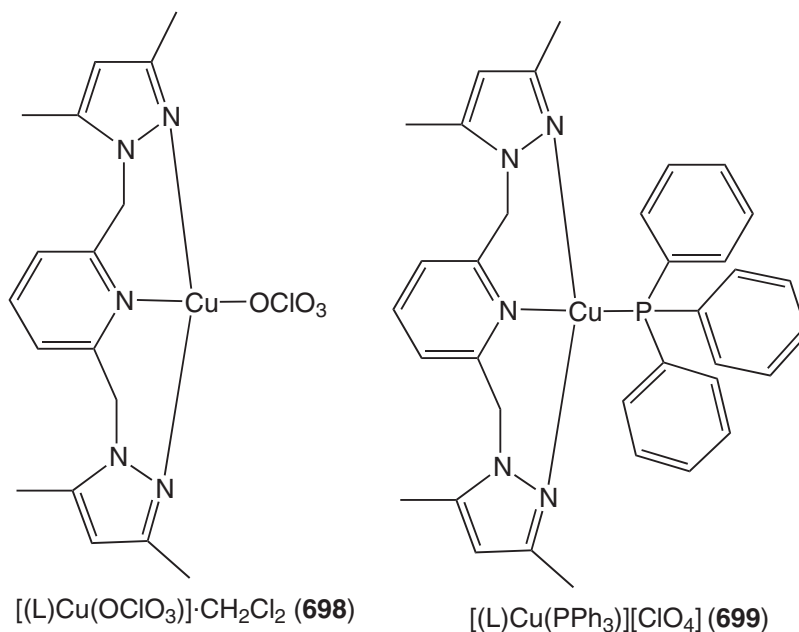

(iv) *Pyridine-containing ligands*

The structure of a copper(I) complex $[Cu(L)][BPh_4]$ (trigonal pyramidal: three pyridyl groups in the trigonal plane and tertiary amine at the apex; ligand as that in complex (**4**)) was also determined.²⁹ The structure of complex $[Cu_2(L)(MeCN)_2][BF_4]_2$ (ligand as that in complex (**179**))¹⁶⁹ and complex $[Cu(L)][BPh_4]$ (ligand as that in complex (**220**))²⁰⁹ were also reported.

Using the ligand present in copper(II) complex (**246**), the corresponding copper(I) complex $[Cu(L)][BF_4]$ (**701**) (TBP geometry) was also structurally characterized.²²⁶ Using a systematically varied set of tris(2-pyridyl)methoxymethane ligands used in the syntheses of copper(II) complexes ((**252**)–(**256**)), corresponding copper(I) complexes $[(L)Cu(MeCN)][CF_3SO_3]$ [(**702**) (L as in (**252**)); (**703**) (L as in (**255**)/(**256**))]; $[(L)Cu(PPh_3)][CF_3SO_3]$ [(**704**) (L as in (**253**))]; $[(L)Cu(PPh_3)][CF_3SO_3] \cdot 0.5Me_2CO$ [(**705**) (L as in (**255**)/(**256**))]; $[Cu(L)_2][CF_3SO_3] \cdot Me_2CO$ [(**706**) (L as in (**252**))]; $[Cu(L)_2][CF_3SO_3]$ [(**707**) (L as in (**253**))]; and $[Cu(L)_2][CF_3SO_3] \cdot 0.5Me_2CO$ [(**708**) (L as in (**254**))] were also thoroughly characterized. Two distinct coordination modes were observed for the Cu^I complexes, both in solution and the solid state. One is a pseudotetrahedral coordination comprised of the facial-capping, tris-pyridyl ligand and a monodentate ligand. The other structural type is also a pseudotetrahedral Cu^I monomer formed by two tris-pyridyl ligands coordinated in a bidentate manner, with preferable binding by the non-methoxy pyridyl subunits. With the exception of the most sterically hindered ligand, which displays only monoligation to Cu^I , all ligands form both types of Cu^I complexes, and the formation is controlled by stoichiometry.²³³

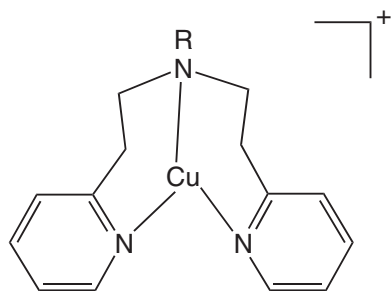

R = PhCH₂; [Cu(L)][PF₆] (**709**)

R = Ph; [Cu(L)][PF₆] (**710**)

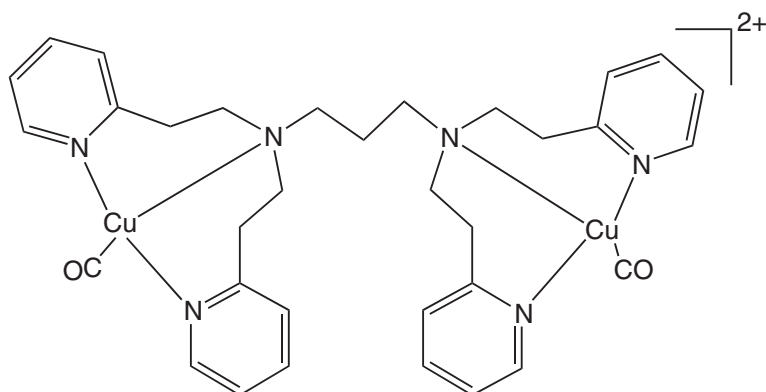

[(L)Cu₂(CO)₂][ClO₄]₂ (**711**)

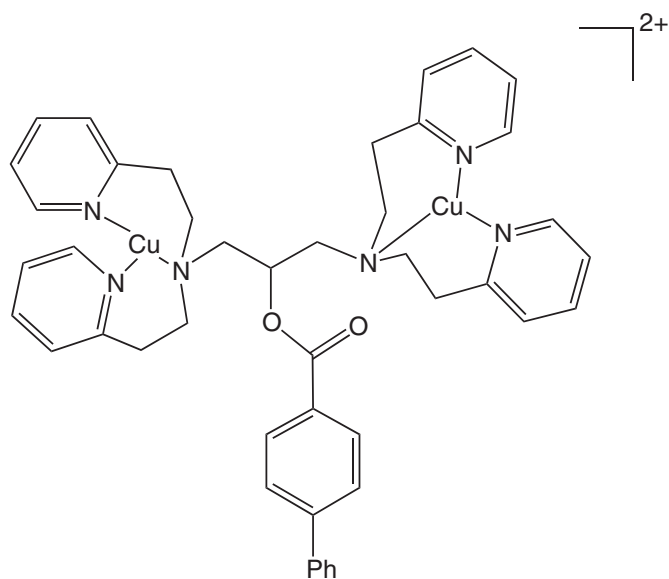

[Cu₂(L)][PF₆]₂·CH₂Cl₂ (**712**)

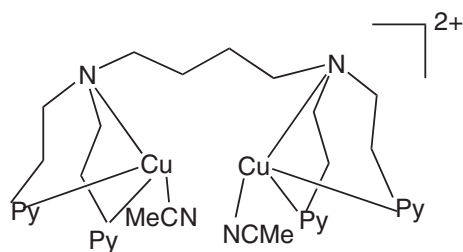

[(L)Cu₂(MeCN)₂][ClO₄]₂ (**713**)
py = 2-pyridyl

Karlin and co-workers synthesized a large number of mononuclear and dinuclear copper(I) complexes in their pursuit to understand the oxygenation behavior of copper(I) complexes (cf. [Section 6.6.3.1.2\(iv\)](#)). A listing of such complexes is provided in [Table 5](#). Tolman and co-workers provided the answer to the question of bis(μ -oxo)dicopper(III) core being capable of hydroxylating

Table 5 Stereochemistries of copper(I) complexes of pyridine-based ligands.^a

Complex/Complex no	Geometry	References
(709)	Distorted trigonal planar	537
(710)	T-shaped	538
(711)	Pseudotetrahedral (Cu–Cu: 6.986 Å)	539
(712)	Distorted trigonal planar (Cu–Cu: 6.262 Å)	540
(713)	Pseudotetrahedral (Cu–Cu: 7.449 Å)	541
(714) ^b	Distorted trigonal planar (Cu–Cu: 6.181 Å)	541
[(L)Cu(PPh ₃)][PF ₆] ^{c,d} (715)	Distorted tetrahedral	213
[(L)Cu(MeCN)][PF ₆] ^e (716)	Distorted tetrahedral	213
(717)	Pseudotetrahedral	542
(718) ^f	Distorted tetrahedral ^f	542
[Cu(L)][BPh ₄] (719)	Distorted trigonal pyramidal	219
(L as that in complex (234))		
[Cu(L)][PF ₆] (720)	Trigonal pyramidal	220
(L as that in complex (235))		
[Cu(L)][PF ₆] (721)	Distorted trigonal pyramidal	220
(L as that in complex (236))		
(722)	Trigonal pyramidal (Cu–Cu: 3.229 Å)	543
(723)	Distorted tetrahedral (Cu–Cu: 11.705 Å)	544,545
(724)	Distorted tetrahedral (Cu–Cu: 5.43 Å)	546
(725)	Distorted trigonal planar (Cu–Cu: 8.94 Å)	547
(726)	Distorted trigonal planar/T-shape (Cu–Cu: 8.904 Å)	548
(727)	Pseudotetrahedral (Cu–Cu: 9.944 Å)	549
(728)	Trigonal pyramidal (Cu–Cu: 3.715 Å)	550
(729)	Pseudotetrahedral (Cu–Cu: 3.992 Å)	550
(730)	Trigonal pyramidal (Cu–Cu: 3.569 Å)	551
(731)	Distorted tetrahedral (Cu–Cu: 3.587 Å)	552
(732)	Trigonal/Pseudotetrahedral (Cu–Cu: 5.654 Å)	553
(733)	Distorted tetrahedral/distorted trigonal pyramidal (Cu–Cu: 6.056 Å, 7.433 Å, and 7.671 Å)	554

^a When only complex number is indicated, structures along with chemical formula are presented in this article. ^b The bonding parameters are closer to those observed for purely tricoordinate structures, with closely similar ligands. ^c [(L)Cu(MeCN)][ClO₄] (L = tris(2-pyridylmethyl)amine) assumes distorted tetrahedral geometry.²¹⁸ ^d L = tris(2-pyridylmethyl)amine; dangling uncoordinated pyridyl arm from the ligand. ^e One pyridyl group carries a -CO₂Me substituent. ^f Dangling uncoordinated quinolyl group from the ligand.

an arene ring. To prove it, they synthesized a copper(I) complex (734) (T-shaped geometry) and investigated its oxygenation behavior spectroscopically.¹⁹¹ Yamauchi and co-workers studied⁵⁵⁵ the effects of a side-chain aromatic ring on the dioxygen reactivity of copper(I) complexes. They reported two complexes (735) (distorted tetrahedral) and (736) (tetrahedral). They were able to stabilize the Cu^{III}₂(μ-O)₂ species. Recently, using a tailor-made 1,8-naphthyridine-based ligand, Lippard and co-workers reported⁵⁵⁶ an interesting dicopper(I) complex (737) with Cu–Cu interaction

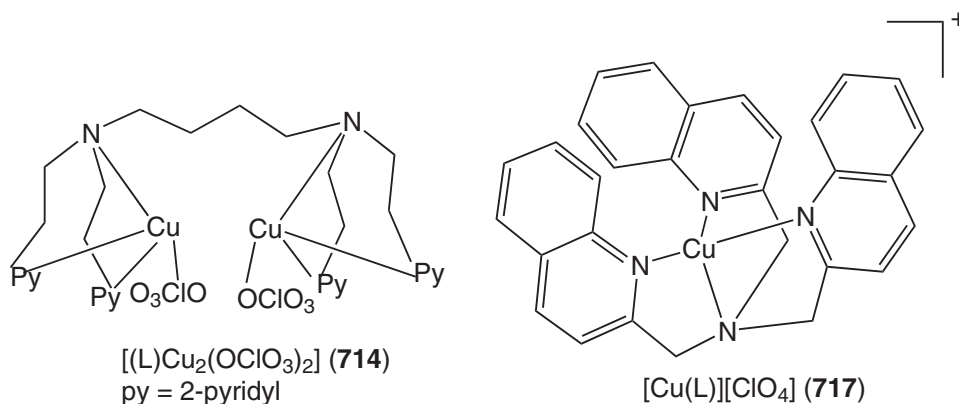

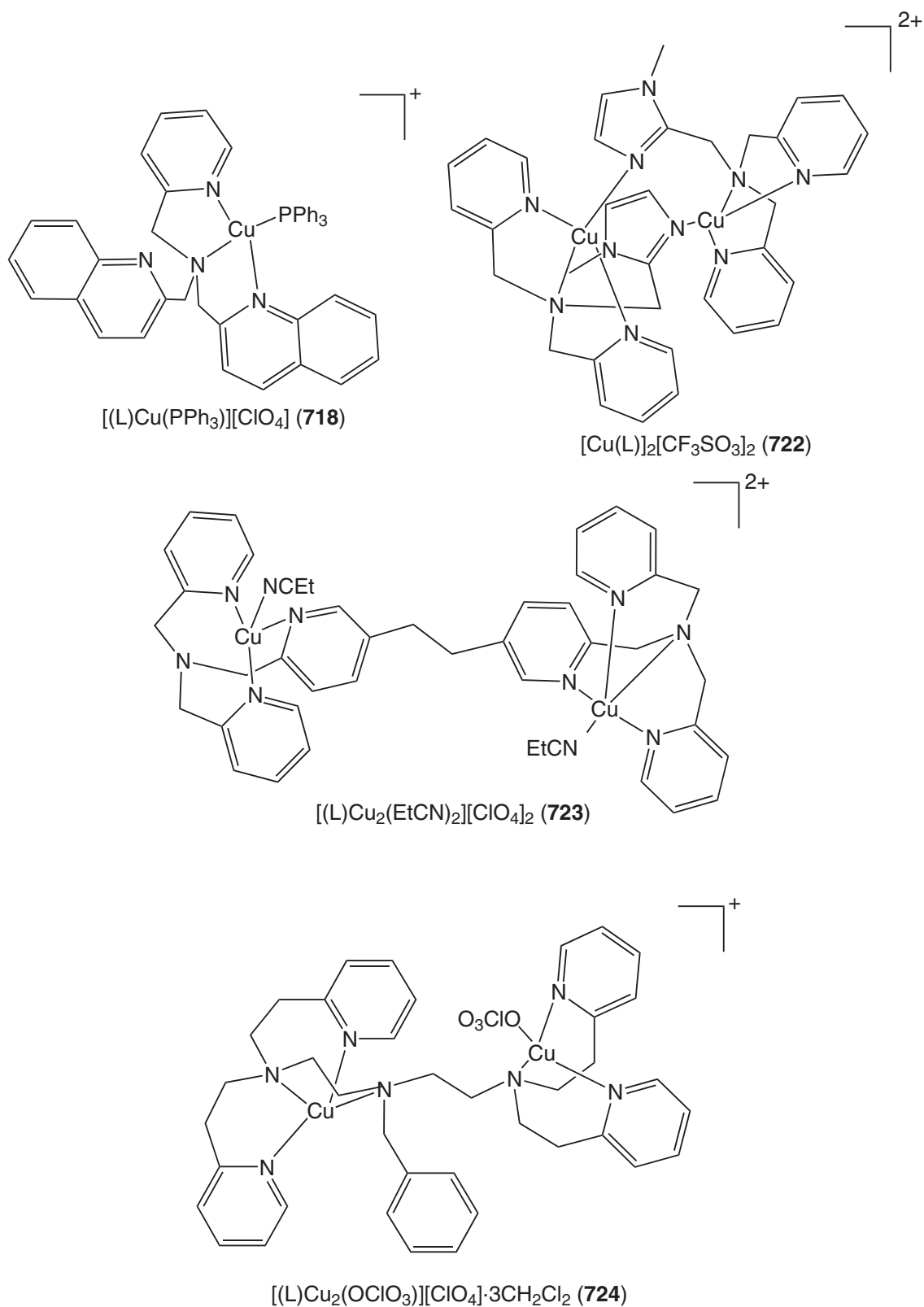

(distorted TBP; Cu–Cu: 2.5947 Å). On exposure to O₂ they provided spectroscopic evidence of the existence of (μ -1,2-peroxy)dicopper(II) species.

Using 1,3-bis[bis(2-pyridylmethyl)amino]benzene, Schindler *et al.* investigated the structures and properties of complexes (**738**) linear (weak interaction with the tertiary amine)/distorted

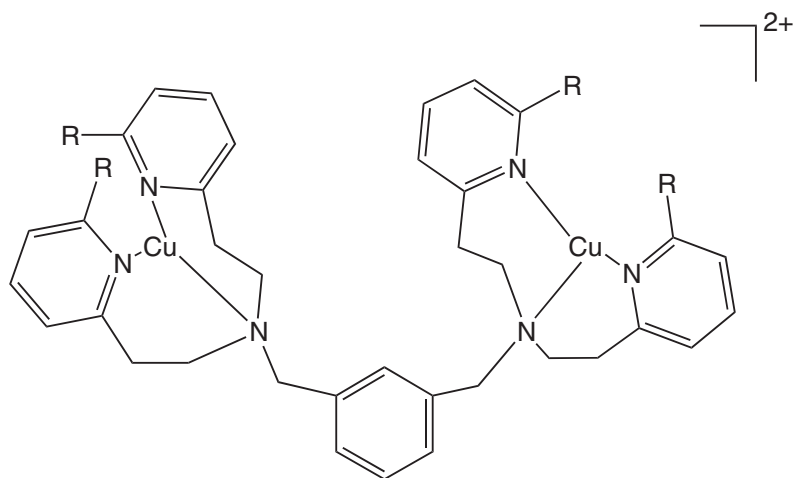

R = H: [(L)Cu₂][PF₆]₂ (**725**)

R = Me: [(L)Cu₂][PF₆]₂ (**726**)

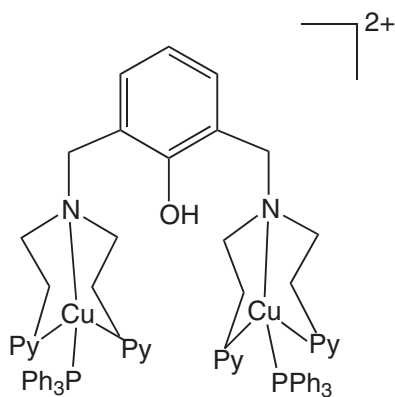

[(HL)Cu₂(PPh₃)₂][ClO₄]₂·2CD₃NO₂ (**727**)
py = 2-pyridyl

trigonal planar; Cu–Cu: 4.156 Å) and (**739**) (distorted trigonal planar; Cu–Cu: 8.157 Å). This group thoroughly characterized these complexes, along with their redox properties.¹⁸¹ Using a tridentate ligand with pyrazine spacer, Oshio reported²⁵³ the complex [Cu₂(L)][ClO₄]₂ (**740**) (L as that in (**291**); trigonal pyramidal; Cu–Cu: 6.743 Å) and also studied its redox properties.

Using a mesityl-based ligand (cf. complex (**194**)), Kim and co-workers structurally characterized complexes (**741**) (distorted trigonal; Cu–Cu: 7.162 Å, 7.823 Å, and 7.949 Å), (**742**) (distorted trigonal planar; Cu–Cu: 7.2371 Å, 7.3418 Å, and 7.8659 Å), and (**743**) (trigonal; Cu–Cu: 7.986 Å).¹⁸⁵

The copper(I) analogue [Cu(L)][ClO₄] (**744**) (distorted tetrahedral) of copper(II) complex (**201**) was also synthesized and its redox property investigated.¹⁹³ Structures of complex (**745**) (distorted tetrahedral)⁵⁵⁷ and complex (**746**) (pseudotetrahedral; Cu–Cu: 4.764 Å)⁵⁵⁸ were also reported.

Copper(I) analogues [(L)Cu(MeCN)][CF₃SO₃] (**747**) [yellow, four-coordinate (two amine donors, one of the two pyridinyl groups and an MeCN)] and [(L)Cu(MeCN)][BF₄] (**748**) [red, five-coordinate (two tertiary amine, two pyridinyl and an MeCN)] [L as that in copper(II) complex (**241**)] were structurally characterized and redox properties of these complexes were also investigated.²²⁴

(v) Bipyridine/phenanthroline-containing ligands

The structures of [Cu(bpy)₂][ClO₄] (bpy = 2,2'-bipyridyl) (**749**) (pseudotetrahedral),⁵⁵⁹ [(L)Cu(MeCN)][ClO₄] (L = 2,9-dimethyl-1,10-phenanthroline) (**750**) (Y-shaped planar)⁵⁶⁰ were

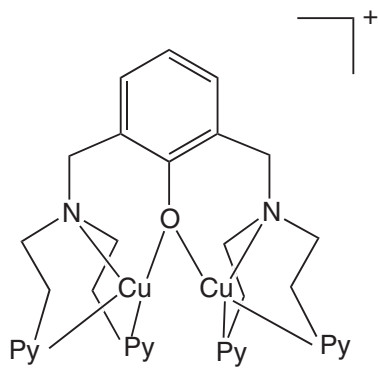

$[(L)Cu_2][PF_6]$ (**728**)
py = 2-pyridyl

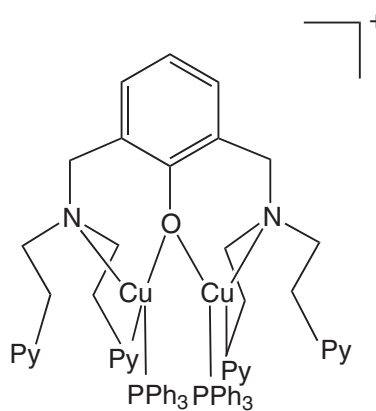

$[(L)Cu_2(PPh_3)_2][PF_6] \cdot CH_2Cl_2$ (**729**)
py = 2-pyridyl

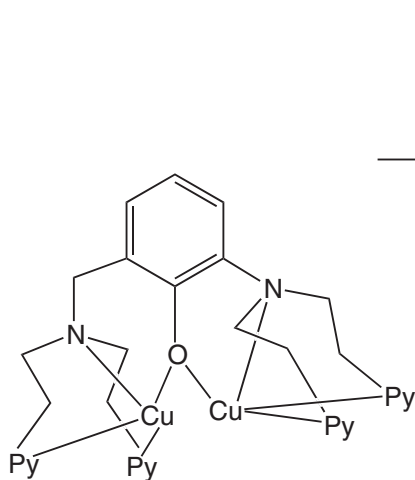

$[(L)Cu_2][PF_6] \cdot MeCN$ (**730**)
py = 2-pyridyl

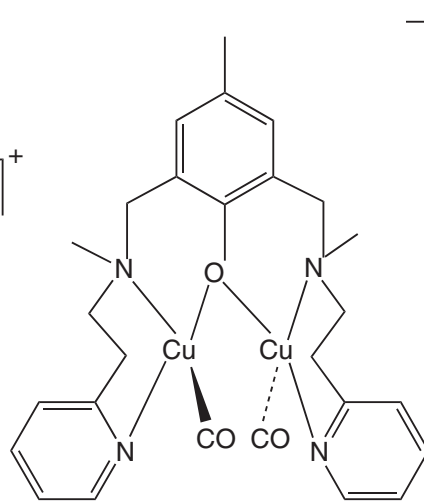

$[(L)Cu_2(CO)_2][PF_6]$ (**731**)

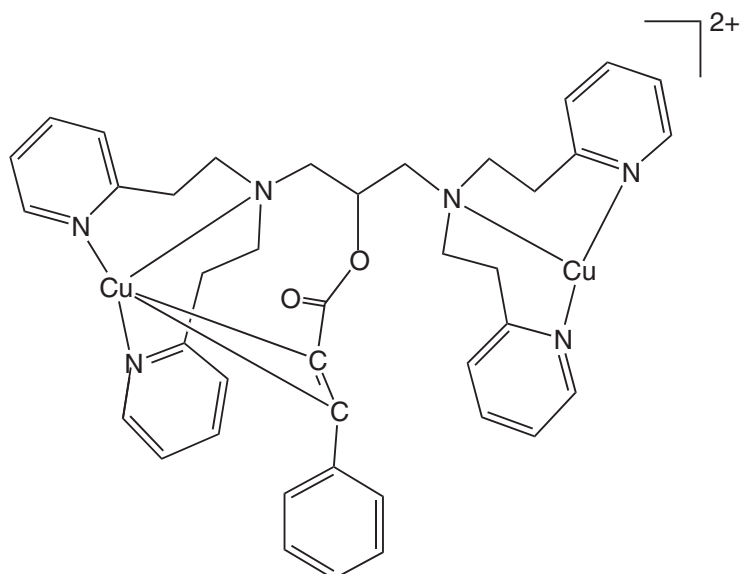

$[Cu_2(L)][PF_6]_2$ (**732**)

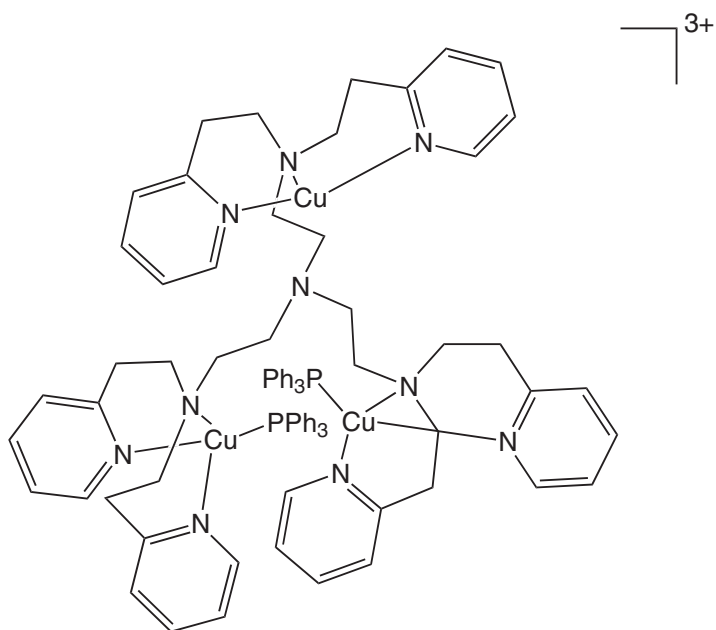

$[(L)Cu_3(PPh_3)_2][PF_6]_3 \cdot 2MeCN$ (733)

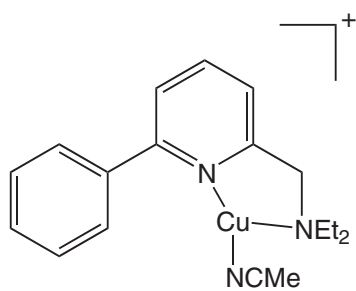

$[(L)Cu(MeCN)][SbF_6]$ (734)

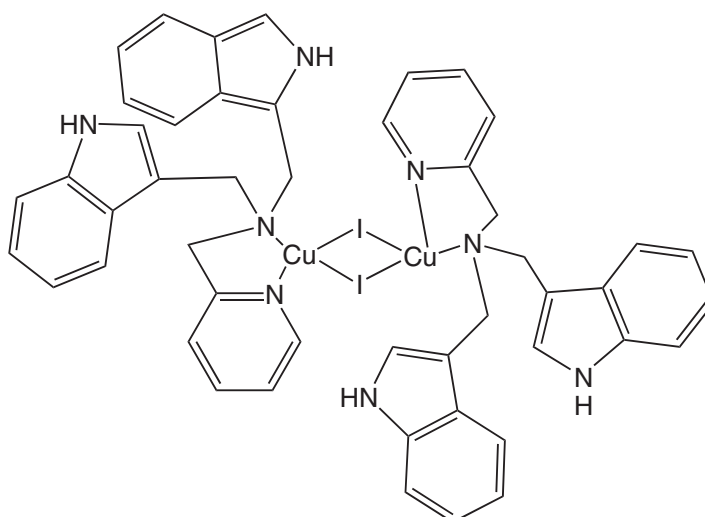

$[(L)CuI]_2 \cdot 2Me_2CO$ (735)

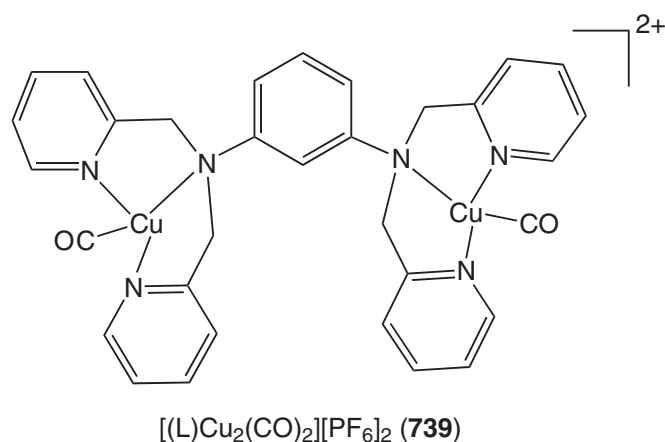
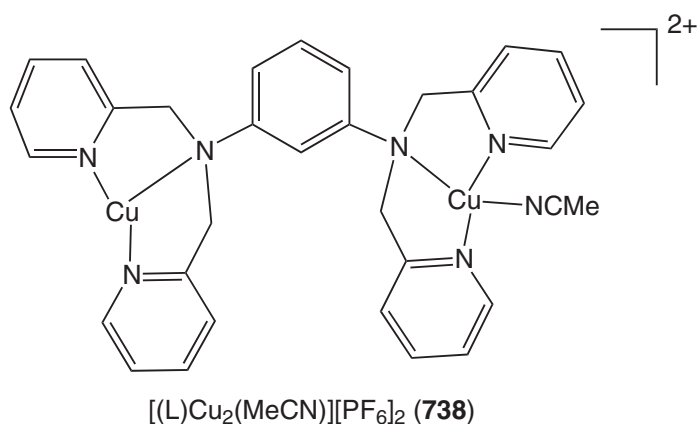
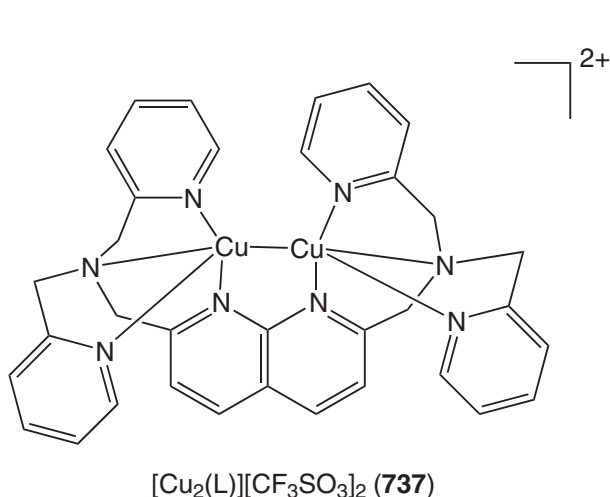
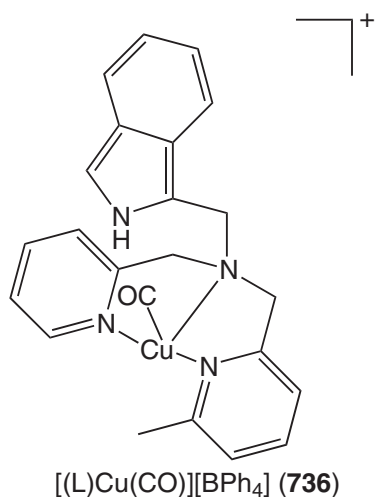

also reported. The corresponding PF_6^- salt (**751**) (Y-shaped planar)⁵⁶⁰ was also structurally characterized. From a series of 2,9-dialkyl-1,10-phenanthrolines, complexes of several structures were made with copper(I) chloride. The complexes: $[(L)CuCl]$ (L = 2,9-di-*tert*-butyl-1,10-phenanthroline) (**752**) (distorted trigonal), $[(L)CuCl]$ (L = 2,9-dineopentyl-1,10-phenanthroline) (**753**) (distorted trigonal), and $[Cu(L)_2][CuCl_2]$ (L = 2,9-di-*n*-pentyl-1,10-phenanthroline) (**754**) (distorted tetrahedral) were examined in detail by 1H NMR and X-ray crystallography.⁵⁶¹ Using the ligand present in the Cu^{II} complex (**261**), pseudotetrahedral Cu^I complex $[Cu(L)][ClO_4] \cdot 2MeCN$ was

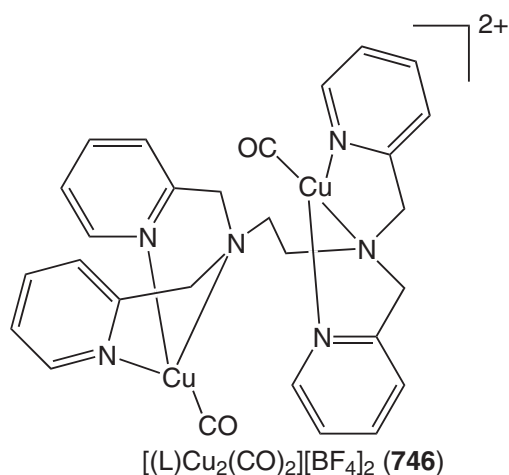
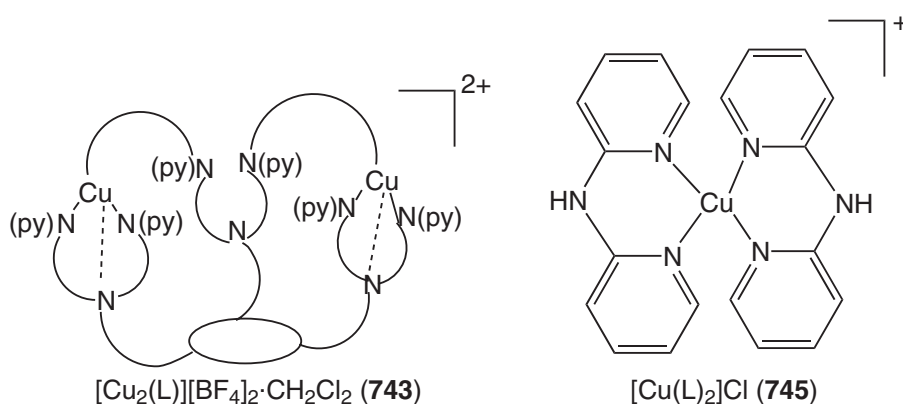
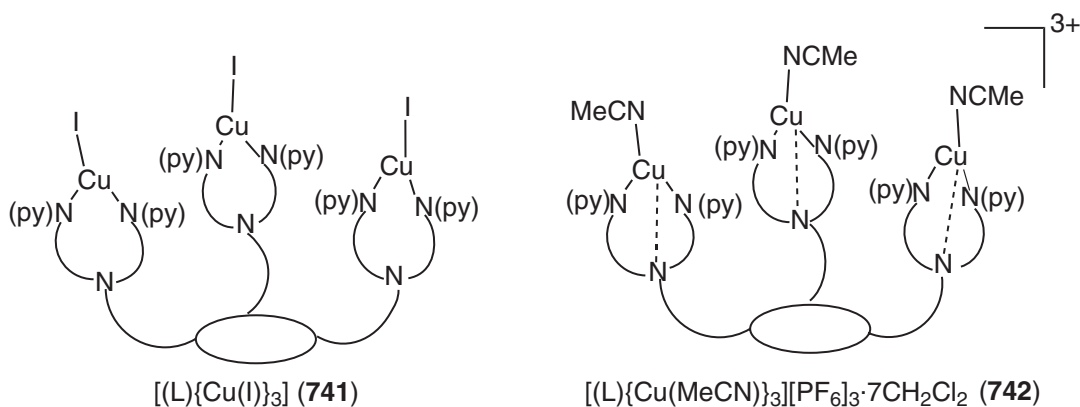

structurally characterized.²³⁶ Rillema and co-workers investigated properties of a dimeric copper(I) complex (**755**) (L as in (**263**)) (distorted tetrahedral; Cu–Cu: 6.629 Å).²³⁸

Using a tetrahedrally enforcing ligand, containing two bipyridyl binding sites linked by a diphenyl disulfide bridge, Ward and co-workers reported the structure of complex (**756**) (pseudotetrahedral).⁵⁶² Using a biphenyl-based ligand enforcing geometrical constraints on metal complexes, Malachowski *et al.* investigated the properties of complex (**757**) (distorted tetrahedral).⁵⁶³

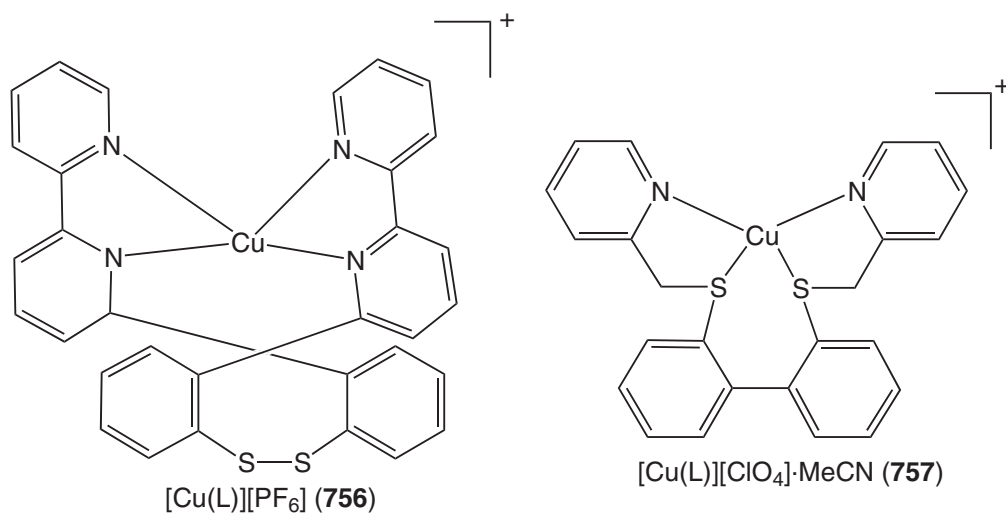
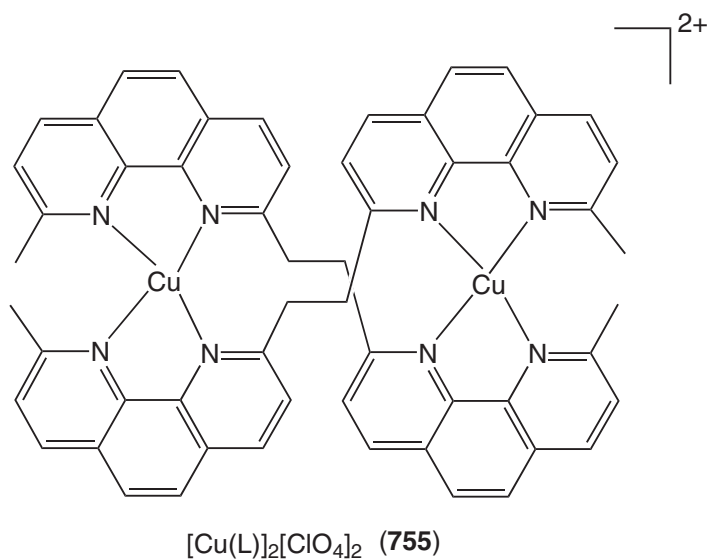

(vi) Other heterocycle-containing ligands

The copper(I) analogue $[\text{Cu}(\text{L})][\text{ClO}_4]$ (758) (distorted pseudotetrahedral) of complex (294) was prepared and its properties investigated.²⁵⁸ Using a bis(diazine) heterocyclic ligand structure of the complex (759) was determined.⁵⁶⁴

6.6.4.3 Phosphorus Donor Ligands

The first copper(I) complex of tris(hydroxymethyl)phosphine ((760); tetrahedral) has been reported by Samuelson and co-workers.⁵⁶⁵ This group addressed the question of anion-controlled nuclearity and metal-metal distances in copper(I)-bis(diphenylphosphino)methane complexes, and in this endeavor they reported the structures of complexes (761) (Cu-Cu separation: 3.005–3.128 Å), (762) (Cu-Cu separation: 3.165 Å) and (763) (tetrahedral; Cu-Cu: 3.293 Å).⁵⁶⁶ They synthesized and provided structural evidence of oxyanion-encapsulated copper(I) complexes of this ligand. The complexes (764) (distorted tetrahedral; Cu-Cu: 3.143 Å), (765) (distorted tetrahedral; Cu-Cu: 3.424 Å), (766) (distorted trigonal; Cu-Cu: 3.170 Å), and (767) (Cu-Cu: 3.032–3.077 Å) were reported. They studied solid-state emission spectra of these complexes.⁵⁶⁷ During this pursuit they

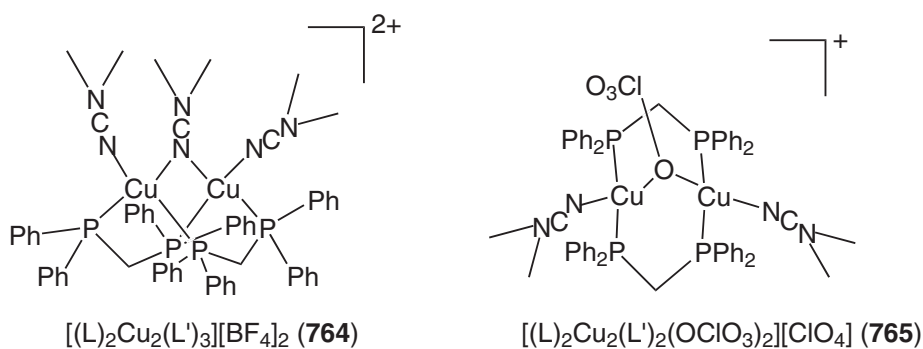
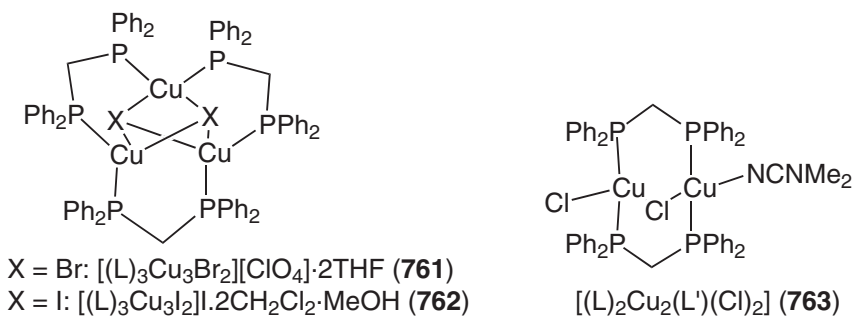
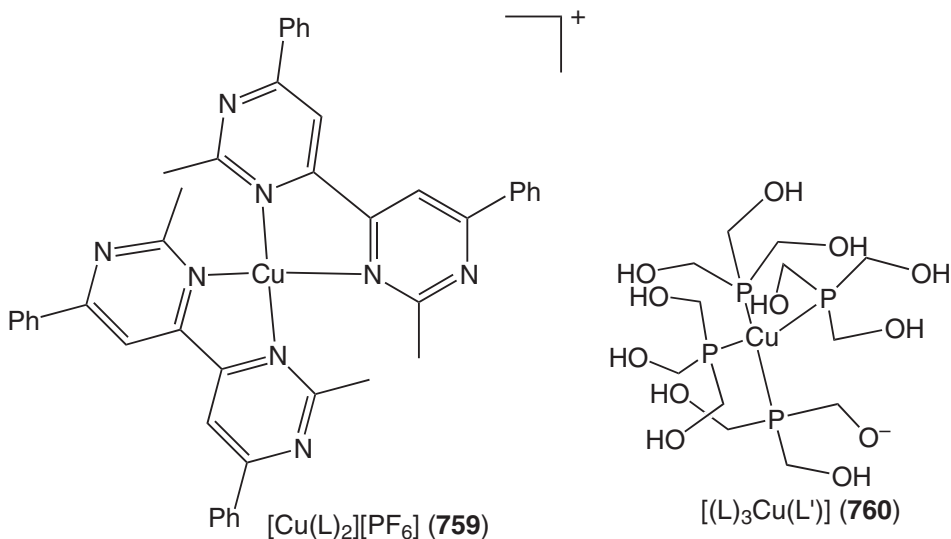

synthesized and characterized complex (768).⁵⁶⁸ The structure of a copper(I) complex (769) (distorted tetrahedral) of polydentate phosphinoamines has been reported.⁵⁶⁹

6.6.4.4 Oxygen Donor Ligands

As part of their activity in investigating the oxygenation behavior of dicopper(I) complexes with *m*-xylyl-based ligands, using a dinucleating ligand with amine and pyrazole as terminal donor sites, Sorrell *et al.*⁵⁷⁰ reported the first copper(I) dimer ((770): distorted tetrahedral; Cu–Cu: 3.825 Å) having only a single phenolate bridge. This group also reported the structure of a monomeric copper(I) phenolate complex ((771): distorted trigonal pyramidal).⁵⁷¹

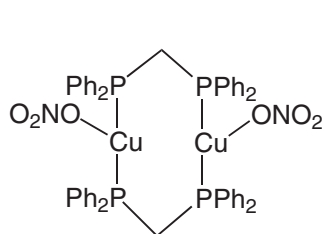
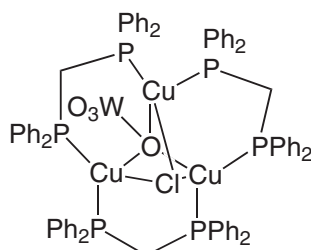
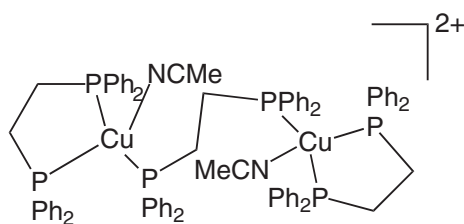
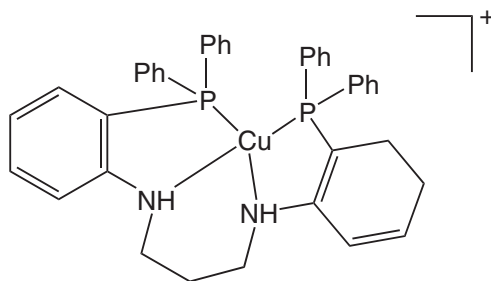
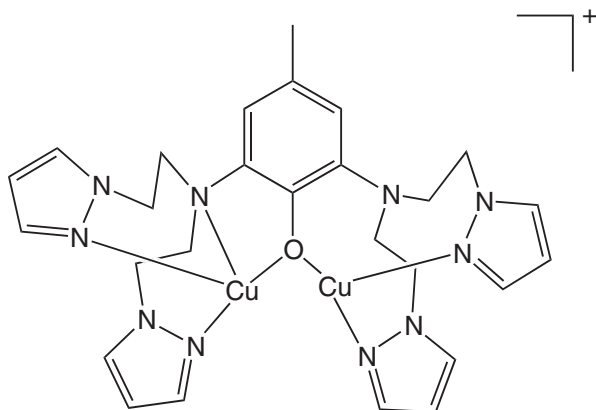
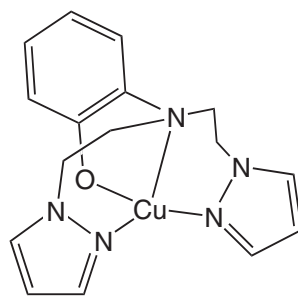
 $[(L)_2Cu_2(ONO_2)_2]$ (**766**)

 $[(L)_3Cu_3(Cl)(OWO_3)]$ (**767**)

 $[(L)Cu(MeCN)]_2[ClO_4]_2$ (**768**)

 $[Cu(L)][BF_4] \cdot MeCN$ (**769**)

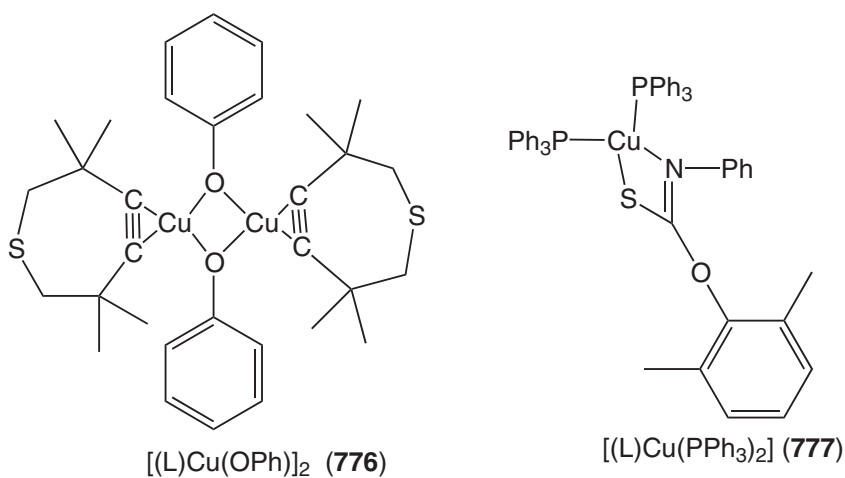
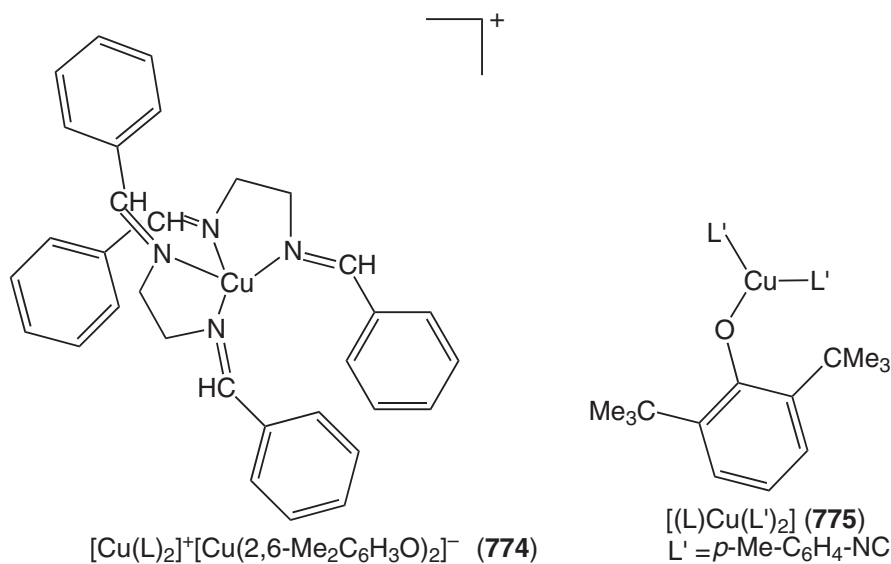
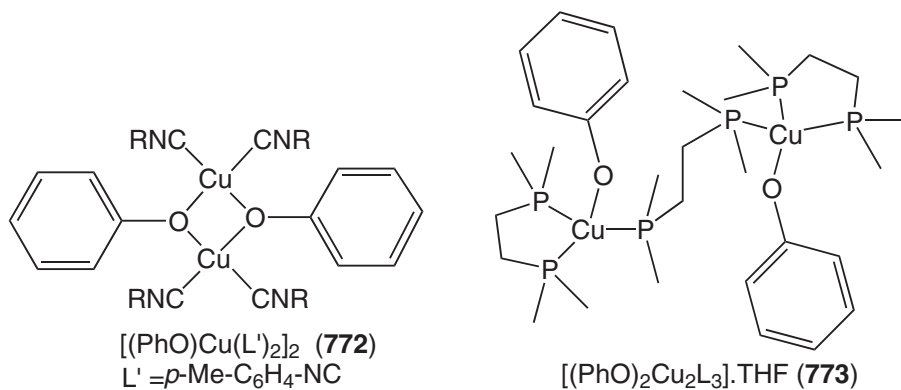
 $[Cu_2(L)][BF_4]$ (**770**)

 $[Cu(L)]$ (**771**)

The copper-alkoxo unit, which is usually synthesized *in situ*, plays a significant role in metal-promoted transformations of organic substrates by copper(I). To determine the reaction form of the Cu–OPh unit, Floriani and co-workers structurally characterized four complexes: (**772**) (pseudotetrahedral; Cu–Cu: 3.223 Å), (**773**) (pseudotetrahedral), (**774**) (anion: linear coordination) and (**775**) (planar trigonal).⁵⁷² Using 3,3,6,6-tetramethyl-1-thia-4-cycloheptyne as terminal ligand the structural characterization of a copper(I)–alkyne complex (**776**) (Cu–Cu: 2.940 Å) was reported.⁵⁷³

Reactions of copper(I) aryloxides with PhNCS were investigated by Samuelson and co-workers,⁵⁷⁴ who characterized three complexes: (**777**) (tetrahedral), (**778**) (trigonal; 2.829 Å), and (**779**) (trigonal; average Cu–Cu: 2.6895 Å). Mono- (**780**): tetrahedral) and dinuclear (**781**): pseudotetrahedral; Cu–Cu: 3.242 Å) alkoxide–copper complexes with PPh₃ ligands were reported.⁵⁷⁵ In 2001 Cotton and co-workers reported structures of two copper(I) complexes (**782**): trigonal; Cu–Cu: 2.707 Å, and (**783**): trigonal; Cu–Cu: 2.833 Å) bridged by dicarboxylates.⁵⁷⁶

Using a low-spin, tris-chelate iron(II) complex (coordinated by three bidentate azo-oxime ligands providing Fe^{II}N₆ coordination) as a facially capping tridentate ligand (the oxime oxygens function as donor sites), Chakravorty and co-workers characterized copper(I) complex (**784**) (distorted tetrahedral) [also copper(II) complex (**785a**): elongated octahedral] and investigated



their properties.⁵⁷⁷ Similarly, Chaudhuri and co-workers characterized a trinuclear complex (**785b**) (tris(nioximato)-bridged Mn^{IV}Cu^{II}Mn^{IV} tetracation; niox = cyclohexane-1,2-dione dioximate dianions; each Mn^{IV} ion is terminally coordinated by 1,4,7-trimethyl-1,4,7-triazacyclonane).⁵⁷⁸

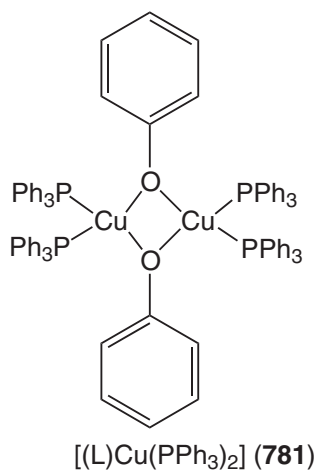
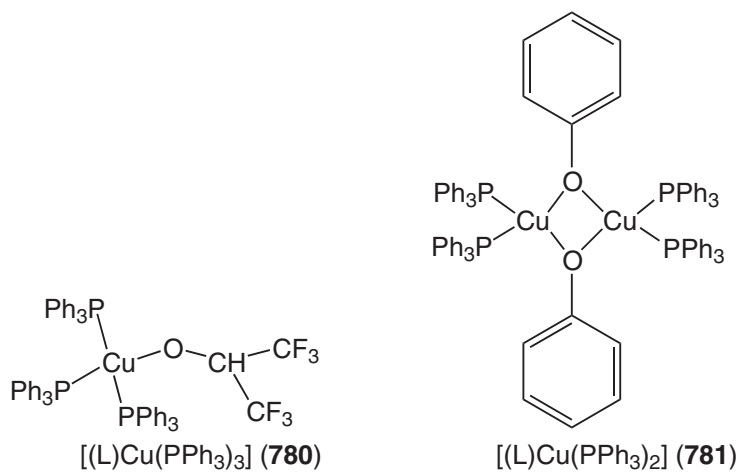
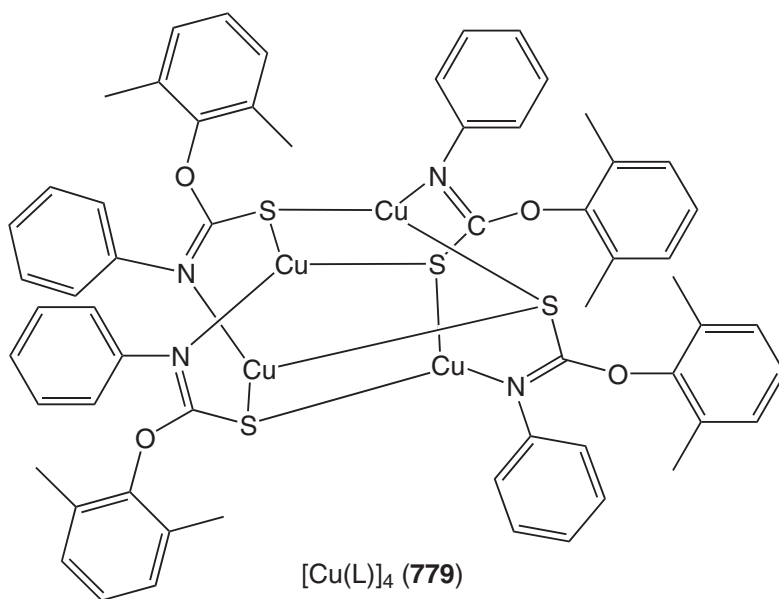
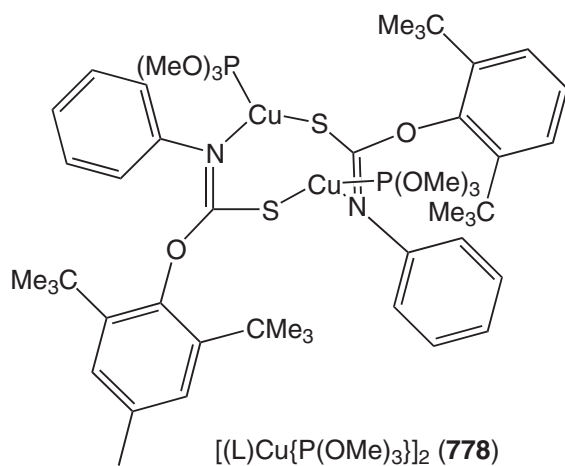

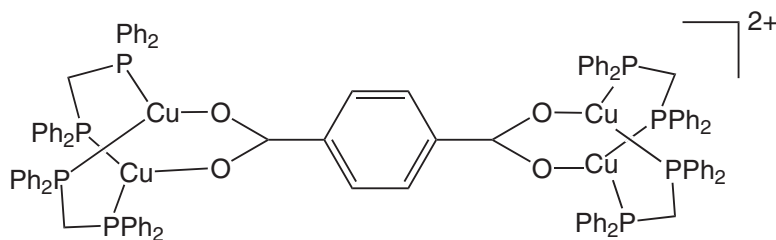

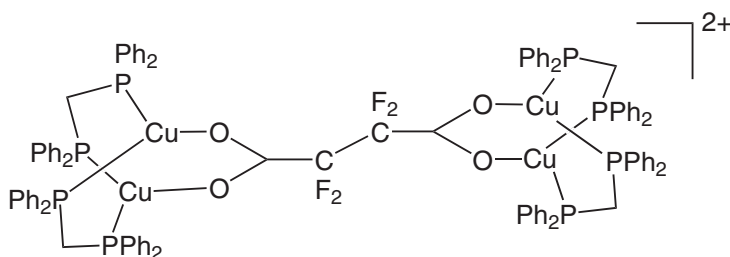
$$[\{(L)_2Cu_2\}_2(O_2CC_6H_4CO_2)][PF_6]_2 \cdot 3.4CH_2Cl_2 \text{ (782)}$$

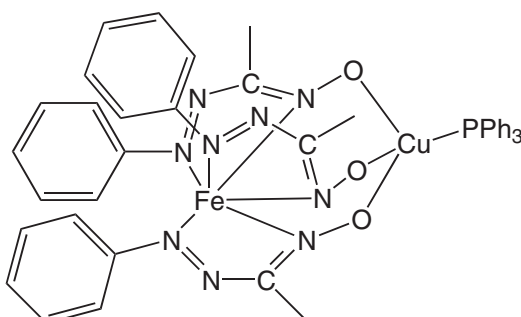
$$[\{(L)_2Cu_2\}_2(O_2CC_2F_4CO_2)][PF_6]_2 \cdot 5CH_2Cl_2 \text{ (783)}$$

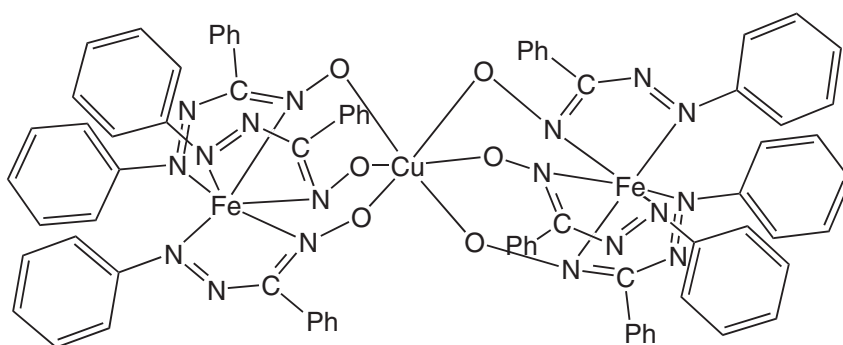
$$[\{Fe(L)_3\}Cu(PPh_3)] \text{ (784)}$$

$$[\{Fe(L)_3\}_2Cu] \cdot 2CH_2Cl_2 \text{ (785a)}$$

6.6.4.5 Sulfur Donor Ligands

6.6.4.5.1 Thiol- and thioether-containing ligands

The copper(I) complexes $[Cu(L)]$ (786) [L as in Cu^{II} complex (426)], and (787) (L as in Cu^{II} complex (427)], were also structurally characterized.³⁶⁵ From the standpoint of aggregation behavior of copper(I) thiolates⁵⁷⁹ through substituent size and ancillary chelate ligands, Kaim

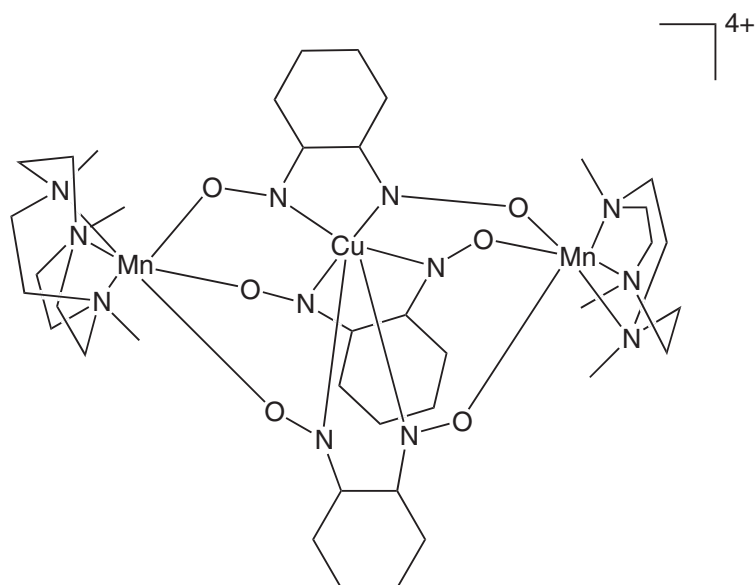
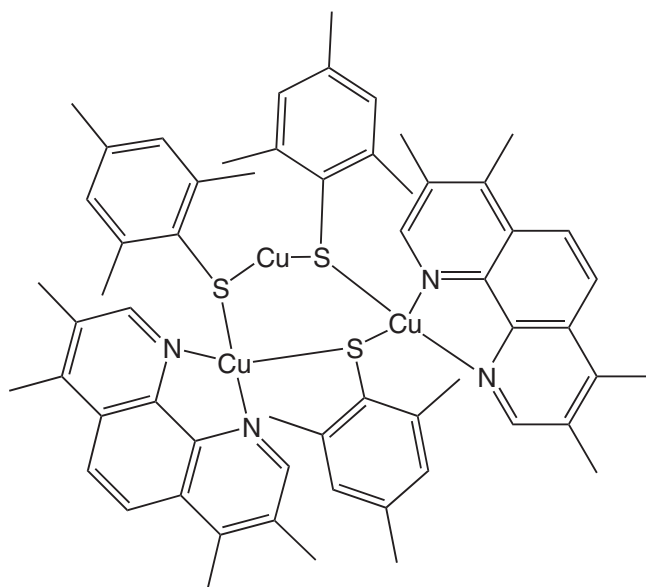

 $[\text{LMn}\{(\text{L}')_3\text{Cu}\}\text{MnL}][\text{ClO}_4]_4$ (**785b**)

 $[(\text{L})_3\text{Cu}_3(\text{L}')_2] \cdot 0.5\text{EtOH}$ (**788**)

$\text{L}' = 3,4,7,8\text{-tetramethyl-}1,10\text{-phenanthroline}$

and co-workers reported crystal structure of complex (**788**) (distorted trigonal pyramidal and linear; Cu–Cu: 2.715 Å, 3.014 Å, and 3.733 Å).⁵⁸⁰ Using a silylpyridine-2-thionate as ligand, Sousa and co-workers reported the structure and physicochemical properties of a dimeric copper(I) complex (**789**) (distorted trigonal planar; Cu–Cu: 3.733 Å).⁵⁸¹

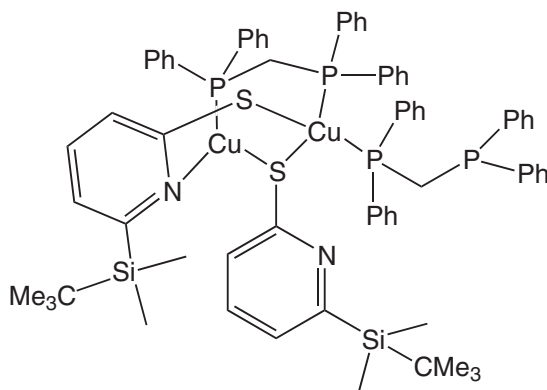
6.6.4.6 Macrocyclic Ligands/Cryptands

Tolman and co-workers investigated the oxygenation behavior of a copper(I) complex (**790**) (trigonal pyramidal) and demonstrated the formation of end-on peroxo-dicopper(II) species.⁵⁸²



$[(L)_2Cu_2(L')_2]$ (**789**)
 L' = bis(diphenylphosphino)methane

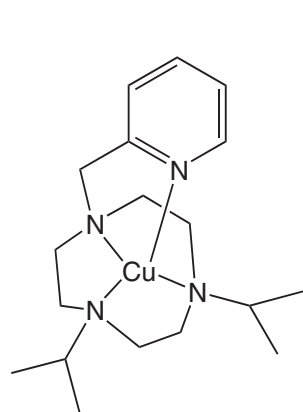

$[Cu(L)][CF_3SO_3]$ (**790**)

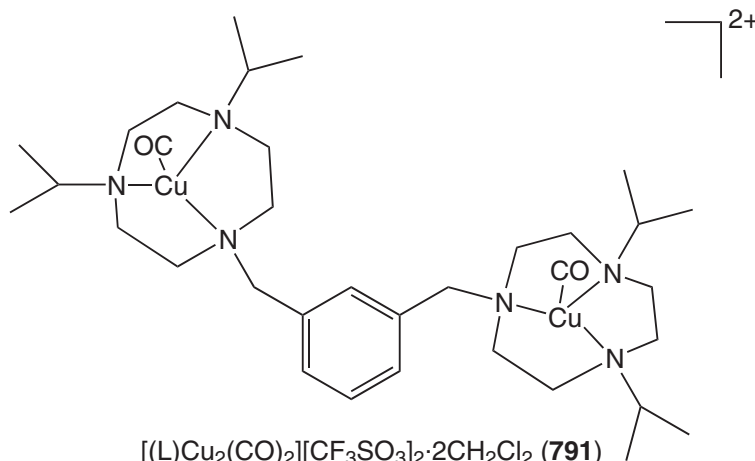

$[(L)Cu_2(CO)_2][CF_3SO_3]_2 \cdot 2CH_2Cl_2$ (**791**)

From this perspective they reported the structure (complex **(791)**; Cu–Cu: 10.061 Å) of a *m*-xylyl-based TACN ligand.⁵⁸³ Structures of four mononuclear copper(I) complexes (**(792)**–**(795)**), supported by tridentate macrocycle, were also reported by this group. They investigated their oxygenation behavior and in each case clean formation of side-on peroxo-dicopper(II) species was demonstrated.⁴¹⁶

In their effort to model nitrite reductases,⁷² Tolman and co-workers reported^{410–412} structures of substrate-bound copper(I) complexes (**(796)** (distorted tetrahedral) and **(797)** (distorted tetrahedral). Using hybrid triazacyclononane (TACN)-pyridyl ligands, this group reported⁵⁸⁴ structural and properties of complexes (**(798)**) and its 6-phenyl-substituted pyridyl derivative $[Cu(L)][SbF_6]$. The copper(I) geometry in both complexes is distorted trigonal pyramidal. They structurally characterized a copper(II) complex $[(L)Cu(ONO)][CF_3SO_3] \cdot CH_2Cl_2$ (L as that in **(798)**); however, without the phenyl substituent in the pyridyl ring (**(799)**) as well. Low-temperature oxygenation experiments demonstrated the formation of trans-1,2-peroxo species.

Using 1,4,8,11-tetraazacyclotetradecane, the structure of complex (**(800)**) (distorted trigonal planar; Cu–Cu: 6.739 Å) was determined. Reactivity with O₂ was investigated to demonstrate the formation of trans-1,2-peroxo species.⁵⁸⁵ As part of their work with copper(I) complexes with O₂, the structure of a dicopper(I) complex (**(801)**: distorted tetrahedral; 7.04 Å), supported by macrocyclic ligand environment, was reported by Comba and co-workers.⁵⁸⁶ Tolman and co-workers structurally characterized a three-coordinate copper(I)–phenoxide complex (**(802)**) (planar T-shaped) that models the reduced form of GO.⁵⁸⁷ The copper(I) analogue $[Cu(L)][CF_3SO_3] \cdot 0.43MeOH$ (**(803)**) of a copper(II) complex (**(534)**) was also reported to demonstrate the role of ligand framework conformability in Cu^{II}/Cu^I redox potentials.⁴³⁴ Wilson and co-workers

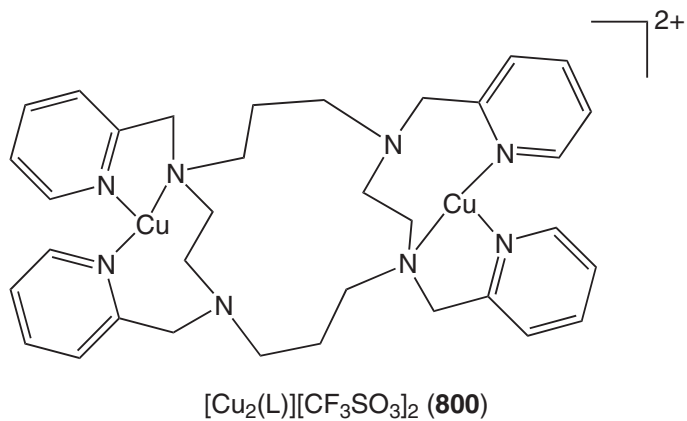
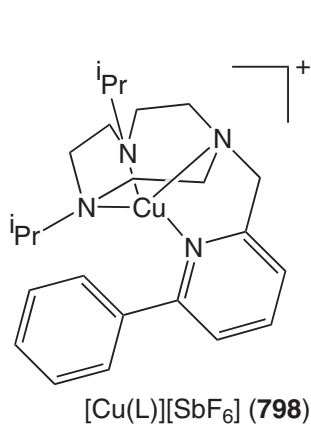
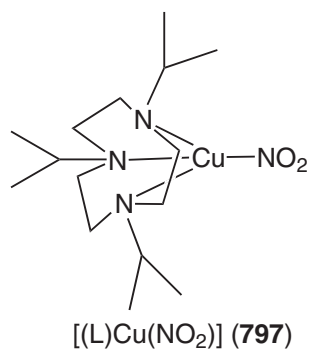
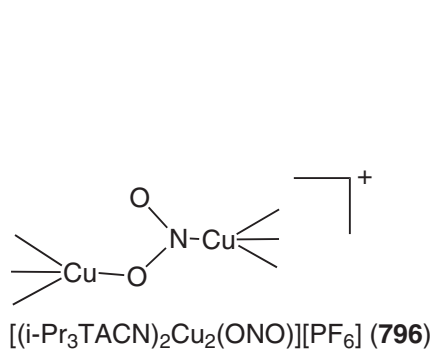
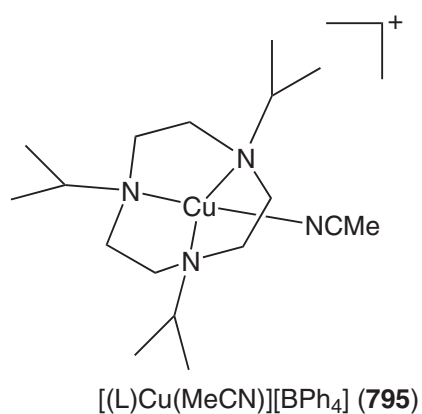
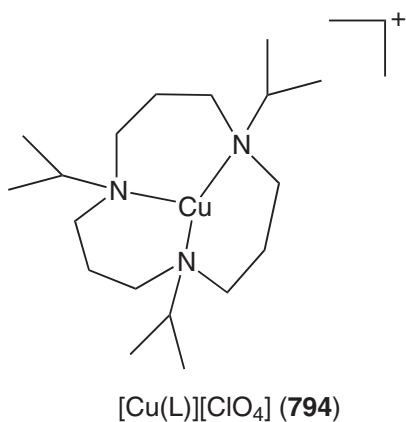
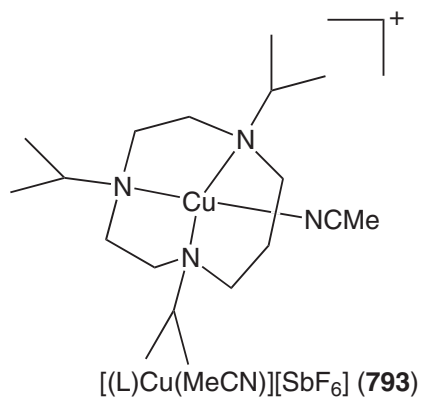
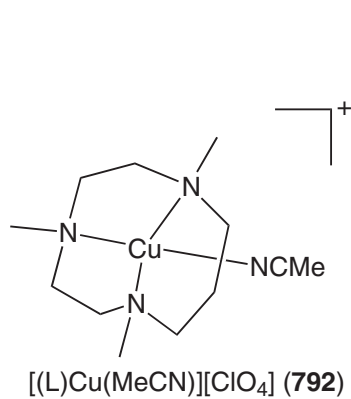

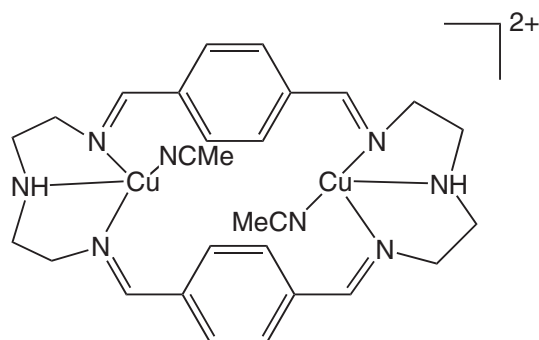
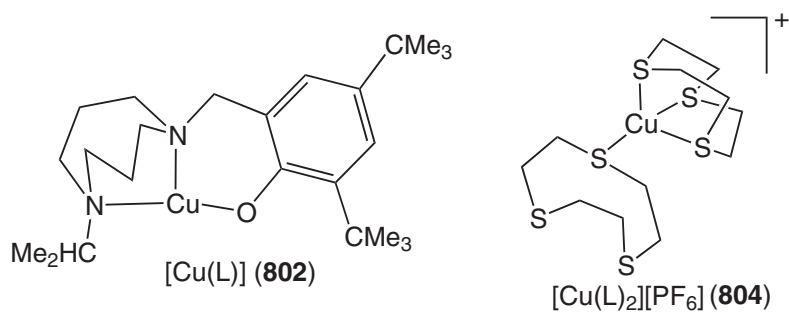
 $[(L)Cu(MeCN)]_2$ (**801**)

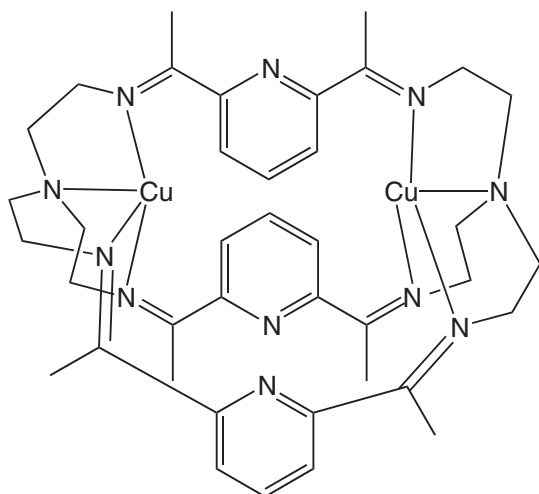
 $[Cu(L)]$ (**802**)

 $[Cu(L)_2][PF_6]$ (**804**)

 $[Cu_2(L)][BF_4]_2$ (**806**)

reported the structure of a copper(I) complex (**804**) having CuS_4 coordination.⁵⁸⁸ Rorabacher and co-workers reported the structure of a complex $[Cu(L)][ClO_4] \cdot 0.25H_2O$ (**805**) (flattened tetrahedral; L as that in complexes (**551**)/(**552**)).⁴⁴⁹ Using a Schiff-base cryptand, Fenton and co-workers structurally characterized a dicopper(I) complex (**806**) (trigonal pyramidal; Cu–Cu: 6.25 Å).⁴⁴⁵

ACKNOWLEDGMENTS

The greater part of this manuscript was prepared during the author's stay in the laboratory of Prof. (Dr.) Siegfried Schindler, Institut für Anorganische Chemie, Universität Erlangen-Nürnberg,

Erlangen, Germany, as part of a joint collaborative project funded by the Volkswagen Foundation. I wish to express my warmest thanks to Prof. Schindler and Prof. (Dr.) Rudi van Eldik of the same Institute for their cooperation.

6.6.5 REFERENCES

1. Hathaway, B. J. In *Comprehensive Coordination Chemistry*; Wilkinson, G.; Gillard, R. D.; McCleverty, J. A., Eds.; Pergamon: Oxford, 1987; Vol. 5, pp 533–594.
2. Smith, D. R. *Coord. Chem. Rev.* **1997**, *162*, 155–240.
3. Smith, D. R. *Coord. Chem. Rev.* **1998**, *172*, 457–573.
4. Karlin, K. D.; Tyeklár, Z.; Eds. *Bioinorganic Chemistry of Copper*; Chapman and Hall: New York, 1993.
5. Solomon, E. I.; Lowery, M. D. *Science* **1993**, *259*, 1575–1581 and references therein.
6. Messerschmidt, A. *Adv. Inorg. Chem.* **1994**, *40*, 121–185.
7. Solomon, E. I.; Sundaram, U. M.; Machonkin, T. E. *Chem. Rev.* **1996**, *96*, 2563–2605 and references therein.
8. Kaim, W.; Rall, J. *Angew. Chem. Int. Ed. Engl.* **1996**, *35*, 43–60.
9. Karlin, K. D.; Gultneh, Y. *J. Chem. Educ.* **1985**, *62*, 983–990.
10. Karlin, K. D.; Gultneh, Y. *Prog. Inorg. Chem.* **1987**, *35*, 219–327.
11. Tyeklár, Z.; Karlin, K. D. *Acc. Chem. Res.* **1989**, *22*, 241–248.
12. Karlin, K. D.; Tyeklár, Z.; Zuberbühler, A. D. In *Bioinorganic Catalysis*; Reedijk, J., Ed.; Marcel Dekker: New York, 1993; pp 261–315.
13. Karlin, K. D.; Tyeklár, Z. *Adv. Inorg. Biochem.* **1994**, *9*, 123–172.
14. Karlin, K. D.; Kaderli, S.; Zuberbühler, A. D. *Acc. Chem. Res.* **1997**, *30*, 139–147.
15. Karlin, K. D.; Lee, D.-H.; Obias, H. V.; Humphreys, K. J. *Pure Appl. Chem.* **1998**, *70*, 855–862.
16. Karlin, K. D.; Zuberbühler, A. D. In *Bioinorganic Catalysis*; Reedijk, J.; Bouwman, E., Eds.; Marcel Dekker: New York, 1999; pp 469–534.
17. Liang, H.-C.; Dahan, M.; Karlin, K. D. *Curr. Opin. Chem. Biol.* **1999**, *3*, 168–175.
18. Sorrell, T. N. *Tetrahedron* **1989**, *45*, 3–68.
19. Kitajima, N. *Adv. Inorg. Chem.* **1992**, *39*, 1–77.
20. Kitajima, N.; Moro-oka, Y. *Chem. Rev.* **1994**, *94*, 737–757.
21. Tolman, W. B. *Acc. Chem. Res.* **1997**, *30*, 227–237.
22. Holland, P. L.; Tolman, W. B. *Coord. Chem. Rev.* **1999**, *190–192*, 855–869.
23. Fontecave, M.; Pierre, J.-L. *Coord. Chem. Rev.* **1998**, *170*, 125–140.
24. Blackman, A. G.; Tolman, W. B. *Struct. Bonding (Berlin)* **2000**, *97*, 179–211.
25. Mahadevan, V.; Klein Gebbink, R. J. M.; Stack, T. D. P. *Curr. Opin. Chem. Biol.* **2000**, *4*, 228–234.
26. Schindler, S. *Eur. J. Inorg. Chem.* **2000**, 2311–2326.
27. Cole, A. P.; Root, D. E.; Mukherjee, P.; Solomon, E. I.; Stack, T. D. P. *Science* **1996**, *273*, 1848–1850.
28. Mahadevan, V.; Hou, Z.; Cole, A. P.; Root, D. E.; Lal, T. K.; Solomon, E. I.; Stack, T. D. P. *J. Am. Chem. Soc.* **1997**, *119*, 11996–11997.
29. Hayashi, H.; Fujinami, S.; Nagatomo, S.; Ogo, S.; Suzuki, M.; Uehara, A.; Watanabe, Y.; Kitagawa, T. *J. Am. Chem. Soc.* **2000**, *122*, 2124–2125.
30. Sigel, H.; Martin, R. B. *Chem. Rev.* **1982**, *82*, 385–426.
31. Anson, F. C.; Collins, T. J.; Richmond, T. G.; Santarsiero, B. D.; Toth, J. E.; Treco, B. G. R. T. *J. Am. Chem. Soc.* **1987**, *109*, 2974–2979 and references therein.
32. Levason, W.; Spicer, M. D. *Coord. Chem. Rev.* **1987**, *76*, 45–120.
33. Hanss, J.; Beckmann, A.; Krüger, H. J. *Eur. J. Inorg. Chem.* **1999**, 163–172.
34. Straub, B. F.; Rominger, F.; Hofmann, P. *Chem. Commun.* **2000**, 1611–1612.
35. Hanss, J.; Krüger, H.-J. *Angew. Chem., Int. Ed. Engl.* **1996**, *35*, 2827–2830.
36. Krebs, C.; Glaser, T.; Bill, E.; Weyhermüller, T.; Meyer-Klaucke, W.; Wieghardt, K. *Angew. Chem. Int. Ed. Engl.* **1999**, *38*, 359–361.
37. Mandal, S.; Das, G.; Singh, R.; Shukla, R.; Bharadwaj, P. K. *Coord. Chem. Rev.* **1997**, *160*, 191–235 and references therein.
38. Chaudhuri, P.; Wieghardt, K. *Prog. Inorg. Chem.* **1987**, *35*, 329–436.
39. Halfen, J. A.; Mahapatra, S.; Wilkinson, E. C.; Kaderli, S.; Young, V. G., Jr.; Que, L., Jr.; Zuberbühler, A. D.; Tolman, W. B. *Science* **1996**, *271*, 1397–1400.
40. Mahapatra, S.; Halfen, J. A.; Wilkinson, E. C.; Pan, G.; Wang, X.; Young, V. G., Jr.; Cramer, C. J.; Que, L., Jr.; Tolman, W. B. *J. Am. Chem. Soc.* **1996**, *118*, 11555–11574.
41. Mahapatra, S.; Young, V. G. Jr.; Kaderli, S.; Zuberbühler, A. D.; Tolman, W. B. *Angew. Chem. Int. Ed. Engl.* **1997**, *36*, 130–133.
42. Malmström, B. G. *Chem. Rev.* **1990**, *90*, 1247–1260.
43. Babcock, G. T.; Wikström, M. *Nature* **1992**, *356*, 301–309.
44. Malmström, B. G. *Acc. Chem. Res.* **1993**, *26*, 332–338.
45. Scott, M. J.; Lee, S. C.; Holm, R. H. *Inorg. Chem.* **1994**, *33*, 4651–4662.
46. Lee, S. C.; Holm, R. H. *J. Am. Chem. Soc.* **1993**, *115*, 11789–11798.
47. Lee, S. C.; Holm, R. H. *J. Am. Chem. Soc.* **1993**, *115*, 5833–5834.
48. Lee, S. C.; Scott, M. J.; Kauffmann, K.; Münck, E.; Holm, R. H. *J. Am. Chem. Soc.* **1994**, *116*, 401–402.
49. Scott, M. J.; Holm, R. H. *J. Am. Chem. Soc.* **1994**, *116*, 11357–11367.
50. Addison, A. W.; Rao, T. N.; Reedijk, J.; van Rijn, J.; Verschoor, G. C. *J. Chem. Soc., Dalton Trans.* **1984**, 1349–1356.
51. Becker, M.; Heinemann, F. W.; Schindler, S. *Chim. Eur. J.* **1999**, *5*, 3124–3129.
52. Schatz, M.; Becker, M.; Walter, O.; Liehr, G.; Schindler, S. *Inorg. Chim. Acta* **2001**, *324*, 173–179.

53. Becker, M.; Heinemann, F. W.; Knoch, F.; Donaubaue, W.; Liehr, G.; Schindler, S.; Golub, G.; Cohen, H.; Meyerstein, D. *Eur. J. Inorg. Chem.* **2000**, 719–726.
54. Bernhardt, P. V.; Comba, P.; Hambley, T. W.; Massoud, S.; Stebler, S. *Inorg. Chim.* **1992**, *31*, 2644–2651.
55. Boeyens, J. C. A.; Comba, P. *Coord. Chem. Rev.* **2001**, *212*, 3–30 and references therein.
56. Bernhardt, P. V.; Comba, P. *Inorg. Chem.* **1992**, *31*, 2638–2644.
57. Bernhardt, P. V. *J. Am. Chem. Soc.* **1997**, *119*, 771–774.
58. Holm, R. H.; Kennepohl, P.; Solomon, E. I. *Chem. Rev.* **1996**, *96*, 2239–2314 and references therein.
59. Sykes, A. G. *Adv. Inorg. Chem.* **1991**, *36*, 377–408.
60. Sykes, A. G. *Struct. Bonding (Berlin)* **1991**, *75*, 175–224.
61. McMillin, D. R. *J. Chem. Educ.* **1985**, *62*, 997–1001.
62. Bouwman, E.; Driessen, W. L.; Reedijk, J. *Coord. Chem. Rev.* **1990**, *104*, 143–172.
63. Bernarducci, E.; Bharadwaj, P. K.; Krogh-Jespersen, K.; Potenza, J. A.; Schugar, H. J. *J. Am. Chem. Soc.* **1983**, *105*, 3860–3866.
64. Bernarducci, E.; Bharadwaj, P. K.; Lalancette, R. A.; Krogh-Jespersen, K.; Potenza, J. A.; Schugar, H. J. *Inorg. Chem.* **1983**, *22*, 3911–3920.
65. Prochaska, H. J.; Schwindinger, W. F.; Schwartz, M.; Burk, M. J.; Bernarducci, E.; Lalancette, R. A.; Potenza, J. A.; Schugar, H. J. *J. Am. Chem. Soc.* **1981**, *103*, 3446–3455.
66. Knapp, S.; Keenan, T. P.; Zhang, X.; Fikar, R.; Potenza, J. A.; Schugar, H. J. *J. Am. Chem. Soc.* **1990**, *112*, 3452–3464.
67. Higgs, T. C.; Helliwell, M.; Garner, C. D. *J. Chem. Soc., Dalton Trans.* **1996**, 2101–2110.
68. McMaster, J.; Beddoes, R. L.; Collison, D.; Eardley, D. R.; Helliwell, M.; Garner, C. D. *Chem. Eur. J.* **1996**, *2*, 685–693.
69. Beretta, M.; Bouwman, E.; Casella, L.; Douziche, B.; Driessen, W. L.; Gutierrez-Soto, L.; Monzani, E.; Reedijk, J. *Inorg. Chim. Acta* **2000**, *310*, 41–50.
70. Oberhausen, K. J.; O'Brien, R. J.; Richardson, J. F.; Buchanan, R. M. *Inorg. Chim. Acta* **1990**, *173*, 145–154.
71. Chen, S.; Richardson, J. F.; Buchanan, R. M. *Inorg. Chem.* **1994**, *33*, 2376–2382.
72. Averill, B. A. *Chem. Rev.* **1996**, *96*, 2951–2964 and references therein.
73. Dominguez-Vera, J. M.; Camara, F.; Moreno, J. M.; Isac-Garcia, J.; Colacio, E. *Inorg. Chim. Acta* **2000**, *306*, 137–141.
74. Doman, T. N.; Richardson, J. F.; Arar, L.; Buchanan, R. M. *Inorg. Chim. Acta* **1989**, *159*, 219–224.
75. Bertini, I.; Mangani, S.; Viezzoli, M. S. *Adv. Inorg. Chem.* **1997**, *45*, 127–250.
76. Valentine, J. S.; de Freitas, D. M. *J. Chem. Educ.* **1985**, *62*, 990–997.
77. Ohtsu, H.; Itoh, S.; Nagatomo, S.; Kitagawa, T.; Ogo, S.; Watanabe, Y.; Fukuzumi, S. *Inorg. Chem.* **2001**, *40*, 3200–3207.
78. Ohtsu, H.; Shimazaki, Y.; Odani, A.; Yamauchi, O.; Mori, W.; Itoh, S.; Fukuzumi, S. *J. Am. Chem. Soc.* **2000**, *122*, 5733–5741.
79. Zoeteman, M.; Bouwman, E.; de Graaff, R. A. G.; Driessen, W. L.; Reedijk, J.; Zanello, P. *Inorg. Chem.* **1990**, *29*, 3487–3492.
80. Bouwman, E.; Day, R.; Driessen, W. L.; Tremel, W.; Krebs, B.; Wood, J. S.; Reedijk, J. *Inorg. Chem.* **1988**, *27*, 4614–4618.
81. Bouwman, E.; Burik, A.; Ten Hove, J. C.; Driessen, W. L.; Reedijk, J. *Inorg. Chim. Acta* **1988**, *150*, 125–131.
82. Birker, P. J. M. W. L.; Godefroi, E. F.; Helder, J.; Reedijk, J. *J. Am. Chem. Soc.* **1982**, *104*, 7556–7560.
83. Sorrell, T. N.; Allen, W. E.; White, P. S. *Inorg. Chem.* **1995**, *34*, 952–960.
84. Klinman, J. P. *Chem. Rev.* **1996**, *96*, 2541–2561 and references therein.
85. Allen, W. E.; Sorrell, T. N. *Inorg. Chem.* **1997**, *36*, 1732–1734.
86. Tabbi, G.; Driessen, W. L.; Reedijk, J.; Bonomo, R. P.; Veldman, N.; Spek, A. L. *Inorg. Chem.* **1997**, *36*, 1168–1175.
87. Riggio, I.; van Albada, G. A.; Ellis, D. D.; Mutikainen, I.; Spek, A. L.; Turpeinen, U.; Reedijk, J. *Polyhedron* **2001**, *20*, 2659–2666.
88. Palaniandavar, M.; Pandiyan, T.; Lakshminarayan, M.; Manohar, H. *J. Chem. Soc., Dalton Trans.* **1995**, 455–461.
89. Pandiyan, T.; Palaniandavar, M.; Lakshminarayanan, M.; Manohar, H. *J. Chem. Soc., Dalton Trans.* **1992**, 3377–3384.
90. Casella, L.; Carugo, O.; Gullotti, M.; Doldi, S.; Frassoni, M. *Inorg. Chem.* **1996**, *35*, 1101–1113.
91. Klabunde, T.; Eicken, C.; Sacchetti, J. C.; Krebs, B. *Nature Structural Biology* **1998**, *5*, 1084–1090.
92. Monzani, E.; Quinti, L.; Perotti, A.; Casella, L.; Gullotti, M.; Randaccio, L.; Geremia, S.; Nardin, G.; Faleschini, P.; Tabbi, G. *Inorg. Chem.* **1998**, *37*, 553–562.
93. Monzani, E.; Battaini, G.; Perotti, A.; Casella, L.; Gullotti, M.; Santagostini, L.; Nardin, G.; Randaccio, L.; Geremia, S.; Zanello, P.; Oromolla, G. *Inorg. Chem.* **1999**, *38*, 5359–5369.
94. Monzani, E.; Casella, L.; Zoppellaro, G.; Gullotti, M.; Pagliarin, R.; Bonomo, R. P.; Tabbi, G.; Nardin, G.; Randaccio, L. *Inorg. Chim. Acta* **1998**, *282*, 180–192.
95. Albrecht, M.; Hübler, K.; Scheiring, T.; Kaim, W. *Inorg. Chem.* **1999**, *287*, 204–208.
96. Lockhart, J. C.; Clegg, W.; Hill, M. N. S.; Rushton, D. J. *J. Chem. Soc., Dalton Trans.* **1990**, 3541–3548.
97. Gilbert, J. G.; Addison, A. W.; Nazarenko, A. Y.; Butcher, R. J. *Inorg. Chim. Acta* **2001**, *324*, 123–130 and references therein.
98. Sanni, S. B.; Behm, H. J.; Beurskens, P. T.; van Albada, G. A.; Reedijk, J.; Lenstra, A. T. H.; Addison, A. W.; Palaniandavar, M. *J. Chem. Soc., Dalton Trans.* **1988**, 1429–1435.
99. Vaidyanathan, M.; Balamurugan, R.; Sivagnanam, U.; Palaniandavar, M. *J. Chem. Soc., Dalton Trans.* **2001**, 3498–3506.
100. Balamurugan, R.; Palaniandavar, M.; Gopalan, R. S. *Inorg. Chem.* **2001**, *40*, 2246–2255.
101. Satcher, J. H., Jr.; Droege, M. W.; Weakley, T. J. R.; Taylor, R. T. *Inorg. Chem.* **1995**, *34*, 3317–3328 and references therein.
102. Müller, E.; Bernardinelli, G.; Reedijk, J. *Inorg. Chem.* **1995**, *34*, 5979–5988.
103. Trofimenko, S. *Prog. Inorg. Chem.* **1986**, *34*, 115–210.
104. Trofimenko, S. *Chem. Rev.* **1993**, *93*, 943–980.

105. Mani, F. *Coord. Chem. Rev.* **1992**, *120*, 325–359.
106. Kitajima, N.; Tolman, W. B. *Prog. Inorg. Chem.* **1995**, *43*, 419–531 and references therein.
107. Mukherjee, R. *Coord. Chem. Rev.* **2000**, *203*, 151–218 and references therein.
108. Kitajima, N.; Moro-oka, Y.; Uchida, A.; Sasada, Y.; Ohashi, Y. *Acta Cryst.* **1988**, *C44*, 1876–1878.
109. Rheingold, A. L.; Haggerty, B. S.; Trofimenko, S. *Angew. Chem. Int. Ed. Engl.* **1994**, *33*, 1983–1985.
110. Siemer, C. J.; Meece, F. A.; Armstrong, W. H.; Eichhorn, D. M. *Polyhedron* **2001**, *20*, 2637–2646.
111. Cvetkovic, M.; Batten, S. R.; Moubaraki, B.; Murray, K. S.; Spiccia, L. *Inorg. Chim. Acta* **2001**, *324*, 131–140.
112. Kitajima, N.; Fujisawa, K.; Moro-oka, Y. *J. Am. Chem. Soc.* **1990**, *112*, 3210–3212.
113. Kitajima, N.; Fujisawa, K.; Tanaka, M.; Moro-oka, Y. *J. Am. Chem. Soc.* **1992**, *114*, 9232–9233.
114. Holland, P. L.; Tolman, W. B. *J. Am. Chem. Soc.* **1999**, *121*, 7270–7271.
115. Kitajima, N.; Fujisawa, K.; Moro-oka, Y. *J. Am. Chem. Soc.* **1989**, *111*, 8975–8976 and references therein.
116. Kitajima, N.; Fujisawa, K.; Fujimoto, C.; Moro-oka, Y.; Hashimoto, S.; Kitagawa, T.; Toriumi, K.; Tatsumi, K.; Nakamura, A. *J. Am. Chem. Soc.* **1992**, *114*, 1277–1291.
117. Magnus, K. A.; Ton-That, H.; Carpenter, J. E. *Chem. Rev.* **1994**, *94*, 727–735.
118. Kitajima, N.; Fujisawa, K.; Moro-oka, Y. *Inorg. Chem.* **1990**, *29*, 357–358.
119. Kitajima, N.; Koda, T.; Hashimoto, S.; Kitagawa, T.; Moro-oka, Y. *J. Am. Chem. Soc.* **1991**, *113*, 5664–5671.
120. Kitajima, N.; Moro-oka, Y. *J. Chem. Soc., Dalton Trans.* **1993**, 2665–2671.
121. Kitajima, N.; Fujisawa, K.; Koda, T.; Hikichi, S.; Moro-oka, Y. *J. Chem. Soc., Chem. Commun.* **1990**, 1357–1358.
122. Kitajima, N.; Hikichi, S.; Tanaka, M.; Moro-oka, Y. *J. Am. Chem. Soc.* **1993**, *115*, 5496–5508.
123. Kitajima, N.; Katayama, T.; Fujisawa, K.; Iwata, Y.; Moro-oka, Y. *J. Am. Chem. Soc.* **1993**, *115*, 7872–7873.
124. Kitajima, N.; Fujisawa, K.; Hikichi, S.; Moro-oka, Y. *J. Am. Chem. Soc.* **1993**, *115*, 7874–7875.
125. Fujisawa, K.; Tanaka, M.; Moro-oka, Y.; Kitajima, N. *J. Am. Chem. Soc.* **1994**, *116*, 12079–12080.
126. Hu, Z.; Gorun, S. M. *Inorg. Chem.* **2001**, *40*, 667–671.
127. Hu, Z.; George, G. N.; Gorun, S. M. *Inorg. Chem.* **2001**, *40*, 4812–4813.
128. Tolman, W. B. *Inorg. Chem.* **1991**, *30*, 4877–4880.
129. Carrier, S. M.; Ruggiero, C. E.; Tolman, W. B.; Jameson, G. B. *J. Am. Chem. Soc.* **1992**, *114*, 4407–4408.
130. Ruggiero, C. E.; Carrier, S. M.; Antholine, W. E.; Whittaker, J. W.; Cramer, C. J.; Tolman, W. B. *J. Am. Chem. Soc.* **1993**, *115*, 11285–11298.
131. Ruggiero, C. E.; Carrier, S. M.; Tolman, W. B. *Angew. Chem. Int. Ed. Engl.* **1994**, *33*, 895–897.
132. Schuitema, A. M.; Engelen, M.; Koval, C. A.; Gorter, S.; Driessen, W. L.; Reedijk, J. *Inorg. Chim. Acta* **2001**, *324*, 57–64.
133. Pons, J.; Chadghan, A.; Alvarez-Larena, A.; Piniella, J. F.; Ros, J. *Inorg. Chim. Acta* **2001**, *324*, 342–346.
134. Blonk, H. L.; Driessen, W. L.; Reedijk, J. *J. Chem. Soc., Dalton Trans.* **1985**, 1699–1705.
135. Veldhuis, J. B. J.; Driessen, W. L.; Reedijk, J. *J. Chem. Soc., Dalton Trans.* **1986**, 537–541.
136. Sheu, S.-C.; Tien, M.-J.; Cheng, M.-C.; Ho, T.-I.; Peng, S.-M. *J. Chem. Soc., Dalton Trans.* **1995**, 3503–3510.
137. van Berkel, P. M.; Driessen, W. L.; Hämäläinen, R.; Reedijk, J.; Turpeinen, U. *Inorg. Chem.* **1994**, *33*, 5920–5926.
138. Riklin, M.; Tran, D.; Bu, X.; Laverman, L. E.; Ford, P. C. *J. Chem. Soc., Dalton Trans.* **2001**, 1813–1819.
139. Driessen, W. L.; deGraaff, R. A. G.; Parlevliet, F. J.; Reedijk, J.; deVos, R. M. *Inorg. Chim. Acta* **1994**, *216*, 43–49.
140. Martens, C. F.; Schenning, A. P. H. J.; Feiters, M. C.; Berens, H. W.; van der Linden, J. G. M.; Admiraal, G.; Beurskens, P. T.; Kooijman, H.; Spek, A. L.; Nolte, R. J. M. *Inorg. Chem.* **1995**, *34*, 4735–4744.
141. Paap, F.; Driessen, W. L.; Reedijk, J.; Dartmann, M.; Krebs, B. *Inorg. Chim. Acta* **1986**, *121*, 185–189.
142. Haanstra, W. G.; Driessen, W. L.; de Graaff, R. A. G.; Sebrechts, G. C.; Suriano, J.; Reedijk, J.; Turpeinen, U.; Hämäläinen, R.; Wood, J. S. *Inorg. Chim. Acta* **1991**, *189*, 243–251.
143. Haanstra, W. G.; van der Donk, W. A. J. W.; Driessen, W. L.; Reedijk, J.; Drew, M. G. B.; Wood, J. S. *Inorg. Chim. Acta* **1990**, *176*, 299–305.
144. Haanstra, W. G.; van der Donk, W. A. J. W.; Driessen, W. L.; Reedijk, J.; Wood, J. S.; Drew, M. G. B. *J. Chem. Soc., Dalton Trans.* **1990**, 3123–3128.
145. Meyer, F.; Pritzkow, H. *Angew. Chem. Int. Ed. Engl.* **2000**, *39*, 2112–2115.
146. Kleywegt, W. J.; Wiesmeijer, W. G. R.; van Driel, G. J.; Driessen, W. L.; Reedijk, J.; Noordik, J. H. *J. Chem. Soc., Dalton Trans.* **1985**, 2177–2184.
147. Sorrell, T. N.; Jameson, D. L. *Inorg. Chem.* **1982**, *21*, 1014–1019.
148. Chen, Z.; Karasek, N.; Craig, D. C.; Colbran, S. B. *J. Chem. Soc., Dalton Trans.* **2000**, 3445–3452.
149. Chang, W. K.; Lee, G. H.; Wang, Y.; Ho, T. I.; Su, Y. O.; Lin, Y. C. *Inorg. Chim. Acta* **1994**, *223*, 139–144.
150. Chang, W. K.; Sheu, S. C.; Lee, G. H.; Wang, Y.; Ho, T. I.; Lin, Y. C. *J. Chem. Soc., Dalton Trans.* **1993**, 687–694.
151. Lal, T. K.; Richardson, J. F.; Mashuta, M. S.; Buchanan, R. M.; Mukherjee, R. *Polyhedron* **1997**, *16*, 4331–4336.
152. Watson, A. A.; House, D. A.; Steel, P. J. *Inorg. Chim. Acta* **1987**, *130*, 167–176.
153. Lal, T. K.; Gupta, R.; Mahapatra, S.; Mukherjee, R. *Polyhedron* **1999**, *18*, 1743–1750.
154. Manikandan, P.; Justin Thomas, K. R.; Manoharan, P. T. *J. Chem. Soc., Dalton Trans.* **2000**, 2779–2785.
155. Manikandan, P.; Justin Thomas, K. R.; Manoharan, P. T. *Acta Cryst.* **2000**, *C56*, 308–309.
156. Gupta, R.; Mukherjee, R. *Polyhedron* **2001**, *20*, 2545–2549.
157. Astley, T.; Canty, A. J.; Hitchman, M. A.; Rowbottom, G. L.; Skelton, B. W.; White, A. H. *J. Chem. Soc., Dalton Trans.* **1991**, 1981–1990.
158. Karlin, K. D.; Dahlstrom, P. L.; Cozette, S. N.; Scensny, P. M.; Zubieta, J. *J. Chem. Soc., Chem. Comm.* **1981**, 881–882.
159. Karlin, K. D.; Hayes, J. C.; Gultneh, Y.; Cruse, R. W.; McKown, J. W.; Hutchinson, J. P.; Zubieta, J. *J. Am. Chem. Soc.* **1984**, *106*, 2121–2128.
160. Karlin, K. D.; Farooq, A.; Hayes, J. C.; Cohen, B. I.; Rowe, T. M.; Sinn, E.; Zubieta, J. *Inorg. Chem.* **1987**, *26*, 1271–1280.
161. Karlin, K. D.; Cohen, B. I.; Hayes, J. C.; Farooq, A.; Zubieta, J. *Inorg. Chem.* **1987**, *26*, 147–153.
162. Karlin, K. D.; Hayes, J. C.; Hutchinson, J. P.; Zubieta, J. *J. Chem. Soc., Chem. Commun.* **1983**, 376–378.
163. Karlin, K. D.; Cohen, B. I.; Farooq, A.; Liu, S.; Zubieta, J. *Inorg. Chim. Acta* **1988**, *153*, 9–11.
164. Karlin, K. D.; Cohen, B. I.; Jacobson, R. R.; Zubieta, J. *J. Am. Chem. Soc.* **1987**, *109*, 6194–6196.
165. Nasir, M. S.; Cohen, B. I.; Karlin, K. D. *J. Am. Chem. Soc.* **1992**, *114*, 2482–2494.

166. Murthy, N. N.; Mahroof-Tahir, M.; Karlin, K. D. *Inorg. Chem.* **2001**, *40*, 628–635.
167. Nasir, M. S.; Karlin, K. D.; McGowty, D.; Zubieta, J. *J. Am. Chem. Soc.* **1991**, *113*, 698–700.
168. Murthy, N. N.; Mahroof-Tahir, M.; Karlin, K. D. *J. Am. Chem. Soc.* **1993**, *115*, 10404–10405.
169. Gelling, O. J.; van Bolhuis, F.; Meetsma, A.; Feringa, B. L. *J. Chem. Soc., Chem. Commun.* **1988**, 552–554.
170. Drew, M. G. B.; Trocha-Grimshaw, J.; McKillop, K. P. *Polyhedron* **1989**, *8*, 2513–2515.
171. Ghosh, D.; Lal, T. K.; Ghosh, S.; Mukherjee, R. *J. Chem. Soc., Chem. Commun.* **1996**, 13–14.
172. Ghosh, D.; Mukherjee, R. *Inorg. Chem.* **1998**, *37*, 6597–6605.
173. Alzuet, G.; Casella, L.; Villa, M. L.; Carugo, O.; Gullotti, M. *J. Chem. Soc., Dalton Trans.* **1997**, 4789–4794 and references therein.
174. Ryan, S.; Adams, H.; Fenton, D. E.; Becker, M.; Schindler, S. *Inorg. Chem.* **1998**, *37*, 2134–2140.
175. Vigato, P. A.; Tamburini, S.; Fenton, D. E. *Coord. Chem. Rev.* **1990**, *106*, 25–170.
176. Spodine, E.; Manzur, J. *Coord. Chem. Rev.* **1992**, *119*, 171–198.
177. Suzuki, M.; Furutachi, H.; Ôkawa, H. *Coord. Chem. Rev.* **2000**, *200–202*, 105–129.
178. Ghosh, P.; Tyeklar, Z.; Karlin, K. D.; Jacobson, R. R.; Zubieta, J. *J. Am. Chem. Soc.* **1987**, *109*, 6889–6891.
179. Karlin, K. D.; Gultneh, Y.; Nicholson, T.; Zubieta, J. *Inorg. Chim.* **1985**, *24*, 3725–3727.
180. Paul, P. P.; Tyeklar, Z.; Farooq, A.; Karlin, K. D.; Liu, S.; Zubieta, J. *J. Am. Chem. Soc.*, **1990**, *112*, 2430–2432.
181. Schindler, S.; Szalda, D. J.; Creutz, C. *Inorg. Chem.* **1992**, *31*, 2255–2264.
182. Karlin, K. D.; Dahlstrom, P. L.; Dipierro, L. T.; Simon, R. A.; Zubieta, J. *J. Coord. Chem.* **1981**, *11*, 61–63.
183. Karlin, K. D.; Gan, Q.-F.; Farooq, A.; Liu, S.; Zubieta, J. *Inorg. Chem.* **1990**, *29*, 2549–2551.
184. Frey, S. T.; Sun, H. H. J.; Murthy, N. N.; Karlin, K. D. *Inorg. Chim. Acta* **1996**, *242*, 329–338.
185. Walsdorff, C.; Park, S.; Kim, J.; Heo, J.; Park, K.-M.; Oh, J.; Kim, K. *J. Chem. Soc., Dalton Trans.* **1999**, 923–929.
186. Itoh, S.; Kondo, T.; Komatsu, M.; Ohshiro, Y.; Li, C.; Kanehisa, N.; Kai, Y.; Fukuzumi, S. *J. Am. Chem. Soc.* **1995**, *117*, 4714–4715.
187. Itoh, S.; Nakao, H.; Berreau, L. M.; Kondo, T.; Komatsu, M.; Fukuzumi, S. *J. Am. Chem. Soc.* **1998**, *120*, 2890–2899.
188. Blain, I.; Bruno, P.; Giorgi, M.; Lojou, E.; Lexa, D.; Réglie, M. *Eur. J. Inorg. Chem.* **1998**, 1297–1304.
189. Blain, I.; Giorgi, M.; De Riggi, I.; Réglie, M. *Eur. J. Inorg. Chem.* **2000**, 393–398.
190. Blain, I.; Giorgi, M.; De Riggi, I.; Réglie, M. *Eur. J. Inorg. Chem.* **2001**, 205–211.
191. Holland, P. L.; Rodgers, K. R.; Tolman, W. B. *Angew. Chem. Int. Ed. Engl.* **1999**, *38*, 1139–1142.
192. Decker, H.; Dillinger, R.; Tuzcek, F. *Angew. Chem. Int. Ed. Engl.* **2000**, *39*, 1591–1595.
193. Spodine, E.; Manzur, J.; Garland, M. T.; Fackler, J. P., Jr.; Staples, R. J.; Trzcinska-Bancroft, B. *Inorg. Chim. Acta* **1993**, *203*, 73–80.
194. Csöreg, I.; Elman, B.; Högberg, K.; Moberg, C.; Nygren, M. *Inorg. Chem.* **1988**, *27*, 235–240.
195. Nasir, M. S.; Karlin, K. D.; Chen, Q.; Zubieta, J. *J. Am. Chem. Soc.* **1992**, *114*, 2264–2265.
196. Lee, D.-H.; Murthy, N. N.; Lin, Y.; Nasir, N. S.; Karlin, K. D. *Inorg. Chem.* **1997**, *36*, 6328–6334.
197. Pidcock, E.; DeBeer, S.; Obias, H. V.; Hedman, B.; Hodgson, K. O.; Karlin, K. D.; Solomon, E. I. *J. Am. Chem. Soc.* **1999**, *121*, 1870–1878.
198. Obias, H. V.; Lin, Y.; Murthy, N. N.; Pidcock, E.; Solomon, E. I.; Ralle, M.; Blackburn, N. J.; Neuhold, Y.-M.; Zuberbühler, A. D.; Karlin, K. D. *J. Am. Chem. Soc.* **1998**, *120*, 12960–12961.
199. Karlin, K. D.; McKown, J. W.; Hayes, J. C.; Hutchinson, J. P.; Zubieta, J. *Transition Met. Chem.* **1984**, *9*, 405–406.
200. Lee, S. C.; Holm, R. H. *Inorg. Chem.* **1993**, *32*, 4745–4753.
201. Karlin, K. D.; Gultneh, Y.; Hayes, J. C.; Zubieta, J. *Inorg. Chem.* **1984**, *23*, 519–521.
202. Palaniandavar, M.; Butcher, R. J.; Addison, A. W. *Inorg. Chem.* **1996**, *35*, 467–471.
203. Palaniandavar, M.; Mahadevan, S.; Köcherling, M.; Henkel, G. *J. Chem. Soc., Dalton Trans.* **2000**, 1151–1154.
204. Karlin, K. D.; Shi, J.; Hayes, J. C.; McKown, J. W.; Hutchinson, J. P.; Zubieta, J. *Inorg. Chim. Acta* **1984**, *91*, L3–L7.
205. Lee, D.-H.; Murthy, N. N.; Karlin, K. D. *Inorg. Chem.* **1996**, *35*, 804–805.
206. Kodera, M.; Shimakoshi, H.; Tachi, Y.; Katayama, K.; Kano, K. *Chem. Lett.* **1998**, 441–442.
207. Kodera, M.; Katayama, K.; Tachi, Y.; Kano, K.; Hirota, S.; Fujinami, S.; Suzuki, M. *J. Am. Chem. Soc.* **1999**, *121*, 11006–11007.
208. Karlin, K. D.; Hayes, J. C.; Juen, S.; Hutchinsonand, J.; Zubieta, P. J. *Inorg. Chem.* **1982**, *21*, 4106–4108.
209. Karlin, K. D.; Hayes, J. C.; Hutchinson, J. P.; Hyde, J. R.; Zubieta, J. *Inorg. Chim. Acta* **1982**, *64*, L219–L220.
210. Wei, N.; Murthy, N. N.; Karlin, K. D. *Inorg. Chem.* **1994**, *33*, 6093–6100.
211. Jacobson, R. R.; Tyeklar, Z.; Karlin, K. D.; Zubieta, J. *Inorg. Chem.* **1991**, *30*, 2035–2040.
212. Jacobson, R. R.; Tyeklar, Z.; Farooq, A.; Karlin, K. D.; Liu, S.; Zubieta, J. *J. Am. Chem. Soc.* **1988**, *110*, 3690–3692.
213. Tyeklar, Z.; Jacobson, R. R.; Wei, N.; Murthy, N. N.; Zubieta, J.; Karlin, K. D. *J. Am. Chem. Soc.* **1993**, *115*, 2677–2689.
214. Jiang, F.; Conry, R. R.; Bubacco, L.; Tyeklar, Z.; Jacobson, R. R.; Karlin, K. D.; Peisach, J. *J. Am. Chem. Soc.* **1993**, *115*, 2093–2102.
215. Komeda, N.; Nagao, H.; Adachi, G.; Suzuki, M.; Uehara, A.; Tanaka, K. *Chem. Lett.* **1993**, 1521–1524.
216. Komeda, N.; Nagao, H.; Kushi, Y.; Adachi, G.; Suzuki, M.; Uehara, A.; Tanaka, K. *Bull. Chem. Soc. Jpn.* **1995**, *68*, 581–589.
217. Nagao, H.; Komeda, N.; Mukaida, M.; Suzuki, M.; Tanaka, K. *Inorg. Chem.* **1996**, *35*, 6809–6815.
218. Lim, B. S.; Holm, R. H. *Inorg. Chem.* **1998**, *37*, 4898–4908.
219. Chuang, C.; Lim, K.; Chen, Q.; Zubieta, J.; Canary, J. W. *Inorg. Chem.* **1995**, *34*, 2562–2568.
220. Schatz, M.; Becker, M.; Thaler, F.; Hampel, F.; Schindler, S.; Jacobson, R. R.; Tyeklar, Z.; Murthy, N. N.; Ghosh, P.; Chen, Q.; Zubieta, J.; Karlin, K. D. *Inorg. Chem.* **2001**, *40*, 2312–2322.
221. Tyeklar, Z.; Paul, P. P.; Jacobson, R. R.; Farooq, A.; Karlin, K. D.; Zubieta, J. *J. Am. Chem. Soc.* **1989**, *111*, 388–389.
222. Rybak-Akimova, E. V.; Nazarenko, A. Y.; Chen, L.; Krieger, P. W.; Herrera, A. M.; Tarasov, V. V.; Robinson, P. D. *Inorg. Chim. Acta* **2001**, *324*, 1–15.
223. Börzel, H.; Comba, P.; Katsichtis, C.; Kiefer, W.; Lienke, A.; Nagel, V.; Pritzkow, H. *Chem. Eur. J.* **1999**, *5*, 1716–1721.

224. Börzel, H.; Comba, P.; Hagen, K. S.; Katsichtis, C.; Pritzkow, H. *Chem. Eur. J.* **2000**, *6*, 914–919.
225. McLachlan, G. A.; Fallon, G. D.; Martin, R. L.; Spiccia, L. *Inorg. Chem.* **1995**, *34*, 254–261.
226. Goodwin, J. A.; Stanbury, D. M.; Wilson, L. J.; Eigenbrot, C. W.; Scheidt, W. R. *J. Am. Chem. Soc.* **1987**, *109*, 2979–2991.
227. Mandel, J. B.; Douglas, B. E. *Inorg. Chim. Acta* **1989**, *155*, 55–69.
228. Marsich, N.; Nardin, G.; Randaccio, L.; Camus, A. *Inorg. Chim. Acta* **1998**, *278*, 237–240.
229. Coombs, T. D.; Brisdon, B. J.; Curtis, C. P.; Mahon, M. F.; Brewer, S. A.; Willis, C. R. *Polyhedron* **2001**, *20*, 2935–2943.
230. Bernhardt, P. V.; Comba, P.; Mahu-Rickenbach, A.; Stebler, S.; Steiner, S.; Várnagy, K.; Zehnder, M. *Inorg. Chem.* **1992**, *31*, 4194–4200.
231. Astley, T.; Ellis, P. J.; Freeman, H. C.; Hitchman, M. A.; Keene, F. R.; Tiekink, E. R. T. *J. Chem. Soc., Dalton Trans.* **1995**, 595–601.
232. Szczepura, L. F.; Witham, L. M.; Takeuchi, K. J. *Coord. Chem. Rev.* **1998**, *174*, 5–32.
233. Jonas, R. T.; Stack, T. D. P. *Inorg. Chem.* **1998**, *37*, 6615–6629.
234. Arnold, P. J.; Davies, S. C.; Dilworth, J. R.; Durrant, M. C.; Griffiths, D. V.; Hughes, D. L.; Richards, R. L.; Sharpe, P. C. *J. Chem. Soc., Dalton Trans.* **2001**, 736–746.
235. Kodera, M.; Tachi, Y.; Kita, T.; Kobushi, H.; Sumi, Y.; Kano, K.; Shiro, M.; Koikawa, M.; Tokii, T.; Ohba, M.; Okawa, H. *Inorg. Chem.* **2000**, *39*, 226–234.
236. Müller, E.; Piguët, C.; Bernardinelli, G.; Williams, A. F. *Inorg. Chem.* **1988**, *27*, 849–855.
237. Garber, T.; Van Wallendael, S.; Rillema, D. P.; Kirk, M.; Hatfield, W. E.; Welch, J. H.; Singh, P. *Inorg. Chem.* **1990**, *29*, 2863–2868.
238. Yao, Y.; Perkovic, M. W.; Rillema, D. P.; Woods, C. *Inorg. Chem.* **1992**, *31*, 3956–3962.
239. Wang, Z.; Reibenspies, J.; Motekaitis, J.; Martell, A. E. *J. Chem. Soc., Dalton Trans.* **1995**, 1511–1518.
240. Dossing, A.; Hazell, A.; Toftlund, H. *Acta Chem. Scand.* **1996**, *50*, 95–101.
241. Lee, D.-H.; Murthy, N. N.; Karlin, K. D. *Inorg. Chem.* **1997**, *36*, 5785–5792.
242. Thomas, A. M.; Mandal, G. C.; Tiwary, S. K.; Rath, R. K.; Chakravarty, A. R. *J. Chem. Soc., Dalton Trans.* **2000**, 1395–1396.
243. Murphy, G.; Nagle, P.; Murphy, B.; Hathaway, B. *J. Chem. Soc., Dalton Trans.* **1997**, 2645–2652.
244. Murphy, G.; Murphy, C.; Murphy, B.; Hathaway, B. *J. Chem. Soc., Dalton Trans.* **1997**, 2653–2660.
245. Murphy, G.; O'sullivan, C.; Murphy, B.; Hathaway, B. *Inorg. Chem.* **1998**, *37*, 240–248.
246. Bush, P. M.; Whitehead, J. P.; Pink, C. C.; Gramm, E. C.; Eglin, J. L.; Watton, S. P.; Pence, L. E. *Inorg. Chem.* **2001**, *40*, 1871–1877.
247. Tran, D.; Skelton, B. W.; White, A. H.; Laverman, L. E.; Ford, P. C. *Inorg. Chem.* **1998**, *37*, 2505–2511.
248. Masood, M. A.; Hodgson, D. J. *Inorg. Chem.* **1993**, *32*, 4839–4844.
249. Pezet, F.; Sasaki, I.; Daran, J.-C.; Hydrio, J.; Ait-Haddou, H.; Balavoine, G. *Eur. J. Inorg. Chem.* **2001**, 2669–2674.
250. Haasnoot, J. G.; Driessen, W. L.; Reedijk, J. *Inorg. Chem.* **1984**, *23*, 2803–2807 and references therein.
251. Kabešoká, M.; Boca, R.; Melnik, M.; Vahgura, D.; Dunaj-Jurco, M. *Coord. Chem. Rev.* **1995**, *140*, 115–135.
252. Oshio, H.; Toriumi, K.; Hayashi, Y. *J. Chem. Soc., Dalton Trans.* **1990**, 293–298.
253. Oshio, H. *J. Chem. Soc., Dalton Trans.* **1990**, 2985–2989.
254. Kato, M.; Muto, Y. *Coord. Chem. Rev.* **1988**, *92*, 45–83.
255. Kahn, O. *Adv. Inorg. Chem.* **1995**, *43*, 179–259.
256. Murray, K. S. *Adv. Inorg. Chem.* **1995**, *43*, 261–358.
257. Munno, G. De; Julve, M.; Verdaguer, M.; Bruno, G. *Inorg. Chem.* **1993**, *32*, 2215–2220.
258. Müller, E.; Bernardinelli, G.; Reedijk, J. *Inorg. Chem.* **1996**, *35*, 1952–1957.
259. Uma, R.; Palaniandavar, M.; Butcher, R. J. *J. Chem. Soc., Dalton Trans.* **1996**, 2061–2066.
260. Itoh, S.; Taki, M.; Fukuzumi, S. *Coord. Chem. Rev.* **2000**, *198*, 3–20.
261. Jazdzewski, B. A.; Tolman, W. B. *Coord. Chem. Rev.* **2000**, *200–202*, 633–685 and references therein.
262. Chaudhuri, P.; Wieghardt, K. *Prog. Inorg. Chem.* **2001**, *50*, 151–216 and references therein.
263. Zanello, P.; Tamburini, S.; Vigato, P. A.; Mazzocchin, G. A. *Coord. Chem. Rev.* **1987**, *77*, 165–273.
264. Fenton, D. E. *Chem. Soc. Rev.* **1999**, *28*, 159–168.
265. Sorrell, T. N.; Jameson, D. L.; O'Connor, C. J. *Inorg. Chem.* **1982**, *23*, 190–195.
266. Sorrell, T. N.; O'Connor, C. J.; Anderson, O. P.; Reibenspies, J. H. *J. Am. Chem. Soc.* **1985**, *107*, 4199–4206.
267. Higgs, T. C.; Ji, D.; Czernusiewicz, R. S.; Carrano, C. J. *Inorg. Chim. Acta* **1998**, *273*, 14–23.
268. Dutta, S. K.; Nanda, K. K.; Flörke, U.; Bhadhbade, M.; Nag, K. *J. Chem. Soc., Dalton Trans.* **1996**, 2371–2379.
269. Fujisawa, K.; Iwata, Y.; Kitajima, N.; Higashimura, H.; Kubota, M.; Miyashita, Y.; Yamada, Y.; Okamoto, K. *Chem. Lett.* **1999**, 739–740 and references therein.
270. Halcrow, M. A.; Chia, L. M. L.; Liu, X.; McInnes, E. J. L.; Yellowlees, L. J.; Mabbs, F. E.; Scowen, I. J.; McPartlin, M.; Davies, J. E. *J. Chem. Soc., Dalton Trans.* **1999**, 1753–1762.
271. Halcrow, M. A.; Chia, L. M. L.; Liu, X.; McInnes, E. J. L.; Yellowlees, L. J.; Mabbs, F. E.; Davies, J. E. *J. Chem. Soc., Chem. Commun.* **1998**, 2465–2466.
272. Gupta, R.; Mukherjee, S.; Mukherjee, R. *J. Chem. Soc., Dalton Trans.* **1999**, 4025–4030.
273. Rajendra, U.; Viswanathan, R.; Palaniandavar, M.; Lakshminarayanan, M. *J. Chem. Soc., Dalton Trans.* **1992**, 3563–3564.
274. Uma, R.; Viswanathan, R.; Palaniandavar, M.; Lakshminarayanan, M. *J. Chem. Soc., Dalton Trans.* **1994**, 1219–1226.
275. Vaidyanathan, M.; Viswanathan, R.; Palaniandavar, M.; Balasubramanian, T.; Prabhakaran, P.; Muthiah, T. P. *Inorg. Chem.* **1998**, *37*, 6418–6427.
276. Vaidyanathan, M.; Palaniandavar, M.; Gopalan, R. S. *Inorg. Chim. Acta* **2001**, *324*, 241–251.
277. Adams, H.; Bailey, N. A.; Fenton, D. E.; He, Q.; Ohba, M.; Okawa, H. *Inorg. Chim. Acta* **1994**, *215*, 1–3.
278. Adams, H.; Bailey, N. A.; Rodriguez de Barbarin, C. O.; Fenton, D. E.; He, Q.-Y. *J. Chem. Soc., Dalton Trans.* **1995**, 2321–2331.
279. Adams, H.; Bailey, N. A.; Campbell, I. K.; Fenton, D. E.; He, Q.-Y. *J. Chem. Soc., Dalton Trans.* **1996**, 2233–2237.

280. Neves, A.; Verani, C. N.; de Brito, M. A.; Vencato, I.; Mangrich, A.; Oliva, G.; Souza, D. D. H. F.; Batista, A. *Inorg. Chim. Acta* **1999**, *290*, 207–212.
281. Jeffery, J. C.; Schatz, E.; Ward, M. D. *J. Chem. Soc., Dalton Trans.* **1992**, 1921–1927.
282. Maher, J. P.; Rieger, P. H.; Thornton, P.; Ward, M. D. *J. Chem. Soc., Dalton Trans.* **1992**, 3353–3356.
283. Holligan, B. M.; Jeffery, J. C.; Ward, M. D. *J. Chem. Soc., Dalton Trans.* **1992**, 3337–3344.
284. Jeffery, J. C.; Maher, J. P.; Otter, C. A.; Thornton, P.; Ward, M. D. *J. Chem. Soc., Dalton Trans.* **1995**, 819–824.
285. Wang, Y.; Stack, T. D. P. *J. Am. Chem. Soc.* **1996**, *118*, 13097–13098.
286. Wang, Y.; duBois, J. L.; Hedman, B.; Hodgson, K. O.; Stack, T. D. P. *Science* **1998**, *279*, 537–540.
287. Krüger, H.-J. *Angew. Chem. Int. Ed. Engl.* **1999**, *38*, 627–631.
288. Chaudhuri, P.; Hess, M.; Weyhermüller, T.; Wieghardt, K. *Angew. Chem. Int. Ed. Engl.* **1999**, *38*, 1095–1098.
289. Chaudhuri, P.; Hess, M.; Flörke, U.; Wieghardt, K. *Angew. Chem. Int. Ed. Engl.* **1998**, *37*, 2217–2220.
290. Chaudhuri, P.; Hess, M.; Müller, J.; Hildenbrand, K.; Bill, E.; Weyhermüller, T.; Wieghardt, K. *J. Am. Chem. Soc.* **1999**, *121*, 9599–9610.
291. Benisvy, L.; Blake, A. J.; Collison, D.; Davies, E. S.; Garner, C. D.; McInnes, E. J. L.; McMaster, J.; Whittaker, G.; Wilson, C. *Chem. Commun.* **2001**, 1824–1825.
292. Whittaker, M. M.; Duncan, W. R.; Whittaker, J. W. *Inorg. Chem.* **1996**, *35*, 382–386.
293. Itoh, S.; Takayama, S.; Arakawa, R.; Furuta, A.; Komatsu, M.; Ishida, A.; Takamuku, S.; Fukuzumi, S. *Inorg. Chem.* **1997**, *36*, 1407–1416.
294. Ochs, C.; Hahn, F. E.; Fröhlich, R. *Eur. J. Inorg. Chem.* **2001**, 2427–2436.
295. Ruf, M.; Pierpont, C. G. *Angew. Chem. Int. Ed. Engl.* **1998**, *37*, 1736–1739.
296. Bailey, N. A.; Fenton, D. E.; Lay, J.; Roberts, P. B.; Latour, J.-M.; Limosin, D. *J. Chem. Soc., Dalton Trans.* **1986**, 2681–2689.
297. Hay, P. J.; Thiebeault, J. C.; Hoffmann, R. *J. Am. Chem. Soc.* **1975**, *97*, 4884–4899.
298. Kahn, O. *Inorg. Chim. Acta* **1982**, *62*, 3–14.
299. Hatfield, W. E. *Comments Inorg. Chem.* **1981**, *1*, 105–121.
300. Adams, H.; Candeland, G.; Crane, J. D.; Fenton, D. E.; Smith, A. J. *J. Chem. Soc., Chem. Commun.* **1990**, 93–95.
301. Crane, J. D.; Fenton, D. E.; Latour, J. M.; Smith, A. J. *J. Chem. Soc., Dalton Trans.* **1991**, 2979–2987.
302. Adams, H.; Bailey, N. A.; Fenton, D. E.; Papageorgiou, G. *J. Chem. Soc., Dalton Trans.* **1995**, 1883–1886.
303. Uozumi, S.; Ohba, M.; Ōkawa, H.; Fenton, D. E. *Chem. Lett.* **1997**, 673–674.
304. Adams, H.; Fenton, D. E.; Haque, S. R.; Heath, S. L.; Ohba, M.; Ōkawa, H.; Spey, S. E. *J. Chem. Soc., Dalton Trans.* **2000**, 1849–1856.
305. Nishida, Y.; Tokii, T.; Mori, Y. *J. Chem. Soc., Chem. Commun.* **1988**, 675–676.
306. Dapporto, P.; Formica, M.; Fusi, V.; Micheloni, M.; Paoli, P.; Pontellini, R.; Rossi, P. *Inorg. Chem.* **2000**, *39*, 4663–4665.
307. Gelling, O. J.; Meetsma, A.; Feringa, B. L. *Inorg. Chem.* **1990**, *29*, 2816–2822.
308. Lubben, M.; Hage, R.; Meetsma, A.; Bÿma, K.; Feringa, B. L. *Inorg. Chem.* **1995**, *34*, 2217–2224.
309. Mallah, T.; Kahn, O.; Gouteron, J.; Jeannin, S.; Jeannin, Y.; O'Connor, C. J. *Inorg. Chem.* **1987**, *26*, 1375–1380.
310. Bertocello, K.; Fallon, G. D.; Hodgkin, J. H.; Murray, K. S. *Inorg. Chem.* **1988**, *27*, 4750–4758.
311. Rajendiran, T. M.; Kannappan, R.; Venkatesan, R.; Rao, P. S.; Kandaswamy, M. *Polyhedron* **1999**, *18*, 3085–3091.
312. Amudha, P.; Kandaswamy, M.; Govindasamy, L.; Velmurugan, D. *Inorg. Chem.* **1998**, *37*, 4486–4492.
313. Asokan, A.; Varghese, B.; Manoharan, P. T. *Inorg. Chem.* **1999**, *38*, 4393–4399.
314. Maekawa, M.; Kitagawa, S.; Munakata, M.; Masuda, H. *Inorg. Chem.* **1989**, *28*, 1904–1909.
315. Lorösch, J.; Haase, W. *Inorg. Chim. Acta* **1985**, *108*, 35–40.
316. Oberhausen, K. J.; Richardson, J. F.; Buchanan, R. M.; McCusker, J. K.; Hendrickson, D. N.; Latour, J.-M. *Inorg. Chem.* **1991**, *30*, 1357–1365.
317. Berends, H. P.; Stephan, D. W. *Inorg. Chim. Acta* **1985**, *99*, L53–L54.
318. Berends, H. P.; Stephan, D. W. *Inorg. Chem.* **1987**, *26*, 749–754.
319. Kamaras, P.; Cajulis, M. C.; Rapta, M.; Brewer, G. A.; Jameson, G. B. *J. Am. Chem. Soc.* **1994**, *116*, 10334–10335.
320. Nishida, Y.; Shimo, H.; Maehara, H.; Kida, S. *J. Chem. Soc., Dalton Trans.* **1985**, 1945–1951.
321. Schindler, S.; Elias, H.; Paulus, H. Z. *Naturforsch* **1990**, *45b*, 607–618.
322. Maloney, J. J.; Glogowski, M.; Rohrbach, D. F.; Urbach, F. L. *Inorg. Chim. Acta* **1987**, *127*, L33–L35.
323. Torelli, S.; Belle, C.; Gautier-Luneau, I.; Pierre, J. L.; Saint-Aman, E.; Latour, J. M.; Le Pape, L.; Luneau, D. *Inorg. Chem.* **2000**, *39*, 3526–3536.
324. Benzekri, A.; Dubourdeaux, P.; Latour, J.-M.; Laugier, J.; Rey, P. *Inorg. Chem.* **1988**, *27*, 3710–3716.
325. Holz, R. C.; Brink, J. M.; Gobena, F. T.; O'Connor, C. J. *Inorg. Chem.* **1994**, *33*, 6086–6092.
326. Reim, J.; Krebs, B. *J. Chem. Soc., Dalton Trans.* **1997**, 3793–3804.
327. Reim, J.; Krebs, B. *Angew. Chem. Int. Ed. Engl.* **1994**, *33*, 1969–1971.
328. Reim, J.; Werner, R.; Haase, W.; Krebs, B. *Chem. Eur. J.* **1998**, *4*, 289–298.
329. Teipel, S.; Griesar, K.; Haase, W.; Krebs, B. *Inorg. Chem.* **1994**, *33*, 456–464.
330. Black, D.; Blake, A. J.; Dancey, K. P.; Harrison, A.; McPartlin, M.; Parsons, S.; Tasker, P. A.; Whittaker, G.; Schröder, M. *J. Chem. Soc., Dalton Trans.* **1998**, 3953–3960.
331. Sangeetha, N. R.; Baradi, K.; Gupta, R.; Pal, C. K.; Manivannan, V.; Pal, S. *Polyhedron* **1999**, *18*, 1425–1429 and references therein.
332. Ikeda, K.; Ohba, M.; Ōkawa, H. *J. Chem. Soc., Dalton Trans.* **2001**, 3119–3124.
333. Fenton, D. E.; Westwood, G. P.; Bashall, A.; McPartlin, M.; Scowen, I. J. *J. Chem. Soc., Dalton Trans.* **1994**, 2213–2214.
334. Das, G.; Shukla, R.; Mandal, S.; Singh, R.; Bharadwaj, P. K.; van Hall, J.; Whitmire, K. H. *Inorg. Chem.* **1997**, *36*, 323–329.
335. McKee, V.; Zvagulis, M.; Reed, C. A. *Inorg. Chem.* **1985**, *24*, 2914–2919.
336. McKee, V.; Zvagulis, M.; Dagdigian, J. V.; Patch, M. G.; Reed, C. A. *J. Am. Chem. Soc.* **1984**, *106*, 4765–4772.
337. McKee, V.; Dagdigian, J. V.; Bau, R.; Reed, C. A. *J. Am. Chem. Soc.* **1981**, *103*, 7000–7001.
338. Mikuriya, M.; Okawa, H.; Kida, S. *Bull. Chem. Soc. Jpn.* **1982**, *55*, 1086–1091 and references therein.

339. Mazurek, W.; Berry, K. J.; Murray, K. S.; O'Connor, M. J.; Snow, M. R.; Wedd, A. G. *Inorg. Chem.* **1982**, *21*, 3071–3080.
340. Mazurek, W.; Kennedy, B. J.; Murray, K. S.; O'Connor, M. J.; Rodgers, J. R.; Snow, M. R.; Wedd, A. G.; Zwack, P. R. *Inorg. Chem.* **1985**, *24*, 3258–3264.
341. Doman, T. N.; Williams, D. E.; Banks, J. F.; Buchanan, R. M.; Chang, H.-R.; Webb, R. J.; Hendrickson, D. N. *Inorg. Chem.* **1990**, *29*, 1058–1062.
342. Nishida, Y.; Kida, S. *J. Chem. Soc., Dalton Trans.* **1986**, 2633–2640.
343. Nishida, S.; Takeuchi, M.; Takahashi, K.; Kida, S. *Chem. Lett.* **1985**, 631–634.
344. Nishida, Y.; Takeuchi, M.; Takahashi, K.; Kida, S. *Chem. Lett.* **1983**, 1815–1818.
345. Kawata, T.; Yamanaka, M.; Ohba, S.; Nishida, Y.; Namagatsu, M.; Tokii, T.; Kato, M.; Steward, O. W. *Bull. Chem. Soc. Jpn.* **1992**, *65*, 2739–2747.
346. Nishida, Y.; Kida, S. *Inorg. Chem.* **1988**, *27*, 447–452.
347. Nie, H.; Aubin, M. J.; Mashuta, M. S.; Porter, R. A.; Richardson, J. F.; Hendrickson, D. A.; Buchanan, R. M. *Inorg. Chem.* **1996**, *35*, 3325–3334.
348. Kodera, M.; Terasako, N.; Kita, T.; Tachi, Y.; Kano, K.; Yamazaki, M.; Koikawa, M.; Tokii, T. *Inorg. Chem.* **1997**, *36*, 3861–3868.
349. Zippel, F.; Ahlers, F.; Werner, R.; Haase, W.; Nolting, H.-F.; Krebs, B. *Inorg. Chem.* **1996**, *35*, 3409–3419 and references therein.
350. Gamez, P.; von Harras, J.; Roubeau, O.; Driessen, W. L.; Reedijk, J. *Inorg. Chim. Acta* **2001**, *324*, 27–34 and references therein.
351. Malachowski, M. R.; Carden, J.; Davidson, M. G.; Driessen, W. L.; Reedijk, J. *Inorg. Chim. Acta* **1997**, *257*, 59–67.
352. Karlin, K. D.; Sanyal, I.; Farooq, A.; Jacobson, R. R.; Shaikh, S. N.; Zubietta, J. *Inorg. Chim. Acta* **1990**, *174*, 13–15.
353. Frey, S. T.; Murthy, N. N.; Weintraub, S. T.; Thompson, L. K.; Karlin, K. D. *Inorg. Chem.* **1997**, *36*, 956–957.
354. Gupta, R.; Hotchandani, R.; Mukherjee, R. *Polyhedron* **2000**, *19*, 1429–1435.
355. Neves, A.; Rossi, L. M.; Vencato, I.; Drago, V.; Haase, W.; Werner, R. *Inorg. Chim. Acta* **1998**, *281*, 111–115.
356. Masuda, H.; Odani, A.; Yamauchi, O. *Inorg. Chem.* **1989**, *28*, 624–625.
357. Gentschev, P.; Lüken, M.; Möller, N.; Rompel, A.; Krebs, B. *Inorg. Chem. Commun.* **2001**, *4*, 753–756.
358. Chung, Y.-H.; Wei, H.-H.; Liu, Y.-H.; Lee, G.-H.; Wang, Y. *J. Chem. Soc., Dalton Trans.* **1997**, 2825–2828 and references therein.
359. Bharadwaj, P. K.; Potenza, J. A.; Schugar, H. J. *J. Am. Chem. Soc.* **1986**, *108*, 1351–1352.
360. Karlin, K. D.; Cruse, R. W.; McKown, J. W.; Hayes, J. C.; Dahlstrom, P. L.; Zubietta, J. *Transition Met. Chem.* **1984**, *9*, 404–405.
361. Glass, R. S.; Sabahi, M.; Hojjatie, M.; Wilson, G. S. *Inorg. Chem.* **1987**, *26*, 2194–2196.
362. Nishida, Y.; Takahashi, K. *Inorg. Chem.* **1988**, *27*, 1406–1410.
363. Escriche, L.; Sanz, M.; Casabó, J.; Teixidor, F.; Molins, E.; Miravittles, C. *J. Chem. Soc., Dalton Trans.* **1989**, 1739–1743.
364. Masuda, H.; Sugimori, T.; Kohzuma, T.; Odani, A.; Yamauchi, O. *Bull. Chem. Soc. Jpn.* **1992**, *65*, 786–793.
365. Ambundo, E. A.; Deydier, M.-V.; Grall, A. J.; Aguera-Vega, N.; Dressel, L. T.; Cooper, T. H.; Heeg, M. J.; Ochrymowycz, L. A.; Rorabacher, D. B. *Inorg. Chem.* **1999**, *38*, 4233–4242 and references therein.
366. Champloy, F.; Benali-Chérif, N.; Bruno, P.; Blain, I.; Pierrot, M.; Réglier, M. *Inorg. Chem.* **1998**, *37*, 3910–3918.
367. Kodera, M.; Kita, T.; Miura, I.; Nakayama, N.; Kawata, T.; Kano, K.; Hirota, S. *J. Am. Chem. Soc.* **2001**, *123*, 7715–7716.
368. Santra, B. K.; Reddy, P. A. N.; Nethaji, M.; Chakravarty, A. R. *J. Chem. Soc., Dalton Trans.* **2001**, 3553–3555.
369. Comba, P.; Gavriš, S. P.; Lampeka, Y. D.; Lightfoot, P.; Peters, A. *J. Chem. Soc., Dalton Trans.* **1999**, 4099–4102.
370. Costes, J.-P.; Dahan, F.; Laurent, J.-P. *J. Chem. Soc., Dalton Trans.* **1989**, 1017–1025.
371. Cervera, B.; Sanz, J. L.; Ibáñez, M. J.; Vila, G.; Lloret, F.; Julve, M.; Ruiz, R.; Ottenwaelder, X.; Aukauloo, A.; Poussereau, S.; Journaux, Y.; Muñoz, M. C. *J. Chem. Soc., Dalton Trans.* **1998**, 781–790.
372. Ruiz, R.; Faus, J.; Lloret, F.; Julve, M.; Journaux, Y. *Coord. Chem. Rev.* **1999**, *193–195*, 1069–1117.
373. Lockwood, M. A.; Blublaugh, T. J.; Collier, A. M.; Lovell, S.; Mayer, J. M. *Angew. Chem. Int. Ed. Engl.* **1999**, *38*, 225–227.
374. Hecht, S. M. *Acc. Chem. Res.* **1986**, *19*, 383–391.
375. Stubbe, J.; Kozarich, J. W. *Chem. Rev.* **1987**, *87*, 1107–1136.
376. Stubbe, J.; Kozarich, J. W.; Wu, W.; Vanderwall, D. E. *Acc. Chem. Res.* **1996**, *29*, 322–330.
377. Brown, S. J.; Tao, X.; Stephan, D. W.; Mascharak, P. K. *Inorg. Chem.* **1986**, *25*, 3377–3384.
378. Brown, S. J.; Mascharak, P. K.; Stephan, D. W. *J. Am. Chem. Soc.* **1988**, *110*, 1996–1997.
379. Brown, S. J.; Hudson, S. E.; Stephan, D. W.; Mascharak, P. K. *Inorg. Chem.* **1989**, *8*, 468–477.
380. Chavez, F. A.; Olmstead, M. M.; Mascharak, P. K. *Inorg. Chem.* **1996**, *35*, 1410–1412.
381. Rowland, J. M.; Olmstead, M. M.; Mascharak, P. K. *Inorg. Chem.* **2000**, *39*, 5326–5332.
382. Rowland, J. M.; Thornton, M. L.; Olmstead, M. M.; Mascharak, P. K. *Inorg. Chem.* **2001**, *40*, 1069–1073.
383. Marlin, D. S.; Olmstead, M. M.; Mascharak, P. K. *Inorg. Chem.* **2001**, *40*, 7003–7008.
384. Kimura, E.; Kurosaki, H.; Kurogi, Y.; Shionoya, M.; Shiro, M. *Inorg. Chem.* **1992**, *31*, 4314–4321.
385. Kurosaki, H.; Hayashi, K.; Ishikawa, Y.; Goto, M.; Inada, K.; Taniguchi, I.; Shionoya, M.; Kimura, E. *Inorg. Chem.* **1999**, *38*, 2824–2832.
386. Shepherd, R. E.; Lomis, T. J.; Koepsel, R. R.; Hedge, R.; Mistry, J. S. *Inorg. Chim. Acta* **1990**, *171*, 139–149.
387. Amadéi, E.; Alilou, E. H.; Eydoux, F.; Pierrot, M.; Réglier, M.; Waegell, B. *J. Chem. Soc., Chem. Commun.* **1992**, 1782–1784.
388. Alilou, E. H.; Amadei, E.; Giorgi, M.; Pierrot, M.; Réglier, M. *J. Chem. Soc., Dalton Trans.* **1993**, 549–557.
389. Ray, M.; Mukherjee, R.; Richardson, J. F.; Mashuta, M. S.; Buchanan, R. M. *J. Chem. Soc., Dalton Trans.* **1994**, 965–969 and references therein.
390. Patra, A. K.; Ray, M.; Mukherjee, R. *J. Chem. Soc., Dalton Trans.* **1999**, 2461–2466.
391. Patra, A. K.; Ray, M.; Mukherjee, R. *Polyhedron* **2000**, *19*, 1423–1428.
392. Kawamoto, T.; Hammes, B. S.; Ostrander, R.; Rheingold, A. L.; Borovik, A. S. *Inorg. Chem.* **1998**, *37*, 3424–3427.

393. Kajikawa, Y.; Sakurai, T.; Azuma, N.; Kohno, S.; Tsuboyama, S.; Kobayashi, K.; Mukai, K.; Ishizu, K. *Bull. Chem. Soc. Jpn.* **1984**, *57*, 1454–1458.
394. Kajikawa, Y.; Azuma, N.; Tajima, K. *Inorg. Chim. Acta* **1998**, *283*, 61–71.
395. Harata, M.; Jitsukawa, K.; Masuda, H.; Einaga, H. *J. Am. Chem. Soc.* **1994**, *116*, 10817–10818.
396. Berreau, L. M.; Mahapatra, S.; Halfen, J. A.; Young, V. G. Jr.; Tolman, W. B. *Inorg. Chem.* **1996**, *35*, 6339–6342.
397. Harata, M.; Jitsukawa, K.; Masuda, H.; Einaga, H. *Chem. Lett.* **1996**, 813–814.
398. Harata, M.; Jitsukawa, K.; Masuda, H.; Einaga, H. *Chem. Lett.* **1995**, 61–62.
399. Harata, M.; Jitsukawa, K.; Masuda, H.; Einaga, H. *Bull. Chem. Soc. Jpn.* **1998**, *71*, 637–645.
400. Wada, A.; Harata, M.; Hasegawa, K.; Jitsukawa, K.; Masuda, H.; Mukai, M.; Kitagawa, T.; Einaga, H. *Angew. Chem. Int. Ed. Engl.* **1998**, *37*, 798–799.
401. Harata, M.; Hasegawa, K.; Jitsukawa, K.; Masuda, H.; Einaga, H. *Bull. Chem. Soc. Jpn.* **1998**, *71*, 1031–1038.
402. Harata, M.; Jitsukawa, K.; Masuda, H.; Einaga, H. *J. Coord. Chem.* **1998**, *44*, 311–324.
403. Jitsukawa, K.; Harata, M.; Arii, H.; Sakurai, H.; Masuda, H. *Inorg. Chim. Acta* **2001**, *324*, 108–116.
404. Challita-Bechara, A.; Chiumia, G. C.; Draig, D. C.; Phillips, D. J.; Rae, A. D. *Inorg. Chim. Acta* **1998**, *271*, 210–216.
405. Folgado, J. V.; Martínez-Tamayo, E.; Beltrán-Porter, A.; Beltrán-Porter, D. *Polyhedron* **1989**, *8*, 1077–1083.
406. Gupta, M.; Mathur, P.; Butcher, R. J. *Inorg. Chem.* **2001**, *40*, 878–885.
407. Kurosaki, H.; Sharma, R. K.; Aoki, S.; Inoue, T.; Okamoto, Y.; Sugiura, Y.; Doi, M.; Ishida, T.; Otsuka, M.; Goto, M. *J. Chem. Soc., Dalton Trans.* **2001**, 441–447.
408. Sunatsuki, Y.; Nakamura, M.; Matsumoto, N.; Kai, F. *Bull. Chem. Soc. Jpn.* **1997**, *70*, 1851–1858.
409. Sunatsuki, Y.; Matsuo, T.; Nakamura, M.; Kai, F.; Matsumoto, N.; Tuchagues, J.-P. *Bull. Chem. Soc. Jpn.* **1998**, *71*, 2611–2619.
410. Halfen, J. A.; Mahapatra, S.; Olmstead, M. M.; Tolman, W. B. *J. Am. Chem. Soc.* **1994**, *116*, 2173–2174.
411. Halfen, J. A.; Tolman, W. B. *J. Am. Chem. Soc.* **1994**, *116*, 5475–5476.
412. Halfen, J. A.; Mahapatra, S.; Wilkinson, E. C.; Gengenbach, A. J.; Young, V. G., Jr.; Que, L., Jr.; Tolman, W. B. *J. Am. Chem. Soc.* **1996**, *118*, 763–776.
413. Schneider, J. L.; Young, V. G., Jr.; Tolman, W. B. *Inorg. Chem.* **1996**, *35*, 5410–5411.
414. Halfen, J. A.; Young, V. G., Jr.; Tolman, W. B. *Inorg. Chem.* **1998**, *37*, 2102–2103.
415. Berreau, L. M.; Mahapatra, S.; Halfen, J. A.; Houser, R. P.; Young, V. G., Jr.; Tolman, W. B. *Angew. Chem. Int. Ed. Engl.* **1999**, *38*, 207–210.
416. Lam, B. M. T.; Halfen, J. A.; Young, V. G., Jr.; Hagadorn, J. R.; Holland, P. L.; Lledós, A.; Cucurull-Sánchez, L.; Novoa, J. J.; Alvarez, S.; Tolman, W. B. *Inorg. Chem.* **2000**, *39*, 4059–4072.
417. Halfen, J. A.; Young, V. G. Jr.; Tolman, W. B. *Angew. Chem. Int. Ed. Engl.* **1996**, *35*, 1687–1690.
418. Halfen, J. A.; Jazdzewski, B. A.; Mahapatra, S.; Berreau, L. M.; Wilkinson, E. C.; Que, L. Jr.; Tolman, W. B. *J. Am. Chem. Soc.* **1997**, *119*, 8217–8227.
419. Müller, J.; Weyhermüller, T.; Bill, E.; Hildebrandt, P.; Ould-Moussa, L.; Glaser, T.; Wieghardt, K. *Angew. Chem. Int. Ed. Engl.* **1998**, *37*, 616–619.
420. Halfen, J. A.; Fox, D. C.; Mehn, M. P.; Que, L. Jr. *Inorg. Chem.* **2001**, *40*, 5060–5061.
421. Chaudhuri, P.; Ventur, D.; Wieghardt, K.; Peters, E.-M.; Peters, K.; Simon, A. *Angew. Chem. Int. Ed. Engl.* **1985**, *24*, 57–59.
422. Chaudhuri, P.; Oder, K.; Weighardt, K.; Weiss, J.; Reedijk, J.; Hinrichs, W.; Wood, J.; Ozarowski, A.; Stratemaier, H.; Reinen, D. *Inorg. Chem.* **1986**, *25*, 2951–2958.
423. Auerbach, U.; Eckert, U.; Weighardt, K.; Nuber, B.; Weiss, J. *Inorg. Chem.* **1990**, *29*, 938–944.
424. Chaudhuri, P.; Karpenstein, I.; Winter, M.; Butzlaff, C.; Bill, E.; Trautwein, A. X.; Flörke, U.; Haupt, H.-J. *J. Chem. Soc., Chem. Commun.* **1992**, 321–322.
425. Schlager, O.; Wieghardt, K.; Nuber, B. *Inorg. Chem.* **1995**, *34*, 6449–6455.
426. Batten, S. R.; Spiccia, L.; Templar, C. E. *Acta Cryst.* **2001**, *E57*, m265–m266.
427. Blake, A. J.; Fallis, I. A.; Gould, R. O.; Parsons, S.; Ross, S. A.; Schröder, M. *J. Chem. Soc., Dalton Trans.* **1996**, 4379–4387.
428. Lindoy, L. F. *Adv. Inorg. Chem.* **1998**, *45*, 75–125.
429. Chartres, J. D.; Lindoy, L. F.; Meehan, G. V. *Coord. Chem. Rev.* **2001**, *216–217*, 249–286.
430. Farrugia, L. J.; Lovatt, P. A.; Peacock, R. D. *J. Chem. Soc., Dalton Trans.* **1997**, 911–912.
431. Graham, B.; Hearn, M. T. W.; Junk, P. C.; Kepert, C. M.; Fabbs, F. E.; Moubaraki, B.; Murray, K. S.; Spiccia, L. *Inorg. Chem.* **2001**, *40*, 1536–1543 and references therein.
432. Spiccia, L.; Graham, B.; Hearn, M. T. W.; Lazarev, G.; Moubaraki, B.; Murray, K. S.; Tiekink, E. R. T. *J. Chem. Soc., Dalton Trans.* **1997**, 4089–4097.
433. Fenton, D. E.; Ōkawa, H. *J. Chem. Soc., Dalton Trans.* **1993**, 1349–1357.
434. Nanda, K. K.; Addison, A. W.; Butcher, R. J.; McDevitt, M. R.; Rao, T. N.; Sinn, E. *Inorg. Chem.* **1997**, *36*, 134–135.
435. Comba, P.; Pritzkow, H.; Schiek, W. *Angew. Chem. Int. Ed. Engl.* **2001**, *40*, 2465–2468.
436. Bol, J. E.; Driessen, W. L.; Reedijk, J. *J. Chem. Soc., Chem. Commun.* **1995**, 1365–1366.
437. Bode, R. H.; Bol, J. E.; Driessen, W. L.; Hulsbergen, F. B.; Reedijk, J.; Spek, A. L. *Inorg. Chem.* **1999**, *38*, 1239–1243.
438. Driessen, W. L.; Baesjou, P. J.; Bol, J. E.; Kooijman, H.; Spek, A. L.; Reedijk, J. *Inorg. Chim. Acta* **2001**, *324*, 16–20.
439. Salata, C. A.; Youinou, M.-T.; Burrows, C. J. *Inorg. Chem.* **1991**, *30*, 3454–3461.
440. Pierre, J.-L.; Chautemps, P.; Refaif, S.; Beguin, C.; Marzouki, A. E.; Serratrice, G.; Saint-Aman, E.; Rey, P. *J. Am. Chem. Soc.* **1995**, *117*, 1965–1973.
441. Ngwenya, M. P.; Chen, D.; Martell, A. E.; Reibenspies, J. *Inorg. Chem.* **1991**, *30*, 2732–2736.
442. Menif, R.; Reibenspies, J.; Martell, A. E. *Inorg. Chem.* **1991**, *30*, 3446–3454.
443. Comba, P.; Gavrish, S. P.; Hay, R. W.; Hilfenhaus, P.; Lampeka, Y. D.; Lightfoot, P.; Peters, A. *Inorg. Chem.* **1999**, *38*, 1416–1421.
444. Adams, H.; Bailey, N. A.; Dwyer, M. J. S.; Fenton, D. E.; Hellier, P. C.; Hempstead, P. D.; Latour, J. M. *J. Chem. Soc., Dalton Trans.* **1993**, 1207–1216.

445. Adams, H.; Bailey, N. A.; Fenton, D. E.; Hursthouse, M. B.; Kanda, W.; Kanesato, M.; Abdul Malik, K. M.; Sadler, E. J. *J. Chem. Soc., Dalton Trans.* **1997**, 921–925.
446. Cooper, S. R.; Rawle, S. C. *Struct. & Bonding (Berlin)* **1990**, 72, 1–72.
447. Blake, A. J.; Schröder, M. *Adv. Inorg. Chem.* **1990**, 35, 1–80.
448. Meagher, N. E.; Juntunen, K. L.; Heeg, M. J.; Salhi, C. A.; Dunn, B. C.; Ochrymowycz, L. A.; Rorabacher, D. B. *Inorg. Chem.* **1994**, 33, 670–679.
449. Salhi, C. A.; Yu, Q.; Heeg, M. J.; Villeneuve, N. M.; Juntunen, K. L.; Schroeder, R. R.; Ochrymowycz, L. A.; Rorabacher, D. B. *Inorg. Chem.* **1995**, 34, 6053–6064.
450. Ōkawa, H.; Furutachi, H.; Fenton, D. E. *Coord. Chem. Rev.* **1998**, 174, 51–75.
451. Thompson, L. K.; Mandal, S. K.; Tandon, S. S.; Bridson, J. N.; Park, M. K. *Inorg. Chem.* **1996**, 35, 3117–3125.
452. Martens, C. F.; Schenning, A. P. H. J.; Feiters, M. C.; Heck, J.; Beurskens, G.; Beurskens, P. T.; Steinwender, E.; Nolte, R. J. M. *Inorg. Chem.* **1993**, 32, 3029–3033.
453. Martens, C. F.; Gebbink, R. J. M. K.; Feiters, M. C.; Kooijman, H.; Smeets, W. J. J.; Spek, A. L.; Nolte, R. J. M. *Inorg. Chem.* **1994**, 33, 5541–5546.
454. Wang, D.; Xiang, H.; Wang, G.; Han, Z.; Yang, X.; Hu, H.; Yu, K. *J. Chem. Soc., Dalton Trans.* **1994**, 3325–3328.
455. Nelson, J.; McKee, V.; Morgan, G. *Prog. Inorg. Chem.* **1998**, 47, 167–316.
456. Chand, D. K.; Bharadwaj, P. K. *Inorg. Chem.* **1998**, 37, 5050–5055.
457. Bu, X. H.; Du, M.; Zhang, L.; Shang, Z.-L.; Zhang, R.-H.; Shionoya, M. *J. Chem. Soc., Dalton Trans.* **2001**, 729–735.
458. Bu, X.-H.; Du, M.; Shang, Z.-L.; Zhang, L.; Zhao, Q.-H.; Zhang, R.-H.; Shionoya, M. *Eur. J. Inorg. Chem.* **2001**, 1551–1558.
459. Steel, P. J. *Coord. Chem. Rev.* **1990**, 106, 227–265.
460. Haasnoot, J. G. *Coord. Chem. Rev.* **2000**, 200–202, 131–185.
461. Brooker, S.; Davidson, T. C.; Hay, S. J.; Kelly, R. J.; Kennepohl, D. M.; Plieger, P. G.; Moubaraki, B.; Murray, K. S.; Bill, E.; Bothe, B. *Coord. Chem. Rev.* **2001**, 216–217, 3–30.
462. Palmer, D. A.; van Eldik, R. *Chem. Rev.* **1983**, 83, 651–731.
463. Tanaka, K. *Adv. Inorg. Chem.* **1997**, 43, 409–435.
464. Yin, X.; Moss, J. R. *Coord. Chem. Rev.* **1999**, 181, 27–59.
465. Escuer, A.; Mautner, F. A.; Peñalba, E.; Vicente, R. *Inorg. Chem.* **1998**, 37, 4190–4196.
466. Sletten, J.; Hope, H.; Julve, M.; Kahn, O.; Verdaguer, M.; Dworkin, A. *Inorg. Chem.* **1988**, 27, 542–549.
467. Escuer, A.; Vicente, R.; Peñalba, E.; Solans, X.; Font-Bardía, M. *Inorg. Chem.* **1996**, 35, 248–251.
468. Escuer, A.; Peñalba, E.; Vicente, R.; Solans, X.; Font-Bardía, M. *J. Chem. Soc., Dalton Trans.* **1997**, 2315–2319.
469. Mao, Z.-W.; Liehr, G.; van Eldik, R. *J. Chem. Soc., Dalton Trans.* **2001**, 1593–1600.
470. Kruger, P. E.; Fallon, G. D.; Moubaraki, B.; Berry, K. J.; Murray, K. S. *Inorg. Chem.* **1995**, 34, 4808–4814.
471. van Albada, G.; Mutikainen, I.; Roubeau, O. S.; Turpeinen, U.; Reedijk, J. *Eur. J. Inorg. Chem.* **2000**, 2179–2184.
472. Mao, Z.-W.; Liehr, G.; van Eldik, R. *J. Am. Chem. Soc.* **2000**, 122, 4839–4840.
473. Youngme, S.; Chaichit, N.; Kongsaree, P.; van Albada, G. A.; Reedijk, J. *Inorg. Chim. Acta* **2001**, 324, 232–240 and references therein.
474. Yan, S.; Cui, J.; Liu, X.; Cheng, P.; Liao, D.; Jiang, Z.; Wang, G.; Wang, H.; Yao, X. *Science in China (Series B)* **1999**, 42, 535–542.
475. Nishida, Y.; Yatani, A.; Nakao, Y.; Taka, J.; Kashino, S.; Mori, W.; Suzuki, S. *Chem. Lett.* **1999**, 135–136.
476. Fernandes, C.; Neves, A.; Bortoluzzi, A. J.; Szpoganicz, B.; Schwingel, E. *Inorg. Chem. Commun.* **2001**, 4, 354–357.
477. Bazzicalupi, C.; Bencini, A.; Bianchi, A.; Fusi, V.; Paoletti, P.; Valtancoli, B. *J. Chem. Soc., Chem. Commun.* **1995**, 1555–1556.
478. Bazzicalupi, C.; Bencini, A.; Bencini, A.; Bianchi, A.; Corana, F.; Fusi, V.; Giorgi, C.; Paoli, P.; Paoletti, P.; Valtancoli, B. *Inorg. Chem.* **1996**, 35, 5540–5548.
479. Springborg, J.; Glerup, J.; Søtofte, I. *Acta Chem. Scand.* **1997**, 51, 832–838.
480. Bode, R. H.; Driessen, W. L.; Hulsbergen, F. B.; Reedijk, J.; Spek, A. L. *Eur. J. Inorg. Chem.* **1999**, 505–507.
481. van den Brek, A. L.; Byriel, K. A.; Fairlie, D. P.; Gahan, L. R.; Hanson, G. R.; Hawkins, C. J.; Jones, A.; Kennard, C. H. L.; Moubaraki, B.; Murray, K. S. *Inorg. Chem.* **1994**, 33, 3549–3557.
482. Tolman, W. B.; Rardin, R. L.; Lippard, S. J. *J. Am. Chem. Soc.* **1989**, 111, 4532–4533.
483. Börzel, H.; Comba, P.; Pritzkow, H. *J. Chem. Soc., Chem. Commun.* **2001**, 97–98.
484. Kahn, O. *Acc. Chem. Res.* **2000**, 33, 647–657.
485. Verdaguer, M. *Polyhedron* **2001**, 20, 1115–1128. A special thematic issue on molecular magnetism.
486. Castro, I.; Faus, J.; Julve, M.; lloret, F.; Verdaguer, M.; Kahn, O.; Jeannin, S.; Jeannin, Y.; Vaisserman, J. *J. Chem. Soc., Dalton Trans.* **1990**, 2207–2212.
487. Escuer, A.; Font-Bardía, M.; Peñalba, E.; Solans, X.; Vicente, R. *Inorg. Chim. Acta* **1999**, 286, 189–196.
488. Escuer, A.; Font-Bardía, M.; Peñalba, E.; Solans, X.; Vicente, R. *Inorg. Chim. Acta* **2000**, 298, 195–201.
489. Parker, R. J.; Spiccia, L.; Moubaraki, B.; Murray, K. S.; Skelton, B. W.; White, A. H. *Inorg. Chim. Acta* **2000**, 300–302, 922–931.
490. Monica, G. L.; Ardizzoia, G. A. *Prog. Inorg. Chem.* **1997**, 46, 151–238.
491. Mann, K. L. V.; Psillakis, E.; Jeffery, J. C.; Rees, L. H.; Harden, N. M.; McClevery, J. A.; Ward, M.; Gatteschi, D.; Totti, F.; Fabbs, F. E.; McInnes, E. J. L.; Riedi, P. C.; Smith, G. M. *J. Chem. Soc., Dalton Trans.* **1999**, 339–348.
492. Matsushima, H.; Hamada, H.; Watanabe, K.; Koikawa, M.; Tokii, T. *J. Chem. Soc., Dalton Trans.* **1999**, 971–977.
493. Chou, J.-L.; Chyn, J.-P.; Urbach, F. L.; Gervasio, D. F. *Polyhedron* **2000**, 19, 2215–2223.
494. Pons, J.; Chadghan, A.; Alvarez-Larena, A.; Piniella, J. F.; Ros, J. *Inorg. Chem. Commun.* **2001**, 4, 610–612.
495. Buchen, T.; Hazell, A.; Jessen, L.; McKenzie, C. J.; Nielsen, L. P.; Pedersen, J. Z.; Schollmeyer, D. *J. Chem. Soc., Dalton Trans.* **1997**, 2687–2703.
496. Spodine, E.; Manzur, J.; Garland, M. T.; Kiwi, M.; Peña, O.; Grandjean, D.; Toupet, L. *J. Chem. Soc., Dalton Trans.* **1991**, 365–369.
497. Komaei, S. A.; van Albada, G. A.; Haasnoot, J. G.; Kooijman, H.; Spek, A. L.; Reedijk, J. *Inorg. Chim. Acta* **1999**, 286, 24–29.
498. van Albada, G. A.; Mutikainen, I.; Turpeinen, U.; Reedijk, J. *Inorg. Chim. Acta* **2001**, 324, 273–277.

499. Tandon, S. S.; Thompson, L. K.; Bridson, J. N. *J. Chem. Soc., Chem. Commun.* **1993**, 804–806.
500. Tandon, S. S.; Thompson, L. K.; Manuel, M. E.; Bridson, J. N. *Inorg. Chem.* **1994**, *33*, 5555–5570.
501. Mukherjee, P. S.; Dalai, S.; Mostafa, G.; Lu, T.-H.; Rentschler, E.; Ray Chaudhuri, N. *New J. Chem.* **2001**, *25*, 1203–1207 and references therein.
502. Manikandan, P.; Muthukumar, R.; Justin Thomas, K. R.; Varghese, B.; Chandramouli, G. V. R.; Manoharan, P. T. *Inorg. Chem.* **2001**, *40*, 2378–2389.
503. Akagi, F.; Nakao, Y.; Matsumoto, K.; Takamizawa, S.; Mori, W.; Suzuki, S. *Chem. Lett.* **1997**, 181–182.
504. Christou, G.; Perlepes, S. P.; Folting, K.; Huffman, J. C.; Webb, R. J.; Hendrickson, D. N. *J. Chem. Soc., Chem. Commun.* **1990**, 746–747.
505. Christou, G.; Perlepes, S. P.; Libby, E.; Folting, K.; Huffman, J. C.; Webb, R. J.; Hendrickson, D. N. *Inorg. Chem.* **1990**, *29*, 3657–3666.
506. Perlepes, S. P.; Huffman, J. C.; Christou, G.; Paschalidou, S. *Polyhedron* **1995**, *14*, 1073–1081.
507. Meenakumari, S.; Tiwari, S. K.; Chakravarty, A. R. *J. Chem. Soc., Dalton Trans.* **1993**, 2175–2181.
508. Tokii, T.; Hamamura, N.; Nakashima, M.; Muto, Y. *Bull. Chem. Soc. Jpn.* **1992**, *65*, 1214–1219.
509. Boxwell, C. J.; Bhalla, R.; Cronin, L.; Turner, S. S.; Walton, P. H. *J. Chem. Soc., Dalton Trans.* **1998**, 2449–2450.
510. Buijs, W.; Comba, P.; Corneli, D.; Mengerink, Y.; Pritzkow, H.; Schickedanz, M. *Eur. J. Inorg. Chem.* **2001**, 3143–3149 and references therein.
511. Fernández, I.; Ruiz, R.; Faus, J.; Julve, M.; Lloret, F.; Cano, J.; Ottenwaelder, X.; Journaux, Y.; Muñoz, M. C. *Angew. Chem. Int. Ed. Engl.* **2001**, *40*, 3039–3042.
512. Grove, H.; Julve, M.; Lloret, F.; Kruger, P. E.; Törnroos, K. W.; Sletten, J. *Inorg. Chim. Acta* **2001**, *325*, 115–124.
513. Rodríguez, M.; Llobet, A.; Corbella, M.; Martell, A. E.; Reibenspies, J. *Inorg. Chem.* **1999**, *38*, 2328–2334 and references therein.
514. Graham, P. G.; Weatherburn, D. C.; March, F. C.; Robinson, W. T. *Inorg. Chim. Acta* **1990**, *178*, 227–232.
515. Bürger, K. S.; Chaudhuri, P.; Wieghardt, K. *Inorg. Chem.* **1996**, *35*, 2704–2707 and references therein.
516. Gallert, S.; Weyhermüller, T.; Wieghardt, K.; Chaudhuri, P. *Inorg. Chim. Acta* **1998**, *274*, 111–114.
517. Bürger, K. S.; Chaudhuri, P.; Wieghardt, K.; Nuber, B. *Chem. Eur. J.* **1995**, *1*, 583–593.
518. Munakata, M.; Kitagawa, S.; Shimono, H.; Masuda, H. *Inorg. Chem.* **1991**, *30*, 2610–2614 and references therein.
519. Dai, X.; Warren, T. H. *Chem. Commun.* **2001**, 1998–1999 and references therein.
520. Straub, B. F.; Eisenträger, F.; Hofmann, P. *Chem. Commun.* **1999**, 2507–2508.
521. Arnold, P. L.; Scarisbrick, A. C.; Blake, A. J.; Wilson, C. *Chem. Commun.* **2001**, 2340–2341 and references therein.
522. Raab, V.; Kipke, J.; Burghaus, O.; Sundermeyer, J. *Inorg. Chem.* **2001**, *40*, 6964–6971.
523. Sorrell, T. N.; Borovik, A. S. *J. Am. Chem. Soc.* **1987**, *109*, 4255–4260.
524. Sorrell, T. N.; Garrity, M. L.; Richards, J. L.; White, P. S. *Inorg. Chim. Acta* **1994**, *218*, 103–108.
525. Lynch, W. E.; Kurtz, D. M., Jr.; Wang, S.; Scott, R. A. *J. Am. Chem. Soc.* **1994**, *116*, 11030–11038.
526. Voo, J. K.; Lam, K. C.; Rheingold, A. L.; Riordan, C. G. *J. Chem. Soc., Dalton Trans.* **2001**, 1803–1805.
527. Patch, M. G.; Choi, H.; Chapman, D. R.; Bau, R.; McKee, V.; Reed, C. A. *Inorg. Chem.* **1990**, *29*, 110–119.
528. Piguet, C.; Bernardinelli, G.; Williams, A. F. *Inorg. Chem.* **1989**, *28*, 2920–2925.
529. Carrier, S. M.; Ruggiero, C. E.; Houser, R. P.; Tolman, W. B. *Inorg. Chem.* **1993**, *32*, 4889–4899 and references therein.
530. Hu, Z.; Williams, R. D.; Tran, D.; Spiro, T. G.; Gorun, S. M. *J. Am. Chem. Soc.* **2000**, *122*, 3556–3557 and references therein.
531. Sorrell, T. N.; Malachowski, M. R. *Inorg. Chem.* **1983**, *22*, 1883–1887.
532. Sorrell, T. N.; Jameson, D. L. *J. Am. Chem. Soc.* **1982**, *104*, 2053–2054.
533. Sorrell, T. N.; Malachowski, M. R.; Jameson, D. L. *Inorg. Chem.* **1982**, *21*, 3250–3252.
534. Pennings, Y. C. M.; Driessen, W. L.; Reedijk, J. *Acta Cryst.* **1988**, *C44*, 2095–2097.
535. Pennings, Y. C. M.; Driessen, W. L.; Reedijk, J. *Polyhedron* **1988**, *7*, 2583–2589.
536. Manikandan, P.; Varghese, B.; Manoharan, P. T. *J. Chem. Soc., Dalton Trans.* **1996**, 371–376.
537. Blackburn, N. J.; Karlin, K. D.; Concannon, M.; Hayes, J. C.; Gultneh, Y.; Zubieta, J. *J. Chem. Soc., Chem. Commun.* **1984**, 939–940.
538. Sanyal, I.; Mahroof-Tahir, M.; Nasir, M. S.; Ghosh, P.; Cohen, B. I.; Gultneh, Y.; Cruse, R. W.; Farooq, A.; Karlin, K. D.; Liu, S.; Zubieta, J. *Inorg. Chem.* **1992**, *31*, 4322–4332.
539. Karlin, K. D.; Tyeklár, Z.; Farooq, A.; Haka, M. S.; Ghosh, P.; Cruse, R. W.; Gultneh, Y.; Hayes, J. C.; Toscano, P. J.; Zubieta, J. *Inorg. Chem.* **1992**, *31*, 1436–1451.
540. Blackburn, N. J.; Strange, R. W.; Reedijk, J.; Volbeda, A.; Farooq, A.; Karlin, K. D.; Zubieta, J. *Inorg. Chem.* **1989**, *28*, 1349–1357.
541. Karlin, K. D.; Haka, M. S.; Cruse, R. W.; Meyer, G. J.; Farooq, A.; Gultneh, Y.; Hayes, J. C.; Zubieta, J. *J. Am. Chem. Soc.* **1988**, *110*, 1196–1207.
542. Wei, N.; Murthy, N. N.; Chen, Q.; Zubieta, J.; Karlin, K. D. *Inorg. Chem.* **1994**, *33*, 1953–1965.
543. Wei, N.; Lee, D.-H.; Murthy, N. N.; Tyeklár, Z.; Karlin, K. D.; Kaderli, S.; Jung, B.; Zuberbühler, A. D. *Inorg. Chem.* **1994**, *33*, 4625–4626.
544. Wei, N.; Murthy, N. N.; Tyeklár, Z.; Karlin, K. D. *Inorg. Chem.* **1994**, *33*, 1177–1183.
545. Lee, D.-H.; Wei, N.; Murthy, N. N.; Tyeklár, Z.; Karlin, K. D.; Kaderli, S.; Jung, B.; Zuberbühler, A. D. *J. Am. Chem. Soc.* **1995**, *117*, 12498–12513.
546. Zhang, C. X.; Liang, H.-C.; Kim, E.; Gan, Q.-F.; Tyeklár, Z.; Lam, K.-C.; Rheingold, A. L.; Kaderli, S.; Zuberbühler, A. D.; Karlin, K. D. *Chem. Commun.* **2001**, 631–632.
547. Karlin, K. D.; Gultneh, Y.; Hutchinson, J. P.; Zubieta, J. *J. Am. Chem. Soc.* **1982**, *104*, 5240–5242.
548. Nasir, M. S.; Jacobson, R. R.; Zubieta, J.; Karlin, K. D. *Inorg. Chim. Acta* **1993**, *203*, 5–7.
549. Karlin, K. D.; Ghosh, P.; Cruse, R. W.; Farooq, A.; Gultneh, Y.; Jacobson, R. R.; Blackburn, N. J.; Strange, R. W.; Zubieta, J. *J. Am. Chem. Soc.* **1988**, *110*, 6769–6780.
550. Karlin, K. D.; Cruse, R. W.; Gultneh, Y.; Farooq, A.; Hayes, J. C.; Zubieta, J. *J. Am. Chem. Soc.* **1987**, *109*, 2668–2679.
551. Mahroof-Tahir, M.; Murthy, N. N.; Karlin, K. D.; Blackburn, N. J.; Shaikh, S. N.; Zubieta, J. *Inorg. Chem.* **1992**, *31*, 3001–3003.

552. Kalin, K. D.; Farooq, A.; Gultneh, Y.; Hayes, J. C.; Zubieta, J. *Inorg. Chim. Acta* **1988**, *153*, 73–74.
553. Sanyal, I.; Murthy, N. N.; Karlin, K. D. *Inorg. Chem.* **1993**, *32*, 5330–5337.
554. Karlin, K. D.; Gan, Q.; Farooq, A.; Liu, S.; Zubieta, J. *Inorg. Chim. Acta* **1989**, *165*, 37–39.
555. Shimazaki, Y.; Nogami, T.; Tani, F.; Odani, A.; Yamauchi, O. *Angew. Chem. Int. Ed. Engl.* **2001**, *40*, 3859–3862.
556. He, C.; DuBois, J. L.; Hedman, B.; Hodgson, K. O.; Lippard, S. J. *Angew. Chem. Int. Ed. Engl.* **2001**, *40*, 1484–1487.
557. Pyrka, G. J.; Seeney, R. J.; Pinkerton, A. A. *Acta Cryst.* **1991**, *C47*, 510–513 and references therein.
558. Gagné, R. R.; Kreh, R. P.; Dodge, J. A.; Marsh, R. E.; McCool, M. *Inorg. Chem.* **1982**, *21*, 254–261.
559. Munakata, M.; Kitagawa, S.; Asahara, A.; Masuda, H. *Bull. Chem. Soc. Jpn.* **1987**, *60*, 1927–1929.
560. Munakata, M.; Maekawa, M.; Kitagawa, S.; Matsuyama, S.; Masuda, H. *Inorg. Chem.* **1989**, *28*, 4300–4302.
561. Pallenberg, A. J.; Koenig, K. S.; Barnhart, D. M. *Inorg. Chem.* **1995**, *34*, 2833–2840.
562. Thompson, A. M. W. C.; Blandford, I.; Redfearn, H.; Jeffery, J. C.; Ward, M. D. *J. Chem. Soc., Dalton Trans.* **1997**, 2661–2665.
563. Malachowski, M. R.; Adams, M.; Elia, N.; Rheingold, A. L.; Kelly, R. S. *J. Chem. Soc., Dalton Trans.* **1999**, 2177–2182.
564. Bodar-Houillon, F.; Humbert, T.; Marsura, A.; Regnouf de Vains, J.-B.; Dusausoy, O.; Bouhaida, N.; Ghermani, N. E.; Dusausoy, Y. *Inorg. Chem.* **1995**, *34*, 5205–5209.
565. Bharathi, D. S.; Sridhar, M. A.; Shashidhara Prasad, J.; Samuelson, A. G. *Inorg. Chem. Commun.* **2001**, *4*, 490–492.
566. Bera, J. K.; Nethaji, M.; Samuelson, A. G. *Inorg. Chem.* **1999**, *38*, 218–228.
567. Bera, J. K.; Nethaji, M.; Samuelson, A. G. *Inorg. Chem.* **1999**, *38*, 1725–1735.
568. Vijayashree, N.; Samuelson, A. G.; Nethaji, M. *Curr. Sci.* **1993**, *65*, 57–67 and references therein.
569. Tisato, F.; Pilloni, G.; Refosco, F.; Bandoli, G.; Corvaja, C.; Corain, B. *Inorg. Chim. Acta* **1998**, 275–276, 401–409.
570. Sorrell, T. N.; Borovik, A. S. *J. Chem. Soc., Chem. Commun.* **1984**, 1489–1490.
571. Sorrell, T. N.; Borovik, A. S.; Shen, C.-C. *Inorg. Chem.* **1986**, *25*, 589–590.
572. Fiaschi, P.; Floriani, C.; Pasquali, M.; Chiesi-Villa, A.; Guastini, C. *Inorg. Chem.* **1986**, *25*, 462–469 and references therein.
573. Olbrich, F.; Behrens, U.; Gröger, G.; Weiss, E. *J. Organomet. Chem.* **1993**, *448*, C10–C12.
574. Abraham, S. P.; Narasimhamurthy, N.; Nethaji, M.; Samuelson, A. G. *Inorg. Chem.* **1993**, *32*, 1739–1745.
575. Osakada, K.; Takizawa, T.; Tanaka, M.; Yamamoto, T. *J. Organomet. Chem.* **1994**, *473*, 359–369.
576. Angaridis, P.; Cotton, F. A.; Petrukhina, M. A. *Inorg. Chim. Acta* **2001**, *324*, 318–323.
577. Manivannan, V.; Dutta, S.; Basu, P.; Chakravorty, A. *Inorg. Chem.* **1993**, *32*, 4807–4811.
578. Birkelbach, F.; Weyhermüller, T.; Lengen, M.; Gerdan, M.; Trautwein, A. X.; Wieghardt, K.; Chaudhuri, P. *J. Chem. Soc., Dalton Trans.* **1997**, 4529–4537.
579. Janssen, M. D.; Grove, D. M.; van Koten, G. *Prog. Inorg. Chem.* **1997**, *46*, 97–149.
580. Stange, A. F.; Klein, A.; Klinkhammer, K.-W.; Kaim, W. *Inorg. Chim. Acta* **2001**, *324*, 336–341.
581. Pérez-Lourido, P.; García-Vázquez, J. A.; Romero, J.; Louro, M. S.; Sousa, A.; Zubieta, J. *Inorg. Chim. Acta* **1998**, *271*, 1–8.
582. Halfen, J. A.; Young, V. G. Jr.; Tolman, W. B. *J. Am. Chem. Soc.* **1996**, *118*, 10920–10921.
583. Mahapatra, S.; Kaderli, S.; Llobet, A.; Neuhold, Y.-M.; Palanché, T.; Halfen, J. A.; Young, V. G., Jr.; Kaden, T. A.; Que, L. Jr.; Zuberbühler, A. D.; Tolman, W. B. *Inorg. Chem.* **1997**, *36*, 6343–6356.
584. Berreau, L. M.; Halfen, J. A.; Young, V. G. Jr.; Tolman, W. B. *Inorg. Chem.* **2000**, *297*, 115–128.
585. Asato, E.; Hashimoto, S.; Matsumoto, N.; Kida, S. *J. Chem. Soc., Dalton Trans.* **1990**, 1741–1746.
586. Comba, P.; Hambley, T. W.; Hilfenhaus, P.; Richens, D. T. *J. Chem. Soc., Dalton Trans.* **1996**, 533–539.
587. Jazdzewski, B. A.; Young, V. G., Jr.; Tolman, W. B. *Chem. Commun.* **1998**, 2521–2522.
588. Sanaullah, Kano, K.; Glass, R. S.; Wilson, G. S. *J. Am. Chem. Soc.* **1993**, *115*, 592–600.

6.7

Silver and Gold

M. C. GIMENO and A. LAGUNA
University of Zaragoza-C.S.I.C., Spain

6.7.1	INTRODUCTION	911
6.7.2	SILVER	914
6.7.2.1	Silver(III)	914
6.7.2.2	Silver(II)	917
6.7.2.3	Silver(I)	919
6.7.2.3.1	<i>Complexes with carbon donor ligands</i>	919
6.7.2.3.2	<i>Complexes with nitrogen donor ligands</i>	925
6.7.2.3.3	<i>Complexes with phosphorus, arsenic, antimony, or bismuth donor ligands</i>	942
6.7.2.3.4	<i>Complexes with oxygen donor ligands</i>	952
6.7.2.3.5	<i>Complexes with sulfur, selenium, and tellurium donor ligands</i>	959
6.7.2.3.6	<i>Complexes with halide and hydride donor ligands</i>	979
6.7.2.3.7	<i>Complexes with mixed donor ligands</i>	983
6.7.3	GOLD	990
6.7.3.1	High Oxidation States	990
6.7.3.2	Gold(III) Complexes	991
6.7.3.2.1	<i>Complexes with carbon donor ligands</i>	991
6.7.3.2.2	<i>Complexes with nitrogen donor ligands</i>	995
6.7.3.2.3	<i>Complexes with phosphorus, arsenic, antimony, or bismuth donor ligands</i>	998
6.7.3.2.4	<i>Complexes with oxygen donor ligands</i>	1003
6.7.3.2.5	<i>Complexes with sulfur, selenium, or tellurium donor ligands</i>	1006
6.7.3.2.6	<i>Complexes with halides as donor ligands</i>	1010
6.7.3.2.7	<i>Complexes with mixed donor ligands</i>	1010
6.7.3.3	Gold(II) Complexes	1016
6.7.3.3.1	<i>Mononuclear gold(II) complexes</i>	1017
6.7.3.3.2	<i>Dinuclear gold(II) complexes</i>	1018
6.7.3.4	Gold(I) Complexes	1025
6.7.3.4.1	<i>Complexes with boron donor ligands</i>	1025
6.7.3.4.2	<i>Complexes with carbon donor ligands</i>	1026
6.7.3.4.3	<i>Complexes with nitrogen donor ligands</i>	1034
6.7.3.4.4	<i>Complexes with phosphorus, arsenic, antimony, or bismuth donor ligands</i>	1039
6.7.3.4.5	<i>Complexes with oxygen donor ligands</i>	1056
6.7.3.4.6	<i>Complexes with sulfur, selenium, and tellurium donor ligands</i>	1058
6.7.3.4.7	<i>Complexes with halide donor ligands</i>	1073
6.7.3.4.8	<i>Complexes with hydride donor ligands</i>	1073
6.7.3.4.9	<i>Complexes with mixed donor ligands</i>	1075
6.7.3.4.10	<i>Gold(I) complexes with Au^I—M bonds</i>	1079
6.7.3.5	Gold Clusters	1083
6.7.3.5.1	<i>Homonuclear clusters</i>	1083
6.7.3.5.2	<i>Heteronuclear clusters</i>	1086
6.7.3.6	Gold(0) Complexes	1089
6.7.3.7	Gold(-I) Compounds	1090
6.7.4	REFERENCES	1090

6.7.1 INTRODUCTION

In spite of the similarity of electronic structures and ionization potentials, the chemistries of Ag and Au differ more than might be expected. Main differences between silver and gold are

consequence of the relativistic effects, which are especially important for gold. There is a contraction of the $6s$ -orbitals and this stabilization diminishes the energy gap between these and the $5d$ -orbitals, which also undergo an expansion. Both of these effects are much less pronounced in silver, with the result that the energetic separation of the valence d and s shells of gold is significantly smaller than that in silver.

- (i) The first consequence of these effects is the color of gold. Gold has an absorption beginning at 2.4 eV, attributed to a transition from the filled $5d$ band to the Fermi level (essentially the $6s$ band). It therefore reflects red and yellow light and strongly absorbs blue and violet. The analogous absorption for silver, however, lies in the ultraviolet, at around 3.7 eV.
- (ii) A marked reduction in the lengths of covalent bonds involving gold atoms is often found and the covalent radius of gold is smaller than that of silver. Schmidbaur has recently confirmed this in the isomorphous di-coordinated complexes $[M(\text{PMes}_3)_2]\text{BF}_4$ ($M = \text{Ag}, \text{Au}$; Mes = mesityl).¹ The estimated covalent radius for silver and gold is 1.33 Å and 1.25 Å, respectively, so di-coordinated gold is smaller than silver in about 0.09(1) Å.
- (iii) In gold, more than in silver, both states are now available for bonding. The closed shell $5d^{10}$ is no longer chemically inert and can interact with other elements, i.e., with other gold atoms in molecules or clusters. It also becomes possible to rationalize bonding between two gold(I) centers with equal charge and a closed shell $5d^{10}$ configuration, which is a very difficult fact to explain in terms of classical bonding. The metal atoms approach each other to an equilibrium distance of between 2.7 Å and 3.3 Å. This range includes the distance between gold atoms in gold metal and approaches, or even overlaps with, the range of distances established for the few authentic Au—Au single bonds. This effect has been called by Schmidbaur as *aurophilic attraction* or *aurophilicity*.²
- (iv) The small difference of energy among the s , p , or d -orbitals leads to the efficient formation of linear two-coordinate complexes in gold(I). However, silver(I) prefers the formation of three- and four-coordinate derivatives.
- (v) The destabilization of the $5d$ -orbitals permits explanation of the ease of formation of the oxidation state III in gold, which is almost absent in silver; and the stabilization of the $6s$ -orbitals, the formation of a gold(I) oxidation state which is unknown in silver.

Theoretical calculations play a key role in understanding the origin of these differences and also in the development of gold and silver chemistry. Bonding between closed-shell atoms was successfully traced in several early theoretical investigations by extended Hückel quantum chemical calculations.³⁻⁶ Based on the hybridization concept, the nature of the bonding interaction could be qualitatively rationalized in the language of chemists. The introduction of relativistic effects in more advance calculations has shown that bonding between closed-shell metal atoms or ions may be strongly enhanced by these effects.⁷⁻¹⁶ Since relativistic effects have been known to reach a local maximum for gold in particular, aurophilicity was accepted as a logical consequence of these contributions. Actually aurophilic bonding is considered as an effect based largely on electron correlation of the closed-shell components, somewhat similar to van der Waals interactions but unusually strong.¹⁴ All of these studies have consistently shown that calculations will reproduce the attractive forces between the gold atoms really well only if relativistic effects are included.

Studies carried out with silver proved that compounds can be found which show convincing evidence for such closed-shell interactions.¹⁵⁻¹⁹ In many of the examples the metal-metal contacts are enforced by the ligands to give what is called "ligand-supported interactions." The number of unsupported contacts is extremely limited¹⁷ and estimations of the energies involved gives values of only a few kilocalories, close to those of standard van der Waals interactions. Nevertheless it is clear that there are small contributions from metallophilic bonding which should not be ignored.

Since the early 1980s the chemistry of gold and silver has been in a continuous expansion, not only well-established areas of research have developed but also new innovative approaches have allowed a great diversification of the research interests.

The chemistry of silver in high oxidation states is not much abundant and is limited to complexes with very electronegative ligands such as $[\text{Ag}^{\text{III}}\text{F}_6]^{3-}$, $[\text{Ag}^{\text{III}}(\text{OH})_4]^-$, etc. or with special ligands, such as porphyrins and N -donor macrocycles.²⁰ Recently, the trivalent fluoride AgF_3 or the oxides Ag_2O_3 or Ag_3O_4 ($\text{Ag}^{\text{II}}/\text{Ag}^{\text{III}}$) have been reported.²¹⁻²³ Oxidation of silver(I) salts in the presence of nitrogen ligands gives the corresponding silver(II) complexes, they are paramagnetic and their electronic spectra are in agreement with square coordination.²⁰

Silver(I) coordination chemistry produces a stream of unusual structures, and a great number of complexes with all type of donor ligands have been prepared. An important feature of the

chemistry of silver(I) is the great tendency to form supramolecular compounds: polynuclear species, oligomers, polymers, clusters, etc.

The silver(I) carbonyl complexes $[\text{Ag}(\text{CO})]^+$, $[\text{Ag}(\text{CO})_2]^+$, and the stable $[\text{Ag}\{\text{HB}[3,5\text{-}(\text{CF}_3)_2\text{pz}]_3\}(\text{CO})]$ (where pz = pyrazolyl) have been characterized spectroscopically and crystallographically, they indicate little or no Ag to CO π -back bonding.^{24–26}

Silver(I) forms several complexes with very weakly coordinating ligands such as CH_2Cl_2 or other halogenated derivatives.^{27–29} It has a relatively low affinity for oxygen atoms, although quite a few complexes with β -diketonates, carboxylate, crown ethers, etc. are known. However, it forms numerous complexes with the donor atoms S, Se, P, and As. Important sulfur ligands are thiolates, dithiocarbamates, thioureas (tu), and thioethers. With thiolates, many oligomers have been described^{30,31} of the type $[\text{Ag}(\text{SR})_n]$ and with other ligands cluster-type complexes are easily obtained, including five- and six-coordinate complexes with sulfur macrocycles. With phosphines and arsines, many stable compounds are known and their structures depend on the steric requirements of the ligands. A combination of diphosphine and chalcogenide silver(I) derivatives, $[\text{Ag}_4(\mu_4\text{-E})(\mu\text{-dppm})_4]^{2+}$ (E = S, Se, Te; dppm = bis(diphenyl phosphino)methane) has been found to be luminescent.^{32,33} High nuclear silver chalcogenide clusters stabilized with phosphine ligands have been prepared; they possess interesting structural frameworks and range from small to very large clusters, e.g., $[\text{Ag}_{172}\text{Se}_{40}(\text{SeBu}^n)_{92}(\text{dppp})_4]^{34}$ (where dppp = 1,3-bis(diphenylphosphino)propane). Complexes with nitrogen donor ligands are very stable and numerous, they also form unusual structures that goes from normal molecular species to supramolecular 2D and 3D networks. Flexible ligands are typical building elements, rigid rod-like organic units are used to connect metal centers and long flexible-chain bidentate ligands have shown the ability to produce unique interwoven extended structural motifs.³⁵

Although the $\text{Ag}\cdots\text{Ag}$ interactions are not very strong, there are many examples of complexes, which contain $\text{Ag}\cdots\text{M}$ contacts. Silver forms very stable heteropolynuclear complexes with different structural motifs, among them it is worth mentioning the species where silver interacts with platinum, gold, iron, mercury, etc.

The chemistry of gold has experimented a great advance in all oxidation states. Gold(V) is limited to the presence of very electronegative groups, $[\text{AuF}_6]^-$.³⁶ Gold(IV) complexes are available by electrochemical oxidation of gold(III) derivatives with ligands able to delocalize electron density such as dithiolates.

Gold(III) gives stable complexes with N, S, P, and C-donor ligands and also with oxygen-based ligands. Orthometallated species have been synthesized. The geometry is generally square-planar but with bidentate ligands pseudo-pentacoordination can be achieved.

The chemistry of mononuclear gold(II) species is not very extensive because most of them are prepared by reduction of the gold(III) species with ligands able to delocalize electron density. A rich chemistry on dinuclear diamagnetic gold(II) derivatives have been carried on bis(ylide) gold(II) species, $[\text{Au}_2\text{X}_2\{\mu\text{-(CH}_2)_2\text{PPh}_2\}_2]$,³⁷ they have a great stability that allows a great variety of substitution reactions. The first metal–xenon compound, $[\text{AuXe}_4](\text{Sb}_2\text{F}_{11})_2$ obtained by reduction of AuX_3 with elemental xenon, deserves special mention.³⁸ The geometry is square-planar and the bonding between gold and xenon is of the σ -donor type, with a charge of approximately 0.4 per xenon atom. Other $\text{Au}^{\text{II}}\text{-Xe}$ and the first $\text{Au}^{\text{III}}\text{-Xe}$ compounds have been reported.³⁹

Gold(I) is by far the most studied oxidation state of this metal. The most striking phenomenon was the tendency of the linear gold(I) compounds to associate in dimers, oligomers, or even polymers via short gold(I)–gold(I) interactions. These attractions are weaker than most covalent or ionic bonds, but stronger than other van der Waals and comparable in strength to typical hydrogen bonds, ca. 33 kJ mol^{-1} . The most convincing example of aurophilicity is found in polyaurated molecules. Double auration at halide anions to give V-shaped cations with small angles are known for chloride and bromide. Oxide anions have shown to accept up to four gold atoms to give trigonal pyramidal or tetrahedral complexes. Sulfide, selenide, and telluride anions can reach coordination numbers from two to six, and the resulting complexes have structures clearly determined by Au–Au interactions. Nitrogen became pentacoordinate, phosphorus hexacoordinate, and arsenic tetracoordinate in homoleptic phosphine species. Carbon was one of the first examples of polyauration and pentacoordinate and hexacoordinate compounds have been described.² This work has also been extended to several ligands containing these atoms, such as alcoxides, thiolates, selenolates, amine, etc.²

Although the $[\text{AuCl}(\text{CO})]$ complex has been known since 1925,² the linear dicarbonyl cation $[\text{Au}(\text{CO})_2]^+$ has been obtained as thermally stable UF_6^{2-} or $\text{Sb}_2\text{F}_{11}^{2-}$ salts only recently; in these compounds back-bonding to CO is almost entirely absent.^{40,41}

Many gold(I) complexes are susceptible of having optical properties and consequently in the last few years several reports have dealt with luminescence in gold complexes.^{34,42,43} It has been shown

that the luminescence has its origin in the nature of the ligands, in the geometry around the metal center, and in the presence of metal–metal interactions. In this area important development has been made in gold-heterometal complexes (Cu, Ag, Tl, Ir, etc.).⁴³ Many Au···Au bonded species show intense photoluminescence in the UV–visible region if investigated in the solid state, although this effect may vanish in solution. It has also demonstrated that luminescence of gold complexes can be triggered by solvation of the donor-free solid substrate either from the vapor phase or by dissolving the material in a solvent. Bachman *et al.* have reported the construction of striking “rotator phases” of gold complexes based solely on their metal–metal interactions. The behavior of gold complexes in these rotator phases could potentially be modified to produce interesting and useful structures, such as metal-based liquid crystals or photoluminescent materials.⁴⁴

Gold clusters, where the gold has an oxidation state intermediate between 0 and +1, have been synthesized with several nuclearities, from the smallest Au₄²⁺ units to the largest structurally characterized gold cluster, [Au₃₉Cl₆(PPh₃)₁₄]²⁺,⁴⁵ although spectroscopic evidence exist for the cluster [Au₅₅Cl₆(PPh₃)₁₂].⁴⁶ Important work has been done in the area of high-nuclearity mixed-metal clusters, mainly of gold and silver, whose metal framework is based on vertex-sharing polyicosahedra.⁴⁷

Monomeric zerovalent gold complexes are rare; they are thermodynamically too unstable to be used in chemical transformations. Recently the reduction of gold(I) complexes with the macrocyclic silacalix[n]phosphinine ligands has allowed the synthesis of gold(0) derivatives.⁴⁸ These ligands possess an adequate electronic balance between σ -donating and π -accepting properties in such a way that they might act as equivalent to carbonyl groups. Gold is unique among the transition metals in its ability to form isolable nonmetallic compounds that contain a monoatomic anion. The compounds NMe₄Au and CsAu·NH₃ are recent examples.^{49,50}

These metals and their complexes also have special characteristics that made them adequate for several uses. Gold possesses special characteristic features, which make it unique, such as high chemical and thermal stability, mechanical softness, high electrical conductivity, and beautiful appearance. All these attributes will rise to many relevant applications. For example, gold is an indispensable element for nanoscale electronic devices because it is resistant to oxidation and mechanically robust. The well-known elegant red color in Venetian crystal glass arises from surface plasmon absorption of blue light by gold nanoparticles a few tens of nm in size. Gold compounds have already been used successfully for the treatment of rheumatoid arthritis. Also gold is an outstanding element for use as heterogeneous catalysts operating at ambient temperature because it is catalytically active at low temperature (200–350 K compared with Pd and Pt at 400–800 K); in the last few years several uses in homogeneous catalysis have been found.^{51–58} Silver(I) exhibits a rich biological chemistry, serving as a widely used antibacterial agent^{59,60} and a transcriptional initiator in plants⁶¹ and mammals.^{61–63} β -Diketonate compounds found use as precursors for chemical vapor deposition (CVD) of silver films.⁶⁴ Silver stilbazole compounds have liquid crystal behavior.⁶⁵ Silver clusters in zeolite host may have found an application for new information storage or optical materials.

The presentation of the material in this review largely follows an order of decreasing oxidation states and, in each oxidation state, a categorization by donor atom will be presented. It covers the major developments in coordination chemistry since the early 1980s. Previous literature can be found in *CCC (1987)* or *Comprehensive Organometallic Chemistry*.^{66–69} Reviews, which have been published since the early 1980s, include for silver surveys of structural chemistry,⁷⁰ organosilver chemistry,⁷¹ high oxidation states,²¹ liquid crystal,^{59–65} and coordination chemistry.^{72,76} The reader is referred to gold surveys on general organogold chemistry^{71,78,79} and more specialized accounts on topics such as structural chemistry (X-ray and Mössbauer data),^{80–86} coordination chemistry,^{87–91} aurophilicity,^{92–96} high-coordinated compounds,⁹⁷ aryl gold chemistry,^{98,99} luminescence properties,^{34,42,43,100} bioinorganic chemistry,^{101–105} liquid crystals,¹⁰⁶ dendrimers,¹⁰⁷ cluster chemistry,^{108–112} and theoretical calculations.^{14,16,113,114} Also of interest is the book “*Gold, Progress in Chemistry, Biochemistry and Technology*.”¹¹⁵

6.7.2 SILVER

6.7.2.1 Silver(III)

Silver(III), with a d^8 electronic configuration, forms only a limited number of stable compounds because of the inaccessibility of a suitable ligand framework to coordinatively bind the unusual, higher valent central metal while, at the same time, resisting intramolecular electron transfer. They are thermodynamically and kinetically unstable.

The long known silver oxide AgO is really a mixed-valence oxide that contains Ag^{III}. Due to its important use in batteries,¹¹⁶ a new economical and high yield process for its preparation has been reported.¹¹⁷ It consists of the oxidation of an aqueous, alkaline silver nitrate solution with mixtures of sulfur dioxide and oxygen in air, or with mixtures of sulfite solutions and oxygen in air. Another example of well-characterized silver(III) compounds is the stoichiometric Ag₂O₃, which is prepared by anodic oxidation of neutral aqueous solutions of AgClO₄ or AgBF₄.²² The structure shows that silver is coordinated by an almost square-planar array of oxygen atoms; the AgO₄ groups are linked via common O-atoms to give a 3D network structure. Oxidation to lower potentials leads to the silver(II, III) oxide Ag₃O₄.²³ The silver atoms are exclusively in a square-planar environment.

Diamagnetic salts of the [AgF₄]⁻ ion were first described by Hoppe in 1957 and they are isomorphous with their [AuF₄]⁻ relatives.¹¹⁸ More recently the use of krypton fluoride in anhydrous hydrogen fluoride has allowed the synthesis of [AgF₄]⁻ at room temperature,¹¹⁹ but this powerful oxidative fluorinator failed in getting any oxidation state beyond Ag^{III}, despite the relative ease of oxidation by that reagent of [AuF₄]⁻ to [AuF₆]⁻.¹²⁰ Another high yield, room temperature synthesis of K[AgF₄] is obtained by reaction of AgF₂ in liquid anhydrous hydrogen fluoride with KF and sunlight or UV-irradiated F₂.¹²¹ In addition, a facile route to [AgF₄]⁻ using O₂F, generated *in situ*, has been described.¹²² The ¹⁰⁹Ag NMR spectrum of [AgF₄]⁻ has a chemical shift far from any other silver compound, thus reflecting the extreme chemical properties of this anion.¹²³ The UV-visible spectra for Ag^{III} fluorides have also been reported.¹²⁴ The unstable NO[AgF₄] has also been described.¹²⁵ The synthesis of AgF₃ has been a matter of controversy. It was first claimed by Bougon, Lance, and Seances in 1983.¹²⁶ They described a red-brown, highly reactive solid, made by fluorination of the metal or its mono- or difluoride in anhydrous HF, by KrF₂ at room temperature. The X-ray powder diffraction data^{125,126} showed that the red-brown solid was not structurally related to AuF₃. Furthermore, the solid proved to be weakly paramagnetic,¹²⁵ thus raising the possibility of some Ag^{III} being in the triplet state. AgF₃ was also claimed by Kiselev *et al.* to be formed in the interaction of AgF₂ with O₂F₂ in ClF₅.¹²⁷ The X-ray powder data showed that the compound was no isomorphous with AuF₃. Recently, red, diamagnetic AgF₃ has been obtained by Bartlett and co-workers as a precipitate by adding to [AgF₄]⁻, in anhydrous HF solutions, fluoro acids such as BF₃, PF₅, or AsF₅.^{24,128} It is isostructural with AuF₃ and the structure consists of a silver atom in a elongated octahedron; the AgF₄ square units are joined by symmetrical fluoro bridges in *cis*, forming a helical chain. It is thermodynamically unstable and loses F₂ in contact with anhydrous HF at ~20 °C, giving Ag₃F₈, a mixed-valence compound Ag^IAg^{III}₂F₈ that is identified as the previously claimed AgF₃. Also another mixed-valence fluoride, Ag^IAg^{III}F₅, is prepared by reaction of AgF⁺ with [AgF₄]⁻ in anhydrous HF.²⁴

The tetrahydroxoargentate(III) ion, [Ag(OH)₄]⁻, is a strongly oxidizing square-planar system that can be prepared by the electrochemical oxidation of a silver anode in 1.2 M NaOH. It is the simplest source of tervalent silver in solution. Rush and Kirschenbaum have carried out kinetic studies upon the substitution reactions of [Ag(OH)₄]⁻ with a variety of substrates including phosphate, borate, carbonate, and arsenate,¹²⁹ and its reduction by H₂O₂,¹³⁰ [Mo(CN)₈]⁴⁻ and [W(CN)₈]⁴⁻,^{131,132} N₃⁻,¹³³ S₂O₃²⁻,¹³⁴ AsO₂⁻,¹³⁵ H₂PO₂⁻,¹³⁶ 4-Bu^tPhO⁻,¹³⁷ SO₃²⁻,¹³⁸ SCN⁻,¹³⁹ CN⁻,¹⁴⁰ and EDTA⁴⁻.¹⁴¹ The results indicate that silver(III) is reduced through a variety of mechanisms. In the oxidation of azide and thiosulfate, transient Ag^{III}-substrate complexes could be detected, [Ag(OH)₃N₃]⁻ or [Ag(OH)₃(S₂O₃)²⁻. In other cases, the redox occurs within the five-coordinate intermediate. In the oxidation of oxoanions such as arsenite, sulfite, or hypophosphite, five-coordinate intermediates are also possible, and a two-electron redox step (inner sphere) and oxygen atom transfer is involved.

Silver(III) forms stable complexes with biguanide ligands. The kinetics of the oxidation of formic acid,¹⁴² hydrogen peroxide,¹⁴³ hydrazine,¹⁴⁴ H₃PO₂,¹⁴⁵ NO₂⁻,¹⁴⁶ oxalic acid, and dioxalate¹⁴⁷ by the ethylenebis(biguanide)silver(III) cation have been investigated. The electron transfer from organic or metal complex reductants to the silver(III) complex has been studied by stopped-flow techniques in aqueous media.¹⁴⁸ The kinetics of the oxidation of ascorbic acid by a silver(III) compound with a related tetraaza macrocyclic ligand have been investigated and the mechanism has been shown to be inner sphere.¹⁴⁹ Silver(III) compounds with periodate or tellurate were reported many years ago, and they were believed to be octahedrally coordinated. The X-ray structure of K₅[Ag(HIO₆)₂]·2H₂O reveals planar four-coordinate silver¹⁵⁰ and the spectroscopic studies of Na₅[Ag{TeO₄(OH)₂}]₂ and Na₅[Ag{IO₅(OH)}₂] indicates the same coordination for silver.¹⁵¹ This type of complexes are strong oxidants, and representative examples of this aspect of their chemistry are the reactions with aldehydes,¹⁵² alcohols,¹⁵³ amines,¹⁵⁴ CH₂=CHX

(X = CN, CONH₂, CO₂⁻),¹⁵⁵ and pyrimidine nucleobases.¹⁵⁶ A kinetic study of the oxidation of azide by [Ag^{III}(H₂TeO₆)₂]⁵⁻ shows that the reaction proceeds through the fast formation of a [Ag^{III}(TeO₄)₂(OH)₃N₃]⁵⁻ intermediate, followed by a slow reaction with H₂O to give [AgI(TeO₄)₂(OH)₄]⁷⁻ and N₃⁺, a one-step, two-electron process.¹⁵⁷

A relatively long-lived Ag^{III}_(solv) species, generated in anhydrous HF solutions of AgF₃ in the presence of strong F⁻ acceptors acids (AsF₅, SbF₅, BiF₃), has been put forward as the most powerful oxidant known, capable of oxidizing O₂ to O₂⁺.¹⁵⁸

The electrochemistry of silver porphyrin complexes has been reinvestigated in compounds [Ag{TPP(*p*-X)}]. Up to four reversible electron reactions were observed for each complex which corresponds to the formation of [Ag^{III}{TPP(*p*-X)}]⁺, [Ag^{III}{TPP(*p*-X)}]²⁺ anion radical, the Ag^I complex, and Ag^I anion radical.¹⁵⁹ Also evidence for residual paramagnetism in silver(III) metalloporphyrin complexes has been reported, this is attributed to the presence of Ag^{II} in small amounts and may have found a use in generating molecular conductors or semiconductors.¹⁶⁰ The Ag^{II} complex with the 14-membered tetraaza macrocycle ligand undergoes a reversible one-electron oxidation process to give an authentic Ag^{III} species. The Ag^{III}/Ag^{II} redox couple potential (0.835 V vs. Ag/AgCl) is affected by variation in the acidity of the solution, indicating that the complex behaves as a fairly strong acid (pK = 2.6).¹⁶¹

Silver(III) complexes with polypeptides¹⁶² such as triglycine (G₃) and tetraglycine (G₄) or with *vic*-dioximate¹⁶³ ligands such as dimethylglyoximate, diphenylglyoximate, and cyclohexane-1,2-dione dioximate have been obtained by direct reaction of [Ag(OH)₄]⁻ and the ligands in alkaline solutions. For the polypeptide complexes the kinetics of the formation reactions are complex. In Equation (1) the proposed structures for the protonated [Ag(H₋₃G₄)]⁻ and [Ag(H₋₄G₄)]²⁻ are shown. The *vic*-dioximate complexes are intensively colored with two ligand-to-metal charge transfer bands; they undergo an internal redox within several minutes.

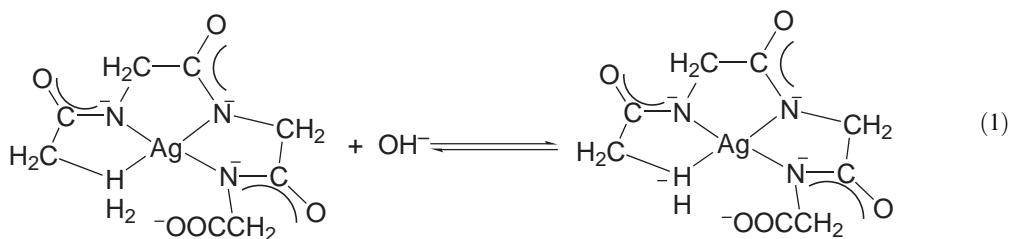

A mixed valence silver(I)–silver(III) cryptate complex (1) has been obtained by condensation of tris(3-aminopropyl)amine and terephthalaldehyde in the presence of AgNO₃. The silver(III) center is coordinated to two imino nitrogens and to one oxygen atom, in a trigonal planar geometry.¹⁶⁴ The nature of (1) has been questioned by a subsequent reinvestigation of its crystal structure. According to this second interpretation the complex has two silver(I) atoms, one four-coordinate and the other disordered between a tetrahedral AgN₄ (22%) and trigonal planar AgN₃ (78%, (2)) with a long interaction to the oxygen atom of the perchlorate anion.¹⁶⁵ Consequently, the theoretical studies in the Ag=O bond length gave a higher value to that found experimentally, 1.59 Å.¹⁶⁶

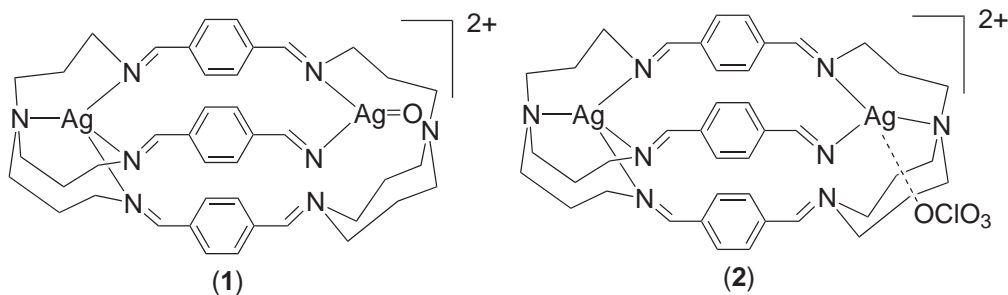

Oxidation of the complexes [Ag(Py)₄][MoF₆] and [Ag(Py)₂][UF₆] in acetonitrile by MoF₆ and UF₆, respectively, leads to the silver(III) compounds [Ag(Py)₄(NCMe)][MoF₆]₃ and [Ag(Py)₂(NCMe)₃][UF₆]₃, which are strong oxidizing agents.¹⁶⁷ Other pyridine silver(III) complexes have been obtained by oxidation of silver nitrate and ammonia with ammonium peroxydisulfate in aqueous

ammonia solution. At high pH *trans*-[Ag(Py)₂(N₂)₂](OH)₃ was obtained, which was converted to [Ag(Py)₂(N₂)₂](ClO₄)₃, and at lower pH *trans*-[Ag(Py)₄](ClO₄)₂(NO₃) was isolated.¹⁶⁸

(Trifluoromethyl)argentates(III) complexes of the type [Ag(CF₃)_n(CN)_{4-n}]⁻ have been prepared by oxidation of [Ag(CF₃)CN]⁻ with bromine. The stability decreases with an increasing number of CN groups. Substitution reactions in these complexes give [Ag(CF₃)_nX_{4-n}]⁻ (X = Cl, Br) or [Ag(CF₃)₃R]⁻ (R = Me, C₂Cy).¹⁶⁹ [Ag(CF₃)₃(MeCN)] is formed in numerous reactions of M[Ag(CF₃)₄] with acidic compounds. This complex reacts with halides to give [Ag(CF₃)₃X]⁻ (X = Cl, Br) or with Cd(C₂F₅)₂ to yield [Ag(CF₃)₃(C₂F₅)]⁻. Oxidation of trifluoromethylsilver(I) compounds with tetraethyl thiuram disulfide leads to the neutral silver(III) complex [Ag(CF₃)₂(S₂CNEt₂)].¹⁷⁰ Another related organometallic compound of silver(III), [N(PPh₃)₂][Ag(CF₂H)₄], has been obtained by oxidation of the corresponding silver(I) compound.¹⁷¹ Also the reaction of diethyldithiocarbamate with silver(I) in the presence of hydrogen peroxide gives [Ag₂(S₂CNEt₂)₂(OH)₂](ClO₄)₂.¹⁷²

The first example of an air-stable silver(III) complex of an *N*-confused tetraphenylporphyrin (5,10,15,20-tetraphenyl-2-aza-21-carboporphyrin argentate(III) (**3**)) has been described.¹⁷³ The complex is diamagnetic and the electrochemistry shows that ring reduction or oxidation is possible.

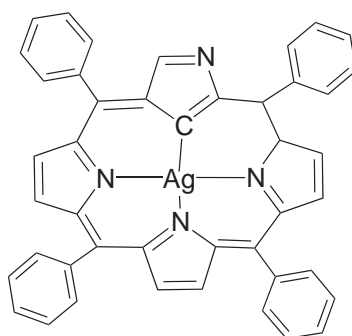

(3)

6.7.2.2 Silver(II)

As *d*⁹ species, silver(II) compounds are expected to be paramagnetic and in practice with the notable exception of AgF₂, the compounds are mostly magnetically dilute with μ_{eff} consistent with one unpaired electron. Many examples of planar four-coordinate compounds are known, and a smaller number of six-coordinate complexes (with Jahn-Teller distortion). The only simple silver(II) compound appears to be the fluoride, AgF₂, and a wide range of related fluorides has been characterized. Heterocyclic nitrogen ligands stabilize silver(II) and many examples have been known for a long time.

The Ag^{II} oxidation state is peculiar for fluoro ligand systems. Although, in its ligand-field effects, oxygen is close to fluorine, Ag^{II} does not occur in oxides where AgO is Ag^IAg^{III}O₂. However, the attempts to disproportionate AgF₂ did not succeed. The mixed-valence fluoride Ag^IAg^{III}F₄ has been obtained as a red-brown diamagnetic solid by interaction of Ag⁺ salts, in anhydrous liquid hydrogen fluoride (aHF), with AgF₄⁻. This compound transforms exothermically to brown, paramagnetic AgF₂ below 0 °C.¹⁷⁴ Disproportionation of Ag^{II} in Ag^I and Ag^{III} has been achieved with Ag^{II}FAsF₆,¹⁷⁵ which disproportionates in aHF to colorless Ag^IAsF₆ and a black pseudotrifluoride (Ag^{II}F⁺)₂Ag^{III}F₄⁻AsF₆⁻.¹⁷⁴ This type of compound, (AgF)₂AgF₄MF₆, is also generated by oxidation of AgF₂ or AgF⁺ salts in aHF with F₂ or in solutions of O₂⁺MF₆⁻ salts (M = As, Sb, Pt, Au, Ru).¹⁷⁴ The reaction of AgF₂ with excess of SbF₅ in aHF gives the adduct AgF₂·2SbF₅, the silver atom is square-planar with two different Ag—F bond lengths and other two long Ag—F distances.¹⁷⁶ Mixed fluoride complexes where the silver atom has a trigonal bipyramidal geometry are AgM^{II}₃M^{IV}₃F₂₀ (M^{II} = Cd, Ca, Hg; M^{IV} = Zr, Hf).¹⁷⁷ Other silver(II) fluorides of the type Ag[MF₆]₂ (M = Nb, Ta) or Ag[AuF₄]₂ have been described.^{178,179} Blue solutions of AgF₂ in aHF with BF₃ or AsF₅ oxidize Xe to Xe^{II} at ~20 °C.¹⁸⁰ A potent oxidant Ag^{II}_(solv) has been generated by treatment of AgFAsF₆ with AsF₅ or AgAsF₆ with O₂AsF₆ in aHF; it is capable of oxidizing O₂ to O₂⁺.¹⁵⁸ The reaction of AgMF₆ (M = Ir, Ru, Bi, Sb) with F₂ in aHF gave (AgF⁺)_n(MF₆⁻)_n.^{158,181} The reaction of UF₆ and AgF in aHF has been re-investigated

and the new results support the formation of an intermediate red solid, proposed to be Ag_2UF_8 , which subsequently decomposes to AgF_2 and AgUF_6 .¹⁸²

Silver(I) in the presence of tetraaza macrocyclic ligands disproportionates to Ag^0 and the Ag^{II} derivatives. Recent studies have shown that disproportionation depends upon the ring size of the macrocycle, thus while 14-, 15-, and 16-ring tetraaza macrocycles cause disproportionation, larger rings do not.^{183,184} The smaller ring sizes lead to strong Ag–N interaction, which raises the antibonding $4d$ -orbitals sufficiently so that removal of an electron is facilitated. The electrochemical behavior of this type of complexes has been studied. The behavior is complex and both solvent and ligand dependent.^{185,186} Also the rate constants for the electron transfer reactions of these complexes have been determined by pulse radiolysis. The self-exchange rate constants reveal slow exchanges for $d^{9/10}$ couples and fast exchanges for $d^{8/9}$ couples.¹⁸⁷ The crystal structures for two silver(II) complexes with macrocycles have been reported, complex (4) and other with the ligand 5,5,7,12,12,14-hexamethyl-1,4,8,11-tetraazacyclotetradecane.^{188,189} The environment about the Ag^{II} is approximately square-planar. Two bimetallic Ag^{II} coordination polymers, $[\text{Ag}(\text{cyclam})\text{M}(\text{CN})_2(\mu\text{-CN})_2]_n$ ($\text{M} = \text{Pd}, \text{Pt}$; cyclam = 1,4,8,11-tetraazacyclotetradecane) (5), were synthesized by reaction of $[\text{Ag}(\text{cyclam})](\text{ClO}_4)_2$ with $\text{K}_2[\text{M}(\text{CN})_4] \cdot 3\text{H}_2\text{O}$.¹⁹⁰

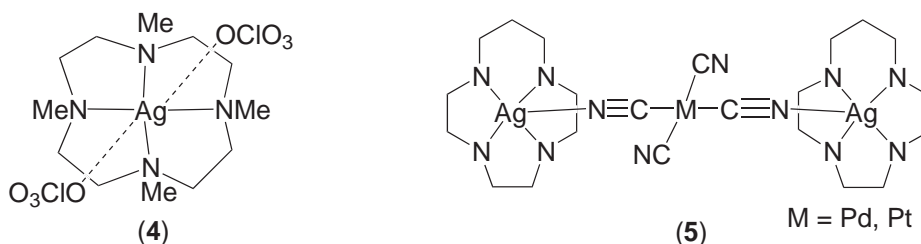

A mixed-valence complex $[\text{Ag}^{\text{II}}(\text{tmc})(\text{BF}_4)][\text{Ag}^{\text{I}}_6(\text{C}_2)(\text{CF}_3\text{CO}_2)_5(\text{H}_2\text{O})] \cdot \text{H}_2\text{O}$ ($\text{tmc} = 1,4,8,11$ -tetramethyl-1,4,8,11-tetraazacyclotetradecane) has been prepared, in which a $[\text{Ag}^{\text{II}}(\text{tmc})(\text{BF}_4)]^+$ cationic column induces the assembly of an anionic zig-zag chain constructed from edge-sharing silver(I) triangulated dodecahedra, each enclosing a C_2^{2-} species. The $\text{Ag} \cdots \text{Ag}$ distances lie in the range 2.818–3.366(1) Å, which is suggestive of significant argentophilic interaction.¹⁹¹

Another class of nitrogen donor ligands, which favor Ag^{II} over Ag^{I} , is porphyrins, which like macrocycles provide strong in-plane ligand fields, which facilitate oxidation of the metal. The electrochemical reduction of silver(II) porphyrins results in generation of an unstable $[\text{Ag}^{\text{I}}(\text{porphyrin})]$ which rapidly demetallates to form Ag^+ ions and the free porphyrin base,¹⁹² also the oxidation and reduction processes has been investigated.¹⁵⁹ The electronic structures of $[\text{Ag}^{\text{II}}(\text{porphyrin})]$ have been investigated by $X\alpha$ -calculations.¹⁹³ Water-soluble silver(II) complexes have been prepared mainly using modified tetraphenylporphyrin, with $p\text{-Me}^+\text{NC}_5\text{H}_4^+$, $p\text{-Me}_3^+\text{NC}_6\text{H}_4^-$, or $p\text{-O}_3\text{SC}_6\text{H}_4$ groups replacing phenyl.^{194–197} Silver(II) complexes with tetraphenylporphyrin, octaethylporphyrin, etioporphyrin, and the one-electron oxidation compounds has been examined by NMR spectroscopy. A metal-centered oxidation occurs for the silver(II) compounds in contrast with the behavior of copper(II) where the oxidation is porphyrin-centered.¹⁹⁸ The oxidation of the labile silver(I) complex $[\text{Ag}_2(\text{tmptp})]$ ($\text{tmptp} = 5,10,15,20$ -tetra(3'-*N*-methylpyridinio)porphyrin) with peroxydisulfate to give the silver(II) compound was found to be first order each in silver(I) and peroxydisulfate ions and zero order in porphyrin.¹⁹⁹ Single-crystal EPR spectra have been obtained for two spin-labeled silver porphyrins doped into zinc tetraphenylporphyrin. For each of the complexes four conformations were obtained.²⁰⁰ The crystal structures of silver(II) derivatives of *meso*-tetraphenylporphyrin have been carried out. The Ag–N distances are found to be statistically nonequivalent, and this probably arises from asymmetric lattice packing.²⁰¹ Fast-atom bombardment mass spectrometry has been used to study porphyrins and their metal complexes; rates of demetallation and inter- and intramolecular electron transfer processes have been investigated. The one-electron reduction of AgP occurs via an excited state intermediate and the rate of electron transfer from the porphyrin ring to Ag^{II} is $2 \times 10^{11} \text{ s}^{-1}$.²⁰² Two Ag^{II} complexes of tetra-(3'-nitrophenyl)porphyrin and tetra-(3'-aminophenyl)porphyrin have been prepared and their ESR spectra reported.²⁰³ A phenanthroline capped porphyrin which combines in a rigid fashion a 2,9-diphenyl-phen (phen = 1,10-phenanthroline) unit and a meso-diphenyl porphyrin reacts with AgNO_3 with a initial complexation to the phen unit but further addition of silver produces the oxidation to Ag^{II} and coordination to the porphyrin unit.²⁰⁴ When 5,10,10,15,20-tetrakis(4-carboxyphenyl)porphyrin, H_2L , is added to a silver colloid, prepared by

reduction of AgNO_3 by NaBH_4 , in 0.02 M phosphate buffer, a complex $[\text{AgL}]$ is formed. SERS (Surface-Enhanced Raman Spectra) spectral data have been collected for the surface complex and have been compared with the resonance Raman spectrum of $[\text{Ag}(\text{TTP})]$.²⁰⁵ The dimer formation constants for silver porphyrins have been obtained through EPR measurements.²⁰⁶

The preparation and characterization of the silver(II) complex $[\text{AgL}]$ (where H_2L = tetraeopentoxypthalocyanine) has been reported. Electrochemical studies show that oxidation to stable $[\text{Ag}^{\text{III}}\text{L}]^+$ occurs followed by further oxidation to the radical cation $[\text{AgL}]^{2+}$. Reduction to $[\text{Ag}^{\text{I}}\text{L}]^-$ leads to demetallation on the electrochemical time scale.²⁰⁷

Silver(II) forms stable complexes with other nitrogen donor ligands such as pyridine, substituted bipyridine, phenanthroline, or citrazinic acid. They are usually obtained by reaction of a silver(I) salt with peroxodisulfate in the presence of the ligand. The complex $[\text{Ag}(\text{Py})_4](\text{S}_2\text{O}_8)$ has been used as oxidation reagent in the oxidation of organic compounds.²⁰⁸ The 6,6'-dimethyl-1,2'-bipyridine and 2,9-dimethyl-phen ligands form complexes of the type $[\text{Ag}(\text{NO}_3\text{L})]\text{PF}_6 \cdot \text{NH}_4\text{PF}_6$ which ESR spectra indicate extensive delocalization involving the nitrate ion.²⁰⁹ The silver(II) complex $[\text{Ag}(\text{H}_2\text{L})_2]$ (6) with citrazinic acid (H_3L) has the ligand acting as mixed bidentate through the nitrogen and one oxygen atom. It reacts with other nitrogen donor ligands such as pyridine and picoline to give the complexes $[\text{Ag}(\text{H}_2\text{L})_2\text{L}^2]$.²¹⁰ The Ag^{II} complex (7) of a Schiff base has been proposed to have a dimeric structure based on its low magnetic moment of 1.63 BM and the presence of Ag–O and Ag–N stretches in the far-IR.²¹¹

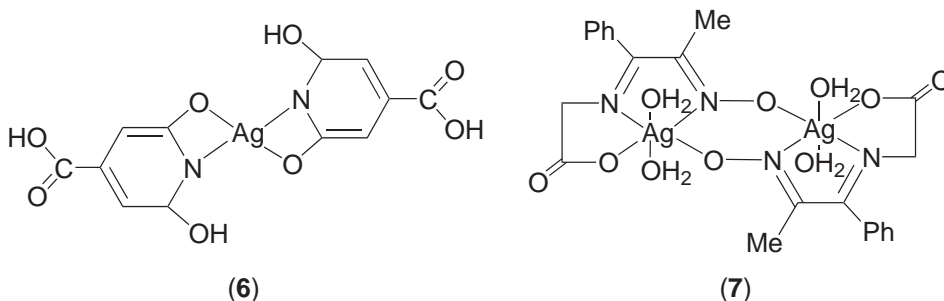

The nature of Ag^{II} in solution and the kinetics and mechanisms of Ag^{II} oxidations of a variety of inorganic and organic substrates have been studied, complexes $[\text{Ag}(\text{Py})_4]^{2+}$ and $[\text{Ag}(\text{bipy})_2]^{2+}$ are typical examples.^{212–215}

Silver(II) complexes in the gas phase have been prepared with several nitrogen- and oxygen-donor ligands including pyridine, tetrahydrofurane, benzene, CO_2 , etc. The complexes are of the type $[\text{AgL}_n]^{2+}$, and the compound $[\text{Ag}(\text{CO})_4]^{2+}$ is particularly stable.²¹⁶

6.7.2.3 Silver(I)

6.7.2.3.1 Complexes with carbon donor ligands

Isolable silver(I) carbonyl complexes have been reported only recently. Previously $[\text{Ag}(\text{CO})_n]^+$ species had been detected in zeolite host or in strongly acidic media at low temperatures and high CO pressures.^{217,218} The use of very large weakly coordinating anions such as $\text{B}(\text{OTeF}_5)_4^-$, $\text{Zn}(\text{OTeF}_5)_4^{2-}$, $\text{Ti}(\text{OTeF}_5)_6^{2-}$, and $\text{Nb}(\text{OTeF}_5)_6^-$, has allowed the isolation and structural characterization of the Ag^{I} carbonyl complexes $[\text{Ag}(\text{CO})]^+$ and $[\text{Ag}(\text{CO})_2]^+$.^{25,26} They are prepared under CO pressure at low temperature (Equation (2)):

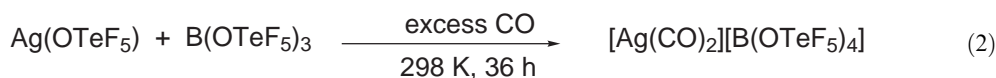

This complex rapidly loses one molecule of CO, leaving $[\text{Ag}(\text{CO})][\text{B}(\text{OTeF}_5)_4]$ and reversibly takes up another equivalent of CO at high pressure. The latter has a short C–O bond length (1.077(16) Å), long Ag–C distance (2.10(1) Å), and very high value of $\nu(\text{CO})$ (2,204 cm^{-1}) suggested little or no π -backbonding, a situation that is virtually unprecedented in metal carbonyl

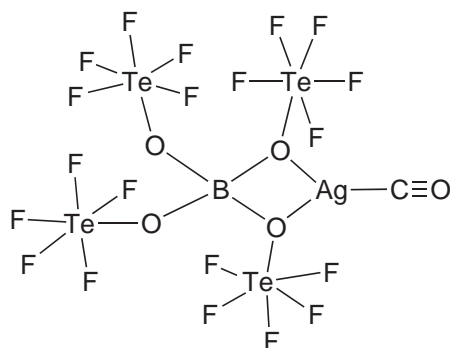
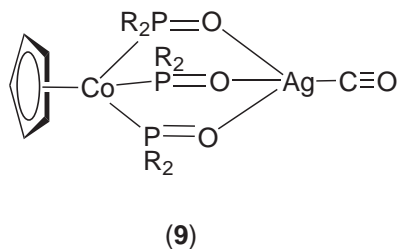
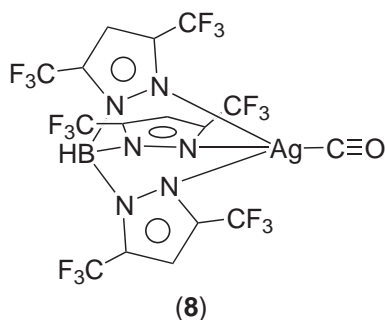

Figure 1 Structure of $[\text{Ag}(\text{CO})] [\text{B}(\text{OTeF}_5)_4]$.

chemistry. The structure shows a trigonal planar geometry for silver bound to the carbonyl and two oxygen atoms of the anion (Figure 1).

The structure of $[\text{Ag}(\text{CO})_2]^+$ is linear and it weakly bonds to two or more $\text{B}(\text{OTeF}_5)_4^-$ anions. These complexes decompose at room temperature giving $[\text{Ag}(\text{CO})(\text{OTeF}_5)]$, CO , and $\text{B}(\text{OTeF}_5)_3$. The $\text{Zn}(\text{OTeF}_5)_4^{2-}$ and $\text{Ti}(\text{OTeF}_5)_6^{2-}$ adducts are more stable when subjected to subambient pressures of CO .

A silver tricarbonyl complex $[\text{Ag}(\text{CO})_3][\text{Nb}(\text{OTeF}_5)_6]$ has been prepared from $\text{Ag}[\text{Nb}(\text{OTeF}_5)_6]$ under 13 atm of CO for 4 h at 298 K. It is stable at 196 K and 5–10 torr, but readily loses CO in toluene solution at 298 K.²¹⁹ An IR spectroscopic study of $\text{Ag}[\text{Nb}(\text{OTeF}_5)_6]$ in solution as well as in the solid state under variable CO pressure reveals the stepwise formation of $[\text{Ag}(\text{CO})]^+$, $[\text{Ag}(\text{CO})_2]^+$, and $[\text{Ag}(\text{CO})_3]^+$, with increasing pressure favoring the higher carbonyl. The $\nu(\text{CO})$ IR band for the tricarbonyl species is assigned at $2,192 \text{ cm}^{-1}$.²²⁰ An analysis of the $\text{Ag}-\text{CO}$ bonding in silver carbonyls has been carried out on the basis of Fenske-Hall calculations. The nonclassical behavior of the $\text{C}-\text{O}$ stretching frequency trends has been attributed to uncompensated CO -to-metal σ -donations due to the very weak metal-to-ligand π -back donation.²²¹ The $\text{Ag}-\text{CO}$ bond dissociation energies for $[\text{Ag}(\text{CO})_n]^+$ complexes, $n=1-4$, has been found by collision-induced dissociation mass spectrometry to be 0.92 eV, 1.13 eV, 0.57 eV, and 0.47 eV, respectively,²²² verifying earlier predictions by *ab initio* calculations. Quantum chemical investigations at the MP2 and CCSD(T) level with relativistic effective core potentials for the metals have been reported for homoleptic carbonyl complexes of the group 11 d^{10} metal cations with up to six carbonyl ligands. The complexes $[\text{Ag}(\text{CO})_n]^+$ are predicted to be bound species for $n=1-6$.²²³ Addition of CO or CNBu to $[\text{Ag}\{\text{HB}[3,5-(\text{CF}_3)_2\text{pz}]_3\}]$ gives the corresponding $[\text{Ag}\{\text{HB}[3,5-(\text{CF}_3)_2\text{pz}]_3\}(\text{CO})]$ (**8**) or $[\text{Ag}\{\text{HB}[3,5-(\text{CF}_3)_2\text{pz}]_3\}(\text{CNBu})]$ complexes.²⁷ These complexes show much higher $\nu(\text{CO})$ and $\nu(\text{CN})$ values compared with the free ligand and seem to have predominantly σ -type Ag -ligand interaction. Similar silver(I) carbonyl or isocyanide complexes with a tripodal ligand $[\text{Co}(\text{C}_5\text{H}_5)\{\text{P}(\text{O})\text{R}_2\}_3]^-$ (L_R) ($\text{R}=\text{OMe}, \text{OEt}, \text{OPr}^i$) have been obtained and are of the form $[\text{AgL}_\text{R}(\text{CO})]$ (**9**) or $[\text{AgL}_\text{R}(\text{CNBu})]$. The $\nu(\text{CO})$ appears at $2,147 \text{ cm}^{-1}$ which is the closer value to that found in free CO ($2,143 \text{ cm}^{-1}$).²²⁴ All the silver(I) carbonyl species are considered to be nonclassical because of the relatively little π -backbonding present, similar fact is found in copper carbonyl species.²²⁵



Silver(I) isocyanide complexes have been known for a long time and they were usually prepared by alkylation of silver cyanide.²²⁶ More recent reports include the study of steric effects of ligands

in silver(I) isocyanide complexes. The reaction of AgPF_6 with CNR in a 1:2 molar ratio gives $[\text{Ag}(\text{CNR})_2]\text{PF}_6$ ($\text{R} = 2,4,6\text{-Bu}^t_3\text{C}_6\text{H}_2$, $2,4\text{-Bu}^t_2\text{-6-MeC}_6\text{H}_2$, $2,6\text{-Me}_2\text{C}_6\text{H}_3$) and further reaction with CNR yields $[\text{Ag}(\text{CNR})_3]\text{PF}_6$ with the exception of the bulky $\text{CN}(2,4,6\text{-Bu}^t_3\text{C}_6\text{H}_2)$. The structure of $[\text{Ag}\{\text{CN}(2,4,6\text{-Bu}^t_3\text{C}_6\text{H}_2)\}_2]$ shows a distorted tetrahedral geometry with the PF_6 acting as bidentate ligand.²²⁷ Other isocyanide silver(I) complexes of stoichiometry $[\text{Ag}(\text{CNR})_4]\text{ClO}_4$ ($\text{R} = \text{Me}$, Cy , Bu^t) and $[\text{Ag}(\text{CNCy})_2]\text{ClO}_4$ have been reported together with substitution reactions. Phosphine or arsine ligands produce complete isocyanide displacement whereas nitrogen donor ligands, polydentate phosphines, or phosphites give complexes of the type $[\text{Ag}(\text{CNR})(\text{bipy})]\text{ClO}_4$ ($\text{R} = \text{Cy}$, Bu^t), $[\text{Ag}(\text{CNCy})(\text{Py})]\text{ClO}_4$, or $[\text{Ag}(\text{CNCy})\text{L}_3]\text{ClO}_4$ ($\text{L}_3 = (\text{Ph}_2\text{PCH}_2)_3\text{CMe}$, $\text{P}(\text{OMe})_3$).²²⁸

Complexes with bridging cyanide groups have been synthesized. The $[\text{Ag}(\text{CN})_2]^-$ anion is used to form additional coordination bonds through the nitrogen atoms of the cyano groups. It can act as an isolated counterion in structures with ionic character such as $[\text{Ni}(\text{bipy})_3]_2[\text{Ag}(\text{CN})_2]_3 \cdot \text{Cl} \cdot 9\text{H}_2\text{O}$,²²⁹ as a ligand when bonded via one bridging cyano group in complexes such as $[(\text{PPh}_3)_2\text{N}][\text{ClPh}_3\text{Sn}(\mu\text{-NC})\text{Ag}(\text{CN})]$,²³⁰ $[\text{L}_n\text{MCNAgCN}]$ ($\text{L}_n\text{M} = [\text{FeCp}(\text{dppe})]^+$ ($\text{dppe} = 2\text{-bis}(\text{diphenylphosphino})\text{ethane}$), $[\text{RuCp}(\text{PPh}_3)_2]^+$,²³¹ or $[\text{Cr}(\text{en})_2\{\text{Ag}(\text{CN})_2\}]\text{ClO}_4$ ($\text{en} = 1,2\text{-ethylenediamine}$),²³² or as bridging spacer between central atoms giving rise to polymeric structures as in complexes such as $[\text{Cu}(\text{bipy})_2\{\text{Ag}(\text{CN})_2\}_2][\text{Ag}(\text{CN})_2] \cdot 2\text{H}_2\text{O}$,²³³ $[\text{Zn}(\text{en})_2\{\text{Ag}(\text{CN})_2\}_2][\text{Ag}(\text{CN})_2]$,²³⁴ or $[\text{Cu}(\text{en})_2\text{Ag}(\text{CN})_2][\text{Ag}(\text{CN})_2]$.²³⁵ The dicyanodargentate(I) anion is also useful to build up multidimensional coordination polymers. Cd^{2+} , $[\text{Ag}(\text{CN})_2]^-$, and the monodentate 4-methylpyridine are self-assembled from an aqueous solution to build up the 1D polymer chain complex $[\text{Cd}(4\text{-Mepy})_4\{\text{Ag}_2(\text{CN})_3\}][\text{Ag}(\text{CN})_2]$ and an interwoven 2D network host clathrate $[\text{Cd}(4\text{-Mepy})_2\{\text{Ag}(\text{CN})_2\}_2] \cdot 4\text{-MePy}$.²³⁶ When L is an ambidentate bridging ligand such as 4,4'-bipyridine and pyrazine, 3D complexes $[\text{Cd}(4,4'\text{-bipyridine})_2\{\text{Ag}(\text{CN})_2\}_2]$ with doubly interpenetrating and $[\text{Cd}(\text{pyrazine})\{\text{Ag}_2(\text{CN})_3\}][\text{Ag}(\text{CN})_2]$ with triply interpenetrating lattice structures are obtained.²³⁷ The less bulky monodentate NH_3 in $[\text{Cd}(\text{NH}_3)_2\{\text{Ag}(\text{CN})_2\}_2]$ gives a 3D warp-and-wool interwoven structure of two sets of 2D networks.²³⁸ Other $\text{Cd}^{2+}\text{-}[\text{Ag}(\text{CN})_2]^- \text{-L}$ systems have been studied (where L = 4-aminopyridine, aminoethanol, imidazole, *N*-methyl, or 2-methylimidazole) and several modes of coordination have been achieved.^{239,240} The $[\text{Ag}(\text{CN})_2]^-$ anion has also been used in the construction of host-guest^{241,242} and low-dimensional magnetic systems.²⁴³ Reaction of AgClO_4 with 2,5-dimethyl-2,5-diisocyanohexane (TMB) gives the complex $[\text{Ag}_2(\text{TMB})_3](\text{ClO}_4)_2$. The structure consists of pairs of $\cdots\text{AgCN}\sim\text{NCAgCN}\sim\text{HCAg}\cdots$ infinite chains with another TMB ligand is bonded to silver.²⁴⁴ The treatment of $(\text{Ph}_4\text{P})[\text{WCpS}_3]$ with AgCN gives an helical polymer $[\{\text{W}(\text{C}_5\text{Me}_5)\text{S}_3\}_2\text{Ag}_3(\text{CN})]_n$ (Figure 2).²⁴⁵ The complex $\eta\text{-}(\text{BEDT-TTF})_2[\text{Ag}(\text{CN})_2]$ (BEDT-TTF = bis(ethylenedithio)tetrathiafulvalene) exhibit semiconducting properties although the band structure calculation predicts metallic behavior.²⁴⁶

Recently the vibrational spectroscopy and determination of the crystal structure of AgCN was carried out by using powder neutron diffractometer data.²⁴⁷ The structure is composed of a packing of parallel, linear $[\text{AgCN}]_n$ chains with $\text{Ag}\cdots\text{Ag}$ separations that exceed 3.88 Å. AgCN dissolves in aqueous solutions of a soluble silver salt giving double salts of the type $3\text{AgCN} \cdot 2\text{AgF} \cdot 3\text{H}_2\text{O}$,²⁴⁸ $\text{AgCN} \cdot 2\text{AgNO}_3$,²⁴⁹ $\text{AgCN} \cdot 2\text{AgClO}_4 \cdot 2\text{H}_2\text{O}$,²⁴⁹ or $\text{AgCN} \cdot \text{AgF} \cdot 4\text{CF}_3$

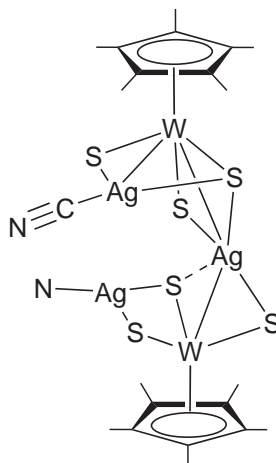

Figure 2 Structure of the repeating unit of $[\{\text{W}(\text{C}_5\text{Me}_5)\text{S}_3\}_2\text{Ag}_3(\text{CN})]_n$.

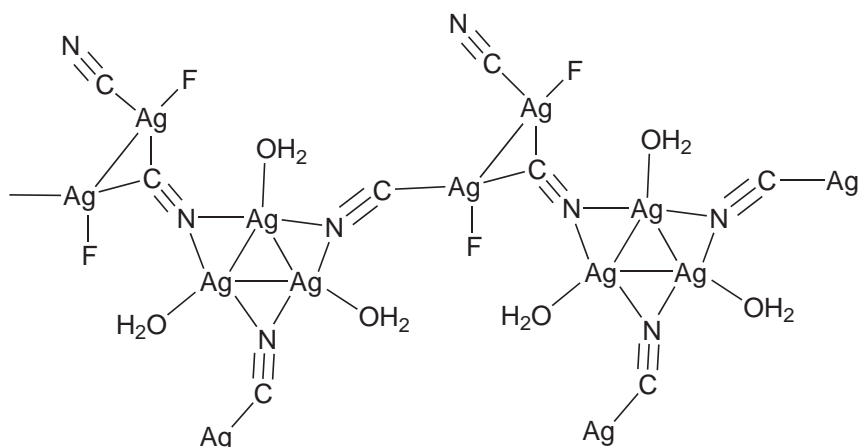

Figure 3 Layer structure of $3\text{AgCN}\cdot 2\text{AgF}\cdot 3\text{H}_2\text{O}$.

$\text{CO}_2\cdot 2\text{L}$ ($\text{L} = \text{MeCN}, \text{H}_2\text{O}$).²⁵⁰ In the nitrate salt the AgCN component essentially retains the linear $[\text{AgCN}]_n$ characteristics of neat silver cyanide, whereas in the perchlorate salt the $[\text{AgCN}]_n$ chain is significantly perturbed to assume a zig-zag conformation, and breaks up completely into fragments in $3\text{AgCN}\cdot 2\text{AgF}\cdot 3\text{H}_2\text{O}$. In the latter the structure consists of a layer-type architecture of a zig-zag $[\text{AgCN}]_n$ chain as a building unit, and an interaction of the ordered cyanide group with two other neighboring Ag^{I} ions leads to an unprecedented $\mu_4\text{-}\eta^1\kappa\text{C}:\eta^1\kappa\text{N}$ coordination mode (Figure 3). The trifluoroacetate salt has a similar structure. The driving force for dissolving AgCN in aqueous solutions of a soluble silver salt is attributed to both argentophilicity and the tendency of the cyanide ligand to achieve its highest ligation number.

Argentophilic attraction has been found in $\text{Ti}[\text{Ag}(\text{CN})_2]$; this compound displays photoluminescence that has been explained in terms of excited-state $\text{Ag}\text{--}\text{Ag}$ interactions leading to exciplex formation, $*[\text{Ag}(\text{CN})_2^-]_3$.²⁵¹ Several photochemical studies have been carried out with this type of compound.^{252–255}

The insoluble alkynylsilver or acetylidesilver complexes are regarded as coordination polymers $[\text{RC}\equiv\text{CAg}]_n$ with cross-linking between the metal atoms and the ethynyls of adjacent $\text{RC}\equiv\text{CAg}$ units. The addition of a ligand can partly break down the polymeric structure. The 1:1 complexes of alkynyl silver compounds with tertiary phosphines build oligomeric or polymeric structures in which alternating $[\text{Ag}(\text{C}\equiv\text{CR})_2]$ units π -donate to adjacent $[\text{Ag}(\text{PMe}_3)]^+$ units rather than monomeric $[\text{Ag}(\text{C}\equiv\text{CR})(\text{PR}_3)]$ molecules.^{256,257} The 1,3-bis(*o*-propargyl)-*t*-butylcalyx[4]arene derivative reacts with AgNO_3 to give the alkynyl species that further react with PPh_3 to yield the $[\text{Ag}(\text{C}\equiv\text{CR})(\text{PPh}_3)]$ complex.²⁵⁸ Several alkynyl silver(I) compounds with diphosphines have been synthesized and they exhibit luminescence in both the solid state and in solution.^{259,260} The reaction of $[\text{PhC}\equiv\text{CAg}]_n$ with dppm yields $[\text{Ag}_3(\mu_3\text{-}\eta^2\text{-C}\equiv\text{CPh})_2(\text{dppm})_3]^+$ (**10**).²⁶¹ Other trinuclear silver(I) acetylides have been prepared by reaction of the silver diphosphine complexes $[\text{Ag}_2(\mu\text{-PP})_2(\text{MeCN})_2]^{2+}$ with $\text{RC}\equiv\text{CLi}$, they are of the stoichiometries $[\text{Ag}_3(\mu\text{-PP})_3(\mu_3\text{-}\eta^1\text{-C}\equiv\text{CR})(\text{BF}_4)_2]$ ($\text{PP} = \text{dppm}, \text{R} = \text{Ph}$ (**11**), $4\text{-NO}_2\text{C}_6\text{H}_4$, $4\text{-MeOC}_6\text{H}_4$; $\text{PP} = \text{Pr}^n\text{N}(\text{PPh}_2)_2$, $\text{R} = \text{Ph}$) or $[\text{Ag}_3(\mu\text{-PP})_3(\mu_3\text{-}\eta^1\text{-C}\equiv\text{CR})_2]\text{PF}_6$.²⁶² By reaction of $[\text{Ag}_2(\mu\text{-dppm})_2(\text{MeCN})_2](\text{BF}_4)_2$ with 1,4-diethynylbenzene in the presence of LiBu^n the complex $[\text{Ag}_3(\mu\text{-dppm})_3(\mu_3\text{-}\eta^1\text{-C}\equiv\text{CC}_6\text{H}_4\text{C}\equiv\text{C})\text{Ag}_3(\mu\text{-dppm})_3](\text{BF}_4)_4$ (**12**) is obtained.²⁶³

The organometallic substituted acetylides $\text{L}_n\text{MC}\equiv\text{CR}$ or organometallic bridged 1,4-diynes $\text{RC}\equiv\text{CML}_n\text{C}\equiv\text{CR}$ ($\text{R} =$ singly bonded organic ligand; $\text{ML}_n =$ organometallic building block) can further coordinate other metal centers as silver.²⁶⁴ There are many complexes that lie in the organometallic chemistry of silver and which will not be discussed here. The reaction of $[\text{PtCl}_2(\text{THT})_2]$ ($\text{THT} =$ tetrahydrothiophene) with $[\text{AgC}\equiv\text{CR}]_n$ gives the cluster compounds $[\text{Pt}_2\text{Ag}_4(\text{C}\equiv\text{CR})_8]$ ($\text{R} = \text{Ph}, \text{Bu}^t$) (**13**).²⁶⁵ This complex reacts with anionic or neutral ligands (molar ratio 1:4) to give trinuclear compounds such as $(\text{Bu}_4\text{N})_2[\{\text{Pt}(\text{C}\equiv\text{CR})_4\}(\text{AgX})_2]$ ($\text{X} = \text{Cl}, \text{Br}$) or $[\{\text{Pt}(\text{C}\equiv\text{CR})_4\}(\text{AgL})_2]$ ($\text{L} = \text{CNBu}^t, \text{Py}$). The reaction in a 1:1 molar ratio gives the hexanuclear species $(\text{Bu}_4\text{N})_2[\text{Pt}_2\text{Ag}_4(\text{C}\equiv\text{CR})_8\text{X}_2]$ or $[\text{Pt}_2\text{Ag}_4(\text{C}\equiv\text{CR})_8(\text{Py})_2]$.²⁶⁶ Also it serves as a precursor for polymeric materials, thus in the reaction with bipy this ligand bridges the equatorial silver atoms giving a polymeric complex.²⁶⁷ Also in the reaction with AgClO_4 (molar

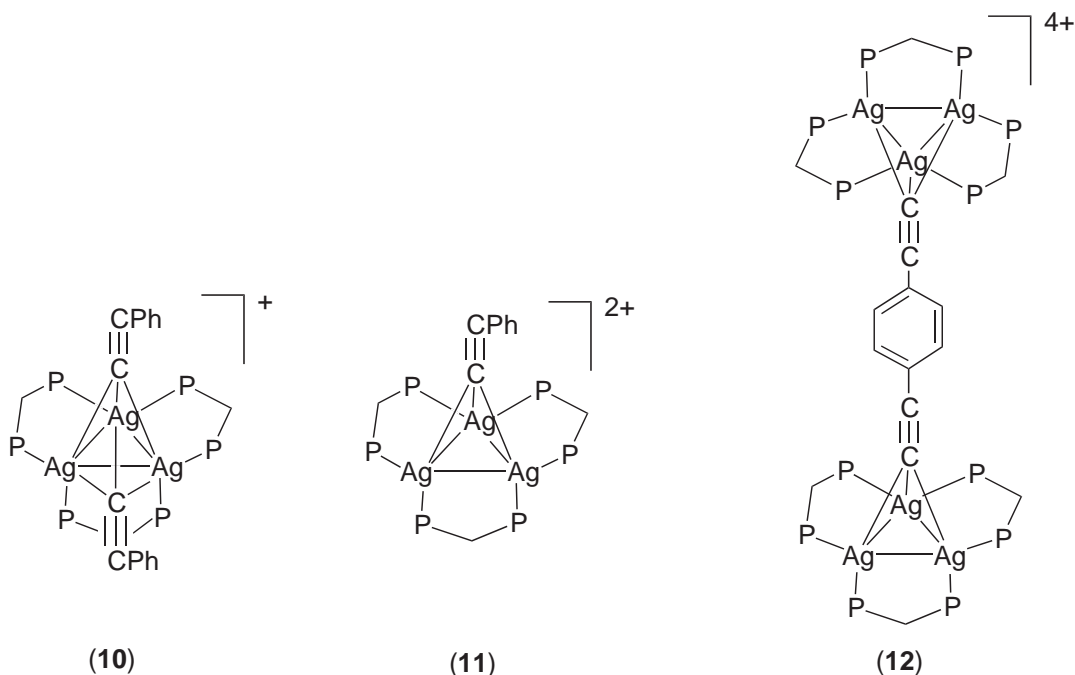

ratio 1:4) the complex acts as an octadentate chelating agent through the external alkynyl coordination sites, the perchlorate ligands can react further with bipy in different molar ratios to give polynuclear derivatives.^{267,268} Other types of complexes are formed by reaction of $[\text{Ti}(\eta^5\text{-C}_5\text{H}_4\text{TMS})_2(\text{C}\equiv\text{CR})_2]$ with silver salts and are of the form $[\text{Ti}(\eta^5\text{-C}_5\text{H}_4\text{TMS})_2(\text{C}\equiv\text{CR})_2(\text{AgX})]$ (14) ($\text{X} = \text{Cl}, \text{Br}, \text{I}, \text{CN}, \text{SCN}, \text{NO}_2, \text{NO}_3, \text{ClO}_4, \text{OTf}, \text{S}_2\text{CNEt}_2, \text{SC}_6\text{H}_2\text{NMe}_2\text{-2}$).^{269,270} The complex $[\text{Ti}(\eta^5\text{-C}_5\text{H}_4\text{TMS})_2(\text{C}\equiv\text{CR})_2(\text{AgOTf})]$ reacts with several ligands such as THT, NCMc, NCPH, $\text{P}(\text{OMe})_3$, PPh_3 , and $\text{P}(\text{C}\equiv\text{CPh})_2(\text{CH}_2\text{Ph})$ to give $[\text{Ti}(\eta^5\text{-C}_5\text{H}_4\text{TMS})_2(\text{C}\equiv\text{CR})_2\text{Ag}(\text{OTf})\text{L}]$ (OTf = trifluoromethanesulfonate).²⁷¹

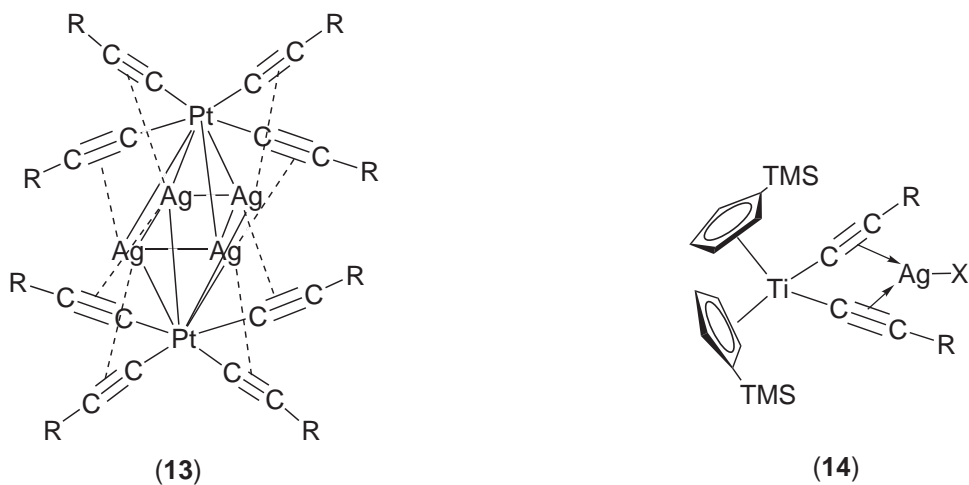

Similar complexes are prepared with platinum and are of the type $\text{Bu}_4\text{N}[\text{Pt}(\text{C}_6\text{F}_5)_2(\text{C}\equiv\text{CR}^1)_2(\text{AgPR}^2_3)]$ ($\text{R}^1 = \text{Ph}, \text{Bu}^t$; $\text{R}^2 = \text{Ph}, \text{Et}$) which are obtained by reaction of the tetranuclear platinum–silver complex $(\text{Bu}_4\text{N})_2[\text{Pt}_2\text{Ag}_2(\text{C}_6\text{F}_5)_4(\text{C}\equiv\text{CR})_4]$ with phosphine.²⁷² The polynuclear complexes $[\text{PtAg}_2(\text{C}_6\text{F}_5)_2(\text{C}\equiv\text{CR})_2]_n$ ($\text{R} = \text{Ph}, \text{Bu}^t$) must have a polymeric structure with the silver atoms η^2 -bonded to the acetylide groups; the *t*-butylacetylide derivative reacts with acetone to give $[\text{Pt}_2\text{Ag}_4(\text{C}_6\text{F}_5)_4(\text{C}\equiv\text{CBu}^t)_4(\text{Me}_2\text{CO})_4]$.²⁷³ Both react with neutral ligands to give $[\text{PtAg}_2(\text{C}_6\text{F}_5)_2(\text{C}\equiv\text{CR})_2\text{L}_2]$ or $[\text{Pt}_2\text{Ag}_4(\text{C}_6\text{F}_5)_4(\text{C}\equiv\text{CR})_4\text{L}_2]$ ($\text{L} = \text{PPh}_3, \text{CNBu}^t, \text{Py}$).²⁷⁴ The crystal structure of $[\text{PtAg}_2(\text{C}_6\text{F}_5)_2(\text{C}\equiv\text{CPh})_2(\text{PPh}_3)_2]$ reveals two different types of unsymmetrical $\mu_3\text{-}\sigma$

and $\mu\text{-}\eta^2,\sigma$ -edge-bridging alkynyl ligand (Scheme 1). The reaction of *trans*-[Pt(C \equiv CBu^t)₂(PMe₂Ph)₂] with AgClO₄ gives *trans*-[PtAg₂(MeCN)_x(μ -C \equiv CBu^t)₂(PMe₂Ph)₂](ClO₄)₂ that reacts further with Py to give the neutral derivative *trans*-[PtAg₂(ClO₄)₂(Py)₂(μ -C \equiv CBu^t)₂(PMe₂Ph)₂](ClO₄)₂.²⁷⁶ Silver(I) also binds in a η^2 fashion to alkynyl manganese complexes such as [Mn(C \equiv CBu^t)(CO)₃(dppe)] to give [Mn{AgP(2-MeC₆H₄)₃}(μ -C \equiv CBu^t)(CO)₃(dppe)]⁺.²⁷⁷

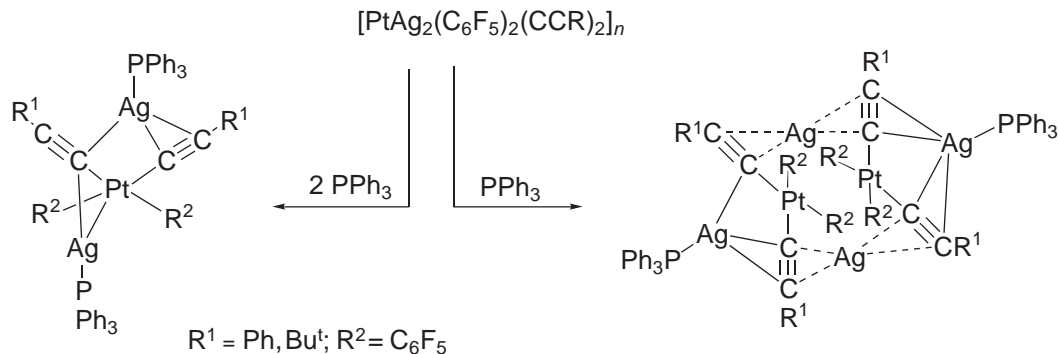

Scheme 1

Various homo- or heteronuclear cluster species which contain both σ - and π -bonded alkynyl groups have been synthesized and characterized, e.g., [Ag₅(C \equiv CPh)₆]⁻,²⁷⁸ [Au₂Ag₂(C \equiv CPh)₄(PPh₃)₂]⁻,^{279,280} [Ag₆Cu₇(C \equiv CPh)₁₄]⁻,²⁸¹ [Ag₃(C \equiv CBu^t)₂X]_n (X = *p*-toluenesulfonate, NO₃),²⁸² and [Ag₁₄(C \equiv CBu^t)₁₂X]BF₄ (X = Cl, Br, I).²⁸²

Several studies have been carried out with the alkynediide silver compound Ag₂C₂. This salt dissolves in aqueous solutions of another soluble silver compound giving double salts of the type Ag₂C₂·8AgF,²⁸³ Ag₂C₂·2AgClO₄·2H₂O,²⁸⁴ Ag₂C₂·*m*AgNO₃ (*m* = 1, 5, 5.5, 6),²⁸⁵ 2Ag₂C₂·12AgCF₃CO₂·3MeCN,²⁸⁶ Ag₂C₂·6AgCF₃CO₂·3MeCN,²⁸⁶ and 4Ag₂C₂·23AgCF₃CO₂·7C₂H₅CN·2.5H₂O,²⁸⁶ triple salts Ag₂C₂·AgF·4AgCF₃SO₃·2L (L = CH₂CN, C₂H₅CN),²⁸⁷ or quadruple salts 2Ag₂C₂·3AgCN·15AgCF₃CO₂·2AgBF₄·9H₂O.²⁸⁸ In all of these silver(I) multiple salts, the C₂²⁻ species is always encapsulated inside a Ag_n (*n* = 6–9) polyhedral cage or (C₂)₂@Ag₁₃ double cage and stabilized through mixed σ - π interactions with its vertices.

The compound *trans*-perfluoro-1-methyl-1-propenylsilver has been shown to be tetrameric, [CF₃CF=C(CF₃)Ag]₄, and it is a suitable precursor to prepare pure silver films by plasma-enhanced CVD, or to deposit silver films under MOCVD conditions.

Arylsilver compounds are air, moisture, and light sensitive, but are sufficiently thermally stable to allow isolation and characterization. They are prepared by reaction of a silver salt with the aryllithium or magnesium compounds. Mesityl silver [Ag(2,4,6-Me₃C₆H₂)₄] (15) has a tetrameric structure.^{289–292} The related complex with the bulkier phenyl-substituted ligand 2,4,6-Ph₃C₆H₂ was originally formulated as monomeric²⁹³ but has recently been disproved.²⁹⁴ Di- and trinuclear gold(I)-silver(I) complexes containing Mes groups acting as bridges between two metal centers have also been described. The reaction of [Au(Mes)(PPh₃)] with [Ag(OTf)L] leads to complexes [(PPh₃)Au(μ -Mes)AgL]OTf (L = THT, PPh₃).²⁹⁵ The structure of the complex where L = THT is a dimer with the THT acting as a bridging ligand. Similarly, the treatment of [Au(Mes)(PPh₃)] with AgOTf in a 2:1 ratio gives the trinuclear Au₂Ag derivative [(PPh₃)Au(μ -Mes)]₂Ag]OTf (16).²⁹⁶

The reaction of *N*-benzyl-*C*-imidazolylithium with [Ag(NO₃)(SMe₂)] affords the corresponding *C*-imidazolylsilver (Equation (3)), which has been proposed by molecular weight determination to be trimeric.²⁹⁷ *N*-Functionalized *C*-imidazolylsilver compounds or carbene-type silver complexes are obtained by reaction of the imidazolium salt with Ag₂O or Ag₂CO₃; some of these are shown in Figure 4.^{298,299}

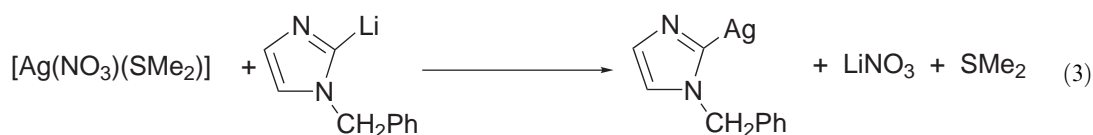

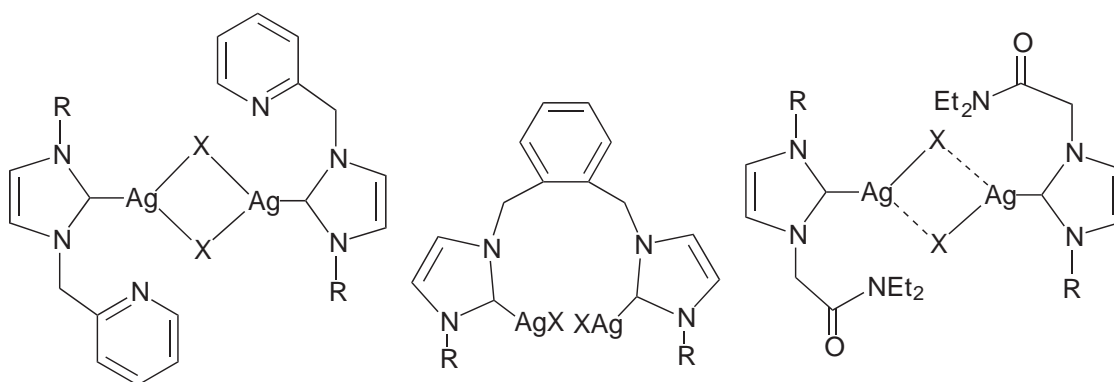
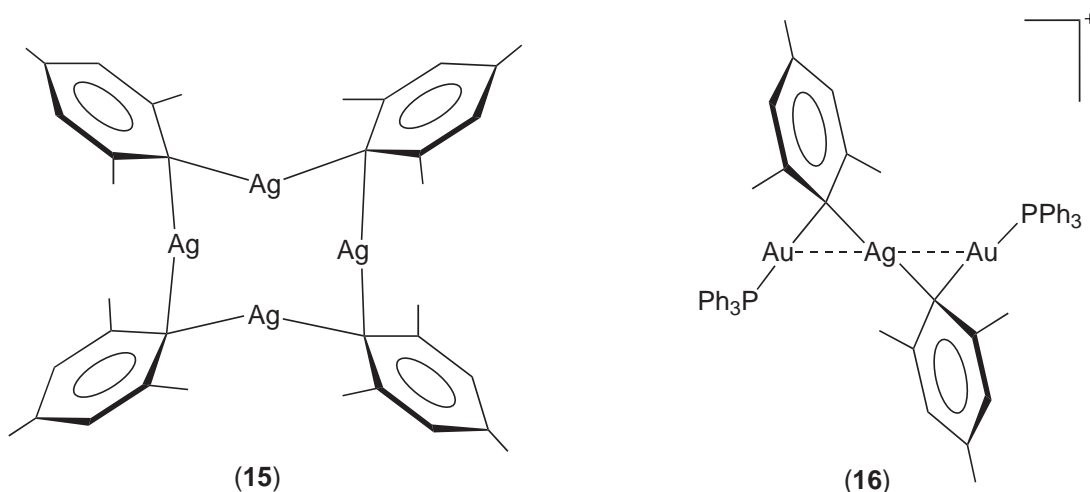

Figure 4 C-imidazolylsilver compounds.



Pentafluorophenyl derivatives of the type $[\text{AgR}]$ were prepared many years ago. A new method consists of the reaction of $\text{Bu}_4\text{N}[\text{AuR}_2]$ with AgClO_4 (Equation (4)):^{300,301}



The reaction of AgR ($\text{R} = 2,4,6\text{-C}_6\text{F}_3\text{H}_2, \text{C}_6\text{F}_5, \text{C}_6\text{Cl}_5$) with neutral ligands L gives the complexes $[\text{Ag}_2\text{R}_2\text{L}_2]$ ($\text{L} = \text{Py}, 3\text{-FPy}, \text{THT}, \text{bipy}$) for which a tetranuclear structure is proposed.³⁰² Reaction of AgCl with the double ylide hexaphenylcarbodiphosphoran $\text{C}(\text{PPh}_3)_2$ gives the complex $[\text{AgCl}\{\text{C}(\text{PPh}_3)_2\}]$.³⁰³

6.7.2.3.2 Complexes with nitrogen donor ligands

(i) Complexes with monodentate ligands

Mononuclear silver(I) complexes with nitrogen ligands can have several coordination numbers, the simplest is dicoordinated and compounds of the type $[\text{AgL}_2]^+$ occur for a variety of ligands such as NH_3 ,^{304–308} 1,2,4-triazol-5-one,³⁰⁹ melamine,³¹⁰ 2,6-Me₂Py,^{311,312} NCCl ,³¹³ NCH ,³¹⁴ 9-methylhypoxanthine,^{315,316} 5-methyl-2-(2,3-diaza-4-(5-methyl-2-thienyl)buta-1,3-dienyl)thiophene,³¹⁷ succinimide,^{318,319} pyridine-4-carbonitrile,³²⁰ 4-benzoylpyridine,³²⁰ thiophene-2-carbaldehyde imine (17),³²¹ Py,³²² benzotriazole,³²³ 9-ethylguanine,³²⁴ substituted sulfonylureas,³²⁵ 2-arylazopyridines,³²⁶ (–)-1-phenylethyl-2-quinolyl (18),³²⁷ pyrazole,³²⁸ nitroimidazole,³²⁹ and methylimidazole.³³⁰ The silver(I) compound with the ligand 1-(*p*-MeOC₆H₄)-4-(CHNOH)-imidazole is highly active *in vitro* against the growth of epimastigotic forms of *Trypanosoma cruzi*.³³¹

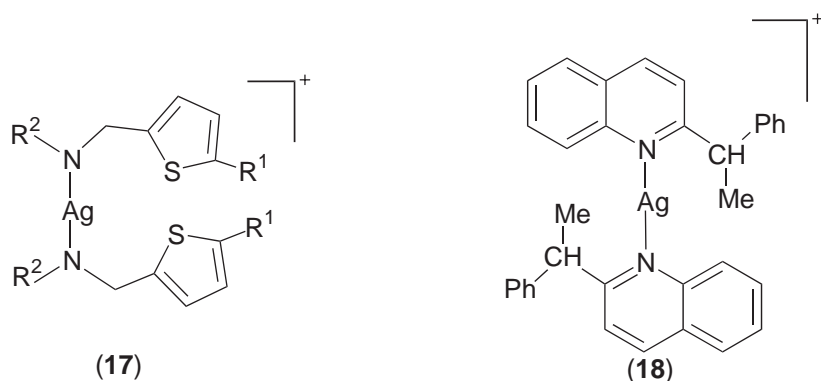

Alkoxystilbazoles can react with a variety of silver salts, AgX, to yield the two-coordinate linear complexes (19). They show liquid crystalline behavior that strongly depends on the anion, the alkoxy chain length, and other substituents which may be present on the stilbazole.⁵⁹⁻⁶⁵

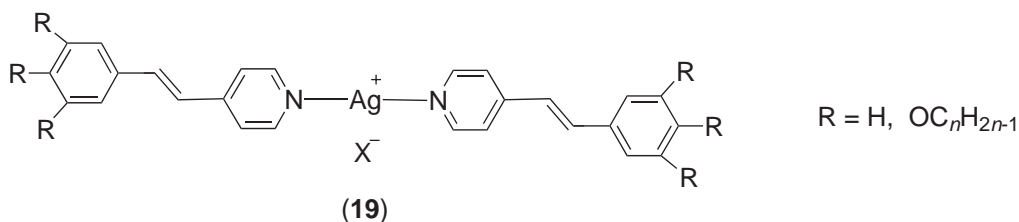

They have been prepared with several anions,³³²⁻³³⁵ the tetrafluoroborate salt exhibits S_A and S_C phases^{332,333} but the triflate shows a nematic phase.³³⁴ One of the problems in studying these complexes was the very high temperatures at which the phases existed and the fact that decomposition was often observed in the upper reaches of the S_A phases. Reduction of these temperatures was achieved by changing the small anions for dodecyl sulfate that also make that more materials exhibit nematic S_A and S_C phases, and another more viscous phase appeared, named cubic phase S_D. With the anion octyl sulfate³³⁶ the crystal structure of one of the complex with 4-metoxystilbazole could be achieved (20), with this anion the cubic phase was not present.

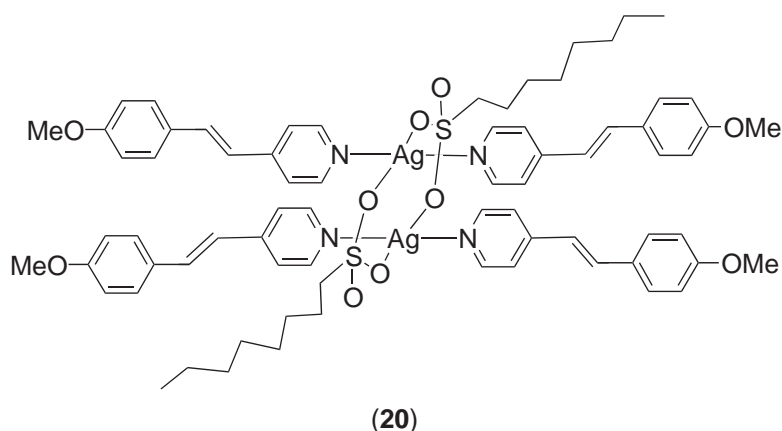

Another approach to get new liquid crystals is the lateral fluorination of the stilbazole ligands,³³⁷ which is a common and highly effective tool to exert control over mesomorphism, crystal phase stability, and physical properties. Other modifications include the use of more alkoxy substituents and other alkyl sulfate anions.³³⁸⁻³⁴⁴ Ionic silver amino complexes also display liquid crystalline behavior at rather low temperatures; they are of the form [Ag(NH₂n-C_nH_{2n+1})₂]⁺X⁻ (X = NO₃, n = 6, 8, 10, 12, 14; X = BF₄, n = 8, 10, 12, 14).³⁴⁵

Silver(I) is also bonded to two nitrogen atoms in heteropolynuclear complexes such as $[\text{Ag}\{(\mu\text{-NC})\text{MnL}_x\}_2]\text{PF}_6$ (**21**) or $[\text{Ag}\{(\mu\text{-NC})\text{MnL}_x\}_2](\text{PF}_6)_3$ ($L_x = \text{trans}(\text{-CO})_2[\text{P}(\text{OEt})_3](\text{dppm})$ or $\text{trans}(\text{-CO})(\text{dppm})_2$),³⁴⁶ or in the mixed silver–gold derivative $[\text{Ag}\{\text{Au}(2\text{-CH}_2\text{-6-RC}_5\text{H}_3\text{N})(\text{PPh}_3)\}_2]\text{ClO}_4$ (**22**) ($R = \text{H, Me}$).³⁴⁷ Complexes in which silver is bonded to a nitrogen ligand as 3-ferrocenylpyridine or 1,1'-bis(2-pyridylthio)ferrocene and triphenylphosphine are $[\text{Ag}(\text{FcPy})(\text{PPh}_3)]$ ³⁴⁸ and $[\text{Ag}_2(\text{PPh}_3)_2\{\text{Fc}(\text{SPy})_2\}](\text{OTf})_2$ ($\text{Fc} = \text{ferrocenyl}$).³⁴⁹ Other complexes include $[\text{Ag}(\text{NO}_3)(2\text{-NCPy})]$, only characterized by IR and elemental analysis,³⁵⁰ silver(I) disulfonylamides $[\text{Ag}\{\text{N}(\text{SO}_2)_2\text{C}_6\text{H}_3\text{-4-X}\}(\text{NCMe})]$ ³⁵¹ and the bridging pyrazolate ligand in complex $[\text{PtCl}(\text{PPh}_3)_2(\mu\text{-3,5-Ph}_2\text{pz})\text{AgCl}]$.³⁵²

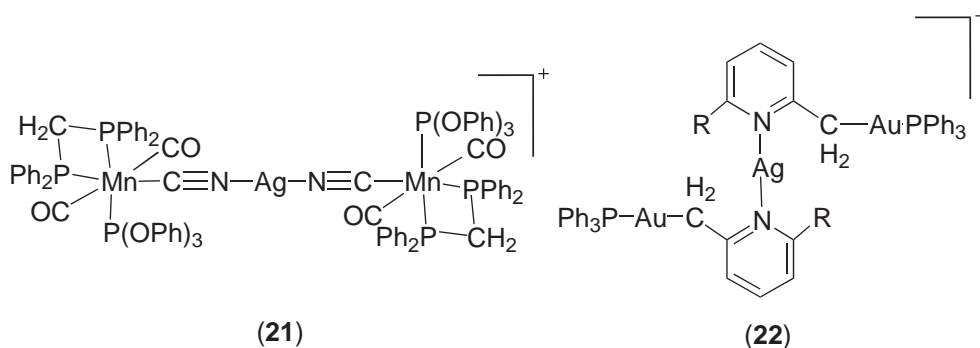

Three-coordinate silver(I) complexes with nitrogen donor ligands are of the form $[\text{AgXL}_2]$ ($L = 3\text{-ferrocenylpyridine}$, $X = \text{OTf}$; $L = 3\text{- or }4\text{-NCPy}$, $2\text{-, }3\text{-, or }4\text{-NCC}_6\text{H}_4\text{NH}_2$, $X = \text{NO}_3$).^{348,350} The model nucleobases (**23**)–(**25**) have been synthesized and their interaction with silver(I) studied; the complexes formed are of the type $[\text{Ag}(\mathbf{23})(\mathbf{25})(\text{NO}_3)]_2 \cdot [(\mathbf{23})(\mathbf{24})(\text{PF}_6)] \cdot 10\text{H}_2\text{O}$ or $[\text{Ag}(\mathbf{23})(\mathbf{24})(\text{H}_2\text{O})]\text{NO}_3$. An XRD study of the latter complex reveals that ligand (**23**) bonds through atom N³ whilst ligand (**24**) is coordinated through atom N⁷.³⁵³

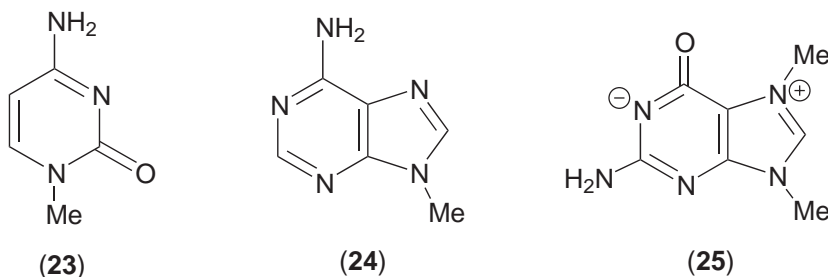

Other tri-coordinate silver(I) complexes are the bridging pyrazolate complexes such as $[\text{Ir}(\eta^5\text{-C}_5\text{Me}_5)(\text{pz})_3\text{Ag}(\text{PPh}_3)]$, $[\text{Ir}(\eta^5\text{-C}_5\text{Me}_5)(\text{pz})_3\{\text{Ag}(\text{PPh}_3)\}_2]\text{BF}_4$, and $[\text{Ir}(\eta^5\text{-C}_5\text{Me}_5)(\text{PPh}_3)(\text{pz})_3\text{Ag}(\text{PPh}_3)]\text{BF}_4$.^{354–357} Silver complexes with azo oximate ligands $[\text{Ag}\{\text{PhN}=\text{NC}(\text{R})=\text{N}(\text{O})\}\{\text{PhN}=\text{NC}(\text{Me})=\text{N}(\text{OH})\}_2]_2$ are dimers through hydrogen bonds.³⁵⁸ The structure of complexes with aminopyridines has been reported for $[\text{Ag}(4\text{-NH}_2\text{Py})_2]\text{NO}_3$ and $[\text{Ag}\{2,6\text{-(NH}_2)_2\text{Py}\}_3]\text{NO}_3$.³⁵⁹ The reaction of $\text{Ag}(\text{OTf})$ with N,N' -diphenylformamidinium gives the $[\text{Ag}(\text{OTf})\text{L}_2]$ complex where the silver(I) center is three coordinate.³⁶⁰

Homoleptic mononuclear tetra-coordinate silver(I) complexes have also been reported and are of the type $[\text{Ag}(\text{Py})_4]^+$,³⁶¹ $[\text{Ag}(\text{NCMe})_4]^+$,^{362,363} or $[\text{Ag}(\text{S}_4\text{N}_4\text{O}_2)_2]^+$.³⁶⁴ The reaction of polymeric silver(I) imidazolate $[\text{Ag}(\text{im})]_n$, which shows a wide spectrum of excellent antimicrobial activities against bacteria yeast and mold, with PPh_3 gives $[\text{Ag}(\text{im})(\text{PPh}_3)_3]$.³⁶⁵ Another tetra-coordinate derivative is the bis(acridine)silver(I), $[\text{Ag}(\text{NO}_3)(\text{C}_{13}\text{H}_9\text{N})_2]$, with the nitrate acting as bidentate ligand.³⁶⁶ The heteronuclear complex $[\{\text{Co}(\text{NH}_3)_5(\mu\text{-pyrazine})\}_2\text{Ag}(\text{H}_2\text{O})_2]$ has been characterized structurally.³⁶⁷

Thermodynamics of complex formation of silver with several ligands such as amines,³⁶⁸ hindered pyridine bases,³⁶⁹ nitrogen donor solvents,³⁷⁰ and azoles³⁷¹ have been carried out. Other studies include the secondary-ion mass spectra of nonvolatile silver complexes,³⁷² the relationship between Lewis acid–base behavior in the gas phase and the aqueous solution,³⁷³ or the rates of hydride abstraction from amines via reactions with ground-state Ag^+ .³⁷⁴

(ii) Complexes with polydentate ligands

Pyrazoles and imidazoles ligands have a very rich coordination chemistry with many metals. Silver(I) complexes are known long time ago but this area has been growing. As early as 1889 Büchner³⁷⁵ reported the synthesis of the insoluble silver salt $[\text{Ag}(\text{pz})]_n$ that always has been claimed to be polymeric. The *ab initio* crystal structure determination from powder diffraction data confirms its polymeric nature and, by changing the synthetic method, a trimeric $[\text{Ag}(\text{pz})]_3$ (26) structure has also been isolated.³⁷⁶ The structure for the diphenyl pyrazolate trimer $[\text{Ag}(3,5\text{-Ph}_2\text{pz})]_3$ has also been reported.³⁷⁷ The reaction of Ag_2O with $[3,5\text{-(CF}_3)_2\text{pzH}]$ gives $[\text{Ag}\{3,5\text{-(CF}_3)_2\text{pz}\}]_3$, the complex exists both as trimers and pairs of trimers with a $\text{Ag}\cdots\text{Ag}$ interaction of 3.307,3(13) Å.³⁷⁸ Treatment of $[\text{Ag}(\text{pz})]_n$ with PPh_3 gives complexes with bridging pyrazolate ligands $[\text{Ag}_2(\mu\text{-pz})(\text{PPh}_3)_2]$ (27) and $[\text{Ag}_2(\mu\text{-pz})(\text{PPh}_3)_3]$.³⁷⁹ The reaction of these complexes with heterocumulenes such as CS_2 , COS , CO_2 , or RNCO produces the insertion of the heterocumulene in the N-Ag silver bond.³⁷⁹ The coordination of the 3,5-bis(2-pyridyl)pyrazole (HbPypz) ligand with silver(I) has been studied. In the dinuclear $[\text{Ag}_2(\text{HbPypz})_4](\text{ClO}_4)_2$ there are two four-coordinate $[\text{Ag}(\text{HbPypz})_2]^+$ units linked by intramolecular hydrogen bonds; while the compound $[\text{Ag}(\text{HbPypz})]_n(\text{ClO}_4)_n$ is polymeric where the silver atom is three coordinate, chelated by two nitrogen atoms of the ligand and the other is bridging with other silver center.³⁸⁰ Heteropoly-nuclear complexes with bridging pyrazolate complexes have been prepared such as $[\text{Pd}_2\text{Ag}_4(3,5\text{-Me}_2\text{pz})_8]$ ³⁸¹ and $\{(\eta^5\text{-C}_5\text{H}_5)\text{Ir}(\mu\text{-pz})(\mu\text{-N}=\text{C}(\text{R})\text{pz})\text{Ag}\}_2(\text{BF}_4)_2$ ($\text{R} = \text{Me, Ph, Bz}$).³⁸²

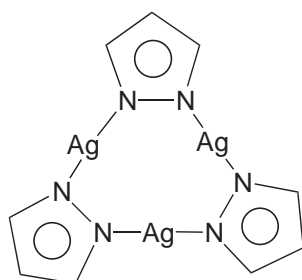

(26)

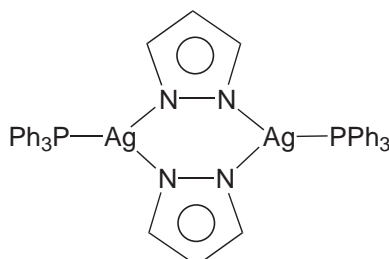

(27)

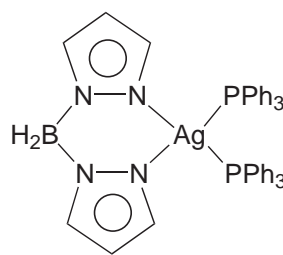

(28)

Bis(pyrazolyl)borate compounds have also been reported and are of the type $[\text{Ag}\{(\text{pz})_2\text{BH}_2\}\{\text{P}(4\text{-MeC}_6\text{H}_4)_3\}]$, $[\text{Ag}\{(\text{pz})_2\text{BH}_2\}(\text{PPh}_3)_2]$ (28), $[\text{Ag}\{(\text{pz})_2\text{BPh}_2\}\text{L}]$ ($\text{L} = \text{P}(4\text{-MeC}_6\text{H}_4)_3$, CNBu^t , $\text{P}(\text{OPh})_3$, $0.5 \text{ Ph}_2\text{PCH}_2\text{PPh}_2$), or $[\text{Ag}\{(3,5\text{-Me}_2\text{pz})_2\text{BH}_2\}\text{L}]$ ($\text{L} = \text{PEtPh}_2$, PCy_3).^{383,384}

Silver(I) complexes are known with the tris(pyrazolyl)borate $[\text{HB}(\text{pz})_3]^-$ and the methyl, phenyl, bromo, or trifluoromethyl-substituted derivatives. The structure of the silver tri(pyrazolyl)borato species has been a puzzle since it was first reported.^{385,386} It was suggested that the structure could be oligomeric, but recently the crystal structure of the compound $[\text{Ag}\{\text{HB}(3,5\text{-Me}_2\text{pz})_3\}]_2$ shows that it has a dimeric structure³⁸⁷ where the silver(I) centers are tricoordinated by a bidentate arm of one ligand and a monodentate arm of the other ligand (29). The related complexes $[\text{Ag}\{\text{HB}(4\text{-Brpz})_3\}]_2$, $[\text{Ag}\{\text{HB}(4\text{-Mepz})_3\}]_2$, $[\text{Ag}\{\text{HB}(3,5\text{-Me}_2\text{pz})_3\}]_2$, $[\text{Ag}\{\text{HB}(3\text{-Mepz})_3\}]_n$, $[\text{Ag}\{\text{B}(\text{pz})_4\}]_n$, and $[\text{Ag}\{\text{B}(\text{im})_4\}]_n$ have also been reported.^{388,389} The structure of the [hydrotris(1,2,4-triazolyl)borato]-silver(I) consist of a 2D coordination polymer (30).³⁹⁰

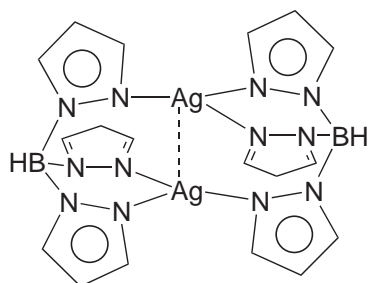

(29)

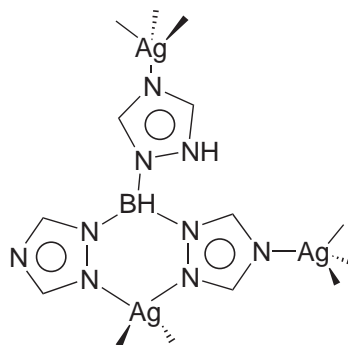

(30)

Complexes of the type $[\text{Ag}\{\text{HB}(\text{pz})_3\}(\text{PR}_3)]$ are known for a variety of phosphine ligands and it has been observed that the ligand properties of $[\text{HB}(\text{pz})_3]^-$ are dependent on the cone angle and basicity of the phosphine. Also the solution and solid-state behavior differs greatly.³⁹¹ The complexes with the related ligands $[\text{HB}(3,5\text{-Me}_2\text{pz})_3]^-$, $[\text{HB}(3,5\text{-Ph}_2\text{pz})_3]^-$, and $[\text{HB}(4\text{-Brpz})_3]^-$ have also been described.^{389,391,392} The reaction of $[\text{Ag}\{\text{HB}(3,5\text{-Me}_2\text{pz})_3\}(\text{PPh}_3)]$ with 1-methylimidazol-2-thione (Hmimt) gives the compound $[\text{Ag}\{\text{HB}(3,5\text{-Me}_2\text{pz})_3\}(\text{Hmimt})(\text{PR}_3)]$ in which the $[\text{HB}(3,5\text{-Me}_2\text{pz})_3]^-$ probably acts as a bidentate donor.³⁹¹ Considerable work has been carried out with polyfluorinated tris(pyrazolyl)borate ligands, which play an important role in stabilizing silver(I) complexes with small unsaturated molecules. Examples are the carbonyl complex mentioned in Section 6.7.2.3.1 or other adducts with nitriles, ethylenes, alkynes, isocyanides, azides (31), ethylene oxide, or propylene sulfide ligands.^{393–395} The complexes with THF or toluene ligands obtained by reaction of $\text{Na}[\text{HB}\{3,5\text{-(CF}_3)_2\text{pz}\}_3]$ with AgOTf in THF or toluene are useful starting materials.^{393,396} Adducts containing phosphine ligands³⁹⁷ or unsupported silver–germanium³⁹⁸ bonds (32) have also been prepared.

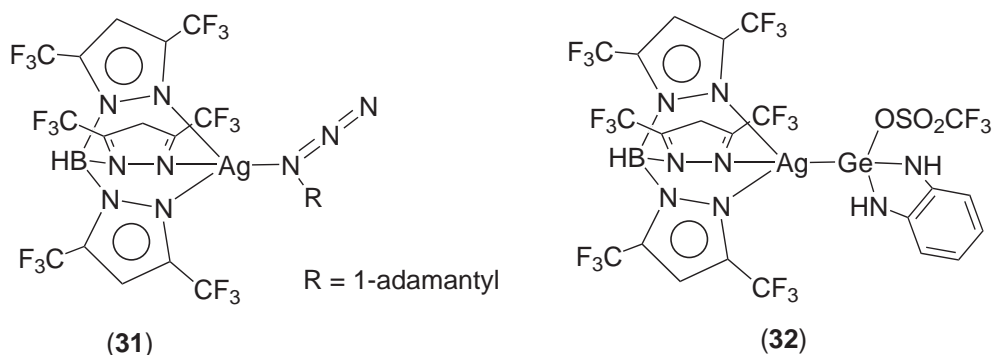

Silver(I) poly(pyrazolyl)borate complexes containing isocyanide ligands have also been prepared for the ligands $[\text{HB}(3,5\text{-Me}_2\text{pz})_3]^-$, $[\text{HB}(3,5\text{-Ph}_2\text{pz})_3]^-$, $[\text{HB}(3\text{-Mepz})_3]^-$, and $[\text{B}(\text{pz})_4]^-$, the latter behaves as a tridentate ligand.³⁹⁹ A series of silver(I)-bidentate phosphine adducts with poly(pyrazolyl)borate ligands have been described. In the solid state they are three- or four-coordinate with the bidentate donors $[\text{H}_n\text{B}(\text{pz})_{4-n}]^-$ but in solution different species can exist depending on the chain which links the two phosphorous atoms and also on the stoichiometry ratio. The structures for the complexes $[\text{Ag}\{(\text{pz})_2\text{BX}_2\}(\text{dppf})]$ ($\text{X} = \text{H}, \text{pz}$; $\text{dppf} = 1,1'$ -bis(diphenylphosphino)ferrocene) have been reported.⁴⁰⁰ The tetrakis(pyrazolyl)borate ligands coordinate in a bi- or tridentate mode in silver(I) complexes with tertiary phosphine ligands, as in $[\text{Ag}\{(\text{pz})_2\text{B}(\text{pz})_2\}(\text{PPh}_3)]$.⁴⁰¹ An interesting derivative $[\text{Ag}_3\text{L}_2]\text{ClO}_4$ (33) is obtained with the tris[3-(2-pyridyl)-pyrazol-1-yl]borate. It contains a triangular Ag_3^{3+} cluster core encapsulated by two ligands, each Ag^I being coordinated by a bidentate arm from each of the two ligands.⁴⁰² An unprecedented trinucleating bridging mode for a tris(pyrazolyl)borate ligand occurs in the 2-methoxyphenyl-substituted derivative. In the complex $[\text{Ag}_3\{(\text{3-MeOPh})_3\text{BH}\}_2]\text{ClO}_4$ (34), the silver centers are bonded to one pyrazolyl nitrogen atom of each ligand.⁴⁰³

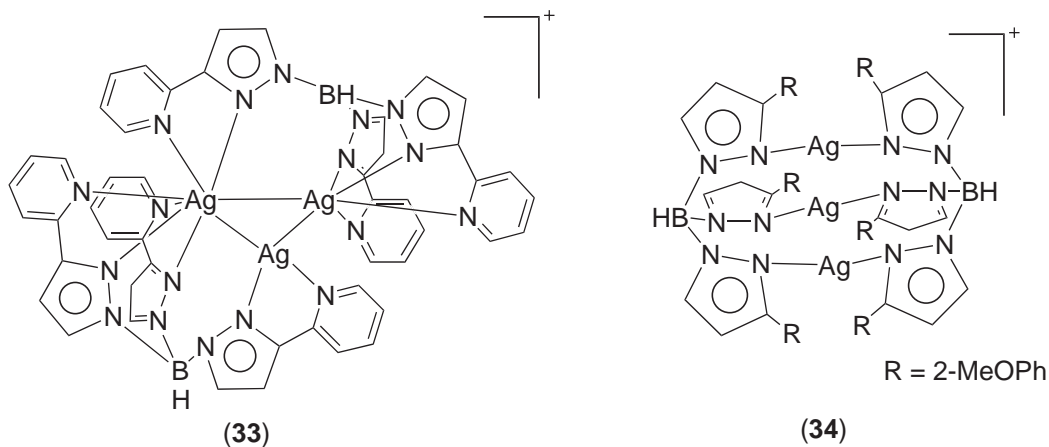

The analogue tris(pyrazolyl)methane ligand has also been used to synthesized silver(I) complexes of the type $[\text{Ag}(\text{OTf})\{(\text{pz})_3\text{CH}\}]$, $[\text{Ag}\{(\text{pz})_3\text{CH}\}(\text{CNBu}^1)]\text{OTf}$, and the six-coordinate $[\text{Ag}\{(\text{pz})_3\text{CH}\}_2]\text{OTf}$ (**35**).⁴⁰⁴ Bis(pyrazolyl)methane ligands of the type $\text{Me}_2\text{C}(\text{pz})_2$, $\text{H}_2\text{C}(3,5\text{-Me}_2\text{pz})_2$, or $\text{H}_2\text{C}(4\text{-NO}_2\text{pz})_2$ have been used to form complexes of the type $[\text{AgXL}]$ ($\text{X}=\text{NO}_3$, OTf) or $[\text{AgL}_2]\text{X}$ ($\text{X}=\text{BF}_4$, ClO_4).⁴⁰⁵ Silver(I) nitrate forms the dinuclear complex (**36**) with a potentially hexadentate tetrapyrazolyl ligand; the silver atoms are two coordinate.⁴⁰⁶ The tetra-kis(pyrazol-1-ylmethyl)methane react with AgNO_3 to yield a dinuclear $[\text{Ag}_2\text{L}_2]$ complex with the silver centers three-coordinated to two pyrazolyl units of one ligand and one of the other ligand.⁴⁰⁷

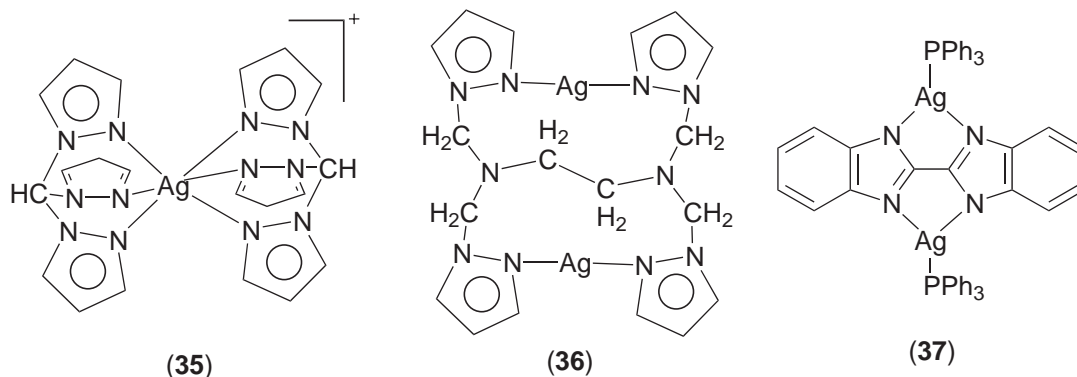

Related ligands are imidazoles. The reaction of AgNO_3 or AgBF_4 in neutral or weakly acidic solutions with the nitroimidazole gives the polymeric silver nitroimidazolate $[\text{Ag}(\text{NO}_2\text{im})]_n$, whereas in strongly acidic solutions yields the complex $[\text{Ag}(\text{NO}_2\text{imH}_2)]^+$.³²⁹ *Ab initio* techniques have been employed for the structure determination of polymeric silver imidazolate, $[\text{Ag}(\text{im})]_n$, from X-ray powder diffraction data. It consist of parallel chains with alternating *cis*, *trans* arrangement of the imidazolate rings with respect to the polymer backbone.⁴⁰⁸ Silver(I) complexes with phosphine ligands and imidazole and the substituted methyl or phenyl derivatives have been reported. They have several stoichiometries as $[\text{Ag}(\text{PR}_3)_{4-n}(\text{im})_n]^+$, $[\text{AgX}(\text{PR}_3)_{3-n}(\text{im})_n]$, or the dinuclear complexes $[\text{Ag}_2(\mu\text{-X})_2(\text{PR}_3)_2(\text{im})_2]^+$.⁴⁰⁹ The tris[2-(1-methylimidazolyl)]methoxymethane (timm) forms the species $[\text{Ag}(\text{timm})]^+$, which has luminescence behavior.⁴¹⁰ The reaction of silver acetate with 2,2-benzimidazole (bbimH₂) and PPh_3 yields the complexes $[\text{Ag}(\text{bbimH}_2)(\text{PPh}_3)_2](\text{COOMe})$ and $[\text{Ag}_2(\mu\text{-bbim})(\text{PPh}_3)_2]$ (**37**).⁴¹¹

The 1,3,5-tris(benzimidazol-2-ylmethyl)benzene (tbid) reacts with AgNO_3 to afford the compound $[\text{Ag}(\text{tbid})(\text{PPh}_3)]\text{NO}_3$.⁴¹² The reaction of 2-amino-1,3,4-thiadiazole (atdz) reacts with AgClO_4 to yield the complex $[\text{Ag}_4(\text{atdz})_6](\text{ClO}_4)_4$ (**38**) in which two metal centers are bridged by two atdz ligands to form a six-membered $\text{N}_2\text{M}_2\text{N}_2$ framework, two of these units are connected by a further bridging ligand.⁴¹³ *N*(1)-Alkyl-2(arylazo)imidazoles $p\text{-R}^1\text{C}_6\text{H}_4\text{N}=\text{NC}_3\text{H}_2\text{NN}(1)\text{R}^2$ ($\text{R}^1=\text{H}$, Me , OMe , Cl , NO_2 ; $\text{R}^2=\text{Me}$, Et) yield cationic bis-chelated complexes with silver(I).^{414,415} Coordination studies of bis(benzimidazole) ligands with silver(I) have been carried out and the structure of the complex with the 1,7-bis(benzimidazol-2-yl)-2,6-dithiaheptane ligand shows the linear coordination mode to the silver center.⁴¹⁶ The reaction of 2,5-dihydro-4,5,5-trimethyl-2,2-di-2-pyridyl-imidazole-1-oxyl with AgSbF_6 gives the complex $[\text{Ag}_2\text{L}_2](\text{SbF}_6)_2$ (**39**), the compound forms a four-membered ring with a short $\text{Ag}\cdots\text{Ag}$ distance of 2.839(2) Å.⁴¹⁷ Silver(I) complexes with isothiazole-based ligands bearing substituents with additional donor sites in the five position of the heterocycle, 3-Me-5- RC_3HNS ($\text{R}=\text{CH}=\text{N}(\text{CH}_2)_2\text{Py}$, $\text{CH}=\text{NCH}_2\text{Py}$, $\text{CH}_2\text{N}(\text{CH}_2\text{CH}_2\text{NET}_2)_2$, $(\text{CH}_2)_2\text{SMe}$) have been synthesized. All the compounds are dinuclear and the silver centers are coordinated to two nitrogen atoms of the ligands or one nitrogen and one sulfur and to the oxygen atoms of the triflate anion.⁴¹⁸ A dinuclear silver complex with the ligand 1,2,4-triazole, $[\text{Ag}_2(\text{NO}_3)_2(\mu\text{-C}_2\text{N}_3\text{H}_3)_2]$, has been described.³²⁸

Other polydentate ligands are polyamines and related ligands. Stability constants of silver(I) complexes with polyamines in dimethyl sulfoxide,⁴¹⁹ *N*-methyl-substituted 4-methyldiethylenetriamines,⁴²⁰ or ethylene- or *N*- or *C*-methylated ethylenediamine in aqueous solution have been reported.⁴²¹ The structure of the silver 1,3-diaminopropane complex, $[\text{Ag}\{\text{NH}_2(\text{CH}_2)_3\text{NH}_2\}]\text{ClO}_4$,⁴²² and complex formation with 1,4-diaminobutane and 1,5-diaminopentane have been reported.⁴²³ A dinuclear silver(I) compound with ethylenediamine $[(\text{enH})\text{Ag}(\text{en})\text{Ag}(\text{enH})_2]^{4+}$ has

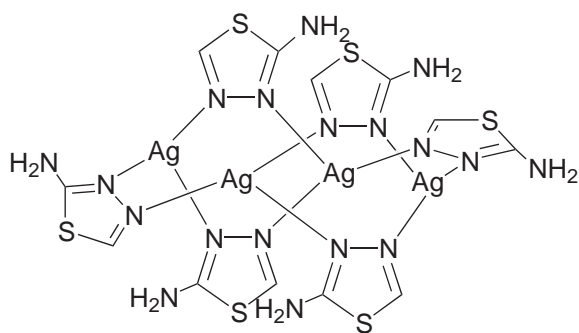

(38)

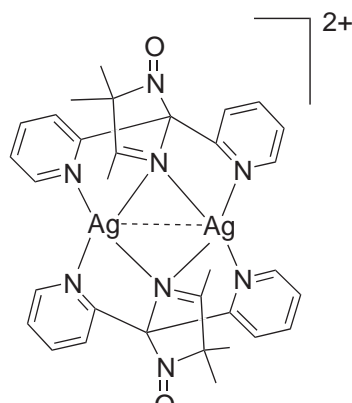

(39)

been prepared and consist of linear Ag-atoms with bridging en and terminal enH.⁴²⁴ The square-planar metal site $M(en)_2$ ($M = Ag, Cu$) in the structure of ethylenediamino CuM -bis(tetraborate) hydrate has been determined crystallographically to be occupied by 40% Cu^{2+} and 60% Ag^+ .⁴²⁵ Silver(I) forms polymeric chain compounds with polydentate nitrogen acyclic ligands such as diethylenetriamine (dien), 2,2',2''-triaminotriethylamine (tren), and N,N' -bis(aminoethyl)propane-1,3-diamine (tetraen). The addition of monodentate ligands such as phosphines or isocyanides to these compounds leads to the formation of simpler binuclear species as $[Ag_2(dien)_2(PMe_3)_2](PF_6)_2$ (40).⁴²⁶ Thermally stable silver(I) amides $[Ag(\mu-NR_2)_4]$ ($R = TMS$ (41), $NCMe_2(CH_2)_3CMe_2$) have been prepared from $AgNCO$ and $Sn(NR_2)_2$, there are tetranuclear compounds comprising a square of Ag-atoms.⁴²⁷ The formation of a $[Ag\{N(SO_2CF_3)_2\}]$ complex from Ag_2CO_3 and $HN(SO_2CF_3)_2$ and its use as an effective $[N(SO_2CF_3)_2]^-$ transfer agent have been reported.⁴²⁸

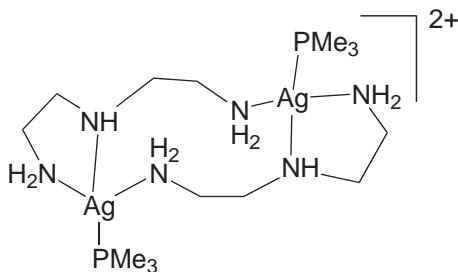

(40)

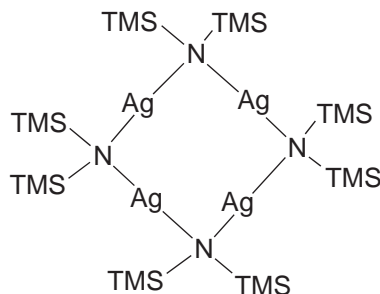

(41)

Silver(I) complexes with bipyridine, dimethylpyridine, or phenanthroline have been synthesized and have shown strong cytotoxicities *in vitro* to both normal and carcinoma cells.⁴²⁹ This bis(chelate) complexes with the tetramethyl substituted bipyridine⁴³⁰ and the 2,4'-bipyridine⁴³¹ ligands have been reported. The ligand 1,1'-bis(2-pyridylthio)ferrocene, $Fc(SPy)_2$, forms complexes with silver(I) of the type $[Ag(OTf)\{Fc(SPy)_2\}]$, $[Ag(PPh_3)\{Fc(SPy)_2\}]OTf$, $[Ag_2\{Fc(SPy)_2\}_3]OTf$, or $[Ag(L-L)\{Fc(SPy)_2\}]OTf$ ($L-L = phen, (SPPH_2)_2CH_2$).³⁴⁹ Similar complexes are obtained with the 1,2-bis(2-pyridylthio)-1,2-dicarba-*closo*-dodecaborane ligand.⁴³² The reaction of 1,1'-bis(2-pyridyl)ferrocene with $RhCl_3 \cdot 3H_2O$ in the presence of $AgNO_3$ gives the silver complex $[Ag(ClO_4)L]$, which is a dimer with perchlorate bridges.⁴³³ The reaction of the pyridine-imine $6-R^1-Py-2-CH=NR^2$ ligands with $Ag(OTf)$ or $AgClO_4$ results in the formation of the bis(chelate) complexes.^{434,435} The related ligands (R,S) -1,2-(6- R^1 Py-2- $CH=N$) $_2R^2$ ($R^1 = H, Me; R^2 = Cy, Et$) react with $Ag(OTf)$ to yield the dinuclear complexes (42).^{436,437} Similarly, the coordination behavior with the related thienyl ketimine ligands with silver(I) have been studied and complexes with stoichiometry 2:2 and 2:1 respectively, have been obtained. The silver atoms are bonded mainly to the imine N-atoms with large contacts to the sulfur thiophene atoms.⁴³⁸⁻⁴⁴¹

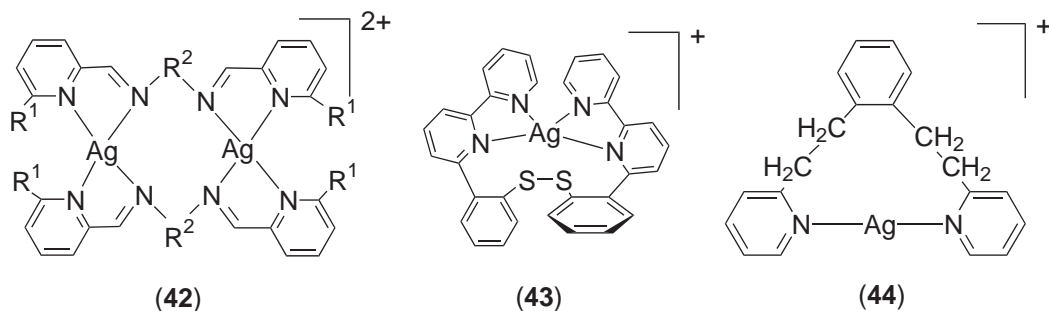

Other bis(chelate) silver(I) derivatives are obtained with ligands derived of two bipyridine moieties linked by a bridging unit such as 1,4-bis(5'-methyl-2,2'-bipyridine-5-ethyl)-benzene,⁴⁴² bis(6'-2,2'-bipyridyl)phthalate or terephthalate,⁴⁴³ or 2,2'-bis[6-(2,2'-bipyridyl)]diphenyldisulfide (43).⁴⁴⁴ The compound [Ru(tpy)(η^3 -tpt)(OH₂)](ClO₄)₂ (tpy = 2,2':6',2''-terpyridine, tpt = 2,4,6-tri-pyridyltriazine) reacts with AgClO₄ (2:1 ratio) to afford the bis-chelate complex [{Ru(tpy)(η^3 -tpt)}₂Ag](ClO₄)₃.⁴⁴⁵ The 1,2-bis(2-pyridylethynyl)benzene ligand coordinates to silver(I) in a *trans*-chelating fashion (44).⁴⁴⁶

The ligands 2-(2-pyridylsulfanyl)quinoline, 2-(2-pyridylsulfanyl)benzothiazole, and dibenzothiazolesulfide react with AgNO₃ with formation of dinuclear complexes where the ligands bridge the two silver centers through the nitrogen atoms.⁴⁴⁷ Similar complexes are obtained with the 1,4-bis(2-pyridyloxy)benzene ligand.⁴⁴⁸ The crystal structure of [Ag(NO₃)L] in which L is 6,6'-dimethyl-2,3'-bipyridine has been determined. In the solid state, dimers are present due to interactions between symmetry related cations.⁴⁴⁹ Silver(I) complexes with the new bipyridine derived ligands (45) and (46) have been prepared and are of the type [Ag₂(45)]²⁺ and [Ag(46)]⁺. In the dinuclear complexes, it is proposed that each silver atom is bound in an *N,N'*-mode to the bipyridine moieties, in addition to interactions with O or S-atoms.⁴⁵⁰

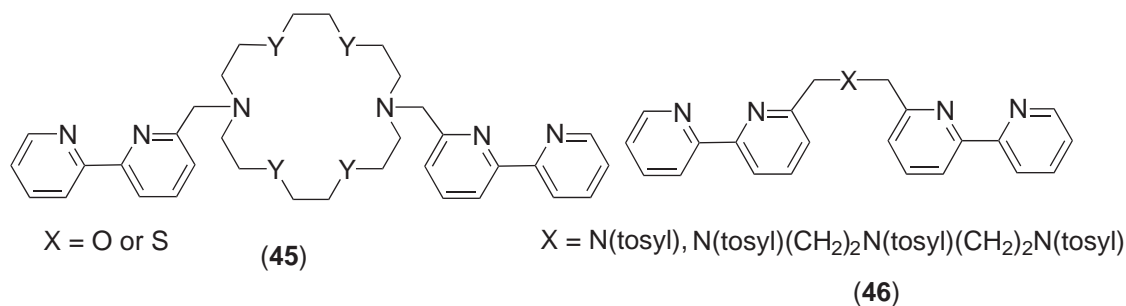

Heteroleptic bis(phenanthroline) silver(I) complexes using 2,9-diarylphenanthrolines as well as unsubstituted or 4,7-disubstituted phenanthrolines have been prepared.⁴⁵¹ The bis(chelate) complexes have also been obtained for the C₆₀-phenanthroline,⁴⁵² the 2,9-dimethyl-phen,⁴⁵³ and the 6,6'-dibromo-2,2'-bipyridine derivatives.⁴⁵⁴ The structure of [AgBr(phen)(PPh₃)] has been reported.⁴⁵⁵ The coordination of silver(I) with 2,2':6',2''-terpyridine (terpy) and 6,6''-diphenyl-2,2':6',2''-terpyridine has been investigated. In weakly coordinating solvents there is evidence of formation of dinuclear double-helical species, but in solvents such as acetonitrile the square-planar complexes [AgL(MeCN)]BF₄ (47) have been isolated. For terpyridine two cations are associated through a Ag—Ag interaction of 3.1698(12) Å.⁴⁵⁶ Treatment of AgClO₄ with terpy in acetonitrile gives species of stoichiometry 4AgClO₄·5terpy·MeCN, which is shown by X-ray analysis to contain two independent cations, the four-coordinate [Ag(terpy)(NCMe)]⁺ and the five-coordinate [Ag₃(μ -terpy)₂(terpy)₂]³⁺.⁴⁵⁷ Another five-coordinate silver complex [Ag(terpy)(PPh₃)₂]ClO₄ has been reported. Two phosphorus and a central pyridine occupy the equatorial sites, while the two distal pyridines occupy the axial sites forming a distorted trigonal bipyramidal geometry.⁴⁵⁸ The ligand 2,2':6',2'':6'',2''':6''',2''''-quinquepyridine forms a mononuclear pentacoordinate complex [AgL]PF₆, in contrast to the double-helical binuclear complexes formed with the first row transition metal ions.⁴⁵⁹ The 1,8-naphthyridine (napy) ligand has also been used to prepare dinuclear silver(I) derivatives of the type [Ag₂(napy)₂](ClO₄)₂ (48), which has a Ag—Ag distance of 2.748(2) Å, shorter than that found in metallic silver.^{460,461} The NO₃⁻ salt has also

been reported.⁴⁶² A dinuclear complex with the phthalazine ligand has been described, $[\text{Ag}_2(\text{C}_8\text{H}_6\text{N}_2)_4(\text{NO}_3)_2]$, which has two bridging and two monodentate ligands.⁴⁶⁰ Bridging bis (triazenido) groups support a rhombus of silver(I) atoms in the complex $[\text{Ag}_4\text{L}_4]$ that results from the reaction of AgNO_3 with $\text{Na}[\text{PhN}_3\text{C}_6\text{H}_4\text{N}_3(\text{H})\text{Ph}]$ (NaL).⁴⁶³ The reaction of $[\text{Ag}(\text{NH}_3)_2]^+$ with 1,2-bis(phenyltriazenido)benzene and ethylenediamine gives the tetranuclear complex $[\text{Ag}_4\{(\text{PhN}_3)_2\text{C}_6\text{H}_4\}(\text{en})_2]$ (**49**).⁴⁶⁴

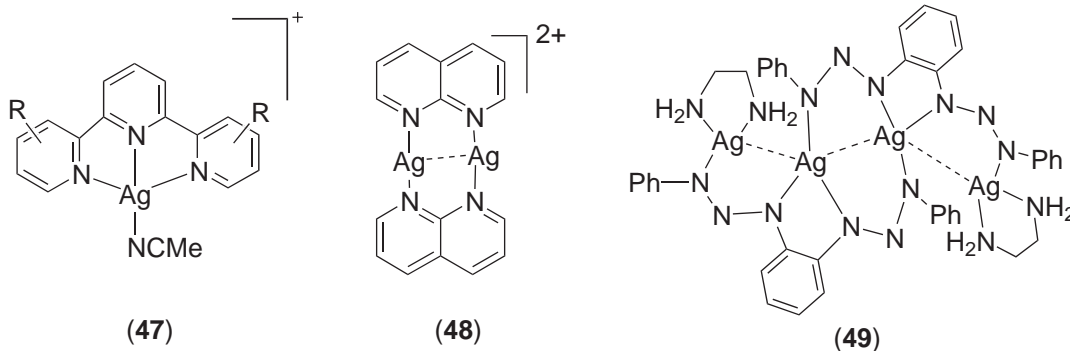

Other dinuclear silver(I) complexes with bridging nitrogen ligands are those with 7-azaindolate,⁴⁶⁵ 8-amino-quinoline,³²⁸ 1,1'-diazaferrrocene,⁴⁶⁶ and 1,2,4-triazolo-1,5-pyrimidine (**50**). In the latter, the nature of the anion appears to play an important role in the stereochemistry of the silver center.⁴⁶⁷ Other dinuclear^{468,469} silver(I) complexes with substituted triazolopyrimidine ligands and also polymeric species have been obtained.⁴⁷⁰ With a related ligand, the anionic form of 4,7-dihydroxo-7-oxo-1,2,4-triazolo-1,5-pyrimidine (7tpO^-) and bypyrimidine (bpm) a tetranuclear $\text{Ag}^{\text{I}}-\text{Pt}^{\text{II}}$ complex, $[\text{Pt}_2\text{Ag}_2(7\text{tpO})_4(\text{bpm})_2(\text{H}_2\text{O})_2](\text{NO}_3)_2$ has been described.⁴⁷¹ Silver(I) complexes with amidinate ligands have been prepared from the reaction of $\text{PhC}(\text{NTMS})[\text{N}(\text{TMS})_2]$ with AgO_2CMe ⁴⁷² (**51**) or from more complex amidinate ligands bearing substituents than can coordinate the silver center with silver acetate, e.g. with (**52**).⁴⁷³ The bis(μ - N,N' - η^2 - N',O' -di(*o*-methoxyphenyl)-formidinato)disilver(I) complex is the first example of a room temperature fluorescent $d^{10}-d^{10}$ compound.⁴⁷⁴ Theoretical studies of the N,N' -di-*p*-tolylformidinato complex have been carried out, concluding that there is little or no direct metal-metal bonding in these molecules.⁴⁷⁵

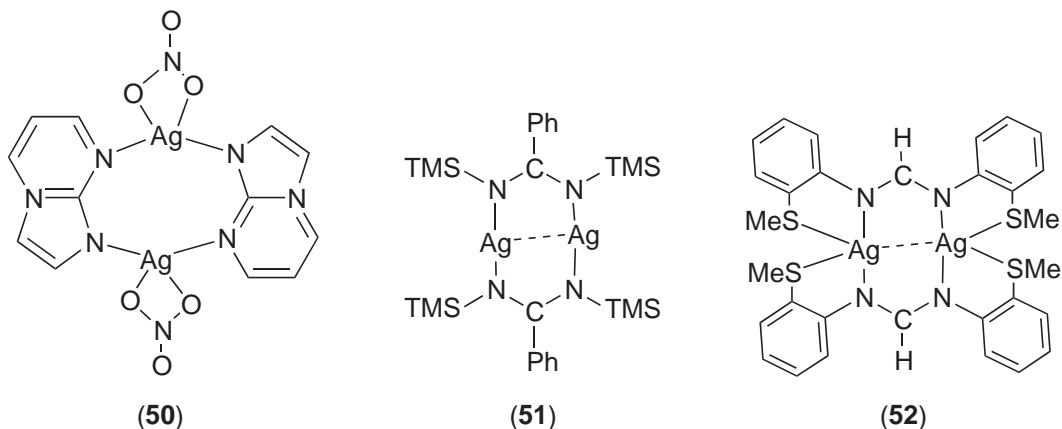

The reaction of silver azide, for which an explosive luminescence has been observed,⁴⁷⁶ with AgNO_3 in aqueous solution gives the salt $\text{AgN}_3 \cdot 2\text{AgNO}_3$, in which the azide unit exhibits an unprecedented bridging hexadentate coordination mode as an encapsulated species inside a trigonal prism.⁴⁷⁷ Different products have been obtained from the reaction of silver triflate with a racemic mixture or with enantiomerically pure (*R,R*) or (*S,S*) forms of the ligand 4,5-bis[2-(2-pyridyl)ethyl]-1,3-dioxolane. With the former, the dimeric *meso*-complex (**53**) has been isolated, while with the latter, the *R,R* or *S,S* forms, respectively, of the polymeric $[\text{AgL}]_n^+$ have been characterized.⁴⁷⁸ The [2-(6-methyl)pyridyl]trimethylsilylamide (Hmps) ligand reacts with AgNO_3 and LiBu to give the tetrameric amido complex $[\text{Ag}_4(\text{mps})_4]$. The ligand bridges the silver(I) centers in a “head-to-head” and “tail-to-tail” fashion to give a cyclic structure.⁴⁷⁹ The

1,1,2,3,3-pentacyanopropenide ligand coordinates as bidentate ligand in the complex $[\text{Ag}\{\text{NCC}[\text{C}(\text{CN})_2\}_2\}(\text{PPh}_3)_2]$.⁴⁸⁰ A similar complex with two phosphine ligands and two nitrogen atoms is obtained with the ligand 4-(4-methylphenyl)-3,5-bis(2-pyridyl)-4H-1,2,4-triazole.⁴⁸¹ Heterocyclic ligands have been prepared by dimerization of 2-thiouracils and the formation of complexes with silver have been studied.⁴⁸² The bicyclic ligand $\text{CF}_3\text{CN}_5\text{S}_3$ reacts with $\text{Ag}(\text{AsF}_6)$ to form complexes of the type $[\text{Ag}(\text{CF}_3\text{CN}_5\text{S}_3)]\text{AsF}_6$ or $[\text{Ag}(\text{CF}_3\text{CN}_5\text{S}_3)_2]\text{AsF}_6$ (**54**), the coordination takes place through the nitrogen atoms.⁴⁸³

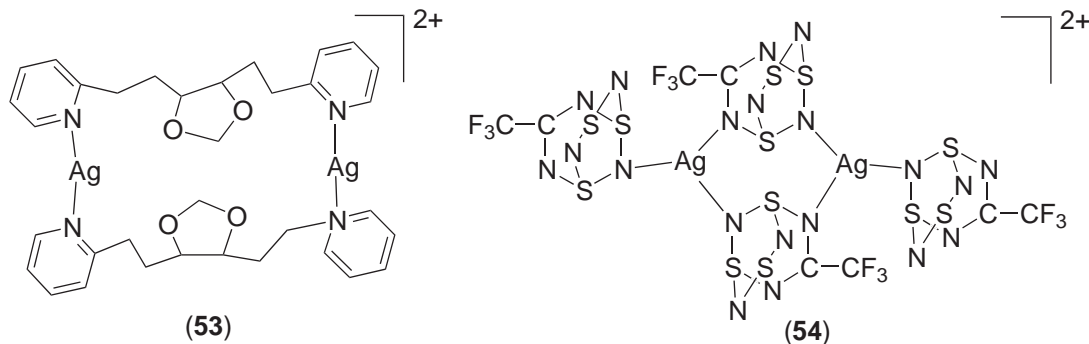

The silver cluster with bridging amido ligands $[\text{Ag}_6\text{Cl}_2(\text{NHPh})_4(\text{PPR}^n)_6]$ have been obtained from the reaction of silver chloride, tertiary phosphine and lithiated aniline.⁴⁸⁴ The metallacryptand $[\text{Ag}_{12}(\text{NPEt}_3)_8](\text{SiF}_6)_{1.5}$ has been obtained by reaction of AgF with the silylated phosphinoimine TMSNPEt_3 .⁴⁸⁵ In the cation, the silver atoms are located on the edges of a nearly undistorted cube and the N-atoms of the ligand occupy the vertices, a fluoride atom is in the center of the cube and has contacts with all the silver atoms.

Silver(I) complexes with macrocyclic nitrogen ligands are also very numerous. Mono- or homodi-nuclear silver-containing molecular clefts can be synthesized from the cyclocondensation of functionalized alkanediamines or triamines with 2,6-diacetylpyridine, pyridine-2,6-dicarbaldehyde, thiophene-2,5-dicarbaldehyde, furan-2,5-dicarbaldehyde, or pyrrole-2,5-dicarbaldehyde in the presence of silver(I).^{486–497} The clefts are derived from bibrachial tetraimine Schiff base macrocycles and have been used, via transmetallation reactions, to complex other metal centers. The incorporation of a range of functionalized triamines has provided the conformational flexibility to vary the homodinuclear intermetallic separation from ca. 3 Å to an excess of 6 Å, and also to incorporate anions as intermetallic spacers. Some examples of the silver(I) complexes obtained are shown in Figure 5.

Similarly, by Schiff-base condensation reactions have been used to generate free cryptands from triamines and dicarbonyls in [2+3] condensation mode. These ligands react with silver(I) compounds to give dinuclear or trinuclear macrocyclic compounds where $\text{Ag}\cdots\text{Ag}$ interactions may be present. Thus, with a small azacryptand a dinuclear complex with a short $\text{Ag}\cdots\text{Ag}$ distance (**55**) is found.⁴⁹⁸ With bigger azacryptand ligands also dinuclear complexes as (**56**) are achieved but without silver–silver interaction.^{165,499–501} A heterobinuclear $\text{Ag}^1\text{—Cu}^1$ cryptate has also been

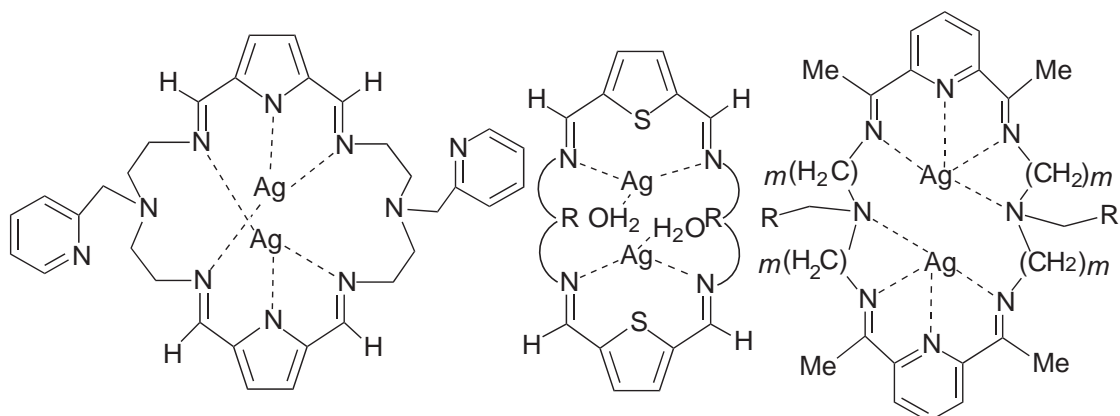
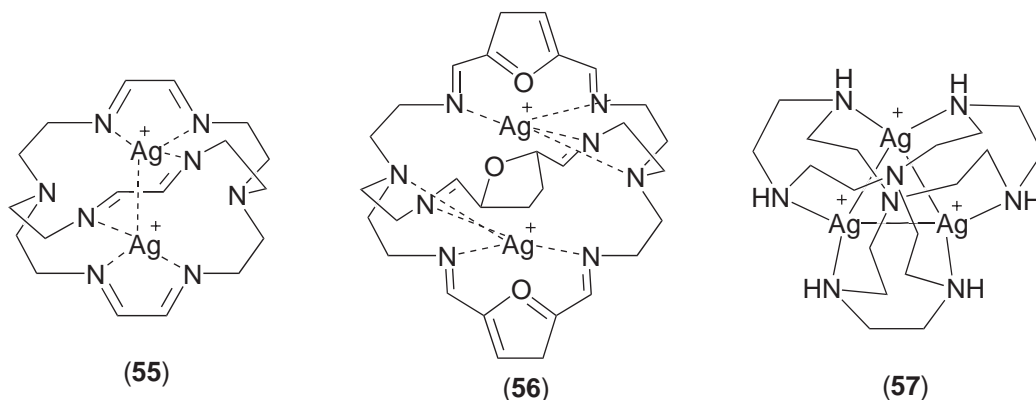
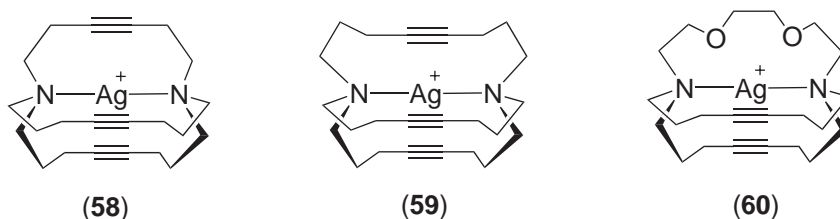

Figure 5 Some examples of silver complexes with Schiff base macrocycles.

synthesized.⁵⁰² Aminocryptand ligands have been less studied but a disilver and a trisilver derivative (57) have been obtained.⁵⁰³



Silver(I) cryptates with a series of (1,k+2)diazabicyclo[k,l,m]alkanes in which the bridges contain either alkyne or benzene such as (58), (59), or (60) have been prepared. The incorporation of a silver ion into the cages results in drastic changes of the conformations of the ligands. The driving force for this change is a close interaction between the nitrogen centers and the metal. As a side effect of these conformational changes close contacts between the silver ion and the triple bonds in the solid state and solution have been observed.^{504,505}



The macrocyclic tris-bipyridine ligand forms a trinuclear silver derivative (61).⁵⁰⁶ Other macrocyclic ligands containing bipyridine or phenanthroline moieties react with AgBF_4 to give $[\text{Ag}_2\text{L}_2](\text{BF}_4)_2$; the crystal structure reveals a dimeric structure with two distinct silver environments (62).⁵⁰⁷ The complex formation between silver(I) ions and the macrocyclic ligand 1,4,7-triazacyclononane (L^1) and its tri-*N*-methylated derivative (L^2) has been investigated. Complexes of the type $[\text{AgXL}^1]$ ($\text{X} = \text{Cl}, \text{Br}, \text{I}$) or $[\text{AgXL}^2]$ ($\text{X} = \text{CN}, \text{SCN}$) and $[\text{AgL}^1_2]^+$ or $[\text{AgL}^2_2]^+$ (63) have been obtained.⁵⁰⁸

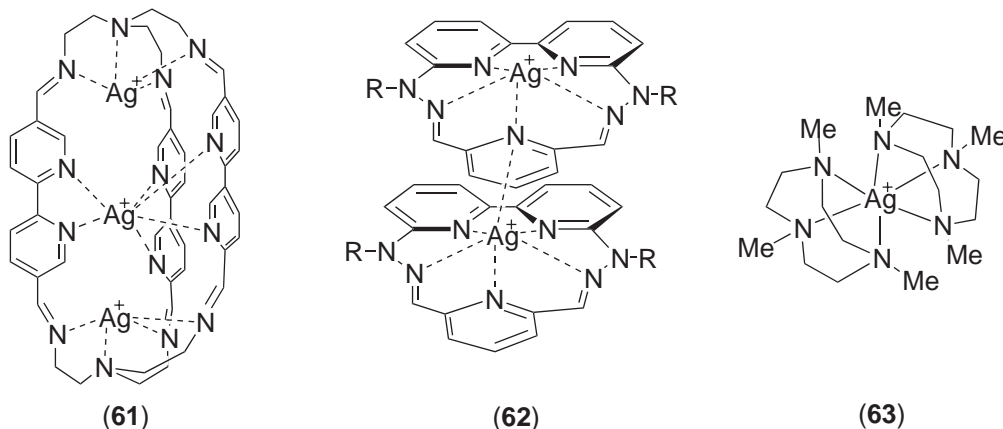

Several silver(I) complexes of the macrocyclic Schiff base derived from the [2+2] condensation of terephthalaldehyde and 3-azapentane-1,5-diamine or *N,N'*-bis(3-aminopropyl)methylamine have been described.^{509,510} The reaction of 2,11-diaza-difluoro-*m*-[3,3]-cyclophane with 2,6-bis(bromomethyl)pyridine lead to the 3 + 3 addition product, which gives a complex with two silver

atoms.⁵¹¹ Complexation studies of the silver(I) cation by catenands have been carried out. Complex (64) represents a probable structure for one of these complexes.⁵¹²⁻⁵¹⁴ The synthesis of heterobimetallic “face to face” dimeric porphyrins (65) is achieved using silver as the protecting group in one of the coordination centers.⁵¹⁵ The structure of hexamethylenetetramine-silver(I) chloride has been carried out showing three Ag^{I} cations with different coordination numbers, octahedral, tetrahedral, and tetragonal pyramidal.⁵¹⁶ A series of differently functionalized *all*-homocalixpyridines and their open-chain analogues have been synthesized. These macrocycles show a pronounced selectivity towards soft metal ions such as Ag^{I} , one example is the trinuclear complex (66).⁵¹⁷ Also bis-calix[4]arene with imine units show high selectivity towards Ag^+ .⁵¹⁸

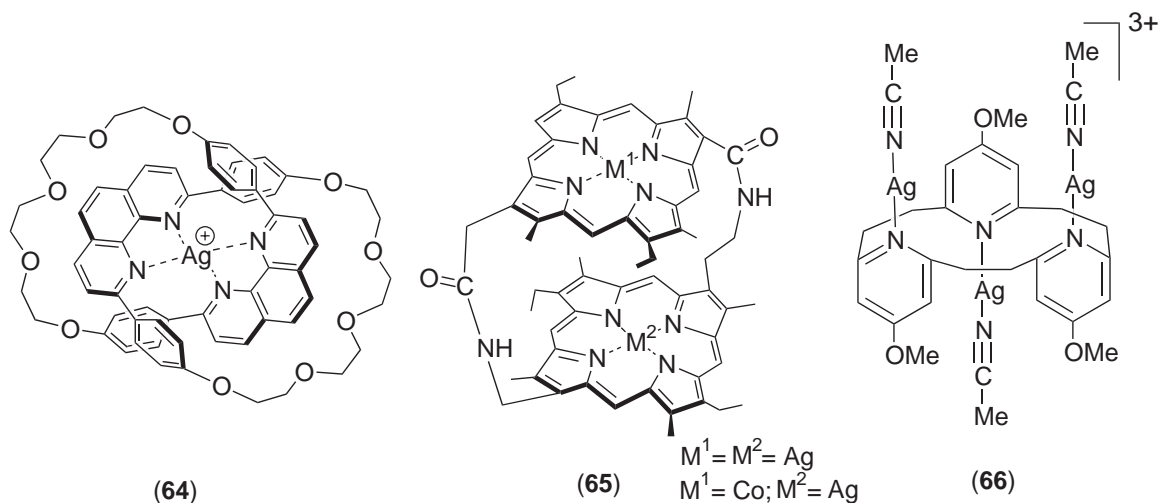

Host-guest complexes such as (67) have been prepared from molecular squares involving Lewis base receptor sites, such as $\{\text{cyclobis}[(\text{cis-dppp})\text{Pt}(4\text{-ethynylpyridyl})_2](\text{cis-LM})\}\text{Ag}_2\}^{6+}(\text{OTf})_6$, where $M = \text{Pd}^{\text{II}}$ or Pt^{II} and $L = \text{dppp}$ or 2PEt_3 , by reaction with pyridine, pyrazine, phenazine, or 4,4'-dipyridyl ketone.⁵¹⁹

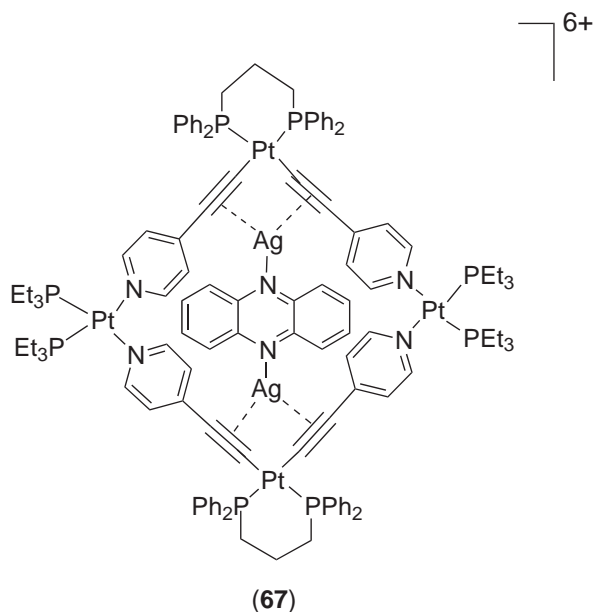

(iii) Supramolecular compounds

Recent years have witnessed considerable interest in the development of rational synthetic routes to supramolecular architecture from self-assembly of component metal complexes. These solid

materials with well-defined, discrete network topologies are attractive to chemists not only for aesthetic reasons but also for their potential applications in many areas. Silver(I) complexes with *N*-donor ligands give rise to an interesting array of stoichiometries and geometric configurations, with the coordination numbers of two to six all occurring. They adopt novel structures such as multidimensional helical, honeycomb channel, interwoven diamondoid, graphite framework, etc.

The majority of silver compounds with helical structures have concentrated on the use of oligopyridines and oligophenanthrolines. They can be single-, double-, or triple-stranded helicates.^{520–559} The ligands involved in this type of structure are listed in Figure 6. The silver complexes with triazolate, tetrazolate [Ag(tetz)(PPh₃)₂]_n, and *L*-histidine [Ag(Hhis)]_n have effective antibacterial and antifungal activities.^{536,537,539}

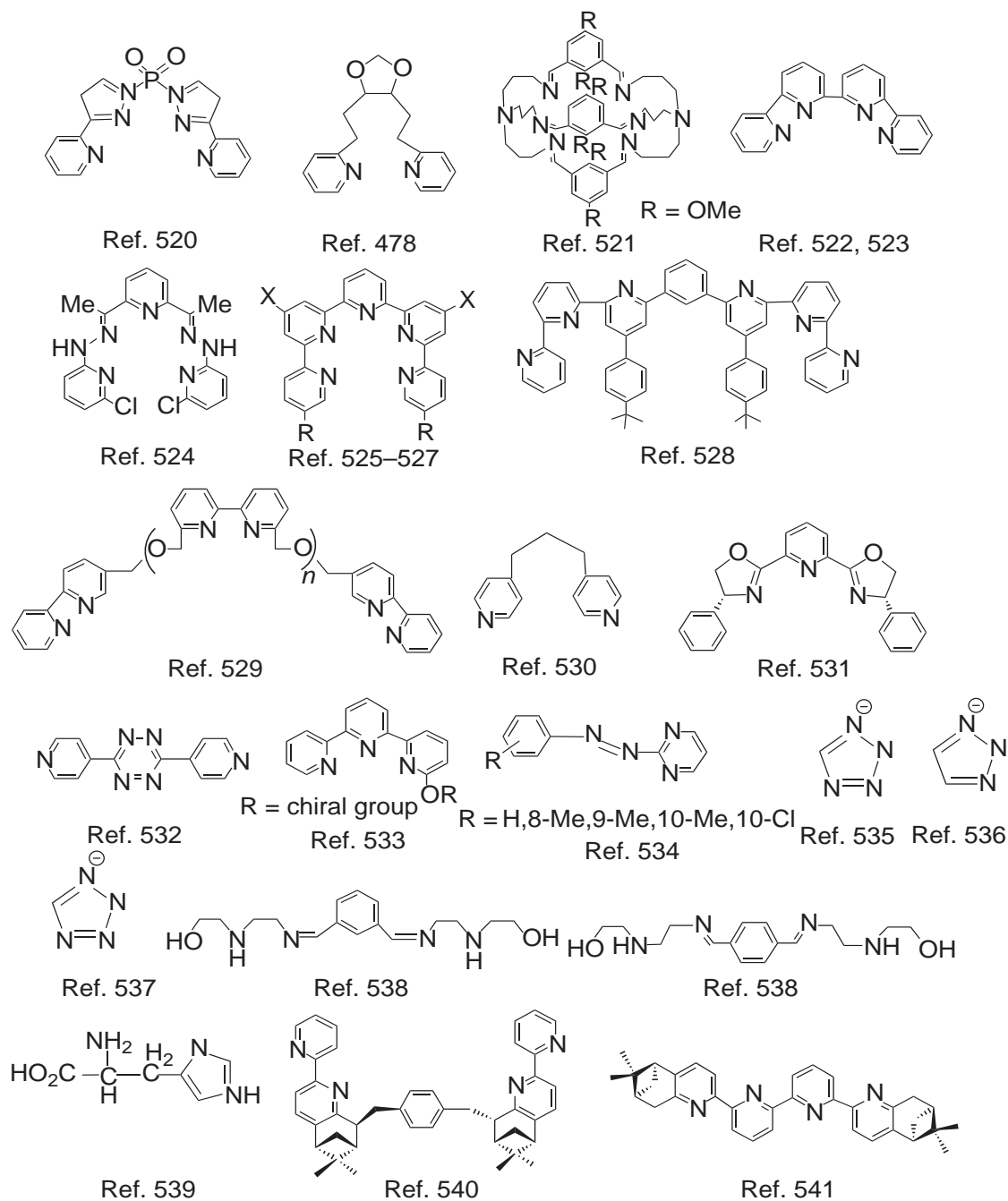

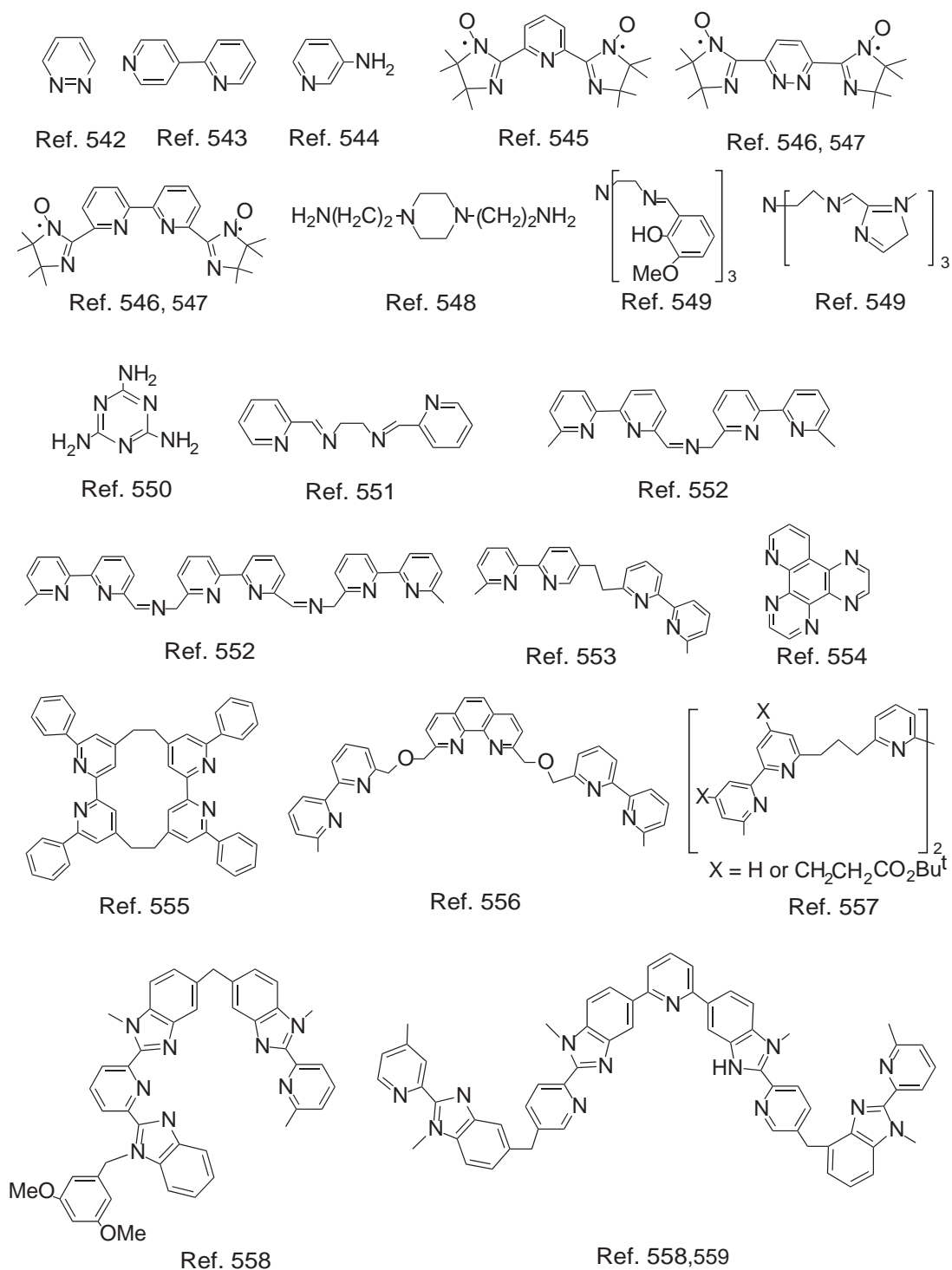

Figure 6 Ligands which form silver(I) complexes with helical structures.

1D-, 2D-, or 3D polymeric structures have been constructed using rigid nitrile ligands such as those shown in [Figure 7](#). If the cyano groups have opposite directions they can act as road-like bridging ligands in the construction of diamondoid frameworks.

Polymeric silver(I) complexes have also been achieved with cyanosulfanes, they react with silver(I) according to [Equation \(5\)](#).

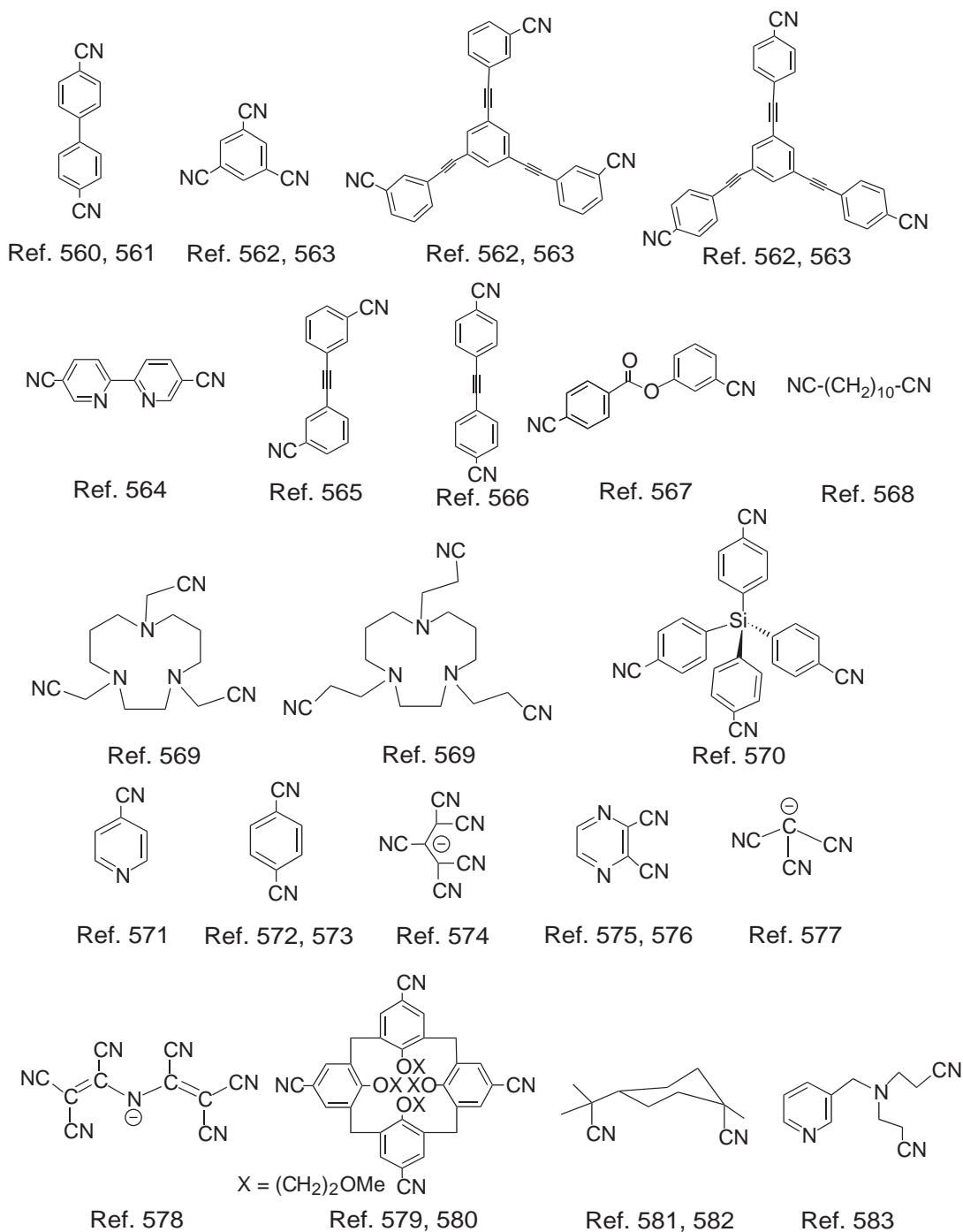
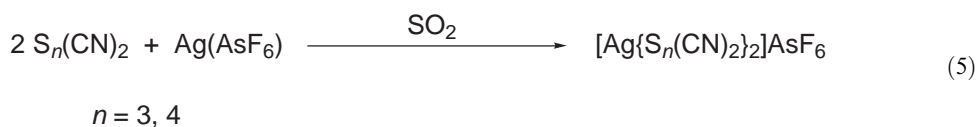

Figure 7 Rigid nitrile ligands which form polymeric silver(I) complexes.



The dicyanosulfanes serve in these complexes as bridging ligands and undergo coordination through their terminal nitrogen atom, giving a chain polymer ($n = 3$) or a layer polymer ($n = 4$).⁵⁸⁴ The tricyanofluoroborate anion, $\text{FB}(\text{CN})_3^-$, forms a network polymer $[\text{Ag}\{\text{BF}(\text{CN})_3\}(\text{NCMe})]_n$ with silver(I), which exhibits 1D channels along the b -axis.⁵⁸⁵

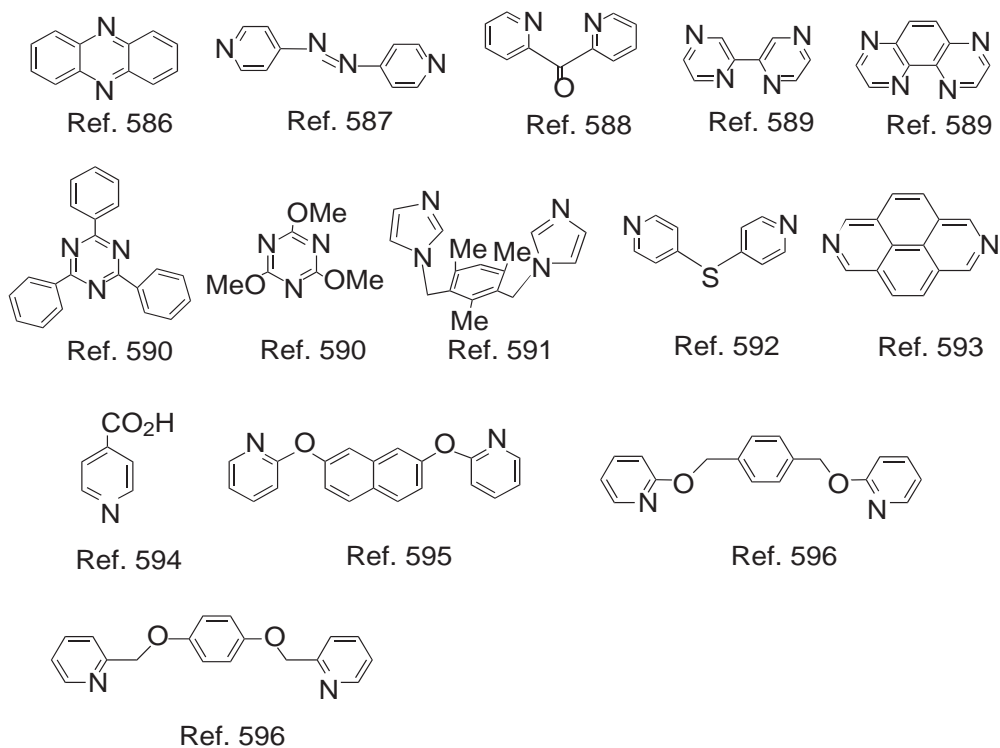

Figure 8 Ligands which form silver(I) complexes with supramolecular structures through π - π interactions.

Planar coordination compounds with aromatic ligands, especially those having extended π -systems, show π - π interactions in the solid state. The ligands shown in Figure 8 form complexes with silver(I) which have a supramolecular structure through π - π interactions.⁵⁸⁶⁻⁵⁹⁶

Hydrogen bonding also plays an important role in the construction of metal aggregates. Amide moieties have a well-established propensity to engage in complementary hydrogen bonds resulting in either in infinite ribbons (through head-to-head interactions), or in infinite chains via equivalent N—H \cdots O interactions. Figure 9 shows the ligands involved in this type of silver(I) aggregates.^{470,597-604}

In some of these type of polymeric materials there are two forces that organize the polymer strands into a supramolecular structure, and are usually hydrogen bonds and π - π interactions, this happens with the complex $[1,2,4,5\text{-C}_6\text{H}_2\{\text{CH}_2\text{OCH}_2\text{C}(\text{pz})_3\}_4\text{Ag}_2(\text{BF}_4)_2]_n$.⁶⁰⁵

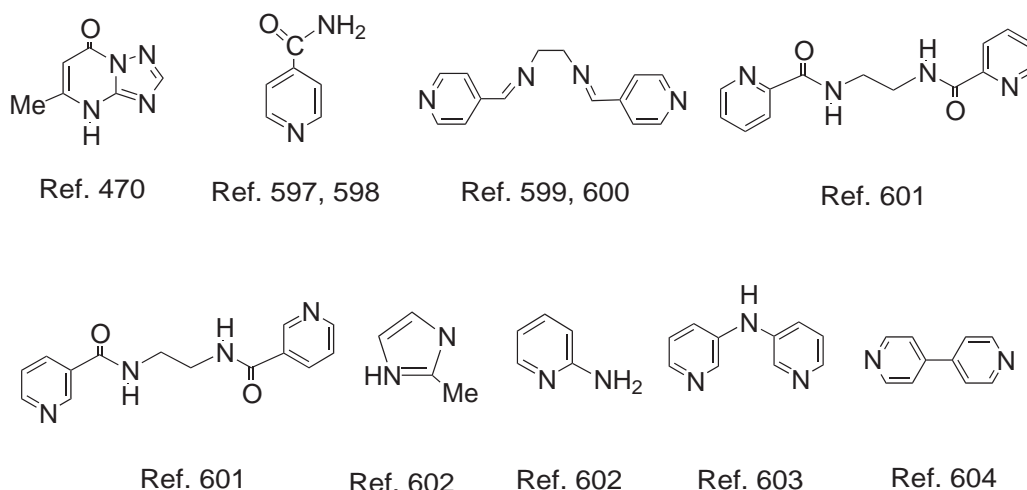

Figure 9 Ligands which form silver(I) complexes with supramolecular structures through hydrogen bond.

Pyrazines and substituted pyrazines have long been known to act as exo-bidentate ligands to linearly bridge metal ions, and then have also been employed for the self-assembly of polymeric materials. With pyrazine (prz) varying the reaction conditions and stoichiometry, 1D, 2D, and 3D structures containing silver(I) atoms with several coordination modes have been prepared.^{606–609} A 3D racemate is present in $[\text{Ag}_2(2,3\text{-Me}_2\text{prz})_3](\text{SbF}_6)_2$.⁶¹⁰ A sawhorse connection has been achieved in the compound $[\text{Ag}(\text{NO}_2)(\text{pyz})]_n$.⁶¹¹ With 2,2'-bipyrazine an infinite loop has been obtained.⁶¹²

Silver(I) complexes with polyamines also form molecular aggregates, thus hexamethylenetetramine yields 2D and 3D coordination networks,⁶¹³ polymeric chains are obtained with diethylenetriamine, tris(2-aminoethyl)amine, or *N,N'*-bis(aminoethyl)propane-1,3-diamine,⁴²⁶ and 2D networks are formed with thiocyanate and bridging polyamines.⁶¹⁴

Pyridine and related ligands gives silver(I) aggregates with different structural motifs. The complexes $[\text{AgBr}(3\text{-MePy})]_n$ and $[\text{AgBr}(4\text{-MePy})]_n$ give a tube and a stair polymer structural type, respectively.⁶¹⁵ The silver adducts with thiocyanate instead of bromo give 2D polymers.⁶¹⁶ The adduct of silver(I) chlorine with quinoline gives a polymer comprising Ag_5X_4 face-centered motifs linked in a linear polymeric array through the silver atoms of the opposite corners of the face.⁶¹⁷ Polymeric structures have also been described with the ligands *trans*-1,2-bis(2-pyridyl)ethane,⁶¹⁸ bipyridine, and thiocyanate,⁶¹⁹ 2-pyridinolates,⁶²⁰ 2-pyridylketone,⁶²¹ 4,4'-bipyridine,⁶²² 1,3-bis(pyridyl)propane,⁶²³ *N,N'*-bis(2-pyridylmethyl)piperazine,⁶²⁴ 1,6-bis(4'-pyridyl)-2,5-diazahexane,⁶²⁵ and 2-(2-pyridyl)quinoxaline.⁶²⁶ A cylindrical-shaped coordination polymer is formed by self-assembly of 2,2,4,4,6,6-hexakis(4-pyridylmethoxy)-2 λ^5 ,4 λ^5 ,6 λ^5 -cyclotris(phosphazene) with AgNO_3 .⁶²⁷ Two more silver(I)-phosphazene polymers have been reported from the reaction of $[-\text{N}=\text{PPh}_2-]_n$ and $[-\text{N}=\text{P}(\text{NHCy})_2-]_n$ with AgOTf and AgNO_3 , respectively.^{628,629} 1,2-Bis(4-pyridyl)ethyne, 1,4-bis(2-pyridyl)butadiyne, and 1,4-(4-pyridyl)butadiyne give 1D or 2D frameworks depending on the anion of the silver salt.^{630–632} Polypyridyl ligands such as 2,3-di-2-pyridylquinoxaline, 2,3-di-2-pyridyl-5,8-dimethoxyquinoxaline, and 2,3,7,8-tetrakis(2-pyridyl)pyrazino[2,3-*g*] gives box-like dinuclear or chain polymeric silver(I) complexes.⁶³³ The mode of coordination of the multidentate ligand 2,2'-dimethyl-4,4'-bipyrimidine depends on the metal ion, anion, metal-to-ligand ratio, and crystallization conditions, with silver(I) 2D and 3D networks being obtained.⁶³⁴ A novel synthetic procedure has been reported for the preparation of soluble, well-defined silver(I) coordination polymers from 4,4''-bis((9-aryl)-2-*o*-phenanthrolyl)-2',5'-dihexyl-*p*-terphenyl, which consist of the exclusion of all molecules that might act as competitive ligands for the metal ions of the polymer.⁶³⁵

Self-assembly of azolate ligands and silver cations also leads to supramolecular networks. The species $[\text{Ag}(\text{tetrazolate})]_n$ or $[\text{Ag}(\text{tetrazolate})\cdot\text{AgNO}_3]_n$ have a 3D structure with a $\mu^4\text{-}\eta^1\text{:}\eta^1\text{:}\eta^1\text{:}\eta^1$ bonding mode.⁶³⁶ The ligands 2,6-bis(pyrazolyl)pyrazine⁶³⁷ and 2-(3-pyridyl)benzimidazole⁶³⁸ form silver(I) complexes with tubular coordination networks or low-dimensional structures, respectively. The chemical reaction of imidazole with metallic silver has been studied by surface-enhanced Raman scattering and X-ray photoelectron spectroscopy and show that the product formed is silver(I) imidazolate, which covers the surface of the metal as a monolayer.⁶³⁹ The 1:1 complex formed by silver(I) and 2,1,3-benzothiadiazole consists of two-coordinate silver atoms and bridging ligands.⁶⁴⁰

An spontaneous assembly of 15 components is reported in the synthesis of $[\text{Ag}_9\text{L}_6](\text{OTf})_9$ where L is the hexadentate, tris-chelating 6,6-bis[2-(6-methylpyridine)]-3,3'-bipyrazine. The structure consists of a 3×3 grid of Ag-atoms (average $\text{Ag}\cdots\text{Ag} = 3.72(3)\text{ \AA}$), sandwiched between two almost perpendicular sets of three parallel L ligands (Figure 10).⁶⁴¹

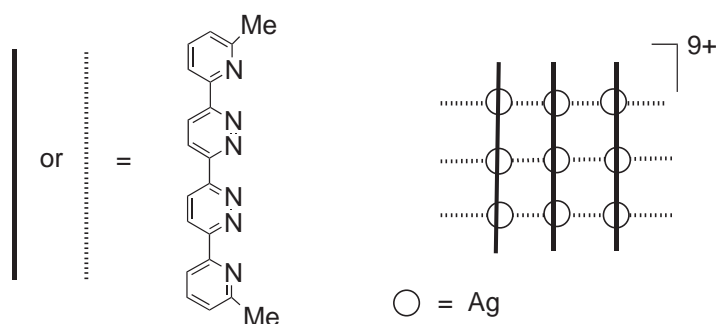
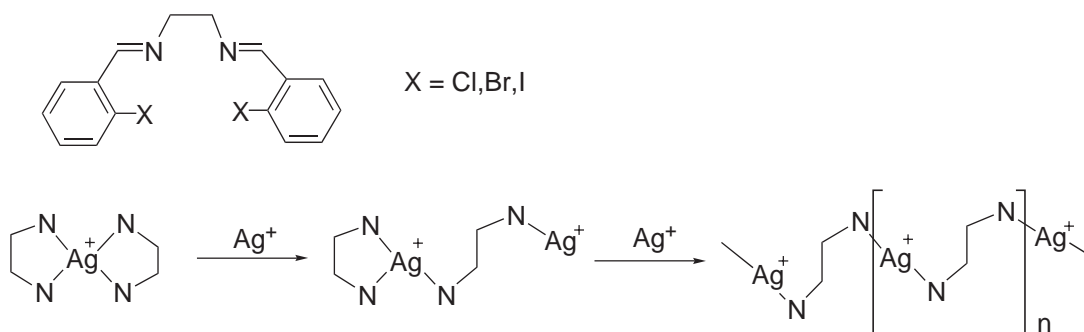

Figure 10 Assembly of components in $[\text{Ag}_9\text{L}_6](\text{OTf})_9$.

The reaction of AgOTf with a flexible diimine ligand in 1:2 and 1:1 ratio leads to the mono- or dinuclear complex, respectively. They further react with AgOTf to give coordination polymers. These complexes are models for the chain-growth process required in the formation of coordination polymers (see Scheme 2).^{642,643} Similar complexes are obtained with the 1,4-di-*t*-butyldiazabut-1,3-diene derivative.⁶⁴⁴



Scheme 2

A trinuclear complex with a bridging tridentate cyanide ion and 1.5 molecules of the tetrapodal ligand 1,2,4,5-tetrakis(pyrazol-1-ylmethyl)benzene has been described. These units assemble further into large macrocyclic rings, and these rings then interlock to produce a 2D metallo-polymeric network.⁶⁴⁵ Another silver(I) polymeric complex has been prepared with the ligand amidoselenato, $\text{Ag}_2\text{SeO}_3\text{N} \cdot 3\text{NH}_3 \cdot 2\text{H}_2\text{O}$.³⁰⁷

Heterometallic polymers are formed by reaction of $[\text{PtI}_2(\text{PP})]$ (PP = 1,2-[bis(2-pyridyl)phosphino]ethane (d(Py)pe) or cyclopentane (d(Py)pcp) with excess of AgNO_3 , which gives the complexes $[\text{Pt}_2\{\text{d(Py)pe}\}_2\text{Ag}_4(\text{NO}_3)_8(\text{H}_2\text{O})_2]_n$ or $[\text{Pt}_2\{\text{d(Py)pcp}\}_2\text{Ag}_6(\text{NO}_3)_{10}]_n$. These compounds contain the $[\text{Pt}_2(\text{PP})_2]^{4+}$ units, with each diphosphine ligand *P,N* bonded to platinum, connected via bridging AgNO_3 cluster, the Ag being bound to the pyridyl nitrogen or nitrate oxygen atoms.⁶⁴⁶

Bovine copper–zinc superoxide dismutase ($\text{Cu}_2\text{Zn}_2\text{SOD}$) is one of the most thoroughly characterized nonheme metalloproteins. This protein serves as unique ligand in reactions where the native metal ions are replaced by another as silver to form derivatives such as $\text{Ag}_2\text{Cu}_2\text{SOD}$, $\text{Ag}_2\text{Co}_2\text{SOD}$, $\text{Ag}_2\text{Ni}_2\text{SOD}$, and $\text{Ag}_2\text{Zn}_2\text{SOD}$, in which it is believed that the imidazole bridges are not maintained.^{647,648}

6.7.2.3.3 Complexes with phosphorus, arsenic, antimony, or bismuth donor ligands

(i) Complexes with monodentate ligands

Numerous phosphine complexes (and some arsine and stibine analogues) are known. With monophosphines these are mainly of the type $[\text{AgX}(\text{PR}_3)_n]$ with $n = 1-4$. The 1:1 compounds are tetrameric, with either cubane or chair structures depending on the steric requirements of both X and PR_3 . Several studies in solution or in the solid state of the coordination of one to four phosphine ligands to a silver center have been performed. They reveal that steric effects as well as electronic effects are important on the coordination behavior of the complexes. For example with phosphine ligands such as $\text{P}(\text{NMe}_2)_3$, $\text{P}(\text{NMeCH}_2)_3\text{CMe}$, or $\text{P}(-\text{NCH}_2\text{CH}_2-)_3$, only with the smaller ligand $\text{P}(-\text{NCH}_2\text{CH}_2-)_3$ coordination number four could be achieved. However, the ligand $\text{P}(-\text{OCH}_2)_2\text{CHO}-$ is shown to form only a monoligated Ag^I complex in solution despite its very small steric requirements, whereas $\text{P}(\text{OCH}_2)_3\text{Cet}$ and even larger phosphites such $\text{P}(\text{OPr}^i)_3$ form isolable four-coordinate complexes. Other two- and three-coordinate silver(I) compounds with phosphite ligands have been described, such as $[\text{Ag}\{\text{P}(\text{OPr}^i)_3\}_n]^+$ ($n = 3, 4$), $[\text{Ag}\{\text{P}(\text{OPh}_3)\}_n]^+$, $[\text{Ag}\{\text{P}(\text{OBu}^t)_3\}_2]^+$, and $[\text{AgX}\{\text{P}(\text{OBu}^t)_3\}]$ (X = Cl, Br, BF_4).^{649,650}

By using PR^1_2R^2 or $\text{As}(\text{C}_5\text{H}_9)_3$ ligands of intermediate size between PCy_3 , which form two-coordinate species, and PPh_3 , which form four-coordinate species, several three-coordinate ($\text{R}^1 = \text{Ph}$; $\text{R}^2 = \text{Ph}, \text{Cy}, \text{C}_5\text{H}_9$) or two-coordinate ($\text{R}^1 = \text{C}_5\text{H}_9, \text{Cy}$; $\text{R}^2 = \text{Ph}$) complexes have been obtained.^{651,652} With the bulky ligand $\text{P}(\text{Mes})_3$ only dicoordination, $[\text{Ag}\{\text{P}(\text{Mes})_3\}_2]\text{PF}_6$, is achieved.^{1,653} With the related sterically hindered and very basic phosphine ligand $\text{P}[2,4,6-(\text{MeO})_3\text{C}_6\text{H}_2]_3$ the complexes $[\text{AgX}\{\text{P}[2,4,6-(\text{MeO})_3\text{C}_6\text{H}_2]_3\}]$ (X = Cl or Br) have been obtained. Both are mononuclear and exhibit

an almost linear silver(I) center. Phosphorus-31 NMR studies show that in solution the reaction with another equivalent of phosphine takes place to generate the species $[\text{Ag}\{\text{P}[2,4,6-(\text{MeO})_3\text{C}_6\text{H}_2]_3\}_2]\text{X}$.⁶⁵⁴ Two-coordinate species have also been achieved with PPh_3 ; the reaction of AgBF_4 with two equivalents of PPh_3 in acetonitrile gives $[\text{Ag}(\text{NCMe})(\text{PPh}_3)_2]\text{BF}_4$. The acetonitrile ligand is loosely bound and recrystallization in CH_2Cl_2 /hexane results in the isolation of the low-coordinate phosphine complex $[\text{Ag}(\text{PPh}_3)_2]\text{BF}_4$.⁶⁵⁵ The crystal structure of $[\text{Ag}(\text{PPh}_2\text{Me})_2]\text{ClO}_4$ has been reported and shows a linear geometry for the silver(I) center.⁶⁵⁶

Silver chloride reacts with triphenylphosphine to give either $[\text{AgCl}(\text{PPh}_3)_2]$ or $[\text{AgCl}(\text{PPh}_3)_3]$, depending on the solvent, whereas silver bromide and iodide afford the tris(triphenylphosphine)-silver(I) halides. These complexes react with SnCl_2 to yield the trichlorostanniosilver derivatives.⁶⁵⁷ The crystal structures for $[\text{AgX}(\text{PPh}_3)_3]$ ($\text{X} = \text{Cl}, \text{Br}, \text{I}$) have been reported.⁶⁵⁷⁻⁶⁶⁰ The structures of the silver(I) derivatives $[\text{AgBr}(\text{PPh}_3)_2]$ and $[\text{Ag}_2\text{X}_2(\text{PPh}_3)_4]$ ($\text{X} = \text{Cl}$ or Br) show discrete monomeric units for the former and dimeric four-coordinate silver(I) units with bridging halides for the latter.⁶⁶¹ The solid state structures of $[\text{AgX}(\text{PPh}_2\text{Bu})]$ ($\text{X} = \text{Cl}, \text{Br}, \text{I}$) have been determined crystallographically and shown to consist of Ag_4X_4 -cubanes.⁶⁶² A ^{31}P NMR study for $[\text{AgI}(\text{PMe}_3)]$ shows two resonances that are assigned to the tetranuclear and mononuclear forms of the complex.⁶⁶³

Several studies have been carried out with triphenylphosphine-silver complexes with various anions. They show different structural motifs and most of them have been characterized by XRD studies and solid-state cross-polarization magic-angle spinning (CPMAS) NMR spectroscopy. The complexes $[\text{Ag}(\text{NO}_3)(\text{PPh}_3)_n]$ ($n = 1-4$) have been prepared and characterized structurally by solid-state ^{31}P NMR or XRD studies. The value of $J(\text{AgP})$ decreases with increasing coordination number. For $n = 1, 2$, or 3 the NO_3^- groups are weakly coordinated and it is ionic in $[\text{Ag}(\text{PPh}_3)_4]\text{NO}_3$.⁶⁶⁴ Also the nitrate complexes $[\text{Ag}(\text{NO}_3)(\text{PPh}_3)_2]$, $[\text{Ag}(\text{NO}_3)\{\text{P}(3\text{-MeC}_6\text{H}_4)_3\}_2]$, and $[\text{Ag}\{\text{P}(\text{CH}_2\text{CH}_2\text{CN})_3\}_2]\text{NO}_3$ (with a linear geometry) have been studied by solid-state magic-angle spinning (MAS) ^{31}P NMR spectra and XRD.^{665,666} The complex $[\text{Ag}(\text{NO}_3)(\text{PPh}_3)_2]$ has been characterized as a mononuclear complex with a bidentate nitrate ligand^{664,667} (**68**) or as a dinuclear complex with a bridging nitrate group (**69**).⁶⁶⁸ Trifluoromethanesulfonate(phosphine) silver(I) complexes of the type $[\text{Ag}(\text{OTf})(\text{PR}_3)_n]$ ($\text{PR}_3 = \text{PPh}_3, \text{PPh}_2\text{Me}; n = 1-4$) have also been characterized structurally. The solid-state structures display a wide variety of nuclearities, silver coordination numbers, and trifluoromethane coordination modes, depending on the phosphine. Thus, for $[\text{Ag}(\text{OTf})(\text{PPh}_3)]$ (**70**) the structure is a trimer with bridging triflates, and for $[\text{Ag}(\text{OTf})(\text{PPh}_2\text{Me})]$ it is a tetramer with a chair geometry, further linked into chains by Ag-phenyl interactions. The complexes $[\text{Ag}(\text{OTf})(\text{PR}_3)_2]$ present a dimer (PPh_3) with bridging triflates or monomer (PPh_2Me).⁶⁶⁹⁻⁶⁷¹

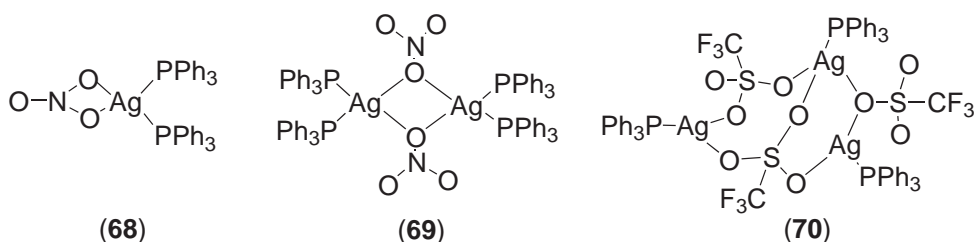

The structure of $[\text{Ag}(\text{O}_2\text{CMe})(\text{PPh}_3)_2]$ has been reported and consists of a dimer with bridging acetate groups through only one oxygen atom.⁶⁷² Other complexes have been reported with several anions such as formate, sulfate, selenate, or phosphate. The species $[\text{Ag}(\text{O}_2\text{CH})(\text{PPh}_3)_2]$ and $[\text{Ag}(\text{O}_2\text{CH})(\text{PPh}_3)_3]$ have been prepared showing a trigonal planar or tetrahedral geometry, respectively.^{673,674} The silver complexes with the oxyanions show different stoichiometries. The compounds $[\text{Ag}_2(\text{EO}_4)(\text{PPh}_3)_4] \cdot 2\text{H}_2\text{O}$ ($\text{E} = \text{S}, \text{Se}$) contain the anion bridging the two silver atoms via two oxygen atoms. The $[\text{Ag}(\text{HEO}_4)(\text{PPh}_3)_2]$ ($\text{E} = \text{S}, \text{Se}$) derivatives contain two independent molecules in which the protonated oxyanion is terminally bound to the silver atoms by a single oxygen atom. In one of them the silver atom makes an extra bond to the oxygen of the water. In the complex $[\text{Ag}(\text{H}_2\text{PO}_4)(\text{PPh}_3)_2]$ the silver atom is also three-coordinate.⁶⁷⁵

Similar studies have been carried out with AsPh_3 and SbPh_3 . The complexes $[\text{Ag}(\text{NO}_3)(\text{AsPh}_3)_n]$ ($n = 1-3$),⁶⁷⁶ $[\text{Ag}(\text{NO}_3)(\text{SbPh}_3)]$, and $[\text{Ag}(\text{NO}_3)(\text{SbPh}_3)_3]$ have been prepared and are isomorphous with the triphenylphosphine analogues.^{677,678} The 1:1 adducts are polymers with bridging nitrate groups. The other complexes have the expected four-coordinate geometry with the silver atom bonded to the nitrate group and to the P/As/Sb ligands.

The four-coordinate homoleptic complexes $[\text{Ag}(\text{EPh}_3)_4]^+$ ($\text{E} = \text{P}, \text{As}, \text{Sb}$) have been characterized structurally with several anions; for PPh_3 , with NO_3^- ,⁶⁶⁴ $[\text{SnPh}_2(\text{NO}_3)_2(\text{Cl}, \text{NO}_3)]^-$ (disordered distribution between Cl^- and NO_3^-),⁶⁷⁹ ClO_4^- ,⁶⁸⁰ PF_6^- ,^{681,682} and BPh_4^- ,⁶⁸³ for AsPh_3 , with $[\text{SnPh}_2(\text{NO}_3)_3]^-$,⁶⁷⁶ $[\text{Sn}_2\text{Ph}_4(\text{NO}_3)_4(\text{OH})_2]^{2-}$,⁶⁸⁴ ClO_4^- ,⁶⁸⁵ and BF_4^- .⁶⁸⁶ The latter allows comparison with the isostructural gold complex reflecting that the covalent radii of gold is found to be 6% smaller than silver. For SbPh_3 , with ClO_4^- ⁶⁸⁵ and BF_4^- have been characterized.⁶⁸⁷ Also the complexes $[\text{Ag}(\text{SbR}_3)_4]\text{BF}_4$ ($\text{R}_3 = \text{Me}_3, \text{Et}_3, \text{Ph}_2\text{Me}, \text{PhMe}_2, \text{Me}_2(2\text{-BrC}_6\text{H}_4)$) have been prepared.⁶⁸⁷

Spectroscopic and structural studies have been carried out on 1:1 and 1:2 adducts of silver(I) salts with tricyclohexylphosphine, $[\text{AgX}(\text{PCy}_3)]$ ($\text{X} = \text{Cl}, \text{Br}, \text{I}$) and $[\text{AgX}(\text{PCy}_3)_2]$ ($\text{X} = \text{CN}, \text{I}, \text{Br}, \text{Cl}, \text{SCN}, \text{NCO}, \text{NO}_3, \text{ClO}_4$). The 1:1 chlorine and bromine adducts have a dimeric structure with bridging halide ligands. The iodine derivative is a cubane but recrystallization from pyridine gives a novel dimer $[\text{Ag}_2\text{I}_2(\text{Py})(\text{PCy}_3)_2]$ (**71**). The 1:2 adducts have the expected three-coordinate planar geometry.^{688,689} The complexes $[\text{Ag}(\text{NO}_3)(\text{PCy}_3)_2]$ and $[\text{Ag}(\text{ClO}_4)(\text{PCy}_3)_2]$ have also been described as tetrahedral or trigonal planar, respectively.⁶⁹⁰ The analogous $[\text{AgX}(\text{AsCy}_3)_2]$ ($\text{X} = \text{Cl}, \text{Br}, \text{I}, \text{NO}_3, \text{NCO}, \text{CN}$) structures have been synthesized and characterized structurally, the chlorine and nitrate are dimers, the bromine and iodine are cubane tetramers, and the cyanide is a linear polymer.⁶⁹¹ The adducts $\text{AgCN}:\text{EPh}_3$ ($\text{E} = \text{P}, \text{As}, \text{Sb}$) (1:2) and $\text{AgCN}:\text{PPh}_3$ (1:1) have been characterized and show for the 1:2 adducts of PPh_3 and AsPh_3 complexes of the form $[(\text{Ph}_3\text{E})_3\text{Ag}(\text{CN})\text{Ag}(\text{EPh}_3)_3][\text{Au}(\text{CN})_2]$ (**72**) and for SbPh_3 adduct and the 1:1 of PPh_3 the structures are single-stranded polymers of the form $\cdots\text{Ag}(\text{EPh}_3)_2(\text{CN})\text{Ag}(\text{EPh}_3)_2(\text{CN})\cdots$ ($\text{E} = \text{P}, \text{Sb}$).⁶⁹² The structure of $[\text{Ag}(\text{NCS})(\text{PPh}_3)_3]$ have been reported.⁶⁹³

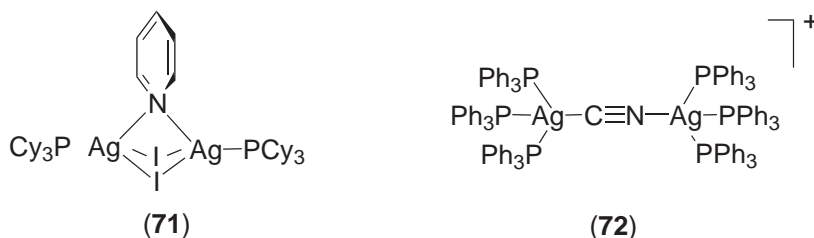

With AsPh_3 the adducts $[\text{AgX}(\text{AsPh}_3)_n]$ ($n = 1-3$; $\text{X} = \text{Cl}, \text{Br}, \text{I}, \text{SCN}$) have been studied and the 1:1 complexes are tetramers,⁶⁹⁴ the 1:2 dimers,⁶⁹⁵ and the 1:3 mononuclear complexes.⁶⁹⁶ The species $[\text{AgX}(\text{SbPh}_3)_n]$ ($n = 2, \text{X} = \text{Cl}, \text{Br}, \text{I}; n = 3, \text{X} = \text{Cl}, \text{Br}, \text{I}, \text{SCN}, \text{NCS}, \text{CN}$) present similar structures.^{678,698} Another crystal structure determination for $[\text{AuCl}(\text{AsPh}_3)_3] \cdot 0.5\text{Me}_2\text{CO}$ has been determined.⁶⁹⁷

The reaction of Ph_3SiLi with PMe_3 and AgCl gives $[\text{Ag}(\text{SiPh}_3)(\text{PMe}_3)_3]$, the first Ag-Si complex reported.⁶⁹⁹ The stability of compounds in the series $[\text{Ag}(\text{SiR}^1_3)(\text{PR}^2_3)_n]$ ($n = 1-3$; R^1 and R^2 aryl or alkyl), $[\text{Ag}_2(\text{SiR}_3)_2(\mu\text{-ddpm})]$ and $[\text{Ag}_2(\text{SiR}_3)_2(\mu\text{-dpp})]$ increases in going from monodentate to bidentate phosphine ligands and for the monodentate examples, complex stability increases with n .⁷⁰⁰ Di-*t*-butyl(trichlorogermyl)phosphine reacts with silver bromide to give $[\text{Ag}_4\text{Br}_4(\text{Bu}^t_2\text{PCl})(\text{Bu}^t_2\text{PGeCl}_3)_2]$; the structure has a cubane-like $(\text{AgBr})_4$ core with two silver atoms coordinated by a chlorophosphine and the other two by trichlorogermylphosphine.⁷⁰¹

Phenyl/2-pyridyl phosphines $\text{P}(2\text{-Py})_n\text{Ph}_{3-n}$ ($n = 1-3$) form 1:1 complexes with AgCl . The insoluble $[\text{AgCl}(\text{PPy}_3)]$ is probably a coordination polymer, but $[\text{AgCl}(\text{PPh}_2\text{Py})]$ is a tetrameric complex where the silver and the chlorine atoms form a distorted cube. The coordination of the PPh_2Py ligand to silver is only through the phosphorus atom.⁷⁰² Similarly with the phosphine ligand $\text{PPh}_2(2\text{-NH}_2\text{C}_6\text{H}_4)$ which gives the silver(I) complexes $[\text{Ag}(\text{EtOH})_2\{\text{PPh}_2(2\text{-NH}_2\text{C}_6\text{H}_4)\}_2]\text{NO}_3$ and $[\text{Ag}\{\text{PPh}_2(2\text{-NH}_2\text{C}_6\text{H}_4)\}_3]\text{NO}_3$, the coordination of the ligand is only through the phosphorus atom.⁷⁰³ The tetrahedral species $[\text{Ag}\{\text{PPh}_2(2\text{-NH}_2\text{C}_6\text{H}_4)\}_4]\text{PF}_6$ has been also prepared and is a potential anticancer agent. Preliminary biological studies have shown it to be active against three mouse tumor cell lines *in vitro* with cytotoxicities being comparable to those of cisplatin.⁷⁰⁴

The stepwise formation of $[\text{AgL}_n]\text{PF}_6$ ($n = 1-4$) for $\text{L} = \text{PPh}_3$ and 5-phenyldibenzophosphole has been observed *in situ* by stopped-exchange solution ³¹P NMR spectroscopy.⁷⁰⁵ A series of phosphole complexes of the type $[\text{AgXL}]_4$ or $[\text{AgXL}_2]_2$ ($\text{X} = \text{Cl}, \text{Br}, \text{I}$; $\text{L} = 1\text{-phenyl-3,4-dimethylphosphole}$) or $[\text{AgXL}_2]_2$ or $[\text{AgXL}_3]_4$ ($\text{X} = \text{Cl}, \text{Br}, \text{I}$; $\text{L} = 1\text{-phenyldibenzophosphole}$) have been prepared.⁷⁰⁶ A four-coordinate silver(I) complex is formed with the phosphorus ligand 5-aza-2,8-dioxa-1-pnictabicyclo[3.3.0]octa-2,4,6-triene. The silver atom is in an unusual square-planar geometry.⁷⁰⁷ The reaction of $[\text{Ag}(\text{NCMe})_4]\text{SbF}_6$ with this ligand in a 1:1 ratio gives the polymeric

complex (73).⁷⁰⁸ Silver(I) complexes with ferrocenylphosphine ligands have been synthesized. $\text{FcCH}_2\text{PPh}_2$ or Fc_2PhP ($\text{Fc} = (\eta^5\text{-C}_5\text{H}_5)\text{Fe}(\eta^5\text{-C}_5\text{H}_4)$) react with AgOTf or $[\text{Ag}(\text{OTf})(\text{PPh}_3)]$ to yield complexes of the type $[\text{Ag}(\text{OTf})(\text{PFc}_2\text{Ph})_2]$, $[\text{Ag}(\text{PPh}_2\text{CH}_2\text{Fc})_3]\text{OTf}$, or $[\text{Ag}(\text{OTf})(\text{PPh}_3)\text{L}]$.^{709,710} The triflate ligand in $[\text{Ag}(\text{OTf})(\text{PFc}_2\text{Ph})_2]$ can be substituted by bidentate ligands such as $\text{S}_2\text{CNEt}_2^-$ or $(\text{SPPH}_2)_2\text{CH}_2$.⁷¹⁰ Dibenzotropyliene phosphines (tropp) reacts with silver(I) trifluoromethanesulfonate to give the complexes $[\text{Ag}(\mu\text{-OTf})(\text{tropp})]$ or $[\text{Ag}(\text{tropp})_2]\text{OTf}$ (74), the structures show a weak interaction between the metal center and the alkene moiety.⁷¹¹ The treatment of bis(phosphonio)isophosphindolide salts with silver salts gives mono- or dinuclear complexes depending upon the anion; the triflate form both mono- or dinuclear (75).⁷¹² The cyclotetraphosphazene ligands $[\text{P}_4\text{N}_4\text{Ph}_4(\mu\text{-C}_6\text{H}_4)_2]$ and $[\text{P}_3(\text{PS})\text{N}_4\text{Ph}_4(\mu\text{-C}_6\text{H}_4)_2]$ form mononuclear AgL^+ complexes identified by mass spectroscopy.⁷¹³ The thermodynamics of complex formation between silver(I) and PPh_3 , dppm , dppe , or dppp has been investigated in propylene carbonate. Triphenylphosphine forms successive mononuclear complexes, dppm only polynuclear species, whereas mono- and polynuclear are formed by dppe and dppp .⁷¹⁴ Electro-spray mass spectrometry has been used to investigate the relative ligand properties of the triphenylpnictogen ligand EPh_3 ($\text{E} = \text{P}, \text{As}, \text{Sb}, \text{Bi}$)⁷¹⁵ or other phosphines⁷¹⁶ towards silver(I). The formed species increases in coordination number from two for PPh_3 to four for SbPh_3 , with donor ability decreasing and M-E bond length increasing; the BiPh_3 species are unstable.⁷¹⁵

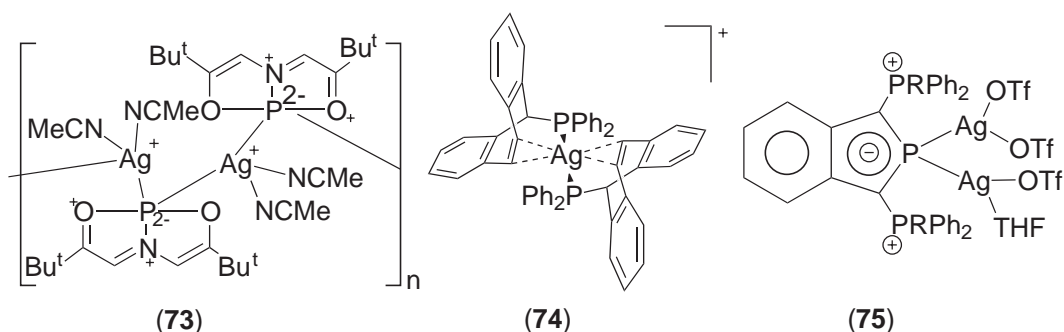

Heteronuclear complexes have been reported in which silver(I) is bound to a phosphine ligand. Heterobimetallic complexes of platinum, rhodium, or group 6 metals and silver with bridged dppm have been obtained, e.g., (76)–(79).^{717–722} The complex $[\text{Pt}(\text{C}\equiv\text{CPh})_2(\mu\text{-PPh}_2\text{CHMePPh}_2)_2\text{AgCl}]$ has also been described.⁷²³ The compound $[\text{Pt}(\text{CN})_2(\mu\text{-dppm})_2\text{Ag}(\text{OTf})]$ has an absorption at 317 nm (77 K), attributed to a $d\sigma^* \rightarrow p\sigma$ excitation with significant $\text{Pt}(\text{CN})_2\text{P}_2\text{MLCT}$ (MLCT = metal to ligand charge transfer) contribution, which generates an emission at 435 nm.⁷²⁴

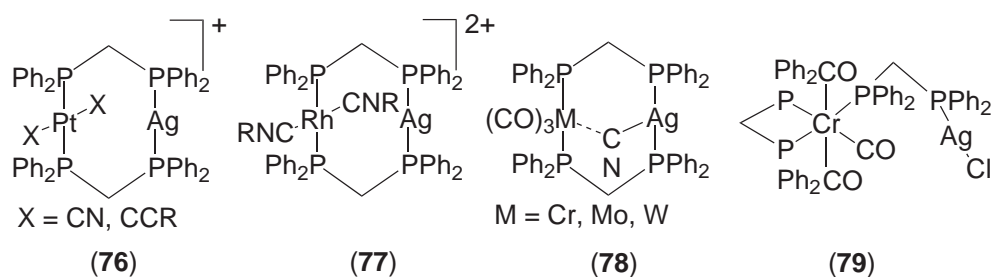

Rhodium or iridium complexes with the tridentate ligand bis[(diphenylphosphino)methyl]phenylarsine (dpma) react with silver ions to give the trimetallic complexes $[\text{M}_2\text{AgCl}_3(\text{CO})_2(\mu\text{-dpma})_2]$ (80).^{725,726} The reactivity of $[\text{CoCl}_2(\text{PR}_3)_2]$ ($\text{PR}_3 = \text{PPh}_3, \text{PPh}_2\text{CH}_2\text{COPh}$) with AgBF_4 has been tested and gives $[\text{Ag}(\text{PR}_3)_2]\text{Cl}$, but the triphenylphosphine derivative in the presence of more PPh_3 gives $[\text{Ag}_2\text{CoCl}_4(\text{PPh}_3)_4]$ (81).⁷²⁷ Reaction of the lithium salts of the anionic complexes $[\text{M}(\eta^5\text{-C}_5\text{H}_4\text{PPh}_2)(\text{CO})_3]^-$ ($\text{M} = \text{Cr}, \text{Mo}, \text{W}$) with AgBF_4 affords the compounds $[\text{M}(\eta^5\text{-C}_5\text{H}_4\text{PPh}_2)_2]$ (82). The mixed silver–gold compound can be obtained by mixing solutions of the silver and the gold complex.^{728,729} The reaction of $[\text{Au}(\text{Mes})(\text{dppm})]$ with AgClO_4 in a 1:2 molar ratio gives $[\{\text{Au}(\text{Mes})\}_2(\mu\text{-dppm})_2\text{Ag}]\text{ClO}_4$.⁷³⁰

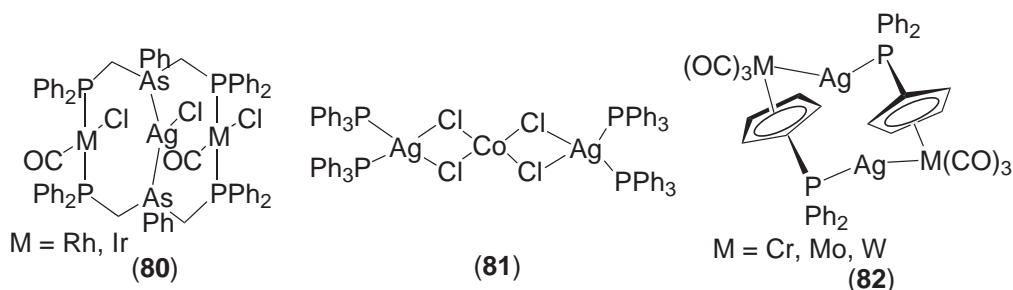

(ii) Complexes with polydentate ligands

Silver(I) complexes with bidentate diphosphines tend to be dimers or tetramers; however, with unusual diphosphines, mononuclear complexes have been obtained. With the rigid 2,11-bis[(diphenylphosphino)methyl]benzo[*c*]phenanthrene complexes of the type $[\text{AgX}(\text{PP})]$ (83) ($\text{X} = \text{SnCl}_3, \text{NO}_3, \text{ClO}_4$) have been reported in which the diphosphine is acting as a chelate.⁷³¹ A dinuclear complex with bridging fluoro ligands is obtained with the same ligand.⁷³² Stable bis-chelate complexes with diphosphines such as *dppf*, $\text{Et}_2\text{PCH}_2\text{CH}_2\text{PPh}_2$, $\text{Et}_2\text{PCH}_2\text{CH}_2\text{PEt}_2$, $\text{Ph}_2\text{PCH}=\text{CHPPh}_2$, and $\text{Ph}_2\text{P}(\text{CH})_3\text{PPh}_2$ have been detected, and some of them isolated, by $^{109}\text{Ag}\{^{31}\text{P}\}$ INEPT (insensitive nuclei enhancement via polarization transfer) pulse sequences.^{733,734} The bis(*dppf*) silver(I) nitrate, $[\text{Ag}(\text{dppf})_2]\text{NO}_3$, and the *cis*-1,2-bis(diphenylphosphino)ethylene derivative, $[\text{Ag}(\text{PPh}_2\text{CH}=\text{CHPPh}_2)_2][\text{SnPh}_3(\text{NO}_3)_2]$ have been prepared and characterized structurally showing a tetrahedral nature.^{735,736} These bis-chelate complexes have been shown to exhibit antitumor activity against P388 leukemia in mice, as well as antifungal and modest antibacterial properties.^{737–739} Although the mechanism for the cytotoxicity is not known, tumor cell mitochondria are likely targets for these large lipophilic cations,^{740,741} and indeed the complex $[\text{Ag}\{\text{Ph}_2\text{P}(\text{CH}_2)_2\text{PEt}_2\}_2]\text{NO}_3$ exhibits selective primary antimicrobial activity in yeast.⁷⁴² Similar complexes have been synthesized with bidentate pyridyl phosphines which have more hydrophilic characteristics. The degree of hydrophilicity depends critically on the position of the N atom in the pyridyl ring. The 1:2 adducts with 1,2-bis(di-*n*-pyridylphosphino)ethane (*dnpype*) for $n = 2–4$ have been prepared and are monomeric for d^3 type and d^4 type and more water soluble than the 2-pyridyl complex which crystallizes as dimeric $[\{\text{Ag}(d^2\text{pype})\}_2]^{2+}$. The latter exists in solution as equilibrium mixtures of monomeric, dimeric, and trimeric species. These complexes show potent and selective antitumor activity against a panel of human cultured ovarian carcinoma cell lines.^{743,744}

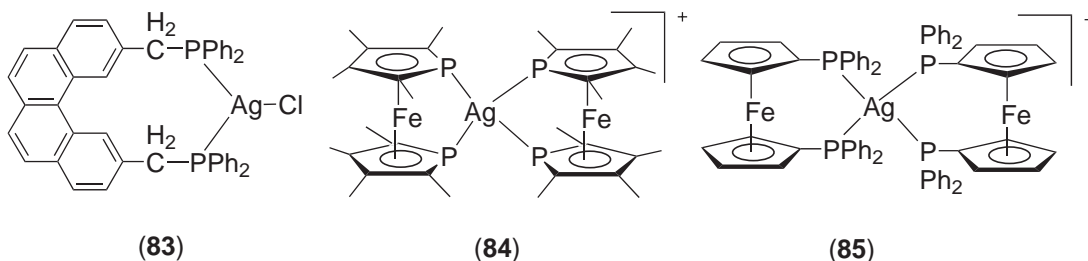

Electrocrystallization of 7,7,8,8-tetracyanoquinodimethane (TCNQ) with diphosphaferrocene ($(\eta^5\text{-Me}_4\text{C}_4\text{P})_2\text{Fe}$) with a silver anode affords the complex $[\text{Ag}\{(\eta^5\text{-Me}_4\text{C}_4\text{P})_2\text{Fe}\}_2]^+[\text{TCNQ}]^-$ (84).⁷⁴⁵ *Dppf* also gives the bis-chelate compound $[\text{Ag}(\text{dppf})_2]\text{ClO}_4$ (85).⁷⁴⁶ The 1:1 adducts have different structures, with the ClO_4^- anion a dimeric structure with bridging perchlorate has been proposed, but with nitrate a dimeric with bridging *dppf* and chelated NO_3^- ligands is obtained.^{746,747} Mononuclear silver(I) complexes with *dppf* acting as chelating ligand can be achieved by reaction of $[\text{Ag}(\text{OClO}_3)(\text{dppf})]_2$ with monodentate or bidentate ligands to give three coordinate complexes of the type $[\text{Ag}(\text{dppf})\text{L}]\text{ClO}_4$ ($\text{L} = \text{PPh}_3, \text{SPPH}_3$) or four coordinate of the type $[\text{Ag}(\text{dppf})(\text{LL})]\text{ClO}_4$ ($\text{LL} = \text{dppf}, \text{phen}, \text{bipy}, (\text{SPPH}_2)_2\text{CH}_2$) or $[\text{Ag}(\text{S}_2\text{CNEt}_2)(\text{dppf})]$.⁷⁴⁶ The ligand bis(neopentylidene)phosphonito)ferrocene also forms the bis-chelate silver(I) complex.⁷⁴⁸ A derivative of the *dppf* ligand, $[\text{Fe}\{\eta^5\text{-C}_5\text{H}_3(\text{PPh}_2)(\text{CHMeNMeCH}_2\text{CH}_2\text{NMe}_2)(\eta^5\text{-C}_5\text{H}_4\text{PPh}_2)\}_2]$, reacts

with AgOTf and excess of $\text{MeO}_2\text{CCH}_2\text{NC}$ in CD_2Cl_2 to yield a tetraordinated silver(I) complex. In solution, it has been observed that the NMe_2 group lies close to the active hydrogen atoms of the coordinated isocyanate. There is interest in this reaction in connection with the catalysis of the aldol reaction.⁷⁴⁹

The ligand 1,2-bis(diphenylphosphino)-*o*-carborane possesses a rigid *o*-carborane moiety that causes the chelating mode of the diphosphine ligand to be preferred to the bridging mode. Complexes of the type $[\text{Ag}\{(\text{PPh}_2)_2\text{C}_2\text{B}_{10}\text{H}_{10}\}_2]\text{ClO}_4$, $[\text{Ag}\{(\text{PPh}_2)_2\text{C}_2\text{B}_{10}\text{H}_{10}\}\text{L}]\text{ClO}_4$ (PR_3 , AsPh_3 , SPPH_3 , PyCO_2H), and $[\text{Ag}\{(\text{PPh}_2)_2\text{C}_2\text{B}_{10}\text{H}_{10}\}(\text{LL})]\text{ClO}_4$ ($\text{LL} = \text{phen}$, bipy , $(\text{SPPH}_2)_2\text{CH}_2$) can be easily formed by substitution reactions on $[\text{Ag}(\text{OCIO}_3)\{(\text{PPh}_2)_2\text{C}_2\text{B}_{10}\text{H}_{10}\}]$, which is obtained by reaction of AgClO_4 with the diphosphine.⁷⁵⁰ Similar complexes have been obtained with the *nido* diphosphine $[7,8-(\text{PPh}_2)_2-7,8-\text{C}_2\text{B}_{10}\text{H}_{10}]^-$ in which the carborane cage has been partially degraded by removal of one boron atom. The complex $[\text{Ag}\{(\text{PPh}_2)_2\text{C}_2\text{B}_9\text{H}_{10}\}\{(\text{PPh}_2)_2\text{C}_2\text{B}_{10}\text{H}_{10}\}]$ (**86**) with a *closo* and a *nido* diphosphine has been synthesized.⁷⁵¹ Silver(I) complexes with diphosphines acting as *trans*-chelating ligands have been obtained with $\text{Ph}_2\text{P}(\text{CH}_2)_2\text{O}(\text{CH}_2)_2\text{O}(\text{CH}_2)_2\text{PPh}_2$ (**87**)⁷⁵² or with an anthraceno-diphosphine (**88**)⁷⁵³ or with 2,11-bis(dialkylphosphinomethyl)benzo[*c*]phenanthrene.^{754,755} The anthraceno-diphosphine has an η^6 -anthracenyl group bonded to silver; the addition of PPh_3 breaks this bond and the new complex shows strong photoluminescence. However, attempts to isolate these species have been unsuccessful and (**88**) is recovered.

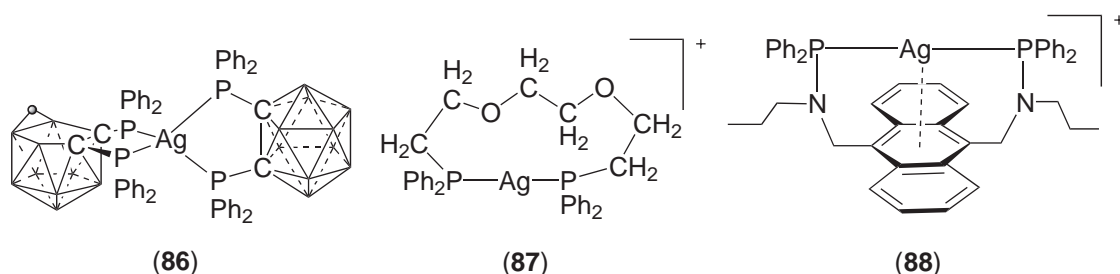

The stability in solution of tetrahedral silver(I) complexes of the type $[\text{Ag}(\text{LL})_2]\text{PF}_6$ with $(R^*, R^*)-(\pm)$ - or (R^*, S^*) -1,2-phenylenebis(methylphenylphosphine) and their arsenic isosteres have been studied. They rearrange in solution by intermolecular ligand distribution and by inversion of the tetrahedral metal stereocenter.⁷⁵⁶ Crystallization of 1:2 silver(I) halide/pseudo-halide:dppp mixtures from acetonitrile results in the isolation of the compounds $[\text{AgX}(\text{dppp}-\text{P}')(\text{dppp}-\text{P})]$ ($\text{X} = \text{Cl}$, Br , I , CN). However, with SCN^- the bis-chelate derivative is obtained, $[\text{Ag}(\text{dppp})_2]\text{SCN}$.⁷⁵⁷ The azine-diphosphine $Z, Z\text{-Ph}_2\text{PCH}_2\text{CBu}^1=\text{NN}=\text{CBu}^1\text{CH}_2\text{PPh}_2$ affords the three-coordinate compound $[\text{AgCl}(\text{PP})]$ with the diphosphine acting as a chelating ligand.⁷⁵⁸

Dppm has been used widely in coordination chemistry. Silver(I)-dppm complexes have been reported in several ratios and they present different structural frameworks. Due to the bite angle of dppm this ligand usually acts as bridging ligand. The $[\text{Ag}_2(\text{dppm})_2]^{2+}$ core structure is present in $[\text{Ag}_2\text{X}_2(\text{dppm})_2]$ ($\text{X} = \text{NO}_3$ (**89**), $\text{O}_2\text{CCH}_2\text{Ph}$, O_2CMe)⁷⁵⁹⁻⁷⁶² or $[\text{Ag}_2\text{X}(\text{Py})_2(\text{dppm})_2]$.⁷⁶³ The tri- and tetranuclear 1:1 species have been reported in $[\text{Ag}_3\text{Br}_2(\text{dppm})_3]\text{Br}$,^{764,765} $[\text{Ag}_3\text{Cl}_2(\text{dppm})_3]\text{X}$ ($\text{X} = \text{ClO}_4^-$, $[\text{SnPh}_2(\text{NO}_3)_2\text{Cl}]^-$) (**90**),^{766,767} or $[\text{Ag}_4(\text{NO}_3)_2(\text{dppm})_4](\text{PF}_6)_2$ (**91**).⁷⁵⁹

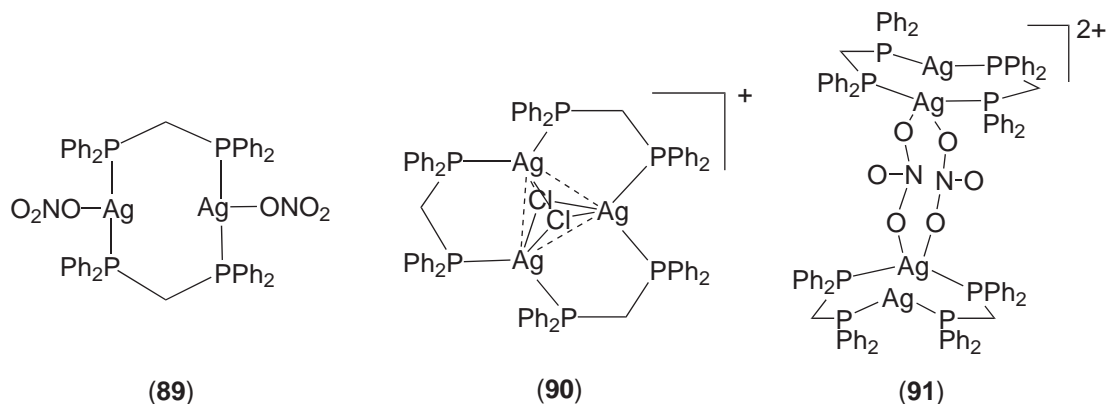

The dinuclear 2:3 species have been characterized in $[\text{Ag}_2(\mu\text{-dppm})_3](\text{OTf})_2$ and $[\text{Ag}_2(\mu\text{-dppm})_3](\text{NO}_3)_2$ (**92**), with the silver centers three coordinate by three phosphorus atoms of different dppm ligands.^{761,768} A tetranuclear species $[\text{Ag}_2(\mu\text{-O}_2\text{CMe-O,O}')(\mu\text{-O}_2\text{CMe-O})(\mu\text{-dppm})_2]$ has been obtained by reaction of dppm with two equivalents of AgOAc .⁷⁶² The reaction of $[\text{Ag}(\text{Mes})_4]$ with dppm gives a trinuclear compound $[\text{Ag}_3(\text{dppm-H})_3]$ (**93**) in which the dppm ligand has been deprotonated with the formation of mesithylene. In the structure, two of the silver centers are three coordinate to three different phosphorus atoms and the other silver atom is bonded to two carbon atoms.^{291,292}

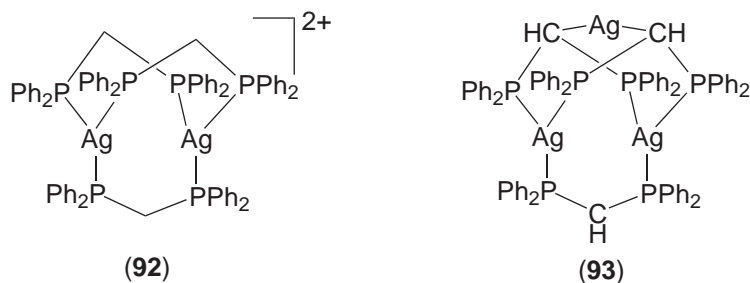

Spectroscopic and structural investigation of dinuclear silver(I) complexes with bis(dicyclohexylphosphino)methane (dcpm) such as $[\text{Ag}_2(\mu\text{-dcpm})_2]\text{X}_2$ ($\text{X} = \text{OTf}, \text{PF}_6$) and $[\text{Ag}_2(\mu\text{-O}_2\text{CCF}_3)_2(\mu\text{-dcpm})]$ have been carried out. All the complexes have short Ag—Ag distances and the UV-visible absorption band at 261 nm is assigned to a $4d\sigma^* \rightarrow 5p\sigma$ transition originating from $\text{Ag}^{\text{I}}\text{-Ag}^{\text{I}}$ interactions. These compounds exhibit photoluminescence in the solid state at room temperature.⁷⁶⁹ The reaction of $\text{Ph}_2\text{PNHPPH}_2$ with AgCl yields $[\text{Ag}_2\text{Cl}_2\{\mu\text{-}(\text{PPh}_2)_2\text{NH}\}]$ for which in the solid state the cluster structure $[\text{Ag}_4\text{Cl}_4\{\mu\text{-}(\text{PPh}_2)_2\text{NH}\}_2]$ is assumed.⁷⁷⁰ The treatment of $\text{Ph}_2\text{PNHPPH}_2$ with the ylide complex $[\text{Ag}(\text{CH}_2\text{PPh}_3)_2]\text{ClO}_4$ gives the dinuclear compound $[\text{Ag}_2\{\mu\text{-}(\text{PPh}_2)_2\text{N}\}_2]$; this complex can react further with $[\text{Au}(\text{C}_6\text{F}_5)\text{THT}]$ or $[\text{Ag}(\text{OCIO}_3)(\text{PPh}_3)]$ with coordination of the gold or silver atoms to the nitrogen atoms to give $[\text{Ag}_2\{\mu\text{-}(\text{PPh}_2)_2\text{N}\}_2\{\text{Au}(\text{C}_6\text{F}_5)\}_2]$ or $[\text{Ag}_2\{\mu\text{-}(\text{PPh}_2)_2\text{N}\}_2\{\text{Ag}(\text{OCIO}_3)(\text{PPh}_3)\}_2]$.⁷⁷¹ The reaction of $\text{LiN}(\text{PPh}_2)_2$ with $[\text{Ag}_2\text{Cl}_2\{\mu\text{-}(\text{PPh}_2)_2\text{NH}\}]$ leads to a mixture of the dinuclear complexes $[\text{Ag}_2\{\mu\text{-}(\text{PPh}_2)_2\text{N}\}_2]$ and $[\text{Ag}_2\{\mu\text{-}(\text{PPh}_2)_2\text{N}\}\{\mu\text{-}(\text{PPh}_2)_2\text{NH}\}]$.⁷⁷⁰

Bis(dialkylphosphino)ethane ligands form very stable bis-chelate complexes; however, two complexes with a $[\text{Ag}_2\text{L}_4]^{2+}$ core ($\text{L} = \text{dppe}, \text{Me}_2\text{P}(\text{CH}_2)_2\text{PMe}_2$), with two diphosphines bridging and the silver atoms are also bound to water molecules.^{772,773} The compound $[\text{Ag}_2\{\text{PBu}^t_2(\text{CH}_2)_2\text{P}^t\text{Bu}^t_2\}(\text{H}_2\text{O})_2](\text{BF}_4)_2$ has a dinuclear structure with a bridging diphosphine ligand and the silver atoms are also bound to water molecules.⁷⁷⁴ Bis(dialkylphosphino)propane forms dinuclear complexes with the $[\text{Ag}_2\text{L}_2]^{2+}$ core, which have been characterized for dppp with the NO_3^- anion and for $\text{Bu}^t_2\text{P}(\text{CH}_2)_3\text{PBu}^t_2$ with the BF_4^- anion.⁷⁷⁴⁻⁷⁷⁶ The complex $[\text{Ag}_2(\text{dppb})_2]\text{NO}_3$ (dppb = 1,4-bis(diphenylphosphino)butane) has the same structural framework.⁷⁷⁶ The thermodynamic parameters of the complexation of silver(I) with dppm, dppe, dppp, and triphosphines in DMSO and ^{31}P NMR studies confirm that very stable complexes of the type $[\text{Ag}_2\text{L}_2]^{2+}$ are formed.⁷⁷⁷

In the diphosphines bis(diphenylphosphino)alkyne and *trans*-1,2-bis(diphenylphosphino)ethylene, due to the rigid backbone, the orientations of the lone pairs are restricted, so that these ligands cannot point inwards and set up the metals for anion bridging. The reaction of $\text{Ph}_2\text{PC}\equiv\text{CPh}_2$ with AgSbF_6 in a 1:1 molar ratio gives a mixture of the 1:2, 2:2, and 3:2 complexes (Equation (6)):

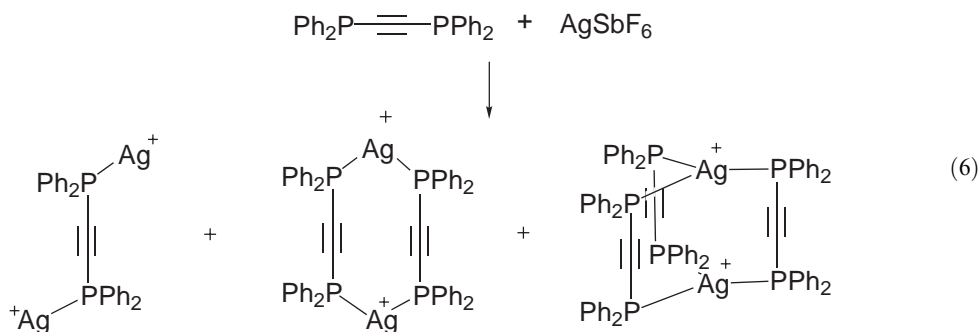

The species $[\text{Ag}_2(\text{PPh}_2\text{C}\equiv\text{CPh}_2)_3]^{2+}$ have been prepared with several anions such as OTf^- , BF_4^- , NO_3^- , and SbF_6^- . When crystals of $[\text{Ag}_2(\text{PPh}_2\text{C}\equiv\text{CPh}_2)_3](\text{OTf})_2$ are stored in its supernatant for 16 weeks, conversion occurs to the isostoichiometric $[\text{Ag}_2\text{L}_3(\text{OTf})_2]_n$ coordination polymer (94). For *trans*- $\text{Ph}_2\text{PCH}=\text{CHPPh}_2$ evidence for the discrete $[\text{Ag}_2\text{L}_3]^{2+}$ cages has been found in solution, although crystallization only gives the ring-opened polymeric structure $[\text{Ag}_2\text{L}_3\text{X}_2]_n$.^{778,779}

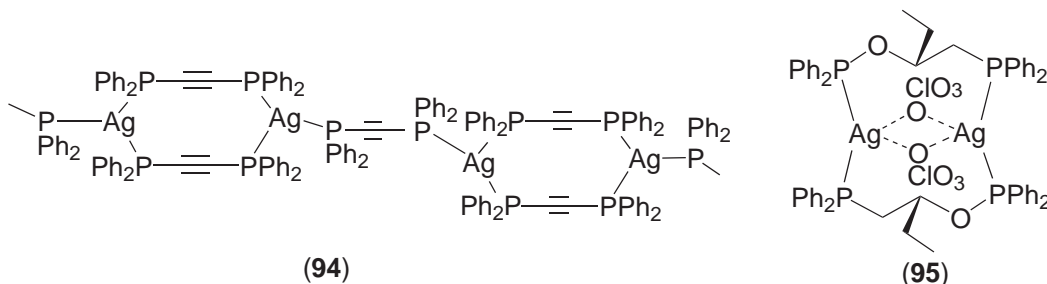

The reaction of silver nitrate with *R,R*-DIOP (4*R*,5*R*-*trans*-4,5-bis[(diphenylphosphino)methyl]-2,2-dimethyl-1,3-dioxalane), gives a helical infinite chain complex $[\text{Ag}(\text{NO}_3)(\text{R,R-DIOP})]$.⁷⁸⁰ By treatment of this compound with NaX , or by direct reaction of AgX with *R,R*-DIOP, the dinuclear derivatives $[\text{AgX}(\text{R,R-DIOP})_2]$ ($\text{X} = \text{Cl}, \text{Br}, \text{I}, \text{SCN}$) are obtained. The structure consists of two silver centers bridged by diphosphine and two halide ligands.⁷⁸¹ Similar complexes are obtained with the chiral ditertiary ligand $\text{Ph}_2\text{PCH}_2\text{CHEtOPPh}_2$ (*R,S*) which yields the silver dinuclear compounds $[\text{AgX}(\text{PP})_2]$ ($\text{X} = \text{Cl}, \text{Br}, \text{ClO}_4$ (95)).⁷⁸²

The complex *p*-Tol-BINAP· AgF (*p*-Tol-BINAP = 2,2'-bis(di-*p*-tolylphosphanyl)-1,1'-binaphthyl) catalyzes the asymmetric addition of allylic trimethoxysilanes to aldehydes (Equation (7)).⁷⁸³ The process can provide various optically active homoallylic alcohols with high enantioselectivity (up to 96% ee) and a remarkable γ and *anti*-selectivities are observed for the reaction with crotylsilanes, irrespective of the configuration of the double bond:

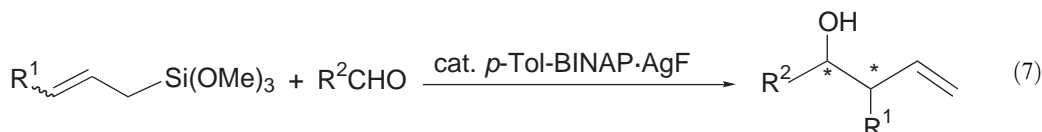

Linear polymeric silver(I) complexes of the type $[\text{Ag}(\mu\text{-L})(\text{MeCN})_2]_n(\text{ClO}_4)_n$ ($\text{L} = 2,6$ -bis(diphenylphosphino)pyridine) have been synthesized by the self-assembly reaction of the ligand with $[\text{Ag}(\text{MeCN})_4]\text{ClO}_4$.⁷⁸⁴ A dinuclear complex has been obtained with this ligand, $[\text{Ag}_2(\mu\text{-L})_3](\text{ClO}_4)_2$, in which the silver atoms are triply bridged by the phosphine ligand.⁷⁸⁵ A related complex $[\text{Ag}_2(\eta^2\text{-NO}_3)(\mu\text{-L})_3]$ (96) has been obtained for $\text{L} = 3,6$ -bis(diphenylphosphino)pyrazine.⁷⁸⁵ 2,5-Bis(diphenylphosphinomethyl)thiophene (dpmt) produces various polynuclear silver(I) complexes of the type $[\text{Ag}_2(\mu\text{-dpmt})_3](\text{BPh}_4)_2$, $[\text{Ag}_2\text{Cl}_2(\mu\text{-dpmt})]$, and $[\text{Ag}_3\text{X}_3(\mu\text{-dpmt})_2]$ ($\text{X} = \text{Br}, \text{I}$) (97).⁷⁸⁶

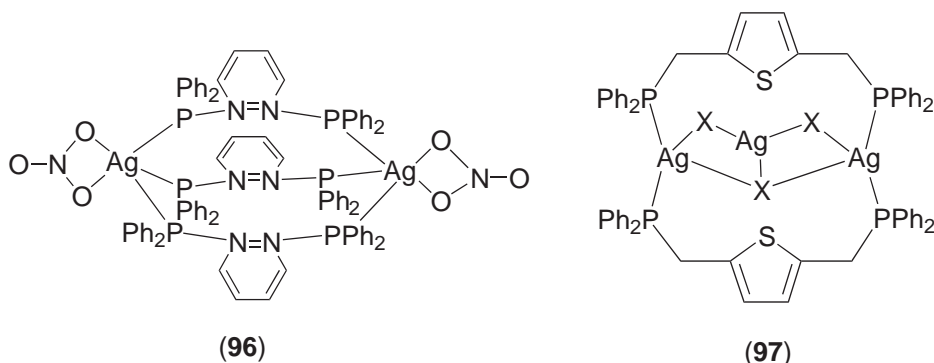

A heterobimetallic compound containing a $\text{Cp}_2\text{Ti}^{\text{IV}}$ unit linked via diphenylphosphinoacetate to a silver(I) center has been isolated, $[\text{TiCp}_2\{\mu\text{-OCOCH}_2\text{PPh}_2\}_2\text{AgCl}]$.⁷⁸⁷ In the complex

[Mo(CO)₄{(Prⁱ₂N)₄P₄O₄}] the Mo-atom binds two of the four phosphorus atoms of the P₄O₄ heterocycle, leaving the other two available for further coordination to silver giving [Mo(CO)₄{(Prⁱ₂N)₄P₄O₄}Ag(NO₃)].⁷⁸⁸ The dinuclear rhenium–silver complexes [ReH₃(PCy₃)₂(μ-L)(μ-H₂)₂AgI] (L = Ph₂PC(=CH₂)PPh₂, dppm) have been prepared from AgI and [ReH₅L(PCy₃)₂].⁷⁸⁹

Several silver(I) complexes have been prepared with triphosphine ligands. Bis(diphenylphosphinophenylphosphine) reacts with AgOTf in a 3:2 molar ratio to give the luminescent complex [Ag₃L₂](OTf)₃ (**98**), the ClO₄⁻ salt was obtained by metathesis.⁷⁹⁰ The bis[2-(diphenylphosphino)phenyl]phenylphosphine ligand reacts with AgCl to give the mononuclear tetrahedral compound [AgClL]. A dinuclear complex [Ag₂L₂](BF₄)₂ (**99**) is obtained by reaction of AgBF₄ with the triphosphine; it has a very short Ag⋯Ag distance of 2.8569(8) Å.⁷⁹¹ A mononuclear complex, [AgI(triphos)], has been prepared with the 1,1,1-tris(diphenylphosphinomethyl)ethane ligand.⁷⁹² In the presence of templating anions such as OTf⁻, ClO₄⁻, or NO₃⁻, 2:3 molar mixtures of triphos and silver(I) cations give novel hexanuclear cages, which result from an unusual “endo-methyl” geometry of the ligand (**100**).⁷⁹³

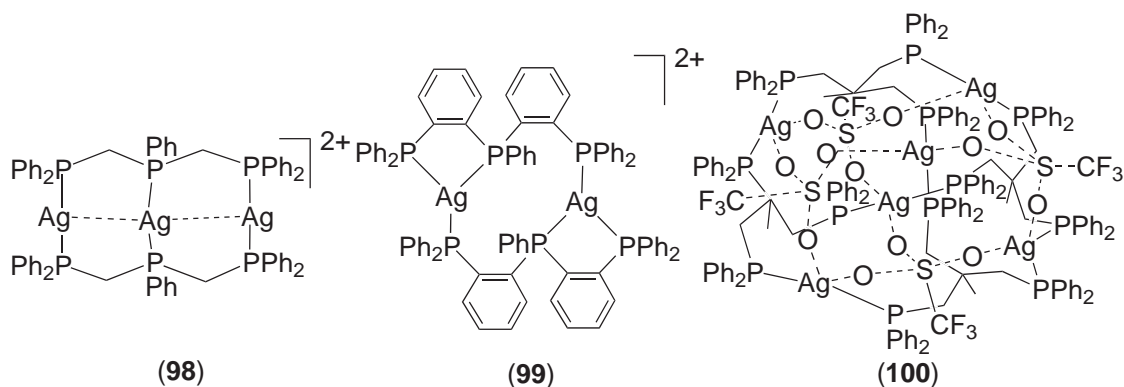

The reaction of the cyclic P₃-ligand 1,3,5-triphospha-2,4,6-trisilacyclohexane with AgOTf results in the synthesis of complex (**101**) with a cyclic P₆ ligand.⁷⁹⁴ Optically pure (*S,S*)-(+)-((PPh₂CH₂CH₂)₂(PPhCH₂CH₂PPh)) spontaneously self-assembles into left-handed double-stranded D₂-double helix (**102**) and C₂-side-by-side helix conformers of the disilver(I) cation.⁷⁹⁵

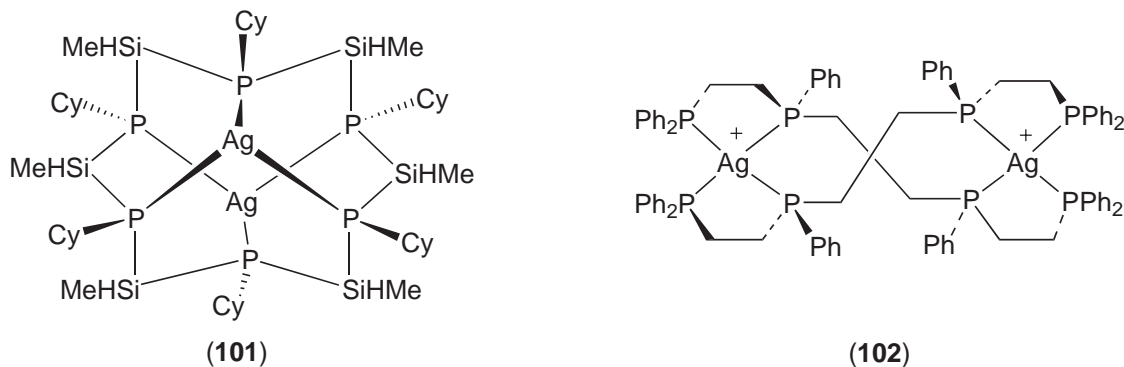

A tetraphosphonitocalixresorcinarene ligand (PhCH₂CH₂CHC₆H₂O₂PPh)₄ (bowl) forms a tetra-silver(I) complex [Ag₄(μ-Cl)₄(bowl)] and the chlorine inclusion compound [Ag₄(μ-Cl)₄(μ₄-Cl)(bowl)]⁻ (**103**). The chlorine ligands are easily replaced by bromine or iodine.^{796,797} The anionic complex acts as host for the selective binding of metal cations.⁷⁹⁸ A related ligand 5,11,17,23-tetra-*t*-butyl-25,26,27,28-tetrakis(diphenylphosphinomethoxy)calix[4]arene reacts with two equivalents of AgBF₄ to form complex (**104**).⁷⁹⁹

(iii) Phosphide- or arsenide-bridged polynuclear complexes

Silver(I) phosphide or arsenide complexes have been synthesized. The reaction of AgCl with Ph₂PTMS in the presence of a tertiary phosphine gives polynuclear complexes such as

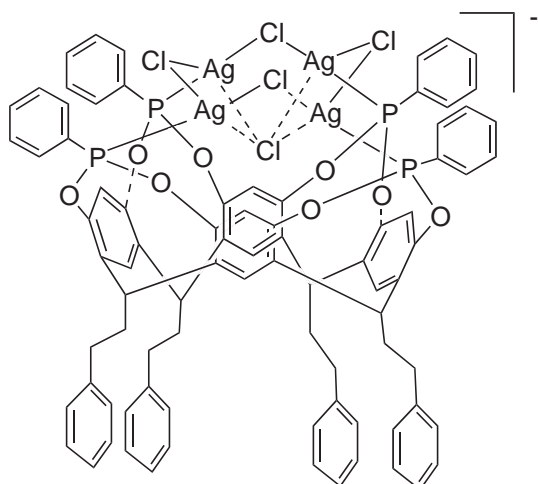

(103)

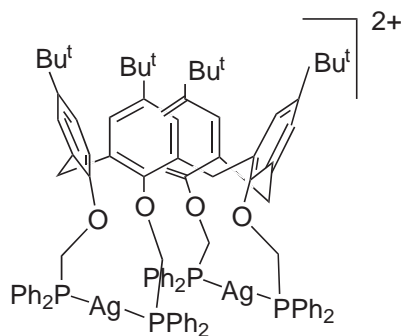

(104)

$[\text{Ag}_3(\text{PPh}_2)_3(\text{PR}_3)_3]$ ($\text{PR}_3 = \text{PBu}^n_2\text{Bu}^t$, PPr^n_3), $[\text{Ag}_4(\text{PPh}_2)_4(\text{PR}_3)_4]$ ($\text{PR}_3 = \text{PMePr}^n_2$, PPr^n_3), $[\text{Ag}_4(\text{PPh}_2)_4(\text{PEt}_3)_4]_n$, and $[\text{Ag}_6(\text{PPh}_2)_6(\text{PBu}^t_3)_2]$.^{800,801} The reaction of AgCl with $\text{PhP}(\text{TMS})_2$ and a tertiary phosphine provides access to phosphinidene-bridged silver clusters (Scheme 3).⁸⁰² Similarly the treatment of AgCl with the arsenic derivative $\text{PhAs}(\text{TMS})_2$ afford the arsinidene-bridged silver clusters $[\text{Ag}_{14}(\text{AsPh})_6\text{Cl}_2(\text{PR}_3)_8]$ ($\text{PR}_3 = \text{PMePr}^n_2$, PPr^n_3 , PEt_3) or $[\text{Ag}_4(\text{As}_4\text{Ph}_4)_2(\text{PR}_3)_4]$ ($\text{PR}_3 = \text{PEt}_3$, PPr^n_3).⁸⁰³

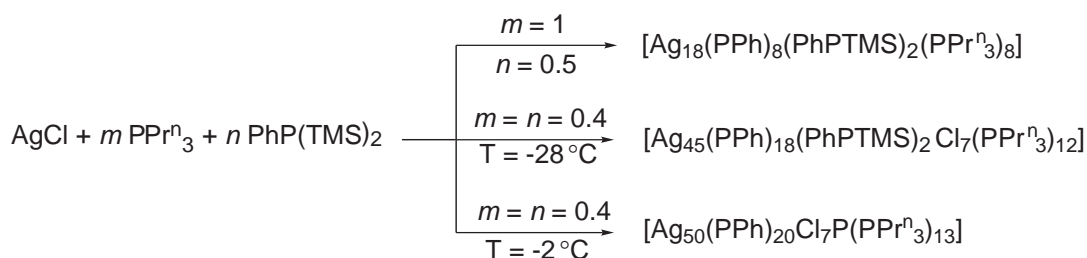

Scheme 3

The treatment of the $[\text{MP}_3(\text{triphos})]$ compounds ($\text{M} = \text{Rh}, \text{Co}$) with silver(I) derivatives yields the complexes $[\{(\text{triphos})\text{MP}_3\}_2\text{Ag}]$ ($\text{M} = \text{Co}; \text{X} = \text{ClO}_4, \text{PF}_6$; $\text{M} = \text{Rh}; \text{X} = \text{OTf}, \text{PF}_6$) (105).⁸⁰⁴ The silver aluminates $\text{AgAl}[\text{OC}(\text{CF}_3)_2(\text{R})]_4$ ($\text{R} = \text{H}, \text{Me}, \text{CF}_3$) react with solutions of white phosphorus P_4 to give complexes that bind one or two almost undistorted tetrahedral P_4 molecules in an η^2 fashion such as $[\text{Ag}(\text{P}_4)_2]^+[\text{Al}\{\text{OC}(\text{CF}_3)_3\}_4]^-$ (106), $[\text{Ag}(\text{P}_4)\{\text{Al}\{\text{OC}(\text{CF}_3)_2\}_4\}]$, and $[\text{Ag}(\text{P}_4)\{\text{Al}\{\text{OC}(\text{CF}_3)_2\}_4\}]_2$. The $\text{Ag}(\text{P}_4)_2^+$ ion has an almost planar coordination environment around the Ag^+ ion due to $d_{x^2-y^2}(\text{Ag}) \rightarrow \sigma^*(\text{PP})$ backbonding.⁸⁰⁵

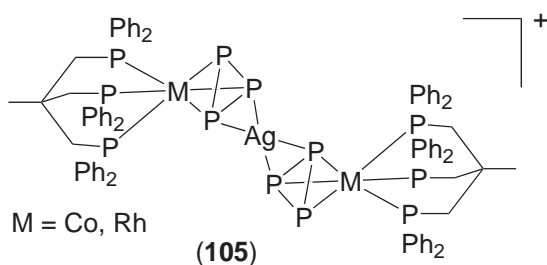

(105)

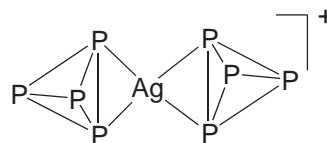

(106)

6.7.2.3.4 Complexes with oxygen donor ligands

Silver(I) complexes with oxygen donor ligands have been prepared with three different types of ligands: β -diketonates, carboxylates, and crown ethers.

Silver(I) β -diketonate derivatives have received significant attention due to the ease with which they can be converted to the elemental metal by thermal decomposition techniques such as metal organic chemical vapor deposition (MOCVD).⁵⁹ The larger cationic radius of silver(I) with respect to copper(I) has caused problems in achieving both good volatility and adequate stability of silver(I) complexes for the use in CVD apparatus. These problems have been overcome with the new techniques such as super critical fluid transport CVD (SFTCVD), aerosol-assisted CVD (AACVD), and spray pyrolysis, where the requirements for volatile precursors are less stringent.

These type of complexes are generally obtained by reaction of Ag_2O with the β -diketone in the presence of other ligands. Some β -diketone silver(I) compounds have been prepared by treatment of AgNO_3 with the diketone in dry methanol and acetonitrile but only characterized by elemental analysis and IR spectroscopy.⁸⁰⁶ Several compounds have been prepared with alkene ligands of the type $[\text{Ag}(\text{hfac})(\text{alkene})]$ (hfac = 1,1,1,5,5,5-hexafluoro-2,4-pentanedionato; alkene = C_6H_{10} , C_7H_{12} , C_8H_{14} , C_8H_{12} , C_8H_8 , $\text{CH}_2=\text{CHTMS}$).⁸⁰⁷⁻⁸⁰⁹ Several of these complexes have been patented as precursors for thermal CVD of silver. However, sublimation of these complexes is generally accompanied by much decomposition, probably because of the formation of involatile $[\text{Ag}(\text{hfac})]_n$.⁸⁰⁷ Many such compounds are actually more complex than indicated by the formula $[\text{Ag}(\text{hfac})(\text{alkene})]$, e.g., the complex with 1,5-cyclooctadiene is properly formulated as $[\text{Ag}_2(\mu\text{-hfac})_2(\text{COD})_2]$ and with norbornadiene (NBD) it is $[\text{Ag}_4(\mu\text{-hfac})_4(\text{NBD})_2]$.^{810,811} Other compounds with alkene ligands are of the type $[\text{Ag}(\beta\text{-diketonate})(\text{VTES})]$ (VTES = vinyltriethylsilane; β -diketonate = hfac, 1,1,1-trifluoro-2,4-pentanedionato (tfac), 2,2-dimethyl-6,6,7,7,8,8,8-hepta-fluoro-3,5-octanedionato (fod) (**107**)). Hot-wall chemical vapor experiments revealed that complex $[\text{Ag}(\text{hfac})(\text{VTES})]$ is suitable as a precursor to deposit pure silver films in the temperature range 160–280 °C.⁸¹² The reaction of hfac with Ag_2O in the presence of dimethyl-1,5-cyclooctadiene (mixture of isomers) gives, after recrystallization, the isomerically pure compound $[\text{Ag}(\text{hfac})(1,5\text{-Me}_2\text{COD})]$; the structure is a dimer with a short Ag—Ag distance of 3.0134(3) Å. Decomposition of this complex in a biphasic $\text{HCl}/\text{CH}_2\text{Cl}_2$ mixture liberates 1,5- Me_2COD that subsequently is used to synthesize $[\text{Cu}(\text{hfac})(1,5\text{-Me}_2\text{COD})]$, which is a useful liquid precursor for Cu CVD.⁸¹³ Alkyne ligands also form complexes of stoichiometry $[\{\text{Ag}(\text{hfac})\}_n\text{L}]$ ($n=1$, $\text{L}=\text{PhC}\equiv\text{CPh}$, $\text{TMSC}\equiv\text{CTMS}$; $n=2$, $\text{L}=2\text{-butyne}$, 2-hexyne, 3-hexyne, 4-octyne (**108**)) that have potential use as CVD precursors.⁸¹⁴

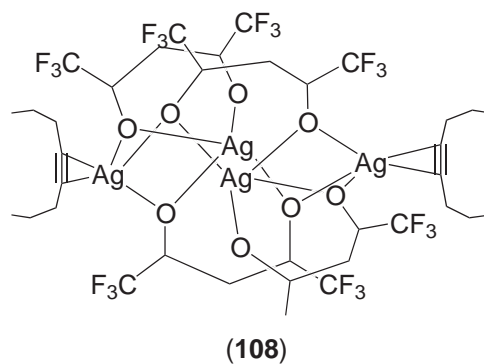
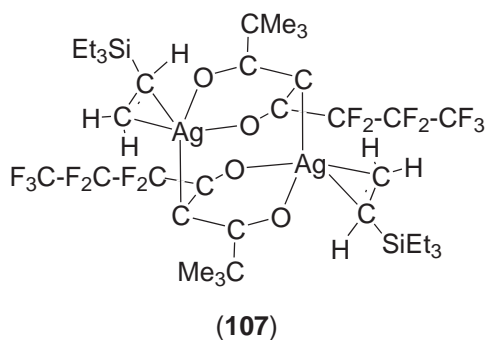

Polyether adducts of hexafluoropentanedionatosilver(I) have also been synthesized and are of the type $[\text{Ag}(\text{hfac})(\text{LL})]_n$ ($\text{LL}=\text{diglyme}$, tryglyme, tetraglyme) or $[\text{Ag}(\text{hfac})(\text{tetraglyme})_{0.5}]_n$. The products show good solubilities in a range of hydrocarbon solvents and fluids such as supercritical carbon dioxide (scCO_2).⁸¹⁵ The adduct $[\text{Ag}(\text{hfac})(\text{tetraglyme})]$ (**109**) has been successfully applied to the fabrication of silver-based films through a single-step route involving its thermal reduction to metallic silver.⁸¹⁶ This type of complex can also be stabilized by multidentate amines such as $\text{Me}_2\text{N}(\text{CH}_2)_2\text{NHMe}$, $\text{Me}_2\text{N}(\text{CH}_2)_2\text{NMe}(\text{CH}_2)_2\text{NMe}_2$ (**110**), or $\text{Me}_2\text{N}(\text{CH}_2)_2\text{NMe}(\text{CH}_2)_2\text{NMe}(\text{CH}_2)_2\text{NMe}_2$, these complexes also present a good solubility in scCO_2 .⁸¹⁷ The methyl-isocyanide complex $[\text{Ag}(\text{hfac})(\text{C}\equiv\text{NMe})]$, which has a trigonal planar geometry, produces thermal CVD of silver at 320 °C to give silver films with carbon and oxygen impurities; pure silver films can be obtained at 250 °C in the presence of hydrogen.⁸¹⁸ The reaction of Ag_2O with Hhfac yields the asymmetric dimer (**111**), with the chelating hfac ligand in both the endo- and exodentate modes. The water molecule is readily displaced by a variety of ligands to give mononuclear

[AgL(hfac)] (L = SMe₂, SEt₂, SPr₂, SBu₂, 1,4-oxathiane).⁸¹¹ The use of aerosol vaporization methods has allowed efficient CVD from complexes [Ag(hfac)(SR₂)].⁸¹⁹

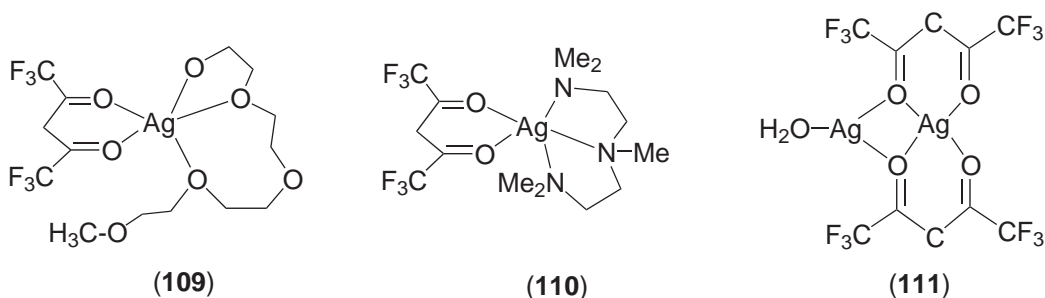

Complexes with phosphine ligands are more stable and although with PPh₃ are involatile with more volatile phosphines, the species [Ag(β -diketonate)(PR₃)] (β -diketonate = hfac, fod; PR₃ = PMe₃, PEt₃) are excellent precursors for the thermal CVD of silver films at temperatures of 250–350 °C.^{820–822} The valence electronic structures of [Ag(hfac)(PMe₃)] and [Ag(fod)(PEt₃)] have been studied by recording their photoelectron spectra and by performing X α -SW calculations on the model compounds [Ag{(HC(O)CHC(O)H){PH₃}}] and have been compared with the copper ones. The binding energies in analogous compounds follow the sequence Ag 4d > Cu 3d with an energy difference of almost 2 eV. Hence, decomposition of the silver(I) complexes by disproportionation is expected to be much less favorable than for the Cu^I analogs.⁸²³

Silver(I) carboxylate compounds are light sensitive which, together with their poor solubility, makes structural characterization difficult. The structural analogues betaine derivatives (R₃N⁺CH₂CO₂⁻) can form stable silver(I) complexes which are soluble in water and ethanol. Their structures are composed of either discrete dimers or polymeric chain/networks constructed by the linkage of dimeric subunits, and the structures have been classified into four principal types (Scheme 4).^{824,825} type a consists of discrete [Ag₂(carboxylate-O,O')] dimers without any axial ligand (*o*-HOC₆H₄CO₂, *p*-HOC₆H₄CO₂, PhCO₂, 2,6-(OH)₂C₆H₃CO₂, glutarate);^{826–830} b and c have additional oxygens in the terminal positions of the dimer (*o*-NH₂COC₆H₄OCH₂CO₂, NCCH₂CO₂, HOCH₂CO₂, *N*-acetylanthranilate, *p*-nitrosalicylate, 3,5-(NO₂)₂C₆H₃CO₂,

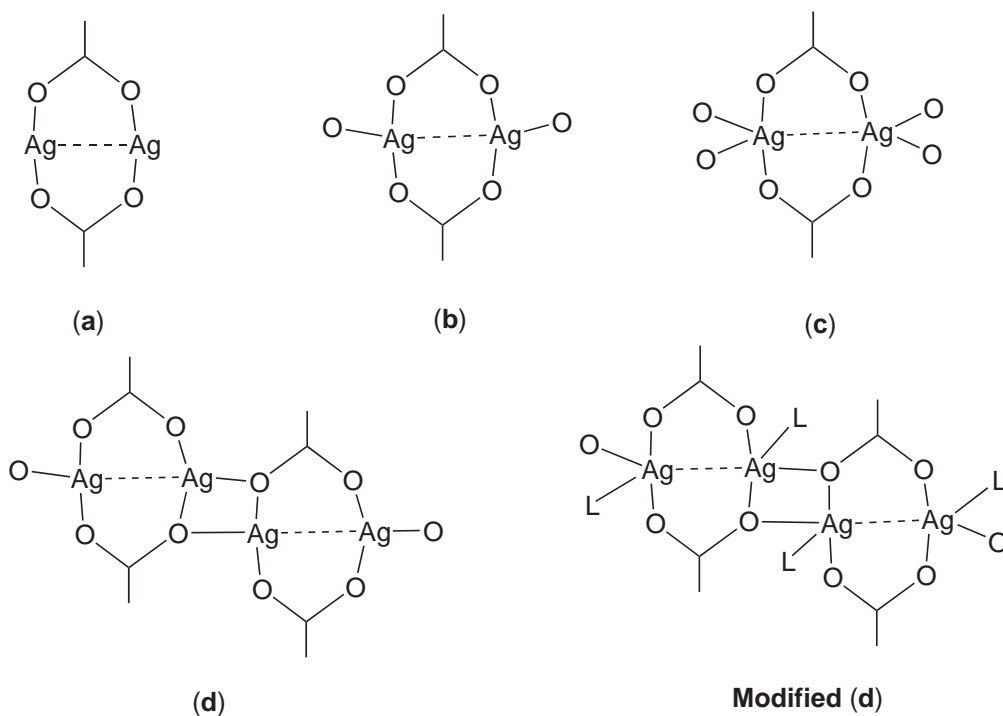

Scheme 4

1,2-(O₂C)-4,5-(HO₂C)C₆H₂),^{824,826,831-836} while in type d dimers, terminal oxygens extend the structure into a polymer through adjacent carboxyl groups (NH₃(CH₂)₂CO₂, *o*-O₂NC₆H₄CO₂, Ph₃P(CH₂)₂CO₂, citrate).⁸³⁷⁻⁸⁴⁰ There is also a modified type D that has an additional axial ligand attached to each metal atom (PhCO₂, Me₃NCH₂CO₂, PyCH₂CO₂, Py(CH₂)₂CO₂, Me₃(CH₂)₂CO₂, Me₂NPyCH₂CO₂, O₂C(CH₂)₂N(CH₂CH₂)₃CH₂CO₂, 4-FC₆H₄CH₂CO₂, Et₃NCH₂CO₂, O₂CCH(R)(CH₂)₂CH(R)CO₂ (R = Py, NMe₃), maleate, *N*-phthaloglycinate, oxalate (ox), *cis*-butenedioate).⁸⁴¹⁻⁸⁵² In some cases the ligand can be another carboxylate group that acts as triply bridging ligands.⁸⁵³ In these compounds there exist short Ag...Ag distances indicating some degree of metal-metal interaction.

Exceptions to these structures are extremely rare but some have been reported that are not based on dimeric subunits^{826,854-856} as the polymeric species [Ag₃(MeN(CH₂CO₂)CH₂CO₂)₂]_n (ClO₄)_n (**112**),⁸⁵⁷ or [Ag(O₂CPyCH₂CO₂)]_n·*n*H₂O,⁸⁵⁸ the tetrameric [Ag₂{O₂C(CH₂)₂CO₂}₂]₂ (**113**),⁸⁵⁹ the pentameric [Ag₅L₄]NO₃ (LH = *N*-oxide-2-pyridinecarboxylic acid) with a six-membered ring of the carboxylate ligand⁸⁶⁰ or in [Ag₁₀(Me₂NpyCH₂CO₂)₁₂(OTf)₂(H₂O)₄](OTf)₈·4H₂O.⁸⁶¹

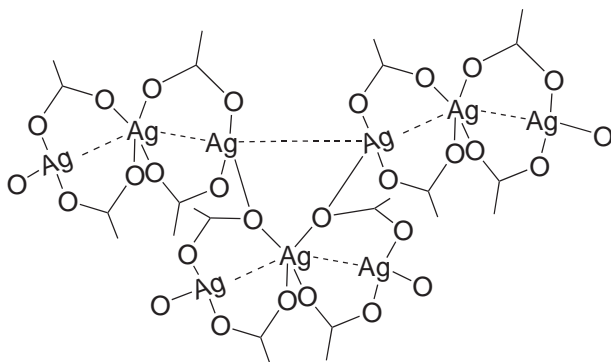

(112)

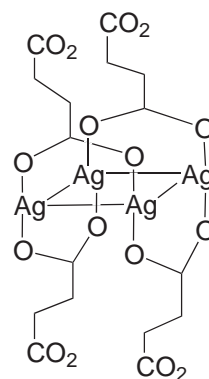

(113)

Water-soluble silver(I) complexes have been prepared with the (*R*)-(+)- and (*S*)-(-)-2-pyrrolidone-5-carboxylic acid and (*R*)-(-)- and (*S*)-(+)-5-oxo-2-tetrahydrofuran-2-carboxylic acid. They show effective antibacterial and antifungal activities. The structures consist of left- and right-handed chiral helical polymers and corresponds to types b or d.^{862,863} When a neutral donor ligand is incorporated in the silver carboxylate coordination sphere other structures can be found as, for example, with phosphine⁸⁶⁴⁻⁸⁷⁴ or ammonia⁸⁷⁵ ligands which lead to mono- or dimeric complexes or with phthalazine the compound is a 1D polymer with planar [Ag(μ-phthalazine)]₂²⁺ dimers which are side-on bridged by the phthalate carboxylates.⁸⁷⁶ With ammonia, a zig-zag polymeric chain in [Ag₂(*p*-NO₂C₆H₄CO₂)₂(NH₃)₂]_n⁸⁷⁷ or a dinuclear compound in [Ag₂{*o*-C₆H₄(CO₂)₂}(NH₃)₂]₂⁸⁷⁸ has also been described. The synthesis of several silver(I) complexes with substituted nicotinic acid derivatives has been carried out, showing the different structural chemistry types depending of the degree of protonation of the nicotinic acid.⁸⁷⁹ Silver(I) complexes with the monocarboxylic acid antibiotics monensin, lasalocid, and D-lactobionate have been reported.⁸⁸⁰⁻⁸⁸³ Mixed silver-antimony carboxylates have also been obtained with tartrate and citric acid such as [AgSb(C₄H₂O₆)(H₂O)] or [Ag₂Sb₂(HL)₄] (H₃L = citric acid),^{884,885} or silver-gadolinium [AgGdL₂(OH₂)₃]·3H₂O (H₂L = 2,6-(HO₂C)Py),⁸⁸⁶ or silver-arsenic [Ag₅As₄(tartrate)₄(H₂O)₅X]_n (X = ClO₄, NO₃),⁸⁸⁷ or silver-iridium [AgIr(COD)(μ-O₂CCF₃)₂]_n.⁸⁸⁸ New aspects of the reaction of Ag⁺ cations with the EDTA ion have been reported.⁸⁸⁹ The compound [Ag{Cu(EDTA)(H₂O)}]·H₂O has been prepared.⁸⁹⁰ A tetrathiacalix[4]arene derivative in 1,3-alternating conformation and bearing four carboxylic acid groups reacts with AgNO₃ to give the complex [Ag₄(L-4H)] which form a 2D coordination network.⁸⁹¹

With the related ox ligand, the 3D complex [Fe^{II}(bipy)₃][Ag^{Cr}Cr^{III}(ox)₃]_n or the tetranuclear [AgCr(bipy)(μ-ox)₂(H₂O)₂]₂ have been obtained.^{892,893}

Several silver(I) complexes with crown-ethers have been synthesized. The reaction of (CH₂O)₃ with AgAsF₆ in liquid SO₂ gives the 12-membered ring [Ag₂(OCH₂)₆](AsF₆)₂ (**114**).⁸⁹⁴ Similarly, the treatment of AgAsF₆ with ethylene oxide in liquid SO₂ leads to the formation of the crown-ether complex [Ag(OCH₂CH₂)₈AsF₆] (**115**).⁸⁹⁵ The complex formation of noncyclic polyethers, crown ethers, and large crown ethers in propylene carbonate have

been reported; the data indicate that in the large crown ethers more than six donor atoms take part in the interaction with the cation.^{896,897} The most frequently used crown ether^{898–901} is the dibenzo-18-crown-6-ether for which several crystal structures have been reported.^{898–901} The complexes have been synthesized in different solvents and it is shown that silver(I) prefers an octahedral coordination and forms close dinuclear complexes based on cation- π interaction in a η^2 -fashion (116).⁹⁰¹

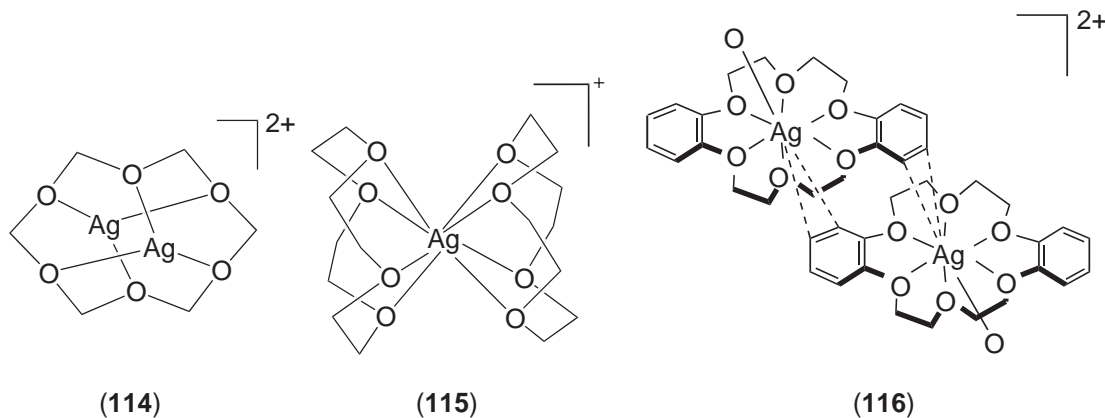

Measurements of the standard Gibbs transfer energies, ΔG_t° , of the $[\text{Ag}(18\text{-crown-6})]\text{ClO}_4$ complex at 303 K show the transfer from MeOH to MeOH/MeCN solutions to be thermodynamically unfavorable.⁹⁰² A study of the extraction of the complex $\text{K}[\text{Ag}(\text{CN})_2]$ by dicyclohexane-18-crown-6 in various media has been reported.⁹⁰³ In silver(I) complexes with 15-crown-5 and benzo-15-crown ethers of the type $[\text{AgL}_2]\text{SbF}_6$ there exists weak intermolecular interactions through $\text{C}\cdots\text{H}\cdots\text{O}$ hydrogen bonds.⁹⁰⁴ Others such as dibenzo-16-crown-4 shows high silver(I) ion selectivity over alkaline metals.⁹⁰⁵ Complexation studies of silver ions with unsubstituted and dicyclohexane-substituted 3M-crown-M ethers in dipolar aprotic solvents and alcohols have been studied.⁹⁰⁶ Also complex formation between the dibenzo-30-crown-10 with silver(I) has been investigated by a conductimeter method in the solvents 1,2- $\text{C}_2\text{Cl}_2\text{H}_4$, MeNO_2 , MeCN, and Me_2CO at 298 K.⁹⁰⁷ A silver(I) derivative of a calix[4]arene bis(crown-6) $[\text{Ag}_2\text{L}(\text{NO}_3)(\text{H}_2\text{O})_{1+x}(\text{DMF})_{0.5}]$ has been prepared; the two silver atoms are coordinated to the crown ethers.⁹⁰⁸ Bisphenol-A copolyether and copolyesters carrying calix[4]arene units in the main chain have been obtained and the binding properties towards silver(I) cations studied.⁹⁰⁹

Silver(I) complexes with other O-based ligands have been reported. *N,N*-Dialkylcarbamato complexes of the type $[\text{Ag}(\text{O}_2\text{CNR}_2)]$ have been only recently prepared according to Equation (8):

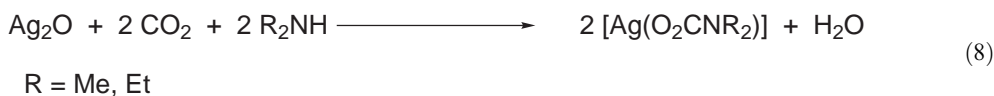

The structure of the methyl derivative (117) consists of dinuclear eight-membered rings with slightly distorted linearly two-coordinated Ag-atoms and an intramolecular Ag—Ag distance of 2.837(2) Å; the dinuclear units are joined further by Ag—O bonds to form an infinite array. The reaction with PPh_3 gives the mononuclear $[\text{Ag}(\text{O}_2\text{CN}(\text{Et})_2)(\text{PPh}_3)_2]$.^{910,911} Silver(I) *p*-toluenesulfonate (pts) adducts with nitrogen bases such as pyridine, 2-aminopyrimidine, 4,6-dimethyl-2-aminopyrimidine, and 3- or 4-aminobenzoic acid of the type $[\text{Ag}(\text{pts})\text{L}]$ have been reported. The structures are dimeric or polymeric, as for example $[\text{Ag}(\text{pts})(2\text{-aminopyrimidine})]$ (118), with stabilization enhanced by hydrogen bonding.^{912,913} The urea adduct $[\{\text{Ag}(\text{pts})\}_2(\text{urea})_2]_n$ has also been synthesized and is a ribbon polymer based on a urea-*N,O*-bridged cyclic dimer in which the silver centers have trigonal bipyramidal AgNO_4 stereochemistry.⁹¹⁴ The crystal structures of silver(I) methanesulfonate,⁹¹⁵ bromomethanesulfonate,⁹¹⁶ 2-pyridinesulfonate,⁹¹⁷ 3-pyridinesulfonate,⁹¹⁸ aminesulfonate,⁹¹⁹ 1,4-disulfonatebutane,⁹²⁰ and *p*-toluenesulfonate⁹¹³ (119) have been described. Supramolecular polymers with lamellar structure have been prepared by self-assembling of 4,4'-bipyridine and alkyl sulfonates.⁹²¹

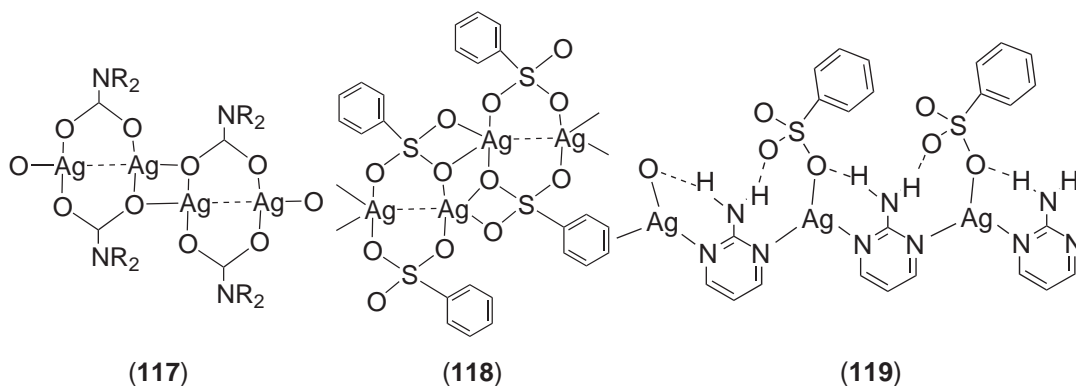

The crystal structures of silver(I) arenesulfonyl amides such as $[\text{Ag}\{\text{N}(\text{SO}_2\text{C}_6\text{H}_4\text{-4-X})\}_2]\cdot\text{H}_2\text{O}$ ($\text{X} = \text{Cl}, \text{Br}$) and $[\text{Ag}\{\text{N}(\text{SO}_2\text{Ph})(\text{SO}_2\text{Me})\}]$ have been reported. The structures consist of infinite ribbons that are associated by means of hydrogen bonds into lamellar layers.⁹²² Potassium thiosulfatoargentate(I) is used as an antimicrobial material and its structure has been refined in the monoclinic system as $\text{K}_{10}[\text{Ag}_6(\text{S}_2\text{O}_3)_8]$.⁹²³ Silver(I) hydrogen sulfates, $[\text{Ag}(\text{H}_3\text{O})(\text{HSO}_4)_2]$, $[\text{Ag}_2(\text{HSO}_4)_2]\cdot\text{H}_2\text{SO}_4$, and $[\text{Ag}(\text{HSO}_4)]$, have been synthesized from Ag_2SO_4 and sulfuric acid. The silver atoms are coordinated to more than six oxygen atoms forming a 3D hydrogen network.⁹²⁴ The crystal structure of disilver(I) sulfoacetate $[\text{Ag}_2(\text{O}_3\text{SCH}_2\text{CO}_2)]$ has been determined and has two types of silver(I) atoms, one is octahedral and the other tetrahedral.⁹²⁵

A series of silver(I) derivatives of pentakis(methoxycarbonyl)cyclopentadiene have been prepared from the diene and silver acetate, including $[\text{Ag}\{\text{C}_5(\text{CO}_2\text{Me})_5(\text{OH}_2)\}_n]\cdot(1.5\text{H}_2\text{O})_n$, $[\text{Ag}\{\text{C}_5(\text{CO}_2\text{Me})_5(\text{PPh}_3)_2\}]$ (**120**), $[\text{Ag}\{\text{C}_5(\text{CO}_2\text{Me})_5(\text{PPh}_3)_2\}]$, $[\text{Ag}\{\text{C}_5(\text{CO}_2\text{Me})_5(\text{dppe})\}]$, and $[\text{Ag}\{\text{C}_5(\text{CO}_2\text{Me})_5(\text{triphos})\}]$.^{926,927} A silver complex with the herbicide glyphosate [*N*-(phosphonomethyl)glycine = H_3L], $[\text{Ag}_2(\text{H}_2\text{L})_n]$ (**121**) has been synthesized.⁹²⁸

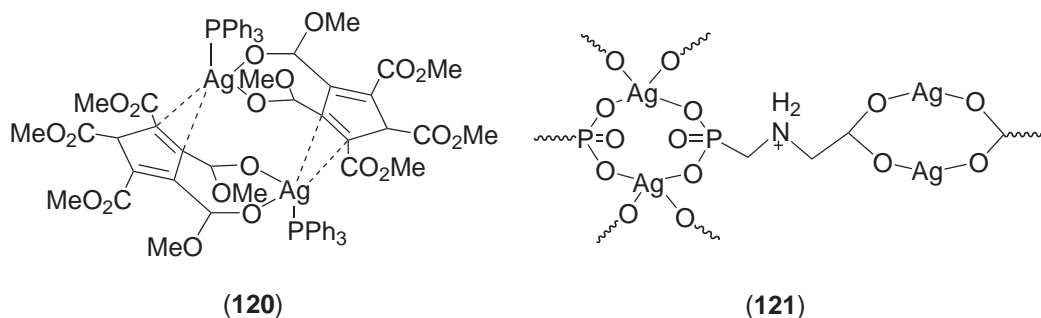

Cyclic or acyclic ligands of the type $\text{S}_3\text{N}_2\text{O}$ ⁹²⁹ or $\text{S}(\text{NSO}_2)_2$,⁹³⁰ form silver(I) complexes in which coordination takes place via nitrogen or oxygen. The complexes $[\text{Ag}(\text{S}_3\text{-N}_2\text{O})_2]\text{AsF}_6$ (**122**) and $[\text{Ag}_4\{\text{S}(\text{NSO})_2\}_9](\text{AsF}_6)_4$, with two different silver atoms, one octahedral with the ligand coordinated through the oxygen atoms (**123**) and one unsymmetrically coordinated by the six nitrogen atoms, have been isolated. Silver triflate reacts with the very stable high polymer MEEP (polydi{2-(2-methoxyethoxy)ethoxy}-phosphazene) prepared from the sodium salt of 2-(2-methoxyethoxy)ethanol and poly(dichlorophosphazene) in the presence of NBu_4Br to give the complexes $[(\text{AgOTf})_x\cdot\text{MEEP}]$.⁹³¹ Pentafluoroorthotellurate (OTeF_5^-) or teflate is a bulky and electronegative pseudohalide that induces coordinative insaturation by means of nonbonded interactions with other ligands in a metal complex; the crystal structure of $\text{Ag}(\text{OTeF}_5)$ as toluene solvate (**124**) has been determined.⁹³² This ligand has allowed the synthesis of silver complexes with very weakly coordinating ligands (see Section 6.7.2.3.6).

Trinuclear disilver(I)-copper(II) complexes, $[\text{Ag}(\text{PPh}_3)_2][\text{Cu}(\text{mtm})_2]$ and $[\text{Ag}_2(\text{dppm})_2][\text{Cu}(\text{mtm})_2]$ ($\text{mtm} = [\text{bis}(\text{methylthio})\text{methylene}]\text{malonate}$), have been prepared (Scheme 5).⁹³³

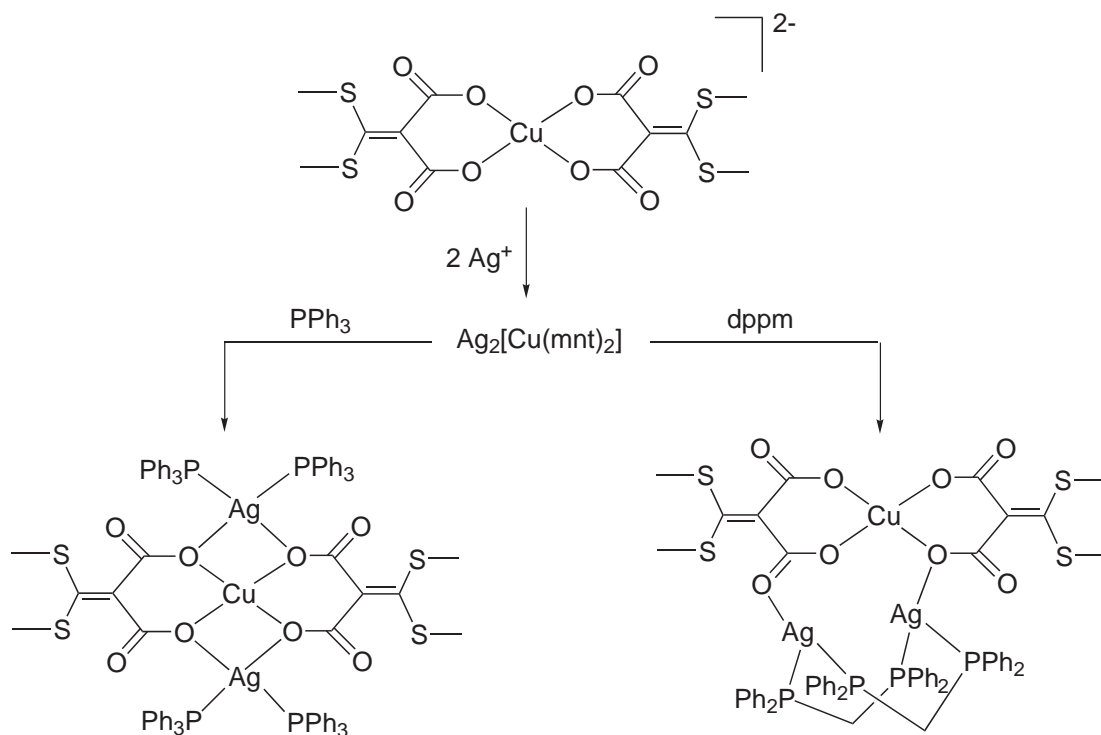

Scheme 5

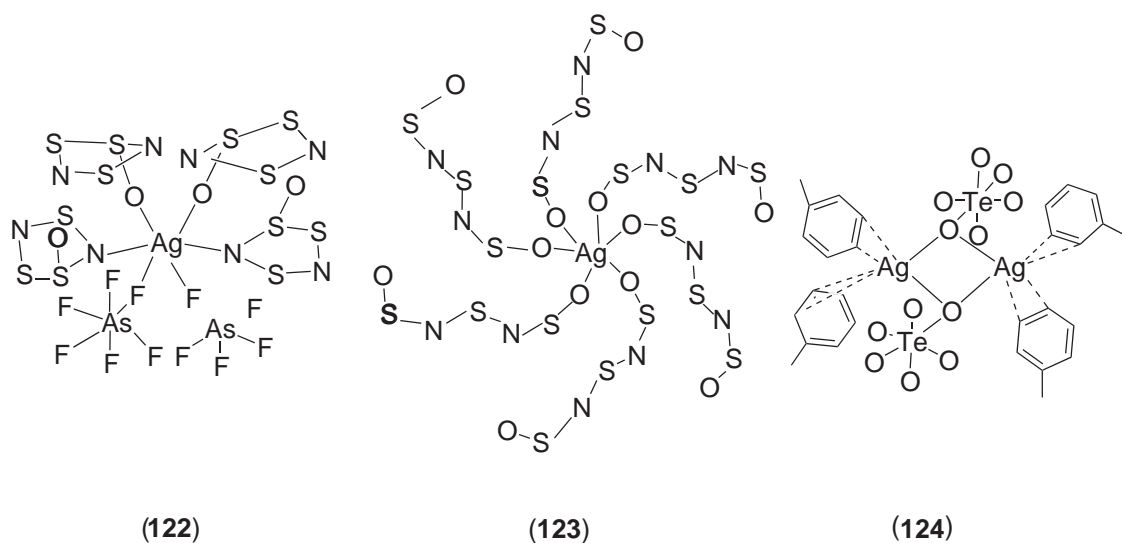

Several silver(I) complexes in which the metallic center is coordinated to ketone oxygen atoms of various ligands have been reported. The crystal structure of the 2:1 adduct of the cyclic peptide *N,N*-dimethylpiperazine-1,5-dione (cyclosarcosylsarcosine) with silver(I) nitrate shows that the Ag^{I} ion interacts with the carbonyl oxygen atoms of the peptide moiety.⁹³⁴ Complexes of the type $[\text{Ag}(\text{ketone})(\text{PPh}_3)_2]$ (ketone = phenalene, diphenylcyclopropenone, tropone, bis(phenalene), bis(diphenylcyclopropenone) (**125**), bis(tropone)) have been obtained by reaction of $[\text{Ag}(\text{BF}_4)(\text{PPh}_3)_2]$ with the ketone.^{935,936} The ligand 1-methyluracilato bridges a platinum and two silver atoms in the complex $[\text{PtAg}_2(\text{C}_5\text{H}_5\text{N}_2\text{O}_2)_2(\text{NO}_3)_2(\text{H}_2\text{O})] \cdot \text{H}_2\text{O}$ (**126**).⁹³⁷ The redox and cation binding properties of a series of four quinone-functionalized calix[4]arenes have been studied in acetonitrile. All four compounds when reduced to the monoanion state demonstrate an interaction with Ag^+ to varying degrees.⁹³⁸ A comparative analysis of the oxidizing and

The crystal structure of $[\text{Ag}(\text{NO}_3)(\text{OPPh}_3)]$ has been reported, consisting of a distorted square-based pyramid with the silver atom bonded to two OPPh_3 , two oxygens of the nitrate group and to an oxygen of the symmetry-related nitrate group.⁹⁴⁷ The reaction of 1,1'-bis(diphenyloxophosphoryl)ferrocene (dpopf) with silver(I) salts gives complexes of the type $[\text{Ag}(\text{OCIO}_3)(\text{dpopf})]$, $[\text{Ag}(\text{dpopf})_2]\text{ClO}_4$, and $[\text{Ag}(\text{dpopf})(\text{PPh}_3)]\text{ClO}_4$ or the dinuclear $[\text{Ag}_2(\text{PPh}_3)_2(\mu\text{-dpopf})](\text{ClO}_4)_2$. Substitution reactions of the perchlorate ligand in $[\text{Ag}(\text{OCIO}_3)(\text{dpopf})]$ lead to the species $[\text{Ag}(\text{LL})(\text{dpopf})]$ ($\text{LL} = (\text{PPh}_3)_2$ (**129**), bipy, $(\text{SPPH}_2)_2\text{CH}_2$).⁹⁴⁸

The crystal structures of $[\text{Ag}(1,4\text{-dioxane})]\text{AsF}_6$ ⁹⁴⁹ and $[\text{Ag}_2(1,4\text{-oxathiane})](\text{NO}_3)_2$ ⁹⁵⁰ have been reported. Two adducts of the 4-nitropyridine *N*-oxide with silver nitrate have been characterized, one is a mononuclear tetracoordinated compound $[\text{Ag}(\text{NO}_3)(\text{ONC}_5\text{H}_4\text{NO}_2)_2]$ and the other is a dinuclear pentacoordinated species $[\text{Ag}_2(\text{NO}_3)_2(\mu\text{-ONC}_5\text{H}_4\text{NO}_2)_2(\text{ONC}_5\text{H}_4\text{NO}_2)_2]$ (**130**).^{951,952} In the mixed compound *trans*- $[\text{RhCl}_2(\text{py})_4]\text{NO}_3 \cdot \text{AgNO}_3$ exists the dinitroargentate(I) ion in a distorted tetrahedral environment.⁹⁵³

The solid-state structure of $[\text{Ag}_2(\text{H}_2\text{P}_2\text{O}_7)]$ has revealed the presence of infinite $[\text{H}_2\text{P}_2\text{O}_7^{2-}]_n$ units which run parallel to the crystallographic *b*-axis; hydrogen bonding is an important structural feature.⁹⁵⁴ In the compound $\text{Ag}_4\text{K}_6\text{P}_{10}\text{O}_{30} \cdot 10\text{H}_2\text{O}$ the structural moiety $[\text{P}_{10}\text{O}_{30}]^{10-}$ is present; four-coordinate silver atoms are incorporated into the Ag_4O_{10} cluster.⁹⁵⁵ The compound $\text{Ag}_{20}\text{O}_{33}\text{H}_{22}(\text{ClO}_4)_4$ is formed by electrochemical oxidation of aqueous AgClO_4 ; the solid-state structure consists of $[\text{H}_{22}\text{O}_{17}]^{12-}$ clusters linked together via $\text{Ag}-\text{O}$ bonds, resulting in a 3D network.⁹⁵⁶

6.7.2.3.5 Complexes with sulfur, selenium, and tellurium donor ligands

(i) Thiolates, selenolates, and tellurolate silver(I) complexes

Homoleptic silver(I) thiolates AgSR have been known and used for a long time,^{957,958} but until recently with little definitive information about their structures. They are insoluble or slightly soluble, yielding unreliable high molecular weights in solution, indicative of nonmolecular crystal structures. These compounds dissolve due to the presence of thiolate ions.

The ring size was found to be dependent on the steric properties of the thiol; thus primary alkanethiolates give only polymeric $[\text{AgSR}]_n$, while some secondary alkanethiolates give $[\text{AgSR}]_{12}$ and tertiary alkanethiolates give $[\text{AgSR}]_8$. The AgSCMeEt_2 derivative has a 1D nonmolecular structure which consist of planar zig-zag $-\text{S}-\text{Ag}-\text{S}-\text{Ag}-$ chains (Figure 11a).⁹⁵⁹ However, in benzene solutions there is an interconversion in the molecular $[\text{AgSCMeEt}_2]_8$ (Figure 11b).⁹⁵⁹

The X-ray structure of $[\text{Ag}(\text{SCy})]_n$ reveals cyclic molecules, $n = 12$, with weak linkages across the ring between sulfur and silver atoms; the silver atoms have a linear coordination.⁹⁶⁰ The structures for the AgSR complexes with $\text{R} = (\text{CH}_2)_2\text{Me}$, $(\text{CH}_2)_3\text{Me}$, $(\text{CH}_2)_5\text{Me}$, $(\text{CH}_2)_7\text{Me}$, Ph, 4- FC_6H_4 , 4- BrC_6H_4 , 4- MeC_6H_4 , and 4- MeOC_6H_4 have been obtained by using X-ray powder diffraction studies. The solid-state structure of each complex exhibits ${}^\infty[\text{AgSR}]$ layers in which the substituents are oriented at right angles to the layer of silver and sulfur atoms.⁹⁶¹ The increase of the steric bulk of the thiol substituents has been one approach to overcome the problem of structural characterization, since they should exhibit a reduced tendency to bridge metal centers, thereby yielding discrete molecular species. The use of sterically hindered (triorganosilyl)methanethiolates has led to the characterization of trimeric $[\text{AgSC}(\text{SiMe}_2\text{Ph})_3]_3$ (**131**) and tetrameric species $[\text{AgSC}(\text{TMS})_3]_4$ (**132**). With the less hindered ligands $-\text{SCH}(\text{TMS})_2$ an octameric compound or with $-\text{SCH}_2(\text{TMS})$ a polymeric derivative are obtained.⁹⁶² With the ligand $-\text{SC}_6\text{H}_4\text{-2-TMS}$, a Ag_4S_4 eight-membered cycle of alternating silver and sulfur atoms is formed, but further

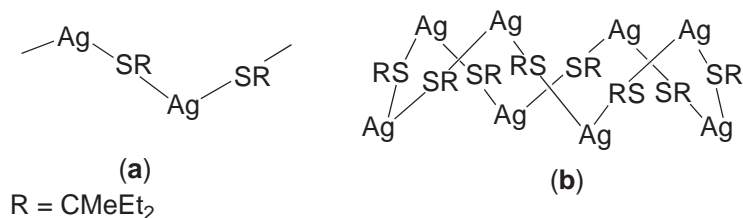

Figure 11 The two structures of $[\text{Ag}(\text{SCMeEt}_2)]$.

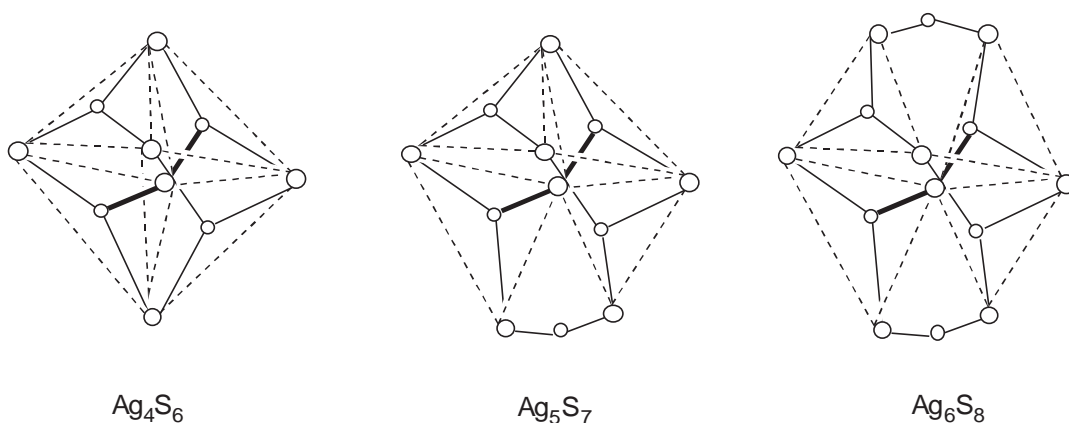
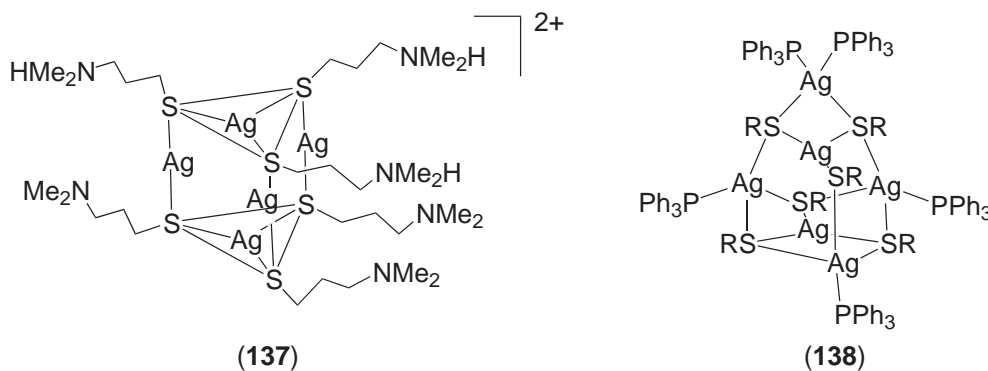

Figure 12 Idealized cage polyhedra.

is proposed to be polymeric and bonded through the S-atoms.^{981–983} The complex $\{\text{Na}[\text{Ag}(\text{SC}_6\text{H}_4\text{COO})] \cdot 2\text{H}_2\text{O}\}_n$ has been commercialized as an antimicrobial agent.⁹⁸⁴ The crystal structure of $\text{K}_{12}[\text{Ag}_8(\text{SC}_6\text{H}_4\text{COO})_{10}] \cdot 12\text{H}_2\text{O}$ has been reported.^{985,986} The ligand 2-dimethylamino-3,4-dioxo-cyclobut-1-en-thiolate, $\text{Me}_2\text{NC}_4\text{O}_2\text{S}^-$ (dimethylaminothiosquarate) forms the complex $[\text{Ag}_2\text{L}_3]^-$.⁹⁸⁶



Other approaches consist of the reaction of silver thiolates with small amounts of bulky and structure-terminating heteroligands, such as tertiary phosphines. In this manner, complexes of the type $[\text{Ag}_5(\text{SC}_6\text{H}_4\text{Cl})_6(\text{PPh}_3)_5]$ (**138**), $[(\text{AgSCMeEt})_8(\text{PPh}_3)_2]$, and $[(\text{AgSBu}^t)_{14}(\text{PPh}_3)_4]$ have been obtained by reaction of the corresponding silver thiolate compound with triphenylphosphine.^{987,988}

Treatment of $[\text{Ag}(\text{PPh}_3)_4]\text{NO}_3$ with benzenethiol in the presence of triethylamine gave the tetrameric compound $[\text{Ag}(\text{SPh})(\text{PPh}_3)_4]$ (**139**).¹⁹ A series of silver(I) trialkoxysilanethiolates $[\text{Ag}(\text{S}-\text{SiR}^1_3)(\text{PPh}_3)_2]$ ($\text{R}^1 = \text{OBu}^t, \text{OBu}^s, \text{OPr}^t$) and triarylsilanethiolates $[\text{Ag}(\text{SSiR}^2_3)(\text{PPh}_3)_2]$ ($2\text{R} = \text{C}_6\text{H}_4\text{Me}-2\text{MeC}_6\text{H}_4, \text{Ph}$) have been synthesized by reaction of $[\text{Ag}(\text{ACAC})(\text{PPh}_3)]$ with the corresponding thiol ($\text{ACAC} = \text{acetylacetonate}$). The structure of $[\text{Ag}\{\text{SSi}(\text{C}_6\text{H}_4\text{Me}-2)_3\}(\text{PPh}_3)_2]$ (**140**) is a dimer.⁹⁸⁹ The reaction of 1-(SH)-1,2- $\text{C}_2\text{B}_{10}\text{H}_{11}$ with $[\text{Ag}(\text{OTf})(\text{PPh}_3)]$ and Na_2CO_3 gives $[\text{Ag}_2(\text{SC}_2\text{B}_{10}\text{H}_{11})(\text{OTf})(\text{PPh}_3)_2]$ (**141**), which is also a dimer in the solid state.⁹⁹⁰ Complexes of the type $[\text{Ag}\{\text{S}(\text{CH}_2\text{CHOHCH}_2\text{OR})\}(\text{PPh}_3)_2]$ ($\text{R} = \text{H}, \text{Me}, \text{Et}$) have been also reported.⁹⁹¹ The structure of $[\text{Ag}(\text{SCN}_4\text{Ph})(\text{PPh}_3)_2]$ with the 1-phenyl-1H-1,2,3,4-tetrazole-5-thiolate ligand has been described.⁹⁹² The silver(I) complexes with 2-thionicotinic acid (H_2mna) and 2-thiobenzoic acid (H_2mba), $[\text{Ag}(\text{Hmna})(\text{PPh}_3)_n]$ ($n = 2, 3$) or $[\text{Ag}(\text{Hmba})(\text{PPh}_3)_3]$ have been obtained and their antimicrobial activities tested.^{993,994} A similar $[\text{Ag}(\text{SR})(\text{PPh}_3)_3]$ compound with $\text{SR} = 4$ -(methylthio)-2-thioxo-1,3-dithiole-5-thiolate has been reported.⁹⁹⁵

Silver(I) trifluoromethanethiolate (AgSCF_3) has been used to prepare trifluoromethyl aryl sulfides by reaction with iodide.⁹⁹⁶ A mixed silver–zinc thiolate complex $[\text{Ag}_4\text{Zn}_2(\text{SC}_6\text{H}_2\text{-Pr}^1\text{-2,4,6})_6(\text{OTf})_2]$ has been prepared by reaction of AgOTf with $\text{Zn}[\text{N}(\text{TMS})_2]_2$ in the presence of the thiol.⁹⁹⁷ Solid-state ¹⁰⁹Ag NMR can be a sensitive environment probe for silver thiolates,⁹⁹⁸ overall for biological thiolates ligands as cysteine,⁹⁹⁹ or proteins such as metallothionein.^{1000,1001}

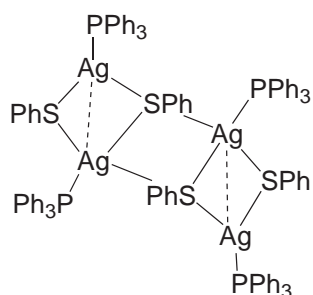

(139)

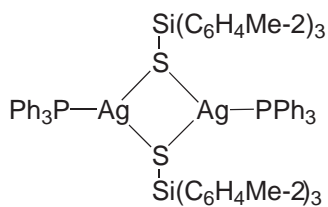

(140)

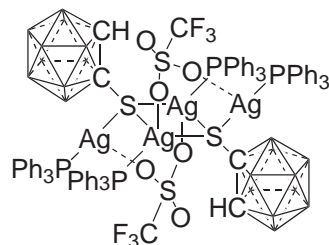

(141)

Far less abundant are selenolate or telluroate silver(I) complexes. The reaction of AgNO_3 with $(\text{DME})\text{LiSeC}(\text{TMS})$ yields the compound $[\text{Ag}\{\text{SeC}(\text{TMS})_3\}]_4$ (**142**).¹⁰⁰³ The telluroate complex $(\text{Ph}_4\text{P})_2[\text{Ag}_4(\text{TeC}_4\text{H}_3\text{S})_6]$ (**143**)¹⁰⁰⁴ and the analogous $(\text{Me}_4\text{N})_2[\text{Ag}_4(\text{SePh})_6]$ ¹⁰⁰⁵ have been reported.

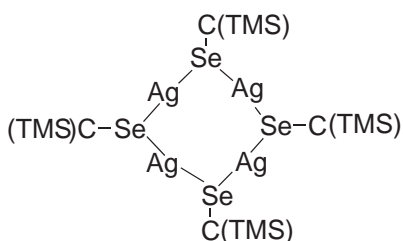

(142)

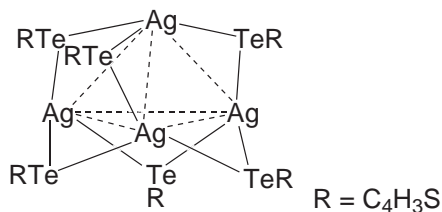

(143)

The homoleptic aryl selenolate complex $[\text{Ag}(\text{SeC}_6\text{H}_2\text{Pr}^i_{3-2,4,6})_8]$ (**144**) has been synthesized by reaction of AgNO_3 with the selenol in acetonitrile and in the presence of NEt_3 . The cluster exhibits a strong optical limiting effect with threshold of 0.2 J cm^{-2} , which is about 2.5 times lower than that of C_{60} in toluene under identical experimental conditions.¹⁰⁰⁶ Silver thiolate and selenolate derivatives of the type $[\text{Ag}_6(\mu\text{-dppm})_4(\mu_3\text{-EAR})_4](\text{PF}_6)_2$ (**145**) ($\text{EAR} = \text{SPh}, \text{SC}_6\text{H}_4\text{Me-4}, \text{SePh}, \text{SeC}_6\text{H}_4\text{Cl-4}$) have been prepared and the luminescence properties studied.¹⁰⁰⁷ The selenolates $[\text{Ag}_4(\text{SePr}^i)_4(\text{dppm})_2]$ and $[\text{Ag}_8(\text{SeEt})_8(\text{dppp})]_n$ have been prepared from AgSCN or AgO_2CPh in the presence of the diphosphine and RSeTMS at low temperature.¹⁰⁰⁸ By the same procedure, silver thiolates and telluroates of the type $[\text{Ag}_2(\text{SPh})_2(\text{triphos})]_n$, $[\text{Ag}_7(\text{SPh})_7(\text{dppm})_3]$, $[\text{Ag}_{22}\text{Cl}(\text{SPh})_{10}(\text{PhCO}_2)_{11}(\text{DMF})_3]_n$, or $[\text{Ag}_7(\text{TePh})_7(\text{dppp})]$ have been synthesized.¹⁰⁰⁹

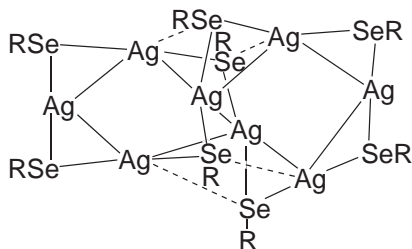

$\text{R} = \text{C}_6\text{H}_2\text{Pr}^i_{3-2,4,6}$

(144)

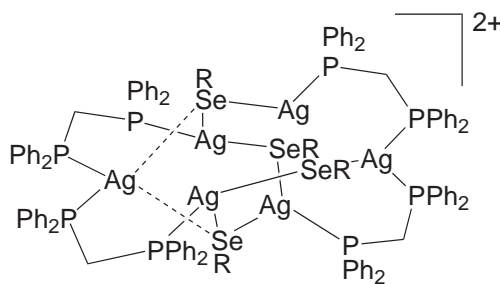

$\text{R} = \text{C}_6\text{H}_4\text{Cl-4}$

(145)

The complexes $[\text{M}(\mu\text{-C}_7\text{H}_4\text{NS}_2)(\text{COD})]_2$ ($\text{M} = \text{Rh}, \text{Ir}$) and $[\text{Rh}(\mu\text{-C}_7\text{H}_4\text{NS}_2)(\text{CO})(\text{PPh}_3)]_2$ react with silver compounds to give the heterometallic derivatives with the silver(I) atoms bonded to the thiolate sulfur atoms. The structure of $[\text{Rh}_2\text{Ag}_2(\mu_3\text{-C}_7\text{H}_4\text{NS}_2)_2(\text{ClO}_4)]$ shows a short Rh-Ag distance.¹⁰¹⁰

(ii) Sulfide, selenide, telluride, and polychalcogenide silver(I) complexes

Polysulfide silver(I) complexes have been obtained and are of the form $(\text{Ph}_4\text{P})_4[\text{Ag}_2\text{S}_{20}] \cdot \text{S}_8$ (145),¹⁰¹¹ $(\text{Ph}_4\text{P})_2[\text{Ag}_2(\text{S}_6)_2]$ (146),¹⁰¹² and $\text{Ph}_4\text{P}[\text{AgS}_9]$.¹⁰¹² Cyclooctasulfur can act as a ligand in complexes such as $[\text{Ag}(\text{S}_8)_2]\text{AsF}_6$ (147).¹⁰¹³

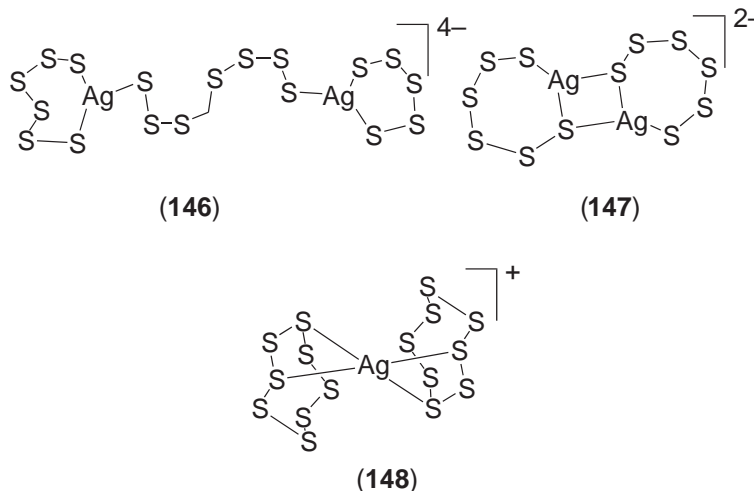

By cleavage of the S—C bond in the presence of phosphine silver(I) complexes polynuclear complexes with bridging sulfido ligands are obtained, such as $[\text{Ag}_{11}(\mu_5\text{-S})(\mu_4\text{-S}_2\text{CNET}_2)_3(\mu_3\text{-S}_2\text{CNET}_2)_6]$.¹⁰¹⁴ Other materials can serve also as a S^{2-} source, as is the case of MoS_4^{2-} which also gives the species $[\text{Ag}_{11}(\mu_5\text{-S})(\mu_4\text{-S}_2\text{CNR}_2)_3(\mu_3\text{-S}_2\text{CNR}_2)_6]$ ¹⁰¹⁵ or $\text{S}_2\text{P}(\text{OEt}_2)_2^-$ which gives the cluster $[\text{Ag}_8(\mu_6\text{-S})\{\text{S}_2\text{P}(\text{OEt}_2)_2\}_6]$.¹⁰¹⁶ Other silver sulfide cluster as $[\text{Ag}_{14}(\mu_6\text{-S})(\text{SPh})_{12}(\text{PPh}_3)_8]$ has been synthesized just leaving solutions of $[\text{Ag}(\text{S}_2\text{CSPH})(\text{PPh}_3)_2]$ in CH_2Cl_2 .¹⁰¹⁷ By the same procedure, decomposition of an CS_2 insertion product, the cluster $(\text{HNEt}_3)_4[\text{Ag}_{50}\text{S}_7(\text{SC}_6\text{H}_4\text{Bu}^t\text{-}4)_{40}]$ has been isolated.¹⁰¹⁸ A quasi-1D barium silver(I) sulfide, $\text{Ba}_2\text{Ag}_8\text{S}_7$, containing mixed $\text{S}^{2-}/\text{S}_2^{2-}$ ligands has been prepared by electrochemical synthesis.¹⁰¹⁹ Hydrothermal conditions in alkaline solutions were employed for the preparation of the 3D materials $\text{NH}_4[\text{Ag}_2(\text{AsS}_2)_3]$ and $(\text{NH}_4)_5[\text{Ag}_{16}(\text{AsS}_3)_7]$.¹⁰²⁰ 2D polychalcogenide materials, AAgTeS_3 ($\text{A} = \text{K}, \text{Rb}, \text{Cs}$), have been prepared and their structures consist of $[\text{AgTeS}_3]_n^{n-}$ networks (149).¹⁰²¹ Other sulfides are $\text{AgLa}_3\text{GeS}_7$,¹⁰²² BaS_3AgS_6 ,¹⁰²³ or $\text{AgPbBi}_3\text{S}_6$.¹⁰²⁴

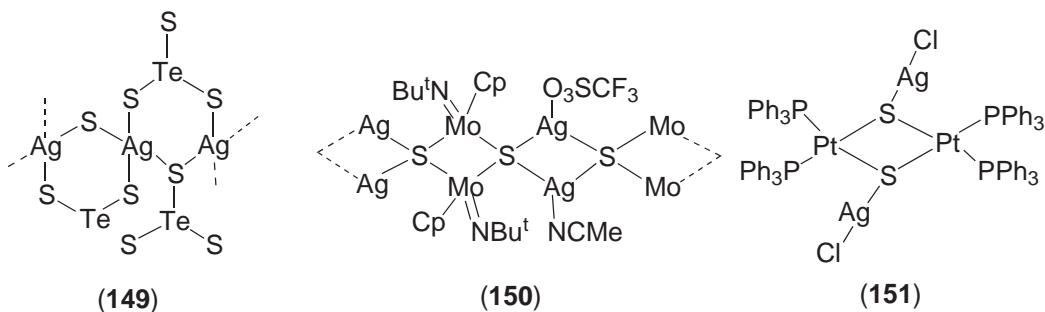

The reaction of $[\text{Ag}_2(\mu\text{-dppm})_2](\text{OTf})_2$ with Na_2E or Li_2E ($\text{E} = \text{S}, \text{Se}, \text{Te}$) gives the tetranuclear complexes $[\text{Ag}_4(\mu_4\text{-E})(\text{dppm})_4](\text{OTf})_2$ with a quadruply bridging chalcogenide ligand (Equation (10)).¹⁰²⁵ Excitation of the complexes in the solid state and in fluid solutions with $1 > 350 \text{ nm}$ results in intense and long-lived green to orange luminescence. The transitions associated with the emissions of the silver(I) clusters originate essentially from a ligand-to-metal charge-transfer ($\text{E}^2 \rightarrow \text{Ag}_4$) excited state, with mixing of a metal-centered ($d\text{-}s/d\text{-}p$) silver(I) state.^{259,260,1026}

Mixed silver-metal sulfide complexes have been reported and are of the type $[\text{MoCp}(\text{NBu}^t\text{-S})_5][\text{Ag}(\text{MeCN})\text{OTf}]_3[\text{AgOTf}]_2$ (150),¹⁰²⁷ $[\text{Ag}_2\text{Pt}_4(\mu\text{-S})_4(\text{PPh}_3)_8](\text{BF}_4)_2$,¹⁰²⁸ $[\text{Ag}_2\text{Pt}_2\text{Cl}_2(\mu_3\text{-S})_2(\text{PPh}_3)_4]$ (151),¹⁰²⁹ $[\text{Ag}_2\{\text{Pt}_2\text{Cl}_2(\mu_3\text{-S})_2(\text{PPh}_3)_4\}_2]^{2+}$,¹⁰²⁹ $[\text{AgPt}_2(\mu_3\text{-S})_2(\text{PPh}_3)_5]^+$,¹⁰²⁹ $[\text{Ag}_2\text{Pd}_2\text{Cl}_2(\mu_3\text{-S})_2$

(dppf)₂,¹⁰³⁰ [Ag₂Pd₄(μ₃-S)₄{*cis*-(PPh₂)₂(CH=CH)}] (**152**),¹⁰³¹ [{S(AuPPh₃)₃]₂Ag](BF₄)₃ (**153**),¹⁰³² or Bu₄N[S{Au(C₆F₅)₃]₂(AgPPh₃)] (**154**).¹⁰³⁴

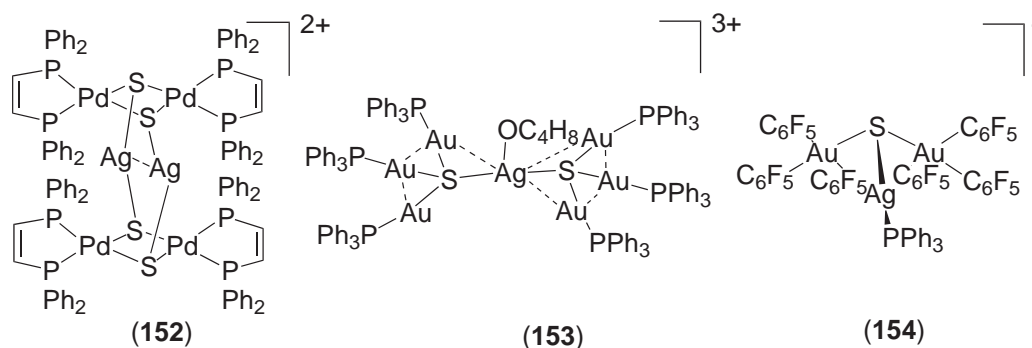
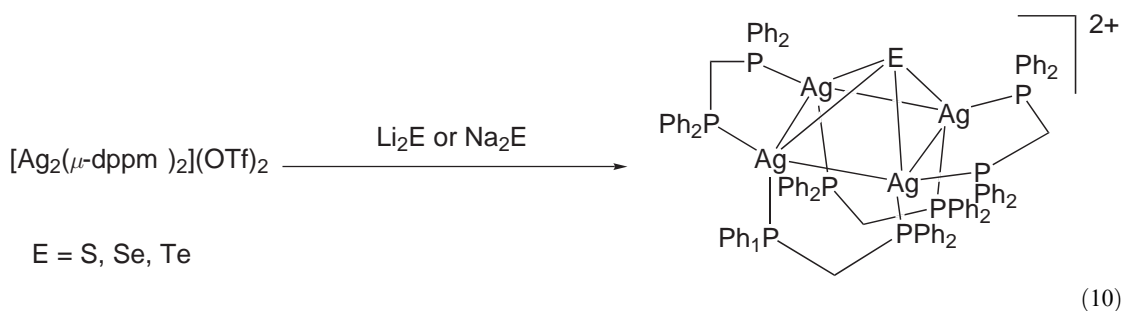

Silver(I) complexes with bridging selenide ligands are not as numerous. The reaction of AgS₂CNET₂ with (Et₄N)₂MoSe₄ or Na₂Se yields the polynuclear silver cluster [Ag₁₁(μ₅-Se)(μ₄-S₂CNET₂)₃(μ₃-S₂CNET₂)₆] (**155**).¹⁰³⁴ Fenske and co-workers have synthesized several high nuclearity silver(I)-selenide clusters using as a selenium source RSeTMS and by reaction with silver salts and in the presence of phosphines in order to stabilize the compounds (Schemes 6 and 7).^{34,1008} The silver-platinum cluster [Ag₂Pt₂(μ₄-Se)₂Cl₂(PPh₃)₄] (**156**) have been obtained mixing [PtCl₂(PPh₃)₂], [Ag(O₂CR)], and Se(TMS)₂.¹⁰³⁵

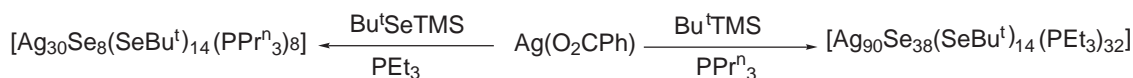

Scheme 6

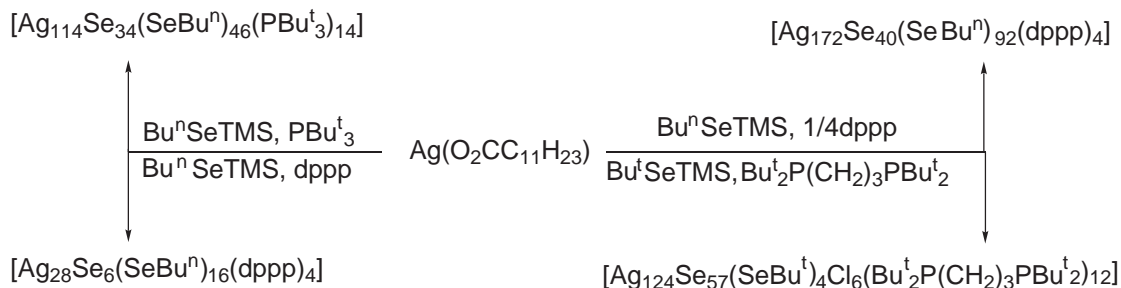

Scheme 7

Kanatzidis and co-workers have obtained polyselenides of varied stoichiometry depending upon reaction conditions. The reaction of AgNO_3 with Na_2Se_5 gives different complexes in function of the cation (Scheme 8).^{1036,1037} A similar compound $(\text{Ph}_4\text{P})_2[\text{Ag}_4(\text{Se}_4)_2(\text{Se}_5)]$ has been obtained from Na_2Se_4 generated “*in situ*.”¹⁰³⁸

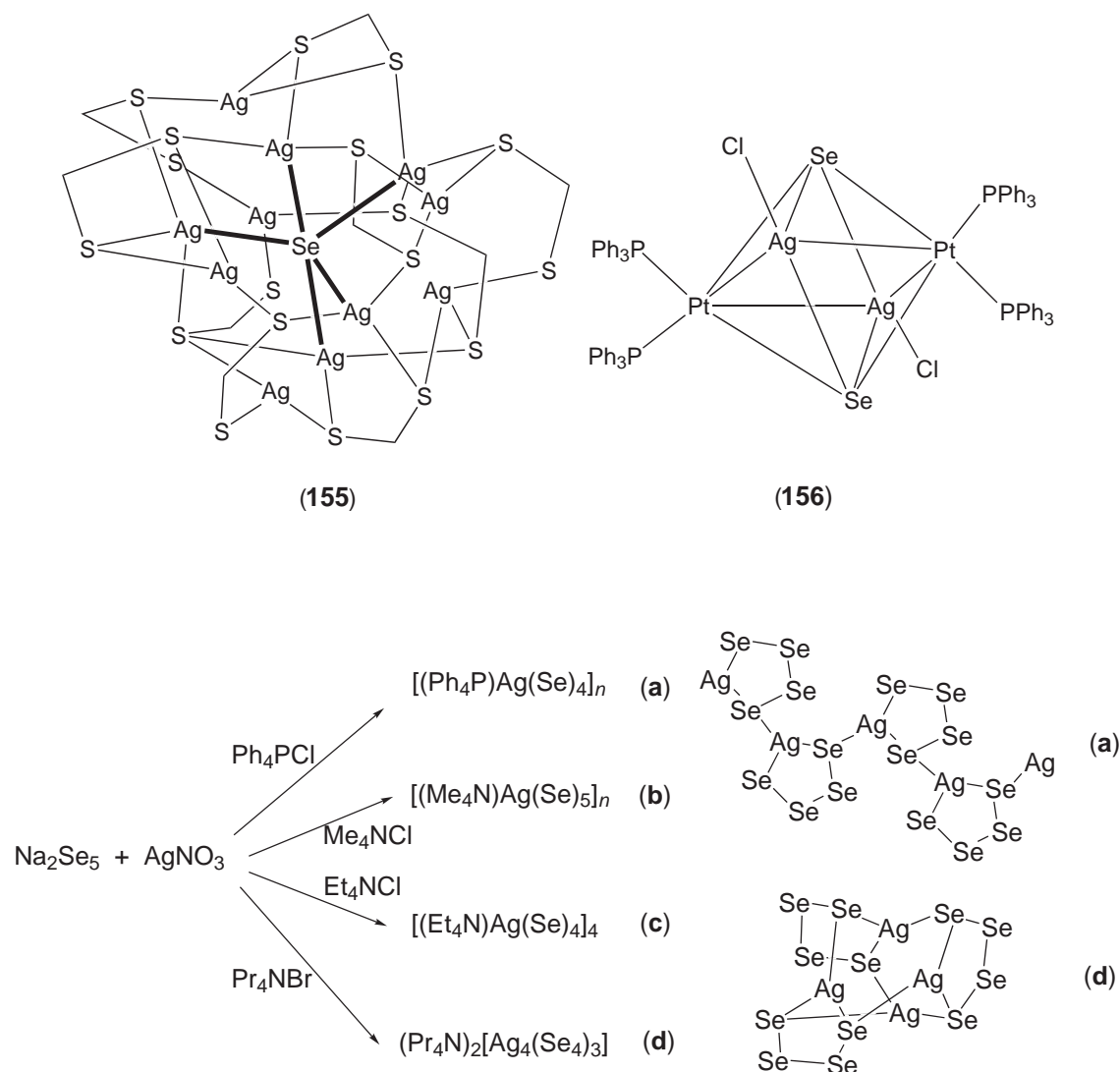

Scheme 8

The compound $\text{K}_2\text{Ag}_{12}\text{Se}_7$ (157) has been prepared from potassium polyselenide and silver powder in supercritical ethylene diamine.¹⁰³⁹ $\text{RbAg}_2\text{As}_3\text{Se}_6$ possesses a unique 3D silver-selenoarsenate framework $^3_{\alpha}[\text{Ag}_2\text{As}_3\text{Se}_6]^-$ which is assembled from $[\text{As}_3\text{Se}_6]^{3-}$ rings and Ag_2^{2+} dumbbell units (158).¹⁰⁴⁰ Discrete complexes incorporating heteropolychalcogenide ligands, $[\text{Ag}_2\text{Te}(\text{TeS}_3)_2]^{2-}$ and $[\text{Ag}_2\text{Te}(\text{TeSe}_3)_2]^{2-}$ (159), have also been obtained.¹⁰⁴¹

The interaction between Ag^+ and selenium in the bloodstream has been studied *in vitro* by means of the HPLC-inductively coupled argon plasma-mass spectrometry (ICPMS) method. The metal ions and selenide form the unit complex $(\text{AgSe})_n$ and then this unit binds to selenoprotein to form the ternary complex $[(\text{AgSe})_n]\cdot\text{selenoprotein}$ in the bloodstream.¹⁰⁴²

Mixed silver telluride-telluroate complexes have been prepared in a similar manner to those of selenium. The reactions of a silver salt with RTeTMS in the presence of phosphines as stabilizing agents are reported in Scheme 9.¹⁰⁴³⁻¹⁰⁴⁶

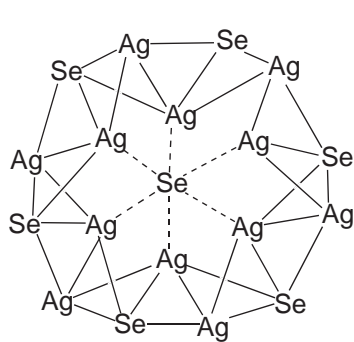

(157)

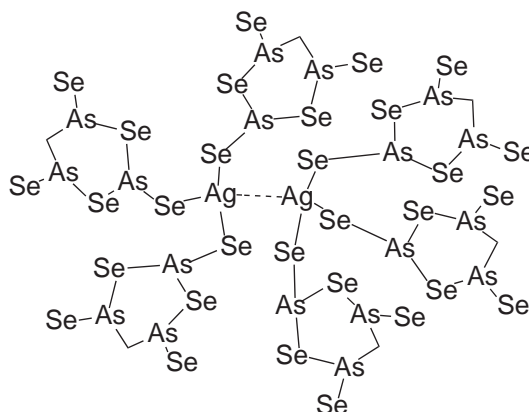

(158)

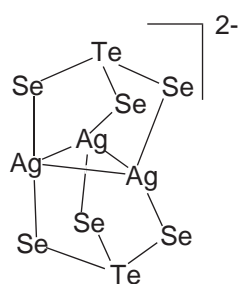

(159)

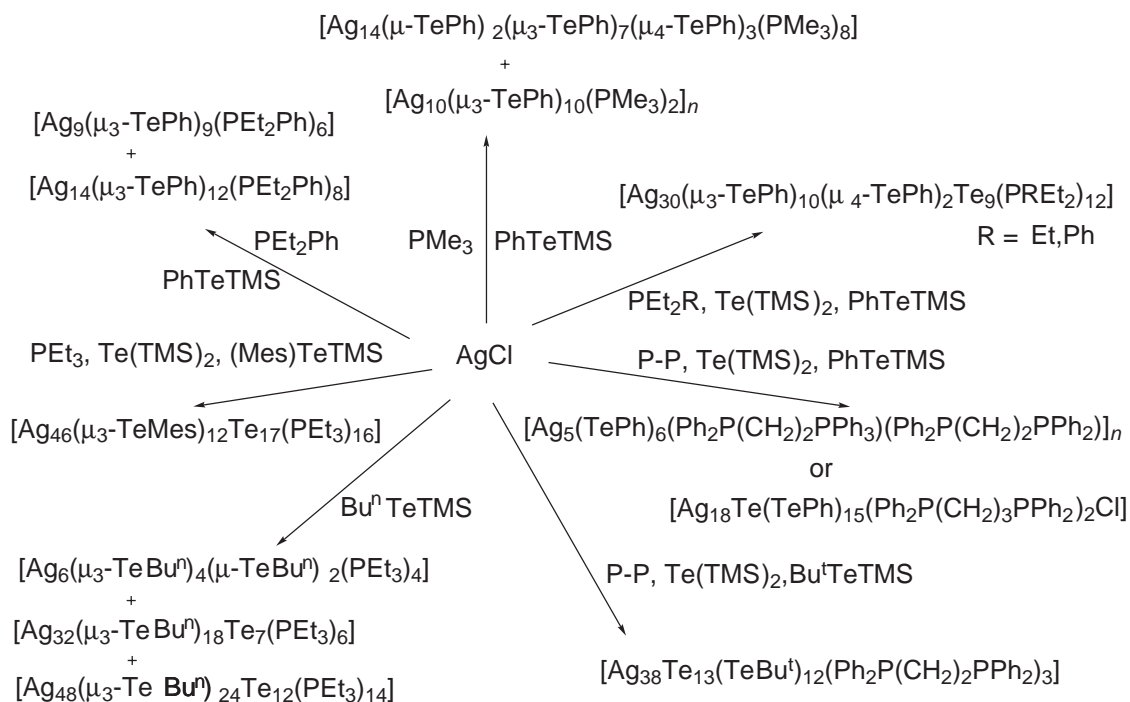

Scheme 9

The homoleptic telluride compound $(\text{PPh}_4)_2(\text{NET}_4)[\text{AgTe}_7]$ (**160**) has been prepared by mixing $\text{Li}_2\text{Te}/\text{Te}/\text{Na}/[\text{AgI}(\text{PMe}_3)]/\text{PET}_3$ following by addition of the cations.¹⁰⁴⁷ If metallic sodium is not used, the compound $(\text{NET}_4)_4[(\text{Te}_4)\text{Ag}(\mu\text{-Te}_4)\text{Ag}(\text{Te}_4)]$ (**161**) is obtained.¹⁰⁴⁸ This complex is also obtained by treatment of Na_2Te_3 with AgNO_3 in DMF and in the presence of $(\text{PPh}_4)\text{Br}$.¹⁰⁴⁹ The reaction of AgBF_4 and K_2Te in DMF in the presence of $(\text{NET}_4)\text{Cl}$ leads to the formation of $\text{Me}_4\text{N}[\text{AgTe}_4]$.¹⁰⁵⁰

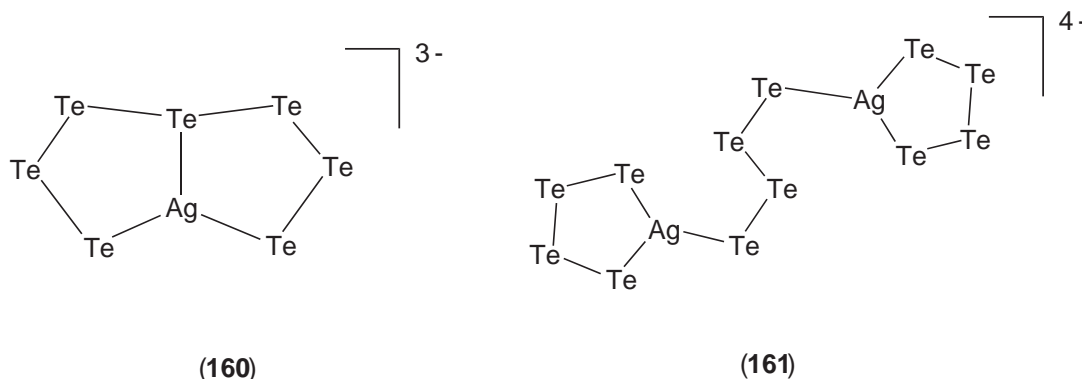

Ternary and quaternary metal telluride materials have been prepared from the metallic elements in telluride fluxes, as the compounds CsAg_5Te_3 ,¹⁰⁵¹ $\text{K}_{0.33}\text{Ba}_{0.67}\text{AgTe}_2$,¹⁰⁵² $\text{CsFe}_{0.72}\text{Ag}_{1.28}\text{Te}_2$,¹⁰⁵³ and $\text{Cs}_2\text{Ag}_2\text{ZrTe}_4$. The latter has a structure that comprises 2D slabs of Ag- and Zr-centered tetrahedral separated by Cs^+ cations.¹⁰⁵⁴ Gas-phase silver chalcogenide ions of the type $[\text{Ag}_{2n-1}\text{E}_n]^-$ (E = S, Se, Te) with $n \leq 14$ have been investigated by laser-ablation Fourier transform ion cyclotron resonance mass spectrometry.¹⁰⁵⁵

Mixed metal sulfide clusters are those synthesized from MS_4^{2-} (M = Mo, W) and VS_4^{3-} anions and silver cations in the presence of various ligands. Many of these silver compounds, together with copper compounds, have been extensively studied because of their relevance to biological systems and industrial significance.¹⁰⁵⁶ For the W(Mo)/S/Ag system many discrete complexes have been obtained, such as $[(\text{PPh}_3)_2\text{AgS}_2\text{MS}_2\text{Ag}(\text{PPh}_3) \cdot 0.8\text{CH}_2\text{Cl}_2]$ (**162**),¹⁰⁵⁷ $\text{Et}_4\text{N}[(\text{PPh}_3)_2\text{AgS}_3\text{MECu}(\text{CN})]$ (E = S, O),^{1058,1059} $[\{\text{Ag}(\text{PPh}_3)\}_3\text{MS}_4\{\text{S}_2\text{P}(\text{OEt})_2\}_2]$,¹⁰⁶⁰⁻¹⁰⁶² $[(\text{EPh}_3)_4\text{Ag}_4\text{W}_2\text{S}_8]$ (E = P, As),^{1063,1064} $(\text{Bu}_4\text{N})_2[\text{M}_2\text{Ag}_3(\mu_3\text{-S})_2(\mu\text{-S})_4(\text{S}_2\text{CNET}_2)_2]$,¹⁰⁶⁵ $[\text{Ag}_6\text{S}_6\text{M}_2(\text{SCMe}_3)_2\text{O}_2(\text{PPh}_3)_4]$,^{1066,1067} $[\text{WS}_4\text{Ag}_3\text{I}(\text{AsPh}_3)_3](\text{SAsPh}_3)$,¹⁰⁶⁸ $[\text{WAg}_3\text{OS}_3(\text{PPh}_3)_3\{\text{S}_2\text{P}(\text{PPr}^i)_2\}]$,¹⁰⁶⁹ $\text{Et}_4\text{N}[\text{AgM}_2\text{S}_4(\text{S}_2\text{C}_2\text{H}_4)_2(\text{PPh}_3)]$ (**163**),¹⁰⁷⁰ $\text{Et}_4\text{N}[\text{AgCuWS}_4(\text{CN})(\text{PPh}_3)_2]$,¹⁰⁷¹ $[\{\text{Ag}_3\text{MoS}_3\text{Cl}\}(\text{E})(\text{PPh}_3)_3]$ (E = O, S) (**164**),^{1072,1073} $[(\text{PPh}_3)_2\text{AgSe}_2\text{WSe}_2\text{Ag}(\text{PPh}_3)]$,^{1074,1075} or $[\text{MS}_4\text{X}\{\text{Ag}(\text{PR}_3)_3\}]$ (X = Cl, Br, $\text{IR}_3 = \text{Ph}_3, \text{Ph}_2\text{Me}$)¹⁰⁷⁶⁻¹⁰⁸⁰ (M = Mo, W). Some of these complexes display very strong nonlinear optical properties.^{1062,1064,1069,1074}

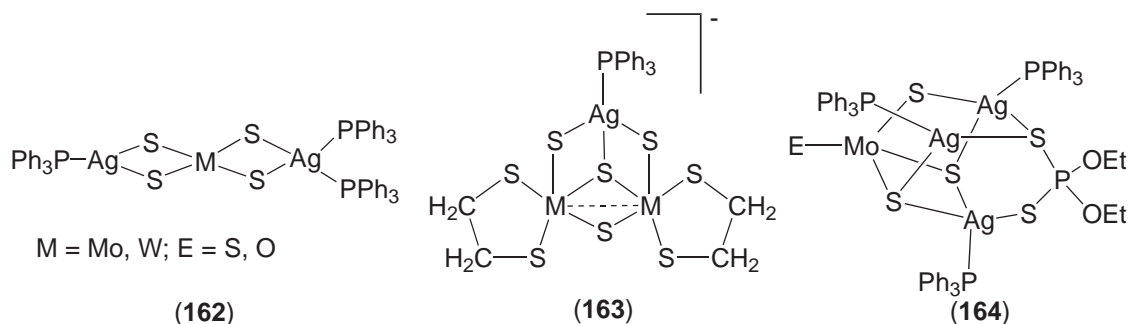

Polymeric species have also been described, such as $[(\text{PPh}_4) \cdot \text{AgMoS}_4]_n$,^{1081,1082} $[\text{AgMS}_4 \cdot 4\text{MePyH}]_n$,¹⁰⁸³ $[(\text{TMEDA})_2 \cdot \text{W}_2\text{Ag}_5\text{S}_8 \cdot \text{TMEDA} \cdot \text{H}_2\text{O}]_n$,¹⁰⁸⁴ $[\text{WS}_4\text{Ag} \cdot \text{NH}_3\text{C}(\text{CH}_2\text{OH})_3 \cdot \text{H}_2\text{O}]_n$,¹⁰⁸⁵ $[\text{WS}_4\text{Ag} \cdot \text{NH}_3\text{C}(\text{CH}_2\text{OH})_3 \cdot 2\text{DMF}]_n$,¹⁰⁸⁶ $[\text{W}_4\text{S}_{16}\text{Ag}_5 \cdot \text{Ln}(\text{DMF})_8]_n$ (**165**) (Ln = Nd, Pr, La)^{1087,1088} $[\text{WS}_4\text{Ag} \cdot \text{HNET}_3 \cdot \text{DMF}]_n$,¹⁰⁸⁹ $[\text{W}_4\text{S}_{16}\text{Ag}_4 \cdot 2\text{Ca}(\text{DMSO})_6]_n$,¹⁰⁹⁰ $[\text{N}(\text{C}_6\text{H}_5\text{CH}_2)(\text{C}_2\text{H}_5)_3 \cdot \text{MoAgS}_4]_n$,¹⁰⁹¹ $[\text{Mo}_2\text{Ag}_2\text{S}_8 \cdot \text{Ca}(\text{DMSO})_6]_n$,¹⁰⁹¹ or $[\text{Mo}_3\text{Ag}_3\text{S}_{12} \cdot \text{Nd}(\text{DM}-\text{Nd}(\text{DMSO})_8)]_n$.¹⁰⁹¹

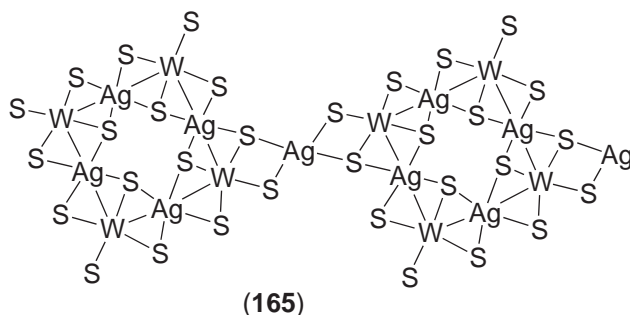

With other transition metal sulfides the mixed vanadium–silver cubane-like cluster, $(\text{Et}_4\text{N})_2[\text{Ag}_2\text{V}_2\text{S}_4\{\text{S}_2\text{CN}(\text{OC}_4\text{H}_8)_2\}_2(\text{SPh})_2]$ (**166**)¹⁰⁹² and $[\{\eta^5\text{-C}_5\text{Me}_5\}\text{WS}_3\}_2\text{Ag}_3(\text{PPh}_3)_3]\text{NO}_3$ (**167**), have been reported.¹⁰⁹³

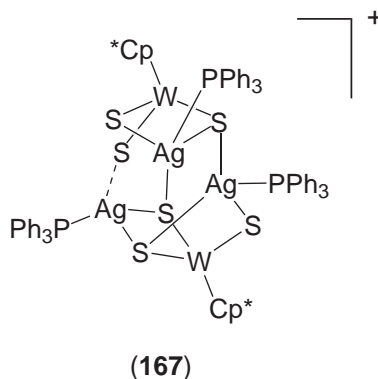
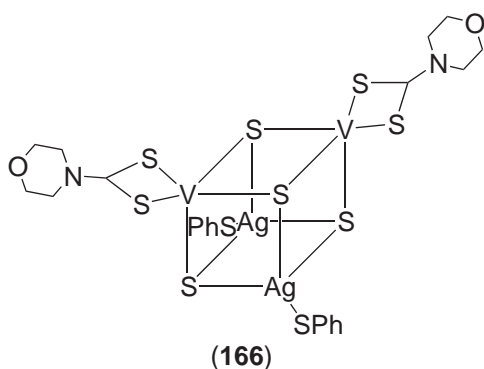

(iii) Thioether silver(I) complexes

The chemistry of silver(I) with crown thioethers has developed in the last years,^{1094,1095} but now numerous examples with a great variety of ligands have been reported. The first homoleptic silver compounds have been described with 1,4,7-trithiacyclononane ($[\text{9}]_{\text{aneS}_3}$), $[\text{Ag}([\text{9}]_{\text{aneS}_3})_2]\text{OTf}$ (**168**), which is octahedral and shows a reversible oxidation assigned to the $\text{Ag}^{\text{I}}/\text{Ag}^{\text{II}}$ couple,^{1096,1097} and the trimeric species $[\text{Ag}_3([\text{9}]_{\text{aneS}_3})_3]^{3+}$ (**169**).¹⁰⁹⁷ The complexes $[\text{AgX}([\text{9}]_{\text{aneS}_3})]$ ($\text{X} = \text{Cl}, \text{Br}$) have also been described.¹⁰⁹⁸ Larger thioethers macrocycles also binds silver(I) and thus complexes of the type $[\text{Ag}([\text{12}]_{\text{aneS}_3})_n]\text{OTf}$ ($n = 1, 2$),¹⁰⁹⁸ $[\text{Ag}_2([\text{15}]_{\text{aneS}_5})_2]^{2+}$ (**170**),¹⁰⁹⁹ $[\text{Ag}([\text{16}]_{\text{aneS}_6})]\text{ClO}_4$ (tetrahedral),¹¹⁰⁰ or $[\text{Ag}([\text{18}]_{\text{aneS}_6})]^+$,¹¹⁰¹ (**171**) have been isolated. The latter can be oxidized to the Ag^{II} compound that is stabilized under acidic conditions.

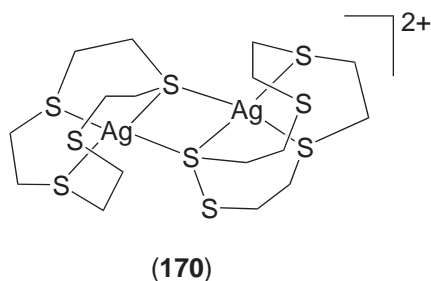
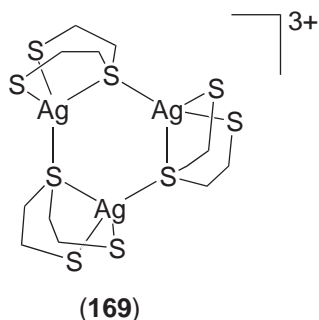
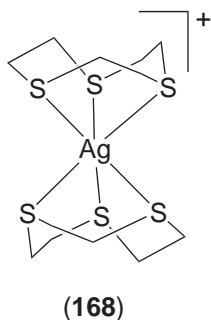

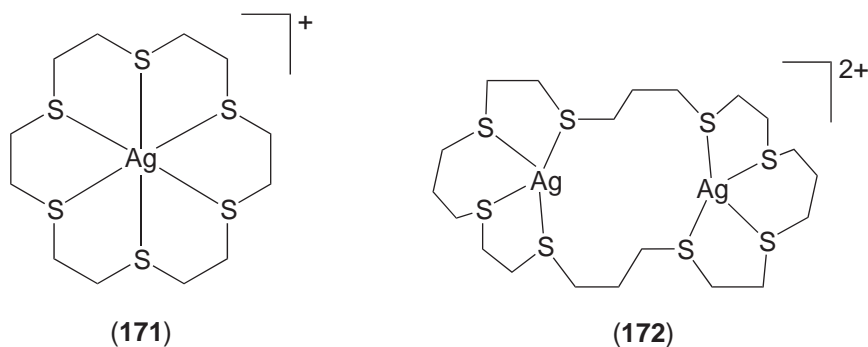

With larger ring size the complexes tend to be polymeric as $[\text{Ag}(\text{[16]aneS}_4)(\text{BF}_4)]_n$,¹¹⁰² $[\text{Ag}_2(\text{[14]aneS}_8)(\text{OTf})_2(\text{MeCN})]_n$,¹¹⁰² $[\text{AgBr}(\text{[18]aneS}_6)]_n$,¹⁰⁹⁸ or $[\text{Ag}_2(\text{[24]aneS}_8)(\text{OTf})_2(\text{MeCN})_2]_n$.¹¹⁰³ In the compound $[\text{Ag}_2(\text{[28]aneS}_8)(\text{NO}_3)_2]$ (172), the macrocycle has a sufficiently large cavity to encapsulate two silver(I) atoms.¹¹⁰³ With $[\text{15]aneS}_5$ monomeric $[\text{Ag}(\text{[15]aneS}_5)]\text{B}(\text{C}_6\text{F}_5)_4$, dimeric $[\text{Ag}_2(\text{[15]aneS}_5)_2](\text{BPh}_4)_2$, or polymeric species $[\text{Ag}_n(\text{[15]aneS}_5)_n](\text{BF}_4)_n$ are obtained depending upon the cation.¹¹⁰⁴ The substituted thiocrown ethers $[\text{19]aneS}_6\text{-OH}$ and $[\text{20]aneS}_6\text{-OH}$ have been synthesized and the silver complexes $[\text{Ag}(\text{[19]aneS}_6\text{-OH})]\text{OTf}$ and $[\text{Ag}(\text{[20]aneS}_6\text{-OH})]\text{BF}_4$ obtained; the silver centers are bonded to four sulfur atoms in a distorted tetrahedral geometry.¹¹⁰⁵ The $[\text{16]aneS}_4\text{-(OH)}_2$ macrocycle coordinates to silver in an exodentate fashion, with four macrocycles coordinating to each distorted tetrahedral Ag and four Ag-atoms bound to each macrocycle forming a polymeric structure.¹¹⁰⁶

These silver(I) crown thioether complexes have been used as templates for the synthesis of extended polyiodide networks, such as $[\text{Ag}_2(\text{[15]aneS}_5)_2]\text{I}_{12}$, $[\text{Ag}(\text{[18]aneS}_6)]\text{I}_7$, $[\text{Ag}(\text{[18]aneS}_6)]\text{I}_3$, and $[\text{Ag}(\text{[9]aneS}_3)_2]\text{I}_5$,^{1107,1108} or as building blocks for the formation of coordination polymers constructed from $\text{Ag}(\text{hfac})$ and $[\text{14]aneS}_4$ or $[\text{9]aneS}_3$.¹¹⁰⁹ The solvent extraction of Ag^{I} by $[\text{14]aneS}_4$, $[\text{18]aneS}_6$, and related ligands has been described.^{1110–1118}

Silver(I) derivatives with macrocyclic thioether ligands with different substituents in the alkyl chain have also been obtained. Several compounds have been reported with macrocyclic ligands such as thiacyclopentane derivatives (Figure 13).^{1120–1127} With the ligand 2,5,8-triathia[9]-*o*-cyclophane (L_1) the complex $[\text{Ag}(\text{L}_1)_2]\text{OTf}$ has been obtained, the silver center has a tetrahedral coordination to both the free ligand *exo*- and the fully organized *endo*-conformation of the ligand.¹¹¹⁹ The ligand L_1 forms an octagonal complex with a $[\text{Ag}_4\text{S}_4]^{4+}$ cavity (173).¹¹²⁸

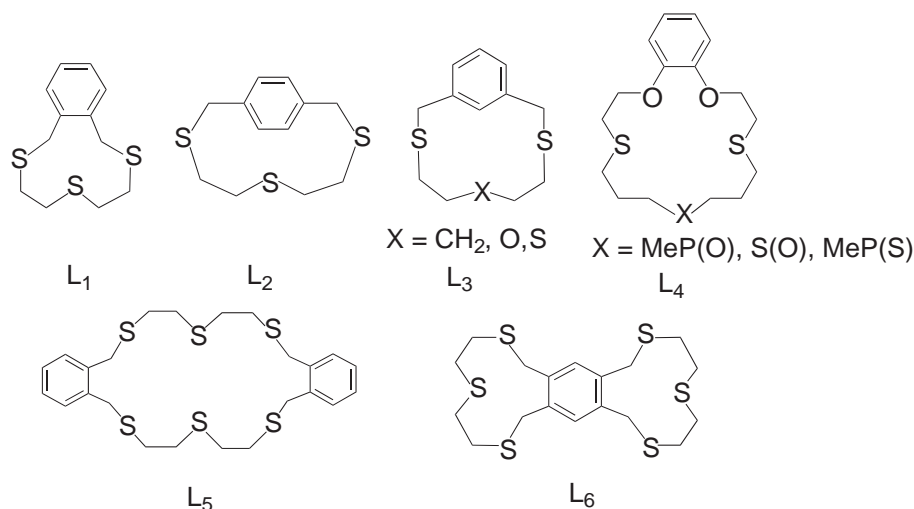
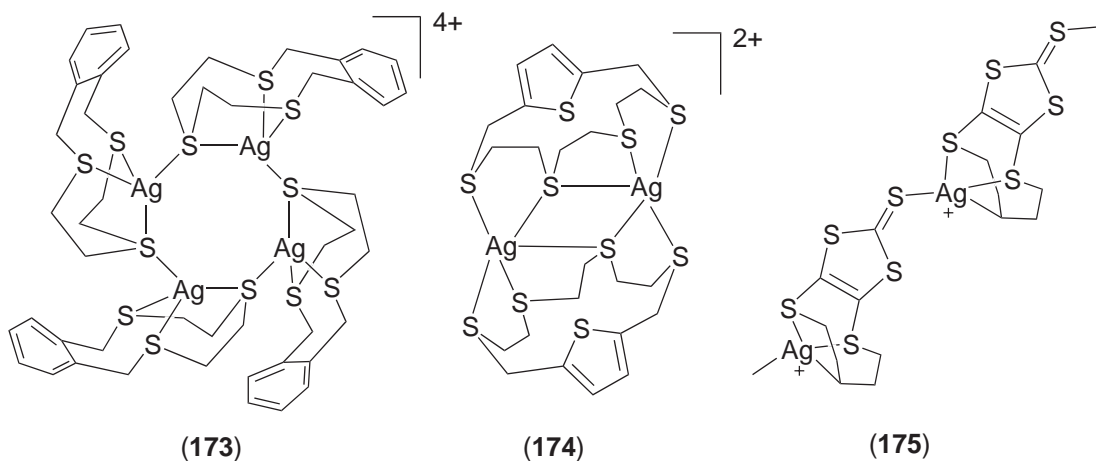
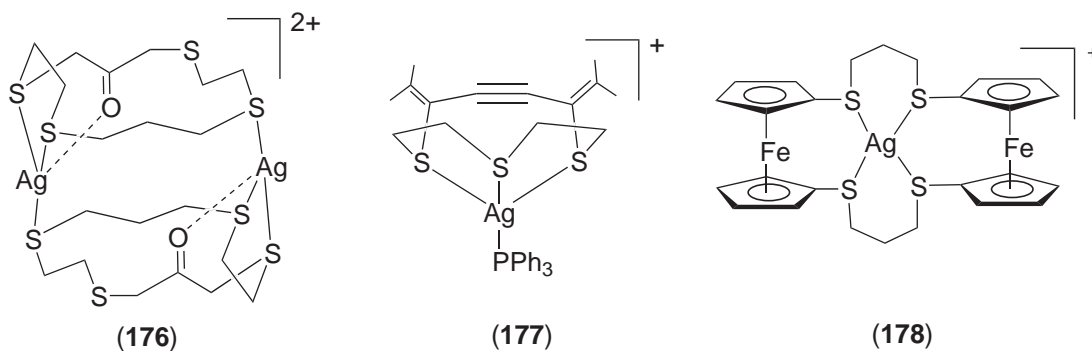

Figure 13 Some thiocyclophane derivatives which form silver(I) complexes.



The thiophenophane $C_{12}H_{18}S_4$ ligand forms a $[Ag_2L_2]^{2+}$ complex (174) where the silver atoms are in a distorted trigonal bipyramidal geometry.¹¹²⁹ Crown thioethers complexes containing rigid 1,2-dithioethene units have been described, they are polymers when there is a thione group (175) or monomers in the case of a carbonyl group.^{1130,1131}

Thia-crown ethers incorporating propan-2-one units and dimeric silver(I) compounds as (176) and other polymeric species have been prepared.^{1132,1133} Other substituents can be diisopropylidene groups which form complexes of the type $[AgL(PPh_3)]OTf$ (177),¹¹³⁴ pyridazine,¹¹³⁵ or phthalazine¹¹³⁶ ligands or even organometallic compounds as ferrocene in (178).¹¹³⁷



A zinc phthalocyanine complex with four fused [13]aneS₄ functional groups forms the monomeric pentanuclear $ZnAg_4$ complex, where each Ag atom is presumably coordinated by a [13]aneS₄ ring.¹¹³⁸ Nonmesogenic ligands containing an N₂S₄ macrocycle coordinate to silver(I) to form mesomorphic structures. It has been proposed that the mesomorphic behavior of the silver complex (179) is caused by its segregation of its polar and apolar regions, resulting in an amphiphilic material.^{1139,1140}

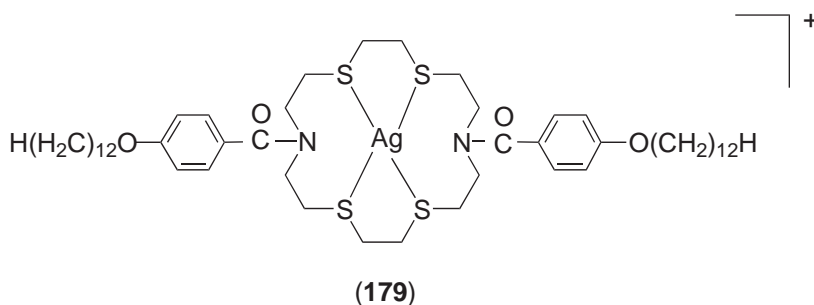

Macrocyclic thioethers which contain a carborane backbone have also been prepared and the silver(I) complexes obtained. The reaction of $AgNO_3$ with the sulfur-containing macrocyclic ligand

$[7,8-\mu-(\text{SCH}_2\text{CH}_2\text{S})-7,8-\text{C}_2\text{B}_9\text{H}_{10}]^-$ leads to the complex $[\text{Ag}\{7,8-\mu-(\text{SCH}_2\text{CH}_2\text{S})-7,8-\text{C}_2\text{B}_9\text{H}_{10}\}]^-$ which is a chain polymer (**180**). By addition of PPh_3 the chain is broken and discrete species $[\text{Ag}(\text{PPh}_3)_4][\text{Ag}\{7,8-\mu-(\text{SCH}_2\text{CH}_2\text{S})-7,8-\text{C}_2\text{B}_9\text{H}_{10}\}(\text{PPh}_3)]$ are obtained.¹¹⁴¹ With the cyclic ligands $[7,8-\mu-\{\text{S}(\text{CH}_2)_m\text{S}\}-7,8-\text{C}_2\text{B}_9\text{H}_{10}]^-$, several silver(I) complexes have been prepared with PPh_3 or bipy as auxiliary ligands, such as (**181**).^{1142,1143} Reaction of $[\text{Co}_2\{\mu-\text{C}_2(\text{CH}_2\text{SCH}_2\text{CH}_2)_2\text{S}\}(\text{CO})_6]$ with AgBF_4 and PPh_3 gives $[\text{Co}_2\{\mu-\text{C}_2(\text{CH}_2\text{SCH}_2\text{CH}_2)_2\text{S}\}(\text{CO})_6\{\text{Ag}(\text{PPh}_3)\}] \text{BF}_4$. The dimeric cobalt compound produces a 1:1 adduct (**182**) when treated with AgBF_4 .¹¹⁴⁴

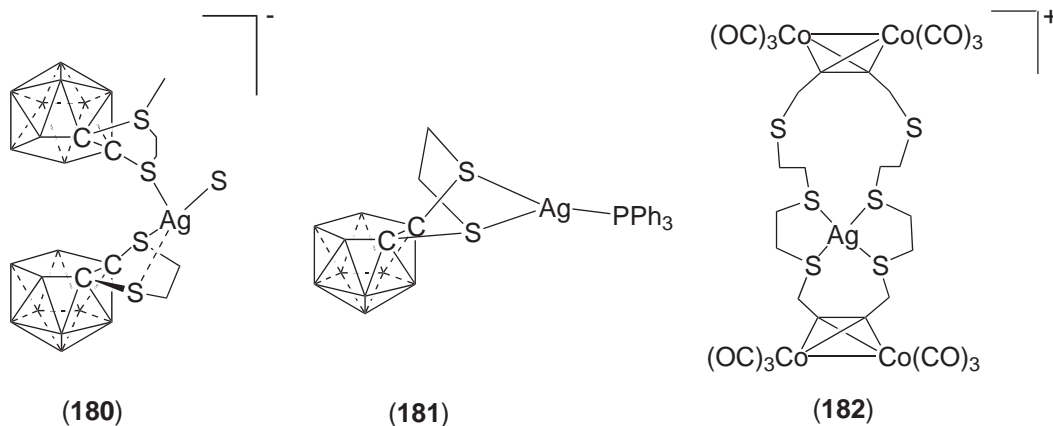

Other silver(I) complexes have been reported with cyclic thioethers, such as $[\text{Ag}_2\{(\text{CH}_2\text{S})_3\}_5]^{2+}$ (**183**) with the trimeric thioformaldehyde as ligand,¹¹⁴⁵ or the thianthrene (**184**),¹¹⁴⁶ or the 2,11-dithia[3.3]paracyclophane which forms an infinite network,¹¹⁴⁷ or with a dithia ligand which form the polymeric compound (**185**).¹¹⁴⁸ The arsathiane ligand *cyclo*-(EtAsS)_n reacts with silver triflate to form $[\text{Ag}\{\text{cyclo}-(\text{EtAsS})_2\}]\text{OTf}$, in which the silver atom is sandwiched between two crown-shaped ligands having their S-atoms directed towards the metal.¹¹⁴⁹ 1,4-Thioxane gives two types of polymeric complexes with silver triflate.¹¹⁵⁰ The structure of $[\text{Ag}_2(\text{htcod})(\text{pic})](\text{picH})$ (htcod = 1,4,7,10,13,16-hexathiacycloctane; pic = picrate) has been reported.¹¹⁵¹

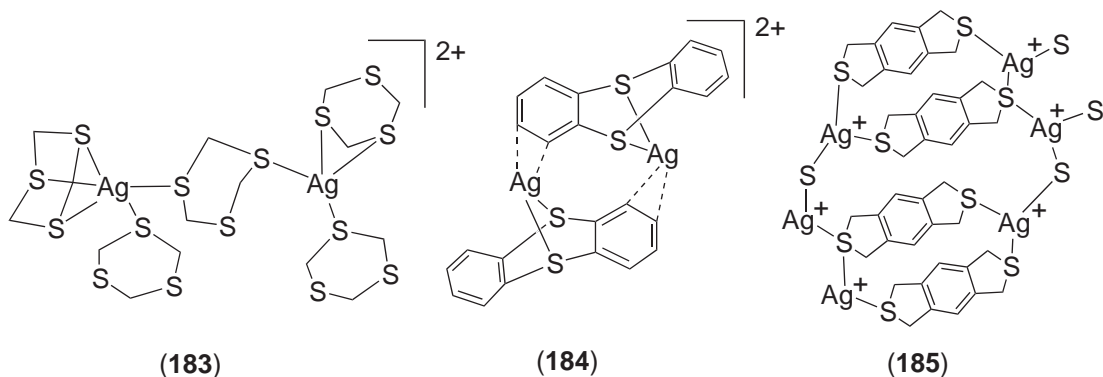

Silver(I) complexes with macrocyclic selenoethers (**186**) and (**187**) are not well represented and have been prepared with the ligands [8]aneSe₂ and 3*H*-1,4,5,7-tetrahydro-2,6-dibenzodiselenonine, respectively.¹¹⁵² Another example is the reaction of 1,3-dihydrobenzo[*c*]tellurophene with AgBF_4 which yields the complex $[\text{AgL}_4]\text{BF}_4$, where the ligand coordinates through the tellurium atom.¹¹⁵³ The thermodynamic parameters and relative cations selectivity for complexation of some cations with 1,5,14,18-tetraselena-8,11,21,24-tetraoxacyclohexacosane have been studied, showing high Ag^+ selectivity.¹¹⁵⁴ The reaction of AgAsF_6 with $(\text{CH}_2\text{Se})_3$ in liquid SO_2 at -196°C gives the compound $[\text{Ag}\{(\text{SeCH}_2)_3\}_2]\text{AsF}_6$ (**188**).¹¹⁵⁵

Coordination studies of acyclic thioether ligands to silver(I) centers has also been studied. Poly(alkylthio)aromatic systems have been used to form supramolecular silver(I) compounds. With the ligand 2,3,5,6-tetrakis(isopropylthio)benzoquinone the compound has a linear chain structure in which silver(I) has a tetrahedral coordination.¹¹⁵⁶ A similar structure has the compound with the hexakis(methylthio)benzene,¹¹⁵⁷ but with the hexakis(tolylthio)benzene the silver

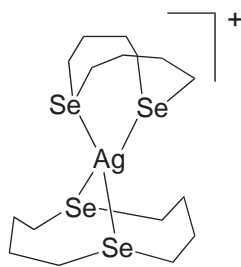

(186)

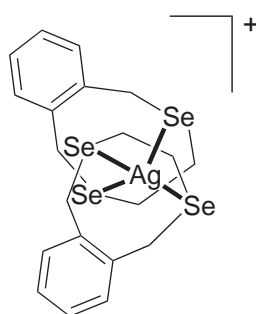

(187)

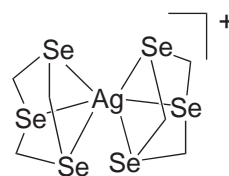

(188)

prefers a square planar coordination geometry and a zig-zag polymer structure (189).¹¹⁵⁸ With the ligand 2,3,4,5-tetrakis(methylthiol)pyridine the compounds $[Ag_3L_4](ClO_4)_3$ (190) and $[Ag_2L_2](C_2F_5CO_2)_2$ have been prepared and they show 2D structures. In (190) the ligands are positioned face to face by the two Ag atoms and form a box structure; the π - π stacking between pyridine rings gives the 2D framework.¹¹⁵⁹

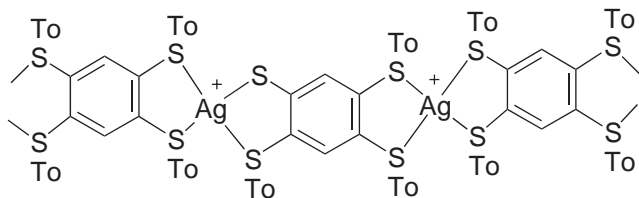

(189)

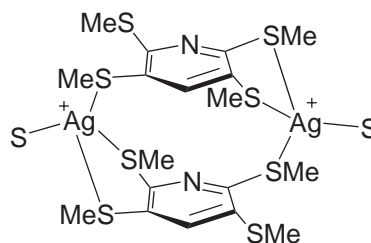

(190)

The silver(I) complexes with the tetrakis(methylthio)tetrathiafulvalene ligand have been reported, the nitrate salt presents a 3D structure with an unprecedented 4.16-net porous inorganic layer of silver nitrate,¹¹⁶⁰ the triflate salt presents a two interwoven polymeric chain structure.¹¹⁶¹ The latter behaves as a semiconductor when doped with iodine. With a similar ligand, 2,5-bis-(5',5'-bis(methylthio)-1',3'-dithiol-2'-ylidene)-1,3,4,6-tetrathiapentalene, a 3D supramolecular network is constructed via coordination bonds and $S \cdots S$ contacts. The iodine-doped compound is highly conductive.¹¹⁶² (Methylthio)methyl-substituted calix[4]arenes have been used as silver-selective chemically modified field effect transistors and as potential extractants for Ag^I .^{1163,1164}

The coordination chemistry of a series of bidentate ligands, $RE(CH_2)_nER$ and $o-C_6H_4(ER)_2$ ($E = S, Se; n = 1-3; E = Te; n = 1$ or 3) with silver(I) has been studied and has shown that subtle ligand variations can have a dramatic influence upon the structures of the compounds produced, generating simple mononuclear bis(chelate) species, as $[Ag\{MeSe(CH_2)_2SeMe\}_2]^+$ (191) or $[Ag\{o-C_6H_4(TeMe)_2\}_2]^+$ (192), linear chain polymers, as $[Ag_n\{MeS(CH_2)_3SMe\}_n]^{n+}$ (193) or 3D networks, as $[Ag_n\{PhSe(CH_2)_3SePh\}_n]^{n+}$.¹¹⁶⁵⁻¹¹⁶⁷ These complexes have been examined by ^{77}Se , ^{125}Te , and ^{109}Ag NMR spectroscopies and showed no $^{77}Se-^{109}Ag$ or $^{125}Te-^{109}Ag$ coupling, indicating labile behavior of those ligands in solution.¹¹⁶⁸ Related work of the coordination of $MeTe(CH_2)_3TeMe$ has been reported and the compound is polymeric with each Ag atom coordinated by four different ligands which bridge the silver centers in a 2D network.¹¹⁶⁹ With the tripod ligand $MeC(CH_2SeMe)_3$ by treatment with $AgOTf$ the compound $[Ag\{MeC(CH_2SeMe)_3\}OTf]$ has been isolated; the structure is a polymeric chain with the silver atoms three-coordinated.¹¹⁷⁰

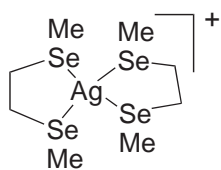

(191)

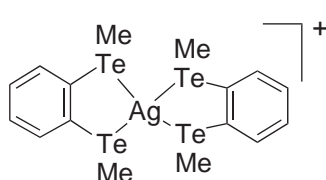

(192)

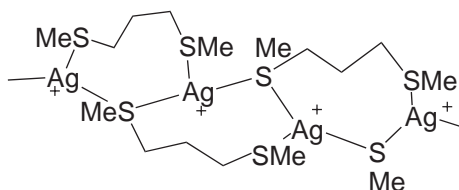

(193)

The reactions of 1,4-bis(phenylthio)butane with silver salts in varied conditions leads to the formation of four 2D coordination polymers with different network structures: $[\text{Ag}_2\text{L}_3(\text{ClO}_4)_2]_n$, $[\text{Ag}_2\text{L}_3(\text{ClO}_4)_2 \cdot \text{MeOH}]_n$, $[\text{AgL}_2]_n(\text{ClO}_4)_n$, and $[\text{AgL}(\text{NO}_3)]_n$.¹¹⁷¹ With 1,3-bis(propylthio)butane the structure of the adduct $3\text{AgNO}_3 \cdot 2\text{L}$ has been described.¹¹⁷² 1,3-Bis(phenylthio)methyl)benzene forms the complex $[\text{AgL}(\text{NO}_3)]_n$ which structure has linear polymeric chains of alternating trigonal silver(I) cations and bridging ligands bonded through the sulfur atoms.¹¹⁷³ The silver complex of the piperazin-2-one derivative with $-\text{SMe}$ substituents was prepared and studied as a model of a nonheme metalloprotein, spectroscopic data indicate coordination to silver through the S-atoms.¹¹⁷⁴ Ni-phthalocyanines with four and eight alkylthio functional groups form $[\text{NiL}][\text{Ag}(\text{NO}_3)_4]$ and $[\text{NiL}][\text{Ag}(\text{NO}_3)_2]$ complexes, respectively, which have been proposed to be polymeric.^{1175,1176} Silver complexation to small molecule cyclotriphosphazenes and high polymeric poly(organophosphazenes) with methylthio groups such as $[\text{NP}(\text{OCH}_2\text{CH}_2\text{SMe})_2]_n$, $[\text{NP}(\text{OCH}_2\text{CH}_2\text{CH}_2\text{CH}_2\text{SMe})_2]_n$, $[\text{NP}(\text{OCH}_2\text{CH}_2\text{CH}(\text{SMe})\text{CH}_2\text{CH}_2\text{SMe})_2]_n$, or $[\text{NP}(\text{OCH}_2\text{C}_6\text{H}_4\text{SMe})_2]_n$, have been studied.¹¹⁷⁷ Stability constants have been measured for Ag^+ with diethylsulfide, ethyl(2-chloroethyl)sulfide, and bis(2-chloroethyl)sulfide in acetone, DMSO, DMF, and methanol.¹¹⁷⁸ The complexes $[\text{Ag}(\text{NO}_3)(\text{SMe}_2)]$ and $[\text{Ag}(\text{SMe}_2)_2]\text{PF}_6$ have been obtained.¹¹⁷⁹ The relative effectiveness of Bu_2E ($\text{E} = \text{S}, \text{Se}, \text{Te}$) in the extraction of gold and silver has been studied by using atomic absorption spectrometry; for the extraction of silver(I) ions the selenium and tellurium derivatives prove to be better than the sulfur analogue.¹¹⁸⁰ The crystal structures of the THT derivatives $[\text{AgI}(\text{THT})_4]$,¹¹⁸¹ and $[\text{Ag}(\text{THT})_2]\text{BF}_4$,¹¹⁸² have been reported.

Silver(I) complexes with 1,1'-bis(alkyl(aryl)thio)ferrocene or 1,1-bis(phenylseleno)ferrocene have been reported. They are mononuclear as $[\text{Ag}\{\text{Fc}(\text{XR})_2\}_2]^+$ ($\text{X} = \text{S}, \text{R} = \text{Me}, \text{Pr}^i, \text{Ph}; \text{X} = \text{Se}, \text{R} = \text{Ph}$)^{1183,1184} or dinuclear as $[\text{Ag}(\text{OTf})\{\text{Fc}(\text{XPh})_2\}_2]$ (**194**) ($\text{X} = \text{S}, \text{Se}$)¹¹⁸³ complexes in contrast to those found with dithio- or diselenoether ligands. The compounds $[\text{Ag}_2(\text{OCIO}_3)_2\{\mu\text{-S}(\text{CH}_2\text{COPh})\text{Py}\}(\text{PPh}_3)_2]$ and $[\text{Ag}(\text{OCIO}_3)\{\text{S}(\text{CH}_2\text{COPh})\text{Py}\}(\text{PPh}_3)]$ (**195**) have been described.¹¹⁸⁵

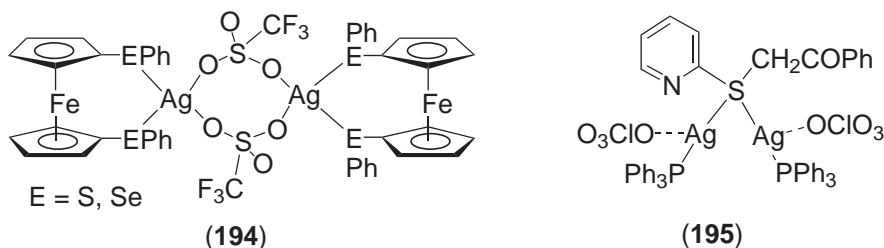

(iv) Silver(I) complexes with polydentate sulfur ligands

Homoleptic dithiolate silver(I) complexes are usually polynuclear species and several have been prepared, such as $[\text{Ag}_4(\text{SCH}_2\text{C}_6\text{H}_4\text{CH}_2\text{S})_3]^{2-}$ (**196**),¹¹⁸⁶ $[\text{Ag}_9(\text{SCH}_2\text{CH}_2\text{S})_6]^{3-}$ (**197**),¹¹⁸⁷ $[\text{Ag}_6(\text{i-mnt})_6]^{6-}$ (**198**),^{1188,1189} $[\text{Ag}_8(\text{i-mnt})_6]^{4-}$,¹¹⁸⁹ $[\text{Ag}_4(\text{i-mnt})_4]^{4-}$,¹¹⁹⁰ $[\text{Ag}_2(\text{mnt})]$,^{1191,1192} and $[\text{Na}([2.2.2]\text{-cryptand})_4[\text{Ag}_4(\text{mnt})_4]^{1193}$ ($\text{i-mnt} = \text{S}_2\text{C}=\text{C}(\text{CN})_2$; $\text{mnt} = \text{S}_2\text{C}_2(\text{CN})_2$). The mixed silver-gold dithiolate compound $[\text{Ag}_4\text{Au}_2(\text{SCH}_2\text{CH}_2\text{S})_4]^{2-}$ has also been reported.¹¹⁸⁷ The electrochemical oxidation of silver in acetonitrile solutions of $\text{R}(\text{SH})_2$ ($\text{R} = 1,2\text{-C}_2\text{H}_4, 1,2\text{-C}_3\text{H}_6, 1,3\text{-C}_3\text{H}_6, 1,4\text{-C}_4\text{H}_8, 2,3\text{-C}_4\text{H}_8, 1,5\text{-C}_5\text{H}_{10}, 1,6\text{-C}_6\text{H}_{12}$) gives the insoluble homopolymeric $\text{Ag}_2\text{S}_2\text{R}$ compounds in high yield.¹¹⁹⁴ A silver-dmit polymer with a 3D supramolecular network, $[(\text{Et}_4\text{N})_2\{\text{Ag}_4(\text{dmit})_3\} \cdot \text{DMF}]_n$ ($\text{dmit} = 1,3\text{-dithiole-2-thione-4,5-dithiolate}$) has been described.¹¹⁹⁵ A variety of spectroscopic methods have been used to deduce the solid-state structure of $[\text{Ag}_2\{\text{S}(\text{CH}_2)_5\text{S}\}]$; the data is consistent with a layered geometry similar to that adopted for neutral Ag thiolates with primary, unbranched alkane chains.¹¹⁹⁶ Stability constants and enthalpies of formation for the $[\text{AgL}]^{2-}$ and $[\text{AgL}_2]^{5-}$ complexes, where $\text{H}_3\text{L} = \text{HSCH}_2\text{CH}(\text{SH})\text{CH}_2\text{SO}_3\text{H}$, have been derived from potentiometric and calorimetric measurements.¹¹⁹⁷

Dithiolate silver(I) compounds with phosphine as auxiliary ligands such as $[\text{Ag}(\text{PPh}_3)_2][\text{Ag}(\text{mnt})(\text{PPh}_3)_2]$,^{1198,1199} $[\text{Ag}_8(\text{mnt})_6(\text{PPh}_3)_4]^{4-}$,¹²⁰⁰ $[\text{Ag}_9(\text{mnt})_6(\text{PPh}_3)_6]^{3-}$,¹²⁰⁰ $[\text{Ag}_4(\mu_4\text{-i-mnt})_2(\mu\text{-dppm})]$ (**199**),¹²⁰¹ $[\text{Ag}_5\{\text{S}_2\text{CC}(\text{CN})\text{P}(\text{O})(\text{OEt})_2\}_2(\text{dppm})_4]\text{PF}_6$, and $[\text{Ag}_4\{\text{S}_2\text{CC}(\text{CN})\text{P}(\text{O})(\text{OEt})_2\}_2(\text{dppm})_4]$ ¹²⁰² have been synthesized.

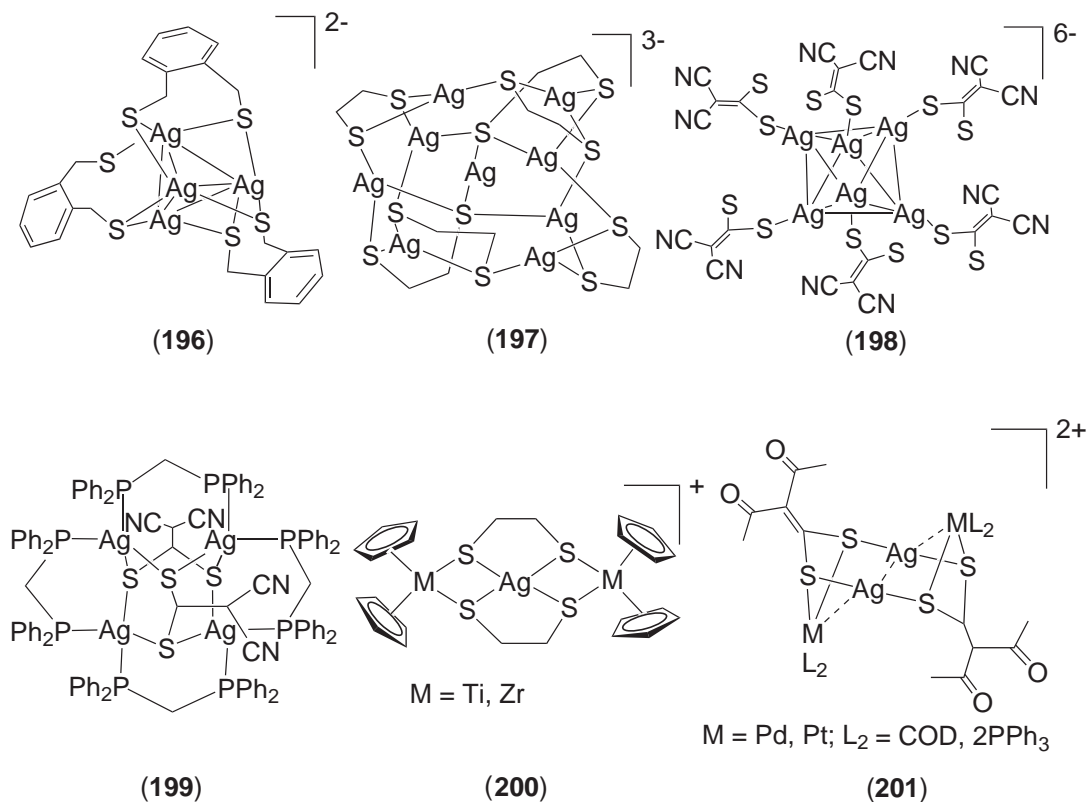

The zirconium or titanium dithiolate complexes $[\text{Cp}_2\text{M}\{\mu\text{-S}(\text{CH}_2)_n\text{S}\}_2\text{MCP}_2]$ ($\text{M} = \text{Zr}, \text{Ti}$) act as macrocyclic ligands and form 1:1 complexes with silver(I) ions as (200).¹²⁰³⁻¹²⁰⁵ Maleonitriledithiolate complexes of Ni, Pd, and Pt of the type $[\text{M}(\text{mnt})_2]^{2-}$ react further with silver salts in the presence of phosphine or diphosphine ligands to give heterometallic complexes such as $[\text{M}(\text{mnt})_2\{\text{Ag}(\text{PR}_3)_2\}_2]$ ($\text{M} = \text{Ni}; \text{PR}_3 = \text{PMe}_3, \text{PEt}_3, \text{PCy}_3$; $\text{M} = \text{Ni}, \text{Pd}, \text{Pt}; \text{PR}_3 = \text{PPh}_3, \text{PBu}^n_3$) or $[\text{Ni}(\text{mnt})_2\{\text{Ag}(\text{PP})\}]$ ($\text{PP} = \text{dppf}, \text{dppm}$).^{1206,1207} The treatment of $[\text{Pd}(\text{mnt})\{\text{O}_2\text{S}_2\text{C}_2(\text{CN})_2\}_2]^{2-}$ with AgClO_4 results in the formation of $[\text{AgPd}(\text{mnt})\{\text{O}_2\text{S}_2\text{C}_2(\text{CN})_2\}_2]^{2-}$. The structure consists of a double decker with the silver atom bridging the Pd moieties through the sulfur atoms.¹²⁰⁸ Similar reactions have been carried out with the complexes $[\text{M}\{\text{S}_2\text{C}=\text{C}[\text{C}(\text{O})\text{Me}]_2\}_2\text{L}_2]$ ($\text{M} = \text{Pd}, \text{Pt}$; $\text{L}_2 = \text{COD}, (\text{PPh}_3)_2$), which react with AgClO_4 to yield $[\text{M}\text{Ag}_2\{\text{S}_2\text{C}=\text{C}[\text{C}(\text{O})\text{Me}]_2\}_2\text{L}_2](\text{ClO}_4)_2$ (201) or with AgClO_4 in the presence of PPh_3 to give $[\text{M}\text{Ag}\{\text{S}_2\text{C}=\text{C}[\text{C}(\text{O})\text{Me}]_2\}(\text{PPh}_3)_4]\text{ClO}_4$.¹²⁰⁹ Maleonitrilediselenate (MNS) silver(I) complexes have been reported and are of the type $[\text{Na}(\{2.2.2\}\text{-cryptand})_4[\text{Ag}_4(\text{MNS})_4]$ (202),¹¹⁹³ $[\text{M}(\{2.2.2\}\text{-cryptand})_3[\text{Ag}(\text{MNS})_2]^{1193}$ ($\text{M} = \text{Na}, \text{K}$), or $[\text{K}(\{2.2.2\}\text{-cryptand})_3[\text{Ag}(\text{MNS})(\text{Se}_6)]$.^{1210,1211}

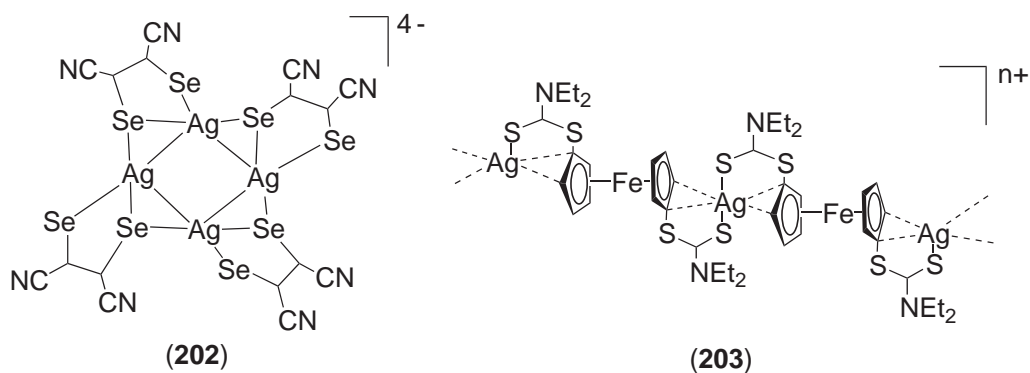

Dithiocarbamates have been used as ligands for a long time. Recently the structure of $[\text{Ag}(\text{S}_2\text{CNET}_2)]_6$ has been reported and the compound is hexanuclear.¹²¹² Complexes of the type

$[\text{Ag}(\text{S}_2\text{CNR}_2)(\text{PPh}_3)_2]$ and $[\text{Ag}(\text{S}_2\text{CNR}_2)(\text{dppe})]$ ($\text{R} = \text{Et}, \text{EtOH}$) have been synthesized.¹²¹³ The ligand 1,1'-bis(diethyldithiocarbamate)ferrocene forms a polymeric silver(I) species $[\text{Ag}\{\text{Fc}(\text{S}_2\text{CNEt}_2)_2\}_n(\text{ClO}_4)_n]$, (**203**) in which the silver atom is bonded to two sulfur atoms of different ferrocene moieties and also to the cyclopentadienyl ring in a η^2 fashion.¹²¹⁴

Mixed metal–silver dithiocarbamate complexes have been reported. The platinum–silver derivatives $[\text{Pt}_3\text{Ag}_2(\text{S}_2\text{CNR}_2)_6]^{2+}$ ($\text{R} = \text{Et}, \text{Pr}^i, \text{Bu}^n$) have been obtained by reaction of $[\text{Pt}(\text{S}_2\text{CNR}_2)_2]$ with AgX ($\text{X} = \text{ClO}_4, \text{BF}_4$).^{1215,1216} Crystallographic studies of the Pr^i and Bu^n species show that there are discrete cations that are held together by metal–metal bonding and long $\text{Ag}—\text{S}$ interactions (**204**); the Et species are polymeric with unsupported $\text{Ag}—\text{Pt}$ bonds. These cations have been observed by electrospray mass spectrometry.¹²¹⁷ Other Pt–Ag dithiocarbamate derivatives have been prepared from $[\text{M}\{\text{CH}_2\text{C}_6\text{H}_4\text{P}(\text{C}_6\text{H}_4\text{Me}-2)_2\}(\text{S}_2\text{CNMe}_2)]$ by reaction with silver salts and are of the type $[\text{M}\{\text{CH}_2\text{C}_6\text{H}_4\text{P}(\text{C}_6\text{H}_4\text{Me}-2)_2\}(\text{S}_2\text{CNMe}_2)\text{Ag}(\text{PPh}_3)]\text{ClO}_4$ (**205**) or $[\text{M}_2\{\text{CH}_2\text{C}_6\text{H}_4\text{P}(\text{C}_6\text{H}_4\text{Me}-2)_2\}_2(\text{S}_2\text{CNMe}_2)_2\text{Ag}\{\text{Ag}(\text{OCIO}_3)\}]\text{ClO}_4$ ($\text{M} = \text{Pd}, \text{Pt}$).¹²¹⁸ A mixed silver–gold dithiocarbamate complex $[\text{Au}_2\text{Ag}(\text{S}_2\text{CNEt}_2)_2\{\mu-(\text{PPh}_2)_2\text{C}=\text{CH}_2\}]\text{ClO}_4$ has been obtained.¹²¹⁹

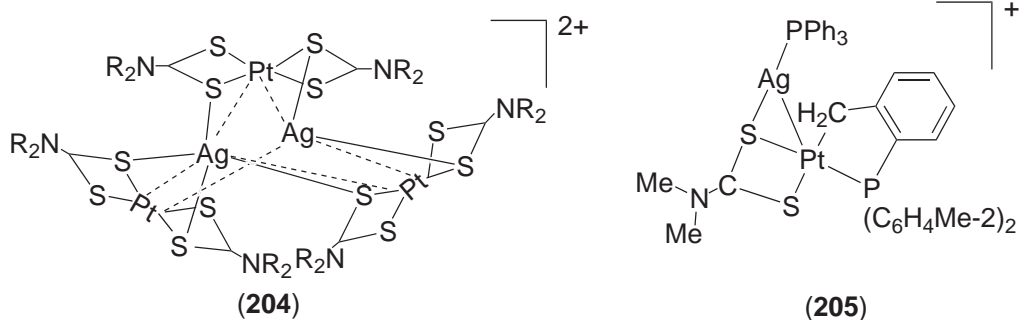

The oxidation product of the dialkyldithiocarbamate, the tetraalkylthiuramdisulfide has also been used as ligand in silver(I) chemistry. The complexes $[\text{Ag}\{\text{CH}_2(\text{S}_2\text{CNR}_2)_2\}]\text{OTf}$ ($\text{R} = \text{Me}, \text{Et}, \text{Bz}$) have been obtained and probably are oligo- or polymeric species.¹²²⁰ Desulfonation–fluorination of thiuramdisulfides with AgF produces a simple route to diorgano(trifluoromethyl) amines, R_2NCF_3 , thiocarbamoyl fluorides, $\text{R}_2\text{NC}(\text{S})\text{F}$, and $\text{Ag}(\text{S}_2\text{CNR}_2)$.¹²²¹ Tetramethylthiuram monosulfide(L) forms silver(I) complexes of the type $\text{AgX}\cdot\text{L}$ ($\text{X} = \text{Cl}, \text{Br}, \text{I}$),¹²²² the crystal structure of $[\text{Ag}(\text{ClO}_4)\text{L}]$ has been determined.¹²²³

Several dithiocarboxylate silver(I) complexes have been synthesized and characterized structurally such as $[\text{Ag}_2(\text{S}_2\text{CPh})_2]$,¹²²⁴ $[\text{Ag}_4\{\text{S}_2\text{CC}_6\text{H}_3\text{Me}_3-2,4,6\}_6]^{2-}$,¹²²⁴ $[\text{Ag}_4(\text{S}_2\text{C}-o\text{-Tol})_4\text{Py}_4]$,¹²²⁵ $[\text{Ag}_4(\text{S}_2\text{C}-o\text{-Tol})_4]$,¹²²⁶ $[\text{Ag}_4(\text{S}_2\text{C}-p\text{-Tol})_4]$,¹²²⁷ $[\text{Ag}(\text{S}_2\text{COEt})(\text{PPh}_3)_2]$,¹²²⁸ and $[\text{Ag}(\text{S}_2\text{C}-p\text{-Tol})(\text{PPh}_3)_2]$ (**207**).¹²²⁹ The reaction of $[\text{AgCl}(\text{PPh}_3)]_4$ with $\text{C}_5\text{Me}_5\text{Li}$ and an excess of CS_2 gives the compound $[\text{Ag}(\text{S}_2\text{CC}_5\text{Me}_5)(\text{PPh}_3)_2]$.¹²³⁰ Insertion of CS_2 in a $\text{Ag}—\text{S}$ (thiolate) bond also gives the dithiocarboxylate compound $[\text{Ag}(\text{S}_2\text{CSBu}^i)(\text{PPh}_3)_2]$.¹²³¹ Related ligands are phosphonodithiocarboxylates such as S_2CPe_3 which forms the silver(I) complex $[\{\text{Ag}(\text{S}_2\text{CPe}_3)_2\}_2](\text{ClO}_4)_2$ (**208**),¹²³² or with the dithiooxalate ligand the compound $[\text{Ag}(\text{S}_2\text{C}_2\text{O}_2\text{Me})(\text{PPh}_3)_2]$ is described.¹²³³

Monothiocarboxylate silver(I) derivatives have been also described and the homoleptic are of the type $\text{Ph}_4\text{P}[\text{Ag}\{\text{SC}(\text{O})\text{Me}\}_2]$ and $\text{Et}_3\text{NH}[\text{Ag}\{\text{SC}(\text{O})\text{Ph}\}_2]$; the latter has a dimeric structure in the solid state (**209**).¹²³⁴ Adducts with phosphine or diphosphine ligands have been prepared such as $[\text{Ag}_4(\text{PPh}_3)_4\{\text{SC}(\text{O})\text{Me}\}_4]$ (**210**) or $[\text{Ag}_3\{\mu-\text{SC}(\text{O})\text{R}\}_2(\mu\text{-dppm})_3]\text{X}$ ($\text{X} = \text{ClO}_4, \text{NO}_3$; $\text{R} = \text{Me}, \text{Ph}$), respectively.^{1235,1236}

Dialkyldithiophosphinates $\text{Ag}(\text{S}_2\text{PR}_2)$ were reported to be polymeric in 1968.¹²³⁷ Complex formation between silver(I) and R_2PS_2^- ($\text{R} = \text{Et}, \text{Pr}^n, \text{Ph}$) has been studied by potentiometric methods and the stabilities of the complexes determined.¹²³⁸ However, the crystal structure of the diisopropyldithiophosphinate silver compound $[\text{Ag}\{\text{S}_2\text{P}(\text{OPr}^i)_2\}_6]$ (**211**) shows it as a hexanuclear derivative.¹²³⁹ With these type of ligands compounds of the type $[\text{Ag}\{\text{S}_2\text{P}(\text{OEt})_2\}(\text{PPh}_3)_2]$ (**212**) and $(\text{Me}_4\text{N})_2[\text{Ag}\{\text{S}_2\text{P}(\text{OEt})_2\}_2]$ have been described.^{1240,1241} A similar hexanuclear compound has been obtained with diselenophosphinate ligands, $[\text{Ag}\{\text{Se}_2\text{P}(\text{OPr}^i)_2\}_6]$ whereas with $(\text{OEt})_2\text{PSe}_2^-$ the polymeric species $[\text{Ag}\{\text{Se}_2\text{P}(\text{OEt})_2\}_n]$ is obtained. The clusters $[\text{Ag}_{10}(\mu_{10}\text{-Se})\{\text{Se}_2\text{P}(\text{OR})_2\}_8]$ ($\text{R} = \text{Et}, \text{Pr}^i$) have also been obtained; the structure consists of a decasilver cluster with an encapsulated

selenium atom in a distorted *cis*-bicapped trapezoidal-prismatic geometry, surrounded by eight ligands having three different coordination modes.¹²⁴²

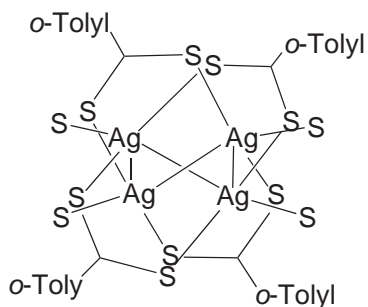

(206)

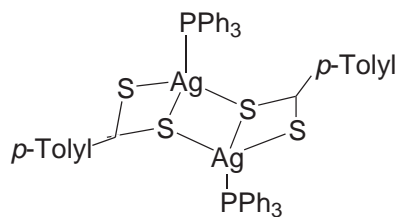

(207)

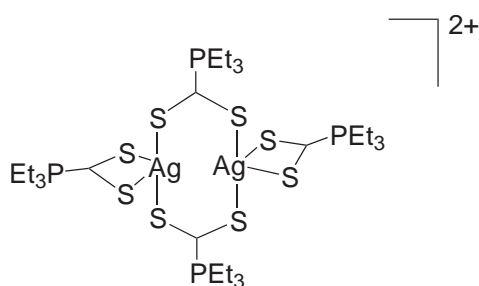

(208)

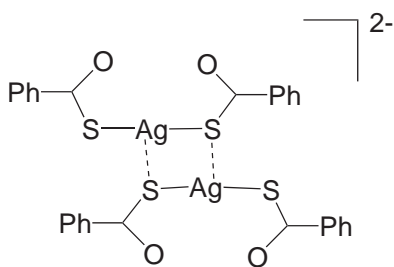

(209)

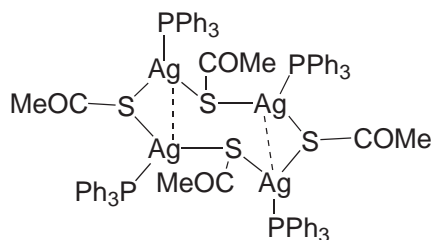

(210)

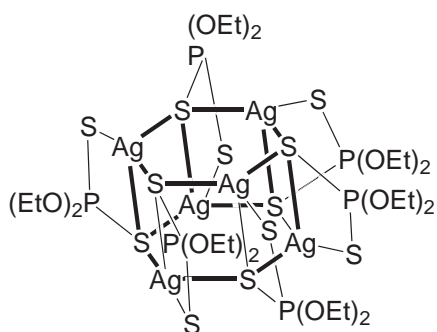

(211)

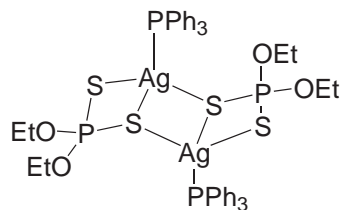

(212)

With the selenium derivative complexes of the type $[\text{Ag}(\text{dpspf})(\text{LL})]\text{OTf}$ ($\text{LL} = (\text{SPPh}_2)\text{CH}_2$, $(\text{SePPh}_2)_2\text{CH}_2$, bipy, phen) have been reported.¹²⁶⁵ Other silver complexes with chalcogenide derivatives are those formed with the mixed ligands $\text{EPPh}_2(\text{CH}_2)_2\text{SRS}(\text{CH}_2)_2\text{PPh}_2\text{E}$ ($\text{E} = \text{S}, \text{Se}$; $\text{R} = (\text{CH}_2)_2, (\text{CH}_2)_3, \text{C}_6\text{H}_4$) that are of the type $[\text{AgL}]^+$, as, for example, (218).¹²⁶⁶ The reaction of AgAsF_6 with $(\text{SPMe}_2)\text{O}$ gives $[\text{Ag}\{(\text{SPMe}_2)\text{O}\}_2]\text{PF}_6$, which has a tetrahedral geometry.¹²⁶⁷ The silver(I) derivative with the dithioimidodifosfinato ligand $[\text{Ag}\{(\text{SPPh}_2)_2\text{N}\}(\text{PPh}_3)]$ has been described.¹²⁶⁸ A silver complex with the bis(diphenylselenofosforyl)amine, $[\text{Ag}\{(\text{SePPh}_2)_2\text{NH}\}_2]\text{Br}$, has been described.¹²⁶⁹ The ligand $\{\text{SP}(2,4,6\text{-Bu}^t_3\text{C}_6\text{H}_2)\}_2(\mu\text{-CH}_2)(\mu\text{-S})$ forms 1:1 complexes with Ag^+ , extracting it from aqueous solutions selectively over Pd^{2+} , Cu^{2+} , Ni^{2+} , Fe^{3+} , and UO_2^{2+} ; it is proposed that bind silver using the $\text{P}=\text{S}$ atoms.¹²⁷⁰ The treatment of $(\text{SPPh}_2)_2\text{C}=\text{CH}_2$ with AgClO_4 yields the mono- and dinuclear complexes $[\text{Ag}_2\{\mu\text{-}(\text{SPPh}_2)_2\text{C}=\text{CH}_2\}_2](\text{ClO}_4)_2$ and $[\text{Ag}\{(\text{SPPh}_2)_2\text{C}=\text{CH}_2\}_2]\text{ClO}_4$, respectively.¹²⁷¹

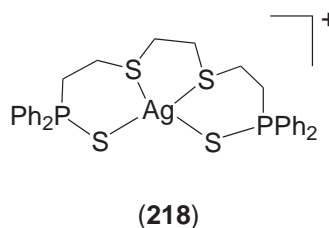
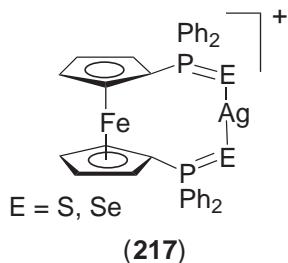
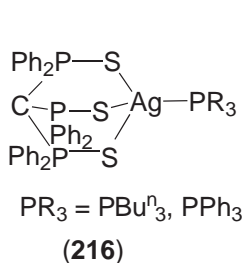

The coordination modes of the ambident thiocyanate ligand in their metal complexes exhibit a considerable diversity. The double salts $\text{AgSCN} \cdot 2\text{AgNO}_3$ (219) and $\text{AgSCN} \cdot \text{AgClO}_4$ feature an unprecedented $\mu_5\text{-}1,2,3\kappa\text{S}:4,5\kappa\text{N}$ coordination mode of the thiocyanate ligand, which generates a 2D or 3D network.¹²⁷² Similar results are obtained with the AgSeCN .¹²⁷³

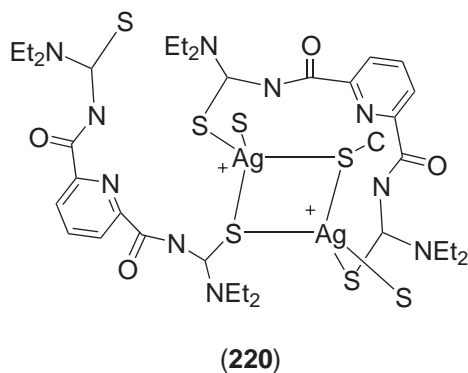
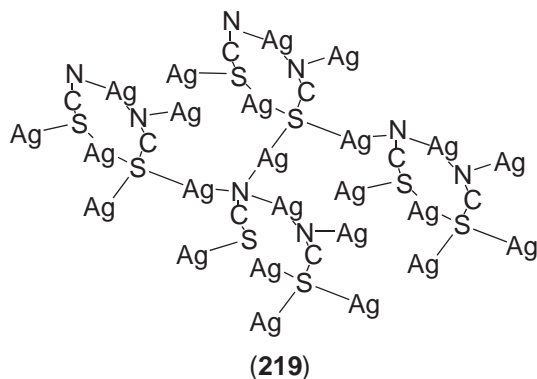

Several crystal structures with thiocyanate as ligands have been reported, such as $[\text{Ag}(\text{SCN})(\text{Etu})_2]$ ($\text{Etu} = \text{ethylthiourea}$),¹²⁷⁴ $[\text{Ag}(\text{SCN})(2,6\text{-Me}_2\text{Py})]$,⁶¹⁶ $\beta\text{-AgSCN}$,¹²⁷⁵ $[\{\text{Ag}_2(\text{SCN})_4\}\text{C}_{18}\text{H}_{36}\text{N}_4]$ ($\text{C}_{18}\text{H}_{36}\text{N}_4 = 5,7,7,12,14,14\text{-hexamethyl-}1,4,8,11\text{-tetrazatricyclo}[9.3.1.1]\text{hexadecane}$),¹²⁷⁶ $\text{Cs}_3\text{M}[\text{Ag}_2(\text{SCN})_7]$ ($\text{M} = \text{Ba}, \text{Sr}$),¹²⁷⁷ $\text{Cs}_2[\text{AgZn}(\text{SCN})_5]$,¹²⁷⁸ $\text{CaCs}_2[\text{Ag}_2(\text{SCN})_6]$,¹²⁷⁹ $[\text{Cd}(\text{en})_{1.5}\text{Ag}(\text{SCN})_3]$,¹²⁸⁰ and $\text{Q}_4[\text{Ag}_2\text{Fe}_2(\text{SCN})_{12}]$ ($\text{Q} = \text{NBu}_4, \text{NEt}_4$).¹²⁸¹ The coordination of silver(I) by thiocyanate, cyanide, and iodide in molten KSCN , KSCN-KCN , and KSCN-KI mixtures have been described.¹²⁸²

Silver(I) complexes with tu, selenourea, or some of their derivatives have been reported. The formation of Ag^+ complexes with tus and N -substituted tus has been studied in EtOH , and the determined thermodynamic parameters for AgL^+ , AgL^{2+} , and AgL^{3+} were compared to those of methanol.¹²⁸³ An N,N' -disubstituted tu has been proposed as a spectrophotometric reagent for Ag^+ determination.¹²⁸⁴ Complexes of the type $[\text{AgXL}(\text{PPh}_3)_2]$ ($\text{X} = \text{Cl}, \text{Br}$; $\text{L} = \text{tus}$, aminothiourea, dithioamide) have been synthesized.¹²⁸⁵ The synthesis and crystal structures of a family of silver cyanide complexes of thioureas (tus) and substituted tus are reported, they are of the type $(\text{AgCN})(\text{tu})$, $(\text{AgCN})(\text{tu})_2$, $(\text{AgCN})_2(\text{Etu})_2$, etc. All the structures involve either 1D or 2D polymeric arrays held together by bridging S and CN groups.¹²⁸⁶ An helical polymeric chain, $[\text{Ag}_2(\text{tepytu})_3 \cdot (\text{ClO}_4)_2]_n$ (220) ($\text{tepytu} = N,N',N'',N'''\text{-tetraethyl-}N,N'\text{-pyridine-}2,6\text{-dicarbonyl-bis}(\text{tus})$), has been obtained.¹²⁸⁷

Selenourea silver(I) derivatives such as $[\text{Ag}_2\{\mu\text{-SeC}(\text{NH}_2)_2\}_2\{\text{SeC}(\text{NH}_2)_2\}_4]\text{Cl}_2$ (**221**),¹²⁸⁸ $[\text{Ag}(\text{NO}_3)\{\text{SeC}(\text{NH}_2)_2\}]$, and $[\text{Ag}(\text{NO}_3)\{\text{SeC}(\text{NH}_2)_2\}_2]$ have been prepared.¹²⁸⁹ The crystal structures of $[\text{AgI}(\text{Et}_2\text{tu})]$,¹²⁹⁰ $[\text{Ag}(\text{Me}_2\text{tu})_n]\text{ClO}_4$ ($n = 2, 3$),¹²⁹¹ $[\text{Ag}(\text{Et}_2\text{btu})_4]$ ($\text{Et}_2\text{btu} = 1,1\text{-diethyl},3\text{-benzoyl-tu}$),¹²⁹² $[\text{Ag}(\text{SH})(\text{Et}_2\text{btu})]$,¹²⁹³ have been determined.

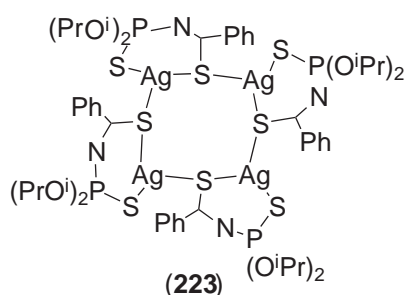
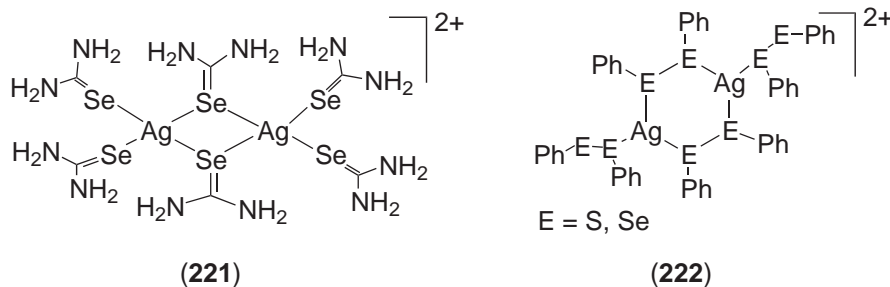

Diphenyldisulfide or diphenyldiselenide react with AgAsF_6 in liquid SO_2 to give $[\text{Ag}_2(\text{Ph}_2\text{E}_2)_4](\text{AsF}_6)_2$ ($\text{E} = \text{S}, \text{Se}$) (**222**).¹²⁹⁴ A dimeric compound has been prepared with the ditelluride, $[\text{Ag}_2\{\text{Te}_2(p\text{-F-C}_6\text{H}_4)\}_2]$.¹¹⁶⁹

Some complexes with thiosemicarbazide $\text{SC}(\text{NH}_2)\text{NHNH}_2$ (tsc) have been prepared, such as $[\text{AgI}(\text{tsc})_2]$,¹²⁹⁵ $[\text{Ag}_2\text{Br}_2(\text{tsc})_3]$,¹²⁹⁵ $\beta\text{-Ag}(\text{Et}_2\text{tsc})$,¹²⁹⁶ $[\text{AgL}_2]^+$ ($\text{L} = 2\text{-methylindole-3-carboxyaldehyde thiosemicarbazone}$).¹²⁹⁷

Other silver compounds with sulfur donor ligands such as fosforiltioamides, $[\text{Ag}_4\{\text{SC}(\text{Ph})\text{NP}(\text{OPr}^i)_2\text{S}\}_4]$ (**223**),¹²⁹⁸ N -(thio)phosphorylated bis(thio)ureas,^{1299,1300} (N,N -diethylthiocarbamoylmethyl)diphenylphosphine sulfide $[\text{Ag}\{\text{Ph}_2\text{P}(\text{S})\text{CH}_2\text{C}(\text{S})\text{NET}_2\}_2]\text{NO}_3$,¹³⁰¹ or N,N' -dimethylthioformamide $[\text{Ag}(\text{SCHNMe}_2)_3]^{2+}$,¹³⁰² have been reported. Stability constants for member of series of silver(I) complexes incorporating DMSO, tus, and thiocyanate ligands have been measured.¹³⁰³

6.7.2.3.6 Complexes with halide and hydride donor ligands

Homoleptic silver(I) halide complexes have been known for a long time, they have various stoichiometries and coordination numbers. $[\text{AgX}_2]^-$ compounds have been reported in complexes such as $[\text{K}(\text{crypt-2,2,2})][\text{AgCl}_2]$,¹³⁰⁴ $\text{Me}_4\text{N}[\text{AgI}_2]$,¹³⁰⁵ and $[\text{Pd}(\text{S}_2\text{CNET}_2)(\text{Ph}_2\text{PCH}_2\text{CH}_2\text{PPh}_2)]-[\text{AgCl}_2]$,¹³⁰⁶ which depending upon the cation are polymeric species or discrete molecules. $[\text{AgX}_3]^{2-}$ have been described in $(\text{PPh}_3\text{Me})_2[\text{AgI}_3]$,^{1307,1308} and $(\text{NH}_4)_2[\text{AgI}_3]$,¹³⁰⁹ which have a trigonal-planar geometry. $[\text{Ag}_2\text{X}_3]^-$ ($\text{X} = \text{Br}, \text{I}$) are polymeric species.¹³⁰⁹ $[\text{Ag}_2\text{X}_4]^{2-}$ (**224**) ($\text{X} = \text{Cl}, \text{Br}, \text{I}$) are dinuclear with a distorted trigonal planar geometry for silver.^{1304,1310-1313} The mixed halide species $(\text{AsPh}_3\text{Me})[\text{Ag}_3\text{I}_3\text{X}]$ ($\text{X} = \text{Cl}, \text{Br}, \text{I}$) have been synthesized and the silver is four-coordinate.¹³¹⁴ Other silver polyhalide anions are $[\text{Ag}_2\text{Cl}_5]^{3-}$,¹³¹¹ $[\text{Ag}_4\text{Br}_8]^{4-}$,¹³⁰⁴ and $[\text{Ag}_4\text{I}_8]^{4-}$,^{1311,1315} which has two different structures (**225**) or (**226**), $[\text{Ag}_4\text{I}_5]^-$,¹³¹⁶ $[\text{Ag}_3\text{I}_5]^{2-}$,¹³¹⁷ and $[\text{Ag}_7\text{I}_{11}]^{4-}$ which has a 1D, twisted double chain,¹³¹⁸ or the polymeric species $[\text{Ag}_5\text{I}_6]^-$,^{1319,1320} $[\text{Ag}_5\text{I}_7]^{2-}$,¹³²¹ and $[\text{Ag}_5\text{Br}_8]^{3-}$.¹³²² The structure of Rb_2AgCl_3 consists of polymeric $[\text{AgCl}_3]^{2-}$ anions composed of corner-sharing slightly distorted AgCl_4 tetrahedra, with Rb^+ ions situated between the chains.¹³²³ An applied theoretical study has been performed on the conformations of

polymetal iodide complexes $[\text{Ag}_m\text{I}]_{m-1}$; they have an overall tendency to prefer bent conformations with short metal–metal separations.¹³²⁴ Electrochemical studies of silver chloro complex formation in low-temperature chloroaluminate melts have been carried out.¹³²⁵ The electronic structure of silver chloride has been probed by use of *ab initio* Hartree–Fock methods. The results support the fact that the bonding in AgCl is strongly (but not exclusively) ionic in nature, and also confirm the importance of correlation effects.¹³²⁶ Photoluminescence has been found in mixed AgCl–AgBr crystals of stoichiometry $\text{AgCl}_{0.45}\text{Br}_{0.55}$.¹³²⁷

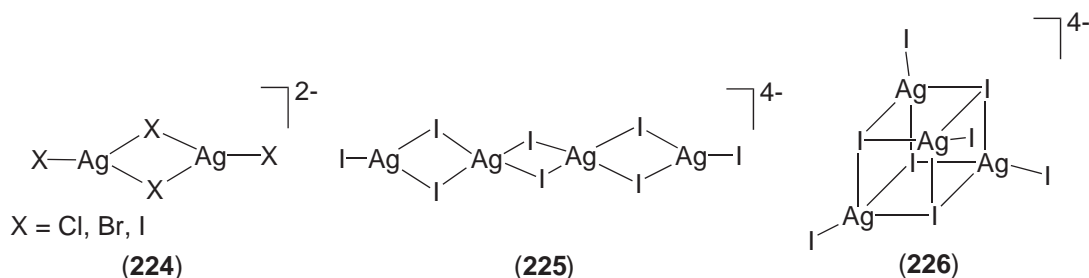

Halocarbons are poor Brönsted bases. Their donor powers as Lewis bases to metal ions are usually regarded as weak. Recently several silver(I) and other metal complexes with halocarbons, even with those as CH_2Cl_2 which is considered as noncoordinating ligand in Gutmann's classic study of solvent donor numbers, have been described.^{1328,1329} The compound AgOTeF_5 is extraordinarily soluble in dichloromethane and 1,2-dichloroethane, the OTeF_5^- oxyanion renders metal ions in MX_m compounds very electron poor and open to coordination by extremely weak donors.⁹³² Thus from saturated chlorocarbon solutions of AgOTeF_5 or in the presence of PdCl_2 the complexes $[\text{Ag}(\text{OTeF}_5)(\text{CH}_2\text{Cl}_2)]_2$ $[\text{Ag}(\text{OTeF}_5)(1,2\text{-C}_2\text{H}_4\text{Cl}_2)]_2$ (**227**), $[\text{Ag}_2(\text{CH}_2\text{Cl}_2)_4\text{Pd}(\text{OTeF}_5)_4]$ (**228**), and $[\text{Ag}_2(1,2\text{-C}_2\text{H}_4\text{Cl}_2)_4\text{Pd}(\text{OTeF}_5)_4]$, have been isolated.^{27,28,1330} With larger and more weakly coordinating anions as $\text{Ti}(\text{OTeF}_5)_6^{2-}$, $\text{Nb}(\text{OTeF}_5)_6^-$, or $\text{Sb}(\text{OTeF}_5)_6^-$ other complexes have been obtained, such as $[\text{Ag}(\text{CH}_2\text{Cl}_2)_3]_2[\text{Ti}(\text{OTeF}_5)_6]$, $[\text{Ag}(\text{CH}_2\text{Br}_2)_3][\text{Nb}(\text{OTeF}_5)_6]$, and $[\text{Ag}(1,2\text{-C}_2\text{H}_4\text{Br}_2)_3][\text{Sb}(\text{OTeF}_5)_6]$.^{1331,1332} The silver salts with the weakly coordinating anions polyfluoroalkoxyaluminates $\text{AgAl}(\text{OR}_F)_4$ also form complexes with the weakly basic solvents CH_2Cl_2 or $1,2\text{-C}_2\text{H}_4\text{Cl}_2$, of the type $[\text{Ag}(\text{C}_2\text{H}_4\text{Cl}_2)_2\text{Al}\{\text{OCH}(\text{CF}_3)_2\}_4]$ (**229**), $[\text{Ag}(\text{CH}_2\text{Cl}_2)\text{Al}\{\text{OC}(\text{Me})(\text{CF}_3)_2\}_4]$, $[\text{Ag}(\text{CH}_2\text{Cl}_2)\text{Al}\{\text{OC}(\text{CF}_3)_3\}_4]$, and $[\text{Ag}(\text{C}_2\text{H}_4\text{Cl}_2)\text{Al}\{\text{OC}(\text{CF}_3)_3\}_4]$.¹³³³

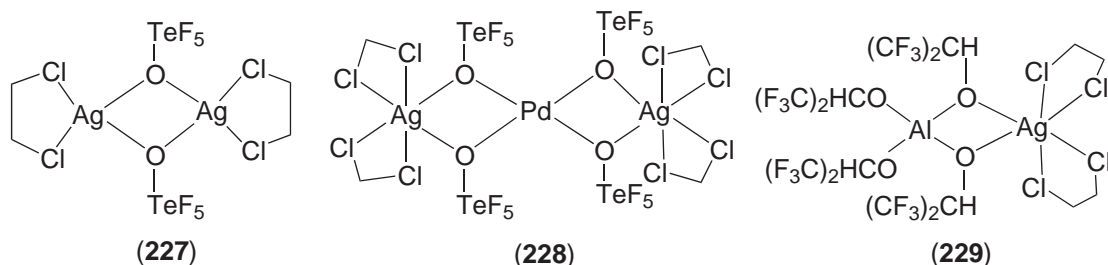

Compounds containing iodocarbon–silver(I) bonds have long been suspected as intermediates in the reactions of the alkyl iodides with the silver salts, but only recently complexes have been isolated. The reaction of AgPF_6 or AgNO_3 with diiodomethane, 1,3-diiodopropane, and aryl iodides has been studied and four-coordinate complexes such as $[\text{Ag}\{\text{I}(\text{CH}_2)_3\text{I}\}]_2\text{PF}_6$ (**230**), $[\text{Ag}(\text{ICH}_2)_2]\text{PF}_6$, $[\text{Ag}(1,2\text{-I}_2\text{C}_6\text{H}_4)_3]\text{PF}_6$ (**231**), and $[\text{Ag}(1,2\text{-BrIC}_6\text{H}_4)_4]\text{PF}_6$ prepared.^{1334,1335} These reactions have been carried out in organic media using ethylene to help solubilize silver salts but they have also been carried out in aqueous solutions, where adducts of the type $\text{AgNO}_3 \cdot \text{C}_n\text{H}_x\text{I}_y$ are obtained; if the silver concentration is high, the inverse compounds $[\text{Ag}_3\text{I}]\text{NO}_3$ are also synthesized.¹³³⁶ Silver(I) iodide complexes with carboxylate ligands have been reported, such as $[\text{Ag}_2(\text{O}_2\text{CCF}_3)_2(\text{RI}_2)_2]_n$ ($\text{R} = \text{CH}_2, \text{C}_6\text{H}_4$ (**232**)), $[\text{Ag}_2(\text{O}_2\text{CCF}_3)(\text{IC}_6\text{H}_5)]_n$, $[\text{Ag}_4(\text{O}_2\text{CCF}_3)_4(\text{H}_2\text{O})_2(p\text{-IC}_6\text{H}_4\text{Me})_2]_n$, $[\text{Ag}_2(\text{O}_2\text{CCl}_3)_2(\text{HO}_2\text{CCl}_3)_2(1,2\text{-I}_2\text{C}_6\text{H}_4)]_n$, $[\text{Ag}_2(\text{O}_2\text{CCl}_3)_2(\text{HO}_2\text{CCl}_3)(\text{IC}_6\text{H}_5)]_n$, or $[\text{Ag}_4(\text{hfac})_4(p\text{-IC}_6\text{H}_4\text{Me})_2]$.^{1337,1338} Most of them are polymeric species with dinuclear silver carboxylate units bridged iodocarbon ligands.

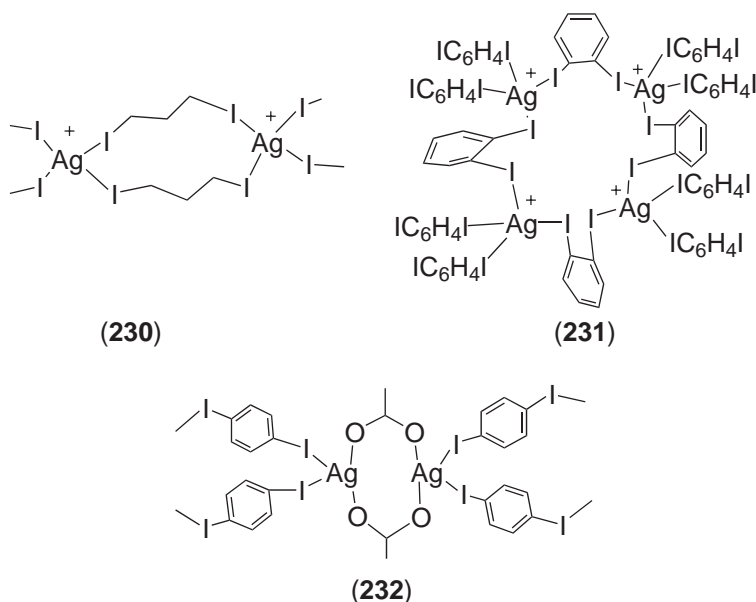

The reaction of AgClO_4 with tetraidoethylene in benzene or toluene yields the complexes $[\text{Ag}(\text{ClO}_4)(\text{C}_2\text{I}_4)(\text{C}_6\text{H}_5)_2]$ or $[\text{Ag}(\text{ClO}_4)(\text{C}_2\text{I}_4)]$, the latter has a 2D framework and in both, the iodo-carbon coordinates via σ -donation of a halogen lone pair.¹³³⁹ Silver polymers with iodine–silver interactions are also obtained in the reaction of silver acetate with triiodobenzoic acid, tris(4-iodophenyl)amine, and 5,7-diiodo-8-hydroxyquinoline.¹³⁴⁰

Other silver–halogen complexes are the heterometallic species. An unusual seven-coordination has been observed in the structure of $\text{AgMnF}_4 \cdot 4\text{H}_2\text{O}$ (233).¹³⁴¹ The reaction of *trans*- $[\text{PtX}_2(\text{C}_6\text{F}_5)\text{L}]^-$ and Ag^+ affords polymeric $[\text{PtAgX}_2(\text{C}_6\text{F}_5)\text{L}]_n$ ($\text{X} = \text{Cl}$, $\text{L} = \text{PPh}_3$, THT, *p*- $\text{MeC}_6\text{H}_4\text{NH}_2$, Py; $\text{X} = \text{Br}$, $\text{L} = \text{PPh}_3$). The structure consists of a polymeric chain with the silver atoms bridging between chlorine ligands and with a short distance $\text{Ag}—\text{Pt}$ of 2.855(2) Å. Addition of PPh_3 breaks the $\text{Ag}—\text{Cl}$ bonds of the chain and forms the dinuclear $[\text{PtAg}(\text{C}_6\text{F}_5)\text{Cl}(\mu\text{-Cl})(\text{PPh}_3)_2]$, containing a longer $\text{Pt}—\text{Ag}$ distance of 2.945(1) Å (234).¹³⁴² The reaction of $[\text{Ag}(\text{ClO}_4)(\text{PPh}_3)]$ with *trans*- $[\text{PtBr}_2(\text{C}_6\text{Cl}_5)(\text{PPh}_3)]^-$ yields the dimeric complex $[(\text{Ph}_3\text{P})(\text{C}_6\text{Cl}_5)\text{BrPt}(\mu\text{-Br})\text{Ag}(\text{PPh}_3)]_2$, in which the $\text{Pt} \cdots \text{Ag}$ interaction is supported by a bromine bridging ligand.¹³⁴³ Halogen-bridging silver–palladium derivatives, such as $[(\text{tmda})(p\text{-tolyl})\text{Pd}(\mu\text{-I})\text{AgL}]$ ($\text{tmda} = N,N,N',N'$ -tetramethylenediamine; $\text{L} = [\text{CpCo}\{\text{P}(\text{OR})_2\text{O}\}_3]^-$; $\text{R} = \text{Me}$, Pr^i) have been described.¹³⁴⁴ Halide abstraction by silver salts is a widely used reaction but sometimes the intermediate species have been isolated, as in the reaction of $[\text{PtClMe}(\text{N}—\text{N})]$ with AgBF_4 which gives the compound $[\text{Me}(\text{N}—\text{N})\text{Pt}(\mu\text{-Cl})\text{Ag}(\mu\text{-Cl})\text{Pt}(\text{N}—\text{N})\text{Me}]\text{BF}_4$ (235),¹³⁴⁵ or in the reaction of *trans*- $[\text{RuCl}_2(\text{PP})_2]$ with silver salts which gives mixtures of $\text{Ru}—\text{Cl}—\text{Ag}$ complexes.¹³⁴⁶

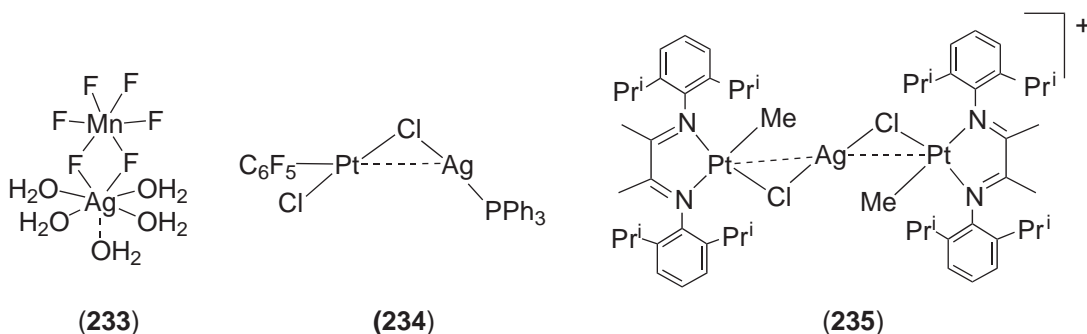

Monoanionic carborane anions based around $[\text{closo-1-CB}_{11}\text{H}_{12}]^-$ are among the most inert and least coordinating anions currently known. The high chemical stability and low nucleophilicity allows the stabilization of cationic species not isolable with other anions. The silver salt of this compound was crystallized as $\text{Ag}(\text{CB}_{11}\text{H}_{12}) \cdot 2\text{C}_6\text{H}_6$ (236), in which the silver is bonded to two

carborane groups via terminal B—H bonds and to one molecule of benzene in a η^1 fashion.¹³⁴⁷ Other silver salts of some of these derivatives such as $\text{Ag}(7,8,9,10,11,12\text{-Br}_6\text{CB}_{11}\text{H}_5)$ or $\text{Ag}(7,8,9,10,11,12\text{-Br}_6\text{CB}_{11}\text{H}_5)_2^-$ (237),¹³⁴⁸⁻¹³⁵⁰ $\text{Ag}(6,7,8,9,10\text{-Br}_5\text{CB}_9\text{H}_5)$ ($\eta^2\text{-C}_7\text{H}_8$),¹³⁵⁰ $\text{Ag}[\text{Co}(1,2\text{-C}_2\text{B}_9\text{H}_{11})_2]$, or $\text{Ag}[\text{Co}(8,9,12\text{-Br}_3\text{-}1,2\text{-C}_2\text{B}_{10}\text{H}_{11})]$,¹³⁵⁰ $\text{Ag}(12\text{-BrB}_{11}\text{H}_{11})$,¹³⁵¹ $\text{Ag}(12\text{-FCB}_{11}\text{H}_{11})(\text{C}_6\text{H}_6)_2$,¹³⁵² $\text{Ag}(6,8\text{-F}_2\text{CB}_9\text{H}_8)(\text{C}_6\text{H}_6)_2$,¹³⁵³ $\text{Ag}(\text{CB}_{11}\text{H}_6\text{X}_6)$ ($\text{X} = \text{Cl}, \text{Br}, \text{I}$),¹³⁵⁴ $\text{Ag}(1\text{-Me-CB}_{11}\text{H}_5\text{X}_6)$ ($\text{X} = \text{H}, \text{Cl}, \text{Br}, \text{I}$),¹³⁵⁵ $\text{Ag}(1\text{-H-CB}_{11}\text{Y}_5\text{X}_6)$ ($\text{X}, \text{Y} = \text{Cl}, \text{Br}, \text{I}$),¹³⁵⁶ have been described.

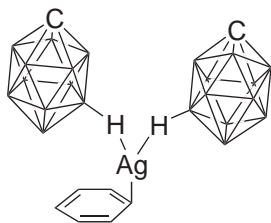

(236)

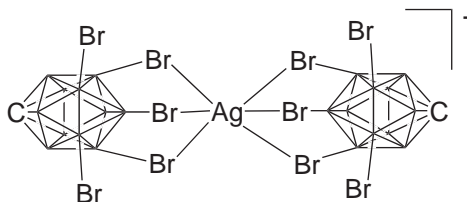

(237)

Halide abstraction reactions with these carborane derivatives gives sometimes intermediate products rather than metathesis, as in the reaction of $\text{Ag}(6,7,8,9,10\text{-Br}_5\text{CB}_9\text{H}_5)(\eta^2\text{-C}_7\text{H}_8)$ with $[\text{IrCl}(\text{CO})(\text{PPh}_3)]$ that yields an Ir—Ag adduct (238),¹³⁵⁰ or the reaction of $[\text{MoCpI}(\text{CO})_3]$ with $\text{Ag}(\text{CB}_{11}\text{H}_{12})$ which gives (239).^{1357,1358}

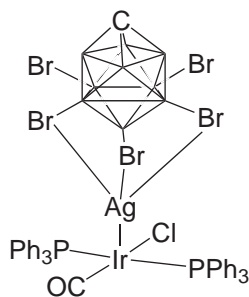

(238)

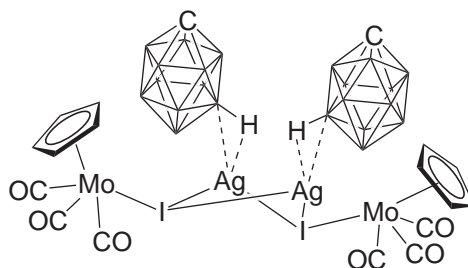

(239)

Silver phosphine or stibine complexes with carborane anions have also been isolated and are of the type $[\text{Ag}(\text{C}_2\text{B}_8\text{H}_{11})(\text{PPh}_3)_2]$,¹³⁵⁹ $[\text{Ag}(\text{CB}_{11}\text{H}_{12})(\text{PPh}_3)]$ (240),¹³⁶⁰ $[\text{Ag}(\text{CB}_{11}\text{H}_{12})(\text{PPh}_3)_2]$,¹³⁶⁰ $[\text{Ag}(\text{CB}_{11}\text{H}_6\text{Br}_6)(\text{PPh}_3)_n]$ ($n = 1, 2$),¹³⁶⁰ or $[9,9'\text{-}\{\text{Ag}(\text{SbPh}_3)_2\}_2\text{-}4,9,4',9'\text{-}(\mu\text{-H})_4\text{-}7,8,7',8'\text{-nido-C}_2\text{B}_9\text{H}_{10}]_2$.¹³⁶¹ The reaction of $\text{Cs}[\text{Re}(\text{CO})_3(\eta^5\text{-}7,8\text{-C}_2\text{B}_9\text{H}_{11})]$ with AgBF_4 in the presence of ligands such as PPh_3 , dppe, tris(pyrazol-1-yl)methanes, amines, di-, and terpyridyls, affords the silver complexes of the type $[\text{ReAg}(\mu\text{-}10\text{-H-}\eta^5\text{-}7,8\text{-C}_2\text{B}_9\text{H}_{10})(\text{CO})_3(\text{PPh}_3)]$ (241) or $[\{\text{ReAg}(\mu\text{-}10\text{-H-}\eta^5\text{-}7,8\text{-C}_2\text{B}_9\text{H}_{10})(\text{CO})_3\}_2(\mu\text{-L-L})]$ which have B—H—Ag bonds.^{1362,1363} In a similar manner the compound $[2,2,2\text{-}(\text{CO})_3\text{-}2\text{-PPh}_3\text{-}7,12\text{-}\{\text{Ag}(\text{PPh}_3)\}\text{-}closo\text{-}2,1\text{-MoCB}_{10}\text{H}_9]$ (242) has been obtained.¹³⁶⁴

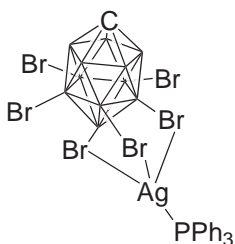

(240)

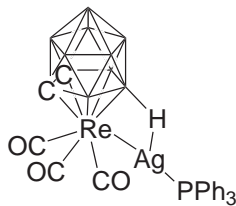

(241)

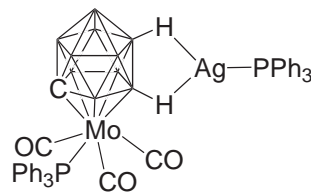

(242)

Polynuclear complexes associated with transition metal polyhydrides and silver cations have been described; those which present silver—metal bonds are more numerous and they will be

discussed in Section 6.7.2.3.6(i). The reaction of $[\text{Nb}(\text{C}_5\text{H}_3\text{R}^1\text{R}^2)_2\text{H}_3]$ with AgBF_4 gives the adducts $[\{\text{Nb}(\text{C}_5\text{H}_3\text{R}^1\text{R}^2)_2\text{H}_3\}_2\text{Ag}]^+$ (**243**) ($\text{R}^1 = \text{H}$, TMS; $\text{R}^2 = \text{TMS}$) in which the silver binds to two hydrides of each niobium center.¹³⁶⁵ Treatment of $[\text{MoCpH}(\text{CO})_2(\text{PMe}_3)]$ with AgBF_4 in THF or acetonitrile leads adducts with bridging hydride bonds such as $[\{\text{MoCp}(\mu\text{-H})(\text{CO})_2(\text{PMe}_3)\}_2\text{Ag}]\text{BF}_4$ $[\text{MoAgCp}(\mu\text{-H})(\text{CO})_2(\text{PMe}_3)(\text{MeCN})_n]$.¹³⁶⁶ The complexes $[\text{Ag}(\text{MCp}_2\text{H}_2)_2]\text{X}$ (**244**) ($\text{M} = \text{W}$, $\text{X} = \text{BF}_4$; $\text{M} = \text{Mo}$, $\text{X} = \text{PF}_6$) and $[\text{MoCp}_2(\mu_2\text{-H})\text{Ag}(\mu_2\text{-H})\text{WCp}_2]$ have been prepared by reaction of $[\text{MCp}_2\text{H}_2]$ with the silver salts.¹³⁶⁷⁻¹³⁶⁹ Also the reactivity with silver(I) halides have been carried out and the compounds $[\text{Ag}(\text{MoCp}_2\text{H}_2)_2\text{Cl}]$, $[\text{Ag}_3(\text{MoCp}_2\text{H}_2)_3\text{X}_3]$ (**245**) ($\text{X} = \text{Br}$, I), and $[\text{Ag}_3(\text{MoCp}_2\text{H}_2)_4\text{Br}_2]\text{PF}_6$ ¹³⁶⁸ have been prepared.

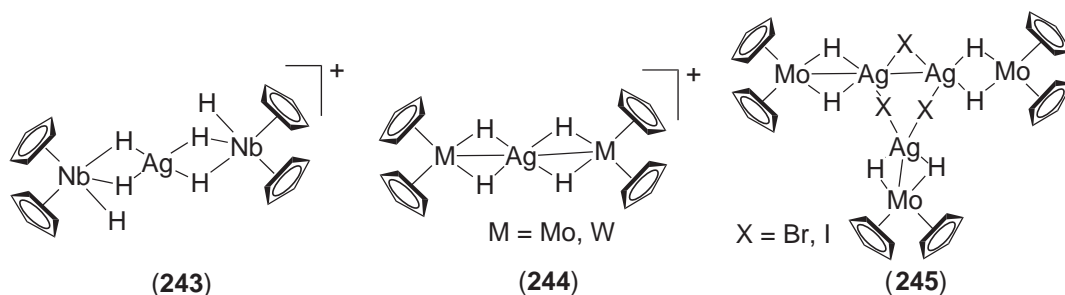

6.7.2.3.7 Complexes with mixed donor ligands

Mixed donor ligands have attracted a great deal of interest mainly because of the possibility of combining soft and hard Lewis bases. This is the case of the *P,N*-donor ligands, mainly pyridyl phosphine ligands. Silver complexes with diphenyl(2-pyridyl)phosphine acting as mixed donor ligand have been prepared and are of the type $[\text{Ag}_2\text{Cl}_2(\text{PPh}_2\text{Py})_3]$ (**246**),¹³⁷⁰ $[\text{Ag}_2(\text{NO}_3)_2(\text{PPh}_2\text{Py})_2]$,¹³⁷¹ or $[\text{Ag}_2(\text{PPh}_2\text{Py})_n]^{2+}$ ($n = 2, 3$).^{1372,1373} The latter complexes are dinuclear with two *P,N* bridging ligands and for $n = 3$ the third ligand is coordinate to one silver atom through the phosphorus. The thermodynamic parameters for the Ag^{I} complexation with PPh_2Py in DMSO and propylene carbonate have been determined, showing that the mononuclear species are *P*-coordinated and in the dinuclear the ligand is bridging the silver atoms.¹³⁷⁴ Similar studies have been carried out with other *P,N*-ligands.¹³⁷⁵ The dinuclear compound $[\text{Ag}_2(\text{PPh}_2\text{CH}_2\text{CH}_2\text{Py})_2](\text{PF}_6)_2$,¹³⁷⁶ and the mononuclear four-coordinate $[\text{Ag}(\text{PPh}_2\text{CH}_2\text{CH}_2\text{Py})_2]^+$ have been prepared. The latter reacts with more phosphine to give $[\text{AgL}_3]^+$ and $[\text{AgL}_4]^+$ species.¹³⁷⁷ Dinuclear silver complexes with the ligand (Bzim) Ph_2P (Bzim = 1-benzyl-2-imidazolylidiphosphine), $[\text{Ag}_2\{\text{PPh}_2(\text{Bzim})\}_2]^{2+}$ (**247**), have been obtained.^{1378,1379} With the methyl-substituted derivative a polymeric compound $[\text{Ag}_2(\text{NO}_3)\{\text{PPh}_2(\text{Meim})\}_2]_n(\text{NO}_3)_n$ has been achieved.¹³⁸⁰ A dinuclear compound has been described with the 2-[bis(diisopropylphosphino)methyl]-1-methyl imidazole, $\text{MeimCH}(\text{P}^i\text{r}_2)_2$, in which the ligand is *P,P,N* bonded.¹³⁸¹ The ligand 3,6-bis(diphenylphosphino)pyridazine self-assembles with Ag^+ cations to form the polymeric chain $[\text{Ag}_2(\mu\text{-PPh}_2\text{C}_4\text{H}_2\text{N}_2\text{PPh}_2)(\text{MeCN})_2]_n(\text{ClO}_4)_{2n}$ (**248**).⁷⁸⁴

The polydentate ligands 2-(diphenylphosphino)-6-[3-(2'-pyridyl)pyrazol-1-yl]pyridine and 2-(diphenylphosphino)-6-(pyrazol-1-yl)pyridine react with $[\text{Ag}(\text{NCMe})_4]\text{ClO}_4$ to give the dinuclear complexes where the ligands are *P,N,N* bonded as in (**249**).¹³⁸² The reaction of two equivalents of AgBF_4 with 6,6-bis(diphenylphosphino)-2,2'-bipyridyl ($\text{P}_2\text{-bipy}$) gives the complex $[\text{Ag}_4(\text{P}_2\text{-bipy})_2](\text{BF}_4)_4$. Addition of Br^- or I^- leads to complexes $[\text{Ag}_4\text{X}_2(\text{P}_2\text{-bipy})_2](\text{BF}_4)_2$ which are in equilibrium between two species with a $\mu_2\text{-X}$ or a $\mu_3\text{-X}$ (**250**) ligand; these complexes add further solvent molecules. All of them have photoluminescent properties that can be attributed to structural rearrangements associated with ligand coordination.¹³⁸³ A trinuclear compound $[\text{Ag}_3(\mu\text{-P}_2\text{-bipy})_3](\text{PF}_6)_3$ has also been synthesized.¹³⁸⁴ The ligands $\text{Ph}_2\text{PCH}_2\text{N}(\text{R})\text{Py}$ ($\text{R} = \text{H}$, Cy) give silver complexes with different coordination modes such as $[\text{Ag}(\mu\text{-PPh}_2\text{CH}_2\text{NHPy})(\text{NCMe})_n(\text{ClO}_4)_n]$, $[\text{Ag}(\text{PPh}_2\text{CH}_2\text{NHPy})_2(2\text{-PyNH}_2)]\text{ClO}_4$, $[\text{Ag}\{\text{PPh}_2\text{CH}_2\text{N}(\text{Cy})\text{Py}\}_2]\text{ClO}_4$, or $[\text{Ag}_2\{\mu\text{-PPh}_2\text{CH}_2\text{N}(\text{Cy})\text{Py}\}_2](\text{ClO}_4)_2$ (**251**).¹³⁸⁵ A similar ligand 1-[(diphenylphosphino)methyl]-4-(2-pyridyl)piperazine gives also a dinuclear *P,N* silver(I) complex.¹³⁸⁶

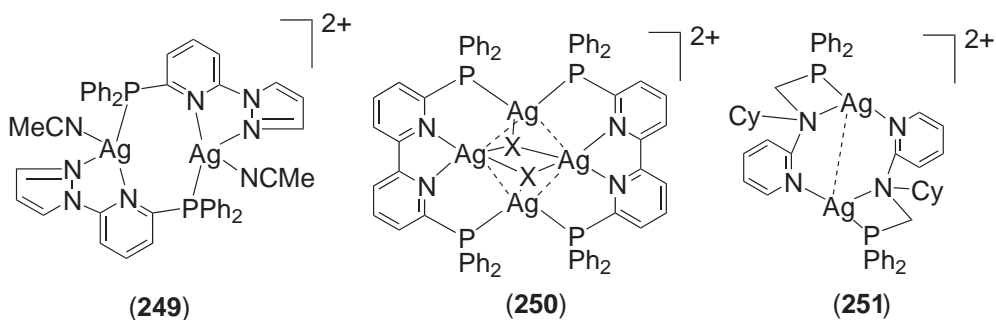
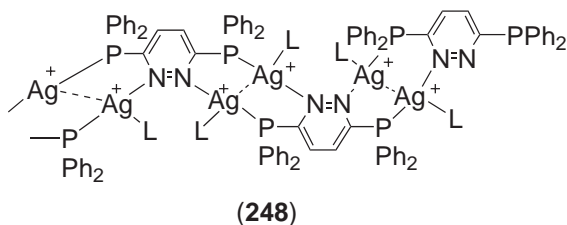
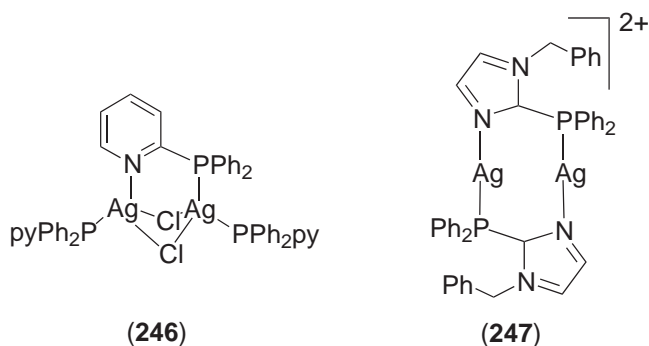

A series of bidentate PN and tetradentate P_2N_2 aminophosphine ligands form stable silver(I) complexes characterized by NMR spectroscopy and (252) by XRD.^{1387,1388} $P(C_6H_4NMe_2-2)_3$ yields on treatment with AgX ($X = Cl, Br, O_2CCF_3$) the monomeric T-shaped planar silver(I) complexes (253).^{1389,1390} The reaction of $[Ag(OTf)\{P(C_6H_4NMe_2-2)_3\}]$ with 4,4-bipyridine leads to the displacement of the triflate ligand; further reaction with $[Cu\{P(C_6H_4NMe_2-2)_3\}]PF_6$ gives the bimetallic compound $[AgCu(4,4-bipy)\{P(C_6H_4NMe_2-2)_3\}_2](OTf)(PF_6)$ (254).¹³⁹¹

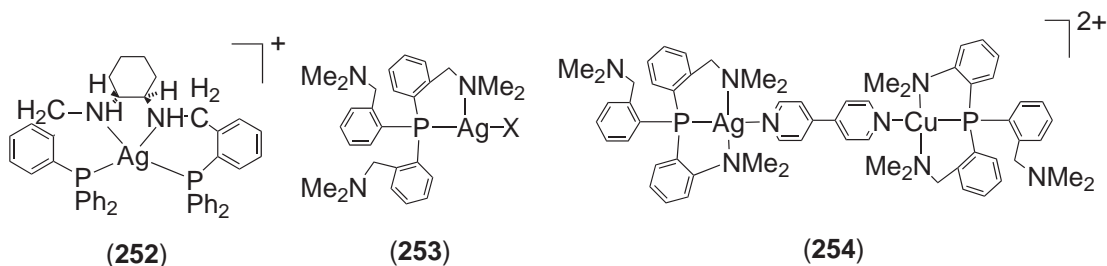

Treatment of $AgOTf$, $N(CH_2CH_2NH_2)_3$, and $2-Ph_2PC_6H_4(CHO)$ lead to the template synthesis of a trinuclear complex with a heptadentate ligand $[Ag_3\{(2-Ph_2PC_6H_4)CH=NCH_2CH_2N\}_2](OTf)_3$; the silver centers are penta P,P,N,N,N or tetra P,P,N,N coordinated.¹³⁹² The platinum or iron derivatives with the 2,6-bis(diphenylphosphino)pyridine ligand act as a host and encapsulate silver atoms to form the complexes $[PtAg_2Me_2(\mu-PPh_2PyPPh_2)_2(CNMe)_2](BF_4)_2$ or $[FeAg_2(CO)_3(\mu-PPh_2PyPPh_2)_2(OEt)_2](ClO_4)_2$ (255), both containing metal-metal dative $Pt \rightarrow Ag$ or $Fe \rightarrow Ag$ bonds which are stabilized by argentophilic interaction.¹³⁹³ The trinuclear complex with 2,7-bis(diphenylphosphino)-1,8-naphthyridine ligand

(256) shows a intraligand emission with lifetime of 5 μ s on excitation at 330–370 nm in acetonitrile at room temperature.¹³⁹⁴

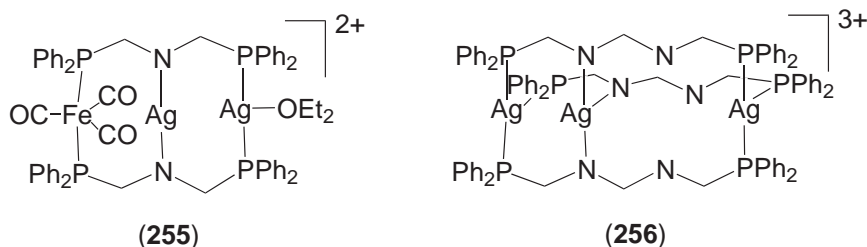

Silver complexes with *P,S* mixed donor ligands have been obtained, such as $[\text{Ag}\{\text{PPh}_2(\text{CH}_2)_2\text{SEt}\}_2]\text{ClO}_4$ ¹³⁹⁵ or $[\text{Ag}_2\{\text{PPh}_2\text{CH}_2\text{SPh}\}_2](\text{ClO}_4)_2$ (257).¹³⁹⁶ The $[\text{AgL}_n]^+$ complex formation for $\text{L} = \text{Ph}_2\text{PCH}_2\text{SPh}$, $\text{Ph}_2\text{P}(\text{CH}_2)_2\text{SR}$ ($\text{R} = \text{Me}$, Et , Ph) has been studied in propylene carbonate, and shows that $\text{Ph}_2\text{PCH}_2\text{SPh}$ behaves as a monodentate *P*-donor but $\text{Ph}_2\text{P}(\text{CH}_2)_2\text{SR}$ acts as bidentate *P,S* chelates. The structure of $[\text{Ag}_2\{\mu\text{-PPh}_2(\text{CH}_2)_2\text{SEt}\}_2](\text{ClO}_4)_2$ consists of co-crystallized open-chain and dimeric forms of the complex.¹³⁹⁷ The $[\text{AgL}]\text{BF}_4$ complex where $\text{L} = \text{PhP}(\text{CH}_2)_2\text{S}(\text{CH}_2)_2\text{PPh}_2$ has been studied by MS, IR, and NMR spectroscopies. The ³¹P NMR spectra suggest a static behavior of the phosphines, but fast exchange of the thioether atoms.¹³⁹⁸ Silver complexes of the anionic forms of 2-(diphenylphosphino)benzenethiol $[2\text{-}(\text{Ph}_2\text{P})\text{C}_6\text{H}_4\text{SH}]$ and 2-(diphenylphosphino)-6-(trimethylsilyl)benzenethiol $[2\text{-}(\text{Ph}_2\text{P})\text{-6-(TMS)}\text{C}_6\text{H}_3\text{SH}]$ have been prepared and are tetrameric (258).¹³⁹⁹ $[\text{SnR}_2(\text{SC}_6\text{H}_4\text{PPh}_2)_2]$ ($\text{R} = \text{Me}$, Et) reacts with $[\text{Ag}(\text{OTf})(\text{PR}_3)]$ ($\text{PR}_3 = \text{PPh}_3$, PPh_2Me) to afford the mixed-complexes $[\text{AgSn}(\mu\text{-SC}_6\text{H}_4\text{PPh}_2)_2\text{R}_2(\text{PR}_3)]\text{OTf}$ (259).¹⁴⁰⁰ Other complexes as (260),¹¹⁸³ the hexanuclear $[\text{Ag}(2\text{-PPh}_2\text{C}_6\text{H}_4\text{CO}_2)]_6$ with *P,O*-,¹⁴⁰¹ $[\text{Ag}_2\{\text{PPh}_2(\text{CH}_2)_n\text{PPh}_2\text{S}\}_2](\text{NO}_3)_2$ with *P,S*-,¹⁴⁰² and $[\text{Ag}(\text{PPh}_2\text{CH}_2\text{PPh}_2\text{Se})_2]\text{Cl}$ with *P,Se*-mixed donor¹⁴⁰³ ligands, have also been reported.

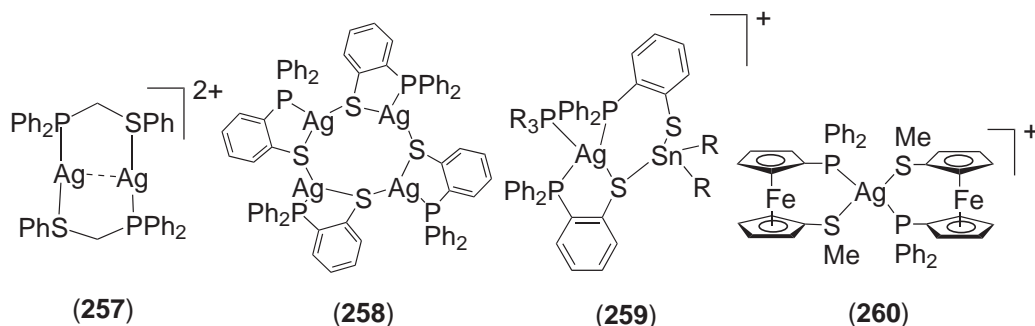

The most thoroughly studied mixed *S,N*-ligand is pyridine-2-thiolate because of its versatile coordination modes. The compound $[\text{Ag}(\text{SPy})]_n$ has a graphite-like array of silver(I) ions and has a semiconductor behavior. The PyS^- ligand acts as a $\mu_3\text{-N,S,S}$ bridge. $[\text{Ag}_5(\text{SPy})(\text{HSPy})\text{BF}_4]_n$ has a layered structure with the coordination modes of PyS^- showed in Figure 14.¹⁴⁰⁴

Depending upon temperature reaction and solvent used other polymeric species such as $[\text{Ag}_6(\mu_3\text{-SPy})_4(\mu_4\text{-SPy})_2]_n$ and $[\text{Ag}(\mu_2\text{-}(\text{HSPy})\text{Cl})]_n$ have been obtained.¹⁴⁰⁵ A related polymeric compound $[\text{Ag}_6(\mu_3\text{-SC}_4\text{N}_2\text{H}_3)_4(\mu_2\text{-SC}_4\text{N}_2\text{H}_3)_2]_n$ has been prepared from the assembly reaction of AgSCN and sodium pyrimidine-2-thiolate.¹⁴⁰⁶ The $[\text{Ag}(\text{ER})]_6$ ($\text{E} = \text{SiSe}$) complexes have been obtained with the sterically hindered $\text{RMe}_2\text{SiPyS}^-$, $(\text{RMe}_2\text{Si})_2\text{PyS}^-$, or 6-TMSPySe⁻ ligands. Electrochemical oxidation of anodic silver in acetonitrile solution of the RSH or RSeH

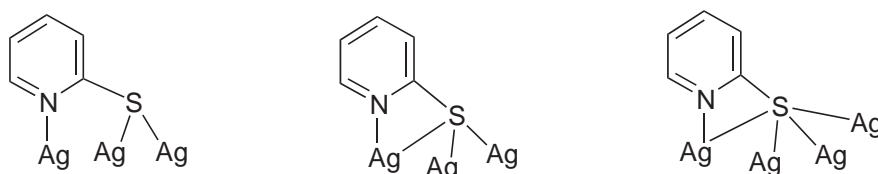
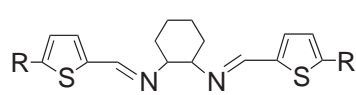

Figure 14 Coordination modes of pyridine-2-thiolate in $[\text{Ag}_5(\text{SPy})(\text{HSPy})\text{BF}_4]_n$.

compounds is another method to obtain these complexes.^{1407–1411} The reaction of PySH with Ag₂O has been reported to give [Ag₂(SPy)₂]. The ligands PySMe or PySCH₂COPh yields the dinuclear [Ag₂(PySMe)₂](ClO₄)₂ or the trinuclear [Ag₃(ClO₄)₃(μ₃-PySCH₂COPh)(PPh₃)₃].^{1185,1412} The tetranuclear butterfly clusters of Ag^I and the mixed Ag^I–Cu^I of the type [Ag₂M₂(mt)₄(PPh₃)₂] (M = Ag, Cu) have been obtained by reaction of the metal acetates with 2-mercaptothiazoline (Hmt) in the presence triphenylphosphine.¹⁴¹³

Several ligands containing pyridine or related groups and sulfur atoms have been synthesized and the silver complexes studied; the ligands used are shown in Figure 15. Many of the complexes have a supramolecular structure.

Silver(I) complexes with mixed donor *S,O*-ligands have been described with 1-hydroxypyridine-2-thione (**261**),^{1437,1438} *cyclo-L*-methionylglycine,¹⁴³⁹ acyclic polyethers (**262**),^{1440–1442} dithio- and trithio-oxalate,¹⁴⁴³ or chlorosulfate.¹⁴⁴⁴



Ref. 1414

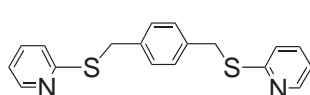

Ref. 1415

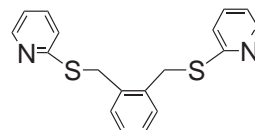

Ref. 1415

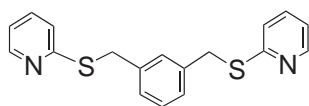

Ref. 1415

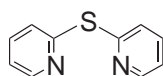

Ref. 1416

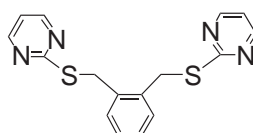

Ref. 1417

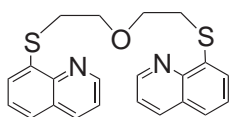

Ref. 1418,1419

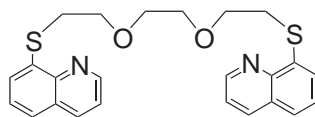

Ref. 1418

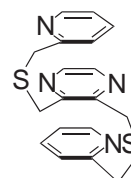

Ref. 1420

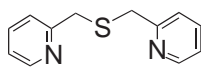

Ref. 1421

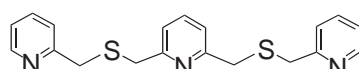

Ref. 1421

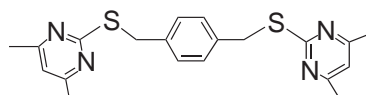

Ref. 1422

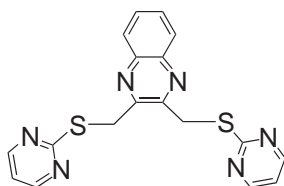

Ref. 1422

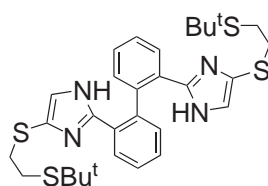

Ref. 1423

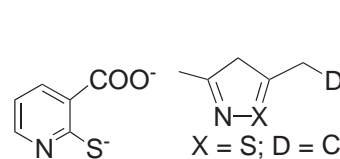

Ref. 1424

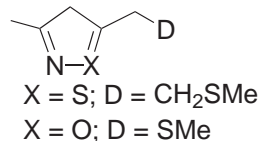

Ref. 1425

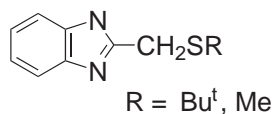

Ref. 1426

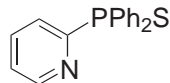

Ref. 1427

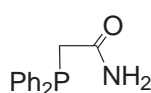

Ref. 1428

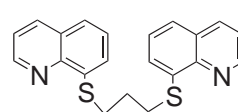

Ref. 1429

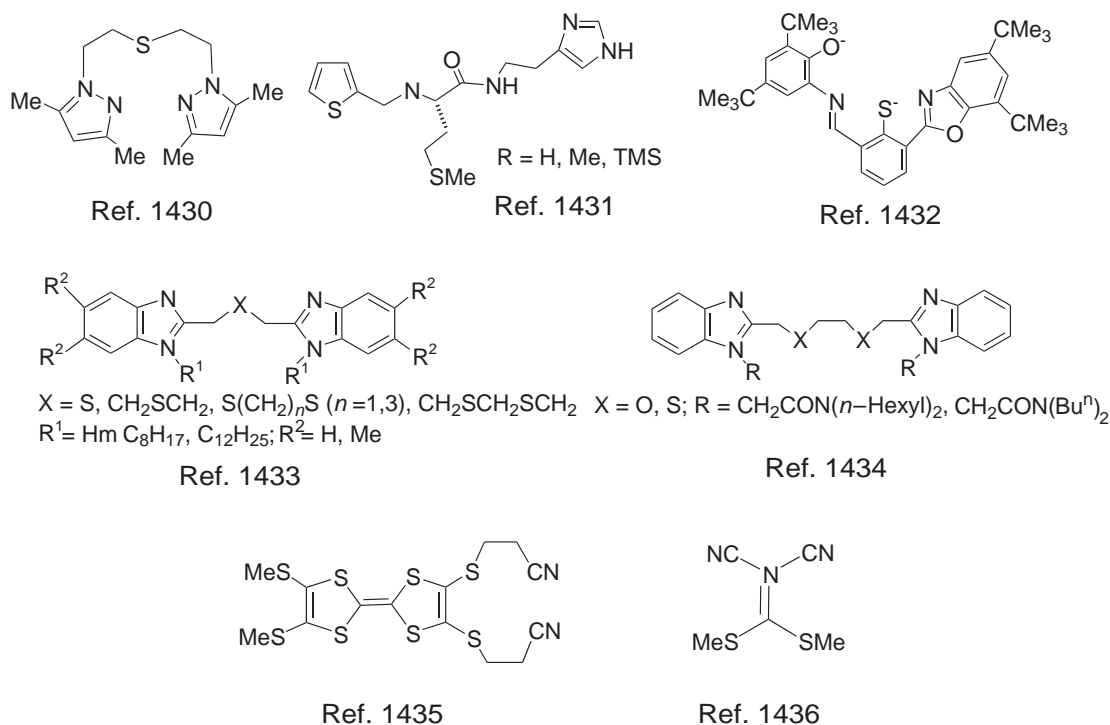
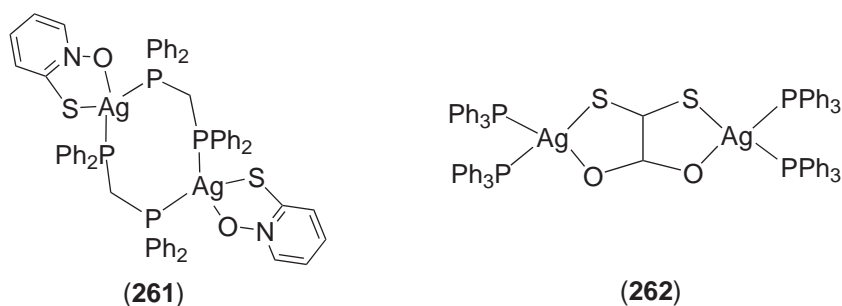
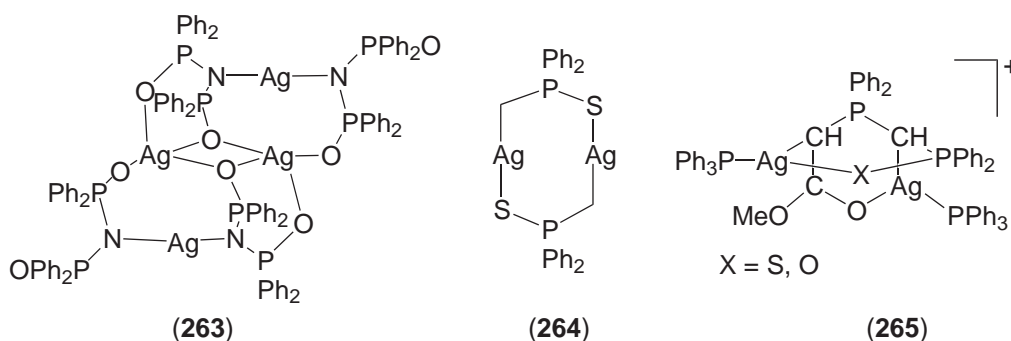

Figure 15 Mixed *N,S*-donor ligands that form silver(I) complexes.



With *N,O* mixed donor ligands several complexes have been reported with ligands such as 4,5-dichloro-2-cyano-3,6-dione-1,4-cyclohexen-1-ol,¹⁴⁴⁵ isonicotinic acid,¹⁴⁴⁶ *p*-aminobenzoic acid,¹⁴⁴⁷ alanine, histidine or histamine derivatives,^{1448–1450} $[\text{N}(\text{O})\text{C}(\text{CN})_2]^-$,¹⁴⁵¹ pyridine-carboxylate derivatives,^{1452–1454} $[\text{N}(\text{PPh}_2\text{O})_2]^-$ (263),¹⁴⁵⁵ bis(sulfonyl)amide derivatives,^{1456,1457} tris(pyridyl)-methanoate,¹⁴⁵⁸ pyrazine-carboxylate,^{1459–1461} 2,2'-bipyridine-3,3'-dicarboxylate,¹⁴⁶² di-2-pyridyl ketone derivatives,^{1463,1464} 1-Bu^t-2-benzoylaziridine,¹⁴⁶⁵ sulfacetamide,¹⁴⁶⁶ nitrite,¹⁴⁶⁷ or SO_3NH_2^- .⁹¹⁹



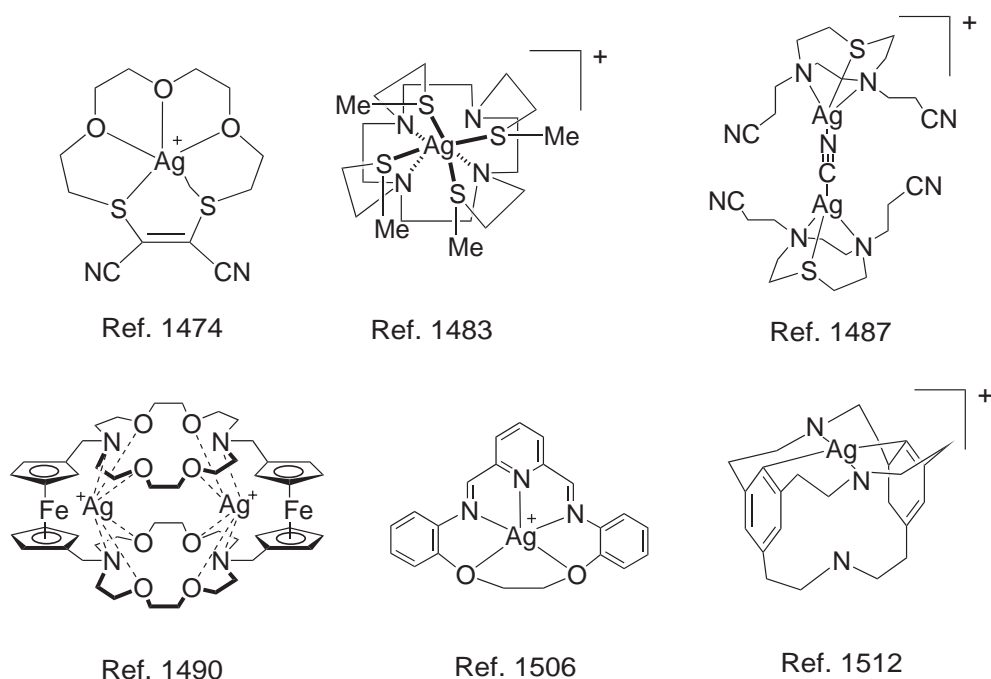

Figure 16 Some examples of silver(I) complexes with mixed donor macrocyclic ligands.

Naphthalenedicarboxylates coordinate to silver(I) atoms through the oxygen atoms and an η^2 -coordination mode involving the aromatic rings.¹⁴⁶⁸ The reaction of AgNO_3 with $\text{Li}[\text{CH}_2\text{PPh}_2\text{S}]_2$ yields $[\text{Ag}(\text{CH}_2\text{PPh}_2\text{S})_2]$ (**264**) in which the ylide C,S bridges the two silver atoms; in the solid state a 1D chain structure is present with short intramolecular $\text{Ag}\cdots\text{Ag}$ separations of 2.990(2) Å.¹⁴⁶⁹ The mixed silver(I)–gold(I) compound $[\text{AgAu}(\text{CH}_2\text{PPh}_2\text{S})_2]$ has also been obtained; it presents a short Ag–Au interaction of 2.9124(13) Å.¹⁴⁷⁰ The compounds $[\text{Ag}_2\{\text{C}(\text{TMS})_2\text{Py}\}_2]$ and $[\text{Ag}(\text{OTf})(\text{Bu}^t\text{-DAB})]$ ($\text{Bu}^t\text{-DAB}$ = 1,4-di-*t*-butyldiazabuta-1,3-diene with a N,C mixed ligand) have been reported.^{644,1471} The silver complexes with mixed S,C or O,C mixed-donor ligands have been obtained with methanide ligands in $[\text{Ag}_2(\text{SPPPh}_2\text{CHPPPh}_2\text{Me})_2](\text{ClO}_4)_2$, $[\text{Ag}(\text{XPPPh}_2\text{CHPPPh}_2\text{Me})_2](\text{ClO}_4)_2$ or $[\text{Ag}_2(\text{XPPPh}_2\text{CHPPPh}_2\text{CHCO}_2\text{Me})(\text{PPh}_3)_2]\text{ClO}_4$ (**265**) ($\text{X} = \text{O}, \text{S}$).^{1471–1473}

Silver(I) complexes with macrocyclic ligands that possess O/N/S as donor atoms have been studied extensively;^{1474–1533} in Figure 16 a selection of some silver complexes with this type of ligands can be seen.

(i) Complexes with silver–metal bonds

Many carbonyl and carbonyl metallate complexes of the second and third row, in low oxidation states, are basic in nature and, for this reason, adequate intermediates for the formation of metal–metal bonds of a donor–acceptor nature. Furthermore, the structural similarity and isolobal relationship between the proton and group 11 cations has led to the synthesis of a high number of cluster complexes with silver–metal bonds.^{1534,1535} Thus, silver(I) binds to ruthenium,^{1536–1556} osmium,^{1557–1560} rhodium,^{1561,1562} iron,^{1563–1572} cobalt,¹⁵⁷³ chromium, molybdenum, or tungsten,^{1574–1576} rhenium,^{1577,1578} niobium or tantalum,¹⁵⁷⁹ or nickel.¹⁵⁸⁰ Some examples are shown in Figure 17.

Complexes with silver(I)–rhodium(I) bonds have been prepared by addition of AgX to Rh–Rh bonds, as $[\text{Rh}(\mu\text{-AgX})(\eta^5\text{-C}_5\text{Me}_5)(\mu\text{-CO})_2]$,^{1581,1582} $[\text{Rh}_2(\eta^5\text{-C}_5\text{H}_5)(\mu\text{-CO})(\mu\text{-dppm})(\mu\text{-AgX})]$,^{1583–1585} or $[\text{Rh}_2\{\mu\text{-Ag}(\text{PPh}_3)\}\{\mu\text{-1,8-(NH}_2)_2\text{C}_{10}\text{H}_6\}(\text{CO})_2(\text{PPh}_3)_2]\text{ClO}_4$.¹⁵⁸⁶ The reaction of $[\text{Rh}(\eta^5\text{-C}_5\text{H}_5)(\text{CO})(\text{PPh}_3)]$ with AgPF_6 gives the adduct $[\text{Ag}\{\text{Rh}(\eta^5\text{-C}_5\text{H}_5)(\text{CO})(\text{PPh}_3)\}_2]\text{PF}_6$.¹⁵⁸⁷ The complex $[\text{Rh}_3\text{Ag}_3\text{H}_9\{\text{PPh}_2\text{CH}_2\}_3\text{CMe}\}_3]^+$ (**266**) has been obtained by treatment of $[\text{RhCl}\{\text{PPh}_2\text{CH}_2\}_3\text{CMe}\}_3]$ with AgOTf in methanol (hydrides not located).¹⁵⁸⁸ The reaction of $\text{cis-}[\text{Rh}(\text{C}_6\text{F}_5)_2\text{L}_2]^-$ with $[\text{Ag}(\text{OClO}_3)(\text{PPh}_3)]$ gives complexes with Ag–Rh unsupported bonds, as show the structure of $\text{cis-}[\text{RhAg}(\text{C}_6\text{F}_5)_2(\text{PPh}_3)\{\text{P}(\text{O}^i\text{Pr})_3\}_2]$ (**267**).¹⁵⁸⁹ The luminescent 1D heterometallic chain, $\{[\text{Rh}_2(\text{dfpma})_2(\text{NCMe})_4]_2[\text{Ag}(\text{NCMe})_4]\text{PF}_6\}$ (dfpma = bis(difluorophosphine)

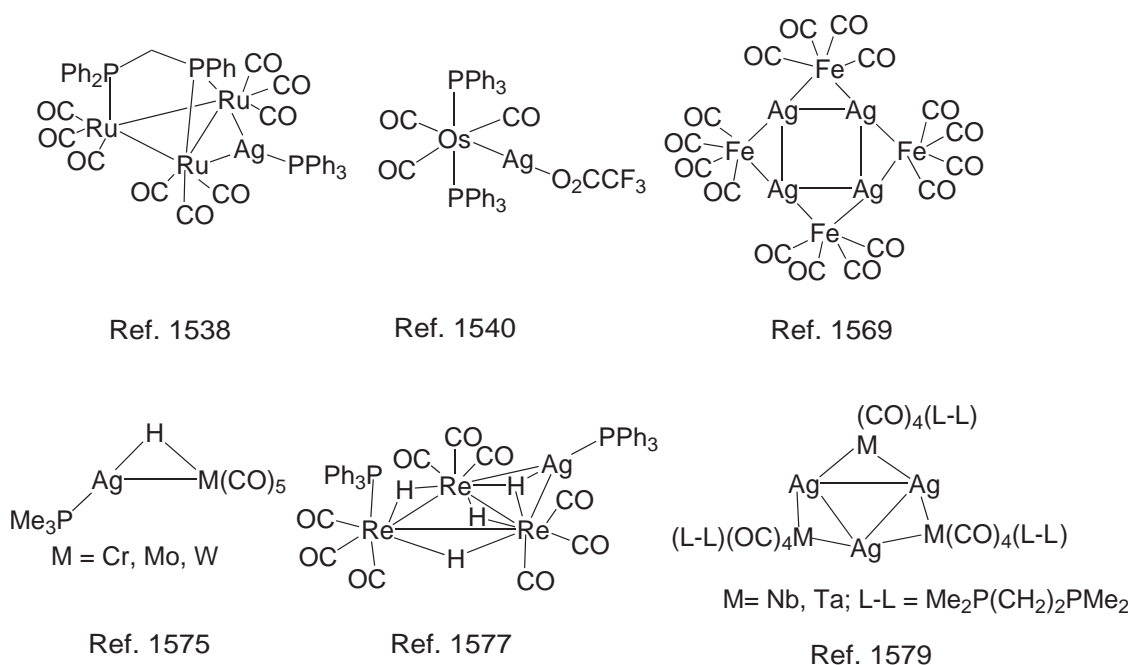
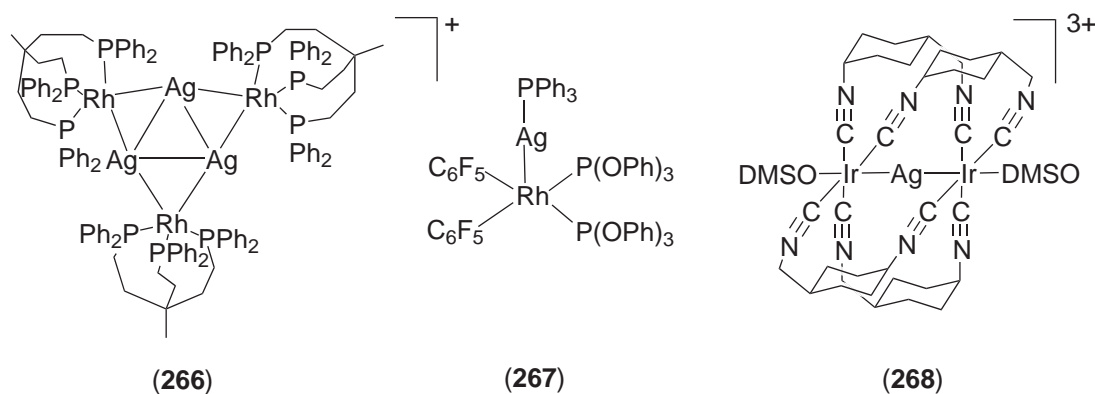

Figure 17 Some examples of metal carbonyl complexes with M-Ag bonds.

methylamine) has been obtained.¹⁵⁹⁰ Complexes with Ag—Ir bonds such as $[\text{AgIr}_2(\text{dimen})_4(\text{DMSO})_2](\text{PF}_6)_3$ (**268**) or $[\text{AgIr}_2(\text{dimen})_4(\text{PPh}_3)_2](\text{PF}_6)_3$ (dimen = 1,8-diisocyanomenthane) have been reported.^{1591–1593} The complexes $[\text{Ag}_n\{\text{ReH}_7(\text{PPhPr}^i)_2\}_n]^+$ ($n = 1, 2$) present a silver rhenium bond (hydrides not located by XRD).¹⁵⁹⁴ Silver(I)—mercury bonds have been described in $[\text{AgHg}_2(\mu\text{-dppm})_3]^{3+}$ ¹⁵⁹⁵ and $[\text{Ag}_2\text{Hg}(\text{Mes})_2\text{X}_2]_2$ ($\text{X} = \text{OTf}, \text{ClO}_4$).¹⁵⁹⁶



Compounds with Ag—Pt bonds are well represented. A method to prepare this type of complexes developed by Forníés and co-workers is the reaction of electron-rich platinum complexes such as anionic pentachloro- or pentafluorophenyl species with silver salts.^{1597–1599} The treatment of mononuclear $(\text{Bu}_4\text{N})_2[\text{Pt}(\text{C}_6\text{F}_5)_{4-x}(\text{C}_6\text{Cl}_5)_x]$ or $(\text{Bu}_4\text{N})[\text{Pt}(\text{C}_6\text{F}_5)_{3-x}(\text{C}_6\text{Cl}_5)_x\text{L}]$ with $[\text{AgXL}]$ or AgX compounds leads to the synthesis of Pt → Ag complexes such as (**269**) and (**270**).^{1600–1603} The use of $(\text{Bu}_4\text{N})_2[\text{PtCl}_2(\text{C}_6\text{F}_5)_2]$ with silver salts also leads to compounds with silver—platinum bonds assisted by other covalent interactions, as in compound (**271**).^{1231,1604–1606}

Starting from anionic dimeric complexes such as $(\text{Bu}_4\text{N})_2[\text{Pt}_2(\mu\text{-X})_2(\text{C}_6\text{X}_5)_4]$ or $(\text{Bu}_4\text{N})_2[\text{Pt}_2(\mu\text{-C}_6\text{F}_5)_2(\text{C}_6\text{F}_5)_4]$ polynuclear complexes as (**272**) are obtained.^{1607–1610} Other precursors for the synthesis of Ag—Pt compounds are the anionic dinuclear complexes with bridging dppm and halide or hydroxo ligands, $[\text{Pt}_2(\text{C}_6\text{F}_5)_2(\mu\text{-X})(\mu\text{-dppm})]^-$,^{1611,1612} or the acetylacetonate complex $[\text{Pt}(\text{C}_6\text{F}_5)_2(\text{ACAC})]^-$.^{1613,1614}

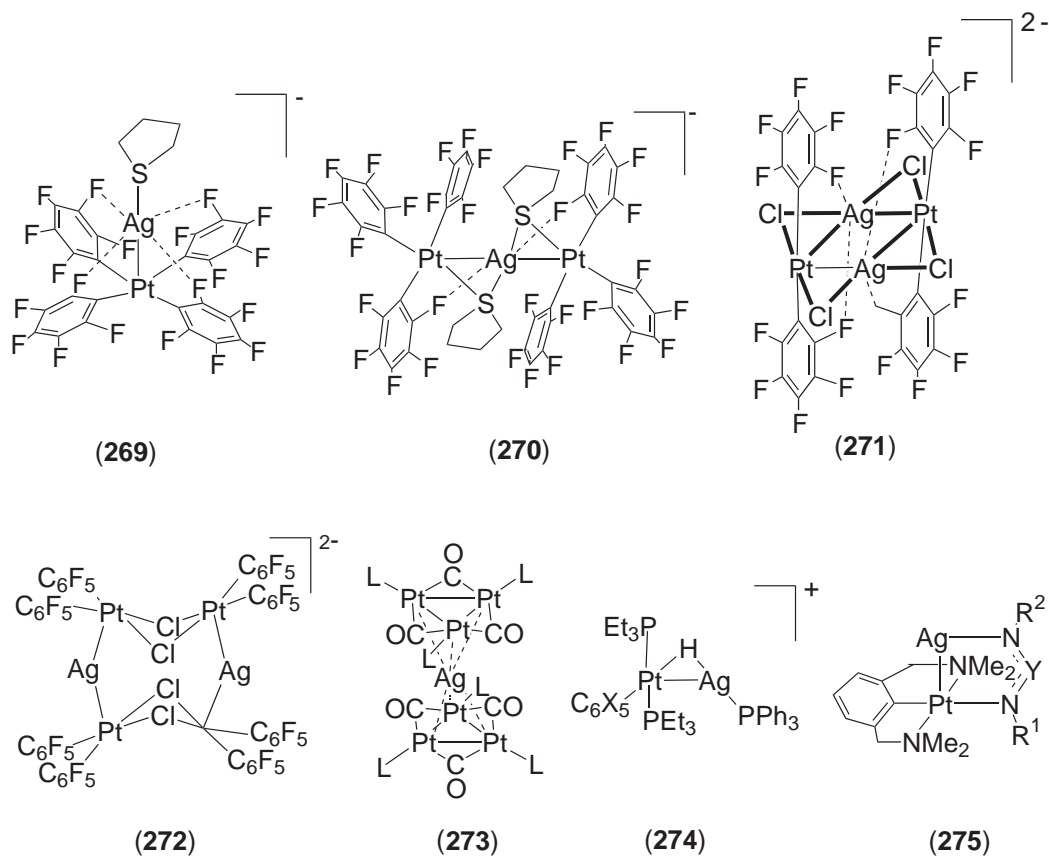

Other examples of complexes with silver—platinum bonds are (273)–(275),^{1615–1617} a W—Pt—Ag cluster,¹⁶¹⁸ the coordination polymers $\text{Ag}_2[\text{Pt}(\text{ox})_2] \cdot 2\text{H}_2\text{O}$ and $[\text{Ag}(\text{H}_2\text{O})]_2[\text{Ag}_2(\text{OTf})_4][\text{Pt}(\text{ACAC})_2]_2$,¹⁶¹⁹ and the helical complex $[\{\text{Pt}(\text{phpy})_2\}_2\{\text{Ag}(\text{acetone})_2\}_n(\text{ClO}_4)_{2n}]$ (Hphpy = 2-phenylpyridine).¹⁶²⁰

6.7.3 GOLD

6.7.3.1 High Oxidation States

High oxidation states are known with very electronegative ligands such as fluorine. The yellow crystalline AuF_7 is prepared by disproportionation of AuF_6 and can be isolated at -196°C , it decomposes in AuF_5 and F_2 at 100°C .¹⁶²¹ AuF_6 is obtained by oxidation of AuF_5 with fluorine.¹⁶²¹ The pentafluoride AuF_5 is formed by vacuum pyrolysis of either $[\text{KrF}][\text{AuF}_6]$ (at 60 – 65°C)^{1622,1623} or $[\text{O}_2][\text{AuF}_6]$ (at 160 – 200°C).¹⁶²⁴ An electron diffraction study of AuF_5 has indicated that the vapor phase consists of di- and trimeric molecules with the gold octahedrally coordinated.¹⁶²⁵

The $[\text{AuF}_6]^-$ complex anion is known with a variety of simple (Na^+ , K^+ , Ca^{2+})^{1623,1626,1627} or more complex ($[\text{KrF}]^+$, $[\text{XeF}_5]^+$, $[\text{Xe}_2\text{F}_{11}]^+$)^{120,1622,1623,1626} counteranions. They are bright yellow to green solids, which are extremely sensitive to oxygen and moisture. The compound $[\text{Xe}_2\text{F}_{11}][\text{AuF}_6]$ was first prepared by fluorination of AuF_3 with XeF_2 in the presence of XeF_6 .^{120,1628} In the solid state the gold is octahedrally surrounded by the fluorine atoms and bonded to the dimeric xenon cation by two of the fluorine atoms (276).^{1629,1630} The complex $\text{Ag}[\text{AuF}_6]$ was also synthesized and the structure was found to be of LiSbF_6 type by Synchrotron X-ray powder diffraction.^{1631,1632} The stability of the high oxidation states in group 11 fluorides has been studied by relativistic Möller-Pleset (MP) and coupled cluster methods. Relativistic effects stabilize higher metal oxidation states. As a result, the hexafluoro complex of group 11 elements with nuclear charge 111 and oxidation state +5 is the most stable compared to the other congeners.¹⁶³³

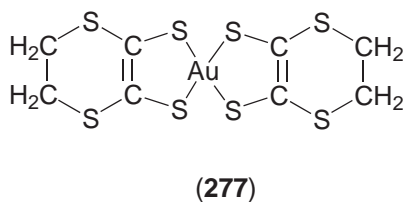
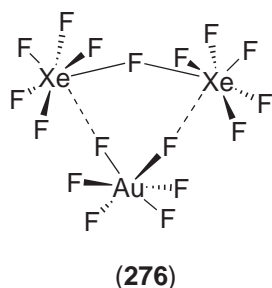

The evidence for the existence of oxidation state +IV is not yet convincing. Some complexes with dithiolene or dithiolate systems have been reported such as $[\text{Au}(\text{ddd})_2]$ (277) (ddd = 5,6-dihydro-1,4-dithiin-2,3-dithiolate),¹⁶³⁴ $[\text{Au}(1,2\text{-S}_2\text{C}_6\text{H}_4)_2]$,¹⁶³⁵ $[\text{Au}\{\text{S}_2\text{C}_2(\text{CN})_2\}_2] \cdot \text{C}_{20}\text{H}_{10}$,¹⁶³⁶ and $[\text{Au}(\text{dtpdt})_2]$ (dtpdt = 2,3-dihydro-5,6-thiophenedithiolate) or $[\text{Au}(\alpha\text{-tpdt})_2]$ ($\alpha\text{-tpdt}$ = 2,3-dithiophenedithiolate).¹⁶³⁷ They have been prepared by chemical or electrochemical oxidation of the corresponding gold(III) derivatives. The molecular orbital calculations suggest that the metal ions of the molecules are best described as d^8 ions as expected for a square planar gold(III) compound, and therefore the unpaired electron in each molecule resides largely on the ligands.

6.7.3.2 Gold(III) Complexes

6.7.3.2.1 Complexes with carbon donor ligands

The majority of gold(III) complexes with carbon donor ligands are with alkyl or aryl donor ligands. Monoalkylgold(III) compounds are not well represented, and only a few trifluoromethyl compounds of the type $[\text{Au}(\text{CF}_3)\text{X}_2(\text{PR}_3)]$ ($\text{X} = \text{Br}, \text{I}$; $\text{R} = \text{Me}, \text{Et}, \text{Ph}$)¹⁶³⁸ have been reported. These are formed by oxidative addition of halogen to the corresponding trifluoromethyl(phosphine)gold(I) derivative. However, monoarylgold(III) species are more abundant and various methods exist for their synthesis:

- (i) oxidative addition of halogen to the respective gold(I) complex,
- (ii) transmetallation reaction with HgR_2 ,
- (iii) electrophilic substitution by gold(III) of one aromatic ring (metalation), or
- (iv) substitution reactions on monoarylgold(III) derivatives.

The first method has been used with haloaryl,^{1639–1643} *ortho*-nitrophenyl,¹⁶⁴⁴ mesityl,²⁵⁵ or ylidgegold(I)^{1645–1648} complexes, which are sufficiently stable to undergo the oxidative addition without cleavage of the gold–carbon bond, an example can be seen in Equation (11):



The reaction between $[\text{Hg}(\text{C}_6\text{F}_5)_2]$ and $\text{Me}_4\text{N}[\text{AuCl}_4]$ gives $\text{Me}_4\text{N}[\text{Au}(\text{C}_6\text{F}_5)\text{Cl}_3]$ in high yield (Equation (12)).¹⁶⁴³



Recently the synthesis of arylgold(III) species by C–H bond activation has been re-investigated. The reaction of anhydrous gold(III) chloride $[\text{AuCl}_3]_2$ with aromatic hydrocarbons (ArH), such as benzene, toluene, xylenes, mesitylene, cumene, methoxybenzene, and chlorobenzene, and the following treatment with 2,6-lutidine (lut), gave the complexes $[\text{AuArCl}_2(\text{lut})]$.¹⁶⁴⁹ The ^1H NMR spectra revealed that auration towards aromatic compounds take place regiospecifically at the position with higher electron density and with less steric hindrances.

The THT ligand in $[\text{AuRX}_2(\text{THT})]$ and in other complexes can be displaced easily for other neutral or anionic ligands (e.g., phosphine, amines, halide, etc.), and a wide variety of derivatives

have been obtained. Au Mössbauer spectra of $[\text{Au}(\text{C}_6\text{F}_5)\text{Cl}_2(\text{phen})]$ support the existence of a weak interaction of gold(III) with the second donor atom of the phen, approaching pentacoordination.¹⁵²⁶ This type of complex can further react with AgClO_4 to give the four-coordinate cationic complexes $[\text{Au}(\text{C}_6\text{F}_5)\text{X}(\text{phen})]\text{ClO}_4$.¹⁶⁴⁰

Oxidation of the dinuclear gold(I) complexes, $[\{\text{Au}(\text{C}_6\text{F}_5)\}_2\{\mu\text{-(PPh}_2)_2\text{NH}\}]$ ¹⁶⁵⁰ or $[\{\text{Au}(\text{C}_6\text{F}_5)\}_2\{\mu\text{-(AsPh}_2)_2\text{CH}_2\}]$,¹⁶⁵¹ with halogens gives the corresponding gold(II) derivatives, these are unstable in solution and isomerization to the mixed gold(III)–gold(I) complexes (**278**, **279**) is observed. Similarly, oxidation addition of chlorine to the dinuclear ylidgegold(I) complex $[\text{Au}_2\text{Cl}_2\{\mu\text{-}\{\text{CH}(\text{PPh}_3)\}_2\text{CO}\}]$ gave the gold(III) derivative (**280**).¹⁶⁵²

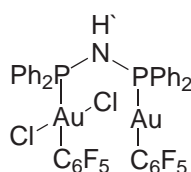

(278)

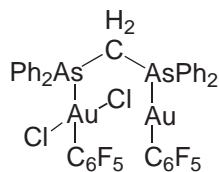

(279)

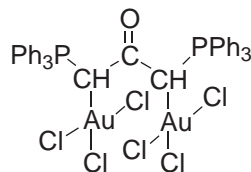

(280)

Usually, the monoarylgold(III) complexes obtained by an arylation or cyclometalation processes contain aryl moieties, which act as bidentate *C,N* or *C,S* or tridentate *C,N,N* donor ligands. Then it will be treated in Section 6.7.3.2.7.

Gold(III) complexes with two gold–carbon bonds are well known and abundant. They are prepared for one of the main established methods for organometallic gold(III) derivatives: Oxidation of gold(0) or gold(I) compounds with halogens or thallium reagents, using arylating or alkylating compounds such as tin, mercury, Grignard, or lithium compounds, and finally by substitution reactions. In many cases the unit $\text{Au}^{\text{III}}\text{R}_2^+$ is used as “syntom” in order to coordinate mono- or bidentate ligands to the gold(III) center and the reactivity is not focused on the organic ligand. These particular cases will be seen in the appropriate sections.

The simplest compounds are of the type $[\text{Au}_2(\mu\text{-X})_2\text{R}_4]$ and they have been known for a long time, the organic ligand being unsubstituted alkyl groups in the majority of the cases.⁶⁷ An improved synthesis has been published recently for $[\text{Au}_2(\mu\text{-Cl})_2\text{Me}_4]$,¹⁶⁵³ which was previously obtained in low yield with Grignard agents or MeLi, and uses SnMe_4 as alkylating agent (Equation (13)):

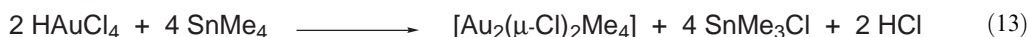

Other alkylgold(III) compounds are $[\text{Au}_2(\mu\text{-X})_2(\text{CF}_3)_4]$ ($\text{X} = \text{Br}, \text{I}$) synthesized by co-condensation of gold with CF_3Br and CF_3I , respectively, and may be sublimed at room temperature.¹⁶⁵⁴ Trifluoromethylated compounds are potentially useful precursors for CVD studies as they are expected to show enhanced volatility.¹⁶⁵⁵ *cis*- $[\text{Au}(\text{CF}_3)_2\text{I}(\text{PMe}_3)]$ is formed in quantitative yield by oxidative addition of trifluoromethyl iodide to $[\text{Au}(\text{CF}_3)(\text{PMe}_3)]$, the reaction is proposed to proceed via radical intermediates.^{1524,1656}

Diarylaurate(III) complexes of the type $[\text{AuR}_2\text{X}_2]^-$ ($\text{R} = \text{C}_6\text{F}_5, \text{C}_6\text{Cl}_5$; $\text{X} = \text{Cl}, \text{Br}$) are known for a variety of polyhalophenyl ligands. They were first prepared by oxidative addition of halogen to the corresponding organogold(I) compound $[\text{AuR}_2]^-$ or by oxidative addition of the corresponding gold(I) complex with $[\text{TiR}_2\text{X}]_2$.^{98,99,1641} Reaction of *trans*- $[\text{Au}(\text{C}_6\text{F}_5)_2\text{X}_2]$ with a silver salt results in the abstraction of halide to give the dimeric diarylgold(III) halides *cis*- $[\text{Au}_2(\mu\text{-X})_2(\text{C}_6\text{F}_5)_4]$ ($\text{X} = \text{Cl}, \text{Br}$) (Equation (14)).¹⁶⁵⁷



Reactivity of these dimeric complexes have been studied for $[\text{Au}_2(\mu\text{-Cl})_2(\text{C}_6\text{F}_5)_4]$; it reacts with salts of anionic ligands such as sodium azide, potassium thiocyanate, AgCF_3COO , or $\text{Ti}(\text{ACAC})$ to give the corresponding dinuclear pseudo-halide derivatives or the monomeric $[\text{Au}(\text{C}_6\text{F}_5)_2(\text{ACAC})]$. The cleavage of the chloro bridges by mono- or bidentate neutral ligands yields $>$ complexes of the type $[\text{Au}(\text{C}_6\text{F}_5)_2\text{Cl}(\text{L})]$ ($\text{L} = \text{Py}, \text{PPh}_3$) or $[\text{Au}(\text{C}_6\text{F}_5)_2(\text{L-L})][\text{Au}(\text{C}_6\text{F}_5)_2\text{Cl}_2]$ ($\text{L-L} = \text{bipy}, \text{phen}, 1,2\text{-(AsMe}_2)_2\text{C}_6\text{H}_4$).¹⁶⁵⁷ Similar complexes have been obtained with

pentachlorophenyl as aryl ligand.¹⁶⁴¹ The reaction of $[\text{Au}_2(\mu\text{-Cl})_2(\text{C}_6\text{F}_5)_4]$ with two equivalents of AgClO_4 in solvents (S), such as acetone or diethyl ether, gives stable solutions of $[\text{Au}(\text{C}_6\text{F}_5)_2(\text{S})_2]\text{ClO}_4$, that can be used "in situ", after removal of AgCl , to further react with neutral or anionic ligands affording complexes of the type $[\text{Au}(\text{C}_6\text{F}_5)_2(\text{L})_2]\text{ClO}_4$ ($\text{L} = \text{THT}$, PPh_2Me , $\text{Ph}_2\text{PCH}_2\text{PPh}_2$, bipy) or $[\text{Au}(\text{C}_6\text{F}_5)_2(\text{ACAC})]$, $\text{Bu}_4\text{N}[\text{Au}(\text{C}_6\text{F}_5)_2(\text{CN})_2]$, or $[\{\text{Au}(\text{C}_6\text{F}_5)_2\}_2(\text{BiBzIm})]$ (BiBzIm = 2,2'-bibenzimidazole).¹⁶⁵⁸ The oxidation of the biaryl complex $[\text{Au}_2(\mu\text{-C}_6\text{H}_4\text{-C}_6\text{H}_4)(\text{PPh}_3)_2]$ with tetraethylthiuram disulfide produces the mononuclear gold(III) derivative $[\text{Au}(\text{C}_6\text{H}_4\text{-C}_6\text{H}_4)(\mu\text{-S}_2\text{CNET}_2)]$.^{1659,1660}

An alternative synthesis of diarylgold(III) halides uses organomercurials as arylating reagents, and compounds of the type *cis*- $\text{NMe}_4[\text{AuR}_2\text{Cl}_2]$ can be obtained where $\text{R} = 2\text{-NO}_2\text{C}_6\text{H}_4$ or $2\text{-Me-6-NO}_2\text{C}_6\text{H}_3$,^{1659,1660} or *cis*- $[\text{N}(\text{PPh}_3)_2][\text{Au}(\text{mes})_2\text{Cl}_2]$.¹⁶⁶¹ The compounds may be derivatized by substitution of one or both halide ligands with various reagents, thus complexes of the type *cis*- $\text{NMe}_4[\text{Au}(2\text{-NO}_2\text{C}_6\text{H}_4)_2(\text{CN})_2]$, *cis*- $[\text{AuR}_2\text{Cl}(\text{PPh}_3)]$, or *cis*- $[\text{AuR}_2\{(\text{PPh}_2)_2\text{CH}_2\}]^+$ can be obtained.¹⁶⁵⁹⁻¹⁶⁶¹

Heterocyclic gold(III) derivatives $[\text{Au}_2(\mu\text{-Cl})_2(\text{C}_4\text{Ph}_4)_2]$ and $[\text{AuCl}(\text{C}_4\text{Ph}_4)(\text{THT})]$ ($\text{C}_4\text{Ph}_4 = 1,2,3,4\text{-tetraphenylbuta-1,3-diene-1,4-diyil}$) have been obtained by reaction of $\text{SnMe}_2(\text{C}_4\text{Ph}_4)$ with $[\text{AuCl}_3(\text{THT})]$. The treatment of $[\text{Au}_2(\mu\text{-Cl})_2(\text{C}_4\text{Ph}_4)_2]$ with various anionic and neutral ligands leads to cleavage of the chloride bridges, some of the resulting products are illustrated in Scheme 10. The crystal structure indicates a distorted square-planar geometry for the metal.¹⁶⁶² The reaction of $[\text{AuCl}_2(\text{L-L})]^+$ with two equivalents of $\text{Mg}(2,4,6\text{-Me}_3\text{C}_6\text{H}_2)\text{X}$ leads to the diaryl species $[\text{Au}(2,4,6\text{-Me}_3\text{C}_6\text{H}_2)_2(\text{L-L})]^+$ ($\text{L-L} = \text{bipy}$, phen, dpphen).¹⁶⁶³ The treatment of the biaryl complex $[\text{Au}_2(\text{C}_6\text{H}_4\text{C}_6\text{H}_4)(\text{PPh}_3)_2]$ with tetraethylthiuram disulfide gives the gold(III) diaryl complex $[\text{Au}(\text{C}_6\text{H}_4\text{C}_6\text{H}_4)(\text{S}_2\text{CNET}_2)]$.^{1663,1664}

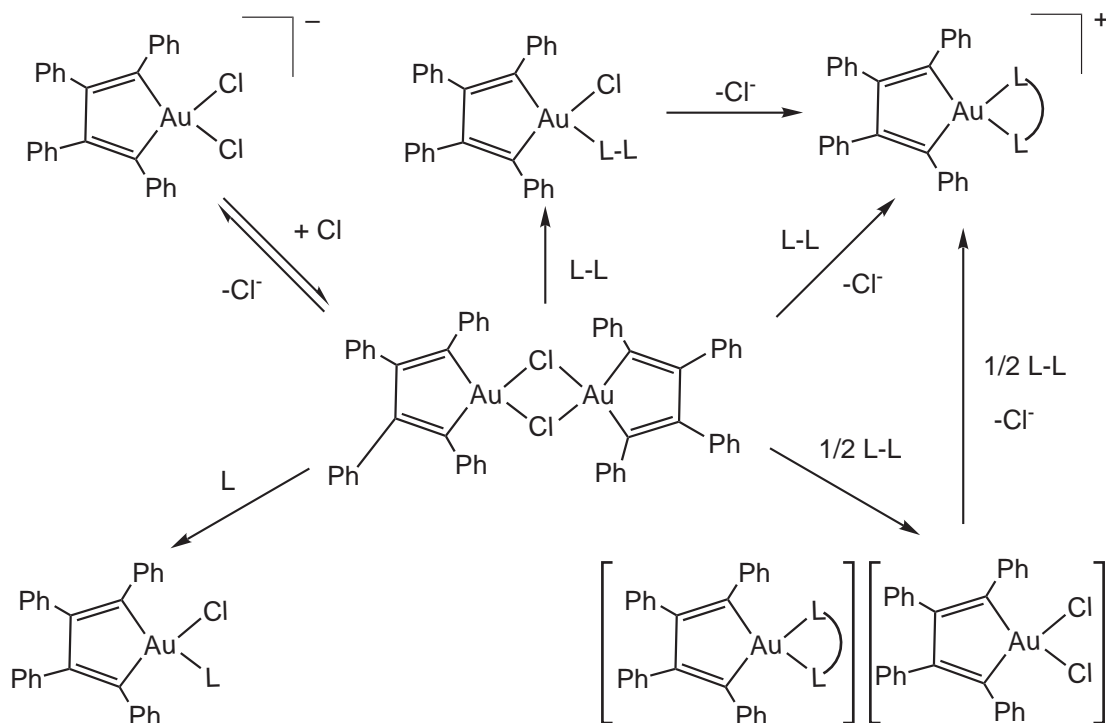

Scheme 10 Reaction of $[\text{Au}_2(\mu\text{-Cl})_2(\text{C}_4\text{Ph}_4)_2]$ with mono and bidentate ligands.

Mononuclear gold(III) ylide complexes may be prepared by oxidative addition of halogens of suitable gold(I) precursors. This approach is exemplified by complexes of general types *trans*- $[\text{Au}(\text{C}_6\text{F}_5)\text{Cl}_2(\text{ylide})]$ (ylide = CH_2PPh_3 , $\text{CH}_2\text{PPh}_2\text{Me}$, $\text{CH}_2\text{PPhMe}_2$)¹⁶⁴⁵ and *trans*- $[\text{AuX}_2\{\text{CH}(\text{PPh}_3)\text{COR}\}_2]^+$ ($\text{R} = \text{Me}$, OMe , OEt ; $\text{X} = \text{Cl}$, Br).^{1646,1648} *Trans*- $[\text{Au}(\text{C}_6\text{F}_5)\text{Cl}_2(\text{CH}_2\text{PPh}_2\text{Me})]$ reacts with potassium thiocyanate to give *trans*- $[\text{Au}(\text{C}_6\text{F}_5)(\text{SCN})_2(\text{CH}_2\text{PPh}_2\text{Me})]$.¹⁶⁴⁵

The dinuclear gold(I) ylide complexes, $[\text{Au}_2\{(\text{CH}_2)_2\text{PR}_2\}_2]$ ($\text{R} = \text{Me}, \text{Ph}$), react with two equivalents of halogens or thionyl chloride to give the gold(III) derivatives $[\text{Au}_2\text{X}_4\{(\text{CH}_2)_2\text{PR}_2\}_2]$ ($\text{X} = \text{Cl}, \text{Br}$) (Scheme 11).¹⁶⁶⁵⁻¹⁶⁶⁹ The treatment of $[\text{Au}_2\{(\text{CH}_2)_2\text{PPh}_2\}_2]$ with CCl_4 in tetrahydrofuran affords the gold(III) compound with halogens and halomethane as ligands, $[\text{Au}_2\text{Cl}_3(\text{CCl}_3)\{(\text{CH}_2)_2\text{PPh}_2\}_2]$.¹⁶⁷⁰ The oxidation of the alkylhalidegold(II) species $[\text{Au}_2\text{X}(\text{CH}_2\text{X})\{(\text{CH}_2)_2\text{PPh}_2\}_2]$ or $[\text{Au}_2\text{X}(\text{CH}_2\text{X})\{(\text{CH}_2)_2\text{PPh}_2\}_2]$ with halogens leads to the *cis,cis* and *trans,trans* gold(III) compounds $[\text{Au}_2\text{X}_3(\text{CH}_2\text{X})\{(\text{CH}_2)_2\text{PPh}_2\}_2]$ (see Scheme 11).¹⁶⁷¹

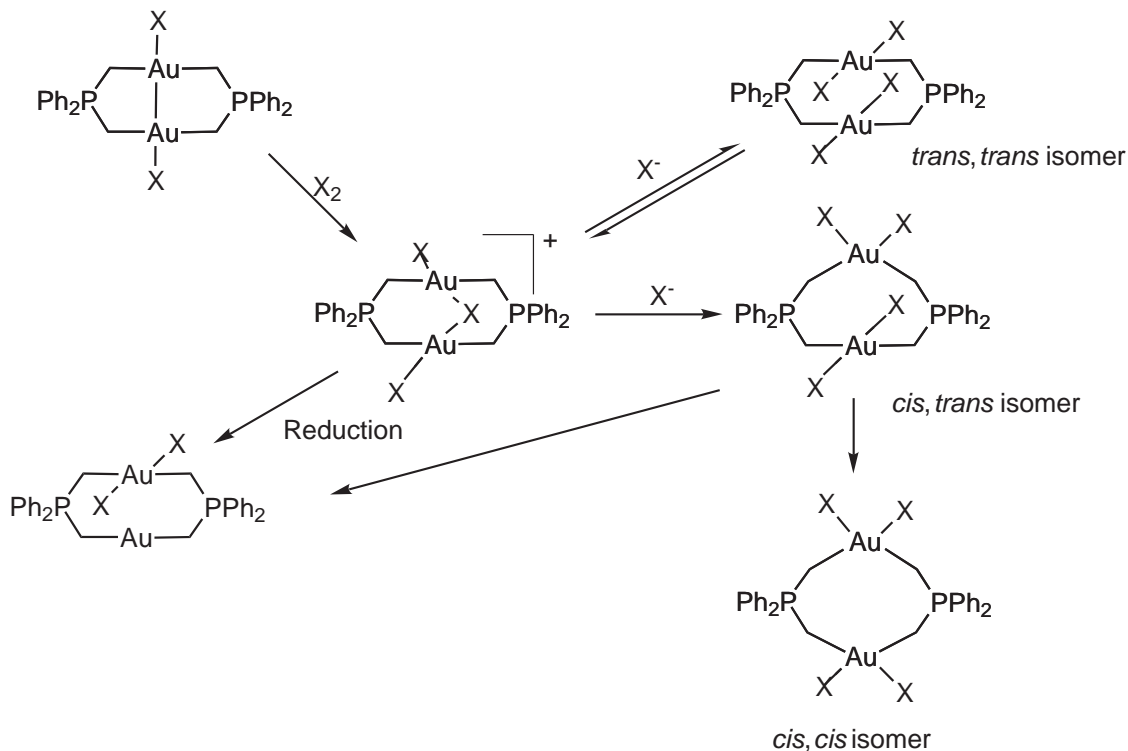

An interesting gold(III) ylide derivative was obtained as by-product in one of these reactions and has a bromine bridging ligand, $[\text{Au}_2\text{Br}_2(\mu\text{-Br})\{\mu\text{-(CH}_2)_2\text{PPh}_2\}_2](\text{IBr}_2)$ (**281**). The latter has been postulated as an intermediate in these types of reactions.¹⁶⁶⁹

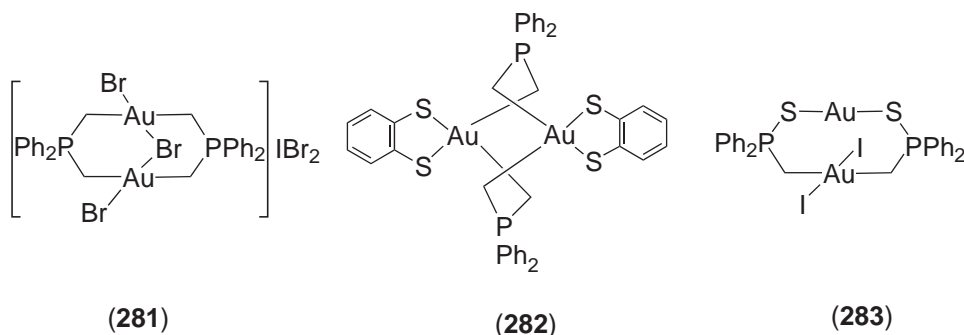

The dinuclear carbonyl-stabilized ylide gold(I) complexes $[\text{Au}_2\{\mu\text{-[CH}(\text{PPh}_3)_2\text{CO}_2\}_2](\text{ClO}_4)_2$ or $[\text{Au}_2\{\mu\text{-[CH}(\text{CO}_2\text{Me})_2\text{PPh}_2\}_2]$ also react with an excess of halogen to give the gold(III) compounds $[\text{Au}_2\text{Cl}_4\{\mu\text{-[CH}(\text{PPh}_3)_2\text{CO}_2\}_2](\text{ClO}_4)_2$ or $[\text{Au}_2\text{X}_4\{\mu\text{-[CH}(\text{CO}_2\text{Me})_2\text{PPh}_2\}_2]$ ($\text{X} = \text{Cl}, \text{I}$), respectively.^{1668,1672} The reaction of 1,2-benzenethiol with the ylide gold(II) complex, $[\text{Au}_2(\text{O}_2\text{CPh})_2\{(\text{CH}_2)_2\text{PPh}_2\}_2]$ does not lead to the substitution of the benzoate ligand, but a disproportionation reaction occurs and the gold(III) complex $[\text{Au}_2(\text{S}_2\text{C}_6\text{H}_4)_2\{\mu\text{-(CH}_2)_2\text{PPh}_2\}_2]$

(282) can be isolated.¹⁶⁷³ Mixed valent ylide gold(I)–gold(III) compounds have also been reported. $[\text{Au}_2\text{Br}_2\{\mu\text{-(CH}_2)_2\text{PPh}_2\}_2]$ can be synthesized both by reduction of the gold(III) species $[\text{Au}_2\text{Br}_4\{\mu\text{-(CH}_2)_2\text{PPh}_2\}_2]$ with AgCN or by oxidation of $[\text{Au}_2(\text{CN})_2\{\mu\text{-(CH}_2)_2\text{PPh}_2\}_2]$ with Br_2 , followed by spontaneous reduction.¹⁶⁷⁴ The dinuclear gold(I) complex with the methylenethio-phosphinate ligands, $[\text{Au}_2(\mu\text{-CH}_2\text{PPh}_2\text{S})_2]$, can be oxidized with iodine to the asymmetrical $[\text{Au}_2\text{I}_2(\mu\text{-CH}_2\text{PPh}_2\text{S})_2]$ (283),¹⁶⁷⁵ this compound is also available from the isomerization of the corresponding gold(II) derivative in nitromethane and other weakly protonic solvents, such as acetone.¹⁶⁷⁶

Mixed perhalophenyl-isocyanide gold(III) derivatives of the type $[\text{AuR}_2(\text{C}\equiv\text{NC}_6\text{H}_4\text{C}_6\text{H}_4\text{OC}_n\text{H}_{2n+1}\text{-}p)]$ ($\text{R} = \text{C}_6\text{F}_5$; $n = 8$; $\text{R} = \text{C}_6\text{F}_4\text{Br-}o$, $n = 10$) and $[(\mu\text{-}4,4'\text{-C}_6\text{F}_4\text{C}_6\text{F}_4)\{\text{AuX}_2\text{C}\equiv\text{N}(\text{C}_6\text{H}_4)_m\text{OC}_n\text{H}_{2n+1}\text{-}p\}]_2$ ($m = 1, 2$; $n = 4, 6, 8, 10, 12$) have been prepared and the liquid crystal behavior has been studied. In spite of the bulkiness of some of these groups, large ranges of N or S_A phases are obtained.¹⁶⁷⁷ The structure of $\text{Ph}_4\text{As}[\text{Au}(\text{CN})_4]$ has been reported and consist of two kind of layers, one composed for cations and the other of anions.¹⁶⁷⁸

6.7.3.2.2 Complexes with nitrogen donor ligands

The gold(III) halides exhibit Lewis acidic behavior and readily react with nitrogen donor ligands. Complexes of the type $[\text{AuX}_3\text{L}]$ with $\text{L} =$ pyridine,¹⁶⁷⁹ substituted pyridines,¹⁶⁸⁰ *t*-butylamine,¹⁶⁸¹ 1,4-benzodiazepin-2-ones,^{1682,1683} 2-phenylthiazole,⁶⁵⁷ 3,3'-dimethyl-2,2'-biquinoline,^{1684,1685} acetimine,¹⁶⁸⁶ 1-[(2-chlorophenyl)diphenylmethyl]-1H-imidazole,¹⁶⁸⁷ nucleosides,¹⁶⁸⁸ or nucleobases¹⁶⁸⁹ have been obtained from Au_2Cl_6 or tetrahaloaurate and the corresponding nitrogen base. $[\text{AuCl}_3\text{Py}]$ can also be prepared by a thermal decomposition of $[\text{Hpy}][\text{AuCl}_4]$ above 195 °C. In some cases the reaction of tetrachloroaurate with amines results in the reduction of gold(III) to yield mixed valence complexes $[\text{AuL}_2][\text{AuCl}_4]$ ($\text{L} =$ aminoalcohol)¹⁶⁷⁹ or the gold(I) derivatives, e.g., with *n*-butylamine¹⁶⁷⁹ or with the alga *Chlorella vulgaris*.¹⁶⁹⁰ The Au^{III} binding in the nucleobase compounds have been found to be via the N(7) of the purine ring. The complex with the 1-[(2-chlorophenyl)diphenylmethyl]-1H-imidazole ligand is active against *in vitro* cultures of *Trypanosoma cruzi*, the causative agent of Chagas disease. The reaction of $[\text{AuCl}_3(\text{THT})]$ with the pyrazolate iridium complex $[\text{Ir}(\text{pz})(\text{CO})(\text{PPh}_3)_2]$ leads to the heterobimetallic compound $[\text{Ir}(\mu\text{-pz})\text{AuCl}_3(\text{CO})(\text{PPh}_3)_2]$, which easily decomposes to $(\text{Aupz})_n$.¹⁶⁹¹ Substitution reactions on $[\text{AuBr}_4]^-$ by several pyridine and substituted pyridine ligands have been done and the kinetics of the forward and reverse reaction has been studied showing a dependence of the second-order rate constants upon the amine basicity.¹⁶⁸⁰

Gold(III) complexes with monodentate nitrogen ligand have also been prepared starting from (pentafluorophenyl)gold(III) compounds. Thus, the reaction of $[\text{Au}(\text{C}_6\text{F}_5)_3(\text{OEt}_2)]$ or $[\text{Au}(\text{C}_6\text{F}_5)_3(\text{OEt}_2)_2]\text{ClO}_4$ with 3-ferrocenylpyridine (FcPy)³⁴⁸ or 1,1'-bis(2-pyridylthio)ferrocene ($\text{Fc}(\text{SPy})_2$)³⁴⁹ gives the gold(III) complexes $[\text{Au}(\text{C}_6\text{F}_5)_3(\text{FcPy})]$, $[\text{Au}(\text{C}_6\text{F}_5)_2(\text{FcPy})_2]\text{ClO}_4$ (284) or $[\{\text{Au}(\text{C}_6\text{F}_5)_3\}_2\{\text{Fc}(\text{SPy})_2\}]$ (285).

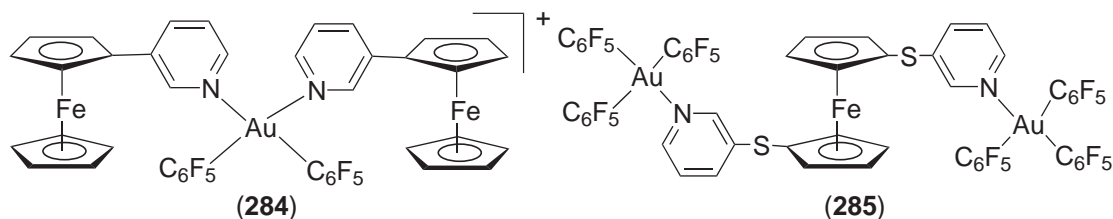

The complex *trans*- $[\text{AuBr}_2(\text{ptm})(\text{PEt}_3)]$ ($\text{ptm} =$ phthalimide) was prepared by oxidative addition to the corresponding gold(I) derivative, this complex rapidly isomerizes to the *cis* isomer.¹⁶⁹² Similarly, the complexes with the acetimine ligands $[\text{AuCl}_3(\text{NH}=\text{CMe}_2)]$ and $[\text{AuCl}_2(\text{NH}=\text{CMe}_2)_2]\text{ClO}_4$ have been obtained by oxidation with PhICl_2 from the corresponding gold(I) precursor.¹⁶⁸⁶

An excess of the nitrogen base affords complexes $[\text{AuCl}_2\text{L}_2]\text{Cl}$, as was shown with $\text{L} =$ pyridine¹⁶⁷⁹ or adenosine.¹⁶⁹³ With the bidentate and tridentate ligands bipy-bipyridine, terpyridine, or substituted terpyridines, bis(2-aminoethyl)amine and bis(2-aminoethyl)amide cationic complexes $[\text{AuCl}_2(\text{bipy})]^+$,¹⁶⁹⁴ $[\text{AuX}(\text{terpy})]^{2+}$ ($\text{X} = \text{Cl}$ (286), OH),^{1695,1696} $[\text{AuCl}(4'\text{-MeS-terpy})]$,¹⁶⁹⁷ $[\text{AuCl}\{\text{NH}(\text{CH}_2\text{CH}_2\text{NH}_2)\}_2]^{2+}$, and $[\text{AuCl}\{\text{N}(\text{CH}_2\text{CH}_2\text{NH}_2)\}_2]^+$ (287),¹⁶⁹⁸ are obtained. The compounds $[\text{AuR}_2(\text{bipy})]$ ($\text{R} = \text{Mes}$, CH_2TMS) present a luminescent behavior.¹⁶⁹⁸

The treatment of gold(III) complexes with the rigid bidentate ligand phen allows the synthesis of pseudo-pentacoordinate gold(III) derivatives. This is the case of $[\text{Au}(\text{dmp})(\text{phen})\text{PPh}_3](\text{BF}_4)_2$ (**288**) (dmp = 2-(dimethylaminomethyl)phenyl)¹⁶⁹⁹ or $[\text{AuCl}(\text{C}_4\text{Ph}_4)(\text{phen})]$.¹⁶⁶² The donor atoms of the phenanthroline ligand occupy one equatorial and the axial position of a square pyramid with distances 2.154(8) Å and 2.627(10) Å in (**288**).

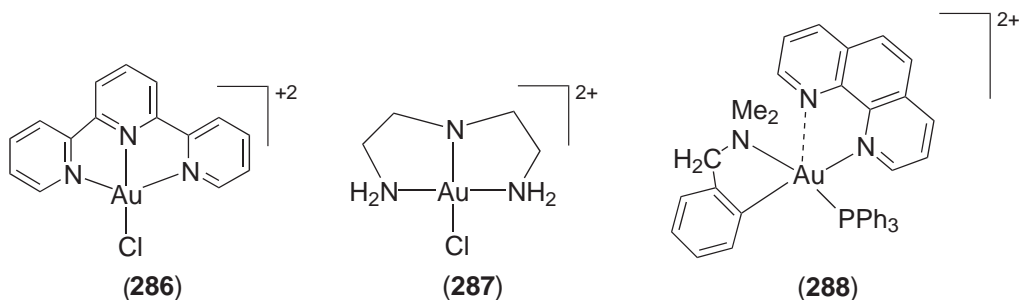

The same behavior is observed in the square-pyramidal complexes $[\text{Au}(\text{CN})_2\text{X}(\text{L-L})]$ (L-L = phen, 5-Mephen, 2,9-Me₂phen; X = Cl or Br) formed by reaction of $\text{trans-}[\text{Au}(\text{CN})_2\text{X}_2]^-$ and the bidentate ligands. They undergo in solution a very rapid intramolecular exchange of the apical and basal nitrogen atoms, together with the loss of the halogen giving the square-planar derivatives $[\text{Au}(\text{CN})_2(\text{L-L})]^+$.¹⁷⁰⁰ Pentacoordination is also achieved with the ligand di-2-pyridyl ketone oximate (dpk-o) in the complex $[\text{AuCl}(\text{dpk-o})_2]$, which has a Au—Cl distance of 2.911(2) Å.¹⁷⁰¹ The structure of trichloro(diethylenetriamine)gold(III), $[\text{AuCl}_3(\text{dien})]$, has been determined by EXAFS spectroscopy, that suggest that the gold(III) center has a pseudooctahedral coordination with the three nitrogen atoms from the dien ligand and one chlorine in the equatorial plane and two Au—Cl axial bonds. An XRD study confirms the overall structure but yields long axial Au—Cl lengths of 3.121 Å and 3.183 Å.¹⁷⁰² The reaction of tetrachloroauric acid with triethylenediamine gives the dinuclear complex $[\text{Au}_2\text{Cl}_3(\text{trien})]^{2+}$ (**289**).¹⁷⁰³

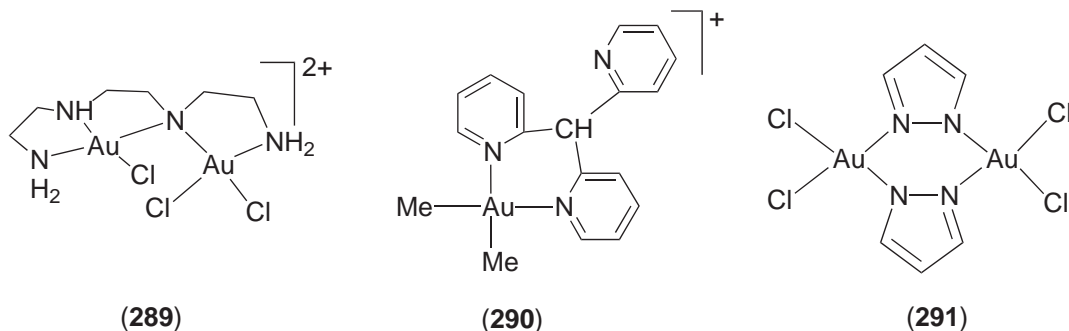

With more flexible ligands, such as the tridentate tris(2-pyridyl)methane (tpm), tris(2-pyridyl)methanol (tpmo), or tris(1-pyrazolyl)methane (tpzm), the corresponding dimethylgold(III) complexes $[\text{Au}(\text{Me})_2\text{AuL}]^{+}$ (L = tpm (**290**), tpmo, or tpzm) exhibit a *cis* square-planar coordination, with the ligands L functioning as bidentate ligands.¹⁷⁰⁴

Dinuclear gold(III) complexes with bridging pyrazolato ligands of the type $[\text{Au}_2(\mu\text{-N-N})_2\text{Cl}_4]$ (N-N = pz (**291**), 3-Me,5-Ph-pz, 3,5-Ph₂,4-Cl-pz) are obtained from the corresponding trimeric gold(I) complexes $[\text{Au}(\text{N-N})]_3$ by oxidation with aqua regia.¹⁷⁰⁵ $[\text{Au}_2(\mu\text{-pz})_2\text{Cl}_4]$ is also obtained by addition of potassium hydroxide in methanol to the gold(III) pyrazole compound $[\text{AuCl}_3(\text{Hpz})]$.¹⁷⁰⁵ Oxidation of the trimeric pyrazolate compound $[\text{Au}_3(3,5\text{-Ph}_2\text{pz})_4]$ with one equivalent of chlorine gives the mixed gold(I)–gold(III) complex $[\text{Au}_3\text{Cl}_2(3,5\text{-Ph}_2\text{pz})_3]$.¹⁷⁰⁶ Gold(III) complexes with tris- and tetrakis(pyrazol-1-yl)borate ligands have been described and are of the type $[\text{AuCl}_2\{N,N'-(\text{pz})_3\text{BH}\}]$, $[\text{Au}\{N,N'-(\text{pz})_3\text{BH}_4\}_2]\text{ClO}_4$, $[\text{AuRCl}\{N,N'-(\text{pz})_4\text{BH}\}]$ (R = C₆H₃(N=NC₆H₄Me-4')-2-Me-5), or $[\text{AuR}\{N,N'-(\text{pz})_4\text{B}\}]\text{ClO}_4$ (R = C₆H₄CH₂NMe₂).¹⁷⁰⁷

The cytotoxic activity of some of these complexes with polydentate nitrogen ligands have been tested. The complex $[\text{AuCl}_2(\text{phen})]\text{Cl}$ has shown to be highly cytotoxic towards the A2780 tumor cell line either sensitive or resistant to cisplatin; the solution chemistry studies point out that the fragment $[\text{Au}^{\text{III}}\text{phen}]^{3+}$ is stable in solution for several hours, even under physiological

conditions. The predominant species existing in solution under physiological conditions is likely to be $[\text{Au}(\text{OH}_2)_2(\text{phen})]^+$.^{1708,1709} Other complexes with polyamines such as $[\text{Au}(\text{en})_2]\text{Cl}_3$ and $[\text{AuCl}(\text{dien})]\text{Cl}_2$ were found to have cytotoxic properties against a human tumor cell line.¹⁷¹⁰

Bis(ethylenediamine)gold(III) chloride reacts with β -diketonates in aqueous base via Schiff base condensation to form complexes of gold(III) with a 14-membered macrocyclic tetraaza ligand such as (292).^{1711–1713} The X-ray structure showed the cation to be nearly planar. Delocalization of π -electrons within the six-membered β -diketonate rings was indicated by the observed pattern of C—C and C—N distances. Open-chain tetraaza ligand complexes in which condensation of only one β -diketonate has occurred, can be isolated as intermediates in this reaction. They may be used for further condensation with a different β -diketonate. Oxidation of this complex with trityl tetrafluoroborate introduces a double bond in position C2–C3.^{1712,1714}

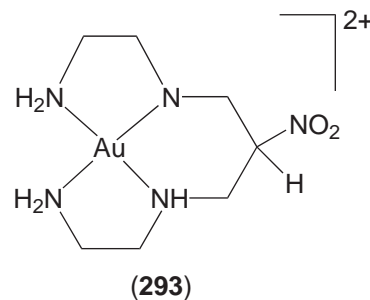
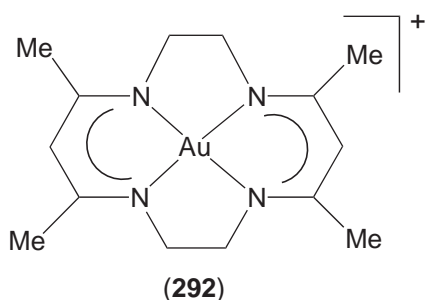

Other complexes with tetraaza macrocycles have been prepared by reaction of $[\text{Au}(\text{en})_2]\text{Cl}_3$, ethylenediamine, or nitroethane and formaldehyde, although with nitroethane an acyclic ligand was also obtained (293).^{1715,1716} A gold(III) complex with a hexaaza macrocycle (1,8-dimethyl-1,3,6,8,10,13-hexaazacyclotetradecane) has been obtained by a transmetallation reaction from the nickel compound $[\text{NiL}]^{2+}$ by reaction with $[\text{AuCl}_4]^-$.¹⁷¹⁷ The chemistry of tetraazamacrocycles in aqueous solution has been reported.¹⁷¹⁸

Gold(III) porphyrins have been used as acceptors in porphyrin diads^{1719,1720} and triads¹⁷²¹ due to their ability to be easily reduced, either chemically or photochemically. A new method for the incorporation of gold(III) into porphyrins (294) has been described and consist of the disproportionation of $[\text{Au}(\text{THT})_2]\text{BF}_4$ in mild conditions.¹⁷²² The complex tetrakis(1-pyrenyl)porphyrinatogold(III) acetate was prepared by metalation of the atropisomeric mixture of the free-base porphyrin ligand with $[\text{AuCl}_4]^-$ in glacial acetic acid (295).¹⁷²³ Optical studies have been carried out and have shown that this system has the potential to serve as a novel type of catalytic photonuclease for the long-wavelength sensitized cleavage of DNA and other guanine-containing nucleic acids.¹⁷²⁴

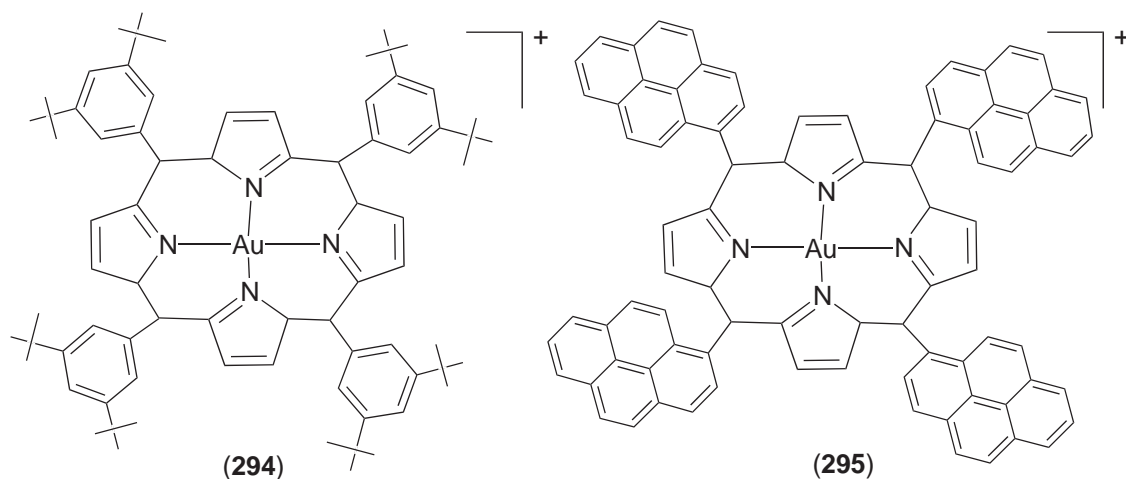

Addition of ammonia to tetrachloroauric(III) acid of gold(III) oxide hydrate yields a highly explosive yellow solid. Although this fulminating gold, as it is called, is probably the oldest known gold nitrogen compound, known since the Middle Ages, its constitution remained unknown until

recently. Primary studies concluded that these reactions afford products of compositions $[\text{NH}\{\text{AuCl}(\text{NH}_2)\}_2]$ or $\text{Au}_2\text{O}_3 \cdot 3\text{NH}_3$. The latest studies show that fulminating gold is part of a reversible equilibrium with $[\text{Au}(\text{NH}_3)_4]^{3+}$ and $\text{NH}_4[\text{AuCl}_4]$. Both products are stable and not explosive. $[\text{Au}(\text{NH}_3)_4]^{3+}$ is a weak acid that in the pH range 2–5 slowly hydrolyzes to give $[\text{Au}(\text{NH}_3)_3\text{OH}]^{2+}$, but at higher pH the tetraamine ion transforms in its conjugate base $[\text{Au}(\text{NH}_2)(\text{NH}_3)_3]^{2+}$ that finally forms fulminating gold.¹⁷²⁵ It can be assumed that fulminating gold is a product of further deprotonation and partial hydrolysis of $[\text{Au}(\text{NH}_2)(\text{NH}_3)_3]^{2+}$.

Substitution reactions of $[\text{Au}(\text{NH}_3)_4]^{2+}$ in acidic solution by halogens were studied by Skibsted. The ammine ligands are substituted by Cl^- or Br^- to finally yield the tetrahalo anions $[\text{AuX}_4]^-$, while with I^- reduction to $[\text{AuI}_2]^-$ occurs.^{1726–1728} Since the rate of substitution of ammonia by chloride or bromine is lowered by five orders of magnitude after substitution of two of the first ammine ligands, it was possible to isolate the complex *trans*- $[\text{AuBr}_2(\text{NH}_3)_2]\text{Br}$.¹⁷²⁹ Other complexes described with ammine as ligands are $[\text{AuBr}_3(\text{NH}_3)]$ ¹⁷³⁰ obtained by substitution in the chloro derivative¹⁷³¹ or $[\text{Au}(\text{C}_6\text{F}_5)_3(\text{NH}_3)]$ or $[\text{Au}(\text{C}_6\text{Cl}_5)_2\text{Cl}(\text{NH}_3)]$, prepared by substitution of the labile ligand tetrahydrothiophene¹⁷³² or cleavage of chlorine bridges.¹⁶⁴¹ Dimethylamido complexes of the type $[\text{AuMe}_2(\text{NR}_2)]_n$ have been synthesized by reaction of $[\text{AuMe}_2(\text{NH}_3)_2]^+$ with KNH_2 , LiNHMe , or LiNMe_2 .¹⁷³³ The structure of $[\text{AuMe}_2(\text{NMe}_2)_2]$ was established and is a dimer¹⁷³⁴ whereas a tetranuclear structure similar to that in $[\text{AuMe}_2(\text{OH})_4]$ is proposed in the others.

The structures of the tetraazido complexes $\text{AsPh}_4[\text{Au}(\text{N}_3)_4]$ ^{1735,1736} and $\text{Na}[\text{Au}(\text{N}_3)_4] \cdot 2\text{H}_2\text{O}$ have been determined.¹⁷³⁷ In the first one the tetraazidogold(III) anion adopts a whirl-wind configuration with the symmetry C_4 , while a lower symmetry was found in the sodium salt. Bridging azido, thiocyanate, or cyano ligands are also presented in organometallic complexes of gold(I) and gold(III), as in $[\text{Au}(\text{C}_6\text{F}_5)_3(\mu\text{-X})\text{Au}(\text{PPh}_3)]$, $[\text{Au}(\text{C}_6\text{F}_5)_2(\text{PPh}_3)(\mu\text{-X})\text{Au}(\text{C}_6\text{F}_5)]$, $[\text{Au}(\text{C}_6\text{F}_5)_3(\mu\text{-X})\text{Au}(\text{C}_6\text{F}_5)_2(\text{PPh}_3)]$, and $[\text{Au}(\text{C}_6\text{F}_5)_3(\mu\text{-X})\text{Au}(\text{C}_6\text{F}_5)_3]$ ($\text{X} = \text{N}_3^-$, SCN^- , CN^-)^{505,1738,1739} or $[\text{Au}_2(\mu\text{-X})_2(\text{C}_6\text{F}_5)_4]$ ($\text{X} = \text{N}_3^-$, SCN^-).¹⁶⁵⁷ Some nitrile complexes have been obtained by substitution of the diethyl ether ligand in $[\text{Au}(\text{C}_6\text{F}_5)_3(\text{OEt}_2)]$ by NCR ($\text{NCR} = \text{NCMe}$, NCPh , NCPr , $\text{NCCH}=\text{CH}_2$, $o\text{-(NC)}_2\text{C}_6\text{H}_4$).¹⁷⁴⁰

6.7.3.2.3 Complexes with phosphorus, arsenic, antimony, or bismuth donor ligands

Most of the (phosphine)gold(III) complexes known in the literature have a square-planar stereochemistry. They are generally stable and can be prepared by two methods: oxidation of the corresponding gold(I) complexes, or substitution processes of weakly coordinated ligands.

(i) Monodentate ligands

Complexes $[\text{AuX}_3(\text{PR}_3)]$ ($\text{X} = \text{Cl}$, Br ; $\text{PR}_3 = \text{PMe}_3$, PET_3 , PPh_3 , 1-phenyl-3,4-dimethylphosphole, or 1-phenyldibenzophosphole) are prepared by oxidation of the gold(I) derivative $[\text{AuX}(\text{PR}_3)]$ with the corresponding halogen.^{1741–1743} Mixed halogen derivatives $[\text{AuX}^1\text{X}^2_2(\text{PR}_3)]$ can also be prepared in an analogous way, probably as pure solid compounds, but in solution the NMR spectra have shown that all possible combinations and isomers of formula $[\text{AuX}_n\text{X}'_{3-n}(\text{PR}_3)]$ are present.¹⁷⁴³ The structures of $[\text{AuX}_3(\text{PR}_3)]$ molecules show that the Au—X bond *trans* to the phosphorus atoms is longer than the others. $[\text{AuBr}_2\text{Cl}(\text{PR}_3)]$ molecules are substitutionally disordered in the crystal, probably with two-thirds bromine and one-third chlorine on each site.¹⁷⁴³ The gold(III) complex *trans*- $[\text{AuBr}_2(\text{ptm})(\text{PET}_3)]$, which isomerizes readily to give the *cis*-isomer, has been prepared by oxidative addition of bromine to *trans*- $[\text{Au}(\text{ptm})(\text{PET}_3)]$.¹⁶⁹²

Displacement of tetrahydrothiophene or diethyl ether from $[\text{Au}(\text{C}_6\text{F}_5)_3(\text{THT})]$, $[\text{Au}(\text{C}_6\text{F}_5)_3(\text{OEt}_2)]$, or cleavage of the chloro bridges in $[\text{Au}_2(\mu\text{-Cl})_2(\text{C}_6\text{F}_5)_4]$ by phosphine, arsine, or stibine ligands gives complexes of the type $[\text{Au}(\text{C}_6\text{F}_5)_3\text{L}]$ ($\text{L} = \text{PMePh}_2$, $\text{P}(\text{OPh})_3$, $\text{FcCH}_2\text{PPh}_2$, FcPh_2P , AsPh_3 , SbPh_3 , 2- $\text{PPh}_2\text{C}_6\text{H}_4\text{SH}$), or $[\text{Au}(\text{C}_6\text{F}_5)_2\text{Cl}(\text{PPh}_2\text{Fc})]$.^{709,1732,1744–1746} Addition of PPh_3 to solutions of the cyclometallated derivatives $[\text{Au}(\text{C-N})\text{RCl}]$ ($\text{C-N} = 2\text{-C}_6\text{H}_4\text{N}=\text{NPh}$; $\text{R} = \text{C}_6\text{F}_5$, CH_2COMe) leads to displacement of the nitrogen atom of the chelate ligand and the formation of $[\text{Au}(\text{C-N})\text{RCl}(\text{PPh}_3)]$.^{1747,1748} The complex with $\text{R} = \text{C}_6\text{F}_5$ slowly decomposes in solution to give a mixture of $[\text{Au}(\text{C}_6\text{F}_5)\text{PPh}_3]$, 2- $\text{C}_6\text{F}_5\text{-C}_6\text{H}_4\text{N}=\text{NPh}$, and $[\text{Au}(\text{C-N})\text{Cl}_2(\text{PPh}_3)]$.¹⁷⁴⁸ With the cyclometallated complexes $[\text{Au}(\text{C-N})\text{Cl}_2]$ ($\text{C-N} = 2\text{-C}_6\text{H}_4\text{CR}_2\text{C}_5\text{H}_5\text{N}$,

R = H, Me), the reaction with PPh_3 leads to the formation of cationic compounds $[\text{Au}(\text{C-N})\text{Cl}(\text{PPh}_3)]^+$.¹⁷⁴⁹

The methylene-bridged dinuclear gold(III) complex $[\text{Au}_2(\mu\text{-CH}_2)\{\mu\text{-(CH}_2)_2\text{PPh}_2\}_2\text{I}_2]$ reacts with $[\text{Ag}(\text{OCIO}_3)\text{L}]$ (L = PPh_3 , PPh_2Me , THT) to give the cationic derivatives $[\text{Au}_2(\mu\text{-CH}_2)\{\mu\text{-(CH}_2)_2\text{PPh}_2\}_2\text{IL}]\text{ClO}_4$ or $[\text{Au}_2(\mu\text{-CH}_2)\{\mu\text{-(CH}_2)_2\text{PPh}_2\}_2\text{L}_2](\text{ClO}_4)_2$ when a 1:1 or 1:2 molar ratio is used, respectively. When L is THT this can be displaced easily by other ligands such as AsPh_3 (Scheme 12).¹⁷⁵⁰

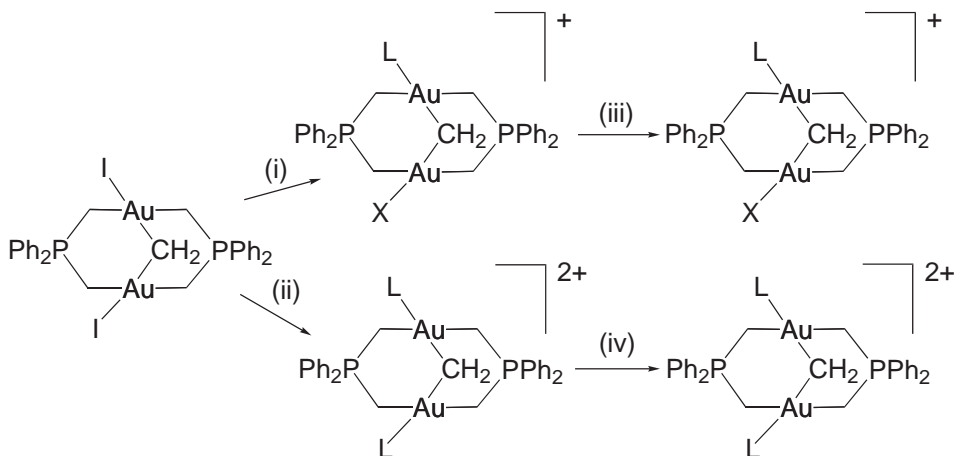

Scheme 12 (i) $[\text{Ag}(\text{OCIO}_3)\text{L}]$, (ii) $2 [\text{Ag}(\text{OCIO}_3)\text{L}]$, (iii) AsPh_3 (L = THT), (iv) 2AsPh_3 (L = THT); L = PPh_3 , PPh_2Me , THT.

The gold(III) complex $[\text{Au}(\text{C}_6\text{F}_5)_3(\text{PPh}_2\text{C}\equiv\text{CH})]$ has been synthesized and contains a phosphinoalkyne. Reactions with sodium alkoxides lead to the single or double addition to the alkyne-phosphine fragment giving $[\text{Au}(\text{C}_6\text{F}_5)_3(\text{PPh}_2\text{CH}=\text{CHOR})]$ or $[\text{Au}(\text{C}_6\text{F}_5)_3\{\text{PPh}_2\text{CH}_2=\text{C}(\text{OR})_2\}]$ (R = Me, Et).¹⁷⁵¹

(ii) Polydentate ligands

The reaction with potentially bidentate ligands (L-L) takes two different courses:

- (i) phenylene-1,2-bis(dimethylarsine), $\text{Ph}_2\text{PCH}_2\text{PPh}_2$, $\text{Ph}_2\text{PNHPPH}_2$, or $\text{Ph}_2\text{PC}(\text{=CH}_2)\text{PPh}_2$ act as monodentate ligands in $[\text{Au}(\text{C}_6\text{F}_5)_3(\text{L-L})]$ ^{1271,1650,1732} and
- (ii) $\text{Ph}_2\text{P}(\text{CH}_2)_2\text{PPh}_2$ (dppe) functions as a bridging ligand in a binuclear derivative $[\{\text{Au}(\text{C}_6\text{F}_5)_3\}_2(\mu\text{-dppe})]$.¹⁷³²

The complex $[\text{Au}(\text{C}_6\text{F}_5)_3\{\text{Ph}_2\text{PC}(\text{=CH}_2)\text{PPh}_2\}]$ reacts with gold(I) compounds with coordination of the gold(I) center to the uncoordinated phosphorus atom to give complexes of the type $[\text{Au}(\mu\text{-Cl})(\text{C}_6\text{F}_5)_2(\text{PPh}_2\text{CH}_2\text{PPh}_2)]$, showing the presence of one uncoordinated phosphorus atom. Both derivatives react with $[\text{Au}(\text{OCIO}_3)(\text{PPh}_3)]$ or $[\text{AuX}(\text{THT})]$ (X = Cl or C_6F_5), to form cationic binuclear complexes of the types $\text{cis-}[\text{Au}(\text{Cl})(\text{C}_6\text{F}_5)_2(\text{PPh}_2\text{CH}_2\text{PPh}_2)\text{Au}(\text{PPh}_3)]\text{ClO}_4$ and $[\text{Au}(\text{C}_6\text{F}_5)_3(\text{PPh}_2\text{CH}_2\text{PPh}_2)\text{Au}(\text{PPh}_3)]\text{ClO}_4$, or of neutral $\text{cis-}[\text{Au}(\text{Cl})(\text{C}_6\text{F}_5)_2(\text{PPh}_2\text{CH}_2\text{PPh}_2)\text{AuX}]$ and $[\text{Au}(\text{C}_6\text{F}_5)_3(\text{PPh}_2\text{CH}_2\text{PPh}_2)\text{AuX}]$, respectively.¹²⁷¹

The cleavage of binuclear $[\{\text{Au}(\text{Cl})(\text{C}_6\text{F}_5)_2\}_2]$ with the diphosphine $\text{Ph}_2\text{PCH}_2\text{PPh}_2$ gives $\text{cis-}[\text{Au}(\mu\text{-Cl})(\text{C}_6\text{F}_5)_2(\text{PPh}_2\text{CH}_2\text{PPh}_2)]$, which has a ^{31}P NMR spectrum analogous of that of $[\text{Au}(\text{C}_6\text{F}_5)_3(\text{PPh}_2\text{CH}_2\text{PPh}_2)]$, showing the presence of one uncoordinated phosphorus atom. Both derivatives react with $[\text{Au}(\text{OCIO}_3)(\text{PPh}_3)]$ or $[\text{AuX}(\text{THT})]$ (X = Cl or C_6F_5), to form cationic binuclear complexes of the types $\text{cis-}[\text{Au}(\text{Cl})(\text{C}_6\text{F}_5)_2(\text{PPh}_2\text{CH}_2\text{PPh}_2)\text{Au}(\text{PPh}_3)]\text{ClO}_4$ and $[\text{Au}(\text{C}_6\text{F}_5)_3(\text{PPh}_2\text{CH}_2\text{PPh}_2)\text{Au}(\text{PPh}_3)]\text{ClO}_4$, or of neutral $\text{cis-}[\text{Au}(\text{Cl})(\text{C}_6\text{F}_5)_2(\text{PPh}_2\text{CH}_2\text{PPh}_2)\text{AuX}]$ and $[\text{Au}(\text{C}_6\text{F}_5)_3(\text{PPh}_2\text{CH}_2\text{PPh}_2)\text{AuX}]$, respectively.¹⁷³² The abstraction of chlorine from $\text{cis-}[\text{Au}(\text{Cl})(\text{C}_6\text{F}_5)_2(\text{PPh}_2\text{CH}_2\text{PPh}_2)]$ by AgClO_4 gives $\text{cis-}[\text{Au}(\text{C}_6\text{F}_5)_2(\mu\text{-PPh}_2\text{CH}_2\text{PPh}_2)]\text{ClO}_4$. The reaction of the latter with NaH causes both deprotonation of the methylene group and elimination of the perchlorate anion to give the neutral (phosphino)methanide complex $[\text{Au}(\text{C}_6\text{F}_5)_2(\mu\text{-PPh}_2\text{CHPPH}_2)]$ (Scheme 13).^{1744,1752} Similar reactions are obtained with the diarsine ligand $\text{Ph}_2\text{AsCH}_2\text{AsPh}_2$.¹⁶⁵¹

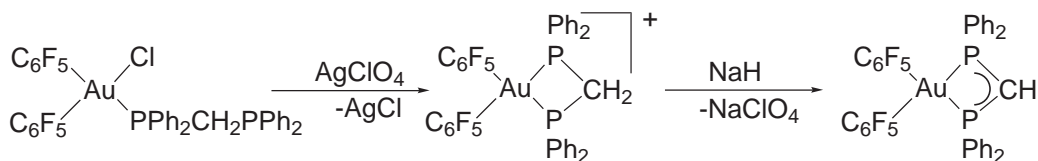

Scheme 13

The complex $[\text{Au}(\text{C}_6\text{F}_5)_2(\mu\text{-PPh}_2\text{CHPPh}_2)]$ can act as C-donor nucleophile in reactions with $[\text{Au}(\text{OCIO}_3)(\text{PPh}_3)]$, $[\text{AuX}(\text{THT})]$, $[\text{Au}(\text{THT})_2]\text{ClO}_4$, or $[\text{Au}(\text{ACAC})(\text{PPh}_3)]$ to form the dinuclear or trinuclear complexes. The use of acetylacetonate (ACAC) complexes allows the double deprotonation of the methylene group and the coordination of two gold(I) centers to the methanediide C-atom (Scheme 14).¹⁷⁵²⁻¹⁷⁵⁴

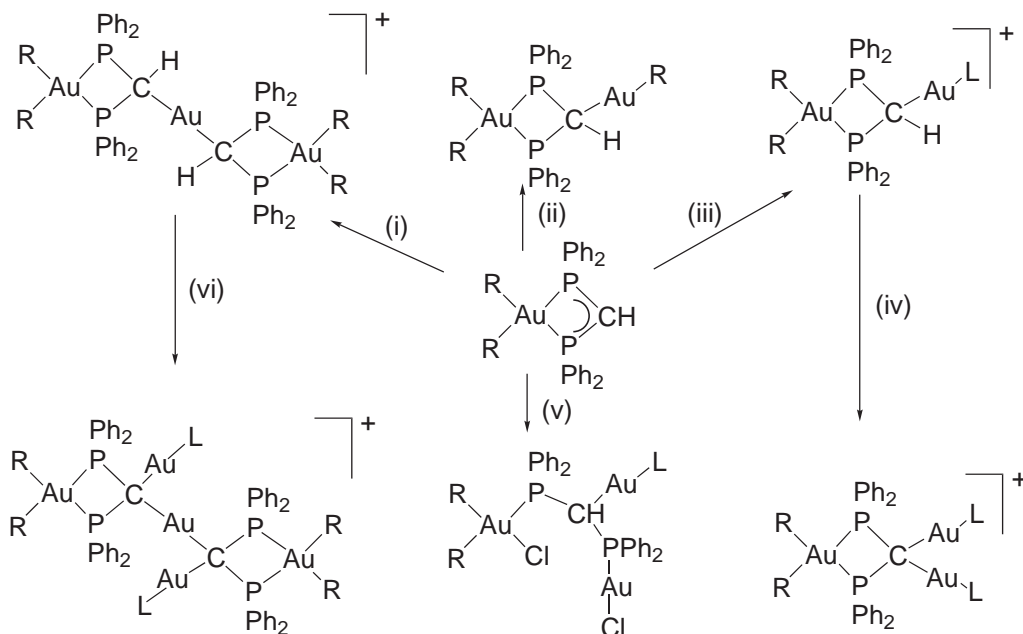

Scheme 14 $\text{R} = \text{C}_6\text{F}_5$, $\text{L} = \text{PPh}_3$; (i) $[\text{Au}(\text{THT})_2]\text{ClO}_4$, (ii) $\text{AuR}(\text{THT})$, (iii) $[\text{Au}(\text{OCIO}_3)\text{L}]$, (iv) $[\text{Au}(\text{ACAC})\text{L}]$, (v) $2[\text{AuClL}]$, (vi) $2[\text{Au}(\text{ACAC})\text{L}]$.

Other phosphinomethanide gold(III) complexes have been obtained starting from $[\text{Au}(\text{C}_6\text{F}_5)_3(\text{PPh}_2\text{CH}_2\text{PPh}_2)]$ by reaction with acetylacetonate salts. Thus the treatment with $\text{Bu}_4\text{N}[\text{Au}(\text{ACAC})_2]$ affords the anionic trinuclear compound $\text{Bu}_4\text{N}\{[\text{Au}(\text{C}_6\text{F}_5)_3(\text{PPh}_2\text{CHPPh}_2)_2\text{Au}]\}$, that can further react with the gold(I) complexes $[\text{AuX}(\text{THT})]$ with coordination of the AuX fragment to the methanide carbon (Scheme 15).¹⁷⁵⁵ Also the uncoordinated phosphorus atom in $[\text{Au}(\text{C}_6\text{F}_5)_3(\text{PPh}_2\text{CH}_2\text{PPh}_2)]$ can displace tetrahydrothiophene from $[\text{Au}(\text{C}_6\text{F}_5)(\text{THT})]$ giving $[\text{Au}(\text{C}_6\text{F}_5)_3(\text{PPh}_2\text{CH}_2\text{PPh}_2)\text{Au}(\text{C}_6\text{F}_5)]$, and the latter can react further with acetylacetonate complexes to yield new mixed gold(I)-gold(III) methanide derivatives (Scheme 15).¹⁷⁵⁶

The bidentate ligands 3,4-bis(diphenylphosphinoamino)toluene and 1,2-bis(diphenylphosphinoamino)benzene reacts with the gold(III) compounds $[\text{Au}(\text{C}_6\text{F}_5)_3(\text{OEt}_2)]$ or $[\text{Au}(\text{C}_6\text{F}_5)_2(\text{OEt}_2)\text{ClO}_4]$ to give complexes $[\text{Au}(\text{C}_6\text{F}_5)_3\{(\text{PPh}_2\text{NH})_2\text{C}_6\text{H}_4\text{R}\}]$, $[\{\text{Au}(\text{C}_6\text{F}_5)_3\}_2\{\mu\text{-}(\text{PPh}_2\text{NH})_2\text{C}_6\text{H}_3\text{R}\}]$, or $[\text{Au}(\text{C}_6\text{F}_5)_2\{(\text{PPh}_2\text{NH})_2\text{C}_6\text{H}_3\text{R}\}]\text{ClO}_4$ ($\text{R} = \text{H}, \text{Me}$). The amino group can be deprotonated with $\text{NBu}_4(\text{ACAC})$ and further coordinate a AuPPh_3^+ fragment yielding (296). Mixed gold(I)-gold(III) species of the type $[\{\text{Au}(\text{C}_6\text{F}_5)_3\}(\text{AuX})\{\mu\text{-}(\text{PPh}_2\text{NH})_2\text{C}_6\text{H}_4\text{R}\}]$ are obtained from $[\text{Au}(\text{C}_6\text{F}_5)_3\{(\text{PPh}_2\text{NH})_2\text{C}_6\text{H}_4\text{R}\}]$ by reaction with $[\text{AuX}(\text{THT})]$ ($\text{X} = \text{Cl}, \text{C}_6\text{F}_5$).¹⁷⁵⁷ The complexes $[\text{AuCl}_2\{\mu\text{-}(\text{PR})_2\text{C}_2\text{B}_9\text{H}_{10}\}]$ ($\text{R} = \text{Pr}^i, \text{Ph}$ (297)), which possess a bidentate chelate *nido*-carborane diphosphine ligand, have been obtained by heating solutions of $[\text{AuCl}_3(\text{THT})]$ with the *closo*-diphosphines $(\text{PR})_2\text{C}_2\text{B}_{10}\text{H}_{10}$.^{1759,1760} The vinylidenebis(diphenylphosphine) reacts with

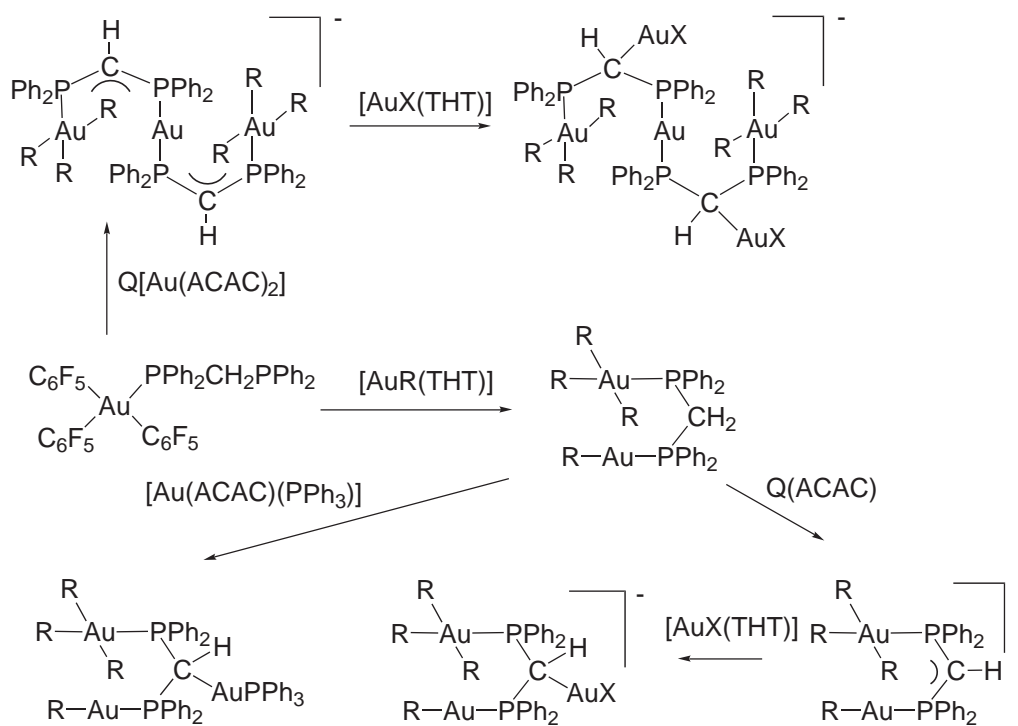

Scheme 15 R = C₆F₅; X = Cl, C₆F₅; Q = NBu₄, N(PPh₂)₂.

[Au₂(μ-Cl)₂(C₆F₅)₄] to yield [Au(C₆F₅)₂Cl{PPh₂C(=CH₂)PPh₂}. The coordination of this diphosphine to the gold(III) center strongly activates the carbon-carbon double bond, and this complex, therefore, undergoes Michael-type additions with several carbon-, sulfur-, or oxygen-based nucleophiles. The addition takes place at the terminal carbon of the double bond, giving methanide-type complexes (Scheme 16).¹⁷⁶¹

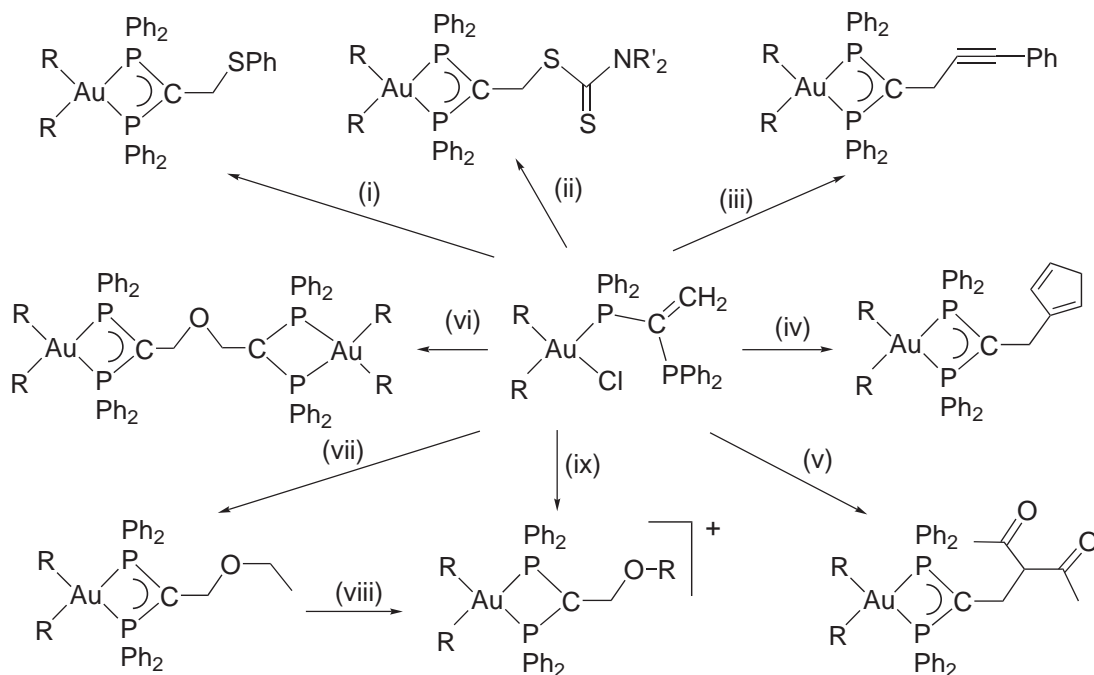

Scheme 16 R=C₆F₅ (i) NaSPh, (ii) NaS₂CNR'₂, (iii) AgCCPh, (iv) TICp, (v) Ti(ACAC), (vi) 1/2 Ag₂O, (vii) NaOEt, (viii) HClO₄, (ix) AgClO₄ + OR.

The reaction of the dinuclear complexes $trans$ -[MX₂(AsPh₂CH₂AsPh₂AuX)₂] (M = Pd or Pt; X = Cl or Br) with the appropriate dihalogen leads to the gold(III) compounds $trans$ -[MX₂(AsPh₂CH₂AsPh₂AuX₃)₂] or $trans$ -[MX₄(AsPh₂CH₂AsPh₂AuX₃)₂].¹⁷⁶² The palladium complex [Pd(C₆F₅)₂(PPh₂CH₂PPh₂)₂] reacts with two equivalents of [Au(C₆F₅)₃(THT)] to give the heteronuclear derivative [Pd(C₆F₅)₂(PPh₂CH₂PPh₂)₂{Au(C₆F₅)₃}₂].¹⁷⁶³

The triphosphine ligand bis(diphenylphosphinomethyl)phenylphosphine (dpmp) forms mono- or dinuclear gold(III) derivatives of the types [{Au(C₆F₅)₃}₂(dpmp)], in which the gold(III) fragments are coordinated to the ended phosphorus or [Au(C₆F₅)₃(dpmp)], for which the crystal structure shows the gold coordinated to the central phosphorus atom, although two isomers are observed in solution. [Au(C₆F₅)₃}₂(dpmp)] reacts with gold(I) compounds to give the mixed-valence trinuclear complexes [{Au(C₆F₅)₃}₂(AuX)(dpmp)] (X = Cl (**298**), C₆F₅).¹⁷⁶⁴ With the related ligand bis(diphenylphosphinoethyl)phenylphosphine (dpep) the gold(III) derivatives [{Au(C₆F₅)₃}₂(dpep)] or [{Au(C₆F₅)₃}₃(dpep)] have been synthesized. The latter shows a luminescent behavior, which is not common for gold(III) complexes.¹⁷⁶⁵

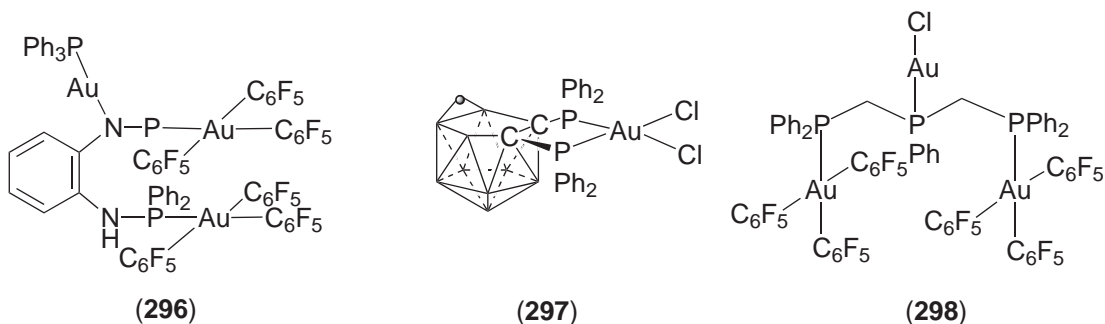

Other gold(III) complexes with triphosphines as ligands are those obtained with the 1,1,1-tris(diphenylphosphinomethyl)ethane (triphos) which form compounds of the type [Au(C₆F₅)₃(η¹-triphos)] or [Au(C₆F₅)₂(η²-triphos)]Cl. The uncoordinated phosphorus atoms in [Au(C₆F₅)₃(η¹-triphos)] are used for further coordination to other gold(I) centers to give [Au(C₆F₅)₃(μ-triphos)(AuX)₂] (X = Cl, C₆F₅), [Au(C₆F₅)₃(η¹,η²-triphos)(AuPPh₃)], or [Au(C₆F₅)₃(μ-triphos)}₂Au]. Compound [Au(C₆F₅)₂(η²-triphos)]Cl reacts with [Au(C₆F₅)₃(THT)] to yield [Au(C₆F₅)₂(μ-triphos)Au(C₆F₅)₃]Cl.¹⁷⁶⁶ Heterodinuclear complexes of the type [M(CO)₄(η²,η¹-triphos)Au(C₆F₅)₂X] (M = Mo, W; X = Cl, C₆F₅) with this triphosphine ligand are achieved by reaction of [M(CO)₄(η²-triphos)] with [Au(C₆F₅)₃(THT)] or [Au₂(μ-Cl)₂(C₆F₅)₄].¹⁷⁶⁷ The reaction of [Au(C₆F₅)₂(ACAC)] with the tris(diphenylphosphino)methane ligand affords the gold(III) methanide complex [Au(C₆F₅)₂((PPh₂)₂CPPH₂)]. Further reaction of this complex with the gold(I) compounds [AuX(THT)] or [Au(THT)₂]ClO₄ or the silver(I) salt AgClO₄ gives the dinuclear [Au(C₆F₅)₂((PPh₂)₂CPPH₂)₂AuX] (X = Cl, C₆F₅) or trinuclear [Au(C₆F₅)₂((PPh₂)₂CPPH₂)₂M]ClO₄ (M = Au, Ag). With gold(III) the following derivatives are obtained [Au(C₆F₅)₂((PPh₂)₂CPPH₂)₂Au(C₆F₅)₂X] (X = Cl, C₆F₅) or [Au(C₆F₅)₂((PPh₂)₂CPPH₂)₂}₂{Au(C₆F₅)₂}ClO₄.¹⁷⁶⁸

(iii) Bridging phosphido ligands

Although the chemistry of phosphido-bridged transition metal complexes is well represented, the corresponding gold chemistry has only recently developed. The synthesis of gold(III) derivatives with diphenylphosphine PPh₂H and further treatment with acetylacetonate compounds gives stable phosphido-bridged gold(III) derivatives. Thus the reaction of [Au(C₆F₅)₃(THT)] or [Au(C₆F₅)₂(OEt)₂]ClO₄ with diphenylphosphine leads to the complexes [Au(C₆F₅)₃(PPh₂H)] or [Au(C₆F₅)₂(PPh₂H)₂]ClO₄, that are useful starting materials to prepare polynuclear derivatives by reaction with acetylacetonate compounds (see Schemes 17 and 18).^{1769,1770} The reaction of PPh₂H with [Au₂(μ-Cl)₂(C₆F₅)₄] gives directly the phosphido-bridged species [Au₂(μ-PPh₂)₂(C₆F₅)₄].¹⁷⁷¹ The treatment of the mixed gold(III)–silver(I) diphenylphosphide complex [Au(C₆F₅)₃(μ-PPh₂)Ag]₂ with [AgCl(PPh₃)₂] leads to the insertion of the latter to give [Au(C₆F₅)₂(μ-PPh₂)₂AgPPh₃]₂(μ-Ag)(μ₃-Cl)] (Scheme 18).¹⁷⁷²

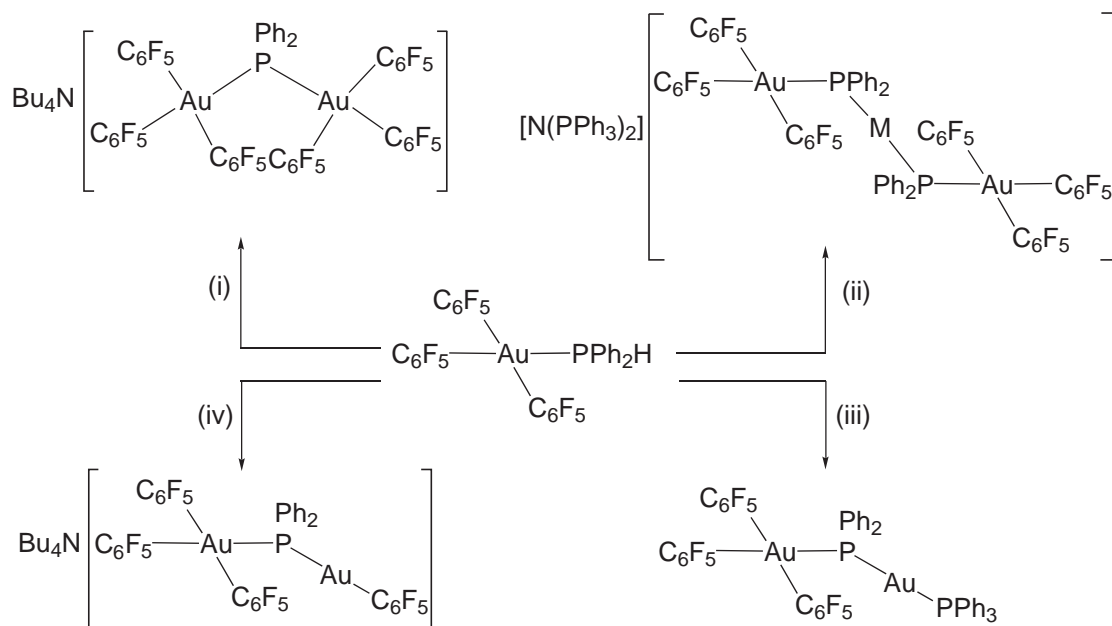

Scheme 17 (i) $[N(PPh_3)_2][Au(C_6F_5)_3(ACAC)]$, (ii) $1/2[N(PPh_3)_2][Au(ACAC)]$, $AgClO_4 + [N(PPh_3)_2]ACAC$, (iii) $[Au(ACAC)(PPh_3)]$, (iv) $[Au(C_6F_5)(THT)]$, $NBu_4(ACAC)$.

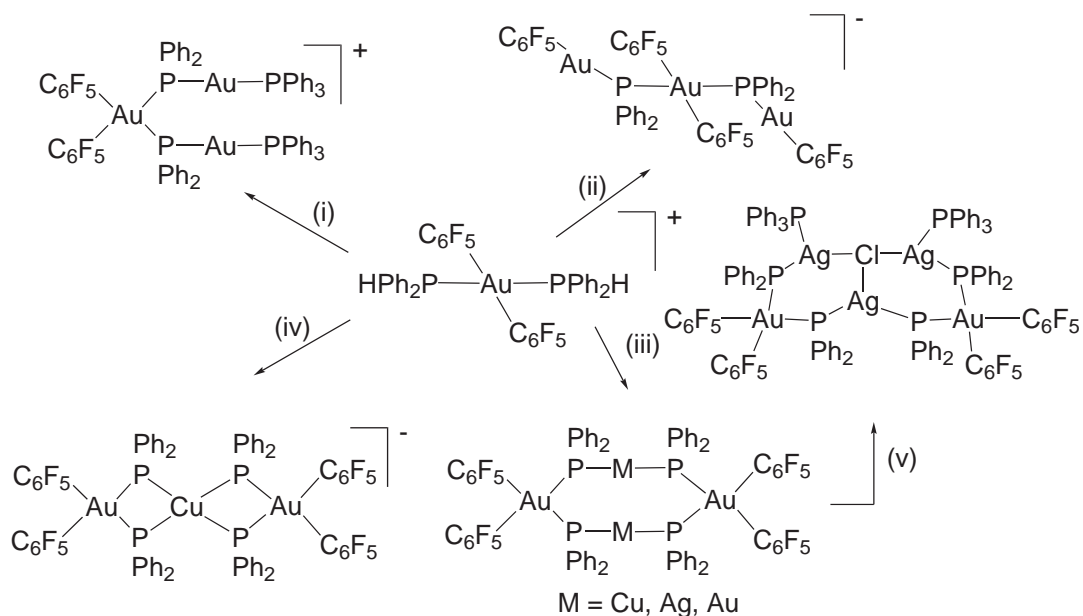

Scheme 18 (i) $2[Au(ACAC)(PPh_3)]$, (ii) $2[Au(C_6F_5)(THT)]$, $2NBu_4(ACAC)$, (iii) $[N(PPh_3)_2][Au(ACAC)_2]$, $AgClO_4$ or $[Cu(NCMe)_4]OTf + [N(PPh_2)_2]ACAC$, (iv) $[Cu(NCMe)_4]OTf + [N(PPh_2)_3]ACAC$, (v) $[AgCl(PPh_3)_2]$.

6.7.3.2.4 Complexes with oxygen donor ligands

Gold shows low affinity for binding to oxygen ligands. Generally these complexes are thermally unstable as the Au—O bond is very weak, and for this reason gold compounds with oxygen ligands are expected to be highly reactive and they may display an interesting reaction chemistry.

For example gold(III) complexes with β -diketonates or alkylsiloxides, are likewise employed as precursors for CVD.^{1773,1774} Another promising result in the field of homogeneous catalysis is the discovery that gold(III) alkoxo complexes promoted the condensation of benzaldehyde with compounds containing an active methylene group.¹⁷⁷⁵

(i) *Hydroxo, oxo, and alkoxo complexes*

Gold(III) hydroxo complexes are generally obtained by reaction of the corresponding precursor with NaOH or KOH in aqueous solution. The hydroxo-bridged complex $[\text{Au}(\text{C}_6\text{H}_4\text{NO}_2-2)_2(\mu\text{-OH})_2]$ (**299**) has been obtained either by reaction of $\text{Na}[\text{Au}(\text{C}_6\text{H}_4\text{NO}_2-2)_2(\text{OPh})_2]$ with traces of water in $\text{CH}_2\text{Cl}_2/n$ -hexane solution or by treatment of the dichloroaurated complex with NaOH.¹⁷⁷⁶ Monomeric gold(III) hydroxo complexes have been described very recently and all of them feature a polypyridine as coligand. The terpy derivative $[\text{Au}(\text{OH})(\text{terpy})](\text{ClO}_4)_2$ (**300**)¹⁶⁹⁶ was isolated in the course of equilibrium and kinetic studies of gold(III) complexes with terpy carried out in aqueous solution. The intermediate species $[\text{Au}(\text{OH}_2)(\text{terpy})]^{3+}$ behave as a strong acid that dissociates completely into the corresponding hydroxo complex, isolated as the perchlorate salt.

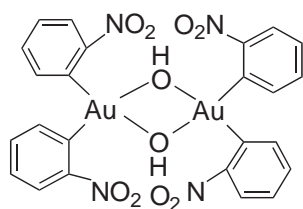

(299)

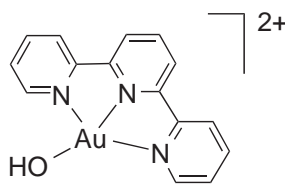

(300)

Treatment of the cyclometallated complex $[\text{Au}(\text{C},\text{N},\text{N})\text{Cl}]\text{PF}_6$ ($\text{HC},\text{N},\text{N} = 6$ -(1,1-dimethylbenzyl)-2,2'-bipyridine) with KOH in aqueous media gave the hydroxo complex $[\text{Au}(\text{C},\text{N},\text{N})(\text{OH})]\text{PF}_6$.^{1777,1778} This complex has been evaluated as a potential antitumor agent, and the preliminary studies show relevant cytotoxic effects towards a variety of tumor cell lines.^{1778,1779} Other monomeric hydroxo complexes are the two bipy derivatives, $[\text{AuCl}(\text{OH})(\text{bipy})]\text{PF}_6$ and $[\text{Au}(\text{OH})_2(\text{bipy})]\text{PF}_6$, which have been obtained by the hydrolysis of $[\text{AuCl}_2(\text{bipy})]\text{PF}_6$ in aqueous solution.¹⁷⁸⁰ These compounds undergo proton exchange in ROH solution to give the corresponding alkoxides. The electrochemical behavior of the oxo species shows an irreversible one-electron reduction process.¹⁷⁸¹

Oxo complexes are, in most cases, obtained by deprotonation or by condensation of hydroxo species. The cyclometallated derivatives $[\text{Au}_2(\text{C},\text{N},\text{N})_2(\mu\text{-O})]\text{X}_2$ ($\text{C},\text{N},\text{N} = \text{N}_2\text{C}_{10}\text{H}_7(\text{CMe}_2\text{C}_6\text{H}_4)-6$, $\text{N}_2\text{C}_{10}\text{H}_7(\text{CHMeC}_6\text{H}_4)-6$; $\text{X} = \text{PF}_6, \text{BF}_4$)¹⁷⁸² (**301**) and the 2,2'-bipyridine derivative $[\text{Au}(\mu\text{-O})(6\text{-R-2,2'-bipy})_2](\text{PF}_6)_2$ ($\text{R} = \text{H}, \text{CH}_2\text{Me}, \text{CHMe}_2, \text{CMe}_3, \text{CH}_2\text{CMe}_3$) (**302**)¹⁷⁸³ are rare examples of metal oxo complexes with an unsupported M-O-M bridge ($\text{M} = \text{late transition metal}$).

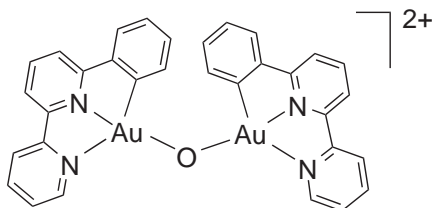

(301)

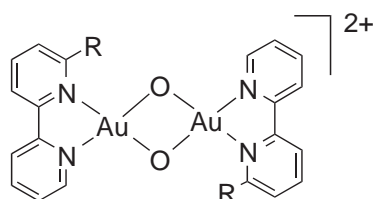

(302)

Gold(III) alkoxo complexes are stabilized by a variety of ancillary ligands. Some of them, as with $[\text{Au}_2(\mu\text{-OTMS})_2\text{Me}_4]$ which was synthesized some time ago¹⁷⁸⁴ have found recent applications as precursor for CVD.¹⁷⁸⁵ Thermally stable aryloxo and fluoroalkoxo complexes of the type

$[\text{AuMe}_2(\text{OR})(\text{PPh}_3)]$ ($\text{R} = \text{Ph}$, $p\text{-Tol}$, CH_2CF_3 , $\text{CH}(\text{CF}_3)_2$) have been prepared by metathesis of *cis*-dimethyliodo(triphenylphosphine)gold(III) with potassium alkoxides (Equation (15)):¹⁷⁸⁶



The reaction of these complexes with metal hydrides of the type $[\text{CoH}(\text{CO})_4]$, $[\text{MnH}(\text{CO})_3]$, $[\text{MoHCp}(\text{CO})_3]$, $[\text{WHCp}(\text{CO})_3]$, or $[\text{WHCp}(\text{CO})_2(\text{PMe}_3)]$ progresses with the liberation of alcohol, ethane, and the corresponding gold(I) derivatives.¹⁷⁸⁷

The reaction with active methylene compounds results in the hydrogen abstraction to give the alcohol and the organogold derivatives.¹⁷⁸⁶

These alkoxo complexes are also capable of cleavage of the C—Si bond of TMSCF_3 . The gold(III) fluoroalkoxides *cis*- $[\text{AuMe}_2(\text{OR})(\text{PPh}_3)]$ ($\text{R} = \text{CH}_2\text{CF}_3$, $\text{CH}(\text{CF}_3)_2$) can act as catalysts for the Knöevenagel condensation reaction.¹⁷⁷⁵

Some alkoxo complexes of the type *cis*- $[\text{AuMe}_2(\text{OR})(\text{PPh}_3)]$ ($\text{R} = \text{Me}$, Et , Pr^i) have been prepared *in situ* from *cis*- $[\text{AuMe}_2\text{I}(\text{PPh}_3)]$ and sodium alkoxide in alcohol or by alcoholysis of *cis*- $[\text{AuMe}_2(\text{CH}_2\text{CH}=\text{CHMe})(\text{PPh}_3)]$ in methanol; the highly reactive alkoxide species readily insert carbon monoxide to give the alkoxocarbonyl complexes *cis*- $[\text{AuMe}_2(\text{COOR})(\text{PPh}_3)]$.^{1788,1789} Other gold(III) alkoxo complexes are $[\text{AuMe}_2\{\text{OCH}(\text{Ph})\text{CH}_2\text{CH}=\text{CH}_2\}(\text{PPh}_3)]$,¹⁷⁹⁰ $\text{Na}[\text{Au}(\text{C}_6\text{H}_4\text{NO}_2)_2(\text{OPh})_2]$,¹⁷⁷⁶ $[\text{Au}(\text{N,N,C})(\text{OR})]\text{PF}_6$ ($\text{N,N,C} = \text{N}_2\text{C}_{10}\text{H}_7(\text{CMe}_2\text{C}_6\text{H}_4)_2$, $\text{N}_2\text{C}_{10}\text{H}_7(\text{CHMeC}_6\text{H}_4)_2$, $2,2'$ -bipy; $\text{R} = \text{Me}$, Et , Pr^i , $\text{CH}_2\text{C}_6\text{H}_4\text{NO}_2$ -3, Ph , $p\text{-Tol}$),¹⁷⁹¹ $[\text{AuCl}(\text{OR})(\text{bipy})]\text{PF}_6$ or $[\text{Au}(\text{OR})_2(\text{bipy})]\text{PF}_6$ ($\text{R} = \text{Me}$, Et , Pr^i).¹⁷⁸⁰

(ii) Complexes with other oxygen donor ligands

Mixed-metal salts with carboxylate, sulfate, or acetate have been synthesized. The gold(III) sulfates $\text{MAu}(\text{SO}_4)_2$ ($\text{M} = \text{Na}$, K , Rb) are obtained by evaporation of $\text{Au}(\text{OH})_3$ and Na_2SO_4 in concentrated sulfuric acid. The gold atoms are coordinated by four oxygen atoms of different SO_4^{2-} groups, forming an infinite chain;¹⁷⁹² in the cesium salt there are 2D layers.¹⁷⁹³ The salts $\text{M}(\text{AuX}_4)_2$ ($\text{X} = \text{O}_2\text{CMe}$, O_2CEt ; $\text{M} = \text{Pb}$, Zn , Ca , Sr) are prepared by reaction of $\text{M}(\text{OH})_2$ with HAuCl_4 , followed by treatment with acetic or propionic acid, or by reaction of aurates $\text{M}[\text{Au}(\text{OH})_4]_2$ with the carboxylic acids.^{1794,1795} The structure of $\text{Zn}(\text{Auac}_4)_2 \cdot 2\text{H}_2\text{O}$ (**303**) is a layer polymer and the one of $\text{Pb}(\text{Auac}_4)_2$ (**304**) is a molecular unit as the $\text{Sr}(\text{Auac}_4)_2$. The structure of $(\text{Pb}_3\text{Cl}_2\text{ac}_3)(\text{AuCl}_4)$ has also been described.¹⁷⁹⁶ Another acetate complex is $[\text{Au}(2\text{-C}_6\text{H}_4\text{CH}_2\text{NMe}_2)(\text{ac})_2]$.¹⁷⁹⁷

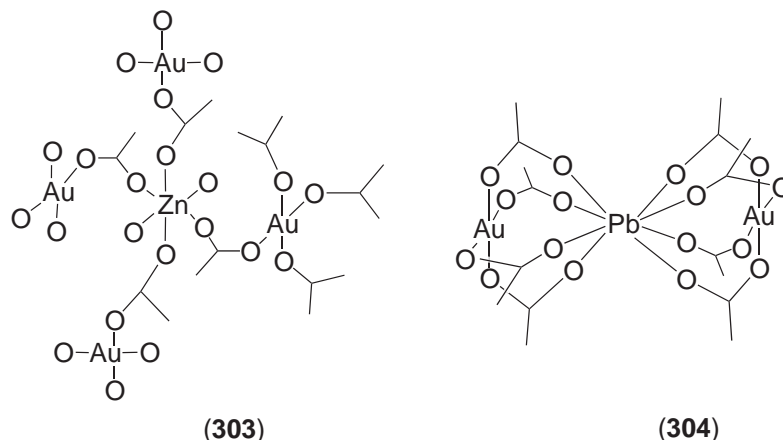

The complex dimethyl(acetylacetonato)gold(III), $[\text{AuMe}_2(\text{ACAC})]$,¹⁷⁹⁸ is of great interest as a precursor for the CVD of gold. A gas-phase electron diffraction study indicates a square-planar structure in which the acetylacetonate ligand is bonded to gold(III) via both oxygen atoms. The mechanism of thermal and photochemical decomposition of this complex and its dimethyl-*d*6 congener have been studied by UV–visible and ^1H NMR spectroscopy. It proceeds with reductive elimination of ethane and protonation of the acetylacetonate ligand.¹⁷⁹⁹ The complex $[\text{Au}(\text{C}_4\text{Ph}_4)(\text{ACAC})]$ can be prepared from the aura cyclopentadiene species $[\text{AuCl}(\text{C}_4\text{Ph}_4)(\text{THT})]$

or $[\text{Au}_2(\mu\text{-Cl})_2(\text{C}_6\text{Ph}_4)_2]$, by reaction with $\text{Ti}(\text{ACAC})$, and has been used as a starting material in the synthesis of several other complexes with oxygen donor ligands (Scheme 19).¹⁷⁹⁹

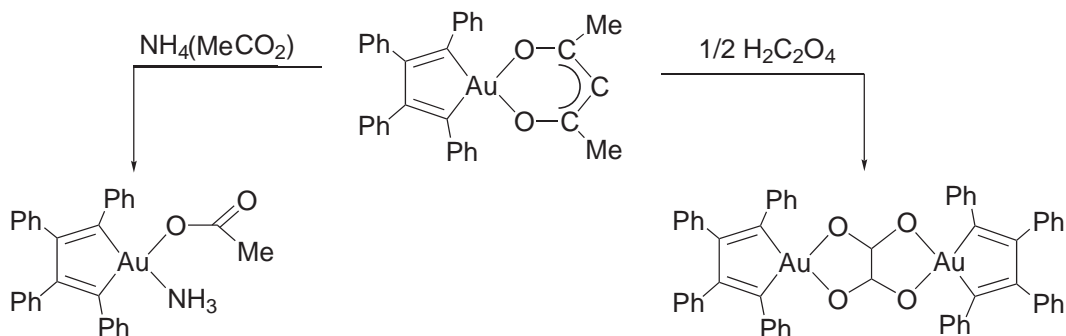

Scheme 19

Tris(pentafluorophenyl)gold(III) complexes with weakly bonded oxygen ligands have been synthesized, as $[\text{Au}(\text{C}_6\text{F}_5)_3\text{L}]$ ($\text{L} = \text{OEt}_2$, OCMe_2 , dioxane, EtOH) or with phosphine oxides as $[\text{Au}(\text{C}_6\text{F}_5)_3\text{L}]$ ($\text{L} = \text{OPPh}_3$, OAsPh_3). The compound $[\text{Au}(\text{C}_6\text{F}_5)_3(\text{OEt}_2)]$ is a useful starting material to introduce “ $\text{Au}(\text{C}_6\text{F}_5)_3$ ” fragments.¹⁷⁴⁰

6.7.3.2.5 Complexes with sulfur, selenium, or tellurium donor ligands

Gold(III) forms very stable bonds with sulfur and many complexes are known; however, fewer examples for selenium and tellurium have been reported.

(i) Complexes with monodentate ligands

Complexes of the type $[\text{Au}(\text{C}_6\text{F}_5)_3(\text{SPR}_3)]$ ($\text{PR}_3 = \text{PPh}_3$, PPh_2Me) or $[\text{Au}(\text{C}_6\text{F}_5)_3(\text{SPPH}_2\text{CH}_2\text{PPh}_2\text{R})]\text{ClO}_4$ ($\text{R} = \text{Me}$, $\text{CH}_2\text{C}_6\text{F}_5$, $\text{CH}_2\text{CO}_2\text{Me}$, CH_2Ph) have been obtained by displacement of the weakly coordinated ligand diethyl ether in $[\text{Au}(\text{C}_6\text{F}_5)_3(\text{OEt}_2)]$.¹⁷⁴⁰ Similarly the complexes $[\text{Au}(\text{C}_6\text{F}_5)_3(\text{HL})]$ ($\text{HL} = \text{heterocyclic thiones}$, $\text{C}_3\text{H}_5\text{NS}_2$, $\text{C}_4\text{H}_4\text{N}_2\text{S}$, $\text{C}_5\text{H}_5\text{NS}$, $\text{C}_7\text{H}_5\text{NS}_2$, $\text{C}_7\text{H}_6\text{N}_2\text{S}$).¹⁸⁰¹ The cationic complex $[\text{Au}(\text{C}_6\text{F}_5)_3(\text{SPPH}_2\text{CH}_2\text{PPh}_2\text{Me})]\text{ClO}_4$ reacts with NaH to yield the neutral methanide species $[\text{Au}(\text{C}_6\text{F}_5)_3(\text{SPPH}_2\text{CH}(\text{AuX})\text{PPh}_2\text{Me})]$ that gives the mixed-valence complexes $[\text{Au}(\text{C}_6\text{F}_5)_3(\text{SPPH}_2\text{CH}(\text{AuX})\text{PPh}_2\text{Me})]$ ($\text{X} = \text{Cl}$, C_6F_5) by reaction with $[\text{AuCl}(\text{THT})]$ or $[\text{Au}(\text{C}_6\text{F}_5)(\text{THT})]$.¹⁴⁷¹ Sulfocyanato or selenocyanato complexes of gold(-III) are also known, such as $[\text{N}(\text{PPh}_3)_2][\text{Au}(\text{C}_6\text{Cl}_5)_3(\text{SCN})]$, $[\text{Au}(\text{SCN})_3(\text{CH}_2\text{PR}_3)]$ ($\text{PR}_3 = \text{PPh}_3$, PPh_2Me , PPhMe_2),¹⁶⁴⁵ or $\text{Ph}_4\text{As}[\text{Au}(\text{SeCN})_4]$.¹⁸⁰² Diphenylselenide can also act as a ligand in the gold(III) derivative $[\text{AuCl}_3(\text{SePh}_2)]$.¹⁸⁰³ The structures for complexes $[\text{AuCl}_3\text{L}]$ ($\text{L} = \text{S}(\text{CH}_2\text{Ph})_2$, SPh_2 , THT),^{1804–1807} $[\text{AuBr}_3\text{L}]$ ($\text{L} = \text{S}(\text{CH}_2\text{Ph})_2$, SMe_2),^{1808,1809} and the mixed-valence $[\text{AuX}_2\text{S}(\text{CH}_2\text{Ph})_2]$ ($\text{X} = \text{Cl}$, Br)^{1804,1810} have been reported. Tris(pentafluorophenyl)gold (III) complexes with phosphonium dithiocarboxylates of the type $[\text{Au}(\text{C}_6\text{F}_5)_3(\text{S}_2\text{CPR}_3)]$ or $[\{\text{Au}(\text{C}_6\text{F}_5)_3\}_2(\text{S}_2\text{CPR}_3)]$ (**305**) ($\text{R}_3 = \text{Cy}_3$, Et_3 , Bu_3 , PhMe_2 , PhEt_2)¹⁸¹¹ or with methylthiocarbamates $[\text{Au}(\text{C}_6\text{F}_5)_3\{\text{S}(\text{MeS})\text{CNHR}\}]$ ($\text{R} = 4\text{-MeC}_6\text{H}_4$, $2\text{-MeC}_6\text{H}_4$, $4\text{-MeOC}_6\text{H}_4$, $3,5\text{-Me}_2\text{C}_6\text{H}_3$) have been prepared.¹⁸¹²

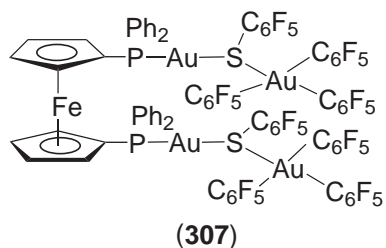
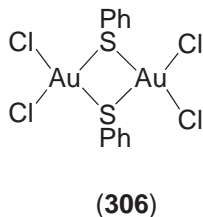
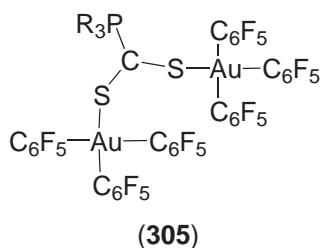

The reaction of $\text{PhCH}_2\text{SSCH}_2\text{Ph}$ with $[\text{AuCl}(\text{CO})]$ yields the dinuclear thiolategold(III) complex $[\text{Au}_2\text{Cl}_4(\mu\text{-SPh})_2]$ (**306**),¹⁸¹³ which has a similar structure to $[\text{Au}_2\text{Me}_4(\mu\text{-SEt})_2]$,¹⁸¹⁴ but in the former the intramolecular gold–gold separation is much shorter 3.357(1) Å and the intermolecular separation is 3.416(1) Å. The reaction of the dithiolategold(I) complex $[\text{Au}_2(\text{SC}_6\text{F}_5)_2(\mu\text{-dppf})]$ with two equivalents of $[\text{Au}(\text{C}_6\text{F}_5)_3(\text{OEt}_2)]$ or with half of $[\text{Au}(\text{C}_6\text{F}_5)_2(\text{OEt}_2)_2]\text{ClO}_4$ affords the mixed-valence compounds $[\text{Au}_4(\mu_2\text{-SC}_6\text{F}_5)_2(\text{C}_6\text{F}_5)_6(\mu\text{-dppf})]$ (**307**) or $[\text{Au}_5(\text{C}_6\text{F}_5)_2(\mu_2\text{-SC}_6\text{F}_5)_2(\mu\text{-dppf})_2](\text{ClO}_4)_3$.¹⁸¹⁵

The ligand 1-methyl-2-thiolate-1,2-dicarba-*closo*-dodecaborane forms gold(III) complexes of the type $\text{Bu}_4\text{N}[\text{Au}(\text{C}_6\text{F}_5)_3(\text{SCB}_{10}\text{H}_{10}\text{CMe})]$ or $[\text{Au}\{\text{P}(\text{Ph})_2\text{C}_2\text{B}_9\text{H}_{19}\}\{\text{SCB}_{10}\text{H}_{10}\text{CMe}\}_2]$ (**308**); they are readily obtained from the corresponding gold(III) precursors and Na_2CO_3 .¹⁸¹⁶ Tetrakis-thiolate gold(III) derivatives have been synthesized, as $[\text{Au}(\text{SR})_4]^-$ (**309**) or $[\text{Au}(\text{C}_6\text{H}_4\text{CH}_2\text{NMe}_2\text{H})(\text{SR})_3]$ ($\text{SR} = 1\text{-methyl-1,2,3,4-tetrazole-5-thiolate}$).^{1817–1819} The treatment of $\text{Bu}_4\text{N}[\text{AuBr}(\text{C}_6\text{F}_5)_3]$ with NaSH leads to the first (hydrosulfido)gold(III) compound $\text{Bu}_4\text{N}[\text{Au}(\text{C}_6\text{F}_5)_3(\text{SH})]$, that readily reacts with $[\text{Au}(\text{C}_6\text{F}_5)_3(\text{OEt}_2)]$ to give $\text{Bu}_4\text{N}[\{\text{Au}(\text{C}_6\text{F}_5)_3\}_2(\text{SH})]$ (**310**); the isolobal analogy existing between the hydrogen atom and the fragments AuPR_3^+ or AgPR_3^+ can be envisaged in the synthesis of the substituted derivatives $\text{Bu}_4\text{N}[\text{Au}(\text{C}_6\text{F}_5)_3(\text{SMPPH}_3)]$ ($\text{M} = \text{Au}, \text{Ag}$).¹⁰³³

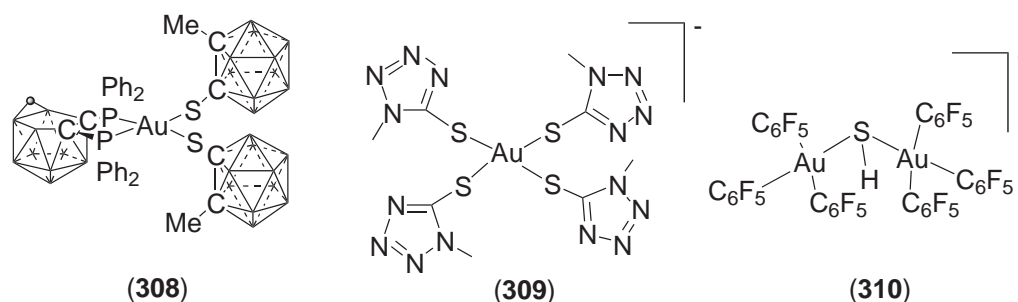

Mixed gold(I)–gold(III) sulfur and selenium centered complexes have been described by reaction of $[\text{X}(\text{AuPPh}_3)_2]$ or $[\text{X}\{\text{Au}_2(\mu\text{-dppf})\}]$ ($\text{X} = \text{S}, \text{Se}$) with gold(III) complexes, such as $[\text{Au}(\text{C}_6\text{F}_5)_3(\text{OEt}_2)]$ or $[\text{Au}(\text{C}_6\text{F}_5)_2(\text{OEt}_2)_2]\text{ClO}_4$ (Scheme 20). The complexes thus obtained have the sulfur or selenium atoms as triply or quadruply bridging ligands. Weak gold(I)–gold(III) interactions have been observed in the triply bridging complexes and theoretical studies show that although weaker than gold(I)–gold(I) there exist gold(I)–gold(III) interactions. The quadruply bridging species have a tetrahedral geometry at the central heteroatom and then no short gold(I)–gold(III) contacts are observed.^{1820–1822} Another mixed gold(I)–gold(III) sulfido complex is $[\{\text{AuCl}_2\}_2(\mu\text{-SAuCl})_2]^-$.¹⁸²³ The tetramethylthiourea complex $[\text{AuBr}_2\{\text{SC}(\text{NMe}_2)_2\}_2][\text{AuBr}_2]$ has been reported.¹⁸²⁴

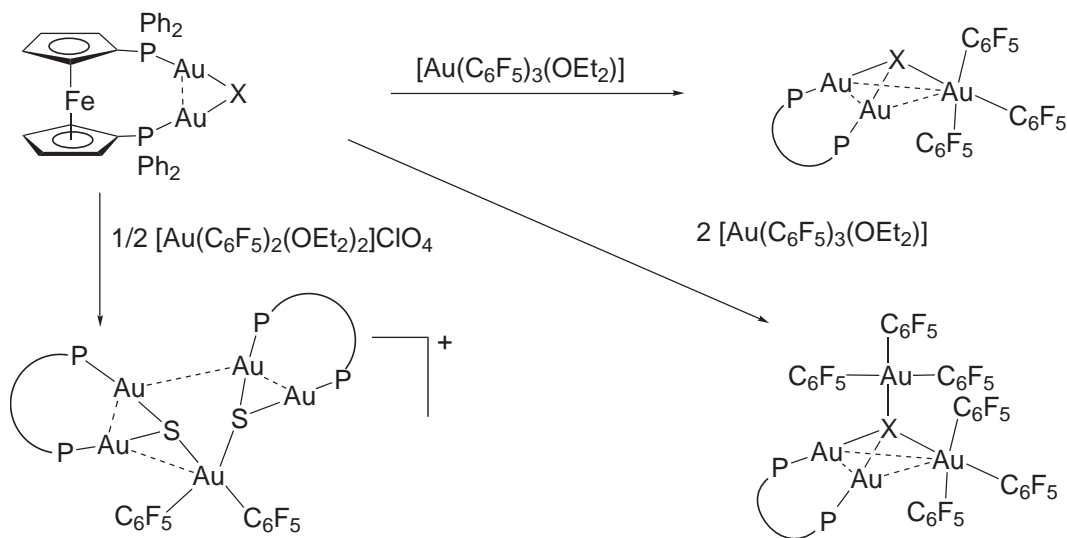

Scheme 20 $\text{X} = \text{S}, \text{Se}$; $\text{P} - \text{P} = \text{Fe}(\text{C}_5\text{H}_4\text{PPh}_2)_2$.

(ii) Complexes with bidentate ligands

The gold(III) complexes bound to bidentate sulfur ligands such as dithiocarbamate, dithiolate, etc. are more numerous. They form very stable square-planar gold(III) compounds that have in many cases interesting redox properties because they can be oxidized to gold(IV) complexes or reduced to gold(II) species. Because of the ability of this type of ligand to delocalize electron density it is clear that in most cases they are not truly real valence complexes. Furthermore, some of these types of square-planar gold complexes have produced organic superconducting properties while others display nonlinear optical properties.

Homoleptic dithiocarbamategold(III) derivatives of the type $[\text{Au}(\text{S}_2\text{CNR}_2)_3]$ or $[\text{Au}(\text{S}_2\text{CNR}_2)_2]^+$ have been known for a long time. New studies have led to the synthesis of gold(III) complexes with amino acid-substituted dithiocarbamates of the type $[\text{Au}\{\text{S}_2\text{CNHCH}(\text{R})\text{CO}_2\text{H}\}_3]$ ($\text{R} = \text{Me}, \text{Pr}^i, \text{Bu}^t$).¹⁸²⁵ The reaction of *N,N,N',N'*-tetramethylthiuran disulfide with gold(III) compounds of the type $[\text{AuX}_3\text{L}]$ leads to complex $[\text{Au}(\text{S}_2\text{CNMe}_2)_2]\text{Br}$ with two bidentate chelate dithiocarbamate ligands.¹⁸²⁶ The reaction of $[\text{AuCl}(\text{CO})]$ with $[\text{TcN}(\text{S}_2\text{CNET}_2)]$ affords the gold(III) compound $[\text{Au}(\text{S}_2\text{CNET}_2)_2][\text{TcNCl}_4]$ that shows in the lattice the expected square-planar coordination for gold and long-range contacts between the technetium atoms and the sulfur atoms of the $[\text{Au}(\text{S}_2\text{CNET}_2)_2]^-$ units.¹⁸²⁷ Complexes of stoichiometry $[\text{AuX}_2(\text{S}_2\text{CNR}_2)]$ have been reported as $[\text{AuCl}_2\{\text{S}_2\text{CN}(\text{CH}_2\text{-CH}_2\text{OH})_2\}]$ ¹⁸²⁸ or $[\text{Au}(\text{C}_6\text{F}_5)_2(\text{S}_2\text{CNR}_2)]$ ($\text{R} = \text{Me}, \text{Et}, \text{CH}_2\text{Ph}$);¹⁸²⁹ the latter is obtained by reaction of $[\text{Au}_2(\mu\text{-Cl})_2(\text{C}_6\text{F}_5)_4]$ with $\text{Na}(\text{S}_2\text{CNR}_2)$ and also by oxidative addition of $[\text{Ti}(\text{C}_6\text{F}_5)_2\text{Cl}]$ to the dinuclear gold(I) derivatives $[\text{Au}_2(\mu\text{-S}_2\text{CNR}_2)_2]$. Complexes where the dithiocarbamate ligands are bonded to two different metals, or in which they are coordinated as monodentate ligands, have also been described as $\text{Bu}_4\text{N}[\text{Au}(\text{C}_6\text{F}_5)_3(\text{S}_2\text{CNR}_2)]$ or $\text{Bu}_4\text{N}[\{\text{Au}(\text{C}_6\text{F}_5)_3\}_2(\text{S}_2\text{CNR}_2)]$.¹⁸²⁹ With the 1,1'-bis-(diethyldithiocarbamate)ferrocene ligand, $\text{Fc}(\text{S}_2\text{CNET}_2)_2$, the complexes $[\{\text{Au}(\text{C}_6\text{F}_5)_3\}_2\{\text{Fc}(\text{S}_2\text{CNET}_2)_2\}]$ (**311**) or $[\{\text{Au}(\text{C}_6\text{F}_5)_2\text{Cl}\}_2\{\text{Fc}(\text{S}_2\text{CNET}_2)_2\}]$ have been reported.¹⁸³⁰ Similar complexes are obtained with the methylenebis(dialkyldithiocarbamate) ligands, $[\{\text{Au}(\text{C}_6\text{F}_5)_3\}_2\{\text{CH}_2(\text{S}_2\text{CNET}_2)_2\}]$ (**312**).¹²²⁰ Other derivatives with mono- and bidentate dithiocarbamate ligands are $[\text{Au}(\text{CH}_2\text{PPh}_2\text{S})(\text{S}_2\text{CNET}_2)_2]$ (**313**) and $[\text{Au}(\text{C}_6\text{H}_4\text{CH}_2\text{NMe}_2)(\text{S}_2\text{CNET}_2)]^+$.^{1831,1832} The reaction of $[\text{AuBr}_2(\text{S}_2\text{CNET}_2)]$ with an excess of $\text{Et}_4\text{N}(\text{B}_9\text{H}_{14})$ leads to the complexes $[4\text{-}(\text{S}_2\text{CNET}_2)\text{-}aracno\text{-}4\text{-AuB}_8\text{H}_{12}]$ and $[6,9\text{-}(\text{S}_2\text{CNET}_2)_2\text{-}aracno\text{-}6,9\text{-Au}_2\text{B}_8\text{H}_{10}]$ (**314**).¹⁸³³ The mixed gold(I)-gold(III) complex $[\text{AuI}(\text{S}_2\text{CNBu}_2)(3\text{-Me-C}_6\text{H}_3\text{PPh}_2\text{AuI})]$ has been prepared by oxidation of the dinuclear gold(I) complex.¹⁸³⁴

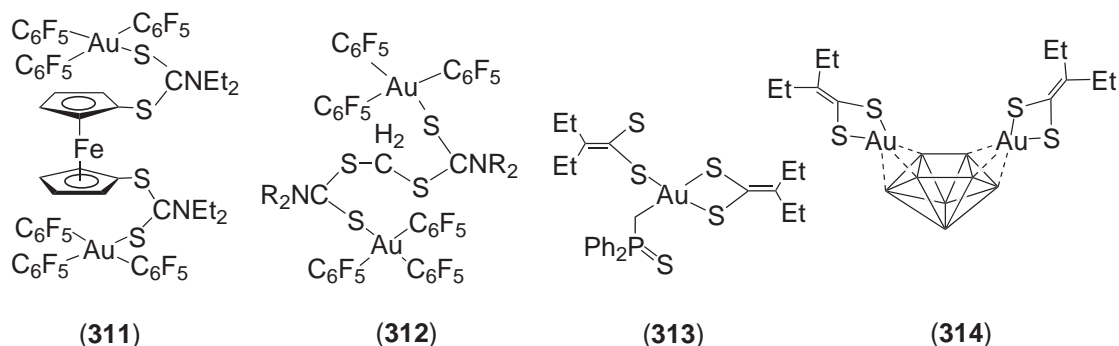

Dithiolate ligands have two negative charges and form very stable homoleptic anionic gold(III) complexes. The mnt ligand is one of the most used and the complex $[\text{Au}(\text{mnt})_2]^-$ is easily obtained by reaction of $\text{Na}_2(\text{mnt})$ with HAuCl_4 ; the complex has been obtained with several cations such as NBu_4^+ ,^{1835,1836} organic cations,¹⁸³⁷⁻¹⁸⁴¹ $[\text{Au}(\text{PPh}_3)_2]^+$,¹⁸⁴² and it is worth mentioning the cation $[\text{Pt}(\text{CNMe})_4]^{2+}$ because the structure consists of linear chains of the cations and the two anions.¹⁸⁴³ With the related *i*-mnt ligand the structure of $\text{Bu}_4\text{N}[\text{Au}(\text{i-mnt})_2]$ has been described.¹⁸⁴⁴ Other types of complexes with mnt have been obtained using tin complexes; the reaction of $[\text{SnMe}_3(\text{mnt})]$ with gold(III) derivatives such as $[\text{AuCl}_3(\text{THT})]$, $[\text{AuCl}(\text{PPh}_3)]$, or $\text{Bu}_4\text{N}[\text{AuBr}_4]$ yields the compounds $[\text{AuCl}(\text{mnt})(\text{THT})]$, $[\text{AuCl}(\text{mnt})(\text{PPh}_3)]$, or $\text{Bu}_4\text{N}[\text{AuBr}_2(\text{mnt})]$, respectively. Substitution reactions of the tetrahydrothiophene lead to complexes of the type $\text{Me}_4\text{N}[\text{AuCl}_2(\text{mnt})]$, $[\text{AuCl}(\text{mnt})(\text{Py})]$, or $[\text{Au}(\text{mnt})(\text{L-L})][\text{AuCl}_2(\text{mnt})]^-$ ($\text{L-L} = \text{bipy}$ or phen).¹⁸⁴⁵ Benzene- or toluene-dithiolate ligands have also been used widely in gold chemistry. The homoleptic species $[\text{Au}(\text{S}_2\text{C}_6\text{H}_4)_2]^-$ (**315**) or $[\text{Au}(3,4\text{-S}_2\text{C}_6\text{H}_3\text{Me}_2)]^-$ are readily obtained by treatment of $[\text{AuCl}_4]^-$ with the dithiol or by oxidation of gold in

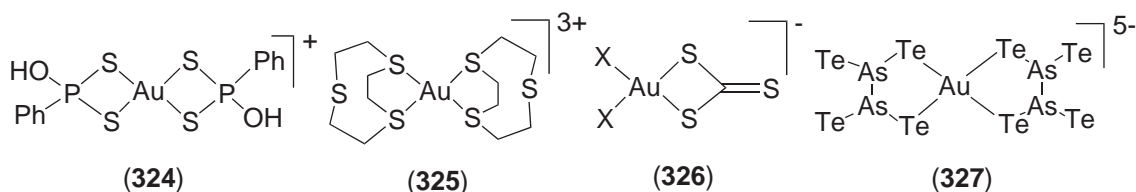

6.7.3.2.6 Complexes with halides as donor ligands

Mixed-valence gold(I)/gold(III) halides of the type $M_3Au_3X_8$ ($M = NH_4, Rb$; $X = Br, I$) and $Rb_3Au_3Cl_8$ have been characterized structurally and consist of linear $[AuX_2]^-$ and square planar $[AuX_4]^-$ anionic units.¹⁷³¹ The structures of the related $Rb_2AgAu_3I_8$ and $Cs_2AgAuBr_6$ have also been reported.^{1891,1892} The physical properties of $Cs_2Au_2X_6$ ($X = Cl, Br, I$) have been studied.^{1893,1894} AuF_3 is reduced in superacidic HF/SbF_5 solutions giving three products, $Au_3F_8 \cdot 2SbF_5$ with a layered structure, $Au_3F_7 \cdot 3SbF_5$ with a ribbon structure and $[Au(HF)_2](SbF_5)_2$ with a square-planar structure.¹⁸⁹⁵

The tetrahalide complexes have been characterized with several cations or more complicated systems, as in $[AuF_4]^-$,^{120,179,1896,1897} $[AuCl_4]^-$,^{1898–1906} $[AuBr_4]^-$,^{1907,1908} or $[AuI_4]^-$.¹⁹⁰⁹ The dialkylimidazolium tetrachloroaurate salts behaves as ionic liquids.¹⁹⁰⁶ The complex $(NH_4)_2[(AuI_4)\{AuI_2(\mu_2-I_4)\}]$ has been prepared and has I_4^{2-} anions as ligands.¹⁹¹⁰ The compounds $AuBiX_6$ ($X = Cl, Br$) have been synthesized by mixing AuX_3 and BiX_3 in sealed glass ampoules.¹⁹¹¹ Kinetic studies of the X^- exchange on $[AuX_4]^-$ square-planar complexes (where $X = Cl^-, CN^-$) have been performed at acidic pH in the case of the chloride system and as a function of pH for the cyanide system.¹⁹¹²

Gold(III) halides as catalysts have been employed, e.g., $H[AuCl_4]$ catalyzes the hydroxylation of alkenes,¹⁹¹³ oxidation of alkanes,¹⁹¹⁴ or the two-phase (gas–liquid) autoclave reaction between alkyne and tributylamine hydrochloride (as a source of HCl) to give $CH_2=CH_2Cl$.¹⁹¹⁵ $H[AuCl_4]$ -impregnated active carbon at 100–120 °C has also been used as catalyst in the addition of HCl to alkyne.^{1916,1917} $AuCl_3$ has been used to catalyze C–C and C–O coupling reactions,^{1918–1921} or cyclization of alpha-hydroxyallenes to 2-5-dihydrofurans.¹⁹²²

6.7.3.2.7 Complexes with mixed donor ligands

Cyclometallation by gold(III) is believed to proceed through direct C–H bond activation of the heterosubstituted molecule. The first cycloauration was established in 1989 with pppy by Constable and Leese.¹⁹²³ The cyclometallated complexes obtained by cycloauration can be classified into two categories: (i) Complexes bearing a bidentate N,C -chelate ligand, and (ii) Complexes having a terdentate N,N,C -chelate ligand.

Most of the substrates that give both types of cycloaurated complexes are limited to pyridine derivatives, although recently a few exceptions have been reported with thiazoles and imidazoles. The reaction of substituted pyridine ligands such as pppy,^{1749,1924} 2-benzoylpyridine,¹⁹²⁴ 2-anilino-pyridine,^{1925,1926} 1-(2-pyridylamino) and 2-pyrimidinylamino)naphthalene,¹⁹²⁷ 2-phenoxy-pyridine,¹⁸¹¹ 2-(phenylsulfanyl)pyridine,¹⁹²⁵ 2-(2-thienyl)pyridine,¹⁹²⁸ 2-(3-thienyl)pyridine,¹⁹²⁸ 2-(alkylsulfanyl)pyridine,¹⁹²⁹ or papavorine¹⁹³⁰ at room temperature yields the nonmetallated compounds which, upon heating, are transformed into the metallated complexes $[Au(N,C)Cl_2]$. The process with pppy is illustrated in Scheme 21.

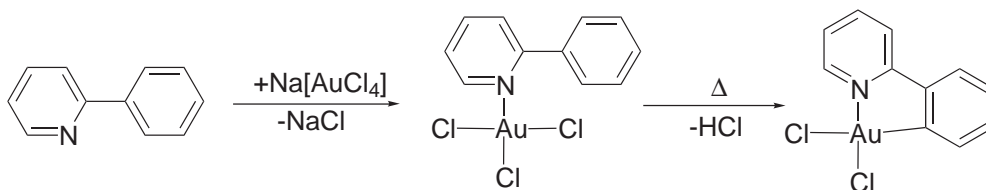

Scheme 21

Recently the cycloauration of 1-ethyl-2-phenylimidazole or 2-phenylthiazole (**328**) has been reported by refluxing solutions of $\text{Na}[\text{AuCl}_4] \cdot 2\text{H}_2\text{O}$ and the ligand in the presence of a silver salt.^{1931,1932} The ligand 6-(2-thienyl)-2,2'-bipyridine although has the possibility of acting as terdentate N,N,C ligand gives analogous reactions with $[\text{AuCl}_4]^-$ to the bidentate N,C ligands (**329**).¹⁹³³⁻¹⁹³⁵

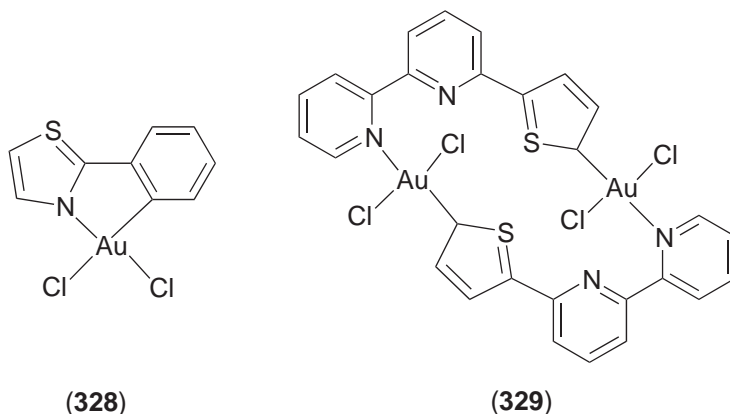

However, cycloauration is, sometimes, difficult to achieve with direct activation of a C—H bond and transmetallation reaction of organomercury or organotin compounds with the appropriate gold compounds is, hence, frequently used. This procedure has been used with azobenzene,¹⁹³⁶ *N,N'*-dimethylbenzilamine,^{1937,1938} 4,4'-dimethyl-2-phenyl-1,3-oxaazoline,¹⁹³⁸ 1-(dimethyl- or methylaminomethyl)naphthalene,¹⁹³⁸ 1,3-bis(dimethylaminomethyl)benzene,¹⁹³⁸ substituted phphys,¹⁹³⁹ 2-phenyl-4-(methylcarboxylato)quinoline,¹⁹³⁹ and 4-butyl-*N*-(3,4,5-trimethoxybenzilidene)aniline.¹⁹⁴⁰ Two examples are illustrated in Equations (16) and (17):

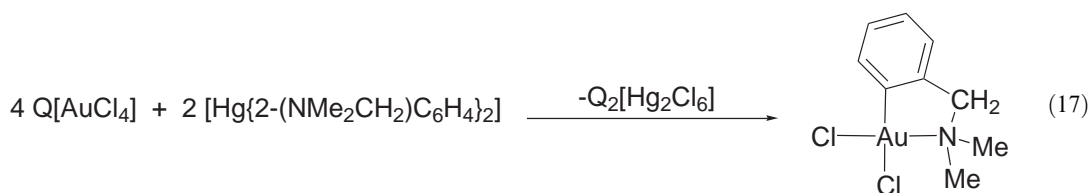
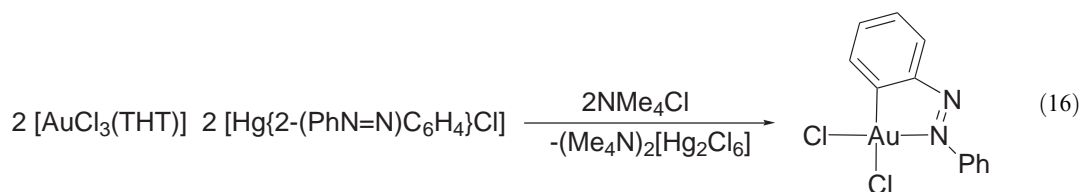

Sequential arylations allows the synthesis of complexes with two different ligands. If the second aryl group does not carry a potential donor group, complexes of the type $[\text{Au}(\text{N,C})\text{ArCl}]$ are obtained.^{1643,1748,1941,1942} Upon treatment with phosphine or chloride, some of the *N,C*-chelated diarylgold(III) chloride complexes undergo reductive elimination of the aryl ligands to give biaryls. The high-yield reaction proceeds at room temperature and can be used for the synthesis of both symmetrical and asymmetrical products.¹⁹⁴³

Complexes having a tridentate *N,N,C* chelate derived from 2,9-diphenyl-phen,¹⁹⁴⁴ 4-(4-methoxyphenyl)-6-phenyl-2,2'-bipyridine,¹⁹⁴⁵ 6-benzyl-2,2'-bipyridine,¹⁹⁴⁶ or 6-Bu^t-2,2'-bipyridine¹⁹⁴⁶ have been prepared from heating solutions of the ligand and $[\text{AuCl}_4]^-$ with the assistance of a silver salt. Equation (18) shows one example.

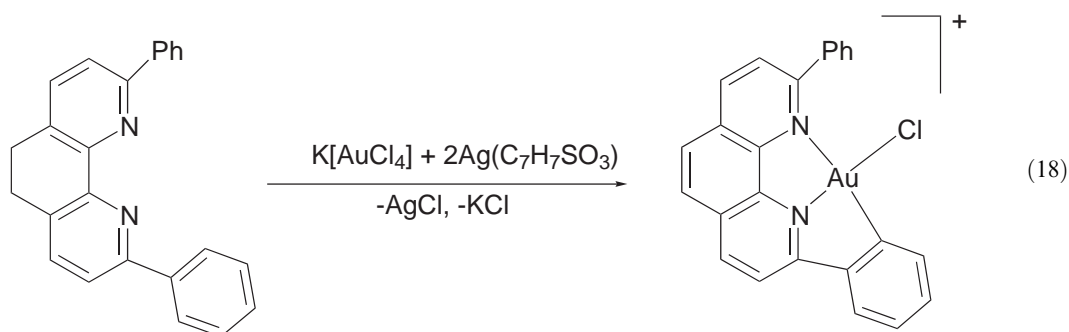

A cyclometallated derivative that also possesses a tridentate N,C,N ligand is $[\text{Au}\{2,6\text{-(NMe}_2\text{CH}_2)_2\text{C}_6\text{H}_3\}\text{Cl}][\text{Hg}_2\text{Cl}_6]$ but in this case it was obtained from the gold(III) precursor and the organomercury reagent.¹⁹³⁸ The compounds $[\text{Au}(\text{N},\text{N},\text{C})\text{Cl}]\text{X}$ (N,N,C = anion of 2,9-diphenyl-phen; X = $\text{C}_7\text{H}_7\text{SO}_3$, ClO_4) present a luminescent behavior and there are powerful photooxidants.¹⁹⁴⁴ The electrochemical behavior of cyclometallated gold(III) complexes has been studied; they show an irreversible one-electron reduction.¹⁹⁴⁷

The chloro ligands in the N,C chelate complexes can be easily displaced by other neutral or anionic ligands affording a great variety of complexes, but in some cases cleavage of the Au—N bond occurs. Examples of substitution reactions in the cyclometallated complexes are those with thiosalicylic acid in the presence of a base, which give the complexes $[\text{Au}(\text{N},\text{C})(\text{SC}_6\text{H}_4\text{CO}_2)]$,¹⁹⁴⁸ and also a range of four-membered ring systems including auracyclobutane,¹⁹⁴⁹ aurareylene,¹⁹⁵⁰ auracyclobutan-3-one,¹⁹⁵¹ as well as other related metallacyclic complexes.^{1820,1952} The antitumor and antimicrobial activity of N,C-chelate ligands^{1952,1953} and also of thiosalicylic ligands has been reported previously. Consequently the activity of these compounds against P388 leukemia has been tested, although only the compound $[\text{Au}(2\text{-Py-4-MeC}_6\text{H}_3)(\text{SC}_6\text{H}_4\text{CO}_2)]$ shows good activity.^{1953,1954} The reaction of $[\text{Au}(2\text{-NMe}_2\text{CH}_2\text{C}_6\text{H}_4)\text{Cl}_2]$ with other bidentate donor ligands such as diphenyl thiocarbazon, PhNHNHC(S)NNPh , progresses with cleavage of the Au—N bond and protonation of the dimethylamino group (330).^{1955,1956} The reaction of $[\text{Au}\{2\text{-(PhN=NC}_6\text{H}_4)\text{Cl}_2]$ with AgClO_4 in acetone yields to the synthesis of $[\text{Au}(\text{C},\text{N})(\mu\text{-CH}_2\text{COMe})]\text{ClO}_4$ (331) with a bridging acetyl ligand, although the complex is very instable and rapidly decomposes in solution.¹⁷⁴⁷ It has been observed that these metallated derivatives $[\text{Au}(\text{C},\text{N})\text{Cl}_2]$ ^{1957–1963} and $[\text{Au}(\text{C},\text{N},\text{N})\text{Cl}]$ ¹⁷⁸² produce the carbon–hydrogen activation of ketones leading to ketonyl species.

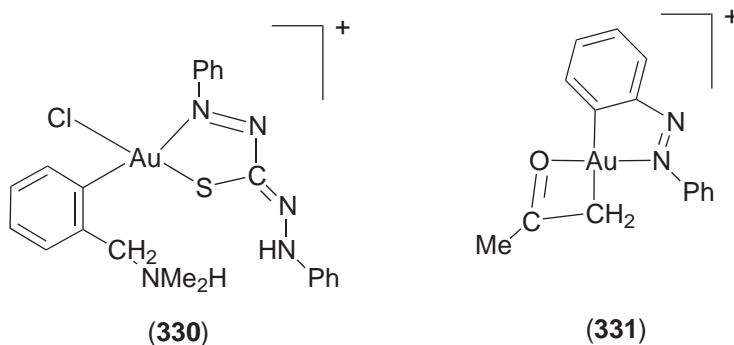

The reaction of the dinuclear gold(I) complex $[\text{Au}_2\{\mu\text{-}2,6\text{-(NMe}_2\text{CH}_2)_2\text{C}_6\text{H}_3\}_2]$ with an excess of CH_2I_2 affords the gold(III) ammonium species (Equation (19)).¹⁹⁶⁴

Other gold(III) complexes with bidentate mixed-donor ligands include salicylaldiminate(esal) complexes. The complex $[\text{AuCl}_2(\text{esal})]$ (332) exhibits favorable cytotoxic properties towards a number of human tumor cell lines either sensitive or resistant to cisplatin. The ability of this complex to bind DNA may represent the mechanism for its cytotoxic action as proposed for other gold(III) complexes.^{1965,1966} Square-planar gold(III) derivatives have been obtained with N,N,Z-tridentate hydrazones (Z = S, O).¹⁹⁶⁷ Gold(III) forms complexes with tetradentate Schiff base ligands such as N,N'-propylenebis(salicylideneimine) (sal_2pn) or N,N'-ethylenebis(salicylideneimine) (sal_2en) of the type $[\text{Au}(\text{sal}_2\text{pn})\text{Cl}]$ or $[\text{Au}(\text{sal}_2\text{en})\text{Cl}]$ (333). An improved method of synthesis has been reported from the reaction of $\text{Bu}_4\text{N}[\text{AuCl}_4]$ with the ligands. Radiochemical

studies with ^{198}Au show that these complexes are also formed at the tracer level from $\text{Bu}_4\text{N}[^{198}\text{AuCl}_4]$.¹⁹⁶⁸

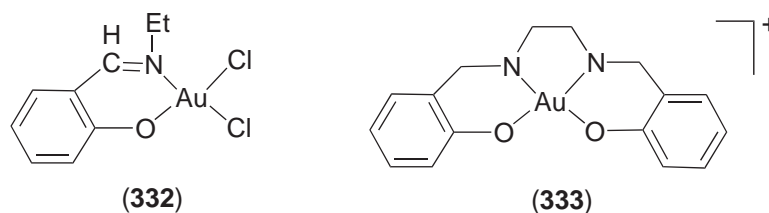
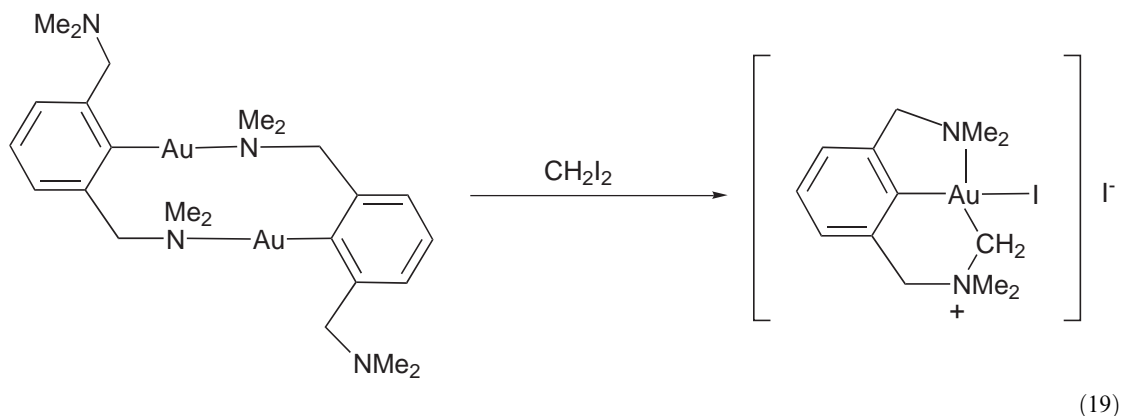

The potentially tri- and tetradentate phosphinothiolates $\text{PhP}(2,3\text{-C}_6\text{H}_3\text{RSH})_2$ ($\text{R} = \text{H}, \text{TMS}$) and $\text{P}(\text{C}_6\text{H}_4\text{SH})_3$ have proved to be powerful chelating ligands that are able to stabilize gold(III) despite the reducing capacity of both aromatic thiols and phosphines. This may be explained by the rapid chelation of *P* and thiolate *S*-donor atoms, which stabilizes a square planar d^8 complex.¹⁹⁶⁹ The reaction of $[\text{Au}(2\text{-NMe}_2\text{CH}_2\text{C}_6\text{H}_4)\text{Cl}_2]$ with $\text{PhP}(\text{C}_6\text{H}_4\text{SH})_2$ gives the complex (334) and small amounts of the dinuclear mixed-valence complex (335). Treatment of $[\text{AuCl}(\text{PPh}_3)]$ with $\text{P}(\text{C}_6\text{H}_4\text{SH})_3$ gives an intermediate gold(I) complex, which oxidizes in air to the gold(III) derivative (336).

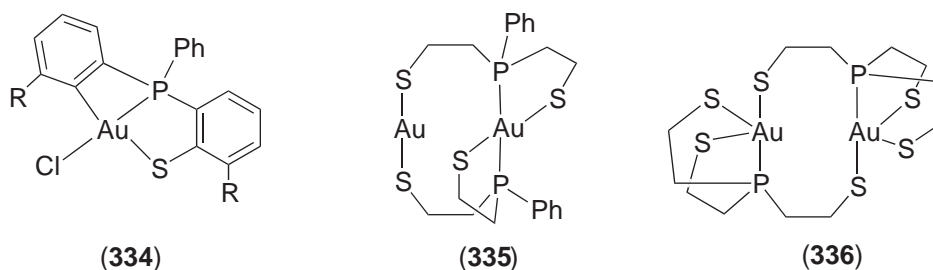

The reaction of tetrachloroaurate(III) with two equivalents of 2-(diphenylphosphino)benzenethiol gives a cation that can be precipitated from solution as the tetraphenylborate salt, $[\text{Au}(2\text{-PPh}_2\text{C}_6\text{H}_4\text{S})_2]\text{BPh}_4$ (337). Very surprisingly, the electrochemical behavior corresponds to a reversible single-electron transfer process and indicates that this gold(III) can be reduced to gold(II) and that the gold(II) state has reasonable stability on the electrochemical time scale.¹⁹⁷⁰

The compounds $[\text{Au}_3\text{I}_n(\text{MeN}=\text{COMe})_3]$ ($n = 2, 4, 6$) obtained by stepwise addition of iodine to the cyclic tetranuclear gold(I) complexes $[\text{Au}_3(\text{MeN}=\text{COMe})_3]$ have been revisited. The structure of $[\text{Au}_3\text{I}_6(\text{MeN}=\text{COMe})_3]$ (338) consists of columns of the molecular units united by weak iodine...iodine interactions which range in length from 3.636(2) Å to 3.716(2) Å. The solid-state molecular packing of the di-iodo and tetra-iodo complexes reveal no unusual features.¹⁹⁷¹

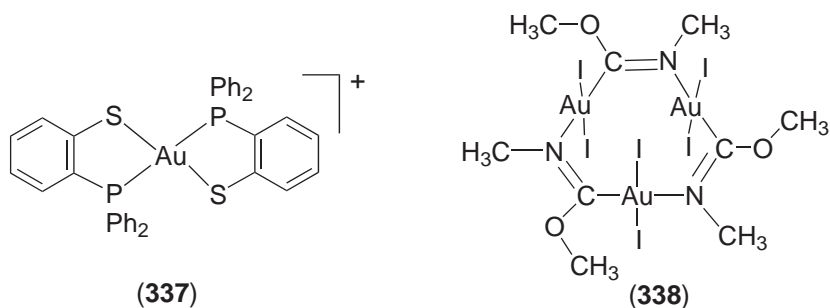

The 2-(diphenylphosphino)aniline (PNH₂) ligand reacts with the gold compounds [Au(C₆F₅)₂(OEt)₂]ClO₄ or [Au(C₆F₅)₂(ACAC)] to yield the P,N chelate complexes [Au(C₆F₅)₂(PNH₂)]ClO₄ or [Au(C₆F₅)₂(PNH)]. The amino group in the latter can coordinate a AgPPh₃⁺ fragment and in the cationic complex one or two protons of the NH₂ group can be substituted by its isolobal fragment AuPPh₃⁺ by using [Au(ACAC)PPh₃] (Scheme 22).¹⁹⁷²

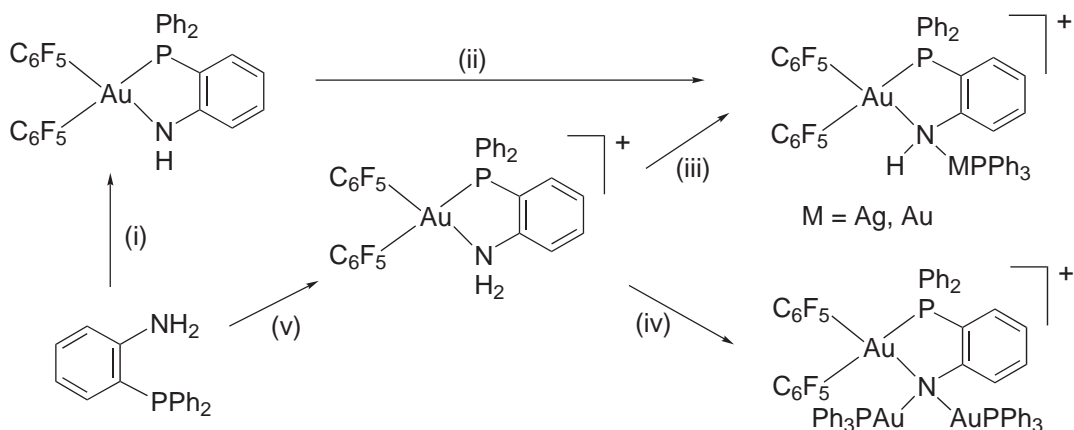

Scheme 22 (i) [Au(C₆F₅)₂(ACAC)], (ii) [Ag(OClO₃)(PPh₃)], (iv) 2 [Au(ACAC)(PPh₃)], (v) [Au(C₆F₅)₂(OEt₂)]ClO₄.

The reaction of [Au₂(μ-Cl₂)Me₄] with 3,7-dimethyl-1,5,7-triaza-3-phosphabicyclo[3.3.1]nonane (L) gives [AuMe₂L][AuMe₂Cl₂] (339) with a chelate P,N ligand.¹⁹⁷³

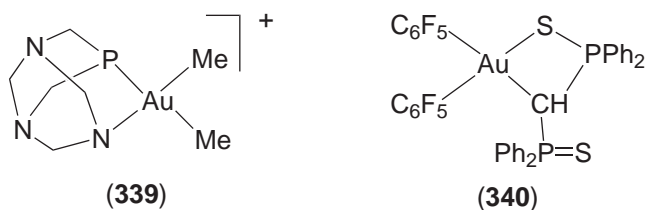

Another type of complex with mixed donor ligands is that derived from phosphino-methanide ligands. The reaction of [Au(C₆F₅)₂{(SPPH₂)₂CH₂}]ClO₄ with NaH provokes the deprotonation of the methylene group and the new ligand bond gold(III) as a S,C chelate ligand (340).¹⁸⁸² Complex (340) reacts with [Au(C₆F₅)(THT)] or [Au(THT)₂]ClO₄ (molar ratio 2:1) with displacement of the tetrahydrothiophene ligand and coordination to the sulfur atom to give dinuclear [Au(C₆F₅)₂{(SPPH₂)₂CH}AuC₆F₅] or trinuclear derivatives [{Au(C₆F₅)₂{(SPPH₂)₂CH₂}₂Au]ClO₄.

A way of increasing the acidity of methylene protons in the diphosphine PPh₂CH₂PPh₂ involves oxidation of one or two phosphorus centers. The reaction of *cis*-[Au(C₆F₅)₂Cl(PPh₂CH₂PPh₂)] with elemental S gives *cis*-[Au(C₆F₅)₂Cl(PPh₂CH₂PPh₂S)], which reacts further with AgClO₄ to give a five-membered auracycle, *cis*-[Au(C₆F₅)₂(PPh₂CH₂PPh₂S)]ClO₄. The CH₂ can be easily deprotonated with NaH to open up further reaction pathways (Scheme 23).¹⁹⁷⁴

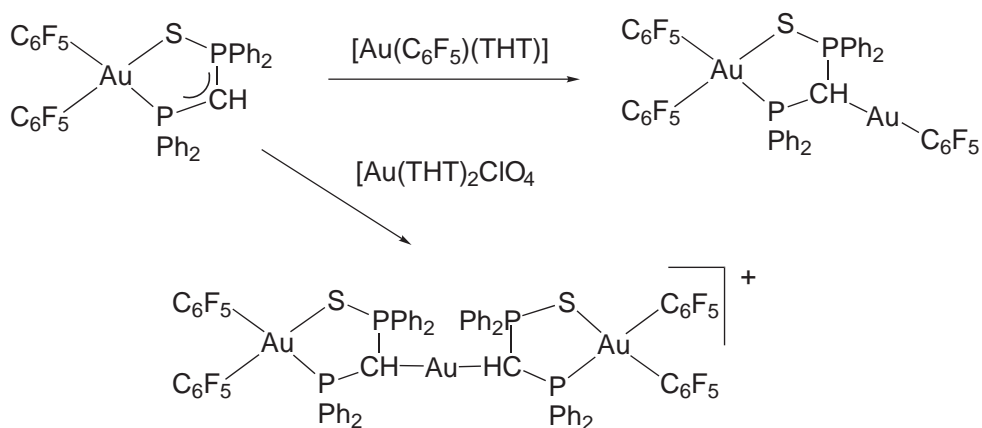

Scheme 23

The reaction of the complex *cis*- $[\text{Au}(\text{C}_6\text{F}_5)_2\text{Cl}(\text{PPh}_2\text{CH}_2\text{PPh}_2\text{CH}_2\text{COOMe})]\text{ClO}_4$ with NaH gives a five-membered auracyclic methanide derivative (Scheme 24).¹⁹⁷⁵ Double deprotonation takes place, but affects both methylene groups. With weaker deprotonating agents, such as Na_2CO_3 , or after chlorine abstraction with AgClO_4 , deprotonation occurs selectively at the CH_2COOMe group. $[\text{Au}(\text{C}_6\text{F}_5)_2\{\text{PPh}_2\text{CH}(\text{AuPPh}_3)\text{PPh}_2\text{CHCOOMe}\}]\text{ClO}_4$ reacts with $[\text{Au}(\text{PPh}_3)(\text{THT})]\text{ClO}_4$ to yield $[\text{Au}(\text{C}_6\text{F}_5)_2\{\text{PPh}_2\text{CH}(\text{AuPPh}_3)\text{PPh}_2\text{CHCOOMe}\}]\text{ClO}_4$, which can further be deprotonated with NaH to give $[\text{Au}(\text{C}_6\text{F}_5)_2\{\text{PPh}_2\text{C}(\text{AuPPh}_3)\text{PPh}_2\text{CHCOOMe}\}]\text{ClO}_4$.¹⁹⁷⁶ This new methanediide derivative can incorporate other gold(I) fragments such as AuPPh_3^+ or $\text{Au}(\text{C}_6\text{F}_5)$. In a similar manner, the complexes *cis*- $[\text{Au}(\text{C}_6\text{F}_5)_2\text{Cl}(\text{SPPH}_2\text{CH}_2\text{PPh}_2\text{CH}_2\text{R})]\text{ClO}_4$ ($\text{R} = \text{H}, \text{Ph}$) react with Na_2CO_3 or NaH to give four-membered methanide auracycles $[\text{Au}(\text{C}_6\text{F}_5)_2(\text{SPPH}_2\text{CHPPh}_2\text{CH}_2\text{R})]\text{ClO}_4$ or $[\text{Au}(\text{C}_6\text{F}_5)_2(\text{SPPH}_2\text{CPh}_2\text{CH}_2\text{R})]$, respectively. The methanediide carbon atom can act as C-nucleophile and coordinate other gold(I) compounds.¹⁹⁷⁷

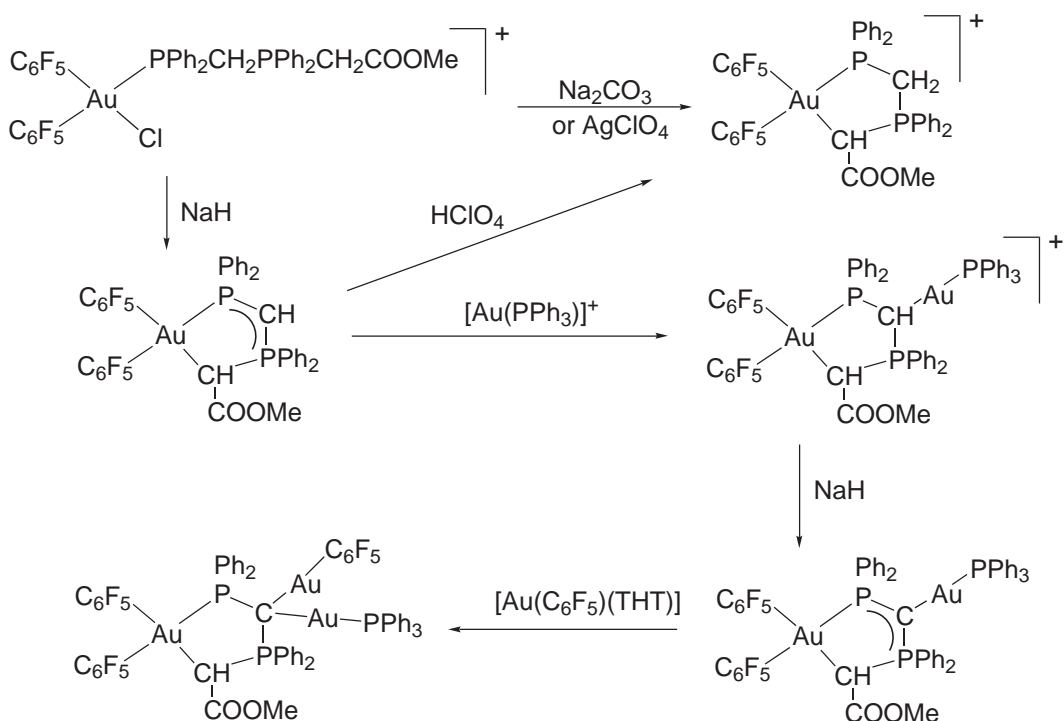

Scheme 24

6.7.3.3.1 Mononuclear gold(II) complexes

Mononuclear gold(II) complexes, consistent with a d^9 configuration, must be paramagnetic ($\mu_{\text{eff}} = 1.79$ MB) and show a hyperfine four-line EPR signal, in accordance with the nuclear spin of ^{197}Au ($I = 3/2$). These two properties are evidence of a real gold(II) complex in addition to their stoichiometry.

In 1992, Herring *et al.* produced a clear ESR and magnetic evidence for Au^{2+} , as a species present in partially reduced $\text{Au}(\text{SO}_3\text{F})_3$ and as a solvated ion in the strong protonic acid HSO_3F .¹⁹⁸¹ Recently, Bartlet and co-workers prepared and structurally characterized Au^{II} fluoro complexes.¹⁹⁸² Gold dissolves around 20°C with F_2 in anhydrous HF acidified with SbF_5 to give a red solution from which orange crystals of $\text{Au}(\text{SbF}_6)_2$ crystallize. Exhaustive fluorination results in total conversion of the gold to an insoluble crystalline red solid which is $\text{Au}^{\text{II}}(\text{SbF}_6)_2\text{Au}^{\text{II}}(\text{Au}^{\text{III}}\text{F}_4)_2$. Solvolysis of $\text{Au}(\text{SbF}_6)_2$ in anhydrous HF results in disproportionation to gold and the mixed-valence fluoride $\text{Au}^{\text{II}}\text{Au}^{\text{III}}_2\text{F}_8$. In $\text{Au}(\text{SbF}_6)_2$, the gold(II) atom is at the center of an elongated octahedron of F ligands, the fluor atoms of the approximately square AuF_4 unit are at $2.09(2)\text{Å}$ and $2.15(2)\text{Å} \times 2$, each F provided by a different SbF_6 species. The two long Au—F interatomic distances are at $2.64(2)\text{Å}$.

Most of the compounds already described were prepared with unsaturated S-donor ligands such as dithiocarbamates, dithiolates, etc. The addition of DMF to the previously reported gold(II) complexes with *o*-aminobenzenedithiolate (abt) gives the deep blue complex $[\text{Au}(\text{abt})_2(\text{DMF})_2]$. This shows a magnetic moment of 1.76 MB and a four-lined EPR spectrum in agreement with a monomeric formulation.¹⁹⁸³ The reaction of these abt gold complexes with SCN^- , SeCN^- , NCO^- , and CN^- affords new paramagnetic species which are postulated to remain as gold(II) compounds. Bis(1,2-dicyanoethylene-1,2-dithiolato)aurate(II), $[\text{Au}(\text{mnt})_2]^{2-}$, is stable, however, all the attempts to crystallize failed and it has been characterized by single crystal EPR, ENDOR, or multi-frequency powder-EPR spectra.^{1984,1985} The reduction of $\text{Bu}_4\text{N}[\text{Au}(\text{dmit})_2]$ electrochemically and with BH_4^- leads to unstable monomeric gold(II) species $[\text{Au}(\text{dmit})_2]^{2-}$, which has been characterized by X-band EPR spectra.¹⁹⁸⁶ More precisely described is the mononuclear gold complex $[\text{Au}(\text{[9]aneS}_3)_2](\text{BF}_4)_2$ (**343**) obtained by reduction of $\text{HAuCl}_4 \cdot 3\text{H}_2\text{O}$ with two equivalents of [9]aneS₃ in refluxing HBF_4 (40%)/MeOH and further extraction with MeNO_2 .^{1888,1987} It has been studied by XRD and shows an octahedral disposition of six sulfur atoms around the gold center, with a Jahn-Teller distortion. The apical Au—S distance 2.839(5) is longer than those in the plane, 2.462(5) Å and 2.452(5) Å. The EPR spectrum shows hyperfine four line EPR signals at $g = 2.010$; the delocalization through the ligand is limited. The oxidation and reduction reactions of $[\text{Au}(\text{[9]aneS}_3)_2]^{2+}$ by an outer-sphere oxidizing reagent $[\text{Ni}(\text{[9]aneS}_3)_2]^{3+}$ have been studied.¹⁹⁸⁸ Another gold(II) derivative with a thiacyclopentane [12]aneS₄ has been obtained, $[\text{Au}\{\text{[12]aneS}_4\}]^{2+}$, which possesses only one ligand coordinated to the gold(II) center.¹⁹⁸⁸

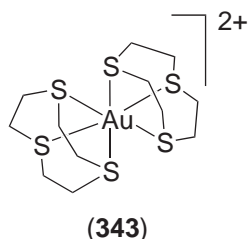

The gold(III) complex with the ligand 2-(diphenylphosphino)benzenedithiolate, $[\text{Au}(2\text{-PPh}_2\text{C}_6\text{H}_4\text{S})_2]$ shows in the cyclic voltammetry experiments that the gold(II) species has a reasonable stability on the electrochemical time scale.¹⁹⁷⁰ The gold(III) porphyrin $[\text{AuL}]\text{PF}_6$ ($\text{L} = 5,10,15,20\text{-tetrakis}(3,5\text{-di-}t\text{-butylphenyl})\text{porphyrin}$) undergoes reduction at the central ion to give initially the gold(II) porphyrin, overturning the long held assumption that reduction of such complexes only occurs at the macrocycle, followed by a formation of a porphyrin π -anion radical and dianion at more negative potentials.¹⁹⁹⁰ Stable gold(II) complexes with nitrogen- and oxygen-containing ligands such as CO_2 , Me_2CO , THF, pyridine, etc. have been prepared in the gas phase. The successful ligands are characterized by being good σ -donor- π -acceptor molecules and the most stable are those with large dipole moment and a high ionization energy.^{1991,1992}

Recently the first metal–xenon compound has been obtained by reduction of AuF_3 with elemental xenon.³⁸ Attempts to synthesize the elusive AuF the reduction of gold(III) was carried out with xenon, which is a very mild reducing and very weakly coordinating agent. Surprisingly the reaction stopped at the Au^{2+} state and resulted in a completely unexpected complex, the cation AuXe_4^{2+} , which crystals can be grown at -78°C . Removal of gaseous xenon under vacuum results in the crystallization of $\text{Au}(\text{SbF}_6)_2$.¹⁹⁸² The crystal structure of $(\text{Sb}_2\text{F}_{11})_2[\text{AuXe}_4]$ shows a regular square with Au–Xe bond lengths ranging from 2.728(1) Å to 2.750(1) Å. Three weak contacts between the cation and the anion complete the coordination sphere around the gold atom with Au–F distances of 2.671 Å and 3.153 Å (Figure 18).

In the complex xenon functions as a σ -donor toward Au^{2+} . This is reflected in the calculated charge distribution within the cation, where the main part of the positive charge resides on the xenon atoms. Relativity plays a large role in stabilizing this and other predicted Au–Xe compounds; about half of the Au–Xe bonding energy comes from relativistic effects.¹⁹⁹³

A further study of this reaction³⁹ has shown that if the concentration of SbF_5 is fairly high, complex $[\text{AuXe}_4][\text{Sb}_2\text{F}_{11}]_2$ forms as the sole product in two crystallographically different modifications, the triclinic already considered and another monoclinic, which has been seldom observed. Both modifications differ only in the cation–anion interactions, with a long $\text{Au}\cdots\text{F}$ contact of 2.928(7) Å in the monoclinic form. By a variation of the xenon pressure and the acid strength of the HF/SbF_5 other species have been isolated such as *cis*- $[\text{AuXe}_2][\text{Sb}_2\text{F}_{11}]_2$, *trans*- $[\text{AuXe}_2][\text{SbF}_6]_2$, $[\text{Au}_2\text{Xe}_2\text{F}][\text{SbF}_6]_3$, and the first Au^{III} –Xe complex $[\text{AuXe}_2\text{F}][\text{SbF}_6][\text{Sb}_2\text{F}_{11}]$. Their structures are collected in Figure 18.

6.7.3.3.2 Dinuclear gold(II) complexes

As earlier mentioned, one of the reasons of the poor stability of gold(II) complexes is the unfavorable energy of the odd electron. The formation of a metal–metal bond in dinuclear gold(II) complexes giving diamagnetic species provides an extra stability. Thus, the number of

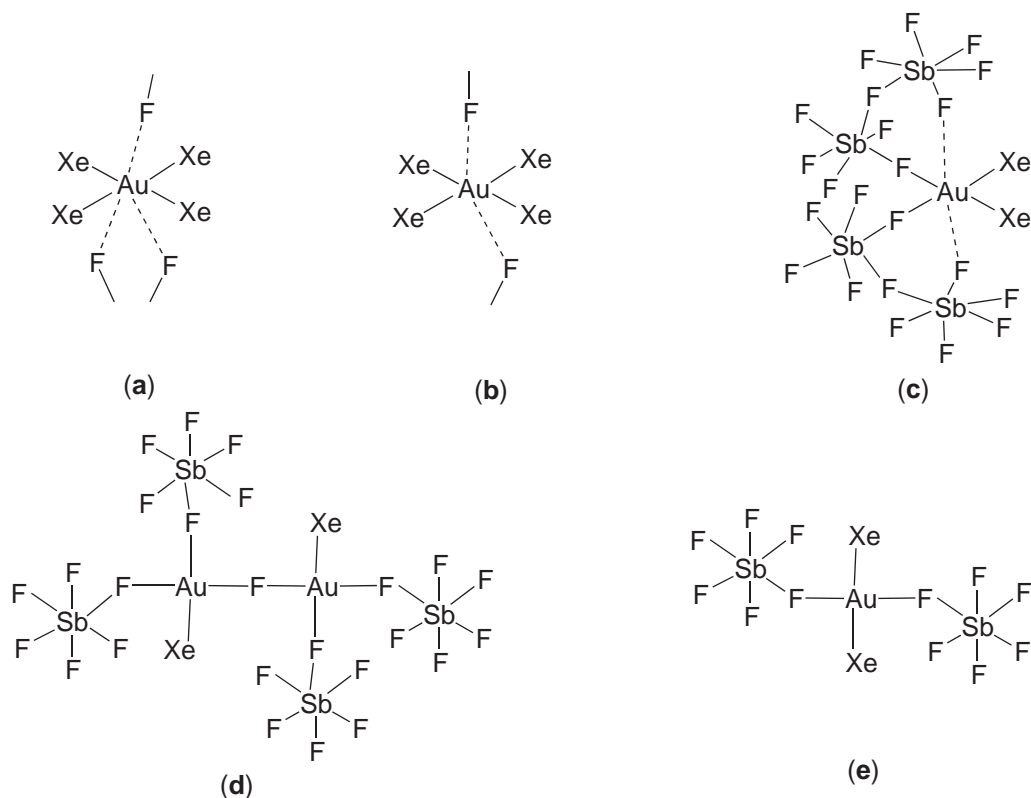
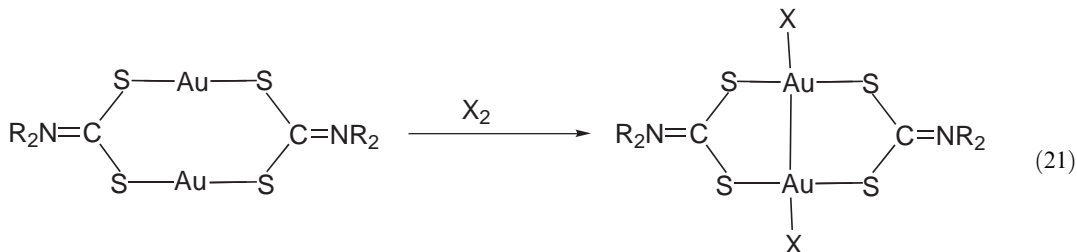

Figure 18 (a) triclinic $[\text{AuXe}_4]^{2+}$; (b) monoclinic $[\text{AuXe}_4]^{2+}$; (c) $[\text{AuXe}_2]^{2+}[\text{Sb}_2\text{F}_{11}]^{2-}$; (d) $[\text{Au}_2\text{Xe}_2\text{F}]^+[\text{SbF}_6]^-$; (e) *trans*- $[\text{AuXe}_2]^+[\text{SbF}_6]^-$.

Dinuclear gold(II) complexes with *S*-donor ligands are known for dithiocarbamate¹⁹⁹⁸ or dithiolate^{1844,1999} ligands. They are obtained by oxidative addition with halogens or (SCN)₂ or (SeCN)₂ to the corresponding gold(I) complexes (Equations (21) and (22)). Although dithiolate complexes are more stable than the dithiocarbamate ones, both decompose in solution to the mixed [Au^{III}(S-S)₂][Au^IX₂]. The structure of (Bu₄N)₂[Au₂X₂{μ-S₂C=C(CN)₂}] shows one of the shortest distance found for a gold—gold bond, 2.550(1) Å.



R Et; X = Br, I, SCN, SeCN

R = Buⁿ; X = SCN

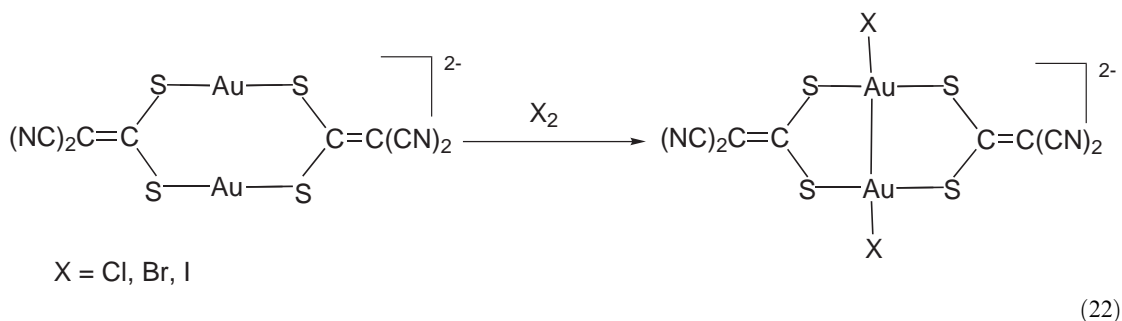

X = Cl, Br, I

Gold(II) derivatives with mixed donor ligands have been achieved starting from the gold(I) complexes with the ylide ligands SPPH₂CH(PPh₂Me) (347),¹⁴⁷¹ SPPH₂CH₂⁻ (348),^{1675,2000,2001} or the cyclometallated phosphine PR₂C₆H₄⁻ (349)²⁰⁰²⁻²⁰⁰⁵ by oxidation with halogens or dibenzoyl peroxide.

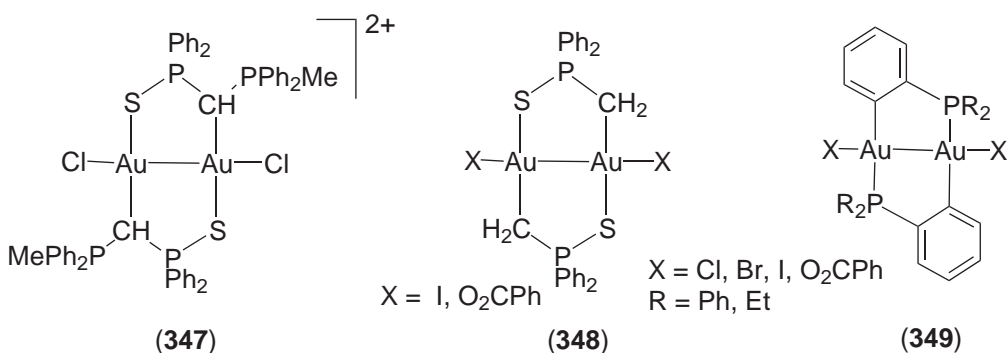

The digold(II) dihalide complexes containing the cyclometallated phosphine isomerize by coupling of the carbanions at the dimetal center to give digold(I) complexes of the corresponding 2,2'-biphenyl-substituted ligands.²⁰⁰⁴ Substitution of the benzoato ligands in this type of complex for C₆F₅ or SCN affords new gold(II) derivatives, [Au₂X₂(μ-2-PR₂C₆H₄)₂] (R = Ph, Et; X = C₆F₅, SCN).²⁰⁰⁵ The oxidative addition of the dinuclear [Au₂(μ-C₆H₃-2-PPH₂-6-Me)₂] with halogens gives gold(II)–gold(II) derivatives, which in solution isomerize to colorless heterovalent complexes (Scheme 26). These complexes have been characterized by ¹⁹⁷Au Mössbauer and X-ray photoelectron spectroscopy.²⁰⁰⁶⁻²⁰⁰⁸

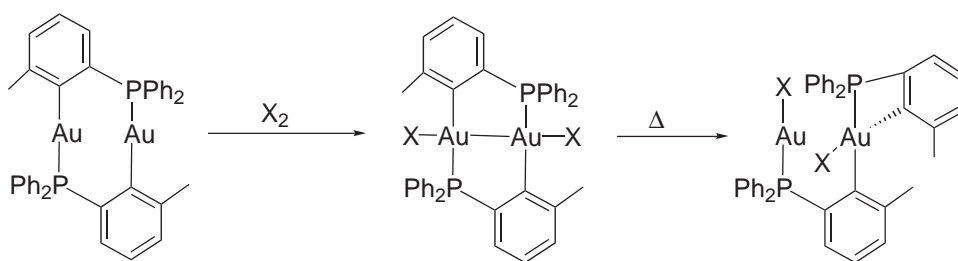

Scheme 26

A heteropolynuclear gold(II) complex with the ligand $\text{SPPH}_2\text{CH}_2^-$ has been reported by Fackler and co-workers by oxidation with Cl_2 or PhICl_2 of the trinuclear species $[\text{Au}_2\text{Pt}(\mu\text{-CH}_2\text{PPh}_2\text{S})_2]$ (Equation (23)).²⁰⁰⁹ The gold–platinum distances are 2.668(1) Å and 2.662(1) Å, clearly in the range of metal–metal bonds. Although a $\text{Au}^{\text{II}}\text{-Pt}^{\text{II}}\text{-Au}^{\text{II}}$ assignment of the oxidation states can be made, a more correct description, based on Fenske-Hall calculations, is that a $[\text{Au-Pt-Au}]^{6+}$ moiety is formed.

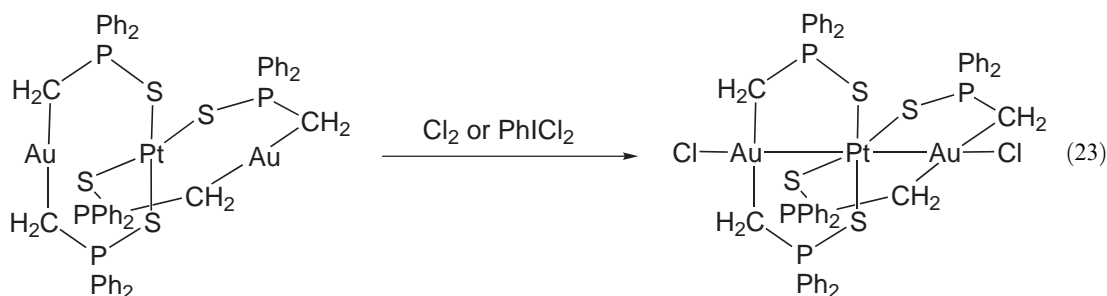

As we have commented earlier the majority of gold(II) derivatives, and the most stable, have been prepared with bis-ylide ligands. Complexes of the type $[\text{Au}_2\{\mu\text{-(CH}_2)_2\text{PR}_2\}_2]$ are useful starting materials for the development of gold(II) chemistry. Other ylide dinuclear gold(I) complexes such as $[\text{Au}_2\{\mu\text{-[CH(CO}_2\text{R)}_2\text{PPh}_2\}_2]$ (R = Me, Et) react with Cl_2 or I_2 to give the gold(II) complexes, although these are not so stable.¹⁶⁷²

The reaction of $[\text{Au}_2\{\mu\text{-(CH}_2)_2\text{PR}_2\}_2]$ with halogens,^{2009–2013} $\text{XCH}_2\text{CH}_2\text{X}$,¹⁶⁶⁵ or RS-SR ^{2014–2017} reagents (where R = CPh, (RCOO)₂, (S₂CNR₂), (SePh)) yields the corresponding gold(II) derivatives. Addition of haloalkanes to dinuclear gold(I) bis-ylide complexes also affords gold(II) species. Considerable effort has been expended to elucidate the course of this type of oxidative addition reaction,²⁰¹⁸ experimental evidence support the notion that the order of reactivity of such substrates is inversely proportional to the carbon–halogen bond dissociation energies.²⁰¹⁹ As shown in Scheme 27, $[\text{Au}_2\{\mu\text{-(CH}_2)_2\text{Ph}_2\}_2]$ reacts with alkyl halides RX (X = Br, I) to give asymmetrically substituted bicyclic digold(II) complexes.^{1665,2011,2020,2021} The reaction is reversible if R bears no electron-withdrawing substituents.²⁰²⁰ NMR spectroscopic data indicate that in solution the Au^{II} alkyl halide complexes are in equilibrium with the Au^{I} complex and the haloalkane.²⁰¹¹ In the solid state, the gold(II) methyl bromide and methyl iodide complexes undergo a thermally induced reductive elimination to give $[\text{Au}_2\{\mu\text{-(CH}_2)_2\text{PR}_2\}_2]$ and MeBr or MeI, respectively.²⁰¹¹ Furthermore, $[\text{Au}_2\{\mu\text{-(CH}_2)_2\text{PR}_2\}_2]$ catalyzes $\text{S}_{\text{N}}2$ halogen exchange MeBr and CD_3I in a process which is thought to involve a $\text{S}_{\text{N}}2$ reaction between the free alkyl halide and the postulated intermediate $[\text{Au}_2(\text{Me})\{\mu\text{-(CH}_2)_2\text{PR}_2\}_2]\text{X}$ or $[\text{Au}_2(\text{CD}_3)\{\mu\text{-(CH}_2)_2\text{PR}_2\}_2]\text{X}$.^{2011,2021} There is no indication that the alkyl halides RX add to $[\text{Au}_2\{\mu\text{-(CH}_2)_2\text{PR}_2\}_2]$ by two-electron oxidation of a single gold center.

Other oxidizing agents used to generate the bis(ylide) species are $\text{Hg}(\text{CN})_2$,²⁰²² N_2O_4 ,²⁰²³ and $[\text{Ti}(\text{C}_6\text{F}_5)_2\text{Cl}]$ ²⁰²⁴ which give the complexes $[\text{Au}_2\text{X}_2\{\mu\text{-(CH}_2)_2\text{PR}_2\}_2]$ (X = CN, NO₂, C₆F₅, respectively).

Another general procedure to prepare gold(II) complexes consists of substitution reactions on gold(II) derivatives. Halide ligands can be substituted by neutral donor ligands^{2025–2032} such as

tetrahydrothiophene, Py, ylide, phosphine, etc., to give the corresponding cationic complexes, or with other anionic ligands^{2023–2030,2033,2034} such as pseudohalides, carboxylates, dithiocarbamates, tu derivatives, etc. Scheme 28 summarizes the gold(II) derivatives obtained by substitution reactions.

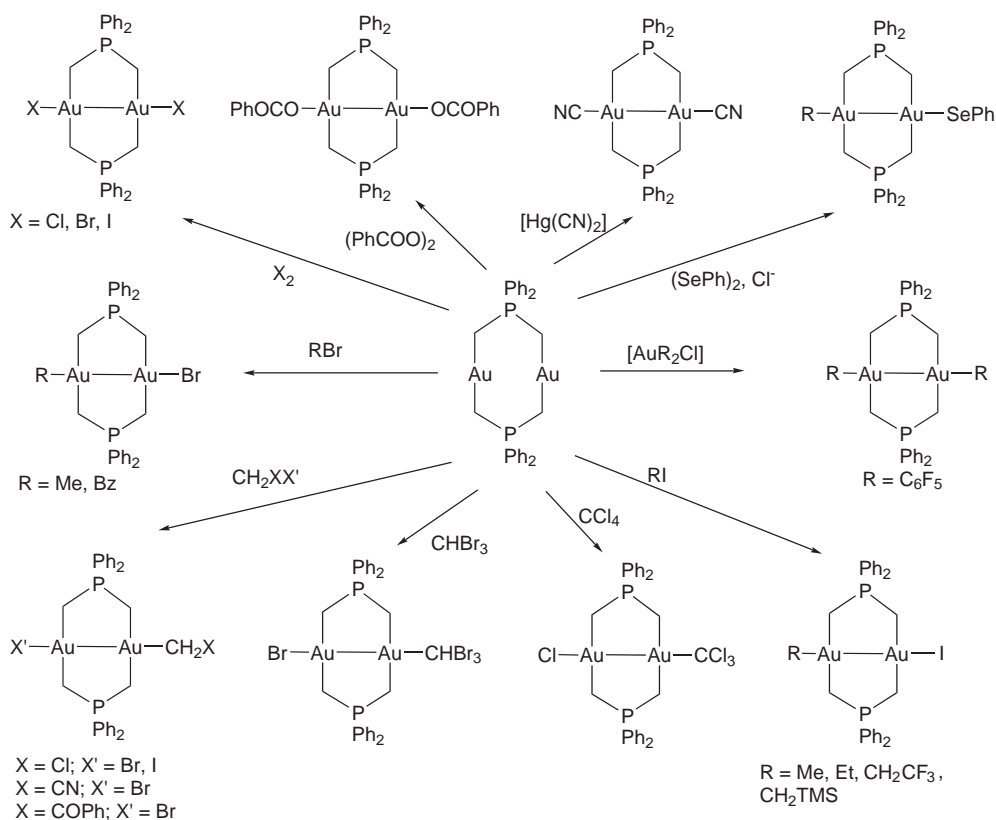

Scheme 27

The tetrahydrothiophene ligand is very labile and then it can be easily replaced by any other neutral or anionic ligand. The reaction with the silver salts of formula $[\text{Ag}(\text{OClO}_3)\text{L}]$ is very useful because it allows the synthesis of cationic symmetric or asymmetric-substituted gold(II) compounds.^{2026–2029,2035} Substitution of chlorine or THT in $[\text{Au}_2\text{Cl}\{\mu\text{-(CH}_2\text{)}_2\text{PR}_2\}_2(\text{PR}_3)]\text{ClO}_4$ or $[\text{Au}_2\{\mu\text{-(CH}_2\text{)}_2\text{PR}_2\}_2(\text{PR}_3)(\text{THT})(\text{ClO}_4)_2]$ is also possible in the dinuclear asymmetrically bridged complexes. The preparation of asymmetrical gold(II) complexes can also be achieved by mixing equimolar quantities of the symmetrical derivatives.

Dinuclear gold(II) derivatives with two different bridging ligands have also been synthesized, all of them have the ylide $(\text{CH}_2)_2\text{PPh}_2^-$ ligand and other bridging ligand that can be diphosphines such as $\text{Ph}_2\text{PCH}_2\text{PPh}_2$ or $\text{Ph}_2\text{PNHPPH}_2$,²⁰³⁶ dithiocarbamates,²⁰³⁶ xanthates,²⁰³⁷ 2-pyridinethiolate,²⁰³⁸ phosphoniodithioformate,²⁰³⁹ or dithiophosphinate (Figure 19).²⁰⁴⁰ The gold(II) complexes with ylide and phosphoniodithioformate ligands undergo substitution reactions with silver salts to afford tricationic gold(II) complexes, $[\text{Au}_2\{\mu\text{-(CH}_2\text{)}_2\text{PPh}_2\}\{\mu\text{-S}_2\text{CPCy}_3\}(\text{PR}_3)_2](\text{ClO}_4)_3$ ($\text{PR}_3 = \text{PPh}_3, \text{P}(4\text{-MeOC}_6\text{H}_4)_3$).²⁰³⁹

An interesting class of substitution reactions in these gold(II) derivatives is those where the new ligands are metal complexes. The reaction of gold(II) $[\text{Au}_2(\text{C}_6\text{F}_5)_2\{\mu\text{-(CH}_2\text{)}_2\text{PR}_2\}_2]$ with gold(III) $[\text{Au}(\text{C}_6\text{F}_5)_3(\text{OEt})_2]$ gives the pentanuclear complex $[\{\text{Au}_2\text{R}\{\mu\text{-(CH}_2\text{)}_2\text{PR}_2\}_2(\text{AuR}_2)] [\text{AuR}_4]$ ($\text{R} = \text{C}_6\text{F}_5$) (Equation (24)).²⁰²⁵ Its backbone is a linear chain of five gold atoms, all of which have square-planar geometry. The Au—Au distances of 2.755(1) Å and 2.640(1) Å are characteristic of metal–metal bonds, the former corresponding to the unsupported gold–gold bond. Extended Hückel calculations indicate that the system is better described as $\text{Au}^{\text{III}}\text{—Au}^{\text{I}}\text{—Au}^{\text{I}}\text{—Au}^{\text{I}}\text{—Au}^{\text{III}}$.

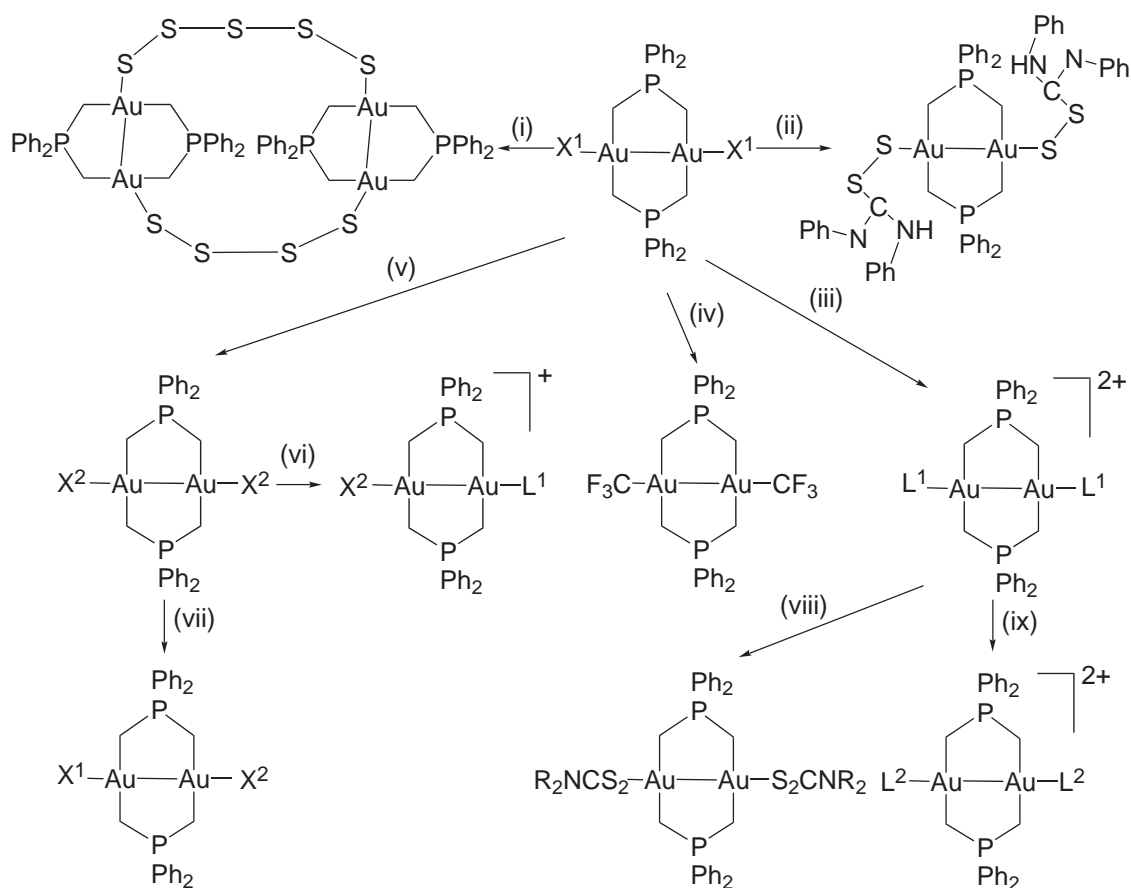

Scheme 28 (i) H_2S , $\text{X}^1 = \text{O}_2\text{CPh}$, (ii) $\text{SC}(\text{NHPh})_2$, O_2 , OH^- , (iii) $2[\text{Ag}(\text{OCIO}_3)\text{L}^1]$ ($\text{L}^1 = \text{THT}$, PPh_3), (iv) $\text{Cd}(\text{CF}_3)_2$, (v) AgX^2 ($\text{X}^2 = \text{Br}$, SCN , NO_3 , MeCO_2 , $\text{C}_6\text{F}_3\text{H}_2$, C_6F_5 , S_2CN^- , $(\text{CH}_2\text{Ph})_2$), (vi) $[\text{Au}(\text{PPh}_3)\text{L}^1]\text{ClO}_4$ ($\text{X}^2 = \text{C}_6\text{F}_5$, $\text{L}^1 = \text{PPh}_3$, THT , $\text{P}(\text{Tol})_3$, AsPh_3 , py ; $\text{X}^2 = \text{C}_6\text{F}_3\text{H}_2$, $\text{L}^1 = \text{PPh}_3$, THT), (vii) $[\text{AuX}^1(\text{PPh}_3)]$ ($\text{X}^2 = \text{C}_6\text{F}_5$, $\text{X}^1 = \text{NO}_3$, MeCO_2 , ClO_4 ; $\text{X}^2 = \text{C}_6\text{F}_3\text{H}_2$, $\text{X}^1 = \text{ClO}_4$), (viii) $2\text{NaS}_2\text{CNR}_2$ ($\text{R} = \text{Me}$, Et , C_4H_8), (ix) 2L^2 ($\text{L}^1 = \text{THT}$, $\text{L}^2 = \text{py}$, AsPh_3 , SbPh_3 , CH_2PPh_3 , $\text{S}(\text{MeS})\text{CHNR}$ ($\text{R} = 4\text{-MeC}_6\text{H}_4$, $2\text{-MeC}_6\text{H}_4$, $4\text{-MeOC}_6\text{H}_4$, $3,5\text{-Me}_2\text{C}_6\text{H}_3$)).

The unit $[\text{Au}_2\text{R}\{\mu\text{-(CH}_2)_2\text{PR}_2\}_2]^+$ is readily accessible from many complexes such as $[\text{Au}_2\text{R}(\text{THT})\{\mu\text{-(CH}_2)_2\text{PR}_2\}_2]^+$ or $[\text{Au}_2\text{R}(\text{OCIO}_3)\{\mu\text{-(CH}_2)_2\text{PR}_2\}_2]$ ($\text{R} = \text{C}_6\text{F}_5$, $2,4,6\text{-C}_6\text{F}_3\text{H}_2$). The reaction of these gold(II) complexes with either organoaurate $\text{Bu}_4\text{N}[\text{AuR}_2]$ or the gold(I) bis-ylide $[\text{Au}_2\{\mu\text{-(CH}_2)_2\text{PR}_2\}_2]$, both compounds with a high nucleophilic character, allows the synthesis of gold chain complexes (Scheme 29).²⁰²⁸

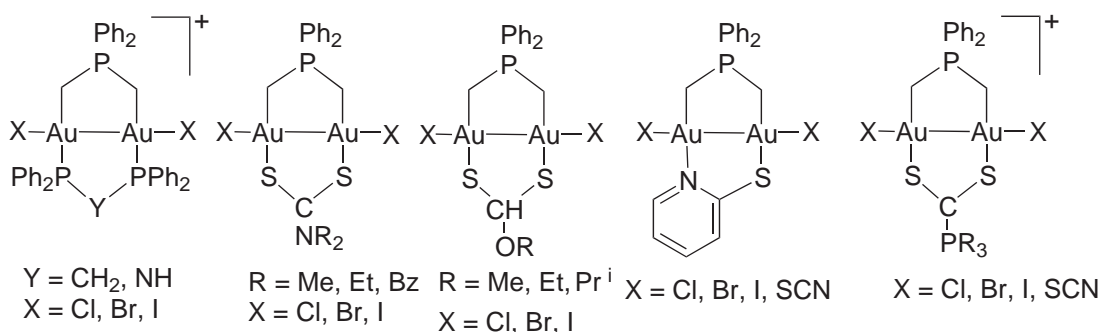
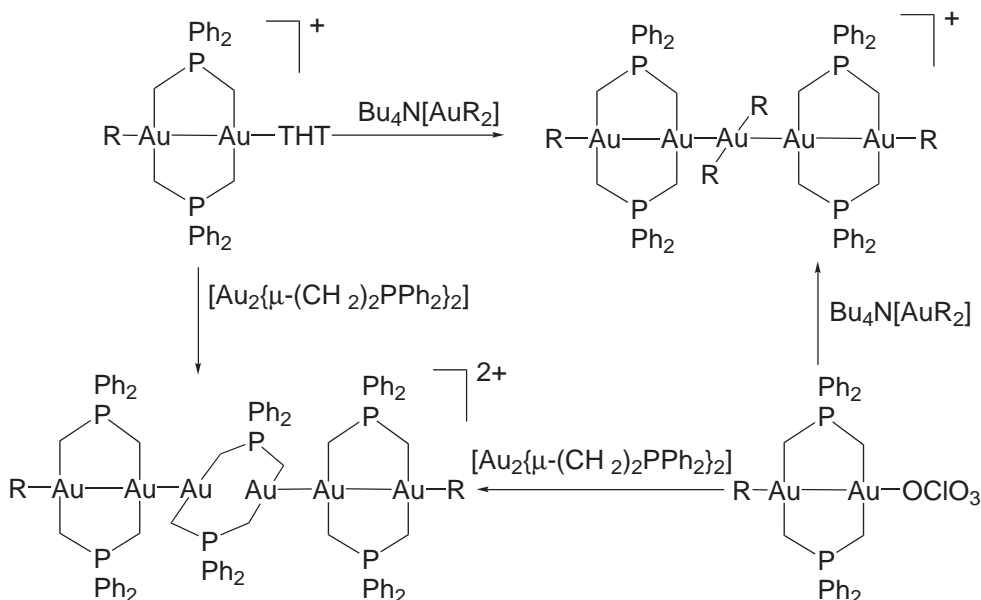
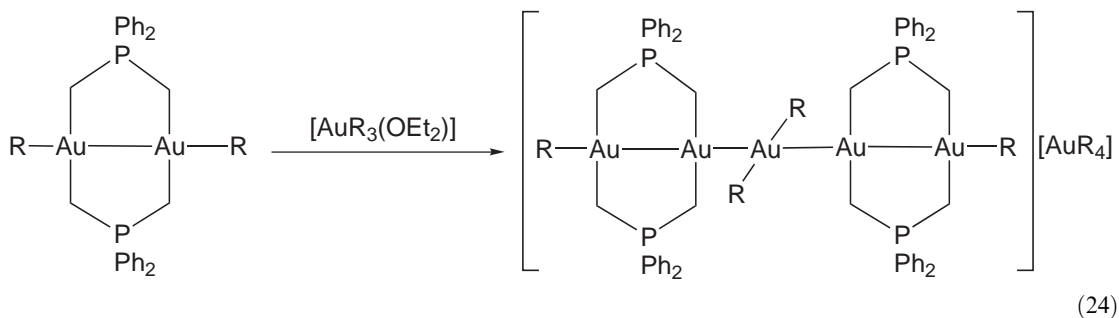
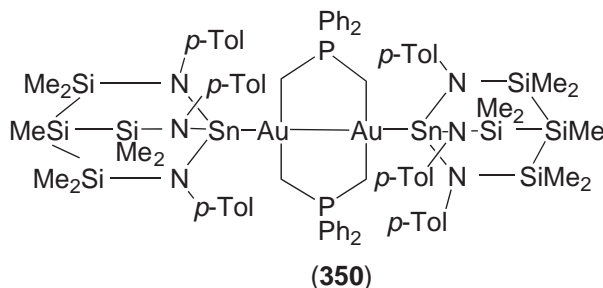

Figure 19 Some examples of asymmetric bridged gold (II) complexes.



Scheme 29 R = C₆F₅, 2,4,6-C₆F₃H₂, Me.

Other heteropolynuclear gold(II) complex that can be obtained by replacement of halide groups in bis(ylide)gold(II) species by other anionic nucleophilic metal complex is the tin derivative $[\text{Au}_2\{\text{Sn}[\text{N}(p\text{-Tol})\text{SiMe}_2]_3\text{SiMe}_2\}_2\{\mu\text{-(CH}_2)_2\text{PPh}_2\}_2]$ (350).²⁰⁴¹



Other less useful general synthetic procedures that have been used to prepare gold(II) compounds are a comproportionation reaction between the gold(III) $[\text{Au}_2\text{Br}_4\{\mu\text{-(CH}_2)_2\text{PPh}_2\}_2]$ and gold(I) $[\text{Au}_2\{\mu\text{-(CH}_2)_2\text{PPh}_2\}_2]$ to give $[\text{Au}_2\text{Br}_2\{\mu\text{-(CH}_2)_2\text{PPh}_2\}_2]$,²⁰²¹ or the simple oxidation in air with 2-thiol-pyridine or 2-sulfanylbenzothiazole of the gold(I) bis-ylide.²⁰⁴²

6.7.3.4 Gold(I) Complexes

6.7.3.4.1 Complexes with boron donor ligands

Only a limited number of complexes containing gold–boron bonds have been reported in the last two decades. Much of the work done in gold borane chemistry was often guided by the isolobal principle that suggests close analogies for species with protons and AuL^+ cations as functional groups.²⁰⁴³ The reaction of the methylated *nido*-carborane, $\text{Na}_2(\text{C}_2\text{B}_9\text{H}_9\text{Me}_2)$, with $[\text{AuCl}(\text{PPh}_3)]$ gives the anionic species $[\text{Au}(\text{C}_2\text{B}_9\text{H}_9\text{Me}_2)(\text{PPh}_3)]^-$, which was isolated as the tetraethylammonium salt.²⁰⁴⁴ This reaction clearly resembles protonation of the carborane. Further auration of this complex with $[\text{AuCl}(\text{PPh}_3)]$ leads to the dinuclear compound $[\text{Au}_2(\text{C}_2\text{B}_9\text{H}_9\text{Me}_2)(\text{PPh}_3)_2]$. The structure shows that each gold atom is predominantly bonded to one boron atom of the open carborane face, but there are also gold contacts between both gold atoms, to one of the neighboring boron atoms and to one of the hydrogen atoms (351).²⁰⁴⁵ Deprotonation of this complex using NaH followed by treatment with $[\text{AuCl}(\text{PPh}_3)]$ yields the trinuclear complex (352), with the three gold atoms predominantly bonded to a single boron atom, with short gold–gold interactions.²⁰⁴⁵ The gold carborane derivative $\text{Me}_4\text{N}[\text{Au}(\text{C}_2\text{B}_9\text{H}_9\text{Me}_2)(\text{PPh}_3)]$ has been used to prepare several mixed metal complexes in which gold atoms are bonded to rhodium,^{2043,2046} iridium,^{2043,2047} and platinum.²⁰⁴⁸ The *nido*-carborane $\text{C}_2\text{B}_9\text{H}_{12}^-$ reacts with $[\text{AuCl}(\text{PPh}_3)]$ to afford the compound $[\text{Au}(\text{C}_2\text{B}_9\text{H}_{12})(\text{PPh}_3)]$,²⁰⁴⁹ or $[\text{Au}(9\text{-SMe}_2\text{-}7,8\text{-C}_2\text{B}_9\text{H}_{10})(\text{PPh}_3)]$.²⁰⁵⁰ Treatment of $\text{Tl}[\textit{closo-}1,2\text{-Me}_2\text{-}3,1,2\text{-TiC}_2\text{B}_9\text{H}_9]$ with $[\text{AuCl}(\text{THT})]$ followed by addition of the alkylidene complexes $[\text{M}(\equiv\text{CR})(\text{CO})_2(\text{C}_5\text{H}_5)]$ ($\text{M} = \text{Mo}$, $\text{R} = \text{C}_6\text{H}_4\text{Me-}4$, $\text{C}_6\text{H}_3\text{Me}_2\text{-}2,6$; $\text{M} = \text{W}$, $\text{R} = \text{C}_6\text{H}_4\text{Me-}4$) and $(\text{NEt}_4)\text{Cl}$ yields the salts $(\text{Et}_4\text{N})_2[10,10'\text{-endo-}\{\text{Au}_2\text{M}(\mu_3\text{-CR})(\text{CO})_2(\text{C}_5\text{H}_5)\}\text{-}7,7',8,8'\text{-Me}_4\text{-nido-}7,7',8,8'\text{-}(\text{C}_2\text{B}_9\text{H}_9)_2]$ (353) and $\text{Et}_4\text{N}[10\text{-endo-}\{\text{AuM}(\mu\text{-CR})(\text{CO})_2(\text{C}_5\text{H}_5)\}\text{-}7,8\text{-Me}_2\text{-nido-}7,8\text{-C}_2\text{B}_9\text{H}_9]$.²⁰⁵¹

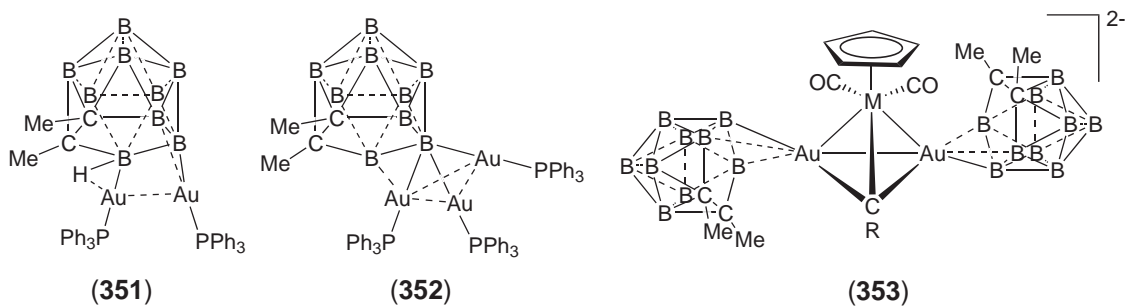

The reaction of $[\text{AuMe}(\text{PCy}_3)]$ with $\text{B}_{10}\text{H}_{14}$ gives methane and the aurred complex $[\text{Au}(\text{B}_{10}\text{H}_{13})(\text{PCy}_3)]$ with a η^2 boron cage,^{2052–2054} whereas the reaction with $\text{B}_{10}\text{H}_{12}(\text{PPh}_3)_2$ causes partial degradation of the B_{10} cluster and leads to $[\text{Au}_2(\text{B}_8\text{H}_{10})(\text{PCy}_3)_2]$ (354) with a double η^3 boron cluster.²⁰⁵⁵ The gold complex with the 7,8-dicarba-9-nickela-undecaborane, $[\text{Au}(9\text{-C}_5\text{H}_5\text{-}7,8,9\text{-C}_2\text{NiB}_8\text{H}_{10})(\text{PPh}_3)]$,²⁰⁵⁶ and a ruthenadecaborane gold derivative,²⁰⁵⁷ have been reported. The dinuclear gold complex containing a hexaborate as bridging ligand, $[\text{Au}_2(\mu\text{-bis-}\eta^3\text{-B}_6\text{H}_6)(\text{PPh}_3)_2]$ (355), have been obtained from $[\text{AuCl}(\text{PPh}_3)]$ and $[\text{B}_6\text{H}_6]^{2-}$. Two different polymorphs have been characterized structurally in which the gold atoms display strongly distorted tetrahedral coordination to three boron atoms and one phosphorus atom.^{2058,2059} The crystal structure of the pentaborane cluster $[\text{Au}(\text{B}_5\text{H}_8)(\text{PPh}_3)]$ has been reported.²⁰⁶⁰

Polyauration of a single boron atom was accomplished using a phosphineborane $(\text{Cy}_3\text{P})(\text{TMS})\text{BH}_2$ which, upon treatment with the oxonium salt $[\text{O}(\text{AuPPh}_3)_3]\text{BF}_4$, gives the tetra-aurated compound $[(\text{Cy}_3\text{P})\text{B}(\text{AuPPh}_3)_4]\text{BF}_4$ (356).²⁰⁶¹ Surprisingly, stoichiometric substitution could only be carried out with an oxonium salt bearing bulky tertiary phosphines such as $\text{P}(o\text{-Tol})_3$, giving $[(\text{Cy}_3\text{P})\text{B}\{\text{Au}(o\text{-Tol})_3\}_3]$.^{115,2062}

Au–B bonds are also present in metal clusters with interstitial or peripheral boron atoms. An example is the cluster $[\text{Fe}_4(\text{CO})_{12}\text{BH}(\text{AuPPh}_3)_2]$, which was prepared by reaction of $[\text{AuCl}(\text{PPh}_3)]$ with the carbonyl iron dihydride. With the oxonium salt the reaction proceeds to the trinuclear gold derivative $[\text{Fe}_4(\text{CO})_{12}\text{B}(\text{AuPPh}_3)_3]$ (357).^{2063–2070} The ruthenium analogues and complexes with other ligands have been also synthesized as, for example, (358).^{2071–2079}

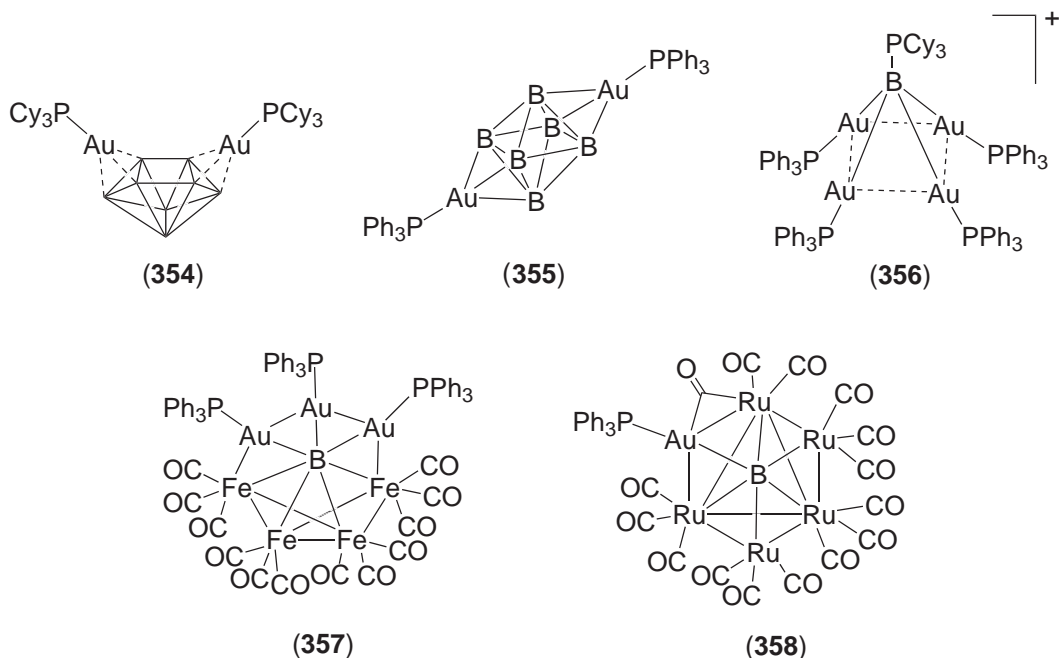

6.7.3.4.2 Complexes with carbon donor ligands

The first carbonyl complex of gold, $[\text{AuCl}(\text{CO})]$, was prepared in 1925^{2080,2081} and since then only a few more derivatives have been obtained. The $[\text{AuBr}(\text{CO})]$ derivative was prepared later and is unstable in the solid state.^{2082,2083} The reductive carbonylation of $\text{Au}(\text{SO}_3\text{F})_3$ in fluorosulfonic acid leads via $[\text{Au}(\text{CO})_2]^+$ (solvent) to solid $[\text{Au}(\text{SO}_3\text{F})(\text{CO})]$ (Scheme 30).²⁰⁸⁴ $[\text{Au}(\text{CO})_2]^+$ salts are produced in strongly ionizing protic acids or in Lewis acids such as SbF_5 .

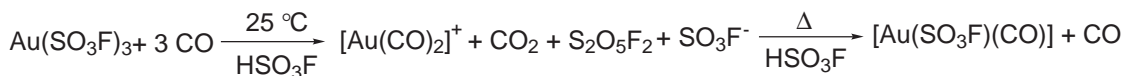

Scheme 30

The oxidation of metallic gold by UF_6 in liquid HF in the presence of CO gives $[\text{Au}(\text{CO})_2][\text{UF}_6]$ (Equation (25)).⁴⁰



Carbonylation of $[\text{Au}(\text{SO}_3\text{F})(\text{CO})]$ in pure SbF_5 gives $[\text{Au}(\text{CO})_2][\text{Sb}_2\text{F}_{11}]$.⁴¹ The reaction of $[\text{Au}(\text{SbF}_6)_2 \cdot \text{Au}(\text{AuF}_4)_2]$ with AsF_3 in HF/ SbF_5 and in the presence of CO yields $[\text{Au}(\text{CO})_2]_2(\text{SbF}_6)(\text{Sb}_2\text{F}_{11})$.²⁰⁸⁵ The mixed valence $[\text{Au}_2\text{Cl}_4(\text{CO})]$ has also been prepared.^{2082,2083} The tris(pyrazolyl)borate analogous to silver (complex **8**) $[\text{Au}\{\text{HB}\{3,5-(\text{CF}_3)_2\text{pz}\}_3\}(\text{CO})]$ has been reported.²⁰⁸⁶ All the compounds exhibit $\nu(\text{CO})$ IR frequencies at higher wave numbers than free CO, indicating insignificant π -back donation from gold to CO. This deduction is supported further by Mössbauer spectroscopy,²⁰⁸⁷ the crystal structure determination of $[\text{AuCl}(\text{CO})]$,²⁰⁸⁸ and *ab initio* calculations.^{2089,2090} A new gold catalyst, $[\text{Au}(\text{CO})_n]^+$ ($n = 1, 2$), has been synthesized by reaction of Au_2O_3 in concentrated sulfuric acid, and exhibits high catalytic activity for carbonylation of alkenes.²⁰⁹¹

Complexes of the type $[\text{AuRL}]$ may contain a great variety of organic ligands such as alkyl, aryl, vinyl, or alkynyl, whereas the neutral donor ligand L is most commonly a tertiary phosphine. Also many polynuclear complexes are known which have the C–Au–L moiety with bridging polyfunctional ligands. Alkyl- or aryl-gold(I) complexes are usually synthesized

by reaction of an alkyllithium or a Grignard reagent with a gold(I) halide compound. The oxonium salt, $[O(AuPPh_3)_3]BF_4$, can be used instead of $[AuCl(PPh_3)]$ and shorter reaction times and higher yields are obtained.^{2092,2093} Methylgold(I) derivatives have been obtained with several ligands as $[AuMe(AsPh_3)]$,²⁰⁹⁴ $[AuMe(TPA)]$ (TPA = 1,3,5-triaza-7-phosphaadamantane),²⁰⁹⁵ $[Au_2Me_2\{\mu-(PPh_2)_2C(CH_2)_2\}]$,²⁰⁹⁶ or $[Au_3Me_3(\mu-dmmp)]$ (dmmp = bis(dimethylbis(dimethylphosphinomethyl)methylphosphine)^{2097,2098} which show interesting photophysical properties. The nature of bonding in $[AuMe(PMe_3)]$ has been studied theoretically and indicates a small *5d* contribution to the overall bonding.²⁰⁹⁹ If relativistic effects are included the results suggest that the contribution of the Au *5d* electrons to the overall bonding is appreciable.²¹⁰⁰ A structural study of this complex by gas-phase electron diffraction has also appeared.²¹⁰¹

Haloalkylgold(I) complexes can be prepared by photochemical insertion of fluoroalkenes into the gold-carbon bond of methylgold(I) complexes.²¹⁰² Other routes include direct auration of halocarbons, such as $CHCl_3$, MeCN, HCl_2CN , with $[O(AuPPh_3)_3]BF_4$ (Equation (26)),^{2103,2104} or the reaction of $Cd(CF_3)_2$ with the gold(I) halide precursors.^{1638,1656} The structure of $[Au(CF_3)(PPh_3)]$ has been reported:²¹⁰⁵



The chloromethyl derivative $[Au(CH_2Cl)(PPh_3)]$ has been prepared by reaction of $[AuCl(PPh_3)]$ with $Mg(CH_2Cl)Cl$. Substitution reactions on this complex with LiI, NaOMe, or PPh_3 lead to $[Au(CH_2X)(PPh_3)]$ (X = I, OMe) or $[Au(CH_2PPh_3)(PPh_3)]Cl$.²¹⁰⁶ $[Au(CH_2Cl)(PPh_3)]$ reacts with $[PtMe_2(bipy)]$ with oxidative addition of the metal complex to give $[PtClMe_2(CH_2AuPPh_3)(bipy)]$.²¹⁰⁷ The complex $[Au(CH_2SPh)(PMe_3)]$ has also been obtained by treatment of $LiCH_2SPh$ and $[AuCl(PMe_3)]$.²¹⁰⁶ Trimethylsilylmethyl gold(I) complexes, $[Au(CH_2TMS)L]$, have been synthesized by reaction of $Mg(CH_2TMS)Cl$ with $[AuClL]$ (L = $AsPh_3$, PPh_3); the derivative with $AsPh_3$ undergoes substitution reactions with several phosphine and diphosphine ligands.²¹⁰⁸

Arylgold(I) compounds can be similarly prepared to alkyl derivatives via the organolithium or the Grignard route. These methods have been used to prepare pentachlorophenyl,¹⁶⁴¹ 4,4'-octafluorobiphenyl (Equation (27)),²¹⁰⁹ 2,4,6-tris(trifluoromethyl)phenyl,^{1642,2110} triphenylarsine,^{2002,2003} bipyridine,¹⁶⁶¹ terphenyl,^{2111,2112} and Mes^{289,290,295,2112} derivatives. The structure of the Mes complex $[Au(Mes)]_5$ is a pentamer with a five-pointed star shape:^{2111,2112}

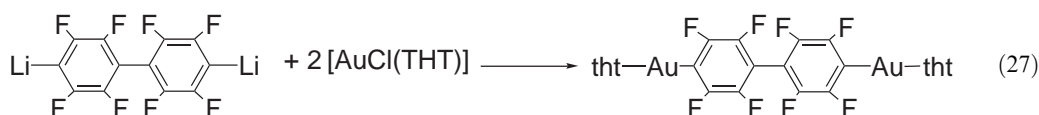

Other methods consist of the use of organosilver or organomercury aryl species, which have been used with 2,4,6-trinitrophenyl (Equation (28)),^{2113,2114} polyhalophenyl,²¹¹⁵ or Mes derivatives (Equation (29)).²¹¹⁶

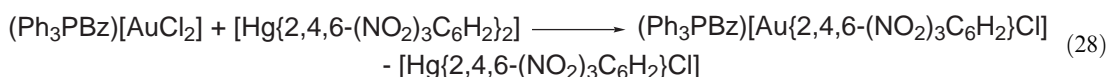

Treatment of (phosphine)gold(I) halides or tris(phosphinegold(I))oxonium salts with $Na(BPh_4)$ affords arylgold(I) phosphine species through an unusual phenyltransfer reaction (Equation (30)).^{2117,2118} A complex with a bridging tetrachlorophenyl group, $[PtCl(PPh_3)_2(\mu-C_6Cl_4)Au(PPh_3)]$, has been obtained by reaction of $[Au(C_6Cl_4H)(PPh_3)]$ with $Pt(PPh_3)_3$.²¹¹⁹

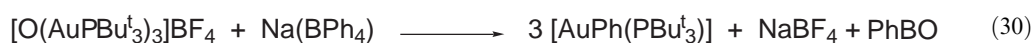

Gold(I) complexes containing cyclopentadienyl or related ligands have been prepared either by the organolithium method as $[\text{AuR}(\text{PR}_3)]$ ($\text{R} = \text{C}_5\text{H}_5, \text{C}_5\text{Me}_5$; $\text{PR}_3 = \text{PMe}_3, \text{PPr}^i_3, \text{PPh}_3$)²¹²⁰ or by direct auration with $[\text{O}(\text{AuPPh}_3)_3]\text{BF}_4$ (Equation (31)).^{2121,2122} The structure of $[\text{Au}(\text{C}_5\text{Ph}_2\text{H}_3)(\text{PPh}_3)]$ has been reported:²¹²³



The pentakis(methoxycarbonyl)cyclopentadiene is a strong acid that displaces weaker organic acids upon interaction with their metal salts (Equation (32)):²¹²⁴

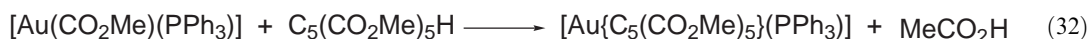

These complexes present a fluxional behavior in solution with rapid migration of the $\text{Au}(\text{PR}_3)$ group around the $\eta^1\text{-C}_5$ ring even at low temperatures; however, the tetraphenylcyclopentadienyl complex has been found to be stereochemically rigid.²¹²¹ Other related ligands are 9-fluorenyl (359),²¹²⁵ Fc,²¹²⁶ dimethylaminoferrocenyl (360),²¹²⁷ and metallocene complexes of cobalt,²¹²⁸ rhodium,²¹²⁸ or chromium.²¹²⁹ Other compounds with Au—C bonds have been obtained with other organic moieties, including those derived of carboranyl anions (361),^{2094,2130,2131} iminoalkyl,²¹³² silylcyclopropyl ethers,²¹³³ pyrazolone derivatives,²¹³⁴ alkyl with carbonyl or sulfonyl groups,^{2135–2138} and ylide ligands.^{1646,1648,2139–2147}

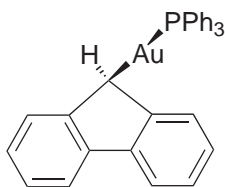

(359)

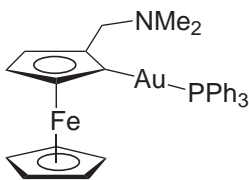

(360)

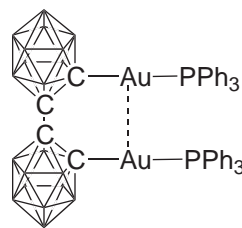

(361)

Other types of compounds with carbon donor ligands are those derived from the multiauration of the carbon giving species from two up to six gold atoms coordinated around a carbon donor ligand. The first examples were obtained in 1974 with the tolyl and Fc derivatives by protonation of the aryl moieties, which liberates AuPPh_3^+ that attacks a second molecule of the aryl gold complex.²¹⁴⁸ Another method to prepare this type of complex is treatment with the oxonium salt, $[\text{O}(\text{AuPPh}_3)_3]\text{BF}_4$. Similar complexes have been obtained with other organic units, such as $[\text{MeC}_6\text{H}_4\{\text{Au}_2(\text{dppm})\}]\text{BF}_4$,²¹⁴⁹ $[2,4,6\text{-C}_6\text{F}_3\text{H}_2(\text{AuPPh}_3)_2]\text{ClO}_4$ (362), $[2,4,6\text{-Me}_3\text{C}_6\text{H}_2(\text{AuPPh}_3)_2]\text{ClO}_4$, $[\text{Ph}_4\text{C}_5(\text{AuPPh}_3)_3]\text{BF}_4$,²¹⁵⁰ $[(\text{CN})_2\text{C}(\text{AuPPh}_3)_3]\text{BF}_4$,²¹⁵¹ *N*-alkylated barbituric acid,^{2152,2153} or $[(\text{Ph}_3\text{PAu})_2\text{C}_6\text{H}_4(\text{CH}_2)_2\text{-C}_6\text{H}_4(\text{AuPPh}_3)_2](\text{BF}_4)_2$ (363).²¹⁵⁴ Ylide or methanide complexes have been obtained where the two protons of a methylene unit have been substituted by two gold phosphine units; the main method used is reaction with acetylacetonate gold complexes.²¹⁵⁵ Thus, ylide complexes of the type $[\text{Ph}_3\text{PCH}(\text{AuPPh}_3)_2]^+$,²¹⁵⁶ $[(\text{Ph}_2\text{MeP})_2\text{C}(\text{AuPPh}_3)_2]^{2+}$ (364),²¹⁵⁷ $[(\text{PPh}_3)(\text{CONMe}_2)\text{C}(\text{AuPPh}_3)_2]$,¹⁶⁴⁷ $[(\text{TMS})_2\text{C}\{\text{B}(\text{NPr}^i_2)_2\}_2\text{C}(\text{AuPPh}_3)_2]$,²¹⁵⁸ $[\text{OC}\{(\text{PPh}_3)\text{-C}(\text{AuPPh}_2\text{Me})_2\}_2]$,¹⁶⁵² $[(\text{EtCO}_2)\text{CH}(\text{AuPPh}_3)\text{PPh}_2(\text{CO}_2\text{EtC})(\text{AuPPh}_3)_2]^+$ (365),¹⁶⁷² or $[(\text{R}_3\text{P})(\text{Py})\text{C}(\text{AuPPh}_3)_2]^+$,^{2159,2160} have been reported.

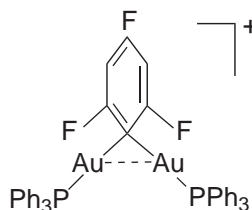

(362)

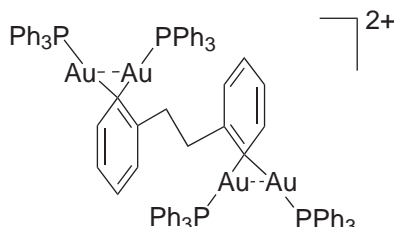

(363)

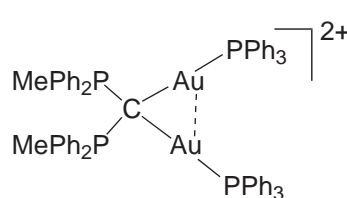

(364)

Also in methanide complexes, mainly derived of $\text{Ph}_2\text{PCH}_2\text{PPh}_2$ and its derivatives, substitution of two protons for gold(I) phosphine units has been achieved in gold(III) complexes (see Section 6.7.3.2.3(ii)), $[(\text{SPPH}_2)_2\text{C}(\text{AuPPh}_3)_2]$ (366),²¹⁶¹ $[(\text{SPPH}_2)(\text{RPPH}_2)\text{C}(\text{AuPPh}_3)_2]\text{ClO}_4$,²³⁰ $[\{(\text{Ph}_3\text{PAu})_2\}_2\{\text{C}(\text{PPh}_2)_2\text{Au}\}_2](\text{ClO}_4)_2$ (367),^{2162,2163} or in heteropolynuclear complexes.²¹⁶⁴⁻²¹⁶⁶

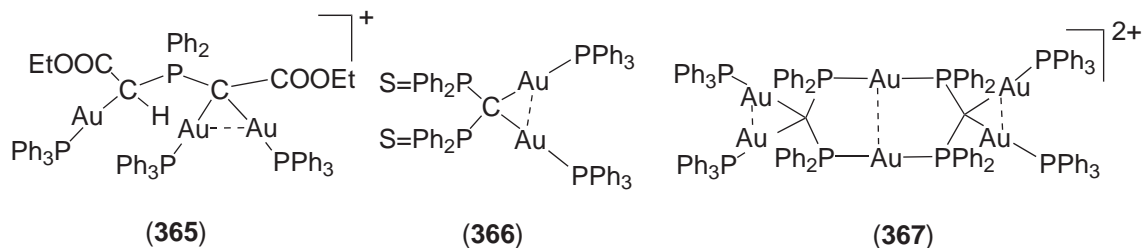

Further auration of a single carbon atom has been reported and thus complexes with three, four, five, or even six gold atoms have been obtained. The silylated ylide $\text{Me}_3\text{P}=\text{CH}(\text{TMS})$ reacts with $[\text{AuCl}(\text{PPh}_3)]$ in the presence of CsF to give $[(\text{Me}_3\text{P})\text{C}(\text{AuPPh}_3)_3]\text{Cl}$ (368).²¹⁵⁷ Another method of obtaining this type of complex is the use of $[\text{O}(\text{AuPPh}_3)_3]\text{BF}_4$ or $[\text{Au}(\text{ACAC})(\text{PPh}_3)]$, and thus the reaction with $[(\text{R}_3\text{Si})_2\text{CH}(\text{AuPPh}_3)]$ ($\text{R} = \text{Me}_3, \text{Me}_2\text{Ph}$) gives a mixture of the di- and triaurated species $[(\text{R}_3\text{Si})_2\text{C}(\text{AuPPh}_3)_2]$ and $[(\text{R}_3\text{Si})_2\text{C}(\text{AuPPh}_3)_3]\text{BF}_4$.^{2167,2168} Similarly the reaction of Me_3SO^+ with three equivalents of $[\text{Au}(\text{ACAC})(\text{PPh}_3)]$ leads to the trinuclear compound $[\text{Me}_2\text{OSC}(\text{AuPPh}_3)_3]^+$.²¹⁶⁹ Tetraaurated species have been synthesized, generally by reaction of $\text{C}[\text{B}(\text{OMe})_2]_4$, $\text{CH}_2[\text{B}(\text{OMe})_2]_2$, or $\text{MeC}[\text{B}(\text{OMe})_3]_3$ with mixtures of $[\text{AuCl}(\text{PR}_3)]$ and CsF ; the same method is used to get higher polyaurated species. Then complexes such as the oxazolonyl derivative (369),²¹⁷⁰ $[\text{RC}(\text{AuPPh}_3)_4]\text{BF}_4$ where R can be H ,²¹⁵⁶ Me ,²¹⁷¹ PMe_3 ,²¹⁵⁷ SOMe_2 ,²¹⁶⁹ or with other phosphines or diphosphines such as PCy_3 ,^{2171,2172} or $(\text{PPh}_2\text{CH}_2\text{CH}_2)_2\text{C}_6\text{H}_4$,²¹⁷¹ have been reported. These complexes have a square-pyramidal structure with short gold–gold interactions.

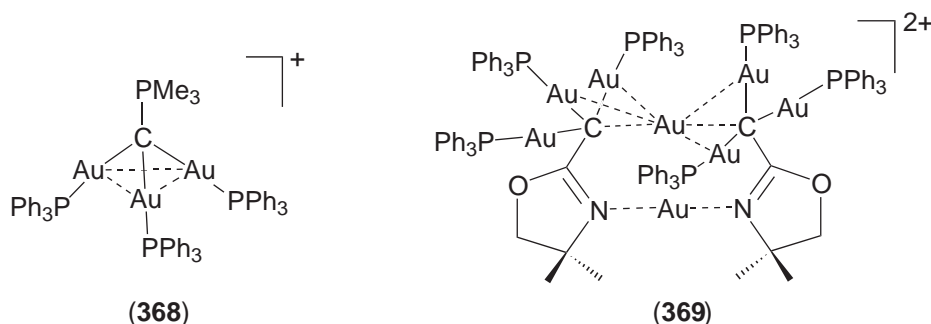

The homoleptic $[\text{C}(\text{AuPCy}_3)_4]$ (370) is only obtained with very bulky phosphines and has the expected tetrahedral geometry.²¹⁷³ In the presence of less steric demanding phosphines, such as PPh_3 or $\text{P}(\text{C}_6\text{H}_4\text{-Me})_3$, the pentacoordinated species $[\text{C}(\text{AuPR}_3)_5]^+$ (371) is produced in high yield,²¹⁷⁴ which possesses a trigonal pyramidal geometry with short gold–gold contacts among the equatorial gold atoms. These pentacoordinate species can accommodate another AuL^+ fragment and, under suitable conditions, the hexacoordinate compounds $[\text{C}(\text{AuPR}_3)_6]^{2+}$ (372) are obtained for a great variety of phosphines or diphosphines.^{2,2175-2178} They have an octahedral geometry with short gold–gold interactions, equivalent phosphorus atoms in ^{31}P NMR, and a septet for the central carbon atom in the ^{13}C NMR. Conventional as well as ^{252}Cf -plasma desorption mass spectrometric studies have also been reported.²¹⁷⁹ A better reaction pathway for the hexaurated species has been developed which consists of the reaction of TMSCHN_2 with $[\text{O}(\text{AuPR}_3)_3]^+$ in the presence of NEt_3 in dichloromethane.²¹⁸⁰

Development of acetylidegold(I) complexes has expanded in recent years. The preference of gold(I) for a linear coordination, together with the linearity of the $\text{C}\equiv\text{C}$ bond of the acetylide unit and its π -unsaturated nature, have made the metal acetylides attractive building blocks for molecular wires and organometallic oligomeric and polymeric materials, which may possess unique properties such as optical nonlinearity,²¹⁸¹ liquid crystallinity,^{2182,2183} or luminescence.²¹⁸⁴ Polymeric gold acetylides $[\text{Au}(\text{C}\equiv\text{CR})]_n$ have been known for a long time. The oligomeric

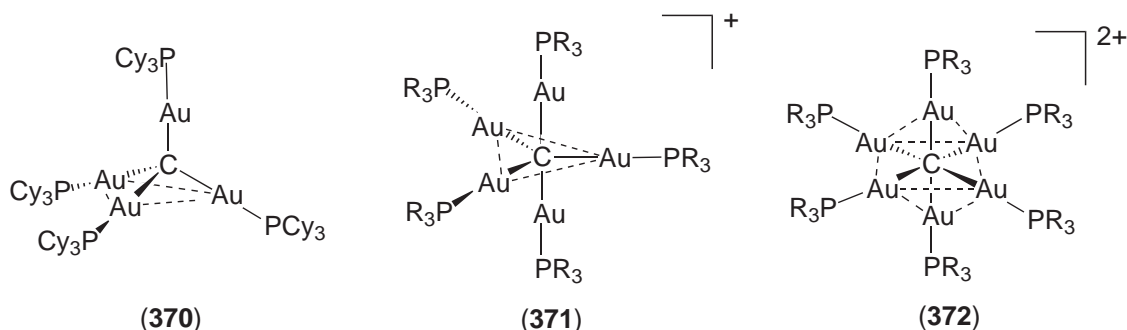

$[\text{Au}(\text{C}\equiv\text{CBu}^t)]_n$ has been prepared by reaction of $[\text{Au}(\text{NH}_3)_2]^+$ with $\text{HC}\equiv\text{CBu}^t$; its structure is a catenate with η^1 and η^2 coordination around the gold atoms.^{2185,2186} Complexes of the type $[\text{Au}(\text{C}\equiv\text{CR})\text{L}]$ are obtained by a variety of synthetic routes, including the reaction of $[\text{Au}(\text{C}\equiv\text{CR})]_n$ with a donor ligand, reaction of $[\text{AuCl}]\text{L}$ with $\text{HC}\equiv\text{CR}$ in the presence of Et_2NH , CuX , NaOR , etc. The neutral complexes $[\text{Au}(\text{C}\equiv\text{CR})\text{L}]$ or $[\text{Au}(\text{C}\equiv\text{CRC}\equiv\text{CR})\text{L}]$ are known mainly with tertiary phosphines and for a great variety of substituents R (see compounds (373) and (374), as some examples),^{258,2187–2207} and other ligands, such as amine,^{2185,2208} or phen.²¹⁸⁹ Anionic complexes of the type $[\text{Au}(\text{C}\equiv\text{CR})\text{X}]^-$ ($\text{X} = \text{Cl}, \text{Br}, \text{I}; \text{R} = \text{H}, \text{Ph}$) have also been reported.^{2192,2209,2210}

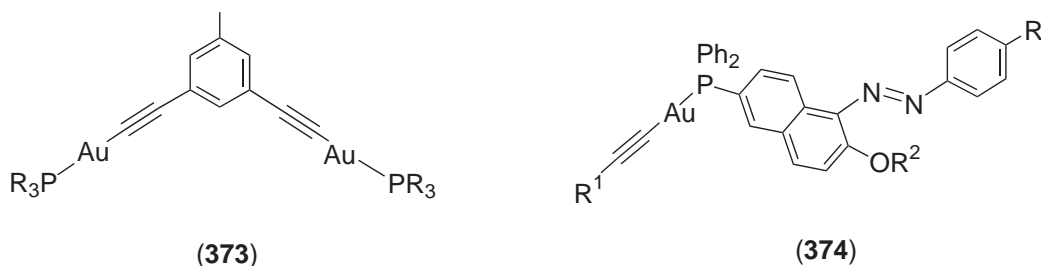

Unsubstituted alkyne gives dinuclear gold(I) acetylides $[\text{Au}_2(\text{C}\equiv\text{C})(\text{PR}_3)_2]$,^{2098,2189,2190,2211,2212} and polyynes also yield similar type of compounds.^{2212–2217} Polynuclear gold(I) acetylides with diphosphines have grown in the last years because of the luminescence properties of many of these complexes. The first report on the luminescence of gold(I) acetylides appeared in 1993 in which the emissive behavior of the complex $[\text{Au}_2(\text{C}\equiv\text{CPh})_2(\mu\text{-dppf})]$ was described.²²¹⁸ The reaction of $[\text{Au}(\text{C}\equiv\text{CPh})]_n$ with diphosphines, as dppm , affords the compound $[\text{Au}_3(\text{C}\equiv\text{CPh})_2(\mu\text{-dppm})_2][\text{Au}(\text{C}\equiv\text{CPh})_2]$ (375),²²¹⁹ but with other diphosphines, such as 2,6-bis(diphenylphosphino)pyridine (dppy) yields a polynuclear complex $[\{\text{Au}_2(\mu\text{-dppy})(\text{C}\equiv\text{CPh})_2\}]_n$.²²²⁰ Also, complexes with monodentate diphosphines such as $[\text{Au}(\text{C}\equiv\text{CBu}^t)(\text{PR}_2\text{CH}_2\text{PR}_2)]$ have been prepared.²¹⁹⁶ Other complexes with acetylide ligands and diphosphines, triphosphines, or tetraphosphines, as, for example, (376) or (377), have been obtained and the luminescent properties tested for some of them.^{2206,2207,2221–2227}

Thermolysis of the dinuclear $[\text{Au}_2(\text{C}\equiv\text{CBu}^t)_2(\mu\text{-PPh}_2\text{CH}_2\text{PPh}_2)]$ in refluxing toluene leads to the intermolecular elimination of $\text{HC}\equiv\text{CBu}^t$ and formation of complex (378).²²²⁸

Polymer complexes have been prepared from diphosphines and acetylides, both of which are bridging ligands, as, for example, (379).²²²⁹ Gold(I) di- and triacetylide complexes have been used to obtain rigid-rod polymers.^{2217,2225,2230,2231} Bifunctional alkyne ligands such as $\text{R}_2\text{PC}\equiv\text{CH}$ ($\text{R} = \text{Ph}, \text{Pr}^t$) form complexes $[\text{AuCl}(\text{PPh}_2\text{C}\equiv\text{CH})]$ that upon treatment with a base eliminate HCl and give the polymers $[\{\text{Au}(\text{PPh}_2\text{C}\equiv\text{C})\}]_n$.²²³²

The same reactions have led to the discovery of organometallic catenanes by self-assembly of an oligomeric digold(I) diacetylide $[\{\text{Au}(\text{C}\equiv\text{CCH}_2\text{OC}_6\text{H}_4)_2\text{X}\}]_n$ and a diphosphine ligand $\text{Ph}_2\text{P}(\text{CH}_2)_n\text{PPh}_2$.²²³³ Systematic investigations of this unusual reaction have shown that the number of methylene spacer groups n in the diphosphine ligand and the nature of the hinge group X are key factors in determining if the self-assembly will give a simple ring by 1+1 assembly, a [2]catenane by 2+2 assembly,^{2233–2235} or a double braided [2]catenane by 4+4 assembly (Scheme 31).^{2236,2237}

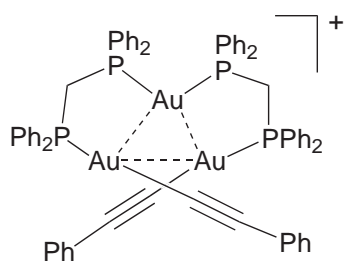

(375)

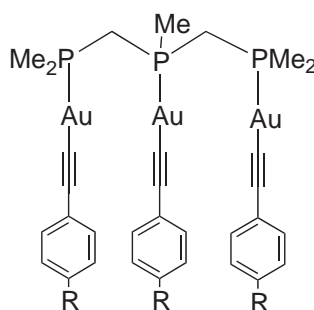

(376)

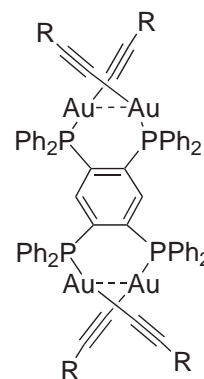

(377)

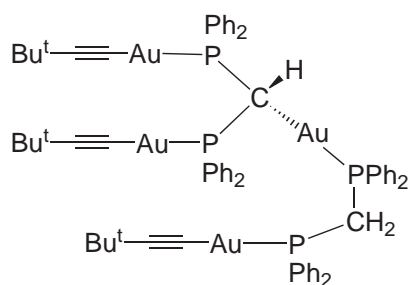

(378)

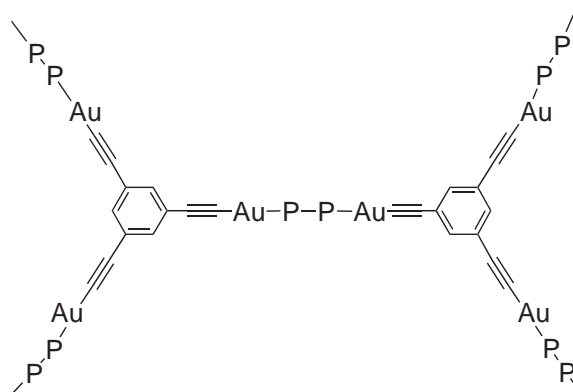

(379)

Mixed gold(I)–gold(III) complexes have been obtained by reaction of $[\text{Au}(\text{C}_6\text{F}_5)_3(\text{PPh}_2\text{C}\equiv\text{CH})]$ with acetylacetonate compounds such as $[\text{Au}(\text{ACAC})(\text{PPh}_3)]$ or $[(\text{Ph}_3\text{P})_2\text{N}][\text{Au}(\text{ACAC})_2]$ to yield $[\text{Au}(\text{C}_6\text{F}_5)_3\{\text{PPh}_2\text{C}\equiv\text{CAu}(\text{PPh}_3)\}]$ or $[(\text{Ph}_3\text{P})_2\text{N}][\{\text{Au}(\text{C}_6\text{F}_5)_3(\text{PPh}_2\text{C}\equiv\text{C})\}_2\text{Au}]$.¹⁷⁵¹ Some heteropolynuclear gold-containing acetylides of iron,²²³⁸ ruthenium,²²³⁸ molybdenum,²²³⁹ tungsten,^{2239,2240} or platinum have also been described.²²⁴¹

(Isonitrile)gold(I) complexes have attracted increasing attention because of their potential use in new domains of applications such as MOCVD precursors for the deposition on thin gold films^{2187,2242,2243} or liquid crystals.^{2182,2244–2251} Most of the complexes described are of the type $[\text{AuX}(\text{CNR})]$ ($\text{X} = \text{Cl}, \text{Br}, \text{I}, \text{SCN}$; $\text{R} = \text{Me}, \text{Ph}, \text{Bu}^t$;^{2252,2253} NO_3 ; $\text{R} = \text{Et}, \text{Bu}^t, 2,6\text{-Me}_2\text{C}_6\text{H}_3$,²²⁵⁴ $\text{X} = \text{Cl}, \text{Br}, \text{I}, \text{CN}$; $\text{R} = o\text{-xylyl}$ ²²⁵⁵). All species show $\text{Au}\cdots\text{Au}$ interactions in the solid state, but with different modes of aggregation. The complexes $[\text{AuCl}(\text{CNR})]$ ($\text{R} = \text{C}_n\text{H}_{2n+1}$; $n = 2\text{--}12$) assemble by aurophilic interactions into structures similar to those seen for the (1-*n*)-alcohols (bilayers with hydrogen bonding) and also show temperature-dependent polymorphism consistent with the formation of rotator phases.⁴⁴ The reaction of $[\text{AuCl}(\text{CNMe}_3)]$ with $[\text{GeCl}_2(\text{diox})]$ gives a compound $[\text{AuGeCl}_3(\text{CNMe}_3)]$, which crystal structure shows a string of alternating $[\text{Au}(\text{CNMe}_3)_2]^+$ cations and $[\text{Au}(\text{GeCl}_3)_2]^-$ anions with short gold–gold distances.²²⁵⁵ Upper-rim functionalized calix[4]arenes with chloro(isonitrile)gold(I) groups have also been prepared.²²⁵⁶

The majority of gold(I) carbene complexes are pure organometallic compounds and are out of the scope of this work. Some halide or triphenylphosphine carbene complexes are known and they will be considered here. Nucleophilic addition of alcohols or amines to gold-coordinated isocyanides is one of the best-established methods to obtain gold carbene derivatives. The reaction of $\text{H}[\text{Au}(\text{CN})_2]$ with propene oxide and estirene oxide yields (cyano)carbene complexes (380) avoiding the intermediate step.²²⁵⁷ A cyclic carbene compound is obtained by reaction of a dinuclear isocyanide with amine (Scheme 32).²²⁵⁸

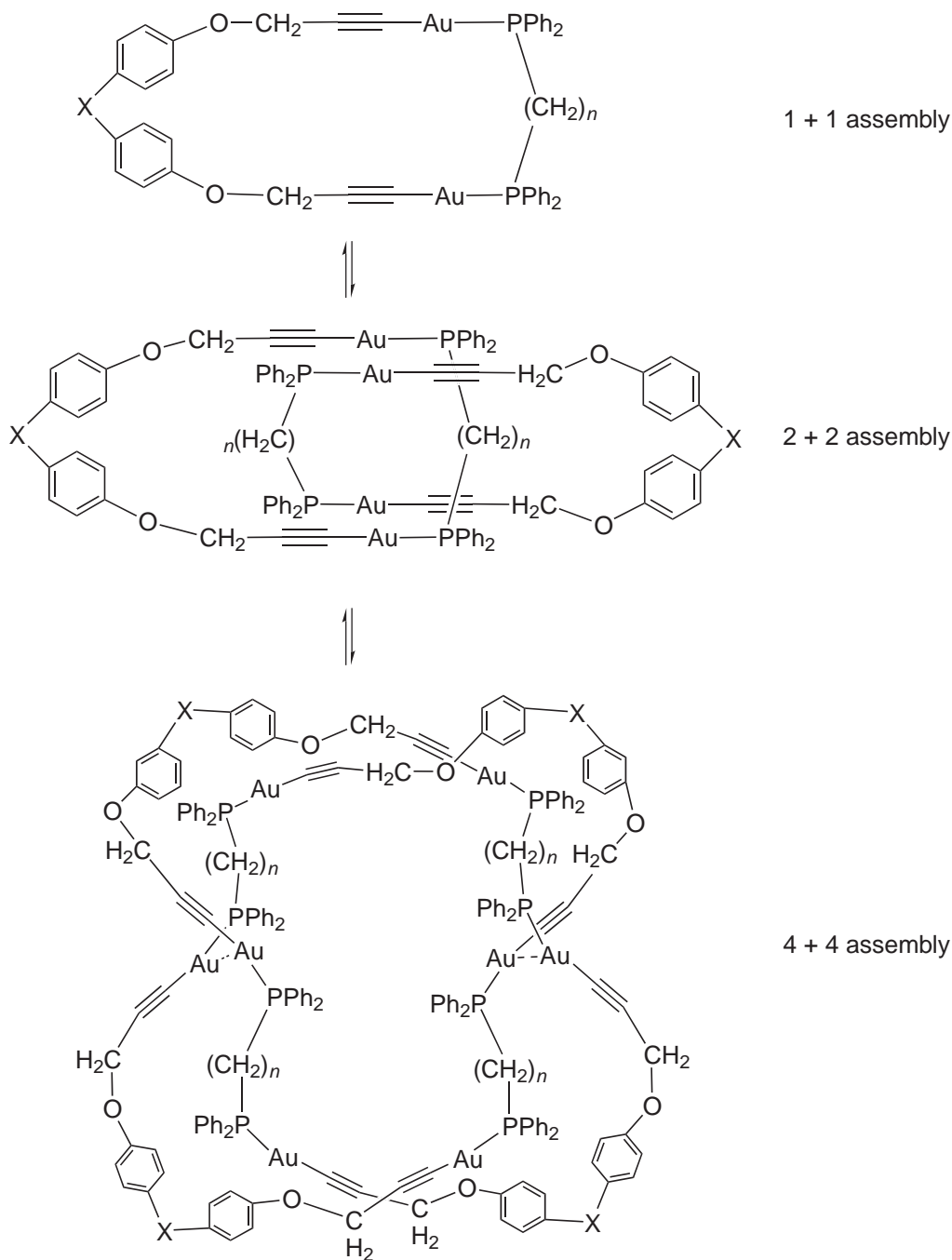

Scheme 31

Carbene complexes have also been prepared by transmetalation reactions. Lithiated azoles react with gold chloride compounds and after protonation or alkylation the corresponding dihydro-azol-ylidene compounds, e.g., (381) or (382), are obtained.^{2259–2264} Silver salts of benzimidazol have also been used to obtain carbene derivatives.²²⁶⁵ Mononuclear gold(I) carbene complexes also form when trimeric gold(I) imidazolyl reacts with ethyl chlorocarbonate or ethyl iodate.^{2266,2267} The treatment of gold halide complexes with 2-lithiated pyridine followed by protonation or alkylation also yields carbene complexes such as (383).²²⁶⁸ Some of these carbene complexes show luminescent properties.^{2269–2271}

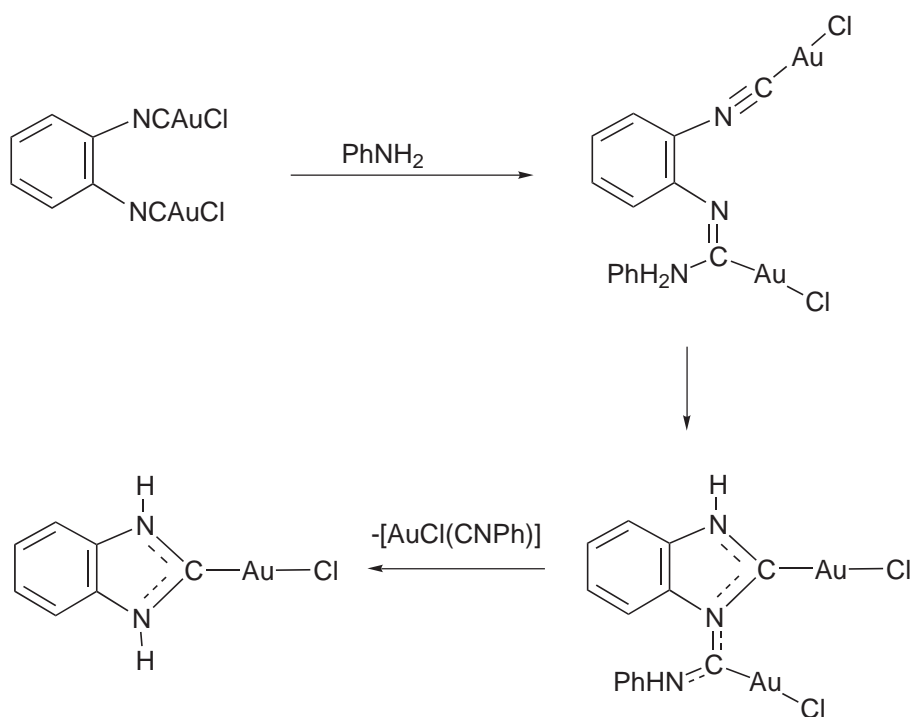

Scheme 32

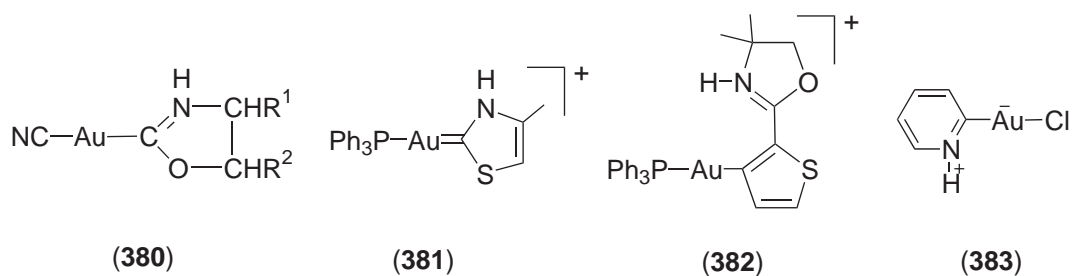

Alkylidene complexes of group 6 metals of mixed group 6 with platinum or cobalt derivatives react with $[\text{AuCl}(\text{PPh}_3)]$, $[\text{AuCl}(\text{THT})]$, or $[\text{Au}(\text{C}_2\text{B}_9\text{H}_9\text{Me}_2)(\text{THT})]^-$ to give di- or trimetallic species with bridging alkylidene ligands such as (384) or (385).^{2051,2272-2279}

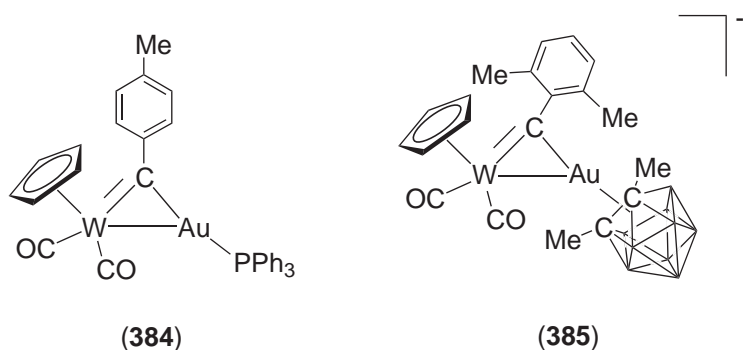

[AuCl(alkene)] (alkene = *cis*-cyclooctene, norbornene, *endo*-dicyclopentadiene) complexes have been obtained by reaction of [AuCl(CO)] with the alkene.^{2280,2281} The structure of [AuCl(C₁₀H₁₂)] shows the ligand η^2 -bonded to gold via the C=C bond in the norbornene ring and the molecules are associated into dimers through Au \cdots Au interactions.²²⁸¹

The dicyanoaurate anion [Au(CN)₂]⁻ is one of the most simple molecules that show aurophilic interactions,^{2282–2284} and thus has been used as building blocks to obtain supramolecular structures as in the complexes of Cu^{II} with [Au(CN)₂]⁻ and different amines.^{2285–2287} It has been found that solutions of K[Au(CN)₂] in water and methanol exhibit a strong photoluminescence.²²⁸⁸ Also the optical charge transfer in the ion paraquat²⁺[Au(CN)₂]⁻ (paraquat²⁺ = *N,N'*-dimethyl-4,4'-bipyridinium²⁺) has been reported and shows that Au^I is a very weak CT donor.²²⁸⁹ Gold(I) cyanide complexes with neutral [Au(CN)(PR₃)]^{2290–2293} or anionic ligands [Au(CN)SR]⁻,^{2290,2294} undergo homoleptic rearrangement to form two different complexes. The structure of [Au(CN)(PPh₃)] has been described.²²⁹⁵ The isocyanate [Au(CNO)(PPh₃)] and fulminate [Au(NCO)(PPh₃)] compounds have been prepared by reaction of [Au(NO₃)(PPh₃)] with CO.²²⁹⁶

6.7.3.4.3 Complexes with nitrogen donor ligands

Gold(I) complexes with amine ligands have not been extensively studied until recently, perhaps because of their limited stability. This can be rationalized in terms of incompatibility of the soft metal center with the hard nitrogen donor. Additional stabilization of these compounds may be provided by aurophilic interactions or by the formation of N—H \cdots X hydrogen bonds. The first complex reported with stoichiometry [AuCIL] was the unstable [AuCl(pip)] (pip = piperidine).²²⁹⁷ This is a tetramer with Au \cdots Au contacts of 3.301(5) Å, hydrogen bonding was not noticed but later was shown to be present. By reaction of [AuCl(THT)] with several aliphatic amine ligands molecular structures [AuCIL] have been found for dicyclohexylamine, 2,2,6,6-tetramethylpiperidine, methylpyridine, and ferrocenylpyridine. For the complexes with crystal structures available they are loose dimers with aurophilic interactions and hydrogen bonding (386).^{348,2298–2300} However, with pyridine or 3-bromopyridine as ligands the complexes [AuX(Py)] (X = Cl, Br, I) exist in the solid state as salts [Au(Py)₂]⁺[AuX₂]⁻; these form Au₄ linear or zig-zag chains (387).^{2301–2303}

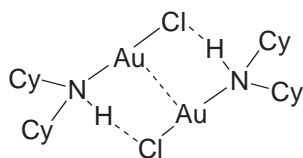

(386)

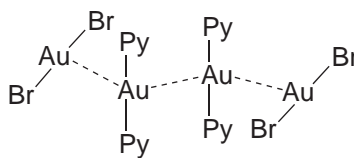

(387)

The complexes [AuCl₂L₂] are all ionic in nature, no structure is known with this empirical formula. Then complexes of the type [AuL₂]X have been described for L = 4-hydroxymethyl-1,5-dimethylimidazole,²³⁰⁴ NH₃,²³⁰⁵ pip,²³⁰⁰ pyrrolidine,²³⁰⁰ morpholine,²³⁰⁰ cyclohexylamine,²³⁰⁰ and benzylamine.²³⁰⁰ In these ionic complexes hydrogen bonding appears to be more important than in the neutral derivatives. The use of disulfonylamines, which are good hydrogen bond acceptors, as counterions increases the stability of gold(I)-amine complexes.²³⁰⁶ Some crystal structures have shown more than one structural type in the crystal. With L = pyrrolidine, a by-product of stoichiometry [Au₃Cl₃L₄] was obtained in which two molecules of [AuCIL] crystallized together with [AuL₂]Cl.²³⁰⁷ For L = 2-aminopyridine one molecule of [AuCIL] crystallized with one molecule of [AuL₂]Cl and in the crystal arrange in the form + neutral -.²³⁰⁸ The complexes [AuCl(NH₂R)] (where R = long chain alkyl group) self-organize in the solid state into a fibrous material; decomposition of the complexes inside the supramolecular framework yields a monolayer of ordered gold nanoparticles.²³⁰⁹

Amine complexes stabilized with phosphine ligands of the type [AuL(PR₃)]⁺ have been obtained for L = bipy,²³¹⁰ phen,^{2310,2311} quinoline,²³¹¹ acridine,²³¹¹ benzo[h]quinoline,²³¹¹ naphthyridine (388),²³¹¹ 2,2'-biquinoline,²³¹¹ di-2-pyridyl-ketone,²³¹¹ di-2-pyridylamine,²³¹¹ 2-(2-pyridyl)-benzimidazole,²³¹¹ ferrocenylpyridine,³⁴⁸ 2-nitroaniline,²³¹² 4-methoxyaniline,²³¹² NHPh₂,²³¹² NHEt₂,²³¹² NMe₃,²³¹² quinuclidine,²³¹³ NEt₃,²³¹⁴ 2-aminothiazoline,²³¹⁵ histidine,²³¹⁶

NH_2R ($\text{R} = \text{H}$, alkyl),²³¹⁷ and NH_2Bu^t .²³¹⁸ Dinuclear gold(I) complexes have been obtained by treatment of $[\text{Au}(\text{BF}_4)(\text{PPh}_3)]$ with diamines such as $\text{Pr}^i_2\text{NH}(\text{CH}_2)_2\text{NHPr}^i$ or 1,4-piperazine (**389**) or with 1,1'-bis(2-pyridylthio)ferrocene (**390**).¹¹⁸⁴ Weak hydrogen bonding with the BF_4^- anions is found.²³¹⁹

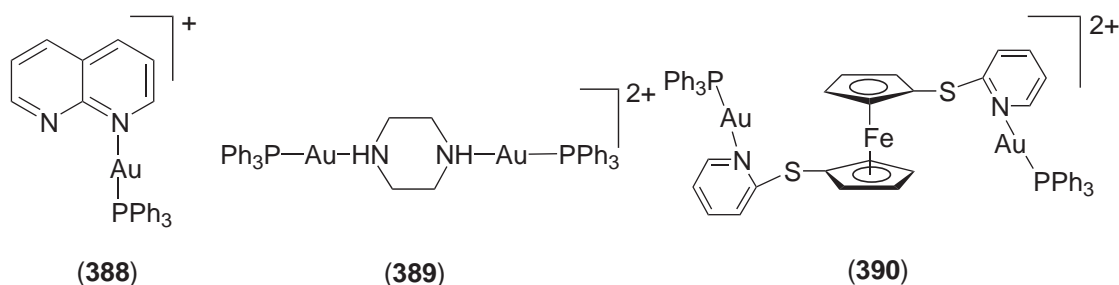

Organometallic derivatives with bidentate nitrogen ligands have also been described such as $[\text{Au}(\text{C}_6\text{F}_5)\text{L}]$ where $\text{L} = \text{NH}_2(\text{CH}_2)_n\text{NH}_2$,²³²⁰ $[\text{Au}_2(\text{C}_6\text{F}_5)\text{X}\{\mu\text{-NH}_2(\text{CH}_2)_n\text{NH}_2\}]$ ($\text{X} = \text{C}_6\text{F}_5$, Cl),²³²⁰ $[\text{Au}(\text{C}_6\text{F}_5)_2(\mu\text{-bipy})]$,²³²⁰ $[\text{Au}_2(\mu\text{-C}_6\text{F}_4\text{-C}_6\text{F}_4)(\text{phen})_2]$,²¹⁰⁹ $[\text{Au}(\text{C}_6\text{F}_4\text{-C}_6\text{F}_4\text{H})(\text{phen})]$,²¹⁰⁹ $[\text{Au}(\text{C}_6\text{Cl}_5)(\text{phen})]$,¹⁶⁴¹ or $[\text{Au}(2,4,6\text{-}(\text{NO}_2)_3\text{C}_6\text{H}_2)(\text{dmphen})]$ (**391**) ($\text{dmphen} = 2,9$ -dimethyl-phen) where a pseudotricoordination is observed.²¹¹⁴

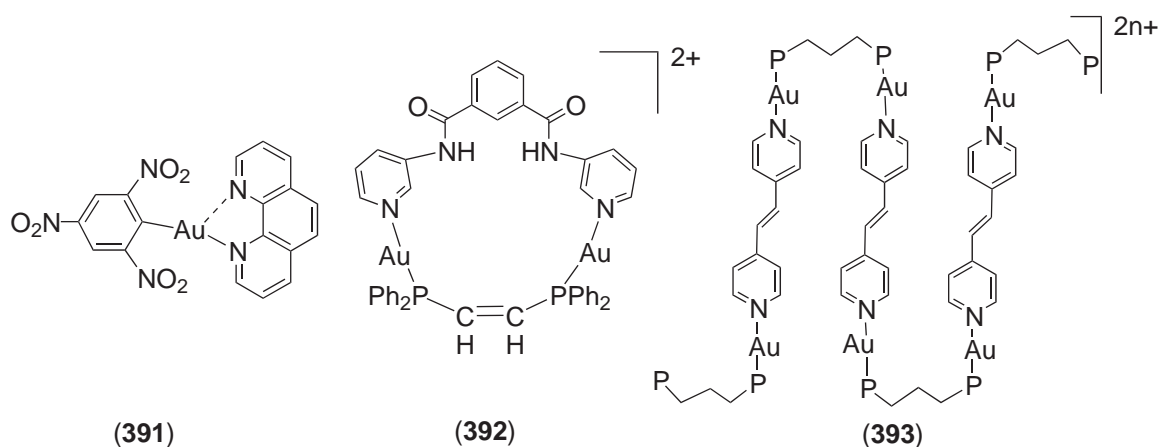

The reaction of the ligand *N,N'*-bis(pyridin-3-yl)-1,3-benzenedicarboxamide with $[\text{Au}_2(\text{O}_2\text{CCF}_3)(\mu\text{-PP})]$ yields the macrocyclic compound (**392**) when the diphosphine is *trans*- $\text{Ph}_2\text{PCH}=\text{CHPPh}_2$, but a helical polymer for $\text{PP} = \text{dppe}$.²³²¹ With the bidentate ligand *trans*-1,2-bis(4-pyridyl)ethylene the reaction with $[\text{Au}_2(\text{O}_2\text{CCF}_3)_2\{\mu\text{-}(\text{PPh}_2)_2(\text{CH}_2)_n\}]$ gives for $n = 2$ the cyclic compound and for $n = 3$ or 4 1D linear or U-shaped polymers (**393**).²³²² In the same reaction with 4,4'-bipyridine in solution the complexes exist as an equilibrium mixture of linear oligomers and cyclic compounds; when $n = 1, 3$, or 5 they exist as 26-, 30-, and 34-membered macrocyclic rings, respectively, and only when $n = 1$ there are significant intramolecular $\text{Au}\cdots\text{Au}$ contacts. Some of these compounds are strongly emissive at room temperature and in the solid state.²³²³

Imine gold(I) compounds have been synthesized and are of the type $[\text{AuCl}(\text{NH}=\text{CR}_2)]$ or $[\text{Au}(\text{NH}=\text{CR}_2)_2][\text{AuCl}_2]$ (obtained as mixtures solution), or $[\text{Au}(\text{NH}=\text{CR})(\text{PR}_3)]\text{BF}_4$ ($\text{R} = \text{Ph}$, NMe_2 ; $\text{PR}_3 = \text{PPh}_3$, Pr^i).^{2324,2325} The complex $[\text{Au}(\text{NH}=\text{CMe}_2)_2]\text{OTf}$ has been obtained by reaction of $[\text{Au}(\text{NH}_3)_2]\text{OTf}$ with acetone.²³²⁶ The reaction of $[\text{Au}(\text{ACAC})(\text{PR}_3)]$ with the ammonium salts $(\text{NH}_3\text{R})\text{Cl}$ dissolved in the appropriate ketone MeCOR^2 gives the neutral $[\text{Au}(\text{NR}=\text{CMeR})(\text{PR}_3)]$.¹⁶⁸⁶ The species $[\text{AuCl}(\text{NH}=\text{CPh}_2)]$ and $[\text{Au}(\text{NH}=\text{CMe}_2)_2]\text{OTf}$ crystallize as polymeric chains with aurophilic interactions and hydrogen bonding. Treatment of $[\text{AuCl}(\text{THT})]$ with NH_3 in acetone leads to the acetone complex (**394**), one of the ligands can be displaced for PPh_3 or Cl^- .^{1686,2327}

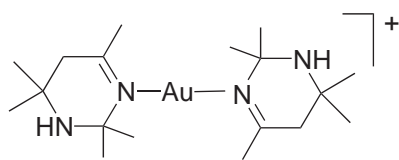

(394)

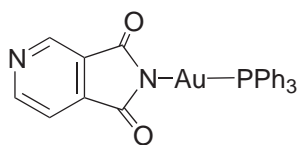

(395)

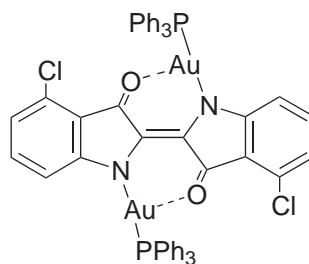

(396)

A great variety of gold(I) complexes with anionic *N*-donor ligands has been synthesized. Examples of the type $[\text{AuL}(\text{PPh}_3)]$ have been obtained for several nitrogen ligands such as the anions of ptm,^{1692,2328,2329} hydantoin,²³³⁰ the imide of 3,4-pyridine dicarboxylic acid (395),²³³⁰ 4,4'-dichloroindigo,²³³¹ isatin,²³³¹ 5-bromoisatin,²³³¹ 2-indolone,²³³¹ oxopurine,^{2332,2333} or 4-nitroaniline,²³³⁴ succinimide,²³³⁵ 2,3-dioxindolonyl,²³³⁶ 1-amino-anthracene-9,10-dione,²³³⁷ benzodiazepiones,²³³⁸ pyrimidinedionato,²³³⁹ adeninate,²³⁴⁰ or 7-aza-indolyl.²³⁴¹ Dinuclear complexes, $[\text{Au}_2(\mu\text{-L})(\text{PPh}_3)_2]$, have also been prepared for the dianions of 4,4'-dichloroindigo (396),²³³⁰ or oxopurine,²³³¹ 4-nitroaniline,²³³⁴ pyrrole derivative,²³⁴² or nucleobases or nucleosides.^{2343,2344}

Gold(I) derivatives with bis(trimethylsilyl)amides have been reported and are of the type $[\text{Au}\{\text{N}(\text{TMS})_2\}(\text{PPh}_3)]$ ²³⁴⁵ or the homoleptic $[\text{Au}_4\{\text{N}(\text{TMS})_2\}_4]$ (397),²³⁴⁶ which has been obtained from the reaction of AuCl with $\text{LiN}(\text{TMS})_3$. The related $[\text{Au}\{\text{N}(\text{CN})_2\}(\text{PPh}_3)]$ has also been reported.²³⁴⁷ Disulfonylamides give gold(I) complexes of the type $[\text{Au}\{\text{N}(\text{SO}_2\text{R})_2\}(\text{PPh}_3)]$ (R = Me, 4-ClC₆H₄, 4-NO₂C₆H₄, F) or $[\text{Au}\{\text{N}(\text{SO}_2\text{R})_2\}(\text{THT})]$ (R = Me, 4-ClC₆H₄, 4-IC₆H₄).^{2348,2349} Amidinato gold(I) complexes have been described and are dinuclear, as $[\text{Au}_2\{\text{C}(\text{Ph})(\text{NTMS})_2\}_2]$ ⁴⁷⁵ (398) or tetranuclear as $[\text{Au}_4\{\text{CH}(\text{NPh})_2\}_4]$.²³⁵⁰ The triazenido ions RN_3R^- react with AuI in liquid ammonia to form the tetranuclear complex (399), which has an analogous structure to that of the tetranuclear formamidinato compound.²³⁵¹ The structure of the azido complex $[\text{Au}(\text{N}_3)(\text{PPh}_3)]$ has been reported.¹⁷³⁶

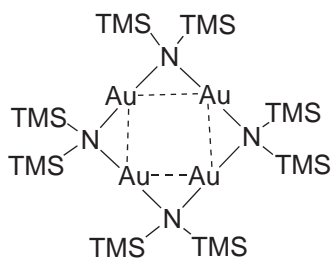

(397)

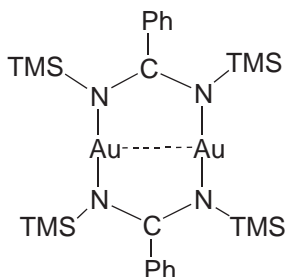

(398)

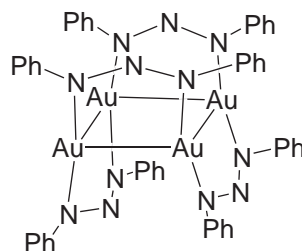

(399)

Gold(I) complexes with azole ligands although not as numerous as those of silver are well represented. The reaction of $[\text{AuCl}(\text{PPh}_3)]$ with $\text{Na}(3,5\text{-Ph}_2\text{pz})$ gives the trinuclear $[\text{Au}(3,5\text{-Ph}_2\text{pz})_3]$ (400),³⁷⁷ which is isostructural with the silver and copper analogues.²³⁵² If in the reaction AgOCOPh is added, the hexamer derivative $[\text{Au}(3,5\text{-Ph}_2\text{pz})_6]$ (401) is obtained.²³⁵³ The trinuclear complexes have been prepared with different substituents,²³⁵⁴⁻²³⁵⁷ or with phenyl groups substituted with two or three aliphatic (decyloxy) chains,^{2358,2359} or with octyl groups,²³⁶⁰ which gives mesogenic pyrazolato gold complexes. Oxidation of the trinuclear pyrazolates with Cl_2 or I_2 is possible and yields the mixed $\text{Au}^{\text{I}}\text{-Au}^{\text{III}}$ derivatives $[\text{Au}_3\text{X}_2(3,5\text{-R}_2\text{pz})_3]$ (R = Ph, Bz).^{1706,2361,2362}

Gold(I) complexes with neutral azoles have been prepared and are of the type $[\text{Au}(\text{PPh}_3)(3,5\text{-Me}_2\text{pzH})\text{BF}_4]$,²³⁶³ $[\text{AuXL}]_2$, (X = Cl, Br; L = *N*-methylimidazole, *N*-ethylimidazole, *N*-propylimidazole, 2-methylbenzoxazole, 2,5-dimethylbenzoxazole),²³⁶⁴ $[\text{Au}(\text{Him})(\text{PPh}_3)]\text{Z}$ (HZ = picrid acid),²³⁶⁵ $[\text{AuCl}(\text{pyrazole})]$,²³⁶⁶ or $[\text{Au}_2(\text{Hpz})(\mu\text{-PP})]^{2+}$ (PP = dppm, dppe, dppp).^{2367,2368}

Neutral complexes with azolate ligands of the type $[\text{AuL}(\text{PPh}_3)]$, with L representing differently substituted pyrazolates,^{2251,2366} imidazoles,^{365,2369,2370} benzimidazolates,^{2371,2372} triazolate,²³⁷³ tetraazolate (403),⁵³⁶ or 2,2'-bibenzimidazolates (404),^{2374,2375} have been prepared. The structure of the $[\text{Au}(1,2,4\text{-triaz})(\text{PPh}_3)]$ is a dimer with $\text{Au}\cdots\text{Au}$ interactions (405).²³⁷³ The antimicrobial

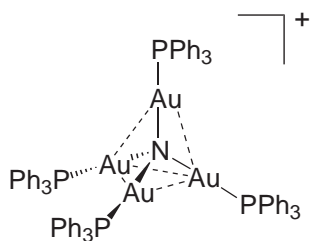

(406)

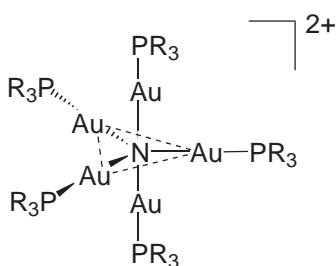

(407)

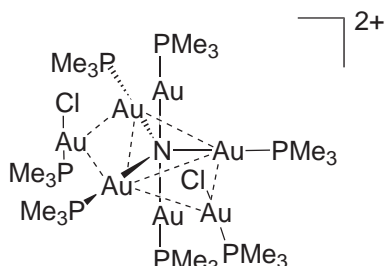

(408)

The first two members of the series of these ammonium-centered complexes, i.e., $[\text{Au}(\text{NH}_3)(\text{PPh}_3)]^+$ or $[\text{H}_2\text{N}(\text{AuPPh}_3)_2]^+$ have been obtained by reaction of $(\text{NH}_4)\text{ClO}_4$ with $[\text{Au}(\text{ACAC})(\text{PPh}_3)]$ but not the third one $[\text{HN}(\text{AuPPh}_3)_3]^+$.^{238f} However, a great number of complexes with monosubstituted amines $[\text{RN}(\text{AuPR}_3)_3]^+$ (409) are known. The reaction of the oxonium cation $[\text{O}(\text{AuPR}_3)_3]^+$ with RNH_2 or RCNO leads to the μ -imido clusters $[\text{RN}(\text{AuPR}_3)_3]^+$ where R can be an aryl, alkyl, or silyl group.^{1502,2313,2318,2382,2392-2396} The treatment of $[\text{AuCl}(\text{PPh}_3)]$ with Bu^tNHLi gives the complex $[\{\text{Bu}^t\text{N}(\text{AuPPh}_3)_2\}_2\text{Au}]\text{Cl}$ (410) which has a structure with two Au_3N pyramids sharing one gold.²³⁹⁷ Diamines such as $\text{NH}_2\text{CH}_2\text{CH}_2\text{NH}_2$, $\text{NH}_2\text{C}_6\text{H}_4\text{NH}_2$, $\text{RN}(\text{CH}_2\text{CH}_2\text{NH}_2)_2$, or $\text{N}(\text{CH}_2\text{CH}_2\text{NH}_2)_3$ can also be aurred with the oxonium salt as, for example, (411),^{2398,2399} as well as aminopyridines such as 8-aminoquinoline to give (412).²⁴⁰⁰ The same reactions have been carried out with phosphine imines,^{2401,2402} hydrazines (413),²⁴⁰³⁻²⁴⁰⁷ hydroxyamines,²⁴⁰⁸ carbodiimide,²⁴⁰⁹ sulfoximine,²⁴¹⁰ or azirine,²⁴¹¹ for which partially or fully aurred species have been isolated.

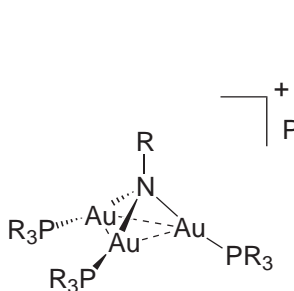

(409)

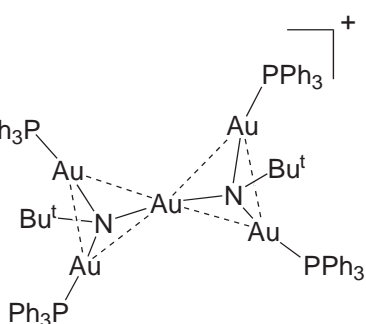

(410)

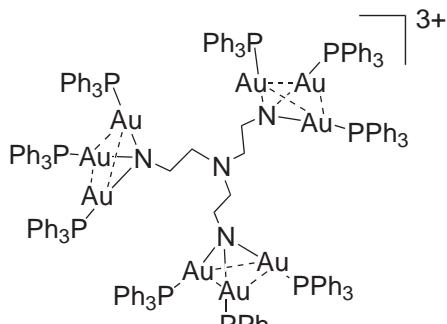

(411)

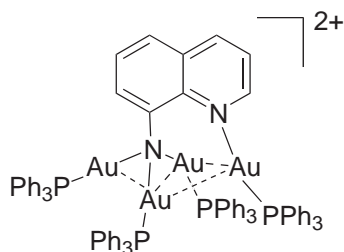

(412)

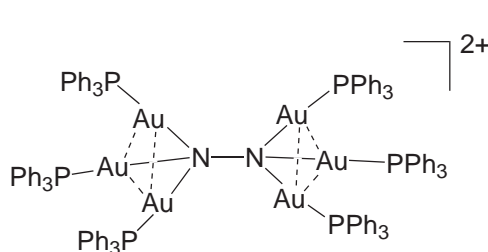

(413)

Some gold(I) derivatives have been obtained with other type of *N*-donor ligands as acetonitrile; the compound $[\text{Au}(\text{NCMe})_2]^+$ can be obtained by halide-catalyzed electrolysis of gold metal in MeCN .²⁴¹² This cation is very moisture sensitive and thermally labile, but the more stable cation $[\text{Au}(\text{NCPh})_2]^+$ has been obtained by oxidation of gold with the nitrosyl cation in benzonitrile.²⁴¹³ From EXAFS spectroscopic studies it has been suggested that the solvated gold(I) cations are tetra-coordinate in pyridine or acetonitrile solutions.²⁴¹⁴ Other gold(I) complexes have been

reported with the benzophenoneazine ligand, $[\text{Au}(\text{C}_6\text{F}_5)(\text{Ph}_2\text{C}=\text{N}-\text{N}=\text{CPh}_2)]$,²⁴¹⁵ the 1,5-di-*p*-tolylpenta-aza-1,4-dien-3-yl $[\text{Au}\{\text{N}(\text{N}=\text{N}-p\text{-Tol})_2\}(\text{PPh}_3)]$,²⁴¹⁶ the nitrido osmium complex $[\text{OsO}_3\text{N}(\text{AuPPh}_3)]$ (**414**),²⁴¹⁷ or with the macrocyclic ligand 1,4,8,11-tetra-azacyclotetradecane (**415**).²⁴¹⁸

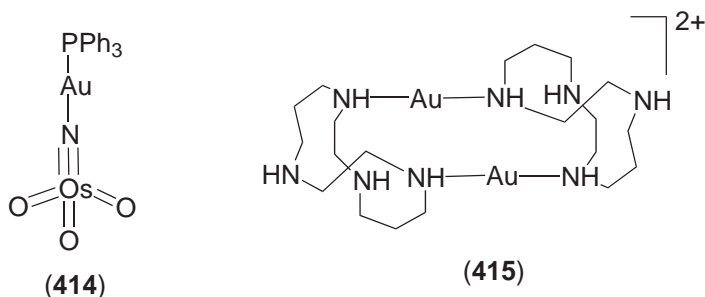

6.7.3.4.4 Complexes with phosphorus, arsenic, antimony, or bismuth donor ligands

(i) Phosphide- or arsenide-bridged polynuclear complexes

This section is dedicated to complexes which formally contain the units: (i) P_3^{3-} , (ii) E^{3-} , (iii) $(\text{RE})^{2-}$, or (iv) $(\text{R}_2\text{E})^-$ ($\text{E} = \text{P}$ or As) as ligands. These moieties commonly act as bridging ligands for equivalent or different gold centers. Important examples include standard homoleptic species such as $[\text{E}(\text{AuPPh}_3)_4]^+$ ($\text{E} = \text{P}$, As) or hypercoordinated cations $[\text{P}(\text{AuPPh}_3)_5]^{2+}$ and $[\text{P}(\text{AuPPh}_3)_6]^{3+}$. Other systems have the phosphide groups bridging gold and other transition metal atoms.

(a) P_3^{3-} . The trinuclear compounds $[\text{Au}\{\text{M}(\text{triphos})(\text{P}_3)\}_2]\text{PF}_6$ [$\text{M} = \text{Co}$, Rh , or Ir ; can be obtained by treatment of a dichloromethane solution of $[\text{M}(\text{triphos})(\text{P}_3)]$ with $[\text{AuCl}(\text{PR}_3)]$ ($\text{R} = \text{Me}$ or Ph) or $[\text{Au}_2\text{Cl}_2\{\text{PPh}_2(\text{CH}_2)_n\text{PPh}_2\}]$ ($n = 1$ or 2) in the presence of TlPF_6 .²⁴¹⁹ The structure shows that the gold atom is bound to two pairs of phosphorus atoms of the P_3 units with a coordination geometry intermediate between tetrahedral and square planar (Equation (33)):

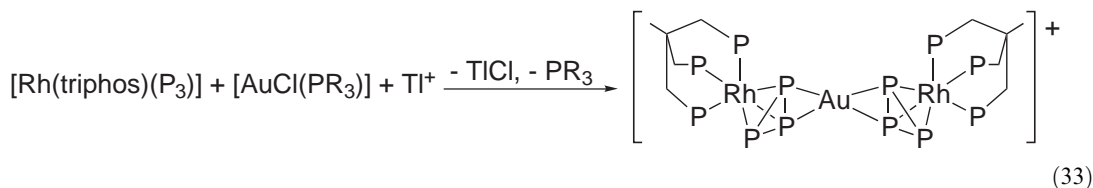

(b) E^{3-} . A series of unusual gold(I) complexes in which a central atom of phosphorus or arsenic (formally P^{3-} or As^{3-} ions) acts as a bridging ligand for several $[\text{AuPR}_3]^+$ units has emerged from recent systematic studies with silylpricogenides as the starting materials. These include the cationic derivatives: $[\text{As}(\text{AuPPh}_3)_4]^+$,²³⁸⁰ $[\text{P}(\text{AuP}^t\text{Bu}_3)_4]^+$,²⁴²⁰ $[\text{P}(\text{AuPPh}_3)_4\{\text{Au}(\text{PPh}_3)_2\}]^{2+}$,²⁴²¹ $[\text{P}(\text{AuPPh}_3)_5]^{2+}$,^{2422,2423} and $[\text{P}(\text{AuPPh}_3)_6]^{3+}$.²⁴²⁴ The preparation of these complexes is summarized in Scheme 33.

The tetra(auro)arsonium cation $[\text{As}(\text{AuPPh}_3)_4]^+$ has a square-pyramidal structure, instead of the classical tetrahedral geometry found in $[\text{N}(\text{AuPPh}_3)_4]^+$,² probably because the radius of the arsenic is too large to allow for metal-metal bonding in a tetrahedral structure. If a lone pair of electrons is allocated to the As apex, then the AsAu_4 core has to be described as electron deficient.^{8,9} It is very likely, however, that the $\text{Au}\cdots\text{Au}$ contacts at the base of the As-capped pyramid (less than 3 \AA) strongly contribute to the stability of the compound. Likely enough the structure of the cation $[\text{P}(\text{AuP}^t\text{Bu}_3)_4]^+$ shows a distorted tetrahedral of PAu_4 skeleton, because closer contacts than those found in the structure (3.40 \AA) are clearly ruled out by the bulkiness of the P^tBu_3 ligands.²⁴²⁰ The severe distortion of the skeleton provides evidence that the system is still gaining in stabilization from the formation of the $\text{Au}\cdots\text{Au}$ contacts. The reaction of $[\text{O}(\text{AuPPh}_3)_3]\text{BF}_4$ with PH_3 leads to a mixture of products such as $[\text{P}(\text{AuPPh}_3)_4\{\text{Au}(\text{PPh}_3)_2\}](\text{BF}_4)_2$, $[\text{P}(\text{AuPPh}_3)_5](\text{BF}_4)_2$, and $[\text{Au}\{\text{P}(\text{AuPPh}_3)_4\}_2](\text{BF}_4)_3$.²⁴²¹ The structure of the first dication contains pentacoordinate phosphorus atoms in an irregular coordination geometry

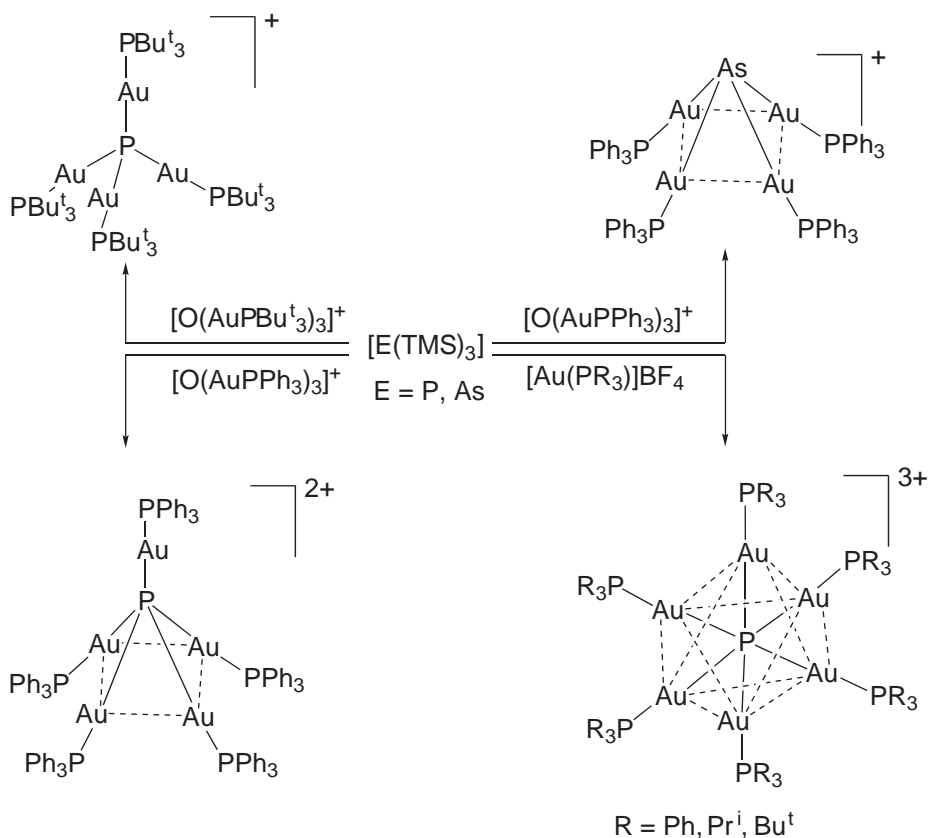

Scheme 33

with one of the five gold atoms attached to two PPh₃ ligands. The cation [Au{P(AuPPh₃)₄}₂]³⁺ can be considered as the result of the interaction of two [P(AuPPh₃)₄]⁺ units, which must be strong nucleophiles, with a further gold(I) center. The structure of the dication [P(AuPPh₃)₅]²⁺ reveals a square-pyramidal arrangement of the gold atoms in contrast to the trigonal-bipyramidal structure expected by classical bonding arguments.²⁴²³ For the trication species [P(AuPPh₃)₆]³⁺ an octahedral structure has been proposed.²⁴²⁴ Distortions of the regular geometry again arise owing to the influence of the gold–gold interactions, which govern the geometry and are responsible for the stability of this type of compound.^{8,9} The hapticity of the central P-atom is easily monitored by ³¹P NMR spectroscopy in these cases.²⁴²¹

(c) (RE)²⁻. The (RE)²⁻ (E = P or As) units can act as bridging ligand for two, three, or even four gold atoms. Thus, primary phosphines^{2425–2427} or arsines,²⁴²⁵ REH₂ [E = P, As; R = Ph, 2-MeC₆H₄, 2,4,6-(Bu^t)₃C₆H₂] can be triply aurated on treatment with a stoichiometric amount of the oxonium reagent [O(AuPPh₃)₃]BF₄ to give species of the type [RE(AuPPh₃)₃]⁺ (Scheme 34) which have a tetrahedral coordination at the P or As atom with long intermetallic distances. In

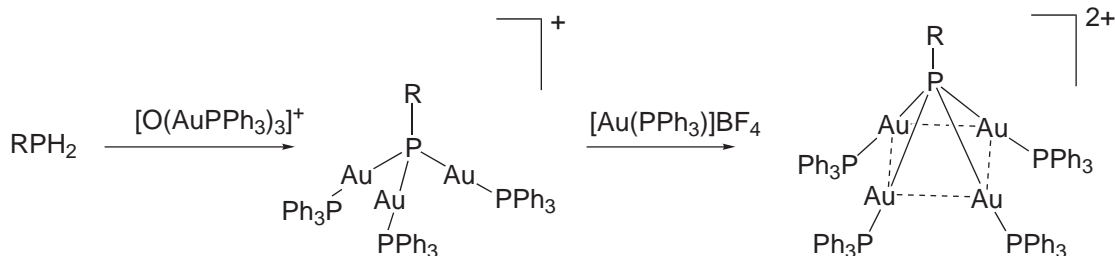

Scheme 34

$[\text{RP}(\text{AuPPh}_3)_3]^+$ [$\text{R} = 2,4,6\text{-}(\text{Bu}^t)_3\text{C}_6\text{H}_2$],²⁴²⁷ with its extremely bulky group R, the phosphorus atom is attached to a single gold atom on one side of the RP plane and to a pair of gold atoms on the other ($\text{Au}\cdots\text{Au}$ 3.15 Å). In solution rapid site exchange renders the AuPPh₃ units NMR equivalent. In the case of the phosphorus compounds, the electrophilic addition of a further $[(\text{AuPPh}_3)_3]^+$ unit produces novel hypercoordinate dications $[\text{RP}(\text{AuPPh}_3)_4]^{2+}$ with a square-pyramidal PAu_4 core and short $\text{Au}\cdots\text{Au}$ distances.

When a bulky phosphine is used ($\text{L} = \text{PBU}^t_3$), the addition of $[\text{AuL}]^+$ does not lead to a trinuclear cation $[\{2,4,6\text{-}(\text{Bu}^t)_3\text{C}_6\text{H}_2\}\text{P}(\text{AuL})_3]^+$, but the neutral dinuclear derivative $[\{2,4,6\text{-}(\text{Bu}^t)_3\text{C}_6\text{H}_2\}\text{P}(\text{AuL})_2]$ can be obtained from the reaction of $[2,4,6\text{-}(\text{Bu}^t)_3\text{C}_6\text{H}_2]\text{PH}_2$ upon treatment with the oxonium reagent.²⁴²⁷ Analogous reactions to those shown in Scheme 32, but starting from the diprimary aromatic phosphine $1,4\text{-C}_6\text{H}_4(\text{PH}_2)_2$, lead to the hexanuclear $[1,4\text{-}(\text{LAu})_3\text{PC}_6\text{H}_4\text{P}(\text{AuL})_3]^{2+}$ ($\text{L} = \text{PPh}_3$ or PBU^t_3) or octanuclear complexes $[1,4\text{-}(\text{Ph}_3\text{PAu})_4\text{PC}_6\text{H}_4\text{P}(\text{AuPPh}_3)_4]^{4+}$, with two polynuclear units in the *trans* position.²⁴²⁶ With the diphosphines $1,2\text{-C}_6\text{H}_4(\text{PH}_2)_2$ the triaurated species, $[1,2\text{-}(\text{LAu})_3\text{PC}_6\text{H}_4\text{P}(\text{AuL})_3]^{2+}$, can be obtained but in the NMR spectra rapid intramolecular scrambling of the AuPR_3^+ units to give probably species of the type $[1,2\text{-}(\text{LAu})_4\text{PC}_6\text{H}_4\text{P}(\text{AuL})_2]^{2+}$ have been observed.²⁴²⁸

There are some examples with a $(\text{CyP})^{2-}$ group bridging three or even four heterometallic centers. The dimanganese complex $[\text{Mn}_2(\mu\text{-H})(\mu\text{-PCyH})(\text{CO})_8]$ reacts with equimolar amounts of $[\text{AuCl}(\text{PR}_3)]$ ($\text{R} = \text{Cy}, \text{Ph}, p\text{-C}_6\text{H}_4\text{OMe}, p\text{-C}_6\text{H}_4\text{F}$) in the presence of a nonnucleophilic base (DBU) to afford mono- or diaurated pairs of isomers: $[\text{Mn}_2(\mu\text{-AuPR}_3)(\mu\text{-PCyH})(\text{CO})_8]$ and $[\text{Mn}_2(\mu\text{-H})\{\mu\text{-PCy}(\text{AuPR}_3)\}(\text{CO})_8]$, $[\text{Mn}_2(\mu\text{-AuPR}_3)\{\mu\text{-PCy}(\text{AuPR}_3)\}(\text{CO})_8]$ and $[\text{Mn}_2(\text{AuPR}_3)_2(\mu_4\text{-PCy})(\text{CO})_8]$ (Scheme 35), by replacement of the H-atoms by the isolobal $[\text{AuPR}_3]^+$ units.²⁴²⁹ In solution, there are dynamic equilibria whose displacement depends on the nature of the R groups and on the solvent used.

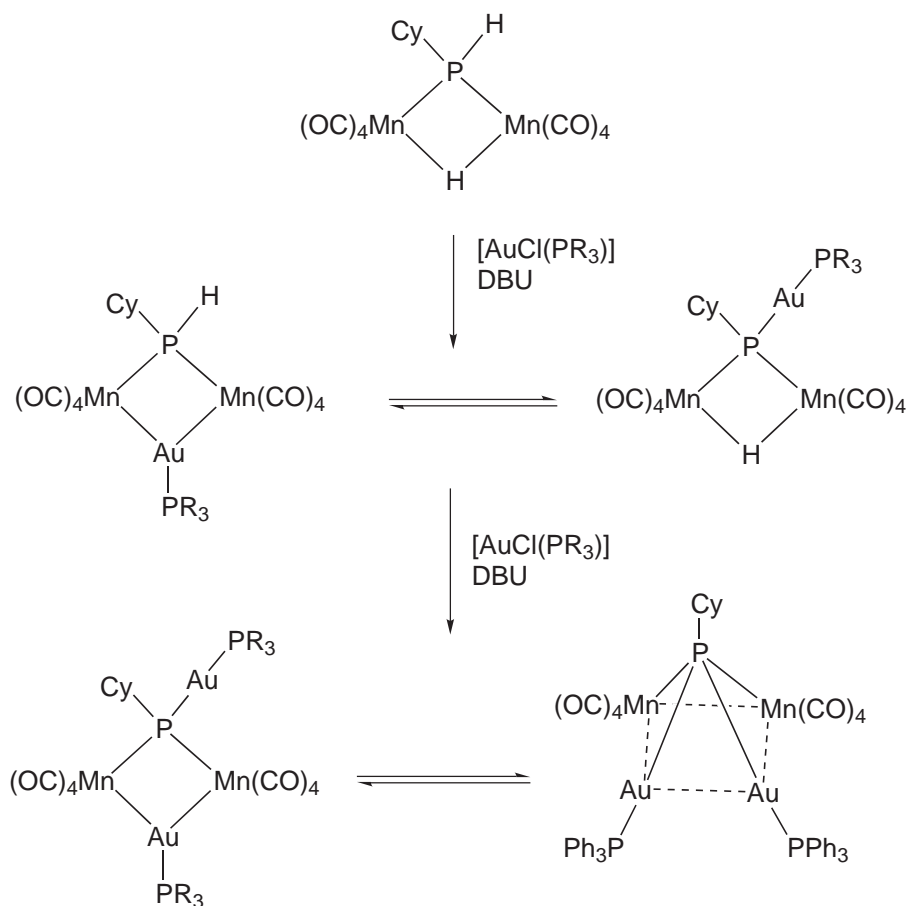

Scheme 35

gold(I) complexes. However, in many cases the reactivity is focused on the other ligands and the AuPPh_3^+ unit is just a suitable precursor. These complexes will be treated in the corresponding section.

These complexes are generally of the formula $[\text{AuX}(\text{ER}_3)]$ ($\text{E} = \text{P}, \text{As}, \text{Sb}$; $\text{R} = \text{alkyl or aryl}$). The most usual methods of synthesis are as follows:

- Reduction of tetrachloroauric acid with the tertiary phosphine, arsine, or stibine, which can act both as the reducing agent and as the ligand, is a straightforward high-yield reaction (Equation (35)), which can be carried out with cheap reagents and with a great variety of solvents, without any special preconditions. One equivalent of the ligand is lost in the process, however, and this aspect needs to be considered whenever more costly components are necessary.
- Displacement of a weakly coordinating ligand from $[\text{AuClL}]$ by a phosphine, arsine, or stibine ligand. Complexes with $\text{L} = \text{alkyl sulfide}$ (obtained by reduction of $[\text{AuCl}_4]^-$ with SR_2 ²⁴⁴³ or CO (obtained by the reaction of anhydrous Au_2Cl_6 with CO at atmospheric pressure)²⁴⁴⁴ are used commonly as starting materials. The chlorine atom can be substituted by other anionic or neutral ligands to form derivatives of the type $[\text{AuX}(\text{ER}_3)]$ or cationic $[\text{Au}(\text{ER}_3)_2]\text{Cl}$, respectively.
- Introduction of $[\text{AuPR}_3]^+$ groups at a reaction site by the use of derivatives $[\text{AuX}(\text{PR}_3)]$ where $\text{X} = \text{ClO}_4, \text{BF}_4, \text{CF}_3\text{SO}_3$, or any other anionic weakly coordinating ligand, or reagents able to remove protons and coordinate one or more $[\text{AuPR}_3]^+$ groups as $[\text{Au}(\text{A-CAC}) (\text{PPh}_3)]$ or $[\text{O}(\text{AuPR}_3)_3]^+$, respectively.



Numerous complexes of the type $[\text{AuX}(\text{PR}_3)]$ have been prepared with a great variety of phosphine ligands. Although this type of complexes has been known for many years there has been a resurgence of interest because recent studies have shown that short intermolecular gold–gold contacts can group the monomeric units into pairs, rings, or chains. The important prerequisite for this type of aggregation is the presence of structurally nondemanding ligands PR_3 or X . These interactions are associated with rather small bond energies estimated to be in the order of 25–37 kJ mol^{-1} for each $\text{Au}\cdots\text{Au}$ bond, and any overcrowding of the substituents can prevent aggregation.^{92,93} Dimers are observed, for example, with primary phosphines, as in $[\text{AuCl}\{\text{PH}_2(2,4,6\text{-Bu}^t_3\text{C}_6\text{H}_2)\}]$,²⁴⁴⁵ or with secondary phosphines, as in $[\text{AuCl}\{\text{PH}(o\text{-Tol})_2\}]$,²⁴⁴⁶ but not with the bulky PHBu^t_2 or $\text{PPh}(2,4,6\text{-Bu}^t_3\text{C}_6\text{H}_2)$ which form independent monomers.^{2446,2447} In $[\text{AuBr}(\text{PPh}_2)]$ there are two independent molecules with an $\text{Au}\text{—}\text{Au}$ distance of 3.256(1) Å.²⁴³¹ The monomers with small phosphines $[\text{AuCl}(\text{PMe}_3)]$,²⁴⁴⁸ $[\text{AuCl}(\text{PCl}_3)]$,²⁴⁴⁹ or $[\text{AuBr}\{\text{PH}_2(o\text{-Tol})\}]$ ²⁴⁵⁰ are aggregated in the solid state through $\text{Au}\cdots\text{Au}$ contacts of 3.081–3.386 Å to give chains of gold atoms. A theoretical study by Pyykkö *et al.* suggests that the $\text{Au}\cdots\text{Au}$ interaction in $[\text{AuX}(\text{PH}_3)]_2$ -type complexes increases as the softness of the ligand X increases.²⁴⁵¹ If medium or large phosphine or arsine ligands are present there are generally no intermolecular $\text{Au}\cdots\text{Au}$ interactions in the lattice.

Many complexes of stoichiometry $[\text{AuCl}(\text{PR}_3)]$ have been reported with $\text{PR}_3 = \text{P}(\text{NMe}_2)_3$,²⁴⁰² $\text{PF}_2(\text{NMe}_2)$,²⁴⁵² $\text{PF}_2(2,5\text{-Me}_2\text{C}_6\text{H}_3)$,²⁴⁵² PPh_3 ,²⁴⁵³ PPr^i_3 ,²⁴⁴⁸ PBu^t_3 ,²¹⁷⁷ PET_3 ,²⁴⁵⁴ PCy_3 ,^{2455,2456} $\text{P}(\text{CH}_2)_2\text{CN}$,^{2457,2458} PCy_2Ph ,²⁴⁵⁹ PMe_2Ph ,²⁴⁶⁰ $\text{PPh}_2(\text{CH}_2\text{CONHMe})$,²⁴⁶¹ PTol_3 ,^{2462–2464} PMe_3 ,²⁴⁶⁵ $\text{P}\{2,4,6\text{-(MeO)}_3\text{C}_6\text{H}_2\}$,^{2466,2467} $\text{PPh}_2(2\text{-Py})$,²⁴⁶⁸ $\text{P}(2\text{-Py})_3$,²⁴⁶⁹ PPhFc_2 ,²⁴⁷⁰ $\text{PPh}_2\text{CH}_2\text{Fc}$,⁷⁰⁹ $\text{PPh}_2\text{C}\equiv\text{CH}$,²⁴⁷¹ $\text{PPr}^i_2\text{C}\equiv\text{CH}$,²²³² $\text{PPh}_2\text{CH}_2\text{TMS}$,²⁰³² $\text{PPh}_2\text{CH}_2\text{CO}_2\text{H}$,²⁴⁷² $\text{PPh}_2(\text{OH})$,²⁴⁷³ $\text{P}(4\text{-MeOC}_6\text{H}_4)_3$,²⁴⁷⁴ $\text{PPh}_2\text{NHCH}(\text{Me})\text{CO}_2$,²⁴⁷⁵ PCl_2Ph ,²⁴⁷⁶ $\text{PPh}(2,4,6\text{-Bu}^t_3\text{C}_6\text{H}_2)$,²⁴⁷⁷ $\text{PPh}_2(\text{C}_6\text{H}_4\text{NMe}_2)$,²¹⁷⁸ $\text{PPh}(\text{C}_6\text{H}_4\text{NMe}_2)_2$,²¹⁷⁸ $\text{P}(\text{C}_6\text{H}_4\text{NMe}_2)_3$,²¹⁷⁸ $[\text{AuX}(\text{ER}_3)]$ ($\text{X} = \text{Br}, \text{I}$; $\text{ER}_3 = \text{PCy}_3, \text{PMe}_3$),^{2478,2479} or $[\text{AuX}(\text{PMe}_3)]$ ($\text{X} = \text{Cl}, \text{Br}, \text{I}$),²⁴⁸⁰ and have been characterized by XRD, showing the expected linear coordination for gold(I). A structural study has been carried out on complexes $[\text{AuX}(\text{PMe}_2\text{Ph})]$ ($\text{X} = \text{Cl}, \text{Br}, \text{I}$) and shows association into trimers or dimers in the solid state through aurophilic interactions.²⁴⁸¹ These complexes show emission from two excited states,²⁴⁸² as has been observed also for compounds $[\text{AuX}(\text{EPh}_3)]$ ($\text{X} = \text{Cl}, \text{Br}$; $\text{E} = \text{P}, \text{As}$).²⁴⁸³ The effects of substituents on aurophilic and $\pi\text{—}\pi$ interactions in complexes $[\text{AuX}\{\text{P}(\text{C}_6\text{H}_4\text{R})_3\}]$ and $[\text{AuX}\{\text{P}[\text{C}_6\text{H}_3(\text{CF}_3)_2]_3\}]$ ($\text{X} = \text{Cl}, \text{SPh}, \text{SPy}$; $\text{R} = \text{Me}, \text{CF}_3$) has been studied.²⁴⁸⁴

Other P -donor ligands have also been used in the synthesis of linear mononuclear gold derivatives. Potentially bidentate ligands, as $\text{L} = \text{PPh}_2(\text{CH}_2)_2\text{SMe}$,²⁴⁸⁵ $\text{PPh}_2\text{CH}_2\text{PPh}_2\text{Se}$,²⁴⁸⁶ $\text{PPh}_2(2\text{-OHC}_6\text{H}_4)$,²⁴⁸⁷ $\text{PPh}_2(2\text{-OTMSC}_6\text{H}_4)$,²⁴⁷³ $\text{PPh}_2(2\text{-NH}_2\text{C}_6\text{H}_4)$,²⁴⁸⁷ $\text{Ph}_2\text{PNHP}(\text{O})\text{Ph}_2$,²⁴⁸⁸ $\text{Bu}^t_2\text{PSePy}$ (419),²⁴⁸⁹ $\text{PPh}_2\text{NH}(2\text{-Py})$ (420),²⁴⁹⁰ $\text{PPh}_2\text{Bzim}(\text{CH}_2\text{Ph})$ (421),¹³⁷⁸ and $\text{PPh}_2(\text{CH}_2)_2\text{CONHMe}$ ²⁴⁹¹ lead to mononuclear complexes $[\text{AuClL}]$ with the gold bound to the chlorine and the phosphorus atoms.

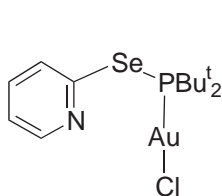

(419)

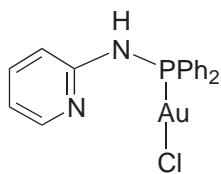

(420)

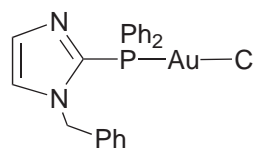

(421)

Phosphole ligands such as 1-phenyldibenzophosphole or 1-phenyl-3,4-dimethylphosphole or $\text{PC}_5\text{H}_3(\text{TMS})_2$,^{2492,2493} form complexes of the type $[\text{AuClL}]$; the structure of (422) shows gold–gold interactions between two independent molecules. P-mono- and bis-(2-chloroethyl)-amino-substituted heterocyclic compounds react with $[\text{AuCl}(\text{THT})]$ with displacement of tetrahydrothiophene to give the corresponding chloro complexes, as for instance complex (423). These derivatives have potential antitumor activity.²⁴⁹⁴ Another chloro(phosphine) gold(I) complex with highly potent activity against human cancer cell is (424).²⁴⁹⁵

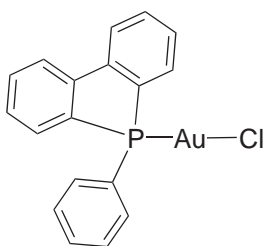

(422)

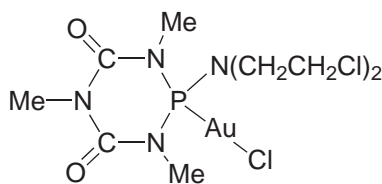

(423)

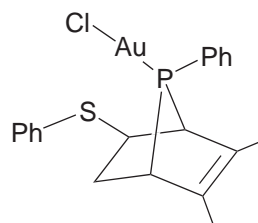

(424)

The reaction of the cage-type ligand TPA with $[\text{AuCl}(\text{THT})]$ gives $[\text{AuCl}(\text{TPA})]$ (425), and a similar reaction was observed with the protonated TPA ligand to give $[\text{AuCl}(\text{TPA}\cdot\text{HCl})]$.²⁴⁹⁶ The small cone angle of the phosphine ligand allows a short intermolecular aurophilic interaction. Reductive cleavage of the methyl phosphonium salt $(\text{TPA}\text{Me}^+\text{I}^-)$ by sodium in liquid ammonia affords the new bicyclic ligand $(\text{PMe})(\text{CH}_2)_5\text{N}_2(\text{NMe})$, which reacts with $[\text{AuCl}(\text{SMe}_2)]$ to give complex (426), which is a monomer.²⁴⁹⁷

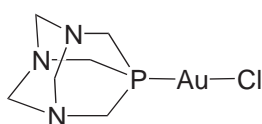

(425)

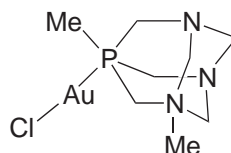

(426)

An interesting physical property exhibited by gold(I) compounds with short $\text{Au}\cdots\text{Au}$ contacts is the visible luminescence observed under UV excitation in the solid state, especially at liquid nitrogen temperature. In mononuclear gold(I) complexes the luminescence has been associated with a trigonal, noncentrosymmetric structure obtained either through intermetallic interactions, or three-coordination associated with a metal centered (MC) $p_z \rightarrow d_s$ phosphorescence.^{2496,2498} Other possible absorption modes, such as ligand centered (LC) or ligand-to-metal charge transfer (LMCT) are also observed depending upon the types of ligands present. The luminescence spectra of $[\text{AuCl}(\text{TPA})]$ and $[\text{AuCl}(\text{TPA}\cdot\text{HCl})]$ are substantially different and are correlated with the change in the $\text{Au}\cdots\text{Au}$ interaction. At 78 K $[\text{AuCl}(\text{TPA})]$ luminesces intensely red (674 nm), while the protonated $[\text{AuCl}(\text{TPA}\cdot\text{HCl})]$ luminesces yellow (596 nm). The emission bands in both complexes blue-shift as the temperature is increased. The interpretation of the phenomena is supported by extended Hückel MO calculations.²⁴⁹⁶ $[\text{AuCl}(\text{TPA})]$ is readily converted into the corresponding bromide or iodide, by reacting with HBr (aqueous) or KI in acetone, respectively.²⁴⁹⁸ They have two emission bands with relative intensities which depend upon the excitation wavelength used.

The chiral phosphine ligand (2-hydroxybutyl)diphenylphosphine (racemic mixture) forms the racemic chiral complex [AuCIL]. Metathesis reactions with KBr or KI lead to the corresponding bromide or iodide complexes, respectively. In the crystal, pairs of enantiomers are aggregated by two long hydrogen bonds between the hydroxy group and the halogen substituent.²⁴⁹⁹ With chiral secondary phosphines the complexes [AuX(PHMePh)] (X = Cl, Br, I) have been obtained, the structures for Cl and Br show chain-like supramolecular aggregates through aurophilic Au—Au contacts. The chain contains both enantiomers following the sequence ...RSRSRS...²⁵⁰⁰ Gold(I) complexes with polyaromatic phosphines PAr_nPh_{3-n} (Ar = naphthyl, naphthyl, anthracenyl, Fc, biphenyl, or phenanthrenyl) of the type [AuX(PR₃)] (X = Cl, NO₃) have been synthesized. The relative complexing abilities of the phosphines follows quite closely the order of the calculated cone angles, indicating that steric factors are the dominant influence in determining the reactivities of these polyaromatic phosphines.²⁵⁰¹ Gold(I) complexes with phosphinoketimines P(N=CPh₂)_nPh_{3-n} (n = 1–3) of the type [AuCIL] have been reported showing that the gold(I) center always prefers coordination to the phosphorus atom than to the nitrogen one.²⁵⁰²

A new example with an intermolecular Au...Au interaction (2.9807(4) Å) is obtained in the reaction of [AuCl(PMePh₂)] with [Au(SiPh₃)(PMePh₂)] (Equation (36)). In solution, the compound is in equilibrium with the mixture of the monomers.²⁵⁰³ Similarly, the complex [Au(SiR¹₃)(PR²₃)] undergoes ligand redistribution in solution to give the homoleptic species; [Au(SiPh₃)(PMe₃)] crystallizes as the heteroleptic complex.²⁵⁰⁴ The reaction of [AuCIL] with [GeCl₂(dioxane)] affords [Au(GeCl₃)L] (L = AsPh₃, PPhMe₂), the complexes are dimers in the crystal with short Au—Au or Au—Cl contacts.^{2313,2505}

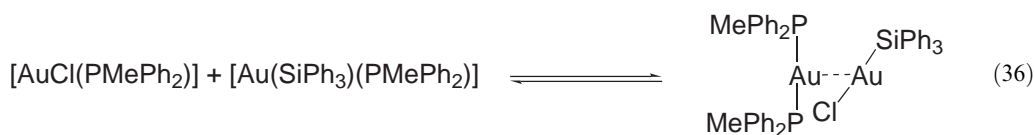

Other [AuCIL] complexes with monophosphines are those derived of *o*-carborane (427),²⁵⁰⁶ pyranoside group (428),²⁵⁰⁷ α -dimethylamino(3)ferrocenophan-2-yl,²⁵⁰⁸ calix[4]arene derived phosphites,²⁵⁰⁹ or aminoxyl radical-substituted phosphines (429),²⁵¹⁰ for which ferromagnetic interactions have been observed.

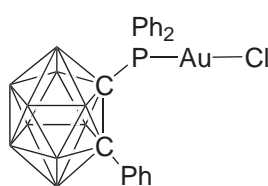

(427)

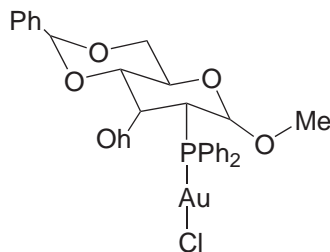

(428)

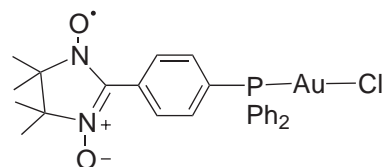

(429)

Homoleptic complexes of the type [AuL₂]⁺ with L = PPh₂CH₂TMS,²⁰³² PCy₃,^{2455,2456} P(CH₂CH₂CN)₃,²⁴⁵⁷ PPh₃,²⁵¹¹ PBuⁿ₃,²⁵¹² P(2,4,6-Me₃C₆H₂),^{1,2513} PPhFc₂,^{1745,2501} PPhMe₂,²⁵⁰⁵ PPh₂CH₂Fc,⁷⁰⁹ PPh₂CH₂SPh,²⁵¹⁴ Ph₂PNHP(O)Ph₂,²⁴⁸⁸ P(CH₂OH)₂CH₂Fc,²⁵¹⁵ or with mixed ligands [AuL¹L²]⁺ (L¹ = PPh₂CH₂TMS,²⁰³² PPhFc₂,¹⁷⁴⁵ P(CH₂SPh)₃,²⁵¹⁶ L² = PPh₃) have also been synthesized with several phosphine or arsine as ligands. In some cases the mixed phosphine derivatives are in equilibria with the homoleptic species.²⁰³² The crystal structures of isostructural silver and gold complexes with the trimesitylphosphine ligand¹ lead to the experimental evidence that gold is smaller than silver as was theoretically predicted in calculations using relativistic and correlation effects.^{2517–2519} The complex [Au(PPhMe₂)₂]⁺[Au(GeCl₃)₂]⁻ (430) forms a chain of gold atoms where unexpectedly the sequence is +—+—+, which is clearly at variance with the simple rules of Coulomb forces.²⁵⁰⁵ Heterometallic complexes with the phosphine ligand PPh₂CH₂SPh have been synthesized from [AuCl(PPh₂CH₂SPh)] or [Au(PPh₂CH₂SPh)₂]OTf; they react with [PdCl₂(NCPH₂)] or AgOTf to give [{AuCl(PPh₂CH₂SPh)}₂PdCl₂], [AuPdCl₂(PPh₂CH₂SPh)₂]OTf (431), or [AuAg(PPh₂CH₂SPh)₂]OTf (432), respectively.^{2514,2520}

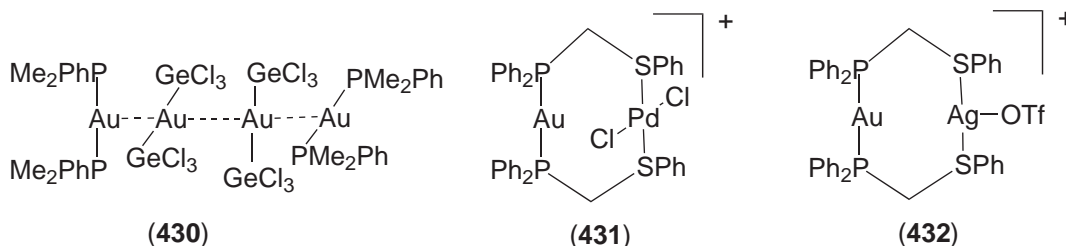

High coordinated gold(I) complexes with monodentate phosphines, arsines, or stibines have been reported. It was first demonstrated, by ^{31}P NMR studies, that bis-, tris-, and even tetrakis (phosphine)gold(I) complexes exist in solution. Owing to rapid ligand exchange on the NMR time scale the individual complexes can only be observed at low temperatures. The linear complexes $[\text{AuX}(\text{PR}_3)]$ interact with an excess of phosphine to give a series of species including primarily $[\text{AuX}(\text{PR}_3)_2]$, $[\text{Au}(\text{PR}_3)_3]\text{X}$, or $[\text{Au}(\text{PR}_3)_4]\text{X}$ as components of equilibria, as shown in Equation (37). The maximum coordination number attainable depends on the particular ligand used. For bulky phosphines, as $\text{PR}_3 = \text{PCy}_3$, only the two-coordinated cation $[\text{Au}(\text{PCy}_3)_2]^+$ is accessible, but with $\text{PR}_3 = \text{PBu}_3$, $\text{P}(4\text{-Tol})_3$, or $\text{PPh}_2\{\text{CH}_2\text{CH}_2(2\text{-Py})\}$ both $[\text{Au}(\text{PR}_3)_2]^+$ and $[\text{Au}(\text{PR}_3)_3]^+$ are detected; for $\text{PR}_3 = \text{PEt}_3$, PMe_2Ph , $\text{P}(\text{OEt})_3$, or $\text{P}(\text{OCH}_2)_3\text{CEt}$ finally the two-, three-, and four-coordinated species are observed.²⁵²¹⁻²⁵²⁴

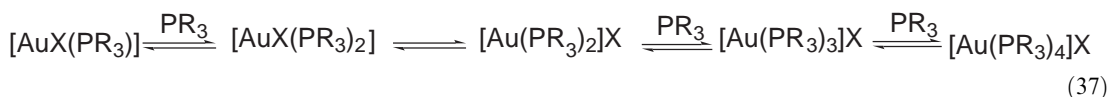

Electrospray mass spectrometry is a technique that allows pre-existing ions to be transferred from solution to the gas phase with minimal fragmentation, followed by conventional mass analysis. Recently electrospray mass spectra have been studied for a number of cationic phosphinegold(I) complexes in dichloromethane/methanol solution.²⁵²⁵ For derivatives of the types $[\text{Au}(\text{PR}_3)_2]^+$ and $[\text{Au}(\text{PR}_3)_3]^+$, the intact cations were observed, but ions of the type $[\text{Au}(\text{PR}_3)_4]^+$ were not detected in the gas phase. Even the three-coordinated $[\text{Au}(\text{PR}_3)_3]^+$ are relatively unstable in the gas phase, and the ions $[\text{Au}(\text{PR}_3)_2]^+$ are readily produced.

Three-coordinate complexes with two phosphines are commonly of the type $[\text{AuX}(\text{PR}_3)_2]$. They show Au—P distances rather longer than those in two-coordinate complexes and P—Au—P angles somewhat wider than 120° ; the extent of the distortion depends on the ligands X and PR_3 . Some recent results of structure determinations are as follows: $\text{PR}_3 = \text{PPh}_3$, X = Cl [$135.7(1)^\circ$], Br [$132.45(8)^\circ$], I [$132.13(7)^\circ$],²⁵²⁶ SCN [$127.8(1)^\circ$],²⁵²⁷ $\text{C}(\text{CN})_3$ [$161.23(9)^\circ$],²⁵²⁸ S_2COEt [$130.1(1)^\circ$],²⁵²⁹ $\text{PR}_3 = \text{PCy}_2\text{Ph}$, X = Cl [$158.24(5)^\circ$],²⁵³⁰ $\text{PR}_3 = \text{P}(\text{CH}_2\text{CH}_2\text{CN})_3$, X = S_2COEt [$145.3(1)^\circ$].²⁵²⁹ In solution the complex $[\text{AuCl}(\text{PPh}_2\text{CH}_2\text{Fc})_2]$ is in equilibrium with linear, three-, and four-coordinated species.⁷⁰⁹ Some of these three-coordinate bis(phosphine) gold(I) complexes luminesce in the solid state, as well as in solution.^{2529,2531} The emission is attributed to metal centered $\text{p}z \rightarrow (d_{x^2-y^2}, d_{xy})$ transition. An example of three-coordinate derivative with triphenylstibine is $[\text{Au}(2\text{-C}_6\text{H}_4\text{NO}_2)(\text{SbPh}_3)_2]$.¹⁶⁴⁴

The most regular three-coordination is observed in compounds where all the three ligands are identical, as in $[\text{Au}(\text{PPh}_3)_3]^+$ salts. Despite the cations being formally identical, small differences are observed in the structures with different anions, such as $\text{B}_9\text{H}_{12}\text{S}^-$,²⁵³² BF_4^- ,²⁵³³ NO_3^- ,²⁵³⁴ $[\text{Mo}(\text{SC}_6\text{F}_5)_4(\eta^5\text{-C}_5\text{H}_5)]^-$,²⁵³⁵ SiF_5^- ,²⁵³⁶ or Cl^- .²⁵³⁷ The cation of $[\text{Au}(\text{PCy}_2\text{Ph})_3]\text{ClO}_4$, obtained by reaction of $[\text{AuCl}(\text{PCy}_2\text{Ph})]$ with an excess of PCy_2Ph in the presence of $(\text{NH}_4)\text{ClO}_4$, also has an almost ideal trigonal planar geometry [P—Au—P angles of $119.3(3)^\circ$].²⁵³⁸ The three-coordinate gold(I) compound with the ferrocenyl phosphine $\text{PPh}_2\text{CH}_2\text{Fc}$ has also been described, $[\text{Au}(\text{PPh}_2\text{CH}_2\text{Fc})_3]\text{ClO}_4$.⁷⁰⁹ The complexes $[\text{Au}(\text{TPA})_3]\text{Cl}$ and $[\text{Au}(\text{TPPTS})_3]^{8-}$ (TPPTS = tris[$(3,3',3''\text{-phosphindynetr})$ tris(benzenesulfonate)]) show luminescence in aqueous solution.²⁵³⁹

Four-coordinate complexes with monodentate ligands have also been reported. The X-ray crystal structures of three modifications of the compound $[\text{Au}(\text{PPh}_3)_4]\text{BPh}_4$ have been determined, none of which shows the expected simple tetrahedral geometry.²⁵⁴⁰ Thus, the chloroform solvate

contains a trigonal planar $\text{Au}(\text{PPh}_3)_3$ unit bound to other phosphine with a very long $\text{Au}\cdots\text{P}$ contact (3.95 Å). However, the cation of $[\text{Au}(\text{PMePh}_2)_4]\text{PF}_6$, obtained by reaction of $\text{K}[\text{AuBr}_4]$ with an excess of PMePh_2 , shows a nearly regular tetrahedral geometry.²⁵⁴¹ The structure of $[\text{Au}(\text{AsPh}_3)_4]\text{BF}_4$ has been carried out and also shows a very regular tetrahedral geometry.⁶⁸⁶ The cations of the triphenylstibine complexes $[\text{Au}(\text{SbPh}_3)_4]\text{X}$ ($\text{X} = \text{ClO}_4$, $[\text{Au}(\text{C}_6\text{F}_5)_2]^-$, or $[\text{Au}\{2,4,6-(\text{NO}_2)_3\text{C}_6\text{H}_2\}_2]^-$)^{2114,2542–2544} show also a tetrahedral coordination at the gold atom, with Sb—Au—Sb angles of 107.8–111.0°. The compounds are readily obtained by addition of SbPh_3 to solutions of $[\text{AuR}(\text{THT})]$ [$\text{R} = \text{C}_6\text{F}_5$, 2,4,6-(NO_2) $_3\text{C}_6\text{H}_2$].^{2114,2544} An equilibrium between the neutral three-coordinate $[\text{AuR}(\text{SbPh}_3)_2]$ and the ionic four-coordinate complex $[\text{Au}(\text{SbPh}_3)_4][\text{AuR}_2]$ has been proposed in solution.²¹¹⁴

The compounds $[\text{AuX}(\text{PR}_3)_3]$ ($\text{PR}_3 = \text{PPh}_3$, $\text{X} = \text{Cl}$, SCN , GeCl_3 ,^{2545–2549} $\text{PR}_3 = 1$ -phenyldibenzophosphole, $\text{X} = \text{Cl}$)²⁴⁹² show the presence of a four-coordinate gold atom in a distorted tetrahedral geometry, with rather long Au—P and Au—X distances. The water soluble and luminescent gold(I) complex $[\text{AuI}(\text{MeTPA})_3]\text{I}_3$ ((MeTPA) $\text{I} = 1$ -methyl-1-azonia-3,5-diaza-7-phosphaadamantane iodide), has been obtained by reaction of $[\text{AuCl}(\text{SMe}_2)]$ with three equivalents of (MeTPA) I .²¹¹⁷ The coordination environment of the gold center is approximately trigonal planar and the iodine is weakly coordinated to the gold atom perpendicular to the AuP_3 plane [Au—I distance 2.936(1) Å]. The solid shows a yellow emission (598 nm) at 77 K and an orange emission (686 nm) at 140 K. $[\text{AuI}(\text{MeTPA})_3]\text{I}_3$ undergoes an unusual phenyl-transfer reaction in aqueous solution with NaBPh_4 to form $[\text{AuPh}(\text{MeTPA})_3]\text{BPh}_4$. An analogous phenyl-transfer reaction has been observed between $[\text{Au}(\text{TPA})_3]\text{Cl}$ and NaBPh_4 , which leads to $[\text{AuPh}(\text{TPA})]$.²¹¹⁷ Reaction of 7-diphenylphosphino-2,4-dimethyl-1,8-naphthyridine (dpnpy) with $[\text{AuCl}(\text{THT})]$ affords the tri-coordinate compound $[\text{Au}(\text{dpnpy})_3]^+$ (**433**); the latter shows strong affinity towards Cu^{I} and Cd^{II} (**434**) ions.²⁵⁵⁰

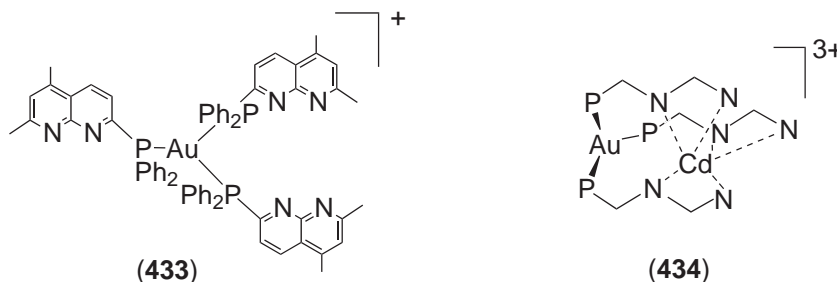

Although in most of the above reports structural information is based on X-ray data, Au Mössbauer spectroscopy has also been successfully employed for the investigation of two-, three-, and four-coordination in gold(I) complexes.²⁵⁵¹ An increase in coordination numbers leads to a decrease in the isomer shift (IS) by 1–2 mm s^{-1} (three-coordination) or 2–4 mm s^{-1} (four-coordination) relative to two-coordination. For the same ligands, the quadrupole splitting (QS) for three-coordinated complexes is expected to be very similar to that for the two-coordinate derivatives, while that for complexes with T_d symmetry should be zero.

Gold(I) complexes of the type $[\text{AuCl}(\text{PPh}_3)_n]$ ($n = 1, 2$) or $[\text{Au}(\text{NO}_3)(\text{PPh}_3)]$ show an excellent performance towards oxidative carbonylation or aromatic amines to form corresponding carbamates, and also towards the carbonilation of aliphatic amines to produce either alkylureas or formamides.^{2552,2553} Cationic gold(I) compounds of the type $[\text{AuL}]^+$ where $\text{L} =$ phosphine, phosphite, or arsine are excellent catalysts for the addition of alcohols to alkynes.²⁵⁵⁴

(iii) Complexes with polydentate ligands

Bi-, tri-, and tetradentate phosphines or arsines have been used quite frequently as bridging ligands between gold(I) centers. Dinuclear (chloro)gold(I) complexes of ditertiary phosphines with the phosphorus atoms bridged by one to eight carbon atoms, of the type $[\text{Au}_2\text{Cl}_2\{\mu\text{-(PPh}_2)_2(\text{CH}_2)_n\}]$ ($n = 1\text{--}8$) have been prepared from $[\text{AuCl}(\text{CO})]$ or $[\text{AuCl}(\text{SR}_2)]$ with the corresponding bidentate phosphine. They can adopt different structural patterns, as the result of the formation of $\text{Au}\cdots\text{Au}$ bonds (see Figure 20). The crystal lattice of the 1,4-bis(diphenylphosphino)butane ($n = 4$) or hexane ($n = 6$) derivatives contain independent molecules (type a),^{2555,2556} which show no intra- or intermolecular $\text{Au}\cdots\text{Au}$ interactions in contrast with the

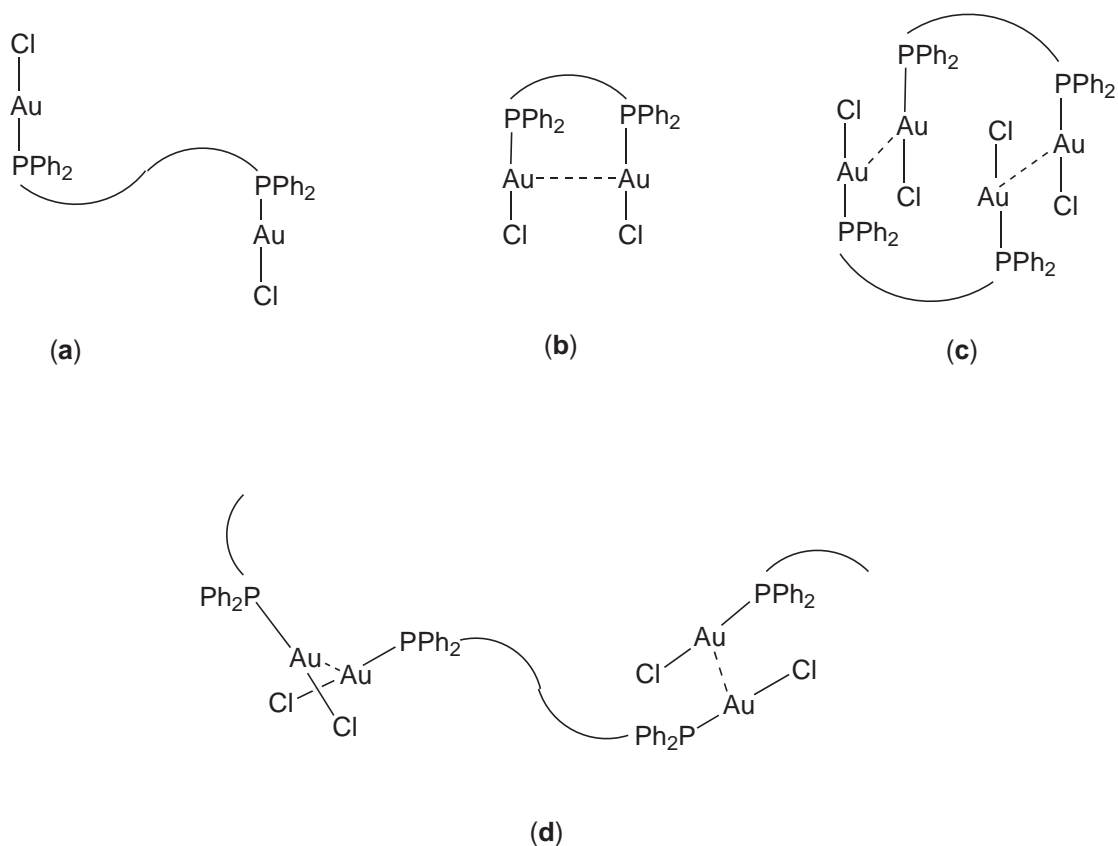
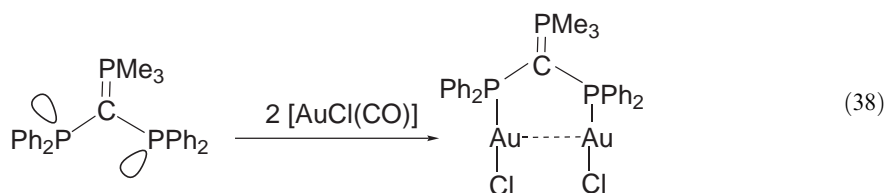

Figure 20 Different structural patterns of $[\text{Au}_2\text{Cl}_2\{\mu\text{-PPh}_2(\text{CH}_2)_n\}]$.

structures of the related gold complexes with shorter or longer chain diphosphines, where intra- ($n=1$, type b)²⁵⁵⁷ and intermolecular metal–metal interactions with formation of discrete dimers (type c),^{2558,2559} or polymeric chains (type d) are found.^{2555,2556,2560,2561} The completely different packing of the monomeric molecules of $[\text{Au}_2\text{Cl}_2\{\mu\text{-(PPh}_2)_2(\text{CH}_2)_4\}]$ and the two polymorphic forms of $[\text{Au}_2\text{Cl}_2\{\mu\text{-(PPh}_2)_2(\text{CH}_2)_2\}]$, where the short $\text{Au}\cdots\text{Au}$ contacts give rise to dimers or to a polymeric chain structure, are particularly remarkable, since the conformation of the free phosphines show a close relationship. It has been suggested that packing effects with or without solvent molecules determine the conformation of these molecules; in fact for $[\text{Au}_2\text{Cl}_2\{\mu\text{-(PPh}_2)_2(\text{CH}_2)_2\}]$ the presence of dichloromethane in the crystal leads to a transformation of the dimeric units present in the solvent-free crystal modification to a polymeric chain. For $n=3$ and larger chains the complexes show monomeric dinuclear molecules connected through intermolecular $\text{Au}\cdots\text{Au}$ contacts of ca. 3.30 Å to give polymeric chains.

Analogous structures occur in other diphosphine complexes of the type $[\text{AuCl}_2\{\mu\text{-(PPh}_2)_2\text{X}\}]$ ^{2562–2569} and thus monomeric molecules without $\text{Au}\cdots\text{Au}$ interactions are found when $\text{X}=\text{C}=\text{PPh}_3$; monomeric molecules with intramolecular metal–metal contacts are formed for $\text{C}=\text{PMe}_3$, $\text{CH}_2=\text{CC}=\text{CH}_2$, bicyclopentyl, *cis*- $\text{CH}=\text{CH}$, and polymeric compounds with intermolecular $\text{Au}\cdots\text{Au}$ interactions are obtained for *trans*- $\text{CH}=\text{CH}$, $\text{CH}_2\text{C}(=\text{CH}_2)\text{CH}_2$, or $\text{C}(=\text{CH}_2)$. Chains are also obtained for the arsino-phosphino ligand $\text{PPh}_2\text{CH}_2\text{CH}_2\text{AsPh}_2$,²⁵⁷⁰ or for the bis(diisopropylphosphino)ethane ligand.²⁵⁷¹ In the complexes with the diphosphine $\text{PPh}_2\text{C}(=\text{PMe}_3)\text{PPh}_2$, the ligands change their ground state *syn/anti* orientation to a symmetrical *syn/syn* conformation upon coordination to gold(I) (Equation (38)). From temperature-dependant NMR studies the energy of the $\text{Au}\cdots\text{Au}$ interaction has been estimated to be in the order of 29–33 kJ mol^{-1} .^{2562,2563} Another example of the conformation-determining attractive interaction between gold(I) centers is the change in the conformation of the butadiene skeleton when 2,3-bis(diphenylphosphino)-1,3-butadiene is coordinated to two gold atoms in $[\text{Au}_2\text{Cl}_2\{\mu\text{-PPh}_2\text{C}(=\text{CH}_2)\text{C}(=\text{CH}_2)\text{PPh}_2\}]$.²⁵⁶⁵



Other bidentate ligands used in the synthesis of dinuclear gold(I) derivatives are $\text{PBu}^t_2\text{OPBu}^t_2$,²⁵⁷² $\text{Ph}_2\text{PNHPPH}_2$,^{2573–2575} 1,1-bis(diphenylphosphino)ferrocene,^{2576–2579} 1,2-bis(diphenylphosphino)-1,2-dicarba-*closo*-dodecaborane,²⁵⁸⁰ $\text{Ph}_2\text{PCF}_2\text{PPh}_2$,²⁵⁸¹ $\text{Ph}_2\text{PN}(o\text{-C}_6\text{H}_4\text{OMe})\text{PPh}_2$,²⁵⁸² dihydrobenzoxazaphosphorinone derivatives,^{2494,2583} 1,4- $\text{Ph}_2\text{PC}_6\text{H}_4\text{PPh}_2$, and 4,4- $\text{Pr}^t_2\text{PC}_6\text{H}_4\text{C}_6\text{H}_4\text{PP}^t_2$,²²²⁵ $\text{Ph}_2\text{PCH}_2\text{C}_6\text{H}_4\text{CH}_2\text{PPh}_2$,²⁵⁸⁴ $\text{Ph}_2\text{P}(\text{CH}_2)_2\text{O}(\text{CH}_2)_2\text{PPh}_2$,⁷⁵² $\text{Ph}_2\text{P}(\text{CH}_2)_2\text{PEt}_2$,²⁵⁸⁵ $n\text{-Py}_2\text{P}(\text{CH}_2)_2\text{PnPy}_2$ ($n = 2, 3, 4$),²⁵⁸⁶ $\text{Bu}^t\text{P}(\mu\text{-CF}_2)_2\text{PBu}^t$ (**435**),²⁵⁸⁷ $\text{Ph}_2\text{P}(\text{CH}_2)_2\text{CONH}(\text{CH}_2)_2\text{NHCO}(\text{CH}_2)_2\text{PPh}_2$,²⁴⁹¹ 2,5-bis(diphenylphosphinomethyl)thiophene,⁷⁸⁶ 2,9-bis(diphenylphosphino)-1,8-naphthyridine,¹³⁸⁴ 3,4-bis(diphenylphosphinoamino)toluene,^{1757,1758} 1,2-bis(diphenylphosphinoamino)benzene,¹⁷⁵⁷ 1,3,5,7-tetramethyl-9,10-(*o*-phenylene)-4,9-dioxa-8, 10-diphospha-adamantane,²⁵⁸⁸ 1,3-bis(diphenylphosphinito)benzene (**436**),²⁵⁸⁹ N,N' -diethyl- N,N' -bis(diphenylphosphino)urea,²⁵⁹⁰ 1,1,3,3,4,4,6,6-octaphenyl-1,3,4,6-tetraphosphazene (**437**),²⁵⁹¹ $\text{Ph}_2\text{P}(\text{CH}_2)_2\text{NR}(\text{CH}_2)_2\text{PPh}_2$ ($R = \text{H}, \text{NO}$),²⁵⁹² or 1,1'-diphenyl-2,2',5,5'-tetrahydro-3,3',4,4'-tetramethyl-1H,1'H-2,2'-biphosphole (**438**).²⁵⁹³ Complexes of the type $[\text{Au}_2\text{X}_2(\mu\text{-PP})]$ where X can be an anionic ligand other than chlorine, pseudohalogen, aryl, silyl group, etc. or even a neutral ligand, as tetrahydrothiophene, ylide, and phosphine that gives cationic complexes of the type $[(\text{AuL}_2)_2(\mu\text{-PP})]_2^+$ have also been synthesized.^{505,1650,1651,1757,2109,2110,2147,2577,2580,2594–2596}

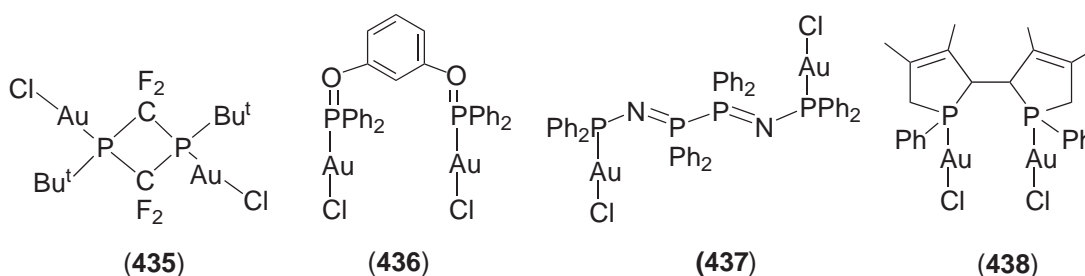

Hayashi and co-workers have reported a very efficient synthesis of optically active dihydrooxazoles involving a gold(I)-catalyzed coupling of isocyanoacetate esters with aldehydes in the presence of the chiral diphosphine $[(\eta^5\text{-C}_5\text{H}_4\text{PPh}_2)\{\eta^5\text{-C}_5\text{H}_3(\text{PPh}_2)\text{CHMeNMeCH}_2\text{CH}_2\text{NR}_2\}\text{Fe}]$ ($R = \text{Me}, \text{Et}$) (PP) (Equation (39)).²⁵⁹⁷ The dinuclear $[\text{Au}_2\text{Cl}_2(\mu\text{-PP})]$ and trinuclear $[\text{Au}_3\text{Cl}_3(\mu\text{-PP})]$ complexes have been isolated.²⁵⁹⁸

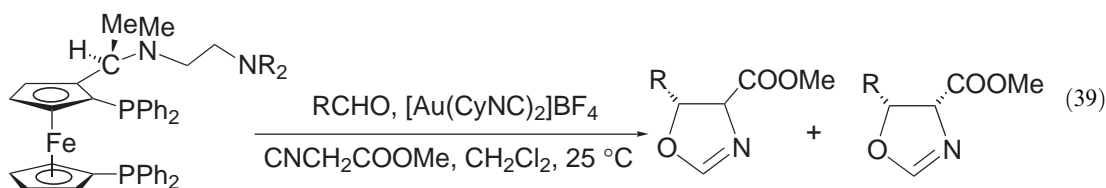

With higher diphosphine/gold ratios other structural patterns can be obtained. The dinuclear derivatives $[\text{Au}_2(\mu\text{-PP})_2]^{2+}$ are known with a great variety of diphosphines $\text{R}_2\text{PXP}^t\text{R}_2$ where X can be CH_2 ,^{2196,2557,2599–2607} $(\text{CH}_2)_2$,^{2604,2608,2609} $(\text{CH}_2)_3$,^{2608,2610} $\text{C}=\text{CH}_2$,²⁵⁶⁹ $\text{C}(\text{CH}_2\text{CH}_2)$,²⁰⁹⁶ CHCH_2OMe ,²⁰⁹⁶ CH_2CHEtO (**439**),⁷⁸² $\text{C}=\text{C}=\text{CMe}_2$,²⁶¹¹ NH (**440**),¹⁶⁵⁰ or NEt .²⁶¹² Analogous complexes have been described with $\text{Ph}_2\text{AsCH}_2\text{AsPh}_2$.^{1651,2313} Most of these derivatives are three-coordinate by bonding to the anionic ligand that can be $\text{Cl}, \text{Br}, \text{I}, \text{S}_2\text{CNEt}_2$, or BH_3CN and also by formation of $\text{Au}\cdots\text{Au}$ interactions with molecules such as $[\text{AuCl}(\text{GeCl}_3)]^-$. The complexes $[\text{Au}_2\{(\text{PR}_2)_2\text{CH}_2\}]^{2+}$ ($R = \text{Me}, \text{Ph}, \text{Cy}$) are luminescent in the solid state and in solution, and several studies have been carried out related to aurophilic attraction and luminescence.^{2601,2613–2618}

The high luminescent complex $[\text{Au}_2\{(\text{PPh}_2)_2\text{-CH}_2\}](\text{OTf})_2$ with a triplet excited state can be used in light-emitting diodes.²⁶¹⁹

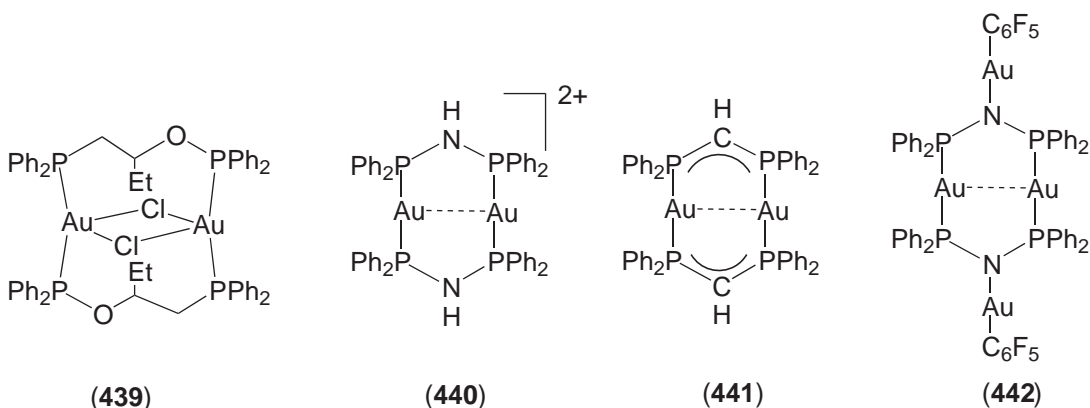

The dinuclear derivatives $[\text{Au}_2\{(\text{PR}_2)_2\text{X}\}]^{2+}$ ($\text{X} = \text{CH}_2, \text{NH}$) can be easily deprotonated to give the neutral complexes $[\text{Au}_2\{(\text{PR}_2)_2\text{Y}\}]$ ($\text{Y} = \text{CH}$ (441), N).^{771,2620–2622} Further coordination of the C or N atoms to other metal complexes gives tetra- or hexanuclear derivatives as, for example, (442).^{771,2162,2163,2622}

Studies of gold(I) cations with empirical formula $[\text{Au}\{\text{PPh}_2(\text{CH}_2)_n\text{PPh}_2\}]^+$ show that the complexes crystallize as rings for $n = 3$ or 5 but as a polymer when $n = 4$. The ring complexes can be connected through aurophilic bonding by addition of $[\text{Au}(\text{CN})_2]^-$ as, for example, in (443).²⁶²³ With the diphosphine 9,10-bis(diphenylphosphino)anthracene the reaction 1:1 with $[\text{AuCl}(\text{SMe}_2)]$ gives the trinuclear complex $[\text{Au}_3(\mu\text{-PP})_3]^{3+}$ (444).²⁶²⁴ This luminescent gold ring is shown to be an inorganic analogue of cyclohexane in terms of structure and solution dynamics. Other stoichiometries with diphosphine ligands are of the type $[\text{Au}_3\text{Cl}_2(\mu\text{-PP})_2]^+$ which are known for dppm (445),^{1744,2625} or $\text{Ph}_2\text{PNEtPPh}_2$,²⁶¹² the mixed gold(I)–gold(III) $[\text{Au}\{\mu\text{-}(\text{AsPh}_2)_2\text{CH}_2\}_2\{\text{Au}(\text{C}_6\text{F}_5)_3\}_2]\text{ClO}_4$,¹⁶⁵¹ or the methanide complexes $\text{Bu}_4\text{N}[\text{Au}\{\mu\text{-}(\text{PPh}_2)_2\text{CH}\}_2\{\text{Au}(\text{C}_6\text{F}_5)_3\}_2]$, $\text{Bu}_4\text{N}[\text{Au}\{\mu\text{-}(\text{PPh}_2)_2\text{CH}(\text{AuX})\}_2\{\text{Au}(\text{C}_6\text{F}_5)_3\}_2]$ ($\text{X} = \text{Cl}, \text{C}_6\text{F}_5$), $[\text{Au}\{\mu\text{-}(\text{PPh}_2)_2\text{C}(\text{AuPPh}_3)_2\}_2\{\text{Au}(\text{C}_6\text{F}_5)_3\}_2]\text{ClO}_4$,¹⁷⁵⁵ and $[\text{AuCl}(\mu\text{-PPH}_2\text{CH}_2\text{PPh}_2)\text{AuCH}(\text{PPh}_2\text{AuCl})_2]$.²⁶²⁶ Another type is the dinuclear derivative $[\text{Au}_2(\text{C}_6\text{F}_5)\{(\text{PPh}_2)_2\text{C}_2\text{B}_9\text{H}_{11}\}(\text{PPh}_3)]$ with an anionic bridging diphosphine ligand and two different terminating ligands.²⁶²⁷

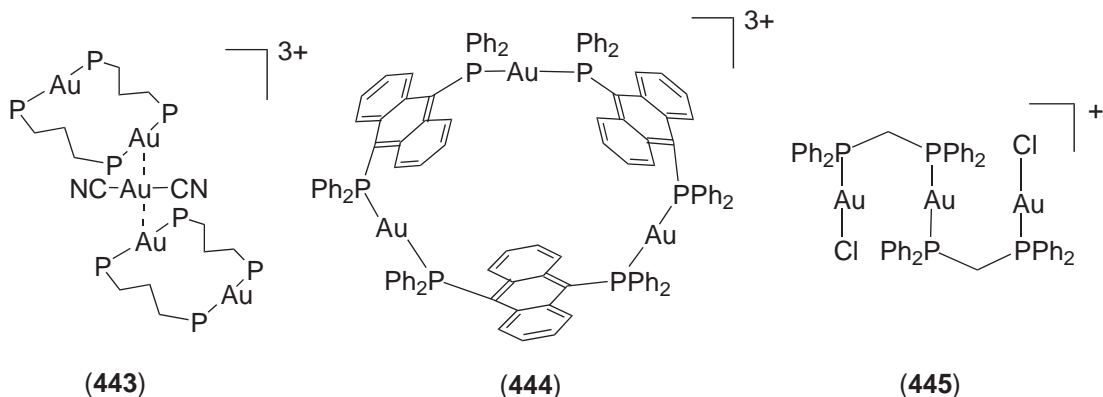

Dppm has also been used to synthesize heterodinuclear complexes with the diphosphine bridging gold and other metal atoms. Thus, a number of heterometallic derivatives with gold and iridium as (446),^{2628–2631} nickel,²⁶³² palladium or platinum,^{1763,2633,2634} iron as (447),^{2635–2637} molybdenum, or tungsten,^{721,2638} are known. Other bimetallic systems with rhodium or platinum and gold have been obtained with the 2-[bis(diphenylphosphino)methyl]pyridine as (448).^{2639,2640} Reaction of *trans*- $[\text{MCl}_2(\text{AsPh}_2\text{CH}_2\text{AsPh}_2)_2]$ ($\text{M} = \text{Pd}, \text{Pt}$) with $[\text{AuCl}(\text{THT})]$ leads to the trinuclear complexes *trans*- $[\text{MCl}_2(\text{AsPh}_2\text{CH}_2\text{AsPh}_2\text{AuCl})_2]$. With the bis(diphenylstibino)methane the result is different and the dinuclear derivative $[\text{AuCl}_2\{\mu\text{-}(\text{SbPh}_2)_2\text{CH}_2\}]$ is obtained.¹⁷⁶²

Other heteronuclear complexes are those of the bis(diphenylphosphino)methanide and the group 6 metals, $[M(CO_4)\{(PPh_2)_2CHAu(PPh_3)\}]$ ($M = Cr, Mo, W$).²⁶⁴¹

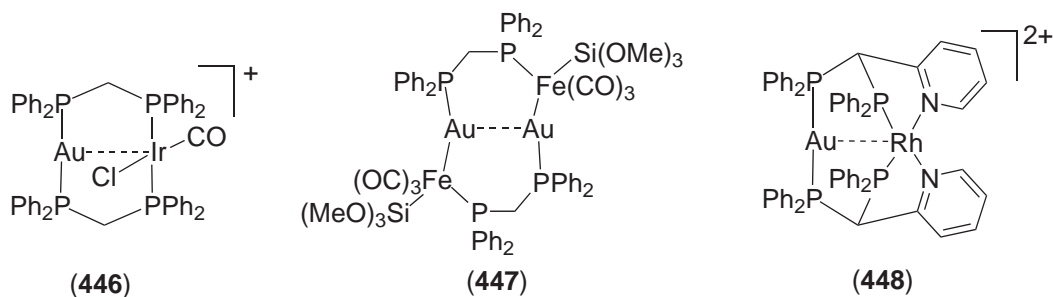

Most of the dinuclear gold(I) complexes are homobridged diauracycles with the same bridging ligand on each side, but some examples of heterobridged derivatives have been reported. These contain a diphosphine in addition to other bidentate ligand such as bis(diphenylphosphino)methanide,^{2096,2621} bis(ylide),^{2626,2642} dithiolate,^{2643,2644} dithiocarbamate,^{2642,2645} xantate,²⁰³⁷ phosphoniodithioformate,²⁰³⁹ dithiophosphate,²⁰⁴⁰ or pyridine-2-thiolate.²⁰³⁸ They can be obtained by reaction of the $[Au_2X_2(\mu-PP)]$ complexes with the bidentate ligand as shown in Equation (40), or by ligand exchange reactions between two different homobridged dinuclear compounds, as shown in Equation (41). Other examples with dithiolate ligands can be seen in Section 6.7.3.4.5.

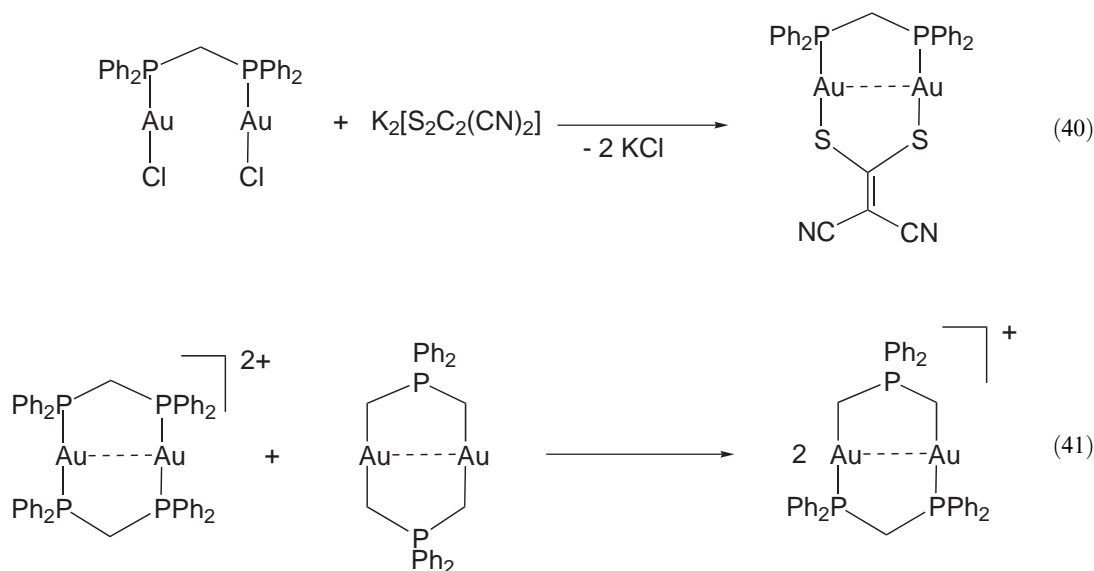

Bidentate ligand transfer also occurs between di- and mononuclear complexes via donor-acceptor intermediates. Reactions of the cationic complex $[Au_2(\mu-dppm)_2]^{2+}$ with $[AuX_2]^-$ ($X = Cl, Br$) salts lead to tri- or dinuclear derivatives depending on the molar ratio (1:1 or 1:2) (Scheme 36).²⁶⁴⁵

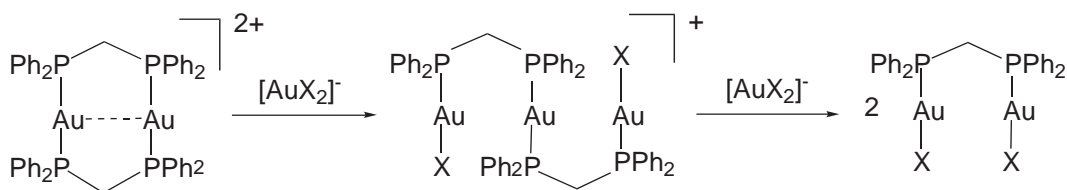

Scheme 36

Tri-tertiary phosphines react with gold(I) complexes of the type $[\text{AuX}(\text{SR}_2)]$ and function as templates for the synthesis of trinuclear derivatives of the type $[\text{Au}_3\text{X}_3(\mu\text{-L})]$. The gold atoms can be aggregated in equilateral triangles or in other forms, depending of the nature of the phosphine. Ligands imposing structure-bases constraints, as $\text{HC}(\text{PPh}_2)_3$, lead to complexes $[\text{Au}_3\text{X}_3\{\mu_3\text{-}(\text{PPh}_2)_2\text{CH}\}]$ ($\text{X} = \text{Cl}$ (**449**), Br , I , C_6F_5)^{2646,2647} with a triangular all-*cis* arrangement of the three gold atoms and rather short $\text{Au}\cdots\text{Au}$ contacts, whereas the conformation of the free ligand is all-*trans*.²⁶⁴⁶ Other stoichiometries, as with the dinuclear $[\text{Au}_2\{\mu\text{-}(\text{PPh}_2)_2\text{CHPPh}_2\}_2](\text{ClO}_4)_2$,²⁶⁴⁷ trinuclear $[\text{Au}_3\text{Cl}\{\mu_3\text{-}(\text{PPh}_2)_3\text{CH}\}_2](\text{ClO}_4)_2$ (**450**), $[\text{Au}_3\{\mu_3\text{-}(\text{PPh}_2)_3\text{CH}\}_2](\text{ClO}_4)_3$,^{2647,2648} and tetranuclear as $[\text{Au}_2\{\mu\text{-}(\text{PPh}_2)_2\text{CHPPh}_2\text{Au}(\text{C}_6\text{F}_5)\}_2](\text{ClO}_4)_2$ (**451**).²⁶⁴⁷ The trinuclear derivative $[\text{Au}_3\text{Cl}\{\mu_3\text{-}(\text{PPh}_2)_3\text{CH}\}_2](\text{ClO}_4)_2$ shows a photoluminescent behavior.²⁶⁴⁸ The CH group of these complexes can be deprotonated to give tris(phosphine)methanide derivatives such as $[\text{Au}_2\{\mu\text{-}(\text{PPh}_2)_2\text{CPh}_2\}_2]$ or $[\text{Au}_2\{\mu\text{-}(\text{PPh}_2)_2\text{CPh}_2\text{AuX}\}_2]$.²⁶⁴⁷ Heteronuclear complexes with this ligand have been obtained with gold and rhodium,²⁶⁴⁹ such as $[\text{Rh}(\text{COD})\{\mu\text{-}(\text{PPh}_2)_2\text{CPh}_2\text{Au}(\text{PPh}_3)\}](\text{BF}_4)_2$ or with gold and group 6 metals, such as $[\text{M}(\text{CO})_4\{\mu\text{-}(\text{PPh}_2)_2\text{CPh}_2\text{AuX}\}]$ ($\text{M} = \text{Cr}, \text{Mo}, \text{W}$; $\text{X} = \text{Cl}, \text{C}_6\text{F}_5$).²⁶⁵⁰

Bis[2-(diphenylphosphino)phenyl]phenylphosphine (TP) is a very inflexible ligand with a rigid backbone and gives the trinuclear complex $[\text{Au}_3\text{Cl}_3(\text{TP})]$ (**452**), that has a compact unsymmetrical structure in the solid state which is retained in solution owing to the fixation of the gold atoms through intermetallic contacts.²⁶⁵¹

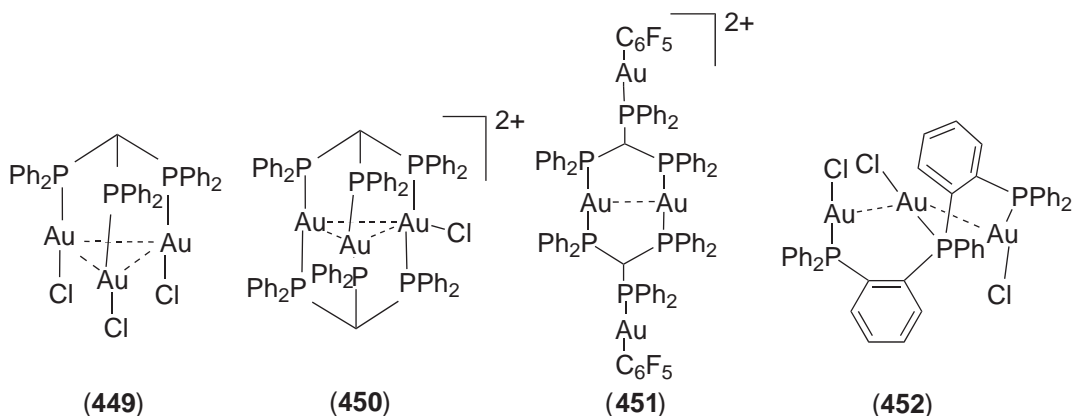

The more flexible ligands $\text{MeC}(\text{CH}_2\text{PR}_2)_3$ ($\text{R} = \text{Me}, \text{Ph}$) form complexes of the type $[\text{Au}_3\text{X}_3\{\mu_3\text{-}(\text{PR}_2\text{CH}_2)_3\text{CMe}\}]$ ($\text{R} = \text{Me}, \text{Ph}$)^{1766,2652,2653} or $[\text{Au}_2(\text{C}_6\text{F}_5)_2\{\mu\text{-}(\text{PPh}_2\text{CH}_2)_2\text{C}(\text{Me})\text{PPh}_2\text{O}\}]$.¹⁷⁶⁶ The compound $[\text{Au}_3\text{Cl}_3\{\mu_3\text{-}(\text{PMe}_2\text{CH}_2)_3\text{CMe}\}]$ has a layer structure with two of the gold atoms associated via intramolecular $\text{Au}\cdots\text{Au}$ contacts and the pair of gold atoms are further aligned in chains through intermolecular $\text{Au}\cdots\text{Au}$ contacts.²⁶⁵³ Heteropolynuclear complexes with gold and group 6 metals have been described with the triphosphine $(\text{PPh}_2\text{CH}_2)_3\text{CMe}$.¹⁷⁶⁷ The related $\text{N}(\text{CH}_2\text{PPh}_2)_3$ yields the trinuclear derivatives $[\text{Au}_3\text{X}_3\{\mu_3\text{-}(\text{PPh}_2\text{CH}_2)_3\text{N}\}]$ ($\text{X} = \text{Cl}, \text{Br}, \text{I}$); for Cl or Br an aggregation into layers through $\text{Au}\text{---}\text{X}$ contacts is observed, but for I the molecules are linked into strings through short intermolecular $\text{Au}\cdots\text{Au}$ contacts.²⁶⁵⁴

Interesting tri- and tetranuclear complexes have been obtained with flexible tridentate ligands of the type $\text{RE}(\text{CH}_2\text{PR}_2)_2$ ($\text{R} = \text{Me}, \text{Ph}$; $\text{E} = \text{P}, \text{As}$). The reaction of $\text{PhAs}(\text{CH}_2\text{PPh}_2)_2$ with two equivalents of $[\text{AuCl}(\text{SMe}_2)]$ yields the dinuclear $[\text{Au}_2\text{Cl}_2\{\mu\text{-}(\text{PPh}_2\text{CH}_2)_2\text{AsPh}\}]$, which crystallized as a dimer with intermolecular gold-gold interactions.²⁶⁵⁵ Further treatment with $[\text{AuCl}(\text{SMe}_2)]$ produces the trinuclear $[\text{Au}_3\text{Cl}_3\{\mu_3\text{-}(\text{PPh}_2\text{CH}_2)_2\text{AsPh}\}]$ (Scheme 37), which has a bent Au_3 chain. Precipitation of half of the halogen from the binuclear complex gives $[\text{Au}_4\text{Cl}_2\{\mu_3\text{-}(\text{PPh}_2\text{CH}_2)_2\text{AsPh}\}]$, which has a bent Au_4 chain.

With the triphosphines $\text{RP}[(\text{CH}_2)_n\text{PR}_2]_2$ ($\text{R} = \text{Me}, \text{Ph}$; $n = 1, 2$) other tri- and tetranuclear species can be obtained as, for example, (**453**)–(**455**).^{1764,1765,2656–2660} These compounds show photoluminescence at room temperature.

The dinuclear complex $[\text{Au}_2\text{Cl}_2\{\mu\text{-}(\text{PPh}_2\text{CH}_2)_2\text{AsPh}\}]$ is a convenient building block for the synthesis of polynuclear aggregates because it contains an uncoordinated arsenic atom, which should make it capable of coordinating another metal, such as palladium, rhodium, or iridium as, for example, (**456**).^{2661,2662} The triphosphine $\text{PhP}(\text{CH}_2\text{PPh}_2)_2$ allows the formation of similar heteronuclear complexes with iridium, such as $[\text{Au}_3\text{IrCl}_3(\text{CO})\{\mu_3\text{-}(\text{PhP}(\text{CH}_2\text{PPh}_2)_2)_2\}]\text{PF}_6$ (**457**) or

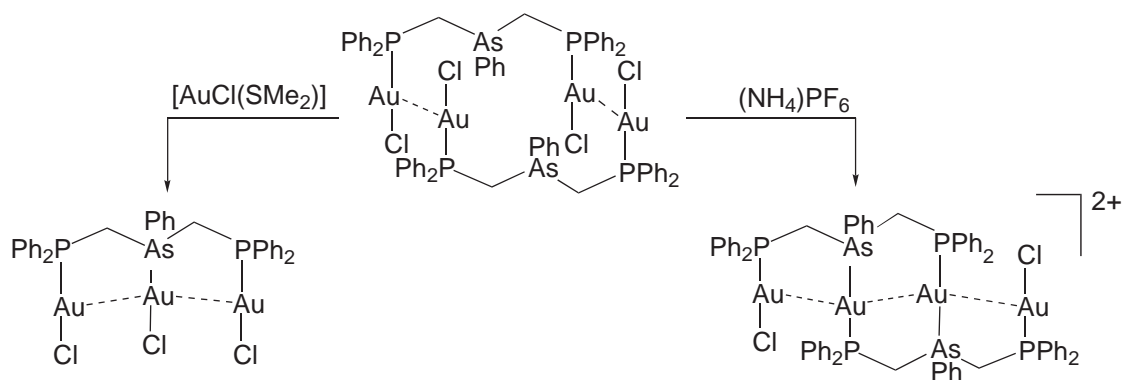

Scheme 37

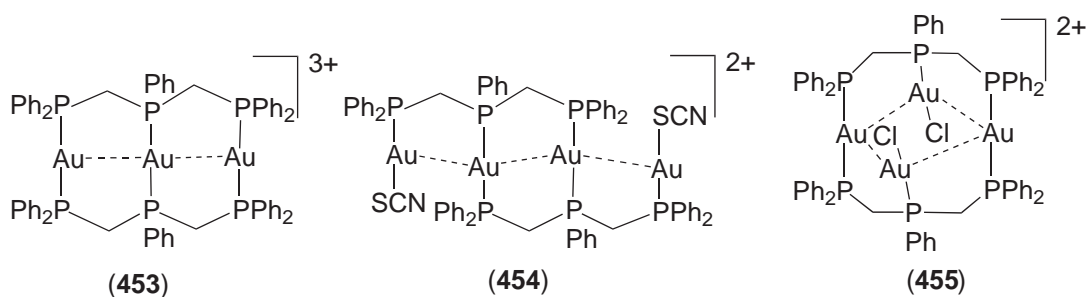

$[\text{Au}_2\text{Ir}(\text{CN})_2\{\text{PhP}(\text{CH}_2\text{PPh}_2)_2\}_2]\text{PF}_6$.²⁶⁶³ The metallomacrocyclic $[\text{IrCl}_2(\text{CO})_2\{\text{PhP}(\text{CH}_2\text{PPh}_2)_2\}_2]$ is a useful starting material for the preparation of trinuclear derivatives and then it reacts with $[\text{AuCl}_4]^-$ to give $[\text{Ir}_2\text{AuCl}_4(\text{CO})_2\{\text{PhP}(\text{CH}_2\text{PPh}_2)_2\}_2]$.²⁶⁶⁴ A similar compound is obtained by treatment with $[\text{AuCl}(\text{CO})]$ followed by Cl_2 .²⁶⁶⁵ Other adducts are obtained by reaction of $[\text{Ir}_2\text{AuCl}_2(\text{CO})_2\{\text{PhP}(\text{CH}_2\text{PPh}_2)_2\}_2]$ with sulfur dioxide.²⁶⁶⁶ Mixed palladium or platinum and gold derivatives as (458) have been synthesized starting from $[\text{MCl}\{\text{PhP}(\text{CH}_2\text{CH}_2\text{PPh}_2)_2\}]\text{Cl}$ by reaction with Au^{I} solutions.²⁶⁶⁷ A dimeric gold(I) triphospholyl complex has been obtained by reaction of 1-trimethylstannyl-3,5-di(Bu^t)-1,2,4-triphosphol with $[\text{AuCl}(\text{PPh}_3)]$.²⁶⁶⁸

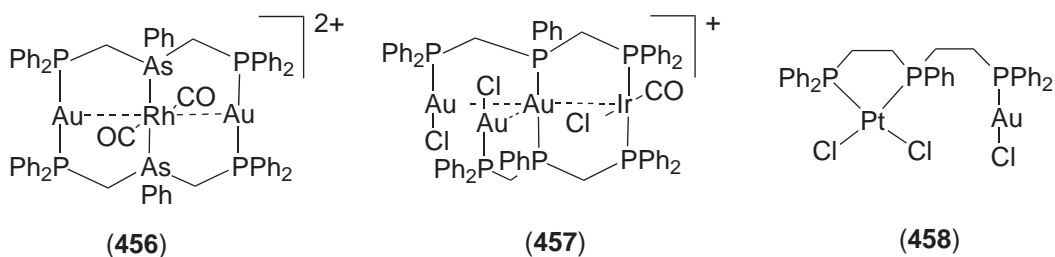

Tetrakis(diphenylphosphinomethyl)methane $\text{C}(\text{CH}_2\text{PPh}_2)_4$ reacts with four equivalents of $[\text{AuCl}(\text{SMe}_2)]$ to give the tetranuclear complex $[\text{Au}_4\text{Cl}_4\{\text{PPh}_2\text{CH}_2\}_4\text{C}]$ (459). The changes in structure and conformation as compared to that of the free ligand are due to intermolecular $\text{Au}\cdots\text{Au}$ interactions for one pair of gold atom centers.²⁶⁵² Another tetradentate ligand, L, derived from a calix[4]resorcinarene by incorporation of four phosphonite donors, leads to the bowl shape complex $[\text{Au}_4\text{Cl}_4\text{L}]$. The latter forms inclusion complexes with amines and alkali metal cations but not with other potential substrates.^{2669,2670} Other tetranuclear gold(I) complexes with calixarene-phosphine ligands are those derived of *p*- Bu^t -calix[4]- $(\text{OCH}_2\text{PPh}_2)_4$ (L),⁷⁹⁹ or related ligands.²⁶⁷¹ The stepwise formation of this complex by reaction of this ligand with $[\text{AuCl}(\text{THT})]$ under conditions that allow the mechanism to be resolved, has led to the isolation of a calixarene polymer $[\text{Au}_2\text{Cl}_2\text{L}]_n$.²⁶⁷² The ligands tetrakis(diphenylphosphine)tetrathiafulvalene,

(PPh₂)₂TTF, and 1,4,8,11-tetrakis(diphenylphosphinomethyl)-1,4,8,11-tetraazacyclotetradecane (L) also form tetranuclear derivatives such as [Au₄Cl₄{(PPh₂)₄TTF}] (460)²⁶⁷³ or [Au₄X₄L₄] (X = Cl, Br, I).²⁶⁷⁴ The complexes with the tetraaza moiety are 2D polymers and show interesting multistate photoluminescence in the solid state. Other gold(I) complexes with potentially tetradentate ligands are those derived of a phosphinine macrocycle (461),⁴⁸ or those obtained by reaction of (Bu^tP)₄ with AuBr₃ which gives [AuBr(PBu^t)₄] or [Au₂Br₂(PBu^t)₄].²⁶⁷⁵ Gold(I) complexes with dendritic polymers containing phosphorus donor ligands have been described,^{2676,2677} those are of generation 2,²⁶⁷⁸ with 16 and 32 ω-phosphine chain-ends of generations 2 and 3,^{2461,2491} or the generation 10 characterized by high-resolution electron microscopy.²⁶⁷⁹

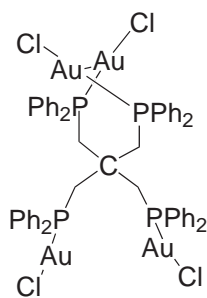

(459)

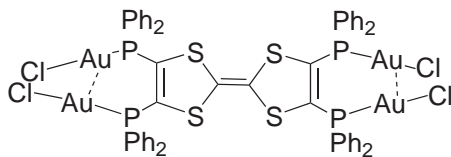

(460)

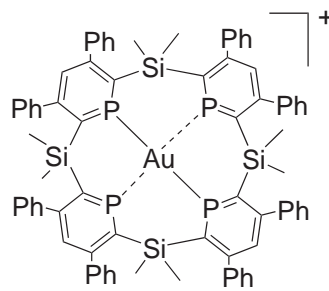

(461)

Three-coordinate neutral or cationic complexes of the type [AuX(P-P)] (X = Cl, C₆F₅) or [AuL(P-P)]⁺ (L = THT, PR₃, AsPh₃, ylide, SPPH₃) with a bidentate chelate phosphine ligand have been obtained for Fe(C₅H₄PPh₂)₂,^{2577,2680,2681} Fe(C₅Me₄PPh₂)₂,²⁶⁸² C₂B₁₀H₁₀(PPh₂)₂,²⁵⁸⁰ and Z,Z-PPh₂CH₂C(Bu^t)=NN=C(Bu^t)CH₂PPh₂.⁷⁵⁸ Three-coordinate neutral complexes of the type [Au(P-P)PR₃] (462) have been obtained with the anionic *nido*-diphosphine ligand [7,8-(PPh₂)₂-7,8-C₂B₉H₁₀]⁻.²⁶⁸³ In the dinuclear complexes considered above, [Au₂X₂(μ-P-P)], the metal atoms can be three coordinate by bonding of the anion X. The coordination of the ligand X is nearly perpendicular to the P—Au—P-axis, which is approximately linear (P—Au—P angles, 156–170°) and leads to a T-shape coordination array at the gold atoms, which have short Au···Au contacts. Some examples are [Au₂Cl₂(μ-dppm)] (463)²⁶⁰² and [Au₂(S₂CNEt₂)(μ-dppm)](BH₃CN) (464).²⁶⁰³ The dinuclear platinum complex [Pt₂(μ-S)(μ-dppm)(η¹-dppm)₂] can act as a tridentate ligand. It reacts with [AuCl(SMe₂)] to give a trinuclear complex with a three-coordinate gold atom (465).²⁶⁸⁴

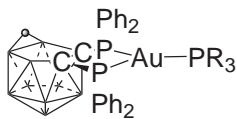

(462)

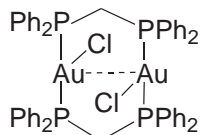

(463)

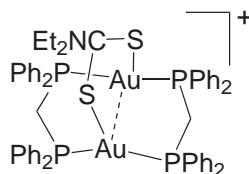

(464)

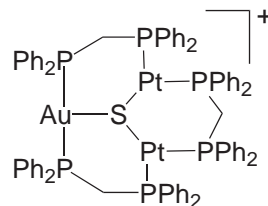

(465)

With diphosphine ligands only several three-coordinate gold(I) complexes have been achieved. The reaction of [AuCl(PPRⁱ)₃] with Me₂PCH₂PMe₂ leads to the dinuclear derivative [Au₂{μ-(PMe₂)₂CH₂}₃]Cl₂ (466), which is readily converted in the tetrafluoroborate salt; the compound has a short gold–gold interaction.^{2685,2686} The resonance Raman and electronic luminescence spectra of [Au₂{μ-(PMe₂)₂CH₂}₃](ClO₄)₂ have been studied, which present an intense band at 256 nm and a weaker at 300 nm. The first is assigned to a ¹(dσ* → pσ) transition, with metal–metal character.²⁶⁸⁷ The structure of [Au₂(2,6-PPh₂PyPPh₂)₃](ClO₄)₂ is similar but the intramolecular Au···Au distance is very large.²⁶⁸⁸ The complex displays photoluminescence at 520 nm in fluid solutions at room temperature. The ligands 2,9-bis(diphenylphosphino)-1,8-naphthyridine or 2,9-bis(diphenylphosphino)-1,10-phananthroline form three-coordinate gold(I) metallocryptates which encapsulate Na⁺, K⁺, or Tl⁺ ions as, for example, (467).^{1384,1394,2689} Compounds of the type [Au₂(μ-PP)(PP)₂] have been described for Cy₂P(CH₂)₂PCy₂ (468),^{2690,2691} dppf,²⁵⁷⁷ or for mixed diphosphines as in [Au₂(μ-PP){(PPh₂)₂C₂B₉H₁₀}₂] (dppe, dppp).²⁶⁸³ When the diphosphine is *trans*-Ph₂PCH=CHPPh₂ the reaction of [Au₂Cl₂(μ-PP)] with AgCF₃CO₂ in the presence of the

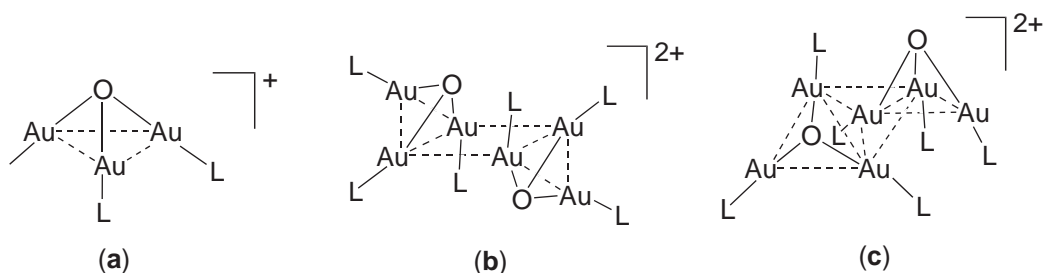
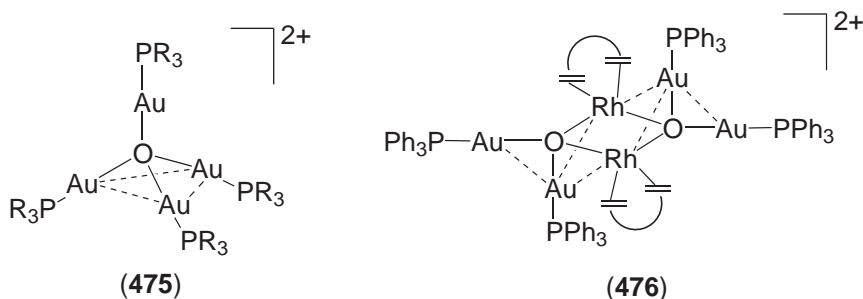

Figure 21 Different structures of $[O(AuL)_3]^+$ cations.

Heteronuclear μ -oxo complexes have been prepared by oxo/halide exchange reactions, then the reaction of metal halide complexes with the gold oxonium species gives complexes of the type $[Rh_2(dien)_2\{O(AuPPh_3)_2\}(BF_4)_2]$ (**476**) (dien = COD, NBD) or $[Pt(COD)_2\{O(Au(PR_3))_2\}_2]$.^{2725,2726}



The decomposition, either thermal or under N_2 , of $[O(AuPR_3)_3]OTf$ ($R = Ph, Me$) in organic solvents has been studied; the phosphine acts as an efficient oxygen trap and gold nanoparticles are produced.²⁷²⁷

Mono- or dinuclear gold(I) aryloxy complexes have been obtained by reaction of $[O(AuPR_3)_3]^+$ with the aryl group or with the potassium salt. Several derivatives with substituted phenols, 8-hydroxyquinoline, pyrochatecol, or 2,2'-dihydroxyazobenzene, such as (**477**) or (**478**) have been reported.^{2728–2735} Alkoxy gold(I) derivatives such as $[Au(OR)(PR_3)]$ ($R = Bu^t, CH(CF_3)_2, CH_2CF_3$) have been prepared by metathesis of the chloride species.^{1787,2736} These alkoxydes can abstract protons from various organic compounds or metal-hydrides to give the corresponding organogold compounds or species having $M-Au$ bonds and free alcohol.^{2738, 2736} Other interesting reactions carried out with the alkoxy or aryloxy species are the selective ring opening of thiiranes to give 2-(alkoxy- or aryloxy)ethylsulfanylgold(I) complexes or the C—Si bond cleavage of trihalomethyltrimethylsilane to give $[Au(CF_3)(PR_3)]$ complexes.^{2737,2738} Siloxane gold(I) compounds of the type $[Au(OTMS)(PR_3)]$ ($PR_3 = PPh_2Me, PMe_3$) have been reported and the structure consists of dimers with short $Au \cdots Au$ contacts for PMe_3 and monomers for PPh_2Me .^{2739,2740}

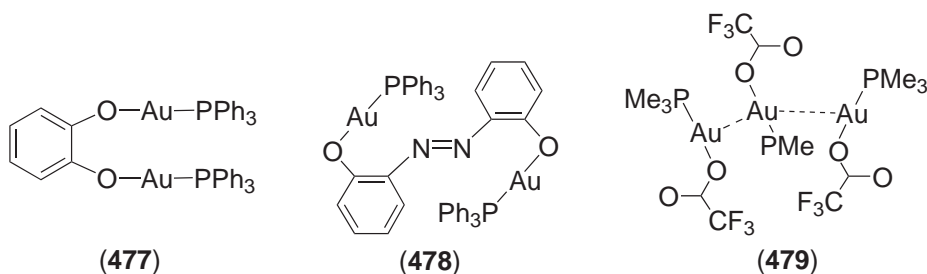

Carboxylate gold(I) complexes are also not very numerous in spite of some of them showing significant antitumor activity.^{2741,2742} The majority of compounds reported have the stoichiometry $[Au(O_2CR)(PR_3)]$ and are known for acetate,^{2743,2744} benzoate,²⁷⁴⁵ lactate,²⁷⁴⁶ isobutyrate,²⁷⁴⁶ pivalate,²⁷⁴⁷ dichloroacetate,²⁷⁴⁸ *o*-carboxybenzoyl-ferrocene,²⁷⁴⁹ or for the fluorocarboxylates trifluoroacetate,^{2750–2752} pentafluoropropionate,²⁷⁴⁷ $O_2CC_6F_{13}$, $O_2CC_7F_{15}$, $O_2CC_8F_{17}$, $O_2CC_9F_{19}$, $O_2CC_6F_5$, or $O_2CC_3F_6$.²⁷⁵³ The structure of $[Au(O_2CCF_3)(PMe_3)]$ (**479**) features trimers with

two short aurophilic interactions. Decarboxylation of some of these complexes at temperatures under 100 °C produces carbon dioxide, metallic gold, phosphine, and organic products.²⁷⁴⁶ Gold(I) complexes with the amino acid derivatives *N*-acetylglycinato,²⁷⁵⁴ *N*-benzoylglycinato (480),²⁷⁵⁴ or *N*-benzoyl-L-alaninato,²⁷⁵⁵ have been described. Dinuclear carboxylate compounds have been obtained and are of the type $[\text{Au}_2(\text{O}_2\text{CR})_2(\mu\text{-P-P})]$ (R = Me, CF₃, Et, Ph; P-P = dppf, dppm); the structure of $[\text{Au}_2(\text{O}_2\text{CCF}_3)_2(\mu\text{-dppf})]$ (481) shows the carboxylate to act as monodentate.²⁷⁵⁶

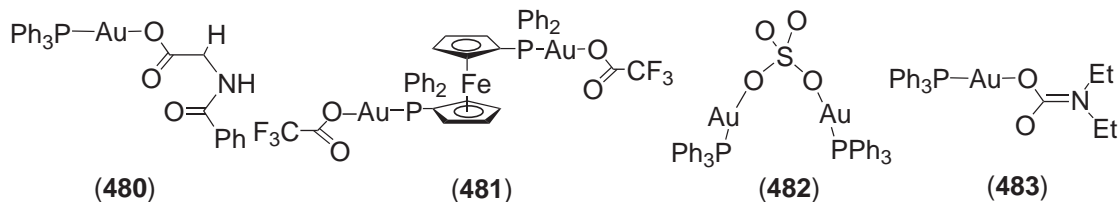

Gold(I) complexes with oxoanions such as sulfate (482),²⁷⁵⁷ nitrate,^{2254,2709,2744,2758–2760} trifluoromethanesulfonate,²⁷⁵¹ or organosulfonates,²⁷⁶¹ have been obtained. Other gold(I) complexes with oxygen donor ligands are those derived of carbamate, $[\text{Au}(\text{O}_2\text{CNET}_2)(\text{PPh}_3)]$ (483),⁹¹¹ acyl species, $[\text{Re}_2(\mu\text{-PPh}_2)_2(\text{CO})_7\text{Au}\{\text{(OCR)(PPh}_3)\}]$ (R = Me, Buⁿ, Bu^t, Ph),²⁷⁶² or nitrosodicyanomethanido.²³⁴⁷ The chemistry of oxoaurates(I) has been recently reviewed.²⁷⁶³

6.7.3.4.6 Complexes with sulfur, selenium, and tellurium donor ligands

(i) Thiolates, selenolates, and tellurolate gold(I) complexes

Gold thiolates are an extremely important class of gold compounds that have found several applications. In medicine, they are well known for their antiarthritic, antitumoral, and antimicrobial activities.^{101–105,2764} The commercial myocrisin, allochrysin, solganol, or auranofin are among the most important antiarthritic compounds. In addition, solganol has *in vitro* inhibitory effects on human immunodeficiency virus (HIV) I,²⁷⁶⁵ and auranofin has been found to be highly cytotoxic to tumor cells and active against i.p. P388 leukemia.^{2766,2767} Gold(I) thiolates are contained in most “liquid golds” for the glass and ceramic industry,^{2768–2770} and also are important in the fields of nanoparticles, nanostructured films, modern electronics, and optoelectronics.^{2712,2771–2778}

Gold(I) thiolate complexes have different stoichiometries, the neutral $[\text{Au}(\text{SR})(\text{PR}_3)]$ complexes are very numerous and have been synthesized for a great variety of thiolate and tertiary phosphine ligands. The phosphine is usually PPh₃ (otherwise state) and the substituent R in the thiolate moiety can be Me (PMe₃),²⁷⁷⁹ Ph (PR₃¹ = PPh₃, TPA),^{2780–2784} 2,4,6-C₆H₂R₂³ (R² = Me, Et, Prⁱ),²⁶⁵³ C₆H₄NMe₂-4,²⁷⁸⁵ C₆H₄NMe₃⁺,²⁷⁸⁵ C₆H₄OMe-2 (PR₃¹ = PPh₃, TPA),^{2784,2786} C₆H₄NO₂-4,²⁷⁸⁷ C₆H₄Cl-2,²⁶⁵⁷ C₆Cl₅,²⁷⁸⁸ C₆H₄Cl-3,²⁷⁸⁴ 3,5-C₆H₃Cl₂ (TPA),²⁷⁸⁴ 2,3,4,6-tetra-*O*-acetyl-β-D-glucopyranoside (PR₃¹ = PET₃, tris(1-ethyl-2-isopropylimidazol-5-yl)phosphine),^{2789,2790} C₆H₄CO₂H-2 (PR₃¹ = PPh₃, PCy₃),^{993,2791–2793} C₆H₄CO₂H-3 (PR₃¹ = PPh₃, PCy₃),²⁷⁹⁴ C₆H₄CO₂H-4 (PR₃¹ = PPh₃, PET₃, PPh₂Py),²⁷⁹⁵ 2-Py-3-CO₂H,⁹⁹⁴ 1-methylimidazole (PCy₃),²³⁶⁵ purine-6-thiolate (PR₃ = PPh₃, P(*o*-Tol)₃),^{2796,2797} Py (PPh₃, PPh₂Py, methyl-4,6-*O*-benzylidene-3-deoxy-3-diphenylphosphino-α-D-altropyranoside),^{2507,2798,2799} pyrimidine-2-thiolate (methyl-4,6-*O*-benzylidene-3-deoxy-3-diphenylphosphino-α-D-altropyranoside),^{2799,2800} Si(OR²)₃ (R² = Prⁱ, Bu^s, Bu^t),²⁶⁷⁴ 6-R²-thiouracilato (R² = Prⁿ, Me; PR₃ = PCy₃, PET₃),^{2797,2802,2803} C₆F₅,²⁸⁰⁴ 2-benzoxazolethiolate,²⁸⁰⁵ quinoline-8-thiolate,^{2787,2806} 2-thiouracilo,^{739,2807} 8-thiotheophyllinato,²⁸⁰⁸ 1-R²-1,2,3,4-tetrazole-5-thiolate (R² = Me, Ph),¹⁸¹⁹ C₆H₄SnBu^tCl-2,²⁸⁰⁹ CR₂CO₂R² (R² = H, Me),²⁸¹⁰ SiPh₃,²⁷⁴⁰ 2-thiothiazoline,²⁸¹¹ 2,5-dihydro-2,2,5,5-tetrakis(trifluoromethyl)-4-thiazolylthio,²⁸¹² 3-(ethoxycarbonylsulfanyl)-5,6-dihydro-1,4-dithiine-2-thiolate,²⁸¹³ 4-(methylthio)-2-thioxo-1,3-dithiole-5-thiolate,⁹⁹⁵ 5-amino-1,3,5-thiadiazole-2-thiolate (PR₃¹ = PPh₃, PMe₃),²⁸¹⁴ C(OR²)=NPh (R² = Me, Et; PR₃ = PPh₃, PCy₃),²⁸¹⁵ FeCH=N(CH₂)₂,²⁸¹⁶ 4-oxo-2-thiopyrimidines (PPh₃, PPh₂Me, AsPh₃),²⁸¹⁷ 1-thiolate-1,2-dicarba-*closo*-dodecaborane (PPh₃, PPh₂Me, AsPh₃),²⁸¹⁸ pyridine-1-oxide-2-thiolate,²⁸¹⁸ 4-amino-2-pyrimidine-thiolate,²⁸²⁰ or C₅Cl₄Mn(CO)₃.²⁸²¹ Thiolate complexes with isocyanide ligands of the type $[\text{Au}(\text{SC}_6\text{H}_4\text{CO}_2\text{H})(\text{CNR}^1)]$, $[\text{Au}(\text{SPy})(\text{CNR}^1)]$, $[\text{Au}(\text{SQuin})(\text{CNR}^1)]$

(Quin = quinoline; $R^1 = \text{Bu}^t$, Mes), or $[\text{Au}(\text{SPh})\{\text{CN}(\text{CH}_2)_n\text{Et}\}]$ ($n = 3, 4$) have also been synthesized.^{2822–2824} Many of these complexes are known to aggregate via intermolecular aurophilic contacts or intermolecular gold–sulfur coordination ($\text{Au}\cdots\text{S}$) depending on the electronic or steric nature of the substituents; with other substituents such as $\text{C}_6\text{H}_4\text{CO}_2\text{H}$ hydrogen bonding is also possible. These interactions lead to interesting supramolecular structures often associated with intriguing photophysical properties. In Figure 22 are collected several thiolate gold(I) complexes with different secondary interactions.

Further aggregation of gold atoms around the thiolate group is possible and then many complexes of stoichiometry $[\text{RS}(\text{AuPR}_3)_2]^+$ or the four-coordinated $[\text{MeS}(\text{AuPMe}_3)_3]^{2+}$ (**484**) have been obtained. The structure of the dinuclear complex also depends on the substituent of the thiolate group and could be monomers or dimers through $\text{Au}\cdots\text{Au}$ interaction. They have been prepared for thiolate groups such as SMe ,²⁷⁷⁹ SPh (**485**),^{2782,2825,2826} $\text{SPh}(\text{PPh}_2\text{OH})$,²⁵⁸⁹ $\text{S}(p\text{-Tol})$,²⁸²⁷ $\text{SC}_6\text{H}_4\text{CO}_2\text{H-4}$,²⁷⁹⁵ $\text{SC}_6\text{H}_4\text{CO}_2\text{H-2}$,²⁸²⁸ SCH_2Ph ,^{1813,2828} 4-amino-2-pyrimidinethiolate,²⁸²⁰ quinoline-8-thiolato,²⁸⁰⁶ $\text{SC}_6\text{H}_4\text{NH}_2\text{-2}$,²⁸²⁹ $\text{S}(\text{CH}_2)_2\text{OH}$,²⁸³⁰ $\text{SC}_2\text{B}_{10}\text{H}_{10}\text{Me}$,²⁸¹⁸ or SBU^t .²⁸³¹ In the complex $[\text{HOCH}_2\text{CH}(\text{OH})\text{CH}_2\text{S}\{\text{Au}_2(\text{PPh}_3)_3\}]\text{BF}_4$ there are a linear gold(I) atom and a three-coordinated one.²⁸³²

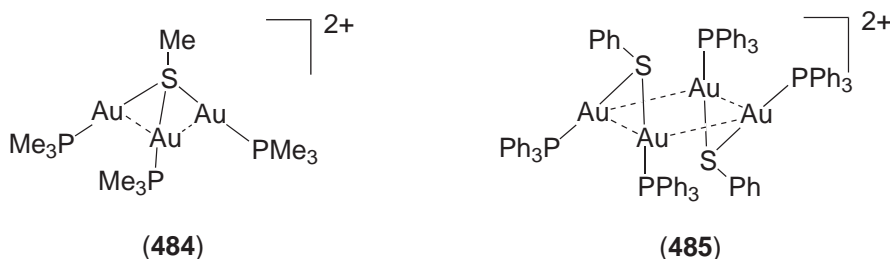

Gold(I) diphosphine ligands of the type $[\text{Au}_2\text{X}_2(\mu\text{-P-P})]$ react with thiols to give dinuclear complexes such as $[\text{Au}_2(\text{S}p\text{-Tol})_2(\mu\text{-P-P})]$ ($\text{P-P} = \text{dppe}$, dppp , dppb , $\text{Ph}_2\text{P}(\text{CH}_2)_5\text{PPh}_2$, dppf),^{2596,2833,2834} $[\text{Au}_2(\text{SMe})_2\{\mu\text{-}(\text{PPh}_2\text{CH}_2)_2\text{C}_6\text{H}_4\}]$,²⁵⁸⁴ $[\text{Au}_2(\text{SPh})_2(\mu\text{-P-P})]$ ($\text{P-P} = (\text{PPh}_2\text{O})_2\text{C}_6\text{H}_4$, dppf , $\text{Ph}_2\text{PCH}=\text{CHPPh}_2$),^{2589,2834,2835} $[\text{Au}_2(\text{SC}_2\text{B}_{10}\text{H}_{10}\text{Me})_2(\mu\text{-dppe})]$,²⁸¹⁸ $[\text{Au}_2(\text{SC}_6\text{F}_5)_2(\mu\text{-dppf})]$,¹⁸¹⁵ $[\text{Au}_2(2\text{-Spym-4-NH}_2)_2(\mu\text{-P-P})]$ ($\text{P-P} = \text{dppf}$, dppm (**486**)),²⁸²⁰ $[\text{Au}_2(\text{SR})_2(\mu\text{-P-P})]$ ($\text{SR} = 2\text{-amino-5-thiolate-1,3,4-thiadiazolate}$; $\text{P-P} = \text{dppm}$, dppe , $\text{Ph}_2\text{PCH}=\text{CHPPh}_2$),²⁸¹⁴ $[\text{Au}_2(\text{S-benzo}[15]\text{crown-5})_2\{\mu\text{-}(\text{PR}_2)_2\text{CH}_2\}]$ ($\text{R} = \text{Ph}$ (**487**), Cy),²⁸³⁶ $[\text{Au}_2(\text{SQuin})_2(\mu\text{-P-P})]$ ($\text{P-P} = \text{dppp}$, dppb),²⁸³⁷ $[\text{Au}_2(\text{SC}_6\text{H}_4\text{CO}_2\text{H-4})_2(\mu\text{-P-P})]$ ($\text{P-P} = \text{dppb}$, dppf),²⁷⁹⁵ $[\text{Au}_2(\text{SC}_6\text{H}_4\text{-CO}_2\text{H-2})_2(\mu\text{-dppe})]$,²⁸³⁸ or $[\text{Au}_2(\text{SC}_6\text{H}_4\text{F-4})_2\{\mu\text{-}(\text{PPh}_2)_2\text{NPh}\}]$.²⁸³⁹ A tetranuclear derivative $[\text{Au}_4(\mu\text{-S}p\text{-Tol})_2(\mu\text{-dppe})_2]$ has also been obtained.²⁸²⁷ The complex $[\text{Au}_2(\text{SC}_6\text{F}_5)_2(\mu\text{-ddpf})]$ can react further with $[\text{Au}(\text{OTf})(\text{PPh}_3)]$ to give the four-coordinate sulfur species $[\text{Au}_4(\text{SC}_6\text{F}_5)_2(\mu\text{-ddpf})(\text{PPh}_3)_2](\text{OTf})_2$ (**488**).¹⁸¹⁵ In the complexes $[\text{Au}_2(\text{S-benzo}[15]\text{crown-5})_2\{\mu\text{-}(\text{PR}_2)_2\text{CH}_2\}]$ the gold–gold separation is large, but the addition of K^+ ions produces a sandwich complex with the crownether, and then force the formation of a $\text{Au}\cdots\text{Au}$ interaction. This formation is clearly detected by the electronic spectra where a change in the luminescence properties is observed.

Other types of complexes are those in which the thiolate ligand bridges the gold atoms as in $[\text{Au}_2(\mu\text{-SMe})\{\mu\text{-}(\text{PPh}_2\text{CH}_2)_2\text{C}_6\text{H}_4\}]^+$ (**489**),²⁵⁸⁴ or $[\text{Au}_2(\mu\text{-SC}_6\text{F}_5)(\mu\text{-dppf})]$, the latter crystallizes as dimers through aurophilic interactions.¹⁸¹⁵ Tri- and tetraphosphine gold(I) complexes also react

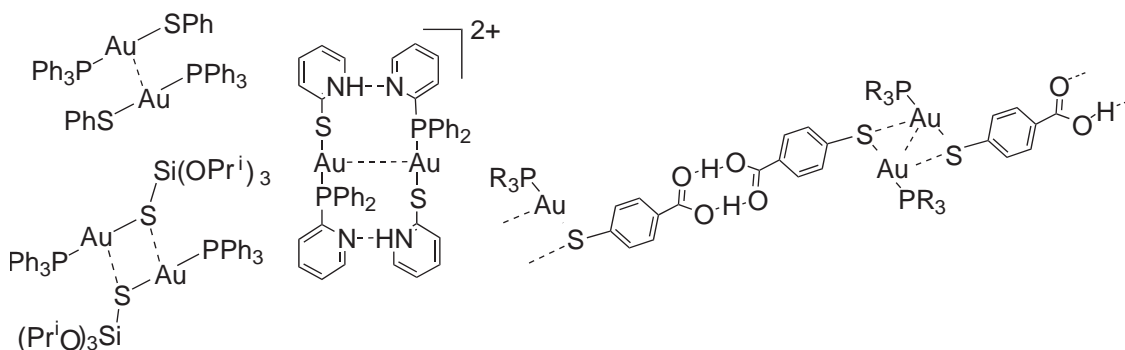
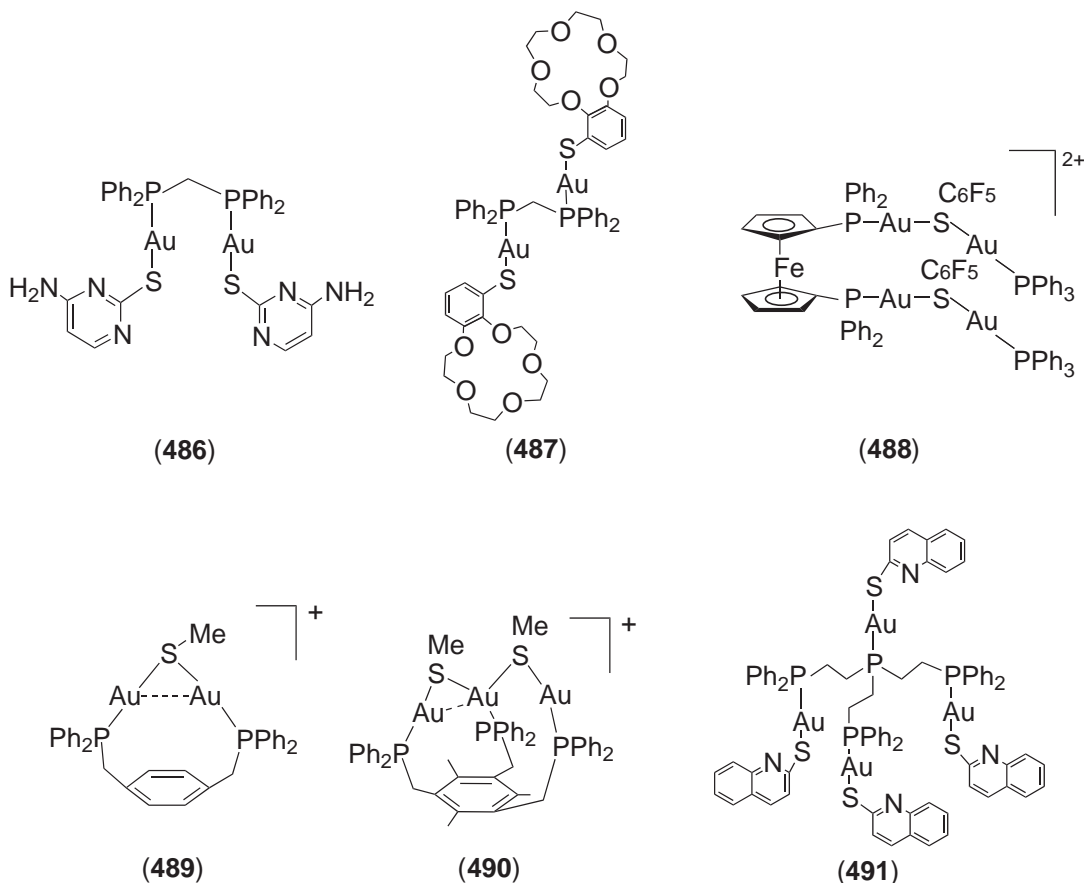
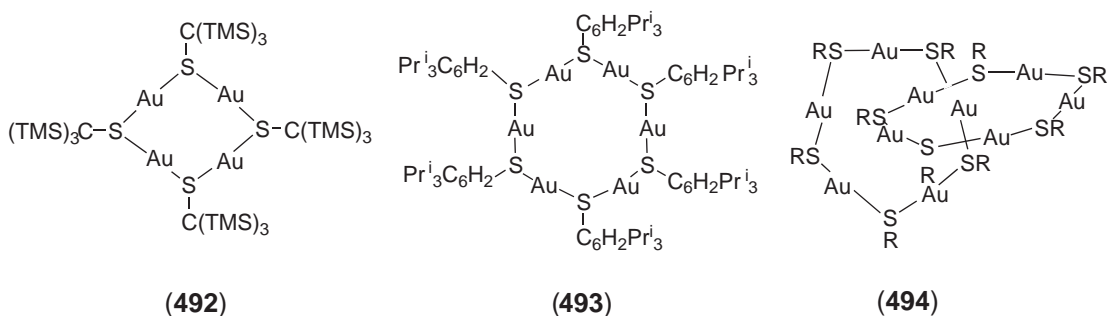

Figure 22 Some thiolate gold(I) complexes with several secondary interactions.

with thiols to give trinuclear $[\text{Au}_3(\text{SR})_3\text{P}_3]$ ($\text{SR} = \text{STol}, \text{SQin}$) or $[\text{Au}_3(\mu\text{-SMe})_2\text{P}_3]^+$ (**490**) ($\text{P}_3 = 1,3,5\text{-tris}[(\text{diphenylphosphanyl)methyl}] \text{trimethylbenzene}, \text{Ph}_2\text{P}(\text{CH}_2)_2\text{PPh}(\text{CH}_2)_2\text{PPh}_2$),^{1765,2840} or tetranuclear $[\text{Au}_4(\text{SQin})_4\text{P}_4]$ (**491**) ($\text{P}_4 = \text{tris}(2\text{-diphenylphosphinoethyl})\text{phosphine}$).²⁸³⁷



Polymeric thiolate compounds $[\text{Au}(\text{SR})_n]$ are usually insoluble and only a limited number have been characterized as the cyclic rings $[\text{Au}_4\{\text{SC}(\text{TMS})_3\}_4]$ (**492**),²⁸⁴¹ $[\text{Au}_4\{\text{SSi}(\text{OBU}^t)_3\}_4]$,²⁸⁴² $[\text{Au}_6\{\text{S}(2,4,6\text{-C}_6\text{H}_2\text{Pr}^i)_3\}_6]$ (**493**),^{2843,2844} or the catenane $[\text{Au}_{10}(\text{SC}_6\text{H}_4\text{-}p\text{-CMe}_3)_{10}]$ (**494**).²⁸⁴⁵



Anionic homoleptic thiolate compounds of the type $[\text{Au}(\text{SR})_2]^-$ have been obtained with $\text{SR} = \text{benzoxazole-2-thiolate}$ (**495**),²⁸⁴⁶ $\text{pyrimidine-2-thiolate}$,²⁸⁴⁶ $2,3,4,6\text{-tetra-}O\text{-acetyl-1-thiolate-}\beta\text{-D-glucopyranosate}$,²⁸⁴⁶ 2-thiouracilate ,²⁸⁴⁶ $2,3\text{-dihydro-benzimidazole-2-thiolate}$,²⁸⁴⁶ $\text{SCH}(\text{CO}_2\text{H})\text{CH}_2\text{CO}_2\text{H}$,²⁸⁴⁶ $\text{SCH}_2\text{CH}_2\text{OH}$,²⁸⁴⁶ $\text{SCMe}_2\text{CH}(\text{CO}_2^-)\text{NH}_3^+$,^{2846,2847} $\text{SC}_6\text{H}_4\text{R}$ ($\text{R} = \text{H}, o\text{-Me}, o\text{-OMe}, o\text{-Cl}, m\text{-Me}, m\text{-OMe}, m\text{-Cl}, p\text{-Me}, p\text{-OMe}, p\text{-Cl}$),²⁸⁴⁸ $\text{SC}_6\text{H}_4\text{CO}_2\text{H-}2$,²⁸⁴⁹ $\text{SC}_6\text{H}_4\text{CO}_2\text{H-}4$,²⁷⁹⁵ $2\text{-dimethylaminothiosquarato}$,^{985,986} $\text{SC}_2\text{B}_{10}\text{H}_{10}\text{Me}$,²⁸¹⁸ $\text{triazolium-thiolates}$ (**496**),²⁸⁵⁰ $\text{SC}_6\text{H}_4(\text{SnClBu}^t_3\text{-}2)$,²⁸⁰⁹ SPh ,²⁸⁵¹ SCN_4Ph ,¹⁸¹⁹ $\text{S}(2,4,6\text{-C}_6\text{H}_2\text{Pr}^i)_3$,²⁸⁴² or $\text{S}(\text{adamantyl})$.⁹⁷³ The compound $[\text{Au}(\text{SPyCO}_2\text{H-}6)(\text{SPyHCO}_2\text{H-}6)]$ shows antimicrobial activity against bacteria, moulds, and yeasts.¹⁴²⁴ The ammonium salts of the 2:1 thiomalate-gold (**497**) complexes have

been described and the structure of both racemic and optically pure samples have been described.²⁸⁵² The structure of the antiarthritic drug gold thiomalate (myochrysin) has been solved and crystallized as a mixed sodium/cesium salt $\text{Na}_2\text{Cs}[\text{Au}_2\text{L}(\text{LH})]$. It is a polymer in the solid state that consists of two interpenetrating spirals, with approximate four-fold symmetry.²⁸⁵³ The only gold(I) compounds which contains the SH^- ligand are the complex $[(\text{PPh}_3)_2\text{N}][\text{Au}(\text{SH})_2]$ which has been obtained by reaction of $[(\text{PPh}_3)_2\text{N}][\text{Au}(\text{ACAC})_2]$ with a CH_2Cl_2 solution saturated with H_2S ,²⁸⁵⁴ and the species $[\text{AuR}(\text{SH})]^-$ ($\text{R} = \text{C}_6\text{F}_5$, $\text{C}_6\text{H}_4\text{NO}_2$ -2, 2,4,6- $\text{C}_6\text{H}_2(\text{NO}_2)_3$).²⁸⁵⁵ Other anionic thiolate gold(I) complexes of the form $[\text{AuX}(\text{SR})]^-$,^{2818,2848,2850} or $[\text{Bu}^t\text{S}(\text{AuCl})_3]^-$,¹⁸²³ have also been reported. The complexes $\text{Bu}_4\text{N}[\text{Au}(\text{SC}_6\text{H}_4\text{R})_2]$ show luminescence in the solid state, the emission maxima ranges from 438 nm (blue emission) to 529 nm (green emission).²⁸⁴⁸

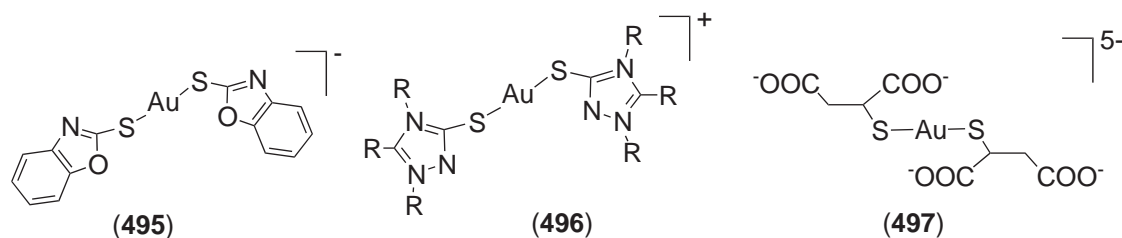

Gold(I) complexes with selenolates and tellurolates are far less numerous, with selenium compounds of the type $[\text{Au}(\text{SeR})(\text{PPh}_3)]$ ($\text{R} = \text{Ph}$, naphthyl),^{2856,2857} $[\text{RSe}(\text{AuPR}_3)_2]^+$ ($\text{R} = \text{Ph}$, $\text{C}_6\text{F}_4\text{Cl}$, CH_2Ph , naphthyl, $\text{C}_6\text{H}_4\text{NH}_2$ -4, $\text{C}_6\text{H}_4\text{Cl}$ -4; $\text{PR}_3 = \text{PPh}_3$, PPh_2Me , PPhMe_2),²⁸⁵⁶⁻²⁸⁵⁹ or $[\text{Au}_2(\text{SePh})_2(\mu\text{-P-P})]$ ($\text{P-P} = \text{dppm}$, dppe) (498),²⁸⁵⁷ or the heterodinuclear $[\text{WCp}(\text{CO})_3\text{Se}(\text{CH}_2\text{TM-S})\text{AuPPh}_3]\text{SbF}_6$,²⁸⁶⁰ have been reported. For tellurium only the compounds $[\text{Au}_4\{\text{TeC}(\text{TMS})\}_4]$ (499), $[\text{Au}\{\text{TeC}(\text{TMS})_3\}(\text{PPh}_3)]$, and $[(2,4,6\text{-Ph}_3\text{C}_6\text{H}_2\text{Te})(\text{AuPPh}_3)_2]^+$ (500) have been synthesized and characterized structurally.^{2841,2861} All the compounds have similar structures to those found with the thiolate ligands.

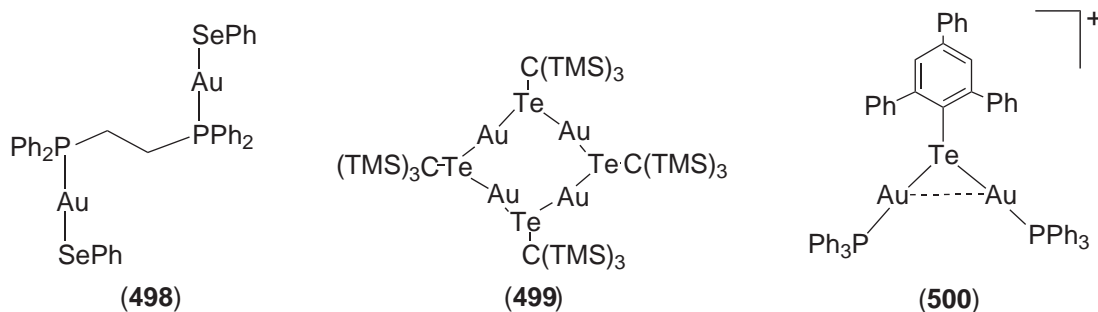

Several bioinorganic studies on thiolate gold(I) complexes have been carried out, as, for example, the study of reactions of gold(0) with amino acids,²⁸⁶² interaction of antiarthritic thiolates with albumin,^{2863,2864} determination of gold levels in rats after topical application,²⁸⁶⁵ competition of thiols and cyanide for gold(I),²²⁹⁵ reactions of auranofin in aqueous hydrochloric acid, exchange reactions with SeCN^- or tu ,²⁸⁶⁶⁻²⁸⁶⁸ or Mössbauer spectra of antiarthritic gold drugs.²⁸⁶⁹

(ii) Sulfide, selenide, telluride, and polychalcogenide gold(I) complexes

In aqueous solutions of polysulfides, gold salts form thio- or polysulfidoaurates(I); the thioaurates $[\text{AuS}]^-$, $[\text{AuS}_2]^{3-}$, and the trisulfidoaurate(I) $[\text{AuS}_3]^-$ were reported many years ago.²⁸⁷⁰ The cyclic polysulfide $\text{Ph}_4\text{As}[\text{AuS}_9]$ (501) has been prepared by reaction of $\text{K}[\text{Au}(\text{CN})_2]$ and tetraphenylarsonium polysulfide.²⁸⁷¹ Depending on the sulfur content of the polysulfide solution, salts of the cyclic anion $[\text{Au}_2\text{S}_8]^{2-}$ are also obtained.²⁸⁷² The cubane-like thioaurate $(\text{Ph}_4\text{As})_4[\text{Au}_{12}\text{S}_8]$ (502) can be prepared by treatment of the gold sulfides Au_2S , Au_2S_3 , and $[\text{AuCl}_4]^-$ in aqueous solutions of Na_2S , followed of addition of Ph_4AsCl .²⁸⁷³ The mixed $(\text{Me}_4\text{N})_2[\text{Au}_2(\text{S}_2\text{Te}=\text{S})_2]$ has also been described.¹⁰⁴¹ The reaction of AuCN with Na_2Se_5 gives the compound $[\text{Au}_2\text{Se}_2(\text{Se}_4)_2]^{2-}$, where oxidation to gold(III) has been produced,²⁸⁷⁴ but with other polyselenides as Na_2Se_3 or K_2Se_4 the gold(I) compounds $[\text{Au}_2(\text{Se}_2)_2(\text{Se}_3)]^{2-}$ or

$[\text{Au}_2(\text{Se})_2(\text{Se})_4]^{2-}$ (**503**) are obtained.²⁸⁷⁵ The reaction of AuCN with Na_2Se gives a cubane similar to that of sulfur $\text{Na}(\text{Et}_4\text{N})_3[\text{Au}_{12}\text{Se}_8]$ but with the sodium atom in the center of the cube.²⁸⁷⁶

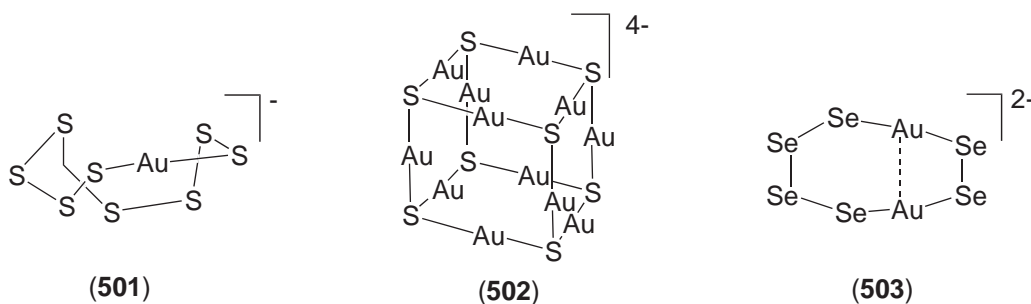

Gold-tellurium polyanions have been prepared from the extraction of ternary K—Au—Te alloys. By heating a 5% excess of K with AuTe_2 a material of the composition K_3AuTe_2 is obtained. The treatment with Ph_4PBr in methanol y dimethylformamide gives the compounds $(\text{Ph}_4\text{P})_4[\text{KAu}_9\text{Te}_7]$ (**504**) or $(\text{Ph}_4\text{P})_2[\text{K}_2\text{Au}_4\text{Te}_4(\text{DMF})_2(\text{MeOH})_2]$. Dissolving the alloy KAuTe in ethylenediamine the compound $(\text{Ph}_4\text{P})_2[\text{K}_2\text{Au}_4\text{Te}_4(\text{en})_4]$ (**505**) is obtained.²⁸⁷⁷ By several extractions with ethylenediamine of ternary and quaternary alloys the compound $[(\text{Ph}_3\text{P})_2\text{N}][\text{Au}_2\text{Te}_4]$ has been isolated.²⁷⁷⁸ Another approach to gold(I) polytellurides is the reaction of AuCN with Te_n^{2-} which gives $[\text{AuTe}_7]^{3-}$ (**506**) anions.^{2879,2880} The compound $[\text{Au}_3\text{Te}_4]^{3-}$ has been obtained by electrochemical synthesis.²⁸⁸¹

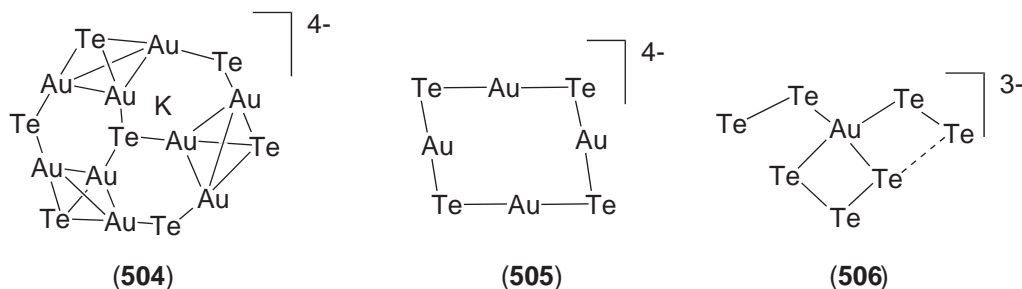

Polychalcogenides of the type $\text{K}_2\text{Au}_2\text{SnS}_4$,²⁸⁸² $\text{K}_2\text{Au}_2\text{Sn}_2\text{S}_6$,²⁸⁸² $(\text{Et}_4\text{N})_2[\text{Au}(\text{Ag}_{1-x}\text{Au}_x)_2\text{Sn}_2\text{Te}_9]$,²⁸⁸³ $(\text{Bu}_4\text{N})_3[\text{AuSn}_7\text{Te}_6]$,²⁸⁸⁴ $\text{K}_2\text{Au}_2\text{Ge}_2\text{S}_6$,²⁸⁸⁵ $\text{K}_2\text{Au}_2\text{Sn}_2\text{Se}_6$,²⁸⁸⁵ $\text{Cs}_2\text{Au}_2\text{SnS}_4$,²⁸⁸⁵ $\text{A}_3\text{AuP}_2\text{Se}_8$ (A = K, Rb, Cs),²⁸⁸⁶ $\text{A}_2\text{Au}_2\text{P}_2\text{Se}_6$ (A = K, Rb),²⁸⁸⁶ A_2AuPSe_4 (A = K, Rb, Cs),²⁸⁸⁶ AAuP_2Se_7 (A = K, Rb),²⁸⁸⁶ A_2AuES_4 (A = K, Tl; E = P, As),²⁸⁸⁷ $\text{KAu}_5\text{P}_2\text{S}_8$,²⁸⁸⁷ $\text{A}_2\text{Au}_2\text{Cd}_2\text{S}_4$ (A = Rb, Cs), or $\text{K}_2\text{Au}_4\text{CdS}_4$ ²⁸⁸⁸ have also been obtained.

Complexes with bridging sulfido ligands, such as $[\text{S}(\text{AuPEt}_3)_2]$ or $[\text{S}(\text{AuPPh}_3)_3]\text{Cl}$ were synthesized a long time ago by reaction of $[\text{AuBr}(\text{PET}_3)]$ with Na_2S or by treatment of $[\text{AuCl}(\text{PPh}_3)]$ with H_2S in ethanolic pyridine, respectively. $[\text{S}(\text{AuPPh}_3)_2]$ was claimed to be unstable or an intermediate in the synthesis of $[\text{S}(\text{AuPPh}_3)_3]\text{Cl}$.^{2889,2890} A high yield synthesis for $[\text{S}(\text{AuPPh}_3)_2]$ has been developed recently and involves the reaction of $[\text{AuCl}(\text{PPh}_3)]$ with Li_2S in ethanol.²⁸⁹¹ The corresponding selenide derivative $[\text{Se}(\text{AuPPh}_3)_2]$ is obtained in a two-step reaction from $[\text{AuCl}(\text{PPh}_3)]$ and selenourea followed by treatment with aqueous Na_2CO_3 .²⁸⁹² These complexes are excellent starting materials for the synthesis of highly aурated homoleptic sulfur- or selenium-centered derivatives. Similar μ_2 -bridging sulfido or selenido gold species have been obtained with diphosphines such as dppf (**507**),^{2893,2894} 1,4-bis[(diphenylphosphino)methyl]benzene (S),²⁵⁸⁴ or 2,5-bis[(diphenylphosphino)methyl]thiophene (S).⁷⁸⁶ In the structure of these complexes the main features are short $\text{Au}\cdots\text{Au}$ distances and an acute $\text{Au}-\text{S}-\text{Au}$ angle.²⁸⁹²⁻²⁸⁹⁶

Complexes with μ_3 chalcogenide ligands are known for sulfur, selenium, and tellurium. There are several methods for their synthesis, as, for example, the reaction of $[\text{AuX}(\text{PR}_3)]$ with $\text{E}(\text{SiR}_3)_2$ (E = S, Se, Te), addition of $[\text{AuX}(\text{PR}_3)]$ to $\text{E}(\text{AuPR}_3)_2$, or addition of a sulfur source to $[\text{O}(\text{AuPPh}_3)_3]^+$. Several complexes with different phosphine ligands, such as PPh_3 ,^{2717,2891,2897,2898} PPh_2Me ,²⁸⁹¹ PMe_3 ,²⁸⁹⁹ PPri_3 ,²⁸⁹⁹ PPhMe_2 ,²⁸⁹⁹ or methyl 4,6-*O*-benzylidene-3-deoxy-3-(diphenylphosphino)- α -D-altropyranoside (mbpa),²⁹⁰⁰ have been prepared. Another homoleptic compound with a triply bridging sulfido ligand is $(\text{Et}_4\text{N})_2[\text{S}\{\text{Au}(\text{C}_6\text{F}_5)\}_3]$, obtained by bubbling H_2S through a solution of $\text{Et}_4\text{N}[\text{Au}(\text{C}_6\text{F}_5)\text{Cl}]$.²⁸⁵⁵ Only the complexes with

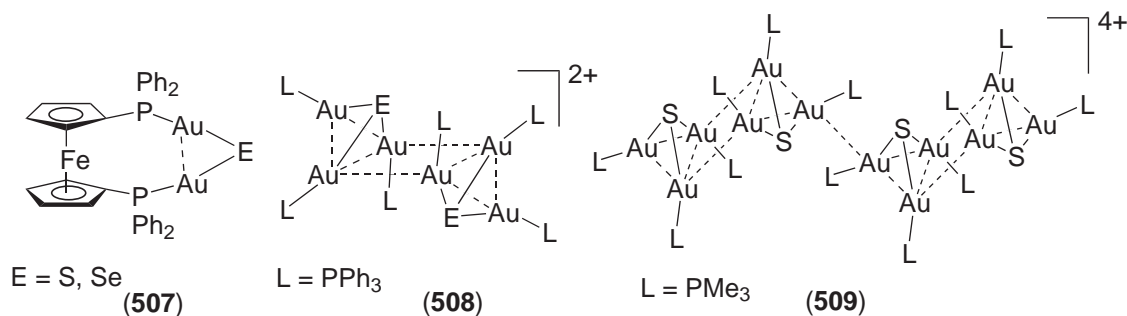

PPh_3 have been obtained for the selenido and tellurido complexes.^{2895,2901} The structure of these complexes resembles those of the trigold oxonium cation. Furthermore, it becomes increasingly obvious that steric and electronic effects play a decisive role in the strength of the $Au \cdots Au$ interaction and the supramolecular aggregation of the chalcogen-centered cations. The basic structural framework consists of a trigonal pyramidal EAu_3 with the chalcogen atom in the apical position and short gold–gold contacts in the base of the pyramid. However, the size of the phosphine influences the further aggregation of the molecules. For the bulky PPr^i_3 or *mbpa* the structure is monomeric, for PPh_3 (508), PPh_2Me , or $PPhMe_2$ are dimers, and with PMe_3 the compound crystallizes as two monomeric units (A and B) which form dimers A_2 and B_2 , then this dimers aggregate forming a chain through a single $Au \cdots Au$ interaction (509).²⁸⁹⁹ Pseudopotential *ab initio* calculations on EAu_3^+ and $S(AuPH_3)^{3+}$ ($E = S, Se$) have been carried out and they reproduce closely the experimental values, if both correlation and relativistic effects are included.^{11,2894}

The complexes $[E\{Au_2(\mu-dppf)\}]$ ($E = S, Se$) also serves as building blocks for preparing polynuclear triply bridging chalcogenide complexes such as (510).^{2893,2894} The crystal structure of $[\{S(Au_2PPh_3)_2\}_2Au][SnMe_3Cl]$ (511) has been reported.²⁹⁰²

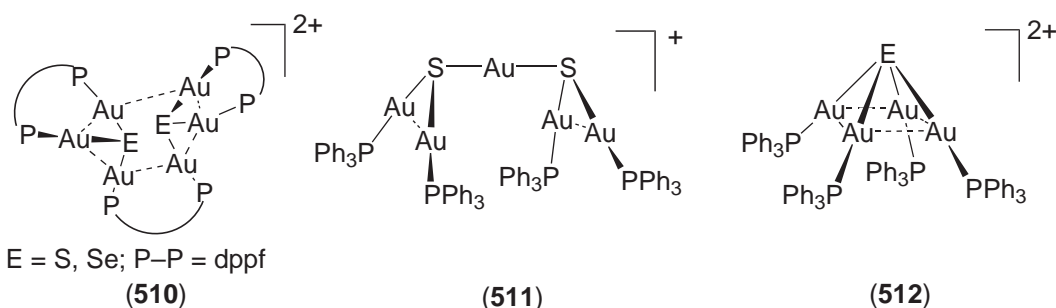

Further addition of $AuPPh_3^+$ fragments to $[E(AuPPh_3)_2]$ affords the complexes with a μ_4 -chalcogenide ligand, $[E(AuPPh_3)_4](OTf)_2$ (512) ($E = S, Se$). The structure corresponds to a square pyramid with the chalcogen atom at the apex and aurophilic bonding among the gold atoms at the base, that clearly contributes to the stability of the complexes.^{2903,2904}

Other quadruply bridging species have been obtained by reaction of $[E\{Au_2(\mu-dppf)\}]$ with two equivalents of $[Au(OTf)(PR_3)]$ or by addition of $[Au_2(OTf)_2(\mu-ddpf)]$ to give $[E\{Au_2(\mu-dppf)\}(AuPR_3)_2]^{2+}$ or $[E\{Au_2(\mu-dppf)\}_2]^{2+}$, respectively.^{2893,2894} Complexes with a μ_5 and μ_6 bridging chalcogenide ligands, $[E(AuPPh_3)_5](OTf)_3$ and $[E(AuPPh_3)_6](OTf)_4$ ($E = S, Se$), have been prepared by adding more $AuPPh_3^+$ fragments to the $[E(AuPPh_3)_2]$ complexes.^{2891,2894} Unfortunately these complexes could not be characterized by X-ray crystallography.

High-nuclearity gold(I) sulfide complexes with bridging diphosphine ligands have been synthesized by bubbling H_2S through ethanol/pyridine solutions of $[Au_2Cl_2(\mu-P-P)]$.^{2905–2907} They have the general formula $[Au_{10}(\mu_3-S)_4\{\mu-(PPh_2)_2NR\}_4]X_2$ ($R = \text{alkyl or aryl}; X = PF_6 \text{ or } ClO_4$), $[Au_{12}(\mu_3-S)_4(\mu-dppm)_6]X_4$ (513), or $[Au_6(\mu_3-S)_2\{\mu-(PPh_2)_2NR\}_3]X_2$ ($R = \text{alkyl or aryl}; X = PF_6 \text{ or } ClO_4$). These compounds display rich luminescence properties; intense green and orange emissions were observed upon excitation at $\lambda > 350 \text{ nm}$ both in the solid state and in solution.^{2905–2909} The selenium derivatives $[Au_{10}Se_4(\mu-dppm)_4]^{2+}$ (514) and $[Au_{18}Se_8(\mu-dppe)_6]^{2+}$ have been obtained by reaction of $[Au_2X_2(\mu-P-P)]$ with $Se(TMS)_2$.²⁹¹⁰

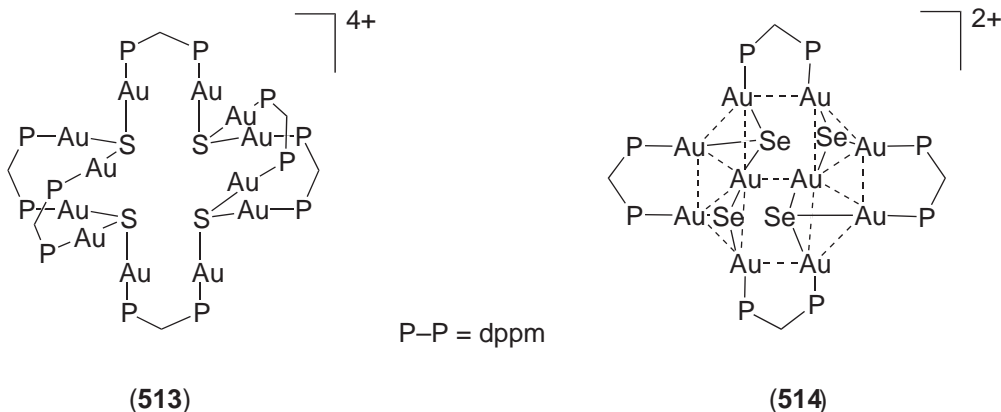

Heteropolynuclear complexes with bridging chalcogenide ligands have also been synthesized, as those obtained by reaction of $[\text{Pt}_2(\mu\text{-S})_2(\text{PPh}_3)_4]$ with gold(I) complexes, to give species such as $[\text{Pt}_2(\mu\text{-S})_2(\text{AuPPh}_3)(\text{PPh}_3)_4]^+$,²⁹¹¹⁻²⁹¹³ $[\text{Pt}_2(\mu\text{-SAuCl})_2(\text{PPh}_3)_4]$,²⁹¹² or $[\text{Pt}_2(\mu\text{-S})_2\{\text{Au}_2(\text{P-P})\}(\text{PPh}_3)_4]^{2+}$ (515) (P-P = dppm, dppf).²⁹¹³ Other complexes are $[\text{Pt}_2(\text{PPh}_3)_3(\text{CO})(\mu_3\text{-S})(\text{AuPPh}_3)]^+$ (516),²⁹¹⁴ the silver(I) derivative $[\{\text{S}(\text{AuPPh}_3)_3\}_2\text{Ag}(\text{THF})]^{3+}$,¹⁰³² or the manganese compound $[\text{Mn}_2(\mu\text{-SAuPPh}_3)(\text{CO})_6(\mu\text{-dppm})]$.²⁹¹⁵ The selenium complex $[\text{Pd}_2\text{Au}_2\text{Se}_2(\text{SeH})_2(\text{PPh}_3)_4]$ (517)¹⁰³⁵ has also been obtained.

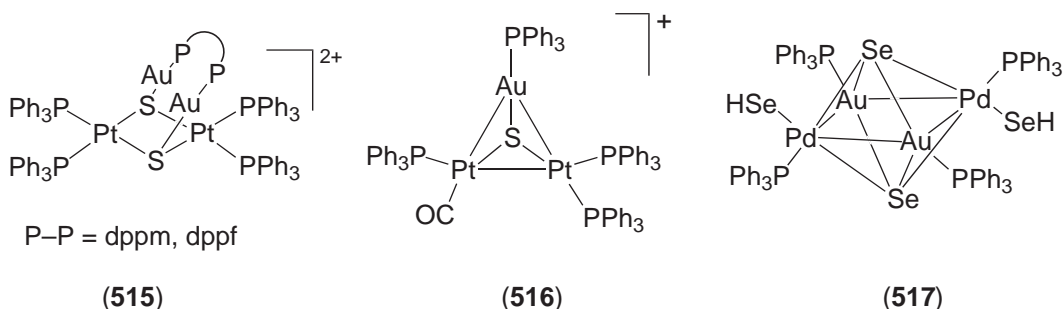

Other mixed metal sulfide or selenide compounds are those synthesized from MS_4^{2-} (M = Mo, W) and VS_4^{3-} anions and gold cations in the presence of various ligands. The reaction of MS_4^{2-} with $[\text{AuX}(\text{PR}_3)]$ gives the complexes $[\text{MS}_4(\text{AuPR}_3)_2]$ (M = Mo, W) in which the gold(I) atoms are three coordinate and have been characterized for $\text{PR}_3 = \text{PEt}_3$,²⁹⁰⁶ PPh_3 ,^{2917,2918} PPh_2Me ,²⁹¹⁹ AsPh_3 ,^{2920,2921} and PCy_3 .²⁹²² Asymmetric compounds are obtained with the ylide ligands $[\text{WS}_4(\text{AuCH}_2\text{PPh}_3)_2]$ (518),²⁹²⁰ or in the oxo-sulfide $[\text{MoOS}_3(\text{AuPPh}_3)\{\text{Au}(\text{PPh}_3)_2\}]$.²⁹¹⁷ Heteropolynuclear complexes such as $[\text{MS}_4(\text{AuPPh}_3)_3]\text{OTf}$ and $[\text{MS}_4(\text{AuPPh}_3)_4](\text{OTf})_2$ have been described.²⁹²³ The inorganic ring system $(\text{Ph}_4\text{P})_2[\text{Au}_2(\text{WS}_4)_2]$ (519) has been prepared from $(\text{NH}_4)_2[\text{WS}_4]$ and $\text{Na}_3[\text{Au}(\text{S}_2\text{O}_3)_2]$ in the presence of $(\text{PPh}_4)\text{Br}$,²⁹²⁴ the analogous with WOS_3^{2-} has also been obtained.²⁹²⁵ Another tungsten-gold derivative is $[\text{WCpS}_3(\text{AuPPh}_3)]$.¹⁰⁹³ The treatment of $(\text{NH}_4)_3\text{VS}_4$ with $[\text{AuCl}(\text{PPh}_3)]$ or $[\text{Au}(\text{PPh}_3)_2]\text{ClO}_4$ gives the heteropolynuclear species $[\text{VS}_4(\text{AuPPh}_3)_3]$ or $[\text{VS}_4(\text{AuPPh}_3)_2\{\text{Au}(\text{PPh}_3)_2\}]$ (520), respectively.²⁹²⁶ The selenium analogues $[\text{MSe}_4(\text{AuPR}_3)_2]$ (M = Mo, W; $\text{PR}_3 = \text{PPh}_3$, PPh_2Me),^{1074,2927,2928} $[\text{WSe}_4(\text{AuPPh}_3)\{\text{Au}(\text{PPh}_3)_2\}]$,²⁹²⁹ $\text{Ph}_4\text{P}[\text{MSe}_4(\text{AuPPh}_3)]$,²⁹³⁰ $(\text{Ph}_4\text{P})_2[\text{MSe}_4(\text{AuCN})_2]$ (521), or $(\text{Ph}_4\text{P})[\text{MSe}_4(\text{AuCN})]$ (M = Mo, W) have also been obtained.²⁹³⁰ With NbSe_4^{3-} the complexes $[\text{NbSe}_4(\text{AuPPh}_3)_2\{\text{Au}(\text{PPh}_3)_2\}]$ and $[\text{Nb}_2\text{Au}_2\text{Se}_4\text{Cl}_2(\text{PMe}_3)_6]$ have been reported.²⁹³¹ Some of these complexes with ME_4^{2-} (E = S, Se) have luminescent and nonlinear optical properties.^{1074,2922}

(iii) Gold(I) complexes with polydentate sulfur ligands

The most important and well-represented gold(I) complexes with polydentate sulfur ligands are dithiolate ligands. Gold(I) complexes with mnt have been synthesized by metathesis reactions and are of the type $[\text{Au}_2(\mu\text{-mnt})(\text{PR}_3)_2]$ ($\text{PR}_3 = \text{PPh}_3$ (522), PEt_3 , $\text{P}(\text{O}^i\text{Pr})_3$, PCy_3), $(\text{Bu}_4\text{N})[\text{Au}(\mu\text{-mnt})(\text{PR}_3)]$,

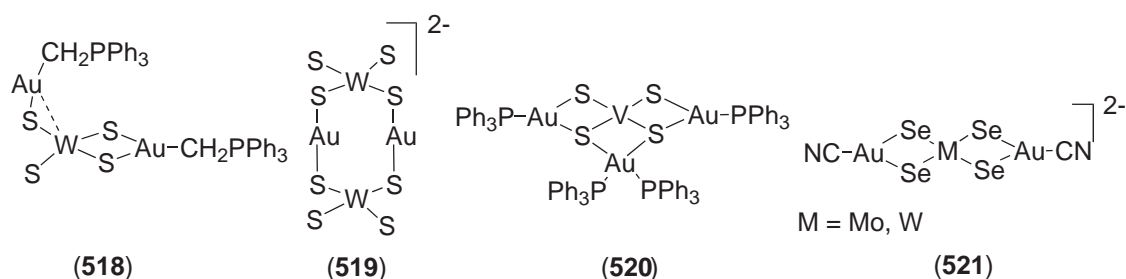

or $[\text{Au}_2(\mu\text{-mnt})(\mu\text{-dppm})]$.^{1845,2643,2932,2933} The structure consists of mononuclear three-coordinate species or dinuclear complexes with a bridging dithiolate ligand and $\text{Au}\cdots\text{S}$ or aurophilic interactions, except when bulky phosphines as PCy_3 are used. The complex $[\text{Au}_4\text{Cl}_2(\mu\text{-mnt})\{(\text{PPh}_2)_2(\text{CH}=\text{CH})\}]$ (**523**) has a gold(I) center coordinated to the dithiolate and the ethylene moiety.²⁹³⁴ With the ligand *i*-mnt, the dinuclear derivatives $[\text{Au}_2(\mu\text{-i-mnt})_2]^{2-}$ (**524**) present a luminescent behavior.^{1844,1999,2935}

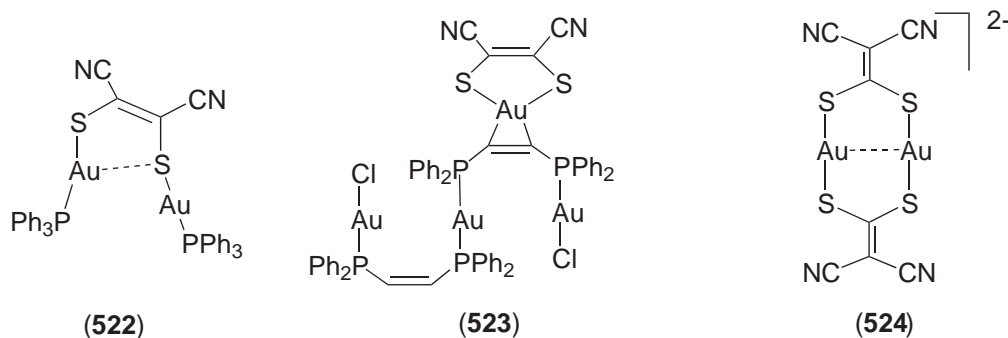

The reaction of $[\text{AuL}_3]\text{Cl}$ (L = phospatriazaadamantane) with $\text{K}_2(\text{i-mnt})$ gives a high luminescent tetranuclear compound (**525**) with an unsupported $\text{Au}\cdots\text{Au}$ interaction.²⁹³⁶ Other complexes are $[\text{Au}_2(\mu\text{-i-mnt})(\text{PPh}_3)_2]$ ^{2937,2938} or $[\text{Au}_2(\mu\text{-i-mnt})(\text{P-P})]$ (P-P = $\text{PR}_2(\text{CH}_2)_n\text{PR}_2$; R = Ph, $n = 1, 2, 3, 4$; R = Me, $n = 1, 2$; $\text{Ph}_2\text{AsCH}_2\text{AsPh}_2$, $\text{Ph}_2\text{PCH}=\text{CHPPh}_2$),^{2644,2939,2940} which has a similar structure to those with mnt, but with formation of a chain through aurophilic interactions, and $[\text{Au}(\text{PET}_3)_2][\text{Au}_3(\mu\text{-i-mnt})_2(\text{PET}_3)_2]$ (**526**).²⁹⁴¹ Similar complexes are obtained with the related 1,1-ethylenedithiolate ligands, 2,2-diacetyl- or 2,2-dibenzoyl-ethylene-1,1-dithiolate as, for example, (**527**), which have been synthesized by insertion of CS_2 on β -diketonate complexes.^{1872,1877} Heteropolynuclear complexes with the *i*-mnt ligand as the platinum–gold derivative $[\text{Pt}(\mu\text{-i-mnt})_2(\text{AuPPh}_3)_2]$ have been described.²⁹³³

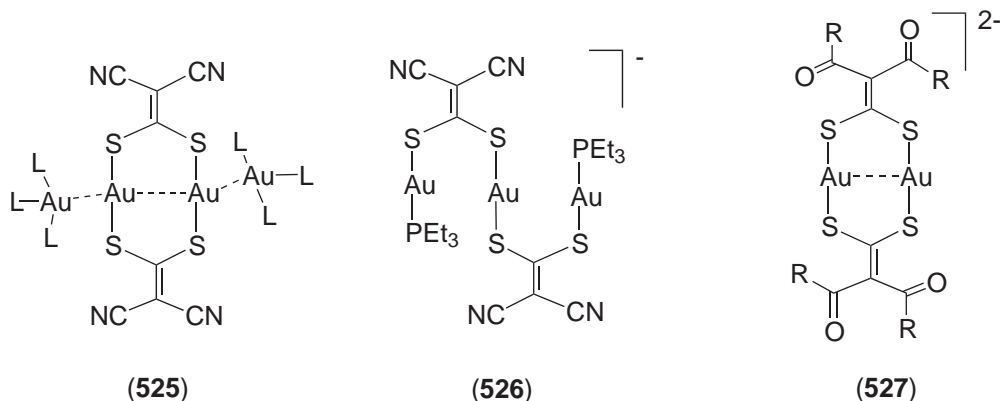

The ligands phenylene-1,2-dithiolate, or its 4-methyl derivative, have been thoroughly studied in their gold(I) complexes and di-, tri-, and tetranuclear derivatives have been prepared of the type

a–c (Figure 23).^{1849–1851,2643,2831,2932,2942–2945} Types a and b have been synthesized by reaction of the alkaline or ammonium salt with aurating agents such as $[\text{AuXL}]$ or $[\text{O}(\text{AuPR}_3)_3]^+$. Type c is obtained in the case of PET_3 where a partial loss of ligand leads to a vacancy in the coordination sphere of gold and formation of a cluster compound.

With the phenylene-1,3-dithiolate di- and trinuclear complexes have also been obtained.^{1850,2946} The trinuclear complex aggregates into 1D array through head-to-tail aurophilic contacts (**528**); a similar compound is obtained with the biphenylene-4,4-dithiolate. The phenylene-1,4-dithiolate affords tetranuclear derivatives of the form $[(p\text{-Tol}_3\text{PAu})_2\text{SC}_6\text{H}_4\text{S}(\text{Au}Pp\text{-Tol}_3)_2](\text{BF}_4)_2$ (**529**). Complexes of osmium, rhodium, or iridium with this ligands can further coordinate gold atoms to give heteropolynuclear species as (**530**).^{2947,2948}

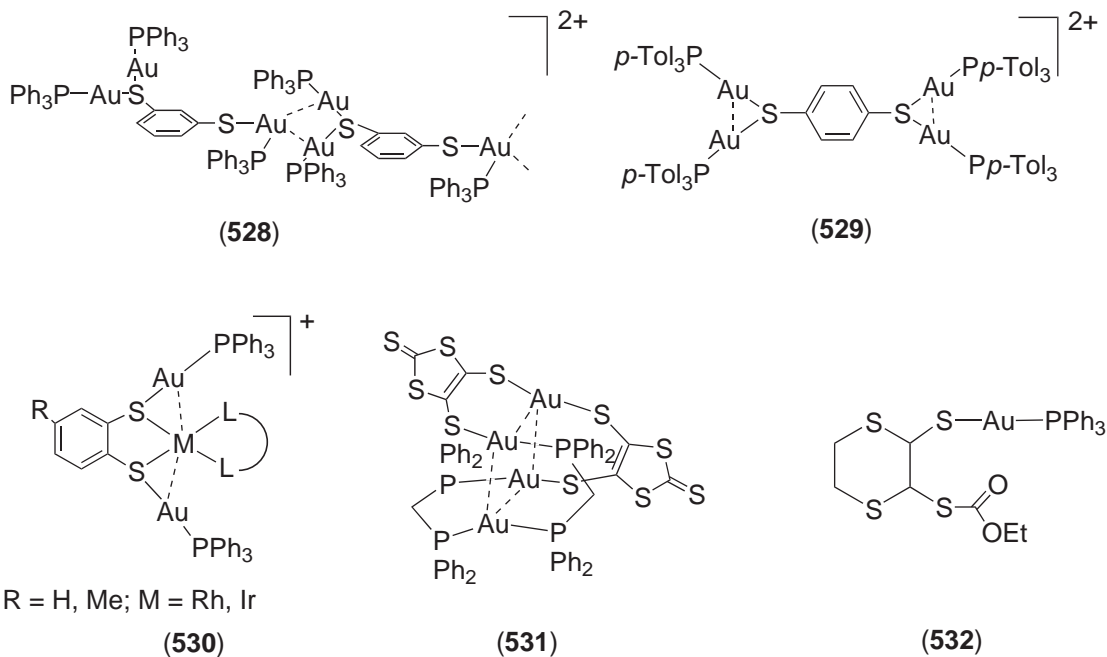

The ligands dmit yields compounds of the type $[\text{Au}_2(\text{C}_6\text{F}_5)_2(\mu\text{-dmit})]^{2-}$, $[\text{Au}(\text{dmit})(\text{PPh}_3)]^-$, $[\text{Au}_2(\mu\text{-dmit})(\text{PR}_3)_2]$, $[\text{Au}_2(\mu\text{-dmit})(\text{dppe})]$, $[\text{Au}_2(\mu\text{-dmit})(\text{L-L})]^-$ ($\text{L-L} = (\text{CH}_2)_2\text{PPh}_2$, S_2CNR_2), or $[\text{Au}_4(\text{dmit})_2(\text{dppm})_2]$ (**531**).^{1874,2949–2951} Similar complexes have been prepared with the 2-selenoxo-1,3-dithiole-4,5-dithiolate or 2-thione-1,3-dithiole-4,5-diselenolate derivatives.^{2952,2953} The reaction of 2,5,7,9-tetrathiaibicyclo[4.3.0]non-1(6)-en-8-one (TTBEO) with NaOR in the presence of $[\text{AuClI}]$ gives thiolene as (**532**) instead of the dithiolene species, the latter are obtained by transmetallation reactions through the zinc complex(I).²⁹⁵⁴

The 1,2-dithiolate-*o*-carborane ligand also yields di- and trinuclear derivatives, such as $[\text{Au}_2(\mu\text{-S}_2\text{C}_2\text{B}_{10}\text{H}_{10})(\text{PPh}_3)_2]$, $[\text{Au}_2(\mu\text{-S}_2\text{C}_2\text{B}_{10}\text{H}_{10})(\text{P-P})_2]$ ($\text{P-P} = \text{dppm}$, dppe , dppp , $\text{Ph}_2\text{PCH}=\text{CHPPh}_2$), $(\text{Bu}_4\text{N})_2[\text{Au}_2(\mu\text{-S}_2\text{C}_2\text{B}_{10}\text{H}_{10})_2]$, $(\text{Ph}_3\text{PMe})_2[\text{Au}_2(\mu\text{-S}_2\text{C}_2\text{B}_{10}\text{H}_{10})(\text{C}_6\text{F}_5)_2]$, or $[\text{Au}_3(\mu_3\text{-S}_2\text{C}_2\text{B}_{10}\text{H}_{10})(\text{PPh}_3)_3]\text{OTf}$ and the novel tetranuclear species $[\text{Au}_4(\text{S}_2\text{C}_2\text{B}_{10}\text{H}_{10})\{(\text{PPh}_2)_2\text{C}_2\text{B}_{10}\text{H}_{10}\}_2]$ (**533**).^{2955,2956} Long-chain thiolates have been used as building blocks for the synthesis of coordination

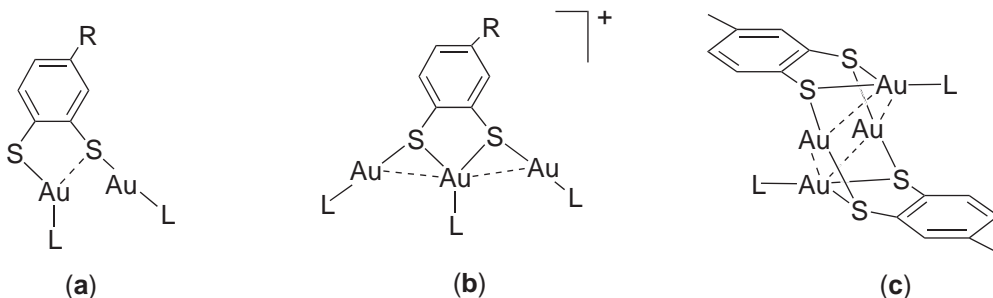
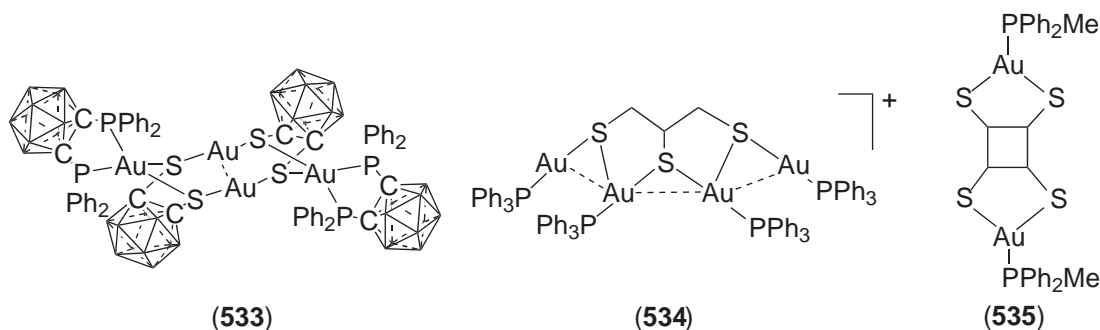
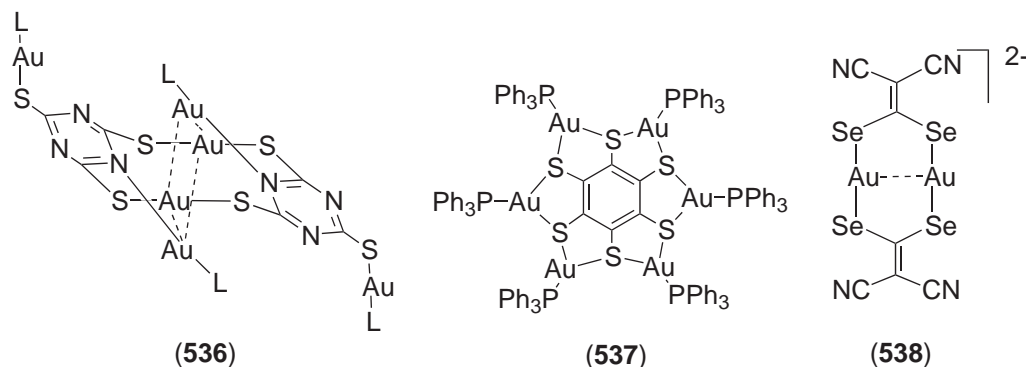

Figure 23 Some gold(I) complexes formed with $4\text{-RC}_6\text{H}_3\text{S}_2^-$ ligands; R = H, Me; L = PR_3 , CNR.

polymers; these are of the type $[\text{Au}_3\{\text{S}(\text{CH}_2)_2\text{S}\}(\text{PPh}_3)_3]^+$, $[\text{Au}_3\{\text{S}(\text{CH}_2)_3\text{S}\}(\text{PPh}_3)_3]^+$, $[\text{Au}_4\{\text{S}(\text{CH}_2)_n\text{S}\}(\text{PPh}_3)_4]^{2+}$ ($n=4, 5, 6$), $[\text{Au}_2\{\text{S}(\text{CH}_2)_n\text{S}\}(\text{PPh}_3)_2]$, $[\text{Au}_4\{\text{S}(\text{CH}_2)_2(\text{CHS})\}(\text{PPh}_3)_4]^+$ (534), $[\text{Au}_4\{\text{S}(\text{CH}_2)_2(\text{X})\}(\text{PPh}_3)_4]^{2+}$ ($\text{X}=\text{O}, \text{S}$), or $[(\text{AuPPH}_3)_2\text{SCH}_2\text{CH}(\text{CH}_2\text{OH})\text{S}](\text{AuPPH}_3)_2]^{2+}$.^{2829,2831,2943,2957} Mixed Au—Ag or Au—Cu complexes, $[\text{M}_4\text{Au}_2(\text{SCH}_2\text{CH}_2\text{S})_4]^{2-}$ ($\text{M}=\text{Cu}, \text{Ag}$), have been obtained with the ethane dithiolate ligand.¹¹⁸⁷ 1,3,4-Thiadiazole-2,5-dithiolate gives open-chain $[\text{Au}_2(\text{S-S})(\text{PR}_3)_2]$ or cyclic $[\text{Au}_2(\text{S-S})(\text{P-P})]$, that depending of the steric size of the phosphine, aggregate in strings with long $\text{Au}\cdots\text{S}$ bonds or a 2D network through auriphilic interactions.²⁹⁵⁸ The tetrathiosquarate ligand gives the three-coordinate compound $[\text{Au}_2(\text{S}_4\text{C}_4)(\text{PPh}_2\text{Me})_2]$ (535)²⁹⁵⁹ and the related dithiosquarate affords the dinuclear $[\text{Au}_2(\text{S}_2\text{O}_2\text{C}_4)]^{2-}$.¹⁸⁶⁸



Trithiocyanuric acid gives the trinuclear derivatives $[\text{Au}_3(\text{S}_3\text{C}_3\text{N}_3)\text{L}_3]$ ($\text{L}=\text{PPh}_3, \text{Bu}^t\text{NC}, \text{P}(\text{OMe})_3, \text{P}(\text{OPh})_3, \text{PCy}_3$), that by loss of one ligand L yields the hexanuclear species $[\text{Au}_6(\text{S}_3\text{C}_3\text{N}_3)\text{L}_4]$ (536) ($\text{L}=\text{PPhMe}_2, \text{Bu}^t\text{NC}$).^{2960,2961} The mononuclear compound $[\text{Au}(\text{S}_3\text{H}_2\text{C}_3\text{N}_3)(\text{PPh}_3)_3]$ has also been prepared.²⁹⁶² Benzenehexathiol reacts with $[\text{AuCl}(\text{PPh}_3)]$, in the presence of triethylamine, to yield the hexanuclear golden wheel $[\text{Au}_6(\text{S}_6\text{C}_6)(\text{PPh}_3)_6]$ (537).²⁹⁶³ The analogue compound with $\text{PPh}(\text{CH}=\text{CH}_2)$ further reacts with PPhH_2 , in the presence of α -azoisobutylnitrile, to give a macrocycle 36-membered ring.²⁹⁶⁴



Other dithiolate complexes are of the type $[\text{Au}_2(\mu\text{-S-S})(\mu\text{-P-P})]$ ($\text{P-P}=\text{dppf}, \text{dppm}$; $\text{S-S}=\text{S}(\text{CH}_2)_3\text{S}$),^{2643,2834} $[\text{Au}_2(\mu\text{-S-S})(\text{PPh}_3)_2]$ ($\text{S-S}=1,4\text{-diethyl-3,6-dithiopiperazine-2,5-dithiolate}$),²⁹⁶⁵ or those derived of the partially methylated dithiolates $[\text{Au}(\text{dmitMe})(\text{PPh}_3)]$ or $[\text{Au}(\text{mnt-Me})(\text{PPh}_3)_2]$.⁹⁹⁵ Diselenolate gold(I) derivatives are not numerous and only the analogues to dmit and *i*-mnt with selenium have been synthesized as $(\text{Bu}_4\text{N})_2[\text{Au}_2\{\mu\text{-Se}_2\text{C}=\text{C}(\text{CN})_2\}_2]$ (538).²⁹⁶⁶

Heteropolynuclear complexes are obtained in the reaction of the S-bridged $\text{Co}^{\text{III}}\text{Ni}^{\text{II}}\text{Co}^{\text{III}}$ trinuclear complex, $\text{C}_2\text{C}_2\text{-}[\text{Ni}\{\text{Co}(\text{aet})_2(\text{en})\}_2]^{4+}$ ($\text{aet}=2\text{-aminoethanethiolate}$), with Au^{I} that yields $\text{C}_2\text{C}_2\text{-}[\text{Au}_2\{\text{Co}(\text{aet})_2(\text{en})\}_2]^{4+}$.²⁹⁶⁷ A similar compound is obtained with rhodium, $[\text{Au}_3\{\text{Rh}(\text{aet})_3\}_2]^{3+}$.²⁹⁶⁸ A mixed Pd—Co—Au derivative, $[\text{Au}_2\{\text{Pd}\{\text{Co}(\text{aet})_2(\text{en})\}_2\}_2]^{6+}$ has also been reported.²⁹⁶⁹ The penicillaminato complexes of Ni or Co react with gold(I) to give the bridged sulfur derivatives $[\text{Au}_2\text{Ni}_2\{\text{SCMe}_2\text{CH}(\text{NH}_2)\text{COO}\}_4]^{2-}$ or $[\text{Au}_3\{\text{Co}\{\text{SCMe}_2\text{CH}(\text{NH}_2)\text{COO}\}_3]$, respectively.^{2970,2971}

Dimeric gold(I) complexes with dithiocarbamate ligands possess a strong propensity to aggregate and form chains with short intermolecular $\text{Au}\cdots\text{Au}$ contacts, they have been known for a long time but new structural characterizations have come into light. Thus compounds of the type

$[\text{Au}_2(\text{S}_2\text{CNR}_2)_2]$ where R can be Et,^{2972,2973} CN,²⁹⁷⁴ $\text{C}_2\text{H}_4\text{OMe}$,²⁸¹⁰ or C_5H_{11} ,²⁹⁷⁵ have been characterized. The compound $[\text{Au}_2\{\text{S}_2\text{CN}(\text{C}_5\text{H}_{11})_2\}_2]$ interacts in a reversible way with VOC vapors with a dramatic change in the color and a positive “switching on” of luminescence.²⁹⁷⁵ Dinuclear derivatives but with different bridging ligands, as $[\text{Au}_2(\mu\text{-L-L})(\mu\text{-S}_2\text{CNR}_2)]$ (L-L = $(\text{CH}_2)_2\text{PPh}_2$, dppm, dppe, $\text{Me}_2\text{PCH}_2\text{PMe}_2$; R = Me, Et, Bz),^{2642,2645,2939} have been obtained by ligand exchange reactions between the homoleptic compounds. The structure of $[\text{Au}_2\{\mu\text{-}(\text{CH}_2)_2\text{PPh}_2\}(\mu\text{-S}_2\text{CNEt}_2)]$ (**539**) reveals the presence of dimeric units with inter- and intramolecular $\text{Au}\cdots\text{Au}$ interactions.²⁶⁴² Mixed dithiocarbamate-phosphine complexes with different stoichiometries, such as $[\text{Au}_2(\mu\text{-S}_2\text{CNEt})(\mu\text{-P-P})_2]^+$ (P-P = dppm, $(\text{PPh}_2)_2\text{C}=\text{CH}_2$),^{1219,2603} $[\text{Au}_2(\mu\text{-S}_2\text{CNEt})(\mu\text{-P-P})]^+$, $[\text{Au}_2(\text{S}_2\text{CNEt})_2(\mu\text{-P-P})]$ (P-P = dppf, dppe, $(\text{PPh}_2)_2\text{C}=\text{CH}_2$) (**540**),^{1219,2578,2976} $[\text{Au}_2\text{M}(\text{S}_2\text{CNEt})_2(\mu\text{-P-P})]^+$ (M = Cu, Ag, Au),¹²¹⁹ or $[\text{Au}_4(\text{S}_2\text{CNEt})_2(\mu\text{-dppf})(\text{PPh}_2\text{Me}_2)_2]^{2+}$ (**541**) have been synthesized.²⁵⁷⁸

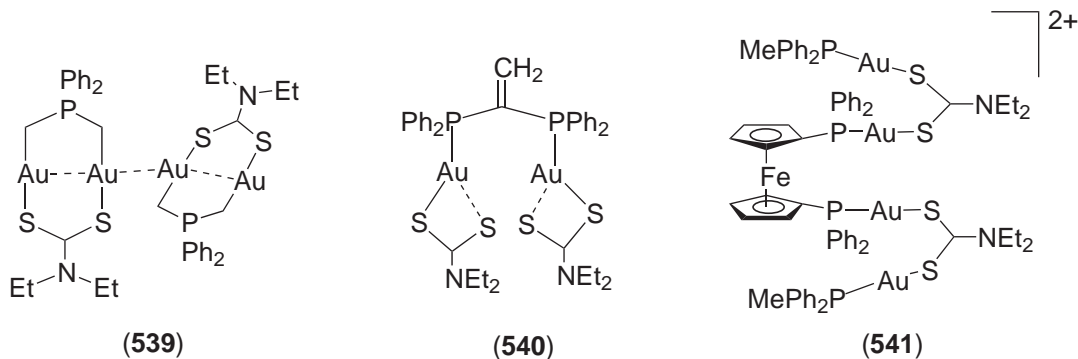

The reaction of triphosphine gold(I) complexes of the type $[\text{Au}_3\text{Cl}_3(\mu\text{-P}_3)]$ with several stoichiometric ratios of NaS_2CNR_2 gives the species with 1–3 dithiocarbamate ligands $[\text{Au}_3\text{Cl}_{3-x}(\text{S}_2\text{CNR}_2)_x(\mu\text{-P}_3)]$ ($x = 1, 2, 3$; $\text{P}_3 = (\text{PPh}_2)_3\text{CH}$, $(\text{PPh}_2\text{CH}_2)_2\text{PPh}$, $(\text{PPh}_2\text{CH}_2\text{CH}_2)_2\text{PPh}$), and also $[\text{Au}_3(\text{S}_2\text{CNMe}_2)_2\{(\text{PPh}_3)_3\text{CH}\}]^+$ (**542**) with one bridging and one terminal dithiocarbamate ligands.^{1765,2977,2978} Some of these complexes present a luminescent behavior.

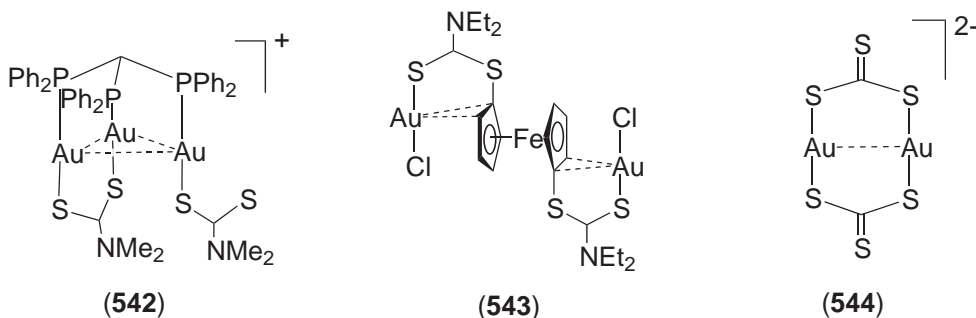

Mononuclear compounds of the type $[\text{Au}(\text{S}_2\text{CNR})(\text{PPh}_3)_2]$ (R = pip, Pr)^{2979,2980} and $[\text{Au}(\text{S}_2\text{CNEt}_2)(\text{PR}_3)]$ ($\text{PR}_3 = \text{PCy}_3$, $\text{P}(p\text{-MeOC}_6\text{H}_4)_3$)^{2981,2982} have been structurally characterized. Monoalkylated dithiocarbamates have also been studied as ligands in gold(I) complexes such as $\text{CH}_2(\text{S}_2\text{CNR}_2)_2$, with complexes of the form $[\text{Au}(\text{C}_6\text{F}_5)_2\{\text{CH}_2(\text{S}_2\text{CNR}_2)_2\}]$, $[\text{Au}_2(\text{PPh}_3)_2\{\text{CH}_2(\text{S}_2\text{CNR}_2)_2\}]^{2+}$, or $[\text{Au}\{\text{CH}_2(\text{S}_2\text{CNR}_2)_2\}]^+$,¹²²⁰ $\text{S}(\text{MeS})\text{NHR}$ (R = Ph, $p\text{-MeC}_6\text{H}_4$, $o\text{-MeC}_6\text{H}_4$, $p\text{-MeOC}_6\text{H}_4$, 3,5- $\text{Me}_2\text{C}_6\text{H}_3$) with compounds of the type $[\text{Au}\{\text{S}(\text{MeS})\text{NHR}\}_2]^+$, or $[\text{Au}(\text{C}_6\text{F}_5)\{\text{S}(\text{MeS})\text{NHR}\}]$,^{1812,2983} or methylthiocarbamates as in $[\text{Au}\{\text{SC}(\text{OEt})\text{NHMe}\}_2]\text{Cl}$,²⁹⁸⁴ or $[\text{Au}\{\text{SC}(\text{OEt})\text{NPh}\}(\text{PPh}_3)]$.²⁹⁸⁵ The ligand $\text{Fc}(\text{S}_2\text{CNEt}_2)_2$ reacts with gold(I) complexes to afford species such as $[\text{Au}_2(\text{PPh}_3)_2\{\text{Fc}(\text{S}_2\text{CNEt}_2)_2\}](\text{OTf})_2$ or $[\text{Au}_2\text{Cl}_2\{\text{Fc}(\text{S}_2\text{CNEt}_2)_2\}]$ (**543**); in the latter there exists an η^2 interaction between the gold atoms and the cyclopentadienyl ligand.¹⁸³⁰ The trithiocarbonate gold(I) complex $[\text{Au}_2(\text{S}_2\text{C}=\text{S})_2]^{2-}$ (**544**) has been synthesized by reaction of $[\text{Au}(\text{SH})_2]^-$ with CS_2 .²⁹⁸⁶ It has a very short $\text{Au}\cdots\text{Au}$ distance of 2.7998(4) Å and for this reason the electronic and resonance Raman spectra of the NBu_4^+ salt have been studied. An absorption band at 314 nm has been assigned as the metal–metal $1(d\sigma^* \rightarrow p\sigma)$ transition.²⁹⁸⁷

Organophosphor-1,1-dithiolato gold(I) compounds (which include dithiophosphinates ($S_2PR_2^-$), dithiophosphates ($S_2P(OR^1)_2^-$), or dithiophosphinates ($S_2PR^1(OR^2)^-$) have only been studied recently. The first examples were reported many years ago, and were also included in several of the early studies of the usage of gold compounds as lubrication additives.^{2988–2990} The determination of the crystal structure of $[Au_2\{S_2P(OPr^1)_2\}_2]$ showed the presence of dimeric units forming a chain through aurophilic interactions. Recently other dinuclear complexes of the type $[Au_2(S_2PR_2)_2]$ have been characterized structurally, where R can be Ph, Me, Et, or ⁱBu.^{2040,2991–2993} The reaction of $R_2P(S)SH$ with $[O(AuPR^2_3)]^+$ yields the dinuclear complexes $[Au_2(\mu-S_2PR^1)(PR^2_3)_2]^+$ ($R^1 = Ph, OEt, OMe; R^2 = Me, Ph, o-Tol$). These complexes can be discrete dinuclear compounds with intracationic $Au \cdots Au$ interactions or form supramolecular structures through intermolecular $Au \cdots Au$ or $Au \cdots S$ contacts as in (545), depending on the steric hindrance of the substituents.^{2992,2994} With $Me_2P(S)SH$ only the monoaurated derivative was achieved.²⁹⁹² The reaction of the related $PhP(S)(STMS)_2$ with the oxonium salt gives $[PhP(SAuPPh_3)_3]BF_4$, which is unstable below $-40^\circ C$; with $PhP(S)(SNa)_2$ the treatment with $[AuCl(PR_3)]$ gives the dinuclear derivatives $[PhP(S)(SAuPR_3)_2]$ (546) ($R = Me, Et, Pr^i, Ph, o-Tol$).^{2992,2995} Mixed dinuclear complexes such as $[Au\{\mu-(CH_2)_2PPh_2\}(S_2PR_2)]$ (547) or three-coordinated species as $[Au_2(S_2PR_2)_2(dppm)]$ ($R = Me, Ph$) have been obtained.²⁰⁴⁰ Other phosphor-1,1-dithiolate ligands used have been of the type $S_2PR^1(OR^2)^-$ which gives the dinuclear derivatives $[Au_2\{S_2PR^1(OR^2)\}_2]$ ($R^1 = Ph, p-C_6H_4OMe; R^2 = CH_2CH=CH_2, SiPh_3$); some of them present luminescent properties.^{2996,2997} The reaction of the Lawesson reagent $(PR(S)S)_2$ with $[Au_2Cl_2(P-P)]$ gives the mixed compounds $[Au_2\{S_2P(S)R^1\}(P-P)]$ ($R^1 = Fc; P-P = dppm, Ph_2PNHPPH_2$); the related $[Au_2\{S_2P(O)R^1\}(P-P)]$ have also been obtained by treatment of $[Au_2\{S_2PR^1(OR^2)\}_2]$ with diphosphines.²⁹⁹⁶ Theoretical studies have been carried out in the dimer $[Au_2(S_2PH_2)_2]$ and in the polymer $[Au_2(S_2PH_2)_2]_n$ showing that the staggered conformation is more stable than the eclipsed one.²⁹⁹⁸ The reaction of $(S)P(SSiMe_3)_3$ with $[AuCl(PPh_3)]$ gives the compound $[Au_4(P_2S_6)(PPh_3)_4]$ (548).²⁹⁹⁹

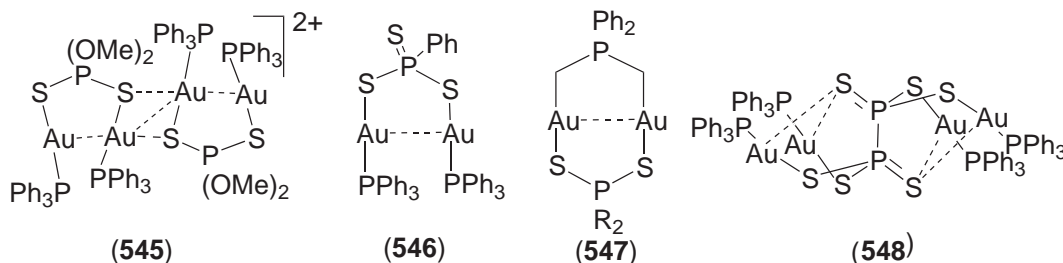

Homoleptic dithiocarboxylate complexes are tetrameric as $[Au_4(S_2CMe)_4]$ (549)^{1880,3000} or hexameric as $[Au_6(S_2C_6H_4Me-2)_6]$ (550).³⁰⁰¹ Other derivatives with S_2CPh , or $S_2C(p-Tol)$ have been prepared but their structure is unknown.^{1880,3002} Other stoichiometries are $[Au(S_2CR)(PPh_3)]$ and $[Au(S_2CR)(PPh_3)_2]$, which have been obtained by the addition of PPh_3 to the $[Au(S_2CR)]_n$ species.³⁰⁰² Another method of synthesis is the insertion of CS_2 in a $Au-C$ bond, as in $[Au(S_2CC_5Me_5)(PPR^i_3)]$.¹²³⁰ With related ligands such as trichlorothioacetate or phosphonium dithiocarboxylates, the complexes $[Au\{SC(O)CCl_3\}(PPh_3)]$,²⁷⁵¹ $[Au_2X_2(\mu-S_2CPR_3)]$ ($X = Cl, C_6F_5$), $[Au_2(\mu-S_2CPR_3)_2]$ ($PR_3 = PEt_3, PPhMe_2, PBu_3$), or $[Au_2(S_2CPCy_3)\{(CH_2)_2PPh_2\}]$ have been synthesized.^{1811,2039}

Dithiocarbonato or xantate ligands have also been used in gold(I) chemistry to prepare compounds of the type $[Au(S_2COR)]_n$ (which have been known for a long time and their structure is unknown³⁰⁰³) $[Au(S_2COR)(PR_3)]$, or $[Au(S_2COR)(PR_3)_2]$ ($R = Me, Et, Pr^i, Bu, Cy; PR_3 = PPh_3, PEt_3, PCy_3, P(o-Tol)_3$), in the complexes from which the structure is available the xantate ligand coordinates as monodentate to the gold(I) center, as in (551).^{3004–3010} Complexes with ylide such as $[Au\{(CH_2)_2PPh_2\}(S_2COPr^i)]$,²⁰³⁷ or triphosphines as $[Au_3Cl_{3-x}(S_2COEt)_x\{\mu-(PPh_2CH_2)_2PPh\}]$ ($x = 1, 2, 3$) are also known.³⁰¹¹

(iv) Gold(I) complexes with phosphine sulfide or selenide ligands

Phosphine sulfides or selenides are well-known ligands in gold(I) chemistry. With monophosphine complexes of the type $[AuX(SPR_3)]$ ($X = Cl, Br, CN; PR_3 = PPh_3, PCy_3, PPh_2Py$,

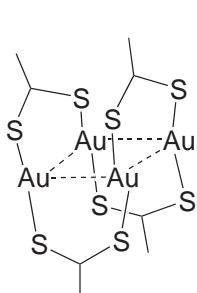

(549)

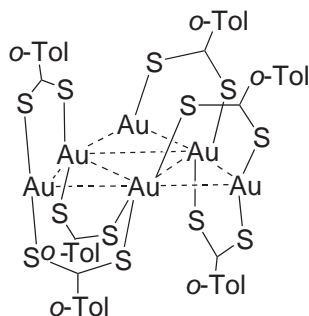

(550)

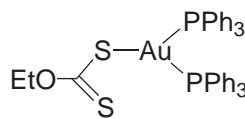

(551)

$\text{PPh}_2\text{N}=\text{CPh}_2$),^{1427,2449,2502,3012,3013} $[\text{Au}(\text{SPPH}_3)_2]\text{PO}_2\text{F}_2$,³⁰¹⁴ $[\text{Au}(\text{PPh}_3)(\text{SPPH}_2\text{NCHN})]$,³⁰¹⁵ or the analogues with selenium $[\text{AuX}(\text{SePR}_3)]$ ($\text{X} = \text{Cl}, \text{Br}, \text{C}_6\text{F}_5$; $\text{PR}_3 = \text{PPh}_3, \text{PCy}_3, \text{PTol}_3$),³⁰¹⁶⁻³⁰³⁰ $[\text{Au}(\text{SePPh}_3)_2]\text{SbF}_6$,³⁰²¹ or $[\text{Au}(\text{PPh}_3)(\text{SePR}_3)]\text{SbF}_6$ ($\text{PR}_3 = \text{PPh}_3, \text{PPhMe}_2$)³⁰²¹ have been obtained.

Gold(I) complexes with diphosphine disulfide ligands have been synthesized and are of the type $[\text{Au}_2\text{X}_2\{(\text{SPPH}_2)_2\text{R}\}]$ ($\text{X} = \text{Cl}, \text{Br}, \text{C}_6\text{F}_5$; $\text{R} = \text{CH}_2, (\text{CH}_2)_2, (\text{CH}_2)_3, \text{Fe}(\text{C}_5\text{H}_4)_2, 4\text{-R-1,2-(NH)}_2\text{C}_6\text{H}_3$ (552) ($\text{R} = \text{H}, \text{Me}$),^{1757,1882,1885,3022} $[\text{Au}_2(\text{PPh}_3)_2\{(\text{SPPH}_2)_2(\text{CH}_2)_n\}]^{2+}$ ($n = 1, 2, 3$),³⁰²² $[\text{Au}_2\{(\text{SPPH}_2)_2\text{CH}_2\}_2](\text{ClO}_4)_2$,¹⁸⁸² and $[\text{Au}_2\{(\text{SPPH}_2)_2\text{R}\}_2]$ ($\text{R} = \text{CH}$ (553), N).^{1882,2161} The ligands $\text{Fc}(\text{PPh}_2\text{E})_2$ ($\text{E} = \text{S}, \text{Se}$) act as *trans* chelate in their gold(I) compounds $[\text{Au}\{(\text{EPPH}_2)_2\text{Fc}\}]^+$ (554), for the selenium derivative the molecules are associated in trimers through auriphilic interactions.^{1262,1265,1885} The ligand $(\text{SPPH}_2)_2\text{CH}_2$ can also act as chelate in gold(I) in the four-coordinate compound $[\text{Au}\{(\text{SPPH}_2)_2\text{CH}_2\}\{(\text{PPh}_2)_2\text{C}_2\text{B}_{10}\text{H}_{10}\}]\text{ClO}_4$.²⁷⁰³

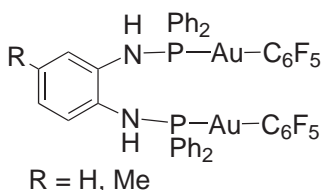

(552)

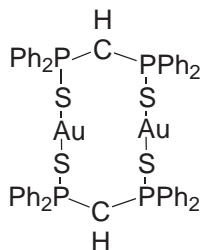

(553)

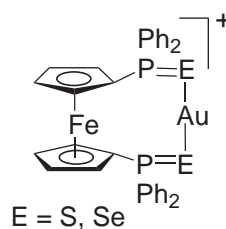

(554)

Dichalcogenoimidodiphosphinato $[\text{R}_2\text{P}(\text{E})\text{NP}(\text{E})\text{PR}_2]^-$ or mixed chalcogen donors $[\text{R}_2\text{P}(\text{O})\text{NP}(\text{E})\text{PR}_2]^-$ form homoleptic gold(I) complexes of stoichiometry $[\text{Au}_2\{(\text{EPPH}_2)_2\text{N}\}_2]$, the structure is unknown and could be dimers or polymeric species.^{2161,3023} Three- and four-coordinate compounds such as $[\text{Au}\{(\text{EPPH}_2)_2\text{N}\}\text{L}_n]$ ($\text{E} = \text{S}, \text{Se}$; $\text{L} = \text{PPh}_3$ (555), PMe_3 , $\text{CNC}_6\text{H}_3\text{Me}_2\text{-2,6}$, $n = 1$; $\text{E} = \text{Se}$; $\text{L} = \text{PMe}_3$, $n = 2$) have been obtained by reaction of $(\text{SePPh}_2)_2\text{N}^- \text{K}^+$ with $[\text{AuCl}]\text{L}$.^{1268,3023} Other types of complexes such as the linear $[\text{Au}_2\{(\text{SePPh}_2)_2\text{N}\}(\text{PPh}_3)_2]\text{BF}_4$ or the mixed dinuclear derivative $[\text{Au}_2\{\mu\text{-}(\text{SePPh}_2)_2\text{N}\}(\mu\text{-dppm})]^+$ (556) have been reported.³⁰²³ With the mixed chalcogen donor ligands the complexes $[\text{Au}(\text{SPPH}_2\text{NPPH}_2\text{O})(\text{PPh}_2\text{C}_6\text{H}_4\text{NH}_2\text{-2})]$,³⁰²⁴ $[\text{Au}\{(\text{SePPh}_2)_2\text{N}\}(\text{PPh}_2\text{NHPPH}_2\text{OH})]$,²⁴⁸⁸ or $[\text{Au}(\text{SPPH}_2\text{NPPH}_2\text{O})(\text{PPh}_2\text{NHPPH}_2\text{O})]$ (557),³⁰²⁵ have been characterized structurally.

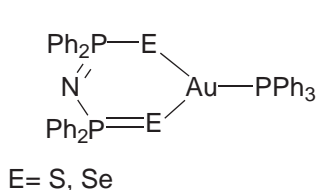

(555)

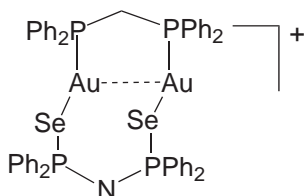

(556)

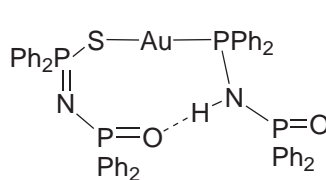

(557)

Other complexes with phosphine sulfides are the three coordinate $[\text{Au}\{(\text{S-PPh}_2)_2\text{C}(\text{PPh}_2\text{S})\}(\text{PPh}_2\text{Bu}^n)]$,³⁰²⁶ the μ_4 -phospha-1-thiethane compound $[\text{Fe}_3(\text{CO})_9(\mu_4\text{-PS})(\text{AuPPh}_3)_2]$ (**558**),³⁰²⁷ and the gold(I) dendrimers containing $\text{P}=\text{NP}=\text{NP}=\text{S}$ or $\text{P}=\text{NP}=\text{S}$ groups as (**559**).³⁰²⁸

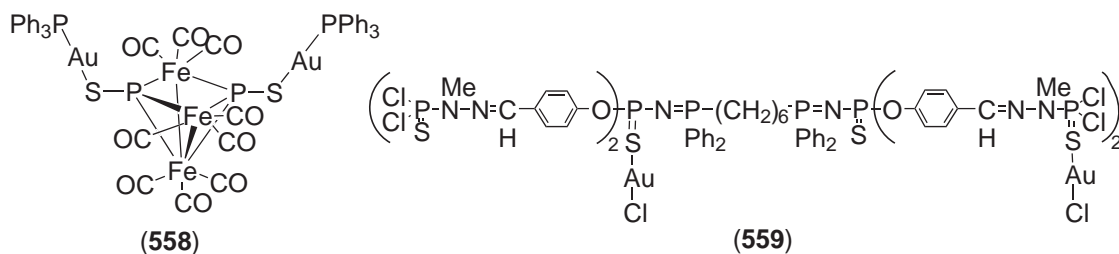

(v) Gold(I) complexes with other sulfur donor ligands

Gold(I) complexes with thiones are numerous and have several stoichiometries. The homoleptic $[\text{AuL}_2]^+$ have been obtained for $\text{L} =$ imidazoline-2-thione,³⁰²⁹ 4-amino-3-methyl-1,2,4-triazoline-5-thione (**560**),³⁰³⁰ *N*-*R*-1,3-imidazoline-2-thione ($\text{R} = \text{Pr}, \text{Et}$),^{3031,3032} 1,3-thiazoline-2-thione,^{1801,3033} 1*H*-pyrimidine-2-thione,¹⁸⁰¹ pyridine-2-thione,¹⁸⁰¹ benzothiazoline-2-thione,¹⁸⁰¹ or benzimidazole-2-thione.¹⁸⁰¹ The structure of $[\text{Au}(\text{C}_5\text{H}_5\text{NS})_2]\text{ClO}_4$ (**561**) shows that five of the six cations in the unit cell are linked by aurophilic interactions and the sixth is monomeric.¹⁸⁰¹ Complexes of the type $[\text{AuXL}]$ have also been reported for $\text{L} =$ 1,3-thiazoline-2-thione,¹⁸⁰¹ 1*H*-pyrimidine-2-thione,¹⁸⁰¹ pyridine-2-thione,^{1801,3034} benzothiazoline-2-thione,¹⁸⁰¹ benzimidazole-2-thione,¹⁸⁰¹ 1-methylpyridine-2-thione,³⁰³⁵ *N*-*R*-1,3-imidazoline-2-thione ($\text{R} = \text{H}, \text{Pr}, \text{Et}$),^{3031,3036,3037} ergothione,³⁰³⁸ substituted thiabenzenthionas,²⁹¹³ trithiapentalene derivative (**562**),³⁰³⁹ and 1,3-dithiolane-2-thione.³⁰⁴⁰

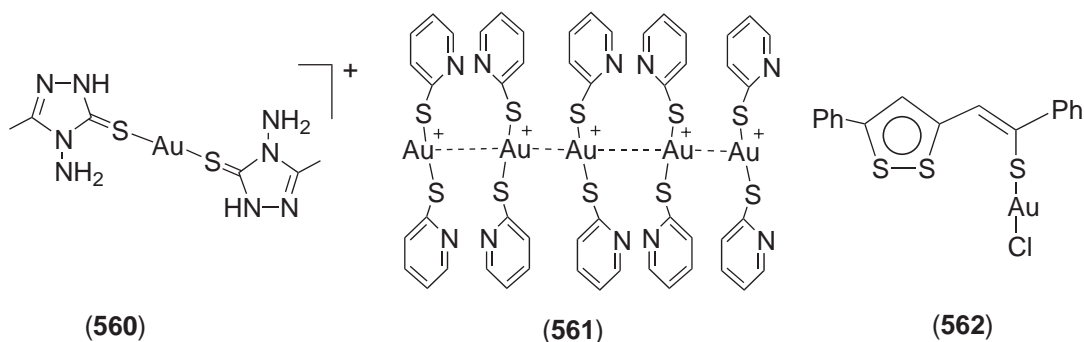

Gold(I) derivatives with tu or substituted tus have been synthesized and are of the form $[\text{Au}\{\text{S}=\text{C}(\text{NHR})_2\}_2]^+$, where R can be H ,^{3041–3043} Me ,^{3036,3044} Et ,³⁰⁴⁴ or $[\text{AuXL}]$ ($\text{L} = \text{S}=\text{C}(\text{NMe}_2)_2$, $\text{S}=\text{C}(\text{NEt}_2)(\text{NHCOPh})$,^{1824,3045} or $[\text{Au}(\text{PPh}_3)\{\text{S}=\text{C}(\text{NHMe})_2\}]^+$.¹²⁸⁸ In the crystal structure of $[\text{Au}\{\text{S}=\text{C}(\text{NHMe})_2\}_2][\text{Au}(\text{CN})_2]$ the cation and anion are connected through $\text{Au}\cdots\text{Au}$ interactions (**563**).³⁰³⁶ With selenourea the complexes $[\text{Au}(\text{PPh}_3)\{\text{Se}=\text{C}(\text{NH}_2)_2\}]^+$ and $[\text{Au}_2\{\text{Se}=\text{C}(\text{NH}_2)_2\}_2(\mu\text{-dppm})]\text{Cl}_2$ (**564**) have been obtained.²⁸⁹² Other gold(I) complexes which have ligands with an $\text{S}=\text{C}$ moiety, are with *N*-phenylthio benzamide,³⁰⁴⁶ $\text{Cy}_2\text{P}(\text{O})\text{C}(\text{NHMe})(\text{S})$,³⁰⁴⁷ *N,N'*-dimethylthioformamide,¹³⁰² or aminothiocarbamoyl-benzamidinato ligands (**565**).³⁰⁴⁸

Thioether gold(I) derivatives of the type $[\text{AuX}(\text{SR}_2)]$ are widely used as starting materials and some crystal structure determinations have been reported for SMe_2 ,^{1809,3049} $\text{S}(\text{CH}_2\text{Ph})_2$,³⁰⁵⁰ or THT.^{3051,3052} In the structure of the chloro and bromo derivatives with tetrahydrothiophene the molecules form a chain through $\text{Au}\cdots\text{Au}$ interactions. In the iodo derivative they are cations and anions of the type $[\text{AuL}_2]^+[\text{AuL}_2]^-$ ($\text{L} =$ tetrahydrothiophene or tetrahydroselenophene) that form a chain through aurophilic interactions (**566**).³⁰⁵² The salt with benzodisulfonylamide has also been reported.³⁰⁵³ Other complexes with stoichiometry $[\text{AuCIL}]$ are those with $\text{L} =$ 3-methyl-5-methylthiomethyl-isoxazole,¹⁴²⁵ or SePh_2 .¹⁸⁰³ Cationic compounds of the type $[\text{Au}(\text{SR}_2)(\text{PR}_3)]^+$

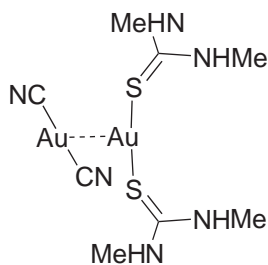

(563)

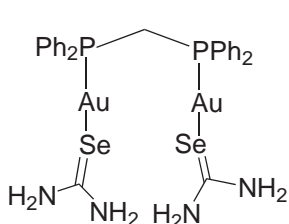

(564)

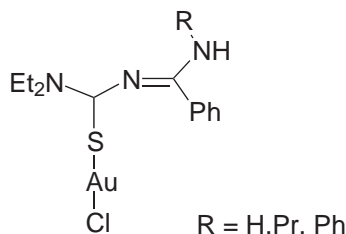

(565)

R = H, Pr, Ph

are known for $\text{SR}_2 = \text{SMe}_2$,³⁰⁵⁴ SMepy ,¹⁴¹² or the three-coordinate $[\text{Au}(\text{PR}_3)\{\text{(EPh)}_2\text{Fc}\}]^+$ (**567**) (E = S, Se).¹¹⁸⁴ Gold(I) also forms complexes with cyclic thioethers such as $[\text{9}]_{\text{aneS}_3}$, which form the tetrahedral $[\text{Au}\{\text{[9]aneS}_3\}_2]\text{PF}_6$ (**568**),¹⁸⁸⁸ or the linear $[\text{AuCl}\{\text{[9]aneS}_3\}]$,³⁰⁵⁵ with $[\text{18}]_{\text{aneS}_6}$ the tetrahedral $[\text{Au}\{\text{[18]aneS}_6\}]\text{PF}_6$,³⁰⁵⁶ or with $[\text{15}]_{\text{aneS}_5}$ and $[\text{28}]_{\text{aneS}_8}$ forms the dinuclear $[\text{Au}_2\{\text{[15]aneS}_5\}_2][\text{B}(\text{C}_6\text{F}_5)_4]_2$,³⁰⁵⁶ or $[\text{Au}_2\{\text{[28]aneS}_8\}](\text{PF}_6)_2$ (**569**),¹¹⁰³ respectively.

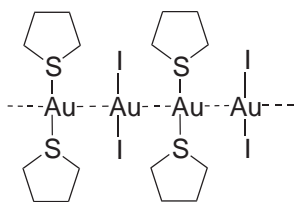

(566)

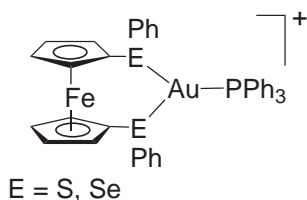

E = S, Se

(567)

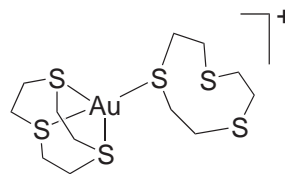

(568)

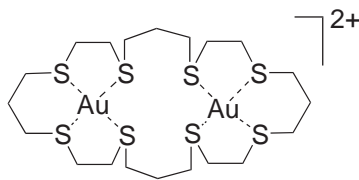

(569)

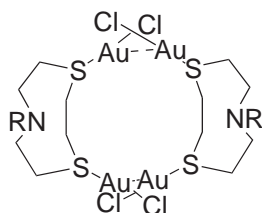

(570)

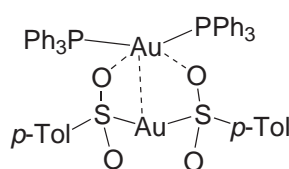

(571)

Other complexes with cyclic thioethers are those with 3,3,6,6-tetramethyl-1-thia-cycloheptane,³⁰⁵⁷ 7-toluensulfonyl-7-aza-1,4-dithiacyclononane (**570**),³⁰⁵⁸ or 1,10-dithia-4,7,13,16-tetraoxa-cyclooctadecane.³⁰⁵⁹ With the cyclic selenoethers $[\text{8}]_{\text{aneSe}_2}$ and 3H-1,4,5,7-tetrahydro-2,6-benzodiselenone the dinuclear complexes $[\text{Au}_2\text{Cl}_2\text{L}]$ have been obtained, these are thought to involve linear $\text{Se}-\text{Au}-\text{Cl}$ fragments.¹¹⁵²

Thiocyanate gold(I) complexes have been investigated in the search of supramolecular structures. Complexes of the type $[\text{Au}(\text{SCN})\text{L}]$ with $\text{L} = \text{THT}$, PMe_3 , 2,6- $\text{Me}_2\text{C}_6\text{H}_3\text{NC}$ have been characterized structurally showing that the THT complex form a polymer of alternating cations $[\text{Au}(\text{THT})_2]^+$ and anions $[\text{Au}(\text{SCN})_2]^-$, the PMe_3 shows dimers with aurophilic interactions and further aggregation through $\text{Au}\cdots\text{S}$ contacts, and with the isocyanide ligand are dimers with $\text{Au}\cdots\text{Au}$ and $\text{Au}\cdots\text{S}$ contacts.³⁰⁶⁰ However, the complex $[\text{Au}(\text{SCN})(\text{PPh}_3)]$ is a monomer in the crystal,²⁷⁵⁸ and also $\text{Ph}_4\text{As}[\text{Au}(\text{SCN})_2]$ shows no aurophilicity.²⁵¹⁸

The organosulfinate complexes $[\text{Au}(\text{SO}_2\text{R})\text{L}]$ (R = *p*-Tol, Me; L = PMe_3 , PPh_3 , 2,6- $\text{Me}_2\text{C}_6\text{H}_3\text{NC}$, Bu^tNC) have been prepared by treatment of the silver sulfinate with $[\text{AuCl}]\text{L}$. The crystal structure also consists of pairs of the homoleptic derivatives $[\text{Au}(\text{PPh}_3)_2]^+[\text{Au}(\text{S}_2\text{O}-\text{p-Tol})_2]^-$ (**571**) bonded through aurophilic interactions.²⁷⁶¹

6.7.3.4.7 Complexes with halide donor ligands

Halide ligands are a very important type of ligands in gold(I) chemistry. Complexes such as $[\text{AuXL}]$ or $[\text{Au}_2\text{X}_2(\mu\text{-L-L})]$ are amongst the most important coordination compounds, and are extensively used as convenient starting materials. Many of these derivatives have been treated in the corresponding section according to the donor atom of the L or L-L ligands, and then it will not be included here.

Halide anions can also act as single-atom bridges between two gold centers, these type of compounds can be achieved by reaction of $[\text{AuX}(\text{PPh}_3)]$ with AgBF_4 (molar ratio 2:1) or by treatment of $[\text{AuX}(\text{PPh}_3)]$ with $[\text{Au}(\text{PPh}_3)]^+\text{A}^-$ ($\text{A} = \text{ClO}_4$ or BF_4).^{3061–3063} The structure of these compounds consists of the halide ligand bridging the two gold atoms that are located to a distance of 3.035 Å or 3.085 Å (two independent molecules) for the Cl (**572**) and 3.6477(1) Å for the Br species (**573**), the latter too large to be considered a bonding interaction.^{3062,3063} In the SbF_6^- salt, the dinuclear chloronium cations undergo an intimate aggregation (**574**). This association is drastically affecting the structure of the monomeric units with a widening of the Au–Cl–Au angle and formation of more gold–gold interactions. The dimerization occurs against electrostatic repulsion, which appears to be offset by the gain in the number or auriphilic interactions (two vs. four).³⁰⁶⁴

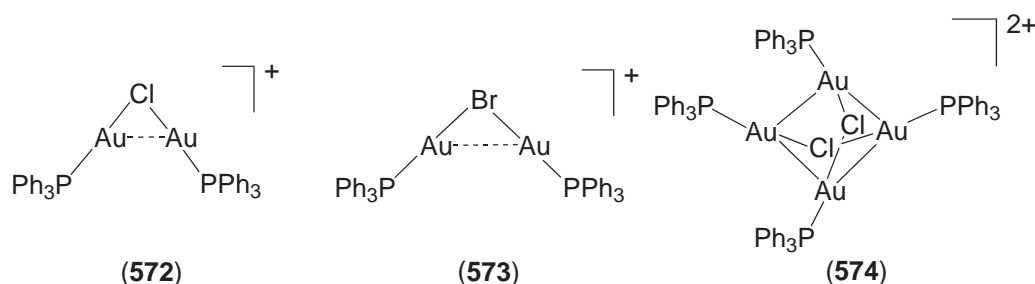

Several crystal structure determinations of $[\text{AuX}_2]^-$ salts with different cations have been carried out for $[\text{AuCl}_2]^-$,^{1823,1904,2854,3065–3068} $[\text{AuBr}_2]^-$,^{3065,3069,3070} or $[\text{AuI}_2]^-$.^{3065,3066,3071–3074} Many other structural determinations have been reported in which $[\text{AuX}_2]^-$ salts act as counterions of conducting or superconducting ion radical salts as bis-ethylenedithiotetrathiafulvalene (ET) and related organic donors.

Historically, AuF has been one of the most elusive of all metal halides. At one time it was believed to be impossible to prepare, and theoretical papers speculating on how it might be observed or predicting spectroscopic and structural properties have been published until recently.^{3075–3081} The existence of AuF has been confirmed by microwave spectroscopy, the sample has been prepared by laser ablation of Au metal in the presence of a F precursor.³⁰⁸² The gas-phase structure of AuI has also been determined by microwave spectroscopy.³⁰⁸³

6.7.3.4.8 Complexes with hydride donor ligands

Gold hydrides have been desirable for a long time, a considerable number of theoretical studies have probed the structure of AuH by using density functional methods.^{2518,3075,3077,3084–3086} It has been shown that the total charge on the Au-atom is reduced significantly from +0.48 to +0.27 by including relativistic effects. Recent ground-breaking solid-matrix investigations have provided the first experimental evidence for $(\text{H}_2)\text{AuH}$.³⁰⁸⁷ The similar electronegativities of I and H has made a comparison between gold hydride and iodide compounds relevant.³⁰⁸⁸

Heteropolynuclear gold(I) complexes with bridging hydride ligands can be prepared by reacting the electrophilic fragment AuPR_3^+ and complexes with terminal M–H bonds or by reaction of metal hydrides with $[\text{AuMe}(\text{PR}_3)]$. Several examples of carbonyl–hydride ruthenium compounds react with gold–phosphine or gold–diphosphine fragments to give species with bridging hydride ligands such as $[\text{Ru}_4(\text{CO})_{12}(\mu_3\text{-H})(\text{AuPPh}_3)_3]$,^{3089,3090} $[\text{Ru}_4(\text{CO})_{12}(\mu\text{-H})(\mu_3\text{-H})(\text{AuPPh}_3)_2]$,^{1540,1541} $[\text{Ru}_4(\text{CO})_{12}(\mu\text{-H})_2\{\text{Au}_2(\mu\text{-P-P})\}]$ (P–P = dppe, dppf),^{3091,3092} and $[\text{Ru}_4(\text{CO})_{12}\text{H}_3(\text{AuPPh}_3)]$ has been found to be significantly more active and selective than $[\text{Ru}_4\text{H}_4(\text{CO})_{12}]$ for the catalytic isomerization of 1-pentene at 35 °C.³⁰⁹³ Other complexes are derived of ruthenium phosphine species such as $[\text{Ru}(\text{dppm})_2(\mu\text{-H})_2(\text{AuPPh}_3)_2](\text{NO}_3)_2$ (**575**),³⁰⁹⁴ $[\text{Ru}(\text{dppm})_2(\mu\text{-H})_2(\text{AuPPh}_3)]\text{PF}_6$,³⁰⁹⁵

[Ru(CO)(PPh₃)₃(μ-H)₂(AuPPh₃)]PF₆,³⁰⁹⁶ [Ru(PPh₃)₃(μ-H)₃(AuPPh₃)₂]PF₆,³⁰⁹⁶ or [Ru(triphos)-(μ-H)₃(AuPPh₃)₃](PF₆)₂ (576).³⁰⁹⁷ The complex [Ru(CO)(PPh₃)₃(μ-H)₂(AuPPh₃)]PF₆ catalyzes the isomerization of 1-hexene to *cis*- and *trans*-2-hexene in CH₂Cl₂ at 25 °C and one atmosphere of N₂; the gold adduct increases the rate of the isomerization compared to the parent compound [Ru(H)₂CO(PPh₃)₃] and is more selective towards producing *trans*-2-hexene.³⁰⁹⁶ Gold-osmium compounds with bridging hydride ligands of the type [Os(PPh₃)₃(μ-H)₃(AuPPh₃)₂],³⁰⁹⁶ [Os₃(CO)₈(μ-dppm-P,P,C,C)H(AuPPh₃)]PF₆,³⁰⁹⁸ or [Os₄H(CO)₁₂Au(PPh₂C≡CPh₂)₂]³⁰⁹⁹ have also been obtained. The reaction of [IrH(C₂H₄)(triphos)] or [Ir(H)₂(C₂H₅)(triphos)] with two equivalents of [AuCl(EPh₃)] in the presence of NH₄PF₆ affords the complexes [IrCl(triphos)(μ-H)(AuEPh₃)₂]PF₆ (E = P, As) (577). The compound [IrCl(triphos)(H)(AuEPh₃)]PF₆ has a terminal hydride ligand in the solid state but bridging in solution.³¹⁰⁰ Similar rhodium derivatives [Rh(triphos)(μ-H)₂(AuPPh₃)₃](OTf)₂³¹⁰¹ or [Rh(triphos)(μ-H)(AuPPh₃)₃]BPh₄³¹⁰² have also been synthesized.

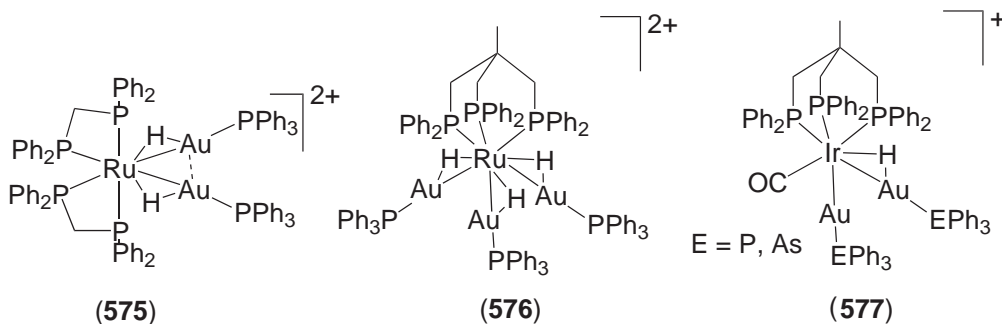

Replacement of hydride ligands for AuPPh₃⁺ fragments has led to the synthesis of the μ-H derivatives [AuIr₃H₆(NO₃)(dppe)₃]BF₄³¹⁰³ or [Ir(PPh₃)₃(H)₂(μ-H)(AuPPh₃)].^{3104,3105} The reaction of [Au(NO₃)(PPh₃)] with [Ir(H)₂(PPh₃)₂(acetone)₂]BF₄ at -78 °C gives the doubly hydrido-bridged adduct [Ir(PPh₃)₂(acetone)₂(μ-H)₂(AuPPh₃)]²⁺, but warming of the solution yields the mono-hydrido derivative [Ir(PPh₃)₂(NO₃)(μ-H)(AuPPh₃)₂]⁺.³¹⁰⁶ The doubled bridging hydrido complex [Ir(bipy)(PPh₃)₂(μ-H)₂(AuPPh₃)](BF₄)₂ (578) has been synthesized by reaction of [Ir(H)₂(bipy)(PPh₃)₂] with [Au(NO₃)(PPh₃)].³⁰⁹⁴ Mixed rhenium-gold derivatives with hydrido bridges have been prepared with phosphine as ligands in [Re₂(H)₄(μ-H)₂(PPh₃)₄(μ-H)(AuPPh₃)],³¹⁰⁷ [ReCl(CO)(PPhMe₂)(μ-H)(AuPPh₃)],¹⁵⁷⁸ or with the trinuclear carbonyl clusters [Re₃(CO)₉(μ-H)₂(μ-MePyNH)(μ₃-H)(AuPPh₃)] (579),³¹⁰⁸ or [Re₃(CO)₈(PPh₃)(μ-H)₃(μ₃-H)(AuPPh₃)].¹⁵⁷⁷ The reaction of [(PPh₃)₂N][MH(CO)₅] with [AuCl(PPh₃)] in the presence of TlPF₆ gives the species [M(CO)₅(μ-H)(AuPPh₃)] (M = Cr, Mo, W); the structure of the chromium derivatives shows a bridging hydrido ligand with a Au—H distance of 1.72(11) Å.^{1575,3109} Other metal carbonyl derivatives with bridging hydrido ligand are [Mo₂(CO)₈(μ-dppm)(μ₃-H)(μ-AuPPh₃)],³¹¹⁰ [Mn₂(CO)₆(μ-dppm)(μ₃-H)(μ-AuPPh₃)₂]PF₆,³¹¹¹ or [Mn₂(CO)₆{μ-{P(OEt)₂}₂O}(μ-H)₂(μ-H)₂(μ₃-H)Au}] (580).³¹¹²

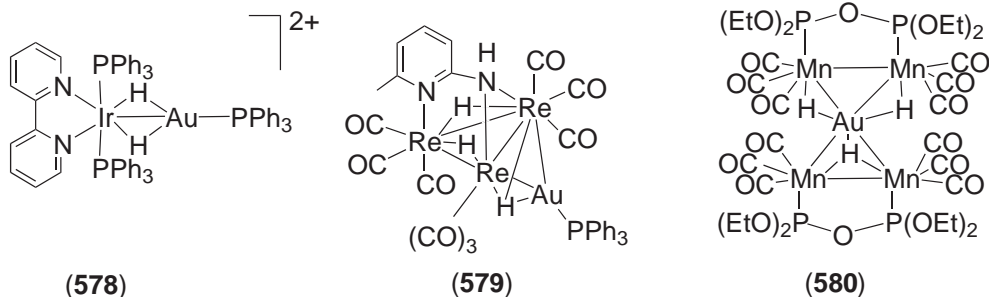

Platinum derivatives of the type [PtH(C₆X₅)(PR₃)₂] react with gold phosphine species to yield [Pt(C₆X₅)(PR₃)₂(μ-H)(AuPPh₃)]⁺ (581) (X = F, Cl; PR₃ = PEt₃, PPh₃).^{3113,3114} Gold-niobium clusters with bridging hydrido ligands have been obtained by reaction of [NbH₃(C₅H₄TMS)] with [Au{N(TMS)₂}(PPh₃)] which produces the triangular cluster [Au₃Nb₃(μ-H)₆{C₅H₄(TMS)}₃] (582),^{3115,3116} or by treatment of [NbH₃(C₅H₃R¹R²)₂] with [AuCl(THT)] in the presence of TlPF₆ which gives [Nb(C₅H₃R¹R²)₂H₃]₂Au]PF₆ (583) (R¹ = H, TMS; R² = H, TMS).^{1365,3117}

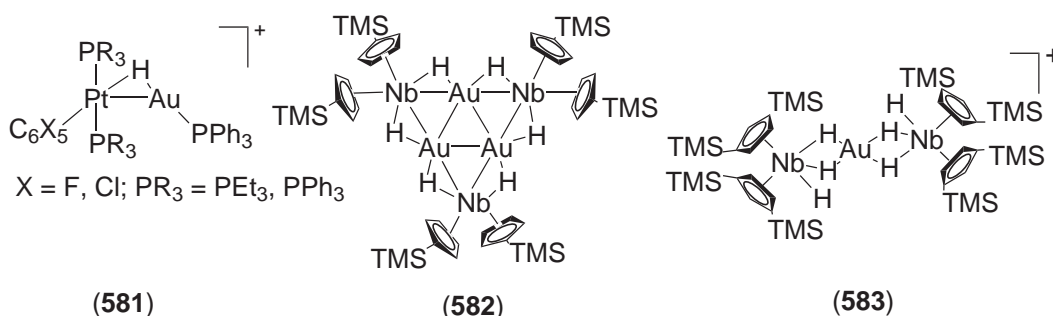

Nido-carborane metal complexes of ruthenium or rhodium also react with gold compounds to give bridging hydrido derivatives such as $[\text{Ru}(\text{C}_2\text{B}_9\text{H}_{11})(\text{PPh}_3)_2(\mu\text{-H})(\text{AuPPh}_3)]^{3118}$ or $[\text{Rh}(\text{C}_2\text{B}_9\text{H}_9\text{Me}_2)(\text{PPh}_3)(\mu\text{-H})(\text{AuPPh}_3)_2]$.^{2043,2046} Other types of complexes with carborane ligands are those that have B—H—Au agostic interactions as $[\text{Rh}(\text{C}_2\text{B}_9\text{H}_9\text{Me}_2)(\text{CO})_2(\text{AuPPh}_3)]$,²²⁷⁷ $[\text{WRh}_2\text{Au}_2(\mu_3\text{-CC}_6\text{H}_4\text{Me-4})(\text{CO})_4\text{Cp}(\text{C}_2\text{B}_9\text{H}_9\text{Me}_2)_2]$ (584),²²⁷⁷ $[\text{WAu}_2(\mu_3\text{-CC}_6\text{H}_4\text{Me-4})(\text{CO})_2\text{Cp}(\text{C}_2\text{B}_9\text{H}_9\text{Me}_2)_2]$,²⁰⁵¹ or $[\text{Au}_2(\text{C}_2\text{B}_9\text{H}_9\text{Me}_2)_2(\text{PPh}_3)_2]$.²⁰⁴⁵ This type of agostic interaction has also been postulated in some organometallic compounds such as $[\text{Au}_2(\mu\text{-C}_6\text{H}_4\text{CH}_2\text{C}_6\text{H}_4)(\text{PPh}_3)_2]$ ³¹¹⁹ or $[\text{Au}_2(\mu\text{-C}_6\text{H}_4\text{CH}_2\text{C}_6\text{H}_4)(\mu\text{-dppe})]$ (585).^{3120,3121}

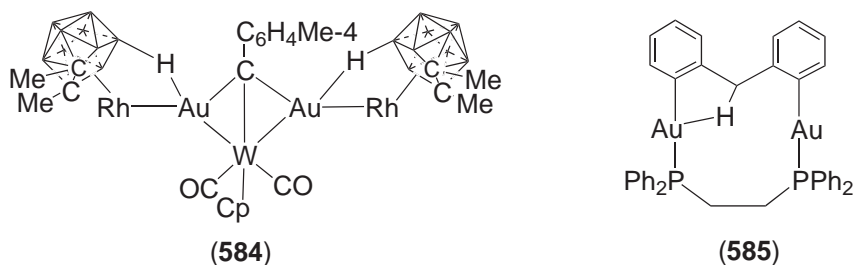

6.7.3.4.9 Complexes with mixed donor ligands

Triangular trigold(I) complexes of the type $[\text{Au}_3\text{L}_3]$, where L is a mixed donor ligand (Figure 24), have been known for over 20 years,^{2355,2362,3122–3125} but it is only recently that some remarkable chemical reactivities and physical properties of these molecules have been recognized.

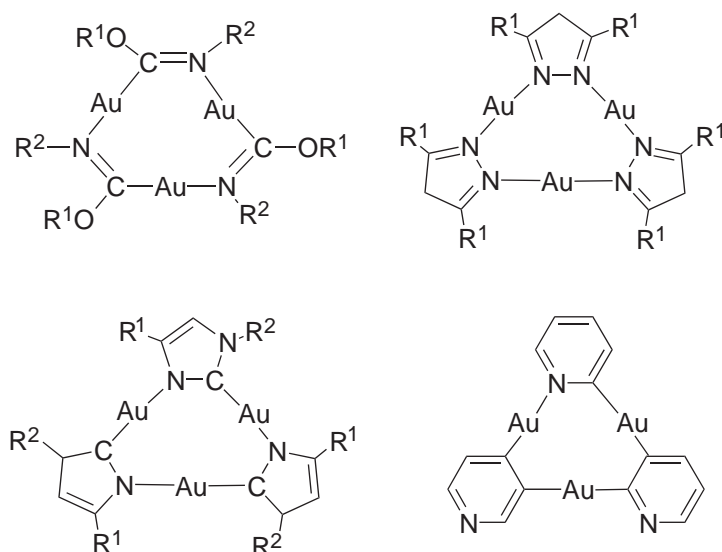

Figure 24 Triangular $[\text{Au}_3\text{L}_3]$ complexes.

The gold trimer $[\text{Au}_3(\text{MeN}=\text{COMe})_3]$ displays the novel phenomenon termed solvoluminescence. After irradiation with near-UV light, crystals of this compound show a long-live photoluminescence that is readily detected by the human eye for tens of seconds after cessation of irradiation. Addition of dichloromethane or chloroform to these previously irradiated crystals produces a bright burst of light. For this phenomenon the solid-state structure is crucial and consists of individual molecules of Au_3L_3 , which aggregate to form columnar stacks through $\text{Au}\cdots\text{Au}$ interactions. Then it is believed that energy storage involves charge separation within the solid, and this charge separation is facilitated by conduction of electrons along the columnar structure.^{3126,3127} A similar complex $[\text{Au}_3(\text{PhCH}_2\text{N}=\text{COMe})_3]$ does not associate into trigonal prismatic array but packs in a stair-step fashion with eight discrete molecules in the asymmetric unit. This compound does not display solvoluminescence.³¹²⁸ Theoretical calculations of the complex $[\text{Au}_3(\text{MeN}=\text{COR})_3]$ in gas phase and in chloroform solution have been carried out. The calculated structure and the vibrational frequency are in good agreement with the experimental results.³¹²⁹

Charge-transfer adducts are formed with the gold(I) trimers $[\text{Au}_3(\text{MeN}=\text{COR})_3]$ ($\text{R} = \text{Me}, \text{Et}$), which act as electron donors, and organic electron acceptors as nitro-9-fluorenes. The structures of these adducts involve mixed stacks in which the gold trimers and the planar nitro-fluorenes are interleaved.³¹³⁰ No luminescence has been observed from these solid charge-transfer adducts, which is not surprising since the luminescence of $[\text{Au}_3(\text{MeN}=\text{COR})_3]$ is a property that is associated with the supramolecular organization in the solid.

The structure of the trimer $[\text{Au}_3(\text{NC}_5\text{H}_4)_3]$ has been studied and shows that individual molecules self-associate through aurophilic interactions into two distinct structural motifs that involve both extended chains of molecules connected by pairwise and individual $\text{Au}\cdots\text{Au}$ contacts, and discrete dimers linked by pairwise $\text{Au}\cdots\text{Au}$ interactions (Figure 25).³¹³¹

The reaction of $[\text{AuCl}(\text{THT})]$ with 2-(4',5'-dihydro-4,4'-dimethyl-2'-oxazoliny)-thien- n -ylthium ($n = 3, 5$) affords dimeric (**586**) or trimeric (**587**) gold(I) derivatives with mixed N, C -donor ligands.²²⁶³ Other complexes with mixed N, C donor ligands which have been prepared in a similar manner are $[\text{Au}_2\{\text{Fc}(\text{CH}_2\text{NMe}_2)_2\}_2]$,²¹²⁷ $[\text{Au}_2\{\text{C}_6\text{H}_4(\text{CH}_2\text{NMe}_2)_2\}_2]$,³¹³² $[\text{Au}_2\{\text{C}_6\text{H}_3(\text{CH}_2\text{NMe}_2)_2\}_2]$,¹⁹⁶⁴ $[\text{Au}_2(\mu\text{-}2\text{-C}(\text{TMS})_2\text{-}6\text{-RPy})_2]$ ($\text{R} = \text{H}, \text{Me}$) (**588**),^{644,1471,3133} or $[\text{Au}_2(\mu\text{-}2\text{-CH}_2\text{-}6\text{-Py})_2]$.³⁴⁷

Complexes with mixed C, P or C, As donor ligands are derived of ortho-metalated phosphines or arsines or of methanide derivatives. The dinuclear complexes $[\text{Au}_2(\text{C}_6\text{H}_3\text{-}2\text{-EPh}_2\text{-}6\text{-R})_2]$ ($\text{E} = \text{P}$ (**589**), As ; $\text{R} = \text{H}, \text{Me}$) are obtained by reaction of 2-EPh₂-6-R-C₆H₃Li with $[\text{AuBr}(\text{PEt}_3)]$ at -70°C .^{2002,2004,2006} The treatment of the dimer $[\text{Au}_2(\text{C}_6\text{H}_4\text{PPh}_2)_2]$ with methyltriflate yields, unexpectedly, $[\text{Au}_5(\text{C}_6\text{H}_4\text{PPh}_2)_4]^+$.³¹³⁴ The mixed dinuclear derivative $[\text{Au}_2(5\text{-Me-C}_6\text{H}_3\text{-}2\text{-PPh}_2)(\text{S}_2\text{CNBu}_2)]$ has also been obtained.¹⁸³⁴ The reaction of $[\text{Au}(\text{C}\equiv\text{CBu}^t)]$ with $(\text{MeO})_2\text{PCH}_2\text{-P}(\text{OMe})_2$ gives the complex $[\text{Au}_8\text{Cl}_2\{\mu_3\text{-P}(\text{OMe})_2\text{CHP}(\text{OMe})_2\}_2\{\mu_4\text{-P}(\text{OMe})_2\text{CP}(\text{OMe})_2\}_2]$, which has a μ_3 - and a μ_4 - PR_2CPR_2 ligand.³¹³⁵ The compound $[\text{Au}_4(\mu\text{-CH}_2\text{SONMe}_2)\{\mu_3\text{-}(\text{PPh}_2)_2\text{CH}\}\text{-}(\mu\text{-dppm})]$ (**590**) has been obtained by treatment of $[\text{Au}_2\text{Cl}_2(\mu\text{-dppm})]$ with $[\text{Me}_2\text{S}(\text{O})\text{NMe}_2]\text{BF}_4$ under phase transfer catalysis conditions.²⁶²⁶ The dinuclear $[\text{Au}_2\{(\text{CH}_2)_3\text{PPh}_2\}_2]$ (**591**) has been synthesized by reaction of $[\text{AuCl}(\text{CO})]$ with the zinc derivative $[\text{Zn}\{(\text{CH}_2)_3\text{PPh}_2\}_2]$.²⁶¹⁰

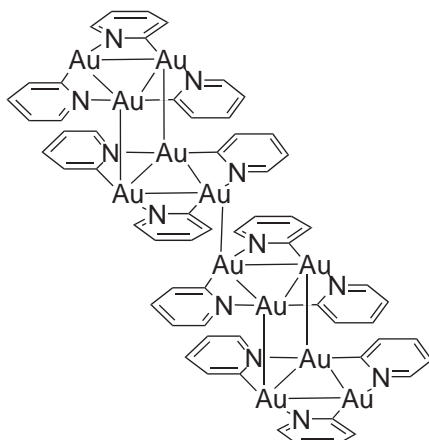
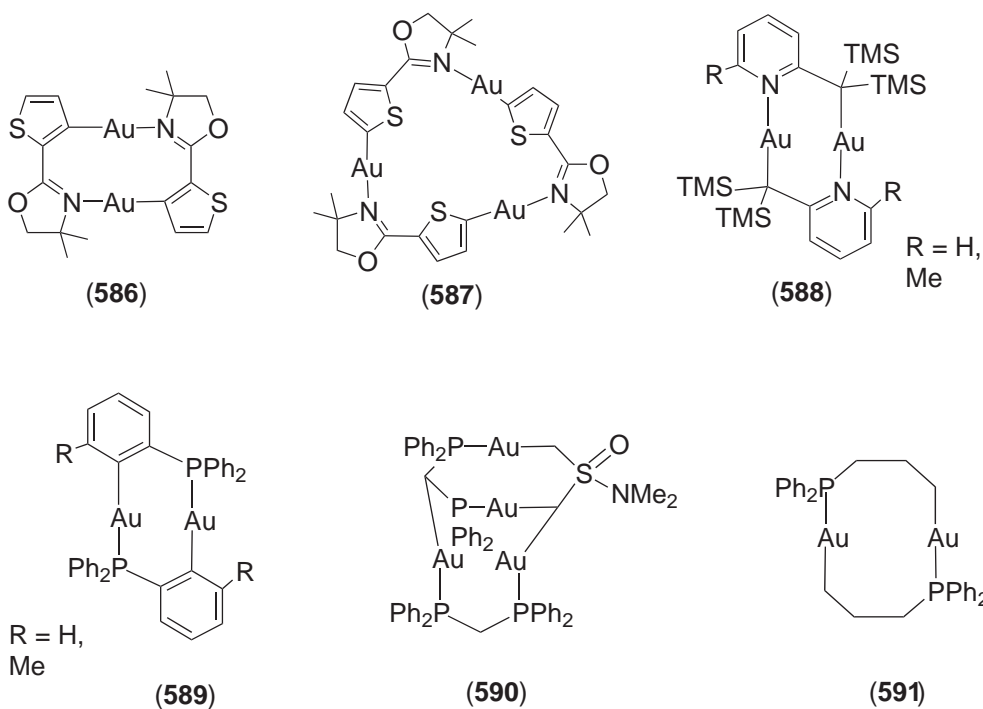
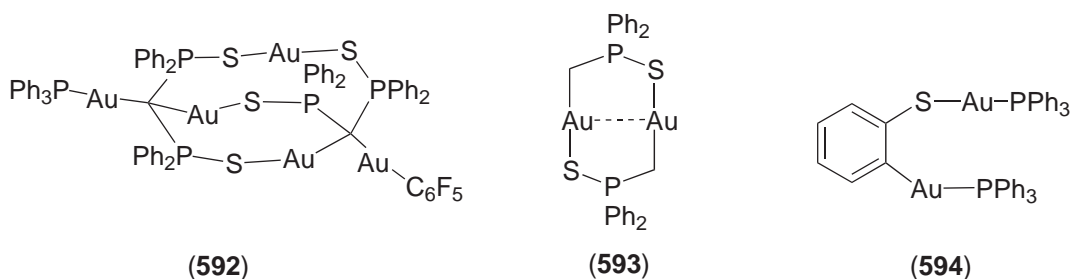

Figure 25 Structure of $[\text{Au}_3(\text{NC}_5\text{H}_4)_3]$.



Complexes with C,S mixed donor ligands are also derived of methanide species and methalated thiolate ligands. The complexes $[\text{Au}_2(\text{C}_6\text{F}_5)_2(\text{SPPH}_2\text{CHPPH}_2\text{Me})](\text{ClO}_4)_2$ or $[\text{Au}_2(\text{SPPH}_2\text{CHPPH}_2\text{Me})_2](\text{ClO}_4)_2$ are obtained by reaction of the methanide ligand $\text{SPPH}_2\text{CHPPH}_2\text{Me}$ with the corresponding gold(I) precursor.¹⁴⁷¹ Treatment of $[\text{Au}_2\{\text{C}(\text{PPh}_2\text{S})_2\}(\text{PPh}_3)_2]$ with $[\text{Au}(\text{C}_6\text{F}_5)(\text{THT})]$ gives the pentanuclear species $[\text{Au}_5(\text{C}_6\text{F}_5)\{\text{SPPH}_2\text{C}\}_2(\text{PPh}_3)]$ (592).²¹⁶¹ Methylene thiophosphinate ligands have been used to synthesize dinuclear gold or gold/mercury compounds, which depending of the synthetic procedure species containing S—Au—C as in $[\text{Au}_2(\text{CH}_2\text{PPh}_2\text{S})_2]$ (593) or S—Au—C/S—Hg—C or S—Au—S/C—Hg—C structural units are obtained.^{1675,3136–3138} Also heterobimetallic Au/Tl, Au/Pb, and Au/Pt species have been obtained; these complexes are strongly luminescent which is associated to the presence of metal–metal interactions.^{2009,3139} The treatment of 2-lithiobenzenethiolate with $[\text{AuCl}(\text{PPh}_3)]$ gives the complex $[\text{Au}_2(\mu\text{-SC}_6\text{H}_4)(\text{PPh}_3)_2]$ (594).²⁸⁰⁹ Similarly the reaction of $[\text{Mn}\{\text{C}_5\text{Cl}_3(\text{SLi})\text{Li}\}(\text{CO})_3]$ with the $[\text{AuCl}(\text{PPh}_3)]$ yields $[\text{Mn}\{\text{C}_5\text{Cl}_3(\text{SAuPPh}_3)\text{AuPPh}_3\}(\text{CO})_3]$.²⁸²¹



Gold(I) complexes with P,S (or Se) donor ligands are in many cases derived of phosphine sulfides or selenides as $[\text{Au}_2(\text{PPh}_2\text{CH}_2\text{PPh}_2\text{Se})_2](\text{ClO}_4)_2$,³¹⁴⁰ and $[\text{Au}(\text{PPh}_2\text{CH}_2\text{PPh}_2\text{Se})_2]^+$ (595),^{1403,3141} $[\text{Au}_2(\text{PPh}_3)_2(\mu\text{-SPPH}_2\text{Py})](\text{BF}_4)_2$,¹⁴²⁷ or phosphine thioethers such as $[\text{Au}_2(\text{PPh}_2\text{CH}_2\text{SPh})_2]^{2+}$ ¹³⁹⁶ and $[\text{AuCl}\{\text{PPh}_2(\text{CH}_2)_2\text{SR}\}]$ (R = β -cyclodextrin),³¹⁴² $[\text{Au}_2\{\text{S-PhCH}_2)_3\text{P}\}]^{2+}$ (596),²⁵¹⁶ or phosphine thiolates complexes as $[\text{Au}_2\{\text{PET}_2(\text{CH}_2)_2\text{S}\}_2]$ ³¹⁴³ and $[\text{Au}(\text{SC}_6\text{H}_4\text{PPhC}_6\text{H}_4\text{SH})(\text{PPh}_3)]$ (597).¹⁹⁶⁹ In the structure of $[\text{Au}(\text{PPh}_2\text{CH}_2\text{PPh}_2\text{Se})_2]\text{Cl}$ the methylene protons of the phosphine act as hydrogen bond donor, with $\text{H}\cdots\text{O}$ distances as short as 2.20 Å, and also form C—H \cdots Cl interactions.¹⁴⁰³ Other complexes with P,S-donor ligands are those with diorganophosphinothioformamido derivatives such as $[\text{Au}_2\{\text{PR}^1_2\text{C}(\text{S})\text{NR}^2\}_2]$ (R¹ = Ph, Cy; R² = Ph, Me).³¹⁴⁴

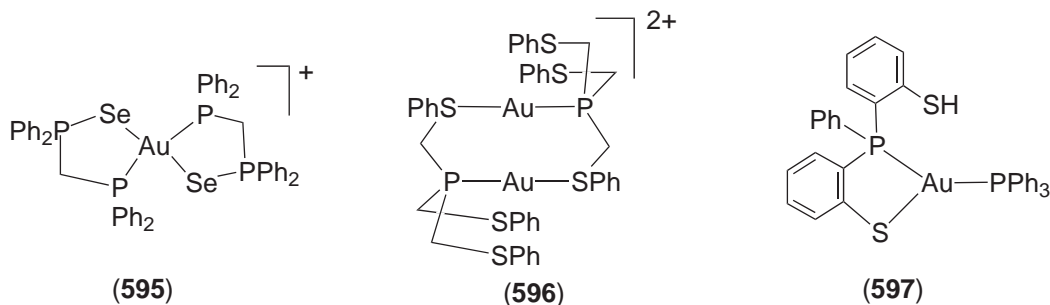

Difunctional ligands with *P,N*-donor centers as PPh_2Py , $\text{PPh}_2(\text{Bzim})$ or $\text{PPh}_2\text{C}_6\text{H}_4\text{NH}_2$ have been used in gold(I) chemistry and compounds of the type $[\text{Au}_2(\text{PPh}_2\text{Py})_2](\text{BF}_4)_2$,¹³⁷³ the polynuclear $[\text{Au}_2\text{Cu}_2(\mu\text{-SPy})_2(\mu\text{-PPh}_2\text{Py})_2](\text{PF}_6)_2$ (598), $[\text{Au}_2\{\text{PPh}_2(\text{Bzim})\}_2]^{2+}$ (599),^{1378,1379} the hetero-bridged $[\text{Au}_2\{\text{PPh}_2(\text{Bzim})\}(\text{P-P})]^{2+}$ (*L-L* = dppm, dppe, dppp),³¹⁴⁵ $[\text{Au}_2(\text{PPh}_2\text{C}_6\text{H}_4\text{NH}_2)_2](\text{ClO}_4)_2$ (600),³¹⁴⁶ or $[\text{Au}_6(\text{PPh}_2\text{C}_6\text{H}_4\text{N})_2(\text{PPh}_3)_4](\text{ClO}_4)_2$ ²⁴⁸⁷ have been synthesized. The reaction of $[\text{Au}_2(\text{PPh}_2\text{C}_6\text{H}_4\text{NH}_2)_2](\text{ClO}_4)_2$ with AgClO_4 in acetone leads to the compound $[\text{Au}_2(\text{PPh}_2\text{C}_6\text{H}_4\text{N}=\text{CMe}_2)_2](\text{ClO}_4)_2$.³¹⁴⁶ Also the mixed gold-silver derivative $[\text{AuAg}(\text{PPh}_2\text{C}_6\text{H}_4\text{NH}_2)_2](\text{ClO}_4)_2$ has been synthesized.³¹⁴⁶

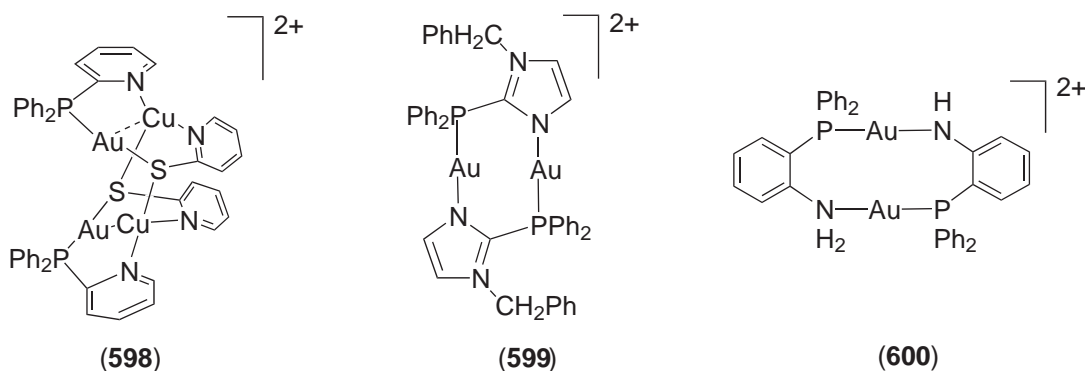

Gold(I) complexes with mixed *S,N*-donor ligands are mostly derived of thiolate ligands. The dinuclear luminescent complex with the ligand 4,6-dimethylpyrimidinethiolate, $[\text{Au}_2(4,6\text{-Me}_2\text{pym-2-S})_2]$, crystallized as two independent dimers with short $\text{Au}\cdots\text{Au}$ distances, these planar dimers stack along the *a*-axis with pyridine moieties in adjacent molecules overlapping.³¹⁴⁷ Pyridinethiolate PyS^- can act as triply bridging ligand in $[\text{Au}_3(\mu_3\text{-SPy})(\mu\text{-dppf})(\text{PPh}_3)](\text{OTf})_2$ (601).²⁵⁷⁸ The ligand $\text{FcCH}=\text{N}(\text{CH}_2)_2\text{S}^-$ also acts as a triply or quadruply bridging ligand in $[\text{Au}_3\{\text{S}(\text{CH}_2)_2\text{N}=\text{CHFc}\}(\text{PPh}_3)_3](\text{OTf})_2$ (602) or $[\text{Au}_4\{\text{S}(\text{CH}_2)_2\text{N}=\text{CHFc}\}(\text{PPh}_3)_4](\text{OTf})_3$.²⁸¹⁶ A similar ligand $\text{NH}_2(\text{CH}_2)_2\text{SH}$ can be polyaurated to yield the compound $[(\text{Ph}_2\text{PAu})_3\text{N}(\text{CH}_2)_2\text{S}(\text{AuPPh}_3)_2](\text{BF}_4)_2$.²⁹⁵⁷ The complex $[\text{Au}_2(\text{CNBu}^t)_2(\mu\text{-S}_3\text{C}_2\text{N}_2)]$ loses the isocyanide ligands to give a polymeric material with a “knitted” network structure (603).³¹⁴⁸

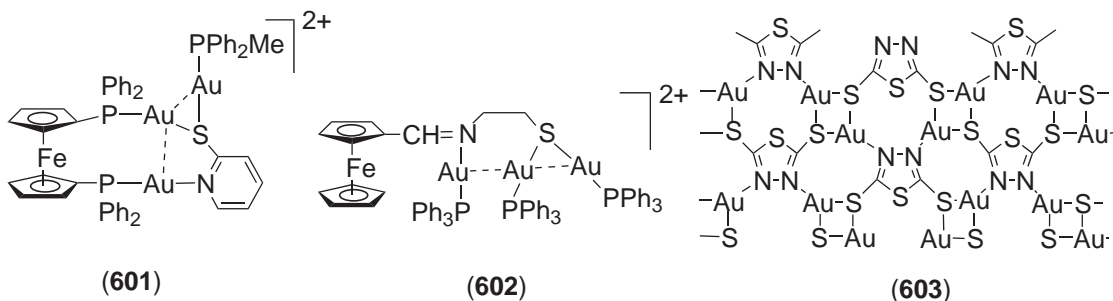

The treatment of 2-amino-4,5-dihydrothiazole with $[\text{Au}(\text{ACAC})(\text{PPh}_3)]$ evolves to an unprecedented ring-opening reaction to give the new ligand (2-cyanamide)ethylthiolate, stabilized as the dinuclear gold complex (Equation (42)).²³¹⁵



Other complexes with bridging N,S ligands are the 1,3-dimethyl-8-thioxantine derivative $[\text{Au}_2(\mu\text{-N,S})\{\mu\text{-PMe}_2(\text{CH}_2)_2\text{PMe}_2\}]$,³¹⁴⁹ or with quinoline thiolates $[\text{Au}_5(\mu\text{-SQuin})_3(\mu\text{-dppm})_2]^{2+}$ (604),³¹⁵⁰ deprotonated ethylenethiourea $[\text{Au}_4(\text{etu-H})_4]$ (605),³¹⁵¹ or with 2-methoxyphenyl-imino(2-pyridyl)methylthio derivatives as $[\text{Au}\{\text{SC}(\text{Py})=\text{NR}\}(\text{PPh}_3)]$.³¹⁵²

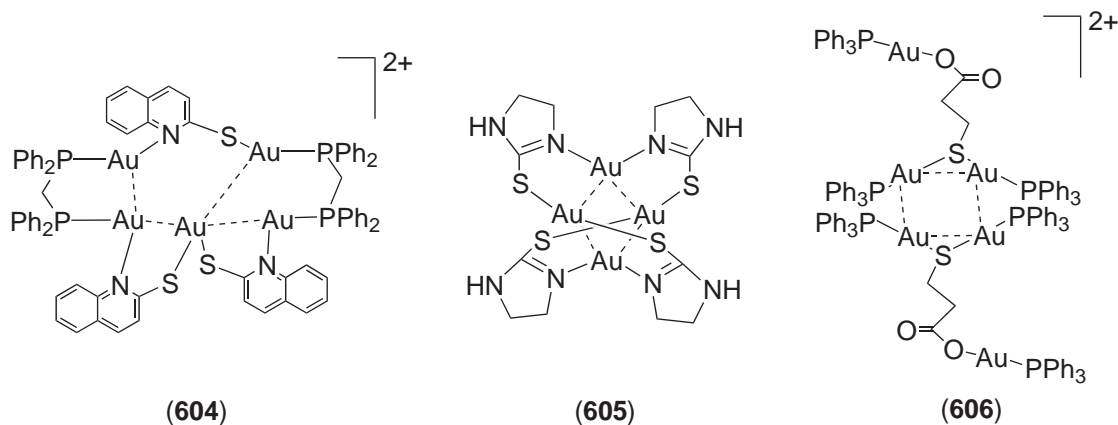

Gold(I) complexes with S,O mixed donor ligands such as $[(\text{Ph}_3\text{PAu})_2\text{S}(\text{CH}_2)_n\text{COO}(\text{AuPPh}_3)]\text{BF}_4$ ($n=2$ (606), 3),²⁸²⁸ or $[(\text{Ph}_3\text{PAu})_2\text{SCH}(\text{COO}(\text{AuPPh}_3))\text{CH}_2\text{COO}(\text{AuPPh}_3)]\text{BF}_4$ have been obtained.²⁸²⁹ The compound $[\text{Au}_2(\mu\text{-C}_9\text{H}_6\text{NO})(\text{PPh}_3)_2]\text{BF}_4$ with the quinolyl group interacting N,O with the gold atoms has been described.²⁷³⁵ A dimeric gold(I) complex with a mixed Se,S thioselenolate ligand has been synthesized, $[\text{Au}_2\{\text{SeSC}=\text{C}(\text{CN})_2\}]^{2-}$.²⁹⁶⁶

6.7.3.4.10 Gold(I) complexes with $\text{Au}^I\text{—M}$ bonds

Heteronuclear compounds containing gold(I) and other metal atoms which present $\text{Au}^I\cdots\text{M}$ interactions are well represented in the area of metal carbonyl clusters. The addition of a AuPR_3^+ or $\text{Au}_2(\mu\text{-P-P})^{2+}$ fragment to a metal cluster results in the formation of Au—M bonds often with retention of the cluster framework. Several reviews have been reported recently,^{3153–3155} and so it will not be treated here. Some representative examples are found in Figure 26.

$\text{Au}^I\cdots\text{Ag}^I$ or $\text{Au}^I\cdots\text{Tl}^I$ interactions are present in polynuclear complexes with bridging ligands, many of these compounds have been seen in other sections and then will not be included here. The reaction of basic/donor gold(I) complexes with acid/acceptor complexes gives acid–basic or acceptor–donor derivatives. Thus, the treatment of the aurate(I) salts $[\text{AuR}_2]^-$ with Ag^+ , in the presence of a ligand L, affords yellow or orange polymers of the type $[\text{R}_2\text{Au}(\mu\text{-AgL})_2\text{AuR}_2]_n$ (607). They are available for a great variety of oxygen, nitrogen, sulfur, phosphorus, or carbon donor ligands and being $\text{R}=\text{C}_6\text{F}_5$, $\text{C}_6\text{F}_3\text{H}_2$, C_6Cl_5 .^{3163–3165} The structure consists of a rhomboidal arrangement of the four metallic centers, these units are further connected through aurophilic interactions. These complexes are only soluble in coordinating solvents. They lose the color in solution, which is related to cleavage of the gold–gold bonds. The optical properties of some of these derivatives have been studied and they are related to the $\text{Au}^I\cdots\text{Au}^I$ interactions. The absorption and emission spectra of $[(\text{C}_6\text{F}_5)_2\text{Au}(\mu\text{-AgOCMe}_2)_2\text{Au}(\text{C}_6\text{F}_5)_2]_n$ in acetone are consistent with molecular aggregation through gold–gold interactions when going from dilute to concentrated solutions.³¹⁶⁶ It is also luminescent in the solid state. The polymeric chain containing the dinuclear

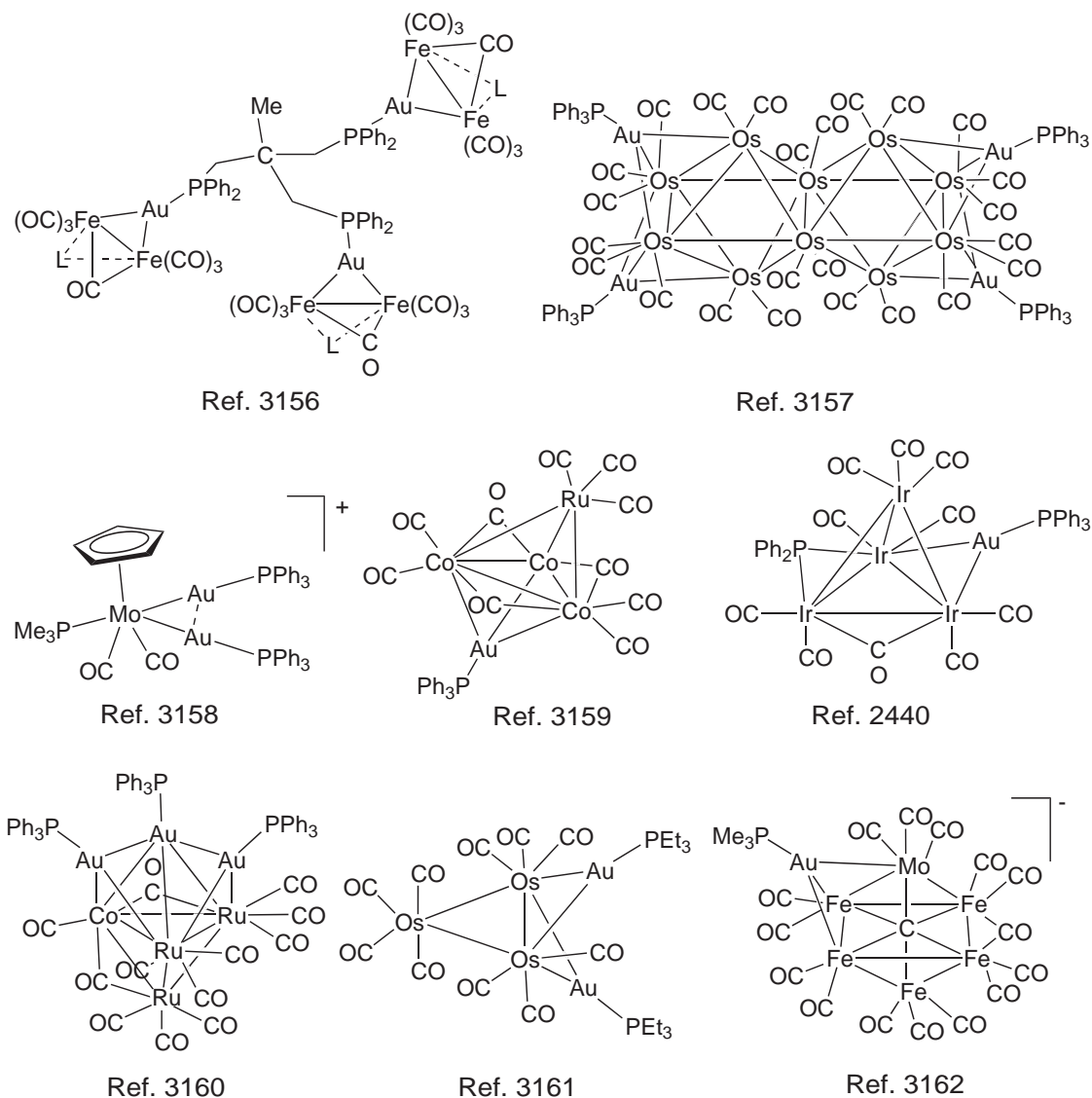
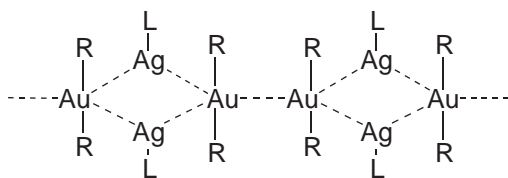
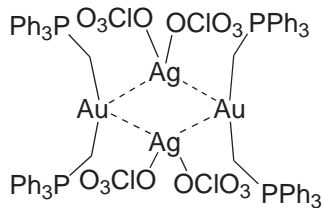

Figure 26 Some examples of carbonyl metal clusters with Au(I)-M bonds.

moiety $[\text{Ag}(\text{Py})_3][\text{Au}(\text{C}_6\text{F}_5)_2]\text{Py}$, instead of the tetranuclear one, has been obtained by the same procedure.³¹⁶⁷ Formation of a chain can be avoided by using bulky ligands at the gold centers, which prevents further aggregation through aurophilic interactions. This has been possible with ylide ligands, and the compounds $[(\text{R}_3\text{PCH}_2)_2\text{Au}(\mu\text{-AgL})_2\text{Au}(\text{CH}_2\text{PR}_3)_2]$ (**608**) ($\text{PR}_3 = \text{PPh}_3, \text{PPh}_2\text{Me}, \text{PPhMe}_2$; $\text{L} = \text{OCIO}_3, \text{PPh}_3$) have been reported.³¹⁶⁸



(607)



(608)

The electron rich aurate $[\text{Au}(\text{C}_6\text{F}_5)_2]^-$ also reacts with thallium salts in the presence of a ligand to give extended unsupported gold-thallium linear chain derivatives. The first example

synthesized was $[\text{Tl}(\text{OPPh}_3)_2][\text{Au}(\text{C}_6\text{F}_5)_2]$.³¹⁶⁹ Another derivative is $[\text{Tl}(\text{OPPh}_3)][\text{Tl}(\text{OPPh}_3)\text{L}][\text{Au}(\text{C}_6\text{F}_5)_2]_2$ (**609**) ($\text{L} = \text{THF}$, acetone),³¹⁷⁰ in which the thallium centers show two different types of geometrical environments. These compounds also show a luminescent behavior. TD-DFT (density functional level using the time-dependent perturbation theory approach) calculations are in agreement with the experimental excitation spectra and confirm the qualitative explanation that the excitation has $\text{AuR}_2 \rightarrow \text{Tl}$ charge-transfer character, whereby the thallium centers act as fluorophores. Tetranuclear derivatives such as $[\text{Tl}(\text{bipy})]_2[\text{Au}(\text{C}_6\text{F}_5)_2]_2$ (**610**) and $[\text{Tl}(\text{bipy})][\text{Tl}(\text{bipy})_{0.5}(\text{THF})][\text{Au}(\text{C}_6\text{Cl}_5)_2]_2$ have been achieved using 4,4-bipyridine as auxiliary ligand.³¹⁷¹ In the first case an $\text{Tl}-\text{Au}-\text{Au}-\text{Tl}$ linear chain is formed and this unit is connected with others through bidentate bipyridine ligands forming a 2D array. Further $\text{Tl}-\text{F}$ contacts form an infinite 3D network. The second example display a $\text{Tl}-\text{Au}-\text{Tl}'-\text{Au}$ arrangement with bridging bipyridine ligands that form a 2D polymer. If in the reaction of $[\text{Au}(\text{C}_6\text{Cl}_5)_2]^-$ with Tl^+ no ligand is added, except the solvent, the compound $[\text{Au}_2\text{Tl}_2(\text{C}_6\text{Cl}_5)_4](\text{OCMe}_2)$ is obtained. The structure consists of a butterfly tetranuclear unit with four unsupported gold–thallium interactions and a long $\text{Tl}\cdots\text{Tl}$ contact (**611**).³¹⁷²

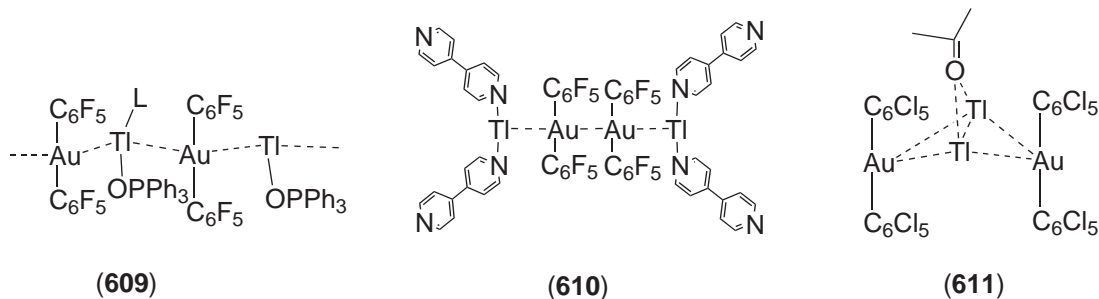

The trinuclear complexes $[\text{Au}_3(p\text{-MeC}_6\text{H}_4\text{N}=\text{OEt})_3]$ and $[\text{Au}_3(\text{Bzim})_3]$ ($\text{Bzim} = 1\text{-benzylimidazole}$), which are colorless, can produce brightly colored materials by sandwiching naked Ag^+ or Tl^+ ions form linear-chain complexes (Figure 27) with luminescence properties as luminescence thermochromism.^{3173,3174}

The reaction of these trimer derivatives with the π molecular acid trinuclear Hg^{II} complex $[\text{Hg}_3(\mu\text{-C}_6\text{H}_4)_3]$ produces a compound with acid–base stacking among the planar molecules (Figure 28).³¹⁷⁵

Other gold(I) complexes with $\text{Au}^{\text{I}}-\text{C}$ bonds, such as $[\text{Au}_2(\text{CH}_2\text{TMS})_2(\mu\text{-dppm})]$ or $[\text{Au}_5(\text{Mes})_5]$, react with naked Ag^+ to give complexes with unsupported gold(I)–silver(I) bonds, such as $[\{\text{Au}_2(\text{CH}_2\text{TMS})_2(\mu\text{-dppm})\}_2\text{Ag}]\text{OTf}$ (**612**)³¹⁷⁶ or $[\text{Au}_6\text{Ag}(\mu\text{-Mes})_6]\text{OTf}$ (**613**).³¹⁷⁷ The compound $[\text{Au}_2\{\mu\text{-C}(\text{PPh}_3)\text{Py}\}(\text{PPh}_3)_2]\text{ClO}_4$ reacts with AgNO_3 to give $[\text{Au}_2(\mu\text{-AgNO}_3)\{\mu\text{-C}(\text{PPh}_3)\text{Py}\}(\text{PPh}_3)_2]\text{ClO}_4$ (**614**) in which the silver(I) is bonded to the gold centers and the nitrogen of the pyridine group.³¹⁷⁸

$\text{Au}-\text{Pt}$ bonds have been described in several complexes, such as the isocyanide compounds $[\{\text{Pt}(\text{CNC}_6\text{H}_3\text{Me}_2\text{-}2,6)_2(\text{PPh}_3)_2(\mu\text{-AuPPh}_3)_2\}(\text{PF}_6)_2]$ (**615**),^{3179,3180} or $[\{\text{Pt}(\mu\text{-CNC}(\text{Me}_2)_2)\text{C}_6\text{H}_4\text{C}(\text{Me}_2)(\text{PPh}_3)_2(\mu\text{-AuPPh}_3)_2\}(\text{PF}_6)_2]$.³¹⁸¹ Triangular platinum clusters easily add gold(I) phosphine fragments to give complexes such as $[\text{Pt}_3\text{Au}(\text{PR}_3)_4(\mu\text{-CO})_3]^+$ ($\text{PR}_3 = \text{PCy}_3$ (**616**), PPh_3),^{3182,3183} $[\text{Pt}_3\text{Au}(\text{PCy}_3)_4(\mu\text{-CO})_2(\mu\text{-SO}_2)]\text{PF}_6$,³¹⁸⁴ $[\text{Pt}_3\text{Au}(\text{PCy}_3)_3(\text{PC}_6\text{H}_4\text{F-}4)(\mu\text{-Cl})(\mu\text{-SO}_2)_2]$,³¹⁸⁴ $[\text{Pt}_3\text{Au}_2$

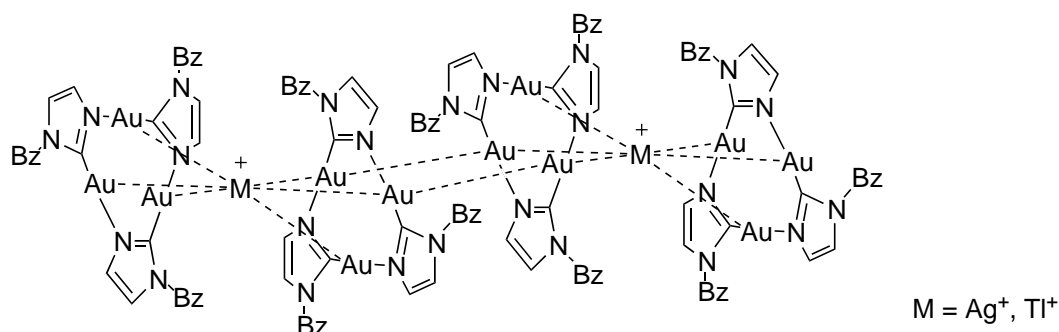

Figure 27 Structure of $[\text{Au}_3\text{M}(\text{Bzim})_3]^+$.

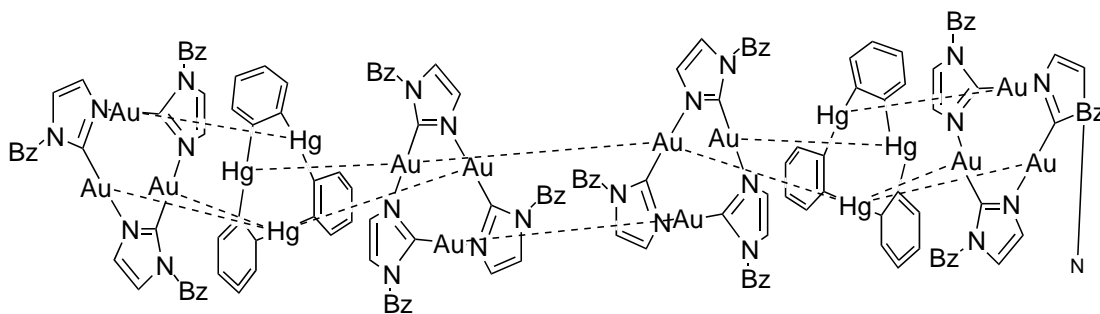
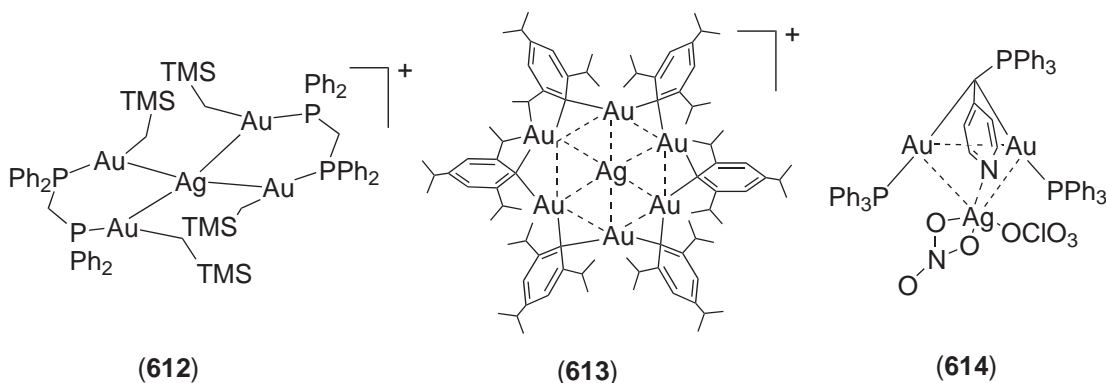
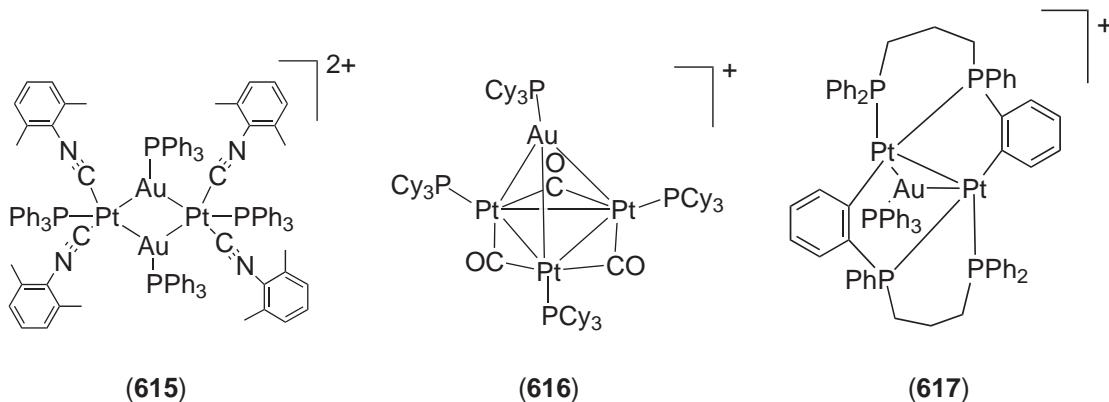

Figure 28 Acid-base stacking among $[\text{Au}_3(\text{Bzim})_3]$ and $\{\text{Hg}(\mu\text{-C}_6\text{H}_4)_3\}$.



$(\text{PCy}_3)_3(\text{PC}_6\text{H}_4\text{F-4})_2(\mu\text{-Cl})(\mu\text{-SO}_2)_2\text{PF}_6$,³¹⁸⁵ $[\{\text{Pt}_3(\text{PPh}_3)_4(\mu\text{-CO})_3\}_2\text{Au}]\text{PF}_6$,³¹⁸⁶ $[\text{Pt}_3\text{Au}(\text{PCy}_3)_4(\mu\text{-CO})(\mu\text{-CNR})_2]\text{PF}_6$,³¹⁸⁷ $[\text{Pt}_6\text{Au}_2(\mu\text{-CO})_6(\mu\text{-dppm})_3(\text{PPt}^i_3)_2](\text{PF}_6)_2$,³¹⁸⁸ $[\{\text{Pt}_3(\text{PCy}_3)_4(\mu\text{-CO})_3\}_2\{\mu\text{-Au}_2(\text{PPh}_2\text{CH}_2\text{C}_6\text{H}_4\text{CH}_2\text{PPh}_2)\}_2]^+$,³¹⁸⁹ $[\text{Pt}_3(\mu\text{-S})(\text{AuPPh}_3)(\mu\text{-AgCl})(\mu\text{-dppm})_3]^+$,³¹⁹⁰ $[\text{Pt}_3(\mu\text{-dppm})_3(\text{AuPPh}_3)]\text{PF}_6$,³¹⁹¹ $[\text{Pt}_3(\mu\text{-dppm})_3(\text{AuPMe}_3)_2]\text{PF}_6$,³¹⁹² or $[\text{Pt}_2\text{Au}(\text{CNR})_2(\mu\text{-SO}_2)(\text{PCy}_3)_3]\text{PF}_6$.³¹⁹³ Dinuclear compounds with bridging diphosphines also give unsupported Au—Pt bonds, as in $[\text{Pt}_2\text{R}_2(\mu\text{-dppm})_2(\mu\text{-AuX})]$ ($\text{R} = \text{C}\equiv\text{CBu}^t$, CN ; $\text{X} = \text{I}$, Cl),^{3194–3196} or $[\text{Pt}_2\{\text{PPh}_2(\text{CH}_2)_2\text{P}(\text{Ph})\text{C}_6\text{H}_4\}_2(\mu\text{-AuPPh}_3)]\text{BF}_4$ (617).³¹⁹⁷ Platinum(0) phosphine complexes with Au—Pt bonds are $[(\text{Ph}_3\text{P})_3\text{PtAu}(\text{PPh}_3)]\text{BF}_4$,²⁷²⁶ $[\text{PtCl}(\text{PEt}_3)_2(\text{AuPPh}_3)_2]\text{OTf}$,³¹⁹⁸ or $[\text{Pt}(\text{NO}_3)(\text{PPh}_3)_2(\text{AuPPh}_3)_2]\text{PF}_6$.³¹⁹⁹ Mixed metal derivatives with bridging phosphide ligands form complexes with Au—Pt—M bonds as in $[\text{Pt}(\text{CO})(\text{PCy}_2\text{H})(\mu\text{-PCy}_2)(\mu\text{-AuPPh}_3)\text{WCp}(\text{CO})_2]\text{PF}_6$ ³²⁰⁰ or $[\text{WCp}(\text{CO})_2(\mu\text{-PPh}_2)(\mu\text{-CO})\text{Pt}(\mu\text{-PPh}_2)(\mu\text{-AuPPh}_3)\text{WCp}(\text{CO})]\text{PF}_6$.³²⁰¹ The reaction of the electron-rich $[\text{PtMe}_2(\text{bipy})]$ with $[\text{AuX}(\text{PPh}_3)]$ gives the complex $[\text{PtMe}_2(\text{bipy})(\text{AuPPh}_3)]\text{X}$, with an unsupported Pt—Au bond.³²⁰² The compound $[\text{Pd}_3\text{Au}(\text{PPh}_3)_4(\mu\text{-N}_3)(\mu\text{-SO}_2)_2]$ is one example of Au—Pd bond.³²⁰³



Carborane platinum or iridium compounds form M—Au bonds in their reaction with gold(I) phosphine complexes, as in $[\text{Pt}(\text{CB}_{10}\text{H}_{11})(\text{PEt}_3)_2(\text{AuPPh}_3)]^{3204}$ or $[\text{Ir}(\text{C}_2\text{B}_9\text{H}_9\text{Me}_2)(\text{CO})(\text{PPh}_3)(\text{AuPPh}_3)]^{2047}$.

Complexes with Au—Rh or Au—Ir bonds have also been described such as $[\text{Rh}_2\text{Cp}_2(\mu\text{-dppm})(\mu\text{-CO})(\text{AuPPh}_3)]\text{BF}_4$,³²⁰⁵ $[\text{Rh}_2(\text{CNC}_6\text{H}_3\text{Me}_2\text{-}2,6)_4(\mu\text{-Cl})_2(\mu\text{-AuPPh}_3)]\text{PF}_6$,³²⁰⁶ $[\text{Rh}_2(\text{CO})_2(\text{PPh}_3)_2\{\mu\text{-}1,8\text{-(NH)}_2\text{C}_{10}\text{H}_6\}(\mu\text{-AuPPh}_3)]^+$ (618),¹⁴⁷² $[\text{Ir}(\text{dppe})_2(\text{AuPPh}_3)](\text{BF}_4)_2$ (619),³²⁰⁷ $[\text{IrH}(\text{CO})(\text{PPh}_3)_3(\text{AuPPh}_3)]\text{PF}_6$,³²⁰⁸ $[\text{Ir}_2(\text{dimen})_4(\text{PPh}_3)(\text{AuPPh}_3)](\text{PF}_6)_3$ ¹⁵⁹² or $[\text{Ir}_3(\text{indenyl})_3(\text{CO})_3(\mu\text{-AuPPh}_3)]\text{PF}_6$.³²⁰⁹

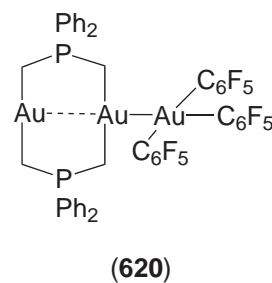
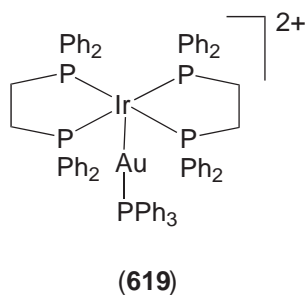
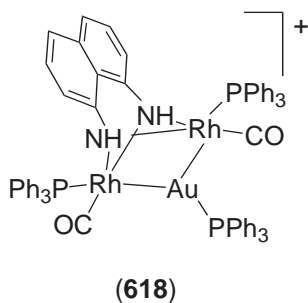

An example of a complex with a formal $\text{Au}^{\text{I}}\text{—Au}^{\text{III}}$ bond is $[\{\text{Au}_2\{\mu\text{-(CH}_2)_2\text{PPh}_2\}_2\text{Au}(\text{C}_6\text{F}_5)_3\}]^{3210}$ (620), which has been obtained by reaction of $[\text{Au}_2\{\mu\text{-(CH}_2)_2\text{PPh}_2\}_2]$ with $[\text{Au}(\text{C}_6\text{F}_5)_3(\text{OEt}_2)]$.³²¹⁰

6.7.3.5 Gold Clusters

There is an important class of gold compounds in which the formal oxidation state is intermediate between 0 and +1. They can be homo- or heteronuclear compounds, for which excellent reviews have been published recently.^{3153-3155,3211}

6.7.3.5.1 Homonuclear clusters

Several synthetic methods have been employed in the preparation of gold clusters compounds. Three main routes can be distinguished:

- (i) Reaction of a suitable gold(I) precursor as $[\text{AuX}(\text{PR}_3)]$ ($\text{X} = \text{halide, SCN, NO}_3$) with a reducing agent, such as NaBH_4 , $\text{Ti}(\mu\text{-C}_6\text{H}_5\text{Me})_2$, or CO , or even by photolysis of gold(I) azides. A representative example is given in Equation (43).³²¹² Also a gold(III) precursor can be used, as in the reaction of HAuCl_4 with NaBH_4 , that in the presence of PPh_3 gives the high nuclearity cluster $[\text{Au}_{39}\text{Cl}_6(\text{PPh}_3)_{14}]\text{Cl}_2$.⁴⁵
- (ii) Treatment of gold vapor in the presence of phosphine ligands as the example shown in Equation (44).³²¹³
- (iii) Reactions of gold clusters with other ligands or metal complexes. These types of reactions can progress with or without change in the metal skeleton. The first ones can be accompanied with an increase or decrease in the nuclearity, as exemplified in Equations (45) and (46).^{3214,3215}



Other reactions where the cluster core remains intact are based on nucleophilic addition, elimination, and substitution reactions, as well as electrochemical interconversions. Some examples are given in Equations (47) and (48):^{2714,3216}



The nuclearity of structurally characterized homonuclear clusters goes from four to 39. The preparation of $[\text{Au}_{55}\text{Cl}_6(\text{PPh}_3)_{12}]$ from the reduction of $[\text{AuCl}(\text{PPh}_3)]$ with B_2H_6 has also been reported.^{46,3217}

The bonding in gold cluster molecules has been interpreted using free electron models which are based on Stone's tensor surface harmonic theory.^{3218–3220} High similarity has been found between alkali metals and gold in the spectra of molecular orbitals when they form clusters, and the primary bonding and antibonding interactions result from the overlap of the *s* valence orbitals.^{3221,3222} For gold the 5*d*-orbitals are core-like and only hybridize slightly with the 6*s*, where the 6*p* valence orbitals are too high-lying to contribute significantly to the bonding. The geometries have been classified as (i) spherical polyhedral clusters characterized by a total of $12n + 8$ valence electrons (*n* is the number of peripheral gold atoms), and (ii) toroidal or elliptical polyhedral clusters characterized by a total of $12n + 6$ valence electrons.¹⁰⁹

Tetranuclear clusters have been described and are of the type $[\text{Au}_4(\text{PR}_3)_4]^{2+}$ ($\text{PR}_3 = \text{PMe}_3, \text{PBu}^t_3$),^{2714,3223} $[\text{Au}_4(\mu\text{-X})_2(\text{PPh}_3)_4]$ ($\text{X} = \text{I}, \text{SNCl}_3$),^{3224,3225} $[\text{Au}_4\text{I}(\mu_3\text{-I})(\text{dppm})_3]$,³²¹⁶ and $[\text{Au}_4\{\text{(PPh}_2)_2\text{C}_2\text{B}_9\text{H}_{10}\}_2\text{L}_2]$ (**621**) ($\text{L} = \text{AsPh}_3, \text{PPh}_3, \text{P}(4\text{-MeC}_6\text{H}_4)_3, \text{P}(4\text{-OMeC}_6\text{H}_4)_3$).^{2704,3226} The structure corresponds to a tetrahedron of metal atoms. The compounds with the carborane diphosphine present a luminescent behavior. Theoretical calculations of the empty $[\text{Au}_4(\text{PH}_3)_4]^{2+}$ reproduce the experimental Au—Au distance in $[\text{Au}_4(\text{PBu}^t_4)]^{2+}$ and suggest that covalent and correlation bonding in this two electron, four center system are comparable.³²²⁷

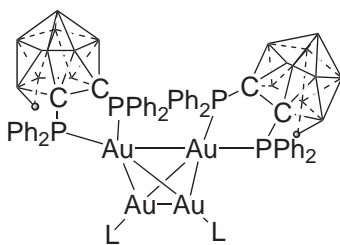

(621)

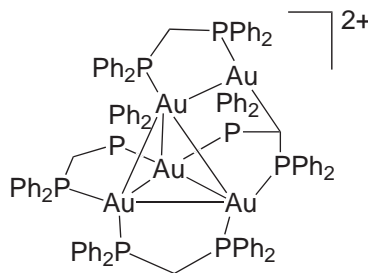

(622)

There is only one example of a pentanuclear cluster, namely $[\text{Au}_5(\text{dppm})_3(\text{dppm-H})(\text{NO}_3)_2]$ (**622**), where the metal core adopts a spiked-tetrahedral geometry of gold atoms.³²¹³

Several hexanuclear gold clusters have been prepared and are of the type $[\text{Au}_6(\text{PR}_3)_6]^{2+}$ (**623**) ($\text{PR}_3 = \text{PPh}_3, \text{PPh}(\text{C}_6\text{H}_4\text{Me-2}), \text{PPh}_2\text{Cy}$),^{3228,3229} $[\text{Au}_6(\text{dppp})_4]^{2+}$,³²³⁰ or $[(\text{H}_{12}\text{B}_{10}\text{Au})(\mu\text{-AuPEt}_3)_4(\text{AuB}_{10}\text{H}_{12})]$ (**624**).²⁰⁵² The geometry, although could be expected to be octahedral, consist of two edge-sharing tetrahedra. An octahedral cluster originally formulated as $[\text{Au}_6(\text{PTol}_3)_6]^{2+}$ was subsequently found to have an interstitial carbon atom.^{2,3231} The compound $[(\text{H}_{12}\text{B}_{10}\text{Au})(\mu\text{-AuPEt}_3)_4(\text{AuB}_{10}\text{H}_{12})]$ has an unusual structure. Only the heptanuclear gold cluster $[\text{Au}_7(\text{PPh}_3)_7]\text{OH}$ (**625**) has been prepared by evaporation of gold into a toluene solution containing PPh_3 . The structure corresponds to a distorted pentagonal bipyramid, with the axial Au—Au bond being the shortest at 2.584(1) Å.^{3214,3232}

Several octanuclear gold cluster have been characterized and are of the type $[\text{Au}_8(\text{PPh}_3)_8]^{2+}$,^{3233,3234} $[\text{Au}_8(\text{PPh}_3)_7]^{2+}$,³²³⁵ or $[\text{Au}_8(\text{PMe}_3)_6]^{2+}$.²⁷¹⁴ The structural skeletons for these compounds are different and are shown in Figure 29.

The majority of nonanuclear clusters have the stoichiometry $[\text{Au}_9(\text{PR}_3)_8]^{3+}$, they have been characterized structurally for the phosphine ligands $\text{P}(\text{C}_6\text{H}_4\text{Me-4})_3$ ³²¹² and $\text{P}(\text{C}_6\text{H}_4\text{OMe-4})_3$ ^{3236,3237} with different anions. It has been found that small changes result in large changes in the structure of the metal core, indicating small energy barriers between the different structural forms. Also pressure can induced skeletal isomerization of $[\text{Au}_9(\text{PPh}_3)_8](\text{PF}_6)_3$ in the solid state.³²³⁸ The

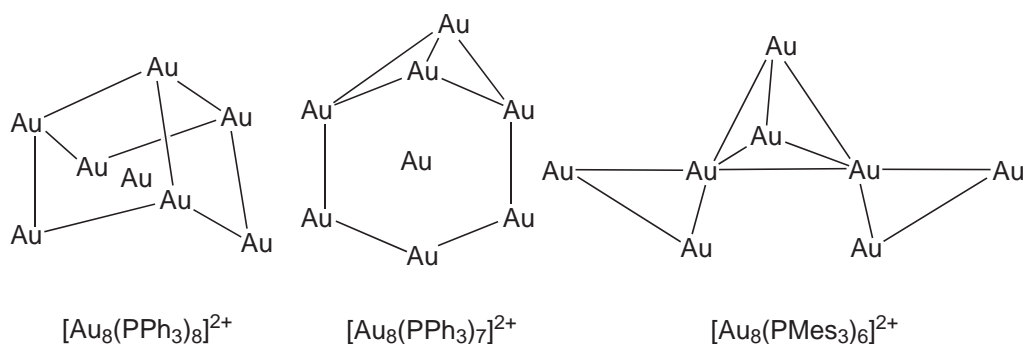
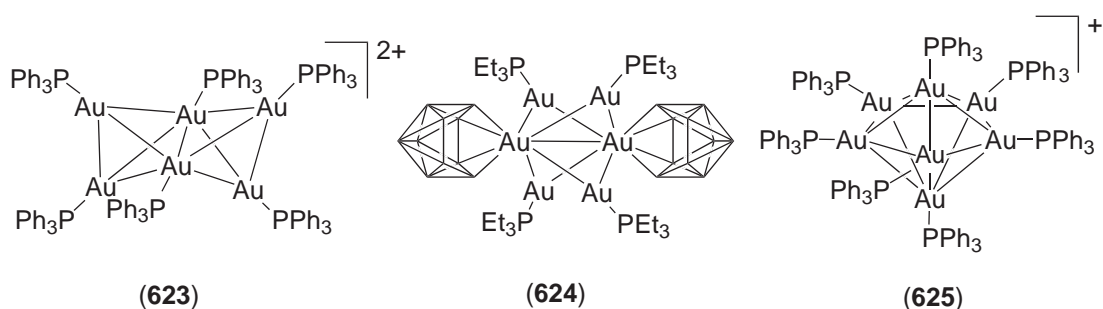

Figure 29 Structures of Au_8 clusters.

electrochemical behavior of these clusters has been studied and can be reduced in two consecutive one-electron step to give $[\text{Au}_9(\text{PR}_3)_8]^{2+}$ and $[\text{Au}_9(\text{PR}_3)_8]^+$.^{3239,3240} The cluster $[\text{Au}_9(\text{SCN})_3(\text{PCy}_3)_5]$ has also been obtained.³²⁴¹ The two different structural forms for nonanuclear clusters are shown in **Figure 30**.



Decanuclear gold clusters have a structure derived of three trigonal bipyramidal Au_5 clusters sharing a common central atom and edge sharing (**Figure 31a**). They can be neutral as $[\text{Au}_{10}\{\text{S}_2\text{C}_2(\text{CN})_2\}_2(\text{PPh}_3)_7]$ or $[\text{Au}_{10}(\text{C}_6\text{F}_5)_4(\text{PPh}_3)_5]$,³²¹⁵ or cationic as $[\text{Au}_{10}\text{Cl}_3(\text{PPhCy}_2)_6]\text{NO}_3$.³²⁴³ Other types of decanuclear gold clusters are those obtained by photolysis of a mixture of $[\text{AuCl}(\text{PPh}_3)]$ and $[\text{AuN}_3(\text{PPh}_3)]$ in the presence of $\text{Na}_2[\text{VCp}(\text{CO}_3)]$ or $\text{Cr}(\text{CO})_6$. They have the stoichiometry $[\text{Au}(\text{AuX})(\text{AuPPh}_3)_8]^+$ ($\text{X} = \text{Cl}, \text{NCO}$), and the structure consists of a centered square antiprism of nine Au atoms with one square face of the antiprism bridged by the AuX group (**Figure 31b**).^{3244,3245}

Several undecagold clusters have been characterized by XRD, such as $[\text{Au}_{11}\text{I}_3(\text{PR}_3)_7]$ ($\text{PR}_3 = \text{PPh}_3, \text{C}_6\text{H}_4\text{F}-4, \text{C}_6\text{H}_4\text{Cl}-4$),^{3233,3246,3247} $[\text{Au}_{11}(\text{SCN})_3(\text{dppm})_5]$,³²⁴⁸ $[\text{Au}_{11}\text{I}(\text{CN-Pr}^1)_2(\text{PPh}_3)_7](\text{PF}_6)_2$,³²⁴⁹ and $[\text{Au}_{11}(\text{PPH}_2\text{Me})_{10}]^{3-}$.³²⁵⁰ The structure of the mixed-ligands clusters corresponds to a C_{3v} metal skeletal framework and the homoleptic to a centered bicapped square antiprism (**Figure 32**). Other stoichiometries are known as, for example, $[\text{Au}_{11}\text{Cl}_2(\text{PPh}_3)_8]\text{Cl}$.³²⁵¹

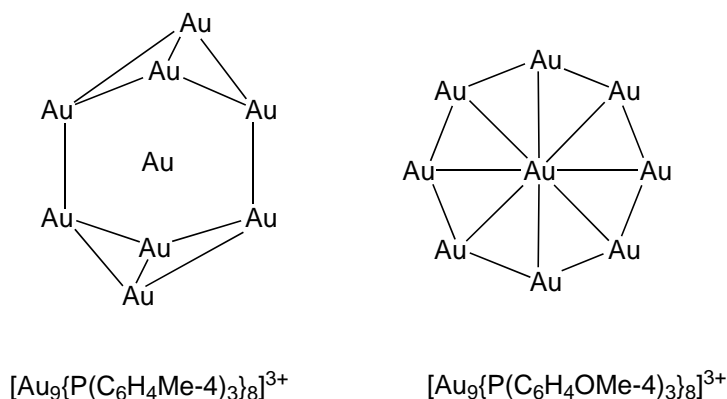

Figure 30 Structures of Au_9 clusters.

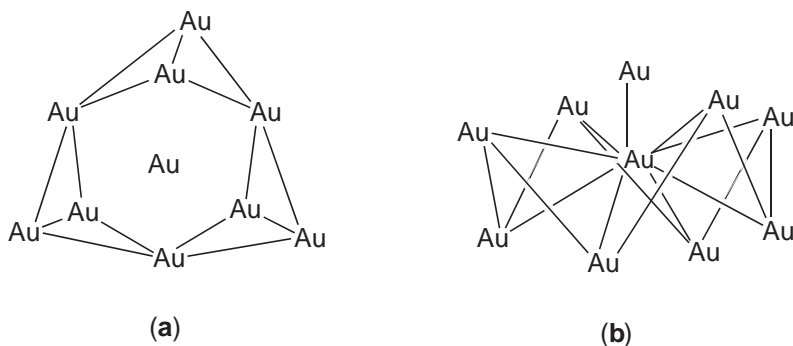

Figure 31 Structures of Au_{10} clusters.

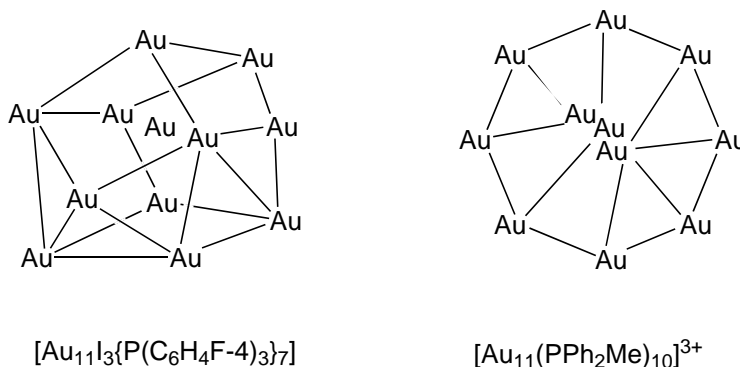

Figure 32 Structures of Au_{11} clusters.

Gold(I) compounds $[\text{AuX}(\text{PPh}_3)]$, where X is a weak coordinated ligand such as NO_3^- , ClO_4^- , BF_4^- , or OAc^- , react with CO to form clusters $[\text{Au}_9(\text{PPh}_3)_8]\text{X}_3$; if the solvent is dichloromethane fulminate, $[\text{Au}(\text{CNO})(\text{PPh}_3)]$, and $[\text{Au}_{11}(\text{CNO})_2(\text{PPh}_3)_8]^+$ are obtained.³²⁵²

The structure of the tridecanuclear cluster $[\text{Au}_{13}\text{Cl}_2(\text{PPhMe}_2)_{10}](\text{PF}_6)_3$ corresponds to a centered icosahedron of gold atoms (Figure 33).³²⁵³ A similar structure, although with disorder, seems to have $[\text{Au}_{13}(\text{dppm})_6](\text{NO}_3)_4$.³²⁵⁴ Recently the cluster $[\text{Au}_{16}\text{Cl}_6(\text{AsPh}_3)_8]$ has been prepared by reduction of $[\text{AuCl}(\text{AsPh}_3)]$ with NaBH_4 , and the structure is derived of a centered icosahedron of which one of the corners binds to three additional Au-atoms forming a tetrahedron pendent (Figure 34).³²⁵⁵

The largest structurally characterized gold cluster is $[\text{Au}_{39}\text{Cl}_6(\text{PPh}_3)_{14}]\text{Cl}_2$, which has a structure related to a hexagonal packed geometry with a 1:9:9:1:9:9:1 individual layers of gold atoms (Figure 35).⁴⁵ Attempts have been made to characterize the cluster $[\text{Au}_{55}\text{Cl}_6(\text{PPh}_3)_{12}]$ and the physical properties of these species have been widely studied.³²⁵⁶

6.7.3.5.2 Heteronuclear clusters

A novel series of Au—Ag supraclusters whose metal frameworks are based on vertex-sharing polyicosahedron have been reported. In the structure of these compounds the basic building block

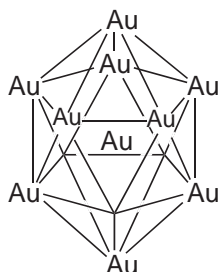

Figure 33 Core of $[\text{Au}_{13}\text{Cl}_2(\text{PPhMe}_2)_{10}]^{3+}$.

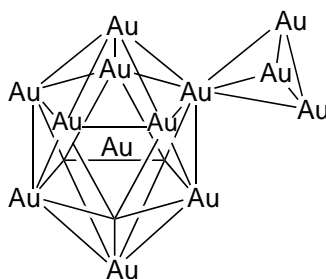

Figure 34 Core of $[\text{Au}_{16}\text{Cl}_6(\text{AsPh}_3)_8]$.

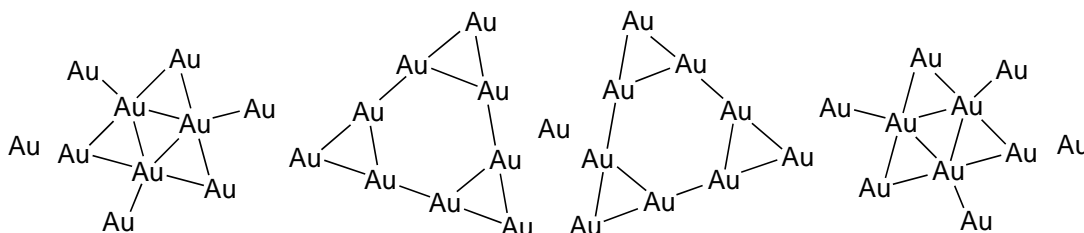

Figure 35 Layers of the cluster $[\text{Au}_{39}\text{Cl}_6(\text{PPh}_3)_{14}]\text{Cl}_2$.

is the 13-metal atom (Au_7Ag_6) icosahedra. These high nuclearity clusters have been termed “clusters of clusters” and they follow a well-defined growth sequence by successive additions of icosahedral units via vertex sharing.⁴⁷

The first member of this vertex-sharing polyicosahedral cluster series is the 25-metal-atom clusters whose metal core can be considered as two icosahedra sharing a common vertex. They have been obtained by reducing a mixture of $[\text{AuX}(\text{PR}_3)]$ and $[\text{AgX}(\text{PR}_3)]$ with NaBH_4 . Several of these types of clusters with different metal configurations have been reported, as, for example, $[(\text{Ph}_3\text{P})_{19}\text{Au}_{13}\text{Ag}_{12}\text{Br}_8]^+$ (Figure 36).^{3257–3263} Using the growth sequence by successive additions of icosahedral units via vertex sharing, the triicosahedral $[(p\text{-Tol}_3\text{P})_{12}\text{Au}_{18}\text{Ag}_{20}\text{Cl}_{14}]$ ^{3264–3266} and the tetraicosahedral $[(p\text{-Tol}_3\text{P})_{12}\text{Au}_{22}\text{Ag}_{24}\text{Cl}_{10}]$ ³²⁶⁷ clusters have been obtained. The 37-metal atom cluster $[(p\text{-Tol}_3\text{P})_{12}\text{Au}_{18}\text{Ag}_{19}\text{Br}_{11}]^{2+}$ is related to the 38-metal atom cluster in that one of the two capping Ag moieties is replaced by a triply bridging halide.³²⁶⁸ The structure of the triicosahedral clusters is three M_{13} atom (Au_7Ag_6) Au-centered icosahedra sharing three Au vertices in a cyclic manner (Figure 37), and the proposed structure for the tetraicosahedral cluster is four similar icosahedra arranged in a tetrahedral arrangement with six shared vertices.

The well-defined large bimetallic Au–Ag cluster as $[(\text{Ph}_3\text{P})_{12}\text{Au}_{18}\text{Ag}_{20}\text{Cl}_{14}]$ can achieve nearly two orders of magnitude of attenuation of high-intensity laser power and, consequently opens the door to a new class of optical materials based on nanosized metal clusters.³²⁶⁹

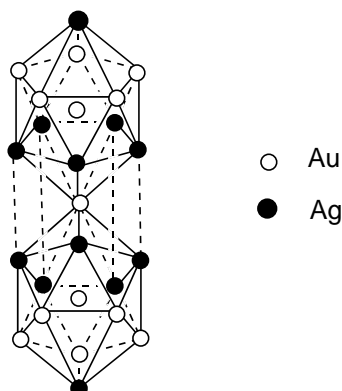

Figure 36 Core of $[(\text{Ph}_3\text{P})_{19}\text{Au}_{13}\text{Ag}_{12}\text{Br}_8]^+$.

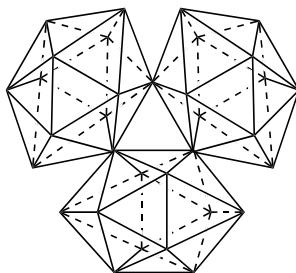
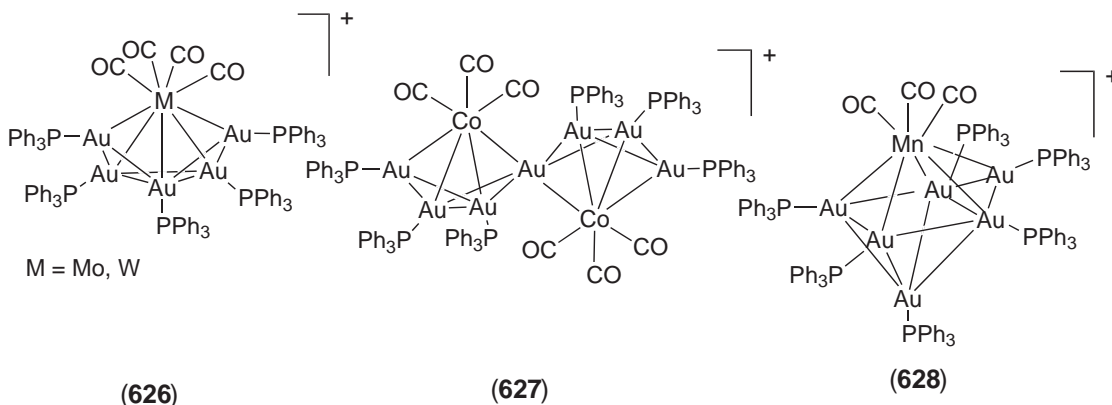

Figure 37 Core of Triicosahedral clusters.

Trimetallic polyicosahedral superclusters such as $[(\text{Ph}_3\text{P})_{10}\text{Au}_{12}\text{Ag}_{12}\text{MCl}_7]^+$ ($\text{M} = \text{Ni}, \text{Pt}$) or $[(\text{Ph}_3\text{P})_{10}\text{Au}_{10}\text{Ag}_{13}\text{Pt}_2\text{Cl}_7]$ have been obtained by reduction of mixtures of $[\text{M}(\text{AuPPh}_3)_8](\text{NO}_3)_2$ ($\text{M} = \text{Pt}, \text{Ni}$) and $[\text{AgCl}(\text{PPh}_3)]_4$ with NaBH_4 ,^{3270,3271} or by reaction of $[\text{Pt}(\text{H})(\text{PPh}_3)(\text{AuPPh}_3)_7]^{2+}$ with $[\text{Ag}(\text{NO}_3)(\text{PPh}_3)]$,³²⁷² respectively. In a similar reaction of $[\text{Pt}(\text{H})(\text{PPh}_3)(\text{AuPPh}_3)_7]^{2+}$ and $[\text{AgI}(\text{PPh}_3)]_4$, the trimetallic cluster $[(\text{Ph}_3\text{P})_6\text{Au}_6\text{Ag}_6\text{Pt}(\text{AgI}_3)_2]$ was isolated. The structure is a icosahedron of the three metal atoms with two capping AgI_3 units.³²⁷³

A large number of mixed metal–gold clusters are known where the metal can vary from an early transition metal, to the platinum group or coinage metals. With coinage metals, apart from the Au–Ag superclusters, centered icosahedral clusters of the type $[\text{Au}_9\text{M}_4\text{Cl}_4(\text{PPh}_2\text{Me})_8](\text{C}_2\text{B}_9\text{H}_{12})$ ($\text{M} = \text{Au}, \text{Ag}, \text{Cu}$) have been obtained.³²⁷⁴ With early transition metals,³²⁷⁵ mixed gold clusters with vanadium as $[\text{V}(\text{CO})_5(\text{AuPPh}_3)]$ or $[\text{V}(\text{CO})_4(\text{AuPPh}_3)_6]^+$,^{3276,3277} molybdenum and tungsten of the type $[\text{M}(\text{CO})_4(\text{AuPPh}_3)_5]^+$ (**626**), $[\text{M}(\text{CO})_3(\text{AuPPh}_3)_7]^+$ ($\text{M} = \text{Mo}, \text{W}$),^{3278–3280} or $[\text{MoCp}(\text{CO})_2(\text{AuPPh}_3)_4]^+$,³²⁸¹ cobalt as $[\text{Co}_2(\text{CO})_6\text{Au}(\text{AuPPh}_3)_6]^+$ (**627**),³²⁷⁹ $[\text{Co}(\text{CO})_3(\text{AuPPh}_3)_4]^+$,^{3278,3282} $[\text{Co}(\text{CO})_2(\text{AuPPh}_3)_7]^{2+}$,³²⁸³ or $[\{\text{Co}(\text{CO})_4\}_2\text{Au}_6(\text{PPh}_3)_4]$,³²⁸⁴ manganese as $[\text{Mn}(\text{CO})_4(\text{AuPPh}_3)_4]^+$, $[\text{Mn}(\text{CO})_4(\text{AuPPh}_3)_4]$, $[\text{Mn}(\text{CO})_3(\text{AuPPh}_3)_6]^+$ (**628**), or $[(\text{Ph}_3\text{PAu})_4\{\text{AuMn}(\text{CO})_5\}_2]$,^{3285–3289} or rhenium as $[\text{Re}(\text{CO})_4\text{Au}(\text{AuPPh}_3)_3]$,³²⁸⁹ have been described. In most of the cases photolysis of $[\text{AuN}_3(\text{PPh}_3)]$ in the presence of metal carbonyl complexes has been the synthetic method.



Mixed gold–platinum group metal complexes are numerous, amongst them the reactivity of the clusters $[\text{M}(\text{AuPPh}_3)_8]^{2+}$ ($\text{M} = \text{Pd}, \text{Pt}$), which possesses a central platinum atom, has been studied thoroughly. They are synthesized by reduction of mixtures of $[\text{M}(\text{PPh}_3)_4]$ and $[\text{Au}(\text{NO}_3)(\text{PPh}_3)]$.^{3290–3292} These cluster compounds undergo several types of reactions as nucleophilic additions to go from 16-electron to 18-electron clusters,^{3293–3295} an example is given in Equation (49). The change from a 16- to an 18-electron cluster provokes a change in the geometry from toroidal to spheroidal as can be seen in Figure 38:

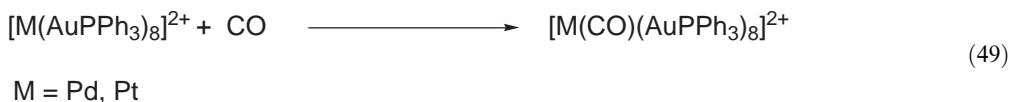

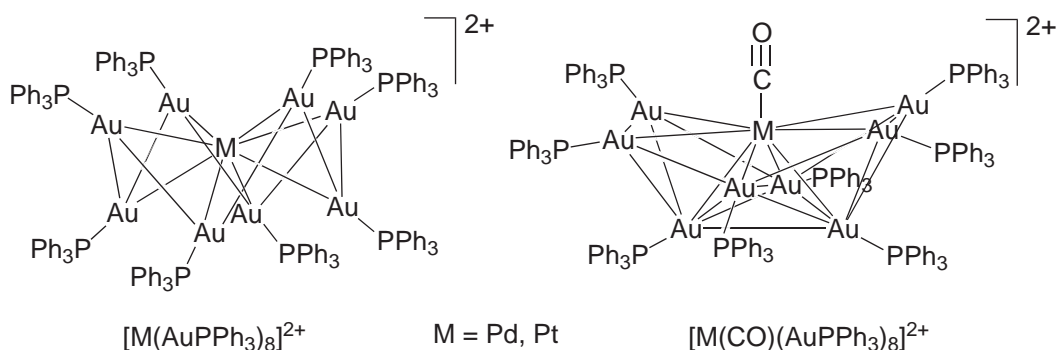
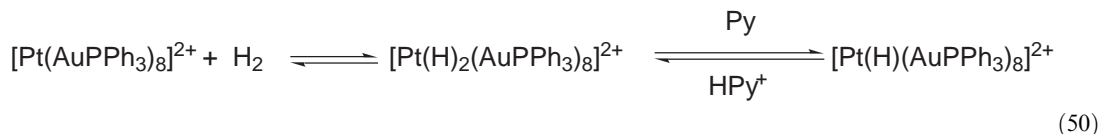
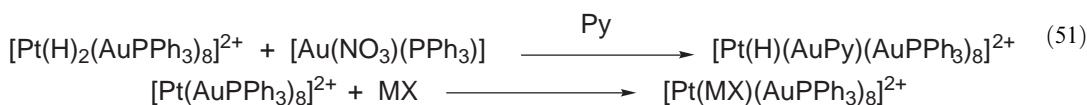

Figure 38 Structures of the 16- and 18-electron clusters.

Other types of reactions have been studied as, for example, a mixture of nucleophilic addition and substitution reactions.^{3296–3298} An interesting reaction due to the potential catalytic applications is the reversible addition of H_2 to $[Pt(AuPPh_3)_8]^{2+}$ to give the 18-electron dihydrido cluster $[Pt(H)_2(AuPPh_3)_8]^{2+}$.^{3299,3300} In nonbasic solvents the dihydrido cluster is stable and upon removal of the H_2 atmosphere, it rapidly loses H_2 to reform $[Pt(AuPPh_3)_8]^{2+}$. These reactions are completely reversible in pyridine solutions as shown in Equation (50):³³⁰¹



The reaction of these platinum or palladium clusters with transition metal compounds has also been studied and many cluster derivatives have been prepared for this method, which included reactions with gold,^{3302–3306} silver,^{3302,3303,3307–3310} copper,^{3302,3303,3309–3311} or mercury complexes.^{3307,3312–3314} Some examples are given in Equations (51) and (52):



Other approach to mixed palladium–gold or platinum–gold clusters is by co-photolysis reactions of $[AuN_3(PPh_3)]$ and $[M(N_3)_2L_2]$ ($M = Pd, Pt$; $L_2 = dppe, (PPh_3)_2$). By this procedure several cluster compounds such as $[Pt(PPh_3)(AuPPh_3)_6(AuCl)_3]$,³³¹⁵ $[Pt(CO)(AuPPh_3)_6(AuCl)_3]$,³³¹⁵ $[Pd(AuPPh_3)_8(AuCl)_4]$,³³¹⁶ or $[Pd(AuPPh_3)_6(Au_2dppe)(AuCl)_4]$ ³³¹⁷ have been obtained. Also the reaction of $[Pt(PPh_3)_4]$ with $[Au(C\equiv CBu^1)]$ yields the mixed cluster $[Pt(C\equiv CBu^1)(PPh_3)(AuPPh_3)_6][Au(C\equiv CBu^1)_2]$.³³¹⁸

Other mixed gold clusters have also been synthesized with iron as $[Fe(CO)_3(AuPPh_3)_5]^+$,³³¹⁹ iridium as $[IrAu_4(H)_4(PPh_3)_6]BF_4$,³³²⁰ rhodium as $[Rh(POPr^i)_2(H)_2(AuPPh_3)_4]^+$,³³²¹ $[Rh(POPr^i)_2(H)(AuPPh_3)_5]^+$,³³²¹ or $[Rh(H)(CO)(PPh_3)_2(AuPPh_3)_2]^+$,³³²² rhenium as $[Re(H)_4(PPh_3)_2(AuPPh_3)_5]^{2+}$,³³²² or indium as $[Au_3In_3Cl_6(THF)_6(dppe)_3]$ or $[Au_3In_3Br_7(THF)_6(dppe)_2]^-$.^{3323,3324}

6.7.3.6 Gold(0) Complexes

The complex $[Au_2(PPh_3)_2]$ has been prepared by reduction of $[AuI(PPh_3)]$ with sodium naphthalene. Its core unit is isoelectronic with mercurous halides Hg_2X_2 ; but, curiously enough, it has a dinuclear *trans* bent structure with $d(Au-Au) = 2.76 \text{ \AA}$ and a $Au-Au-P$ angle of 129° .³³²⁵ There is no confirmation as yet of the original preliminary report.

The synthesis of silicalix[n]phosphinines, a new class of macrocycles incorporating sp^2 -hybridized phosphorus atoms has allowed the preparation of gold(0) macrocycles. These ligands possess an adequate balance between σ -donating and π -accepting properties and then can act as macrocyclic equivalent of carbonyl groups. The reaction of these macrocycles with $[\text{AuCl}(\text{SMe}_2)]$ in the presence of GaCl_3 yields the complexes $[\text{AuL}][\text{GaCl}_4]$. The electrochemical reduction of one of these derivatives allows the synthesis of the gold(0) compound (Equation (53)).⁴⁸

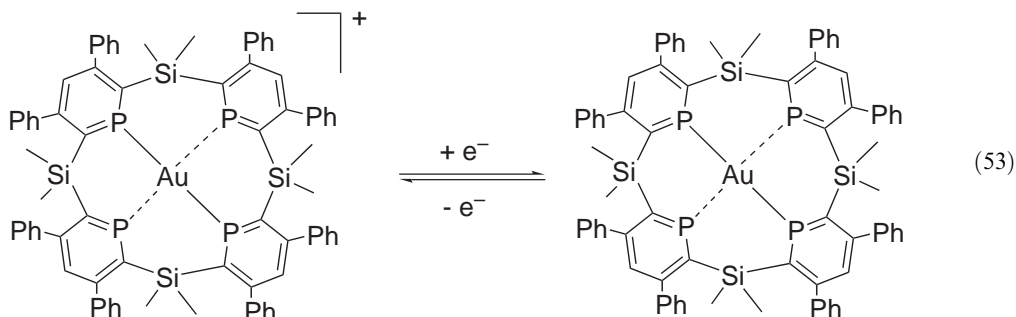

6.7.3.7 Gold(-I) Compounds

Gold is unique among the transition metals in its ability to form isolable nonmetallic compounds that contain a monoatomic anion. The binary alkali metal aurides RbAu and CsAu have been known for about 50 years, but the ternary auride oxides M_3AuO ($\text{M} = \text{K}, \text{Rb}, \text{Cs}$) and the aurideaurates $\text{Rb}_5\text{Au}_3\text{O}_2$ and $\text{M}_7\text{Au}_5\text{O}_2$ ($\text{M} = \text{Rb}, \text{Cs}$) have been discovered only recently.^{3326–3329}

Using a macroreticular ion exchange resin with a high affinity toward caesium ions in liquid ammonia, it has been possible to exchange caesium for tetramethylammonium and the first compound of negatively charged gold with a nonmetal cation has been isolated, $\text{NMe}_4^+\text{Au}^-$.⁴⁹

An estimation of auride radius has been made of 1.9 Å, which is very similar to the bromine ion. CsAu dissolves in liquid ammonia forming a yellow solution that on removing ammonia, CsAu was not recovered directly, instead a new, intense blue solid crystallizes which has the composition $\text{CsAu}\cdot\text{NH}_3$.⁵⁰ The crystal structure exhibits features characteristic for low-dimensional systems. Slabs of overall composition CsAu are separated by single NH_3 layers. The gold atoms are shifted towards each other forming zig-zag chains with a $\text{Au}\cdots\text{Au}$ separation of 3.02 Å (4.36 Å in CsAu). This “auridophilic attraction” takes place between $d^{10}s^2$ anions but surprisingly yields a similar distance as the aurophilic attraction in d^{10} cations. The nature of this effect is not theoretically clear. Both the dispersion effects and the net bonding, resulting from partial oxidation from the top of 6s band, could play a role. The observed Mössbauer isomer shift at gold (CsAu 7.00 mm S^{-1} , RbAu 6.70 mm S^{-1} , $\text{CsAu}\cdot\text{NH}_3$ 5.96 mm S^{-1} , Au -1.23 mm S^{-1}) does not show a full -1 auride charge and keeps the latter possibility open.³³³⁰

6.7.4 REFERENCES

1. Bayler, A.; Schier, A.; Bowmaker, G. A.; Schmidbaur, H. *J. Am. Chem. Soc.* **1996**, *118*, 7006–7007.
2. Scherbaum, F.; Grohmann, A.; Huber, B.; Krüger, C.; Schmidbaur, H. *Angew. Chem., Int. Ed. Engl.* **1988**, *27*, 1544–1546.
3. Mehrotra, P. K.; Hoffmann, R. *Inorg. Chem.* **1978**, *17*, 2182–2187.
4. Dediou, A.; Hoffmann, R. *J. Am. Chem. Soc.* **1978**, *100*, 2074–2080.
5. Janiak, C.; Hoffmann, R. *J. Am. Chem. Soc.* **1990**, *112*, 5924–5946.
6. Burdett, J. K.; Eisenstein, O.; Schweizer, W. B. *Inorg. Chem.* **1994**, *33*, 3261–3268.
7. Mingos, D. M. P.; Slee, T.; Shenyang, L. *Chem. Rev.* **1990**, *90*, 383–402.
8. Häberlein, O. D.; Schmidbaur, H.; Rösch, N. *J. Am. Chem. Soc.* **1994**, *116*, 8241–8248.
9. Rösch, N.; Görling, A.; Ellis, D. E.; Schmidbaur, H. *Inorg. Chem.* **1991**, *30*, 3986–3994.
10. Rösch, N.; Görling, A.; Ellis, D. E.; Schmidbaur, H. *Angew. Chem., Int. Ed. Engl.* **1989**, *28*, 1357–1359.
11. Pyykkö, P.; Angermaier, K.; Assmann, B.; Schmidbaur, H. *J. Chem. Soc., Chem. Commun.* **1995**, 1889–1890.
12. Pyykkö, P.; Runeberg, N.; Mendizabal, F. *Chem. Eur. J.* **1997**, *3*, 1451–1457.
13. Pyykkö, P.; Mendizabal, F. *Chem. Eur. J.* **1997**, *3*, 1458–1465.
14. Pyykkö, P. *Chem. Rev.* **1997**, *97*, 597–636.
15. Schwerdtfeger, P.; Bruce, A. E.; Bruce, M. R. M. *J. Am. Chem. Soc.* **1998**, *120*, 6587–6597.

16. Kaltsoyannis, N. *J. Chem. Soc., Dalton Trans.* **1997**, 1–11.
17. Singh, K.; Long, J. R.; Stavropoulos, P. *J. Am. Chem. Soc.* **1997**, *119*, 2942–2943.
18. Strähle, J. *Unkonventionelle Wechselwirkungen in der Chemie Metallischer Elemente*; Krebs, B. Ed.; VCH Publishers: New York, 1992; p 357.
19. Ahmed, L. S.; Dilworth, J. R.; Miller, J. R.; Whetley, N. *Inorg. Chim. Acta* **1998**, *278*, 229–231.
20. Levason, W.; Spicer, M. D. *Coord. Chem. Rev.* **1987**, *76*, 45–120.
21. Standke, B.; Jansen, M. *Angew. Chem., Int. Ed. Engl.* **1985**, *24*, 118–119.
22. Standke, B.; Jansen, M. *Angew. Chem., Int. Ed. Engl.* **1986**, *25*, 77–78.
23. Zemva, B.; Lutar, K.; Jesih, A.; Casteel, W. J., Jr.; Wilkinson, A. P.; Cox, D. E.; Von Dreele, R. B.; Borrmann, H.; Bartlett, N. *J. Am. Chem. Soc.* **1991**, *113*, 4192–4198.
24. Hurlburt, P. K.; Anderson, O. P.; Strauss, S. H. *J. Am. Chem. Soc.* **1991**, *113*, 6277–6278.
25. Hurlburt, P. K.; Rack, J. J.; Dec, S. F.; Anderson, O. P.; Strauss, S. H. *Inorg. Chem.* **1993**, *32*, 373–374.
26. Dias, H. V. R.; Jin, W. *J. Am. Chem. Soc.* **1995**, *117*, 11381–11382.
27. Newbound, T. D.; Colman, M. R.; Miller, M. M.; Wulfsberg, G. P.; Anderson, O. P.; Strauss, S. H. *J. Am. Chem. Soc.* **1989**, *111*, 3762–3764.
28. Colman, M. R.; Newbound, T. D.; Marshall, L. J.; Noirot, M. D.; Miller, M. M.; Wulfsberg, G. P.; Frye, J. S.; Anderson, O. P.; Strauss, S. H. *J. Am. Chem. Soc.* **1990**, *112*, 2349–2362.
29. Colman, M. R.; Noirot, M. D.; Miller, M. M.; Anderson, O. P.; Strauss, S. H. *J. Am. Chem. Soc.* **1988**, *110*, 6886–6888.
30. Blower, P. J.; Dilworth, J. R. *Coord. Chem. Rev.* **1987**, *76*, 121–185.
31. Dance, I. J. *Polyhedron* **1986**, 1037–1104.
32. Yam, V. W. W.; Lo, K. K. W. *Comments Inorg. Chem.* **1997**, *19*, 209–220.
33. Yam, V. W. W.; Lo, K. K. W. *Chem. Soc. Rev.* **1999**, *28*, 323–334.
34. Fenske, D.; Zhu, N.; Langetepe, T. *Angew. Chem., Int. Ed. Engl.* **1988**, *37*, 2640–2644.
35. Munakata, M.; Wu, L. P.; Kuroda-Sowa, T. *Adv. Inorg. Chem.* **1999**, *46*, 173–303.
36. Cotton, F. A.; Wilkinson, G.; Murillo, C. A.; Bochmann, M. Eds. *Advanced Inorganic Chemistry*, 6th ed.; 1999, Wiley: New York.
37. Laguna, A.; Laguna, M. *Coord. Chem. Rev.* **1999**, *193–195*, 837–856.
38. Seidel, S.; Seppelt, K. *Science* **2000**, *290*, 117–118.
39. Drews, T.; Seidel, S.; Seppelt, K. *Angew. Chem., Int. Ed. Engl.* **2002**, *41*, 454–456.
40. Adelhelm, M.; Bacher, W.; Höhn, E. G.; Jacob, E. *Chem. Ber.* **1991**, *124*, 1559–1561.
41. Willner, H.; Schaebs, J.; Hwang, G.; Mistry, F.; Jones, R.; Trotter, J.; Aubke, F. *J. Am. Chem. Soc.* **1992**, *114*, 8972–8960.
42. Forward, J. M.; Fackler, J. P., Jr.; Assefa, Z. *Optoelectronic Properties of Inorganic Compounds*; Roundhill, D. M.; Fackler, J. P., Jr., Eds.; Plenum Press: New York 1999, pp 195–229.
43. Fernández, E. J.; Laguna, A.; López de Luzuriaga, J. M. *Gold Bull.* **2001**, *34*, 14–19.
44. Bachman, R. E.; Fioritto, M. S.; Fetics, S. K.; Cocker, T. M. *J. Am. Chem. Soc.* **2001**, *123*, 5376–5377.
45. Teo, B. K.; Shi, X.; Zhang, H. *J. Am. Chem. Soc.* **1992**, *114*, 2743–2745.
46. Schmid, G.; Pfeil, R.; Boese, R.; Bandermann, F.; Meyer, S.; Calis, G. H. M.; Van der Velden, J. W. A. *Chem. Ber.* **1981**, *114*, 3634–3642.
47. Teo, B. K.; Zhang, H.; Shi, X. *The Chemistry of the Copper and Zinc Triads*, Welch, A. J.; Chapman, S. K., Eds., Royal Society of Chemistry, 1993.
48. Mézailles, N.; Avarvari, N.; Maigrot, N.; Ricard, L.; Mathey, F.; Le Floch, P.; Cataldo, L.; Berclaz, T.; Geoffroy, M. *Angew. Chem., Int. Ed. Engl.* **1999**, *38*, 3194–3197.
49. Dietzel, P. D. C.; Jansen, M. *Chem. Commun.* **2001**, 2208–2209.
50. Mudring, A. V.; Jansen, M.; Daniels, J.; Krämer, S.; Mehring, M.; Prates Ramalho, J. P.; Romero, A. H. Parrinelo, M. *Angew. Chem., Int. Ed. Engl.* **2002**, *41*, 120–124.
51. Hutching, G. J. *Gold Bull.* **1996**, *29*, 123–130.
52. Haruta, M. *Catal. Today* **1997**, *36*, 153–166.
53. Thompson, D. T. *Gold Bull.* **1998**, *31*, 111–118.
54. Thompson, D. T. *Gold Bull.* **1999**, *32*, 12–19.
55. Bond, G. C.; Thompson, D. T. *Catal. Rev.-Sci. Eng.* **1999**, *41*, 319–388.
56. Bond, G. C.; Thompson, D. T. *Gold Bull.* **2000**, *33*, 41–51.
57. Thompson, D. *Gold Bull.* **2001**, *34*, 56–66.
58. Diker, G. *Angew. Chem., Int. Ed. Engl.* **2000**, *39*, 4237–4242.
59. Richards, R. M. E.; Taylor, R. B.; Xing, D. K. L. *J. Pharm. Sci.* **1991**, *80*, 861–867.
60. Grier, N. In *Disinfection, Sterilization, and Preservation*, 3rd ed.; Block, S. S., Ed.; Lea & Febiger: Philadelphia, 1983; Chapter 18.
61. Rauser, W. E. *Annu. Rev. Biochem.* **1990**, *59*, 61–86.
62. Fürst, P.; Hamer, D. *Proc. Natl. Acad. Sci. USA* **1989**, *86*, 5267–5271.
63. Ralston, D. M.; O'Halloran, T. V. *Proc. Natl. Acad. Sci. USA* **1990**, *87*, 3846–3850.
64. Kodas, T. T.; Hampden-Smith, M. J., Eds. *The Chemistry of Metal CVD*; VCH: Weinheim, 1994.
65. Bruce, D. W. *Acc. Chem. Res.* **2000**, *33*, 831–840.
66. Lancashire, R. J. *Comprehensive Coordination Chemistry*; Wilkinson, G.; Gillard, R. D.; McCleverty, J. A., Eds., Pergamon Press, Oxford 1987, Vol. 5, p 775–859.
67. Puddephatt, R. J. *Comprehensive Coordination Chemistry*; Wilkinson, G.; Gillard, R. D.; McCleverty, J. A., Eds., Pergamon Press, Oxford 1987, Vol. 5, p 861–923.
68. Van Koten, G.; James, S. L.; Jastrzebski, J. T. B. H. *Comprehensive Organometallic Chemistry II*; Abel, E. W.; Stone, F. G. A.; Wilkinson, G., Eds., Pergamon Press, Oxford, 1995, Vol. 3, p 57–133.
69. Grohmann, A.; Schmidbaur, H. *Comprehensive Organometallic Chemistry II*; Abel, E. W.; Stone, F. G. A.; Wilkinson, G., Eds., Pergamon Press, Oxford, 1995, Vol. 3, p 1–56.
70. Holloway, C. E.; Melnik, M.; Nevin, W. A.; Liu, W. *J. Coord. Chem.* **1995**, *35*, 85–178.
71. *The Chemistry of Organic Derivatives of Gold and Silver*; Patai, S.; Rappoport, Z., Eds., Wiley: Chichester, U.K., 1999.
72. Housecroft, C. E. *Coord. Chem. Rev.* **1992**, *115*, 141–161.

73. Housecroft, C. E. *Coord. Chem. Rev.* **1994**, *131*, 1–43.
74. Housecroft, C. E. *Coord. Chem. Rev.* **1995**, *146*, 211–233.
75. Housecroft, C. E. *Coord. Chem. Rev.* **1996**, *152*, 87–105.
76. Cortez, S. M.; Raptis, R. G. *Coord. Chem. Rev.* **1997**, *162*, 495–538.
77. Cortez, S. M.; Raptis, R. G. *Coord. Chem. Rev.* **1998**, *169*, 363–426.
78. Anderson, G. K. *Adv. Organomet. Chem.* **1982**, *20*, 39–61.
79. Grandberg, K. I.; Dyadchenko, V. J. *Organomet. Chem.* **1994**, *474*, 1–21.
80. Pathaneni, S. S.; Desiraju, G. R. *J. Chem. Soc., Dalton Trans.* **1993**, 319–322.
81. Parish, R. V. *Hyperfine Interact.* **1988**, *40*, 159–165.
82. Melnik, M.; Parish, R. V. *Coord. Chem. Rev.* **1986**, *70*, 157–257.
83. Jones, P. G. *Gold Bull.* **1981**, *14*, 102–118.
84. Jones, P. G. *Gold Bull.* **1981**, *14*, 159–166.
85. Jones, P. G. *Gold Bull.* **1983**, *16*, 114–124.
86. Jones, P. G. *Gold Bull.* **1986**, *19*, 46–57.
87. Smith, W. E. *Coord. Chem. Rev.* **1981**, *35*, 259–281.
88. Smith, W. E. *Coord. Chem. Rev.* **1982**, *45*, 319–360.
89. Smith, W. E. *Coord. Chem. Rev.* **1985**, *67*, 311–341.
90. Housecroft, C. E. *Coord. Chem. Rev.* **1992**, *115*, 117–140.
91. Housecroft, C. E. *Coord. Chem. Rev.* **1993**, *127*, 187–221.
92. Schmidbaur, H. *Gold Bull.* **1990**, *23*, 11–21.
93. Schmidbaur, H. *Interdisc. Sci. Rev.* **1992**, *17*, 213–220.
94. Schmidbaur, H. *Pure Appl. Chem.* **1993**, *65*, 691–698.
95. Schmidbaur, H. *Chem. Soc. Rev.* **1995**, 391–400.
96. Schmidbaur, H. *Gold Bull.* **2000**, *33*, 3–10.
97. Gimeno, M. C.; Laguna, A. *Chem. Rev.* **1997**, *97*, 511–522.
98. Usón, R.; Laguna, A. *Coord. Chem. Rev.* **1986**, *70*, 1–50.
99. Laguna, A.; Gimeno, M. C. *Trends Organomet. Chem.* **1994**, *1*, 231–261.
100. Roundhill, D. M. *Photochemistry and Photophysics of Metal Complexes*, Fackler, J. P., Jr., Ed., Plenum Press: New York, 1994, p 138–144.
101. Sadler, P. J. *Adv. Inorg. Chem.* **1991**, *36*, 1–48.
102. Sadler, P. J.; Guo, Z. *Pure Appl. Chem.* **1998**, *70*, 863–871.
103. Dhubhghaill, O. M. N.; Sadler, P. J. Gold Complexes in Cancer Chemotherapy. In *Metal Complexes in Cancer Chemotherapy*, Keppler, B. K., Ed., 1993, VCH: Weinheim, pp 221–248.
104. Shaw III, C. F. *Chem. Rev.* **1999**, *99*, 2589–2600.
105. Parish, D. V. *Interdisc. Sci. Rev.* **1992**, *17*, 221–228.
106. Espinet, P. *Gold Bull.* **1999**, *32*, 127–134.
107. Rossel, O.; Seco, M.; Caminade, A. M.; Majoral, J. P. *Gold Bull.* **2001**, *34*, 88–94.
108. Steggerda, J. J.; Bour, J. J.; Van der Velden, J. W. A. *Recl. Trav. Chim. Pays-Bas* **1982**, *101*, 164–170.
109. Hall, K. P.; Mingos, D. M. P. *Prog. Inorg. Chem.* **1984**, *32*, 237–325.
110. Mingos, D. M. P. *Gold Bull.* **1984**, *17*, 5–12.
111. Mueting, A. M.; Bos, W.; Alexander, B. D.; Boyle, P. D.; Casalnuovo, J. A.; Balaban, S.; Ito, L. N.; Johson, S. M.; Pignolet, L. H. *New J. Chem.* **1988**, *12*, 505–527.
112. Ferrer, M.; Reina, R.; Rossell, O.; Seco, M. *Coord. Chem. Rev.* **1999**, *193–195*, 619–642.
113. Pykkö, P. *Chem. Rev.* **1988**, *88*, 563–594.
114. Jansen, M. *Angew. Chem., Int. Ed. Engl.* **1987**, *26*, 1098–1110.
115. Schmidbaur, H., Eds.; *Gold, Progress in Chemistry, Biochemistry and Technology.* **1999**, Wiley: Chichester, U.K.
116. *Ullmann's Encycl. Ind. Chem.*, 5th ed.; Verlag Chemie: Weinheim, 1982; Vol. A3 p 340.
117. Kielhorn, S.; Buß, F.; Glemser, O.; Gerner, R.; Jeske, G. *Angew. Chem., Int. Ed. Engl.* **1991**, *30*, 1017–1018.
118. Hoppe, R. Z. *Inorg. Allg. Chem.* **1957**, *292*, 28–35.
119. Lutar, K.; Jesih, A.; Zemva, B. *Rev. Chimie Miner.* **1986**, *23*, 565–570.
120. Lutar, K.; Jesih, A.; Leban, I.; Zemva, B.; Bartlett, N. *Inorg. Chem.* **1989**, *28*, 3467–3471.
121. Lucier, G. M.; Whalen, J. M.; Bartlett, N. *J. Fluorine Chem.* **1998**, *89*, 101–104.
122. Lucier, G. M.; Shen, C.; Elder, S. H.; Bartlett, N. *Inorg. Chem.* **1998**, *37*, 3829–3834.
123. Eujen, R.; Zemva, B. *J. Fluorine Chem.* **1999**, *99*, 139–140.
124. Hector, A. L.; Levason, W.; Weller, M. T.; Hope, E. G. *J. Fluorine Chem.* **1997**, *86*, 105–108.
125. Bougon, R.; Bai Huy, T.; Lance, M.; Abazli, H. *Inorg. Chem.* **1984**, *23*, 3667–3668.
126. Bougon, R.; Lance, M.; Seances, C. R. *Acad. Sic., Ser. 2* **1983**, *297*, 117–122.
127. Kiselev, YuM.; Popov, A. I.; Timakov, A. A.; Bukharin, K. V.; Sukhoverkhov, V. F. *Zh. Neorg. Khim.* **1988**, *33*, 1252–1257.
128. Zemva, B.; Lutar, K.; Jesih, A.; Casteel, W. J., Jr.; Bartlett, N. *J. Chem. Soc., Chem. Commun.* **1989**, 346–347.
129. Rush, J. D.; Kirschenbaum, L. J. *Polyhedron* **1985**, *4*, 1573–1580.
130. Borish, E. T.; Kirschenbaum, L. J. *J. Chem. Soc., Dalton Trans.* **1983**, 749–753.
131. Kirschenbaum, L. J.; Borish, E. T.; Rush, J. D. *Isr. J. Chem.* **1985**, *25*, 159–163.
132. Borish, E. T.; Kirschenbaum, L. J.; Mentasti, E. *J. Chem. Soc., Dalton Trans.* **1985**, 1789–1794.
133. Borish, E. T.; Kirschenbaum, L. J. *Inorg. Chem.* **1984**, *23*, 2355–2359.
134. Rush, J. D.; Kirschenbaum, L. J. *Inorg. Chem.* **1985**, *24*, 744–748.
135. Kirschenbaum, L. J.; Rush, J. D. *Inorg. Chem.* **1983**, *22*, 3304–3310.
136. Mehrotra, R. N.; Kirschenbaum, L. J. *Inorg. Chem.* **1989**, *28*, 4327–4330.
137. Panda, R. K.; Kirschenbaum, L. J. *J. Chem. Soc., Dalton Trans.* **1989**, 217–222.
138. Kirschenbaum, L. J.; Kouadio, I.; Mentasti, E. *Polyhedron* **1989**, *8*, 1299–1306.
139. Kirschenbaum, L. J.; Sun, Y. F. *Inorg. Chem.* **1991**, *30*, 2360–2365.
140. Sun, Y. F.; Kirschenbaum, L. J. *J. Coord. Chem.* **1992**, 1317–1322.
141. Sun, Y. F.; Kirschenbaum, L. J.; Kouadio, I. *J. Chem. Soc., Dalton Trans.* **1991**, 2311–2315.

142. Banerjee, R.; Das, K.; Das, A.; Dasgupta, S. *Inorg. Chem.* **1989**, *28*, 585–588.
143. Banerjee, R.; Das, A.; Dasgupta, S. *J. Chem. Soc., Dalton Trans.* **1989**, 1645–1649.
144. Banerjee, R.; Das, A.; Dasgupta, S. *J. Chem. Soc., Dalton Trans.* **1990**, 2271–2276.
145. Banerjee, R.; Das, A.; Mukhopadhyay, S. *J. Chem. Soc., Dalton Trans.* **1992**, 1317–1322.
146. Mukhopadhyay, S.; Banerjee, R. *J. Chem. Soc., Dalton Trans.* **1994**, 1349–1353.
147. Mukhopadhyay, S.; Kundu, S.; Banerjee, R. *Proc. Indian Acad. Sci.* **1995**, *107*, 403–408.
148. Ghosh, S. P.; Ghosh, M. C.; Gould, E. S. *Inorg. Chim. Acta* **1994**, *225*, 83–88.
149. Dasgupta, S.; Herlinger, E.; Linert, W. *J. Chem. Soc., Dalton Trans.* **1993**, 567–570.
150. Masse, R.; Simon, A. *J. Solid State Chem.* **1982**, *44*, 201–206.
151. Levason, W.; Spicer, M. D.; Webster, M. *J. Chem. Soc., Dalton Trans.* **1988**, 1377–1381.
152. Prasad, T. R.; Sethuram, B.; Rao, T. N. *Ind. J. Chem. Part A* **1980**, *19*, 241–246.
153. Prasad, T. R.; Sethuram, B.; Rao, T. N. *Ind. J. Chem. Part A* **1982**, *21*, 169–170.
154. Prasad, T. R.; Sethuram, B.; Rao, T. N. *Ind. J. Chem. Part A* **1982**, *21*, 170–174.
155. Sengupta, K. K.; Bera, A. K.; Bhattacharjee, N.; Ghosh, S. P. *Transition Met. Chem.* **1998**, *23*, 169–173.
156. Krishna, K. V.; Rao, P. J. P. *Ind. J. Chem. Part A* **1998**, *37*, 1106–1110.
157. Sengupta, K. K.; Sanyal, A.; Ghosh, S. P. *J. Chem. Soc., Dalton Trans.* **1995**, 1227–1232.
158. Lucier, G.; Shen, C.; Casteel, W. J., Jr.; Chacon, L.; Bartlett, N. *J. Fluorine Chem.* **1995**, *72*, 157–163.
159. Kadish, K. M.; Lin, X. Q.; Ding, J. Q.; Wu, Y. T.; Araullo, C. *Inorg. Chem.* **1986**, *25*, 3236–3242.
160. Milgrom, L. R.; Jones, C. C. *J. Chem. Soc., Chem. Commun.* **1988**, 576–577.
161. Pesavento, M.; Profumo, A.; Soldi, T.; Fabbrizzi, L. *Inorg. Chem.* **1985**, *24*, 3873–3875.
162. Kirschenbaum, L. J.; Rush, J. D. *J. Am. Chem. Soc.* **1984**, *106*, 1003–1010.
163. Kirschenbaum, L. J.; Panda, R. K.; Borish, E. T.; Mentasti, E. *Inorg. Chem.* **1989**, *28*, 3623–3628.
164. Shu-Yan, Y.; Qin-Hui, L.; Meng-Chang, S.; Xiao-Yun, H. *Inorg. Chem.* **1994**, *33*, 1251–1252.
165. Morgan, G.; McKee, V.; Nelson, J. *Inorg. Chem.* **1994**, *33*, 4427–4428.
166. Cundari, T. R.; Harvey, J. N.; Klinckman, R.; Fu, W. *Inorg. Chem.* **1999**, *38*, 5611–5615.
167. Iqbal, J.; Sharp, D. W. A.; Winfield, J. M. *J. Chem. Soc., Dalton Trans.* **1989**, 461–464.
168. Kahani, A.; Abedini, M.; Farnia, M. *J. Coord. Chem.* **2001**, *53*, 1–6.
169. Eujen, R.; Hoge, B.; Brauer, D. *J. Inorg. Chem.* **1997**, *36*, 1464–1475.
170. Naumann, D.; Tyrra, W.; Trinius, F.; Wessel, W.; Roy, T. *J. Fluorine Chem.* **2000**, *101*, 131–135.
171. Eujen, R.; Hoge, B.; Brauer, D. *J. Inorg. Chem.* **1997**, *36*, 3160–3166.
172. Abedini, M.; Farnia, M.; Kahani, A. *J. Coord. Chem.* **2000**, *50*, 39–42.
173. Furuta, H.; Ogawa, T.; Uwatoko, Y.; Araki, K. *Inorg. Chem.* **1999**, *38*, 2676–2682.
174. Shen, C.; Zemva, B.; Lucier, G. M.; Graudejus, O.; Llamas, J. A.; Bartlett, N. *Inorg. Chem.* **1999**, *38*, 4570–4577.
175. Gantar, D.; Frlc, B.; Russell, D. R.; Holloway, J. H. *Acta Crystallogr. Sect. C* **1987**, *43*, 618–619.
176. Gantar, D.; Leban, I.; Frlc, B.; Holloway, J. H. *J. Chem. Soc., Dalton Trans.* **1987**, 2379–2383.
177. Graudejus, O.; Müller, B. G. *Z. Anorg. Allg. Chem.* **1996**, *622*, 1549–1556.
178. Müller, B. G. *Angew. Chem., Int. Ed. Engl.* **1987**, *26*, 689–690.
179. Fischer, R.; Müller, B. G. *Z. Anorg. Allg. Chem.* **1997**, *623*, 1729–1733.
180. Zemva, B.; Hagiwara, R.; Casteel, W. J., Jr.; Lutar, K.; Jesih, A.; Bartlett, N. *J. Am. Chem. Soc.* **1990**, *112*, 4846–4849.
181. Lucier, G.; Muzenberg, J.; Casteel, W. J., Jr.; Bartlett, N. *Inorg. Chem.* **1995**, *34*, 2692–2698.
182. Hagiwara, R.; Katayama, Y.; Ema, K.; Ito, Y. *Eur. J. Solid State Inorg. Chem.* **1995**, *32*, 283–291.
183. Tolentino, L. U.; Po, H. N. *J. Coord. Chem.* **1984**, *13*, 341–347.
184. Suet, E.; Laouenan, A.; Handel, H.; Guglielmetti, R. *Helv. Chim. Acta* **1984**, *67*, 441–449.
185. Clark, I. J.; Harrowfield, J. M. *Inorg. Chem.* **1984**, *23*, 3740–3745.
186. Kodama, M.; Mahatma, A. B.; Toike, K.; Kimura, E. *Bull. Chem. Soc. Jpn.* **1990**, *63*, 2803–2808.
187. Ronco, S.; Vlierberge, B. V.; Ferraudi, G. *Inorg. Chem.* **1988**, *27*, 3453–3458.
188. Po, H. N.; Shen, S. C.; Doedens, R. J. *Acta Crystallogr. Sect. C* **1993**, *49*, 1914–1916.
189. Po, H. N.; Brinkman, E.; Doedens, R. J. *Acta Crystallogr. Sect. C* **1991**, *47*, 2310–2312.
190. Munakata, M.; Zhong, J. C.; Ino, I.; Kuroda-Sowa, T.; Maekawa, M.; Suenaga, Y.; Oiji, N. *Inorg. Chim. Acta* **2001**, *317*, 268–275.
191. Wang, Q. M.; Mak, T. C. W. *Chem. Commun.* **2001**, 807–808.
192. Girardeau, A.; Louati, A.; Callot, H. J.; Gross, M. *Inorg. Chem.* **1981**, *20*, 769–772.
193. Sontum, S. F.; Case, D. A. *J. Phys. Chem.* **1982**, *86*, 1597–1692.
194. Harriman, A.; Richoux, M. C.; Neta, P. *J. Phys. Chem.* **1983**, *87*, 4957–4962.
195. Krishnamurthy, M. *Inorg. Chem.* **1978**, *17*, 2242–2246.
196. Krishnamurthy, M.; Sutter, J. *Inorg. Chem.* **1985**, *24*, 1943–1949.
197. Langley, P.; Hambright, P.; Williams, R. F. X. *Inorg. Chim. Acta* **1985**, *104*, L25–L27.
198. Godziela, G. M.; Goff, H. M. *J. Am. Chem. Soc.* **1986**, *108*, 2237–2243.
199. Okoh, J. M.; Krishnamurthy, M. *J. Chem. Soc., Dalton Trans.* **1986**, 449–451.
200. Damer, R.; More, K. M.; Eaton, G. R.; Eaton, S. S. *Inorg. Chem.* **1983**, *22*, 3738–3744.
201. Scheidt, W. R.; Mondal, J. U.; Eigenbrot, C. W.; Adler, A.; Radonovich, L. J.; Hoard, J. L. *Inorg. Chem.* **1986**, *25*, 795–799.
202. Naylor, S.; Hunter, C. A.; Cowan, J. A.; Lamb, J. H.; Sanders, J. K. M. *J. Am. Chem. Soc.* **1990**, *112*, 6507–6514.
203. Gautam, P.; Krishnan, V. *Proc. Indian Acad. Sci.* **1995**, *107*, 477–485 (*Chem. Abstr.* **1996**, *124*, 20295g).
204. Girardeau, A.; Gisselbrecht, J. P.; Gross, M.; Weiss, J. *J. Chem. Soc., Dalton Trans.* **1993**, 1103–1105.
205. Vlčkova, B.; Matejka, P.; Pančoška, P.; Baumruk, V.; Král, V. *Inorg. Chem.* **1991**, *30*, 4103–4105.
206. Banci, L. *Inorg. Chem.* **1985**, *24*, 782–786.
207. Fu, G.; Fu, Y.; Jayaraj, K.; Lever, A. B. P. *Inorg. Chem.* **1990**, *29*, 4090–4095.
208. Firouzabadi, H.; Salehi, P.; Mohammadpourbaltork, I. *Bull. Chem. Soc. Jpn.* **1992**, *65*, 2878–2883.
209. Swarnabala, G.; Rajsekharan, M. V. *Inorg. Chem.* **1989**, *28*, 662–666.
210. Goher, M. A. S.; Abdou, A. E. H. *Acta Chim. Hung.* **1991**, *128*, 219–231 (*Chem. Abstr.* **1991**, *115*, 125631f).
211. Rai, H. C.; Kumari, V. *Asian J. Chem.* **1995**, *7*, 881–886 (*Chem. Abstr.* **1996**, *124*, 20295g).

212. Heyward, M. P.; Wells, C. F. *J. Chem. Soc., Dalton Trans.* **1982**, 2185–2189.
213. Heyward, M. P.; Wells, C. F. *J. Chem. Soc., Dalton Trans.* **1986**, 2593–2596.
214. Arseli, P.; Baiocchi, C.; Mentasti, E.; Coe, J. S. *J. Chem. Soc., Dalton Trans.* **1984**, 475–477.
215. Mentasti, E.; Baiocchi, C.; Coe, J. S. *Coord. Chem. Rev.* **1984**, *54*, 131–253.
216. Walker, N. R.; Wright, R. R.; Stace, A. J. *J. Am. Chem. Soc.* **1999**, *121*, 4837–4844.
217. Baumann, J.; Beer, R.; Calzaferri, G.; Waldeck, B. *J. Phys. Chem.* **1989**, *93*, 2292–2297.
218. Backen, W.; Ericsson, A. *Acta Chem. Scand., Ser. A.* **1981**, *35*, 1–9.
219. Hurlburt, P. K.; Rack, J. J.; Luck, J. S.; Dec, S. F.; Webb, J. D.; Anderson, O. P.; Strauss, S. H. *J. Am. Chem. Soc.* **1994**, *116*, 10003–10014.
220. Rack, J. J.; Moasser, B.; Gargulak, J. D.; Gladfelter, H. D.; Hochheimer, H. D.; Strauss, S. H. *J. Chem. Soc., Chem. Commun.* **1994**, 685–686.
221. Lynn, M. A.; Burnsten, B. E. *Inorg. Chim. Acta* **1995**, *229*, 437–443.
222. Meyer, F.; Chen, Y. M.; Armentrout, P. B. *J. Am. Chem. Soc.* **1995**, *117*, 4071–4081.
223. Lupinetti, A. J.; Jonas, V.; Thiel, W.; Strauss, S. H.; Frenking, G. *Chem. Eur. J.* **1999**, *5*, 2573–2583.
224. Lenders, L.; Kläui, W. *Chem. Ber.* **1990**, *123*, 2233–2240.
225. Strauss, S. H. *J. Chem. Soc., Dalton Trans.* **2000**, 1–6.
226. Malatesta, L.; Bonati, F. *Isocyanide Complexes of Metals*; Wiley-Interscience, New York, 1969.
227. Yamamoto, Y.; Aoki, K.; Yamazaki, H. *Inorg. Chim. Acta* **1982**, *68*, 75–78.
228. Bell, A.; Edwards, D. A. *J. Chem. Soc., Dalton Trans.* **1984**, 1317–1984.
229. Černák, J.; Kaňuchová, M.; Chomič, J.; Potočnák, I.; Kameníček, J.; Žak, Z. *Acta Crystallogr., Sect. C* **1994**, *50*, 1563–1566.
230. Carcelli, M.; Ferrari, C.; Pelizzi, C.; Pelizzi, G.; Predieri, G.; Solinas, C. *J. Chem. Soc., Dalton Trans.* **1992**, 2127–2128.
231. Comte, V.; Chen, Z. N.; Flay, M. L.; Vahrenkamp, H. *J. Organomet. Chem.* **2000**, *614–615*, 131–136.
232. Šakaguchi, U.; Tomioka, K.; Yoneda, H. *Inorg. Chim. Acta* **1985**, *101*, 23–28.
233. Černák, J.; Gérard, J.; Chomič, J. *Acta Crystallogr., Sect. C* **1993**, *49*, 1294–1297.
234. Kappenstein, C.; Ouali, A.; Guerin, M.; Černák, J.; Chomič, J. *Inorg. Chim. Acta* **1988**, *147*, 189–197.
235. Černák, J.; Chomič, J.; Gravereau, P.; Orendáčová, A.; Orendáč, M.; Kováč, J.; Feher, A.; Kappenstein, C. *Inorg. Chim. Acta* **1998**, *281*, 134–140.
236. Soma, T.; Iwamoto, T. *Chem. Lett.* **1994**, 821–824.
237. Soma, T.; Yuge, H.; Iwamoto, T. *Angew. Chem., Int. Ed. Engl.* **1994**, *33*, 1665–1666.
238. Soma, T.; Iwamoto, T. *Chem. Lett.* **1995**, 271–272.
239. Soma, T.; Iwamoto, T. *Inorg. Chem.* **1996**, *35*, 1849–1856.
240. Soma, T.; Iwamoto, T. *Acta Crystallogr., Sect. C* **1996**, *52*, 1200–1203.
241. Soma, T.; Iwamoto, T. *Mol. Cryst. Liq. Cryst.* **1995**, *276*, 19–24.
242. Iwamoto, T. *J. Inclusion Phenom.* **1996**, *24*, 61–132.
243. Horrenda, A.; Orendáč, M.; Chomič, J.; Feher, A. *J. Magn. Magn. Mater.* **1996**, *157–158*, 583–584.
244. Guizard, A.; Mari, A.; Beauchamp, A. L.; Dartiguenave, Y.; Dartiguenave, M. *Inorg. Chem.* **1983**, *22*, 1603–1606.
245. Lang, J. P.; Tatsumi, K. *Inorg. Chem.* **1999**, *38*, 1364–1367.
246. Kurmoo, M.; Day, P.; Mitani, T.; Kitagawa, H.; Shimoda, H.; Yoshida, D.; Guionneau, P.; Barrans, Y.; Chasseau, D.; Ducasse, L. *Bull. Chem. Soc. Jpn.* **1996**, *69*, 1233–1240.
247. Bowmaker, G. A.; Kennedy, B. J.; Reid, J. C. *Inorg. Chem.* **1998**, *37*, 3968–3974.
248. Guo, G. C.; Mak, T. C. W. *Angew. Chem., Int. Ed. Engl.* **1998**, *37*, 3183–3186.
249. Guo, G. C.; Wang, Q. M.; Mak, T. C. W. *Inorg. Chem. Commun.* **2000**, *3*, 313–315.
250. Wang, Q. M.; Mak, T. C. W. *Chem. Commun.* **2000**, 1435–1436.
251. Omary, M. A.; Patterson, H. H. *Inorg. Chem.* **1998**, *37*, 1060–1066.
252. Omary, M. A.; Webb, T. R.; Assefa, Z.; Shankle, G. E.; Patterson, H. H. *Inorg. Chem.* **1998**, *37*, 1380–1386.
253. Omary, M. A.; Patterson, H. H. *J. Am. Chem. Soc.* **1998**, *120*, 7696–7705.
254. Srisook, N.; Rizzolo, J.; Shankle, G. E.; Patterson, H. H. *Inorg. Chim. Acta* **2000**, *300*, 314–318.
255. Rawashdeh-Omary, M. A.; Omary, M. A.; Patterson, H. H. *J. Am. Chem. Soc.* **2000**, *122*, 10371–10380.
256. Corfield, P. W. R.; Shearer, H. M. M. *Acta Crystallogr., Sect. C* **1966**, *20*, 502–503.
257. Brasse, C.; Raithby, P. R.; Rennie, M. A.; Russell, C. A.; Steiner, A.; Wright, D. S. *Organometallics* **1996**, *15*, 639–644.
258. Xu, W.; Vittal, J. J.; Puddephatt, R. J. *Can. J. Chem.* **1996**, *74*, 766–774.
259. Yam, V. W. W.; Lo, K. K. W.; Fung, W. K. M.; Wang, C. R. *Coord. Chem. Rev.* **1998**, *171*, 17–41.
260. Yam, V. W. W. *J. Photochem. Photobiol. A. Chem.* **1997**, *106*, 75–84.
261. Wang, C. F.; Peng, S. M.; Chan, C. K.; Che, C. M. *Polyhedron* **1996**, *15*, 1853–1858.
262. Yam, V. W. W.; Fung, W. K. M.; Cheung, K. K. *Organometallics* **1997**, *16*, 2032–2037.
263. Yam, V. W. W.; Fung, W. K. M.; Cheung, K. K. *Chem. Commun.* **1997**, 963–964.
264. Lang, H.; Köhler, K.; Blau, S. *Coord. Chem. Rev.* **1995**, *143*, 113–168.
265. Espinet, P.; Forníés, J.; Martínez, F.; Tomás, M.; Lalinde, E.; Moreno, M.; Ruiz, A.; Welch, A. J. *J. Chem. Soc., Dalton Trans.* **1990**, 791–798.
266. Forníés, J.; Lalinde, E.; Martín, A.; Moreno, M. T. *J. Organomet. Chem.* **1995**, *490*, 179–188.
267. Ara, I.; Forníés, J.; Gómez, J.; Lalinde, E.; Moreno, M. T. *Organometallics* **2000**, *19*, 3137–3144.
268. Ara, I.; Forníés, J.; Gómez, J.; Lalinde, E.; Merino, R. I.; Moreno, M. T. *Inorg. Chem. Commun.* **1999**, *2*, 62–65.
269. Lang, H.; Herres, M.; Zsolnai, L. *Organometallics* **1993**, *12*, 5008–5011.
270. Janssen, M. D.; Herres, M.; Zsolnai, L.; Spek, A. L.; Grove, D. M.; Lang, H.; van Koten, G. *Inorg. Chem.* **1996**, *35*, 2476–2483.
271. Köhler, K. Diplom-Thesis, University of Heidelberg, 1994.
272. Forníés, J.; Lalinde, E.; Martínez, F.; Moreno, M.; Welch, A. J. *J. Organomet. Chem.* **1993**, *455*, 271–281.
273. Forníés, J.; Gómez-Saso, M. A.; Martínez, F.; Lalinde, E.; Moreno, M. T.; Welch, A. J. *New J. Chem.* **1992**, *16*, 483–488.
274. Ara, I.; Forníés, J.; Lalinde, E.; Moreno, M. T.; Tomás, M. *J. Chem. Soc., Dalton Trans.* **1994**, 2735–2736.

275. Ara, I.; Forniés, J.; Lalinde, E.; Moreno, M. T.; Tomás, M. *J. Chem. Soc., Dalton Trans.* **1995**, 2397–2405.
276. Yamazaki, S.; Deeming, A. J.; Speel, D. M.; Hibbs, D. E.; Hursthouse, M. B.; Malik, K. M. A. *Chem. Commun.* **1997**, 177–178.
277. Carriedo, G. A.; Miguel, D.; Riera, V.; Soláns, X. *J. Chem. Soc., Dalton Trans.* **1987**, 2867–2873.
278. Al-Farham, K. A.; Abu-Salah, O. M.; Mukhalalati, M.; Jaafar, M. *Acta Crystallogr., Sect. C* **1995**, 51, 1089–1092.
279. Abu-Salah, O. M.; Knobler, C. B. *J. Organomet. Chem.* **1986**, 302, C10–C11.
280. Abu-Salah, O. M. *J. Organomet. Chem.* **1990**, 387, 123–129.
281. Abu-Salah, O. M.; Hussain, M. S.; Schlemper, E. O. *J. Chem. Soc., Chem. Commun.* **1988**, 212–213.
282. Rais, D.; Mingos, D. M. P.; Vilar, R.; White, A. J. P.; Williams, D. J. *J. Organomet. Chem.* **2002**, 652, 87–93.
283. Guo, G. C.; Zhou, G. D.; Wang, Q. G.; Mak, T. C. W. *Angew. Chem., Int. Ed. Engl.* **1998**, 37, 630–631.
284. Guo, G. C.; Wang, Q. G.; Zhou, G. D.; Mak, T. C. W. *Chem. Commun.* **1998**, 339–340.
285. Guo, G. C.; Zhou, G. D.; Mak, T. C. W. *J. Am. Chem. Soc.* **1999**, 121, 3136–3141.
286. Wang, Q. M.; Mak, T. C. W. *J. Am. Chem. Soc.* **2001**, 123, 7594–7600.
287. Wang, Q. M.; Mak, T. C. W. *J. Am. Chem. Soc.* **2000**, 122, 7608–7609.
288. Wang, Q. M.; Mak, T. C. W. *J. Am. Chem. Soc.* **2001**, 123, 1501–1502.
289. Gambarotta, S.; Floriani, C.; Chiesi-Villa, A.; Guastini, C. *J. Chem. Soc., Chem. Commun.* **1983**, 1087–1089.
290. Meyer, E. M.; Gambarotta, S.; Floriani, C.; Chiesi-Villa, A.; Guastini, C. *Organometallics* **1989**, 8, 1067–1079.
291. Jeffries, P. M.; Wilson, S. R.; Girolami, G. S. *J. Organomet. Chem.* **1993**, 449, 203–209.
292. Oehr, C.; Suhr, H. *Appl. Phys. A* **1989**, 49, 691–698.
293. Lignau, R.; Strähle, J. *Angew. Chem., Int. Ed. Engl.* **1988**, 27, 436–436.
294. Haaland, A.; Rypdal, K.; Verne, H. P.; Scherer, W.; Thiel, W. R. *Angew. Chem., Int. Ed. Engl.* **1994**, 33, 2443–2444.
295. Contel, M.; Jiménez, J.; Jones, P. G.; Laguna, A.; Laguna, M. *J. Chem. Soc., Dalton Trans.* **1994**, 2515–2518.
296. Contel, M.; Garrido, J.; Gimeno, M. C.; Jones, P. G.; Laguna, A.; Laguna, M. *Organometallics* **1996**, 15, 4939–4943.
297. Bonati, F.; Burini, A.; Pietroni, B. R.; Bovio, B. *J. Organomet. Chem.* **1989**, 375, 147–154.
298. Tulloch, A. A. D.; Danopoulos, A. A.; Winston, S.; Kleinhenz, S.; Eastham, G. *J. Chem. Soc., Dalton Trans.* **2000**, 4499–4506.
299. Chen, W.; Wu, B.; Matsumoto, K. *J. Organomet. Chem.* **2002**, 654, 233–236.
300. Usón, R.; Laguna, A.; Abad, J. A. *J. Organomet. Chem.* **1983**, 246, 341–348.
301. Usón, R.; Laguna, A.; Fernández, E. J.; Mendía, A.; Jones, P. G. *J. Organomet. Chem.* **1988**, 350, 129–136.
302. Fernández, E. J.; Laguna, A.; Mendía, A. *Inorg. Chim. Acta* **1994**, 223, 161–164.
303. Schmidbaur, H.; Zybilla, C. E.; Müller, G.; Kruger, G. *Angew. Chem., Int. Ed. Engl.* **1983**, 22, 729–730.
304. Zachwieja, U.; Jacobs, H. Z. *Anorg. Allg. Chem.* **1989**, 571, 37–42.
305. Zachwieja, U.; Jacobs, H. Z. *Kristallogr.* **1992**, 201, 207–210.
306. Yamaguchi, T.; Lindqvist, O. *Acta Chem. Scand. A* **1983**, 37, 685–690.
307. Zák, Z.; Ruzicka, A.; Glowiak, T. *Can. J. Chem.* **1991**, 69, 1080–1083.
308. Pajunen, A.; Pajunen, S. *Acta Crystallogr., Sect. C* **1994**, 50, 1884–1886.
309. Zhang, J. G.; Zhang, T. L.; Lu, Z.; Yu, K. B. *Acta Chim. Sin.* **1999**, 57, 1233–1238.
310. Zhu, H. G.; Yu, Z.; You, X. Z.; Hu, H. M.; Huang, X. Y. *J. Chem. Crystallogr.* **1999**, 29, 239–242.
311. Engelhardt, L. M.; Pakawatchai, C.; White, A. H.; Healy, P. C. *J. Chem. Soc., Dalton Trans.* **1985**, 117–124.
312. Horn, E.; Snow, M. R.; Tiekink, E. R. T. *Aust. J. Chem.* **1987**, 40, 761–770.
313. Roesky, H. W.; Schimkowiak, J.; Jones, P. G.; Noltemeyer, M.; Sheldrick, G. M. *J. Chem. Soc., Dalton Trans.* **1988**, 2507–2508.
314. Jones, P. G.; Roesky, H. W.; Schimkowiak, J. *J. Chem. Soc., Chem. Commun.* **1988**, 730–730.
315. Belanger-Gariepy, F.; Beauchamp, A. L. *J. Am. Chem. Soc.* **1980**, 102, 3461–3466.
316. Aoki, K.; Saenger, W. *Acta Crystallogr., Sect. C* **1984**, 40, 772–774.
317. Lin, C. J.; Hwang, W. S.; Chiang, M. Y. *Polyhedron* **2001**, 20, 3275–3280.
318. Khayata, W.; Baylocq, D.; Pellerin, F.; Rodier, N. *Acta Crystallogr., Sect. C* **1984**, 40, 765–767.
319. Perron, J.; Beauchamp, A. L. *Inorg. Chem.* **1984**, 23, 2853–2859.
320. Gotsis, S.; White, A. H. *Aust. J. Chem.* **1987**, 40, 1603–1610.
321. Modder, J. F.; Ernsting, J. M.; Vrieze, K.; de Wit, M.; Stam, C. H.; van Koten, G. *Inorg. Chem.* **1991**, 30, 1208–1214.
322. Dyason, J. C.; Healy, P. C.; Engelhardt, L. M.; White, A. H. *Aust. J. Chem.* **1985**, 38, 1325–1331.
323. Sotofte, I.; Nielsen, K. *Acta Chim. Scand. A* **1983**, 37, 891–896.
324. Menzer, S.; Hillgeris, E. C.; Lippert, B. *Inorg. Chim. Acta* **1993**, 210, 167–171.
325. Kessissoglou, D. P.; Manoussakis, G. E.; Hatzidimitriou, A. G.; Kanatzidis, M. G. *Inorg. Chem.* **1987**, 26, 1395–1402.
326. Deb, A. K.; Choudhury, S.; Goswami, S. *Polyhedron* **1990**, 9, 2251–2255.
327. Iwasaki, F.; Hirota, M.; Yamazaki, N.; Yasui, M. *Acta Crystallogr., Sect. C* **1991**, 47, 2406–2410.
328. Schmidbaur, H.; Mair, A.; Müller, G.; Lachmann, J.; Gampfer, S. Z. *Naturforsch.* **1991**, 46b, 912–918.
329. Segalas, I.; Beauchamp, A. L. *Can. J. Chem.* **1992**, 70, 943–948.
330. Mylrajan, M.; Andersson, L. A.; Sun, J.; Loehr, T. M.; Thomas, C. S.; Sullivan, E. P., Jr.; Thompson, M. A.; Long, K. M.; Anderson, O. P.; Strauss, S. H. *Inorg. Chem.* **1995**, 34, 3953–3963.
331. López, D. R. *J. Inorg. Biochem.* **1994**, 54, 21–32.
332. Bruce, D. W.; Dunmur, D. A.; Lalinde, E.; Maitlis, P. M.; Styring, P. *Nature* **1986**, 323, 791–792.
333. Bruce, D. W.; Dunmur, D. A.; Hudson, D. A.; Maitlis, P. M.; Styring, P. *Adv. Mater. Opt. Electron.* **1992**, 1, 37–42.
334. Bruce, D. W.; Dunmur, D. A.; Maitlis, P. M.; Styring, P.; Esteruelas, M. A.; Oro, L. A.; Ros, M. B.; Serrano, J. L.; Sola, E. *Chem. Mater.* **1989**, 1, 479–481.
335. Marcos, M.; Ros, M. B.; Serrano, J. L.; Esteruelas, M. A.; Sola, E.; Oro, L. A.; Barberá, J. *J. Chem. Mater.* **1990**, 2, 748–758.
336. Adams, H.; Bailey, N. A.; Bruce, D. W.; Davis, S. C.; Dunmur, D. A.; Hempstead, P. D.; Hudson, S. A.; Thorpe, S. *J. Mater. Chem.* **1992**, 2, 395–400.
337. Bruce, D. W.; Hudson, S. A. *J. Mater. Chem.* **1994**, 4, 479–486.
338. Bruce, D. W.; Dunmur, D. A.; Hudson, S. A.; Lalinde, E.; Maitlis, P. M.; McDonald, M. P.; Orr, R.; Styring, P.; Cherodian, A.; Richardson, R. M.; Feijoo, J. L.; Ungar, G. *Mol. Cryst. Liq. Cryst.* **1991**, 206, 79–92.
339. Donnio, B.; Bruce, D. W. *J. Mater. Chem.* **1998**, 8, 1993–1997.

340. Donnio, B.; Bruce, D. W. *New J. Chem.* **1999**, *23*, 275–286.
341. Donnio, B.; Bruce, D. W. *New J. Chem.* **1999**, *23*, 563–563.
342. Levelut, A. M.; Donnio, B.; Bruce, D. W. *Liq. Cryst.* **1997**, *22*, 753–756.
343. Donnio, B.; Heinrich, B.; Gulikkrzywicki, T.; Delacroix, H.; Guillon, D.; Bruce, D. W. *Chem. Mater.* **1997**, *9*, 2951–2965.
344. Kihara, H.; Kato, T.; Uryu, T. *Macromolecular Rapid Commun.* **1997**, *18*, 281–282.
345. Albéniz, A. C.; Barberá, J.; Espinet, P.; Lequerica, M. C.; Levelut, A. M.; López-Marcos, F. J.; Serrano, J. L. *Eur. J. Inorg. Chem.* **2000**, 133–138.
346. Brown, N. C.; Carpenter, G. B.; Connelly, N. G.; Crossley, J. G.; Martín, A.; Orpen, A. G.; Rieger, A. L.; Rieger, P. H.; Worth, G. H. *J. Chem. Soc., Dalton Trans.* **1996**, 3977–3984.
347. Casas, J. E.; Gimeno, M. C.; Jones, P. G.; Laguna, A.; Laguna, M. *J. Chem. Soc., Dalton Trans.* **1999**, 2819–2822.
348. Barranco, E. M.; Crespo, O.; Gimeno, M. C.; Jones, P. G.; Laguna, A.; Villacampa, M. D. *J. Organomet. Chem.* **1999**, *592*, 258–264.
349. Barranco, E. M.; Crespo, O.; Gimeno, M. C.; Jones, P. G.; Laguna, A.; Sarroca, C. *J. Chem. Soc., Dalton Trans.* **2001**, 2523–2529.
350. Ajuha, I. S.; Tripathi, S.; Yadava, C. L. *Synth. React. Inorg. Met.-Org. Chem.* **1990**, *20*, 189–198.
351. Blaschette, A.; Jones, P. G.; Hamann, T.; Näveke, M.; Schomburg, D.; Cammenga, H. K.; Epple, M.; Steppuhn, I. *Z. Anorg. Allg. Chem.* **1993**, *619*, 912–922.
352. Fackler, J. P., Jr.; Raptis, R. G.; Murray, H. H. *Inorg. Chim. Acta* **1992**, *193*, 173–179.
353. Menzer, S.; Sabat, M.; Lippert, B. *J. Am. Chem. Soc.* **1992**, *114*, 4644–4649.
354. Carmona, D.; Lahoz, F. J.; Oro, L. A.; Lamata, M. P.; Buzarra, S. *Organometallics* **1991**, *10*, 3123–3131.
355. Carmona, D.; Oro, L. A.; Lamata, M. P.; Jimeno, M. L.; Elguero, J.; Belguise, A.; Lux, P. *Inorg. Chem.* **1994**, *33*, 2196–2203.
356. Carmona, D.; Ferre, J.; Lamata, M. P.; Oro, L. A.; Limbach, H. H.; Scherer, G.; Elguero, J.; Jimeno, M. J. *J. Organomet. Chem.* **1994**, *470*, 271–274.
357. Carmona, D.; Ferrer, J.; Atencio, R.; Lahoz, F. J.; Oro, L. A. *Organometallics* **1995**, *14*, 2057–2065.
358. Ganguly, S.; Chattopadhyay, S.; Sinha, C.; Chakravorty, A. *Inorg. Chem.* **2000**, *39*, 2954–2956.
359. Kristiansson, O. *Acta Crystallogr., Sect. C* **2000**, *56*, 165–167.
360. Arnold, D. I.; Cotton, F. A.; Matonic, J. H.; Murillo, C. A. *Polyhedron* **1997**, *16*, 1837–1841.
361. Nilsson, K.; Oskarsson, A. *Acta Chem. Scand., Ser. A* **1982**, *36*, 605–609.
362. Nilsson, K.; Oskarsson, A. *Acta Chem. Scand., Ser. A* **1984**, *38*, 79–85.
363. Jones, P. G.; Bembenek, E. *Z. Kristallogr.* **1993**, *208*, 213–215.
364. Roesky, H. W.; Thomas, M.; Schmidt, H. G.; Clegg, W.; Noltemeyer, M.; Sheldrick, G. M. *J. Chem. Soc., Dalton Trans.* **1983**, 405–407.
365. Nomiya, K.; Tsuda, K.; Tanabe, Y.; Nagano, H. *J. Inorg. Biochem.* **1998**, *69*, 9–14.
366. Sloufova, I.; Slouf, M. *Acta Crystallogr., Sect. C* **2000**, *56*, 1312–1313.
367. Xu, B.; Chen, D.; Tang, W. X.; Yu, K. B.; Zhou, Z. Y. *Acta Crystallogr., Sect. C* **1991**, *47*, 1805–1808.
368. Cassol, A.; Di Bernardo, P.; Zanonato, P.; Portanova, R.; Tolazzi, M. *J. Chem. Soc., Dalton Trans.* **1987**, 657–659.
369. Elias, H.; Rass, U.; Wannowius, K. *J. Inorg. Chim. Acta* **1984**, *86*, L37–L38.
370. Yamaguchi, T.; Wakita, H.; Nomura, M. *J. Chem. Soc., Chem. Commun.* **1988**, 433–434.
371. Barszcz, B.; Gabryszewski, M.; Kulig, J.; Lenarcik, B. *J. Chem. Soc., Dalton Trans.* **1986**, 2025–2028.
372. Pierce, J. L.; Busch, K. L.; Cooks, G.; Walton, R. A. *Inorg. Chem.* **1983**, *22*, 2492–2494.
373. Hancock, R. D.; Nakani, B. S.; Marsicano, F. *Inorg. Chem.* **1983**, *22*, 2531–2535.
374. Sigsworth, S. W.; Castleman, A. W., Jr. *J. Am. Chem. Soc.* **1989**, *111*, 3566–3569.
375. Büchner, E. *Ber. Dtsch. Chem. Ges.* **1889**, *22*, 842–847.
376. Masciocchi, N.; Moret, M.; Cairati, P.; Sironi, A.; Ardizzoia, G. A.; La Monica, G. *J. Am. Chem. Soc.* **1994**, *116*, 7668–7676.
377. Murray, H. H.; Raptis, R. G.; Fackler, J. P., Jr. *Inorg. Chem.* **1988**, *27*, 26–33.
378. Dias, H. V. R.; Polach, S. A.; Wang, Z. Y. *J. Fluorine Chem.* **2000**, *103*, 163–169.
379. Ardizzoia, G. A.; La Monica, G.; Maspero, A.; Moret, M.; Masciocchi, N. *Inorg. Chem.* **1997**, *36*, 2321–2328.
380. Munakata, M.; Wu, L. P.; Yamamoto, M.; Kuroda-Sowa, T.; Maekawa, M.; Kawata, S.; Kitagawa, S. *J. Chem. Soc., Dalton Trans.* **1995**, 4099–4106.
381. Ardizzoia, G. A.; La Monica, G.; Cenini, S.; Moret, M.; Masciocchi, N. *J. Chem. Soc., Dalton Trans.* **1996**, 1351–1357.
382. Carmona, D.; Ferrer, J.; Lahoz, F. J.; Oro, L. A.; Lamata, M. P. *Organometallics* **1996**, *15*, 5175–5178.
383. Bruce, M. I.; Walsh, J. D.; Skelton, B. W.; White, A. H. *J. Chem. Soc., Dalton Trans.* **1981**, 956–961.
384. Effendy; Lobbia, G. G.; Pellei, M.; Pettinari, C.; Santini, C.; Skelton, B. W.; White, A. H. *J. Chem. Soc., Dalton Trans.* **2000**, 2123–2129.
385. Abu Salah, O. M.; Ashby, G. S.; Bruce, M. I.; Pederzoli, E. A.; Walsh, J. D. *Aust. J. Chem.* **1979**, *32*, 1613–1619.
386. Bruce, M. I.; Walsh, J. D. *Aust. J. Chem.* **1979**, *32*, 2753–2759.
387. Humphrey, E. R.; Reeves, Z.; Jeffery, J. C.; McCleverty, J. A.; Ward, M. D. *Polyhedron* **1999**, *18*, 1335–1338.
388. Effendy; Lobbia, G. G.; Pettinari, C.; Santini, C.; Skelton, B. W.; White, A. H. *Inorg. Chim. Acta* **2000**, *308*, 65–72.
389. Santini, C.; Pettinari, C.; Lobbia, G. G.; Leonesi, D.; Valle, G.; Calogero, S. *Polyhedron* **1998**, *17*, 3201–3210.
390. Janiak, C.; Scharmann, T. G.; Albrecht, P.; Marlow, F.; Macdonald, R. *J. Am. Chem. Soc.* **1996**, *118*, 6307–6308.
391. Santini, C.; Lobbia, G. G.; Pettinari, C.; Pellei, M.; Valle, G.; Calogero, S. *Inorg. Chem.* **1998**, *37*, 890–900.
392. Santini, C.; Lobbia, G. G.; Pellei, M.; Pettinari, C.; Valle, G.; Calogero, S. *Inorg. Chim. Acta* **1998**, *282*, 1–9.
393. Dias, H. V. R.; Wang, Z.; Jin, W. *Inorg. Chem.* **1997**, *36*, 6205–6215.
394. Dias, H. V. R.; Polach, S. A.; Goh, S. K.; Archibong, E. F.; Marynick, D. S. *Inorg. Chem.* **2000**, *39*, 3894–3901.
395. Dias, H. V. R.; Wang, Z. *Inorg. Chem.* **2000**, *39*, 3724–3727.
396. Dias, H. V. R.; Jin, W. *Inorg. Chem.* **1996**, *35*, 267–268.
397. Dias, H. V. R.; Jin, W.; Kim, H. J.; Lu, H. L. *Inorg. Chem.* **1996**, *35*, 2317–2328.
398. Dias, H. V. R.; Wang, Z. *Inorg. Chem.* **2000**, *39*, 3890–3893.
399. Effendy; Lobbia, G. G.; Pettinari, C.; Santini, C.; Skelton, B. W.; White, A. H. *Inorg. Chim. Acta* **2000**, *298*, 146–153.

400. Effendy; Lobbia, G. G.; Pellai, M.; Pettinari, C.; Santini, C.; Skelton, B. W.; White, A. H. *Inorg. Chim. Acta* **2001**, *315*, 153–162.
401. Effendy; Lobbia, G. G.; Pettinari, C.; Santini, C.; Skelton, B. W.; White, A. H. *J. Chem. Soc., Dalton Trans.* **1998**, 2739–2748.
402. Amoroso, A. J.; Jeffery, J. C.; Jones, P. L.; McCleverty, J. A.; Psillakis, E.; Ward, M. D. *J. Chem. Soc., Chem. Commun.* **1995**, 1175–1176.
403. Humphrey, E. R.; Harden, N. C.; Rees, L. H.; Jeffery, J. C.; McCleverty, J. A.; Ward, M. D. *J. Chem. Soc., Dalton Trans.* **1998**, 3353–3354.
404. Reger, D. L.; Collins, J. E.; Rheingold, A. L.; Liable-Sands, L. M.; Yap, G. P. A. *Organometallics* **1997**, *16*, 349–353.
405. Lorenzotti, A.; Bonati, F.; Cingolani, A.; Lobbia, G. G.; Leonesi, D.; Bovio, B. *Inorg. Chim. Acta* **1990**, *170*, 199–208.
406. Clegg, W.; Cooper, P. J.; Lockhart, J. C.; Rushton, D. J. *Acta Crystallogr., Sect. C* **1994**, *50*, 383–386.
407. McMorran, D. A.; Pfadenhauer, S.; Steel, P. J. *Inorg. Chem. Commun.* **2002**, *5*, 449–451.
408. Masciocchi, N.; Moret, M.; Cairati, P.; Sironi, A.; Ardizzoi, G. A.; La Monica, G. *J. Chem. Soc., Dalton Trans.* **1995**, 1671–1675.
409. Cingolani, A.; Effendy; Marchetti, F.; Pettinari, C.; Skelton, B. W.; White, A. H. *J. Chem. Soc., Dalton Trans.* **1999**, 4047–4055.
410. Sorrell, T. N.; Borovik, A. S. *J. Am. Chem. Soc.* **1986**, *108*, 2479–2481.
411. De Souza-Lemos, S.; Bessler, K. E.; Lang, E. S. *Z. Anorg. Allg. Chem.* **1998**, *624*, 30–34.
412. Sun, W. Y.; Xie, J.; Mei, Y. H.; Yu, K. B. *New J. Chem.* **2000**, *24*, 519–522.
413. Maekawa, M.; Munakata, M.; Kuroda-Sowa, T.; Suenaga, Y.; Sugimoto, K. *Inorg. Chim. Acta* **1999**, *290*, 153–158.
414. Misra, T. K.; Das, D.; Sinha, C. *Polyhedron* **1997**, *16*, 4163–4170.
415. Das, D.; Misra, T. K.; Sinha, C. *Transition Met. Chem.* **1998**, *23*, 73–75.
416. Mathews, C. J.; Clegg, W.; Heath, S. L.; Martin, N. C.; Hill, M. N. S.; Lockhart, J. C. *Inorg. Chem.* **1998**, *37*, 199–207.
417. Hintermaier, F.; Mihan, S.; Gerdan, M.; Schünemann, V.; Trautwein, A.; Beck, W. *Chem. Ber.* **1996**, *129*, 571–573.
418. Konrad, M.; Meyer, F.; Büchner, M.; Heinze, K.; Zsolnai, L. *Chem. Ber.* **1997**, *130*, 95–100.
419. Cassol, A.; Di Bernardo, P.; Zanonato, P.; Portanova, R.; Tolazzi, M.; Tomat, G. *J. Chem. Soc., Dalton Trans.* **1988**, 1781–1783.
420. Yperman, J.; Mullens, J.; François, J. P.; Van Poucke, L. C. *Inorg. Chem.* **1983**, *22*, 1361–1365.
421. Garner, R.; Yperman, J.; Mullens, J.; Van Poucke, L. C. *Inorg. Chim. Acta* **1994**, *224*, 97–104.
422. Bang, E. *Acta Chem. Scand.* **1996**, *50*, 952–953.
423. Guedens, W. J.; Yperman, J.; Mullens, J.; Vanpoucle, L. C. *J. Coord. Chem.* **1999**, *47*, 17–29.
424. Timper, U.; Heller, G. *Z. Naturforsch., Teil B* **1994**, *49*, 215–220.
425. Shakibaie-Moghadam, M.; Timper, U.; Heller, G. *Z. Naturforsch., Teil B* **1994**, *49*, 627–634.
426. Plappert, E. C.; Mingos, D. M. P.; Lawrence, S. E.; Williams, D. J. *J. Chem. Soc., Dalton Trans.* **1997**, 2119–2123.
427. Hitchcock, P. B.; Lappert, M. F.; Pierssens, L. J. M. *Chem Commun.* **1996**, 1189–1190.
428. Vij, A.; Zheng, Y. Y.; Kirchmeier, R. L.; Shreeve, J. M. *Inorg. Chem.* **1994**, *33*, 3281–3288.
429. Zhu, H. L.; Chen, Q.; Peng, W. L.; Qi, S. J.; Xu, A. L.; Chen, X. M. *Chin. J. Chem.* **2001**, *19*, 263–267.
430. Goodwin, K. V.; McMillin, D. R.; Robinson, W. R. *Inorg. Chem.* **1986**, *25*, 2033–2036.
431. Czakissulikowska, D.; Radwanskadoczekalska, J.; Kuznik, B.; Malinoswska, A. *Transition Met. Chem.* **1996**, *21*, 19–22.
432. Crespo, O.; Gimeno, M. C.; Laguna, A. *J. Organomet. Chem.* **1998**, *561*, 13–18.
433. Tani, K.; Mihana, T.; Yamagata, T.; Saito, T. *Chem. Lett.* **1991**, 2047–2050.
434. van Stein, G. C.; van Koten, G.; de Bok, B.; Taylor, L. C.; Vrieze, K.; Brevard, C. *Inorg. Chim. Acta* **1984**, *89*, 29–39.
435. Choudhury, S.; Deb, A. K.; Goswami, S. *Polyhedron* **1994**, *13*, 1063–1068.
436. van Stein, G. C.; van Koten, G.; Vrieze, K.; Brevard, C.; Spek, A. L. *J. Am. Chem. Soc.* **1984**, *106*, 4486–4492.
437. van Stein, G. C.; van Koten, G.; Vrieze, K.; Brevard, C. *Inorg. Chem.* **1984**, *23*, 4269–4278.
438. van Stein, G. C.; van Koten, G.; Blank, F.; Taylor, L. C.; Vrieze, K.; Spek, A. L.; Duisenberg, A. J. M.; Schreurs, A. M. M.; Kojic'-Prodic', B.; Brevard, C. *Inorg. Chim. Acta* **1985**, *98*, 107–205.
439. van Stein, G. C.; van Koten, G.; Vrieze, K.; Spek, A. L.; Klop, E. A.; Brevard, C. *Inorg. Chem.* **1985**, *24*, 1367–1372.
440. Spek, A. L.; Duisenberg, G. C.; van Stein, G. C.; van Koten, G. *Acta Crystallogr., Sect. C* **1985**, *41*, 374–375.
441. Modder, J. F.; Leijen, R. J.; Vrieze, K.; Smeets, J. J.; Spek, A. L.; van Koten, G. *J. Chem. Soc., Dalton Trans.* **1995**, 4021–4028.
442. Fu, Y. J.; Yang, H.; Wang, D. F.; Tang, W. X.; Wu, B. M.; Mak, T. C. W. *Polyhedron* **1997**, *16*, 1505–1512.
443. König, B. *Chem. Ber.* **1995**, *128*, 1141–1144.
444. Cargill Thompson, A. M. W.; Blandford, I.; Redfearn, H.; Jeffery, J. C.; Ward, M. D. *J. Chem. Soc., Dalton Trans.* **1997**, 2661–2665.
445. Gupta, N.; Grover, N.; Neyhart, G. A.; Singh, P.; Thorp, H. H. *Inorg. Chem.* **1993**, *32*, 310–316.
446. Bosch, E.; Barnes, C. L. *Inorg. Chem.* **2001**, *40*, 3097–3100.
447. Fitchett, C. M.; Steel, P. J. *Inorg. Chim. Acta* **2000**, *310*, 127–132.
448. Hartshorn, C. M.; Steel, P. J. *Inorg. Chem.* **1996**, *35*, 6902–6903.
449. Venkatalakshmi, N.; Rajasekharan, M. V.; Mathews, I. I. *Transition Met. Chem.* **1992**, *17*, 455–461.
450. Beer, P. D.; Weeler, J. W.; Moore, C. P. *J. Chem. Soc., Dalton Trans.* **1992**, 2667–2673.
451. Schmittel, M.; Ganz, A.; Fenske, D.; Herderich, M. *J. Chem. Soc., Dalton Trans.* **2000**, 353–359.
452. Shu, L.; Pyo, S.; rivera, J.; Echegoyen, L. *Inorg. Chim. Acta* **1999**, *292*, 34–40.
453. Pallenberg, A. J.; Marschner, T. M.; Barnhart, D. M. *Polyhedron* **1997**, *16*, 2711–2719.
454. Ward, M. D.; Couchman, S. M.; Jeffery, J. C. *Acta Crystallogr., Sect. C* **1998**, *54*, 1820–1823.
455. Jin, Q. H.; Xin, X. L.; Zhu, F. J.; Li, Y. Z. *Krystallogr.* **1999**, *214*, 503–504.
456. Constable, E. C.; Edwards, A. J.; Haire, G. R.; Hannon, M. J.; Raithby, P. R. *Polyhedron* **1998**, *17*, 243–253.
457. bin Silong, S.; Kildea, J. D.; Patalinghug, W. C.; Skelton, B. W.; White, A. H. *Aust. J. Chem.* **1994**, *47*, 1545–1551.
458. Ainscough, E. W.; Brodie, A. M.; Ingham, S. L.; Waters, J. M. *J. Chem. Soc., Dalton Trans.* **1994**, 215–220.
459. Constable, E. C.; Drew, M. G. B.; Forsyth, G.; Ward, M. D. *J. Chem. Soc., Chem. Commun.* **1988**, 1450–1451.

460. Tsuda, T.; Ohba, S.; Takahashi, M.; Ito, M. *Acta Crystallogr., Sect. C* **1989**, *45*, 887–890.
461. Munakata, M.; Maekawa, M.; Kitakagawa, S.; Adachi, M.; Masuda, H. *Inorg. Chim. Acta* **1990**, *167*, 181–188.
462. Griffith, W. P.; Koh, T. Y.; White, A. J. P.; Willians, D. J. *Polyhedron* **1995**, *14*, 2019–2025.
463. Hörner, M.; Pedroso, A. G.; de Menezes Peixoto, C. R.; Beck, J. *Z. Naturforsch. B: Anorg. Chem. Org. Chem.* **1990**, *45*, 689–694.
464. Hörner, M.; Pedroso, A. G.; Beck, J.; Strähle, J. *Z. Naturforsch. B: Anorg. Chem. Org. Chem.* **1996**, *51*, 686–690.
465. Beck, J.; Reitz, M. *Z. Naturforsch., B: Anorg. Chem. Org. Chem.* **1997**, *52*, 604–608.
466. Kuhn, N.; Horn, E. M.; Boese, R.; Bläser, D. *Chem. Ber.* **1989**, *122*, 2275–2277.
467. Navarro, J. A. R.; Salas, J. M.; Romero, M. A.; Faure, R. *J. Chem. Soc., Dalton Trans.* **1998**, 901–904.
468. Romero, M. A.; Salas, J. M.; Quiros, M.; Sánchez, M. P.; Molina, J.; El Bahraoui, J. *J. Mol. Struct.* **1995**, *354*, 189–195.
469. Salas, J. M.; Romero, M. A.; Rahmani, A.; Quiros, M. *An. Quim. Int. Ed.* **1996**, *92*, 249–253.
470. Navarro, J. A. R.; Romero, M. A.; Salas, J. M.; Faure, R.; Solans, X. *J. Chem. Soc., Dalton Trans.* **1997**, 2321–2326.
471. Haj, M. A.; Quirós, M.; Salas, J. M.; Faure, R. *Inorg. Chem. Commun.* **2001**, *4*, 254–256.
472. Fenske, D.; Baum, G.; Zinn, A.; Dehnicke, K. *Z. Naturforsch. B: Anorg. Chem. Org. Chem.* **1990**, *45*, 1273–1278.
473. Archibald, S. J.; Alcock, N. W.; Busch, D. H.; Whitcomb, D. R. *Inorg. Chem.* **1999**, *38*, 5571–5578.
474. Ren, T.; Lin, C.; Amalberti, P.; Macikenas, D.; Protasiewicz, J. D.; Baum, J. C.; Gibson, T. L. *Inorg. Chem. Commun.* **1998**, *1*, 23–26.
475. Cotton, F. A.; Feng, X.; Matusz, M.; Poli, R. *J. Am. Chem. Soc.* **1988**, *110*, 7077–7083.
476. Aduv, B. P.; Aluker, E. D.; Zakharov, Y. A.; Krechetov, A. G.; Chubukin, I. V. *JETP Lett.* **1997**, *66*, 111–113.
477. Guo, G. C.; Mak, T. C. W. *Angew. Chem., Int. Ed. Engl.* **1998**, *37*, 3268–3270.
478. Suzuki, T.; Kotsuki, H.; Isobe, K.; Moriya, N.; Nakagawa, Y.; Ochi, M. *Inorg. Chem.* **1995**, *34*, 530–531.
479. Engelhardt, L. M.; Jacobsen, G. E.; Patalinghug, W. C.; Skelton, B. W.; Raston, C. L.; White, A. H. *J. Chem. Soc., Dalton Trans.* **1991**, 2859–2868.
480. Jager, L.; Tretner, C.; Sunkel, K.; Kozisek, J. *Z. Anorg. Allg. Chem.* **1998**, *624*, 1381–1386.
481. Shao, S. C.; Zhu, d. r.; Zhu, X. H.; You, X. Z.; Raj, S. S. S.; Fun, H. K. *Acta Crystallogr., Sect. C* **1999**, *55*, 1412–1413.
482. Itakara, T. *Chem. Lett.* **1996**, 1099–1100.
483. Maggiulli, R.; Mews, R.; Stohrer, W. D.; Noltemeyer, M. *Chem. Ber.* **1990**, *123*, 29–34.
484. Reiss, P.; Fenske, D. *Z. Anorg. Allg. Chem.* **2000**, *626*, 2245–2247.
485. Ackermann, H.; Seybert, G.; Massa, W.; Bock, O.; Muller, U.; Dehnicke, K. *Z. Anorg. Allg. Chem.* **2000**, *626*, 2463–2466.
486. Bailey, N. A.; Eddy, M. M.; Fenton, D. E.; Moss, S.; Mukhopadhyay, A.; Jones, G. *J. Chem. Soc., Dalton Trans.* **1984**, 2281–2288.
487. Fenton, D. E.; Rossi, G. *Inorg. Chim. Acta* **1985**, *98*, L29–L30.
488. Adams, H.; Bailey, N. A.; Carlisle, W. D.; Fenton, D. E.; Rossi, G. *J. Chem. Soc., Dalton Trans.* **1990**, 1271–1283.
489. Ngwenya, M. P.; Martell, A. E.; Reibenspies, J. *J. Chem. Soc., Chem. Commun.* **1990**, 1207–1208.
490. Adams, H.; Bailey, N. A.; Fenton, D. E.; Fukuhara, C.; Hellier, P. C.; Hempstead, P. D. *J. Chem. Soc., Dalton Trans.* **1992**, 729–730.
491. Fenton, D. E.; Hellier, P. C. *Inorg. Chim. Acta* **1992**, *198–200*, 577–581.
492. Adams, H.; Bailey, N. A.; Dwyer, M. J. S.; Fenton, D. E.; Hellier, P. C.; Hempstead, P. D.; Latour, J. M. *J. Chem. Soc., Dalton Trans.* **1993**, 1207–1221.
493. Bailey, N. A.; Rodriguez de Barbarin, C. O.; Fenton, D. E.; Hellier, P. C.; Hempstead, P. D.; Kanasato, M.; Leeson, P. B. *J. Chem. Soc., Dalton Trans.* **1995**, 765–776.
494. Adams, H.; Bailey, N. A.; Bertrand, P.; Collinson, S. R.; Fenton, D. E.; Kitchen, S. J. *Inorg. Chim. Acta* **1996**, *250*, 139–148.
495. Adams, H.; Elsegood, M. R. J.; Fenton, D. E.; Heath, S. L.; Ryan, S. J. *J. Chem. Soc., Dalton Trans.* **1999**, 2031–2037.
496. Yu, S. Y.; Luo, Q. Y.; Shen, M. C.; Huang, X. Y.; Zhang, Z. *Inorg. Chim. Acta* **1994**, *223*, 181–186.
497. Yu, S. Y.; Luo, Q. Y.; Shen, M. C.; Zhang, Z.; Huang, X. Y.; Wu, W. J. *Polyhedron* **1994**, *13*, 2467–2469.
498. Coyle, J. L.; McKee, V.; Nelson, J. *Chem. Commun.* **1998**, 709–710.
499. Harding, C. J.; Lu, Q.; Malone, J. F.; Marrs, D. J.; Martin, N.; McKee, V.; Nelson, J. *J. Chem. Soc., Dalton Trans.* **1995**, 1739–1747.
500. Howarth, O. W.; Morgan, G. G.; McKee, V.; Nelson, J. *J. Chem. Soc., Dalton Trans.* **1999**, 2097–2102.
501. Drew, M. G. B.; McDowell, D.; Nelson, J. *Polyhedron* **1988**, *7*, 2229–2232.
502. Drew, M. G. B.; Farrell, Morgan G. G.; McKee, V.; Nelson, J. *J. Chem. Soc., Dalton Trans.* **2000**, 1513–1519.
503. McKee, V.; Nelson, J.; Speed, D. J.; Town, R. M. *J. Chem. Soc., Dalton Trans.* **2001**, 3641–3646.
504. Kunze, A.; Gleiter, R.; Rominger, F. *Chem. Commun.* **1999**, 171–172.
505. Gleiter, R.; von Hirschheydt, T.; Rominger, F. *Eur. J. Inorg. Chem.* **2000**, 2127–2130.
506. de Mendoza, J.; Mesa, E.; Rodríguez-Ubis, J. C.; Vázquez, P.; Vögtle, F.; Windscheif, P. M.; Rissanen, K.; Lehn, J. M.; Lilienbaum, D.; Ziesel, R. *Angew. Chem., Int. Ed. Engl.* **1991**, *30*, 1331–1333.
507. Constable, E. C.; Khan, M. S.; Liptrot, M. C.; Lewis, J.; Raithbay, P. R. *Inorg. Chim. Acta* **1991**, *179*, 239–244.
508. Stockheim, C.; Weighardt, K.; Nuber, B.; Weiis, J.; Flörke, U.; Haupt, H. J. *J. Chem. Soc., Dalton Trans.* **1991**, 1487–1490.
509. Zhu, H. L.; Tong, Y. X.; Long, L. S.; Tong, M. L.; Chen, X. M. *Supramol. Chem.* **1999**, *11*, 119–133.
510. Mckenzie, C. J.; Nielsen, L. P.; Sotofte, I. *Acta Chem. Scand.* **1998**, *52*, 571–577.
511. Plenio, H.; Hermann, J. *Z. Anorg. Allg. Chem.* **1998**, *624*, 792–796.
512. Albrecht-Gary, A. M.; Dietrich-Buchecker, C.; Saad, Z.; Sauvage, J. P. *J. Am. Chem. Soc.* **1988**, *110*, 1467–1472.
513. Dietrich-Buchecker, C.; Sauvage, J. P.; Kern, J. M. *J. Am. Chem. Soc.* **1989**, *111*, 7791–7800.
514. Dietrich-Buchecker, C.; Hemmert, C.; Khemiss, A. K.; Sauvage, J. P. *J. Am. Chem. Soc.* **1990**, *112*, 8002–8008.
515. Collman, J. P.; Bencosme, C. S.; Durand, R. R., Jr.; Kreh, R. P.; Anson, F. C. *J. Am. Chem. Soc.* **1983**, *105*, 2699–2703.
516. Mak, T. C. W. *Inorg. Chim. Acta* **1984**, *84*, 19–23.

517. Stephan, H.; Krüger-Rambusch, T.; Gloe, K.; Hasse, W.; Ahlers, B.; Camman, K.; Rissanen, K.; Brodesser, G.; Vögtle, F. *Chem. Eur. J.* **1998**, *4*, 434–440.
518. Kumar, M.; Mahajan, R. K.; Sharma, V.; Singh, H.; Sharma, N.; Kaur, I. *Tetrahedron Lett.* **2001**, *42*, 5315–5318.
519. Whiteford, J. A.; Stang, P. J.; Huang, S. D. *Inorg. Chem.* **1998**, *37*, 5595–5601.
520. Psillakis, E.; Jeffery, J. C.; McCleverty, J. A.; Ward, M. D. *J. Chem. Soc., Dalton Trans.* **1997**, 1645–1651.
521. Yu, S. Y.; Luo, Q. H.; Wu, B.; Huang, X. Y.; Sheng, T. L.; Wu, X. T.; Wu, D. X. *Polyhedron* **1997**, *16*, 453–461.
522. Constable, E. C.; Elder, S. M.; Hannon, M. J.; Martin, A.; Raithby, P. R.; Tocher, D. A. *J. Chem. Soc., Dalton Trans.* **1996**, 2423–2433.
523. Constable, E. C.; Hannon, M. J.; Martin, A.; Raithby, P. R.; Tocher, D. A. *Polyhedron* **1992**, *11*, 2967–2972.
524. Constable, E. C.; Holmes, J. M.; Raithby, P. R. *Polyhedron* **1991**, *10*, 127–132.
525. Constable, E. C.; Walker, J. V. *J. Chem. Soc., Chem. Commun.* **1992**, 884–886.
526. Constable, E. C.; Edwards, A. J.; Raithby, P. R.; Walker, J. V. *Angew. Chem., Int. Ed. Engl.* **1993**, *32*, 1465–1467.
527. Fu, Y. J.; Sun, J.; Li, Q.; Chen, Y.; Dai, W. N.; Wang, D. F.; Mak, T. C. W.; Tang, W. X.; Hu, H. W. *J. Chem. Soc., Dalton Trans.* **1996**, 2309–2313.
528. Ho, P. K. K.; Peng, S. M.; Wong, K. Y.; Che, C. M. *J. Chem. Soc., Dalton Trans.* **1996**, 1829–1834.
529. Garrett, T. M.; Koert, U.; Lehn, J. M.; Rigault, A.; Meyer, D.; Fischer, J. *J. Chem. Soc., Chem. Commun.* **1990**, 557–558.
530. Carlucci, L.; Ciani, G.; v. Gudenberg, D. W.; Proserpio, D. M. *Inorg. Chem.* **1997**, *36*, 3812–3813.
531. Provent, C.; Hewage, S.; Brand, G.; Bernardinelli, G.; Charbonnière, L. J.; Williams, A. F. *Angew. Chem., Int. Ed. Engl.* **1997**, *36*, 1287–1289.
532. Withersby, M. A.; Blake, A. J.; Champness, N. R.; Hubberstey, P.; Li, W. S.; Schröder, M. *Angew. Chem., Int. Ed. Engl.* **1997**, *36*, 2327–2329.
533. Baum, G.; Constable, E. C.; Fenske, D.; Housecroft, C. E.; Kulke, T. *Chem. Commun.* **1998**, 2659–2660.
534. Baum, G.; Constable, E. C.; Fenske, D.; Housecroft, C. E.; Kulke, T.; Neuburger, M.; Zehnder, M. *J. Chem. Soc., Dalton Trans.* **2000**, 945–959.
535. Santra, P. K.; Ray, U.; Pal, S.; Sinha, C. *Inorg. Chem. Commun.* **2001**, *4*, 269–273.
536. Nomiya, K.; Noguchi, R.; Oda, M. *Inorg. Chim. Acta* **2000**, *298*, 24–32.
537. Nomiya, K.; Tsuda, K.; Kasuga, N. C. *J. Chem. Soc., Dalton Trans.* **1998**, 1653–1659.
538. Zhu, H. L.; Tong, Y. X.; Chen, X. M. *J. Chem. Soc., Dalton Trans.* **2000**, 4182–4186.
539. Nomiya, K.; Takahashi, S.; Noguchi, R.; Nemoto, S.; Takayama, T.; Oda, M. *Inorg. Chem.* **2000**, *39*, 3301–3311.
540. Mamula, O.; Monlien, F. J.; Porquet, A.; Hopfgartner, G.; Merbach, A. E.; von Zelewsky, A. *Chem. Eur. J.* **2001**, *7*, 533–539.
541. Baum, G.; Constable, E. C.; Fenske, D.; Kulke, T. *Chem. Commun.* **1997**, 2043–2044.
542. Carlucci, L.; Ciani, G.; Proserpio, D. M.; Sironi, A. *Inorg. Chem.* **1998**, *37*, 5941–5943.
543. Tong, L. M.; Chen, X. M.; Ye, B. H.; Ng, S. W. *Inorg. Chem.* **1998**, *37*, 5278–5281.
544. Sailaja, S.; Rajasekharan, M. V. *Inorg. Chem.* **2000**, *39*, 4586–4590.
545. Oshio, H.; Yamamoto, M.; Ito, T. *J. Chem. Soc., Dalton Trans.* **1999**, 2641–2643.
546. Oshio, H.; Yaginuma, T.; Ito, T. *Inorg. Chem.* **1999**, *38*, 2750–2752.
547. Oshio, H.; Hikichi, T.; Yaginuma, T.; Onodera, H.; Yamamoto, M.; Ito, T. *Mol. Cryst. Liq. Cryst.* **1999**, *334*, 479–509.
548. Zhang, H.; Cai, J.; Feng, X. L.; Liu, J. Z.; Li, X. Y.; Ji, L. N. *Inorg. Chem. Commun.* **2001**, *4*, 241–244.
549. Yang, S. P.; Zhu, H. L.; Yin, X. H.; Chen, X. M.; Ji, L. N. *Polyhedron* **2000**, *19*, 2237–2242.
550. Sivashankar, K.; Ranganathan, A.; Pedireddi, V. R.; Rao, C. N. R. *J. Mol. Struct.* **2001**, *559*, 41–48.
551. Bowyer, P. K.; Porter, K. A.; Rae, A. D.; Willis, A. C.; Wild, S. B. *Chem. Commun.* **1998**, 1153–1154.
552. Stiller, R.; Lehn, J. M. *Eur. J. Inorg. Chem.* **1998**, 977–982.
553. Shu, M. H.; Sun, W. Y.; Duan, C. Y.; Tang, W. X.; Zhang, W. J. *Transition Met. Chem.* **1999**, *24*, 628–632.
554. Abrahams, B. F.; Jackson, P. A.; Robson, R. *Angew. Chem., Int. Ed. Engl.* **1998**, *37*, 2656–2659.
555. Kaes, C.; Hosseini, M. W.; Rickard, C. E. F.; Skelton, B. W.; White, A. H. *Angew. Chem., Int. Ed. Engl.* **1998**, *37*, 920–922.
556. Greenwald, M.; Wessely, D.; Goldberg, I.; Cohen, Y. *New J. Chem.* **1999**, 337–344.
557. Garrett, T. M.; Koert, U.; Lehn, J. M. *J. Phys. Org. Chem.* **1992**, *5*, 529–535.
558. Piguet, C.; Hopfgartner, G.; Bocquet, B.; Schaad, O.; Williams, A. F. *J. Am. Chem. Soc.* **1994**, *116*, 9092–9102.
559. Piguet, C.; Bernardinelli, G.; Williams, A. F.; Bocquet, B. *Angew. Chem., Int. Ed. Engl.* **1995**, *34*, 582–584.
560. Hirsch, K. A.; Venkataraman, D.; Wilson, S. R.; Moore, J. S.; Lee, S. *J. Chem. Soc., Chem. Commun.* **1995**, 2199–2000.
561. Hirsch, K. A.; Wilson, S. R.; Moore, J. S. *Chem. Eur. J.* **1997**, *3*, 765–771.
562. Gardner, G. B.; Venkataraman, D.; Moore, J. S.; Lee, S. *Nature* **1995**, *374*, 792–795.
563. Venkataraman, D.; Gardner, G. B.; Lee, S.; Moore, J. S. *J. Am. Chem. Soc.* **1995**, *117*, 11600–11601.
564. Wu, H. P.; Janiak, C.; Rheinwald, G.; Lang, H. *J. Chem. Soc., Dalton Trans.* **1999**, 183–190.
565. Hirsch, K. A.; Wilson, S. R.; Moore, J. S. *Inorg. Chem.* **1997**, *36*, 2960–2968.
566. Hirsch, K. A.; Wilson, S. R.; Moore, J. S. *Acta Crystallogr., Sect. C* **1996**, *52*, 2419–2422.
567. Hirsch, K. A.; Wilson, S. R.; Moore, J. S. *J. Chem. Soc., Chem. Commun.* **1998**, 13–14.
568. Carlucci, L.; Ciani, G.; Macchi, P.; Proserpio, D. M.; Rizzato, S. *Chem. Eur. J.* **1999**, *5*, 237–243.
569. Tei, L.; Lippolis, V.; Blake, A. J.; Cooke, P. A.; Schröder, M. *Chem. Commun.* **1998**, 2633–2634.
570. Liu, F. Q.; Tilley, T. D. *Inorg. Chem.* **1997**, *36*, 5090–5096.
571. Carlucci, L.; Ciani, G.; Proserpio, D. M.; Sironi, A. *J. Chem. Soc., Chem. Commun.* **1995**, 2755–2756.
572. Li, M. X.; Cheung, K. K.; Mayr, A. *J. Solid State Chem.* **2000**, *152*, 247–252.
573. Venkataraman, D.; Gardner, G. B.; Covey, A. C.; Lee, S.; Moore, J. S. *Acta Crystallogr., Sect. C* **1996**, *52*, 2416–2419.
574. Jager, L.; Wagner, C.; Hanke, W. *J. Molec. Struct.* **2000**, *525*, 107–111.
575. Suenaga, Y.; Kamiya, T.; Kuroda Sowa, T.; Maekawa, M.; Munakata, M. *Inorg. Chim. Acta* **2000**, *308*, 17–21.
576. Suenaga, Y.; Kuroda Sowa, T.; Munakata, M.; Maekawa, M. *Polyhedron* **1999**, *18*, 191–195.
577. Batten, S. R.; Hoskins, B. F.; Robson, R. *New J. Chem.* **1998**, *22*, 173–175.

578. Decoster, M.; Guerschais, J. E.; Le Mest, Y.; Pala, J. S.; Smail, T.; Toupet L. *Polyhedron* **1996**, *15*, 195–202.
579. Mislin, G.; Graf, E.; Hosseini, M. W.; De Cian, A.; Kyritsakas, N.; Fischer, J. *Chem. Commun.* **1998**, 2545–2546.
580. Kleina, C.; Graf, E.; Hosseini, M. W.; De Cian, A.; Fischer, J. *Chem. Commun.* **2000**, 239–240.
581. Fortin, D.; Drouin, M.; Turcotte, M.; Harvey, P. D. *J. Am. Chem. Soc.* **1997**, *119*, 531–541.
582. Harvey, P. D.; Fortin, D. *Coord. Chem. Rev.* **1998**, *171*, 17–41.
583. Kang, Y.; Lee, S. S.; Park, K. M.; Lee, S. H.; Kang, S. O.; Ko, J. *Inorg. Chem.* **2001**, *40*, 7027–7031.
584. Roesky, H. W.; Gries, T.; Schimkowiak, J.; Jones, P. G. *Angew. Chem., Int. Ed. Engl.* **1986**, *25*, 84–85.
585. Hamilton, B. H.; Ziegler, C. J. *Chem. Commun.* **2002**, 842–843.
586. Munakata, M.; Kitagawa, S.; Ujimar, N.; Nakamura, M.; Maekawa, M.; Matsuda, H. *Inorg. Chem.* **1993**, *32*, 826–832.
587. He, C.; Zhang, B. G.; Duan, C. Y.; Li, J. H.; Meng, Q. J. *Eur. J. Inorg. Chem.* **2000**, 2549–2554.
588. Yang, G.; Zheng, S. L.; Chen, X. M.; Lee, H. K.; Zhou, Z. Y.; Mak, T. C. W. *Inorg. Chim. Acta* **2000**, *303*, 86–93.
589. Blake, A. J.; Champness, N. R.; Cooke, P. A.; Nicolson, J. E. B.; Wilson, C. J. *Chem. Soc., Dalton Trans.* **2000**, 3811–3819.
590. Munakata, M.; Wen, M.; Suenaga, Y.; Kuroda-Sowa, T.; Maekawa, M.; Anahata, M. *Polyhedron* **2001**, *20*, 2037–2043.
591. Liu, H. K.; Hu, J.; Wang, T. W.; Yu, X. L.; Liu, J.; Kang, B. J. *Chem. Soc., Dalton Trans.* **2001**, 3534–3540.
592. Jun, O. S.; Park, S. H.; Park, C. H.; Park, J. K. *Chem. Lett.* **1999**, 923–924.
593. Blake, A. J.; Champness, N. R.; Khlobystov, A. N.; Lemenovskii, D. A.; Li, W. S.; Schröder, M. *Chem. Commun.* **1997**, 1339–1340.
594. Cova, B.; Bricenno, A.; Atencio, R. *New J. Chem.* **2001**, *25*, 1516–1519.
595. O'Keefe, B. J.; Steel, P. J. *Inorg. Chem. Commun.* **1998**, *1*, 147–149.
596. Hartshorn, C. M.; Steel, P. J. *J. Chem. Soc., Dalton Trans.* **1998**, 3927–3933.
597. Aakeröy, C. B.; Beatty, A. M. *Chem. Commun.* **1998**, 1067–1068.
598. Aakeröy, C. B.; Beatty, A. M.; Helfrich, B. A. *J. Chem. Soc., Dalton Trans.* **1998**, 1943–1945.
599. Fei, B. L.; Sun, W. Y.; Yu, K. B.; Tang, W. X. *J. Chem. Soc., Dalton Trans.* **2000**, 805–811.
600. Fei, B. L.; Sun, W. Y.; Zhang, Y. A.; Yu, K. B.; Tang, W. X. *Inorg. Chim. Acta* **2000**, *306*, 106–111.
601. Muthu, S.; Yip, J. H. K.; Vittal, J. J. *J. Chem. Soc., Dalton Trans.* **2001**, 3577–3584.
602. Xu, A. W.; Su, C. Y.; Zhang, Z. F.; Cai, Y. P.; Chen, C. L. *New J. Chem.* **2001**, *25*, 479–482.
603. Zuo, J. L.; Fun, H. K.; Chinnakali, Z.; You, X. Z.; Che, C. M. *New J. Chem.* **1998**, *22*, 923–925.
604. Tong, M. L.; Chen, X. M.; Ng, S. W. *Inorg. Chem. Comm.* **2000**, *3*, 436–441.
605. Reger, D. L.; Semeniuc, R. F.; Smith, M. D. *Inorg. Chem.* **2001**, *40*, 6545–6546.
606. Carlucci, L.; Ciani, G.; Proserpio, D. M.; Sironi, A. *J. Am. Chem. Soc.* **1995**, *117*, 4562–4569.
607. Carlucci, L.; Ciani, G.; Proserpio, D. M.; Sironi, A. *Inorg. Chem.* **1995**, *34*, 5698–5700.
608. Carlucci, L.; Ciani, G.; Proserpio, D. M.; Sironi, A. *Angew. Chem., Int. Ed. Engl.* **1995**, *34*, 1895–1898.
609. Lange, I.; Jones, P. G.; Blaschette, A. Z. *Anorg. Allg. Chem.* **1995**, *621*, 476–478.
610. Carlucci, L.; Ciani, G.; Proserpio, D. M.; Sironi, A. *Chem. Commun.* **1996**, 1393–1394.
611. Blake, A. J.; Champness, N. R.; Crew, M.; Parsons, S. *New J. Chem.* **1999**, *23*, 13–15.
612. Schnebeck, R. D.; Freisinger, E.; Lippert, B. *Eur. J. Inorg. Chem.* **2000**, 1193–1200.
613. Bu, W. M.; Ye, L.; Fan, Y. G. *Inorg. Chem. Commun.* **2000**, *3*, 194–197.
614. Ren, C. X.; Zhu, H. L.; Yang, G.; Chen, X. M. *J. Chem. Soc., Dalton Trans.* **2001**, 85–90.
615. Healy, P. C.; Mills, N. K.; White, A. H. *J. Chem. Soc., Dalton Trans.* **1985**, 111–116.
616. Mills, N. K.; White, A. H. *J. Chem. Soc., Dalton Trans.* **1984**, 229–237.
617. Mills, N. K.; White, A. H. *J. Chem. Soc., Dalton Trans.* **1984**, 225–228.
618. Kitagawa, S.; Matsuyama, S.; Munakata, M.; Emori, T. *J. Chem. Soc., Dalton Trans.* **1991**, 2869–2874.
619. Davydov, V. V.; Sokol, V. I.; Poraikoshits, M. A.; Zaitsev, B. E.; Belonosov, V. A.; Balebanova, E. V. *Koord. Khim.* **1991**, *17*, 976–984.
620. Quiros, M. *Acta Crystallogr., Sect. C* **1994**, *50*, 1236–1239.
621. Sommerer, S. O.; Westcott, B. L.; Abboud, K. A. *Acta Crystallogr., Sect. C* **1994**, *50*, 48–52.
622. Robinson, F.; Zaworotko, M. J. *J. Chem. Soc., Chem. Commun.* **1995**, 2413–2414.
623. Batten, S. R.; Jeffery, J. C.; Ward, M. D. *Inorg. Chim. Acta* **1999**, *292*, 231–237.
624. Ratilainen, J.; Airola, K.; Fröhlich, R.; Nieger, M.; Rissanen, K. *Polyhedron* **1999**, *18*, 2265–2273.
625. Sun, W. Y.; Fei, B. L.; Zhang, Y. A.; Tang, W. X.; Yu, K. B. *Acta Chim. Sin.* **2000**, *58*, 491–493.
626. Raj, S. S. S.; Fun, H. K.; Chen, X. F.; Zhu, X. H.; You, X. Z. *Acta Crystallogr., Sect. C* **1999**, *55*, 2035–2037.
627. Itaya, T.; Inoue, K. *Bull. Chem. Soc. Jpn.* **2000**, *73*, 2615–2619.
628. Chen-Yang, Y. W.; Hwang, J. J.; Kan, J. Y. *J. Polym. Sci., Part. A: Polym. Chem.* **1997**, *35*, 1023–1031.
629. Garcia-Alonso, F. J.; Wisian-Neilson, P. *Macromolecules.* **1993**, *26*, 7156–7160.
630. Richardson, C.; Steel, P. J. *Inorg. Chem. Commun.* **1998**, *1*, 260–262.
631. Maekawa, M.; Konaka, H.; Suenaga, Y.; Kuroda-Sowa, T.; Munakata, M. *J. Chem. Soc., Dalton Trans.* **2000**, 4160–4166.
632. Carlucci, L.; Ciani, G.; Proserpio, D. M. *Chem. Commun.* **1999**, 449–450.
633. Bu, X. H.; Liu, H.; Du, M.; Wong, K. M. C.; Yam, V. W. W.; Shionoya, M. *Inorg. Chem.* **2001**, *40*, 4143–4149.
634. Janiak, C.; Uehlin, L.; Wu, H. P.; Klüfers, P.; Piotrowski, H.; Scharmann, T. G. *J. Chem. Soc., Dalton Trans.* **1999**, 3121–3131.
635. Velten, U.; Lahn, B.; Rehahn, M. *Macromol. Chem. Phys.* **1997**, *198*, 2789–2816.
636. Carlucci, L.; Ciani, G.; Proserpio, D. M. *Angew. Chem., Int. Ed. Engl.* **1999**, *38*, 3488–3492.
637. Loi, M.; Hosseini, M. W.; Jouati, A.; Dician, A.; Fischer, J. *Eur. J. Inorg. Chem.* **1999**, 1981–1985.
638. Su, C. Y.; Yang, X. P.; Liao, S.; Mak, R. C. W.; Kang, B. S. *Inorg. Chem. Commun.* **1999**, *2*, 383–385.
639. Xue, G.; Dai, Q.; Jiang, S. *J. Am. Chem. Soc.*, **1988**, *110*, 2393–2395.
640. Munakata, M.; Kuroda-Sowa, T.; Maekawa, M.; Nakamura, M.; Akiyama, S.; Kitagawa, S. *Inorg. Chem.* **1994**, *33*, 1284–1291.
641. Baxter, P. N. W.; Lehn, J. M.; Fischer, J. M.; Youinou, M. T. *Angew. Chem., Int. Ed. Engl.* **1994**, *33*, 2284–2287.
642. Richmond, T. G.; Kelson, E. P.; Patton, A. T. *J. Chem. Soc., Chem. Commun.* **1988**, 96–97.

643. Richmond, T. G.; Kelson, E. P.; Arif, A. M. *J. Am. Chem. Soc.* **1988**, *110*, 2334–2335.
644. Arif, A. M.; Richmond, T. G. *J. Chem. Soc., Chem. Commun.* **1990**, 871–872.
645. Hartshorn, C. M.; Steel, P. J. *Aus. J. Chem.* **1997**, *50*, 1195–1198.
646. Jones, N. D.; Rettig, S. J.; James, B. R. *J. Cluster Sci.* **1998**, *9*, 243–258.
647. Ming, L. J.; Valentine, J. S. *J. Am. Chem. Soc.*, **1987**, *109*, 4426–4428.
648. Roe, J. A.; Peoples, R.; Scholler, D. M.; Valentine, J. S. *J. Am. Chem. Soc.*, **1990**, *112*, 1538–1545.
649. Socol, S. M.; Jacobson, R. A.; Verkade, J. G. *Inorg. Chem.* **1984**, *23*, 88–94.
650. Socol, S. M.; Verkade, J. G. *Inorg. Chem.* **1984**, *23*, 3487–3493.
651. Baiada, A.; Jardine, F. H.; Willett, R. D. *Inorg. Chem.* **1990**, *29*, 4805–4808.
652. Baiada, A.; Jardine, F. H.; Willett, R. D. *Inorg. Chem.* **1990**, *29*, 3042–3046.
653. Alyea, E. C.; Ferguson, G.; Somogyvari, A. *Inorg. Chem.* **1982**, *21*, 1369–1371.
654. Baker, L. J.; Bowmaker, G. A.; Camp, D.; Effendy; Healy, P. C.; Schmidbaur, H.; Steigelmann, O.; White, A. H. *Inorg. Chem.* **1992**, *31*, 3656–3661.
655. Bachman, R. E.; Andretta, D. F. *Inorg. Chem.* **1998**, *37*, 5657–5663.
656. Jones, P. G. Z. *Kristallogr.* **1995**, *210*, 896–896.
657. Sangani, D. V.; Smith, P. J.; Allen, D. W.; Taylor, B. F. *Inorg. Chim. Acta* **1982**, *59*, 203–206.
658. Cassel, A. *Acta Crystallogr., Sect. B* **1981**, *37*, 229–230.
659. Engelhardt, L. M.; Healy, P. C.; Patrick, V. A.; White, A. H. *Aust. J. Chem.* **1987**, *40*, 1873–1879.
660. Camalli, A.; Caruso, F. *Inorg. Chim. Acta* **1987**, *127*, 209–214.
661. Bowmaker, G. A.; Effendy; Hanna, J. V.; Healy, P. C.; Skelton, B. W.; White, A. H. *J. Chem. Soc., Dalton Trans.* **1993**, 1387–1397.
662. Bowen, R. J.; Camp, D.; Effendy; Healy, P. C.; Skelton, B. W.; White, A. H. *Aust. J. Chem.* **1994**, *47*, 693–701.
663. Edwards, H. G. M.; Maitland, D. J. *J. Mol. Struct.* **1994**, *319*, 161–165.
664. Barron, P. F.; Dyason, J. C.; Healy, P. C.; Engelhardt, L. M.; Skelton, B. W.; White, A. H. *J. Chem. Soc., Dalton Trans.* **1986**, 1965–1970.
665. Liu, C. W.; Pan, H.; Fackler, J. P., Jr.; Wu, G.; Wasylishen, R. E.; Shang, M. *J. Chem. Soc., Dalton Trans.* **1995**, 3691–3697.
666. Wu, G.; Wasylishen, R. E.; Pan, H. Y.; Liu, C. W.; Fackler, J. P., Jr.; Shang, M. Y. *Magn. Res. Chem.* **1995**, *33*, 734–738.
667. Harker, C. S. W.; Tiekink, E. R. T. *Acta Crystallogr., Sect. C* **1989**, *45*, 1815–1817.
668. Jones, P. G. *Acta Crystallogr., Sect. C* **1993**, *49*, 1148–1150.
669. Bardaji, M.; Crespo, O.; Laguna, A.; Fischer, A. K. *Inorg. Chim. Acta* **2000**, *304*, 7–16.
670. Terroba, R.; Hursthouse, M. B.; Laguna, M.; Mendia, A. *Polyhedron* **1999**, *18*, 807–810.
671. Lettko, L.; Wood, J. S.; Rausch, M. D. *Inorg. Chim. Acta* **2000**, *308*, 37–44.
672. Ng, S. W.; Othman, A. H. Z. *Krist.* **1995**, *210*, 674–675.
673. Bowmaker, G. A.; Effendy; Hanna, J. V.; Healy, P. C.; Millar, G. J.; Skelton, B. W.; White, A. H. *J. Phys. Chem.* **1995**, *99*, 3909–3917.
674. Bowmaker, G. A.; Effendy; Hanna, J. V.; Healy, P. C.; Reid, J. C.; Rickard, C. E. F.; White, A. H. *J. Chem. Soc., Dalton Trans.* **2000**, 753–761.
675. Bowmaker, G. A.; Hanna, J. V.; Rickard, C. E. F.; Lipton, A. S. *J. Chem. Soc., Dalton Trans.* **2001**, 20–28.
676. Nardelli, M.; Pelizzi, C.; Pelizzi, G.; Tarasconi, P. *J. Chem. Soc., Dalton Trans.* **1985**, 321–331.
677. Effendy; Kildea, J. D.; White, A. H. *Aust. J. Chem.* **1997**, *50*, 671–674.
678. Effendy; Kildea, J. D.; White, A. H. *Aust. J. Chem.* **1997**, *50*, 587–604.
679. Pelizzi, C.; Pelizzi, G.; Tarasconi, P. *J. Organomet. Chem.* **1984**, *277*, 29–35.
680. Engelhardt, L. M.; Pakawatchai, C.; White, A. H.; Healy, P. C. *J. Chem. Soc., Dalton Trans.* **1985**, 125–133.
681. Bowmaker, G. A.; Healy, P. C.; Engelhardt, L. M.; Kildia, J. D.; Skelton, B. W.; White, A. H. *Aust. J. Chem.* **1990**, *43*, 1697–1705.
682. Cotton, F. A.; Luck, R. L. *Acta Crystallogr., Sect. C* **1989**, *45*, 1222–1223.
683. Ellis, D. D.; Spek, A. L. *Acta Crystallogr., Sect. C* **2000**, *56*, E547–E548.
684. Bonardi, A.; Cantón, A.; Pelizzi, C.; Pelizzi, G.; Tarasconi, P. *J. Organomet. Chem.* **1991**, *402*, 281–288.
685. Bowmaker, G. A.; Effendy; Hart, R. D.; Kildea, J. D.; Desilva, E. N.; Skelton, B. W.; White, A. H. *Aust. J. Chem.* **1997**, *50*, 539–552.
686. Tripathi, U. M.; Bauer, A.; Schmidbaur, H. *J. Chem. Soc., Dalton Trans.* **1997**, 2865–2868.
687. Hill, A. M.; Levason, W.; Webster, M. *Inorg. Chem.* **1996**, *35*, 3428–3430.
688. Bowmaker, G. A.; Effendy; Harvey, P. J.; Healy, P. C.; Skelton, B. W.; White, A. H. *J. Chem. Soc., Dalton Trans.* **1996**, 2459–2465.
689. Bowmaker, G. A.; Effendy; Harvey, P. J.; Healy, P. C.; Skelton, B. W.; White, A. H. *J. Chem. Soc., Dalton Trans.* **1996**, 2449–2457.
690. Camalli, M.; Caruso, F. *Inorg. Chim. Acta* **1988**, *144*, 205–211.
691. Bowmaker, G. A.; Effendy; Junk, P. C.; White, A. H. *J. Chem. Soc., Dalton Trans.* **1998**, 2131–2138.
692. Bowmaker, G. A.; Effendy; Reid, J. C.; Rickard, C. E. F.; Skelton, B. W.; White, A. H. *J. Chem. Soc., Dalton Trans.* **1998**, 2139–2146.
693. Othman, A. H.; Fun, H. K.; Sivakumar, K.; Farina, Y.; Baba, I. *Acta Crystallogr., Sect. C* **1996**, *52*, 1933–1935.
694. Bowmaker, G. A.; Effendy; Hart, R. D.; Kildea, J. D. *Aust. J. Chem.* **1997**, *50*, 653–670.
695. Bowmaker, G. A.; Effendy; Kildea, J. D.; Desilva, E. N.; White, A. H. *Aust. J. Chem.* **1997**, *50*, 627–640.
696. Bowmaker, G. A.; Effendy; Kildea, J. D.; White, A. H. *Aust. J. Chem.* **1997**, *50*, 577–586.
697. Pelizzi, C.; Pelizzi, G.; Tarasconi, P. *J. Organomet. Chem.* **1985**, *281*, 403–410.
698. Bowmaker, G. A.; Effendy; Desilva, E. N.; White, A. H. *Aust. J. Chem.* **1997**, *50*, 641–651.
699. Cowley, A. H.; Elkins, T. M.; Jones, R. A.; Nunn, C. M. *Angew. Chem., Int. Ed. Engl.* **1988**, *27*, 1349–1350.
700. Wagner, H.; Schubert, U. *Chem. Ber.* **1990**, *123*, 2101–2107.
701. du Mont, W. W.; Karnop, M.; Mahnke, J.; Martens, R.; Druckenbrodt, C.; Jeske, J.; Jones, P. G. *Chem. Ber.* **1997**, *130*, 1619–1623.
702. Inoguchi, Y.; Mileski-Mahrle, B.; Neugebauer, D.; Jones, P. G.; Schmidbaur, H. *Chem. Ber.* **1983**, *116*, 1487–1493.

703. Tiekink, E. R. T. *J. Coord. Chem.* **1993**, *28*, 223–230.
704. Papathanasiou, P.; Salem, G.; Waring, P.; Willis, A. C. *J. Chem. Soc., Dalton Trans.* **1997**, 3435–3443.
705. Alyea, E. C.; Malito, J.; Nelson, J. H. *Inorg. Chem.* **1987**, *26*, 4294–4296.
706. Attar, S.; Alcock, N. W.; Bowmaker, G. A.; Frye, J. S.; Bearden, W. H.; Nelson, J. H. *Inorg. Chem.* **1991**, *30*, 4166–4176.
707. Arduengo III, A. J.; Dias, H. V. R.; Calabrese, J. C. *J. Am. Chem. Soc.* **1991**, *113*, 7071–7072.
708. Arduengo III, A. J.; Dias, H. V. R.; Calabrese, J. C. *Inorg. Chem.* **1991**, *30*, 4880–4882.
709. Barranco, E. M.; Crespo, O.; Gimeno, M. C.; Laguna, A.; Jones, P. G.; Ahrens, B. *Inorg. Chem.* **2000**, *39*, 680–687.
710. Gimeno, M. C.; Jones, P. G.; Laguna, A.; Sarroca, C. *Polyhedron* **1998**, *17*, 3681–3688.
711. Thomaier, J.; Boulmaaz, S.; Schönberg, H.; Rügger, H.; Currao, A.; Grützmacher, H.; Hillebrecht, H.; Pritzkow, H. *New J. Chem.* **1998**, 947–958.
712. Gudat, D.; Schrott, M.; Bajorat, V.; Nieger, M.; Kotila, S.; Fleischer, R.; Stalke, D. *Chem. Ber.* **1996**, *129*, 337–345.
713. Young, S. M.; Barendt, J. M.; Carperos, V.; Haltiwanger, R. C.; Hands, R. M.; Norman, A. D. *Inorg. Chem.* **1995**, *34*, 5003–5012.
714. Del Zotto, A.; Di Bernardo, P.; Tolazzi, M.; Tomat, G.; Zanamoto, P. *J. Chem. Soc., Dalton Trans.* **1993**, 3009–3013.
715. Bonnington, L. S.; Coll, R. K.; Gray, E. J.; Flett, J. I.; Henderson, W. *Inorg. Chim. Acta* **1999**, *290*, 213–221.
716. Henderson, W.; Olsen, G. M. *Polyhedron* **1996**, *15*, 2105–2115.
717. McEwan, D. M.; Pringle, P. G.; Shaw, B. L. *J. Chem. Soc., Chem. Commun.* **1982**, 1240–1241.
718. Pringle, P. G.; Shaw, B. L. *J. Chem. Soc., Chem. Commun.* **1982**, 956–957.
719. McDonald, W. S.; Pringle, P. G.; Shaw, B. L. *J. Chem. Soc., Chem. Commun.* **1982**, 861–863.
720. Langrick, C. R.; Shaw, B. L. *J. Chem. Soc., Dalton Trans.* **1985**, 511–516.
721. Blagg, A.; Shaw, B. L.; Thorton-Pett, M. *J. Chem. Soc., Dalton Trans.* **1987**, 769–775.
722. Xu, C.; Anderson, G. K.; Brammer, L.; Braddock-Wilking, J.; Rath, N. P. *Organometallics* **1996**, *15*, 3972–3979.
723. Al-Jibori, S. A. *Transition Met. Chem.* **1995**, *20*, 523–527.
724. Yip, H. K.; Lin, H. M.; Cheung, K. K.; Che, C. M.; Wang, Y. *Inorg. Chem.* **1994**, *33*, 1644–1651.
725. Balch, A. J.; Ghedini, M.; Oram, D. E.; Reedy, P. E., Jr. *Inorg. Chem.* **1987**, *26*, 1223–1229.
726. Balch, A. J.; Davis, B. J.; Neve, F.; Olmstead, M. M. *Organometallics* **1989**, *8*, 1000–1007.
727. Braunstein, P.; Kelly, D. G.; Dusausoy, Y.; Bayeul, D.; Lanfranchi, M.; Tiripicchio, A. *Inorg. Chem.* **1994**, *33*, 233–242.
728. Brumas, B.; de Caro, D.; Dahan, F.; de Montauzon, D.; Poilblanc, R. *Organometallics* **1993**, *12*, 1503–1505.
729. Brumas-Soula, B.; Dahan, F.; Poilblanc, R. *New J. Chem.* **1998**, 1067–1074.
730. Contel, M.; Garrido, J.; Gimeno, M. C.; Jiménez, J.; Jones, P. G.; Laguna, A.; Laguna, M. *Inorg. Chim. Acta* **1997**, *254*, 157–161.
731. Barrow, M.; Bürgi, H. B.; Camalli, M.; Caruso, F.; Fischer, E.; Venanzi, L. M.; Zambonelli, L. *Inorg. Chem.* **1983**, *22*, 2356–2362.
732. Camalli, M.; Caruso, F.; Zambonelli, L. *Inorg. Chim. Acta* **1982**, *61*, 195–198.
733. Berners-Price, S. J.; Brevard, C.; Pagelot, A.; Sadler, P. J. *Inorg. Chem.* **1985**, *24*, 4278–4281.
734. Berners-Price, S. J.; Sadler, P. J. *Magn. Reson. Chem.* **1990**, *28*, 145–148.
735. Harker, C. S. W.; Tiekink, E. R. T. *J. Coord. Chem.* **1990**, *21*, 287–293.
736. Franzoni, D.; Pelizzi, G.; Predieri, G.; Tarasconi, P.; Pelizzi, C. *Inorg. Chim. Acta* **1988**, *150*, 279–285.
737. Berners-Price, S. J.; Sadler, P. J. *Struct. Bond.* **1988**, *70*, 27–51.
738. Berners-Price, S. J.; Johnson, R. K.; Giovenella, A. J.; Faucette, L. F.; Mirabelli, C. K.; Sadler, P. J. *J. Inorg. Biochem.* **1988**, *33*, 285–291.
739. Harker, C. S. W.; Tiekink, E. R. T.; Whitehouse, M. W. *Inorg. Chim. Acta* **1991**, *181*, 23–30.
740. Berners-Price, S. J.; Sadler, P. J. *Coord. Chem. Rev.* **1996**, *151*, 1–40.
741. Dong, Y.; Berners-Price, S. J.; Thorburn, D. R.; Antalis, T.; Dickinson, J.; Hurst, T.; Qui, L.; Khoo, S. K.; Parsons, P. G. *Biochem. Pharmacol.* **1997**, *53*, 1673–1682.
742. Berners-Price, S. J.; Collier, D. C.; Mazid, M. A.; Sadler, P. G.; Sue, R. E.; Wilkie, D. *Met.-Based Drugs* **1995**, *2*, 111–118.
743. Berners-Price, S. J.; Bowen, R. J.; Harvey, P. J.; Healy, P. C.; Koutsantonis, G. A. *J. Chem. Soc., Dalton Trans.* **1998**, 1743–1750.
744. Berners-Price, S. J.; Bowen, R. J.; Galettis, P.; Healy, P. C.; McKeage, M. J. *Coord. Chem. Rev.* **1999**, *185–186*, 823–836.
745. Atwood, D. A.; Cowley, A. H.; Dennis, S. M. *Inorg. Chem.* **1993**, *32*, 1527–1528.
746. Gimeno, M. C.; Jones, P. G.; Laguna, A.; Sarroca, C. *J. Chem. Soc., Dalton Trans.* **1995**, 1473–1481.
747. Hor, T. S. A.; Neo, S. P.; Tan, C. S.; Mak, T. C. W.; Leung, K. W. P.; Wang, R. J. *Inorg. Chem.* **1992**, *31*, 4510–4516.
748. Nifant'ev, I. E.; Manzhukova, L. F.; Antipin, M. Y.; Struchkov, Y. T.; Nifant'ev, E. E. *Zh. Obsch. Khim.* **1995**, *65*, 756–760.
749. Sawamura, M.; Ito, Y. *Tetrahedron Lett.* **1990**, *31*, 2723–2726.
750. Bembenek, E.; Crespo, O.; Gimeno, M. C.; Jones, P. G.; Laguna, A. *Chem. Ber.* **1994**, *127*, 835–840.
751. Crespo, O.; Gimeno, M. C.; Jones, P. G.; Laguna, A. *J. Chem. Soc., Dalton Trans.* **1996**, 4583–4588.
752. Heuer, B.; Pope, S. J. A.; Reid, G. *Polyhedron* **2000**, *19*, 743–749.
753. Xu, F. B.; Weng, L. H.; Sun, L. J.; Zhang, Z. Z. *Organometallics* **2000**, *19*, 2658–2660.
754. Camalli, M.; Caruso, F.; Chaloupka, S.; Venanzi, L. M. *Helv. Chim. Acta* **1988**, *71*, 703–708.
755. Camalli, M.; Caruso, F.; Chaloupka, S.; Kapoor, P. N.; Pregosin, P. S.; Venanzi, L. M. *Helv. Chim. Acta* **1984**, *67*, 1603–1608.
756. Salem, G.; Schier, A.; Wild, S. B. *Inorg. Chem.* **1988**, *27*, 3029–3032.
757. Affandi, D.; Berners-Price, S. J.; Effendy; Harvey, P. J.; Healy, P. C.; Ruch, B. E.; White, A. H. *J. Chem. Soc., Dalton Trans.* **1997**, 1411–1420.
758. Cooke, P. A.; Perera, S. D.; Shaw, B. L.; Thornton-Pett, M.; Vessey, J. D. *J. Chem. Soc., Dalton Trans.* **1997**, 435–438.
759. Ho, D. M.; Bau, R. *Inorg. Chem.* **1983**, *22*, 4073–4079.
760. Peng, Z.; Mingsheng, H.; Ying, Z.; Lansun, Z.; Huahui, Y. *Huaxue Xuobao* **1991**, *49*, 1120–1123 (*Chem. Abstr.* **1992**, *116*, 74889g).

761. Hong, M.; Wu, D.; Liu, H.; Mak, T. C. W.; Zhou, Z.; Wu, D.; Li, S. *Polyhedron* **1997**, *16*, 1957–1962.
762. Neo, S. P.; Zhou, Z. Y.; Mak, T. C. W.; Hor, T. S. A. *Inorg. Chem.* **1995**, *34*, 520–523.
763. Peng, Z.; Ying, Z.; Mingsheng, H.; Lansun, Z.; Huahui, Y. *Chin. Sci. Bull.* **1991**, *36*, 1844–1845 (*Chem. Abstr.* **1992**, *117*, 82209w).
764. Aly, A. A. M.; Neugebauer, D.; Orama, O.; Schubert, U.; Schmidbaur, H. *Angew. Chem., Int. Ed. Engl.* **1978**, *17*, 125–126.
765. Schubert, U.; Neugebauer, D.; Aly, A. A. M. *Z. Anorg. Allg. Chem.* **1980**, *464*, 217–222.
766. Franzoni, D.; Pelizzi, G.; Predieri, G.; Tarasconi, P.; Vitali, F.; Pelizzi, C. *J. Chem. Soc., Dalton Trans.* **1989**, 247–252.
767. Peng, Z.; Ying, Z.; Lansun, Z.; Huahui, Y.; Qianen, Z. *Xiamen Daxue Xuabao Ziran Kexueban* **1990**, *29*, 549–552 (*Chem Abstr* **1992**, *117*, 59488c).
768. Obendorf, D.; Probst, M.; Peringer, P.; Falk, H.; Müller, N. *J. Chem. Soc., Dalton Trans.* **1988**, 1709–1711.
769. Che, C. M.; Tse, M. C.; Chan, M. C. W.; Cheung, K. K.; Phillips, D. L.; Leung, K. H. *J. Am. Chem. Soc.*, **2000**, *122*, 2464–2468.
770. Ellermann, J.; Utz, J.; Knoch, F. A.; Moll, M. *Z. Anorg. Allg. Chem.* **1996**, *622*, 1871–1878.
771. Usón, R.; Laguna, A.; Laguna, M.; Gimeno, M. C. *J. Chem. Soc., Dalton Trans.* **1989**, 1883–1886.
772. Saboonchian, V.; Wilkinson, G.; Hussain-Bates, B.; Hursthouse, M. B. *Polyhedron* **1991**, *10*, 737–739.
773. Yang, H.; Zheng, L.; Xu, Y.; Zhang, Q. *Wuji Huaxue Xuebao* **1992**, *8*, 65–67 (*Chem Abstr* **1992**, *117*, 212593e).
774. Grabtree, S. P.; Batsanov, A. S.; Howard, J. A. K.; Kilner, M. *Polyhedron* **1998**, *17*, 367–372.
775. Tiekink, E. R. T. *Acta Crystallogr. Sect., C* **1990**, *46*, 1933–1934.
776. Ruina, Y.; Yimin, H.; Baoyu, X.; Dongmei, W.; Douman, J. *Transition Met. Chem.* **1996**, *21*, 28–30.
777. Di Bernardo, P.; Dolcetti, G.; Portanova, R.; Tolazzi, M.; Tomat, G. *Inorg. Chem.* **1990**, *29*, 2859–2862.
778. James, S. L.; Lozano, E.; Niuwenhuyzen, M. *Chem. Commun.* **2000**, 617–618.
779. Lozano, E.; Niuwenhuyzen, M.; James, S. L. *Chem. Eur. J.* **2001**, *7*, 2644–2651.
780. Wu, B.; Zhang, W. J.; Yu, S. Y.; Wu, X. T. *J. Chem. Soc., Dalton Trans.* **1997**, 1795–1796.
781. Wu, B.; Wu, X. T.; Tian, X.; Sun, W. H. *J. Organomet. Chem.* **2001**, *640*, 57–64.
782. Bayler, A.; Schier, A.; Schmidbaur, H. *Inorg. Chem.* **1998**, *37*, 4353–4359.
783. Yanagisawa, A.; Kageyama, H.; Nakatsuka, Y.; Asakawa, K.; Matsumoto, Y.; Yamamoto, H. *Angew. Chem., Int. Ed. Engl.* **1999**, *38*, 3701–3703.
784. Kuang, S. M.; Zhang, Z. Z.; Wang, Q. G.; Mak, T. C. W. *Chem. Commun.* **1998**, 581–582.
785. Kuang, S. M.; Zhang, L. M.; Zhang, Z. Z.; Wu, B. M.; Mak, T. C. W. *Inorg. Chim. Acta* **1999**, *284*, 278–283.
786. Chen, B. L.; Mok, K. F.; Ng, S. C. *J. Chem. Soc., Dalton Trans.* **1998**, 4035–4041.
787. Edwards, D. A.; Mahon, M. F.; Paget, T. J. *Polyhedron* **2000**, *19*, 757–764.
788. Yang, H. Y.; Wong, E. H.; Rheingold, A. L.; Owens-Watermire, B. E.; Haggerty, B. S. *Organometallics* **1994**, *13*, 4825–4834.
789. Carr, S. W.; Fontaine, X. L. R.; Shaw, B. L. *J. Chem. Soc., Dalton Trans.* **1991**, 1025–1027.
790. Che, C. M.; Yip, H. K.; Li, D.; Peng, S. M.; Lee, G. H.; Wang, Y. M.; Liu, S. T. *J. Chem. Soc., Dalton Trans.* **1991**, 1615–1617.
791. Zank, J.; Schier, A.; Schmidbaur, H. *J. Chem. Soc., Dalton Trans.* **1999**, 415–420.
792. Camalli, M.; Caruso, F. *Inorg. Chim. Acta* **1990**, *169*, 189–194.
793. James, S. L.; Mingos, D. M. P.; White, A. J. P.; Williams, D. *J. Chem. Commun.* **1998**, 2323–2324.
794. Driess, M.; Faulhaber, M.; Pritzkow, H. *Angew. Chem., Int. Ed. Engl.* **1997**, *36*, 1892–1894.
795. Airey, A. L.; Swiegers, G. F.; Willis, A. C.; Wild, S. B. *J. Chem. Soc., Chem. Commun.* **1995**, 695–696.
796. Xu, W.; Vittal, J. J.; Puddephatt, R. J. *J. Am. Chem. Soc.*, **1993**, *115*, 6456–6457.
797. Xu, W.; Vittal, J. J.; Puddephatt, R. J. *J. Am. Chem. Soc.*, **1995**, *117*, 8362–8371.
798. Xu, W.; Vittal, J. J.; Puddephatt, R. J. *Inorg. Chem.* **1997**, *36*, 86–94.
799. Dieleman, C. B.; Matt, D.; Neda, I.; Schmutzler, R.; Thönnessen, H.; Jones, P. G.; Harriman, A. *J. Chem. Soc., Dalton Trans.* **1998**, 2115–2121.
800. Eichhöfer, A.; Eisenmann, J.; Fenske, D.; Simon, F. *Z. Anorg. Allg. Chem.* **1993**, *619*, 1360–1368.
801. Eisenmann, J.; Fenske, D.; Simon, F. *Z. Anorg. Allg. Chem.* **1995**, *621*, 1681–1688.
802. Fenske, D.; Simon, F. *Angew. Chem., Int. Ed. Engl.* **1997**, *36*, 230–233.
803. Fenske, D.; Simon, F. *Z. Anorg. Allg. Chem.* **1996**, *622*, 45–52.
804. Di Vaira, M.; Ehse, M. P.; Peruzzini, M.; Stoppioni, P. *Polyhedron* **1999**, *18*, 2331–2336.
805. Krossing, I.; Van Wüllen, L. *Chem. Eur. J.* **2002**, *8*, 700–711.
806. Wakeshima, I.; Ohgi, H.; Kijima, I. *Synth. React. Inorg. Metal-Org., Sect. C* **1993**, *23*, 1507–1513.
807. Baum, T. H.; Larson, C. E. Ligand Stabilised +1 Metal β -diketonate Coordination Complexes and their Use in Chemical Vapour Deposition of Metal Thin Films. U.S. Patent 5,096,737, March 17, 1992.
808. Yuan, Z.; Dryden, N. H.; Vittal, J. J.; Puddephatt, R. J. *Can. J. Chem.* **1994**, *72*, 1605–1609.
809. Doyle, G.; Eriksen, K. A.; Van Engen, D. *Organometallics* **1985**, *4*, 830–835.
810. Bailey, A.; Corbitt, T. S.; Hampden-Smith, M. J.; Duesler, E. N.; Kostas, T. T. *Polyhedron* **1993**, *12*, 1785–1792.
811. Xu, C. Y.; Corbitt, T. S.; Hampden-Smith, M. J.; Kostas, T. T.; Duesler, E. N. *J. Chem. Soc., Dalton Trans.* **1994**, 2841–2849.
812. Chi, K. M.; Chen, K. H.; Peng, S. M.; Lee, G. H. *Organometallics* **1996**, *15*, 2575–2578.
813. Doppelt, P.; Baum, T. H.; Ricard, L. *Inorg. Chem.* **1996**, *35*, 1286–1291.
814. Chi, K. M.; Lin, C. T.; Peng, S. M.; Lee, G. H. *Organometallics* **1996**, *15*, 2660–2663.
815. Darr, J. A.; Poliakov, M.; Blake, A. J.; Li, W. S. *Inorg. Chem.* **1998**, *37*, 5491–5496.
816. Fragalà, Malandrino G.; Puglisi, O. *Chem. Mater.* **2000**, *12*, 290–293.
817. Darr, J. A.; Poliakov, M.; Li, W. S.; Blake, A. J. *J. Chem. Soc., Dalton Trans.* **1997**, 2869–2874.
818. Yuan, Z.; Dryden, N. H.; Li, X.; Vittal, J. J.; Puddephatt, R. J. *J. Mater. Chem.* **1995**, *5*, 303–307.
819. Xu, C. Y.; Hampden-Smith, M. J.; Kostas, T. T. *Adv. Mater.* **1994**, *6*, 775–779.
820. Lin, W.; Warren, T. H.; Nuzzo, R. G.; Girolami, G. S. *J. Am. Chem. Soc.*, **1993**, *115*, 11644–11645.
821. Dryden, N. H.; Vittal, J. J.; Puddephatt, R. J. *Chem. Mater.* **1993**, *5*, 765–766.
822. Yuan, Z.; Dryden, N. H.; Vittal, J. J.; Puddephatt, R. J. *Chem. Mater.* **1995**, *7*, 1696–1702.
823. Li, X.; Bancroft, M.; Puddephatt, R. J.; Yuan, Z.; Tan, K. H. *Inorg. Chem.* **1996**, *35*, 5040–5049.

824. Mak, T. C. W.; Yip, W. H.; Kennard, C. H. L.; Smith, G.; O'Reilly, E. J. *Aust. J. Chem.* **1986**, *39*, 541–548.
825. Mak, T. C. W.; Yip, W. H.; Kennard, C. H. L.; Smith, G.; O'Reilly, E. J. *Aust. J. Chem.* **1988**, *41*, 883–891.
826. Smith, G.; Kennard, C. H. L.; Mak, T. C. W. *Kristallogr.* **1988**, *184*, 275–276.
827. Usabaliev, B. T.; Movsumov, E. M.; Amiraslanov, I. R.; Akhmedov, A. I.; Musaev, A. A.; Mameov, K. S. *Zh. Strukt. Khim.* **1981**, *22*, 98–101.
828. Movsumov, E. M.; Antsyshkina, A. S.; Ostrikova, V. N.; Karaeba, K. T.; Porai-koshits, M. A. *Koord. Khim.* **1990**, *16*, 517–520.
829. Mak, T. C. W.; Smith, G.; Kennard, C. H. L. *Z. Kristallogr.* **1993**, *207*, 33–38.
830. Michaelides, A.; Skoulika, S.; Kiritsis, V.; Aubry, A. *J. Chem. Soc., Chem. Commun.* **1995**, 1415–1416.
831. Edwards, D. A.; Mahon, M. F.; Paget, T. J. *Polyhedron* **1997**, *16*, 25–31.
832. Smith, G.; Reddy, A. N.; Byriel, K. A.; Kennard, C. H. L. *Aust. J. Chem.* **1994**, *47*, 1179–1183.
833. Smith, G.; Reddy, A. N.; Byriel, K. A.; Kennard, C. H. L. *Polyhedron* **1994**, *13*, 2425–2430.
834. Tahir, M. N.; Ulku, D.; Muvsumov, E. M. *Acta Crystallogr., Sect. C* **1996**, *52*, 593–595.
835. Ulku, D.; Tahir, M. N.; Movsumov, E. M. *Acta Crystallogr., Sect. C* **1996**, *52*, 2678–2680.
836. Jaber, F.; Charbonnier, F.; Faure, R. *J. Chem. Crystallogr.* **1997**, *27*, 397–400.
837. Kamwaya, M. E.; Papavinasam, E.; Teoh, S. G.; Rajaram, R. K. *Acta Crystallogr., Sect. C* **1984**, *40*, 1318–1319.
838. Jaber, F.; Charbonnier, F.; Faure, R. *Acta Crystallogr., Sect. C* **1994**, *50*, 1444–1447.
839. Li, S. L.; Mak, T. C. W. *Struc. Chem.* **1997**, *8*, 49–63.
840. Sagatys, D. S.; Smith, G.; Bott, R. C.; Lynch, D. E.; Kennard, C. H. L. *Polyhedron* **1993**, *12*, 709–713.
841. Hedrich, M.; Hartl, H. *Acta Crystallogr., Sect. C* **1983**, *39*, 533–536.
842. Mak, T. C. W.; Yip, W. H.; Kennard, C. H. L.; Smith, G.; O'Reilly, E. J. *J. Chem. Soc., Dalton Trans.* **1988**, 2353–2356.
843. Chen, X. M.; Mak, T. C. W. *J. Chem. Soc., Dalton Trans.* **1991**, 1219–1222.
844. Chen, X. M.; Mak, T. C. W. *J. Chem. Soc., Dalton Trans.* **1991**, 3253–3258.
845. Wei, P. R.; Li, Q.; Wu, B. M.; Mak, T. C. M. *Polyhedron* **1997**, *16*, 153–160.
846. Smith, G.; Sagatys, D. S.; Campbell, C. A.; Lynch, D. E.; Kennard, C. H. L. *Aust. J. Chem.* **1990**, *43*, 1707–1712.
847. Huang, W. Y.; Lu, L.; Chen, X. M.; Mak, T. C. W. *Polyhedron* **1991**, *10*, 2687–2695.
848. Wu, D. D.; Mak, T. C. W. *J. Chem. Soc., Dalton Trans.* **1995**, 2671–2678.
849. Smith, G.; Sagatys, D. S.; Lynch, D. E.; Bott, R. C.; Byriel, K. A.; Kennard, C. H. L. *Z. Kristallogr.* **1995**, *210*, 44–48.
850. Jaber, F.; Charbonnier, F.; Faure, R. *Acta Crystallogr., Sect. C* **1995**, *51*, 1765–1767.
851. Naumov, D. Y.; Virovets, A. V.; Podberezskaya, N. V.; Boldyreva, E. V. *Acta Crystallogr., Sect. C* **1995**, *51*, 60–62.
852. Eriksson, L.; Kriticos, M. *Acta Crystallogr., Sect. C* **1995**, *51*, 1508–1510.
853. Mak, T. C. W.; Yip, W. H.; Chen, X. M. *Inorg. Chim. Acta* **1993**, *203*, 97–99.
854. Chen, X. M.; Mak, T. C. W. *Polyhedron* **1991**, *10*, 1723–1726.
855. Bott, R. C.; Smith, G.; Sagatys, D. S.; Lynch, D. E.; Reddy, A. N.; Kennard, C. H. L. *Z. Kristallogr.* **1994**, *209*, 803–807.
856. Karpova, E. V.; Boltalin, A. I.; Korenev, Y. M.; Zakharov, M. A.; Troyanov, S. I. *Russ. J. Coord. Chem.* **2001**, *27*, 286–291.
857. Wei, P. R.; Li, Q.; Wu, B. M.; Mak, T. C. W. *Inorg. Chim. Acta* **1996**, *249*, 169–174.
858. Chen, X. M.; Mak, T. C. W. *Aust. J. Chem.* **1991**, *44*, 1783–1787.
859. Michaelides, A.; Kiritsis, V.; Skoulika, S.; Aubry, A. *Angew. Chem., Int. Ed. Engl.* **1993**, *32*, 1495–1497.
860. Jaber, F.; Charbonnier, F.; Petramel, M.; Faure, R. *E. J. Solid State Inorg. Chem.* **1996**, *33*, 429–440.
861. Wei, P. R.; Mak, T. C. W.; Atwood, D. A. *Inorg. Chem.* **1998**, *37*, 2605–2607.
862. Nomiya, K.; Takahashi, S.; Noguchi, R. *J. Chem. Soc., Dalton Trans.* **2000**, 4369–4373.
863. Nomiya, K.; Takahashi, S.; Noguchi, R. *J. Chem. Soc., Dalton Trans.* **2000**, 1343–1348.
864. Zheng, L.; Yang, H.; Zhang, Q. *Jiegou Huaxue* **1991**, *10*, 97–102.
865. Van der Ploeg, A. F. M. J.; Van Koten, G.; Spel, A. L. *Inorg. Chem.* **1979**, *18*, 1052–1058.
866. Van der Ploeg, A. F. M. J.; Van Koten, G. *Inorg. Chim. Acta* **1981**, *51*, 225–239.
867. Kozitsyna, N. Y.; Ellern, A. M.; Struchkov, Y. T.; Moiseev, I. Y. *Medeleev Commun.* **1992**, *3*, 100–101.
868. Hong, M. C.; Mak, T. C. W.; Zhou, Z. Y.; Xue, F.; Wu, D. D.; Zhen, Y.; Liu, H. Q. *J. Chem. Crystallogr.* **1996**, *26*, 553–557.
869. Whitcomb, D. R.; Rogers, R. D. *J. Chem. Crystallogr.* **1996**, *26*, 99–105.
870. Szlyk, E.; Lakomska, I.; Surdykowski, A.; Golinski, A. *Polish J. Chem.* **1999**, *73*, 1763–1769.
871. Hanna, J. V.; Ng, S. W. *Acta Crystallogr., Sect. C* **2000**, *56*, 24–25.
872. Szlyk, E.; Piszczek, P.; Lakomska, I.; Grodzicki, A.; Szatkowski, J.; Blaszczyk, T. *Chem. Vapor Depositon* **2000**, *6*, 105–108.
873. Subramanian, R. R.; Anandan, S. S.; Kwek, K. H.; Low, K. S.; Raj, S. S. S.; Fun, H. K.; Razak, I. A.; Hanna, J. V.; Ng, S. W. *Acta Crystallogr., Sect. C* **2000**, *56*, E292–E294.
874. Toman, A. H.; Yang, Y. Y.; Chen, X. M.; Ng, S. W. *Acta Crystallogr., Sect. C* **2000**, *56*, E318–E319.
875. Whitcomb, D. R.; Rogers, R. D. *Polyhedron* **1997**, *16*, 863–868.
876. Whitcomb, D. R.; Rogers, R. D. *Inorg. Chim. Acta* **1997**, *256*, 263–267.
877. Jaber, F.; Charbonnier, F.; Faure, R. *Eur. J. Solid State Inorg. Chem.* **1995**, *32*, 25–33.
878. Smith, G.; Reddy, A. N.; Byriel, K. A.; Kennard, C. H. L. *J. Chem. Soc., Dalton Trans.* **1995**, 3565–3570.
879. Aakeroy, C. B.; Beatty, A. M. *J. Mol. Struc.* **1999**, *474*, 91–101.
880. Cox, B. G.; Van Truong, N.; Rzeszotarska, J.; Schneider, H. *J. Am. Chem. Soc.*, **1984**, *106*, 5965–5969.
881. Walba, D. M.; Hermsmeier, M.; Curtis Haltiwanger, R.; Noordik, J. H. *J. Org. Chem.* **1986**, *51*, 245–251.
882. Suh, I. H.; Aoki, K.; Yamazaki, H. *Inorg. Chem.* **1989**, *28*, 358–362.
883. Kim, K. M.; Song, S. C.; Lee, S. B.; Kang, H. C.; Sohn, Y. S. *Inorg. Chem.* **1998**, *37*, 5764–5768.
884. Sagatys, D. S.; Smith, G.; Lynch, D. E.; Kennard, C. H. L. *J. Chem. Soc., Dalton Trans.* **1991**, 361–364.
885. Hartley, D. W.; Smith, G.; Sagatys, D. S.; Kennard, C. H. L. *J. Chem. Soc., Dalton Trans.* **1991**, 2735–2739.
886. Goodgame, D. M. L.; Müller, T. E.; Williams, D. J. *Polyhedron* **1992**, *11*, 1513–1516.
887. Bott, R. C.; Smith, G.; Sagatys, D. S.; Mak, T. C. W.; Lynch, D. E.; Kennard, C. H. L. *Aust. J. Chem.* **1993**, *46*, 1055–1065.

888. Feldman, J.; Calabrese, J. C. *Inorg. Chem.* **1994**, *33*, 5955–5956.
889. Saran, L.; Cavalheiro, E.; Neves, E. A. *Talanta* **1995**, *42*, 2027–2032.
890. Broucabarrecq, C.; Marrot, B.; Mosset, A. *Acta Crystallogr., Sect. C* **1996**, *52*, 1903–1906.
891. Akdas, H.; Graf, E.; Hosseini, M. W.; De Cian, A.; Harrowfield, J. M. *Chem. Commun.* **2000**, 2219–2220.
892. Schmalle, H. W.; Pellaux, R.; Decurtins, S. *Z. Kristallogr.* **1996**, *211*, 533–538.
893. Andruh, M.; Melanson, R.; Stager, C. V.; Rochon, F. D. *Inorg. Chim. Acta* **1996**, *251*, 309–317.
894. Roesky, H. W.; Peymann, E.; Schimkowiak, J.; Noltemeyer, Pinkert W.; Sheldrick, G. M. *J. Chem. Soc., Chem. Commun.* **1983**, 981–982.
895. Jones, P. G.; Gries, T.; Grützmacher, H.; Roesky, H. W.; Schimkowiak, J.; Sheldrick, G. M. *Angew. Chem., Int. Ed. Engl.* **1984**, *23*, 376–376.
896. Buschmann, H. J.; Schollmeyer, E. *J. Electroanal. Chem.* **1999**, *474*, 188–191.
897. Buschmann, H. J.; Wego, A.; Schollmeyer, E. *Inorg. Chem. Commun.* **2001**, *4*, 9–11.
898. Zuocai, L.; Meicheng, S. *Beijing Daxue Xuebao Ziron Kexueban* **1987**, *109*, 17–23 (*Chem Abstr* **1988**, 10983821m).
899. Barannikov, V. P.; Guseinov, S. S.; Matveev, A. V.; Vyugin, A. I. *Koord. Khim.* **1996**, *22*, 279–284.
900. Kalidas, C.; Balaji, S. *Ind. J. Chem., Sect. A* **1999**, *38*, 618–620.
901. Wen, M.; Munakata, M.; Suenaga, Y.; Kuroda-Sowa, T.; Makawa, M. *Inorg. Chim. Acta* **2002**, *332*, 18–24.
902. Kalidas, C.; Raghunath, R. *J. Inclusion Phenom. Mol. Recognition Chem.* **1994**, *17*, 345–349 (*Chem Abstr* **1994**, 121, 309436b).
903. Tromp, M.; Burgard, M.; Elbachiri, A. *Analysis* **1991**, *19*, 97–102 (*Chem Abstr* **1991**, 114, 235867z).
904. Prince, P. D.; Steed, J. W. *Supramol. Chem.* **1998**, *10*, 155–158.
905. Ouchi, M.; Shibutani, Y.; Yakabe, K.; Shono, T.; Shintani, H.; Yoneda, A.; Hakushi, T.; Weber, E. *Bioorg. Med. Chem.* **1999**, *7*, 1123–1126.
906. Kolthoft, I. M.; Chantooni, M. K.; Roland, G. *J. Coord. Chem.* **1999**, *48*, 207–217.
907. Amini, M. K.; Shamsipur, M. *Inorg. Chim. Acta* **1991**, *183*, 65–69.
908. Thuery, P.; Nierlich, M.; Arnaudne, F.; Souley, B.; Asfari, Z.; Vicens, J. *Supramol. Chem.* **1999**, *11*, 143–150.
909. Dondoni, A.; Ghiglione, C.; Marra, A.; Scoponi, M. *Macromol. Chem. Phys.* **1999**, *200*, 77–86.
910. Alessio, R.; Belli, Dell'Amico D.; Calderazzo, F.; Englert, U. *Gazz. Chim. Ital* **1993**, *123*, 719–721.
911. Alessio, R.; Belli, Dell'Amico D.; Calderazzo, F.; Englert, U.; Guarini, A.; Labella, L.; Strasser, P. *Helv. Chim. Acta* **1998**, *81*, 219–230.
912. Smith, G.; Lynch, D. E.; Byriel, K. A.; Kennard, C. H. L. *Inorg. Chem.* **1996**, *35*, 2711–2712.
913. Smith, G.; Cloutt, B. A.; Lynch, D. E.; Byriel, K. A.; Kennard, C. H. L. *Inorg. Chem.* **1998**, *37*, 3236–3242.
914. Smith, G.; Cloutt, B. A.; Byriel, K. A.; Kennard, C. H. L. *Aust. J. Chem.* **1997**, *50*, 741–746.
915. Charbonnier, F.; Faure, R.; Loiseleur, H. *Acta Crystallogr., Sect. B* **1977**, *33*, 2824–2826.
916. Charbonnier, F.; Faure, R.; Loiseleur, H. *Acta Crystallogr., Sect. B* **1978**, *34*, 3598–2601.
917. Charbonnier, F.; Faure, R.; Loiseleur, H. *Cryst. Struct. Commun.* **1981**, *10*, 1129–1132.
918. Charbonnier, F.; Faure, R.; Loiseleur, H. *J. Less Common Met.* **1983**, *92*, 1–8.
919. Belaj, F.; Kratky, C.; Nachbaur, E.; Popitsch, A. *Monatsh. Chem.* **1987**, *118*, 19–23.
920. Charbonnier, F.; Faure, R.; Loiseleur, H. *Acta Crystallogr., Sect. B* **1981**, *37*, 822–824.
921. Itaya, T.; Inoue, K. *Kobunshi Ronbunshu* **2000**, *57*, 665–671.
922. Mores, O.; Henschel, D.; Blaschette, A.; Jones, P. G. *Z. Anorg. Allg. Chem.* **2000**, *626*, 2399–2408.
923. Tomiaka, T.; Tomita, K.; Nishino, A.; Kusunoki, M. *Nippon Kagaku Kaishi* **1996**, 411–515.
924. Stiewe, A.; Kennitz, E.; Troyanov, S. *Z. Anorg. Allg. Chem.* **1999**, *625*, 329–335.
925. Charbonnier, F.; Faure, R.; Petitranel, M. *Eur. J. Solid State Inorg. Chem.* **1992**, *29*, 93–98.
926. Bruce, M. I.; Skelton, B. W.; Wallis, R. C.; Walton, J. K.; White, A. H.; Williams, M. L. *J. Chem. Soc., Chem. Commun.* **1981**, 428–430.
927. Bruce, M. I.; Williams, M. L.; Skelton, B. W.; White, A. H. *J. Chem. Soc., Dalton Trans.* **1983**, 799–808.
928. Sagatys, D. S.; Dahlgren, C.; Smith, G.; Bott, R. C.; White, J. M. *J. Chem. Soc., Dalton Trans.* **2000**, 3404–3410.
929. Roesky, H. W.; Thomas, M.; Schimkowiak, J.; Schmidt, M.; Noltemeyer, M.; Sheldrick, G. M. *J. Chem. Soc., Chem. Commun.* **1982**, 790–791.
930. Roesky, H. W.; Thomas, M.; Jones, P. G.; Pinkert, W.; Sheldrick, G. M. *J. Chem. Soc., Dalton Trans.* **1983**, 1211–1213.
931. Blonsky, P. M.; Shriver, D. F. *J. Am. Chem. Soc.*, **1984**, *106*, 6854–6855.
932. Strauss, S. H.; Noirot, M. D.; Anderon, O. P. *Inorg. Chem.* **1985**, *24*, 4307–4311.
933. Park, Y. J.; Do, Y.; Kim, K. M.; Choi, M. G.; Jun, M. J.; Kim, C. *Polyhedron* **2002**, *21*, 33–37.
934. Benedetti, E.; Bavoso, A.; Di Blasio, B.; Pavone, V.; Pedone, C.; Rossi, F. *Inorg. Chim. Acta* **1986**, *116*, 31–35.
935. Lin, C. J.; Lin, S.; Lee, G. H.; Wang, Y. *J. Organomet. Chem.* **1997**, *535*, 149–154.
936. Chen, Y. H.; Lin, C. J.; Lin, S. *J. Chin. Chem. Soc.*, **2001**, *48*, 855–859.
937. Schöllhorn, H.; Thewalt, U.; Lippert, B. *J. Chem. Soc., Chem. Commun.* **1984**, 769–770.
938. Gómez-Kaifer, M.; Reddy, P. A.; Gutsche, C. D.; Echegoyen, L. *J. Am. Chem. Soc.*, **1994**, *116*, 3580–3587.
939. Shirshova, L. V.; Lavrentev, I. P. *Russ. J. Coord. Chem.* **2001**, *27*, 511–515.
940. Eduok, E. E.; Kashyap, R. P.; Nagl, A.; Bourne, S. A.; Watson, W. H. *J. Chem. Crystallogr.* **1994**, *24*, 627–638.
941. Sagatys, D. S.; Bott, R. C.; Smith, G.; Byriel, K. A.; Kennard, C. H. L. *Polyhedron* **1992**, *11*, 49–54.
942. Bakker, W. I. I.; Verboom, W.; Reinhoudt, D. N. *J. Chem. Soc., Chem. Commun.* **1994**, 71–72.
943. Hueso-Ureña, F.; Moreno-Carretero, M. N.; Salas-Peregrin, J. M.; Alvarez de Cienfuegos-López, G. *Transition Met. Chem.* **1995**, *20*, 262–269.
944. Wulfsberg, G.; Jackson, D.; Ilsley, W.; Dou, S.; Weiss, A.; Gagliardi J., Jr. *Z. Naturforsch. Teil A* **1992**, *47*, 75–81.
945. Tong, M. L.; Chen, X. M.; Ye, B. H.; Ji, L. N. *Angew. Chem., Int. Ed. Engl.* **1999**, *38*, 2237–2240.
946. Aoyama, Y.; Motomura, T.; Ogoshi, H. *Angew. Chem., Int. Ed. Engl.* **1989**, *28*, 921–922.
947. Grossie, D. A.; Watson, W. H. *Acta Crystallogr., Sect. C* **1989**, *45*, 1998–2000.
948. Gimeno, M. C.; Jones, P. G.; Laguna, A.; Sarroca, C.; Villacampa, M. D. *Inorg. Chim. Acta* **2001**, *316*, 89–93.
949. Jones, P. G.; Roesky, H. W.; Liebermann, J.; Sheldrick, G. M. *Z. Naturforsch.* **1984**, *39b*, 1729–1734.
950. Barnes, J. C.; Paton, J. D. *Acta Crystallogr., Sect. C* **1984**, *40*, 72–74.
951. Aoyama, T.; Yamanaka, M.; Ohba, S.; Saito, Y. *Acta Crystallogr., Sect. C* **1990**, *46*, 762–765.

952. Bagieu-Beucher, M.; Le Fur, Y.; Levy, J. P.; Pécaut, J. *Acta Crystallogr., Sect. C* **1994**, *50*, 1079–1084.
953. Gillard, R. D.; Hanton, L. R.; Mitchell, S. H. *Polyhedron* **1990**, *9*, 2127–2133.
954. Averbuch-Pouchot, M. T.; Durif, A. *Eur. J. Solid State Inorg. Chem.* **1992**, *29*, 993–1000.
955. Averbuch-Pouchot, M. T.; Durif, A.; Schulke, U. *Eur. J. Solid State Chem.* **1992**, *97*, 299–307.
956. Fischer, P.; Jansen, M. *Z. Naturforsch., Teil B* **1992**, *47*, 365–371.
957. Åkerström, S. *Acta Chem. Scand.* **1964**, *18*, 1308–1314.
958. Åkerström, S. *Ark. Kemi.* **1965**, *24*, 505–511.
959. Dance, I. G.; Fitzpatrick, L. J.; Rae, D. A.; Scudder, M. L. *Inorg. Chem.* **1983**, *22*, 3785–3788.
960. Dance, I. G. *Inorg. Chim. Acta* **1977**, *25*, L17–L18.
961. Dance, I. G.; Fischer, K. J.; Banda, R. M. H.; Scudder, M. L. *Inorg. Chem.* **1991**, *30*, 183–187.
962. Tang, K.; Aslam, M.; Block, E.; Nicholson, T.; Zubieta, J. *Inorg. Chem.* **1987**, *26*, 1488–1497.
963. Block, E.; Gernon, M.; Kang, H.; Ofori-Okai, G.; Zubieta, J. *Inorg. Chem.* **1989**, *28*, 1263–1271.
964. Wojnowski, W.; Wojnowski, M.; Peters, K.; Peters, E. M.; Von Schnering, H. G. *Z. Anorg. Allg. Chem.* **1985**, *503*, 79–84.
965. Tang, K.; Yang, J.; Yang, Q.; Tang, Y. *J. Chem. Soc., Dalton Trans.* **1989**, 2297–2302.
966. Jin, X.; Xie, X.; Qian, H.; Tang, K.; Liu, C.; Wang, X.; Gong, Q. *Chem. Commun.* **2002**, 600–601.
967. Habibi, D.; Ghaemi, E.; Parish, R. V.; Pritchard, R. G. *Polyhedron* **1999**, *18*, 2977–2979.
968. Block, E.; Macherone, D.; Shaikh, S. N.; Zubieta, J. *Polyhedron* **1990**, *9*, 1429–1432.
969. Baena, M. J.; Espinet, P.; Lequerica, M. C.; Levelut, A. M. *J. Am. Chem. Soc.*, **1992**, *114*, 4182–4185.
970. Bowmaker, G. A.; Tan, L. C. *Aust. J. Chem.* **1979**, *32*, 1443–1451.
971. Dance, I. G. *Aust. J. Chem.* **1978**, *31*, 2195–2201.
972. Dance, I. G. *Inorg. Chem.* **1981**, *20*, 1487–1492.
973. Fujisawa, K.; Imai, S.; Moro-oka, Y. *Chem. Lett.* **1998**, 167–168.
974. Fujisawa, K.; Imai, S.; Suzuki, S.; Morooka, Y.; Miyashita, Y.; Yamada, Y.; Okamoto, K. *J. Inorg. Biochem.* **2000**, *82*, 229–238.
975. González-Duarte, P.; Sola, J.; Vives, J.; Solans, X. *J. Chem. Soc., Chem. Commun.* **1987**, 1641–1642.
976. González-Duarte, P.; Vives, J. *J. Chem. Soc., Dalton Trans.* **1990**, 2483–2489.
977. González-Duarte, P.; Vives, J. *J. Chem. Soc., Dalton Trans.* **1990**, 2477–2482.
978. Casals, I.; González-Duarte, P.; Sola, J.; Vives, J.; Font-Bardia, M.; Solans, X. *Polyhedron* **1990**, *9*, 769–771.
979. Su, W.; Cao, R.; Hong, M.; Chen, J.; Lu, J. *Chem. Commun.* **1998**, 1389–1390.
980. Habibi, D.; Ghaemi, E.; Nematollahi, D. *Molecules* **2000**, *5*, 1194–1200.
981. Nomiya, K.; Onoue, K. I.; Kondoh, Y.; Kasuga, N. C.; Nagano, H.; Oda, M.; Sakuma, S. *Polyhedron* **1995**, *14*, 1359–1367.
982. Nomiya, K.; Kondoh, Y.; Onoue, K. I.; Kasuga, N. C.; Nagano, H.; Oda, M.; Sudoh, T.; Sakuma, S. *J. Inorg. Biochem.* **1995**, *58*, 255–267.
983. Nomiya, K.; Kondoh, Y.; Nagano, H.; Oda, M. *J. Chem. Soc., Chem. Commun.* **1995**, 1679–1680.
984. Oda, M.; Itoh, H.; Sudo, T.; Sakuma, S.; Nomiya, K.; Suzuki, Y.; Jonoshita, Y.; Kikuchi, A.; Takabatake, Y. *PTC. WO95/12602* (1995).
985. Nomiya, K.; Noguchi, R.; Kato, C. *Chem. Lett.* **2000**, 162–163.
986. Heintz, U.; Hinse, P.; Frohlich, R.; Mattes, R. *Z. Anorg. Allg. Chem.* **2002**, *628*, 770–778.
987. Dance, I. G.; Fitzpatrick, L. J.; Scudder, M. L. *Inorg. Chem.* **1984**, *23*, 2276–2281.
988. Dance, I. G.; Fitzpatrick, L. J.; Craig, D. C.; Scudder, M. L. *Inorg. Chem.* **1989**, *28*, 1853–1861.
989. Chojnacki, J.; Becker, B.; Konitz, A.; Potrzebowski, M. J.; Wojnowski, W. *J. Chem. Soc., Dalton Trans.* **1999**, 3063–3068.
990. Artigas, M. M.; Crespo, O.; Gimeno, M. C.; Jones, P. G. Laguna A.; Villacampa, M. D. *Inorg. Chem.* **1997**, *36*, 6454–6456.
991. Shakir, M.; Kumar, D.; Varkey, S. P. *Polyhedron* **1992**, *11*, 2831–2836.
992. Molley, K. C.; Mahon, M. F.; Barret, M. C. *Acta Crystallogr., Sect. C* **1999**, *55*, 555–557.
993. Nomiya, K.; Kasuga, N. C.; Takamori, I.; Tsuda, K. *Polyhedron* **1998**, *17*, 3519–3530.
994. Nomiya, K.; Noguchi, R.; Shigeta, T.; Kondoh, Y.; Tsuda, K.; Ohsawa, K.; Chikaraishi-Kasuga, N.; Oda, M. *Bull. Chem. Soc., Jpn.* **2000**, *73*, 1143–1152.
995. Zeltner, S.; Jelonek, S.; Sieler, J.; Olk, R. M. *Eur. J. Inorg. Chem.* **2001**, 1535–1541.
996. Adams, D. J.; Clark, J. H. *J. Org. Chem.* **2000**, *65*, 1456–1460.
997. Steiner, M.; Grützmacher, H.; Zolnai, L.; Huttner, G. *J. Chem. Soc., Chem. Commun.* **1992**, 689–690.
998. Fijolek, H. G.; Oriskovich, T. A.; Benesi, A. J.; González-Duarte, P.; Natan, M. J. *Inorg. Chem.* **1996**, *35*, 797–799.
999. Krebs, B.; Henkel, G. *Angew. Chem., Int. Ed. Engl.* **1991**, *30*, 769–788.
1000. Kull, F. J.; Reed, M. F.; Elgren, T. E.; Ciardelli, T. L.; Wilcox, D. E. *J. Am. Chem. Soc.*, **1990**, *112*, 2291–2298.
1001. Zelazowski, A. J.; Gasyna, Z.; Stillman, M. J. *J. Biol. Chem.* **1989**, *264*, 17091–17096.
1002. Zelazowski, A. J.; Stillman, M. J. *Inorg. Chem.* **1992**, *31*, 3363–3368.
1003. Bonasia, P. J.; Mitchell, G. P.; Hollander, F. J.; Arnold, J. *Inorg. Chem.* **1994**, *33*, 1797–1802.
1004. Zhao, J.; Adcock, D.; Pennington, W. T.; Kolis, J. W. *Inorg. Chem.* **1990**, *29*, 4358–4360.
1005. Jin, X. L.; Tang, K. L.; Long, Y. L.; Liang, Y.; Tang, Y. Q. *Chem. J. Chinese Univ. Chinese* **1999**, *20*, 831–834.
1006. Tang, K.; Jin, X.; Yan, H.; Xie, X.; Liu, C.; Gong, Q. *J. Chem. Soc., Dalton Trans.* **2001**, 1374–1377.
1007. Yam, V. W. W.; Cheng, E. C. C.; Zhu, N. *New J. Chem.* **2002**, *26*, 279–284.
1008. Fenske, D.; Langetepe, T. *Angew. Chem., Int. Ed. Engl.* **2002**, *41*, 300–304.
1009. Wang, X. J.; Langetepe, T.; Fenske, D.; Kang, B. S. *Z. Anorg. Allg. Chem.* **2002**, *628*, 1158–1167.
1010. Ciriano, M. A.; Pérez Torrente, J. J.; Oro, L. A.; Tiripicchio, A.; Tiripicchio-Camellini, M. *J. Chem. Soc., Dalton Trans.* **1991**, 255–262.
1011. Müller, A.; Römer, M.; Bögge, H.; Krickemeyer, E.; Baumann, F. W.; Schmitz, K. *Inorg. Chim. Acta* **1984**, *89*, L7–L8.
1012. Müller, A.; Krickemeyer, E.; Zimmermann, M.; Römer, M.; Bögge, H.; Penk, M.; Schmitz, K. *Inorg. Chim. Acta* **1984**, *90*, L69–L71.

1013. Roesky, H. W.; Thomas, M.; Shimkowiak, J.; Jones, P. G.; Pinkert, W.; Sheldrick, G. M. *J. Chem. Soc., Chem. Commun.* **1982**, 895–896.
1014. Su, W.; Hong, M.; Jiang, F.; Liu, H.; Zhou, Z.; Wu, D.; Mak, T. C. W. *Polyhedron* **1996**, *15*, 4047–4051.
1015. Huang, Z. Y.; Lei, X. J.; Hong, M. C.; Liu, H. Q. *Inorg. Chem.* **1992**, *31*, 2991–2996.
1016. Matsumoto, K.; Tanaka, R.; Shimomura, R.; Nakao, Y. *Inorg. Chim. Acta* **2000**, *304*, 293–296.
1017. Jin, X.; Tang, K.; Liu, W.; Zeng, H.; Zhao, H.; Ouyang, Y.; Tang, Y. *Polyhedron* **1996**, *15*, 1207–1211.
1018. Tang, K.; Xie, X.; Zhang, Y.; Zhao, X.; Jin, X. *Chem. Commun.* **2002**, 1024–1025.
1019. Li, H.; Hwu, S. J. *Angew. Chem., Int. Ed. Engl.* **1999**, *38*, 3067–3070.
1020. Pertlik, F. *Monath. Chem.* **1994**, *125*, 1311–1316.
1021. Zhang, X.; Kanatzidis, M. G. *J. Am. Chem. Soc.*, **1994**, *116*, 1890–1898.
1022. Hwu, S. J.; Bucher, C. K.; Carpenter, J. D.; Taylor, S. P. *Inorg. Chem.* **1995**, *34*, 1979–1980.
1023. Wu, P.; Pell, M. A.; Cody, J. A.; Ibers, J. A. *J. Alloys Compd.* **1995**, *224*, 199–202.
1024. Bente, K.; Engel, M.; Steins, M. Z. *Kristallogr.* **1993**, *205*, 327–328.
1025. Yam, V. W. W.; Lo, K. K. W.; Wang, C. R.; Cheung, K. K. *Inorg. Chem.* **1996**, *35*, 5116–5117.
1026. Wang, C. R.; Lo, K. K. W.; Yam, V. W. W. *J. Chem. Soc., Dalton Trans.* **1997**, 227–229.
1027. Allshouse, J.; Haltiwanger, R. C.; Allured, V.; Rakowski Dubois, M. *Inorg. Chem.* **1994**, *33*, 2505–2506.
1028. Briant, C. E.; Hor, T. S. A.; Howells, N. D.; Mings, D. M. P. *J. Organomet. Chem.* **1983**, *256*, C15–C18.
1029. Liu, H.; Tan, A. L.; Cheng, C. R.; Mok, K. F.; Hor, T. S. A. *Inorg. Chem.* **1997**, *36*, 2916–2918.
1030. Li, G.; Li, S.; Tan, A. L.; Yip, W. H.; Mak, T. C. W.; Hor, T. S. A. *J. Chem. Soc., Dalton Trans.* **1996**, 4315–4316.
1031. Oberhauser, W.; Bachmann, C.; Stampfl, T.; Haid, R.; Langes, C.; Rieder, A.; Brüggeller, P. *Inorg. Chem. Commun.* **1998**, *1*, 185–189.
1032. Sladek, A.; Schmidbaur, H. *Z. Naturforsch., Teil B* **1997**, *52*, 301–303.
1033. Canales, F.; Canales, S.; Crespo, O.; Gimeno, M. C.; Jones, P. G.; Laguna, A. *Organometallics* **1998**, *17*, 1617–1621.
1034. Zhang, Q.; Cao, R.; Hong, M.; Su, W.; Liu, H. *Inorg. Chim. Acta* **1998**, *277*, 171–176.
1035. Harvey, P. D.; Eichhöfer, A.; Fenske D. *J. Chem. Soc., Dalton Trans.* **1998**, 3901–3903.
1036. Kanatzidis, M. G.; Huang, S. P. *Angew. Chem., Int. Ed. Engl.* **1989**, *28*, 1513–1514.
1037. Huang, S. P.; Kanatzidis, M. G. *Inorg. Chem.* **1991**, *30*, 1455–1466.
1038. Cusick, J.; Scudder, M. L.; Dance, I. G. *Polyhedron* **1989**, *8*, 1139–1141.
1039. Wood, P. T.; Pennington, W. T.; Kolis, J. W. *J. Am. Chem. Soc.*, **1992**, *114*, 9233–9235.
1040. Wachhold, M.; Kanatzidis, M. G. *Inorg. Chem.* **1999**, *38*, 4178–4180.
1041. Chung, D. Y.; Huang, S. P.; Kim, K. W.; Kanatzidis, M. G. *Inorg. Chem.* **1995**, *34*, 4292–4293.
1042. Sasakura, C.; Suzuki, K. T. *J. Inorg. Biochem.* **1998**, *71*, 159–162.
1043. Corrigan, J. F.; Fenske, D. *Chem. Commun.* **1996**, 943–944.
1044. Corrigan, J. F.; Fenske, D. *Chem. Commun.* **1997**, 1837–1838.
1045. Corrigan, J. F.; Fenske, D.; Powe, W. P. *Angew. Chem., Int. Ed. Engl.* **1997**, *36*, 1176–1179.
1046. Langetepe, T.; Fenske, D. *Z. Anorg. Allg. Chem.* **2001**, *627*, 820–826.
1047. McConnachie, J. M.; Ansari, M. A.; Bollinger, J. C.; Salm, R. J.; Ibers, J. A. *Inorg. Chem.* **1993**, *32*, 3201–3202.
1048. Ansari, M. A.; Bollinger, J. C.; Ibers, J. A. *Inorg. Chem.* **1993**, *32*, 1746–1748.
1049. Fenske, D.; Schreiner, B.; Dehnicke, K. *Z. Anorg. Allg. Chem.* **1993**, *619*, 253–260.
1050. Kim, K. W.; Kanatzidis, M. G. *J. Am. Chem. Soc.*, **1993**, *115*, 5871–5872.
1051. Li, J.; Guo, H. Y.; Zhang, X.; Kanatzidis, M. G. *J. Alloys Compd.* **1995**, *218*, 1–4.
1052. Zhang, X.; Li, J.; Foran, B.; Lee, S.; Guo, H. Y.; Hogan, T.; Kannewurf, C. R.; Kanatzidis, M. G. *J. Am. Chem. Soc.*, **1995**, *117*, 10513–10520.
1053. Li, J.; Guo, H. Y.; Yglesias, R. A.; Enge, T. J. *Chem. Mater.* **1995**, *7*, 599–601.
1054. Pell, M. A.; Ibers, J. A. *J. Am. Chem. Soc.*, **1995**, *117*, 6284–6286.
1055. El-Nakat, J.; Dance, I.; Fischer, K.; Willet, G. *J. Chem. Soc., Chem. Commun.* **1991**, 746–748.
1056. Stiefel, E. I.; Matsumoto, K. *Transition Metal Sulfur Chemistry: Biological and Industrial Significances*; ACS Symposium Series; American Chemical Society: Washington, DC, 1996, 653.
1057. Müller, A.; Bögge, H.; Koniger-Ahlborn, E. *Z. Naturforsch., Teil B* **1979**, *34*, 1698–1703.
1058. Zhu, N. Y.; Du, S. W.; Chen, P. C.; Wu, X. T.; Lu, J. X. *J. Chem. Soc., Dalton Trans.* **1992**, 26, 35–41.
1059. Du, S. W.; Zhu, N. Y.; Chen, P. C.; Wu, X. T.; Lu, J. X. *J. Chem. Soc., Dalton Trans.* **1992**, 339–345.
1060. Du, S. W.; Zhu, N. Y.; Chen, P. C.; Wu, X. T. *J. Mol. Struct.* **1993**, *291*, 167–171.
1061. Du, S. W.; Wu, X. T. *Acta Crystallogr., Sect. C* **1994**, *50*, 700–702.
1062. Wu, X. T.; Wang, Q. M.; Sui, S. *Polyhedron* **1997**, *16*, 945–948.
1063. Müller, A.; Bögge, H.; Koniger-Ahlborn, E. *J. Chem. Soc., Chem. Commun.* **1978**, 739–740.
1064. Sakane, G.; Shibahara, T.; Hou, H. W.; Xin, X. Q.; Shi, S. *Inorg. Chem.* **1995**, 4785–4789.
1065. Lin, C. C.; Huang, Z. X. *Chin. J. Struct. Chem.* **1990**, *9*, 58–63.
1066. Du, S. W.; Wu, X. T. *J. Coord. Chem.* **1993**, *30*, 183–188.
1067. Du, S. W.; Zhu, N. Y.; Chen, P. C.; Wu, X. T. *Polyhedron* **1992**, *11*, 2489–2493.
1068. Sakane, G.; Shibahara, T.; Hou, H. W.; Xin, X. Q. *Transition Met. Chem.* **1996**, *21*, 398–400.
1069. Zheng, H. G.; Tan, W. L.; Low, M. K. L.; Ji, W.; Long, D. L.; Wong, W. T.; Yu, K. B.; Xin, X. Q. *Polyhedron* **1999**, *18*, 3115–3121.
1070. Zhu, N. Y.; Wu, X. T.; Lu, J. X. *J. Chem. Soc., Chem. Commun.* **1991**, 235–237.
1071. Du, S. W.; Zhu, N. Y.; Chen, P. C.; Wu, X. T.; Lu, J. X. *Polyhedron* **1992**, *11*, 109–114.
1072. Zhu, N. Y.; Wu, J. H.; Du, S. W.; Wu, X. T.; Lu, J. X. *Inorg. Chim. Acta* **1992**, *191*, 65–71.
1073. Wu, J. H.; Zhu, N. Y.; Du, S. W.; Wu, X. T.; Lu, J. X. *Polyhedron* **1992**, *11*, 1201–1206.
1074. Zhang, Q. F.; Leung, W. H.; Song, Y. L.; Hong, M. C.; Kennard, C. H. L.; Xin, X. Q. *New J. Chem.* **2001**, *25*, 465–470.
1075. Müller, A.; Schimanski, U.; Schimanski, J. *Inorg. Chim. Acta* **1983**, *76*, L245–L246.
1076. Ansari, M. A.; Bollinger, J. C.; Chrustyk, C. C.; Ibers, J. A. *Acta Crystallogr., Sect. C* **1994**, *50*, 869–871.
1077. Du, S.; Wu, X.; Lu, J. *Polyhedron* **1994**, *13*, 841–845.
1078. Zhang, Q.; Hong, M.; Liu, H. *Transition Met. Chem.* **1996**, *22*, 156–160.
1079. Zhang, Q.; Xiu, X.; Hong, M.; Cao, R.; Raj, S. S. S.; Fun, H. K. *Acta Crystallogr., Sect. C* **1999**, *55*, 726–728.

1080. Wang, Q.; Wu, X.; Shang, T.; Liu, P. *Polyhedron* **1997**, *16*, 1543–1548.
1081. Müller, A.; Jaegermann, W.; Hellmann, W. *J. Mol. Struct.* **1983**, *100*, 559–563.
1082. Müller, A.; Hellmann, W. *Spectrochim. Acta* **1985**, *41a*, 359–364.
1083. Lang, J. P.; Li, J. G.; Bao, S.; Xin, X. Q. *Polyhedron* **1993**, *12*, 801–806.
1084. Huang, Q.; Wu, X. T.; Sheng, T. L.; Wang, Q. M. *Acta Crystallogr., Sect. C* **1996**, *52*, 29–31.
1085. Huang, Q.; Wu, X. T.; Sheng, T. L.; Wang, Q. M. *Inorg. Chem.* **1995**, *34*, 4931–4932.
1086. Huang, Q.; Wu, X. T.; Sheng, T. L.; Wang, Q. M.; Lu, J. X. *Polyhedron* **1997**, *16*, 217–222.
1087. Huang, Q.; Wu, X. T.; Wang, Q. M.; Sheng, T. L.; Lu, J. X. *Angew. Chem., Int. Ed. Engl.* **1996**, *35*, 868–870.
1088. Huang, Q.; Wu, X. T.; Lu, J. X. *Polyhedron* **1997**, *16*, 833–838.
1089. Huang, Q.; Wu, X. T.; Sheng, T. L.; Wang, Q. M. *Acta Crystallogr., Sect. C* **1996**, *52*, 795–797.
1090. Huang, Q.; Wu, X. T.; Lu, J. X. *Inorg. Chem.* **1996**, *35*, 7445–7447.
1091. Yu, H.; Zhang, W. J.; Wu, X. T.; Sheng, T. L.; Wang, Q.; Lin, P. *Angew. Chem., Int. Ed. Engl.* **1998**, *37*, 2520–2521.
1092. Yang, Y.; Liu, Q. T.; Huang, L.; Kang, B. H.; Lu, J. X. *J. Chem. Soc., Chem. Commun.* **1992**, 1512–1514.
1093. Lang, J. P.; Kawaguchi, H.; Tatsumi, K. *J. Organomet. Chem.* **1998**, *569*, 109–119.
1094. Blake, A. J.; Schröder, M. *Adv. Inorg. Chem.* **1990**, *35*, 1–80.
1095. Cooper, S. R.; Rawle, S. C. *Struct. Bond.* **1990**, *72*, 1–72.
1096. Clarkson, J.; Yagbasan, R.; Blower, P. J.; Rawle, S. C.; Cooper, S. R. *J. Chem. Soc., Chem. Commun.* **1987**, 950–951.
1097. Küppers, H. J.; Wieghardt, K.; Tsay, Y. H.; Krüger, C.; Nuber, B.; Weiss, J. *Angew. Chem., Int. Ed. Engl.* **1987**, *26*, 575–576.
1098. Blowe, P. J.; Clarkson, J. A.; Rawle, S. C.; Hartman, J. A. R.; Wolf, R. E., Jr.; Yagbasan, R.; Bott, S. G.; Cooper, S. R. *Inorg. Chem.* **1989**, *28*, 4040–4046.
1099. Blake, A. J.; Gould, R. O.; Reid, G.; Schröder, M. *J. Chem. Soc., Chem. Commun.* **1990**, 974–976.
1100. Groot, B.; Loeb, S. J. *Inorg. Chem.* **1991**, *30*, 3103–3105.
1101. Blake, A. J.; Gould, R. O.; Holder, A. J.; Hyde, T. I.; Schröder, M. *Polyhedron* **1989**, *8*, 513–518.
1102. Blake, A. J.; Li, W. S.; Lippolis, V.; Schröder, M. *Chem. Commun.* **1997**, 1943–1944.
1103. Blake, A. J.; Li, W. S.; Lippolis, V.; Taylor, A.; Schröder, M. *J. Chem. Soc., Dalton Trans.* **1998**, 2931–2937.
1104. Blake, A. J.; Collison, D.; Gould, R. O.; Reid, G.; Schröder, M. *J. Chem. Soc., Dalton Trans.* **1993**, 521–531.
1105. Alberto, R.; Nef, W.; Smith, A.; Kaden, T. A.; Neuburger, M.; Zehnder, M.; Frey, A.; Abram, U.; Schubiger, P. A. *Inorg. Chem.* **1996**, *35*, 3420–3427.
1106. Munakata, M.; Wu, L. P.; Yamamoto, M.; Kuroda-Sowa, T.; Maekawa, M. *J. Chem. Soc., Dalton Trans.* **1995**, 3215–3220.
1107. Blake, A. J.; Gould, R. O.; Li, W. S.; Lippolis, V.; Parsons, S.; Radek, C.; Schröder, M. *Inorg. Chem.* **1998**, *37*, 5070–5077.
1108. Blake, A. J.; Gould, R. O.; Parsons, S.; Radek, C.; Schröder, M. *Angew. Chem., Int. Ed. Engl.* **1995**, *34*, 2374–2376.
1109. Blake, A. J.; Champness, N. R.; Howdle, S. M.; Webb, P. B. *Inorg. Chem.* **2000**, *39*, 1035–1038.
1110. Chayama, K.; Sekido, E. *Anal. Sci.* **1987**, *3*, 535–542.
1111. Oue, M.; Kimura, K.; Shono, T. *Analitica Chim. Acta* **1987**, *194*, 293–298.
1112. Saito, K.; Masudo, Y.; Sekido, E. *Anal. Chim. Acta* **1983**, *151*, 447–452.
1113. Saito, K.; Masudo, Y.; Sekido, E. *Bull. Chem. Soc. Jpn.* **1984**, *57*, 189–196.
1114. Sekido, E.; Kawakara, H.; Tsuji, K. *Bull. Chem. Soc., Jpn.* **1988**, *61*, 1587–1592.
1115. Sekido, E.; Saito, K.; Nagamuna, Y.; Kumazaki, H. *Anal. Sci.* **1985**, *1*, 363–369.
1116. Sevdic, D.; Fekete, L.; Meider, H. *J. Inorg. Nucl. Chem.* **1980**, *42*, 885–892.
1117. Sevdic, D.; Meider, H. *J. Inorg. Nucl. Chem.* **1981**, *43*, 153–159.
1118. Saito, K.; Murakami, S.; Muromatsu, A.; Sekido, E. *Polyhedron* **1993**, *12*, 1587–1591.
1119. De Groot, B.; Loeb, S. J. *J. Chem. Soc., Chem. Commun.* **1990**, 1755–1757.
1120. De Groot, B.; Jenkins, H. A.; Loeb, S. J. *Inorg. Chem.* **1992**, *31*, 203–209.
1121. Almajano, L.; Escriche, L.; Casabo, J.; Sillanpää, Kivekäs R. *J. Chem. Soc., Dalton Trans.* **1992**, 2889–2894.
1122. De Groot, B.; Giesbrecht, G. R.; Loeb, S. J.; Shimizu, G. K. H. *Inorg. Chem.* **1991**, *30*, 177–182.
1123. Talanova, G. G.; Podgorny, A. V.; Zazorina, V. A.; Yatsimirskii, K. B. *Dokl. Akad. Nauk SSSR* **1991**, *318*, 347–351 (*Chem Abstr* **1991**, *115*, 159261a).
1124. Casabó, J.; Mestres, L.; Esriche, L.; Teixidor, F.; Pérez-Jiménez, C. *J. Chem. Soc., Dalton Trans.* **1991**, 1969–1971.
1125. Casabó, J.; Flor, T.; Hill, M. N. S.; Jenkins, H. A.; Lockhardt, J. C.; Loeb, S. J.; Romero, I.; Teixidor, F. *Inorg. Chem.* **1995**, *34*, 5410–5415.
1126. Loeb, S. J.; Shimizu, G. K. H. *Inorg. Chem.* **1993**, *32*, 1001–1006.
1127. De Groot, B.; Loeb, S. J.; Shimizu, G. K. H. *Inorg. Chem.* **1994**, *33*, 2663–2667.
1128. Kenkins, H. A.; Loeb, S. J.; Riera, A. M. *Inorg. Chim. Acta* **1996**, *246*, 207–215.
1129. Lucas, C. R.; Liu, S.; Newlands, M. J.; Charland, J. P.; Gabe, E. J. *Can. J. Chem.* **1990**, *68*, 644–649.
1130. Wagner, M.; Drutkowski, U.; Jörchel, P.; Kempe, R.; Hoyer, E.; Olk, R. M. *Chem. Ber.* **1997**, *130*, 425–429.
1131. Gloe, K.; Kruger, T.; Stephan, H.; Wagner, M.; Drutkowski, U.; Olk, R.; Leckelt, U.; Richter, E.; Hoyer, E. Z. *Angew. Chem.* **1998**, *624*, 152–158.
1132. Buter, J.; Kellogg, R. M.; van Bolhuis, F. *J. Chem. Soc., Chem. Commun.* **1991**, 910–912.
1133. Edema, J. J. H.; Buter, J.; Schoonbeek, F. S.; Kellogg, R. M.; van Bolhuis, F.; Spek, A. L. *Inorg. Chem.* **1994**, *33*, 2448–2452.
1134. Gleiter, R.; Röckel, H.; Nuber, B. *Chem. Ber.* **1996**, *129*, 581–584.
1135. Chen, L. Q.; Thompson, L. K.; Bridson, J. N. *Can. J. Chem.* **1992**, *70*, 2709–2716.
1136. Chen, L. Q.; Thompson, L. K.; Tandon, S. S.; Bridson, J. N. *Inorg. Chem.* **1993**, *32*, 4063–4068.
1137. Sato, M.; Anano, H. *J. Organomet. Chem.* **1998**, *555*, 167–175.
1138. Gürek, A. G.; Bekaroglu, Ö. *Helv. Chim. Acta* **1994**, *77*, 1616–1622.
1139. Neve, F.; Ghedini, M.; De Munno, G.; Levelut, A. M. *Chem. Mater.* **1995**, *7*, 688–693.
1140. Neve, F.; Ghedini, M.; Francescangeli, O. *J. Mater. Chem.* **1995**, *5*, 931–932.
1141. Teixidor, F.; Ayllón, J. A.; Viñas, C.; Rius, J.; Miravittles, C.; Casabó, J. *J. Chem. Soc., Chem. Commun.* **1992**, 1279–1280.

1142. Teixidor, F.; Ayllón, J. A.; Viñas, C.; Kivekas, R.; Sillanpää, J. Casabó. *Inorg. Chem.* **1994**, *33*, 1756–1761.
1143. Teixidor, F.; Ayllón, J. A.; Viñas, C.; Kivekas, R.; Sillanpää, J. Casabó. *Inorg. Chem.* **1994**, *33*, 2645–2650.
1144. Demirhan, F.; Gelling, A.; Irisli, S.; Jeffery, J. C.; Salek, S. N.; Sentürk, O. S.; Went, M. J. *J. Chem. Soc., Dalton Trans.* **1993**, 2765–2773.
1145. Roesky, H. W.; Hofmann, H.; Jones, P. G.; Pinkert, W.; Sheldrick, G. M. *J. Chem. Soc., Dalton Trans.* **1983**, 1215–1216.
1146. Munakata, M.; Yan, S. G.; Ino, I.; Kuroda-Sowa, T.; Maekawa, M.; Suenaga, Y. *Inorg. Chim. Acta* **1998**, *271*, 145–150.
1147. Munakata, M.; Wu, L. P.; Kuroda-Sowa, T.; Maekawa, M.; Suenaga, Y.; Nakagawa, S. *J. Chem. Soc., Dalton Trans.* **1996**, 1525–1530.
1148. Shimizu, G. K. H.; Enright, G. D.; Ratcliffe, C. I.; Ripmeester, J. A. *Chem. Commun.* **1999**, 461–462.
1149. Häusler, T.; Sheldrick, W. S. *Z. Naturforsch., Teil B* **1994**, *49*, 1215–1222.
1150. Buschholz, H. A.; Prakash, G. K. S.; Vaughan, J. F. S.; Bau, R.; Olah, G. A. *Inorg. Chem.* **1996**, *35*, 4076–4077.
1151. Galešić, N.; Herceg, M.; Sevdic, D. *Acta Crystallogr., Sect. C* **1988**, *44*, 1405–1408.
1152. Booth, D. G.; Levason, W.; Quirk, J. J.; Reid, G.; Smith, S. M. *J. Chem. Soc., Dalton Trans.* **1997**, 3493–3500.
1153. Levason, W.; Reid, G.; Tolhurst, V. A. M. *J. Chem. Soc., Dalton Trans.* **1998**, 3411–3416.
1154. Liu, Y.; Dong, S. P.; Inoue, Y.; Wada, T. *J. Chem. Res.* **1999**, 284–285.
1155. Hoffmann, H.; Pinkert, W.; Roesky, W. W.; Sheldrick, G. M. *J. Organomet. Chem.* **1983**, *249*, 97–102.
1156. Suenaga, Y.; Kuroda-Sowa, T.; Maekawa, M.; Munakata, M. *Acta Crystallogr., Sect. C* **1999**, *55*, 1623–1625.
1157. Suenaga, Y.; Kuroda-Sowa, T.; Munakata, M.; Maekawa, M.; Morimoto, M. *Polyhedron* **1999**, *18*, 429–436.
1158. Suenaga, Y.; Kitamura, K.; Kuroda-Sowa, T.; Maekawa, M.; Munakata, M. *Inorg. Chim. Acta* **2002**, *328*, 105–110.
1159. Suenaga, Y.; Kuroda-Sowa, T.; Maekawa, M.; Munakata, M. *J. Chem. Soc., Dalton Trans.* **1999**, 2737–2741.
1160. Jia, C.; Zhang, D.; Liu, C. M.; Xu, W.; Hu, H.; Zhu, D. *New J. Chem.* **2002**, *26*, 490–494.
1161. Munakata, M.; Wu, L. P.; Gan, X. M.; Kuroda-Sowa, T.; Suenaga, Y. *Mol. Cryst. Liq. Cryst.* **1996**, *284*, 319–327.
1162. Zhong, J. C.; Misaki, Y.; Munakata, M.; Kuroda-Sowa, T.; Maekawa, M.; Suenaga, Y.; Konaba, H. *Inorg. Chem.* **2001**, *40*, 7096–7098.
1163. Cobben, P. L. H. M.; Egberink, R. J. M.; Bomer, J. G.; Bergveld, P.; Verboom, W.; Reinhoudt, D. N. *J. Am. Chem. Soc.*, **1992**, *114*, 10573–10578.
1164. Yordanov, A. T.; Falana, O. M.; Koch, H. F.; Roundhill, D. M. *Inorg. Chem.* **1997**, *36*, 6468–6471.
1165. Black, J. R.; Champness, N. R.; Levason, W.; Reid, G. *J. Chem. Soc., Chem. Commun.* **1995**, 1277–1278.
1166. Black, J. R.; Champness, N. R.; Levason, W.; Reid, G. *Inorg. Chem.* **1996**, *35*, 1820–1824.
1167. Black, J. R.; Champness, N. R.; Levason, W.; Reid, G. *Inorg. Chem.* **1996**, *35*, 4432–4438.
1168. Black, J. R.; Champness, N. R.; Levason, W.; Reid, G. *J. Chem. Soc., Dalton Trans.* **1995**, 3439–3445.
1169. Liaw, W. F.; Lai, C. H.; Chiou, S. J.; Horng, Y. C.; Chou, C. C.; Liaw, M. C.; Lee, G. H.; Peng, S. M. *Inorg. Chem.* **1995**, *34*, 3755–3759.
1170. Levason, W.; Orchard, S. D.; Reid, G. *Inorg. Chem.* **2000**, *39*, 3853–3859.
1171. Bu, X. H.; Chen, W.; Hou, W. F.; Du, M.; Zhang, R. H.; Brisse, F. *Inorg. Chem.* **2002**, *41*, 3477–3482.
1172. Shao, P. X.; Yao, X. K.; Wang, H. G.; Wang, R. J.; Luo, L. W.; Wang, W. H.; Wang, W. Z.; Wang, Z. T. *Acta Chim. Sinica (Huaxue Xuebao)* **1991**, *49*, 677–683 (*Chem Abstr* **1991**, *115*, 219484n).
1173. Romero, I.; Sánchez-Castelló, G.; Teixidor, F.; Whitaker, C. R.; Rius, J.; Miravittles, C.; Flor, T.; Escriche, L.; Casabó, J. *Polyhedron* **1996**, *15*, 2057–2065.
1174. Kojima, Y.; Watanabe, M.; Miyake, H. *Chem. Lett.* **1995**, 1097–1098.
1175. Gürol, I.; Ahsen, V.; Bekaroglu, Ö. *J. Chem. Soc., Dalton Trans.* **1994**, 497–500.
1176. Gürek, A. G.; Bekaroglu, Ö. *J. Chem. Soc., Dalton Trans.* **1994**, 1419–1423.
1177. Diefenbach, U.; Cannon, A. M.; Stromburg, B. E.; Olmeijer, D. L.; Allcock, H. R. *J. Appl. Polymer Sci.* **2000**, *78*, 650–661.
1178. Tilley, R. I. *Aust. J. Chem.* **1990**, *43*, 1573–1576.
1179. El-Etri, M. M.; Scovell, W. M. *Inorg. Chim. Acta* **1991**, *187*, 201–206.
1180. Burmaa, G.; Potapov, V. A.; Amosova, S. V.; Khlebnikova, A. A. *Zh. Anal. Khim.* **1992**, *47*, 930–932 (*Chem Abstr* **1992**, *117*, 263757u).
1181. Noren, B.; Oskarsson, A. *Acta Chem. Scand., Ser. A* **1985**, *39*, 701–706.
1182. Noren, B.; Oskarsson, A. *Acta Chem. Scand., Ser. A* **1984**, *38*, 479–475.
1183. Long, N. J.; Martin, J.; Opromolla, G.; White, A. J. P.; Williams, D. J.; Zanello, P. *J. Chem. Soc., Dalton Trans.* **1999**, 1981–1986.
1184. Canales, S.; Crespo, O.; Fortea, A.; Gimeno, M. C.; Jones, P. G.; Laguna, A. *J. Chem. Soc., Dalton Trans.* **2002**, 2250–2255.
1185. Vicente, J.; Chicote, M. T.; Huertas, S.; Ramírez de Arellano, M. C.; Jones, P. G. *Eur. J. Inorg. Chem.* **1998**, 511–516.
1186. Henkel, G.; Betz, P.; Krebs, B. *Angew. Chem., Int. Ed. Engl.* **1987**, *26*, 145–146.
1187. Henkel, G.; Krebs, B.; Betz, P.; Fietz, H.; Saatkamp, K. *Angew. Chem., Int. Ed. Engl.* **1988**, *27*, 1326–1329.
1188. Birker, P. J.; Verschoor, G. C. *J. Chem. Soc., Chem. Commun.* **1981**, 322–323.
1189. Dietrich, H.; Storck, W.; Manecke, G. *J. Chem. Soc., Chem. Commun.* **1982**, 1306–1037.
1190. Fackler, J. P., Jr.; Staples, R. J.; Liu, C. W.; Stubbs, R. T.; Lopez, C.; Pitts, J. T. *Pure Appl. Chem.* **1998**, *70*, 839–844.
1191. Yoshimura, T.; Storck, W.; Manecke, G. *Makromol. Chem.* **1977**, *178*, 75–96.
1192. Wolmershäuser, G.; Kraft, G. *Chem. Ber.* **1989**, *122*, 385–387.
1193. McLauchlan, C. C.; Ibers, J. A. *Inorg. Chem.* **2001**, *40*, 1809–1815.
1194. Annan, T. A.; Kumar, R.; Tuck, D. G. *Inorg. Chem.* **1990**, *29*, 2475–2479.
1195. Sheng, T. L.; Wu, X. T.; Wang, Q. M.; Gao, X. C.; Lin, P. *Polyhedron* **1998**, *17*, 4519–4524.
1196. Fijolek, H. G.; González-Duarte, P.; Park, S. H.; Suib, S. L.; Natan, M. J. *Inorg. Chem.* **1997**, *36*, 5299–5305.
1197. Nukhin, A. N. *Russ. J. Coord. Chem.* **1995**, *21*, 145–153.
1198. Estevan, F.; Lahuerta, P.; Solana, I. *Polyhedron* **1985**, *4*, 1965–1967.
1199. Heinrich, D. D.; Fackler, J. P., Jr.; Lahuerta, P. *Inorg. Chim. Acta* **1986**, *116*, 15–19.

1200. Liu, C. W.; McNeal, C. J.; Fackler, J. P., Jr. *J. Cluster Sci.* **1996**, *7*, 385–406.
1201. Su, W. P.; Hong, M. C.; Cao, R.; Chen, J. T.; Wu, D. X.; Liu, H. Q.; Lu, J. X. *Inorg. Chim. Acta* **1998**, *267*, 313–317.
1202. Liu, C. W.; Liaw, B. J.; Wang, J. C.; Keng, T. C. *Inorg. Chem.* **2000**, *39*, 1329–1332.
1203. Stephan, D. W. *J. Chem. Soc., Chem. Commun.* **1991**, 129–131.
1204. Stephan, D. W. *Organometallics* **1991**, *10*, 2037–2045.
1205. Nadashi, T. T.; Stephan, D. W. *Organometallics* **1992**, *11*, 116–122.
1206. Ebihara, M.; Tsuchiya, M.; Yamada, M.; Tokoro, K.; Kawamura, T. *Inorg. Chim. Acta* **1995**, *231*, 35–43.
1207. Youm, K. T.; Kim, Y.; Do, Y.; Jun, M. J. *Inorg. Chim. Acta* **2000**, *310*, 203–209.
1208. Sugimoto, K.; Kuroda-Sowa, T.; Maekawa, M.; Munakata, M. *Bull. Chem. Soc. Jpn.* **2000**, *73*, 391–394.
1209. Vicente, J.; Chicote, M. T.; Huertas, S.; Bautista, D.; Jones, P. G.; Fischer, A. K. *Inorg. Chem.* **2001**, *40*, 2051–2057.
1210. Smith, D. M.; Albrecht-Schmitt, T. E.; Ibers, J. A. *Angew. Chem., Int. Ed. Engl.* **1998**, *37*, 1089–1091.
1211. McLauchlan, C. C.; Ibers, J. A. *Inorg. Chem.* **2000**, *39*, 1046–1048.
1212. Zhang, W. G.; Zhong, Y.; Tan, M. Y.; Liu, W. S.; Su, C. Y. *Chin. J. Chem.* **2002**, *20*, 420–423.
1213. Ventakachalam, V.; Ramalingam, K. *Synt. React. Met-Org. Chem.* **1996**, *26*, 1125–1133.
1214. Crespo, O.; Gimeno, M. C.; Jones, P. G.; Laguna, A.; Sarroca, C. *Chem. Commun.* **1998**, 1481–1482.
1215. Ebihara, M.; Sakurai, K.; Kawamura, T.; Katayama, H.; Masuda, H.; Taga, T. *Chem. Lett.* **1990**, 415–418.
1216. Ebihara, M.; Okoro, K.; Imaeda, K.; Sakurai, K.; Masuda, H.; Kawamura, T. *J. Chem. Soc., Chem. Commun.* **1992**, 1591–1592.
1217. Bond, A. M.; Colton, R.; Mah, Y. A.; Traeger, J. C. *Inorg. Chem.* **1994**, *33*, 2548–2554.
1218. Fornies, J.; Martin, A.; Navarro, R.; Sicilia, V.; Villarroya, P.; Orpen, G. *J. Chem. Soc., Dalton Trans.* **1998**, 3721–3726.
1219. Fernández, E. J.; López de Luzuriaga, J. M.; Monje, M.; Olmos, E.; Gimeno, M. C.; Laguna, A.; Jones, P. G. *Inorg. Chem.* **1998**, *37*, 5532–5536.
1220. Gimeno, M. C.; Jambrina, E.; Laguna, A.; Laguna, M.; Murray, H. H.; Terroba, R. *Inorg. Chim. Acta* **1996**, *249*, 69–77.
1221. Tyrre, W. *J. Fluor. Chem.* **2001**, *109*, 189–194.
1222. Victoriano, L. I. *Boletín Soc. Chi. Qui.* **2000**, *45*, 583–586.
1223. Mendoza, C. S.; Kamata, S.; Kawaminami, M. *Analyt. Sci.* **1997**, *13*, 161–163.
1224. Tang, K.; Jim, X.; Xiao, Q.; Tang, Y. *J. Struct. Chem. (Jiegou, Huaxue)* **1988**, *7*, 159–163 (*Chem Abstr* **1988**, *109*, 141495w).
1225. Schuerman, J. A.; Fronczek, F. R.; Selbin, J. *Inorg. Chim. Acta* **1989**, *160*, 43–48.
1226. Marsich, N.; Pellizer, G.; Camus, A.; Manotti Lanfredi, A. M.; Ugozzoli, F. *Inorg. Chim. Acta* **1990**, *169*, 171–179.
1227. Manotti Lanfredi, A. M.; Ugozzoli, F.; Camus, A.; Marsich, N. *J. Chem. Crystallogr.* **1995**, *25*, 37–41.
1228. Tiekink, E. R. *J. Coord. Chem.* **1988**, *17*, 239–235.
1229. Lanfredi, A. M. M.; Ugozzoli, F.; Asaro, F.; Pellicer, G.; Marsich, N.; Camus, A. *Inorg. Chim. Acta* **1991**, *190*, 71–77.
1230. Otto, H.; Werner, H. *Chem. Ber.* **1987**, *120*, 97–104.
1231. Tang, K.; Xing, Q.; Yang, J.; Yang, Q.; Tang, Y. *Huaxue Xuebao* **1990**, *48*, 242–246 (*Chem Abstr* **1990**, *113*, 125244r).
1232. Bianchini, C.; Ghilardi, C. A.; Meli, A.; Orlandini, A.; Scapacci, G. *J. Chem. Soc., Dalton Trans.* **1983**, 1969–1972.
1233. Strauch, P.; Dempe, B.; Kempe, R.; Dietzsch, W.; Sieler, J.; Hoyer, E. *Z. Anorg. Allg. Chem.* **1994**, *620*, 498–504.
1234. Sampanthar, J. T.; Vittal, J. J.; Dean, P. A. W. *J. Chem. Soc., Dalton Trans.* **1999**, 3153–3156.
1235. Deivaraj, T. C.; Vittal, J. J. *J. Chem. Soc., Dalton Trans.* **2001**, 329–335.
1236. Deivaraj, T. C.; Vittal, J. J. *J. Chem. Soc., Dalton Trans.* **2001**, 322–328.
1237. Kuchen, W.; Mayatepek, H. *Chem. Ber.* **1968**, *101*, 3454–3461.
1238. Malakova, H. G.; Vasileva, A. E. *Z. Naturforsch., Teil B* **1993**, *48*, 911–913.
1239. Liu, C. W.; Pitts, J. T.; Fackler, J. P., Jr. *Polyhedron* **1997**, *16*, 3899–3909.
1240. Drew, M. G. B.; Hobson, R. J.; Mumba, P. P. E. M.; Rice, D. A. *J. Chem. Soc., Dalton Trans.* **1987**, 1569–1571.
1241. Drew, M. G. B.; Hobson, R. J.; Mumba, P. P. E. M.; Rice, D. A. *Inorg. Chim. Acta* **1988**, *142*, 301–308.
1242. Liu, C. W.; Shang, I. J.; Hung, C. M.; Wang, J. C.; Keng, T. C. *J. Chem. Soc., Dalton Trans.* **2002**, 1974–1979.
1243. Karagiannidis, P.; Aslanidis, P.; Kokkou, S.; Cheer, C. J. *Inorg. Chim. Acta* **1990**, *172*, 247–253.
1244. Aslanidis, P.; Karagiannidis, P.; Akrivos, P. D.; Krebs, B.; Läge, M. *Inorg. Chim. Acta* **1997**, *254*, 277–284.
1245. McFarlane, W.; Akrivos, P. D.; Aslanidis, P.; Karagiannidis, P.; Hatzisymeon, C.; Numan, M.; Kokkou, S. *Inorg. Chim. Acta* **1998**, *281*, 121–125.
1246. Cox, P. J.; Aslanidis, P.; Karagiannidis, P.; Hadjikakou, S. *Inorg. Chim. Acta* **2000**, *310*, 268–272.
1247. Biagini, M. C.; Lanfranchi, M.; Marchiò, L.; Pellingelli, M. A. *Inorg. Chim. Acta* **2000**, *305*, 95–101.
1248. Su, W.; Hong, M.; Weng, J.; Liang, Y.; Zhao, Y.; Cao, R.; Zhou, Z.; Chan, A. S. C. *Inorg. Chim. Acta* **2002**, *331*, 8–15.
1249. Bernès, S.; Aguilar, J. C.; Rodríguez de San Miguel Guerrero, E.; Núñez Gaitan, M. E.; De Gynes, J. *Acta Crystallogr., Sect. C* **1999**, *55*, 1627–1631.
1250. Ghassemzadeh, M.; Adhami, F.; Heravi, M. M.; Taeb, A.; Chistas, S.; Neumuller, B. *Z. Anorg. Allg. Chem.* **2001**, *627*, 815–819.
1251. Casas, J. S.; García Martínez, E.; Sánchez, A.; Sánchez González, A.; Sordo, J.; Casellato, U.; Graziani, R. *Inorg. Chim. Acta* **1996**, *241*, 117–123.
1252. Santini, C.; Pettinari, C.; Gioia Lobbina, G.; Spagna, R.; Pellai, M.; Vallorani, F. *Inorg. Chim. Acta* **1999**, *285*, 81–88.
1253. Isab, A. A. *Transition Met. Chem.* **1992**, *17*, 374–380.
1254. Dai, J.; Kuroda-Sowa, T.; Munakata, M.; Maekawa, M.; Suenaga, Y.; Ohno, Y. *J. Chem. Soc., Dalton Trans.* **1997**, 2363–2368.
1255. Braun, U.; Sieler, J.; Ritcher, R.; Hetlich, B.; Simon, A. *Z. Anorg. Allg. Chem.* **1988**, *557*, 134–139.
1256. Olk, R. M.; Hoyer, E.; Faize, R.; Loiseleur, H.; Thomas David, G. *Cryst. Struct. Commun.* **1982**, *11*, 585–586.
1257. Buisti, G.; Geier, G.; Currao, A.; Nesper, R. *Acta Crystallogr., Sect. C* **1996**, *52*, 1914–1917.
1258. Schmidt, U.; Sieler, J.; Roewer, G. *J. Prakt. Chem.* **1994**, *336*, 53–57 (*Chem Abstr* **1994**, *120*, 207317a).
1259. Whitcomb, D. R.; Rogers, R. D. *J. Imaging Sci. Technol.* **1999**, *43*, 498–502.

1260. Grim, S. O.; Sangokoya, S. A.; Rheingold, A. L.; McFarlane, W.; Colquhoun, I. J.; Gilardi, R. D. *Inorg. Chem.* **1991**, *30*, 2519–2522.
1261. Gimeno, M. C.; Jones, P. G.; Laguna, A.; Villacampa, M. D. *Chem. Ber.* **1996**, *129*, 585–588.
1262. Gimeno, M. C.; Jones, P. G.; Laguna, A.; Sarroca, C. J. *Chem. Soc., Dalton Trans.* **1995**, 3563–3564.
1263. Pilloni, G.; Longato, B.; Bandoli, G. *Inorg. Chim. Acta* **2000**, *298*, 251–255.
1264. Gimeno, M. C.; Jones, P. G.; Laguna, A.; Sarroca, C. J. *Chem. Soc., Dalton Trans.* **1999**, 1277–1280.
1265. Canales, S.; Crespo, O.; Gimeno, M. C.; Jones, P. G.; Laguna, A. *J. Organomet. Chem.* **2000**, *613*, 50–55.
1266. Genge, A. R. J.; Gibson, A. M.; Guymer, N. K.; Reid, G. J. *Chem. Soc., Dalton Trans.* **1996**, 4099–4107.
1267. Gremler, S.; Scheer, M. Z. *Anorg. Allg. Chem.* **1993**, *619*, 466–470.
1268. Herndon, W. C.; Haiduc, I. J. *Molec. Struc.* **2001**, *598*, 127–131.
1269. Wilton-Ely, J. D. E. T.; Schier, A.; Schmidbaur, H. J. *Chem. Soc., Dalton Trans.* **2001**, 3647–3651.
1270. Yoshifujii, M.; Toyota, K.; Shirabe, K.; Iki, H.; Nagasaki, T.; Sinkai, S. *Tetrahedron Lett.* **1994**, *35*, 6313–6316.
1271. Fernández, E. J.; Gimeno, M. C.; Jones, P. G.; Laguna, A.; López de Luzuriaga, J. M.; Olmos, E. *Chem. Ber.* **1997**, *130*, 1513–1517.
1272. Guo, G. C.; Mak, T. C. W. *Chem. Commun.* **1999**, 813–814.
1273. Wang, Q. M.; Guo, G. C.; Mak, T. C. W. *Polyhedron* **2001**, *20*, 2683–2687.
1274. Ferrari, M. B.; Fava, G. G.; Vidoni Tani, M. E. *Cryst. Struct. Commun.* **1981**, *10*, 571–572.
1275. Smith, D. L.; Maskarsky, J. E.; Spaulding, L. R. *J. Appl. Cryst.* **1982**, *15*, 488–492.
1276. Wang, J. L.; Sun, M.; Miao, F. M.; Yu, S.; Gong, F. S.; Duan, X. H. *Acta Crystallogr., Sect. C* **1991**, *47*, 2203–2205.
1277. Bohaty, L.; Fröhlich, R. Z. *Kristallogr.* **1992**, *198*, 33–36.
1278. Gunes, M.; Valkonen, J. *Acta Crystallogr., Sect. C* **2002**, *58*, 11–12.
1279. Gunes, M.; Nattinen, K.; Valkonen, J. *Acta Crystallogr., Sect. C* **2002**, *58*, 121–122.
1280. Shen, L.; Xu, D. J.; Liu, J. G.; Xu, Y. Z. *J. Coord. Chem.* **2002**, *55*, 301–307.
1281. Krautscheid, H.; Gerber, S. Z. *Anorg. Allg. Chem.* **1999**, *625*, 2041–2044.
1282. Karring, K.; Holmberg, B.; Bengtsson, L. *Inorg. Chem.* **1988**, *27*, 2445–2449.
1283. De Marco, D.; Giannetto, A.; Barone, F.; Visco, A. *Thermochim. Acta* **1994**, *246*, 229–242.
1284. Ma, D.; Li, J.; Wang, C.; Wang, Y. *Fenxi Shiyanshi* **1994**, *13*, 12–17 (*Chem Abstr* **1994**, *121*, 244380g).
1285. Long, D. L.; Zeng, D. X.; Xin, X. Q.; Huang, X. Y.; Kang, B. S. *Synth. React. Inorg. Met.-Org. Chem.* **1996**, *26*, 723–733.
1286. Stocker, F. B.; Britton, D.; Young, V. G., Jr. *Inorg. Chem.* **2000**, *39*, 3479–3484.
1287. Schröder, U.; Beyer, L.; Sieler, J. *Inorg. Chem. Commun.* **2000**, *3*, 630–633.
1288. Eikens, W.; Jones, P. G.; Lautner, J.; Thöne, C. Z. *Naturforsch., Teil B* **1994**, *49*, 21–26.
1289. Ahmad, S.; Isab, A. A. *Inorg. Chem. Commun.* **2002**, *5*, 355–357.
1290. Fun, H. K.; Razak, I. A.; Pakawatchai, C.; Khaolong, C.; Chantapromma, S.; Saithong, S. *Acta Crystallogr., Sect. C* **1998**, *54*, 453–456.
1291. Pakawatchai, C.; Sivakumar, K.; Fun, H. K. *Acta Crystallogr., Sect. C* **1996**, *52*, 1954–1957.
1292. Richter, R.; Dietze, F.; Schmidt, S.; Hoyer, E. Z. *Anorg. Allg. Chem.* **1997**, *623*, 135–140.
1293. Braun, U.; Richter, R.; Sieler, J.; Yanovsky, A. I.; Struchkov, Y. T. Z. *Anorg. Allg. Chem.* **1985**, *529*, 201–206.
1294. Roesky, H. W.; Gries, T.; Jones, P. G.; Weber, K. L.; Sheldrick, G. M. *J. Chem. Soc., Dalton Trans.* **1984**, 1781–1784.
1295. Corradi Bonamartini, A.; Fava Gasparri, G.; Ferrari Belicchi, M.; Nardelli, M. *Acta Crystallogr., Sect. C* **1987**, *43*, 407–409.
1296. Anacker-Eroff, H.; Hesse, R.; Jennische, P.; Wahlberg, A. *Acta Chem. Scand., Ser. A* **1982**, *36*, 251–256.
1297. Atalay, T.; Özkan, E. *Thermochim. Acta* **1994**, *244*, 291–295.
1298. Solov'ev, A. N.; Chekhlov, A. N.; Zabiroy, N. G.; Martynov, I. V. *Dokl. Akad. Nauk.* **1995**, *341*, 502–506.
1299. Toropova, V. F.; Lazareva, G. A.; Batoryshina, A. I.; Zimin, M. G. *Zh. Anal. Khim.* **1982**, *37*, 1739–1743.
1300. Zabiroy, N. G.; Brus'ko, V. V.; Kashevarov, S. V.; Sokolov, F. D.; Shcherbakova, V. A.; Verat, A. Y.; Cherkasov, R. A. *Russ. J. Gen. Chem.* **2000**, *70*, 1214–1221.
1301. Pasechnik, M. P.; Starikova, Z. A.; Yanovsky, A. I.; Aladzheva, I. M.; Bykhovskaya, O. V.; Matrosov, E. I.; Mastryukova, T. A.; Kabachnik, M. I. *Russ. Chem. Bull.* **1997**, *46*, 813–819.
1302. Stålhandske, C. M. V.; Stålhandske, C. I.; Persson, I.; Sandström, M.; Jalilehvand, F. *Inorg. Chem.* **2001**, *40*, 6684–6693.
1303. Tudoryanu, K. I.; Migal, P. K.; Konishesku, L. F. *Zh. Neorg. Khim.* **1990**, *35*, 129–132.
1304. Helgesson, G.; Jagner, S. *Inorg. Chem.* **1991**, *30*, 2574–2577.
1305. Peters, K.; Von Schnering, H. G.; Ott, W.; Seidenspinner, H. M. *Acta Crystallogr., Sect. C* **1984**, *40*, 789–792.
1306. Exarchos, G.; Nyburg, S. C.; Robinson, S. D. *Polyhedron* **1998**, *17*, 2257–2266.
1307. Bowmaker, G. A.; Clark, G. R.; Rogers, D. A.; Camus, A.; W.; Marsich, N. *J. Chem. Soc., Dalton Trans.* **1984**, 37–45.
1308. Bowmaker, G. A.; Camus, A.; Skelton, B. W.; White, A. H. *J. Chem. Soc., Dalton Trans.* **1990**, 727–731.
1309. Kildea, J. D.; Skelton, B. W.; White, A. H. *Aust. J. Chem.* **1986**, *39*, 171–177.
1310. Helgesson, G.; Jagner, S. *J. Chem. Soc., Dalton Trans.* **1988**, 2117–2122.
1311. Helgesson, G.; Jagner, S. *J. Chem. Soc., Dalton Trans.* **1990**, 2413–2420.
1312. Hou, H. W.; Ye, X.; Xin, X. *Acta Crystallogr., Sect. C* **1995**, *51*, 2013–2015.
1313. Neumuller, B.; Chistas, S.; Dehnicke, K. Z. *Anorg. Allg. Chem.* **2002**, *628*, 523–525.
1314. Bowmaker, G. A.; Effendy; Kildea, J. D.; Skelton, B. W.; White, A. H. *Aust. J. Chem.* **1990**, *43*, 2113–2117.
1315. Olson, S.; Helgesson, G.; Jagner, S. *Inorg. Chim. Acta* **1994**, *217*, 15–20.
1316. Chadha, R. K. *Inorg. Chem.* **1988**, *27*, 1507–1510.
1317. Myllyviita, S.; Sillanpää, R. *J. Chem. Soc., Dalton Trans.* **1994**, 2125–2128.
1318. Reuter, H. *Angew. Chem. Int. Ed.* **1991**, *30*, 1482–1483.
1319. Jin, X.; Tang, K.; Liu, W.; Tang, Y. *Heteroat. Chem.* **1995**, *6*, 41–46.
1320. Peters, K.; Ott, W.; Von Schnering, H. G. *Angew. Chem., Int. Ed. Engl.* **1982**, 697–698.
1321. Baker, L. J.; Bowmaker, G. A.; Effendy; Skelton, B. W.; White, A. H. *Aust. J. Chem.* **1992**, *45*, 1909–1914.
1322. Kildea, J. D.; White, A. H. *Inorg. Chem.* **1984**, *23*, 3825–3827.

1323. Hasselgren, C.; Jagner, S. *Acta Crystallogr., Sect. C* **1999**, *55*, 1208–1210.
1324. Alemany, P.; Bengtssonkloo, L.; Holmberg, B. *Acta Chem. Scand.* **1998**, *52*, 718–727.
1325. Laher, T. M.; Hussey, C. L. *Inorg. Chem.* **1983**, *22*, 1279–1283.
1326. Apra, E.; Stefanovich, E.; Dovesi, R.; Roetti, C. *Chem. Phys. Lett.* **1991**, *186*, 329–335.
1327. Oster, L.; Kristianpoller, N.; Chen, R.; Katzir, A. *J. Phys. D, Apply. Phys.* **1993**, *26*, 1759–1763.
1328. Kulawiec, R. J.; Crabtree, R. H. *Coord. Chem. Rev.* **1990**, *99*, 89–115.
1329. Strauss, S. H. *Chem. Rev.* **1993**, *93*, 927–942.
1330. Colsmán, M. R.; Noirot, M. D.; Miller, M. M.; Anderson, O. P.; Strauss, S. H. *J. Am. Chem. Soc.* **1988**, *110*, 6886–6888.
1331. Van Seggen, S. M.; Hurlburt, P. K.; Anderson, O. P.; Strauss, S. H. *J. Am. Chem. Soc.*, **1992**, *114*, 10995–10997.
1332. Van Seggen, D. M.; Hurlburt, P. K.; Anderson, O. P.; Strauss, S. H. *Inorg. Chem.* **1995**, *34*, 3453–3464.
1333. Krossing, I. *Chem. Eur. J.* **2001**, *7*, 490–502.
1334. Powell, J.; Horvath, M. J.; Lough, A. *J. Chem. Soc., Chem. Commun.* **1993**, 733–735.
1335. Powell, J.; Horvath, M. J.; Lough, A. *J. Chem. Soc., Dalton Trans.* **1996**, 1669–1677.
1336. Aliyu, H. N.; Gillard, R. D.; Honeywill, J. D.; Lightfoot, P.; Rocha, J. *Polyhedron* **1996**, *15*, 2409–2419.
1337. Powell, J.; Horvath, M. J.; Lough, A. *J. Organomet. Chem.* **1993**, *456*, C27–C28.
1338. Powell, J.; Horvath, M. J.; Lough, A.; Phillips, A.; Brunet, J. *J. Chem. Soc., Dalton Trans.* **1998**, 637–645.
1339. Wu, L. P.; Munakata, M.; Kuroda-Sowa, T.; Maekawa, M.; Suenaga, Y.; Kitamori, Y. *Inorg. Chim. Acta* **1999**, *290*, 251–255.
1340. Ino, I.; Wu, L. P.; Munakata, M.; Maekawa, M.; Suenaga, Y.; Kuroda-Sowa, T.; Kitamori, Y. *Inorg. Chem.* **2000**, *39*, 2146–2151.
1341. Molinier, M.; Massa, W. *Z. Anorg. Allg. Chem.* **1994**, *620*, 833–838.
1342. Usón, R.; Fornies, J.; Tomas, M.; Ara, I. *Inorg. Chem.* **1994**, *33*, 4023–4028.
1343. Usón, R.; Fornies, J.; Tomás, M.; Ara, I. *Inorg. Chim. Acta* **1991**, *186*, 67–71.
1344. Glaum, M.; Klau, W.; Skelton, B. W.; White, A. H. *Aust. J. Chem.* **1997**, *50*, 1047–1052.
1345. Albano, V. G.; Di Serio, M.; Monari, M.; Orabona, I.; Panunzi, A.; Rufo, F. *Inorg. Chem.* **2002**, *41*, 2672–2677.
1346. Higgins, S. J.; Stuart, C. A.; Mills, A. *Inorg. Chem. Commun.* **2000**, *3*, 208–210.
1347. Shelly, K.; Finster, D. C.; Lee, Y. J.; Scheidt, W. R.; Reed, C. A. *J. Am. Chem. Soc.*, **1985**, *107*, 5955–5959.
1348. Liston, D. J.; Lee, Y. J.; Scheidt, W. R.; Reed, C. A. *J. Am. Chem. Soc.*, **1989**, *111*, 6643–6648.
1349. Xie, Z.; Bau, R.; Reed, C. A. *Angew. Chem., Int. Ed. Engl.* **1994**, *33*, 2433–2434.
1350. Xie, Z.; Jelinek, T.; Bau, R.; Reed, C. A. *J. Am. Chem. Soc.*, **1994**, *116*, 1907–1913.
1351. Jelinek, T.; Baldwin, P.; Scheidt, W. R.; Reed, C. A. *Inorg. Chem.*, **1993**, *32*, 1982–1990.
1352. Ivanov, S. V.; Lupinetti, A. J.; Miller, S. M.; Anderson, O. P.; Solntsev, K. A.; Strauss, S. H. *Inorg. Chem.* **1995**, *34*, 6419–6420.
1353. Ivanov, S. V.; Rockwell, J. J.; Miller, S. M.; Anderson, O. P.; Solntsev, K. A.; Strauss, S. H. *Inorg. Chem.* **1996**, *35*, 7882–7891.
1354. Xie, Z.; Wu, B. M.; Mak, T. C. W.; Manning, J.; Reed, C. A. *J. Chem. Soc., Dalton Trans.* **1997**, 1213–1217.
1355. Xie, Z.; Tsang, C. W.; Xue, F.; Mak, T. C. W. *J. Organomet. Chem.* **1999**, *577*, 197–204.
1356. Tsang, C. W.; Yang, Q.; Sze, E. T. P.; Mak, T. C. W.; Chan, D. T. W.; Xie, Z. *Inorg. Chem.* **2000**, *39*, 5851–5858.
1357. Patmore, N. J.; Steed, J. W.; Weller, A. S. *Chem. Commun.* **2000**, 1055–1056.
1358. Patmore, N. J.; Mahon, M. F.; Steed, J. W.; Weller, A. S. *J. Chem. Soc., Dalton Trans.* **2001**, 277–283.
1359. Colquhoun, H. M.; Greenhough, T. J.; Wallbridge, M. G. H. *J. Chem. Soc., Chem. Commun.* **1980**, 192–194.
1360. Patmore, N. J.; Hague, C.; Cotgreave, J. H.; Mahon, M. F.; Frost, C. G.; Weller, A. S. *Chem. Eur. J.* **2002**, *8*, 2088–2098.
1361. Park, Y. W.; Kim, J.; Do, Y. *Inorg. Chem.* **1994**, *33*, 1–2.
1362. Ellis, D. D.; Jelliss, P. A.; Stone, F. G. A. *Organometallics* **1999**, *18*, 4982–4994.
1363. Ellis, D. D.; Jeffery, J. C.; Jelliss, P. A.; Kautz, J. A.; Stone, F. G. A. *Inorg. Chem.* **2001**, *40*, 2041–2050.
1364. Ellis, D. D.; Franken, A.; Jelliss, P. A.; Kautz, J. A.; Stone, F. G. A.; Yu, P. Y. *J. Chem. Soc., Dalton Trans.* **2000**, 2509–2520.
1365. Antiñolo, A.; Carrillo-Hermosilla, F.; Chaudret, B.; Fajardo, M.; Fernández-Baeza, J.; Lanfranchi, M.; Limbach, H. H.; Maurer, M.; Otero, A.; Pellinghelli, M. A. *Inorg. Chem.* **1996**, *35*, 7873–7881.
1366. Quadrelli, E. A.; Poli, R. *Organometallics* **1998**, *17*, 5776–5781.
1367. Rhodes, L. F.; Huffman, J. C.; Caulton, K. G. *Inorg. Chim. Acta* **1992**, *198*, 639–649.
1368. Brunner, H.; Muschiol, M.; Neuhierl, T.; Nuber, B. *Chem. Eur. J.* **1998**, *4*, 168–171.
1369. Brunner, H.; Mijolovic, D.; Wrackmeyer, B.; Nuber, B. *J. Organomet. Chem.* **1999**, *579*, 298–303.
1370. Alcock, N. W.; Moore, P.; Lampe, P. A. Mok K. F. *J. Chem. Soc., Dalton Trans.* **1982**, 207–210.
1371. Liu, H. F.; Liu, W.; Zhang, P.; Huang, M. S.; Zhen, L. X. *Xiamen Daxue Xuebao, Ziran Kexue Ban* **1992**, *31*, 57–62.
1372. Del Zotto, A.; Sangrando, E. *Inorg. Chim. Acta* **1998**, *277*, 111–117.
1373. Olmos, M. E.; Schier, A.; Schmidbaur, H. *Z. Naturforsch., Teil B* **1997**, *52*, 203–208.
1374. Comuzzi, C.; Di Bernardo, P.; Portanova, R.; Tolazzi, M.; Zanonato, P. L. *Inorg. Chim. Acta* **2000**, *306*, 17–23.
1375. Del Zotto, A.; Di Bernardo, P.; Tolazzi, M.; Zanonato, P. L. *J. Chem. Soc., Dalton Trans.* **1999**, 979–986.
1376. Del Zotto, A.; Rigo, P.; Nardin, G. *Inorg. Chim. Acta* **1996**, *247*, 183–188.
1377. Del Zotto, A.; Nardin, G.; Rigo, P. *J. Chem. Soc., Dalton Trans.* **1995**, 3343–3351.
1378. Burini, A.; Pietroni, B. R.; Galassi, R.; Valle, G.; Calogero, S. *Inorg. Chim. Acta* **1995**, *229*, 299–305.
1379. Bachechi, F.; Burini, A.; Galassi, R.; Macchioni, A.; Pietroni, B. R.; Ziarelli, F.; Zuccaccia, C. *J. Organomet. Chem.* **2000**, *593–594*, 392–402.
1380. Jalil, M. A.; Yamada, T.; Fujinami, S.; Honjo, T.; Nishikawa, H. *Polyhedron* **2001**, *20*, 627–633.
1381. Jalil, M. A.; Fujinami, S.; Honjo, T.; Nishikawa, H. *Polyhedron* **2001**, *20*, 1071–1078.
1382. Kuang, S. M.; Zhang, Z. Z.; Wang, Q. G.; Mak, T. C. W. *J. Chem. Soc., Dalton Trans.* **1988**, 2927–2929.
1383. Catalano, V. J.; Kar, H. M.; Garnas, J. *Angew. Chem., Int. Ed. Engl.* **1999**, *38*, 1979–1982.
1384. Catalano, V. J.; Kar, H. M.; Bennett, B. L. *Inorg. Chem.* **2000**, *39*, 121–127.
1385. Song, H. B.; Zhang, Z. Z.; Mak, T. C. W. *J. Chem. Soc., Dalton Trans.* **2002**, 1336–1343.
1386. Kuang, S. M.; Zhang, Z. Z.; Wang, Q. G.; Mak, T. C. W. *Inorg. Chem.* **1998**, *37*, 6090–6092.

1387. Crociani, L.; Anacardio, R.; Traldi, P.; Corain, B. *Inorg. Chim. Acta* **1988**, *282*, 119–122.
1388. Wonk, W. K.; Chik, T. W.; Hui, K. N.; Williams, I.; Feng, X.; Mak, T. C. W.; Che, C. M. *Polyhedron* **1996**, *16*, 4447–4460.
1389. Lang, H.; Leschke, M.; Rheinwald, G.; Melter, M. *Inorg. Chem. Commun.* **1998**, *1*, 254–256.
1390. Leschke, M.; Melter, M.; Weber, C.; Rheinwald, G.; Lang, H.; Driess, A.; Huttner, G. *Z. Anorg. Allg. Chem.* **2001**, *627*, 1199–1203.
1391. Leschke, M.; Lang, H. *Inorg. Chem. Commun.* **2002**, *5*, 203–205.
1392. Wong, W. K.; Zhang, L.; Xue, F.; Mak, T. C. W. *Chem. Commun.* **1997**, 1525–1526.
1393. Song, H. B.; Zhang, Z. Z.; Hui, Z.; Che, C. M.; Mak, T. C. W. *Inorg. Chem.* **2002**, *41*, 3146–3154.
1394. Uang, R. H.; Chan, C. K.; Peng, S. M.; Che, C. M. *J. Chem. Soc., Chem. Commun.* **1994**, 2561–2562.
1395. Di Bernardo, P.; Tolazzi, M.; Zanonato P. *Inorg. Chim. Acta* **1994**, *215*, 199–201.
1396. Fernández, E. J.; López de Luzuriaga, J. M.; Monge, M.; Rodríguez, M. A.; Crespo, O.; Gimeno, M. C.; Laguna, A.; Jones, P. G. *Inorg. Chem.* **1998**, *37*, 6002–6006.
1397. Di Bernardo, P.; Tolazzi, M.; Zanonato P. *J. Chem. Soc., Dalton Trans.* **1995**, 1349–1355.
1398. Doel, C. L.; Gibson, A. M.; Reid, G.; Frampton, C. S. *Polyhedron* **1995**, *14*, 3139–3146.
1399. Perez-Lourido, P.; Garcia-Vazquez, J. A.; Romero, J.; Sousa, A.; Block, E.; Maresca, K. P.; Zubieta, J. *Inorg. Chem.* **1999**, *38*, 538–544.
1400. Aznar, J.; Cerrada, E.; Hursthouse, M. B.; Laguna, M.; Pozo, C.; Romero, M. P. *J. Organomet. Chem.* **2001**, *622*, 274–279.
1401. Wong, W. K.; Zhang, L.; Wong, W. T. *Chem. Commun.* **1998**, 673–674.
1402. Matrosov, E. I.; Starikova, Z. A.; Yanovsky, A. I.; Lobanov, D. I.; Aladzheva, I. M.; Bykhovskaya, O. V.; Mastryukova, T. A.; Kabachnik, M. I. *Russ. Chem. Bull.* **1998**, *47*, 1702–1709.
1403. Jones, P. G.; Ahrens, B. *Chem. Commun.* **1998**, 2307–2308.
1404. Su, W.; Hong, M.; Weng, J.; Cao, R.; Lu, S. *Angew. Chem., Int. Ed. Engl.* **2000**, *39*, 2911–2914.
1405. Hong, M.; Su, W.; Cao, R.; Zhang, W.; Lu, J. *Inorg. Chem.* **1999**, *38*, 600–602.
1406. Su, W.; Cao, R.; Hong, M.; Wong, W. T.; Lu, J. *Inorg. Chem. Commun.* **1999**, *2*, 241–243.
1407. Block, E.; Gernon, M.; Kang, H.; Zubieta, J. *Angew. Chem., Int. Ed. Engl.* **1988**, *27*, 1342–1344.
1408. Pérez-Lourido, P. A.; García-Vázquez, J. A.; Romero, J.; Louro, M. S.; Sousa, A.; Chen, Q.; Chang, Y.; Zubieta, J. *J. Chem. Soc., Dalton Trans.* **1996**, 2047–2054.
1409. Rodríguez, A.; Romero, J.; García-Vázquez, J. A.; Durán, M. L.; Sousa-Pedrares, A.; Sousa, A.; Zubieta, J. *Inorg. Chim. Acta* **1999**, *284*, 133–138.
1410. García-Vázquez, J. A.; Romero, J.; Sousa-Pedrares, A.; Louro, M. L.; Sousa, A.; Zubieta, J. *J. Chem. Soc., Dalton Trans.* **2000**, 559–567.
1411. Pérez-Lourido, P.; García-Vázquez, J. A.; Romero, J.; Louro, M. S.; Sousa, A.; Zubieta, J. *Inorg. Chim. Acta* **1998**, *271*, 1–8.
1412. Vicente, J.; Chicote, M. T.; Rubio, C. *Chem. Ber.* **1996**, *129*, 327–330.
1413. Fackler, J. P., Jr.; López, C. A.; Staples, R. J.; Wang, S.; Winpenny, R. E. P.; Lattimer, R. P. *J. Chem. Soc., Chem. Commun.* **1992**, 146–148.
1414. Van Stein, G. C.; Van Koten, G.; Spek, A. L.; Duisenberg, A. J. M.; Klop, E. A. *Inorg. Chim. Acta* **1983**, *78*, L61–L63.
1415. Hartshorn, C. M.; Steel, P. J. *J. Chem. Soc., Dalton Trans.* **1998**, 3935–3940.
1416. Anderson, R. J.; Steel, P. J. *Acta Crystallogr., Sect. C* **1998**, *54*, 223–225.
1417. Hong, M.; Su, W.; Cao, R.; Fujita, M.; Lu, J. *Chem. Eur. J.* **2000**, *6*, 427–431.
1418. Su, C. Y.; Liao, S.; Zhu, H. L.; Kang, B. S.; Chen, X. M.; Liu, H. Q. *J. Chem. Soc., Dalton Trans.* **2000**, 1985–1993.
1419. Liao, S.; Su, C. Y.; Yeung, C. H.; Xu, A. W.; Zhang, H. X.; Liu, H. Q. *Inorg. Chem. Commun.* **2000**, *3*, 405–407.
1420. Caradoc-Davies, P. L.; Hanton, L. R. *Chem. Commun.* **2001**, 1098–1099.
1421. Caradoc-Davies, P. L.; Hanton, L. R.; Lee, K. *Chem. Commun.* **2000**, 783–784.
1422. Wang, R. H.; Hong, M. C.; Su, W. P.; Liang, Y. C.; Cao, R.; Zhao, Y. J.; Weng, J. B. *Polyhedron* **2001**, *20*, 3165–3170.
1423. Knapp, S.; Keenan, T. P.; Liu, J.; Potenza, J. A.; Schugar, H. J. *Inorg. Chem.* **1990**, *29*, 2189–2191.
1424. Nomiya, K.; Takahashi, S.; Noguchi, R. *J. Chem. Soc., Dalton Trans.* **2000**, 2091–2097.
1425. Meyer, F.; Pritzkow, H. *Polyhedron* **1999**, *18*, 2769–2774.
1426. Albrecht, M.; Hübler, K.; Kaim, W. *Z. Anorg. Allg. Chem.* **2000**, *626*, 1033–1037.
1427. Olmos, M. E.; Schier, A.; Schmidbaur, H. *Z. Naturforsch., Teil B* **1997**, *52*, 385–390.
1428. Pasechnik, M. P.; Starikova, Z. A.; Yanovsky, A. I.; Aladzheva, I. M.; Matrosov, E. I.; Mastryukova, T. A.; Kabachnik, M. I. *Russ. Chem. Bull.* **1997**, *46*, 805–812.
1429. Yuchi, A.; Shiro, M.; Wada, H.; Nakagawa, G. *Bull. Chem. Soc. Jpn.* **1992**, *65*, 2275–2280.
1430. Haanstra, W. G.; Driessen, W. L.; Van Roon, M.; Stoffels, A. L. E.; Reedijk, J. *J. Chem. Soc., Dalton Trans.* **1992**, 481–486.
1431. Modder, J. F.; Vrieze, K.; Spek, A. L.; Challa, G.; Van Koten, G. *Inorg. Chem.* **1992**, *31*, 1238–1244.
1432. Hoskins, B. F.; Robson, R.; Williams, G. A.; Wilson, J. C. *Inorg. Chem.* **1991**, *30*, 4160–4166.
1433. Lockhart, J. C.; Rushton, D. J. *J. Chem. Soc., Dalton Trans.* **1991**, 2633–2638.
1434. Kinnear, K. I.; Lockhart, J. C.; Rushton, D. J. *J. Chem. Soc., Dalton Trans.* **1990**, 1365–1373.
1435. Wu, L. P.; Dai, J.; Munakata, M.; Kuroda-Sowa, T.; Maekawa, M.; Suenaga, Y.; Ohno, Y. *J. Chem. Soc., Dalton Trans.* **1998**, 3255–3261.
1436. Suenaga, Y.; Yan, S. G.; Wu, L. P.; Ino, I.; Kuroda-Sowa, T.; Maekawa, M.; Munakata, M. *J. Chem. Soc., Dalton Trans.* **1998**, 1121–1125.
1437. Lobana, T. S.; Paul, S.; Castineiras, A. *J. Chem. Soc., Dalton Trans.* **1999**, 1819–1824.
1438. Lobana, T. S.; Paul, S.; Hundal, G.; Obral, S. *Transition Met. Chem.* **1999**, *24*, 202–205.
1439. Valle, G.; Ettore, R. *J. Chem. Soc., Dalton Trans.* **1983**, 453–454.
1440. Sakamoto, H.; Ito, S.; Otomo, M. *Chem. Lett.* **1995**, 37–38.
1441. Lee, S. S.; Jung, J. H.; Yu, S. H.; Cho, M. H. *Termochim. Acta* **1995**, *259*, 133–141.
1442. Ishikawa, J.; Sakamoto, H.; Mizuno, T.; Otomo, M. *Bull. Chem. Soc. Jpn.* **1995**, *68*, 3071–3076.

1443. Strauch, P.; Dietzsch, W.; Golic, L.; Sieler, J.; Franke, A.; Münzberg, I.; Trübenbach, K.; Kirmes, R.; Rheinhold, J.; Hoyer, E. *Inorg. Chem.* **1995**, *34*, 763–766.
1444. Shakir, M.; Hameed, P. S.; Firdaus, F. *Synth. React. Inorg. Met.-Org. Chem.* **1994**, *24*, 1647–1660.
1445. Tong, M. L.; Yu, X. L.; Chen, X. M. *Inorg. Chem. Commun.* **2000**, *3*, 694–696.
1446. Burrows, A. D.; Mahon, M. F.; Palmer, M. T. *J. Chem. Soc., Dalton Trans.* **1998**, 1941–1942.
1447. Smith, G.; Lynch, D. E.; Kennard, C. H. L. *Inorg. Chem.* **1996**, *35*, 2711–2712.
1448. Arranz-Mascarós, P.; Godino-Salido, M. L.; López-Garzón, R.; Gutiérrez-Valero, M. D.; Moreno, J. M. *Polyhedron* **1999**, *18*, 793–797.
1449. Pérez-Cadenas, A.; López-Garzón, R.; Godino-Salido, M. L.; Arranz-Mascarós, P.; Gutiérrez-Valero, M. D.; Carillo-Márquez, T. *Transition Met. Chem.* **2002**, *27*, 184–190.
1450. Modder, J. F.; Van Koten, G.; Vrieze, K.; Spek, A. L. *Angew. Chem., Int. Ed. Engl.* **1989**, *28*, 1698–1699.
1451. Jäger, L.; Tretner, C.; Hartung, H.; Biedermann, M. *Eur. J. Inorg. Chem.* **1998**, 1051–1055.
1452. Jaber, F.; Charbonnier, F.; Faure, R. *Polyhedron* **1996**, *15*, 2909–2913.
1453. Leiva, A.; Clegg, W.; Cucurull-Sanchez, L.; Gonzalez-Duarte, P.; Pons, J. *J. Chem. Crystallogr.* **1999**, *29*, 1097–1101.
1454. Brzyska, W.; Ozga, W. *Polish J. Chem.* **1997**, *71*, 436–440.
1455. Rudler, H.; Denise, B.; Gregorio, J. R.; Vaissermann, J. *Chem. Commun.* **1997**, 2299–2300.
1456. Jones, P. G.; Henschel, D.; Weitze, A.; Blaschette, A. Z. *Anorg. Allg. Chem.* **1994**, *620*, 1524–1529.
1457. Weitze, A.; Blaschette, A.; Jones, P. G. *Acta Crystallogr., Sect. C* **1997**, *53*, 1195–1197.
1458. Giorgi, R. V.; Tocher, D. A. *Polyhedron* **1999**, *18*, 2981–2985.
1459. Dong, Y. B.; Smith, M. D.; Zur Loye, H. C. *Inorg. Chem.* **2000**, *39*, 1943–1949.
1460. Dong, Y. B.; Smith, M. D.; Zur Loye, H. C. *Solid State Sci.* **2000**, *2*, 335–341.
1461. Jaber, F.; Charbonnier, F.; Faure, R. *J. Chem. Crystallogr.* **1994**, *24*, 681–684.
1462. Tong, M. L.; Yang, G.; Chen, X. M. *Aust. J. Chem.* **2000**, *53*, 607–610.
1463. Sommerer, S. O.; Westcott, B. L.; Jircitano, A. J.; Abboud, K. A. *Inorg. Chim. Acta* **1995**, *238*, 149–153.
1464. Sommerer, S. O.; Westcott, B. L.; Jircitano, A. J.; Abboud, K. A. *Acta Crystallogr., Sect. C* **1996**, *52*, 1426–1428.
1465. Faure, R.; Gebicki, K.; Bartnik, R. *J. Cryst. Spectrosc. Res.* **1993**, *23*, 795–798.
1466. Ghost, M.; Basak, A. K.; Mazumdar, S. K. *Acta Crystallogr., Sect. C* **1990**, *46*, 1223–1226.
1467. Ishikara, M.; Ohba, S.; Saito, Y.; Shiozaki, Y. *Acta Crystallogr., Sect. B* **1987**, *43*, 160–162.
1468. Zheng, S. L.; Tong, M. L.; Tan, S. D.; Wang, Y.; Shi, J. X.; Tong, Y. X.; Lee, H. K.; Chen, X. M. *Organometallics* **2001**, *20*, 5319–5325.
1469. Wang, S.; Fackler, J. P., Jr.; Carlson, T. F. *Organometallics* **1990**, *9*, 1973–1975.
1470. Rawashdeh-Omary, M. A.; Omary, M. A.; Fackler, J. P., Jr. *Inorg. Chim. Acta* **2002**, *334*, 376–384.
1471. Papasergio, R. I.; Raston, C. L.; White, A. H. *J. Chem. Soc., Dalton Trans.* **1987**, 3085–3091.
1472. Usón, R.; Laguna, A.; Laguna, M.; Fraile, M. N.; Lázaro, I.; Gimeno, M. C.; Jones, P. G.; Reihs, C.; Sheldrick, G. M. *J. Chem. Soc., Dalton Trans.* **1990**, 333–338.
1473. Gimeno, M. C.; Jones, P. G.; Laguna, A.; Villacampa, M. D. *J. Chem. Soc., Dalton Trans.* **1995**, 805–810.
1474. Sibert, J. W.; Lange, S. J.; Williams, D. J.; Barrett, A. G. M.; Hoffman, B. M. *Inorg. Chem.* **1995**, *34*, 2300–2305.
1475. Sibert, J. W.; Lange, S. J.; Stern, C. L.; Barrett, A. G. M.; Hoffman, B. M. *Angew. Chem., Int. Ed. Engl.* **1995**, *34*, 2020–2022.
1476. Adam, K. R.; Baldwin, D. S.; Duckworth, P. A.; Lindoy, L. F.; McPartlin, M.; Bashall, A.; Powell, H. R.; Tasker, P. A. *J. Chem. Soc., Dalton Trans.* **1995**, 1127–1131.
1477. Krakowiak, K. E.; Maas, G. E.; Bradshaw, J. S.; Hathaway, J. K.; Izatt, R. M. *J. Heterocycl. Chem.* **1995**, *32*, 179–181.
1478. Matsumoto, K.; Okuno, S.; Lida, H.; Lown, J. W. *Heterocycles* **1995**, *40*, 521–524.
1479. Matsumoto, K.; Hashimoto, M.; Toda, M.; Tsukube, H. *J. Chem. Soc., Perkin Trans.* **1995**, 2497–2502.
1480. Bordunov, A. V.; Hellier, P. C.; Bradsaw, J. S.; Dalley, N. K.; Kou, X.; Zhang, X. X.; Izatt, R. M. *J. Org. Chem.* **1995**, *60*, 6097–6102.
1481. Drexler, H. J.; Reinke, H.; Holdt, H. *J. Chem. Ber.* **1996**, *129*, 807–814.
1482. Drexler, H. J.; Grotjahn, M.; Kleinpeter, E.; Holdt, H. *Inorg. Chim. Acta* **1999**, *285*, 305–308.
1483. Gyr, T.; Mäcke, H. R.; Henning, M. *Angew. Chem., Int. Ed. Engl.* **1997**, *36*, 2786–2788.
1484. Ahearn, M. A.; Kim, J.; Leong, A. J.; Lindoy, L. F.; Mathews, O. A.; Meehan, G. V. *J. Chem. Soc., Dalton Trans.* **1996**, 3591–3594.
1485. Blake, A. J.; Reid, G.; Schröder, M. *J. Chem. Soc., Chem. Commun.* **1992**, 1074–1076.
1486. Blake, A. J.; Gould, R. O.; Radek, C.; Schröder, M. *J. Chem. Soc., Chem. Commun.* **1994**, 985–986.
1487. Lippolis, V.; Blake, A. J.; Cooke, P. A.; Isaia, F.; Li, W. S.; Schröder, M. *Chem. Eur. J.* **1999**, *5*, 1987–1991.
1488. Rosser, M.; Parker, D.; Ferguson, G.; Gallagher, J. F.; Howard, J. A. K.; Yufit, D. S. *J. Chem. Soc., Chem. Commun.* **1993**, 1267–1269.
1489. Wu, G.; Jiang, W.; Lamb, J. D.; Bradshaw, J. S.; Izatt, R. M. *J. Am. Chem. Soc.*, **1991**, *113*, 6538–6541.
1490. Medina, J. C.; Goodnow, T. T.; Rojas, M. T.; Atwood, J. L.; Lynn, B. C.; Kaifer, A. E.; Gokel, G. W. *J. Am. Chem. Soc.*, **1992**, *114*, 10583–10595.
1491. Alberts, A. H.; Lehn, J. M.; Parker, D. *J. Chem. Soc., Dalton Trans.* **1985**, 2311–2317.
1492. Craig, A. S.; Katakya, R.; Parker, D.; Adams, H.; Bailey, N.; Schneider, H. *J. Chem. Soc., Chem. Commun.* **1989**, 1870–1872.
1493. Fenton, R. R.; Gauci, R.; Junk, P. C.; Lindoy, L. F.; Luckay, R. C.; Meehan, G. V.; Price, J. R.; Turner, P.; Wei, G. *J. Chem. Soc., Dalton Trans.* **2002**, 2185–2193.
1494. Buschmann, H. J.; Schollmeyer, E.; Trültzsch, R.; Beger, J. *Transition Met. Chem.* **2002**, *27*, 295–298.
1495. Cox, B. G.; Garcia-Rosas, J.; Schneider, H.; Van Truong, Ng. *Inorg. Chem.* **1986**, *25*, 1165–1168.
1496. Gubelmann, M.; Arriman, A.; Lehn, J. M.; Sessler, J. L. *J. Chem. Soc., Chem. Commun.* **1988**, 77–79.
1497. Nabeshima, T.; Nishijima, K.; Tsukada, N.; Furusawa, H.; Hosoya, T.; Yano, Y. *J. Chem. Soc., Chem. Commun.* **1992**, 1092–1094.
1498. Buschmann, H. *J. Chem. Ber.* **1985**, *118*, 4297–4302.
1499. Wang, J.; Luo, Q. H.; Shen, M. C.; Huang, X. Y.; Wu, Q. *J. Chem. Soc., Chem. Commun.* **1995**, 2373–2374.

1500. Xu, X. X.; Luo, Q. H.; Shen, M. C. *Synth. React. Inorg. Met-Org. Chem.* **1997**, *27*, 51–57.
1501. Plenio, H.; Diodone, R. *Chem. Ber.* **1996**, *129*, 1211–1217.
1502. Habata, Y.; Yamashita, Y.; Akabori, S. *J. Chem. Soc., Dalton Trans.* **2001**, 966–968.
1503. Prince, P. D.; Cragg, P. J.; Steed, J. W. *Chem. Commun.* **1999**, 1179–1180.
1504. Liang, W.; Liu, S.; Lucas, C. R.; Miller, D. O. *Polyhedron* **1998**, *17*, 1323–1328.
1505. Graubaus, H.; Tittelbach, F.; Lutze, G.; Gloe, K.; Mackrodt, M.; Krüger, T.; Krauss, N.; Deege, A.; Hinrichs, H. *Angew. Chem., Int. Ed. Engl.* **1997**, *36*, 1648–1650.
1506. Valencia, L.; Adams, H.; Bastida, R.; Fenton, D. E.; Macías, A. *Inorg. Chim. Acta* **2001**, *317*, 45–52.
1507. Heidari, N.; Thaler, A.; Scheneidr, H.; Cox, B. G. *Inorg. Chim. Acta* **1998**, *279*, 186–191.
1508. Thaler, A.; Bergter, R.; Ossowsky, T.; Cox, B. G.; Scheneidr, H. *Inorg. Chim. Acta* **1999**, *285*, 1–9.
1509. Kerton, F. M.; Mohmand, G. F.; Webb, J. D.; Went, M. J. *Polyhedron* **1997**, *16*, 1529–1534.
1510. Davies, H. O.; Dilworth, J. R.; Griffiths, D. V.; Miller, J. R.; Zheng, Y. *Polyhedron* **1999**, *18*, 459–467.
1511. Futterer, T.; Merz, A.; Lex, J. *Angew. Chem., Int. Ed. Engl.* **1997**, *36*, 611–613.
1512. Mascall, M.; Hansen, J.; Blake, A. J.; Li, W. S. *Chem. Commun.* **1998**, 355–356.
1513. Davis, C. A.; Leong, A. J.; Lindoy, L. F.; Kim, J.; Lee, S. H. *Aust. J. Chem.* **1998**, *51*, 189–193.
1514. Yoon, I.; Park, K. M.; Jung, J. H.; Kim, J.; Park, S. B.; Lee, S. S. *J. Inclusion Phenom. Macrocycl. Chem.* **2002**, *42*, 45–50.
1515. Wipf, P.; Venkatraman, S.; Miller, C. P.; Geib, S. J. *Angew. Chem., Int. Ed. Engl.* **1994**, *33*, 1516–1518.
1516. Lucas, J.; Lincoln, S. F. *Inorg. Chim. Acta* **1994**, *219*, 217–220.
1517. Lucas, J.; Lincoln, S. F. *J. Chem. Soc., Dalton Trans.* **1994**, 423–427.
1518. Dhillon, R.; Lincoln, S. F. *Aust. J. Chem.* **1994**, *47*, 123–130.
1519. Nabeshima, T.; Yosejima, I.; Yano, Y. *Heterocycles* **1994**, *38*, 1471–1474.
1520. Adam, K. R.; Baldwin, D. S.; Bashall, A.; Lindoy, L. F.; McPartlin, M.; Powell, H. R. *J. Chem. Soc., Dalton Trans.* **1994**, 237–238.
1521. Bashall, A.; McPartlin, M.; Murphy, B. P.; Powell, H. R. *J. Chem. Soc., Dalton Trans.* **1994**, 1383–1390.
1522. Burchard, T.; Cox, B. G.; Firman, P.; Schneider, H.; Bunsenges, B. *Phys. Chem.* **1994**, *98*, 1526–1533.
1523. Burchard, T.; Firman, P.; Schneider, H.; Cox, B. G.; Bunsenges, B. *Phys. Chem.* **1994**, *98*, 1534–1540.
1524. Turonek, M. L.; Clarke, P.; Laurence, G. S.; Lincoln, S. F.; Pittet, P. A.; Politis, S.; Wainwright, K. P. *Inorg. Chem.* **1993**, *32*, 2195–2198.
1525. Reddy, P. J.; Chacko, K. K.; Suh, I. H.; Weber, E.; Köhler, H. J.; Piel, M. *Inorg. Chim. Acta* **1993**, *207*, 31–37.
1526. Lincoln, S. F.; Rodopoulos, T. *Inorg. Chim. Acta* **1993**, *205*, 23–30.
1527. Hirotsu, K.; Miyahara, I.; Higuchi, T.; Toda, M.; Rsukube, H.; Matsumoto, K. *Chem. Lett.* **1992**, 699–705.
1528. Heinzl, U.; Mattes, R. *Polyhedron* **1992**, *11*, 597–604.
1529. Kallert, U.; Mattes, R. *Polyhedron* **1992**, *11*, 617–623.
1530. Heinzl, U.; Mattes, R. *Polyhedron* **1991**, *10*, 19–25.
1531. Kallert, U.; Mattes, R. *Inorg. Chim. Acta* **1991**, *180*, 263–269.
1532. Blake, A. J.; Reid, G.; Schröder, M. *J. Chem. Soc., Dalton Trans.* **1991**, 615–620.
1533. Abouhamdan, A.; Lincoln, S. F. *Inorg. Chem.* **1991**, *30*, 462–466.
1534. Salter, I. D. *Adv. Organomet. Chem.* **1989**, *29*, 249–255.
1535. Mingos, D. M. P.; May, A. S. In *Chemistry of Metal Cluster Complexes*; Shriver, D. F.; Kaesz, H. D.; Adams, R. D., Eds.; VCH: Weinheim, Germany, 1990.
1536. Salter, I. D.; Stone, F. G. A. *J. Organomet. Chem.* **1984**, *260*, C71–C74.
1537. Ladd, J. A.; Hope, H.; Balch, A. J. *Organometallics* **1984**, *3*, 1838–1646.
1538. Bruce, M. I.; Williams, M. L.; Patrick, J. M.; Skelton, B. W.; White, A. H. *J. Chem. Soc., Dalton Trans.* **1986**, 2557–2567.
1539. Brice, R. A.; Pearse, S. C.; Salter, I. D.; Henrick, K. *J. Chem. Soc., Dalton Trans.* **1986**, 2181–2192.
1540. Freeman, M. J.; Orpen, A. G.; Salter, I. D. *J. Chem. Soc., Dalton Trans.* **1987**, 379–390.
1541. Freeman, M. J.; Orpen, A. G.; Salter, I. D. *J. Chem. Soc., Dalton Trans.* **1987**, 1001–1008.
1542. Brown, S. S. D.; Salter, I. D.; Šik, V.; Colquhoun, I. J.; McFarlane, W.; Bates, P. A.; Hursthouse, M. B.; Murray, M. *J. Chem. Soc., Dalton Trans.* **1988**, 2177–2185.
1543. Brown, S. S. D.; McCarthy, P. J.; Salter, I. D.; Bates, P. A.; Hursthouse, M. B.; Colquhoun, I. J.; McFarlane, W.; Murray, M. *J. Chem. Soc., Dalton Trans.* **1988**, 2787–2796.
1544. Brown, S. S. D.; Salter, I. D.; Toupet, L. *J. Chem. Soc., Dalton Trans.* **1988**, 757–767.
1545. Adatia, T.; McPartlin, M.; Salter, I. D. *J. Chem. Soc., Dalton Trans.* **1988**, 2889–2891.
1546. Blaxill, C. P.; Brown, S. S. D.; Frankland, J. C.; Salter, I. D.; Šik, V. *J. Chem. Soc., Dalton Trans.* **1989**, 2039–2047.
1547. Engel, D. W.; Haines, R. J.; Horsfield, E. C.; Sundermeyer, J. *J. Chem. Soc., Chem. Commun.* **1989**, 1457–1459.
1548. Brown, C. J.; McCarthy, P. J.; Salter, I. D. *J. Chem. Soc., Dalton Trans.* **1990**, 3583–3590.
1549. Brown, S. S. D.; McCarthy, P. J.; Salter, I. D.; Armstrong, K. P.; McPartlin, M.; Powell, H. R. *J. Organomet. Chem.* **1990**, *384*, 711–732.
1550. Brown, S. S. D.; Salter, I. D.; Adatia, T.; McPartlin, M. *J. Chem. Soc., Dalton Trans.* **1990**, 799–805.
1551. Brown, S. S. D.; Salter, I. D.; Smith, D. J.; Calyden, N. J.; Dobson, C. M. *J. Organomet. Chem.* **1991**, *408*, 439–450.
1552. Draper, S. M.; Hattersley, A. D.; Housecroft, C. E.; Rheingold, A. L. *J. Chem. Soc., Chem. Commun.* **1992**, 1365–1367.
1553. Brown, S. S. D.; Salter, I. D.; Adatia, T. *J. Chem. Soc., Dalton Trans.* **1993**, 559–566.
1554. Engel, D. W.; Field, J. S.; Haines, R. J.; Honrath, U.; Horsfield, E. C.; Sundermeyer, J.; Woollam, S. F. *J. Chem. Soc., Dalton Trans.* **1994**, 1131–1143.
1555. McCarthy, P. J.; Salter, I. D.; Adatia, T. *J. Organomet. Chem.* **1995**, *485*, 191–199.
1556. Salter, I. D.; Williams, S. A.; Adatia, T. *Polyhedron* **1995**, *14*, 2803–2817.
1557. Fajardo, M.; Gómez-Sal, M. P.; Holden, H. D.; Jonson, B. F. G.; Lewis, J.; McQueen, R. C. S.; Raithby, P. R. *J. Organomet. Chem.* **1984**, *267*, C25–C28.
1558. Jonson, B. F. G.; Khattar, R.; Lewis, J.; Raithby, P. R. *J. Chem. Soc., Dalton Trans.* **1989**, 1421–1426.
1559. Drake, S. R.; Jonson, B. F. G.; Lewis, J. *J. Chem. Soc., Dalton Trans.* **1989**, 505–510.
1560. Song, L.; Trogler, W. C. *Angew. Chem., Int. Ed. Engl.* **1992**, *31*, 770–771.

1561. Heaton, B. T.; Strona, L.; Martinengo, S.; Strumolo, D.; Albano, V. G.; Braga, D. *J. Chem. Soc., Dalton Trans.* **1983**, 2175–2182.
1562. Fumagalli, A.; Martinengo, S.; Albano, V. G.; Braga, D. *J. Chem. Soc., Dalton Trans.* **1988**, 1237–1247.
1563. Mott, G. N.; Taylor, N. J.; Carty, A. J. *Organometallics* **1983**, *2*, 447–452.
1564. Briant, C. E.; Smith, R. G.; Mingos, D. M. P. *J. Chem. Soc., Chem. Commun.* **1984**, 586–588.
1565. Deck, W.; Schwarz, M.; Vahrenkamp, H. *Chem. Ber.* **1987**, *120*, 1515–1521.
1566. Schubert, U.; Kunz, E.; Knorr, M.; Müller, J. *Chem. Ber.* **1987**, *120*, 1079–1085.
1567. Deng, H.; Shore, S. G. *Organometallics* **1991**, *10*, 3486–3498.
1568. Albano, V. G.; Grossi, L.; Longoni, G.; Monari, M.; Mulley, S.; Sironi, A. *J. Am. Chem. Soc.*, **1992**, *114*, 5708–5713.
1569. Albano, V. G.; Azzaroni, F.; Iapalucci, M. C.; Longoni, G.; Monari, M.; Mulley, S.; Proserpio, D. M.; Sironi, A. *Inorg. Chem.* **1994**, *33*, 5320–5328.
1570. Albano, V. G.; Calderón, F.; Iapalucci, M. C.; Longoni, G.; Monari, M.; Zanello, P. *J. Cluster Sci.* **1995**, *6*, 107–113.
1571. Albano, V. G.; Iapalucci, M. C.; Longoni, G.; Monari, M.; Paselli, A.; Zacchini, S. *Organometallics* **1998**, *17*, 4438–4443.
1572. Albano, V. G.; Castellari, C.; Iapalucci, M. C.; Longoni, G.; Monari, M.; Paselli, A.; Zacchini, S. *J. Organomet. Chem.* **1999**, *573*, 261–266.
1573. Braunstein, P.; Rosé, J. *J. Organomet. Chem.* **1984**, *262*, 223–226.
1574. Ashford, P. K.; Baker, P. K.; Connelly, N. G.; Kelly, R. L.; Woodley, V. A. *J. Chem. Soc., Dalton Trans.* **1982**, 477–479.
1575. Green, M.; Orpen, A. G.; Salter, I. D.; Stone, F. G. A. *J. Chem. Soc., Dalton Trans.* **1984**, 2497–2503.
1576. Horton, A. D.; Mays, M. J.; Adatia, T.; Henrick, K.; McPartlin, M. *J. Chem. Soc., Dalton Trans.* **1988**, 1683–1688.
1577. Beringhelli, T.; D'Alfonso, G.; Garavaglia, M. G.; Panigati, M.; Mercandelli, P.; Sironi, A. *Organometallics* **2002**, *21*, 2705–2714.
1578. Luo, S.; Burns, C. J.; Kubas, G.; Bryan, J. C.; Grabtze, R. H. *J. Cluster Sci.* **2000**, *11*, 189–216.
1579. Calderazzo, F.; Pampaloni, G.; Englert, U.; Strähle, J. *Angew. Chem., Int. Ed. Engl.* **1989**, *28*, 471–472.
1580. Zhang, J. M.; Dahl, L. F. *J. Chem. Soc., Dalton Trans.* **2002**, 1269–1274.
1581. Herrmann, W. A.; Bauer, C.; Weichmann, J. *Chem. Ber.* **1984**, *117*, 1271–1286.
1582. Herrmann, W. A.; Kalcher, W. *Chem. Ber.* **1985**, *118*, 3861–3871.
1583. Bruno, G.; Lo Schiavo, S.; Piraino, P.; Faraone, F. *Organometallics* **1985**, *4*, 1098–1100.
1584. Lo Schiavo, S.; Bruno, G.; Piraino, P.; Faraone, F. *Organometallics* **1986**, *5*, 1400–1404.
1585. Bruno, G.; Lo Schiavo, S.; Rotondo, E.; Piraino, P.; Faraone, F. *Organometallics* **1987**, *6*, 2502–2507.
1586. Fernández, M. J.; Modrego, J.; Oro, L. A.; Apreada, M. C.; Cano, F. H.; Foces-Foces, C. *J. Chem. Soc., Dalton Trans.* **1989**, 1249–1252.
1587. Connelly, N. G.; Lucy, A. R.; Payne, J. D.; Galas, A. M. R.; Geiger, W. E. *J. Chem. Soc., Dalton Trans.* **1983**, 1879–1885.
1588. Bachèchi, F.; Ott, J.; Venanzi, L. M. *J. Am. Chem. Soc.*, **1985**, *107*, 1760–1761.
1589. García, M. P.; Jiménez, M. V.; Lahoz, F. J.; Oro, L. A. *Inorg. Chem.* **1995**, *34*, 2153–2159.
1590. Heyduck, A. F.; Krodell, D. J.; Meyer, E. E.; Nocera, D. G. *Inorg. Chem.* **2002**, *41*, 634–636.
1591. Sykes, A.; Mann, K. R. *J. Am. Chem. Soc.*, **1988**, *110*, 8252–8253.
1592. Sykes, A.; Mann, K. R. *J. Am. Chem. Soc.*, **1990**, *112*, 7247–7254.
1593. Sykes, A.; Mann, K. R. *J. Inorg. Chem.* **1990**, *29*, 4449–4453.
1594. Connelly, N. G.; Howard, J. A. K.; Spencer, J. L.; Woodley, P. K. *J. Chem. Soc., Dalton Trans.* **1984**, 2003–2009.
1595. Knoepfler, A.; Wurst, K.; Peringer, P. *J. Chem. Soc., Chem. Commun.* **1995**, 131–132.
1596. Laguna, M.; Villacampa, M. D.; Contel, M.; Garrido, J. *Inorg. Chem.* **1998**, *37*, 133–135.
1597. Usón, R.; Forniés, J.; Tomás, M. *J. Organomet. Chem.* **1988**, *358*, 529–535.
1598. Usón, R.; Forniés, J. *Inorg. Chim. Acta* **1992**, *198–200*, 165–177.
1599. Forniés, J.; Martín, A. *Metal Clusters in Chemistry*, Vol. 1, Braunstein, P.; Oro, L. A.; Raithby, R. R., Eds.; Wiley-VCH 1999, pp 417–443.
1600. Usón, R.; Forniés, J.; Tomás, M.; Casas, J. M. *J. Am. Chem. Soc.*, **1985**, *107*, 2556–2557.
1601. Cotton, F. A.; Falvelo, L. R.; Usón, R.; Forniés, J.; Tomás, M.; Casas, J. M.; Ara, I. *Inorg. Chem.* **1987**, *26*, 1366–1370.
1602. Usón, R.; Forniés, J.; Tomás, M.; Ara, I.; Casas, J. M. *J. Chem. Soc., Dalton Trans.* **1991**, 2253–2264.
1603. Usón, R.; Forniés, J.; Falvelo, L. R.; Tomás, M.; Casas, J. M.; Martín, A. *Inorg. Chem.* **1993**, *32*, 5212–5215.
1604. Usón, R.; Forniés, J.; Tomás, M. *J. Am. Chem. Soc.*, **1984**, *106*, 2482–2483.
1605. Usón, R.; Forniés, J.; Menjón, B.; Cotton, F. A.; Falvelo, L. R.; Tomás, M. *Inorg. Chem.* **1985**, *24*, 4651–4657.
1606. Usón, R.; Forniés, J.; Tomás, M.; Casas, J. M.; Cotton, F. A.; Falvelo, L. R. *Inorg. Chem.* **1986**, *25*, 4519–4525.
1607. Usón, R.; Forniés, J.; Tomás, M.; Casas, J. M.; Cotton, F. A.; Falvelo, L. R. *Inorg. Chem.* **1987**, *26*, 3482–3486.
1608. Usón, R.; Forniés, J.; Tomás, M.; Casas, J. M.; Cotton, F. A.; Falvelo, L. R.; Llusar, R. *Organometallic* **1988**, *7*, 2279–2285.
1609. Usón, R.; Forniés, J.; Tomás, M.; Casas, J. M. *Angew. Chem., Int. Ed. Engl.* **1989**, *28*, 748–750.
1610. Casas, J. M.; Forniés, J.; Martín, A.; Menjón, B.; Tomás, M. *Polyhedron* **1996**, *15*, 3599–3604.
1611. Casas, J. M.; Falvelo, L. R.; Forniés, J.; Martín, A.; Tomás, M. *J. Chem. Soc., Dalton Trans.* **1993**, 1107–1111.
1612. Casas, J. M.; Falvelo, L. R.; Forniés, J.; Martín, A. *Inorg. Chem.* **1996**, *35*, 7867–7872.
1613. Forniés, J.; Navarro, R.; Tomás, M.; Urriolabeitia, E. P. *Organometallics* **1993**, *12*, 940–943.
1614. Forniés, J.; Martínez, F.; Navarro, R.; Urriolabeitia, E. P. *Organometallics* **1996**, *15*, 1813–1819.
1615. Albinati, A.; Dahmen, K. H.; Togni, A.; Venanzi, L. *Angew. Chem., Int. Ed. Engl.* **1985**, *24*, 766–767.
1616. Albinati, A.; Demartin, F.; Venanzi, L.; Wolfer, M. K. *Angew. Chem., Int. Ed. Engl.* **1988**, *27*, 563–564.
1617. Van der Ploeg, A. F. M. J.; Van Koten, G.; Vrieze, K. *Inorg. Chem.* **1982**, *21*, 2026–2031.
1618. Blum, T.; Braunstein, P. *Organometallics* **1989**, *8*, 2497–2503.
1619. Yamaguchi, T.; Yamazaki, F.; Ito, T. *J. Chem. Soc., Dalton Trans.* **1999**, 273–274.
1620. Yamaguchi, T.; Yamazaki, F.; Ito, T. *J. Am. Chem. Soc.*, **2001**, *123*, 743–744.

1621. Timakov, A. A.; Prusakov, V. N.; Drobyshevskii, Y. V. *Dokl. Akad. Nauk SSSR* **1986**, *291*, 125–131.
1622. Holloway, J. H.; Schrobilgen, G. J. *J. Chem. Soc., Chem. Commun.* **1975**, 623–624.
1623. Sokolov, V. B.; Prusakov, V. N.; Ryzhkov, A. V.; Drobyshevskii, Y. V.; Khoroshev, S. S. *Dokl. Akad. Nauk SSSR* **1976**, *229*, 884–891.
1624. Vasile, M. J.; Richardson, T. J.; Stevie, F. A.; Falconer, W. E. *J. Chem. Soc., Dalton Trans.* **1976**, 351–356.
1625. Brunvoll, J.; Ischenko, A. A.; Ivanov, A. A.; Romanov, G. V.; Sokolov, V. B.; Spiridonov, V. P.; Strand, T. G. *Acta Chem. Scand. Ser. A* **1982**, *36*, 705–712.
1626. Bartlett, N.; Leary, K. *Rev. Chim. Miner.* **1976**, *13*, 82–88.
1627. Müller, B. G. *Angew. Chem., Int. Ed. Engl. Engl.* **1987**, *26*, 1081–1097.
1628. Leary, K.; Bartlett, N. *J. Chem. Soc., Chem. Commun.* **1972**, 903–905.
1629. Leary, K.; Zalkin, A.; Bartlett, N. *Inorg. Chem.* **1974**, *13*, 775–779.
1630. Leary, K.; Zalkin, A.; Bartlett, N. *J. Chem. Soc., Chem. Commun.* **1973**, 131–132.
1631. Graudejus, O.; Elder, S. H.; Lucier, G. M.; Shen, C.; Bartlett, N. *Inorg. Chem.* **1999**, *38*, 2503–2509.
1632. Graudejus, O.; Wilkinson, A. P.; Bartlett, N. *Inorg. Chem.* **2000**, *39*, 1545–1548.
1633. Seth, N.; Cooke, F.; Schwerdtfeger, P.; Heully, J. L.; Pelissier, M. *J. Chem. Phys.* **1998**, *109*, 3935–3943.
1634. Schultz, A. J.; Wang, H. H.; Soderholm, L. C.; Sifter, T. L.; Williams, J. M.; Bechgaard, K.; Whangbo, M.-H. *Inorg. Chem.* **1987**, *26*, 3757–3761.
1635. Rindorf, G.; Thorup, N.; Bjørnholm, T.; Bechgaard, K. *Acta Crystallogr., Sect. C* **1990**, *46*, 1437–1439.
1636. Domingos, A.; Hérriques, R. T.; Gama, V.; Almeida, M.; Viera, A. L.; Alcacer, L. *Synth. Met.* **1988**, *27*, B411–B415.
1637. Belo, D.; Alves, H.; Lopes, E. B.; Duarte, M. T.; Gama, V.; Henriques, R. T.; Almeida, M.; Pérez-Benítez, A.; Rovira, C.; Veciana, J. *Chem. Eur. J.* **2001**, *7*, 511–519.
1638. Sanner, R. D.; Satcher, J. H., Jr.; Droege, M. W. *Organometallics* **1989**, *8*, 1498–1506.
1639. Usón, R.; Laguna, A.; Bergareche, B. *J. Organomet. Chem.* **1980**, *184*, 411–416.
1640. Usón, R.; Laguna, A.; de la Orden, M. U.; Parish, D. V.; Moore, L. S. *J. Organomet. Chem.* **1985**, *282*, 145–148.
1641. Usón, R.; Laguna, A.; de la Orden, M. U.; Arrese, M. L. *Synth. React. Inorg. Met.-Org. Chem.* **1984**, *14*, 369–381.
1642. Espinet, P.; Martín-Barrios, S.; Villafañe, F.; Jones, P. G.; Fischer, A. K. *Organometallics* **2000**, *19*, 290–295.
1643. Vicente, J.; Bermúdez, M. D.; Chicote, M. T.; Sánchez-Santano, M. J. *J. Organomet. Chem.* **1989**, *371*, 129–135.
1644. Vicente, J.; Arcas, A.; Mora, M.; Solans, X.; Font-Altaba, M. *J. Organomet. Chem.* **1986**, *309*, 369–378.
1645. Usón, R.; Laguna, A.; Laguna, M.; Gimeno, M. C.; de Pablo, A.; Jones, P. G.; Meyer-Bäse, K.; Erdbrügger, C. F. *J. Organomet. Chem.* **1987**, *336*, 461–468.
1646. Vicente, J.; Chicote, M. T.; Cayuelas, J. A.; Fernández-Baeza, J.; Jones, P. G.; Sheldrick, G. M.; Espinet, P. *J. Chem. Soc., Dalton Trans.* **1985**, 1163–1168.
1647. Vicente, J.; Chicote, M. T.; Laguna, M. C.; Jones, P. G. *J. Chem. Soc., Dalton Trans.* **1991**, 2579–2583.
1648. Vicente, J.; Chicote, M. T.; Saura-Llamas, I.; Turpin, J.; Fernández-Baeza, J. *J. Organomet. Chem.* **1987**, *333*, 129–137.
1649. Fuchita, Y.; Utsunomiya, Y.; Yasutake, M. *J. Chem. Soc., Dalton Trans.* **2001**, 2330–2334.
1650. Usón, R.; Laguna, A.; Laguna, M.; Fraile, M. N.; Jones, P. G.; Sheldrick, G. M. *J. Chem. Soc., Dalton Trans.* **1986**, 291–296.
1651. Laguna, A.; Laguna, M.; Fañanas, J.; Jones, P. G.; Fittschen, C. *Inorg. Chim. Acta* **1986**, *121*, 39–45.
1652. Vicente, J.; Chicote, M. T.; Saura-Llamas, I.; Jones, P. G.; Meyer-Bäse, K.; Erdbrügger, C. F. *Organometallics* **1988**, *7*, 997–1006.
1653. Paul, M.; Schmidbaur, H. *Z. Naturforsch., Teil B* **1994**, *49*, 647–649.
1654. Margrave, J. L.; Witmire, K. H.; Hauge, R. H.; Norem, N. T. *Inorg. Chem.* **1990**, *29*, 3252–3253.
1655. Morrison, J. A. *Adv. Organomet. Chem.* **1993**, *35*, 211–239.
1656. Nair, H. K.; Morrison, J. A. *J. Organomet. Chem.* **1989**, *376*, 149–155.
1657. Usón, R.; Laguna, A.; Laguna, M.; Abad, M. *J. Organomet. Chem.* **1983**, *249*, 437–443.
1658. Usón, R.; Laguna, A.; Arrese, M. L. *Synth. React. Inorg. Met.-Org. Chem.* **1984**, *14*, 557–567.
1659. Vicente, J.; Chicote, M. T.; Arcas, A.; Artigao, M. *Inorg. Chim. Acta* **1982**, *65*, L251–L253.
1660. Vicente, J.; Chicote, M. T.; Arcas, A.; Artigao, M.; Jiménez, R. *J. Organomet. Chem.* **1983**, *247*, 123–131.
1661. Contel, M.; Edwards, A. J.; Garrido, J.; Hursthouse, M. B.; Laguna, M.; Terroba, R. *J. Organomet. Chem.* **2000**, *607*, 129–136.
1662. Usón, R.; Vicente, J.; Chicote, M. T.; Jones, P. G.; Sheldrick, G. M. *J. Chem. Soc., Dalton Trans.* **1983**, 1131–1136.
1663. Yam, V. W. W.; Choi, S. W. K.; Lai, T. F.; Lee, W. K. *J. Chem. Soc., Dalton Trans.* **1993**, 1001–1002.
1664. Dyadchenko, V. P.; Krasik, P. E.; Grandberg, K. I.; Kiz'mina, L. G.; Dvortsova, N. V.; Parai-Koshits, M. A.; Perevalova, E. G. *Metalloorg.-Khim.* **1990**, *6*, 1260–1265.
1665. Schmidbaur, H.; Jandik, P. *Inorg. Chim. Acta* **1983**, *74*, 97–99.
1666. Dudis, D. S.; Fackler, J. P., Jr. *Inorg. Chem.* **1985**, *24*, 3758–3762.
1667. Porter, L. C.; Murray, H. H.; Fackler, J. P., Jr. *Acta Crystallogr., Sect. C* **1987**, *43*, 877–879.
1668. Raptis, R. G.; Fackler, J. P., Jr.; Murray, H. H.; Porter, L. C. *Inorg. Chem.* **1989**, *28*, 4057–3059.
1669. Raptis, R. G.; Murray, H. H.; Staples, R. J.; Porter, L. C.; Fackler, J. P., Jr. *Inorg. Chem.* **1993**, *32*, 5576–5581.
1670. Murray III, H. H.; Fackler, J. P., Jr.; Porter, L. C.; Mazany, A. M. *J. Chem. Soc., Chem. Commun.* **1986**, 321–322.
1671. Murray III, H. H.; Porter, L. C.; Fackler, J. P., Jr.; Raptis, R. G. *J. Chem. Soc., Dalton Trans.* **1988**, 2669–2674.
1672. Vicente, J.; Chicote, M. T.; Saura-Llamas, I. *J. Chem. Soc., Dalton Trans.* **1990**, 1941–1944.
1673. Heinrich, D. D.; Fackler, J. P., Jr. *Inorg. Chem.* **1990**, *29*, 4402–4404.
1674. Raptis, R. G.; Porter, L. C.; Emrich, R. J.; Murria, H. H.; Fackler, J. P., Jr. *Inorg. Chem.* **1990**, *29*, 4408–4412.
1675. Mazany, A. M.; Fackler, J. P., Jr. *J. Am. Chem. Soc.* **1984**, *106*, 801–802.
1676. Fackler, J. P., Jr.; Trzcinska-Bancroft, B. *Organometallics* **1985**, *4*, 1891–1893.
1677. Bayón, R.; Coco, S.; Espinet, P.; Fernández-Mayordomo, C.; Martín-Alvarez, J. M. *Inorg. Chem.* **1997**, *36*, 2329–2334.
1678. Jones, P. G.; Thöne, C. *Acta Crystallogr., Sect. C* **1989**, *45*, 11–13.
1679. Adams, H.-N.; Strähle, J. *Z. Anorg. Allg. Chem.* **1982**, *485*, 65–71.
1680. Cattalini, L.; Chessa, G.; Michelon, G.; Pitteri, B.; Tobe, M. L.; Zanardo, A. *Inorg. Chem.* **1985**, *24*, 3409–3413.

1681. Nagel, Y.; Beck, W. *Z. Anorg. Allg. Chem.* **1985**, *529*, 57–63.
1682. Minghetti, G.; Foddai, C.; Cariati, F.; Ganadu, L.; Manassero, M. *Inorg. Chim. Acta* **1982**, *64*, L235–L236.
1683. Minghetti, G.; Ganadu, L.; Foddai, C.; Cinellu, M. A.; Cariati, F.; Demartin, F.; Manassero, M. *Inorg. Chim. Acta* **1984**, *86*, 93–100.
1684. Peters, K.; Peters, E. M.; von Schnering, H. G.; Honle, W.; Schmidt, R.; Moya, S. A.; Gullpi, M.; Binder, H. *Z. Kristallogr.* **2000**, *215*, 407–408.
1685. Peters, K.; Peters, E. M.; von Schnering, H. G.; Honle, W.; Schmidt, R.; Binder, H. *Z. Kristallogr.* **2000**, *215*, 415–417.
1686. Vicente, J.; Chicote, M. T.; Guerrero, R.; Saura-Llamas, I. M.; Jones, P. G.; Ramírez de Arellano, M. C. *Chem. Eur. J.* **2001**, *7*, 638–646.
1687. Sánchez Delgado, R. A.; Navarro, M.; Lazard, K.; Atencio, R.; Capparelli, M.; Vargas, F.; Urbina, J. A.; Bonillez, A.; Noels, A. F.; Masi, D. *Inorg. Chim. Acta* **1998**, *276*, 528–540.
1688. Calis, G. H. M.; Hadjiliadis, N. *Inorg. Chim. Acta* **1984**, *91*, 203–212.
1689. Schimanski, A.; Freisinger, E.; Erxleben, A.; Lippert, B. *Inorg. Chim. Acta* **1998**, *283*, 223–232.
1690. Watkins II, W.; Elder, R. C.; Greene, B.; Darnall, D. W. *Inorg. Chem.* **1987**, *26*, 1147–1151.
1691. Bandini, A. L.; Banditelli, G.; Bonati, F.; Minguetti, G.; Demartin, F.; Manassero, M. *Inorg. Chem.* **1987**, *26*, 1351–1357.
1692. Berners Price, S. J.; Dimartino, M. J.; Hill, D. T.; Kuroda, R.; Mazid, M. A.; Sadler, P. G. *Inorg. Chem.* **1985**, *24*, 3425–3434.
1693. Mikulski, C. M.; Braccia, D.; Delacato, D.; Fleming, J.; Fleming, D.; Karayannis, M. *Inorg. Chim. Acta* **1985**, *106*, L13–L15.
1694. McInnes, E. J. L.; Welch, A. J.; Yellowlees, L. J. *Acta Crystallogr., Sect. C* **1995**, *51*, 2023–2023.
1695. Hollis, L. S.; Lippard, S. J. *J. Am. Chem. Soc.*, **1983**, *105*, 4293–4299.
1696. Pitteri, B.; Marangoni, G.; Visentin, F.; Bobbo, T.; Bertolasi, V.; Gilli, P. *J. Chem. Soc., Dalton Trans.* **1999**, 677–682.
1697. Sampath, U.; Putnam, W. C.; Osiek, T. A.; Touami, S.; Xie, J.; Cohen, D.; Cagnolini, A.; Droegge, P.; Klug, D.; Barnes, C. L.; Modak, A.; Bashkin, J. K.; Jurisson, S. S. *J. Chem. Soc., Dalton Trans.* **1999**, 2049–2058.
1698. Nardin, G.; Randaccio, L.; Annibale, G.; Natile, G.; Pitteri, B. *J. Chem. Soc., Dalton Trans.* **1980**, 220–225.
1699. Vicente, J.; Chicote, M. T.; Bermúdez, M. D.; Jones, P. G.; Fittschen, C.; Sheldrick, G. M. *J. Chem. Soc., Dalton Trans.* **1986**, 2361–2366.
1700. Cattalini, L.; Marangoni, G.; Paolucci, G.; Pitteri, B.; Tobe, M. L. *Inorg. Chem.* **1987**, *26*, 2450–2454.
1701. Sommerer, S. O.; Macbeth, C. E.; Jircitano, A. J.; Abboud, K. A. *Acta Crystallogr., Sect. C* **1997**, *53*, 1551–1553.
1702. Elder, R. C.; Watkins II, J. W. *Inorg. Chem.* **1986**, *25*, 223–226.
1703. Messori, L.; Abate, F.; Orioli, P.; Temp, C.; Marcon, G. *Chem. Commun.* **2002**, 612–613.
1704. Canty, A. J.; Minchin, N. G.; Healy, P. C.; White, A. H. *J. Chem. Soc., Dalton Trans.* **1982**, 1795–1801.
1705. Bandini, A. L.; Banditelli, G.; Bonatti, F.; Minghetti, G.; Pinillos, M. T. *Inorg. Chim. Acta* **1985**, *99*, 165–171.
1706. Raptis, R. G.; Fackler, J. P., Jr. *Inorg. Chem.* **1990**, *29*, 5003–5006.
1707. Vicente, J.; Chicote, M. T.; Guerrero, R.; Herber, U. *Inorg. Chem.* **2002**, *41*, 1870–1875.
1708. Messori, L.; Abbate, F.; Marcon, G.; Orioli, P.; Fontani, M.; Mini, E.; Mazzei, T.; Carotti, S.; O'Connell, T.; Zanello, P. *J. Med. Chem.* **2000**, *43*, 3541–3548.
1709. Abbate, F.; Orioli, P.; Bruni, B.; Marcon, G.; Messori, L. *Inorg. Chim. Acta* **2000**, *311*, 1–5.
1710. Carotti, S.; Guerri, A.; Mazzei, T.; Messori, L.; Mini, E.; Orioli, P. *Inorg. Chim. Acta* **1998**, *281*, 90–94.
1711. Brawner, S. A.; Lin, I. J. B.; Kim, J. H.; Everett, G. W., Jr. *Inorg. Chem.* **1978**, 1304–1309.
1712. Kim, J.-H.; Everett, G. W., Jr. *Inorg. Chem.* **1979**, *18*, 3145–3151.
1713. Kim, J.-H.; Everett, G. W., Jr. *Inorg. Chem.* **1981**, *20*, 853–859.
1714. Park, C. H.; Lee, B.; Everett, G. W., Jr. *Inorg. Chem.* **1982**, *21*, 1681–1682.
1715. Suh, M. P.; Kim, I. S.; Shim, B. Y.; Hong, D.; Yoon, T.-S. *Inorg. Chem.* **1996**, *35*, 3595–3598.
1716. Rossignoli, M.; Bernhardt, P. V.; Lawrance, A.; Maeder, M. *J. Chem. Soc., Dalton Trans.* **1997**, 323–327.
1717. Bang, H.; Lee, E. J.; Lee, E. Y.; Suh, J.; Suh, M. P. *Inorg. Chim. Acta* **2000**, *308*, 150–154.
1718. Afanaseva, V. A.; Mironov, I. V. *Russ. J. Coord. Chem.* **2001**, *27*, 878–883.
1719. Brun, A. M.; Harriman, A.; Heitz, V.; Sauvage, J. P. *J. Am. Chem. Soc.*, **1991**, *113*, 8657–8663.
1720. Kilsä, K.; Kajanus, J.; Macpherson, A. N.; Mårtensson, J.; Albinsson, B. *J. Am. Chem. Soc.*, **2001**, *123*, 3069–3080.
1721. Flamigni, L.; Dixon, I. M.; Collin, J. P.; Sauvage, J. P. *Chem. Commun.* **2000**, 2479–2480.
1722. Chambron, J. C.; Heitz, V.; Sauvage, J. P. *New J. Chem.* **1997**, *21*, 237–240.
1723. Knör, G. *J. Inf. Record.* **2000**, *25*, 111–117.
1724. Knör, G. *Inorg. Chem. Commun.* **2001**, *4*, 160–163.
1725. Brønnum, B.; Johansen, H. S.; Skibsted, L. H. *Inorg. Chem.* **1988**, *27*, 1859–1862.
1726. Skibsted, L. H. *Acta Chem. Scand.* **1979**, *A33*, 113–119.
1727. Skibsted, L. H. *Adv. Inorg. Bioinorg. Mech.* **1986**, *4*, 137–142.
1728. Elding, L. I.; Skibsted, L. H. *Inorg. Chem.* **1986**, *25*, 4084–4087.
1729. Kaas, K.; Skibsted, L. H. *Acta Chem. Scand.* **1985**, *A39*, 1–6.
1730. Skibsted, L. H. *Acta Chem. Scand.* **1983**, *A37*, 613–619.
1731. Strähle, J.; Gelinek, J.; Kölmel, M. *Z. Anorg. Allg. Chem.* **1979**, *456*, 241–246.
1732. Usón, R.; Laguna, A.; Laguna, M.; Fernández, E.; Jones, P. G.; Sheldrick, G. M. *J. Chem. Soc., Dalton Trans.* **1982**, 1971–1976.
1733. Adams, H.-N.; Grässle, U.; Hiller, W.; Strähle, J. *Z. Anorg. Allg. Chem.* **1983**, *504*, 7–12.
1734. Grässle, U.; Hiller, W.; Strähle, J. *Z. Anorg. Allg. Chem.* **1985**, *529*, 29–35.
1735. Beck, W.; Nöth, H. *Chem. Ber.* **1984**, *117*, 419–425.
1736. Beck, W.; Klapötke, T. M.; Klüfers, P.; Kramer, G.; Rienäcker, C. M. *Z. Anorg. Allg. Chem.* **2001**, *627*, 1669–1674.
1737. Psilitelis, J. Diplom Thesis, University of Tübingen, Germany, 1996.
1738. Usón, R.; Laguna, A.; Laguna, M.; Perez, V. *Synth. React. Inorg. Met.-Org. Chem.* **1981**, *11*, 361–364.
1739. Usón, R.; Laguna, A.; Brun, P.; Laguna, M.; Abad, M. *J. Organomet. Chem.* **1981**, *218*, 265–273.
1740. Usón, R.; Laguna, A.; Laguna, M.; Jiménez, J.; Durana, M. E. *Inorg. Chim. Acta* **1990**, *168*, 89–92.

1741. Eggleston, D. S.; Chodosh, D. F.; Hill, D. T.; Girard, G. R. *Acta Crystallogr., Sect. C* **1984**, *40*, 1357–1360.
1742. Staples, R. J.; Grant, T.; Fackler, J. P., Jr.; Elduque, A. *Acta Crystallogr., Sect. C* **1994**, *50*, 39–40.
1743. Attar, S.; Nelson, J. H.; Bearden, W. H.; Alcock, N. W.; Solujic, L.; Milosavljevic, E. B. *Polyhedron* **1991**, *10*, 1939–1949.
1744. Usón, R.; Laguna, A.; Laguna, M.; Fernández, E. J.; Villacampa, M. D.; Jones, P. G.; Sheldrick, G. M. *J. Chem. Soc., Dalton Trans.* **1983**, 1679–1685.
1745. Gimeno, M. C.; Jones, P. G.; Laguna, A.; Sarroca, C. *J. Organomet. Chem.* **1999**, *579*, 206–210.
1746. Jones, P. G.; Terroba, R.; Fernández, E.; Laguna, M. *Acta Crystallogr., Sect. E* **2002**, *58*, M90–M92.
1747. Vicente, J.; Bermúdez, M. D.; Carrillo, M. P.; Jones, P. G. *J. Organomet. Chem.* **1993**, *456*, 305–312.
1748. Vicente, J.; Bermúdez, M. D.; Escribano, J.; Carrillo, M. P.; Jones, P. G. *J. Chem. Soc., Dalton Trans.* **1990**, 3083–3089.
1749. Cinellu, M. A.; Zucca, A.; Stoccoro, S.; Minghetti, G.; Manassero, M.; Sansón, M. *J. Chem. Soc., Dalton Trans.* **1995**, 2865–2872.
1750. Bardaji, M.; Gimeno, M. C.; Jiménez, J.; Laguna, A.; Laguna, M.; Jones, P. G. *J. Organomet. Chem.* **1992**, *441*, 339–348.
1751. Bardaji, M.; Laguna, A.; Jones, P. G. *Organometallics* **2001**, *20*, 3906–3912.
1752. Usón, R.; Laguna, A.; Laguna, M.; Manzano, B. R.; Jones, P. G.; Sheldrick, G. M. *J. Chem. Soc., Dalton Trans.* **1984**, 839–844.
1753. Usón, R.; Laguna, A.; Laguna, M.; Manzano, B. R.; Jones, P. G.; Sheldrick, G. M. *J. Chem. Soc., Dalton Trans.* **1985**, 2417–2420.
1754. Fernández, E. J.; Gimeno, M. C.; Jones, P. G.; Laguna, A.; Laguna, M.; López de Luzuriaga, J. M. *J. Chem. Soc., Dalton Trans.* **1992**, 3365–3370.
1755. Fernández, E. J.; Gimeno, M. C.; Jones, P. G.; Laguna, A.; Laguna, M.; López de Luzuriaga, J. M. *Organometallics* **1995**, *14*, 2918–2922.
1756. Fernández, E. J.; Gimeno, M. C.; Laguna, A.; López de Luzuriaga, J. M.; Olmos, M. E. *Polyhedron* **1998**, *17*, 3919–3925.
1757. Bella, P. A.; Crespo, O.; Fernández, E. J.; Fischer, A. K.; Jones, P. G.; Laguna, A.; López de Luzuriaga, J. M.; Monge, M. *J. Chem. Soc., Dalton Trans.* **1999**, 4009–4017.
1758. Ly, T.; Slawin, A. M. Z.; Woollins, J. D. *J. Chem. Soc., Dalton Trans.* **1997**, 1611–1616.
1759. Teixidor, F.; Viñas, C.; Abad, M. M.; Kivekäs, R.; Sillanpää, R. *J. Organomet. Chem.* **1996**, *509*, 139–150.
1760. Jones, P. G.; Villacampa, M. D.; Crespo, O.; Gimeno, M. C.; Laguna, A. *Acta Crystallogr., Sect. C* **1997**, *53*, 570–572.
1761. Fernández, E. J.; Gimeno, M. C.; Jones, P. G.; Laguna, A.; Olmos, E. *Organometallics* **1997**, *16*, 1130–1136.
1762. Chiffey, A. F.; Evans, J.; Lavason, W.; Webster, M. *Polyhedron* **1996**, *15*, 591–596.
1763. Usón, R.; Laguna, A.; Forniés, J.; Valenzuela, I.; Jones, P. G.; Sheldrick, G. M. *J. Organomet. Chem.* **1984**, *273*, 129–139.
1764. Bardaji, M.; Laguna, A.; Orera, V. M.; Villacampa, M. D. *Inorg. Chem.* **1998**, *37*, 5125–5130.
1765. Bardaji, M.; Laguna, A.; Vicente, J.; Jones, P. G. *Inorg. Chem.* **2001**, *40*, 2675–2681.
1766. Fernández, E. J.; Gimeno, M. C.; Laguna, A.; Laguna, M.; López de Luzuriaga, J. M.; Olmos, E. *J. Organomet. Chem.* **1996**, *514*, 169–175.
1767. Fernández, E. J.; Gimeno, M. C.; Jones, P. G.; Laguna, A.; Laguna, M.; Olmos, E. *J. Chem. Soc., Dalton Trans.* **1996**, 3603–3608.
1768. Fernández, E. J.; Gimeno, M. C.; Jones, P. G.; Ahrens, B.; Laguna, A.; Laguna, M.; López de Luzuriaga, J. M. *J. Chem. Soc., Dalton Trans.* **1994**, 3487–3492.
1769. Blanco, M. C.; Fernández, E. J.; Jones, P. G.; Laguna, A.; López de Luzuriaga, J. M.; Olmos, M. E. *Angew. Chem., Int. Ed. Engl.* **1998**, *37*, 3042–3043.
1770. Blanco, M. C.; Fernández, E. J.; López de Luzuriaga, J. M.; Olmos, M. E.; Crespo, O.; Gimeno, M. C.; Laguna, A.; Jones, P. G. *Chem. Eur. J.* **2000**, *6*, 4116–4123.
1771. Blanco, M. C.; Fernández, E. J.; Fischer, A. K.; Jones, P. G.; Laguna, A.; Olmos, M. E.; Villacampa, M. D. *Inorg. Chem. Commun.* **2000**, *3*, 163–165.
1772. Blanco, M. C.; Fernández, E. J.; Olmos, M. E.; Crespo, O.; Laguna, A.; Jones, P. G. *Organometallics* **2002**, *21*, 2426–2429.
1773. Puddephatt, R. J. Gold Metal and Gold Alloys in Electronics and Thin Film Technology. In *Gold, Progress in Chemistry, Biochemistry and Technology*. Schmidbaur, H., Ed.; Wiley: Chichester, U.K., 1999; pp 237–256.
1774. Bravo-Vasquez, J. P.; Hill, R. H. *Polyhedron* **2000**, *19*, 343–349.
1775. Komiyama, S.; Sone, T.; Usui, Y.; Hirano, M.; Fukuoka, A. *Gold Bull.* **1996**, *29*, 131–136.
1776. Vicente, J.; Bermúdez, M. D.; Carrión, F. J.; Jones, P. G. *J. Organomet. Chem.* **1996**, *508*, 53–57.
1777. Pinna, M. V. Ph.D. Thesis, University of Sassari, Italy, 2000.
1778. Cinellu, M. A.; Minghetti, G. *Gold Bull.* **2002**, *35*, 11–20.
1779. Marcon, G.; Carotti, S.; Coronello, M.; Messori, L.; Mini, E.; Orioli, P.; Mazzei, T.; Cinellu, M. A.; Minghetti, G. *J. Med. Chem.* in press.
1780. Cinellu, M. A.; Minghetti, G.; Pinna, M. V.; Stoccoro, S.; Zucca, A.; Manassero, M. *J. Chem. Soc., Dalton Trans.* **2000**, 1261–1265.
1781. Sanna, G.; Pilo, M. I.; Minghetti, G.; Cinellu, M. A.; Spano, N.; Seiber, R. *Inorg. Chim. Acta* **2000**, *310*, 34–40.
1782. Cinellu, M. A.; Minghetti, G.; Pinna, M. V.; Stoccoro, S.; Zucca, A.; Manassero, M. *Chem. Commun.* **1998**, 2397–2398.
1783. Cinellu, M. A.; Minghetti, G.; Pinna, M. V.; Stoccoro, S.; Zucca, A.; Manassero, M. *J. Chem. Soc., Dalton Trans.* **1998**, 1735–1741.
1784. Schmidbaur, H.; Bergebel, M. *Inorg. Chem.* **1966**, *5*, 2069–2075.
1785. Uchida, H.; Saito, N.; Sato, M.; Take, M.; Ogi, K. *Jpn. Kokai Tokkyo Koho JP* 06101046, 1994.
1786. Sone, T.; Iwata, M.; Kasuga, N.; Komiyama, S. *Chem. Lett.* **1991**, 1949–1952.
1787. Usui, Y.; Hirano, M.; Fukuoka, A.; Komiyama, S. *Chem. Lett.* **1997**, 981–982.
1788. Komiyama, S.; Ishikawa, M.; Ozaki, S. *Organometallics* **1988**, *7*, 2238–2243.
1789. Komiyama, S.; Sone, T.; Ozaki, S.; Ishikawa, M.; Kasuga, N. *J. Organomet. Chem.* **1992**, *428*, 303–309.

1790. Sone, T.; Ozaki, S.; Kasuga, N. C.; Fukoaka, A.; Komiyama, S. *Bull. Chem. Soc. Jpn.* **1995**, *68*, 1523–1533.
1791. Cinelli, M. A.; Minghetti, G.; Pinna, M. V.; Stoccoro, S.; Zucca, A.; Manassero, M. *J. Chem. Soc., Dalton Trans.* **1999**, 2823–2831.
1792. Wickleder, M. S.; Büchner, O. *Z. Naturforsch.* **2001**, *56b*, 1340–1343.
1793. Wickleder, M. S.; Esser, K. *Z. Anorg. Allg. Chem.* **2002**, *628*, 911–912.
1794. Jones, P. G.; Schelbach, R.; Schwarzmann, E.; Thöne, C.; Vielmäder, A. *Z. Naturforsch.* **1988**, *43b*, 807–812.
1795. Jones, P. G. *Acta Crystallogr., Sect. C* **1984**, *40*, 804–805.
1796. Jones, P. G.; Schelbach, R.; Schwarzmann, E.; Thöne, C. *Acta Crystallogr., Sect. C* **1988**, *44*, 1196–1199.
1797. Mack, J.; Ortner, K.; Abram, U.; Parish, R. V. *Z. Anorg. Allg. Chem.* **1997**, *623*, 873–879.
1798. Shibata, S.; Iijima, K.; Baum, T. H. *J. Chem. Soc., Dalton Trans.* **1990**, 1519–1520.
1799. Klassen, R. B.; Baum, T. H. *Organometallics* **1989**, *8*, 2477–2482.
1800. Usón, R.; Vicente, J.; Chicote, M. T. *J. Organomet. Chem.* **1981**, *209*, 271–276.
1801. Usón, R.; Laguna, A.; Laguna, M.; Jiménez, J.; Gómez, M. P.; Sainz, A.; Jones, P. G. *J. Chem. Soc., Dalton Trans.* **1990**, 3457–3463.
1802. Jones, P. G.; Thöne, C. *Acta Crystallogr. Sect., C* **1987**, *43*, 1915–1917.
1803. Jones, P. G.; C. *Z. Naturforsch., Teil B* **1991**, *46*, 50–54.
1804. Takahashi, K. *Bull. Chem. Soc. Jpn.* **1991**, *64*, 2572–2574.
1805. Takahashi, K.; Tanino, H. *Chem. Lett.* **1998**, 641–643.
1806. Jones, P. G.; Lautner, J. *Z. Kristallogr.* **1993**, *208*, 130–132.
1807. Jones, P. G.; Bembenek, E. *Z. Kristallogr.* **1993**, *208*, 126–127.
1808. Takahashi, K.; Kato, K. *Bull. Chem. Soc. Jpn.* **1988**, *61*, 991–996.
1809. Nifontova, G. A.; Krasochka, O. N.; Lavrent'ev, I. P.; Makitova, D. D.; Atovmyan, L. O.; Khidekel, M. L. *Izv. Akad. Nauk. SSSR, Ser. Khim.* **1988**, 450–456.
1810. Takahashi, K.; Tanino, H. *Chem. Lett.* **1991**, 1977–1980.
1811. Usón, R.; Laguna, A.; Laguna, M.; Castilla, M. L.; Jones, P. G.; Fittschen, C. *J. Chem. Soc., Dalton Trans.* **1987**, 3017–3022.
1812. Bardaji, M.; Laguna, A.; Laguna, M.; Merchán, F. *Inorg. Chim. Acta* **1994**, *215*, 215–218.
1813. Wang, S.; Fackler, J. P., Jr. *Inorg. Chem.* **1990**, *29*, 4404–4407.
1814. Chen, H. W.; Pappas, C.; Fackler, J. P., Jr. *Inorg. Chim. Acta* **1985**, *96*, 137–142.
1815. Crespo, O.; Canales, F.; Gimeno, M. C.; Jones, P. G.; Laguna, A. *Organometallics* **1999**, *18*, 3142–3148.
1816. Crespo, O.; Gimeno, M. C.; Jones, P. G.; Laguna, A.; Villacampa, M. D. *J. Chem. Soc., Dalton Trans.* **1987**, 2963–2967.
1817. Abram, U.; Mack, J.; Ortner, K.; Müller, M. *J. Chem. Soc., Dalton Trans.* **1998**, 1011–1019.
1818. Lang, E. S.; Dahmer, M.; Abram, U. *Acta Crystallogr., Sect. C* **1999**, *55*, 854–856.
1819. Noth, H.; Beck, W.; Burger, K. *Eur. J. Inorg. Chem.* **1998**, 93–99.
1820. Canales, F.; Gimeno, M. C.; Laguna, A.; Jones, P. G. *Organometallics* **1996**, *15*, 3412–3415.
1821. Calhorda, M. J.; Canales, F.; Gimeno, M. C.; Jiménez, J.; Jones, P. G.; Laguna, A.; Veiros, L. F. *Organometallics* **1997**, *16*, 3837–3844.
1822. Canales, S.; Crespo, O.; Gimeno, M. C.; Jones, P. G.; Laguna, A.; Mendizabal, F. *Organometallics* **2001**, *20*, 4812–4818.
1823. Dell'Amico, D. B.; Calderazzo, F.; Pasqualetti, N.; Hubener, R.; Maichle-Mossmer, C.; Strahle, J. *J. Chem. Soc., Dalton Trans.* **1995**, 3917–3924.
1824. Fabretti, A. C.; Giusti, A.; Malavasi, W. *J. Chem. Soc., Dalton Trans.* **1990**, 3091–3093.
1825. Criado, J. L.; López Arias, J. A.; Macias, B.; Fernández-Lago, L. R.; Salas, J. M. *Inorg. Chim. Acta* **1992**, *193*, 229–235.
1826. Radanovic, D. J.; Matovic, Z. D.; Miletic, V. D.; Battaglia, L. P.; Ianelli, S.; Efimenko, I. A.; Ponticelli, G. *Transition Met. Chem.* **1996**, *21*, 169–175.
1827. Abram, U. *Z. Anorg. Allg. Chem.* **2000**, *626*, 619–620.
1828. Lock, C. J. L.; Turner, M. A.; Parish, R. V.; Potter, G. *Acta Crystallogr., Sect. C* **1988**, *44*, 2082–2084.
1829. Usón, R.; Laguna, A.; Laguna, M.; Castilla, M. L.; Jones, P. G.; Meyer-Bäse, K. *J. Organomet. Chem.* **1987**, *336*, 453–460.
1830. Gimeno, M. C.; Jones, P. G.; Laguna, A.; Sarroca, C.; Calhorda, M. J.; Veiros, L. F. *Chem. Eur. J.* **1998**, *4*, 2308–2314.
1831. Murray, H. H.; Garzón, G.; Raptis, R. G.; Mazany, A. M.; Porter, L. C.; Fackler, J. P., Jr. *Inorg. Chem.* **1988**, *27*, 836–842.
1832. Parish, R. V.; Howe, B. P.; Wright, J. P.; Mack, J.; Pritchard, R. G.; Buckley, R. G.; Elsome, A. M.; Fricker, S. P. *Inorg. Chem.* **1996**, *35*, 1659–1666.
1833. Beckett, M. A.; Crook, J. E.; Greenwood, N. N.; Kennedy, J. D. *J. Chem. Soc., Dalton Trans.* **1984**, 1427–1422.
1834. Bhargava, S. K.; Mohr, F.; Bennett, M. A.; Welling, L. L.; Willis, A. C. *Inorg. Chem.* **2001**, *40*, 4271–4275.
1835. Kirmse, R.; Stach, J.; Dietzsch, W.; Steimecke, G.; Hoyer, E. *Inorg. Chem.* **1980**, *19*, 2679–2684.
1836. Fitzmaurice, J. C.; Slawin, A. M. Z.; Williams, D. J.; Woollins, J. D. *Polyhedron* **1990**, *9*, 1561–1565.
1837. Rovira, C.; Veciana, J.; Rivera, E.; Tarres, J.; Canadell, E.; Rousseau, R.; Mas, M.; Molins, E.; Almeida, M.; Henriques, R. T.; Morgado, J.; Schoeffel, J. P.; Pouget, P. *Angew. Chem., Int. Ed. Engl.* **1997**, *36*, 2324–2324.
1838. Rivera, E.; Rovira, C.; Veciana, J.; Tarres, J.; Canadell, E.; Rousseau, R.; Molins, E.; Mas, M.; Schoeffel, J. P.; Pouget, P.; Morgado, J.; Henriques, R. T.; Almeida, M. *Chem. Eur. J.* **1999**, *5*, 2025–2039.
1839. Tarres, J.; Mas, M.; Molins, E.; Veciana, J.; Rivera, E.; Morgado, J.; Henriques, R. T.; Almeida, M. *J. Mat. Chem.* **1995**, *5*, 1653–1658.
1840. Uruichi, M.; Yakushi, K.; Yamashita, Y.; Qin, J. *J. Mat. Chem.* **1998**, *8*, 141–146.
1841. Kuppasamy, J.; Venkatarakshmi, N.; Manoharan, P. T. *J. Crystallogr. Spectrosc. Res.* **1985**, *15*, 629–632.
1842. Staples, R. J.; Fackler, J. P., Jr. *Z. Kristallogr.* **1995**, *210*, 696–697.
1843. Connelly, N. G.; Crossley, J. G.; Orpen, A. G.; Salter, H. *J. Chem. Soc., Chem. Commun.* **1992**, 1564–1565.
1844. Khan, M. N. I.; Wang, S.; Fackler, J. P., Jr. *Inorg. Chem.* **1989**, *28*, 3579–3588.
1845. Usón, R.; Vicente, J.; Oro, J. *J. Inorg. Chim. Acta* **1981**, *52*, 29–34.

1846. Mazid, M. A.; Razi, M. J.; Sadler, P. J. *Inorg. Chem.* **1981**, *20*, 2872–2876.
1847. Nazrul, M.; Thoruf, N.; Bjornholm, T.; Bechgaard, K. *Acta Crystallogr., Sect. C* **1989**, *46*, 3579–3581.
1848. Staples, R. J.; Fackler, J. P., Jr.; Dávila, R. M.; Albreit, T. E. *Z. Kristallogr.* **1995**, *210*, 383–384.
1849. Nakamoto, M.; Kojima, H.; Paul, M.; Hiller, W.; Schmidbaur, H. *Z. Anorg. Allg. Chem.* **1993**, *619*, 1341–1346.
1850. Gimeno, M. C.; Jones, P. G.; Laguna, A.; Laguna, M.; Terroba, R. *Inorg. Chem.* **1994**, *33*, 3932–3938.
1851. Dávila, R. M.; Staples, R. J.; Fackler, J. P., Jr. *Acta Crystallogr., Sect. C* **1994**, *50*, 1898–1900.
1852. Ehlich, H.; Schier, A.; Schmidbaur, H. *Z. Naturforsch., Teil B* **2002**, *57*, 890–894.
1853. Cerrada, E.; Fernández, E. J.; Gimeno, M. C.; Laguna, A.; Laguna, M.; Terroba, R.; Villacampa, M. D. *J. Organomet. Chem.* **1995**, *492*, 105–110.
1854. Cerrada, E.; Fernández, E. J.; Jones, P. G.; Laguna, A.; Laguna, M.; Terroba, R. *Organometallics* **1995**, *14*, 5537–5543.
1855. Imai, H.; Oksuka, T.; Naito, T.; Awaga, K.; Inabe, T. *J. Am. Chem. Soc.*, **1999**, *121*, 8098–8103.
1856. Yagubskii, E. B.; Ukhin, L. Yu.; Shklover, V. E.; Struchkov, Yu.T.; Dolgopola, N. A.; Belousova, L. V. *Dokl. Akad. Nauk. SSSR* **1986**, *290*, 115–121.
1857. Macharashvili, A. A.; Belousova, L. V.; Morkovnit, Z. S.; Struchkov, Yu.T.; Ukhin, L. Yu.; Shklover, V. E. *Zh. Neorg. Khim.* **1987**, *32*, 1897–1902.
1858. Nagepetyan, S. S.; Arakalova, E. R.; Vetoshkina, L. V.; Struchkov, Yu.T.; Ukhin, L. Yu.; Shklover, V. E. *Zh. Neorg. Khim.* **1989**, *34*, 696–701.
1859. Nagepetyan, S. S.; Arakalova, E. R.; Belousova, L.; Struchkov, Yu.T.; Ukhin, L. Yu.; Shklover, V. E. *Zh. Neorg. Khim.* **1988**, *33*, 160–166.
1860. Honda, K.; Goto, M.; Kurahashi, M.; Miura, Y.; Nakamura, T.; Matsumoto, M.; Kawabata, Y. *Anal. Sci.* **1990**, *6*, 927–928.
1861. Matsubayashi, G.; Yokozawa, A. *J. Chem. Soc., Dalton Trans.* **1990**, 3535–3539.
1862. Matsubayashi, G.; Yokozawa, A. *Inorg. Chim. Acta* **1992**, *193*, 137–142.
1863. Swaminathan, K.; Carol, P. J.; Kochurani; Singh, H. B.; Bhargava, H. D. *Acta Crystallogr., Sect. C* **1993**, *49*, 1243–1246.
1864. Jones, P. G.; Cerrada, E.; Gimeno, M. C.; Laguna, M. *Z. Kristallogr.* **1994**, *209*, 827–828.
1865. Schultz, A. J.; Wang, H. H.; Soderholm, L. C.; Sifter, T. L.; Williams, J. M.; Bechgaard, K.; Wangho, M. H. *Inorg. Chem.* **1987**, *26*, 375–380.
1866. Geiser, U.; Schultz, A. J.; Wang, H. H.; Beno, M. A.; Williams, J. M. *Acta Crystallogr., Sect. C* **1988**, *44*, 259–260.
1867. Takahashi, M.; Robertson, N.; Kobayashi, A.; Becker, H.; Friend, R. H.; Underhill, A. E. *J. Mater. Chem.* **1998**, *8*, 319–324.
1868. Kleinitz, U.; Mattes, R. *Chem. Ber.* **1994**, *127*, 605–609.
1869. Tanaka, H.; Kobayashi, A.; Kobayashi, H. *Bull. Chem. Soc. Jpn.* **1997**, *70*, 3137–3152.
1870. Charlton, A.; Underhill, A. E.; Kobayashi, A.; Kobayashi, H. *J. Chem. Soc., Dalton Trans.* **1995**, 1285–1295.
1871. Lo Shivo, S.; Nicolo, F.; Scopilletti, R.; Tresoldi, G.; Piraino, P. *Inorg. Chim. Acta* **2000**, *304*, 108–113.
1872. Vicente, J.; Chicote, M. T.; González-Herrero, P.; Jones, P. G. *Chem. Commun.* **1997**, 2047–2048.
1873. Crespo, O.; Gimeno, M. C.; Jones, P. G.; Laguna, A. *J. Chem. Soc., Dalton Trans.* **1997**, 1099–1102.
1874. Cerrada, E.; Jones, P. G.; Laguna, A.; Laguna, M. *Inorg. Chem.* **1996**, *35*, 2995–3000.
1875. Takahashi, M.; Robertson, N.; Clark, R. J. H.; Underhill, A. E. *Polyhedron* **1999**, *18*, 1545–1548.
1876. Crespo, O.; Gimeno, M. C.; Jones, P. G.; Laguna, A. *J. Organomet. Chem.* **1997**, *547*, 89–95.
1877. Vicente, J.; Chicote, M. T.; González-Herrero, P.; Jones, P. G.; Humphrey, M. G.; Cifuentes, M. P. Samoc M.; Luther-Davies, B. *Inorg. Chem.* **1999**, *38*, 5018–5026.
1878. Brunn, K.; Endres, H.; Weiss, J. *Z. Naturforsch., Teil B* **1988**, *43*, 224–229.
1879. Jentsch, D.; Jones, P. G.; Thöne, C.; Schwarzmann, E. *J. Chem. Soc., Chem. Commun.* **1989**, 1495–1496.
1880. Chiari, B.; Piovesana, O.; Tarantelli, T.; Zanazzi, P. F. *Inorg. Chem.* **1985**, *24*, 366–371.
1881. Mansour, M. A.; Lachicotte, R. J.; Gysling, H. J.; Eisenberg, R. *Inorg. Chem.* **1998**, *37*, 4625–4632.
1882. Laguna, A.; Laguna, M.; Rojo, A.; Fraile, M. N. *J. Organomet. Chem.* **1986**, *315*, 269–276.
1883. Alvarez, B.; Fernández, E. J.; Gimeno, M. C.; Jones, P. G.; Laguna, A.; López de Luzuriaga, J. M. *Polyhedron* **1998**, *17*, 2029–2035.
1884. Laguna, A.; Laguna, M.; Fraile, M. N.; Fernández, E.; Jones, P. G. *Inorg. Chim. Acta* **1988**, *150*, 233–236.
1885. Gimeno, M. C.; Jones, P. G.; Laguna, A.; Sarroca, A. *J. Organomet. Chem.* **2000**, *596*, 10–15.
1886. Fernández, E. J.; Gimeno, M. C.; Jones, P. G.; Laguna, A.; López de Luzuriaga, J. M.; Olmos, E. *J. Chem. Soc., Dalton Trans.* **1997**, 3515–3518.
1887. Bigoli, F.; Deplano, P.; Mercuri, M. L.; Pellingheli, M. A.; Pintus, G.; Serpe, G.; Trogu, E. F. *Chem. Commun.* **1998**, 2351–2352.
1888. Blake, A. J.; Gould, R. O.; Greig, J. A.; Holder, A. J.; Hyde, T. I.; Schröder, M. *J. Chem. Soc., Chem. Commun.* **1989**, 876–878.
1889. Vicente, J.; Chicote, M. T.; González-Herrero, P.; Jones, P. G. *Inorg. Chem.* **1997**, *36*, 5735–5739.
1890. Wang, C.; Haushalter, R. C.; Whangbo, M. H. *Inorg. Chem.* **1998**, *37*, 6096–6099.
1891. Strähle, J.; Gelinek, J.; Koelmel, M.; Nemecek, A. M. *Z. Naturforsch., Teil B* **1979**, *34*, 1047–1052.
1892. Werner, W.; Strähle, J. *Z. Naturforsch., Teil B* **1979**, *34*, 952–958.
1893. Kitagawa, H.; Kojima, N.; Nakajima, T. *J. Chem. Soc., Dalton Trans.* **1991**, 3121–3125.
1894. Kojima, N.; Hasegawa, M.; Kitagawa, H.; Kikegawa, T.; Shimomura, O. *J. Am. Chem. Soc.*, **1994**, *116*, 11368–11374.
1895. Hwang, I. C.; Seppelt, K. *Z. Anorg. Allg. Chem.* **2002**, *628*, 765–769.
1896. Bialowons, H.; Müller, B. G. *Z. Anorg. Allg. Chem.* **1997**, *623*, 1719–1722.
1897. Schmidt, R.; Müller, B. G. *Z. Anorg. Allg. Chem.* **1999**, *625*, 602–604.
1898. Jones, P. G.; Schelbach, R.; Schwarzmann, E. *Acta Crystallogr., Sect. C* **1987**, *43*, 607–609.
1899. Erdbrüger, C. F.; Jones, P. G.; Schelbach, R.; Schwarzmann, E.; Sheldrick, G. M. *Acta Crystallogr., Sect. C* **1987**, *43*, 1857–1859.
1900. Jones, P. G.; Schelbach, R.; Schwarzmann, E.; Thöne, C. *Acta Crystallogr., Sect. C* **1988**, *44*, 1198–1200.
1901. Jones, P. G.; Hohbein, R.; Schwarzmann, E. *Acta Crystallogr., Sect. C* **1988**, *44*, 1164–1166.

1902. Jones, P. G.; Schelbach, R.; Schwarzmann, E.; Thöne, C. *Acta Crystallogr., Sect. C* **1988**, *44*, 1162–1164.
1903. Jones, P. G.; Jentsch, D.; Schwarzmann, E. *Acta Crystallogr., Sect. C* **1988**, *44*, 210–212.
1904. Schröder, U.; Richter, R.; Hartung, J.; Abram, U.; Beyer, L. *Z. Naturforsch., Teil B* **1997**, *52*, 620–628.
1905. Peloso, A. *J. Chem. Soc., Dalton Trans.* **1983**, 1285–1290.
1906. Hasan, M.; Kozhevnikov, I. V.; Siddiqui, M. R. H.; Steiner, A.; Winterton, N. *Inorg. Chem.* **1999**, *38*, 5637–5641.
1907. Goher, M. A. S.; Kafez, A. K.; Yip, W. H.; Mak, T. C. W. *J. Crystallogr. Spectrosc. Res.* **1992**, *22*, 317–322.
1908. Schulz Lang, E.; Abram, U.; Strähle, J. *Z. Anorg. Allg. Chem.* **1997**, *623*, 1791–1795.
1909. Schulz Lang, E.; Abram, U.; Strähle, J.; Vázquez-López, E. M. *Z. Anorg. Allg. Chem.* **1999**, *625*, 359–362.
1910. Schulz Lang, E.; Strähle, J. *Z. Anorg. Allg. Chem.* **1996**, *622*, 981–984.
1911. Beck, J.; Wagner, Z. *Anorg. Allg. Chem.* **1997**, *623*, 1810–1814.
1912. Monlien, F. J.; Helm, L.; Abou-Hamdan, A.; Merbach, A. E. *Inorg. Chim. Acta* **2002**, *331*, 257–269.
1913. Kumazawa, T.; Kitamura, M. Idemitsu Kosan Co., Ltd., Jpn Kokai Tokkyo Koho, 61–118334[86–118334], pp 1–7, 1986..
1914. Shulpin, G. B.; Shilov, A. E.; SussFink, G. *Tetrahedron Lett.* **2001**, *42*, 7253–256.
1915. Hutching, G. J.; Joffe, R. *Appl. Catal.* **1986**, *20*, 215–221.
1916. Nkosi, B.; Adams, M. D.; Coville, N. J.; Hutchings, G. J. *J. Catal.* **1991**, *128*, 378–386.
1917. Nkosi, B.; Adams, M. D.; Coville, N. J.; Hutchings, G.; Adams, M. D.; Friedl, J.; Wagner, F. E. *J. Catal.* **1991**, *128*, 366–377.
1918. Hashmi, S. K.; Schwarz, L.; Choi, J. H.; Frost, T. M. *Angew. Chem., Int. Ed. Engl.* **2000**, *39*, 2285–2288.
1919. Hashmi, A. S. K.; Frost, T. M.; Bats, J. W. *J. Am. Chem. Soc.*, **2000**, *122*, 11553–11554.
1920. Hashmi, A. S. K.; Frost, T. M.; Bats, J. W. *Org. Lett.* **2001**, *3*, 3769–3771.
1921. Hashmi, A. S. K.; Frost, T. M.; Bats, J. W. *Catal. Today* **2002**, *72*, 19–27.
1922. Hoffmann-Roder, A.; Krause, N. *Org. Lett.* **2001**, *3*, 2537–2538.
1923. Constable, E. C.; Leese, T. A. *J. Organomet. Chem.* **1989**, *363*, 419–426.
1924. Fuchita, Y.; Ieda, H.; Tsunemune, Y.; Kinoshita-Kawashima, J.; Kawano, H. *J. Chem. Soc., Dalton Trans.* **1998**, 791–796.
1925. Fuchita, Y.; Ieda, H.; Tsunemune, Y.; Kayama, A.; Kinoshita-Nagaoka, J.; Kawano, H.; Kameda, S.; Mikuriya, M. *J. Chem. Soc., Dalton Trans.* **1998**, 4095–4100.
1926. Nonoyama, M.; Nakajima, K. *Polyhedron* **1997**, *16*, 4039–4044.
1927. Nonoyama, M.; Nakajima, K. *Transition Met. Chem.* **1999**, *24*, 449–453.
1928. Fuchita, Y.; Ieda, H.; Wada, S.; Kameda, S.; Mikuriya, M. *J. Chem. Soc., Dalton Trans.* **1999**, 4431–4435.
1929. Vicente, J.; Chicote, M. T.; Lozano, M. I.; Huertas, S. *Organometallics* **1999**, *18*, 753–757.
1930. Nonoyama, M. *Synth. React. Inorg. Met.-Org. Chem.* **1999**, *29*, 119–124.
1931. Fuchita, Y.; Ieda, H.; Yasutake, M. *J. Chem. Soc., Dalton Trans.* **2000**, 271–274.
1932. Ieda, H.; Fujiwara, H.; Fuchita, Y. *Inorg. Chim. Acta* **2001**, *319*, 203–206.
1933. Constable, E. C.; Henney, R. P. G.; Raithby, P. R.; Sousa, L. R. *J. Chem. Soc., Dalton Trans.* **1992**, 2251–2256.
1934. Constable, E. C.; Henney, R. P. G.; Raithby, P. R.; Sousa, L. R. *Angew. Chem., Int. Ed. Engl.* **1991**, *30*, 1363–1364.
1935. Constable, E. C.; Henney, R. P. G.; Leese, T. A. *J. Organomet. Chem.* **1989**, *361*, 277–283.
1936. Vicente, J.; Chicote, M. T.; Bermúdez, M. D. *Inorg. Chim. Acta* **1982**, *63*, 35–41.
1937. Vicente, J.; Chicote, M. T.; Bermúdez, M. D. *J. Organomet. Chem.* **1984**, *268*, 191–197.
1938. Bonnardel, P. A.; Parish, R. V.; Pritchard, R. G. *J. Chem. Soc., Dalton Trans.* **1996**, 3185–3193.
1939. Parish, R. V.; Wright, J. P.; Pritchard, R. G. *J. Organomet. Chem.* **2000**, *596*, 165–176.
1940. Vicente, J.; Bermúdez, M. D.; Carrion, F. J.; Jones, P. G. *Chem. Ber.* **1996**, *129*, 1301–1306.
1941. Vicente, J.; Bermúdez, M. D.; Chicote, M. T.; Sánchez-Santano, M. J. *J. Organomet. Chem.* **1990**, *381*, 285–292.
1942. Vicente, J.; Bermúdez, M. D.; Chicote, M. T.; Sánchez-Santano, M. J.; Jones, P. G. *J. Organomet. Chem.* **1988**, *354*, 381–387.
1943. Vicente, J.; Bermúdez, M. D.; Escribano, J. *Organometallics* **1991**, *10*, 3380–3384.
1944. Chan, C. W.; Wong, W. T.; Che, C. M. *Inorg. Chem.* **1994**, *33*, 1266–1272.
1945. Liu, H. Q.; Cheung, T. C.; Peng, S. M.; Che, C. M. *J. Chem. Soc., Chem. Commun.* **1995**, 1787–1788.
1946. Cinellu, M. A.; Zucca, A.; Stoccoro, S.; Minghetti, G.; Manassero, M.; Sansoni, M. *J. Chem. Soc., Dalton Trans.* **1996**, 4217–4225.
1947. Sanna, G.; Pilo, M. I.; Spano, N.; Minghetti, G.; Cinellu, M. A.; Zucca, A.; Seeber, R. *J. Organomet. Chem.* **2001**, *622*, 47–53.
1948. Henderson, W.; Nicholson, B. K.; Faville, S. J.; Fan, D.; Ranford, J. D. *J. Organomet. Chem.* **2001**, *631*, 41–46.
1949. Dinger, M. B.; Henderson, W. *J. Organomet. Chem.* **1999**, *577*, 219–222.
1950. Dinger, M. B.; Henderson, W. *J. Organomet. Chem.* **1998**, *557*, 231–241.
1951. Dinger, M. B.; Henderson, W. *J. Organomet. Chem.* **1997**, *547*, 243–252.
1952. Dinger, M. B.; Henderson, W.; Nicholson, B. K.; Robinson, W. T. *J. Organomet. Chem.* **1998**, *560*, 169–181.
1953. Buckley, R. G.; Elsome, A. M.; Fricker, S. P.; Henderson, G. R.; Theobald, B. R. C.; Parish, R. V.; Howe, B. P.; Kelland, L. R. *J. Med. Chem.* **1996**, *39*, 5208–5214.
1954. Dinger, M. B.; Henderson, W. *J. Organomet. Chem.* **1998**, *560*, 233–243.
1955. Ortner, K.; Abram, U. *Inorg. Chem. Commun.* **1998**, *1*, 251–253.
1956. Ortner, K.; Abram, U. *Polyhedron* **1999**, *18*, 749–754.
1957. Vicente, J.; Bermúdez, M. D.; Chicote, M. T.; Sánchez-Santano, M. J. *J. Chem. Soc., Chem. Commun.* **1989**, 141–142.
1958. Vicente, J.; Bermúdez, M. D.; Chicote, M. T.; Sánchez-Santano, M. J. *J. Chem. Soc., Dalton Trans.* **1990**, 1945–1950.
1959. Henderson, W.; Nicholson, B. K.; Faville, S. J.; Fan, D.; Ranford, J. D. *J. Organomet. Chem.* **2001**, *631*, 41–46.
1960. Dinger, M. B.; Henderson, W. *J. Organomet. Chem.* **1999**, *577*, 219–222.
1961. Dinger, M. B.; Henderson, W. *J. Organomet. Chem.* **1998**, *557*, 231–241.
1962. Dinger, M. B.; Henderson, W. *J. Organomet. Chem.* **1997**, *547*, 243–252.
1963. Vicente, J.; Bermúdez, M. D.; Carrillo, M. P.; Jones, P. G. *J. Chem. Soc., Dalton Trans.* **1992**, 1975–1979.
1964. Contel, M.; Nobel, D.; Spek, A. L.; van Koten, G. *Organometallics* **2000**, *19*, 3288–3295.

1965. Calamai, P.; Carotti, S.; Guerri, A.; Mazzei, T.; Messori, L.; Mini, E.; Orioli, P.; Speroni, G. P. *Anticancer Drug Des.* **1998**, *13*, 67–80.
1966. Calamai, P.; Guerri, A.; Messori, L.; Orioli, P.; Speroni, G. P. *Inorg. Chim. Acta* **1999**, *285*, 309–312.
1967. Hueso-Ureña, F.; Illán-Cabeza, N. A.; Moreno-Carretero, M. N.; Peñas-Chamorro, A. L. *Transition Met. Chem.* **2001**, *26*, 160–163.
1968. Barnholtz, S. L.; Lydon, J. D.; Huang, G.; Venkatesh, M.; Barnes, C. L.; Ketring, A. R.; Jurisson, S. S. *Inorg. Chem.* **2001**, *40*, 972–976.
1969. Ortner, K.; Hilditch, L.; Zheng, Y.; Dilworth, J. R.; Abram, U. *Inorg. Chem.* **2000**, *39*, 2801–2806.
1970. Dilworth, J. R.; Hutson, A. J.; Zubietta, J.; Chen, Q. *Transition Met. Chem.* **1994**, *19*, 61–64.
1971. Vickery, J. C.; Balch, A. L. *Inorg. Chem.* **1997**, *36*, 5978–5983.
1972. Fernández, E. J.; Gil, M.; Olmos, M. E.; Crespo, O.; Laguna, A.; Jones, P. G. *Inorg. Chem.* **2001**, *40*, 3018–3024.
1973. Assmann, B.; Angermaier, K.; Paul, M.; Riede, J.; Schmidbaur, H. *Chem. Ber.* **1995**, *128*, 891–900.
1974. Usón, R.; Laguna, A.; Laguna, M.; Fraile, M. N.; Jones, P. G.; Erdbrügger, C. F. *J. Chem. Soc., Dalton Trans.* **1989**, 73–77.
1975. Usón, R.; Laguna, A.; Laguna, M.; Lázaro, I.; Jones, P. G. *Organometallics* **1987**, *6*, 2326–2331.
1976. Gimeno, M. C.; Jones, P. G.; Laguna, A.; Laguna, M.; Lázaro, I. *J. Chem. Soc., Dalton Trans.* **1993**, 2223–2227.
1977. Usón, R.; Laguna, A.; Laguna, M.; Lázaro, I.; Jones, P. G.; Fittschen, C. *J. Chem. Soc., Dalton Trans.* **1988**, 2323–2327.
1978. Bardaji, M.; Gimeno, M. C.; Jones, P. G.; Laguna, A.; Laguna, M.; Merchán, F.; Romeo, I. *Organometallics* **1997**, *16*, 1083–1085.
1979. Bariain, C.; Matias, I. R.; Romeo, I.; Garrido, J.; Laguna, M. *Sens. Actuators, B* **2001**, *76*, 25–31.
1980. Parish, R. V.; Boyer, P.; Fowler, A.; Kahn, T. A.; Cross, W. I.; Pritchard, R. G. *J. Chem. Soc., Dalton Trans.* **2000**, 2287–2294.
1981. Herring, F. G.; Hwang, G.; Lee, K. C.; Mistry, F.; Phillips, P. S.; Willner, H.; Aubke, F. *J. Am. Chem. Soc.*, **1992**, *114*, 1271–1276.
1982. Elder, S. H.; Lucier, G. M.; Hollander, F. J.; Bartlett, N. *J. Am. Chem. Soc.*, **1997**, *119*, 1020–1026.
1983. Koley, A. P.; Purohit, S.; Ghosh, S.; Prasad, L. S.; Manoharn, P. T. *J. Chem. Soc., Dalton Trans.* **1988**, 2607–2612.
1984. Ihlo, L.; Böttcher, R.; Olk, R.-M.; Kirmse, R. *Inorg. Chim. Acta* **1998**, *281*, 160–164.
1985. Ihlo, L.; Stöber, R.; Hofbauer, W.; Böttcher, R.; Kirmse, R. *Z. Naturforsch.* **1999**, *54b*, 597–602.
1986. Ihlo, L.; Olk, R. M.; Kirmse, R. *Inorg. Chem. Commun.* **2001**, *4*, 626–628.
1987. Blake, A. J.; Greig, J. A.; Holder, A. L.; Hyde, T. I.; Taylor, A.; Schröder, M. *Angew. Chem., Int. Ed. Engl.* **1990**, *29*, 197–198.
1988. Matsumoto, M.; Itoh, M.; Funahashi, S.; Takagi, H. D. *Can. J. Chem.* **1999**, *77*, 1638–1647.
1989. Kampf, M.; Olk, R. M.; Kirmse, R. *Z. Anorg. Allg. Chem.* **2002**, *628*, 34–36.
1990. Kadish, K. M.; Wenbo, E.; Ou, Z.; Shao, J.; Sintic, P. J.; Ohkubo, K.; Fukuzime, S.; Crossley, M. J. *J. Chem. Soc., Chem. Commun.* **2002**, 356–357.
1991. Walker, N. R.; Wright, R. R.; Barran, P. E.; Stace, A. J. *Organometallics* **1999**, *18*, 3569–3571.
1992. Walker, N. R.; Wright, R. R.; Barran, P. E.; Murrell, J. N.; Stace, A. J. *J. Am. Chem. Soc.* **2001**, *123*, 4223–4227.
1993. Pyykkö, P. *Science* **2000**, *290*, 64–65.
1994. Wickleder, M. S. *Z. Anorg. Allg. Chem.* **2001**, *627*, 2112–2114.
1995. Yam, V. W. W.; Choi, S. W. K.; Cheung, K. K. *J. Chem. Soc., Chem. Commun.* **1996**, 1173–1174.
1996. Yam, V. W. W.; Li, C. K.; Chan, C. L.; Cheung, K. K. *Inorg. Chem.* **2001**, *40*, 7054–7058.
1997. Gimeno, M. C.; Jiménez, J.; Jones, P. G.; Laguna, A.; Laguna, M. *Organometallics* **1994**, *13*, 2508–2511.
1998. Calabro, D. C.; Harrison, B. A.; Palmer, G. T.; Moguel, M. K.; Rebbert, R. L.; Burmeister, J. L. *Inorg. Chem.* **1981**, *20*, 4311–4316.
1999. Khan, M. N. I.; Fackler, J. P., Jr.; King, C.; Wang, J. C.; Wang, S. *Inorg. Chem.* **1988**, *27*, 1672–1673.
2000. Porter, L. C.; Fackler, J. P., Jr. *Acta Crystallogr., Sect. C* **1987**, *43*, 587–590.
2001. Carlson, T. F.; Fackler, J. P., Jr. *J. Organomet. Chem.* **2000**, *596*, 237–241.
2002. Bennett, M. A.; Bhargava, S. K.; Griffiths, K. D.; Robertson, G. B. Wickramasinghe W. A. *Angew. Chem., Int. Ed. Engl.* **1987**, *26*, 258–259.
2003. Bennett, M. A.; Bhargava, S. K.; Griffiths, K. D.; Robertson, G. B. *Angew. Chem., Int. Ed. Engl.* **1987**, *26*, 260–261.
2004. Bennett, M. A.; Bhargava, S. K.; Hockless, D. C. R.; Welling, L. L.; Willis, A. C. *J. Am. Chem. Soc.* **1996**, *118*, 10469–10478.
2005. Bennett, M. A.; Hockless, D. C. R.; Rae, A. D.; Welling, L. L.; Willis, A. C. *Organometallics* **2001**, *20*, 79–87.
2006. Bhargava, S. K.; Mohr, F.; Bennett, M. A.; Welling, L. L.; Willis, A. C. *Organometallics* **2000**, *19*, 5628–5635.
2007. Bhargava, S. K.; Mohr, F.; Gorman, J. D. *J. Organomet. Chem.* **2000**, *607*, 93–96.
2008. Bhargava, S. K.; Mohr, F.; Takahashi, M.; Takeda, M. *Bull. Chem. Soc. Jpn.* **2001**, *74*, 1051–1053.
2009. Murray, H. H.; Briggs, D. A.; Garzon, G.; Raptis, R. G.; Porter, L. C.; Fackler, J. P., Jr. *Organometallics* **1987**, *6*, 1992–1997.
2010. Clark, R. J. H.; Tocher, J. H.; Fackler, J. P., Jr.; Neira, R.; Murray, H. H.; Knachel, H. *J. Organomet. Chem.* **1986**, *303*, 437–445.
2011. Basil, J.; Murray, H. H.; Facker, J. P., Jr.; Tocher, J.; Mazany, A. M.; Trzcinska-Bancroft, B.; Knachel, H.; Dudis, D.; Delord, T. J.; Marler, D. O. *J. Am. Chem. Soc.* **1985**, *107*, 6908–6913.
2012. Murray, H. H.; Facker, J. P., Jr.; Porter, L. C.; Mazany, A. M. *J. Chem. Soc., Chem. Commun.* **1986**, 321–322.
2013. Fackler, J. P., Jr.; Basil, J. D. *Organometallics* **1982**, *1*, 871–876.
2014. Knachel, H.; Dudis, D. S.; Fackler, J. P. *Organometallics* **1984**, *3*, 1312–1317.
2015. Porter, L. C.; Fackler, J. P., Jr. *Acta Crystallogr., Sect. C* **1986**, *42*, 1128–1131.
2016. Porter, L. C.; Fackler, J. P., Jr. *Acta Crystallogr., Sect. C* **1986**, *42*, 1646–1649.
2017. Porter, L. C.; Fackler, J. P., Jr. *Acta Crystallogr., Sect. C* **1987**, *43*, 29–31.
2018. Friedrich, H. B.; Moss, J. R. *Adv. Organomet. Chem.* **1991**, *33*, 235–290.
2019. Murray, H. H.; Fackler, J. P., Jr. *Inorg. Chim. Acta* **1986**, *115*, 207–213.
2020. Murray, H. H.; Fackler, J. P., Jr.; Trzcinska-Bancroft, B. *Organometallics* **1985**, *4*, 1633–1638.
2021. Fackler, J. P., Jr.; Murray, H. H.; Basil, J. D. *Organometallics* **1984**, *3*, 821–826.

2022. Murray, H. H.; Mazany, A. M.; Fackler, J. P., Jr. *Organometallics* **1985**, *4*, 154–160.
2023. Trzcinska-Bancroft, B.; Khan, M. N. I.; Fackler, J. P., Jr. *Organometallics* **1988**, *7*, 993–998.
2024. Murray, H. H.; Fackler, J. P., Jr.; Porter, L. C.; Briggs, D. A.; Guerra, M. A.; Lagow, R. J. *Inorg. Chem.* **1987**, *26*, 357–363.
2025. Usón, R.; Laguna, A.; Laguna, M.; Jiménez, J.; Jones, P. G. *Angew. Chem., Int. Ed. Engl.* **1991**, *30*, 198–199.
2026. Usón, R.; Laguna, A.; Laguna, M.; Jiménez, J.; Jones, P. G. *J. Chem. Soc., Dalton Trans.* **1991**, 1361–1365.
2027. Laguna, A.; Laguna, M.; Jiménez, J.; Lahoz, F. J.; Olmos, E. *J. Organomet. Chem.* **1992**, *435*, 235–247.
2028. Laguna, A.; Laguna, M.; Jiménez, J.; Lahoz, F. J.; Olmos, E. *Organometallics* **1994**, *13*, 253–257.
2029. Bardají, M.; Blasco, A.; Jiménez, J.; Jones, P. G.; Laguna, A.; Laguna, M.; Merchán, F. *Inorg. Chim. Acta* **1994**, *223*, 55–61.
2030. Schmidbaur, H.; Hartmann, C.; Wagner, F. E.; Reber, G.; Müller, G. *Angew. Chem., Int. Ed. Engl.* **1987**, *26*, 1146–1147.
2031. Schmidbaur, H.; Hartmann, C.; Wagner, F. E. *Angew. Chem., Int. Ed. Engl.* **1987**, *26*, 1148–1149.
2032. Bardají, M.; Jones, P. G.; Laguna, A. *Eur. J. Inorg. Chem.* **1998**, 989–992.
2033. Heinrich, D. D.; Fackler, J. P., Jr. *J. Chem. Soc., Chem. Commun.* **1987**, 1260–1261.
2034. Fackler, J. P., Jr.; Porter, L. C. *J. Am. Chem. Soc.* **1986**, *108*, 2750–2755.
2035. Gimeno, M. C.; Jiménez, J.; Jones, P. G.; Laguna, A.; Laguna, M.; Parish, R. V. *J. Organomet. Chem.* **1994**, *481*, 37–44.
2036. Bardají, M.; Gimeno, M. C.; Jones, P. G.; Laguna, A.; Laguna, M. *Organometallics* **1994**, *13*, 3415–3419.
2037. Bardají, M.; Jones, P. G.; Laguna, A.; Laguna, M. *Organometallics* **1995**, *14*, 1310–1315.
2038. Bardají, M.; Connolly, N. G.; Gimeno, M. C.; Jones, P. G.; Laguna, A.; Laguna, M. *J. Chem. Soc., Dalton Trans.* **1995**, 2245–2250.
2039. Bardají, M.; Laguna, A.; Laguna, M. *J. Organomet. Chem.* **1995**, *496*, 245–248.
2040. Van Zyl, W. E.; López de Luzuriaga, J. M.; Fackler, J. P., Jr.; Staples, R. J. *Can. J. Chem.* **2001**, *79*, 896–903.
2041. Findeis, B.; Contel, M.; Gade, L. H.; Laguna, M.; Gimeno, M. C.; Scowen, I. J.; McPartlin, M. *Inorg. Chem.* **1997**, *36*, 2386–2390.
2042. Bardají, M.; Cerrada, E.; Jones, P. G.; Laguna, A.; Laguna, M. *J. Chem. Soc., Dalton Trans.* **1997**, 2263–2266.
2043. Howard, J. A. K.; Jeffery, J. C.; Jelliss, P. A.; Sommerfeld, T.; Stone, F. G. A. *J. Chem. Soc., Chem. Commun.* **1991**, 1664–1666.
2044. Jeffery, J. C.; Jelliss, P. A.; Stone, F. G. A. *Inorg. Chem.* **1993**, *32*, 3382–3384.
2045. Jeffery, J. C.; Jelliss, P. A.; Stone, F. G. A. *J. Chem. Soc., Dalton Trans.* **1994**, 25–32.
2046. Jeffery, J. C.; Jelliss, P. A.; Stone, F. G. A. *J. Chem. Soc., Dalton Trans.* **1993**, 1073–1081.
2047. Jeffery, J. C.; Jelliss, P. A.; Stone, F. G. A. *J. Chem. Soc., Dalton Trans.* **1993**, 1083–1091.
2048. Jeffery, J. C.; Jelliss, P. A.; Stone, F. G. A. *Inorg. Chem.* **1993**, *32*, 3943–3947.
2049. Hamilton, E. J. M.; Welch, A. J. *Polyhedron* **1990**, *9*, 2407–2412.
2050. Hamilton, E. J. M.; Welch, A. J. *Acta Crystallogr., Sect. C* **1990**, *46*, 1228–1231.
2051. Jeffery, J. C.; Jelliss, P. A.; Stone, F. G. A. *Organometallics* **1994**, *13*, 2651–2661.
2052. Wynd, A. J.; Robins, S. E.; Welch, D. A.; Welch, A. J. *J. Chem. Soc., Chem. Commun.* **1985**, 819–820.
2053. Wynd, A. J.; McLennan, A. J.; Reed, D.; Welch, A. J. *J. Chem. Soc., Dalton Trans.* **1987**, 2761–2766.
2054. Wynd, A. J.; Welch, A. J.; Parish, R. V. *J. Chem. Soc., Dalton Trans.* **1990**, 2185–2193.
2055. Wynd, A. J.; Welch, A. J. *J. Chem. Soc., Dalton Trans.* **1990**, 2803–2807.
2056. Barker, G. K.; Godfrey, N. R.; Green, M.; Parge, H. E.; Stone, F. G. A.; Welch, A. J. *J. Chem. Soc., Chem. Commun.* **1983**, 277–279.
2057. McLennan, A. J.; Welch, A. J. *Acta Crystallogr., Sect. C* **1989**, *45*, 1721–1722.
2058. Franken, A.; Preetz, W. *Chem. Ber.* **1997**, *130*, 405–407.
2059. Schaper, T.; Näther, C.; Preetz, W. *Z. Naturforsch.* **1999**, *54b*, 345–348.
2060. Alcock, N. W.; Parkhill, L.; Wallbridge, M. G. H. *Acta Crystallogr., Sect. C* **1985**, *41*, 716–719.
2061. Blumenthal, A.; Beruda, H.; Schmidbaur, H. *J. Chem. Soc., Chem. Commun.* **1993**, 1005–1006.
2062. Blumenthal, A. Diss. TU München, 1995.
2063. Housecroft, C. E.; Rheingold, A. L. *J. Am. Chem. Soc.*, **1986**, *108*, 6420–6425.
2064. Housecroft, C. E.; Rheingold, A. L. *Organometallics* **1987**, *6*, 1332–1337.
2065. Harpp, K. S.; Housecroft, C. E.; Rheingold, A. L.; Shongwe, M. S. *J. Chem. Soc., Chem. Commun.* **1988**, 965–966.
2066. Housecroft, C. E.; Shongwe, M. S.; Rheingold, A. L. *Organometallics* **1988**, *7*, 1885–1890.
2067. Housecroft, C. E.; Shongwe, M. S.; Rheingold, A. L. *Organometallics* **1989**, *8*, 2651–2656.
2068. Housecroft, C. E.; Rheingold, A. L.; Shongwe, M. S. *J. Chem. Soc., Chem. Commun.* **1988**, 1630–1631.
2069. Housecroft, C. E.; Shongwe, M. S.; Rheingold, A. L.; Zanello, P. *J. Organomet. Chem.* **1991**, *408*, 7–18.
2070. Draper, S. M.; Housecroft, C. E.; Rees, J. E.; Shongwe, M. S.; Haggerty, B. S.; Rheingold, A. L. *Organometallics* **1992**, *11*, 2356–2361.
2071. Ellis, D. D.; Franken, A.; Stone, F. G. A. *Organometallics* **1999**, *18*, 2362–2369.
2072. Hattersley, A. D.; Housecroft, C. E.; Rheingold, A. L. *Inorg. Chim. Acta* **1999**, *289*, 149–157.
2073. Draper, S. M.; Housecroft, C. E.; Rheingold, A. L. *J. Organomet. Chem.* **1992**, *435*, 9–17.
2074. Housecroft, C. E.; Nixon, D. M.; Rheingold, A. L. *Polyhedron* **1999**, *18*, 2415–2421.
2075. Chipperfield, A. K.; Housecroft, C. E.; Rheingold, A. L. *Organometallics* **1990**, *9*, 681–687.
2076. Galsworthy, J. R.; Housecroft, C. E.; Rheingold, A. L. *J. Chem. Soc., Dalton Trans.* **1996**, 2917–2922.
2077. Housecroft, C. E.; Matthews, D. M.; Rheingold, A. L. *Organometallics* **1992**, *11*, 2959–2964.
2078. Galsworthy, J. R.; Housecroft, C. E.; Rheingold, A. L. *J. Chem. Soc., Dalton Trans.* **1995**, 2639–2647.
2079. Hattersley, A. D.; Housecroft, C. E.; Rheingold, A. L. *J. Chem. Soc., Dalton Trans.* **1996**, 603–610.
2080. Mancho, W.; Gall, H. *Chem. Ber.* **1925**, *58b*, 2175–2180.
2081. Kharash, M. S.; Isbell, H. S. *J. Am. Chem. Soc.*, **1931**, *52*, 2919–2922.
2082. Belli Dell'Amico, D.; Calderazzo, F.; Robino, P.; Segre, A. *Gazz. Chim. Ital.* **1991**, *121*, 51–52.
2083. Belli Dell'Amico, D.; Calderazzo, F.; Robino, P.; Segre, A. *J. Chem. Soc., Dalton Trans.* **1991**, 3017–3022.
2084. Willner, H.; Aubke, F. *Inorg. Chem.* **1990**, *29*, 2195–2200.
2085. Küster, R.; Seppelt, K. *Z. Anorg. Allg. Chem.* **2000**, *626*, 236–240.

2086. Dias, H. V. R.; Jin, W. C. *Inorg. Chem.* **1996**, *35*, 3687–3694.
2087. Jones, P. G.; Maddock, A. G.; Mays, M. J.; Muir, M. M.; Williams, A. F. *J. Chem. Soc., Dalton Trans.* **1977**, 1434–1439.
2088. Jones, P. G. *Z. Naturforsch., Teil B* **1982**, *37*, 823–829.
2089. Veldkamp, A.; Frenking, G. *Organometallics* **1993**, *12*, 4613–4622.
2090. Mendizabal, F. *Organometallics* **2001**, *20*, 261–265.
2091. Xu, Q.; Imamuza, Y.; Fujiwara, M.; Souma, Y. *J. Org. Chem.* **1997**, *62*, 1594–1598.
2092. Perevalova, E. G.; Bolesov, I. G.; Kalyuzhnaya, Y. S.; Voyevodskaya, T. I.; Kuzmina, L. G.; Korsunsky, V. I.; Grandberg, K. I. *J. Organomet. Chem.* **1989**, *369*, 267–277.
2093. Perevalova, E. G.; Grandberg, K. I.; Smyslova, E. I.; Kalyuzhnaya, Y. S. *Bull. Acad. Sci. USSR. Chem. Ser.* **1985**, 191–196.
2094. Reid, B. D.; Welch, A. J. *J. Organomet. Chem.* **1992**, *438*, 371–384.
2095. Assefa, Z.; McBurnett, B. G.; Staples, R. J.; Fackler, J. P., Jr.; Assmann, B.; Angermaier, K.; Schmidbaur, H. *Inorg. Chem.* **1995**, *34*, 75–83.
2096. Schmidbaur, H.; Pollok, T.; Herr, R.; Wagner, F. E.; Bau, R.; Riede, J.; Müller, G. *Organometallics* **1986**, *5*, 566–574.
2097. Yam, V. W. W.; Choi, S. W. K. *J. Chem. Soc., Dalton Trans.* **1994**, 2057–2059.
2098. Hong, X.; Cheung, K. K.; Guo, C. X.; Che, C. M. *J. Chem. Soc., Dalton Trans.* **1994**, 1867–1871.
2099. Bancroft, G. M.; Chan, T.; Puddephatt, R. J.; Tse, J. S. *Inorg. Chem.* **1982**, *21*, 2946–2951.
2100. DeKock, R. L.; Baerends, E. J.; Boerrigter, P. M.; Hengelmolen, R. *J. Am. Chem. Soc.*, **1984**, *106*, 3387–3393.
2101. Haaland, A.; Hougen, J.; Volden, H. V.; Puddephatt, R. J. *J. Organomet. Chem.* **1987**, *325*, 311–319.
2102. Sykora, J.; Sima, J. *Coord. Chem. Rev.* **1990**, *107*, 1–212.
2103. Perevalova, E. G.; Smyslova, E. I.; Grandberg, K. I. *Bull. Acad. Sci. USSR Chem. Ser.* **1982**, 2506–2512.
2104. Perevalova, E. G.; Struchkov, Y. T.; Dyadchenko, V. P.; Smyslova, E. I.; Slovokhotov, Y. L.; Grandberg, K. I. *Bull. Acad. Sci. USSR Chem. Ser.* **1983**, 2529–2536.
2105. Flörke, U.; Haupt, H. J.; Jones, P. G. *Acta Crystallogr., Sect. C* **1996**, *52*, 609–611.
2106. Steinborn, D.; Becke, S.; Herzog, R.; Günther, M.; Kircheisen, R.; Stoekli-Evans, H.; Bruhn, C. *Z. Anorg. Allg. Chem.* **1998**, *624*, 1303–1307.
2107. Arsenault, G. J.; Crespo, M.; Puddephatt, R. J. *Organometallics* **1987**, *6*, 2255–2256.
2108. Contel, M.; Garrido, J.; Jiménez, J.; Jones, P. G.; Laguna, A.; Laguna, M. *J. Organomet. Chem.* **1997**, *543*, 71–75.
2109. Usón, R.; Laguna, A.; Laguna, M.; Colera, I.; De Jesús, E. *J. Organomet. Chem.* **1984**, *263*, 121–129.
2110. Bardaji, M.; Jones, P. G.; Laguna, A.; Moracho, A.; Fischer, A. K. *J. Organomet. Chem.* **2002**, *648*, 1–7.
2111. Rabe, G. W.; Mitzel, N. W. *Inorg. Chim. Acta* **2001**, *316*, 132–134.
2112. Gambarotta, S.; Floriani, C.; Chiesi-Villa, A.; Guastini, C. *J. Chem. Soc., Chem. Commun.* **1983**, 1304–1306.
2113. Vicente, J.; Arcas, A.; Chicote, M. T. *J. Organomet. Chem.* **1983**, *252*, 257–262.
2114. Vicente, J.; Arcas, A.; Jones, P. G.; Lautner, J. *J. Chem. Soc., Dalton Trans.* **1990**, 451–456.
2115. Usón, R.; Laguna, A.; Fernández, E. J.; Mendia, A.; Jones, P. G. *J. Organomet. Chem.* **1988**, *350*, 129–138.
2116. Usón, R.; Laguna, A.; Fernández, E. J.; Ruiz-Romero, M. E.; Jones, P. G.; Lautner, J. *J. Chem. Soc., Dalton Trans.* **1989**, 2127–2131.
2117. Forward, J. M.; Fackler, J. P., Jr.; Staples, R. J. *Organometallics* **1995**, *14*, 4194–4198.
2118. Sladek, A.; Hofreiter, S.; Paul, M.; Schmidbaur, H. *J. Organomet. Chem.* **1995**, *501*, 47–51.
2119. Rossell, O.; Sales, J. *Inorg. Chim. Acta* **1981**, *64*, L43–L44.
2120. Werner, H.; Otto, H.; Ngo-Khac, T.; Burschka, C. *J. Organomet. Chem.* **1984**, *262*, 123–136.
2121. Perevalova, E. G.; Grandberg, K. I.; Dyadchenko, V. P.; Baukova, T. V. *J. Organomet. Chem.* **1981**, *217*, 403–413.
2122. Baukova, T. V.; Slovokhotov, Y. L.; Struchkov, Y. T. *J. Organomet. Chem.* **1981**, *220*, 125–137.
2123. Kuz'mina, L. G.; Churakov, A. V.; Grandberg, K. I.; Kuz'min, V. S. *Russ. J. Coord. Chem.* **1997**, *23*, 170–176.
2124. Bruce, M. I.; Walton, J. K.; Skelton, B. W.; White, A. H. *J. Chem. Soc., Dalton Trans.* **1983**, 809–814.
2125. Struchkov, Y. T.; Slovokhotov, Y. L.; Kratsov, D. N.; Baukova, T. V.; Perevalova, E. G.; Grandberg, K. I. *J. Organomet. Chem.* **1988**, *338*, 269–280.
2126. Perevalova, E. G.; Baukova, T. V.; Sazonenco, M. M.; Grandberg, K. I. *Bull. Acad. Sci. USSR Chem. Ser.* **1985**, 1726–1731.
2127. Jacob, K.; Voigt, F.; Merzweiler, K.; Pietzsch, C. *J. Organomet. Chem.* **1997**, *545–546*, 421–433.
2128. Geilich, K.; Stumpf, K.; Pritzkow, H.; Siebert, W. *Chem. Ber.* **1987**, *120*, 911–914.
2129. Van Rooyen, P. H.; Schindehutte, M.; Lotz, S. *Organometallics* **1992**, *11*, 1104–1111.
2130. Harwell, D. E.; Mortimer, M. D.; Knobler, C. B.; Anet, F. A. L.; Hawthorne, M. F. *J. Am. Chem. Soc.* **1996**, *118*, 2679–2685.
2131. Crespo, O.; Gimeno, M. C.; Laguna, A.; Peña, A. M. *Polyhedron* **1998**, *17*, 4163–4167.
2132. Banditelli, G.; Bandini, A. L.; Bonati, F.; Goel, R. G.; Minghetti, G. *Gazz. Chim. Ital.* **1982**, *112*, 539–546.
2133. Ito, Y.; Inoue, M.; Sugimoto, M.; Murakami, M. *J. Organomet. Chem.* **1988**, *342*, C41–C44.
2134. Bonati, F.; Burini, A.; Pietroni, B. R.; Felici, M. J. *J. Organomet. Chem.* **1984**, *273*, 275–281.
2135. Kneuper, H. J.; Harms, K.; Boche, G. *J. Organomet. Chem.* **1989**, *364*, 275–279.
2136. Perevalova, E. G.; Bolesov, I. G.; Struchkov, Y. T.; Leschova, I. F.; Kalyuzhnaya, Y. S.; Voyevodskaya, T. I.; Slovokhotov, Y. L.; Grandberg, K. I. *J. Organomet. Chem.* **1985**, *286*, 129–143.
2137. Perevalova, E. G.; Reshetova, M. D.; Kokhanyik, G. M. *J. Gen. Chem. USSR* **1984**, 2424–2428.
2138. Komiya, S.; Iwata, M.; Sone, T.; Fukoaka, A. *J. Chem. Soc., Chem. Commun.* **1992**, 1109–1110.
2139. Usón, R.; Laguna, A.; Laguna, M.; Usón, A.; Gimeno, M. C. *Inorg. Chim. Acta* **1986**, *114*, 91–94.
2140. Usón, R.; Laguna, A.; Laguna, M.; Usón, A.; Gimeno, M. C. *Organometallics* **1987**, *6*, 682–683.
2141. Cerrada, E.; Gimeno, M. C.; Jiménez, J.; Laguna, A.; Laguna, M.; Jones, P. G. *Organometallics* **1994**, *13*, 1470–1475.
2142. Vicente, J.; Chicote, M. T.; Lagunas, M. C. *Helv. Chim. Acta* **1999**, *82*, 1202–1210.
2143. Falvello, R.; Fernández, S.; Navarro, R.; Urriolabeitia, E. P. *Inorg. Chem.* **1999**, *38*, 2455–2463.
2144. Romeo, I.; Bardaji, M.; Gimeno, M. C.; Laguna, M. *Polyhedron* **2000**, *19*, 1837–1841.
2145. Barranco, E. M.; Gimeno, M. C.; Laguna, A. *Inorg. Chim. Acta* **1999**, *291*, 60–65.
2146. Bowmaker, G. A.; Schmidbaur, H. *J. Chem. Soc., Dalton Trans.* **1984**, 2859–2864.

2147. Aguirre, C. J.; Gimeno, M. C.; Laguna, A.; Laguna, M.; López de Luzuriaga, J. M.; Puente, F. *Inorg. Chim. Acta* **1993**, *208*, 31–36.
2148. Nesmeyanov, A. N.; Perevalova, E. G.; Grandberg, K. I.; Lemenovskii, D. A.; Vaukova, T. V.; Afanossova, O. B. *J. Organomet. Chem.* **1974**, *65*, 131–144.
2149. Schmidbaur, H.; Inoguchi, Y. *Chem. Ber.* **1980**, *113*, 1646–1653.
2150. Baukova, T. V.; Slovokhotov, Y. L.; Struchkov, Y. T. *J. Organomet. Chem.* **1981**, *221*, 375–384.
2151. Myslova, E. I.; Perevalova, E. G.; Dyadchenko, V. P.; Grandberg, K. I.; Slovokhotov, Y. L.; Struchkov, Y. T. *J. Organomet. Chem.* **1981**, *215*, 269–279.
2152. Bonati, F.; Burini, A.; Pietroni, B. R.; Bovio, B. *J. Organomet. Chem.* **1986**, *317*, 121–135.
2153. Bonati, F.; Burini, A.; Pietroni, B. R.; Giorgini, E. *Inorg. Chim. Acta* **1987**, *137*, 81–85.
2154. Kuz'mina, L. G.; Churakov, A. V.; Howard, J. A. K. *Russ. J. Coord. Chem.* **1998**, *24*, 282–287.
2155. Vicente, J.; Chicote, M. T. *Coord. Chem. Rev.* **1999**, *193–195*, 1143–1161.
2156. Schmidbaur, H.; Gabbai, F. P.; Schier, A.; Riede, J. *Organometallics* **1995**, *14*, 4696–4970.
2157. Schmidbaur, H.; Scherbaum, F.; Huber, B.; Müller, G. *Angew. Chem., Int. Ed. Engl.* **1988**, *27*, 419–421.
2158. Karger, G.; Hornbach, P.; Krämer, A.; Pritzko, H.; Siebert, W. *Chem. Ber.* **1989**, *122*, 1881–1886.
2159. Vicente, J.; Chicote, M. T.; Lagunas, M. C. *Inorg. Chem.* **1993**, *32*, 3748–3754.
2160. Vicente, J.; Chicote, M. T.; Lagunas, M. C.; Jones, P. G.; Ahrens, B. *Inorg. Chem.* **1997**, *36*, 4938–4944.
2161. Gimeno, M. C.; Laguna, A.; Laguna, M.; Sanmartín, F.; Jones, P. G. *Organometallics* **1993**, *12*, 3984–3991.
2162. Fernández, E. J.; Gimeno, M. C.; Jones, P. G.; Laguna, A.; Laguna, M.; López de Luzuriaga, J. M. *Angew. Chem., Int. Ed. Engl.* **1994**, *33*, 87–88.
2163. Fernández, E. J.; Gimeno, M. C.; Jones, P. G.; Laguna, A.; Laguna, M.; López de Luzuriaga, J.; Rodríguez, M. A. *Chem. Ber.* **1995**, *128*, 121–124.
2164. Riera, V.; Ruiz, J.; Solans, X.; Tauler, E. *J. Chem. Soc., Dalton Trans.* **1990**, 1607–1611.
2165. Ruiz, J.; Riera, V.; Vivanco, M.; García-Granda, S.; García-Fernández, A. *Organometallics* **1992**, *11*, 4077–4082.
2166. Ruiz, J.; Mosquera, M. E. G.; Riera, V.; Vivanco, M. *Organometallics* **1997**, *16*, 3388–3394.
2167. Dufour, N.; Schier, A.; Schmidbaur, H. *Organometallics* **1993**, *12*, 2408–2410.
2168. Bommers, S.; Beruda, H.; Dufour, N.; Paul, M.; Schier, A.; Schmidbaur, H. *Chem. Ber.* **1995**, *128*, 137–142.
2169. Vicente, J.; Chicote, M. T.; Guerrero, R.; Jones, P. G. *J. Am. Chem. Soc.* **1996**, *118*, 699–700.
2170. Scherbaum, F.; Huber, B.; Müller, G.; Schmidbaur, H. *Angew. Chem., Int. Ed. Engl.* **1988**, *27*, 1542–1544.
2171. Steigelmann, O.; Bissinger, P.; Schmidbaur, H. *Z. Naturforsch., Teil B* **1993**, *48*, 72–78.
2172. Schmidbaur, H.; Steigelmann, O. *Z. Naturforsch., Teil B* **1992**, *47*, 72–78.
2173. Schmidbaur, H.; Steigelmann, O. *Z. Naturforsch., Teil B* **1992**, *47*, 1721–1724.
2174. Scherbaum, F.; Grohmann, A.; Müller, G.; Schmidbaur, H. *Angew. Chem., Int. Ed. Engl.* **1989**, *28*, 463–465.
2175. Steigelmann, O.; Bissinger, P.; Schmidbaur, H. *Angew. Chem., Int. Ed. Engl.* **1990**, *29*, 1399–1400.
2176. Schmidbaur, H.; Brachthäuser, B.; Steigelmann, O. *Angew. Chem., Int. Ed. Engl.* **1991**, *30*, 1488–1490.
2177. Schmidbaur, H.; Brachthäuser, B.; Steigelmann, O.; Beruda, H. *Chem. Ber.* **1992**, *125*, 2705–2710.
2178. Schmidbaur, H.; Brachthäuser, B.; Gamper, A.; Schier, A.; Steigelmann, O. *Z. Naturforsch. Teil B* **1992**, *47*, 1725–1735.
2179. McNeal, C. J.; Winpenny, R. E. P.; Hughes, J. M.; Macfarlane, R. D.; Pignolet, L. H.; Nelson, L. T. J.; Gardner, T. G.; Irgens, L. H.; Vigh, G.; Fackler, J. P., Jr. *Inorg. Chem.* **1993**, *32*, 5582–5590.
2180. Gabbai, F. P.; Schier, A.; Riede, J.; Schmidbaur, H. *Chem. Ber.* **1997**, *130*, 111–113.
2181. Whittall, I. R.; Humphrey, M. G.; Samoc, M.; Luther-Davies, B. *Angew. Chem., Int. Ed. Engl.* **1997**, *36*, 370–371.
2182. Alejos, P.; Coco, S.; Espinet, P. *New J. Chem.* **1995**, *19*, 799–805.
2183. Irwin, M. J.; Gia, G.; Payne, N. C.; Puddephatt, R. J. *Organometallics* **1996**, *15*, 51–57.
2184. Yam, V. W. W.; Lo, K. K. W.; Wong, K. M. C. *J. Organomet. Chem.* **1999**, *578*, 3–30.
2185. Mingos, D. M. P.; Yau, J.; Menzer, S.; Williams, D. J. *Angew. Chem., Int. Ed. Engl.* **1995**, *34*, 1894–1895.
2186. Grohmann, A. *Angew. Chem., Int. Ed. Engl.* **1995**, *34*, 2107–2109.
2187. Puddephatt, R. J.; Treurnicht, I. *J. Organomet. Chem.* **1987**, *319*, 129–137.
2188. Bruce, M. I.; Horn, E.; Matisons, J. G.; Snow, M. R. *Aust. J. Chem.* **1984**, *37*, 1163–1168.
2189. Cross, R. J.; Davidson, M. F. *J. Chem. Soc., Dalton Trans.* **1986**, 411–417.
2190. Müller, T. E.; Choi, S. W. K.; Mingos, D. M. P.; Murphy, D.; Williams, D. J.; Yam, V. W. W. *J. Organomet. Chem.* **1994**, *484*, 209–224.
2191. Casey, A. T.; Vecchio, A. M. *Appl. Organomet. Chem.* **1990**, *4*, 513–523.
2192. Vicente, J.; Chicote, M. T.; Abrisqueta, M. D. *J. Chem. Soc., Dalton Trans.* **1995**, 497–498.
2193. Vicente, J.; Chicote, M. T.; Abrisqueta, M. D.; Jones, P. G. *Organometallics* **1997**, *16*, 5628–5636.
2194. Carriedo, G. A.; Riera, V.; Solans, X.; Solans, J. *Acta Crystallogr., Sect. C* **1988**, *44*, 978–981.
2195. Xiao, H.; Weng, Y. X.; Peng, S. M.; Che, C. M. *J. Chem. Soc., Dalton Trans.* **1996**, 3155–3157.
2196. Payne, N. C.; Puddephatt, R. J.; Ravindranath, R.; Treurnicht, I. *Can. J. Chem.* **1988**, *66*, 3176–3183.
2197. Bruce, M. I.; Liddell, M. J. *J. Organomet. Chem.* **1992**, *427*, 263–274.
2198. Alder, M. J.; Flower, K. R.; Pritchard, R. G. *J. Organomet. Chem.* **2001**, *629*, 153–159.
2199. McDonagh, A. M.; Lucas, N. T.; Cifuentes, M. P.; Humphrey, M. G.; Houbrechts, S.; Persoons, A. *J. Organomet. Chem.* **2000**, *605*, 184–192.
2200. Lang, H.; Köcher, S.; Back, S.; Rheinwald, G.; Van Koten, G. *Organometallics* **2001**, *20*, 1968–1972.
2201. Hurst, S. K.; Lucas, N. T.; Humphrey, M. G.; Asselberghs, I.; Van Boxel, R.; Persoons, A. *Aust. J. Chem.* **2001**, *54*, 447–451.
2202. Shiotsuka, M.; Yamamoto, Y.; Okuno, S.; Kitou, M.; Nozaki, K.; Onaka, S. *Chem. Commun.* **2002**, 590–591.
2203. Sheloumov, A. M.; Koridze, A. A.; Dolgushin, F. M.; Starikova, Z. A.; Ezernitskaya, M. G.; Petrovskii, P. V. *Russ. Chem. Bull.* **2000**, *49*, 1292–1296.
2204. Mihan, S.; Sunkel, K.; Beck, W. *Chem. Eur. J.* **1999**, *5*, 745–753.
2205. Bruce, M. I.; Hall, B. C.; Skelton, B. W.; Smith, M. E.; White, A. H. *J. Chem. Soc., Dalton Trans.* **2002**, 995–1001.
2206. McDonald, M. A.; Puddephatt, R. J.; Yap, G. P. A. *Organometallics* **2000**, *19*, 2194–2199.
2207. Hunks, W. J.; McDonald, M. A.; Jennings, M. C.; Puddephatt, R. J. *Organometallics* **2000**, *19*, 5063–5070.
2208. Yau, J.; Mingos, D. M. P. *J. Chem. Soc., Dalton Trans.* **1997**, 1103–1111.

2209. Abu-Salah, O. M.; Al-Ohaly, A. R. *Inorg. Chim. Acta* **1983**, *77*, L159–L160.
2210. Abu-Salah, O. M.; Al-Ohaly, A. R.; Al-Showiman, S. S.; Al-Najjar, I. M. *Transition Met. Chem.* **1985**, *10*, 207–212.
2211. Cross, R. J.; Davidson, M. F.; McLennan, A. J. *J. Organomet. Chem.* **1984**, *265*, C37–C39.
2212. Che, C. M.; Chao, H. Y.; Miskowski, V. M.; Li, Y.; Cheung, K. K. *J. Am. Chem. Soc.* **2001**, *123*, 4985–4991.
2213. Lu, W.; Xiang, H. F.; Zhu, N.; Che, C. M. *Organometallics* **2002**, *21*, 2343–2346.
2214. Hurst, S. K.; Cifuentes, M. P.; McDonagh, A. M.; Humphrey, M. G.; Samoc, M.; Luther-Davies, B.; Asselberghs, I.; Persoons, A. *J. Organomet. Chem.* **2002**, *642*, 259–267.
2215. Wong, W. Y.; Choi, K. H.; Lu, G. L.; Shi, J. X.; Lai, P. Y.; Chan, S. M.; Lin, Z. Y. *Organometallics* **2001**, *20*, 5446–5454.
2216. Yam, V. W. W.; Cheung, K. L.; Yuan, L. H.; Wong, K. M. C.; Cheung, K. K. *Chem. Commun.* **2000**, 1513–1514.
2217. Irwin, M. J.; Vittal, J. J.; Puddephatt, R. J. *Organometallics* **1997**, *16*, 3541–3547.
2218. Li, D.; Hong, X.; Che, C. M.; Lo, W. C.; Peng, S. M. *J. Chem. Soc., Dalton Trans.* **1993**, 2929–2932.
2219. Che, C. M.; Yip, H. K.; Lo, W. C.; Peng, S. M. *Polyhedron* **1994**, *13*, 887–890.
2220. Shieh, S. J.; Hong, X.; Peng, S. M.; Che, C. M. *J. Chem. Soc., Dalton Trans.* **1994**, 3067–3068.
2221. Yam, V. W. W.; Choi, S. W. K. *J. Chem. Soc., Dalton Trans.* **1996**, 4227–4232.
2222. Yam, V. W. W.; Choi, S. W. K.; Cheung, K. K. *Organometallics* **1996**, *15*, 1734–1739.
2223. Yam, V. W. W.; Choi, S. W. K.; Cheung, K. K. *J. Chem. Soc., Dalton Trans.* **1996**, 3411–3415.
2224. Tzeng, B. C.; Lo, W. C.; Che, C. M.; Peng, S. M. *Chem. Commun.* **1996**, 181–182.
2225. Jia, G.; Puddephatt, R. J.; Scott, J. D.; Vittal, J. J. *Organometallics* **1993**, *12*, 3565–3574.
2226. Irwin, M. J.; Rendina, L. M.; Vittal, J. J.; Puddephatt, R. J. *Chem. Commun.* **1996**, 1281–1282.
2227. Hunks, W. J.; Macdonald, M. A.; Jennings, M. C.; Puddephatt, R. J. *Organometallics* **2002**, *19*, 5063–5070.
2228. Payne, N. C.; Ramachandran, R.; Puddephatt, R. J. *Can. J. Chem.* **1995**, *73*, 6–11.
2229. Puddephatt, R. J. *Coord. Chem. Rev.* **2001**, *216–217*, 313–332.
2230. Puddephatt, R. J. *Chem. Commun.* **1998**, 1055–1062.
2231. Irwin, M. J.; Manojlović-Muir, L.; Muir, K. W.; Puddephatt, R. J. *Chem. Commun.* **1997**, 219–220.
2232. Jia, G.; Puddephatt, R. J.; Vittal, J. J. *J. Organomet. Chem.* **1993**, *449*, 211–217.
2233. Irwin, M. J.; Jennings, M. C.; Puddephatt, R. J. *Angew. Chem., Int. Ed. Engl.* **1999**, *38*, 3376–3378.
2234. McArdle, C. P.; Van, S.; Jennings, M. C.; Puddephatt, R. J. *J. Am. Chem. Soc.* **2002**, *124*, 3959–3965.
2235. McArdle, C. P.; Irwin, M. J.; Jennings, M. C.; Vittal, J. J.; Puddephatt, R. J. *Chem. Eur. J.* **2001**, *7*, 723–734.
2236. McArdle, C. P.; Vittal, J. J.; Puddephatt, R. J. *Angew. Chem., Int. Ed. Engl.* **2000**, *39*, 3819–3819.
2237. McArdle, C. P.; Jennings, M. C.; Vittal, J. J.; Puddephatt, R. J. *Chem. Eur. J.* **2001**, *7*, 3572–3583.
2238. Gamasa, M. P.; Gimeno, J.; Godefroy, I.; Lastra, E.; Martín-Vaca, B. M.; García-Granda, S.; Gutierrez-Rodriguez, A. *J. Chem. Soc., Dalton Trans.* **1995**, 1901–1906.
2239. Ferrer, M.; Rossell, O.; Seco, M.; Pellinghelli, M. A.; Tiripicchio, A. *Organometallics* **1995**, *14*, 57–62.
2240. Ipaktschi, J.; Munz, F. *Organometallics* **2002**, *21*, 977–981.
2241. Ursini, C. V.; Dias, G. H. M.; Hörner, M.; Bortoluzzi, A. J.; Morigaki, M. K. *Polyhedron* **2000**, *19*, 2261–2268.
2242. Dryden, N. H.; Shapter, J. G.; Coastworth, L. L.; Norton, P. R.; Puddephatt, R. J. *Chem. Mater.* **1992**, *4*, 979–987.
2243. Norton, P. R.; Young, P. A.; Cheng, Q.; Dryden, N. H.; Puddephatt, R. J. *Surf. Sci.* **1994**, *309*, 172–176.
2244. Benouazzane, M.; Coco, S.; Espinet, P.; Martín-Alvarez, J. M. *J. Mater. Chem.* **1995**, *5*, 441–445.
2245. Coco, S.; Espinet, P.; Falgán, S.; Martín-Alvarez, J. M. *New J. Chem.* **1995**, *19*, 959–964.
2246. Benouazzane, M.; Coco, S.; Espinet, P.; Martín-Alvarez, J. M. *J. Mater. Chem.* **1999**, *9*, 2327–2332.
2247. Benouazzane, M.; Coco, S.; Espinet, P.; Martín-Alvarez, J. M.; Barbera, J. J. *J. Mater. Chem.* **2002**, *12*, 691–696.
2248. Omenat, A.; Serrano, J. L.; Sierra, T.; Amabilino, D. B.; Minguet, M.; Ramos, E.; Veciana, J. *J. Mater. Chem.* **1999**, *9*, 2301–2305.
2249. Kaharu, T.; Ishii, R.; Takahashi, S. *J. Chem. Soc., Chem. Commun.* **1994**, 1349–1350.
2250. Ishii, R.; Kaharu, T.; Pirio, N.; Zhang, S. W.; Takahashi, S. *J. Chem. Soc., Chem. Commun.* **1995**, 1215–1216.
2251. Kaharu, T.; Ishii, R.; Adachi, T.; Yoshida, T.; Takahashi, S. *J. Mater. Chem.* **1995**, *5*, 687–692.
2252. Schneider, W.; Angermaier, K.; Sladek, A.; Schmidbaur, H. *Z. Naturforsch., Teil B* **1996**, *51*, 790–800.
2253. Liao, R. Y.; Mathieson, T.; Schier, A.; Berger, R. J. F.; Runeberg, N.; Schmidbaur, H. *Z. Naturforsch., Teil B* **2002**, *57*, 881–889.
2254. Mathieson, T. J.; Langdon, A. G.; Milestone, N. B.; Nicholson, B. K. *J. Chem. Soc., Dalton Trans.* **1999**, 201–207.
2255. Ecken, H.; Olmstead, M. M.; Noll, B. C.; Attar, S.; Schlyer, B.; Balch, A. L. *J. Chem. Soc., Dalton Trans.* **1998**, 201–207.
2256. Gagnon, J.; Drouin, M.; Harvey, P. D. *Inorg. Chem.* **2001**, *40*, 6052–6056.
2257. Beck, W.; Weigand, W.; Nagel, U.; Schaal, M. *Angew. Chem., Int. Ed. Engl.* **1984**, *23*, 377–378.
2258. Fehlhammer, W. P.; Finck, W. *J. Organomet. Chem.* **1991**, *414*, 261–270.
2259. Bonati, F.; Burini, A.; Pietroni, B. R.; Bovio, B. *J. Organomet. Chem.* **1989**, *375*, 147–160.
2260. Raubenheimer, H. G.; Cronje, S. *J. Organomet. Chem.* **2001**, *617–618*, 170–181.
2261. Raubenheimer, H. G.; Scott, F.; Kruger, G. J.; Toerien, J. G.; Otte, R.; Van Zyl, W.; Taljaard, I.; Olivier, P.; Linfoord, L. *J. Chem. Soc., Dalton Trans.* **1994**, 2091–2097.
2262. Raubenheimer, H. G.; Desmet, M.; Kruger, G. J. *J. Chem. Soc., Dalton Trans.* **1995**, 2067–2071.
2263. Desmet, M.; Raubenheimer, H. G.; Kruger, G. *Organometallics* **1997**, *16*, 3324–3332.
2264. Raubenheimer, H. G.; Lindeque, L.; Cronje, S. *J. Organomet. Chem.* **1996**, *511*, 177–184.
2265. Wang, H. M. J.; Lin, I. J. B. *Organometallics* **1998**, *17*, 972–975.
2266. Bonati, F.; Burini, A.; Pietroni, B. R.; Bovio, B. *J. Organomet. Chem.* **1991**, *408*, 271–280.
2267. Bobio, B.; Burini, A.; Pietroni, B. R. *J. Organomet. Chem.* **1993**, *452*, 287–291.
2268. Raubenheimer, H. G.; Toerien, J. G.; Kruger, G. J.; Otte, R.; Van Zyl, W.; Olivier, P. *J. Organomet. Chem.* **1994**, *466*, 291–295.
2269. White-Morris, R. L.; Olmstead, M. M.; Jiang, F.; Balch, A. L. *J. Am. Chem. Soc.* **2002**, *124*, 2327–2336.
2270. White-Morris, R. L.; Olmstead, M. M.; Jiang, F.; Balch, A. L. *Inorg. Chem.* **2002**, *41*, 2313–2315.
2271. Wang, H. M. J.; Chen, C. Y. L.; Lin, I. J. B. *Organometallics* **1999**, *18*, 1216–1223.
2272. Carriedo, G. A.; Hodgson, D.; Howard, J. A. K.; Marsden, K.; Stone, F. G. A.; Went, M. J.; Woodward, P. *J. Chem. Soc., Chem. Commun.* **1982**, 1006–1008.

2273. Carriedo, G. A.; Howard, J. A. K.; Stone, F. G. A. *J. Chem. Soc., Dalton Trans.* **1984**, 2545–2550.
2274. Green, M.; Howard, J. A. K.; James, A. P.; Nunn, C. M.; Stone, F. G. A. *J. Chem. Soc., Dalton Trans.* **1987**, 61–72.
2275. Crennell, S. J.; Devore, D. D.; Henderson, S. J. B.; Howard, J. A. K.; Stone, F. G. A. *J. Chem. Soc., Dalton Trans.* **1989**, 1363–1374.
2276. Gimeno, M. C.; Stone, F. G. A. *J. Chem. Soc., Dalton Trans.* **1990**, 2239–2245.
2277. Carr, N.; Gimeno, M. C.; Goldberg, J. E.; Pilotti, M. U.; Stone, F. G. A.; Topaloglu, I. *J. Chem. Soc., Dalton Trans.* **1990**, 2253–2261.
2278. Carriedo, G. A.; Riera, V.; Sánchez, G.; Solans, X.; Labrador, M. *J. Organomet. Chem.* **1990**, 391, 431–437.
2279. Carr, N.; Fernandez, J. R.; Stone, F. G. A. *Organometallics* **1991**, 10, 2718–2725.
2280. Dell'Amico, D. G.; Calderazzo, F.; Dantona, R.; Strähle, H.; Weiss, H. *Organometallics* **1987**, 6, 1207–1213.
2281. Hakånsson, M.; Eriksson, H.; Jagner, S. *J. Organomet. Chem.* **2000**, 602, 133–136.
2282. Blom, N.; Ludi, A.; Bürgi, H. B.; Tichý, K. *Acta Crystallogr., Sect. C* **1984**, 40, 1767–1769.
2283. Hussain, M. S.; Al-Arfaj, A. R.; Akhtar, M. N.; Isab, A. A. *Polyhedron* **1996**, 15, 2781–2785.
2284. Cramer, R. E.; Smith, D. W.; VanDoorne, W. *Inorg. Chem.* **1998**, 37, 5895–5901.
2285. Leznoff, D. B.; Xue, B. Y.; Patrick, B. O.; Sanchez, V.; Thompson, R. C. *Chem. Commun.* **2001**, 259–260.
2286. Leznoff, D. B.; Xue, B. Y.; Stevens, C. L.; Storr, A.; Thompson, R. C.; Patrick, B. O. *Polyhedron* **2001**, 20, 1247–1254.
2287. Leznoff, D. B.; Xue, B. Y.; Batchelor, R. J.; Einstein, F. W. B.; Patrick, B. O. *Inorg. Chem.* **2001**, 40, 6026–6034.
2288. Rawashdeh-Omary, M. A.; Omary, M. A.; Patterson, H. H.; Fackler, J. P., Jr. *J. Am. Chem. Soc.* **2001**, 123, 11237–11247.
2289. Kunkely, H.; Vogler, A. *Inorg. Chem. Commun.* **2000**, 3, 205–207.
2290. Graham, G. G.; Bales, J. R.; Grootveld, M. C.; Sadler, P. J. *J. Inorg. Biochem.* **1985**, 25, 163–170.
2291. Hormann, A. L.; Shaw III, C. F.; Bennett, D. W.; Reiff, W. M. *Inorg. Chem.* **1986**, 25, 3953–3957.
2292. Hormann, A. L.; Shaw III, C. F. *Inorg. Chem.* **1990**, 29, 4683–4687.
2293. Isab, A. A.; Hussain, M. S.; Akhtar, M. N.; Wazeer, M. I. M.; Al-Arfaj, A. R. *Polyhedron* **1999**, 18, 1401–1409.
2294. Lewis, G.; Shaw III, C. F. *Inorg. Chem.* **1986**, 25, 58–62.
2295. Jones, P. G.; Lautner, J. *Acta Crystallogr., Sect. C* **1988**, 44, 2091–2093.
2296. Bosman, w.P.; Boss, W.; Smits, J. M. M.; Beurskens, P. T.; Bour, J. J.; Steggerda, J. *J. Inorg. Chem.* **1986**, 25, 2093–2096.
2297. Guy, J. J.; Jones, P. G.; Mays, M. J.; Sheldrick, G. M. *J. Chem. Soc., Dalton Trans.* **1977**, 8–10.
2298. Jones, P. G.; Ahrens, B. Z. *Naturforsch., Teil B* **1998**, 53, 653–662.
2299. Jones, P. G.; Ahrens, B. *New J. Chem.* **1998**, 1041–1042.
2300. Ahrens, B.; Jones, P. G.; Fischer, A. K. *Eur. J. Inorg. Chem.* **1999**, 1103–1110.
2301. Adams, H. N.; Hiller, W.; Strähle, J. Z. *Anorg. Allg. Chem.* **1982**, 485, 81–91.
2302. Conzelmann, W.; Hiller, W.; Strähle, J. Z. *Anorg. Allg. Chem.* **1984**, 512, 169–175.
2303. Jones, P. G.; Freytag, M. *Chem. Commun.* **2000**, 277–278.
2304. Lock, C. J. L.; Wang, Z. *Acta Crystallogr., Sect. C* **1993**, 49, 1330–1333.
2305. Mingos, D. M. P.; Yau, J.; Menzer, S.; Williams, D. J. *J. Chem. Soc., Dalton Trans.* **1995**, 319–320.
2306. Ahrens, B.; Friedrichs, S.; Herbst-Irmer, R.; Jones, P. G. *Eur. J. Inorg. Chem.* **2000**, 2017–2029.
2307. Jones, P. G.; Ahrens, B. *Chem. Ber.* **1997**, 130, 1813–1814.
2308. Yip, J. H. K.; Feng, R.; Vittal, J. J. *Inorg. Chem.* **1999**, 38, 3586–3589.
2309. Gomez, S.; Philippot, K.; Collière, V.; Chaudret, B.; Senocq, F.; Lecante, P. *Chem. Commun.* **2000**, 1945–1946.
2310. Usón, R.; Laguna, A.; Navarro, A.; Parish, R. V.; Moore, L. S. *Inorg. Chim. Acta* **1986**, 112, 205–208.
2311. Munakata, M.; Yan, S. G.; Maekawa, M.; Akiyama, M.; Kitagawa, S. *J. Chem. Soc., Dalton Trans.* **1997**, 4257–4262.
2312. Vicente, J.; Chicote, M. T.; Guerrero, R.; Jones, P. G. *J. Chem. Soc., Dalton Trans.* **1995**, 1251–1254.
2313. Grohmann, A.; Riede, J.; Schmidbaur, H. *Z. Naturforsch., Teil B* **1992**, 47, 1255–1260.
2314. Tripathi, U. M.; Wegner, G. L.; Schier, A.; Jockisch, A.; Schmidbaur, H. *Z. Naturforsch., Teil B* **1998**, 53, 939–945.
2315. Bardají, M.; Laguna, A.; Pérez, M. R.; Jones, P. G. *Organometallics* **2002**, 21, 1877–1881.
2316. Zou, J.; Taylor, P.; Dornan, J.; Robinson, S. P.; Walkinshaw, M. D.; Sadler, P. J. *Angew. Chem., Int. Ed. Engl.* **2000**, 39, 2931–2934.
2317. Vollano, J. F.; Picker, D. H.; Statler, J. A. *Inorg. Chim. Acta* **1989**, 155, 31–34.
2318. Angermaier, K.; Schmidbaur, H. *J. Chem. Soc., Dalton Trans.* **1995**, 559–564.
2319. López de Luzuriaga, J. M.; Söldner, M.; Schier, A.; Schmidbaur, H. *Z. Naturforsch., Teil B* **1997**, 52, 209–213.
2320. Usón, R.; Laguna, A.; Villacampa, M. D. *Inorg. Chim. Acta* **1984**, 81, 25–31.
2321. Qin, Z.; Jennings, M. C.; Puddephatt, R. J. *Chem. Eur. J.* **2002**, 8, 735–738.
2322. Irwin, M. J.; Vittal, J. J.; Yap, G. P. A.; Puddephatt, R. J. *J. Am. Chem. Soc.* **1996**, 118, 13101–13102.
2323. Brandys, M. C.; Jennings, M. C.; Puddephatt, R. J. *J. Chem. Soc., Dalton Trans.* **2000**, 4601–4606.
2324. Schneider, W.; Bauer, A.; Schmidbaur, H. *J. Chem. Soc., Dalton Trans.* **1997**, 415–420.
2325. Schneider, W.; Bauer, A.; Schier, A.; Schmidbaur, H. *Chem. Ber.* **1997**, 130, 1417–1422.
2326. Vicente, J.; Chicote, M. T.; Abrisqueta, M. D.; Guerrero, R.; Jones, P. G. *Angew. Chem., Int. Ed. Engl.* **1997**, 36, 1203–1205.
2327. Vicente, J.; Chicote, M. T.; Guerrero, R.; Ramirez de Arellano, M. C. *Chem. Commun.* **1999**, 1541–1542.
2328. Lange, P.; Schier, A.; Riede, J.; Schmidbaur, H. *Z. Naturforsch., Teil B* **1994**, 49, 642–646.
2329. Berners Price, S. J.; DiMartino, M. J.; Hill, D. T.; Kuroda, R.; Mazid, M. A.; Sadler, P. J. *Inorg. Chem.* **1986**, 25, 1072–1077.
2330. Koch, D.; Sünkel, K.; Beck, W. *Z. Naturforsch., Teil B* **1999**, 54, 96–102.
2331. Lenk, A.; Sünkel, K.; Beck, W. *Z. Naturforsch., Teil B* **1996**, 51, 1639–1643.
2332. Colacio, E.; Romerosa, A.; Ruiz, J.; Román, P.; Gutiérrez-Zorrilla, J. M.; Matínez-Ripoll, M. *J. Chem. Soc., Dalton Trans.* **1989**, 2323–2329.
2333. Pajunen, A.; Kivekäs, R.; Colacio, E.; Cuesta, R. *Acta Crystallogr., Sect. C* **1995**, 51, 2551–2554.
2334. Perevalova, E. G.; Grandberg, K. I.; Smyslova, E. I.; Kuzmina, L. G.; Korsunskii, V. I.; Kratsov, D. N. *J. Organomet. Chem. USSR* **1989**, 2, 523–528.

2335. Goodgame, D. M. L.; O'Mahoney, C. A.; Plank, S. D.; Williams, D. J. *Polyhedron* **1993**, *12*, 2705–2710.
2336. Churakov, A. V.; Kuz'mina, L. G.; Howard, J. A. K.; Grandberg, K. I. *Acta Crystallogr., Sect. C* **1998**, *54*, 54–56.
2337. Churakov, A. V.; Kuz'mina, L. G.; Howard, J. A. K. *Acta Crystallogr., Sect. C* **1998**, *54*, 212–214.
2338. Cinellu, M. A.; Stoccoro, S.; Minghetti, G.; Bandini, A. L.; Demartin, F. *Inorg. Chim. Acta* **1990**, *168*, 33–41.
2339. Amagai, T.; Miyamoto, T. K.; Ichida, H.; Sasaki, Y. *Bull. Chem. Soc. Jpn.* **1989**, *62*, 1078–1084.
2340. Tiekink, E. R. T.; Kurucsev, T.; Hoskins, B. F. *J. Crystallogr. Spectrosc. Res.* **1989**, *19*, 823–828.
2341. Chan, C. K.; Guo, C. X.; Cheung, K. K.; Li, D.; Che, C. M. *J. Chem. Soc., Dalton Trans.* **1994**, 3677–3682.
2342. Langhals, H.; Limmert, M.; Lorenz, I. P.; Mayer, P.; Piotrowski, H.; Polborn, K. *Eur. J. Inorg. Chem.* **2000**, 2345–2349.
2343. Rosopulos, Y.; Nagel, U.; Beck, W. *Chem. Ber.* **1985**, *118*, 931–938.
2344. Faggiani, R.; Howard-Lock, H. E.; Lock, C. J. L.; Turner, M. A. *Can. J. Chem.* **1986**, *317*, 121–126.
2345. Wegner, G. L.; Jockisch, A.; Schier, A.; Schmidbauer, H. *Z. Naturforsch., Teil B* **2000**, *55*, 347–351.
2346. Bunge, S. D.; Just, O.; Rees, W. S., Jr. *Angew. Chem., Int. Ed. Engl.* **2000**, *39*, 3082–3084.
2347. Bessler, K. E.; Romualdo, L. L.; Filho, P. T. S.; Deflon, V. M.; Maichle-Mössmer, C. *Z. Anorg. Allg. Chem.* **2001**, *627*, 651–654.
2348. Jones, P. G.; Blaschette, A.; Lautner, J.; Thöne, C. *Z. Anorg. Allg. Chem.* **1997**, *623*, 775–779.
2349. Ahrens, B.; Jones, P. G. *Z. Naturforsch., Teil B* **2000**, *55*, 803–813.
2350. Hartmann, E.; Strähle, J. *Z. Naturforsch., Teil B* **1989**, *44*, 1–4.
2351. Beck, J.; Strähle, J. *Angew. Chem., Int. Ed. Engl.* **1986**, *25*, 95–96.
2352. Raptis, R. G.; Fackler, J. P., Jr. *Inorg. Chem.* **1988**, *27*, 4179–4182.
2353. Raptis, R. G.; Murray III, H. H.; Fackler, J. P., Jr. *Chem. Commun.* **1987**, 737–739.
2354. Minghetti, G.; Banditelli, G.; Bonati, F. *Inorg. Chem.* **1979**, *18*, 658–663.
2355. Bovio, B.; Bonati, F.; Bantitelli, G. *Inorg. Chim. Acta* **1984**, *87*, 25–33.
2356. Bonati, F.; Burini, A.; Pietroni, B. R.; Galassi, R. *Gazz. Chim. Ital.* **1993**, *123*, 691–695.
2357. Rawashdeh-Omary, M. A.; Omary, M. A.; Fackler, J. P., Jr. *J. Am. Chem. Soc.* **2001**, *123*, 9689–9691.
2358. Barberá, J.; Elduque, A.; Giménez, R.; Oro, L. A.; Serrano, J. L. *Angew. Chem., Int. Ed. Engl.* **1996**, *35*, 2832–2835.
2359. Barberá, J.; Elduque, A.; Giménez, R.; Lahoz, F. J.; López, J. A.; Oro, L. A.; Serrano, J. L. *Inorg. Chem.* **1998**, *37*, 2960–2967.
2360. Kim, S. J.; Kang, S. H.; Park, K. M.; Kim, H.; Zin, W. C.; Choi, M. G.; Kim, K. *Chem. Mater.* **1998**, *10*, 1889–1893.
2361. Raptis, R. G.; Murray, H. H.; Fackler, J. P., Jr. *Acta Crystallogr., Sect. C* **1988**, *44*, 970–973.
2362. Bovio, B.; Calogero, S.; Wagner, F. E.; Burini, A.; Pietroni, B. R. *J. Organomet. Chem.* **1994**, *470*, 275–283.
2363. Lechat, J. R.; DeAlmeidaSantos, R. H.; Banditelli, G.; Bonati, F. *Cryst. Struct. Commun.* **1982**, *11*, 471–473.
2364. Matovic, Z. D.; Radanovic, D. J.; Ponticelli, G.; Scano, P.; Efimenko, I. A. *Transition Met. Chem.* **1994**, *19*, 461–464.
2365. Bonati, F.; Burini, A.; Pietroni, B. R.; Giorgini, E. *J. Organomet. Chem.* **1988**, *344*, 119–135.
2366. Banditelli, G.; Bandini, A. L.; Minghetti, G.; Bonati, F. *Can. J. Chem.* **1981**, *59*, 1241–1246.
2367. Bachechi, F.; Burini, A.; Galassi, R.; Pietroni, B. R.; Severini, M. *J. Organomet. Chem.* **1999**, *575*, 269–277.
2368. Bachechi, F.; Burini, A.; Galassi, R.; Pietroni, B. R.; Tesi, D. *Z. Kristallogr.* **1999**, *214*, 497–498.
2369. Felici, M.; Pietroni, B. R.; Burini, A. *Gazz. Chim. Ital.* **1982**, *112*, 5–12.
2370. Bovio, B.; Bonati, F.; Burini, A.; Pietroni, B. R. *Z. Naturforsch., Teil B* **1984**, *39*, 1747–1753.
2371. Usón, R.; Oro, L. A.; Gimeno, J.; Ciriano, M. A.; Cabeza, J. A.; Tiripicchio, A.; Tiripicchio Camellini, M. *J. Chem. Soc., Dalton Trans.* **1983**, 323–329.
2372. Albrecht, M.; Hübler, K.; Kaim, W. *Z. Naturforsch., Teil B* **1999**, *54*, 1606–1608.
2373. Nomiya, K.; Noguchi, R.; Ohsawa, K.; Tsuda, K. *J. Chem. Soc., Dalton Trans.* **1998**, 4101–4108.
2374. Usón, R.; Gimeno, J.; Fornies, J.; Martínez, F.; Fernández, C. *Inorg. Chim. Acta* **1982**, *63*, 91–96.
2375. Tzeng, B. C.; Li, D.; Peng, S. M.; Che, C. M. *J. Chem. Soc., Dalton Trans.* **1993**, 2365–2371.
2376. Nomiya, K.; Noguchi, R.; Ohsawa, K.; Tsuda, K.; Oda, M. *J. Inorg. Biochem.* **2000**, *78*, 363–370.
2377. Arduozia, G. A.; La Monica, G.; Maspero, A.; Masciocchi, N.; Moret, M. *Eur. J. Inorg. Chem.* **1999**, 1301–1307.
2378. Perevalova, E. G.; Smyslova, E. I.; Dyadchenko, V. P.; Grandberg, K. I.; Nesmeyanov, A. N. *Izv. Akad. Nauk. SSSR Ser. Khim.* **1980**, 1455–1460.
2379. Brodbeck, A. Thesis, University of Tübingen, 1990.
2380. Zeller, E.; Beruda, H.; Kolb, A.; Bissinger, P.; Riede, J.; Schmidbauer, H. *Nature* **1991**, *352*, 141–143.
2381. Vicente, J.; Chicote, M. T.; Guerrero, R.; Jones, P. G.; Ramírez de Arellano, M. C. *Inorg. Chem.* **1997**, *36*, 4438–4443.
2382. Sladek, A.; Schmidbauer, H. *Z. Naturforsch., Teil B* **1995**, *50*, 859–863.
2383. Slovokhotov, Yu. L.; Struchkov, Yu. T. *J. Organomet. Chem.* **1984**, *277*, 143–146.
2384. Korsunsky, V. I. *J. Organomet. Chem.* **1986**, *311*, 357–369.
2385. Grohmann, A.; Riede, J.; Schmidbauer, H. *Nature* **1990**, *345*, 140–142.
2386. Pykkö, P.; Zhao, Y. F. *Inorg. Chem.* **1993**, *32*, 2630–2634.
2387. Häberlen, O. D.; Chung, S. C.; Rösch, N. *Int. J. Quantum Chem.* **1994**, *S28*, 595–601.
2388. Angermaier, K.; Schmidbauer, H. *Inorg. Chem.* **1995**, *34*, 3120–3122.
2389. Schier, A.; Grohmann, A.; López de Luzuriaga, J. M.; Schmidbauer, H. *Inorg. Chem.* **2000**, *39*, 547–554.
2390. Brodbeck, A.; Strähle, J. *Acta Crystallogr., Sect. A* **1990**, *46*, C232–C234.
2391. Sautter, E. Thesis, University of Tübingen, 1994.
2392. Ramamoorthy, V.; Sharp, P. R. *Inorg. Chem.* **1990**, *29*, 3336–3339.
2393. Grohmann, A.; Riede, J.; Schmidbauer, H. *J. Chem. Soc., Dalton Trans.* **1991**, 783–787.
2394. Kolb, A.; Bissinger, P.; Schmidbauer, H. *Z. Anorg. Allg. Chem.* **1993**, *619*, 1580–1588.
2395. Angermaier, K.; Schmidbauer, H. *Chem. Ber.* **1995**, *128*, 817–822.
2396. López de Luzuriaga, J. M.; Schier, A.; Schmidbauer, H. *Chem. Ber.* **1997**, *130*, 221–223.
2397. Allan, R. E.; Beswick, A.; Paver, M. A.; Raithby, P. R.; Steiner, A.; Wright, D. S. *Angew. Chem., Int. Ed. Engl.* **1996**, *35*, 208–209.
2398. Grohmann, A.; Schmidbauer, H. *Inorg. Chem.* **1992**, *31*, 3378–3380.

2399. Lange, P.; Beruda, H.; Hiller, W.; Schmidbauer, H. *Z. Naturforsch., Teil B* **1994**, *49*, 781–787.
2400. Schmidbauer, H.; Kolb, A.; Bissinger, P. *Inorg. Chem.* **1992**, *31*, 4370–4375.
2401. Bauer, A.; Gabbai, F. P.; Schier, A.; Schmidbauer, H. *Philos. Trans. R. Soc. London Ser. A* **1996**, *354*, 381–394.
2402. Bauer, A.; Mittel, N. W.; Schier, A.; Rankin, D. W. H.; Schmidbauer, H. *Chem. Ber.* **1997**, *130*, 323–328.
2403. Ramamoorthy, V.; Wu, Z.; Yi, Y.; Sharp, P. R. *J. Am. Chem. Soc.* **1992**, *114*, 1526–1527.
2404. Shan, H.; Yang, Y.; James, A. J.; Sharp, P. R. *Science* **1997**, *275*, 1460–1462.
2405. Xia, A.; James, A. J.; Sharp, P. R. *Organometallics* **1999**, *18*, 451–453.
2406. Flint, B. W.; Yang, Y.; Sharp, P. R. *Inorg. Chem.* **2000**, *39*, 602–608.
2407. Sharp, P. R. *Comments Inorg. Chem.* **1999**, *21*, 85–114.
2408. Tripathi, U.; Scherer, W.; Schier, A.; Schmidbauer, H. *Inorg. Chem.* **1998**, *37*, 174–175.
2409. Scheneider, W.; Angermaier, K.; Schmidbauer, H. *Z. Naturforsch., Teil B* **1996**, *51*, 801–805.
2410. Hamel, A.; Hollatz, C.; Schier, A.; Schmidbauer, H. *Z. Naturforsch., Teil B* **2000**, *55*, 889–894.
2411. Kuz'mina, L. G.; Howard, J. A. K.; Grandberg, K. I.; Aleksandrov, G. C.; Kuzmin, V. S. *Russ. J. Coord. Chem.* **1999**, *25*, 511–515.
2412. Kissner, R.; Latal, P.; Geier, G. *J. Chem. Soc., Chem. Commun.* **1993**, 136–137.
2413. Mingos, D. M. P.; Yau, J. *J. Organomet. Chem.* **1994**, *479*, C16–C17.
2414. Ahland, S.; Nilsson, K.; Persson, I.; Yuchi, A.; Pennner-Hahn, J. E. *Inorg. Chem.* **1989**, *28*, 1833–1838.
2415. Bordoni, S.; Busseto, L.; Cassani, M. C.; Albano, V. G.; Sabatino, P. *Inorg. Chim. Acta* **1994**, *222*, 267–273.
2416. Beck, J. *Z. Naturforsch., Teil B* **1988**, *43*, 1219–1225.
2417. Leung, W. H.; Chim, J. L. C.; Wong, W. T. *J. Chem. Soc., Dalton Trans.* **1996**, 3153–3154.
2418. Yau, J.; Mingos, D. M. P.; Powell, H. R. *Polyhedron* **1996**, *15*, 367–369.
2419. Di Vaira, M.; Stoppioni, P.; Peruzzini, M. *J. Chem. Soc., Dalton Trans.* **1990**, 109–113.
2420. Zeller, E.; Beruda, H.; Schmidbauer, H. *Chem. Ber.* **1993**, *126*, 2033–2036.
2421. Beruda, H.; Zeller, E.; Schmidbauer, H. *Chem. Ber.* **1993**, *126*, 2037–2040.
2422. Schmidbauer, H.; Weidenhiller, G.; Steigelmann, O. *Angew. Chem., Int. Ed. Engl.* **1991**, *30*, 433–435.
2423. Bachman, R. E.; Schmidbauer, H. *Inorg. Chem.* **1996**, *35*, 1399–1401.
2424. Zeller, E.; Schmidbauer, H. *J. Chem. Soc., Chem. Commun.* **1993**, 69–70.
2425. Schmidbauer, H.; Zeller, E.; Weidenhiller, G.; Steigelmann, O.; Beruda, H. *Inorg. Chem.* **1992**, *31*, 2370–2376.
2426. Schmidbauer, H.; Zeller, E.; Ohshita, J. *Inorg. Chem.* **1993**, *32*, 4254–4526.
2427. Zeller, E.; Beruda, H.; Riede, H.; Schmidbauer, H. *Inorg. Chem.* **1993**, *32*, 3068–3071.
2428. Assmann, B.; Schmidbauer, H. *Chem. Ber.* **1997**, *130*, 217–219.
2429. Haupt, H. J.; Schwefer, M.; Egold, H.; Flörke, U. *Inorg. Chem.* **1995**, *34*, 5461–5467.
2430. Pritchard, R. G.; Dyson, D. B.; Parish, R. V.; McAuliffe, C. A.; Beagley, B. *J. Chem. Soc., Chem. Commun.* **1987**, 371–372.
2431. Dyson, D. B.; Parish, R. V.; McAuliffe, C. A.; Pritchard, R. G.; Fields, R.; Beagley, B. *J. Chem. Soc., Dalton Trans.* **1989**, 907–914.
2432. Vicente, J.; Chicote, M. T.; Jones, P. G. *Inorg. Chem.* **1993**, *32*, 4960–4964.
2433. Hollatz, C.; Schier, A.; Schmidbauer, H. *Chem. Ber.* **1997**, *130*, 1333–1338.
2434. Hollatz, C.; Schier, A.; Schmidbauer, H. *Inorg. Chim. Acta* **2000**, *300–302*, 191–199.
2435. Hollatz, C.; Schier, A.; Schmidbauer, H. *J. Am. Chem. Soc.* **1997**, *119*, 8115–8116.
2436. Hollatz, C.; Schier, A.; Schmidbauer, H. *Inorg. Chem. Commun.* **1998**, *1*, 115–117.
2437. Hollatz, C.; Schier, A.; Riede, J.; Schmidbauer, H. *J. Chem. Soc., Dalton Trans.* **1999**, 111–113.
2438. Carriedo, G. A.; Riera, V.; Rodriguez, M. L.; Jones, P. G.; Lautner, J. *J. Chem. Soc., Dalton Trans.* **1989**, 639–644.
2439. Braga, D.; Grepioni, F.; Livotto, F. S.; Vargas, M. D. *J. Organomet. Chem.* **1990**, *391*, C28–C32.
2440. Livotto, F. S.; Vargas, M. D.; Braga, D.; Grepioni, F. *J. Chem. Soc., Dalton Trans.* **1992**, 577–584.
2441. Bender, R.; Braunstein, P.; Dedieu, A.; Dusaausoy, Y. *Angew. Chem., Int. Ed. Engl.* **1989**, *28*, 923–925.
2442. Umbarkar, S. b.; Sekar, P.; Scheer, M. *Phosphorus, Sulfur Silicon Relat. Elem.* **2001**, *168*, 529–532.
2443. Usón, R.; Laguna, A.; Laguna, M. *Inorg. Synth.* **1989**, *26*, 85–91.
2444. Calderazzo, F. *J. Organomet. Chem.* **1990**, *400*, 303–320.
2445. Schmidbauer, H.; Weidenhiller, G.; Steigelmann, O.; Müller, G. *Chem. Ber.* **1990**, *123*, 285–287.
2446. Schmidbauer, H.; Weidenhiller, G.; Aly, A. A. M.; Steigelmann, O.; Müller, G. *Z. Naturforsch., Teil B* **1989**, *44*, 1503–1508.
2447. Brauer, D. J.; Bitterer, F.; Dörrenbach, F.; Heßler, G.; Stelzer, O.; Krüger, C.; Lutz, F. *Z. Naturforsch., Teil B* **1996**, *51b*, 1183–1196.
2448. Angermayer, K.; Zeller, E.; Schmidbauer, H. *J. Organomet. Chem.* **1994**, *472*, 371–376.
2449. Jones, P. G.; Bembenek, E. *J. Crystallogr. Spect. Res.* **1992**, *22*, 397–401.
2450. Schmidbauer, H.; Weidenhiller, G.; Steigelmann, O.; Müller, G. *Z. Naturforsch., Teil B* **1990**, *45*, 747–752.
2451. Pyykkö, P.; Li, J.; Runeberg, N. *Chem. Phys. Lett.* **1994**, *218*, 133–138.
2452. Lin, Y.; Jones, P. G.; Schmutzler, R.; Sheldrick, G. M. *Eur. J. Solid State Inorg. Chem.* **1992**, *29*, 887–898.
2453. Khan, M.; Oldham, C.; Tuck, D. G. *Can. J. Chem.* **1981**, *59*, 2714–2722.
2454. Tiekink, E. R. T. *Acta Crystallogr., Sect. C* **1989**, *45*, 1233–1236.
2455. Muir, J. A.; Muir, M. M.; Pulgar, L. B.; Jones, P. G.; Sheldrick, G. M. *Acta Crystallogr., Sect. C* **1985**, *41*, 1174–1176.
2456. Bowmaker, G. A.; Brown, C. L.; Hart, R. D.; Healy, P. C.; Rickard, C. E. F.; White, A. H. *J. Chem. Soc., Dalton Trans.* **1999**, 881–889.
2457. Khan, M. N. I.; King, C.; Fackler, J. P., Jr.; Winpenny, R. E. *P. Inorg. Chem.* **1993**, *32*, 2502–2505.
2458. Fackler, J. P. Jr.; Staples, R. J.; Khan, M. N. I.; Winpenny, R. E. *Acta Crystallogr., Sect. C* **1994**, *50*, 1020–1023.
2459. Muir, J. A.; Cuadrado, S. I.; Muir, M. M. *Acta Crystallogr., Sect. C* **1991**, *47*, 1072–1074.
2460. Cookson, P. D.; Tiekink, E. R. T. *Acta Crystallogr., Sect. C* **1993**, *49*, 1602–1603.
2461. Lange, P.; Schier, A.; Schmidbauer, H. *Inorg. Chim. Acta* **1995**, *235*, 263–272.
2462. Harker, C. S. W.; Tiekink, E. R. T. *Acta Crystallogr., Sect. C* **1990**, *46*, 1546–1547.
2463. Harker, C. S. W.; Tiekink, E. R. T. *Acta Crystallogr., Sect. C* **1991**, *47*, 878–879.
2464. Cookson, P. D.; Tiekink, E. R. T. *Acta Crystallogr., Sect. C* **1994**, *50*, 1896–1898.

2465. Alyea, E. C.; Ferguson, G.; Gallagher, J. F.; Malito, J. *Acta Crystallogr., Sect. C* **1993**, *49*, 1473–1476.
2466. Baker, L. J.; Bott, R. C.; Bowmaker, G. A.; Healy, P. C.; Skelton, B. W.; Schwerdtfeger, P.; White, A. H. *J. Chem. Soc., Dalton Trans.* **1995**, 1341–1347.
2467. Alyea, E. M.; Ferguson, G.; Kannan, S. *Polyhedron* **2000**, *19*, 2211–2213.
2468. Alcock, N. W.; Moore, P.; Lampe, P. A. *J. Chem. Soc., Dalton Trans.* **1982**, 207–210.
2469. Look, C. J. L.; Turner, M. A. *Acta Crystallogr., Sect. C* **1987**, *43*, 2096–2099.
2470. Jones, P. G.; Erdbrügger, C. F.; Hohbein, R.; Schwarzmann, E. *Acta Crystallogr., Sect. C* **1988**, *44*, 1302–1305.
2471. Bardaji, M.; Jones, P. G.; Laguna, A. *J. Chem. Soc., Dalton Trans.* **2002**, 3624–3629.
2472. Edwards, D. A.; Mahon, M. F.; Paget, T. J. *Polyhedron* **1998**, *17*, 4121–4130.
2473. Hollatz, C.; Schier, A.; Schmidbaur, H. *Z. Naturforsch., Teil B* **1999**, *54*, 30–37.
2474. Ho, S. Y.; Tiekink, E. R. T. *Acta Crystallogr., Sect. E* **2001**, *57*, M549–M550.
2475. Slawin, A. M. Z.; Woollins, J. D.; Zhang, Q. *J. Chem. Soc., Dalton Trans.* **2001**, 621–632.
2476. Jones, P. G.; Bembenek, E. Z. *Kristallogr.* **1998**, *213*, 611–614.
2477. Brauer, D. J.; Bitterer, F.; Dorrenbach, F.; Hessler, G.; Stelzer, O.; Kruger, C.; Lutz, F. *Z. Naturforsch., Teil B* **1996**, *51*, 1183–1196.
2478. Angermair, K.; Bowmaker, G.; De Silva, E. N.; Healy, P. C.; Jones, B. E.; Schmidbaur, H. *J. Chem. Soc., Dalton Trans.* **1996**, 3121–3129.
2479. Bott, R. C.; Bowmaker, G. A.; Buckley, R. W.; Healy, P. C.; Perera, M. C. S. *Aust. J. Chem.* **1999**, *52*, 271–277.
2480. Bott, R. C.; Bowmaker, G. A.; Buckley, R. W.; Healy, P. C.; Perera, M. C. S. *Aust. J. Chem.* **2000**, *53*, 175–181.
2481. Toronto, D. V.; Weissbart, B.; Tinti, D. S.; Balch, A. L. *Inorg. Chem.* **1996**, *35*, 2484–2489.
2482. Weissbart, B.; Toronto, D. V.; Balch, A. L.; Tinti, D. S. *Inorg. Chem.* **1996**, *35*, 2490–2496.
2483. Larson, L. J.; McCauley, E. M.; Weissbart, B.; Tinti, D. S. *J. Phys. Chem.* **1995**, *99*, 7218–7226.
2484. Nunokawa, K.; Onaka, S.; Tatematsu, T.; Ito, M.; Sakai, J. *Inorg. Chim. Acta* **2001**, *322*, 56–64.
2485. Turpin, R.; Larssonneur, A. M.; Jaud, J.; Castan, P. *Inorg. Chim. Acta* **1995**, *237*, 207–210.
2486. Jones, P. G.; Thöne, C. *Acta Crystallogr., Sect. C* **1992**, *48*, 2114–2116.
2487. López de Luzuriaga, J. M.; Schier, A.; Schmidbaur, H. *Chem. Ber.* **1997**, *130*, 647–650.
2488. Slawin, A. M. Z.; Smith, M. B.; Woollins, J. D. *Polyhedron* **1999**, *18*, 1135–1140.
2489. Laube, J.; Jäger, S.; Thöne, C. *Eur. J. Inorg. Chem.* **2001**, 1883–1992.
2490. Aucott, S. M.; Slawin, A. M. Z.; Woollins, J. D. *J. Chem. Soc., Dalton Trans.* **2000**, 2559–2575.
2491. Lange, P.; Schier, A.; Schmidbaur, H. *Inorg. Chem.* **1996**, *35*, 637–642.
2492. Attar, S.; Bearden, W. H.; Alcock, N. W.; Alyea, E. C.; Nelson, J. H. *Inorg. Chem.* **1990**, *29*, 425–433.
2493. Mezailles, N.; Ricard, L.; Mathey, F.; Le Floch, P. *Eur. J. Inorg. Chem.* **1999**, 2233–2241.
2494. Fischer, A.; Neda, I.; Jones, P. G.; Schmutzler, R. *Phosphorus, Sulfur Silicon, Relat. Elem. Inorg. Chem.* **1994**, *91*, 103–127.
2495. Song, Y.; Vittal, J. J.; Srinivasan, N.; Chan, S. H.; Leung, P. H. *Tetrahedron: Asymmetry* **1999**, *10*, 1433–1436.
2496. Assefa, Z.; McBurnett, B. G.; Staples, R. J.; Fackler, J. P., Jr.; Assmann, B.; Angermaier, K. *Inorg. Chem.* **1995**, *34*, 75–83.
2497. Assmann, B.; Angermaier, K.; Schmidbaur, H. *J. Chem. Soc., Chem. Commun.* **1994**, 941–942.
2498. Assefa, Z.; McBurnett, B. G.; Staples, R. J.; Fackler, J. P., Jr. *Inorg. Chem.* **1995**, *34*, 4965–4972.
2499. Bayler, A.; Bauer, A.; Schmidbaur, H. *Z. Naturforsch., Teil B* **1997**, *52b*, 1477–1483.
2500. Angermaier, K.; Sladek, A.; Schmidbaur, H. *Z. Naturforsch., Teil B* **1996**, *51b*, 1671–1674.
2501. Müller, T. E.; Green, J. C.; Mingos, D. M. P.; McPartlin, C. M.; Whittingham, C.; Williams, D. J.; Woodroffe, T. M. *J. Organomet. Chem.* **1998**, *551*, 313–330.
2502. Schneider, W.; Bauer, A.; Schier, A.; Schmidbaur, H. *Chem. Ber.* **1997**, *130*, 1423–1426.
2503. Meyer, J.; Piana, H.; Wagner, H.; Schubert, U. *Chem. Ber.* **1990**, *123*, 791–793.
2504. Oroz, M. M.; Schier, A.; Schmidbaur, H. *Z. Naturforsch., Teil B* **1999**, *54*, 26–29.
2505. Bauer, A.; Schmidbaur, H. *J. Am. Chem. Soc.* **1996**, *118*, 5324–5325.
2506. McWhannell, M. A.; Rosair, G. M.; Welch, A. J. *Acta Crystallogr., Sect. C* **1998**, *54*, 13–15.
2507. Shi, J. C.; Huang, X. Y.; Wu, D. X.; Liu, Q. T.; Kang, B. S. *Inorg. Chem.* **1996**, *35*, 2742–2746.
2508. Viotte, M.; Gautheron, B.; Parish, R. G.; Pritchard, R. G. *Acta Crystallogr., Sect. C* **1996**, *52*, 1891–1894.
2509. Cobley, C. J.; Ellis, D. D.; Orpen, A. G.; Pringle, P. G. *J. Chem. Soc., Dalton Trans.* **2000**, 1101–1107.
2510. Leznoff, D. B.; Rancurel, C.; Sutter, J. P.; Rettig, S. J.; Pink, M.; Paulsen, C.; Kahn, O. *J. Chem. Soc., Dalton Trans.* **1999**, 3593–3599.
2511. Staples, R. J.; King, C.; Khan, M. N. I.; Winpenny, R. E. P.; Fackler, J. P., Jr. *Acta Crystallogr., Sect. C* **1993**, *49*, 472–475.
2512. Staples, R. J.; Fackler, J. P., Jr.; Khan, M. N. I.; Winpenny, R. E. P. *Acta Crystallogr., Sect. C* **1994**, *50*, 191–193.
2513. Bayler, A.; Bowmaker, G. A.; Schmidbaur, H. *Inorg. Chem.* **1996**, *35*, 5959–5960.
2514. Fernández, E. J.; López de Luzuriaga, J. M.; Monge, M.; Rodríguez, M. A.; Crespo, O.; Gimeno, M. C.; Laguna, A.; Jones, P. G. *Chem. Eur. J.* **2000**, *6*, 636–644.
2515. Goodwin, N. J.; Henderson, W. *Polyhedron*, **1998**, *17*, 4071–4077.
2516. Fuchs, S.; López de Luzuriaga, J. M.; Olmos, M. E.; Sladek, A.; Schmidbaur, H. *Z. Naturforsch., Teil B* **1997**, *52*, 217–220.
2517. Schwerdtfeger, P.; Dolg, M.; Schwarz, W. H. E.; Bowmaker, G. A.; Boyd, P. D. W. *J. Chem. Phys.* **1989**, *91*, 1762–1767.
2518. Schwerdtfeger, P.; Boyd, P. D. W.; Burrell, A. K.; Robinson, W. T.; Taylor, M. J. *Inorg. Chem.* **1990**, *29*, 3593–3607.
2519. Bowmaker, G. A.; Schmidbaur, H.; Krüger, S.; Rösch, N. *Inorg. Chem.* **1997**, *36*, 1754–1757.
2520. Crespo, O.; Laguna, A.; Fernández, E. J.; López de Luzuriaga, J. M.; Jones, P. G.; Teichert, M.; Monge, M.; Pyykkö, P.; Runeberg, N.; Schütz, M.; Werner, H. J. *Inorg. Chem.* **2000**, *39*, 4786–4792.
2521. Colburn, C. B.; Hill, W. E.; McAuliffe, C. A.; Parish, R. V. *J. Chem. Soc., Chem. Commun.* **1979**, 218–219.
2522. Parish, R. V.; Parry, O.; McAuliffe, C. A. *J. Chem. Soc., Dalton Trans.* **1981**, 2098–2104.
2523. DelZotto, A.; Nardin, G.; Rigo, P. *J. Chem. Soc., Dalton Trans.* **1995**, 3343–3351.
2524. Fenske, G. P.; Mason, W. R. *Inorg. Chem.* **1974**, *13*, 1783–1786.
2525. Colton, R.; Harrison, K. L.; Mah, Y. A.; Traeger, J. C. *Inorg. Chim. Acta* **1995**, *231*, 65–71.

2526. Bowmaker, G. A.; Dyason, J. C.; Healy, P. C.; Engelhardt, L. M.; Pakawatchai, C.; White, A. H. *J. Chem. Soc., Dalton Trans.* **1987**, 1089–1097.
2527. Muir, J. A.; Muir, M. M.; Arias, S. *Acta Crystallogr. Sect. B* **1982**, *38*, 1318–1320.
2528. Wang, J. C.; Wang, Y. *Acta Crystallogr., Sect. C* **1993**, *49*, 131–132.
2529. Assefa, Z.; Stapless, R. J.; Fackler, J. P., Jr. *Inorg. Chem.* **1994**, *33*, 2790–2798.
2530. Muir, M. M.; Cuadrado, S. I.; Muir, J. A.; Barnes, C. L. *Acta Crystallogr., Sect. C* **1988**, *44*, 1659–1660.
2531. King, C.; Khan, M. N. I.; Staples, R. J.; Fackler, J. P., Jr. *Inorg. Chem.* **1992**, *31*, 3236–3241.
2532. Guggenberger, L. J. *J. Organomet. Chem.* **1974**, *81*, 271–280.
2533. Clegg, W. *Acta Crystallogr., Sect. C* **1976**, *32*, 2712–2714.
2534. Beurskens, F. T.; Pet, R.; Noordik, J. H.; Van der Velden, J. W. A.; Bour, J. *J. Cryst. Struct. Commun.* **1982**, *11*, 1039–1042.
2535. Davidson, J. L.; Lindsell, W. E.; McCullough, K. J.; McIntosh, C. H. *Organometallics* **1995**, *14*, 3497–3506.
2536. Olbrich, F.; Lagow, R. J. *Z. Anorg. Allg. Chem.* **1995**, *621*, 1929–1932.
2537. Hamel, A.; Schier, A.; Schmidbaur, H. *Z. Naturforsch., Teil B* **2002**, *57*, 877–880.
2538. Muir, J. A.; Cuadrado, S. I.; Muir, M. M. *Acta Crystallogr., Sect. C* **1992**, *48*, 915–917.
2539. Forward, J. M.; Assefa, Z.; Fackler, J. P., Jr. *J. Am. Chem. Soc.* **1995**, *117*, 9103–9104.
2540. Jones, P. G. *J. Chem. Soc., Chem. Commun.* **1980**, 1031–1033.
2541. Elder, R. C.; Zeiher, E. H. K.; Onadi, M.; Whittle, R. W. *J. Chem. Soc., Chem. Commun.* **1981**, 900–901.
2542. Jones, P. G. *Acta Crystallogr., Sect. C* **1992**, *48*, 1487–1488.
2543. Jones, P. G. *Z. Naturforsch., Teil B* **1982**, *37*, 937–942.
2544. Usón, R.; Laguna, A.; Vicente, J.; García, J.; Jones, P. G.; Sheldrick, G. M. *J. Chem. Soc., Dalton Trans.* **1981**, 655–657.
2545. Hitchcock, P. B.; Pye, P. L. *J. Chem. Soc., Dalton Trans.* **1977**, 1457–1460.
2546. Bauer, A.; Schier, A.; Schmidbaur, H. *J. Chem. Soc., Dalton Trans.* **1995**, 2919–2920.
2547. Jones, P. G.; Sheldrick, G. M.; Muir, J. A.; Muir, M. M.; Pulgar, L. B. *J. Chem. Soc., Dalton Trans.* **1982**, 2123–2125.
2548. Muir, J. A.; Muir, M. M.; Arias, S.; Jones, P. G.; Sheldrick, G. M. *Inorg. Chim. Acta* **1984**, *81*, 169–174.
2549. Muir, J. A.; Muir, M. M.; Arias, S.; Campana, C. F.; Dwight, S. K. *Acta Crystallogr., Sect. B* **1982**, *38*, 2047–2049.
2550. Chan, W. H.; Cheung, K. K.; Mak, T. C. W.; Che, C. M. *J. Chem. Soc., Dalton Trans.* **1998**, 873–874.
2551. Parish, R. V. *NMR, NQR, EPR, and Mössbauer Spectroscopy in Inorganic Chemistry*, Ellis Horwood: Chichester, U.K., 1990, p 152.
2552. Shi, F.; Den, Y.; Yang, Y.; SiMa, T. *Chem. Commun.* **2001**, 345–346.
2553. Shi, F.; Den, Y. *Chem. Commun.* **2001**, 345–346.
2554. Teles, J. H.; Brode, S.; Chabanas, M. *Angew. Chem., Int. Ed. Engl.* **1998**, *37*, 1415–1418.
2555. Schmidbaur, H.; Bissinger, P.; Lachmann, J.; Steigelmann, O. *Z. Naturforsch., Teil B* **1992**, *47*, 1711–1716.
2556. Van Calcar, P. M.; Olmstead, M. M.; Balch, A. L. *J. Chem. Soc., Chem. Commun.* **1995**, 1773–1774.
2557. Schmidbaur, H.; Wohlleben, A.; Wagner, F.; Orama, O.; Huttner, G. *Chem. Ber.* **1977**, *119*, 1748–1754.
2558. Bates, P. A.; Waters, J. M. *Inorg. Chim. Acta* **1985**, *98*, 125–129.
2559. Eggleston, D. S.; Chodosh, D. F.; Girard, G. R.; Hill, D. T. *Inorg. Chim. Acta* **1985**, *108*, 221–226.
2560. Cooper, M. K.; Mitchell, L. E.; Henrick, K.; McPartlin, M.; Scott, A. *Inorg. Chim. Acta* **1984**, *84*, L9–L10.
2561. Van Calcar, P. M.; Olmstead, M. M.; Balch, A. L. *Inorg. Chem.* **1997**, *36*, 5231–5238.
2562. Schmidbaur, H.; Graf, W.; Müller, G. *Angew. Chem., Int. Ed. Engl.* **1988**, *27*, 417–421.
2563. Schmidbaur, H.; Graf, W.; Müller, G. *Helv. Chim. Acta* **1986**, *69*, 1748–1756.
2564. Dziwok, K.; Lachmann, J.; Wilkinson, D. L.; Müller, G.; Schmidbaur, H. *Chem. Ber.* **1990**, *123*, 423–431.
2565. Schmidbaur, H.; Dziwok, K.; Grohmann, A.; Müller, G. *Chem. Ber.* **1989**, *122*, 893–895.
2566. Jones, P. G. *Acta Crystallogr., Sect. B* **1980**, *36*, 2775–2776.
2567. Eggleston, D. S.; McArdle, J. V.; Zuber, G. E. *J. Chem. Soc., Dalton Trans.* **1987**, 677–679.
2568. Schmidbaur, H.; Paschalidis, C.; Steigelmann, O.; Müller, G. *Chem. Ber.* **1989**, *122*, 1851–1855.
2569. Schmidbaur, H.; Herr, R.; Müller, G.; Riede, J. *Organometallics* **1985**, *4*, 1208–1213.
2570. Dhuhghaill, O. M. N.; Sadler, P. J.; Kuroda, R. *J. Chem. Soc., Dalton Trans.* **1990**, 2913–2921.
2571. Baker, R. T.; Calabrese, J. C.; Wescott, S. A. *J. Organomet. Chem.* **1995**, *498*, 109–117.
2572. Schmidbaur, H.; Aly, A. A. M.; Schubert, U. *Angew. Chem., Int. Ed. Engl.* **1978**, *17*, 846–847.
2573. Schmidbaur, H.; Wagner, F. E.; Wohlleben-Hammer, *Chem. Ber.* **1979**, *112*, 496–500.
2574. Moore, L. S.; Parish, R. V.; Usón, R.; Laguna, A.; Laguna, M.; Fraile, M. N. *J. Chem. Soc., Dalton Trans.* **1988**, 23–26.
2575. Lange, P.; Schier, A.; Schmidbaur, H. *Z. Naturforsch., Teil B* **1997**, *52*, 769–771.
2576. Hill, D. T.; Girard, G. R.; McCabe, F. L.; Johnson, R. K.; Stupik, P. R.; Zhang, J. H.; Reiff, W. M.; Eggleston, D. S. *Inorg. Chem.* **1989**, *28*, 3529–3533.
2577. Gimeno, M. C.; Laguna, A.; Sarroca, C.; Jones, P. G. *Inorg. Chem.* **1993**, *32*, 5926–5932.
2578. Canales, F.; Gimeno, M. C.; Jones, P. G.; Laguna, A.; Sarroca, C. *Inorg. Chem.* **1997**, *36*, 5206–5211.
2579. Crespo, O.; Gimeno, M. C.; Jones, P. G.; Laguna, A. *Acta Crystallogr., Sect. C* **2000**, *56*, 1433–1434.
2580. Crespo, O.; Gimeno, M. C.; Laguna, A.; Jones, P. G. *J. Chem. Soc., Dalton Trans.* **1992**, 1601–1605.
2581. Jones, P. G.; Bembenek, E. *Acta Crystallogr., Sect. C* **1996**, *52*, 2396–2399.
2582. Gaw, K. G.; Smith, M. B.; Slawin, A. M. *Z. New J. Chem.* **2000**, *24*, 429–435.
2583. Neda, I.; Fischer, A.; Kaukorat, T.; Jones, P. G.; Schmutzler, R. *Chem. Ber.* **1994**, *127*, 1579–1586.
2584. Hofreiter, S.; Paul, M.; Schmidbaur, H. *Chem. Ber.* **1995**, *128*, 901–905.
2585. Berners-Price, S.; Sadler, P. J. *Inorg. Chem.* **1986**, *25*, 3822–3827.
2586. Berners-Price, S.; Bowen, R. J.; Hambley, T. W.; Healy, P. C. *J. Chem. Soc., Dalton Trans.* **1999**, 1337–1346.
2587. Jones, P. G.; Thöne, C. *Acta Crystallogr., Sect. C* **1997**, *53*, 42–45.
2588. Gee, V.; Orpen, A. G.; Phetmung, H.; Pringle, P. G.; Pugh, R. I. *Chem. Commun.* **1999**, 901–902.
2589. Hunks, W. J.; Jennings, M. C.; Puddephatt, R. J. *Inorg. Chem.* **2000**, *39*, 2699–2702.
2590. Slawin, A. M. Z.; Wainwright, M.; Woollins, J. D. *J. Chem. Soc., Dalton Trans.* **2001**, 2724–2730.
2591. Slawin, A. M. Z.; Smith, M. B.; Woollins, J. D. *Chem. Commun.* **1996**, 2095–2096.

2592. García-Sejido, M. I.; Habtemariam, A.; Parsons, S.; Gould, R. O.; Gracia-Fernández, M. F. *New J. Chem.* **2002**, *26*, 636–644.
2593. He, G. S.; Mok, K. F.; Leung, P. H. *Organometallics* **1999**, *18*, 4027–4031.
2594. Jones, P. G.; Thöne, C. *Acta Crystallogr., Sect. C* **1992**, *48*, 1312–1314.
2595. Piana, H.; Wagner, H.; Schubert, U. *Chem. Ber.* **1991**, *124*, 63–67.
2596. Narayanaswamy, R.; Young, M. A.; Parkhurst, E.; Ouellette, M.; Kerr, M. E.; Ho, D. M.; Elder, R. C.; Bruce, A. E.; Bruce, M. R. M. *Inorg. Chem.* **1993**, *32*, 2506–2517.
2597. Ito, Y.; Sawamura, M.; Hayashi, T. *J. Am. Chem. Soc.* **1986**, *108*, 6405–6406.
2598. Togni, A.; Pastor, S. D.; Rihs, G. *J. Organomet. Chem.* **1990**, *381*, C21–C25.
2599. Liou, L. S.; Liu, C. P.; Wang, J. C. *Acta Crystallogr., Sect. C* **1994**, *50*, 538–540.
2600. Kozelca, J.; Oswald, H. R.; Dubler, E. *Acta Crystallogr., Sect. C* **1986**, *42*, 1007–1009.
2601. Jaw, H. R. C.; Savas, M. M.; Rogers, R. D.; Mason, W. R. *Inorg. Chem.* **1989**, *28*, 1028–1037.
2602. Shain, J.; Fackler, J. P., Jr. *Inorg. Chim. Acta* **1987**, *131*, 157–158.
2603. Khan, M. N. I.; King, C.; Heinrich, D. D.; Fackler, J. P.; Porter, L. C. *Inorg. Chem.* **1989**, *28*, 2150–2154.
2604. Bauer, A.; Schmidbaur, H. *J. Chem. Soc., Dalton Trans.* **1997**, 1115–1116.
2605. Puddephatt, R. *J. Chem. Soc. Rev.* **1983**, *12*, 99–127.
2606. Porter, L. C.; Khan, M. N. I.; King, C.; Fackler, J. P., Jr. *Acta Crystallogr., Sect. C* **1989**, *45*, 947–949.
2607. Preault, D.; Drouin, M.; Michel, A.; Miskowski, V. M.; Schaefer, W. P.; Harvey, P. D. *Inorg. Chem.* **1992**, *31*, 695–702.
2608. Ludwig, W.; Meyer, W. *Helv. Chim. Acta* **1982**, *65*, 934–943.
2609. Schaefer, W. P.; Marsh, R. E.; McCleskey, T. M.; Gray, H. B. *Acta Crystallogr., Sect. C* **1991**, *47*, 2553–2556.
2610. Dekker, J.; Munninghoff, J. W.; Boersma, J.; Spek, A. L. *Organometallics* **1987**, *6*, 1236–1239.
2611. Schmidbaur, H.; Pollok, T.; Reber, G.; Müller, G. *Chem. Ber.* **1988**, *121*, 1345–1348.
2612. Field, J. S.; Grieve, J.; Haines, R. J.; May, N.; Zulu, M. M. *Polyhedron* **1998**, *17*, 3021–3029.
2613. King, C.; Wang, J. C.; Khan, M. N. I.; Fackler, J. P., Jr. *Inorg. Chem.* **1989**, *28*, 2145–2149.
2614. Che, C. M.; Kwong, H. L.; Poon, C. K.; Yam, V. W. W. *J. Chem. Soc., Dalton Trans.* **1990**, 3215–3219.
2615. Leung, K. H.; Phillips, D. L.; Tse, M. C.; Che, C. M.; Miskowski, V. M. *J. Am. Chem. Soc.* **1999**, *121*, 4799–4803.
2616. Fu, W. F.; Chan, K. C.; Miskowski, V. M.; Che, C. M. *Angew. Chem., Int. Ed. Engl.* **1999**, *38*, 2783–2785.
2617. Fu, W. F.; Chan, K. C.; Cheung, K. K.; Che, C. M. *Chem. Eur. J.* **2001**, *7*, 4656–4664.
2618. Zhang, H. X.; Che, C. M. *Chem. Eur. J.* **2001**, *7*, 4887–4893.
2619. Ma, Y.; Che, C. M.; Chao, H. Y.; Zhou, X.; Chan, W. H.; Shen, J. *Adv. Mater.* **1999**, *11*, 852–857.
2620. Briant, C. E.; Hall, K. P.; Mingos, D. M. P. *J. Organomet. Chem.* **1982**, *229*, C5–C8.
2621. Schmidbaur, H.; Mandl, J. R.; Bassett, J. M.; Blaschke, G.; Zimmer-Gasser, B. *Chem. Ber.* **1981**, *114*, 433–440.
2622. Usón, R.; Laguna, A.; Laguna, M.; Gimeno, M. C.; Jones, P. G.; Fittschen, C.; Sheldrick, G. M. *J. Chem. Soc., Chem. Commun.* **1986**, 509–510.
2623. Brandys, M. C.; Puddephatt, R. *J. Chem. Commun.* **2001**, 1280–1281.
2624. Yip, J. H. K.; Prabhavathy, J. *Angew. Chem., Int. Ed. Engl.* **2001**, *40*, 2159–2162.
2625. Lin, I. J. B.; Hwang, J. M.; Feng, D. F.; Cheng, M. C.; Wang, Y. *Inorg. Chem.* **1994**, *33*, 3467–3472.
2626. Feng, D. F.; Tang, S. S.; Liu, C. W.; Lin, I. J. B.; Wen, Y. S.; Liu, L. K. *Organometallics* **1997**, *16*, 901–909.
2627. Crespo, O.; Gimeno, M. C.; Laguna, A.; Villacampa, M. D. *Acta Crystallogr., Sect. C* **1998**, *54*, 203–205.
2628. Hutton, A. T.; Pringle, P. G.; Shaw, B. L. *Organometallics* **1983**, *2*, 1889–1891.
2629. Balch, A. J.; Catalano, V. J.; Olmstead, M. M. *Inorg. Chem.* **1990**, *29*, 585–586.
2630. Balch, A. L.; Catalano, V. J. *Inorg. Chem.* **1991**, *30*, 1302–1308.
2631. Balch, A. L.; Catalano, V. J. *Inorg. Chem.* **1992**, *31*, 2730–2734.
2632. Kim, H. P.; Fanwick, P. E.; Kubiak, C. P. *J. Organomet. Chem.* **1988**, *346*, C39–C42.
2633. Yip, H. K.; Che, C. M.; Peng, S. M. *J. Chem. Soc., Chem. Commun.* **1991**, 1626–1628.
2634. Yip, H. K.; Lin, H. M.; Wang, Y.; Che, C. M. *J. Chem. Soc., Dalton Trans.* **1993**, 2939–2944.
2635. Braunstein, P.; Knorr, M.; Schubert, U.; Lanfranchi, M.; Tiripicchio, A. *J. Chem. Soc., Dalton Trans.* **1991**, 1507–1514.
2636. Braunstein, P.; Knorr, M.; Tiripicchio, A.; Tiripicchio Camellini, M. *Inorg. Chem.* **1992**, *31*, 3685–3687.
2637. Liu, L. K.; Luh, L. S.; Wen, Y. S.; Eke, U. B.; Mesubi, M. A. *Organometallics* **1995**, *14*, 4474–4482.
2638. Balch, A. L.; Noll, B. C.; Olmstead, M. M.; Toronto, D. V. *Inorg. Chem.* **1992**, *31*, 5226–5230.
2639. McNair, R. J.; Nilsson, P. V.; Pignolet, L. H. *Inorg. Chem.* **1985**, *24*, 1935–1939.
2640. McNair, R. J.; Pignolet, L. H. *Inorg. Chem.* **1986**, *25*, 4717–4723.
2641. Fernández, E. J.; Gimeno, M. C.; Jones, P. G.; Laguna, A.; Olmos, E. *Inorg. Chim. Acta* **1995**, *238*, 173–177.
2642. Bardají, M.; Connelly, N. G.; Gimeno, M. C.; Jiménez, J.; Jones, P. G.; Laguna, A.; Laguna, M. *J. Chem. Soc., Dalton Trans.* **1994**, 1163–1167.
2643. Dávila, R. M.; Elduque, A.; Grant, T.; Staples, R. J.; Fackler, J. P., Jr. *Inorg. Chem.* **1993**, *32*, 1749–1755.
2644. Dávila, R. M.; Elduque, A.; Staples, R. J.; Harlass, M.; Fackler, J. P., Jr. *Inorg. Chim. Acta* **1994**, *217*, 45–49.
2645. Bardají, M.; Laguna, A.; Laguna, M. *J. Chem. Soc., Dalton Trans.* **1995**, 1255–1258.
2646. Stützer, A.; Bissinger, P.; Schmidbaur, H. *Chem. Ber.* **1992**, *125*, 367–372.
2647. Fernández, E. J.; Gimeno, M. C.; Jones, P. G.; Laguna, A.; Laguna, M.; López de Luzuriaga, J. M. *J. Chem. Soc., Dalton Trans.* **1993**, 3401–3406.
2648. Che, C. M.; Yip, H. K.; Yam, V. W. W.; Cheung, P. Y.; Lai, T. F.; Shieh, S. J.; Peng, S. M. *J. Chem. Soc., Dalton Trans.* **1992**, 427–433.
2649. El-Amouri, H.; Bahsoun, A. A.; Fischer, J.; Osborn, J. A.; Youinou, M. T. *Organometallics* **1991**, *10*, 3582–3588.
2650. Fernández, E. J.; Gimeno, M. C.; Jones, P. G.; Laguna, A.; Laguna, M.; Olmos, E. *J. Chem. Soc., Dalton Trans.* **1994**, 2891–2898.
2651. Zank, J.; Schier, A.; Schmidbaur, H. *J. Chem. Soc., Dalton Trans.* **1998**, 323–324.
2652. Schmidbaur, H.; Stützer, A.; Bissinger, P. *Z. Naturforsch., Teil B* **1992**, *47*, 640–645.
2653. Stützer, A.; Bissinger, P.; Schmidbaur, H. *Z. Naturforsch., Teil B* **1992**, *47*, 1261–1266.
2654. Zank, J.; Schier, A.; Schmidbaur, H. *Z. Naturforsch., Teil B* **1997**, *52*, 1471–1476.
2655. Balch, A. L.; Fung, E. Y.; Olmstead, M. M. *J. Am. Chem. Soc.* **1990**, *112*, 5181–5186.

2656. Yam, V. W. W.; Lai, T. F.; Che, C. M. *J. Chem. Soc., Dalton Trans.* **1990**, 3747–3752.
2657. Li, D.; Che, C. M.; Peng, S. M.; Liu, S. T.; Zhou, Z. Y.; Mak, T. C. W. *J. Chem. Soc., Dalton Trans.* **1993**, 189–194.
2658. Xiao, H.; Weng, Y. X.; Wong, W. T.; Mak, T. C. W.; Che, C. M. *J. Chem. Soc., Dalton Trans.* **1997**, 221–226.
2659. Bardaji, M.; Laguna, A.; Villacampa, M. D. *Acta Crystallogr., Sect. C* **2000**, 56, e487–e488.
2660. Tanase, T.; Masuda, K.; Matsuo, J.; Hamaguchi, M.; Begum, R. A.; Yano, S. *Inorg. Chim. Acta* **2000**, 299, 91–99.
2661. Balch, A. L.; Fung, E. Y.; Olmstead, M. M. *Inorg. Chem.* **1990**, 29, 3203–3207.
2662. Balch, A. L.; Catalano, V. J.; Olmstead, M. M. *J. Am. Chem. Soc.* **1990**, 112, 2010–2011.
2663. Balch, A. L.; Catalano, V. J.; Noll, B. C.; Olmstead, M. M. *J. Am. Chem. Soc.* **1990**, 112, 7558–7566.
2664. Balch, A. L.; Oram, D. E.; Reedy, P. E., Jr. *Inorg. Chem.* **1987**, 26, 1837–1842.
2665. Balch, A. L.; Nagle, J. K.; Oram, D. E.; Reedy, P. E., Jr. *J. Am. Chem. Soc.* **1988**, 110, 454–462.
2666. Balch, A. L.; Davis, B. J.; Olmstead, M. M. *Inorg. Chem.* **1989**, 28, 3148–3153.
2667. Sevillano, P.; Habtemariam, A.; Parsons, S.; Castiñeiras, A.; Garcia, M. E.; Sadler, P. J. *J. Chem. Soc., Dalton Trans.* **1999**, 2861–2870.
2668. Hofmann, M.; Heinemann, F. W.; Zenneck, U. *J. Organomet. Chem.* **2002**, 643–644, 357–362.
2669. Xu, W.; Rourke, J. P.; Vittal, J. J.; Puddephatt, R. J. *J. Chem. Soc., Chem. Commun.* **1993**, 145–147.
2670. Xu, W.; Rourke, J. P.; Vittal, J. J.; Puddephatt, R. J. *Inorg. Chem.* **1995**, 34, 323–329.
2671. Sakhaii, P.; Neda, I.; Freytag, M.; Thonnessen, H.; Jones, P. G.; Schmutzler, R. Z. *Anorg. Allg. Chem.* **2000**, 626, 1246–1254.
2672. Dieleman, C. B.; Matt, D.; Harriman, A. *Eur. J. Inorg. Chem.* **2000**, 831–834.
2673. Cerrada, E.; Diaz, C.; Diaz, M. C.; Hursthouse, M. B.; Laguna, M.; Light, M. E. *J. Chem. Soc., Dalton Trans.* **2002**, 1104–1109.
2674. Tzeng, B. C.; Cheung, K. K.; Che, C. M. *Chem. Commun.* **1996**, 1681–1682.
2675. Schmidt, R.; Moya, S. A.; Villagra, D.; Binder, H.; Heckmann, Y. G. *Bol. Soc. Chil. Quím.* **1996**, 41, 371–375.
2676. Caminade, A. M.; Laurent, R.; Chaudret, B.; Majoral, J. P. *Chem. Soc. Rev.* **1998**, 180, 793–821.
2677. Dasgupta, M.; Peori, M. B.; Kakkar, A. K. *Coord. Chem. Rev.* **2002**, 233–234, 223–235.
2678. Engel, R.; Rengan, K.; Chan, C. S. *Heteroatom Chem.* **1993**, 4, 181–184.
2679. Slany, M.; Bardaji, M.; Casanove, M. J.; Caminade, A. M.; Majoral, J. P.; Chaudret, B. *J. Am. Chem. Soc.* **1995**, 117, 9764–9765.
2680. Phang, L. T.; Hor, T. S. A.; Zhou, Z. Y.; Mak, T. C. W. *J. Organomet. Chem.* **1994**, 469, 253–261.
2681. Houlton, A.; Mingos, D. M. P.; Murphy, D. M.; Williams, D. J.; Phang, L. T.; Hor, T. S. A. *J. Chem. Soc., Dalton Trans.* **1993**, 3629–3630.
2682. Viotte, M.; Gautheron, B.; Kubicki, M. M.; Mugnier, Y.; Parish, R. V. *Inorg. Chem.* **1995**, 34, 3465–3473.
2683. Crespo, O.; Gimeno, M. C.; Jones, P. G.; Laguna, A. *Inorg. Chem.* **1996**, 35, 1361–1366.
2684. Hadj-Bagheri, N.; Puddephatt, R. J. *Inorg. Chim. Acta* **1993**, 213, 29–39.
2685. Bensch, W.; Prelati, M.; Ludwig, W. *J. Chem. Soc., Chem. Commun.* **1986**, 1762–1763.
2686. Jaw, H. R. C.; Savas, M. M.; Mason, W. R. *Inorg. Chem.* **1989**, 28, 4366–4369.
2687. Leung, K. H.; Phillips, D. L.; Mao, Z.; Che, C. M.; Miskowski, V. M.; Chan, C. K. *Inorg. Chem.* **2002**, 41, 2054–2059.
2688. Shieh, S. J.; Li, D.; Peng, S. M.; Che, C. M. *J. Chem. Soc., Dalton Trans.* **1993**, 195–196.
2689. Catalano, V. J.; Bennett, B. L.; Kar, H. M. *J. Am. Chem. Soc.* **1999**, 121, 10235–10236.
2690. McClensky, T. M.; Henling, L. M.; Flanagan, K. A.; Gray, H. B. *Acta Crystallogr., Sect. C* **1993**, 49, 1467–1469.
2691. McClensky, T. M.; Gray, H. B. *Inorg. Chem.* **1992**, 31, 1733–1734.
2692. Brandys, M. C.; Puddephatt, R. J. *J. Am. Chem. Soc.* **2001**, 123, 4839–4840.
2693. Khan, M. N. I.; Staples, R. J.; King, C.; Fackler, J. P., Jr.; Winpenny, R. E. P. *Inorg. Chem.* **1993**, 32, 5800–5807.
2694. Bates, P. A.; Waters, J. M. *Inorg. Chim. Acta* **1984**, 81, 151–156.
2695. Berners-Price, S. J.; Mazid, M. A.; Sadler, P. J. *J. Chem. Soc., Dalton Trans.* **1984**, 969–974.
2696. Berners-Price, S. J.; Jarrett, P. S.; Sadler, P. J. *Inorg. Chem.* **1987**, 26, 3074–3077.
2697. Berners-Price, S. J.; Colquhoun, L. A.; Healy, P. C.; Byriell, K. A.; Hanna, J. V. *J. Chem. Soc., Dalton Trans.* **1992**, 3357–3363.
2698. Palmer, J. A. L.; Wild, S. B. *Inorg. Chem.* **1983**, 22, 4054–4059.
2699. Yam, V. W. W.; Chan, C. L.; Choi, S. W. K.; Wong, K. M. C.; Cheng, E. C. C.; Yu, S. C.; Ng, P. K.; Chan, W. K.; Cheung, K. K. *Chem. Commun.* **2000**, 53–54.
2700. Balch, A. L.; Olmstead, M. M.; Reedy, P. E., Jr.; Rowley, S. P. *Inorg. Chem.* **1988**, 27, 4289–4294.
2701. Balch, A. L.; Fung, E. Y. *Inorg. Chem.* **1990**, 29, 4764–4768.
2702. Sevillano, P.; Garcia, M. E.; Habtemariam, A.; Parsons, S.; Sadler, P. J. *Met.-Based Drugs* **1999**, 6, 211–216.
2703. Crespo, O.; Gimeno, M. C.; Jones, P. G.; Laguna, A. *Inorg. Chem.* **1994**, 33, 6128–6131.
2704. Crespo, O.; Gimeno, M. C.; Jones, P. G.; Laguna, A.; Villacampa, M. D. *Angew. Chem., Int. Ed. Engl.* **1997**, 36, 993–995.
2705. Airey, A. L.; Swiegers, G. F.; Willis, A. C.; Wild, B. *Inorg. Chem.* **1997**, 36, 1588–1597.
2706. Cook, V. C.; Willis, A. C.; Zank, J.; Wild, S. B. *Inorg. Chem.* **2002**, 41, 1897–1906.
2707. Chatterjee, S.; Moore, F. K. E.; Salem, G.; Waring, P.; Willis, A. C. *J. Chem. Soc., Dalton Trans.* **2000**, 4487–4489.
2708. Burke, L. D.; Nugent, P. F. *Gold Bull.* **1998**, 31, 39–50.
2709. Mathieson, T. J.; Lagdon, A. G.; Milestone, N. B.; Nicholson, B. K. *Chem. Commun.* **1998**, 371–372.
2710. Yuan, Y. Z.; Kozlova, A. P.; Asakura, K.; Wan, H.; Tsai, K.; Iwasawa, Y. *J. Catal.* **1997**, 170, 191–199.
2711. Yuan, Y. Z.; Asakura, K.; Wan, H.; Tsai, K.; Iwasawa, Y. *Chem. Lett.* **1996**, 129, 755–756.
2712. Puddephatt, R. J. In *Gold Progress in Chemistry, Biochemistry and Technology*; Schmidbaur, H. Ed. Wiley: Chichester, U.K., 1999, pp 237–256.
2713. Kissner, R.; Welti, G.; Geier, G. Gold Metal and Gold Alloys in Electronics and Thin Film Technology. *J. Chem. Soc., Dalton Trans.* **1997**, 1773–1777.
2714. Yang, Y.; Sharp, P. R. *J. Am. Chem. Soc.* **1994**, 116, 6983–6984.
2715. Nesmeyanov, A. N.; Perevalova, E. G.; Struchkov, Y. T.; Antipin, M. Y.; Grandberg, K. I.; Dyachenko, V. P. *J. Organomet. Chem.* **1980**, 201, 343–349.
2716. Yang, Y.; Ramamoorthy, V.; Sharp, P. R. *Inorg. Chem.* **1993**, 32, 1946–1950.
2717. Schmidbaur, H.; Kolb, A.; Zeller, E.; Schier, A.; Beruda, H. Z. *Anorg. Allg. Chem.* **1993**, 619, 1575–1579.

2718. Angermaier, K.; Schmidbauer, H. *Inorg. Chem.* **1994**, *33*, 2069–2070.
2719. Angermaier, K.; Schmidbauer, H. *Acta Crystallogr., Sect. C* **1995**, *51*, 1793–1795.
2720. Tripathi, U. M.; Schier, A.; Schmidbauer, H. *Z. Naturforsch., Teil B* **1998**, *53*, 171–174.
2721. Mathieson, T.; Schier, A.; Schmidbauer, H. *Z. Naturforsch., Teil B* **2000**, *55*, 1000–1004.
2722. Kuz'mina, L. G.; Bagatur'yants, A. A.; Howard, J. A. K.; Grandberg, K. I.; Karchava, A. V.; Shubina, E. S.; Saitkulova, L. N.; Bakhmutova, E. V. *J. Organomet. Chem.* **1999**, *575*, 39–50.
2723. Chung, S. C.; Krüger, S.; Schmidbauer, H.; Rösch, N. *Inorg. Chem.* **1996**, *35*, 5387–5392.
2724. Schmidbauer, H.; Hofreiter, S.; Paul, M. *Nature* **1995**, *377*, 503–504.
2725. Shan, H.; Sharp, P. R. *Angew. Chem., Int. Ed. Engl.* **1996**, *35*, 635–636.
2726. Shan, H.; James, A.; Sharp, P. R. *Inorg. Chem.* **1998**, *37*, 5727–5732.
2727. Bardaji, M.; Uznanski, P.; Amiens, C.; Chaudret, B.; Laguna, A. *Chem. Commun.* **2002**, 598–599.
2728. Kuz'mina, L. G.; Struchkov, Y. T. *Koord. Khim.* **1988**, *14*, 1262–1267.
2729. Kuz'mina, L. G.; Struchkov, Y. T.; Smyslova, E. I. *Koord. Khim.* **1989**, *15*, 368–372.
2730. Perevalova, E. G.; Smyslova, E. I.; Grandberg, K. I.; Struchkov, Y. T.; Kuz'mina, L. G.; Kratsov, D. N.; Voevodskaya, T. I. *Koord. Khim.* **1989**, *15*, 504–510.
2731. Kuz'mina, L. G.; Burtseva, O. Y.; Dvortsova, N. V.; Porai-Koshits, M. A.; Smyslova, E. I. *Koord. Khim.* **1989**, *15*, 773–778.
2732. Kuz'mina, L. G.; Dvortsova, N. V.; Porai-Koshits, M. A.; Smyslova, E. I.; Grandberg, K. I. *Metalloorg. Khim.* **1989**, *2*, 1179–1183.
2733. Kuz'mina, L. G.; Dvortsova, N. V.; Porai-Koshits, M. A.; Smyslova, E. I.; Grandberg, K. I.; Perevalova, E. G. *Metalloorg. Khim.* **1989**, *2*, 1344–1349.
2734. Kuz'mina, L. G.; Dvortsova, N. V.; Porai-Koshits, M. A.; Smyslova, E. I.; Grandberg, K. I.; Perevalova, E. G. *Metalloorg. Khim.* **1991**, *4*, 778–782.
2735. Kolb, A.; Bissinger, P.; Schmidbauer, H. *Inorg. Chem.* **1993**, *32*, 5132–5135.
2736. Sutherland, B. R.; Folting, K.; Streib, W. E.; Ho, D. M.; Huffman, J. C.; Caulton, K. G. *J. Am. Chem. Soc.* **1987**, *109*, 3489–3490.
2737. Usui, Y.; Noma, J.; Hirano, M.; Komiya, S. *J. Chem. Soc., Dalton Trans.* **1999**, 4397–4406.
2738. Usui, Y.; Noma, J.; Hirano, M.; Komiya, S. *Inorg. Chim. Acta* **2000**, *309*, 151–154.
2739. Bauer, A.; Schier, A.; Schmidbauer, H. *Acta Crystallogr., Sect. C* **1995**, *51*, 2030–2032.
2740. Bauer, A.; Schneider, W.; Angermaier, K.; Schier, A.; Schmidbauer, H. *Inorg. Chim. Acta* **1996**, *251*, 249–253.
2741. Hill, D. T.; Johnson, R. K.; Mirabelli, C. K. Antitumor Pharmaceutical Compositions for Treating Tumors Employing [α,ω -bis(disubstituted phosphino) hydrocarbon] digold(I), digold(III), disilver(I), and dicopper(I) derivatives. Eur. Pat. Appl., EP 151046, January 31, 1985.
2742. Hill, D. T.; Johnson, R. K.; Mirabelli, C. K. Antitumor Pharmaceutical Compositions and Methods for Treating Tumors Employing α,ω -Bis(disubstituted phosphino) hydrocarbon Derivatives of [α,ω -Bis(disubstituted phosphino) hydrocarbon] digold(I), digold(III), disilver(I), and dicopper(I) derivatives. U.S. Patent 4766226, August 23, 1988.
2743. Jones, P. G. *Acta Crystallogr., Sect. C* **1984**, *40*, 1320–1322.
2744. Kuz'mina, L. G. *Zh. Neorg. Khim.* **1993**, *38*, 990–993.
2745. Jones, P. G. *Acta Crystallogr., Sect. C* **1985**, *41*, 905–906.
2746. Fackler, J. P., Jr.; Khan, M. N. I.; King, C.; Staples, R. J.; Winpenny, R. E. P. *Organometallics* **1991**, *10*, 2178–2183.
2747. Römcke, P.; Schier, A.; Schmidbauer, H. *Z. Naturforsch., Teil B* **2002**, *57*, 605–609.
2748. Skoweranda, J.; Wiczorek, W.; Bukowska-Strzyzewska, M.; Grodzicki, A.; Szyk, E. *J. Crystallogr. Spectrosc. Res.* **1992**, *22*, 527–532.
2749. Baukova, T. V.; Kuz'mina, L. G.; Dvortsova, N. V. *Zh. Neorg. Khim.* **1992**, *37*, 1497–1502.
2750. Zhang, Z. Y.; Szyk, E.; Palenik, G. J.; Colgate, S. O. *Acta Crystallogr., Sect. C* **1988**, *44*, 2197–2198.
2751. Preisenberger, M.; Schier, A.; Schmidbauer, H. *J. Chem. Soc., Dalton Trans.* **1999**, 1645–1650.
2752. Kuz'mina, L. G. *Koord. Khim.* **1994**, *20*, 318–320.
2753. Lakomska, I.; Grodzicki, A.; Szyk, E. *Polish J. Chem.* **1998**, *72*, 492–497.
2754. Jones, P. G.; Schelbach, R. *J. Chem. Soc., Chem. Commun.* **1988**, 1338–1339.
2755. Jones, P. G.; Schelbach, R. *Inorg. Chim. Acta* **1991**, *182*, 239–242.
2756. Low, P. M. N.; Zhang, Z. Y.; Mak, T. C. W.; Hor, T. S. A. *J. Organomet. Chem.* **1997**, *539*, 45–51.
2757. Hohbein, R.; Jones, P. G.; Meyer-Bäse, K.; Schwarzmann, E.; Sheldrick, G. M. *Z. Naturforsch., Teil B* **1985**, *40*, 1029–1031.
2758. Barron, P. F.; Engelhardt, L. M.; Healy, P. C.; Oddy, J.; White, A. H. *Aust. J. Chem.* **1987**, *40*, 1545–1551.
2759. Mathieson, T.; Schier, A.; Schmidbauer, H. *J. Chem. Soc., Dalton Trans.* **2000**, 3881–3884.
2760. Wang, J. C.; Khan, M. N. I.; Fackler, J. P., Jr. *Acta Crystallogr., Sect. C* **1989**, *45*, 1008–1010.
2761. Römcke, P.; Schier, A.; Schmidbauer, H. *J. Chem. Soc., Dalton Trans.* **2001**, 2482–2486.
2762. Haupt, H. J.; Petters, D.; Flörke, U. *J. Organomet. Chem.* **1998**, *553*, 497–501.
2763. Müller-Buschbaum, H. *Z. Anorg. Allg. Chem.* **2002**, *628*, 2559–2584.
2764. Shaw III, C. F. The Biochemistry of Gold. In *Gold Progress in Chemistry, Biochemistry and Technology*; Schmidbauer, H., Ed., Wiley: Chichester, U.K., 1999, pp 259–308.
2765. Okada, T.; Patterson, B. K.; Ye, S. Q.; Gurney, M. E. *Virology* **1993**, *192*, 631–642.
2766. Simon, T. M.; Kunishima, D. H.; Vibert, D. H.; Lorber, A. *Cancer Res.* **1981**, *41*, 94–99.
2767. Mirabelli, C. K.; Jonson, R. K.; Sung, C. M.; Faucette, L.; Muirhead, K.; Crooke, S. T. *Cancer Res.* **1985**, *45*, 32–37.
2768. Landgraf, H. M. Gold in Decoration of Glass and Ceramics. In *Gold Progress in Chemistry, Biochemistry and Technology*; Schmidbauer, H., Ed., Wiley: Chichester, U.K., 1999, pp 143–171.
2769. Darque Ceretti, E.; Hélyar, D.; Aucouturier, M. *Gold Bull.* **2002**, *35*, 118–129.
2770. Papazian, A. N. *Gold Bull.* **1982**, *15*, 81–89.
2771. Klabunde, K. J., Ed. *Free Atoms, Clusters, and Nanoscale Particles*; Academic: San Diego, 1994.
2772. Joachim, C.; Roth, S., Eds. *Atomic and Molecular Wires*; Kluwer, Dordrecht, 1997.
2773. Ingram, R. S.; Hostetler, M. J.; Murray, R. W.; Shaaff, T. G.; Khoury, J. T.; Whetten, R. L.; Bigioni, T. P.; Guthrie, D. K.; First, P. N. *J. Am. Chem. Soc.* **1997**, *119*, 9279–9280.

2774. Ingram, R. S.; Hostetler, M. J.; Murray, R. W. *J. Am. Chem. Soc.* **1997**, *119*, 9178–9178.
2775. Badia, A.; Singh, S.; Demers, L.; Cuccia, L.; Brown, G. R.; Lennox, R. B. *Chem. Eur. J.* **1996**, *2*, 359–363.
2776. Vossmeier, T.; DeIonno, E.; Heath, J. R. *Angew. Chem., Int. Ed. Engl.* **1997**, *36*, 1080–1083.
2777. Sarathy, K. V.; Kulkarni, G. U.; Rao, C. N. R. *Chem. Commun.* **1997**, 537–538.
2778. Corti, C. W.; Holliday, R. J.; Thompson, D. T. *Gold Bull.* **2002**, *35*, 111–117.
2779. Sladek, A.; Angermaier, K.; Schmidbauer, H. *Chem. Commun.* **1996**, 1959–1960.
2780. Nakamoto, M.; Hiller, W.; Schmidbauer, H. *Chem. Ber.* **1993**, *126*, 605–610.
2781. Facker, J. P., Jr.; Staples, R. J.; Elduque, A.; Grant, T. *Acta Crystallogr., Sect. C* **1994**, *50*, 520–523.
2782. Kuz'mina, L. G.; Baukova, T. V.; Churakov, A. V.; Kuz'min, V. S.; Dvortsova, N. V. *Russ. J. Coord. Chem.* **1997**, *23*, 279–288.
2783. Onaka, S.; Katsukawa, Y.; Yamashita, M. *Chem. Lett.* **1998**, 525–526.
2784. Forward, J. M.; Bochmann, D.; Facker, J. P., Jr.; Staples, R. J. *Inorg. Chem.* **1995**, *34*, 6330–6036.
2785. Ahmed, L. S.; Clegg, W.; Davies, D. A.; Dilworth, J. R.; Elsegood, M. R. J.; Griffiths, D. V.; Horsburgh, L.; Miller, J. R.; Wheatley, N. *Polyhedron* **1999**, *18*, 593–600.
2786. Facker, J. P., Jr.; Staples, R. J.; Raptis, R. G. *Acta Crystallogr., Sect. C* **1994**, *50*, 523–525.
2787. Kuz'mina, L. G.; Dvortsova, N. V.; Burtseva, O. Y.; Porai-Koshits, M. A.; Smyslova, E. I.; Grandberg, K. I. *Metalloorg. Khim.* **1990**, *3*, 364–370.
2788. Kuz'mina, L. G.; Smyslova, E. I.; Grandberg, K. I. *Zh. Neorg. Khim.* **1993**, *38*, 1009–1011.
2789. Hill, D. T.; Sutton, B. M. *Cryst. Struct. Commun.* **1980**, *9*, 679–686.
2790. Bell, R. A.; Lock, C. J. L.; Scholten, C.; Valliant, J. F. *Inorg. Chim. Acta* **1998**, *274*, 137–142.
2791. De Vos, D.; Clements, P.; Pyke, S. M.; Smyth, D. R.; Tiekink, E. R. T. *Met.-Based Drugs* **1999**, *6*, 31–36.
2792. Cookson, P. D.; Tiekink, E. R. T. *J. Coord. Chem.* **1992**, *26*, 313–320.
2793. Smyth, D. R.; Vincent, B. R.; Tiekink, E. R. T. *Cryst. Growth Des.* **2001**, *1*, 113–117.
2794. Smyth, D. R.; Vincent, B. R.; Tiekink, E. R. T. *Z. Kristallogr.* **2001**, *216*, 298–302.
2795. Wilton-ely, J. D. E. T.; Schier, A.; Mitzel, N. W.; Schmidbauer, H. *J. Chem. Soc., Dalton Trans.* **2001**, 1058–1062.
2796. Cookson, P. D.; Tiekink, E. R. T.; Whitehouse, M. W. *Aust. J. Chem.* **1994**, *47*, 577–586.
2797. Cookson, P. D.; Tiekink, E. R. T. *J. Chem. Cryst.* **1994**, *24*, 805–810.
2798. Hao, L.; Mansour, M. A.; Lachicotte, R. J.; Gysling, H. J.; Eisenberg, R. *Inorg. Chem.* **2000**, *39*, 5520–5529.
2799. Cookson, P. D.; Tiekink, E. R. T. *J. Chem. Soc., Dalton Trans.* **1993**, 259–263.
2800. Shi, J. C.; Chen, L. J.; Huang, X. Y.; Wu, D. X.; Kang, B. S. *J. Organomet. Chem.* **1997**, *553*, 17–23.
2801. Chojnacki, J.; Becker, B.; Konitz, A.; Wojnowski, W. *Z. Anorg. Allg. Chem.* **2000**, *626*, 2173–2177.
2802. Cookson, P. D.; Tiekink, E. R. T. *Z. Kristallogr.* **1994**, *209*, 749–751.
2803. Cookson, P. D.; Tiekink, E. R. T. *J. Crystallogr. Spectrosc. Res.* **1993**, *23*, 231–234.
2804. Delgado, E.; Hernandez, E. *Polyhedron* **1992**, *11*, 3135–3138.
2805. Muir, M. M.; Cuadrado, S. I.; Muir, J. A. *Acta Crystallogr., Sect. C* **1989**, *45*, 1420–1422.
2806. Tzeng, B. C.; Chan, C. K.; Cheung, K. K.; Che, C. M.; Peng, S. M. *Chem. Commun.* **1997**, 135–136.
2807. Hoskins, B. F.; Zhenrong, L.; Tiekink, E. R. T. *Inorg. Chim. Acta* **1989**, *158*, 7–8.
2808. Colacio, E.; Romero, A.; Ruiz, J.; Roman, P.; Gutierrez Zorrilla, J. M.; Vegas, A.; Martinez Ripoll, M. *Inorg. Chem.* **1991**, *30*, 3743–3749.
2809. Fernández, E. J.; Hursthouse, M. B.; Laguna, M.; Terroba, R. *Organometallics* **1997**, *16*, 5637–5640.
2810. Bishop, P.; Marsh, P.; Brisdon, A. K.; Brisdon, B. J.; Mahon, M. F. *J. Chem. Soc., Dalton Trans.* **1998**, 675–682.
2811. Grant, T. A.; Forward, J. M.; Facler, J. P., Jr. *Z. Kristallogr.* **1996**, *211*, 483–484.
2812. Sundermeyer, J.; Roesky, H. W.; Lautner, J.; Jones, P. G. *Chem. Ber.* **1990**, *123*, 433–438.
2813. Cerrada, E.; Farcia, J. F.; Laguna, M.; Terroba, R.; Villacampa, M. D. *J. Chem. Soc., Dalton Trans.* **1998**, 3511–3516.
2814. Tzeng, B. C.; Schier, A.; Schmidbauer, H. *Inorg. Chem.* **1999**, *38*, 3978–3984.
2815. Hall, V. J.; Siasios, G.; Tiekink, E. R. T. *Aust. J. Chem.* **1993**, *46*, 561–570.
2816. Barranco, E. M.; Gimeno, M. C.; Laguna, A.; Villacampa, M. D.; Jones, P. G. *Inorg. Chem.* **1999**, *38*, 702–706.
2817. Gimeno, M. C.; Jambriña, E.; Fernández, E. J.; Laguna, A.; Laguna, M.; Jones, P. G.; Merchán, F. L.; Terroba, R. *Inorg. Chim. Acta* **1997**, *258*, 71–75.
2818. Artigas, M. M.; Crespo, O.; Gimeno, M. C.; Jones, P. G.; Laguna, A.; Villacampa, M. D. *J. Organomet. Chem.* **1998**, *561*, 1–6.
2819. Shi, J. C.; Wen, T. B.; Lu, G. T.; Wu, D. X.; Liu, Q. T.; Kang, B. S. *J. Coord. Chem.* **1997**, *41*, 199–205.
2820. Wilton-ely, J. D. E. T.; Schier, A.; Mitzel, N. W.; Nogai, S.; Schmidbauer, H. *J. Organomet. Chem.* **2002**, *643–644*, 313–323.
2821. Sünkel, K.; Blum, A.; Birk, U.; Kempinger, W.; Soheili, S. *Polyhedron* **1997**, *16*, 2681–2687.
2822. Schneider, W.; Bauer, A.; Schmidbauer, H. *Organometallics* **1996**, *15*, 5445–5446.
2823. Wilton-ely, J. D. E. T.; Ehlich, H.; Schier, A.; Schmidbauer, H. *Helv. Chim. Acta* **2001**, *84*, 3216–3332.
2824. Bachman, R. E.; Bodolosky Bettis, S. A.; Glennon, S. C.; Sirchio, S. A. *J. Am. Chem. Soc.* **2000**, *122*, 7146–7147.
2825. Jones, P. G.; Weinkauff, A. *Z. Kristallogr.* **1994**, *209*, 87–88.
2826. Baukova, T. V.; Kuz'mina, L. G.; Churakov, A. V.; Oleinikova, N. A.; Petrovskii, P. V. *Russ. Chem. Bull.* **1998**, *47*, 343–348.
2827. Chen, J.; Jiang, T.; Wei, G.; Mohamed, A. A.; Homrighausen, C.; Bauer, J. A. K.; Bruce, A. E.; Bruce, M. R. M. *J. Am. Chem. Soc.* **1999**, *121*, 9225–9226.
2828. Sladek, A.; Schneider, W.; Angermaier, K.; Bauer, A.; Schmidbauer, H. *Z. Naturforsch., Teil B* **1996**, *51*, 765–772.
2829. López de Luzuriaga, J. M.; Sladek, A.; Schneider, W.; Schmidbauer, H. *Chem. Ber.* **1997**, *130*, 641–646.
2830. Kuz'mina, L. G.; Dvortsova, N. V.; Smyslova, E. I.; Grandberg, K. I. *Zh. Neorg. Khim.* **1992**, *37*, 2745–2754.
2831. Sladek, A.; Schmidbauer, H. *Chem. Ber.* **1995**, *128*, 907–909.
2832. López de Luzuriaga, J. M.; Sladek, A.; Schmidbauer, H. *J. Chem. Soc., Dalton Trans.* **1996**, 4511–4512.
2833. Jones, W. B.; Yuan, J.; Narayanaswamy, R.; Young, M. A.; Elder, R. C.; Bruce, A. E.; Bruce, M. R. M. *Inorg. Chem.* **1995**, *34*, 1996–2001.
2834. Viotte, M.; Gautheron, B.; Nifant'ev, I.; Kuz'mina, L. G. *Inorg. Chim. Acta* **1996**, *253*, 71–76.
2835. Onaka, S.; Katsukawa, Y.; Shiotsuka, M.; Kanegawa, O.; Yamashita, M. *Inorg. Chim. Acta* **2001**, *312*, 100–110.

2836. Yam, V. W. W.; Li, C. K.; Chan, C. L. *Angew. Chem., Int. Ed. Engl.* **1998**, *37*, 2857–2859.
2837. Tzeng, B. C.; Jank, J.; Schier, A.; Schmidbaur, H. *Z. Naturforsch., Teil B* **1999**, *54*, 825–831.
2838. Smyth, D. R.; Vincent, B. R.; Tiekink, E. R. T. *Crys. Eng. Commun.* **2000**, 21–23.
2839. Yam, V. W. W.; Chan, C. L.; Cheung, K. K. *J. Chem. Soc., Dalton Trans.* **1996**, 4019–4022.
2840. Wilton-ely, J. D. E. T.; Hoffreiter, S.; Mitzel, N. W.; Schmidbaur, H. *Z. Naturforsch., Teil B* **2001**, *56*, 1257–1263.
2841. Bonasia, P. J.; Gindleberger, D. E.; Arnold, J. *Inorg. Chem.* **1993**, *32*, 5126–5131.
2842. Wojnowski, W.; Becker, B.; Sassmannhausen, J.; Peters, E. M.; Peters, K.; Von Schneering, H. G. *Z. Anorg. Allg. Chem.* **1994**, *620*, 1417–1421.
2843. Schroter, I.; Strähle, J. *Chem. Ber.* **1991**, *124*, 2161–2164.
2844. Le Blanc, D. J.; Lock, C. J. L. *Acta Crystallogr., Sect. B* **1997**, *53*, 1765–1768.
2845. Wiseman, M. R.; Marsh, P. A.; Bishop, P. T.; Brisdon, B. J.; Mahon, M. F. *J. Am. Chem. Soc.* **2000**, *122*, 12598–12599.
2846. Vicente, J.; Chicote, M. T.; González Herrero, P.; Jones, P. G. *J. Chem. Soc., Dalton Trans.* **1994**, 3183–3187.
2847. Le Blanc, D. J.; Britten, J. F.; Wan, Z.; Howard Lock, H. E.; Lock, C. J. L. *Acta Crystallogr., Sect. C* **1997**, *53*, 1763–1765.
2848. Watase, S.; Nakamoto, M.; Kitamura, T.; Kanehisa, N.; Kai, Y.; Yanagida, S. *J. Chem. Soc., Dalton Trans.* **2000**, 3585–3590.
2849. Nomiya, K.; Noguchi, R.; Sakurai, T. *Chem. Lett.* **2000**, 274–275.
2850. Deaton, J. C.; Luss, H. R. *J. Chem. Soc., Dalton Trans.* **1999**, 3163–3167.
2851. Bates, P. A.; Waters, J. M. *Acta Crystallogr., Sect. C* **1985**, *41*, 862–865.
2852. Le Blanc, D. J.; Smith, R. W.; Wang, Z.; Howard Lock, H. E.; Lock, C. J. L. *J. Chem. Soc., Dalton Trans.* **1997**, 3263–3267.
2853. Bau, R. *J. Am. Chem. Soc.* **1998**, *120*, 9380–9381.
2854. Vicente, J.; Chicote, M. T.; González Herrero, P.; Jones, P. G.; Ahrens, B. *Angew. Chem., Int. Ed. Engl.* **1994**, *33*, 1852–1853.
2855. Vicente, J.; Chicote, M. T.; González Herrero, P.; Grünwald, C.; Jones, P. G. *Organometallics* **1997**, *16*, 3381–3387.
2856. Jones, P. G.; Thöne, C. *Chem. Ber.* **1990**, *123*, 1975–1978.
2857. Eikens, W.; Kienitz, C.; Jones, P. G.; Thöne, C. *J. Chem. Soc., Dalton Trans.* **1994**, 83–90.
2858. Jones, P. G.; Thöne, C. *Z. Naturforsch., Teil B* **1992**, *47*, 600–605.
2859. Jones, P. G.; Lautner, J.; Thöne, C. *Z. Kristallogr.* **1993**, *208*, 354–357.
2860. Eikens, W.; Jones, P. G.; Thöne, C. *Z. Anorg. Allg. Chem.* **1997**, *623*, 735–741.
2861. Lang, E. S.; Maichle-Mossmer, C.; Strähle, J. *Z. Anorg. Allg. Chem.* **1994**, *620*, 1678–1685.
2862. Brown, D. H.; Smith, W. E.; Fox, P.; Sturrock, R. D. *Inorg. Chim. Acta* **1982**, *67*, 27–30.
2863. Kinsch, E. M.; Stephan, D. W. *Inorg. Chim. Acta* **1984**, *91*, 263–267.
2864. Coffey, M. T.; Shaw III, C. F.; Eidsness, M. K.; Watkins II, J. W.; Elder, R. C. *Inorg. Chem.* **1986**, *25*, 333–339.
2865. Brown, D. H.; Smith, W. E.; Rodgers, A. *Inorg. Chim. Acta* **1984**, *93*, L41–L42.
2866. Bryan, D. L. B.; Mikuriya, Y.; Hempel, J. C.; Millinger, D.; Hashim, M.; Pasternack, R. F. *Inorg. Chem.* **1987**, *26*, 4180–4185.
2867. Alarfaj, A. R.; Saeed, A. A.; Akhtar, M. N.; Isab, A. A. *J. Coord. Chem.* **1998**, *43*, 257–272.
2868. Ahmad, S.; Isab, A. A. *J. Inorg. Biochem.* **2002**, *88*, 44–52.
2869. Hill, D. T.; Sutton, B. M.; Isab, A. A.; Razi, T.; Sadler, P. G.; Trooster, J. M.; Calis, G. H. M. *Inorg. Chem.* **1983**, *22*, 2936–2942.
2870. *Gmelin Handbuch der Anorganischen Chemie*, 8th ed.; System-No. 62: Gold V. Meyer, R. J.; Pietsch, E. H. E. Eds.; Verlag Chemie: Weinheim 1954.
2871. Marbach, G.; Strähle, J. *Angew. Chem., Int. Ed. Engl.* **1984**, *23*, 246–247.
2872. Müller, A.; Römer, M.; Bögge, H.; Krickemeyer, E.; Schmitz, K. *Inorg. Chim. Acta* **1984**, *85*, L39–L41.
2873. Marbach, G.; Strähle, J. *Angew. Chem., Int. Ed. Engl.* **1984**, *23*, 715–716.
2874. Kanatzidis, M. G.; Huang, S. P. *Inorg. Chem.* **1989**, *28*, 4667–4669.
2875. Huang, S. P.; Kanatzidis, M. G. *Inorg. Chem.* **1991**, *30*, 3572–3575.
2876. Huang, S. P.; Kanatzidis, M. G. *Angew. Chem., Int. Ed. Engl.* **1992**, *31*, 787–789.
2877. Haushalter, R. C. *Angew. Chem., Int. Ed. Engl.* **1985**, *24*, 432–433.
2878. Haushalter, R. C. *Inorg. Chim. Acta* **1985**, *102*, L37–L38.
2879. Ansari, M. A.; Bollinger, J. C.; Ibers, J. A. *J. Am. Chem. Soc.* **1993**, *115*, 3838–3839.
2880. Smith, D. M.; Roof, L. C.; Ansari, M. A.; McConnachie, J. M.; Bollinger, J. C.; Pell, M. A.; Salm, R. J.; Ibers, J. A. *Inorg. Chem.* **1996**, *35*, 4999–5006.
2881. Warren, C. J.; Ho, D. M.; Bocarsly, A. B. *J. Am. Chem. Soc.* **1993**, *115*, 6416–6417.
2882. Liao, J. H.; Kanatzidis, M. G. *Chem. Mater.* **1993**, *5*, 1561–1569.
2883. Dhingra, S. S.; Seo, D. K.; Kowach, G. R.; Kremer, R. K.; Shreeve Keyer, J. L.; Haushalter, R. C.; Whangbo, M. H. *Angew. Chem., Int. Ed. Engl.* **1997**, *36*, 1087–1090.
2884. Wang, C.; Haushalter, R. C. *Inorg. Chem.* **1999**, *38*, 595–597.
2885. Löken, S.; Tremel, W. *Z. Anorg. Allg. Chem.* **1998**, *624*, 1588–1594.
2886. Chondroudis, K.; Hanco, J. A.; Kanatzidis, M. G. *Inorg. Chem.* **1997**, *36*, 2623–2632.
2887. Löken, S.; Tremel, W. *Eur. J. Inorg. Chem.* **1998**, 283–289.
2888. Axtell III, E. A.; Kanatzidis, M. G. *Chem. Eur. J.* **1998**, *4*, 2435–2441.
2889. Kowala, C.; Swan, J. M. *Aust. J. Chem.* **1966**, *19*, 547–554.
2890. El-Etri, M. M.; Scovell, W. M. *Inorg. Chem.* **1990**, *29*, 480–484.
2891. Canales, F.; Gimeno, M. C.; Laguna, A.; Villacampa, M. D. *Inorg. Chim. Acta* **1996**, *244*, 95–103.
2892. Jones, P. G.; Thöne, C. *Chem. Ber.* **1991**, *124*, 2725–2729.
2893. Canales, F.; Gimeno, M. C.; Laguna, A.; Jones, P. G. *J. Am. Chem. Soc.* **1996**, *118*, 4839–4845.
2894. Canales, S.; Crespo, O.; Gimeno, M. C.; Jones, P. G.; Laguna, A.; Mendizabal, F. *Organometallics* **2000**, *19*, 4985–4994.
2895. Lensch, C.; Jones, P. G.; Sheldrick, G. M. *Z. Naturforsch., Teil B* **1982**, *37*, 944–949.
2896. Müller, A.; Krickemeyer, E.; Sprafke, A.; Schladerberk, N. H.; Bogge, H. *Chimia* **1988**, *42*, 69–73.

2897. Jones, P. G.; Sheldrick, G. M.; Hädicke, E. *Acta Crystallogr., Sect. C* **1980**, *36*, 2777–2779.
2898. Albano, V. G.; Castellari, C.; Femoni, C.; Iapalucci, M. C.; Longini, G.; Monari, M.; Rauccio, M.; Zacchini, S. *Inorg. Chim. Acta* **1999**, *291*, 372–379.
2899. Angermaier, K.; Schmidbaur, H. *Chem. Ber.* **1994**, *127*, 2387–2391.
2900. Shi, J. C.; Kang, B. S.; Mak, T. C. W. *J. Chem. Soc., Dalton Trans.* **1997**, 2171–2175.
2901. Angermaier, K.; Schmidbaur, H. *Z. Naturforsch., Teil B* **1996**, *51*, 879–882.
2902. Jones, P. G.; Lensch, C.; Sheldrick, G. M. *Z. Naturforsch., Teil B* **1982**, *37*, 141–143.
2903. Canales, F.; Gimeno, M. C.; Jones, P. G.; Laguna, A. *Angew. Chem., Int. Ed. Engl.* **1994**, *33*, 769–770.
2904. Canales, S.; Crespo, O.; Gimeno, M. C.; Jones, P. G.; Laguna, A. *Chem. Commun.* **1999**, 679–680.
2905. Yam, V. W. W.; Cheng, E. C. C.; Cheung, K. K. *Angew. Chem., Int. Ed. Engl.* **1999**, *38*, 197–199.
2906. Yam, V. W. W.; Cheng, E. C. C.; Zhou, Z. Y. *Angew. Chem., Int. Ed. Engl.* **2000**, *39*, 1683–1685.
2907. Yam, V. W. W.; Cheng, E. C. C.; Zhu, N. *Angew. Chem., Int. Ed. Engl.* **2001**, *40*, 1763–1765.
2908. Yam, V. W. W.; Cheng, E. C. C. *Gold Bull.* **2001**, *34*, 20–23.
2909. V. W. W.; Cheng, E. C. C. *Angew. Chem., Int. Ed. Engl.* **2000**, *39*, 4240–4242.
2910. Fenske, D.; Langetepe, T.; Kappes, M. M.; Hampe, O.; Weis, P. *Angew. Chem., Int. Ed. Engl.* **2000**, *39*, 1857–1860.
2911. Aw, B. H.; Looh, K. K.; Chan, H. S. O.; Tan, L. K.; Hor, T. S. A. *J. Chem. Soc., Dalton Trans.* **1994**, 3177–3182.
2912. Bos, W.; Bour, J. J.; Schlebos, P. P.; Hageman, P.; Bosman, W. P.; Smits, J. M. M.; Van Wiertmarschen, J. A. C.; Beurskens, P. T. *Inorg. Chim. Acta* **1986**, *119*, 141–148.
2913. Li, Z. H.; Loh, Z. H.; Mok, K. F.; Hor, T. S. A. *Inorg. Chem.* **2000**, *39*, 5299–5305.
2914. Hallam, M. F.; Luke, M. A.; Mingos, D. M. P.; Williams, I. D. *J. Organomet. Chem.* **1987**, *325*, 271–283.
2915. García Alonso, F. J.; García Sanz, M.; Riera, V.; García Grandó, S.; Perez Carreño, E. *J. Chem. Soc., Dalton Trans.* **1992**, 545–548.
2916. Kinsch, E. M.; Stephan, S. W. *Inorg. Chim. Acta* **1985**, *96*, L87–L90.
2917. Charnock, J. M.; Bristow, S.; Nicholson, J. R.; Garner, C. D.; Clegg, W. *J. Chem. Soc., Dalton Trans.* **1987**, 303–306.
2918. Pritchard, R. G.; Moore, L. S.; Parish, R. V.; McAuliffe, C. A.; Beagley, B. *Acta Crystallogr., Sect. C* **1988**, *44*, 2022–2024.
2919. Huffman, J. C.; Roth, R. S.; Siedle, A. R. *J. Am. Chem. Soc.* **1976**, *98*, 4340–4341.
2920. Canales, F.; Gimeno, M. C.; Jones, P. G.; Laguna, A. *J. Chem. Soc., Dalton Trans.* **1997**, 439–442.
2921. Zheng, H. G.; Ji, W.; Low, M. L. K.; Sakane, G.; Shibahara, T.; Xin, X. Q. *J. Chem. Soc., Dalton Trans.* **1997**, 2357–2361.
2922. Che, C. M.; Xia, B. H.; Huang, J. S.; Chan, C. K.; Zhou, Z. Y.; Cheung, K. K. *Chem. Eur. J.* **2001**, *7*, 3998–4006.
2923. Canales, F.; Gimeno, M. C.; Laguna, A. *Ana. Quim. Int. Ed.* **1997**, *93*, 168–170.
2924. Müller, A.; Dornfeld, H.; Henkel, G.; Krebs, B.; Viagers, M. P. A. *Angew. Chem., Int. Ed. Engl.* **1978**, *17*, 52–52.
2925. Müller, A.; Bogge, H.; Schimanski, U.; Penk, M.; Nieradzik, K.; Dartmann, M.; Krickemeyer, E.; Schimanski, J.; Romer, C.; Romer, M.; Dornfeld, H.; Wienboker, U.; Hellmann, W.; Zimmermann, M. *Monatsh. Chem.* **1989**, *120*, 367–391.
2926. Canales, F.; Gimeno, M. C.; Laguna, A. *Inorg. Chem.* **1998**, *37*, 5376–5379.
2927. Christuk, C. C.; Ansari, M. A.; Ibers, J. A. *Inorg. Chem.* **1992**, *31*, 4365–4369.
2928. Zhang, Q.; Cao, R.; Hong, M.; Wu, D.; Zhang, W.; Zhen, Y.; Liu, H. *Inorg. Chim. Acta* **1998**, *271*, 93–98.
2929. Müller, A.; Wienboker, U.; Penk, M. *Chimia* **1989**, *43*, 50–52.
2930. Salm, R. J.; Misetich, A.; Ibers, J. A. *Inorg. Chim. Acta* **1995**, *240*, 239–249.
2931. Lorenz, A.; Fenske, D. *Z. Anorg. Allg. Chem.* **2001**, *627*, 2232–2248.
2932. Dávila, R. M.; Staples, R. J.; Elduque, A.; Harlass, M. M.; Kyle, L.; Fackler, J. P., Jr. *Inorg. Chem.* **1994**, *33*, 5940–5945.
2933. Fritsch, E.; Polborn, K.; Robl, C.; Sunkel, K.; Beck, W. *Z. Anorg. Allg. Chem.* **1993**, *619*, 2050–2060.
2934. Dávila, R. M.; Staples, R. J.; Fackler, J. P., Jr. *Organometallics* **1994**, *13*, 418–420.
2935. Staples, R. J.; Fackler, J. P., Jr.; Assefa, Z. *Z. Kristallogr.* **1995**, *210*, 379–380.
2936. Fackler, J. P., Jr.; Staples, R. J.; Assefa, Z. *J. Chem. Soc., Chem. Commun.* **1994**, 431–432.
2937. Khan, M. N. I.; Wang, S.; Heinrich, D. D.; Fackler, J. P., Jr. *Acta Crystallogr., Sect. C* **1988**, *44*, 822–825.
2938. Hanna, S. D.; Zink, J. I. *Inorg. Chem.* **1996**, *35*, 297–302.
2939. Tang, S. S.; Chang, C. P.; Lin, I. J. B.; Liou, L. S.; Wang, J. C. *Inorg. Chem.* **1997**, *36*, 2294–2300.
2940. Matos, M. J.; Santos, I. C.; Henriques, R. T.; Duarte, M. T. *Synth. Met.* **1991**, *42*, 2155–2158.
2941. Hanna, S. D.; Khan, S. I.; Zink, J. I. *Inorg. Chem.* **1996**, *35*, 5813–5819.
2942. Nakamoto, M.; Schier, A.; Schmidbaur, H. *J. Chem. Soc., Dalton Trans.* **1993**, 1347–1348.
2943. Sladek, A.; Schmidbaur, H. *Inorg. Chem.* **1996**, *35*, 3268–3272.
2944. Terroba, R.; Fernández, E. J.; Hursthouse, M. B.; Laguna, M. *Polyhedron* **1998**, *17*, 2433–2439.
2945. Ehlich, H.; Schier, A.; Schmidbaur, H. *Organometallics* **2002**, *21*, 2400–2406.
2946. Ehlich, H.; Schier, A.; Schmidbaur, H. *Inorg. Chem.* **2002**, *41*, 3721–3727.
2947. Leung, W. H.; Chim, J. L. C.; Wong, W. T. *Inorg. Chem.* **1998**, *37*, 6382–6384.
2948. Del Rio, I.; Terroba, R.; Cerrada, E.; Hursthouse, M. B.; Laguna, M.; Light, M. E.; Ruiz, A. *Eur. J. Inorg. Chem.* **2001**, 2013–2019.
2949. Cerrada, E.; Laguna, A.; Laguna, M.; Jones, P. G. *J. Chem. Soc., Dalton Trans.* **1994**, 1325–1326.
2950. Cerrada, E.; Jones, P. G.; Laguna, A.; Laguna, M. *Inorg. Chim. Acta* **1996**, *249*, 163–168.
2951. Cerrada, E.; Laguna, M.; Villacampa, M. D. *Acta Crystallogr., Sect. C* **1998**, *54*, 201–203.
2952. Cerrada, E.; Laguna, M.; Sorolla, P. A. *Polyhedron* **1998**, *17*, 295–298.
2953. Cerrada, E.; Laguna, M.; Can, J. *Chem.* **1998**, *76*, 1033–1037.
2954. Cerrada, E.; García, J. F.; Laguna, M.; Terroba, R.; Villacampa, M. D. *J. Chem. Soc., Dalton Trans.* **1998**, 3511–3516.
2955. Crespo, O.; Gimeno, M. C.; Jones, P. G.; Ahrens, B.; Laguna, A. *Inorg. Chem.* **1997**, *36*, 495–500.
2956. Crespo, O.; Gimeno, M. C.; Jones, P. G.; Laguna, A. *J. Chem. Soc., Chem. Commun.* **1993**, 1696–1697.
2957. López de Luzuriaga, J. M.; Sladek, A.; Schier, A.; Schmidbaur, H. *Inorg. Chem.* **1997**, *36*, 966–968.
2958. Wilton-Ely, J. E. D. T.; Schier, A.; Mitzel, N. W.; Schmidbaur, H. *Inorg. Chem.* **2001**, *40*, 6266–6271.
2959. Jones, P. G.; Sheldrick, G. M.; Fügner, A.; Götzfried, F.; Beck, W. *Chem. Ber.* **1981**, *114*, 1413–1417.

2960. Tzeng, B. C.; Che, C. M.; Peng, S. M. *Chem. Commun.* **1997**, 1771–1772.
2961. Hunks, W. J.; Jennings, M. C.; Puddephatt, R. J. *Inorg. Chem.* **1999**, *38*, 5930–5931.
2962. Zhao, Y. J.; Su, W. P.; Cao, R.; Hong, M. C. *Acta Crystallogr., Sect. C* **2000**, *56*, E331–E332.
2963. Yip, H. K.; Schier, A.; Riede, J.; Schmidbaur, H. *J. Chem. Soc., Dalton Trans.* **1994**, 2333–2334.
2964. Harnisch, J. A.; Angelici, R. J. *Inorg. Chim. Acta.* **2000**, *300–302*, 273–279.
2965. Chai, C. L. L.; Hockless, D. C. R.; Weerasuria, K. D. V. *Polyhedron* **1997**, *16*, 1577–1580.
2966. Dietzsch, W.; Franke, A.; Hoyer, E.; Gruss, D.; Hummel, H. U.; Otto, P. Z. *Anorg. Allg. Chem.* **1992**, *611*, 81–84.
2967. Konno, T.; Hattori, M.; Yoshimura, T.; Hirotsu, M. *Chem. Lett.* **2002**, 230–231.
2968. Konno, T.; Tokuda, K.; Abe, T.; Hirotsu, M. *Mol. Cryst. Liquid Cryst.* **2000**, *342*, 45–50.
2969. Konno, T.; Chikamoto, Y.; Okamoto, K.; Yamaguchi, T.; Ito, T.; Hirotsu, M. *Angew. Chem., Int. Ed. Engl.* **2000**, *39*, 4098–4101.
2970. Birker, P. J. M. W. L.; Verschoor, G. C. *Inorg. Chem.* **1982**, *21*, 990–995.
2971. Konno, T.; Hattori, M.; Yoshimura, T.; Hirotsu, M. *Chem. Lett.* **2000**, 852–853.
2972. Heinrich, D. D.; Wang, J. C.; Fackler, J. P., Jr. *Acta Crystallogr., Sect. C* **1990**, *46*, 1444–1447.
2973. Hong, M. C.; Lei, X. J.; Huang, Z. Y.; Kang, B. Z.; Jiang, F. L.; Liu, H. Q. *Chin. Sci. Bull. (Engl. Trans. Kexue Tongbao)* **1993**, *38*, 912–917.
2974. Assefa, Z.; Staples, R. J.; Fackler, J. P., Jr. *Acta Crystallogr., Sect. C* **1995**, *51*, 2271–2273.
2975. Mansour, M. A.; Connick, W. B.; Lachicotte, R. J.; Gysling, H. J.; Eisenberg, R. *J. Am. Chem. Soc.* **1998**, *120*, 1329–1330.
2976. Faamau, J. W.; Tiekink, E. R. T. *J. Coord. Chem.* **1994**, *31*, 93–101.
2977. Fernández, E. J.; López de Luzuriaga, J. M.; Monge, M.; Olmos, E.; Laguna, A.; Villacampa, M. D.; Jones, P. G. *J. Clus. Sci.* **2000**, *11*, 153–167.
2978. Bardaji, M.; Laguna, A.; Jones, P. G.; Fischer, A. K. *Inorg. Chem.* **2000**, *39*, 3560–3566.
2979. Razak, I. A.; Raj, S. S. S.; Fun, H. K.; Jian, F.; Bei, F.; Yang, X.; Lu, L.; Wang, X. *Acta Crystallogr., Sect. C* **2000**, *56*, 666–667.
2980. Jian, F.; Lu, L.; Wang, X.; Raj, S. S. S.; Razak, I. A.; Fun, H. K. *Acta Crystallogr., Sect. C* **2000**, *56*, 939–940.
2981. Ho, S. Y.; Tiekink, E. R. T. *Acta Crystallogr., Sect. E* **2001**, *57*, M603–M604.
2982. Ho, S. Y.; Tiekink, E. R. T. *Acta Crystallogr., Sect. E* **2002**, *58*, M86–M87.
2983. Schulbert, K.; Mattes, R. Z. *Naturforsch., Teil B* **1993**, *48*, 1227–1233.
2984. Casellato, U.; Fracasso, G.; Graziani, R.; Sindellari, L.; Gonzalez, A. S.; Nicolini, M. *Inorg. Chim. Acta* **1990**, *167*, 21–24.
2985. Hall, V. J.; Tiekink, E. R. T. *Z. Kristallogr.* **1993**, *203*, 313–315.
2986. Vicente, J.; Chicote, M. T.; González Herrero, P.; Jones, P. G. *J. Chem. Soc., Chem. Commun.* **1995**, 745–746.
2987. Cheng, E. C. C.; Leung, K. H.; Miskowski, V. M.; Yam, V. W. W.; Phillips, D. L. *Inorg. Chem.* **2000**, *39*, 3690–3695.
2988. Kuchen, W.; Strolenberg, K.; Metten, J. *Chem. Ber.* **1968**, *101*, 3454–3466.
2989. Lawton, S. L.; Rohrbraught, W. J.; Kokotailo, G. T. *Inorg. Chem.* **1972**, *11*, 2227–2233.
2990. Kuchen, W.; Hertel, H. *Angew. Chem. Int. Ed.* **1969**, *8*, 89–97.
2991. Siasios, G.; Tiekink, E. R. T. *Z. Kristallogr.* **1995**, *210*, 698–698.
2992. Preisenberger, M.; Bauer, A.; Schier, A.; Schmidbaur, H. *J. Chem. Soc., Dalton Trans.* **1997**, 4753–4758.
2993. Gysling, H. J.; Blanton, T. N.; McMillan, S. M.; Lushington, K. J. *Z. Kristallogr.* **1999**, *214*, 309–312.
2994. Preisenberger, M.; Schier, A.; Schmidbaur, H. Z. *Naturforsch., Teil B* **1998**, *53*, 781–787.
2995. Preisenberger, M.; Pykkö, P.; Schier, A.; Schmidbaur, H. *Inorg. Chem.* **1999**, *38*, 5870–5875.
2996. Van Zyl, W. E.; Staples, R. J.; Fackler, J. P., Jr. *Inorg. Chem. Commun.* **1998**, *1*, 51–54.
2997. Van Zyl, W. E.; López de Luzuriaga, J. M.; Fackler, J. P., Jr. *J. Mol. Struct.* **2000**, *516*, 99–106.
2998. Jiang, Y.; Alvarez, S.; Hoffmann, R. *Inorg. Chem.* **1985**, *2*, 749–757.
2999. Weigend, F.; Wirth, S.; Ahlrichs, R.; Fenske, D. *Chem. Eur. J.* **2000**, *6*, 545–551.
3000. Piovesana, O.; Zanazzi, P. F. *Angew. Chem., Int. Ed. Engl.* **1980**, *19*, 561–562.
3001. Schuerman, J. A.; Fronczek, F. R.; Selbin, J. *J. Am. Chem. Soc.* **1986**, *108*, 336–337.
3002. Lanfredi, A. M. M.; Ugozzoli, F.; Asaro, F.; Pellicer, G.; Marsich, N.; Camus, A. *Inorg. Chim. Acta* **1992**, *192*, 271–282.
3003. Denko, C. W.; Anderson, A. K. *J. Am. Chem. Soc.* **1945**, *67*, 2241–2241.
3004. Tiekink, E. R. T. *Z. Kristallogr.* **1985**, *173*, 243–247.
3005. Asefa, Z.; Staples, R. J.; Fackler, J. P., Jr. *Inorg. Chem.* **1994**, *33*, 2790–2798.
3006. Siasios, G.; Tiekink, E. R. T. *Z. Kristallogr.* **1992**, *198*, 139–141.
3007. Siasios, G.; Tiekink, E. R. T. *Z. Kristallogr.* **1993**, *203*, 117–119.
3008. Siasios, G.; Tiekink, E. R. T. *Z. Kristallogr.* **1993**, *204*, 95–105.
3009. Siasios, G.; Tiekink, E. R. T. *Z. Kristallogr.* **1993**, *205*, 261–270.
3010. Collins, A. J.; Tiekink, E. R. T. *Z. Kristallogr.* **1995**, *210*, 51–55.
3011. Bardaji, M.; Laguna, A. *Inorg. Chim. Acta* **2001**, *318*, 38–44.
3012. Hussain, M. S.; Schlemper, E. O. *Acta Crystallogr., Sect. C* **1987**, *43*, 450–453.
3013. Ahmad, S.; Isab, A. A.; Perzanowski, H. P.; Hussain, M. S.; Akhtar, M. N. *Transition Met. Chem.* **2002**, *27*, 177–183.
3014. Le Blanc, D. J.; Britten, J. F.; Lock, C. J. L. *Acta Crystallogr., Sect. C* **1997**, *53*, 1204–1206.
3015. Fritsch, E.; Polborn, K.; Sunkel, K.; Beck, W.; Kohler, H.; Jager, L. Z. *Anorg. Allg. Chem.* **1992**, *617*, 110–116.
3016. Hussain, M. S. *J. Crystallogr. Spectrosc. Res.* **1986**, *16*, 91–96.
3017. Jones, P. G.; Thöne, C. *Chem. Zeit.* **1991**, *115*, 366–368.
3018. Hussain, M. S.; Isab, A. A. *J. Chem. Cryst* **2000**, *30*, 731–735.
3019. Ahmad, S.; Akhtar, M. N.; Isab, A. A.; Al Arfaj, A. R.; Hussain, M. S. *J. Coord. Chem.* **2000**, *51*, 225–234.
3020. Hussain, M. S.; Isab, A. A. Z. *Kristallogr.* **2001**, *216*, 479–480.
3021. Jones, P. G.; Thöne, C. *Inorg. Chim. Acta* **1991**, *181*, 291–294.
3022. Preisenberger, M.; Bauer, A.; Schmidbaur, H. *Chem. Ber.* **1997**, *130*, 955–958.
3023. Wilton-Ely, J. D. E. T.; Schier, A.; Schmidbaur, H. *Inorg. Chem.* **2001**, *40*, 4656–4661.

3024. Slawin, A. M. Z.; Smith, M. B. *New J. Chem.* **1999**, *23*, 777–783.
3025. Slawin, A. M. Z.; Smith, M. B.; Woollins, J. D. *J. Chem. Soc., Dalton Trans.* **1998**, 1537–1539.
3026. Staples, R. J.; Wang, S.; Fackler, J. P., Jr.; Grim, S. O.; De Laubenfels, E. *Acta Crystallogr., Sect. C* **1994**, *50*, 1242–1244.
3027. Borg Breen, C. C.; Bautista, M. T.; Schauer, C. K.; White, P. S. *J. Am. Chem. Soc.* **2000**, *122*, 3952–3962.
3028. Larré, C.; Donnadieu, B.; Caminade, A. M.; Mojoral, J. P. *Chem. Eur. J.* **1998**, *4*, 2031–2036.
3029. Friedrichs, S.; Jones, P. G. *Acta Crystallogr., Sect. C* **1999**, *55*, 1625–1627.
3030. Cingi, M. B.; Bigoli, F.; Lanfranchi, M.; Leporati, E.; Pellinghelli, M. A.; Foglia, C. *Inorg. Chim. Acta* **1995**, *235*, 37–43.
3031. Hussain, M. S.; Isab, A. A. *Transition Met. Chem.* **1984**, *9*, 398–401.
3032. Hussain, M. S.; Isab, A. A. *Transition Met. Chem.* **1985**, *10*, 178–181.
3033. Akrivos, P. D.; Hajjikakou, S. K.; Karagiannidis, P.; Gdaniec, M.; Kosturkiewicz, Z. *Polyhedron* **1994**, *13*, 753–758.
3034. Jia, G.; Puddephatt, R. J.; Vittal, J. J. *Polyhedron* **1992**, *11*, 2009–2014.
3035. Stickson, P. N.; Wehrli, A.; Geier, G. *Inorg. Chem.* **1988**, *27*, 2921–2925.
3036. Stocker, F. B.; Britton, D. *Acta Crystallogr., Sect. C* **2000**, *56*, 798–800.
3037. Hussain, M. S.; Isab, A. A. *J. Coord. Chem.* **1985**, *14*, 17–26.
3038. Ahmad, S.; Isab, A. A. *Inorg. Chem. Commun.* **2001**, *4*, 362–364.
3039. Wang, S.; Fackler, J. P., Jr. *J. Chem. Soc., Dalton Trans.* **1988**, 22–23.
3040. Raubenheimer, H. G.; Otte, R.; Linford, L.; Van Zyl, W. E.; Lombard, A.; Kruger, G. J. *Polyhedron* **1992**, *11*, 893–900.
3041. Porter, L. C.; Fackler, J. P., Jr.; Costamagna, J.; Schmidt, R. *Acta Crystallogr., Sect. C* **1992**, *48*, 1751–1754.
3042. Lin, C. C.; Liu, S. X.; Yong, R. S. *Jiegou Huaxue* **1990**, *9*, 42–45.
3043. Piro, O. E.; Castellano, E. E.; Piatti, R. C. V.; Bolzan, A. E.; Arvia, A. J. *Acta Crystallogr., Sect. C* **2002**, *58*, M252–M255.
3044. Staples, R. J.; Fackler, J. P., Jr.; Costamagna, J. *Acta Crystallogr., Sect. C* **1997**, *53*, 1555–1558.
3045. Bensch, W.; Schuster, M. Z. *Anorg. Chem.* **1992**, *611*, 99–103.
3046. Bao, S. A.; Lang, J. P.; Xin, X. Q.; Yu, K. B. *Chin. Chem. Lett.* **1992**, *3*, 1027–1028.
3047. Siasios, G.; Tiekink, E. R. T. *Aust. J. Chem.* **1995**, *48*, 757–762.
3048. Richter, R.; Schröder, U.; Kampf, M.; Hartung, J.; Beyer, L. Z. *Anorg. Allg. Chem.* **1997**, *623*, 1021–1026.
3049. Jones, P. G.; Lautner, J. *Acta Crystallogr., Sect. C* **1988**, *44*, 2098–2091.
3050. Strähle, J.; Hiller, W.; Conzelmann, W. Z. *Naturforsch., Teil B* **1984**, *39*, 538–541.
3051. Ahrland, S.; Dreisch, K.; Noren, B.; Oskarsson, A. *Mater. Chem. Phys.* **1993**, *35*, 281–289.
3052. Ahrland, S.; Noren, B.; Oskarsson, A. *Inorg. Chem.* **1985**, *24*, 1330–1333.
3053. Friedrichs, S.; Jones, P. G. *Acta Crystallogr., Sect. C* **2000**, *56*, 56–57.
3054. Sladek, A.; Schmidbaur, H. Z. *Naturforsch., Teil B* **1996**, *51*, 1207–1209.
3055. Parker, D.; Roy, P. S.; Ferguson, G.; Hunt, M. M. *Inorg. Chim. Acta* **1989**, *155*, 227–230.
3056. Blake, A. J.; Taylor, A.; Schröder, M. *J. Chem. Soc., Chem. Commun.* **1993**, 1097–1098.
3057. Schulte, P.; Behrens, U. *Chem. Commun.* **1998**, 1633–1634.
3058. Amoroso, A. J.; Blake, A. J.; Danks, J. P.; Fenske, D.; Schröder, M. *New J. Chem.* **1999**, *23*, 345–346.
3059. Dvorkin, A. A.; Fesenko, E. V.; Budarin, L. I.; Simonov, Y. A.; Malinovskii, T. I. *Dokl. Akad. Nauk. SSSR* **1990**, *311*, 1126–1129.
3060. Mathieson, T.; Schier, A.; Schmidbaur, H. *J. Chem. Soc., Dalton Trans.* **2001**, 1196–1200.
3061. Usón, R.; Laguna, A.; Castrillo, M. V. *Synth. React. Inorg. Met.-Org. Chem.* **1979**, *9*, 317–324.
3062. Jones, P. G.; Sheldrick, G. M.; Usón, R.; Laguna, A. *Acta Crystallogr., Sect. C* **1980**, *36*, 1486–1488.
3063. Bayler, A.; Bauer, A.; Schmidbaur, H. *Chem. Ber.* **1997**, *130*, 115–118.
3064. Hamel, A.; Mitzel, N. W.; Schmidbaur, H. *J. Am. Chem. Soc.* **2001**, *123*, 5106–5107.
3065. Braunstein, P.; Müller, A.; Bogge, H. *Inorg. Chem.* **1986**, *25*, 2104–2106.
3066. Helgesson, G.; Jagner, S. *Acta Chem. Scand. Ser. A* **1987**, *41*, 556–561.
3067. Jones, P. G. Z. *Kristallogr.* **1995**, *210*, 375–376.
3068. Kivekas, R.; Colacio, E.; Ruiz, J.; López Gonzalez, J. D.; Leon, P. *Inorg. Chim. Acta* **1989**, *159*, 103–110.
3069. Suarez Varela, J.; Legros, J. P.; Galy, J.; Colacio, E.; Ruiz, J.; López Gonzalez, J. D.; Leon, P.; Perona, R. *Inorg. Chim. Acta* **1989**, *161*, 199–206.
3070. Butcher, R. A.; Staples, R. J. Z. *Kristallogr.* **1998**, *213*, 213–214.
3071. Svensson, P. H.; Rosdahl, J.; Kloo, L. *Chem. Eur. J.* **1999**, *5*, 305–311.
3072. Bohm, E.; Dehnicke, K.; Beck, J.; Hiller, W.; Strähle, J.; Maurer, A.; Fenske, D. Z. *Naturforsch., Teil B* **1988**, *43*, 138–143.
3073. Staples, R. J.; Wang, S.; Fackler, J. P., Jr. *Acta Crystallogr., Sect. C* **1994**, *50*, 1580–1582.
3074. Godfrey, S. M.; Ho, N.; McAuliffe, C. A.; Pritchard, R. G. *Angew. Chem., Int. Ed. Engl.* **1996**, *35*, 2344–2346.
3075. Schwerdtfeger, P.; Dolg, M.; Schwarz, W. H. E.; Bowmaker, G. A.; Boyd, P. D. W. *J. Chem. Phys.* **1989**, *91*, 1762–1774.
3076. Schwerdtfeger, P.; McFeaters, J. S.; Stephens, R. L.; Liddell, M. J.; Dolg, M.; Hess, B. A. *Chem. Phys. Lett.* **1994**, *218*, 362–366.
3077. Schwerdtfeger, P.; Boyd, P. D. W.; Brienne, S.; Burrell, A. K. *Inorg. Chem.* **1992**, *31*, 3411–3422.
3078. Schwerdtfeger, P.; McFeaters, J. S.; Liddell, M. J.; Hrušák, J.; Schwarz, H. *J. Chem. Phys.* **1995**, *103*, 245–252.
3079. Iliáš, M.; Furdik, P.; Urban, M. *J. Phys. Chem. A* **1998**, *102*, 5263–5268.
3080. Van Wüllen, C. *J. Chem. Phys.* **1998**, *109*, 392–399.
3081. Laerdahl, J. K.; Saue, T.; Falgri, K., Jr. *Theor. Chim. Acc.* **1997**, *97*, 177–184.
3082. Evans, C. J.; Gerry, M. C. L. *J. Am. Chem. Soc.* **2000**, *122*, 1560–1561.
3083. Reynard, L. M.; Evans, C. J.; Gerry, M. C. L. *J. Mol. Spectrosc.* **2001**, *205*, 344–346.
3084. Bayse, C. A.; Hall, M. B. *J. Am. Chem. Soc.* **1999**, *121*, 1348–1358.
3085. Bayse, C. A. *J. Phys. Chem. A* **2001**, *105*, 5902–5905.
3086. Balasubramanian, K.; Liao, M. Z. *J. Phys. Chem.* **1988**, *92*, 361–364.
3087. Wang, X.; Andrews, L. *J. Am. Chem. Soc.* **2001**, *123*, 12899–12900.

3088. Crawford, M. J.; Klapötke, T. M. *Angew. Chem., Int. Ed. Engl.* **2002**, *41*, 2269–2271.
3089. Bateman, L. W.; Green, M.; Howard, J. A. K.; Mead, K. A.; Mills, R. M.; Salter, I. D.; Stone, F. G. A.; Woodward, P. *J. Chem. Soc., Chem. Commun.* **1982**, 773–775.
3090. Howard, J. A. K.; Salter, I. D.; Stone, F. G. A. *Polyhedron* **1984**, *3*, 567–573.
3091. Brown, S. S. D.; Salter, I. D.; Dent, A. J.; Kitchen, G. F. M.; Orpen, A. G.; Bates, P. A.; Hursthouse, M. B. *J. Chem. Soc., Dalton Trans.* **1989**, 1227–1236.
3092. Salter, I. D.; Sik, V.; Williams, S. A.; Adatia, T. *J. Chem. Soc., Dalton Trans.* **1996**, 643–652.
3093. Evans, J.; Jingxing, G. *J. Chem. Soc., Chem. Commun.* **1985**, 39–40.
3094. Alexander, B. D.; Johnson, B. J.; Johnson, S. M.; Casalnuovo, A. L.; Pignolet, L. H. *J. Am. Chem. Soc.* **1986**, *108*, 4409–4417.
3095. Alexander, B. D.; Johnson, B. J.; Johnson, S. M.; Boyle, P. D.; Kann, N. C.; Mueting, A. M.; Pignolet, L. H. *Inorg. Chem.* **1987**, *26*, 3506–3513.
3096. Alexander, B. D.; Gomez Sal, M. P.; Gannon, P. R.; Blaine, C. A.; Boyle, P. D.; Mueting, A. M.; Pignolet, L. H. *Inorg. Chem.* **1988**, *27*, 3301–3308.
3097. Albinati, A.; Venanzi, L. M.; Wang, G. *Inorg. Chem.* **1993**, *32*, 3660–3669.
3098. Dodd, I. M.; Hao, Q.; Harding, M. M.; Prince, S. M. *Acta Crystallogr., Sect. B* **1994**, *50*, 441–447.
3099. Amoroso, A. J.; Jonson, B. F. G.; Lewis, J.; Massey, A. D.; Raithby, P. R.; Wong, W. T. *J. Organomet. Chem.* **1992**, *440*, 219–231.
3100. Bianchini, C.; Meli, A.; Peruzzini, M.; Vacca, A.; Vizza, F.; Albinati, A. *Inorg. Chem.* **1992**, *31*, 3841–3850.
3101. Albinati, A.; Demartin, F.; Janser, P.; Rhodes, L. F.; Venanzi, L. M. *J. Am. Chem. Soc.* **1989**, *111*, 2115–2125.
3102. Bianchini, C.; Elsevier, C. J.; Ernstring, J. M.; Peruzzini, M.; Zanobini, F. *Inorg. Chem.* **1995**, *34*, 84–92.
3103. Casalnuovo, A. L.; Pignolet, L. H. *J. Am. Chem. Soc.* **1983**, *105*, 5957–5958.
3104. Lehner, H.; Matt, D.; Pregosin, P. S.; Venanzi, L. M.; Albinati, A. *J. Am. Chem. Soc.* **1982**, *104*, 6825–6827.
3105. Albinati, A.; Anklin, C.; Janser, P.; Lehner, H.; Matt, D.; Pregosin, P. S.; Venanzi, L. S. *Inorg. Chem.* **1989**, *28*, 1105–1111.
3106. Casalnuovo, A. L.; Laska, T.; Nilsson, P. V.; Olofson, J.; Pignolet, L. H.; Bos, W.; Bour, J. J.; Steggerda, J. J. *Inorg. Chem.* **1985**, *24*, 182–187.
3107. Moehring, G. A.; Fanwick, P. E.; Walton, R. A. *Inorg. Chem.* **1987**, *26*, 1861–1866.
3108. Cabeza, J. A.; Riera, V.; Trivedi, R.; Grepioni, F. *Organometallics* **2000**, *19*, 2043–2046.
3109. Green, M.; Orpen, A. G.; Salter, I. D.; Stone, F. G. A. *J. Chem. Soc., Chem. Commun.* **1982**, 813–814.
3110. Ferrer, M.; Reina, R.; Rossell, O.; Seco, M.; Alvarez, S.; Ruiz, E.; Pellinghelli, M. A.; Tiripicchio, A. *Organometallics* **1992**, *11*, 3753–3759.
3111. Carreño, R.; Riera, V.; Ruiz, M. A.; Bois, C.; Jeannin, Y. *Organometallics* **1992**, *11*, 2923–2930.
3112. Carreño, R.; Riera, V.; Ruiz, M. A.; Tiripicchio, A.; Tiripicchio-Camellini, M. *Organometallics* **1994**, *13*, 993–1004.
3113. Albinati, A.; Lehner, H.; Venanzi, L. M.; Wolfer, M. *Inorg. Chem.* **1987**, *26*, 3933–3939.
3114. Crespo, M.; Sales, J.; Solans, X. *J. Chem. Soc., Dalton Trans.* **1989**, 1089–1092.
3115. Antiñolo, A.; Burdett, J. K.; Chaudret, B.; Eisenstein, O.; Fajardo, M.; Jalón, F.; Lahoz, F.; López, J. A.; Otero, A. *J. Chem. Soc., Chem. Commun.* **1990**, 17–19.
3116. Antiñolo, A.; Jalón, F. A.; Otero, A.; Fajardo, M.; Chaudret, B.; Lahoz, F.; López, J. A. *J. Chem. Soc., Dalton Trans.* **1991**, 1861–1866.
3117. Antiñolo, A.; Carrillo, F.; Chaudret, B.; Fajardo, M.; Fernández-Baeza, J.; Lanfranchi, M.; Limbach, H. H.; Maurer, M.; Otero, A.; Pellinghelli, A. *Inorg. Chem.* **1994**, *33*, 5163–5164.
3118. Ellis, D. D.; Couchman, S. M.; Jeffery, J. C.; Malget, J. M.; Stone, F. G. A. *Inorg. Chem.* **1999**, *38*, 2981–2988.
3119. Baukova, T. V.; Dyadchenko, V. P.; Oleinikova, N. A.; Lemenovskii, D. A.; Kuz'mina, L. G. *Izv. Akad. Nauk SSSR, Ser Khim.* **1994**, 1125–1130.
3120. Baukova, T. V.; Kuz'mina, L. G.; Oleinikova, N. A.; Lemenovskii, D. A. *Izv. Akad. Nauk SSSR, Ser Khim.* **1995**, 2032–2034.
3121. Baukova, T. V.; Kuz'mina, L. G.; Oleinikova, N. A.; Lemenovskii, D. A.; Blumenfel'd, A. L. *J. Organomet. Chem.* **1997**, *530*, 27–38.
3122. Parks, J. E.; Balch, A. L. *J. Organomet. Chem.* **1974**, *71*, 453–463.
3123. Minghetti, G.; Bonati, F. *Inorg. Chem.* **1974**, *13*, 1600–1602.
3124. Minghetti, G.; Bonati, F. *Angew. Chem., Int. Ed. Engl.* **1972**, *11*, 429–430.
3125. Vaughan, L. G. *J. Am. Chem. Soc.* **1970**, *92*, 730–731.
3126. Vickery, J. C.; Olmstead, M. M.; Fung, E. Y.; Balch, A. L. *Angew. Chem., Int. Ed. Engl.* **1997**, *36*, 1179–1181.
3127. Fung, E. Y.; Olmstead, M. M.; Vickery, J. C.; Balch, A. L. *Coord. Chem. Rev.* **1998**, *171*, 151–159.
3128. Balch, A. L.; Olmstead, M. M.; Vickery, J. C. *Inorg. Chem.* **1999**, *38*, 3494–2499.
3129. Sanches, L. E.; Salcedo, R.; Flores, H.; Martinez, A. *THEOCHEM* **2000**, *530*, 125–129.
3130. Olmstead, M. M.; Jiang, F.; Attar, S.; Balch, A. L. *J. Am. Chem. Soc.* **2001**, *123*, 3260–3267.
3131. Hayashi, A.; Olmstead, M. M.; Attar, S.; Balch, A. L. *J. Am. Chem. Soc.* **2002**, *124*, 5791–5795.
3132. Van Koten, G.; Schaap, C. S.; Jastrzebski, J. T. B. H.; Noltes, J. G. *J. Organomet. Chem.* **1980**, *186*, 427–445.
3133. Van den Ancker, T. R.; Bhargava, S. K.; Mohr, F.; Papadopoulos, S.; Raston, C. L.; Skelton, B. W.; White, A. H. *J. Chem. Soc., Dalton Trans.* **2001**, 3069–3072.
3134. Bennett, M. A.; Welling, L. L.; Willis, A. C. *Inorg. Chem.* **1997**, *36*, 5670–5672.
3135. Payne, N. C.; Ramachandran, R.; Treurnicht, I.; Puddephatt, R. J. *Organometallics* **1990**, *9*, 880–882.
3136. Wang, S.; Fackler, J. P., Jr. *Organometallics* **1988**, *7*, 2515–2417.
3137. Wang, S.; Fackler, J. P., Jr. *Organometallics* **1990**, *9*, 111–115.
3138. Wang, S.; Fackler, J. P., Jr. *Acta Crystallogr., Sect. C* **1990**, *46*, 2253–2255.
3139. Wang, S.; Garzón, G.; King, C.; Wang, J. C.; Fackler, J. P., Jr. *Inorg. Chem.* **1989**, *28*, 4623–4629.
3140. Schmidbauer, H.; Von Eschenbach, J. E.; Kumberger, O.; Müller, G. *Chem. Ber.* **1990**, *123*, 2261–2265.
3141. Ahrens, B.; Jones, P. G. *Z. Naturforsch., Teil B* **1999**, *54*, 1474–1477.
3142. Reetz, M. T.; Kostas, I. D.; Waldvogel, S. R. *Inorg. Chem. Commun.* **2002**, *5*, 252–254.
3143. Crane, W. S.; Beall, H. *Inorg. Chim. Acta* **1978**, *31*, L469–L470.
3144. Clajus, D.; Kramolovsky, R.; Siasios, G.; Tiekink, E. R. T. *Inorg. Chim. Acta* **1998**, *281*, 64–69.

3145. Burini, A.; Galassi, R.; Pietroni, B. R.; Rafaiani, G. *J. Organomet. Chem.* **1996**, *519*, 161–167.
3146. Crespo, O.; Fernández, E. J.; Gil, M.; Gimeno, M. C.; Jones, P. G.; Laguna, A.; López de Luzuriaga, J. M.; Olmos, E. *J. Chem. Soc., Dalton Trans.* **2002**, 1319–1326.
3147. Hao, L.; Lachicotte, R. J.; Gysling, H. J.; Eisenberg, R. *Inorg. Chem.* **1999**, *38*, 4616–4617.
3148. Wilton-Ely, J. D. E. T.; Schier, A.; Schmidbaur, H. *Organometallics* **2001**, *20*, 1895–1897.
3149. Colacio, E.; Cuesta, R.; Gutierrez-Zorrilla, J. M.; Luque, A.; Roman, P.; Giraldi, T.; Taylor, M. R. *Inorg. Chem.* **1996**, *35*, 4232–4238.
3150. Tzeng, B. C.; Che, C. M.; Peng, S. M. *J. Chem. Soc., Dalton Trans.* **1996**, 1769–1770.
3151. Jones, P. G.; Friedrichs, S. *Chem. Commun.* **1999**, 1365–1366.
3152. Kuz'mina, L. G.; Grandberg, K. I.; Il'ina, L. G. Russ. *J. Inorg. Chem.* **1995**, *40*, 1759–1764.
3153. Pignolet, L. H.; Krogstad, D. A. The Heteronuclear Cluster Chemistry of the Group 11 Metals—Some Recent Advances. In *Gold, Progress in Chemistry, Biochemistry and Technology*; Schmidbaur, H., Ed.; Wiley: Chichester, U.K., 1999, pp 429–493.
3154. Lewis, J.; Raithby, P. R. High Nuclearity Osmium-Gold Clusters. In *Metal Clusters in Chemistry*, Vol. 1, Braunstein, P.; Oro, L. A.; Raithby, R. R. Eds.; Wiley-VCH: Weinheim 1999, pp 348–380.
3155. Salter, I. D. Molecular Compounds of Gold with Main Group and Transition Metals. *Metal Clusters in Chemistry*, Vol. 1, Braunstein, P.; Oro, L. A.; Raithby, R. R. Wiley-VCH: Weinheim 1999, pp 509–534.
3156. Ferrer, M.; Julià, A.; Rossell, O.; Seco, M. *Organometallics* **1997**, *16*, 3715–3718.
3157. Akhter, Z.; Ingham, S. L.; Lewis, J.; Raithby, P. R. *Angew. Chem., Int. Ed. Engl.* **1996**, *35*, 992–993.
3158. Galassi, R.; Poli, R.; Quadrelli, E. A.; Fetting, J. C. *Inorg. Chem.* **1997**, *36*, 3001–3007.
3159. Braunstein, P.; Rose, J.; Dedieu, A.; Dusaouy, Y.; Mangeot, J. P.; Tiripicchio, A.; Tiripicchio-Camellini, M. *J. Chem. Soc., Dalton Trans.* **1986**, 225–234.
3160. Bruce, M. I.; Nicholson, B. K. *J. Chem. Soc., Chem. Commun.* **1982**, 1141–1142.
3161. Burgess, K.; Johnson, B. F. G.; Kaner, D. A.; Lewis, J.; Raithby, P. R.; Azman, S. N.; Syed-Mustafa, B. *J. Chem. Soc., Chem. Commun.* **1983**, 455–457.
3162. Reina, R.; Rodríguez, L.; Rossell, O.; Seco, M.; Font-Bardia, M.; Solans, X. *Organometallics* **2001**, *20*, 1575–1579.
3163. Usón, R.; Laguna, A.; Laguna, M. *J. Chem. Soc., Chem. Commun.* **1981**, 1097–1098.
3164. Usón, R.; Laguna, A.; Laguna, M.; Manzano, B. R.; Jones, P. G.; Sheldrick, G. M. *J. Chem. Soc., Dalton Trans.* **1984**, 285–292.
3165. Usón, R.; Laguna, A.; Laguna, M.; Manzano, B. R.; Tapia, A. *Inorg. Chim. Acta* **1985**, *101*, 151–153.
3166. Fernández, E. J.; Gimeno, M. C.; Laguna, A.; López de Luzuriaga, J. M.; Monge, M.; Pyykkö, P.; Sundholm, D. *J. Am. Chem. Soc.* **2000**, *122*, 7287–7293.
3167. Fernández, E. J.; Laguna, A.; López de Luzuriaga, J. M.; Monge, M.; Pyykkö, P.; Runeberg, N. *Eur. J. Inorg. Chem.* **2002**, 750–753.
3168. Usón, R.; Laguna, A.; Laguna, M.; Usón, A. *Organometallics* **1987**, *6*, 1778–1780.
3169. Crespo, O.; Fernández, E. J.; Jones, P. G.; Laguna, A.; López de Luzuriaga, J. M.; Monge, M.; Olmos, M. E. *Chem. Commun.* **1998**, 2233–2234.
3170. Fernández, E. J.; Laguna, A.; López de Luzuriaga, J. M.; Mendizabal, F.; Monge, M.; Olmos, M. E.; Pérez, J. *Chem. Eur. J.* **2003**, *9*, 456–465.
3171. Fernández, E. J.; Jones, P. G.; Laguna, A.; López de Luzuriaga, J. M.; Monge, M.; Pérez, J.; Olmos, M. E. *Inorg. Chem.* **2002**, *41*, 1056–1063.
3172. Fernández, E. J.; López de Luzuriaga, J. M.; Monge, M.; Olmos, M. E.; Pérez, J.; Laguna, A. *J. Am. Chem. Soc.* **2002**, *124*, 5942–5943.
3173. Burini, A.; Fackler, J. P., Jr.; Galassi, R.; Pietroni, B. R.; Staples, R. J. *Chem. Commun.* **1998**, 95–96.
3174. Burini, A.; Bravi, R.; Fackler, J. P., Jr.; Galassi, R.; Grant, T. A.; Omary, M. A.; Pietroni, B. R.; Staples, R. J. *Inorg. Chem.* **2000**, *39*, 3158–3165.
3175. Burini, A.; Fackler, J. P., Jr.; Galassi, R.; Grant, T. A.; Omary, M. A.; Rawashdeh-Omary, M. A.; Pietroni, B. R.; Staples, R. J. *J. Am. Chem. Soc.* **2000**, *122*, 11264–11265.
3176. Contel, M.; Garrido, J.; Gimeno, M. C.; Laguna, M. *J. Chem. Soc., Dalton Trans.* **1998**, 1083–1084.
3177. Cerrada, E.; Contel, M.; Valencia, A. D.; Laguna, M.; Gelbrich, T.; Hursthouse, M. B. *Angew. Chem., Int. Ed. Engl.* **2000**, *39*, 2353–2356.
3178. Vicente, J.; Chicote, M. T.; Lagunas, M. C.; Jones, P. G. *J. Chem. Soc., Chem. Commun.* **1991**, 1730–1731.
3179. Briant, C. E.; Gilmour, D. I.; Mingos, D. M. P. *J. Organomet. Chem.* **1984**, *267*, C52–C55.
3180. Briant, C. E.; Gilmour, D. I.; Mingos, D. M. P. *J. Chem. Soc., Dalton Trans.* **1986**, 835–841.
3181. Zhang, T. L.; Drouin, M.; Harvey, P. D. *Inorg. Chem.* **1999**, *38*, 4928–4936.
3182. Briant, C. E.; Wardle, R. W. M.; Mingos, D. M. P. *J. Organomet. Chem.* **1984**, *267*, C49–C51.
3183. Bour, J. J.; Kanters, R. P. F.; Schlebos, P. P. J.; Bos, W.; Bosman, W. P.; Behm, H.; Beurskens, P. T.; Steggerda, J. J. *J. Organomet. Chem.* **1987**, *329*, 405–412.
3184. Mingos, D. M. P.; Wardle, R. W. M. *J. Chem. Soc., Dalton Trans.* **1986**, 73–80.
3185. Mingos, D. M. P.; Oster, P.; Sherman, D. J. *J. Organomet. Chem.* **1987**, *320*, 257–266.
3186. Hallam, M. F.; Mingos, D. M. P.; Adatia, T.; McPartlin, M. *J. Chem. Soc., Dalton Trans.* **1988**, 335–340.
3187. Imhof, D.; Burckhardt, U.; Dahmen, K. H.; Ruegger, H.; Gerfin, T.; Gramlich, V. *Inorg. Chem.* **1993**, *32*, 5206–5211.
3188. Spivak, G. J.; Vittal, J. J.; Puddephatt, R. J. *Inorg. Chem.* **1998**, *37*, 5474–5481.
3189. Imhof, D.; Burckhardt, U.; Dahmen, K. H.; Joho, F.; Nesper, R. *Inorg. Chem.* **1997**, *36*, 1813–1820.
3190. Douglas, G.; Jennings, M. C.; Manojlović-Muir, L.; Puddephatt, R. J. *Inorg. Chem.* **1988**, *27*, 4516–4520.
3191. Muir, K. W.; Manojlović-Muir, L.; Fullard, J. *Acta Crystallogr., Sect. C* **1996**, *52*, 295–297.
3192. Payne, N. C.; Ramachandran, R.; Schoettel, G.; Vittal, J. J.; Puddephatt, R. J. *Inorg. Chem.* **1991**, *30*, 4048–4053.
3193. Arsenaault, G. J.; Manojlović-Muir, L.; Muir, K. W.; Puddephatt, R. J.; Treurnicht, I. *Angew. Chem., Int. Ed. Engl.* **1987**, *26*, 86–87.
3194. Hill, C. M.; Mingos, D. M. P.; Powell, H.; Watson, M. J. *J. Organomet. Chem.* **1992**, *441*, 499–511.
3195. Manojlović-Muir, L.; Muir, K. W.; Treurnicht, I.; Puddephatt, R. J. *Inorg. Chem.* **1987**, *26*, 2418–2422.
3196. Toronto, D. V.; Balch, A. L. *Inorg. Chem.* **1994**, *33*, 6132–6139.

3197. Bennett, M. A.; Berry, D. E.; Beveridge, K. A. *Inorg. Chem.* **1990**, *29*, 4148–4152.
3198. Braunstein, P.; Lehner, H.; Matt, D.; Tiripicchio, A.; Tiripicchio-Camellini, M. *Angew. Chem., Int. Ed. Engl.* **1984**, *23*, 304–305.
3199. Boyle, P. D.; Johnson, B. J.; Alexander, B. D.; Casalnuovo, J. A.; Gannon, P. R.; Johnson, S. M.; Larka, E. A.; Mueting, A. M.; Pignolet, L. H. *Inorg. Chem.* **1987**, *26*, 1346–1350.
3200. Blum, T.; Braunstein, P.; Tiripicchio, A.; Tiripicchio-Camellini, M. *New J. Chem.* **1988**, *12*, 539–546.
3201. Braunstein, P.; De Jesus, E.; Tiripicchio, A.; Ugozzoli, F. *Inorg. Chem.* **1992**, *31*, 411–418.
3202. Arsenault, G. J.; Anderson, C. M.; Puddephatt, R. J. *Organometallics* **1988**, *7*, 2094–2097.
3203. Burrows, A. D.; Gosden, A. A.; Hill, C. M.; Mingos, D. M. P. *J. Organomet. Chem.* **1993**, *452*, 251–255.
3204. Batten, S. A.; Jeffery, J. C.; Jones, P. L.; Mullica, D. F.; Rudd, M. D.; Sappenfield, E. L.; Stone, F. G. A.; Wof, A. *Inorg. Chem.* **1997**, *36*, 2570–2577.
3205. Shiavo, S. L.; Bruno, G.; Nicolo, F.; Piraino, P.; Faraone, F. *Organometallics* **1985**, *4*, 2091–2096.
3206. Bray, K. L.; Drickamer, H. G.; Mingos, D. M. P.; Watson, M. J.; Shapley, J. R. *Inorg. Chem.* **1991**, *30*, 864–866.
3207. Casalnuovo, A. L.; Laska, T.; Nilsson, P. V.; Olofson, J.; Pignolet, L. H. *Inorg. Chem.* **1985**, *24*, 233–235.
3208. Luke, M. A.; Mingos, D. M. P.; Sherman, D. J.; Wardle, R. W. M. *Transition Met. Chem.* **1987**, *12*, 37–41.
3209. Comstock, M. C.; Prussak-Wieckowska, T.; Wilson, S. R.; Shapley, J. R. *Organometallics* **1997**, *16*, 4033–4040.
3210. Usón, R.; Laguna, A.; Laguna, M.; Tartón, M. T.; Jones, P. G. *J. Chem. Soc., Chem. Commun.* **1988**, 740–741.
3211. Dyson, P. J.; Mingos, D. M. P. Homonuclear Clusters and Colloids of Gold: Synthesis, Reactivity, Structural and Theoretical Considerations. In *Gold, Progress in Chemistry, Biochemistry and Technology*. Schmidbaur, H., Ed.; Wiley: Chichester, U.K., 1999; pp 511–556.
3212. Bellon, P. L.; Cariati, F.; Manassero, M.; Naldini, L.; Sansoni, M. *J. Chem. Soc., Chem. Commun.* **1971**, 1423–1424.
3213. Van der Velden, J. W. A.; Bour, J. J.; Vollenbroek, F. A.; Beurskens, P. T.; Smits, J. M. M. *J. Chem. Soc., Chem. Commun.* **1979**, 1162–1163.
3214. Van der Velden, J. W. A.; Beurskens, P. T.; Bour, J. J.; Bosman, W. P.; Noordik, J. H.; Kolenbrander, M.; Buskes, J. A. K. M. *Inorg. Chem.* **1984**, *23*, 146–151.
3215. Laguna, A.; Laguna, M.; Gimeno, M. C.; Jones, P. G. *Organometallics* **1992**, *11*, 2759–2760.
3216. Van der Velden, J. W. A.; Bour, J. J.; Pet, R.; Bosman, W. P.; Noordik, J. H. *Inorg. Chem.* **1983**, *22*, 3112–3115.
3217. Schmid, G. *Inorg. Synth.* **1990**, *27*, 214–218.
3218. Stone, A. J. *Inorg. Chem.* **1981**, *20*, 563–571.
3219. Evans, D. G.; Mingos, D. M. P. *J. Organomet. Chem.* **1982**, *232*, 171–191.
3220. Mingos, D. M. P.; Wales, D. J. *Introduction to Cluster Chemistry*. Prentice-Hall: Englewood Cliffs, NJ, 1990.
3221. Mingos, D. M. P.; Kanters, R. P. F. *J. Organomet. Chem.* **1990**, *384*, 405–415.
3222. Wales, D. J.; Mingos, D. M. P. *Zhenyang L. Inorg. Chem.* **1989**, *28*, 2748–2754.
3223. Zeller, E.; Beruda, H.; Schmidbaur, H. *Inorg. Chem.* **1993**, *32*, 3203–3204.
3224. Demartin, F.; Manassero, M.; Naldini, L.; Ruggeri, R.; Sansoni, M. *J. Chem. Soc., Chem. Commun.* **1981**, 222–223.
3225. Mingos, D. M. P.; Powell, H. R.; Stolberg, T. L. *Transition Met. Chem.* **1992**, *17*, 334–337.
3226. Calhorda, M. J.; Crespo, O.; Gimeno, M. C.; Jones, P. G.; Laguna, A.; López de Luzuriaga, J. M.; Perez, J. L.; Ramón, M. A.; Veiros, L. F. *Inorg. Chem.* **2000**, *39*, 4280–4285.
3227. Pyykkö, P.; Runeberg, N. *J. Chem. Soc., Chem. Commun.* **1993**, 1812–1813.
3228. Briant, C. E.; Hall, K. P.; Mingos, D. M. P. *J. Organomet. Chem.* **1983**, *254*, C18–C20.
3229. Briant, C. E.; Hall, K. P.; Mingos, D. M. P.; Wheeler, A. C. *J. Chem. Soc., Dalton Trans.* **1986**, 687–692.
3230. Van der Velden, J. W. A.; Bour, J. J.; Steggerda, J. J.; Beurskens, P. T.; Noordik, J. H. *Inorg. Chem.* **1982**, *21*, 4321–4324.
3231. Bellon, P. L.; Manassero, M.; Sansoni, M. *J. Chem. Soc., Dalton Trans.* **1973**, 2423–2427.
3232. Marsh, R. E. *Inorg. Chem.* **1984**, *23*, 3682.
3233. Vollenbroek, F. A.; Bosman, W. P.; Bour, J. J.; Noordik, J. H.; Beurskens, P. T. *J. Chem. Soc., Chem. Commun.* **1979**, 387–388.
3234. Manassero, M.; Naldini, L.; Sansoni, M. *J. Chem. Soc., Chem. Commun.* **1979**, 385–386.
3235. Van der Velden, J. W. A.; Bour, J. J.; Bosman, W. P.; Noordik, J. H. *Inorg. Chem.* **1983**, *22*, 1913–1918.
3236. Hall, K. P.; Theobald, B. R. C.; Gilmour, D. I.; Mingos, D. M. P.; Welch, A. J. *J. Chem. Soc., Chem. Commun.* **1982**, 528–530.
3237. Briant, C. E.; Hall, K. P.; Mingos, D. M. P. *J. Chem. Soc., Chem. Commun.* **1984**, 290–291.
3238. Coffey, J. L.; Shapley, J. R.; Drickamer, H. G. *Inorg. Chem.* **1990**, *29*, 3900–2901.
3239. Van der Linden, J. G. M.; Paulissen, M. L. H.; Schmitz, J. E. J. *J. Am. Chem. Soc.* **1983**, *105*, 1903–1907.
3240. Van der Linden, J. G. M.; Roelofsen, A. M.; Ipskamp, G. H. W. *Inorg. Chem.* **1989**, *28*, 967–970.
3241. Cooper, M. K.; Dennis, G. R.; Hendrick, K.; McPartlin, M. *Inorg. Chim. Acta* **1980**, *45*, L151–L152.
3242. Cheetham, G. M. T.; Harding, M. M.; Haggitt, J. L.; Mingos, D. M. P.; Powell, H. R. *J. Chem. Soc., Chem. Commun.* **1993**, 1000–1001.
3243. Briant, C. E.; Hall, K. P.; Wheeler, A. C.; Mingos, D. M. P. *J. Chem. Soc., Chem. Commun.* **1984**, 248–250.
3244. Pethe, J.; Maichle-Mössner, C.; Strähle, J. Z. *Anorg. Allg. Chem.* **1998**, *624*, 1207–1210.
3245. Pethe, J.; Strähle, J. Z. *Naturforsch., Teil B* **1999**, *54*, 381–384.
3246. Vollenbroek, F. A.; Bouten, D. C. P.; Trooster, J. M.; Van der Berg, J. P.; Bour, J. J. *Inorg. Chem.* **1978**, *17*, 1345–1347.
3247. McCleverty, J. A.; Da Motta, M. M. M. *J. Chem. Soc., Dalton Trans.* **1973**, 2571–2574.
3248. Vollenbroek, F. A.; Van der Velden, J. W. A.; Bour, J. J.; Trooster, J. M. *Recl. Trav. Chim. Pays-Bas* **1981**, *100*, 375–377.
3249. Bos, W.; Kanters, R. P. F.; Van Halen, C. J.; Bosman, W. P.; Behm, H.; Smits, J. M. M.; Beurskens, P. T.; Bour, J. J.; Pignolet, L. H. *J. Organomet. Chem.* **1986**, *307*, 385–398.
3250. Copley, R. C. B.; Mingos, D. M. P. *J. Chem. Soc., Dalton Trans.* **1996**, 479–489.
3251. Vollenbroek, F. A.; Bour, J. J.; Van der Velden, J. W. A. *Recl. Trav. Chim. Pays-Bas* **1980**, *99*, 137–141.
3252. Bos, W.; Bour, J. J.; Steggerda, J. J.; Pignolet, L. H. *Inorg. Chem.* **1985**, *24*, 4298–4301.
3253. Briant, C. E.; Theobald, B. R. C.; White, J. W.; Bell, L. K.; Mingos, D. M. P. *J. Chem. Soc., Chem. Commun.* **1981**, 201–202.

3254. Van der Velden, J. W. A.; Vollenbroek, F. A.; Bour, J. J.; Beurskens, P. T.; Smits, J. M. M.; Bosman, W. P. *Recl. Trav. Chim. Pays-Bas* **1981**, *100*, 148–152.
3255. Richter, M.; Strähle, J. *Z. Anorg. Allg. Chem.* **2001**, *627*, 918–920.
3256. Thiel, R. C.; Benfield, R. E.; Zanon, R.; Smit, H. H. A.; Dirken, M. W. *Struct. Bond.* **1993**, *81*, 1–39.
3257. Teo, B. K.; Keating, K. *J. Am. Chem. Soc.* **1984**, *106*, 2224–2226.
3258. Teo, B. K.; Zhang, H.; Shi, X. *Inorg. Chem.* **1990**, *29*, 2083–2091.
3259. Teo, B. K.; Shi, X.; Zhang, H. *J. Am. Chem. Soc.* **1991**, *113*, 4329–4331.
3260. Teo, B. K.; Zhang, H. *Inorg. Chem.* **1991**, *30*, 3115–3116.
3261. Teo, B. K.; Zhang, H. *Angew. Chem., Int. Ed. Engl.* **1992**, *31*, 445–446.
3262. Teo, B. K.; Shi, X.; Zhang, H. *J. Chem. Soc., Chem. Commun.* **1992**, 1195–1196.
3263. Teo, B. K.; Dang, H.; Campana, C. F.; Zhang, H. *Polyhedron* **1998**, *17*, 617–621.
3264. Teo, B. K.; Zhang, H.; Shi, X. *J. Chem. Soc., Chem. Commun.* **1988**, 204–206.
3265. Teo, B. K.; Keating, K.; Kao, Y. H. *J. Am. Chem. Soc.* **1987**, *109*, 3494–3495.
3266. Teo, B. K.; Zhang, H.; Shi, X. *J. Am. Chem. Soc.* **1990**, *112*, 8552–8562.
3267. Teo, B. K.; Shi, X.; Zhang, H. *Chem. Eng. News* **1989**, *67*, 6.
3268. Teo, B. K.; Zhang, H.; Huang, D. B. *Angew. Chem., Int. Ed. Engl.* **1987**, *26*, 897–900.
3269. Zhang, H.; Zelmon, D. E.; Deng, L.; Liu, H. K.; Teo, B. K. *J. Am. Chem. Soc.* **2001**, *123*, 11300–11301.
3270. Teo, B. K.; Zhang, H.; Shi, X. *J. Am. Chem. Soc.* **1993**, *115*, 8489–8490.
3271. Teo, B. K.; Zhang, H.; Shi, X. *Inorg. Chem.* **1994**, *33*, 4086–4097.
3272. Kappen, T. G. M. M.; Schlebos, P. P. J.; Bour, J. J.; Bosman, W. P.; Smits, J. M. M.; Beurskens, P. T.; Steggerda, J. J. *Inorg. Chem.* **1994**, *33*, 754–758.
3273. Teo, B. K.; Zhang, H. *J. Organomet. Chem.* **2000**, *614–615*, 66–69.
3274. Copley, R. C. B.; Mingos, D. M. P. *J. Chem. Soc., Dalton Trans.* **1996**, 491–500.
3275. Strähle, J. Homonuclear and Heteronuclear Cluster Compounds of Gold. *Metal Clusters in Chemistry*, Vol. 1; Braunstein, P.; Oro, L. A.; Raithby, R. R., Eds.; Wiley-VCH, Weinheim 1999, pp 535–560.
3276. Ellis, J. E. *J. Am. Chem. Soc.* **1981**, *103*, 6106–6110.
3277. Wurst, K.; Strähle, J.; Beuter, G.; Belli Dell'Amico, D.; Calderazzo, F. *Acta Chem. Scand.* **1991**, *45*, 844–849.
3278. Beuter, G.; Mielcke, J.; Strähle, J. *Z. Anorg. Allg. Chem.* **1991**, *593*, 35–45.
3279. Beuter, G.; Strähle, J. *J. Organomet. Chem.* **1989**, *372*, 67–78.
3280. Kappen, T. G. M. M.; Van den Broek, A. C. M.; Schlebos, P. P. J.; Bour, J. J.; Bosman, W. P.; Smits, J. M. M.; Beurskens, P. T.; Steggerda, J. J. *Inorg. Chem.* **1992**, *31*, 4075–4080.
3281. Pethe, J.; Maichle-Mössner, C.; Strähle, J. *Z. Anorg. Allg. Chem.* **1997**, *623*, 1413–1417.
3282. Beuter, G.; Brodbeck, A.; Holzer, M.; Maier, S.; Strähle, J. *Z. Anorg. Allg. Chem.* **1992**, *616*, 27–34.
3283. Holzer, M.; Strähle, J.; Baum, G.; Fenske, D. *Z. Anorg. Allg. Chem.* **1994**, *620*, 192–198.
3284. Van der Velden, J. W. A.; Bour, J. J.; Otterloo, B. F.; Bosman, W. P.; Noordik, J. H. *J. Chem. Soc., Chem. Commun.* **1981**, 583–584.
3285. Beuter, G.; Strähle, J. *Less-Common Met.* **1989**, *156*, 387–395.
3286. Mielcke, J.; Strähle, J. *Angew. Chem., Int. Ed. Engl.* **1992**, *31*, 464–466.
3287. Holzer, M.; Strähle, J. *Z. Anorg. Allg. Chem.* **1994**, *620*, 786–790.
3288. Ellis, J. E.; Faltynek, R. A. *J. Am. Chem. Soc.* **1977**, *99*, 1801–1808.
3289. Richter, M.; Fenske, D.; Strähle, J. *Z. Naturforsch., Teil B* **2000**, *55*, 907–912.
3290. Steggerda, J. J. *Comments Inorg. Chem.* **1990**, *11*, 113–129.
3291. Bour, J. J.; Kanters, R. P. F.; Schlebos, P. P. J.; Steggerda, J. J. *Recl. Trav. Chim. Pays-Bas* **1988**, *107*, 211–215.
3292. Ito, L. N.; Johnson, B. J.; Mueting, A. M.; Pignolet, L. H. *Inorg. Chem.* **1989**, *28*, 2026–2028.
3293. Kanters, R. P. F.; Schlebos, P. P. J.; Bour, J. J.; Bosman, W. P.; Behm, H. J.; Steggerda, J. J. *Inorg. Chem.* **1988**, *27*, 4034–4037.
3294. Ito, L. N.; Sweet, J. D.; Mueting, A. M.; Pignolet, L. H.; Schoondergang, M. J. F.; Steggerda, J. J. *Inorg. Chem.* **1989**, *28*, 3696–3701.
3295. Ito, L. N.; Felicissimo, A. M. P.; Pignolet, L. H. *Inorg. Chem.* **1991**, *30*, 387–396.
3296. Ito, L. N.; Felicissimo, A. M. P.; Pignolet, L. H. *Inorg. Chem.* **1991**, *30*, 988–994.
3297. Rubinstein, L. I.; Pignolet, L. H. *Inorg. Chem.* **1996**, *35*, 6755–6762.
3298. Schoondergang, M. J. F.; Bour, J. J.; Van Strijdonck, G. P. F.; Schlebos, P. P. J.; Bosman, W. P.; Smits, J. M. M.; Beurkens, P. T.; Steggerda, J. J. *Inorg. Chem.* **1991**, *30*, 2048–2052.
3299. Kappen, T. G. M. M.; Bour, J. J.; Schlebos, P. P. J.; Roelofsen, A. M.; Van der Linden, J. G. M.; Steggerda, J. J.; Aubart, M. A.; Krogstad, D. A.; Schoondergang, M. J. F.; Pignolet, L. H. *Inorg. Chem.* **1993**, *32*, 1074–1075.
3300. Aubart, M. A.; Chandler, B. D.; Gould, R. T. A.; Krogstad, D. A.; Schoondergang, M. J. F.; Pignolet, L. H. *Inorg. Chem.* **1994**, *33*, 3724–3734.
3301. Aubart, M. A.; Koch, J. D. F.; Pignolet, L. H. *Inorg. Chem.* **1994**, *33*, 3852–3854.
3302. Kappen, T. G. M. M.; Schlebos, P. P. J.; Bour, J. J.; Bosman, W. P.; Beurkens, G.; Smits, J. M. M.; Beurkens, P. T.; Steggerda, J. J. *Inorg. Chem.* **1995**, *34*, 2121–2132.
3303. Kappen, T. G. M. M.; Schlebos, P. P. J.; Bour, J. J.; Bosman, W. P.; Smits, J. M. M.; Beurkens, P. T.; Steggerda, J. J. *Inorg. Chem.* **1995**, *34*, 2133–2142.
3304. Bour, J. J.; Kanters, R. P. F.; Schlebos, P. P. J.; Bosman, W. P.; Behm, H.; Beurkens, P. T.; Steggerda, J. J. *Recl. Trav. Chim. Pays-Bas* **1987**, *106*, 157–158.
3305. Kanters, R. P. F.; Bour, J. J.; Schlebos, P. P. J.; Bosman, W. P.; Behm, H.; Steggerda, J. J.; Ito, L. N.; Pignolet, L. H. *Inorg. Chem.* **1989**, *28*, 2591–2594.
3306. Craighead, K. L.; Felicissimo, A. M. P.; Krogstad, D. A.; Nelson, L. T. J.; Pignolet, L. H. *Inorg. Chim. Acta* **1993**, *212*, 31–39.
3307. Kanters, R. P. F.; Bour, J. J.; Schlebos, P. P. J.; Steggerda, J. J. *J. Chem. Soc., Chem. Commun.* **1988**, 1634–1635.
3308. Kanters, R. P. F.; Schlebos, P. P. J.; Bour, J. J.; Bosman, W. P.; Smits, J. M. M.; Beurkens, P. T.; Steggerda, J. J. *Inorg. Chem.* **1990**, *29*, 324–328.
3309. Schoondergang, M. J. F.; Bour, J. J.; Schlebos, P. P. J.; Vermeer, A. W. P.; Bosman, W. P.; Smits, J. M. M.; Beurkens, P. T.; Steggerda, J. J. *Inorg. Chem.* **1991**, *30*, 4704–4709.

3310. Krogstad, D. A.; Young, V. G., Jr.; Pignolet, L. H. *Inorg. Chim. Acta* **1997**, *264*, 19–32.
3311. Kappen, T. G. M. M.; Schlebos, P. P. J.; Bour, J. J.; Bosman, W. P.; Smits, J. M. M.; Beurkens, P. T.; Steggerda, J. J. *J. Am. Chem. Soc.* **1995**, *117*, 8227–8334.
3312. Bour, J. J.; Van der Berg, W.; Schlebos, P. P. J.; Kanters, R. P. F.; Schoondergang, M. J. F.; Bosman, W. P.; Smits, J. M. M.; Beurkens, P. T.; Steggerda, J. J.; Van der Sluis, P. *Inorg. Chem.* **1990**, *29*, 2971–2975.
3313. Gould, R. A. T.; Pignolet, L. H. *Inorg. Chem.* **1994**, *33*, 40–46.
3314. Gould, R. A. T.; Craighead, K. L.; Wiley, J. S.; Pignolet, L. H. *Inorg. Chem.* **1995**, *34*, 2902–2913.
3315. Breuer, M.; Strähle, J. Z. *Anorg. Allg. Chem.* **1993**, *619*, 1564–1574.
3316. Laupp, M.; Strähle, J. Z. *Naturforsch., Teil B* **1995**, *50*, 1369–1372.
3317. Laupp, M.; Strähle, J. *Angew. Chem., Int. Ed. Engl.* **1994**, *33*, 207–209.
3318. Smith, D. E.; Welch, A. J.; Treurnicht, I.; Puddephatt, R. J. *Inorg. Chem.* **1986**, *25*, 4616–4617.
3319. Beuter, G.; Strähle, J. Z. *Naturforsch., Teil B* **1989**, *44*, 747–752.
3320. Casalnuovo, A. L.; Casalnuovo, J. A.; Nilsson, P. V.; Pignolet, L. H. *Inorg. Chem.* **1985**, *24*, 2554–2559.
3321. Alexander, B. D.; Mueting, A. M.; Pignolet, L. H. *Inorg. Chem.* **1990**, *29*, 1313–1319.
3322. Boyle, P. D.; Johnson, B. J.; Buehler, A.; Pignolet, L. H. *Inorg. Chem.* **1986**, *25*, 7–9.
3323. Gabbai, F. P.; Schier, A.; Riede, J.; Schmidbaur, H. *Inorg. Chem.* **1995**, *34*, 3855–3856.
3324. Gabbai, F. P.; Chung, S. C.; Schier, A.; Krüger, S.; Rösch, N.; Schmidbaur, H. *Inorg. Chem.* **1997**, *36*, 5699–5705.
3325. Mingos, D. M. P. *Pure Appl. Chem.* **1980**, *52*, 705–712.
3326. Feldman, C.; Jansen, M. *Angew. Chem., Int. Ed. Engl.* **1993**, *32*, 1049–1050.
3327. Feldman, C.; Jansen, M. Z. *Anorg. Allg. Chem.* **1995**, *621*, 1907–1912.
3328. Mudring, A.-V.; Jansen, M. *Angew. Chem., Int. Ed. Engl.* **2000**, *39*, 3066–3067.
3329. Mudring, A.-V.; Nuss, J.; Wedig, U.; Jansen, M. *J. Solid State Chem.* **2000**, *155*, 29–36.
3330. Pyykkö, P. *Angew. Chem., Int. Ed. Engl.* **2002**, *41*, 3573–3578.

6.8

Zinc

S. J. ARCHIBALD
University of Hull, UK

6.8.1	INTRODUCTION	1148
6.8.1.1	Coordination Geometry Preferences	1149
6.8.2	ANALYTICAL AND PHYSICAL TECHNIQUES FOR THE STUDY OF ZINC COORDINATION COMPLEXES	1150
6.8.3	CARBON LIGANDS	1151
6.8.3.1	Carbonyls	1151
6.8.3.2	Cyanide and Isocyanide Ligands	1151
6.8.3.3	Alkyls and Aryls	1152
6.8.4	NITROGEN LIGANDS	1153
6.8.4.1	Ammine and Amine	1153
6.8.4.2	Pyridyl Ligands	1153
6.8.4.3	Imidazole Ligands	1154
6.8.4.3.1	<i>Monoimidazole ligands</i>	1154
6.8.4.3.2	<i>Bisimidazole ligands</i>	1154
6.8.4.3.3	<i>Trisimidazole and greater</i>	1155
6.8.4.3.4	<i>Bridging imidazoles</i>	1156
6.8.4.4	Pyrazole, Triazole, and other Heterocycle Ligands	1157
6.8.4.5	Nucleobase and Nucleoside Ligands	1159
6.8.4.6	Amides, Amidinates, and Guanidinates	1160
6.8.4.7	Bipyridine and Phenanthroline Ligands	1161
6.8.4.8	Tripodal Nitrogen Ligands	1162
6.8.4.8.1	<i>Tris(pyrazolyl)borate ligands</i>	1162
6.8.4.8.2	<i>Other nitrogen donor tripodal ligands</i>	1164
6.8.4.9	Supramolecular Compounds with Nitrogen Donor Ligands	1166
6.8.5	PHOSPHORUS AND ARSENIC LIGANDS	1169
6.8.5.1	Phosphorus Ligands	1169
6.8.5.2	Arsenic Ligands	1171
6.8.6	OXYGEN LIGANDS	1172
6.8.6.1	Hydroxides and Hydrated Species	1172
6.8.6.2	Alkoxides and Aryloxides	1173
6.8.6.3	Aldehydes, Ketones, and Ethers	1174
6.8.6.4	Carboxylates	1176
6.8.6.4.1	<i>Basic carboxylates</i>	1176
6.8.6.4.2	<i>Mixed-metal carboxylate compounds</i>	1177
6.8.6.4.3	<i>Polymeric or framework carboxylate compounds</i>	1177
6.8.6.4.4	<i>Other carboxylate type ligands</i>	1178
6.8.6.5	Phosphate and other Oxyanion Ligands	1180
6.8.6.5.1	<i>Phosphates and phosphonate ligands</i>	1180
6.8.6.5.2	<i>Other oxyanion ligands</i>	1181
6.8.6.6	Ester and Phosphate Diester Binding and Hydrolysis	1182
6.8.6.7	Binding and Formation of Carbonate Species	1184
6.8.6.8	Acetylacetonate and Related Ligands	1186
6.8.6.9	Other Oxygen Donor Ligands	1187
6.8.7	SULFUR, SELENIUM, AND TELLURIUM LIGANDS	1189
6.8.7.1	Sulfur Ligands	1189
6.8.7.1.1	<i>Thiolates</i>	1189
6.8.7.1.2	<i>Thioether ligands and methylation of cysteines</i>	1194
6.8.7.1.3	<i>Dithiolates and polysulfides</i>	1195
6.8.7.1.4	<i>Dithiocarbamates</i>	1196

6.8.7.1.5	<i>Thioformamide, thiocyanate, thiophosphate, and other sulfur donor ligands</i>	1197
6.8.7.2	Selenium	1198
6.8.7.2.1	<i>Selenides</i>	1198
6.8.7.2.2	<i>Selenolates</i>	1198
6.8.7.3	Tellurium	1200
6.8.8	HALIDE LIGANDS	1201
6.8.8.1	Chlorides, Bromides, and Iodides	1201
6.8.8.2	Reactions and Catalysis	1202
6.8.8.3	Fluorides	1202
6.8.9	HYDRIDE AND RELATED LIGANDS	1203
6.8.9.1	Hydrides	1203
6.8.9.2	Hydroborate Ligands	1203
6.8.10	MACROCYCLIC LIGANDS	1204
6.8.10.1	Azamacrocycles	1204
6.8.10.1.1	<i>Ligands based on triaza crowns</i>	1204
6.8.10.1.2	<i>Ligands based on tetraaza crowns</i>	1206
6.8.10.1.3	<i>Ligands based on pentaaza crowns and larger</i>	1208
6.8.10.2	Oxacrowns and Thiocrowns (see Chapter 1.18)	1209
6.8.10.3	Mixed Donor Macrocycles (see Chapter 1.20)	1210
6.8.10.4	Cryptands and Crossbridged Macrocycles	1213
6.8.10.5	Compartmental Macrocycles (see Chapter 1.19)	1214
6.8.10.6	Porphyrins and Phthalocyanines	1215
6.8.10.6.1	<i>Porphyrin-based ligands (see Chapter 1.23)</i>	1216
6.8.10.6.2	<i>Phthalocyanine-based ligands (see Chapter 1.24)</i>	1220
6.8.11	LIGANDS WITH MIXED DONORS	1221
6.8.11.1	Bidentate Mixed Donor Ligands	1221
6.8.11.1.1	<i>N/O ligands</i>	1221
6.8.11.1.2	<i>N/S ligands</i>	1222
6.8.11.1.3	<i>O/S and other ligands</i>	1223
6.8.11.2	Tridentate Mixed Donor Ligands	1223
6.8.11.3	Tetradentate Mixed Donor Ligands	1225
6.8.11.4	Pentadentate and Higher Denticity Mixed Donor Ligands	1227
6.8.11.5	Liver Alcohol Dehydrogenase Models with Mixed Donor Ligands	1228
6.8.12	COMPOUNDS CONTAINING ZINC-METAL BONDS	1229
6.8.13	APPLICATIONS	1230
6.8.13.1	Drug Applications (see Chapter 9.18)	1230
6.8.13.2	Catalysts (see Chapter 9.1)	1230
6.8.13.3	Fluorescent Detection of Zinc in Cellular Systems	1231
6.8.14	BIOLOGICAL CHEMISTRY OF ZINC	1233
6.8.14.1	Zinc in Biological Systems (see Chapter 8.24)	1233
6.8.14.2	Other Aspects of Zinc Enzyme and Protein Chemistry	1234
6.8.15	REFERENCES	1234

6.8.1 INTRODUCTION

Comparing the developments since the early 1980s with the zinc coordination chemistry reported in the first edition of *Comprehensive Coordination Chemistry (CCC, 1987)* reveals a number of areas where there have been particularly important advances. Ligand design coupled with the developing understanding of biological systems has allowed an expansion in the modeling of zinc enzyme active sites, resulting in the synthesis of systems which help to identify roles and structurally or functionally mimic zinc enzymes. There is also interest in the detection of zinc in biological systems, which has many functions, and detection can be considerably enhanced by the use of appropriately designed ligands.

Zinc has been called a “boring” element, but a dramatic increase in published research and potential applications stand against this.^{1,2} Indeed, the very properties that lead to the tag of boring are those that make zinc an element of strong interest in biology, medicine, materials, and catalysis. A “galvanization of biology” has been observed, particularly with the discovery of zinc finger proteins and their key function in gene expression and also with the expanding understanding of its roles in the central nervous system and neurodegenerative disorders, and as a critical cofactor for many cellular functions.³

There is significant interest in zinc sulfide, selenide, and oxide materials and while extensive discussion is not appropriate here, a number of novel complexes that have been developed for their deposition characteristics of these important semiconductors will be highlighted in the context of the ligand types. Zinc has also been used in supramolecular building blocks as a structural element, much as in zinc finger proteins. In these cases the lack of redox chemistry is

often the key factor in the choice of metal center. In porphyrin and phthalocyanine ligand systems the zinc center can impart important electronic effects altering the reactivity and redox potentials of the ligand. The catalytic applications of zinc in designed processes have increased, as might be expected for an element with a ubiquitous role in biological systems. Some of these processes will be discussed with reference to ligand design. In addition, compound types that previously had few or no examples have now been characterized, and an increased number of rare compounds such as fluorides and tellurium compounds are now known and further studied.

This review cannot claim to be a comprehensive account of all the coordination chemistry of zinc since the early 1980s. The approach has been to attempt selection of references by key workers or important results in areas where much work has been carried out. It is hoped that it will be possible by following the key references and articles to gain an overview of achievements and advances in the important areas. In many cases, examples where X-ray structural data is included have been selected preferentially for inclusion.

The particularly important properties of zinc that will be assumed throughout are the stable zinc(II) oxidation state and lack of redox chemistry, the flexibility in coordination number and geometry, and the Lewis acidity which is key to the catalytic roles. Some review articles specifically concerning the coordination chemistry of zinc have been published since 1982.⁴⁻⁶ Review articles referring to specific areas of zinc chemistry will be referenced at the appropriate points. A number of important researchers have emerged over this period of zinc coordination chemistry and although a full representation of the body of work is not possible, key references should allow an appreciation of their contribution. References to particular enzyme active site models or the increased biological relevance of certain ligands are included in the text with the ligands utilized in these systems and a brief summary of some other important aspects of these areas provided at the end of the chapter. Throughout the chapter the use of zinc will indicate reference to zinc(II), the only oxidation state of any relevance, and if zinc metal, zinc(0), is discussed it will be specifically referred to.

6.8.1.1 Coordination Geometry Preferences

Coordination numbers of zinc are most commonly four to six, with three not quite so common, and two, seven and eight less often observed and more dependent on donor or ligand types. In the case of zinc, which can adopt a variety of distorted coordination geometries without significant energy penalty, it is highly useful to have a method to classify the closest classical geometry. In this work reference will occasionally be made to the method of Addison *et al.* for classifying geometry.⁷ Distorted tetrahedral, five-coordinate geometries and octahedral are frequently observed geometries and the Cambridge Structural Database (CSD) contains a large number of square planar complexes due to the vast array of porphyrin and related ligand systems structurally characterized with zinc.

Two-coordinate zinc centers are known and around twenty have been structurally determined and deposited in the CSD.⁸ A coordination number of two is mainly observed with amide, silyl, and alkyl donors, e.g., $\text{Zn}[\text{Si}(\text{SiMe}_3)_2]$, zinc bis(*di-t*-butylamide).⁹⁻¹¹ Extremely bulky thiophenolate and selenophenolate complexes of zinc also show structurally characterized two-coordinate zinc centers, with an S_2 or Se_2 donor set.^{12,13} Trigonal planar geometry is more common for zinc especially with alkyl, amide, and bulky phenolate and thiophenolate ligands.¹⁴⁻¹⁶ Dimeric or larger species can be formed and trigonal geometry is very much dependent on the steric bulk of the ligands. Three-coordinate complexes have also shown important properties as catalysts; for example, in the ring opening of cyclic monomers such as lactides.¹⁷ Calculations show the distortion of trigonal planar geometries can be due to a mixed donor set around the zinc center.¹⁸

Trigonal-pyramidal geometry has been observed for zinc with an appropriately restricted ligand.¹⁹ Square planar zinc is most often observed in porphyrin and phthalocyanine complexes where the ligand restricts the binding geometry. Examples of square planar geometry with oxygen are rare. The solid-state layer structure of $\text{Ba}_2\text{Zn}_3\text{As}_2\text{O}_2$ contains a planar ZnO_2^{2-} layer with the zinc having a square planar geometry. It is thought that the stability offered by the lattice structure overcomes the energetic penalty of the less favorable coordination geometry.²⁰ For similar reasons, a one-dimensional chain structure $\text{Sr}_3\text{ZnPtO}_6$ contains an unusual trigonal prismatic ZnO_6 motif; in this case the rigidity of the PtO_6 units are thought to enforce the unusual geometry.²¹ Higher coordination numbers of seven and eight are unusual for zinc. For example, the coordination number of eight is observed in a tetraamide calixarene zinc structure.²²

Studies into the coordination number preference of zinc have been carried out by comparing data in the CSD to *ab initio* molecular orbital calculations on hydrated structures.²³ They reveal a small energy difference between four- and six-coordinate structures. The data from the CSD suggests a preference for lower coordination numbers from sulfur. The flexibility of coordination geometry and number is important in solution as well as in the solid state and leads to equilibria of species with different coordination numbers. For example, zinc with the relatively simple ligand 1,2-ethylenediamine forms 1:1 and 1:2 metal to ligand ratio complexes in aqueous solution and equilibria exist between tetrahedral and octahedral species, with 50% and 90% existing as tetrahedral, respectively.²⁴ Of particular interest is the coordination environment of zinc in proteins and the preference for tetrahedral or octahedral geometry. Four-coordinate zinc plays a structural role in zinc finger proteins and enzymes. Calculations to determine the stability of this arrangement show the lowest energy ground state coordination number of zinc bound to one acidic or two or more neutral protein ligands to be four.²⁵ The decrease in coordination number on protein binding primarily reflects the requirements of the metal and ligands rather than constraints from protein binding site orientation. *Ab initio* calculations have been used to study four- and five-coordinate geometries with the ligands water, hydroxide ion, methanol, methoxide ion, and ammonia. The calculations, when compared with experimental data, gave closer results when solvent effects were included rather than the gas phase calculations.²⁶

The symmetry of five-coordinate zinc complexes has been analyzed using continuous symmetry measures. This approach and the computational tool allow the degree of polyhedricity to be evaluated quantitatively. The methodology identifies the minimal distance of a given structure to a desired general shape with the same number of vertices.²⁷

6.8.2 ANALYTICAL AND PHYSICAL TECHNIQUES FOR THE STUDY OF ZINC COORDINATION COMPLEXES

The use of different characterization and analytical techniques will be discussed when relevant with the examples of compounds studied; however, a few general techniques or examples are presented in this section.

IR and Raman spectroscopy have been commonly used and, for example, the effects of pressure on the Raman spectrum of a zinc compound with a N_2Cl_2 coordination sphere around the metal, have been investigated.²⁸ IR spectroscopy has been utilized in studies of the hydration of zinc in aqueous solution and in the hydrated perchlorate salt.²⁹ Gas phase chemistry of zinc complexes has been studied with some gas phase electron diffraction structures including amide and dithiocarbamate compounds.^{30–32}

In the tradition of metal replacement to study the properties of zinc-containing proteins with cobalt analogs by UV-vis or EPR spectroscopy, a number of recent studies have been carried out using ^{113}Cd NMR on cadmium-containing analogs of zinc proteins and compounds. ^{113}Cd ($I = 1/2$) has similar binding properties but there are a number of differences, not least the ionic radii of Zn^{2+} and Cd^{2+} (radii 0.69 and 0.92 Å respectively). Notwithstanding, this has been an extremely productive technique with a lot of information gained.³³ The abundant isotope of Zn with nuclear spin is the quadrupolar ^{67}Zn ($I = 5/2$). Solution or liquid state NMR has been used but the large line width and poor receptivity inhibit the collection of useful data on biological samples.³⁴ Solid-state and single-crystal NMR of zinc compounds have now been investigated.³⁵ The use of single-crystal NMR can circumvent many of the difficulties involved in solid-state zinc NMR. A particular aim is to avoid using costly enriched zinc in the sample. Solid-state ^{67}Zn NMR experiments have been carried out using QE (quadrupolar echo) or QCPMG NMR.³⁶

^{13}C NMR is a common tool to study zinc complexes.^{37,38} ^{13}C NMR can be used in conjunction with other markers or variation allowing dynamic interpretation of the chemical shifts observed. For example: chemical shifts as a function of pH can give information about the protonation state of nitrogen-containing ligands, e.g., deprotonation occurs at the pyrrole-ring nitrogen rather than zinc-bound water.³⁹ ^{13}C relaxation measurements have been carried out in the presence of ^{67}Zn which shows induced relaxation, demonstrating that a cyano group can be directly bound to the metal center in carbonic anhydrase.⁴⁰ ^{13}C MAS and CPMAS experiments have been used to study a variety of zinc-containing solid-state systems but especially reactions occurring on the surface of catalysts such as those related to the highly important chemistry of methanol synthesis.⁴¹ 1H relaxation has been studied by NMR in bimetallic zinc complexes.⁴² ^{31}P NMR studies of dithiophosphate zinc complexes have been carried out.^{43,44} ^{15}N NMR studies have been used to

provide evidence for the coordination of a deprotonated amide-containing ligand in the active site of a zinc enzyme.⁴⁵ NMR spectra of peptide complexes have also been reported.⁴⁶

X-ray absorption spectroscopic measurements have been carried out on zinc proteins to determine structural properties. Investigation of coordination complexes and zinc binding peptides have assisted in the interpretation of the more complex systems.⁴⁷ Zinc and sulfur K-edge EXAFS have both been used to investigate the polyzinc species in metallothionein proteins and cadmium-substituted derivatives.⁴⁸ Zinc K-edge EXAFS has been used to determine the zinc coordination donor set in a variety of proteins.^{49,50} The coordination structure of zinc ions on a Langmuir monolayer was observed using total reflection XAFS.⁵¹ EXAFS has been used to determine the structures of solvated complexes and compare coordination numbers in solution and with variation in the solvent.⁵² Zn and N K-edge XANES give structural information, and comparisons have been made with single-crystal X-ray data to demonstrate the utility of this technique.⁵³ There have not been many Zn K-edge XANES studies carried out, probably due to the absence of any pre-edge structure. The complexes studied are often tetrahedral zinc compounds in solid-state or doped materials.^{54,55}

EPR spectroscopy and single-crystal EPR have been used to investigate systems where a ligand-based radical species can be generated and are useful for obtaining information regarding metal-bound radical species in the absence of any metal-based redox processes.⁵⁶ Mass spectrometry has been frequently used in the characterization of zinc complexes and the advent of electrospray mass spectrometry has had a particular impact on the investigation of polymetallic zinc compounds. The compounds of special interest here have included thiophenolate polyzinc compounds and metallothionein protein fragments.⁵⁷ A quadrupole ion trap mass spectrometer can be used to evaluate relative binding energies of complexes in solution.⁵⁸ Circular dichroism spectra have been recorded for a variety of zinc species, particularly those involved in supramolecular assemblies but also simpler monomeric complexes with chiral ligands.⁵⁹

6.8.3 CARBON LIGANDS

6.8.3.1 Carbonyls

The CSD contains no known X-ray structures of zinc carbonyl compounds and much of the work reported is theoretical.⁸ Semiempirical NDO calculations have been carried out to determine the dissociation and bonding energy of the species $\text{Zn}(\text{CO})_6^{2+}$.⁶⁰ Phosgene chemical weapons are decomposed by zinc(II) and other ions in charcoal gas mask filters and, in studies to determine why saturation occurs, quantum chemical calculations were performed on the species ZnCOCl_2 .⁶¹ Calculations have been carried out on the interaction of carbonyls with zinc porphyrin and phthalocyanine compounds. Calculations on a Zn–CO derivative were carried out as part of a study of the effects on incorporating C_{60} as an electron acceptor in a zinc porphyrin CO system.⁶² Density functional calculations were also completed on a six-coordinate zinc phthalocyanine complex with two axial carbonyl ligands.⁶³ Carbonyl bonding on a zinc oxide surface has been investigated by electronic structure calculations on $[\text{ZnO}_3\text{CO}]^{4-}$ and comparisons made with binding to copper(I) sites. The σ donation was found to be a third of that exhibited by copper(I) and π bonding not present in the zinc species.⁶⁴

6.8.3.2 Cyanide and Isocyanide Ligands

A number of cyanide complexes of zinc have been structurally characterized, with bridging cyanide ligands frequently observed in both zinc and zinc-containing mixed metal species. Discrete mononuclear trispyrazolylborate zinc cyanide complexes have been synthesized and structurally characterized as part of a study of crystallographic disorder.⁶⁵ The zinc cyanide unit was partially replaced in the presence of halides as zinc chloride, zinc bromide, and zinc iodide. *t*-Butylisocyanide complexes of zinc were synthesized from chalcogenolate-bridged dimers resulting in four-coordinate monomeric zinc species with two selenium or sulfur donors and two isocyanide donors. The X-ray structure of the selenium derivative demonstrates a distorted tetrahedral coordination geometry.⁶⁶

Zinc complexes of a fused pyrroloporphyrin, cyclopropanochlorin, that contain an appended isocyano group show dimer formation. The X-ray structure reveals five-coordinate zinc centers

with bonding to four nitrogens from the chlorin macrocycle and an intermolecular bond to the isocyano carbon.⁶⁷

Both zinc and mixed-metal clathrate compounds are known containing cyanide bridged metal centers, e.g., $\text{Zn}(\text{CN})_2$.⁶⁸ The mixed-metal clathrate compounds contain bridging cyanides between zinc and cadmium or copper. Both Cd–Zn and Cu–Zn compounds show tetrahedral zinc centers and carbon tetrachloride guest molecules. The cyanide ligands bridge the zinc and other metal centers to give a C_2N_2 coordination environment. The discrimination between the carbon and nitrogen atoms of the cyanide ligands was made on the basis of the X-ray data from a number of single-crystal structures.⁶⁹ A 3D network that also contains structural space for the inclusion of solvent molecules is formed from 2,4,6-tris(4-pyridyl)-1,3,5-triazine ligands and contains cyano groups bridging the zinc ions.⁷⁰ Alternate tetrahedral and octahedral zinc ions are observed in the polymeric crystal structure of $[\text{Zn}(\text{pyridine})_2][\text{Zn}(\text{CN})_4]$ with all cyano ligands μ_2 -bridging. The pyridyl bound zinc is shown to be ZnN_6 and the other type of zinc center tetrahedral ZnC_4 .⁷¹ A coordination polymer with a chain structure is observed in the crystals of the complex $[\text{K}(\text{benzo-18-crown-6})][\text{Zn}(\text{CN})_3]$. A Zn–CN–Zn chain is formed with a terminal cyano group bridging to the potassium center.⁷² A hydrogen bonded assembled chain structure is observed in the structure of dicyano(2,2'-dipyridylamine)zinc. The blue luminescent compound shows four-coordinate N_2C_2 coordination with the hydrogen bonds formed between the amine groups and cyano nitrogens.⁷³

6.8.3.3 Alkyls and Aryls

There are over 140 zinc alkyl or aryl structures reported in the CSD in which more than half of the donors are noncarbon. Those selected for discussion show representative structures and coordination numbers, or particularly prevalent ligand systems.

Monomeric monoalkyl zinc complexes have been characterized with tris(pyrazolyl)borate ligands. The monomeric complexes include the structurally characterized methyl derivative (1).⁷⁴ A variety of tris(3-*t*-butylpyrazolyl)borate zinc alkyl and phenyl complexes have been synthesized, for example, by Chisholm and co-workers as catalyst precursors for ring opening polymerization reactions. These include ethyl, *t*-butyl, and phenyl derivatives.⁷⁵ A number of other tripodal ligand systems, including mixed donor tripods, have also been characterized with bound alkyl groups.^{65,76–78} Monomeric species can also be synthesized, with diamine ligands such as TMEDA, of the formula $[\text{LZnClEt}]$ or $[\text{LZnEt}_2]$.⁷⁹

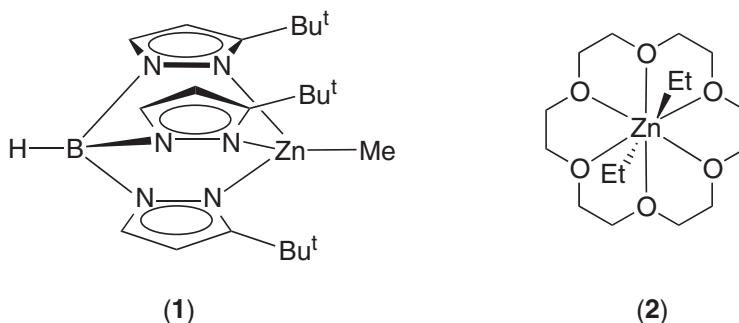

Dimeric structures with methyl or ethyl zinc units linked by bridging amides have been formed, e.g., $[\text{MeZnNMe}(\text{CH}_2)_2\text{NMe}_2]_2$, with the presence of moisture expanding the structure to incorporate six zinc atoms, a μ_4 -oxo and the μ_2 -amide ligand.⁸⁰ Trimeric hexametallocyclic structures are formed with a number of zinc alkyl species.^{81,82} A dodecanuclear zinc phosphonate structure is known which incorporates ethyl ligands on the outer zinc atoms and contains a $\text{Zn}_4(\mu_4\text{-O})$ core.⁸³ The complex bis(*N,N*-diethylmonothiocarbamato)zinc, $[\text{Et}_4\text{Zn}_4(\text{OSCNEt}_2)_2(\text{NET}_2)_2]$, is a tetrameric cage complex with both the oxygen and the sulfur donor from the monothiocarbamato ligand binucleating, and terminal ethyl groups present. The variable temperature ^1H NMR reveals that the metal assembly remains intact in solution.⁸⁴

The monocation tris(diethylether) ethylzinc is formed from diethyl zinc as a tetrakis(pentafluorophenyl)borate salt.⁸⁵ Longer-chain linear and cyclic ether complexes (2) of zinc alkyls have also been observed. The reaction between zinc dialkyls and primary amines gives a number of structurally diverse products dependent on the reaction conditions and the amine.⁸⁶ The

iodomethyl 18-crown-6 complex of $\text{Zn}(\text{CH}_2\text{I})_2$ shows a five-coordinate zinc center with three oxygen donor ligands. In the same unit cell the complex $\text{ZnI}(\text{CH}_2\text{I})\cdot 18\text{-crown-6}$ is also observed with a related O_3CI coordination donor set.⁸⁷ Halomethyl zinc reagents are very important in the Simmons–Smith reaction.⁸⁸

A zinc-mediated carbon–carbon coupling reaction can be carried out on the metallated form of (*t*-butyldimethylsilyl)(2-pyridylmethyl)amine, formed in reaction with dimethylzinc. The isolated dimeric species can be reacted with further dimethyl zinc to give bis(methylzinc)-1,2-dipyridyl-1,2-bis(*t*-butyldimethylsilylamido)ethane, which contains two N_3C coordinated zinc centers.⁸⁹

6.8.4 NITROGEN LIGANDS

6.8.4.1 Ammines and Amines

The chemistry of zinc ammine complexes is well known. There are X-ray structural examples of both the tetrahedral tetra-ammine and octahedral hexa-ammine.^{90,91} Four- and five-coordinate mixed ligand complexes are common and participation in coordination networks as terminal ligands is observed.^{92,93}

Open chain polyamine ligands have been widely studied. Often the coordination of zinc is compared with other first row transition metals and factors, such as behavior across a pH range, studied. The protonation patterns and stability constants are of particular interest. Octahedral zinc tris(ethylenediamine) structures have been characterized by X-ray diffraction with a number of different counter anions.⁹⁴ The X-ray structure of zinc tris(ethylenediamine) with fluoride counter ions reveals extensive hydrogen bonding.⁹⁵

Synthesis and thermal decomposition of zinc thiocyanate complexes of cyclic bidentate amines piperazine, *N*-methyl piperazine, and 1,4-diazacycloheptane were studied. The thermal stability of the complexes showed piperazine the most stable and 1,4-diazacycloheptane the least stable.⁹⁶ The zinc complex of open chain polyamine 4,8,11,15-tetraazaoctadecane-1,18-diamine has been studied by potentiometry and ^1H and ^{13}C NMR. From these data sets, the coordination is shown to be by no more than four nitrogens from the hexaamine. Also, in contrast to the coordination of other characterized hexaamine ligands, it shows the ability to form binuclear species with zinc. Formation of predominant binuclear hydroxo species, dependent on pH, is observed.⁹⁷ ^{13}C NMR studies have been carried out on zinc complexes of 3,7-diazanonane-1,9-diamine and 1,2-diaminoethane.⁹⁸ The equilibria between branched hexaamine *N,N,N',N'*-tetrakis(3-aminopropyl) ethylenediamine and zinc and other transition metal ions has been studied.⁹⁹ The zinc complexes of terminally methylated open-chain polyazaalkanes, $\text{CH}_3\text{NHCH}_2\text{CH}_2\text{NH}[\text{CH}_2\text{CH}_2\text{NH}]_n\text{-CH}_2\text{CH}_2\text{NHCH}_2\text{CH}_2\text{NHCH}_3$ ($n = 1\text{--}5$), have also been studied by potentiometry, direct microcalorimetry, and ^1H and ^{13}C NMR. The stability constants and the enthalpy of formation of the species $[\text{ZnL}]^{2+}$ are roughly constant along the series. Mononuclear complexes are formed and a coordination number of five is suggested for the complexes. The ligands where $n = 3\text{--}5$ also form binuclear complexes with stability increasing with the increasing number of nitrogen donors. Comparison with macrocyclic equivalents of these ligands show the macrocyclic effect is only observed for the shortest chain ($n = 1$) analog. For all the other ligands in this series and mono- or binuclear complexes the open chain ligand complexes have higher stability.¹⁰⁰

A number of ^{13}C NMR studies on zinc amine complexes have been reported.^{101–104}

6.8.4.2 Pyridyl Ligands

Pyridyl donors are common and feature in later sections as part of many multidentate ligands, such as macrocycles. Functionalized pyridyl donors will also be discussed and Section 6.8.4.7 provides examples of the bidentate bipyridyl and phenanthroline complexes.

Calorimetry investigations of zinc ions with functionalized pyridines have been carried out in both dimethylformamide and acetonitrile. The pyridines used were pyridine, 3-methylpyridine, and 4-methylpyridine. In DMF, for all three pyridines, four- and six-coordinate species formed and their formation constants, reaction enthalpies and entropies were determined. The stability increases linearly with increasing basicity of the pyridine derivative. The formation of the 3-methylpyridine complex is enthalpically less favorable and entropically more favorable than

the others due to steric interactions with DMF in the first coordination sphere.¹⁰⁵ In acetonitrile complexes $[\text{ZnL}(\text{MeCN})_5]^{2+}$ and $[\text{ZnL}_2(\text{MeCN})_4]^{2+}$ exist and a structural change from octahedral to tetrahedral to give $[\text{ZnL}_3(\text{MeCN})]^{2+}$ and $[\text{ZnL}_4]^{2+}$ is observed.¹⁰⁶ In DMF the formation of the zinc complexes is more favorable due to weaker solvation of the metal ion.

The zinc complexes with diphenyl-2-pyridylmethane, ZnL_2Cl_2 and ZnL_2Br_2 , have been characterized by IR spectroscopy and conductivity measurements.¹⁰⁷ The $[(\text{pyridyl})_2\text{P}(\text{NSiMe}_3)_2]^-$ ligand forms an aminoiminophosphoranate complex with zinc which structural characterization shows to be four-coordinate bound to two pyridyl and two amide nitrogen donors (**3**).¹⁰⁸

The zinc complexes of bis(2-pyridylmethyl)amine have been studied by X-ray crystallography and ^{13}C NMR. The structures of $[\text{ZnL}_2](\text{ClO}_4)_2$ and $[\text{ZnL}_2]\text{Cl}_2 \cdot 6\text{H}_2\text{O}$ have been determined and ^{13}C NMR demonstrated to be applicable to distinguishing the isomers.¹⁰⁹

The zinc chloride complex of 1-(2-pyridyl)-2-(2-thienyl)ethyne has been structurally characterized by single crystal X-ray diffraction showing the ligand is a monodentate nitrogen donor. The N_2Cl_2 tetrahedral coordination geometry reveals little apparent influence of the acetylene or thiophene groups.¹¹⁰

6.8.4.3 Imidazole Ligands

Imidazole is of particular relevance to biological mimic ligands due to the presence of histidine as a coordinating group for zinc in biological systems and has been a particular target for zinc complex formation.

6.8.4.3.1 Monoimidazole ligands

Simple imidazole complexes have been further studied with the monomeric complex $[\text{Zn}(\text{imidazole})_2(\text{CH}_3\text{CO}_2)_2]$.¹¹¹ In the X-ray structure the metal is in a tetrahedral environment with a network of intermolecular hydrogen bonding between the non-coordinated imidazole nitrogen and the acetate oxygen.¹¹² A study of the stability of transition metal imidazole complexes by potentiometric titration in the presence of *N,N*-bis(2-hydroxyethyl)glycinate showed an interesting result for zinc in comparison with the other transition metals studied. A particularly high stability was observed on the formation of the ternary complex that could be attributed to a reduction in coordination number on binding of the imidazole, entropically favoring complex formation.¹¹³ Equilibrium studies have also been carried out in the formation of binary and mixed ligand complexes with imidazole, histamine, and L-histidine.¹¹⁴ The ligand 5-amino-4-carboethoxy-1-*para*-methoxyphenyl-imidazole forms a monomeric complex, ZnL_2Cl_2 , which exhibits a distorted tetrahedral geometry and the zinc ion coordinates to the imidazole *N*-donor from each ligand.¹¹⁵

An imidazole/pyridyl ligand (**4**) coordinates to a copper(II) center and on deprotonation the imidazole reacts with bis(hexafluoroacetylacetonato)zinc to form a trimeric Cu_2Zn species bridged by imidazoles. The zinc ion is in an octahedral coordination environment with Zn–N distances of 2.029(2) Å.¹¹⁶

The ligand 4,5-bis(di(2-pyridylmethyl)aminomethyl)imidazole has been utilized in the formation of Cu–Zn dinuclear complex $[\text{CuZnL}(\text{CH}_3\text{CN})_2](\text{ClO}_4)_3$. The resonance Raman spectra of hydroperoxo intermediates were studied.¹¹⁷

6.8.4.3.2 Bisimidazole ligands

Bouwman synthesized complexes of tridentate ligand *N,N*-bis(2-ethyl-5-methyl-imidazol-4-ylmethyl)aminopropane (**5**). $[\text{ZnL}_2]^{2+}$ complexes were synthesized with IR spectroscopic data indicating octahedral coordination.¹¹⁸

The biphenyl ligand functionalized with two imidazoles (**6**) was used to produce distorted tetrahedral complexes of zinc.¹¹⁹ 2,2'-Biimidazole can act as a bidentate ligand coordinating to one zinc ion (**7**) or as a bridging ligand in the formation of dimeric species (**8**) with X-ray structures of both binding motifs.¹²⁰

Bhalla *et al.* synthesized and studied the zinc complex of bis(1-methyl-4,5-diphenylimidaz-2-oyl)carbinol. The ligand coordinates as bidentate resulting in a slightly distorted tetrahedral geometry, $[\text{ZnL}_2]^{2+}$.¹²¹

Breslow and co-workers were among the first to design polyimidazole ligands to mimic coordination in zinc enzymes.¹²² Oxygen and sulfur-bridged bis-benzimidazole ligands 1-(*N*-methyl)benzimidazolyl-3-benzimidazolyl-2-oxapropane and 1-(5,6-dimethylbenzimidazolyl)-3-benzimidazolyl-2-thiapropane result, respectively, in coordination of an N₂O and an N₂ donor set on zinc complex formation.¹²³ Related benzimidazole ligands have been used as transfer agents for metal ions in a three-phase transport system.¹²⁴

Monomeric complexes have been formed with the bis(benzimidazolylmethyl) sulfide ligands to give tetrahedral N₂S₂ coordinated zinc in combination with thiolates.¹²⁵ The benzimidazole ligand (9) shown has also been used to form polynuclear complexes with zinc and benzylthiolates.¹²⁶

The mononuclear zinc complex of the ligand 1-(5,6 dimethylbenzimidazolyl)-3-benzimidazolyl-2-thiapropane has been structurally characterized.¹²³ The thioether bridge present in the ligand does not coordinate to the metal center. The thiapropane complex ZnLCl₂ shows a distorted tetrahedral geometry with an N₂Cl₂ coordination sphere. Identical to the coordination observed by Vahrenkamp in a symmetric bis-benzimidazole ligand with ZnBr₂.¹²⁷ Tridentate, bis(benzimidazole) pyridine, ligands with pyridyl and imidazole donors have been used in zinc complexation.¹²⁸

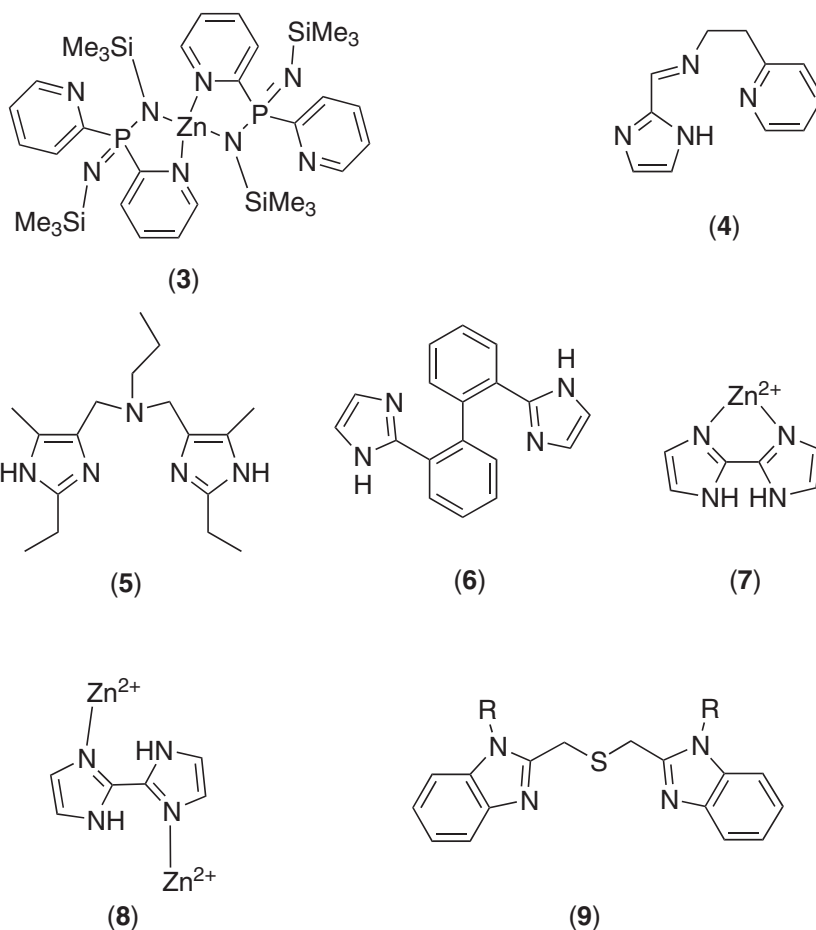

Pentadentate ligands with two imidazole nitrogen donors have been prepared and the zinc complex characterized (10). A distorted trigonal-bipyramidal geometry was observed around the metal center with all nitrogen donors from the ligand coordinated. Variable temperature NMR was used to calculate rate constants for the exchange processes involving the imidazole groups.¹²⁹

6.8.4.3.3 Trisimidazole and greater

Gajda *et al.* have produced a number of zinc imidazole complexes with substituted imidazoles.¹³⁰⁻¹³² The ligands 4-(imidazol-4-ylmethyl)-2-(imidazol-2-ylmethyl)imidazole (11) and

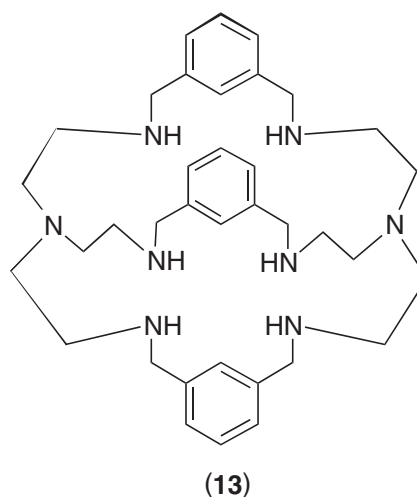
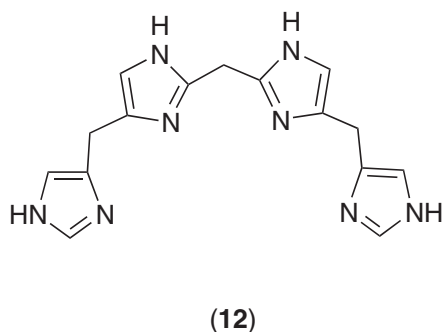
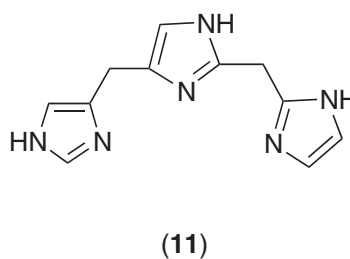
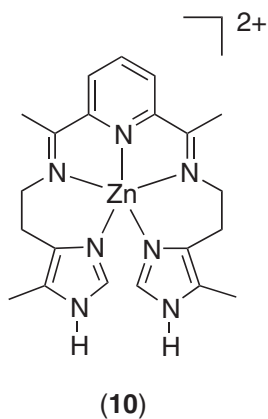

bis[4-(imidazol-4-ylmethyl) imidazol-2-ylmethane] (**12**) contain three and four imidazole groups respectively.¹³³ Potentiometric titrations were carried out to determine formation constants. It is anticipated that other ligands, such as solvent molecules, complete the coordination sphere and could be displaced. The binding of L-cysteine to the zinc complex was studied. Different ligand ratios gave different products and the introduction of cysteine resulted in formation of ternary complexes suggesting favored formation of N/S⁻ coordination around the zinc.

A cage-like complex results from the tris(imidazol-1-ylmethyl)benzene ligand in the presence of zinc acetate, [Zn₃L₂(OAc)₆], and exhibits inclusion properties to neutral guest molecules in aqueous solution.¹³⁴

Ligands with imidazoles groups attached to calixarenes show interesting complexation properties and the adjacent presence of a hydrophobic cavity mimics a further important element of many zinc enzyme active sites.^{135–138} A *t*-butylcalix[6]arene is functionalized in alternating positions by three imidazole groups thus presenting three *N*-methyl imidazole donors next to a cavity. The ligand is shown to stabilize four coordinated zinc species with a variety of neutral molecules. Amino, nitrilo, ethanol, and formamide complexes were characterized by X-ray crystallography (Figure 1) showing the role of hydrogen bonding and CH/ π interactions between the zinc-bound neutral molecule and the cavity.^{135,136} The alcohol complex has a Zn—O distance of 1.993(3) Å compared with 2.0–2.1 Å in liver alcohol dehydrogenase.¹³⁵ The most remarkable aspect of this class of compound is the stability of the tetrahedral Zn funnel complexes.

6.8.4.3.4 Bridging imidazolates

Imidazoles are of interest as bridging ligands particularly with regard to mimics of the active site of Cu–Zn superoxide dismutase (SOD). Structures with imidazolate bridges have been

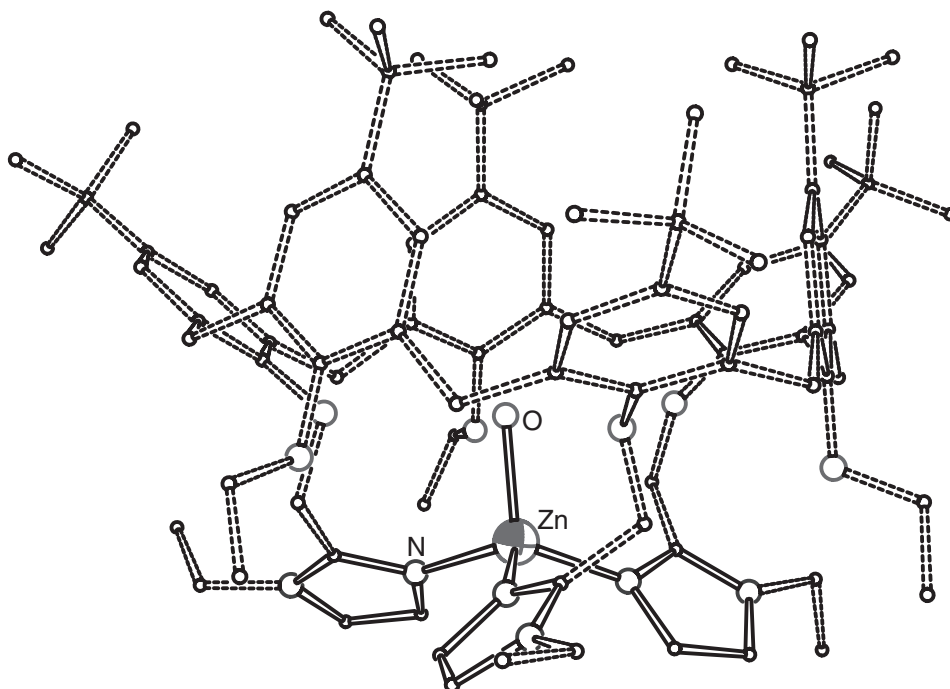

Figure 1 The molecular structure of the zinc complex of an imidazole-functionalized *t*-butylcalix[6]arene.¹³⁵

characterized.^{139–142} In particular, Ohtsu *et al.* have contributed a number of complexes of this type.^{117,143,144} These compounds are often two independent mononuclear complexes bridged by the imidazolite and so may break apart. Imidazolite-bridged Cu–Zn hydroperoxo complexes have been generated and characterized as intermediates in Cu,Zn-SOD. The reaction between the heterodinuclear imidazolite bridged complex and hydrogen peroxide in the presence of triethylamine generates the hydroperoxo complex.¹⁴⁵ Spectroscopic characterization was carried out.

The imidazolite bridged Cu/Zn bimetallic complex of the cryptand (**13**) was structurally characterized and shown to have a Cu–Zn distance of 5.93 Å (native Cu, Zn-SOD 6.2 Å).¹⁴⁶ The complex shows some activity in the dismutation of superoxide at biological pH that is retained in the presence of bovine serum albumin.

Diethylenetriamineacetic acid has been used in the formation of homodinuclear zinc complexes with the bridging imidazole. The crystal structure of [LZn(imidazolite)ZnL]ClO₄ was obtained. The magnetics of the heterodinuclear Cu–Zn complex were studied and single crystal EPR of the Zn₂ dimer doped with the CuZn dimer.¹³⁹

Bridging imidazolites have also been found in the copper(II)–zinc binuclear complexes with triethylenetetramine completing the coordination sphere of each metal center, [LCu(imidazolite)ZnL](ClO₄)₃. The X-ray structure reveals a five-coordinate zinc center with a distorted tetragonal–pyramidal geometry and a Cu–Zn distance of 6.081(2) Å. As the pH is lowered to 9.6–10.3, the bridge is broken at the copper, which is in contrast to the equivalent diethylenetriamineacetic acid or tris(2-aminoethyl)amine derivatives, where the bridge is broken at the zinc center.¹⁴¹ The analogous structure is also known for an imidazolite bridged zinc dimer with the tris(2-pyridyl)methylamine ligand.¹⁴⁷

Dinucleating ligands have been used to incorporate the two metal centers with a bridging imidazole, 4,5-bis(di(2-pyridylmethyl)aminomethyl)imidazole and 4,5-bis(di(6-methyl-2-pyridylmethyl)aminomethyl)imidazole.¹⁴⁸ The X-ray crystal structure of the copper zinc complex [CuZnL(CH₃CN)₂](ClO₄)₃ reveals a Cu^{II}–Zn distance of 6.197(2) Å. The zinc center is pentacoordinate bound to the imidazolite nitrogen, two pyridine nitrogens, the tertiary amine nitrogen and a CH₃CN. The solvent molecule can easily be exchanged and the complex was tested for SOD activity.¹⁴⁹

6.8.4.4 Pyrazole, Triazole, and other Heterocycle Ligands

3-Amino-4-acetyl-5-methylpyrazole acts as a monodentate ligand binding to zinc via the tertiary ring nitrogen donor. The mononuclear 2:1 complex was structurally characterized with two

monodentate nitrate anions completing the distorted tetrahedral coordination. Hydrogen bonding interactions linked neighboring molecules in the solid state.¹⁵⁰ 3-Methyl-5-phenylpyrazole is a monodentate ligand forming a monomeric compound ZnL_2Br_2 , which similarly exhibits a distorted tetrahedral geometry.¹⁵¹

Spontaneous deprotonation of 1,2,4-1H-triazole in the presence of zinc chloride gives a solid state structure where each zinc has tetrahedral coordination with N_3Cl donors. The compound $ZnLCl$ has 1,2,4-triazolato units each bridging three zinc atoms through the three nitrogen donors to form a corrugated layer structure. The shortest interlayer Zn...Zn separation is 5.701 Å.¹⁵²

Reaction of 3-(2-pyridyl)pyrazole and 6-(3-pyrazolyl)-2,2'-bipyridine with zinc salts results in mononuclear pseudo-octahedral complexes $[ZnL_3](PF_6)_2$ and $[ZnL_2](PF_6)_2$ respectively. The ligands coordinate as neutral mononucleating chelates in a similar fashion to the bidentate 2,2'-bipyridine or tridentate 2,2':6',2''-terpyridine respectively.¹⁵³

The bidentate ligand *N,N*-bis(pyrazol-1-ylmethyl)benzylamine forms a distorted tetrahedrally coordinated monomer, $ZnLBr_2$.¹⁵⁴ The ligand 1,6-bis(3,5-dimethyl-1-pyrazolyl)-2,5-dithiahexane forms a 1:1 complex with $ZnCl_2$ where the ligand binds in a bidentate fashion through the pyrazole nitrogen donors.¹⁵⁵ Reaction of 2,3,5,6-tetra(2-pyridyl)pyrazine with $ZnCl_2$ results in a mononuclear five-coordinate complex where the pyridylpyrazine ligand is tridentate.¹⁵⁶

Compartmental pyrazole ligands (**14**) can be used to form bimetallic complexes (**15**).¹⁵⁷ This ligand enforces a separation distance between the metal ions. Stability constants were calculated showing a stability for both mononuclear and dinuclear compounds that was less than Cu^{II} but greater than Ni^{II} .

The pyrazole phosphazine ligand, hexakis(3,5-dimethylpyrazolyl)cyclotriphosphazene (**16**) forms a dizinc complex, that has been structurally characterized, and the analogous copper zinc complex.¹⁵⁸ Two $ZnCl_2$ units are coordinated, one distorted tetrahedral and one distorted trigonal-bipyramidal, separated by 7.51 Å. Cu^I and $ZnCl_2$ can also be coordinated giving a heteronuclear compound with a Zn-Cu separation of 6.798 Å.

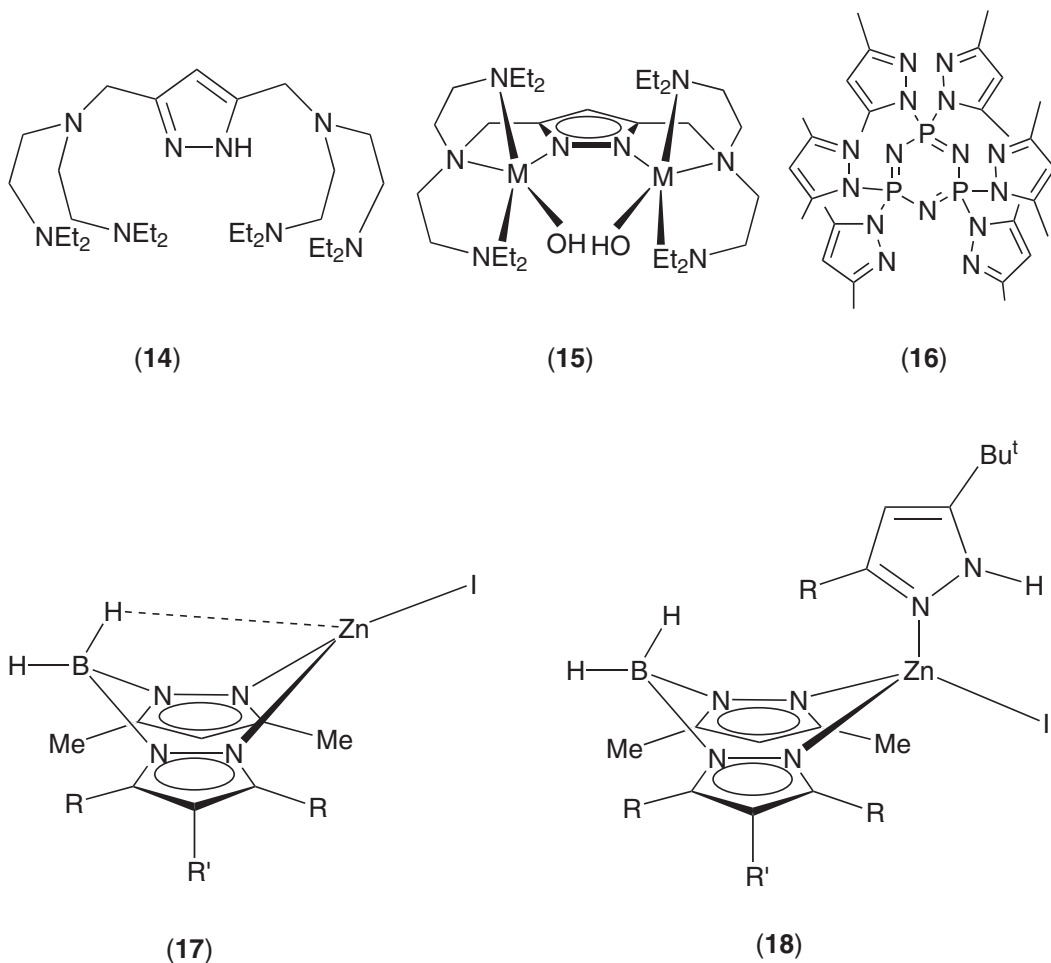

A series of unsymmetric bis(pyrazolyl) ligands have been synthesized and complexed with zinc via metathesis of a thallium derivative, (17) and (18). This allowed the synthesis and complexation of NNS and NNO pyrazolylborate derivatives.^{159,160} Parkin and co-workers synthesized zinc complexes of a series of unsymmetric pyrazole-containing ligands.^{161–163} The asymmetric bis(pyrazolyl)hydroborato zinc complex has been structurally characterized,¹⁶⁴ and will also be discussed in the context of its interaction with the B–H hydrogen in Section 6.8.9.2.

A highly fluorinated bis(pyrazolyl)borate ligand, dihydridobis(3,5-bis(trifluoromethyl)pyrazolyl)borate has been synthesized. The zinc triflate complex was prepared from the potassium salt of the ligand and exhibits distorted tetrahedral coordination which allows comparison of the amount of distortion, in relation to the electronic properties of substituents, with the methylated analog.¹⁶⁵

The complex bis(1,2,6,7-tetracyano-3,5-dihydro-3,5-diiminopyrrolizimido)zinc (19) has been crystallographically characterized demonstrating a six-coordinate octahedral metal center with two longer apical bonds to the ether oxygen donor tetrahydrofuran ligands. The electronic absorption spectra, including the polarized single crystal reflection spectra, have been assigned on the basis of calculation and comparison to related systems.¹⁶⁶

Zinc binding to triazole derivatives, 3,5-di(2-pyridyl)-1,2,4-triazole (20) and 3,5-di(2-pyridyl)-4-amino-1,2,4-triazole (21), was investigated due to the occurrence of the triazole group in a number of drugs that function via interaction with zinc-dependent enzymes. NMR and IR suggested varying coordination modes were possible with different anions (1:1 complex for ZnCl₂ and 2:1 complexes for Zn(NO₃)₂, Zn(ClO₄)₂ and Zn(BF₄)). The crystal structure from the zinc perchlorate showed a complex which was octahedrally coordinated to two 3,5-di(2-pyridyl)-4-amino-1,2,4-triazole and two water molecules. Each triazole ligand was bidentate with bonding to a pyridyl N and a triazole N.¹⁶⁷

Two crystalline polymorphic forms are obtained in the formation of crystals of bis[hydrotris(1,2,4-triazolyl)borato]zinc. In the fast-crystallizing compound the zinc was shown to be coordinated to two tridentate chelate ligands by the endodentate nitrogens, forming a molecular monomeric complex; the slower-crystallizing compound was a coordination polymer with the borate centered ligand bridging three zinc centers via the exodentate nitrogen donor atoms.¹⁶⁸

The ligand 2,5-bis(2-pyridyl)pyrazine was used in the synthesis of a range of zinc compounds to contrast with copper coordination polymers prepared with this ligand.¹⁶⁹ Three zinc compounds were structurally characterized, [ZnCl₂L(DMF)], [Zn₃(OAc)₆L₂], and [Zn₃Cl₆L₃]; respectively a distorted square planar monomer, a linear trimer, and a triangular arrangement of zinc centers.

The reaction of zinc bromide and pyrazine can give two different coordination polymers. [ZnBr₂L] was structurally characterized demonstrating a 1D zigzag chain polymer which yields [ZnBr₂L₂] on solid state reaction with pyrazine. The crystal structure of [ZnBr₂L₂] shows a regular square-grid network with the axial bromides from one layer projecting into the grid cavity on an adjacent layer. This second structural type can be converted back into the first by heating.¹⁷⁰ The ligand 2,3,5,6-tetrakis(aminomethyl)pyrazine has two tridentate binding sites and forms a binuclear complex with zinc, [Cl₂ZnLZnCl₂]. The crystal structure reveals two five-coordinate zinc atoms, both in a trigonal–bipyramidal arrangement.¹⁷¹

6.8.4.5 Nucleobase and Nucleoside Ligands

Zinc binding directly to DNA and RNA bases has been studied, and in particular the interaction of zinc with the guanine N7.¹⁷² Zinc binding directly to DNA can cause kinking or induce conformational changes.^{173,174} NMR investigations of zinc oligonucleotide complexes have been carried out as part of a study to determine a sequence-selective metal binding pattern with binding predominantly to 5'-G in 5'-GG and 5'-GA steps.¹⁷⁵ This binding was preferred to GT and no evidence was found for binding in GC steps or to non-guanine residues. All binding was assumed to be to guanine N7. Spectroscopic studies have suggested that the zinc may also interact with the guanine O6.¹⁷⁶ Polymeric complexes of zinc have been structurally determined with the mono-methyl phosphate-esters of cytidine and deoxycytidine 5'-monophosphate nucleotides.¹⁷⁷ A trinuclear complex with a Zn(OH)Zn(OH)Zn backbone is proposed to be a model for metal crosslinks in DNA, coordination to an endocyclic nitrogen of one base and an exocyclic oxygen of another base is observed (Figure 2).¹⁷⁸

It has been suggested that zinc ions prevent formation of DNA quadruplexes containing guanine quartets by binding to the guanine N7 and O6. The quadruplexes are believed to be important to a number of areas of the genome including telomeres.¹⁷⁹

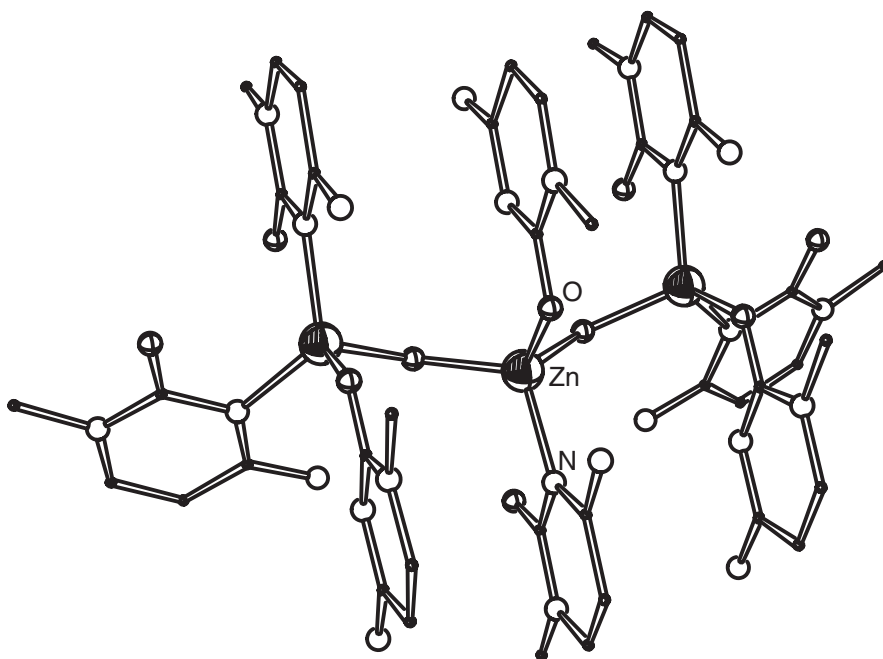

Figure 2 Molecular structure of the trinuclear zinc complex formed with 3-methylcytosine. All ligands are monodentate and bonding through either a nitrogen or exocyclic oxygen is observed.¹⁷⁸

Zinc complexes of the purine analog ligand, 5,7-diphenyl-1,2,4-triazolo[1,5- α]pyrimidine, have been described and characterized spectroscopically and by X-ray crystallography.¹⁸⁰ The tris(pyrazolyl)borate derivatized ligand, tris(3-cumenyl-5-methylpyrazolyl)borate, stabilizes zinc complexes of nucleobases and related compounds. For example, uracil is coordinated via its deprotonated N1 and 6-methylthiouracil acts as a bidentate ligand bonding through N1 and S.¹⁸¹

Zinc cyclen ([12]aneN₄) complexes have been shown to bind to thymidine bases such as AZT. Interest came from the demonstrated action of the zinc cyclen complex against HIV-1.¹⁸² The zinc binds to the deprotonated N(3) of the 3'-azido-3'-deoxythymidine and the X-ray structure shows a distorted square pyramidal N₅ coordination with Zn—N(3) = 2.053(8) Å. It is possible that hydrogen bonding contributes to the stability of the complex in solution although distances were long in the solid state. Potentiometric titrations of deoxyribonucleosides showed extremely selective binding of thymidine and its derivatives. This could be attributed to the formation of hydrogen bonds between the cyclen amino groups and the carbonyl oxygens of deoxythymidine. Strong binding to deoxythymidine and uridine bases over other nucleosides in aqueous solution shows the importance of the imide functionality.

Kimura and co-workers have also demonstrated that the acridine pendent cyclen ligand can expand on the recognition potential by providing “multipoint” binding.¹⁸³ The acridine may π -stack with the nucleobase or even insert into DNA or RNA to facilitate the zinc cyclen thymine base interaction. The X-ray structure shows a stacking interaction of the acridine with the pyrimidine ring of thymine when bound to the zinc. A distortion of the square pyramidal geometry around the zinc is observed to allow more favorable hydrogen bonding and π -stacking interactions. Fluorescence spectra indicated the relative strength of interaction of the coordinated thymine with the acridine. The complex of this deoxythymidine is stable and does not dissociate at physiological pH.

6.8.4.6 Amides, Amidinates, and Guanidinates

The zinc complex formed with *N,N'*-diphenylformamidinate is structurally analogous to the basic zinc acetate structure, as [Zn₄(μ_4 -O)L₆], and the basic beryllium acetate structure. It is prepared by hydrolysis of zinc bis(diphenylformamidinate).¹⁸⁴ Mixed metal zinc lithium species were assembled from dimethyl zinc, *t*-butyl lithium, *N,N'*-diphenylbenzamidinate and molecular oxygen. The amidinate compounds formed are dependent on the solvent and conditions. Zn₂Li₂ and

Zn_2Li_6 compounds are formed with bridging amidinate and oxo ligands.¹⁸⁵ The X-ray structure of the dinuclear complex of zinc with tetraphenyl oxalic amidinate shows two tetrahedral zinc centers each coordinated to two nitrogen donors from the ligand and two chloride ligands.¹⁸⁶ Multinuclear oxalamidinato complexes have been characterized with only zinc atoms or a combination of zinc and palladium or nickel atoms. The resulting heteronuclear complexes were structurally characterized and their catalytic reactions, such as ethene polymerization and Heck coupling, investigated with zinc playing an inactive structural role.^{187,188} A trinuclear zinc complex was formed with deprotonation of tris(2-hydroxybenzylidene)triaminoguanidine. A propeller-like conformation was demonstrated by the X-ray structure with ammonia and water molecules completing the coordination sphere to give $[\text{LZn}_3(\text{NH}_3)_3(\text{H}_2\text{O})_3]^+$. Triply bridging guanidinate cores are isoelectronic with characterized μ_3 -carbonates.¹⁸⁹

Amide and alkyl donors are often found in the same complexes and hence a number of amide compounds have already been mentioned in Section 6.8.3. Zinc alkylamides are of interest as precursors for the nitrogen doping of material in metal organic chemical vapor deposition (MOCVD). A number of bis[(alkyl)(trimethylsilyl)amide] zinc complexes have been prepared and characterized.¹⁹⁰ Linear N–Zn–N diamide units are known.^{11,191} Inverse crown ethers were formed using Zn amide compounds $[\text{Na}_2\text{Zn}_2\text{L}_4(\text{O})]$ and $[\text{K}_2\text{Zn}_2\text{L}_4(\text{O}_2)_x(\text{O})_y]_n$, L = hexamethyldisilylamide.¹⁹² The structures show trigonal planar zinc centers encapsulating oxygen or peroxide. Dimeric species exist with μ_2 -amide groups in a compound with a CN_3 donor set around each zinc atom with the amide donors from *N,N,N'*-trimethylethylene-1,2-diamide or *N,N,N'*-trimethylpropylene-1,2-diamide.⁸⁰ Zinc complexes of dicyanamide, $\text{Zn}[\text{N}(\text{CN})_2]_2$, have an extended lattice structure in the solid state. A 2D network is formed of tetrahedral zinc centers with each zinc bound to four μ_2 dicyanamide ligands forming a repeating square array.¹⁹³ The shortest zinc–zinc distance is 4.492 Å and is found between layers, contrasting with the structure of $\text{Zn}[\text{C}(\text{CN})_3]_2$, which contains octahedral zinc centers forming an interpenetrating network.¹⁹⁴

A series of compounds of zinc with a diazabutadiene ligand have been prepared to study the different oxidation states of the ligand when coordinated.^{195,196} The studies were carried out using EPR spectroscopy and X-ray crystallography. Mono- and dicationic, neutral, and mono- and dianionic zinc diazabutadiene complexes were prepared and structurally characterized as $\text{K}_x[\text{Zn}(\text{}^t\text{BuNCHCHN}^t\text{Bu})_2]$, $\text{Zn}(\text{}^t\text{BuNCHCHN}^t\text{Bu})_2$, and $[\text{Zn}(\text{}^t\text{BuNCHCHN}^t\text{Bu})_2](\text{OTf})_x$ ($x = 1, 2$). The formal charge on the ligand varies from +2 to –2. The crystal structures of the monoanionic and mono- and dicationic species show structural variations with the N–C bonds lengthening and the C–C bonds shortening with each reduction step with the distortion as expected from the occupation of the ligand π^* orbitals.

6.8.4.7 Bipyridine and Phenanthroline Ligands

Pyridyl-containing ligands have already been discussed but the large body of work involving bipyridyl type ligands is represented here. Bipyridine and polybipyridine ligands in particular have found application with zinc in the formation of supramolecular structures and examples will be mentioned in Section 6.8.4.9.

The tetracyanoquinodimethane salt of tris(1,10-phenanthroline)zinc has been synthesized, structurally characterized by X-ray diffraction, and the magnetic properties investigated.¹⁹⁷ No charge conduction was observed in the compound and the single-crystal and polycrystalline powder EPR spectra were recorded.¹⁹⁸ The kinetics and equilibrium of zinc complex formation with 2-chloro-1,10-phenanthroline in aqueous solution have been studied.¹⁹⁹ The formation of bis- and tris-phenanthroline complexes of zinc is known.^{200,201} The preparation of heteroleptic bis-phenanthroline zinc complexes was attempted with sterically hindered 2,9-diarylphenanthroline and 4,7-disubstituted phenanthrolines. The products were sensitive to condition and methods of preparation and characterized by mass spectrometry and NMR.²⁰² The crystal structure of $[\text{Zn}(1,10\text{-phenanthroline})_2(\text{CH}_3\text{CO}_2)]\text{BF}_4$ has been reported with all three ligands binding as bidentate resulting in an octahedral N_4O_2 coordination sphere around the zinc ion.²⁰³ Tris(1,10-phenanthroline)zinc shows enantioselective binding to DNA.²⁰⁴

Studies of the thermodynamics of formation of complexes of zinc with 2,2'-bipyridine in the presence of halide and thiocyanate ions in DMF has been carried out.²⁰⁵ The zinc complexes of 2,2'-bipyridine with *N*-(benzenesulfonyl)glycine and *N*-(toluene-*p*-sulfonyl)glycine were synthesized and infrared data implied a structural analogy with the cadmium complexes. This suggests that the zinc promotes sulfonamide nitrogen deprotonation in the amino acid ligands in the solid state.²⁰⁶

A 2,7-disubstituted pyrene linker between two pyridyl groups (**22**) forms the $[\text{Zn}_2\text{L}_2]^{4+}$ complex with zinc trifluoromethanesulfonate that is non-helical. The single-crystal X-ray structure of bis{2,7-bis[3-(6'-methyl-2,2'-bipyridin-6-yl)-2-oxapropyl]pyrene}dizinc reveals two six-coordinate octahedral zinc centers with an N_4O_2 donor set. The non-helical geometry shows the pyrene rings separated by 3.65 Å. The X-ray structure was in agreement with solution structure from NMR measurements. The NMR data from the equivalent compound with a 1,4-benzene linker in place of the pyrene linker demonstrated an equal mixture of helical and non-helical complexes in solution.²⁰⁷

Formation of the zinc complex of the derivatized bipyridyl ligand, *N*-methyl-2,2'-bipyridylum, has been investigated.²⁰⁸ The planar tetraheterocyclic ligand 6,6'-bis(4-methylthiazol-2-yl)-2,2'-bipyridine coordinates through the two bipyridine nitrogens, and more weakly through the thiazolyl nitrogen atoms. The crystal structure of the zinc complex shows a distorted octahedral environment with two water molecules completing the coordination sphere.²⁰⁹ Zinc complexes of bipyridyl ligands with azo- and imino-linked chromophores, 4,4'-bis(dialkylaminophenylazo)-2,2'-bipyridine and 4,4'-bis(dialkylaminophenylimino)-2,2'-bipyridine, have been synthesized for nonlinear optical studies by electric field-induced second harmonic generation.²¹⁰ 4-(*N*-*t*-Butylaminoxyl)-2,2'-bipyridine forms 1:1 complexes with bis(hexafluoroacetylacetonato) zinc. The crystallographic analysis shows mononuclear structures in which the bipyridine moieties are coordinated to the metal ions in a *cis* configuration and the aminoxyl groups do not participate in the coordination.²¹¹

The presence of zinc with bidentate nitrogen donor ligands in the formation of novel composite materials by hydrothermal reactions has been studied. A zinc-containing one-dimensional material, $[\text{Zn}(\text{phenanthroline})\text{MoO}_4]$ was isolated from molybdate, and from vanadium oxide in the presence of zinc 2,2'-bipyridine $[\text{Zn}(2,2'\text{-bipyridine})_2\text{V}_4\text{O}_{12}]$ was obtained.^{212,213}

N,N'-coordination was found in the zinc complex of 2,2'-dipyridyl diselenide, $[\text{ZnLCl}_2]$.²¹⁴ The tridentate ligand 6-(2-aminophenyl)-2,2'-bipyridine contains two pyridyl and one aniline donor ligand to form a complex of the form $[\text{ZnL}_2]^{2+}$. The X-ray structure shows a distorted octahedral metal center with each ligand twisting from planar to accommodate the meridional binding.²¹⁵

6.8.4.8 Tripodal Nitrogen Ligands

Polydentate nitrogen donor tripod ligands are discussed in this section. Mixed donor ligands containing nitrogen donors are discussed in Section 6.8.11.

6.8.4.8.1 Tris(pyrazolyl)borate ligands

A large body of work with particular reference to the mimicry of mononuclear zinc enzymes has utilized tris(pyrazolyl)borate ligands. This ligand class offers a facial coordination mode of three pyrazole *N*-donors and can be functionalized in the three and five positions on the rings to increase steric bulk and vary the electronic properties of the ligand. The synthesis and complex formation with these ligands has been extensively reviewed.^{2,216–219}

These versatile ligands have also shown applications in catalysis and more recently the formation of a variety of related ligands has led to varied donor sets and cavity properties from pyrazolylborate ligands. As this important area has been recently and extensively reviewed only a few representative examples will be discussed. Other examples appear elsewhere in relation to zinc coordination of other donors in the remaining coordination site or sites. A large volume of work has been produced recently in this area, particularly by the research groups of Parkin and Vahrenkamp.^{181,220–228}

Catalysis of the formation of diethyl carbonate from ethanol and carbon dioxide has been observed with zinc hydroxide complexes of sterically restricted ligands, tris(3-cumenyl-5-methylpyrazolyl)borate and tris(3-*t*-butyl-5-methylpyrazolyl)borate. The zinc hydroxides could be converted to the alkyl carbonate complexes. For the cumenyl ligand reversible formation of the hydroxide and methyl carbonate in a methanol solution was observed by repeated bubbling with nitrogen or carbon dioxide.²²⁹ Kitajima and co-workers studied the reactivity of zinc hydroxides complexed to less sterically bulky tris(pyrazolyl)borate ligands.²³⁰

The reactions of carbon dioxide with zinc hydroxide complexes of the 3-*t*-butyl 5-methyl and 3,5-di-*iso*-propyl pyrazolyl derivatives were investigated. IR spectroscopy demonstrated formation of a bicarbonate derivative of the former complex and ¹H NMR showed a rapid reversible

reaction. However, a slower transformation occurs from the bicarbonate complex to a bridged carbonate dimer. This contrasts with the behavior of the latter, and less sterically bulky hydroxide complex which shows more rapid formation of $(\mu\text{-CO}_3)\text{Zn}_2$ complex where the carbonate is unsymmetrically bound.²³¹

The X-ray structure of the unsubstituted tris(pyrazolyl)borato zinc nitrate has been solved showing a unidentate coordination mode for nitrate, in contrast with the *t*-butyl substituted ligand, which shows anisobidentate nitrate coordination due to the steric effects.²³² A partial explanation of the reduced activity of cadmium-substituted carbonic anhydrase is offered by Parkin on the basis of the comparison of nitrate coordination to cadmium and zinc trispyrazolylborate moieties. A contributing factor may be the bidentate coordination supported by the cadmium that does not allow the facile access to a unidentate bicarbonate intermediate, which could be highly important to carbonic anhydrase activity.²³³

Pyridyl functionalized tris(pyrazolyl)borate ligands show some interesting properties including the formation of polynuclear zinc complexes.²³⁴ Some of these contain extensive H bonding and have potential as models for multinuclear zinc enzymes such as phospholipase C or P1 nuclease.²³⁵ A bis-ligand complex of the hydrotris(5-methyl-3-(3-pyridyl)pyrazolyl)borate ligand (**23**) shows octahedral coordination of all six pyrazole nitrogen donors despite the steric bulk.

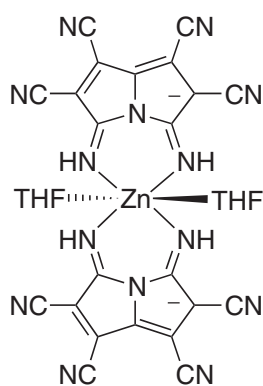

(19)

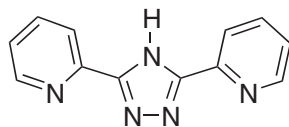

(20)

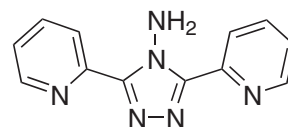

(21)

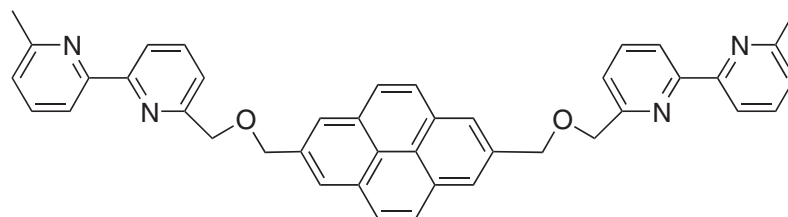

(22)

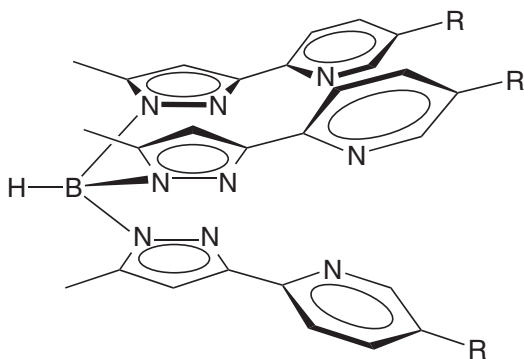

(23)

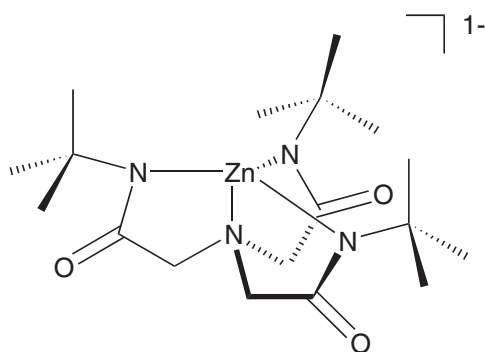

(24)

The zinc complex of hydrotris(3-*p*-cumenyl-5-methylpyrazolyl)borate with a bound 3,5-*t*-butyl-1,2-semiquinonate ligand has been prepared, the X-ray structure showing a five-coordinate metal center with three ligand nitrogens and two semiquinonate oxygens binding. The parent catechol-ate complex is unusually air stable but undergoes slow air oxidation to give the semiquinonate.²³⁶ The hydroxide complex of this ligand has been prepared.²³⁷ The hydroxide complex can be converted into a hydrosulfide complex and thermal condensations of the two derivatives result in molecular zinc oxide or sulfide dimeric species. The hydroxide also reacts to give alkylcarbonate, *O*-ethylthiocarbonate, and thiocarbamate ligands under appropriate conditions.

The alcohol dehydrogenase enzyme has been modeled using the tris(3-cumenyl-5-methylpyrazolyl)borate ligand. The *iso*-propoxide complex can be oxidized by *N*-benzylnicotinamide chloride to acetone in a low yield. A stronger oxidant oxidizes phenolates with *o*-hydroxymethyl substituents to phenolates with *o*-formyl substituents. The presence of the zinc hydroxide complex showed increased reduction rates of benzaldehydes with electronegative substituents to corresponding benzyl alcohols by *N*-benzylidihydronicotinamide.²³⁸

The zinc acetate complex of tris(3-*t*-butyl-5-methylpyrazol-1-yl)borate was prepared as a structural model for carbonic anhydrase and comparison with the enzyme active site structures confirmed that the complexes are excellent structural models.²³⁹ A mononuclear zinc hydroxide complex can also be formed with the tris(pyrazolyl) borate ligand system as a structural model for carbonic anhydrase.²⁴⁰

Zinc fluoride complexes of 3-*para*-tolyl and 3-*t*-butyl of hydrotris(3-*R*-5-methylpyrazol-1-yl)borato zinc complexes have been synthesized via complex formation in the presence of potassium fluoride. Facile substitution of the fluoride yields the zinc pyridyl, diethyl ether, or hydride derivatives.²⁴¹

6.8.4.8.2 Other nitrogen donor tripodal ligands

Tris(2-aminoethyl)amine (tren) and hexamethyl tren form pentacoordinate complexes with a bound water. The enthalpies of ionization have been determined.²⁴² These results dispute the data from the systems that led to the view that solvent structure mediates the pK_a of zinc bound water in zinc hydrolytic enzymes. The effect was shown to be entirely enthalpic.

Borovik and co-workers developed a ligand, formed by deprotonation of tris((*N*-*t*-butylcarbomoyl)methyl)amine, to form trigonal-monopyramidal transition metal complexes.¹⁹ The structure of the zinc complex (**24**) shows identical ligand coordination to the cobalt and nickel complexes and is crystallized as the tetraethylammonium salt. The unusual geometry is favored due to the presence of bulky *t*-butyl groups. The N amidate-zinc-N amidate angles in the trigonal plane are $119.5(5)^\circ$ and the zinc sits 0.14 Å above this plane. The formation of chiral cavities was investigated with the related homochiral tripodal ligand tris(*N*-(*S*)-(-)-(α)-methylbenzylcarbomoylmethyl)amine (Figure 3).²⁴³

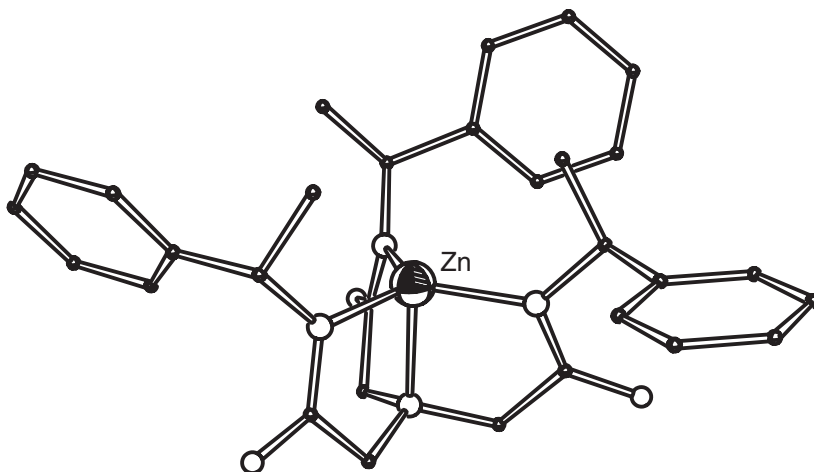

Figure 3 Molecular structure of the trigonal-monopyramidal zinc complex formed on deprotonation of tris(*N*-(*S*)-(-)-(α)-methylbenzylcarbomoylmethyl)amine.²⁴³

In reaction with zinc salts, the tridentate ligand tris(2-pyridyl)methylamine forms the crystallographically characterized $[\text{ZnL}(\text{H}_2\text{O})_3]^{2+}$ cation with the three pyridine nitrogens face capping the octahedron and a hydrogen bonding network in the solid state.²⁴⁴ This contrasts with the tetradentate ligand tris(2-pyridylmethyl)amine and its zinc halide complexes (chloride, bromide, and iodide), which were synthesized and studied. Electrospray mass spectrometry analysis of solutions, with added competing anions, was consistent with NMR data. The solid-state structures of $[\text{ZnLCI}]\text{ClO}_4$ and $[\text{ZnLI}]\text{ClO}_4$ contain trigonal-bipyramidal metal ions with the halide coordinated in an apical position.²⁴⁵

The zinc complex of the unsymmetrical pyrazoly/pyridyl tripod, bis(pyrazol-1-yl)(pyridin-2-yl)methane, has been structurally characterized and can be compared to trispyridyl donor ligands.²⁴⁶ Similarly, instead of varying the nitrogen donor group of the tripod the bridgehead can be changed from a -CH to P or N. Structural studies allow comparisons of the phosphine and amine equivalents in the formation of 1:2 zinc tris(2-pyridyl)methylamine complexes, e.g., $[\text{Zn}(\text{P}(\text{C}_5\text{H}_4\text{N})_3)_2]^{2+}$, with all structures showing trigonal distortion from octahedral geometry due to the restricted bite angle of the ligands.²⁴⁷

The ligand tris[2-(1-methylbenzimidazol-2-yl)ethyl] nitromethane (**25**) has been used in the formation of zinc complexes as models of the active site of carbonic anhydrase, and the formed complexes reveal affinity for the sulfonamide-containing enzyme inhibitor acetazolamide.²⁴⁸

Bis and tris(imidazolyl) phosphine ligand complexes of zinc have been of interest for a number of years as models of the active site of carbonic anhydrase and probed for reactivity with bicarbonate and carbon dioxide.²⁴⁹ Recently, related phosphine ligand derivatives that are increasingly sterically demanding have been synthesized and studied. The comparison of X-ray structures of zinc nitrate tris(1-isopropyl-4-*t*-butylimidazolyl) phosphine ligand derivative (**26**), which has a charge of 1+, with the equivalent tris(3-*t*-butylpyrazolyl)hydroborato complex, which is neutral, demonstrates that the charged complex has a greater tendency to adopt bidentate coordination of the nitrate ligand.²⁵⁰

The coordination mode of nitrate to a number of transition metal ions bound to the ligand tris(1-isopropyl-4-*t*-butylimidazolyl)phosphine has been studied using X-ray crystallography.^{250,251} The nitrate ligand coordination modes correlate with the activity of the metal-substituted carbonic anhydrases; those with a greater degree of asymmetry in the binding are the most active metals (Co, Zn). This may point to access to a monodentate rather than a bidentate coordination mode for the bicarbonate intermediate as a requirement for high CA activity. The zinc is five-coordinate with Zn—O distances 1.986 Å and 2.518 Å and the nitrate ligand anisobidentate.²⁵¹ This ligand has been used to characterize a highly important example of a zinc hydroxide complex with tris imidazole coordination, as is observed in the carbonic anhydrase active site.²⁵² The comparison between zinc and cadmium hydroxide complexes has also been made. These studies are of relevance to the active site of carbonic anhydrase and metal substituted forms.²⁵³ The analogy of bicarbonate to nitrate is not always appropriate as bicarbonate has more than one option for bidentate binding; it could bond through the two oxygen atoms or an oxygen atom and a hydroxide.

The face capping ligand *cis,cis*-1,3,5-triaminocyclohexane provides the basis for a number of functionalized ligand and biomimetic complexes of zinc.^{254,255} The zinc complexation chemistry of *cis,cis*-1,3,5-triaminocyclohexane and simple derivatives was thoroughly investigated by Vahrenkamp and co-workers. The nonfunctionalized ligand forms 1:1 ligand to metal ratio complexes with zinc acetate and zinc halides, and 2:1 complexes with zinc perchlorate and zinc triflate. The 2:1 compounds were not observed with the tris-*N*-methylated derivative. It was suggested that the 1:1 halide-containing complexes exhibit tetrahedral metal centers with one face capping N_3 ligand and an X-ray structure of the 2:1 complex of *cis,cis*-1,3,5-triaminocyclohexane with zinc triflate revealed an octahedral metal center coordinated by two N_3 face capping ligands. NMR solution studies show little or no ligand exchange in solution. Vahrenkamp also investigated Schiff base formation reactions with benzaldehyde forming a tris-iminophenyl derivative. This ligand was hydrolyzed on complexation with zinc.²⁵⁶ Walton and co-workers have investigated the formation of cavity-type ligands from *cis,cis*-1,3,5-triaminocyclohexane, and Schiff base derivatives were formed from cinnamaldehydes (**27**).^{257,258} These compounds are of relevance to the active site of the enzyme carbonic anhydrase. It was observed by Walton that the steric interactions were too unfavorable to allow coordination of the tris-iminophenyl derivative as a face capping ligand and partial hydrolysis occurred to give (**28**). Walton's compounds are of particular interest in modeling the enzyme carbonic anhydrase as they mimic not only the donor set of the active site but also aspects of the surrounding cavity. The related face capping triamine ligand 1,3,5-triamino-1,3,5-trideoxy-*cis*-inositol forms a 2:1 complex with zinc where each of the ligands is coordinated through

the three nitrogen donors.²⁵⁹ Brechbiel and co-workers have synthesized the hexadentate ligand, *N,N',N''*-tris(2-pyridylmethyl)-*cis,cis*-triaminocyclohexane and structurally characterized the zinc complex.²⁶⁰

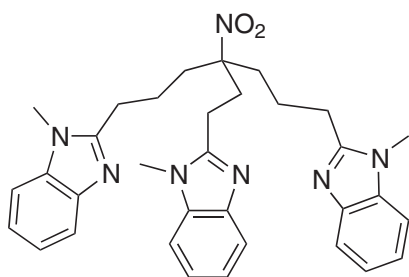

(25)

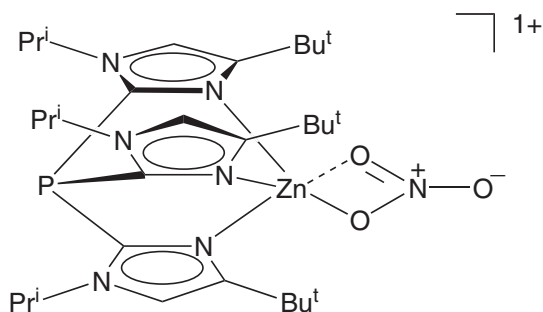

(26)

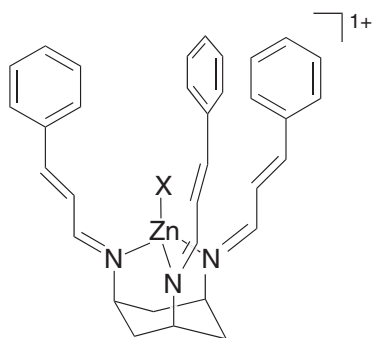

(27)

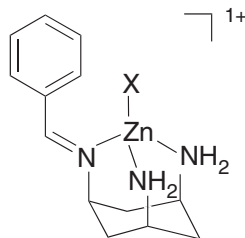

(28)

6.8.4.9 Supramolecular Compounds with Nitrogen Donor Ligands

Zinc is frequently used as a supramolecular building block due to its inert oxidation state and flexibility in coordination number and geometry.

A mononuclear zinc complex forms with 2,2':6':2'':6''-quaterpyridine.²⁶¹ Helical quinquepyridine derivatives can be formed with 6,6''-dimethyl-2,2':6':2'':6''-2''':6''':2''''-quinquepyridine. A dimeric monohelical (or single-stranded helicate) complex is formed with a hydroxy bridge between five-coordinate and four-coordinate zinc centers, $[\text{Zn}_2\text{L}(\text{OOCCH}_3)_2(\mu\text{-OH})][\text{ClO}_4]$.²⁶² The intermetallic distance is 3.277(4) Å and the Zn—O—Zn angle is 116.82(17)°. This structure contrasts with saturated helices as produced by Constable and co-workers with septipyridines where all donor atoms come from the same strand. The crystal structure of the zinc complex of 2,2':6':2'':6''-2''':6''':2''''-sexipyridine, $[\text{Zn}_2\text{L}_2](\text{PF}_6)_4 \cdot 2\text{MeCN} \cdot 2\text{H}_2\text{O}$, confirmed the double-helical topology.²⁶³ The solubilized septipyridine reacts with zinc acetate to give $[\text{Zn}_2\text{L}_2][\text{PF}_6]_4 \cdot 6\text{MeCN}$ which was structurally characterized to show a head-to-head directional double helicate.²⁶⁴

Spontaneous self assembly of a dinuclear triple helical complex is observed with linked bis-[4,5]-pineno-2,2'-bipyridines. Studies by electrospray mass spectrometry, CD and NMR determined that the major species in solution was a complex of Zn:L = 2:3 stoichiometry with a triple helical structure and an enantiomerically pure homochiral configuration at the metal centers. The preference for the formation of one of the possible stereoisomers over the other is of interest.²⁶⁵ Another binuclear triple helical complex is formed from zinc addition to bis[5-(1-methyl-2-(6-methyl-2'-pyridyl)benzimidazolyl)]methane. Spectrophotometric titrations with a zinc solution

shows successive formation of a triple helical complex $[\text{Zn}_2\text{L}_3]^{4+}$, a double helical complex $[\text{Zn}_2\text{L}_2]^{4+}$, and $[\text{Zn}_3\text{L}_2]^{6+}$.²⁶⁶

Metal complexes of pteridine have provided 3D H-bonded networks containing H bonding between pteridine ligands and water molecules, and π -stacking and H bonding between adjacent pteridine ligands. The complex $[\text{ZnL}(\text{H}_2\text{O})_2] \cdot 2\text{H}_2\text{O}$ has been prepared.²⁶⁷

Metal complexes of bilinones have helical chirality and the introduction of point chirality may give some insight into the structural features of chiral functional molecules including biomolecules. A chiral group was introduced at the helix terminal of 19-alkoxybilinone. A series of zinc derivatives (**29**) were examined to observe the helical chirality induction of the point chiral alkoxy group. Chiral induction was sensitive to the distance to the asymmetric carbon as well as to substituents on the asymmetric carbon. The compounds were studied by ^1H NMR and CD spectroscopy. In one case ($\text{R}=(R)$ -2-methyl-1-phenylpropanoxy group) helical chirality induction was observed in $>95\%$ enantiomeric excess at 223 K in CD_2Cl_2 .^{268,269}

The template effect of a metal center in organizing two phenanthroline subunits has been exploited to form polypyrrole films from which the zinc center can be removed and rebound. The chelating ligand used is a 2,9-diphenyl-1,10-phenanthroline subunit functionalized with two pyrrole groups and on binding to zinc or another metal center the two ends are entwined leading to a highly entangled network on electropolymerization of the pyrrole rings. The ligand is related to those used by Sauvage in catenane formation. The zinc can be removed from the polymer with thiocyanate and no collapse of the 3D structure occurs. The facile rebinding of zinc suggests some organization is retained in the polymer. Electrochemical studies show the low-oxidation-state formal zinc(I) is remarkably stabilized by the entwined and entangled system.²⁷⁰

Chiral [2 + 2] metallomacrocycles, assembled from functionalized 2,2'-bipyridines and zinc, have been studied for the effect of guest molecules and linker length. Equimolar amounts of zinc triflate and the ligand (**30**) with $\text{R}=\text{CH}_2$ assemble exclusively into the chiral [2 + 2] metallomacrocyclic $[\text{Zn}_2\text{L}_2]^{4+}$ at low concentrations ($<10 \text{ mmol dm}^{-3}$) or in the presence of an aromatic guest molecule which binds in the cavity of the macrocycle. The X-ray structures of these compounds with either 1,2- or 1,4-dimethoxybenzene bound in the cavity were obtained. The structures demonstrate a variation in cavity size dependent on the substrate to maximize the possible interactions. The less rigid ligands, where $\text{R}=\text{CH}_2\text{CH}_2$ or OCH_2 , show a mixture of oligomers when studied by NMR.²⁷¹

Rebek and co-workers have generated a species containing a zinc ion coordinated in conjunction with a "deep" cavity in the metallocavitand species. The molecular cavity of $8 \times 10 \text{ \AA}$ has a Zn-phenanthroline fragment at the top edge directed toward the cavity. The binding of the metallocavitand to quinclidine and DABCO was studied by UV-vis and ^1H NMR spectroscopy, demonstrating the binding and slow exchange kinetics. The cavity and the appended zinc ion are both involved in the binding, demonstrating the potential for these compounds in biomimetic hydrolysis or esterification reactions.²⁷²

The structure of coordination polymers formed with 3,6-bis(pyridin-3-yl)-1,2,4,5-tetrazine and zinc salts can be controlled by the choice of alcoholic solvents. Infinite lattice compounds of the form $\{[\text{Zn}_2\text{L}_2(\text{NO}_3)_4(\text{MeOH})_2(\mu\text{-L})]\}$ and $\{[\text{Zn}_2(\mu\text{-L})_3(\text{NO}_3)_4](\text{CH}_2\text{Cl}_2)_2\}$ have been structurally characterized. The former structure shows an alternating single- and double-bridged species whereas the latter exists as a non-interpenetrated ladder complex.²⁷³

Two-dimensional planar interpenetrating networks have been formed using the spacer ligand 2,2'-bis-1,6-naphthyridine with a zinc salt.²⁷⁴ Helicate structures have been synthesized which rely heavily on non-covalent interactions in the metal-assisted self-assembly process in solution.²⁷⁵

Incorporation of interactions such as π - π stacking can lead to further aggregation in the solid state. The use of biphenyl derivatives of terpyridine ligands [4'(4-biphenyl)-2,2':6',2''-terpyridine] (**31**) has given one such example.²⁷⁶ The X-ray structure of the zinc complex reveals a pseudo-octahedral zinc ion forming a two-dimensional sheet with face-to-face π stacks with a centroid-to-centroid distance of 3.87 \AA and also edge on face interactions. Luminescence studies were carried out showing strong blue emission with higher quantum yield (0.80) than the free ligand.

Blue luminescence of zinc complexes of pyridyl-containing complexes is an area of current interest.²⁷⁷ Design of blue luminescent materials is of relevance to display applications, as blue-light-emitting diodes, and to this end Che examined solution luminescence of zinc pyridylamine complexes.^{73,278} Che and co-workers studied the complex $\text{Zn}_4\text{O}(7\text{-azaindoyl})_6$ which has a blue emission at 433 nm in the solid state.^{279,280} In an attempt to improve on stability Wang *et al.* examined compounds with neutral 7-azaindole and an *N*-functionalized pyridyl derivative.²⁸¹ In contrast with other metal complexes of the neutral 7-azaindole (**32**), $\text{Zn}(7\text{-azaindole})_2(\text{OAc})_2$ is a blue luminescent compound and a *N*-(2-pyridyl) 2-azaindole (**33**) and its complexes were also

studied. The 7-azaindole complex has extensive intramolecular H bonding around a four-coordinate Zn center with two pyridyl nitrogens and two monodentate acetates binding. The *N*-(2-pyridyl) 2-azaindole formed a 1:1 complex (34). The zinc complexes of the azaindole pyridyl derivatives formed complexes which did not have sufficient thermal stability for use in devices and showed rapid exchange in solution, but electroluminescent devices producing blue light were fabricated

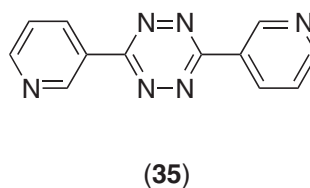
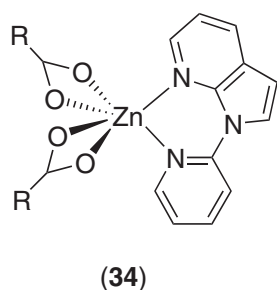
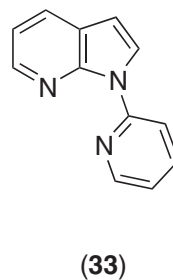
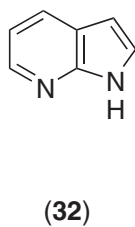
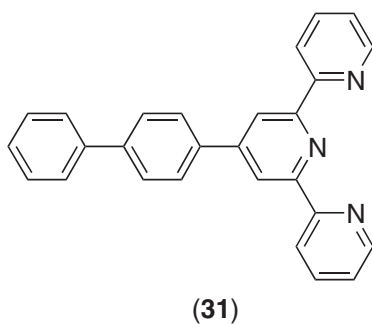
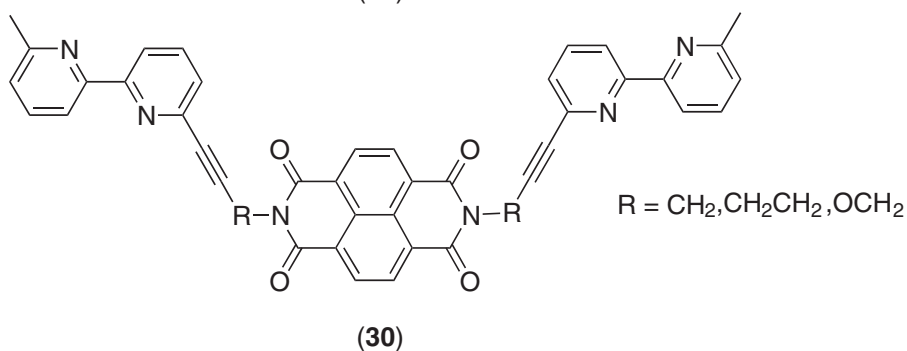
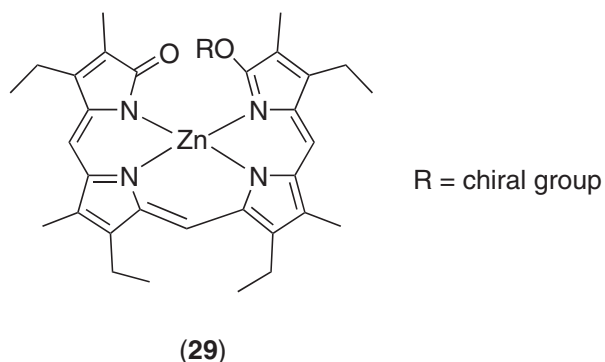

with $\text{Zn}(\text{7-azaindole})_2(\text{OAc})_2$.²⁸¹ The shift of the emission to the visible part of the spectrum on zinc coordination has also been observed in tripyridyl compounds by Yang *et al.*²⁸²

Coordination networks can be crystallized from the zinc ion and 4,4'-bipyridyl.^{283,284} Some of these networks, including that of Hoskins *et al.* show interpenetration of an independent grid such as square sheets.²⁸⁵ These do not form spontaneously with bridging hydroxides as is observed with flexible bipyridyls.

Plater *et al.* structurally characterized a number of coordination network-type supramolecular structures with flexible bipyridyl ligands 1,3-bis(4-pyridyl)propane, 1,4-bis(4-pyridyl)butane, and 1,7-bis(4-pyridyl)heptane.²⁸⁶ The characterization of the complex with the propane bridged ligand showed each zinc in a distorted tetrahedral environment with two pyridine nitrogen and two metal bridging hydroxide ligands. A $\text{Zn}_3(\text{OH})_3$ six-membered ring forms the basis of the structure with Zn—O bond lengths in the range 1.908–1.934 Å. The other ligands give different solid state coordination network structures. All contain hydroxyl ion bridges and as chain lengths increase so does alkyl chain disorder. Coordination networks can also be formed with rigidly bridged pyridyl ligands such as 3,6-bis(pyridin-3-yl)-1,2,4,5-tetrazine (**35**). Three different zinc networks were formed and structurally characterized with the structural type controlled by the choice of alcoholic solvent.²⁷³ Zinc nitrates were used in compound formation and hydrogen bonding observed to the metal-bound alcohols. Six-coordinate distorted octahedral zinc ions were observed.

Self-assembly methods have been used to form zinc bisquinoline assemblies with high refractive index and film uniformity.²⁸⁷

Other supramolecular structures such as catenanes and rotaxanes can be formed using zinc as a template ion; for example, a benzylic imine catenane formed by Leigh *et al.*²⁸⁸ The reversible five-component assembly of a [2]catenane from a chiral metallomacrocyclic and a dinaphtho-crown ether has been achieved. Zinc is used as the metal component and drives assembly via the coordination to a bipyridyl unit; π interactions between the aromatic components are also important.²⁸⁹

An ethidium bromide-peptide conjugate has been prepared that shows induction of chirality on binding to zinc.²⁹⁰ Circular dichroism and spectroscopic studies show an increase in α -helicity of the 16 amino acid peptide and effects are thought to be synergistic between the ethidium group and the zinc. The changes in the secondary and tertiary structure on binding the zinc induce the chirality of the ethidium group and are very sensitive to changes in temperature and pH.

1,1'-(1,4-butanediyl)bis(imidazole) can be used as a linker in the formation of coordination networks with zinc. X-ray structural studies show two different types of coordination polymers dependent on the anion present.²⁹¹ In each example zinc is five-coordinate trigonal bipyramidal, with three imidazole *N*-donors from three different bisimidazole ligands, a water *O*-donor and either a sulfate ion *O*-donor or a further water molecule completing the coordination sphere.

6.8.5 PHOSPHORUS AND ARSENIC LIGANDS

6.8.5.1 Phosphorus Ligands

The CSD reveals that the mean zinc phosphorus bond length is 2.404(5) Å based on all single-crystal X-ray structural data in the database and uncorrected for temperature.

A number of monomeric zinc complexes were synthesized from zinc powder in the presence of R_3PI_2 with aryl R groups resulting in triphenylphosphine, diphenylethylphosphine, or diphenylmethylphosphine ligands. The monomeric structure of $\text{ZnI}_2(\text{PPh}_2\text{Me})_2$ is somewhat surprising as less bulky groups do not form the more sterically crowded monomeric species and formation of the species is attributed to favorable π stacking interactions.²⁹²

An air-sensitive homoleptic silyl phosphido zinc dimer (**36**) was structurally characterized with each zinc three-coordinate in a trigonal planar geometry.²⁹³ Studies with ^{31}P NMR spectroscopy demonstrates that the phosphido complex remains dimeric in solution; however, the ligands undergo bridging to terminal site exchange with a barrier of 14.3(2) kcal mol⁻¹. The $\text{P}(\text{SiMe}_3)_2$ ligands have stronger bridging tendencies than the related amide, $\text{N}(\text{SiMe}_3)_2$, ligands.²⁹⁴

Dimeric zinc complexes of tertiary phosphines, $[\text{Zn}(\text{PR}_3)_2]_2$, are also formed from zinc powder and R_3PI_2 , (R = Me, Et, *n*-Pr, *n*-Bu). The crystal structure of the ethyl derivative demonstrates the dimeric nature of the complexes.²⁹⁵ Metallation of diphenylphosphine with ZnEt_2 results in a trimeric species with a Zn_3P_3 core and bridging diphenyl phosphide ligands. Two protic (HPPH₂)

phosphine ligands act as donors to two of the zinc centers.²⁹⁶ A related trimeric chair-shaped species is formed with dicyclohexylphosphine, giving two three-coordinate and one four-coordinate zinc center, $[\text{Zn}(\text{Et})(\mu\text{-P}(\text{cyclohexyl})_2)]_3 \cdot \text{THF}$. The tetrahydrofuran is an oxygen donor ligand bound to the four-coordinate zinc center.²⁹⁷

The X-ray structure of a tetrameric zinc species reveals a planar Zn_4P_4 ring with the phosphorus donor, a diorganophosphide, and hydroxide donors completing the coordination around the zinc, $[\text{Zn}_2(\text{Bu}^t_2\text{P})_2(\text{OH})(\mu\text{-OH})]_2$.²⁹⁸ The tetranuclear complex $[\text{Zn}_4\text{Cl}_4(\text{PPh}_2)_4(\text{PPR}_3)_2]$ is formed from zinc chloride and can be regarded as an intermediate on the route to polymeric $[\text{Zn}(\text{PPh}_2)_2]_n$.²⁹⁹ Zinc chloride in the presence of tris(trimethylsilyl)phosphine forms tetranuclear complexes $[\text{Zn}_4\text{Cl}_4(\text{P}(\text{SiMe}_3)_2)_4(\text{MeCN})_2]$ and addition of diethylphenyl phosphine to the reaction mixture results in the formation of $[\text{Zn}_{10}\text{Cl}_{12}(\text{PSiMe}_3)_4(\text{PET}_2\text{Ph})_4]$. Zinc iodide forms the binuclear complex $[\text{ZnI}_2\text{P}(\text{SiMe}_3)_2]_2$ in the presence of tris(trimethyl)silylphosphine and further reaction with tetra-*n*-butyl ammonium iodide results in the hexameric complex $[(\text{NBu}_4)_2][\text{Zn}_6\text{I}_6(\text{PSiMe}_3)_4(\text{C}_4\text{H}_8\text{O})_2]$.³⁰⁰

Zinc telluride and zinc selenide polymetallic species with phosphine ligands have been structurally characterized;³⁰¹ further details are discussed in Section 6.8.7. The use of mono- and bidentate phosphine ligands of varying steric bulk contributes to the variation of structural types in the formation of zinc tellurolate polyzinc species with Zn_{10} , Zn_{14} , and Zn_{16} species structurally characterized by Fenske *et al.*³⁰²

Phosphido-bridged multinuclear complexes have been formed from zinc chloride of the form $[\text{Zn}_4(\text{PPh}_2)_4\text{Cl}_4(\text{PRR}')_2]_2$, where R and R' are alkyl or phenyl groups. Related tetrameric structures can be formed with a bridging dialkyl phosphide or (trimethyl)silylphenyl phosphide.³⁰³

Three-coordinate zinc complexes have been characterized with a PS_2 or PSe_2 donor set with bulky thio- or selenophenolates and trimethyl- or dimethylphenylphosphine.³⁰⁴ The reaction of zinc chloride with trimethylphosphine produces different products dependent on the reaction conditions. A monomeric and a dimeric species, $\text{ZnCl}_2(\text{PMe}_3)_2$ and $\text{Zn}_2\text{Cl}_4(\text{PMe}_3)_3$, have been structurally characterized by X-ray crystallography; the latter species has one bridging chloride ligand between a $\text{Zn}(\text{PMe}_3)_3$ unit and a ZnCl_3 unit.³⁰⁵ A series of complexes with SiPh_3 or SnCl_3 coordinated and two phosphine ligands per zinc center have been characterized with trimethyl- and triphenylphosphine.³⁰⁶ Zinc can be inserted in a cyclophosphazene unit resulting in a six-membered ring monomeric structure in the solid state.³⁰⁷

Dimeric phenoxide derivatives of zinc with coordinated tetrahydrofuran solvent show ligand exchange in the presence of tricyclohexylphosphine, $[\text{Zn}(\text{O}-2,6\text{-F}_2\text{C}_6\text{H}_3)_2 \cdot \text{PCy}_3]_2$. The dimeric structure remains, with the phosphine ligands accommodated in the trans configuration. The ^{31}P NMR spectra, recorded in the presence of free tricyclohexylphosphine, indicate slow exchange of the phosphine ligands.³⁰⁸ The zinc (2,6-di-*t*-butylphenoxide) dimeric complex that has the same structure has been formed with phosphine donors tricyclohexylphosphine and diphenylmethylphosphine. Again, slow phosphine exchange is observed but more rapid displacement of tricyclohexylphosphine with the smaller trimethylphosphine occurs.³⁰⁹

A triazacyclononane ligand with a diphenyl phosphine pendant connected via a propyl linker formed a dimeric complex of zinc $[\text{Zn}_2\text{L}_2\text{Cl}_3][\text{ClO}_4]$.³¹⁰

Bis-phosphaallyl complexes of zinc have been prepared and characterized from cyclic amino-phosphazanes and aminoiminophosphanes. The structure of the bis(1,3-diaza-2-phosphaallyl)zinc complex $[\text{Zn}(\text{RNPNR}')_2]$ ($\text{R} = \text{R}' = \text{C}_6\text{H}_3\text{Pr}2i\text{-}2,6$) was determined.³¹¹

Zinc bis(diethylthiocarbamato) trialkylphosphine complexes were synthesized as single-source molecular precursors to zinc sulfide. The monomeric five-coordinate species were synthesized with alkyl = methyl or ethyl. The bidentate phosphine ligand, 1,2-bis(diethylphosphino)ethane, formed a dimeric zinc species with zinc bis(diethylthiocarbamate) $[(\text{Et}_2\text{NCS}_2)_2\text{Zn}]_2(\mu\text{-L})$ and in the presence of a mixture of zinc and cadmium bis(diethylthiocarbamates) a heterobinuclear complex, $[(\text{Et}_2\text{NCS}_2)_2\text{Zn}](\mu\text{-Et}_2\text{PCH}_2\text{CH}_2\text{PET}_2)[\text{Cd}(\text{Et}_2\text{NCS}_2)_2]$. The X-ray structures show five-coordinate zinc centers with a bridging phosphine ligand; ^{31}P NMR was used to study ligand exchange.³¹²

Dialkyl zinc compounds form phosphine complexes of formula $\text{RZnP}(\text{SiMe}_3)_2$ on addition of one equivalent of bis(trimethylsilyl)phosphine. Solution and solid-state studies showed that the complexes are dimeric or trimeric in solution or the solid state. Bis(trimethylsilyl)phosphido-methylzinc crystallizes as a trimeric molecule with a Zn_3P_3 core in the twist-boat conformation. Bis(trimethylsilyl)phosphido-*n*-butylzinc, shows a similar central Zn_3P_3 fragment. The sterically more demanding trimethylsilylmethyl substituent forms a dimeric species of bis(trimethylsilyl)phosphido-trimethylsilylmethylzinc. Solution studies of bis(trimethylsilyl)phosphido-*iso*-propylzinc demonstrate a temperature-dependent equilibrium of the dimeric and trimeric species and the crystalline state contains a 1:1 mixture of these two oligomers. A monomeric bis(trimethylsilyl)phosphido-tris(trimethylsilyl)methylzinc has also been synthesized.³¹³

The trinuclear complex [1,2-dipyridyl-1,2-*t*-bis(butyldimethylsilylamido)ethane] trizinc-bis(μ -triisopropylsilylphosphane-diide) has one zinc coordinated in a bent geometry between two phosphorus donors.³¹⁴ The related compound bis[tris(trimethylsilyl)methylzinc] triisopropylsilylphosphane-diide shows a similar coordination geometry around a zinc center with one of the shortest Zn–P bond distances (2.23 Å), attributed to the low coordination number.³¹⁵ A bidentate diposphine ligand can act as a bridging ligand between two zinc centers resulting in a distorted trigonal–bipyramidal geometry with one phosphine bound to each zinc in μ -[1,2-bis(diethylphosphino)ethane]-*P-P'*-bis[bis(diethyl-dithiocarbamate-S,S')zinc].³¹⁶

A chloride-bridged Zn–V–Zn trimer contains terminal triphenylphosphine ligands bound to a tetrahedral zinc, each zinc with two bridging chloride and a terminal chloride.³¹⁷

A number of zinc phosphine complexes have been synthesized due to interest in chemical vapor deposition; for example, Zn(S-2,4,6-¹BuC₆H₂)₂(Ph₂PMe) and [ZnI₂(PET₃)₂].^{295,304} The structure of bis[(diphenylphosphino)propyl] zinc shows a highly distorted tetrahedral environment with an alkyl and a phosphorus donor binding from each bidentate ligand.³¹⁸

6.8.5.2 Arsenic Ligands

The limited number of characterized complexes of arsine and arsenide ligands contain some similar structural motifs to those exhibited for equivalent phosphorus ligands. Coordination numbers of two, three, or four are observed with monomeric up to decameric zinc complexes structurally determined by X-ray crystallography.

A monomeric zinc complex with arsine ligands can be formed from zinc powder and Me₃AsI₂ with the X-ray structure showing a significantly distorted tetrahedral ZnI₂(AsMe₃)₂ species. If the alkyl group is changed from methyl to ethyl a dimeric zinc species, Zn₂I₄(AsEt₃)₂, with two bridging iodide ligands was formed. This could be attributed to the increased steric bulk of the arsine ligand.³¹⁹

A series of polyzinc compounds was synthesized in the reaction of zinc halides with tris(trimethylsilyl)arsine.³²⁰ The product obtained was dependent on the halide used, the solvent, and the presence of other phosphorus ligands. Polymetallic arsenide and arsine species with two, four, six, and ten zinc atoms were structurally characterized. A dimer with a bridging iodide and terminal arsine ligands was characterized in contrast to a dimer with bridging arsenide ligands in the presence of phosphine and chloride ligands.³⁰⁰ A zinc complex of a dipivaloylarsenide ligand forms to give a tetrahedral zinc center with two chloride and two arsenide ligands. The structure also contains two lithium atoms bound to the pivaloyl oxygens and bridging with the zinc via the chlorides.³²¹

Bis(trimethylsilyl)arsine reacts with diethyl- or dimethylzinc to form different arsenide complexes with the structure dependent on the steric demands of the alkyl group. In the presence of both methyl and ethyl groups alkylzinc bis(trimethylsilylarsenide) forms which has a trimeric solid state structure (37) with a six-membered Zn₃As₃ and Zn–As distances with an average of 2.48 Å.³²²

Two-coordinate zinc centers are observed in a dimeric complex (38) synthesized in the reaction of lithium tri-*iso*-propylsilylarsenide and tris(trimethylsilyl)methylzinc chloride. Again, the increased steric bulk of the alkyl groups on the zinc and arsenic centers is the major factor in determining the structural type.³²³ Comparison of group 12 metals in the formation of metal–arsenic bonds confirmed that zinc formed the most stable compounds. A dimeric structure with bridging di(*tert*-butyl) arsenide groups was determined by X-ray crystallography and other species were characterized by molecular weight measurements in solution.³²⁴

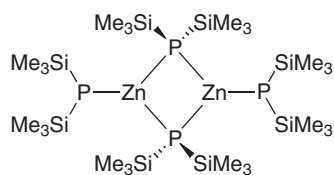

(36)

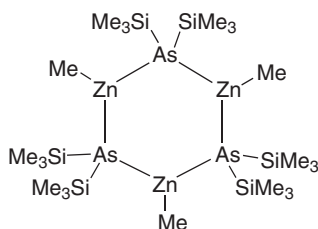

(37)

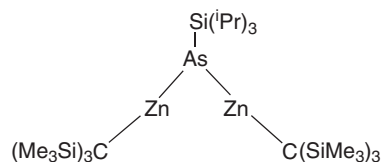

(38)

6.8.6 OXYGEN LIGANDS

Zinc hydroxide and alkoxide species are particularly relevant to catalytic processes, often forming the active species. The cooperative effects of more than one zinc ion and bridged hydroxides are exploited in some enzymatic systems. Zinc alkyl phosphate and carboxylate materials have been important in the formation of framework compounds, often containing large amounts of free space for the inclusion of guest molecules. Aldehyde and ketone compounds are of low stability due to the poor donor capabilities of the ligands; however, a number of examples have recently been characterized.

Zinc oxide has various uses but the most important is as co-catalyst with CuO supported on Al₂O₃ for low-pressure synthesis of methanol from methane.³²⁵

Electron spectroscopic studies of methanol chemisorption on ZnO single-crystal surfaces were performed using XPS, NEXAFS, variable-energy photoelectron spectroscopy, and SCF-X alpha Scattered Wave molecular orbital calculations. The methoxide bonding and reactivity gave insight into the molecular mechanism of methanol synthesis.³²⁶ Zinc coordination compounds are used as precursors in the formation of the zinc oxide materials; for example, a zinc copper maleate precursor has been structurally characterized and the dehydration and decomposition studied together with the final phases.³²⁷ In relation to catalytic poisoning, photoelectron spectroscopic studies of H₂S binding to the surface zinc sites in ZnO have been carried out.³²⁸ The properties of zinc oxide as a semiconductor are also of importance, for example, room-temperature ultraviolet nanowire nanolasers based on zinc oxide semiconductor nanowires have been synthesized. Such short-wavelength nanolasers could have many important applications including optical computing and information storage.³²⁹

A number of compounds with Zn₄O core, including carboxylate and carbamates, have been isolated and discussed as potential molecular models of bulk ZnO.^{330,331}

6.8.6.1 Hydroxides and Hydrated Species

The trigonal-bipyramidal pentaquo zinc species has been structurally characterized.³³² IR spectroscopy has been utilized in studies of the hydration of zinc in aqueous solution and in the hydrated perchlorate salt aqua ions Zn(H₂O)₆²⁺.²⁹

Zinc hydroxides with the metal ligated by nitrogen and sulfur are relatively rare. Most structures show dimeric zinc compounds with the hydroxide bridging the two metal centers. For example, in the presence of hydroxide, the potentially tetradentate ligand *N*-bis-2-(methylthio)ethyl-*N*-(6-neopentylamino-2-pyridylmethyl)amine acts as a tridentate ligand with an N₂S donor set and one of the thioether sulfur donors does not participate in the zinc coordination.³³³ The X-ray crystal structure shows the remaining coordination sites are filled by two bridging hydroxide ligands forming a dimeric species (**39**). A hydrogen bonding interaction is present involving the proton on the secondary amine and the hydroxide oxygen and may contribute to the stability of the structure.

Borovik and co-workers have developed a tripod ligand N[CH₂CH₂NHC(O)NHC(CH₃)₃]₃, which offers a hydrogen bonding cavity around the metal ion on complexation.³³⁴ The monomeric complex of zinc with a hydroxide ligand was structurally characterized. The source of the hydroxo ligand is water and the complex is synthesized under basic conditions. The complex has trigonal-bipyramidal coordination with the hydroxo group trans to the apical nitrogen. Intramolecular hydrogen bonds are formed from the ligand to the coordinated hydroxo and the Zn—O distance is 2.024(2) Å. This relatively long bond distance reflects the presence of hydrogen bonding and is markedly similar to that observed in carbonic anhydrase, where hydrogen bonding interactions are also present.

Comparison of zinc alkoxide and zinc hydroxide bond energies has been made. The relative heterolytic bond energies for hydroxide, methoxide, ethoxide, and *tert*-butoxide were determined from studies of a series of alkoxide exchange equilibria using a four-coordinate monomeric zinc tris(pyrazolyl)borate compound.³³⁵

H₃O₂ bridges have been characterized between zinc atoms and have been suggested as a resting form of active metal-bound hydroxides in dinuclear zinc complexes and as a possible structural or functional motif in multi-zinc enzymes such as phospholipase C or P1 nuclease. Tris(pyrazolyl)borate zinc dimers have been structurally characterized with this motif, [L₃Zn₂O₂H₃]₂ClO₄. The coordination around the zinc atoms was dependent on the tris(pyrazolyl)borate derivative but intriguingly in one example the Zn—OH group was involved in a hydrogen bonding interaction

with a methanol included in the crystal lattice.²³⁵ The reaction of carbon dioxide with a pyrazole compound containing the intramolecular bridge $\text{Zn}-\text{O}_2\text{H}_3-\text{Zn}$ is enhanced relative to the $\text{Zn}-\text{OH}-\text{Zn}$ equivalent.³³⁶

Zinc hydroxy double salts are layered materials similar to layered double hydroxides which show intercrystalline reactivity and incorporate organic compounds between layers.³³⁷ Hydroxy double salts of high crystallinity can be obtained by reacting ZnO with organic metal salts in water. Zinc oxide crystals could then be prepared by thermal treatment of hydroxy zinc acetate.³³⁸

The hydrolysis of the zinc ion in varying anionic media has been investigated. In the pH range of 2.0 to 6.0 a dependence on the anion present is observed, with either sodium nitrate, sodium perchlorate, or sodium chloride at 0.5 M concentration. Only monomeric species were observed and $[\text{Zn}(\text{OH})]_{(\text{aq})}^+$ was found in all three solutions while $\text{Zn}(\text{OH})_{2(\text{aq})}$ was only found in the perchlorate solution, demonstrating the effect of the anionic medium on the formation and stability of the hydrolytic species.³³⁹

EXAFS has been used to determine the second hydration shell of zinc in aqueous solution. Aqueous solutions of zinc nitrate over a range of concentrations were examined and a $\text{Zn}-\text{O}$ distance of 2.05 Å for the first shell of the six-coordinate zinc center found, which is unaffected by concentration. The second hydration shell shows a $\text{Zn}-\text{O}$ distance which has no systematic trend but an average distance of 4.1 Å. The coordination number for the second shell is 11.6 ± 1.6 with unusual behavior for the most concentrated 2.7 M solution, which has a decrease in coordination number to 6.8 ± 1.5 .³⁴⁰

6.8.6.2 Alkoxides and Aryloxides

Zinc alkoxide and aryloxide complexes have been of particular interest as enzyme models and catalysts. Tetrameric alkyl zinc alkoxides are a common structurally characterized motif.⁸¹

A series of zinc alkoxide complexes were characterized of the form $[\text{RZnOR}]_n$ where $n=2$ or 4 (Figure 4). Complexes of the form $[\text{Zn}_3\{\text{O}(2,6-i\text{-Pr}_2\text{C}_6\text{H}_3)\}_4\text{R}_2]$ were produced by stoichiometry

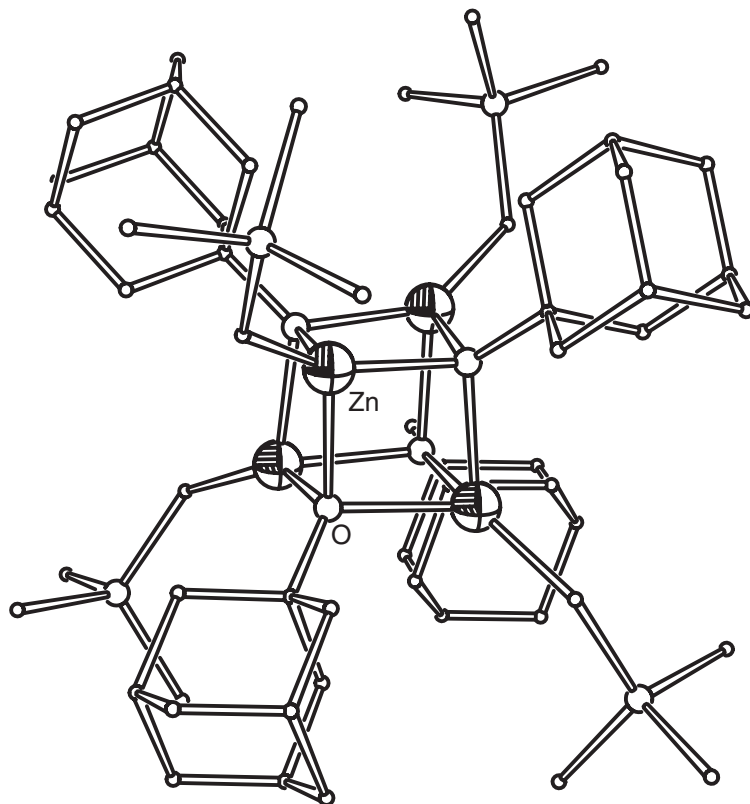

Figure 4 The molecular structure of a tetrameric zinc alkoxide formed from 1-adamantol with (trimethylsilyl)methyl groups also coordinated.⁸¹

change and reveal an almost linear Zn_3 array, in which the zinc centers are linked by bridging -OR' groups.⁸¹

Some interest in soluble zinc bisaryloxides and alkoxides has been based on the production of zinc oxide materials.³⁴¹

Zinc alkoxide complexes have been used as catalysts in the ring-opening polymerization of lactide. A number of zinc alkoxide complexes with tris(pyrazolyl)borate or tris(indazolyl)borate derivative ligands were synthesized. The tris(pyrazolyl)borate complex with 500 equivalents of L-lactide results in 90% conversion to polylactide within six days. This is considerably slower than the magnesium catalyst but the zinc complex has the advantage of decreased air and moisture sensitivity. The chiral tris(indazolyl)borate zinc catalyst shows only low enantioselectivity in the polymerization of racemic lactide but significant diastereoselectivity in the preferential polymerization of meso-lactide from a mixture of racemic and meso-lactide. Crystal structures of zinc alkyls and the zinc siloxide structure of the tris(pyrazolyl)borate derivative ligand were determined.⁷⁵ Soluble and volatile zinc dialkoxides have been prepared including an amido zinc alkoxide, $(Zn(\mu-OCEt_3)[N(SiMe_3)_2])_2$.³⁴²

The trigonal planar zinc phenoxide complex $[K(THF)_6][Zn(O-2,6-t-Bu_2C_6H_3)_3]$ is formed by the reaction of a zinc amide complex, via a bis phenoxide, which is then further reacted with potassium phenoxide. The X-ray structure shows a nearly perfect planar arrangement of the three ligands with zinc only 0.04 Å out of the least squares plane defined by the three oxygen atoms.¹⁵ Unlike the bisphenoxide complexes of zinc with coordinated THF molecules, these complexes are not catalytically active in the copolymerization of epoxides with CO_2 . The bisphenoxide complex has also been structurally characterized and shown to be an effective polymerization catalyst.³⁴³

2,6-functionalized phenoxides can be used to form "double phenoxide" complexes where an alkali metal is also present in the phenoxide structure. The crystal structure of $Na[Zn(2,6-diphenylphenoxide)_3(H_2O)]$ shows a four-coordinate zinc center with three phenoxide oxygen donors, bridging to the sodium, and a bound water molecule. In the presence of chloride a $Na[Zn_2(2,6-diisopropylphenoxide)_4Cl] \cdot 3THF$ forms with the phenoxide ligand bridging the two tetrahedral zinc centers.³⁴⁴

The binding of phenoxyl radical species to zinc has been observed. The pendent arm macrocyclic ligand 1-ethyl-4,7-*t*-bis(3-butyl-5-methoxy-2-hydroxybenzyl)-1,4,7-triazacyclononane deprotonates on reaction with zinc to form a neutral complex, and the structure has been determined, $[ZnL] \cdot H_2O$. Via electrochemical methods a dichloromethane solution of the complex can be reversibly oxidized by two successive one-electron processes generating the stable phenoxyl mono- and diradicals. The oxidations are ligand centered generating phenoxyl radicals which have been studied by EPR and UV-vis spectroscopy. In the monoradical species the phenoxyl radical is localized on one phenyl ring. The diradical has a diamagnetic ground state.³⁴⁵

6.8.6.3 Aldehydes, Ketones, and Ethers

A number of chelating ketone ligands are reported in Section 6.8.11. Due to the weak binding, chelation helps to stabilize the complexes and there are few structural examples of monodentate ketone ligands.

Zinc halide complexes with acetophenone have been structurally characterized and form monomeric or polymeric structural motifs.³⁴⁶ The bromide and iodide derivatives are monomeric and the chloride derivative is a coordination polymer with bridging chlorides.

The X-ray structures are known of a number of ketone ligands, including hexanedione and 4-methylcyclohexanone, that have bound as monodentate ligands in the fifth coordination site of zinc porphyrin complexes.^{347,348} Oxaphlorin dimeric compounds are also known where the oxygen from a neighboring porphyrin ring coordinates in the fifth coordination site of a neighboring zinc porphyrin unit.³⁴⁹

Vahrenkamp and co-workers formed a number of chelate-stabilized ketone complexes with pyridylphenyl ketone. Octahedral complexes formed with a 2:1 ratio of ligand to zinc were formed with trifluoromethanesulfonate, chloride, and bromide anions. 1:1 reactions resulted in the formation of square pyramidal $[ZnL_2X]^+$ with $X = Br, I$, and a trigonal-bipyramidal dimer $[L_2Zn(NCS)_2]_2$ with thiocyanate bridges.³⁵⁰

Acetone has been structurally characterized as a ligand in a zinc crown ether (15-crown-5) complex, where the zinc is seven-coordinate bound to all five ring ether donors, a chloride, and the acetone molecule.³⁵¹

The reported structural chemistry of zinc aldehyde complexes is dominated by Vahrenkamp and co-workers. A systematic investigation is reported over three papers published in 1999. All X-ray structures reported in these papers are aryl aldehydes and no aliphatic aldehyde structures with zinc were found in the CSD. Zinc is frequently exploited in preparative organic chemistry and enzyme-catalyzed transformations of organic carbonyl compounds.

The function of the zinc in these transformations is to bind to the carbonyl, resulting in activation by the Lewis acidic metal center. The aldehyde oxygen is only a weak donor and, as the important reactions with zinc are often catalytic, this has resulted in isolation of few compounds prior to the studies of Vahrenkamp. A systematic approach to the study of aldehyde coordination has been taken with variation in the other zinc donors or anions and the investigation of chelating aldehydes. Interesting results were also obtained with respect to competing donor ligands, further elucidating the donor qualities of the aldehydes. Water was shown to be a better ligand for the zinc ion and aliphatic aldehydes tended to undergo reaction, thus the synthesis of the complexes required restriction of the amount of water present and the use of aromatic aldehydes. Two to six aldehydes could be incorporated into octahedral complexes with the hexaaldehyde complex (**40**) only obtained in the presence of SbCl_6^- as anion (Figure 5).³⁵²

The presence of halides in the coordination sphere with aldehydes is important as zinc halides are typically used in organic synthesis as organic carbonyl activators. Large excesses of aldehydes and anhydrous zinc halides were necessary. Both monomeric and polymeric structures with halide bridges were observed. Tetrahedral geometries were observed for mixed ligand, aldehyde, and halide complexes.³⁵³

For a liver alcohol dehydrogenase (LADH) model an NS_2O coordination sphere is required. The chelating aldehydes are ideal for the formation of this donor set when combined with bis(pentafluoro-thiophenolato)zinc. Structural data on the complexes with one equivalent of 6-methylpyridine-2-carbaldehyde, 6-methoxypyridine-2-carbaldehyde, 2-(dimethylamino)benzaldehyde) demonstrate that the coordination sphere for LADH has been reproduced to a close approximation and the corresponding alcohol complexes have also been characterized.³⁵⁴ Other thiophenols have been used to form such complexes but have not been structurally characterized.³⁰⁴

Formation of aldehyde complexes from the zinc hydroxide complexes of tris(3-cumenyl-5-methylpyrazolyl)borate] was observed. The aldehyde ligands, such as pentafluorobenzaldehyde,

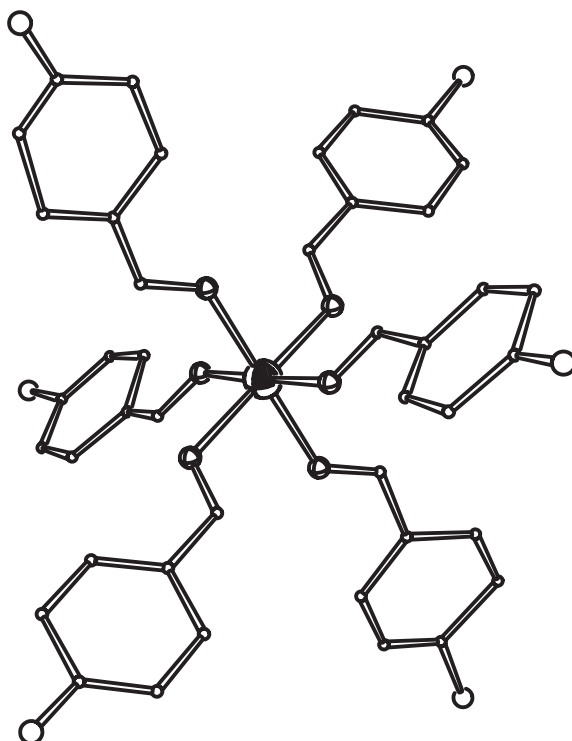

Figure 5 Molecular structure of a zinc hexaaldehyde complex (**40**).³⁵²

were bound as deprotonated aldehyde hydrates. Formyl phenols were deprotonated and coordinated as chelate ligands.³⁵⁵

Zinc porphyrin complexes with coordinated benzaldehyde in the fifth coordination site have also been structurally characterized.^{347,356}

Again, weak coordination is expected for ether ligands to zinc, however, the larger number of structurally characterized examples is at least partially attributable to the frequent use of solvents such as diethyl ether or tetrahydrofuran which may provide additional ligands to the metal center.

There are a reasonable number of structurally characterized zinc compounds with bound THF molecules. For example, a six-coordinate zinc porphyrin complex with axial THF donors and a four-coordinate zinc center with two THF ligands and two phenolate ligands.^{341,357} Although less common there are other structural examples of ether solvents, such as diethyl ether, coordinated.³⁵⁸ The X-ray structure of zinc chloride with 1,4-dioxane ligands shows a monomeric four-coordinate zinc center with two 1,4-dioxane ligands.³⁵⁹

Markies *et al.* have studied the coordination of zinc to cyclic and acyclic polyether ligands. In some cases the zinc is not coordinated within the ligand cavity but only through two of the ether donors in the macrocyclic ring.³⁶⁰ The bis(methoxyethyl)ether complex of zinc diphenyl (**41**) is five-coordinate with three ether oxygens coordinating from the acyclic ligand.³⁶¹

6.8.6.4 Carboxylates

Monomeric, dimeric, and polymeric zinc carboxylates are known.

Dimeric zinc carboxylates do not have a large number of structurally characterized examples.^{362,363} Quite a number of monomeric carboxylate and particularly salicylate complexes have been structurally characterized.^{364–367}

Singh *et al.* have shown that, dependent on the solvent, zinc acetate, pyridine mixtures can give a monomeric, dimeric, or polymeric product.³⁶² $[\text{Zn}(\text{pyridine})_2(\text{CH}_3\text{CO}_2)_2]$ is four-coordinate with monodentate carboxylates. A dimeric tetraacetate structure is known with a metal–metal separation of 2.976 Å, $[\text{Zn}_2(\text{MeCH}=\text{CHCO}_2)_4(\text{C}_9\text{H}_7\text{N})_2]$, with two quinoline units completing the ZnO_4N coordination at the zinc centers.³⁶³ This compares with the zinc–zinc separation in the binuclear triacetate structure, $[\text{Zn}_2(\text{MeCO}_2)_3]^+$, of 3.264 Å.³⁶⁸

A polymeric chain structure is frequently observed for zinc carboxylates. Basic zinc carboxylates form a common tetrameric species, and altering conditions can result in an interconversion between the basic and regular carboxylates.³⁶⁹ Mass spectrometry studies have been carried out on zinc acetate structures.³⁷⁰

6.8.6.4.1 Basic carboxylates

The basic zinc carboxylate structure with a Zn_4O core is now well characterized structurally with a number of examples.³⁷¹ It can also form part of higher nuclearity structures and coordination networks.^{372,373}

The tetranuclear structure observed for basic zinc/acetate/ $[\text{Zn}_4\text{O}(\text{O}_2\text{CCH}_3)_6]$ is also observed for basic zinc pivalate and benzoate. Solution studies showed an equilibrium between hydrated basic structures and the hydrated form of 3,1 bridging structures in the presence of a trace amount of water. Zinc crotonate shows a less common basic carboxylate polymeric structure, $[\text{Zn}_5(\text{OH})_2(\text{O}_2\text{CCHCH}_3)_8]_n$.³⁶⁹

The influence of the alkyl chain on the reaction products of zinc hydroxide and aliphatic carboxylic acids was studied with structural types identified by IR spectroscopy. Straight chain acids produced zinc bis-carboxylates with the polymeric sheet structure with either reagent in excess. Branched chain carboxylic acids produced different structures dependent on the ratio of reagents and the bulk of the alkyl group. Mixtures of a zinc bis-carboxylate with an additional IR stretch and the tetrameric $\text{Zn}_4\text{O}(\text{RCOO})_6$ in varying ratios resulted. Formation conditions appeared driven by how close the alkyl chains were packed in the varying structures with the possibility for steric interaction considerably reduced in the tetramer.³⁷⁴

The tetrazinc $[\text{Zn}_4(\mu_4\text{-O})(\mu\text{-CO}_2\text{CR})_6]$ can be prepared by a variety of methods with short straight chain carboxylic acids and this structural type identified by characteristic IR bands. The formation process and influence of water were monitored by IR spectroscopy and a mechanism of formation and decomposition proposed.³⁷⁵ Further evidence for the validity of the mechanism,

which relies on the presence of water shifting the equilibrium to the tetramer, was found in the formation of zinc complexes of straight chain fatty acids (C_6 to C_{18} chain lengths). IR spectroscopy studies detected the formation of the $[Zn_4(\mu_4-O)(\mu-CO_2CR)_6]$ species and the key factor in formation was shown to be the presence of water.³⁷⁶

6.8.6.4.2 Mixed-metal carboxylate compounds

Multinuclear mixed-metal complexes can be formed with carboxylate ligands.

Trinuclear zinc carboxylate structures of the form $MZn_2(MeCH=CHCO_2)_6(quinoline)_2$ have been structurally characterized with $M = Mn, Co, Ni, Zn, Cd, Mg, Ca, Sr$. Structural variation is observed for the group 2 metals. The remaining complexes all show linear trimers with the central metal atom octahedrally coordinated and linked to each zinc by two bidentate and one monodentate carboxylate.³⁷⁷ A basic benzoate octanuclear structure with four vanadium(III) and four zinc atoms has been characterized, $[VZnO(benzoate)_3(THF)]_4 \cdot 2THF$.³⁷⁸

A series of di-, tri-, and tetranuclear complexes containing lanthanide(III) and zinc ions have been characterized by single-crystal X-ray diffraction. Four different carboxylate-bridged structural types were characterized from the reaction of lanthanide and zinc nitrates in the presence of quinoline and carboxylic acids. Propionic and pivalic acid were used along with the following lanthanides: erbium, yttrium, dysprosium, and gadolinium. The first type is isostructural for $Ln = Y$ or Er and contains a triply propionate bridged dimeric $LnZn$ dimer, $[C_9H_7NH][LnZn(O_2CC_2H_5)_3(C_9H_7N)(NO_3)_3] \cdot H_2O$. Trinuclear $LnZn_2$ species are formed with $Ln = Dy$; in one structural type a symmetric structure shows both zinc ions triply bridged by pivalate ligands $[DyZn_2(O_2CCMe_3)_6(C_9H_7N)_2(NO_3)]$. The remaining trinuclear structure is unsymmetric with one zinc triply bridged to the dysprosium and the other zinc doubly bridged, $[DyZn_2(\mu-O_2CC_2H_5)_5(O_2CC_2H_5)-(C_9H_7N)_2(NO_3)(H_2O)]$. The tetranuclear Gd_2Zn_2 complex has two triply propionate-bridged dinuclear $GdZn$ units linked by propionate groups bridging the two Gd ions, $[Gd_2Zn_2(O_2CC_2H_5)_8(C_9H_7N)_2(NO_3)_2(H_2O)_2]$.³⁷⁹

6.8.6.4.3 Polymeric or framework carboxylate compounds

Metal organic frameworks formed using benzene polycarboxylates have been extensively studied and have revealed some very interesting properties.

1,4-benzene dicarboxylate and 1,3,5-benzene tricarboxylate form different porous frameworks with zinc dependent on solvent and other conditions for formation. The frameworks can be considered as extended analogs of molecular polyzinc carboxylates. Gas sorption isotherm measurements revealed highly organized and accessible channels in a microporous structure for the 1,4-benzenedicarboxylate structures. The 1,3,5-benzene tricarboxylate structure did not show gas sorption due to zinc centers occupying the pores. Sorption of ethanol for this structure demonstrated that these zinc structures were unsaturated and could undergo coordination transitions. The materials produced have high thermal stability with air stability up to $300^\circ C$ and can have a free pore volume up to 55–60% of the crystal.³⁸⁰ 1,3,5-benzenetricarboxylate has been used in the formation of molecular frameworks, which grow as homochiral single crystals. The interpenetrating nature of the networks is controlled by the auxiliary ligands bound. Ethylene glycol and 1,2-propanediol were used as auxiliary ligands with ethylene glycol acting as a unidentate ligand and giving a lower accessible solvent volume than the bidentate 1,2-propanediol. Crystallinity can be lost on removal of bound ligands and restored by exposure to alcohol vapor, allowing interconversion between the two network topologies. The crystals can be grown homochirally from enantiomerically pure diol templates. This is an interesting example of chiral molecules templating helix handedness in a chiral porous framework solid.³⁸¹ Selective guest binding by channels in a zinc-benzenetricarboxylate network was studied, $Zn_2L(NO_3) \cdot (H_2O)(C_2H_5OH)_5$, synthesized by diffusion of triethylamine into an ethanol solution containing 1,3,5-benzenetricarboxylic acid and zinc nitrate. The pore structure of this network has about 44% of volume comprising an extended channel system and similarly shows the facile removal and exchange of alcohols. The exchange is shown to be specific to alcohols and tetrahydrofuran, acetonitrile and acetone are not included in the channels. Solid state NMR, TGA, and X-ray powder and single-crystal techniques were used in the characterization. The specificity is due to the

coordination to the zinc center as is demonstrated by the exclusion of molecules which are an appropriate size and shape but do not offer the possibility of this interaction.³⁸²

Polymeric compounds are formed from 1,3,5-benzene tricarboxylate and zinc with 2,2'-bipyridyl, phenanthroline, or a pyridyl-2-(1-methyl-1H-pyrazol-3-yl) derivative. A number of compounds were characterized with varying ligand protonation and some, such as $[\text{ZnL}(\text{pyridine-2-(1-methyl-4-nitro-1H-pyrazol-3-yl)})(\text{H}_2\text{O})]$, containing single-stranded coordinative chains.³⁸³

1,3,5-cyclohexanetricarboxylate can also be used along with zinc to construct open framework solids. The single-crystal X-ray structure of $\text{Zn}_3[\text{L}(\text{C}_5\text{H}_5\text{N})]_2$ reveals one-dimensional channels with a diameter of about 6 Å.³⁸⁴

6.8.6.4.4 Other carboxylate type ligands

Zinc squarate ($\text{C}_4\text{O}_4^{2-}$) can form a solid state compound with a layered structure when DMSO is present, $[\text{Zn}(\text{C}_4\text{O}_4)(\text{OH}_2)_2(\text{DMSO})_2]$. The DMSO occupies the axial positions at the six-coordinate zinc center and prevents formation of a 3D cage network. The compounds are insoluble at room temperature but are converted into the 3D cage network $[\text{Zn}(\text{C}_4\text{O}_4)(\text{OH}_2)_2]$ by heating in aqueous media.³⁸⁵

As a model of the active site of dihydroorotase, the crystal structure of diaquabis(L-dihydroorotato)zinc demonstrates that the ureido nitrogen adjacent to the coordinated carboxylate does not coordinate to the zinc ion.³⁸⁶ Intramolecular hydrogen bonds are present between the non-coordinated carboxylate oxygen atoms and the coordinated water molecules, stabilizing this coordination geometry. Monodentate rather than bidentate binding of the ligand could be accounted for by the higher $\text{p}K_a$ of the ureido group.

Zinc bis(methoxyacetate) has distorted octahedral coordination with bonds to a carboxylate and methoxy oxygen donor from each ligand and two water molecules completing the coordination sphere.³⁸⁷ 2-Methyl 2-phenoxy propionate ligands form a one-dimensional polymer with a repeating pentamer unit, $[\text{Zn}_5\text{L}_{10}(\text{H}_2\text{O})_2]$. A bidentate chelate mode with an acetate and the phenoxy oxygen donor is observed for some ligands.³⁸⁸ This contrasts with structures of other phenoxyalkanoic acids which are monomeric.

Zinc carboxylate interactions have been exploited as part of a fluorescent molecular sensor for uronic acids. The sensors feature two interactions; coordination of the carboxylate to the zinc and a boronic acid–diol interaction.³⁸⁹ Photoluminescent coordination polymers from hydrothermal syntheses containing Zn_4O or $\text{Zn}_4(\text{OH})_2$ cores with isophthalate or fumarate and 4,4'-bipyridine form two- and three-dimensional structures. Single X-ray diffraction of both dicarboxylates identified the network structure.³⁷³

Zinc oxydiacetate complexes have been formed in the presence of 2,2'-bipyridine, 1,10-phenanthroline, and imidazole. The X-ray structure of zinc oxydiacetate with no additional *N*-donor ligands is a polymeric sheet with ZnO_5 units bridged by carboxylates. The presence of 2,2'-bipyridine or 1,10-phenanthroline gives a mononuclear complex, $[\text{Zn}(\text{oxydiacetate})\text{L}(\text{H}_2\text{O})]$, with distorted octahedral geometry and an N_2O_4 donor set. Thermal decomposition of these compounds gives ZnO .³⁹⁰ However, in the presence of imidazole the X-ray structure shows polymeric chains in $[\text{Zn}(\text{imidazole})_2(\text{oxydiacetate})]_n$. Considerable H bonding is present in the chain structure formed by carboxylate bridged tetrahedral ZnN_2O_2 units.³⁹¹

L-piperidine-2-carboxylic acid is a non-proteinogenic amino acid that is a metabolite of lysine. The zinc complexes of DL-piperidine-2-carboxylic acid, DL-piperidine-3-carboxylic acid, and piperidine-4-carboxylic acid have been studied. The X-ray crystal structures have been determined for the latter two. $[\text{ZnCl}_2(\text{DL-piperidine 3-carboxylate})_2]$ (**42**) is monomeric with a tetrahedral metal center and monodentate carboxylates. $[\text{Zn}_2\text{Cl}_4(\text{piperidine-4-carboxylate})_2]$ (**43**) contains two bridging carboxylates in a dimeric structure. IR studies suggest that the DL-piperidine-2-carboxylato zinc has monodentate carboxylate ligands coordinating.³⁹²

Bis(but-3-enoato)zinc, a two-dimensional coordination polymer, has been polymerized in the solid state by irradiation of a crystalline sample resulting in isotactic zinc poly(but-3-enoate).³⁹³

Carboxylate functionalized cobalt clusters have been used as "cluster ligands" in formation of zinc complexes. The carboxylate cluster $(\text{CO})_9\text{Co}_3\{\mu_3\text{-C}[1,4\text{-C}_6\text{H}_4(\text{CH}_2)_2\text{COOH}]\}$ reacts with diethyl zinc to give $\text{Zn}[(\text{CO})_9\text{Co}_3\text{C}[1,4\text{-C}_6\text{H}_4(\text{CH}_2)_2\text{CO}_2]_2]$ which is analogous to the product formed under identical conditions with acetic acid as the carboxylic acid reagent. The Zn_4O core type structure, $\text{Zn}_4\text{O}[(\text{CO})_9\text{Co}_3(\text{CCO}_2)]_6$, is formed in the reaction of equimolar amounts of diethyl zinc and $(\text{CO})_9\text{Co}_3(\mu_3\text{-CCOOH})$. The differing products formed are attributed to the

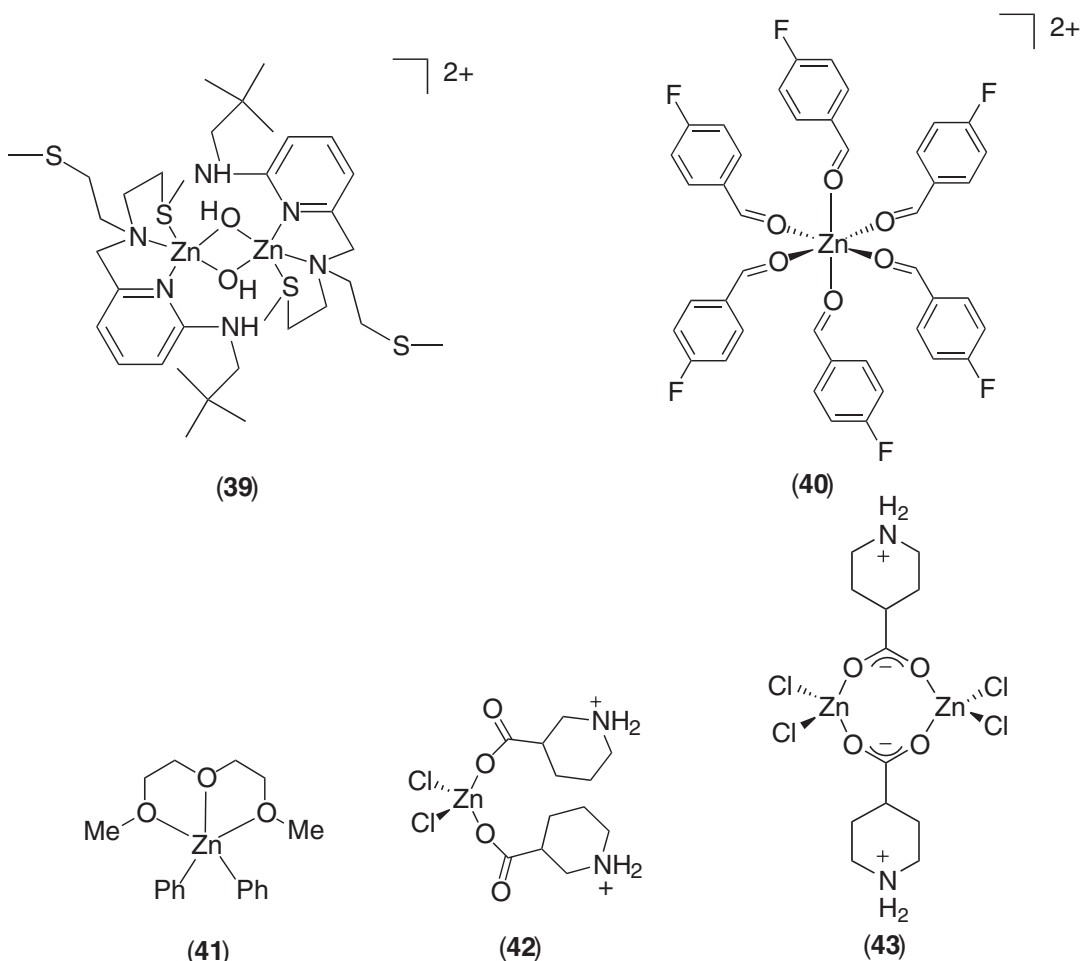

electronic interaction of the cobalt cluster with the carboxylate functionality. All complexes were studied by IR spectroscopy.³⁹⁴ Dimeric carboxylates have been formed and structurally characterized with 2,2'-bipyridine ligands, $[\text{Zn}_2(\text{bipyridine})_2(\text{MeCO}_2)_3]\text{ClO}_4$.³⁹⁵

Dimeric zinc complexes with bridging oxalate groups, $\text{LZn}(\text{C}_2\text{O}_4)\text{ZnL}$, are formed with tetradentate *N*-donor ligands *N,N'*-bis(2-pyridylmethyl)-1,2-ethanediamine, *N,N'*-bis(2-pyridylmethyl)1,3-propanediamine, and *N,N'*-bis(2-pyridylmethyl)-*N,N'*-dimethyl-1,2-ethanediamine. Although not structurally characterized, by analogy and comparison of spectroscopic data it is suggested that the oxalate has two oxygen donors coordinating to each metal center.³⁹⁶ In this compound further oxalate bridging is inhibited as the N_4O_2 zinc centers are coordinatively saturated; however, oxalates are frequently involved in solid state polymeric or layer structures via this mode of bridging.³⁹⁷⁻³⁹⁹

The water ligands in $[\text{Zn}(\text{salicylate})_2(\text{H}_2\text{O})_2]$ and the analogous 3,5-di-*t*-butyl salicylate derivative can easily be displaced by other ligands such as 2,2'-bipyridine or pyridine. For example, recrystallization from alcohols results in replacement of the water molecule with an alcohol solvent molecule. Crystals grown of the bipyridine analog in methanol result in the isolation of the structurally characterized octahedral complex, $[\text{Zn}(\text{O}_2\text{CC}_6\text{H}_4\text{OH}-2)_2(\text{bipyridine})(\text{MeOH})]$, which has one monodentate and one bidentate salicylate ligand with both coordinating through carboxylate oxygens. The coordination sphere is completed by a chelating bipyridyl and a methanol and there is extensive hydrogen bonding in the structure.⁴⁰⁰

The ligand 1-(*o*-carboxymethoxyphenoxy)-2-(*o*-hydroxyphenoxy)ethane acts as a monodentate carboxylate ligand in the formation of $[\text{Zn}(\text{NH}_4)_2\text{L}_4]$.⁴⁰¹ The four ligands participate extensively in hydrogen bonding resulting in two cavities where the hydrogen bonding is maximized for the ammonium cations.

The compound $\text{Zn}_2(\text{diacetoamidoglutarate})_2\text{hexaquo}$ is dimeric with two slightly distorted trigonal-bipyramidal zinc centers. The *N*-protected amino acids bridge the two zinc centers,

with each zinc coordinated to two carboxylate oxygens and the remaining three coordination sites occupied by water molecules.⁴⁰²

6.8.6.5 Phosphate and other Oxyanion Ligands

6.8.6.5.1 Phosphates and phosphonate ligands

Zinc phosphates and phosphonates can form highly interesting coordination networks, some in the presence of additional ligands. A number of compounds that have useful properties for the formation of zinc phosphate materials will also be discussed.

A zinc phosphonate tetramer can be used as a precursor to organic-containing networks or layered zinc phosphate materials.⁴⁰³ The tetramer (**44**) has a Zn_4O core and six bridging phosphate ligands, $[O_2P(O^tBu)_2]^-$. A solution of this complex reacts with 1,6-hexanediamine to form a layered coordination network $\{Zn[O_2P(O^tBu)_2][H_2N(CH_2)_6NH_2]\}_n$. A one-dimensional polymer can be formed from the tetramer under acidic conditions $\{Zn-[O_2P(O^tBu)_2]\}_n$.⁴⁰⁴ Zinc phosphate materials are formed on clean loss of the “hydrocarbon shell” on heating.

A range of zinc phosphonates were prepared and structurally characterized by reaction of zinc nitrate with phosphonic acids in an autoclave in the presence of sodium hydroxide, including an enantiomerically pure zinc phosphonate—for example, $Zn(O_3PCH_2P(O)(C_6H_5)_2)$ and $Zn(O_3PCH_2P(O)(CH_3)(C_6H_5))$.^{405,406}

$Zn(O_3PC_6H_5) \cdot H_2O$ exhibits a reversible dehydration to yield isomorphous structures to the corresponding monohydrate derivative. It appears that the dehydration leaves a vacant coordination site on the zinc ion allowing intercalation of ammonia, but not carbon dioxide, oxygen, or ethylene. IR and TGA studies were supplemented by computer simulations which demonstrated the potential for intercalation of ammonia but the exclusion of larger primary amines such as propylamine.⁴⁰⁷ The reaction of zinc acetate with diethyl hydroxymethylphosphonate forms $Zn(O_3PCH_2OH)$ where hydrolysis of the phosphonate to produce phosphonic acid has occurred *in situ*. The X-ray structure shows channels formed by phosphonate groups bridging the octahedral coordinated zinc atoms. The zinc atoms are coordinated by the three oxygens of the phosphonate group and the oxygen of the hydroxy group.⁴⁰⁸

The crystal structure of zinc phenylphosphonate was solved and demonstrated the anticipated layer structure with the phenyl rings occupying the interlamellar space.⁴⁰⁹ The structure of zinc ethylphosphonate and (2-aminoethyl)phosphonate both show four-coordinate zinc centers in contrast to the coordination number of six in the phenylphosphonate compound.⁴¹⁰

The presence of triethylenetetramine in the hydrothermal synthesis of open-framework zinc phosphates results in a number of frameworks with one- to three-dimensional structures. The structures include one-dimensional ladders, two-dimensional layer structures, and one structure where the tetramine is bound to the zinc center. The structural type was highly sensitive to the relative concentration of the amine and phosphoric acid.⁴¹¹ Piperazine and 2-methylpiperazine can be used as templating molecules in solvothermal syntheses of zinc phosphates. The crystallization processes of the zinc compounds were investigated by real time *in situ* measurements of synchrotron X-ray powder diffraction patterns.⁴¹²

Attempts have been made to incorporate functional groups into the phosphonates in zinc phosphonate structures. $Zn(O_3P(CH_2)_2CO_2H) \cdot H_2O$ was reacted with aromatic amines but no amide formation was observed. However, $Zn(O_3P(CH_2)_2CONHC_6H_5)$ could be synthesized directly from zinc nitrate, (2-carboxyethyl)phosphonic acid, and aniline in a one-step procedure.⁴⁰⁶

Di-*t*-butyl phosphate complexes of zinc were synthesized as precursors for ceramic material formation. A tetrameric zinc complex was characterized from the treatment of zinc acetate with the phosphate resulting in a compound with a bridging oxo at the center, $[Zn_4(\mu_4-O)(di-t-butyl phosphate)_6]$. In the presence of auxiliary donor ligands such as imidazole or ethylenediamine, monomeric complexes are formed, $[Zn(di-t-butyl phosphate)_2(imidazole)_4]$. It is also possible to convert the tetramer into the monomer by treating with a large excess of imidazole.⁴¹³

An open-framework zinc phosphate synthesized under mild hydrothermal conditions possesses two interpenetrating helical channels.⁴¹⁴ Piperazine phosphate yields a variety of open framework structures in reaction with zinc, including linear chain, layer, and three-dimensional systems.⁴¹⁵

A zinc phosphate material formed in the presence of *trans*-1,2-diaminocyclohexane forms with pores of 24-membered rings and a consequent large amount of free space in the structure, $Zn_3(PO_4)_2(PO_3OH)(diaminocyclohexane) \cdot 2H_2O$. The tubular channels formed

show the *trans*-diaminocyclohexane templates and water near the walls and have an empty space diameter of about 8.6 Å.⁴¹⁶

Zinc biphenylenebis(phosphonate) was obtained with a linear chain rather than a layer structure when the same preparative method was used as for the zinc phenylenebis(phosphonate) layer structure. The presence of base allows a solid phase transformation from the linear chain to the layer structure.⁴¹⁷

A series of zinc diphosphonate complexes were synthesized in the presence of diamines of varying chain length. 1-hydroxyethylidenediphosphonate bridges the metal ions with the protonated diamine (ethyl-, butyl-, pentyl-, or hexylenediamine) filling in channels or residing between chains. All four structures are different with one-, two-, and three-dimensional networks formed. The coordination number (4–6) and geometry also varies.⁴¹⁸

Chloromethyl phosphonates can yield different network or layer structures dependent on preparation conditions or other coordinating groups present.⁴¹⁹ $\text{Zn}(\text{O}_3\text{PCH}_2\text{Cl})\cdot\text{H}_2\text{O}$ has a layered structure similar to $\text{Zn}(\text{O}_3\text{PC}_6\text{H}_5)\cdot\text{H}_2\text{O}$. In the presence of urea another layer structure results with phosphonate oxygens bridging the zinc centers, the coordination changes with the urea participating to give tetrahedrally coordinated zinc centers with one urea and three phosphonate oxygens bound. $\text{Zn}_2\text{Cl}(\text{O}_3\text{PCH}_2\text{Cl})(\text{HO}_3\text{PCH}_2\text{Cl})\cdot\text{H}_2\text{O}$ results when zinc chloride is used as starting material and contains both tetrahedrally and octahedrally coordinated zinc centers with the chloride bound to the tetrahedral zinc. The positioning of the chloromethyl group has an influence on the interlayer distances.

Anhydrous zinc phosphonate $\text{Zn}(\text{O}_3\text{PCH}_3)$ is unreactive with water but reacts with primary amines (chain length up to C_8) and ammonia to form intercalation compounds. The intercalation is shape selective as amines with branching at the α -carbon cannot coordinate to the zinc. Different structures are noted for even and odd carbon chain lengths with odd numbers of carbons in the alkyl chain forming a more efficiently packed interdigitated structure.⁴²⁰

Zinc phosphite compounds, $\text{Zn}(\text{H}_2\text{PO}_3)_2\cdot 3\text{H}_2\text{O}$ and $\text{Zn}_3\text{Na}_2(\text{HPO}_3)_4$, have also been characterized in the solid state and revealed structures in contrast with those observed for the phosphates. The tendency to form structures with open cavities is greater due to the reduced bridging ability of the phosphite donor ligand.⁴²¹

The zinc-pyridoxal 5'-phosphate-2-amino-3-phosphonopropionic acid system exhibits deprotonation of the coordinated phosphonate group to bind to the zinc center at increased pH but cannot be coordinated to the zinc ion below pH 8.5 when it is protonated and hydrogen bound to the phosphate group.⁴²²

The metal complex formation of a series of phosphonodipeptides containing glycyl, L-alanyl, L-leucyl, or L-phenylalanyl and a terminal aminomethylphosphonic acid residue was studied and stability constants determined. Zinc formed 1:1 metal-to-ligand molar ratio complexes with protonated, non-protonated, and deprotonated ligands. No formation of 1:2 metal-to-ligand ratio complexes was observed for zinc in contrast to the other transition metals studied.⁴²³ Zinc complexes of phosphonic acid analogs of aspartic acid, glutamic acid, and asparagines have been studied.⁴²⁴ Two aspartic acid analog ligands with the α -carboxylic acid replaced with a phosphonic acid group are proposed to yield a cyclic phosphonamidate in the presence of the zinc ion.⁴²⁵ However, the aspartic acid analog with the β -carboxylic acid group replaced did not show this reaction. The reaction of a series of aminophosphonic acids was studied by NMR to provide further insight into this reaction, which appears to require neutral or slightly alkaline media.

The coordinating properties of a zinc 2,2'-bipyridyl unit with adenosine 5'-triphosphate and cytidine 5'-triphosphate were studied in aqueous solution. The binding of zinc to both phosphate and ATP nitrogen donor was observed with the potential for displacement of the ATP nitrogen donor by hydroxide.⁴²⁶ The interaction of zinc with the phosphate groups in a platinum(II) bound 2'-deoxyguanosine 5'-monophosphate has been studied in aqueous solution, with little difference noted in the coordinating properties of the phosphate residue or backbone relative to the free nucleobase.⁴²⁷

6.8.6.5.2 Other oxyanion ligands

The zinc teflate $\text{Zn}(\text{OTeF}_5)_2$ has been synthesized and characterized by IR and ^{19}F NMR spectroscopy. The interaction with a number of weakly coordinating solvents was studied and the single-crystal X-ray structures determined for nitrobenzene derivatives $[\text{Zn}(\text{OTeF}_5)_2(\text{PhNO}_2)_2]$ and $\text{Zn}(\text{OTeF}_5)_2(\text{PhNO}_2)_3$.⁴²⁸

A barium zinc arsenate compound has been synthesized and structurally characterized, $\text{BaZn}_2(\text{HAS}_2\text{O}_7)\text{AsO}_4$, and is a rare example of a compound containing the hydrogen diarsenate group. Infinite sheets of $[\text{Zn}_2\text{AsO}_4]$ are held together by the HAS_2O_7 groups to form a three-dimensional network.^{405,429}

Layered zinc arylsulfonates can be prepared from sodium arylsulfonate in the presence of zinc salts. Some compounds have been structurally characterized.⁴³⁰

Zinc benzenesulfonate, $\text{Zn}(\text{C}_6\text{H}_5\text{SO}_3)_2 \cdot 6\text{H}_2\text{O}$, is prepared in aqueous solution and has a structure containing alternate layers of $[\text{Zn}(\text{H}_2\text{O})_6]^{2+}$ and benzenesulfonate ions. They can be compared to layered metal phosphonates.⁴³¹

Amine ligated transition metal complexes have been used as building blocks in the formation of composite metal oxide materials. These are attempts to apply coordination chemistry principles to provide control over the solid state materials formed i.e. incorporate organic ligands into the structure. Phases constructed from vanadium or molybdenum oxides are modified by the presence of a zinc complex. Examples include $[(2,2'\text{-bpy})_2\text{Zn}]_2[\text{V}_6\text{O}_{17}]$ and $[\text{Zn}(o\text{-phen})\text{MnO}_4]$.^{212,432} The structure of the compound $[\text{Zn}(o\text{-phen})\text{MnO}_4]$ has the zinc ion in a square pyramidal coordination geometry bound to two phenanthroline nitrogens and three molybdate oxygens. Further structurally characterized hybrid organic-inorganic materials were obtained— $\text{Zn}(2,2'\text{-bipyridine})[\text{V}_2\text{O}_6]$ and $[\text{V}_6\text{O}_{17}\{\text{Zn}(\text{terpy})\}_2]$ —by hydrothermal techniques from a mixture of zinc chloride, amine ligand, and V_2O_5 .²¹³

There has been particular recent interest in zinc nitrate complexes as coordination models for bicarbonate binding in carbonic anhydrase. The mono- or bidentate coordination modes have been studied with tris-pyrazolyl borate complexes and can be rationalized in the context of the enzyme activity.⁴³³ Caution in this comparison is introduced by *ab initio* calculations on these model systems demonstrating both monodentate and bidentate coordination energy minima for nitrate binding to zinc.⁴³⁴

Zinc boryloxides with a tetrameric Zn_4O_4 core (45) have only recently been characterized. The single-crystal X-ray structure and multinuclear NMR spectroscopy studies were used as a basis for discussion of deformation of the central core.⁴³⁵ Alkali metal zinc orthoborates $\text{MZn}_4(\text{BO}_3)_3$ ($\text{M} = \text{K}, \text{Rb}, \text{Cs}$) have been synthesized and single-crystal X-ray structures determined for $\text{M} = \text{K}$ and Rb .⁴³⁶

6.8.6.6 Ester and Phosphate Diester Binding and Hydrolysis

Hydrolysis reactions catalyzed by zinc centers and the formation of hydroxide bridged dimeric species have been the subject of much recent study, and reproduction of the activity of hydrolytic zinc enzymes has been the goal of many research groups.

The complexation of zinc by mixed oxo aza ligands (46), (47), and (48), and subsequent reactivity was investigated.⁴³⁷ Two ligand ring sizes were studied. Structural characterization of the dizinc complex of (46) shows two identically coordinated zinc centers with distorted trigonal prismatic coordination of N_3O_2 and a bridging hydroxide completing the coordination sphere with a $\text{Zn}-\text{Zn}$ distance of 3.543(2) Å. The ligand synthesized is ditopic for zinc and has also been functionalized with an ethanol pendent.⁴³⁸ Potentiometric titrations show stable dizinc complexes are formed at neutral to alkaline aqueous solutions, with the alcohol pendent in (47) deprotonating with a $\text{p}K_a$ of 6.9. A zinc coordinated water molecule undergoes hydrolysis with a $\text{p}K_a$ of 8.46 that results in a system with a coordinated alkoxide and a $\text{Zn}-\text{OH}$ nucleophile at slightly alkaline pH. This is analogous to the alkaline phosphatases that involve both a deprotonated serine and a $\text{Zn}-\text{OH}$ in the hydrolysis of phosphate monoesters. The analogy is borne out by the increased hydrolysis rate of bis(*p*-nitrophenyl)phosphate by the dizinc complex of (47) over (46), with the higher activity due to the superior nucleophilicity of a zinc-bound alkoxide over a zinc-bound hydroxide. Crystallographic characterization of a stable analog of the dizinc macrocycle complex with diphenyl phosphate shows formation of a 1:2 complex with the two phosphates bridging the metal centers, and some evidence that the structure is retained in solution.⁴³⁹

The hydrolysis of *p*-nitrophenyl acetate and bis(*p*-nitrophenyl phosphate) are frequently used to probe hydrolytic activity. A problem with some other dinuclear systems is that the Zn units are held together by bridging ligands which can be cleaved on reaction with the substrate.⁴⁴⁰ This is not the case in a ditopic ligand such as those designed by Lippard and co-workers based on Kemp's triacid imide with a xylyl spacer.^{441,442} Both zinc dimers and mixed metal dimers were formed and a structure characterized with a bridging phosphodiester (Figure 6).

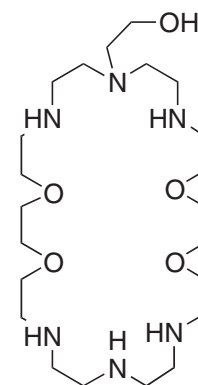
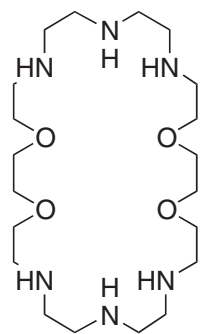
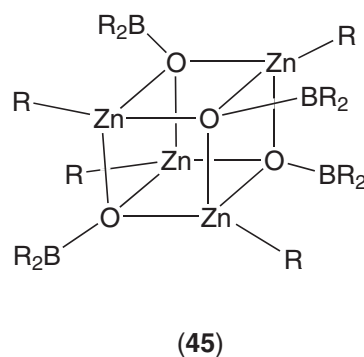
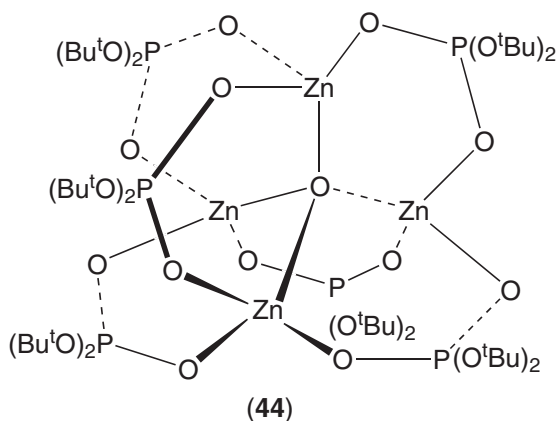

A structurally characterized example of a dinuclear zinc complex with a bridging phosphate monoester was provided by Kitajima and co-workers using the tris(pyrazolyl)borate ligand system. The P—O bond in a tris- or bis-phosphate ester is cleaved by a hydroxo zinc complex resulting in the monoester compound.⁴⁴³

Bimetallic zinc complexes formed with hexaazamacrocycles were studied in the hydrolysis of activated carboxyesters. Potentiometric titration demonstrated the dominant presence of a dinuclear hydroxo bridged species at pH > 7. *p*-Nitrophenyl acetate is hydrolyzed with no loss of catalytic activity for at least 2.7 catalytic cycles.⁴⁴⁴

Kimura and co-workers have made a major contribution to this area with dizinc azamacrocycle complexes characterized including phosphate ester X-ray structures.^{445,446} They have also studied ligands with pendent alcohol groups.⁴⁴⁷

Two dinuclear complexes, with five-coordinate zinc centers, derived from tris((2-pyridyl)methyl) amine were synthesized and bridging phosphate or phosphate ester groups. The X-ray structure of the phosphate monoester complex shows a syn-anti bridging mode in contrast to alkaline phosphatase in which it is syn-syn.⁴⁴⁸ Fenton and co-workers have also studied other related dizinc species of compartmental ligands.⁴⁴⁹

Phosphate ester crystal structures have been determined of zinc 1,5,9-triazacyclononane including an interesting structure containing an oligophosphate bridged zinc unit.⁴⁵⁰ The zinc complex of 1,5,9-triazacyclododecane was studied as a hydrolysis catalyst for substituted phenyl acetates.⁴⁵¹ Kinetic analysis suggested that hydrolysis occurs by a mechanism involving hydroxide attack of a metal-bound carbonyl.

Corrano and co-workers have characterized phosphate ester species with a mixed donor heteroscorpionate tripod zinc species.⁴⁵² Krebs and co-workers synthesized purple acid phosphatase mimics including a structurally characterized Fe^{III}Zn^{II} phosphate bridged dimeric species.⁴⁵³

As already mentioned, Lippard and co-workers have also studied the μ -hydroxy dizinc unit found in metallohydrolases in a model system $[\text{Zn}_2\text{L}(\mu\text{-OH})(\mu\text{-O}_2\text{PPh}_2)]^{2+}$, L = 2,7-bis [2-(2-pyridylethyl)-aminomethyl]-1,8-naphthyridine.⁴⁵⁴ Hydrolysis of phosphodiester and beta-lactams was studied and related to the PI nuclease and beta-lactamase enzymes. The dinuclear complex

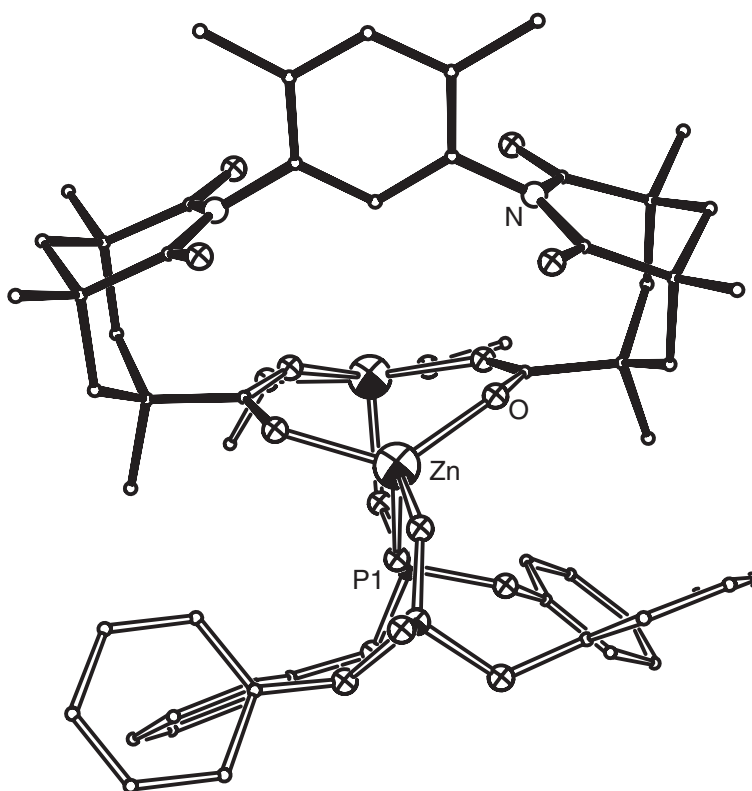

Figure 6 Molecular structure of a dimeric zinc compound with a bridging phosphodiester formed with ligands based on Kemp's triacid imide.⁴⁴¹

was 1.8 times more reactive in hydrolysis of phosphodiester than a mononuclear analog. However, some mononuclear complexes have equivalent reactivity to the dinuclear complex towards beta-lactam hydrolysis. The low reactivity of the bridging hydroxide could be attributed to the alignment of the substrate on binding being unfavorable and the diminished nucleophilicity of the hydroxide due to being simultaneously bound to the two zinc ions.

Dinuclear complexes with hydroxide bridged dizinc centers were synthesized with a ligand based on the phthalazine framework.⁴⁵⁵ The dizinc complex of 1,4-bis(2,2'-dipyridylmethyl)phthalazine (**49**) is bridged by the phthalazine moiety, a water molecule, and a hydroxide ion. Both centers are pseudooctahedral with two pyridine donors and a water molecule occupying the remaining coordination sites.

6.8.6.7 Binding and Formation of Carbonate Species

Ito and co-workers observed the formation of zinc bound alkyl carbonates on reaction of carbon dioxide with tetraaza macrocycle zinc complexes in alcohol solvents.⁴⁵⁶ This reversible reaction was studied by NMR and IR, and proceeds by initial attack of a metal-bound alkoxide species. The metal-bound alkyl carbonate species can be converted into dialkyl carbonate. Spectroscopic studies suggested that some complexes showed monodentate alkyl carbonates, and varying the macrocycle gave a bidentate or bridging carbonate. Darensbourg isolated arylcarbonate compounds from zinc alkoxides as a by-product from work on polycarbonate formation catalysis.³⁴³

X-ray structural data shows both the predicted structural types in the solid state with [14]aneN₄ (**50**) and [15]aneN₄ (**51**) showing chains of zinc macrocycles bridged by alkyl carbonate oxygens, and Me₄[14]aneN₄ (**52**) showing the monodentate methyl carbonate binding to a discrete Zn macrocycle unit (Figure 7).⁴⁵⁷ The bridged complexes are tetrahedral and the discrete complex trigonal bipyramidal with the methyl groups providing steric hindrance.

Van Eldik attempted to achieve catalytic reactions with substituted nitrogen macrocycles and carbon dioxide but was unsuccessful in the synthesis of alkyl and aryl carbonates.⁴⁵⁸ A bridging

μ_3 -CO₃ species was formed and the X-ray structure solved. It is thought that the carbonate species forms on reaction with water, which was problematic in the selected strategy, as water was produced in the formation of the dialkyl carbonates. Other problems included compound solubility and the stability of the monoalkyl carbonate complex. Van Eldik and co-workers also carried out a detailed kinetic study of the hydration of carbon dioxide and the dehydration of bicarbonate both in the presence and absence of the zinc complex of 1,5,9-triazacyclododecane (12[ane]N₃). The zinc hydroxo form is shown to catalyze the hydration reaction and only the aquo complex catalyzes the dehydration of bicarbonate. Kinetic data including second order rate constants were discussed in reference to other model systems and the enzyme carbonic anhydrase.⁴⁵⁹ The zinc complex of the tetraamine 1,4,7,10-tetraazacyclododecane (cyclen) was also studied as a catalyst for these reactions in aqueous solution and comparison of activity suggests formation of a bidentate bicarbonate intermediate inhibits the catalytic activity. Van Eldik concludes that a unidentate bicarbonate intermediate is most likely to be the active species in the enzyme carbonic anhydrase.⁴⁶⁰

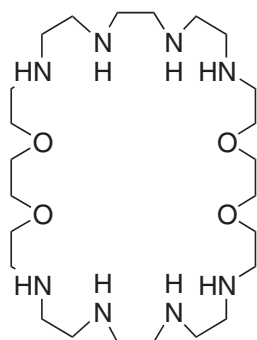

(48)

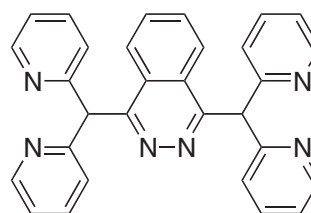

(49)

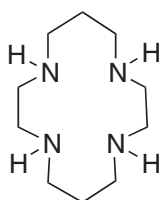

(50)

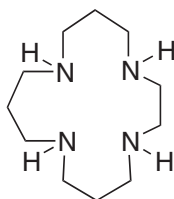

(51)

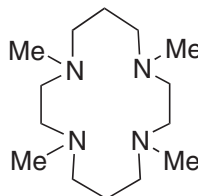

(52)

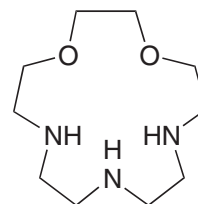

(53)

Paoletti *et al.* used a mixed aza oxo macrocycle (**53**) to form (μ_3 -CO₃) carbonate species on absorption of atmospheric CO₂. The crystal structure showed a trimer with threefold symmetry and six-coordinate zinc centers.⁴⁶¹ This was described as CO₂ fixation; however, three equivalents of zinc complex are required for each CO₂ molecule and so it is not a catalytic process.

Synthesis of functional models of carbonic anhydrase has been attempted with the isolation of an initial mononuclear zinc hydroxide complex with the ligand hydrotris(3-*t*-butyl-5-methylpyrazolyl)borate. Vahrenkamp and co-workers demonstrate the functional as well as the structural analogy to the enzyme carbonic anhydrase. A reversible uptake of carbon dioxide was observed, although the unstable bicarbonate complex rapidly forms a dinuclear bridged complex. In addition, coordinated carbonate esters have been formed and hydrolyzed, and inhibition by small ions noted.⁴⁶² A number of related complexes are discussed in the earlier Section 6.8.4.

An unusual example of a solid-state complex of zinc containing both carbonate and hydrogen carbonate ligands has been structurally characterized, NaA₂{Zn₂[H(CO₃)₂](CO₃)₂(H₂O)₂}, A = K, Rb. The zinc is coordinated in a slightly distorted trigonal-bipyramidal geometry, and a layer structure, held together by hydrogen bonding, is formed with the potassium or rubidium atoms located between the layers. The hydrogen bond of the [H(CO₃)₂]³⁻ anion is very short with O—O distance of 2.474(2) or 2.469(5) Å.⁴⁶³

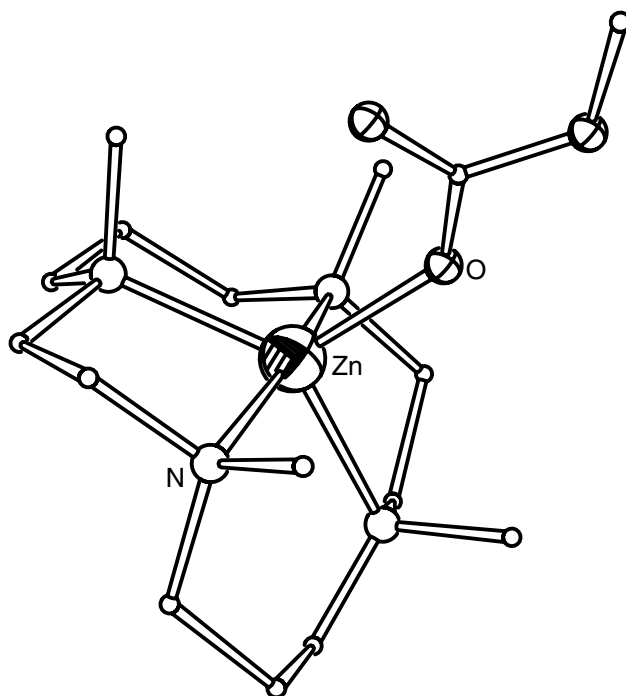

Figure 7 Molecular structure of zinc tetramethylcyclam (**52**) with a zinc-bound methylcarbonate.⁴⁵⁷

The ligand 1,3-bis[3-(2-pyridyl)pyrazol-1-yl]propane contains two bidentate chelating pyridyl/pyrazolyl fragments linked by a flexible trimethylene chain allowing variation in the binding geometry. In the structurally characterized zinc complex each ligand bonds in a tetradentate fashion to a five-coordinate zinc ion, the coordination sphere is completed by a carbonate oxygen from a μ_3 carbonate resulting in the species $[(ZnL)_3(CO_3)](ClO_4)_4$. The symmetrically bridging carbonate results from fixation of atmospheric CO_2 .⁴⁶⁴ Geometry around the metal centers is distorted trigonal bipyramidal ($\tau = 0.64$ using the Addison method).

Triply bridging carbonates between three zinc centers have been identified in nine different X-ray structures deposited in the CSD.^{458,461,465–467} For example, a binuclear μ -OH zinc complex with a tetradentate *N*-donor ligand absorbs atmospheric carbon dioxide to a triply bridged carbonate.⁴⁶⁸ Examples are also known where the metal atoms are in varying coordination environments. The complex cation $[Zn_3(bipyridine)_6(\mu_3-CO_3)(H_2O)_2]^{4+}$ contains one penta- and two hexacoordinate zinc centers.⁴⁶⁹ A tetrapodal compartmental ligand forms a tetrameric complex with zinc that contains the carbonate bridging between three of the four zinc centers.⁴⁷⁰

6.8.6.8 Acetylacetonate and Related Ligands

Zinc complex formation with 1,3-diketones in aqueous solution has been investigated with pentane-2,4-dione, 1,1,1-trifluoropentane-2,4-dione, and 4,4,4-trifluoro-1-(2-thienyl)butane-1,3-dione. The buffer dimethylarsinic acid was shown to have a catalytic effect on complex formation with pentane-2,4-dione and the proton transfer reactions were affected.^{471,472} High-resolution solid state ^{13}C NMR studies of bis(2,4-pentanedionato) zinc complexes have been carried out.⁴⁷³

Photochromic compounds based on diarylethenes have been of interest due to their potential application in photonic switching devices. Materials involving these compounds and coordinated metal ions can show the desired changes on irradiation. $Zn(1,1,1,5,5,5$ -hexafluoroacetylacetonate)₂ forms a linear chain polymer with 1,2-bis[2-methyl-5-(4-pyridyl)-3-thienyl]perfluorocyclopentene which has been structurally characterized demonstrating an octahedral zinc center with axial pyridyl ligands from two different cyclopentene ligands. The single-crystal phase had

photochromic activity, with irradiation at 366 nm the crystal turned blue on formation of the closed ring and on irradiation at 578 nm the blue color disappeared (Scheme 1).⁴⁷⁴

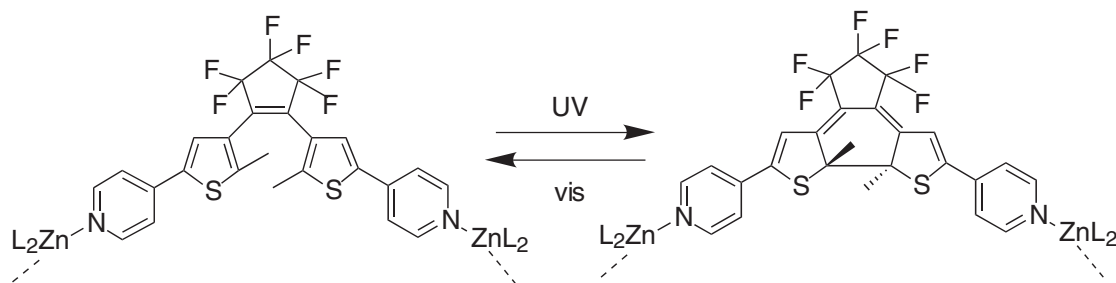

Scheme 1

Zinc dibenzoylmethanates have been synthesized and characterized by differential scanning calorimetry and solid state ^{13}C CPMAS NMR. Two forms have been studied by single crystal X-ray diffraction showing a monomer and a dimer. The monomer, ZnL_2 (**54**), has tetrahedral geometry with two bidentate ligands and the dimer Zn_2L_4 has two of the oxygens from the ligands bridging the octahedral zinc centers.⁴⁷⁵ Other structurally characterized complexes include the Sn—Zn bond containing bis((dibenzoylmethanato)-(3-(dimethylamino)propyl))-tin-zinc⁴⁷⁶ (**55**) and the zinc macrocycle complexes synthesized by Wieghardt and co-workers.⁴⁷⁷ Additionally, either one or two pyridine ligands can be incorporated into the coordination sphere giving five- and six-coordinate complexes respectively.⁴⁷⁸

The zinc complex of 1,1,1,5,5,5-hexafluoroacetylacetonate forms coordination polymers in reaction with either 2,5-bis(4-ethynylpyridyl)furan or 1,2-bis(4-ethynylpyridyl)benzene. The X-ray crystal structures demonstrate an isotactic helical structure for the former and a syndiotactic structure for the latter in the solid state. Low-temperature ^1H and ^{19}F NMR studies gave information on the solution structures of oligomers. Chiral polymers were prepared from L_2Zn where $\text{L} = 3$ -((trifluoromethyl)hydroxymethylene)-(+)-camphorate. Reaction with 2,5-bis(4-ethynylpyridyl)furan gave a linear zigzag structure and reaction with tris(4-pyridyl)methanol a homo-chiral helical polymer.⁴⁷⁹

Heterocyclic β -diketonate ligands have been studied in the formation of zinc complexes in the presence of other donor ligands. The chemistry of 4-acyl-5-pyrazolonate ligand donors with zinc has been relatively unexplored. 1-Phenyl-3-methyl-4-acyl-5-pyrazolone (**56**) formed bidentate 4-acylpyrazolonate complexes with zinc in the presence of donor ligands including amines, bipyridyls, and water. A six-coordinate monomer was structurally characterized and a range of complexes formed. Hydrogen bonding to the pyrazole nitrogen was thought to be an important factor in determining structural type.⁴⁸⁰

Ligands with pyrrolidine-2,4-dione ring systems are of interest due to the presence of the potentially bidentate coordinating group in natural products, 3-acyl tetramic acids, that have a range of biological activities. The complexation of *N*-acetyl-3-butanoyltetramic acid (*N*-acetyl-3-butanoyl-4-hydroxypyrrolidin-2-one) to zinc depends on the ratio of ligand to metal, and gave different results to those observed for copper and cobalt, with deacetylation occurring in some cases.⁴⁸¹

6.8.6.9 Other Oxygen Donor Ligands

Zinc carbamate complexes are well known, and the structural types and stabilities can be compared with thiocarbamates and dithiocarbamates which are discussed in Sections 6.8.11.1.3 and 6.8.7.1.4⁴⁸² Carbamates of zinc can be formed from the reaction of carbon dioxide with alkylzinc alkyl amides and further reaction with alkylzinc can give a distorted cubane structure.⁴⁸³ The tetrameric diethylcarbamate species initially formed can also be used to produce monomeric or dimeric carbamate structures in reaction with amines; tetramethylethylenediamine forms a monomer $[(\text{Me}_2\text{NCH}_2)_2\text{Zn}(\text{O}_2\text{CN}(\text{C}_2\text{H}_5)_2)_2]$ with an octahedral zinc center and pyridine forms a dimer $[\text{C}_5\text{H}_5\text{NZn}_2\text{Me}(\text{O}_2\text{CN}(\text{C}_2\text{H}_5)_2)_3]$ with tetrahedral zinc centers.⁴⁸⁴

A tetranuclear complex is formed from $\text{Rh}(\text{Hdmg})_2(\text{PPh}_3)\text{Cl}$ on reduction with zinc amalgam, $[\text{Rh}(\text{Hdmg})(\text{ClZndmg})(\text{PPh}_3)]_2$ ($\text{H}_2\text{dmg} = \text{dimethylglyoxime}$). The complex was characterized by

NMR, IR spectroscopy, and single-crystal X-ray diffraction. The structure is held together by a Rh—Rh bond and by the two zinc ions bridging oxygens from the dimethylglyoximate ligand.⁴⁸⁵ Zinc has been used to mediate a ferromagnetic interaction between two paramagnetic metal ions.⁴⁸⁶ However, the small value of the coupling probably limits the application of this strategy. The heterotrinnuclear complex $[\text{Cu}_2\text{Zn}(\text{Hdmg})_2(\text{dmg})_2(\text{H}_2\text{O})]$ has the zinc bridging to the copper centers via the oximate oxygens of the dimethylglyoximate ligands.

A tetrameric structure with the Zn_4O core can also be formed with the 7-azaindolate ligand, $[\text{Zn}_4\text{O}(\text{C}_7\text{H}_5\text{N}_2)_6]$, and has been structurally characterized. The tetramer displays intense photoluminescence at 448 nm in the solid state and 425 nm in acetonitrile with a lifetime and quantum yield of 0.1 μs and 0.17 μs respectively.²⁸⁰

A phthalocyanate complex with a peripheral catechol group can act as an oxygen donor ligand for zinc. A trispyrazolylborate complex of zinc hydroxide was treated with (2,3,9,10,16,17,23,24-octahydroxyphthalocyaninato)nickel(II) to displace the hydroxide ligand. This interaction was modeled in the complex formed by the addition of dihydroxyphthalimide to trispyrazolylborate zinc hydroxide, showing monodeprotonation of the catechol ligand.⁴⁸⁷ Zinc catecholates have also been synthesized by direct electrochemical methods.⁴⁸⁸

To form stable complexes with semi-quinone-based redox active ligands a coligand is required to bind to the zinc; face capping tris(pyrazolyl)borate ligands have been used for this purpose.^{236,489} Complexes have been constructed using the coligand hydrotris(3-cumenyl-5-methyl-pyrazolyl)borate with 3,5-di-*t*-butyl-1,2-semiquinone and the bis semi-quinone from the catechol (**57**). The zinc 3,5-di-*t*-butyl-1,2-semiquinone complex was structurally characterized and shows a distorted trigonal-bipyramidal geometry. The parent catecholate complex was unusually stable in air but in solution slowly oxidized to the semiquinone.²³⁶ The bis-catechol ligand has two zinc binding sites and both $S = 1/2$ and $S = 1$ species were generated by oxidation and characterized spectroscopically.⁴⁸⁹

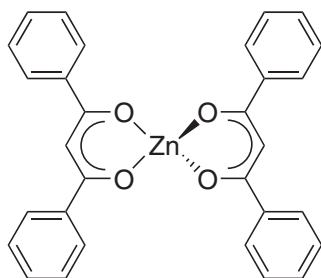

(54)

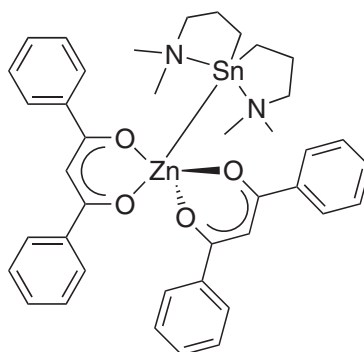

(55)

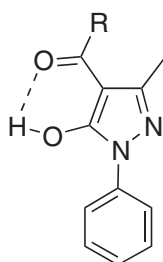

(56)

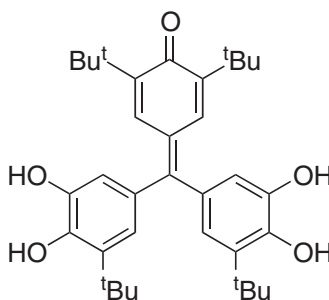

(57)

6.8.7 SULFUR, SELENIUM, AND TELLURIUM LIGANDS

6.8.7.1 Sulfur Ligands

Zinc sulfur chemistry has been studied with particular reference to ZnS material formation and the characterization, and modeling of enzymes and proteins containing Zn—S bonding. In 1991 Christianson stated that typically the coordination patterns produced in nature for “structural zinc” have not been replicated; i.e., four cysteinyl ligands bound or two histidine *N*-donors and two cysteine *S*-donors, with monodentate *N*'s and aliphatic thiolates.⁴⁹⁰ However, there have been many advances in recent years in the production of mixed donor set zinc complexes involving thiolates and thioether donors that will be presented. Some of these polydentate ligand systems will be discussed in Section 6.8.11. A large number of compounds have also been studied with the N_2S_2 coordination sphere and a preference noted for this donor set.^{304,491,492} Zinc dithiocarbamates are well known and have important applications as antioxidants/antiabrasives in motor oils and as vulcanization accelerators in rubber.

In biology, the metallothioneins are a family of proteins that contain seven zinc ions chelated by twenty cysteine residues and their coordination chemistry has been reviewed.⁴⁹³ Polyzinc species with thiolate ligands and bridged sulfur species have been of particular interest in the modeling of metallothioneins and also as molecular fragments to model the bulk properties of the zinc sulfide lattice. Zinc sulfide deposition has been extensively studied and characterized, and a number of molecular precursors will be discussed.^{494,495} Some interesting advances in this area include the observation of the formation of sphalerite (ZnS) deposits in natural biofilms of sulfate-reducing bacteria, demonstrating how microbes control metal concentrations in ground-water- and wetland-based remediation systems. It also suggests biological routes for formation of low-temperature ZnS deposits.⁴⁹⁶ Again bringing the areas of materials and biological sciences together, highly luminescent semiconductor quantum dots containing zinc sulfide can be covalently coupled to biomolecules for use in ultrasensitive biological detection. The quantum dots labeled with immunomolecules successfully recognize specific antibodies or antigens.⁴⁹⁷

6.8.7.1.1 Thiolates

In general, it is easier to form bridging sulfur ligands and polymetallic or polymeric compounds, rather than discrete complexes, with thiolate ligands.^{498,499} Thiolates frequently form infinite lattice structures with tetrahedral zinc centers. The introduction of steric bulk and the potential for heteroleptic complex formation can result in the preferential isolation of discrete complexes. The tendency of zinc thiolates to form polymetallic species is well known, including the metallothioneins. Another area of interest has been as molecular fragments of sulfidic solids. Since the early 1980s there has been a major increase in the variety of structural types; mononuclear, oligomeric, and polymeric. Both monodentate and bidentate thiolate ligands with varying electronic and steric capabilities have been used in the formation of zinc compounds. Studies advancing the understanding of metallothioneins have been carried out on model systems and the proteins.⁵⁰⁰

The tendency to oligomerize can be countered by the use of sterically hindered thiolates.^{358,501} Dependent on the degree of steric bulk, monomeric homoleptic complexes have been characterized with two- or three-coordinate geometries. The X-ray structures of a trigonal planar and a T-shaped zinc complex have been solved.^{16,358,502} The rare two-coordinate monomeric zinc thiolate complex with 2,6-dimesitylphenylthiolate ligands (**58**) was also structurally characterized by X-ray crystallography and studied by IR and NMR.¹² A bent geometry is observed in contrast to the selenolate equivalent.

A number of *N*-donor multidentate ligands were used in conjunction with monodentate thiolate ligands (thiophenolate, benzylthiolate, benzene ethylthiolate) in the formation of a series of monomeric N_2S_2 complexes. The polydentate ligands all coordinated as bis *N*-donor ligands (bis(benzimidazolylmethyl)sulfides, 2,9-dimethylphenanthroline and bis(dimethylpyrazolyl-*N*-ethyl)amine) leaving uncoordinated donor atoms in some cases.¹²⁵ The polymeric zinc complex of benzothiazole-2-thiolate, $[Zn(C_7H_4NS_2)_2]$, forms mononuclear adducts in the presence of pyridine, 2,2'-bipyridine, and 1,10-phenanthroline. The complexes $[Zn(C_7H_4NS_2)_2(\text{pyridine})_2]$ and $[Zn(C_7H_4NS_2)_2(2,2'\text{-bipyridine})]$ were structurally characterized showing a distorted tetrahedral N_2S_2 geometry with coordination by two exocyclic S atoms of the benzothiazole-2-thiolates

and two pyridyl nitrogen donors. Thermal degradation of all the complexes affords ZnS.⁵⁰³ A series of monomeric complexes with 4-substituted thiophenolates and bidentate nitrogen donors, tetramethylethylenediamine, 2,2'-bipyridyl, and 1,10-phenanthroline have been synthesized, e.g., $[\text{Zn}(\text{SC}_6\text{H}_4(4\text{-NH}_2))_2(1,10\text{-phenanthroline})_2]$. The crystal structures showed O—H \cdots S or N—H \cdots S hydrogen bonding patterns in the solid, dependent on functional groups present.⁵⁰⁴ Neutral zinc complexes with an N₂S₂ donor set from 2-(benzoylamino)thiophenolate and 1-methylimidazole have been synthesized. The monomeric distorted tetrahedral complex with two of each type of the monodentate ligands coordinated. The X-ray structure, IR analysis and ¹H NMR studies showed the presence of NH \cdots S hydrogen bonding. The hydrogen bonding interactions have been considered as important in controlling the conformation and properties of complexes with S₂N₂ binding sites in proteins.⁵⁰⁵ The luminescence spectra of bis(thiophenolato)(2,9-dimethyl-1,10-phenanthroline)zinc were correlated with the phase change of the solid at 77 K. Structure determinations for both phases suggested that the change in optical properties were due to rotation of the planes of the two thiol rings on a single zinc ion, from an approximately perpendicular to an almost face-to-face conformation, as the crystal was slowly warmed.⁴⁹¹

An S₄ coordination sphere of the type seen in the Ada protein, where four cysteines coordinate, was achieved with the tridentate tris(2-mercapto-1-phenylimidazolyl)hydroborato ligand. The zinc thiophenolate derivative showed reactivity of the thiolate linkage (Figure 8).⁵⁰⁶

Dimeric zinc thiolate complexes of 2,4,6-*t*-butyl thiophenolate have been characterized by variable temperature and solid state NMR. The X-ray crystal structure shows that the dimeric structure has trigonal planar S₃ coordinated zinc centers with two bridging thiolates. In benzene solution a two-coordinate monomeric species is formed; however, the dimer exists at low temperatures in dichloromethane or toluene. EHMO calculations were carried out showing that the Zn—S bonds are essentially σ in character.⁵⁰⁷ Luminescent dinuclear zinc complexes with the zinc ions in nonidentical coordination environments have been synthesized and studied, $[(\text{bipyridine})\text{Zn}_2(\text{SC}_6\text{H}_4\text{-Cl-}p)(\mu\text{-SC}_6\text{H}_4\text{-Cl-}p)(\mu\text{-OAc})_2]$. The X-ray crystal structure demonstrates that the dimer is held together by two bridging acetates and one bridging thiolate, with one zinc four-coordinate with a terminal thiolate and the other five-coordinate with a bipyridine ligand completing the coordination sphere. The luminescence, electrochemistry, and fluxional behavior in solution have been studied.⁵⁰⁸

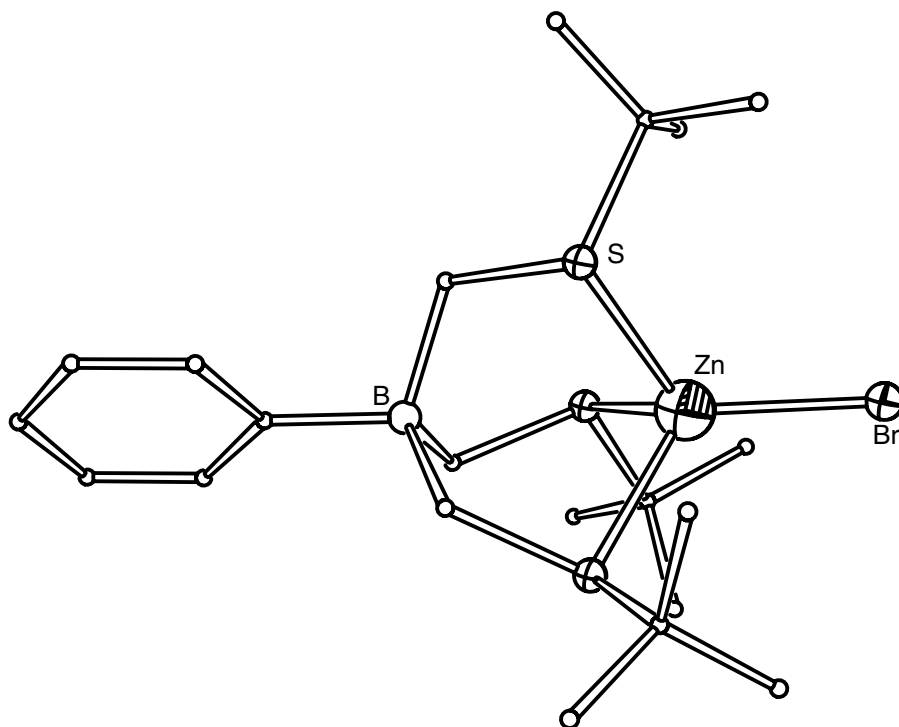

Figure 8 Molecular structure of the zinc complex of the tridentate tris(2-mercapto-1-phenylimidazolyl)hydroborato ligand.⁵⁰⁶

1-(Methylthio)-*cis*-stilbene-2-thiol, $\text{Ph}(\text{SCH}_3)\text{C}=\text{C}(\text{SH})\text{Ph}$, forms a dimeric zinc complex, $\text{Zn}_2[(\text{CH}_3)_2\text{S}_2\text{C}_2\text{Ph}_2]_4$, with bridging thiolates and equivalent five-coordinate zinc centers. In the presence of nitrogen donor ligands such as 4-(dimethylamino)pyridine and 2,2'-bipyridine, monomeric five-coordinate zinc complexes are formed with the $-\text{SMe}$ groups binding weakly or not interacting. Ligand exchange in solution was monitored by ^1H NMR.⁵⁰⁹

A large number of polymetallic zinc species with terminal and bridging thiolate ligands have been characterized. Already discussed in Section 6.8.6 are the compounds with a μ_4 -oxo giving a Zn_4O core. Equivalent compounds with a μ_4 -sulfide are known but are much less common. A zinc compound with a Zn_4O core and bridging thiolate ligands to chromium(III) centers has been characterized. Chromium tris(2-aminoethanethiolate) in the presence of zinc ions formed the complex $[\{\text{Cr}(\text{aminoethanethiolate})_3\}_4\text{Zn}_4\text{O}]^{6+}$. The X-ray structure shows the Zn_4O unit similarly arranged to previously discussed structures with the four chromium(III) atoms bridging via thiolate sulfur atoms.⁵¹⁰ Few examples of the Zn_4S core with μ_4 -S related to the basic zinc carboxylate structure with a Zn_4O core have been structurally characterized. An example has been shown to be a discrete tetrameric structure with dialkyldithiophosphate ligands bridging the zinc centers (Figure 9).⁵¹¹

A further example, hexakis[μ -(dimethylarsinodithioate- $\text{S}:\text{S}'$)]- μ_4 -thioxotetrazinc, $[\text{Zn}_4(\mu_4\text{-S})\{\mu\text{-S}_2\text{As}(\text{CH}_3)_2\}_6]$, contains the Zn_4S core forming an irregular tetrahedron. The compound was studied by X-ray crystallography, electrospray mass spectrometry, UV spectroscopy, and DFT calculations.⁵¹² Each of the zinc ions is tetrahedrally coordinated to four sulfur atoms in the discrete molecular complex. The emission and excitation spectra of the $\text{Zn}_4(\mu_4\text{-S})^{6+}$ core encapsulated in a borate cage have been studied and were identical to those of the dimethylarsine-dithioate compound.⁵¹⁵

The arrangement of zinc and sulfur atoms in the Zn_4S core is similar to the observed Zn_4O . Theoretical calculations demonstrated that the compound is a poor model of extended metal chalcogenide semiconductors (ZnS). Octanuclear zinc compounds have also been structurally characterized with this core. In the presence of an alkylammonium cation, a sulfide containing octanuclear zinc species was formed $[\text{BzEt}_3\text{N}]_2[\text{Zn}_8(\text{S})(\text{SBz})_{16}]$.¹²⁶ The complexes with benzylthiolate

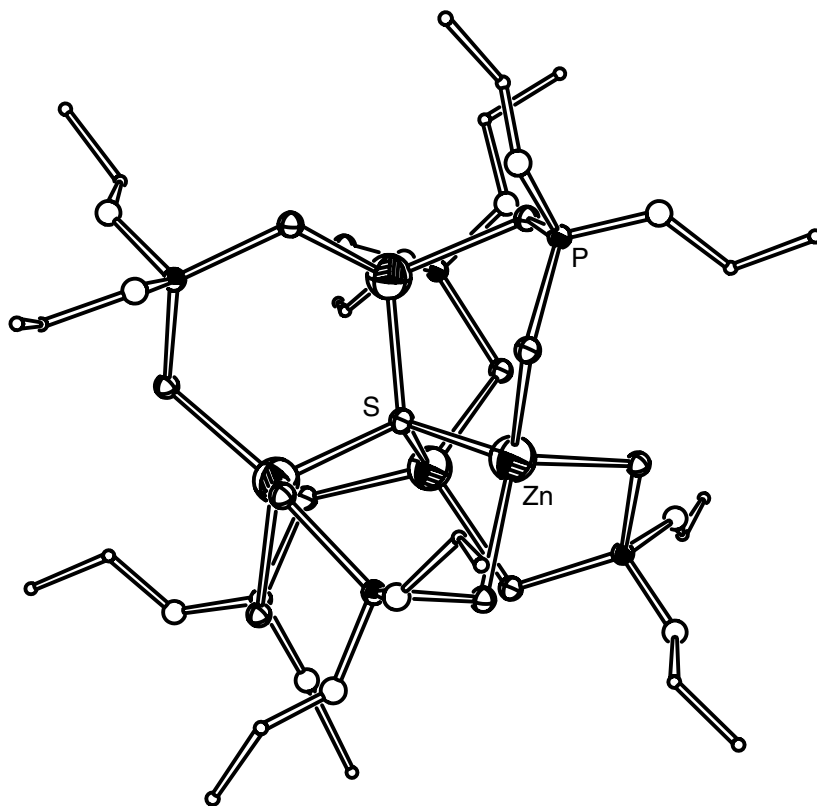

Figure 9 Molecular structure of a compound containing four zinc atoms bridged by a central sulfur.⁵¹¹

ligands form an arrangement based on a tetracapped octahedron and show interesting radical scavenging properties.^{126,514} Varying the synthetic conditions allows controlled formation of tri- and octanuclear benzylthiolate complexes of zinc. A decanuclear compound is also known with the μ_4 -S core, with a combination of sulfide, sulfate, and pyridine ligands completing the coordination about the zinc ions.⁵¹⁵

There is of particular interest in zinc sulfur species that have properties between those of small molecules and extended lattices. The zinc thiophenolate complexes $\text{Zn}(\text{SPh})_4^{2-}$ and $\text{Zn}_4(\text{SPh})_{10}^{2-}$ were studied by electrochemical and spectroscopic methods as representations of tetrahedral fragments of the cubic zinc sulfide lattice. The mononuclear complex shows intraligand transitions and the tetranuclear complex a composite of both intraligand and ligand-to-metal charge-transfer transitions. Photodegradation and excitation of the charge-transfer absorption band were investigated.⁵¹⁶ Casarin and co-workers synthesized and investigated a series of zinc polymetallic species including those already mentioned ($[\text{Zn}(\text{SPh})_4]^{2-}$, $[\text{Zn}_4(\mu\text{-SPh})_6(\text{SPh})_4]^{2-}$, $\text{Zn}_{10}(\mu_3\text{-S})_4(\mu\text{-SPh})_{12}$, and $[\text{Zn}_{10}(\mu_3\text{-S})_4(\mu_2\text{-SPh})_{12}(\text{SPh})_4]^{4-}$) by UV spectroscopy, X-ray photoelectron spectroscopy, and DFT calculations.⁵¹⁷ The lowest-energy absorption band is always an intraligand transition rather than a LMCT, and both the Zn and Cd compounds have similar spectra but none of the clusters was a particularly good model for bulk ZnS. The studies indicate a change in the nature of the frontier orbitals on moving from the smaller up to tetranuclear polyzincates to the decanuclear compounds. In the lower nuclearity compounds the frontier orbitals are delocalized and in the higher nuclearity compounds the HOMO and LUMO are highly localized, the former on the μ_3 -S atoms and the latter on the peripheral zinc atoms. The species most relevant to bulk ZnS modeling was $\text{Zn}_{10}(\mu_3\text{-S})_4(\mu_2\text{-SPh})_{12}$ as a molecular model of ZnS nonpolar surfaces.⁵¹⁷ With all these systems care has to be taken in applying the properties of the polymetallic species as models of extended systems such as zinc sulfides.

Electrospray mass spectrometry was used to study polymetallic sulfide thiolate zinc anions, $[\text{Me}_4\text{N}]_4[\text{S}_4\text{Zn}_{10}(\text{SPh})_{16}]$ and of the metal thiophenolate complexes $[\text{Me}_4\text{N}]_2[\text{Zn}(\text{SPh})_4]$ and $[\text{Me}_4\text{N}]_2[\text{Zn}_4(\text{SPh})_{10}]$.⁵¹⁷ The dissociation of the complexes at high cone voltages with the loss of fragments such as SPh^- and $[\text{Zn}(\text{SPh})_3]^-$ gives relative stability data. Ligand exchange is of particular relevance to the formation of larger aggregates from structures with capping organics. A pyridyl containing zinc polymetallate $[\text{Zn}_{10}\text{S}_7(\text{pyridine})_9(\text{SO}_4)_3]$ was synthesized from the thermolysis product of $[\text{NMe}_4]_4[\text{Zn}_{10}\text{S}_4(\text{SPh})_{16}]$ which is thought to be $[\text{Zn}_{10}\text{S}_4(\text{SPh})_{12}]$. The X-ray structure shows an unusual arrangement with a central Zn_4S connected to a Zn_6 hexagon via μ_3 -sulfides. All zinc atoms are tetrahedral with sulfate ions bridging some, and the coordination sphere completed for nine of the zinc atoms by a pyridyl *N*-donor ligand.⁵¹⁵ The Zn—S connectivity in this cluster is different from that in the cubic or hexagonal lattices of ZnS, and from that commonly observed in other polymetallates formed by group 12 metals. Another approach is the use of counterions to give lower nuclearity species.^{518,519} $[\text{Me}_4\text{N}]_4[\text{S}_4\text{Zn}_{10}(\text{SPh})_{16}]$ in particular has been described as a molecular supertetrahedral fragment of the cubic zinc sulfide lattice.⁵²⁰ Some other polyzinc species including $[\text{NMe}_4][\text{Zn}_8(\text{Cl})(\text{SPh})_{16}]_{16}$ have been characterized.^{519,521} Sulfur L-edge XANES spectra were recorded for metallothionein species and model compounds. Some differences were observed from the expected well-defined tetrahedral geometries.⁵²²

Thiophenolate complexes have been discussed, however, a considerable amount of alkylthiolate zinc chemistry is also known. The zinc alkylthiolate complexes with methanethiolate, ethanethiolate, and *iso*-propylthiolate have been synthesized and characterized as precursors for ZnS formation. Thermolysis studies demonstrated the formation of ZnS and release of dimethylsulfide. Reactivity was similar with only the *iso*-propyl derivative showing much slower reaction.⁵²³ The polyzincate $\text{Zn}_{10}\text{S}_4(\text{SEt})_{12}\text{L}_4$ is a well-characterized neutral zinc sulfur compound.⁵²⁴

A trimeric species was formed with one equivalent of a bis(benzimidazole) ligand in the presence of benzylthiolates (**59**) (Figure 10). Zinc–zinc distances were in the range 3.069–3.958(2) Å.¹²⁶ Other zinc–thiolate trinuclear compounds include $\text{Zn}_3(\text{CH}_2\text{SiMe}_3)_3(\text{SC}_6\text{H}_2\text{iPr}_3)_3$ and $\text{Zn}_3(o\text{-phen})_2(\text{toluene-3,4-dithiolate})_3$ but have little structural similarity.^{81,525}

Mixed metal zinc polymetallates are also known with bridging sulfur ligands. The luminescent heteronuclear rhenium(I)–zinc complex, $[(\text{bpy})\text{Re}(\text{CO})_3(\mu\text{-SC}_6\text{H}_4\text{Me-}p)_2\text{Zn}(\text{bipyridine})](\text{PF}_6)_2$, was synthesized and structurally characterized.⁵²⁶ The polymetallate $[(\text{pyridine})_3\text{Eu}(\mu_2\text{-SPh})_2(\mu_3\text{-SPh})\text{Hg}(\text{SPh})_2]$ reacts with zinc in tetrahydrofuran to give $[(\text{THF})_3\text{Eu}(\mu_2\text{-SPh})_2(\mu_3\text{-SPh})\text{Zn}(\text{SPh})_2]\cdot\text{THF}$. The tetrameric metallospecies contains bridging and terminal thiolate ligands with Eu and Zn metal centers. Thermolysis gives a mixture of EuS and ZnS.⁵²⁷ In the presence of zinc chloride, *N,N'*-bis(mercaptoethyl)-1,5-diazacyclooctane nickel(II) forms a heteropentanuclear structure, $([\text{NiL}]_3[\text{ZnCl}]_2)(\text{BF}_4)_2$ with bridging thiolate ligands and S_3Cl tetrahedrally coordinated zinc centers.⁵²⁸

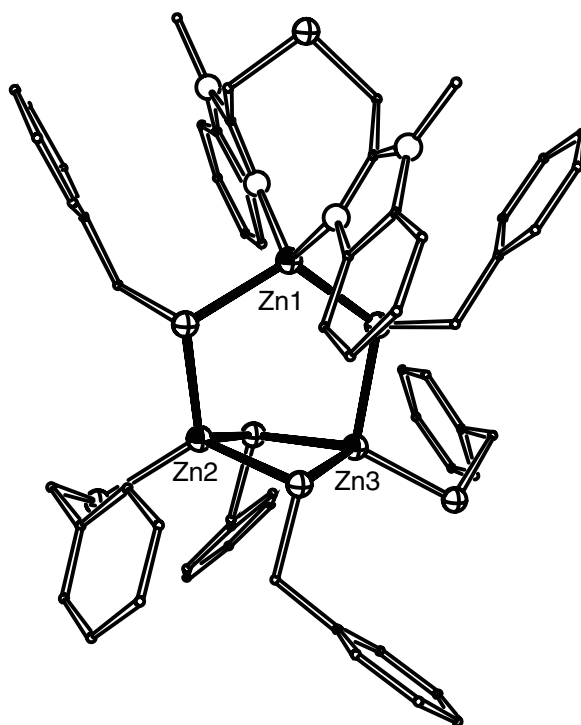

Figure 10 Molecular structure of a zinc trimer (59) with bridging benzyl thiolates and a bis(benzimidazole) ligand.¹²⁶

Polymer formation is still observed with some sterically hindered thiolates, 2,4,6-*iso*-propyl thiophenolate, and 2,4,6-trimethyl thiophenolate complexes have been studied. They can be synthesized by the reaction of $\text{Zn}[\text{N}(\text{SiMe}_3)_2]_2$ with the appropriate arene chalcogenol. With the least steric bulk, the trimethyl derivative forms coordination polymers that can only be dissolved in strongly coordinating solvents. The *iso*-propyl derivative is more soluble forming oligomers in solution.⁵⁰¹

The function and characterization of zinc polymetallic species in proteins has been an important area of research in recent years. The zinc thiol polymetallic species can have a protein structural role, regulate zinc homeostasis, participate in catalysis, and contribute to signal transduction.^{3,529} They include metallothionein, CCHC zinc finger motifs in the HIV nucleocapsid protein, and the gene 32 protein from bacteriophage T4.^{493,530,531} The latter two examples show zinc centers chelated entirely by protein residues with a mixture of cysteine thiols and histidine imidazoles coordinated. The degree of protonation of thiols in polyzinc compounds in proteins has been investigated by mass spectrometry. Electrospray mass spectrometry has demonstrated retention of thiol protons in some classes of protein coordinated zinc centers.⁵³² XAFS has been used to study the structural properties of zinc metallothioneins at 77 K and the structure showed close agreement with the similarly studied cadmium(II) analog.⁵³³

A range of complexes can be formed with dithiol ligands (1,2-benzenedithiol or 3,4-dimercaptotoluene), nitrogen donor ligands (1,10-phenanthroline and biquinoline), and zinc. X-ray crystal structure data showed a mononuclear complex, $\text{Zn}(1,2\text{-benzenedithiolate})(\text{biquinoline})$; two binuclear species, $[\text{Zn}(1,2\text{-benzenedithiolate})(1,10\text{-phenanthroline})_2]$ and $[\text{Zn}(3,4\text{-dimercaptotoluene})(1,10\text{-phenanthroline})_2]$ and a trinuclear species, $\text{Zn}_3(3,4\text{-dimercaptotoluene})_3(1,10\text{-phenanthroline})_2$.⁵²⁵ The redox chemistry and electronic spectra of the doubly deprotonated zinc complex of toluene-3,4-dithiol was studied. The formation of a one-electron ligand-based oxidation product was observed.⁵³⁴ Alkanedithiols can be reacted electrochemically with zinc and the reaction of the product with carbon disulfide studied.⁵³⁵ In bis(2-mercapto-1-methylimidazolyl)(pyrazolyl)hydroborato zinc, ZnL_2 , analysis by X-ray diffraction demonstrates that the zinc exhibits a tetrahedral ZnS_4 structure with only sulfur donors coordinated. This is in contrast with other transition metal complexes of the same ligand showing the preference of zinc for this donor set and coordination sphere.⁵³⁶

Binding of bidentate sulfur ligands can also be of importance in the inhibition of zinc containing enzymes. An aminopeptidase which is essential for vancomycin antibiotic resistance in

Enterococcus faecium is inhibited by binding of dithiol ligands. The most potent inhibitors were dithiols with a two-carbon chain between the thiol groups. It is suggested that both thiols bind from the ligand forming a five-membered chelate ring with the zinc ion at the active site, preventing approach of the vancomycin substrate.⁵³⁷

Varying ratios of the ligands *N*-(2-thiophenyl)-2,5-dimethylpyrrole and *N*-methylimidazole were used to form tetrahedral zinc complexes with S₄, S₃N, and S₂N₂ coordination spheres. X-ray structural analyses and IR spectra were recorded for all compounds and the relevance to zinc finger proteins was discussed. The comparison to cobalt and cadmium structures showed only minor differences, supporting the theory that changes on substituting these metals into zinc proteins would be minor.⁵³⁸

6.8.7.1.2 Thioether ligands and methylation of cysteines

Thioether ligand complexes are not very common, however, studies since the mid 1990s have dramatically increased the number of structurally characterized examples. Almost all of these compounds are with chelate or macrocyclic ligands that will stabilize thioether coordination. Mixed donor multidentate ligands containing thioether donors will be discussed in Section 6.8.11.

A number of zinc-bound bidentate bis(thioether) donor ligands were characterized as distorted tetrahedral complexes of zinc dichloride. The complexes 2,3-bis(methylthio)hexane,1,2-bis(methylthio)cyclohexane, and *cis*-[5,6-bis(methylthio)-1,3-cycloheptadiene] showed a variation in S—Zn—S angles.⁵³⁹

The X-ray structure of the bis(1,4,7-trithiacyclononane) zinc shows an unusual S₆ thioether-coordinated zinc center.⁵⁴⁰ A rare monodentate thioether donor is observed in a phenyl-bridged zinc dimer that has been structurally characterized with a tetrahydrothiophene coordinated to each zinc center.⁵⁴¹

There has been much recent interest in the role of zinc in activating cysteine residues to nucleophilic attack.^{542–545} Alkyl group transfer to coordinated cysteine residues occurs in a number of zinc proteins, such as Ada (the *E. coli* DNA repair protein) and the cobalamin dependent and independent methionine synthases.

Lippard and co-workers have shown thiolate dissociation prior to alkylation in the reaction of Zn(SPh)₄²⁻ with trimethyl phosphate as methyl donor. The kinetics of the reaction were studied and the presence of other amino acids modeled using compounds incorporating imidazole derivatives.^{544,546} The dimeric dithiolate complex [1,5-bis(mercaptoethyl)-1,5-diazacyclooctanato (60)] zinc, [LZn]₂ has been investigated as a model for the active site of zinc-dependent methylation proteins by Darensbourg and co-workers.⁵⁴³ The zinc complex has been characterized by X-ray crystallography, showing a dimeric structure with two five-coordinate zinc centers.⁵²⁸ Alkylation of the thiolate and whether it remains bound in this state were the key issues in this study. It was postulated that the rigidity and chelate effect offered by the tetradentate ligand would encourage the sulfur to remain bound when alkylated. No evidence for thioether ligation after alkylation was observed for these compounds. The aim of encouraging thioether coordination was unsuccessful possibly due to geometric restraints, however, further alterations such as macrocycle formation show thioether coordination. It is suggested that the resultant thioether is still coordinated in the Ada protein. It is possible that either thiolate alkylation occurs while the thiolate is bound or that structural changes in the zinc binding site favor this coordination of the thioether.⁵⁴³

A non-dissociative mechanism was suggested by Vahrenkamp and co-workers in the alkylation of the tris(pyrazolyl)borate complex of ZnSR with methyl iodide, dimethylsulfate, or trimethylsulfonium iodide as the methylating agents.⁵⁴² Corrano and co-workers have also used a tripodal ligand system to investigate the methyl transfer reaction.⁷⁸ The heteroscorpionate ligands (61) have either an N₂S or N₂O donor set, and benzyl mercaptate or thiophenolate were coordinated to complete the coordination sphere. Methylation of the bound thiolate could be carried out with methyl iodide with the reaction rates and lack of solvent dependence consistent with a non-dissociative mechanism. There may be several mechanisms by which zinc complexes participate in the alkylation reaction of cysteine thiolates, with both inter- and intramolecular reactions occurring under different conditions.

The binding of thioether ligands has been further studied by Berg and co-workers in an attempt to gain understanding of the role of the zinc in the reactivity regulation of the cysteine residues to alkylation. Variants of a consensus zinc finger peptide were modified to mimic the effects of

cysteine alkylation and the metal binding and stability of the peptide structure studied. The zinc finger framework had a histidine residue replaced by methionine or S-methyl cysteine, which can be done with no loss of stability. ^1H NMR studies showed the structure of the peptide zinc complex was affected by methylation but only in the vicinity of the modification. Titration and alkylation experiments were carried out with the cobalt analog. As expected, the studies reveal that zinc has a lower affinity for thioether groups than cysteine or histidine.⁵⁴⁵

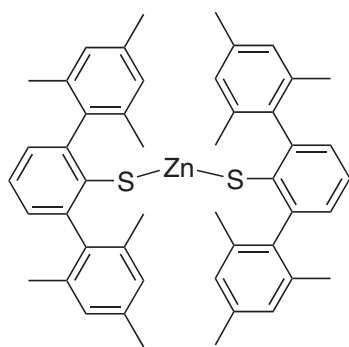

(58)

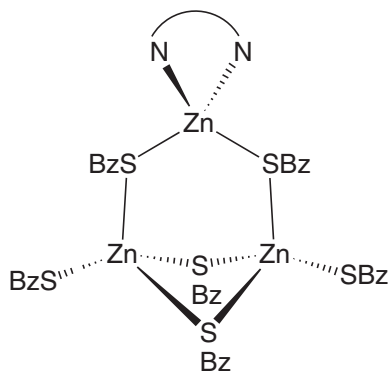

(59)

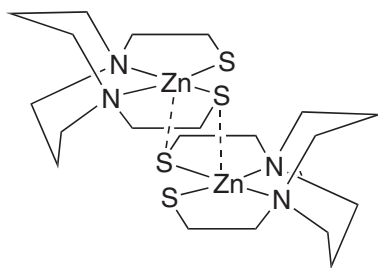

(60)

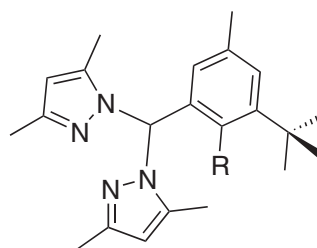

(61)

R=OH, SH

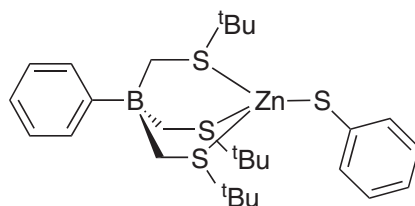

(62)

Models of the active site in *E. coli* methionine synthases were prepared by Riordan and co-workers using the S_3 donor ligand phenyltris((*t*-butylthio)methyl)borate (**62**) (Figure 8). In the zinc complex a thiophenolate ligand, $\text{LZn}(\text{SPh})$, mimics the homocysteine ligated form of the enzyme. Analogous complexes were formed with the NS_2 donor ligand phenyl(3-*t*-butylpyrazolyl)bis((*t*-butylthio)methyl)borate and the zinc complex with a thiophenolate ligand bound presented as mimicking the homocysteine ligated form of cobalamin independent methionine synthase. The average Zn—S bond length in the complex (2.37 Å) compares well with the EXAFS-derived distance observed for the enzyme (2.31 Å).⁵⁴⁷ Other S_3 face-capping ligands are also known in zinc complexes.⁵⁴⁸

6.8.7.1.3 Dithiolates and polysulfides

Dithiolate ligands are of interest in biological and materials chemistry, and zinc polysulfido complexes can effect the dehydrogenative conversion of alkenes into dithiolates (Scheme 2).

If required, the dithiolate ligand can then be removed from the metal center. Zinc polysulfido complexes of diamines and triamines ($\text{ZnS}_6(\text{TMEDA})$, $\text{ZnS}_4(\text{PMDETA})$, and $\text{ZnS}_4(\text{Me}_3\text{TACN})$) can react with electrophilic alkenes to give dithiolate complexes. TMEDA, Me_3TACN , and PMDETA complexes were investigated with the triazacyclononane ligand having the highest reactivity and the PMDETA complexes moderate reactivity. A number of alkenes with cyano, ester, and aldehyde functionalities were tested for reaction.⁵⁴⁹

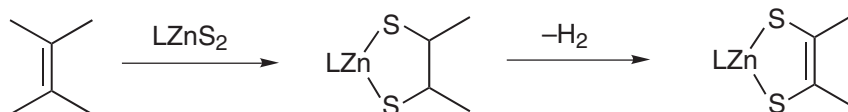

Scheme 2

Some of the proposed dithiolate intermediates were synthesized for study. It was possible to remove the dithiolate ligand by reaction with other species. Crystal structure analysis of $\text{ZnS}_4(\text{PMDETA})$ and $\text{ZnS}_4(\text{Me}_3\text{TACN})$ show five-coordinate species bound to two sulfur atoms from S_4 and the three ligand nitrogens.^{549,550} Both have distorted geometries with one elongated $\text{Zn}-\text{N}$ bond and the reactivity parallels the nucleophilicity of the compounds; the four-coordinate TMEDA species is considerably less nucleophilic.

Rauchfuss and co-workers have carried out extensive recent studies on dithiolate and polysulfide compounds.⁵⁵¹⁻⁵⁵³ Reactions of zinc powder with elemental sulfur can be controlled in donor solvents. The presence of the ligands tetramethylethylenediamine, *N*-methylimidazole, and 4-(*N,N*-dimethylamino)pyridine result in complexes of the type ZnS_6L_2 or ZnS_6L . The solid state structure of the tetramethylethylenediamine complex shows a tetrahedral geometry with a seven-membered ZnS_6 ring. The $[\text{ZnS}_{12}]^{2-}$ can be formed by ligand exchange of the amine ligand with a further S_6^{2-} ligand. The reactivity of the complexes and decomposition to ZnS was studied.⁵⁵¹ The ZnS_6L (L = tetramethylethylenediamine) complex can be used as a polysulfide transfer agent to prepare, for example, sulfur selenide species in isomeric purity.⁵⁵² Zinc dithiolates have also been used as a source for zinc sulfide materials.⁵⁵⁴

6.8.7.1.4 Dithiocarbamates

Zinc dithiocarbamates have been used for many years as antioxidants/antiabrasives in motor oils and as vulcanization accelerators in rubber. The crystal structure of bis[*N,N*-di-*n*-propyldithiocarbamato]zinc shows identical coordination of the two zinc atoms by five sulfur donors in a trigonal-bipyramidal environment with a zinc-zinc distance of 3.786 Å.⁵⁵⁵ The electrochemistry of a range of dialkylthiocarbamate zinc complexes was studied at platinum and mercury electrodes. An exchange reaction was observed with mercury of the electrode.⁵⁵⁶ Different structural types have been identified by variation of the nitrogen donor in the pyridine and *N,N,N',N'*-tetramethylenediamine adducts of bis[*N,N*-di-*iso*-propyldithiocarbamato]zinc. The pyridine shows a 1:1 complex and the TMEDA gives an unusual bridging coordination mode.⁵⁵⁷ The anionic complexes of zinc tris(*N,N*-dialkyldithiocarbamates) can be synthesized and have been spectroscopically characterized.⁵⁵⁸

Thermochemical studies of $\text{Zn}(\text{di-}n\text{-propyldithiocarbamate})_2$ were carried out using solution-reaction calorimetry and differential scanning calorimetry.⁵⁵⁹ Similarly, these values were determined for the di-*n*-butylthiocarbamate compound.⁵⁶⁰ The mean metal-sulfur bond enthalpies were also calculated for each compound and the zinc-sulfur bond enthalpy has also been determined for bis(diethylthiocarbamato) zinc.⁵⁶¹ Structural studies to determine the effects of solid state solvation of zinc bis(diethylthiocarbamate) complexes with a morpholine ligand have been carried out, $[\text{Zn}(\text{O}(\text{CH}_2)_4\text{NH})(\text{S}_2\text{CN}(\text{C}_2\text{H}_5)_2)_2]$. Solvation with morpholine or benzene leads to significant structural reorganization at molecular level with different $\text{Zn}-\text{N}$ bond lengths, a reoriented heterocyclic ring of the coordinated morpholine molecule, and an enhanced contribution of trigonal-bipyramidal character to the geometry of the coordination polyhedra of the zinc center. The data was obtained from single-crystal X-ray studies and solid-state ^{13}C and ^{15}N CP/MAS NMR spectroscopy.⁵⁶²

Complexes of zinc dialkyldithiocarbamates with bidentate nitrogen ligands such as 1,10-phenanthroline have been structurally characterized.⁵⁶³ The related complexes (4,4'-bipyridyl)

bis(di(2-hydroxyethyl)dithiocarbamato)zinc and (4,4'-bipyridyl)bis(bis(*N*-methyl, *N*-ethanol-dithiocarbamato)zinc were synthesized and structurally characterized. Both complexes are dimeric with each zinc five-coordinate with an S₄N donor set. Comparisons are made to the parent dithiocarbamate ligands, with the thioureide C—N stretch at a lower value for these complexes and the cyclic voltammetry studies indicating a presence of excess electron density on the zinc ion relative to the dithiocarbamate ligands.⁵⁶⁴

6.8.7.1.5 Thioformamide, thiocyanate, thiophosphate, and other sulfur donor ligands

The formation of zinc complexes with *N,N*-dimethylthioformamide has been studied by crystallography and in solution by vibrational spectroscopy and large angle X-ray scattering.^{565,566} Both solid state and solution studies show four-coordinate zinc complexes with Zn—S bond lengths of 2.34 (mean) and 2.362(5) Å. In large-angle X-ray scattering studies, the zinc ions in *N,N*-dimethylthioformamide solution are found to coordinate to four *N,N*-dimethylthioformamide molecules with Zn—S bond distances of 2.362(5) Å. Raman and far-IR spectra were assigned for both solution and solid state.⁵⁶⁵ A series of single-crystal X-ray structures demonstrates the variation in geometry between the group 12 ions. The tetrahedral coordination geometry of [Zn(SCHN(CH₃)₂)₄](CF₃SO₃)₂ shows a mean Zn—S distance of 2.34 Å. Hydrogen bonding is observed between neighboring *N,N*-dimethylthioformamide ligands.⁵⁶⁶

The most stable structures and formation energies of zinc thiocyanate complexes have been calculated by *ab initio* density functional methods. The formation energies of the linkage isomers [Zn(NCS)₄]²⁻, [Zn(NCS)₂(SCN)₂]²⁻, and [Zn(SCN)₄]²⁻ were determined. A comparison of the formation energies indicated that [Zn(SCN)₄]²⁻ is the most stable isomer both in water and in dimethyl sulfoxide.⁵⁶⁷

A number of dialkyldithiophosphate zinc complexes were prepared and characterized in liquid and solid states, and as surface complexes on sphalerite. ³¹P NMR was used to characterize the coordination modes, whether terminal chelating or bridging between two metal centers. Correlations were made between data for the structurally characterized *O,O'*-dicyclohexyldithiophosphate zinc and the NMR of the surface complexes demonstrating bridging coordination between two neighboring zinc atoms on the synthetic sphalerite.⁵⁶⁸

Harrison and co-workers reported the ([Zn₄(μ₄-S){μ-S₂P(OC₂H₅)₂}]₆) as a by-product in the synthesis of [Zn{S₂P(OC₂H₅)₂}]₂ which contains the Zn₄(μ₄-S) structural motif.⁵¹¹ A series of zinc dialkyldithiophosphates have been investigated by this research group, including recording ³¹P NMR spectra and studies of the reaction of these compounds with *N*-donor ligands. Monomeric complexes are formed in reaction with pyridine, 2,2'-bipyridine, and 2,2'-6',2''-terpyridine with a combination of *N*-donor and thiophosphate ligands.^{569,570}

As part of a study into the activation of metal catalysts in thiol or thiolate-rich environments, *S*-substituted coenzyme M and thioglycolate derivatives were investigated in a Ni-catalyzed cross-coupling reaction with a zinc co-factor; the role of zinc was shown to be in a transmetallation process.⁵⁷¹

The interaction of carbon disulfide as a substrate in carbonic anhydrase model systems has been studied using density functional theory methods. A higher activation energy of CS₂ compared to CO₂ in the reaction with [L₃ZnOH]⁺ was due to the reduced electrophilicity of CS₂. The reversibility of the reaction on the basis of these calculations is questionable with [L₃ZnSC(O)SH]⁺ as intermediate.⁵⁷²

An example of thione coordination is demonstrated with the thiocarbonyl donor ligand 2,6-dimethyl-4H-pyran-4-thione, that gives a complex with zinc chloride of the form ZnL₂Cl₂. The crystal structure shows the zinc is tetrahedrally coordinated by two chloride and two sulfur donors and the compound was further studied by ¹H NMR and IR spectroscopy.⁵⁷³ Both monomeric and dimeric heterocyclic thione complexes have been formed with zinc.^{574,575}

The dithiolate ligand dithiosquarate forms mononuclear complexes with zinc in the presence of N₂ donor ligands 2,2'-biquinoline, 1,10-phenanthroline, and 1,4-diphenyl-2,9-dimethyl-1,10-phenanthroline. X-ray crystallography shows a tetrahedral complex with one equivalent of each ligand binding to the zinc center. The phenanthroline-based complexes are emissive in the solid state at room temperature and show multiple emissions at lower temperature, assigned as metal-assisted ligand-to-ligand charge transfer and intraligand π-π* transitions.⁵⁷⁶ Bipyridinium and phenanthroline acceptors of different reduction potentials form ion-pair charge-transfer complexes with zinc 1,2-dithiooxalates. Absorptions are observed in the range 390–490 nm, which can be

attributed to ion-pair charge-transfer. The mean reorganization energy of the complexes exceeds the values found for the dithiolate systems. The X-ray structures of the compounds show the relative geometry of the two components.⁵⁷⁷

A dithiolate ligand forms a structurally characterized dizinc bisligand complex with both of the ligands bridging, bis{ μ -[(dimercaptomethylene)propanedinitrilato-*S,S'*]}tetrakis(4-methylpyridine) dizinc.⁵⁷⁸

6.8.7.2 Selenium

6.8.7.2.1 Selenides

A number of zinc selenium complexes have now been characterized, with particular interest in the formation of zinc selenide semiconductors and quantum dots. In many cases analogous structures to those observed with thiol or thiolates are recorded. ⁷⁷Se NMR is frequently used in characterization, and comparison with the sulfur equivalent is relevant. Zinc selenium compounds are of particular interest as precursors for metal/selenide materials and their relevance as models for selenocysteine-containing metalloproteins.

The reaction of carbon diselenide with sodium and zinc chloride present results in the complexes [Zn(C₃Se₅)₂]²⁻ (**63**) and [Zn(CSe₄)₂]²⁻. X-ray structure showed the zinc ions were tetrahedral with four selenium atoms coordinated. The UV-vis spectra and ⁷⁷Se NMR spectra were recorded.⁵⁷⁹ A tetrahedral selenolate complex can be formed from a ligand containing a 1,3-thiaselenole heterocycle. The zinc complex, bis(tetraphenylphosphonium)-bis(1,3-thiaselenole-2-selone-4,5-diselenolato) zinc, with the selenole ester-containing ligand was characterized in detail by NMR with extensive ⁷⁷Se and ¹³C spectra recorded.⁵⁸⁰

The zinc bis(tetraseleno) anion, [Zn(Se₄)₂]²⁻, has been crystallized with a number of cations, synthesized by a variety of methods, and its reactivity studied.⁵⁸¹⁻⁵⁸⁴ The compound (hexaseleno) (tetraseleno)zinc (**64**) was synthesized from zinc acetate in the presence of lithium polyselenide and structurally characterized, demonstrating seven-membered and five-membered ZnSe_n rings.⁵⁸⁵ Mixed donor neutral monomers have also been formed with imidazole *N*-donor ligands, ZnSe₄ (*N*-methylimidazole)₂.⁵⁵³

Polymeric network structures of zinc and selenium with *N,N'*-ethylenediamine have been formed and structurally characterized. The tetrahedral zinc centers are Se₃N coordinated with the diamine bridging to give two-dimensional slabs.⁵⁸⁶

6.8.7.2.2 Selenolates

A monomeric selenolato complex of zinc (**65**) was synthesized with a chelating oxazoline ligand.⁵⁸⁷ The complex was characterized by X-ray crystal structure, ¹H, ¹³C, and ⁷⁷Se NMR. These studies demonstrate that the compound is "helically" chiral and solution studies appear to show retention of chirality in solution. The zinc complex is tetrahedral with a Zn-Se average bond length of 2.378(1) Å.

A monomeric zinc selenophenolate, bis(phenylselenolato)zinc TMEDA, has been isolated and structurally characterized and used as a precursor in the size-controlled synthesis of ZnSe quantum dots. The growth temperature afforded the different-sized quantum dots that showed a variation in luminescence emission wavelength dependent on size.⁵⁸⁸ A trigonal planar monomeric selenophenolate complex can be synthesized using the bulkier 2,4,6-(trifluoromethyl)selenophenolate. The complex has two of the selenophenolate ligands and a bisilylamide completing the trigonal coordination.⁵⁸⁹ Bochmann *et al.* structurally characterized a number of zinc selenates including three-coordinate and four-coordinate monomeric species.^{304,507,590}

Monomeric selenophenolate derivatives with pyridine have also been synthesized and characterized, [Zn(SeC₆H₂Me₃-2,4,6)₂(pyridine)₂] with distorted N₂Se₂ tetrahedral coordination geometry.⁵⁹¹ Zinc areneseelenolate complexes are usually infinite lattice solid state compounds with bridging selenolato ligands.⁵⁹² Zinc selenophenolate complexes have been characterized by single-crystal X-ray diffraction, showing tetrahedral metal centers, and far-infrared and Raman spectroscopy.⁴⁹⁹ Increasing the steric hindrance from the (2,4,6-trimethylphenylselenato) group to the *t*-butyl equivalent results in different complexes dependent on the other ligands available. In the presence of one equivalent of *t*-butylisocyanide the compounds is thought to be

dimeric with bridging selenolates and in the presence of excess of *t*-butylisocyanide the X-ray structure shows a monomeric species with an S_2C_2 donor set and distorted tetrahedral coordination geometry.⁶⁶ A dimeric species is formed in the presence of benzaldehydes or ketones. The X-ray structure of $[Zn(SeC_6H_2^1Bu_{3-2,4,6})(4\text{-methoxybenzaldehyde})_2]$ demonstrates two bridging selenolates between the tetrahedral zinc centers.⁵⁹³ The complex $[Zn(CH_2SiMe_3)_2(SeC_6H_2^1Bu_{3-2,4,6})_3]$ contains a nonplanar six-membered Zn_3Se_3 ring and is characterized by X-ray diffraction, and 1H NMR and IR spectroscopy.⁸² The dimeric $[Zn(SeC_6H_2^1Bu_{3-2,4,6})_2]$ can be reacted with nitrogen, phosphorus, or sulfur donor ligands to give monomeric three-coordinate species. The ligands 2,6-lutidine, tetrahydrothiophene, trimethylphosphine, and methylphenyl phosphine all result in monomer formation and the solid-state structures show a wide variation in Se—Zn—Se angles from $129.0(2)^\circ$ to $156.26(4)^\circ$. Theoretical interpretations of the hybridization of zinc were used to account for these variations. A four-coordinate monomeric complex, $[Zn(SeC_6H_2^1Bu_{3-2,4,6})_2L_2]$, could be formed in the presence of excess 1-methylimidazole but on recrystallization one ligand was lost to give the three-coordinate showing the balance between electronic and steric factors.³⁰⁴

The sterically demanding selenolate ligand, $HSeC_6H_3\text{-}2,6\text{-}(\text{mesityl})_2$, reacts with zinc to form either two- or three-coordinate complexes in the solid state. If recrystallized from tetrahydrofuran the monomeric complex $Zn(HSeC_6H_3\text{-}2,6\text{-}(\text{mesityl})_2)_2(\text{THF})$ with two selenolate ligands and a coordinated THF is isolated; however, when recrystallized from hexane a two-coordinate monomeric complex with only the selenolate ligands is isolated. The two-coordinate complex appears to be the only example of this geometry with selenium. Intriguingly, the geometry of this complex is exactly linear in contrast to the analogous thiolate complex which has a bent conformation with $Zn\text{-}S\text{-}Zn = 151.7^\circ$. Power and co-workers comment on a number of important factors to the setting of two-coordinate geometries but offer no simple explanation of this difference.¹³

The tetrameric zinc anion $[Zn_4(\mu\text{-}SePh)_6(SePh)_4]^{2-}$ has been structurally characterized as the first example of a Zn_4Se_4 adamantane cage-type structure.⁵⁹⁴ A further example was characterized by Bochmann and co-workers as part of a study of polymetallic zinc selenophenolates, in this case with chlorides replacing the terminal selenophenolates, $[Zn_4(\mu\text{-}SePh)_6Cl_4]^{2-}$. Octameric zinc species were also characterized with either chloride or phosphine ligands resulting in anionic and neutral complexes respectively, $[Zn_8(\mu\text{-}SePh)_{12}Cl_4]^{2-}$ and $Zn_8(\mu\text{-}SePh)_{12}(SePh)_2(P^iPr_3)_2$.³⁰¹

The heterotrinnuclear linear selenolate complex, $[(OC)_3Fe(\mu\text{-}SePh)_3Zn(\mu\text{-}SePh)_3Fe(CO)_3]$, was synthesized and structurally characterized. The structure shows a zinc center in a $ZnSe_6$ octahedral environment.⁵⁹⁵ A bimetallic complex containing europium and zinc has been characterized with three bridging selenophenolate ligands. Analysis of the structural data by Berardini *et al.* shows a clear polarization of the Se electron density away from the europium ion, making the Eu—Se bond longer and weaker.⁵⁹⁶ A related structural motif with a triply bridged samarium zinc unit is observed; however, in this case the samarium is also singly bridged to a further zinc resulting in a coordination polymer in the solid state.⁵⁹⁷ A tetracobalttetrazinc structure with Zn_4O core has been characterized with aminoethaneselenolato ligands bridging the cobalt(III) and zinc centers. Each zinc is bound to three bridging selenium atoms and the central oxo forms a cage-type structure.⁵⁹⁸ The bis(1,2-diselenosquarato) zinc dianion is a tetrahedral monomer with coordination to the bidentate ligands via the selenium donors.⁵⁹⁹

A monomeric diselenocarbamate complex of zinc has been structurally characterized as a pyridine adduct, $[Zn(Se_2CNet_2)_2(\text{pyridine})]$, showing distorted trigonal-bipyramidal geometry. Mixed selenophenolate/diselenocarbamate complexes have been formed with a 1:1 ratio of each ligand to the zinc center.⁵⁹¹ The structural type is strongly influenced by functionalization on the selenophenolate ring. The (2,4,6-trimethylphenylselenato) zinc complex is a polymeric solid which dissolves in coordinating solvents.⁵⁰¹ The compound $Zn[Se_2CN(Me)CH_2CH_2CH_2NMe]_2$ is polymeric in the solid state with a Se_4N donor set. The *N*-donor is from a neighboring ZnL_2 unit, resulting in the polymeric arrangement. Attempts to grow ZnSe films were made and discussed.⁶⁰⁰ The zinc complex with methyl(*n*-hexyl)diselenocarbamate was found to be a more effective precursor for ZnSe deposition by MOCVD than simpler derivatives and possible explanations were suggested.⁶⁰¹ Bis(μ_2 -diethyldiselenocarbamate-*Se,Se,Se'*)-dimethyl dizinc gives a structure with four-coordinate zinc centers and two bridging selenium atoms.⁶⁰² Other related structures with variation in the alkyl groups are also known.⁶⁰³

The preparation of ZnSe materials is an area of interest and study. The coordinating ability of the solvent used in the solvothermal synthesis of zinc selenide was demonstrated to play an important role in the nucleation and growth of nanocrystalline ZnSe.⁶⁰⁴ Thermolysis of bis [methyl(*n*-hexyl)di-seleno]carbamate]zinc gave highly monodispersed particles characterized by electronic spectroscopy, photoluminescence, X-ray diffraction, and electron microscopy.⁶⁰⁵

6.8.7.3 Tellurium

Although numbering even fewer than the structurally characterized selenium zinc complexes there are examples of zinc tellurides and tellurates with typical coordination numbers of three or four and species from monomeric up to polymeric.

Addition of K_2Te_3 to a solution of zinc acetate results in a compound containing the $[ZnTe_7]^{2-}$ complex ion. The heptatellurido zinc has a trigonal-planar coordination geometry, demonstrated by X-ray crystallography. The ligands are best described as a chelating Te_4^{2-} ion and a terminal Te_3^{2-} ion.⁶⁰⁶ The bis(tetratellurido) zinc complex is an anion ($ZnTe_8^{2-}$) which shows the metal coordinated tetrahedrally by two Te_4^{2-} chelates. The ^{125}Te NMR spectrum was recorded and compared with ^{77}Se NMR spectra from analogous compounds.⁶⁰⁷ An ionic polymetallate results from zinc chloride in acetone in the presence $PhTeSiMe_3$ and tertiary phosphines, $[(HPPR_2R)-Pr-n]_2[Zn_8Cl_4Te(TePh)_{12}]$ ($R = n-Pr, Ph$). If the solvent is changed to tetrahydrofuran an uncharged Zn_{10} compound is isolated, $[Zn_{10}Te_4(TePh)_{12}(PR_3)_2]$ ($R = Pr-n, Ph$). All compounds have been characterized by X-ray crystallography.³⁰¹

Zinc tellurolates have been synthesized with bulky silyl tellurolate ligands giving hydrocarbon solubility and enforcing low coordination numbers. The anion $[TeSi(SiMe_3)_3]$ gave the complex $Zn[TeSi(SiMe_3)_3]_2$ (**66**) which exists as a dimer, with two bridging and two terminal tellurolate ligands, in solution and in the solid state. In the presence of pyridine or 2,2'-bipyridine a monomer is formed, $Zn[TeSi(SiMe_3)_3]_2(pyridine)_2$ (**67**). The compounds were studied using 1H and ^{125}Te NMR in solution and by single-crystal X-ray diffraction.⁶⁰⁸

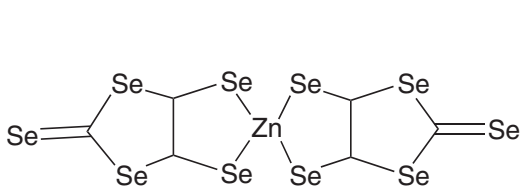

(63)

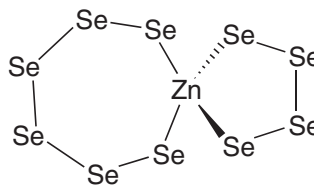

(64)

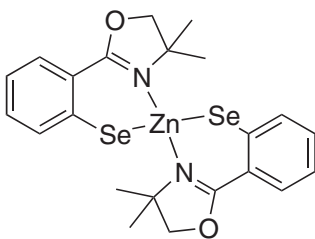

(65)

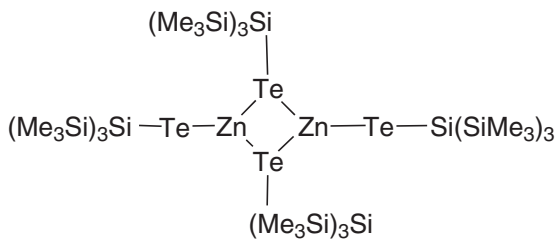

(66)

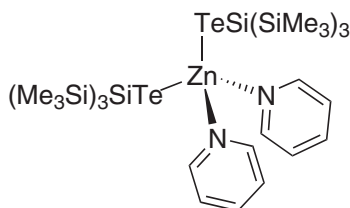

(67)

The monomeric compound bis(phenyltellurido)(TMEDA) zinc has been synthesized with, once again, a particular interest in the controlled deposition of a pure solid state compound, in this case $ZnTe$ nanocrystals.^{302,609}

TMEDA can also participate in the formation of multinuclear zinc telluride complexes with Zn_{10} , Zn_{14} , and Zn_{16} complexes structurally characterized. A comparison was carried out by Pfister *et al.* replacing the diamine with a diphosphorus ligand, bis(diphenylphosphino)methane,

and a new type of Zn_{12} structure was observed.³⁰² Li and co-workers produced polymeric network solids from diamines, *N,N'*-ethylenediamine and propylenediamine, with zinc and bridging telluride ligands. These covalent inorganic–organic lattices show different topologies dependent on the conditions of synthesis or the diamine used. All structures show tetrahedral $ZnTe_3N$ units with μ_2 -diamines and μ_3 -tellurides.⁶¹⁰

A number of zinc derivatives of a mesityl tellurolate, $(2,4,6-Me_3C_6H_2Te^-)$, have been synthesized. A $[Zn(2,4,6-Me_3C_6H_2Te)_2]_n$ coordination polymer forms which can only be dissolved in strongly coordinating solvent. In the presence of one equivalent of trimethylphosphine a dimeric complex forms with two trigonal zinc centers whereas excess trimethylphosphine or other Lewis bases gave a four-coordinate monomeric adduct. The compound $[Zn(2,4,6-Me_3C_6H_2Te)_2(pyridyl)_2]$ was structurally characterized showing the expected tetrahedral zinc center; thermal deposition to form ZnTe was investigated.⁶¹¹

6.8.8 HALIDE LIGANDS

A number of zinc halide complexes, including bridging halides, have already been mentioned in the context of the other ligands systems discussed in this Chapter. Examples will be presented of catalytic systems and solution speciation, particularly in the presence of other coordinating ligands. There are now also a few zinc fluoride species that have been well characterized.

6.8.8.1 Chlorides, Bromides, and Iodides

The molecular structures from electron diffraction of zinc dichloride, zinc dibromide, and zinc diiodide have been reinvestigated.⁶¹² The important effects halides have on geometry have also been investigated, in particular the changes from octahedral to tetrahedral geometry in the presence of chloride ions have been studied.⁶¹³

There are a number of structurally characterized examples of the tetrahedral $[ZnCl_4]^{2-}$ anion.^{614–616} Hydrogen bonding to the chlorine atoms involving NH groups and water molecules has been observed.⁶¹⁷ For example, the reaction of xanthine with zinc chloride in dilute hydrochloric acid results in a solid-state structure, $(Hxanthine)_2[ZnCl_4]$, in which the ions are linked by strong hydrogen bonding.⁶¹⁴ A polyimidazole ligand has been developed for the coordination of zinc tetrachloride (**68**), $[ZnCl_4]^{2-}$ via hydrogen bonding. The X-ray crystal structure shows that the inorganic ion is bound via protonation of imidazoles of the tripodal ligand resulting in $NH\dots Cl$ hydrogen bonds.⁶¹⁸

The stability of zinc monohalide complexes in alcohol and solvent mixtures containing methanol, dimethylsulfoxide, acetonitrile, and water has been determined.⁶¹⁹ Formation of binary and ternary complexes of zinc ions with halides and 2,2'-bipyridine was studied by calorimetry in DMF at 25 °C.^{205,620,621} The study of concentrated aqueous solutions and liquid hydrates of zinc chloride have been carried out using a number of spectroscopic techniques.⁶²² Four-coordinate compounds $[ZnX_2(DMF)_2]$ and $[ZnX_3(DMF)]^-$ were suggested to be present, amongst others, in the presence of bromide and iodide ions. The chloride ions gave a predominant species $[ZnCl_2(bpy)]$ which is present to a lesser extent for bromide and at very low level for iodide. This species is in equilibrium between four- and six-coordinate with two DMF molecules completing the coordination sphere. The concentration of the species $[ZnX(bpy)_2]^+$ is high for iodide, less for bromide, and this species is not found for chloride.

Heterocyclic nitrogen donors and their adducts with zinc chloride have been studied.^{623,624} A large number of other ligand systems have also been characterized, for example, zinc halide adducts of 2,2-dimethylpropane-1,3-diamine and hexamethylphosphoramide have been studied.^{625,626} The formation of mixed ligand complexes with chloride and substituted pyridines has been studied.⁶²⁷ The zinc tris(pyridyl) chloride anion has also been structurally characterized.⁶²⁸ Manganese(II) ions have been used to probe the stereochemistry in reactions of zinc halides with pyrazine.⁶²⁹

Although less common than zinc chlorides, there has been much synthetic and structural work carried out on zinc bromide and iodide complexes. For example, the 1:1 adduct of *N,N,N',N'*-tetramethyl-*o*-phenylenediamine with zinc bromide has been structurally characterized.⁶³⁰ The ion exchange properties of zinc bromide and iodide have been studied in ethylene glycol.⁶³¹ The electrolytic behavior of zinc bromide in propylene carbonate has been studied and the conductance data shows the existence of dimers.⁶³²

6.8.8.2 Reactions and Catalysis

In the presence of zinc chloride, stereoselective aldol reactions can be carried out. The aldol reaction with the lithium enolate of *t*-butyl malonate and various α -alkoxy aldehydes gave anti-1,2-diols in high yields, and 2-trityloxypropanal yielded the syn-1,2-diol under the same conditions.⁶³³ Stoichiometric amounts of zinc chloride contribute to the formation of aminonitropyridines by direct amination of nitropyridines with methoxyamine under basic conditions.⁶³⁴ Zinc chloride can also be used as a radical initiator.⁶³⁵

Cycloaddition of 2-cyanoalk-2-enones with several conjugated dienes proceeded under zinc chloride catalysis.⁶³⁶ Zinc halides have also shown reactivity with phenylacetylenes.⁶³⁷ Zinc chloride is an effective Lewis acid catalyst in the Diels–Alder reactions of the keto esters and the effects on stereochemistry of catalysts used have been examined.⁶³⁸

Zinc chloride was used as a catalyst in the Friedel–Crafts benzylation of benzenes in the presence of polar solvents, such as primary alcohols, ketones, and water.⁶³⁹ Friedel–Crafts catalysis has also been carried out using a supported zinc chloride reagent. Mesoporous silicas with zinc chloride incorporated have been synthesized with a high level of available catalyst. Variation in reaction conditions and relation of catalytic activity to pore size and volume were studied.⁶⁴⁰ Other supported catalytic systems include a zinc bromide catalyst that is fast, efficient, selective, and reusable in the *para*-bromination of aromatic substrates.⁶⁴¹

Zinc iodide catalysts are also known. Desulfonylative iodination of naphthalenesulfonyl chlorides has been carried out by treatment with zinc iodide in the presence of a palladium(II) catalyst.⁶⁴²

6.8.8.3 Fluorides

Fluoride ion selective spectrometry was used to determine the stability constants for zinc fluoride complexes in water at 25 °C, giving values $\beta_1[\text{ZnF}_{(\text{aq})}]^+ = 3.5 \pm 0.1$ and $\beta_2[\text{ZnF}_{2(\text{aq})}] = 3.8 \pm 0.5$.⁶⁴³ These results demonstrate that the complexation of fluoride is very weak and in aqueous chemistry no species beyond ZnF^+ is of much importance. Organotitanium fluorides have been used as matrices for trapping “molecular” ZnF_2 and MeZnF .⁶⁴⁴

The structurally characterized fluoro[tris(3-*p*-tolyl-5-methylpyrazol-1-yl)hydroborato]zinc complex was synthesized by metathesis of the acetate complex with potassium fluoride or from the free ligand and zinc perchlorate in the presence of potassium fluoride, and used as a convenient precursor in the formation of hydride complexes.²⁴¹ Pyridyl-substituted tris (pyrazolyl)borate ligands give a dimeric structure with each zinc atom coordinated to four nitrogen donors and one fluoride with one of the pyridyl donors from the neighboring ligand coordinated.²³⁴ Tris (1-*t*-butyl-2-thioimidazolyl)hydroborate coordinates as a face-capping S_3 ligand with a fluoride completing the tetrahedral coordination.⁶⁴⁵

The CSD revealed only one example of the fluoride-bridged dimeric Zn_2F_2 , analogous to the commonly observed unit for the other halides. The compound characterized by Roesky and co-workers is the only structure known with fluoride-bridged zinc atoms.⁶⁴⁶ Maggard *et al.* show a bridging fluoride between a molybdenum(V) and the zinc center in a coordination

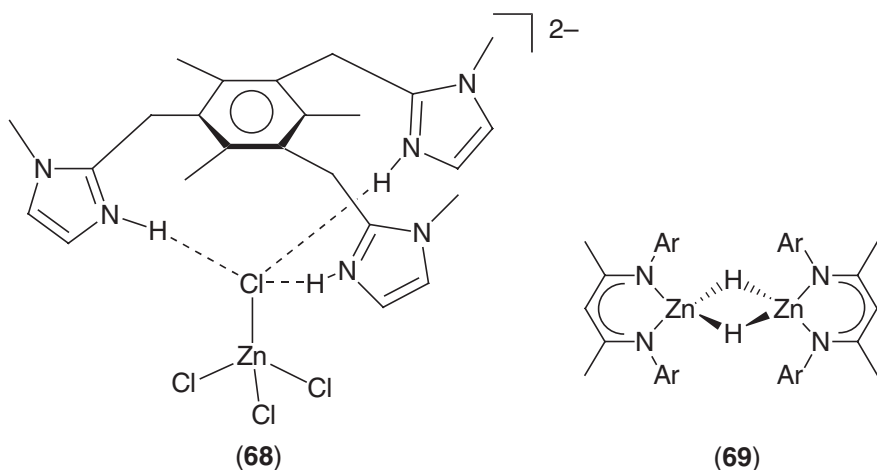

polymer with pyrazine bridging the zinc centers.⁶⁴⁷ An interaction with a fluorine from a hexafluorosilane, SiF₆ unit is observed in zinc coordination polymer.⁶⁴⁸ A porous solid formed via a related route, with a pyridyl donor linker, shows a similar interaction in a coordination polymer with Zn—SiF₆—Zn bridges.²⁸⁴

6.8.9 HYDRIDE AND RELATED LIGANDS

6.8.9.1 Hydrides

There has been an increasing number of reports of the utilization of zinc hydride complexes as precursors in organic transformations and as reducing agents. Zinc hydrides have been less well investigated than the other group 13 hydrides due to the formation of polymeric and oligomeric species that are difficult to characterize.

Complexes of hydrido zinc chloride and TMEDA can be formed by reaction of zinc hydride and zinc chloride in the presence of TMEDA. The reactions of the zinc hydride species with organic substrates have been investigated.⁶⁴⁹ Roesky and co-workers have structurally characterized an example of a dizinc compound with a bridging hydride. No other examples of this type were found in the CSD. The complex $[\{\text{HC}(\text{CMeNAr})_2\}\text{Zn}(\mu\text{-H})_2]$ (Ar = 2,6-Me₂C₆H₃) (**69**) cannot be obtained directly by reaction of the ligand with zinc hydride but rather by initial formation of the analogous $\mu\text{-F}$ complex and subsequent reaction with triethylsilane.⁶⁴⁶ The Zn—H bond lengths (1.766 Å) are longer than those observed in the terminal hydride structures. The bulky aryl substituents favor the formation of the electron-deficient three-center-two-electron Zn—H—Zn bonds.

There are a few structurally characterized zinc compounds with terminal hydrides. A zinc tetramer forms a cube with four phosphoraneiminato ligands, $[\text{ZnH}(\text{NPMe}_3)]_4$ has a terminal hydride ligand coordinated to each zinc center. The structure shows a virtually undistorted Zn₄N₄ cube with an average Zn—H bond distance of 1.50 Å and the compound is highly reactive.⁶⁵⁰ A monomeric zinc hydride, tris(3-*tert*-butylpyrazolyl)hydroborato zinc hydride, has been synthesized, the structure determined and reactivity investigated.^{651,652} Synthesis was carried out by transmetalation of a thallium compound with ZnH₂ but a related compound, tris(3-tolyl-5-methylpyrazolyl)hydroborato zinc hydride, was synthesized by reaction of the fluoride derivative with triethylsilane.²⁴¹

Bridging hydrides can be present in heteromultimetallic species. A tantalum/zinc dimer is bridged by two hydride ligands and similarly a rhodium/zinc dimer is triply bridged by hydrides.^{653,654} A structurally characterized trimeric Mn₂Zn complex has been synthesized from a manganese dimer with two bridging hydrides in reaction with zinc amalgam and TMEDA. The zinc–manganese edges in the product are bridged by the hydride ligands and the compound has been studied by NMR.⁶⁵⁵

6.8.9.2 Hydroborate Ligands

In recent years a number of zinc hydroborate complexes have been structurally characterized with one or more hydrogens interacting with the zinc center. The simplest is probably the tris(tetrahydroborato)zinc anion, $[\text{Zn}(\text{BH}_4)_3]^-$, which was crystallized as the tetraphenylphosphonium salt. The structure shows an octahedral zinc coordinated by three bidentate tetrahydroborate ligands.⁶⁵⁶ Methylzinc tetrahydroborate is also known. The X-ray crystal structure shows a helical polymer with alternating methyl zinc and tetrahydroborate units. The BH₄⁻ acts as a bidentate ligand to two zinc centers giving a structure that resembles Be(BH₄)₂ with the MeZn unit replacing the beryllium. Reactions of the compound were investigated with disproportionation a common feature.⁶⁵⁷ A chelating tetrahydroborate is also observed in a monomeric zinc complex with a TMEDA ligand and a chloride also coordinating.⁶⁵⁸

A tetrameric Zn₂V₂ compound contains both zinc-to-vanadium bridging hydride ligands and chelating tetrahydroborate groups.⁶⁵⁹ The neutral borane ligand bis(trimethylphosphine)diborane acts as a bidentate donor in the formation of a monomeric complex with ZnCl₂. A hydrogen ligand is bound from each boron giving a five-membered chelate ring.⁶⁶⁰ Parkin and co-workers have synthesized bispyrazolylborate complexes of zinc that have an N₂ donor set bound from the ligand, with an additional weak interaction with the B—H group. Monomeric complexes are

formed with methyl or iodide ligands.^{163,164} This research group has also investigated bis(mercaptoimidazolyl)borato zinc complexes, where similar interactions are observed. The 3-center-2-electron $\text{Zn} \cdots \text{H}-\text{B}$ interactions in the bis(mercaptoimidazolyl)borato zinc X-ray structures are at distances of between 1.77 and 2.06 Å.⁶⁶¹

6.8.10 MACROCYCLIC LIGANDS

Macrocyclic complexes of zinc have inspired interest in varied areas such as supramolecular and biomimetic chemistry; including hydrolysis enzymes, such as phosphatases and esterases, and also for the fluorescent detection of zinc. The polyaza macrocycles and their *N*-functionalized derivatives are particularly well represented. An important aspect of macrocycle synthesis is the use of metal templates to form the ligand. Examples of zinc as a template ion will be discussed where relevant.

6.8.10.1 Azamacrocycles

Small-ring cyclic diamines have already been discussed in Chapter 1.20. The azamacrocycles offer the possibility for functionalization at the nitrogen donor groups and many examples will be presented from triazamacrocycles up to much larger polyaza macrocycles that will bind more than one zinc ion. Particular mention must be made of the large contribution of Kimura and co-workers to this area.

6.8.10.1.1 Ligands based on triaza crowns

The crystal structure of trimethyltriazacyclononane zinc nitrate shows an unexpected octahedral environment.⁶⁶² The coordinated aquo ligands are hydrogen bonded to the nitrate counterion. It had typically been assumed that a tetrahedral or a square-pyramidal complex with bound water is formed for other aza-containing ligands. The $\text{p}K_{\text{a}}$ was shown to be 10.9 followed by 12.3 for $\text{p}K_{\text{a}2}$. These results demonstrate that a decrease in coordination number increases the acidity as is borne out by the coordination numbers in zinc enzymes. Only a few zinc enzymes contain octahedral centers, such as glyoxalase 1; however, bound hydroxides are not implicated as intermediates in these enzymes. Weighardt and co-workers produced a binuclear complex with the same ligand by variation of the pH, counter ion and solvent. Using water as solvent and the perchlorate salt, the bis(hydroxo) bridged dimer was formed.⁶⁶³

¹H NMR studies of the zinc complex formed with the hexadentate aniline functionalized triazacyclononane ligand (**70**) showed C_3 symmetry in solution. It is suggested a six-coordinate complex is formed with all *N*-donors bound.⁶⁶⁴ This compares with the benzyl amino derivative, 1,4,7-tris(*ortho*-aminobenzyl)-1,4,7-triazacyclononane.⁶⁶⁵ The X-ray structure shows a six-coordinate octahedral coordination with average Zn–N distances of 2.23 Å. The solution NMR spectra were studied showing dynamic equilibria. Zinc forms six-coordinate complexes of amide functionalized triazacyclononane ligands (**71**) and (**72**).⁶⁶⁶ The crystal structure of the zinc complex of 1,4,7-triazacyclononane monoacetate reveals a six-coordinate structure forming polymeric chains in the solid state bridged by the acetate pendent arm. The zinc is bound to the three ring nitrogens and an acetate oxygen from the ligand, a water molecule and a bridging acetate from an adjacent ligand. The solubility of the compound suggests the bridging acetate is not maintained in solution and ¹H and ¹³C NMR were recorded.⁶⁶⁷ The zinc complex of 1,4,7-triazacyclononane-*N,N',N''*-tris(methylenephosphonate monoethylester) has been studied by potentiometry and NMR.⁶⁶⁸ Triazacyclononane with one, two, or three pendent phosphine arms has been complexed to zinc. The complex with *N*-(diphenylphosphinopropyl)-1,4,7-triazacyclononane $[\text{Zn}_2\text{L}_2\text{Cl}_3][\text{ClO}_4]$ has been structurally characterized by X-ray crystallography.³¹⁰ Secondary amine pendent arms in the ligands 1-(2-aminoethyl)- and 1-(3-aminopropyl)-1,5,9-triazacyclododecane form complexes with increased stability relative to tertiary amine pendants and allow an increase in coordination number. The structurally characterized complex of the 2-aminoethyl ligand $[\text{ZnL}(\text{ClO}_4)]^+$ reveals a trigonal-bipyramidal geometry.⁶⁶⁹

Bis(triazacyclononane) ligands (**73**) where the two macrocycles are linked with chains two to eight carbons in length have been complexed with zinc to form monomeric and dimeric

complexes. A two- or three-carbon linker gives a monomeric complex with the X-ray structure showing an octahedral zinc bound to all six nitrogen donors. The five-carbon linker gives a complex $[\text{Zn}_2\text{L}(\mu\text{-Cl})_3]_2(\text{ClO}_4)_2$ where each macrocycle in the ligand has one zinc bound to three nitrogen donors and three bridging chlorides link it to an adjacent molecule giving an octahedral coordination geometry. As with copper the most stable structure switches from monomeric to oligomeric complexes between a four- and five-carbon linker.⁶⁷⁰

Functionalization of the bis(triazacyclononane) compounds has been carried out to give ligands with 2-pyridyl-methyl pendent arms (74). The bridge has been varied including ethyl, propyl, *meta*- $\text{CH}_2\text{C}_6\text{H}_4\text{CH}_2$, and $\text{CH}_2\text{CH}(\text{OH})\text{CH}_2$.⁶⁷¹ The crystal structure of the zinc complex of the ligand with the propanol linker showed deprotonation to form an alkoxide bridge between the two zinc centers giving a Zn—Zn separation of 3.904(2) Å. The coordination sphere for the two six-coordinate zinc ions is completed by the five nitrogen donors from each side of the ligand. This separation matches that found in alkaline phosphatase.⁴⁴¹ The ligand with the ethyl linker shows two six-coordinate zinc centers each with five nitrogen donors from the ligand and a bromide ion bound and a Zn—Zn distance of 6.545(9) Å. Solution structure was studied by NMR and compared with the solid state data.

As already mentioned, larger ring size triazamacrocyclic ligand complexes have also been characterized. The zinc bromide complex of 1,5,9-triazacyclododecane has been characterized as a mononuclear complex with a tetrahedral zinc center.⁶⁷² Kimura and co-workers have extensively studied zinc complex formation with 1,5,9-triazacyclododecane-based ligands.^{445,673–676} 1,6,11-triazacyclopentadecane forms a zinc complex of the composition $\text{Zn}_3\text{L}_2\text{Cl}_6$. NMR studies

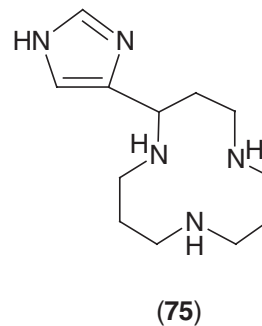
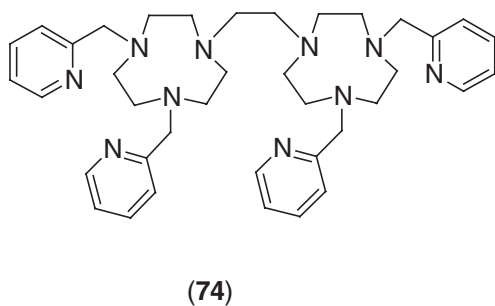
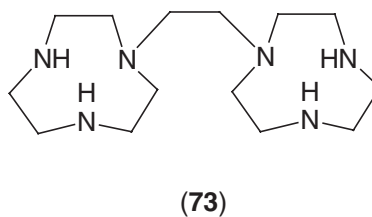
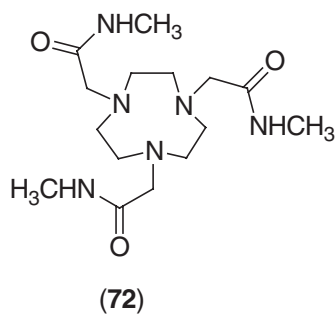
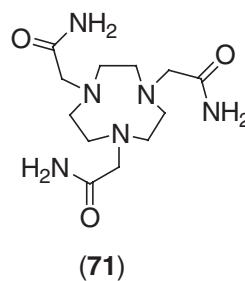
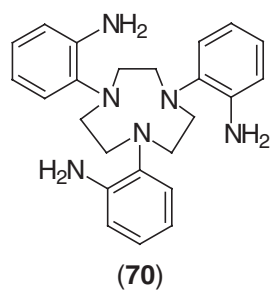

indicated that the zinc complex is stable in *N,N*-dimethylformamide and the formula was assigned as $[\text{ZnLCl}]_2[\text{ZnCl}_4]$, assuming a tetradral zinc center coordinated to the three macrocyclic nitrogens and a chloride ion.⁶⁷⁷

The crystal structure of the C-functionalized imidazole derivative of 1,5,9-triazacyclododecane (**75**) shows a five-coordinate zinc with four *N*-donors from ligand and chloride in a distorted trigonal-bipyramidal arrangement. The Zn—N imidazole bonds are the shortest at 2.025(3) Å.⁶⁷⁸ Deprotonation of the imidazole group resulted in a bridging imidazolate to form dinuclear zinc complexes. The $\text{p}K_{\text{a}}$ of 10.3 varies from the $\text{p}K_{\text{a}}$ of bound water with similar ligands (as low as 7.3) and the complex is not catalytic for the hydrolysis of esters.

The zinc nitrate complexes of pyridyl functionalized 12[ane]N₃ ligands 1-(2-pyridylmethyl)-1,5,9-triazacyclododecane and 1-(2-pyridyl-2'-ethyl)-1,5,9-triazacyclododecane were formed.¹³C NMR studies were used to determine conformation in solution suggesting the former gave a trigonal-bipyramidal isomer in solution with a water bound and the latter gave a 2:1 mixture of tetrahedral and asymmetric trigonal-bipyramidal isomers. The crystal structure of the zinc complex of 1-(2-pyridyl-2'-ethyl)-1,5,9-triazacyclododecane reveals a tetrahedral geometry in the solid state.⁶⁷⁹

Tri- and tetraaza macrocycles *N*-functionalized with imidazole and pyrazole groups have been coordinated to zinc. The zinc complexes of functionalized 1,5,9-triazacyclododecane and 1,4,8,11-tetraazacyclododecane have been synthesized, (**76**) and (**77**).^{680–685} The formation constants with the mono-armed 1,5,9-triazacyclododecane were calculated and found to be higher than for the non-functionalized macrocycle and coordination was demonstrated to be through four nitrogen atoms.⁶⁸⁴

6.8.10.1.2 Ligands based on tetraaza crowns

The classification for this section is based on the number of nitrogens in the macrocyclic ring of the azacrown ligands. Many of the examples presented will also have nitrogen-containing pendent arms attached to the ring nitrogens, increasing the denticity of the ligand.

Complexation and determination of formation constants has been studied with the tetramethylcyclam (1,4,8,11-tetramethyl-1,4,8,11-tetraazacyclotetradecane) ligand.⁶⁸⁶ A series of zinc N₄ donor macrocyclic complexes with different ring sizes were synthesized and characterized for comparison with cadmium derivatives.⁶⁸⁷

The zinc complex of the saturated macrocycle (1,2,3,4,5,6,7,8,9,10,11,12,13,14,15,16,17,18,19,20,21,22-docosahydrodibenzo-[B,I][1,4,8,11] tetra-azacyclotetradecine), which is a 14[ane]N₄ (cyclam) ring incorporating two cyclohexyl rings into the macrocycle, has been prepared and characterized.⁶⁸⁸ Two isomers of the ligand were separately complexed with zinc and characterized by NMR.

Macrocycles attached to redox responsive groups such as ferrocene (**78**) can give selective transition metal ion receptors. The X-ray structure reveals a five-coordinate zinc with distorted square-pyramidal geometry bound to the four macrocycle nitrogens and an iodide. In the solid state the two ferrocenyl groups are positioned on the same side of the ligand with distances to the metal center of 5.347(7) and 6.120(8) Å and these distances can be related to the redox behavior.⁶⁸⁹

The crystal structure of the zinc complex of 6,13-bis(2-pyridinyl)-1,4,8,11-tetraazacyclotetradecane (**79**) shows an octahedral zinc with minimal distortion which is in close agreement with that expected from force field calculations.⁶⁹⁰

Moore and co-workers have studied a number of tetraaza macrocycles with nitrogen-containing pendent arms. Pentadentate 14-membered aza macrocyclic ligands containing a pyridyl group, with a nitrogen-containing pendent arm, 2-pyridylmethyl and 1-pyrazolylmethyl, have been complexed with zinc and the structure determined of (3,11-dibenzyl-7-(2'-pyridylmethyl)-3,7,11,17-tetra-azabicyclo[11.3.1]-heptadeca-1(17),13,15-triene)zinc perchlorate.⁶⁹¹ A further crystal structure shows the zinc coordinated to all five nitrogen donors from the ligand in a distorted square-pyramidal geometry.⁶⁹² The zinc complex of a methyl functionalized version of this pyridine-containing macrocycle has been characterized.⁶⁹³ The 3,11-dibenzyl and 3,7,11-tribenzyl derivatives of this ligand have also been complexed with zinc.⁶⁹⁴

Moore and co-workers have also studied the complexation of zinc with other tetraaza macrocycles and pendent arm derivatives. Zinc complexes of 11-(2'-dimethylaminoethyl)-1,4,7-trimethyl-1,4,7,11-tetra-azacyclotetradecane have been characterized.⁶⁹⁵ A pyridine analog of this

macrocycle and the related 11-methyl-1,4,7,11-tetra-azacyclotetradecane have also been complexed with zinc.⁶⁹⁶

The ligand 6,13-dimethyl-1,4,8,11-tetra-azacyclotetradecane-6,13-diamine coordinates as a hexadentate ligand to zinc in neutral aqueous solution. Potentiometric titrations were used to determine the stability constant for formation. The pK_a values were determined for five of the six possible protonation steps of the hexamine (2.9, 5.5, 6.3, 9.9 and 11.0).⁶⁹⁷ Studies of the syn and anti isomers of 6,13-dimethyl-1,4,8,11-tetraazacyclotetradecane-6,13-diamine reveal that they offer different shapes for metal binding, which is reflected in the stability constants for 1:1 zinc:ligand ratio complexes. The selectivity of binding to the zinc ion compared to the cadmium(II) ion by both isomers is significant.⁶⁹⁸

The complexation of zinc with *N,N',N'',N'''*-tetrakis(2-aminoethyl)-1,4,8,11-tetraazacyclotetradecane has been investigated by X-ray crystallography and potentiometry. The only complexes isolated in aqueous or methanol/water solvents contained the μ -hydroxo-bridged bimetallic cation $[Zn_2(OH)L]^{3+}$, although potentiometric titration data suggest the presence of small amounts of $[Zn(H_3L)]^{5+}$ at low pH. The crystal structure of $[Zn_2(OH)L]^{3+}$ showed two five-coordinate zinc ions bound to two tertiary amine donors, two primary amine donors and the bridging hydroxide. Substitution of the bridging hydroxo group by other bridging anions was unsuccessful. The pK_a for the aqua species, from which the μ -hydroxo species is formed, is <5.3 . Zinc is shown to have a higher tendency for μ -hydroxo formation than the other group 12 metals.⁶⁹⁹

Zinc complexes have been characterized with hexadentate macrocycles formed from a tetraaza macrocycle functionalized with pyridylmethyl or pyrazolylethyl groups.⁷⁰⁰

Larger tetraaza ring complexes are also known. The zinc complex of 1,5,9,13-tetraazacyclohexadecane ([16]aneN₄) has been characterized by X-ray crystallography showing a distorted tetrahedral geometry around the zinc ion in $Zn([16]aneN_4)[ClO_4]_2$. Molecular mechanics analysis was used to determine the possible conformations of the macrocycle over a range of Zn—N bond lengths. The calculation confirmed the expected stability increase for smaller tetrahedral metal ions such as zinc. The predicted conformer was the one observed in the structural characterization.⁷⁰¹

Lippard characterized the structural effect of variation in the alkyl bridge length in tropocoronand complexes of zinc (**80**). Six complexes of ligands with bridge lengths from $n=m=3$ to $n=m=6$ were structurally characterized.⁷⁰² The complexes had distorted tetrahedral–square planar geometries, with the exception of the $m=n=3$ adduct which was five-coordinate with an additional pyridine ligand.

The zinc iodide complex of a 15-membered diamine diimine macrocycle has been structurally characterized.⁷⁰³

A dinucleating ligand with two dimethylcyclam rings reacts with zinc perchlorate to give $[Zn_2L](ClO_4)_4$. This product spontaneously reacts with atmospheric carbon dioxide to give $[Zn_2(\mu-CO_3)L](ClO_4)_2 \cdot 2H_2O$. X-ray analysis shows that two cyclam rings are arranged in a face-to-face manner with a bridging carbonate resulting in a Zn—Zn distance of 6.806(2) Å.⁷⁰⁴

Aza macrocycles have also been used as templating agents in the formation of zinc and other metal cation-containing aluminophosphates via hydrothermal synthesis.⁷⁰⁵ The zeolite-like structures have been formed in the presence of cyclam- and hexaaza-based macrocycles.

Breslow demonstrated the catalytic effect of having not only a Lewis acid zinc center but also an auxiliary catalytic center held in close, but non-binding, proximity. An imidazole or thiophenol (**81**) demonstrated increase in effectiveness in cyclization of a phosphate derivative.^{706,707} Pyridine pendants on this macrocycle gave a stability for zinc in line with the Irving Williams series for two pyridine and three pyridine pendants.⁷⁰⁸ A contrast was noted with other metals (Ni, Cu, Cd, Pb, Fe, and In), all of which increase in stability with three pendent arms as does zinc; this was attributed to coordination preferences.

Electron transfer from a macrocycle (**82**), based on cyclen, complex to coordinated riboflavin proceeds via an inner sphere electron transfer pathway. The riboflavin coordinates through the imide and the relevance to the interception of biological electron transfer pathways is discussed.⁷⁰⁹

The catecholate and semiquinonate complexes of zinc with tetraaza macrocycles have been synthesized and CD spectra recorded.⁷¹⁰

A bipyridine-containing macrocycle gives a color switching zinc complex. The color of the zinc complex solution varied with the solvent and the presence of acid or base (Scheme 3). The transformation between the solution colors is reversible. As shown in the scheme the conjugation of the ligand changes with the position of the facile hydrogen atom making the compounds very sensitive to the chemical environment (pH and solvent).⁷¹¹

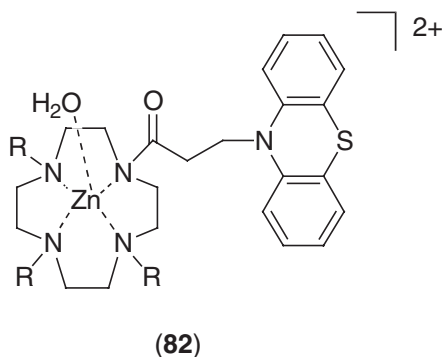
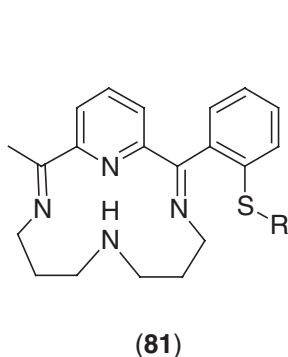
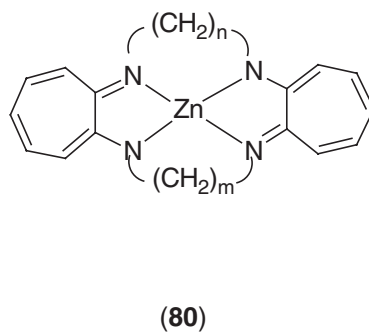
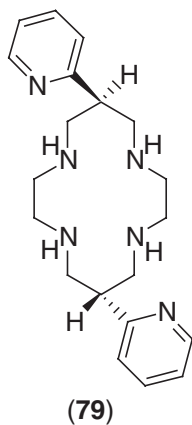
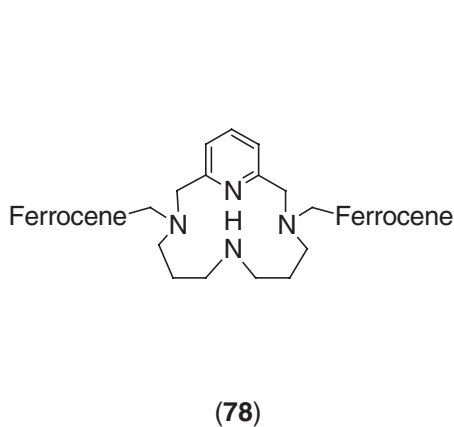
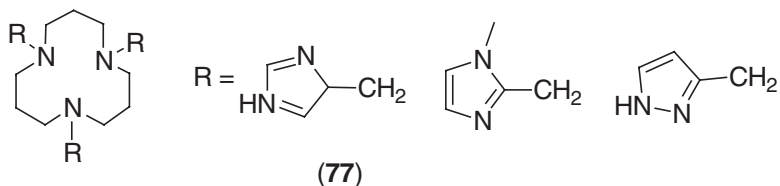
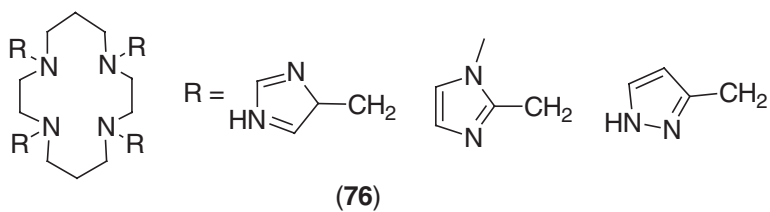

6.8.10.1.3 Ligands based on pentaaza crowns and larger

The X-ray structure of a mono-pyridyl containing pentaaza crown macrocycle (3,6,9,12-tetra-methyl-3,6,9,12,18-penta-azabicyclo[12.3.1]octadeca-1(18),14,16-triene) with zinc perchlorate has been determined.⁷¹²

An 18-membered hexaaza macrocycle containing four amine and two pyridine nitrogens (**83**) forms a helical complex of which the enantiomers have been resolved. The crystal structure of the complex as (3,6,14,17,23,24-hexaazatricyclo[17.3.1.1(8,12)]tetracos-1(23),8,10,12(24),19,21-hex-aene)zinc trifluoromethanesulfonate, $[\text{ZnL}](\text{CF}_3\text{SO}_3)_2$ showing a six-coordinate zinc center. The rigidity afforded by the addition of the pyridyl group gives an exceptionally inert complex with zinc. Spin simulation analysis of the ^1H NMR spectra and the dihedral angles calculated were in agreement with those from the solid-state X-ray analysis; both gave 222 symmetry. The CD spectra were recorded of the resolved right- and left-handed helical isomers.⁷¹³ The binding constants for a series of metals including zinc were determined for hexaaza macrocycles with pyridyl and amine donors of varying ring sizes in the above ligand and

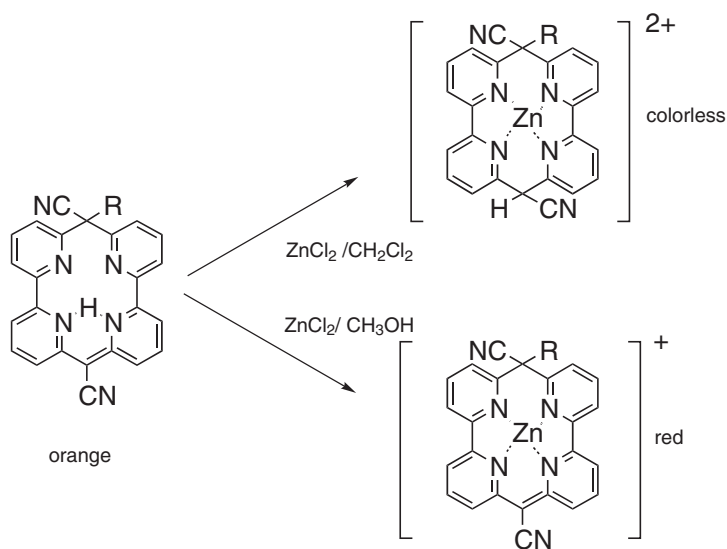

Scheme 3

(3,7,15,19,25,26-hexaazatricyclo[19.3.1.1(9,13)]hexacos-1(25),9,11,13(26),21,23-hexaene).⁷¹⁴ As would be predicted by the Irving Williams series, the 1:1 zinc complexes were less stable than those for nickel(II) and copper(II) for both ligands. The zinc complexes were also more stable than those of cadmium(II) and lead(II) but the difference in the stability was smaller for the larger ring size.

The stability of zinc complexes of hexadentate polyamine macrocycles have been studied. A comparison of the ring size effects was made on moving from [18]aneN₆ (1,4,7,10,13,16-hexaazacyclooctadecane) to [24]aneN₆ (1,5,9,13,17,21-hexaazacyclotetracosane). Potentiometric titrations were carried out to determine the protonation and stability constants. A mononuclear complex was formed and the stability constant for [Zn([24]aneN₆)]²⁺ was related to those of other transition metals, showing it to be less stable than copper(II), similar to nickel(II), and greater than cadmium(II).⁷¹⁵

The structure of the dinuclear zinc [24]aneN₈ (or 1,4,7,10,13,16,19,22-octaazacyclotetracosane) complex was determined and complexes of the ligands [18]aneN₆, [21]aneN₇ and [36]aneN₁₂ synthesized. Trends were observed with variation in ring size;⁷¹⁶ [24]aneN₈ forms both mono- and dinuclear species, smaller macrocycles only mononuclear, and larger have more stable dinuclear; the larger the macrocycle the more stable the binuclear species. The structure of [Zn₂([24]aneN₈)Cl₂]²⁺ shows two five-coordinate zinc ions with distorted square-pyramidal geometry bound to four macrocycle nitrogens and one chloride. The Zn—Zn distance is 5.44 Å.

The binuclear complex [Zn₂([30]aneN₁₀(**84**))NCS)](ClO₄)₃ was characterized crystallographically and the complexes of [27]aneN₉ and [33]aneN₁₁ reported.⁷¹⁷ The dizinc macrocyclic complexes had stability constants around 20, the slight increase in stability on going to the larger macrocycles is attributed to the ease of accommodation of two zinc centers while minimizing any interactions between them. Hydroxo species are present above pH 8. The first zinc is coordinated by five macrocycle nitrogens and the second zinc is coordinated by four macrocycle nitrogens and one from the thiocyanate; both show distorted trigonal-bipyramidal geometry. The Zn—Zn distance is 6.40 Å.

6.8.10.2 Oxacrowns and Thiocrowns (see Chapter 1.18)

Some examples of oxa crown coordination have already been presented earlier in the context of other ligands coordinated, see Sections 6.8.3.3 and 6.8.6.3. A few further examples are included in this section.

Diffusion of solutions containing zinc chloride and crown ethers can give solid state structure where the zinc ion is coordinated to the crown ether oxygens.⁷¹⁸ A five-coordinate zinc is observed with distorted trigonal-bipyramidal geometry bound to a chloride, a water molecule,

and three O donors from the crown ether. Alternately, recrystallization from organic solvents results in a structure where the zinc is no longer directly coordinated to the crown ether but interacts via a hydrogen bonding network. A tetrahedral $[\text{ZnCl}_3(\text{H}_2\text{O})]^-$ and an octahedral hexaaquozinc are present for each crown ether in the structure. Such compounds are suggested to be snapshots of desolvation.

The zinc complexes with 15-crown-5 were revealed to be seven-coordinate with a number of examples crystallized with metal bound to the five crown ether donors and variation in the remaining two ligand positions.³⁵¹ Structural examples are known of zinc coordinated to 18-crown-6 by three ring oxygens and the remaining coordination positions occupied by iodide or alkyl iodide ligands.⁸⁷ The smaller 12-crown-4 ring results in a bis-ligand complex where the zinc is eight-coordinate with four ether donors from each macrocycle (Figure 11).⁷¹⁹

The 1,4,7-trithiacyclononane ligand, [9]aneS₃, zinc complex was synthesized to compare with the electrochemistry of related complexes and showed an irreversible oxidation and an irreversible reduction at +1.30 V and -1.77 V vs. ferrocene/ferrocenium, and the X-ray crystal structure of the bis macrocycle zinc complex was reported.^{540,720}

6.8.10.3 Mixed Donor Macrocycles (see Chapter 1.20)

A number of mixed crown ligands have been synthesized combining N, O, or S ligands. The larger, more flexible, ligand systems can show interesting coordination patterns as the zinc binds to its preferred donor set.

A series of mixed N/O and N/S donor macrocycles of varying ring sizes was synthesized to determine the effects on metal ion binding selectivity with a variation in macrocycle size giving ion recognition properties.^{721,722} X-ray structural results of three zinc complexes showed either distorted trigonal-bipyramidal or distorted octahedral coordination geometry. Stability constants were calculated for the zinc complexes and trends analyzed. Non-coordination of ether and thioether donors was observed in a number of the compounds. The 17-membered ring with an N₅ donor set showed the highest stability constant for both cadmium and zinc complexes.

The properties of the complex formed with an N₂O₂ macrocycle containing pendent hydroxyethyl or carbamoylethyl has been investigated. The thermodynamic stability of 1:1 zinc to ligand ratio has been determined by potentiometry.⁷²³ Similar studies have also been carried out on pyridylmethyl pendent arm derivatives of 14- to 17-membered N₂O₂ macrocycles at a 1:1 ratio, with the data indicating the involvement of the pyridyl nitrogen in coordination in solution.⁷²⁴

An 18-membered N₃O₃ macrocycle could not be synthesized with transition metal templates but the N₄O₂ analog (85) was successfully synthesized with a zinc template. This gave dinuclear μ -hydroxy bridged zinc complexes including a rare example of a single unsupported

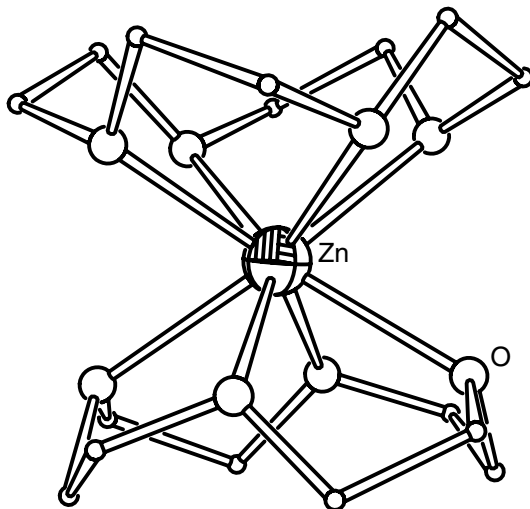
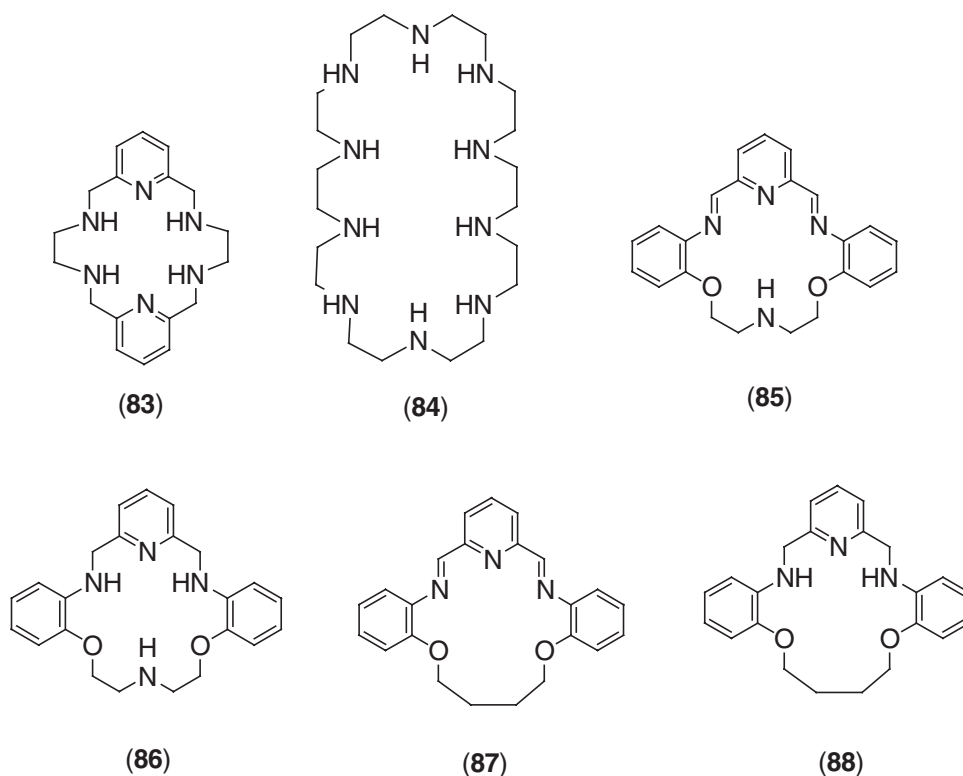

Figure 11 The molecular structure of zinc with two 14-crown-4 ether macrocycles giving an unusual coordination number of eight.⁷¹⁹

μ -hydroxy zinc dimer. The metal ions are distorted square pyramidal bound to the four macrocyclic nitrogens and the oxygen from the bridging hydroxide. The reduced form of the macrocycle (**86**) was synthesized from the free ligand and complexed.⁷²⁵ The zinc complex of the related N_3O_2 macrocycle (**87**) was also formed by condensation of 2,6-pyridinecarbaldehyde and 1,4-bis(2-aminophenoxy)butane as both a nitrate and perchlorate salt.⁷²⁶ Similarly, the ether oxygen atoms in the macrocycle are not coordinated in the solid state. The reduced form (**88**) has also been synthesized and complexed.⁷²⁷ The X-ray structure shows a distorted trigonal-bipyramidal geometry with the three macrocycle nitrogens, an acetonitrile, and a water molecule coordinated.



A seven-coordinate zinc complex (**89**) has been structurally characterized with a N_3O_2 15-membered macrocycle demonstrating a distorted trigonal-bipyramidal geometry with a monodentate nitrate and water completing the coordination sphere.⁷²⁸ The complexation of the related macrocycle with a propyl bridge replacing the ethyl bridge between the two amine nitrogens was also studied. It was noted that the change from 15- to 16-membered ring made a large change in coordination properties for zinc but less so for cadmium. Two further zinc coordinated structures of the 15-membered ring ligand were determined. $ZnLI_2$ showed the zinc diiodide unit coordinated outside the macrocyclic cavity and $[ZnL(NO_3)]NO_3$ displayed a six-coordinate approximately trigonal-prismatic geometry bound to the N_3O_2 donors of the macrocycle and a nitrate oxygen.⁷²⁹

The complexation of other mixed oxa aza macrocycles has been studied, and protonation and stability constants of the zinc complexes of macrocycles 1,4,10,13-tetraoxa-7,16-diazacyclooctadecane-7,16-bis(malonate), the -7-malonate derivative and -7,16-bis(methylacetate) derivative have been determined by potentiometry at a 1:1 ligand-to-metal ratio.⁷³⁰

The pentadentate macrocyclic ligand 4,7-bis(2-hydroxybenzyl)-1-oxa-4,7-diazacyclononane forms a dimeric zinc species with bridging hydroxide ligands. The crystal structure of $[(LH)_2Zn_2(\mu-OH)](PF_6)$ shows two octahedrally coordinated zinc ions connected by a μ -hydroxo bridge. There are hydrogen bonding interactions from the coordinated phenolic and phenolate groups in both ligands. Ligand deprotonation allowed preparation of $[LZn(H_2O)ZnCl_2]$.⁷³¹

A number of crown and related ligand systems have been synthesized with pendent arms that contain donors other than nitrogen. Potentiometric titration studies of dihydroxamate derivatives

of dioxacyclam (**90**) were carried out. It is suggested that the ligand binds via the hydroxamate *O,O* and there is no evidence for bimetallic complex formation.⁷³²

¹³C NMR studies suggest that 1,4,7,10-tetra-azacyclododecane-1,7-diacetic acid binds to zinc in a *cis* octahedral geometry—the two carboxylate oxygens are *cis* and the remaining four donors from the cyclen macrocycle. The formation constant was determined for the complex.⁷³³

The zinc complexes formed in aqueous solution with the 12-membered macrocycle 2,9-dioxo-1,4,7,10-tetra-aza-4,7-cyclododecanediacyetic acid and the 13-membered macrocycle 2,9-dioxo-1,4,7,10-tetra-aza-4,7-cyclotridecanediacyetic acid have been examined and stability constants determined. The structure of the zinc complex of the 12-membered macrocycle was determined by single-crystal X-ray analysis. The zinc has a distorted octahedral coordination sphere with two amine nitrogens, an amide nitrogen, and two acetate oxygen atoms from one ligand and an acetate oxygen from a neighboring complex. The acetate group links the zinc ions to form a one-dimensional array.⁷³⁴

Pendent arm 1,4,7-triazacyclononane macrocycles (**91**) and (**92**) have been used to stabilize the zinc-to-phenoxyl bond allowing characterization of these compounds.⁴⁷⁷ The interest in the zinc complexes comes from the wide potential range in which it is redox stable allowing observation of the ligand-based redox processes, this allows study of the radical by EPR and the electronic spectra is unperturbed by *d-d* transitions. Macrocycles of the type 1,4,7-tris(2-hydroxybenzyl)-1,4,7-triazacyclononane form a bound phenoxyl radical in a reversible one-electron oxidation of the ligand. The EPR, resonance Raman, electronic spectra, and crystal structure of the phenoxide complexes were reported. This compound can be compared to a zinc complex with a non-coordinated phenoxyl radical as a pendent from the ligand.⁷³⁵

Mixed N/O donor macrocycles (**93**) have been used to extract metals from solution via competitive metal transport.⁷³⁶

Kimura and co-workers have synthesized a series of alkoxide complexes with the alcohol functionality as a pendent arm.^{447,674,737} A zinc complex of 1-(4-bromophenacyl)-1,4,7,10-tetraazacyclododecane was also synthesized by the same workers to mimic the active site of class II aldolases. The X-ray structure shows a six-coordinate zinc center with five donors from the ligand and a water molecule bound. The ketone is bound with a Zn—O distance of 2.159(3) Å (Figure 12). Potentiometric titration indicated formation of a mixture of the hydroxide and the enolate. Enolate formation was also independently carried out by reaction with sodium methoxide, allowing full characterization.⁷³⁸

The zinc complex of a 14-membered *cis*-N₂S₂ dibenzo macrocycle with two pendent pyridylmethyl groups was studied (L = 8,11-bis(2-pyridylmethyl)5,6,7,8,9,10,16,17-octahydro-dibenzo[e,m][1,4]dithia[8,11]diazacyclotetradecine). In solution, [ZnL]²⁺ takes up atmospheric carbon dioxide and transforms to the dinuclear complex [(μ-CO₃)(ZnL)₂](ClO₄)₂. The structures of both complexes have been elucidated. The zinc atoms, which are situated outside the macrocyclic ring, are unsymmetrically bridged by the μ-carbonato group.⁷³⁹

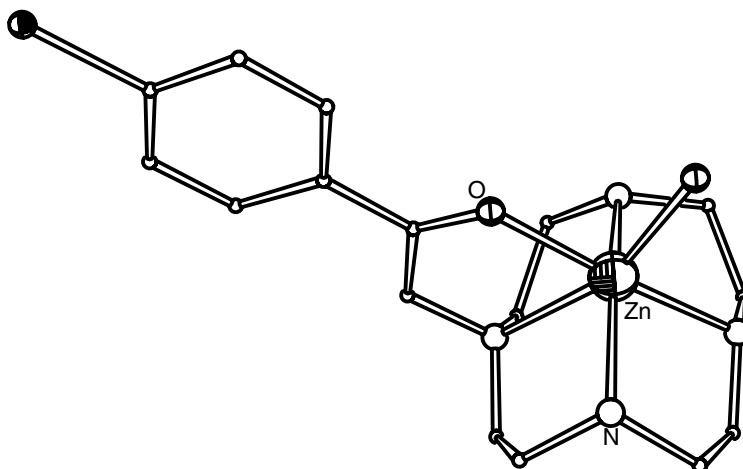
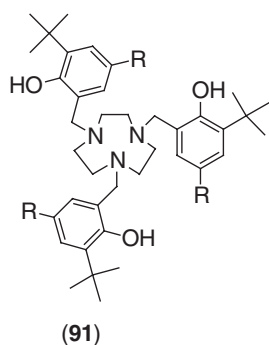
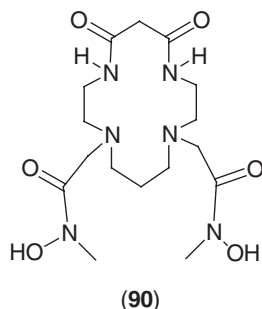
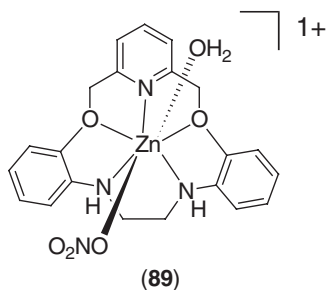
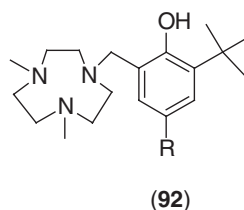
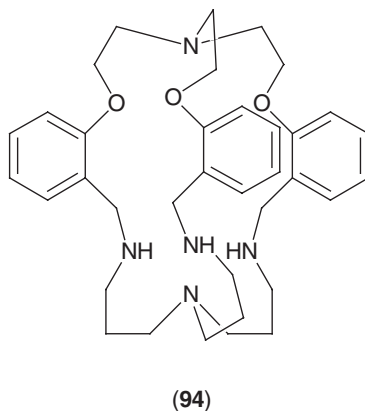
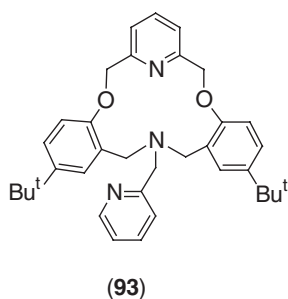

Figure 12 The molecular structure of zinc with a coordinated ketone pendent.⁷³⁸

R = *t*-butyl or methoxyR = *t*-butyl or methoxy

6.8.10.4 Cryptands and Crossbridged Macrocycles

Cryptands and rigid crossbridged macrocyclic zinc complexes have been characterized with varying degrees of encapsulation.

Bharadwaj synthesized the zinc complex of a mixed donor cryptand (**94**). The X-ray structure shows that the zinc binds in the tetraamine cavity at the base of the ligand in a tetrahedral environment and not to the oxygen donors. This demonstrates the expansion potential of the cavity compared with the free ligand.⁷⁴⁰

Stability data via potentiometric titration has been determined for a number of octaminocryptands with different spacer groups and is shown to follow the Irving–Williams series trend resulting in selectivity for copper.⁷⁴¹ Zinc binding to a range of these ligands has been examined and compared with copper ions. Selectivity for copper is demonstrated with a pyridine spacer.⁷⁴¹

Sargeson and co-workers have structurally characterized encapsulated zinc in hexaaza cryptands.^{742,743} Related cryptands (1-methyl-8-amino-3,13-dithia-6,10,16,19-tetraazabicyclo[6.6.6]-icosane and 1-methyl-8-amino-3-thia-6,10,13,16,19-pentaazabicyclo[6.6.6]icosane) incorporating thioether donors also formed complexes with zinc which were structurally characterized. In both cases the zinc ion was encapsulated in the macrobicyclic cavity and the octahedral coordination geometry distorted to the mixed nitrogen and thioether donor atoms.⁷⁴⁴

Strapped tetramines show conformationally rigid coordination environments that can lead to novel stability properties. The coordination properties of bowl-shaped cavities or adamantanes such as the ligand 1,5,9,13-tetraazabicyclo-[7.7.3]nonadecane (**95**) were investigated.⁷⁴⁵ The

complex has slightly distorted tetrahedral coordination and a dissociation half life of 14 min at 40 °C in 5 M HCl. This contrasts with a smaller cavity in 1,8-crossbridged cyclam that forms six-coordinate complexes with the remaining two ligands chloride or aquo, and the former shown to be a chloro bridged dimer.⁷⁴⁶ The cavity is too small to encapsulate the zinc and imposes a higher coordination number.

6.8.10.5 Compartmental Macrocycles (see Chapter 1.19)

Compartmental ligands contain binding sites for more than one metal center. The calixarene-related tetramino tetraphenolic polynucleating macrocyclic ligand (**96**) gives the structurally characterized $[LZn_4(OH)(CH_3CO_2)_3(CH_3OH)]$. The zinc ions are in an asymmetric kite arrangement with a hydroxo ligand bridging three of them with the fourth at a distance of 2.849(5) Å. Of the hydroxo bridged zinc centers, two are five-coordinate, and the other is six-coordinate. The fourth zinc ion has a distorted four-coordinate geometry.⁷⁴⁷ The dizinc complex of a pyridyl functionalized compartmental ligand (**97**) was formed in reaction with the sodium salt of the ligand and characterized by NMR and mass spectrometry.⁷⁴⁸

A mixed zinc barium dimeric complex (**98**) was formed with a ligand containing polyether and isothiosemicarbazide groups.⁷⁴⁹ Ligand synthesis was carried out by templating around the barium ion but the monozinc complex could be isolated by removal of the barium ion from the Ba/Zn complex. The crystal structure of the barium zinc dimer complex $[ZnBaLI(CF_3SO_3)]$

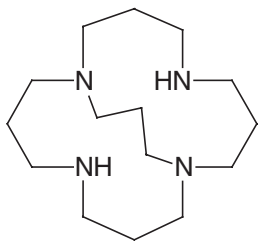

(95)

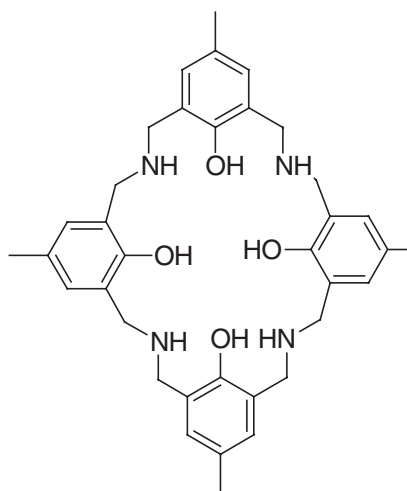

(96)

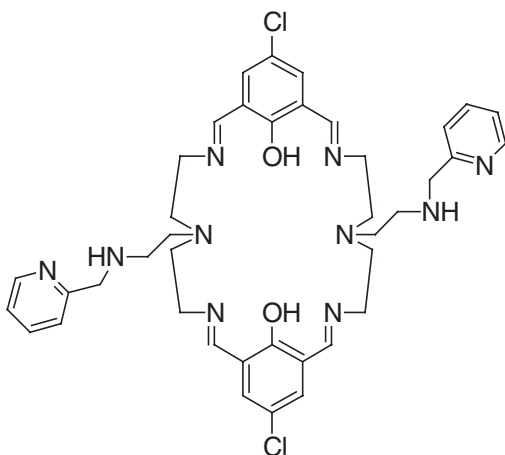

(97)

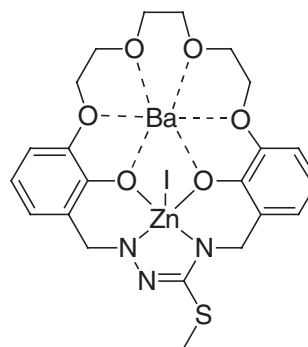

(98)

(CH₃OH)₂ has a distorted square–pyramidal zinc center with the iodide in the apical position and a Zn–Ba distance of 3.736(1) Å. The iodide can be removed by treatment with a silver salt.

Okawa produced a series of heterobimetallic zinc–lead complexes using the unsymmetric compartmental ligand (**99**).^{750,751} ZnPbL(ClO₄)₂·2DMF·MeOH and [ZnPbL(OH)](ClO₄) have been structurally characterized. The activity towards hydrolysis of trisnitrophenylphosphate to bisnitrophenylphosphate was studied. The crystal structure of a bisnitrophenylphosphate analog [ZnPbL(bisnitrophenylphosphate)](ClO₄) reveals the phosphate ester group bridging the two metal ions binding through two oxygens.

A Robson-type compartmental macrocycle (**100**) gives dinuclear zinc complexes on complexation.⁷⁵² Both five-coordinate and six-coordinate zinc ions are observed, dependent on the anion present. The crystal structure for the compound Zn₂L(ClO₄)₂·2H₂O reveals two independent dinuclear zinc complexes, one with two six-coordinate zinc centers with an intermetallic distance of 3.166 Å, and one with two five-coordinate zinc centers with a Zn···Zn distance of 3.177 Å. In the compound [Zn₂L(N₃)₂] the two zinc atoms are five-coordinate, bound to the ligand and the azide anion and are separated by 3.333 Å. This type of macrocycle has also been used as a molecular building block in formation of ordered networks in the solid state. Two different molecular ladders were formed and structurally characterized with different ratios of 4,4′-bipyridine to the zinc complex building block, [Zn₂L(H₂O)₂]²⁺.⁷⁵³

The zinc-templated condensation of 2,6-diformyl-4-methylphenol with 1,11-diamino-3,6,9-trioxaundecane gave a tetranuclear zinc complex [Zn₄L(μ-O₂CMe)₄][ClO₄]₂, where H₂L is a [2 + 2] tetra-Schiff base macrocycle.⁷⁵⁴ The X-ray structure shows a complex cation that is centrosymmetric and contains two pairs of zinc ions bridged by a phenolic oxygen and two acetate ligands. Another tetranuclear complex [Zn₄L(μ-OH)₂(μ-O₂CMe)₂][ClO₄]₂ can be isolated for structural analysis by changing the recrystallization solvent to methanol. In both complexes the four zinc ions are encapsulated in the macrocycle but in the second complex the two dimeric units formed by phenoxo and acetato bridges are also connected by two hydroxo bridges. Proton NMR spectroscopy was used to show that structural conversion is reversible. Reduction of the tetranuclear complex gave a dinuclear zinc complex of the imine reduced form of the ligand.

A heterotrinnuclear complex, [Cu₂Zn(**101**)](ClO₄)₃·3H₂O was synthesized from the 38-membered macrocycle (**101**). The compound has been characterized by single-crystal X-ray diffraction showing the macrocycle complex twisted into a helical conformation. The zinc has a trigonal–bipyramidal N₃O₂ coordination sphere with all donor atoms from the macrocycle; the phenolic oxygen donors bridge to one of the copper ions.⁷⁵⁵

Dicompartmental ligands bearing picolyl pendent arms on the amine nitrogen donors were synthesized and the monozinc complex structurally characterized.⁷⁵⁶

Thiolate-containing macrocycles have been of great interest due to the prevalence of thiolate ligands in a number of enzyme active sites and the interactions of zinc with thiolates in proteins.⁷⁵⁷ Zinc complexes of thiolate-containing compartmental Schiff base macrocycles (**102**) and (**103**) formed with 2,6-diformyl-4-methylthiophenolate have been investigated. The structure of the zinc complex of the macrocycle with a secondary amine linker group (**102**) shows an unusual arrangement containing two zinc ions but no thiolate bridge.^{758,759} It is postulated that this is due to the spatial arrangement of the donors. In the macrocycle formed with a shorter linker (**103**), a thio version of the Robson-type ligand, the zinc ions are coordinated in a square–pyramidal geometry. The structure of a tetranuclear zinc complex has been determined. The complex [Zn₂(**103**)(μ-OH)₂][ClO₄]₂·2H₂O shows two unique dinuclear zinc units linked by two hydroxy bridges.⁷⁶⁰

6.8.10.6 Porphyrins and Phthalocyanines

Square–planar zinc compounds predominate with these ligand types as would be predicted. This is in contrast to the prevalence of tetrahedral or distorted tetrahedral geometries for four-coordinate species that have been discussed thus far. Zinc porphyrin complexes are frequently used as building blocks in the formation of supramolecular structures. Zinc porphyrins can also act as electron donors and antenna in the formation of photoexcited states. Although the coordination of zinc to the porphyrin shows little variation, the properties of the zinc-coordinated compounds are extremely important and form the most extensively structurally characterized multidentate ligand class in the CSD. The examples presented here reflect only a fraction of these compounds but have been selected as recent and representative examples. Expanded ring porphyrins have also

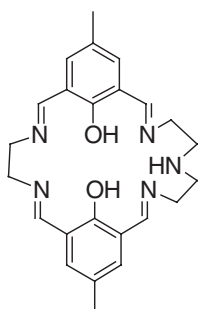

(99)

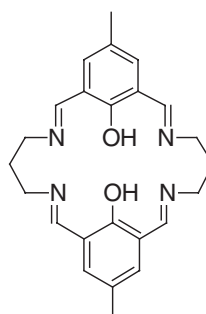

(100)

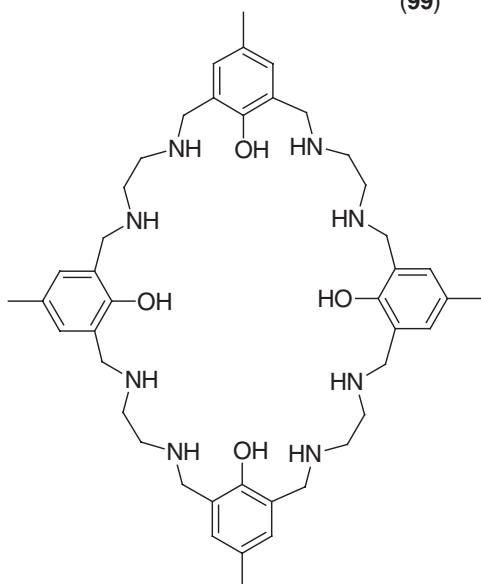

(101)

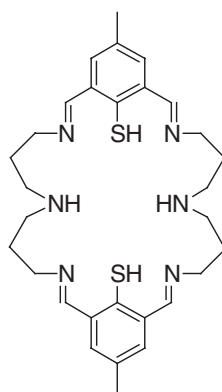

(102)

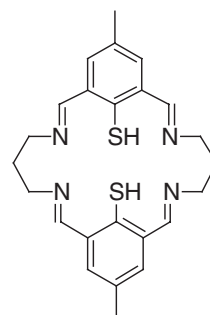

(103)

been characterized with zinc but show that the cavity is too large to accommodate binding to all ring nitrogens; for example, a porphocyanine incorporating a zinc dichloride unit binds through only two of the six ring nitrogens.⁷⁶¹

6.8.10.6.1 Porphyrin-based ligands (see Chapter 1.23)

The functionalization of zinc porphyrin complexes has been studied with respect to the variation in properties. The structure and photophysics of octafluorotetraphenylporphyrin zinc complexes were studied.⁷⁶² Octabromoporphyrin zinc complexes have been synthesized and the effects on the ¹H NMR and redox potential of 2,3,7,8,12,13,17,18-octabromo-5,10,15,20-tetraarylporphyrin were observed.⁷⁶³ The chiral nonplanar porphyrin zinc 3,7,8,12,13,17,18-heptabromo-2-(2-methoxyphenyl)-5,10,15,20-tetraarylporphyrin was synthesized and characterized.⁷⁶⁴ X-ray structures for cation radical zinc 5,10,15,20-tetra(2,6-dichlorophenyl)porphyrin and the iodinated product that results from reaction with iodine and silver(I) have been reported.⁷⁶⁵ Molecular mechanics calculations, X-ray structures, and resonance Raman spectroscopy compared the distortion due to zinc and other metal incorporation into meso dialkyl-substituted porphyrins. Zinc disfavors ruffling over doming with the total amount of nonplanar distortion reduced relative to smaller metals.⁷⁶⁶ Resonance Raman spectroscopy has also been used to study the lowest-energy triplet state of zinc tetraphenylporphyrin.⁷⁶⁷

Functionalization can be used to alter the redox properties of the zinc metalloporphyrin; the zinc heptanitroporphyrin shows facile reduction to the air-stable π -anion radical.⁷⁶⁸ Modification of the zinc porphyrin at the β position with chlorine or bromine to induce saddling of the

macrocycle, as demonstrated by spectral shifts, can be used as a strategy to lower the energy of the porphyrin HOMOs which can be important in catalysis applications.⁷⁶⁹ The zinc complexes of the octaethylxophlorin dianion and the oxidized stable free radical species were characterized by single-crystal X-ray diffraction. Both structures show a five-coordinate zinc center with an axial bound pyridine.⁷⁷⁰ Substituent effects in axial ligation, by 1-methyl imidazole, of zinc tetraphenylporphyrin complexes have been studied. Relatively large entropy losses are associated with electron-donating substituents in the *para* position of the phenyl rings.⁷⁷¹ The reduction potentials of the zinc complexes of nonplanar tetrakis (pentafluorophenyl) porphyrins were analyzed electrochemically and were in agreement with the prediction that the resultant symmetry change from distortion of the macrocycle destabilizes the HOMOs.⁷⁷²

The kinetics of complexation to the zinc ion have been studied with a number of examples. The kinetics of zinc insertion into tetraphenyl porphyrin were compared to a capped porphyrin, a co-facial bis-porphyrin, and a spheroidal bis-porphyrin.⁷⁷³ The insertion of the second zinc center into the bis-porphyrins was followed by HPLC. The insertion into the spheroidal bis-porphyrin was extremely slow and slower than the other porphyrins studied. The kinetics of incorporation of zinc into a large number of free base porphyrins of varying charges and structures has been investigated in *N,N*-dimethylformamide. Meso-phenyl rings substituted in the *para* position to donate electron density are more reactive to zinc complexation. Mercury(II) catalyzes the formation of the zinc complexes by rapid initial formation of the mercury(II) porphyrin, which is more reactive to zinc.⁷⁷⁴ Mercury(II) has also been shown to enhance the incorporation of zinc into 5,10,15,20-tetrakis(4-sulfonatophenyl)porphyrin with formation of a heterodinuclear HgZn porphyrin intermediate suggested by the kinetic results and absorption spectra.⁷⁷⁵ The zinc incorporation kinetics of porphyrins, chlorins, and isobacteriochlorins were compared. Tetraphenyl isobacteriochlorin had the highest reactivity with zinc in pyridine solvent with tetraphenyl chlorin showing higher reactivity than tetraphenyl porphyrin.⁷⁷⁶ Rapid complexation of tetraphenyl porphyrin, in organic solution, with zinc at the solid-liquid interface was observed with zinc adsorbed on a silica surface.⁷⁷⁷

Ligands with more than one coordination site have been synthesized. A superstructured porphyrin ligand with an additional binding site for a second zinc ion was synthesized. The X-ray structure shows a bridging acetate ligand between the porphyrin cavity-bound zinc and the zinc bound to the appended tripodal chelator.⁷⁷⁸

Appended groups can also be used to change the coordination properties at the zinc porphyrin center. Picket fence and modified picket fence zinc porphyrin complexes have been formed and characterized. Modification products, such as one of the pivalamido groups being replaced by a methylamino or a hydroxybenzoylamino group, have been studied by ¹H NMR and electronic spectroscopy.⁷⁷⁹ Other "picket fence" complexes include a tetrahydrothiophene picket zinc complex, zinc 5,10,15,20-tetrakis[*o*-(tetrahydro-2-thenoylamino)phenyl] porphyrin, which can bind two silver(I) ions to the thiophene pickets.⁷⁸⁰ The bis-pocket porphyrin aquo(tetramesitylporphyrinato)zinc has been structurally characterized.⁷⁸¹ A variety of "basket handle" porphyrin zinc complexes have been synthesized with varying chain lengths.⁷⁸² UV-visible spectral measurements and electrochemical studies have shown a zinc complex of a tetraphenylporphyrin with an appended pyridyl group showing temperature-dependent formation of a five-coordinate compound with the pyridyl group bound intramolecularly.⁷⁸³

Aggregates or linked zinc porphyrins are common, including dimers and trimers. Co-facial zinc porphyrin dimeric units have been synthesized with xanthene bridges and X-ray structural and spectroscopic data collected (Figure 13).⁷⁸⁴ Excitonic interactions in covalently linked zinc porphyrin dimers have been studied using the flash photolysis time-resolved microwave conductivity technique. Increasing the length of the linker group increases the electronic interaction between the two porphyrin units showing an inverse distance effect.⁷⁸⁵ Diarylurea-linked porphyrin dimers and trimers have been formed.⁷⁸⁶ [5-(Pyrazol-4-yl)-10,20-bis(*p*-tolyl)-15-(2-ethoxycarbonylphenyl)porphyrinato]-zinc forms a cyclic porphyrin trimer which is linked by both a coordinate bond to the pyrazole nitrogen and a hydrogen bond between the pyrazole and the 2-ethoxycarbonyl units. NMR, UV-vis, and IR spectra have been recorded in addition to electrochemical studies.⁷⁸⁷ Bridged zinc tetraphenylporphyrin can be formed electrochemically in the presence of bis(diphenyl-phosphino)acetylene. Dimer formation occurs with bis(diphenylphosphonium)acetylene bridge.⁷⁸⁸ Aromatic spacers bridging between two zinc porphyrins and a pyromellitimide gave a complex studied for the photo-induced charge separation. Solvent effects were also observed with solvent polarity having a marked effect on the lifetime of different states.⁷⁸⁹ The zinc complexes of amino acid derivatized porphyrins have been synthesized and characterized, with the amino acid bridged dimeric species showing significant induced circular dichroism.⁷⁹⁰

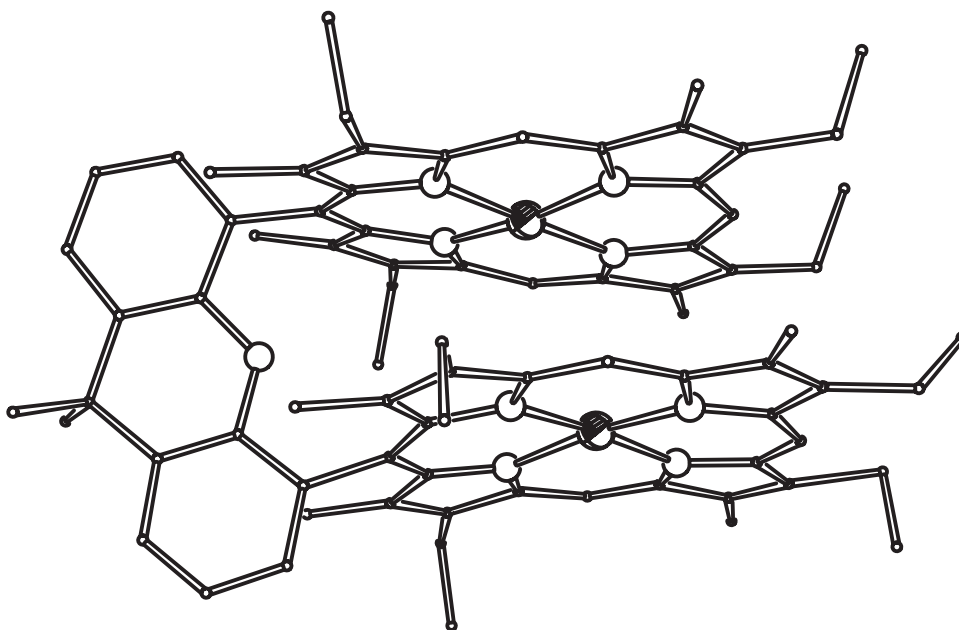

Figure 13 Molecular structure of a co-facial zinc porphyrin dimer with a xanthene spacer.⁷⁸⁴

Larger oligomeric and polymeric aggregates also form. Aggregates of free porphyrins can show quite different properties to the zinc porphyrinates due to the possibility for axial binding to the zinc ion. This is of specific interest in the fluorescent quenching properties.⁷⁹¹ Meso-meso linked porphyrin arrays have been synthesized as light-harvesting antennas and molecular photonic wire. Increase in the number of porphyrins resulted in the high-energy Soret bands remaining at almost the same wavelength (413–414 nm), while the low-energy exciton split Soret bands are gradually red-shifted, giving an increase in the exciton splitting energy.⁷⁹² A number of functionalized tetraphenylporphyrin zinc compounds have shown formation of meso-meso linked porphyrin arrays by one-pot electrochemical oxidation, with oligomers up to the octamer isolated from [5,15-bis(3,5-di-*t*-butylphenyl)porphyrinato]zinc as starting material.⁷⁹³ Conjugated zinc porphyrin oligomers have been shown to form ladder-type structures by ¹H NMR, with linear bidentate ligands 1,4-diazabicyclo[2.2.2]octane and 4,4'-bipyridyl.⁷⁹⁴ The oxidation of zinc-5,15-diarylporphyrins by silver(I) gives a polymer, poly(zinc-5,15-porphyrinylene), in high yields.⁷⁹⁵ Investigation has been carried out of photo-induced electron transfer at liquid-liquid (water/1,2-dichloroethane) interface with zinc tetra(3-carboxyphenyl) porphyrin. In particular, pH effects demonstrate the importance of hydrogen bonding to the self assembly at the interface.⁷⁹⁶ Electropolymerization of zinc-10-bipyridinium-octaethyl-porphyrinate results in a polymer with a zigzag configuration and can give micrometer-long, wire-shaped linear polymers if 5,15-chloro substituted. The wires have two parallel strands based on the dimers formed in solution.⁷⁹⁷ A template-directed formation of a hexameric wheel of covalently linked free base and zinc porphyrin units was demonstrated. The porphyrins were templated around a tripyridyl unit and linked at the meso position by diphenylethyne units, resulting in a face-to-face distance across the cavity of 35 Å.⁷⁹⁸

Non-covalently linked porphyrin arrays have been synthesized from nucleobase-substituted free base porphyrins and zinc porphyrin complexes. Hydrogen-bonded assemblies from rigid hydrogen-bonded guanosine to cytidine base pair porphyrins are formed from the functionalized units.⁷⁹⁹ Conjugated fused tape-shaped arrays of covalently linked zinc porphyrins showed electronic absorption bands that reach into the infrared. It was shown that the oxidation potentials decreased upon increase in the number of porphyrins; both properties suggest potential use as molecular wires.⁸⁰⁰ The photophysical properties of a series of ethynyl-bridged porphyrinato zinc oligomers have been investigated over the femtosecond and picosecond time scales. The linkage topology strongly influences the dynamics over these time scales.⁸⁰¹ (5-Pyridyl-10,15,20-triphenylporphyrinato)zinc forms a polymer with the pyridyl unit coordinating to the zinc center of a neighboring porphyrin complex. The X-ray structure reveals zigzag chains forming in the solid state. NMR studies demonstrated a similar structure in solution. Dimers and trimers could be

formed from pyridyl- or dipyridyl-functionalized zinc porphyrins with zinc tetraphenylporphyrin.⁸⁰²

There are many sensor and receptor applications of zinc porphyrins. Dimeric zinc porphyrin tweezers have shown specific recognition properties for chiral monoalcohols and monoamines, inducing a preferred helicity in the dimeric compound.^{803,804} Other bis(zinc porphyrin) tweezers show intercalation of a variety of Lewis base guests.⁸⁰⁵ Water-soluble zinc porphyrin receptors incorporating a hydrophobic binding pocket and a carboxylate group to form electrostatic interactions was synthesized. The zinc is a Lewis acid site and the tetraphenyl porphyrins were substituted with long-chain alkyloxy groups to give the receptors. Selective binding to amines, α -amino acid esters, and oligopeptides in water was observed. Histamine was also bound and revealed imidazole coordination to the zinc center.⁸⁰⁶ Selective anion receptors have been synthesized by functionalization of zinc porphyrins with ferrocene groups. Receptors based on 5,10,15,20-tetrakis(*o*-ferrocenyl-carbonylaminophenyl-substituted) zinc strongly bind to halide, nitrate, and hydrogen sulfate anions. The electrochemistry of the system shows perturbations of the porphyrin oxidation and ferrocene redox couples allowing electrochemical sensing.⁸⁰⁷

Zinc porphyrins have been used in the molecular recognition of carbohydrates. [5,15-bis(8-quinolyl)porphyrinato] zinc showed affinity for octyl glucoside and mannoside in chloroform solutions with ¹H NMR studies demonstrating that zinc coordination and hydrogen bonding to the quinolyl group were both important to the binding interaction.⁸⁰⁸ Hydroquinone–quinone pairing has been used in molecular recognition with [5,10,15-triphenyl-20-(2,5-dihydroxyphenyl)-porphyrinato] zinc–quinone complexes.⁸⁰⁹

The photoactive properties and potential for use of some of these compounds as photoactive antennas have been explored. Electron transfer studies between C₆₀ fullerene and zinc porphyrins linked by a short spacer unit have been studied. Varying lifetimes for the radical ion pairs have been observed.^{810,811} Fullerenes have also been linked in a three-component system with a zinc tetraphenylporphyrin and a free base porphyrin.⁸¹² The zinc porphyrin acts as an antenna molecule transferring the resultant singlet excited state energy to the lower energy free base porphyrin. A mixed metalloporphyrin trimer with one ruthenium and two zinc porphyrins templated by tripyridyltriazine has been synthesized and its properties investigated.⁸¹³ A zinc porphyrin and ruthenium(II) tris(2,2'-bipyridyl) have been linked by a platinum(II) unit and the compound shows excitation in the ruthenium fragment followed by rapid intermolecular transfer to the porphyrin triplet state.⁸¹⁴ A trimeric compound consisting of a zinc porphyrin, an iridium(III) bis-terpyridine, and a gold(III) porphyrin was studied for multistep electron transfer producing a charge-separated state almost quantitatively and a lifetime of 450 ns⁻¹.⁸¹⁵ A zinc porphyrin–rhenium carbonyl complex has been characterized with the zinc tetraphenyl porphyrin linked with Re(CO)₃(4'-methyl-2,2'-bipyridyl) by an amide bond.⁸¹⁶ A covalently linked photosynthetic model *N,N,N',N'*-tetraalkyl-*p*-phenylenediamine-zinc porphyrin-naphthoquinone has been investigated by experimental techniques, such as time resolved EPR, and *ab initio* calculations.⁸¹⁷

The inclusion of additional fifth and sixth ligands in the coordination sphere of a zinc porphyrin compound has been of interest. The stability constants of five-coordinate complexes of zinc–octaethylporphyrin and zinc–tetraphenylporphyrin have been studied by absorption and steady-state fluorescent measurements in the presence of different donor molecules for axial ligation, over a temperature range of 20–60 °C.⁸¹⁸ The X-ray structure of the zinc 5,10,15,20-tetraphenylporphyrin complex as an 18-crown-6, dichloromethane solvate shows a five-coordinate zinc center with an axial water molecule. The displacement from the mean plane of 0.36 Å is compared with other five-coordinate zinc porphyrins with axial oxygen donors.⁸¹⁹ Six-coordinate zinc porphyrin complexes have been structurally characterized by X-ray diffraction; for example, zinc tetraphenylporphyrin with two axial tetrahydrofuran ligands.³⁵⁷ The possibility of π – π interactions in the axial binding of amines to zinc porphyrins was investigated by comparing the binding of aromatic amines to zinc porphyrins with appended phenyl groups to the binding of butylamine. Enhanced binding of the aromatic amines was discussed in terms of ligand geometries and the superstructure.⁸²⁰ Site selection was observed in imidazole binding to a single strapped zinc porphyrin.⁸²¹ Selective binding was observed within the cavity of a cyclic zinc porphyrin dimer.⁸²²

Other supramolecular structures such as dendrimers have also been synthesized with zinc-containing porphyrins. Sixteen free base and sixteen zinc porphyrin units were added at the fifth generation of dendritic poly(L-lysine) and intramolecular fluorescence energy transfer was observed.⁸²³ Assembly of supramolecular arrays in the solid state has been achieved with the incorporation of an amide group for hydrogen bonding. Zinc meso-tetra(4-amidophenyl)porphyrin

forms open two-dimensional arrays via hydrogen bonding of adjacent molecules.⁸²⁴ Low-melting liquid crystal zinc porphyrins have been characterized with calamitic nematic mesophases. The control of the intermolecular π - π interaction by functionalization at the 5,15 positions on the zinc porphyrin reduces the melting and clearing points.⁸²⁵ Supramolecular structures such as rotaxanes have been produced with zinc porphyrins acting as the stoppers on the thread. A copper(I) bis(1,10)phenanthroline forms the central part of the rotaxane and is involved in photoinduced electron transfer between the terminal porphyrin units.⁸²⁶

A trianionic zinc porphyrin anchored to a membrane by an imidazole link has been used to bind cytochrome c at the membrane surface. UV spectra confirmed the insertion of the zinc porphyrin into the phospholipid vesicle and was used to study surface association of cytochrome c.⁸²⁷

The 5-oxaporphyrin macrocycle is a modified porphyrin (with an oxygen atom instead of a meso-methine unit) and is produced during heme degradation. The diamagnetic zinc verdoheme analogs, with the monoanion of octaethyl-5-oxaporphyrin as ligand, undergo ring opening when treated with alkoxide ions, forming the zinc complex of the dianion of octaethylmethoxybiliverdin. The X-ray structure of the ring-opened product demonstrates a four-coordinate zinc complex where the geometry is controlled by the helical nature of the ligand and does not form a regular tetrahedral geometry (Figure 14).⁸²⁸

6.8.10.6.2 Phthalocyanine-based ligands (see Chapter 1.24)

Once again, a representative sample of zinc phthalocyanine complexes is presented highlighting particular areas of importance.

The X-ray structure of zinc naphthalocyanate has been determined with Zn—N bond lengths of 1.983(4) Å.⁸²⁹ Pentanuclear complexes with a zinc phthalocyanine core and four ruthenium subunits linked via a terpyridyl ligand demonstrate interaction between the photoactive and the redox active components of the molecule. The absorbance and fluorescence spectra showed considerable variation with the ruthenium subunits in place.⁸³⁰ Tetra-*t*-butylphthalocyaninato zinc coordinated by nitroxide radicals form excited-state phthalocyanine complexes and have been studied by time-resolved electron paramagnetic resonance.⁸³¹

Tetrakis(2',2',3',3',4',4',5',5'-octafluoropentoxy) phthalocyanine zinc was synthesized and characterized demonstrating the effects of the strongly electron-withdrawing groups on the electronic and spectroscopic properties of the complex.⁸³² Zinc phthalocyanate,

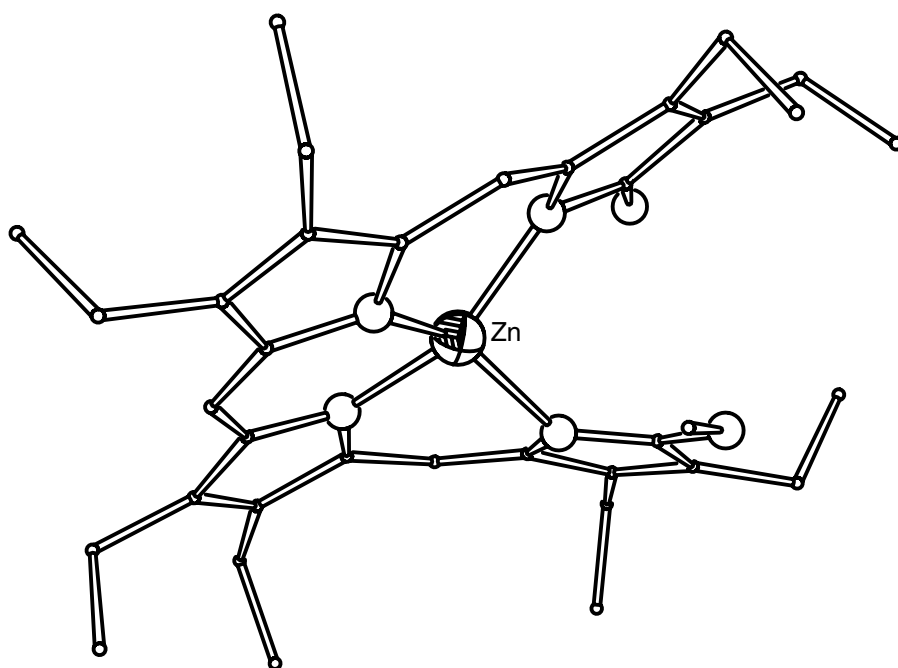

Figure 14 Molecular structure showing the helical nature of the zinc complex with a 19-methoxyoctaethylbiliverdin ligand formed on ring opening of the oxaporphyrin macrocycle.⁸²⁸

2,3,9,10,16,17,23,24-octabutylthiophthalocyaninato zinc with thio linkages to alkyl substituents have been characterized and spectral and electrochemical properties compared to the oxy-linked equivalent.⁸³³

The photochemical formation and the analysis of the absorption and magnetic circular dichroism spectra of the anion radical of zinc phthalocyanine were carried out. A complete assignment of the optical spectrum of the anion radical was proposed.⁸³⁴ Similarly, spectroelectrochemical cells have been used to record absorption and magnetic circular dichroism spectra of zinc phthalocyanines and a band assignment scheme proposed.⁸³⁵

The redox potentials of zinc-substituted phthalocyanines are shown to be linearly dependent on the total Hammett substituent constant.⁸³⁷ In 1987, Stillman and co-workers used the absorption and magnetic circular dichroism spectra of the zinc phthalocyanine and its π -cation-radical species to assign the observed bands on the basis of theoretical calculations. The neutral and oxidized zinc phthalocyanine complexes with cyanide, imidazole, and pyridine were used with the key factor in these studies the stability of the π -cation-radical species.⁸³⁸ The structure of zinc chloro(phthalocyaninato) has been determined and conductivity investigated.⁸³⁹

Dinaphthotetraazaporphyrins are structural isomers of phthalocyanines. The zinc complex was formed and the properties compared to zinc phthalocyanines demonstrating a lower fluorescence quantum yield for the zinc-fused naphthalene porphyrin (D_{2h} symmetry) vs. the zinc phthalocyanine (D_{4h}).⁸³⁶

A porphyrin compound with a 2,9-dimethyl-1,10-phenanthroline functionality fused at the beta-pyrrole positions is a phthalocyanine analog, and formed a complex with zinc in the cavity and a further zinc binding to the phenanthroline group. The absorption and emission spectra of the compound with and without the external zinc demonstrated the strong effects of the second metal binding on the porphyrin π -system.⁸⁴⁰

Unsymmetrical zinc phthalocyanine analogs with three 15-crown-5 ether ligands appended at the 3,4-positions were synthesized and characterized. Introduction of alkali metal ions results in cofacial dimer formation with evidence for this dimerization from ^1H NMR.⁸⁴¹

6.8.11 LIGANDS WITH MIXED DONORS

Mixed-donor ligands have been of particular interest in the modeling of enzyme active sites that may contain, for example, a mixture of cysteine and histidine ligands. The binding of some species is stabilized by a chelating ligand giving more examples of less well characterized donor groups, and in other cases the chelating ligands allow isolation of molecular species that would otherwise form bridged multimetallic compounds.

6.8.11.1 Bidentate Mixed Donor Ligands

6.8.11.1.1 N/O ligands

There are a number of important N/O bidentate ligands including the chelate stabilized ketone and aldehyde complexes, and amino acid complexes.

Zinc alkoxides are oligomeric or polymeric. The preparation of monomeric species is challenging and has resulted in the use of chelate ligands to try to stabilize them. The chelate ligand 2-pyridylmethanol, however, has been shown to give dinuclear and heptanuclear zinc structures $[(\text{HL})_2\text{Zn}(\mu\text{-Cl})_2\text{Zn}(\text{HL})_2]\text{ZnCl}_4$ and $[\text{Zn}(\text{ZnL}_2)_6]\text{Cl}_2$. The Zn_7 compound contains bridging alkoxides and resembles a fragment of the brucite structure while the dimeric structure shows the relatively common Zn_2Cl_2 bridging motif.⁸⁴²

Chelating aldehydes such as 2-pyridine carbaldehyde and 2-dimethylamino benzaldehyde improve the stability of the aldehyde complexes via N,O chelation. NMR studies show that the complexes are present in solution without an excess of aldehyde and can be formed in the presence of donor ligands. The X-ray structures showed longer and weaker Zn—O bonds when more than one chelating ligand was present. IR demonstrates the variation in C=O bond strengths and how the environment of the zinc ion will influence potential catalytic activity via reaction rates or pathways. Tetrahedral chelate complexes, and octahedral bis- and tris-chelate complexes, were isolated.⁸⁴³

The complexes of zinc with pyridylphenylketone and pyridylphenylmethanol are stabilized by the chelate effect. The complexes formed were dependent on anions present and the ratio of the

ligand. Pyridylphenylketone gave tetrahedral, square-pyramidal, trigonal-bipyramidal and octahedral complexes with either one or two ketone chelate ligands present and anions or solvent completing the coordination sphere. Only one analogous pyridylphenylmethanol complex was characterized, $\text{ZnL}_2(\text{OSO}_2\text{CF}_3)_2$. An octahedral complex was formed with three chelate alcohol ligands and polymeric zinc pyridylphenylmethoxide could be synthesized on deprotonation.³⁵⁰

Amino acid complexes, where the amino acid acts as a bidentate ligand donor towards zinc, have been isolated. The complexation behavior of racemic isovalinate and valinate towards zinc has been studied. The bidentate ligands form a number of complex types with zinc including a number of mononuclear complexes and a hexanuclear structure. The relevance of these compounds to conditions early in the history of the Earth and the possibility that amino acid complexes of zinc may have been some of the prebiotic compounds on Earth was discussed by Strasdeit *et al.* in the light of thermolysis reaction results.⁸⁴⁴ The molecular structure of bis (L-leucinato) zinc shows it to be monomeric.⁸⁴⁵ Amino acids containing a thiazolidine ring were studied via formation of zinc complexes with thiazolidinecarboxylic acid and the X-ray structure of trans-diaqua bis-(2-thiazolidinecarboxylato)zinc determined.⁸⁴⁶

Distorted octahedral geometry is observed with the 2-quinolinecarboxylate ligand in the complex $[\text{Zn}(\text{2-quinolinecarboxylato})_2(\text{1-methylimidazole})_2]$ synthesized from zinc oxide.⁸⁴⁷ 2-Pyridinecarboxylate esters act as bidentate NO ligands and a number of zinc complexes have been structurally characterized in the presence of halides. Zinc-to-ligand ratios of 1:1 and 1:2 have been used. Monomeric distorted octahedral complexes are demonstrated with the halides *cis* and the 2-pyridinecarboxylate esters coordinating via the pyridine nitrogen and the carbonyl oxygen atoms.⁸⁴⁸

The complexes formed from salicylhydroxamic acid and acetylsalicylhydroxamic acid (**104**) with zinc show loss of one ligand proton and loss of two ligand protons respectively. The zinc complex of the acetyl derivative appears to show coordination via the deprotonated amide and phenolate oxygen of the ligand. IR studies are presented.⁸⁴⁹

Chelating pyrazole ligands are also known. The pseudo-octahedrally coordinated zinc complex $\text{ZnL}_2(\text{pyridine})_2$ was formed where $\text{L} = 5\text{-(4-methoxyphenyl)pyrazole-3-carboxylate}$.⁸⁵⁰

Polymeric or monomeric complexes are formed in the reaction between zinc halides and dimethyl(aminomethyl)phosphine oxide dependent on the ratio of reactants. The ligand can bind as bidentate to one metal center or bridge two metal centers through the amine N and phosphine oxide O atoms.⁸⁵¹

6.8.11.1.2 N/S ligands

N/S mixed-donor ligands are of particular interest due to the biological relevance of the combination of these donors around zinc.

The ligand mercaptoethyl pyridine forms a monomeric ZnL_2 complex with the chelate ligand binding through the nitrogen and thioether sulfur.¹²⁵

A tetranuclear complex is formed with (dimethylamino)ethanethiolate of type $[\text{Zn}_4\text{L}_4\text{Cl}_4]$. It can be obtained directly from the zinc chloride salt or from zinc acetate in the presence of HCl.⁸⁵²

The stability constants of zinc complexes of 4,6-dimethyl-2-thiopyrimidine have been determined by potentiometric measurements. The crystal structure shows infinite zigzag chains of ZnL_2 units with each zinc coordinated by an N_3S_2 donor set in a trigonal-bipyramidal geometry.⁸⁵³

The terephthalate anion was used to form hydrogen-bonded bridged zinc thiosemicarbazide complexes. The bidentate thiosemicarbazide ligands (**105**) are not displaced from coordination to the zinc center and the polymeric layer structure is based on hydrogen bonding interactions of ligands with the terephthalate anions. In contrast the addition of terephthalate to the zinc thiourea complex displaces two of the four unidentate thiourea ligands forming a zigzag chain network with zinc ions bridged by terephthalate groups. The thiourea ligands also bridge, linking the structure in a double strand motif.⁸⁵⁴

The synthesis of ferrocene-appended zinc complexes from a zinc phosphohydrazide, $[\text{PhP}(\text{S})(\text{NMeNH}_2)_2]\text{ZnCl}_2$, with the ferrocene functionality added via a Schiff base condensation is presented in Scheme 4. A series of ferrocene-containing compounds including a macrocycle were synthesized by this method, showing a five-membered ring with the zinc bound to the S and N-donors of the phosphodihydrazone ligand.⁸⁵⁵

2-Mercaptomethylpyridine forms a zinc complex of the form ZnL_2 , and the zinc has a tetrahedral N_2S_2 geometry.¹²⁵ Similarly, the monomeric tetrahedral zinc complex of 2-(dimethylamino)ethanethiolate, ZnL_2 , was structurally characterized.⁸⁵⁶

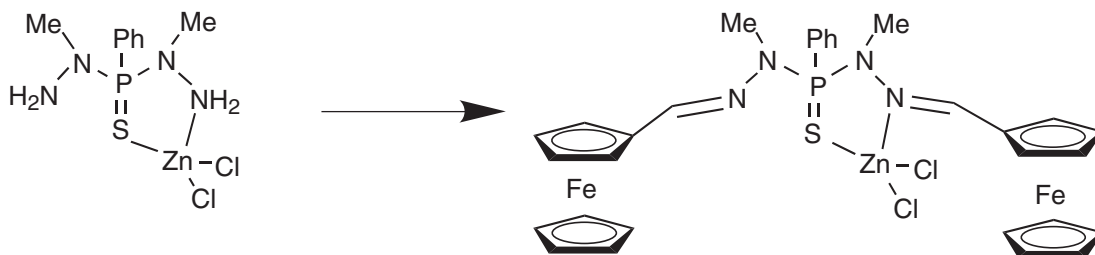

Scheme 4

Zinc complexes of peptides with N-terminal cysteine are monomeric of the form ZnL_2 where the peptide is an anion with the SH deprotonated. Tetrahedral N_2S_2 coordination is observed with the chelating peptides and $Zn(Cys-Gly-NH_2)_2$ was structurally characterized.⁸⁵⁷

Bidentate ligand systems are also known with selenium and nitrogen donors. For example, Se/N bidentate phosphinochalcogenoic ligand and zinc amides react to form a distorted tetrahedral complex with two di-*t*-butylphosphinoselenoic isopropylamidate ligands.⁵⁹⁰

6.8.11.1.3 O/S and other ligands

O/S ligands, such as monothiocarbamates and thiocarboxylates, have been quite extensively characterized and some representative examples are discussed.

Sodium monothiocarbamate in the presence of zinc chloride gives zinc bis(diethylmonothiocarbamate).⁸⁴ A cage complex is formed from the reaction of $EtZnNEt_2$ with carbon disulfide, $[Et_4Zn_4(OSCNEt_2)_2(NEt_2)_2]$. The crystal structure shows the cage is comprised of two six-membered Zn_2CNOS metallocycles linked by pairs of $Zn-S$ and $Zn-O$ bonds. Both the oxygen and the sulfur atoms are binucleating in the observed binding mode for the monothiocarbamate ligand. The polymetallic cage structure was demonstrated to remain intact in solution by variable temperature 1H NMR studies.⁸⁴ Zinc thiocarboxylate complexes $Zn(SOCR)_2(3,5\text{-dimethylpyridine})_2$ with $R = Me$ or tBu were synthesized and their potential evaluated as precursors for zinc sulfide materials formation. It was anticipated that thiocarboxylic anhydride elimination would occur to give stoichiometric metal sulfides with clean removal of the ligands.

The complexes were shown to be monomeric in the solid state and have monodentate S-thiocarboxylate ligands. The thiocarboxylic anhydride elimination was studied by 1H and ^{13}C NMR in solution, varying the R group and solvent.⁸⁵⁸

Some O-Se ligands are also known. *N,N*-diethyl-*N'*-benzoylselenoureato zinc has been characterized where the zinc is bidentately coordinated to the two ligands through the oxygen and selenium atoms, forming a distorted tetrahedral geometry.⁸⁵⁹

Se-S and P-S ligands are much less common with relatively few examples structurally characterized. The bidentate Se-S donor ligand $[N(SPPH_2)(SePPh_2)]^-$ forms a monomeric bis-chelate zinc complex which has been studied using X-ray diffraction and ^{31}P and ^{77}Se NMR.⁸⁶⁰ Zinc complexes of bidentate S-P donor arenephosphinothiolate ligands have been synthesized by electrochemical oxidation of a zinc anode. The zinc thiolate complex formed in reaction with 2-(Ph_2P)-6-(Me_3Si) C_6H_3SH is of the form ZnL_2 . Adducts can also be formed with bipyridine and phenanthroline ligands.⁸⁶¹ This compound is a rare example of a structurally characterized bidentate S/P ligand as part of a zinc complex.

6.8.11.2 Tridentate Mixed Donor Ligands

There are a number of mixed-donor tripodal ligand systems which have been characterized with zinc coordinated, some of which will be discussed in this and the following sections.^{125,466,862,863}

N,N-bis(2-hydroxy-di-3,5-*t*-butylphenyl)amine forms complexes of zinc which have ligand-based redox processes with four oxidation levels of the coordinated anion.⁸⁶⁴ 2:1 and 1:1 complexes are formed in the presence of zinc with the 2:1 complex coordinated in an octahedral geometry and the 1:1 complex square planar with a triethylamine ligand completing the coordination sphere. The complexes, at the different redox levels, have been investigated by EPR, spectroelectrochemistry, ¹H NMR, and magnetochemistry, as appropriate.

Bis(pyrazolylethyl)ether derivatives (**106**) have been coordinated to zinc providing an N₂O donor set. The structural data shows that the ligand coordinates in a meridional rather than facial geometry limiting the application for the modeling of N₂O zinc enzyme sites. (derivatives R = *i*-Pr or Me).¹⁶¹

The 1-(*N*-methyl)benzimidazolyl-3-benzimidazolyl-2-oxapropane ligand (**107**) shows coordination through the N₂O donor set of the ligand, a water molecule and an acetonitrile to give a five-coordinate distorted trigonal-bipyramidal metal center.¹²³ This contrasts with the behavior of the related thiapropane ligand that forms bidentate complexes with zinc.

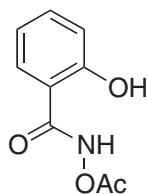

(104)

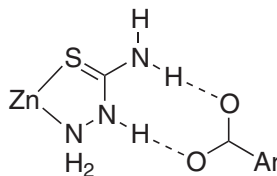

(105)

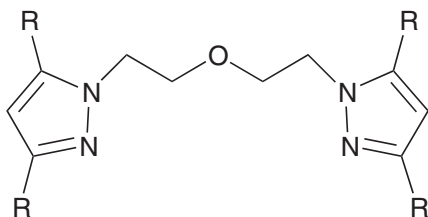

(106)

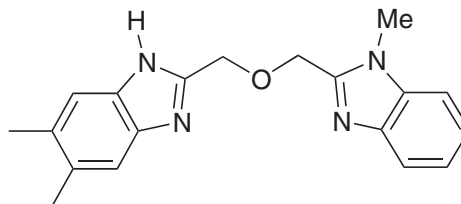

(107)

A tridentate NO₂ donor set complex was formed from 2-pyridinecarboxaldehyde N-oxide and 2-aminophenol and gave mononuclear and trinuclear compounds. The trinuclear zinc complex was structurally characterized and revealed bridging acetate groups, [ZnLZn(OAc)₄ZnL].⁸⁶⁵

The zinc complex of 2-[[[2-(2-pyridinyl)ethyl]amino]methyl]phenol forms a dimeric species, [ZnL(NO₃)₂]₂, with the two phenolates bridging and each ligand offering an N₂O donor set.⁸⁶⁶

Zinc sites in enzymes are usually pseudo-tetrahedral with N, O, S donors from histidine, tyrosine, glutamic acid, aspartic acid, water or cysteine. A systematic evaluation of all the different possibilities was carried out with a heteroscorpionate ligand system (**61**). Seven heteroscorpionate complexes were structurally characterized in one study.⁷⁸ Five complexes revealed the expected tridentate coordination to the deprotonated ligand with the coordination sphere completed by acetate, thiophenolate, methylate, or chloride. All the compounds apart from the acetate structure showed pseudotetrahedral coordination. The acetate-containing structure is five-coordinate with an unsymmetrically bound acetate. Two of the structures showed different coordination modes. The diiodide zinc complex of the phenol ligand shows bidentate binding to the two nitrogen ligands and no bond to the phenol, giving a pseudotetrahedral geometry. Two equivalents of the thiophenol ligand gives a zinc bound to two bidentate ligands by one thiophenolate sulfur and one pyrazolyl nitrogen.

A tridentate SNO ligand coordinates with a bipyridine to give ((2,2'-bipyridine)[2-(2-mercapto-phenyl)iminophenoxy])zinc. The monomeric complex has a distorted trigonal-bipyramidal geometry with a phenolate and a thiolate coordinated. The synthesis was carried out electrochemically from anodic zinc in the presence of a disulfide-linked ligand precursor.⁸⁶⁷

Aliphatic thiosemicarbazones reveal varying coordination behavior dependent on the degree of deprotonation. The X-ray structure of the zinc complex of methyl pyruvate thiosemicarbazone shows different coordination of the two thiosemicarbazone ligands in the monomer, with one tridentate NOS and the other monodentate.⁸⁶⁸

Riordan and co-workers have examined zinc complexes of pyrazolyl-bis[(methylthio)methyl]-borate ligands as models for methionine synthase.^{547,869} The ligand coordinates in a face-capping fashion with the desired NS₂ donor set.

The NSN donor ligand 5-(3,5-dimethylpyrazol-1-yl)-3-thia-1-pentaneamine forms 1:1 ligand-to-metal monomeric complexes with zinc chloride and nitrate salts.⁸⁷⁰

The potentially tridentate thiol ligand *N*-(2-mercaptoethyl)picolylamine shows zinc complex formation that varies with the anion and presence of other ligands. Trinuclear complexes are formed with non-coordinating anions [Zn₃L₄]²⁺. In the presence of halides or acetate, 1:1 complexes are formed that are polymeric and dimeric respectively. The 2:1 complex can also be obtained with the ligands binding as bidentate, giving an N₂S₂ coordination sphere, and due to the free binding sites on the ligands this form can be converted to either the trinuclear compound or the polymer by reaction with zinc salts or HCl respectively.⁸⁷¹ The related N₂S ligand *N*-(2-mercapto-iso-butyl)picolylamine also forms the 2:1 zinc complex with two uncoordinated nitrogen donors and can be converted to the trinuclear compound.⁸⁷²

2-Methyl-1-[methyl-(2-pyridin-2-yl-ethyl)amino]propane-2-thiol (**108**) is a tridentate N₂S ligand with an aliphatic thiolate ligand. The single-crystal X-ray structures demonstrate that the zinc complexes are close structural analogs of the His₂Cys site found in peptide deformylase.⁸⁷³

Methyl pyruvate thiosemicarbazone in the presence of zinc chloride or acetate resulted in the formation of complexes with the ligand hydrolyzed or transesterified. The complexes with pyruvate thiosemicarbazone, ZnL₂, or ethyl pyruvate thiosemicarbazone, ZnLCl₂ were structurally characterized by single-crystal X-ray crystallography showing respectively a distorted octahedral and distorted square pyramidal geometry.⁸⁷⁴

The ligand *N,N*-bis(2-mercaptoethyl)benzylamine complexes zinc in the doubly deprotonated form resulting in a tetranuclear complex, Zn₄L₄, which has an unusual Zn₄S₄ metalacyclic structure.⁸⁷⁵

The compounds Zn[E₂CN(Me)CH₂CH₂CH₂NMe₂]₂ E = Se, S were synthesized and found to be polymeric in the solid state. Their potential as single-molecule precursors for material growth by low-pressure metal-organic chemical vapor deposition (LP-MOCVD) was evaluated by attempts to grow ZnS and ZnSe films.⁶⁰⁰ The X-ray structures of the complexes show the two S or Se donors coordinating to one zinc center and the amine binding to a neighboring zinc atom resulting in the coordination polymer.

6.8.11.3 Tetradentate Mixed Donor Ligands

Mixed donor ligands based on tris(2-aminoethyl)amine, often referred to as tren, have been complexed with zinc. The replacement of one or two primary amines by hydroxy groups gives N₃O and N₂O₂ donor set ligands, 2-hydroxy-*N,N*-bis(2-amino ethyl)ethylamine and 2-amino-*N,N*-bis(2-hydroxyethyl)ethylamine respectively. The zinc complexes were formed and studied by potentiometric and NMR titrations. The zinc appears to show only weak interaction with the hydroxy group in acidic or neutral solution. The [ZnL]²⁺ cation can be deprotonated at the hydroxyl group with one or two protons released dependent on the ligand. The stabilities of the compounds show a decrease with sequential replacement of -NH₂ with -OH. The crystal structure of 2-amino-*N,N*-bis(2-hydroxyethyl)ethylamine with zinc demonstrates a dimeric structure in the solid state, [Zn(OH)(LH)ZnL]²⁺. Both zinc ions have a distorted trigonal-bipyramidal coordination geometry, one zinc is bound to the three nitrogens and one alkoxide from the monodeprotonated ligand and a hydroxide ion, the alkoxide group bridges to the second zinc ion which is additionally coordinated to the N₃O donor set of the remaining ligand.⁸⁷⁶

An unusual unsymmetric tripodal ligand, (2-picoly)(*N*-pyrrolidinyethyl)(2-hydroxy-3,5-di-*t*-butylbenzyl)amine, with three different donor groups attached to the central amine was synthesized by Vahrenkamp and co-workers. The zinc complex of the N₃O ligand with an additional phenoxide coordinated was structurally characterized (Figure 15).⁸⁷⁷

The bis(*N,N'*-[dithiobis(ethylene)](4,6-dimethoxysalicylideneiminato)) zinc complex is characterized as a distorted tetrahedral complex with an N₂O₂ donor set from the tetradentate ligand.⁸⁷⁸

A tetradentate ligand 2-{bis[2-(2-pyridyl)ethyl]aminomethyl}phenolate complexes zinc with an N₃O donor set including pyridyl and phenolic groups. The X-ray structure reveals that a dimeric

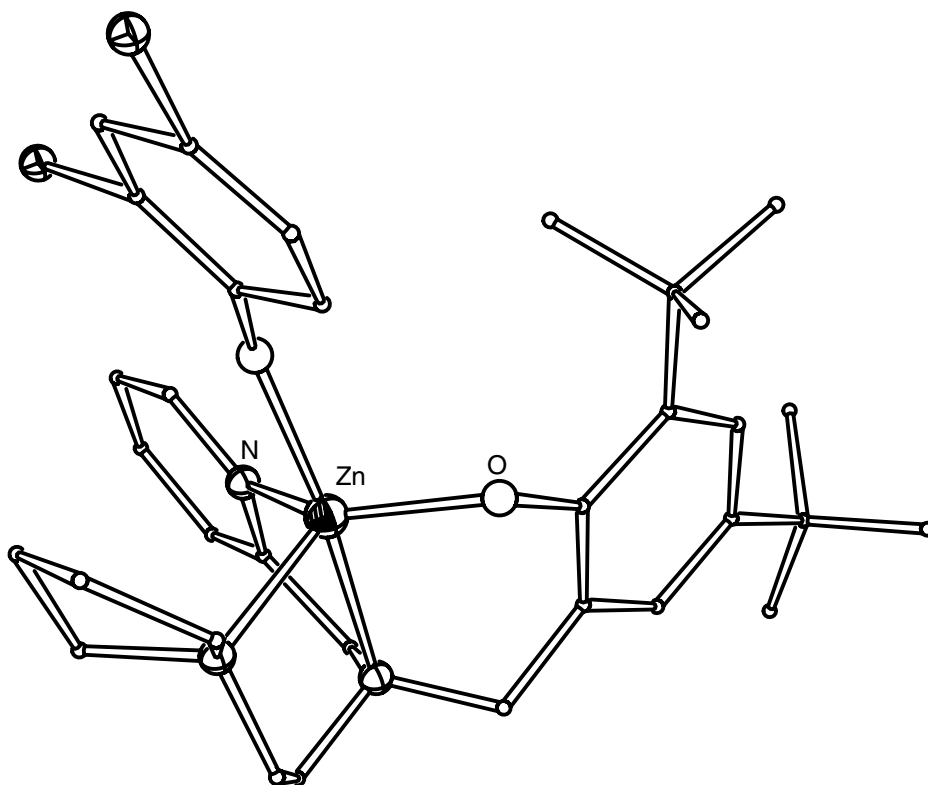

Figure 15 The molecular structure of the zinc complex formed with the unsymmetric tripod, (2-picolyl) (*N*-pyrrolidinyethyl)(2-hydroxy-3,5-di-*t*-butylbenzyl)amine and 2,4-dibromophenoxide.⁸⁷⁷

species has formed with the phenoxide oxygens bridging the two distorted square-pyramidal zinc centers with a zinc-zinc separation of 3.284 Å. The complexes were demonstrated to promote the hydrolysis of tris(*p*-nitrophenyl) phosphate.⁸⁷⁹

Zn and N K-edge XANES have been used to distinguish the coordination geometries in (1,2-ethanediylidene)-bis(*S*-methylhydrazoncarbodithionate) zinc complexes (**109**). The technique distinguished between tetrahedral species, square-pyramidal dimers, and square-pyramidal monomers, formed when pyridine was present. These studies were in conjunction with spectroscopic characterization and X-ray single-crystal data where possible.⁵³ The results demonstrated the value of this technique when single crystals could not be obtained.

The zinc complexes of tetradentate ligands derived from the condensation of (1*R*)-3-hydroxymethylenebornane-2-thione and symmetric diamines were synthesized. The binding to zinc occurs through the enethiolate imine form of the ligands. The complexes were studied by circular dichroism and NMR spectroscopy. In solution there are several species present due to the conformational flexibility offered by the chelate ligands. Increasing the length of the carbon chain in the diamine moiety from two to four carbon atoms favors tetrahedral geometry at the zinc center.⁸⁸⁰

A series of N₂S₂ donor set complexes of zinc with Schiff base ligands with thiopyrazolyl units, (**110**) and (**111**), were characterized by X-ray crystallography and NMR studies. For example, the structure of bis[4-(2,6-dimethylphenyliminomethyl)-1-methyl-3-phenylpyrazole-5-thiolato-*N,S*]zinc showed a similar geometry to horse liver alcohol dehydrogenase. The electronic spectra demonstrated the development of thiolate character on complexation of the mainly thione ligand.⁸⁸¹

Solution studies of zinc binding to *N,N'*-dimethyl-*N,N'*-bis(2-mercaptoethyl)ethylenediamine and (2-mercaptoethyl)amine did not show formation of polynuclear complexes, as was observed for cadmium(II). The titrations carried out with a variation in excess of the ligands showed 1:1 complex formation with the tetradentate N₂S₂ ligand and 1:2 and 1:3 metal-to-ligand ratios for the bidentate (2-mercaptoethyl)amine ligand.⁸⁸² Tetradentate N₂S₂ Schiff base complexes of zinc incorporating pyrazole or oxazole heterocycles were synthesized and the configuration of the complexes determined by the chemical shift differences in the ¹H NMR spectra.⁸⁸³

Ferrocene-containing sulfur ligands have been used in complex formation with zinc. 3-Ferrocenyl-3-mercapto-propenal and 1,1'-bis(3-mercapto-propenal)ferrocene (**112**) form stable complexes as do their Schiff base derivatives with aniline or 1,2-ethylenediamine. The $\text{Fe}^{\text{II}}/\text{Fe}^{\text{III}}$ redox couple shows only minor metal dependence, this is attributed to tetrahedral distortion.⁸⁸⁴

The ligand bis(2-picolyl)(2-hydroxy-3,5-di-*t*-butylbenzyl)amine is a tetradentate N_3O tripodal ligand which enforces a five-coordinate geometry in its complexes. Cleavage of tris(*p*-nitrophenyl) phosphate was investigated and LZnOH was shown to be the hydrolytically active species.⁴⁶⁶ *N,N*-bis(2-picolyl)glycine was introduced as a ligand via a hydrolysis reaction of its ethyl ester with zinc. Monomeric complexes formed which were shown to be five- or six-coordinate dependent on the coligands.⁸⁸⁵

Zinc complexes of cyclohexane-1,2-dione bis(thiosemicarbazone) have been formed in the neutral and doubly deprotonated form. The X-ray structures show distorted square-based pyramidal geometries for both complexes $[\text{ZnL}(\text{OH}_2)]$ and $[\text{Zn}(\text{H}_2\text{L})\text{Cl}]\text{Cl}$ with the water or chloride occupying the axial position.⁸⁸⁶ The binuclear complex bis[1-phenylglyoxal bis(3-piperidylthiosemicarbazone)zinc] was synthesized by electrochemical methods and reveals a Zn_2L_2 with two tetradentate bis-thiosemicarbazone ligands bridging the metal centers.⁸⁸⁷

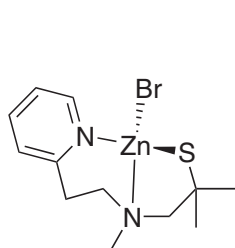

(108)

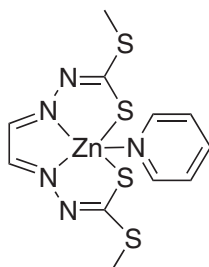

(109)

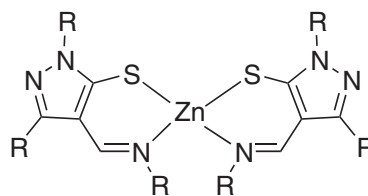

(110)

R = alkyl or phenyl

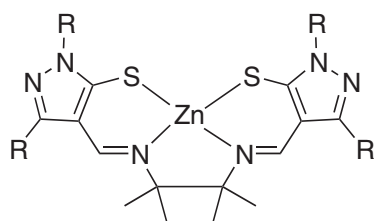

(111)

R = alkyl or phenyl

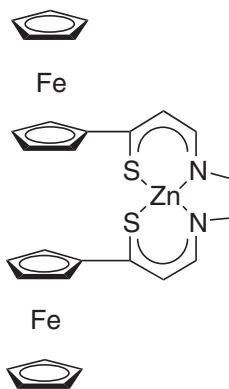

(112)

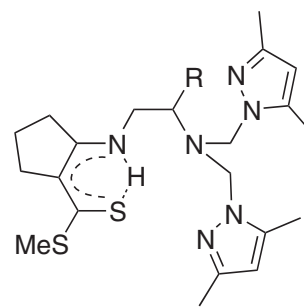

(113)

R = H, Me

6.8.11.4 Pentadentate and Higher Denticity Mixed Donor Ligands

N_4O donor set ligands with pyridyl and phenolic arms form mononuclear complexes with approximately trigonal-bipyramidal coordination geometries.⁸⁸⁸

The pentadentate ligand 2,6-diacetylpyridinebis(thiosemicarbazone) produces complexes of zinc which vary structurally, dependent on the protonation state of the ligand and the solvent. The ligand in its neutral form results in a structurally characterized mononuclear complex with pentagonal-bipyramidal geometry. The planar ligand and two axial water molecules form the zinc-containing cation. The doubly deprotonated ligand forms dinuclear complexes with a 1:1 ligand-to-metal ratio. The coordination number of the zinc centers is dependent on solvent.⁸⁸⁹

Fenton and co-workers observed the hydrolysis of bis- and tris-nitrophenyl phosphate with the zinc complex of the pentadentate N_3O_2 ligand N,N' -{(salicylideneimino)-ethyl}-2-hydroxy-5-nitrobenzylamine.⁸⁹⁰

Pentadentate ligands with N_4S donors based on methyl 2-aminocyclopent-1-ene-1-dithiocarboxylate with pendent pyrazolyl groups (**113**) form complexes with zinc including a structurally characterized trigonal-bipyramidal zinc compound.⁸⁹¹

The reaction of ligand O,O' -(N,N' -dipicolinylidene) diazadiphenyldisulfide with zinc chloride forms $[ZnCl_2][Zn_2Cl_6]$, where the zinc center has octahedral coordination with the ligand pentadentate with an N_4S donor set.⁸⁹²

The zinc complex of a tripodal N_2S_2O pentadentate ligand undergoes amide alcoholysis of a coordinated amide group.⁸⁹³ Examples of amide hydrolysis are known for other ligand systems.⁸⁹⁴

2,2'-[1,2-ethanediylbis(1,3-diazolidone-2-yl)]bis(1-oxo-pyridine) (**114**) is a pyridine N -oxide containing ligand used to complex zinc. The imidazolidone rings cleave on reaction with zinc perchlorate forming a hexadentate ligand (**115**) that coordinates zinc in a distorted octahedral environment as shown by structural characterization. In the presence of DMSO, however, the ligand is transformed back to the ring-formed four-coordinate ligand with two DMSO molecules filling the coordination sites. The mechanism relies on the strong Lewis acidity of the zinc.⁸⁹⁵

A hexadentate $N_2O_2S_2$ ligand (**116**) has been synthesized as a dithiaalkyl-substituted triazene-1-oxide and forms an unusual hexacoordinated zinc complex with thioether donors. Both the phenyl and the methyl derivatives form structurally characterized octahedral complexes.⁸⁹⁶

A number of ligands based on the encapsulating hexadentate edta ligand have been structurally characterized with zinc, including the 3,4-toluenediamine- N,N',N'',N''' -tetraacetate.⁸⁹⁷

Hexadentate ligands 1,12-bis(2-pyridyl)-5,8-dioxa-2,11-diazadodecane and 1,12-bis(2-pyridyl)-5,8-dithia-2,11-diazadodecane have pyridine, amine, and ether or thioether donors offering an N_4O_2 or N_4S_2 donor set. The X-ray structures of the zinc complexes are distorted octahedral with the zinc center encapsulated by the ligand.⁸⁹⁸

An N_5O_2 donor open chain precursor for a macrocycle forms a seven-coordinate zinc complex.⁸⁹⁹

6.8.11.5 Liver Alcohol Dehydrogenase Models with Mixed Donor Ligands

There has been recent expansion of work in this area with major contributions from Vahrenkamp, Parkin, Corrano, and their co-workers. The main aim has been to reproduce the coordination sphere of the enzyme-bound zinc.^{2,335,900-902}

LADH contains a tetrahedral zinc which is coordinated by one histidine nitrogen and two cysteine sulfurs. One aim is to make synthetic analogs of this coordination sphere that also feature the catalytically important water or hydroxide ligand in the fourth coordination site. Analogs containing bound substrates such as alcohols are also of interest.

The catalytic site of LADH has been modeled using the mixed donor NS_2 tripodal pyrazolylbis(thioimidazolyl)borate ligand (**117**) in complex formation with zinc iodide.⁹⁰² Vahrenkamp and co-workers synthesized the pyrazolylbis(thioimidazolyl)borate ligand from 1-(*o*-anisyl)-2-thioimidazole and formed the complex with zinc. This complex, which contains a neutral $ZnNS_2$ unit and binds to ethanol without forming the alkoxide, is an accurate structural model of the LADH active site showing good agreement with the enzyme structure.⁹⁰³

In any model system for an alcohol dehydrogenase enzyme the binding of aldehydes, ketones, and alcohols will be of particular interest. The compounds bis(pentafluorothiophenolato)zinc and bis(2,4,6-tri-*iso*-propylthiophenolato)zinc react with NO chelate ligands to form derivatives with bound aldehyde and alcohol donors as structural models for the LADH active site. Polymeric, tetrameric, and some structures with bridging thiolate or alkoxides were produced, however, the monomeric complexes [(6-methylpyridine-2-carbaldehyde) $_2Zn(SC_6F_5)_2$] and [(6-picolylmethanol) $_2Zn(SC_6F_5)_2$] demonstrated a bound alcohol and a bound aldehyde respectively, with the desired NS_2O coordination. The X-ray structures demonstrate almost superimposable geometry for these two complexes.³⁵⁴

Thiolate ligated zinc complexes have been characterized with a co-crystallized methanol molecule that is hydrogen bonded to a zinc-bound sulfur, and the possibility the alcohols may be activated without coordination to the metal center was discussed by Shoner *et al.*⁹⁰⁴

The substituted tris(2-thioimidazolyl)borate ligands with 1-R-2-thioimidazole groups where $R = ^1Bu$ and C_6H_4 -*p*- $CH(CH_3)_2$ yielded tetrahedral complexes on reaction with zinc salts. The

labile S_3O bound zinc complexes formed with zinc perchlorate were used as starting materials for incorporation of substrates and complexes were formed with ethanol, *p*-nitrophenol, pyridine-2-carbaldehyde, and salicylic aldehyde. The ethanol formed a S_3O complex without deprotonation whereas nitrophenolate was the bound species in the case of nitrophenol. Some preliminary results showing promotion of both the dehydrogenation of 2-propanol and the hydrogenation of pentafluorobenzaldehyde were presented.⁶⁴⁵

Complexes of heteroscorpionate ligands, (3-*t*-butyl-2-hydroxy(or thio)-5-methylphenyl)bis(3,5-dimethylpyrazolyl)methane offering N_2O or N_2S donor sets have been characterized with zinc. The fourth ligand, resulting in a distorted tetrahedral geometry, was varied from halides to sulfur donors or alkyls. The ligand offers a useful comparison with the well-investigated tris(pyrazolyl)borate, N_3 donor ligand and initial studies of reactivity showed a variation in the reactivity properties for the zinc complexes of the three types of ligand.⁷⁸ Further comparisons with the ligand bis(3,5-dimethylpyrazolyl)(1-methyl-1-sulfanylethyl)methane and the octahedral and pseudotetrahedral complexes of zinc have been carried out. Of particular relevance to enzyme modeling is the variation in the binding mode of acetate from unidentate to anisobidentate as the ligand donor is changed from S to N to O.⁴⁵² The Zn- CH_3 complexes of the heteroscorpionate ligands (3-*tert*-butyl-2-hydroxy(or thio)-5-methylphenyl)bis(3,5-dimethyl-pyrazolyl)methane react with pentafluorothiophenol (HSPHF₅). The structures of four of the complexes revealed one or two coordinating thiophenolates dependent on the ratio of the reactants.⁹⁰⁵

Berreau and co-workers recently synthesized a tetradentate mixed nitrogen sulfur donor ligand *N,N*-bis-(2-methylthio)ethyl-*N*-(6-amino-2-pyridylmethyl) amine that was utilized in the formation of mononuclear zinc complexes with a methanol (118) or DMF molecule completing the coordination sphere. The X-ray structures demonstrated the presence of hydrogen bonding from the ligand to the bound solvent oxygen donor. This is again of relevance to the hydrogen bonding interactions found in liver alcohol dehydrogenase.⁹⁰⁶

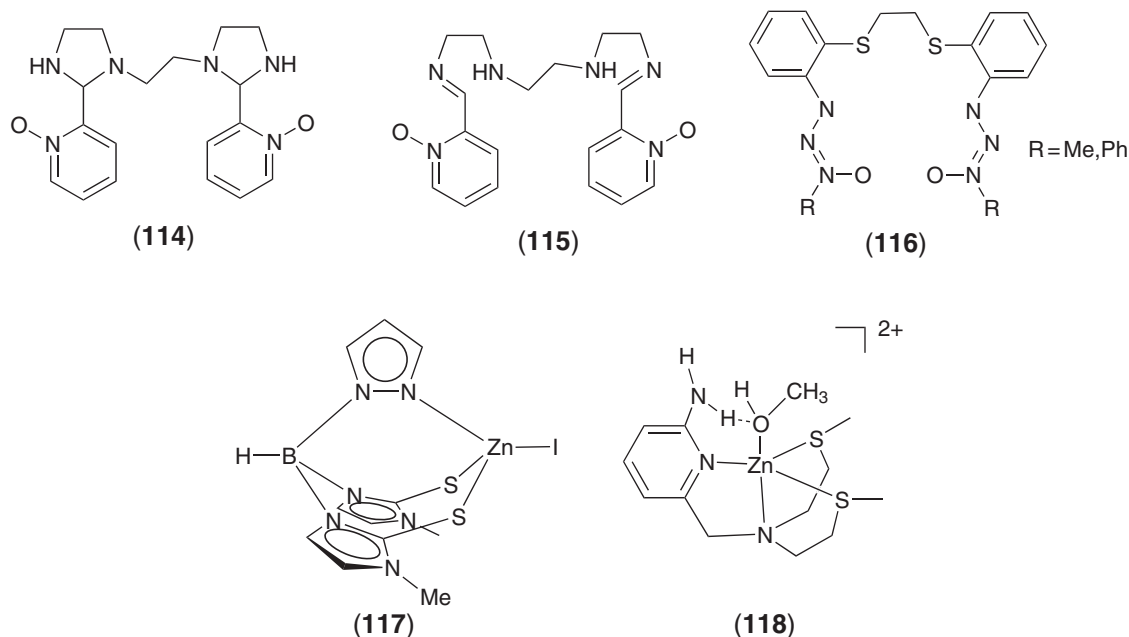

6.8.12 COMPOUNDS CONTAINING ZINC-METAL BONDS

There are a number of structurally characterized compounds exhibiting zinc-metal interactions. Riera and co-workers show a zinc bipyridine unit bridging two manganese atoms in a trimeric unit.⁹⁰⁷ A tetrameric cluster, of form Rh_2Zn_2 , has the two zinc atoms bridging the Rh-Rh bond with a benzyl group completing the coordination.⁹⁰⁸ A rhodium zinc trimer has been characterized that contains only one zinc, a zinc amide unit in this case, bridging the two rhodium centers. A terminal zinc amide has also been observed with an Rh-Zn bond.⁹⁰⁹ A triply bridging $ZnPt_3$ cluster shows a zinc diiodide unit bound over the face of a triangular Pt_3 arrangement.⁹¹⁰ An aquo zinc species has also been observed to bind to platinum with the platinum acting as a weak

σ donor.⁹¹¹ A hepta-rhenium carbonyl cluster has a face-capping μ_3 -ZnCl unit.⁹¹² Zn–Fe bonds have been observed in zinc–iron carbonyl compounds.⁹¹³ $[\text{Zn}_2\text{Cl}_2\text{Fe}(\text{CO})_4(\text{THF})_2]$ is a polymer in the solid state with each zinc tetrahedrally bound to two bridging chloride donors, a THF oxygen donor, and the iron center. In the presence of TMEDA a trimeric species was characterized, $[\text{Zn}_2\text{Cl}_2\text{Fe}(\text{CO})_4\text{L}_2]$, with a ZnFeZn unit of metal–metal bonded atoms. This unit is analogous to that observed in the polymer without bridging chloride ligands between the zinc centers.

6.8.13 APPLICATIONS

6.8.13.1 Drug Applications (see Chapter 9.18)

Advances in drug applications include the use of zinc to reduce gastrototoxicity of some drugs and, in conjunction with designed ligands, for viral inhibition. Binding to zinc in enzyme active sites is a very important part of the action of a number of organic drugs. Other organic drugs may recruit zinc after administration.

Indomethacin (**119**) is a nonsteroidal anti-inflammatory drug that has side effects of inducing gastrointestinal ulceration and hemorrhages. The zinc, and copper, indomethacin complexes have been patented as veterinary pharmaceuticals. Five structures were solved with different coordinating solvents.⁹¹⁴ The dimeric structures, e.g., $[\text{Zn}_2\text{L}_4(\text{pyridine})_2]$, are five-coordinate dimers with the “paddlewheel” structure. In a number of solvents, including methanol, ethanol, and an aqueous/amine donor mixture, a six-coordinate monomer is formed, $[\text{ZnL}_2(\text{MeOH})_2]$. Problems with toxicity to the stomach of the zinc compound may be related to the stability of the dimer. For similar reasons, complexes of 4-hydroxy-3-(5-methyl-3-isoxazolocarbamyl)-2-methyl-2*H*-1,2-benzothiazine-1,1-dioxide (Isoxicam), an anti-inflammatory drug, with zinc and other metals were studied spectroscopically and the zinc complex shown to be of formula $\text{ZnL}_2 \cdot 4\text{H}_2\text{O}$.⁹¹⁵

The complex formation with zinc of drugs that have a relation to the status of zinc-containing species in the human body was also investigated. Captopril, Isoniazid, naldixic acid, and mercaptopurine formed structurally characterized complexes which tended to form polymeric species in the solid state.^{92,916} The binding to the anti-tumor drug streptonegrin has also been studied.⁹¹⁷ Similarly, NMR and molecular dynamics studies of the binding of anti-cancer antibiotics tallysomyin and bleomycin show an interesting arrangement on zinc binding.⁹¹⁸ Studies of enzyme active sites in relation to the binding of ligands to zinc as directed inhibitors have been carried out.⁹¹⁹

Kimura and co-workers have demonstrated the potent antiviral inhibitory action of zinc complexes of bi-cyclam ligands against HIV *in vitro*. A series of compounds, with variation in the bridge between the macrocycles, was synthesized and tested.⁹²⁰

The monomeric zinc complex of the xanthine oxidase inhibitor, alloxanthine, has been structurally characterized.⁹²¹ Potent and highly selective zinc-dependent inhibitors of several therapeutically important serine proteases have been designed and tested.⁹²² Removal of zinc from the retroviral zinc finger protein has shown antiviral action and may offer an anti-HIV strategy that restricts drug resistance development.^{923–925} Cyclosporin A is an immunosuppressant drug used in organ transplantation and is thought to function via intracellular signaling events, and complexation of zinc and calcium suggests that it may act by regulating local concentrations of metal ions.⁹²⁶ The equilibria for binding of zinc ions to ampicillin in the presence of different nucleobases were studied, as was the dimeric complex formation in the presence of chloride ions.^{927,928} The crystal structure of the widely used topical burn drug zinc 2-sulfanilamidopyrimidine shows the structure is a one-dimensional polymer, which is relevant to the desired slow release of zinc ions when applied in therapy.⁹²⁹

6.8.13.2 Catalysts (see Chapter 9.1)

Zinc catalysts have shown a major increase in their possible applications. Some examples of catalysis using halide complexes, including immobilized catalytic systems, have been discussed in Section 6.8.8. Some areas such as asymmetric alkynylation of aldehydes have been recently reviewed.⁹³⁰

There are a number of examples of enantioselective catalysis with a zinc catalyst. The use of zinc as a catalyst in the Diels–Alder reaction of (*R,R*)-4,6-dibenzofurandiyl-2,2'-bis(4-phenyloxazoline) with cyclopentadiene shows high enantioselectivity. Chiral amplification is observed in the

same reaction if the starting material is of low enantio purity, with 20% ee starting material converted to 96% ee for the cycloadduct product. Hydrogen bond formation in the zinc complex contributes to the mechanism of chiral amplification.⁹³¹ Chiral zinc catalysts have been used in the enantioselective reduction of ketones to secondary alcohols by polymethylhydrosiloxane. Enantiomeric excesses (ee) up to 88% were achieved in the presence of a zinc alkyl or zinc carboxylate with a chiral diamine. The process is of particular interest due to the economy and non-problematic scale up of the reaction.⁹³²

The zinc alkoxide of 2-methyl-1-(3-quinolyl)propan-1-ol was used in a catalytic amount to give ee up to 94% in the enantioselective alkylation of quinoline-3-carbaldehyde by diisopropyl-zinc.⁹³³

A few further general examples of zinc catalytic activity or reactivity include the following. Other zinc-containing systems include a zinc phenoxide/nickel(0) catalytic system that can be used to carry out the chemo- and regioselective cyclotrimerization of monoynes.⁹³⁴ Zinc homoenolates have been used as novel nucleophiles in acylation and addition reactions and shown to have general utility.^{935,936} Iron/zinc species have been used in the oxidation of hydrocarbons, and the selectivity and conditions examined.³⁶² There are implications for the mechanism of metal-catalyzed iododisplacement reactions with olefins from the observation that zinc triflate and a dizinc complex catalyze these reactions.⁹³⁷

Zinc polymerization catalysts have been extensively studied. Darensbourg investigated the coupling of carbon dioxide and epoxides with zinc phenoxide complexes including $\text{Zn}(\text{2,6-diphenylphenoxide})_2(\text{THF})_2$.^{343,938} Further research efforts were directed towards the minimization of the polyether formation side reaction. Other zinc catalysts have also found application in polycarbonate formation.⁹³⁹ Different donor ligands for the zinc center were examined as the copolymerization appears to proceed via an anionic coordinative mechanism. Organophosphine ligands were examined, with variation in the substituents on the phosphorus, and changes in the reactivity observed. The X-ray structures of the phosphine/phenoxide complexes show both three- and four-coordinate monomeric complexes.^{309,940} The complex $\text{Zn}(\text{O-2,6-}^t\text{BuC}_6\text{H}_3)_2(\text{PPh}_2\text{Me})$ is trigonal-planar with P—Zn—O angles larger than O—Zn—O angles. The diphosphine compound $\text{Zn}(\text{O-2,4,6-}^t\text{BuC}_6\text{H}_2)_2(\text{PMe}_3)_2$ has a distorted tetrahedral geometry. Competitive binding studies of phosphines studied by ³¹P NMR showed the greatest binding for smaller phosphines indicating that steric effects drive the binding. In the polymerization process with cyclohexene, oxide and carbon dioxide addition of phosphine did not significantly alter reactivity but did appear to reduce polyether linkage formation.

β -Diiminate zinc complexes are highly active catalysts in the copolymerization of epoxides and CO_2 . Complexes that are catalytic are of the form ZnLX , where X is alkoxide, acetate, or bis(trimethylsilyl)amide. Changing the ligand geometries of the complexes allows variation in the catalytic behavior and activity.⁹⁴¹ The polymerization of lactide with diiminate zinc has also been studied.⁹⁴²

6.8.13.3 Fluorescent Detection of Zinc in Cellular Systems

A number of multidentate nitrogen donor ligands have been used in the detection of zinc in cellular systems. Zinc is the second most abundant transition metal in the brain. In the region of 90% of this zinc is bound to proteins but neurons have been shown to contain ionic zinc, with higher concentrations noted in the cerebral cortex and the limbic region.⁹⁴³ There is a distinction between the detection of intracellular and extracellular zinc. A number of strategies have been described, from the simpler classical method of Timm's sulfide-silver stain⁹⁴⁴ to protein- or peptide-based sensors. Kimura and Koike provide a review of progress in this area, with a particular focus on macrocyclic ligands.⁹⁴⁵ The topic has also been more extensively reviewed by Burdette and Lippard.⁹⁴⁶

Detection of intracellular zinc ions is an important aim of biological studies in cell biology and neurology.^{947–958} To clarify the role of zinc in neurotransmission, further study is required and ongoing in a number of research groups. Lippard and co-workers discuss the importance of zinc to the central nervous system and the form it is found in the brain, whether free ions or protein bound. In parts of the hippocampus pools of free zinc are found. As zinc can modulate ion channels it may play a role in a number of essential neurological processes and disorders. Levels of zinc in the body are regulated by zinc transport proteins and by metallothioneins, which are expressed mainly in the brain. Zinc can be released from synaptic vesicles and enter postsynaptic cells via voltage-dependent Ca^{II} channels.

A number of strategies have been successfully pursued in the detection of zinc by fluorescence imaging with the use of proteins, peptides, and amine or macrocycle ligands with attached fluorophores.^{948,956,957,959} As an example, a maltose binding protein has been converted into a zinc sensor via a process of rational design and the engineering of an increased affinity for zinc binding.⁹⁶⁰ Quinoline-based probes have been used for the detection of intracellular zinc (Scheme 5). In particular, Zinquin, an arylsulfonamide derivative of 8-aminoquinoline, has shown, in a variety of eukaryotic cells, 100 pM concentrations of intracellular zinc are revealed by a vesicle-like staining pattern.⁹⁶¹

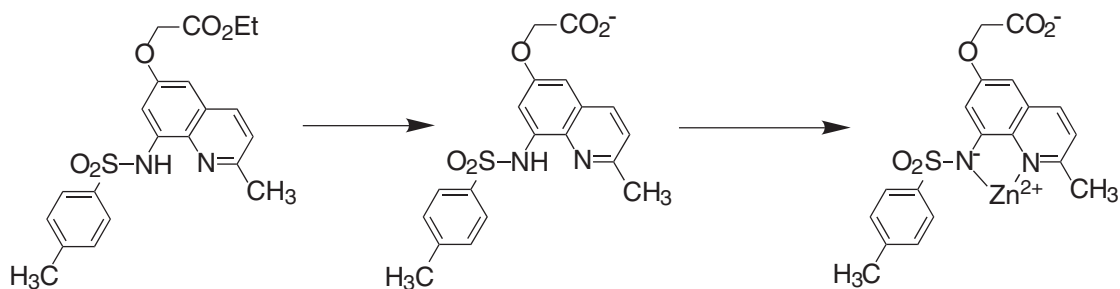

Scheme 5

Probes based on macrocyclic amines include dansylamidoethylcyclen, which can detect zinc at sub-nanomolar concentrations and probes containing xanthene as the chromophore with an ideal wavelength range for intracellular studies.^{953,962} It is also important that the sensors can differentiate between the alkali metals, which are present at higher concentrations, and zinc. 2',7'-dichlorofluorescein-based sensors have been used in biological systems and reveal concentrations up to ca. 0.3 mM in hippocampal nerve synaptic vesicles.⁹⁶³

Lippard and co-workers have developed zinc sensors for intracellular use based upon fluorescein, which has a number of attractive properties for sensor applications. The excitation and emission spectra of Lippard's zinpyr (**120**) compounds show ideal wavelengths for intracellular work and appropriate quantum yield and fluorescence enhancement.^{946,947,958} The compound can bind two zinc ions but the 1:1 stoichiometry is responsible for the intensity increase with no change on binding the second zinc ion. The X-ray crystal structure of the zinc complexes was investigated. The structure of [Zn₂L(H₂O)₂(ClO₄)₂] shows two zinc ions coordinated with each zinc trigonal-bipyramidal bound to the three nitrogen donors of one di-2-picolylamine arm, a phenolic oxygen, and a water molecule. The zinpyr compounds designed by Lippard and co-workers have shown improvements in the optical properties relative to other intracellular zinc sensors, attributed to the use of a fluorescein chromophore. They have demonstrated the potential for this system to monitor the intracellular zinc showing staining of the Golgi or

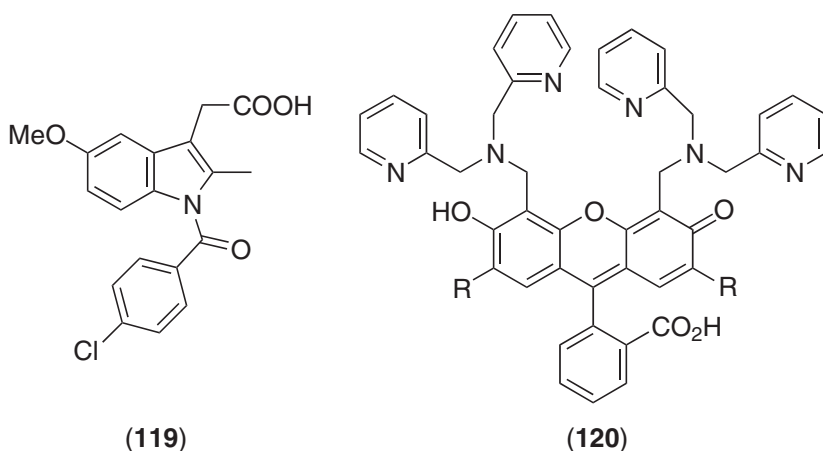

Golgi-associated vesicle. Further improvements in fluorescence enhancement on binding at physiological pH are a stated target for further research.

6.8.14 BIOLOGICAL CHEMISTRY OF ZINC

The increased knowledge of the role of zinc in biological systems has allowed study of the coordination chemistry of small-molecule mimics and the enzymes themselves.⁹⁶⁴ A number of texts deal with biological aspects of zinc and zinc enzymes.^{965–968}

Mimicry of some enzyme systems, such as alcohol dehydrogenase, carbonic anhydrase, Cu/Zn SOD, and phosphate diesterase, has already been discussed with the relevant ligands.

6.8.14.1 Zinc in Biological Systems (see Chapter 8.24)

The lack of zinc can also be a problem in biological systems and is responsible for disease states. For example, nitric oxide-dependent apoptosis can be induced in motor neurons by zinc-deficient SOD, and in some cases of amyotrophic lateral sclerosis, zinc-deficient SOD may participate in this type of oxidative mechanism involving nitric oxide.⁹⁶⁹ One form of hereditary human hair loss or alopecia was mapped to a specific gene and a mutation found in affected individuals. The gene encodes a single zinc finger transcription factor protein with restricted expression in the brain and skin.⁹⁷⁰ Zinc has been implicated in Alzheimer's via beta amyloid formation, and a role has been attributed for the cerebral zinc metabolism in the neuropathogenesis of Alzheimer's disease.⁹⁷¹

The key roles for zinc in biological systems, particularly as structural components of a large number of proteins, are attributed to the ability to bind to a wide range of tetrahedral sites, lack of redox chemistry, and binding and exchange kinetics. The binding of zinc stabilizes the folded conformations of domains allowing interactions between the proteins and other biological molecules such as DNA.³

Zinc is present in presynaptic nerve terminals throughout the mammalian central nervous system and is thought to act as a modulator of synaptic transmission. Excessive exposure to extracellular zinc can damage central neurons. It has been demonstrated that zinc accumulates in degenerating neurons after ischemia, and that the accumulation occurs prior to neurodegeneration, offering therapeutic chelation possibilities. This toxic increase in zinc could be a key mechanism causing selective neuronal death after short ischemia.⁹⁷² Extracellular zinc concentration has also been shown to have a role in blocking aminobutyric acid-caused inhibition in a temporal mode epilepsy model. It is suggested that zinc is released from the terminals of certain granule cells during epileptic seizures.⁹⁷³

It has been demonstrated that extremely tight control is exhibited over the intracellular zinc concentrations by the metalloregulatory proteins controlling zinc homeostasis. It had previously been thought that intracellular zinc was available in a pool of free zinc ions in the micro- to picomolar concentration. An important study shows that these concentrations of free zinc are inconsistent with the concentrations required to trigger zinc uptake.⁹⁷⁴

The recruitment of zinc for a structural role, or to activate an enzyme, has been observed. The zinc ion induces the dimerization of human growth hormone (hGH), with two Zn ions associated per dimer of hGH. This is confirmed by replacement of possible zinc binding residues resulting in weakened binding of the zinc ion. Formation of a zinc-hGH dimeric complex may be important for storage of hGH in secretory granules.⁹⁷⁵ In a toxic role, anthrax lethal factor is one of the three components of the secreted toxin and is a zinc-dependent protease that cleaves a protein kinase and causes lysis of macrophages.⁹⁷⁶

Many serine proteases are targets for therapeutic intervention because they often play key roles in disease. Potent and highly selective zinc-mediated serine protease inhibitors have been designed where the zinc binds to two residues from the enzyme active site and a chelating ligand from an administered drug, bis(5-amidino-2-benzimidazolyl)methane. This is an example where the drug or metal chelator is given and recruits a zinc atom physiologically.⁹²²

The importance of zinc may extend even further as the processes that control carbon uptake by marine phytoplankton are important in the carbon cycle, and the zinc enzyme carbonic anhydrase could be a limiting factor. The concentration of zinc available to some marine phytoplankton has

been shown to affect bicarbonate uptake. It has been postulated that zinc levels may limit oceanic production and influence the global carbon cycle.⁹⁷⁷

6.8.14.2 Other Aspects of Zinc Enzyme and Protein Chemistry

Zinc is a constituent of over 300 enzymes with much research into the coordination of zinc to the protein backbone, and how its chemistry is modulated by the donor set and environment.² As well as the Lewis acid catalysis properties in enzymes, the structural role in zinc finger proteins has been a major area of research since the late 1990s. A number of reviews on zinc physiology, enzymology, and proteins in general have been published.^{978–981} There is extensive analysis available to classify the mononuclear sites in zinc proteins and identification of structural relationships of the extended environment.^{982,983}

The transport and storage of zinc has continued to be investigated with much work on metallothioneins. The oxidation of cysteine ligands in metallothioneins, and a possible role for selenium in the redox regulation of bound thiolates, are particular areas of interest.^{984,985} The control of zinc transfer from metallothionein to zinc enzymes has been studied.⁹⁸⁶ It is thought that thionein (apometallothionein) may participate in cellular regulatory processes. An effect of its enhanced synthesis *in vivo* could be reduction of the intracellular free zinc and modulation of zinc-dependent enzymes and proteins including zinc finger transcription proteins.⁹⁸⁷ COM is a 62 amino acid protein that binds zinc via four cysteine residues. The specificity of binding and high relative affinity for zinc over cobalt were demonstrated.⁹⁸⁸

Theoretical calculations have been carried out on a number of zinc-containing enzymatic systems. For example, calculations on the mechanism of the Cu/Zn enzyme show the importance of the full protein environment to get an accurate description of the copper redox process, i.e., including the electronic effects of the zinc ion.⁹⁸⁹ Transition structures at the active site of carbonic anhydrase have been the subject of *ab initio* calculations, in particular $[\text{ZnOHCO}_2]^+$, $[\text{ZnHCO}_3\text{H}_2\text{O}]^+$, and $[\text{Zn}(\text{NH}_3)_3\text{HCO}_3]^+$.⁹⁹⁰

Zinc is also used in biological studies to gain information about non-zinc containing systems. It can be a convenient redox inactive replacement for the study of complex systems with multiple redox centers. For example, the mechanism of quenching the triplet state of zinc cytochrome c by iron(II) and iron(III) cytochrome c has been studied. Zinc insertion has been used to get around the difficulty of studying two heme proteins with the same absorption spectra and provides rate constants for iron and iron-free cytochrome c quenching.⁹⁹¹

Another stage in development is the engineering of zinc binding sites into proteins, for example, a zinc binding site of three histidines based on carbonic anhydrase has been engineered into a fluorescein-binding antibody and metal binding assessed by fluorescence quenching. Such compounds could potentially be useful for antibody catalysis with relatively few amino acid changes.⁹⁹²

Since their discovery in the 1980s, studies on how zinc fingers select and bind DNA and elucidate their role in switching on genes have been ongoing.^{993,994} In particular, Berg and co-workers have carried out much research in this area.⁹⁹⁵ Studies on metal binding specificity and kinetics of metal binding have been carried out with zinc finger peptides.^{996,997} Pavletich *et al.* contributed an X-ray structure containing three zinc fingers bound to a DNA site.⁹⁹⁸

It has been suggested that two thiolates are required to maintain chelation of bound zinc to zinc finger proteins.^{532,999} Electrospray ionization mass spectrometry investigations have shown that zinc bound to consensus peptide region of the three types of zinc finger arrays requires two deprotonated thiolates. Methylation studies showed that zinc could still be bound as long as two thiolate anions from cysteine side chains were present. The others could remain as thiols or be methylated without loss of chelating abilities.⁹⁹⁹ A number of other mass spectrometry-based analyses of zinc finger proteins have been carried out.^{1000,1001} The oxidation of zinc finger cysteines to thiolsulfinate has also been investigated.¹⁰⁰²

6.8.15 REFERENCES

1. Vahrenkamp, H. *Chem. Unserer Zeit* **1988**, 22, 73–84.
2. Parkin, G. *Chem. Commun.* **2000**, 1971–1985.
3. Berg, J. M.; Shi, Y. G. *Science* **1996**, 271, 1081–1085.
4. Dakternieks, D. *Coord. Chem. Rev.* **1987**, 78, 125–146.
5. Dakternieks, D. *Coord. Chem. Rev.* **1990**, 98, 279–294.

6. Koch, K. R. *Coord. Chem. Rev.* **1994**, *134*, A99–A131.
7. Addison, A. W.; Rao, T. N.; Reedijk, J.; Vanrijn, J.; Verschoor, G. C. *J. Chem. Soc., Dalton Trans.* **1984**, 1349–1356.
8. Allen, F. H.; Kennard, O. *Chem. Des. Automat. News* **1993**, *8*, 1; 31–37.
9. Arnold, J.; Tilley, T. D.; Rheingold, A. L.; Geib, S. J. *Inorg. Chem.* **1987**, *26*, 2106–2109.
10. Rees, W. S.; Just, O.; Schumann, H.; Weimann, R. *Polyhedron* **1998**, *17*, 1001–1004.
11. Rees, W. S.; Green, D. M.; Hesse, W. *Polyhedron* **1992**, *11*, 1697–1699.
12. Ellison, J. J.; Power, P. P. *Inorg. Chem.* **1994**, *33*, 4231–4234.
13. Ellison, J. J.; Ruhlandtsenge, K.; Hope, H. H.; Power, P. P. *Inorg. Chem.* **1995**, *34*, 49–54.
14. Chinn, M. S.; Chen, J. Z. *Inorg. Chem.* **1995**, *34*, 6080–6084.
15. Darensbourg, D. J.; Niezgodna, S. A.; Draper, J. D.; Reibenspies, J. H. *Inorg. Chem.* **1999**, *38*, 1356–1359.
16. Gruff, E. S.; Koch, S. A. *J. Am. Chem. Soc.* **1989**, *111*, 8762–8763.
17. Chisholm, M. H.; Gallucci, J. C.; Zhen, H. H.; Huffman, J. C. *Inorg. Chem.* **2001**, *40*, 5051–5054.
18. Gais, H. J.; Bulow, G.; Raabe, G. *J. Am. Chem. Soc.* **1993**, *115*, 7215–7218.
19. Ray, M.; Hammes, B. S.; Yap, G. P. A.; Rheingold, A. L.; Borovik, A. S. *Inorg. Chem.* **1998**, *37*, 1527–1532.
20. Brock, S. L.; Kauzlarich, S. M. *Inorg. Chem.* **1994**, *33*, 2491–2492.
21. Lampe-Onnerud, C.; zur Loye, H. C. *Inorg. Chem.* **1996**, *35*, 2155–2156.
22. Beer, P. D.; Drew, M. G. B.; Leeson, P. B.; Ogdan, M. I. *J. Chem. Soc., Dalton Trans.* **1995**, 1273–1283.
23. Bock, C. W.; Katz, A. K.; Glusker, J. P. *J. Am. Chem. Soc.* **1995**, *117*, 3754–3763.
24. Sigel, H.; Martin, R. B. *Chem. Soc. Rev.* **1994**, *23*, 83–91.
25. Dudev, T.; Lim, C. *J. Am. Chem. Soc.* **2000**, *122*, 11146–11153.
26. Sola, M.; Lledos, A.; Duran, M.; Bertran, J. *Inorg. Chem.* **1991**, *30*, 2523–2527.
27. Pinsky, M.; Avnir, D. *Inorg. Chem.* **1998**, *37*, 5575–5582.
28. Venter, M. W.; Heyns, A. M. *Inorg. Chem.* **1987**, *26*, 1095–1098.
29. Bergstrom, P. A.; Lindgren, J.; Sandstrom, M.; Zhou, Y. X. *Inorg. Chem.* **1992**, *31*, 150–152.
30. Bartmess, J. E.; Kester, J. G. *Inorg. Chem.* **1984**, *23*, 1877–1880.
31. Haaland, A.; Hedberg, K.; Power, P. P. *Inorg. Chem.* **1984**, *23*, 1972–1975.
32. Hagen, K.; Holwill, C. J.; Rice, D. A. *Inorg. Chem.* **1989**, *28*, 3239–3242.
33. Lipton, A. S.; Mason, S. S.; Myers, S. M.; Reger, D. L.; Ellis, P. D. *Inorg. Chem.* **1996**, *35*, 7111–7117.
34. Shimizu, T.; Hatano, M. *Inorg. Chem.* **1985**, *24*, 2003–2009.
35. Vosegaard, T.; Andersen, U.; Jakobsen, H. J. *J. Am. Chem. Soc.* **1999**, *121*, 1970–1971.
36. Larsen, F. H.; Lipton, A. S.; Jakobsen, H. J.; Nielsen, N. C.; Ellis, P. D. *J. Am. Chem. Soc.* **1999**, *121*, 3783–3784.
37. Hague, D. N.; Moreton, A. D. *J. Chem. Soc., Dalton Trans.* **1987**, 2889–2895.
38. Hague, D. N.; Moreton, A. D. *J. Chem. Soc., Dalton Trans.* **1989**, 1171–1177.
39. Couves, L. D.; Hague, D. N.; Moreton, A. D. *J. Chem. Soc., Dalton Trans.* **1992**, 217–223.
40. Bertini, I.; Luchinat, C.; Pierattelli, R.; Vila, A. J. *Inorg. Chem.* **1992**, *31*, 3975–3979.
41. Lazo, N. D.; Murray, D. K.; Kieke, M. L.; Haw, J. F. *J. Am. Chem. Soc.* **1992**, *114*, 8552–8559.
42. Owens, C.; Drago, R. S.; Bertini, I.; Luchinat, C.; Banci, L. *J. Am. Chem. Soc.* **1986**, *108*, 3298–3303.
43. Harrison, P. G.; Kikabhai, T. *J. Chem. Soc., Dalton Trans.* **1987**, 807–814.
44. Harrison, P. G.; Brown, P.; McManus, J.; Hynes, M. J.; Kiely, J. *Inorg. Chim. Acta* **1991**, *190*, 209–215.
45. Mukherjee, J.; Rogers, J. I.; Khalifah, R. G.; Everett, G. W. *J. Am. Chem. Soc.* **1987**, *109*, 7232–7233.
46. Rabenstein, D. L.; Daignault, S. A.; Isab, A. A.; Arnold, A. P.; Shoukry, M. M. *J. Am. Chem. Soc.* **1985**, *107*, 6435–6439.
47. Clark-Baldwin, K.; Tierney, D. L.; Govindaswamy, N.; Gruff, E. S.; Kim, C.; Berg, J.; Koch, S. A.; Penner-Hahn, J. E. *J. Am. Chem. Soc.* **1998**, *120*, 8401–8409.
48. Gui, Z.; Green, A. R.; Kasrai, M.; Bancroft, G. M.; Stillman, M. J. *Inorg. Chem.* **1996**, *35*, 6520–6529.
49. Guo, J. Q.; Wang, S. K.; Dong, J.; Qiu, H. W.; Scott, R. A.; Giedroc, D. P. *J. Am. Chem. Soc.* **1995**, *117*, 9437–9440.
50. Holz, R. C.; Salowe, S. P.; Smith, C. K.; Cuca, G. C.; Que, L. *J. Am. Chem. Soc.* **1992**, *114*, 9611–9614.
51. Watanabe, I.; Tanida, H.; Kawauchi, S. *J. Am. Chem. Soc.* **1997**, *119*, 12018–12019.
52. Inada, Y.; Sugimoto, K.; Ozutsumi, K.; Funahashi, S. *Inorg. Chem.* **1994**, *33*, 1875–1880.
53. Hennig, C.; Hallmeier, K. H.; Zahn, G.; Tschwatschal, F.; Hennig, H. *Inorg. Chem.* **1999**, *38*, 38–43.
54. Lawniczakjablonska, K.; Iwanowski, R. J.; Golacki, Z.; Traverse, A.; Pizzini, S.; Fontaine, A. *Physica B* **1995**, *209*, 497–499.
55. Yang, C. Y.; Moodenbaugh, A. R.; Wang, Y. L.; Xu, Y. W.; Heald, S. M.; Welch, D. O.; Suenaga, M.; Fischer, D. A.; Pennerhahn, J. E. *Phys. Rev. B* **1990**, *42*, 2231–2241.
56. Caneschi, A.; Gatteschi, D.; Sessoli, R.; Cabello, C. I.; Rey, P.; Barra, A. L.; Brunel, L. C. *Inorg. Chem.* **1991**, *30*, 1882–1886.
57. Lover, T.; Henderson, W.; Bowmaker, G. A.; Seakins, J. M.; Cooney, R. P. *Inorg. Chem.* **1997**, *36*, 3711–3723.
58. Satterfield, M.; Brodbelt, J. S. *Inorg. Chem.* **2001**, *40*, 5393–5400.
59. Sakiyama, H.; Okawa, H.; Matsumoto, N.; Kida, S. *J. Chem. Soc., Dalton Trans.* **1990**, 2935–2939.
60. Pinchuk, V. M.; Korobskii, V. A.; Shevardina, L. B. *Zhurnal Neorganicheskoi Khimii* **1984**, *29*, 1111–1113.
61. Fattal, E.; Carter, E. A. *J. Phys. Chem. A* **2000**, *104*, 2248–2252.
62. Guldi, D. M. *Chem. Commun.* **2000**, 321–327.
63. Liao, M. S.; Scheiner, S. *J. Chem. Phys.* **2001**, *114*, 9780–9791.
64. Jones, P. M.; May, J. A.; Solomon, E. I. *Inorg. Chim. Acta* **1998**, *276*, 327–333.
65. Yoon, K.; Parkin, G. *Inorg. Chem.* **1992**, *31*, 1656–1662.
66. Bochmann, M.; Bwembya, G. C.; Powell, A. K. *Polyhedron* **1993**, *12*, 2929–2932.
67. Jaquinod, L.; Gros, C.; Olmstead, M. M.; Antolovich, M.; Smith, K. M. *Chem. Commun.* **1996**, 1475–1476.
68. Hoskins, B. F.; Robson, R. *J. Am. Chem. Soc.* **1990**, *112*, 1546–1554.
69. Kitazawa, T.; Nishikiori, S.; Kuroda, R.; Iwamoto, T. *J. Chem. Soc., Dalton Trans.* **1994**, 1029–1036.
70. Batten, S. R.; Hoskins, B. F.; Robson, R. *J. Am. Chem. Soc.* **1995**, *117*, 5385–5386.
71. Pickardt, J.; Staub, B. Z. *Naturforsch. B: Anorg. Chem. Org. Chem.* **1995**, *50*, 1517–1520.
72. Pickardt, J.; Wischlinski, P. Z. *Naturforsch. B: Anorg. Chem. Org. Chem.* **1999**, *54*, 747–750.
73. Ho, K. Y.; Yu, W. Y.; Cheung, K. K.; Che, C. M. *Chem. Commun.* **1998**, 2101–2102.

74. Gorrell, I. B.; Looney, A.; Parkin, G.; Rheingold, A. L. *J. Am. Chem. Soc.* **1990**, *112*, 4068–4069.
75. Chisholm, M. H.; Eilerts, N. W.; Huffman, J. C.; Iyer, S. S.; Pacold, M.; Phomphrai, K. *J. Am. Chem. Soc.* **2000**, *122*, 11845–11854.
76. Yoon, K.; Parkin, G. *J. Am. Chem. Soc.* **1991**, *113*, 8414–8418.
77. Kimblin, C.; Bridgewater, B. M.; Hascall, T.; Parkin, G. *J. Chem. Soc., Dalton Trans.* **2000**, *8*, 1267–1274.
78. Hammes, B. S.; Carrano, C. J. *Inorg. Chem.* **1999**, *38*, 4593–4600.
79. Andrews, P. C.; Raston, C. L.; Skelton, B. W.; White, A. H. *Organometallics* **1998**, *17*, 779–782.
80. Malik, M. A.; O'Brien, P.; Motevallii, M.; Jones, A. C. *Inorg. Chem.* **1997**, *36*, 5076–5081.
81. Olmstead, M. M.; Power, P. P.; Shoner, S. C. *J. Am. Chem. Soc.* **1991**, *113*, 3379–3385.
82. Ruhlandtsenge, K.; Power, P. P. *Inorg. Chem.* **1993**, *32*, 4505–4508.
83. Yang, Y.; Pinkas, J.; Noltemeyer, M.; Schmidt, H. G.; Roesky, H. W. *Angew. Chem.-Int. Edit.* **1999**, *38*, 664–666.
84. Chunggaze, M.; Malik, M. A.; O'Brien, P.; White, A. J. P.; Williams, D. J. *J. Chem. Soc., Dalton Trans.* **1998**, 3839–3844.
85. Walker, D. A.; Woodman, T. J.; Hughes, D. L.; Bochmann, M. *Organometallics* **2001**, *20*, 3772–3776.
86. Olmstead, M. M.; Grigsby, W. J.; Chacon, D. R.; Hascall, T.; Power, P. P. *Inorg. Chim. Acta* **1996**, *251*, 273–284.
87. Charette, A. B.; Marcoux, J. F.; Belanger-Gariepy, F. *J. Am. Chem. Soc.* **1996**, *118*, 6792–6793.
88. Denmark, S. E.; Edwards, J. P.; Wilson, S. R. *J. Am. Chem. Soc.* **1992**, *114*, 2592–2602.
89. Westerhausen, M.; Bollwein, T.; Makropoulos, N.; Rotter, T. M.; Habereeder, T.; Suter, M.; Noth, H. *Eur. J. Inorg. Chem.* **2001**, 851–857.
90. Brumm, H.; Jansen, M. Z. *Anorg. Allg. Chem.* **2001**, *627*, 1433–1435.
91. Klufers, P.; Wilhelm, U. *J. Organomet. Chem.* **1991**, *421*, 39–54.
92. Koppelhofer, A.; Hartmann, U.; Vahrenkamp, H. *Chem. Ber.* **1995**, *128*, 779–785.
93. Becker, B.; Dolega, A.; Konitz, A.; Swinder, L.; Wojnowski, W. *Z. Anorg. Allg. Chem.* **2001**, *627*, 280–286.
94. Li, J.; Chen, Z.; Emge, T. J.; Yuen, T.; Proserpio, D. M. *Inorg. Chim. Acta* **1998**, *273*, 310–315.
95. Emsley, J.; Arif, M.; Bates, P. A.; Hursthouse, M. B. *Inorg. Chim. Acta* **1989**, *165*, 191–195.
96. Singh, L. K.; Mitra, S. *J. Chem. Soc., Dalton Trans.* **1987**, 2089–2094.
97. Aguilar, J. A.; Bianchi, A.; Garcia-Espana, E.; Luis, S. V.; Llinares, J. M.; Ramirez, J. A.; Soriano, C. *J. Chem. Soc., Dalton Trans.* **1994**, 637–644.
98. Dagnall, S. P.; Hague, D. N.; Moreton, A. D. *J. Chem. Soc., Dalton Trans.* **1987**, 2897–2904.
99. Garcia-Espana, E.; Micheloni, M.; Paoletti, P.; Bianchi, A. *Inorg. Chem.* **1986**, *25*, 1435–1438.
100. Arago, J.; Bencini, A.; Bianchi, A.; Garcia-Espana, E.; Micheloni, M.; Paoletti, P.; Ramirez, J. A.; Rodriguez, A. *J. Chem. Soc., Dalton Trans.* **1991**, 3077–3083.
101. Dagnall, S. P.; Hague, D. N.; McAdam, M. E.; Moreton, A. D. *J. Chem. Soc., Dalton Trans.* **1985**, 2381–2385.
102. Dagnall, S. P.; Hague, D. N.; Moreton, A. D. *J. Chem. Soc., Dalton Trans.* **1986**, 1505–1511.
103. Dagnall, S. P.; Hague, D. N.; Moreton, A. D. *J. Chem. Soc., Dalton Trans.* **1986**, 1499–1504.
104. Dagnall, S. P.; Hague, D. N.; Moreton, A. D. *J. Chem. Soc., Dalton Trans.* **1988**, 1989–1997.
105. Kurihara, M.; Ozutsumi, K.; Kawashima, T. *J. Chem. Soc., Dalton Trans.* **1993**, 3379–3382.
106. Kurihara, M.; Ozutsumi, K.; Kawashima, T. *J. Chem. Soc., Dalton Trans.* **1994**, 3267–3271.
107. Allan, J. R.; Carson, B.; Paton, A. D.; Turvey, K.; Bowley, H. J.; Gerrard, D. L. *Inorg. Chim. Acta* **1989**, *158*, 249–253.
108. Wingerter, S.; Pfeiffer, M.; Murso, A.; Lustig, C.; Stey, T.; Chandrasekhar, V.; Stalke, D. *J. Am. Chem. Soc.* **2001**, *123*, 1381–1388.
109. Glerup, J.; Goodson, P. A.; Hodgson, D. J.; Michelsen, K.; Nielsen, K. M.; Wiehe, H. *Inorg. Chem.* **1992**, *31*, 4611–4616.
110. Neenan, T. X.; Driessen, W. L.; deGraaff, R. A. G.; van der Plas, J. L.; Reedijk, J. *Inorg. Chim. Acta* **1998**, *267*, 193–199.
111. Chen, X. M.; Xu, Z. T.; Huang, X. C. *J. Chem. Soc., Dalton Trans.* **1994**, 2331–2332.
112. Chen, X. M.; Ye, B. H.; Huang, X. C.; Xu, Z. T. *J. Chem. Soc., Dalton Trans.* **1996**, 3465–3468.
113. Ji, L. N.; Corfu, N. A.; Sigel, H. *Inorg. Chim. Acta* **1993**, *206*, 215–220.
114. Nair, M. S.; Venkatachalapathi, K.; Santappa, M. *J. Chem. Soc., Dalton Trans.* **1982**, 555–559.
115. Lopez-Garzon, R.; Gutierrez-Valero, M. D.; Godino-Salido, M. L.; Sanchez-Rodrigo, A.; Montiel, M. N.; Moreno, J. M.; Odedra, R.; El-Bayouki, K. A. M. *Inorg. Chim. Acta* **1997**, *258*, 33–38.
116. Colacio, E.; Ghazi, M.; Kivekas, R.; Klinga, M.; Lloret, F.; Moreno, J. M. *Inorg. Chem.* **2000**, *39*, 2770–2776.
117. Ohtsu, H.; Itoh, S.; Nagatomo, S.; Kitagawa, T.; Ogo, S.; Watanabe, Y.; Fukuzumi, F. *Inorg. Chem.* **2001**, *40*, 3200–3207.
118. Bouwman, E.; Douzich, B.; Gutierrez-Soto, L.; Beretta, M.; Driessen, W. L.; Reedijk, J.; Mendoza-Diaz, G. *Inorg. Chim. Acta* **2000**, *304*, 250–259.
119. Knapp, S.; Keenan, T. P.; Zhang, X. H.; Fikar, R.; Potenza, J. A.; Schugar, H. J. *J. Am. Chem. Soc.* **1987**, *109*, 1882–1883.
120. Kirchner, C.; Krebs, B. *Inorg. Chem.* **1987**, *26*, 3569–3576.
121. Bhalla, R.; Helliwell, M.; Beddoes, R. L.; Collison, D.; Garner, C. D. *Inorg. Chim. Acta* **1998**, *273*, 225–233.
122. Breslow, R.; Hunt, J. T.; Smiley, R.; Tarnowski, T. *J. Am. Chem. Soc.* **1983**, *105*, 5337–5342.
123. Matthews, C. J.; Clegg, W.; Heath, S. L.; Martin, N. C.; Hill, M. N. S.; Lockhart, J. C. *Inorg. Chem.* **1998**, *37*, 199–207.
124. Matthews, C. J.; Leese, T. A.; Thorp, D.; Lockhart, J. C. *J. Chem. Soc., Dalton Trans.* **1998**, 79–88.
125. Burth, R.; Vahrenkamp, H. *Inorg. Chim. Acta* **1998**, *282*, 193–199.
126. Burth, R.; Gelinsky, M.; Vahrenkamp, H. *Inorg. Chem.* **1998**, *37*, 2833–2836.
127. Gregorzik, R.; Vahrenkamp, H. *Chem. Ber.* **1994**, *127*, 1857–1863.
128. Sanni, S. B.; Behm, H. J.; Beurskens, P. T.; Vanalbada, G. A.; Reedijk, J.; Lenstra, A. T. H.; Addison, A. W.; Palaniandavar, M. *J. Chem. Soc., Dalton Trans.* **1988**, 1429–1435.
129. Coggin, D. K.; Gonzalez, J. A.; Kook, A. M.; Stanbury, D. M.; Wilson, L. J. *Inorg. Chem.* **1991**, *30*, 1115–1125.
130. Torok, I.; Surdy, P.; Rockenbauer, A.; Korecz, L.; Koolhaas, G.; Gajda, T. *J. Inorg. Biochem.* **1998**, *71*, 7–14.
131. Torok, I.; Gajda, T.; Gyurcsik, B.; Toth, G. K.; Peter, A. *J. Chem. Soc., Dalton Trans.* **1998**, 1205–1212.

132. Gajda, T.; Kramer, R.; Jancso, A. *Eur. J. Inorg. Chem.* **2000**, 1635–1644.
133. Jancso, A.; Gajda, T.; Mulliez, E.; Korecz, L. *J. Chem. Soc., Dalton Trans.* **2000**, 2679–2684.
134. Liu, H. K.; Sun, W. Y.; Ma, D. J.; Yu, K. B.; Tang, W. X. *Chem. Commun.* **2000**, 591–592.
135. Seneque, O.; Giorgi, M.; Reinaud, O. *Chem. Commun.* **2001**, 984–985.
136. Seneque, O.; Rager, M. N.; Giorgi, M.; Reinaud, O. *J. Am. Chem. Soc.* **2000**, *122*, 6183–6189.
137. Seneque, O.; Rager, M. N.; Giorgi, M.; Reinaud, O. *J. Am. Chem. Soc.* **2001**, *123*, 8442–8443.
138. Seneque, O.; Rondelez, Y.; Le Clinche, L.; Inisan, C.; Rager, M. N.; Giorgi, M.; Reinaud, O. *Eur. J. Inorg. Chem.* **2001**, 2597–2604.
139. Mao, Z. W.; Yu, K. B.; Chen, D.; Han, S. Y.; Sui, Y. X.; Tang, W. X. *Inorg. Chem.* **1993**, *32*, 3104–3108.
140. Mao, Z. W.; Chen, D.; Tang, W. X.; Yu, K. B.; Liu, L. *Polyhedron* **1992**, *11*, 191–196.
141. Mao, Z. W.; Chen, M. Q.; Tan, X. S.; Liu, J.; Tang, W. X. *Inorg. Chem.* **1995**, *34*, 2889–2893.
142. Lu, Q.; Luo, Q. H.; Dai, A. B.; Zhou, Z. Y.; Hu, G. Z. *J. Chem. Soc.-Chem. Commun.* **1990**, 1429–1430.
143. Ohtsu, H.; Fukuzumi, S. *Angew. Chem.-Int. Edit.* **2000**, *39*, 4537–4539.
144. Ohtsu, H.; Fukuzumi, S. *Chem.-Eur. J.* **2001**, *7*, 4947–4953.
145. Ohtsu, H.; Itoh, S.; Nagatomo, S.; Kitagawa, T.; Ogo, S.; Watanabe, Y.; Fukuzumi, S. *Chem. Commun.* **2000**, 1051–1052.
146. Pierre, J. L.; Chautemps, P.; Refaif, S.; Beguin, C.; Elmarzouki, A.; Serratrice, G.; Saintaman, E.; Rey, P. *J. Am. Chem. Soc.* **1995**, *117*, 1965–1973.
147. Mao, Z. W.; Hang, Q. W.; Tang, W. X.; Liu, S. X.; Wang, Z. M.; Huang, J. L. *Polyhedron* **1996**, *15*, 321–325.
148. Ohtsu, H.; Shimazaki, Y.; Odani, A.; Yamauchi, O. *Chem. Commun.* **1999**, 2393–2394.
149. Ohtsu, H.; Shimazaki, Y.; Odani, A.; Yamauchi, O.; Mori, W.; Itoh, S.; Fukuzumi, S. *J. Am. Chem. Soc.* **2000**, *122*, 5733–5741.
150. Hergoldbrundic, A.; Kaitner, B.; Kamenar, B.; Leovac, V. M.; Iveges, E. Z.; Juranic, N. *Inorg. Chim. Acta* **1991**, *188*, 151–158.
151. Verweij, P. D.; Rietmeijer, F. J.; Degraaff, R. A. G.; Erdonmez, A.; Reedijk, J. *Inorg. Chim. Acta* **1989**, *163*, 223–230.
152. Krober, J.; Bkouhewaksman, I.; Pascard, C.; Thomann, M.; Kahn, O. *Inorg. Chim. Acta* **1995**, *230*, 159–163.
153. Mann, K. L. V.; Psillakis, E.; Jeffery, J. C.; Rees, L. H.; Harden, N. M.; McCleverty, J. A.; Ward, M. D.; Gatteschi, D.; Totti, F.; Mabbs, F. E.; McInnes, E. J. L.; Riedi, P. C.; Smith, G. M. *J. Chem. Soc., Dalton Trans.* **1999**, 339–348.
154. Sheu, S. C.; Tien, M. J.; Cheng, M. C.; Ho, T. I.; Peng, S. M.; Lin, Y. C. *J. Chem. Soc., Dalton Trans.* **1995**, 3503–3510.
155. Haanstra, W. G.; Driessen, W. L.; Reedijk, J.; Frohlich, R.; Krebs, B. *Inorg. Chim. Acta* **1991**, *185*, 175–180.
156. Graf, M.; Greaves, B.; Stoecklievans, H. *Inorg. Chim. Acta* **1993**, *204*, 239–246.
157. Siegfried, L.; Kaden, T. A.; Meyer, F.; Kircher, P.; Pritzkow, H. *J. Chem. Soc., Dalton Trans.* **2001**, 2310–2315.
158. Byun, Y.; Min, D.; Do, J.; Yun, H.; Do, Y. *Inorg. Chem.* **1996**, *35*, 3981–3989.
159. Ghosh, P.; Parkin, G. *J. Chem. Soc., Dalton Trans.* **1998**, 2281–2283.
160. Ghosh, P.; Parkin, G. *Chem. Commun.* **1998**, 413–414.
161. Dowling, C.; Murphy, V. J.; Parkin, G. *Inorg. Chem.* **1996**, *35*, 2415–2420.
162. Dowling, C.; Parkin, G. *Polyhedron* **1996**, *15*, 2463–2465.
163. Dowling, C. M.; Parkin, G. *Polyhedron* **2001**, *20*, 285–289.
164. Ghosh, P.; Hascall, T.; Dowling, C.; Parkin, G. *J. Chem. Soc., Dalton Trans.* **1998**, 3355–3357.
165. Dias, H. V. R.; Gorden, J. D. *Inorg. Chem.* **1996**, *35*, 318–324.
166. Fares, V.; Flamini, A.; Jasin, J. R.; Musselman, R. L.; Poli, N. *J. Chem. Soc., Dalton Trans.* **1995**, 281–286.
167. Hartmann, U.; Vahrenkamp, H. *Inorg. Chim. Acta* **1995**, *239*, 13–17.
168. Janiak, C.; Hemling, H. *J. Chem. Soc., Dalton Trans.* **1994**, 2947–2952.
169. Neels, A.; Stoeckli-Evans, H. *Inorg. Chem.* **1999**, *38*, 6164–6170.
170. Bourne, S. A.; Kilkenny, M.; Nassimbeni, L. R. *J. Chem. Soc., Dalton Trans.* **2001**, 1176–1179.
171. Ferigo, M.; Bonhote, P.; Marty, W.; Stoeckli-Evans, H. *J. Chem. Soc., Dalton Trans.* **1994**, 1549–1554.
172. Sigel, A.; Sigel, H. *Metal Ions in Biological Systems*; Marcel Dekker: New York, 1996, Vol. 32.
173. Kang, S. M.; Wells, R. D. *J. Biol. Chem.* **1994**, *269*, 9528–9532.
174. Han, W. H.; Lindsay, S. M.; Dlakic, M.; Harington, R. E. *Nature* **1997**, *386*, 563–563.
175. Froystein, N. A.; Davis, J. T.; Reid, B. R.; Sletten, E. *Acta Chemica Scandinavica* **1993**, *47*, 649–657.
176. Duguid, J.; Bloomfield, V. A.; Benevides, J.; Thomas, G. *J. Biophys. J.* **1993**, *65*, 1916–1928.
177. Miller, S. K.; Marzilli, L. G.; Dorre, S.; Kollat, P.; Stigler, R. D.; Stozowski, J. *J. Inorg. Chem.* **1986**, *25*, 4272–4277.
178. Fusch, E. C.; Lippert, B. *J. Am. Chem. Soc.* **1994**, *116*, 7204–7209.
179. Hardin, C. C.; Perry, A. G.; White, K. *Biopolymers* **2000**, *56*, 147–194.
180. Szlyk, E.; Wojtczak, A.; Jaskolski, M.; Gilski, M.; Haasnoot, J. G.; Reedijk, J. *Inorg. Chim. Acta* **1997**, *260*, 145–150.
181. Ruf, M.; Weis, K.; Vahrenkamp, H. *Inorg. Chem.* **1997**, *36*, 2130–2137.
182. Shionoya, M.; Kimura, E.; Shiro, M. *J. Am. Chem. Soc.* **1993**, *115*, 6730–6737.
183. Shionoya, M.; Ikeda, T.; Kimura, E.; Shiro, M. *J. Am. Chem. Soc.* **1994**, *116*, 3848–3859.
184. Cotton, F. A.; Daniels, L. M.; Falvello, L. R.; Matonic, J. H.; Murillo, C. A.; Wang, X.; Zhou, H. *Inorg. Chim. Acta* **1997**, *266*, 91–102.
185. Bond, A. D.; Linton, D. J.; Schooler, P.; Wheatley, A. E. *J. Chem. Soc., Dalton Trans.* **2001**, 3173–3178.
186. Ruben, M.; Walther, D.; Knake, R.; Gorls, H.; Beckert, R. *Eur. J. Inorg. Chem.* **2000**, 1055–1060.
187. Walther, D.; Dohler, T.; Theyssen, N.; Gorls, H. *Eur. J. Inorg. Chem.* **2001**, 2049–2060.
188. Dohler, T.; Gorls, H.; Walther, D. *Chem. Commun.* **2000**, 945–946.
189. Muller, I. M.; Robson, R. *Angew. Chem., Int. Ed. Engl.* **2000**, *39*, 4357–4359.
190. Gaul, D. A.; Just, O.; Rees, W. S. *Inorg. Chem.* **2000**, *39*, 5648–5654.
191. Power, P. P.; Ruhlandtsenge, K.; Shoner, S. C. *Inorg. Chem.* **1991**, *30*, 5013–5015.
192. Forbes, G. C.; Kennedy, A. R.; Mulvey, R. E.; Rowlings, R. B.; Clegg, W.; Liddle, S. T.; Wilson, C. C. *Chem. Commun.* **2000**, 1759–1760.
193. Manson, J. L.; Lee, D. W.; Rheingold, A. L.; Miller, J. S. *Inorg. Chem.* **1998**, *37*, 5966–5967.
194. Batten, S. R.; Hoskins, B. F.; Robson, R. *J. Chem. Soc., Chem. Commun.* **1991**, 445–447.
195. Gardiner, M. G.; Hanson, G. R.; Henderson, M. J.; Lee, F. C.; Raston, C. L. *Inorg. Chem.* **1994**, *33*, 2456–2461.

196. Rijnberg, E.; Richter, B.; Thiele, K. H.; Boersma, J.; Veldman, N.; Spek, A. L.; van Koten, G. *Inorg. Chem.* **1998**, *37*, 56–63.
197. Bencini, A.; Midollini, S.; Zanchini, C. *Inorg. Chem.* **1989**, *28*, 1963–1969.
198. Bencini, A.; Zanchini, C. *Inorg. Chem.* **1991**, *30*, 4245–4251.
199. Laurency, G.; Ducommun, Y.; Merbach, A. E. *Inorg. Chem.* **1989**, *28*, 3024–3028.
200. Pallenberg, A. J.; Marschner, T. M.; Barnhart, D. M. *Polyhedron* **1997**, *16*, 2711–2719.
201. Xie, A. L.; Xu, D. J.; Xu, Y. Z.; Zhou, K. J. *Acta Chimica Sinica* **1997**, *55*, 853–859.
202. Schmittel, M.; Ganz, A.; Fenske, D.; Herderich, M. *J. Chem. Soc., Dalton Trans.* **2000**, 353–359.
203. Fitzgerald, W.; Hathaway, B.; Simmons, C. J. *J. Chem. Soc., Dalton Trans.* **1985**, 141–149.
204. Barton, J. K.; Dannenberg, J. J.; Raphael, A. L. *J. Am. Chem. Soc.* **1982**, *104*, 4967–4969.
205. Ishiguro, S. I.; Miyauchi, M.; Ozutumi, K. *J. Chem. Soc., Dalton Trans.* **1990**, 2035–2041.
206. Corradi, A. B.; Menabue, L.; Saladini, M.; Sola, M.; Battaglia, L. P. *J. Chem. Soc., Dalton Trans.* **1992**, 2623–2628.
207. Bilyk, A.; Harding, M. M.; Turner, P.; Hambley, T. W. *J. Chem. Soc., Dalton Trans.* **1994**, 2783–2790.
208. Wimmer, F. L. *Inorg. Chim. Acta* **1987**, *130*, 259–264.
209. Baxter, P. N. W.; Connor, J. A.; Schweizer, W. B.; Wallis, J. D. *J. Chem. Soc., Dalton Trans.* **1992**, 3015–3019.
210. Hilton, A.; Renouard, T.; Maury, O.; Le Bozec, H.; Ledoux, I.; Zyss, J. *Chem. Commun.* **1999**, 2521–2522.
211. Kumada, H.; Sakane, A.; Koga, N.; Iwamura, H. *J. Chem. Soc., Dalton Trans.* **2000**, 911–914.
212. Hagrman, P. J.; Zubieta, J. *Inorg. Chem.* **1999**, *38*, 4480–4485.
213. Hagrman, P. J.; Zubieta, J. *Inorg. Chem.* **2001**, *40*, 2800–2809.
214. Kienitz, C. O.; Thone, C.; Jones, P. G. *Inorg. Chem.* **1996**, *35*, 3990–3997.
215. Thompson, A.; Bardwell, D. A.; Jeffery, J. C.; Ward, M. D. *Inorg. Chim. Acta* **1998**, *267*, 239–247.
216. Trofimenko, S. *Chem. Rev.* **1993**, *93*, 943–980.
217. Parkin, G. In *Adv. Inorg. Chem.*, 1995, Vol. 42, p 291.
218. Kitajima, N.; Tolman, W. B. *Prog. Inorg. Chem.* **1995**, *43*, 419.
219. Trofimenko, S. *Scorpionates — The Coordination Chemistry of Polypyrazolylborate Ligands* **1999**, Imperial College Press: London.
220. Alsfasser, R.; Powell, A. K.; Vahrenkamp, H. *Angew. Chem., Int. Ed. Engl.* **1990**, *29*, 898–899.
221. Alsfasser, R.; Vahrenkamp, H. *Inorg. Chim. Acta* **1993**, *209*, 19–22.
222. Looney, A.; Parkin, G.; Alsfasser, R.; Ruf, M.; Vahrenkamp, H. *Angew. Chem., Int. Ed. Engl.* **1992**, *31*, 92–93.
223. Looney, A.; Cornebise, M.; Miller, D.; Parkin, G. *Inorg. Chem.* **1992**, *31*, 989–992.
224. Ruf, M.; Vahrenkamp, H. *J. Chem. Soc., Dalton Trans.* **1995**, 1915–1916.
225. Ruf, M.; Weis, K.; Brasack, I.; Vahrenkamp, H. *Inorg. Chim. Acta* **1996**, *250*, 271–281.
226. Weis, K.; Vahrenkamp, H. *Inorg. Chem.* **1997**, *36*, 5589–5591.
227. Weis, K.; Vahrenkamp, H. *Eur. J. Inorg. Chem.* **1998**, 271–274.
228. Weis, K.; Rombach, M.; Ruf, M.; Vahrenkamp, H. *Eur. J. Inorg. Chem.* **1998**, 263–270.
229. Ruf, M.; Schell, F. A.; Walz, R.; Vahrenkamp, H. *Chem. Ber., Recueil* **1997**, *130*, 101–104.
230. Kitajima, N.; Hikichi, S.; Tanaka, M.; Morooka, Y. *J. Am. Chem. Soc.* **1993**, *115*, 5496–5508.
231. Looney, A.; Han, R. Y.; McNeill, K.; Parkin, G. *J. Am. Chem. Soc.* **1993**, *115*, 4690–4697.
232. Looney, A.; Parkin, G. *Inorg. Chem.* **1994**, *33*, 1234–1237.
233. Looney, A.; Saleh, A.; Zhang, Y. H.; Parkin, G. *Inorg. Chem.* **1994**, *33*, 1158–1164.
234. Weis, K.; Vahrenkamp, H. *Inorg. Chem.* **1997**, *36*, 5592–5596.
235. Ruf, M.; Weis, K.; Vahrenkamp, H. *J. Am. Chem. Soc.* **1996**, *118*, 9288–9294.
236. Ruf, M.; Noll, B. C.; Groner, M. D.; Yee, G. T.; Pierpont, C. G. *Inorg. Chem.* **1997**, *36*, 4860–4865.
237. Ruf, M.; Vahrenkamp, H. *Inorg. Chem.* **1996**, *35*, 6571–6578.
238. Walz, R.; Vahrenkamp, H. *Inorg. Chim. Acta* **2001**, *314*, 58–62.
239. Hambley, T. W.; Lynch, M. J.; Zvargulis, E. S. *J. Chem. Soc., Dalton Trans.* **1996**, 4283–4286.
240. Alsfasser, R.; Trofimenko, S.; Looney, A.; Parkin, G.; Vahrenkamp, H. *Inorg. Chem.* **1991**, *30*, 4098–4100.
241. Klau, W.; Schilde, U.; Schmidt, M. *Inorg. Chem.* **1997**, *36*, 1598–1601.
242. Canary, J. W.; Xu, J. Q.; Castagnetto, J. M.; Rentzeperis, D.; Marky, L. A. *J. Am. Chem. Soc.* **1995**, *117*, 11545–11547.
243. Hammes, B. S.; Ramos-Maldonado, D.; Yap, G. P. A.; Liable-Sands, L.; Rheingold, A. L.; Young, V. G.; Borovik, A. S. *Inorg. Chem.* **1997**, *36*, 3210–3211.
244. Arnold, P. J.; Davies, S. C.; Dilworth, J. R.; Durrant, M. C.; Griffiths, D. V.; Hughes, D. L.; Richards, R. L.; Sharpe, P. C. *J. Chem. Soc., Dalton Trans.* **2001**, 736–746.
245. Allen, C. S.; Chuang, C. L.; Cornebise, M.; Canary, J. W. *Inorg. Chim. Acta* **1995**, *239*, 29–37.
246. Astley, T.; Cauty, A. J.; Hitchman, M. A.; Rowbottom, G. L.; Skelton, B. W.; White, A. H. *J. Chem. Soc., Dalton Trans.* **1991**, 1981–1990.
247. Astley, T.; Hitchman, M. A.; Keene, F. R.; Tiekink, E. R. T. *J. Chem. Soc., Dalton Trans.* **1996**, 1845–1851.
248. Alzuet, G.; Casella, L.; Perotti, A.; Borrás, J. *J. Chem. Soc., Dalton Trans.* **1994**, 2347–2351.
249. Slebockatilk, H.; Cocho, J. L.; Frakman, Z.; Brown, R. S. *J. Am. Chem. Soc.* **1984**, *106*, 2421–2431.
250. Kimblin, C.; Murphy, V. J.; Parkin, G. *Chem. Commun.* **1996**, 235–236.
251. Kimblin, C.; Murphy, V. J.; Hascall, T.; Bridgewater, B. M.; Bonanno, J. B.; Parkin, G. *Inorg. Chem.* **2000**, *39*, 967–974.
252. Kimblin, C.; Allen, W. E.; Parkin, G. *J. Chem. Soc., Chem. Commun.* **1995**, 1813–1815.
253. Kimblin, C.; Allen, W. E.; Parkin, G. *Main Group Chem.* **1996**, *1*, 297–300.
254. Cronin, L.; Greener, B.; Foxon, S. P.; Heath, S. L.; Walton, P. H. *Inorg. Chem.* **1997**, *36*, 2594–2600.
255. Greener, B.; Moore, M. H.; Walton, P. H. *Chem. Commun.* **1996**, 27–28.
256. Brand, U.; Vahrenkamp, H. *Inorg. Chim. Acta* **1992**, *200*, 663–669.
257. Greener, B.; Foxon, S. P.; Walton, P. H. *New J. Chem.* **2000**, *24*, 269–273.
258. Cronin, L.; Foxon, S. P.; Lusby, P. J.; Walton, P. H. *J. Biol. Inorg. Chem.* **2001**, *6*, 367–377.
259. Hegetschweiler, K.; Gramlich, V.; Ghisletta, M.; Samaras, H. *Inorg. Chem.* **1992**, *31*, 2341–2346.
260. Park, G.; Ye, N.; Rogers, R. D.; Brechbiel, M. W.; Planalp, R. P. *Polyhedron* **2000**, *19*, 1155–1161.

261. Constable, E. C.; Elder, S. M.; Hannon, M. J.; Martin, A.; Raithby, P. R.; Tocher, D. A. *J. Chem. Soc., Dalton Trans.* **1996**, 2423–2433.
262. Fu, Y. J.; Sun, W. Y.; Dai, W. N.; Shu, M. H.; Xue, F.; Wang, D. F.; Mak, T. C. W.; Tang, W. X.; Hu, H. W. *Inorg. Chim. Acta* **1999**, *290*, 127–132.
263. Chotalia, R.; Constable, E. C.; Neuburger, M.; Smith, D. R.; Zehnder, M. *J. Chem. Soc., Dalton Trans.* **1996**, 4207–4216.
264. Constable, E. C.; Neuburger, M.; Smith, D. R.; Zehnder, M. *Chem. Commun.* **1996**, 1917–1918.
265. Murner, H.; von Zelewsky, A.; Hopfgartner, G. *Inorg. Chim. Acta* **1998**, *271*, 36–39.
266. Piguet, C.; Bernardinelli, G.; Bocquet, B.; Quattropiani, A.; Williams, A. F. *J. Am. Chem. Soc.* **1992**, *114*, 7440–7451.
267. Mitsumi, M.; Toyoda, J.; Nakasuji, K. *Inorg. Chem.* **1995**, *34*, 3367–3370.
268. Mizutani, T.; Yagi, S.; Morinaga, T.; Nomura, T.; Takagishi, T.; Kitagawa, S.; Ogoshi, H. *J. Am. Chem. Soc.* **1999**, *121*, 754–759.
269. Mizutani, T.; Sakai, N.; Yagi, S.; Takagishi, T.; Kitagawa, S.; Ogoshi, H. *J. Am. Chem. Soc.* **2000**, *122*, 748–749.
270. Bidan, G.; Divisia-Blohorn, B.; Lapkowski, M.; Kern, J. M.; Sauvage, J. P. *J. Am. Chem. Soc.* **1992**, *114*, 5986–5994.
271. Houghton, M. A.; Bilyk, A.; Harding, M. M.; Turner, P.; Hambley, T. W. *J. Chem. Soc., Dalton Trans.* **1997**, 2725–2733.
272. Lucking, U.; Chen, J.; Rudkevich, D. A.; Rebek, J. *J. Am. Chem. Soc.* **2001**, *123*, 9929–9934.
273. Withersby, M. A.; Blake, A. J.; Champness, N. R.; Cooke, P. A.; Hubberstey, P.; Li, W. S.; Schroder, M. *Inorg. Chem.* **1999**, *38*, 2259–2266.
274. Wu, H. P.; Janiak, C.; Uehlin, L.; Klufers, P.; Mayer, P. *Chem. Commun.* **1998**, 2637–2638.
275. Yoshida, N.; Ichikawa, K. *Chem. Commun.* **1997**, 1091–1092.
276. Alcock, N. W.; Barker, P. R.; Haider, J. M.; Hannon, M. J.; Painting, C. L.; Pikramenou, Z.; Plummer, E. A.; Rissanen, K.; Saarenketo, P. *J. Chem. Soc., Dalton Trans.* **2000**, *9*, 1447–1461.
277. Albano, G.; Balzani, V.; Constable, E. C.; Maestri, M.; Smith, D. R. *Inorg. Chim. Acta* **1998**, *277*, 225–231.
278. Ho, K. Y.; Yu, W. Y.; Cheung, K. K.; Che, C. M. *J. Chem. Soc., Dalton Trans.* **1999**, 1581–1586.
279. Ma, Y. G.; Chao, H. Y.; Wu, Y.; Lee, S. T.; Yu, W. Y.; Che, C. M. *Chem. Commun.* **1998**, 2491–2492.
280. Lee, C. F.; Chin, K. F.; Peng, S. M.; Che, C. M. *J. Chem. Soc., Dalton Trans.* **1993**, 467–470.
281. Wu, Q. G.; Lavigne, J. A.; Tao, Y.; D'Iorio, M.; Wang, S. N. *Inorg. Chem.* **2000**, *39*, 5248–5254.
282. Yang, W. Y.; Schmider, H.; Wu, Q. G.; Zhang, Y. S.; Wang, S. N. *Inorg. Chem.* **2000**, *39*, 2397–2404.
283. Halasyamani, P. S.; Drewitt, M. J.; Ohare, D. *Chem. Commun.* **1997**, 867–868.
284. Subramanian, S.; Zaworotko, M. J. *Angew. Chem., Int. Ed. Engl.* **1995**, *34*, 2127–2129.
285. Gable, R. W.; Hoskins, B. F.; Robson, R. *J. Chem. Soc., Chem. Commun.* **1990**, 1677–1678.
286. Plater, M. J.; Foreman, M. R. S.; Gelbrich, T.; Hursthouse, M. B. *J. Chem. Soc., Dalton Trans.* **2000**, 1995–2000.
287. Thomsen, D. L.; Phely-Bobin, T.; Papadimitrakopoulos, F. *J. Am. Chem. Soc.* **1998**, *120*, 6177–6178.
288. Leigh, D. A.; Lusby, P. J.; Teat, S. J.; Wilson, A. J.; Wong, J. K. Y. *Angew. Chem., Int. Ed.* **2001**, *40*, 1538–1539.
289. Try, A. C.; Harding, M. M.; Hamilton, D. G.; Sanders, J. K. M. *Chem. Commun.* **1998**, 723–724.
290. Houser, R. P.; Fitzsimons, M. P.; Barton, J. K. *Inorg. Chem.* **1999**, *38*, 1368–1370.
291. Ma, J. F.; Liu, J. F.; Xing, Y.; Jia, H. Q.; Lin, Y. H. *J. Chem. Soc., Dalton Trans.* **2000**, 2403–2407.
292. Godfrey, S. M.; McAuliffe, C. A.; Pritchard, R. G.; Sheffield, J. M. *Inorg. Chim. Acta* **1999**, *292*, 213–219.
293. Goel, S. C.; Chiang, M. Y.; Buhro, W. E. *J. Am. Chem. Soc.* **1990**, *112*, 5636–5637.
294. Goel, S. C.; Chiang, M. Y.; Rauscher, D. J.; Buhro, W. E. *J. Am. Chem. Soc.* **1993**, *115*, 160–169.
295. Bricklebank, N.; Godfrey, S. M.; McAuliffe, C. A.; Mackie, A. G.; Pritchard, R. G. *J. Chem. Soc., Chem. Commun.* **1992**, 944–945.
296. Davidson, M. G.; Edwards, A. J.; Paver, M. A.; Raithby, P. R.; Russell, C. A.; Steiner, A.; Verhorevoort, K. L.; Wright, D. S. *J. Chem. Soc., Chem. Commun.* **1995**, 1989–1990.
297. Edwards, A. J.; Paver, M. A.; Raithby, P. R.; Russell, C. A.; Wright, D. S. *Organometallics* **1993**, *12*, 4687–4690.
298. Arif, A. M.; Cowley, A. H.; Jones, R. A.; Koschmieder, S. U. *J. Chem. Soc., Chem. Commun.* **1987**, 1319–1320.
299. Eichhofer, A.; Eisenmann, J.; Fenske, D.; Simon, F. Z. *Anorg. Allgemeine Chemie* **1993**, *619*, 1360–1368.
300. Eichhofer, A.; Fenske, D.; Fuhr, O. Z. *Anorg. Allgemeine Chemie* **1997**, *623*, 762–768.
301. Eichhofer, A.; Fenske, D.; Pfistner, H.; Wunder, M. Z. *Anorg. Allgemeine Chemie* **1998**, *624*, 1909–1914.
302. Pfistner, H.; Fenske, D. Z. *Anorg. Allgemeine Chemie* **2001**, *627*, 575–582.
303. Eisenmann, J.; Fenske, D.; Simon, F. Z. *Anorg. Allgemeine Chemie* **1995**, *621*, 1681–1688.
304. Bochmann, M.; Bwembya, G. C.; Grinter, R.; Powell, A. K.; Webb, K. J.; Hursthouse, M. B.; Malik, K. M. A.; Mazid, M. A. *Inorg. Chem.* **1994**, *33*, 2290–2296.
305. Cotton, F. A.; Schmid, G. *Polyhedron* **1996**, *15*, 4053–4059.
306. Klein, H. F.; Montag, J.; Zucha, U. *Inorg. Chim. Acta* **1990**, *177*, 43–46.
307. Pandey, S. K.; Steiner, A.; Roesky, H. W.; Stalke, D. *Inorg. Chem.* **1993**, *32*, 5444–5446.
308. Darensbourg, D. J.; Wildeson, J. R.; Yarbrough, J. C.; Reibenspies, J. H. *J. Am. Chem. Soc.* **2000**, *122*, 12487–12496.
309. Darensbourg, D. J.; Zimmer, M. S.; Rainey, P.; Larkins, D. L. *Inorg. Chem.* **1998**, *37*, 2852–2853.
310. Ellis, D.; Farrugia, L. J.; Hickman, D. T.; Lovatt, P. A.; Peacock, R. D. *Chem. Commun.* **1996**, 1817–1818.
311. Wirringa, U.; Voelker, H.; Roesky, H. W.; Shermolovich, Y.; Markovski, L.; Uson, I.; Noltemeyer, M.; Schmidt, H. G. *J. Chem. Soc., Dalton Trans.* **1995**, 1951–1956.
312. Zeng, D.; Hampden-Smith, M. J.; Alam, T. M.; Rheingold, A. L. *Polyhedron* **1994**, *13*, 2715–2730.
313. Rademacher, B.; Schwarz, W.; Westerhausen, M. Z. *Anorg. Allgemeine Chemie* **1995**, *621*, 287–300.
314. Westerhausen, M.; Bollwein, T.; Warchhold, M.; Noth, H. Z. *Anorg. Allgemeine Chemie* **2001**, *627*, 1141–1145.
315. Westerhausen, M.; Wieneke, M.; Doderer, K.; Schwarz, W. Z. *Naturforsch. B: Anorg. Chem. Org. Chem.* **1996**, *51*, 1439–1442.
316. Zeng, D.; Hampden-Smith, M. J.; Larson, E. M. *Acta Crystallogr. Section C-Crystal Structure Communications* **1994**, *50*, 1000–1002.
317. Cotton, F. A.; Duraj, S. A.; Roth, W. J.; Schmulbach, C. D. *Inorg. Chem.* **1985**, *24*, 525–527.
318. Dekker, J.; Muntinghoff, J. W.; Boersma, J.; Spek, A. L. *Organometallics* **1987**, *6*, 1236–1239.
319. Godfrey, S. M.; McAuliffe, C. A.; Pritchard, R. G.; Sheffield, J. M. *J. Chem. Soc., Dalton Trans.* **1996**, 3309–3311.
320. Fuhr, O.; Fenske, D. Z. *Anorg. Allgemeine Chemie* **1999**, *625*, 1229–1236.

321. Jones, C.; Junk, P. C.; Steed, J. W.; Thomas, R. C.; Williams, T. C. *J. Chem. Soc., Dalton Trans.* **2001**, 3219–3226.
322. Rademacher, B.; Schwarz, W.; Westerhausen, M. Z. *Anorg. Allg. Chem.* **1995**, 621, 1439–1446.
323. Westerhausen, M.; Wieneke, M.; Schwarz, W. *J. Organomet. Chem.* **1999**, 572, 249–257.
324. Groshens, T. J.; Higa, K. T.; Butcher, R. J. *J. Organomet. Chem.* **1993**, 463, 97–101.
325. Smith, K. J.; Young, C. W.; Herman, R. G.; Klier, K. *Ind. Eng. Chem. Res.* **1991**, 30, 61–71.
326. Jones, P. M.; May, J. A.; Reitz, J. B.; Solomon, E. I. *J. Am. Chem. Soc.* **1998**, 120, 1506–1516.
327. Cernak, J.; Chomic, J.; Kappenstein, C.; Robert, F. *J. Chem. Soc., Dalton Trans.* **1997**, 2981–2985.
328. Lin, J. Y.; May, J. A.; Didziulis, S. V.; Solomon, E. I. *J. Am. Chem. Soc.* **1992**, 114, 4718–4727.
329. Huang, M. H.; Mao, S.; Feick, H.; Yan, H. Q.; Wu, Y. Y.; Kind, H.; Weber, E.; Russo, R.; Yang, P. D. *Science* **2001**, 292, 1897–1899.
330. Bertocello, R.; Bettinelli, M.; Casarin, M.; Gulino, A.; Tondello, E.; Vittadini, A. *Inorg. Chem.* **1992**, 31, 1558–1565.
331. Casarin, M.; Tondello, E.; Calderazzo, F.; Vittadini, A.; Bettinelli, M.; Gulino, A. *J. Chem. Soc.-Faraday Trans.* **1993**, 89, 4363–4367.
332. Podlahova, J.; Kratochvil, B.; Podlaha, J.; Hasek, J. *J. Chem. Soc., Dalton Trans.* **1985**, 2393–2396.
333. Berreau, L. M.; Allred, R. A.; Makowska-Grzyska, M. M.; Arif, A. M. *Chem. Commun.* **2000**, 1423–1424.
334. MacBeth, C. E.; Hammes, B. S.; Young, V. G.; Borovik, A. S. *Inorg. Chem.* **2001**, 40, 4733–4741.
335. Bergquist, C.; Parkin, G. *Inorg. Chem.* **1999**, 38, 422–423.
336. Meyer, F.; Rutsch, P. *Chem. Commun.* **1998**, 1037–1038.
337. Meyn, M.; Beneke, K.; Lagaly, G. *Inorg. Chem.* **1993**, 32, 1209–1215.
338. Morioka, H.; Tagaya, H.; Karasu, M.; Kadokawa, J.; Chiba, K. *Inorg. Chem.* **1999**, 38, 4211–4216.
339. Milic, N. B.; Jelic, R. M. *J. Chem. Soc., Dalton Trans.* **1995**, 3597–3600.
340. Munoz-Paez, A.; Pappalardo, R. R.; Marcos, E. S. *J. Am. Chem. Soc.* **1995**, 117, 11710–11720.
341. Geerts, R. L.; Huffman, J. C.; Caulton, K. G. *Inorg. Chem.* **1986**, 25, 1803–1805.
342. Goel, S. C.; Chiang, M. Y.; Buhro, W. E. *Inorg. Chem.* **1990**, 29, 4646–4652.
343. Darensbourg, D. J.; Holtcamp, M. W.; Struck, G. E.; Zimmer, M. S.; Niezgod, S. A.; Rainey, P.; Robertson, J. B.; Draper, J. D.; Reibenspies, J. H. *J. Am. Chem. Soc.* **1999**, 121, 107–116.
344. Darensbourg, D. J.; Yoder, J. C.; Struck, G. E.; Holtcamp, M. W.; Draper, J. D.; Reibenspies, J. H. *Inorg. Chim. Acta* **1998**, 274, 115–121.
345. Bill, E.; Muller, J.; Weyhermuller, T.; Wieghardt, K. *Inorg. Chem.* **1999**, 38, 5795–5802.
346. Edwards, R. A.; Gladkikh, O. P.; Nieuwenhuysen, M.; Wilkins, C. J. *Z. Kristallogr.* **1999**, 214, 111–118.
347. Byrn, M. P.; Curtis, C. J.; Hsiou, Y.; Khan, S. I.; Sawin, P. A.; Tendick, S. K.; Terzis, A.; Strouse, C. E. *J. Am. Chem. Soc.* **1993**, 115, 9480–9497.
348. Krupitsky, H.; Stein, Z.; Goldberg, I. *Journal of Inclusion Phenomena and Molecular Recognition in Chemistry* **1994**, 20, 211–232.
349. Senge, M. O.; Smith, K. M. *Acta Crystallogr., C-Cryst. Struct. Commun.* **1997**, 53, 1022–1024.
350. Sudbrake, C.; Vahrenkamp, H. *Inorg. Chim. Acta* **2001**, 318, 23–30.
351. Belsky, V. K.; Streltsova, N. R.; Bulychev, B. M.; Storozhenko, P. A.; Ivankina, L. V.; Gorbunov, A. I. *Inorg. Chim. Acta* **1989**, 164, 211–220.
352. Muller, B.; Vahrenkamp, H. *Eur. J. Inorg. Chem.* **1999**, 117–127.
353. Muller, B.; Vahrenkamp, H. *Eur. J. Inorg. Chem.* **1999**, 129–135.
354. Muller, B.; Schneider, A.; Tesmer, M.; Vahrenkamp, H. *Inorg. Chem.* **1999**, 38, 1900–1907.
355. Walz, R.; Ruf, M.; Vahrenkamp, H. *Eur. J. Inorg. Chem.* **2001**, 139–143.
356. Goldberg, I.; Krupitsky, H.; Stein, Z.; Hsiou, Y.; Strouse, C. E. *Supramol. Chem.* **1994**, 4, 203–221.
357. Schauer, C. K.; Anderson, O. P.; Eaton, S. S.; Eaton, G. R. *Inorg. Chem.* **1985**, 24, 4082–4086.
358. Power, P. P.; Shoner, S. C. *Angew. Chem.-Int. Edit. Engl.* **1990**, 29, 1403–1404.
359. Boardman, A.; Small, R. W. H.; Worrall, I. *J. Acta Crystallogr. Sect. C-Cryst. Struct. Commun.* **1983**, 39, 1005–1007.
360. Markies, P. R.; Schat, G.; Akkerman, O. S.; Bickelhaupt, F.; Smeets, W. J. J.; Spek, A. L. *Organometallics* **1991**, 10, 3538–3544.
361. Markies, P. R.; Schat, G.; Akkerman, O. S.; Bickelhaupt, F.; Spek, A. L. *J. Organomet. Chem.* **1992**, 430, 1–13.
362. Singh, B.; Long, J. R.; deBiani, F. F.; Gatteschi, D.; Stavropoulos, P. *J. Am. Chem. Soc.* **1997**, 119, 7030–7047.
363. Clegg, W.; Little, I. R.; Straughan, B. P. *J. Chem. Soc., Dalton Trans.* **1986**, 1283–1288.
364. Chan, W. H.; Mak, T. C. W.; Yip, W. H.; Smith, G.; O'Reilly, E. J.; Kennard, C. H. L. *Polyhedron* **1987**, 6, 881–889.
365. Baumgartner, M. R.; Schmale, H.; Dubler, E. *Inorg. Chim. Acta* **1996**, 252, 319–331.
366. Smith, G.; Lynch, D. E.; Mak, T. C. W.; Yip, W. H.; Kennard, C. H. L. *Polyhedron* **1993**, 12, 203–208.
367. O'Reilly, E. J.; Smith, G.; Kennard, C. H. L.; Mak, T. C. W. *Aust. J. Chem.* **1987**, 40, 1147–1159.
368. Birnbaum, A.; Cotton, F. A.; Dori, Z.; Kapon, M. *Inorg. Chem.* **1984**, 23, 1617–1619.
369. Clegg, W.; Harbron, D. R.; Homan, C. D.; Hunt, P. A.; Little, I. R.; Straughan, B. P. *Inorg. Chim. Acta* **1991**, 186, 51–60.
370. Didonato, G. C.; Busch, K. L. *Inorg. Chem.* **1986**, 25, 1551–1556.
371. Hiltunen, L.; Leskela, M.; Makela, M.; Niinisto, L. *Acta Chem. Scand. Series a-Phys. Inorg. Chem.* **1987**, 41, 548–555.
372. Lalioti, N.; Raptopoulou, C. P.; Terzis, A.; Aliev, A. E.; Perlepes, S. P.; Gerotheranassis, I. P.; Manessi-Zoupa, E. *Chem. Commun.* **1998**, 1513–1514.
373. Tao, J.; Tong, M. L.; Shi, J. X.; Chen, X. M.; Ng, S. W. *Chem. Commun.* **2000**, 2043–2044.
374. Dreveni, I.; Berkesi, O.; Andor, J. A.; Mink, J. *Inorg. Chim. Acta* **1996**, 249, 17–23.
375. Berkesi, O.; Dreveni, I.; Andor, J. A.; Goggin, P. L. *Inorg. Chim. Acta* **1991**, 181, 285–289.
376. Berkesi, O.; Dreveni, I.; Andor, J. A.; Mink, J. *Inorg. Chim. Acta* **1992**, 195, 169–173.
377. Clegg, W.; Little, I. R.; Straughan, B. P. *Inorg. Chem.* **1988**, 27, 1916–1923.
378. Cotton, F. A.; Duraj, S. A.; Roth, W. J. *Inorg. Chem.* **1984**, 23, 4042–4045.
379. Cui, Y.; Zheng, F.; Qian, Y.; Huang, J. *Inorg. Chim. Acta* **2001**, 315, 220–228.
380. Eddaoudi, M.; Li, H. L.; Yaghi, O. M. *J. Am. Chem. Soc.* **2000**, 122, 1391–1397.
381. Kepert, C. J.; Prior, T. J.; Rosseinsky, M. J. *J. Am. Chem. Soc.* **2000**, 122, 5158–5168.
382. Yaghi, O. M.; Davis, C. E.; Li, G. M.; Li, H. L. *J. Am. Chem. Soc.* **1997**, 119, 2861–2868.

383. Plater, M. J.; Foreman, M. R. S.; Howie, R. A.; Skakle, J. M. S.; Coronado, E.; Gomez-Garcia, C. J.; Gelbrich, T.; Hursthouse, M. B. *Inorg. Chim. Acta* **2001**, *319*, 159–175.
384. Yaghi, O. M.; Jernigan, R.; Li, H. L.; Davis, C. E.; Groy, T. L. *J. Chem. Soc., Dalton Trans.* **1997**, 2383–2384.
385. Yaghi, O. M.; Li, G. M.; Groy, T. L. *J. Chem. Soc., Dalton Trans.* **1995**, 727–732.
386. Hambley, T. W.; Christopherson, R. L.; Zvargulis, E. S. *Inorg. Chem.* **1995**, *34*, 6550–6552.
387. Prout, K.; Edwards, A.; Mtetwa, V.; Murray, J.; Saunders, J. F.; Rossotti, F. J. C. *Inorg. Chem.* **1997**, *36*, 2820–2825.
388. Smith, G.; O'Reilly, E. J.; Kennard, C. H. L.; Mak, T. C. W. *Inorg. Chem.* **1985**, *24*, 2321–2324.
389. Takeuchi, M.; Yamamoto, M.; Shinkai, S. *Chem. Commun.* **1997**, 1731–1732.
390. Baggio, R.; Garland, M. T.; Pereg, M. *J. Chem. Soc., Dalton Trans.* **1996**, 2747–2753.
391. Baggio, R.; Garland, M. T.; Pereg, M.; Vega, D. *Inorg. Chim. Acta* **1999**, *284*, 49–54.
392. Inomata, Y.; Sasaki, K.; Umehara, H.; Howell, F. S. *Inorg. Chim. Acta* **2001**, *313*, 95–99.
393. Vela, M. J.; Buchholz, V.; Enkelmann, V.; Snider, B. B.; Foxman, B. M. *Chem. Commun.* **2000**, 2225–2226.
394. Cen, W.; Haller, K. J.; Fehlner, T. P. *Inorg. Chem.* **1993**, *32*, 995–1000.
395. Chen, X. M.; Tong, Y. X.; Mak, T. C. W. *Inorg. Chem.* **1994**, *33*, 4586–4588.
396. Glerup, J.; Goodson, P. A.; Hodgson, D. J.; Michelsen, K. *Inorg. Chem.* **1995**, *34*, 6255–6264.
397. Neeraj, S.; Natarajan, S.; Rao, C. N. R. *J. Chem. Soc., Dalton Trans.* **2001**, 289–291.
398. Vaidyanathan, R.; Natarajan, S.; Rao, C. N. R. *J. Chem. Soc., Dalton Trans.* **2001**, 699–706.
399. Evans, O. R.; Lin, W. B. *Crystal Growth & Design* **2001**, *1*, 9–11.
400. Brownless, N. J.; Edwards, D. A.; Mahon, M. F. *Inorg. Chim. Acta* **1999**, *287*, 89–94.
401. Hughes, D. L.; Wingfield, J. N. *J. Chem. Soc., Dalton Trans.* **1985**, 459–463.
402. Gomez-Lara, J.; Toscano, R. A.; Negron, G.; Zarate, E.; Campero, A. *J. Chem. Crystallogr.* **1994**, *24*, 441–444.
403. Lugmair, C. G.; Tilley, T. D. *Inorg. Chem.* **1998**, *37*, 6304–6307.
404. Lugmair, C. G.; Tilley, T. D.; Rheingold, A. L. *Chem. Mater.* **1997**, *9*, 339–348.
405. Fredoueil, F.; Penicaud, V.; Bujoli-Doeuff, M.; Bujoli, B. *Inorg. Chem.* **1997**, *36*, 4702–4706.
406. Drumel, S.; Janvier, P.; Barboux, P.; Bujoli-Doeuff, M.; Bujoli, B. *Inorg. Chem.* **1995**, *34*, 148–156.
407. Frink, K. J.; Wang, R. C.; Colon, J. L.; Clearfield, A. *Inorg. Chem.* **1991**, *30*, 1438–1441.
408. Hix, G. B.; Kariuki, B. M.; Kitchin, S.; Tremayne, R. *Inorg. Chem.* **2001**, *40*, 1477–1481.
409. Martin, K. J.; Squattrito, P. J.; Clearfield, A. *Inorg. Chim. Acta* **1989**, *155*, 7–9.
410. Ortizavila, Y.; Rudolf, P. R.; Clearfield, A. *Inorg. Chem.* **1989**, *28*, 2137–2141.
411. Choudhury, A.; Natarajan, S.; Rao, C. N. R. *Inorg. Chem.* **2000**, *39*, 4295–4304.
412. Christensen, A. N.; Bareges, A.; Nielsen, R. B.; Hazell, R. G.; Norby, P.; Hanson, J. C. *J. Chem. Soc., Dalton Trans.* **2001**, 1611–1615.
413. Murugavel, R.; Sathiyendiran, M.; Walawalkar, M. G. *Inorg. Chem.* **2001**, *40*, 427–434.
414. Neeraj, S.; Natarajan, S.; Rao, C. N. R. *Chem. Commun.* **1999**, 165–166.
415. Rao, C. N. R.; Natarajan, S.; Neeraj, S. *J. Am. Chem. Soc.* **2000**, *122*, 2810–2817.
416. Yang, G. Y.; Sevov, S. C. *J. Am. Chem. Soc.* **1999**, *121*, 8389–8390.
417. Zhang, B. L.; Pojary, D. M.; Clearfield, A. *Inorg. Chem.* **1998**, *37*, 1844–1852.
418. Song, H. H.; Zheng, L. M.; Wang, Z. M.; Yan, C. H.; Xin, X. Q. *Inorg. Chem.* **2001**, *40*, 5024–5029.
419. Bhardwaj, C.; Hu, H. L.; Clearfield, A. *Inorg. Chem.* **1993**, *32*, 4294–4299.
420. Cao, G.; Mallouk, T. E. *Inorg. Chem.* **1991**, *30*, 1434–1438.
421. Ortizavila, C. Y.; Squattrito, P. J.; Shieh, M.; Clearfield, A. *Inorg. Chem.* **1989**, *28*, 2608–2615.
422. Szpoganicz, B.; Martell, A. E. *Inorg. Chem.* **1984**, *23*, 4442–4447.
423. Hermann, P.; Lukes, I. *J. Chem. Soc., Dalton Trans.* **1995**, 2605–2610.
424. Matczak-Jon, E.; Kurzak, B.; Sawka-Dobrowolska, W.; Kafarski, P.; Lejczak, B. *J. Chem. Soc., Dalton Trans.* **1996**, 3455–3464.
425. Matczak-Jon, E.; Kurzak, B.; Sawka-Dobrowolska, W.; Lejczak, B.; Kafarski, P. *J. Chem. Soc., Dalton Trans.* **1998**, 161–169.
426. Sigel, H.; Scheller, K. H.; Milburn, R. M. *Inorg. Chem.* **1984**, *23*, 1933–1938.
427. Song, B.; Oswald, G.; Zhao, J.; Lippert, B.; Sigel, H. *Inorg. Chem.* **1998**, *37*, 4857–4864.
428. Rack, J. J.; Hurlburt, P. K.; Kellett, P. J.; Luck, J. S.; Anderson, O. P.; Strauss, S. H. *Inorg. Chim. Acta* **1996**, *242*, 71–79.
429. Fan, N. Y.; Wang, S. L. *Inorg. Chem.* **1996**, *35*, 4708–4712.
430. Shubnell, A. J.; Kosnic, E. J.; Squattrito, P. J. *Inorg. Chim. Acta* **1994**, *216*, 101–112.
431. Kosnic, E. J.; McClymont, E. L.; Hodder, R. A.; Squattrito, P. J. *Inorg. Chim. Acta* **1992**, *201*, 143–151.
432. Auld, D. S.; Falchuk, K. H.; Zhang, K.; Montorzi, M.; Vallee, B. L. *Proc. Natl. Acad. Sci. USA* **1996**, *93*, 3227–3231.
433. Han, R.; Parkin, G. *J. Am. Chem. Soc.* **1991**, *113*, 9707–9708.
434. Kumar, P.; Marynick, D. S. *Inorg. Chem.* **1993**, *32*, 1857–1859.
435. Lulinski, S.; Madura, I.; Serwatowski, J.; Zachara, J. *Inorg. Chem.* **1999**, *38*, 4937–4941.
436. Smith, R. W.; Luce, J. L.; Keszler, D. A. *Inorg. Chem.* **1992**, *31*, 4679–4682.
437. Bazzicalupi, C.; Bencini, A.; Bianchi, A.; Fusi, V.; Paoletti, P.; Piccardi, G.; Valtancoli, B. *Inorg. Chem.* **1995**, *34*, 5622–5631.
438. Bazzicalupi, C.; Bencini, A.; Berni, E.; Bianchi, A.; Fedi, V.; Fusi, V.; Giorgi, C.; Paoletti, P.; Valtancoli, B. *Inorg. Chem.* **1999**, *38*, 4115–4122.
439. Bazzicalupi, C.; Bencini, A.; Bianchi, A.; Fusi, V.; Giorgi, C.; Paoletti, P.; Valtancoli, B.; Zanchi, D. *Inorg. Chem.* **1997**, *36*, 2784–2790.
440. Bazzicalupi, C.; Bencini, A.; Bianchi, A.; Fusi, V.; Mazzanti, L.; Paoletti, P.; Valtancoli, B. *Inorg. Chem.* **1995**, *34*, 3003–3010.
441. Tanase, T.; Yun, J. W.; Lippard, S. J. *Inorg. Chem.* **1996**, *35*, 3585–3594.
442. Tanase, T.; Yun, J. W.; Lippard, S. J. *Inorg. Chem.* **1995**, *34*, 4220–4229.
443. Hikichi, S.; Tanaka, M.; Morooka, Y.; Kitajima, N. *J. Chem. Soc., Chem. Commun.* **1992**, 814–815.
444. Wendelstorf, C.; Warzeska, S.; Kovari, E.; Kramer, R. *J. Chem. Soc., Dalton Trans.* **1996**, 3087–3092.
445. Koike, T.; Inoue, M.; Kimura, E.; Shiro, M. *J. Am. Chem. Soc.* **1996**, *118*, 3091–3099.
446. Kimura, E.; Aoki, S.; Koike, T.; Shiro, M. *J. Am. Chem. Soc.* **1997**, *119*, 3068–3076.

447. Koike, T.; Kajitani, S.; Nakamura, I.; Kimura, E.; Shiro, M. *J. Am. Chem. Soc.* **1995**, *117*, 1210–1219.
448. Adams, H.; Bailey, N. A.; Fenton, D. E.; He, Q. Y. *J. Chem. Soc., Dalton Trans.* **1995**, 697–699.
449. Adams, H.; Bailey, N. A.; Fenton, D. E.; He, Q. Y. *J. Chem. Soc., Dalton Trans.* **1997**, 1533–1539.
450. Gross, F.; Muller-Hartmann, A.; Vahrenkamp, H. *Eur. J. Inorg. Chem.* **2000**, 2363–2370.
451. Suh, J. H.; Son, S. J.; Suh, M. P. *Inorg. Chem.* **1998**, *37*, 4872–4877.
452. Hammes, B. S.; Carrano, C. J. *J. Chem. Soc., Dalton Trans.* **2000**, 3304–3309.
453. Schepers, K.; Bremer, B.; Krebs, B.; Henkel, G.; Althaus, E.; Mosel, B.; Mullerwarmuth, W. *Angew. Chem. Int. Ed. Engl.* **1990**, *29*, 531–533.
454. Kaminskaia, N. V.; He, C.; Lippard, S. J. *Inorg. Chem.* **2000**, *39*, 3365–3373.
455. Barrios, A. M.; Lippard, S. J. *Inorg. Chem.* **2001**, *40*, 1060–1064.
456. Kato, M.; Ito, T. *Inorg. Chem.* **1985**, *24*, 509–514.
457. Kato, M.; Ito, T. *Inorg. Chem.* **1985**, *24*, 504–508.
458. Schrodt, A.; Neubrand, A.; van-Eldik, R. *Inorg. Chem.* **1997**, *36*, 4579–4584.
459. Zhang, X. P.; Van-Eldik, R.; Koike, T.; Kimura, E. *Inorg. Chem.* **1993**, *32*, 5749–5755.
460. Zhang, X. P.; Van-Eldik, R. *Inorg. Chem.* **1995**, *34*, 5606–5614.
461. Bazzicalupi, C.; Bencini, A.; Bianchi, A.; Corana, F.; Fusi, V.; Giorgi, C.; Paoli, P.; Paoletti, P.; Valtancoli, B.; Zanchini, C. *Inorg. Chem.* **1996**, *35*, 5540–5548.
462. Alfasser, R.; Ruf, M.; Trofimenko, S.; Vahrenkamp, H. *Chem. Ber.* **1993**, *126*, 703–710.
463. Zheng, Y. Q.; Adam, A. Z. *Naturforsch. B: ANorg. Chem. Org. Chem.* **1995**, *50*, 1185–1194.
464. Mann, K. L. V.; Jeffery, J. C.; McCleverty, J. A.; Ward, M. D. *J. Chem. Soc., Dalton Trans.* **1998**, 3029–3035.
465. Mao, Z. W.; Liehr, G.; van Eldik, R. *J. Chem. Soc., Dalton Trans.* **2001**, 1593–1600.
466. Troesch, A.; Vahrenkamp, H. *Inorg. Chem.* **2001**, *40*, 2305–2311.
467. Itoh, T.; Fujii, Y.; Tada, T.; Yoshikawa, Y.; Hisada, H. *Bull. Chem. Soc. Jpn.* **1996**, *69*, 1265–1274.
468. Murthy, N. N.; Karlin, K. D. *J. Chem. Soc., Chem. Commun.* **1993**, 1236–1238.
469. Chen, X. M.; Deng, Q. Y.; Wang, G. Y. S.; Xu, Y. J. *Polyhedron* **1994**, *13*, 3085–3089.
470. Adams, H.; Bradshaw, D.; Fenton, D. E. *J. Chem. Soc., Dalton Trans.* **2001**, 3407–3409.
471. Hynes, M. J.; Mooney, M. T. *J. Chem. Soc.-Chem. Commun.* **1991**, 519–520.
472. Hynes, M. J.; Mooney, M. T.; Moloney, A. *J. Chem. Soc., Dalton Trans.* **1993**, 313–318.
473. Takegoshi, K.; Schenk, K. J.; McDowell, C. A. *Inorg. Chem.* **1987**, *26*, 2552–2554.
474. Matsuda, K.; Takayama, K.; Irie, M. *Chem. Commun.* **2001**, 363–364.
475. Soldatov, D. V.; Henegouwen, A. T.; Enright, G. D.; Ratcliffe, C. I.; Ripmeester, J. A. *Inorg. Chem.* **2001**, *40*, 1626–1636.
476. Jastrzebski, J.; Sypkens, H. A. J.; Tombe, F.; Van der Schaaf, P. A.; Boersma, J.; Van Koten, G.; Spek, A. L.; Duisenberg, A. J. M. *J. Organomet. Chem.* **1990**, *396*, 25–31.
477. Sokolowski, A.; Muller, J.; Weyhermuller, T.; Schnepf, R.; Hildebrandt, P.; Hildenbrand, K.; Bothe, E.; Wiegardt, K. *J. Am. Chem. Soc.* **1997**, *119*, 8889–8900.
478. Soldatov, D. V.; Enright, G. D.; Ratcliffe, C. I.; Henegouwen, A. T.; Ripmeester, J. A. *Chem. Mater.* **2001**, *13*, 4322–4334.
479. Ellis, W. W.; Schmitz, M.; Arif, A. A.; Stang, P. J. *Inorg. Chem.* **2000**, *39*, 2547–2557.
480. Marchetti, F.; Pettinari, C.; Pettinari, R.; Arriva, D.; Troyanov, S.; Drozdov, A. *Inorg. Chim. Acta* **2000**, *307*, 97–105.
481. Gavrielatos, E.; Mitsos, C.; Athanasellis, G.; Heaton, B. T.; Steiner, A.; Bickley, J. F.; Igglessi-Markopoulou, O.; Markopoulos, J. *J. Chem. Soc., Dalton Trans.* **2001**, 639–644.
482. Abrahams, I.; Malik, M. A.; Motevalli, M.; O'Brien, P. *J. Chem. Soc., Dalton Trans.* **1995**, 1043–1046.
483. Hursthouse, M. B.; Malik, M. A.; Motevalli, M.; O'Brien, P. *Polyhedron* **1992**, *11*, 45–48.
484. Malik, M. A.; Motevalli, M.; O'Brien, P. *Inorg. Chem.* **1995**, *34*, 6223–6225.
485. Kubiak, M.; Glowiak, T.; Moszner, M.; Ziolkowski, J. J.; Asaro, F.; Costa, G.; Pellizer, G.; Tavagnacco, C. *Inorg. Chim. Acta* **1995**, *236*, 141–147.
486. Ruiz, R.; Julve, M.; Faus, J.; Lloret, F.; Munoz, M. C.; Journaux, Y.; Bois, C. *Inorg. Chem.* **1997**, *36*, 3434–3439.
487. Ruf, M.; Lawrence, A. M.; Noll, B. C.; Pierpont, C. G. *Inorg. Chem.* **1998**, *37*, 1992–1999.
488. Mabrouk, H. E.; Tuck, D. G.; Khan, M. A. *Inorg. Chim. Acta* **1987**, *129*, 75–80.
489. Shultz, D. A.; Bodnar, S. H. *Inorg. Chem.* **1999**, *38*, 591–594.
490. Christianson, D. W. *Adv. Protein Chem.* **1991**, *42*, 281–355.
491. Jordan, K. J.; Wacholtz, W. F.; Crosby, G. A. *Inorg. Chem.* **1991**, *30*, 4588–4593.
492. Corwin, D. T.; Koch, S. A. *Inorg. Chem.* **1988**, *27*, 493–496.
493. Stillman, M. J. *Coord. Chem. Rev.* **1995**, *144*, 461–511.
494. Czekaj, C. L.; Rau, M. S.; Geoffroy, G. L.; Guiton, T. A.; Pantano, C. G. *Inorg. Chem.* **1988**, *27*, 3267–3269.
495. Evans, J.; Corker, J. M.; Hayter, C. E.; Oldman, R. J.; Williams, B. P. *Chem. Commun.* **1996**, 1431–1432.
496. Labrenz, M.; Druschel, G. K.; Thomsen-Ebert, T.; Gilbert, B.; Welch, S. A.; Kemner, K. M.; Logan, G. A.; Summons, R. E.; De Stasio, G.; Bond, P. L.; Lai, B.; Kelly, S. D.; Banfield, J. F. *Science* **2000**, *290*, 1744–1747.
497. Chan, W. C. W.; Nie, S. M. *Science* **1998**, *281*, 2016–2018.
498. Dance, I. G. *Polyhedron* **1986**, *5*, 1037–1104.
499. Ueyama, N.; Sugawara, T.; Sasaki, K.; Nakamura, A.; Yamashita, S.; Wakatsuki, Y.; Yamazaki, H.; Yasuoka, N. *Inorg. Chem.* **1988**, *27*, 741–747.
500. Krebs, B.; Henkel, G. *Angew. Chem. Int. Ed. Engl.* **1991**, *30*, 769–788.
501. Bochmann, M.; Webb, K. J.; Hursthouse, M. B.; Mazid, M. *J. Chem. Soc., Dalton Trans.* **1991**, 2317–2323.
502. Gruff, E. S.; Koch, S. A. *J. Am. Chem. Soc.* **1990**, *112*, 1245–1247.
503. Baggio, R.; Garland, M. T.; Pereg, M. *J. Chem. Soc., Dalton Trans.* **1993**, 3367–3372.
504. Anjali, K. S.; Sampanthar, J. T.; Vital, J. J. *Inorg. Chim. Acta* **1999**, *295*, 9–17.
505. Sun, W. Y.; Zhang, L.; Yu, K. B. *J. Chem. Soc., Dalton Trans.* **1999**, 795–798.
506. Bridgewater, B. M.; Fillebeen, T.; Friesner, R. A.; Parkin, G. *J. Chem. Soc., Dalton Trans.* **2000**, 4494–4496.
507. Bochmann, M.; Bwembya, G.; Grinter, R.; Lu, J. J.; Webb, K. J.; Williamson, D. J.; Hursthouse, M. B.; Mazid, M. *Inorg. Chem.* **1993**, *32*, 532–537.
508. Yam, V. W. W.; Pui, Y. L.; Cheung, K. K. *Inorg. Chem.* **2000**, *39*, 5741–5746.

509. Zhang, C.; Chadha, R.; Reddy, H. K.; Schrauzer, G. N. *Inorg. Chem.* **1991**, *30*, 3865–3869.
510. Okamoto, K.; Matsumoto, M.; Miyashita, Y.; Sakagami, N.; Hidaka, J.; Konno, T. *Inorg. Chim. Acta* **1997**, *260*, 17–26.
511. Harrison, P. G.; Begley, M. J.; Kikabhai, T.; Killer, F. *J. Chem. Soc., Dalton Trans.* **1986**, 925–928.
512. Albinati, A.; Casarin, M.; Maccato, C.; Pandolfo, L.; Vittadini, A. *Inorg. Chem.* **1999**, *38*, 1145–1152.
513. Blasse, G.; Dirksen, G. J.; Brenchley, M. E.; Weller, M. T. *Chem. Phys. Lett.* **1995**, *234*, 177–181.
514. Guo, S. L.; Ding, E.; Chen, H.; Yin, Y. Q.; Li, X. J. *Polyhedron* **1999**, *18*, 735–740.
515. Ali, B.; Dance, I. G.; Craig, D. C.; Scudder, M. L. *J. Chem. Soc., Dalton Trans.* **1998**, 1661–1667.
516. Turk, T.; Resch, U.; Fox, M. A.; Vogler, A. *Inorg. Chem.* **1992**, *31*, 1854–1857.
517. Bertocello, R.; Bettinelli, M.; Casarin, M.; Maccato, C.; Pandolfo, L.; Vittadini, A. *Inorg. Chem.* **1997**, *36*, 4707–4716.
518. Watson, A. D.; Rao, C. P.; Dorfman, J. R.; Holm, R. H. *Inorg. Chem.* **1985**, *24*, 2820–2826.
519. Dance, I. G.; Choy, A.; Scudder, M. L. *J. Am. Chem. Soc.* **1984**, *106*, 6285–6295.
520. Hencher, J. L.; Khan, M. A.; Said, F. F.; Tuck, D. G. *Polyhedron* **1985**, *4*, 1263–1267.
521. Dance, I. G. *Aust. J. Chem.* **1985**, *38*, 1391–1411.
522. Lu, W. H.; Kasrai, M.; Bancroft, G. M.; Stillman, M. J. *Inorg. Chem.* **1990**, *29*, 2561–2563.
523. Osakada, K.; Yamamoto, T. *Inorg. Chem.* **1991**, *30*, 2328–2332.
524. Nyman, M. D.; Hampden-Smith, M. J.; Duesler, E. N. *Inorg. Chem.* **1996**, *35*, 802–803.
525. Halvorsen, K.; Crosby, G. A.; Wacholtz, W. F. *Inorg. Chim. Acta* **1995**, *228*, 81–88.
526. Yam, V. W. W.; Pui, Y. L.; Wong, K. M. C.; Cheung, K. K. *Chem. Commun.* **2000**, 1751–1752.
527. Brewer, M.; Lee, J.; Brennan, J. G. *Inorg. Chem.* **1995**, *34*, 5919–5924.
528. Tuntulani, T.; Reibenspies, J. H.; Farmer, P. J.; Darensbourg, M. Y. *Inorg. Chem.* **1992**, *31*, 3497–3499.
529. Vallee, B. L.; Auld, D. S. *Biochemistry* **1990**, *29*, 5647–5659.
530. Karpel, R. L. In *The Biology of Non-specific DNA-Protein Interactions*; Revson, A., Ed., CRC Press: Boca Raton, FL, 1990, pp 103–130.
531. South, T. L.; Blake, P. R.; Sowder, R. C.; Arthur, L. O.; Henderson, L. E.; Summers, M. F. *Biochemistry* **1990**, *29*, 7786–7789.
532. Fabris, D.; Zaia, J.; Hathout, Y.; Fenselau, C. *J. Am. Chem. Soc.* **1996**, *118*, 12242–12243.
533. Jiang, D. T.; Heald, S. M.; Sham, T. K.; Stillman, M. J. *J. Am. Chem. Soc.* **1994**, *116*, 11004–11013.
534. Sawyer, D. T.; Srivatsa, G. S.; Bodini, M. E.; Schaefer, W. P.; Wing, R. M. *J. Am. Chem. Soc.* **1986**, *108*, 936–942.
535. Mabrouk, H. E.; Tuck, D. G. *Inorg. Chim. Acta* **1988**, *145*, 237–241.
536. Kimblin, C.; Bridgewater, B. M.; Churchill, D. G.; Hascall, T.; Parkin, G. *Inorg. Chem.* **2000**, *39*, 4240–4243.
537. Wu, Z.; Walsh, C. *J. Am. Chem. Soc.* **1996**, *118*, 1785–1786.
538. Otto, J.; Jolk, I.; Viland, T.; Wonnemann, R.; Krebs, B. *Inorg. Chim. Acta* **1999**, *285*, 262–268.
539. Parvez, M.; Mesher, S. T. E.; Clark, P. D. *Acta Crystallogr. Sect. C-Cryst. Struct. Commun.* **1997**, *53*, 681–685.
540. Kuppers, H. J.; Wiegardt, K.; Nuber, B.; Weiss, J. Z. *Anorg. Chem.* **1989**, *577*, 155–164.
541. Dickson, R. S.; Fallon, G. D.; Zhang, Q. Q. *J. Chem. Soc., Dalton Trans.* **2000**, 1973–1974.
542. Brand, U.; Rombach, M.; Vahrenkamp, H. *Chem. Commun.* **1998**, 2717–2718.
543. Grapperhaus, C. A.; Tuntulani, T.; Reibenspies, J. H.; Darensbourg, M. Y. *Inorg. Chem.* **1998**, *37*, 4052–4058.
544. Wilker, J. J.; Lippard, S. J. *Inorg. Chem.* **1997**, *36*, 969–978.
545. Roehm, P. C.; Berg, J. M. *J. Am. Chem. Soc.* **1998**, *120*, 13083–13087.
546. Wilker, J. J.; Lippard, S. J. *J. Am. Chem. Soc.* **1995**, *117*, 8682–8683.
547. Chiou, S. J.; Innocent, J.; Riordan, C. G.; Lam, K. C.; Liable-Sands, L.; Rheingold, A. L. *Inorg. Chem.* **2000**, *39*, 4347–4353.
548. Garner, M.; Reglinski, J.; Cassidy, I.; Spicer, M. D.; Kennedy, A. R. *Chem. Commun.* **1996**, 1975–1976.
549. Pafford, R. J.; Chou, J. H.; Rauchfuss, T. B. *Inorg. Chem.* **1999**, *38*, 3779–3786.
550. Pafford, R. J.; Rauchfuss, T. B. *Inorg. Chem.* **1998**, *37*, 1974–1980.
551. Verma, A. K.; Rauchfuss, T. B.; Wilson, S. R. *Inorg. Chem.* **1995**, *34*, 3072–3078.
552. Verma, A. K.; Rauchfuss, T. B. *Inorg. Chem.* **1995**, *34*, 6199–6201.
553. Dev, S.; Ramlı, E.; Rauchfuss, T. B.; Stern, C. L. *J. Am. Chem. Soc.* **1990**, *112*, 6385–6386.
554. Zeug, N.; Bucheler, J.; Kisch, H. *J. Am. Chem. Soc.* **1985**, *107*, 1459–1465.
555. Sreehari, N.; Varghese, B.; Manoharan, P. T. *Inorg. Chem.* **1990**, *29*, 4011–4015.
556. Bond, A. M.; Hollenkamp, A. F. *Inorg. Chem.* **1990**, *29*, 284–289.
557. Malik, M. A.; Motevalli, M.; O'Brien, P.; Walsh, J. R. *Inorg. Chem.* **1997**, *36*, 1263–1264.
558. Frigerio, A.; Halac, B.; Perec, M. *Inorg. Chim. Acta* **1989**, *164*, 149–154.
559. Decarvalho, M.; Airoidi, C.; Desouza, A. G. *J. Chem. Soc., Dalton Trans.* **1992**, 1235–1238.
560. Desouza, A. G.; Desouza, J. H.; Airoidi, C. *J. Chem. Soc., Dalton Trans.* **1991**, 1751–1754.
561. Airoidi, C. *J. Chem. Soc., Dalton Trans.* **1985**, 369–372.
562. Ivanov, A. V.; Kritikos, M.; Antzutkin, O. N.; Forsling, W. *Inorg. Chim. Acta* **2001**, *321*, 63–74.
563. Bell, N. A.; Johnson, E.; March, L. A.; Marsden, S. D.; Nowell, I. W.; Walker, Y. *Inorg. Chim. Acta* **1989**, *156*, 205–211.
564. Manohar, A.; Ramalingam, K.; Bocelli, G.; Righi, L. *Inorg. Chim. Acta* **2001**, *314*, 177–183.
565. Stalhandske, C. M. V.; Persson, I.; Sandstrom, M.; KamienskaPiotrowicz, E. *Inorg. Chem.* **1997**, *36*, 3174–3182.
566. Stalhandske, C. M. V.; Stalhandske, C. I.; Sandstrom, M.; Persson, I. *Inorg. Chem.* **1997**, *36*, 3167–3173.
567. Fukushima, N.; Iisaka, G.; Saito, M.; Waizumi, K. *Inorg. Chim. Acta* **1997**, *255*, 211–214.
568. Ivanov, A. V.; Antzutkin, O. N.; Larsson, A. C.; Kritikos, M.; Forsling, W. *Inorg. Chim. Acta* **2001**, *315*, 26–35.
569. Harrison, P. G.; Begley, M. J.; Kikabhai, T.; Killer, F. *J. Chem. Soc., Dalton Trans.* **1986**, 929–938.
570. Harrison, P. G.; Brown, P.; McManus, J. *Inorg. Chim. Acta* **1992**, *202*, 3–5.
571. Srogl, J.; Liu, W. S.; Marshall, D.; Liebeskind, L. S. *J. Am. Chem. Soc.* **1999**, *121*, 9449–9450.
572. Sinnecker, S.; Brauer, M.; Koch, W.; Anders, E. *Inorg. Chem.* **2001**, *40*, 1006–1013.
573. Faraglia, G.; Graziani, R.; Guo, Z. J.; Casellato, U.; Sitran, S. *Inorg. Chim. Acta* **1992**, *192*, 17–23.
574. Castro, R.; Duran, M. L.; Garcia-Vazquez, J. A.; Romero, J.; Sousa, A.; Castineiras, A.; Hiller, W.; Strahle, J. Z. *Naturforsch. B: Anorg. Chem. Org. Chem.* **1992**, *47*, 1067–1074.

575. Castro, R.; Garcia-Vazquez, J. A.; Romero, J.; Sousa, A.; Castineiras, A.; Hiller, W.; Strahle, J. *Inorg. Chim. Acta* **1993**, *211*, 47–54.
576. Gronlund, P. J.; Burt, J. A.; Wacholtz, W. F. *Inorg. Chim. Acta* **1995**, *234*, 13–18.
577. Hofbauer, M.; Mobius, M.; Knoch, F.; Benedix, R. *Inorg. Chim. Acta* **1996**, *247*, 147–154.
578. Xiong, R. G.; Zuo, J. L.; You, X. Z. *Inorg. Chem.* **1997**, *36*, 2472–2474.
579. Matsubayashi, G. E.; Akiba, K.; Tanaka, T. *J. Chem. Soc., Dalton Trans.* **1990**, 115–119.
580. Poleschner, H.; Radeglia, R.; Fuchs, J. *J. Organomet. Chem.* **1992**, *427*, 213–230.
581. Banda, R. M. H.; Cusick, J.; Scudder, M. L.; Craig, D. C.; Dance, I. G. *Polyhedron* **1989**, *8*, 1995–1998.
582. Ansari, M. A.; Mahler, C. H.; Chorghade, G. S.; Lu, Y. J.; Ibers, J. A. *Inorg. Chem.* **1990**, *29*, 3832–3839.
583. Adel, J.; Weller, F.; Dehnicke, K. *Z. Naturforsch. (B)* **1988**, *43*, 1094–1100.
584. Neumuller, B.; Haierdanz, M. L.; Muller, U.; Magull, S.; Krauter, G.; Dehnicke, K. *Z. Anorg. Allg. Chem.* **1992**, *609*, 12–18.
585. Fenske, D.; Magull, S.; Dehnicke, K. *Z. Naturforsch. B: Anorg. Chem. Org. Chem.* **1991**, *46*, 1011–1014.
586. Huang, X. Y.; Heulings, H. R.; Le, V.; Li, J. *Chem. Mater.* **2001**, *13*, 3754–3759.
587. Muges, G.; Singh, H. B.; Patel, R. P.; Butcher, R. J. *Inorg. Chem.* **1998**, *37*, 2663–2669.
588. Jun, Y. W.; Koo, J. E.; Cheon, J. *Chem. Commun.* **2000**, 1243–1244.
589. Labahn, D.; Bohnen, F. M.; Herbstirmer, R.; Pohl, E.; Stalke, D.; Roesky, H. W. *Z. Naturforsch. B: Anorg. Chem. Org. Chem.* **1994**, *620*, 41–47.
590. Bochmann, M.; Bwembya, G. C.; Hursthouse, M. B.; Coles, S. J. *J. Chem. Soc.-Dalton Trans.* **1995**, 2813–2817.
591. Malik, M. A.; Motevalli, M.; O'Brien, P. *Polyhedron* **1999**, *18*, 1259–1264.
592. Dance, I. G.; Garbutt, R. G.; Craig, D. C.; Scudder, M. L. *Inorg. Chem.* **1987**, *26*, 4057–4064.
593. Bochmann, M.; Webb, K. J.; Hursthouse, M. B.; Mazid, M. J. *Chem. Soc., Chem. Commun.* **1991**, 1735–1737.
594. Vittal, J. J.; Dean, P. A. W.; Payne, N. C. *Rev. Can. Chim.* **1992**, *70*, 792–801.
595. Liaw, W. F.; Chen, C. H.; Lee, C. M.; Lin, G. Y.; Ching, C. Y.; Lee, G. H.; Peng, S. M. *J. Chem. Soc., Dalton Trans.* **1998**, 353–358.
596. Berardini, M.; Emge, T. J.; Brennan, J. G. *Inorg. Chem.* **1995**, *34*, 5327–5334.
597. Freedman, D.; Kornienko, A.; Emge, T. J.; Brennan, J. G. *Inorg. Chem.* **2000**, *39*, 2168–2171.
598. Okamoto, K.; Watanabe, Y.; Konno, T.; Hidaka, J. *Bull. Chem. Soc. Jpn.* **1992**, *65*, 3015–3021.
599. Drutkowski, U.; Wenzel, B.; Tews, D.; Strauch, P. *Z. Naturforsch. B: Anorg. Chem. Org. Chem.* **2001**, *627*, 1888–1894.
600. O'Brien, P.; Walsh, J. R.; Watson, I. M.; Motevalli, M.; Henriksen, L. *J. Chem. Soc., Dalton Trans.* **1996**, 2491–2496.
601. Chunggaze, M.; McAleese, J.; O'Brien, P.; Otway, D. J. *Chem. Commun.* **1998**, 833–834.
602. Hursthouse, M. B.; Malik, M. A.; Motevalli, M.; O'Brien, P. *J. Mater. Chem.* **1992**, *2*, 949–955.
603. Malik, M. A.; Motevalli, M.; Walsh, J. R.; O'Brien, P. *Organometallics* **1992**, *11*, 3136–3139.
604. Li, Y. D.; Ding, Y.; Qian, Y. T.; Zhang, Y.; Yang, L. *Inorg. Chem.* **1998**, *37*, 2844–2845.
605. Ludolph, B.; Malik, M. A.; O'Brien, P.; Revaprasadu, N. *Chem. Commun.* **1998**, 1849–1850.
606. Muller, U.; Grebe, C.; Neumuller, B.; Schreiner, B.; Dehnicke, K. *Z. Naturforsch. B: Anorg. Chem. Org. Chem.* **1993**, *619*, 500–506.
607. Bollinger, J. C.; Roof, L. C.; Smith, D. M.; McConnachie, J. M.; Ibers, J. A. *Inorg. Chem.* **1995**, *34*, 1430–1434.
608. Bonasia, P. J.; Arnold, J. *Inorg. Chem.* **1992**, *31*, 2508–2514.
609. Jun, Y. W.; Choi, C. S.; Cheon, J. *Chem. Commun.* **2001**, 101–102.
610. Huang, X. Y.; Li, J.; Fu, H. X. *J. Am. Chem. Soc.* **2000**, *122*, 8789–8790.
611. Bochmann, M.; Bwembya, G. C.; Powell, A. K.; Song, X. J. *Polyhedron* **1995**, *14*, 3495–3500.
612. Hargittai, M.; Tremmel, J.; Hargittai, I. *Inorg. Chem.* **1986**, *25*, 3163–3166.
613. Silber, H. B.; Simon, D.; Gaizer, F. *Inorg. Chem.* **1984**, *23*, 2844–2848.
614. Hanggi, G.; Schmalle, H.; Dubler, E. *Inorg. Chim. Acta* **1992**, *197*, 135–140.
615. Prins, R.; Biagini-Cingi, M.; Drillon, M.; de Graaff, R. A. G.; Haasnoot, J.; Manotti-Lanfredi, A. M.; Rabu, P.; Reedijk, J.; Uggozzoli, F. *Inorg. Chim. Acta* **1996**, *248*, 35–44.
616. Macdonald, C. J.; Browning, J.; House, D. A. *Inorg. Chim. Acta* **1999**, *292*, 198–203.
617. Godino-Salido, M. L.; Lopez-Garzon, R.; Gutierrez-Valero, M. D.; Moreno, J. M. *Inorg. Chim. Acta* **1995**, *236*, 197–201.
618. Sun, W. Y.; Xie, J.; Okamura, T.; Huang, C.; Ueyama, N. *Chem. Commun.* **2000**, 1429–1430.
619. Bixler, J. W.; Cobb, M. E.; French, R. J.; Morse, B. E.; O'Toole, T. R.; Schudel, J. A.; Yogis, G. A.; Bond, A. M. *Inorg. Chim. Acta* **1987**, *128*, 105–111.
620. Ishiguro, S.; Nagy, L.; Ohtaki, H. *Bull. Chem. Soc. Jpn.* **1987**, *60*, 2865–2869.
621. Ishiguro, S.; Ozutsumi, K.; Ohtaki, H. *Bull. Chem. Soc. Jpn.* **1987**, *60*, 531–538.
622. Duffy, J. A.; Wood, G. L. *J. Chem. Soc., Dalton Trans.* **1987**, 1485–1488.
623. Airoidi, C.; Silva, M.; Chagas, A. P. R. *J. Chem. Soc., Dalton Trans.* **1986**, 1913–1916.
624. Allan, J. R.; Paton, A. D.; Turvey, K.; Bowley, H. J.; Gerrard, D. L. *Inorg. Chim. Acta* **1988**, *149*, 289–293.
625. Masciocchi, N.; Moret, M.; Sironi, A.; Bruni, S.; Cariati, F.; Pozzi, A.; Manfredini, T.; Menabue, L.; Benedetti, A. *Inorg. Chim. Acta* **1989**, *159*, 173–180.
626. Dequeiroz, J. C.; Airoidi, C.; Chagas, A. P. *J. Chem. Soc., Dalton Trans.* **1985**, 1103–1105.
627. Sawada, K.; Sakaguchi, T.; Suzuki, T. *J. Chem. Soc., Dalton Trans.* **1983**, 447–451.
628. Toscano, P. J.; Dimauro, P. T.; Geremia, S.; Randaccio, L.; Zangrando, E. *Inorg. Chim. Acta* **1994**, *217*, 195–199.
629. Birdy, R. B.; Goodgame, M. J. *Chem. Soc., Dalton Trans.* **1983**, 1469–1471.
630. Hughes, C. M.; Favas, M. C.; Skelton, B. W.; White, A. H. *Aust. J. Chem.* **1985**, *38*, 1521–1527.
631. Kumagai, T. *Bull. Chem. Soc. Jpn.* **1984**, *57*, 2738–2740.
632. Pandey, R. N.; Bapat, M. G. *Bull. Chem. Soc. Jpn.* **1994**, *67*, 1792–1796.
633. Marumoto, S.; Kogen, H.; Naruto, S. *Chem. Commun.* **1998**, 2253–2254.
634. Seko, S.; Miyake, K. *Chem. Commun.* **1998**, 1519–1520.
635. Yamamoto, Y.; Onuki, S.; Yumoto, M.; Asao, N. *J. Am. Chem. Soc.* **1994**, *116*, 421–422.
636. Zhu, J. L.; Shia, K. S.; Liu, H. J. *Chem. Commun.* **2000**, 1599–1600.
637. Emokpae, T. A.; Ukwueze, A. C. *Inorg. Chim. Acta* **1986**, *112*, L17–L18.

638. Liu, H. J.; Ulibarri, G.; Browne, E. N. *Can. J. Chem.-Rev. Can. Chim.* **1992**, *70*, 1545–1554.
639. Hayashi, E.; Takahashi, Y.; Itoh, H.; Yoneda, N. *Bull. Chem. Soc. Jpn.* **1993**, *66*, 3520–3521.
640. Miller, J. M.; Wails, D.; Hartman, J. S.; Schebesh, K.; Belelie, J. L. *Can. J. Chem.-Rev. Can. Chim.* **1998**, *76*, 382–388.
641. Clark, J. H.; Ross, J. C.; Macquarrie, D. J.; Barlow, S. J.; Bastock, T. W. *Chem. Commun.* **1997**, 1203–1204.
642. Satoh, T.; Itoh, K.; Miura, M.; Nomura, M. *Bull. Chem. Soc. Jpn.* **1993**, *66*, 2121–2123.
643. Hefter, G. T.; Tioh, N. H.; Chan, C. B. *Polyhedron* **1990**, *9*, 901–906.
644. Yu, P. H.; Muller, P.; Roesky, H. W.; Noltemeyer, M.; Demsar, A.; Uson, I. *Angew. Chem.-Int. Edit.* **1999**, *38*, 3319–3321.
645. Tesmer, M.; Shu, M. H.; Vahrenkamp, H. *Inorg. Chem.* **2001**, *40*, 4022–4029.
646. Hao, H. J.; Cui, C. M.; Roesky, H. W.; Bai, G. C.; Schmidt, H. G.; Noltemeyer, M. *Chem. Commun.* **2001**, 1118–1119.
647. Maggard, P. A.; Stern, C. L.; Poepelmeier, K. R. *J. Am. Chem. Soc.* **2001**, *123*, 7742–7743.
648. Abrahams, B. F.; Batten, S. R.; Hamit, H.; Hoskins, B. F.; Robson, R. *Chem. Commun.* **1996**, 1313–1314.
649. Bell, N. A.; Kassik, A. L. *Inorg. Chim. Acta* **1996**, *250*, 345–349.
650. Krieger, M.; Neumuller, B.; Dehnicke, K. Z. *Naturforsch. B: Anorg. Chem. Org. Chem.e* **1998**, *624*, 1563–1564.
651. Han, R.; Gorrell, I. B.; Looney, A. G.; Parkin, G. *J. Chem. Soc.-Chem. Commun.* **1991**, 717–719.
652. Looney, A.; Han, R. Y.; Gorrell, I. B.; Cornebise, M.; Yoon, K.; Parkin, G.; Rheingold, A. L. *Organometallics* **1995**, *14*, 274–288.
653. Geerts, R. L.; Huffman, J. C.; Caulton, K. G. *Inorg. Chem.* **1986**, *25*, 590–591.
654. Arkhireeva, T. M.; Bulychev, B. M.; Sokolova, T. A.; Soloveichik, G. L.; Belsky, V. K.; Boiko, G. N. *Inorg. Chim. Acta* **1988**, *141*, 221–226.
655. Riera, V.; Ruiz, M. A.; Tiripicchio, A.; Tiripicchio-Camellini, M. *Organometallics* **1993**, *12*, 2962–2972.
656. Saidov, B. I.; Borisov, A. P.; Makhaev, V. D.; Boiko, G. N.; Antsyshkina, A. S.; Kedrova, N. S.; Maltseva, N. N. *Zhurnal Neorganicheskoi Khimii* **1990**, *35*, 626–632.
657. Aldridge, S.; Blake, A. J.; Downs, A. J.; Parsons, S.; Pulham, C. R. *J. Chem. Soc., Dalton Trans.* **1996**, 853–859.
658. Koutsantonis, G. A.; Lee, F. C.; Raston, C. L. *J. Chem. Soc.-Chem. Commun.* **1994**, 1975–1976.
659. Bansemer, R. L.; Huffman, J. C.; Caulton, K. G. *J. Am. Chem. Soc.* **1983**, *105*, 6163–6164.
660. Snow, S. A.; Shimoï, M.; Ostler, C. D.; Thompson, B. K.; Kodama, G.; Parry, R. W. *Inorg. Chem.* **1984**, *23*, 511–512.
661. Kimblin, C.; Bridgewater, B. M.; Hascall, T.; Parkin, G. *J. Chem. Soc., Dalton Trans.* **2000**, 891–897.
662. Silver, G. C.; Gantzel, P.; Trogler, W. C. *Inorg. Chem.* **1995**, *34*, 2487–2489.
663. Chaudhuri, P.; Stockheim, C.; Wieghardt, K.; Deck, W.; Gregorzik, R.; Vahrenkamp, H.; Nuber, B.; Weiss, J. *Inorg. Chem.* **1992**, *31*, 1451–1457.
664. Fallis, I. A.; Farley, R. D.; Malik, K. M. A.; Murphy, D. M.; Smith, H. J. *J. Chem. Soc., Dalton Trans.* **2000**, 3632–3639.
665. Schlager, O.; Wieghardt, K.; Grondey, H.; Rufinska, A.; Nuber, B. *Inorg. Chem.* **1995**, *34*, 6440–6448.
666. Weyhermuller, T.; Weighardt, K.; Chaudhuri, P. *J. Chem. Soc., Dalton Trans.* **1998**, 3805–3813.
667. Odum, D.; Gramer, C. J.; Young, V. G.; Hilderbrand, S. A.; Sherman, S. E. *Inorg. Chim. Acta* **2000**, *297*, 404–410.
668. Lazar, I.; Ramasamy, R.; Brucher, E.; Geraldcs, C.; Sherry, A. D. *Inorg. Chim. Acta* **1992**, *195*, 89–93.
669. Rawle, S. C.; Clarke, A. J.; Moore, P.; Alcock, N. W. *J. Chem. Soc., Dalton Trans.* **1992**, 2755–2757.
670. DasGupta, B.; Haidar, R.; Hsieh, W. Y.; Zompa, L. J. *Inorg. Chim. Acta* **2000**, *306*, 78–86.
671. Brudenell, S. J.; Spiccia, L.; Hockless, D. C. R.; Tiekink, E. R. T. *J. Chem. Soc., Dalton Trans.* **1999**, 1475–1481.
672. Schaber, P. M.; Fettingner, J. C.; Churchill, M. R.; Nalewajek, D.; Fries, K. *Inorg. Chem.* **1988**, *27*, 1641–1646.
673. Kimura, E.; Shiota, T.; Koike, T.; Shiro, M.; Kodama, M. *J. Am. Chem. Soc.* **1990**, *112*, 5805–5811.
674. Kimura, E.; Kodama, Y.; Koike, T.; Shiro, M. *J. Am. Chem. Soc.* **1995**, *117*, 8304–8311.
675. Koike, T.; Kimura, E. *J. Am. Chem. Soc.* **1991**, *113*, 8935–8941.
676. Koike, T.; Kimura, E.; Nakamura, I.; Hashimoto, Y.; Shiro, M. *J. Am. Chem. Soc.* **1992**, *114*, 7338–7345.
677. Ida, K.; Okawa, H.; Sakiyama, H.; Kodera, M.; Kida, S.; Murase, I. *Inorg. Chim. Acta* **1991**, *184*, 197–201.
678. Kimura, E.; Kurogi, Y.; Shionoya, M.; Shiro, M. *Inorg. Chem.* **1991**, *30*, 4524–4530.
679. Turonek, M. L.; Moore, P.; Clase, H. J.; Alcock, N. W. *J. Chem. Soc., Dalton Trans.* **1995**, 3659–3666.
680. Di Vaira, M.; Mani, F.; Stoppioni, P. *Inorg. Chim. Acta* **1998**, *273*, 151–159.
681. Di Vaira, M.; Mani, F.; Stoppioni, P. *J. Chem. Soc., Dalton Trans.* **1994**, 3739–3743.
682. Di Vaira, M.; Mani, F.; Stoppioni, P. *J. Chem. Soc., Dalton Trans.* **1998**, 1879–1884.
683. Di Vaira, M.; Mani, F.; Stoppioni, P. *Inorg. Chim. Acta* **2000**, *303*, 61–69.
684. Di Vaira, M.; Mani, F.; Menicatti, M.; Stoppioni, P.; Vacca, A. *J. Chem. Soc., Dalton Trans.* **1997**, 661–667.
685. Di Vaira, M.; Mani, F.; Nardi, N.; Stoppioni, P.; Vacca, A. *J. Chem. Soc., Dalton Trans.* **1996**, 2679–2684.
686. Nakani, B. S.; Welsh, J. J. B.; Hancock, R. D. *Inorg. Chem.* **1983**, *22*, 2956–2958.
687. Baillie, P. K.; Choi, N.; Lindoy, L. F.; McPartlin, M.; Powell, H. R.; Tasker, P. A. *J. Chem. Soc., Dalton Trans.* **1996**, 3039–3043.
688. Sakata, K.; Wada, S.; Sato, N.; Kurisu, M.; Hashimoto, M.; Kato, Y. *Inorg. Chim. Acta* **1986**, *119*, 111–119.
689. Costa, J.; Delgado, R.; Drew, M. G. B.; Felix, V.; Saint-Maurice, A. *J. Chem. Soc., Dalton Trans.* **2000**, 1907–1916.
690. Comba, P.; Luther, S. M.; Maas, O.; Pritzkow, H.; Viefort, A. *Inorg. Chem.* **2001**, *40*, 2335–2345.
691. Alcock, N. W.; Balakrishnan, K. P.; Berry, A.; Moore, P.; Reader, C. J. *J. Chem. Soc., Dalton Trans.* **1988**, 1089–1093.
692. Grant, S. J.; Moore, P.; Omar, H. A. A.; Alcock, N. W. *J. Chem. Soc., Dalton Trans.* **1994**, 485–489.
693. Alcock, N. W.; Moore, P.; Omar, H. A. A. *J. Chem. Soc., Dalton Trans.* **1986**, 985–989.
694. Alcock, N. W.; Balakrishnan, K. P.; Moore, P.; Pike, G. A. *J. Chem. Soc., Dalton Trans.* **1987**, 889–894.
695. Alcock, N. W.; Omar, H. A. A.; Moore, P.; Pierpoint, C. *J. Chem. Soc., Dalton Trans.* **1985**, 219–221.
696. Alcock, N. W.; Moore, P.; Pierpoint, C. *J. Chem. Soc., Dalton Trans.* **1984**, 2371–2376.
697. Bernhardt, P. V.; Lawrance, G. A.; Maeder, M.; Rossignoli, M.; Hambley, T. W. *J. Chem. Soc., Dalton Trans.* **1991**, 1167–1182.
698. Lye, P. G.; Lawrance, G. A.; Maeder, M.; Skelton, B. W.; Wen, H.; White, A. H. *J. Chem. Soc., Dalton Trans.* **1994**, 793–798.
699. Tan, L. H.; Taylor, M. R.; Wainwright, K. P.; Duckworth, P. A. *J. Chem. Soc., Dalton Trans.* **1993**, 2921–2928.

700. Balakrishnan, K. P.; Omar, H. A. A.; Moore, P.; Alcock, N. W.; Pike, G. A. *J. Chem. Soc., Dalton Trans.* **1990**, 2965–2969.
701. Luckay, R.; Chantson, T. E.; Reibenspies, J. H.; Hancock, R. D. *J. Chem. Soc., Dalton Trans.* **1995**, 1363–1367.
702. Doerrler, L. H.; Lippard, S. J. *Inorg. Chem.* **1997**, *36*, 2554–2563.
703. Ansell, C. W. G.; Dancy, K. P.; McPartlin, M.; Tasker, P. A.; Lindoy, L. F. *J. Chem. Soc., Dalton Trans.* **1983**, 1789–1791.
704. Kajiwara, T.; Yamaguchi, T.; Kido, H.; Kawabata, S.; Kuroda, R.; Ito, T. *Inorg. Chem.* **1993**, *32*, 4990–4991.
705. Wright, P. A.; Maple, M. J.; Slawin, A. M. Z.; Patinec, V.; Aitken, R. A.; Welsh, S.; Cox, P. A. *J. Chem. Soc., Dalton Trans.* **2000**, *8*, 1243–1248.
706. Breslow, R.; Berger, D.; Huang, D. L. *J. Am. Chem. Soc.* **1990**, *112*, 3686–3687.
707. Gellman, S. H.; Petter, R.; Breslow, R. *J. Am. Chem. Soc.* **1986**, *108*, 2388–2394.
708. Costa, J.; Delgado, R.; Drew, M. G. B.; Felix, V. *J. Chem. Soc., Dalton Trans.* **1999**, 4331–4339.
709. Konig, B.; Pelka, M.; Zieg, H.; Ritter, T.; Bouas-Laurent, H.; Bonneau, R.; Desvergne, J. P. *J. Am. Chem. Soc.* **1999**, *121*, 1681–1687.
710. Benelli, C.; Dei, A.; Gatteschi, D.; Pardi, L. *Inorg. Chem.* **1989**, *28*, 1476–1480.
711. Ibrahim, R.; Tsuchiya, S.; Ogawa, S. *J. Am. Chem. Soc.* **2000**, *122*, 12174–12185.
712. Alcock, N. W.; Moore, P.; Omar, H. A. A.; Reader, C. J. *J. Chem. Soc., Dalton Trans.* **1987**, 2643–2648.
713. Bryant, L. H.; Lachgar, A.; Coates, K. S.; Jackels, S. C. *Inorg. Chem.* **1994**, *33*, 2219–2226.
714. Dhont, K. I.; Herman, G. G.; Fabretti, A. C.; Lippens, W.; Goeminne, A. M. *J. Chem. Soc., Dalton Trans.* **1996**, 1753–1760.
715. Kurisaki, T.; Yamaguchi, T.; Fujiwara, M.; Kiraly, R.; Wakita, H. *J. Chem. Soc., Dalton Trans.* **1996**, 3727–3730.
716. Bencini, A.; Bianchi, A.; Dapporto, P.; Garcia-Espana, E.; Micheloni, M.; Paoletti, P. *Inorg. Chem.* **1989**, *28*, 1188–1191.
717. Bencini, A.; Bianchi, A.; Garcia-Espana, E.; Mangani, S.; Micheloni, M.; Orioli, P.; Paoletti, P. *Inorg. Chem.* **1988**, *27*, 1104–1107.
718. Doxsee, K. M.; Hagadorn, J. R.; Weakley, T. J. R. *Inorg. Chem.* **1994**, *33*, 2600–2606.
719. Junk, P. C.; Smith, M. K.; Steed, J. W. *Polyhedron* **2001**, *20*, 2979–2988.
720. Blake, A. J.; Gould, R. O.; Halcrow, M. A.; Holder, A. J.; Hyde, T. I.; Schroder, M. *J. Chem. Soc., Dalton Trans.* **1992**, 3427–3431.
721. Adam, K. R.; Dancy, K. P.; Leong, A. J.; Lindoy, L. F.; McCool, B. J.; McPartlin, M.; Tasker, P. A. *J. Am. Chem. Soc.* **1988**, *110*, 8471–8477.
722. Adam, K. R.; Arshad, S. P. H.; Baldwin, D. S.; Duckworth, P. A.; Leong, A. J.; Lindoy, L. F.; McCool, B. J.; McPartlin, M.; Taylor, B. A.; Tasker, P. A. *Inorg. Chem.* **1994**, *33*, 1194–1200.
723. Adam, K. R.; Clarkson, C.; Leong, A. J.; Lindoy, L. F.; McPartlin, M.; Powell, H. R.; Smith, S. V. *J. Chem. Soc., Dalton Trans.* **1994**, 2791–2798.
724. Adam, K. R.; Lindoy, L. F.; Skelton, B. W.; Smith, S. V.; White, A. H. *J. Chem. Soc., Dalton Trans.* **1994**, 3361–3367.
725. Adams, H.; Bastida, R.; Fenton, D. E.; Macias, A.; Spey, S. E.; Valencia, L. *J. Chem. Soc., Dalton Trans.* **1999**, 4131–4137.
726. Valencia, L.; Adams, H.; Bastida, R.; Fenton, D. E.; Macias, A. *Inorg. Chim. Acta* **2001**, *317*, 45–52.
727. Valencia, L.; Adams, H.; Bastida, R.; de Blas, A.; Fenton, D. E.; Macias, A.; Rodriguez, A.; Rodriguez-Blas, T. *Inorg. Chim. Acta* **2000**, *300*, 234–242.
728. Adam, K. R.; Donnelly, S.; Leong, A. J.; Lindoy, L. F.; McCool, B. J.; Bashall, A.; Dent, M. R.; Murphy, B. P.; McPartlin, M.; Fenton, D. E.; Tasker, P. A. *J. Chem. Soc., Dalton Trans.* **1990**, 1635–1643.
729. Adams, H.; Bailey, N. A.; Fenton, D. E.; Ford, I. G.; Kitchen, S. J.; Williams, M. G.; Tasker, P. A.; Leong, A. J.; Lindoy, L. F. *J. Chem. Soc., Dalton Trans.* **1991**, 1665–1674.
730. Brucher, E.; Gyori, B.; Emri, J.; Jakab, S.; Kovacs, Z.; Solymosi, P.; Toth, I. *J. Chem. Soc., Dalton Trans.* **1995**, 3353–3357.
731. Flassbeck, C.; Wiegardt, K.; Bill, E.; Butzlaff, C.; Trautwein, A. X.; Nuber, B.; Weiss, J. *Inorg. Chem.* **1992**, *31*, 21–26.
732. Santos, M. A.; Gaspar, M.; Amorim, M. T. *Inorg. Chim. Acta* **1999**, *284*, 20–29.
733. Weeks, J. M.; Taylor, M. R.; Wainwright, K. P. *J. Chem. Soc., Dalton Trans.* **1997**, 317–322.
734. Inoue, M. B.; Oram, P.; Andreu de Riquer, G.; Inoue, M.; Borbat, P.; Raitsimring, A.; Fernando, Q. *Inorg. Chem.* **1995**, *34*, 3528–3535.
735. Goldberg, D. P.; Watton, S. P.; Masschelein, A.; Wimmer, L.; Lippard, S. J. *J. Am. Chem. Soc.* **1993**, *115*, 5346–5347.
736. Atkinson, I. M.; Chartres, J. D.; Everett, G. W.; Ji, X. K.; Lindoy, L. F.; Matthews, O. A.; Meehan, G. V.; Skelton, B. W.; Wei, G.; White, A. H. *J. Chem. Soc., Dalton Trans.* **2000**, *7*, 1191–1198.
737. Kimura, E.; Nakamura, I.; Koike, T.; Shionoya, M.; Kodama, Y.; Ikeda, T.; Shiro, M. *J. Am. Chem. Soc.* **1994**, *116*, 4764–4771.
738. Kimura, E.; Gotoh, T.; Koike, T.; Shiro, M. *J. Am. Chem. Soc.* **1999**, *121*, 1267–1274.
739. Ehlers, N.; Mattes, R. *Inorg. Chim. Acta* **1995**, *236*, 203–207.
740. Ghosh, P.; Bharadwaj, P. K. *J. Chem. Soc., Dalton Trans.* **1997**, 2673–2676.
741. Arnaud-Neu, F.; Fuangswadi, S.; Maubert, B.; Nelson, J.; McKee, V. *Inorg. Chem.* **2000**, *39*, 573–579.
742. Bernhardt, P. V.; Bramley, R.; Engelhardt, L. M.; Harrowfield, J. M.; Hockless, D. C. R.; Korybutdaszkiewicz, B. R.; Krausz, E. R.; Morgan, T.; Sargeson, A. M.; Skelton, B. W.; White, A. H. *Inorg. Chem.* **1995**, *34*, 3589–3599.
743. Bottomley, G. A.; Clark, I. J.; Creaser, II; Engelhardt, L. M.; Geue, R. J.; Hagen, K. S.; Harrowfield, J. M.; Lawrance, G. A.; Lay, P. A.; Sargeson, A. M.; See, A. J.; Skelton, B. W.; White, A. H.; Wilner, F. R. *Aust. J. Chem.* **1994**, *47*, 143–179.
744. Bruce, J. I.; Donlevy, T. M.; Gahan, L. R.; Kennard, C. H. L.; Byriel, K. A. *Polyhedron* **1996**, *15*, 49–55.
745. Broge, L.; Pretzmann, U.; Jensen, N.; Sotofte, I.; Olsen, C. E.; Springborg, J. *Inorg. Chem.* **2001**, *40*, 2323–2334.
746. Niu, W. J.; Wong, E. H.; Weisman, G. R.; Lam, K. C.; Rheingold, A. L. *Inorg. Chem. Commun.* **1999**, *2*, 361–363.
747. Grannas, M. J.; Hoskins, B. F.; Robson, R. *Inorg. Chem.* **1994**, *33*, 1071–1079.

748. Qian, M.; Gou, S. H.; Chantrapromma, S.; Raj, S. S. S.; Fun, H. K.; Zeng, Q. D.; Yu, Z.; You, X. Z. *Inorg. Chim. Acta* **2000**, *305*, 83–90.
749. Arion, V. B.; Bill, E.; Reetz, M. T.; Goddard, R.; Stockigt, D.; Massau, M.; Levitsky, V. *Inorg. Chim. Acta* **1998**, *282*, 61–70.
750. Yamami, M.; Furutachi, H.; Yokoyama, T.; Okawa, H. *Inorg. Chem.* **1998**, *37*, 6832–6838.
751. Yamami, M.; Furutachi, H.; Yokoyama, T.; Okawa, H. *Chem. Lett.* **1998**, 211–212.
752. Adams, H.; Bailey, N. A.; Bertrand, P.; Debarbarin, C. O. R.; Fenton, D. E.; Gou, S. H. *J. Chem. Soc., Dalton Trans.* **1995**, 275–279.
753. Huang, W.; Gou, S. H.; Hu, D. H.; Chantrapromma, S.; Fun, H. K.; Meng, Q. J. *Inorg. Chem.* **2001**, *40*, 1712–1715.
754. Asato, E.; Furutachi, H.; Kawahashi, T.; Mikuriya, M. *J. Chem. Soc.-Dalton Trans.* **1995**, 3897–3904.
755. Nanda, K. K.; Mohanta, S.; Florke, U.; Dutta, S. K.; Nag, K. *J. Chem. Soc., Dalton Trans.* **1995**, 3831–3836.
756. Rybak-Akimova, E. V.; Alcock, N. W.; Busch, D. H. *Inorg. Chem.* **1998**, *37*, 1563–1574.
757. Brooker, S.; Croucher, P. D.; Roxburgh, F. M. *J. Chem. Soc., Dalton Trans.* **1996**, 3031–3037.
758. Brooker, S.; Davidson, T. C. *Inorg. Chim. Acta* **2000**, *306*, 227–231.
759. Brooker, S.; Davidson, T. C. *Chem. Commun.* **1997**, 2007–2008.
760. Branscombe, N. D. J.; Blake, A. J.; Marin-Becerra, A.; Li, W. S.; Parsons, S.; Ruiz-Ramirez, L.; Schroder, M. *Chem. Commun.* **1996**, 2573–2574.
761. Xie, L. Y.; Boyle, R. W.; Dolphin, D. *J. Am. Chem. Soc.* **1996**, *118*, 4853–4859.
762. Smirnov, V. V.; Woller, E. K.; Tatman, D.; DiMagno, S. G. *Inorg. Chem.* **2001**, *40*, 2614–2619.
763. Hariprasad, G.; Dahal, S.; Maiya, B. G. *J. Chem. Soc., Dalton Trans.* **1996**, 3429–3436.
764. Muzzi, C. M.; Medforth, C. J.; Smith, K. M.; Jia, S. L.; Shelnut, J. A. *Chem. Commun.* **2000**, 131–132.
765. Ehlinger, N.; Scheidt, W. R. *Inorg. Chem.* **1999**, *38*, 1316–1321.
766. Song, X. Z.; Jaquinod, L.; Jentzen, W.; Nurco, D. J.; Jia, S. L.; Khoury, R. G.; Ma, J. G.; Medforth, C. J.; Smith, K. M.; Shelnut, J. A. *Inorg. Chem.* **1998**, *37*, 2009–2019.
767. Walters, V. A.; Depaula, J. C.; Babcock, G. T.; Leroi, G. E. *J. Am. Chem. Soc.* **1989**, *111*, 8300–8302.
768. Ozette, K.; Leduc, P.; Palacio, M.; Bartoli, J. F.; Barkigia, K. M.; Fajer, J.; Battioni, P.; Mansuy, D. *J. Am. Chem. Soc.* **1997**, *119*, 6442–6443.
769. Takeuchi, T.; Gray, H. B.; Goddard, W. A. *J. Am. Chem. Soc.* **1994**, *116*, 9730–9732.
770. Balch, A. L.; Noll, B. C.; Zovinka, E. P. *J. Am. Chem. Soc.* **1992**, *114*, 3380–3385.
771. Marbury, G. S.; Brewer, C.; Brewer, G. *J. Chem. Soc., Dalton Trans.* **1991**, 1377–1378.
772. Hodge, J. A.; Hill, M. G.; Gray, H. B. *Inorg. Chem.* **1995**, *34*, 809–812.
773. Zhang, H. Y.; Bruce, T. C. *Inorg. Chim. Acta* **1996**, *247*, 195–202.
774. Robinson, L. R.; Hambright, P. *Inorg. Chim. Acta* **1991**, *185*, 17–24.
775. Tabata, M.; Miyata, W.; Nahar, N. *Inorg. Chem.* **1995**, *34*, 6492–6496.
776. Sutter, T. P. G.; Hambright, P. *Inorg. Chem.* **1992**, *31*, 5089–5093.
777. Tsukahara, S.; Suzuki, N. *Inorg. Chim. Acta* **1996**, *245*, 105–108.
778. Bag, N.; Chern, S. S.; Peng, S. M.; Chang, C. K. *Inorg. Chem.* **1995**, *34*, 753–756.
779. Imai, H.; Nakagawa, S.; Kyuno, E. *Inorg. Chim. Acta* **1992**, *193*, 105–109.
780. Dsouza, F.; Krishnan, V. *J. Chem. Soc., Dalton Trans.* **1992**, 2873–2876.
781. Song, H.; Scheidt, W. R. *Inorg. Chim. Acta* **1990**, *173*, 37–41.
782. Simonis, U.; Walker, F. A.; Lee, P. L.; Hanquet, B. J.; Meyerhoff, D. J.; Scheidt, W. R. *J. Am. Chem. Soc.* **1987**, *109*, 2659–2668.
783. Dsouza, F.; Hsieh, Y. Y.; Deviprasad, G. R. *Inorg. Chem.* **1996**, *35*, 5747–5749.
784. Chang, C. J.; Deng, Y. Q.; Heyduk, A. F.; Chang, C. K.; Nocera, D. G. *Inorg. Chem.* **2000**, *39*, 959–966.
785. Piet, J. J.; Taylor, P. N.; Anderson, H. L.; Osuka, A.; Warman, J. M. *J. Am. Chem. Soc.* **2000**, *122*, 1749–1757.
786. Yagi, S.; Yonekura, I.; Awakura, M.; Ezoe, M.; Takagishi, T. *Chem. Commun.* **2001**, 557–558.
787. Ikeda, C.; Tanaka, Y.; Fujihara, T.; Ishii, Y.; Ushiyama, T.; Yamamoto, K.; Yoshioka, N.; Inoue, H. *Inorg. Chem.* **2001**, *40*, 3395–3405.
788. Ruhlmann, L.; Giraudeau, A. *Chem. Commun.* **1996**, 2007–2008.
789. Osuka, A.; Nakajima, S.; Maruyama, K.; Mataga, N.; Asahi, T.; Yamazaki, I.; Nishimura, Y.; Ohno, T.; Nozaki, K. *J. Am. Chem. Soc.* **1993**, *115*, 4577–4589.
790. Liu, H. Y.; Huang, J. W.; Tian, X.; Jiao, X. D.; Luo, G. T.; Ji, L. N. *Inorg. Chim. Acta* **1998**, *272*, 295–299.
791. Lauceri, R.; Campagna, T.; Raudino, A.; Purrello, R. *Inorg. Chim. Acta* **2001**, *317*, 282–289.
792. Kim, Y. H.; Jeong, D. H.; Kim, D.; Jeoung, S. C.; Cho, H. S.; Kim, S. K.; Aratani, N.; Osuka, A. *J. Am. Chem. Soc.* **2001**, *123*, 76–86.
793. Ogawa, T.; Nishimoto, Y.; Yoshida, N.; Ono, N.; Osukua, A. *Chem. Commun.* **1998**, 337–338.
794. Taylor, P. N.; Anderson, H. L. *J. Am. Chem. Soc.* **1999**, *121*, 11538–11545.
795. Yoshida, N.; Aratani, N.; Osuka, A. *Chem. Commun.* **2000**, 197–198.
796. Jensen, H.; Kakkassery, J. J.; Nagatani, H.; Fermin, D. J.; Girault, H. H. *J. Am. Chem. Soc.* **2000**, *122*, 10943–10948.
797. Ruhlmann, L.; Schulz, A.; Giraudeau, A.; Messerschmidt, C.; Fuhrhop, J. H. *J. Am. Chem. Soc.* **1999**, *121*, 6664–6667.
798. Li, J. Z.; Ambroise, A.; Yang, S. I.; Diers, J. R.; Seth, J.; Wack, C. R.; Bocian, D. F.; Holten, D.; Lindsey, J. S. *J. Am. Chem. Soc.* **1999**, *121*, 8927–8940.
799. Sessler, J. L.; Wang, B.; Harriman, A. *J. Am. Chem. Soc.* **1995**, *117*, 704–714.
800. Tsuda, A.; Osuka, A. *Science* **2001**, *293*, 79–82.
801. Kumble, R.; Palese, S.; Lin, V. S. Y.; Therien, M. J.; Hochstrasser, R. M. *J. Am. Chem. Soc.* **1998**, *120*, 11489–11498.
802. Fleischer, E. B.; Shachter, A. M. *Inorg. Chem.* **1991**, *30*, 3763–3769.
803. Kurtan, T.; Nesnas, N.; Koehn, F. E.; Li, Y. Q.; Nakanishi, K.; Berova, N. *J. Am. Chem. Soc.* **2001**, *123*, 5974–5982.
804. Kurtan, T.; Nesnas, N.; Li, Y. Q.; Huang, X. F.; Nakanishi, K.; Berova, N. *J. Am. Chem. Soc.* **2001**, *123*, 5962–5973.
805. Brettar, J.; Gisselbrecht, J. P.; Gross, M.; Solladie, N. *Chem. Commun.* **2001**, 733–734.
806. Mizutani, T.; Wada, K.; Kitagawa, S. *J. Am. Chem. Soc.* **1999**, *121*, 11425–11431.
807. Beer, P. D.; Drew, M. G. B.; Jagessar, R. *J. Chem. Soc., Dalton Trans.* **1997**, 881–886.
808. Mizutani, T.; Kurahashi, T.; Murakami, T.; Matsumi, N.; Ogoshi, H. *J. Am. Chem. Soc.* **1997**, *119*, 8991–9001.

809. Dsouza, F. *J. Am. Chem. Soc.* **1996**, *118*, 923–924.
810. Fukuzumi, S.; Ohkubo, K.; Imahori, H.; Shao, J. G.; Ou, Z. P.; Zheng, G.; Chen, Y. H.; Pandey, R. K.; Fujitsuka, M.; Ito, O.; Kadish, K. M. *J. Am. Chem. Soc.* **2001**, *123*, 10676–10683.
811. Fukuzumi, S.; Imahori, H.; Yamada, H.; El-Khouly, M. E.; Fujitsuka, M.; Ito, O.; Guldi, D. M. *J. Am. Chem. Soc.* **2001**, *123*, 2571–2575.
812. Luo, C.; Guldi, D. M.; Imahori, H.; Tamaki, K.; Sakata, K. *J. Am. Chem. Soc.* **2000**, *122*, 6535–6551.
813. Webb, S. J.; Sanders, J. K. M. *Inorg. Chem.* **2000**, *39*, 5912–5919.
814. Harriman, A.; Hissler, M.; Trompette, O.; Ziessel, R. *J. Am. Chem. Soc.* **1999**, *121*, 2516–2525.
815. Flamigni, L.; Dixon, I. M.; Collin, J. P.; Sauvage, J. P. *Chem. Commun.* **2000**, 2479–2480.
816. Aspley, C. J.; Smith, J. R. L.; Perutz, R. N. *J. Chem. Soc., Dalton Trans.* **1999**, 2269–2271.
817. Kiefer, A. M.; Kast, S. M.; Wasielewski, M. R.; Laukenmann, K.; Kothe, G. *J. Am. Chem. Soc.* **1999**, *121*, 188–198.
818. Szintay, G.; Horvath, A. *Inorg. Chim. Acta* **2000**, *310*, 175–182.
819. Cheng, B. S.; Scheidt, W. R. *Inorg. Chim. Acta* **1995**, *237*, 5–11.
820. Uemori, Y.; Takinami, S.; Takahashi, A.; Munakata, H.; Imai, H.; Nakagawa, S.; Kyuno, E. *Inorg. Chim. Acta* **1994**, *224*, 157–161.
821. Froidevaux, J.; Ochsenbein, P.; Bonin, M.; Schenk, K.; Maltese, P.; Gisselbrecht, J. P.; Weiss, J. *J. Am. Chem. Soc.* **1997**, *119*, 12362–12363.
822. Wylie, R. S.; Levy, E. G.; Sanders, J. K. M. *Chem. Commun.* **1997**, 1611–1612.
823. Maruo, N.; Uchiyama, M.; Kato, T.; Arai, T.; Akisada, H.; Nishino, N. *Chem. Commun.* **1999**, 2057–2058.
824. Kumar, R. K.; Balasubramanian, S.; Goldberg, I. *Chem. Commun.* **1998**, 1435–1436.
825. Wang, Q. M.; Bruce, D. W. *Chem. Commun.* **1996**, 2505–2506.
826. Chambon, J. C.; Harriman, A.; Heitz, V.; Sauvage, J. P. *J. Am. Chem. Soc.* **1993**, *115*, 6109–6114.
827. Lahiri, J.; Fate, G. D.; Ungashe, S. B.; Groves, J. T. *J. Am. Chem. Soc.* **1996**, *118*, 2347–2358.
828. Latos-Grazynski, L.; Johnson, J.; Attar, S.; Olmstead, M. M.; Balch, A. L. *Inorg. Chem.* **1998**, *37*, 4493–4499.
829. Morishige, K.; Araki, K. *J. Chem. Soc., Dalton Trans.* **1996**, 4303–4305.
830. Kimura, M.; Hamakawa, T.; Hanabusa, K.; Shirai, H.; Kobayashi, N. *Inorg. Chem.* **2001**, *40*, 4775–4779.
831. Ishii, K.; Ishizaki, T.; Kobayashi, N. *J. Chem. Soc., Dalton Trans.* **2001**, 3227–3231.
832. Sugimori, T.; Horike, S.; Handa, M.; Kasuga, K. *Inorg. Chim. Acta* **1998**, *278*, 253–255.
833. Takahashi, K.; Kawashima, M.; Tomita, Y.; Itoh, M. *Inorg. Chim. Acta* **1995**, *232*, 69–73.
834. Mack, J.; Stillman, M. J. *J. Am. Chem. Soc.* **1994**, *116*, 1292–1304.
835. Mack, J.; Stillman, M. J. *Inorg. Chem.* **1997**, *36*, 413–425.
836. Kobayashi, N.; Ashida, T.; Osa, T.; Konami, H. *Inorg. Chem.* **1994**, *33*, 1735–1740.
837. Lever, A. B. P. *Inorg. Chim. Acta* **1993**, *203*, 171–174.
838. Nyokong, T.; Gasyna, Z.; Stillman, M. J. *Inorg. Chem.* **1987**, *26*, 1087–1095.
839. Mossoyandeneux, M.; Benlian, D.; Pierrot, M.; Fournel, A.; Sorbier, J. P. *Inorg. Chem.* **1985**, *24*, 1878–1882.
840. Vannelli, T. A.; Karpishin, T. B. *Inorg. Chem.* **2000**, *39*, 340–347.
841. Kobayashi, N.; Togashi, M.; Osa, T.; Ishii, K.; Yamauchi, S.; Hino, H. *J. Am. Chem. Soc.* **1996**, *118*, 1073–1085.
842. Tesmer, M.; Muller, B.; Vahrenkamp, H. *Chem. Commun.* **1997**, 721–722.
843. Muller, B.; Vahrenkamp, H. *Eur. J. Inorg. Chem.* **1999**, 137–144.
844. Strasdeit, H.; Busching, I.; Behrends, S.; Saak, W.; Barklage, W. *Chem.-Eur. J.* **2001**, *7*, 1133–1142.
845. Steren, C. A.; Calvo, R.; Piro, O. E.; Rivero, B. E. *Inorg. Chem.* **1989**, *28*, 1933–1938.
846. Nagase, M.; Yukawa, Y.; Inomata, Y.; Takeuchi, T. *Bull. Chem. Soc. Jpn.* **1989**, *62*, 3247–3251.
847. Zevaco, T. A.; Gorus, H.; Dinjus, E. *Inorg. Chim. Acta* **1998**, *269*, 283–286.
848. Gonzalez-Duarte, P.; March, R.; Pons, J.; Clegg, W.; Cucurull-Sanchez, L.; AlvarezLarena, A.; Piniella, J. F. *Polyhedron* **1996**, *15*, 2747–2754.
849. O'Brien, E. C.; LeRoy, S.; Levaillain, J.; Fitzgerald, D. J.; Nolan, K. B. *Inorg. Chim. Acta* **1997**, *266*, 117–120.
850. Crane, J. D.; Fox, O. D.; Sinn, E. *J. Chem. Soc.-Dalton Trans.* **1999**, 1461–1465.
851. Borisov, G.; Varbanov, S. G.; Venanzi, L. M.; Albinati, A.; Demartin, F. *Inorg. Chem.* **1994**, *33*, 5430–5437.
852. Casals, I.; Gonzalez-Duarte, P.; Clegg, W.; Foces-Foces, C.; Cano, F. H.; Martinezripoll, M.; Gomez, M.; Solans, X. *J. Chem. Soc., Dalton Trans.* **1991**, 2511–2518.
853. Godino-Salido, M. L.; Gutierrez-Valero, M. D.; Lopez-Garzon, R.; Moreno-Sanchez, J. M. *Inorg. Chim. Acta* **1994**, *221*, 177–181.
854. Burrows, A. D.; Menzer, S.; Mingos, D. M. P.; White, A. J. P.; Williams, D. J. *J. Chem. Soc., Dalton Trans.* **1997**, 4237–4240.
855. Delavauxnicot, B.; Douziech, B.; Mathieu, R.; Lavigne, G. *Inorg. Chem.* **1995**, *34*, 4256–4261.
856. Casals, I.; Gonzalez-Duarte, P.; Lopez, C.; Solans, X. *Polyhedron* **1990**, *9*, 763–768.
857. Albrich, H.; Vahrenkamp, H. *Chem. Ber.* **1994**, *127*, 1223–1233.
858. Nyman, M. D.; Hampden-Smith, M. J.; Duesler, E. N. *Inorg. Chem.* **1997**, *36*, 2218–2224.
859. Bensch, W.; Schuster, M. Z. *Naturforsch. B: Anorg. Chem. Org. Chem.* **1993**, *619*, 786–790.
860. Sekar, P.; Ibers, J. A. *Inorg. Chim. Acta* **2001**, *319*, 117–122.
861. Perez-Lourido, P.; Romero, J.; Garcia-Vazquez, J. A.; Sousa, A.; Maresca, K. P.; Zubieta, J. *Inorg. Chem.* **1999**, *38*, 3709–3715.
862. Trosch, A.; Vahrenkamp, H. *Eur. J. Inorg. Chem.* **1998**, 827–832.
863. Burth, R.; Stange, A.; Schafer, M.; Vahrenkamp, H. *Eur. J. Inorg. Chem.* **1998**, 1759–1764.
864. Chaudhuri, P.; Hess, M.; Hildenbrand, K.; Bill, E.; Weyhermuller, T.; Wiegardt, K. *Inorg. Chem.* **1999**, *38*, 2781–2790.
865. Gembicky, M.; Baran, P.; Boca, R.; Fuess, H.; Svoboda, I.; Valko, M. *Inorg. Chim. Acta* **2000**, *305*, 75–82.
866. Tandon, S. S.; Chander, S.; Thompson, L. K.; Bridson, J. N.; McKee, V. *Inorg. Chim. Acta* **1994**, *219*, 55–65.
867. Labisbal, E.; Garcia-Vazquez, J. A.; Gomez, C.; Macias, A.; Romero, J.; Sousa, A.; Englert, U.; Fenton, D. E. *Inorg. Chim. Acta* **1993**, *203*, 67–72.
868. Ferrari, M. B.; Fava, G. G.; Pelosi, G.; Tarasconi, P. *Polyhedron* **2000**, *19*, 1895–1901.
869. Chiou, S. J.; Ge, P. H.; Riordan, C. G.; Liable-Sands, L. M.; Rheingold, A. L. *Chem. Commun.* **1999**, 159–160.
870. Bouwman, E.; Goetz, S.; Driessen, W. L. *Inorg. Chim. Acta* **2001**, *319*, 219–223.
871. Brand, U.; Vahrenkamp, H. *Inorg. Chem.* **1995**, *34*, 3285–3293.

872. Brand, U.; Vahrenkamp, H. *Inorg. Chim. Acta* **2000**, *308*, 97–102.
873. Chang, S. C.; Karambelkar, V. V.; diTargiani, R. C.; Goldberg, D. P. *Inorg. Chem.* **2001**, *40*, 194–195.
874. Ferrari, M. B.; Fava, G. G.; Pelizzi, C.; Tarasconi, P. *J. Chem. Soc., Dalton Trans.* **1992**, 2153–2159.
875. Spencer, D. J. E.; Blake, A. J.; Parsons, S.; Schroder, M. *J. Chem. Soc., Dalton Trans.* **1999**, 1041–1042.
876. Song, B.; Reuber, J.; Ochs, C.; Hahn, F. E.; Lugger, T.; Orvig, C. *Inorg. Chem.* **2001**, *40*, 1527–1535.
877. Abufarag, A.; Vahrenkamp, H. *Inorg. Chem.* **1995**, *34*, 3279–3284.
878. Labisbal, E.; Romero, J.; Deblas, A.; Garcia-Vazquez, J. A.; Duran, M. L.; Castineiras, A.; Sousa, A.; Fenton, D. E. *Polyhedron* **1992**, *11*, 53–57.
879. Adams, H.; Bailey, N. A.; Fenton, D. E.; He, Q. Y. *J. Chem. Soc., Dalton Trans.* **1996**, 2857–2865.
880. Casella, L.; Gullotti, M.; Pagliarini, R.; Sisti, M. *J. Chem. Soc., Dalton Trans.* **1991**, 2527–2531.
881. Anderson, O. P.; la Cour, A.; Findeisen, M.; Hennig, L.; Simonsen, O.; Taylor, L. F.; Toftlund, H. *J. Chem. Soc., Dalton Trans.* **1997**, 111–120.
882. Avdeef, A.; Hartenstein, F.; Chemotti, A. R.; Brown, J. A. *Inorg. Chem.* **1992**, *31*, 3701–3705.
883. la Cour, A.; Findeisen, M.; Hazell, A.; Hazell, R.; Zdobinsky, G. *J. Chem. Soc., Dalton Trans.* **1997**, 121–128.
884. Seidelmann, O.; Beyer, L.; Richter, R.; Herr, T. *Inorg. Chim. Acta* **1998**, *271*, 40–48.
885. Abufarag, A.; Vahrenkamp, H. *Inorg. Chem.* **1995**, *34*, 2207–2216.
886. Rodriguez-Arguelles, M. C.; Battaglia, L. P.; Ferrari, M. B.; Fava, G. G.; Pelizzi, C.; Pelosi, G. *J. Chem. Soc., Dalton Trans.* **1995**, 2297–2303.
887. Duran, M. L.; Sousa, A.; Romero, J.; Castineiras, A.; Bermejo, E.; West, D. X. *Inorg. Chim. Acta* **1999**, *294*, 79–82.
888. deBarbarin, C. O. R.; Bailey, N. A.; Fenton, D. E.; He, Q. Y. *J. Chem. Soc., Dalton Trans.* **1997**, 161–166.
889. Bino, A.; Cohen, N. *Inorg. Chim. Acta* **1993**, *210*, 11–16.
890. Debarbarin, C. O. R.; Bailey, N. A.; Fenton, D. E.; He, Q. Y. *Inorg. Chim. Acta* **1994**, *219*, 205–208.
891. Bhattacharyya, S.; Kumar, S. B.; Dutta, S. K.; Tiekink, E. R. T.; Chaudhury, M. *Inorg. Chem.* **1996**, *35*, 1967–1973.
892. Bremer, J.; Wegner, R.; Krebs, B. *Z. Anorg. Allg. Chem.* **1995**, *621*, 1123–1132.
893. Berreau, L. M.; Makowska-Grzyska, M. M.; Arif, A. M. *Inorg. Chem.* **2000**, *39*, 4390–4391.
894. Groves, J. T.; Olson, J. R. *Inorg. Chem.* **1985**, *24*, 2715–2717.
895. Boca, M.; Baran, P.; Boca, R.; Fuess, H.; Kickelbick, G.; Linert, W.; Renz, F.; Svoboda, I. *Inorg. Chem.* **2000**, *39*, 3205–3212.
896. Chakraborty, P.; Chandra, S. K.; Chakravorty, A. *Inorg. Chim. Acta* **1995**, *229*, 477–481.
897. Hernandez-Padilla, M.; Dominguez, S.; Mederos, A.; Arrieta, J. M. *Acta Crystallogr. Sect. C-Cryst. Struct. Commun.* **1995**, *51*, 1549.
898. Jubert, C.; Mohamadou, A.; Marrot, J.; Barbier, J. P. *J. Chem. Soc., Dalton Trans.* **2001**, 1230–1238.
899. Nelson, S. M.; Knox, C. V. *J. Chem. Soc., Dalton Trans.* **1983**, 2525–2528.
900. Bergquist, C.; Storrie, H.; Koutcher, L.; Bridgewater, B. M.; Friesner, R. A.; Parkin, G. *J. Am. Chem. Soc.* **2000**, *122*, 12651–12658.
901. Kimblin, C.; Bridgewater, B. M.; Churchill, D. G.; Parkin, G. *Chem. Commun.* **1999**, 2301–2302.
902. Kimblin, C.; Hascall, T.; Parkin, G. *Inorg. Chem.* **1997**, *36*, 5680–5681.
903. Seebacher, J.; Shu, M. H.; Vahrenkamp, H. *Chem. Commun.* **2001**, 1026–1027.
904. Shoner, S. C.; Humphreys, K. J.; Barnhart, D.; Kovacs, J. A. *Inorg. Chem.* **1995**, *34*, 5933–5934.
905. Hammes, B. S.; Carrano, C. J. *Inorg. Chim. Acta* **2000**, *300*, 427–433.
906. Berreau, L. M.; Makowska-Grzyska, M. M.; Arif, A. M. *Inorg. Chem.* **2001**, *40*, 2212–2213.
907. Liu, X. Y.; Riera, V.; Ruiz, M. A.; Tiripicchio, A.; TiripicchioCamellini, M. *Organometallics* **1996**, *15*, 974–983.
908. Fryzuk, M. D.; McConville, D. H.; Rettig, S. J. *Organometallics* **1990**, *9*, 1359–1360.
909. Geerts, R. L.; Huffman, J. C.; Westerberg, D. E.; Foltz, K.; Caulton, K. G. *New J. Chem.* **1988**, *12*, 455–465.
910. Stockhammer, A.; Dahmen, K. H.; Gerfin, T.; Venanzi, L. M.; Gramlich, V.; Petter, W. *Helv. Chim. Acta* **1991**, *74*, 989–992.
911. Navarro, J. A. R.; Freisinger, E.; Lippert, B. *Eur. J. Inorg. Chem.* **2000**, 147–151.
912. Wright, C. A.; Shapley, J. R. *Inorg. Chem.* **2001**, *40*, 6338–6340.
913. Fuhr, O.; Fenske, D. *Z. Naturforsch. B: Anorg. Chem. Org. Chem.* **2000**, *626*, 1822–1830.
914. Zhou, Q. D.; Hambley, T. W.; Kennedy, B. J.; Lay, P. A.; Turner, P.; Warwick, B.; Biffin, J. R.; Regtop, H. L. *Inorg. Chem.* **2000**, *39*, 3742–3748.
915. Harrison, D. O.; Thomas, R.; Underhill, A. E.; Fletcher, J. K.; Gomm, P. S.; Hallway, F. *Polyhedron* **1985**, *4*, 681–685.
916. Mendoza-Diaz, G.; Ireta-Moreno, J. *J. Inorg. Biochem.* **1994**, *54*, 235–246.
917. Long, G. V.; Harding, M. M.; Turner, P. *Polyhedron* **2000**, *19*, 1067–1071.
918. Calafat, A. M.; Won, H.; Marzilli, L. G. *J. Am. Chem. Soc.* **1997**, *119*, 3656–3664.
919. Feinberg, H.; Greenblatt, H. M.; Behar, V.; Gilon, C.; Cohen, S.; Bino, A.; Shoham, G. *Acta Crystallogr. Section D-Biol. Crystallogr.* **1995**, *51*, 428–449.
920. Inouye, Y.; Kanamori, T.; Sugiyama, M.; Yoshida, T.; Koike, T.; Shionoya, M.; Enomoto, K.; Suehiro, K.; Kimura, E. *Antiviral Chem. & Chemother.* **1995**, *6*, 337–344.
921. Hanggi, G.; Schmale, H.; Dubler, E. *Inorg. Chem.* **1993**, *32*, 6095–6101.
922. Katz, B. A.; Clark, J. M.; Finer-Moore, J. S.; Jenkins, T. E.; Johnson, C. R.; Ross, M. J.; Luong, C.; Moore, W. R.; Stroud, R. M. *Nature* **1998**, *391*, 608–612.
923. Rice, W. G.; Supko, J. G.; Malspeis, L.; Buckheit, R. W.; Clanton, D.; Bu, M.; Graham, L.; Schaeffer, C. A.; Turpin, J. A.; Domagala, J.; Gogliotti, R.; Bader, J. P.; Halliday, S. M.; Coren, L.; Sowder, R. C.; Arthur, L. O.; Henderson, L. E. *Science* **1995**, *270*, 1194–1197.
924. Rice, W. G.; Schaeffer, C. A.; Graham, L.; Bu, M.; McDougal, J. S.; Orloff, S. L.; Villinger, F.; Young, M.; Oroszlan, S.; Fesen, M. R.; Pommier, Y.; Mendeleyev, J.; Kun, E. *Proc. Natl. Acad. Sci. USA.* **1993**, *90*, 9721–9724.
925. Tummino, P. J.; Scholten, J. D.; Harvey, P. J.; Holler, T. P.; Maloney, L.; Gogliotti, R.; Domagala, J.; Hupe, D. *Proc. Natl. Acad. Sci. USA.* **1996**, *93*, 969–973.
926. Dancer, R. J.; Jones, A.; Fairlie, D. P. *Aust. J. Chem.* **1995**, *48*, 1835–1841.
927. Mukherjee, G.; Ghosh, T. *J. Inorg. Biochem.* **1995**, *59*, 827–833.

928. Bravo, A.; Anaconda, J. R. *J. Coord. Chem.* **1998**, *44*, 173–182.
929. Yuan, R. X.; Xiong, R. G.; Chen, Z. F.; Zhang, P.; Ju, H. X.; Dai, Z.; Guo, Z. J.; Fun, H. K.; You, X. Z. *J. Chem. Soc., Dalton Trans.* **2001**, 774–776.
930. Frantz, D. E.; Fassler, R.; Tomooka, C. S.; Carreira, E. M. *Accounts Chem. Res.* **2000**, *33*, 373–381.
931. Kanemasa, S.; Oderaotoshi, Y.; Sakaguchi, S.; Yamamoto, H.; Tanaka, J.; Wada, E.; Curran, D. P. *J. Am. Chem. Soc.* **1998**, *120*, 3074–3088.
932. Mimoun, H.; de Saint Laumer, J. Y.; Giannini, L.; Scopelliti, R.; Floriani, C. *J. Am. Chem. Soc.* **1999**, *121*, 6158–6166.
933. Shibata, T.; Choji, K.; Morioka, H.; Hayase, T.; Soai, K. *Chem. Commun.* **1996**, 751–752.
934. Mori, N.; Ikeda, S.; Odashima, K. *Chem. Commun.* **2001**, 181–182.
935. Nakamura, E.; Aoki, S.; Sekiya, K.; Oshino, H.; Kuwajima, I. *J. Am. Chem. Soc.* **1987**, *109*, 8056–8066.
936. Nakamura, E.; Kuwajima, I. *J. Am. Chem. Soc.* **1984**, *106*, 3368–3370.
937. Nam, W.; Valentine, J. S. *J. Am. Chem. Soc.* **1990**, *112*, 4977–4979.
938. Darensbourg, D. J.; Holtcamp, M. W. *Macromolecules* **1995**, *28*, 7577–7579.
939. Cheng, M.; Lobkovsky, E. B.; Coates, G. W. *J. Am. Chem. Soc.* **1998**, *120*, 11018–11019.
940. Darensbourg, D. J.; Zimmer, M. S.; Rainey, P.; Larkins, D. L. *Inorg. Chem.* **2000**, *39*, 1578–1585.
941. Cheng, M.; Moore, D. R.; Reczek, J. J.; Chamberlain, B. M.; Lobkovsky, E. B.; Coates, G. W. *J. Am. Chem. Soc.* **2001**, *123*, 8738–8749.
942. Chamberlain, B. M.; Cheng, M.; Moore, D. R.; Ovitt, T. M.; Lobkovsky, E. B.; Coates, G. W. *J. Am. Chem. Soc.* **2001**, *123*, 3229–3238.
943. Huang, E. P. *Proc. Natl. Acad. Sci. USA.* **1997**, *94*, 13386–13387.
944. Frederickson, C. J. *Int. Rev. Neurobiol.* **1989**, *31*, 145–238.
945. Kimura, E.; Koike, T. *Chem. Soc. Rev.* **1998**, *27*, 179–184.
946. Burdette, S. C.; Lippard, S. J. *Coord. Chem. Rev.* **2001**, *216*, 333–361.
947. Burdette, S. C.; Walkup, G. K.; Spingler, B.; Tsien, R. Y.; Lippard, S. J. *J. Am. Chem. Soc.* **2001**, *123*, 7831–7841.
948. Elbaum, D.; Nair, S. K.; Patchan, M. W.; Thompson, R. B.; Christianson, D. W. *J. Am. Chem. Soc.* **1996**, *118*, 8381–8387.
949. Fahrni, C. J.; O'Halloran, T. V. *J. Am. Chem. Soc.* **1999**, *121*, 11448–11458.
950. Godwin, H. A.; Berg, J. M. *J. Am. Chem. Soc.* **1996**, *118*, 6514–6515.
951. Hirano, T.; Kikuchi, K.; Urano, Y.; Higuchi, T.; Nagano, T. *J. Am. Chem. Soc.* **2000**, *122*, 12399–12400.
952. Hirano, T.; Kikuchi, K.; Urano, Y.; Higuchi, T.; Nagano, T. *Angew. Chem.-Int. Ed.* **2000**, *39*, 1052–1054.
953. Koike, T.; Watanabe, T.; Aoki, S.; Kimura, E.; Shiro, M. *J. Am. Chem. Soc.* **1996**, *118*, 12696–12703.
954. Mahadevan, I. B.; Kimber, M. C.; Lincoln, S. F.; Tiekink, E. R. T.; Ward, A. D.; Betts, W. H.; Forbes, I. J.; Zalewski, P. D. *Aust. J. Chem.* **1996**, *49*, 561–568.
955. Pearce, D. A.; Jotterand, N.; Carrico, I. S.; Imperiali, B. *J. Am. Chem. Soc.* **2001**, *123*, 5160–5161.
956. Walkup, G. K.; Imperiali, B. *J. Am. Chem. Soc.* **1996**, *118*, 3053–3054.
957. Walkup, G. K.; Imperiali, B. *J. Am. Chem. Soc.* **1997**, *119*, 3443–3450.
958. Walkup, G. K.; Burdette, S. C.; Lippard, S. J.; Tsien, R. Y. *J. Am. Chem. Soc.* **2000**, *122*, 5644–5645.
959. Bencini, A.; Bernardo, M. A.; Bianchi, A.; Fusi, V.; Giorgi, C.; Pina, F.; Valtancoli, B. *Eur. J. Inorg. Chem.* **1999**, 1911–1918.
960. Marvin, J. S.; Hellinga, H. W. *Proc. Natl. Acad. Sci. USA.* **2001**, *98*, 4955–4960.
961. Nasir, M. S.; Fahrni, C. J.; Suh, D. A.; Kolodsick, K. J.; Singer, C. P.; O'Halloran, T. V. *J. Biol. Inorg. Chem.* **1999**, *4*, 775–783.
962. Hirano, T.; Kikuchi, K.; Matsumoto, N.; Kudo, Y.; Nagano, T. *J. Inorg. Biochem.* **2001**, *86*, 263–263.
964. Frausto da Silva, J. J. R.; Williams, R. J. P. *The Biological Chemistry of the Elements* **1991**, Clarendon Press: Oxford, UK.
965. Lippard, S. J.; Berg, J. M. *Principles of Bioinorganic Chemistry* **1994**, University Science Books: Mill Valley, CA.
966. Mills, C. F. *Zinc in Human Biology* **1989**, Springer-Verlag: New York.
967. Bertini, I.; Gray, H. B.; Lippard, S. J.; Valentine, J. S. *Bioinorganic Chemistry* **1994**, University Science Books: Mills Valley, CA.
968. Trautwein, A. X. *Bioinorganic Chemistry—Transition Metals in Biology and their Coordination Chemistry* **1997**, Wiley-VCH: Weinheim.
969. Estevez, A. G.; Crow, J. P.; Sampson, J. B.; Reiter, C.; Zhuang, Y. X.; Richardson, G. J.; Tarpey, M. M.; Barbeito, L.; Beckman, J. S. *Science* **1999**, *286*, 2498–2500.
970. Ahmad, W.; Haque, W. F. U.; Brancolini, V.; Tsou, H. C.; Haque, S. U.; Lam, H.; Aita, V. M.; Owen, J.; de Blaquiere, M.; Frank, J.; Cserhalmi-Friedman, P. B.; Leask, A.; McGrath, J. A.; Peacocke, M.; Ahmad, M.; Ott, J.; Christiano, A. M. *Science* **1998**, *279*, 720–724.
971. Bush, A. I.; Pettingell, W. H.; Multhaup, G.; Paradis, M. D.; Vonsattel, J. P.; Gusella, J. F.; Beyreuther, K.; Masters, C. L.; Tanzi, R. E. *Science* **1994**, *265*, 1464–1467.
972. Koh, J. Y.; Suh, S. W.; Gwag, B. J.; He, Y. Y.; Hsu, C. Y.; Choi, D. W. *Science* **1996**, *272*, 1013–1016.
973. Buhl, E. H.; Otis, T. S.; Mody, I. *Science* **1996**, *271*, 369–373.
974. Outten, C. E.; O'Halloran, T. V. *Science* **2001**, *292*, 2488–2492.
975. Cunningham, B. C.; Mulkerrin, M. G.; Wells, J. A. *Science* **1991**, *253*, 545–548.
976. Bradley, K. A.; Mogridge, J.; Mourez, M.; Collier, R. J.; Young, J. A. T. *Nature* **2001**, *414*, 225–229.
977. Morel, F. M. M.; Reinfelder, J. R.; Roberts, S. B.; Chamberlain, C. P.; Lee, J. G.; Yee, D. *Nature* **1994**, *369*, 740–742.
978. Lipscomb, W. N.; Strater, N. *Chem. Rev.* **1996**, *96*, 2375–2433.
979. Coleman, J. E. *Annu. Rev. Biochem.* **1992**, *61*, 897–946.
980. Vallee, B. L.; Auld, D. S. *Acc. Chem. Res.* **1993**, *26*, 543–551.
981. Vallee, B. L.; Falchuk, K. H. *Physiol. Rev.* **1993**, *73*, 79–118.
982. Karlin, S.; Zhu, Z. Y.; Karlin, K. D. *Proc. Natl. Acad. Sci. USA.* **1997**, *94*, 14225–14230.
983. Karlin, S.; Zhu, Z. Y. *Proc. Natl. Acad. Sci. USA.* **1997**, *94*, 14231–14236.
984. Maret, W.; Vallee, B. L. *Proc. Natl. Acad. Sci. USA.* **1998**, *95*, 3478–3482.

985. Jacob, C.; Maret, W.; Vallee, B. L. *Proc. Natl. Acad. Sci. USA*. **1999**, *96*, 1910–1914.
986. Jacob, C.; Maret, W.; Vallee, B. L. *Proc. Natl. Acad. Sci. USA*. **1998**, *95*, 3489–3494.
987. Zeng, J.; Vallee, B. L.; Kagi, J. H. R. *Proc. Natl. Acad. Sci. USA* **1991**, *88*, 9984–9988.
988. Witkowski, R. T.; Ratnaswamy, G.; Larkin, K.; McLendon, G.; Hattman, S. *Inorg. Chem.* **1998**, *37*, 3326–3330.
989. Konecny, R.; Li, J.; Fisher, C. L.; Dillet, V.; Bashford, D.; Noodleman, L. *Inorg. Chem.* **1999**, *38*, 940–950.
990. Jacob, O.; Cardenas, R.; Tapia, O. *J. Am. Chem. Soc.* **1990**, *112*, 8692–8705.
991. Tremain, S. M.; Kostic, N. M. *Inorg. Chim. Acta* **2000**, *300*, 733–740.
992. Wade, W. S.; Koh, J. S.; Han, N.; Hoekstra, D. M.; Lerner, R. A. *J. Am. Chem. Soc.* **1993**, *115*, 4449–4456.
993. Rhodes, D.; Klug, A. *Sci. Am.* **1993**, *268*, 56–65.
994. Pabo, C. O.; Sauer, R. T. *Annu. Rev. Biochem.* **1992**, *61*, 1053–1095.
995. Berg, J. M. *Acc. Chem. Res.* **1995**, *28*, 14–19.
996. Krizek, B. A.; Merkle, D. L.; Berg, J. M. *Inorg. Chem.* **1993**, *32*, 937–940.
997. Buchsbaum, J. C.; Berg, J. M. *Inorg. Chim. Acta* **2000**, *297*, 217–219.
998. Pavletich, N. P.; Pabo, C. O. *Science* **1991**, *252*, 809–817.
999. Fabris, D.; Hathout, Y.; Fenselau, C. *Inorg. Chem.* **1999**, *38*, 1322–1325.
1000. Witkowska, H. E.; Shackleton, C. H. L.; Dahlman-Wright, K.; Kim, J. Y.; Gustafsson, J. A. *J. Am. Chem. Soc.* **1995**, *117*, 7582–7582.
1001. Witkowska, H. E.; Shackleton, C. H. L.; Dahlman-Wright, K.; Kim, J. Y.; Gustafsson, J. A. *J. Am. Chem. Soc.* **1995**, *117*, 3319–3324.
1002. Xu, Y.; Wilcox, D. E. *J. Am. Chem. Soc.* **1998**, *120*, 7375–7376.

6.9

Cadmium and Mercury

D. K. BREITINGER

University of Erlangen–Nürnberg, Erlangen, Germany

6.9.1	INTRODUCTION	1253
6.9.1.1	Bibliography	1253
6.9.1.2	Scope of the Review	1254
6.9.2	METHODS FOR STUDYING FORMATION, PROPERTIES, STRUCTURES AND BONDING IN COMPLEX COMPOUNDS OF CADMIUM AND MERCURY	1254
6.9.2.1	Experimental Methods	1254
6.9.2.1.1	<i>UV/vis spectrometry, thermochemical and electrochemical techniques</i>	1254
6.9.2.1.2	<i>NMR spectrometry</i>	1255
6.9.2.1.3	<i>NQR spectrometry</i>	1255
6.9.2.1.4	<i>Diffraction methods on solids and solutions</i>	1255
6.9.2.1.5	<i>X-ray absorption spectrometry</i>	1256
6.9.2.1.6	<i>Photoelectron spectrometries</i>	1256
6.9.2.1.7	<i>Vibrational spectrometries</i>	1256
6.9.2.1.8	<i>Mass spectrometry</i>	1256
6.9.2.2	Quantum-chemical Calculations	1257
6.9.3	THE OCCURRENCE OF Cd AND Hg	1257
6.9.4	COORDINATION COMPOUNDS OF CADMIUM AND MERCURY	1257
6.9.4.1	Higher Oxidation States of Cd and Hg; Quantum-chemical Studies	1257
6.9.4.2	The +2 Oxidation States of Cd and Hg	1258
6.9.4.2.1	<i>Compounds with donor atom C</i>	1258
6.9.4.2.2	<i>Compounds with donor atoms Si and Ge</i>	1261
6.9.4.2.3	<i>Compounds with donor atom N</i>	1262
6.9.4.2.4	<i>Compounds with donor atom P</i>	1276
6.9.4.2.5	<i>Compounds with donor atoms As and Sb</i>	1278
6.9.4.2.6	<i>Frameworks made up of Cd, Hg, and P, As, Sb</i>	1279
6.9.4.2.7	<i>Compounds with donor atom O</i>	1279
6.9.4.2.8	<i>Compounds with donor atoms S, Se, and Te</i>	1282
6.9.4.2.9	<i>Compounds with halides as donor atoms</i>	1283
6.9.4.2.10	<i>Compounds with pseudohalides</i>	1284
6.9.4.2.11	<i>Compounds with hydrido ligands</i>	1284
6.9.4.3	Lower Oxidation States of Cd and Hg	1284
6.9.4.3.1	<i>Compounds with formal oxidation states intermediate between +2 and +1</i>	1284
6.9.4.3.2	<i>Compounds with oxidation state +1</i>	1285
6.9.4.3.3	<i>Subvalent mercury compounds</i>	1286
6.9.5	REFERENCES	1286

6.9.1 INTRODUCTION

6.9.1.1 Bibliography

This survey of the coordination chemistry of cadmium and mercury is based on, and continues, the reviews given in the first edition of this series.^{1,2}

State-of-the-art overviews of the general chemistry of these elements are offered in recent editions of well-known textbooks.³⁻⁵

Periodical accounts of research in these fields are given in the Annual Reports on the Progress of Chemistry, Section A, Inorganic Chemistry.⁶⁻¹⁷

Accounts of the preparation, properties, characterization by physical methods and use of representative inorganic and organometallic compounds of cadmium and mercury have been published.^{18,19}

References to reviews on special topics will be given where appropriate.

6.9.1.2 Scope of the Review

In a first part, experimental methods for studying formation, properties, structures and bonding in complex compounds of cadmium and mercury are briefly surveyed, usually with hints to reviews of the respective field and to examples of recent applications.

The growing importance of quantum-chemical calculations is dealt with in a short section, with emphasis on the consideration of relativistic effects, especially in systems containing mercury. These calculations aim at optimization of structures, determination of bond energies, simulation of spectra, and estimation of spectral parameters, independent of but complementary to experiments.

In the main part, dealing with complex compounds of cadmium and mercury, those with complicated organic ligands are not considered, neither are complexes with bio-relevance systematically described. However, it is unavoidable to address the formation of frameworks with the metals and certain organic ligands, and even seemingly simple compounds like $\text{Cd}(\text{CN})_2$, especially in the presence of appropriate guest molecules, tend to form wide-pore host frameworks.

Organometallic compounds are considered only with strong restrictions, namely when organic ligands, e.g., methyl groups, are introduced to avoid formation of coordination polymers, as is the case with mononuclear metallo-onium complexes.

Typical solid-state systems like alloys, polynary halides, oxides, and higher chalcogenides (e.g., semi- and superconductors), and so on, are not included in this context.

Environmental aspects are not dealt with here; surveys on this topic are available in specialized compilations (see, e.g., refs. 20, 21).

6.9.2 METHODS FOR STUDYING FORMATION, PROPERTIES, STRUCTURES AND BONDING IN COMPLEX COMPOUNDS OF CADMIUM AND MERCURY

Experimental methods used for studies of Cd and Hg complexes in solution and in the solid state are reviewed briefly, with examples for the application of the method under discussion in recent work. In a separate section quantum-chemical studies, including consideration of relativistic effects, on existing and not-yet-existing species with Cd and/or Hg, are also surveyed.

6.9.2.1 Experimental Methods

6.9.2.1.1 UV/vis spectrometry, thermochemical and electrochemical techniques

Classical methods for the investigation of complex formation equilibria in solution (UV/Vis spectrometry, thermochemical and electrochemical techniques) are still in use (for an appraisal of these and other methods see, e.g., ref. 22). Examples for the determination of the ratio of metal to ligand in an Hg-protein complex by UV spectrometry are given in ref. 23, for the study of distributions of complex species of Cd in equilibria by combined UV spectrometry and potentiometry in ref. 24 and by potentiometry alone in ref. 25, and for the combination of calorimetry and potentiometry to obtain thermodynamic data in ref. 26.

6.9.2.1.2 NMR spectrometry

The growing importance of metal-nuclide NMR spectrometry, here of the nuclei ^{111}Cd , ^{113}Cd , and ^{199}Hg , is reflected in several reviews, from which only the more recent are mentioned;^{27–32} the latter two references, with compilations of ^{199}Hg NMR data, are to be considered as complementary (solution and solid state).

Both of the nuclei ^{111}Cd and ^{113}Cd with spin $I=1/2$, with similar abundances (12.75% and 12.26%, respectively) and receptivities (6.93 and 7.6 with reference to ^{13}C , respectively) are easily observed nowadays, but ^{113}Cd data are a bit more frequently reported in the literature. Chemical shifts $\delta(^{111,113}\text{Cd})$ (usual references dimethylcadmium $\text{Cd}(\text{CH}_3)_2$ or 0.1 M aqueous solution of $\text{Cd}(\text{ClO}_4)_2$), coupling with other nuclei, e.g., ^1H , ^{13}C , ^{19}F , or ^{31}P , and temperature dependence of the NMR spectra provide insight into structure, bonding, and dynamics of Cd complexes in solution, whereas MAS-NMR spectra give informations on the complex species in the solid state.

With mercury only the nuclide ^{199}Hg ($I=1/2$, abundance 16.84%, receptivity 5.42 re ^{13}C) is routinely measured, as ^{210}Hg ($I=3/2$) with a large nuclear quadrupole moment can be painstakingly observed only under special conditions. Usually, dimethylmercury $\text{Hg}(\text{CH}_3)_2$, sometimes also aqueous $\text{Hg}(\text{ClO}_4)_2$ solution, are taken as references for the chemical shifts $\delta(^{199}\text{Hg})$. Temperature-dependent NMR spectra of mercury compounds in solution reveal that exchange processes occur as in the corresponding cadmium species, sometimes more quickly, sometimes more slowly, depending on the ligands (appearance of heteronuclear couplings of the ^{199}Hg nuclei at lower temperatures, see e.g., ref. 33).

6.9.2.1.3 NQR spectrometry

In general, nuclear quadrupole resonance (NQR) spectrometry of solids with appropriate quadrupole nuclides yields information on electrical fields and field gradients, i.e., on charge distributions around these quadrupole nuclei, on molecular reorientations, and on fluxional behavior. Since the only quadrupole nuclide of interest here, namely ^{201}Hg (see above), has too low an abundance (13.22%), NQR spectrometry is not routinely applicable to this nucleus. However, mercury compounds containing, e.g., the halides Cl, Br, and I can readily be studied, since all naturally occurring nuclides of these elements ($^{35,37}\text{Cl}$, $^{79,81}\text{Br}$, ^{127}I) are “good” NQR nuclei. An instructive example for the study of fluxional behavior in solid pentachlorocyclopentadiene mercurials $\text{C}_5\text{Cl}_5\text{HgR}$ by ^{35}Cl NQR, together with ^{13}C MAS NMR, is described.³⁴

6.9.2.1.4 Diffraction methods on solids and solutions

Diffraction methods applied to crystalline coordination compounds in general—especially using X-rays, and to some extent also synchrotron radiation and neutrons—are now of paramount importance for the determination of structures. X-ray structure analysis on single crystals can now routinely be performed, even if special problems have to be solved again and again, e.g., treatment of twinning, determination of superstructures or of absolute configurations, analyses of disorder of different kinds. In the case of Cd, and even more with Hg compounds, special care has to be taken to reduce absorption by the proper choice of the wavelength and to perform the best possible absorption correction of the diffractometer data set. Even so, the location of light atoms besides mercury is not very accurate, due to the very different scattering power for X-rays. A remedy is provided by neutron diffraction, since the coherent scattering cross-sections for the light atoms and for mercury are similar and the absorption cross-section of Hg for neutrons is moderate (scattering cross-sections σ_{coh} for, e.g., N and Hg 11.01 and 20.24 barn (10^{-24}cm^2); absorption cross-sections σ_{abs} 1.90 and 372.3 barn, respectively).³⁵ A recommendable procedure nowadays is to determine the structure by X-ray diffraction (on single crystal or powder) and then to refine it on the basis of neutron powder diffraction data (Rietveld method). A generic survey and perspectives of the complementary use of X-ray and neutron diffraction is available³⁶, while one example for this combined structure determination is mercury cyanamide HgCN_2 .³⁷

Neutron diffraction on Cd compounds is not feasible, as one of the Cd nuclides (^{113}Cd) has an extremely high absorption cross-section for neutrons, yielding an average $\sigma_{\text{abs}}(\text{Cd})$ of 2,520 barn (Cd metal is used for the shielding of neutron radiation).

X-ray diffraction also of solutions can provide insight into the structures of the dominating complexes present. A review outlines the experimental procedure and the processing of measured data in order to extract the structural information.³⁸

6.9.2.1.5 X-ray absorption spectrometry

In order to gain information on the environments of certain atoms in dissolved species, in melts or in solids (crystalline or noncrystalline), which are not accessible to diffraction studies for one reason or another, X-ray absorption spectrometry (XAS) can be applied, with the analysis of the X-ray absorption near-edge structure (XANES) and/or the extended X-ray absorption fine structure (EXAFS). Surveys of these methods are available;^{39,40} a representative study of the solvation of some mercury species, HgX_2 , in water and dimethylsulfoxide (DMSO) by EXAFS and XANES, combined with quantum-chemical calculations, has been published.⁴¹

6.9.2.1.6 Photoelectron spectrometries

Charge distributions and bonding in compounds of Cd and Hg in the solid and gaseous states can be studied by the well-established X-ray photoelectron spectrometry (XPS) and ultraviolet photoelectron spectrometry (UPS), respectively. With XPS, inner-shell electrons are removed which are indirectly influenced by the bonding, i.e., distribution of the valence electrons. UPS sees this electron distribution directly, since it measures the residual kinetic energies of electrons removed from the valence shells of the atoms, or, better, from the outer occupied orbitals of the molecules. The most detailed information accessible by UPS is obtained on gases, and it is thus applied here to volatile compounds, i.e., to the halides mainly of Hg and to organometallic compounds.

6.9.2.1.7 Vibrational spectrometries

The equally well-established methods of optical vibrational spectrometry (IR and Raman), sometimes complemented by other methods, can answer quite different questions. Examples are studies of the solvation state of mercury halides HgX_2 in different solvents, and derivation of Lewis basicity or donor ability scales for these solvents based on the shift of the valence vibrations of dissolved HgX_2 molecules.^{42,43} In another multimethod study (XANES, EXAFS, UV/Vis, IR, Raman) of the state of HgX_2 molecules occluded in several varieties of crystalline microporous silica (porosils), Raman spectra yielded information not only on the interactions between guest molecules and the host lattice, but also on the orientation of the HgX_2 guests;⁴⁴ in this case X-ray diffraction does not provide the information sought. In general, optical vibrational spectrometry, combined with inelastic neutron scattering where desirable and reasonable, gives hints as to the symmetry, structure, and bonding modes of complexes in dissolved and solid states, and yields the basis for force-field studies with empirical normal coordinate analyses. The valence force constants and their variations thus obtained are often a more sensitive measure for changing bond strengths than are differences in bond lengths.

6.9.2.1.8 Mass spectrometry

Mass spectrometry (MS) in its various forms, and with various procedures for vaporization and ionization, contributes to the identification and characterization of complex species by their isotopomer pattern of the intact ions (usually cation) and by their fragmentation pattern. Upon ionization by the rough electron impact (EI) the molecular peak often does not appear, in contrast to the more gentle field desorption (FD) or fast-atom bombardment (FAB) techniques. An even more gentle way is provided by the electrospray (ES) method, which allows all ionic species (optionally cationic or anionic) present in solution to be detected. Descriptions of ESMS and its application to selected problems are published;^{45–47} also a representative application of this method in a study of phosphine–mercury complexes in solution is reported.⁴⁸

6.9.2.2 Quantum-chemical Calculations

Progress in computer efficiency and in theory, especially with respect to relativistic effects in systems with heavy atoms, also led to an increasing number of quantum-chemical studies of cadmium- and mercury-containing species. These studies deal with apparently simple problems, like bonding in Hg_2 ,^{49–51} and in increasing clusters Hg_n up to Hg_{40} ,⁵² with calculation of NMR parameters in small organomercury species,⁵³ and with as-yet-hypothetical systems with Cd and Hg in the oxidation state +4.^{54,55}

The primary effects of relativity are contraction and energetic stabilization of the $6s$ orbitals and expansion, destabilization, and spin-orbit splitting of the $5d$ orbitals, with consequences for the physical properties of the atoms and of the metals, and for bonding in their compounds; these effects are strongest with Au, slightly weaker with Pt and Hg.⁵⁶

6.9.3 THE OCCURRENCE OF Cd AND Hg

Minerals dominated by cadmium are rare; the sulfide CdS (greenockite), especially, is very rarely found. However, cadmium is widespread in zinc ores in low concentrations (0.2–0.4%) and is separated during processing of these ores and production of zinc.

It is now established that cadmium, besides zinc, is accumulated in some native cysteine-rich proteins (e.g., metallothioneins) and the binding mode and sites in the protein are studied and largely understood.⁵⁷ Also, the detection and study of native Cd-enzymes and Cd-substituted Zn-enzymes is just beginning at the time of writing (for a short survey see ref. 58).

In contrast to cadmium, mercury occurs in various minerals—partly highly interesting in view of the mercury species present—and in enriched deposits. The most remarkable and important of these is the mine of Almadén, Spain, already known and exploited for cinnabar by the Romans, i.e., for more than two thousand years. Almadén still contributes about one-third of the world production of mercury. The geology and geochemistry of this region have been reviewed.⁵⁹ Recently, exploration in the Almadén district detected a new deposit, Nuevo Entredicho—even more remarkable in that the mercury content of this cinnabar/native mercury deposit locally rises up to 45% and that the deposit is actually monometallic, i.e., the HgS/Hg mixture contains other metals only at the trace level of some umpteen ppm, with lead reaching a maximum of more than 1,000 ppm in some parts. On the basis of the results of isotope analyses for sulfur and lead, conclusions on the geological and geochemical history of the deposit have been drawn.⁶⁰

The common occurrence of a mercury(II) compound and metallic mercury in this and other deposits could lead to the secondary formation of minerals with mercury in lower oxidation states: for instance, in the intermediate oxidation state $+1\frac{1}{3}$ of the highly remarkable *triangulo-* Hg_3^{4+} entity in the minerals terlinguaite $(\text{Hg}_3)\text{HgO}_2\text{Cl}_2$ ^{61–63} and kuznetsovite $(\text{Hg}_3)\text{AsO}_4\text{Cl}$,^{64–66} or in the oxidation state +1 of the Hg_2^{2+} dumbbells in the long-known but only recently structurally studied mineral eglestonite $(\text{Hg}_2)_3\text{Cl}_3\text{O}_2\text{H}$,^{67,68} in the newly found shakhovite $(\text{Hg}_2)_2\text{Sb}(\text{OH})_3\text{O}_3$,^{69,70} and in the deceptively simple-looking, but structurally complicated, poyarkovite Hg_3OCl (six independent Hg_2^{2+} groups!).⁷¹

Structural aspects of minerals and related synthetic materials with mercury in lower oxidation states and with oxocentered building blocks, OHg_n , have been reviewed.^{72,73}

6.9.4 COORDINATION COMPOUNDS OF CADMIUM AND MERCURY

6.9.4.1 Higher Oxidation States of Cd and Hg; Quantum-chemical Studies

Some time ago experimental evidence for the electrochemical generation of a transient complexed Hg^{III} species was given,⁷⁴ but never since has an Hg^{III} compound been isolated and studied. Also, compounds with Hg^{IV} , corresponding to the well-known Au^{III} , have not yet been prepared.

With this situation in mind quantum-chemical calculations have been started, aiming at testing the possible existence of simple Hg^{IV} compounds, e.g., HgF_4 ,⁵⁴ and later on also of respective Zn and Cd species;⁵⁵ a complementary study was undertaken to confirm the questioned results of the former calculations.⁷⁵ As a result of these studies with comparative nonrelativistic and relativistic calculations, including electron correlation at different levels, HgF_4 (gas) can be considered to be thermodynamically stable (in contrast to ZnF_4 and CdF_4) with respect to decay into HgF_2 (gas)

and F_2 ; a reaction energy (RE) of $+19 \text{ kJ mol}^{-1}$ (endothermic) has been recommended for $\text{HgF}_4 \rightarrow \text{HgF}_2 + F_2$.⁷⁵ A possible exothermic, gas-phase reaction yielding HgF_4 could be: $\text{HgF}_2 + \text{KrF}_2 \rightarrow \text{HgF}_4 + \text{Kr}$ (RE = -94 kJ mol^{-1}).⁵⁴

As expected, HgF_4 is square planar (cf. AuF_4^-), with a bond length $r_e(\text{Hg}-\text{F}) = 188.4 \text{ pm}$ ^{54,55} (189.1 pm ⁷⁵), optimized at the highest level. The bond lengths calculated at different levels, but always with consideration of relativistic effects, are shorter than those from nonrelativistic calculations (relativistic bond contraction). Reaction energies for the addition of F^- anions to HgF_4 and HgF_2 , to yield HgF_5^- , HgF_6^{2-} and HgF_3^- , HgF_4^{2-} , respectively, have also been calculated, as well as the structures of these complex anions and of the dimers $(\text{HgF}_4)_2$ and $(\text{HgF}_2)_2$.^{55,76} Calculated vibrational frequencies of the above neutral monomers and dimers should assist in the future identification of the products of the suggested fluorination reaction by vibrational spectrometry.^{54,55} Totally symmetric harmonic frequencies of HgF_4 and HgF_2 , calculated at various levels, are also reported⁷⁵.

Finally, calculations for HgCl_2 and HgCl_4 show unequivocally that the latter is rather unstable (strongly negative atomization energy).⁷⁵

6.9.4.2 The +2 Oxidation States of Cd and Hg

6.9.4.2.1 Compounds with donor atom C

(i) Carbonyl complexes

In a most remarkable reaction, a solution of $\text{Hg}(\text{SO}_3\text{F})_2$ in liquid SbF_5 at 80°C absorbs gaseous CO (500–800 mbar) to yield colorless bis(carbonyl)mercury(II) undecafluorodiantimonate(V), $[\text{Hg}(\text{CO})_2][\text{Sb}_2\text{F}_{11}]_2$ (recrystallization from magic acid, $\text{HSO}_3\text{F}/\text{SbF}_5$!); similarly, the corresponding dimercury(I) compound, $[\text{Hg}_2(\text{CO})_2][\text{Sb}_2\text{F}_{11}]_2$, has been obtained also.^{77,78} The Hg^{II} compound is thermally stable up to 160°C ; the Hg_2^{I} compound decomposes earlier. In the IR and Raman spectra of $[\text{Hg}(\text{CO})_2][\text{Sb}_2\text{F}_{11}]_2$ the $\nu(\text{CO})$ vibrations appear at $2,278 \text{ cm}^{-1}$ and $2,281 \text{ cm}^{-1}$, respectively (force constant f_r $21.0 \times 10^2 \text{ Nm}^{-1}$); these are so far the highest $\nu(\text{CO})$ values for any metal carbonyl complex. An IR band at 335 cm^{-1} is assigned to $\nu_{\text{as}}(\text{HgC})$. Evaluation of the ^{13}C -MAS-NMR spectrum of the ^{13}C -labeled isotopomer yields $\delta(^{13}\text{C})$ 168.8 ppm, and the extraordinarily high $^1J(^{199}\text{Hg}, ^{13}\text{C})$ of 5,219 Hz. X-ray structure analysis (195 K; $P2_1/n$, $Z=2$) reveals a centrosymmetric, slightly kinked $[\text{Hg}(\text{CO})_2]^{2+}$ cation ($r(\text{Hg}-\text{C})$ 208.3, $r(\text{C}-\text{O})$ 110.4 pm; $\alpha(\text{Hg}-\text{C}-\text{O})$ 177.7°), with the counteranions on general positions. Secondary bonds $\text{F} \cdots \text{Hg}$ (259.5 pm and 269.1 pm) complete the coordination around Hg to distorted octahedral and link the lattice constituents; contacts $\text{F} \cdots \text{C}$ shorter than the sum of the van der Waals' radii contribute to the stabilization of the compound. The collected data suggest a relatively weak, σ -only Hg—C bond with no π -back bonding, and therefore a strong C—O bond.

(ii) Acetylides

Compounds $\text{A}_2\text{Cd}(\text{C}\equiv\text{CH})_4$ (A = Rb and Cs) (space group $I 4_1/a$, isotopic to $\text{K}_2\text{Cd}(\text{C}\equiv\text{CH})_4$), obtained from the acetylides AC_2H and $\text{Cd}(\text{SCN})_2$ in liquid NH_3 , contain complex anions with symmetry $\bar{4} - S_4$.⁷⁹ Also, an ammoniate $\text{K}_2\text{Cd}(\text{C}\equiv\text{CH})_4 \cdot 2\text{NH}_3$ has been prepared and its structure determined ($r_{\text{av}}(\text{Cd}-\text{C})$ 224.0 pm (average), $r_{\text{av}}(\text{C}\equiv\text{C})$ 119.0 pm). A neutral heteroleptic Cd complex $[\text{Cd}(\text{C}\equiv\text{CPh})_2\text{tmen}]$ (tmen = tetramethylethylenediamine) has been obtained by reacting $\text{Cd}[\text{N}(\text{SiMe}_3)_2]$ with Li-phenylacetylide $\text{PhC}\equiv\text{CLi}$ and tmen in toluene, and its structure solved: Cd has a distorted tetrahedral environment with $r_{\text{av}}(\text{Cd}-\text{C})$ 214.1 pm (average), $r_{\text{av}}(\text{C}\equiv\text{C})$ 120.8 pm and a wide $\alpha(\text{C}-\text{Cd}-\text{C})$ 142.8° ; in contrast, the bite-angle of the tmen ligand is small, $\alpha(\text{N}-\text{Cd}-\text{N})$ 76.16° ($r_{\text{av}}(\text{Cd}-\text{N})$ 245.4 pm).⁸⁰ In a related Hg compound $[\text{Hg}(\text{C}\equiv\text{CPh})_2\text{phen}]$ (phen = 1,10-phenanthroline), the angle $\alpha(\text{C}-\text{Hg}-\text{C})$, 165.6° , is even wider and tends to a linear arrangement.⁸¹ The long-known, uncomplexed $\text{Hg}(\text{C}\equiv\text{CPh})_2$ and also $\text{Hg}(\text{C}\equiv\text{CSiMe}_3)_2$ have been prepared in a crystalline form appropriate for X-ray structure analyses.⁸² Both of these compounds crystallize in huge unit cells, with eight and five independent quasi-linear molecules, respectively, with $r_{\text{av}}(\text{Hg}-\text{C})$ 200 pm in both cases, and slightly different $r_{\text{av}}(\text{C}\equiv\text{C})$, 119 pm and 122 pm, respectively. The peculiarity in both structures is aggregation of these eight and five molecules by 'mercuriophilic' interaction, i.e., weak attraction between the Hg

atoms with Hg···Hg distances in the ranges 375 up to 425 pm, and 376–407 pm, respectively. With a new value for the van der Waals' radius of Hg of 200 pm,^{83,84} the limit for attraction between Hg atoms would be at a distance of ~400 pm. Closer inspection reveals that there are also intermolecular contacts Hg···C₂ of 330–370 pm (sum of the van der Waals' radii of Hg and C ~ 370 pm). Thus, aggregation of the molecules is probably a cooperative effect of both Hg···Hg and Hg···C₂ interactions.

For Hg(C≡CPh)₂ and for other symmetrical, as well as asymmetrical, alkynyl mercury compounds R'–Hg–C≡CR and R'–Hg–C≡C–Hg–R', multinuclear NMR measurements (¹H, ¹³C, ¹⁹⁹Hg) have been performed,⁸⁵ especially both the solvent and temperature dependencies of the δ(¹⁹⁹Hg) data of Hg(C≡CPh)₂ have been carefully measured. Also, Hg(C≡CSiMe₃)₂, other silylalkynyl mercurials R'–Hg–C≡CSiMe₃, and various trimethylsilyl mercury compounds have been studied by ¹³C, ²⁹Si, and ¹⁹⁹Hg NMR.⁸⁶ The δ(¹⁹⁹Hg) values proved to be remarkably sensitive to changes in R', but also in the more remote substituents R of the alkynyl ligands; also the coupling constants ¹J(¹⁹⁹Hg, ¹³C≡) span a wide range, from 650 to almost 3,000 Hz.

(iii) Cyanides

Investigations of cyanides and cyano complexes of Cd and Hg have augmented tremendously since about 1990, after detection of inclusion compounds of Cd(CN)₂. A thorough review on transition-metal cyanides especially emphasizes the chemistry of inclusion compounds of both the Hofmann type (frameworks dominated by planar Ni(CN)₄ building blocks) and the cyanocadmate type (frameworks with tetrahedral Cd(CN)₄ units).⁸⁷ The structures of these inclusion compounds, but also of cyanides themselves, often topologically resemble the structures of minerals; this aspect ('mineralomimetic chemistry') is dealt with in a simultaneous survey.⁸⁸ A more generic review of framework structures, with a section on cyanide inclusion compounds, is also to be mentioned.⁹⁰

The structure of Cd(CN)₂ (and of the isomorphous Zn(CN)₂) has been determined by state-of-the-art techniques;⁹¹ Cd(CN)₂ adopts the *anti*-cuprite structure (cuprite Cu₂O, space group *P* $\bar{4}$ 3m) with two interpenetrating, independent, diamond-type frameworks (with respect to the composition frameworks related to the high-cristobalite (Hc) form of SiO₂). This space group implies two independent Cd atoms with ordered orientation of the CN bridges, i.e., distinct CdC₄ and CdN₄ entities (*r*(Cd–C) 209.9(5), *r*(Cd–N) 219.6(4), *r*(C–N) 116.2(5) pm). However, ¹¹³Cd MAS NMR of Cd(CN)₂ displays five signals with different intensities, assigned to CdC₄, CdC₃N, CdC₂N₂, CdCN₃, and CdN₄ species (upfield sequence), indicating static disorder of the CN groups aligned between adjacent Cd atoms; the species CdC₂N₂ seemingly has some preference compared with a purely statistical distribution.⁹² Consequently, the space group should be changed to *Pn*3m, allowing for orientational disorder, as has been confirmed by a redetermination of the structures of Zn(CN)₂ and Cd(CN)₂ (*r*_{av}(Cd–C,N) 216.9(9), *r*_{av}(C–N) 114.3(19) pm).⁹³

As mentioned above Cd(CN)₂ itself, and related materials with partial or full substitution of Cd by other transition or post-transition metals, e.g., Zn or Hg, form a huge and still-increasing number of inclusion compounds Cd(CN)₂·x G (G = guest molecule). In just three papers, no fewer than twenty such clathrates and their structures are described.^{93–95} Basically, in the clathrates one of the two frameworks of the mother-structure is retained as the host lattice, and its voids are filled with the guest molecules. In most of the cases the host lattice resembles one of the H-, L-cristobalite, H- or L-tridymite forms of SiO₂; a case with a framework intermediate between H- and L-cristobalite has also been found.⁹⁶ A systematic representation of these and of other clathrates structurally related to clay and zeolite minerals is already developed.⁸⁸ A special case is met with Cd(CN)₂·2/3 H₂O·*t*-BuOH, in which tetrahedrally and octahedrally coordinated Cd (ratio Cd_{tet}:Cd_{oct} = 2:1) form a honeycomb framework with pseudohexagonal channels hosting the guest molecules *t*-BuOH.^{97–99} Below 240 K a phase transition with doubling of the unit cell occurs, obviously due to ordering of the guest molecules and of the hydrogen-bond system between the H₂O coordinated to Cd_{oct} and the *t*-BuOH molecules.⁹⁹ Phase transitions of clathrates at low temperatures with ordering of the guest molecules (e.g., HCCl₃, HCBBr₃, and the like) have also been observed by means of temperature-dependent IR, Raman, and ²H NMR spectroscopy.¹⁰⁰ A short survey of the most important clathrate types involving Cd(CN)₂ is provided by Table 1 (modified after ref. 88). Vibrational spectra of benzene clathrates of the type Cd(ND)_nM(CN)₄·2 C₆H₆ (ND heterocyclic N-donor such as pyrazine or adenine, *n* = 1, 2; M = Cd, Hg) have been discussed.^{101,102}

Table 1 Types of Cd(CN)₂ and related clathrates, space groups and examples.

Clathrate	Host lattice	Space group	Examples for G
Cd(CN) ₂ ·G	Hc ^a	<i>Fd3m</i>	CCl ₄ , CMe ₄
Cd(CN) ₂ ·0.5 G	Hc	<i>Fd3m</i>	<i>i</i> -Bu ₂ O
Cd(CN) ₂ ·G	Lc	<i>P4₁(4₃)2₁2</i>	CHCl ₂ CH ₂ Cl
Cd(CN) ₂ ·G	H/Lc	<i>I4_{1/amd}</i>	CH ₂ BrCH ₂ Br
Cd(CN) ₂ ·0.5 G	Ht	<i>P6_{3/mmc}</i>	<i>n</i> -Bu ₂ O·H ₂ O
Cd(CN) ₂ ·2/3 H ₂ O·G	special type	<i>Cmmm</i> (r.t.) <i>Pbcm</i> (<230 K)	<i>t</i> -BuOH
[CdZn(CN) ₄] ₂ ·2 G	Hc	<i>Fd3m</i>	CCl ₄
[CdHg(CN) ₄] ₂ ·2 G	Hc	<i>Fd3m</i>	CCl ₄

^a Hc high cristobalite, Lc low cristobalite, H/l intermediate between Hc and Lc, Ht high tridymite.

Hg(CN)₂ in the solid state has a structure (*I* $\bar{4}$ 2*d*; neutron diffraction), completely different from that of Cd(CN)₂: Almost-linear molecules ($r(\text{Hg}-\text{C})$ 201.9, $r(\text{C}-\text{N})$ 116.0 pm (corrected for thermal motion); $\alpha(\text{C}-\text{Hg}-\text{C})$ 175.0°) are arranged such that four secondary bonds $\text{N}\cdots\text{Hg}$ (274.2 pm) yield the often-occurring 2 + 4 coordination around Hg.¹⁰³ Analysis of the ¹⁹⁹Hg MAS NMR spectrum of Hg(CN)₂ has yielded the chemical shift and shielding tensor parameters.¹⁰⁴

Several quantum-chemical studies have been performed on Hg(CN)₂ and related species, applying different approaches with consideration of relativistic effects in order to get MO schemes and energies as a basis for discussion of bonding, valence XPS,¹⁰⁵ UPS,¹⁰⁶ XANES and EXAFS spectra.⁴¹ The latter study also showed Hg(CN)₂ to be dissolved in H₂O in molecular form ($r(\text{Hg}-\text{C})$ 202, $r(\text{C}-\text{N})$ 114 pm), and obviously not to be hydrated, a remarkable finding insofar as solvates of Hg(CN)₂ with various donor molecules are well known.² However, in contrast to Cd(CN)₂ (see above), Hg(CN)₂ as such does not form clathrates.

Also, in complex compounds of the types AHg(CN)₂X or A₂Hg(CN)₂X₂ (cf. ref. 2), almost unperturbed Hg(CN)₂ units are present. In a recent example, [NH₃Et]₂Hg(CN)₂Cl₂, (*A2/a*), the Hg(CN)₂ molecules ($r(\text{Hg}-\text{C})$ 206.4, $r(\text{C}-\text{N})$ 111 pm) are inserted in half of the meshes of a near-tetragonal net of Cl⁻ anions with weak Cl⁻···Hg interactions (distances 2 × 290.1, 2 × 343.2 pm).¹⁰⁷ In a comproportionation reaction Hg(CN)₂ and Hg(OAc)₂ (OAc = acetate) readily form crystalline Hg(CN)(OAc). The structure (*P2₁/c*) contains two independent molecules with unidentate OAc and almost linear arrangements NC–Hg–OAc ($r_{\text{av}}(\text{Hg}-\text{C})$ 201.8, $r_{\text{av}}(\text{Hg}-\text{O})$ 206.3, $r_{\text{av}}(\text{C}-\text{N})$ 115 pm; $\alpha_{\text{av}}(\text{C}-\text{Hg}-\text{O})$ 174.2°); secondary bonds O⁻···Hg and N⁻···Hg (range ~260–280 pm) yield a distorted 2 + 4 coordination around Hg. IR and Raman bands below 500 cm⁻¹ have been assigned to skeletal valence and deformation modes. $\delta_{\text{iso}}(^{199}\text{Hg})$ of this compound lies upfield from that of Hg(CN)₂.¹⁰⁴

In an admirable microwave study of methylmercury cyanide, H₃CHgCN (five isotopomers), the structural parameters have been obtained with high precision (data for substitution structure: $r_{\text{s}}(\text{H}_3\text{C}-\text{Hg})$ 205.63(1), $r_{\text{s}}(\text{Hg}-\text{CN})$ 203.69(2), $r_{\text{s}}(\text{C}-\text{N})$ 115.70(2) pm); the dipole moment is high, $\mu = 4.69(4)$ D.¹⁰⁸

The tetrahedral Cd(CN)₄ building block present in Cd(CN)₂ and its clathrates also occurs in K₂Cd(CN)₄, crystallizing in the spinel structure (*Fd3m*); here, the anion has full tetrahedral symmetry (43*m* – *T_d*), with $r(\text{Cd}-\text{C})$ 222.5(3) and $r(\text{C}-\text{N})$ 111.3(3) pm.¹⁰⁹

From K₂Cd(CN)₄, CdCl₂, and [PPh₄]Br under controlled conditions (pH, solvent mixture, temperature), [PPh₄]₃[Cd₂(CN)₇] (*R3c*) is obtained with the anion analogous to disilicate Si₂O₇⁶⁻; this anion has staggered conformation and a disordered bridging CN group,¹¹⁰ as required by crystallography. This reaction is the first step to catenation and the formation of oligomeric and polymeric cyanocadmates. As a consequence, the end member of this catenation exists in [SbPh₄][Cd(CN)₃] with a chain anion $\infty^1[\text{Cd}(\text{CN})_3]^-$, analogous to the ino-silicate $\infty^1[\text{SiO}_3]^{2-}$ in pyroxenes.¹¹¹ Further analogies between cyanocadmates and silicates are discussed in the survey already mentioned.⁸⁸ Recently, polycyano-polycadmamate host clathrates, including the methylviologen (1,1'-dimethyl-4,4'-bipyridinium) dication, have been obtained which adopt 3-D framework structures related to zeolites with different kinds of cavities, depending on the guest molecules; altogether a dozen such structures have been classified into five structural types on the basis of the shapes of the cavities (cages, channels, 3-D cavities).⁸⁹

The long-known K₂Hg(CN)₄ and related compounds are still the object of structural studies. Thus, a neutron-diffraction study confirmed the spinel structure of K₂Hg(CN)₄ at room temperature (298 K) with exactly tetrahedral anions, Hg(CN)₄²⁻ ($r(\text{Hg}-\text{C})$ 215.2, $r(\text{C}-\text{N})$ 114.9 pm).¹¹²

Remarkably, the Hg—C bonds are shorter than the Cd—C bonds in the respective cyanospinel;¹⁰⁹ the probable reason is relativistic bond contraction with the Hg atom.

Also known for some time is a phase transition at low temperature (111 K), observed in studies with various methods (NQR, elasticity measurement by ultrasound, Raman spectrometry),¹¹² temperature-dependent neutron diffraction showed the phase transition to be caused by an antiphase rotation of adjacent anions around the threefold axis ([111] in the cubic cell) and to lower the symmetry from cubic to rhombohedral ($R\bar{3}c$). As shown by inelastic neutron scattering, this phase transition is driven by a low-frequency rotatory soft mode (0.288 THz = 9.61 cm⁻¹/298 K);¹¹³ a more recent NQR study revealed a small hysteresis and hence first-order character of this transition.¹¹⁴ This rhombohedral structure is adopted by Rb₂Hg(CN)₄ already at room temperature ($r_{av}(\text{Hg—C})$ 218.6, $r_{av}(\text{C—N})$ 114.0 pm for two independent cyano groups), and the analogous phase transition to the cubic structure occurs at 398 K.¹¹⁵

K₂Hg(CN)₄ and the crown ether dibenzo-18-crown-6 in aqueous ethanol yield the crystalline [K(C₂₀H₂₄O₆)₂][Hg(CN)₄]·2H₂O; the structure contains two independent potassium-crown complexes and a distorted tetrahedral Hg(CN)₄ entity ($r_{av}(\text{Hg—C})$ 218.4, $r_{av}(\text{C—N})$ 112.3 pm) which coordinates to one of the complexed K ions through one of the CN ligands (slight lengthening of the C—N bond).¹¹⁶

For K₂Hg(CN)₄ in aqueous solution, ¹⁹⁹Hg NMR indicates deshielding on complexation ($\delta(^{199}\text{Hg})$ -502 vs. -1021 ppm for Hg(CN)₂; reference 90% HgMe₂/10% C₆F₆).¹¹⁷

Quaternary cyanomercurates NR₄[MHg(CN)₄] (R = Et, Pr; M = Li, Na, K, Cu) at higher temperatures adopt cubic framework structures ($F\bar{4}3m$) topologically related to cristobalite, with tetrahedral surroundings of both M and Hg and ordered cyano groups (M—NC—Hg); the cations are located in the cavities.^{118,119} These compounds undergo reversible phase transitions (first order, displacive) to tetragonal ($I\bar{4}$) studied by DTA/DSC, X-ray diffraction, Raman and MAS NMR spectrometries, with transition temperatures depending on R and M.¹²⁰

The thermal behavior and degradation of the sulfonium tetracyanometallates (R₂R'S)[M(CN)₄] (R = R' = Me and R = Me, R' = Ph; M = Cd, Hg) and the degradation products (IR spectra) have been studied.^{121,122}

(iv) Fulminates

In contrast to cyanides, for fulminates just a handful of papers has appeared in the period to be reviewed and only one is relevant here, namely on the structure of a tetrafulminatomercurate [AsPh₄]₂[Hg(CNO)₄].¹²³ Seemingly the compound is quite stable, since the authors mention that the crystals used for X-ray structure analysis were 35 years old! The compound ($C2/c$) contains distorted tetrahedral anions (site symmetry 2 - C₂) with one angle $\alpha(\text{C—Hg—C})$ widened to 118.4° and the opposite angle compressed to 101.8° (packing effects); the two independent Hg—C bonds are significantly different (average 218.7 pm) and the Hg—C—N—O groups nearly, but not fully, collinear. Recent DFT calculations with a quasirelativistic pseudopotential for mercury yielded structural parameters and vibrational frequencies of the free [Hg(CNO)₄]²⁻ anion (idealized symmetry $\bar{4}3m - T_d$) which agree pretty well with the experimental data.¹²⁴

6.9.4.2.2 Compounds with donor atoms Si and Ge

Recently, the crystal structure of bis(trimethylsilyl)mercury Hg(SiMe₃)₂ (by reaction of Me₃SiCl with Na/Hg) has been redetermined.¹²⁵ The most remarkable finding is the formation of dimers by “mercuriophilic” attraction with a distance $r(\text{Hg}\cdots\text{Hg})$ of 314.6 pm, i.e., shorter than twice the van der Waals’ radius of Hg (see the discussion in Section 6.9.4.2.1(i)); the axes of the two quasilinear molecules in the dimers are approximately perpendicular to each other. Otherwise, the bond lengths are $r(\text{Hg—Si})$ 249.13(18) and $r(\text{Si—C})$ 186.6(8) pm; the angles $\alpha(\text{Hg—Si—C})$, 111.9°, are widened and $\alpha(\text{C—Si—C})$, 107.4°, compressed.

In Li₂Hg(SiMe₃)₄ and Li₂Hg(SiMe₂Ph)₄ (simplified from the respective disilyl mercury compounds and lithium metal), both crystallizing in $C2/c$, the basically tetrahedral ate species are distorted by interaction with, and linking by, lithium.¹²⁶ The Hg—Si bonds ($r_{av}(\text{Hg—Si})$ 254.4 pm and 252.1 pm, respectively) are slightly longer than in Hg(SiMe₃)₂, as might be expected.

NMR data for Hg(SiMe₃)₂ in different solvents have been compiled and discussed,^{86,117} as well as data for asymmetric mercurials RHgSiMe₃⁸⁶ and for compounds with simple SiH₃ and mixed silyl groups (SiMe_{3-x}R_x); even data for the ate complexes LiHg(SiMe₃)₃ and Li₂Hg(SiMe₂Ph)₄

and for germyl species $\text{Me}_3\text{SiHgGeH}_3$ and $\text{Hg}(\text{GeH}_3)_2$ are presented.¹¹⁷ Substitution of one SiMe_3 group in $\text{Hg}(\text{SiMe}_3)_2$ by alkyl groups R increases the shielding of the Hg nuclei (negative shift of $\delta(^{199}\text{Hg})$); a similar effect is brought about by substitution with SiH_3 and even more strongly with GeH_3 . The extremes on the $\delta(^{199}\text{Hg})$ scale for silyl mercury compounds are $\text{Li}_2\text{Hg}(\text{SiMe}_2\text{Ph})_4$, (1,681 ppm, the least shielded) and $\text{Hg}(\text{SiCl}_3)_2$ (-1,177 ppm in dimethoxyethane DME, the most shielded).¹¹⁷ As a rule of thumb the coupling constants $^1J(^{199}\text{Hg}, ^{29}\text{Si})$, where observed, also increase with increasing shielding (maximum 3,864 Hz for $\text{Hg}(\text{SiCl}_3)_2$).

In recent years, the chemistry of compounds with tris(trimethylsilyl)silyl groups $\text{Si}(\text{SiMe}_3)_3$ ("hypersilyl" group¹²⁷) has been expanded. For bis(hypersilyl)cadmium and -mercury, $\text{M}[\text{Si}(\text{SiMe}_3)_3]_2$ (M = Cd, Hg), the crystal structures have been solved and low-frequency vibrational spectra measured and discussed.¹²⁸ In the isomorphous compounds ($P\bar{1}$, $Z = 1$) the molecules, since centrosymmetric, have an exactly linear arrangement Si—M—Si and staggered conformation. Again, the Hg—Si bonds (246.9(2) pm) are significantly shorter than the Cd—Si bonds (250.4(1) pm) (relativistic bond contraction), the Si—Si bonds show only small scatter ($r_{\text{av}}(\text{Si—Si})$ 233.2 pm); in both compounds the very similar angles $\alpha(\text{Si—Si—Si})$ are widened (total average 112.5°) at the expense of the angles $\alpha(\text{M—Si—Si})$ (106.3°), probably as a consequence of steric interaction (compare the contrasting findings with $\text{Hg}(\text{SiMe}_3)_2$).

^1H , ^{13}C , and ^{29}Si NMR, as well as UV/Vis data (λ_{max} , ϵ_{max}), have been reported for all $\text{M}[\text{Si}(\text{SiMe}_3)_3]_2$ (M = Zn, Cd, Hg) (also the crystal structure for M = Zn, isomorphous with the above compounds).¹²⁹ The ^{29}Si resonances move to lower field (decreasing shielding) in the series $\text{Zn} > \text{Cd} > \text{Hg}$: as expected, more pronounced for Si immediately bound to M; the UV absorption maxima move to lower wavenumbers. For M = Hg alone $\delta(^{199}\text{Hg})$ and $^1J(^{199}\text{Hg}, ^{29}\text{Si})$ have been reported; as compared with $\text{Hg}(\text{SiMe}_3)_2$ δ moves downfield (987 vs. 499 ppm, deshielding) and 1J decreases (432 vs. 981 Hz) under the same conditions.¹¹⁷

From CdI_2 and $\text{LiTt}(\text{SiMe}_3)_3$ (Tt = Si, Ge) in the presence of thf, the tris(μ -iodo)bis[tris(trimethylsilyl)tetrylcadmate] [$\text{Li}(\text{thf})_4][(\text{Me}_3\text{Si})_3\text{TtCdI}_3\text{CdTt}(\text{SiMe}_3)_3]$ are obtained (IR and ^1H NMR data); an X-ray structure analysis of the Ge compound ($Cmcm$, $Z = 4$) has been performed.¹³⁰ In the anion (symmetry $mm2 - C_{2v}$) one of the bridging I atoms, the Cd, germanium, and two of the Si atoms are all lying in the same mirror plane, with the remaining two I atoms in the mirror plane orthogonal to the first one. The bond length $r(\text{Cd—Ge})$ is 253.3 pm (no reference data are given) and the distances in the symmetrical bridges $r(\text{Cd—I})$ 293.1 pm and 295.3 pm, respectively. The angles around Cd deviate considerably from the ideal tetrahedral angles ($\alpha_{\text{av}}(\text{germanium—Cd—I})$ 124.7 and $\alpha_{\text{av}}(\text{I—Cd—I})$ 90.8°) caused by the steric demands of the $\text{Ge}(\text{SiMe}_3)_3$ ligands.

6.9.4.2.3 Compounds with donor atom N

The large group of compounds with cadmium- and mercury-nitrogen bonds can be subdivided into two sections, one with amide ligands derived from molecules with acidic hydrogen or electropositive leaving groups attached to nitrogen, the other one with amine ligands just coordinated to the metal, with the option of further metal substitution on the bonded ligands. In the former case isolated mononuclear, but also oligonuclear complexes may be formed; in the latter case progressive substitution may lead to formation of 2-D or 3-D networks. With amides nitrogen is often three-coordinate, but secondary bonds between N and the metals, sometimes additional metals, can make things more complicated; with amine complexes tetra-coordinate nitrogen is always present.

Analogous considerations also apply to ligands with phosphorus and the other elements of the pentel group.

A special situation is met in systems containing Cd or Hg combined with cyano-complexes of other elements. In these cases, the coordination sphere of Cd or Hg is fully or partly made up of the N-ends of cyano-groups C-bonded to another metal.

(i) Amides

Among the simplest metal amides are the cyanamides CdCN_2 ¹³¹ (from CdCl_2 and $\text{H}_2\text{N-CN}/\text{NaOH}$ in aqueous solution at pH 12.5/350 K)¹³² and HgCN_2 (from HgCl_2 and $\text{H}_2\text{N-CN}/\text{NaOH}$ in aqueous solution).³⁷ In CdCN_2 ($R\bar{3}m$ or $R3m$, $Z = 3$; from X-ray powder data) Cd is surrounded by six equidistant N atoms ($r(\text{Cd—N})$ 238.0 pm) of the N—C—N groups, which are

aligned along the threefold axes and symmetrical in $R\bar{3}m$, but asymmetrical in $R3m$.¹³² The authors prefer the noncentrosymmetric structure with reference to the IR spectrum, but the arguments for this choice are not convincing.

The structure of HgCN_2 ($Pbca$, $Z=8$; from combined X-ray and neutron powder data)³⁷ contains zigzag chains $\infty^1[\text{Hg}(\text{NCN})_{2/2}]$ (Hg atoms bonded to both ends of NCN: $\mu_{1,3}$ -NCN bridges) with $r_{\text{av}}(\text{Hg}-\text{N})$ 206.5 pm, $r_{\text{av}}(\text{C}-\text{N})$ 122.2 pm, and $\alpha_{\text{av}}(\text{Hg}-\text{N}-\text{C})$ 117.5°. The fragments $\text{N}-\text{Hg}-\text{N}$ and $\text{N}-\text{C}-\text{N}$ are almost symmetrical and only slightly bent; thus, the compound is rather to be considered as a carbodiimide than as a cyanamide. Four secondary bonds $\text{N}\cdots\text{Hg}$ ($r_{\text{av}}(\text{Hg}\cdots\text{N})$ 278.5 pm) between adjacent chains complete the coordination sphere of Hg to distorted octahedral (2+4). As shown by X-ray diffraction and Raman spectrometry, HgCN_2 decomposes under pressure (diamond-anvil cell), starting at about 1.9 GPa, to give first rhombohedral α -Hg ($R\bar{3}m$) and then tetragonal β -Hg ($I4/mmm$) ($p \geq 7$ GPa).¹³³

From the same educts, but under controlled-pH conditions (pH kept constant at ~ 6) a second, monoclinic form of HgCN_2 is obtained ($\text{HgCN}_2(\text{II})$, $P2_1/a$, $Z=4$; again from combined X-ray and neutron powder data).¹³⁴ In this case again zigzag chains are found, but now with two Hg atoms covalently bonded to one end of the $\text{N}-\text{C}-\text{N}$ fragment ($\mu_{1,1}$ -NCN bridges) ($r_{\text{av}}(\text{Hg}-\text{N})$ 208.1 pm) with the consequence of clearly different C—N bonds ($r(\text{C}-\text{N})$ 135.3/112.0 pm; single/triple bond), i.e., $\text{HgCN}_2(\text{II})$ is a true cyanamide; the $\text{N}-\text{C}-\text{N}$ fragment deviates considerably from linearity ($\alpha(\text{N}-\text{C}-\text{N})$ 160.7°). The interlocked arrangement of the chains to form layers also leads to four secondary bonds $\text{N}\cdots\text{Hg}$, involving the 'free' ends of the $\text{N}-\text{C}-\text{N}$ entities ($265 \leq r(\text{Hg}\cdots\text{N}) \leq 296$ pm). Quantum-chemical calculations at three different levels always indicate $\text{HgCN}_2(\text{II})$ to be less stable than the orthorhombic $\text{HgCN}_2(\text{I})$, but a transition $\text{HgCN}_2(\text{II}) \rightarrow \text{HgCN}_2\text{H}(\text{I})$ on heating is not observed prior to decomposition (~ 230 °C). To conclude, $\text{HgCN}_2(\text{II})$ seems to be a metastable phase formed under kinetic control, with a high barrier to conversion into the thermodynamically stable $\text{HgCN}_2(\text{I})$.

On diffusion of separated dilute aqueous solutions of HgCl_2 and H_2NCN through a ceramic filter, besides the above $\text{HgCN}_2\text{H}(\text{II})$ also two new crystalline phases $\text{Hg}_2(\text{NCN})\text{Cl}_2$ and $\text{Hg}_3(\text{NCN})_2\text{Cl}_2$ are formed; the former crystallizes in $P2_1/c$ ($Z=4$), the latter in $Pca2_1$ ($Z=4$).¹³⁵ Both compounds contain zigzag chains $\infty^1[\text{Hg}(\text{NCN})_{2/2}]$, like those in $\text{HgCN}_2\text{H}(\text{I})$, linked by additional Hg atoms to form 2-D networks $\infty^2[\text{Hg}_3(\text{NCN})_2]^{2+}$, with 20-membered rings. The Hg—N bonds are similar in both cases, with a larger scatter in the latter one ($r_{\text{av}}(\text{Hg}-\text{N})$ 207.0 pm and 210.5 pm, respectively). In the first case the $\text{N}-\text{C}-\text{N}$ entity has carbodiimide character ($r_{\text{av}}(\text{C}-\text{N})$ 123 pm); in the other one two independent $\text{N}-\text{C}-\text{N}$ groups are also different in bonding, the one tending to carbodiimide ($r_{\text{av}}(\text{C}-\text{N})$ 122 pm), the other one to cyanamide ($r(\text{C}-\text{N})$ 113 pm and 128 pm). In both compounds two additional Cl^- ions form secondary bonds to the linking Hg atoms ($r(\text{Hg}\cdots\text{Cl})$ 296.9 pm and 285.6 pm, respectively); in the first one an additional, exactly linear HgCl_2 molecule is occluded in the meshes of the network. Thus, the formulae should reasonably have been written $[\text{Hg}_3(\text{NCN})_2]\text{Cl}_2 \cdot \text{HgCl}_2$ and $[\text{Hg}_3(\text{NCN})_2]\text{Cl}_2$, respectively.

Homo- and heteroleptic complexes of Cd alone^{136,137} and of Cd and Hg¹³⁸ with the ligand dicyanamide (dca) $\text{N}(\text{CN})_2^-$, homologous to cyanamide NCN^{2-} , have been studied in various solvents (formation constants of the complexes $[\text{M}(\text{dca})_n]^{(n-2)}$ ($\text{M} = \text{Cd}, \text{Hg}; 1 \leq n \leq 4$)), with the result that the complexes of Hg are more stable than those of Cd. Otherwise, obviously no studies on the isolated compounds $\text{M}(\text{dca})_2$ or on homoleptic complexes derived therefrom have been published.

Some heteroleptic Cd-dca complexes with exciting structures have been studied very recently, the simplest being the coordination polymer $[\text{Cd}(\mu_{1,5}\text{-dca})_2(\text{py})_2]_n$ ($\text{py} = \text{pyridine}; C2/m, Z=2$).¹³⁹ Here, double end-to-end dicyanamide bridges $\text{N}-\text{C}-\text{N}-\text{C}-\text{N}$ link the octahedral Cd centers to form chains or flat ribbons, with the py ligands in *trans*-position at Cd (barbed-wire like) (bond lengths $r(\text{Cd}-\text{N}_{\text{dca}})$ 233.8 and $r(\text{Cd}-\text{N}_{\text{py}})$ 231.7 pm); the dca bridges are bent (angle at the central N atom $\alpha(\text{NC}-\text{N}-\text{CN})$ 123.4°) and all of the angles between adjacent Cd—N bonds very close to 90°. The individual chains are interlocked into a 2-D arrangement. Similar chains are formed when py is replaced by N-coordinated 4-aminobenzoic acid (aba) as a ligand in $\{[\text{Cd}(\mu_{1,5}\text{-dca})_2(\text{aba})_2] \cdot 2 \text{H}_2\text{O}\}_n$ ($P2_1/c, Z=4$), with $r_{\text{av}}(\text{Cd}-\text{N}_{\text{dca}})$ 236.6 and $r(\text{Cd}-\text{N}_{\text{aba}})$ 237.7 pm; here, the chains are linked to sheets by twin hydrogen bonds involving the carboxylic groups of aba and H_2O molecules.¹⁴⁰

Replacement of the two py ligands in the above complex by the bidentate 2,2'-bipyridyl ligand (bipy) forces its *cis*-coordination at Cd and consequently an all-*cis* arrangement of the four bridging dca ligands in the polymeric $[\text{Cd}(\text{dca})_2(\text{bipy})]_n$ ($C2/c, Z=4$), yielding an undulating chain.¹⁴¹ The comparable bonds have similar lengths as before ($r_{\text{av}}(\text{Cd}-\text{N}_{\text{dca}})$ 232.5 and

$r(\text{Cd}-\text{N}_{\text{bipy}})$ 232.2 pm); since the bite-angle of the bipy ligand is only 70.4° , all other angles around Cd deviate more or less from the expected 90° or 180° . Again the chains are interlocked into an efficiently space-filling arrangement. Further replacement of bipy by the very similar 1,10-phenanthroline (phen) to yield $[\text{Cd}(\text{dca})_2(\text{phen})]_n$ ($P2_1/c$, $Z=4$) changes the structure completely.¹⁴¹ The Cd(phen) fragments are now linked to one adjacent fragment by a double, and to two others by single ($\mu_{1,5}$ -dca)-bridges, to create a very peculiar 2-D network. Due to the structural difference of the dca linkers, the Cd—N_{dca} bond lengths scatter considerably ($224.6 \leq r(\text{Cd}-\text{N}_{\text{dca}}) \leq 248.1$ pm, $r_{\text{av}}(\text{Cd}-\text{N}_{\text{dca}})$ 232.4 pm), whereas the Cd—N_{phen} bonds ($r_{\text{av}}(\text{Cd}-\text{N}_{\text{phen}})$ 233.2 pm) are close to the Cd—N_{bipy} bonds. Stacking of the layers is such as to allow π — π interaction between the phen ligands.

With the bidentate ligand 1,3-bis(4'-pyridyl)propane (bpp) in place of two py ligands, other highly interesting structures are created. From Cd(NO₃)₂, Na(dca), and bpp in methanol–water, two different forms of crystals (columns, blocks) with the same composition $[\text{Cd}(\text{dca})_2(\text{bpp})]_n$ are deposited and manually separated; under the mother liquor the columns disappear after some time, leaving exclusively the block crystals (transformation of a metastable to a thermodynamically stable phase).¹⁴² The columns ($C2/c$, $Z=4$) contain chains with double ($\mu_{1,5}$ -dca) bridges similar to those in $[\text{Cd}(\text{dca})_2(\text{py})_2]_n$, but with additional, arc-shaped, end-to-end bpp bridges between adjacent Cd centers. The arcs force the Cd(dca)₂Cd units (12-membered rings) into boat conformation and the chains as a whole into sinusoidal form. The chains interdigitate into layers. The stable phase (block crystals; $Fddd$, $Z=16$) contains cisoidal chains as in $[\text{Cd}(\text{dca})_2(\text{bipy})]_n$, but with arc-shaped bpp bridges to Cd centers in two adjacent chains, yielding undulating layers. In addition, neighboring layers interpenetrate by means of their protruding arc bridges, creating a 3-D framework.

Cd and Hg complexes of tricyanamide N(CN)₃ are unknown, but the isoelectronic tricyanomethanide C(CN)₃[−] (tcm) forms some compounds with highly interesting structural chemistry. Cd[C(CN)₃]₂ and Hg[C(CN)₃]₂, isomorphous to Zn[C(CN)₃]₂ ($Pmna$, $Z=2$),^{143–145} adopt a structure with two interpenetrating, equivalent 3-D frameworks which are topologically related to rutile (TiO₂), i.e., with octahedrally coordinated metal particles, carbon atoms with trigonal-planar surrounding, and CN groups as connectors between the coordination centers.

Reaction of Cd(NO₃)₂, K(tcm), and NaBPh₄ in methanol (MeOH) yields crystalline Cd(tcm)[B(OMe)₄]₂·1.6 MeOH ($P6_122$, $Z=6$),¹⁴⁴ in which Cd is surrounded by three N atoms of tcm in T-shape ($r(\text{Cd}-\text{N})$ 240.0 pm and 239.6 pm) and two bidentate B(OMe)₄ ligands ($r(\text{Cd}-\text{O})$ 235.6 pm and 239.6 pm), giving an overall coordination number of seven (3 N, 4O). B(OMe)₄ further links the Cd particles to helical chains connected by tcm groups. The solvate molecules MeOH are hosted in the helical channels.

From Cd(NO₃)₂, (Me₄N)(tcm), and hexamethylenetetramine (hmt) in H₂O, crystals of $[\text{Cd}(\text{tcm})(\text{hmt})(\text{H}_2\text{O})](\text{tcm})$ ($P2_1/c$, $Z=4$)¹⁴⁵ are obtained. In the structure two different Cd atoms, both on inversion centers, are octahedrally coordinated to two *trans* hmt and four tcm ligands, and to two H₂O, hmt, and tcm ligands each, respectively; the Cd—N bonds to tcm are shorter than those to hmt ($r_{\text{av}}(\text{Cd}-\text{N})$ 228.4 pm and 244.0 pm). These two complex units are joined in alternating sequence to chains with hmt and tcm bridges; the third N atoms of the μ -tcm's provide links to Cd atoms in two adjacent chains, creating a 3-D connectivity. A further tcm entity is not involved in the framework, but is acceptor for a hydrogen bond from an H₂O ligand; hydrogen bonds from H₂O are also directed to N atoms of hmt not coordinated to Cd. Again, the overall connectivity pattern is related to the rutile topology.

The acidification of N—H bonds in amines and stabilization of the amide anion resulting on dissociation can be achieved by a variety of groups, which all have electron-withdrawal properties in common. These anions can then act as N-donors towards Cd or Hg.

A highly variable group of amines, and amides derived therefrom, are secondary silylated amines HNR(SiR'₃), where R can be an organic substituent, but also a silyl group, and R' again an organic group. The steric requirements of R and R' often strongly influence the structures of the Cd and Hg amides obtained from salts of these metals and the substituted amides.

Simple amides of this type are the bis(trimethylsilyl)amides $\text{M}[\text{N}(\text{SiMe}_3)_2]_2$ ($\text{M} = \text{Cd}$ and Hg) the essential thermodynamic data of which have been determined in calorimetric measurements of the heats of hydrolysis in dilute H₂SO₄.¹⁴⁶ Evaluation of the measured data yielded the standard enthalpies of formation $\Delta H_f^0 = -854(21)$ kJ mol^{−1} and $-834(9)$ kJ mol^{−1} for $\text{M} = \text{Cd}$ and Hg , respectively. Using subsidiary data, the average thermochemical bond energies $\bar{E}-(\text{Cd}-\text{N})$ 144 and $\bar{E}(\text{Hg}-\text{N})$ 108 kJ mol^{−1} were also obtained, i.e., the Cd—N bonds are considerably stronger than the Hg—N bonds.

Both trimethylsilylamides $M[N(\text{SiMe}_3)_2]_2$ ($M = \text{Cd}$ and Hg) have been studied in the gas phase by electron diffraction. The diffraction data are best interpreted assuming monomers with linear N—M—N cores and two planar M—NSi_2 groups in staggered conformation.^{147,148}

A series of amides of the type $M[\text{NR}(\text{SiMe}_2\text{R}')_2]$ with group 12 metals has been prepared from the metal chlorides MCl_2 and the respective Li amide, and studied by mass spectrometry, ^1H and ^{13}C NMR spectrometry, and X-ray structure analyses.¹⁴⁹ In the case of the Cd compounds the mass spectra show the molecular cation M^+ and the fragments M—L^+ (L = the respective amide ligand); with the Hg compounds usually M^+ and M—Me^+ are found. For the Hg compounds with $\text{R}' = \text{Me}$ and $\text{R} = \text{Ph}$ and with Me and *i*-Pr 2,6-substituted phenyl groups, as well as with $\text{R}' = \text{NMe}_2$, crystal structure analyses have been performed; in all cases the N—Hg—N fragment is almost or exactly linear, depending on the real crystallographic symmetry, and the Hg—N bonds are short with only a small scatter ($199.4 \leq r(\text{Hg—N}) \leq 202.9$ pm, $r_{\text{av}}(\text{Hg—N})$ 201.5 pm).

Mixing of red CdCp^*_2 (Cp^* = pentamethylcyclopentadienide) and of $\text{Cd}[\text{N}(\text{SiMe}_3)_2]_2$ (colorless) yields yellow, crystalline $\text{Cp}^*\text{Cd}[\text{N}(\text{SiMe}_3)_2]$, actually as the dimer, as shown by X-ray structure analysis at -73°C ($P2_1/a$, $Z = 4$).¹⁵⁰ As is often the case with Cd amides, the N atoms link the Cd atoms in slightly asymmetric bridges ($r_{\text{av}}(\text{Cd—N})$ 229.3 pm) to form a distorted Cd_2N_2 square. The Cp^* ligands are η^1 -bonded to Cd ($r_{\text{av}}(\text{Cd—C})$ 222.2 pm); thus, the coordination around Cd is distorted trigonal-planar. An orange solution of $\text{Cp}^*\text{Cd}[\text{N}(\text{SiMe}_3)_2]$ in benzene gives the same ^1H NMR spectrum as the mixture of the educts CdCp^*_2 and $\text{Cd}[\text{N}(\text{SiMe}_3)_2]_2$, showing that these three components are engaged in a Schlenk-type equilibrium.

Upon reaction of $\text{Cd}[\text{N}(\text{SiMe}_3)_2]_2$ with the cyclohexylamide $\{[\text{Sb}(\text{NCy})_3]_2\text{Li}_6\}$ (Cy = cyclohexyl) in tetrahydrofuran (thf), the complicated heterometallic complex amide $\{[\text{Sb}(\text{NCy})_3]\{[\text{Cd}[\text{N}(\text{SiMe}_3)_2]_2]_3\}[\text{Li}\{\text{N}(\text{SiMe}_3)_2\} \cdot \text{thf}]\}$ is produced.¹⁵¹ In the Cd-containing part, a pyramidal Sb atom is surrounded by three Cd atoms with three bridging μ_3 -NCy ligands; this SbN_3Cd_3 core of the complex can be considered as a defective heterocubane, with one missing corner opposite to Sb ($r_{\text{av}}(\text{Sb—N})$ 205 pm, $\alpha_{\text{av}}(\text{N—Sb—N})$ 87.9° ; $r_{\text{av}}(\text{Cd—N})$ 226 pm, $\alpha_{\text{av}}(\text{N—Cd—N})$ 78.1°). A highly irregular trigonal-planar coordination around the Cd atoms is completed by terminal $\text{N}(\text{SiMe}_3)_2$ ligands ($r_{\text{av}}(\text{Cd—N})$ 208 pm).

In a remarkable disproportionation reaction, dimercury(I) diacetate $\text{Hg}_2(\text{OOCCH}_3)_2$ and $\text{N,N,N}'$ -tris(trimethylsilyl)benzamidine $\text{Ph—C}(\text{NSiMe}_3)[\text{N}(\text{SiMe}_3)_2]$ give the mercury(II) $\text{N,N}'$ -bis(trimethylsilyl)benzamidinate $\text{Hg}[\text{Ph—C}(\text{NSiMe}_3)_2]_2$ and mercury.¹⁵² The crystals ($P\bar{1}$, $Z = 2$) contain molecules with a nearly centrosymmetric skeleton, although they have no crystallographically imposed symmetry. The ligands are bonded to Hg through one N-donor atom each ($r_{\text{av}}(\text{Hg—N})$ 207.0 pm) in an almost linear arrangement; the other two N atoms form secondary bonds $\text{N} \cdots \text{Hg}$ ($r_{\text{av}}(\text{Hg} \cdots \text{N})$ 271.9 pm). The C—N bonds in the coordinated amidinate tend to single and double bonds, respectively.

The fairly acidic dimesylamine $\text{HN}(\text{SO}_2\text{Me})_2$ reacts with $\text{Hg}(\text{NO}_3)_2$ and $\text{Hg}_2(\text{NO}_3)_2$ in aqueous solution to form the sparingly soluble dimesylamides $\text{Hg}[\text{N}(\text{SO}_2\text{Me})_2]_2$ and $\text{Hg}_2[\text{N}(\text{SO}_2\text{Me})_2]_2$; the former can be recrystallized to give single crystals appropriate for a structure analysis.¹⁵³ Both amides, the latter under disproportionation, add donor molecules—*inter alia* the O-donors dimethyl sulfoxide (dmsO) or hexamethylphosphoric triamide (hmpa)—to give $\text{Hg}[\text{N}(\text{SO}_2\text{Me})_2]_2 \cdot 2\text{dmsO}$ and $\text{Hg}[\text{N}(\text{SO}_2\text{Me})_2]_2 \cdot \text{hmpa}$, respectively. In the structures of $\text{Hg}[\text{N}(\text{SO}_2\text{Me})_2]_2$ ($I4_1/a$, $Z = 8$), and of the latter compounds ($P\bar{1}$, $Z = 1$; $P2_1/c$, $Z = 4$), the molecules contain nearly or exactly linear N—Hg—N groups with nonsignificantly different Hg—N bonds (total $r_{\text{av}}(\text{Hg—N})$ 206.6 pm). In the solvates, two dmsO molecules ($r(\text{Hg—O})$ 261.2 pm) and one hmpa molecule ($r(\text{Hg—O})$ 246.2 pm) complete the coordination sphere of Hg to distorted square planar and T-shaped, respectively. In the solvate-free $\text{Hg}[\text{N}(\text{SO}_2\text{Me})_2]_2$, intermolecular secondary $\text{O} \cdots \text{Hg}$ bonds ($r(\text{Hg} \cdots \text{O})$ 282.5 pm) create weakly bonded dimers. In all of the three compounds, additional intra- and intermolecular $\text{O} \cdots \text{Hg}$ distances are around or beyond the sum of the van der Waals' radii (300 pm).

Organomercurials with one dimesylamide ligand $\text{R—Hg—N}(\text{SO}_2\text{Me})_2$ have been obtained by reaction of the appropriate chloride RHgCl with $\text{AgN}(\text{SO}_2\text{Me})_2$ and characterized by ^1H and ^{13}C NMR spectrometry.¹⁵⁴ The crystal structure of $\text{Ph—Hg—N}(\text{SO}_2\text{Me})_2$ has been solved ($Pbca$, $Z = 8$); it contains molecules with slightly bent C—Hg—N groups ($r(\text{Hg—C})$ 204.0 and $r(\text{Hg—N})$ 209.1 pm, (C—Hg—N) 172.7°). Two similar intra- and intermolecular secondary $\text{O} \cdots \text{Hg}$ bonds, respectively ($r(\text{Hg} \cdots \text{O})$ 296.1 pm and 297.6 pm), assisted by pairs of intermolecular $\text{C—H} \cdots \text{O}$ bonds, link the molecules to a 1-D polymer. Thus, the Hg atoms get an unusual distorted 2 + 2 coordination.

Various substituted sulfonylurea derivatives, partly in use as diabetes drugs, have been coordinated to Cd and Hg. Besides the IR and ^1H NMR spectra of several species, the structures of one each of the Cd and Hg compounds have been solved.¹⁵⁵ In the Cd complex three ligands act as

bidentate N,O-donors, yielding an approximately trigonal-prismatic surrounding; in the Hg compound two monodentate ligands are bonded to give a strictly linear symmetric N—Hg—N fragment ($r(\text{Hg—N})$ 205.2 pm), with two pairs of intramolecular secondary $\text{O}\cdots\text{Hg}$ bonds ($r_{\text{av}}(\text{Hg}\cdots\text{O}) \sim 297$ pm).

Some relation to sulfonylureas has saccharine (1,2-benzisothiazol-3(2H)-one 1,1,dioxide) which, as an anion (sac), with CdCl_2 in aqueous medium readily forms tetraaquabis(saccharinato-N)-cadmium(II) dihydrate $[\text{Cd}(\text{sac})_2(\text{H}_2\text{O})_4] \cdot 2\text{H}_2\text{O}$.¹⁵⁶ In the crystal structure ($P2_1/c$, $Z=2$), the complex molecules occupy inversion centers and therefore adopt an all-*trans* octahedral configuration, with $r(\text{Cd—N})$ 232.3 pm and $r(\text{Cd—O})$ 227.9 pm and 234.2 pm, respectively, and minor deviations from 90° of the angles between adjacent bonds. The coordinated H_2O molecules are involved in a hydrogen-bonding network. Comparisons with other saccharinato complexes of lighter transition metals have been drawn.

Examples of Cd and Hg complexes with other cyclic sulfonamides, e.g., *p*-nitrobenzoxasulfamate, derived from the respective *o*-aminophenol, should also be mentioned. IR spectra and crystal structures of the compounds $[\text{Cd}(\text{nbs})_2(\text{H}_2\text{O})_4]$ and $[\text{Hg}(\text{nbs})_2(\text{H}_2\text{O})_4]$ (nbs = *p*-nitrobenzoxasulfamate) have been reported.¹⁵⁷ In the Cd complex ($P1$, $Z=1$) Cd has a centrosymmetric, almost perfectly octahedral surrounding, with very similar Cd—N and Cd—O bonds ($r(\text{Cd—N})$ 231.0, $r(\text{Cd—O})$ 230.3 pm and 230.9 pm) and angles between adjacent bonds close to 90° ; a system of intermolecular hydrogen bonds with the coordinated H_2O molecules as donors holds the structure together. In the Hg complex, the Hg atoms (on a twofold axis) surprisingly adopt a basically pentagonal-bipyramidal coordination with a clearly bent N—Hg—N axis ($r(\text{Hg—N})$ 207.3 pm, $\alpha(\text{N—Hg—N})$ 167.0°), and three H_2O molecules ($r(\text{Hg—O})$ 249.2 pm and 266.4 pm) and two O atoms from nitro groups in neighboring molecules (secondary bonds $r(\text{Hg}\cdots\text{O})$ 321.6 pm) in the equatorial plane. The weak secondary bonds, and again numerous hydrogen bonds, link the molecules to a 3-D network.

A yellow complex $\{\text{Hg}[\text{PhN}_3\text{C}_6\text{H}_4\text{N}_3(\text{H})\text{Ph}](\text{NO}_3)\}$, obtained from $\text{Hg}(\text{NO}_3)_2$ and the monoanion derived from *ortho*-bis(phenyltriazeno)benzene $\text{PhN}_3(\text{H})\text{C}_6\text{H}_4\text{N}_3(\text{H})\text{Ph}$, exhibits interesting structural features ($P2_1$, $Z=2$).¹⁵⁸ The ligand strongly coordinates to Hg, with an N atom directly bonded to the central benzene ring ($r(\text{Hg—N})$ 210.1 pm), while opposite to this Hg—N bond a monodentate NO_3 ligand is similarly strongly bonded ($r(\text{Hg—O})$ 211 pm), giving an almost linear N—Hg—O fragment ($\alpha(\text{N—Hg—O})$ 174.6°). As expected, two more N-donors of the ligand form secondary bonds with Hg ($r(\text{N}\cdots\text{Hg})$ 266.2 pm and 285.0 pm), such that both covalent and secondary bonds are almost coplanar. These roughly planar complexes are stacked in columns in such a way that Hg gets contact with the terminal Ph rings of two neighboring molecules, with clear tendency to η^2 coordination ($r(\text{C}\cdots\text{Hg})$ 340/341 pm and 381/410 pm); these arene-metal interactions obviously afford the main contribution to the cohesion of the lattice constituents.

Interesting complexes of Cd and Hg have been prepared with pentaazadienide ligands $[\text{R—N=N—N=N—R}]^-$ (obtained from the respective diazonium salts and NH_3 in aqueous solution); especially, the pyridine solvates $[\text{Cd}(\text{R—N}_5\text{—R})_2\text{py}_2]$ (red; R = *p*-ethoxyphenyl) and $[\text{Hg}(\text{Tol—N}_5\text{—Tol})_2\text{py}]$ (dark yellow, Tol = *p*-tolyl) have been obtained by recrystallization of the sparingly soluble primary products from pyridine (py).¹⁵⁹ Both of the compounds crystallize in $P1$ ($Z=2$), but with different structures. In the Cd complex, the two R—N₅—R ligands coordinate bidentate (N1,N3)- η^2 with unsystematically different Cd—N bond lengths ($r_{\text{av}}(\text{Cd—N})$ 237 pm) and small bite-angles ($\alpha_{\text{av}}(\text{N—Cd—N})$ 52.7°); in the zigzag N₅ chain the terminal bonds tend to be shorter than the central ones; the py ligands coordinate in the *cis*-position ($r_{\text{av}}(\text{Cd—N})$ 233 pm). In the Hg complex the two ligands bind monodentate, with the central N atoms as donor to form a bent arrangement ($r_{\text{av}}(\text{Hg—N})$ 209.8 pm), $\alpha(\text{N—Hg—N})$ 163.5°); the py ligand ($r(\text{Hg—N})$ 249.0 pm) coordinates in such a way that the overall coordination around Hg becomes T-shaped planar, with a tendency to trigonal planar.

Structurally surprising compounds have been obtained upon reaction of Cd halides CdX_2 with silylated phosphoranimes $\text{R}_3\text{P}=\text{NSiMe}_3$ in the presence of alkali-metal fluoride MF (formally yielding the imide $\text{R}_3\text{P}=\text{N}^-$ as an intermediate), to give the tetrameric phosphoraniminato species $[\text{CdX}(\text{NPR}_3)]_4$ (X = Cl, Br, I, R = Et; X = I, R = Me) as shown by EI mass spectrometry.¹⁶⁰ For X = Br, R = Et reactions with organolithium reagents LiR' (R' = Me, $\text{C}\equiv\text{CSiMe}_3$) smoothly give the substituted $[\text{CdR}'(\text{NPR}_3)]_4$. These complexes have further been characterized by IR and ^1H , ^{13}C , ^{31}P , and ^{29}Si NMR spectrometries, where applicable. Crystal-structure analyses have been performed for the complexes with X = Cl, Br, I, R' = $\text{C}\equiv\text{CSiMe}_3$ and R = Et (mostly as solvates with dichloromethane or toluene). Although different in the space groups, they all contain molecules with heterocubane cores Cd_4N_4 . The differences in the Cd—N bond lengths are non-systematic and nonsignificant (overall average $r_{\text{av}}(\text{Cd—N})$ 227.6 pm); in all cases the angles

between adjacent Cd—N bonds in the cube are slightly below 90° around the four-coordinate Cd ($\alpha_{\text{av}}(\text{N—Cd—N}) 88.9^\circ$), and over 90° around N ($\alpha_{\text{av}}(\text{Cd—N—Cd}) 91.0^\circ$). Consequently, the angles between the terminal bonds Cd—X or N—P and the edges of the cube are over or below $\sim 125^\circ$, respectively, as expected. Recrystallization of the raw material with X = I, R = Et from $\text{CH}_2\text{Cl}_2/\text{MeCN}$ gives small amounts of $[\text{Cd}_4\text{I}_4(\text{OSiMe}_3)(\text{NPEt}_3)_3]$, probably as a consequence of partial hydrolysis of the silylated starting material. The structure analysis shows that in the heterocubane core a $\mu_3\text{-OSiMe}_3$ ligand has replaced a NPEt_3 group leading to a clear distortion of the cube, with long Cd—O bonds ($r_{\text{av}}(\text{Cd—O}) 231.5 \text{ pm}$) and shorter Cd—N bonds ($r_{\text{av}}(\text{Cd—N}) 224.6 \text{ pm}$) adjacent to the Cd—O bonds. A comparison of these heterocubanes with others containing lighter transition metals has appeared.¹⁶¹

An analogous reaction of Cd acetate $\text{Cd}(\text{O}_2\text{CCH}_3)_2$ with $\text{Me}_3\text{SiNPEt}_3$ in excess yields the heterocubane $[\text{Cd}(\text{O}_2\text{CCH}_3)(\text{NPR}_3)_4]$ (CH_2Cl_2 solvate after recrystallization; $C2/c$, $Z = 4$), with crystallographic symmetry $2 - C_2$ of the tetranuclear complexes.¹⁶² The acetate groups bind as asymmetric bidentate ligands ($r_{\text{av}}(\text{Cd—O}) 232.0 \text{ pm}$ and 237.8 pm), leading to five-coordinate Cd. As a consequence the heterocubane core is more distorted (the angles at the corners vary between 87.3° and 92.6°) than in the previous examples with four-coordinate Cd; the Cd—N bonds are almost unaffected ($r_{\text{av}}(\text{Cd—N}) 228.0 \text{ pm}$).

(ii) Ammine and organic amine complexes

Ammine complexes and their condensation products. Ammine complexes of Cd, or fragments thereof, are scarce in the literature. Fragments *trans*- $[\text{Cd}(\text{NH}_3)_2]$ have been mentioned as part of octahedral CdN_6 constituents of the interwoven 2-D networks in *trans*- $\text{Cd}(\text{NH}_3)_2\{\text{Ag}(\text{CN})_2\}_2$, but no structural data have been given (see also Section 6.9.4.2.3(iii)).¹⁶³ The fragments $[\text{Cd}(\text{NH}_3)_5]$ and $[\text{Cd}(\text{NH}_3)_3]$ (*mer* configuration) with Cd—N distances $229 \leq r(\text{Cd—N}) \leq 247 \text{ pm}$ and $225 \leq r(\text{Cd—N}) \leq 239 \text{ pm}$, respectively, occur in the structure of $[\text{Cd}(\text{NH}_3)_5][\text{Cd}(\text{NH}_3)_3][\text{Re}_4\text{Te}_4(\text{CN})_{12}]$, bound to the heterocubane anion by bridging CN groups (see Section 6.9.4.2.3(iii)).¹⁶⁴ $[\text{Cd}(\text{NH}_3)_6](\text{ClO}_4)_2$ has also been studied: It crystallizes in the anti- K_2PtCl_6 type ($Fm\bar{3}m$, $Z = 4$), with strictly octahedral cations ($r(\text{Cd—N}) 237.8(13) \text{ pm}$) and disordered anions.¹⁶⁵

There is good news from the field of ammine–mercury complexes. For the first time the structures of compounds with the ammine–mercury cations $[\text{Hg}(\text{NH}_3)_2]^{2+}$ and $[\text{Hg}(\text{NH}_3)_4]^{2+}$ have been solved from single-crystal X-ray data.¹⁶⁶ An aqueous solution of HgCl_2 and NH_4Cl at 60°C dissolves $[\text{Hg}(\text{NH}_2)]\text{Cl}$ to some extent; upon cooling the supernatant, crystals of $[\text{Hg}(\text{NH}_3)_2][\text{HgCl}_3]_2$ deposit. In its structure ($Pmna$, $Z = 2$), the linear cations $[\text{Hg}(\text{NH}_3)_2]^{2+}$ (symmetry $2/m - C_{2h}$) have short Hg—N bonds ($r(\text{Hg—N}) 207.2 \text{ pm}$) and a pair of equivalent Cl atoms ($r(\text{Cl}\cdots\text{Hg}) 317.6 \text{ pm}$) in the same mirror plane, and two pairs of more remote equivalent Cl atoms ($r(\text{Cl}\cdots\text{Hg}) 342.3 \text{ pm}$) in two neighboring mirror planes. Thus, the overall coordination number of Hg rises to an unusual $2 + 2 + 4$. The T-shaped planar anion $[\text{HgCl}_3]^-$ can be considered as a distorted HgCl_2 molecule ($r(\text{Hg—Cl}) 235.8 \text{ pm}$ and 236.9 pm , $\alpha(\text{Cl—Hg—Cl}) 167.68^\circ$) plus a more distant Cl^- anion ($r(\text{Hg—Cl}) 280.0 \text{ pm}$); however, $\text{Cl}\cdots\text{Hg}$ contacts ($r(\text{Cl}\cdots\text{Hg}) 297.1 \text{ pm}$ and 333.8 pm) from neighboring $[\text{HgCl}_3]^-$ entities generate a highly distorted octahedral environment of Hg. The bubbling of gaseous NH_3 into an aqueous solution of $\text{Hg}(\text{ClO}_4)_2$ under cooling yields $[\text{Hg}(\text{NH}_3)_4](\text{ClO}_4)_2$. In the structure ($P2_1/c$, $Z = 4$) all constituents lie on general positions; as a consequence the Hg—N bonds in the complex cation $[\text{Hg}(\text{NH}_3)_4]^{2+}$ are independent, but not significantly different ($r_{\text{av}}(\text{Hg—N}) 226.6 \text{ pm}$). Yet, the basically tetrahedral coordination is severely distorted, in that two opposite angles $\alpha(\text{N—Hg—N})$ are strongly widened (115.4° and 125.0°), i.e., the tetrahedron is flattened. Interionic distances $\text{N}\cdots\text{O}$ of 289 pm to 328 pm suggest hydrogen bonds, also indicated by the position and profile of the $\nu(\text{NH})$ bands in the IR spectrum. IR and Raman bands at 436 cm^{-1} and 407 cm^{-1} are assigned to the valence vibrations of the HgN_4 entities.

Another old problem finally solved!/? The long-known ‘mercury amidochloride’ (‘infusible precipitate’), HgNH_2Cl , has been obtained as single crystals appropriate for X-ray structure analysis under hydrothermal conditions (160°C).¹⁶⁷ Basically the earlier suggested structure with chains $\infty^1[\text{Hg}(\text{NH}_2)_2]^{2+}$ or $\infty^1[(\text{NH}_2)\text{Hg}_2]^{2+}$ (polymeric dimercurio-ammonium ion) has been confirmed, but now in a space group of higher symmetry ($Pmma$, $Z = 2$) with Hg in an inversion center. The Hg—N bonds ($r(\text{Hg—N}) 207.5 \text{ pm}$) are very similar to those in $[\text{Hg}(\text{NH}_3)_2][\text{HgCl}_3]_2$; the angle at the ammonium center is slightly less than required for a tetrahedral surrounding ($\alpha(\text{Hg—N—Hg}) 107.9^\circ$). Four equivalent Cl particles complete the coordination around Hg to distorted octahedral

($r(\text{Cl}\cdots\text{Hg})$ 309.3 pm) and link the octahedra to layers by edge sharing; the layers are connected by hydrogen bonds $\text{N}-\text{H}\cdots\text{Cl}$ (H atoms located).

The next step of mercuration of the ammonium ion and generation of a network $\infty[(\text{NH})\text{Hg}_3]_2^+$ is realized in $\text{NH}_4[\text{Hg}_3(\text{NH})_2](\text{NO}_3)_3$ (simply from aqueous solutions of $\text{Hg}(\text{NO}_3)_2$ and NH_3).^{168,169} The structure ($P4_132$, $Z=4$) can be considered to be built up of HNHg_3 tetrahedra ($r(\text{Hg}-\text{N})$ 207.0 pm, $\alpha(\text{Hg}-\text{N}-\text{Hg})$ 112.2°) sharing the Hg corners to give a 3-D framework. The nitrate and ammonium ions occupy voids in the framework, such that secondary bonds between NO_3^- and Hg ($282.2 \leq r(\text{O}\cdots\text{Hg}) \leq 344.0$ pm) and hydrogen bonds between NH_4^+ and NO_3^- are formed. Thermal analysis (DTA, TG, combined with mass spectrometry) and temperature-dependent X-ray powder diffractometry show $\text{NH}_4[\text{Hg}_3(\text{NH})_2](\text{NO}_3)_3$ to decompose essentially in one step above 270 °C to gaseous products (H_2O , NH_3 , N_2 , N_2O) and solid $[\text{Hg}_2\text{N}](\text{NO}_3)$ (decay to HgO and N_2O above 380 °C). The latter can also be prepared by hydrothermal synthesis (180 °C) from $\text{Hg}(\text{NO}_3)_2$ and NH_3 .

This deceptively simple-looking $[\text{Hg}_2\text{N}](\text{NO}_3)$ ($P4_32_12$, $Z=20!$) adopts a complex framework structure with three independent tetrahedral NHg_4 entities ($r_{\text{av}}(\text{Hg}-\text{N})$ 205.3 pm) corner-linked to two different types of helical strands running parallel to the tetragonal c -axis, which in turn are interlocked into the 3-D framework. The NO_3^- anions occupy the largest of three different types of cages and contact the Hg atoms of the framework, forming numerous secondary bonds $\text{O}\cdots\text{Hg}$.

To conclude: structural data for carefully studied representatives of mercury–nitrogen compounds are now available, starting from $[\text{Hg}(\text{NH}_3)_2]^{2+}$ (formally two H_3NHg tetrahedra with the Hg corner in common) and going through stepwise, increasing mercury substitution of the ammonium unit with formation of coordination polymers $\infty[\text{NH}_{4-n}\text{Hg}_n]_2^+$ of increasing dimensionality. Irrespective of the degree n of mercuration, the $\text{Hg}-\text{N}$ bonds retain almost the same length with $r(\text{Hg}-\text{N}) \approx 207$ pm, the differences, if significant, being due to type and number of secondary bonds to Hg.

Organic amine complexes. An immense number of aliphatic and aromatic mono- and oligofunctional amines, as well as nitrogen-containing heterocycles, have been used as ligands in complexes of Cd and Hg. In organic ligands N-donor functions can be combined with other donors like O, S, Se and/or Te, and so on, and other ligands can compete; thus a highly complex and often unpredictable coordination chemistry without frontiers becomes possible, even with relatively simple ligands, e.g., cysteine. Therefore, only a selection of representative examples of Cd and Hg complexes can be offered here.

The thermodynamic parameters (formation constants, enthalpies ΔG^0 and ΔH^0 , entropy terms $T\Delta S^0$) for complexation of Cd^{II} by open-chain N-donor ligands in dmsO solution have been determined by potentiometric and calorimetric techniques under controlled conditions.²⁶ *n*-Butylamine, ethylenediamine (en), diethylenetriamine (dien), and various methyl derivatives of the latter two have been used for complexation. Mononuclear complexes CdL_m , with the polyamines as chelating ligands L, are formed; with the ligands en ($n \leq 3$) and dien ($n \leq 2$) all these species CdL_n have higher formation constants and higher absolute values of ΔH^0 in dmsO than in water, i.e., they are more stable in dmsO. Increasing methylation and thus increasing steric requirements of the N-donors decrease the stability, to the extent that the fully methylated ligands only form the species CdL with low stability. On the whole, the complexes are enthalpy stabilized, whereas the entropy changes counteract the complexation.

The crystal structure of a tris(ethylenediamine)cadmium dibenzohydroxamate hydrate $[\text{Cd}(\text{en})_3](\text{ONH}(\text{OC})\text{Ph})_2 \cdot \text{H}_2\text{O}$ ($Fdd2$, $Z=16$) has been briefly described without giving structural data.¹⁷⁰ From the given crystallographic data, the bond lengths in the distorted octahedral core CdN_6 of the cation can be calculated ($235.4 \leq r(\text{Cd}-\text{N}) \leq 238.4$ pm, $r_{\text{av}}(\text{Cd}-\text{N})$ 237.2 pm). Similar averaged data ($r_{\text{av}}(\text{Cd}-\text{N})$ 238 pm) for the $[\text{Cd}(\text{en})_3]^{2+}$ are given in another source.¹⁷¹

¹¹³Cd NMR spectra of a series of $[\text{Cd}(\text{en})_3]^{3+}$ salts with different inorganic anions in H_2O , en, and dmsO as solvents have shown the ¹¹³Cd chemical shifts (around 350 ppm/re aqueous $\text{Cd}(\text{ClO}_4)_2$) to be practically independent of the changes of solvent, concentration and counterion.¹⁷² However, increasing ring size in the chelate complexes with the diamine ligands $\text{H}_2\text{N}(\text{CH}_2)_n\text{NH}_2$ ($2 \leq n \leq 4$) causes an increase in shielding (up to 230 ppm in the series), as does methylation of the amino group. ¹¹³Cd NMR data of complexes with several pyridine, dipyridine, and 1,10-phenanthroline derivatives, both in solution and as solids, have also been reported in this paper.

The effects of sterically more demanding ligands related to en are obvious for Cd complexes with *N'*-isopropyl-2-methylpropane-1,2-diamine (npda) or 2-amino-2,5-dimethyl-4-azahexane *i*-PrNH(CH₂)CMe₂NH₂. From $\text{Cd}(\text{ClO}_4)_2$ and excess npda, solid $[\text{Cd}(\text{npda})_3](\text{ClO}_4)_2$ has been obtained,¹⁷³ which in aqueous solution dissociates to $[\text{Cd}(\text{npda})_2(\text{H}_2\text{O})_2]^{2+} + \text{npda}$; this solution

absorbs CO₂, even from the air, to give the dinuclear complex [Cd(npda)₂(O₂CO)Cd(npda)₂(H₂O)](ClO₄)₂·H₂O with an asymmetric μ -carbonato bridge.¹⁷⁴ In the structure (*P*2₁, *Z* = 2), both Cd centers have a distorted octahedral surrounding CdN₄O₂ with two bidentate npda ligands (230.9 ≤ *r*(Cd—N) ≤ 240.7 pm, *r*_{av}(Cd—N) 236.6 pm) each, the bidentate/monodentate carbonato bridge (*r*(Cd—O) 217.2, 276.8/223.8 pm), and an H₂O ligand (*r*(Cd—O) 235.1 pm). The bite-angles involving the bidentate μ -O₂CO ligand and in the four chelate rings are as small as α (O—Cd—O) 51.5° and, as expected, α _{av}(N—Cd—N) 74.9°, respectively.

Recent structural studies of dien complexes of light transition-metal saccharinates (sac) also comprise a respective Cd compound, namely [Cd(dien)₂](sac)₂.¹⁷⁵ This complex is obtained by reaction of [Cd(sac)₂(H₂O)₄]·2 H₂O in MeOH with dien. In the crystal structure (*P*1̄, *Z* = 2), the cation [Cd(dien)₂]²⁺ Cd has a strongly distorted octahedral environment, with Cd—N bonds varying in the range 232.7 ≤ *r*(Cd—N) ≤ 243.1 pm (*r*_{av}(Cd—N) 237.7 pm) and with the bonds between Cd and the tertiary N atoms being the longest; the bite-angles in the chelate rings are between 72.6° and 75.8°. The sac anions are linked to the cation only by hydrogen bonds N—H···O.

A related study deals with complexes formed from Cd(NO₃)₂ and α,ω -diamino-azaalkanes H₂N(CH₂)_{*m*}NH(CH₂)_{*n*}NH₂ (L), with increasing chain length leading to increasing chelate-ring size in the complexes.¹⁷⁶ The compounds [CdL₂](NO₃)₂ are prepared by simply mixing Cd(NO₃)₂ in MeOH with the amine in the appropriate molar ratio and then partial evaporation. In the structure of the first compound with 1,5-diamino-3-azapentane = dien (*m* = *n* = 2) (*I*4₁/acd, *Z* = 16; huge cell!) the cation [Cd(dien)₂]²⁺ (symmetry 2 — C₂) again clearly deviates from octahedral coordination, with the bonds Cd—1 N and Cd—5 N much shorter (*r*_{av}(Cd—N) 233.8 pm) than Cd—3 N (*r*(Cd—N) 243.1 pm); the bite-angles are close together at ≈74.0°. For 1,6-diamino-3-azahexane (*m* = 2, *n* = 3) as a ligand with the structure (*P*2₁/*c*, *Z* = 4), the cation is still distorted with bonds Cd—1 N and Cd—6 N (*r*_{av}(Cd—N) 235.7 pm) shorter than Cd—3 N (*r*_{av}(Cd—N) 240.6 pm); the bite-angles in the five-membered chelate rings (≈74.4°) are smaller than those in the six-membered rings (≈83.0°), of course. Finally, in the case of L = 1,7-diamino-4-azaheptane (*m* = *n* = 3) the bonds between Cd and the terminal and central N-donors approach each other (*r*_{av}(Cd—N) 236.8 pm and 239.4 pm, respectively) and the bite-angles scatter considerably, with an average of 84.9°. As a result, the distortion of the octahedral surrounding of Cd and the strains in the chelate rings are reduced.

The ligand 1,4,7-triazacyclononane (tacn) or [9]aneN₃, formally derived from dien by ring closure with a CH₂CH₂ group, has been used for complexation of Cd to yield [Cd(tacn)₂](ClO₄)₂ and [Cd(tacn)₂](BPh₄)₂·2 dmsO.¹⁷⁷ In both compounds (*P*1̄, *Z* = 2 and *Z* = 1, respectively) the complexes have crystallographically imposed centrosymmetry, with approximately trigonally elongated octahedra CdN₆ (*r*_{av}(Cd—N) 236.3 pm and 236.2 pm, respectively) and average bite-angles of 75.7°.

An easily accessible hexadentate derivative of tacn, namely 1,4,7-tris(*o*-aminobenzyl)-1,4,7-triazacyclononane (tabtacn), forms a 1:1 complex [Cd(tabtacn)](ClO₄)₂·0.5 H₂O (*Pc*2₁/*n*/*Pna*2₁, *Z* = 4) with a distorted trigonal prismatic CdN₆ core. The Cd—N bonds to the N donors in both the tacn moiety and in the aniline pendant arms are very similar in a rather narrow range (*r*_{av}(Cd—N) 237 pm).¹⁷⁸ Both solution and solid-state ¹H, ¹³C, and ¹¹³Cd NMR spectra have been measured and analyzed with respect to details of the stereochemistry and to dynamics in solution.

Systematic studies by potentiometric and calorimetric measurements have been performed of the complexation of Cd and polyazacycloalkanes (CH₂CH₂NH)_{*k*} or [3*k*]aneN_{*k*} with increasing ring size (6 ≤ *k* ≤ 11).¹⁷⁹ Both mononuclear (6 ≤ *k* ≤ 8) and dinuclear (8 ≤ *k* ≤ 11) complexes are formed, with the mononuclear species showing increasing stability in the series 3 ≤ *k* ≤ 5 (literature data) and decreasing stability for 6 ≤ *k* ≤ 8; the formation constants of the dinuclear complexes increase continuously for 8 ≤ *k* ≤ 11. The dinuclear complex Na[CdCl₂([30]aneN₁₀)Cd](ClO₄)₃ has been isolated and its structure solved (*Pbna*/*Pbcn*, *Z* = 4): the complex has symmetry 2 — C₂, with both independent Cd atoms on the twofold axis; one of the Cd atoms has a distorted octahedral environment CdN₄Cl₂, the other one approaches trigonal-prismatic coordination CdN₆ (*r*_{av}(Cd—N) 240 pm, *r*(Cd—Cl) 253.5 pm).

A survey of transition-metal polyazacycloalkane complexes in general, with data also for Cd and Hg species in particular, has been published.¹⁸⁰ Structural, ¹H and ¹³C NMR, UV/vis, and conductivity data of several transition-metal complexes, including Cd and Hg complexes, with derivatives of the 16-membered ligand 1,9-dithia-5,13-diazacyclohexadecane have been compiled and compared. In particular, conversion between configurational isomers and exchange processes in solution have been discussed.¹⁸¹

Condensation of diethylenetriamine (dien) and glyoxal, OCH—CHO, gives a hexazapentacyclooctadecane (hapcod, C₁₂H₂₂N₆; three linearly fused six-rings plus two five-rings), which forms complexes with Cd salts.¹⁸² The Cd halides CdX₂ (X = Cl, Br, I) and the ligand in MeOH yield

the complexes $[\text{CdX}_2(\text{hapcod})]$, partly as MeOH solvates. Their structures, albeit in three different space groups, have in common that the complexes adopt crystallographic symmetry $2 - C_2$. Basically, Cd has tetrahedral coordination, with two X ligands ($r(\text{Cd}-\text{X})$ 246.8, 258.6, 277.4 pm, for X = Cl, Br, I, respectively) and two N-donors from the ligand ($r(\text{Cd}-\text{N})$ 236.9, 233.6, 237.2 pm); the angle between these Cd—N bonds is widened to $\approx 120^\circ$, giving space for approach of two additional more remote N-donors (secondary bonds, $r(\text{Cd}\cdots\text{N})$ 262.5, 273.6, 273.9 pm). Two N atoms of the ligand are not involved in complexation.

The formally comparable complex with $\text{Cd}(\text{NO}_3)_2$, $[\text{Cd}(\text{O}_2\text{NO})_2(\text{hapcod})]$ ($C2/c$, $Z=4$),¹⁸³ has a deviating structure in that Cd is eight-coordinate, with two concentric tetrahedra of primary and secondary bonds, respectively. Thus, nitrate acts as an aniso-bidentate ligand with strongly asymmetric coordination ($r(\text{Cd}-\text{O})$ 233.1, $r(\text{Cd}\cdots\text{O})$ 259.3 pm) and the primary and secondary Cd—N bonds from the pentacyclic ligand are even more different ($r(\text{Cd}-\text{N})$ 230.8, $r(\text{Cd}\cdots\text{N})$ 267.6 pm). With $\text{Cd}(\text{BF}_4)_2$ the complex $[\text{Cd}(\text{hapcod})_2](\text{BF}_4)_2$ ($P2_1/n$, $Z=4$) is obtained.¹⁸³ Again Cd is eight-coordinate, with two pairs of clearly different primary Cd—N bonds from the two independent hapcod ligands ($r_{\text{av}}(\text{Cd}-\text{N})$ 237.4 pm and 243.8 pm) and two complementary pairs of secondary bonds ($r_{\text{av}}(\text{Cd}\cdots\text{N})$ 274.6 pm and 270.2 pm). The nitrate complex in aqueous solution behaves as a 1:2 electrolyte (conductance measurements) indicating almost full dissociation; the complicated, time-dependent ^{13}C NMR spectrum (D_2O solution) suggests solvolysis reactions, obviously also occurring in solution of the complex $[\text{Cd}(\text{hapcod})_2]^{2+}$. Combined ^{13}C and ^{113}Cd NMR studies of $[\text{Cd}(\text{hapcod})_2]^{2+}$ in $\text{dms}-d_6$ solution suggest fast partial and full exchange of the hapcod ligand by solvent molecules.

Complexation of Cd with a series of polyamine macrocycles, but also related open-chain polyamines, comprising or attached to the 2,2'-bipyridine (bipy) and 1,10-phenanthroline (phen) moieties, has been studied by combined UV/vis spectrometry and potentiometry.²⁴ Formation constants and distribution diagrams of the species present have been evaluated. As a result the thermodynamic stabilities, i.e., the formation constants, are lower for the bipy- and phen-containing ligands than those for Cd complexes with aliphatic oligoaza macrocycles containing the same number of N donors. The probable reason is loss of flexibility of the ligands caused by the size and stiffness of the inserted heteroaromatic moieties.

Complexes of transition metals, including Cd, with 17- and 20-membered N,O-donor macrocycles containing the dien and related fragments, have been prepared.¹⁸⁴ Conductances and formation constants in MeOH and crystal structures, *inter alia* of a complex obtained from $\text{Cd}(\text{NO}_3)_2$ and a ligand L with the dien group, a pyridine ring, and two ether O donors, have been determined. In this $[\text{CdL}(\text{NO}_3)]_2[\text{Cd}(\text{NO}_3)_4]$ ($C2/c$, $Z=4$), the cation contains Cd in eight-coordinate with four unsystematically varying Cd—N bonds to the N donors of the dien and py moieties ($237.1 \leq r(\text{Cd}-\text{N}) \leq 244.1$ pm), two Cd—O bonds to ether O donors ($r(\text{Cd}-\text{O})$ 244.7 pm and 252.1 pm), and two rather different Cd—O bonds to a bidentate NO_3 ligand ($r(\text{Cd}-\text{O})$ 250.3 pm and 268.5 pm). For comparison, relevant structural data for eight-coordinate Cd and for the other transition metals under discussion in this paper from the Cambridge Structural Data Bank (CSD) are presented.

A flood of papers, dealing with mostly heteroleptic Cd complexes with heterocyclic/heteroaromatic N donors, has been published. Often minor changes in the substitution pattern of the N-heterocyclus induce severe structural changes in the environment of Cd (coordination number, topology) and/or in the arrangement and linking of the building blocks of a crystal structure. Some examples with nitrogen-dominated coordination spheres or structure-commanding effect of the heterocyclus are selected to be dealt with here.

A coordination dominated by pyridine has been found in the complex bis(thiosaccharinato)-trispyridine cadmium $[\text{Cd}(\text{tsac})_2(\text{py})_3]$ ($C2/c$, $Z=8$).¹⁸⁵ In a distorted octahedral coordination the py ligands are bound in *mer*-configuration with the donor atoms of the tsac ligands in a (pseudo)-plane approximately perpendicular to the plane $\text{Cd}(\text{py})_3$; surprisingly, the tsac anions are bound to Cd in different modes, one as a monodentate S-coordinated ligand, the other one as a bidentate N,S-chelate ligand. The bond lengths Cd—N(py) scatter ($234.8 \leq r(\text{Cd}-\text{N}) \leq 247.8$ pm), the bond Cd—N(tsac) 259.6 pm is even longer; the Cd—S bonds are 259.9 pm and 277.9 pm for the mono- and bidentate tsac ligands, respectively.

The seemingly very similar pyridine derivatives 2- and 4-acetylpyridine (acpy) and 4-bromopyridine (4-Brpy), together with azide N_3^- , produce structurally completely different Cd complexes.¹⁸⁶ The compounds are simply prepared by mixing CdSO_4 with the ligands (in excess) in aqueous-alcoholic media. In $[\text{Cd}(2\text{-acpy})(\text{N}_3)_2]_n$ ($P2_1/a$, $Z=4$), centrosymmetric dinuclear units $[(\text{acpy})\text{Cd}(\text{N}_3)_2\text{Cd}(\text{acpy})]$ with chelate acpy ligands and a pair of μ -1,1 azide bridges are linked by two pairs of μ -1,3 N_3 bridges to form a 2-D network with pseudosquare meshes and the dinuclear

units as knots; Cd has a distorted octahedral coordination. In $[\text{Cd}(4\text{-acpy})_2(\text{N}_3)_2]_n$ ($P2_1/a$, $Z=2$), Cd (on an inversion center) has an environment of two axial N-coordinated acpy ligands and four equatorial azide ligands, which as μ -1,3 bridges provide the links to four neighboring Cd centers; thus, a simple 2-D network with pseudosquare meshes is generated. Finally, with the ligand 4-Brpy a compound with a more complicated composition $[\text{Cd}_3(4\text{-Brpy})_4(\text{N}_3)_6]_n$ is obtained. Also the structure ($P\bar{1}$, $Z=1$) is much more complicated than before. First, there are two kinds of nonequivalent Cd atoms on an inversion center and in general position, respectively, both with pseudo-octahedral surroundings; second, μ -1,1 and μ -1,3 azide bridges join the Cd atoms to di-, tri-, and tetranuclear subunits and finally to a 2-D network with meshes of three different sizes. The bond lengths Cd—N(azide) span wide ranges in the 2-acpy and 4-Brpy complexes ($226.2 \leq r(\text{Cd—N}) \leq 237.7$ pm and $227.8 \leq r(\text{Cd—N}) \leq 236.9$ pm, respectively), but are much the same in the 4-acpy complex ($r(\text{Cd—N})$ 232.3 pm and 232.6(4) pm); for all of the complexes the Cd—N(py) bonds do not differ significantly ($232.2 \leq r(\text{Cd—N}) \leq 235.1(4)$ pm).

The ligand 1,2-bis(4-pyridyl)ethane (bpe) $\text{NC}_5\text{H}_4\text{CH}_2\text{CH}_2\text{C}_5\text{H}_4\text{N}$ and $\text{Cd}(\text{NO}_3)_2$ form the coordination polymer $[\text{Cd}(\text{O}_2\text{NO})_2(\mu\text{-bpe})_2\text{Cd}(\text{O}_2\text{NO})_2(\mu\text{-bpe})]_n$.¹⁸⁷ In its structure ($P2_1/n$, $Z=4$) two bpe units bridge two Cd atoms to form a cyclic structural element which is linked to the next one by another bpe unit, thus giving chains. Each Cd is coordinated by two aniso-bidentate nitrate ligands and one pyridyl moiety in one plane, with two more pyridyl groups in an axial position to yield an overall pentagonal-bipyramidal coordination. In this case the nitrate ligands are bound in an almost symmetrical manner ($r_{\text{av}}(\text{CdO})$ 244.3 pm) and the Cd—N(py) bonds show little variance ($r_{\text{av}}(\text{Cd—N})$ 233.0 pm).

Cd adopts similar seven-coordinate topologies in complexes prepared from $\text{Cd}(\text{NO}_3)_2$ and the bifunctional pyridine ligands 1,4-bis(4-pyridylmethyl)benzene (bpmb) $(\text{NC}_5\text{H}_4\text{CH}_2)_2\text{C}_6\text{H}_4$ ($\text{CH}_2\text{C}_5\text{H}_4\text{N}$) and its tetrafluoro analog $(\text{NC}_5\text{H}_4\text{CH}_2)_2\text{C}_6\text{F}_4$ ($\text{CH}_2\text{C}_5\text{H}_4\text{N}$), with two aniso-bidentate nitrate ligands and three py moieties in a T-shaped arrangement.¹⁸⁸ The minor changes in the ligands cause great differences in the overall structures: the common substructures are chains, e.g., $[\text{Cd}(\text{O}_2\text{NO})_2(\mu\text{-bpmb})]_n$, but in the first case two of these chains are linked by bpmb ligands to double chains (ladder), while in the second case one chain is alternately linked to two neighboring chains and eventually to a 2-D network with a brickwork pattern. To make things even more complicated, in both cases these polymeric ladder and brickwork structures, respectively, interpenetrate each other; closer inspection reveals that in the latter case three independent partial structures are interlocked to form thick sheets.

A pyridine derivative related to dien with respect to the number and distribution of N-donor atoms, namely bis(2-pyridylmethyl)amine (bpma), also gives comparable complexes with Cd, e.g., $[\text{Cd}(\text{bpma})_2](\text{ClO}_4)_2$ with potentially three isomers (including a pair of enantiomers). As shown by the structure analysis ($C2/c$, $Z=4$), a distorted octahedral *fac*-isomer with symmetry $2 - C_2$ has been isolated, necessarily with both enantiomers in the crystal lattice. No significant difference in the two kinds of Cd—N bonds ($r_{\text{av}}(\text{Cd—N})$ 235.0 pm) is observed.¹⁸⁹ Solid-state ^{13}C NMR spectra of this complex and related Mn and Zn complexes have been discussed.

Reaction of bpma with $\text{Cd}(\text{ClO}_4)_2 \cdot 6\text{H}_2\text{O}$ in acetonitrile, MeCN, yields a complicated compound $[\text{Cd}(\text{bpma})(\text{NCMe})(\text{OH}_2)(\text{OCIO}_3)][\text{Cd}(\text{bpma})_2](\text{ClO}_4)_3 \cdot (\text{MeCN})$ with two different complex cations, both with six-coordinate Cd.¹⁹⁰ In the first complex the four N-donor atoms are arranged in the equatorial plane of a distorted octahedron, with the Cd—NCMe bond being the shortest (226.3 pm) and the other three in a narrow range 228.1–232.1 pm; H_2O and the monodentate OCIO_3^- ligand occupy the axial positions ($r(\text{Cd—O})$ 231.3 pm and 247.8 pm, respectively). In the second cation Cd adopts a pseudotrigonal prismatic coordination with clearly longer Cd—N bonds ($r_{\text{av}}(\text{Cd—N}(\text{py}))$ 236.2, $r_{\text{av}}(\text{Cd—N}(\text{amine}))$ 239.5 pm). The tetradentate ligand tris[(2-pyridyl)methyl]amine (tpma) forms the complex $[\text{Cd}(\text{tpma})_2](\text{ClO}_4)_2 \cdot \text{toluene}$, with eight-coordinate Cd and much longer, unsystematically scattering Cd—N bonds ($249.1 \leq r(\text{Cd—N}) \leq 263.0$ pm). The complexation equilibria in MeCN— d_3 have been studied by ^1H NMR spectrometry and coupling constants $J(^{117/113}\text{Cd}, ^1\text{H})$ reported.

Pyridine derivatives with additional donor functions and sterically demanding substituents have been used with the intention of producing complexes of Cd (and of other metals) with low coordination number; one of these ligands is the tridentate, planar-bonding 2,6-bis[(2,6-dimethylphenylimino)methyl]pyridine (pydim; a Schiff base derived from 2,6-pyridine dialdehyde), which with $\text{Cd}(\text{BF}_4)_2$ and thiocyanate gives a dinuclear complex $[(\text{pydim})\text{Cd}(\mu\text{-NCS-S,N})_2(\text{BF}_4)_2]$ with N-dominated coordination sphere.¹⁹¹ As centrosymmetric ($P2_1/c$, $Z=2$), the complex has an antiparallel μ -1,3 NCS double bridge with Cd—N and Cd—S bonds (224.6 pm and 255.5 pm, respectively); the Cd—N(py) bond is clearly shorter than the Cd—N(imino) bonds (225.6 pm and 245.0 pm,

respectively). Remarkably, the arrangement of these ligands leaves space for a secondary bond $\text{Cd}\cdots\text{F}$ (254.4 pm) to the counterion BF_4^- .

A further pyridine-based ligand, that is, 2,6-bis(1-salicyloylhydrazonoethyl)pyridine (a Schiff base derivative of 2,6-diacetylpyridine, abbreviated H_4daps), as a pentadentate mono- H_3daps^- or dianion $\text{H}_2\text{daps}^{2-}$, respectively, forms several structurally interesting Cd complexes, which all have an almost planar pentagonal CdN_3O_2 environment in common. Hepta-coordination is achieved by the addition of two more ligands in axial positions, e.g., in the neutral complexes $[\text{Cd}(\text{H}_2\text{daps})(\text{H}_2\text{O})_2]$, $[\text{Cd}(\text{H}_2\text{daps})(\text{H}_2\text{O})(i\text{-PrOH})]$, $[\text{Cd}(\text{H}_3\text{daps})\text{Cl}(\text{MeOH})]\cdot 2\text{H}_2\text{O}\cdot\text{MeOH}$, and in the anion of $\text{NMe}_4[\text{Cd}(\text{H}_2\text{daps})\text{Cl}(\text{H}_2\text{O})]$; in $[\text{Cd}(\text{H}_3\text{daps})\text{Cl}]\cdot 0.25\text{H}_2\text{O}\cdot\text{MeCN}$ only hexa-coordination is achieved.¹⁹²

The ligand pyrazineformamide N(4)-methylthiosemicarbazone (Hpyztsc, from cyanopyrazine and N(4)-methylthiosemicarbazide under reducing conditions) acts as a tridentate N,N,S-chelate ligand towards Cd to give $[\text{Cd}(\text{pyztsc})_2]$ (as a MeCN solvate).¹⁹³ The two almost-planar ligands are arranged in *mer*-configuration, each with the planes roughly perpendicular to each other. The Cd—N bonds to the central N(imine) donors are substantially shorter ($r_{\text{av}}(\text{Cd—N})$ 231.3 pm) than to the N donors of the pyrazine rings ($r_{\text{av}}(\text{Cd—N})$ 250.4 pm); the Cd—S bonds are 257.5 pm on average. Remarkably, the second N atom of pyrazine does not coordinate to Cd, but is involved in hydrogen bonding; thus the coordination behavior of this pyrazine derivative is rather that of a pyridine-containing ligand.

Naked pyrazine (pyz) acts as a bidentate bridging ligand between Cd centers in $[\text{Cd}(\text{pyz})(\text{H}_2\text{O})_2\text{MoO}_2\text{F}_4]$ ($P3_221$, $Z=3$).¹⁹⁴ However, the dominating structural features are octahedral *trans*- $\text{Cd}(\text{pyz})_2(\text{H}_2\text{O})_2\text{F}_2$ and *cis*- MoO_2F_4 units that share fluoride vertices to form helical chains along the threefold screw axes. Linking of the helices is achieved by pyz bridges (along twofold axes), as mentioned above, with bond lengths $r_{\text{av}}(\text{Cd—N})$ 232.5 pm. The Cd—OH₂ and Cd—F bonds are quite similar (227.1 pm and 226.2 pm, respectively). As a consequence of the symmetry of the structure nonlinear optical behavior is expected, and indeed second harmonic generation (SHG) is observed.

Hydrido-(1-pyrazolyl)borates $[\text{H}_{4-n}\text{B}(\text{C}_3\text{H}_3\text{N}_2)_n]^-$, in short $[\text{H}_{4-n}\text{B}(\text{pz})_n]^-$, often with more or less bulky substituents in 3- and/or 5-positions of the pz ring, have been used for the preparation of mononuclear complexes with controlled coordination sphere about a metal.¹⁹⁵ With Cd as a metal center different coordination numbers and geometries can be realized, depending on the pyrazolylborate used, but also on the co-ligands.

Unsubstituted dihydridobis(1-pyrazolyl)borate, for instance, gives a mononuclear, severely distorted tetrahedral complex $[\text{Cd}\{\text{H}_2\text{B}(\text{pz})_2\}_2]$ ($Pbca$, $Z=8$).¹⁹⁶ The four independent Cd—N bonds vary significantly ($r_{\text{av}}(\text{Cd—N})$ 221.5 pm); the intraligand (bite-) angles are both slightly over 90°, but the interligand angles vary considerably in the range 106.9° to 131.7°, obviously due to the molecular packing.

With the sterically more demanding *t*-Bu-substituted tripod ligand tris(3-*t*-Bu-pyrazolyl)borate and CdCl_2 , $[\text{CdCl}\{\text{HB}(3\text{-}t\text{-Bu}\text{pz})_3\}]$ is obtained with nearly threefold rotational symmetry (true symmetry $m - C_3$ in $Pnma$). The Cd—N bonds do not differ significantly ($r_{\text{av}}(\text{Cd—N})$ 224.3 pm) and the Cd—Cl bond is 235.5 pm.¹⁹⁷

$[\text{CdI}\{\text{HB}(3\text{-}t\text{-Bu}\text{pz})_3\}]$ adopts the same site symmetry, but in $P\bar{4}2_1m$ ($Z=4$). The Cd—N bonds are almost the same ($r_{\text{av}}(\text{Cd—N})$ 224.7 pm) as in the chloro complex, and the Cd—I bond length is 267.3 pm.¹⁹⁸ With the further methyl-substituted ligand, the compounds $[\text{CdMe}\{\text{HB}(3\text{-}t\text{-Bu}\text{-}5\text{-Mepz})_3\}]$ ($I\bar{4}3d$, $Z=16$) and $[\text{Cd}(\text{O}_2\text{NO})\{\text{HB}(3\text{-}t\text{-Bu}\text{-}5\text{-Mepz})_3\}]$ ($P2_1/n$, $Z=4$) have been prepared. The former takes the symmetry $3 - C_3$ ($r(\text{Cd—N})$ 231.1, $r(\text{Cd—C})$ 207.4 pm); the latter occupies a general position in the lattice ($r_{\text{av}}(\text{Cd—N})$ 224.2 pm) and has an almost symmetrical bidentate nitrate ligand ($r_{\text{av}}(\text{Cd—O})$ 228.4 pm), as indicated in the formula. Finally, a complex with two *i*-Pr substituents in 3,5-positions of the pz moieties of the ligand has been presented, namely $[\text{CdI}\{\text{HB}(3,5\text{-}i\text{-Pr}_2\text{pz})_3\}]$ ($P2_1/m$, $Z=2$; symmetry of the complex again $m - C_3$). The bond lengths are $r_{\text{av}}(\text{Cd—N})$ 222.0 and $r(\text{Cd—I})$ 262.2 pm.

For $[\text{Cd}(\text{NCS})\{\text{HB}(3\text{-}t\text{-Bu}\text{pz})_3\}]$ IR spectra indicate N-coordinated thiocyanate, which is confirmed by the crystal-structure analysis ($Pna2_1$, $Z=4$).¹⁹¹ The three independent Cd—N(pz) bond lengths are all very similar ($r_{\text{av}}(\text{Cd—N})$ 222.4 pm), and the Cd—NCS bond is clearly shorter ($r(\text{Cd—N})$ 210.7 pm).

Five-coordinate Cd complexes have been realized by combined ligation of dipode and tripod pyrazolylhydridoborates, e.g., in $[\{\text{HB}(3,5\text{-Me}_2\text{pz})_3\}\text{Cd}\{\text{H}_2\text{B}(3,5\text{-Me}_2\text{pz})_2\}]$, $[\{\text{HB}(3\text{-Phpz})_3\}\text{Cd}\{\text{H}_2\text{B}(\text{pz})_2\}]_2$ and $[\{\text{HB}(3\text{-Phpz})_3\}\text{Cd}\{\text{H}_2\text{B}(3,5\text{-Me}_2\text{pz})_2\}]$; the crystal structure of the latter has been solved ($P\bar{1}$, $Z=2$).¹⁹⁹ The Cd—N bonds to the dipode ligand are clearly shorter ($r_{\text{av}}(\text{Cd—N})$ 224.8 pm) than those to the tripod ligand ($r_{\text{av}}(\text{Cd—N})$ 234.2 pm); they are arranged in a severely

distorted, square-pyramidal geometry. Highly irregular five-coordination is also observed in the dithiocarbamate complex $[\{\text{HB}(3,5\text{-Me}_2\text{pz})_3\}\text{Cd}\{\text{S}_2\text{CNEt}_2\}]$ ($P2_1/c$, $Z=4$), with strongly scattering Cd—N bonds (224.9–235.1 pm) and an asymmetrically bonded dithiocarbamate ligand ($r(\text{Cd—S})$ 254.0 pm and 270.8 pm). ^1H and particularly ^{113}Cd NMR data for these and a series of other pyrazolylhydridoborate complexes with varying coordination numbers and environments have been measured and discussed. In the four-coordinate complexes the Cd nuclei are much more deshielded than in the five- and six-coordinate species, the ^{113}Cd shift ranges of which overlap substantially.

Substitution of boron in the pyrazolylhydridoborates by carbon gives neutral pyrazolylmethanes, which on coordination to Cd yield cationic complexes completely analogous to the neutral complexes with pyrazolylhydridoborates. The structure of a representative of a tris(pyrazolyl)methane Cd complex, namely $[\{\text{HC}(3,5\text{-Me}_2\text{pz})_3\}_2\text{Cd}](\text{BF}_4)_2$, has been elucidated ($R\bar{3}$, $Z=3$; trigonal setting).²⁰⁰ The cation has symmetry $\bar{3}-C_{3i}$, i.e., all six Cd—N bonds are equivalent ($r(\text{Cd—N})$ 232.1 pm) and span a trigonally elongated octahedron with an intraligand bite-angle of 80.0° . The analogous neutral pyrazolylhydridoborate complex crystallizes in the same space group and adopts the same symmetry; both Cd—N bonds and bite-angles are much the same ($r(\text{Cd—N})$ 234.8 pm, $\alpha(\text{N—Cd—N})$ 82.7°).²⁰¹ At the same time, the structure of $[\{\text{HB}(3,5\text{-Me}_2\text{pz})_3\}_2\text{Cd}]$ has been described in the same space group ($R\bar{3}$, $Z=2$), but with two independent, slightly differing molecules in the rhombohedral unit cell;²⁰² the structural data are moderately precise due to disorder, but on the average they match the above data properly, as do ^1H NMR data.

Interestingly, the homoleptic tris(pyrazolyl)methane and -hydridoborate complexes undergo conproportionation reactions to yield mixed-ligand complexes, as is also shown by ^1H , ^{13}C , and ^{113}Cd NMR spectrometries of the respective solutions; surprisingly, tris(pyrazolyl)methane and -hydridoborate complexes with the same substitution pattern have similar ^{113}Cd shifts, irrespective of the different charge, but change in the substitution also changes the $\delta(^{113}\text{Cd})$ values considerably.²⁰⁰

Homoleptic complexes have been obtained also with tetrakis(1-pyrazolyl)borates, e.g., $[\{\text{B}(\text{pz})_4\}_2\text{Cd}]$ and $[\{\text{B}(3\text{-Mepz})_4\}_2\text{Cd}]$ (both $P2_1/c$, $Z=2$); in both compounds' structure analyses the ligands have been shown to coordinate trihapto, i.e., with one pz ring free. In both cases Cd has a distorted octahedral environment, with averaged structural data very similar to those for the tris(1-pyrazolyl)hydridoborate complexes.²⁰¹ Variable-temperature ^1H NMR studies of these and of mixed complexes with tris- and bis(1-pyrazolyl)hydridoborates indicate fluxional behavior (coalescence temperatures and barriers for the dynamic processes are given).

Cd (and Hg) complexes with bis- and tris(1-pyrazolyl)methanes and -ethanes, as well as with bis(1-triazolyl)methane, have been prepared and studied by conductance measurements (H_2O , dmsO, and dimethylformamide (dmf) solutions), IR, far-IR, ^1H , and ^{13}C NMR spectrometries.²⁰³ The Cd halides form complexes of the type $[\text{CdLX}_2]$; complexes of the types $[\text{CdL}_2](\text{ClO}_4)_2$ and $[\text{CdL}_3](\text{BF}_4)_2$ are obtained from the respective Cd salts.

Complex formation in the system aqueous $\text{Hg}^{2+}/1,2\text{-ethanediamine (en)}$ as a function of the pH has been studied by potentiometry. The data have been discussed on the basis of a system of coupled equilibria comprising $[\text{Hg}(\text{en})_2]^{2+}$, $[\text{Hg}(\text{en})(\text{enH})]^{3+}$, $[\text{Hg}(\text{en})]^{2+}$, and $[\text{Hg}(\text{enH})]^{3+}$, depending on the pH value.^{204–206}

The crystal structures of ethylenediamine mercury(II) dibromide and iodide have been reported.²⁰⁷ Both compounds are coordination polymers with centrosymmetric en bridging the Hg centers. In the first compound ($Pbam$, $Z=2$), Hg is bonded to two N donors in the *trans*-position ($r(\text{Hg—N})$ 219 pm) and to four Br atoms ($r(\text{Hg—Br})$ 301.2 pm), forming a distorted octahedron. In the second, Hg is bonded to two N atoms ($r(\text{Hg—N})$ 234 pm and 235 pm) and to two I atoms ($r(\text{Hg—I})$ 269.1 pm and 274.0 pm), forming a distorted tetrahedron.

Stepwise formation constants have been determined in the system $\text{Hg}^{2+}/\text{Cl}^-/\text{diethylenetriamine (dien)}$ and related systems by potentiometry. Thermodynamic parameters have been calculated and the contribution of the entropy term to complex stability discussed.²⁰⁸

The reactions of mercury(II) salts with oligo-amines afford informative examples for the fact that counterions induce the formation of a distinct complex or select a distinct complex in an equilibrium to crystallize with. Thus, Hg^{II} acetate with dien under exactly the same reaction conditions, in the presence of ClO_4^- or PF_6^- , yields the dinuclear complex $[\text{Hg}_2(\text{dien})_3](\text{ClO}_4)_4$ or the mononuclear species $[\text{Hg}(\text{dien})(\text{H}_2\text{O})](\text{PF}_6)_2$, respectively, both characterized by IR, ^1H , and ^{13}C NMR spectrometries, by fast-atom bombardment (FAB) MS, cyclovoltammetry, and X-ray structure analyses.²⁰⁹ In the first compound ($Pna2_1$, $Z=4$), one Hg adopts five-coordination with one tridentate and one bidentate dien ligand, which with the remaining N-donor binds to the

second tetrahedral Hg center. Similarly to the Cd dien complexes, the central Hg—N bonds to the secondary N donors are longer than those to the primary N donors (NH₂ groups), whereby differences due to different coordination numbers have to be considered. The Hg—N bond in the bridge between the coordination centers is exceptionally short (217.4 pm). In the second complex (*P*₂₁2₁, *Z* = 8), the two independent, tetrahedral, cationic entities have very similar structures, with *r*_{av}(Hg—N) 230.8 pm and 235.7 pm, respectively, for the two kinds of Hg—N bonds to primary and secondary N donors; the Hg—OH₂ bonds (214.1 pm) are much shorter than all the different Hg—N bonds in both complexes.

In a way related are the complexes formed by Hg salts and multicrown dendrimers of different generations (dendrimers with a polypropylene amine interior of different volume and benzo[15]-crown-5 ether periphery), studied by extraction methods using radioactive ²⁰³Hg²⁺.²¹⁰ Up to 12 Hg²⁺ ions were found to be bound per dendrimer molecule, obviously in the amine-dominated interior, not in the crown-ether periphery.

The 1:2 complex of Hg²⁺ with the tacn derivative mono-N-(4-vinylbenzyl)-1,4,7-triazacyclononane copolymerizes with *p*-divinylbenzene to give an Hg-templated polymer which, after demetalation with 6 N HCl, is a highly selective gathering material for Hg²⁺ in competition with other transition metals like Cd²⁺, Ag⁺, Pb²⁺, Cu²⁺, and Fe³⁺ at low pH values.²¹¹

The crystal structure of hexakis(pyridine)mercury(II) trifluoromethanesulfonate [Hg(py)₆](O₃SCF₃)₂ has been determined both at ambient and low temperatures (183 K; *P*₁, *Z* = 2; no phase transition). In the complex cation the six Hg—N bonds form tetragonally elongated octahedra (two long bonds in *trans*-position, four shorter ones in the equatorial plane), with the distortion more pronounced at low temperature (*r*_{av}(Hg—N) 249.8 pm vs. 241.9 pm).²¹² Thermoanalysis (TG, DSC, also of [Hg(py)₆](ClO₄)₂) also suggests that two molecules are more weakly bound than the others; in the further thermal degradation py molecules leave in pairs via the intermediate [Hg(py)₂](O₃SCF₃)₂. Electronic effects are discussed as a reason for the distortion; contributions of packing effects are ruled out.

A wealth of structures of Hg complexes with py, e.g., [Hg(py)₂]*X*₂ (*X* = Cl, Br, I), [Hg(py)₄](ClO₄)₂, [Hg(py)₄](ClO₄)₂·2 py, but also with other N heterocycles, e.g., [Hg(pyridazine)]*X*₂, [Hg(pyrimidine)]*X*₂, [Hg(pyrazine)]*X*₂, and with other N-donor ligands, has been determined and dealt with in a recent dissertation.²¹³

As with Cd, the tri- and tetradentate ligands bis- and tris(2-pyridylmethyl)amine (bpma and tpma) have been used for complexation of Hg. Thus, [Hg(bpma)₂](ClO₄)₂ (as toluene solvate) has been prepared and its structure elucidated (*P*₁, *Z* = 2). Differing from the [Cd(bpma)₂]²⁺ cation, [Hg(bpma)₂]²⁺ approaches a trigonal prismatic coordination with similar Hg—N bonds (*r*_{av}(Hg—N) 238.8 pm), except for one rather long Hg—N(py) bond (255.7 pm); a weak interaction with one of the counterions (secondary Hg···O bond) could be the reason for this deviation.²¹⁴ Hg(ClO₄)₂ and bpma (ratio 1:1) in MeCN give [Hg(bpma)(NCMe)](ClO₄)₂ in crystals appropriate for structure determination (*P*₂₁/*c*, *Z* = 4). In this case, the N donors of bpma and MeCN are arranged in an equatorial pseudoplane with a short Hg—NCMe bond (222.6 pm), a longer bond in the *trans*-position (240.1 pm), and two similar Hg—N(py) bonds (about 222 pm); the strongly distorted octahedral coordination is completed by two secondary Hg···O bonds (270 pm and 290 pm). The complexation equilibria in MeCN-*d*₃ solution have been studied by ¹H NMR spectrometry, and possible mechanisms of slow rearrangements discussed.

Hg(ClO₄)₂ and tpma in acetone yield [Hg(tpma)₂](ClO₄)₂; HgCl₂ and tpma in MeCN give [Hg(tpma)Cl](HgCl₄). The former (*P*₂₁/*n*, *Z* = 2) has an eight-coordinate centrosymmetric cation, best described as a bicapped trigonal antiprism, with very similar, long Hg—N bonds (256.0 ≤ *r*(Hg—N) ≤ 259.5 pm, *r*_{av}(Hg—N) 257.8 pm). The latter (*P*₁, *Z* = 2) contains five-coordinate Hg in a distorted trigonal bipyramid, with the chloro ligand opposite to the amine N in axial positions. As expected for a lower coordination number, the Hg—N bonds in both of the two independent complex cations are shorter than before, namely *r*_{av}(Hg—N(py)) 239.4 and *r*_{av}(Hg—N(amine)) 243.4 pm; the Hg—Cl distances in the cations (average 235.4 pm) are close to those in HgCl₂. ¹H and ¹³C NMR studies of solutions help to identify the species present in the equilibria; under conditions which slow down the exchange processes, ¹⁹⁹Hg, ¹H and ¹⁹⁹Hg, ¹³C couplings become observable²¹⁵ (cf. also ref. 190).

In the presence of Hg(SCN)₂, pyridine-2,6-dicarbaldehyde and 2,6-bis(2-aminothiophenoxy-methyl)pyridine undergo a metal-templated cyclocondensation to give immediately the 1:1 complex of Hg(SCN)₂ and the macrocyclic, 18-membered diimine (Schiff base). The structure analysis shows that the Hg(SCN)₂ molecule is strongly asymmetrically located in the macrocyclic ring, close to its Schiff-base segment, with the S—Hg—S axis nearly perpendicular to the pseudoplane of the ring; the two sulfur donors in the ring form only long, secondary bonds to Hg. Thus, Hg

adopts a peculiar 2(S)+3(N)+2(S) coordination (distances $r_{\text{av}}(\text{Hg}-\text{SCN})$ 246.4, $r_{\text{av}}(\text{Hg}-\text{N})$ 266.6, $r_{\text{av}}(\text{Hg}\cdots\text{S})$ 312.8 pm).²¹⁶ This complex and related others have been further characterized by IR, ^1H , and ^{13}C NMR and FAB mass spectrometries.

Simple mixing of $\text{Hg}(\text{ClO}_4)_2$ in MeOH and 2,4,6-tris(4'-pyridyl)-1,3,5-triazine (tpt) in tetrachloroethane $\text{C}_2\text{H}_2\text{Cl}_4$ produces the structurally highly interesting compound $[\text{Hg}(\text{tpt})_2](\text{ClO}_4)_2 \cdot 6 \cdot \text{C}_2\text{H}_2\text{Cl}_4$ ($P\bar{a}3$, $Z=4$), in which Hg (site symmetry $3 - C_{3i}$) adopts an almost perfect octahedral coordination, with six equivalent Hg—N bonds to six tpt ligands ($r(\text{Hg}-\text{N})$ 244.3 pm) and angles deviating only slightly from 90° ($\alpha(\text{N}-\text{Hg}-\text{N})$ 88.8/91.2°). As each tpt coordinates to three Hg centers a wide-pore 3-D framework $\infty^3[\text{Hg}(\text{tpt})_{6/3}]^{2+}$ is generated, with the counteranions and solvate molecules located in its large voids.²¹⁷ Possible relationships of this type of framework to simple inorganic AX_2 structures are discussed.

(iii) N-coordinating cyanometallates

As mentioned in the introductory part of Section 6.9.4.2.3, compounds are known in which Cd or Hg is coordinated to the N-ends of cyano groups C-bonded to another element.

To start with a relatively simple case, $\text{Rb}[\text{Cd}\{\text{Ag}(\text{CN})_2\}_3]$ (from RbCl , AgNO_3 , $\text{Cd}(\text{NO}_3)_2$, and NaCN in H_2O) is discussed. In its structure ($P312$, $Z=1$), Cd and the rod-like N-coordinating $\text{NC}-\text{Ag}-\text{CN}$ units create three independent, interpenetrating, 3-D frameworks; Cd (symmetry $32 - D_3$) has trigonally distorted octahedral coordination ($r(\text{Cd}-\text{N})$ 232.4 pm). Rb occupies one of two types of trigonal channels.²¹⁸

From CdCl_2 , $\text{K}[\text{Ag}(\text{CN})_2]$ (ratio 1:2), and NH_3 at pH 10 (citrate buffer), colorless crystals of $[\text{Cd}(\text{NH}_3)_2\{\text{Ag}(\text{CN})_2\}_2]$ ($P4_2/m\bar{b}c$, $Z=4$) are formed. Therein, *trans*- $\text{Cd}(\text{NH}_3)_2$ entities ($2/m - C_{2h}$) are linked by slightly bent $\text{NC}-\text{Ag}-\text{CN}$ units to form a puckered 2-D network with large, 24-membered meshes. Two of these networks (transformed into each other by the 4_2 operation, i.e., they are perpendicular) interpenetrate.¹⁶³ Similar corrugated sheets occur in $[\text{trans}-\text{Cd}(4\text{-Mepy})_2\{\text{Ag}(\text{CN})_2\}_2] \cdot (4\text{-Mepy})$ (4-Mepy = 4-methylpyridin) (*Ibca*, $Z=16$; all atoms in general positions); but here, they are pairwise interwoven in the same layer. The intercalated 4-Mepy molecules are located in the meshes of this layer.²¹⁹ From the same reaction medium, $[\text{Cd}(4\text{-Mepy})_4\{\text{Ag}_2(\text{CN})_3\}[\text{Ag}(\text{CN})_2]]$ ($C2/m$, $Z=2$) crystallizes after some days. Here, the $\text{Cd}(4\text{-Mepy})_4$ units ($2/m - C_{2h}$) are linked by almost linear $\text{NC}-\text{Ag}-(\text{C},\text{N})-\text{Ag}-\text{CN}$ rods to form chains, which in turn are arranged in layers. Inserted between the chains or into the layers are linear $[\text{Ag}(\text{CN})_2]^-$ anions.²¹⁹

4,4'-Bipyridyl (4bipy) in place of 4-Mepy, under otherwise the same conditions, produces $[\text{trans}-\text{Cd}(4\text{bipy})_2\{\text{Ag}(\text{CN})_2\}_2]$ ($P2_1/c$, $Z=2$); with pyrazine (pyz), $\text{K}_2[\text{Cd}(\text{CN})_4]$, and AgNO_3 (1:2:1) $[\text{trans}-\text{Cd}(\text{pyz})\{\text{Ag}_2(\text{CN})_3\}\{\text{Ag}(\text{CN})_2\}]$ ($P2/c$, $Z=2$) is generated. In the former, 4bipy acts as a linker between layers $\infty^2[\text{Cd}\{\text{Ag}(\text{CN})_2\}_{4/2}]$ to form a 3-D framework, with two of these interpenetrating each other. In the latter, Cd and $\{\text{Ag}_2(\text{CN})_3\}$ form nearly linear chains in one direction, which are linked to a 2-D network with rectangular meshes by $\{\text{Ag}(\text{CN})_2\}$, and linkage of these nets to a 3-D framework is achieved by pyz. Here, even three identical 3-D frameworks interpenetrate one another.²²⁰

Finally, a highly complex structure is created when *trans*- $\text{Cd}(4\text{-ampy})_2$ (4-ampy = 4-aminopyridine) and $\text{Cd}(4\text{-ampy})(\text{ame})\{\text{Ag}(\text{CN})_2\}$ units (ame = 2-aminoethanol) are linked by bridging $\mu\text{-}\{\text{Ag}(\text{CN})_2\}$ groups to form a 2-D network with rhombus meshes and almost linear chains. These antiparallel chains in pairs embrace the nets.²²¹

Cd^{2+} and hexacyanometallates $[\text{M}(\text{CN})_6]^{3-}$ ($\text{M} = \text{Fe}, \text{Co}$) join to build up interesting framework structures in $\text{NMe}_4\text{Cd}[\text{M}(\text{CN})_6] \cdot 3\text{H}_2\text{O}$ (*I4*, $Z=10$). Two different kinds of Cd centers (octahedral and square pyramidal, respectively) are linked by octahedral $\text{M}(\text{CN})_6$ units to form primarily slightly puckered 2-D networks with nearly square meshes; in addition, 3-D linkage of these nets is achieved by CN bridges between $\text{M}(\text{CN})_6$ groups and square-pyramidal Cd in adjacent nets. Thus, the two Cd centers get $\text{Cd}(\text{OH}_2)_2\text{N}_4$ and CdN_5 coordinations ($r_{\text{av}}(\text{Cd}-\text{N})$ 229.5, $r_{\text{av}}(\text{Cd}-\text{O})$ 237.1, and $r_{\text{av}}(\text{Cd}-\text{N})$ 224.4 pm, respectively, for $\text{M} = \text{Fe}$).²²²

Together with Cd, $\text{Fe}(\text{CN})_6$ also acts as a layer builder in $[\text{Cd}(\text{tren})_2][\text{Fe}(\text{CN})_6] \cdot 3\text{H}_2\text{O}$ (*tren* = tris(2-aminoethyl)amine) ($P2_1/n$, $Z=2$). Here, two $\text{Cd}(\text{tren})$ fragments (with tetradentate *tren*) and two Fe centers are linked by two $\mu_3\text{-CN}$ to form a tetranuclear, heterometallic unit with a central square Cd_2N_2 entity; this tetranuclear unit is the building block of a 2-D layer. A further $\mu\text{-CN}$ group augments the coordination polyhedron of Cd to a distorted pentagonal bipyramid ($232.6 \leq r(\text{Cd}-\text{N}) \leq 265.3$ pm).²²³

Minor changes in one of the reagents can induce drastically different structures. Thus, if $[\text{Fe}(\text{CN})_6]^{4-}$ is replaced by $[\text{Fe}(\text{CN})_5(\text{NO})]^{2-}$ in the reaction with $[\text{Cd}(\text{tren})]^{2+}$, the simple-looking $[\text{Cd}(\text{tren})][\text{Fe}(\text{CN})_5(\text{NO})]$ ($P2_1/n$, $Z=2$) is formed. Here, two $[\text{Cd}(\text{tren})]$ (with tridentate tren!) and two $[\text{Fe}(\text{CN})_5(\text{NO})]$ units join to a tetranuclear, centrosymmetric ring $\text{Cd}_2\text{Fe}_2(\text{CN})_4$ (CN on the edges), which is linked to two adjacent rings by the pendant arms of the tren ligand to form a shelf-type polymer. In the similarly prepared $[\text{Cd}(\text{tren})][\text{Pd}(\text{CN})_4]$ ($P2_12_12_1$, $Z=4$), the $[\text{Cd}(\text{tren})]$ units (tetradentate tren) are linked by $[\text{Pd}(\text{CN})_4]$ groups (cisoid) to a battlement-like chain or ribbon. Finally, $[\text{Pt}(\text{CN})_6]^{2-}$ in place of $[\text{Pd}(\text{CN})_4]^{2-}$ simply links two $[\text{Cd}(\text{tren})]$ units to a discrete, trinuclear, centrosymmetric cation $[(\text{tren})\text{Cd}(\text{NC})\text{Pt}(\text{CN})_4(\text{CN})\text{Cd}(\text{tren})]^{2+}$, with $[\text{Pt}(\text{CN})_6]^{2-}$ as counterion ($P2_1/c$, $Z=4$).²²⁴

A rather complex structure is built up when reacting the heterocubane $[\text{Re}_4\text{Te}_4(\text{CN})_{12}]^{4-}$ with CdSO_4 in aqueous ammonia to yield $[\text{Cd}(\text{NH}_3)_5][\text{Cd}(\text{NH}_3)_3][\text{Re}_4\text{Te}_4(\text{CN})_{12}]$ ($P1$, $Z=2$) (cf. Section 6.9.4.2.3.ii). One *mer*- $\text{Cd}(\text{NH}_3)_3$ group links three heterocubane clusters via μ -CN bridges, and vice versa, to form a double-strand chain, and to each of these linked clusters a further terminal $\text{Cd}(\text{NH}_3)_5$ group is bound by a μ -CN bridge ($236 \leq r(\text{Cd}-\text{NC}) \leq 243$ pm).¹⁶⁴

Back to simplicity: $\text{Hg}(\text{NO}_3)_2$ in aqueous HNO_3 with $\text{K}[\text{B}(\text{CN})_4]$ gives $\text{Hg}[\text{B}(\text{CN})_4]_2$ ($P\bar{3}m1$, $Z=1$), with Hg in an almost perfect octahedral environment HgN_6 (symmetry $3m - D_{3d}$) but with relatively long Hg—N bonds ($r(\text{Hg}-\text{N})$ 236.4 pm, $\alpha(\text{N}-\text{Hg}-\text{N})$ 89.2/90.8°). This compound undergoes comproportionation with metallic Hg to yield the simple dimercury(I) compound $\text{Hg}_2[\text{B}(\text{CN})_4]_2$. IR and Raman spectra of both compounds have been discussed, and assignments suggested; strangely enough, vibrations of the HgN_6 entities have not been mentioned. A compilation and comparison of structural data of 10 compounds with the HgN_6 core, of different topologies and symmetries, has been included.²²⁵

6.9.4.2.4 Compounds with donor atom P

Phosphides and amides are closely related, as a synthetic route is based on metathesis of metal amides, especially the respective trimethylsilyl amides, with the appropriate free acidic phosphine or an anion derived therefrom. Reaction of metal halides and trisilylphosphines is an alternative for preparing metal phosphides.

(i) Phosphides

A reaction of the first type, in a broad sense, uses the mixture obtained from *n*-BuLi and the phosphinic acid $(\text{mes})_2\text{P}(\text{H})=\text{O}$ ($\text{mes} = 2,4,6$ -trimethylphenyl) in thf/hexane to which the Cd amide $\text{Cd}[\text{N}(\text{SiMe}_3)_2]_2$ is added; a mixed amide-phosphinite is obtained, namely $[\{\text{MeSi}(\text{N})\text{Cd}\{(\text{mes})_2\text{PO}\}_2\text{Li} \cdot 2 \text{ thf}\}]_2$. The structure analysis (153 K) reveals that the two phosphinite ligands act as a double bridge between Cd and Li to give a six-membered, twisted ring with two independent Cd—P bonds ($r_{\text{av}}(\text{Cd}-\text{P})$ 259.4 pm); the exocyclic Cd—N bond is rather short (213.6 pm).²²⁶

In a metathesis reaction $\text{M}[\text{N}(\text{SiMe}_3)_2]_2$ ($\text{M} = \text{Cd}, \text{Hg}$) and $\text{HP}(\text{SiMe}_3)_2$ (ratio 1:2) give the dimers $\{\text{M}[\text{P}(\text{SiMe}_3)_2]\}_2$ in good yield.^{227,228} Methanolysis of the Cd compound gives Cd_3P_2 (potential semiconductor).²²⁷ In their structures (both in $P1$, $Z=1$, similar unit-cell volumes), the centrosymmetric dinuclear units have almost symmetric bridges μ - $\text{P}(\text{SiMe}_3)_2$ for $\text{M} = \text{Cd}$ ($r_{\text{b}}(\text{Cd}-\text{P})$ 257.5 pm and 261.2 pm), but strongly asymmetric bridges for $\text{M} = \text{Hg}$ ($r_{\text{b}}(\text{Hg}-\text{P})$ 241.0 pm and 324.6 pm); the terminal M—P bonds are shorter, as expected ($r_{\text{t}}(\text{Cd}-\text{P})$ 246.9 and $r_{\text{t}}(\text{Hg}-\text{P})$ 240.2 pm). The Hg compound can also be considered to be a monomer, with an almost linear P—Hg—P axis and secondary $\text{P} \cdots \text{Hg}$ bonds perpendicular to this axis.²²⁸ A similar structural situation is met in the homologous compound $[\text{Hg}(\text{P}-t\text{-Bu}_2)_2]_2$ (linear P—Hg—P axis, $r_{\text{av}}(\text{Hg}-\text{P})$ 244.7 pm; secondary $\text{P} \cdots \text{Hg}$ bonds $r(\text{P} \cdots \text{Hg})$ 316 pm).²²⁹ Temperature-dependent ^1H and ^{31}P NMR spectrometries show the Cd compound to persist as a (fluxional) dimer in solution; kinetic parameters are given and possible pathways for the bridging-to-terminal site exchange of the phosphido ligands discussed. In contrast, the Hg compound in solution is a monomer under all conditions studied.²²⁸

The above-mentioned $[\text{Hg}(\text{P}-t\text{-Bu}_2)_2]_2$ has been obtained in a phosphide-transfer reaction between HgMe_2 and $\text{Ga}(\text{P}-t\text{-Bu}_2)_3$. If CdMe_2 and $\text{Ga}(\text{P}-t\text{-Bu}_2)_3$ are reacted, the product is the trimeric $[\text{MeCd}(\text{P}-t\text{-Bu}_2)_2]_3$ with a six-membered Cd_3P_3 ring in twist-boat conformation and exocyclic Cd—Me bonds; thus, Cd achieves near-planar, three-coordinate geometry. The Cd—P bond lengths in the ring are all similar ($r_{\text{av}}(\text{Cd}-\text{P})$ 258.5 pm); in solution these Cd—P bonds

obviously level, as only one sharp single line (with $^{111/113}\text{Cd}$ satellites) is observed in the $^{31}\text{P}\{^1\text{H}\}$ NMR spectrum.²²⁹

Upon reaction of $\text{M}[\text{N}(\text{SiMe}_3)_2]_2$ ($\text{M} = \text{Cd}, \text{Hg}$) with the bulky phosphide $\text{LiP}(\text{SiPh}_3)_2$, the stable monomeric complexes $\text{M}[\text{P}(\text{SiPh}_3)_2]_2$ are produced (one single ^{31}P resonance). The crystal structure of $\text{Cd}[\text{P}(\text{SiPh}_3)_2]_2$ ($C2/c$, $Z=4$) contains centrosymmetric molecules with an exactly linear $\text{P}-\text{Cd}-\text{P}$ group ($r(\text{Cd}-\text{P})$ 242.7 pm). In spite of the strong steric shielding this molecule retains some Lewis acidity, as shown by monitoring its reaction with py or PMe_3 by ^{31}P NMR spectrometry (estimation of formation constants of the complexes $\text{Cd}[\text{P}(\text{SiPh}_3)_2]_2 \cdot \text{L}$).²³⁰

With the sterically less demanding phosphide LiPPh_2 in thf, $\text{Cd}[\text{N}(\text{SiMe}_3)_2]_2$ reacts to give the product $[\text{Li}(\text{thf})_4]_2[\text{Cd}_4(\text{PPh}_2)_{10}]$. In the adamantoid complex anion $\mu\text{-PPh}_2$ ligands are located in front of all of the edges of the Cd_4 tetrahedron, and terminal PPh_2 ligands complete the coordination around Cd to distorted tetrahedral. The Cd—P bond lengths in the bridges vary unsystematically ($r_{\text{av}}(\text{Cd}-\text{P})$ 265.7(20) pm), as do the terminal Cd—P bonds ($r_{\text{av}}(\text{Cd}-\text{P})$ 260.9(12) pm).²³¹ At room temperature the $^{31}\text{P}\{^1\text{H}\}$ NMR spectrum shows a single resonance which splits at lower temperatures (also $^{111/113}\text{Cd}$ satellites appear), indicating the freezing of an intramolecular exchange of terminal and bridging phosphide ligands.

Reaction of CdCl_2 with $\text{Ph}_2\text{PSiMe}_3$ in the presence of $\text{P}(n\text{-Pr})_3$ also leads to an adamantoid species $[\text{Cd}_4\text{Cl}_4(\text{PPh}_2)_4(\text{PPr}_3)_2]$ ($C2/c$, $Z=4$). The molecules have crystallographically imposed symmetry $2-C_2$, with two bridging PPh_2 ligands on opposite edges of the Cd_4 tetrahedron on the twofold axes; two more $\mu\text{-PPh}_2$ and two $\mu\text{-chloro}$ ligands are related by symmetry, as are pairs of terminal PPr_3 and Cl ligands. Two of the $\mu\text{-PPh}_2$ bridges are necessarily the other two *de facto* symmetric ($r_{\text{av}}(\text{Cd}-\text{P})$ 253.8 pm), whereas the $\mu\text{-Cl}$ bridges are clearly asymmetric. Remarkably, the terminal Cd— PPr_3 bonds are longer ($r(\text{Cd}-\text{P})$ 260.9 pm) than the bridging ones, in contrast to the terminal Cd—Cl bonds.²³²

CdI_2 and $\text{P}(\text{SiMe}_3)_3$ in dimethoxyethane (dme) react to give simply $[\text{CdI}_2\{\text{P}(\text{SiMe}_3)_3\}]_2$, a near-centrosymmetric dinuclear species with an almost square core Cd_2I_2 and two terminal I and $\text{P}(\text{SiMe}_3)_3$ ligands, respectively ($P2_12_12_1$, $Z=4$, general positions only). The four Cd—I bonds in the central Cd_2I_2 unit are all independent, but very similar ($r_{\text{av}}(\text{Cd}-\text{I})$ 287.5 pm); also the terminal Cd—I and Cd—P bonds show minor differences ($r_{\text{av}}(\text{Cd}-\text{I})$ 271.5 and $r_{\text{av}}(\text{Cd}-\text{P})$ 255.5 pm).²³³ Upon reaction of $[\text{CdI}_2\{\text{P}(\text{SiMe}_3)_3\}]_2$ with $n\text{-Bu}_4\text{NI}$ in thf $[n\text{-Bu}_4\text{N}]_2[\text{Cd}_4\text{I}_8\{\text{P}(\text{SiMe}_3)_2\}_2]$ is formed, again with an adamantoid anionic complex unit ($Pna2_1$, $Z=4$, general positions only). A tetrahedral Cd_4 core is bridged on two opposite edges by $\mu\text{-P}(\text{SiMe}_3)_2$ ligands, four $\mu\text{-iodo}$ ligands are placed on the other edges, and four terminal iodo ligands are bound to each of the Cd corners, completing a tetrahedral coordination of Cd. Although crystallographically independent, the chemically equivalent bonds are very similar throughout. Thus, both of the $\mu\text{-P}(\text{SiMe}_3)_2$ bridges are nearly symmetric, with nonsignificant differences in the Cd—P bonds ($r_{\text{av}}(\text{Cd}-\text{P})$ 250.7(3) pm); out of the four $\mu\text{-I}$ bridges only one is significantly asymmetric ($r_{\text{av}}(\text{Cd}-\text{I})$ 285.4(9) pm), and the terminal Cd—I bonds show minor scatter ($r_{\text{av}}(\text{Cd}-\text{I})$ 273.2(10) pm).²³³

(ii) Phosphine complexes

A series of Cd phosphine complexes $(\text{Et}_3\text{P})_2\text{Cd}_2\text{X}_4$ and $(\text{R}_3\text{P})_2\text{CdX}_2$ ($\text{R}_3\text{P} = \text{Ph}_3\text{P}, \text{Bu}_3\text{P}, \text{Et}_3\text{P}$, 1-phenyldibenzophosphole (dbp), 1-phenyl-3,4-dimethylphosphole (dmpp); $\text{X} = \text{Cl}, \text{Br}, \text{I}$) have been prepared and studied by IR, solution and solid-state CP/MAS spectrometries ($^{31}\text{P}\{^1\text{H}\}$ and $^{113}\text{Cd}\{^1\text{H}\}$), and partly by X-ray structure analyses.²³⁴ Both $(\text{Ph}_3\text{P})_2\text{CdI}_2$ and $(\text{dbp})_2\text{CdI}_2$ ($P2_1/a$, $P2_1/c$, $Z=4$) own distorted tetrahedral coordination around Cd, with similar Cd—P and Cd—I bond lengths, respectively ($260.3 \leq r(\text{Cd}-\text{P}) \leq 265.3$ pm, $271.8 \leq r(\text{Cd}-\text{I}) \leq 273.1$ pm). On the basis of the temperature dependences of $^{31}\text{P}\{^1\text{H}\}$ NMR spectra of some $(\text{R}_3\text{P})_2\text{CdX}_2$ species, kinetic and thermodynamic data for the equilibria $(\text{R}_3\text{P})_2\text{CdX}_2 \rightleftharpoons (\text{R}_3\text{P})\text{CdX}_2 + \text{R}_3\text{P}$ have been determined. For the compounds $(\text{Et}_3\text{P})_2\text{Cd}_2\text{X}_4$ NMR spectra suggest dinuclear symmetric entities with double halide bridges, and for solid $(\text{Bu}_3\text{P})_3\text{Cd}_2\text{X}_4$ a structure $(\text{Bu}_3\text{P})_2\text{Cd}(\mu\text{-X})_2\text{CdX}_2(\text{PBu}_3)$, with four- and five-coordinate Cd, is proposed.

In a thorough work with an extensive literature survey, crystal structures, vibrational and ^{31}P NMR spectra of several phosphine complexes of mercury(II) halides HgX_2 are presented.²³⁵ In the dibenzophosphole complex $(\text{dbp})_2\text{HgBr}_2$, Hg adopts a distorted tetrahedral coordination ($r_{\text{av}}(\text{Hg}-\text{P})$ 250.2, $r_{\text{av}}(\text{Hg}-\text{Br})$ 261.1 pm) (cf. the related Cd complex in the previous paragraph), with slightly shorter Hg—P and Hg—Br bonds, respectively, than in the comparable

$(\text{Ph}_3\text{P})_2\text{HgBr}_2$.²³⁶ $[(\text{Ph}_3\text{P})\text{HgBr}_2]_2$ can be described as two edge-sharing tetrahedra around Hg centers, with asymmetric, double μ -Br bridges $[(\text{Ph}_3\text{P})\text{HgBr}(\mu\text{-Br})_2\text{HgBr}(\text{PPh}_3)]$ ($r_{\text{av}}(\text{Hg-P})$ 242, $r_{\text{av}}(\text{Hg-Br}_t)$ 250.2, $r_{\text{av}}(\text{Hg-Br}_b)$ 275.7 pm); the analogous $[(\text{Ph}_3\text{P})\text{HgI}_2]_2$ adopts a comparable structure ($r_{\text{av}}(\text{Hg-P})$ 247.2, $r_{\text{av}}(\text{Hg-I}_t)$ 267.8, $r_{\text{av}}(\text{Hg-I}_b)$ 291.4 pm) with even more asymmetric μ -I bridges.²³⁷ Finally, in the dimethylphosphole complex $[(\text{dmpp})\text{HgI}_2]_2$ with a similar overall structure, the terminal bonds are shorter, but the μ -I bridges longer and less asymmetric than before ($r_{\text{av}}(\text{Hg-P})$ 245.4, $r_{\text{av}}(\text{Hg-I}_t)$ 263.9, $r_{\text{av}}(\text{Hg-I}_b)$ 295.6 pm).²³⁵ The seemingly analogous $[(\text{Bu}_3\text{P})\text{HgI}_2]_2$ adopts a different structure, approximately given by the formula $[(\text{Bu}_3\text{P})_2\text{Hg}(\mu\text{-I})_2\text{HgI}_2]$; the $(\text{Bu}_3\text{P})_2\text{Hg}$ fragments ($r_{\text{av}}(\text{Hg-P})$ 239.2, $\alpha_{\text{av}}(\text{P-Hg-P})$ 161.5°) tend to linearity, the μ -I bridges are strongly asymmetric, and the terminal Hg-I bonds of the HgI_2 fragment the shortest in this entity ($r_{\text{av}}(\text{Hg-I}_t)$ 268.8 pm). Thus, the complex can formally be considered to contain $[(\text{Bu}_3\text{P})_2\text{Hg}]^{2+}$ and $[\text{HgI}_4]^{2-}$ ions, connected by two secondary $\text{I}\cdots\text{Hg}$ bonds.²³⁵ $[(\text{Pr}_3\text{P})\text{HgI}_2]_2$ has a similar structure, but the separation of the constituents is less pronounced.²³⁸ IR and Raman data, as well as findings from solution and solid-state ^{31}P NMR spectra, have been correlated with structural data.²³⁵

An insight into the equilibria present in solutions of several complexes of the type $(\text{R}_3\text{P})_2\text{HgX}_2$ ($\text{X} = \text{ClO}_4, \text{CF}_3\text{COO}$) is provided by electrospray mass spectrometry (ES MS) (cf. Section 6.9.2.1.8).²³⁹ In all cases the principal ions $[(\text{R}_3\text{P})_2\text{HgX}]^+$ are observed, even if these ions and other ionic constituents of the equilibria are known to be labile on the NMR timescale. In the presence of excess R_3P the principal ions $[(\text{R}_3\text{P})_3\text{HgX}]^+$ appear. Also fragments of collisionally activated decomposition (CAD, can be influenced and controlled to some extent) are detected, e.g., $[(\text{R}_3\text{P})\text{HgX}]^+$.

In a paper on complexes of mercury(II) halides with the sterically demanding ligand tris(2,4,6-trimethoxyphenyl)phosphine (tmpp), a selective literature survey of the field of $\text{HgX}_2\text{-PR}_3$ complexes has been given.²⁴⁰ In particular, tmpp complexes with HgX_2 ($\text{X} = \text{Cl}, \text{Br}, \text{I}$) and P:Hg ratios 1:1, 2:1, and 2:3, and their vibrational and solution ^{31}P NMR spectra, are presented and discussed. Crystal structures of the monomeric complexes $(\text{tmpp})\text{HgX}_2$ ($\text{X} = \text{Br}, \text{I}$) and of $(\text{tmpp})(\text{HgI}_2)_2$ have been reported. The first two compounds have basically the same structures (albeit in different space groups), with three-coordinate Hg (short Hg-P bond of about 243 pm, two different terminal Hg-X bonds); two secondary $\text{O}\cdots\text{Hg}$ from the OMe groups in *o*-positions of the organic substituents have also to be considered. In $(\text{tmpp})(\text{HgI}_2)_2$ Hg tends to be two-coordinate, with even shorter Hg-P and terminal Hg-I bonds (240.8 pm and 261.9 pm); two fragments $(\text{tmpp})(\text{HgI})$ are linked by a dinuclear bridge, described in some detail with the formula $[(\text{tmpp})(\text{HgI})(\mu\text{-I})\text{HgI}(\mu\text{-I})_2\text{HgI}(\mu\text{-I})(\text{HgI})[(\text{tmpp})]]$, or with some simplification in the shorter $[(\text{tmpp})(\text{HgI})(\mu\text{-Hg}_2\text{I}_6)(\text{HgI})[(\text{tmpp})]]$. The secondary $\text{O}\cdots\text{Hg}$ contacts are shorter than before.

Again a distorted tetrahedral coordination of Hg is achieved in the 1,1-bis(diphenylphosphino)ferrocene (dppf) complex with HgI_2 . Both Hg-P in the dppf chelate ring and terminal Hg-I bonds (averages 256.5 pm and 277.6 pm, respectively) are clearly longer than in the previous examples; all angles around Hg are close to the value for a tetrahedron. Nonlinear optical properties of the material have been studied.²⁴¹

A completely different structural situation is met with the mixed phosphine complex $[\text{Hg}\{\text{OP}(\text{O})\text{CF}_3(\text{OH})\}_2(\text{PMe}_3)_3]$, obtained from $[\text{Hg}\{\text{P}(\text{CF}_3)_2\}_2(\text{PMe}_3)_2]$ (for formation and properties of this compound see ref. 242) in a multistep hydrolysis in the presence of PMe_3 .²⁴³ In a trigonal-planar fragment $\text{Hg}(\text{PMe}_3)_3$ ($r_{\text{av}}(\text{Hg-P})$ 246.7 pm), the coordination is expanded to distorted trigonal bipyramidal by two O donors of the phosphinic acid ligands in axial positions. These units are linked to polymers by rather short hydrogen bonds ($\text{O-H}\cdots\text{O}$).

6.9.4.2.5 Compounds with donor atoms As and Sb

A Cd-Sb compound with potential application in semiconductor technology has yet to be mentioned. CdI_2 and tetraethylstibine, Sb_2Et_4 , in thf react to give crystalline $\text{Sb}_2\text{Et}_4 \cdot 2 \text{CdI}_2$ after some time. The crystal structure is made up of molecules $(\text{I}_2\text{Cd})\text{Sb}(\text{Et}_2)\text{Sb}(\text{Et}_2)(\text{CdI}_2)$, with the central Sb_2Et_4 moiety ($r(\text{Sb-Sb})$ 278.4 pm) in skew conformation and the terminal Cd centers in trigonal-planar coordination ($r_{\text{av}}(\text{Cd-I})$ 275.1, $r_{\text{av}}(\text{Cd-Sb})$ 282.2 pm). Intermolecular secondary bonds $\text{I}\cdots\text{Cd}$ expand the coordination to distorted trigonal bipyramidal and link the molecules to chains, which in turn are covalently connected by the Sb_2Et_4 linkages to form a 2-D network.²⁴⁴

6.9.4.2.6 Frameworks made up of Cd, Hg, and P, As, Sb

In recent years a great variety of ternary and/or quaternary systems containing Cd or Hg, one of the pentels (Pn = P, As, Sb), and a halogen or a halogenometalate have been prepared by heating a metal halide, e.g., HgX_2 or Hg_2X_2 , with an elemental pentel, and if desirable, an additional metal M' or a halide thereof. A typical example is the deceptively simple-looking $(\text{Hg}_2\text{P})_2\text{HgBr}_4$, obtained as a bright yellow, crystalline material by heating HgBr_2 , red phosphorus, and mercury in the appropriate ratio in a sealed ampoule at 300°C for several days.²⁴⁵ In the structure ($P2_1$, $Z=2$), a cationic 3-D framework with tridymite-like topology is built up by corner-sharing tetrahedra PHg_4 corresponding to the Niggli formula $\infty^3[\text{PHg}_{4/2}]^+$; in pseudo-hexagonal channels of this framework, chains of apex-sharing trigonal bipyramids HgBr_5 ($\infty^1[\text{HgBr}_3\text{Br}_{2/2}]^{2-}$) are running along the 2_1 axes. The cationic framework can be considered as a coordination-polymeric tetramercurio-phosphonium complex, i.e. a metallo-onium complex. Another, related example is $[\text{Hg}_2\text{Sb}]\text{GaCl}_4$ ($Pbcn$, $Z=8$), with a framework of low-cristobalite topology and cavities hosting the isolated anions.²⁴⁶

In these structures the PnM_4 ($M = \text{Cd}, \text{Hg}$) tetrahedra can fully or partly be replaced by Pn_2M_6 groups (trigonally elongated octahedra with a Pn_2 core), as is found in $[\text{Hg}_6\text{P}_4][M'\text{X}_6]\text{X}$,²⁴⁷ in $[\text{Hg}_6\text{As}_4][M'\text{X}_6]\text{X}$,^{248,249} in $[\text{Hg}_6\text{Sb}_4][M'\text{X}_6]\text{X}$,²⁵⁰ or in the phases $[\text{Hg}_6\text{Pn}_4\text{X}_3][\text{SnX}_3]$ ²⁵¹ and $[\text{Hg}_7\text{Pn}_4\text{X}_3][\text{SnX}_3]$.²⁵²

A further modification can be achieved by combining Hg, Hg_2 , and Hg_3 groups as linkers between Pn atoms, as is the case with $[\text{Hg}_{11}\text{As}_4](\text{GaBr}_4)_4$.²⁵³ Here Hg and As form corrugated layers $\infty^2[\text{AsHg}_{3/2}]$, which are linked in one crystallographic direction alternately by Hg_2 and Hg_3 sticks, thus creating two types of channel with different cross-sections and filled by the isolated anions as guests.

A review on mercury and cadmium pentelide halides has appeared,²⁵⁴ with emphasis on discussion of the structures, based on the Zintl–Klemm concept, and their relationship to the electronic properties.

6.9.4.2.7 Compounds with donor atom O

In many closely related compounds of Cd and Hg with all-oxygen or oxygen dominated coordination spheres, the metals adopt different coordination numbers and geometries—even independent metals in the same structure. As a rule, in the rare isostructural Cd and Hg compounds, Hg possesses the more distorted coordination.

As the structures of comparable or analogous Cd and Hg compounds are often different, they are dealt with separately.

(i) Cadmium

In a simple triple oxide $\text{Sr}_3\text{CdPtO}_6$ ($R\bar{3}c$, $Z=6$, trigonal setting), Cd has a trigonal-prismatic ($r(\text{Cd—O})$ 232.8 pm), but Pt an octahedral six-coordination; these polyhedra share opposite triangular faces to form columns $\infty^1[\text{Cd}_{\text{trip}}\text{O}_{6/2}\text{Pt}_{\text{oct}}\text{O}_{6/2}]^{6-}$ along the three-fold axes in a hexagonal rod packing arrangement.²⁵⁵

In contrast, Cd in $[\text{Cd}(\text{H}_2\text{O})_6](\text{ClO}_4)_2$ ($P\bar{3}m1$, $Z=1$) ($[\text{Hg}(\text{H}_2\text{O})_6](\text{ClO}_4)_2$ has the same structure²⁵⁶) has an almost perfect octahedral surrounding ($r(\text{Cd—O})$ 227.7 pm, $\alpha(\text{O—Cd—O})$ 87.69°);²⁵⁷ the Cd—O bond length of $[\text{Cd}(\text{H}_2\text{O})_6]^{2+}$ in aqueous solution is only slightly different (229.2 pm).²⁵⁸ Quantum-chemical calculations (SCF, effective core potentials, relativistic effects) for the hexa-aqua complexes $[\text{M}(\text{H}_2\text{O})_6]^{2+}$ ($M = \text{Zn}, \text{Cd}, \text{Hg}$) give results for *inter alia* bond lengths and vibrational frequencies that are in reasonable agreement with experimental data.²⁵⁹

Another structure with reference character is that of $[\text{Cd}(\text{thf})_4(\text{BF}_4)_2]$ ($P2_1/n$, $Z=2$), with a centrosymmetric octahedral complex unit ($r(\text{Cd—O})$ 221.9 pm and 226.3 pm) and, rather unusual, strongly coordinated BF_4 ligands in axial positions ($r(\text{Cd—F})$ 230.7 pm).²⁰⁰

Hydroxo complexes of Cd are rare. In one example, two μ -OH groups link two Cd centers to a distorted square $\text{Cd}_2(\text{OH})_2$ ($r_{\text{av}}(\text{Cd—O})$ 222.5 pm); otherwise two tetradentate N,S-donor ligands complete the coordination sphere of Cd. Remarkably, in a reaction with CO_2 the two μ -OH groups are replaced by one μ -carbonato group.²⁶⁰

Towards Cd the *cis*- $[\text{Cr}(\text{OH})_2(\text{en})_2]^+$ unit acts as a chelating ligand and yields heterometallic $\text{Cd}(\mu\text{-OH})_2\text{Cr}$ moieties as components in structures. Examples are the straight cationic chain

$\infty^1[\text{Cd}(\mu\text{-Cl})(\text{H}_2\text{O})_2\{\text{Cr}(\mu\text{-OH})_2(\text{en})_2\}]^{2+}$ with a —Cd—Cl— backbone, the kinked neutral chain $\infty^1[\text{Cd}_2(\mu\text{-Cl})_2\text{Cl}_3(\text{H}_2\text{O})_3\{\text{Cr}(\mu\text{-OH})_2(\text{en})_2\}]$ with both bridging and terminal chloro ligands, and the isolated centrosymmetric pentanuclear complex $[\text{Cd}_3(\mu\text{-Cl})_4\text{Cl}_4(\text{H}_2\text{O})_3\{\text{Cr}(\mu_3\text{-OH})(\mu\text{-OH})(\text{en})_2\}_2]$ with a triply bridging OH group.²⁶¹

These $\mu_3\text{-OH}$ groups also occur in heterocubanes, e.g., $[\text{C}_6\text{F}_5\text{CdOH}]_4$ with a Cd_4O_4 core and tetrahedral Cd.²⁶² Alkoxy groups can replace OH groups in heterocubanes as in $[\text{MeCdO-}t\text{-Bu}]_4$.²⁶³ Use of 2-methoxyethanolate as a ligand can induce formation of a heterocubane with a Cd_4O_4 core as before, of a diheterocubane with two Cd corner-linked cubes (Cd_7O_8 entities), or a heterododecahedrane (Cd_6 octahedron with $\mu_3\text{-O}$ in front of each of the octahedral faces: Cd_6O_8 core).²⁶⁴ A Cd_4O_4 core with a strongly shielded periphery is obtained with the hydrate of di-2,2'-pyridyl ketone (*gem*-diol) as a ligand.²⁶⁵ A certain shielding of a Cd_4O_4 core is also achieved by the oxide of a bora-bicyclooctane $\text{C}_8\text{H}_{14}\text{BO}$ in $[\text{MeCd}(\text{OBC}_8\text{H}_{14})_4]$.²⁶⁶

Cadmium phenoxides (phenolates) with bulky substituents like Ph or *t*-Bu in 2,6-positions seemingly do not form heterocubanes, but do add slim donor molecules. Thus, thf adducts $[\text{Cd}(\text{OC}_6\text{H}_3\text{R}_2)_2(\text{thf})_2]$ ($\text{R} = t\text{-Bu}$,²⁶⁷ Ph²⁶⁸), with short Cd—O(phenoxide) (205.8/207.4 pm) and long Cd—O(thf) bonds (249.8/230.7 pm), are accessible; however, in the *t*-Bu compound the CdO_4 core is planar, but it is strongly distorted tetrahedral in the Ph compound. Also planar is the central CdO_2S_2 moiety in $[\text{Cd}(\text{OC}_6\text{H}_3t\text{-Bu}_2)_2(\text{tht})_2]$ (tht = tetrahydrothiophen) with $r(\text{Cd—O})$ 210.2 and $r(\text{Cd—S})$ 276.8 pm.²⁶⁸ With the stronger N-donor py $[\text{Cd}(\text{OC}_6\text{H}_3t\text{-Bu}_2)_2(\text{py})_3]$ is obtained, with five-coordinate Cd intermediate between square pyramidal and trigonal bipyramidal ($r_{\text{av}}(\text{Cd—O})$ 219.2, $r_{\text{av}}(\text{Cd—N})$ 235.4 pm).²⁶⁸ ¹¹³Cd NMR data for the above mentioned species in solution are given.²⁶⁸

Consequently, addition of a further phenoxide ligand should be possible, and this has indeed been realized in the anion of the compound $[\text{K}(\text{thf})_6][\text{Cd}(\text{OC}_6\text{H}_3t\text{-Bu}_2)_3]$, with planar three-coordinate Cd ($r_{\text{av}}(\text{Cd—O})$ 207.1 pm).²⁶⁹

Numerous compounds of Cd with mono- and difunctional carboxylic acids have been prepared and studied. Special ¹¹³Cd solid-state NMR studies on single crystals of some simple Cd carboxylates have been reported, with a short review of the structural chemistry of these compounds.^{270,271}

Special emphasis has been laid on structural studies of Cd compounds with dicarboxylic acids, because these combinations form coordination polymers of differing dimensionalities depending on the carboxylate component and on coligands coordinated to Cd. The simplest compound of this type, namely Cd oxalate CdC_2O_4 , adopts a 3-D framework structure, with CdO_6 octahedra linked by oxalate groups.²⁷² Further interesting structures containing Cd, oxalate and other components have been described recently.^{273,274}

The monoanion of aspartic acid $\text{HOOCCH}_2\text{CH}(\text{NH}_2)\text{COOH}$ (aspH) and Cd together with nitrate give $\text{Cd}(\text{aspH})\text{NO}_3$, with a seven-coordinate, all-oxygen environment of Cd in a layer structure.²⁷⁵ A similar coordination is found in the chain structure of the Cd salt of acetylenedicarboxylic acid, $[\text{Cd}\{\text{C}_2(\text{COO})_2\}(\text{H}_2\text{O})_3]\cdot\text{H}_2\text{O}$.²⁷⁶ In a template reaction Cd acetate, terephthalic acid H_2tp , and $[\text{Ph}_3\text{PCH}_2\text{Ph}]\text{Cl}$ give the polymeric $[\text{Ph}_3\text{PCH}_2\text{Ph}][\text{Cd}(\text{tp})\text{Cl}]\cdot 2\text{H}_2\text{O}$, forming a twofold interpenetrating 3-D framework with giant rhombic channels (about $33 \times 23 \text{ \AA}$).²⁷⁷ Under hydrothermal conditions Cd^{2+} , biphenyl-4,4'-dicarboxylate (bpdc), and 1,2-bis(4'-pyridyl)ethane (bpe) join to a polymeric compound $[\text{Cd}(\text{bpdc})(\text{bpe})(\text{H}_2\text{O})]$, with a threefold interpenetrating 3-D framework with different large voids.²⁷⁸ A layer structure is built up by Cd and the anion of 4,4'-oxydibenzoic acid ($\text{HOOC-C}_6\text{H}_4\text{-O-C}_6\text{H}_4\text{-COOH}$) (Cd is five-coordinate).²⁷⁹ The Cd(phen) fragment and adipic or pimelic acid ($\text{HOOC}(\text{CH}_2)_n\text{COOH}$, $n = 4$ and 5, respectively) primarily form chains with seven-coordinate Cd (slightly different geometries), which join to layers due to $\pi\text{—}\pi$ interaction between the phen ligands.²⁸⁰

To finish the topic of carboxylate-dominated Cd complexes, a representative of three closely related species is briefly discussed. $\text{Cd}(\text{NO}_3)_2$ and the betaine-type ligand triphenylphosphoniopropionate $\text{Ph}_3\text{P}(\text{CH}_2)_2\text{CO}_2$ (tpp) in H_2O combine to the dinuclear complex $[\{\text{Cd}(\text{tpp})_2(\text{NO}_3)\}_2](\text{NO}_3)_2$, with a centrosymmetric tetrakis(μ -carboxylato-*O,O'*) dicadmium core, the apical sites being occupied by chelating nitrate ligands; the nitrate groups can be replaced by chloro ligands and the extracomplex NO_3^- by ClO_4^- .²⁸¹

Various Cd compounds with inorganic oxo-anions have been studied. A model system for the application of solid-state MAS NMR spectrometry is the β' -form of tricadmium phosphate $\text{Cd}_3(\text{PO}_4)_2$, obtained by heating of the hydroxyapatite phase $\text{Cd}_{10}(\text{PO}_4)_2(\text{OH})_2$. The structure of $\text{Cd}_3(\text{PO}_4)_2$ contains nine crystallographically independent Cd atoms and six PO_4 groups. Each Cd has a primary five-coordination, but varying secondary coordinations. The ³¹P MAS NMR spectrum exhibits the required number of six narrow resonances with similar intensities; in the ¹¹³Cd MAS NMR spectrum eight narrow lines are observed, one being an overlap of two signals

in view of the much higher intensity. The ^{31}P signals have been assigned to the different PO_4 groups on the basis of bond-valence calculations.²⁸² In a related study of a series of mixed Cd—Pb hydroxyapatites by combination of X-ray powder diffraction and ^{31}P MAS NMR spectrometry, the site-occupancy analysis indicated a clear preference of Cd for one of the two possible sites.²⁸³

Certain Cd phosphonates are interesting materials, because of their layer structure and the potential for intercalation of guest molecules. As an example, the structure of Cd 2-aminoethylphosphonate $\text{Cd}(\text{O}_3\text{PC}_2\text{H}_4\text{NH}_2)$ has been solved *ab initio* from X-ray powder data with Rietveld refinement. Corrugated layers formed by Cd and the phosphonate ends of the ligands are connected by coordination of the amino ends to Cd atoms in the adjacent layers (pillared layer structure). ^{31}P and ^{113}Cd MAS NMR data are correlated with the structural facts.²⁸⁴ Similarly, the layers in $\text{Cd}_2(\text{O}-\text{H})(\text{O}_3\text{PC}_2\text{H}_4\text{CO}_2)$, containing two differently coordinated Cd atoms and μ_3 -OH groups, are linked by the carboxylate ends. ^{113}Cd MAS NMR spectra of this material and of the related $\text{Cd}_3(\text{O}_3\text{PC}_2\text{H}_4\text{CO}_2)_2 \cdot 2\text{H}_2\text{O}$ indicate that the latter contains Cd in three different sites.²⁸⁵ In a logical next step diphosphonates, e.g., *p*-xylenediphosphonate in the compound $\text{Cd}_2(\text{O}_3\text{PCH}_2\text{C}_6\text{H}_4\text{CH}_2\text{PO}_3) \cdot 2\text{H}_2\text{O}$, can be used as both builder in the layers and linker between them.²⁸⁶

Two simple Cd arsenates have been described, namely $\text{Cd}_2\text{As}_2\text{O}_7$, with a ditetrahedral anion²⁸⁷ and CdAs_2O_6 , with both Cd and As in octahedral environment.²⁸⁸

Out of the Cd compounds with oxoanions of elements of group 16, the trimorphic CdSO_3 is to be mentioned, with different six-coordinate Cd in each of the three phases.²⁸⁹

With diammonium ions $[\text{H}_3\text{N}(\text{CH}_2)_n\text{NH}_3]^{2+}$ ($2 \leq n \leq 6$) as counterions, several linear and layered polymeric Cd sulfates are generated. In the chain anion ${}_{\infty}^1[\text{CdCl}_{4/2}(\text{SO}_4)_{2/2}]^{2-}$ ($n=2$), octahedral units are linked by both μ -chloro and μ -sulfato bridges; a similar structural situation is met in the compounds with ${}_{\infty}^1[\text{CdX}_{4/2}(\text{SO}_4)_{2/2}]^{2-}$ anions ($\text{X} = \text{Cl}, \text{Br}; n=6$). A layered structure of the anion ${}_{\infty}^2[\text{Cd}_2(\text{H}_2\text{O})_2(\text{SO}_4)_3]^-$ ($n=3$) is achieved by linking two different octahedral CdO_6 units by SO_4 bridges exclusively.²⁹⁰

Also CdSeO_3 exists in two polymorphic forms, with octahedral and trigonal-prismatic coordinations, respectively; in the hydrate $\text{CdSeO}_3 \cdot 4/3 \text{H}_2\text{O}$ a coordination polyhedron intermediate between these two forms occurs.²⁹¹ Two mixed Cd selenites have been described: in $\text{LiCd}_2(\text{SeO}_3)_2(\text{OH})$ a 3-D framework contains columns as subunits with linked CdO_6 and CdO_7 groups and inserted $\text{Cd}_2(\mu\text{-OH})_2$ squares as sub-subunits.²⁹² In $\text{Cd}_3(\text{SeO}_3)(\text{CO}_3)(\text{OH})_2$ buckled sheets are built up by connected CdO_6 octahedra, and linked to a 3-D network by SeO_3 , CO_3 , and square anti-prisms CdO_8 .²⁹³

A Cd compound $\text{Cd}_3(\text{SeO}_3)_2(\text{SeO}_4)$, with both selenite and selenate, has been presented. The 3-D network with channels running along the *b* axes in $P2_1$ ($Z=2$) contains three independent CdO_x polyhedra ($x=6, 8$), three independent SeO_3 pyramids, and one SeO_4 tetrahedron.²⁹⁴ It should be mentioned that this compound is isotopic with the analogous mercury compound.²⁹⁵

Finally, in $\text{K}_2\text{Cd}(\text{SeO}_4)_2 \cdot 2\text{H}_2\text{O}$ the SeO_4 groups act as bridging ligands to link octahedral CdO_6 units to chains ${}_{\infty}^1[\text{Cd}(\text{OH})_2(\text{SeO}_4)_{4/2}]^{2-}$ (the H_2O ligands are in the *trans*-position).²⁹⁶

(ii) Mercury

Among others, a 1:1 complex of $\text{Hg}(\text{NO}_3)_2$ with the aza-crown-ether 1-aza-4,7,10-cyclododecane has been prepared and structurally studied. The coordination sphere of Hg (2+6 coordinate) is oxygen dominated, with a Hg— ONO_2 bond (216.6 pm) being the shortest, followed by the Hg—N bond to the N-donor of the macrocyclic ring (218.4 pm); all other Hg—O bonds (two chelating NO_3 ligands, three O-donors of the crown-ether) are much longer, in the range 254.1–290.6 pm.²⁹⁷

More recent reports on Hg^{II} phosphates are rather rare. The structure of mercury(II) diphosphate $\text{Hg}_2\text{P}_2\text{O}_7$ has been solved; it contains two different six-coordinate Hg atoms: one of them lying in an axially compressed octahedron (2+4 coordination, average bond lengths 213.2 pm and 258.3 pm, respectively), the other one in an expanded octahedron (4+2, averages 228 pm and 249 pm).²⁹⁸ The polyphosphate $\text{Hg}(\text{PO}_3)_2$ has been obtained from HgO in an acidic polyphosphate melt and contains polymeric anions ${}_{\infty}^1[\text{PO}_2\text{O}_{2/2}]^-$ and Hg in distorted octahedra, which in turn are linked to chains ${}_{\infty}^1[\text{HgO}_2\text{O}_{4/2}]$ ($217.5 \leq r(\text{Hg}-\text{O}) \leq 250.3$ pm).²⁹⁹

Mercury(II) arsenate $\text{Hg}_3(\text{AsO}_4)_2$ has three independent Hg particles with coordination numbers five and seven, but each of them has two short Hg—O bonds ($206 \leq r(\text{Hg}-\text{O}) \leq 214$ pm) in a nearly linear arrangement; linking of these polyhedra including the AsO_4 tetrahedra leads to a 3-D network.³⁰⁰

Heating of the dimercury(I) compound $\text{Hg}_2\text{As}_2\text{O}_6$ gives a mercury(II) compound of the same composition, crystallizing in the PbSb_2O_6 structure type with $[\text{As}_2\text{O}_6]^{2-}$ layers and Hg in a pseudo-octahedral environment ($r(\text{Hg}-\text{O})$ 235.3 pm).³⁰¹

The structure of the long-known basic sulfate, formally $\text{HgSO}_4 \cdot 2\text{HgO}$ —with respect to its structure better written as $[\text{Hg}_3\text{O}_2](\text{SO}_4)$ —has been reinvestigated ($P3_121$, $Z=3$). The slightly corrugated hexagonal layers $\infty^2[\text{Hg}_3\text{O}_2]^{2+}$ ($r_{\text{av}}(\text{Hg—O})$ 209.2 pm), or the other way round $\infty^2[\text{OHg}_{3/2}]^+$, can be considered as a typical case of a coordination polymeric trimercurio-oxonium complex (metallo-onium complex); the disordered SO_4^{2-} anions are located in the meshes of the layers and donate secondary bonds to the Hg atoms.³⁰²

Mercury(II) selenite HgSeO_3 has been found to crystallize in a perovskite-like structure with axially compressed, corner-sharing HgO_6 octahedra (2+4 coordination).³⁰³ The hydrate $\text{HgSeO}_3 \cdot 0.5 \text{H}_2\text{O}$ adopts a different structure, with five- and seven-coordinate Hg in a 3-D framework containing cavities in which the H_2O molecules are located.³⁰⁴ Formally related but structurally different is an ammonia-containing $\text{HgSeO}_3 \cdot \text{NH}_3$, which *de facto* is an ammine complex with an almost linear $\text{H}_3\text{N—Hg—O}$ fragment with short bonds (209.9 pm and 212.9 pm, respectively); the overall coordination around Hg is octahedral 2 + 4.³⁰⁵

Two new modifications of HgSeO_3 have been structurally studied. Hydrothermal treatment of HgSeO_3 yields $(\text{HgSeO}_3)_3\text{HgSe}$, with Se in two different oxidation states; the structure contains pyramidal Hg_3Se groups (trimercurio-selenonium groups; $r_{\text{av}}(\text{Hg—Se})$ 248.9 pm).³⁰⁶ In the basic selenite $\text{HgSeO}_3 \cdot \text{HgO} \cdot 1/6 \text{H}_2\text{O}$, HgO_x polyhedra ($x=6, 7$) are linked to a 3-D framework with channels running in one crystallographic direction.³⁰⁷ Also an acidic mercury(II) selenite is known, namely $\text{Hg}_3(\text{HSeO}_3)_2(\text{SeO}_3)_2$, with a layer structure and medium-strong interlayer hydrogen bonds;³⁰⁸ in this Hg^{II} compound the distortion of the polyhedra around the metal is more pronounced than in the corresponding Cd compound $\text{Cd}_3(\text{HSeO}_3)_2(\text{SeO}_3)_2$.³⁰⁹

The compound $\text{Hg}_3\text{Se}_3\text{O}_{10}$ with both selenite and selenate has already been mentioned.²⁹⁵ The selenates HgSeO_4 and $[\text{Hg}_3\text{O}_2](\text{SeO}_4)$ are isotypic with the corresponding sulfates (for the latter see above), but $\text{HgSeO}_4 \cdot \text{HgO}$ crystallizes in a hitherto unknown structure type with kinked chains $\infty^1[\text{HgO}_2/2]$, SeO_4 tetrahedra, and again HgO_x polyhedra ($x=6, 7$) which have O atoms in common with the above structural units.³¹⁰

In this context, Hg compounds with anions containing chromium and tungsten can be mentioned. Thus, the triple oxide $\text{Pb}_2\text{HgCrO}_6$ can be described as containing isolated CrO_4^{2-} tetrahedra and nearly linear HgO_2^{2-} dumbbells ($r(\text{Hg—O})$ 200.6 pm), which form layers of composition $[\text{HgCrO}_6]^{4-}$. These are intercalated with corrugated pseudohexagonal Pb^{2+} layers.³¹¹ HgWO_4 , prepared in aqueous medium, has been shown by neutron powder diffraction (Rietveld refinement) to consist of chains of edge-sharing HgO_6 and WO_6 octahedra; Hg on an inversion center forms two short collinear Hg—O bonds (200.6 pm).³¹² HgWO_4 prepared under high-pressure/high-temperature conditions (300 MPa/973 K) contains chains of edge-sharing WO_6 octahedra, but layers of strongly distorted, corner-sharing HgO_6 octahedra (centrosymmetric O—Hg—O entities, $r(\text{Hg—O})$ 204.4 pm).³¹³

6.9.4.2.8 Compounds with donor atoms S, Se, and Te

The detection of metal-binding proteins, especially of Cd- and Hg-binding metallothioneins or of the *merR* protein, induced numerous studies of model compounds of Cd and Hg with more or less simple sulfur- and selenium-containing ligands.

(i) Cd and Hg chalcogenido complexes

The simplest possible coordination compounds of Cd and Hg with chalcogen donors are the anions MCh_2^{2-} . Multinuclear NMR studies of these species ($\text{Ch} = \text{Se}, \text{Te}$) in NH_3 or en solutions with $[\text{K}(2.2.2\text{-cryptand})]^+$ counterions have been reported.³¹⁴ Structural studies³¹⁵, also combined with new multinuclear NMR measurements, have been performed.³¹⁶

(ii) Cd and Hg thiolate and selenolate complexes

Cd thiolates and selenolates tend to form $\mu\text{-S-}$ or $\mu\text{-Se-}$ bridged dinuclear species, even with bulky organic groups, e.g., 2,4,6-tri-*t*-butylphenyl.^{317,318} With some ligand combinations, heterocubanes with Cd_4S_4 core or oligonuclear species derived from heterocubanes are formed.^{319,320}

With simple Hg thiolates the structures of bis(ethanethiolato)mercury $\text{Hg}(\text{SEt})_2$ ³²¹ and of the cysteamine complex $[\text{Hg}\{\text{S}(\text{CH}_2)_2\text{NH}_3\}_2]\text{Cl}_2$ ³²² have reference character, as only weak or no secondary bonds are present, and therefore the central S—Hg—S entities can be considered to be unperturbed. In mercury bis(tri-*t*-butoxysilanethiolate) $\text{Hg}[\text{SSi}(\text{o-}t\text{-Bu})_3]$, with a strictly linear S—Hg—S unit, two weak intramolecular $\text{O}\cdots\text{Hg}$ interactions obviously do not affect the bonding in this unit.³²³

As for thiolato complexes $[\text{M}(\text{SR})_3]^-$ ($\text{M} = \text{Cd}, \text{Hg}$), the anion $[\text{Hg}(\text{SPh})_3]^-$ can be mononuclear³²⁴ or dinuclear $[\text{Hg}_2(\text{SPh})_6]^{2-}$,³²⁵ depending on the counterion; the methanethiolato complex is also dinuclear $[\text{Hg}_2(\text{SMe})_6]^{2-}$ in the solid.³²⁶ Further mononuclear trithiolato complexes of Cd and Hg with bulky organic groups have been described.^{23,327–330} Correlations between structures and solid-state ¹¹³Cd and ¹⁹⁹Hg NMR data have been worked out.^{329,331} Ligand-exchange processes in dissolved thiolate complexes of Hg have been studied by ¹³C NMR spectrometry.³³²

Reviews on mercury—thiolate complexes and their bio-relevance³³³ and complexes with sterically hindered thiolate ligands have been published.³³⁴

The benzeneselenolates of mercury, $[\text{Hg}(\text{SePh})_2]$ and $(\text{Bu}_4\text{N})[\text{Hg}(\text{SePh})_3]$, both adopt simple structures, with mononuclear complex entities which possess near-linear Se—Hg—Se and near trigonal-planar HgSe_3 cores, respectively.³³⁵

Interesting molecular mercury zinc sulfides $\text{Hg}[\text{SZn}(\text{3-Ph-5-Mepz})_3\text{BH}]_2$ and $\text{PhHg}[\text{SZn}(\text{3-Ph-5-Mepz})_3\text{BH}]$ ($\text{pz} = \text{pyrazole}$) have been obtained and structurally studied.³³⁶

(iii) Cd and Hg chalcogene clusters

Adamantoid systems $[(\mu\text{-ChR})_6(\text{MX})_4]^{2-}$ ($\text{Ch} = \text{S}, \text{Se}, \text{Te}$; R usually Ph ; $\text{M} = \text{Cd}, \text{Hg}$; $\text{X} = \text{halogene}$) have been prepared and studied by X-ray structure analyses, heteronuclear NMR and vibrational spectrometries, and partly by UV/vis spectrometry.^{337–341} Meanwhile, the systems have been expanded to superadamantoid clusters with four fused adamantoid subunits $[\text{M}_{10}\text{Ch}_4(\text{ChPh})_{12}(\text{PPh}_3)_4]$ ^{342,343} and related clusters,³⁴⁴ and finally to nanoclusters with up to 32 metal atoms in one cluster.^{345,346}

(iv) Cd and Hg polychalcogenide complexes

The field of polysulfide complexes has been reviewed earlier.³⁴⁷ A more recent survey covers polychalcogenide complexes in general,³⁴⁸ and in a review on ate complexes also further examples of anionic polychalcogenide species are dealt with.³⁴⁹

6.9.4.2.9 Compounds with halides as donor atoms

A huge number of studies have been done in the past on cadmium and mercury halides and their complexes, and there is still research interest in the field, sometimes yielding surprising results. And simple-looking systems, on closer inspection, turn out to be rather complex.

(i) Mercury fluoride systems

The ternary fluorides M_2HgF_4 ($\text{M} = \text{Rb}, \text{Cs}$), obtained by heating the alkali-metal fluorides MF with Hg_2F_2 under carefully controlled conditions, crystallize in the well-known K_2NiF_4 type, with octahedra sharing four corners to form layers ${}_{\infty}^2[\text{HgF}_2\text{F}_4/2]^{2-}$ and the cations M^+ embedded between these layers.³⁵⁰

In the fluoride phase $\text{HgFeF}_5 \cdot 2\text{H}_2\text{O}$, *trans*- $\text{Hg}(\text{OH})_2\text{F}_4$ octahedra and FeF_6 octahedra share F-corners to form layers connected by hydrogen bonds.³⁵¹ Similarly, *trans*- $\text{Hg}(\text{OH})_2\text{F}_4$ octahedra and FeF_6 octahedra share F corners, but the $\text{Hg}(\text{OH})_2\text{F}_4$ octahedra also share the OH corners to form the layers in $\text{Hg}_2\text{FeF}_5(\text{OH})_2 \cdot \text{H}_2\text{O}$.³⁵²

In $\text{Hg}_3\text{AlF}_6\text{O}_2\text{H}$, Hg on an inversion center is eight-coordinate (distorted cube), with two short Hg—O bonds (214.6 pm) and two sets of Hg—F interactions (252.6 pm and 267.0 pm); linking of these polyhedra and of AlF_6 octahedra generates OHg_3 units (trimercurio-oxonium groups).³⁵³

(ii) Cd and Hg halide complexes

Halogenocadmates can occur as simple tetrahedral anions CdX_4^{2-} ,³⁵⁴ or they form the backbone of chain polymers $\infty^1[\text{CdL}_2\text{Br}_{4/2}]^{2-}$ (L = N-donor ligand).³⁵⁵ Isolated dinuclear complexes as in $[\{\text{Me}_3\text{Si}\}_3\text{Ge}-\text{Cd}(\mu\text{-I})_3\text{Cd}-\text{Ge}\{\text{SiMe}_3\}_3]$ with a triple iodo bridge,³⁵⁶ and heterocubanes with Cd_4X_4 cores³⁵⁷ or derivatives or fragments thereof³⁵⁸ are also encountered.

Solvation of the higher mercury(II) halides in donor solvents has been studied by X-ray diffraction on these solutions (large-angle X-ray scattering, LAXS), X-ray diffraction on complexes isolated from the solutions, and vibrational spectrometries; a paper (and references cited therein) on the halides HgX_2 in dimethylthioformamide is typical for this kind of multimethod approach.³⁵⁹ Systematic studies of frequency shifts of the mercury halides HgX_2 in various solvents afforded the basis for a new scale of donor strengths.³⁶⁰

Chloromercurates adopt an incredible diversity of structures, as has been discussed in one review.³⁶¹ The sobering *facit* of this critical discussion: “The configuration of the anion cannot be determined from the stoichiometry. It is still not possible to predict, even for simple stoichiometries, the form that will be adopted in the solid state.” Two more recent examples support this view. CsHgCl_3 does not adopt the simple perovskite-type structure assumed for a long time, but a complicated lattice with three different distorted octahedra HgCl_6 (2 + 2 + 2 coordinate), even with bent HgCl_2 moieties, and only at pressures above 3.5 GPa, is the structure forced to perovskite.³⁶² Even minor changes in the counteraction of chloromercurates can alter the structure of the anion, as is shown for the compounds with the isomeric 2-, 3-, and 4-chloropyridinium cations.³⁶³ The diversity of structures of chloro- and bromomercurates has once more been demonstrated in a series of very recent (2002) papers.^{364–368}

Iodomercurates can adopt the simple forms of tetrahedra HgI_4^{2-} or bitetrahedra $\text{Hg}_2\text{I}_6^{2-}$, even in overall complicated structures.^{369,370}

6.9.4.2.10 Compounds with pseudohalides

In recent years research in the field of transition-metal thiocyanates and selenocyanates received a new impetus, because of the partly interesting physical properties of such crystalline species. A review on Cd and Hg thiocyanate systems collects and sorts results of this endeavor.³⁷¹ The nonlinear optical (NLO) properties of Cd thiocyanate and selenocyanate systems and criteria for the design of NLO crystals (crystal engineering), especially, have been discussed afterwards.³⁷² Further contributions to the field have also been described.^{373,374}

The structure of mercury chlorothiocyanate has been re-determined.³⁷⁵

6.9.4.2.11 Compounds with hydrido ligands

After earlier indications of the existence of mercury hydrides³⁷⁶ and the proof that MeHgH exists,³⁷⁷ several organomercury hydrides RHgH and their deuterated isotopomers with simple aliphatic substituents, phenyl, fluorophenyl, and substituted fluorophenyl ligands have been prepared from the respective chlorides and NaBH_4 in aqueous solution, and thoroughly studied by mass spectrometry and ^1H NMR spectrometry.^{378,379} Correlations between chemical shifts $\delta(\text{HHgR})$, coupling constants $^1J(^{199}\text{Hg}, ^1\text{H})$, and the electron-withdrawing nature of the R groups have been established. Quantum-chemical calculations considering relativistic effects have yielded optimized structures and ^1H chemical shifts; the latter have been compared with experimental data.⁵³

6.9.4.3 Lower Oxidation States of Cd and Hg**6.9.4.3.1 Compounds with formal oxidation states intermediate between +2 and +1***(i) Compounds with triangulo- Hg_3^{4+} entities*

As mentioned in Section 6.9.3, nature produces the minerals terlinguaite $(\text{Hg}_3)\text{HgO}_2\text{Cl}_2$ ^{61–63} and kuznetsovite $(\text{Hg}_3)\text{AsO}_4\text{Cl}$,^{64–66} both with the *triangulo- Hg_3^{4+}* entities in which the Hg atoms formally possess the oxidation number +4/3; in the former compound the Hg–Hg bonds are the

same accidentally, in the latter by symmetry (270.3 pm and 265.8 pm, respectively). Meanwhile, further arsenates and phosphates with analogous compositions to kuznetsovite have been synthesized;⁶⁶ as for the overall average of the Hg—Hg bonds, the value 266.9 pm is given. The phosphate $(\text{Hg}_3)_3(\text{PO}_4)_4$ ³⁸⁰ and the isotypic arsenate $(\text{Hg}_3)_3(\text{AsO}_4)_4$,³⁸¹ as well as the phosphate $(\text{Hg}_3)_2(\text{HgO}_2)(\text{PO}_4)_2$,³⁸⁰ all contain this unusual constituent.

Independently, *triangulo*-Hg₃ compounds with stabilizing chelating diphosphine and diarsine ligands have been prepared;^{382–387} crystal-structure analyses have been solved (the Hg—Hg bonds, ≈280 pm, are longer than before), and careful multinuclear NMR spectra measured and analysed.

(ii) Mixed-valence compounds with Hg²⁺ and Hg₂²⁺

A deceptively simple-looking compound, Hg₂OI contains 2-D networks built up from kinked —Hg—O— chains which are linked by Hg₂ dumbbells;³⁸⁸ this network can be described in brief as $\infty^2[\text{OHg}_{2/2}(\text{Hg}_2)_{2/2}]^+$. Quite a similar network is found in one of the hydrolysis products of Hg₂(NO₃)₂, namely Hg₄O₂(NO₃)₂, with the above mixed-valence mercurio-oxonium units as building blocks.³⁸⁹ A product of the partial hydrolysis of Hg(ClO₄)₂ treated with elemental Hg, namely (Hg₂)Hg(OH)₂(ClO₄)₂, can be isolated; this basic chlorate(VII) (C2/c, Z=4) contains chains with alternating Hg and Hg₂ groups between OH groups: $\infty^1[(\text{OH})\text{Hg}_{1/2}(\text{Hg}_2)_{1/2}]^+$.³⁹⁰

6.9.4.3.2 Compounds with oxidation state +I

(i) Dimercury(I) compounds

The crystal structures of Hg₂F₂³⁵⁰ and Hg₂Cl₂ (neutron diffraction)³⁹¹ have been redetermined ($r(\text{Hg—Hg})$ 251.0, $r(\text{Hg—F})$ 213.3 pm; $r(\text{Hg—Hg})$ 259.55, $r(\text{Hg—Cl})$ 236.22 pm). [Hg₂(OH₂)₂][SbF₆]₂·4 HF obtained from the dimercury(I) carbonyl complex, mentioned in Section 6.9.4.2.1(i), in super-acid has been studied by X-ray diffraction ($r(\text{Hg—Hg})$ 249.2, $r(\text{Hg—O})$ 214.8 pm).³⁹²

The crystal structure of dimercury(I) bis(tricyanomethanide), Hg₂{C(CN)₃}₂, has been solved (2-D network).³⁹³ Further hydrolysis products of Hg₂{NO₃}₂ have been structurally elucidated.^{394–396} Several dimercury(I) phosphates and arsenates have been thoroughly studied (X-ray diffraction, vibrational spectra, thermal analyses).^{397–399} The methanesulfonate Hg₂(O₃SMe)₂ has basically molecular units, with monodentate O₃SMe ligands and secondary O···Hg bonds ($r(\text{Hg—Hg})$ 251.4, $r(\text{Hg—O})$ 220.5 pm).⁴⁰⁰ The molybdates Hg₂Mo₂O₇, Hg₂MoO₄ (two modifications), and the tungstate Hg₂WO₄ have been prepared by solid-state reactions and structurally studied.^{401,402}

In an Hg₂²⁺ asymmetrically complexed by two crown-ethers of different ring size, an extremely high coupling constant $^1J(^{199}\text{Hg}, ^{199}\text{Hg})$ of 284 kHz between the magnetically inequivalent Hg nuclei has been observed.⁴⁰³

¹⁹⁹Hg MAS NMR and vibrational spectra of several inorganic dimercury(I) compounds have been measured and discussed.⁴⁰⁴

Reasonably stable compounds of Hg₂ groups bound to silyl groups have been obtained, e.g., Hg₂{Si(SiMe₂SiMe₃)₃}₂, with a straight Si—Hg—Hg—Si arrangement ($r(\text{Hg—Hg})$ 265.7, $r(\text{Hg—Si})$ 248.5 pm).⁴⁰⁵

Interaction of Hg₂ groups with electron-rich aromatic rings has been observed in the structure of [Hg₂(C₆Me₆)](AlCl₄)₂ ($r(\text{Hg—Hg})$ 251.5 pm).⁴⁰⁶

As mentioned at the end of Section 6.9.3, reviews of the crystal chemistry of mercury minerals with lower oxidation states and with oxo-centered building blocks have been published^{72,73} and the structural role of Hg₂²⁺ and Hg₃⁴⁺ groups discussed.⁴⁰⁷

(ii) Dicadmium(I) compounds

Only a few dicadmium(I) compounds are known so far. The very first structurally characterized is Cd₂(AlCl₄)₂, which contains Cd₂ groups in a trigonally elongated octahedron of chloro ligands

($r(\text{Cd—Cd})$ 257.6 pm) (see the Hg—Hg distances above!).⁴⁰⁸ In an independent study the results have basically been confirmed ($r(\text{Cd—Cd})$ 256.2 pm).⁴⁰⁹

A Cd_2 complex with one of the tris(pyrazolyl)borate ligands mentioned in Section 6.9.4.2.3(ii) has been identified in solution by its large coupling constant $^1J(^{113}\text{Cd}, ^{111}\text{Cd})$ of 20.626 kHz; also a Cd^{II} hydride complex has been detected by NMR.⁴¹⁰

6.9.4.3.3 Subvalent mercury compounds

Compounds such as $\text{Hg}_3(\text{AsF}_6)_2$, $\text{Hg}_3(\text{SO}_3\text{F})_2$, and $\text{Hg}_4(\text{AsF}_6)_2$ in liquid SO_2 have been studied by ^{199}Hg NMR, with large coupling constants $^1J(^{199}\text{Hg}, ^{199}\text{Hg})$ for the Hg_3^{2+} ion observable only below -40°C .⁴¹¹ Structure analyses of the silvery-shining compounds HgMF_6 ($M = \text{Nb}, \text{Ta}$) reveal that the Hg atoms are arranged in hexagonal layers sandwiched between layers of the anions.⁴¹² Completely different structures, with almost-linear Hg_3^{2+} ions ($r(\text{Hg—Hg})$ 256.9 pm) and also nearly linear Hg_4^{2+} ions ($r(\text{Hg—Hg})$ 259.3 pm and 263.0 pm), have been found for $\text{Hg}_3(\text{MF}_5)_2\text{SO}_4$ ($M = \text{Nb}, \text{Ta}$) and for $\text{Hg}_4(\text{Ta}_2\text{F}_{11})_2$, respectively.⁴¹³

6.9.5 REFERENCES

1. Prince, R. H. In *Comprehensive Coordination Chemistry*; Wilkinson, G., Gillard, R. D., McCleverty, J. A., Eds.; Pergamon: Oxford, 1987, Vol. 5, pp 925–1045.
2. Brodersen, K.; Hummel, H.-U. In *Comprehensive Coordination Chemistry*; Wilkinson, G., Gillard, R. D., McCleverty, J. A., Eds.; Pergamon: Oxford, 1987, Vol. 5, pp 1047–1097.
3. Cotton, F. A.; Wilkinson, G.; Murillo, C. A.; Bochmann, M. *Advanced Inorganic Chemistry*, 6th ed. Wiley–Interscience: New York, 1999.
4. Greenwood, N. N.; Earnshaw, A. *Chemistry of the Elements*, 2nd ed. Butterworth Heinemann: Oxford, UK, 1997.
5. Holleman, A. F.; Wiberg, E.; Wiberg, N. *Inorganic Chemistry*, Academic Press: San Diego, CA, 2001.
6. Silver, J. *Ann. Rep. Prog. Chem., Sect. A* **1986**, *83*, 351–356.
7. Silver, J. *Ann. Rep. Prog. Chem., Sect. A* **1987**, *84*, 278–284.
8. Richens, D. T. *Ann. Rep. Prog. Chem., Sect. A* **1989**, *86*, 61–75.
9. Sloan, H. *Ann. Rep. Prog. Chem., Sect. A* **1993**, *90*, 91–102.
10. Gorrell, I. B. *Ann. Rep. Prog. Chem., Sect. A* **1994**, *91*, 115–129.
11. Gorrell, I. B. *Ann. Rep. Prog. Chem., Sect. A* **1995**, *92*, 113–125.
12. Gorrell, I. B. *Ann. Rep. Prog. Chem., Sect. A* **1997**, *93*, 117–127.
13. Gorrell, I. B. *Ann. Rep. Prog. Chem., Sect. A* **1998**, *94*, 137–148.
14. Malito, J. *Ann. Rep. Prog. Chem., Sect. A* **1999**, *95*, 93–104.
15. Malito, J. *Ann. Rep. Prog. Chem., Sect. A* **2000**, *96*, 147–159.
16. Malito, J. *Ann. Rep. Prog. Chem., Sect. A* **2001**, *97*, 117–132.
17. Malito, J. *Ann. Rep. Prog. Chem., Sect. A* **2002**, *98*, 115–128.
18. Bretinger, D. K. In *Synthetic Methods of Organometallic and Inorganic Chemistry*; Bretinger, D. K., Herrman, W. A., Eds.; Thieme: Stuttgart, Germany, 1999, Vol. 5, pp 166–192.
19. Bretinger, D. K. In *Synthetic Methods of Organometallic and Inorganic Chemistry*; Bretinger, D. K., Herrman, W. A., Eds.; Thieme: Stuttgart, Germany, 1999, Vol. 5, pp 193–238.
20. Olson, B. H.; Panigrahi, A. K. In *Metals and their Compounds in the Environment*; Merian, E., Ed.; VCH: Weinheim, Germany, 1991, Chapter I.7h.
21. von Burg, A.; Greenwood, M. R. In *Metals and their Compounds in the Environment*; Merian, E., Ed.; VCH: Weinheim, Germany, 1991, Chapter II.20.
22. Martell, A. E.; Motekaitis, R. J. *Determination and Use of Stability Constants*, 2nd ed. VCH: New York, 1992.
23. Watton, S. P.; Wright, J. G.; MacDonnel, F. M.; Bryson, J. W.; Sabbat, M.; O'Halloran, T. V. *J. Am. Chem. Soc.* **1990**, *112*, 2824–2826.
24. Bencini, A.; Bianchi, A.; Fornasari, P.; Giorgi, C.; Paoletti, P.; Valtancoli, B. *Polyhedron* **2002**, *21*, 1329–1335.
25. Crisponi, G.; Diaz, A.; Nurchi, V. M.; Pivetta, T.; Tapia Estévez, M. J. *Polyhedron* **2002**, *21*, 1319–1327.
26. Comuzzi, C.; Grespan, M.; Melchior, A.; Portanova, R.; Tolazzi, M. *Eur. J. Inorg. Chem.* **2001**, 3087–3094.
27. Dechter, J. J. In *Progress in Inorganic Chemistry*; Lippard, S. J., Ed.; Wiley: New York, 1985; Vol. 33, pp 393–507.
28. Goodfellow, R. J. In *Multinuclear NMR*, Mason, J., Ed., Plenum Press: New York, 1987; Chapter 21, 563–589.
29. Summers, M. F. *Coord. Chem. Rev.* **1988**, *86*, 43–134.
30. Granger, P. In *Transition Metal Nuclear Magnetic Resonance*; Pregosin, P. S., Ed.; Elsevier: Amsterdam 1991; pp 288–345.
31. Wrackmeyer, B.; Contreras, R. In *Ann. Rep. NMR Spectrosc.* Webb, G. A., Ed., Academic Press: London 1992; Vol. 24, pp 267–329.
32. Bowmaker, G. A.; Harris, R. K.; Oh, S.-W. *Coord. Chem. Rev.* **1997**, *167*, 49–94.
33. Bowmaker, G. A.; Clase, H. J.; Alcock, N. W.; Kessler, J. M.; Nelson, J. H.; Frye, J. S. *Inorg. Chim. Acta* **1993**, *210*, 107–124.
34. Wulfsberg, G. P.; Frye, J. S.; Buchanan, A. C.; Weiss, A.; Chia-Chung Jui, C.; Davis, D. A.; Bass, K.; Todd, R. W. *Organometallics* **1987**, *6*, 2363–2370.
35. Rauch, H.; Waschkowski, W. In *Neutron Data Booklet*; Dianoux, A.-J., Lander, G., Eds., Institut Laue–Langevin: Grenoble, France, 2001, *1.1*, 1–19.

36. Finney, J. L. *Acta Cryst.* **1995**, *B51*, 447–467.
37. Becker, M.; Jansen, M. Z. *Anorg. Allg. Chem.* **2000**, *626*, 1639–1641.
38. Johansson, G. In *Advances in Inorganic Chemistry*; Sykes, A. G., Ed., Academic Press: San Diego, CA, 1992; Vol. 39; pp 159–232.
39. Garner, C. D. In *Advances in Inorganic Chemistry*; Sykes, A. G., Ed., Academic Press: San Diego, CA, 1991; Vol. 36; pp 303–339.
40. Bertagnolli, H.; Ertel, T. S. *Angew. Chem., Int. Ed. Engl.* **1994**, *33*, 15–44.
41. Åkesson, R.; Persson, I.; Sandström, M.; Wahlgren, U. *Inorg. Chem.* **1994**, *33*, 3715–3723.
42. Persson, I.; Sandström, M.; Goggin, P. L. *Inorg. Chim. Acta* **1987**, *129*, 183–197.
43. Sandström, M.; Persson, I.; Persson, P. *Acta Chem. Scand.* **1990**, *44*, 653–675.
44. Wirnsberger, G.; Pillep, B. M.; Popitsch, A.; Knoll, P.; Behrens, P. *Chem. Eur. J.* **2002**, *8*, 3927–3937.
45. Yamashita, M.; Fenn, J. B. *J. Phys. Chem.* **1984**, *88*, 4451–4459.
46. Yamashita, M.; Fenn, J. B. *J. Phys. Chem.* **1984**, *88*, 4671–4675.
47. Whitehouse, C. M.; Yamashita, M.; Fenn, J. B.; Dreyer, R. N. *Anal. Chem.* **1985**, *57*, 675–679.
48. Colton, R.; Dakternieks, D. *Inorg. Chim. Acta* **1993**, *208*, 173–177.
49. Kunz, C. F.; Hättig, C.; Hess, B. A. *Mol. Phys.* **1996**, *89*, 139–156.
50. Schwerdtfeger, P.; Wesendrup, R.; Moyano, G. E.; Sadlej, A. J.; Greif, J.; Hensel, F. *J. Chem. Phys.* **2001**, *115*, 7401–7412.
51. Schwerdtfeger, P.; Wesendrup, R.; Moyano, G. E.; Sadlej, A. J.; Greif, J.; Hensel, F. *J. Chem. Phys.* **2002**, *117*, 6881.
52. Moyano, G. E.; Wesendrup, R.; Söhnle, T.; Schwerdtfeger, P. *Phys. Rev. Lett.* **2002**, *89*, 103401/1–103401/4.
53. Kaupp, M.; Malkina, O. L. *J. Chem. Phys.* **1998**, *108*, 3648–3659.
54. Kaupp, M.; von Schnering, H. G. *Angew. Chem., Int. Ed. Engl.* **1993**, *32*, 861–863.
55. Kaupp, M.; Dolg, M.; Stoll, H.; von Schnering, H. G. *Inorg. Chem.* **1994**, *33*, 2122–2131.
56. Pyykkö, P. *Angew. Chem., Int. Ed. Engl.* **2002**, *41*, 3573–3578.
57. Furey, W. F.; Robbins, A. H.; Clancy, L. L.; Winge, D. R.; Wang, B. C.; Stout, C. D. *Science* **1986**, *231*, 704–710.
58. Strasdeit, H. *Angew. Chem., Int. Ed. Engl.* **2001**, *40*, 707–709.
59. Ortega Gironés, E.; Hernandez Sobrino, A. *Chron. Rech. Min.* **1992**, *506*, 3–24.
60. Jébrak, M.; Higuera, P. L.; Marcoux, É.; Lorenzo, S. *Miner. Deposita* **2002**, *37*, 421–432.
61. Ščavničar, S. *Acta Cryst.* **1956**, *9*, 956–959.
62. Aurivillius, K.; Folkmarson, L. *Acta Chem. Scand.* **1968**, *22*, 2529–2540.
63. Brodersen, K.; Göbel, G.; Liehr, G. Z. *Anorg. Allg. Chem.* **1989**, *575*, 145–153.
64. Romanenko, G. V.; Pervukhina, N. V.; Borisov, S. V.; Magarill, S. A.; Vasiliev, V. I. *J. Struct. Chem.* **1999**, *40*, 270–275.
65. Romanenko, G. V.; Borisov, S. V. *J. Struct. Chem.* **2000**, *41*, 888–889.
66. Weil, M. Z. *Naturforsch.* **2001**, *56b*, 753–758.
67. Mereiter, K.; Zemann, J. *Tschermaks Min. Petr. Mitt.* **1976**, *23*, 105–115.
68. Mereiter, K.; Zemann, J.; Hewat, A. W. *Am. Miner.* **1992**, *77*, 839–842.
69. Vasiliev, V. I.; Lavrentiev, Y. G.; Palchik, N. A. *Geol. Geofiz.* **1980**, 128–132.
70. Tillmanns, E.; Krupp, R.; Abraham, K. *Tschermaks Min. Petr. Mitt.* **1982**, *30*, 227–235.
71. Pervukhina, N. V.; Romanenko, G. V.; Magarill, S. A.; Vasiliev, V. I.; Borisov, S. V. *J. Struct. Chem.* **1999**, *40*, 155–158.
72. Pervukhina, N. V.; Romanenko, G. V.; Borisov, S. V.; Magarill, S. A.; Palchik, N. A. *J. Struct. Chem.* **1999**, *40*, 461–476.
73. Magarill, S. A.; Romanenko, G. V.; Pervukhina, N. V.; Borisov, S. V.; Palchik, N. A. *J. Struct. Chem.* **2000**, *41*, 96–105.
74. Deming, R. L.; Allred, A. L.; Dahl, A. R.; Herlinger, A. W.; Kestner, M. O. *J. Am. Chem. Soc.* **1976**, *98*, 4132–4137.
75. Liu, W.; Franke, R.; Dolg, M. *Chem. Phys. Lett.* **1999**, *302*, 231–239 and references therein.
76. Kaupp, M.; von Schnering, H. G. *Inorg. Chem.* **1994**, *33*, 4718–4722.
77. Willner, H.; Bodenbinder, M.; Wang, C.; Aubke, F. *J. Chem. Soc., Chem. Commun.* **1994**, 1189.
78. Bodenbinder, M.; Balzer-Jöllenbeck, G.; Willner, H.; Batchelor, R. J.; Einstein, F. W. B.; Wang, C.; Aubke, F. *Inorg. Chem.* **1996**, *35*, 82–92.
79. Cremer, U.; Ruschewitz, U. Z. *Anorg. Allg. Chem.* **2002**, *628*, 2207.
80. Barr, D.; Edwards, A. J.; Raithby, P. R.; Rennie, M.-A.; Verhorevoort, K.; Wright, D. S. *J. Chem. Soc., Chem. Commun.* **1994**, 1627–1628.
81. Gutierrez-Puebla, E.; Vegas, A.; Garcia-Blanco, S. *Acta Crystallogr. B* **1978**, *34*, 3382–3384.
82. Faville, S. J.; Henderson, W.; Mathieson, T. J.; Nicholson, B. K. *J. Organomet. Chem.* **1999**, *580*, 363–369.
83. Pyykkö, P. *Chem. Rev.* **1997**, *97*, 597–636.
84. Batsanov, S. S. *J. Chem. Soc., Dalton Trans.* **1998**, 1541–1546.
85. Sebal, A.; Wrackmeyer, B. *Spectrochim. Acta* **1982**, *38A*, 163–173.
86. Sebal, A.; Wrackmeyer, B. *Spectrochim. Acta* **1986**, *42A*, 1107–1111.
87. Dunbar, K. R.; Heintz, R. A. In *Progress in Inorganic Chemistry*; Karlin, K. D., Ed., Wiley: New York, 1997; Vol. 45, pp 283–391.
88. Iwamoto, T.; Nishikiori, S.; Kitazawa, T.; Yuge, H. *J. Chem. Soc., Dalton Trans.* **1997**, 4127–4136.
89. Yoshikawa, H.; Nishikiori, S.; Watanabe, T.; Ishida, T.; Watanabe, G.; Murakami, M.; Suwinska, K.; Luboradzki, R.; Lipkowski, J. *J. Chem. Soc., Dalton Trans.* **2002**, 1907–1917.
90. Bowes, C. L.; Ozin, G. A. *Adv. Mater.* **1996**, *8*, 13–27.
91. Hoskins, B. F.; Robson, R. *J. Am. Chem. Soc.* **1990**, *112*, 1546–1554.
92. Nishikiori, S.; Ratcliffe, C. I.; Ripmeester, J. A. *Can. J. Chem.* **1990**, *68*, 2270–2273.
93. Kitazawa, T.; Nishikiori, S.; Kuroda, R.; Iwamoto, T. *J. Chem. Soc., Dalton Trans.* **1994**, 1029–1036.
94. Yuge, H.; Iwamoto, T. *J. Chem. Soc., Dalton Trans.* **1993**, 2841–2847.
95. Kitazawa, T.; Kikuyama, T.; Takeda, M.; Iwamoto, T. *J. Chem. Soc., Dalton Trans.* **1995**, 3715–3720.
96. Kitazawa, T. *J. Chem. Soc., Chem. Commun.* **1999**, 891–892.
97. Abrahams, B. F.; Hoskins, B. F.; Robson, R. *J. Chem. Soc., Chem. Commun.* **1990**, 60–61.

98. Nishikiori, S.; Ratcliffe, C. I.; Ripmeester, J. A. *J. Chem. Soc., Chem. Commun.* **1991**, 735–736.
99. Abrahams, B. F.; Hoskins, B. F.; Lam, Y.-H.; Robson, R.; Separovic, F.; Woodberry, P. J. *Solid State Chem.* **2001**, *156*, 51–56.
100. Kanesaka, I.; Kita, Y.; Nishikiori, S. *J. Raman Spectrosc.* **2002**, *33*, 26–30.
101. Ekici, N.; Kantarci, Z.; Akyüz, S. *J. Incl. Phenom.* **1991**, *10*, 9–18.
102. Bayari, S.; Bayrak, C.; Kantarci, Z. *J. Incl. Phenom.* **2000**, *38*, 23–35.
103. Seccombe, R. C.; Kennard, C. H. L. *J. Organometal. Chem.* **1969**, *18*, 243–247.
104. Bowmaker, G. A.; Churakov, A. V.; Harris, R. K.; Oh, S.-W. *J. Organomet. Chem.* **1998**, *550*, 89–99.
105. Sano, M.; Adachi, H.; Yamatera, H. *Bull. Chem. Soc. Jpn.* **1982**, *55*, 1022–1027.
106. DeKock, R. L.; Baerends, E. J.; Boerrigter, P. M.; Hengelmolen, R. J. *Am. Chem. Soc.* **1984**, *106*, 3387–3396.
107. Zouari, R.; Ben Salah, A.; Daoud, A.; Rothammel, W.; Burzlaff, H. *Acta Crystallogr. C* **1993**, *49*, 1596–1598.
108. Rego, C. A.; Cox, A. P. *J. Chem. Phys.* **1988**, *89*, 124–128.
109. Ziegler, B.; Babel, D. Z. *Naturforsch.* **1991**, *46b*, 47–49.
110. Kitazawa, T.; Takeda, M. *J. Chem. Soc., Chem. Commun.* **1993**, 309–310.
111. Kitazawa, T.; Akiyama, M.; Takahashi, M.; Takeda, M. *J. Chem. Soc., Chem. Commun.* **1993**, 1112–1113.
112. Gerlach, P. N.; Powell, B. M. *J. Chem. Phys.* **1986**, *85*, 6004–6009.
113. Powell, B. M.; Gerlach, P. N. *Mater. Science Forum* **1988**, *27/28*, 99–102.
114. Asaji, T.; Ikeda, R. *J. Mol. Struct.* **1995**, *345*, 93–95.
115. Klüfers, P.; Fuess, H.; Haussühl, S. Z. *Kristallogr.* **1981**, *156*, 255–263.
116. Mok, K. F.; McKee, V.; Robinson, W. T. *Acta Crystallogr., Sect. C* **1993**, *49*, 1596–1598.
117. Albright, M. J.; Schaaf, T. F.; Hovland, A. K.; Oliver, J. P. *J. Organomet. Chem.* **1983**, *259*, 37–50.
118. Thiele, G.; Grossmann, J. *Kristallogr.* **1986**, *174*, 194–195.
119. Thiele, G.; Grossmann, J.; Pürzer, A. W. *Z. Naturforsch.* **1986**, *41b*, 1346–1350.
120. Grossmann, J.; Thiele, G. *Thermochim. Acta* **1987**, *112*, 71–74.
121. Györyová, K.; Mohai, B. Z. *Anorg. Allg. Chem.* **1982**, *492*, 175–187.
122. Györyová, K. *J. Thermal Anal.* **1990**, *36*, 1831–1839.
123. Ponikvar, W.; Schuierer, E.; Beck, W. *Z. Anorg. Allg. Chem.* **2000**, *626*, 1282–1284.
124. Beck, W.; Klapötke, T. M. *Z. Naturforsch.* **2001**, *56b*, 1376–1378.
125. Pickett, N. L.; Just, O.; VanDerveer, D. G.; Rees, Jr., W. S. *Acta Crystallogr. C* **2000**, *56*, 412–413.
126. Ilsley, W. H.; Albright, M. J.; Anderson, T. J.; Glick, M. D.; Oliver, J. P. *Inorg. Chem.* **1980**, *19*, 3577–3585.
127. Henkel, S.; Klinkhammer, K. W.; Schwarz, W. *Angew. Chem., Int. Ed. Engl.* **1994**, *33*, 681–683.
128. Klinkhammer, K. W.; Weidlein, J. *Z. Anorg. Allg. Chem.* **1996**, *622*, 1209–1214.
129. Arnold, J.; Tilley, T. D.; Rheingold, A. L.; Geib, S. J. *Inorg. Chem.* **1987**, *26*, 2106–2109.
130. Mallela, S. P.; Schwan, F.; Geanangel, R. A. *Inorg. Chem.* **1996**, *35*, 745–748.
131. Dvoinin, V. I.; Skorniyakov, L. G.; Yatlova, L. E.; Degtyarev, M. V.; Kitaev, G. A. *Zh. Prikl. Khim. (Leningrad)* **1982**, *55*, 213–215.
132. Baldinozzi, G.; Malinowska, B.; Rakib, M.; Durand, G. *J. Mater. Chem.* **2002**, *12*, 268–272.
133. Liu, H.; Klein, W.; Bender, H.; Jansen, M. *Z. Anorg. Allg. Chem.* **2002**, *628*, 4–6.
134. Liu, X.; Müller, P.; Kroll, P.; Dronskowski, R. *Inorg. Chem.* **2002**, *41*, 4259–4265.
135. Liu, X.; Dronskowski, R. *Z. Naturforsch.* **2002**, *57b*, 1108–1114.
136. Movchan, O. G.; Samoilenko, V. M.; Skopenko, V. V. *Ukrainskii Khim. Zh.* **1982**, *48*, 124–126.
137. Samoilenko, V. M.; Movchan, O. G. *Ukrainskii Khim. Zh.* **1986**, *52*, 904–907.
138. Movchan, O. G.; Skopenko, V. V.; Samoilenko, V. M. *Ukrainskii Khim. Zh.* **1982**, *48*, 546–548.
139. Luo, J.-H.; Hong, M.-C.; Weng, J.-B.; Zhao, Y.-J.; Cao, R. *Inorg. Chim. Acta* **2002**, *329*, 59–65.
140. Wang, R.; Hong, M.-C.; Luo, J.-H.; Cao, R.; Shi, Q.; Weng, J.-B. *Eur. J. Inorg. Chem.* **2002**, 2904–2912.
141. Luo, J.-H.; Hong, M.-C.; Cao, R.; Liang, Y.-C.; Zhao, Y.-J.; Wang, R.-H.; Weng, J.-B. *Polyhedron* **2002**, *21*, 893–898.
142. Gao, E.-Q.; Wang, Z.-M.; Liao, C.-S.; Yan, C.-H. *New J. Chem.* **2002**, *26*, 1096–1098.
143. Batten, S. R.; Hoskins, B. F.; Robson, R. *J. Chem. Soc., Chem. Commun.* **1991**, 445–447.
144. Batten, S. R.; Hoskins, B. F.; Robson, R. *Angew. Chem., Int. Ed. Engl.* **1997**, *36*, 636–637.
145. Batten, S. R.; Hoskins, B. F.; Robson, R. *Inorg. Chem.* **1998**, *37*, 3432–3434.
146. Gümrükçüoğlu, I. E.; Jeffery, J.; Lappert, M. F.; Pedley, J. B.; Rai, A. K. *J. Organomet. Chem.* **1988**, *341*, 53–62.
147. Alyea, E. C.; Fisher, K.; Fjeldberg, T. *J. Mol. Struct.* **1985**, *127*, 325–335.
148. Alyea, E. C.; Fisher, K.; Fjeldberg, T. *J. Mol. Struct.* **1985**, *130*, 263–273.
149. Schumann, H.; Gottfriedsen, J.; Dechert, S.; Girgsdies, F. *Z. Anorg. Allg. Chem.* **2000**, *626*, 747–758.
150. Cummins, C. C.; Schrock, R. R.; Davis, W. M. *Organometallics* **1991**, *10*, 3781–3785.
151. Bashall, A.; Beswick, M. A.; Harmer, C. N.; McPartlin, M.; Paver, M. A.; Wright, D. S. *J. Chem. Soc., Dalton Trans.* **1998**, 517–518.
152. Zinn, A.; Dehnicke, K.; Fenske, D.; Baum, G. *Z. Anorg. Allg. Chem.* **1991**, *596*, 47–53.
153. Blaschette, A.; Jones, P. G.; Michalides, A.; Linoh, K. *Z. Anorg. Allg. Chem.* **1993**, *619*, 392–402.
154. Michalides, A.; Blaschette, A.; Jones, P. G. *Z. Anorg. Allg. Chem.* **2000**, *626*, 717–721.
155. Kessissoglou, D. P.; Manoussakis, G. E.; Hatzidimitriou, A. G.; Kanatzidis, M. G. *Inorg. Chem.* **1987**, *26*, 1395–1402.
156. Haider, S. Z.; Malik, K. M. A.; Das, D.; Hursthouse, M. B. *Acta Crystallogr. C* **1984**, *40*, 1147–1150.
157. Yilmaz, V. T.; Yazicilar, T. K.; Andac, O.; Kutuk, H.; Bekdemir, Y.; Harrison, W. T. A. *Z. Anorg. Allg. Chem.* **2002**, *628*, 1908–1912.
158. Hörner, M.; Bortoluzzi, A. J.; Beck, J.; Serafin, M. *Z. Anorg. Allg. Chem.* **2002**, *628*, 1104–1107.
159. Dieterich, S.; Strähle, J. *Z. Anorg. Allg. Chem.* **1994**, *620*, 145–150.
160. Harms, K.; Merle, J.; Maichle-Mössmer, C.; Massa, W.; Krieger, M. *Inorg. Chem.* **1998**, *37*, 1099–1104.
161. Dehnicke, K.; Krieger, M.; Massa, W. *Coord. Chem. Rev.* **1999**, *182*, 19–65.
162. Ackermann, H.; Leo, R.; Massa, W.; Neumüller, B.; Dehnicke, K. *Z. Anorg. Allg. Chem.* **2000**, *626*, 284–289.
163. Soma, T.; Iwamoto, T. *Chem. Lett.* **1995**, 271–272.
164. Mironov, Y. V.; Oeckler, O.; Simon, A.; Fedorov, V. E. *Eur. J. Inorg. Chem.* **2001**, 2751–2753.
165. Nockemann, P.; Meyer, G. unpublished results.

166. Nockemann, P.; Meyer, G. Z. *Anorg. Allg. Chem.* **2003**, *629*, 123–128.
167. Leineweber, A.; Jacobs, H. Z. *Anorg. Allg. Chem.* **2000**, *626*, 2143–2145.
168. Nockemann, P.; Meyer, G. Z. *Anorg. Allg. Chem.* **2002**, *628*, 2200.
169. Nockemann, P.; Meyer, G. Z. *Anorg. Allg. Chem.* **2002**, *628*, 2709–2714.
170. Breitwieser, M.; Göttlicher, S.; Paulus, H. Z. *Kristallogr.* **1984**, *166*, 207–212.
171. Mahadevan, C.; Seshasayee, M.; Sastry, S.; Subrahmanyam, C. Z. *Kristallogr.* **1985**, *171*, 173.
172. Munakata, M.; Kitagawa, S.; Yagi, F. *Inorg. Chem.* **1986**, *25*, 964–970.
173. Pariya, C.; Ghosh, A.; Ganguli, S.; Ray Chaudhuri, N. *Thermochim. Acta* **1994**, *242*, 195.
174. Pariya, C.; Puranik, V. G.; Ray Chaudhuri, N. *J. Chem. Soc., Chem. Commun.* **1997**, 1307–1308.
175. Johns, C. A.; Abdul Malik, K. M. *Polyhedron* **2002**, *21*, 395–401.
176. Bartoszak-Adamska, E.; Bregier-Jarzebowska, R.; Lomozik, L. *Polyhedron* **2002**, *21*, 739–744.
177. Strasdeit, H.; Duhme A.-K.; Weber, M.; Pohl, S. *Acta Crystallogr. C* **1992**, *48*, 437–440.
178. Schlager, O.; Wieghardt, K.; Grondey, H.; Rufinska, A.; Nuber, B. *Inorg. Chem.* **1995**, *34*, 6440–6448.
179. Bencini, A.; Bianchi, A.; Castello, M.; Di Vaira, M.; Faus, J.; Garcia-España, E.; Micheloni, M.; Paoletti, P. *Inorg. Chem.* **1989**, *28*, 347–351.
180. Bianchi, A.; Micheloni, M.; Paoletti, P. *Coord. Chem. Rev.* **1991**, *110*, 17–113.
181. McCrindle, R.; Ferguson, G.; McAlees, A. J.; Parvez, M.; Ruhl, B. L.; Stephenson, D. K.; Wieckowski, T. *J. Chem. Soc., Dalton Trans.* **1986**, 2351–2359.
182. Strasdeit, H.; Saak, W.; Pohl, S.; Driessen, W. L.; Reedijk, J. *Inorg. Chem.* **1988**, *27*, 1557–1563.
183. Strasdeit, H.; Pohl, S. Z. *Naturforsch.* **1988**, *43b*, 1579–1588.
184. Fenton, R. R.; Gauci, R.; Junk, P. C.; Lindoy, L. F.; Luckay, R. C.; Meehan, G. V.; Price, J. R.; Turner P.; Wei, G. *J. Chem. Soc., Dalton Trans.* **2002**, 2185–2193.
185. Tarulli, S. H.; Quinzani, O. V.; Baran, E. J.; Piro, O. E. Z. *Anorg. Allg. Chem.* **2002**, *628*, 751–754.
186. Goher, M. A. S.; Mautner, F. A.; Abu-Youssef, M. A. M.; Hafez, A. K.; Badr, A. M.-A. *J. Chem. Soc., Dalton Trans.* **2002**, 3309–3312.
187. Fujita, M.; Kwon, Y. J.; Miyazawa, M.; Ogura, K. *J. Chem. Soc., Chem. Commun.* **1994**, 1977–1978.
188. Fujita, M.; Kwon, Y. J.; Sasaki, O.; Yamaguchi, K.; Ogura, K. *J. Am. Chem. Soc.* **1995**, *117*, 7287–7288.
189. Glerup, J.; Goodson, P. A.; Hodgson, D. J.; Michelsen, K.; Nielsen, K. M.; Weihe, H. *Inorg. Chem.* **1992**, *31*, 4611–4616.
190. Bebout, D. C.; Stokes, S. W.; Butcher, R. J. *Inorg. Chem.* **1999**, *38*, 1126–1133.
191. Reger, D. L.; Wright, T. D.; Smith, M. D.; Rheingold, A. L.; Kassel, S.; Concolino, T.; Rhagitan, B. *Polyhedron* **2002**, *21*, 1795–1807.
192. Fondo, M.; Sousa, A.; Bermejo, M. R.; Garca-Deibe, A.; Sousa-Pedrares, A.; Hoyos, O. L.; Helliwell, M. *Eur. J. Inorg. Chem.* **2002**, 703–710.
193. Labisbal, E.; Sousa-Pedrares, A.; Castiñeiras, A.; Swearingen, J. K.; West, D. X. *Polyhedron* **2002**, *21*, 1553–1559.
194. Maggard, P. A.; Kopf, A. L.; Stern, C. L.; Poepelmeier, K. R.; Ok, K. M.; Halasyamani, P. S. *Inorg. Chem.* **2002**, *41*, 4852–4858.
195. Trofimenko, S. *Chem. Rev.* **1993**, *93*, 943–980.
196. Reger, D. L.; Mason, S. S.; Rheingold, A. L. *Inorg. Chim. Acta* **1995**, *240*, 669–672.
197. Reger, D. L.; Mason, S. S.; Takats, J.; Zhang, X. W.; Rheingold, A. L.; Haggerty, B. S. *Inorg. Chem.* **1993**, *32*, 4345–4348.
198. Looney, A.; Saleh, A.; Zhang, Y.; Parkin, G. *Inorg. Chem.* **1994**, *33*, 1158–1164.
199. Reger, D. L.; Myers, S. M.; Mason, S. S.; Rheingold, A. L.; Haggerty, B. S. *Inorg. Chem.* **1995**, *34*, 4996–5002.
200. Reger, D. L.; Collins, J. E.; Myers, S. M.; Rheingold, A. L.; Liable-Sands, L. M. *Inorg. Chem.* **1996**, *35*, 4904–4909.
201. Reger, D. L.; Mason, S. S.; Rheingold, A. L.; Ostrander, R. L. *Inorg. Chem.* **1993**, *32*, 5216–5222.
202. McWhinnie, W. R.; Monsef-Mirzai, Z.; Perry, M. C.; Shaikh, N. *Polyhedron* **1993**, *12*, 1193–1199.
203. Pettinari, C.; Santini, C.; Leonesi, D. *Polyhedron* **1994**, *13*, 1553–1562.
204. Wilgocki, M. *Pol. J. Coord. Chem.* **1988**, *16*, 357–374.
205. Wilgocki, M. *Pol. J. Coord. Chem.* **1988**, *18*, 263–267.
206. Wilgocki, M. *Pol. J. Coord. Chem.* **1988**, *18*, 369.
207. Matković-Čalogović, D.; Sikirica, M. Z. *Kristallogr.* **1990**, *190*, 171–177.
208. Sharma, R. R.; Bhat, B. L.; Dubey, K. P. *J. Indian Chem. Soc.* **1987**, *64*, 437–440.
209. Patra, G. K.; Goldberg, I. *Polyhedron* **2002**, *21*, 2195–2199.
210. Stephan, H.; Spies, H.; Johannsen, B.; Gloe, K.; Gorika, M.; Vögtle, F. *Eur. J. Inorg. Chem.* **2001**, 2957–2963.
211. Lo, H. C.; Chen, H.; Fish, R. H. *Eur. J. Inorg. Chem.* **2001**, 2217–2220.
212. Åkesson, R.; Sandström, M.; Stålhandske, C.; Persson, I. *Acta Chem. Scand.* **1991**, *45*, 165–171.
213. Nockemann, P. Dissertation, Köln (Cologne), 2002 (abstract in English); accessible via www.ub.uni-koeln.de/ediss/mathnat_volltext_2002.htm.
214. Bebout, D. C.; DeLanoy, A. E.; Ehmann, D. E.; Kastner, M. E.; Parrish, D. A.; Butcher, R. J. *Inorg. Chem.* **1998**, *37*, 2952–2959.
215. Bebout, D. C.; Ehmann, D. E.; Trinidad, J. C.; Crahan, K. K.; Kastner, M. E.; Parrish, D. A. *Inorg. Chem.* **1997**, *36*, 4257–4264.
216. Bashall, A.; McPartlin, M.; Murphy, B. P.; Powell, H. R.; Waikar, S. *J. Chem. Soc., Dalton Trans.* **1994**, 1383–1390.
217. Batten, S. R.; Hoskins, B. F.; Robson, R. *Angew. Chem., Int. Ed. Engl.* **1995**, *34*, 820–822.
218. Hoskins, B. F.; Robson, R.; Scarlett, N. V. Y. *J. Chem. Soc., Chem. Commun.* **1994**, 2025–2026.
219. Soma, T.; Iwamoto, T. *Chem. Lett.* **1994**, 821–824.
220. Soma, T.; Yuge, H.; Iwamoto, T. *Angew. Chem., Int. Ed. Engl.* **1994**, *33*, 1665–1666.
221. Soma, T.; Iwamoto, T. *Acta Crystallogr. C* **1996**, *52*, 1200–1203.
222. Witzel, M.; Ziegler, B.; Babel, D. Z. *Anorg. Allg. Chem.* **2000**, *626*, 471–477.
223. Zhang, H.; Cai, J.; Feng, X.-L.; Ye, B.-H.; Li, X.-Y.; Ji, L.-N. *J. Chem. Soc., Dalton Trans.* **2000**, 1687–1688.
224. Zhang, H.; Cai, J.; Feng, X.-L.; Sang, H.-Y.; Liu, J.-Z.; Li, X.-Y.; Ji, L.-N. *Polyhedron* **2002**, *21*, 721–728.
225. Berkei, M.; Bernhardt, E.; Schürmann, M.; Mehring, M.; Willner, H. Z. *Anorg. Allg. Chem.* **2002**, *628*, 1734–1740.
226. Beswick, M. A.; Cromhout, N. L.; Harmer, C. N.; Palmer, J. S.; Raithby, P. R.; Steiner, A.; Verhorevoort, K. L.; Wright, D. S. *J. Chem. Soc., Chem. Commun.* **1997**, 583–584.
227. Goel, S. C.; Chiang, M. Y.; Buhro, W. E. *J. Am. Chem. Soc.* **1990**, *112*, 5636–5637.

228. Goel, S. C.; Chiang, M. Y.; Rauscher, D. J.; Buhro, W. E. *J. Am. Chem. Soc.* **1993**, *115*, 160–169.
229. Benac, B. L.; Cowley, A. H.; Jones, R. A.; Nunn, C. M.; Wright, T. C. *J. Am. Chem. Soc.* **1989**, *111*, 4986–4988.
230. Matchett, M. A.; Chiang, M. Y.; Buhro, W. E. *Inorg. Chem.* **1994**, *33*, 1109–1114.
231. Beswick, M. A.; Raithby, P. R.; Russell, C. A.; Steiner, A.; Verhorevoort, K. L.; Ward, G. N.; Wright, D. S. *Angew. Chem., Int. Ed. Engl.* **1995**, *35*, 2662–2663.
232. Eichhöfer, A.; Eisenmann, J.; Fenske, D.; Simon, F. Z. *Anorg. Allg. Chem.* **1993**, *619*, 1360–1368.
233. Eichhöfer, A.; Fenske, D.; Fuhr, O. Z. *Anorg. Allg. Chem.* **1997**, *623*, 762–768.
234. Kessler, J. M.; Reeder, J. H.; Vac, R.; Yeung, C.; Nelson, J. H.; Frye, J. S.; Alcock, N. W. *Magn. Reson. Chem.* **1991**, *29*, S94–105.
235. Bowmaker, G. A.; Clase, H. J.; Alcock, N. W.; Kessler, J. M.; Nelson, J. H.; Frye, J. S. *Inorg. Chim. Acta* **1993**, *210*, 107–124.
236. Bell, N. A.; Dee, T. D.; Goldstein, M.; McKenna, P. J.; Nowell, I. W. *Inorg. Chim. Acta* **1983**, *71*, 135–140.
237. Bell, N. A.; March, L. A.; Nowell, I. W. *Inorg. Chim. Acta* **1989**, *156*, 201–204.
238. Bell, N. A.; Chudley, N. A.; March, L. A.; Nowell, I. W. *Inorg. Chim. Acta* **1988**, *141*, 155–156.
239. Colton, R.; Dakternieks, D. *Inorg. Chim. Acta* **1993**, *208*, 173–177.
240. Bell, N. A.; Coles, S. J.; Constable, C. P.; Hursthouse, M. B.; Light, M. E.; Mansor, R.; Salvin, N. J. *Polyhedron* **2002**, *21*, 1845–1855.
241. Niu, Y.-Y.; Song, Y.-L.; Liu, S.-X.; Xin, X.-Q. *Z. Anorg. Allg. Chem.* **2002**, *628*, 179–182.
242. Hoge, B.; Thösen, C.; Pantenburg, I. *Inorg. Chem.* **2001**, *40*, 3112.
243. Pantenburg, I.; Thösen, C.; Hoge, B. Z. *Anorg. Allg. Chem.* **2002**, *628*, 1785–1788.
244. Dickson, R. S.; Heazle, K. D.; Pain, G. N.; Deacon, G. B.; West, B. O.; Fallon, G. D.; Rowe, R. S.; Leech, P. W.; Faith, M. J. *Organomet. Chem.* **1993**, *449*, 131–139.
245. Shevelkov, A. V.; Mustyakimov, M. Yu.; Dikarev, E. V.; Popovkin, B. A. *J. Chem. Soc., Dalton Trans.* **1996**, 147–148.
246. Schlrif, J.; Reiner, C.; Deiseroth, H. J. Z. *Anorg. Allg. Chem.* **2002**, *628*, 2208.
247. Olenev, A. V.; Shevelkov, A. V. *J. Solid State Chem.* **2001**, *160*, 88–92.
248. Beck, J.; Neisel, U. Z. *Anorg. Allg. Chem.* **2000**, *626*, 1620–1626.
249. Olenev, A. V.; Baranov, A. I.; Shatruk, M. M.; Tyablikov, A. S.; Shevelkov, A. V. *Russ. Chem. Bull.* **2002**, *51*, 444–448.
250. Beck, J.; Hedderich, S.; Neisel, U. *J. Solid State Chem.* **2000**, *154*, 350–355.
251. Olenev, A. V.; Baranov, A. I.; Shevelkov, A. V.; Popovkin, B. A. *Eur. J. Inorg. Chem.* **2002**, 547–553.
252. Olenev, A. V.; Baranov, A. I.; Shevelkov, A. V.; Popovkin, B. A. *Eur. J. Inorg. Chem.* **2000**, 265–270.
253. Olenev, A. V.; Shevelkov, A. V. *Angew. Chem., Int. Ed. Engl.* **2001**, *40*, 2353–2354.
254. Shevelkov, A. V.; Shatruk, M. M. *Russ. Chem. Bull.* **2001**, *50*, 337–352.
255. Smith, M. D.; Loye, H.-C. *Acta Crystallogr. C* **2001**, *57*, 337–338.
256. Johansson, G.; Sandström, M. *Acta Chem. Scand., Ser. A* **1978**, *32*, 109.
257. Johansson, G.; Sandström, M. *Acta Chem. Scand., Ser. A* **1987**, *41*, 113–116.
258. Caminiti, R.; Johansson, G. *Acta Chem. Scand., Ser. A* **1981**, *35*, 373–381.
259. Strömberg, D.; Sandström, M.; Wahlgren, U. *Chem. Phys. Lett.* **1990**, *172*, 49–54.
260. Allred, R. A.; Arif, A. M.; Berreau, L. M. *J. Chem. Soc., Dalton Trans.* **2002**, 300–301.
261. Rominger, F.; Thewalt, U. Z. *Naturforsch.* **1996**, *51b*, 1716–1724.
262. Weidenbruch, M.; Herndorf, M.; Schäfer, A.; Pohl, S.; Saak, W. *J. Organomet. Chem.* **1989**, *361*, 139–145.
263. Nöth, H.; Thomann, M. *Chem. Ber.* **1995**, *128*, 923–927.
264. Büsching, I.; Strasdeit, H. *J. Chem. Soc., Chem. Commun.* **1994**, 2789–2790.
265. Tong, M.-L.; Zheng, S.-L.; Shi, J.-X.; Tong, Y.-X.; Lee, H. K.; Chen, X.-M. *J. Chem. Soc., Dalton Trans.* **2002**, 1727–1734.
266. Lulinski, S.; Madura, I.; Serwatowski, J.; Zachara J. *Inorg. Chem.* **1999**, *38*, 4937–4941.
267. Goel, S. C.; Chiang, M. Y.; Buhro, W. E. *J. Am. Chem. Soc.* **1990**, *112*, 6724.
268. Darensbourg, D. J.; Niezgodá, S. A.; Reibenspies, J. H.; Draper, J. D. *Inorg. Chem.* **1997**, *36*, 5686–5688.
269. Darensbourg, D. J.; Niezgodá, S. A.; Draper, J. D.; Reibenspies, J. H. *Inorg. Chem.* **1999**, *38*, 1356–1359.
270. Honkonen, R. S.; Ellis, P. D. *J. Am. Chem. Soc.* **1984**, *106*, 5488–5497.
271. Honkonen, R. S.; Marchetti P. S.; Ellis, P. D. *J. Am. Chem. Soc.* **1986**, *108*, 912–915.
272. Jeanneau, E.; Audebrand, N.; Louër, D. *Acta Crystallogr. C* **2001**, *57*, 1012–1013.
273. Prasad, P. A.; Neeraj, S.; Vaidhyanathan, R.; Natarajan, S. *J. Solid State Chem.* **2002**, *166*, 128–141.
274. Vaidhyanathan, R.; Natarajan, S.; Rao, C. N. R. *J. Solid State Chem.* **2002**, *167*, 274–281.
275. Gasque, L.; Bernès, S.; Ferrari, R.; Mendoza-Díaz, G. *Polyhedron* **2002**, *21*, 935–941.
276. Ruschewitz, U.; Pantenburg, I. *Acta Crystallogr. C* **2002**, *58*, m483–m484.
277. Dai, J.-C.; Wu, X.-T.; Fu, Z.-Y.; Hu, S.-M.; Du, W.-X.; Cui, C.-P.; Wu, L.-M.; Zhang, H.-H.; Sun, R.-Q. *J. Chem. Soc., Chem. Commun.* **2002**, 12–13.
278. Almeida Paz, F. A.; Khimiyak, Y. Z.; Bond, A. D.; Rocha, J.; Klinowski, J. *Eur. J. Inorg. Chem.* **2002**, 2823–2828.
279. Hu, M.-L.; Gao, P.; Ng, S. W. *Acta Crystallogr. C* **2002**, *58*, m323–m324.
280. Zheng, Y.-Q.; Liu, W.-H.; Lin, J.-L. Z. *Anorg. Allg. Chem.* **2002**, *628*, 1401–1405.
281. Li, S.-L.; Mak, T. C. W. *J. Chem. Soc., Dalton Trans.* **1995**, 1519–1524.
282. Aime, S.; Digilio, G.; Gobetto, R.; Bigi, A.; Ripamonti, A.; Roveri, N. *Inorg. Chem.* **1996**, *35*, 149–154.
283. Badraoui, B.; Bigi, A.; Debbabi, M.; Gazzano, M.; Roveri, R.; Thouvenot, R. *Eur. J. Inorg. Chem.* **2001**, 1261–1267.
284. Fredoueil, F.; Massiot, D.; Janvier, P.; Gingl, F.; Bujoli-Doeuff, M.; Evain, M.; Clearfield, A.; Bujoli, B. *Inorg. Chem.* **1999**, *38*, 1831–1833.
285. Fredoueil, F.; Evain, M.; Massiot, D.; Bujoli-Doeuff, M.; Janvier, P.; Clearfield, A.; Bujoli, B. *J. Chem. Soc., Dalton Trans.* **2002**, 1508–1512.
286. Stock, N.; Bein, T. *J. Solid State Chem.* **2002**, *167*, 330–336.
287. Weil, M. *Acta Crystallogr., Sect. E: Struct. Rep. Online* **2001**, *E57(4)*, i28–i29.
288. Weil, M. *Acta Crystallogr., Sect. E: Struct. Rep. Online* **2001**, *E57(4)*, i22–i23.
289. Engelen, B.; Buchmeier, W.; Lutz, H. D. Z. *Naturforsch.* **1987**, *42b*, 37–41.
290. Paul, G.; Choudhury, A.; Rao, C. N. R. *J. Chem. Soc., Dalton Trans.* **2002**, 3859–3867.
291. Valkonen, J. *Acta Crystallogr., Sect. C* **1994**, *50*, 991–994.

292. Johnston, M. G.; Harrison, W. T. A. *Z. Anorg. Allg. Chem.* **2002**, *628*, 1913–1916.
293. Johnston, M. G.; Harrison, W. T. A. *Z. Anorg. Allg. Chem.* **2002**, *628*, 2063–2066.
294. Weil, M. *Acta Crystallogr., Sect. E: Struct. Rep. Online* **2002**, *58(12)*, i127–i129.
295. Weil, M.; Kolitsch, U. *Acta Crystallogr. C* **2002**, *58*, i47–i49.
296. Fleck, M.; Kolitsch, U.; Hertweck, B.; Giester, G.; Wildner, M.; Prem, M.; Wohlschläger, A. *Z. Kristallogr.* **2002**, *217*, 242–248.
297. Marcus, S. T.; Gahan, L. R.; Bernhardt, P. V. *Acta Crystallogr., Sect. C* **2000**, *56*, 655–658.
298. Weil, M.; Glaum, R. *Acta Crystallogr. C* **1997**, *53*, 1000–1003.
299. Weil, M.; Glaum, R. *Acta Crystallogr. C* **2000**, *56*, 133–135.
300. Larsson, A.-K.; Lidin, S.; Stålhandske, C.; Albertsson, J. *Acta Crystallogr. C* **1993**, *49*, 784–786.
301. Weil, M. *Z. Naturforsch.* **2000**, *55b*, 699–706.
302. Weil, M. *Acta Crystallogr., Sect. E: Struct. Rep. Online* **2001**, *E57(11)*, i98–i100.
303. Koskenlinna, M.; Valkonen, J. *Acta Crystallogr. C* **1995**, *51*, 1040–1042.
304. Koskenlinna, M.; Valkonen, J. *Acta Crystallogr. C* **1996**, *52*, 1070–1072.
305. Koskenlinna, M.; Valkonen, J.; Fröhlich, R. *Acta Crystallogr. C* **1996**, *52*, 1072–1074.
306. Weil, M. *Solid State Sciences* **2002**, *4*, 1153–1162.
307. Weil, M. *Acta Crystallogr. C* **2002**, *58*, i164–i166.
308. Koskenlinna, M.; Valkonen, J. *Acta Crystallogr. C* **1996**, *52*, 491–493.
309. Valkonen, J. *Acta Crystallogr. C* **1994**, *50*, 1381–1384.
310. Weil, M. *Z. Naturforsch.* **2002**, *57b*, 1043–1050.
311. Klein, W.; Curda, J.; Freise, K.; Jansen, M. *Acta Crystallogr. C* **2002**, *58*, i23–i24.
312. Åsberg Dahlborg, M. B.; Svensson, G.; Ouarova, T. *Acta Crystallogr. C* **2000**, *56*, 397–398.
313. Åsberg Dahlborg, M. B.; Svensson, G. *Acta Crystallogr. C* **2002**, *58*, i35–i36.
314. Burns, R. C.; Devereux, L. A.; Granger, P.; Schrobilgen, G. J. *Inorg. Chem.* **1985**, *24*, 2615–2624.
315. Burns, R. C.; Corbett, J. D. *Inorg. Chem.* **1981**, *20*, 4433–4434.
316. Park, C.-W.; Smith, D. M.; Pell, M. A.; Ibers, J. A. *Inorg. Chem.* **1997**, *36*, 942–943.
317. Bochmann, M.; Webb, K.; Harman, M.; Hursthouse, M. B. *Angew. Chem., Int. Ed. Engl.* **1990**, *29*, 638–639.
318. Bochmann, M.; Webb, K.; Hursthouse, M. B.; Mazid, M. J. *Chem. Soc., Dalton Trans.* **1991**, 2317–2323.
319. Duhme, A.-K.; Strasdeit, H. *Z. Naturforsch.* **1994**, *49b*, 119–127.
320. Duhme, A.-K.; Strasdeit, H. *Eur. J. Inorg. Chem.* **1998**, 657–662.
321. Fraser, K. A.; Clegg, W. *Acta Crystallogr. C* **1995**, *51*, 406–408.
322. Kim, C.-H.; Parkin, S.; Bharara, M.; Atwood, D. *Polyhedron* **2002**, *21*, 225–228.
323. Wojnowski, W.; Wojnowski, M.; von Schnering, H. G. *Z. Anorg. Allg. Chem.* **1985**, *531*, 153–157.
324. Christou, G.; Foltling, K.; Huffman, J. C. *Polyhedron* **1984**, *3*, 1247–1253.
325. Bowmaker, G. A.; Dance, I. G.; Harris, R. K.; Henderson, W.; Laban, I.; Scudder, M. L.; Oh, S.-W. *J. Chem. Soc., Dalton Trans.* **1996**, 2381–2388.
326. Bowmaker, G. A.; Dance, I. G.; Dobson, B. C.; Rogers, D. A. *Aust. J. Chem.* **1984**, *37*, 1607–1618.
327. Gruff, E. S.; Koch, S. A. *J. Am. Chem. Soc.* **1990**, *112*, 1245–1247.
328. Alsina, T.; Clegg, W.; Fraser, K. A.; Sola, J. *J. Chem. Soc., Dalton Trans.* **1992**, 1393–1399.
329. Santos, R. A.; Gruff, E. S.; Koch, S. A.; Harbison, G. S. *J. Am. Chem. Soc.* **1991**, *113*, 469–475.
330. Duhme, A.-K.; Strasdeit, H. *Z. Anorg. Allg. Chem.* **1999**, *625*, 6–8.
331. Natan, M. J.; Millikan, C. F.; Wright, J. G.; O'Halloran, T. V. *J. Am. Chem. Soc.* **1990**, *112*, 3255–3257.
332. Cheesman, B. V.; Arnold, A. P.; Rabenstein, D. L. *J. Am. Chem. Soc.* **1988**, *110*, 6359–6364.
333. Wright, J. G.; Natan, M. J.; MacDonnell, F. M.; Ralston, D. M.; O'Halloran, T. V. In *Progress in Inorganic Chemistry*; Lippard, S. J., Ed., Wiley: New York, 1990; Vol. 38, pp 323–412.
334. Dilworth, J. R.; Hu, J. In *Advances in Inorganic Chemistry*; Sykes, G., Ed., Academic Press: San Diego, CA, 1994; Vol. 40, pp 411–459.
335. Schulz Lang, E.; Müller Dias, M.; Abram, U.; Vázquez-López, E. M. *Z. Anorg. Allg. Chem.* **2000**, *626*, 784–788.
336. Rombach, M.; Vahrenkamp, H. *Eur. J. Inorg. Chem.* **2002**, 2022–2025.
337. Hencher, J. L.; Khan, M. A.; Said, F. F.; Tuck, D. G. *Polyhedron* **1985**, *4*, 1263–1267.
338. Dean, P. A. W.; Vittal, J. J.; Payne, N. C. *Inorg. Chem.* **1987**, *26*, 1683–1689.
339. Dean, P. A. W.; Manivannan, V. *Inorg. Chem.* **1990**, *29*, 2997–3002.
340. Dean, P. A. W.; Vittal, J. J.; Wu, Y. *Can. J. Chem.* **1992**, *70*, 779–791.
341. Dean, P. A. W.; Payne, N. C.; Vittal, J. J.; Wu, Y. *Inorg. Chem.* **1993**, *32*, 4632–4639.
342. Eichhöfer, A.; Aharoni, A.; Banin, U. *Z. Anorg. Allg. Chem.* **2002**, *628*, 2415–2421.
343. Eichhöfer, A.; Tröster, E. *Eur. J. Inorg. Chem.* **2002**, 2253–2256.
344. Lee, G. S. H.; Fisher, K. J.; Craig, D. C.; Scudder, M. L.; Dance, J. G. *J. Am. Chem. Soc.* **1990**, *112*, 6435–6437.
345. Behrens, S.; Bettenhausen, M.; Deveson, A. C.; Eichhöfer, A.; Fenske, D.; Lohde, A.; Woggon, U. *Angew. Chem., Int. Ed. Engl.* **1996**, *36*, 2215–2218.
346. Soloviev, V. N.; Eichhöfer, A.; Fenske, D.; Banin, U. *J. Am. Chem. Soc.* **2001**, *123*, 2354–2364.
347. Müller, A.; Diemann, E. In *Advances in Inorganic Chemistry*; Emeleus, H. J., Sharpe A. G., Ed., Academic Press: Orlando, FL, 1987; Vol. 31, pp 89–122.
348. Kanatzidis, M. G.; Huang, S.-P. *Coord. Chem. Rev.* **1994**, *130*, 509–621.
349. Linton, D. J.; Schooler, P.; Wheatley, A. E. H. *Coord. Chem. Rev.* **2001**, *223*, 53–115.
350. Schrötter, F.; Müller, B. *Z. Anorg. Allg. Chem.* **1992**, *618*, 53–58.
351. Fourquet, J. L.; Courant, E.; Chevalier, P.; De Pape, R. *Acta Crystallogr. C* **1985**, *41*, 165–167.
352. Courant, E.; Fourquet, J. L.; De Pape, R. *J. Solid State Chem.* **1985**, *60*, 343–346.
353. Weil, M. *Acta Crystallogr. C* **2002**, *58*, i37–i39.
354. Ishihara, H.; Horiuchi, K.; Gesing, T. M.; Dou, S.; Buhl, J.-C.; Erk, P. *Z. Naturforsch.* **2002**, *57b*, 503–508.
355. Hester, C. A.; Collier, H. L.; Baughman, R. G. *Polyhedron* **1996**, *23*, 4255–4258.
356. Mallela, S. P.; Schwan, F.; Geanangel, R. A. *Inorg. Chem.* **1996**, *35*, 745–748.
357. Al-Juaid, S. S.; Buttrus, N. H.; Eaborn, C.; Hitchcock, P. B.; Smith, J. D.; Tavakkoli, K. *J. Chem. Soc., Chem. Commun.* **1988**, 1389–1391.

358. Buttrus, N. H.; Eaborn, C.; El-Kheli, M. N. A.; Hitchcock, P. B.; Smith, J. D.; Sullivan, A. C.; Tavakkoli, K. J. *Chem. Soc., Dalton Trans.* **1988**, 381–391.
359. Stålhandske, C. M. V.; Persson, I.; Sandström, M.; Åberg, M. *Inorg. Chem.* **1997**, *36*, 4945–4953.
360. Sandström, M.; Persson, I.; Persson, P. *Acta Chem. Scand.* **1990**, *44*, 653–675.
361. House, D. A.; Robinson, W. T.; McKee, V. *Coord. Chem. Rev.* **1994**, *135/136*, 533–586.
362. Albarski, O.; Hillebrecht, H.; Rotter, H. W.; Thiele, G. Z. *Anorg. Allg. Chem.* **2000**, *626*, 1296–1304.
363. Linden, A.; James, B. D.; Liesegang, J.; Gonis, N. *Acta Crystallogr., Sect. B* **1999**, *55*, 396–409.
364. Nockemann, P.; Meyer, G. *Acta Crystallogr., Sect. E: Struct. Rep. Online* **2002**, *E58*, i68–i69.
365. Nockemann, P.; Meyer, G. *Acta Crystallogr., Sect. E: Struct. Rep. Online* **2002**, *E58*, m527–m528.
366. Nockemann, P.; Meyer, G. *Acta Crystallogr., Sect. E: Struct. Rep. Online* **2002**, *E58*, m534–m536.
367. Nockemann, P.; Meyer, G. *Acta Crystallogr., Sect. E: Struct. Rep. Online* **2002**, *E58*, m529–m530.
368. Nockemann, P.; Meyer, G. *Acta Crystallogr., Sect. E: Struct. Rep. Online* **2002**, *E58*, m531–m533.
369. Pickardt, J.; Wischinsky, P. Z. *Anorg. Allg. Chem.* **1996**, *622*, 1125–1128.
370. Pickardt, J.; Wischinsky, P. Z. *Anorg. Allg. Chem.* **1999**, *625*, 1527–1531.
371. Zhang, H.; Wang, X.; Zhang, K.; Teo, B. K. *Coord. Chem. Rev.* **1999**, *183*, 157–195.
372. Zhang, H.; Zelmon, D. E.; Price, G. E.; Teo, B. K. *Inorg. Chem.* **2000**, *39*, 1868–1873.
373. Chen, W.; Liu, F.; You, X. *J. Solid State Chem.* **2002**, *167*, 119–125.
374. Liu, F.; Chen, W.; You, X. *J. Solid State Chem.* **2002**, *169*, 199–207.
375. Mosset, A.; Bagieu-Beucher, M. Z. *Kristallogr. NCS* **2002**, *217*, 1–2.
376. Devaud, M. *J. Organomet. Chem.* **1981**, *220*, C27–C29.
377. Craig, P. J.; Mennie, D.; Needham, M.; Oshah, N.; Donard, O. F. X.; Martin, F. *J. Organomet. Chem.* **1993**, *447*, 5–8.
378. Craig, P. J.; Garraud, H.; Laurie, S. H.; Mennie, D.; Stojak, G. H. *J. Organomet. Chem.* **1994**, *468*, 7–11.
379. Craig, P. J.; Needham, M.; Oshah, N.; Stojak, G. H.; Symons, M.; Teesdale-Spittle, P. *J. Chem. Soc., Dalton Trans.* **1996**, 153–156.
380. Weil, M.; Glaum, R. *J. Solid State Chem.* **2001**, *157*, 68–75.
381. Wessels, A.; Jeitschko, W.; Möller, M. H. *Z. Naturforsch.* **1997**, *52b*, 469–473.
382. Hämmerle, B.; Müller, E. P.; Wilkinson, D. L.; Müller, G.; Peringer, P. *J. Chem. Soc., Chem. Commun.* **1989**, 1527–1528.
383. Mühlecker-Knoepfler, A.; Ellmerer-Müller, E.; Konrat, R.; Ongania, K.-H.; Wurst, K.; Peringer, P. *J. Chem. Soc., Dalton Trans.* **1997**, 1607–1610.
384. Mühlecker-Knoepfler, A.; Scheffter, B.; Kopacka, H.; Wurst, K.; Peringer, P. *J. Chem. Soc., Dalton Trans.* **1999**, 2525–2528.
385. Mühlecker-Knoepfler, A.; Schuh, W.; Scheffter, B.; Kopacka, H.; Wurst, K.; Peringer, P. *Inorg. Chim. Acta* **2000**, *303*, 70–76.
386. Scheffter, B.; Schuh, W.; Ongania, K.-H.; Kopacka, H.; Malleier, R.; Wurst, K.; Peringer, P. *Polyhedron* **2000**, *19*, 871–876.
387. Schuh, W.; Hägele, G.; Olschner, R.; Lindner, A.; Dvortsak, P.; Kopacka, H.; Wurst, K.; Peringer, P. *J. Chem. Soc., Dalton Trans.* **2002**, 19–27.
388. Stålhandske, C.; Aurivillius, K.; Bertinsson, G.-I. *Acta Crystallogr. C* **1985**, *41*, 167–168.
389. Brodersen, K.; Liehr, G.; Schottner, G. Z. *Anorg. Allg. Chem.* **1985**, *531*, 158–166.
390. Wickleder, M. S. Z. *Anorg. Allg. Chem.* **2002**, *628*, 1459–1460.
391. Calos, N. J.; Kennard, C. H. L.; Davis, R. L. Z. *Kristallogr.* **1989**, *187*, 305–307.
392. Berkei, M.; Schürmann, M.; Bernhardt, E.; Willner, H. Z. *Naturforsch.* **2002**, *57b*, 615–620.
393. Brodersen, K.; Hofmann, J. Z. *Anorg. Allg. Chem.* **1992**, *609*, 29–34.
394. Brodersen, K.; Liehr, G.; Schottner, G. Z. *Anorg. Allg. Chem.* **1985**, *529*, 15–21.
395. Brodersen, K.; Liehr, G.; Prohaska, D.; Schottner, G. Z. *Anorg. Allg. Chem.* **1985**, *521*, 215–223.
396. Kamenar, B.; Matković-Čalogović D.; Nagl, A. *Acta Crystallogr. C* **1986**, *42*, 385–389.
397. Weil, M.; Glaum, R. Z. *Anorg. Allg. Chem.* **1999**, *625*, 1752–1761.
398. Weil, M. Z. *Anorg. Allg. Chem.* **2000**, *626*, 1752–1756.
399. Weil, M. Z. *Naturforsch.* **2000**, *55b*, 699–706.
400. Wickleder, M. S. *Anorg. Allg. Chem.* **2002**, *628*, 1848–1852.
401. Wessels, A.; Jeitschko, W. Z. *Naturforsch.* **1996**, *51b*, 37–41.
402. Mormann, T. J.; Jeitschko, W. *Inorg. Chem.* **2000**, *39*, 4219–4223.
403. Malleier, R.; Kopacka, H.; Schuh, W.; Wurst, K.; Peringer, P. *J. Chem. Soc., Chem. Commun.* **2001**, 51–52.
404. Bowmaker, G. A.; Harris, R. K.; Apperley, D. C. *Inorg. Chem.* **1999**, *38*, 4956–4962.
405. Bravo-Zhivotovskii, D.; Yuzefovich, M.; Bendikov, M.; Klinkhammer, K.; Apeloig, Y. *Angew. Chem., Int. Ed. Engl.* **1999**, *38*, 1100–1102.
406. Frank, W.; Dincher, B. Z. *Naturforsch.* **1987**, *42b*, 828–834.
407. Borisov, S. V.; Magarill, S. A.; Romanenko, G. V.; Pervukhina, N. V. *J. Struct. Chem.* **2000**, *41*, 272–279.
408. Faggiani, R.; Gillespie, R. J.; Vekris, J. E. *J. Chem. Soc., Chem. Commun.* **1986**, 517–518.
409. Staffel, T.; Meyer, G.; Z. *Anorg. Allg. Chem.* **1987**, *548*, 45–54.
410. Reger, D. L.; Mason, S. S.; Rheingold, A. L. *J. Am. Chem. Soc.* **1993**, *115*, 10406–10407.
411. Gillespie, R. J.; Granger, P.; Morgan, K. R.; Schrobilgen, G. J. *Inorg. Chem.* **1984**, *23*, 887–891.
412. Brown, I. D.; Gillespie, R. J.; Morgan, K. R.; Tun, Z.; Ummat, P. K. *Inorg. Chem.* **1984**, *23*, 4506–4508.
413. Brown, I. D.; Gillespie, R. J.; Morgan, K. R.; Sawyer, J. F.; Schmidt, K. J.; Tun, Z.; Ummat, P. K.; Vekris, J. E. *Inorg. Chem.* **1987**, *26*, 689–693.

6.10

Appendix to Volume 6

JON A. McCLEVERTY

University of Bristol, Bristol, UK

and

THOMAS J. MEYER

Los Alamos National University, Los Alamos, New Mexico, USA

This appendix provides access to original chapters from Comprehensive Coordination Chemistry (published in 1987) that are relevant to this volume of Comprehensive Coordination Chemistry II (CCC2) but that are not cited by a specific chapter in CCC2.

For further details please see the end of the Preface under the General Information tab.

PDF 1. Chapter 48 Rhodium