

Inorganic Chemistry

James E. House

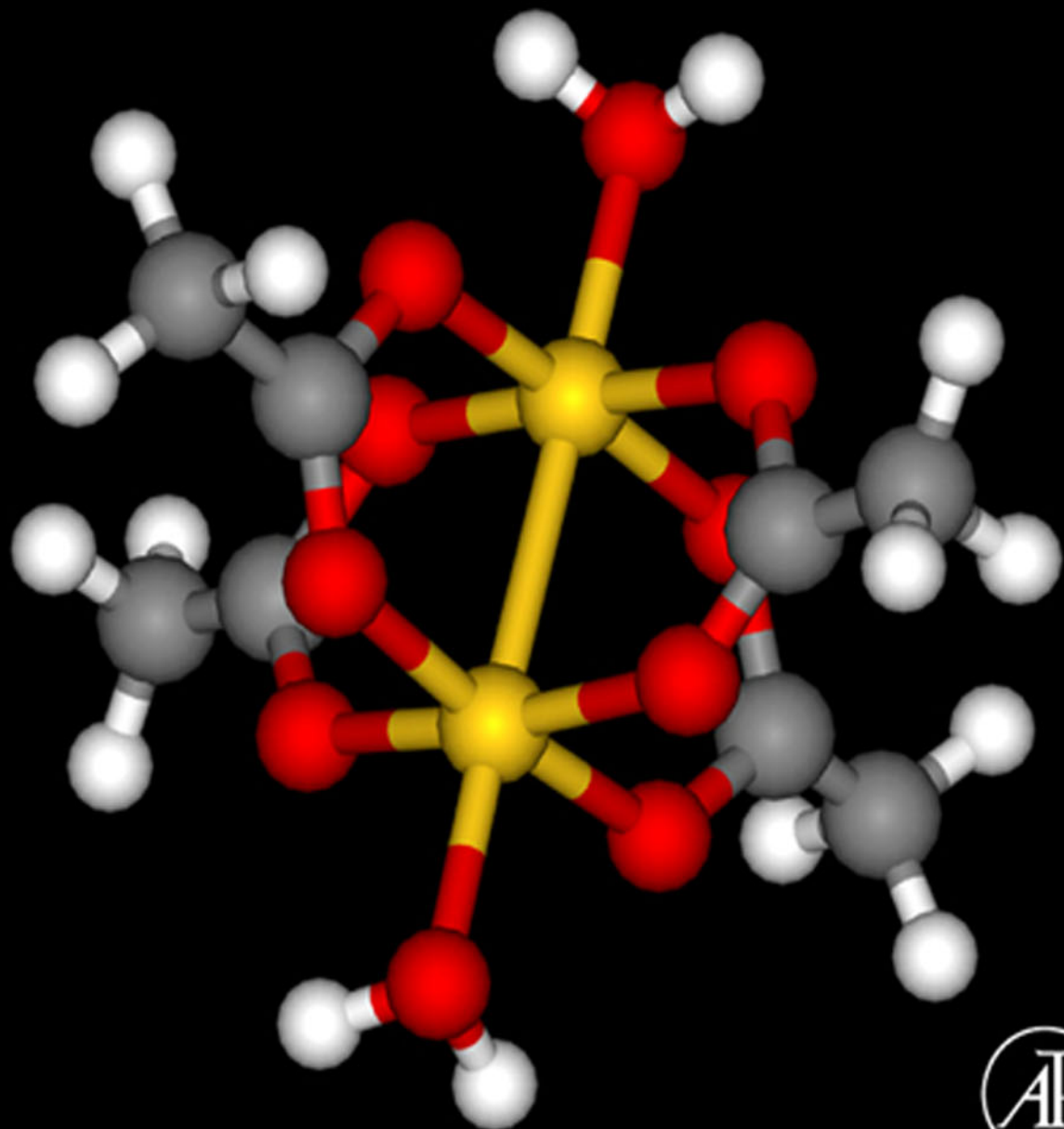

Inorganic Chemistry

This page intentionally left blank

Inorganic Chemistry

James E. House

Illinois Wesleyan University
and Illinois State University



AMSTERDAM • BOSTON • HEIDELBERG • LONDON • OXFORD • NEW YORK
PARIS • SAN DIEGO • SAN FRANCISCO • SINGAPORE • SYDNEY • TOKYO

Academic Press is an imprint of Elsevier



Academic Press is an imprint of Elsevier

30 Corporate Drive, Suite 400, Burlington, MA 01803, USA
525 B Street, Suite 1900, San Diego, California 92101-4495, USA
84 Theobald's Road, London WC1X 8RR, UK

∞ **This book is printed on acid-free paper.**

Copyright © 2008, Elsevier Inc. All rights reserved.

No part of this publication may be reproduced or transmitted in any form or by any means, electronic or mechanical, including photocopy, recording, or any information storage and retrieval system, without permission in writing from the publisher.

Permissions may be sought directly from Elsevier's Science & Technology Rights Department in Oxford, UK: phone: (+44) 1865 843830, fax: (+44) 1865 853333, E-mail: permissions@elsevier.com. You may also complete your request on-line via the Elsevier homepage (<http://elsevier.com>), by selecting "Support & Contact" then "Copyright and Permission" and then "Obtaining Permissions."

Library of Congress Cataloging-in-Publication Data

House, J. E.

Inorganic chemistry / James E. House.

p. cm.

Includes index.

ISBN 978-0-12-356786-4 (paper cover : alk. paper) 1. Chemistry, Inorganic—Textbooks. I. Title.

QD151.5.H68 2008

546—dc22

2008013083

British Library Cataloguing-in-Publication Data

A catalogue record for this book is available from the British Library.

ISBN: 978-0-12-356786-4

For information on all Academic Press publications
visit our Web site at www.books.elsevier.com

Printed in Canada

08 09 10 11 9 8 7 6 5 4 3 2 1

Working together to grow
libraries in developing countries

www.elsevier.com | www.bookaid.org | www.sabre.org

ELSEVIER

BOOK AID
International

Sabre Foundation

Contents

Preface

xi

PART 1	Structure of Atoms and Molecules	1
CHAPTER 1	Light, Electrons, and Nuclei	3
1.1	Some Early Experiments in Atomic Physics	3
1.2	The Nature of Light	7
1.3	The Bohr Model	11
1.4	Particle-Wave Duality	15
1.5	Electronic Properties of Atoms	17
1.6	Nuclear Binding Energy	22
1.7	Nuclear Stability	24
1.8	Types of Nuclear Decay	25
1.9	Predicting Decay Modes	29
CHAPTER 2	Basic Quantum Mechanics and Atomic Structure	35
2.1	The Postulates	35
2.2	The Hydrogen Atom	44
2.3	The Helium Atom	49
2.4	Slater Wave Functions	51
2.5	Electron Configurations	52
2.6	Spectroscopic States	56
CHAPTER 3	Covalent Bonding in Diatomic Molecules	65
3.1	The Basic Ideas of Molecular Orbital Methods	65
3.2	The H_2^+ and H_2 Molecules	73
3.3	Diatomic Molecules of Second-Row Elements	76
3.4	Photoelectron Spectroscopy	83
3.5	Heteronuclear Diatomic Molecules	84
3.6	Electronegativity	87
3.7	Spectroscopic States for Molecules	91
CHAPTER 4	A Survey of Inorganic Structures and Bonding	95
4.1	Structures of Molecules Having Single Bonds	95
4.2	Resonance and Formal Charge	105

4.3	Complex Structures—A Preview of Coming Attractions	117
4.4	Electron-Deficient Molecules	125
4.5	Structures Having Unsaturated Rings	127
4.6	Bond Energies	129
CHAPTER 5	Symmetry and Molecular Orbitals	137
5.1	Symmetry Elements	137
5.2	Orbital Symmetry	145
5.3	A Brief Look at Group Theory	148
5.4	Construction of Molecular Orbitals	153
5.5	Orbitals and Angles	158
5.6	Simple Calculations Using the Hückel Method	161
PART 2	Condensed Phases	177
CHAPTER 6	Dipole Moments and Intermolecular Interactions	179
6.1	Dipole Moments	179
6.2	Dipole-Dipole Forces	184
6.3	Dipole-Induced Dipole Forces	186
6.4	London (Dispersion) Forces	187
6.5	The van der Waals Equation	191
6.6	Hydrogen Bonding	193
6.7	Cohesion Energy and Solubility Parameters	203
CHAPTER 7	Ionic Bonding and Structures of Solids	211
7.1	Energetics of Crystal Formation	211
7.2	Madelung Constants	216
7.3	The Kapustinskii Equation	219
7.4	Ionic Sizes and Crystal Environments	220
7.5	Crystal Structures	224
7.6	Solubility of Ionic Compounds	229
7.7	Proton and Electron Affinities	234
7.8	Structures of Metals	237
7.9	Defects in Crystals	240
7.10	Phase Transitions in Solids	243
7.11	Heat Capacity	245
7.12	Hardness of Solids	248
CHAPTER 8	Dynamic Processes in Inorganic Solids	255
8.1	Characteristics of Solid-State Reactions	255
8.2	Kinetic Models for Reactions in Solids	258

8.3	Thermal Methods of Analysis	266
8.4	Effects of Pressure	267
8.5	Reactions in Some Solid Inorganic Compounds	270
8.6	Phase Transitions	272
8.7	Reactions at Interfaces	276
8.8	Diffusion in Solids	277
8.9	Sintering	280
8.10	Drift and Conductivity	282
PART 3 Acids, Bases, and Solvents		287
CHAPTER 9	Acid-Base Chemistry	289
9.1	Arrhenius Theory	289
9.2	Brønsted-Lowry Theory	292
9.3	Factors Affecting Strength of Acids and Bases	296
9.4	Acid-Base Character of Oxides	301
9.5	Proton Affinities	302
9.6	Lewis Theory	305
9.7	Catalytic Behavior of Acids and Bases	309
9.8	The Hard-Soft Interaction Principle (HSIP)	313
9.9	Electronic Polarizabilities	323
9.10	The Drago Four-Parameter Equation	324
CHAPTER 10	Chemistry in Nonaqueous Solvents	331
10.1	Some Common Nonaqueous Solvents	331
10.2	The Solvent Concept	332
10.3	Amphoteric Behavior	335
10.4	The Coordination Model	335
10.5	Chemistry in Liquid Ammonia	336
10.6	Liquid Hydrogen Fluoride	342
10.7	Liquid Sulfur Dioxide	345
10.8	Superacids	349
PART 4 Chemistry of the Elements		353
CHAPTER 11	Chemistry of Metallic Elements	355
11.1	The Metallic Elements	355
11.2	Band Theory	356
11.3	Group IA and IIA Metals	359
11.4	Zintl Phases	367
11.5	Aluminum and Beryllium	370

11.6	The First-Row Transition Metals	372
11.7	Second- and Third-Row Transition Metals	374
11.8	Alloys	376
11.9	Chemistry of Transition Metals	379
11.10	The Lanthanides	387
CHAPTER 12	Organometallic Compounds of the Main Group Elements	395
12.1	Preparation of Organometallic Compounds	396
12.2	Organometallic Compounds of Group IA Metals	398
12.3	Organometallic Compounds of Group IIA Metals	400
12.4	Organometallic Compounds of Group IIIA Metals	403
12.5	Organometallic Compounds of Group IVA Metals	408
12.6	Organometallic Compounds of Group VA Elements	409
12.7	Organometallic Compounds of Zn, Cd, and Hg	410
CHAPTER 13	Chemistry of Nonmetallic Elements I. Hydrogen, Boron, Oxygen and Carbon	415
13.1	Hydrogen	415
13.2	Boron	422
13.3	Oxygen	433
13.4	Carbon	444
CHAPTER 14	Chemistry of Nonmetallic Elements II. Groups IVA and VA	463
14.1	The Group IVA Elements	463
14.2	Nitrogen	480
14.3	Phosphorus, Arsenic, Antimony, and Bismuth	497
CHAPTER 15	Chemistry of Nonmetallic Elements III. Groups VIA to VIIIA	523
15.1	Sulfur, Selenium, and Tellurium	523
15.2	The Halogens	545
15.3	The Noble Gases	564
PART 5	Chemistry of Coordination Compounds	575
CHAPTER 16	Introduction to Coordination Chemistry	577
16.1	Structures of Coordination Compounds	577
16.2	Metal-Ligand Bonds	582
16.3	Naming Coordination Compounds	583
16.4	Isomerism	585
16.5	A Simple Valence Bond Description of Coordinate Bonds	592
16.6	Magnetism	597
16.7	A Survey of Complexes of First-Row Metals	599

16.8	Complexes of Second- and Third-Row Metals	599
16.9	The 18-Electron Rule	601
16.10	Back Donation	604
16.11	Complexes of Dinitrogen, Dioxygen, and Dihydrogen	609
CHAPTER 17	Ligand Fields and Molecular Orbitals	617
17.1	Splitting of <i>d</i> Orbital Energies in Octahedral Fields	617
17.2	Splitting of <i>d</i> Orbital Energies in Fields of Other Symmetry	621
17.3	Factors Affecting Δ	625
17.4	Consequences of Crystal Field Splitting	627
17.5	Jahn-Teller Distortion	630
17.6	Spectral Bands	631
17.7	Molecular Orbitals in Complexes	633
CHAPTER 18	Interpretation of Spectra	645
18.1	Splitting of Spectroscopic States	645
18.2	Orgel Diagrams	650
18.3	Racah Parameters and Quantitative Methods	652
18.4	The Nephelauxetic Effect	655
18.5	Tanabe-Sugano Diagrams	658
18.6	The Lever Method	662
18.7	Jørgensen's Method	665
18.8	Charge Transfer Absorption	666
CHAPTER 19	Composition and Stability of Complexes	671
19.1	Composition of Complexes in Solution	671
19.2	Job's Method of Continuous Variations	673
19.3	Equilibria Involving Complexes	675
19.4	Distribution Diagrams	681
19.5	Factors Affecting the Stability of Complexes	685
CHAPTER 20	Synthesis and Reactions of Coordination Compounds	695
20.1	Synthesis of Coordination Compounds	695
20.2	Substitution Reactions in Octahedral Complexes	701
20.3	Ligand Field Effects	708
20.4	Acid-Catalyzed Reactions of Complexes	712
20.5	Base-Catalyzed Reactions of Complexes	713
20.6	The Compensation Effect	715
20.7	Linkage Isomerization	716
20.8	Substitution in Square Planar Complexes	719
20.9	The <i>Trans</i> Effect	721

20.10	Electron Transfer Reactions	725
20.11	Reactions in Solid Coordination Compounds	728
CHAPTER 21	Complexes Containing Metal-Carbon and Metal-Metal Bonds	739
21.1	Binary Metal Carbonyls	739
21.2	Structures of Metal Carbonyls	742
21.3	Bonding of Carbon Monoxide to Metals	744
21.4	Preparation of Metal Carbonyls	747
21.5	Reactions of Metal Carbonyls	748
21.6	Structure and Bonding in Metal Alkene Complexes	754
21.7	Preparation of Metal Alkene Complexes	760
21.8	Chemistry of Cyclopentadienyl and Related Complexes	761
21.9	Bonding in Ferrocene	764
21.10	Reactions of Ferrocene and Other Metallocenes	767
21.11	Complexes of Benzene and Related Aromatics	770
21.12	Compounds Containing Metal-Metal Bonds	773
CHAPTER 22	Coordination Compounds in Catalysis and Biochemistry	779
22.1	Elementary Steps in Catalysis Processes	780
22.2	Homogeneous Catalysis	792
22.3	Bioinorganic Chemistry	802
Appendix A: Ionization Energies		817
Appendix B: Character Tables for Selected Point Groups		821
Index		827

Preface

No single volume, certainly not a textbook, can come close to including all of the important topics in inorganic chemistry. The field is simply too broad in scope and it is growing at a rapid pace. Inorganic chemistry textbooks reflect a great deal of work and the results of the many choices that authors must make as to what to include and what to leave out. Writers of textbooks in chemistry bring to the task backgrounds that reflect their research interests, the schools they attended, and their personalities. In their writing, authors are really saying “this is the field as I see it.” In these regards, this book is similar to others.

When teaching a course in inorganic chemistry, certain core topics are almost universally included. In addition, there are numerous peripheral areas that may be included at certain schools but not at others depending on the interests and specialization of the person teaching the course. The course content may even change from one semester to the next. The effort to produce a textbook that presents coverage of a wide range of optional material in addition to the essential topics can result in a textbook for a one semester course that contains a thousand pages. Even a “concise” inorganic chemistry book can be nearly this long. This book is not a survey of the literature or a research monograph. It is a textbook that is intended to provide the background necessary for the reader to move on to those more advanced resources.

In writing this book, I have attempted to produce a concise *textbook* that meets several objectives. First, the topics included were selected in order to provide essential information in the major areas of inorganic chemistry (molecular structure, acid-base chemistry, coordination chemistry, ligand field theory, solid state chemistry, etc.). These topics form the basis for competency in inorganic chemistry at a level commensurate with the one semester course taught at most colleges and universities.

When painting a wall, better coverage is assured when the roller passes over the same area several times from different directions. It is the opinion of the author that this technique works well in teaching chemistry. Therefore, a second objective has been to stress fundamental principles in the discussion of several topics. For example, the hard-soft interaction principle is employed in discussion of acid-base chemistry, stability of complexes, solubility, and predicting reaction products. Third, the presentation of topics is made with an effort to be clear and concise so that the book is portable and user friendly. This book is meant to present in convenient form a readable account of the essentials of inorganic chemistry that can serve as both as a textbook for a one semester course upper level course and as a guide for self study. It is a *textbook* not a review of the literature or a research monograph. There are few references to the original literature, but many of the advanced books and monographs are cited.

Although the material contained in this book is arranged in a progressive way, there is flexibility in the order of presentation. For students who have a good grasp of the basic principles of quantum mechanics and atomic structure, Chapters 1 and 2 can be given a cursory reading but not included in the required course material. The chapters are included to provide a resource for review and self study. Chapter 4 presents an overview structural chemistry early so the reader can become familiar with many types of inorganic structures before taking up the study of symmetry or chemistry of specific elements. Structures of inorganic solids are discussed in Chapter 7, but that material could easily be studied

before Chapters 5 or 6. Chapter 6 contains material dealing with intermolecular forces and polarity of molecules because of the importance of these topics when interpreting properties of substances and their chemical behavior. In view of the importance of the topic, especially in industrial chemistry, this book includes material on rate processes involving inorganic compounds in the solid state (Chapter 8). The chapter begins with an overview of some of the important aspects of reactions in solids before considering phase transitions and reactions of solid coordination compounds.

It should be an acknowledged fact that no single volume can present the descriptive chemistry of all the elements. Some of the volumes that attempt to do so are enormous. In this book, the presentation of descriptive chemistry of the elements is kept brief with the emphasis placed on types of reactions and structures that summarize the behavior of many compounds. The attempt is to present an overview of descriptive chemistry that will show the important classes of compounds and their reactions without becoming laborious in its detail. Many schools offer a descriptive inorganic chemistry course at an intermediate level that covers a great deal of the chemistry of the elements. Part of the rationale for offering such a course is that the upper level course typically concentrates more heavily on principles of inorganic chemistry. Recognizing that an increasing fraction of the students in the upper level inorganic chemistry course will have already had a course that deals primarily with descriptive chemistry, this book is devoted to a presentation of the principles of inorganic chemistry while giving an a brief overview of descriptive chemistry in Chapters 12–15, although many topics that are primarily descriptive in nature are included in other sections. Chapter 16 provides a survey of the chemistry of coordination compounds and that is followed by Chapters 17–22 that deal with structures, bonding, spectra, and reactions of coordination compounds. The material included in this text should provide the basis for the successful study of a variety of special topics.

Doubtless, the teacher of inorganic chemistry will include some topics and examples of current or personal interest that are not included in any textbook. That has always been my practice, and it provides an opportunity to show how the field is developing and new relationships.

Most textbooks are an outgrowth of the author's teaching. In the preface, the author should convey to the reader some of the underlying pedagogical philosophy which resulted in the design of his or her book. It is unavoidable that a different teacher will have somewhat different philosophy and methodology. As a result, no single book will be completely congruent with the practices and motivations of all teachers. A teacher who writes the textbook for his or her course should find all of the needed topics in the book. However, it is unlikely that a book written by someone else will ever contain exactly the right topics presented in exactly the right way.

The author has taught several hundred students in inorganic chemistry courses at Illinois State University, Illinois Wesleyan University, University of Illinois, and Western Kentucky University using the materials and approaches set forth in this book. Among that number are many who have gone on to graduate school, and virtually all of that group have performed well (in many cases very well!) on registration and entrance examinations in inorganic chemistry at some of the most prestigious institutions. Although it is not possible to name all of those students, they have provided the inspiration to see this project to completion with the hope that students at other universities may find this book

useful in their study of inorganic chemistry. It is a pleasure to acknowledge and give thanks to Derek Coleman and Philip Bugeau for their encouragement and consideration as this project progressed. Finally, I would like to thank my wife, Kathleen, for reading the manuscript and making many helpful suggestions. Her constant encouragement and support have been needed at many times as this project was underway.

This page intentionally left blank

Part

1

Structure of Atoms and Molecules

This page intentionally left blank

Light, Electrons, and Nuclei

The study of inorganic chemistry involves interpreting, correlating, and predicting the properties and structures of an enormous range of materials. Sulfuric acid is the chemical produced in the largest tonnage of any compound. A greater number of tons of concrete is produced, but it is a mixture rather than a single compound. Accordingly, sulfuric acid is an inorganic compound of enormous importance. On the other hand, inorganic chemists study compounds such as hexaaminecobalt(III) chloride, $[\text{Co}(\text{NH}_3)_6]\text{Cl}_3$, and Zeise's salt, $\text{K}[\text{Pt}(\text{C}_2\text{H}_4)\text{Cl}_3]$. Such compounds are known as coordination compounds or coordination complexes. Inorganic chemistry also includes areas of study such as non-aqueous solvents and acid-base chemistry. Organometallic compounds, structures and properties of solids, and the chemistry of elements other than carbon are areas of inorganic chemistry. However, even many compounds of carbon (e.g., CO_2 and Na_2CO_3) are also inorganic compounds. The range of materials studied in inorganic chemistry is enormous, and a great many of the compounds and processes are of industrial importance. Moreover, inorganic chemistry is a body of knowledge that is expanding at a very rapid rate, and a knowledge of the behavior of inorganic materials is fundamental to the study of the other areas of chemistry.

Because inorganic chemistry is concerned with structures and properties as well as the synthesis of materials, the study of inorganic chemistry requires familiarity with a certain amount of information that is normally considered to be physical chemistry. As a result, physical chemistry is normally a prerequisite for taking a comprehensive course in inorganic chemistry. There is, of course, a great deal of overlap of some areas of inorganic chemistry with the related areas in other branches of chemistry. A knowledge of atomic structure and properties of atoms is essential for describing both ionic and covalent bonding. Because of the importance of atomic structure to several areas of inorganic chemistry, it is appropriate to begin our study of inorganic chemistry with a brief review of atomic structure and how our ideas about atoms were developed.

1.1 SOME EARLY EXPERIMENTS IN ATOMIC PHYSICS

It is appropriate at the beginning of a review of atomic structure to ask the question, "How do we know what we know?" In other words, "What crucial experiments have been performed and what do

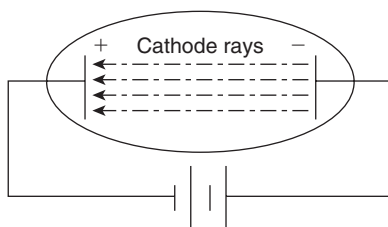

■ FIGURE 1.1 Design of a cathode ray tube.

the results tell us about the structure of atoms?” Although it is not necessary to consider all of the early experiments in atomic physics, we should describe some of them and explain the results. The first of these experiments was that of J. J. Thomson in 1898–1903, which dealt with cathode rays. In the experiment, an evacuated tube that contains two electrodes has a large potential difference generated between the electrodes as shown in Figure 1.1.

Under the influence of the high electric field, the gas in the tube emits light. The glow is the result of electrons colliding with the molecules of gas that are still present in the tube even though the pressure has been reduced to a few torr. The light that is emitted is found to consist of the spectral lines characteristic of the gas inside the tube. Neutral molecules of the gas are ionized by the electrons streaming from the cathode, which is followed by recombination of electrons with charged species. Energy (in the form of light) is emitted as this process occurs. As a result of the high electric field, negative ions are accelerated toward the anode and positive ions are accelerated toward the cathode. When the pressure inside the tube is very low (perhaps 0.001 torr), the mean free path is long enough that some of the positive ions strike the cathode, which emits rays. Rays emanating from the cathode stream toward the anode. Because they are emitted from the cathode, they are known as *cathode rays*.

Cathode rays have some very interesting properties. First, their path can be bent by placing a magnet near the cathode ray tube. Second, placing an electric charge near the stream of rays also causes the path they follow to exhibit curvature. From these observations, we conclude that the rays are electrically charged. The cathode rays were shown to carry a negative charge because they were attracted to a positively charged plate and repelled by one that carried a negative charge.

The behavior of cathode rays in a magnetic field is explained by recalling that a moving beam of charged particles (they were not known to be electrons at the time) generates a magnetic field. The same principle is illustrated by passing an electric current through a wire that is wound around a compass. In this case, the magnetic field generated by the flowing current interacts with the magnetized needle of the compass, causing it to point in a different direction. Because the cathode rays are negatively charged particles, their motion generates a magnetic field that interacts with the external magnetic field. In fact, some important information about the nature of the charged particles in cathode rays can be obtained from studying the curvature of their path in a magnetic field of known strength.

Consider the following situation. Suppose a cross wind of 10 miles/hour is blowing across a tennis court. If a tennis ball is moving perpendicular to the direction the wind is blowing, the ball will follow

a curved path. It is easy to rationalize that if a second ball had a cross-sectional area that was twice that of a tennis ball but the same mass, it would follow a more curved path because the wind pressure on it would be greater. On the other hand, if a third ball having twice the cross-sectional area and twice the mass of the tennis ball were moving perpendicular to the wind direction, it would follow a path with the same curvature as the tennis ball. The third ball would experience twice as much wind pressure as the tennis ball, but it would have twice the mass, which tends to cause the ball to move in a straight line (inertia). Therefore, if the path of a ball is being studied when it is subjected to wind pressure applied perpendicular to its motion, an analysis of the curvature of the path could be used to determine the ratio of the cross-sectional area to the mass of a ball, but neither property alone.

A similar situation exists for a charged particle moving under the influence of a magnetic field. The greater the mass, the greater the tendency of the particle to travel in a straight line. On the other hand, the higher its charge, the greater its tendency to travel in a curved path in the magnetic field. If a particle has two units of charge and two units of mass, it will follow the same path as one that has one unit of charge and one unit of mass. From the study of the behavior of cathode rays in a magnetic field, Thomson was able to determine the charge-to-mass ratio for cathode rays, but not the charge or the mass alone. The negative particles in cathode rays are electrons, and Thomson is credited with the discovery of the electron. From his experiments with cathode rays, Thomson determined the charge-to-mass ratio of the electron to be -1.76×10^8 coulomb/gram.

It was apparent to Thomson that if atoms in the metal electrode contained negative particles (electrons), they must also contain positive charges because atoms are electrically neutral. Thomson proposed a model for the atom in which positive and negative particles were embedded in some sort of matrix. The model became known as the plum pudding model because it resembled plums embedded in a pudding. Somehow, an equal number of positive and negative particles were held in this material. Of course we now know that this is an incorrect view of the atom, but the model did account for several features of atomic structure.

The second experiment in atomic physics that increased our understanding of atomic structure was conducted by Robert A. Millikan in 1908. This experiment has become known as the Millikan oil drop experiment because of the way in which oil droplets were used. In the experiment, oil droplets (made up of organic molecules) were sprayed into a chamber where a beam of x-rays was directed on them. The x-rays ionized molecules by removing one or more electrons producing cations. As a result, some of the oil droplets carried an overall positive charge. The entire apparatus was arranged in such a way that a negative metal plate, the charge of which could be varied, was at the top of the chamber. By varying the (known) charge on the plate, the attraction between the plate and a specific droplet could be varied until it exactly equaled the gravitational force on the droplet. Under this condition, the droplet could be suspended with an electrostatic force pulling the drop upward that equaled the gravitational force pulling downward on the droplet. Knowing the density of the oil and having measured the diameter of the droplet gave the mass of the droplet. It was a simple matter to calculate the charge on the droplet, because the charge on the negative plate with which the droplet interacted was known. Although some droplets may have had two or three electrons removed, the calculated charges on the oil droplets were always a multiple of the smallest charge measured. Assuming that the smallest measured charge

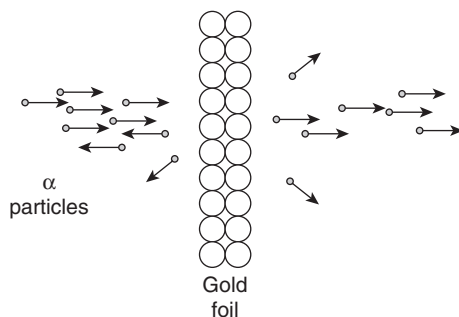

■ FIGURE 1.2 A representation of Rutherford's experiment.

corresponded to that of a single electron, the charge on the electron was determined. That charge is -1.602×10^{-19} coulombs or -4.80×10^{-10} esu (electrostatic units: $1 \text{ esu} = 1 \text{ g}^{1/2} \text{ cm}^{3/2} \text{ sec}^{-1}$). Because the charge-to-mass ratio was already known, it was now possible to calculate the mass of the electron, which is 9.11×10^{-31} kg or 9.11×10^{-28} g.

The third experiment that is crucial to understanding atomic structure was carried out by Ernest Rutherford in 1911 and is known as Rutherford's experiment. It consists of bombarding a thin metal foil with alpha (α) particles. Thin foils of metals, especially gold, can be made so thin that the thickness of the foil represents only a few atomic diameters. The experiment is shown diagrammatically in Figure 1.2.

It is reasonable to ask why such an experiment would be informative in this case. The answer lies in understanding what the Thomson plum pudding model implies. If atoms consist of equal numbers of positive and negative particles embedded in a neutral material, a charged particle such as an α particle (which is a helium nucleus) would be expected to travel near an equal number of positive and negative charges when it passes through an atom. As a result, there should be no *net* effect on the α particle, and it should pass directly through the atom or a foil that is only a few atoms in thickness.

A narrow beam of α particles impinging on a gold foil should pass directly through the foil because the particles have relatively high energies. What happened was that most of the α particles did just that, but some were deflected at large angles and some came essentially back toward the source! Rutherford described this result in terms of firing a 16-inch shell at a piece of tissue paper and having it bounce back at you. How could an α particle experience a force of repulsion great enough to cause it to change directions? The answer is that such a repulsion could result only when all of the positive charge in a gold atom is concentrated in a very small region of space. Without going into the details, calculations showed that the small positive region was approximately 10^{-13} cm in size. This could be calculated because it is rather easy on the basis of electrostatics to determine what force would be required to change the direction of an α particle with a $+2$ charge traveling with a known energy. Because the overall positive charge on an atom of gold was known (the atomic number), it was possible to determine the approximate size of the positive region.

Rutherford's experiment demonstrated that the total positive charge in an atom is localized in a very small region of space (the nucleus). The majority of α particles simply passed through the gold foil, indicating that they did not come near a nucleus. In other words, most of the atom is empty space. The diffuse cloud of electrons (which has a size on the order of 10^{-8} cm) did not exert enough force on the α particles to deflect them. The plum pudding model simply did not explain the observations from the experiment with α particles.

Although the work of Thomson and Rutherford had provided a view of atoms that was essentially correct, there was still the problem of what made up the remainder of the mass of atoms. It had been postulated that there must be an additional ingredient in the atomic nucleus, and this was demonstrated in 1932 by James Chadwick. In his experiments a thin beryllium target was bombarded with α particles. Radiation having high penetrating power was emitted, and it was initially assumed that they were high-energy γ rays. From studies of the penetration of these rays in lead, it was concluded that the particles had an energy of approximately 7 MeV. Also, these rays were shown to eject protons having energies of approximately 5 MeV from paraffin. However, in order to explain some of the observations, it was shown that if the radiation were γ rays, they must have an energy that is approximately 55 MeV. If an α particle interacts with a beryllium nucleus so that it becomes captured, it is possible to show that the energy (based on mass difference between the products and reactants) is only about 15 MeV. Chadwick studied the recoil of nuclei that were bombarded by the radiation emitted from beryllium when it was a target for α particles and showed that if the radiation consists of γ rays, the energy must be a function of the mass of the recoiling nucleus, which leads to a violation of the conservation of momentum and energy. However, if the radiation emitted from the beryllium target is presumed to carry no charge and consist of particles having a mass approximately that of a proton, the observations could be explained satisfactorily. Such particles were called neutrons, and they result from the reaction

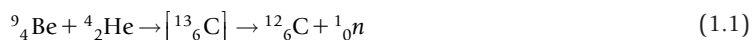

Atoms consist of electrons and protons in equal numbers and, in all cases except the hydrogen atom, some number of neutrons. Electrons and protons have equal but opposite charges, but greatly different masses. The mass of a proton is 1.67×10^{-24} grams. In atoms that have many electrons, the electrons are not all held with the same energy; later we will discuss the shell structure of electrons in atoms. At this point, we see that the early experiments in atomic physics have provided a general view of the structures of atoms.

1.2 THE NATURE OF LIGHT

From the early days of physics, a controversy had existed regarding the nature of light. Some prominent physicists, such as Isaac Newton, had believed that light consisted of particles or "corpuscles." Other scientists of that time believed that light was wavelike in its character. In 1807, a crucial experiment was conducted by T. Young in which light showed a diffraction pattern when a beam of light was passed through two slits. Such behavior showed the wave character of light. Other work by A. Fresnel and F. Arago had dealt with interference, which also depends on light having a wave character.

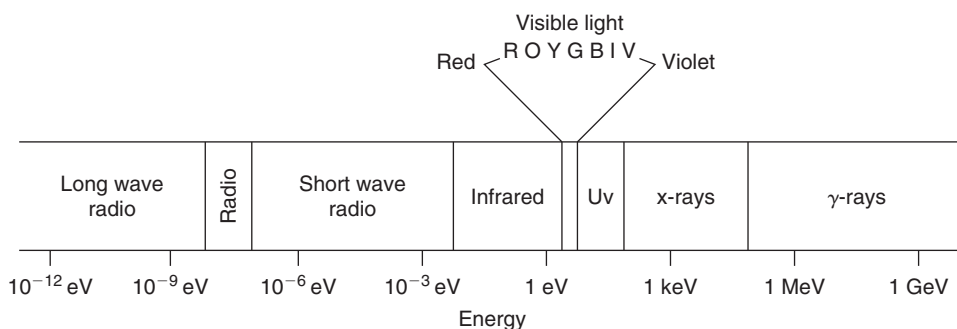

■ FIGURE 1.3 The electromagnetic spectrum.

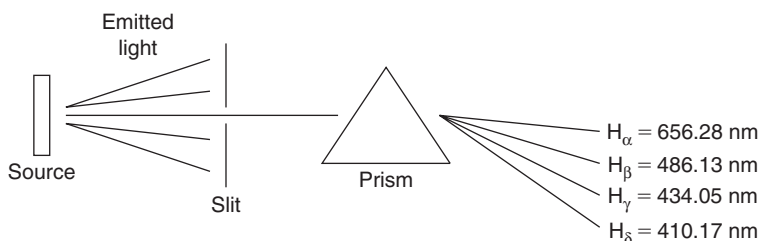

■ FIGURE 1.4 Separation of spectral lines due to refraction in a prism spectroscope.

The nature of light and the nature of matter are intimately related. It was from the study of light emitted when matter (atoms and molecules) was excited by some energy source or the absorption of light by matter that much information was obtained. In fact, most of what we know about the structure of atoms and molecules has been obtained by studying the interaction of electromagnetic radiation with matter or electromagnetic radiation emitted from matter. These types of interactions form the basis of several types of spectroscopy, techniques that are very important in studying atoms and molecules.

In 1864, J. C. Maxwell showed that electromagnetic radiation consists of transverse electric and magnetic fields that travel through space at the speed of light (3.00×10^8 m/sec). The electromagnetic spectrum consists of the several types of waves (visible light, radio waves, infrared radiation, etc.) that form a continuum as shown in Figure 1.3. In 1887, Hertz produced electromagnetic waves by means of an apparatus that generated an oscillating electric charge (an antenna). This discovery led to the development of radio.

Although all of the developments that have been discussed are important to our understanding of the nature of matter, there are other phenomena that provide additional insight. One of them concerns the emission of light from a sample of hydrogen gas through which a high voltage is placed. The basic experiment is shown in Figure 1.4. In 1885, J.J. Balmer studied the visible light emitted from the gas by passing it through a prism that separates the light into its components.

The four lines observed are as follows.

$$H_{\alpha} = 656.28 \text{ nm} = 6562.8 \text{ \AA}$$

$$H_{\beta} = 486.13 \text{ nm} = 4861.3 \text{ \AA}$$

$$H_{\gamma} = 434.05 \text{ nm} = 4340.5 \text{ \AA}$$

$$H_{\delta} = 410.17 \text{ nm} = 4101.7 \text{ \AA}$$

This series of spectral lines for hydrogen became known as Balmer's series, and the wavelengths of these four spectral lines were found to obey the relationship

$$\frac{1}{\lambda} = R_{\text{H}} \left(\frac{1}{2^2} - \frac{1}{n^2} \right) \quad (1.2)$$

where λ is the wavelength of the line, n is an integer larger than 2, and R_{H} is a constant known as Rydberg's constant that has the value $109,677.76 \text{ cm}^{-1}$. The quantity $1/\lambda$ is known as the *wave number* (the number of complete waves per centimeter), which is written as $\bar{\nu}$ ("nu bar"). From Eq. (1.2) it can be seen that as n assumes larger values, the lines become more closely spaced, but when n equals infinity, there is a limit reached. That limit is known as the *series limit* for the Balmer series. Keep in mind that these spectral lines, the first to be discovered for hydrogen, were in the visible region of the electromagnetic spectrum. Detectors for visible light (human eyes and photographic plates) were available at an earlier time than were detectors for other types of electromagnetic radiation.

Eventually, other series of lines were found in other regions of the electromagnetic spectrum. The Lyman series was observed in the ultraviolet region, whereas the Paschen, Brackett, and Pfund series were observed in the infrared region of the spectrum. All of these lines were observed as they were *emitted* from excited atoms, so together they constitute the *emission spectrum* or *line spectrum* of hydrogen atoms.

Another of the great developments in atomic physics involved the light emitted from a device known as a black body. Because black is the best absorber of all wavelengths of visible light, it should also be the best emitter. Consequently, a metal sphere, the interior of which is coated with lampblack, emits radiation (blackbody radiation) having a range of wavelengths from an opening in the sphere when it is heated to incandescence. One of the thorny problems in atomic physics dealt with trying to predict the intensity of the radiation as a function of wavelength. In 1900, Max Planck arrived at a satisfactory relationship by making an assumption that was radical at that time. Planck assumed that absorption and emission of radiation arises from oscillators that change frequency. However, Planck assumed that the frequencies were not continuous but rather that only certain frequencies were allowed. In other words, the frequency is *quantized*. The permissible frequencies were multiples of some fundamental frequency, ν_0 . A change in an oscillator from a lower frequency to a higher one involves the absorption

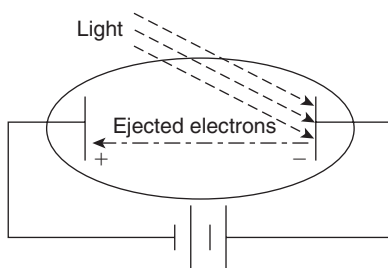

■ FIGURE 1.5 Apparatus for demonstrating the photoelectric effect.

of energy, whereas energy is emitted as the frequency of an oscillator decreases. Planck expressed the energy in terms of the frequency by means of the relationship

$$E = h\nu \quad (1.3)$$

where E is the energy, ν is the frequency, and h is a constant (known as Planck's constant, 6.63×10^{-27} erg sec = 6.63×10^{-34} J sec). Because light is a transverse wave (the direction the wave is moving is perpendicular to the displacement), it obeys the relationship

$$\lambda\nu = c \quad (1.4)$$

where λ is the wavelength, ν is the frequency, and c is the velocity of light (3.00×10^{10} cm/sec). By making these assumptions, Planck arrived at an equation that satisfactorily related the intensity and frequency of the emitted blackbody radiation.

The importance of the idea that energy is quantized is impossible to overstate. It applies to all types of energies related to atoms and molecules. It forms the basis of the various experimental techniques for studying the structure of atoms and molecules. The energy levels may be electronic, vibrational, or rotational depending on the type of experiment conducted.

In the 1800s, it was observed that when light is shined on a metal plate contained in an evacuated tube, an interesting phenomenon occurs. The arrangement of the apparatus is shown in Figure 1.5. When the light is shined on the metal plate, an electric current flows. Because light and electricity are involved, the phenomenon became known as the *photoelectric effect*. Somehow, light is responsible for the generation of the electric current. Around 1900, there was ample evidence that light behaved as a wave, but it was impossible to account for some of the observations on the photoelectric effect by considering light in that way. Observations on the photoelectric effect include the following:

1. The incident light must have some minimum frequency (the *threshold frequency*) in order for electrons to be ejected.
2. The current flow is instantaneous when the light strikes the metal plate.
3. The current is proportional to the intensity of the incident light.

In 1905, Albert Einstein provided an explanation of the photoelectric effect by assuming that the incident light acts as particles. This allowed for instantaneous collisions of light particles (*photons*) with electrons (called photoelectrons), which resulted in the electrons being ejected from the surface of the metal. Some minimum energy of the photons was required because the electrons are bound to the metal surface with some specific binding energy that depends on the type of metal. The energy required to remove an electron from the surface of a metal is known as the *work function* (w_0) of the metal. The ionization potential (which corresponds to removal of an electron from a gaseous atom) is not the same as the work function. If an incident photon has an energy that is greater than the work function of the metal, the ejected electron will carry away part of the energy as kinetic energy. In other words, the kinetic energy of the ejected electron will be the difference between the energy of the incident photon and the energy required to remove the electron from the metal. This can be expressed by the equation

$$\frac{1}{2}mv^2 = hv - w_0 \quad (1.5)$$

By increasing the negative charge on the plate to which the ejected electrons move, it is possible to stop the electrons and thereby stop the current flow. The voltage necessary to stop the electrons is known as the *stopping potential*. Under these conditions, what is actually being determined is the kinetic energy of the ejected electrons. If the experiment is repeated using incident radiation with a different frequency, the kinetic energy of the ejected electrons can again be determined. By using light having several known incident frequencies, it is possible to determine the kinetic energy of the electrons corresponding to each frequency and make a graph of the kinetic energy of the electrons versus ν . As can be seen from Eq. (1.5), the relationship should be linear with the slope of the line being h , Planck's constant, and the intercept is $-w_0$. There are some similarities between the photoelectric effect described here and photoelectron spectroscopy of molecules that is described in Section 3.4.

Although Einstein made use of the assumption that light behaves as a particle, there is no denying the validity of the experiments that show that light behaves as a wave. Actually, light has characteristics of both waves and particles, the so-called *particle-wave duality*. Whether it behaves as a wave or a particle depends on the type of experiment to which it is being subjected. In the study of atomic and molecular structure, it necessary to use both concepts to explain the results of experiments.

1.3 THE BOHR MODEL

Although the experiments dealing with light and atomic spectroscopy had revealed a great deal about the structure of atoms, even the line spectrum of hydrogen presented a formidable problem to the physics of that time. One of the major obstacles was that energy was not emitted continuously as the electron moves about the nucleus. After all, velocity is a vector quantity that has both a magnitude and a direction. A change in direction constitutes a change in velocity (acceleration), and an accelerated electric charge should emit electromagnetic radiation according to Maxwell's theory. If the moving electron lost energy continuously, it would slowly spiral in toward the nucleus and the atom would "run down." Somehow, the laws of classical physics were not capable of dealing with this situation, which is illustrated in Figure 1.6.

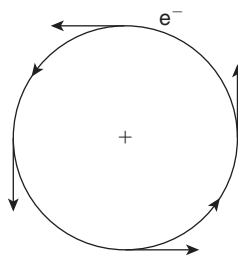

■ **FIGURE 1.6** As the electron moves around the nucleus, it is constantly changing direction.

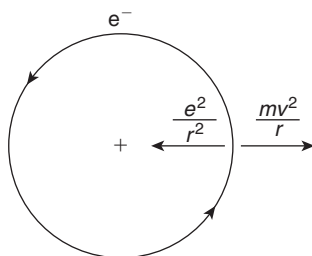

■ **FIGURE 1.7** Forces acting on an electron moving in a hydrogen atom.

Following Rutherford's experiments in 1911, Niels Bohr proposed in 1913 a dynamic model of the hydrogen atom that was based on certain assumptions. The first of these assumptions was that there were certain "allowed" orbits in which the electron could move without radiating electromagnetic energy. Further, these were orbits in which the angular momentum of the electron (which for a rotating object is expressed as mvr) is a multiple of $h/2\pi$ (which is also written as \hbar),

$$mvr = \frac{nh}{2\pi} = n\hbar \quad (1.6)$$

where m is the mass of the electron, v is its velocity, r is the radius of the orbit, and n is an integer that can take on the values 1, 2, 3, ..., and \hbar is $h/2\pi$. The integer n is known as a *quantum number* or, more specifically, the *principal quantum number*.

Bohr also assumed that electromagnetic energy was emitted as the electron moved from a higher orbital (larger n value) to a lower one and absorbed in the reverse process.

This accounts for the fact that the line spectrum of hydrogen shows only lines having certain wavelengths. In order for the electron to move in a stable orbit, the electrostatic attraction between it and the proton must be balanced by the centrifugal force that results from its circular motion. As shown in Figure 1.7, the forces are actually in opposite directions, so we equate only the magnitudes of the forces.

The electrostatic force is given by the coulombic force as e^2/r^2 while the centrifugal force on the electron is mv^2/r . Therefore, we can write

$$\frac{mv^2}{r} = \frac{e^2}{r^2} \quad (1.7)$$

From Eq. (1.7) we can calculate the velocity of the electron as

$$v = \sqrt{\frac{e^2}{mr}} \quad (1.8)$$

We can also solve Eq. (1.6) for v to obtain

$$v = \frac{nh}{2\pi mr} \quad (1.9)$$

Because the moving electron has only one velocity, the values for v given in Eqs. (1.8) and (1.9) must be equal:

$$\sqrt{\frac{e^2}{mr}} = \frac{nh}{2\pi mr} \quad (1.10)$$

We can now solve for r to obtain

$$r = \frac{n^2 h^2}{4\pi^2 m e^2} \quad (1.11)$$

In Eq. (1.11), only r and n are variables. From the nature of this equation, we see that the value of r , the radius of the orbit, increases as the square of n . For the orbit with $n = 2$, the radius is four times that when $n = 1$, etc. Dimensionally, Eq. (1.11) leads to a value of r that is given in centimeters if the constants are assigned their values in the cm-g-s system of units (only h , m , and e have units).

$$\frac{[(g \text{ cm}^2/\text{sec}^2) \text{ sec}]^2}{[g(g^{1/2} \text{ cm}^{3/2}/\text{sec}^2)^2]} = \text{cm} \quad (1.12)$$

From Eq. (1.7), we see that

$$mv^2 = \frac{e^2}{r} \quad (1.13)$$

Multiplying both sides of the equation by $1/2$ we obtain

$$\frac{1}{2} mv^2 = \frac{e^2}{2r} \quad (1.14)$$

where the left-hand side is simply the kinetic energy of the electron. The total energy of the electron is the sum of the kinetic energy and the electrostatic potential energy, $-e^2/r$.

$$E = \frac{1}{2}mv^2 - \frac{e^2}{r} = \frac{e^2}{2r} - \frac{e^2}{r} = -\frac{e^2}{2r} \quad (1.15)$$

Substituting the value for r from Eq. (1.11) into Eq. (1.15) we obtain

$$E = -\frac{e^2}{2r} = -\frac{2\pi^2me^4}{n^2h^2} \quad (1.16)$$

from which we see that there is an inverse relationship between the energy and the square of the value n . The lowest value of E (and it is negative!) is for $n = 1$ while $E = 0$ when n has an infinitely large value that corresponds to complete removal of the electron. If the constants are assigned values in the cm-g-s system of units, the energy calculated will be in ergs. Of course $1\text{ J} = 10^7\text{ erg}$ and $1\text{ cal} = 4.184\text{ J}$.

By assigning various values to n , we can evaluate the corresponding energy of the electron in the orbits of the hydrogen atom. When this is done, we find the energies of several orbits as follows:

$$\begin{aligned} n = 1, & \quad E = -21.7 \times 10^{-12} \text{ erg} \\ n = 2, & \quad E = -5.43 \times 10^{-12} \text{ erg} \\ n = 3, & \quad E = -2.41 \times 10^{-12} \text{ erg} \\ n = 4, & \quad E = -1.36 \times 10^{-24} \text{ erg} \\ n = 5, & \quad E = -0.87 \times 10^{-12} \text{ erg} \\ n = 6, & \quad E = -0.63 \times 10^{-12} \text{ erg} \\ n = \infty, & \quad E = 0 \end{aligned}$$

These energies can be used to prepare an energy level diagram like that shown in Figure 1.8. Note that the binding energy of the electron is lowest when $n = 1$ and the binding energy is 0 when $n = \infty$.

Although the Bohr model successfully accounted for the line spectrum of the hydrogen atom, it could not explain the line spectrum of any other atom. It could be used to predict the wavelengths of spectral lines of other species that had only one electron such as He^+ , Li^{2+} , and Be^{3+} . Also, the model was based on assumptions regarding the nature of the allowed orbits that had no basis in classical physics. An additional problem is also encountered when the Heisenberg Uncertainty Principle is considered. According to this principle, it is impossible to know exactly the position and momentum of a particle simultaneously. Being able to describe an orbit of an electron in a hydrogen atom is equivalent

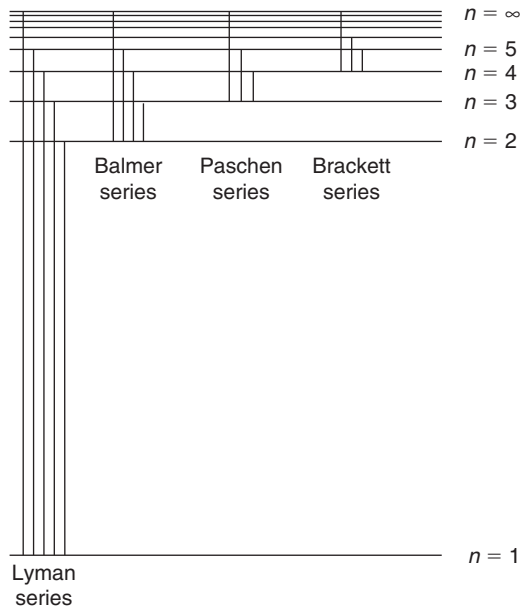

■ **FIGURE 1.8** An energy level diagram for the hydrogen atom.

to knowing its momentum and position. The Heisenberg Uncertainty Principle places a limit on the accuracy to which these variables can be known simultaneously. That relationship is

$$\Delta x \times \Delta(mv) \geq \hbar \quad (1.17)$$

where Δ is read as the uncertainty in the variable that follows. Planck's constant is known as the fundamental unit of action (it has units of energy multiplied by time), but the product of momentum multiplied by distance has the same dimensions. The essentially classical Bohr model explained the line spectrum of hydrogen, but it did not provide a theoretical framework for understanding atomic structure.

1.4 PARTICLE-WAVE DUALITY

The debate concerning the particle and wave nature of light had been lively for many years when in 1924 a young French doctoral student, Louis V. de Broglie, developed a hypothesis regarding the nature of particles. In this case, the particles were "real" particles such as electrons. De Broglie realized that for electromagnetic radiation, the energy could be described by the Planck equation

$$E = h\nu = \frac{hc}{\lambda} \quad (1.18)$$

However, one of the consequences of Einstein's special theory of relativity (in 1905) is that a photon has an energy that can be expressed as

$$E = mc^2 \quad (1.19)$$

This famous equation expresses the relationship between mass and energy, and its validity has been amply demonstrated. This equation does not indicate that a photon has a mass. It does signify that because a photon has energy, its *energy* is *equivalent* to some mass. However, for a given photon there is only one energy, so

$$mc^2 = \frac{hc}{\lambda} \quad (1.20)$$

Rearranging this equation leads to

$$\lambda = \frac{h}{mc} \quad (1.21)$$

Having developed the relationship shown in Eq. (1.21) for photons, de Broglie considered the fact that photons have characteristics of both particles and waves, as we have discovered earlier in this chapter. He reasoned that if a "real" particle such as an electron could exhibit properties of both particles and waves, the wavelength for the particle would be given by an equation that is equivalent to Eq. (1.21) except for the velocity of light being replaced by the velocity of the particle:

$$\lambda = \frac{h}{mv} \quad (1.22)$$

In 1924, this was a result that had not been experimentally verified, but the verification was not long in coming. In 1927, C. J. Davisson and L. H. Germer conducted the experiments at Bell Laboratories in Murray Hill, New Jersey. A beam of electrons accelerated by a known voltage has a known velocity. When such a beam impinges on a crystal of nickel metal, a diffraction pattern is observed! Moreover, because the spacing between atoms in a nickel crystal is known, it is possible to calculate the wavelength of the moving electrons, and the value corresponds exactly to the wavelength predicted by the de Broglie equation. Since this pioneering work, electron diffraction has become one of the standard experimental techniques for studying molecular structure.

De Broglie's work clearly shows that a moving electron can be considered as a wave. If it behaves in that way, a stable orbit in a hydrogen atom must contain a whole number of wavelengths, or otherwise there would be interference that would lead to cancellation (destructive interference). This condition can be expressed as

$$mvr = \frac{nh}{2\pi} \quad (1.23)$$

This is precisely the relationship that was required when Bohr assumed that the angular momentum of the electron is quantized for the allowed orbits.

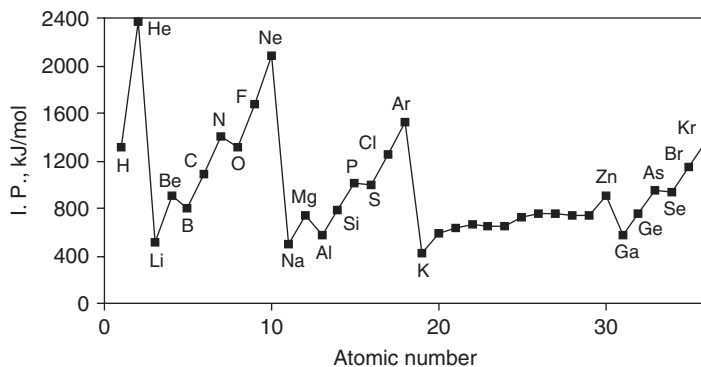

■ FIGURE 1.9 The relationship between first ionization potential and atomic number.

Having now demonstrated that a moving electron can be considered as a wave, it remained for an equation to be developed to incorporate this revolutionary idea. Such an equation was obtained and solved by Erwin Schrödinger in 1926 when he made use of the particle-wave duality ideas of de Broglie even before experimental verification had been made. We will describe this new branch of science, wave mechanics, in Chapter 2.

1.5 ELECTRONIC PROPERTIES OF ATOMS

Although we have not yet described the modern methods of dealing with theoretical chemistry (quantum mechanics), it is possible to describe many of the properties of atoms. For example, the energy necessary to remove an electron from a hydrogen atom (the *ionization energy* or *ionization potential*) is the energy that is equivalent to the series limit of the Lyman series. Therefore, atomic spectroscopy is one way to determine ionization potentials for atoms.

If we examine the relationship between the first ionization potentials for atoms and their atomic numbers, the result can be shown graphically as in Figure 1.9. Numerical values for ionization potentials are shown in Appendix A.

Several facts are apparent from this graph. Although we have not yet dealt with the topic of electron configuration of atoms, you should be somewhat familiar with this topic from earlier chemistry courses. We will make use of some of the ideas that deal with electron shells here but delay presenting the details until later.

1. The helium atom has the highest ionization potential of any atom. It has a nuclear charge of +2, and the electrons reside in the lowest energy level close to the nucleus.
2. The noble gases have the highest ionization potentials of any atoms in their respective periods. Electrons in these atoms are held in shells that are completely filled.

3. The group IA elements have the lowest ionization potentials of any atoms in their respective periods. As you probably already know, these atoms have a single electron that resides in a shell outside of other shells that are filled.
4. The ionization potentials within a period generally increase as you go to the right in that period. For example, $B < C < O < F$. However, in the case of nitrogen and oxygen, the situation is reversed. Nitrogen, which has a half-filled shell, has a higher ionization potential than oxygen, which has one electron more than a half-filled shell. There is some repulsion between the two electrons that reside in the same orbital in an oxygen atom, which makes it easier to remove one of them.
5. In general, the ionization potential decreases for the atoms in a given group going down in the group. For example, $Li > Na > K > Rb > Cs$ and $F > Cl > Br > I$. The outer electrons are farther from the nucleus for the larger atoms, and there are more filled shells of electrons between the nucleus and the outermost electron.
6. Even for the atom having the *lowest* ionization potential, Cs, the ionization potential is approximately 374 kJ mol^{-1} .

These are some of the general trends that relate the ionization potentials of atoms with regard to their positions in the periodic table. We will have opportunities to discuss additional properties of atoms later.

A second property of atoms that is vital to understanding their chemistry is the energy released when an electron is added to a gaseous atom,

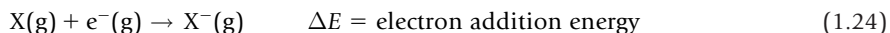

For most atoms, the addition of an electron occurs with the *release* of energy, so the value of ΔE is *negative*. There are some exceptions, most notably the noble gases and group IIA metals. These atoms have completely filled shells, so any additional electrons would have to be added in a new, empty shell. Nitrogen also has virtually no tendency to accept an additional electron because of the stability of the half-filled outer shell.

After an electron is added to an atom, the “affinity” that it has for the electron is known as the *electron affinity*. Because energy is released when an electron is added to most atoms, it follows that to remove the electron would require energy, so the quantity is positive for most atoms. The electron affinities for most of the main group elements are shown in Table 1.1. It is useful to remember that 1 eV per atom is equal to 96.48 kJ/mol.

Several facts are apparent when the data shown in Table 1.1 are considered. In order to see some of the specific results more clearly, Figure 1.10 has been prepared to show how the electron affinity varies with position in the periodic table (and therefore orbital population). From studying Figure 1.10 and the data shown in Table 1.1, the following relationships emerge:

1. The electron affinities for the halogens are the highest of any group of elements.
2. The electron affinity generally increases in going from left to right in a given period. In general, the electrons are being added to the atoms in the same outer shell. Because the nuclear charge

Table 1.1 Electron Affinities of Atoms in kJ mol^{-1} .							
H 72.8							
Li 59.6	Be −18		B 26.7	C 121.9	N −7	O ^a 141	F 328
Na 52.9	Mg −21		Al 44	Si 134	P 72	S ^b 200	Cl 349
K 48.4	Ca −186	Sc ... Zn 18 ... 9	Ga 30	Ge 116	As 78	Se 195	Br 325
Rb 47	Sr −146	Y ... Cd 30 ... −26	In 30	Sn 116	Sb 101	Te 190	I 295
Cs 46	Ba −46	La ... Hg 50 ... −18	Tl 20	Pb 35	Bi 91	Po 183	At 270

^a−845 kJ mol^{-1} for addition of two electrons.
^b−531 kJ mol^{-1} for addition of two electrons.

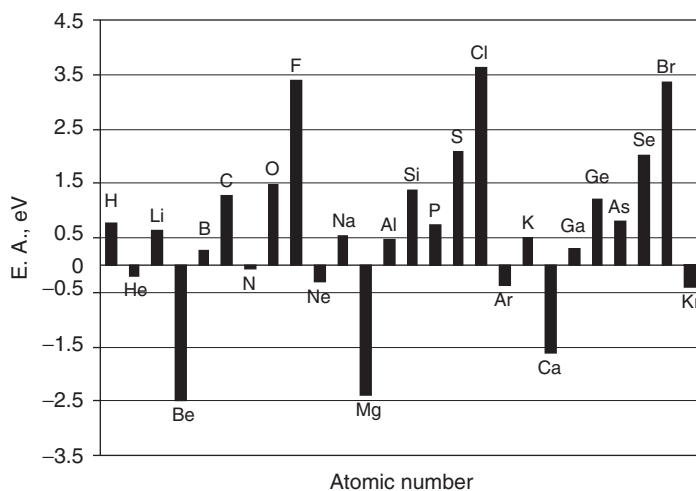

■ FIGURE 1.10 Electron affinity as a function of atomic number.

increases in going to the right in a period, the attraction for the outer electron shell increases accordingly.

3. In general, the electron affinity decreases going downward for atoms in a given group.
4. The electron affinity of nitrogen is out of line with those of other atoms in the same period because it has a stable half-filled shell.
5. Whereas nitrogen has an electron affinity that is approximately zero, phosphorus has a value greater than zero even though it also has a half-filled outer shell. The effect of a half-filled

shell decreases for larger atoms because that shell has more filled shells separating it from the nucleus.

- In the case of the halogens (group VIIA), the electron affinity of fluorine is *lower* than that of chlorine. This is because the fluorine atom is small and the outer electrons are close together and repelling each other. Adding another electron to an F atom, although very favorable energetically, is not as favorable as it is for chlorine, which has the highest electron affinity of any atom. For Cl, Br, and I, the trend is in accord with the general relationship.
- Hydrogen has a substantial electron affinity, which shows that we might expect compounds containing H^- to be formed.
- The elements in group IIA have negative electron affinities, showing that the addition of an electron to those atoms is not energetically favorable. These atoms have two electrons in the outer shell, which can hold only two electrons.
- The elements in group IA can add an electron with the release of energy (a small amount) because their singly occupied outer shells can hold two electrons.

As is the case with ionization potential, the electron affinity is a useful property when considering the chemical behavior of atoms, especially when describing ionic bonding, which involves electron transfer.

In the study of inorganic chemistry, it is important to understand how atoms vary in size. The relative sizes of atoms determine to some extent the molecular structures that are possible. Table 1.2 shows the sizes of atoms in relationship to the periodic table.

Some of the important trends in the sizes of atoms can be summarized as follows.

- The sizes of atoms in a given group increase as one progresses down the group. For example, the covalent radii for Li, Na, K, Rb, and Cs are 134, 154, 227, 248, and 265 pm, respectively. For F, Cl, Br, and I the covalent radii are 71, 99, 114, and 133 pm, respectively.

Table 1.2 Atomic Radii in Picometers (pm).							
H 78							
Li 152	Be 113		B 83	C 77	N 71	O 72	F 71
Na 154	Mg 138		Al 143	Si 117	P 110	S 104	Cl 99
K 227	Ca 197	Sc Zn 161 133	Ga 126	Ge 123	As 125	Se 117	Br 114
Rb 248	Sr 215	Y Cd 181 149	In 163	Sn 140	Sb 141	Te 143	I 133
Cs 265	Ba 217	La Hg 188 160	Tl 170	Pb 175	Bi 155	Po 167	At —

2. The sizes of atoms decrease in progressing across a given period. Nuclear charge increases in such a progression while electrons in the outer shell are contained in the same type of shell. Therefore, the higher the nuclear charge (farther to the right in the period), the greater the attraction for the electrons and the closer to the nucleus they will reside. For example, the radii for the first long row of atoms are as follows.

Atom:	Li	Be	B	C	N	O	F
Radius, pm	134	113	83	77	71	72	71

Other rows in the periodic table follow a similar trend. However, for the third row, there is a general decrease in radius except for the last two or three elements in the transition series. The covalent radii of Fe, Co, Ni, Cu, and Zn are 126, 125, 124, 128, and 133 pm, respectively. This effect is a manifestation of the fact that the $3d$ orbitals shrink in size as the nuclear charge increases (going to the right), and the additional electrons populating these orbitals experience greater repulsion. As a result, the size decreases to a point (at Co and Ni), but after that the increase in repulsion produces an increase in size (Cu and Zn are larger than Co and Ni).

3. The largest atoms in the various periods are the group IA metals. The outermost electron resides in a shell that is outside other completed shells (the noble gas configurations) so it is loosely held (low ionization potential) and relatively far from the nucleus.

An interesting effect of nuclear charge can be seen by examining the radius of a series of species that have the same nuclear charge but different numbers of electrons. One such series involves the ions that have 10 electrons (the neon configuration). The ions include Al^{3+} , Mg^{2+} , Na^+ , F^- , O^{2-} , and N^{3-} , for which the nuclear charge varies from 13 to 7. Figure 1.11 shows the variation in size of these species with nuclear charge.

Note that the N^{3-} ion (radius 171 pm) is much larger than the nitrogen atom, for which the covalent radius is only 71 pm. The oxygen atom (radius 72 pm) is approximately half the size of the oxide ion

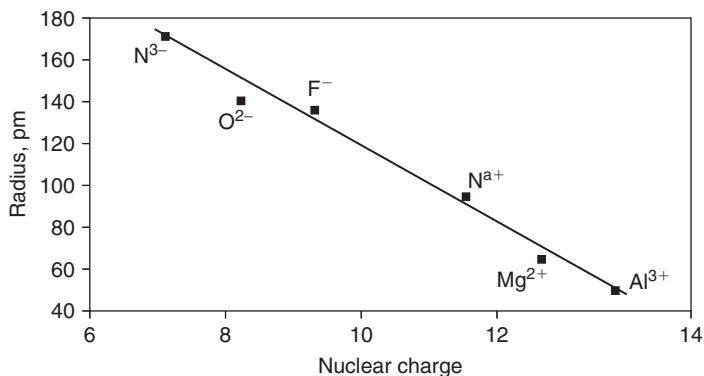

■ FIGURE 1.11 Radii of ions having the neon configuration.

(radius 140 pm). Anions are always larger than the atoms from which they are formed. On the other hand, the radius of Na^+ (95 pm) is much smaller than the covalent radius of the Na atom (radius 154 pm). Cations are always smaller than the atoms from which they are formed.

Of particular interest in the series of ions is the Al^{3+} ion, which has a radius of only 50 pm while the atom has a radius of 126 pm. As will be described in more detail later (see Chapter 6), the small size and high charge of the Al^{3+} ion causes it (and similar ions with high charge-to-size ratio or *charge density*) to have some very interesting properties. It has a great affinity for the negative ends of polar water molecules so that when an aluminum compound is dissolved in water, evaporating the water does not remove the water molecules that are bonded directly to the cation. The original aluminum compound is not recovered.

Because inorganic chemistry is concerned with the properties and reactions of compounds that may contain any element, understanding the relationships between properties of atoms is important. This topic will be revisited numerous times in later chapters, but the remainder of this chapter will be devoted to a brief discussion of the nuclear portion of the atom and nuclear transformations. We now know that it is not possible to express the weights of atoms as whole numbers that represent multiples of the mass of a hydrogen atom as had been surmised about two centuries ago. Although Dalton's atomic theory was based on the notion that all atoms of a given element were identical, we now know that this is not correct. As students in even elementary courses now know, the atomic masses represent *averages* resulting from most elements existing in several isotopes. The application of mass spectroscopy techniques has been of considerable importance in this type of study.

1.6 NUCLEAR BINDING ENERGY

There are at present 116 known chemical elements. However, there are well over 2000 known nuclear species as a result of several isotopes being known for each element. About three-fourths of the nuclear species are unstable and undergo radioactive decay. Protons and neutrons are the particles which are found in the nucleus. For many purposes, it is desirable to describe the total number of nuclear particles without regard to whether they are protons or neutrons. The term *nucleon* is used to denote both of these types of nuclear particles. In general, the radii of nuclides increase as the mass number increases with the usual relationship being expressed as

$$R = r_0 A^{1/3} \quad (1.25)$$

where A is the mass number and r_0 is a constant that is approximately 1.2×10^{-13} cm.

Any nuclear species is referred to as a *nuclide*. Thus, ${}^1_1\text{H}$, ${}^{23}_{11}\text{Na}$, ${}^{12}_6\text{C}$, ${}^{238}_{92}\text{U}$ are different recognizable species or nuclides. A nuclide is denoted by the symbol for the atom with the mass number written to the upper left, the atomic number written to the lower left, and any charge on the species, q^\pm to the upper right. For example,



As was described earlier in this chapter, the model of the atom consists of shells of electrons surrounding the nucleus, which contains protons and, except for the isotope ${}^1_1\text{H}$, a certain number of neutrons.

Each type of atom is designated by the atomic number, Z , and a symbol derived from the name of the element. The mass number, A , is the whole number nearest to the mass of that species. For example, the mass number of ${}^1_1\text{H}$ is 1, although the actual mass of this isotope is 1.00794 atomic mass units (amu). Because protons and neutrons have masses that are essentially the same (both are approximately 1 atomic mass unit, amu), the mass number of the species minus the atomic number gives the number of neutrons, which is denoted as N . Thus, for ${}^{15}_7\text{N}$, the nucleus contains seven protons and eight neutrons.

When atoms are considered to be composed of their constituent particles, it is found that the atoms have lower masses than the sum of the masses of the particles. For example, ${}^4_2\text{He}$ contains two electrons, two protons, and two neutrons. These particles have masses of 0.0005486, 1.00728, and 1.00866 amu, respectively, which gives a total mass of 4.03298 amu for the particles. However, the actual mass of ${}^4_2\text{He}$ is 4.00260 amu, so there is a *mass defect* of 0.030377 amu. That “disappearance” of mass occurs because the particles are held together with an energy that can be expressed in terms of the Einstein equation,

$$E = mc^2 \quad (1.26)$$

If 1 gram of mass is converted to energy, the energy released is

$$E = mc^2 = 1 \text{ g} \times (3.00 \times 10^{10} \text{ cm/sec})^2 = 9.00 \times 10^{20} \text{ erg}$$

When the mass being converted to energy is 1 amu (1.66054×10^{-24} g), the amount of energy released is 1.49×10^{-3} erg. This energy can be converted to electron volts by making use of the conversion that $1 \text{ eV} = 1.60 \times 10^{-12}$ erg. Therefore, $1.49 \times 10^{-3} \text{ erg} / 1.60 \times 10^{-12} \text{ erg/eV}$ is 9.31×10^8 eV. When dealing with energies associated with nuclear transformations, energies are ordinarily expressed in MeV with 1 MeV being 10^6 eV. Consequently, the energy equivalent to 1 amu is 931 MeV. When the mass defect of 0.030377 amu found for ${}^4_2\text{He}$ is converted to energy, the result is 28.3 MeV. In order to make a comparison between the stability of various nuclides, the total binding energy is usually divided by the number of nucleons, which in this case is 4. Therefore, the *binding energy per nucleon* is 7.07 MeV.

As a side issue, it may have been noted that we neglected the attraction energy between the electrons and the nucleus. The first ionization energy for He is 24.6 eV and the second is 54.4 eV. Thus, the total binding energy of the electrons to the nucleus in He is only 79.9 eV, which is 0.000079 MeV and is totally insignificant compared to the 28.3 MeV represented by the total binding energy. Attractions between nucleons are enormous compared to binding energies of electrons in atoms. Neutral atoms have the same number of electrons and protons, the combined mass of which is almost exactly the same as that of a hydrogen atom. Therefore, no great error is introduced when calculating mass defects by adding the mass of an appropriate number of hydrogen atoms to that of the number of neutrons. For example, the mass of ${}^{16}_8\text{O}$ can be approximated as the mass of 8 hydrogen atoms and 8 neutrons. The binding energy of the electrons in the 8 hydrogen atoms is ignored.

When similar calculations are performed for many other nuclides, it is found that the binding energy per nucleon differs considerably. The value for ${}^{16}_8\text{O}$ is 7.98 MeV, and the highest value is approximately 8.79 MeV for ${}^{56}_{26}\text{Fe}$. This suggests that for a very large number of nucleons, the most stable arrangement is for them to make ${}^{56}_{26}\text{Fe}$, which is actually abundant in nature. Figure 1.12 shows the binding energy per nucleon as a function of mass number of the nuclides.

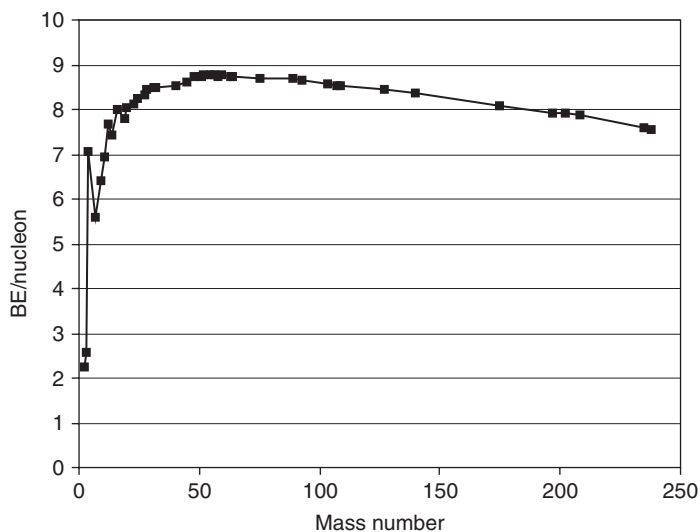

■ **FIGURE 1.12** The average binding energy per nucleon as a function of mass number.

With the highest binding energy per nucleon being for species like ${}^{56}_{26}\text{Fe}$, we can see that the *fusion* of lighter species to produce nuclides that are more stable should release energy. Because the very heavy elements have lower binding energy per nucleon than do nuclides having mass numbers from about 50 to 80, fission of heavy nuclides is energetically favorable. One such nuclide is ${}^{235}_{92}\text{U}$, which undergoes fission when bombarded with low-energy neutrons:

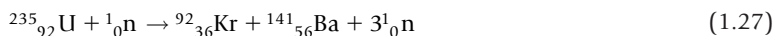

When ${}^{235}_{92}\text{U}$ undergoes fission, many different products are obtained because there is not a great deal of difference in the binding energy per nucleon for nuclides having a rather wide range of mass numbers. If the abundances of the products are plotted against the mass numbers, a double humped curve is obtained, and the so-called symmetric split of the ${}^{235}_{92}\text{U}$ is not the most probable event. Fission products having atomic numbers in the ranges of 30–40 and 50–60 are much more common than are two ${}_{46}\text{Pd}$ isotopes.

1.7 NUCLEAR STABILITY

The atomic number, Z , is the number of protons in the nucleus. Both the proton and neutron have masses that are approximately 1 atomic mass unit, amu. The electron has a mass of only about $1/1837$ of the proton or neutron, so almost all of the mass of the atoms is made up by the protons and neutrons. Therefore, adding the number of protons to the number of neutrons gives the approximate mass of the nuclide in amu. That number is called the mass number and is given the symbol A . The number of neutrons is found by subtracting the atomic number, Z , from the mass number, A . Frequently, the number of neutrons is designated as N and $(A - Z) = N$. In describing a nuclide, the atomic number and mass number are included with the symbol for the atom. This is shown for an isotope of X as A_ZX .

Table 1.3 Numbers of Stable Nuclides Having Different Arrangements of Nucleons.

Z	N	Number of Stable Nuclides
even	even	162
even	odd	55
odd	even	49
odd	odd	4

Although the details will not be presented here, there is a series of energy levels or shells where the nuclear particles reside. There are separate levels for the protons and neutrons. For electrons, the numbers 2, 10, 18, 36, 54, and 86 represent the closed shell arrangements (the noble gas arrangements). For nucleons, the closed shell arrangements correspond to the numbers 2, 8, 20, 28, 50, and 82 with a separate series for protons and neutrons. It was known early in the development of nuclear science that these numbers of nucleons represented stable arrangements, although it was not known why these numbers of nucleons were stable. Consequently, they were referred to as *magic numbers*.

Another difference between nucleons and electrons is that nucleons pair whenever possible. Thus, even if a particular energy level can hold more than two particles, two particles will pair when they are present. Thus, for two particles in degenerate levels, we show two particles as $\uparrow\downarrow$ rather than $\uparrow\uparrow$. As a result of this preference for pairing, nuclei with even numbers of protons and neutrons have all paired particles. This results in nuclei that are more stable than those which have unpaired particles. The least stable nuclei are those in which *both* the number of neutrons and the number of protons is odd. This difference in stability manifests itself in the number of stable nuclei of each type. Table 1.3 shows the numbers of stable nuclei that occur. The data show that there does not seem to be any appreciable difference in stability when the number of protons or neutrons is even while the other is odd (the even-odd and odd-even cases). The number of nuclides that have odd Z and odd N (so-called odd-odd nuclides) is very small, which indicates that there is an inherent instability in such an arrangement. The most common stable nucleus which is of the odd-odd type is $^{14}_7\text{N}$.

1.8 TYPES OF NUCLEAR DECAY

Figure 1.13 shows graphically the relationship between the number of neutrons and the number of protons for the stable nuclei.

We have already stated that the majority of known nuclides are unstable and undergo some type of decay to produce another nuclide. The starting nuclide is known as the parent and the nuclide produced is known as the daughter. The most common types of decay processes will now be described.

When the number of neutrons is compared to the number of protons that are present in all stable nuclei, it is found that they are approximately equal up to atomic number 20. For example, in $^{40}_{20}\text{Ca}$

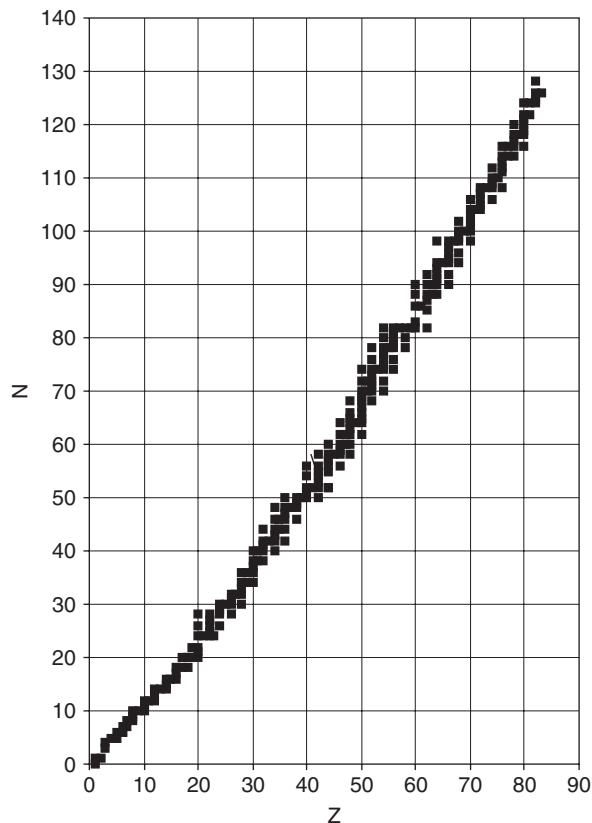

■ **FIGURE 1.13** The relationship between the number of neutrons and protons for stable nuclei.

it is seen that $Z = N$. Above atomic number 20, the number of neutrons is generally greater than the number of protons. For ${}^{235}_{92}\text{U}$, $Z = 92$, but $N = 143$. In Figure 1.13, each small square represents a stable nuclide. It can be seen that there is a rather narrow band of stable nuclei with respect to Z and N , and that the band gets farther away from the line representing $Z = N$ as the atomic number increases. When a nuclide lies outside the band of stability, radioactive decay occurs in a manner that brings the daughter into or closer to the band of stability.

1. *Beta ($-$) decay (β^-)*. When we consider ${}^{14}_6\text{C}$, we see that the nucleus contains six protons and eight neutrons. This is somewhat “rich” in neutrons, so the nucleus is unstable. Decay takes place in a manner that decreases the number of neutrons and increases the number of protons. The type of decay that accomplishes this is the emission of a β^- particle as a neutron in the nucleus is converted into a proton. The β^- particle is simply an electron. The beta particle that is emitted is an electron that is

produced as a result of a neutron in the nucleus being transformed into a proton, which remains in the nucleus.



The ejected electron did not exist before the decay, and it is not an electron from an orbital. One common species that undergoes β^- decay is $^{14}_6\text{C}$,



In this decay process, the mass number stays the same because the electron has a mass that is only 1/1837 of the mass of the proton or neutron. However, the nuclear charge increases by 1 unit as the number of neutrons is decreased by 1. As we shall see later, this type of decay process takes place when the number of neutrons is somewhat greater than the number of protons.

Nuclear decay processes are often shown by means of diagrams that resemble energy level diagrams, with the levels displaced to show the change in atomic number. The parent nucleus is shown at a higher energy than the daughter. The x-axis is really the value of Z with no values indicated. The decay of $^{14}_6\text{C}$ can be shown as follows.

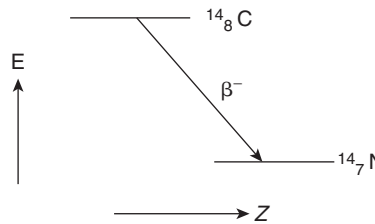

2. *Beta (+) or positron emission (β^+)*. This type of decay occurs when a nucleus has a greater number of protons than neutrons. In this process, a proton is converted into a neutron by emitting a positive particle known as a β^+ particle or *positron*. The positron is a particle having the mass of an electron but carrying a positive charge. It is sometimes called the antielectron and shown as e^+ . The reaction can be shown as



One nuclide that undergoes β^+ decay is $^{14}_8\text{O}$,



In β^+ decay, the mass number remains the same but the number of protons decreases by 1 while the number of neutrons increases by 1. The decay scheme for this process is shown as follows.

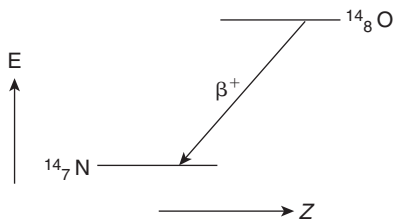

In this case, the daughter is written to the left of the parent because the nuclear charge is decreasing.

3. *Electron capture (EC)*. In this type of decay, an electron from outside the nucleus is captured by the nucleus. Such a decay mode occurs when there is a greater number of protons than neutrons in the nucleus.



In electron capture, the nuclear charge decreases by 1 because what happens is that a proton in the nucleus interacts with the electron to produce a neutron.



In order for this to occur, the orbital electron must be very close to the nucleus. Therefore, electron capture is generally observed when the nucleus has a charge of $Z \approx 30$. However, a few cases are known in which the nucleus has a considerably smaller charge than this. Because the electron that is captured is one in the shell closest to the nucleus, the process is sometimes called K-capture. Note that electron capture and β^+ decay accomplish the same changes in the nucleus. Therefore, they are sometimes competing processes and the same nuclide may decay simultaneously by both processes.

4. *Alpha (α) decay*. As we shall see later, the alpha particle, which is a helium nucleus, is a stable particle. For some unstable heavy nuclei, the emission of this particle occurs. Because the α particle contains a magic number of both protons and neutrons (2), there is a tendency for this particular combination of particles to be the one emitted rather than some other combination such as ${}^6_3\text{Li}$. In alpha decay, the mass number decreases by 4 units, the number of protons decreases by 2, and the number of neutrons decreases by 2. An example of alpha decay is the following:



5. *Gamma emission* (γ). Gamma rays are high-energy photons that are emitted as an atomic nucleus undergoes deexcitation. This situation is entirely equivalent to the spectral lines emitted by atoms as electrons fall from higher energy states to lower ones. In the case of gamma emission, the deexcitation occurs as a proton or neutron that is in an excited state falls to a lower nuclear energy state. However, the question naturally arises as to how the nuclide attains the higher energy state. The usual process is that the excited nuclear state results from some other event. For example, $^{38}_{17}\text{Cl}$ decays by β^- emission to $^{38}_{18}\text{Ar}$, but this nuclide exists in an excited state. Therefore, it is designated as $^{38}_{18}\text{Ar}^*$ and it relaxes by the emission of gamma rays. A simplified decay scheme can be shown as follows.

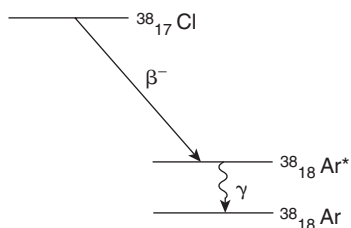

Gamma emission almost always follows some other decay process that results in an excited state in the daughter nucleus due to a nucleon being in a state above the ground state.

The decay of $^{226}_{88}\text{Ra}$ to $^{222}_{86}\text{Rn}$ can occur to either the ground state of the daughter or to an excited state that is followed by emission of a γ ray. The equation and energy diagram for this process are shown as follows.

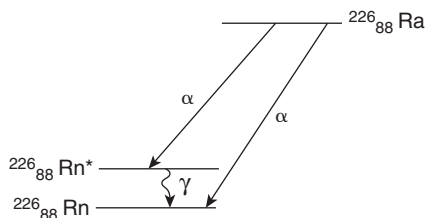

1.9 PREDICTING DECAY MODES

For light nuclei, there is a strong tendency for the number of protons to be approximately equal to the number of neutrons. In many stable nuclides, the numbers are exactly equal. For example, ^4_2He , $^{12}_6\text{C}$, $^{16}_8\text{O}$, $^{20}_{10}\text{Ne}$, and $^{40}_{20}\text{Ca}$ are all stable nuclides. In the case of the heavier stable nuclides, the number of neutrons is greater than the number of protons. Nuclides such as $^{64}_{30}\text{Zn}$, $^{208}_{82}\text{Pb}$, and $^{235}_{92}\text{U}$ all have a larger number of neutrons than protons with the difference increasing as the number of protons increases. If a graph is made of number of protons versus number of neutrons and all the

stable nuclides are located on the graph, it is seen that the stable nuclides fall in a rather narrow band. This band is sometimes referred to as the band of stability as shown in Figure 1.13. If a nucleus has a number of either type of nuclide that places it outside this band, the nuclide will typically undergo a type of decay that will bring it into the band. For example, $^{14}_6\text{C}$ has 6 protons and 8 neutrons. This excess of neutrons over protons can be corrected by a decay process that transforms a neutron into a proton. Such a decay scheme can be summarized as



Therefore, $^{14}_6\text{C}$ undergoes radioactive decay by β^- emission,



On the other hand, $^{14}_8\text{O}$ has 8 protons but only 6 neutrons. This imbalance of protons and neutrons can be corrected if a proton is transformed into a neutron as is summarized by the equation

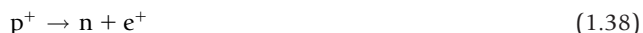

Thus, $^{14}_8\text{O}$ undergoes decay by positron emission,



Electron capture accomplishes the same end result as positron emission, but because the nuclear charge is low, positron emission is the expected decay mode in this case. Generally, electron capture is not a competing process unless $Z \approx 30$ or so.

Figure 1.14 shows how the transformations shown in Eqs. (1.37) and (1.39) are related to the relationship between the numbers of protons and neutrons for the two decay processes. The point labeled *a* on the graph and the arrow starting from that point shows the decay of $^{14}_6\text{C}$. Point *b* on the graph represents $^{14}_8\text{O}$, and the decay is indicated by the arrow.

Although the use of the number of protons and neutrons to predict stability is straightforward, there are further applications of the principles discussed that are useful also. For example, consider the following cases:

$$^{34}_{14}\text{Si} \quad t_{1/2} = 2.8 \text{ sec}$$

$$^{33}_{14}\text{Si} \quad t_{1/2} = 6.2 \text{ sec}$$

$$^{32}_{14}\text{Si} \quad t_{1/2} = 100 \text{ years}$$

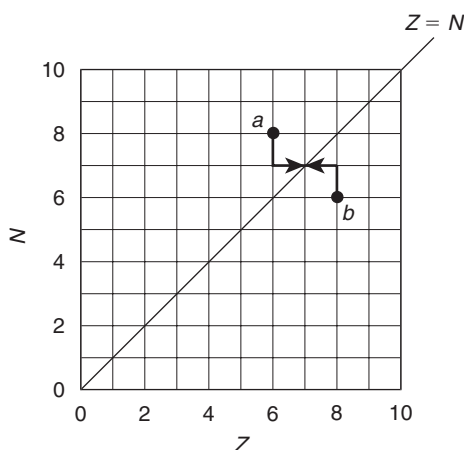

■ **FIGURE 1.14** Predicting decay mode from the relative number of protons and neutrons.

Although all three of these isotopes of silicon are radioactive, the heaviest of them, ^{34}Si , lies farthest from the band of stability and it has the shortest half-life. Generally, the farther a nuclide lies from the band of stability, the shorter its half-life. There are numerous exceptions to this general rule and we will discuss some of them here. First, consider these cases:

$$\text{(even-odd)} \quad {}^{27}_{12}\text{Mg} \quad t_{1/2} = 9.45 \text{ min}$$

$$\text{(even-even)} \quad {}^{28}_{12}\text{Mg} \quad t_{1/2} = 21.0 \text{ hours}$$

Although ^{28}Mg is farther from the band of stability than is ^{27}Mg , the former is an even-even nuclide while the latter is an even-odd nuclide. As we have seen earlier, even-even nuclides tend to be more stable. Consequently, the even-even effects here outweigh the fact that ^{28}Mg is farther from the band of stability. Another interesting case is shown by considering these isotopes of chlorine:

$$\text{(odd-odd)} \quad {}^{38}_{17}\text{Cl} \quad t_{1/2} = 37.2 \text{ min}$$

$$\text{(odd-even)} \quad {}^{39}_{17}\text{Cl} \quad t_{1/2} = 55.7 \text{ min}$$

In this case, the $^{38}_{17}\text{Cl}$ is an odd-odd nucleus, whereas $^{39}_{17}\text{Cl}$ is an odd-even nucleus. Thus, even though $^{39}_{17}\text{Cl}$ is farther away from the band of stability, it has a slightly longer half-life. Finally, let us consider two cases where both of the nuclei are similar in terms of numbers of nucleons. Such cases are the following:

$$\text{(odd-even)} \quad {}^{39}_{17}\text{Cl} \quad t_{1/2} = 37.2 \text{ min}$$

$$\text{(even-odd)} \quad {}^{39}_{18}\text{Ar} \quad t_{1/2} = 259 \text{ years}$$

In this case, there is no real difference with respect to the even/odd character. The large difference in half-life is related to the fact that $^{39}_{17}\text{Cl}$ is farther from the band of stability than is $^{39}_{18}\text{Ar}$. This is in accord with the general principle stated earlier. While specific cases might not follow the general trend, it is *generally* true that the farther a nuclide is from the band of stability, the shorter its half life will be.

In some cases, a nuclide may undergo decay by more than one process at the same time. For example, ^{64}Cu undergoes decay by three processes simultaneously:

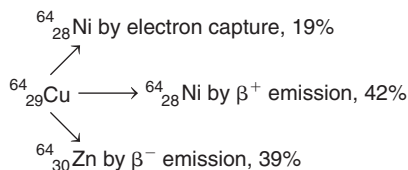

The overall rate of disappearance of ^{64}Cu is the sum of three processes, but by making use of different types of counting methods, it is possible to separate the rates of the processes.

There are three naturally occurring radioactivity series that consist of a sequence of steps that involve α and β decay processes until a stable nuclide results. The uranium series involves the decay of $^{238}_{92}\text{U}$ in a series of steps that eventually produces $^{206}_{82}\text{Pb}$. Another series involves $^{235}_{92}\text{U}$ that decays in a series of steps that ends in $^{207}_{82}\text{Pb}$, which is stable. In the thorium series, $^{232}_{90}\text{Th}$ is converted into $^{206}_{82}\text{Pb}$. Although there are other individual nuclides that are radioactive, these are the three most important naturally occurring decay series.

The characteristics of nuclei described here are intimately related to how certain species figure prominently in chemistry (such as dating materials by determining their carbon-14 content). The use of isotopic tracers is a technique that finds applications in all areas of chemistry.

REFERENCES FOR FURTHER READING

- Blinder, S. M. (2004). *Introduction to Quantum Mechanics in Chemistry, Materials Science, and Biology*. Academic Press, San Diego. A good survey book that shows the applications of quantum mechanics to many areas of study.
- Emsley, J. (1998). *The Elements*, 3rd ed. Oxford University Press, New York. This book presents a wealth of data on properties of atoms.
- House, J. E. (2004). *Fundamentals of Quantum Chemistry*. Elsevier, New York. An introduction to quantum mechanical methods at an elementary level that includes mathematical details.
- Krane, K. (1995). *Modern Physics*, 2nd ed. Wiley, New York. A good introductory book that described developments in atomic physics.
- Loveland, W. D., Morrissey, D., and Seaborg, G. T. (2006). *Modern Nuclear Chemistry*. Wiley, New York.
- Serway, R. E. (2000). *Physics for Scientists and Engineers*, 5th ed. Saunders (Thompson Learning), Philadelphia. An outstanding physics text that presents an excellent treatment of atomic physics.
- Sharpe, A. G. (1992). *Inorganic Chemistry*. Longman, New York. Chapter 2 presents a good account of the development of the quantum mechanical way of doing things in chemistry.
- Warren, W. S. (2000). *The Physical Basis of Chemistry*, 2nd ed. Academic Press, San Diego, CA. Chapter 5 presents the results of some early experiments in atomic physics.

■ QUESTIONS AND PROBLEMS

1. If a short-wave radio station broadcasts on a frequency of 9.065 megahertz (MHz), what is the wavelength of the radio waves?
2. One of the lines in the line spectrum of mercury has a wavelength of 435.8 nm. (a) What is the frequency of this line? (b) What is the wave number for the radiation? (c) What energy (in kJ mol^{-1}) is associated with this radiation?
3. The ionization potential for the NO molecule is 9.25 eV. What is the wavelength of a photon that would just ionize NO with the ejected electron having no kinetic energy?
4. What is the de Broglie wavelength of an electron (mass 9.1×10^{-28} g) moving at 1.5% of the velocity of light?
5. What energy is associated with an energy change in a molecule that results in an absorption at 2100 cm^{-1} ? (a) in ergs; (b) in joules; (c) in kJ mol^{-1} .
6. What wavelength of light will just eject an electron from the surface of a metal that has a work function of 2.75 eV?
7. If an electron in a hydrogen atom falls from the state with $n = 5$ to that where $n = 3$, what is the wavelength of the photon emitted?
8. If a moving electron has a kinetic energy of 2.35×10^{-12} erg, what would be its de Broglie wavelength?
9. The work function for barium is 2.48 eV. If light having a wavelength of 400 nm is shone upon a barium cathode, what is the maximum velocity of the ejected electrons?
10. If a moving electron has a velocity of 3.55×10^5 m/sec, what is its de Broglie wavelength?
11. What is the velocity of the electron in the first Bohr orbit?
12. In each of the following pairs, select the one that has the highest first ionization potential: (a) Li or Be; (b) Al or F; (c) Ca or P; (d) Zn or Ga.
13. In each of the following pairs, which species is larger? (a) Li^+ or Be^{2+} ; (b) Al^{3+} or F^- ; (c) Na^+ or Mg^{2+} ; (d) S^{2-} or F^- .
14. In each of the following pairs, which atom releases the greater amount of energy when an electron is added? (a) P or C; (b) N or Na; (c) H or I; (d) S or Si.
15. The bond energy in H_2^+ is 256 kJ mol^{-1} . What wavelength of electromagnetic radiation would have enough energy to dissociate H_2^+ ?
16. For the HCl molecule, the first excited vibrational state is 2886 cm^{-1} above the ground state. How much energy is this in erg/molecule? In kJ mol^{-1} ?
17. The ionization potential for the PCl_3 molecule is 9.91 eV. What is the frequency of a photon that will just remove an electron from a PCl_3 molecule? In what spectral region would such a photon be found? From which atom in the molecule is the electron removed?
18. Arrange the following in the order of increasing first ionization potential: B, Ne, N, O, P.
19. Explain why the first ionization potentials for P and S differ by only 12 kJ mol^{-1} (1012 and 1000 kJ mol^{-1} , respectively) whereas those for N and O differ by 88 kJ mol^{-1} (1402 and 1314 kJ mol^{-1} , respectively).
20. Arrange the following in the order of increasing first ionization potential: H, Li, C, F, O, N.

21. Arrange the following in the order of decreasing amount of energy released when an electron is added to the atom: O, F, N, Cl, S, Br.
22. Arrange the following in the order of decreasing size: Cl, O, I^- , O^{2-} , Mg^{2+} , F^- .
23. Calculate the binding energy per nucleon for the following: $^{18}_8\text{O}$; $^{23}_{11}\text{Na}$; $^{40}_{20}\text{Ca}$.
24. Predict the decay mode for the following and write the reaction for the predicted decay mode: (a) $^{35}_{16}\text{S}$; (b) $^{17}_9\text{F}$; (c) $^{43}_{20}\text{Ca}$.
25. How much energy (in MeV) would be released by the fusion of three ^4_2He nuclei to produce $^{12}_6\text{C}$?

Basic Quantum Mechanics and Atomic Structure

In the previous chapter, we saw that the energies of electron orbits are quantized. It was also mentioned that dealing with an electron in an atom would require considering the wave character of the moving particle. The question remains as to how we proceed when formulating and solving such a problem. The procedures and methods employed constitute the branch of science known as quantum mechanics or wave mechanics. In this chapter, we will present only a very brief sketch of this important topic because it is assumed that readers of this book will have studied quantum mechanics in a physical chemistry course. The coverage here is meant to provide an introduction to the terminology and basic ideas of quantum mechanics or, preferably, provide a review.

2.1 THE POSTULATES

In order to systematize the procedures and basic premises of quantum mechanics, a set of postulates has been developed that provides the usual starting point for studying the topic. Most books on quantum mechanics give a precise set of rules and interpretations, some of which are not necessary for the study of inorganic chemistry at this level. In this section, we will present the postulates of quantum mechanics and provide some interpretation of them, but for complete coverage of this topic the reader should consult a quantum mechanics text such as those listed in the references at the end of this chapter.

Postulate I: For any possible state of a system, there exists a wave function ψ that is a function of the parts of the system and time and that completely describes the system.

This postulate establishes that the description of the system will be in the form of a mathematical function. If the coordinates used to describe the system are Cartesian coordinates, the function ψ will contain these coordinates and the time as variables. For a very simple system that consists of only a single particle, the function ψ , known as the *wave function*, can be written as

$$\psi = \psi(x, y, z, t) \quad (2.1) \quad \mathbf{35}$$

If the system consists of two particles, the coordinates must be specified for each of the particles, which results in a wave function that is written as

$$\psi = \psi(x_1, y_1, z_1, x_2, y_2, z_2, t) \quad (2.2)$$

As a general form of the wave function, we write

$$\psi = \psi(q_i, t) \quad (2.3)$$

where the q_i are appropriate coordinates for the particular system. Since the form of the coordinates is not specified, the q_i are referred to as *generalized* coordinates. Because ψ describes the system in some particular state, the state is known as the *quantum state* and ψ is called the *state function* or *complete wave function*.

There needs to be some physical interpretation of the wave function and its relationship to the state of the system. One interpretation is that the square of the wave function, ψ^2 , is proportional to the probability of finding the parts of the system in a specified region of space. For some problems in quantum mechanics, differential equations arise that can have solutions that are complex (contain $(-1)^{1/2} = i$). In such a case, we use $\psi^*\psi$, where ψ^* is the complex conjugate of ψ . The complex conjugate of a function is the function that results when i is replaced by $-i$. Suppose we square the function $(a + ib)$:

$$(a + ib)^2 = a^2 + 2aib + i^2b^2 = a^2 + 2aib - b^2 \quad (2.4)$$

Because the expression obtained contains i , it is still a complex function. Suppose, however, that instead of squaring $(a + ib)$ we multiply by its complex conjugate, $(a - ib)$:

$$(a + ib)(a - ib) = a^2 - i^2b^2 = a^2 + b^2 \quad (2.5)$$

The expression obtained by this procedure is a real function. Thus, in many instances we will use the product $\psi^*\psi$ instead of ψ^2 , although if ψ is real, the two are equivalent.

For a system of particles, there is complete certainty that the particles are *somewhere* in the system. The probability of finding a particle in a volume element, $d\tau$, is given by $\psi^*\psi d\tau$ so that the total probability is obtained from the integration

$$\int \psi^*\psi d\tau \quad (2.6)$$

An event that is impossible has a probability of zero and a “sure thing” has a probability of 1. For a given particle in the system, the probability of finding the particle in all of the volume elements that make up all space must add up to 1. Of course, the way of summing the volume elements is by performing an integration. Therefore, we know that

$$\int_{\text{All space}} \psi^*\psi d\tau = 1 \quad (2.7)$$

When this condition is met, we say that the wave function, ψ , is *normalized*. In fact, this is the definition of a normalized wave function.

However, there are other requirements on ψ that lead to it being a “well-behaved” wave function. For example, since the integral shown above must equal 1.00 ..., the wave function cannot be infinite. As a result, we say that ψ must be *finite*. Another restriction on ψ relates to the fact that there can be only one probability of finding a particle in a particular place. As an example, there is only one probability of finding an electron at a particular distance from the nucleus in a hydrogen atom. Therefore, we say that the wave function must be *single valued* so that there results only one value for the probability. Finally, we must take into account the fact that the probability does not vary in an abrupt way. Increasing the distance by 1% should not cause a 50% change in probability. The requirement is expressed by saying that ψ must be *continuous*. Probability varies in some continuous manner, not abruptly. A wave function is said to be well behaved if it has the characteristics of being finite, single valued, and continuous.

Another concept that is important when considering wave functions is that of *orthogonality*. If the functions ϕ_1 and ϕ_2 are related so that

$$\int \phi_1^* \phi_2 \, d\tau \quad \text{or} \quad \int \phi_1 \phi_2^* \, d\tau = 1 \quad (2.8)$$

the functions are said to be *orthogonal*. In this case, changing the limits of integration may determine whether such a relationship exists. For Cartesian coordinates, the limits of integration are $-\infty$ to $+\infty$ for the coordinates x , y , and z . For a system described in terms of polar coordinates (r , θ , and ϕ), the integration limits are the ranges of those variables, $0 \rightarrow \infty$, $0 \rightarrow \pi$, and $0 \rightarrow 2\pi$, respectively.

Postulate II: For every dynamical variable (also known as a classical observable) there exists a corresponding operator.

Quantum mechanics is concerned with operators. An *operator* is a symbol that indicates some mathematical action must be performed. For example, operators with which you are familiar include $(x)^{1/2}$ (taking the square root of x), $(x)^2$ (squaring x), and dy/dx (taking the derivative of y with respect to x). Physical quantities such as momentum, angular momentum, position coordinates, and energy are known as *dynamical variables* (classical observables for a system), each of which has a corresponding operator in quantum mechanics. Coordinates are identical in both operator and classical forms. For example, the coordinate r is simply r in either case. On the other hand, the operator for momentum in the x direction (p_x) is $(\hbar/i)/(d/dx)$. The operator for the z component of angular momentum (in polar coordinates) is $(\hbar/i)/(d/d\phi)$. Kinetic energy, $1/2mv^2$, can be written in terms of momentum, p , as $p^2/2m$ so it is possible to arrive at the operator for kinetic energy in terms of the operator for momentum. Table 2.1 shows some of the operators that are necessary for an introductory study of quantum mechanics. Note that the operator for kinetic energy is obtained from the momentum operator because the kinetic energy, T , can be expressed as $p^2/2m$. Note also that the operator for potential energy is expressed in terms of the generalized coordinates, q_i , because the form of the potential energy depends on the system. For example, the electron in a hydrogen atom has a potential energy

Table 2.1 Some Common Operators in Quantum Mechanics.		
Quantity	Symbol Used	Operator Form
Coordinates	x, y, z, r	x, y, z, r
Momentum		
x	p_x	$\frac{\hbar}{i} \frac{\partial}{\partial x}$
y	p_y	$\frac{\hbar}{i} \frac{\partial}{\partial y}$
z	p_z	$\frac{\hbar}{i} \frac{\partial}{\partial z}$
Kinetic energy	$\frac{p^2}{2m}$	$-\frac{\hbar^2}{2m} \left(\frac{\partial^2}{\partial^2 x} + \frac{\partial^2}{\partial^2 y} + \frac{\partial^2}{\partial^2 z} \right)$
Kinetic energy	T	$-\frac{\hbar}{i} \frac{\partial}{\partial t}$
Potential energy	V	$V(q_i)$
Angular momentum		
L_z (Cartesian)		$\frac{\hbar}{i} \left(x \frac{\partial}{\partial y} - y \frac{\partial}{\partial x} \right)$
L_z (polar)		$\frac{\hbar}{i} \frac{\partial}{\partial \phi}$

that is $-e^2/r$, where e is the charge on the electron. Therefore, the operator for the potential energy is simply $-e^2/r$, which is unchanged from the classical form.

Operators have properties that can be expressed in mathematical terms. If an operator is *linear*, it means that

$$\alpha(\phi_1 + \phi_2) = \alpha\phi_1 + \alpha\phi_2 \quad (2.9)$$

where ϕ_1 and ϕ_2 are functions that are being operated on by the operator α . Another property of the operators that is often useful in quantum mechanics is that when C is a constant,

$$\alpha(C\phi) = C(\alpha\phi) \quad (2.10)$$

An operator is Hermitian if

$$\int \phi_1^* \alpha \phi_2 \, d\tau = \int \phi_2 \alpha^* \phi_1^* \, d\tau \quad (2.11)$$

It can be shown that if an operator, α , meets this condition, the quantities calculated will be real rather than complex or imaginary. Although it is stated without proof, all of the operators to be discussed subsequently meet these conditions.

Postulate III: The permissible values that a dynamical variable may have are those given by $\alpha\phi = a\phi$, where α is an operator corresponding to the dynamical variable whose permissible values are a and ϕ is an eigenfunction of the operator α .

When reduced to an equation, Postulate III can be written as

$$\begin{array}{ccccccc} \alpha & \phi & = & a & \phi \\ \text{operator} & \text{wave} & & \text{constant} & \text{wave} \\ & \text{function} & & \text{(eigenvalue)} & \text{function} \end{array} \quad (2.12)$$

When an operator operates on a wave function to produce a constant times the original wave function, the function is said to be an *eigenfunction* of that operator. In terms of the equation just shown, the operator α operating on ϕ yields a constant a times the original wave function. Therefore, ϕ is an eigenfunction of the operator α with an *eigenvalue* a . We can use several examples to illustrate these ideas.

Suppose $\phi = e^{ax}$ where a is a constant and the operator is $\alpha = d/dx$. Then

$$d\phi/dx = a e^{ax} = (\text{constant}) e^{ax} \quad (2.13)$$

Thus, we see that the function e^{ax} is an eigenfunction of the operator d/dx with an eigenvalue of a . If we consider the operator $()^2$ operating on the same function, we find

$$(e^{ax})^2 = e^{2ax}, \quad (2.14)$$

which does not represent the original function multiplied by a constant. Therefore, e^{ax} is not an eigenfunction of the operator $()^2$. When we consider the function $e^{in\phi}$ (where n is a constant) being operated on by the operator for the z component of angular momentum, $(\hbar/i)(d/d\phi)$, where $h/2\pi$ is represented as \hbar (read as "h bar"), we find

$$\frac{\hbar}{i} \left[\frac{d(e^{in\phi})}{d\phi} \right] = n \frac{\hbar}{i} e^{in\phi} \quad (2.15)$$

which shows that the function $e^{in\phi}$ is an eigenfunction of the operator for the z component of angular momentum.

One of the most important techniques in quantum mechanics is known as the *variation method*. That method provides a way of starting with a wave function and calculating a value for a property (dynamical

variable or classical observable) by making use of the operator for that variable. It begins with the equation $\alpha\phi = a\phi$. Multiplying both sides of the equation by ϕ^* we obtain

$$\phi^* \alpha \phi = \phi^* a \phi \quad (2.16)$$

Because α is an *operator*, it is not necessarily true that $\phi^* \alpha \phi$ is equal to $\phi \alpha \phi^*$, so the order in writing the symbols is preserved. We now perform integration using the equation in the form

$$\int_{\text{All space}} \phi^* \alpha \phi \, d\tau = \int_{\text{All space}} \phi^* a \phi \, d\tau \quad (2.17)$$

However, the eigenvalue a is a constant, so it can be removed from the integral on the right-hand side of the equation. Then, solving for a gives

$$\langle a \rangle = \frac{\int \phi^* \alpha \phi \, d\tau}{\int \phi^* \phi \, d\tau} \quad (2.18)$$

The order of the quantities in the numerator must be preserved because α is an operator. For example, if an operator is d/dx , it is easy to see that $(2x)(d/dx)(2x) = (2x)(2) = 4x$ is not the same as $(d/dx)(2x)(2x) = (d/dx)(4x^2) = 8x$.

If the wave function ϕ is normalized, the denominator in Eq. (2.18) is equal to 1. Therefore, the value of a is given by the relationship

$$\langle a \rangle = \int \phi^* \alpha \phi \, d\tau \quad (2.19)$$

The value of a calculated in this way is known as the *average* or *expectation* value, and it is indicated by a or $\langle a \rangle$. The operator to be used is the one that corresponds to the variable being calculated.

The utilization of the procedure just outlined will be illustrated by considering an example that is important as we study atomic structure. In polar coordinates, the normalized wave function for the electron in the 1s state of a hydrogen atom is

$$\psi_{1s} = \frac{1}{\sqrt{\pi}} \frac{1}{a_0^{3/2}} e^{-r/a_0} = \psi_{1s}^* \quad (2.20)$$

where a_0 is a constant known as the first Bohr radius. Note that in this case the wave function is real (meaning that it does not contain i) so ψ and ψ^* are identical. We can now calculate the average value for the radius of the 1s orbit by making use of

$$\langle r \rangle = \int \psi^* (\text{operator}) \psi \, d\tau \quad (2.21)$$

where the operator is simply r , which is the same in operator or classical form. The volume element, $d\tau$, in polar coordinates is $d\tau = r^2 \sin \theta dr d\theta d\phi$. Making the substitutions for $d\tau$ and the operator, we obtain

$$\langle r \rangle = \int_0^{\infty} \int_0^{\pi} \int_0^{2\pi} \frac{1}{\sqrt{\pi}} \left(\frac{1}{a_0} \right)^{3/2} e^{-r/a_0} (r) \frac{1}{\sqrt{\pi}} \left(\frac{1}{a_0} \right)^{3/2} e^{-r/a_0} r^2 \sin \theta dr d\theta d\phi \quad (2.22)$$

Although this integral looks like it might be very difficult to evaluate, it becomes much simpler when some factors are combined. For example, the r that is the operator is the same as the r in the volume element. Combining these gives a factor of r^3 . Next, the factors involving π and a_0 can be combined. When these simplifications are made, the integral can be written as

$$\langle r \rangle = \int_0^{\infty} \int_0^{\pi} \int_0^{2\pi} \frac{1}{\pi a_0^3} e^{-2r/a_0} r^3 \sin \theta dr d\theta d\phi \quad (2.23)$$

We can further simplify the problem by recalling the relationship from calculus that

$$\int \int f(x)g(y) dx dy = \int f(x) dx \int g(y) dy \quad (2.24)$$

which allows us to write the integral above in the form

$$\langle r \rangle = \int_0^{\infty} \frac{1}{\pi a_0^3} e^{-2r/a_0} r^3 dr \int_0^{\pi} \int_0^{2\pi} \sin \theta d\theta d\phi \quad (2.25)$$

From a table of integrals, it is easy to verify that the integral involving the angular coordinates can be evaluated to give 4π . Also from a table of integrals, it can be found that the exponential integral can be evaluated by making use of a standard form,

$$\int_0^{\infty} x^n e^{-bx} dx = \frac{n!}{b^{n+1}} \quad (2.26)$$

For the integral being evaluated here, $b = 2/a_0$ and $n = 3$, so that the exponential integral can be written as

$$\int_0^{\infty} r^3 e^{-2r/a_0} dr = \frac{3!}{(2/a_0)^4} \quad (2.27)$$

Making the substitutions for the integrals and simplifying, we find that

$$\langle r \rangle = (3/2)a_0 \quad (2.28)$$

where a_0 , the first Bohr radius, is 0.529 \AA . The expectation value for the radius of the $1s$ orbit is 1.5 times that distance. Note that a complicated-looking problem actually turns out to be much simpler than might have been supposed. In this case, looking up two integrals in a table removes the necessity for integrating the functions by brute force. A great deal of elementary quantum mechanics can be handled in this way.

It may have been supposed that the average value for the radius of the first orbit in a hydrogen atom should evaluate to 0.529 \AA . The answer to why it does not lies in the fact that the probability of finding the electron as a function of distance from the nucleus in a hydrogen atom can be represented as shown in Figure 2.1. The *average* distance is that point where there is an equal probability of finding the electron on either side of that distance. It is that distance that we have just calculated by the foregoing procedure. On the other hand, the probability as a function of distance is represented by a function that goes through a maximum. Where the probability function has its maximum value is the *most probable* distance, and that distance for an electron in the $1s$ state of a hydrogen atom is a_0 .

The applications of the principles just discussed are many and varied. It is possible to calculate the expectation values for a variety of properties by precisely the procedures illustrated. Do not be intimidated by such calculations. Proceed in a stepwise fashion, look up any needed integrals in a table, and handle the algebra in a clear, orderly manner.

In addition to the postulates stated earlier, one additional postulate is normally included in the required list.

Postulate IV: The state function, ψ , results from the solution of the equation

$$\hat{H}\psi = E\psi$$

where \hat{H} is the operator for total energy, the Hamiltonian operator.

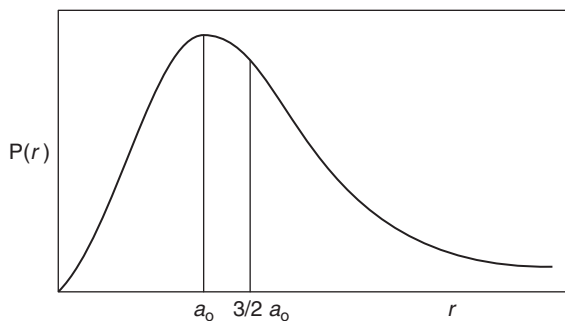

■ **FIGURE 2.1** The probability of finding the electron as a function of distance from the nucleus.

For a variety of problems in quantum mechanics, the first step in the formulation is to write the equation

$$\hat{H}\psi = E\psi$$

and then substitute the appropriate function for the Hamiltonian operator. In classical mechanics, Hamilton's function is the sum of the kinetic (translational) and potential energies. This can be written as

$$H = T + V \quad (2.29)$$

where T is the kinetic energy, V is the potential energy, and H is Hamilton's function. When written in operator form, the equation becomes

$$\hat{H}\psi = E\psi \quad (2.30)$$

For some systems, the potential energy is some function of a coordinate. For example, the potential energy of an electron bound to the nucleus of a hydrogen atom is given by $-e^2/r$, where e is the charge on the electron and r is a coordinate. Therefore, when this potential function is placed in operator form, it is the same as in classical form, $-e^2/r$ (see Table 2.1).

In order to put the kinetic energy in operator form, we make use of the fact that the kinetic energy can be written in terms of the momentum as

$$T = \frac{1}{2}mv^2 = \frac{(mv)^2}{2m} = \frac{p^2}{2m} \quad (2.31)$$

Because momentum has x , y , and z components, the momentum can be represented as

$$T = \frac{p_x^2}{2m} + \frac{p_y^2}{2m} + \frac{p_z^2}{2m} \quad (2.32)$$

Earlier it was shown that the operator for the x component of momentum can be written as $(\hbar/i)(\partial/dx)$. The operators for the y and z components have the same form except for the derivatives being with respect to those variables. Because the momentum in each direction is squared, the operator must be correspondingly used twice:

$$\left(\frac{\hbar}{i} \frac{\partial}{\partial x}\right)^2 = \frac{\hbar^2}{i^2} \frac{\partial^2}{\partial x^2} = -\hbar^2 \frac{\partial^2}{\partial x^2} \quad (2.33)$$

As a result, the operator for the total kinetic energy is

$$T = -\frac{\hbar^2}{2m} \left(\frac{\partial^2}{\partial x^2} + \frac{\partial^2}{\partial y^2} + \frac{\partial^2}{\partial z^2} \right) = -\frac{\hbar^2}{2m} \nabla^2 \quad (2.34)$$

where ∇^2 is the *Laplacian operator*, which is often referred to as simply the *Laplacian*.

2.2 THE HYDROGEN ATOM

There are several introductory problems that can be solved exactly by quantum mechanical methods. These include the particle in a one-dimensional box, the particle in a three-dimensional box, the rigid rotor, the harmonic oscillator, and barrier penetration. All of these models provide additional insight into the methods of quantum mechanics, and the interested reader should consult a quantum mechanics text such as those listed in the references at the end of this chapter. Because of the nature of this book, we will progress directly to the problem of the hydrogen atom, which was solved in 1926 by Erwin Schrödinger. His starting point was a three-dimensional wave equation that had been developed earlier by physicists who were dealing with the so-called flooded planet problem. In this model, a sphere was assumed to be covered with water, and the problem was to deal with the wave motion that would result if the surface were disturbed. Schrödinger did not derive a wave equation. He adapted one that already existed. His adaptation consisted of representing the wave motion of an electron by means of the de Broglie relationship that had been established only 2 years earlier. Physics was progressing at a rapid pace in that time period.

We can begin directly by writing the equation

$$\hat{H}\psi = E\psi \quad (2.35)$$

and then determine the correct form for the Hamiltonian operator. We will assume that the nucleus remains stationary with the electron revolving around it (known as the Born-Oppenheimer approximation) and deal with only the motion of the electron. The electron has a kinetic energy of $(1/2)mv^2$, which can be written as $p^2/2m$. Equation (2.34) shows the operator for kinetic energy.

The interaction between an electron and a nucleus in a hydrogen atom gives rise to a potential energy that can be described by the relationship $-e^2/r$. Therefore, using the Hamiltonian operator and postulate IV, the wave equation can be written as

$$-\frac{\hbar^2}{2m}\nabla^2\psi - \frac{e^2}{r}\psi = E\psi \quad (2.36)$$

Rearranging the equation and representing the potential energy as V gives

$$\nabla^2\psi + \frac{2m}{\hbar^2}(E - V)\psi = 0 \quad (2.37)$$

The difficulty in solving this equation is that when the Laplacian is written in terms of Cartesian coordinates we find that r is a function of x , y , and z ,

$$r = \sqrt{x^2 + y^2 + z^2} \quad (2.38)$$

The wave equation is a second-order partial differential equation in three variables. The usual technique for solving such an equation is to use a procedure known as the separation of variables. However, with r expressed as the square root of the sum of the squares of the three variables, it is impossible

to separate the variables. To circumvent this problem, a change of coordinates to polar coordinates is made. After that is done, the Laplacian must be transformed into polar coordinates, which is a tedious task. When the transformation is made, the variables can be separated so that three second-order differential equations, each containing one coordinate as the variable, are obtained. Even after this is done, the resulting equations are quite complex, and the solution of two of the three equations requires the use of series techniques. The solutions are described in detail in most quantum mechanics books, so it is not necessary to solve the equations here (see suggested readings at the end of this chapter), but Table 2.2 shows the wave functions. These wave functions are referred to as *hydrogen-like* wave functions because they apply to any one-electron system (e.g., He^+ , Li^{2+}).

From the mathematical restrictions on the solution of the equations comes a set of constraints known as *quantum numbers*. The first of these is n , the principal quantum number, which is restricted to integer values (1, 2, 3, ...). The second quantum number is l , the orbital angular momentum quantum number, and it must also be an integer such that it can be at most $(n - 1)$. The third quantum number is m , the magnetic quantum number, which gives the projection of the l vector on the z axis as shown in Figure 2.2.

The three quantum numbers that arise as mathematical restraints on the differential equations (boundary conditions) can be summarized as follows:

$$n = \text{principal quantum number} = 1, 2, 3 \dots$$

$$l = \text{orbital angular quantum number} = 0, 1, 2, \dots, (n - 1)$$

$$m = \text{magnetic quantum number} = 0, \pm 1, \pm 2, \dots, \pm l$$

Note that from the solution of a problem involving three dimensions, three quantum numbers result, unlike the Bohr approach, which specified only one. The quantum number n is essentially equivalent to the n that was assumed in the Bohr model of hydrogen.

A spinning electron also has a spin quantum number that is expressed as $\pm 1/2$ in units of \hbar . However, that quantum number does not arise from the solution of a differential equation in Schrödinger's solution of the hydrogen atom problem. It arises because, like other fundamental particles, the electron has an intrinsic spin that is half integer in units of \hbar , the quantum of angular momentum. As a result, four quantum numbers are required to completely specify the state of the electron in an atom. The Pauli Exclusion Principle states that *no two electrons in the same atom can have identical sets of four quantum numbers*. We will illustrate this principle later.

The lowest energy state is that characterized by $n = 1$, which requires that $l = 0$ and $m = 0$. A state for which $l = 0$ is designated as an *s* state so the lowest energy state is known as the *1s* state, since states are designated by the value of n followed by a lower case letter to represent the l value. The values of l are denoted by letters as follows:

Value of l :	0	1	2	3
State designation:	sharp	principal	diffuse	fundamental

Table 2.2 Complete Normalized Hydrogen-Like Wave Functions.

$\psi_{1s} = \frac{1}{\pi^{1/2}} \left(\frac{Z}{a} \right)^{3/2} e^{-Zr/a}$
$\psi_{2s} = \frac{1}{4(2\pi)^{1/2}} \left(\frac{Z}{a} \right)^{3/2} \left(2 - \frac{Zr}{a} \right) e^{-Zr/2a}$
$\psi_{2p_z} = \frac{1}{4(2\pi)^{1/2}} \left(\frac{Z}{a} \right)^{5/2} r e^{-Zr/2a} \cos \theta$
$\psi_{2p_x} = \frac{1}{4(2\pi)^{1/2}} \left(\frac{Z}{a} \right)^{5/2} r e^{-Zr/2a} \sin \theta \sin \phi$
$\psi_{2p_y} = \frac{1}{4(2\pi)^{1/2}} \left(\frac{Z}{a} \right)^{5/2} r e^{-Zr/2a} \sin \theta \cos \phi$
$\psi_{3s} = \frac{1}{81(3\pi)^{1/2}} \left(\frac{Z}{a} \right)^{3/2} \left(27 - 18 \frac{Zr}{a} + 2 \frac{Z^2 r^2}{a^2} \right) e^{-Zr/3a}$
$\psi_{3p_z} = \frac{2^{1/2}}{81\pi^{1/2}} \left(\frac{Z}{a} \right)^{5/2} \left(6 - \frac{Zr}{a} \right) r e^{-Zr/3a} \cos \theta$
$\psi_{3p_x} = \frac{2^{1/2}}{81\pi^{1/2}} \left(\frac{Z}{a} \right)^{5/2} \left(6 - \frac{Zr}{a} \right) r e^{-Zr/3a} \sin \theta \cos \phi$
$\psi_{3p_y} = \frac{2^{1/2}}{81\pi^{1/2}} \left(\frac{Z}{a} \right)^{5/2} \left(6 - \frac{Zr}{a} \right) r e^{-Zr/3a} \sin \theta \sin \phi$
$\psi_{3d_{xy}} = \frac{1}{81(2\pi)^{1/2}} \left(\frac{Z}{a} \right)^{7/2} r^2 e^{-Zr/3a} \sin^2 \theta \sin 2\phi$
$\psi_{3d_{xz}} = \frac{2^{1/2}}{81\pi^{1/2}} \left(\frac{Z}{a} \right)^{7/2} r^2 e^{-Zr/3a} \sin \theta \cos \theta \cos \phi$
$\psi_{3d_{yz}} = \frac{2^{1/2}}{81\pi^{1/2}} \left(\frac{Z}{a} \right)^{7/2} r^2 e^{-Zr/3a} \sin \theta \cos \theta \sin \phi$
$\psi_{3d_{x^2-y^2}} = \frac{1}{81(2\pi)^{1/2}} \left(\frac{Z}{a} \right)^{7/2} r^2 e^{-Zr/3a} \sin \theta \cos 2\phi$
$\psi_{3d_{z^2}} = \frac{1}{81(6\pi)^{1/2}} \left(\frac{Z}{a} \right)^{7/2} r^2 e^{-Zr/3a} (3\cos^2 \theta - 1)$

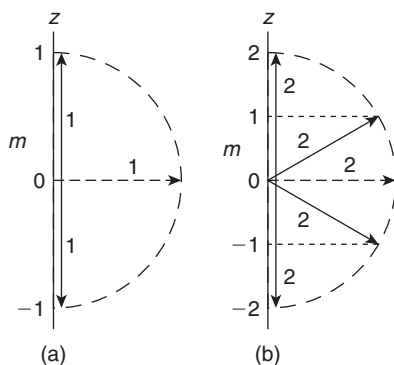

■ **FIGURE 2.2** Projections of vectors $l = 1$ and $l = 2$ on the z -axis.

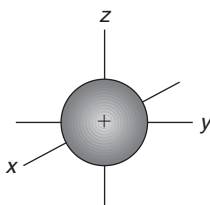

■ **FIGURE 2.3** The three-dimensional surface representing the probability region of an s orbital.

The words sharp, principal, diffuse, and fundamental were used to describe certain lines in atomic spectra, and it is the first letter of each word that is used to name s , p , d , and f states.

For hydrogen, the notation $1s^1$ is used, where the superscript denotes a single electron in the $1s$ state. Because an electron can have a spin quantum number of $+1/2$ or $-1/2$, two electrons having opposite spins can occupy the $1s$ state. The helium atom, having two electrons, has the configuration $1s^2$ with the electrons having spins of $+1/2$ and $-1/2$.

As we have seen in earlier sections, wave functions can be used to perform useful calculations to determine values for dynamical variables. Table 2.2 shows the normalized wave functions in which the nuclear charge is shown as Z ($Z = 1$ for hydrogen) for one electron species (H, He^+ , etc.). One of the results that can be obtained by making use of wave functions is that it is possible to determine the shapes of the surfaces that encompass the region where the electron can be found some fraction (perhaps 95%) of the time. Such drawings result in the orbital contours that are shown in Figures 2.3, 2.4, and 2.5.

It is interesting to examine the probability of finding an electron as a function of distance when s orbitals having different n values are considered. Figure 2.6 shows the radial probability plots for the $2s$ and $3s$ orbitals. Note that the plot for the $2s$ orbital has one node (where the probability goes to 0)

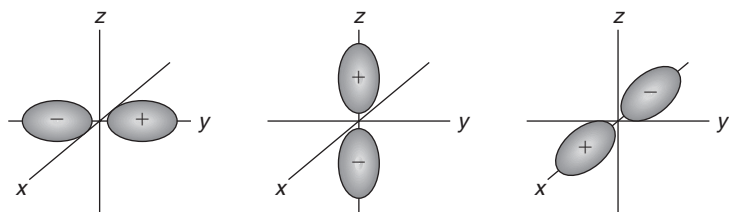

■ FIGURE 2.4 The three-dimensional surfaces of p orbitals.

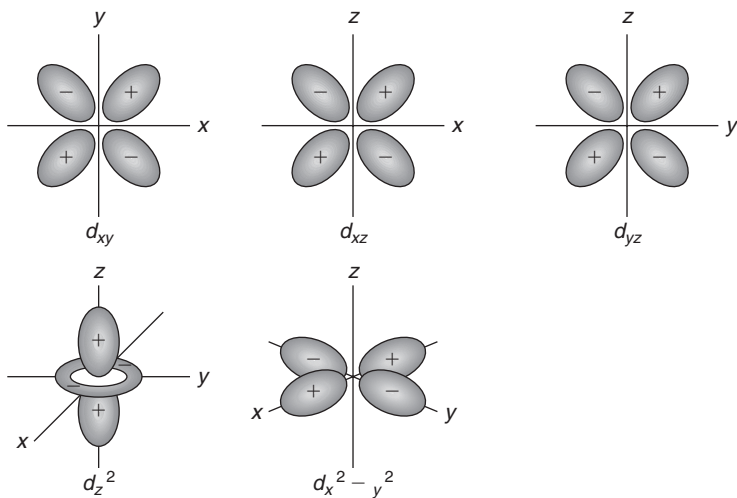

■ FIGURE 2.5 Three-dimensional representations of the five d orbitals.

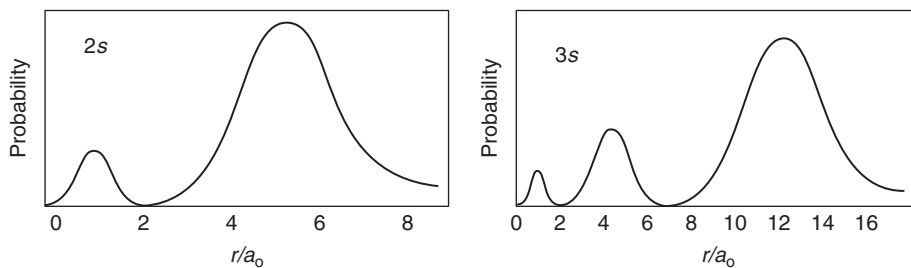

■ FIGURE 2.6 Radial distribution plots for $2s$ and $3s$ wave functions.

whereas that for the 3s orbital has two nodes. It can be shown that the nodes occur at $r = 2a_0$ for the 2s orbital and at $1.90a_0$ and $7.10a_0$ for the 3s orbital. It is a general characteristic that ns orbitals have $(n - 1)$ nodes. It is also noted that the distance at which the maximum probability occurs increases as the value of n increases. In other words, a 3s orbital is "larger" than a 2s orbital. Although not exactly identical, this is in accord with the idea from the Bohr model that the sizes of allowed orbits increase with increasing n value.

2.3 THE HELIUM ATOM

In previous sections, the basis for applying quantum mechanical principles has been illustrated. Although it is possible to solve exactly several types of problems, it should not be inferred that this is always the case. For example, it is easy to formulate wave equations for numerous systems, but generally they cannot be solved exactly. Consider the case of the helium atom, which is illustrated in Figure 2.7 to show the coordinates of the parts of the system.

We know that the general form of the wave equation is

$$\hat{H}\psi = E\psi \quad (2.39)$$

in which the Hamiltonian operator takes on the form appropriate to the particular system. In the case of the helium atom, there are two electrons, each of which has kinetic energy and is attracted to the +2 nucleus. However, there is also the repulsion between the two electrons. With reference to Figure 2.7, the attraction terms can be written as $-2e^2/r_1$ and $-2e^2/r_2$. The kinetic energies can be represented as $\frac{1}{2}mv_1^2$ and $\frac{1}{2}mv_2^2$, which in operator forms are written as $(-\hbar^2/2m)\nabla_1^2$ and $(-\hbar^2/2m)\nabla_2^2$. However, we now must include the repulsion between the two electrons, which gives rise to the term $+e^2/r_{12}$ in the Hamiltonian. When the complete Hamiltonian is written out, the result is

$$\hat{H} = -\frac{\hbar^2}{2m}\nabla_1^2 - \frac{\hbar^2}{2m}\nabla_2^2 - \frac{2e^2}{r_1} - \frac{2e^2}{r_2} + \frac{e^2}{r_{12}} \quad (2.40)$$

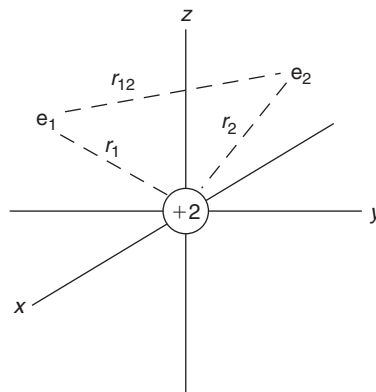

■ FIGURE 2.7 Coordinate system for the helium atom.

from which we obtain the wave equation for the helium atom,

$$\hat{H}\psi = E\psi \quad (2.41)$$

or

$$\left(-\frac{\hbar^2}{2m} \nabla_1^2 - \frac{\hbar^2}{2m} \nabla_2^2 - \frac{2e^2}{r_1} - \frac{2e^2}{r_2} + \frac{e^2}{r_{12}} \right) \psi = E\psi \quad (2.42)$$

In order to solve the wave equation for the hydrogen atom, it is necessary to transform the Laplacian into polar coordinates. That transformation allows the distance of the electron from the nucleus to be expressed in terms of r , θ , and ϕ , which in turn allows the separation of variables technique to be used. Examination of Eq. (2.40) shows that the first and third terms in the Hamiltonian are exactly like the two terms in the operator for the hydrogen atom. Likewise, the second and fourth terms are also equivalent to those for a hydrogen atom. However, the last term, e^2/r_{12} , is the troublesome part of the Hamiltonian. In fact, even after polar coordinates are employed, that term prevents the separation of variables from being accomplished. Not being able to separate the variables to obtain three simpler equations prevents an exact solution of Eq. (2.40) from being carried out.

When an equation describes a system exactly but the equation cannot be solved, there are two general approaches that are followed. First, if the exact equation cannot be solved exactly, it may be possible to obtain approximate solutions. Second, the equation that describes the system exactly may be modified to produce a different equation that now describes the system only approximately but which can be solved exactly. These are the approaches to solving the wave equation for the helium atom.

Because the other terms in the Hamiltonian essentially describe two hydrogen atoms except for the nuclear charge of $+2$, we could simply neglect the repulsion between the two electrons to obtain an equation that can be solved exactly. In other words, we have “approximated” the system as two hydrogen atoms, which means that the binding energy of an electron to the helium nucleus should be 27.2 eV , twice the value of 13.6 eV for the hydrogen atom. However, the actual value for the first ionization potential of helium is 24.6 eV because of the repulsion between the two electrons. Clearly, the approximate wave equation does not lead to a correct value for the binding energy of the electrons in a helium atom. This is equivalent to saying that an electron in a helium atom does not experience the effect of being attracted by a nucleus having a $+2$ charge, but an attraction which is less than that value because of the repulsion between electrons. If this approach is taken, it turns out that the effective nuclear charge is $27/16 = 1.688$ instead of exactly 2 .

If the problem is approached from the standpoint of considering the repulsion between the electrons as being a minor irregularity or perturbation in an otherwise solvable problem, the Hamiltonian can be modified to take into account this perturbation in a form that allows the problem to be solved. When this is done, the calculated value for the first ionization potential is 24.58 eV .

Although we cannot solve the wave equation for the helium atom exactly, the approaches described provide some insight in regard to how we might proceed in cases where approximations must be made. The two major approximation methods are known as the variation and perturbation methods. For details of these methods as applied to the wave equation for the helium atom, see the quantum

mechanics books listed in the suggested readings at the end of this chapter. A detailed treatment of these methods is beyond the scope of this book.

2.4 SLATER WAVE FUNCTIONS

We have just explained that the wave equation for the helium atom cannot be solved exactly because of the term involving $1/r_{12}$. If the repulsion between two electrons prevents a wave equation from being solved, it should be clear that when there are more than two electrons the situation is worse. If there are three electrons present (as in the lithium atom) there will be repulsion terms involving $1/r_{12}$, $1/r_{13}$, and $1/r_{23}$. Although there are a number of types of calculations that can be performed (particularly the self-consistent field calculations), they will not be described here. Fortunately, for some situations, it is not necessary to have an exact wave function that is obtained from the exact solution of a wave equation. In many cases, an approximate wave function is sufficient. The most commonly used approximate wave functions for one electron are those given by J. C. Slater, and they are known as Slater wave functions or *Slater-type orbitals* (usually referred to as STO orbitals).

Slater wave functions have the mathematical form

$$\psi_{n,l,m} = R_{n,l}(r)e^{-Zr/a_0^n} Y_{l,m}(\theta,\phi) \quad (2.43)$$

When the radial function $R_{n,l}(r)$ is approximated, the wave functions can be written as

$$\psi_{n,l,m} = r^{n^*-1}e^{-(Z-s)r/a_0^{n^*}} Y_{l,m}(\theta,\phi) \quad (2.44)$$

where s is a constant known as a screening constant, n^* is an effective quantum number that is related to n , and $Y_{l,m}(\theta,\phi)$ is a spherical harmonic that gives the angular dependence of the wave function. The spherical harmonics are functions that depend on the values of l and m as indicated by the subscripts. The quantity $(Z - s)$ is sometimes referred to as the effective nuclear charge, Z^* . The screening constant is calculated according to a set of rules that are based on the effectiveness of electrons in shells to screen the electron being considered from the effect of the nucleus.

The calculation of the screening constant for a specific electron is as follows.

1. The electrons are written in groups as follows:

$$1s \mid 2s \ 2p \mid 3s \ 3p \mid 3d \mid 4s \ 4p \mid 4d \mid 4f \mid 5s \ 5p \mid 5d \mid \dots$$

2. Electrons residing outside the shell in which the electron being described resides do not contribute to the screening constant.
3. A contribution of 0.30 is assigned for an electron in the 1s level, but for other groups 0.35 is added for each electron in that group.
4. A contribution of 0.85 is added for each electron in an s or p orbital for which the principle quantum number is one less than that for the electron being described. For electrons in s or p orbitals which have an n value of two or more lower than that of the orbital for the electron being considered, a contribution of 1.00 is added for each electron.

5. For electrons in *d* and *f* orbitals, a contribution of 1.00 is added for each electron in orbitals having lower *n* than the one where the electron being considered resides.
6. The value of n^* is determined from *n* as based on the following table.

$n = 1$	2	3	4	5	6
$n^* = 1$	2	3	3.7	4.0	4.2

To illustrate the use of the foregoing rules, we will write the Slater wave function for an electron in an oxygen atom. The electron resides in a $2p$ orbital, so $n = 2$, which means that $n^* = 2$. There are four electrons in the $2p$ orbitals in an oxygen atom, so the fourth electron is screened by three others. However, an electron in a $2p$ orbital is also screened by the two electrons in the $1s$ orbital and two in the $2s$ orbital. Two electrons in the $1s$ level give screening that can be written as $2(0.85) = 1.70$. The screening constant is the same for electrons in the $2s$ and $2p$ states, and the electron in the $2p$ state that is being considered has five other electrons involved in screening. Therefore, those five give a contribution to the screening constant of $5(0.35) = 1.75$. Adding the contributions gives a total screening constant of $1.70 + 1.75 = 3.45$, which means that the effective nuclear charge is $8 - 3.45 = 4.55$. Using this value gives $(Z - s)/n^* = 2.28$ and a Slater wave function that can be written as

$$\psi = re^{-2.28r/a_0 n^*} Y_{2,m}(\theta, \phi) \quad (2.45)$$

The important aspect of this approach is that it is now possible to arrive at an approximate one-electron wave function that can be used in other calculations. For example, Slater-type orbitals form the basis of many of the high-level molecular orbital calculations using self-consistent field theory and other approaches. However, in most cases, the Slater-type orbitals are not used directly. Quantum mechanical calculations on molecules involve the evaluation of a large number of integrals, and exponential integrals of the STO type are much less efficient in calculations. In practice, the STO functions are represented as a series of functions known as Gaussian functions, which are of the form $a \exp(-br^2)$. The set of functions to be used, known as the *basis set*, is then constructed as a series of Gaussian functions representing each STO. When a three-term Gaussian is used, the orbitals are known as a STO-3G basis set. The result of this transformation is that the computations are completed much more quickly because Gaussian integrals are much easier to compute. For a more complete discussion of this advanced topic, see the book *Quantum Chemistry* by J. P. Lowe, listed in the references at the end of this chapter.

2.5 ELECTRON CONFIGURATIONS

For $n = 1$, the only value possible for both l and m is 0. Therefore, there is only a single state possible, the one for $n = 1$, $l = 0$, and $m = 0$. This state is denoted as the $1s$ state. If $n = 2$, it is possible for l to be 0 or 1. For the $l = 0$ state, the $n = 2$ and $l = 0$ combination gives rise to the $2s$ state. Again, $m = 0$ is the only possibility because of the restriction on the values of m being 0 up to $\pm l$. Two electrons can be accommodated in the $2s$ state, which is filled in the beryllium atom, so the electron configuration is $1s^2 2s^2$.

For the quantum state for which $n = 2$ and $l = 1$, we find that there are three values of m possible, $+1$, 0 , and -1 . Therefore, each value of m can be used with spin quantum numbers of $+1/2$ and $-1/2$.

This results in six combinations of quantum numbers that obey the restrictions on their values given above. The six possible sets of quantum numbers can be shown as follows.

Electron 1	Electron 2	Electron 3	Electron 4	Electron 5	Electron 6
$n = 2$	$n = 2$	$n = 2$	$n = 2$	$n = 2$	$n = 2$
$l = 1$	$l = 1$	$l = 1$	$l = 1$	$l = 1$	$l = 1$
$m = +1$	$m = 0$	$m = -1$	$m = +1$	$m = 0$	$m = -1$
$s = +1/2$	$s = +1/2$	$s = +1/2$	$s = -1/2$	$s = -1/2$	$s = -1/2$

A state for which $l = 1$ is known as a p state, so the six sets of quantum numbers just shown belong to the $2p$ state. Population of the $2p$ state is started with boron and completed with neon in the first long period of the periodic table. However, each m value denotes an orbital, so there are three orbitals where electrons can reside. *Electrons remain unpaired as long as possible* when populating a set of orbitals. For convenience, we will assume that **the orbitals fill by starting with the highest positive value of m first and then going to successive lower values**. Table 2.3 shows the maximum population of states based on the value for l .

According to the Bohr model, the quantum number n determines the energies of the allowed states in a hydrogen atom. We now know that both n and l are factors that determine the energy of a set of orbitals. In a general way, it is the sum $(n + l)$ that determines the energy, and the energy increases as the sum of n and l . However, when there are two or more ways to get a particular sum of $(n + l)$ the combination with lower n is normally used first. For example, the $2p$ state has $(n + l) = (2 + 1) = 3$ as does the $3s$ state where $(n + l) = (3 + 0) = 3$. In this case, the $2p$ level fills first because of the greater importance of the lower n value. Table 2.4 shows the scheme used to arrange the orbitals in the order in which they are normally filled. As a result, the general order of filling shells is as follows, with the sum $(n + l)$ being given directly below for each type of shell.

State	1s	2s	2p	3s	3p	4s	3d	4p	5s	4d	5p	6s
$(n + l)$	1	2	3	3	4	4	5	5	5	6	6	6

By following the procedures described, we find that for the first 10 elements, the results are as follows.

H	$1s^1$
He	$1s^2$
Li	$1s^2 2s^1$
Be	$1s^2 2s^2$
B	$1s^2 2s^2 2p^1$
C	$1s^2 2s^2 2p^2$
N	$1s^2 2s^2 2p^3$
O	$1s^2 2s^2 2p^4$
F	$1s^2 2s^2 2p^5$
Ne	$1s^2 2s^2 2p^6$

<i>l</i> Value	State	<i>m</i> Values Possible	Maximum Population
0	<i>s</i>	0	2
1	<i>p</i>	0, ±1	6
2	<i>d</i>	0, ±1, ±2	10
3	<i>f</i>	0, ±1, ±2, ±3	14
4	<i>g</i>	0, ±1, ±2, ±3, ±4	18

<i>n</i>	<i>l</i>	(<i>n</i> + <i>l</i>)	State
1	0	1	1 <i>s</i>
2	0	2	2 <i>s</i>
2	1	3	2 <i>p</i>
3	0	3	3 <i>s</i>
3	1	4	3 <i>p</i>
4	0	4	4 <i>s</i>
3	2	5	3 <i>d</i>
4	1	5	4 <i>p</i>
5	0	5	5 <i>s</i>
4	2	6	4 <i>d</i>
5	1	6	5 <i>p</i>
6	0	6	6 <i>s</i>
4	3	7	4 <i>f</i>
5	2	7	5 <i>d</i>
6	1	7	6 <i>p</i>
7	0	7	7 <i>s</i>

^aIn general, energy increases in going down in the table.

For some of the atoms, this is an oversimplification because an electron configuration like $1s^2 2s^2 2p^2$ does not give the complete picture. Each *m* value denotes an orbital in which two electrons can reside with opposite spins. When $l = 1$, *m* can have the values of +1, 0, and -1, which denote three orbitals. Therefore, the two electrons could be paired in one of the three orbitals or they could be unpaired and

reside in different orbitals. We have already stated that **we will start with the highest positive value of m first and with the positive value of s** . For a $2p^2$ configuration, two possible arrangements are as follows:

$$m = \begin{array}{c} \uparrow\downarrow \\ +1 \\ \hline \end{array} \begin{array}{c} \\ 0 \\ \hline \end{array} \begin{array}{c} \\ -1 \\ \hline \end{array} \quad \text{or} \quad \begin{array}{c} \uparrow \\ +1 \\ \hline \end{array} \begin{array}{c} \uparrow \\ 0 \\ \hline \end{array} \begin{array}{c} \\ -1 \\ \hline \end{array}$$

Although the explanation will be provided later, the configuration on the right is lower in energy than the one on the left. As we have already stated, electrons remain unpaired as long as possible. Therefore, the carbon atom that has the electron configuration $1s^2 2s^2 2p^2$ has two unpaired electrons. In a similar way, the nitrogen atom has three electrons in the $2p$ orbitals,

$$m = \begin{array}{c} \uparrow \\ +1 \\ \hline \end{array} \begin{array}{c} \uparrow \\ 0 \\ \hline \end{array} \begin{array}{c} \uparrow \\ -1 \\ \hline \end{array}$$

so it has three unpaired electrons. On the other hand, the oxygen atom, which has the configuration $1s^2 2s^2 2p^4$, has only two unpaired electrons.

$$m = \begin{array}{c} \uparrow\downarrow \\ +1 \\ \hline \end{array} \begin{array}{c} \uparrow \\ 0 \\ \hline \end{array} \begin{array}{c} \uparrow \\ -1 \\ \hline \end{array}$$

It is important when discussing the chemistry of elements to keep in mind the actual arrangement of electrons, not just the overall configuration. For example, with the nitrogen atom having one electron in each of the three $2p$ orbitals, the addition of another electron would require it to be paired in one of the orbitals. Because of repulsion between electrons in the same orbital, there is little tendency of the nitrogen atom to add another electron. Therefore, the electron affinity of nitrogen is very close to 0. We have already mentioned in Chapter 1 that the ionization potential for the oxygen atom is lower than that of nitrogen even though the oxygen atom has a higher nuclear charge. We can now see why this is so. Because oxygen has the configuration $1s^2 2s^2 2p^4$, one of the $2p$ orbitals has a pair of electrons in it. Repulsion between the electrons in this pair reduces the energy with which they are bound to the nucleus so it is easier to remove one of them than it is to remove an electron from a nitrogen atom. There are numerous other instances in which the electron configuration gives a basis for interpreting properties of atoms.

We could follow the procedures just illustrated to write the electron configurations of elements 11 through 18 in which the $3s$ and $3p$ orbital are being filled. However, we will not write all of these out; rather, we will summarize the electron configuration of argon, $1s^2 2s^2 2p^2 3s^2 3p^6$, as (Ar). When this is done, the next element, potassium, has the configuration (Ar) $4s^1$ and that of calcium is (Ar) $4s^2$. The sum ($n + l$) is 4 for both the $3p$ and $4s$ levels, and the lower value of n is used first ($3p$). The next levels to be filled are those for which ($n + l$) = 5, and these are the $3d$, $4p$, and $5s$. In this case, the $3d$ orbitals

have the lower n , so that set of orbitals is filled next. Therefore, the configurations for the next few elements are as follows.

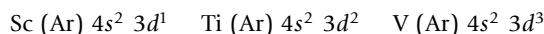

Following this pattern, we expect chromium to have the configuration (Ar) $4s^2 3d^4$, but it is actually (Ar) $4s^1 3d^5$. The reason for this will be explained later, but we will mention here that it has to do with the interaction of electrons having the same spin by means of coupling of their angular momenta. The next element, Mn, has the configuration (Ar) $4s^2 3d^5$, and filling of the $3d$ shell is regular until copper is reached. There, instead of the configuration being (Ar) $4s^2 3d^9$, it is (Ar) $4s^1 3d^{10}$, but the configuration of zinc is the expected $4s^2 3d^{10}$.

It is not necessary here to list all of the irregularities that occur in electron configurations. We should point out that irregularities of the type just discussed occur only when the orbitals involved have energies that differ only slightly. There is no case where an atom such as carbon is found with the ground state configuration of $1s^2 2s^1 2p^3$ or $1s^2 2s^2 2p^1 3s^1$ instead of $1s^2 2s^2 2p^2$. The difference in energy between the $2s$ and $2p$ states and that between the $2p$ and $3s$ states is simply too great for an electron to reside in the higher state unless there has been electron excitation by some means. Electron configurations for atoms can now be written by making use of the procedures described earlier and referring to the periodic table shown in Figure 2.8. Table 2.5 gives the ground state electron configurations for all of the atoms.

2.6 SPECTROSCOPIC STATES

We have already alluded to the fact that within an overall electron configuration of an atom, there is interaction of the electrons by means of coupling of angular momenta. This results from the fact that a spinning electron that is moving in an orbit has angular momentum resulting from its spin as well as from its orbital movement. These are vector quantities that couple in accord with quantum-mechanical rules. In one of the coupling schemes, the individual spin angular momenta of the electrons couple to give an overall spin of S . In addition, the orbital angular momenta of the electrons couple to give an overall orbital angular momentum, L . Then, these resulting vector quantities couple to give the total angular momentum vector, J , for the atom. Coupling occurs by this scheme, which is known as L - S or Russell-Saunders coupling, for atoms in approximately the top half of the periodic table.

In a manner similar to that by which the atomic states were designated as s , p , d , or f , the letters S , P , D , and F correspond to the values of 0, 1, 2, and 3, respectively, for the angular momentum vector, L . After the values of the vectors L , S , and J have been determined, the overall angular momentum is described by a symbol known as a *term symbol* or *spectroscopic state*. This symbol is constructed as $(2S+1)L_J$ where the appropriate letter is used for the L value as listed earlier, and the quantity $(2S+1)$ is known as the *multiplicity*. For one unpaired electron, $(2S+1) = 2$, and a multiplicity of 2 gives rise to a doublet. For two unpaired electrons, the multiplicity is 3, and the state is called a triplet state.

Figure 2.9 shows how two vectors can couple according to the quantum-mechanical restrictions. Note that vectors l_1 and l_2 having lengths of 1 and 2 units can couple to give resultants that are 3,

IA 1																VIII A 18													
1 H 1.0079	IIA 2										5 B 10.81	6 C 12.011	7 N 14.0067	8 O 15.9994	9 F 18.9984	10 Ne 20.179													
3 Li 6.941	4 Be 9.0122											13 Al 26.9815	14 Si 28.0855	15 P 30.9738	16 S 32.06	17 Cl 35.453	18 Ar 39.948												
11 Na 22.9898	12 Mg 24.305	IIIB 3	IVB 4	VB 5	VIB 6	VII B 7	VIII B 8 9 10			IB 11	II B 12	19 K 39.0983	20 Ca 40.08	21 Sc 44.9559	22 Ti 47.88	23 V 50.9415	24 Cr 51.996	25 Mn 54.9380	26 Fe 55.847	27 Co 58.9332	28 Ni 58.69	29 Cu 63.546	30 Zn 65.38	31 Ga 69.72	32 Ge 72.59	33 As 74.9216	34 Se 78.96	35 Br 79.904	36 Kr 83.80
37 Rb 85.4678	38 Sr 87.62	39 Y 88.9059	40 Zr 91.22	41 Nb 92.9064	42 Mo 95.94	43 Tc (98)	44 R 101.07	45 Rh 102.906	46 Pd 106.42	47 Ag 107.868	48 Cd 112.41	49 In 114.82	50 Sn 118.69	51 Sb 121.75	52 Te 127.60	53 I 126.905	54 Xe 131.29												
55 Cs 132.905	56 Ba 137.33	57 La* 138.906	72 Hf 178.48	73 Ta 180.948	74 W 183.85	75 Re 186.207	76 Os 190.2	77 Ir 192.22	78 Pt 195.09	79 Au 196.967	80 Hg 200.59	81 Tl 204.383	82 Pb 207.2	83 Bi 208.980	84 Po (209)	85 At (210)	86 Rn (222)												
87 Fr (223)	88 Ra 226.025	89 Ac* 227.028	104 Rf (257)	105 Ha (260)	106 Sg (263)	107 Ns (262)	108 Hs (265)	109 Mt (266)	110 Ds (271)	111 Rg (272)																			

*Lanthanide Series	58 Ce 140.12	59 Pr 140.908	60 Nd 144.24	61 Pm (145)	62 Sm 150.36	63 Eu 151.96	64 Gd 157.25	65 Tb 158.925	66 Dy 162.50	67 Ho 164.930	68 Er 167.26	69 Tm 168.934	70 Yb 173.04	71 Lu 174.967
*Actinide Series	90 Th 232.038	91 Pa 231.036	92 U 238.029	93 Np 237.048	94 Pu (244)	95 Am (243)	96 Cm (247)	97 Bk (247)	98 Cf (251)	99 Es (252)	100 Fm (257)	101 Md (258)	102 No (259)	103 Lr (260)

■ FIGURE 2.8 The periodic table of the elements.

2, or 1 units in length. Therefore, the resultant, R , for these combinations can be written as $|l_1 + l_2|$, $|l_1 + l_2 - 1|$ or $|l_1 - l_2|$.

In heavier atoms, a different type of coupling scheme is sometimes followed. In that scheme, the orbital angular momentum, l , couples with the spin angular momentum, s , to give a resultant, j , for a single electron. Then, these j values are coupled to give the overall angular momentum for the atom, J . Coupling of angular momenta by this means, known as j - j coupling, occurs for heavy atoms, but we will not consider this type of coupling further.

In L - S coupling, we need to determine the following sums in order to deduce the spectroscopic state of an atom:

$$L = \sum l_i \quad S = \sum s_i \quad M = \sum m_i = L, L - 1, L - 2, \dots, 0, \dots, -L \quad J = |L + S|, \dots, |L - S|$$

Note that if all of the electrons are paired, the sum of spins is 0, so a singlet state results. Also, if all of the orbitals in a set are filled, for each electron with a positive value of m there is also one having

Table 2.5 Electronic Configurations of Atoms.

Z	Symbol	Configuration	Z	Symbol	Configuration
1	H	$1s^1$	56	Ba	(Xe) $6s^2$
2	He	$1s^2$	57	La	(Xe) $5d^1 6s^2$
3	Li	$1s^2 2s^1$	58	Ce	(Xe) $4f^2 6s^2$
4	Be	$1s^2 2s^2$	59	Pr	(Xe) $4f^3 6s^2$
5	B	$1s^2 2s^2 2p^1$	60	Nd	(Xe) $4f^4 6s^2$
6	C	$1s^2 2s^2 2p^2$	61	Pm	(Xe) $4f^5 6s^2$
7	N	$1s^2 2s^2 2p^3$	62	Sm	(Xe) $4f^6 6s^2$
8	O	$1s^2 2s^2 2p^4$	63	Eu	(Xe) $4f^7 6s^2$
9	F	$1s^2 2s^2 2p^5$	64	Gd	(Xe) $4f^7 5d^1 6s^2$
10	Ne	$1s^2 2s^2 2p^6$	65	Tb	(Xe) $4f^9 6s^2$
11	Na	(Ne) $3s^1$	66	Dy	(Xe) $4f^{11} 6s^2$
12	Mg	(Ne) $3s^2$	67	Ho	(Xe) $4f^{11} 6s^2$
13	Al	(Ne) $3s^2 3p^1$	68	Er	(Xe) $4f^{12} 6s^2$
14	Si	(Ne) $3s^2 3p^2$	69	Tm	(Xe) $4f^{13} 6s^2$
15	P	(Ne) $3s^2 3p^3$	70	Yb	(Xe) $4f^{14} 6s^2$
16	S	(Ne) $3s^2 3p^4$	71	Lu	(Xe) $4f^{14} 5d^1 6s^2$
17	Cl	(Ne) $3s^2 3p^5$	72	Hf	(Xe) $4f^{14} 5d^2 6s^2$
18	Ar	(Ne) $3s^2 3p^6$	73	Ta	(Xe) $4f^{14} 5d^3 6s^2$
19	K	(Ar) $4s^1$	74	W	(Xe) $4f^{14} 5d^4 6s^2$
20	Ca	(Ar) $4s^2$	75	Re	(Xe) $4f^{14} 5d^5 6s^2$
21	Sc	(Ar) $3d^1 4s^2$	76	Os	(Xe) $4f^{14} 5d^6 6s^2$
22	Ti	(Ar) $3d^2 4s^2$	77	Ir	(Xe) $4f^{14} 5d^7 6s^2$
23	V	(Ar) $3d^3 4s^2$	78	Pt	(Xe) $4f^{14} 5d^9 6s^1$
24	Cr	(Ar) $3d^5 4s^1$	79	Au	(Xe) $4f^{14} 5d^{10} 6s^1$
25	Mn	(Ar) $3d^5 4s^2$	80	Hg	(Xe) $4f^{14} 5d^{10} 6s^2$
26	Fe	(Ar) $3d^6 4s^2$	81	Tl	(Xe) $4f^{14} 5d^{10} 6s^2 6p^1$
27	Co	(Ar) $3d^7 4s^2$	82	Pb	(Xe) $4f^{14} 5d^{10} 6s^2 6p^2$
28	Ni	(Ar) $3d^8 4s^2$	83	Bi	(Xe) $4f^{14} 5d^{10} 6s^2 6p^3$
29	Cu	(Ar) $3d^{10} 4s^1$	84	Po	(Xe) $4f^{14} 5d^{10} 6s^2 6p^4$
30	Zn	(Ar) $3d^{10} 4s^2$	85	At	(Xe) $4f^{14} 5d^{10} 6s^2 6p^5$
31	Ga	(Ar) $3d^{10} 4s^2 4p^1$	86	Rn	(Xe) $4f^{14} 5d^{10} 6s^2 6p^6$
32	Ge	(Ar) $3d^{10} 4s^2 4p^2$	87	Fr	(Rn) $7s^1$
33	As	(Ar) $3d^{10} 4s^2 4p^3$	88	Ra	(Rn) $7s^2$

(Continued)

Table 2.5 (Continued)					
Z	Symbol	Configuration	Z	Symbol	Configuration
34	Se	(Ar) $3d^{10} 4s^2 4p^4$	89	Ac	(Rn) $6d^1 7s^2$
35	Br	(Ar) $3d^{10} 4s^2 4p^5$	90	Th	(Rn) $6d^2 7s^2$
36	Kr	(Ar) $3d^{10} 4s^2 4p^6$	91	Pa	(Rn) $5f^2 6d^1 7s^2$
37	Rb	(Kr) $5s^1$	92	U	(Rn) $5f^3 6d^1 7s^2$
38	Sr	(Kr) $5s^2$	93	Np	(Rn) $5f^5 7s^2$
39	Y	(Kr) $4d^1 5s^2$	94	Pu	(Rn) $5f^6 7s^2$
40	Zr	(Kr) $4d^2 5s^2$	95	Am	(Rn) $5f^7 7s^2$
41	Nb	(Kr) $4d^4 5s^1$	96	Cm	(Rn) $5f^7 6d^1 7s^2$
42	Mo	(Kr) $4d^5 5s^1$	97	Bk	(Rn) $5f^8 6d^1 7s^2$
43	Tc	(Kr) $4d^5 5s^2$	98	Cf	(Rn) $5f^{10} 7s^2$
44	Ru	(Kr) $4d^7 5s^1$	99	Es	(Rn) $5f^{11} 7s^2$
45	Rh	(Kr) $4d^8 5s^1$	100	Fm	(Rn) $5f^{12} 7s^2$
46	Pd	(Kr) $4d^{10}$	101	Md	(Rn) $5f^{13} 7s^2$
47	Ag	(Kr) $4d^{10} 5s^1$	102	No	(Rn) $5f^{14} 7s^2$
48	Cd	(Kr) $4d^{10} 5s^2$	103	Lr	(Rn) $5f^{14} 6d^1 7s^2$
49	In	(Kr) $4d^{10} 5s^2 5p^1$	104	Rf	(Rn) $5f^{14} 6d^2 7s^2$
50	Sn	(Kr) $4d^{10} 5s^2 5p^2$	105	Ha	(Rn) $5f^{14} 6d^3 7s^2$
51	Sb	(Kr) $4d^{10} 5s^2 5p^3$	106	Sg	(Rn) $5f^{14} 6d^4 7s^2$
52	Te	(Kr) $4d^{10} 5s^2 5p^4$	107	Ns	(Rn) $5f^{14} 6d^5 7s^2$
53	I	(Kr) $4d^{10} 5s^2 5p^5$	108	Hs	(Rn) $5f^{14} 6d^6 7s^2$
54	Xe	(Kr) $4d^{10} 5s^2 5p^6$	109	Mt	(Rn) $5f^{14} 6d^7 7s^2$
55	Cs	(Xe) $6s^1$	110	Ds	(Rn) $5f^{14} 6d^8 7s^2$
			111	Rg	(Rn) $5f^{14} 6d^9 7s^2$

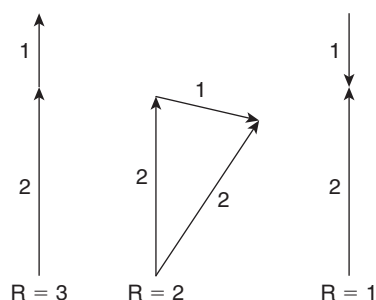

■ FIGURE 2.9 Vector sums for two vectors having lengths of 2 and 1 units. The resultant can have values of 3, 2, or 1.

a negative m value. Therefore, the sum of the m values is 0 (which means that $L = 0$), which leads to the conclusion that for an electron configuration that represents all filled shells, the spectroscopic state is 1S_0 . The subscript 0 arises because the combination $J = L + S = 0 + 0 = 0$. This is the case for the noble gas atoms, which have all filled shells. We will now illustrate the application of these principles by showing how to determine the spectroscopic states of several atoms.

For the hydrogen atom, the single electron resides in the $1s$ state, so the l and m values for that orbital are 0 (which means that L is also 0), and the single electron has a spin of $1/2$. Because $L = 0$, the spectroscopic state is an S state, and the multiplicity is 2 because the sum of spins is $1/2$. Therefore, the spectroscopic state of the hydrogen atom is 2S . Note that the state being denoted as an S state is not related to the sum of spins vector, S . The value of J in this case is $|0 + 1/2| = 1/2$, which means that the spectroscopic state for the hydrogen atom is written as $^2S_{1/2}$. Any electron in an s orbital has l and m values of 0 regardless of the n value. As a result, any atom, such as Li, Na, or K, having all closed shells and an ns^1 electron outside the closed shells has a spectroscopic state of $^2S_{1/2}$.

In the simple example just given, only one spectroscopic state is possible. In many cases, more than one spectroscopic state can result from a given electron configuration because the electrons can be arranged in different ways. For example, the electron configuration np^2 could be arranged as

$$m = \begin{array}{c} \uparrow\downarrow \\ +1 \quad 0 \quad -1 \end{array} \quad \text{or} \quad \begin{array}{c} \uparrow \quad \uparrow \\ +1 \quad 0 \quad -1 \end{array}$$

which result in different spectroscopic states. With the electrons paired as shown in the diagram on the left, the state will be a singlet, whereas that on the right will give rise to a triplet state. Although we will not show the details here, the np^2 configuration gives rise to several spectroscopic states, but only one of them is the state of lowest energy, the spectroscopic *ground state*. Fortunately there is a set of rules, known as Hund's rules, that permits us to determine the *ground state* (which usually concerns us most) very easily. Hund's rules can be stated as follows.

1. The state with the highest multiplicity gives the lowest energy for equivalent electrons.
2. For states having the highest multiplicity, the state with highest L is lowest in energy.
3. For shells that are less than half filled, the state with the lowest J lies lowest in energy, but for shells that are more than half filled, the lowest energy state has the highest J value.

In accord with the first rule, the electrons remain unpaired as long as possible when filling a set of orbitals because that is how the maximum multiplicity is achieved. With regard to the third rule, if a state is exactly half filled, the sum of the m values that gives the L vector is 0 and $|L + S|$ and $|L - S|$ are identical so only one J value is possible.

Suppose we wish to find the spectroscopic ground state for the carbon atom. We need not consider the filled $1s$ and $2s$ shells because both give $S = 0$ and $L = 0$. If we place the two electrons in the $2p$ level in the two orbitals that have $m = +1$ and $m = 0$, we will find that the sum of spins is 1, the maximum value possible. Moreover, the sum of the m values will be 1, which leads to a P state. With

$S = 1$ and $L = 1$, the J values possible are 2, 1, and 0. Therefore, by application of rule 3, the spectroscopic ground state for the carbon atom is 3P_0 , but there are two other states, 3P_1 and 3P_2 , that have energies that are only slightly higher (16.5 and 43.5 cm^{-1} , respectively). It can be shown that there are also states designated as 1D_2 and 1S_0 possible for the np^2 configuration. These have energies that are $10,193.7$ and $21,648.4 \text{ cm}^{-1}$ (122 and 259 kJ mol^{-1} , respectively) above the ground state. Note that these singlet states, which correspond to arrangements in which the two electrons have been forced to pair, are significantly higher in energy than the ground state, and it is correct to say that the electrons remain unpaired as long as possible.

As has already been mentioned, the ground state is generally the only one that is of concern. If we need to determine the ground state for Cr^{3+} , which has the outer electron arrangement of $3d^3$ (for transition metals, the electrons are lost from the $4s$ level first), we proceed as before by placing the electrons in a set d orbitals beginning with the highest m value and working downward while keeping the electrons unpaired to give the highest multiplicity:

$$m = \begin{array}{cccccc} \uparrow & \uparrow & \uparrow & \underline{\quad} & \underline{\quad} & \underline{\quad} \\ +2 & +1 & 0 & -1 & -2 & \end{array}$$

For this arrangement, the sum of spins is $3/2$ and the L value is 3. These values give rise to the J values of $|3 + 3/2|$, $|3 + 3/2 - 1|$, ..., $|3 - 3/2|$, which are $9/2$, $7/2$, $5/2$, and $3/2$. Because the set of orbitals is less than half filled, the lowest J corresponds to the lowest energy, and the spectroscopic ground state for Cr^{3+} is $^4F_{3/2}$. The spectroscopic states can be worked out for various electron configurations using the procedures described above. Table 2.6 shows a summary of the spectroscopic states that arise from various electron configurations.

Although we have not given a complete coverage to the topic of spectroscopic states, the discussion here is adequate for the purposes described in this book. In Chapter 17 it will be necessary to describe what happens to the spectroscopic states of transition metal ions when these ions are surrounded by other groups when coordination compounds form.

Table 2.6 Spectroscopic States Arising for Equivalent Electrons.

Electron Configuration	Spectroscopic States	Electron Configuration	Spectroscopic States
s^1	2S	d^2	$^3F, ^3P, ^1G, ^1D, ^1S$
s^2	1S	d^3	4F (ground state)
p^1	2P	d^4	5D (ground state)
p^2	$^3P, ^1D, ^1S$	d^5	6S (ground state)
p^3	$^4S, ^2D, ^2P$	d^6	5D (ground state)
p^4	$^3P, ^1D, ^1S$	d^7	4F (ground state)
p^5	2P	d^8	3F (ground state)
p^6	1S	d^9	2D
d^1	2D	d^{10}	1S

In this chapter, a brief review of quantum mechanical methods and the arrangement of electrons in atoms has been presented. These topics form the basis for understanding how quantum mechanics is applied to problems in molecular structure and the chemical behavior of the elements. The properties of atoms discussed in Chapter 1 are directly related to how the electrons are arranged in atoms. Although the presentation in this chapter is not exhaustive, it provides an adequate basis for the study of topics in inorganic chemistry. Further details can be found in the references.

■ REFERENCES FOR FURTHER STUDY

- Alberty, R. A., and Silbey, R. J. (2000). *Physical Chemistry*, 3rd ed. Wiley, New York. Excellent coverage of early experiments that led to development of quantum mechanics.
- DeKock, R. L., and Gray, H. B. (1980). *Chemical Bonding and Structure*. Benjamin-Cummings, Menlo Park, CA. One of the best introductions to bonding concepts available.
- Emsley, J. (1998). *The Elements*, 3rd ed. Oxford University Press, New York. A good source for an enormous amount of data on atomic properties.
- Gray, H. B. (1965). *Electrons and Chemical Bonding*. Benjamin, New York. An elementary presentation of bonding theory that is both readable and well illustrated.
- Harris, D. C., and Bertolucci, M. D. (1989). *Symmetry and Spectroscopy*. Dover Publications, New York. Chapter 2 presents a very good introduction to quantum mechanics.
- House, J. E. (2003). *Fundamentals of Quantum Chemistry*. Elsevier, New York. An introduction to quantum-mechanical methods at an elementary level that includes mathematical details.
- Lowe, J. P. (1993). *Quantum Chemistry*, 2nd ed. Academic Press, New York. An excellent treatment of advanced applications of quantum mechanics to chemistry.
- Mortimer, R. G. (2000). *Physical Chemistry*, 2nd ed. Academic Press, San Diego, CA. A physical chemistry text that described the important experiments in atomic physics.
- Sharpe, A. G. (1992). *Inorganic Chemistry*, 3rd ed. Longman, New York. An excellent book that gives a good summary of quantum mechanics at an elementary level.
- Warren, W. S. (2000). *The Physical Basis of Chemistry*, 2nd ed. Academic Press, San Diego, CA. Chapter 6 presents a good tutorial on elementary quantum mechanics.

■ QUESTIONS AND PROBLEMS

- Determine which of the following are eigenfunctions of the operator d/dx (a and b are constants): (a) e^{-ax} ; (b) $x e^{-bx}$; (c) $(1 + e^{bx})$.
- Is the function $\sin e^{ax}$ an eigenfunction of the operator d^2/dx^2 ?
- Normalize the function e^{-ax} in the interval zero to infinity.
- Write the complete Hamiltonian operator for the lithium atom. Explain why the wave equation for Li cannot be solved exactly.
- Write a set of four quantum numbers for the "last" electron in each of the following: (a) Ti; (b) S; (c) Sr; (d) Co; (e) Al.
- Write a set of four quantum numbers for the "last" electron in each of the following: (a) Sc; (b) Ne; (c) Se; (d) Ga; (e) Si.
- Draw vector coupling diagrams to show all possible ways in which vectors $L = 3$ and $S = 5/2$ can couple.

8. Write a set of four quantum numbers for the "last" electron in each of the following: (a) Cl; (b) Ge; (c) As; (d) Sn; (e) Ar.
9. Write complete electron configurations for the following: (a) Si; (b) S^{2-} ; (c) K^+ ; (d) Cr^{2+} ; (e) Fe^{2+} ; (f) Zn.
10. Determine the spectroscopic ground states for the following: (a) P; (b) Sc; (c) Si; (d) Ni^{2+} .
11. The difference in energy between the 3P_0 and 3P_1 states of the carbon atom is 16.4 cm^{-1} . How much energy is this in kJ mol^{-1} ?
12. Determine the spectroscopic ground state for each of the following: (a) Be; (b) Ga; (c) F^- ; (d) Al; (e) Sc.
13. Determine the spectroscopic ground state for each of the following: (a) Ti^{3+} ; (b) Fe; (c) Co^{2+} ; (d) Cl; (e) Cr^{2+} .
14. The spectroscopic ground state for a certain first row transition metal is $^6S_{5/2}$. (a) Which metal is it? (b) What would be the ground state spectroscopic state of the +2 ion of the metal described in (a)? (c) What would be the spectroscopic ground state for the +3 ion of the metal described in (a)?
15. What are all the types of atomic orbitals possible for $n = 5$? How many electrons can be held in orbitals which have $n = 5$? What would be the atomic number of the atom that would have all of the shells with $n = 5$ filled?
16. Calculate the expectation value for $1/r$ for the electron in the 1s state of a hydrogen atom.
17. Calculate the expectation value for r^2 for the electron in the 1s state of a hydrogen atom.

This page intentionally left blank

Covalent Bonding in Diatomic Molecules

Although the first two chapters were devoted to presenting the basic principles of quantum mechanics and their application to atomic structure, we must also be concerned with providing information about the structure of molecules. In fact, the structures of molecules constitute the basis for their chemical behavior. The observation that SF_4 reacts very rapidly and vigorously with water whereas SF_6 does not exhibit this behavior is related to the difference in the structures of the molecules. A good understanding of molecular structure is necessary to interpret differences in chemical behavior of inorganic species. Although the chemical formulas for CO_2 and NO_2 may not look much different, the chemistry of these compounds is greatly different. In this chapter, a description of the covalent bond will be presented as it relates to diatomic molecules and their properties. In the next two chapters, bonding in more complex molecules will be described, and the topic of molecular symmetry will be addressed.

3.1 THE BASIC IDEAS OF MOLECULAR ORBITAL METHODS

The formalism that applies to the molecular orbital method will be illustrated by considering a hydrogen molecule, but a more detailed description of both H_2^+ and H_2 will be given in the next section. To begin our description of diatomic molecules, let us imagine that two hydrogen atoms that are separated by a relatively large distance are being brought closer together. As the atoms approach each other, there is an attraction between them that gets greater the shorter the distance between them becomes. Eventually, the atoms reach a distance of separation that represents the most favorable (minimum energy) distance, the bond length in the H_2 molecule (74 pm).

As the distance between the atoms decreases, the nuclei begin to repel each other, as do the two electrons. However, there are forces of attraction between the nucleus in atom 1 and the electron in atom 2 and between the nucleus in atom 2 and the electron in atom 1. We can illustrate the interactions involved as shown in Figure 3.1.

We know that for each atom the ionization potential is 13.6 eV, the bond energy for the H_2 molecule is 4.51 eV (432 kJ mol^{-1}), and the bond length is 74 pm. Keep in mind that bond energies are expressed as the energy necessary to *break* the bond and are therefore *positive* quantities. If the bond *forms*, energy equivalent to the bond energy is released so it is a *negative* quantity.

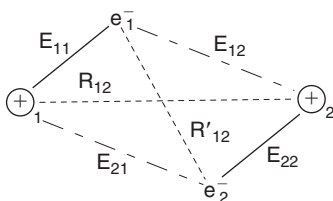

■ **FIGURE 3.1** Interactions within a hydrogen molecule. The quantities represented as R are the repulsions and those as E are the attraction energies. The subscripts indicate the nuclei and electrons involved.

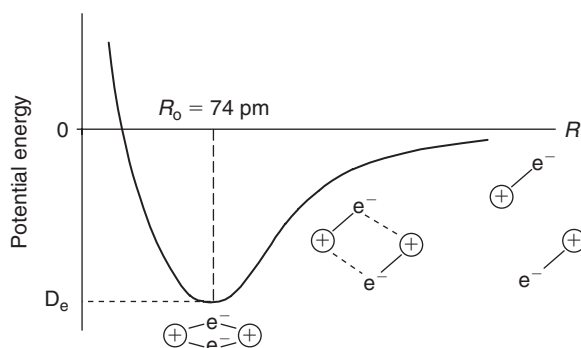

■ **FIGURE 3.2** The interaction of two hydrogen atoms that form a molecule.

The fact that the nuclei do not get closer together does not mean that the forces of attraction and repulsion are equal. The minimum distance is that distance where the total energy (attraction and repulsion) is most favorable. Because the molecule has some vibrational energy, the internuclear distance is not constant, but the equilibrium distance is R_0 . Figure 3.2 shows how the energy of interaction between two hydrogen atoms varies with internuclear distance.

In order to describe the hydrogen molecule by quantum mechanical methods, it is necessary to make use of the principles given in Chapter 2. It was shown that a wave function provided the starting point for application of the methods that permitted the calculation of values for the dynamical variables. It is with a *wave function* that we must again begin our treatment of the H_2 molecule by the molecular orbital method. But what wave function do we need? The answer is that we need a wave function for the H_2 molecule, and that wave function is constructed from the *atomic* wave functions. The technique used to construct molecular wave functions is known as the linear combination of atomic orbitals (abbreviated as LCAO-MO). The linear combination of atomic orbitals can be written mathematically as

$$\psi = \sum a_i \phi_i \quad (3.1)$$

In this equation, ψ is the molecular wave function, ϕ is an atomic wave function, and a is a weighting coefficient that gives the relative weight in the “mix” of the atomic wave functions. The summation is

over i , the number of atomic wave functions (number of atoms) being combined. If a diatomic molecule is being described, there are only two atoms involved, so the equation becomes

$$\psi = a_1\phi_1 + a_2\phi_2 \quad (3.2)$$

Although the combination has been written as a sum, the difference is also an acceptable linear combination. The weighting coefficients are variables that must be determined.

In Chapter 2, it was shown that in order to calculate the average value for a dynamical variable a whose operator is α , it is necessary to make use of the relationship

$$\langle a \rangle = \frac{\int \psi^* \alpha \psi d\tau}{\int \psi^* \psi d\tau} \quad (3.3)$$

If the property we wish to determine is the energy, this equation becomes

$$E = \frac{\int \psi^* \hat{H} \psi d\tau}{\int \psi^* \psi d\tau} \quad (3.4)$$

where \hat{H} is the Hamiltonian operator, the operator for total energy. The expression shown in Eq. (3.2) is substituted for ψ in the equation above, to give

$$E = \frac{\int (a_1\phi_1^* + a_2\phi_2^*) \hat{H} (a_1\phi_1 + a_2\phi_2) d\tau}{\int (a_1\phi_1^* + a_2\phi_2^*) (a_1\phi_1 + a_2\phi_2) d\tau} \quad (3.5)$$

When the multiplications are carried out and the constants are removed from the integrals, we obtain

$$E = \frac{a_1^2 \int \phi_1^* \hat{H} \phi_1 d\tau + 2a_1a_2 \int \phi_1^* \hat{H} \phi_2 d\tau + a_2^2 \int \phi_2^* \hat{H} \phi_2 d\tau}{a_1^2 \int \phi_1^* \phi_1 d\tau + 2a_1a_2 \int \phi_1^* \phi_2 d\tau + a_2^2 \int \phi_2^* \phi_2 d\tau} \quad (3.6)$$

In writing this equation, it was assumed that

$$\int \phi_1^* \hat{H} \phi_2 d\tau = \int \phi_2^* \hat{H} \phi_1 d\tau \quad (3.7)$$

and that

$$\int \phi_1^* \phi_2 d\tau = \int \phi_2^* \phi_1 d\tau \quad (3.8)$$

These assumptions are valid for a diatomic molecule composed of identical atoms (*homonuclear diatomic*) because ϕ_1 and ϕ_2 are identical and real in this case. In working with the quantities in

equations like Eq. (3.6), certain elements are frequently encountered. For simplicity, the definitions that will be adopted are as follows.

$$H_{11} = \int \phi_1^* \hat{H} \phi_1 d\tau \quad (3.9)$$

$$H_{12} = \int \phi_1^* \hat{H} \phi_2 d\tau \quad (3.10)$$

Because \hat{H} is the operator for total energy, H_{11} represents the binding energy of an electron in atom 1 to its nucleus. If the subscripts on the wave functions are both 2, the binding energy of electron 2 to its nucleus is indicated. Such integrals represent the energy of an electrostatic interaction so they are known as *Coulomb integrals*. Integrals of the type shown in Eq. (3.10) indicate the energy of the interaction of the electron in atom 1 with the nucleus in atom 2. Therefore, they are known as *exchange integrals*. As a result of the Hamiltonian being an operator for energy, both types of integrals represent energies. Furthermore, because these integrals represent favorable interactions, they are both negative (representing attractions) in sign.

Because the integral shown in Eq. (3.9) represents the energy with which electron 1 is bound to nucleus 1, it is simply the binding energy of the electron in atom 1. The binding energy of an electron is the reverse (with respect to sign) of the ionization potential. Therefore, it is customary to represent these Coulomb integrals in terms of the ionization potentials by reversing the sign. Although it will not be shown here, the validity of this approximation lies in a principle known as Koopmans' theorem. The valence state ionization potential (VSIP) is generally used to give the value of the Coulomb integral. This assumes that the orbitals are identical in the ion and the neutral atom. However, this relationship is not strictly correct. Suppose an electron is being removed from a carbon atom, which has a configuration of $2p^2$. Because there are two electrons in a set of three orbitals, there are 15 microstates that represent the possible permutations in placing the electrons in the orbitals. There is an exchange energy that is associated with this configuration because of the interchangeability of the electrons in the orbitals, and we say that the electrons are correlated. When one electron is removed, the single electron remaining in the $2p$ orbitals has a different exchange energy, so the measured ionization potential also has associated with it other energy terms related to the difference in exchange energy. Such energies are small compared to the ionization potential, so the VSIP energies are normally used to represent the Coulomb integrals.

The exchange integrals (also known as resonance integrals) represent the interaction of nucleus 1 with electron 2 and the interaction of nucleus 2 with electron 1. Interactions of this type must be related to the distance separating the nuclei, so the value of an exchange integral can be expressed in terms of the distance separating the atomic nuclei.

In addition to the integrals that represent energies, there are integrals of a type in which no operator occurs. These are represented as

$$S_{11} = \int \phi_1^* \phi_1 d\tau \quad (3.11)$$

$$S_{12} = \int \phi_1^* \phi_2 d\tau \quad (3.12)$$

Integrals of this type are known as *overlap integrals*, and in a general way, they represent effectiveness with which the orbitals overlap in a region of space. If the subscripts are identical, orbitals on the same atom are indicated, and if the atomic wave functions are normalized, the value of such an integral is 1. As a result, we can write

$$S_{11} = \int \phi_1^* \phi_1 d\tau = S_{22} = \int \phi_2^* \phi_2 d\tau = 1 \quad (3.13)$$

On the other hand, the integrals of the type

$$S_{12} = \int \phi_1^* \phi_2 d\tau = S_{21} = \int \phi_2^* \phi_1 d\tau \quad (3.14)$$

are related to the degree of overlap of an orbital on atom 1 with an orbital on atom 2. If the two atoms are separated by a large distance, the overlap integral approaches 0. However, if the atoms are closer together, there is some overlap of the orbitals and $S > 0$. If the atoms were forced together in such a way that the two nuclei coincided (internuclear distance is 0), we would expect $S = 1$ because the orbitals would be congruent. Clearly, the value of an overlap integral like those shown in Eq. (3.14) must be somewhere between 0 and 1, and it must be a function of the internuclear distance. With the exchange integrals and overlap integrals both being functions of the internuclear distance, it should be possible to express one in terms of the other. We will return to this point later.

The appearance of Eq. (3.6) can be simplified greatly by using the notation described earlier. When the substitutions are made, the result is

$$E = \frac{a_1^2 H_{11} + 2a_1 a_2 H_{12} + a_2^2 H_{22}}{a_1^2 + 2a_1 a_2 S_{12} + a_2^2} \quad (3.15)$$

in which we have assumed that S_{11} and S_{22} are both equal to 1 because of the atomic wave functions being normalized. We now seek to find values of the weighting coefficients that make the energy a minimum. To find a minimum in the energy expression, we take the partial derivatives with respect to a_1 and a_2 and set them equal to 0:

$$\left(\frac{\partial E}{\partial a_1} \right)_{a_2} = 0, \quad \left(\frac{\partial E}{\partial a_2} \right)_{a_1} = 0 \quad (3.16)$$

When the differentiations are carried out with respect to a_1 and a_2 in turn while keeping the other constant, we obtain two equations that after simplification can be written as

$$a_1(H_{11} - E) + a_2(H_{12} - S_{12}E) = 0 \quad (3.17)$$

$$a_1(H_{21} - S_{21}E) + a_2(H_{22} - E) = 0 \quad (3.18)$$

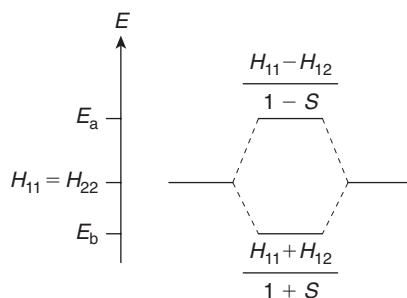

■ FIGURE 3.3 Combination of two s orbitals to produce bonding and antibonding orbitals.

These equations are known as the *secular equations*, and in them the weighting coefficients a_1 and a_2 are the unknowns. These equations constitute a pair of linear equations that can be written in the form

$$ax + by = 0 \quad \text{and} \quad cx + dy = 0 \quad (3.19)$$

It can be shown that a nontrivial solution for a pair of linear equations requires that the determinant of the coefficients must be equal to 0. This means that

$$\begin{vmatrix} H_{11} - E & H_{12} - S_{12}E \\ H_{21} - S_{21}E & H_{22} - E \end{vmatrix} = 0 \quad (3.20)$$

The molecule being described is a homonuclear diatomic, so $H_{12} = H_{21}$ and $S_{12} = S_{21}$. If we represent S_{12} and S_{21} by S and let $H_{11} = H_{22}$, the expansion of the determinant yields

$$(H_{11} - E)^2 - (H_{12} - SE)^2 = 0 \quad (3.21)$$

By equating the two terms on the left-hand side of Eq. (3.21), taking the square root gives

$$H_{11} - E = \pm (H_{12} - SE) \quad (3.22)$$

from which we find two values for E (denoted as E_b and E_a):

$$E_b = \frac{H_{11} + H_{12}}{1 + S} \quad \text{and} \quad E_a = \frac{H_{11} - H_{12}}{1 - S} \quad (3.23)$$

The energy state labeled E_b is known as the *bonding* or *symmetric* state, whereas that designated as E_a is called the *antibonding* or *asymmetric* state. Because both H_{11} and H_{12} are *negative* (binding) energies, E_b represents the state of lower energy. Figure 3.3 shows the qualitative energy diagram for the bonding and antibonding molecular orbitals relative to the $1s$ atomic orbital.

Figure 3.4 shows a more correctly scaled energy level diagram that results for the hydrogen molecule. Note that the energy for the $1s$ atomic orbital of a hydrogen atom is at $-1312 \text{ kJ mol}^{-1}$ because the

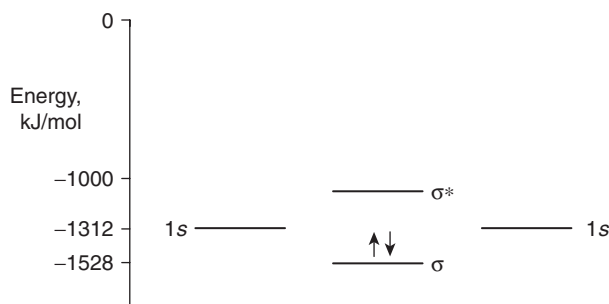

■ FIGURE 3.4 The energy level diagram for the H_2 molecule.

ionization potential is 1312 kJ mol^{-1} (13.6 eV). Note also that the *bonding* molecular orbital has an energy of $-1528 \text{ kJ mol}^{-1}$, which is *lower* than that of the $1s$ state.

If a hydrogen molecule is separated into the two constituent atoms, the result is equivalent to taking the two electrons in the bonding molecular orbital and placing them back in the atomic orbitals. Because there are two electrons, that energy would be $2(1528 - 1312) = 432 \text{ kJ mol}^{-1}$, the bond energy of the H_2 molecule. From the molecular orbital diagram, it can be seen that although the energy of the antibonding state is higher than that of the hydrogen atom, it is still very *negative*. An energy of 0 does not result because even when the atoms are completely separated, the energy of the system is the sum of the binding energies in the atoms, which is $2(-1312) \text{ kJ mol}^{-1}$. The bonding and antibonding states are “split” above and below the energy state of the electron in an atom, not above and below an energy of 0. However, the antibonding state is raised a greater amount than the bonding state is lowered relative to the atomic orbital energy. This can be seen from the relationships shown in Eqs. (3.23) because in the first case the denominator is $(1 + S)$ while in the other it is $(1 - S)$.

If we substitute the values for the energy as shown in Eq. (3.23) into the secular equations, we find that

$$a_1 = a_2 (\text{for the symmetric state}) \text{ and } a_1 = -a_2 (\text{for the antisymmetric state})$$

When these relationships between the weighting coefficients are used, it is found that

$$\psi_b = a_1\phi_1 + a_2\phi_2 = \frac{1}{\sqrt{2 + 2S}}(\phi_1 + \phi_2) \quad (3.24)$$

$$\psi_a = a_1\phi_1 - a_2\phi_2 = \frac{1}{\sqrt{2 - 2S}}(\phi_1 - \phi_2) \quad (3.25)$$

If we let A represent the normalization constant, the condition for normalization is that

$$1 = \int A^2(\phi_1 + \phi_2) d\tau = A^2 \left[\int \phi_1^2 d\tau + \int \phi_2^2 d\tau + 2 \int \phi_1\phi_2 d\tau \right] \quad (3.26)$$

The first and second integrals on the right-hand side of this equation evaluate to 1 because the atomic wave functions are assumed to be normalized. Therefore, the right-hand side of the equation reduces to

$$1 = A^2[1 + 1 + 2S] \quad (3.27)$$

and we find that the normalization constant is given by

$$A = \frac{1}{\sqrt{2 + 2S}} \quad (3.28)$$

and the wave functions can be represented as shown in Eqs. (3.24) and (3.25).

Although we have dealt with a diatomic molecule consisting of two hydrogen atoms, the procedure is exactly the same if the molecule is Li_2 , except that the atomic wave functions are $2s$ wave functions and the energies involved are those appropriate to lithium atoms. The VSIP for lithium is only 513 kJ mol^{-1} rather than 1312 kJ mol^{-1} as it is for hydrogen.

When performing molecular orbital calculations, overlap and exchange integrals must be evaluated. With modern computing techniques, overlap integrals are most often evaluated as part of the calculation. The wave functions are of the Slater type (see Section 2.4), and the overlap integrals can be evaluated for varying bond lengths and angles. Many years ago, it was common for the values of overlap integrals to be looked up in a massive set of tables that presented the values of the overlap integrals for the various combinations of atomic orbitals and internuclear distances. These tables, known as the Mulliken tables, were prepared by R. A. Mulliken and coworkers, and they were essential for giving part of the data needed to perform molecular orbital calculations.

The exchange integrals, H_{ij} , are evaluated by representing them as functions of the Coulomb integrals, H_{ii} , and the overlap integrals. One such approximation is known as the Wolfsberg-Helmholtz approximation, which is written as

$$H_{12} = -KS \left(\frac{H_{11} + H_{22}}{1 + S} \right) \quad (3.29)$$

where H_{11} and H_{22} are the Coulomb integrals for the two atoms, S is the overlap integral, and K is a constant having a numerical value of approximately 1.75. Because the overlap integral is a function of the bond length, so is the exchange integral.

The quantity $(H_{11} + H_{22})$ may not be the best way to combine Coulomb integrals for cases where the atoms have greatly different ionization potentials. In such cases, it is preferable to use the Ballhausen-Gray approximation,

$$H_{12} = -KS(H_{11}H_{22})^{\frac{1}{2}} \quad (3.30)$$

Another useful approximation for the H_{12} integral is that known as the Cusachs approximation and is written as

$$H_{12} = \frac{1}{2} S(K - |S|)(H_{11} + H_{22}) \quad (3.31)$$

Although the energy of a chemical bond as a function of internuclear distance can be represented by the potential energy curve shown in Figure 3.2, neither the Wolfsberg-Helmholtz nor the Ballhausen-Gray approximation is a function that possesses a minimum. However, the approximation of Cusachs is a mathematical expression that does pass through a minimum.

It has already been shown that the energy of the bonding molecular orbital can be written as $E_b = (H_{11} + H_{12})/(1 + S)$. Suppose there are two electrons in a bonding orbital having this energy and the bond is being broken. If the bond breaking is homolytic (one electron ends up on each atom), the electrons will reside in atomic orbitals having an energy of H_{11} (which is the same as H_{22} if a homonuclear molecule is being disrupted). Before the bond is broken, the two electrons have a total energy that is given by the expression $2[(H_{11} + H_{12})/(1 + S)]$, and after the bond is broken the binding energy for the two electrons is $2H_{11}$. Therefore, the bond energy (BE) can be expressed as

$$BE = 2H_{11} - 2\left(\frac{H_{11} + H_{12}}{1 + S}\right) \quad (3.32)$$

In order to use this equation to calculate a bond energy, it is necessary to have the values for H_{12} (the values for the H_{ii} integrals are usually available by approximating from the ionization potentials) and S . To a rough approximation (known as neglecting the overlap), the value of S can be assumed to be 0 because the value is small (in the range 0.1 to 0.4) in many cases.

3.2 THE H_2^+ AND H_2 MOLECULES

The simplest diatomic molecule consists of two nuclei and a single electron. That species, H_2^+ , has properties some of which are well known. For example, in H_2^+ the internuclear distance is 104 pm and the bond energy is 268 kJ/mol. Proceeding as illustrated in the previous section, the wave function for the bonding molecular orbital can be written as

$$\psi_b = a_1\phi_1 + a_2\phi_2 = \frac{1}{\sqrt{2 + 2S}}(\phi_1 + \phi_2) \quad (3.33)$$

This wave function describes a bonding orbital of the σ type that arises from the combination of two $1s$ wave functions for atoms 1 and 2. To make that point clear, the wave function could be written as

$$\psi_b(\sigma) = a_1\phi_{1(1s)} + a_2\phi_{2(1s)} = \frac{1}{\sqrt{2 + 2S}}(\phi_{1(1s)} + \phi_{2(1s)}) \quad (3.34)$$

The foregoing expression is actually a one-electron wave function, which is adequate in this case but not for the H_2 molecule. The energy associated with this molecular orbital can be calculated as shown in Eq. (3.4), from which we obtain

$$E[\psi_b(\sigma)] = \int [\psi_b(\sigma)] \hat{H} [\psi_b(\sigma)] d\tau \quad (3.35)$$

When the approximation is made that the overlap can be neglected, $S = 0$ and the normalization constant is $1/2^{1/2}$. Therefore, after substituting the results shown in Eq. (3.34) for $\psi_b(\sigma)$ the expression for the energy of the molecular orbital can be written as

$$E[\psi_b(\sigma)] = \frac{1}{2} \int (\phi_{1(1s)} + \phi_{2(1s)}) \hat{H} (\phi_{1(1s)} + \phi_{2(1s)}) d\tau \quad (3.36)$$

Separating the integral gives

$$E[\psi_b(\sigma)] = \frac{1}{2} \int \phi_{1(1s)} \hat{H} \phi_{1(1s)} d\tau + \frac{1}{2} \int \phi_{2(1s)} \hat{H} \phi_{2(1s)} d\tau + \frac{1}{2} \int \phi_{1(1s)} \hat{H} \phi_{2(1s)} d\tau + \frac{1}{2} \int \phi_{2(1s)} \hat{H} \phi_{1(1s)} d\tau \quad (3.37)$$

As we saw earlier, the first two terms on the right-hand side of this equation represent the electron binding energies in atoms 1 and 2, respectively, which are H_{11} and H_{22} , the Coulomb integrals. The last two terms represent the exchange integrals, H_{12} and H_{21} . In this case, $H_{11} = H_{22}$ and $H_{12} = H_{21}$ because the nuclei are identical. Therefore, the energy of the orbital is

$$E[\psi_b(\sigma)] = \frac{1}{2}H_{11} + \frac{1}{2}H_{11} + \frac{1}{2}H_{12} + \frac{1}{2}H_{12} = H_{11} + H_{12} \quad (3.38)$$

Although the development will not be shown here, the energy of the antibonding orbital can be written as

$$E[\psi_a(\sigma)] = \frac{1}{2}H_{11} + \frac{1}{2}H_{11} - \frac{1}{2}H_{12} - \frac{1}{2}H_{12} = H_{11} - H_{12} \quad (3.39)$$

We have already noted that in the case where $S = 0$, the molecular orbitals reside above and below the atomic states by an amount H_{12} . Using this approach, the calculated values for the bond energy and internuclear distance in H_2^+ do not agree well with the experimental values. Improved values are obtained when an adjustment in the total positive charge of the molecule is made as was done in the case of the helium atom. For H_2^+ , it turns out that the electron is acted on as if the total nuclear charge were about 1.24 rather than 2. This is essentially the same approach as that taken in the case of the helium atom (see Section 2.3). Also, the molecular orbital wave function was constructed by taking a linear combination of $1s$ atomic wave functions. A better approach is to take an atomic wave function that contains not only s character but also a contribution from the $2p_z$ orbital that lies along the internuclear axis. When these changes are made, the agreement between the calculated and experimental properties of H_2^+ is much better.

The wave functions just described are one-electron wave functions, but the H_2 molecule has two electrons to be dealt with. In the methods of molecular orbital theory, a wave function for the

two electrons in the hydrogen molecule is formed by taking the product of the two one-electron wave functions. Therefore, the wave function for the bonding molecular orbital in H_2 is written in terms of the atomic wave functions, ϕ , as

$$\psi_{b,1}\psi_{b,2} = [\phi_{A,1} + \phi_{B,1}][\phi_{A,2} + \phi_{B,2}] \quad (3.40)$$

In this case, the subscript b indicates the bonding (σ) orbital, A and B subscripts denote the two nuclei, and subscripts 1 and 2 denote electrons 1 and 2, respectively. Expanding the expression on the right-hand side of Eq. (3.40) gives

$$\psi_{b,1}\psi_{b,2} = \phi_{A,1}\phi_{B,2} + \phi_{A,2}\phi_{B,1} + \phi_{A,1}\phi_{A,2} + \phi_{B,1}\phi_{B,2} \quad (3.41)$$

In this expression, the term $\phi_{A,1}\phi_{B,2}$ essentially represents the interaction of two $1s$ orbitals for hydrogen atoms A and B. The term $\phi_{A,2}\phi_{B,1}$ represents the same type of interaction with the electrons interchanged. However, the term $\phi_{A,1}\phi_{A,2}$ represents *both* electrons 1 and 2 interacting with nucleus A. That means the structure described by the wave function is ionic, $H_A^- H_B^+$. In an analogous way, the term $\phi_{B,1}\phi_{B,2}$ represents both electrons interacting with nucleus B, which corresponds to the structure $H_A^+ H_B^-$. Therefore, what we have devised for a molecular wave function actually describes the hydrogen molecule as a "hybrid" (a valence bond term that is applied incorrectly) of

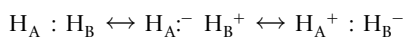

As in the case of the H_2^+ molecule, the calculated properties (bond energy and bond length) of the H_2 molecule do not agree well with the experimental values when this wave function is utilized. An improvement is made by allowing the nuclear charge to be a variable with the optimum value being about 1.20. Additional improvement between calculated and experimental values is achieved when the atomic wave functions are not considered to be pure $1s$ orbitals but rather allow some mixing of the $2p$ orbitals. Also, the wave function shown in Eq. (3.41) makes no distinction in the weighting given to the covalent and ionic structures. Our experience tells us that for identical atoms that have the same electronegativity, an ionic structure would not be nearly as significant as a covalent one. Therefore, weighting parameters should be introduced that adjust the contributions of the two types of structures to reflect the chemical nature of the molecule.

The preceding discussion is presented in order to show how the basic ideas of the molecular orbital approach are employed. It is also intended to show how to approach getting improved results after the basic ideas are used to generate molecular wave functions. For the purposes here, it is sufficient to indicate the nature of the changes rather than presenting quantitative results of the calculations.

A simple interpretation of the nature of a covalent bond can be seen by considering some simple adaptations of the wave function. For example, it is ψ^2 that is related to probability of finding the electrons. When we write the wave function for a bonding molecular orbital as ψ_b , that means that because $\psi_b = \phi_A + \phi_B$,

$$\psi_b^2 = (\phi_A + \phi_B)^2 = \phi_A^2 + \phi_B^2 + 2\phi_A\phi_B \quad (3.42)$$

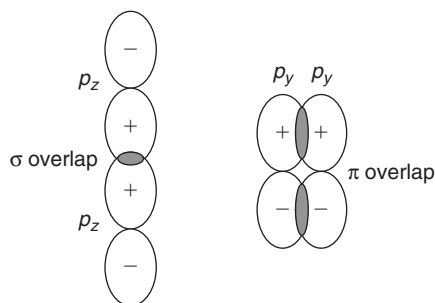

■ FIGURE 3.5 Possible ways for overlap of p orbitals to occur.

Because the last term (when integration is performed over all space) becomes

$$\int \phi_A \phi_B d\tau$$

which is actually an overlap integral. The expression in Eq. (3.42) indicates that there is an *increased* probability of finding the electrons between the two nuclei as a result of orbital overlap. This is, of course, for the *bonding* molecular orbital. For the antibonding orbital the combination of atomic wave functions is written as

$$\psi_a^2 = (\phi_A - \phi_B)^2 = \phi_A^2 + \phi_B^2 - 2\phi_A\phi_B \quad (3.43)$$

This expression indicates that there is a decreased probability (indicated by the term $-2\phi_A\phi_B$) of finding the electrons in the region between the two nuclei. In fact, there is a nodal plane between the positive and negative (with respect to algebraic sign) of the two regions of the molecular orbital. As a simple definition, we can describe a covalent bond as the increased probability of finding electrons between two nuclei or an increase in electron density between the two nuclei when compared to the probability or density that would exist simply because of the presence of two atoms.

3.3 DIATOMIC MOLECULES OF SECOND-ROW ELEMENTS

The basic principles dealing with the molecular orbital description of the bonding in diatomic molecules have been presented in the previous section. However, somewhat different considerations are involved when second-row elements are involved in the bonding because of the differences between s and p orbitals. When the orbitals being combined are p orbitals, the lobes can combine in such a way that the overlap is symmetric around the internuclear axis. Overlap in this way gives rise to a σ bond. This type of overlap involves p orbitals for which the overlap is essentially “end on” as shown in Figure 3.5. For reasons that will become clear later, it will be assumed that the p_z orbital is the one used in this type of combination.

The essential idea is that orbital lobes of the same sign can lead to favorable overlap (the overlap integral has a value >0). This can occur between orbitals of different types in several ways. Figure 3.6 shows a few of the types of orbital overlap that lead to bonding. As we shall see in later chapters, some of these types are quite important.

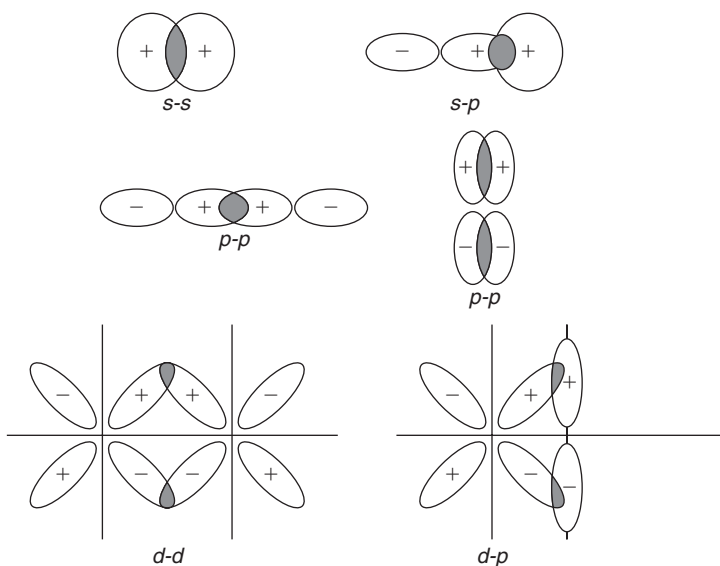

■ **FIGURE 3.6** Some types of orbital overlap that lead to energetically favorable interactions.

Representing the p_z orbitals on atoms 1 and 2 by z_1 and z_2 , the combinations of atomic wave functions can be shown as

$$\psi(\sigma_z) = \frac{1}{\sqrt{2 + 2S}} [\phi(z_1) + \phi(z_2)] \quad (3.44)$$

$$\psi(\sigma_z)^* = \frac{1}{\sqrt{2 - 2S}} [\phi(z_1) - \phi(z_2)] \quad (3.45)$$

After the σ bond has formed, further interaction of the p orbitals on the two atoms is restricted to the p_x and p_y orbitals, which are perpendicular to the p_z orbital. When these orbitals interact, the region of orbital overlap is not symmetrical around the internuclear axis but rather on either side of the internuclear axis, and a π bond results. Orbital overlap of this type is also shown in Figures 3.5 and 3.6. The combinations of wave functions for the bonding π orbitals can be written as

$$\psi(\pi_x) = \frac{1}{\sqrt{2 + 2S}} [\phi(x_1) + \phi(x_2)] \quad (3.46)$$

$$\psi(\pi_y) = \frac{1}{\sqrt{2 + 2S}} [\phi(y_1) + \phi(y_2)] \quad (3.47)$$

The two bonding π orbitals represented by these wave functions are degenerate. The wave functions for the antibonding states are identical in form except that negative signs are used in the combination of atomic wave functions and in the normalization constants.

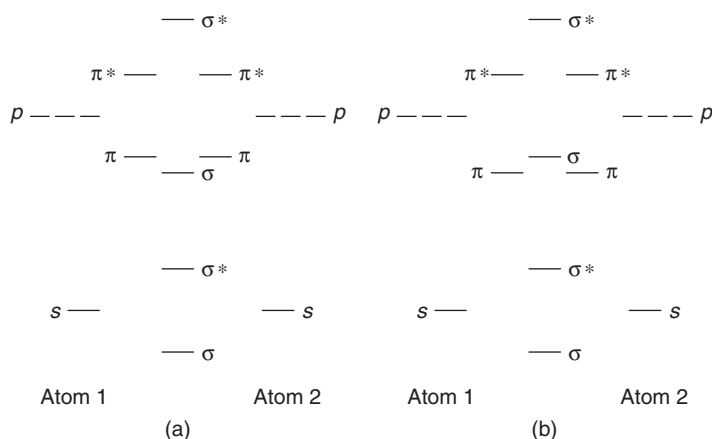

■ **FIGURE 3.7** Energy level diagrams for diatomic molecules of second-row elements. Early members of the series follow the diagram shown in (b), whereas later members follow (a).

The combination of three p orbitals on one atom with three p orbitals on another leads to the formation of one σ and two π bonding molecular orbitals. The order in which the orbitals are populated is

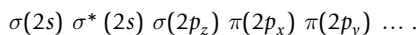

It might be assumed that the $\sigma(2p_z)$ orbital would always have a lower energy than the two π orbitals, but that is not necessarily the case. Orbitals of similar energy interact best when combining as a result of hybridization. Mixing of the $2s$ and $2p_z$ orbitals is allowed in terms of symmetry (see Chapter 5), but the $2s$ and $2p_x$ or $2p_y$ results in zero overlap because they are orthogonal. For the elements early in the second period where the nuclear charge is low, the $2s$ and $2p$ orbitals are similar in energy, so it is possible for them to hybridize extensively. For the later members of the group (N, O, and F), the higher nuclear charge causes the difference in energy between the $2s$ and $2p$ orbitals to be great enough that they cannot hybridize effectively. One result of hybridizing orbitals is that their energies are changed, and in this case that results in the order of filling the σ and π orbitals to be reversed so that for B_2 and C_2 , there is experimental evidence to show that the π orbitals lie lower in energy than the σ orbital. For the atoms later in the second period, the extent of hybridization of the $2s$ and $2p$ orbitals is slight, which results in the σ orbital lying lower in energy than the two π orbitals. The order of filling the molecular orbitals is

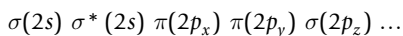
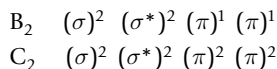

Figure 3.7 shows both of the molecular orbital energy diagrams that result for diatomic molecules of second-row elements.

The fact that the B_2 molecule is paramagnetic shows that the highest occupied molecular orbitals (usually abbreviated as HOMO) are the degenerate π orbitals, each of which is occupied by one electron.

Further evidence that this is the correct energy level scheme to be used for C_2 comes from the fact that the molecule is diamagnetic. The molecular orbital configurations for these molecules can be written as



Sometimes, these configurations are shown with the atomic orbitals indicated from which the molecular orbitals arise. For example, B_2 could be described as

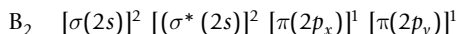

Although the subject of symmetry has not yet been discussed in this book, it is true that σ orbitals that are bonding in character have "g" symmetry because the wave functions are symmetric with respect to the center of the bond. Essentially, this means that if $\psi(x, y, z)$ is equal to $\psi(-x, -y, -z)$, the function is said to be an even function or to have *even parity*. This is signified by "g," which comes from the German word *gerade*, meaning "even." If $\psi(x, y, z)$ is equal to $-\psi(-x, -y, -z)$ the function has *odd parity* and it is indicated by "u" which comes from the word *ungerade*, meaning "uneven." An atomic s orbital is g whereas a p orbital is u in symmetry. Although a bonding σ orbital is g, π bonding orbitals have u symmetry because they are antisymmetric with respect to the internuclear axis. Antibonding molecular orbitals of each type have the symmetry labels reversed. Sometimes the symmetry character of the molecular orbital is indicated by means of a subscript. When this is done, the representation for B_2 is

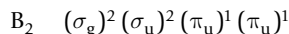

Molecular orbitals are sometimes given numerical prefixes to show the order in which the orbitals having those type and symmetry designations are encountered. When this is done, the order of filling the molecular orbitals for the second-row elements is shown as

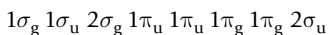

In this case, "1" indicates the first instance where an orbital of that type is encountered. A "2" indicates the second time an orbital having the designation following the number is encountered. The various ways to identify molecular orbitals are shown here because different schemes are sometimes followed by different authors.

In writing these configurations for diatomic molecules of second-row elements, we have omitted the electrons from the $1s$ orbitals because they are not part of the valence shells of the atoms. When considering the oxygen molecule, for which the σ orbital arising from the combinations of the $2p_z$ orbitals lies lower in energy than the π orbitals, we find that the electron configuration is

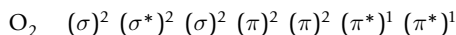

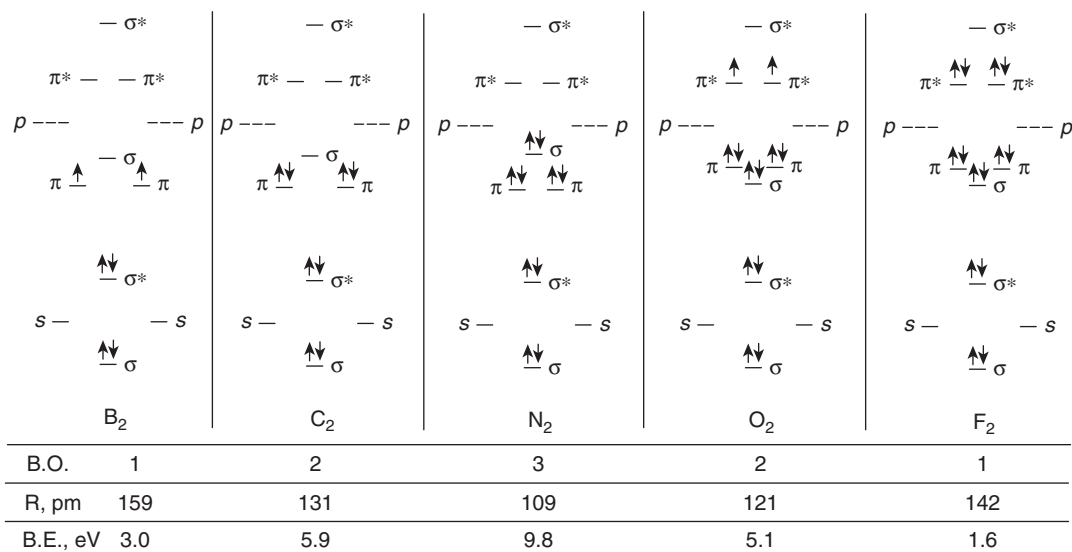

■ **FIGURE 3.8** Molecular orbital diagrams for second-row homonuclear diatomic molecules.

Note that there are two unpaired electrons in the degenerate π^* orbitals, and as a result, the oxygen molecule is paramagnetic. Figure 3.8 shows the orbital energy diagrams for the diatomic molecules of the second-row elements. Keep in mind that in these molecular orbital diagrams the atomic orbitals are not all at the same energy, so neither do the molecular orbitals of the same type have the same energy for different molecules.

A concept that is important when considering bonds between atoms is the *bond order*, B . The bond order is a measure of the *net* number of electron pairs used in bonding. It is related to the number of electrons in bonding orbitals (N_b) and the number in antibonding orbitals (N_a) by the equation

$$B = \frac{1}{2}(N_b - N_a) \quad (3.48)$$

The bond order for each diatomic molecule is given in Figure 3.8, as is the bond energy. Note that there is a general increase in bond energy as the bond order increases. This fact makes it possible to see why certain species behave as they do. For example, the bond order for the O_2 molecule is $(8 - 4)/2 = 2$, and we say that a bond order of 2 is equivalent to a double bond. If an electron is removed from an oxygen molecule, the species O_2^+ results, and the electron removed comes from the highest occupied orbital, which is a π^* (antibonding) orbital. The bond order for O_2^+ is $(8 - 3)/2 = 2.5$, which is higher than that of the O_2 molecule. Because of this, it is not at all unreasonable to expect there to be some reactions in which an oxygen molecule reacts by losing an electron to form O_2^+ , the dioxygenyl cation. Of course, such a reaction would require the reaction of oxygen with a very strong oxidizing

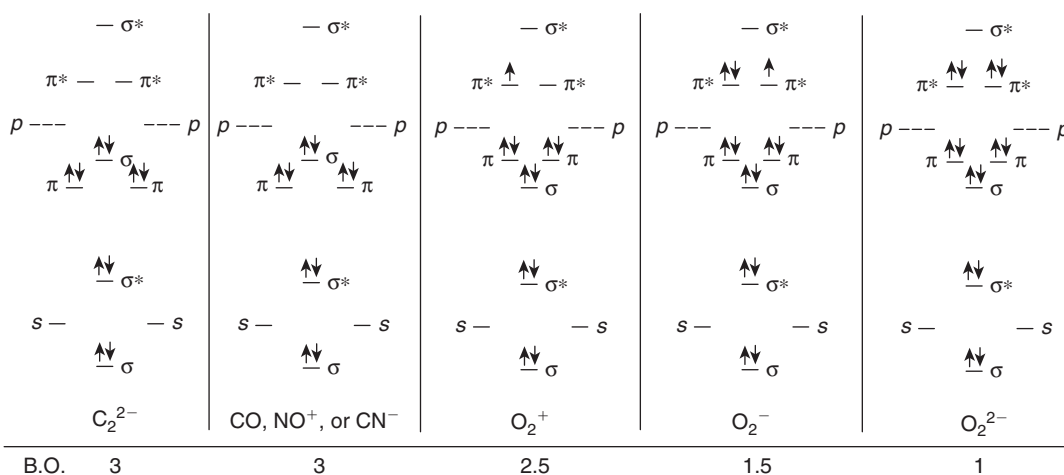

■ FIGURE 3.9 Molecular orbital diagrams for some heteronuclear molecules and ions of second-row elements.

agent. One such oxidizing agent is PtF_6 which contains platinum in the +6 oxidation state. The reaction with oxygen can be written as



Although this reaction shows the formation of O_2^+ , it is also possible to add one electron to the O_2 molecule to produce O_2^- , the superoxide ion, or two electrons to form O_2^{2-} , the peroxide ion. In each case, the electrons are added to the antibonding π^* orbitals, which reduces the bond order from the value of 2 in the O_2 molecule. For O_2^- the bond order is 1.5, and it is only 1 for O_2^{2-} , the peroxide ion. The O–O bond energy in the peroxide ion has a strength of only 142 kJ mol^{-1} and, as expected, most peroxides are very reactive compounds. The superoxide ion is produced by the reaction



In addition to the homonuclear molecules, the elements of the second period form numerous important and interesting heteronuclear species, both neutral molecules and diatomic ions. The molecular orbital diagrams for several of these species are shown in Figure 3.9. Keep in mind that the energies of the molecular orbitals having the same designations are not equal for these species. The diagrams are only qualitatively correct.

It is interesting to note that both CO and CN^- are isoelectronic with the N_2 molecule. That is, they have the same number and arrangement of electrons as the N_2 molecule. However, as we will see later, these species are quite different from N_2 in their chemical behavior. The properties of many homonuclear and heteronuclear molecules and ions are presented in Table 3.1.

Table 3.1 Characteristics of Some Diatomic Species.

Species	N_b	N_a	B^a	R , pm	DE^b , eV
H_2^+	1	0	0.5	106	2.65
H_2	2	0	1	74	4.75
He_2^+	2	1	0.5	108	3.1
Li_2	2	0	1	262	1.03
B_2	4	2	1	159	3.0
C_2	6	2	2	131	5.9
N_2	8	2	3	109	9.76
O_2	8	4	2	121	5.08
F_2	8	6	1	142	1.6
Na_2	2	0	1	308	0.75
Rb_2	2	0	1	—	0.49
S_2	8	4	2	189	4.37
Se_2	8	4	2	217	3.37
Te_2	8	4	2	256	2.70
N_2^+	7	2	2.5	112	8.67
O_2^+	8	3	2.5	112	6.46
BN	6	2	2	128	4.0
BO	7	2	2.5	120	8.0
CN	7	2	2.5	118	8.15
CO	8	2	3	113	11.1
NO	8	3	2.5	115	7.02
NO^+	8	2	3	106	—
SO	8	4	2	149	5.16
PN	8	2	3	149	5.98
SiO	8	2	3	151	8.02
LiH	2	0	1	160	2.5
NaH	2	0	1	189	2.0
PO	8	3	2.5	145	5.42

^a B is the bond order, $(N_a - N_b)/2$.

^b DE is the dissociation energy (1 eV = 96.48 kJ mol⁻¹).

3.4 PHOTOELECTRON SPECTROSCOPY

Most of what we know about the structure of atoms and molecules has been obtained by studying the interaction of electromagnetic radiation with matter. Line spectra reveal the existence of shells of different energy where electrons are held in atoms. From the study of molecules by means of infrared spectroscopy, we obtain information about vibrational and rotational states of molecules. The types of bonds present, the geometry of the molecule, and even bond lengths may be determined in specific cases. The spectroscopic technique known as photoelectron spectroscopy (PES) has been of enormous importance in determining how electrons are bound in molecules. This technique provides direct information on the energies of molecular orbitals in molecules.

In PES, high-energy photons are directed to the target from which electrons are ejected. The photon source that is frequently employed is the He(I) source, which emits photons having an energy of 21.22 eV as the excited state $2s^1 2p^1$ relaxes to the $1s^2$ ground state. The ionization potential for the hydrogen atom is 13.6 eV, and the first ionization potential for many molecules is of comparable magnitude. The principle on which PES works is that a photon striking an electron causes the electron to be ejected. The kinetic energy of the ejected electron will be

$$\frac{1}{2} mv^2 = h\nu - I \quad (3.51)$$

where $h\nu$ is the energy of the incident photon and I is the ionization potential for the electron. This situation is somewhat analogous to the photoelectric effect (see Section 1.2). In PES, a molecule, M , is ionized by a photon,



Electrons that are ejected are passed through an analyzer, and by means of a variable voltage, electrons having different energies can be detected. The numbers of electrons having specific energies are counted, and a spectrum showing the number of electrons emitted (intensity) versus energy is produced. In most cases, when an electron is removed during ionization, most molecules are in their lowest vibrational state. Spectra for diatomic molecules show a series of closely spaced peaks that correspond to ionization that leads to ions that are in excited vibrational states. If ionization takes place with the molecule in its lowest vibrational state to produce the ion in its lowest vibrational state, the transition is known as an *adiabatic ionization*. When a diatomic molecule is ionized, the most intense absorption corresponds to ionization with the molecule and the resulting ion having the same bond length (see Section 17.6). This is known as the *vertical ionization*, and it leads to the ion being produced in excited vibrational states. In general, the molecule and the ion have nearly identical bond lengths when the electron is ejected from a nonbonding orbital.

Applications of the PES technique to molecules have yielded an enormous amount of information regarding molecular orbital energy levels. For example, PES has shown that the bonding π orbitals in oxygen are higher in energy than the σ orbital arising from the combination of the $2p$ wave functions. For nitrogen, the reverse order of orbitals is found. When electrons are ejected from the bonding σ_{2p} orbital of O_2 , two absorption bands are observed. There are two electrons populating that orbital, one

with a spin of $+1/2$ and the other with a spin of $-1/2$. If the electron removed has a spin of $-1/2$, the electron having a spin of $+1/2$ remains, and it can interact with the two electrons in the π^* orbitals that have spins of $+1/2$. This can be shown as follows, where $(\sigma)^{1(+1/2)}$ means that there is one electron having a spin of $+1/2$ in the σ orbital, and so forth.

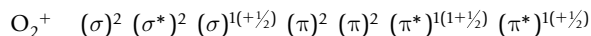

If the electron removed from the σ orbital has a spin of $+1/2$, the resulting O_2^+ ion is

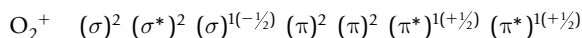

These two O_2^+ ions have slightly different energies, as is exhibited by their photoelectron spectra. Studies such as these have contributed greatly to our understanding of molecular orbital energy diagrams. We will not describe the technique further, but more complete details of the method and its use can be found in the references at the end of this chapter.

3.5 HETERONUCLEAR DIATOMIC MOLECULES

Atoms do not all have the same ability to attract electrons. When two different types of atoms form a covalent bond by sharing a pair of electrons, the shared pair of electrons will spend more time in the vicinity of the atom that has the greater ability to attract them. In other words, the electron pair is *shared*, but it is not shared *equally*. The ability of an atom in a molecule to attract electrons to it is expressed as the *electronegativity* of the atom. Earlier, for a homonuclear diatomic molecule we wrote the combination of two atomic wave functions as

$$\psi = a_1\phi_1 + a_2\phi_2 \quad (3.53)$$

where we did not have to take into account the difference in the ability of two atoms to attract electrons. For two different types of atoms, we can write the wave function for the bonding molecular orbital as

$$\psi = \phi_1 + \lambda\phi_2 \quad (3.54)$$

where the parameter λ is a weighting coefficient. Actually, a weighting coefficient for the wave function of one atom is assumed to be 1, and a different weighting factor, λ , is assigned for the other atom depending on its electronegativity.

When two atoms share electrons unequally, it means that the bond between them is polar. Another way to describe this is to say that the bond has *partial ionic character*. For the molecule AB, this is equivalent to drawing two structures, one of which is covalent and the other ionic. However, there are actually three structures that can be drawn



If we write a wave function for the molecule to show a combination of these structures, it is written as

$$\psi_{\text{molecule}} = a\psi_{\text{I}} + b\psi_{\text{II}} + c\psi_{\text{III}} \quad (3.56)$$

where a , b , and c are constants and ψ_{I} , ψ_{II} , and ψ_{III} are wave functions that correspond to the structures I, II, and III, respectively. Generally, we have some information about the magnitudes of a , b , and c . For example, if the molecule being considered is HF, the resonance structure $\text{H}^- \text{F}^+$ will contribute very little to the actual structure of the molecule. It is contrary to the chemical nature of the H and F atoms to have a structure with a negative charge on H and a positive charge on F. Accordingly, the weighting coefficient for structure III must be approximately 0. For molecules that are predominantly covalent in nature, even structure II will make a smaller contribution than will structure I.

The dipole moment, μ , for a diatomic molecule (the situation for polyatomic molecules that have several bonds is more complex) can be expressed as

$$\mu = q \times r \quad (3.57)$$

where q is the quantity of charge separated and r is the distance of separation. If an electron were completely transferred from one atom to the other, the quantity of charge separated would be e , the charge on an electron. For bonds in which an electron pair is shared unequally, q is less than e , and if the sharing is equal there is no charge separation, $q = 0$, and the molecule is nonpolar. For a polar molecule, there is only one bond length, r . Therefore, the ratio of the actual or observed dipole moment (μ_{obs}) to that assuming complete transfer of the electron (μ_{ionic}) will give the ratio of the amount of charge separated to the charge of an electron:

$$\frac{\mu_{\text{obs}}}{\mu_{\text{ionic}}} = \frac{q \cdot r}{e \cdot r} = \frac{q}{e} \quad (3.58)$$

The ratio q/e gives the fraction of an electron that appears to be transferred from one atom to another. This ratio can also be considered as the partial ionic character of the bond between the atoms. It follows that the percent of ionic character is 100 times the fraction of ionic character. Therefore,

$$\% \text{ Ionic character} = \frac{100 \mu_{\text{obs}}}{\mu_{\text{ionic}}} \quad (3.59)$$

The actual structure of HF can be represented as a composite of the covalent structure H–F, in which there is equal sharing of the bonding electron pair, and the ionic structure $\text{H}^+ \text{F}^-$, where there is complete transfer of an electron from H to F. Therefore, the wave function for the HF molecule wave function can be written in terms of the wave functions for those structures as

$$\psi_{\text{molecule}} = \psi_{\text{covalent}} + \lambda\psi_{\text{ionic}} \quad (3.60)$$

The squares of the coefficients in a wave function are related to probability. Therefore, the total contribution from the two structures is $1^2 + \lambda^2$ while the contribution from the ionic structure is given by λ^2 . As a result, $\lambda^2/(1^2 + \lambda^2)$ gives the fraction of ionic character to the bond and

$$\% \text{ Ionic character} = \frac{100\lambda^2}{(1 + \lambda^2)} \quad (3.61)$$

because $1^2 = 1$. Therefore,

$$\frac{\mu_{\text{obs}}}{\mu_{\text{ionic}}} = \frac{\lambda^2}{(1 + \lambda^2)} \quad (3.62)$$

For the HF molecule, the bond length is 0.92 \AA ($0.92 \times 10^{-8} \text{ cm} = 0.92 \times 10^{-10} \text{ m}$) and the measured dipole moment is 1.91 debye or $1.91 \times 10^{-18} \text{ esu cm}$. If an electron were completely transferred from H to F, the dipole moment (μ_{ionic}) would be

$$\mu_{\text{ionic}} = 4.80 \times 10^{-10} \text{ esu} \times 0.92 \times 10^{-8} \text{ cm} = 4.41 \times 10^{-18} \text{ esu cm} = 4.41 \text{ D}$$

Therefore, the ratio $\mu_{\text{obs}}/\mu_{\text{ionic}}$ is 0.43, which means that

$$0.43 = \frac{\lambda^2}{(1 + \lambda^2)} \quad (3.63)$$

from which we find that $\lambda = 0.87$. Therefore, the wave function for the HF molecule can be written as

$$\psi_{\text{molecule}} = \psi_{\text{covalent}} + 0.87 \psi_{\text{ionic}} \quad (3.64)$$

From the foregoing analysis, it appears that we can consider the polar HF molecule as consisting of a hybrid made from a purely covalent structure contributing 57% and an ionic structure contributing 43% to the actual structure:

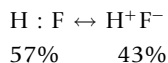

Of course, HF is actually a polar covalent molecule, but from the extent of the polarity, it behaves *as if* it were composed of the two structures shown above. A similar analysis can be carried out for all of the hydrogen halides, and the results are shown in Table 3.2.

A simple interpretation of the effect of two atoms in a diatomic molecule is seen from the molecular orbital description of the bonding. Different atoms have different ionization potentials, which results in the values for the Coulomb integrals used in a molecular orbital calculation being different. In fact, according to Koopmans' theorem, the ionization potential with the sign changed gives the value for the Coulomb integral. In terms of a molecular orbital energy level diagram, the atomic states of the two atoms are different and the bonding molecular orbital will be closer in energy to that of the atom having the higher ionization potential. For example, in the HF molecule, there is a single

Table 3.2 Parameters for Hydrogen Halide Molecules, HX.

Molecule	r , pm	μ_{obs} D	μ_{ionic} D	% Ionic character ($100 \mu_{\text{obs}} / \mu_{\text{ionic}}$)	$\chi_X - \chi_H$
HF	92	1.91	4.41	43	1.9
HCl	128	1.03	6.07	17	0.9
HBr	143	0.78	6.82	11	0.8
HI	162	0.38	7.74	5	0.4

1 debye 10^{-18} esu cm. The electronegativities of atoms H and X are χ_A and χ_B .

σ bond between the two atoms. The ionization potential for H is 1312 kJ/mol (13.6 eV), whereas that for F is 1680 kJ/mol (17.41 eV). When the wave functions for the hydrogen 1s and fluorine 2p orbital are combined, the resulting molecular orbital will have an energy that is closer to that of the fluorine orbital than to that of the hydrogen orbital. In simple terms, that means that the bonding molecular orbital is more like a fluorine orbital than a hydrogen orbital. This is loosely equivalent to saying that the electron spends more time around the fluorine atom, as we did in describing bonding in HF in valence bond terms.

The bonding in heteronuclear species can be considered as the mixing of atomic states to generate molecular orbitals with the resulting molecular orbitals having a larger contribution from the more electronegative atom. For example, the ionization potential for Li is 520 kJ/mol (5.39 eV), whereas that of hydrogen is 1312 kJ/mol (13.6 eV). Therefore, the bonding orbital in the LiH molecule will have a great deal more of the character of the hydrogen 1s orbital. In fact, the compound LiH is substantially ionic and we normally consider the hydrides of the group IA metals to be ionic. When we consider the compound LiF, the ionization potentials of the two atoms (energy of the atomic states for which the wave functions are being combined) are so different that the resulting "molecular orbital" is essentially the same as an atomic orbital on the fluorine atom. This means that in the compound, the electron is essentially transferred to the F atom when the bond forms. Accordingly, we consider LiF to be an ionic compound in which the species present are Li^+ and F^- .

3.6 ELECTRONEGATIVITY

As has just been described, when a covalent bond forms between two atoms, there is no reason to assume that the pair of electrons is shared *equally* between the atoms. What is needed is some sort of way to provide a relative index of the ability of an atom to attract electrons. Linus Pauling developed an approach to this problem by describing a property now known as the *electronegativity* of an atom. This property gives a measure of the tendency of an atom in a molecule to attract electrons. Pauling devised a way to give numerical values to describe this property that makes use of the fact that the covalent bonds between atoms of different electronegativity are more stable than if they were purely

covalent (with equal sharing of the electron pair). For a diatomic molecule AB, the actual bond energy, D_{AB} , is written as

$$D_{AB} = \frac{1}{2}[D_{AA} + D_{BB}] + \Delta_{AB} \quad (3.65)$$

where D_{AA} and D_{BB} are the bond energies in the purely covalent diatomic species A_2 and B_2 , respectively. Because the actual bond between A and B is stronger than if the bond were purely covalent, the term Δ_{AB} corrects for the additional stability. The degree to which the sharing of the electron pair is unequal depends on the property known as electronegativity. Pauling related the additional stability of the bond to the tendency of the atoms to attract electrons by means of the equation

$$\Delta_{AB} = 96.48 |\chi_A - \chi_B|^2 \quad (3.66)$$

In this equation, χ_A and χ_B are values that describe the electron-attracting ability (electronegativity) of atoms A and B, respectively. The constant 96.48 appears so that the value of Δ_{AB} will be given in kJ mol^{-1} . If the constant is 23.06, the value of Δ_{AB} will be in kcal mol^{-1} . Note that it is the *difference* between the values for the two atoms that is related to the additional stability of the bond. With the values of Δ_{AB} known for many types of bonds, it is possible to assign values for χ_A and χ_B , but only when there is a value known for at least one atom. Pauling solved this problem by *assigning* a value of 4.0 for the electronegativity of fluorine. In that way, the electronegativities of all other atoms are positive values between 0 and 4. Based on more recent bond energy values, the value of 3.98 is sometimes used. It would not have made any difference if the fluorine atom had been assigned a value of 100 because other atoms would then have electronegativities between 96 and 100.

With the electronegativity of the fluorine atom being assigned a value of 4.0, it was now possible to determine a value for hydrogen because the H-H and F-F bond energies were known, as was the bond energy for the H-F molecule. Using those bond energies, the electronegativity of H is found to be about 2.2. Keep in mind that it is only the *difference* in electronegativity that is related to the additional stability of the bond, not the actual values. Pauling electronegativity values for many atoms are shown in Table 3.3.

Whereas the approach just described is based on the average bond energy of A_2 and B_2 as described by the arithmetic mean, $\frac{1}{2}(D_{AA} + D_{BB})$, a different approach is based on the average bond energy being given by $(D_{AA} \times D_{BB})^{1/2}$. This is a geometric mean, which gives a value for the additional stability of the molecule as

$$\Delta' = D_{AB} - (D_{AA} \times D_{BB})^{1/2} \quad (3.67)$$

For molecules that are highly polar, this equation gives better agreement with the electronegativity difference between the atoms and the additional stability of the bond than does Eq. (3.65).

Pauling based electronegativity values on bond energies between atoms, but that is not the only way to approach the problem of the ability of atoms in a molecule to attract electrons. For example, the ease of removing an electron from an atom, the ionization potential, is related to its ability to attract electrons to itself. The electron affinity also gives a measure of the ability of an atom to hold on to an electron that it has gained. These *atomic* properties should therefore be related to the ability of an atom in a molecule to attract electrons. Therefore, it is natural to make use of these properties in an equation

Table 3.3 Pauling Electronegativities of Atoms.

H 2.2							
Li 1.0	Be 1.6		B 2.0	C 2.6	N 3.0	O 3.4	F 4.0
Na 1.0	Mg 1.3		Al 1.6	Si 1.9	P 2.2	S 2.6	Cl 3.2
K 0.8	Ca 1.0	Sc Zn 1.2 1.7	Ga 1.8	Ge 2.0	As 2.2	Se 2.6	Br 3.0
Rb 0.8	Sr 0.9	Y Cd 1.1 1.5	In 1.8	Sn 2.0	Sb 2.1	Te 2.1	I 2.7
Cs 0.8	Ba 0.9	La Hg 1.1 1.5	Tl 1.4	Pb 1.6	Bi 1.7	Po 1.8	At 2.0

to express the electronegativity of an atom. Such an approach was taken by Mulliken, who proposed that the electronegativity, χ , of an atom A could be expressed as

$$\chi_A = \frac{1}{2} [I_A + E_A] \quad (3.68)$$

In this equation, I_A is the ionization potential and E_A is the electron affinity for the atom, and it is the average of these two properties that Mulliken proposes to use as the electronegativity of the atom. When the energies are expressed in electron volts, the Mulliken electronegativity for the fluorine atom is 3.91 rather than the value of 4.0 assigned by Pauling. In general, the electronegativity values on the two scales do not differ by very much.

If a property is as important as is electronegativity, it is not surprising that a large number of approaches have been taken to provide measures of the property. Although we have already described two approaches, we should also mention one additional method. Allred and Rochow made use of the equation

$$\chi_A = 0.359 \left(\frac{Z^*}{r^2} \right) + 0.744 \quad (3.69)$$

In this equation, Z^* is the *effective* nuclear charge, which takes into account the fact that an outer electron is screened from experiencing the effect of the *actual* nuclear charge by the electrons that are closer to the nucleus (see Section 2.4). In principle, the Allred-Rochow electronegativity scale is based on the electrostatic interaction between valence shell electrons and the nucleus.

Probably the most important use of electronegativity values is in predicting bond polarities. For example, in the H–F bond, the shared electron pair will reside closer to the fluorine atom because it has an electronegativity of 4.0 while that of the hydrogen atom is 2.2. In other words, the electron pair is shared, but not equally. If we consider the HCl molecule, the shared electron pair will reside closer to the chlorine atom, which has an electronegativity of 3.2, but the electron pair will be shared more

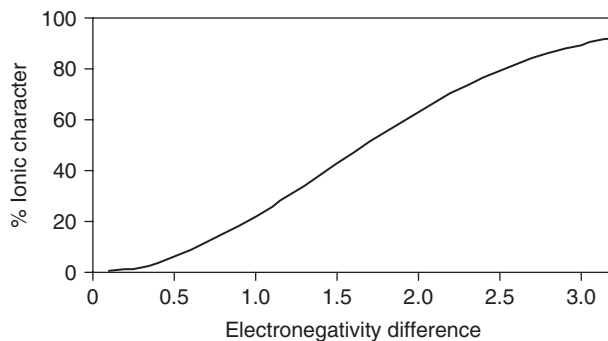

■ **FIGURE 3.10** The variation in percent ionic character to a bond and the difference in the electronegativities of the atoms.

nearly equally than is the case for HF because the difference in electronegativity is smaller for HCl. We will have many opportunities to use this principle when describing structures of inorganic compounds.

Having shown that the weighting coefficient (λ) of the term giving the contribution of an ionic structure to the molecular wave function is related to the dipole moment of the molecule, it is logical to expect that equations could be developed that relate the ionic character of a bond to the electronegativities of the atoms. Two such equations that give the percent ionic character of the bond in terms of the electronegativities of the atoms are

$$\% \text{ Ionic character} = 16 |\chi_A - \chi_B| + 3.5 |\chi_A - \chi_B|^2 \quad (3.70)$$

$$\% \text{ Ionic character} = 18 |\chi_A - \chi_B|^{1.4} \quad (3.71)$$

Although the equations look very different, the calculated values for the percent ionic character are approximately equal for many types of bonds. If the difference in electronegativity is 1.0, Eq. (3.70) predicts 19.5% ionic character while Eq. (3.71) gives a value of 18%. This difference is insignificant for most purposes. After one of these equations is used to estimate the percent ionic character, Eq. (3.61) can be used to determine the coefficient λ in the molecular wave function. Figure 3.10 shows how percent ionic character varies with the difference in electronegativity.

When the electrons in a covalent bond are shared equally, the length of the bond between the atoms can be approximated as the sum of the covalent radii. However, when the bond is polar, the bond is not only stronger than if it were purely covalent, it is also shorter. As shown earlier, the amount by which a polar bond between two atoms is stronger than if it were purely covalent is related to the difference in electronegativity between the two atoms. It follows that the amount by which the bond is shorter than the sum of the covalent radii should also be related to the difference in electronegativity. An equation that expresses the bond length in terms of atomic radii and the difference in electronegativity is the Schomaker-Stevenson equation. That equation can be written as

$$r_{AB} = r_A + r_B - 9.0 |\chi_A - \chi_B| \quad (3.72)$$

where χ_A and χ_B are the electronegativities of atoms A and B, respectively, and r_A and r_B are their covalent radii expressed in picometers. This equation provides a good approximation to bond lengths. When the correction for the difference in electronegativity is applied to polar molecules, the calculated bond lengths agree considerably better with experimental values.

In this chapter, the basic ideas related to the molecular orbital approach to covalent bonds have been presented. Other applications of the molecular orbital method will be discussed in Chapters 5 and 17.

3.7 SPECTROSCOPIC STATES FOR MOLECULES

For diatomic molecules, there is coupling of spin and orbital angular momenta by a coupling scheme that is similar to the Russell-Saunders procedure described for atoms. When the electrons are in a specific molecular orbital, they have the same orbital angular momentum as designated by the m_l value. As in the case of atoms, the m_l value depends on the type of orbital. When the internuclear axis is the z -axis, the orbitals that form σ bonds (which are symmetric around the internuclear axis) are the s , p_z , and d_{z^2} orbitals. Those which form π bonds are the p_x , p_y , d_{xz} , and d_{yz} orbitals. The $d_{x^2-y^2}$ and d_{xy} can overlap in a "sideways" fashion with one stacked above the other, and the bond would be a δ bond. For these types of molecular orbitals, the corresponding m_l values are

$$\begin{aligned}\sigma &: m_l = 0 \\ \pi &: m_l = \pm 1 \\ \delta &: m_l = \pm 2\end{aligned}$$

As in the case of atoms, the molecular term symbol is written as ^{2S+1}L , where L is the absolute value of M_L (the highest positive value). The molecular states are designated as for atoms except for the use of capital Greek letters:

$$\begin{aligned}M_L = 0 & \text{ the spectroscopic state is } \Sigma \\ M_L = 1 & \text{ the spectroscopic state is } \Pi \\ M_L = 2 & \text{ the spectroscopic state is } \Delta\end{aligned}$$

After writing the molecular orbital configuration, the vector sums are obtained. For example, in H_2 the two bonding electrons reside in a σ orbital, and they are paired so $S = +\frac{1}{2} + (-\frac{1}{2}) = 0$. As shown earlier, for a σ orbital the m_l is 0 so the two electrons combined have $M_L = 0$. Therefore, the ground state for the H_2 molecule is $^1\Sigma$. As in the case of atoms, all filled shells have $\sum s_i = 0$, which results in a $^1\Sigma$ state.

The N_2 molecule has the configuration $(\sigma)^2 (\sigma^*)^2 (\sigma)^2 (\pi)^2 (\pi)^2$, so all of the populated orbitals are filled. Therefore, the spectroscopic state is $^1\Sigma$. For O_2 the unfilled orbitals are $(\pi_x^*)^1 (\pi_y^*)^1$ and the filled orbitals do not determine the spectroscopic state. For a π orbital, $m_l = \pm 1$. These vectors could be combined with spin vectors of $\pm\frac{1}{2}$. If both spins have the same sign, $|S| = 1$ and the state will be a triplet. If the spins are opposite, $|S| = 0$ and the state is a singlet. Because $M_L = \sum m_l$ and the m_l values

for the π orbitals are ± 1 , the possible values for M_L are 2, 0, and -2 . Possible ways to combine M_S and M_L are shown below when the values are (m_l, s) :

M_L	M_S		
	1	0	-1
2		$(1, \frac{1}{2}), (1, -\frac{1}{2})$	
0	$(1, \frac{1}{2}), (-1, \frac{1}{2})$	$(1, \frac{1}{2}), (-1, -\frac{1}{2})$ $(1, -\frac{1}{2}), (-1, \frac{1}{2})$	$(1, -\frac{1}{2}), (-1, -\frac{1}{2})$
-2		$(-1, \frac{1}{2}), (-1, -\frac{1}{2})$	

Those cases for $M_L = 2$ result when the spins are *opposed* and, therefore, represent a $^1\Delta$ state. There is one combination where $M_L = 0$ with the S vector having values of $+1$, 0 , and -1 , which corresponds to $^3\Sigma$. The remaining combinations correspond to the $^1\Sigma$ term. Of these states ($^1\Delta$, $^1\Sigma$, and $^3\Sigma$), the one having the highest multiplicity lies lowest in energy, so the ground state of the O_2 molecule is $^3\Sigma$. The *ground state* could be identified quickly by simply placing the electrons in separate π orbitals with parallel spins and obtaining the M_L and M_S values.

For the CN molecule, the configuration is $(\sigma)^2 (\sigma_z)^2 (\pi_x)^2 (\pi_y)^2 (\sigma_z)^1$. The single electron in the σ_z orbital gives $M_L = 0$ and $S = \frac{1}{2}$, so the ground state is $^3\Sigma$. Several species such as N_2 , CO, NO^+ , and CN^- have the configuration $(\sigma)^2 (\sigma_z)^2 (\pi_x)^2 (\pi_y)^2 (\sigma_z)^2$, which is a closed-shell arrangement. Therefore, the ground state for these species is $^1\Sigma$. The NO molecule has the configuration $(\sigma)^2 (\sigma_z)^2 (\pi_x)^2 (\pi_y)^2 (\sigma_z)^2 (\pi_x^*)^1$, which gives rise to $S = \frac{1}{2}$ and $M_L = 1$. These values give rise to a ground state that is $^2\Pi$.

REFERENCES FOR FURTHER STUDY

- Cotton, F. A., Wilkinson, G., and Murillo, C. A. (1999). *Advanced Inorganic Chemistry*, 6th ed. John Wiley, New York. Almost 1400 pages devoted to all phases of inorganic chemistry. An excellent reference text.
- DeKock, R. L., and Gray, H. B. (1980). *Chemical Bonding and Structure*. Benjamin Cummings, Menlo Park, CA. One of the best introductions to bonding available. Highly recommended.
- Greenwood, N. N., and Earnshaw, A. (1997). *Chemistry of the Elements*, 2nd ed. Butterworth-Heinemann, New York. Although this is a standard reference text on descriptive chemistry, it contains an enormous body of information on bonding.
- House, J. E. (2003). *Fundamentals of Quantum Chemistry*. Elsevier, New York. An introduction to quantum-mechanical methods at an elementary level that includes mathematical details.
- Lide, D. R., Ed. (2003). *CRC Handbook of Chemistry and Physics*, 84th ed. CRC Press, Boca Raton, FL. Various sections in this massive handbook contain a large amount of data on molecular parameters.
- Lowe, J. P. (1993). *Quantum Chemistry*, 2nd ed. Academic Press, New York. This is an excellent book for studying molecular orbital methods at a higher level.
- Mackay, K., Mackay, R. A., and Henderson, W. (2002). *Introduction to Modern Inorganic Chemistry*, 6th ed. Nelson Thornes, Cheltenham, UK. One of the very successful standard texts in inorganic chemistry.

- Mulliken, R. S., Rieke, A., Orloff, D., and Orloff, H. (1949). Overlap integrals and chemical binding. *J. Chem. Phys.* 17, 510, and Formulas and numerical tables for overlap integrals, *J. Chem. Phys.* 17, 1248–1267. These two papers present the basis for calculating overlap integrals and show the extensive tables of calculated values.
- Pauling, L. (1960). *The Nature of the Chemical Bond*, 3rd ed. Cornell University Press, Ithaca, NY. Although somewhat dated in some areas, this is a true classic in bonding theory.
- Sharpe, A. G. (1992). *Inorganic Chemistry*, 3rd ed. Longman, New York. Excellent coverage of bonding concepts in inorganic molecules.

■ QUESTIONS AND PROBLEMS

- For each of the following, draw a molecular orbital energy level diagram and give the bond order. Tell whether the species would be more or less stable after gaining an electron. (a) O_2^+ ; (b) CN; (c) S_2 ; (d) NO; (e) Be_2^+ .
- Explain in terms of molecular orbitals why Li_2 is stable but Be_2 is not.
- Which has the greater bond energy, NO or C_2 ? Explain by making appropriate drawings.
- Numerical data are given below for the BN and BO molecules. Match the properties to these molecules and explain your answers.
Data: 120 pm, 128 pm, 8.0 eV, 4.0 eV.
- If the H–H and S–S bond energies are 266 and 432 kJ mol⁻¹, respectively, what would be the H–S bond energy?
- The stretching vibration for NO is found at 1876 cm⁻¹, whereas that for NO⁺ is at 2300 cm⁻¹. Explain this difference.
- What is the Cl–F bond length if the covalent radii of Cl and F are 99 and 71 pm, respectively? Explain your answer in terms of resonance.
- Consider a diatomic molecule A_2 in which there is a single σ bond. Excitation of an electron to the σ^* state gives rise to an absorption at 15,000 cm⁻¹. The binding energy of an electron in the valence shell of atom A is -9.5 eV.
(a) If the overlap integral has a value of 0.12, determine the value of the exchange integral, H_{12} .
(b) Calculate the actual values of the bonding and antibonding molecular orbitals for the A_2 molecule.
(c) What is the single bond energy in the A_2 molecule?
- Arrange the species O_2^{2-} , O_2^+ , O_2 , and O_2^- in the order of decreasing bond length. Explain this order in terms of molecular orbital populations.
- Explain why the electron affinity of the NO molecule is 88 kJ mol⁻¹ but that of the CN molecule is 368 kJ mol⁻¹.
- In the spectrum of the CN molecule, an absorption band centered around 9,000 cm⁻¹ appears. Explain the possible origin of this band in terms of the molecular orbitals in this molecule. What type of transition is involved?
- Consider the Li_2 molecule, which has a dissociation energy of 1.03 eV. The first ionization potential for the Li atom is 5.30 eV. Describe the bonding in Li_2 in terms of a molecular orbital energy diagram. If a value of 0.12 is appropriate for the overlap integral, what is the value of the exchange integral?
- For a molecule XY, the molecular wave function can be written as

$$\psi_{\text{molecule}} = \psi_{\text{covalent}} + 0.70 \psi_{\text{ionic}}$$

Calculate the percent of ionic character in the X–Y bond. If the X–Y bond length is 142 pm, what is the dipole moment of XY?

14. What Pauling electronegativity is predicted for an element X if the H–X bond energy is 402 kJ mol^{-1} ? The H–H bond energy is 432 kJ mol^{-1} and the X–X bond energy is 335 kJ mol^{-1} . What would be the percent ionic character of the H–X bond? If the molecular wave function is written as

$$\psi_{\text{molecule}} = \psi_{\text{covalent}} + \lambda \psi_{\text{ionic}}$$

what is the value of λ ?

15. Suppose the bond energies of A_2 and X_2 are 210 and 345 kJ mol^{-1} , respectively. If the electronegativities of A and X are 2.0 and 3.1 , respectively, what will be the strength of the A–X bond? What will be the dipole moment if the internuclear distance is 125 pm ?
16. For a molecule XY, the molecular wave function can be written as

$$\psi_{\text{molecule}} = \psi_{\text{covalent}} + 0.50 \psi_{\text{ionic}}$$

Calculate the percent ionic character of the X–Y bond. If the bond length is 148 pm , what is the dipole moment of XY?

17. Determine the spectroscopic ground states for the following diatomic molecules: (a) BN; (b) C_2^+ ; (c) LiH; (d) CN^- ; (e) C_2^- .

A Survey of Inorganic Structures and Bonding

Molecular structure is the foundation on which chemistry, the study of matter and the changes it undergoes, rests. Much of chemistry is concerned with changes at the molecular level as structures are elucidated and chemical reactions occur. This is true not only in inorganic chemistry, but also in all areas of chemical science. Consequently, this chapter is devoted to an overview of some of the basic ideas concerning bonding and the structure of molecules. Although other aspects of bonding will be discussed in later chapters, this chapter is intended to provide an introduction to structural inorganic chemistry early in the study of the subject. More details concerning the structure of specific inorganic materials will be presented in later chapters, because most of the structures discussed here will be revisited in the context of the chemistry of the compounds. It should be kept in mind that for many purposes, a theoretical approach to bonding is not necessary. Accordingly, this chapter provides a nonmathematical view of molecular structure that is useful and adequate for many uses in inorganic chemistry. Because some of the principles are different for molecules that contain only single bonds, this topic will be introduced first.

In this chapter, the descriptions of molecular structure will be primarily in terms of a valence bond approach, but the molecular orbital method will be discussed in Chapter 5. As we shall see, construction of molecular orbital diagrams for polyatomic species is simplified by making use of symmetry, which will also be discussed in Chapter 5.













4.1 STRUCTURES OF MOLECULES HAVING SINGLE BONDS

One of the most important factors when describing molecules that have only single bonds is the repulsion that exists between electrons. Repulsion is related to the number of electron pairs both shared and unshared around the central atom. When only two pairs of electrons surround the central atom (as in BeH_2), the structure is almost always linear because that gives the configuration of lowest energy. When there are four pairs of electrons around the central atom (as in CH_4), the structure is tetrahedral. From your prior study of chemistry, the hybrid orbital types sp and sp^3 used to describe these cases are probably familiar. It is not unusual to hear someone say that CH_4 is tetrahedral because the carbon atom is sp^3 hybridized. However, CH_4 is tetrahedral because that structure represents the *configuration of lowest energy*, and our way of *describing* a set of orbitals that *matches* that geometry is by combining

the wave functions for the 2s and three 2p orbitals. It can be shown that the four resulting orbitals point toward the corners of a tetrahedron.

Based on the requirement that repulsion should be minimized, idealized structures can be obtained based on the number of electrons surrounding the central atom. However, unshared pairs (sometimes called lone pairs) of electrons behave somewhat differently than do shared pairs. A shared pair of electrons is essentially localized in the region of space between the two atoms sharing the pair. An unshared pair of electrons is bound only to the atom on which they reside, and as a result, they are able to move more freely than a shared pair, so more space is required for an unshared pair. This has an effect on the structure of the molecule.

Figure 4.1 shows the common structural types that describe a very large number of inorganic molecules. Linear, trigonal planar, tetrahedral, trigonal bipyramid, and octahedral structures result when

Number of pairs on central atom and hybrid type	Number of unshared pairs of electrons on central atom			
	0	1	2	3
2 sp	 Linear BeCl_2			
3 sp^2	 Trig. planar BCl_3	 Bent SnCl_2		
4 sp^3	 Tetrahedral CH_4	 Trig. pyramid NH_3	 Bent H_2O	
5 sp^3d	 Trig. bipyramid PCl_5	 Irreg. tetrahedral TeCl_4	 "T" shaped ClF_3	 Linear ICl_2^-
6 sp^3d^2	 Octahedral SF_6	 Sq. base bipyr. IF_5	 Square planar ICl_4^-	

■ FIGURE 4.1 Molecular structure based on hybrid orbital type.

there are 2, 3, 4, 5, and 6 bonding pairs, respectively, but no unshared pairs on the central atom. The hybrid orbital types for these structures are sp , sp^2 , sp^3 , sp^3d , and sp^3d^2 , respectively.

Rationalizing the probable structure for a molecule involves finding the number of electrons around the central atom and placing them in orbitals pointing in directions that minimize repulsion. However, there are complications when the details of the structure are considered. For example, a molecule such as BF_3 has only three pairs of electrons around the central atom (three valence shell electrons from B and one from each F atom). Therefore, the structure that gives the lowest energy is a trigonal plane with bond angles of 120° ,

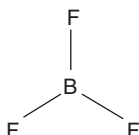

and the hybrid orbital type is sp^2 . On the other hand, there are also six electrons around Sn in the gaseous SnCl_2 molecule (four valence electrons from Sn and one from each Cl atom). Molecules that have the same number of electrons are said to be *isoelectronic*. However, the hybrid orbital type may not be sp^2 because the bond angle certainly is *not* 120° in this case, and the structure of SnCl_2 is

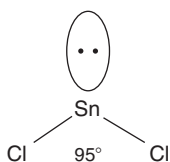

The unshared pair of electrons resides in an orbital that might be considered as sp^2 , but since the electrons are held to only one atom, there is more space required than there is for a shared pair. A shared pair is more restricted in its motion because of being attracted to two atoms simultaneously. As a result, the repulsion between the unshared pair and the shared pairs is sufficient to force the bonding pairs closer together, which causes the bond angle to be much smaller than the expected 120° . In fact, the bond angle is much closer to that expected if p orbitals are used by Sn. On the other hand, the Sn-Cl bonds are quite polar, so the bonding electron pairs reside much closer to the Cl atoms, which makes it easier for the bond angle to be small than if they were residing close to the Sn atom.

In some molecules that involve sp^2 hybrid orbitals on the central atom, the bond angles deviate considerably from 120° . For example in F_2CO , the bond angle is 108° :

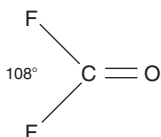

Various explanations have been proposed for the large deviation of the bonding from that expected on the basis of sp^2 hybrids. One simple approach to this problem is to consider that C–F bonds are quite polar with the shared electron pairs drawn closer to the fluorine atoms. Therefore, those bonding pairs are farther apart than they would be if they were being shared equally by C and F. There is less repulsion between the bonding pairs of electrons, and the effect of the C–O double bond is that the π orbitals give rise to some repulsion with the C–F bonding pairs, forcing them closer together. Using this approach, we would expect the bond angle in phosgene, Cl_2CO , to be *larger* than it is in F_2CO because the electron pairs in the C–Cl bonds will reside closer to the carbon atom than if the bonds were C–F. Therefore, the bonding electron pairs would be closer to each other in F_2CO than in Cl_2CO . In either case, the carbon atom is at the positive end of the bond dipole because both F and Cl atoms have higher electronegativities than carbon. The structure of Cl_2CO ,

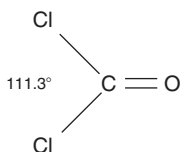

indicates that this interpretation is correct. Of course, the Cl atoms are larger than the F atoms, so it is tempting to attribute the larger bond angle in Cl_2CO to that cause. The structure of formaldehyde, H_2CO , is useful in this connection because the H atom is *smaller* than either F or Cl. However, the structure

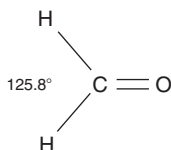

indicates that repulsion between the terminal atoms may not be significant. In this case, the H–C–H bond angle is *larger* than that expected for sp^2 hybrids on the central atom. When the polarity of the C–H bonds is considered, it is found that the carbon atom is at the *negative* end of the bond dipoles (see Chapter 6). Therefore, the C–H bonding pairs of electrons reside closer to the carbon atom (and hence closer to each other), and we should expect repulsion between them to cause the bond angle to be larger than 120° . The measured bond angle is in agreement with this rationale.

It is interesting to also see the difference in the bond angles in OF_2 and OCl_2 , which have the structures

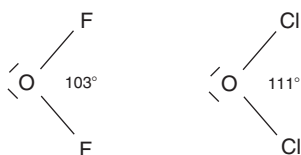

Although it might be tempting to ascribe this difference in bond angles to the difference in size between F and Cl, the location of *bonding* pairs of electrons is also important. The O–F bonds are polar with the bonding pairs closer to the fluorine atoms (and thus farther away from O and each other) allowing the bond angle to be smaller. The O–Cl bonds are polar, but with oxygen having the higher electronegativity, the shared pairs of electrons are closer to the oxygen atom (and to each other). As a result, there should be greater repulsion between the *bonding* pairs in OCl_2 than in OF_2 , and the OCl_2 bond angle is the larger of the two in agreement with this rationale. In both cases, there are two unshared pairs of electrons on the oxygen atom, and the bond angle deviates from the tetrahedral angle. If the situation were as simple as the effect produced by the unshared pairs, we would expect the bond angle to be *slightly* larger in OCl_2 because the Cl atoms are larger than F. A difference of 8° probably indicates more repulsion between *bonding* pairs also.

In the CH_4 molecule, the bond angle is the expected value, $109^\circ 28'$. There are eight electrons around the carbon atom (four valence shell electrons from C and one from each H atom), which results in a regular tetrahedral structure. In the ammonia molecule, the nitrogen atom has eight electrons around it (five from the N atom and one from each H atom), but one pair of electrons is an unshared pair.

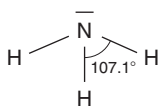

Although the hybrid orbital type used by N is sp^3 , the bond angles in the NH_3 molecule are 107.1° rather than $109^\circ 28'$ found in a regular tetrahedron. The reason for this difference is that the unshared pair requires more space and forces the bonding pairs slightly closer together. Although a structure such as that just shown displays a *static* model, the ammonia actually undergoes a vibrational motion known as *inversion*. In this vibration, the molecule passes from the structure shown to that which is inverted by passing through a trigonal planar transition state:

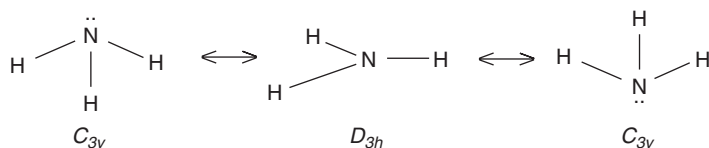

This vibration has a frequency that is approximately 1010 sec^{-1} . The barrier height for inversion is 2076 cm^{-1} , but the difference between the first and second vibrational states is only 950 cm^{-1} , which is equivalent to 1.14 kJ mol^{-1} . Using the Boltzmann distribution law, we can calculate that the second vibrational state is populated only to the extent of 0.0105, so clearly there is not a sufficient amount of thermal energy available to cause the *rapid* inversion if the molecule must pass *over* a barrier that is 2076 cm^{-1} in height. In this case, the inversion involves *quantum mechanical tunneling*, which means that the molecule passes from one structure to the other without having to pass *over* the barrier.

The structure of the H₂O molecule shows the effect of two unshared pairs of electrons:

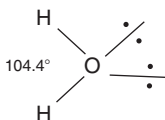

In this case, the two unshared pairs of electrons force the bonding pairs closer together so the observed bond angle is only 104.4°. Two unshared pairs in the H₂O molecule cause a greater effect than does one unshared pair in the NH₃ molecule. The effects that produce slight deviations from the bond angles expected for regular geometric structures are the result of a principle known as *valence shell electron pair repulsion*, VSEPR. The basis for this principle is that in terms of repulsion,

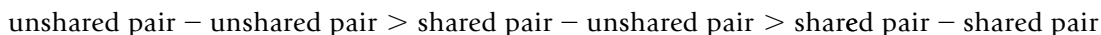

When the effects of unshared pairs are considered according to this scheme, not only is the correct overall structure often deduced, but also the slight deviations from regular bond angles are often predicted.

An interesting application of VSEPR is illustrated by the structure of SF₄. The sulfur atom has 10 electrons around it (six valence shell electrons from S and one from each of the four F atoms). We predict that the structure will be based on a trigonal bipyramid, but there are two possible structures:

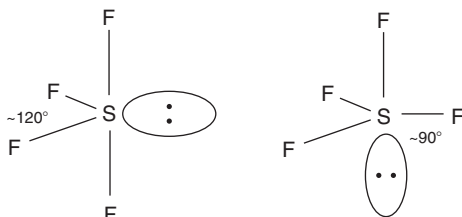

Only one of these structures is observed for the SF₄ molecule. In the structure on the left, the unshared pair of electrons is located at ~90° from two bonding pairs and ~120° from the other two bonding pairs. In the structure on the right, the unshared pair is located at ~90° from three bonding pairs and 180° from the other bonding pair. These two possibilities may not look very different, but the repulsion between electron pairs is inversely related to the distance of separation raised to an exponent that may be as large as 6. A small difference in distance leads to a substantial difference in repulsion. As a result, the structure that has only two bonding electron pairs at 90° from the unshared pair is lower in energy, and the structure on the left is the correct one for SF₄. *In structures based on a trigonal bipyramid, unshared pairs of electrons are found in equatorial positions.*

Note that violations of the octet rule by the central atom occur with atoms such as sulfur and phosphorus. These are atoms that have *d* orbitals as part of their valence shells, so they are not limited to

a maximum of eight electrons. There is another interesting feature for molecules that are based on the trigonal bipyramid model for five bonds. If we consider the molecules PF_5 and PCl_5 , there are 10 electrons around the phosphorus atom (five bonds) that point toward the corners of a trigonal bipyramid:

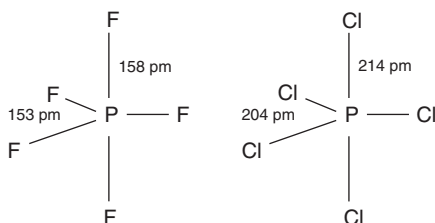

However, the bonds in the axial positions are slightly longer than those in the equatorial positions. For this type of structure, the hybrid bond type on the phosphorus atom is considered as sp^3d . However, the hybrid orbital type that gives three bonds in a trigonal plane is sp^2 , and it can be shown that the dp combination is one that gives two orbitals directed at 180° from each other. Therefore, sp^3d hybrids can be considered as $sp^2 + dp$, and the bond lengths reflect the fact that the orbitals used in bonding three of the chlorine atoms are different than for the other two. This is a general characteristic of molecules having five pairs of electrons around the central atom in a structure based on a trigonal bipyramid, and the axial bonds are usually longer than those in the equatorial plane.

One of the interesting aspects of the structure in which five pairs of electrons surround the central atom is that the equatorial positions make use of sp^2 hybrids whereas the axial bonds are dp . As we have seen, any *unshared* pairs of electrons are found in *equatorial* positions. A further consequence of this is that peripheral atoms of high electronegativity bond best to orbitals of low s character, and peripheral atoms of low electronegativity bond better to orbitals of high s character. The result of this preference is that if the mixed halide PCl_3F_2 is prepared, the fluorine atoms are found in axial positions. Also, atoms that can form multiple bonds (which usually have lower electronegativity) bond better to orbitals of higher s character (the sp^2 equatorial positions).

In view of the principles just described, the molecule PCl_2F_3 would be expected to have two fluorine atoms in the axial positions and two chlorine atoms and one fluorine atom in equatorial positions. However, at temperatures greater than -22°C , the nuclear magnetic resonance (NMR) spectrum of PCl_2F_3 shows only one doublet, which results from the splitting of the fluorine resonance by the ^{31}P . When the NMR is taken at -143°C , the NMR spectrum is quite different and shows the presence of fluorine atoms bonded in more than one way. It is evident that at temperatures above -22°C either all of the fluorine atoms are equivalent or somehow they exchange rapidly so that only fluorine atoms in one environment are present. Earlier, the inversion vibration of the NH_3 molecule, which has a frequency that is on the order of 1010 sec^{-1} , was described. The question arises as to what type of structural change could occur in PCl_2F_3 or PF_5 that would make the fluorine atoms in equatorial and axial positions appear

equivalent on the time scale of NMR experiments. A mechanism that is believed to correctly describe this situation is known as the *Berry pseudorotation*, and it is illustrated in the following scheme:

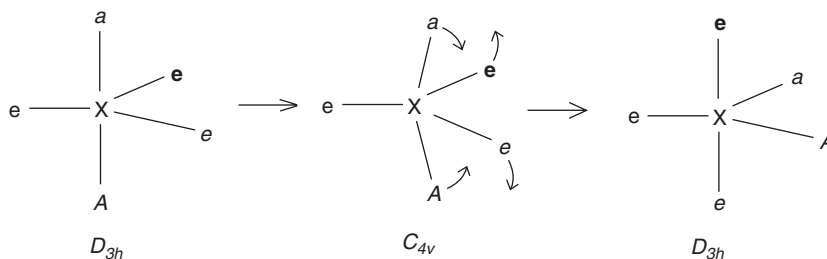

In this process, the groups initially in equatorial positions are e , e , and e , whereas those in axial positions are a and A . These designations are only to keep track of the positions, because all peripheral atoms would have to be identical for the symmetry designations to be correct. The molecule passes through a square base pyramid configuration as the rotation of four of the groups occurs. This mechanism is similar to the inversion of the ammonia molecule except for the fact that the movement of atoms is by *rotational* motion. At very low temperature, thermal energy is low and the vibration occurs slowly enough that the fluorine resonance indicates fluorine atoms in two different environments (axial and equatorial). At higher temperatures, the structural change is rapid, and only one fluorine environment is indicated. As we saw for NH_3 , not all molecules have static structures.

Perhaps no other pair of molecules exhibits the effect of molecular structure on reactivity like SF_4 (sp^3d orbitals) and SF_6 (sp^3d^2 orbitals), whose structures are

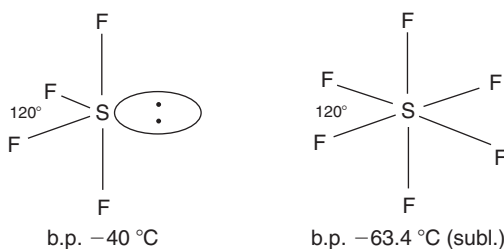

SF_6 is a remarkably inert compound. In fact, it is so unreactive that it is used as a gaseous dielectric material. Also, the gas can be mixed with oxygen to create a kind of synthetic atmosphere, and rats can breathe the mixture for several hours with no ill effects. On the other hand, SF_4 is a very reactive molecule that reacts with H_2O rapidly and vigorously:



Because of the instability of H_2SO_3 , this reaction can also be written as



The fact that SF_6 does not react with water is not due to thermodynamic stability. Rather, it is because there is no low-energy pathway for the reaction to take place (kinetic stability). Six fluorine atoms surrounding the sulfur atom effectively prevent attack, and the sulfur atom has no unshared pairs of electrons where other molecules might attack. In SF_4 , not only is there sufficient space for an attacking species to gain access to the sulfur atom, but also the unshared pair is a reactive site. As a result of these structural differences, SF_6 is relatively inert, whereas SF_4 is very reactive.

There are several compounds that consist of two different halogens. These *interhalogen* compounds have structures that contain only single bonds and unshared pairs of electrons. For example, in BrF_3 , the bromine atom has 10 electrons surrounding it (seven valence shell electrons and one from each fluorine atom). The structure is drawn to place the unshared pairs of electrons in equatorial positions based on a trigonal bipyramid. Because of the effects of the unshared pairs of electrons, the axial bonds are forced closer together to give bond angles of 86° :

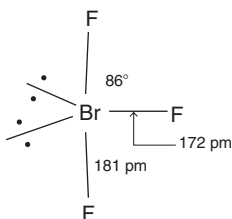

Except for slight differences in bond angles, this is also the structure for ClF_3 and IF_3 . When IF_3 reacts with SbF_5 , the reaction is



The structure of IF_2^+ can be deduced by recognizing that there are eight electrons around the iodine atom. There are seven valence electrons from I, one from each of the two fluorine atoms, but one electron has been removed, giving the positive charge. The electrons will reside in four orbitals pointing toward the corners of a tetrahedron, but two pairs are unshared.

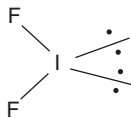

Note that the structures of many of these species are similar to the model structures shown in Figure 4.1. Although the hybrid orbital type is sp^3 , the structure is characterized as bent or angular, not

tetrahedral. On the other hand, the IF_2^- ion, which has 10 electrons around the iodine atom, has a linear structure.

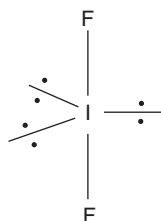

Note that in this case the unshared pairs of electrons are in equatorial positions, which results in a linear structure for IF_2^- even though the hybrid orbital type is sp^3d . It is the arrangement of *atoms*, not electrons, that determines the structure for a molecule or ion. It is apparent that the simple procedures described in this section are adequate for determining the structures of many molecules and ions in which there are only single bonds and unshared pairs of electrons.

Xenon forms several compounds with fluorine, among which are XeF_2 and XeF_4 . With filled s and p valence shell orbitals, the xenon atom provides eight electrons while each fluorine atom contributes one electron. Therefore, in XeF_2 , there are 10 electrons around the Xe atom, which makes the XeF_2 molecule isoelectronic with the IF_2^- ion. Both XeF_2 and IF_2^- are linear. In XeF_4 , there are 12 electrons around the Xe atom, which results in the structure being

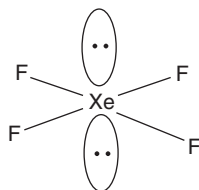

The molecule is square planar, as is IF_4^- , which is isoelectronic with XeF_4 .

Although we have described the structures of several molecules in terms of hybrid orbitals and VSEPR, not all structures are this simple. The structures of H_2O (bond angle 104.4°) and NH_3 (bond angles 107.1°) were described in terms of sp^3 hybridization of orbitals on the central atom and *comparatively small* deviations from the ideal bond angle of $109^\circ 28'$ caused by the effects of unshared pairs of electrons. If we consider the structures of H_2S and PH_3 in those terms, we have a problem. The reason is that the bond angle for H_2S is 92.3° , and the bond angles in PH_3 are 93.7° . Clearly, there is more than a minor deviation from the expected tetrahedral bond angle of $109^\circ 28'$ caused by the effect of unshared pairs of electrons!

If the bond angles in H_2S and PH_3 were 90° , we would suspect that the orbitals used in bonding were the $3p$ valence shell orbitals. The sulfur atom has two of the p orbitals singly occupied, and overlap of hydrogen $1s$ orbital could produce two bonds at 90° . Similarly, the phosphorus atom has the three $3p$ orbitals singly occupied, and overlap of three hydrogen $1s$ orbitals could lead to three bonds at 90° . Although we were correct to assume that sp^3 orbitals were used by the central atoms in H_2O and NH_3 , it appears that we are not justified in doing so for H_2S and PH_3 .

Why does hybridization occur when the central atom is oxygen or nitrogen but not when it is S or P? The answer lies in the fact that there are two major results of hybridization of orbitals. The first is that the orbitals are directed in space at different angles than are the unhybridized atomic orbitals. We have already seen the types of structures that result and how less repulsion results. However, the other result of hybridization is that the orbitals are *changed in size*. The hybridization of $3s$ and $3p$ orbitals on sulfur or phosphorus would produce more favorable bond angles with regard to repulsion, but the overlap between those orbitals and the hydrogen $1s$ orbitals is less effective. The hydrogen orbital can overlap better with a smaller unhybridized p orbital on sulfur or phosphorus. The result is that the orbitals used by the central atom have a very slight degree of hybridization but closely resemble pure p orbitals. Based on this analysis, we would expect that H_2Se and AsH_3 would have bond angles that deviate even more from the tetrahedral bond angle. In accord with this, the bond angles for these molecules are 91.0° and 91.8° , respectively, indicating that the bonding orbitals on the central atoms are nearly pure p orbitals. The hydrogen compounds of the heavier members of groups V and VI have bond angles that are even closer to right angles (H_2Te , 90° ; SbH_3 , 91.3°).

4.2 RESONANCE AND FORMAL CHARGE

For many species, the approach taken earlier with molecules that have only single bonds and unshared pairs of electrons is inadequate. For example, the molecule CO has only 10 valence shell electrons with which to achieve an octet around each atom. The structure $|\text{C}\equiv\text{O}|$ makes use of exactly 10 electrons, and that makes it possible to place an octet (three shared pairs and one unshared pair) around each atom. A simple procedure for deciding how to place the electrons is as follows:

1. Determine the total number of valence shell electrons from all of the atoms (N) that are available to be distributed in the structure.
2. Multiply the number of atoms present by eight to determine how many electrons would be required to give an octet around each atom (S).
3. The difference ($S-N$) gives the number of electrons that must be shared in the structure.
4. If possible, change the distribution of electrons to give favorable formal charges (discussed later in this chapter) on the atoms.

For CO, the total number of valence shell electrons is 10, and to give octets around two atoms would require 16 electrons. Therefore, $16 - 10 = 6$ electrons must be shared by the two atoms. Six electrons are equivalent to three pairs or three covalent bonds. Thus, we are led to the structure for CO that was shown earlier.

For a molecule such as SO_2 , we find that the number of valence shell electrons is 18, whereas three atoms would require 24 electrons to make three octets. Therefore, $24 - 18 = 6$, the number of electrons that must be shared, which gives a total of three bonds between the sulfur atom and the two oxygen atoms. However, because we have already concluded that each atom in the molecule must have an octet of electrons around it, the sulfur atom must also have an unshared pair of electrons

that is localized in the atom in addition to the three pairs that it is sharing. This can be shown as in the structure

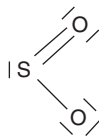

However, the same features are shown in the structure

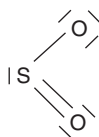

A situation in which the electrons can be arranged in more than one way constitutes *resonance*. In Chapter 3, the resonance structures HF and H⁺ F⁻ were used to describe HF, but in the case of SO₂ neither of the resonance structures contains ions. The structures just shown involve different ways of arranging the electrons that still conform to the octet rule. The true structure of SO₂ is one that lies halfway between the two structures shown (a hybrid made up of equal contributions from these two structures). It does *not* spend part of the time as one structure and part of the time as the other. The molecule is *all* of the time a *resonance hybrid* of the structures shown. In this case, the two structures contribute equally to the true structure, but this is not always the case. As a result of the unshared pair of electrons on the sulfur atom, the bond angle in SO₂ is 119.5°.

The double bond that is shown in each of the two structures just shown is not localized as is reflected by the two resonance structures. However, the two single bonds and the unshared pair are localized as a result of the hybrid orbitals in which they reside. The hybrid orbital type is sp^2 , which accounts for the bond angle being 119.5°. There is one p orbital not used in the hybridization that is perpendicular to the plane of the molecule, which allows for the π bonding to the two oxygen atoms simultaneously. The π bond is described as being *delocalized*, and this can be shown as follows:

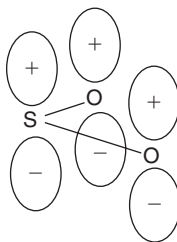

A single S–O bond has a length of approximately 150 pm, but as a result of the multiple bonding between sulfur and oxygen, the observed bond length in SO₂ where the bond order is 1.5 is 143 pm.

The following are rules that apply to drawing resonance structures. Remember that resonance relates to different ways of placing electrons in the structures, not ways of arranging the atoms themselves.

1. The atoms must be in the same relative positions in all structures drawn. For example, it can be demonstrated experimentally that the SO_2 molecule has a bent or angular structure. Structures showing the molecule with some other geometry (e.g., linear) are not permitted.
2. Structures that maximize the number of electrons used in bonding (consistent with the octet rule) contribute more to the true structure.
3. All resonance structures drawn must show the same number of unpaired electrons if there are any. A molecule or ion has a fixed number of unpaired electrons, and all resonance structures drawn for that species must show that number of unpaired electrons.
4. Negative formal charges normally reside on the atoms having higher electronegativity.

The NO_2 molecule illustrates the application of rule 3. Because the NO_2 molecule has a total of 17 valence shell electrons, there are eight pairs of electrons and one unpaired electron. Structures drawn for NO_2 must reflect this. Therefore, we draw the structure for NO_2 as

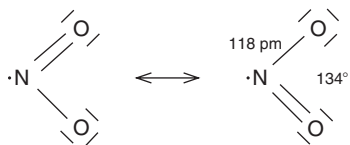

Note that the unpaired electron resides on the nitrogen atom, giving it a total of seven electrons. Because the oxygen atom has higher electronegativity, the oxygen atoms are given complete octets. This is also consistent with the observation that NO_2 dimerizes by pairing of electrons on two molecules as shown by the equation



Note that in the NO_2 molecule the bond angle is much larger than the 120° expected when the central atom is using sp^2 hybrid orbitals. In this case, the nonbonding orbital located on the nitrogen atom contains only one electron, so repulsion between that orbital and the shared electron pairs is small. Therefore, the bond angle is larger because the repulsion between the bonding pairs is not balanced by the repulsion of the single electron in the nonbonding orbital. However, when the structure of NO_2^- is considered, there is an unshared *pair* of electrons on the nitrogen atom:

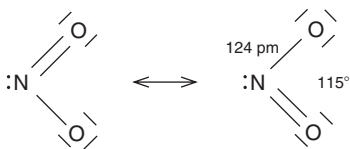

The repulsion between the unshared pair and the bonding electrons is much greater than in NO_2 , as is reflected by the bond angle being only 115° . The N–O bond length is 124 pm in NO_2^- because the nitrogen atom has an octet of electrons. There is less residual attraction for the bonding pairs of electrons, so the N–O bonds are longer than in NO_2 .

The concept of *formal charges* is a very useful one that is essentially a way of keeping track of electrons. In order to determine the formal charge on each atom in a structure, we must first apportion the electrons among the atoms. This is done according to the following procedure:

1. Any unshared pairs of electrons belong to the atom on which the electrons are located.
2. Shared electron pairs are divided equally between the atoms sharing them.
3. The total number of electrons on an atom in a structure is the sum from steps 1 and 2.
4. Compare the total number of electrons that appear to be on each atom to the number of valence shell electrons that it normally has. If the number of electrons in the valence shell is greater than indicated in step 3, the atom *appears* to have lost one or more electrons and has a *positive* formal charge. If the number indicated in step 3 is larger than the number in the valence shell, the atom *appears* to have gained one or more electrons and has a *negative* formal charge.
5. Structures that have formal charges with the same sign on adjacent atoms will contribute little to the true structure.
6. The sum of formal charges on the atoms must total the overall charge on the species.

Earlier we showed the structure $|\text{C}\equiv\text{O}|$ for the carbon monoxide molecule. Each atom has one unshared pair of electrons and there are three shared pairs. The triple bond is only about 112.8 pm in length. If the shared pairs are divided equally, each atom appears to have three electrons from among those shared. Therefore, each atom in the structure *appears* to have a total of five electrons. Carbon normally has four electrons in its valence shell, so in the structure shown it has a formal charge of -1 . An oxygen atom normally has six valence shell electrons, so it *appears* that the oxygen atom has lost one electron, giving it a formal charge of $+1$. Of course, the procedure is simply a bookkeeping procedure because no electrons have been lost or gained.

Formal charges can be used to predict the stable arrangement of atoms in many molecules. For example, nitrous oxide, N_2O , might have the structures shown as follows:

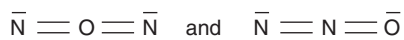

It might be tempting to assume that the structure on the left is correct, but not when the formal charges are considered. Note that the formal charges are circled to distinguish them from ionic charges. Following the procedure just outlined, the formal charges are

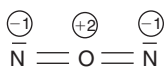

A +2 formal charge on oxygen, the atom with the second highest electronegativity, is not in agreement with the rules for distributing formal charges. Therefore, the correct structure is the one shown on the right, which also accounts for the fact that N_2O can react as an oxidizing agent because the oxygen atom is in a terminal position. *In general, the atom of lowest electronegativity will be found as the central atom.* Although we know that the arrangement of atoms is NNO , there is still the problem of resonance structures. For the N_2O molecule, three resonance structures can be shown as follows.

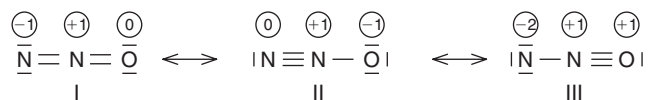

Structure III will contribute approximately 0% to the true structure because it has like formal charges on adjacent atoms, it has a positive formal charge on the oxygen atom while a nitrogen atom has a -2 formal charge, and it has higher formal charges overall. Deciding the relative contributions from structures I and II is somewhat more difficult. Although structure II has the negative formal charge on the oxygen atom, it also has a triple bond between the two nitrogen atoms, which results in six shared electrons in a small region of space. Two double bonds are generally preferred over a triple bond and a single bond. Structure I has two double bonds even though it places a negative formal charge on a nitrogen atom. As a result of these factors, we suspect that structures I and II would contribute about equally to the actual structure.

In this case, there is a simple experiment that will determine whether this is correct. Structure I places a negative formal charge on the terminal nitrogen atom, while structure II places a negative formal charge on the oxygen atom on the opposite end of the molecule. If the two structures contribute equally, these effects should cancel, which would result in a molecule that is not polar. In fact, the dipole moment of N_2O is only 0.17 D, so structures I and II must make approximately equal contributions.

Bond lengths are also useful when deciding contributions from resonance structures. Structure I shows a double bond between N and O, while structure II shows the N–O bond as a single bond. If the structures contribute equally, the experimental N–O bond length should be approximately half way between the values for N–O and N=O, which is the case. Thus, we have an additional piece of evidence that indicates structures I and II contribute about equally to the actual structure. The observed bond lengths in the N_2O molecule are shown below (in picometers).

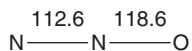

Known bond lengths for other molecules that contain bonds between N and O atoms are useful in assessing the contributions of resonance structures in this case. The $\text{N}\equiv\text{N}$ bond length is 110 pm, whereas that for the $\text{N}=\text{N}$ bond is usually approximately 120 to 125 pm depending on the type of molecule. Likewise, the nitrogen-to-oxygen bond length in the NO molecule in which the bond order is 2.5 is 115 pm. On the other hand, in NO^+ (which has a bond order of 3), the bond length is 106 pm. From these values, it can be seen that the observed bond lengths in N_2O are consistent with the fact that the true structure is a hybrid of structures I and II shown earlier.

We can also illustrate the application of these principles by means of other examples. Consider the cyanate ion, NCO^- . In this case, there are 16 valence shell electrons that need to be distributed. To provide

a total of three octets, 24 electrons would be needed. Therefore, eight electrons must be shared, which means that there will be a total of four bonds, two from the central atom to each of the terminal atoms. Four bonds in the form of two double bonds in each direction can be expected to give a linear structure. Our first problem is how to arrange the atoms. Showing the total of 16 electrons, the arrangements can be illustrated as follows (the formal charges also indicated):

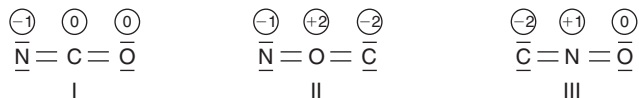

Deciding which arrangement of atoms is correct is based on the formal charge on the central atom. In the first structure, there are four shared pairs of electrons on the carbon atom, and dividing each pair equally leads to a total of four electrons around the carbon atom. Because a carbon atom normally has four valence-shell electrons, the carbon atom in structure I has a formal charge of 0. In structure II, dividing each of the bonding pairs equally leads to accounting for four electrons on the oxygen atom, which normally has six valence-shell electrons. Therefore, in structure II, the oxygen atom has a formal charge of +2. Of the three atoms in the structure, oxygen has the highest electronegativity, so this structure is very unfavorable. In structure III, dividing each bonding pair equally makes it *appear* that the nitrogen atom has four electrons on it, but there are five electrons in the valence shell of nitrogen. This results in a formal charge of +1 on the nitrogen atom and a -2 formal charge on the carbon atom.

Both structures II and III have an arrangement of atoms that places a positive formal charge on atoms that are higher in electronegativity than carbon. Consequently, the most stable arrangement of atoms is as shown in structure I. Some compounds containing the ion having structure III (the fulminate ion) are known, but they are much less stable than the cyanates (structure I). In fact, mercury fulminate has been used as a detonator.

As a general rule, we can see that for triatomic species containing 16 electrons, the fact that there must be four bonds to the central atom will result in a positive formal charge on that atom unless it is an atom that has only four valence-shell electrons. Therefore, in cases where one of the three atoms is carbon, that atom is likely to be the central atom. A nitrogen atom in the central position would be forced to have a +1 formal charge, and an oxygen atom would have a +2 formal charge. By considering the structures of numerous 16-electron triatomic species it will be generally found that the central atom is the one having the lowest electronegativity.

Now that we have determined that structure I is correct for the cyanate ion, we still need to consider resonance structures. In keeping with the rules given earlier, the acceptable resonance structures that can be devised are

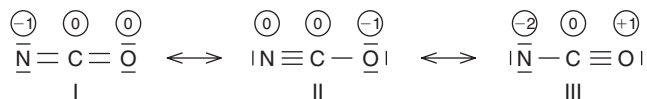

In structure I, the formal charges are -1, 0, and 0 on the nitrogen, carbon, and oxygen atoms, respectively. In structure II, the corresponding formal charges are 0, 0, and -1. However, in structure III, the

formal charges on the atoms are nitrogen -2 , carbon 0 , and oxygen $+1$. Immediately, we see that the most electronegative atom, oxygen, has a positive formal charge, and we realize that if the actual structure is a resonance hybrid of these three structures, structure III will contribute approximately 0% . This structure essentially represents removing electron density from an oxygen atom and placing it on a nitrogen atom. We now must estimate the contributions of the other two structures.

Although structure II has a negative formal charge on the atom having the highest electronegativity, it also has a triple bond, which places a great deal of electron density in a small region of space. The repulsion that arises causes the bond to be less favorable than the -1 formal charge on the oxygen atom would suggest. On the other hand, the two double bonds in structure I still provide a total of four bonds without as much repulsion as that resulting from a triple bond. Structure I also has a -1 formal charge on nitrogen, the second most electronegative of the three atoms. When all of these factors are considered, we are led to the conclusion that structures I and II probably contribute about equally to the true structure.

For CO_2 , the structure contains two σ bonds and two π bonds, and it can be shown as

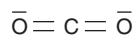

Two σ bonds are an indication of sp hybridization on the central atom, which leaves two p orbitals unhybridized. These orbitals are perpendicular to the molecular axis and can form π bonds with p orbitals on the oxygen atoms.

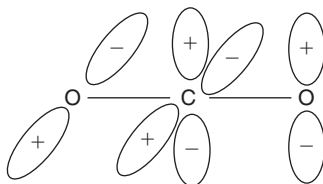

In CO_2 , the $\text{C}=\text{O}$ bond length is 116 pm, which is slightly shorter than the usual length of $\text{C}=\text{O}$ bonds, which are approximately 120 pm. Note that CO_2 , NO_2^+ , SCN^- , OCN^- , and N_2O are all triatomic molecules having 16 electrons and all are linear.

There are several important chemical species that consist of four atoms and have a total of 24 valence-shell electrons. Some of the most common isoelectronic species of this type are CO_3^{2-} , NO_3^- , SO_3 , and PO_3^- (known as the *metaphosphate ion*). Because four atoms would require a total of 32 electrons for each to have an octet, we conclude that eight electrons must be shared in four bonds. With four bonds to the central atom, there can be no unshared pairs on that atom if the octet rule is to be obeyed. Therefore, we can draw the structure for CO_3^{2-} showing one double $\text{C}=\text{O}$ bond and two single $\text{C}-\text{O}$ bonds as

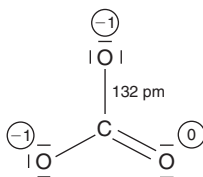

The double bond could also be shown in the other two positions, so the true structure is a resonance hybrid of the three structures. The structure is a trigonal plane that has three identical bonds with each being an average of one double bond and two single bonds. The result is that there is a bond order of 1.33. Because the structure is a trigonal plane, we understand that the hybrid orbital type used by carbon is sp^2 . As a result, there is one additional p orbital on the central atom that is perpendicular to the plane, and that orbital is empty. Therefore, a filled p orbital on an oxygen atom can overlap with the empty p orbital on the carbon atom to yield a π bond. This π bond is not restricted to one oxygen atom, because the other two also have filled p orbitals that can be used in π bonding. The result is that the π bond is delocalized over the entire structure:

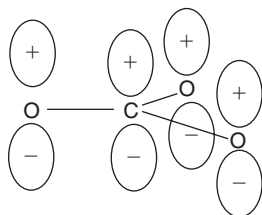

Note that because the carbon atom has a formal charge of 0, there is no necessity to draw structures having more than one double bond. The carbon atom has no valence-shell orbitals other than $2s$ and $2p$ orbitals, so only four pairs of electrons can be held in four valence-shell orbitals. The structures of CO , CO_2 , and CO_3^{2-} have been described in which the bond orders are 3, 2, and $4/3$ and the bond lengths are 112.8, 116 (in CO_2 , but ~ 120 in most $\text{C}=\text{O}$ bonds), and 132 pm, respectively. As expected, the bond length decreases as the bond order increases. A typical bond length for a $\text{C}-\text{O}$ single bond is 143 pm, so we have four $\text{C}-\text{O}$ bond lengths that can be correlated with bond order. Figure 4.2 shows the relationship between the bond order and bond length for these types of $\text{C}-\text{O}$ bonds.

A relationship such as this is useful in cases where a $\text{C}-\text{O}$ bond length is known because from it the bond order can be inferred. On this basis, it is also sometimes possible to estimate the contributions

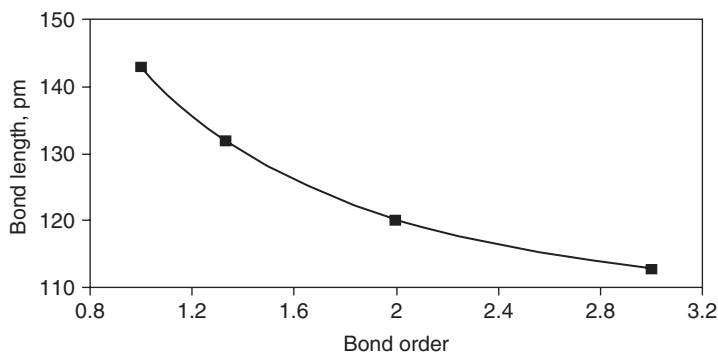

■ FIGURE 4.2 The relationship between bond order and bond length for bonds between carbon and oxygen.

of various resonance structures. Pauling proposed an equation relating bond length relative to that of a single bond between the atoms that is written as

$$D_n = D_1 - 71 \log n \quad (4.5)$$

where D_n is the bond length for a bond of order n , D_1 is the length of a single bond, and n is the bond order. Using this equation, calculated bond lengths for C–O bonds having bond orders of $4/3$, 2, and 3 are 134, 122, and 106 pm, respectively. The calculated length of a bond of $4/3$ order is quite close to that in CO_3^{2-} . In many molecules, the length of a C=O bond is approximately 120 pm, so the agreement is again satisfactory. In the case of the C \equiv O bond, the molecule that possesses this bond is carbon monoxide, which has some unusual characteristics because of ionic character (see Chapter 3), so the agreement is not as good between the experimental and calculated bond length. However, Eq. (4.5) is useful in many situations to provide approximate bond lengths.

For the SO_3 molecule, the structure we draw first by considering the number of valence shell electrons and the octet rule is

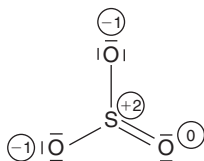

In this case, even with there being one double bond, the formal charge on the sulfur atom is +2, so structures that show two double bonds are possible, which can reduce further the positive formal charge. In order for structures such as

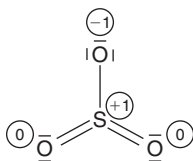

to be drawn, the sulfur atom has 10 electrons around it, which means that the octet rule is not obeyed. However, in addition to the $3s$ and $3p$ valence orbitals, the sulfur atom also has empty $3d$ orbitals that can overlap with filled p orbitals on oxygen atoms. Therefore, unlike the carbon atom in CO_3^{2-} , the sulfur atom in SO_3 can accept additional electron density, and structures showing two double bonds are permissible. The S–O bond length in SO_2 where the bond order is 1.5 is 143 pm. That is almost exactly the S–O bond length in SO_3 , which indicates that a bond order of about 1.5 is correct for this molecule. Therefore, there must be some contributions from structures that show two double bonds because the bond order would be $4/3$ if only one double bond is present.

The sulfate ion, SO_4^{2-} , exhibits some bonding aspects that deserve special consideration. First, there are five atoms, so 40 electrons would be required to provide an octet of electrons around each atom. However, with only 32 valence-shell electrons (including the two that give the -2 charge), there must

be eight electrons shared. The four bonds will be directed toward the corners of a tetrahedron, which gives the structure

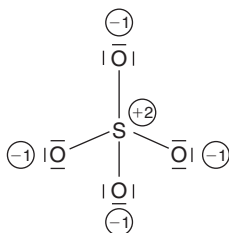

Although this structure agrees with several of our ideas about structure and bonding, there is at least one problem. If we determine the formal charges on the atoms, we find that there is a -1 formal charge on each oxygen atom but a $+2$ formal charge on the sulfur atom. Although sulfur has a lower electronegativity than oxygen, there is disparity in the electron densities on the atoms. This situation can be improved by taking an unshared pair on one of the oxygen atoms and making it a shared pair:

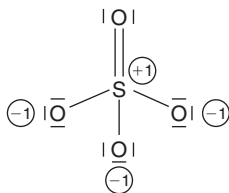

There is no reason that any particular oxygen atom should be chosen, so there are four equivalent structures in which the double bond is shown to a different oxygen atom in each one. The question arises as to how this type of bonding occurs. When an oxygen atom is bonded to the sulfur atom by a single bond, there are three unshared pairs of electrons that reside in p orbitals on the oxygen atom. Although the sulfur atom makes use of sp^3 hybrid orbitals (from $3s$ and $3p$ valence shell orbitals) in forming the four single bonds, the $3d$ orbitals are not greatly higher in energy, and they are empty. The symmetry (mathematical signs) of the filled p orbitals on an oxygen atom matches that of a d orbital. Therefore, electron density is shared between the oxygen and sulfur atoms, but the electrons come from filled orbitals on the oxygen atom. The result is that there is some double bond character to each S–O bond as a result of π bond formation, and the S–O bond lengths are shorter than expected for a single bond between the atoms.

In the H_2SO_4 molecule, there are two oxygen atoms that are bonded to hydrogen atoms and the sulfur atom. These oxygen atoms are unable to participate effectively in π bonding, so the structure of the molecule is

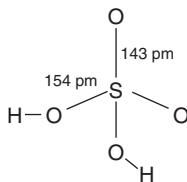

This structure reflects the fact that there is significant multiple bonding to two oxygen atoms, but not to the two others that have hydrogen atoms attached. This behavior is also seen clearly in the structure of HSO_4^- ,

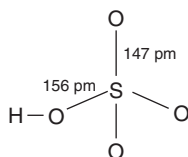

Note that the distance between the sulfur atom and the three oxygen atoms that do not have hydrogen attached is slightly greater than the corresponding distance in H_2SO_4 . The reason is that the back donation is now spread over three terminal oxygen atoms rather than only two. The bond order of S-O bonds is slightly greater in H_2SO_4 than in HSO_4^- when only terminal oxygen atoms are considered.

The PO_4^{3-} (known as the *orthophosphate* ion) and ClO_4^- ions are isoelectronic with SO_4^{2-} ion, and their structures are



Although the phosphorus atom in PO_4^{3-} has a positive formal charge, it has a significantly lower electronegativity than oxygen. Therefore, there is not as much contribution from structures having double bonds. On the other hand, a +3 formal charge on the chlorine atom in ClO_4^- can be partially relieved by shifting some electron density from nonbonding orbitals on oxygen atoms to the empty d orbitals on the chlorine atom:

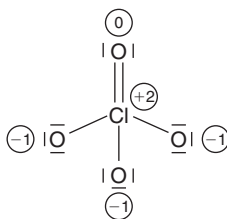

As in the case of the SO_4^{2-} ion, this is accomplished by overlap of filled p orbitals on oxygen atoms with empty d orbitals on the chlorine to give π bonds. The result of the contributions from structures in which there is some double bond character is that the bonds between chlorine and oxygen atoms

are shorter than expected if the bonds were only single bonds. There is no reason why there can not be some double bond character to more than one oxygen atom, which results in structures like

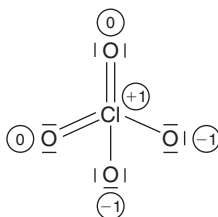

As expected, the extent to which the bonds in ClO_4^- are shortened from the single bond distance is rather large.

The following structure of the H_3PO_4 molecule is similar in many regards to that of H_2SO_4 , but there are some significant differences:

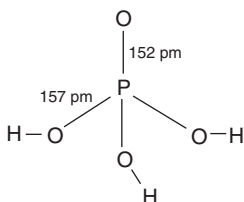

In sulfuric acid, the distance between the sulfur atom and the oxygen atoms without hydrogen atoms attached is 143 pm; the corresponding P-O distance in H_3PO_4 is 152 pm. This indicates that there is much less double bond character to the P-O bonds than there is to the S-O bonds. This is to be expected because of the +2 formal charge on sulfur when the structure is drawn showing only single bonds, whereas the phosphorus atom has only a +1 formal charge in a structure for H_3PO_4 showing only single bonds. Moreover, the phosphorus atom has a lower electronegativity than sulfur (2.2 compared to 2.6) so less double bonding to relieve a negative formal charge would be expected. The bond length of the HO-P single bond is 157 pm.

A structure for phosphorous acid, $(\text{HO})_2\text{HPO}$, can be drawn as follows:

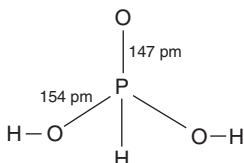

One of the hydrogen atoms is bound directly to the phosphorus atom and is not normally acidic. Note that in this case, the distance between the phosphorus atom and the oxygen atom without a hydrogen atom attached is only 147 pm, indicating more double bond character than there is in the corresponding bond in the H_3PO_4 molecule.

Another interesting structure is that of the dithionite ion, $\text{S}_2\text{O}_4^{2-}$, which is shown as

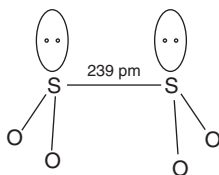

In several compounds that contain S–S single bonds, the bond length is approximately 205 pm. The very long S–S bond in $\text{S}_2\text{O}_4^{2-}$ is indicative of “loose” bonding, which is illustrated by the fact that when $^{35}\text{SO}_2$ is added to a solution containing $\text{S}_2\text{O}_4^{2-}$, some of the $^{35}\text{SO}_2$ is incorporated in $\text{S}_2\text{O}_4^{2-}$ ions. In contrast, the structure of dithionate, $\text{S}_2\text{O}_6^{2-}$,

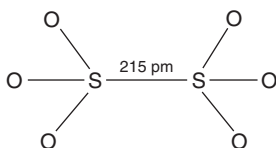

contains an S–S bond of more normal length, and the ion is more stable than is $\text{S}_2\text{O}_4^{2-}$. In $\text{S}_2\text{O}_4^{2-}$, the SO bonds are typical of SO bonds that have very little double bond character (151 pm). The fact that the SO bonds in dithionate have substantial double bond character is indicated by the 143 pm bond length, which is equal to that in SO_2 .

4.3 COMPLEX STRUCTURES—A PREVIEW OF COMING ATTRACTIONS

In addition to the structures discussed so far in this chapter, inorganic chemistry involves many others that can be considered to be chains, rings, or cages. In this section, several of the important structures will be described without resorting to theoretical interpretation. Some of the structures shown occur for several isoelectronic species so they represent structural *types*. In some cases, reactions are shown to illustrate processes that lead to products having such structures. These structures are often the result of an atom bonding to others of its own kind (which is known as *catenation*) or the formation of structures in which there are bridging atoms (especially oxygen, because oxygen normally forms two bonds). An example of the latter type of structure is the pyrosulfate ion, $\text{S}_2\text{O}_7^{2-}$. This ion can be formed by adding SO_3 to sulfuric acid, or by removing water (as in heating and thus the name *pyrosulfate*) from H_2SO_4 or a bisulfate:



The structure of the $\text{S}_2\text{O}_7^{2-}$ ion contains an oxygen bridge,

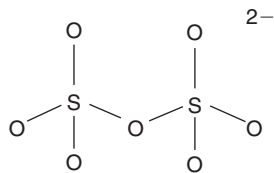

In this structure, as in the case of SO_4^{2-} , there is some double bond character to the bonds between the sulfur atoms and the terminal oxygen atoms. In addition to being the structure of $\text{S}_2\text{O}_7^{2-}$, this is the structure of the isoelectronic species $\text{P}_2\text{O}_7^{4-}$ (the *pyrophosphate* ion), $\text{Si}_2\text{O}_7^{6-}$ (pyrosilicate) and Cl_2O_7 (dichlorine heptoxide). The peroxydisulfate ion, $\text{S}_2\text{O}_8^{2-}$, has a *peroxide* linkage between the two sulfur atoms:

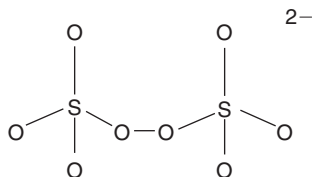

Dichlorine heptoxide, Cl_2O_7 , results from the dehydration of HClO_4 with a strong dehydrating agent such as P_4O_{10} :

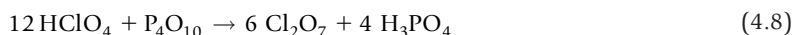

The *di-* or *pyrophosphate* ion results from the partial dehydration of phosphoric acid,



which can be shown as a molecule of water being formed from two H_3PO_4 molecules:

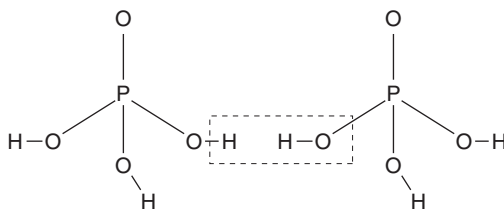

The polyphosphoric acids can be considered as arising from the reaction of $\text{H}_4\text{P}_2\text{O}_7$ with additional molecules of H_3PO_4 by the loss of water. In the following process, the product is $\text{H}_5\text{P}_3\text{O}_{10}$, which is

known as tripolyphosphoric acid:

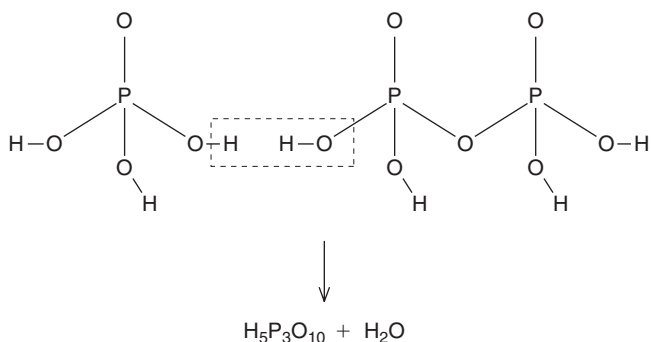

The pyrophosphate ion also results from the dehydration of a salt such as Na_2HPO_4 ,



Complete hydration of P_4O_{10} in excess water produces orthophosphoric acid (H_3PO_4),



but partial hydration of the oxide P_4O_{10} produces $\text{H}_4\text{P}_2\text{O}_7$:



Elemental phosphorus is obtained on a large scale by the reduction of calcium phosphate with carbon in an electric furnace at 1200 to 1400 °C:

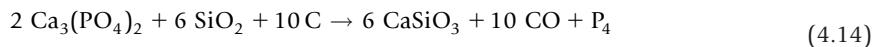

The element has several allotropic forms that are made up of tetrahedral P_4 molecules.

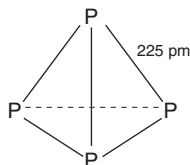

Combustion of phosphorus produces two oxides, P_4O_6 and P_4O_{10} , depending on the relative concentrations of the reactants.



The structures of both P_4O_6 and P_4O_{10} are based on the P_4 tetrahedron. In the case of P_4O_6 , there is an oxygen atom forming a bridge between each pair of phosphorus atoms along the edges of the tetrahedron, resulting a structure which can be shown as

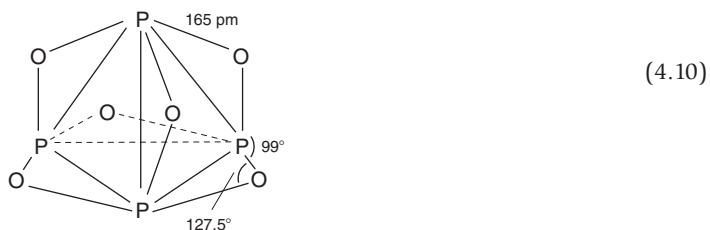

In this structure, the tetrahedron of phosphorus atoms is preserved. In keeping with the fact that when compared to P_4O_6 , P_4O_{10} has four additional oxygen atoms, these oxygen atoms are bonded to the phosphorus atoms to give a structure that has not only the six bridging oxygen atoms but also one terminal oxygen atom bonded to each of the phosphorus atoms:

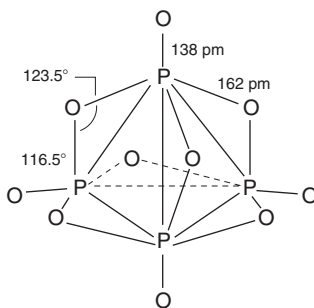

Elemental phosphorus is only one of several elements whose structures are polyatomic species. Another is the structure of elemental sulfur, which consists of puckered S_8 rings:

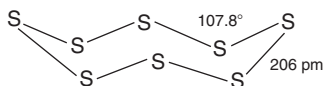

Although this eight-membered ring represents the structure of the molecule in the rhombic crystal phase, it is by no means the only sulfur molecule. Other ring structures have the formulas S_6 , S_7 , S_9 , S_{10} , S_{12} , and S_{20} . Just as gaseous oxygen contains O_2 molecules, sulfur vapor contains S_2 molecules that are paramagnetic. Selenium also exists as Se_8 molecules, but catenation is less pronounced than in the case of sulfur, and tellurium shows even less tendency in this regard. Tellurium resembles metals in its chemistry more than does either sulfur or selenium.

Tetrasulfur tetranitride, S_4N_4 , has a structure that can be considered as a hybrid of the following two resonance structures:

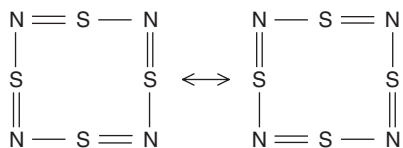

Although these structures show positions of the bonds in the resonance structures, the geometric structure of the molecule is

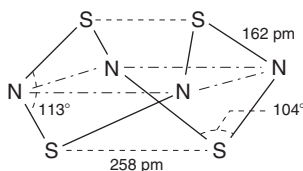

The distance between the sulfur atoms is considerably shorter than expected on the basis of radii of the isolated atoms. Therefore, there is believed to be a long, weak bond between the sulfur atoms. A very large number of derivatives of S_4N_4 are known, and some of them are described in Chapter 15.

Elemental boron exists as an icosahedral B_{12} molecule that has the structure

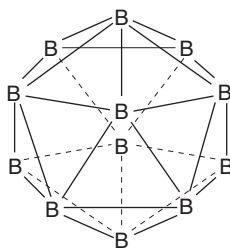

This structure has two staggered planes that contain five boron atoms in each, as well as two boron atoms in apical positions.

No survey of polyatomic elements would be complete without showing the form of carbon that exists as C_{60} . Known as *buckminsterfullerene* (named after R. Buckminster Fuller, the designer of the geodesic dome), C_{60} has a cage structure that has 12 pentagons and 20 hexagons on the surface as shown in Figure 4.3a. Each carbon atom makes use of sp^2 hybrid orbitals and is bonded by three σ bonds and one π bond, with the π bonds being delocalized. A very large number of derivatives of C_{60} are known, and other forms of carbon have general formula C_x ($x \neq 60$). Carbon also exists as diamond and graphite, which have the structures shown in Figure 4.3b and 4.3c.

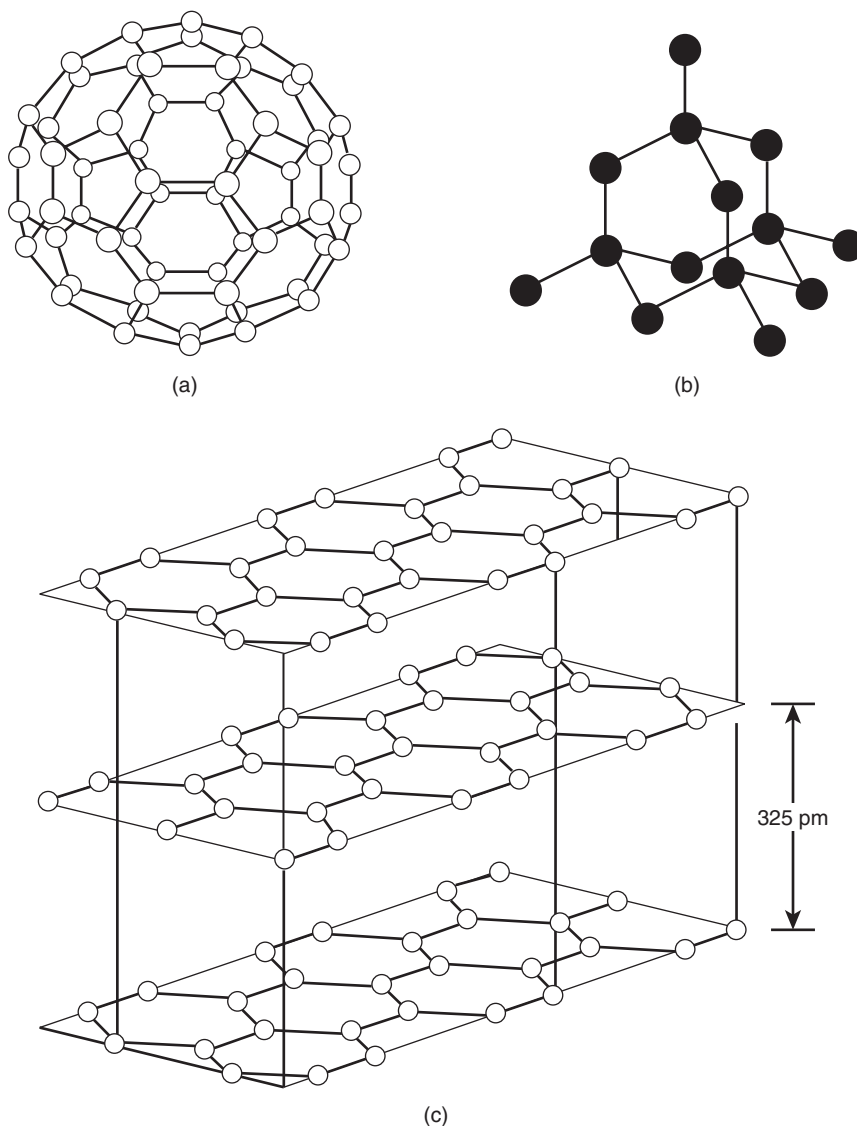

■ FIGURE 4.3 Some of the structures of elemental carbon (see Chapter 13).

In addition to the structures of these elements, a great deal of structural inorganic chemistry is concerned with the silicates. These materials form a vast array of naturally occurring and synthetic solids whose structures are based on the tetrahedral unit SiO_4 . There are structures that contain discrete SiO_4^{4-} ions as well as bridged structures such as $\text{Si}_2\text{O}_7^{6-}$. Because the Si atom has two fewer valence-shell electrons than the S atom, the SiO_4^{4-} and SO_4^{2-} ions are isoelectronic, as are the $\text{Si}_2\text{O}_7^{6-}$ and $\text{S}_2\text{O}_7^{2-}$ ions.

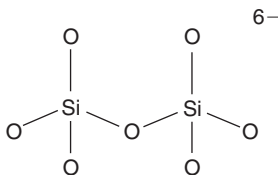

The SiO_4^{4-} ion, known as *orthosilicate*, occurs in minerals such as *zircon*, ZrSiO_4 , *phenacite*, Be_2SiO_4 , and *willemite*, Zn_2SiO_4 . The SiO_3^{2-} ion is known as the *metasilicate* ion. Some of the minerals that contain the $\text{Si}_2\text{O}_7^{6-}$ ion are *thortveitite*, $\text{Sc}_2\text{Si}_2\text{O}_7$, and *hemimorphite*, $\text{Zn}_4(\text{OH})_2\text{Si}_2\text{O}_7$.

Another important silicate structural type is based on a six-membered ring that contains alternating Si and O atoms and has the formula $\text{Si}_3\text{O}_9^{6-}$.

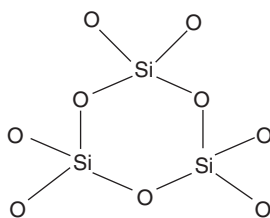

The $\text{P}_3\text{O}_9^{3-}$ ion (known as the *trimetaphosphate* ion) and $(\text{SO}_3)_3$, a trimer of SO_3 , also have this structure. The trimetaphosphate ion can be considered as the anion of the acid $\text{H}_3\text{P}_3\text{O}_9$ (trimetaphosphoric acid), a trimeric form of HPO_3 (metaphosphoric acid). Note that this acid is formally related to $\text{H}_5\text{P}_3\text{O}_{10}$, tripolyphosphoric acid, by the reaction



A six-membered ring also is present in the anion of $\text{Na}_3\text{B}_3\text{O}_6$. It contains bridging oxygen atoms but has only one terminal oxygen atom on each boron atom:

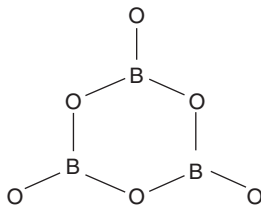

Although the complete description of its structure will not be shown here, boric acid, $\text{B}(\text{OH})_3$, has a sheet structure in which each boron atom resides in a trigonal planar environment of oxygen atoms. There is hydrogen bonding between the OH groups in neighboring molecules.

Because there are numerous silicates whose structures are made up of repeating patterns based on the SiO_4 tetrahedron, a type of shorthand notation has been developed for drawing the structures. For example, the SiO_4 unit can be shown as follows.

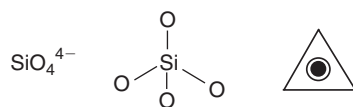

Then, the complex structures shown in Figure 4.4 are built up by combining these units. These structures are based on SiO_4 tetrahedra that share a corner or an edge. In the drawings, the solid circle

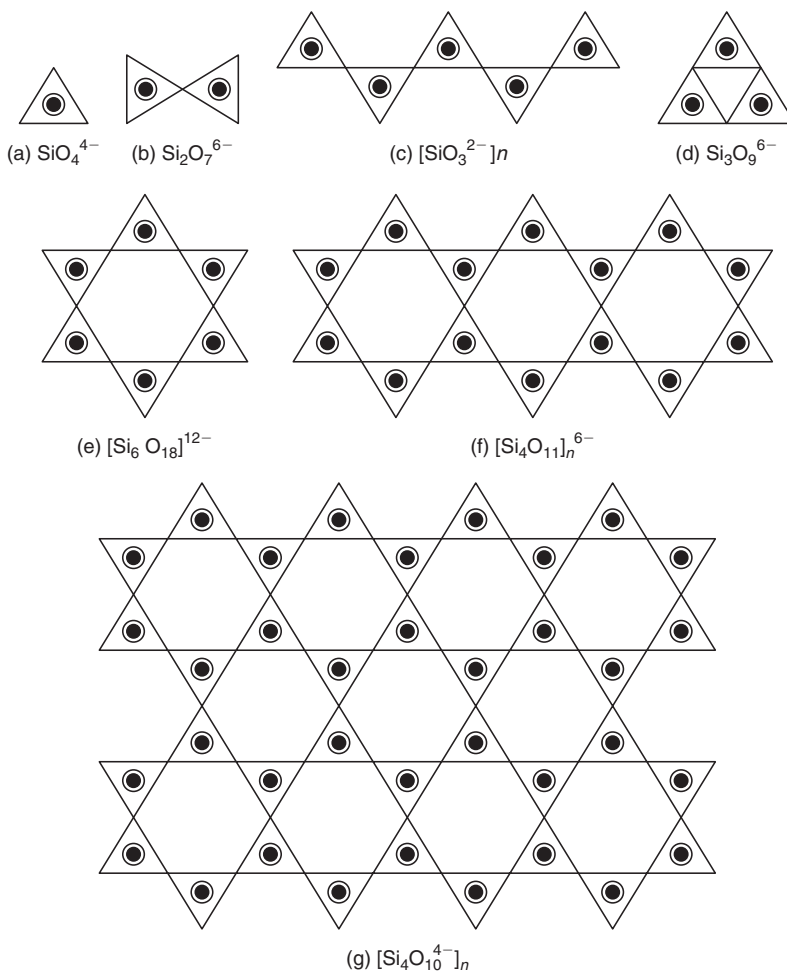

■ FIGURE 4.4 Structures of some common silicates.

represents the silicon atom, and the open circle around it represents an oxygen atom that is directed upward out of the page. From combinations of the basic SiO_4 units, a wide range of complex structures results as shown in Figure 4.4.

Although the formula for beryllium chloride is BeCl_2 , the compound exists in chains in the solid state. The bonding is covalent, and the environment around each Be is essentially tetrahedral with each Cl bridging between two Be atoms separated by 263 pm.

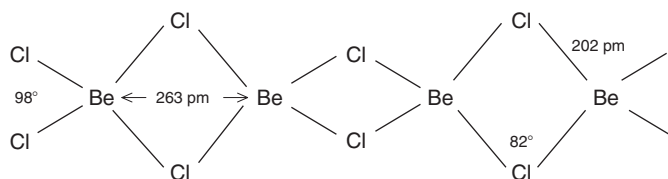

In the BeCl_2 monomer, there are only two bonds to Be, which gives only four electrons around the atom. In the bridged structure, unshared pairs of electrons on Cl are donated to complete octets around Be atoms.

In this chapter, procedures for drawing molecular structures have been illustrated, and a brief overview of structural inorganic chemistry has been presented. The structures shown include a variety of types, but many others could have been included. The objective is to provide an introduction and review to the topics of VSEPR, hybrid orbitals, formal charge, and resonance. The principles discussed and types of structures shown will be seen later to apply to the structures of many other species.

4.4 ELECTRON-DEFICIENT MOLECULES

In this chapter many of the basic principles related to structure and bonding in molecules have already been illustrated. However, there is another type of compound that is not satisfactorily described by the principles illustrated so far. The simplest molecule of this type is diborane, B_2H_6 . The problem is that there are only 10 valence shell electrons available for use in describing the bonding in this molecule.

The BH_3 molecule is not stable as a separate entity. This molecule can be stabilized by combining it with another molecule that can donate a pair of electrons (indicated as $:$) to the boron atom to complete the octet (see Chapter 9). For example, the reaction between pyridine and B_2H_6 produces $\text{C}_5\text{H}_5\text{N}:\text{BH}_3$. Another stable adduct is carbonyl borane, $\text{OC}:\text{BH}_3$ in which a pair of electrons is donated from carbon monoxide, which stabilizes borane. In CO , the carbon atom has a negative formal charge, so it is the “electron-rich” end of the molecule. Because the stable compound is B_2H_6 rather than BH_3 , the bonding in that molecule should be explained.

The *framework* of B_2H_6 can be visualized by considering $B_2H_4^{2-}$, which is isoelectronic with C_2H_4 . Starting with $B_2H_4^{2-}$, which would have a π bond like that in C_2H_4 , the bonding can be described similarly:

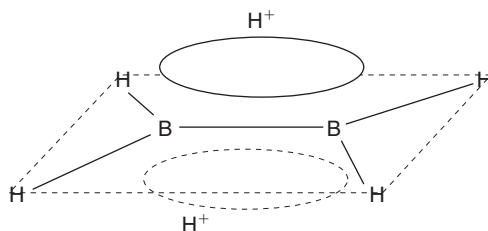

The planar framework has σ bonds as just shown, which involve sp^2 hybrid orbitals on the boron atoms. This leaves one unhybridized p orbital that is perpendicular to the plane. The B_2H_6 molecule can be considered being made by adding two H^+ ions to a hypothetical $B_2H_4^{2-}$ ion that is isoelectronic with C_2H_4 because each carbon atom has one more electron than does a boron atom. In the $B_2H_4^{2-}$ ion, the two additional electrons reside in a π bond that lies above and below the plane of the structure just shown. When two H^+ ions are added, they become attached to the lobes of the π bond to produce a structure, the details of which can be shown as

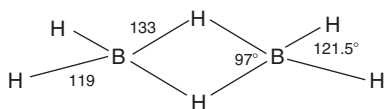

In each of the B-H-B bridges, only two electrons bond the three atoms together by having the orbitals on the boron atoms simultaneously overlap the hydrogen $1s$ orbital. A bond of this type is known as a *two-electron three-center bond*. In terms of molecular orbitals, the bonding can be described as the combination of two boron orbitals and one hydrogen orbital to produce three molecular orbitals, of which only the one of lowest energy is populated:

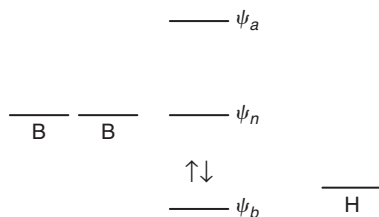

Bonding of this type and other boron hydrides that have three-center two-electron bonds with hydrogen bridges is discussed in Chapter 13.

Aluminum alkyls having the empirical formula AlR_3 are dimerized to give Al_2R_6 structures in which the two-electron three-center bonds involve alkyl groups as the bridging units. For example, $\text{Al}_2(\text{CH}_3)_6$ has the arrangement and dimensions shown in the following structure:

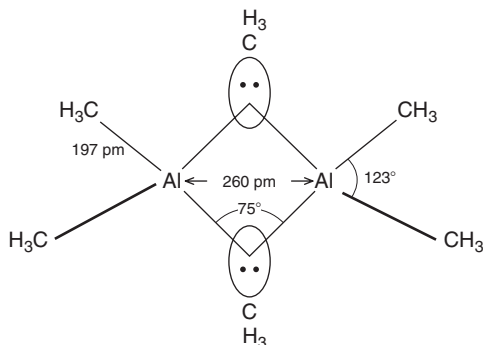

Other aluminum alkyls also exist as dimers as a result of bridging by the alkyl groups. In the structure just shown, there are four CH_3 groups that are nonbridging and only two that are bridging. If an aluminum alkyl is prepared that contains more than one type of alkyl group, it is possible to determine which type of group forms the bridges. One such case is that of $\text{Al}_2(\text{CH}_3)_2(t\text{-C}_4\text{H}_9)_4$. In this case, it is found that the methyl groups are contained in the bridges, but none are found in the more numerous terminal positions. Therefore, we conclude that the methyl group forms stronger bridges between two aluminum atoms than does the *t*-butyl group. When other compounds of this type are prepared so that competition is set up between potential bridging groups, it is found that the strengths of bridges between aluminum atoms varies as $\text{CH}_3 > \text{C}_2\text{H}_5 > t\text{-C}_4\text{H}_9$. The associated nature of the aluminum alkyls is discussed in greater detail in Chapter 12. Chloride ions form the bridges in the Al_2Cl_6 dimer. In fact, dimers exist when aluminum is bonded to numerous atoms and groups. The stability of the bridges formed varies in the order $\text{H} > \text{Cl} > \text{Br} > \text{I} > \text{CH}_3$.

A polymeric structure is exhibited by "beryllium dimethyl," which is actually $[\text{Be}(\text{CH}_3)_2]_n$ (see the structure of $(\text{BeCl}_2)_n$ shown earlier), and LiCH_3 exists as a tetramer, $(\text{LiCH}_3)_4$. The structure of the tetramer involves a tetrahedron of Li atoms with a methyl group residing above each face of the tetrahedron. An orbital on the CH_3 group forms multicentered bonds to four Li atoms. There are numerous compounds for which the electron-deficient nature of the molecules leads to aggregation.

4.5 STRUCTURES HAVING UNSATURATED RINGS

In addition to the types of structures shown thus far, there are several others that are both interesting and important. One such type of structure contains unsaturated rings. Because $\text{R}-\text{C}\equiv\text{N}$ is called a nitrile, compounds containing the $-\text{P}\equiv\text{N}$ group were originally called phosphonitriles. An unstable molecule having the formula $:\text{N}-\text{PH}_2$ is known as phosphazine. Although this molecule is unstable,

polymers containing this monomer unit with chlorine replacing the hydrogen atoms are well known. Heating a solution of PCl_5 and NH_4Cl in $\text{C}_6\text{H}_5\text{Cl}$ or $\text{HCl}_2\text{C}-\text{CHCl}_2$ leads to the reaction

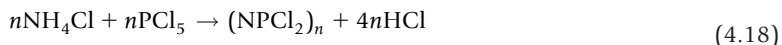

Several materials having the formula $(\text{NPCl}_2)_n$ are known, but the most extensively studied of them is the cyclic trimer, $(\text{NPCl}_2)_3$, which has the structure

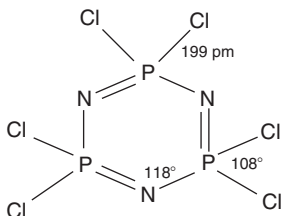

Compounds of this type are known as *phosphazines*, and they have structures that have a planar ring because of π bonding. In $(\text{NPCl}_2)_3$, the P-N distance is 158 pm, which is much shorter than the approximately 175 pm that is characteristic of a P-N single bond. Whether or not these compounds are strictly aromatic in character is not certain. The bonding in $(\text{NPCl}_2)_3$ is much more complex than that in benzene because, unlike benzene in which the delocalized π orbital arises from overlap of unhybridized p orbitals on the carbon atoms, the P-N bonding involves $p_{\text{N}} - d_{\text{P}}$ (the subscripts show the atoms involved) overlap to give $p_{\pi} - d_{\pi}$ bonding. Delocalization does not appear to be as complete in the phosphazines as it is in benzene. Substitution of two groups on the phosphorus atoms in the ring can lead to three types of products. If the substituents are on the same phosphorus atom, the product is known as *geminal*, but if substitution is on different phosphorus atoms, the product may have *cis* or *trans* configuration depending on whether the two groups are on the same or opposite sides of the ring:

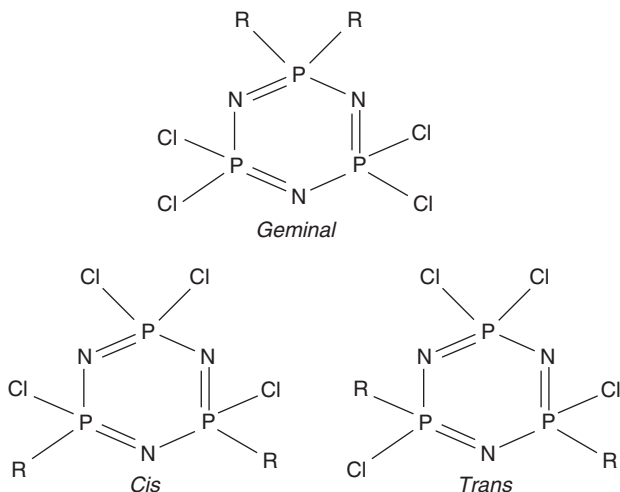

The chemistry of these compounds is discussed in greater detail in Chapter 14.

Carbon atoms have four valence-shell electrons. Because boron and nitrogen atoms have three and five valence-shell electrons, respectively, one boron and one nitrogen atom are formally equivalent to two carbon atoms. Therefore, a compound that contains an even number (n) of carbon atoms, could have an analogous structure that contains $n/2$ atoms of boron and $n/2$ atoms of nitrogen. The most common case of this type is a compound that is analogous to benzene, C_6H_6 , which has the formula $B_3N_3H_6$. This compound, sometimes referred to as “inorganic benzene,” is actually *borazine*, which has a structure that can be shown using resonance structures analogous to those used to describe benzene:

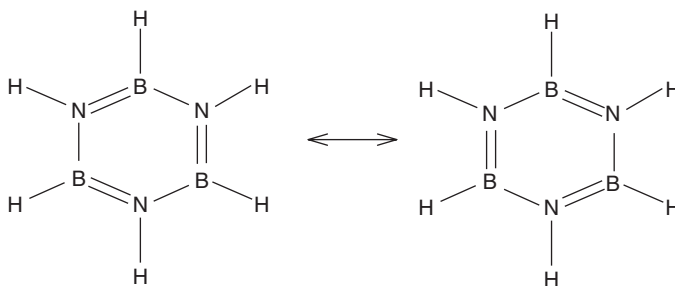

Therefore, the borazine molecule is considered to be aromatic. Borazine has many properties that are similar to those of benzene, although it is more reactive as a result of the B–N bonds being somewhat polar rather than purely covalent.

The trichloro derivative having a chlorine atom bound to each of the boron atoms is known as *B*-trichloroborazine. Borazine can be prepared by several different methods, one of which is the reduction of the trichloro compound:

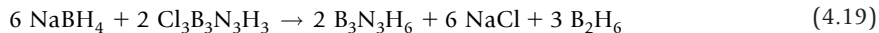

Borazine can also be prepared directly by the reaction of diborane with ammonia.

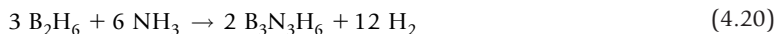

More of the chemistry of this interesting compound is presented in Chapter 13.

4.6 BOND ENERGIES

Closely related to molecular structure are the energies associated with chemical bonds. It is frequently possible to make decisions regarding the stability of alternative structures based on the types of bonds present. However, because SF_4 has four S–F single bonds, it is not possible to determine whether the trigonal pyramidal or irregular tetrahedron is the stable structure because each of them has four bonds. However, for many situations, bond energies provide a useful tool (see Table 4.1).

Table 4.1 Average Bond Energies.

Bond	Energy, kJ mol ⁻¹	Bond	Energy, kJ mol ⁻¹	Bond	Energy, kJ mol ⁻¹
H-H	435	O=S	523	Ge-Ge	188
H-O	459	O-N	201	Ge-H	285
H-F	569	O-P	335	Ge-F	473
H-Cl	431	O-As	331	P-P	209
H-Br	368	O-C	360	P-F	498
H-I	297	O=C	799	P-Cl	331
H-N	389	O=C	1075	P-Br	268
H-P	326	O-Si	464	P-I	215
H-As	297	O=Si	640	Si-F	598
H-Sb	255	O=Si	803	Si-Cl	402
H-S	368	O-Ge	360	As-As	180
H-Se	305	S-S	264	As-F	485
H-Te	241	S=S	431	As-Cl	310
H-C	414	S-Cl	272	As-Br	255
H-Si	319	S-Br	212	C-C	347
H-Ge	285	S-C	259	C=C	611
H-Sn	251	N-F	280	C≡C	837
H-Pb	180	N-Cl	188	C-N	305
H-B	389	N-N	159	C-F	490
H-Mg	197	N=N	418	C-Cl	326
H-Li	238	N≡N	946	C-Br	272
H-Na	201	N=O	594	O-F	213
H-K	184	N-Ge	255	O-S	364
H-Rb	167	N-Si	335		
O=O	498	O-Cl	205		
O-O	142	C=N	615		

Consider a compound such as $\text{N}(\text{OH})_3$, which we would suspect is not the most stable arrangement for one nitrogen atom, three oxygen atoms, and three hydrogen atoms. Suppose one reaction of such a molecule can be written as

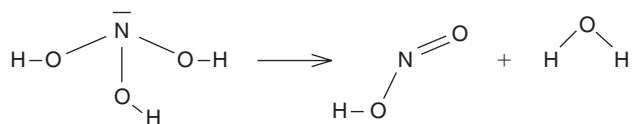

We can consider this reaction as taking place by breaking all the bonds in $\text{N}(\text{OH})_3$ and then making all the bonds in HNO_2 (which is actually HONO) and H_2O . Breaking the bonds in $\text{N}(\text{OH})_3$ means breaking three N–O bonds (201 kJ each) and three H–O bonds (459 kJ each). The energy required would be $3(201 \text{ kJ}) + 3(459 \text{ kJ}) = 1980 \text{ kJ}$. When the products form, the bonds formed are two H–O bonds in water and one H–O bond, one N–O bond (201 kJ), and one N=O bond (607 kJ) in HNO_2 . These bonds give a total of 2185 kJ for the bonds *formed*, which means this is the amount of energy *released*. Therefore, for the entire process the energy change is $(1980 \text{ kJ} - 2185 \text{ kJ}) = -205 \text{ kJ}$, so $\text{N}(\text{OH})_3$ should be unstable with respect to the HNO_2 and H_2O products. Such calculations tell us nothing about the *rate* of a process, because the rate depends on the pathway, whereas the thermodynamic stability depends only on the initial and final states. Even reactions that are energetically favorable may take place slowly (or not at all) because there may be no low-energy pathway.

An additional example of the use of bond energies will be considered. Earlier in this chapter, we considered the structure of the cyanate ion, OCN^- . Suppose the structures being considered are



and we wish to make a prediction regarding the relative stability of the structures. From the discussion presented earlier, we know that structure I is more likely because in structure II there is a positive formal charge on the nitrogen atom. The bond energies that are needed are as follows:



If we start with the atoms (and one additional electron) and form the bonds, structure I would release a total energy of -1414 kJ while structure II would release -1209 kJ . Therefore, we predict (correctly) that the structure for the ion should be OCN^- rather than ONC^- . However, the structure

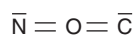

involves one N=O bond (594 kJ) and one C=O bond (799 kJ), so it appears from bond energies to be almost as stable as structure I just shown (1414 kJ versus 1393 kJ). However, this structure places a +2 formal charge on the oxygen atom, which is contrary to the principles of bonding. It is best not to

stretch the bond energy approach too far and to use it in conjunction with other information such as formal charges and electronegativities when trying to decide issues related to stability.

The bond energy approach may not always be adequate because it is the free energy change, ΔG , that is related to equilibrium constants, and the free energy is given by

$$\Delta G = \Delta H - T\Delta S \quad (4.22)$$

Accordingly, the difference in entropy for the structures in question may also be a factor in some cases. In spite of this, bond energies provide a basis for comparing structures. In order to use this approach, energies for many types of bonds are needed, and they are given in Table 4.1.

It should always be kept in mind that bond energies are usually *average* values based on the energies of bonds in several types of molecules. In a given molecule, a certain bond may have an energy that is somewhat different from the value given in the table. Therefore, in cases where a decision on the difference in stability between two structures is based on bond energies, regard small differences as being inconclusive.

One interesting and highly significant application of bond energies involves the enormous difference in the character of CO_2 and SiO_2 . In the case of CO_2 , the structure is a monomeric molecule that has two double bonds,

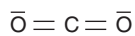

In the case of SiO_2 , the structure is a *network* in which oxygen atoms form bridges between silicon atoms, with each Si being surrounded by four oxygen atoms:

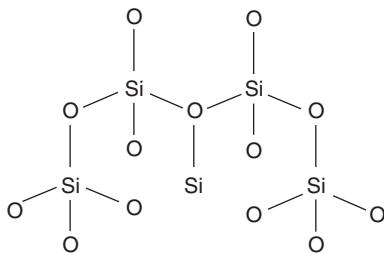

The π bonding in CO_2 results in strong double bonds that actually are stronger than two C–O single bonds (C=O is 745 kJ mol^{-1} , whereas each C–O is 360 kJ mol^{-1}). Between Si and O, π bonding is not as strong because of the difference in size of the orbitals on the two atoms. As a result, a Si–O single bond is 464 kJ mol^{-1} (which is stronger than a C–O bond because of the greater polarity), whereas a Si=O bond is only 640 kJ mol^{-1} . Therefore, it is energetically more favorable for carbon to form two C=O double bonds, but four Si–O single bonds are more favorable energetically compared to two Si=O bonds. Carbon dioxide is a monomeric gas, whereas SiO_2 (which exists in several forms) is an extended solid that melts at over 1600°C .

A compound that is less stable than some other compound into which it should transform with a release of energy may be locked in the less stable form because of the unfavorable kinetics for its transformation. Suppose the reaction



is thermodynamically favorable. If the pathway for the reaction is such that the rate is very slow, A may not react because of kinetic inertness rather than its thermodynamic stability. Such a situation is known as *kinetic* stability rather than *thermodynamic* stability. A similar situation exists when the following system is considered:

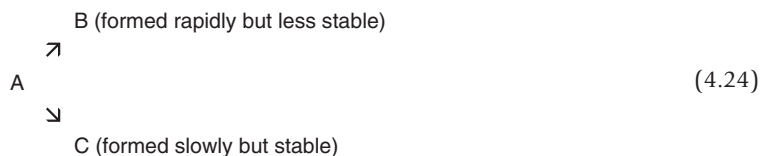

In this case, the predominant product of the reaction will be B even though it is less stable than C because of the difference in reaction rates. Sometimes, B is referred to as the *kinetic* product while C is called the *thermodynamic* product.

In this chapter has been presented an elementary discussion of bonding principles that have broad applicability in the study of inorganic chemistry. These topics have been introduced by showing many of the important types of structures that are encountered in the study of inorganic materials. These structures will be revisited in later chapters, but the intent is to show many different types of structures and the relationships between many of them. Resonance, repulsion, electronegativity, and formal charge have been used to explain many of the aspects of bonding and they are useful for understanding structures.

■ REFERENCES FOR FURTHER STUDY

- Bowser, J. R. (1993). *Inorganic Chemistry*. Brooks/Cole Publishing Co, Pacific Grove, CA. An excellent, readable text in inorganic chemistry.
- Cotton, F. A., Wilkinson, G., and Murillo, C. A. (1999). *Advanced Inorganic Chemistry*, 6th ed. John Wiley, New York. Almost 1400 pages devoted to all phases of inorganic chemistry. An excellent reference text.
- DeKock, R. L., and Gray, H. B. (1980). *Chemical Bonding and Structure*. Benjamin Cummings, Menlo Park, CA. An excellent introduction to many facets of bonding and structure of a wide range of molecules.
- Douglas, B. E., McDaniel, D., and Alexander, J. (1994). *Concepts and Models of Inorganic Chemistry*, 3rd ed. John Wiley, New York. A well-known text that provides a wealth of information on structures of inorganic materials.
- Greenwood, N. N., and Earnshaw, A. (1997). *Chemistry of the Elements*, 2nd ed. Butterworth-Heinemann, New York. Although this is a standard reference text on descriptive chemistry, it contains an enormous body of information on structures of inorganic compounds.
- Huheey, J. E., Keiter, E. A., and Keiter, R. L. (1993). *Inorganic Chemistry: Principles of Structure and Reactivity*, 4th ed. Benjamin Cummings, New York. A popular text that has stood the test of time.

- Lide, D. R., Ed. (2003). *CRC Handbook of Chemistry and Physics*, 84th ed. CRC Press, Boca Raton, FL. Structural and thermodynamic data are included for an enormous number of inorganic molecules in this massive data source.
- Mackay, K., Mackay, R. A., and Henderson, W. (2002). *Introduction to Modern Inorganic Chemistry*, 6th ed. Nelson Thornes, Cheltenham, UK. One of the standard texts in inorganic chemistry.
- Pauling, L. (1960). *The Nature of the Chemical Bond*, 3rd ed. Cornell University Press, Ithaca, NY. A true classic in bonding theory. Although somewhat dated, this book still contains a wealth of information on chemical bonding.
- Sharpe, A. G. (1992). *Inorganic Chemistry*, 3rd ed. Longman, New York. Excellent coverage of bonding concepts in inorganic molecules and many other topics.
- Shriver, D. F., and Atkins, P. W. (2006). *Inorganic Chemistry*, 4th ed. Freeman, New York. A highly regarded textbook in inorganic chemistry.

■ QUESTIONS AND PROBLEMS

- Draw structures for the following showing correct geometry and all valence shell electrons. (a) OCS; (b) XeF₂; (c) H₂Te; (d) ICl₄⁺; (e) BrCl₂⁺; (f) PH₃.
- Draw structures for the following showing correct geometry and all valence shell electrons. (a) SbF₄⁺; (b) ClO₂⁻; (c) CN₂²⁻; (d) ClF₃; (e) OPCl₃; (f) SO₃²⁻.
- Suppose that a molecule is composed of two atoms of phosphorus and one of oxygen. Draw structures for two possible isomers of the molecule. For the more stable structure, draw the resonance structures. Which structure is least important?
- Draw structures for the following showing correct geometry and all valence shell electrons. (a) Cl₂O; (b) ONF; (c) S₂O₃²⁻; (d) PO₃⁻; (e) ClO₃⁻; (f) ONC⁻.
- The bond angle in ONCl is 116°. Explain what this means in terms of hybridization and how hybridization of orbitals on N allows a π bond to be present.
- Explain why the bond length for two of the N to O bonds in HNO₃ are shorter than they are in NO₃⁻.
- The N–O bond length in NO₂⁺ is 115 pm, but it is 120 pm in the NO₂ molecule. Explain this difference.
- In H₃PO₄, one P–O bond has a different length than the other three. Would it be shorter or longer than the others? Why?
- A P–N single bond normally has a length of approximately 176 pm. In (PNF₂)₃ (which contains a six-membered ring of alternating P and N atoms) a P–N bond length of 156 pm is found. Explain the difference in bond lengths.
- The C–O bond has a length of 113 pm, and it is the strongest bond found for a diatomic molecule. Why is it stronger than the bond in N₂, which is isoelectronic?
- The reaction CaC₂ + N₂ → CaCN₂ + C produces calcium cyanamide, which has been widely used as a fertilizer. Draw the structure of the cyanamide ion and describe the bonding.
- The O=O and S=S bond energies are 498 and 431 kJ mol⁻¹, respectively, and the O–O and S–S bond energies are 142 and 264. Explain why it is reasonable to expect structures containing sulfur that have extensive catenation but such structures are not expected for oxygen.
- Why are there two different P–O bond lengths in P₄O₁₀, and why do they differ by such a large extent?
- Explain the slight difference in N–O bond lengths in NO₂⁻ (124 pm) and NO₃⁻ (122 pm).
- In the compound ONF₃, the O–N bond length is 116 pm. The N–O single bond length is 121 pm. Draw resonance structures for ONF₃ and explain the short observed bond length.

16. Given the bond energies (in kJ mol^{-1}) CO , 360, $\text{C}=\text{O}$, 799; $\text{Si}-\text{O}$, 464; and $\text{Si}=\text{O}$, 640, explain why extensive structures containing SiOSi linkages are stable, whereas similar structures containing $\text{C}-\text{O}-\text{C}$ bonds are not.
17. The dehydration of malonic acid, $\text{HO}_2\text{C}-\text{CH}_2-\text{CO}_2\text{H}$, produces C_3O_2 (known as tricarbon dioxide or carbon suboxide). Draw the structure for C_3O_2 and describe the bonding in terms of resonance structures.
18. Explain why the $\text{N}-\text{O}$ bond lengths decrease for the following species in the order $\text{NO}_2^- > \text{NO}_2 > \text{NO}_2^+$.
19. In the solid state, PBr_5 exists as $\text{PBr}_4^+\text{Br}^-$ but PCl_5 exists as $\text{PCl}_4^+\text{PCl}_6^-$. Explain this difference in behavior.
20. The stability of the oxy anions of the group V elements decrease in the order $\text{PO}_4^{3-} > \text{AsO}_4^{3-} > \text{SbO}_4^{3-}$. Explain this trend in stability.
21. Although the electron affinity of fluorine is less than that of chlorine, F_2 is more reactive than Cl_2 . Explain some of the reasons for this difference in reactivity.
22. Draw the structure for H_5IO_6 . Explain why iodine can form H_5IO_6 but chlorine does not form H_5ClO_6 .
23. Draw structures for $\text{N}(\text{OH})_3$ and ONOH and show using bond energies why $\text{N}(\text{OH})_3$ would not be expected to be stable.
24. By making use of bond energies, show that H_2CO_3 would be expected to decompose into CO_2 and H_2O .
25. Most *gem* diol compounds of carbon (containing two OH groups on the same carbon atom) are unstable. Using bond energies, show that this is expected.
26. The following species containing antimony are known: SbCl_3 , SbCl_4^- , SbCl_5 , SbCl_5^{2-} , and SbCl_6^- . Draw structures for each and predict bond angles using VSEPR. What type of hybrid orbitals are used by Sb in each case?
27. A reaction that produces NCN_3 , known as cyanogen azide, is

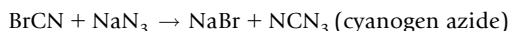

Draw the structure of cyanogen azide. Speculate on the stability of this molecule.

28. Draw two possible structures for thiocyanogen, $(\text{SCN})_2$, and comment on the relative stability of the structures you draw.
29. Explain why the $\text{F}-\text{O}-\text{F}$ bond angle in OF_2 is 102° , whereas the $\text{Cl}-\text{O}-\text{Cl}$ angle in OCl_2 is 115° .

This page intentionally left blank

Symmetry and Molecular Orbitals

In the previous chapter, the structures of many molecules and ions were described by drawing structures showing how the electrons are distributed. However, there is another way in which the structures of molecules are described. That way uses different language and symbols to convey information about the structures in an efficient, unambiguous way. In this way, the structures of molecules and ions are described in terms of their *symmetry*. Symmetry has to do with the spatial arrangement of objects and the ways in which they are interrelated. For example, the letter “T” has a plane that bisects it along the “post,” giving two halves that are identical in relationship to that plane. However, the letter “R” does not have such a plane that divides it into two identical parts. This simple example illustrates a symmetry characteristic that is known as a plane of symmetry. There is much more that can be done with symmetry in terms of molecular structure so this chapter is devoted to this important topic.

5.1 SYMMETRY ELEMENTS

Understanding symmetry as related to molecular structure is learning to look at molecules in ways to see the spatial relationships of atoms to each other. Visualization of a molecule as a three-dimensional assembly is accomplished in terms of symmetry elements. Symmetry elements are lines, planes, and points that have a special relationship to a structure. In the foregoing discussion, it was pointed out that the letter “T” has a plane that divides it into two identical fragments. That plane is known as a *plane of symmetry* or a *mirror plane* (which is designated as σ). The letter “H” also has such a plane that divides it into two identical parts, the plane perpendicular to the page that cuts the cross bar in half. There are also lines about which the letter H can be rotated to achieve an orientation that is identical to that shown. For example, a line in the plane of the page that passes through the midpoint of the cross bar is such a line. There is another that is perpendicular to the plane of the page that passes through the center of the cross bar, and a third line about which H can be rotated to give the identical structure lines in the plane of the page and runs along the cross bar. Rotation by 180° around any of these three lines gives a structure that is identical to H.

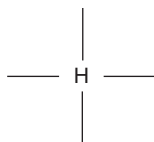

Rotation of the H around either of the lines shown gives the letter in the orientation shown. The third line is perpendicular to the page and passes through the center of the cross bar.

The lines that we have just described are known as lines of symmetry or *rotation axes* that are designated by the letter *C*. In this case, the angle of rotation required to give the same orientation of H is 180° , so the axes are C_2 axes. The subscript is an index that is obtained by dividing 360° by the angle through which the structure must be rotated to give an orientation that is indistinguishable from the original. Therefore, $360^\circ/180^\circ = 2$, so each of the axes is known as a C_2 axis. To be precise, the axes that we have described are known more correctly as *proper rotation axes*. It is important to distinguish between the proper rotation axis itself and the *operation* of actually rotating the molecule. Of course any object can be rotated by 360° to give an orientation that is unchanged so all objects have a C_1 axis. Rotations may be carried out sequentially, and the rotation of a molecule m times around an axis of degree of symmetry n is indicated as C_n^m .

If we consider the H_2O molecule, which has the arrangement of atoms (electrons are not localized and therefore are not considered when determining symmetry) shown as

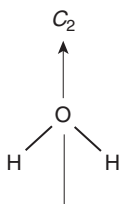

we see that there is a line through the oxygen atom that bisects the H–O–H bond angle about which rotation by 180° would leave the molecule unchanged. That line is a C_2 axis. Although any line through the structure is a C_1 axis, the C_2 axis is the axis of highest symmetry because a smaller rotation around it gives back the original structure. *The axis of highest symmetry in a structure is defined as the z-axis.*

From the structure just shown for the water molecule (and that shown later in Figure 5.5), we can see that there are also two planes that divide the H_2O molecule into identical fragments. One is the plane of the page; the other is perpendicular to the page and bisects the oxygen atom, leaving one hydrogen atom on either side. A plane of symmetry is denoted as σ . Because we ordinarily take the z axis to be the vertical direction, both of the planes of symmetry are vertical planes that contain the z -axis. They are designated as σ_v planes. The H_2O molecule thus has one C_2 axis and two vertical planes (σ_v), so its symmetry designation (also known as the *point group*) is C_{2v} . We will explain more about such designations later.

The structure of the ClF_3 molecule is based on there being 10 electrons around the central atom (seven valence electrons from Cl, one from each F atom). As we have seen earlier, unshared pairs of electrons are found in equatorial positions, so the structure can be shown as

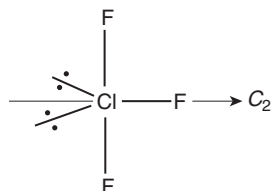

It is easy to see that the line passing through the chlorine atom and the fluorine atom in the equatorial position is a C_2 axis. Rotation about this axis by 180° leaves these two atoms unchanged, but the fluorine atoms in axial positions are interchanged. There are two planes that bisect the molecule. One of these is the plane of the page, which cuts all the atoms in half, and the other is the plane perpendicular to that plane that bisects the Cl atom and the fluorine atom in the equatorial position. This collection of symmetry elements (one C_2 axis and two vertical planes) means that the ClF_3 molecule can also be designated as a molecule having C_{2v} symmetry.

The formaldehyde molecule, H_2CO , has a structure that is shown as

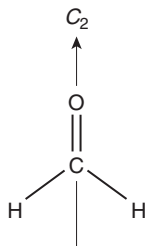

The line passing through the carbon and oxygen atoms is a C_2 axis, rotation around which by 180° leaves those two atoms in their positions but interchanges the positions of the two hydrogen atoms. Moreover, there are two planes that bisect the molecule. One is perpendicular to the plane of the page and bisects the carbon and oxygen atoms, leaving one hydrogen on either side. The other plane is the plane of the page that bisects all four atoms. Therefore, the formaldehyde molecule also has C_{2v} symmetry. In each of the cases just described, we find that the molecule has one C_2 axis and two σ_v planes that intersect along the C_2 axis. These characteristics define the symmetry type known as C_{2v} , which is also the point group to which the molecule belongs.

The ammonia molecule has a structure that can be shown as

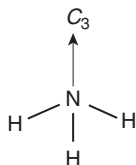

This pyramidal molecule has a C_3 axis that runs through the nitrogen atom and through the center of the triangular base formed by the three hydrogen atoms. Rotation around this axis by 120° leaves the position of the nitrogen atom unchanged but interchanges the hydrogen atoms. Viewed from the top looking down the C_3 axis, the ammonia molecule is seen as

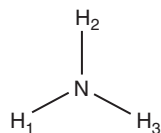

The subscripts on the hydrogen atoms are to identify their positions. Clockwise rotation by 120° around the C_3 axis results in the molecule having the orientation

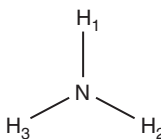

There are also three mirror planes that bisect the molecule along each N–H bond. Therefore, the NH_3 molecule has one C_3 axis and three σ_v planes, so the point group for the molecule is C_{3v} .

The BF_3 molecule has a planar structure which can be shown as

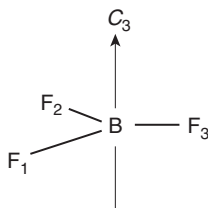

with a C_3 axis perpendicular to the plane of the molecule. Rotation of the molecule by 120° around that axis causes the fluorine atoms to interchange positions but gives an orientation that is identical to that shown:

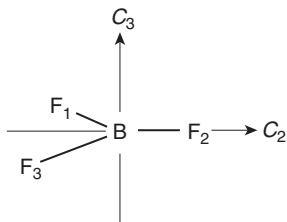

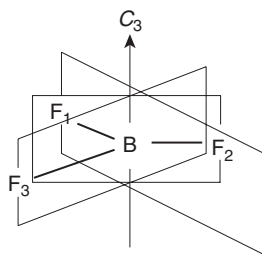

■ FIGURE 5.1 The BF_3 molecule showing planes of symmetry.

In addition to the C_3 axis (the z -axis), there are also three vertical planes of symmetry which can be seen clearly in Figure 5.1. They are perpendicular to the plane of the molecule and bisect the molecule along each B–F bond. Because the molecule is planar, there is also a horizontal plane of symmetry (σ_h) that bisects all four of the atoms. Each B–F bond is also a C_2 axis because rotation around the bond would give the same orientation of the molecule except for changing the positions of the fluorine atoms. One of the C_2 axes is shown above, and rotation by 180° around that axis would produce the orientation

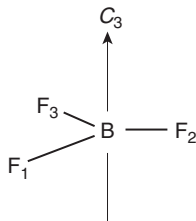

Note that each of the C_2 axes not only is coincident with a B–F bond but also is the line of intersection of the horizontal plane with one of the vertical planes. It is generally true that the intersection of a vertical plane of symmetry with a horizontal plane generates a C_2 axis. The list of symmetry elements that we have found for the BF_3 molecule includes one C_3 axis, three vertical planes (σ_v), three C_2 axes, and one horizontal plane (σ_h). A molecule possessing these symmetry elements, such as BF_3 , SO_3 , CO_3^{2-} , and NO_3^- , is said to have D_{3h} symmetry. In the cases of H_2O , ClF_3 , H_2CO , and NH_3 , the symmetry elements included only a C_n axis and n vertical planes. These molecules belong to the general symmetry type known as C_{nv} . Molecules that have a C_n axis and also have n C_2 axes perpendicular to the C_n axis are known as D_n molecules.

The XeF_4 molecule has a planar structure with unshared pairs of electrons above and below the plane.

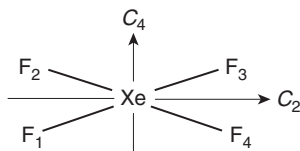

A line perpendicular to the plane of the molecule that passes through the Xe atom is a C_4 axis. There are four vertical mirror planes that intersect along the C_4 axis. Two of them cut the molecule along opposite Xe–F bonds; the other two bisect the molecule by bisecting opposite F–Xe–F angles. One of these planes cuts the horizontal plane of the molecule along the C_2 axis shown in the drawing. There is, of course, a horizontal plane of symmetry, σ_h . The intersections of the four vertical planes with the horizontal plane generates four C_2 axes that are perpendicular to the C_4 axis.

However, the XeF_4 molecule has one additional symmetry element. The center of the Xe atom is a point through which each fluorine atom can be moved the same distance that it was originally from that point to achieve an orientation that is identical with the original. If this operation is carried out with the XeF_4 molecule oriented as just shown, the resulting orientation can be shown as

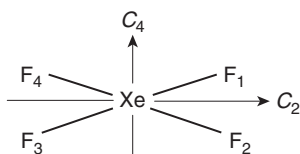

A center of symmetry (designated as i) is a point through which each atom can be moved a like distance to achieve an orientation that is identical to the original. The center of the Xe atom in XeF_4 is such a point. Having four C_2 axes perpendicular to the C_4 (as a result of having a horizontal plane of symmetry), the XeF_4 belongs to the D_{4h} symmetry type.

Linear molecules belong to one of two symmetry types. The first is typified by HCN, which has the structure



Rotation of the molecule any angle around the axis that lies along the bonds gives the same orientation. The rotation may even be by an infinitesimally small angle. Division of 360° by such a small angle gives a value approaching infinity, so the axis is known as a C_∞ axis. An infinite number of planes that intersect along the C_∞ axis bisect the molecule. Having a C_∞ axis and an infinite number of σ_v planes, the symmetry type is $C_{\infty v}$. Some other molecules and ions that have this symmetry are N_2O , OCS , CNO^- , SCN^- , and HCCF .

Linear molecules having a different symmetry type are typified by CO_2 , which has the structure

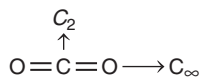

In this case, the C_∞ axis (the z or vertical axis) functions as it did in the case of HCN, and there are an infinite number of σ_v planes that intersect along the C_∞ axis. However, the molecule also has a plane of symmetry that bisects the carbon atom, leaving one oxygen atom on either side. Because that plane is perpendicular to the C_∞ axis, it is a horizontal plane. The intersection of an infinite number of vertical

planes with a horizontal plane generates an infinite number of C_2 axes, one of which is shown above. Moreover, the molecule has a center of symmetry, the center of the carbon atom. A center of symmetry is a point through which each atom can be moved the same distance it lies from the point initially to achieve an identical orientation of the molecule. The symmetry type (point group) that corresponds to one C_∞ axis, an infinite number of σ_v planes, one horizontal σ_h plane, an infinite number of C_2 axes perpendicular to the C_∞ , and a center of symmetry is known as $D_{\infty h}$. Linear molecules that have a center of symmetry belong to this point group. In addition to CO_2 , other examples of molecules of this type include XeF_2 , ICl_2^- , CS_2 , and BeF_2 .

In addition to molecules having the symmetry types discussed previously, there are a few special types. One of them is illustrated by the molecule ONCl . This molecule has the structure

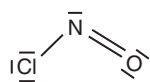

This molecule has no rotation axis of higher symmetry than C_1 . However, it does have one plane of symmetry, the one that bisects all three of the atoms. A molecule that has only a plane of symmetry is designated as C_s .

A tetrahedral molecule such as CH_4 or SiF_4 illustrates another of the special symmetry types. The structure of CH_4 is shown in Figure 5.2, which shows the four bonds as being directed toward opposite corners of a cube. It should be readily apparent that each of the C–H bonds constitutes a C_3 axis, and that there are four such axes. Three mirror planes intersect along a C_3 axis, which suggests that there should be 12 such planes. However, each plane of this type also bisects the molecule along another C–H bond so there are actually only six planes of symmetry. Although a tetrahedron has a geometric center, there is no center of symmetry. However, it is also apparent that each of the coordinate axes is a C_2 axis, and there are three such axes. These C_2 axes bisect pairs of H–C–H bond angles. When considering a tetrahedral structure, we encounter a type of symmetry element different from those we have seen so far.

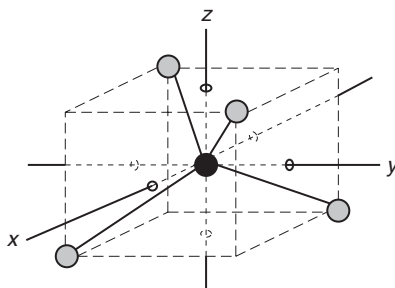

■ **FIGURE 5.2** The tetrahedral CH_4 molecule shown in relationship to a cube.

Consider the z -axis in the tetrahedral structure shown in Figure 5.2. If the molecule is rotated by 90° clockwise around that axis and each atom is reflected through the xy plane, the structure obtained is identical to that of the original molecule. The operation of rotating a molecule around an axis and then reflecting each atom through a plane perpendicular to the axis of rotation defines an *improper rotation axis*, which is designated as an S axis. Each of the three axes in the coordinate system for a tetrahedral molecule is an improper rotation axis. Because the amount of rotation required to produce an orientation like the original is 90° , the axes are S_4 axes.

It should be noted that if one hydrogen atom (on the z -axis) in the CH_4 structure is replaced by F, the resulting molecule, CH_3F , no longer has T_d symmetry. In fact, there is a C_3 axis that runs along the C–F bond and three vertical planes that intersect along that axis so the symmetry is reduced to C_{3v} . We say that the symmetry is reduced because there are not as many symmetry elements present as there were in the original molecule.

Collectively, the symmetry elements present in a regular tetrahedral molecule consist of three S_4 axes, four C_3 axes, three C_2 axes (coincident with the S_4 axes), and six mirror planes. These symmetry elements define a point group known by the special symbol T_d .

The chair conformation of the cyclohexane molecule, which can be shown as



also illustrates the nature of an improper rotation axis. That structure can also be visualized as shown in Figure 5.3 with the z -axis pointing out of the page. Atoms represented as filled circles lie above the plane of the page while those represented by open circles lie below the page. The z -axis is a C_3 axis, but it is also an S_6 axis. Rotation around the z -axis by $360^\circ/6$ followed by reflection of each atom through the plane of the page (which is the xy plane that is perpendicular to the axis about which the molecule is rotated) gives the identical orientation of the molecule. It should be apparent that in this case rotation around the z -axis by 120° accomplishes the same result as the S_6 operation.

From the foregoing discussion, it should be apparent that the S_6 axis and the operations performed can be described as

$$C_6 \cdot \sigma_{xy} = S_6$$

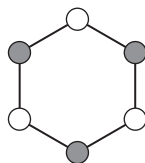

■ **FIGURE 5.3** A representation of the cyclohexane molecule. Filled circles represent atoms above the plane of the page and open circles represent atoms below the page.

in which there is rotation around the z -axis by 120° followed by reflection of each atom through the xy plane. Performing the operations twice would give

$$S_6^2 = C_6 \cdot \sigma_{xy} \cdot C_6 \cdot \sigma_{xy} = C_6^2 \cdot \sigma_{xy}^2 = C_3 = C_3 \cdot E$$

where E is known as the identity operation.

Another of the special symmetry types is the regular octahedron, which is illustrated by the structure of the SF_6 molecule. The lines that run along pairs of bonds at 180° to each other are C_4 axes, and there are four of them. A regular octahedron has four triangular faces on both the top and bottom halves of the structure. A line drawn through the center of a triangular face on the top half of the structure and out the center of the triangular face opposite it on the bottom half of the structure is an S_3 axis. There are four axes of this type. Lines drawn to bisect opposite pairs of bond angles are C_2 axes, and there are eight of them. There are a total of nine mirror planes, and a molecule that has a regular octahedral structure also has a center of symmetry, i . All of these symmetry elements are typical of a symmetry type known as O_h .

In Chapter 4, the icosahedral structure of the B_{12} molecule was shown. Although all of the symmetry elements of a molecule having this structure will not be enumerated, the symmetry type is known as I_h .

Although not listed among the symmetry elements for a structure, there is also the identity operation, E . This operation leaves the orientation of the molecule unchanged from the original. This operation is essential when considering the properties that are associated with group theory. When a C_n operation is carried out n times, it returns the structure to its original orientation. Therefore, we can write

$$C_n^n = E$$

During the study of inorganic chemistry, the structures for a large number of molecules and ions will be encountered. Try to visualize the structures and think of them in terms of their symmetry. In that way, when you see that Pt^{2+} is found in the complex $PtCl_4^{2-}$ in an environment described as D_{4h} , you will know immediately what the structure of the complex is. This "shorthand" nomenclature is used to convey precise structural information in an efficient manner. Table 5.1 shows many common structural types for molecules along with the symmetry elements and point groups of those structures.

5.2 ORBITAL SYMMETRY

The mathematics that gives the rules for manipulating groups is known as group theory. Before we can describe how to make use of symmetry to describe molecular orbitals and molecular structure, we will present a very brief introduction to the basic ideas related to group theory. A group consists of a set of symmetry elements and the operations that can be performed on the set. The group must obey a set of rules that will be presented later. At this point, we need only to use the designations as follows, which for the present can be regarded as definitions that will be amplified later.

A denotes a nondegenerate orbital or state that is symmetric around the principal axis.

Table 5.1 Common Point Groups and Their Symmetry Elements.

Point Group	Structure	Symmetry Elements	Examples
C_1	—	None	CHFCIBr
C_s	—	One plane	ONCl, OSCl ₂
C_2	—	One C_2 axis	H ₂ O ₂
C_{2v}	Bent AB ₂ or planar XAB ₂	One C_2 axis and two σ_v planes at 90°	NO ₂ , H ₂ CO
C_{3v}	Pyramidal AB ₃	One C_3 axis and three σ_v planes	NH ₃ , SO ₃ ²⁻ , PH ₃
C_{nv}	—	One C_n axis and n σ_v planes	BrF ₅ (C_{4v})
$C_{\infty v}$	Linear ABC	One C_{∞} axis and ∞ σ_v planes	OCS, HCN, HCCH
D_{2h}	Planar	Three C_2 axes, one σ_h , two σ_v planes and i	C ₂ H ₄ , N ₂ O ₄
D_{3h}	Planar AB ₃ or AB ₅ trigonal bipyramid	One C_3 axis, three C_2 axes, three σ_v , and one σ_h	BF ₃ , NO ₃ ⁻ , CO ₃ ²⁻ , PCl ₅
D_{4h}	Planar AB ₄	One C_4 axis, four C_2 axes, four σ_v , one σ_h , and i	XeF ₄ , IF ₄ ⁻ , PtCl ₄ ²⁻
$D_{\infty h}$	Linear AB ₂	One C_{∞} axis, one σ_h , ∞ σ_v planes and i	CO ₂ , XeF ₂ , NO ₂ ⁺
T_d	Tetrahedral AB ₄	Four C_3 , three C_2 , and three S_4 and six σ_v planes	CH ₄ , BF ₄ ⁻ , NH ₄ ⁺
O_h	Octahedral AB ₆	Three C_4 , four C_3 , six C_2 , and four S_6 axes, nine σ_v and i	SF ₆ , PF ₆ ⁻ , Cr(CO) ₆
I_h	Icosahedral	Six C_5 , 10 C_3 , 15 C_2 , and 20 S_6 axes, and 15 planes	B ₁₂ , B ₁₂ H ₁₂ ²⁻

B denotes a nondegenerate orbital or state that is antisymmetric around that axis.

E and T denote doubly and triply degenerate states, respectively.

Subscripts 1 and 2 indicate symmetry or antisymmetry, respectively, with respect to a rotation axis other than the principal axis of symmetry.

In Chapter 3, the molecular orbital approach was used to describe the bonding in diatomic molecules. When considering more complicated molecules, the molecular orbital approach is more complicated, but the use of symmetry greatly simplifies the process of constructing the energy level diagrams. One important aspect of the use of symmetry is that the symmetry character of the orbitals used in bonding by the central atom must match the symmetry of the orbitals on the peripheral atoms. For example, the combination of two hydrogen atom 1s wave functions, $\phi_{1s}(1) + \phi_{1s}(2)$, transforms as A_1 (or a_1 if molecular orbitals are described), but the combination $\phi_{1s}(1) - \phi_{1s}(2)$ transforms as B_1 (or b_1 for the molecular orbitals). From the character tables, it can be seen that a singly degenerate state that is symmetric about the internuclear axis is designated as A_1 . A singly degenerate state that is antisymmetric about the

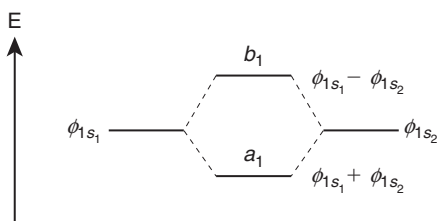

■ **FIGURE 5.4** Two combinations of 1s wave functions that give different symmetry.

internuclear axis is designated as B_1 . As shown in Chapter 3, the orbital combinations $\phi_{1s}(1) + \phi_{1s}(2)$ and $\phi_{1s}(1) - \phi_{1s}(2)$ represent the bonding and antibonding molecular orbitals for the H_2 molecule. Therefore, the qualitative molecular orbital diagram for the H_2 molecule can be constructed as shown in Figure 5.4.

Although it is stated here without proof, it can be shown that the irreducible representations of any group are *orthogonal*. Only combinations of orbitals that have the same irreducible representation give nonzero elements in the secular determinant. For a 2s orbital, any of the four operations on the C_2 group leaves the 2s orbital unchanged. Therefore, the 2s orbital transforms as A_1 . It can also be seen that the signs of the p_x orbital are unchanged under the E and σ_{xy} operations, but the C_2 and σ_{yz} operations do change the signs of the orbital, which means that it transforms as B_1 . The p_z orbital does not change signs during the C_2 , E , σ_{xz} , or σ_{yz} operations so it transforms as A_1 . Following this procedure, it is found that the p_y orbital transforms as B_2 . We can summarize the symmetry character of the valence shell orbitals on the oxygen atom as follows:

Orbital	Symmetry
2s	A_1
2p _z	A_1
2p _x	B_1
2p _y	B_2

Molecular orbitals are constructed in such a way that the combinations of atomic orbitals are the same as the irreducible representations of the groups that conform to the symmetry of the molecule. The character table for the point group to which the molecule belongs lists these combinations. Because H_2O is a C_{2v} molecule, the character table shown later in this chapter lists only A_1 , A_2 , B_1 , and B_2 in accord with the symmetry of the oxygen orbitals listed earlier. The orbitals from both hydrogen atoms must be combined in such a way that the combination matches the symmetry of the oxygen orbitals. The combinations of hydrogen orbitals are known as *group orbitals*. Because they are combined in such a way that they match the symmetry of the orbitals on the central atom, they are sometimes referred to as *symmetry adapted linear combinations*, SALC.

The two combinations of hydrogen orbitals are $\phi_{1s}(1) + \phi_{1s}(2)$ and $\phi_{1s}(1) - \phi_{1s}(2)$, which have A_1 and B_1 symmetry (or a_1 and b_2 symmetry for orbitals). From the table just shown, it can be seen that the

$2s$ and $2p_z$ oxygen orbitals have an A_1 symmetry designation, so their combinations with the hydrogen group orbitals produce a_1 and b_1 molecular orbitals. To deal with more complicated molecules, we need to know how s and p orbitals transform in environments of different symmetry. The designations for the s and p orbitals on the central atom in several structural types will be shown later.

5.3 A BRIEF LOOK AT GROUP THEORY

The mathematical apparatus for treating combinations of symmetry operations lies in the branch of mathematics known as group theory. A mathematical group behaves according to the following set of rules. A group is a set of elements and the operations that obey these rules.

1. The combination of any two members of a group must yield another member of the group (closure).
2. The group contains the identity, E , multiplication by which commutes with all other members of the group ($EA = AE$) (identity).
3. The associative law of multiplication must hold so that $(AB)C = A(BC) = (AC)B$ (associative).
4. Every member of the group has a reciprocal such that $B \cdot B^{-1} = B^{-1} \cdot B = E$ where the reciprocal is also a member of the group (inverse).

Let us illustrate the use of these rules by considering the structure of the water molecule shown in Figure 5.5.

First, it is apparent that reflection through the xz plane, indicated by σ_{xz} , transforms H' into H'' . More precisely, we could say that H' and H'' are interchanged by reflection. Because the z -axis contains a C_2 rotation axis, rotation about the z -axis of the molecule by 180° will take H' into H'' and H'' into H' , but with the "halves" of each interchanged with respect to the yz plane. The same result would follow from reflection through the xz plane followed by reflection through the yz plane. Therefore, we can represent this series of symmetry operations in the following way:

$$\sigma_{xy} \cdot \sigma_{yz} = C_2 = \sigma_{yz} \cdot \sigma_{xz}$$

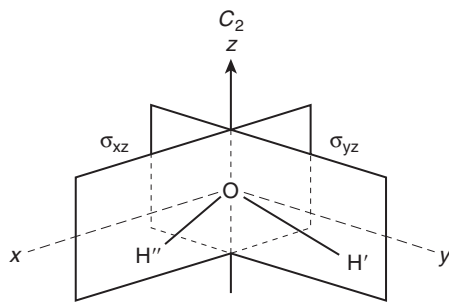

■ FIGURE 5.5 Symmetry elements of the water molecule.

where C_2 is rotation around the z -axis by $360^\circ/2$. This establishes that C_2 and σ_{xz} are both members of the group for this molecule. We see that in accord with rule 1 that the combination of two members of the group has produced another member of the group, C_2 .

If reflection through the xz plane is followed by that operation, the molecule goes back to the same arrangement shown in Figure 5.5. Symbolically, this combination of operations can be described as

$$\sigma_{xz} \cdot \sigma_{xz} = E$$

Also, from the figure it easy to see that

$$\sigma_{yz} \cdot \sigma_{yz} = E$$

and

$$C_2 \cdot C_2 = E$$

Further examination of Figure 5.5 shows that reflection through the yz plane, σ_{yz} , will cause the "halves" of the H' and H" atoms lying on either side of the yz plane to be interchanged. If we perform that operation and then rotate the molecule by $360^\circ/2$ around the C_2 axis, we achieve exactly the same result that reflection through the xz plane produces. Thus,

$$\sigma_{yz} \cdot C_2 = \sigma_{xz} = C_2 \cdot \sigma_{yz}$$

In a similar way, it is easy to see that reflection through the xz plane followed by a C_2 operation gives the same result as σ_{yz} . Finally, it can be seen that the reflections σ_{xz} and σ_{yz} in either order lead to the same orientation that results from the C_2 operation:

$$\sigma_{xz} \cdot \sigma_{yz} = C_2 = \sigma_{yz} \cdot \sigma_{xz}$$

The associative law, rule 3, has also been demonstrated here. Additional relationships are provided by the following:

$$\begin{aligned} E \cdot E &= E \\ C_2 \cdot E &= C_2 = E \cdot C_2 \\ \sigma_{yz} \cdot E &= \sigma_{yz} = E \cdot \sigma_{yz}, \text{ etc.} \end{aligned}$$

All of these combinations of operations can be summarized in a *group multiplication table* like that shown in Table 5.2. The multiplication table (see Table 5.2) for the C_{2v} group is thus constructed so that the combination of operations follow the four rules presented at the beginning of this section.

Table 5.2 Multiplication of Symmetry Operations for the H₂O (C_{2v}) Molecule.

	<i>E</i>	<i>C</i> ₂	<i>σ</i> _{xz}	<i>σ</i> _{yz}
<i>E</i>	<i>E</i>	<i>C</i> ₂	<i>σ</i> _{xz}	<i>σ</i> _{yz}
<i>C</i> ₂	<i>C</i> ₂	<i>E</i>	<i>σ</i> _{yz}	<i>σ</i> _{xz}
<i>σ</i> _{xz}	<i>σ</i> _{xz}	<i>σ</i> _{yz}	<i>E</i>	<i>C</i> ₂
<i>σ</i> _{yz}	<i>σ</i> _{yz}	<i>σ</i> _{xz}	<i>C</i> ₂	<i>E</i>

Start with the operation in the left-hand column and proceed to the desired operation at the top of a column. Then, read down that column to obtain the desired product.

Obviously, a molecule having a different structure (symmetry elements and operations) would require a different table.

To provide further illustrations of the use of symmetry elements and operations, the ammonia molecule, NH₃, will be considered (Figure 5.6). Figure 5.6 shows that the NH₃ molecule has a C₃ axis through the nitrogen atom and three mirror planes containing that C₃ axis. The identity operation, *E*, and the C₃² operation complete the list of symmetry operations for the NH₃ molecule. It should be apparent that

$$\begin{aligned}
 C_3 \cdot C_3 &= C_3^2 \\
 C_3^2 \cdot C_3 &= C_3 \cdot C_3^2 = E \\
 \sigma_1 \cdot \sigma_1 &= E = \sigma_2 \cdot \sigma_2 = \sigma_3 \cdot \sigma_3
 \end{aligned}$$

Reflection through *σ*₂ does not change H'' but it does interchange H' and H'''. Reflection through *σ*₁ leaves H' in the same position but interchanges H'' and H'''. We can summarize these operations as

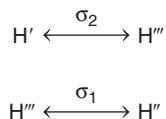

However, C₃² would move H' to H''', H'' to H', and H''' to H'', which is exactly the same orientation as that *σ*₂ followed by *σ*₁ produced. It follows, therefore, that

$$\sigma_2 \cdot \sigma_1 = C_3^2$$

This process could be continued so that all the combinations of symmetry operations would be worked out. Table 5.3 shows the multiplication table for the C_{3v} point group, which is the point group to which a pyramidal molecule such as NH₃ belongs.

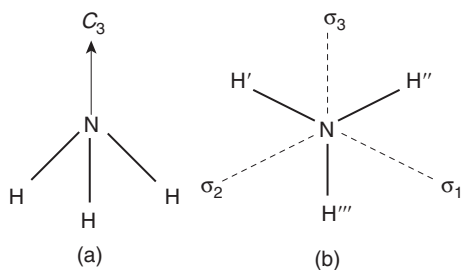

■ **FIGURE 5.6** The pyramidal NH_3 molecule, which has C_{3v} symmetry. In (b), the C_3 axis is directed upward perpendicular to the plane of the paper at the nitrogen atom.

Table 5.3 The Multiplication Table for the C_{3v} Point Group.

	E	C_3	C_3^2	σ_1	σ_2	σ_3
E	E	C_3	C_3^2	σ_1	σ_2	σ_3
C_3	C_3	C_3	E	σ_3	σ_1	σ_2
C_3^2	C_3^2	E	C_3	σ_2	σ_3	σ_1
σ_1	σ_1	σ_2	σ_3	E	C_3	C_3^2
σ_2	σ_2	σ_3	σ_1	C_3^2	E	C_3
σ_3	σ_3	σ_1	σ_2	C_3	C_3^2	E

Multiplication tables can be constructed for the combination of symmetry operations for other point groups. However, it is not the multiplication table as such which is of interest. The multiplication table for the C_{2v} point group is shown in Table 5.2. If we replace E , C_2 , σ_{xz} and σ_{yz} by $+1$, we find that the numbers still obey the multiplication table. For example,

$$C_2 \cdot \sigma_{xz} = \sigma_{yz} = 1 \cdot 1 = 1$$

Thus, the values of the operations all being $+1$ satisfies the laws of the C_{2v} group. This set of four numbers (all $+1$) provides one representation of the group. Another is given by the relationships

$$E = 1, C_2 = 1, \sigma_{xz} = -1, \sigma_{yz} = -1$$

which also obey the rules shown in the table. From other relationships, we know that the character table summarizes the four *irreducible* representations for the C_{2v} point group. The symbols at the left in Table 5.4 give the symmetry properties of the irreducible representation of the group. We will now briefly discuss what the symbols mean.

Table 5.4 Character Table for the C_{2v} Point Group.

	E	C_2	σ_{xz}	σ_{yz}
A_1	1	1	1	1
A_2	1	1	-1	-1
B_1	1	-1	1	-1
B_2	1	-1	-1	1

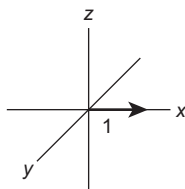

■ **FIGURE 5.7** A unit vector lying along the x -axis.

Suppose we have a vector of unit length lying coincident with the x -axis as shown in Figure 5.7. The identity operation does not change the orientation of the vector. Reflection in the xz plane leaves the vector unchanged but reflection through the yz plane changes it to a vector of unit length in the $-x$ direction. Likewise, the C_2 operation around the z -axis changes the vector in the same way. Therefore, the vector is said to transform as $+1$ for the operations E and σ_{xz} but it transforms as -1 for the operations C_2 and σ_{yz} . Table 5.4 shows the row containing these numbers ($+1$, -1 , $+1$, and -1 under the operations E , C_2 , σ_{xz} , and σ_{yz} , respectively) labeled as B_1 . It is easy to show how the other rows can be obtained in a similar manner. The four representations, A_1 , A_2 , B_1 , and B_2 are the irreducible representations of the C_{2v} group. It can be shown that these four irreducible representations cannot be separated or decomposed into other representations.

For a given molecule belonging to a particular point group, it is possible to consider the various symmetry species as indicating the behavior of the molecule under symmetry operations. As will be shown later, these species also determine the ways in which the atomic orbitals can combine to produce molecular orbitals because the combinations of atomic orbitals must satisfy the character table of the group. We need to give some meaning that is related to molecular structure for the species A_1 , B_2 , and so on.

The following conventions are used to label species in the character tables of the various point groups:

1. The symbol A is used to designate a nondegenerate species that is symmetric about the principal axis.
2. The symbol B is used to designate a nondegenerate species that is antisymmetric about the principal axis.

3. The symbols E and T represent double and triply degenerate species, respectively.
4. If a molecule possesses a center of symmetry, the subscript g indicates symmetry with respect to that center, and the subscript u indicates antisymmetry with respect to that center.
5. For a molecule that has a rotation axis other than the principal one, symmetry or antisymmetry with respect to that axis is indicated by subscripts 1 or 2, respectively. When no rotation axis other than the principal one is present, these subscripts are sometimes used to indicate symmetry or antisymmetry with respect to a vertical plane, σ_v .
6. The marks ' and " are sometimes used to indicate symmetry or antisymmetry with respect to a horizontal plane, σ_h .

It should now be apparent how the species A_1 , A_2 , B_1 , and B_2 arise. Character tables have been worked out and are tabulated for all the common point groups. Presenting all the tables here would go beyond the scope of the discussion of symmetry and group theory as used in this book. However, tables for some common point groups are shown in Appendix B.

We have barely scratched the surface of the important topic of symmetry. An introduction such as that presented here serves to introduce the concepts and the nomenclature as well as making one able to recognize the more important point groups. Thus, the symbol T_d or D_{4h} takes on precise meaning in the language of group theory. The applications of group theory include, among others, coordinate transformations, analysis of molecular vibrations, and the construction of molecular orbitals. Only the last of these uses will be illustrated here. For further details on the applications of group theory, see the books by Cotton and by Harris and Bertolucci listed in the references.

5.4 CONSTRUCTION OF MOLECULAR ORBITALS

The application of symmetry concepts and group theory greatly simplifies the construction of molecular orbitals. For example, it can be shown that the combination of two hydrogen $1s$ wave functions $\phi_{1s}(1) + \phi_{1s}(2)$ transforms as A_1 (usually written as a_1 when orbitals are considered) and the combination $\phi_{1s}(1) - \phi_{1s}(2)$ transforms as B_1 (sometimes written as b_1). According to the description of species in the character tables, we see that the A_1 combination is a singly degenerate state that is symmetric about the internuclear axis. Also, the B_1 combination represents a singly degenerate state that is antisymmetric about the internuclear axis. Therefore, the states described by the combinations $(\phi_{1s}(1) + \phi_{1s}(2))$ and $(\phi_{1s}(1) - \phi_{1s}(2))$ describe the bonding (a_1) and antibonding (b_1) molecular orbitals, respectively, in the H_2 molecule as shown in Figure 5.4.

For any group, the irreducible representations must be orthogonal. Therefore, only interactions of orbitals having the same irreducible representations lead to nonzero elements in the secular determinant. It remains, then, to determine how the various orbitals transform under different symmetry groups. For H_2O , the coordinate system is shown in Figure 5.5. Performing any of the four operations possible for the C_{2v} group leaves the $2s$ orbital unchanged. Therefore, that orbital transforms as A_1 . Likewise, the p_x orbital does not change sign under E or σ_{xz} operations, but it does change signs under

C_2 and σ_{yz} operations. This orbital thus transforms as B_1 . In a like manner, we find that p_z transforms as A_2 (does not change signs under C_2 , E , σ_{xz} , or σ_{yz} operations). Although it may not be readily apparent, the p_y orbital transforms as B_2 . Using the four symmetry operations for the C_{2v} point group, the valence shell orbitals of oxygen behave as follows:

Orbital	Symmetry
$2s$	A_1
$2p_z$	A_1
$2p_x$	B_1
$2p_y$	B_2

The possible wave functions for the molecular orbitals for molecules are those constructed from the irreducible representations of the groups giving the symmetry of the molecule. These are readily found in the character table for the appropriate point group. For water, which has the point group C_{2v} , the character table (see Table 5.4) shows that only A_1 , A_2 , B_1 , and B_2 representations occur for a molecule having C_{2v} symmetry.

We can use this information to construct a qualitative molecular orbital scheme for the H_2O molecule as shown in Figure 5.8. In doing this, we must recognize that there are two hydrogen $1s$ orbitals and the orbitals from the oxygen atom must interact with both of them. Therefore, it is not each hydrogen $1s$ orbital individually that is used, but rather a combination of the two. These combinations are called *group orbitals*, and in this case the combinations can be written as $(\phi_{1s}(1) + \phi_{1s}(2))$ and $(\phi_{1s}(1) - \phi_{1s}(2))$. In this case, the $2s$ and $2p_z$ orbitals having A_1 symmetry mix with the combination of hydrogen $1s$

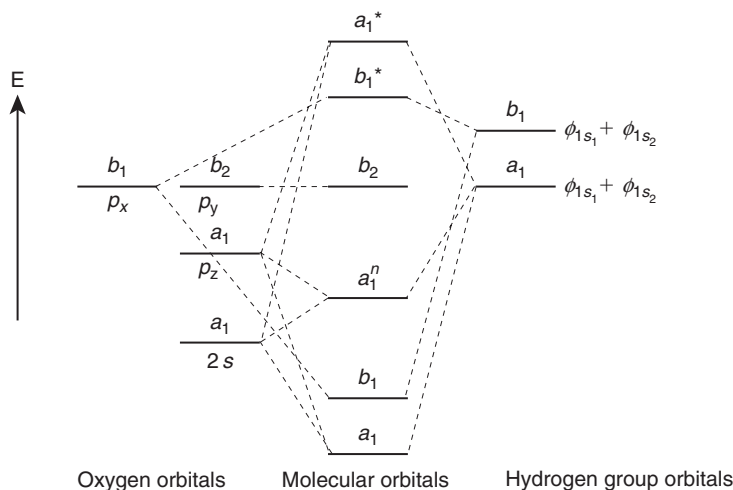

■ FIGURE 5.8 A molecular orbital diagram for the H_2O molecule.

orbitals having A_1 symmetry to produce three molecular orbitals having A_1 symmetry (one bonding, one nonbonding, and one antibonding). The $2p_x$ orbital having B_1 symmetry combines with the combination of hydrogen orbitals having the same symmetry ($\phi_{1s}(1) - \phi_{1s}(2)$). The $2p_y$ orbital remains uncombined as a $2p_y$ orbital that does not have the correct symmetry to interact with either of the combinations of hydrogen orbitals. Therefore, it remains as a nonbonding π orbital of b designation. In the case of H_2O , the four orbitals of lowest energy will be populated because the atoms have a total of eight valence shell electrons. Therefore, the bonding can be represented as

$$(a_1)^2(b_1)^2(a_1^n)^2(b_2)^2$$

As in the case of atomic orbitals and spectroscopic states (see Chapter 2), we use *lowercase letters to denote orbitals or configurations* and *uppercase letters to indicate states*. It should also be pointed out that the a_1 and b_1 orbitals are σ bonding orbitals, but the b_2 molecular orbital is a nonbonding π orbital.

Having considered the case of the H_2O molecule, we would like to be able to use the same procedures to construct the qualitative molecular orbital diagrams for molecules having other structures. To do this requires that we know how the orbitals of the central atom transform when the symmetry is different. Table 5.5 shows how the s and p orbitals are transformed, and more extensive tables can be found in the comprehensive books listed at the end of this chapter.

If we now consider a planar molecule like BF_3 (D_{3h} symmetry), the z -axis is defined as the C_3 axis. One of the B–F bonds lies along the x -axis as shown in Figure 5.9. The symmetry elements present for this molecule include the C_3 axis, three C_2 axes (coincident with the B–F bonds and perpendicular to the C_3 axis), three mirror planes each containing a C_2 axis and the C_3 axis, and the identity. Thus, there are 12 symmetry operations that can be performed with this molecule. It can be shown that the p_x and p_y orbitals both transform as E' and the p_z orbital transforms as A_2'' . The s orbital is A_1' (the prime indicating symmetry with respect to σ_h). Similarly, we could find that the fluorine p_z orbitals are A_1 , E_1 , and E_1 . The qualitative molecular orbital diagram can then be constructed as shown in Figure 5.10.

Table 5.5 Central Atom s and p Orbital Transformations under Different Symmetries.

Point Group	Structure	Orbital			
		S	p_x	p_y	p_z
C_{2v}	Bent triatomic	A_1	B_1	B_2	A_1
C_{3v}	Pyramidal	A_1	E	E	A_1
D_{3h}	Trigonal planar	A_1'	E'	E'	A_2''
C_{4v}	Pyramidal	A_1	E	E	A_1
D_{4h}	Square planar	A_1'	E_u	E_u	A_{2u}
T_d	Tetrahedral	A_1	T_2	T_2	T_2
O_h	Octahedral	A_1	T_{1u}	T_{1u}	T_{1u}
$D_{\infty h}$	Linear	Σ_g	Σ_u	Σ_u	Σ_g^+

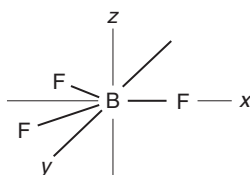

■ FIGURE 5.9 The coordinate system for the BF_3 molecule.

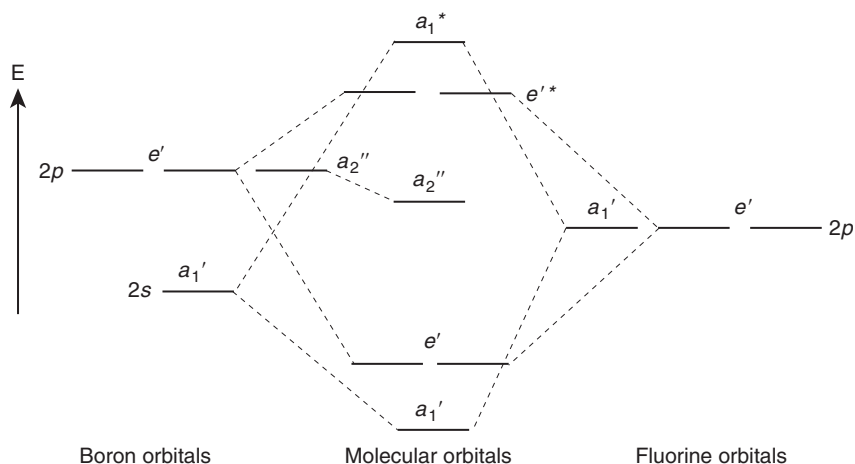

■ FIGURE 5.10 A molecular orbital diagram for the BF_3 molecule.

It is readily apparent that the three σ bonds are capable of holding the six bonding electrons in the a_1' and e' molecular orbitals. The possibility of some π -bonding is seen in the molecular orbital diagram as a result of the availability of the a_2'' orbital, and in fact there is some experimental evidence for this type of interaction. The sum of the covalent radii of boron and fluorine atoms is about 152 pm (1.52 Å), but the experimental B–F bond distance in BF_3 is about 129.5 pm (1.295 Å). Part of this “bond shortening” may be due to partial double bonds resulting from the π -bonding. A way to show this is by means of the three resonance structures of the valence bond type that can be shown as

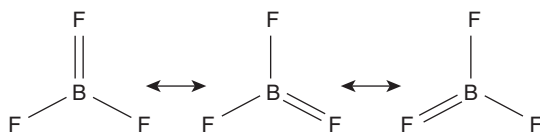

From these resonance structures, we determine a bond order of 1.33 for the B–F bonds, which would predict the observed bond shortening. However, another explanation of the “short” B–F bonds is based

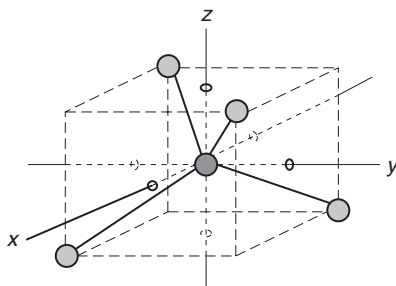

■ FIGURE 5.11 The regular tetrahedral structure.

on the fact that the difference in electronegativity between B and F is about 2.0 units, which causes the bonds to have substantial ionic character. In fact, calculations show that the positive charge on boron is probably as high as 2.5 to 2.6, indicating that the bonding is predominantly ionic. The B^{3+} ion is very small, and as will be shown in Chapter 7, the relative size of the cation and anion determines the number of anions that can be placed around a cation in a crystal. In the case of BF_3 , only three F^- ions can surround B^{3+} , so there is no possibility of forming an extended network as is required in a crystal lattice. Therefore, it is likely that BF_3 is best considered as a monomer that is in reality an “ionic molecule.”

Having seen the development of the molecular orbital diagram for AB_2 and AB_3 molecules, we will now consider tetrahedral molecules such as CH_4 , SiH_4 , or SiF_4 . In this symmetry, the valence shell s orbital on the central atom transforms as A_1 , whereas the p_x , p_y , and p_z orbitals transform as T_2 (see Table 5.5). For methane, the combination of hydrogen orbitals that transforms as A_1 is

$$\phi_{1s}(1) + \phi_{1s}(2) + \phi_{1s}(3) + \phi_{1s}(4)$$

and the combination transforming as T_2 is

$$\phi_{1s}(1) + \phi_{1s}(2) - \phi_{1s}(3) - \phi_{1s}(4)$$

where the coordinate system is as shown in Figure 5.11.

Using the orbitals on the carbon atom and combining them with the group orbitals from the four hydrogen atoms (linear combinations of orbitals having symmetry matching the carbon atom orbitals) we obtain the molecular orbital diagram shown in Figure 5.12.

The hydrogen group orbitals are referred to as *symmetry adjusted linear combinations* (SALC). Although their development will not be shown here, the molecular orbital diagrams for other tetrahedral molecules are similar.

For an octahedral AB_6 molecule such as SF_6 , the valence-shell orbitals are considered to be the s , p , and d orbitals of the central atom. It is easy to see that a regular octahedron has a center of symmetry so

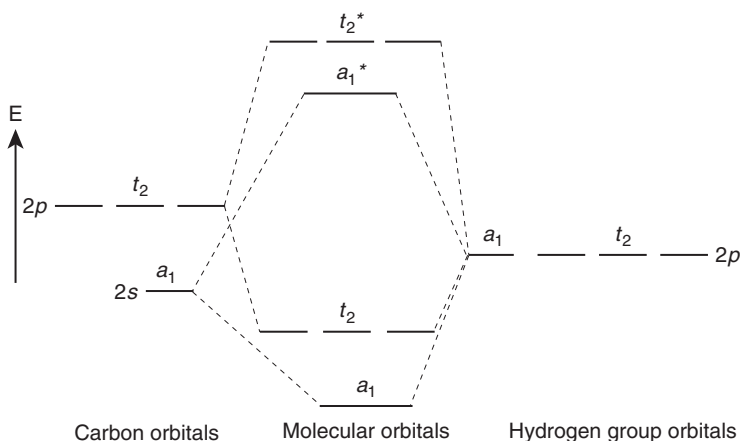

■ FIGURE 5.12 The molecular orbital diagram for a tetrahedral molecule such as CH_4 .

that g and u designations must be used on the symmetry species to designate symmetry or asymmetry with respect to that center. Clearly the s orbital transforms as A_{1g} . The p orbitals being directed toward the corners of the octahedron are degenerate and change sign upon reflection through the center of symmetry. They thus constitute a T_{1u} set. Of the set of d orbitals, the d_{z^2} and $d_{x^2-y^2}$ orbitals are directed toward the corners of the octahedron, and they do not change sign upon inversion through the center of symmetry. Thus, these orbitals are designated as E_g . The remaining d_{xy} , d_{yz} , and d_{xz} orbitals form a triply degenerate nonbonding set designated as T_{2g} .

If we consider only σ bonding, we find that T_{1u} , E_g , and A_{1g} orbitals are used by the six groups attached. The resulting energy level diagram is shown in Figure 5.13.

In this section, we have seen how symmetry considerations are used to arrive at qualitative molecular orbital diagrams for molecules having several common structural types. The number of molecules and ions that have C_{2v} , C_{3v} , $C_{\infty v}$, $D_{\infty h}$, T_d , or O_h symmetry is indeed large. Energy level diagrams such as those shown in this section are widely used to describe structural, spectroscopic, and other properties of the molecules. We have not, however, set about to actually calculate anything. In Chapter 17 we will present an overview of the molecular orbital approach to the bonding in coordination compounds. The more sophisticated mathematical treatments of molecular orbital calculations are beyond the intended scope of this inorganic text, and they are not necessary for understanding the basic applications of symmetry to molecular orbital diagrams.

5.5 ORBITALS AND ANGLES

Up to this point in this chapter, we have approached the description of the molecular orbitals for molecules with the structure already being known. Intuitively, we know that the H_2O molecule has an

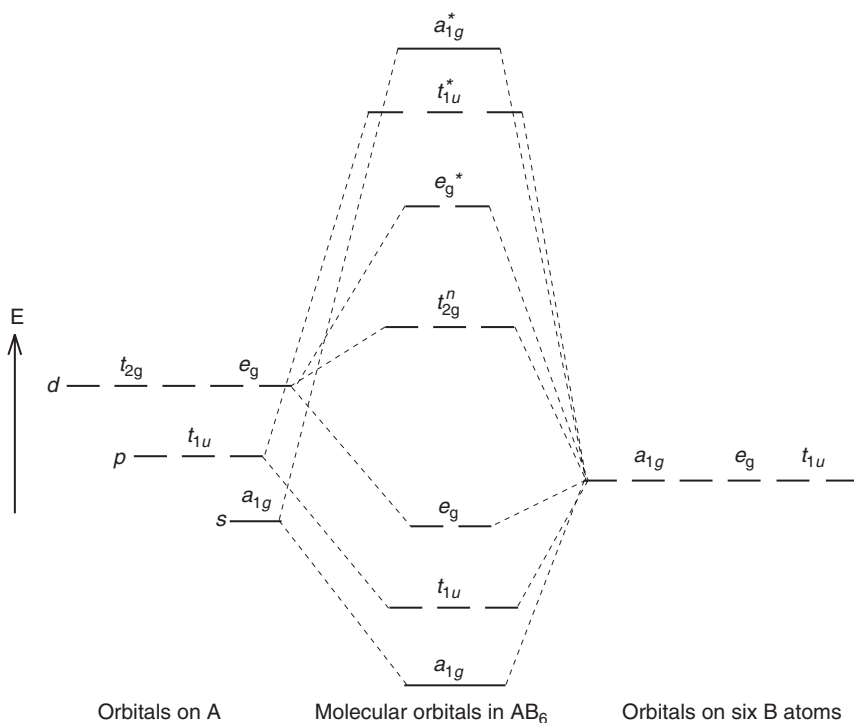

■ FIGURE 5.13 The molecular orbital diagram for an octahedral molecule.

angular structure, whereas the BeH_2 molecule is linear. From prior experience, we know that there are eight electrons around the central atom in H_2O , but only four around the Be atom in BeH_2 . We now want to address the difference in structure using the molecular orbital approach.

One of the simplest approaches to comprehensive molecular orbital calculations is the extended Hückel method. This method was developed by Roald Hoffman in the 1960s, and it was applied to hydrocarbon molecules. From the discussion presented in Chapters 2 and 3, we know that one of the first things that has to be done is to choose the *atomic* wave functions that will be used in the calculations. One of the most widely used types of wave functions is that known as the Slater wave functions (see Section 2.4). In the extended Hückel method, the molecular wave functions are approximated as

$$\psi_i = \sum_j c_j \phi_j \quad (5.1)$$

where $j = 1, 2, \dots, n$. For a hydrocarbon molecule having the formula C_nH_m , there will be m hydrogen $1s$ orbitals, n carbon $2s$ orbitals, and $3n$ carbon $2p$ orbitals. Although the details will not be shown, this combination of orbitals leads to a secular determinant of dimension $4n + m$. Unlike the original

method developed by Erich Hückel, which neglected all interactions except between adjacent atoms, the extended Hückel method retains the off-diagonal elements so it takes into account additional interactions between atoms in the molecule. As was described in Chapter 3, there are both Coulomb and exchange integrals to evaluate, and the overlap integrals must be approximated.

Coulomb integrals, written as H_{ii} , represent the binding energy of an electron in atom i . Therefore, by Koopmans' theorem, these energies are equivalent in magnitude to the ionization potential of an electron from those orbitals. Accordingly, the values used (in electron volts) are as follows: H(1s), -13.6 ; C(2s), -21.4 ; and C(2p), -11.4 . Next, it is necessary to represent the exchange integrals, written as H_{ij} , and one of the most common ways is to use the Wolfsberg-Helmholtz approximation,

$$H_{ij} = 0.5K (H_{ii} + H_{jj})S_{ij} \quad (5.2)$$

where K is a constant having a value of approximately 1.75 and S_{ij} is the overlap integral for the wave functions for the orbitals on atoms i and j .

Although the overlap integral for two 1s wave functions is a function of internuclear distance, the situation is different when p orbitals are involved. Because of their angular character, the overlap of a p orbital with two hydrogen 1s orbitals will have a value that depends on the angle formed by the H-X-H bonds. Therefore, an adjustment that depends on the bond angle must be made to the value of the overlap integral. When the molecular orbital energies are calculated, it is found that they vary (as is expected) depending on the bond angle. In fact, the bond angle can be treated as an adjustable parameter and the energies of the molecular orbitals can be plotted as a function of the bond angle as it is varied from 90° to 180° . It must be remembered that the molecular orbitals will have different designations that depend on symmetry. A linear H-X-H molecule will give rise to σ_g , σ_u and two degenerate π_u molecular orbitals (that are perpendicular to the axis of the molecule). As was shown earlier in this chapter, if the bond angle is 90° , the molecular orbitals will be a_1 , b_2 , a_1 , and b_1 (in order of increasing energy).

Knowing how the orbitals are arranged in terms of energy, we can make a graph (that is only qualitative) to show the energy of the orbitals as the bond angle is varied from 90° to 180° . A diagram of this type was prepared by Arthur D. Walsh over half a century ago, and it is appropriately known now as a *Walsh diagram*. Figure 5.14 shows the diagram for a triatomic molecule. When interpreting this diagram, it is essential to have a mental picture of how the two hydrogen 1s orbitals interact with the s and p orbitals on the central atom as the bond angle varies from 90° to 180° .

For two pairs of electrons around the central atom (as in BeH_2), the lowest energy is achieved when the two pairs of electrons occupy the a_1 and b_2 orbitals when the bond angle is 180° . For three pairs of electrons (as in BH_2^+ or CH_2^{2+}) occupying the three orbitals of lowest energy, a lower energy is obtained when the structure is bent. For four pairs of electrons (as in the H_2O molecule), the lowest energy is not 90° , but it is closer to that value than to 180° . Keep in mind that these are *qualitative* applications of a graph. The results are, of course, in accord with what we know from simple valence bond (hybrid orbital) approaches described in Chapter 4. However, it is important to know that such a molecular orbital approach as that of Walsh exists.

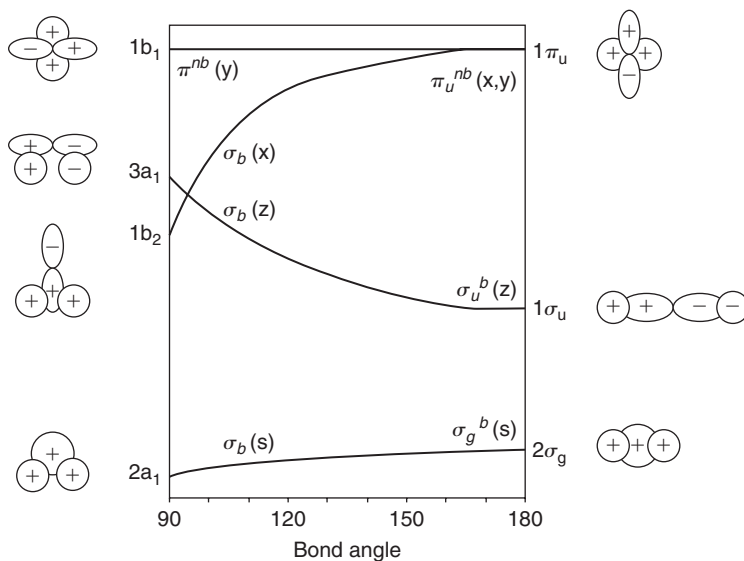

■ **FIGURE 5.14** A Walsh diagram for a molecule having the formula XH_2 . The energy levels are labeled with both of the commonly used types of symbols. In the drawing at the upper left, the bending causes the hydrogen $1s$ orbitals to be nonbonding with regard to overlap with the p_y orbital of the central atom. In the diagram at the upper right, the combination of hydrogen $1s$ orbitals is nonbonding with respect to the p_x and p_z orbitals.

Although the complexity increases rapidly, there is no reason that Walsh diagrams cannot be constructed for XY_3 pyramidal, XY_4 tetrahedral, XY_6 octahedral, and other molecules. In fact, they have been prepared, but their applications will not be described here. Insofar as these diagrams are amenable to quantitative interpretation, the predictions are in accord with what we know from experimental evidence and valence bond methods.

5.6 SIMPLE CALCULATIONS USING THE HÜCKEL METHOD

Although we have presented some of the principles related to symmetry and its use in describing molecular orbital methods, it is still reassuring to be able to calculate *something* even at an elementary level. Such a simple approach was developed in the 1930s by Erich Hückel. It was developed to make molecular orbital calculations for organic molecules, and the method is now called the HMO method. In this connection, the interested reader should consult the classic book on the subject by John D. Roberts, *Notes on Molecular Orbital Calculations*. However, it is possible to extend the Hückel approach to include atoms other than carbon, so a brief description of the method will be presented and its use for some “inorganic” molecules will be illustrated. An essential idea is that the σ and π bonding can be separated and that the energy is given by

$$E_{\text{total}} = E_{\sigma} + E_{\pi} \quad (5.3)$$

When dealing with carbon atoms, the coulomb integral (H_{ii}) is represented as α and the exchange integral (H_{ij}) is represented as β . It is also assumed that interaction between nonadjacent atoms can be ignored so if $|i - j| \geq 2$ the $H_{ij} = 0$. Finally, in simple HMO there is complete neglect of overlap so $S_{ij} = 0$.

If we begin with a simple molecule such as ethylene, it is apparent that the σ bonded structure is represented as

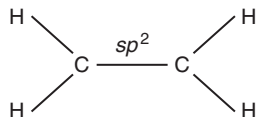

with the hybridization scheme being sp^2 . This leaves a p orbital perpendicular to the plane of the molecule that can form a π bond. Although they are not included explicitly in the calculations, the wave functions for the σ bonds can be written as

$$\psi_{\text{CH}} = a_1\psi_1 + a_2\psi_2 \quad (5.4)$$

$$\psi_{\text{CC}(\sigma)} = a_3\psi_{sp^2(1)} + a_4\psi_{sp^2(2)} \quad (5.5)$$

The useful part of the calculation in the Hückel method is with regard to the π bond,

$$\psi_{\text{CC}(\pi)} = a_5\psi_{p(1)} + a_6\psi_{p(2)} \quad (5.6)$$

As was shown earlier, the secular determinant can be written as

$$\begin{vmatrix} H_{11} - E & H_{12} - S_{12}E \\ H_{12} - S_{12}E & H_{22} - E \end{vmatrix} = 0 \quad (5.7)$$

Note that it has been assumed that $H_{12} = H_{21}$ and that $S_{12} = S_{21}$, which means that the two bonded atoms are identical. When $S_{12} = S_{21} = 0$, as has been described, after letting $H_{11} = H_{22} = \alpha$ and $H_{12} = H_{21} = \beta$, the secular determinant becomes

$$\begin{vmatrix} \alpha - E & \beta \\ \beta & \alpha - E \end{vmatrix} = 0 \quad (5.8)$$

Dividing each element in the determinant by β gives

$$\begin{vmatrix} \frac{\alpha - E}{\beta} & 1 \\ 1 & \frac{\alpha - E}{\beta} \end{vmatrix} = 0 \quad (5.9)$$

In order to simplify handling this expression, we let $x = (\alpha - E)/\beta$. Therefore, the determinant can be written as

$$\begin{vmatrix} x & 1 \\ 1 & x \end{vmatrix} = 0 \quad (5.10)$$

so that $x^2 - 1 = 0$ and $x^2 = 1$. This equation has roots of $x = 1$ and $x = -1$, which lead to

$$\frac{\alpha - E}{\beta} = 1 \text{ and } \frac{\alpha - E}{\beta} = -1 \quad (5.11)$$

These equations lead to the energy values $E = \alpha + \beta$ and $E = \alpha - \beta$. Both α and β represent negative quantities, and each carbon atom contributes one electron to the π bond, so the energy level diagram can be shown as illustrated in Figure 5.15.

From the molecular orbital diagram, we predict that electronic transitions of the $\pi \rightarrow \pi^*$ type should be possible. In fact, most hydrocarbon molecules that have an empty π^* orbital absorb in the ultraviolet region around 200 to 250 nm.

If the two electrons were residing in p orbitals on separate carbon atoms, their total energy would be 2α . However, when they are in a π molecular orbital, their energy is $2(\alpha + \beta)$. The difference

$$2(\alpha + \beta) - 2\alpha = 2\beta \quad (5.12)$$

represents the delocalization energy. Because a C–C bond has an energy of about 347 kJ/mol and C=C is about 619 kJ/mol, the additional stability (the energy of the π bond) must be approximately 272 kJ/mol, so $\beta \approx 136$ kJ/mol. The ionization potential for a carbon atom is 1086 kJ/mol, so this is the value for α . It is often found that H_{12} is approximately 15% of H_{11} , so the values shown are in reasonable agreement with this.

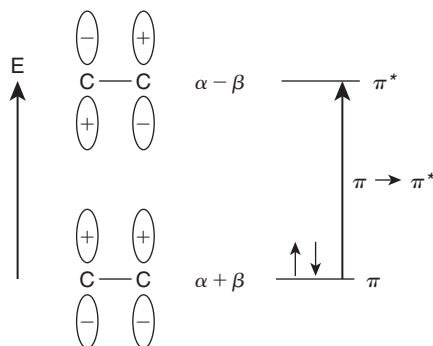

■ **FIGURE 5.15** Molecular orbitals for ethylene. Promotion of an electron from the ground state to the excited state is known as a $\pi - \pi^*$ transition and is usually accompanied by an absorption of radiation in the ultraviolet region of the spectrum.

Despite its simplicity, the Hückel method enables other useful properties to be deduced. For example, the wave function for the bonding molecular orbital is

$$\psi_b = a_1\phi_1 + a_2\phi_2 \quad (5.13)$$

so we can evaluate the constants a_1 and a_2 . We know that

$$\int \psi_b^2 d\tau = \int (a_1\phi_1 + a_2\phi_2) d\tau \quad (5.14)$$

and by using the abbreviations as shown in Section 3.1, we find that

$$a_1^2 S_{11} + a_2^2 S_{22} + 2a_1 a_2 S_{12} = 1 \quad (5.15)$$

Because we assume that $S_{11} = S_{22} = 1$ and $S_{12} = S_{21} = 0$, this equation reduces to

$$a_1^2 + a_2^2 = 1 \quad (5.16)$$

From the secular equations and the minimization of energy [see Eqs. (3.17) and (3.18)],

$$a_1(\alpha - E) + a_2\beta = 0 \quad (5.17)$$

$$a_1\beta + a_2(\alpha - E) = 0 \quad (5.18)$$

Dividing by β and letting $x = (\alpha - E)/\beta$, we find that

$$a_1x + a_2 = 0 \quad (5.19)$$

$$a_1 + a_2x = 0 \quad (5.20)$$

For the bonding state, $x = -1$ so $a_1^2 = a_2^2 = 1 = 2a_1^2$. Therefore,

$$a_1 = \frac{1}{\sqrt{2}} = 0.707 = a_2 \quad (5.21)$$

and

$$\psi_b = 0.707 \phi_1 + 0.707 \phi_2 \quad (5.22)$$

Because $a_1^2 = a_2^2 = 1/2$, half of the bonding pair of electrons (one electron) resides on each atom. Therefore, the *electron density* (ED) is $2(1/2) = 1$. The *bond order* between two atoms is given by

$$B_{XY} = \sum_{i=1}^n a_x a_y p_i \quad (5.23)$$

where the a is a weighting factor (as calculated earlier) and p_i is the population of orbital i . The summation is made over all n populated orbitals. For the ethylene molecule, the bond order between the carbon atoms is $B_{CC} = 2(0.707)(0.707) = 1$, so the order of the π bond is 1. When the σ bond is included, the bond order between the carbon atoms is 2.

For a linear system consisting of three carbon atoms (which includes the allyl radical and the cation and anion derived from it), the coulomb integrals will be identical:

$$H_{11} = H_{22} = H_{33} = \alpha \quad (5.24)$$

Because only interactions between *adjacent* atoms are considered,

$$H_{13} = H_{31} = 0 \quad (5.25)$$

The exchange integrals for interaction of adjacent atoms will be

$$H_{12} = H_{21} = H_{23} = H_{32} = \beta \quad (5.26)$$

As before, the overlap integrals are neglected and we can proceed directly to the secular determinant. After the substitutions are made and each element is divided by β , the result can be shown as follows (where $x = (\alpha - E)/\beta$):

$$\begin{vmatrix} H_{11} - E & H_{12} & 0 \\ H_{21} & H_{22} - E & H_{23} \\ 0 & H_{32} & H_{33} - E \end{vmatrix} = \begin{vmatrix} \alpha - E & \beta & 0 \\ \beta & \alpha - E & \beta \\ 0 & \beta & \alpha - E \end{vmatrix} = \begin{vmatrix} x & 1 & 0 \\ 1 & x & 1 \\ 0 & 1 & x \end{vmatrix} = 0 \quad (5.27)$$

By expanding the determinant, we obtain the characteristic equation

$$x^3 - 2x = 0 \quad (5.28)$$

for which the roots are $x = 0$, $x = -(2)^{1/2}$, and $x = 2^{1/2}$. Setting each of these values equal to $(\alpha - E)/\beta$, we obtain

$$\begin{array}{ccc} \frac{\alpha - E}{\beta} = -\sqrt{2} & \frac{\alpha - E}{\beta} = 0 & \frac{\alpha - E}{\beta} = \sqrt{2} \\ E = \alpha + \sqrt{2}\beta & E = \alpha & E = \alpha - \sqrt{2}\beta \end{array}$$

The energy level diagram including electron populations for the allyl radical, cation, and anion can be shown as illustrated in Figure 5.16. The orbital diagram and energy levels for the allyl system is shown in Figure 5.17.

The arrangement of the molecular orbitals of the allyl species will be useful when discussing the bonding of this ligand in metal complexes (Chapters 16 and 21).

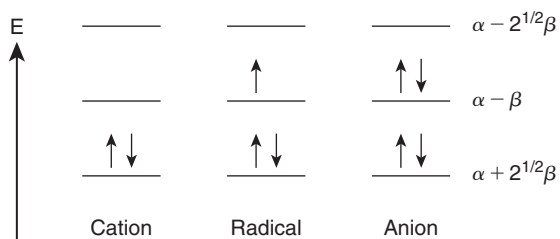

■ FIGURE 5.16 The energy level diagram for the allyl radical, cation, and anion species.

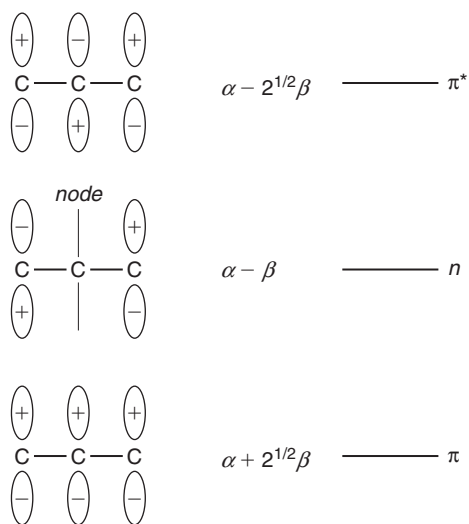

■ FIGURE 5.17 Molecular orbital diagram for the allyl species.

From the secular equations and determinant, we obtain

$$\begin{vmatrix} a_1x & a_2 & 0 \\ a_1 & a_2x & a_3 \\ 0 & a_2 & a_3x \end{vmatrix} = 0 \quad (5.29)$$

$$a_1x + a_2 = 0 \quad a_1 + a_2x + a_3 = 0 \quad a_2 + a_3x = 0$$

Starting with the $x = -2^{1/2}$ root, we find

$$-a_1 2^{1/2} + a_2 = 0 \quad a_1 - a_2 2^{1/2} + a_3 = 0 \quad a_2 - a_3 2^{1/2} = 0$$

From the first of these equations, we find that $a_2 = a_1 2^{1/2}$, and from the last, $a_2 = a_3 2^{1/2}$. Therefore, $a_1 = a_3$, and substituting this into the second equation gives

$$a_1 - a_2 2^{1/2} + a_1 = 0 \quad (5.30)$$

However, $a_2 = a_1 2^{1/2}$, and we know that

$$a_1^2 + a_2^2 + a_3^2 = 1 \quad (5.31)$$

and when the values found earlier are substituted into this equation, we find that

$$a_1^2 + 2a_1^2 + a_1^2 = 4a_1^2 = 1 \quad (5.32)$$

Therefore, $a_1^2 = 1/4$ and $a_1 = 1/2$, which is also true for a_3 , and $a_2 = 2^{1/2}/2 = 0.707$. The wave function for the bonding orbital is

$$\psi_b = 0.500 \psi_1 + 0.707 \psi_2 + 0.500 \psi_3 \quad (5.33)$$

Using the root $x = 0$, a similar procedure allows us to evaluate the constants for the next molecular orbital (which is nonbonding) and gives the wave function

$$\psi_n = 0.707 \psi_1 - 0.707 \psi_3 \quad (5.34)$$

The root $x = 2^{1/2}$ leads to the wave function for the antibonding orbital,

$$\psi_b = 0.500 \psi_1 - 0.707 \psi_2 + 0.500 \psi_3 \quad (5.35)$$

By making use of the weighting coefficients and the populations of the orbitals, the electron density at each atom can be calculated as before. For the allyl radical,

$$ED_{C_1} = 2(0.500)^2 + 1(0.707)^2 = 1.00 \quad (5.36)$$

$$ED_{C_2} = 2(0.707)^2 + 1(0)^2 = 1.00 \quad (5.37)$$

$$ED_{C_3} = 2(0.500)^2 + 1(-0.707)^2 = 1.00 \quad (5.38)$$

In a similar way, the electron densities can be found for the atoms in the cation and anion. The results can be summarized as follows:

Electron density at	C ₁	C ₂	C ₃
Radical	1.00	1.00	1.00
Cation	0.50	1.00	0.500
Anion	1.50	1.00	1.50

Although the evaluations will not be shown, the bond orders between the atoms are identical because the difference in the orbital populations occurs in the *nonbonding* orbital. For the arrangement C=C-C, the π bond is localized between two atoms in the same way it is in ethylene. Therefore, the energy would be $2(\alpha + \beta)$. If the π bond is spread over the whole molecule, C \cdots C \cdots C the energy would be $2(\alpha + 2^{1/2}\beta)$, which is lower than that of the previous structure by -0.828β . This energy represents the amount by which the structure with delocalized electron density is more stable than one in which the π bond is restricted to a location between two carbon atoms. This energy of stabilization is known as the *resonance energy*.

If we suppose that the carbon atoms form a ring structure, the problem is somewhat different because $H_{13} = H_{31} = \beta$. The secular determinant can be written as

$$\begin{vmatrix} x & 1 & 1 \\ 1 & x & 1 \\ 1 & 1 & x \end{vmatrix} = 0 \quad (5.39)$$

which leads to the equation

$$x^3 - 3x + 2 = 0 \quad (5.40)$$

and the roots are $x = -2$, $x = 1$, and $x = 1$. Therefore, $E = \alpha + 2\beta$ and $E = \alpha - \beta$. Because the latter energy occurs twice, *degenerate* orbitals are indicated. The energy level diagram for a three-membered ring system is shown in Figure 5.18.

For the cation, a localized π bond would lead to an energy of $2(\alpha + \beta)$, whereas a delocalized π bond would have an energy of $2(\alpha + 2\beta)$. The resonance energy is 2β . For the anion, the total energy is $2(\alpha + 2\beta) + 2(\alpha - \beta)$, which gives $4\alpha + 2\beta$. If there were a localized π bond and two electrons located on two carbon atoms, the energy would be $2(\alpha + \beta) + 2\alpha$, which is $4\alpha + 2\beta$. This is identical to the result for the case when the π bond is delocalized, so there is no resonance stabilization of the anion. Based on resonance stabilization, we predict (correctly) that the ring structure is more stable for the cation than the anion. The molecular orbital diagram for the cyclopropene ring is shown in Figure 5.19.

An interesting conjecture is in regard to whether H_3^+ , which has been observed in gas discharge and mass spectrometry, would have a linear or ring structure. The energy level *diagrams* will be identical to those for the C_3 systems shown in Figures 5.16 and 5.18, although the *actual values* for α and β will be different. For the arrangement [H-H-H] $^+$, the energy levels are found to be $\alpha + 2^{1/2}\beta$, α , and $\alpha - 2^{1/2}\beta$. For the ring structure,

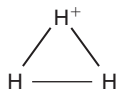

the energy levels are $\alpha + 2\beta$, $\alpha - \beta$, and $\alpha - \beta$. Therefore, for two electrons, the total energies are $E_L = 2(\alpha + 2^{1/2}\beta)$ for the linear structure and $E_R = 2(\alpha + 2\beta)$ for the ring structure. From this calculation, it is predicted that the ring structure is more stable by an amount -1.2β . This is expected because

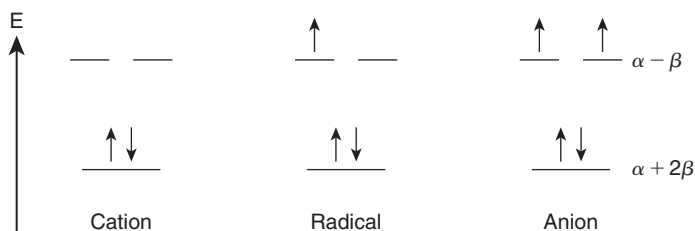

■ FIGURE 5.18 Energy level diagrams for species containing three carbon atoms in a ring.

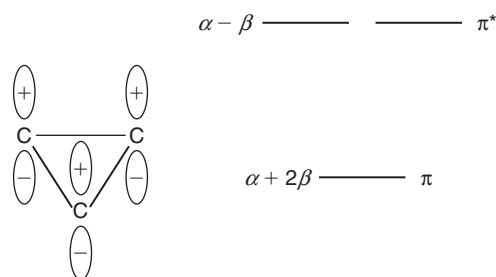

■ FIGURE 5.19 The molecular orbital diagram for cyclopropene.

if H_3^+ is formed by the interaction of H_2 and H^+ , the H^+ will attach at the region of highest electron density, which is the bond in H_2 .

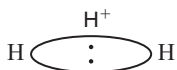

Thus, the cyclic structure for H_3^+ is indicated by both experimental evidence and high-level calculations. Several species have been identified that can be represented as H_n^+ (with n equal to an odd number). They are derived from H_3^+ by adding H_2 molecules at the corners of the ring (presumably perpendicular to the ring). The species with n equal to an even number are less stable.

Over half a century ago, Arthur Frost and Boris Musulin (1953) published an interesting procedure for obtaining the energies of molecular orbitals of ring systems. The first step involves drawing a circle having a convenient radius that will be defined as 2β . Next, inscribe a regular polygon having a number of sides equal to the number of carbon atoms in the structure. Place one vertex of the polygon at the bottom of the circle. The height above the bottom where each vertex makes contact with the circle gives the energy of a molecular orbital. This is illustrated in Figure 5.20 for rings containing three, four, five, six, seven, and eight carbon atoms. Above the lowest level, the levels occur in degenerate pairs until the highest level is reached. From this simple procedure, the energy levels summarized in Table 5.6 are found for several cyclic systems.

Although the details will not be shown, it is easy to compute the resonance energies to determine the stabilities of rings with five carbon atoms (the cyclopentadiene, Cp, ring). When this is done, it is found that $\text{Cp}^- > \text{Cp} > \text{Cp}^+$, which is in agreement with the fact that there is an extensive chemistry associated with the cyclopentadienyl anion.

The procedure of Frost and Musulin can be adapted to chain systems with π bonding in the following way. For a chain having m atoms, draw a polygon as before, except it must have $m + 2$ sides. Disregard the top and bottom vertices and use only one side of the polygon where it makes contact with the circle to determine the energy levels.

Although the Hückel method is most often applied to organic molecules, the H_3^+ case discussed shows that it can also be applied to some inorganic species. Suppose we consider the pyrrole molecule,

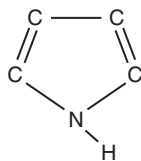

We can write the wave functions as linear combinations of atomic orbitals as before, but in this case, atom 1 is the nitrogen atom, and it has a coulomb integral H_{11} that is *not* the same as that for a carbon atom. Therefore, H_{11} will be represented as α_N , which is often approximated in terms of the value for carbon. In this case, the nitrogen contributes two electrons to the π system, and the correction is made that results in the secular determinant having the form $\alpha_N = \alpha_C + (3/2)\beta$. The secular determinant becomes

$$\begin{vmatrix} \alpha + \frac{3}{2}\beta - E & \beta & 0 & 0 & \beta \\ \beta & \alpha - E & \beta & 0 & 0 \\ 0 & \beta & \alpha - E & \beta & 0 \\ 0 & 0 & \beta & \alpha - E & \beta \\ \beta & 0 & 0 & \beta & \alpha - E \end{vmatrix} = 0 \quad (5.41)$$

Letting $x = (\alpha - E)/\beta$ and simplifying gives the secular determinant

$$\begin{vmatrix} x + \frac{3}{2} & 1 & 0 & 0 & 1 \\ 1 & x & 1 & 0 & 0 \\ 0 & 1 & x & 1 & 0 \\ 0 & 0 & 1 & x & 1 \\ 1 & 0 & 0 & 1 & x \end{vmatrix} = 0 \quad (5.42)$$

which results in the polynomial equation

$$x^5 + \frac{3}{2}x^4 - 5x^3 - \frac{9}{2}x^2 + 5x + \frac{7}{2} = 0 \quad (5.43)$$

Equations such as this were normally solved by graphing before the days in which a calculator removed the need for such tedious techniques. Using numerical techniques, the roots can be found to be $x = -2.55, -1.15, -0.618, 1.20, \text{ and } 1.62$. The three lowest energy states are populated with six electrons (nitrogen is presumed to contribute two electrons to the bonding). Therefore, the resonance energy is $6\alpha + 7.00\beta - (6\alpha + 8.64\beta) = -1.64\beta$. After the constants $a_1 \dots a_5$ are evaluated, the wave functions can be shown to be

$$\psi_{\text{MO}(1)} = 0.749\psi_1 + 0.393\psi_2 + 0.254\psi_3 + 0.254\psi_4 + 0.393\psi_5 \quad (5.44)$$

$$\psi_{\text{MO}(2)} = 0.503\psi_1 - 0.089\psi_2 - 0.605\psi_3 - 0.605\psi_4 - 0.089\psi_5 \quad (5.45)$$

$$\psi_{\text{MO}(3)} = 0.602\psi_2 + 0.372\psi_3 - 0.372\psi_4 - 0.602\psi_5 \quad (5.46)$$

$$\psi_{\text{MO}(4)} = 0.430\psi_1 - 0.580\psi_2 + 0.267\psi_3 + 0.267\psi_4 - 0.580\psi_5 \quad (5.47)$$

$$\psi_{\text{MO}(5)} = 0.372\psi_2 - 0.602\psi_3 + 0.602\psi_4 - 0.372\psi_5 \quad (5.48)$$

Only the three lowest levels are populated. By following the procedure shown earlier, the electron densities at each position can be calculated (the nitrogen atom is in position 1):

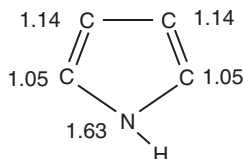

The electron densities total 6, the number of electrons in the π system. Note that the highest electron density is at the nitrogen atom, which has the highest electronegativity.

As should be evident, part of the problem in dealing with structures that contain atoms other than carbon is what values to use for α and β . The values that have been suggested are based on correlating calculated properties with other known data. Because the Hückel method is not a quantitative scheme for calculating properties of molecules, we will not address the issue of correcting the values of α and β further.

If we perform an analysis of the NCN molecule where the nitrogen atoms are contributing one electron each, we let $\alpha_N = \alpha + \frac{1}{2}\beta$. Following the Hückel procedures, we arrive at the secular determinant

$$\begin{vmatrix} x + \frac{1}{2} & 1 & 0 \\ 1 & x & 1 \\ 0 & 1 & x + \frac{1}{2} \end{vmatrix} = 0 \quad (5.49)$$

from which it can be shown that the polynomial equation has roots of $x = -1.686$, -0.500 , and 1.186 . Therefore, the values calculated for the energies of the molecular orbitals are $\alpha + 1.686\beta$, $\alpha + 0.500\beta$, and $\alpha - 1.186\beta$. The first of these is doubly occupied, whereas the second is singly occupied. The wave functions for the first two levels are

$$\psi_{\text{MO}(1)} = 0.542\psi_1 + 0.643\psi_2 + 0.541\psi_3 \quad (5.50)$$

$$\psi_{\text{MO}(2)} = 0.707\psi_1 - 0.707\psi_3 \quad (5.51)$$

In earlier sections, we have seen that the energy of a molecular orbital can be expressed in terms of the coefficients, a_i , and the Coulomb and exchange integrals. For the second wave function, this can be expressed as

$$E_2 = a_1^2(\alpha + \frac{1}{2}\beta) + a_2^2(\alpha) + a_3^2(\alpha + \frac{1}{2}\beta) + 2a_1a_3\beta + 2a_2a_3\beta \quad (5.52)$$

The last two terms are zero, which after substituting for the coefficients gives

$$\begin{aligned} E_2 &= 0.707^2(\alpha + \frac{1}{2}\beta) + 0(\alpha) + (-0.707)^2(\alpha + \frac{1}{2}\beta) \\ &= 0.500\alpha + 0.250\beta + 0 + 0.500\alpha + 0.250\beta = \alpha + 0.500\beta \end{aligned} \quad (5.53)$$

which is precisely the energy found for that orbital. The calculated electron densities are

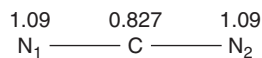

Although no claim can be made that the calculation is quantitative, it is somewhat encouraging that the values obtained are in agreement with what we know about the nature and electronegativities of the atoms. Although it is a primitive method, the Hückel approach provides some interesting exercises for small inorganic species (such as the H_3^+ case discussed earlier). The insight that the method provides about orbitals in organic species (particularly alkenes) that function as ligands in coordination compounds will be useful in the discussion of these complexes in Chapters 16 and 21.

In this chapter, we have presented an overview of symmetry and its importance when applying molecular orbital methods to molecular structure. Although far from rigorous and complete, the principles

described are sufficient for the study of inorganic chemistry at the undergraduate level. Additional details for readers seeking more advanced coverage are to be found in the references listed. It should also be mentioned that computer programs are available for carrying out molecular orbital calculations on several levels that include simple Hückel, extended Hückel, and more sophisticated types of calculations.

REFERENCES FOR FURTHER STUDY

- Adamson, A. W. (1986). *A Textbook of Physical Chemistry*, 3rd ed., Chapter 17. Academic Press College Division, Orlando, FL. One of the best treatments of symmetry available in a physical chemistry text.
- Cotton, F. A. (1990). *Chemical Applications of Group Theory*, 3rd ed. Wiley, New York. The standard text on group theory for chemical applications.
- DeKock, R. L., and Gray, H. B. (1980). *Chemical Bonding and Structure*. Benjamin Cummings, Menlo Park, CA. An excellent introduction to bonding that makes use of group theory at an elementary level.
- Drago, R. S. (1992). *Physical Methods for Chemists*. Saunders College Publishing, Philadelphia. Chapters 1 and 2 present a thorough foundation in group theory and its application to interpreting experimental techniques in chemistry. Highly recommended.
- Fackler, J. P. (1971). *Symmetry in Coordination Chemistry*. Academic Press, New York. A clear introduction to symmetry.
- Frost, A., and Musulin, B. (1953). *J. Chem. Phys.* **21**, 572. The original description showing energies of molecular orbitals by means of inscribed polygons.
- Harris, D. C., and Bertolucci, M. D. (1989). *Symmetry and Spectroscopy*. Dover, New York. Chapter 1 presents a good summary of symmetry and group theory.

QUESTIONS AND PROBLEMS

- Make sketches of the following showing approximately correct geometry and all valence shell electrons. Identify all symmetry elements present and determine the point group for the species.
(a) OCN^- , (b) IF_2^+ , (c) ICl_4^- , (d) SO_3^{2-} , (e) SF_6 , (f) IF_5 , (g) ClF_3 , (h) SO_3 , (i) ClO_2^- , (j) NSF
- Make sketches of the following showing approximately correct geometry and all valence shell electrons. Identify all symmetry elements present and determine the point group for the species.
(a) CN_2^{2-} , (b) PH_3 , (c) PO_3^- , (d) $\text{B}_3\text{N}_3\text{H}_6$, (e) SF_2 , (f) ClO_3^- , (g) SF_4 , (h) C_3O_2 , (i) AlF_6^{3-} , (j) F_2O
- Consider the molecule AX_3Y_2 , which has no unshared electron pairs on the central atom. Sketch the structures for all possible isomers of this compound and determine the point group to which each belongs.
- Match each characteristic listed on the left with the appropriate species from the list on the right that exhibits the characteristic.

has three C_2 axes	OCN^-
has $C_{\infty v}$ symmetry	BrO_3^-
has one C_3 axis	SO_4^{2-}
has only one mirror plane	XeF_4
has a center of symmetry	OSCl_2

5. How many chlorine atoms in CCl_4 must be replaced by hydrogen atoms to give molecules having C_{3v} and C_{2v} symmetry, respectively?
6. Draw structures for the following showing correct geometry and identify all of the symmetry elements present in each.
(a) SCN^- , (b) $\text{S}_2\text{O}_3^{2-}$, (c) H_2S , (d) IF_4^- , (e) ICl_3 , (f) ClO_2^- , (g) NO_2^- , (h) IF_5
7. Draw structures for the following showing correct geometry and identify all of the symmetry elements present in each.
(a) C_6H_6 , (b) SF_2 , (c) ClO^- , (d) OF_2 , (e) XeF_4 , (f) SeO_3 , (g) Cl_2CO , (h) NF_3
8. Use the symmetry of the atomic orbitals of the central atom to construct (using appropriate hydrogen group orbitals) the molecular orbital diagrams for the following.
(a) BeH_2 , (b) HF_2^- , (c) CH_2 , (d) H_2S
9. Use the symmetry of the atomic orbitals of the central atom to construct (using appropriate combinations of group orbitals peripheral atoms) the molecular orbital diagrams for the following.
(a) AlF_3 , (b) BH_4^- , (c) SF_6 , (d) NF_3
10. Consider the molecule $\text{Cl}_2\text{B}-\text{BCl}_2$.
(a) If the structure is planar, what is the point group of the molecule?
(b) Draw a structure for $\text{Cl}_2\text{B}-\text{BCl}_2$ that has an S_4 axis.
11. Use the procedure outlined in the text to obtain the multiplication table for the C_{4v} point group.
12. Follow the procedure used in the text in obtaining the character table for the C_{2v} point group and develop the character table for the C_{3v} point group.
13. Using the procedure shown in this chapter, calculate the electron density at each position in the pyrrole molecule.
14. By analogy to the carbon systems that contain three atoms, describe the structure of interhalogen species (see Chapter 15) such as I_3^- . Assuming that only p orbitals are used, describe the bonding in this species.
15. From the diagrams shown in Figure 5.20, would you expect the lowest energy spectral band to be at higher energy for the cyclopropene cation, cyclopentadiene anion, or benzene?
16. Use the Hückel method to determine whether H_3^- should have a linear or a ring structure. Calculate the electron density at each atom and the bond orders for the more stable structure.
17. Describe how you would carry out a Hückel calculation for the HFH^+ ion. What would you expect to find the most stable structure to be?
18. Repeat the procedure in Question 17 for the FHF^- ion.

This page intentionally left blank

Part

2

Condensed Phases

This page intentionally left blank

Dipole Moments and Intermolecular Interactions

Although the forces that hold molecules and solids together dominate the study of matter, there are other forces that affect chemical and physical properties. These are forces that arise as a result of the interactions between complete molecular units. Matter is composed of electrically charged particles, so it is reasonable to expect that there exists *some* force between any two molecules in close proximity.

Forces between molecules are of several types. Some compounds consist of polar molecules that attract each other as a result of the electrical charges. Other compounds consist of nonpolar molecules, but the electrons in one molecule are weakly attracted to the nuclei in another as a result of instantaneous electron distributions that are not symmetrical. Still other molecules contain hydrogen atoms that are attached to other atoms having high electronegativity, which leaves the hydrogen with a residual positive charge. As a result, the hydrogen atom can become attracted to an unshared pair of electrons on an atom in the same or another molecule. This type of interaction is known as hydrogen bonding. Although the forces that exist between molecules may amount to only 10 to 20 kJ mol⁻¹, they have a great influence on physical properties and in some cases chemical behavior. It is essential to have an understanding of these types of forces (sometimes called *nonchemical* or *nonvalence* forces) in order to predict and interpret the properties and behavior of inorganic compounds. This chapter is devoted to the subject of intermolecular interactions.

6.1 DIPOLE MOMENTS

Because atoms have different electronegativities, pairs of electrons that are shared in covalent bonds are not necessarily shared equally. The result is that the bond has a polarity with the center of negative charge generally residing on the atom having the higher electronegativity. For a covalent bond between two atoms, the dipole moment, μ , is expressed as

$$\mu = q \times r \quad (6.1)$$

where q is the quantity of charge separated and r is the distance of separation. In Chapter 3, the relationship between the dipole moment and the weighting coefficient of the ionic term in the molecular wave function for a diatomic molecule was determined. Several properties of molecules are

related to their polarity, and it is a useful parameter for understanding molecular structure, so it is appropriate to explore this topic in greater detail. Before doing so, a comment on units is appropriate. The charge on an electron is 1.6022×10^{-19} coulomb, and internuclear distances can be expressed in meters. As a result, the units on dipole moments are coulomb-meter (C m). A unit of polarity is defined as the *debye*, which is named after Peter Debye, who did pioneering work on polar molecules. The relationship in SI units is

$$1 \text{ debye} = 1 \text{ D} = 3.33564 \times 10^{-30} \text{ C m}$$

Historically (as well as currently by many chemists), the quantity of charge separated is expressed in electrostatic units, esu, which is $\text{g}^{1/2} \text{ cm}^{3/2} \text{ sec}^{-1}$. The charge on the electron is 4.80×10^{-10} esu, and when the internuclear distances are expressed in centimeters,

$$1 \text{ debye} = 1 \text{ D} = 10^{-18} \text{ esu cm}$$

Of course the results are identical in either set of units, but the latter units are somewhat more convenient for some purposes and will be used in this discussion.

For molecules that have several polar bonds, a rough approximation of the overall dipole moment can be made by considering the *bond moments* as vectors and finding the vector sum. Consider the water molecule, which has the structure

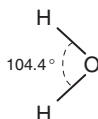

and for which the overall dipole moment is 1.85 D. If we consider that value to be the vector sum of the two O–H bond moments, we find that

$$1.85 \text{ D} = 2 \cos 52.25^\circ \times \mu_{\text{O-H}} \quad (6.2)$$

Solving for $\mu_{\text{O-H}}$, we find a value of 1.51 D. We have another way to estimate the dipole moment of the O–H bond by making use of the equation

$$\% \text{ Ionic character} = 16 |\chi_A - \chi_B| + 3.5 |\chi_A - \chi_B|^2 \quad (6.3)$$

where χ_A and χ_B are the electronegativities of the atoms. By calculating the percent ionic character, we can determine the charge on the atoms. For an O–H bond,

$$\% \text{ Ionic character} = 16 |3.5 - 2.1| + 3.5 |3.5 - 2.1|^2 = 29.4\% \quad (6.4)$$

Therefore, because the length of the O–H bond is 1.10×10^{-8} cm (110 pm),

$$\mu_{\text{O-H}} = 0.294 \times 4.8 \times 10^{-10} \text{ esu} \times 1.10 \times 10^{-8} \text{ cm} = 1.58 \times 10^{-18} \text{ esu cm} = 1.58 \text{ D} \quad (6.5)$$

In this case, the agreement of the values calculated by the two methods is good, but it is not always so. One reason is that the simple vector approach ignores the effects of unshared pairs of electrons. Also, highly polar bonds can induce additional charge separation in bonds that might not otherwise

be polar. In some cases, bonds may be essentially nonpolar, as is the case for C–O and C–H bonds. Finally, many molecules are not adequately represented by a single structure because of resonance. As a result, the calculation of dipole moments for all but simple molecules is not a trivial problem.

The effect of molecular geometry can often be evaluated in a straightforward manner. Consider the tetrahedral CH_4 molecule, which will be shown as having one C–H bond pointing “up” and the other three forming a tripod-like base:

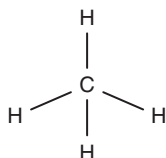

The bond pointing “up” constitutes one C–H bond in that direction while the other three must exactly equal the effect of one C–H pointing “down.” The “down” component of each of the three bonds can be obtained from $\cos(180 - 109^\circ 28') = 1/3$. Therefore, the three bonds exactly equal the effect of the one bond pointing in the “up” direction. This would be true for any regular tetrahedral molecule, so the dipole moment would be zero.

In Chapter 4, it was discussed that peripheral atoms of high electronegativity tend to bond to hybrid orbitals having a low degree of s character. In that connection, the molecule PCl_3F_2 is nonpolar indicating that the structure of the molecule is

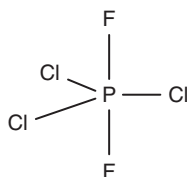

The axial orbitals used by phosphorus in this molecule can be considered as dp in character (see Chapter 4), which means they have no s character, whereas the orbitals in equatorial positions are sp^2 hybrids. As expected, the fluorine atoms are found in axial positions and the molecule is nonpolar. This illustration shows the value of dipole moments in predicting the details of molecular structure. Table 6.1 shows dipole moments for a large number of inorganic molecules.

One of the interesting aspects of dipole moments for molecules is seen when the molecules NH_3 and NF_3 are considered:

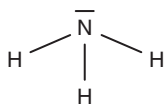

Bond angle: 107°
Dipole moment: 1.47 D

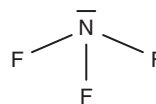

Bond angle: 102°
Dipole moment: 0.23 D

Table 6.1 Dipole Moments for Some Inorganic Molecules.

Molecule	Dipole Moment, D	Molecule	Dipole Moment, D
H ₂ O	1.85	NH ₃	1.47
PH ₃	0.58	AsH ₃	0.20
SbH ₃	0.12	AsCl ₃	1.59
AsF ₃	2.59	HF	1.82
HCl	1.08	HBr	1.43
HI	0.44	SOCl ₂	1.45
SO ₂ Cl ₂	1.81	SO ₂	1.63
PCl ₃	0.78	F ₂ NH	1.92
OPF ₃	1.76	SPF ₃	0.64
SF ₄	0.63	IF ₅	2.18
HNO ₃	2.17	H ₂ O ₂	2.2
H ₂ S	0.97	N ₂ H ₄	1.75
NO	0.15	NO ₂	0.32
N ₂ O	0.16	PFCl ₄	0.21
NF ₃	0.23	ClF ₃	0.60

For these two molecules, the structures are quite similar, and with the electronegativities of the atoms being N = 3.0, H = 2.1, and F = 4.0, even the polarities of the bonds are similar. The large difference in dipole moment is caused by the fact that in NH₃ there is a considerable effect produced by the unshared pair of electrons that causes the negative end of the dipole to lie in that direction. The N–H bonds are polar, with the positive ends lying in the direction of the hydrogen atoms. Therefore, the effect of the polar bonds adds to the effect of the unshared pair of electrons, giving rise to a large dipole moment. In NF₃, the unshared pair of electrons gives a negative charge to that region of the molecule, but because the fluorine atoms have higher electronegativity than the nitrogen atom, the negative ends of the polar N–F bonds lie toward the fluorine atoms. Thus, the unshared pair of electrons and the polar N–F bonds act in opposition to each other, which results in a low dipole moment for the NF₃ molecule.

The dipole moments of ClF₃ and BrF₃ provide another interesting illustration of the effects of unshared pairs of electrons. The molecules can be shown as follows:

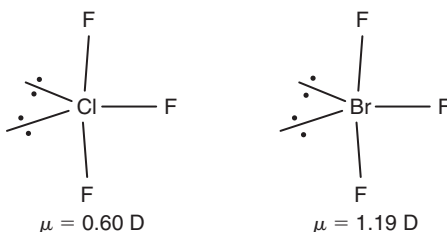

Bond	Moment, D	Bond	Moment, D
H-O	1.51	C-F	2.0
H-N	1.33	C-Cl	1.47
H-S	0.68	C-Br	1.4
H-P	0.36	C-O	0.74
H-C	0.40	C=O	2.3
P-Cl	0.81	C-N	0.22
P-Br	0.40	C=N	0.9
As-F	2.0	C≡N	3.5
As-Cl	1.6	As-Br	1.3

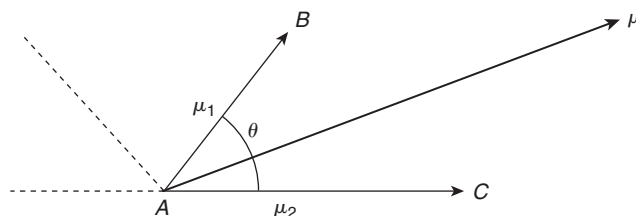

■ **FIGURE 6.1** The vector model used to calculate dipole moments from bond moments.

Owing to the difference in electronegativities, the Br-F bonds are more polar than are the Cl-F bonds. However, the unshared pairs in ClF_3 are held closer to the Cl atom and the polarity of the Cl-F bond is in the opposite direction as the resultant of the two unshared pairs of electrons. In BrF_3 , the equatorial Br-F bond is slightly more polar than a Cl-F bond, but the unshared pairs reside farther away from the Br atom. Therefore, there is a greater effect produced by the two unshared pairs of electrons in BrF_3 that dominates the polarity of the equatorial Br-F bond. The result is that the dipole moment of BrF_3 is about twice as large as that of ClF_3 .

In many cases, it is useful to have some way to approximate the polarity of a molecule or a portion of the molecule. For this purpose, knowing the polarity of specific bonds can provide an approach to the problem. Table 6.2 shows the bond moments for numerous types of bonds.

If the structure of a molecule and the bond moments are known, an approximate dipole moment can be obtained by treating the polar bonds as vectors. Figure 6.1 provides the vector diagram from which we obtain the resultant for two bonds as

$$\mu = \sqrt{\mu_1^2 + \mu_2^2 + 2 \mu_1 \mu_2 \cos \theta} \quad (6.6)$$

For molecules where the angle is obtuse (indicated by the dotted lines in Figure 6.1) the relationship is written as

$$\mu = \sqrt{\mu_1^2 + \mu_2^2 + 2 \mu_1 \mu_2 \cos (180 - \theta)} \quad (6.7)$$

If this approach is taken for the methyl chloride, CH_3Cl , molecule, which has the structure

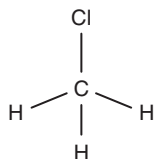

the polarity of each C–H bond results in the negative end being toward the carbon atom. The resultant of the three C–H bonds added to the moment for the C–Cl bond gives the overall dipole moment for the molecule. It is found that each C–H bond is at $(180 - 109.5)^\circ = 70.5^\circ$ from a line directly opposite the C–Cl bond. Consequently, for three C–H bonds the result is

$$3 \mu_{\text{CH}} \times \cos 70.5 = 3 \mu_{\text{CH}} \times 0.33 = 1 \mu_{\text{CH}}$$

Therefore, the dipole moment for CH_3Cl is calculated to be

$$\mu_{\text{molecule}} = \mu_{\text{CH}} + \mu_{\text{CCl}} = 0.40 + 1.47 = 1.87 \text{ D}$$

For CClF_3 , the polarity of the three C–F bonds is in opposition to the C–Cl bond so that

$$\mu_{\text{molecule}} = \mu_{\text{CF}} - \mu_{\text{CCl}} = 2.00 - 1.47 = 0.53 \text{ D}$$

which is very close to the measured dipole moment of 0.50 D.

6.2 DIPOLE-DIPOLE FORCES

When two atoms having different electronegativities share a pair of electrons, the electrons are not shared equally. As a result, the bond between the atoms is said to be polar because the electrons will reside closer to the atom of higher electronegativity, giving it a negative charge. For a diatomic molecule, the dipole moment, μ , is given by

$$\mu = q \times r \quad (6.8)$$

and in Chapter 3, it was shown that HCl behaves as if 17% of the charge on an electron is transferred from H to Cl. For HF, the charge separation is 43% of the charge on the electron. When molecules having charge separations approach each other, there are electrostatic forces between them. Orientations such as those shown in Figures 6.2a and 6.2b that place opposite charges closer together represent lower energy (a negative value, E_A).

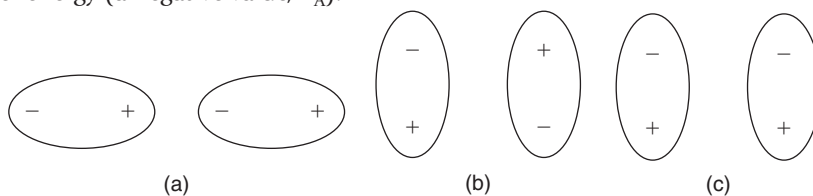

■ **FIGURE 6.2** Arrangements of dipoles. (a) and (b) lead to attraction (interaction energy negative) and (c) leads to repulsion (interaction energy positive).

An arrangement such as that shown in Figure 6.2c leads to repulsion (the energy is positive, E_R). Although it might be assumed that such an arrangement could not occur, this is not exactly true. It represents a higher energy state than those in which the orientations place opposite charges in close proximity, but the population of a state of higher energy is governed by the Boltzmann distribution law. For two states having energies defined by E_A and E_R as described earlier, the populations of the states (n_A and n_R) can be related to the energy difference between them, ΔE , by

$$\frac{n_R}{n_A} = e^{-\Delta E / kT} \quad (6.9)$$

where k is Boltzmann's constant, T is the temperature (K), and the other quantities were defined earlier. Therefore, although the repulsive state is higher in energy, it can have a small population depending on the temperature and ΔE . Because the population of the attractive state is larger, there is a net attraction between two polar molecules. The net energy between two dipoles that are restricted in orientation, E_D , is

$$E_D = -\frac{\mu_1 \mu_2}{r^3} [2 \cos \theta_1 \cos \theta_2 - \sin \theta_1 \sin \theta_2 \cos(\phi_1 - \phi_2)] \quad (6.10)$$

In this equation, θ_1 , θ_2 , ϕ_1 , and ϕ_2 are the angular coordinates that describe the orientations of the polar molecules 1 and 2, μ_1 and μ_2 are their dipole moments, and r is the average distance of separation of the molecules. It should be noted that if two dipoles are restricted to fixed orientations in a solid, the energy varies as $1/r^3$ as shown earlier, and an energy expression containing that factor is frequently encountered. However, in a liquid the orientations change, and all orientations from the antiparallel attractive arrangement to the parallel repulsive arrangement are possible. There is some average orientation which is obtained by summing all of the possible orientations. When this is taken into account and the average orientation is used, the energy varies as $1/r^6$ and is expressed as

$$E_D = -\frac{2\mu_1^2 \mu_2^2}{3r^6 kT} \quad (6.11)$$

If only one type of polar molecule is present, the interaction energy can be expressed as

$$E_D = -\frac{2\mu^4}{3r^6 kT} \quad (6.12)$$

On a molar basis, the energy of interaction is given by

$$E_D = -\frac{2\mu^4}{3r^6 RT} \quad (6.13)$$

Although the association of polar molecules is accompanied by an energy change of only approximately 2 to 5 kJ mol⁻¹, the effect on physical properties is great.

It is important to keep in mind that the ability of dipoles to associate is influenced by their environment. Many studies on association of dipoles have been carried out in solutions containing the polar molecules. If the molecules of the solvent are polar or can have polarity induced in them (see Section 6.3), association of the solute molecules will be hindered. The solvent molecules will surround the polar solute molecules, which will inhibit their interaction with other solute molecules. The solute

molecules must be at least partially “desolvated” before association can occur. If we represent a polar molecule as D , the association reaction to form dimers can be written as



or, in a more general form where aggregates may contain n molecules, the reaction is



The equilibrium constants for these reactions may differ by as much as a factor of 10 to 100 depending on the nature of the solvent. If the solvent is a nonpolar one such as hexane, the interactions between the polar solute molecules are much stronger than are the interactions between solvent and solute. As a result, the equilibrium constant for dipole association will be large. On the other hand, if the solvent consists of polar molecules such as CH_3OH , the association of the solute molecules may be completely prevented owing to the interaction of polar solute molecules with the polar solvent molecules. The solute molecules must become partially “desolvated” in order to form dimers or larger aggregates. A solvent such as chlorobenzene or chloroform may not prevent association of polar molecules completely, but the equilibrium constant will almost always be smaller than it is when the solvent consists of nonpolar molecules such as hexane or CCl_4 .

Although it does not strictly involve dipole association, an interesting case that illustrates the principles just described involves the association of lithium alkyls. For LiCH_3 , one of the stable aggregates is the hexamer, $(\text{LiCH}_3)_6$. In a solvent such as toluene, the hexamer units are maintained, but in a solvent like $(\text{CH}_3)_2\text{NCH}_2\text{CH}_2\text{N}(\text{CH}_3)_2$, which interacts strongly because of the unshared pairs of electrons on the nitrogen atoms, methyllithium exists as a solvated monomer. As will be shown in Chapter 9, the association of electron donors and acceptors is also strongly affected by the ability of the solvent to interact with solute molecules.

6.3 DIPOLE-INDUCED DIPOLE FORCES

The electrons in molecules and atoms can be moved somewhat under the influence of a charge that generates an electrostatic force on the electrons. As a result, the electron cloud has some *polarizability*, which is represented as α . The total number of electrons may not be as important as the mobility of the electrons in determining the polarizability of a molecule. Consequently, molecules that have delocalized π electron systems generally have higher polarizabilities than do molecules having a similar number of electrons that are held in localized bonds. When a polarizable molecule having a spherical charge distribution approaches a polar molecule, a charge separation is induced in the molecule that was originally nonpolar. This interaction results in some force of attraction between the two species.

The polarizability of one molecule and the magnitude of the dipole moment of the other are the major factors that determine the strength of the interaction. The larger the dipole moment (μ) of the polar molecule and the higher the polarizability of the other molecule, the greater the strength of the interaction. Mathematically, the energy of the interaction of a dipole with a polarizable molecule can be expressed as

$$E_1 = -\frac{2\alpha\mu^2}{r^6} \quad (6.16)$$

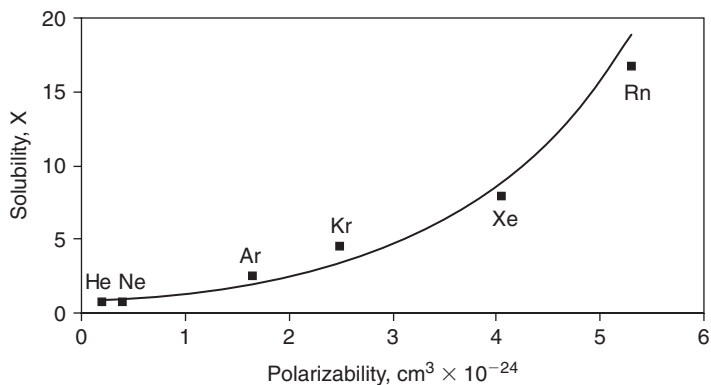

■ FIGURE 6.3 Solubility of noble gases in water as a function of polarizability.

The interaction by dipole-induced dipole forces exists in addition to the London forces that cause an attraction even between molecules that are nonpolar. One of the most striking manifestations of dipole-induced dipole forces is that shown by the solubility of the noble gases in water. The greater the energy of interaction between the solute and solvent, the greater the solubility of the gas. Polar water molecules induce a charge separation in the noble gas molecules that increases with the polarizability of the noble gas. Accordingly, it would be expected that helium would interact very weakly with water and radon should interact more strongly in accord with their polarizabilities. Consequently, the solubility of the noble gases in water decreases in the order $\text{Rn} > \text{Xe} > \text{Kr} > \text{Ar} > \text{Ne} > \text{He}$, as is clearly shown graphically in Figure 6.3.

Another important consequence of dipole-induced dipole interactions is the difference in the solubility of oxygen and nitrogen in water. Expressed as grams of gas dissolved per 100 grams of water, the solubilities are 0.006945 and 0.002942, respectively, at 0°C . Both are nonpolar molecules, but the O_2 molecule has a greater polarizability. As a result, polar H_2O molecules cause a greater charge to be induced in the oxygen molecules, which results in stronger interactions with the solvent leading to greater solubility.

An important extension of these ideas is to cases where an ion interacts with polar molecules (ion-dipole forces). In such cases the polarity of the molecule is increased because of the inductive effect caused by the ion. Polar solvent molecules that surround an ion in the solvation sphere do not have the same polarity as do the molecules in the bulk solvent.

6.4 LONDON (DISPERSION) FORCES

In addition to the intermolecular forces that exist as a result of permanent charge separations in molecules, there must be some other type of force. Sometimes referred to as electronic van der Waals forces, they cause deviations from the ideal gas equation. These forces are not related to whether or not the molecules have a permanent dipole moment, but rather they exist between all molecules.

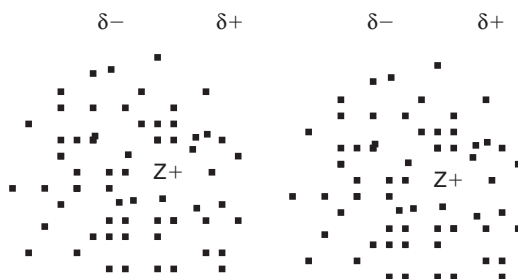

■ **FIGURE 6.4** An instantaneous distribution of electrons that leads to polarity in two atoms. There will be a force of attraction between the atoms (or molecules) even though they do not have permanent polarity. The number of electrons and their ability to be moved will determine the magnitude of the attractive force.

Otherwise, it would be impossible to liquefy substances such as CH_4 , O_2 , N_2 , and noble gases. The liquid and solid phases of many nonpolar compounds simply would not exist. We can see how such forces arise by considering two noble gas atoms that are in close proximity as shown in Figure 6.4. At some instant, the majority of electrons in one atom might be located on one side of the atom leaving the other half with an instantaneous positive charge. That charge can attract the electrons in another atom so that there is a net force of attraction between them. The result is an electron arrangement that can be called an *instantaneous dipole*. In 1929, Fritz London studied the forces that arise from this type of interaction, and they are called *London forces* or *dispersion forces*.

In order to arrive at a mathematical relationship to describe London forces, we will use an intuitive approach. First, the ability of the electrons to be moved within the molecule is involved. Atoms or molecules in which the electrons are highly localized cannot have instantaneous dipoles of any great magnitude induced in them. A measure of the ability of electrons in a molecule to be shifted is known as the electronic polarizability, α . In fact, each of the interacting molecules has a polarizability, so the energy arising from London forces, E_L is proportional to α^2 . London forces are important only at short distances, which means that the distance of separation is in the denominator of the equation. In fact, unlike Coulomb's law, which has r^2 in the denominator, the expression for London forces involves r^6 . Therefore, the energy of interaction as a result of London forces is expressed as

$$E_L = -\frac{3h\nu_0\alpha^2}{4r^6} \quad (6.17)$$

where α is the polarizability, ν_0 is the zero point vibration frequency, and r is the average distance of separation between the molecules. The quantity $h\nu_0$ is the ionization potential, I , for the molecule. Therefore, the London energy can be represented by

$$E_L = -\frac{3I\alpha^2}{4r^6} \quad (6.18)$$

It is interesting to note that many different types of molecules have ionization potentials that do not differ greatly. Table 6.3 shows typical values for molecular ionization potentials for a wide variety of substances.

Table 6.3 Ionization Potentials for Selected Molecules.

Molecule	IP, eV	Molecule	IP, eV
CH ₃ CN	12.2	C ₂ H ₅ NH ₂	8.86
(CH ₃) ₂ NH	8.24	(CH ₃) ₃ N	7.82
NH ₃	10.2	HCN	13.8
H ₂ O	12.6	H ₂ S	10.4
CH ₄	12.6	CS ₂	10.08
HF	15.77	SO ₂	12.34
CH ₃ SH	9.44	C ₆ H ₅ SH	8.32
C ₆ H ₅ OH	8.51	CH ₃ OH	10.84
C ₂ H ₅ OH	10.49	BF ₃	15.5
CCl ₄	11.47	PCl ₃	9.91
AsH ₃	10.03	AsCl ₃	11.7
(CH ₃) ₂ CO	9.69	Cr(CO) ₆	8.03
C ₆ H ₆	9.24	1,4-Dioxane	9.13
<i>n</i> -C ₄ H ₁₀	10.63	OF ₂	13.6
<i>1 eV is equivalent to 98.46 kJ/mol.</i>			

Because the ionization potentials are similar in magnitude, I can be replaced by a constant with no great effect on the value of E_L . The values of α for helium and argon are $2.0 \times 10^5 \text{ pm}^3$ and $1.6 \times 10^6 \text{ pm}^3$, respectively. Calculations show that for helium atoms separated by a distance of 300 pm (3 Å), the energy of interaction is 76.2 J mol^{-1} , but the interaction of argon atoms at a distance of 400 pm (4 Å) is 1050 J mol^{-1} . In agreement with the difference in these energies, solid argon melts at 84 K, whereas solid helium is obtained at 1.76 K at a pressure of 29.4 atmospheres. If we consider two nonpolar molecules such as CCl₄ ($\alpha = 2.6 \times 10^7 \text{ pm}^3$, b.p. 77°C) and C₆H₆ ($\alpha = 2.5 \times 10^7 \text{ pm}^3$, b.p. 80°C), we find that the polarizabilities are very nearly equal as are the boiling points. For these molecules, the interaction is only by London forces, so the comparison of boiling points and polarizabilities is valid.

In general, if the intermolecular forces are only of the London type, the boiling point (the temperature at which molecules of a liquid become separated from each other) will be higher the larger the molecule and the greater the number of electrons. For example, F₂ and Cl₂ are gases, Br₂ is a liquid, and I₂ is a solid at room temperature. The boiling points for GeCl₄ and SnCl₄ are 86.5°C and 114.1°C in accord with the difference in numbers of electrons and hence the polarizabilities. The increase in boiling point for the hydrocarbon series, C_{*n*}H_{2*n*+2} as *n* increases provides a familiar illustration of this principle.

If two different types of molecules having polarizabilities α_1 and α_2 are interacting, the London energy between them can be expressed as

$$E_L = -\frac{3h\alpha_1\alpha_2}{2r^6} \cdot \frac{v_1v_2}{v_1 + v_2} = -\frac{3\alpha_1\alpha_2I_1I_2}{2r^6(I_1 + I_2)} \quad (6.19)$$

In Chapter 7, it will be pointed out that the bonding in solid silver halides is somewhat covalent. This results from the ions being polarizable so that the cation and anion have induced charge separations. For AgI, the electrostatic attraction is 808 kJ mol^{-1} , but the London attraction is 130 kJ mol^{-1} . From the examples presented, it is clear that London forces are significant enough to greatly affect the physical properties of compounds.

One of the consequences of increasing the number of electrons that accompanies an increase in molecular weight is that the London forces between molecules increase. The boiling points of a series of compounds composed of nonpolar molecules should reflect the greater force of attraction between molecules. To illustrate this trend, the boiling points of a series of organic compounds such as the hydrocarbons are considered. However, the trend is also well illustrated by numerous series of inorganic compounds. Figure 6.5 shows the boiling points of some of the halogen compounds of group IIIA and IV having the formulas EX_3 and EX_4 .

For those compounds, most of which consist of covalent molecules, there is the expected increase in boiling point with increasing molecular weight. The trigonal planar BX_3 and tetrahedral SiX_4 and GeX_4 compounds follow the expected trend as X progresses from F to I. Except for AlF_3 , the aluminum compounds are essentially covalent and exist as dimers, as do the aluminum alkyls, $[\text{AlR}_3]_2$, the structures of which were described in Chapter 4 and will be discussed further later in this chapter. However, there is a marked difference when AlF_3 is considered. In this case, the compound is essentially ionic, which results in a boiling point of approximately 1300°C . The total ionization potential to produce Al^{3+} is 5139 kJ mol^{-1} , so only in a case where there is a high lattice energy will the compound be ionic. Thus, the small size of the Al^{3+} and F^- allows them to form a lattice that is sufficiently stable to offset

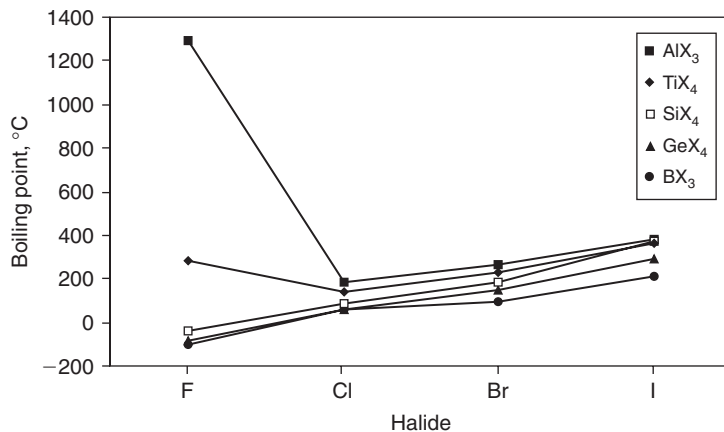

■ FIGURE 6.5 Boiling points of group IIIA and IVA halides.

the high ionization energy required to produce Al^{3+} . The high boiling point for AlF_3 is a reflection of the different type of bonding present in that compound compared to the other aluminum halides. It is useful to remember that there is a continuum of bond character from covalent to ionic, and the bonding in AlF_3 is definitely toward the ionic end of the spectrum.

When a molecule dissolves in a liquid, some of the forces between the solvent molecules must be overcome. Unless an individual molecule of solute is considered, forces between the solute molecules must also be overcome. Effective solvation of solute molecules requires that the solute-solvent interactions lead to a favorable energy if the solute is to have significant solubility. Because nonpolar molecules interact as a result of the London forces between them, it should not be surprising to learn that compounds such as BI_3 that are nonpolar are soluble in nonpolar solvents such as CCl_4 and CS_2 . The polarizability of BI_3 is substantial owing to the large number of electrons contained in three iodine atoms, so the BI_3 molecules interact well with CCl_4 and CS_2 , both of which have relatively high polarizability. Likewise, AlBr_3 and AlI_3 are soluble in alcohol, ether, and carbon disulfide, whereas AlF_3 , which is composed of essentially nonpolarizable ions, is not.

6.5 THE VAN DER WAALS EQUATION

In 1873, J. D. van der Waals recognized deficiencies in the ideal gas equation and developed an equation to eliminate two problems. First, the volume of the container is not the *actual* volume available to the molecules of the gas because the molecules themselves occupy some volume. The first correction to the ideal gas equation was to subtract the volume of the molecules from V , the volume of the container, to give the net volume accessible to the molecules. When modified to include the number of moles, n , the corrected volume is $(V - nb)$ where b is a constant that depends on the type of molecule.

From the ideal gas equation, it is found that for 1 mole of gas, $PV/RT = 1$, which is known as the *compressibility factor*. For most real gases, there is a large deviation from the ideal value, especially at high pressure where the gas molecules are forced closer together. From the discussions in previous sections, it is apparent that the molecules of the gas do not exist independently from each other because of forces of attraction even between nonpolar molecules. Dipole-dipole, dipole-induced dipole, and London forces are sometimes *collectively* known as van der Waals forces because all of these types of forces result in deviations from ideal gas behavior. Because forces of attraction between molecules reduce the pressure that the gas exerts on the walls of the container, van der Waals included a correction to the pressure to compensate for the “lost” pressure. That term is written as n^2a/V^2 , where n is the number of moles, a is a constant that depends on the nature of the gas, and V is the volume of the container. The resulting equation of state for a real gas, known as van der Waals’ equation, is written as

$$\left(P + \frac{n^2a}{V^2}\right)(V - nb) = nRT \quad (6.20)$$

In van der Waals’ equation, it is the term n^2a/V^2 that is of interest in this discussion, because that term gives information about intermolecular forces. Specifically, it is the parameter a that is related to intermolecular forces rather than the number of moles, n , or the volume, V . It should be expected that the

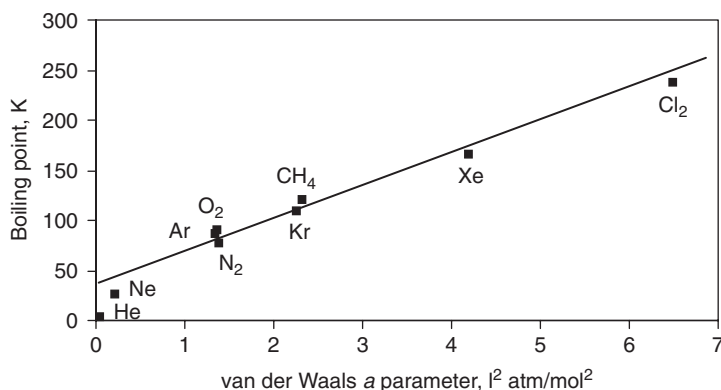

■ FIGURE 6.6 Variation in boiling points of nonpolar molecules with van der Waals a parameter.

parameter a would show a correlation with other properties that are related to the forces between both organic and inorganic molecules.

We will consider first a relatively simple case where the interactions between molecules are all of the same type (nonpolar molecules interacting as a result of London forces). For a liquid, the boiling point gives a measure of the strength of the forces between molecules in the liquid state because those forces must be overcome in order for the molecules to escape as a vapor. Figure 6.6 shows the boiling points of the noble gases and a few other substances as a function of the van der Waals a parameter.

It is apparent that for these nonpolar molecules the correlation is satisfactory. In this case, a characteristic of the liquid state (the boiling point) is correlated with a parameter from an equation that was developed to explain the behavior of gases. The liquid and gaseous states are referred to as *fluids*, and van der Waals' equation can be considered as an equation that applies to fluids as well as to gases through the use of the reduced variables (see references at the end of this chapter). Table 6.4 gives values for the van der Waals a parameter for molecules most of which are nonpolar.

Although a correlation between a property of a *liquid* and the a parameter in van der Waals' equation might be expected, we should remember that for nonpolar molecules the solid phase is also held together by London forces. Of course, the energy holding the solid together is the lattice energy so we should attempt a correlation of the lattice energy of solids composed of nonpolar molecules with the van der Waals a parameter. Such a correlation is shown in Figure 6.7, where the lattice energies of the noble gases and a few other nonpolar substances are plotted against a . It is immediately apparent that a linear relationship results, even though a property of a *solid* is being considered as a function of the parameter that results from considering the interaction of molecules of real gases.

The utility of the van der Waals a parameter should not be underestimated when physical properties of substances are being correlated and interpreted. Neither for that matter should the b parameter, because it is related to effective molecular dimensions, but that is not our concern in this chapter.

Table 6.4 Values for the van der Waals a Parameter for Selected Molecules.

Molecule	a , liter ² atm/mol ²	Molecule	a , liter ² atm/mol ²
He	0.03412	C ₂ H ₆	5.489
H ₂	0.2444	SO ₂	6.714
Ne	0.2107	NH ₃	4.170
Ar	1.345	PH ₃	4.631
Kr	2.318	C ₆ H ₆	18.00
Xe	2.318	CCl ₄	20.39
N ₂	1.390	SiH ₄	4.320
O ₂	1.360	SiF ₄	4.195
CH ₄	2.253	SnCl ₄	26.91
Cl ₂	6.493	C ₂ H ₆	5.489
CO ₂	3.592	N ₂ O	3.782
CS ₂	11.62	GeCl ₄	22.60

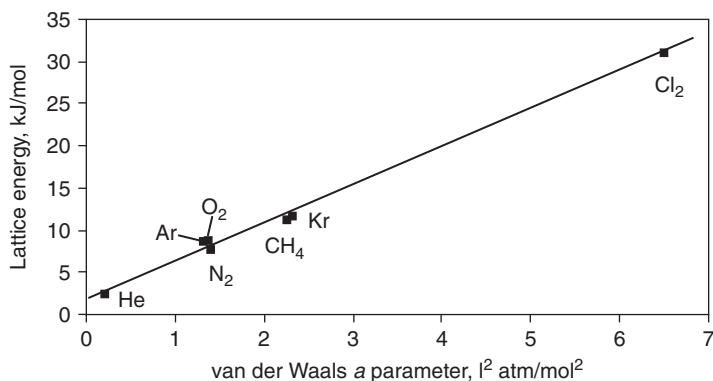

■ **FIGURE 6.7** Variation in lattice energy of some nonpolar molecules with van der Waals a parameter.

6.6 HYDROGEN BONDING

Thousands of articles and several books have been published on the subject of hydrogen bonding. It is a phenomenon that pertains to many areas of the chemical sciences, and it is an important type of molecular interaction. The fact that it is referred to as *hydrogen* bonding suggests that hydrogen is unique in this ability, and so it is. Of all the atoms, only hydrogen leaves a completely bare nucleus exposed when it forms a single covalent bond to another atom. Even lithium has a filled 1s level around the nucleus after the single electron in the 2s level is used in covalent bonding. When a

hydrogen atom is bonded to an element having an electronegativity of about 2.6 or higher (F, O, N, Cl, or S), the polarity of the bond is sufficient that the hydrogen carries a positive charge that enables it to be attracted to a pair of electrons on another atom. That attraction is known as a hydrogen bond (sometimes referred to as a hydrogen bridge). This type of interaction can be shown as

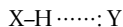

Hydrogen bonding occurs in many situations in chemistry. Materials such as proteins, cellulose, starch, and leather have properties that are the result of hydrogen bonding. Even solid materials such as NH_4Cl , NaHCO_3 , NH_4HF_2 , and ice have strong hydrogen bonding between units. Water and other liquids that have OH groups on the molecules (e.g., alcohols) have extensive hydrogen bonding. There are two types of hydrogen bonds, which are illustrated by the following examples:

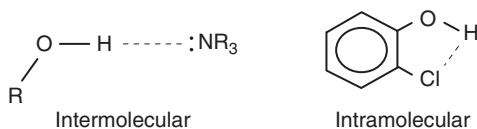

Both types of hydrogen bonds occur in pure liquids as well as in solutions. Many substances are associated at least partially in the vapor phase as a result of hydrogen bonding. For example, hydrogen cyanide is associated to give structures such as



The association of acetic acid in the vapor phase occurs so that the molecular weight of the gas indicates that it exists as dimers:

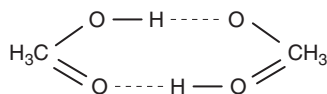

Studies have indicated that the association of HF in the gas phase leads predominantly to dimers or hexamers with small amounts of tetramers. Hydrogen bonding in liquids such as sulfuric and phosphoric acids is responsible for them being viscous liquids that have high boiling points.

Association of alcohols in the liquid state occurs with the formation of several types of species including chains,

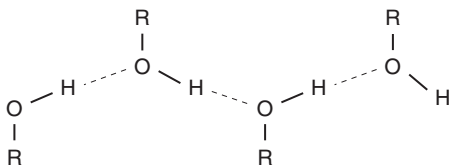

in which the O–H \cdots O bond distance is approximately 266 pm. The liquid also contains rings with the most predominant unit apparently being (ROH)₆, which can be shown as

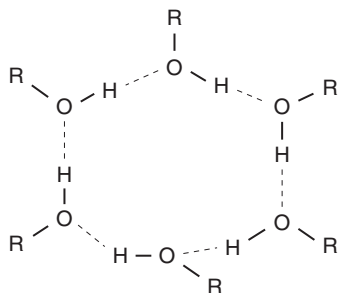

The vapor of CH₃OH also contains some cyclic tetramer, (CH₃OH)₄,

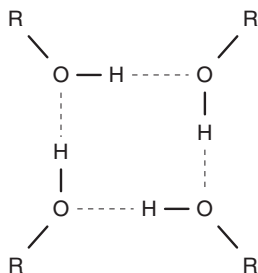

for which the heat of association has been found to be 94.4 kJ mol⁻¹ leading to a value of 23.6 kJ mol⁻¹ for each hydrogen bond. The equilibrium composition of alcohols in the vapor phase is temperature and pressure dependent. Boric acid, B(OH)₃, consists of sheetlike structures as a result of hydrogen bonding.

The body of information relating hydrogen bonding to physical properties is enormous. Only a brief summary will be presented, but more complete discussions can be found in the references cited at the end of this chapter. Perhaps the most familiar and elementary example of the effect of hydrogen bonding is reflected by the fact that the boiling point of water is 100 °C while that of liquid H₂S is -61 °C. Figure 6.8 shows the boiling points of the hydrogen compounds of the elements in groups IVA to VIIA.

There is no hydrogen bonding in the hydrogen compounds of the elements in group IV elements, so CH₄, SiH₄, GeH₄, and SnH₄ show the expected increase in boiling point with increasing molecular weight. For the hydrogen compounds of the group V elements, only NH₃ exhibits significant hydrogen bonding, so its boiling point (-33.4 °C) is clearly out of line with those of the other compounds (for example, PH₃ has a boiling point of -85 °C). Water shows clearly the effect of strong hydrogen bonds (in fact, multiple hydrogen bonds), which results in a boiling point of 100 °C for a compound that has a molecular weight of only 18. With the high electronegativity of fluorine, the polar H–F bond is susceptible to forming strong hydrogen bonds, as is clearly illustrated by the boiling point of HF being 19.4 °C while HCl boils at -84.9 °C.

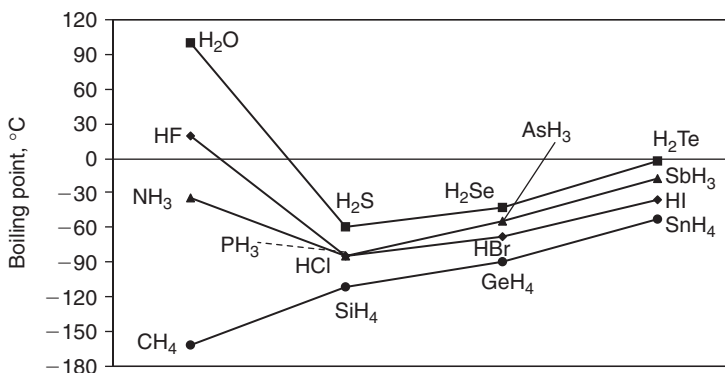

■ FIGURE 6.8 Boiling points of hydrides of groups IVA, VA, VIA, and VIIA.

It is also interesting to note that although the compounds have almost identical formula weights, the boiling point of BF_3 is -101°C while boric acid, $\text{B}(\text{OH})_3$, is a solid that decomposes at 185°C . Dimethyl ether and ethanol both have the formula $\text{C}_2\text{H}_6\text{O}_2$, but the boiling points are -25°C and 78.5°C , respectively. Hydrogen bonding between OH groups in alcohols leads to intermolecular forces that are not present in dimethyl ether.

When a liquid is changed into a vapor, the entropy of vaporization can be defined as

$$\Delta S_{\text{vap}} = S_{\text{vapor}} - S_{\text{liquid}} \cong S_{\text{vapor}} \cong \Delta H_{\text{vap}}/T \quad (6.21)$$

where T is the boiling point (in K). If the liquid is one in which London forces give the only type of interaction between molecules and the vapor is completely random, the entropy of vaporization can be represented as $\Delta H_{\text{vap}}/T$. The entropy of a mole of a random gas is approximately $88\text{ J mol}^{-1}\text{ K}^{-1}$, and the constant value for the entropy of vaporization of a liquid is known as *Trouton's rule*. Table 6.5 shows the data for testing this rule with a wide range of liquids.

For CCl_4 , the heat of vaporization is 30.0 kJ mol^{-1} and the boiling point is 76.1°C , which gives a value of ΔS_{vap} of $86\text{ J mol}^{-1}\text{ K}^{-1}$, a value that is in good agreement with Trouton's rule. On the other hand, the heat of vaporization of CH_3OH is 35.3 kJ mol^{-1} and the boiling point is 64.7°C . These values lead to a value for ΔS_{vap} of $104\text{ J mol}^{-1}\text{ K}^{-1}$. The deviation from Trouton's rule is caused by the fact that in the liquid state the molecules are strongly associated giving a structure to the liquid (lower entropy). Therefore, vaporization of CH_3OH leads to a larger entropy of vaporization than would be the case if the molecules of the liquid and vapor were arranged randomly.

Acetic acid provides a different situation. The boiling point of acetic acid is 118.2°C and the heat of vaporization is 24.4 kJ mol^{-1} . These values yield an entropy of vaporization of only $62\text{ J mol}^{-1}\text{ K}^{-1}$. In this case, the liquid is associated to produce dimers as described earlier, but those dimers also exist in the vapor. Therefore, structure persists in the vapor so that the entropy of vaporization is much lower than would be the case if a vapor consisting of randomly arranged monomers were produced. It is interesting to note from the examples just described that a property such as the entropy of vaporization can provide insight as to the extent of molecular association.

Table 6.5 Thermodynamic Data for the Vaporization of Several Liquids.

Liquid	Boiling point, °C	ΔH_{vap} , J mol ⁻¹	ΔS_{vap} , J mol ⁻¹ K ⁻¹
Butane	-1.5	22,260	83
Naphthalene	218	40,460	82
Methane	-164.4	9,270	85
Cyclohexane	80.7	30,100	85
Carbon tetrachloride	76.7	30,000	86
Benzene	80.1	30,760	87
Chloroform	61.5	29,500	88
Ammonia	-33.4	23,260	97
Methanol	64.7	35,270	104
Water	100	40,650	109
Acetic acid	118.2	24,400	62

Other properties are also affected by hydrogen bonding. For example, the solubility of *o*-, *m*-, and *p*-nitrophenols (NO₂C₆H₄OH) are greatly different as a result of hydrogen bonding. The solubility of *p*-nitrophenol (which can hydrogen bond to a solvent such as water) in water is greater than that of *o*-nitrophenol, in which there is intramolecular hydrogen bonding. On the other hand, *o*-nitrophenol is much more soluble in benzene than is *p*-nitrophenol. The *ortho* isomer has intramolecular hydrogen bonds that allow the interaction of the solvent with the ring of the solute to be the dominant factor. As a result, *o*-nitrophenol is many times more soluble in benzene than is *p*-nitrophenol.

Hydrogen bond formation also leads to differences in chemical properties. For example, the enolization reaction of 2,4-pentadione (acetylacetone) is assisted by the formation of an intramolecular hydrogen bond:

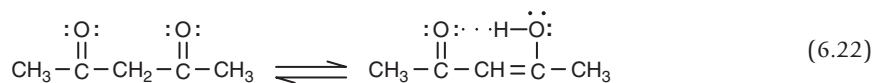

In the neat liquid, the enol form is dominant, and in solutions the composition of the equilibrium mixture depends greatly on the solvent. For example, when the solvent is water, hydrogen bonding between the solvent and the two oxygen atoms can occur, which helps to stabilize the keto form that makes up 84% of the mixture. When the solvent is hexane, 92% of the acetylacetone exists in the enol form, in which intramolecular hydrogen bonding stabilizes that structure. Acetone undergoes only an extremely small amount of enolization (estimated to be less than 10⁻⁵%), which is at least partially the result of there being no possibility of hydrogen bonding in the enol form.

One of the most convenient ways to study hydrogen bonding experimentally is by means of infrared spectroscopy. When a hydrogen atom becomes attracted to an unshared pair of electrons on an atom

in another molecule, the covalent bond holding the hydrogen atom becomes weakened slightly. As a result, the absorption band that corresponds to the stretching vibration of the bond is shifted to a position that may be *lower* by up to 400 cm^{-1} . Because of the attraction between the hydrogen atom and a pair of electrons in another molecule, the bending vibrations of the covalent bonds holding the hydrogen atom are hindered. Therefore, the bending vibrations are shifted to *higher* frequencies. Although the hydrogen bond itself is weak, there is a stretching vibration for that bond that does not exist prior to the formation of the hydrogen bond. Because hydrogen bonds are weak, the stretching vibration occurs at very low wave numbers (generally $100\text{--}200\text{ cm}^{-1}$). All of these vibrations and the regions where they are found in the infrared spectrum are summarized in Table 6.6.

In very dilute solutions of CH_3OH in CCl_4 , the alcohol molecules are widely separated and the equilibrium



is shifted far to the left. The infrared spectrum of such a dilute solution shows a single band at 3642 cm^{-1} that corresponds to the “free” OH stretching vibration. As the concentration of alcohol is increased, other bands appear at 3504 and 3360 cm^{-1} that are due to higher aggregates that result from intermolecular hydrogen bonding between the OH groups as shown earlier. Figure 6.9 shows the spectra of 0.05 M , 0.15 M , and 0.25 M CH_3OH in CCl_4 solutions.

Vibration	Assignment	Spectral region, cm^{-1}
$\leftarrow \rightarrow$ $\text{X}-\text{H} \cdots \text{B}$ $/$	ν_{st} , the X–H stretch	3500–2500
\uparrow $\text{X}-\text{H} \cdots \text{B}$ $/ \downarrow$	ν_{bt} , the in-plane bend ^a	1700–1000
\oplus $\text{X}-\text{H} \cdots \text{B}$ $/ \oplus$	ν_{ot} , the out-of-plane bend ^b (torsion)	400–300
$\leftarrow \rightarrow$ $\text{X}-\text{H} \cdots \text{B}$ $/$	ν_{st} , the H \cdots B stretch ^c	200–100
^a Bending in the plane of the page. Hydrogen bonding causes higher ν_{bt} . ^b Bending perpendicular to the plane of the page. Hydrogen bonding causes higher ν_{ot} . ^c Stretching of the hydrogen bond to the donor atom. Increases with hydrogen bond strength.		

The spectra show that there are “free” OH groups at all concentrations, but the very broad peak at 3360cm^{-1} shows a large fraction of the alcohol is bound in aggregates when the concentration is 0.25M . In addition to the cyclic structures shown earlier, these aggregates are believed to have structures like the following:

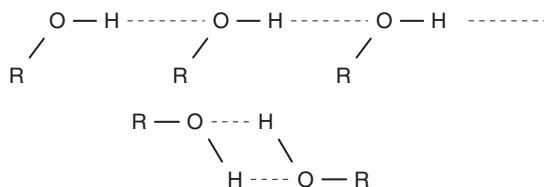

As described earlier, there is doubtless a complex equilibrium that involves several species of aggregates having both chain and ring structures.

The effect of the solvent on equilibria involving molecular aggregation has been discussed in connection with dipole association. However, the nature of the solvent also has an effect on the position where the OH stretching band is observed in the infrared spectrum even though the OH group may not be involved in hydrogen bonding. The ability of the solvent to “solvate” the OH group affects vibrational energy levels even though the interaction is not actually considered to be hydrogen bonding. The absorption band due to the stretching vibration of the O–H bond in CH_3OH in the vapor phase is seen at 3687cm^{-1} . In $n\text{-C}_7\text{H}_{16}$, CCl_4 , and CS_2 , the band is seen at 3649 , 3642 , and 3626cm^{-1} , respectively. A hydrocarbon molecule has no unshared electron pairs to interact even weakly with the O–H bond, so the stretching vibration is at the highest position found in any of these solvents when $n\text{-C}_7\text{H}_{16}$ is the solvent. The band appearing at 3626cm^{-1} when the solvent is CS_2 is indicative of very weak hydrogen bonding to the solvent in this case. When the solvent is benzene, the position of the OH stretching vibration for CH_3OH in a dilute solution is at 3607cm^{-1} , indicating significant interaction of the OH group with the π -electron system of the benzene ring. Benzene is known to form complexes

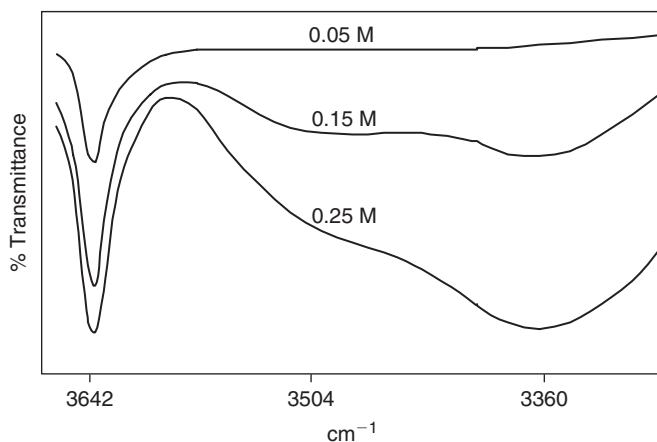

■ FIGURE 6.9 Infrared spectra for solutions of CH_3OH in CCl_4 .

with Lewis acids because of its ability to behave as a Lewis base (see Chapter 9). It is certainly not an “inert” solvent that should be chosen when hydrogen bonding studies are being carried out.

A relationship has been developed that relates the position of the O–H stretching band of an alcohol to the electronic character of the solvent. That equation is based on the assumption that an oscillating electric dipole is interacting with a solvent of dielectric constant ϵ . The equation can be written as

$$\frac{\nu_g - \nu_s}{\nu_g} = C \frac{\epsilon - 1}{2\epsilon + 1} \quad (6.24)$$

where ν_g and ν_s are the stretching frequencies in the gas phase and in solution and C is a constant. The dielectric constant at high frequency is usually approximated as the square of the index of refraction, n . When that is done, the shift in the position of the stretching band, $\Delta\nu = (\nu_g - \nu_s)$ is represented by the equation

$$\frac{\Delta\nu}{\nu_g} = C \frac{n^2 - 1}{2n^2 + 1} \quad (6.25)$$

which is known as the Kirkwood-Bauer equation. Figure 6.10 shows the correlation of the positions of the O–H stretching band of CH₃OH in heptane, CCl₄, CS₂, and benzene. The first three solvents appear to solvate CH₃OH in a “normal” manner and obey the Kirkwood-Bauer equation, but benzene is clearly interacting in a different way. As mentioned earlier, benzene is an electron donor that even forms complexes with metals. It is apparent from Figure 6.10 that benzene is by no means an “inert” solvent with regard to hydrogen bonding.

Hydrogen bond energies are sometimes described as weak, normal, or strong based on the strength of the bonds. Weak hydrogen bonds are those that are weaker than about 12 kJ mol⁻¹ and are typical of the intramolecular hydrogen bond in 2-chlorophenol. Normal hydrogen bonds (which include

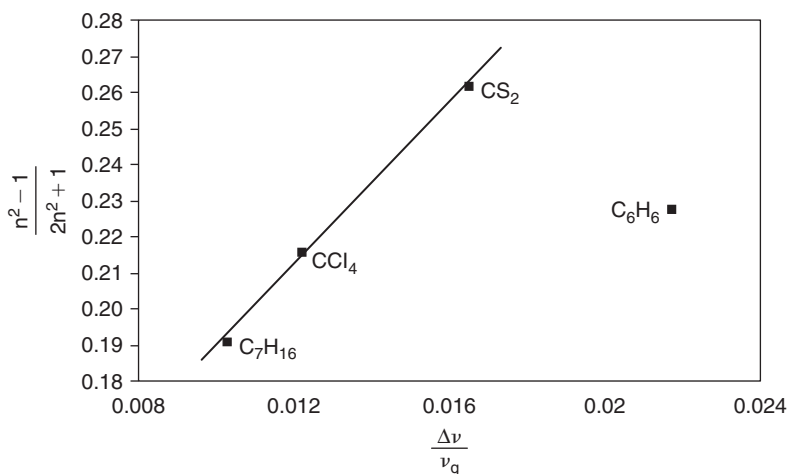

■ FIGURE 6.10 A Kirkwood-Bauer plot showing the effect of solvent on the O—H stretching band of methanol in different solvents.

the vast majority of cases) are those which have energies of perhaps 10 to 40 kJ mol⁻¹. Typical of this type of bond are those that occur between alcohols and amines. The strong hydrogen bonds found in the symmetric bifluoride ion, [F ··· H ··· F]⁻, have a bond energy of approximately 142 kJ mol⁻¹. This ion has a distance between fluorine centers of 226 pm, so each bond is 113 pm, in accord with the bond order being 1/2. In this case, the strength of the hydrogen bonds is comparable to that of weak covalent bonds such as F-F, I-I, and the O-O bond in O₂²⁻.

Strengths of chemical bonds correspond to the bond enthalpies for molecules in the gas phase, and it is desirable to measure enthalpies of hydrogen bonding for that type of interaction. However, most hydrogen-bonded systems are not stable enough to exist at the temperatures required to vaporize the donor and acceptor. Therefore, strengths of hydrogen bonds are usually determined calorimetrically by mixing solutions containing the donor and acceptor. When the influence of the solvent is considered, as illustrated by the relationship shown in Eq. (6.25), the question arises as to whether the measured enthalpy is actually that of the hydrogen bond. The situation can be illustrated by means of a thermochemical cycle in which B is an electron pair donor and -X-H is the species that forms the hydrogen bond:

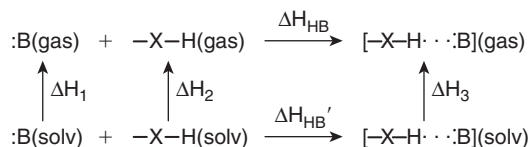

The actual strength of the hydrogen bond, ΔH_{HB} , is not necessarily the same as that given by the enthalpy of the reaction measured in solution, $\Delta H_{\text{HB}'}$. An ideal solution is one in which the heat of mixing is 0, so the question arises as to whether -X-H and B form ideal solutions with the solvent. If the solvent is one such as benzene, which forms weak hydrogen bonds to -X-H, those bonds must be broken before the hydrogen bond to B can form. Therefore, the enthalpy measured in solution will not be the same as that which corresponds to the gas phase reaction. The same situation exists if the solvent is one that interacts with B. Mathematically, the requirement for the gas and solution phase enthalpies to be equal is that $|\Delta H_1 + \Delta H_2| = |\Delta H_3|$. If the extent to which the solvent is a participant in the process is indicated by the position of the "free" O-H stretching band, it can be seen that heptane is the most nearly "inert" solvent of those just discussed. In fact, the "inertness" decreases in the order heptane > CCl₄ > CS₂ >> C₆H₆. This series is in accord with the trend illustrated in Figure 6.10. A good test for evaluating the role (if any) of the solvent in hydrogen bonding is to determine the enthalpy of the hydrogen bond formation in different solvents to see if the measured enthalpy is the same. Although the solvent most widely used in hydrogen bonding studies has probably been CCl₄, hexane or heptane is usually a better choice.

There have been many studies on the formation of hydrogen bonds between alcohols and a wide range of bases. If the bases are of similar type (for example, all nitrogen donor atoms in amines), there is also frequently a rather good correlation between the shift of the O-H stretching band and other properties. For example, stretching frequency shifts of the OH bonds in alcohols have been correlated

with base strength of the electron pair donor. As long as the bases have similar structure, the correlations are generally satisfactory. Figure 6.11 shows such a correlation for trimethylamine and triethylamine as well as a series of methyl-substituted pyridines. It is apparent that the correlation is quite good, and it can be expressed as

$$\Delta\nu_{\text{OH}} = a \text{p}K_b + b \quad (6.26)$$

where a and b are constants. The availability of electrons on the donor atom in a base molecule determines not only its ability to bind H^+ but also its ability to attract a hydrogen atom in forming a hydrogen bond. Consequently, it is reasonable to expect some relationship to exist between base strength and hydrogen bonding ability.

Relationships between the stretching frequency shifts and hydrogen bond enthalpies have also been established. Such a correlation can be written in the form

$$-\Delta H = c \Delta\nu_s + d \quad (6.27)$$

where c and d are constants. For bases of a different structural type, the constants may have different values. Many correlations of this type have been developed, and some of them are useful, empirical relationships.

Hydrogen bonding is a special type of acid-base interaction (see Chapter 9). Probably the most important equation relating hydrogen bond strengths is the equation known as the Drago four-parameter equation,

$$-\Delta H = C_A C_B + E_A E_B \quad (6.28)$$

which applies to many types of acid-base interactions. This equation is based on the assumption that a bond (including a hydrogen bond) is made up of a covalent part and an electrostatic part. The covalent contribution to the bond enthalpy is given by the product of parameters giving the covalent bonding

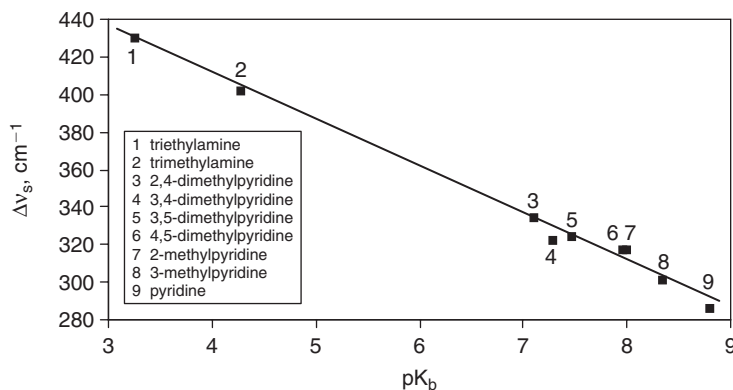

■ FIGURE 6.11 Shift of the OH stretching band for methanol hydrogen bonded to several bases as a function of base strength.

ability of the acid and base (C_A and C_B), and the product of the electrostatic parameters (E_A and E_B) gives the ionic contribution to the bond. When tables are available that give the needed parameters, the calculated enthalpies of interaction agree remarkably well with the experimental values. Because of the wider use of the Drago equation in other types of acid-base interactions, it will be discussed more fully in Chapter 9.

As the brief introduction to the subject presented here shows, hydrogen bonding is extremely important in all areas of chemistry. Additional topics including discussions of experimental methods for studying hydrogen bonding can be found in the references cited at the end of this chapter.

6.7 COHESION ENERGY AND SOLUBILITY PARAMETERS

Molecules have forces of attraction between them, and these intermolecular forces are responsible for many of the properties of liquids. There is a cohesion energy that holds the molecules together. The energy necessary to overcome these forces to vaporize a mole of liquid is known as the *cohesion energy* of the liquid or the *energy of vaporization*. It is related to the enthalpy of vaporization by the equation

$$\Delta H_{\text{vap}} = \Delta E_{\text{vap}} + \Delta(PV) \quad (6.29)$$

Therefore, since $\Delta(PV) = RT$

$$\Delta E_{\text{vap}} = E_c = \Delta H_{\text{vap}} - RT \quad (6.30)$$

where E_c is the cohesion energy of the liquid. The quantity E_c/V_m where V_m is the molar volume of the liquid is known as the cohesion energy density. A useful thermodynamic relationship is

$$dE = T dS - P dV \quad (6.31)$$

This equation can be written as

$$\frac{\partial E}{\partial V} = T \left(\frac{\partial S}{\partial V} \right)_T - P = T \left(\frac{\partial P}{\partial T} \right)_V - P \quad (6.32)$$

where P is the *external* pressure. The internal pressure, P_i , is given by

$$P_i = T \left(\frac{\partial P}{\partial T} \right)_V \quad (6.33)$$

which can also be written as

$$P_i = \left(\frac{(\partial V/\partial T)_P}{(\partial V/\partial P)_T} \right) \quad (6.34)$$

The quantity $(\partial V/\partial T)_P$ is the coefficient of thermal expansion and $(\partial V/\partial P)_T$ is the coefficient of compressibility of the liquid. For many liquids, the internal pressure is in the range 2000 to 8000 atm. Because the internal pressure is so much greater than the external pressure,

$$E_c = P_i - P \approx P_i \quad (6.35)$$

The solubility parameter, δ , is expressed in terms of the cohesion energy per unit volume by the equation

$$\delta = \sqrt{\frac{E_c}{V}} \quad (6.36)$$

where V is the molar volume. The dimensions for δ are (energy/volume)^{1/2} with suitable units being [cal/cm³]^{1/2} or cal^{1/2} cm^{-3/2}, a unit, h, known as 1 hildebrand in honor of Joel Hildebrand, who did pioneering research on the liquid state for many years. Many of the standard tables that give solubility parameters are in those units. Because 1 cal = 4.184 J, the conversion factor from cal^{1/2} cm^{-3/2} to J^{1/2} cm^{-3/2} is 4.184^{1/2} = 2.045. Both sets of units are in common use (sometimes both are indiscriminately referred to as h), and most of the extensive tables found in the older literature give values in cal^{1/2} cm^{-3/2}. The solubility parameters in J^{1/2} cm^{-3/2} for some common liquids are shown in Table 6.7.

The cohesion energies of liquids determine their mutual solubility. If two liquids have greatly differing cohesion energies, they will not mix because each liquid has a greater affinity for molecules of its own kind than for those of the other liquid. Water ($\delta = 53.2$ h) and carbon tetrachloride ($\delta = 17.6$ h) provide an example that illustrates this principle. In contrast, methanol ($\delta = 29.7$ h) and ethanol ($\delta = 26.0$ h) are completely miscible.

Solubility parameters for many liquids are available in extensive tables (see references at the end of this chapter). In order to determine solubility parameters for liquids, we need to know the heat of

Liquid	Solubility Parameter, h	Liquid	Solubility Parameter, h
C ₆ H ₁₄	14.9	CS ₂	20.5
CCl ₄	17.6	CH ₃ NO ₂	25.8
C ₆ H ₆	18.6	Br ₂	23.5
CHCl ₃	19.0	HCON(CH ₃) ^a	24.7
(CH ₃) ₂ CO	20.5	C ₂ H ₅ OH	26.0
C ₆ H ₅ NO ₂	23.7	H ₂ O	53.2
<i>n</i> -C ₅ H ₁₂	14.5	CH ₃ COOH	21.3
C ₆ H ₅ CH ₃	18.2	CH ₃ OH	29.7
XeF ₂	33.3	XeF ₄	30.9
(C ₂ H ₅) ₂ O	15.8	<i>n</i> -C ₈ H ₁₈	15.3
(C ₂ H ₅) ₃ B	15.4	(C ₂ H ₅) ₂ Zn	18.2
(CH ₃) ₃ Al ^b	20.8	(C ₂ H ₅) ₃ Al ^b	23.7
(<i>n</i> -C ₃ H ₇) ₃ Al ^b	17.0	(<i>i</i> -C ₄ H ₉) ₃ Al ^b	15.7

^a*N,N*-Dimethylformamide.
^bThese compounds are extensively dimerized.

vaporization. Over a reasonable temperature range, the relationship between the vapor pressure of a liquid and temperature is given by

$$\ln p = -\frac{\Delta H_{\text{vap}}}{RT} + C \quad (6.37)$$

where p is the vapor pressure, ΔH_{vap} is the heat of vaporization, T is the temperature (K), and C is a constant. If the vapor pressure is available at several temperatures, one way in which the heat of vaporization is determined is from the slope of the line that results when natural logarithm of the vapor pressure is plotted against $1/T$. Therefore, it is possible to evaluate the solubility parameter for a liquid if vapor pressure data are available and if the density is known so that the molar volume can be calculated.

Although Eq. (6.37) is commonly used to represent the vapor pressure as a function of temperature, it is by no means the best equation for the purpose. For many compounds, a more accurate representation of the vapor pressure is given by the Antoine equation,

$$\log p = A - \left(\frac{B}{C + t} \right) \quad (6.38)$$

In this equation, A , B , and C are constants that are different for each liquid, and t is the temperature in °C. Numerical procedures exist for determining the values for A , B , and C for a liquid if the vapor pressure is known at several temperatures. By making use of the equation

$$E_c = \Delta H_{\text{vap}} - RT \quad (6.39)$$

after determining the heat of vaporization from a plot of $\ln p$ versus $(C + t)$, the cohesion energy can be expressed as

$$E_c = RT \left(\frac{2.303 BT}{(C + t)} - 1 \right) \quad (6.40)$$

This equation is the one most often used to calculate the cohesion energy of a liquid. From the molar mass and density of the liquid, the molar volume can be determined, and by means of Eq. (6.36) the value of δ can be determined. The importance of the solubility parameter for interpreting several types of interactions will now be illustrated.

The solubility parameter provides a way to assess the degree of cohesion within a liquid. The values for nonpolar liquids in which there are only relatively weak intermolecular forces are typically in the range 15 to 18 h ($\text{J}^{1/2} \text{cm}^{-3/2}$). This includes compounds such as CCl_4 , C_6H_6 , and alkanes. Molecules of these liquids interact only by London forces, so there is no strong association of molecules. For a given series of molecules (such as alkanes) it is to be expected that the value of δ should increase slightly as the molecular weight increases. This trend is observed with the solubility parameter for n -pentane being 14.5 h while that for n -octane is 15.3 h. On the other hand, molecules of CH_3OH and $\text{C}_2\text{H}_5\text{OH}$ interact by not only London forces but also dipole-dipole forces and hydrogen bonding. As a result, the solubility parameters for these compounds are in the range 25 to 30 h. It is clear that the solubility parameter can provide useful insight to the nature of the intermolecular forces in liquids.

In addition to the obvious uses of solubility parameters in predicting physical properties, it is also possible in some cases to study other types of intermolecular interactions. For example, the solubility parameter for triethylboron, $(\text{C}_2\text{H}_5)_3\text{B}$, is 15.4 h, whereas that for triethylaluminum $(\text{C}_2\text{H}_5)_3\text{Al}$ is 23.7 h. Triethylboron is known from other studies not to associate, whereas triethylaluminum exists as dimers.

Another important use of solubility parameters is in interpreting the effects of different solvents on the rates of reactions. In a chemical reaction, it is the concentration of the transition state that determines the rate of the reaction. Depending on the characteristics of the transition state, the solvent used can either facilitate or hinder its formation. For example, a transition state that is large and has little charge separation is hindered in its formation by using a solvent that has a high value of δ . The volume of activation is usually positive for forming such a transition state which requires expansion of the solvent. A reaction of this type is the esterification of acetic anhydride with ethyl alcohol:

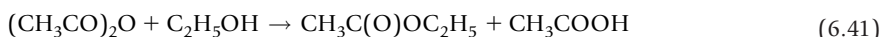

Because the transition state is a large aggregate with low charge separation, the rate decreases with increasing δ of the solvent. The rate of the reaction is almost 100 times as great in hexane ($\delta = 14.9$ h) as it is in nitrobenzene ($\delta = 23.7$ h).

When two reacting species form a transition state in which ions are being formed, the volume of activation is often negative. The formation of such a transition state is assisted by a solvent that has a high solubility parameter. The reaction



is of this type, and it passes through a transition state in which charge is being separated. The formation of such a transition state is assisted by a solvent having a large solubility parameter. For this reaction, the rate constant increases approximately as a linear function of δ for several solvents. In the reaction



the transition state can be shown as

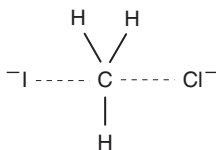

in which the -1 charge is spread over a large structure. Consequently, a solvent of high δ inhibits the formation of the transition state, and it is found that the rate constant for the reaction when dimethylformamide, $\text{HCON}(\text{CH}_3)_2$ ($\delta = 24.7$ h) is the solvent is over 10^6 times as great as when the solvent is CH_3OH ($\delta = 29.7$ h).

The cases just described serve to illustrate two important principles that relate the rates of reactions to the solubility parameter of the solvent. First, solvents having large δ values assist in the formation of transition states having high polarity or charge separation. Second, solvents having large δ values hinder the formation of transition states which are large, nonpolar structures. However, a large number of properties of solvents have been used to try to correlate and interpret how changing solvents alters the rates of reactions. It is clear that the solubility parameter is one important consideration when interpreting the role of the solvent in reaction kinetics or choosing a solvent as a reaction medium. It is not appropriate to discuss this topic further in a general book such as this, but the references listed should be consulted for additional details.

■ REFERENCES FOR FURTHER STUDY

- Atkins, P. W., and de Paula, J. (2002). *Physical Chemistry*, 7th ed. Freeman, New York. Chapter 21 of this well-known physical chemistry text gives a good introduction to intermolecular forces.
- Connors, K. A. (1990). *Chemical Kinetics: The Study of Reaction Rates in Solution*. Wiley, New York. A valuable resource for learning about solvent effects on reactions.
- Dack, M. J. R. Ed. (1975). *Solutions and Solubilities*, Vol. VIII, in A. Weissberger Ed., *Techniques of Chemistry*. Wiley, New York. Detailed discussions of solution theory and the effects of solvents on processes.
- Hamilton, W. C., and Ibers, J. A. (1968). *Hydrogen Bonding in Solids*. W.A. Benjamin, New York. This book shows how hydrogen bonding is an important factor in the structure of solids.
- Hildebrand, J., and Scott, R. (1962). *Regular Solutions*. Prentice Hall, Englewood Cliffs, NJ. One of the standard reference texts on theory of solutions.
- Hildebrand, J., and Scott, R. (1949). *Solubility of Non-Electrolytes*, 3rd ed. Reinhold, New York. The classic book on solution theory.
- House, J. E. (2007). *Principles of Chemical Kinetics*, 2nd ed. Elsevier/Academic Press, San Diego, CA. Chapters 5 and 9 contain discussions of factors affecting reactions in solution and the influence of solubility parameter of the solvent on reaction rates.
- Israelachvili, J. (1991). *Intermolecular and Surface Forces*, 2nd ed. Academic Press, San Diego, CA. Good coverage of intermolecular forces.
- Jeffrey, G. A. (1997). *An Introduction to Hydrogen Bonding*. Oxford University Press, New York. An excellent, modern treatment of hydrogen bonding and its effects. Highly recommended.
- Joesten, M. D., and Schaad, L. J. (1974). *Hydrogen Bonding*. Marcel Dekker, New York. A good survey of hydrogen bonding.
- Parsegian, V. A. (2005). *Van der Waals Forces: A Handbook for Biologists, Chemists, Engineers, and Physicists*. Cambridge University Press, New York. A good reference on a topic that pervades all areas of chemistry.
- Pauling, L. (1960). *The Nature of the Chemical Bond*, 3rd ed. Cornell University Press, Ithaca, NY. This classic monograph in bonding theory also presents a great deal of information on hydrogen bonding.
- Pimentel, G. C., and McClellan, A. L. (1960). *The Hydrogen Bond*. Freeman, New York. The classic book on all aspects of hydrogen bonding. It contains an exhaustive survey of the older literature.
- Reid, R. C., Prausnitz, J. M., and Sherwood, T. K. (1977). *The Properties of Gases and Liquids*. McGraw-Hill, New York. This book contains an incredible amount of information on the properties of gases and liquids. Highly recommended.

■ QUESTIONS AND PROBLEMS

- For OF_2 and H_2O , the bond angles are 103° and 104.5° , respectively. However, the dipole moments of these molecules are 0.30 D and 1.85 D, respectively. Explain the factors that cause such a large difference in the dipole moments of the molecules.
- Explain why the heat of interaction between $\text{C}_6\text{H}_5\text{OH}$ and R_2O is considerably larger than that for $\text{C}_6\text{H}_5\text{OH}$ interacting with R_2S .
- Explain why *m*- $\text{NO}_2\text{C}_6\text{H}_4\text{OH}$ and *p*- $\text{NO}_2\text{C}_6\text{H}_4\text{OH}$ have different acid strengths. Which is stronger? Why?
- In a certain solvent (A), the O–H stretching band of methanol is observed at 3642 cm^{-1} . In that solvent, the heat of reaction of methanol with pyridine is -36.4 kJ mol^{-1} . In another solvent (B), the O–H stretching band is observed at 3620 cm^{-1} and the heat of reaction with pyridine is -31.8 kJ mol^{-1} .
 - Write the equation for the interaction between methanol and pyridine.
 - Explain the thermodynamic data using a completely labeled thermochemical cycle as part of your discussion.
- The boiling points of methanol and cyclohexane are 64.7 and 80.7°C , respectively, and their heats of vaporization are 34.9 and 30.1 kJ mol^{-1} . Determine the entropy of vaporization for these liquids and explain the difference between them.
- The boiling point of CH_3OH is 64.7°C and that of CH_3SH is 6°C . Explain this difference.
- The viscosities for three liquids at various temperatures are given below.

Temp, $^\circ\text{C}$	10	20	30	40	60
C_8H_{18} : η , cP	6.26	5.42	4.83	4.33	2.97
CH_3OH : η , cP	6.90	5.93	—	4.49	3.40
C_6H_6 : η , cP	7.57	6.47	5.61	4.36(50°)	—

- Explain why the viscosity of CH_3OH (formula weight 32) is approximately the same as that of octane (formula weight 114).
 - Explain why the viscosity of C_6H_6 is higher than that of C_8H_{18} despite the difference in formula weights.
 - Make an appropriate graph for each liquid to determine the activation energy of viscous flow.
 - Explain the values for the activation energy of viscous flow in terms of intermolecular forces.
- The viscosities for three liquids at various temperatures are given below.

Temp., $^\circ\text{C}$	Viscosity, cP		
	C_6H_{14}	$\text{C}_6\text{H}_5\text{NO}_2$	<i>i</i> - $\text{C}_3\text{H}_7\text{OH}$
0	4.012	28.2	45.646
20	3.258	19.8	23.602
35	—	15.5	—
40	2.708	—	13.311
60	2.288	—	—
80	—	—	5.292

- (a) Explain why the viscosity of C_6H_{14} is so much lower than that of nitrobenzene.
- (b) Explain why the viscosity of $i\text{-}C_3H_7OH$ is higher than that of C_6H_{14} despite the significant difference in formula weights.
- (c) Make an appropriate graph for each liquid to determine the activation energy of viscous flow.
- (d) Explain the values for the activation energy of viscous flow in terms of intermolecular forces.
9. Explain why acetic acid is extensively dimerized in dilute solutions when benzene is the solvent but not when the solvent is water.
10. (a) Phenol, C_6H_5OH , hydrogen bonds to both diethyl ether, $(C_2H_5)_2O$ and diethyl sulfide, $(C_2H_5)_2S$. In one case, the OH stretching band is shifted by 280 cm^{-1} , and in the other the shift is 250 cm^{-1} . Match the band shifts to the electron pair donors and explain your answer.
- (b) The strengths of the hydrogen bonds between phenol and the two electron pair donors are 15.1 and 22.6 kJ mol^{-1} . Match the bond strengths to the donors and explain your answer.
11. Explain why the solubility of NaCl in CH_3OH is 0.237 grams per 100 grams of solvent, whereas in C_2H_5OH the solubility is only 0.0675 grams per 100 grams of solvent. Estimate the solubility of NaCl in $i\text{-}C_3H_7OH$.
12. Use structural arguments to explain why SF_4 has a boiling point of -40°C whereas SF_6 sublimates at -63.8°C .
13. Molecules of both Br_2 and ICl have 70 electrons, but one of the substances boils at 97.4°C and the other boils at 58.8°C . Which has the higher boiling point? Explain your answer.
14. Molecules of H_2S , Ar, and HCl have 18 electrons. Boiling points for these substances are -84.9 , -60.7 , and -185.7°C . Match the boiling points to the compounds and explain your answer.
15. Explain why hydrazine, N_2H_4 , has a viscosity of 0.97 cP at 20°C , whereas hexane, C_6H_{14} , has a viscosity of 0.326 cP at the same temperature.
16. Although fluorobenzene and phenol have almost identical formula weights, one has a viscosity of 2.61 cP at a temperature of 60°C and the other has a viscosity of 0.389 cP at the same temperature. Assign the viscosities to the correct liquids and explain your answer.
17. The solubility of NO in water at 25°C is more than twice that of CO . Explain this difference in terms of the difference in the structures of the molecules.
18. Explain in terms of molecular structure the following trend in solubilities of the gases in water: $C_2H_2 > C_2H_4 > C_2H_6$. How does the trend in solubility reflect other chemical properties?
19. Make a sketch showing a water molecule approaching a molecule of Xe and how that affects the electron cloud of the Xe atom. Use this sketch to explain how the $Xe\text{-}H_2O$ pair would interact with an additional water molecule.
20. Ammonium salts such as NH_4Cl are sometimes observed to undergo an abrupt change in heat capacity (and hence entropy) at some temperature below the melting point. Describe the processes likely responsible for these observations.
21. Use the bond moments shown in Table 6.2 and the fact that the bond angle in H_2S is 92.2° to calculate the dipole moment of the molecule.
22. Using molecular structures and principles of intermolecular forces, explain why liquid BrF_3 has a viscosity that is approximately three times that of BrF_5 at a temperature of 20°C .

23. Explain why the viscosities of *m*-ClC₆H₄OH and *p*-ClC₆H₄OH at 45 °C are approximately equal while that of *o*-ClC₆H₄OH is about half as large.
24. Explain why the heat of vaporization of 2-pentanone is 33.4 kJ mol⁻¹ while that of 2-pentanol is 41.4 kJ mol⁻¹.
25. The viscosity of 1-chloropropane is only about one-seventh that of 1-propanol. Explain this difference in terms of intermolecular forces.

Ionic Bonding and Structures of Solids

Molecular geometry and bonding in covalent molecules are covered in detail in several courses in chemistry including inorganic chemistry. A thorough knowledge of these topics is essential for interpreting properties of inorganic compounds and predicting their reactions. However, one should not lose sight of the fact that a great many inorganic materials are solids. Some covalent solids were described briefly in Chapter 4, but many others are metals or crystals that are essentially ionic in nature. In order to deal with the chemistry of these materials, it is necessary to be familiar with the basic crystal structures and the forces that hold them together. Consequently, this chapter presents a survey of ionic bonding, describes the structures of several types of crystals, and explains the structures of metals. Crystals are never perfectly regular, so it is also essential to discuss the types of defects that occur in the structures of ionic salts and metals.

Although ionic crystals are held together by electrostatic forces, the ions become separated when the solid dissolves. Ions are strongly attracted to the ends of polar molecules that have charges opposite to those of the ions. Because the dissolution of solids is intimately related to their chemical behavior, the energy relationships for dissolving ionic solids will also be discussed. Moreover, the proton affinities of some anions can be determined by means of thermodynamic studies on the decomposition of solids as will be illustrated in this chapter. This chapter provides an overview of several aspects of structures and bonding in inorganic solids. Transformations of materials in the solid state is a growing area of importance, and Chapter 8 will deal with the behavior of solids from the standpoint of the rates and mechanisms of such processes.

7.1 ENERGETICS OF CRYSTAL FORMATION

When ions are formed by electron transfer, the resulting charged species interact according to Coulomb's law,

$$F = \frac{q_1 q_2}{\epsilon r^2} \quad (7.1)$$

In this equation, q_1 and q_2 are the charges, r is the distance separating them, and ϵ is the dielectric constant, which has a value of 1 for a vacuum or free space. This force law has no directional component

and operates equally well in any direction. Therefore, we are concerned primarily with the energies of ionic bond formation, although the arrangement of ions in the lattice is of considerable importance.

Sodium chloride is formed from the elements in their standard states with a heat of formation of -411 kJ mol^{-1} :

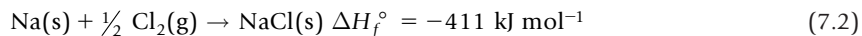

This process can be represented as taking place in a series of steps, each of which has a well-known enthalpy associated with it. The application of Hess's law provides a useful way to obtain the enthalpy for the overall process because it is independent of the path.

The enthalpy of formation of a compound is a so-called thermodynamic state function, which means that the value depends only on the initial and final states of the system. When the formation of crystalline NaCl from the elements is considered, it is possible to consider the process as if it occurred in a series of steps that can be summarized in a thermochemical cycle known as a Born-Haber cycle. In this cycle, the overall heat change is the same regardless of the pathway that is followed between the initial and final states. Although the *rate* of a reaction depends on the pathway, the enthalpy change is a function of initial and final states only, not the pathway between them. The Born-Haber cycle for the formation of sodium chloride is shown as follows:

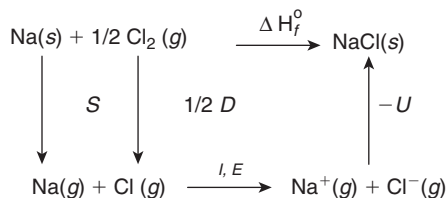

In this cycle, S is the sublimation enthalpy of Na, D is the dissociation enthalpy of Cl_2 , I is the ionization potential of Na, E is the energy released when an electron is added to a Cl atom, and U is the lattice energy.

Sometimes, the unknown quantity in the cycle is the lattice energy, U . From the cycle just shown, we know that the heat change is the same regardless of the pathway by which NaCl(s) is formed. Therefore, we see that

$$\Delta H_f^\circ = S + \frac{1}{2} D + I + E - U \quad (7.3)$$

Solving this equation for U , we obtain

$$U = S + \frac{1}{2} D + I + E - \Delta H_f^\circ \quad (7.4)$$

Using the appropriate data for the formation of sodium chloride, $U (\text{kJ mol}^{-1}) = 109 + 121 + 496 - 349 - (-411) = 786 \text{ kJ mol}^{-1}$. Although this is a useful approach for determining the lattice energy of a crystal, the electron affinity of the atom gaining the electron is difficult to measure experimentally.

In fact, it may be impossible to measure the heat associated with an atom gaining two electrons, so the only way to obtain a value for the second electron affinity is to calculate it. As a result, the Born-Haber cycle is often used in this way, and this application of a Born-Haber cycle will be illustrated later in this chapter. In fact, electron affinities for some atoms are available only as values calculated by this procedure, and they have not been determined experimentally.

Consider the process in which 1 mole of $\text{Na}^+(\text{g})$ and 1 mole of $\text{Cl}^-(\text{g})$ are allowed to interact to produce 1 mole of ion pairs rather than the usual three-dimensional lattice. Energy will be released as the positive and negative charges get closer together. In this case, the energy released is approximately -439 kJ per mole of ion pairs formed when the internuclear distance is the same as it is in the crystal, 279 pm (2.79 \AA). However, if 1 mole of $\text{Na}^+(\text{g})$ and 1 mole of $\text{Cl}^-(\text{g})$ are allowed to form a mole of solid crystal, the energy released is about -786 kJ . The term *lattice energy* is applied to the process of separating 1 mole of crystal into the gaseous ions. Therefore, if the energy *released* when a mole of crystal *forms* from the gaseous ions is -786 kJ , the energy *absorbed* when 1 mole of crystal is *separated* into the gaseous ions will be $+786 \text{ kJ}$. This convention is exactly the same as that which applies to covalent bond energies. If we divide the lattice energy by the energy released when ion pairs form, we find that $-786 \text{ kJ mol}^{-1} / -439 \text{ kJ mol}^{-1} = 1.78$. This ratio is of particular importance in considering crystal energies, and it is known as the *Madelung constant*, which will be discussed later.

As we have seen, several atomic properties are important when considering the energies associated with crystal formation. Ionization potentials and heats of sublimation for the metals, electron affinities, and dissociation energies for the nonmetals, and heats of formation of alkali halides are shown in Tables 7.1 and 7.2.

When a single ion having a $+1$ charge and one having a -1 charge are brought closer together, the electrostatic energy of the interaction can be represented by the equation

$$E = -\frac{e^2}{r} \quad (7.5)$$

Table 7.1 Ionization Potentials and Heats of Sublimation of Alkali Metals and the Heats of Formation of Alkali Metal Halides.

Element	I^a (kJ mol ⁻¹)	S^b (kJ mol ⁻¹)	ΔH_f° (kJ mol ⁻¹) of halide MX			
			X = F	X = Cl	X = Br	X = I
Li	518	160	605	408	350	272
Na	496	109	572	411	360	291
K	417	90.8	563	439	394	330
Rb	401	83.3	556	439	402	338
Cs	374	79.9	550	446	408	351

^a Ionization potential of the metal.

^b Heat of sublimation of the metal.

Table 7.2 Electron Affinities and Dissociation Energies for Halogens.

Element	Electron affinity (kJ mol ⁻¹)	Dissociation energy (kJ mol ⁻¹)
F ₂	333	158
Cl ₂	349	242
Br ₂	324	193
I ₂	295	151

where e is the charge on the electron and r is the distance of separation. If the number of ions of each type is increased to Avogadro's number, N_o , the energy released will be N_o times the energy for one ion pair,

$$E = -\frac{N_o e^2}{r} \quad (7.6)$$

It is easy to use this equation to determine what the attraction energy would be for 1 mole of Na⁺(g) interacting with 1 mole of Cl⁻(g) at a distance of 2.79 Å (279 pm). We will calculate the value first in ergs and then convert the result into kilojoules. Because the charge on the electron is 4.8×10^{-10} esu and $1 \text{ esu} = 1 \text{ g}^{1/2} \text{ cm}^{3/2} \text{ sec}^{-1}$, the attraction energy is

$$E = \frac{(6.02 \times 10^{23})(4.8 \times 10^{-10} \text{ g}^{1/2} \text{ cm}^{3/2} \text{ sec}^{-1})^2}{2.79 \times 10^{-8} \text{ cm}} = 4.97 \times 10^{12} \text{ erg} = 4.97 \times 10^5 \text{ J} = 497 \text{ kJ}$$

We have already mentioned that for sodium chloride approximately 1.78 times as much energy is released when the crystal lattice forms as when ion pairs form. This value, the Madelung constant (A) for the sodium chloride lattice, could be incorporated to predict the total energy released when 1 mole of NaCl crystal is formed from the gaseous Na⁺ and Cl⁻ ions. The result would be

$$E = -\frac{N_o A e^2}{r} \quad (7.7)$$

Multiplying the result just obtained for ion pairs by 1.75 indicates that the lattice energy would be 875 kJ mol⁻¹, but the actual value is 786 kJ mol⁻¹. The question to be answered is, why does forming the crystal release less energy than expected?

A sodium ion has 10 electrons surrounding the nucleus, and a chloride ion has 18 electrons. Even though the sodium ion carries a positive charge and the chloride ion has a negative charge, as the ions get closer together, there is repulsion between the electron clouds of the two ions. As a result, the calculated attraction energy is larger than the lattice energy. The equation for the lattice energy should take into account the repulsion between ions that increases as the distance between them becomes smaller. This can be done by adding a term to the expression that gives the attraction energy to take into account the repulsion as a function of distance. The repulsion is expressed as

$$R = \frac{B}{r^n} \quad (7.8)$$

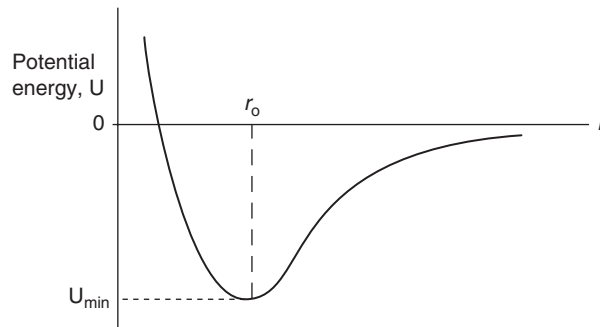

■ **FIGURE 7.1** Variation of potential energy with distance separating a cation and an anion.

where B and n are constants and r is the distance separating the ion centers. The value of n depends on the number of electrons surrounding the ions, and it is usually assigned the values 5, 7, 9, 10, or 12 for ions having the electron configurations of He, Ne, Ar, Kr, or Xe, respectively. For example, if the crystal is NaF, an n value of 7 is appropriate. If the crystal is one in which the cation has the configuration of one noble gas but the anion has a different noble gas configuration, an average value for n is chosen. For example, Na^+ has the configuration of Ne ($n = 7$), but Cl^- has the configuration of Ar ($n = 9$). Therefore, a value of 8 can be used in calculations for NaCl. When the repulsion is included, the lattice energy, U , is expressed as

$$U = -\frac{N_o A e^2}{r} + \frac{B}{r^n} \quad (7.9)$$

We know the values of all of the quantities shown in this equation except B .

When positive and negative ions are relatively far apart, the overall electrostatic charges (which lead to attraction) dominate the interaction. If the ions are forced very close together, there is repulsion. At some distance, the energy is most favorable, which means that the total energy is a minimum at that distance as shown in Figure 7.1. To find where the minimum energy occurs, we take the derivative dU/dr and set it equal to zero:

$$\frac{dU}{dr} = 0 = \frac{N_o A e^2}{r^2} - \frac{nB}{r^{n+1}} \quad (7.10)$$

When we solve for B , we obtain

$$B = \frac{N_o A e^2 r^{n-1}}{n} \quad (7.11)$$

We have approached this problem in terms of the lattice *forming* from the ions. However, the lattice energy is defined in terms of the energy required to separate it into the gaseous ions. Therefore, as used in Eq. (7.9), the value for U will be negative because the attraction energy is much larger than the

repulsion energy at the usual internuclear distance. When we substitute the value for B into Eq. (7.9) and change the sign to show the separation of the crystal into gaseous ions, we obtain

$$U = \frac{N_o A e^2}{r} \left(1 - \frac{1}{n} \right) \quad (7.12)$$

This equation is known as the Born-Landé equation, and it is very useful for calculating lattice energies of crystals when the values are known for A , r , and n . If ions having charges other than $+1$ and -1 form the lattice, the charges on the cation and anion, Z_c and Z_a , must be included in the numerator of the factor preceding $(1 - 1/n)$ to give $(Z_c Z_a N_o A e^2 / r)(1 - 1/n)$.

7.2 MADELUNG CONSTANTS

We have already defined the Madelung constant as the ratio of the energy released when a mole of crystal forms from the gaseous ions to that released when ion pairs form. In order to understand what this means, we will consider the following example. Suppose that a mole of Na^+ and a mole of Cl^- ions form a mole of ion pairs where the internuclear distance is r . As was shown earlier, the energy of interaction would be $-N_o e^2 / r$, where the symbols have the same meaning as in Eq. (7.12). Now let us arrange a mole of Na^+ and a mole of Cl^- ions in a chain structure:

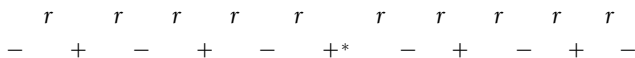

It is now necessary to calculate the energy of interaction for the ions in this arrangement. The energy of interaction of a charge q located in an electric field of strength V that has an opposite charge is given by $-Vq$. The procedure that we will use to calculate the interaction energy for the chain of ions involves calculating the electric field strength, V , at the reference ion $+^*$ that is produced by all of the other ions. Then, the total interaction energy will be given by Ve where e is the charge on the electron. In the arrangement of ions just shown, the cation labeled as $+^*$ is located at a distance of r from two negative ions, so the contribution to the electric field potential at $+^*$ is $-2e/r$. However, two positive ions are located at a distance of $2r$ from the $+^*$ ion, which gives a contribution of $+2e/2r$ to the electric field strength. Continuing outward from $+^*$ we find two anions at a distance of $3r$, and the contribution to the field strength is $-2e/3r$. If we continue working outward from the reference ion $+^*$, we would find that the contributions to the electric field strength can be represented as a series that can be written as

$$V = -\frac{2e}{r} + \frac{2e}{2r} - \frac{2e}{3r} + \frac{2e}{4r} - \frac{2e}{5r} + \frac{2e}{6r} - \dots \quad (7.13)$$

If we factor out $-e/r$, the field strength, V , can be written as

$$V = -\frac{e}{r} \left(2 - 1 + \frac{2}{3} - \frac{2}{4} + \frac{2}{5} - \frac{2}{6} + \dots \right) \quad (7.14)$$

The series inside the parentheses converges to a sum that is $2 \ln 2$ or 1.38629. This value is the Madelung constant for a hypothetical chain consisting of Na^+ and Cl^- ions. Thus, the total interaction energy for the chain of ions is $-1.38629N_0e^2/r$, and the *chain* is more stable than *ion pairs* by a factor of 1.38629, the Madelung constant. Of course NaCl does not exist in a chain, so there must be an even more stable way of arranging the ions.

In the preceding illustration, the series happened to be one that is recognizable for which the sum is known. A more likely situation is that the series might be made up of terms that do not lead to a recognizable sum and may not converge quickly. In that case, a numerical procedure for finding the value to which the series converges is available, and it will be described by using the foregoing example. The procedure consists of finding the sums progressively by summing the first term (only one value, 2.0000), then adding one term each time. After the sums (A) for several terms are found, the averages are obtained for adjacent sums and written in another column. Then, the average values for the previous averages are obtained and written in a different column. In each step, there is one less average value than the number of sums being taken. Eventually, only one average value results, and that gives an approximation to the summation of the series. The procedure is a numerical converging process that is illustrated below where the subscripts on A give the numbers of the terms being included in the summation. For example, $A_{1,2,3}$ indicates that the summation is over terms 1, 2, and 3 of the series.

		Averages		
A_1	=2.0000			
		1.5000		
$A_{1,2}$	=1.0000		1.4167	
		1.3384		1.3959
$A_{1,2,3}$	=1.6667		1.3751	1.3896
		1.4167		1.3834
$A_{1,2,3,4}$	=1.1667		1.3917	
		1.3917		
$A_{1,2,3,4,5}$	=1.5667			

Note that in this case only five terms have been included in the partial summation, but the averaging procedure produces an approximate convergence to a value of 1.3896. This value differs only insignificantly from the correct sum of 1.38629, which was obtained earlier as the value $2 \ln 2$. Finding the Madelung constant for a crystal that has a three-dimensional lattice is by no means this easy. However, the numerical convergence technique just illustrated is a very useful technique in cases where it can be applied. For three-dimensional lattices, it becomes much more difficult to determine the distances of ions from the reference ion used as the initial point in determining the electric field strength. While the hypothetical chain structure does not correspond to an actual crystal, it provides a convenient

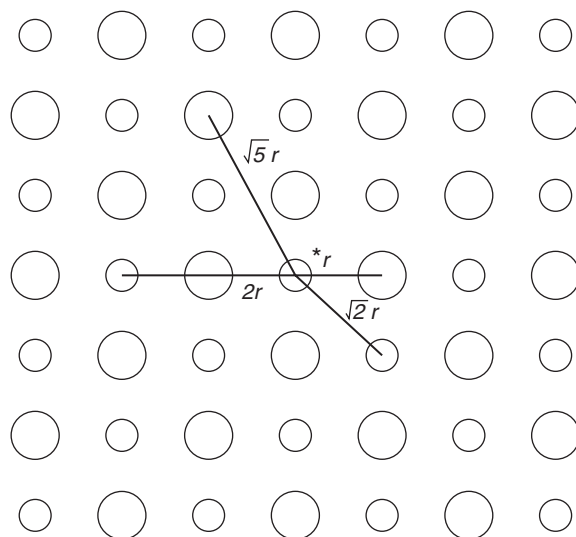

■ FIGURE 7.2 A layer of ions in the sodium chloride crystal structure.

model to show how a Madelung constant can be obtained, but it is difficult when the lattice has three dimensions.

When a three-dimensional crystal lattice forms from ions, each ion is surrounded by several nearest neighbors, the number and geometrical distribution of which depends on the type of crystal structure. The Madelung constant takes into account the interaction of an ion with all of the other ions rather than with only one ion of opposite charge. As a result, it has a numerical value that depends on the structure of the crystal. Consider the layer of ions shown in Figure 7.2 which shows the sodium chloride arrangement. Keep in mind that the layer below the one shown has ions of opposite charge directly below those in this layer, and the layer above the one shown will be arranged like the one below the layer shown. We begin by starting with the reference ion $+^*$ and work outward to determine the contributions to the electric field strength at that point.

First, there are six negative ions surrounding $+^*$ at a distance r : four in the layer shown, one above page, and one below the page. These six negative ions generate a potential of $-6e/r$. Next, there are 12 cations at a distance of $2^{1/2}r$, four in the layer shown, four in the layer below the page, and four in the layer above the page. The eight cations that are above and below the layer shown are directly below and above the four anions shown closest to $+^*$. These 12 cations generate a contribution to the field that is expressed by $12e/2^{1/2}r$. Working outward from $+^*$ we next encounter eight anions at a distance of $3^{1/2}r$, which give rise to a contribution to the field that is expressed as $-8e/3^{1/2}r$. There are six cations at a distance of $2r$, which give rise to a contribution of $6e/2r$. We could continue working outward and obtain many other terms in the series. The series that represents V can be written as

$$V = -\frac{6e}{r} + \frac{12e}{\sqrt{2}r} - \frac{8e}{\sqrt{3}r} + \frac{6e}{2r} + \dots \quad (7.15)$$

Table 7.3 Madelung Constants for Some Common Crystal Lattices.

Crystal type	Madelung constant ^a
Sodium chloride	1.74756
Cesium chloride	1.76267
Zinc blende	1.63806
Wurtzite	1.64132
Rutile	2.408
Fluorite	2.51939

^a Rutile and fluorite have twice as many anions as cations. The factor of 2 is not included in the numerical value shown.

from which we obtain

$$V = -\frac{e}{r} \left(6 - \frac{12}{\sqrt{2}} + \frac{8}{\sqrt{3}} - 3 + \dots \right) \quad (7.16)$$

In this series, the terms neither lead to a recognizable series nor converge very rapidly. In fact, it is a rather formidable process to determine the sum, but the value obtained is 1.74756. Note that this is approximately equal to the value given earlier for the ratio of the energy released when a crystal forms to that when only ion pairs form. As stated earlier, the Madelung constant is precisely that ratio.

Details of the calculation of Madelung constants for all of the common types of crystals are beyond the scope of this book. When the arrangement of ions differs from that present in NaCl, the number of ions surrounding the ion chosen as a starting point and the distances between them may be difficult to determine. They will most certainly be much more difficult to represent as a simple factor of the basic distance between a cation and an anion. Therefore, each arrangement of ions (crystal type) will have a different value for the Madelung constant. The values for several common types of crystals are shown in Table 7.3.

7.3 THE KAPUSTINSKII EQUATION

Although the Born-Landé equation provides a convenient way to evaluate the lattice energy of many crystals, it has some limitations. First, the crystal structure must be known so that the appropriate Madelung constant can be chosen. Second, some ions are not spherical (for example, NO_3^- is planar and SO_4^{2-} is tetrahedral), so the distance between ion centers may be different in different directions. As a result, another way to calculate lattice energies is needed. One of the most successful approaches to calculating lattice energies for a wide range of crystals is provided by the Kapustinskii equation,

$$U (\text{kJ mol}^{-1}) = \frac{120,200 m Z_c Z_a}{r_c + r_a} \left(1 - \frac{34.5}{r_c + r_a} \right) \quad (7.17)$$

In this equation, r_c and r_a are the radii of the cation and anion in pm, Z_a and Z_c are their charges, and m is the number of ions in the formula for the compound. Note that the Madelung constant does not appear in the Kapustinskii equation and that we need only the sum of the ionic radii (distance between ion centers), not the individual radii. It is not necessary to know the crystal structure (and hence the Madelung constant) for the crystal in order to use the Kapustinskii equation. The equation gives highly reliable calculated values for crystals where the bonding is almost completely ionic (as is the case for NaCl, KI, etc.). If there is a substantial amount of covalence (as there is in cases such as AgI or CuBr), the calculated lattice energy does not agree well with the actual value. The large ions in compounds of this type are easily deformed (polarizable) so they also have a substantial attraction that results from their having charge separations because of being distorted. As was described in Chapter 6, the van der Waals forces are significant between ions of this type. In spite of these limitations, the Kapustinskii equation provides a useful way to calculate crystal energies.

There is another use of the Kapustinskii equation that is perhaps even more important. For many crystals, it is possible to determine a value for the lattice energy from other thermodynamic data or the Born-Landé equation. When that is done, it is possible to solve the Kapustinskii equation for the sum of the ionic radii, $r_a + r_c$. When the radius of one ion is known, carrying out the calculations for a series of compounds that contain that ion enables the radii of the counterions to be determined. In other words, if we know the radius of Na^+ from other measurements or calculations, it is possible to determine the radii of F^- , Cl^- , and Br^- if the lattice energies of NaF, NaCl, and NaBr are known. In fact, a radius could be determined for the NO_3^- ion if the lattice energy of NaNO_3 were known. Using this approach, which is based on thermochemical data, to determine ionic radii yields values that are known as *thermochemical radii*. For a planar ion such as NO_3^- or CO_3^{2-} , it is a sort of average or effective radius, but it is still a very useful quantity. For many of the ions shown in Table 7.4, the radii were obtained by precisely this approach.

7.4 IONIC SIZES AND CRYSTAL ENVIRONMENTS

It is apparent from the data shown in Table 7.4 that there is a great difference between the sizes of some ions. For example, the ionic radius of Li^+ is 60 pm, whereas that of Cs^+ is 169 pm. When these ions are forming a crystal with Cl^- , which has a radius of 181 pm, it is easy to understand that the geometrical arrangement of ions in the crystals may be different even though both LiCl and CsCl have equal numbers of cations and anions in the formulas.

When spherical objects are stacked to produce a three-dimensional array (crystal lattice), the relative sizes of the spheres determine what types of arrangements are possible. It is the interaction of the cations and anions by electrostatic forces that leads to stability of any ionic structure. Therefore, it is essential that each cation be surrounded by several anions and each anion be surrounded by several cations. This local arrangement is largely determined by the relative sizes of the ions. The number of ions of opposite charge surrounding a given ion in a crystal is called the *coordination number*. This is actually not a very good term because the bonds are not *coordinate* bonds (see Chapter 16). For a specific cation, there will be a limit to the number of anions that can surround the cation because

Table 7.4 Radii of Common Monatomic and Polyatomic Ions.

Singly charged		Doubly charged		Triply charged	
Ion	<i>r</i> , pm	Ion	<i>r</i> , pm	Ion	<i>r</i> , pm
Li ⁺	60	Be ²⁺	30	Al ³⁺	50
Na ⁺	98	Mg ²⁺	65	Sc ³⁺	81
K ⁺	133	Ca ²⁺	94	Ti ³⁺	69
Rb ⁺	148	Sr ²⁺	110	V ³⁺	66
Cs ⁺	169	Ba ²⁺	129	Cr ³⁺	64
Cu ⁺	96	Mn ²⁺	80	Mn ³⁺	62
Ag ⁺	126	Fe ²⁺	75	Fe ³⁺	62
NH ₄ ⁺	148	Co ²⁺	72	N ³⁻	171
F ⁻	136	Ni ²⁺	70	P ³⁻	212
Cl ⁻	181	Zn ²⁺	74	As ³⁻	222
Br ⁻	195	O ²⁻	145	Sb ³⁻	245
I ⁻	216	S ²⁻	190	PO ₄ ³⁻	238
H ⁻	208	Se ²⁻	202	SbO ₄ ³⁻	260
ClO ₄ ⁻	236	Te ²⁻	222	BiO ₄ ³⁻	268
BF ₄ ⁻	228	SO ₄ ²⁻	230		
IO ₄ ⁻	249	CrO ₄ ²⁻	240		
MnO ₄ ⁻	240	BeF ₄ ²⁻	245		
NO ₃ ⁻	189	CO ₃ ²⁻	185		
CN ⁻	182				
SCN ⁻	195				

the anions will be touching each other. The opposite is also true, but the problem is greater with the anions touching because most anions are larger than most cations.

Consider the arrangement of ions in which six anions surround a cation as shown in Figure 7.3. In this arrangement, the six anions have their centers at the corners of an octahedron with the cation at the center. There are four anions whose centers are in the same plane as the center of the cation in addition to one anion above and below the plane.

Calculating the minimum size for the cation that can be in contact with the six anions as the anions are just touching each other is a simple problem. The critical factor is the relative sizes of the ions,

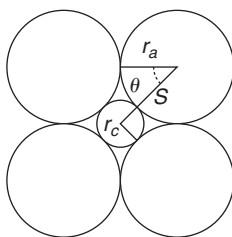

■ **FIGURE 7.3** Anions surrounding a cation in an octahedral arrangement. Only the four in a plane are shown.

which is expressed as the radius ratio, r_c/r_a . In the development that follows, the ions are considered to be hard spheres, which is not exactly correct.

The geometry of the arrangement shown in Figure 7.3 is such that θ is 45° . With this arrangement, the four anions shown just touch the cation and just touch each other. Because $S = r_c + r_a$, the relationship between the distances is

$$\cos 45^\circ = \frac{\sqrt{2}}{2} = \frac{r_c}{S} = \frac{r_c}{r_c + r_a} \quad (7.18)$$

The right-hand side of this equation can be expanded, after which solving for r_c/r_a gives a value of 0.414. The significance of this value is that if the cation is smaller than $0.414 r_a$, this arrangement will probably not be stable because the anions will be touching each other without touching the cation. A radius ratio of at least 0.414 is required for all six of the anions to touch the cation. It is possible to consider an arrangement in which four anions surround a cation in a tetrahedral arrangement. Performing a calculation similar to that just described leads to the conclusion that the four anions will touch the cation only when r_c is at least $0.225 r_a$. Earlier it was shown that a radius ratio of at least 0.414 is required to fit six anions around a cation when both are considered as hard spheres. Therefore, it can be seen that when $0.225 < r_c/r_a < 0.414$, a tetrahedral arrangement of anions around each cation should result. Similar calculations can easily be carried out to determine values for r_c/r_a that lead to other stable arrangements of ions in other crystal environments. Keep in mind that this is only a guide because ions are not actually hard spheres. The results of the calculations are summarized in Table 7.5.

Based on the ionic radii, nine of the alkali halides should not have the sodium chloride structure. However, only three, CsCl, CsBr, and CsI, do not have the sodium chloride structure. This means that the hard sphere approach to ionic arrangement is inadequate. It should be mentioned that it does predict the correct arrangement of ions in the majority of cases. It is a *guide*, not an infallible *rule*. One of the factors that is not included is related to the fact that the electron clouds of ions have some ability to be deformed. This *electronic polarizability* leads to additional forces of the types that were discussed in the previous chapter. Distorting the electron cloud of an anion leads to part of its electron density being drawn toward the cations surrounding it. In essence, there is some sharing of electron density as a result. Thus the bond has become partially covalent.

Table 7.5 Arrangements of Ions Predicted to Be Stable from Radius Ratio Values.

r_c/r_a^a	Cation environment	Number of nearest neighbors	Example
1.000	<i>fcc</i> or <i>hcp</i> ^a	12	Ni, Ti
0.732–1.000	Cubic	8	CsCl
0.414–0.732	Octahedral	6	NaCl
0.225–0.414	Tetrahedral	4	ZnS
0.155–0.225	Trigonal	3	—
0.155	Linear	2	—

^a*fcc* and *hcp* are face-centered cubic and hexagonal close packing of spheres (see Section 7.8).

Although the structure of CsCl is quite different from that of NaCl, even CsCl can be transformed into the sodium chloride structure when heated to temperatures above 445 °C. Some of the other alkali halides that do not have the sodium chloride structure under ambient conditions are converted to that structure when subjected to high pressure. Many solid materials exhibit this type of polymorphism, which depends on the external conditions. Conversion of a material from one structure to another is known as a *phase transition*.

One interesting thing to note is that in cases where the radius ratio does not predict the correct structure, it usually fails when its value is close to one of the limiting values between two predicted structures. A value of r_c/r_a of 0.405 is very close to the limiting value for coordination numbers of 4 and 6. Subtle factors could cause the environment around the cation to be either 4 or 6, even though strictly speaking we would expect a coordination number of 4. In contrast, if r_c/r_a is 0.550, we would expect a coordination number of 6 for the cation, and in almost every case we would be correct. When the radius ratio is not close to the limiting values, it takes more than a *subtle* factor to cause the structure to be different from that predicted. Although the radius ratio does not *always* predict the correct crystal structure, it *usually* works very well except when the ratio is close to one of the limiting values.

We can see how the polarizability of ions affects lattice energies by considering the silver halides. When the lattice energies are calculated using the Kapustinskii equation, the calculated values are significantly lower than the experimental values, as shown by the data presented in Table 7.6. Most of this difference is due to polarization effects, the resulting partial covalent bonding, and large London forces (see Chapter 6).

Although we have illustrated the effects of polarizability of ions by considering a few cases where the effects are large, there must be *some* polarization effect for any combination of ions. However, there is an even more important consideration. It is known that the *apparent* radius of a given ion depends somewhat on the environment of the ion. For example, an ion surrounded by four nearest neighbors will appear to be slightly different in size from one that is surrounded by six ions of opposite charge. We have treated the ionic radius as if it were a fixed number that is the same in any type of

Table 7.6 Lattice Energies of Silver Halides.

Compound	Lattice energy, kJ mol^{-1}	
	Calculated (Eq. 7.17)	Experimental
AgF	816	912
AgCl	715	858
AgBr	690	845
AgI	653	833

crystal environment, but this is not the case. Moreover, ionic radii are determined from x-ray diffraction experiments that actually determine the distance between ion centers. For example, if the distance between ion centers is determined for NaF and the radius of the fluoride ion is known from other measurements, we can then deduce the radius of the sodium ion. Ionic radii are somewhat variable depending on the values assigned to other ions. In fact, for some ions a range of tabulated values for the radii is encountered. The ionic radii shown in Table 7.4 may not be exactly correct for certain ions in specific crystal structures.

In a crystal lattice, a cation is surrounded by a certain number of anions. Electrostatic forces exist between the oppositely charged ions. If a +1 ion is surrounded by six anions (most +1 cations are relatively large) having -1 charges, each anion is attached to other cations and a rigid lattice results. Such a lattice is characterized by a high melting point. For smaller, more highly charged cations, the coordination number is smaller and each anion is attached to a smaller number of cations. When the coordination number of a cation becomes equal to its valence, the cation and its nearest neighbors constitute a discrete, neutral structure. Therefore, there will be no strong extended forces and the lattice is held together much more loosely, which results in a lower melting point. For example, the melting points of NaF, MgF_2 , and SiF_4 (a molecular solid) are 1700, 2260, and -90°C , respectively.

7.5 CRYSTAL STRUCTURES

By means of the radius ratio, we have already described the type of local environment around the ions in several types of simple crystals. For example, in the sodium chloride *structure* (not restricted to NaCl itself), there are six anions surrounding each cation. The sodium chloride crystal structure is shown in Figure 7.4.

For the NaCl crystal, the radius ratio is 0.54, which is well within the range for an octahedral arrangement of anions around each cation (0.414 – 0.732). However, because this is a 1:1 compound, there are equal numbers of cations and anions. This means that there must be an identical arrangement of cations around each anion. In fact, for 1:1 compounds, the environment around each type of ion must be identical. We can see that this is so from a very important concept known as the *electrostatic bond character*. If we predict (and find) that six Cl^- ions surround each Na^+ , each “bond” between a sodium ion and a chloride ion must have a bond character of $1/6$ because the sodium has a unit valence, and

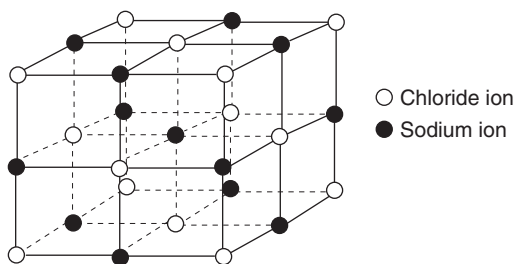

■ **FIGURE 7.4** The rock salt or sodium chloride crystal structure.

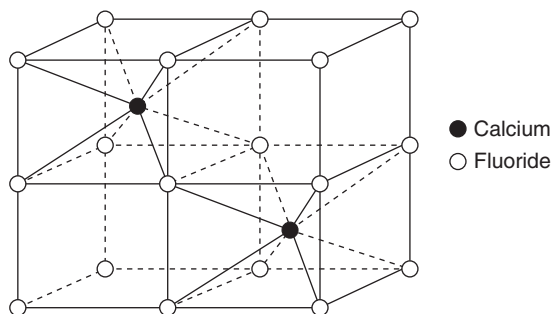

■ **FIGURE 7.5** The calcium fluoride structure (also known as the fluorite structure).

the six “bonds” must add up to the valence of Na^+ . If each “bond” has a character of $1/6$, there must also be six bonds to each Cl^- because the chloride ion also has a unit valence (although it is negative in this case). Each bond has only a single magnitude, regardless of which ion we are considering.

The electrostatic bond character is an extremely useful property for understanding crystal structures. Consider the structure of CaF_2 , in which each Ca^{2+} is surrounded by eight F^- ions in a cubic arrangement as shown in Figure 7.5. Because calcium in CaF_2 has a valence of 2, the eight bonds to fluoride ions must total two electrostatic bonds so that each bond has a character of $1/4$. However, because each bond between Ca^{2+} and F^- amounts to $1/4$ bond, there can be only four bonds to each F^- because it has a valence of 1 (it is negative, of course, but that doesn't matter). As a result, the coordination number of Ca^{2+} is 8, whereas that of F^- is 4 in the crystal of CaF_2 . Note how those coordination numbers correspond exactly to the fact that there are twice as many fluoride ions as there are calcium ions in the formula.

The fluorite structure is a common one for compounds that have 1:2 stoichiometry. A great many compounds have formulas that have twice as many cations as anions. Examples include compounds such as Li_2O and Na_2S . These compounds have crystal structures that are like the fluorite structure but with the roles of the cations and anions reversed. This structure is known as the *antifluorite* structure, in which there are eight cations surrounding each anion and four anions surrounding each cation. The antifluorite structure is the most common one for compounds that have formulas containing twice as many cations as anions.

In the case of the CsCl structure shown in Figure 7.6, the coordination number of the cation is eight. Because this is a 1:1 compound, the coordination number of the anion must also be eight. In terms of the electrostatic bond character approach, each bond between a cation and an anion must have a bond character of $1/8$ because eight bonds must add up to the valence of Cs, which is 1. The valence of chlorine in cesium chloride is also 1, so there must be eight bonds to each Cl^- . In accord with this, the CsCl structure has eight anions arranged on the corners of a cube around each Cs^+ . Eight cubes come together at each corner, and each cube contains a Cs^+ ion, so there are eight Cs^+ ions surrounding each Cl^- .

There are two forms of zinc sulfide that have structures known as *wurtzite* and *zinc blende*. These structures are shown in Figures 7.7a and 7.7b. Using the ionic radii shown in Table 7.4, we determine the radius ratio for ZnS to be 0.39, and as expected there are four sulfide ions surrounding each zinc ion in a tetrahedral arrangement. Zinc has a valence of 2 in zinc sulfide, so each bond must be $1/2$ in character because four such bonds must satisfy the valence of 2. Because the sulfide ion also has a valence of 2, there must be four bonds to each sulfide ion. Therefore, both of the structures known for zinc sulfide have a tetrahedral arrangement of cations around each anion and a tetrahedral arrangement of anions around each cation. The difference between the structures is in the way in which the ions are arranged in layers that have different structures.

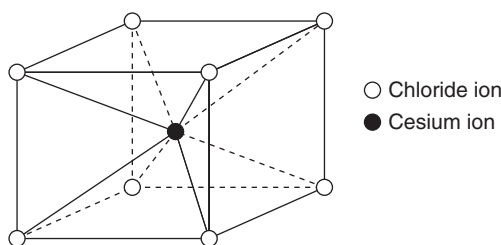

■ FIGURE 7.6 The cesium chloride structure.

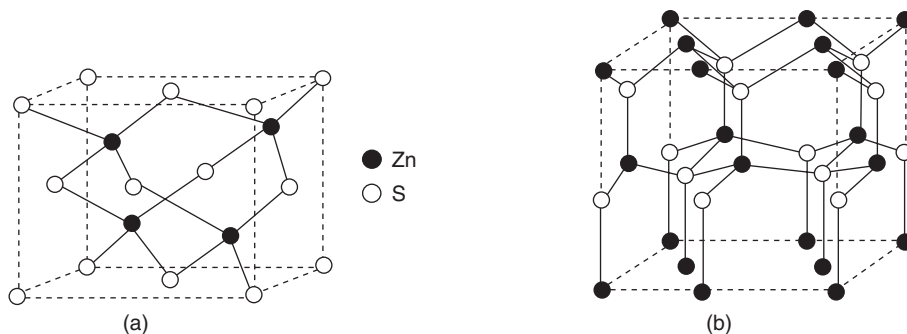

■ FIGURE 7.7 The zinc blende (a) and wurtzite (b) structures for zinc sulfide.

It should not be inferred that the crystal structures described so far apply to only binary compounds. Either the cation or anion may be a polyatomic species. For example, many ammonium compounds have crystal structures that are identical to those of the corresponding rubidium or potassium compounds because the radius NH_4^+ ion (148 pm) is similar to that of K^+ (133 pm) or Rb^+ (148 pm). Both NO_3^- and CO_3^{2-} have ionic radii (189 and 185 pm, respectively) that are very close to that of Cl^- (181 pm), so many nitrates and carbonates have structures identical to the corresponding chloride compounds. Keep in mind that the structures shown so far are *general* types that are not necessarily restricted to binary compounds or the compounds from which they are named.

Rutile, TiO_2 , which has the structure shown in Figure 7.8, is an important chemical that is used in enormous quantities as the opaque white material to provide covering ability in paints. Because the Ti^{4+} ion is quite small (56 pm), the structure of TiO_2 has only six O^{2-} ions surrounding each Ti^{4+} , as predicted by the radius ratio of 0.39. Therefore, each Ti–O bond has an electrostatic bond character of $2/3$ because the six bonds to O^{2-} ions total the valence of 4 for Ti. There can be only three bonds from Ti^{4+} to each O^{2-} ion because three such bonds would give the total valence of 2 for oxygen ($3 \times 2/3 = 2$).

A lattice arrangement known as the ReO_3 structure (shown in Figure 7.9) provides an interesting application of the electrostatic bond character approach. In ReO_3 , the valence of Re is 6, and in the ReO_3 structure each Re is surrounded by six oxide ions. Therefore, each Re–O bond must have a bond character of 1 because six bonds add up to a valence of 6 for Re. It follows that each oxygen can have only two bonds to it because each bond has a character of 1. The structure we are led to is one in which there are six oxide ions (arranged octahedrally as expected) surrounding each Re but only two Re^{6+} ions surrounding each oxide ion in a linear arrangement. This is also the crystal structure of AlF_3 in which each Al^{3+} is surrounded by six F^- ions in an octahedral arrangement and each F^- ion has an Al^{3+} ion on either side.

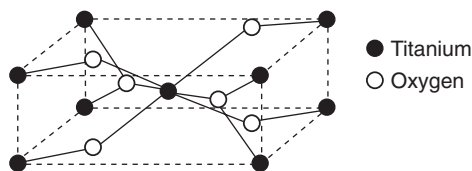

■ FIGURE 7.8 The rutile structure.

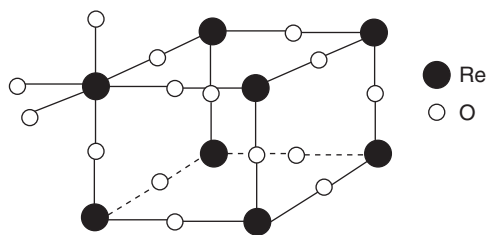

■ FIGURE 7.9 The ReO_3 structure.

The difference in physical properties between BeF_2 and BF_3 (melting points 800 and -127°C) as well as between AlF_3 and SiF_4 (melting points 1040°C and -96°C) is striking. Although BF_3 is predominantly ionic, the B^{3+} ion is so small that no more than four F^- ions can surround it (as in the BF_4^- ion). To form an extended lattice, the B^{3+} ion would have to be surrounded by six F^- ions for the electrostatic bond character to add up to $+3$ for B and -1 for F. The small size of B^{3+} prevents this, so BF_3 is a monomer even though it is predominantly ionic. In the case of BeF_2 , four fluoride ions surrounding the Be^{2+} satisfy its valence, and each fluoride ion bridges between two Be^{2+} ions. Accordingly, BeF_2 forms an extended lattice, which is reflected by its high melting point. For SiF_4 to form a lattice, it would be necessary for eight F^- ions to surround Si^{4+} , which is too small to allow this. The result is that SiF_4 exists as molecules that are predominantly ionic. Again we see the great utility of the electrostatic bond character approach of Pauling. Although not using the electrostatic bond character, R. J. Gillespie has written eloquently regarding the difference in properties of the fluorides just discussed (see *J. Chem. Educ.* 75, 923, 1998).

Aluminum oxide, which has the mineral name *corundum*, is a solid that has several important uses. Because it will withstand very high temperatures, it is a refractory material, and because of its hardness it is commonly used in abrasives. Corundum often contains traces of other metals that impart a color to the crystals, making them valuable as gemstones. For example, *ruby* contains a small amount of chromium oxide, which causes the crystal to have a red color. By adding a small amount of a suitable metal oxide, it is possible to produce gemstones having a range of colors.

Aluminum is produced commercially by the electrolysis of *cryolite*, Na_3AlF_6 , but *bauxite*, Al_2O_3 , is the usual naturally occurring source of the metal. The oxide is a widely used catalyst which has surface sites that function as a Lewis acid. A form of the oxide known as activated alumina has the ability to adsorb gases and effectively remove them. Other uses of the oxide include ceramics, catalysts, polishing compounds, abrasives, and electrical insulators.

Aluminum forms mixed oxides with other metals that have the general formula AB_2O_4 , where A is an ion that has a charge of $+2$ while B is a metal ion with a $+3$ charge. The compound MgAl_2O_4 is the mineral known as *spinel*, which is why compounds having the general formula AB_2O_4 have the general name *spinel*s. This general formula can be written as $\text{AO}\cdot\text{B}_2\text{O}_3$, so MgAl_2O_4 can also be written as $\text{MgO}\cdot\text{Al}_2\text{O}_3$. A large number of materials are known in which Fe^{2+} , Zn^{2+} , Co^{2+} , Ni^{2+} , or other $+2$ ions replace Mg^{2+} . Some common minerals of this type include *ghanite* (ZnAl_2O_4), *hercynite* (FeAl_2O_4), and *galestite* (MnAl_2O_4).

Spinel has a crystal structure in which there is a face-centered cubic arrangement of O^{2-} ions. There are two types of structures in which cations have octahedral or tetrahedral arrangements of anions surrounding them. In the *spinel* structure, it is found that the $+3$ ions are located in octahedral holes and the tetrahedral holes are occupied by the $+2$ ions. A different structure is possible for these ions. That structure has half of the $+3$ metal ions located in the tetrahedral holes while the other half of these ions and the $+2$ ions are located in the octahedral holes. In order to indicate the population of the two types of lattice sites, the formula for the compound is grouped with the tetrahedral hole population indicated first (the position normally occupied by the $+2$ ion, A) followed by the groups populating the octahedral holes. Thus, the formula AB_2O_4 becomes $\text{B}(\text{AB})\text{O}_4$ in order to correctly

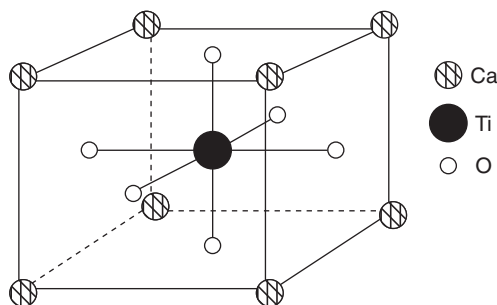

■ **FIGURE 7.10** The structure of perovskite, CaTiO₃.

indicate the places of the ions in the lattice. Because of the reversal of the roles of the +2 and +3 ions in the lattice, the structure is called the *inverse spinel* structure.

Although many ternary compounds containing NH₄⁺, NO₃⁻, CO₃²⁻, and so forth have structures that are identical to those of binary compounds, the mineral *perovskite*, CaTiO₃, has a different type of structure. In fact, this is a very important structure type that is exhibited by a large number of other compounds. The *perovskite* structure is shown in Figure 7.10. By examining the structure, it is easy to see that a Ti⁴⁺ ion resides in the center of a cube, each corner of which is the location of a Ca²⁺ ion. The oxide ions are located at the center of the six faces of the cube. It is easy to see that the only bonds to the Ti⁴⁺ are those from its nearest neighbors, the six O²⁻ ions. Therefore, each Ti–O bond must have a bond character of 4/6 because six such bonds total the +4 valence of Ti.

Consider now the bonds to each O²⁻ ion in the perovskite structure. First, there are two bonds to Ti⁴⁺ ions that have a character of 4/6 each, which gives a total of 4/3. However, there are four Ca²⁺ ions on the corners of the face of the cube where an oxide ion resides. These four bonds must add up to a valence of 2/3 so that the total valence of 2 for oxygen is satisfied. If each Ca–O bond amounts to a bond character of 1/6, four such bonds would give the required 2/3 bond to complete the valence of oxygen. From this it follows that each Ca²⁺ must be surrounded by 12 oxide ions so that 12(1/6) = 2, the valence of calcium. It should be apparent that the concept of electrostatic bond character is a very important tool for understanding crystal structures.

There are a large number of ternary compounds that are oxides for which the general formula is ABO₃, where A = Ca, Sr, Ba, and so on, and B = Ti, Zr, Al, Fe, Cr, Hf, Sn, Cl, or I. Many have the perovskite structure, so it is an important structural type.

7.6 SOLUBILITY OF IONIC COMPOUNDS

An enormous amount of chemistry is carried out in solutions that consist of ionic compounds that have been dissolved in a solvent. In order to separate the ions from the lattice in which they are held, there must be strong forces of interaction between the ions and the molecules of the solvent. The most common solvent for ionic compounds is water, and that solvent will be assumed for the purposes of this discussion.

When an ionic compound is dissolved in a solvent, the crystal lattice is broken apart. As the ions separate, they become strongly attached to solvent molecules by ion-dipole forces. The number of water molecules surrounding an ion is known as its *hydration number*. However, the water molecules clustered around an ion constitute a shell that is referred to as the primary solvation sphere. The water molecules are in motion and are also attracted to the bulk solvent that surrounds the cluster. Because of this, solvent molecules move into and out of the solvation sphere, giving a hydration number that does not always have a fixed value. Therefore, it is customary to speak of the average hydration number for an ion.

From the standpoint of energy, the processes of separating the crystal lattice and solvating the ions can be related by means of a thermochemical cycle of the Born–Haber type. For an ionic compound MX, the cycle can be shown as follows:

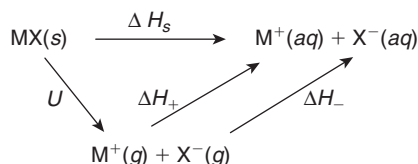

In this cycle, U is the lattice energy, ΔH_+ and ΔH_- are the heats of hydration of the gaseous cation and anion, and ΔH_s is the heat of solution. From this cycle, it is clear that

Ion	r , pm	$\Delta H_{\text{hyd}}^\circ$, kJ mol ⁻¹
H ⁺	—	-1100
Li ⁺	74	-520
Na ⁺	102	-413
K ⁺	138	-321
Rb ⁺	149	-300
Cs ⁺	170	-277
Mg ²⁺	72	-1920
Ca ²⁺	100	-1650
Sr ²⁺	113	-1480
Ba ²⁺	136	-1360
Al ³⁺	53	-4690
F ⁻	133	-506
Cl ⁻	181	-371
Br ⁻	196	-337
I ⁻	220	-296

$$\Delta H_s = U + \Delta H_+ + \Delta H_- \quad (7.19)$$

As defined earlier, the lattice energy is positive while the solvation of ions is strongly negative. Therefore, the overall heat of solution may be either positive or negative depending on whether it requires more energy to separate the lattice into the gaseous ions than is released when the ions are solvated. Table 7.7 shows the heats of hydration, $\Delta H_{\text{hydr}}^\circ$ for several ions.

The data presented in Table 7.7 show that for cations the enthalpies of hydration are dependent on the charges on the ions and their sizes. For ions having the same charge, the heat of hydration decreases as the size of the ion increases. This is reasonable because the polar solvent molecules are attracted more strongly to small, compact ions where the charge is localized to a small region of space. The heat of hydration increases dramatically as the charge on the ion increases. A simple principle of electrostatics suggests that this would be the case because the negative ends of polar water molecules will be attracted more strongly to a higher positive ion by Coulomb's law. The charge density as reflected by the charge-to-size ratio is one factor in determining the heats of hydration of ions.

The hydration enthalpy (H) for an ion can be expressed as

$$H = -\frac{Ze^2}{2r} \left(1 - \frac{1}{\epsilon} \right) \quad (7.20)$$

where Z is the charge on the ion, r is its radius, and ϵ is the dielectric constant of the medium (78.4 for water). The hydration enthalpy increases with increasing charge on the ion, whereas it decreases with increasing size of the ion. One reason that small anions such as F^- have high hydration enthalpies is because they are attracted to the centers of positive charge in the water molecules, which are the hydrogen atoms. As a result, a very small distance separates the negative ion from the positive centers in the water molecule.

The interactions between ions and solvent molecules are primarily electrostatic, so the dipole moment of the solvent is an important consideration. However, the structure of the solvent molecules is also important. For example, nitrobenzene has a high dipole moment of 4.22 D, which is much larger than the value of 1.85 D for water. The nitrobenzene has a large dipole moment, but it is a poor solvent for ionic salts such as NaCl. The high dipole moment results from the charge being separated over a long distance. Also, the molecules of nitrobenzene are too large for them to pack efficiently around small ions, so the solvation number is too small to result in strong solvation. Although the dipole moment of nitrobenzene indicates that it might be a suitable solvent for ionic compounds, this is not actually the case.

The hydration enthalpy of the Al^{3+} ion is enormous ($-4690 \text{ kJ mol}^{-1}$), and there are some interesting effects produced as a result. When NaCl is dissolved in water and the solvent evaporated, the solid NaCl can be recovered. If AlCl_3 is dissolved in water, evaporation of the water does not yield the solid AlCl_3 . The Al^{3+} ion is so strongly solvated that other reactions become energetically more favorable than removing the solvent. This can be shown as follows.

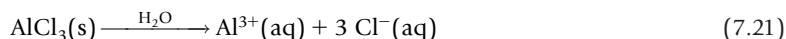

When the solvent is evaporated, a solid is obtained that contains the hydrated aluminum ion and chloride ions. This solid can be described as $[\text{Al}(\text{H}_2\text{O})_6]\text{Cl}_3$, although the number of water molecules may depend on the conditions. When this solid is heated, water is lost until the composition $[\text{Al}(\text{H}_2\text{O})_3\text{Cl}_3]$ is approached. When heated to still higher temperature, this compound loses HCl rather than water:



When heated to very high temperature, $\text{Al}(\text{OH})_3$ loses H_2O to yield Al_2O_3 :

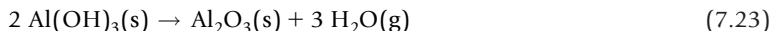

The essence of this behavior is that the bonds between Al^{3+} and oxygen are so strong that reactions other than dehydration become energetically favored. When beryllium compounds are dissolved in water, the Be^{2+} ion is so strongly solvated that it also behaves in this way. The charge-to-size ratios for Al^{3+} and Be^{2+} are approximately equal ($+3/53$ and $+2/30$, respectively), which results in their having similar chemical behavior. This is known as a *diagonal* relationship because aluminum is one row below beryllium in the periodic table, but it is also one column farther to the right along a “diagonal.”

By considering the dissolution of NaCl, it is found that the lattice energy is 786 kJ mol^{-1} , and the heat of solvation of Na^+ is -413 kJ mol^{-1} while that of Cl^- is -371 kJ mol^{-1} . Using these data, the heat of solution is calculated to be only 4 kJ mol^{-1} . This indicates that there is essentially no heat absorbed or released when NaCl dissolves in water. As a result, changing the temperature has almost no effect on the solubility of NaCl in water. If a graph is made of the solubility of NaCl in water as a function of temperature, it has a slope that is almost 0. In fact, the solubility of NaCl in water at 0°C is about 35.7 grams per 100 grams of water, and at 100°C it is approximately 39.8 grams per 100 grams of water. On the other hand, for some solids, separating the crystal lattice requires much more energy than is released when the ions are hydrated. In this case, the overall process absorbs heat, so increasing the temperature favors the dissolution process, and a graph of solubility of the compound as a function of temperature yields a line that rises as the temperature is increased. If the solid is one for which more heat is released when the ions are solvated than is absorbed in separating the lattice, the heat of solution will be negative, and the compound will become less soluble as the temperature increases. Figure 7.11 shows solubility curves for these three types of behavior.

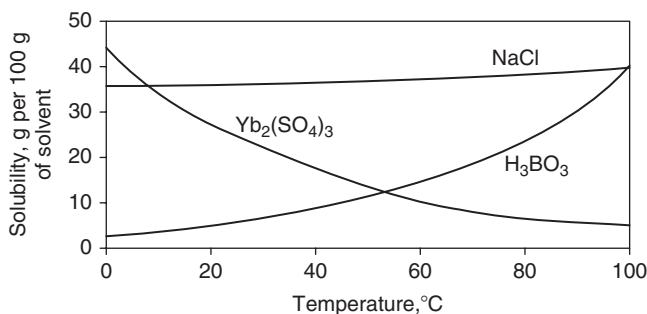

■ FIGURE 7.11 Variation in solubility of three inorganic compounds with temperature.

If a solvent that does not strongly solvate ions is used, the crystal will not dissolve because the lattice energy will be much larger in magnitude than the sum of the solvation energies for the ions. From this discussion, it should be clear that solution behavior of a solid compound also is related to how strongly the crystal is held together. However, it must be kept in mind that the heats of solvation of ions are not constant over a wide range of temperature. They are themselves variables, which means that when a wide range of temperature is considered, solubility behavior is not exactly predictable from this simple approach.

A simple approach to the effect of temperature on solubility can be illustrated by considering the cases shown in Figure 7.12. Increasing the temperature of a system at equilibrium causes a shift in the endothermic direction. In Figure 7.12a, the endothermic direction is toward the solution phase, so increasing the temperature will cause an increase in the solubility of the solute. For the case illustrated in Figure 7.12b, increasing the temperature will cause the system to shift in the direction to increase the amounts of solute and solvent, so the solubility will decrease. In the case illustrated in Figure 7.12c, the solubility will not change much as the temperature is changed.

Quantitatively, the effect of temperature on solubility can be explained by considering the dissolution process as represented by the population of states of unequal energy. The Boltzmann distribution law relating the populations n_1 and n_2 for states E_1 and E_2 which are of unequal energy can be written as

$$\frac{n_2}{n_1} = e^{-\Delta E/KT} \quad (7.24)$$

where k is Boltzmann's constant, ΔE is the difference in energy between two states, and T is the temperature (K). When expressed on a molar basis where the heat of solution is ΔH_s , the expression for the variation in solubility with temperature becomes

$$\frac{n_2}{n_1} = e^{-\Delta H_s/RT} \quad (7.25)$$

Taking the logarithm of both sides of the equation yields

$$\ln n_2 - \ln n_1 = -\frac{\Delta H_s}{RT} \quad (7.26)$$

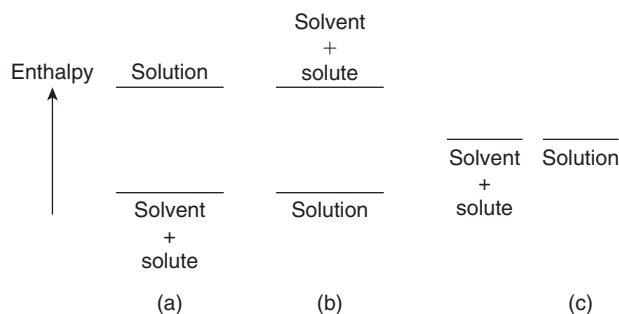

■ **FIGURE 7.12** Thermal changes during dissolution of a solid in a liquid.

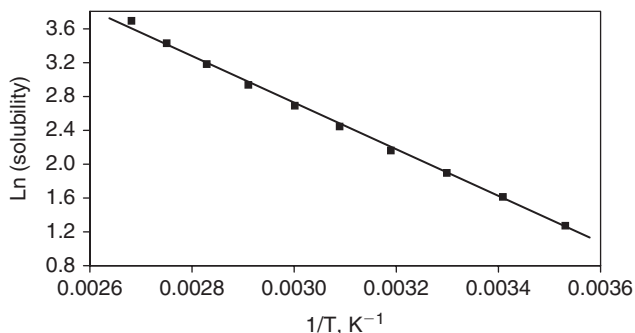

■ **FIGURE 7.13** The linear $\ln(\text{solubility})$ versus $1/T$ relationship for boric acid in water.

Considering the dissolution process represented as shown in Figure 7.12a, we see that the amount of solute is immaterial as long as there is enough to give a saturated solution. Therefore, the $\ln n_1$ term can be treated as a constant, C , and the population n_2 can be replaced by the solubility, S , to give

$$\ln S = -\frac{\Delta H_s}{RT} + C \quad (7.27)$$

From this equation, it can be seen that a plot of $\ln S$ versus $1/T$ should yield a straight line having a slope of $-\Delta H_s/R$. Determining the solubility of a compound at several temperatures allows the heat of solution to be determined in this way. For the process illustrated in Figure 7.12a, the heat of solution is positive so the slope of the line will be negative. For the process illustrated in Figure 7.12b, the heat of solution is negative so a line having a positive slope is obtained. As shown in Figure 7.11, for NaCl the heat of solution is very close to 0, and as a result, the solubility is almost constant in the temperature range 0 to 100 °C. Figure 7.13 shows the application of Eq. (7.27) to the solubility of boric acid in water. Linear regression yields a slope of -2737 K^{-1} , which is equal to $-\Delta H/R$. Therefore, from the solubility data the value for the heat of solution of boric acid is 22.7 kJ mol^{-1} .

7.7 PROTON AND ELECTRON AFFINITIES

Some cations can be considered as neutral molecules that have accepted a hydrogen ion. For example, the ammonium ion results from the addition of H^+ to NH_3 . Although the subject of acid-base chemistry will be discussed in Chapter 9, it is appropriate to discuss one related topic in this chapter because it deals with the behavior of solids. That topic is the proton affinity of a base. The proton affinity of a base is similar to the electron affinity of an atom, which was discussed in Chapter 1. Whereas the electron affinity is the energy required to remove an electron from a gaseous atom that has gained the electron, the proton affinity is the energy necessary to remove a proton from a gaseous base that has gained a proton. It is a measure of the intrinsic basicity of a species in the gas phase without the complicating effects that are often caused by solvents.

Ammonium compounds decompose in a number of ways when heated. For many of them, the heat of decomposition is either known or rather easily measured by techniques such as differential scanning

calorimetry. The Kapustinskii equation can be employed to determine the lattice energy. With this information and by using the known proton affinity for NH_3 (866 kJ mol^{-1}), it is possible to determine the proton affinity of the anion in an ammonium compound. Although this has been done for numerous compounds, the procedure will be illustrated for ammonium bisulfate and ammonium sulfate.

The decomposition of NH_4HSO_4 and the appropriate thermochemical cycle for determining the proton affinity of the HSO_4^- (g) ion can be shown as follows:

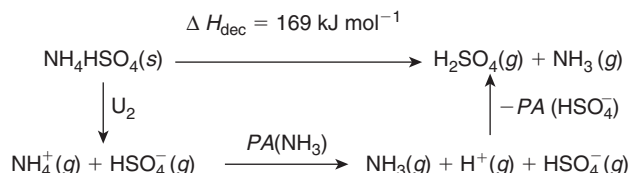

In this cycle, ΔH_{dec} is the heat of decomposition and U_2 is the lattice energy for NH_4HSO_4 , $PA(\text{NH}_3)$ is the proton affinity of $\text{NH}_3(\text{g})$, and $PA(\text{HSO}_4^-)$ is the proton affinity of the bisulfate ion. The heat of decomposition of NH_4HSO_4 has been determined to be 169 kJ mol^{-1} , and the proton affinity of $\text{NH}_3(\text{g})$ is 866 kJ mol^{-1} . The ionic radii for NH_4^+ and HSO_4^- are 143 pm and 206 pm, respectively, and the lattice energy calculated for NH_4HSO_4 by means of the Kapustinskii equation is 641 kJ mol^{-1} . From the cycle just shown, we find that

$$PA(\text{HSO}_4^-) = U_2 + PA(\text{NH}_3) - \Delta H_{\text{dec}} \quad (7.28)$$

and substituting for the known quantities yields a value of 1338 kJ mol^{-1} for the proton affinity of the HSO_4^- (g) ion. Proton affinities for other -1 ions range from a value of 1309 kJ mol^{-1} for I^- to 1695 kJ mol^{-1} for the CH_3^- ion. Therefore, the value 1338 kJ mol^{-1} found for the HSO_4^- ion is in good agreement with the values for other ions having a -1 charge.

The procedure just illustrated can also be applied to the decomposition of $(\text{NH}_4)_2\text{SO}_4$ to determine the proton affinity of the gaseous SO_4^{2-} ion. The radius of the SO_4^{2-} ion is 230 pm, so the Kapustinskii equation leads to a value of 1817 kJ mol^{-1} for the lattice energy of $(\text{NH}_4)_2\text{SO}_4$. When $(\text{NH}_4)_2\text{SO}_4(\text{s})$ is heated, it produces $\text{NH}_4\text{HSO}_4(\text{s})$ and NH_3 with the heat of decomposition being 195 kJ mol^{-1} . The thermochemical cycle to be used can be written as follows:

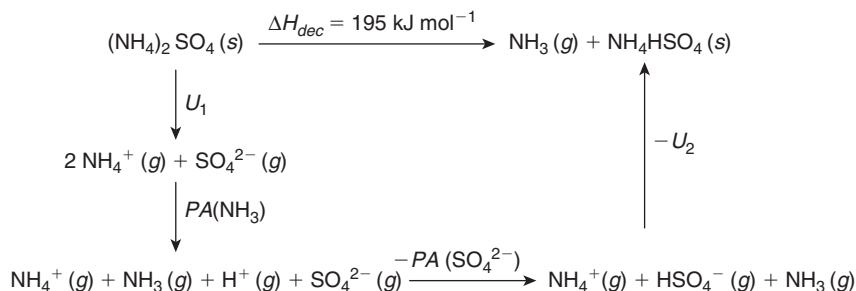

From this cycle, it is apparent that

$$PA(\text{SO}_4^{2-}) = U_1 + PA(\text{NH}_3) - \Delta H_{\text{dec}} - U_2 \quad (7.29)$$

where U_2 is the lattice energy for NH_4HSO_4 , which was shown earlier to be 641 kJ mol^{-1} . When the values are substituted for the known quantities shown in Eq. (7.29), a value of 1847 kJ mol^{-1} is found for the proton affinity for $\text{SO}_4^{2-}(\text{g})$. Proton affinities for most other -2 ions are somewhat higher than this value, but most of the ions are smaller in size (see Chapter 9). The SO_4^{2-} ion has extensive double bonding between the sulfur and oxygen atoms (see Chapter 4), which may decrease the availability of electron pairs on the oxygen atoms to attract H^+ ions. After all, H_2SO_4 is a very strong acid, so it loses protons readily.

By means of appropriate thermochemical cycles, it is possible to calculate proton affinities for species for which experimental values are not available. For example, using the procedure illustrated by the two foregoing examples, the proton affinities of ions such as $\text{HCO}_3^-(\text{g})$ (1318 kJ mol^{-1}) and $\text{CO}_3^{2-}(\text{g})$ (2261 kJ mol^{-1}) have been evaluated. Studies of this type show that lattice energies are important in determining other chemical data and that the Kapustinskii equation is a very useful tool.

In Chapter 1 we discussed the electron affinities of atoms and how they vary with position in the periodic table. It was also mentioned that no atom accepts two electrons with a release of energy. As a result, the only value available for the energy associated with adding a second electron to O^- is one calculated by some means. One way in which the energy for this process can be estimated is by making use of a thermochemical cycle such as the one that follows, showing the steps that could lead to the formation of MgO .

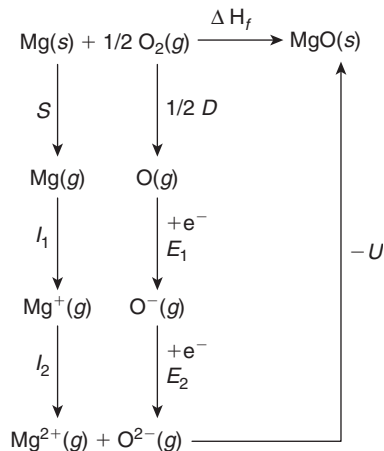

From this cycle, it is possible to calculate E_2 , the electron affinity for the second electron added to an oxygen atom. The heat of formation and lattice energy for $\text{MgO}(\text{s})$ are -602 and 3795 kJ/mol , respectively. For $\text{Mg}(\text{g})$, the first two ionization potentials are 738 and 1451 kJ/mol , and one-half of the heat of dissociation of $\text{O}_2(\text{g})$ is 249 kJ/mol . The first electron affinity for $\text{O}(\text{g})$ is 141 kJ/mol , so adding the electron has an enthalpy associated with it of -141 kJ/mol . Knowing values for all of these quantities makes it possible to obtain a value of $+750 \text{ kJ/mol}$ for the second electron affinity for the oxygen atom. Energetically, this is a very unfavorable process! Even though addition of the first electron to an

oxygen atom is energetically favorable, the sum of the energies for adding two electrons is +609 kJ/mol. It should be mentioned that this calculation is not likely to give a highly accurate value. The dominant term in the equation is the lattice energy of MgO, which is approximately 3800 kJ/mol, but that value is not known with certainty. For example, if the lattice energy is calculated by means of the Kapustinskii equation, it must be remembered that the covalent contribution is not taken into account. Even though the uncertainty in the second electron affinity (and hence the sum of the first and second) for oxygen is rather large, there is no doubt that adding *two* electrons is energetically unfavorable. If it were not for the fact that lattices containing the doubly charged oxide ion are extremely stable, it would be very unlikely that compounds containing O^{2-} would be obtainable. This situation also exists for other ions having charges more negative than -1 (e.g., S^{2-}).

7.8 STRUCTURES OF METALS

Metals consist of spherical atoms that are arranged in three-dimensional lattices. The number of ways in which this occurs is limited, and only four types of structures (shown in Figure 7.14) are needed to show the arrangements of atoms in almost all metals. These arrangements for packing spheres are sometimes called *closest packing*. One way in which spherical atoms can be packed is with one atom on each corner of a cube. This structure is known as the simple cubic structure. When we realize that atoms in a metal are bonded to each other, we see one of the problems with the simple cubic structure. Each atom is surrounded by only six other atoms (the *coordination number*), and even when the atoms are touching, there is a great deal of free space. When cubes are stacked, eight cubes come together at

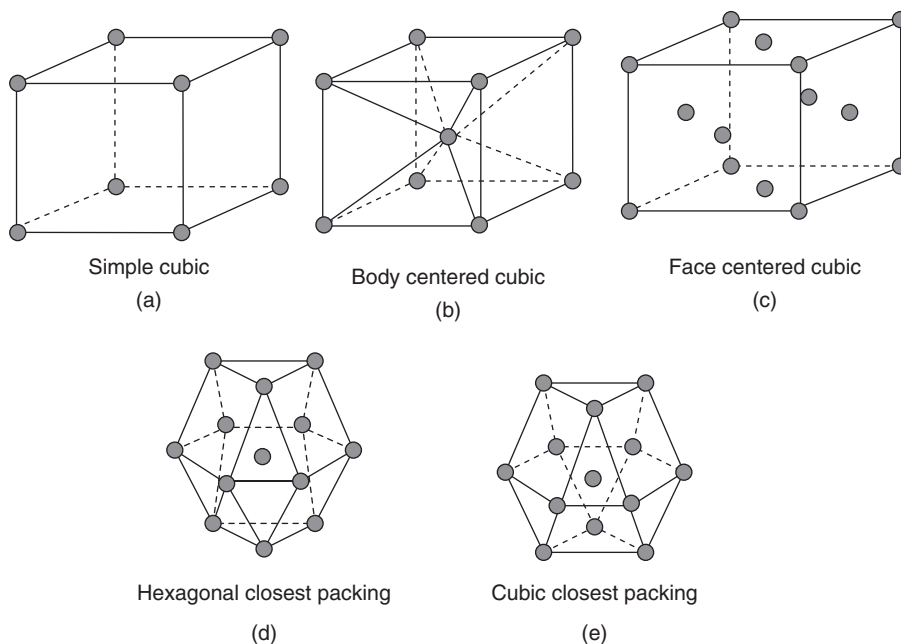

■ **FIGURE 7.14** The most common structures of metals.

each corner and there are eight corners to each cube where an atom resides. Therefore, because eight cubes share a common corner, only one-eighth of each atom belongs in any one cube. The total occupancy of the cube is $8(1/8) = 1$, and there is one atom per cubic unit cell. Figure 7.14a shows the simple cubic structure.

We can determine the amount of empty space in the simple cubic (a space-filling model is shown in Figure 7.15) structure by considering it to have an edge length l , which will be twice the radius of an atom. Therefore, the radius of the atom is $l/2$, so the volume of one atom is $(4/3)\pi(l/2)^3 = 0.524l^3$, but the volume of the cube is l^3 . From this we see that because the cube contains only one atom that occupies 52.4% of the volume of the cube, there is 47.6% empty space. Because of the low coordination number and the large amount of empty space, the simple cubic structure does not represent an efficient use of space and does not maximize the number of metal atoms bonded to each other. Consequently, the simple cubic structure is not a common one for metals.

The body-centered cubic structure (abbreviated *bcc*) contains one atom in the center of a cubic cell that also has one atom on each corner of the cube that is touching the center atom. In this structure, shown in Figure 7.14b, there are two atoms per unit cell. The atom in the center resides totally within the cube, and one-eighth of each atom on a corner resides in the cube. When we realize that the atoms are touching, we see that a diagonal through the cube must represent one diameter of an atom plus two times the radius of an atom. If the cube has an edge length l , the length of the diagonal will be $3^{1/2}l$, which is equal to 4 times the radius of an atom. Therefore, the radius of an atom is given as $3^{1/2}l/4$ and the volume of two atoms is $2(4/3)\pi r^3$ or $2(4\pi/3)(3^{1/2}l/4)^3 = 0.680l^3$. Thus we see that 68.0% of the cube is occupied by the two atoms in the cell, or that 32.0% of the volume of the cell is empty space. Not only is this an improvement over the simple cubic structure in terms of space utilization, but also in the *bcc* structure each atom is surrounded by eight nearest neighbors. Several metals are found to have the *bcc* structure.

In addition to the two structures already discussed, another arrangement of atoms in a cubic unit cell is possible. Atoms of a metal are identical, so the ratio of atomic sizes is 1.000, which allows a coordination number of 12. One structure that has a coordination number of 12 is known as face-centered cubic (*fcc*), and it has one atom on each corner of the cube and an atom on each of the six faces of the cube. The atoms on the faces are shared by two cubes, so one-half of each atom belongs in each cube. With there

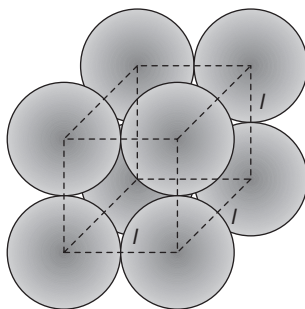

■ FIGURE 7.15 A space-filling model of spheres arranged in the simple cubic pattern.

being six faces, there are $6(1/2) = 3$ atoms in each cube from this source in addition to the $8(1/8) = 1$ from the atoms on the corners. The total number of atoms per unit cell is four. The *fcc* structure (also referred to as cubic closest packing) is shown in Figure 7.14c. It can be shown that there is 26% free space in this arrangement, and the coordination number of each atom is 12. Therefore, the *fcc* arrangement is the most efficient of the three structures described so far, and many metals have this structure (Table 7.8).

Hexagonal closest packing (*hcp*), which also involves a coordination number of 12, is shown in Figure 7.14d. If we examine the environment around an atom, we find that there are six others arranged around it in a hexagonal pattern. It can be shown that these six atoms touch the one in the center just as they touch each other. In addition to the six atoms in the same layer, each atom is also surrounded by atoms that are contained in the layers above and below it. Three atoms from each of those layers make contact with the atom that resides in the center of the hexagon. In *hcp*, the groups of three atoms in the layers above and below the atom being considered are aligned. The layers above and below the atom under consideration are exactly alike, although in most cases they are slightly farther away than the six atoms that are in the same plane. If we call the layers *A* and *B*, the repeating pattern in *hcp* is ...*ABABAB*... . In this arrangement, the coordination number is 12, and there is 26% free space as in the *fcc* structure. In fact, the only difference between *hcp* and *fcc* is that while each has an atom surrounded by six others in the same plane, the planes above and below that plane are different. In *fcc*, the repeating pattern is ...*ABCABCABC*... where the *C* layer has atoms that are not in alignment with those in the *A* layer. Figure 7.14e shows the layer arrangement in the *fcc* structure. Many metals have either *fcc* or *hcp* as the stable arrangement of atoms. The most common structures for a large number of metals are summarized in Table 7.8.

Having shown that the coordination numbers and the percent of free space are equal for *fcc* and *hcp*, we would conclude that they represent arrangements of atoms that have energies that are very similar. As a result, it might be expected that a transformation of a metal from one structure to the other would be possible. Such transformations have been observed for several metals, and one example is

Table 7.8 Closest Packing Structures of Metals.

Li <i>bcc</i>	Be <i>hcp</i>										
Na <i>bcc</i>	Mg <i>hcp</i>										
K <i>bcc</i>	Ca <i>fcc</i> ^a	Sc <i>hcp</i> <i>fcc</i>	Ti <i>hcp</i>	V <i>bcc</i>	Cr <i>bcc</i>	Mn <i>hcp</i> ^b	Fe <i>bcc</i>	Co <i>fcc</i> <i>hcp</i>	Ni <i>fcc</i>	Cu <i>fcc</i>	Zn <i>hcp</i> ^c
Rb <i>bcc</i>	Sr <i>fcc</i> ^a	Y <i>hcp</i>	Zr <i>hcp</i>	Nb <i>bcc</i>	Mo <i>bcc</i>	Tc <i>hcp</i>	Ru <i>hcp</i>	Rh <i>fcc</i>	Pd <i>fcc</i>	Ag <i>fcc</i>	Cd <i>hcp</i> ^c
Cs <i>bcc</i>	Ba <i>bcc</i>	La <i>hcp</i>	Hf <i>hcp</i>	Ta <i>bcc</i>	W <i>bcc</i>	Re <i>hcp</i>	Os <i>hcp</i>	Ir <i>fcc</i>	Pt <i>fcc</i>	Au <i>fcc</i>	Hg —

^aCalcium and strontium have other structures depending on the temperature.

^bManganese has a distorted *hcp* structure, but two other complex forms are known.

^cZinc and cadmium have distorted *hcp* structures in which the six nearest neighbors in the same plane are at one distance, but atoms in the planes above and below are farther away.



It is also possible to bring about changes between other types of packing arrangements. For example, titanium undergoes a change from *hcp* to *bcc*,



which means that there is a change in coordination number in this case. The ability to exist in more than one structure (*polymorphism*) is quite common in metals. As a general rule, metals that have *fcc* structures (e.g., Ag, Au, Ni, and Cu) are more malleable and ductile than are those with other structures. Metals that have the *hcp* structure (e.g., W, Mo, V, and Ti) tend to be more brittle and less ductile, which makes them harder to work into desired shapes and forms. These differences in properties are related to the ease with which the planes of metal atoms can be moved in relation to each other. Although the topic will not be discussed in more detail in this book, the structures and properties of metals are of great importance in the area of materials science.

7.9 DEFECTS IN CRYSTALS

Although several types of lattices have been described for ionic crystals and metals, it should be remembered that no crystal is perfect. The irregularities or defects in crystal structures are of two general types. The first type consists of defects that occur at specific sites in the lattice, and they are known as *point defects*. The second type of defect is a more general type that affects larger regions of the crystal. These are the *extended defects* or *dislocations*. Point defects will be discussed first.

One type of point defect that cannot be entirely eliminated from a solid compound is the *substituted ion* or *impurity* defect. For example, suppose a large crystal contains 1 mole of NaCl that is 99.99 mole percent pure and that the 0.01% impurity is KBr. As a fraction, there is 0.0001 mole of both K^+ and Br^- ions, which is 6.02×10^{19} ions of each type present in the 1 mole of NaCl! Although the level of purity of the NaCl is high, there is an enormous number of impurity ions that occupy sites in the lattice. Even if the NaCl were 99.9999 mole percent pure, there would still be 6.02×10^{17} impurity cations and anions in a mole of crystal. In other words, there is a defect, known as a substituted ion or impurity defect, at each point in the crystal where some ion other than Na^+ or Cl^- resides. Because K^+ is larger than Na^+ and Br^- is larger than Cl^- , the lattice will experience some strain and distortion at the sites where the larger cations and anions reside. These strain points are frequently reactive sites in a crystal.

An analogous situation exists in crystals that are not ionic. For example, a highly pure metal might contain 99.9999 mole percent of one metal but still contain 0.0001 mole percent of another. There will be atoms of the metal impurity at specific sites in the lattice, which will constitute defects that alter the structure of the lattice slightly.

A different type of defect occurs at specific sites when an atom or ion is missing from a lattice position and is transferred to the surface of the crystal. It is also possible for pairs of ions of opposite charge

to be missing in relatively close proximity, which allows the crystal to be electrically neutral in that region. Defects of the missing-ion type, known as *Schottky defects*, are illustrated in Figure 7.16.

Removing an ion or atom from its lattice site leaves unbalanced forces between the atoms surrounding the site, so such a defect constitutes a high-energy site. At any given temperature, the number of high-energy sites is n_2 when the total number of sites is n_1 . Actually, the number of occupied sites is $n_1 - n_2$, but the number of vacancies is small compared to the total number of sites in the lattice, so n_1 is essentially a constant. The Boltzmann distribution law gives the relationship between the numbers of sites,

$$\frac{n_2}{n_1} = e^{-\Delta E/kT} \quad (7.32)$$

where ΔE is the difference in energy between an occupied site and a vacancy, k is Boltzmann's constant, and T is the temperature (K). The defect population is increased if the temperature is increased. However, with the energy to form a vacancy being in the 0.5 – 1.0 eV (50 – 100 kJ mol⁻¹) range, the population of vacancies is small even at high temperature. For example, if the energy necessary to form a Schottky defect is 0.75 eV and the temperature is 750 K, the fraction of Schottky defects compared to total number of lattice sites, n_2/n_1 , is

$$\frac{n_2}{n_1} = \exp(-0.75 \text{ eV} \times 1.60 \times 10^{-12} \text{ erg/eV} / (1.38 \times 10^{-16} \text{ erg/K} \times 750 \text{ K})) = 9.2 \times 10^{-5}$$

Although this is a small fraction, for 1 mole of lattice sites, this amounts to 5.6×10^{18} Schottky defects. The ability of ions to move from their sites into vacancies and by so doing creating new vacancies is largely responsible for the conductivity in ionic crystals.

It is possible to create a population of Schottky defects that is much higher than the equilibrium population that is based on Eq. (7.32). If a crystal is heated to high temperature, lattice vibrations become more pronounced, and eventually ions begin to migrate from their lattice sites. If the crystal is quickly cooled, the extent of the motion of ions decreases rapidly so that ions that have moved from their lattice sites cannot return. As a result, the crystal will contain a population of Schottky defects that is much higher than the equilibrium population at the lower temperature. If a crystal of KCl is prepared so that it contains some CaCl₂ as an impurity, incorporating a Ca²⁺ ion in the crystal at a K⁺ site

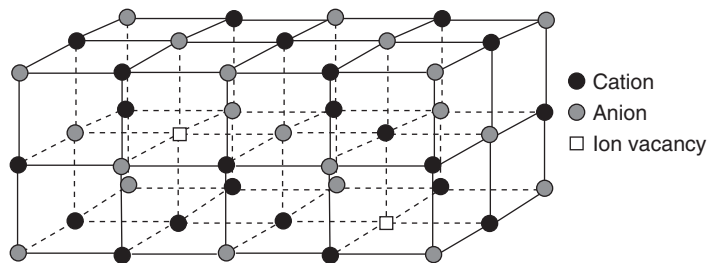

■ FIGURE 7.16 An illustration of Schottky defects in an ionic crystal.

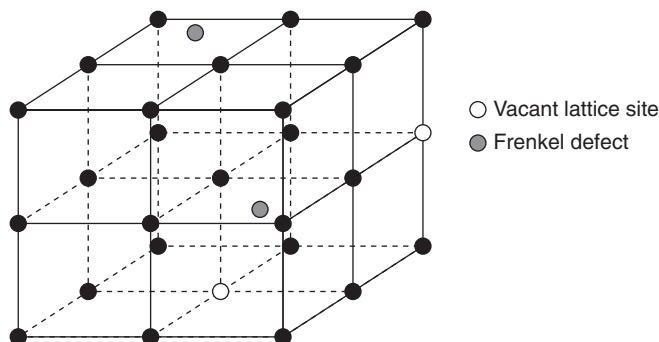

■ FIGURE 7.17 Frenkel defects in a crystal structure.

requires that another K^+ site be vacant to maintain electrical neutrality, although the added Cl^- ions can occupy anion sites. However, the atomic weights of Ca and K are very similar. As a result of the vacancies, the crystal of KCl containing $CaCl_2$ has a lower density than pure KCl in which each cation site contains K^+ .

A somewhat different situation is found in the type of point defect known as a *Frenkel defect*. In this case, an atom or ion is found in an interstitial position rather than in a normal lattice site as is shown in Figure 7.17. In order to position an atom or ion in an interstitial position, it must be possible for it to be close to other lattice members. This is facilitated when there is some degree of covalence in the bonding as is the case for silver halides and metals. Accordingly, Frenkel defects are the dominant type of defect in these types of solids.

When a crystal of an alkali halide has the vapor of the alkali metal passed over it, the alkali halide crystal becomes colored. The reason for this is that a type of defect that leads to absorption of light is created in the crystal. Such a defect is known as an *F-center* because the German word for “color” is *Farbe*. It has been shown that such a defect results when an electron occupies a site normally occupied by an anion (an anion “hole”). This arises as a result of the reaction

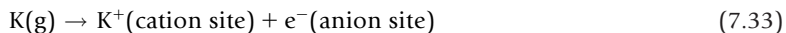

The potassium ions that are produced occupy cation lattice sites, but no anions are produced so electrons occupy anion sites. In this situation, the electron behaves as a particle restricted to motion in a three-dimensional box that can absorb energy as it is promoted to an excited state. It is interesting to note that the position of the maximum in the absorption band is below 4000 \AA (400 nm , 3.1 eV) for LiCl but it is at approximately 6000 \AA (600 nm , 2 eV) for CsCl. One way to explain this observation is by noting that for a particle in a three-dimensional box the difference between energy levels increases as the size of the box becomes smaller, which is the situation in LiCl. Schottky, Frenkel, and *F-center* defects are not the only types of point defects known, but they are the most common and important types.

In addition to the point defects that occur at specific lattice sites, there are types of defects, known as extended defects, that extend over a region of the crystal. The three most important types of extended

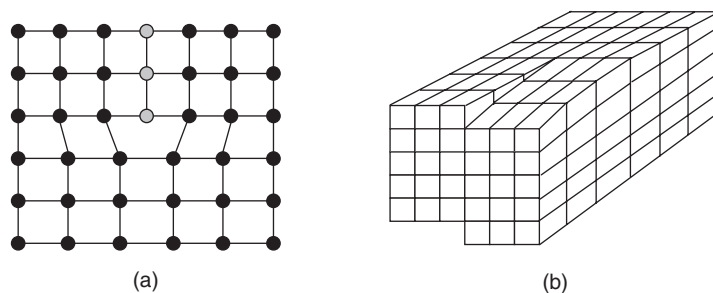

■ **FIGURE 7.18** An edge dislocation (a) and screw dislocation (b) in a crystal.

defects are the *stacking fault*, *edge displacement*, and *screw dislocation*. A stacking fault involves an extra layer of atoms or a missing layer of atoms in the structure. For example, if the layers of atoms are represented as *A*, *B*, and *C*, the normal sequence of layers in the *fcc* structure is ...*ABCABCABC*... . Stacking faults in this type of structure might be of the types ...*ABCABABC*... (missing *C* layer) or ...*ABCBABCABC*... (extra *B* layer). Stacking faults are normally encountered in metals in which all the atoms are identical, but the layers are distinct.

An edge dislocation occurs when an extra plane or layer of atoms extends partway into the crystal, which causes atoms in that region of the crystal to be compressed while in the region where the extra plane does not extend they are spread apart. This type of crystal defect is shown in Figure 7.18a. It is rather like a stacking fault that does not extend through the entire crystal. One consequence of an edge dislocation is that it is easier to produce slip or movement along a plane perpendicular to the edge dislocation. The bonds between atoms are already somewhat stretched in that region of the crystal.

A screw dislocation, shown in Figure 7.18b, arises when the planes of atoms line up on one side of the crystal, but the planes are out of register by one cell dimension on the other side of the crystal. Suppose this book were cut in such a way that the pages were cut from the outside edge halfway to the binding. Then, turn the edges that are cut in such a way that the first sheet in the top half of the book lines up with the second sheet in the bottom half of the book. The second sheet in the top half lines up with the third sheet in the bottom half, and the *n*th sheet in the top half lines up with the *n* + 1 sheet in the bottom half. However, at the edges of the pages that are bound, the pages are still aligned because the dislocation extends only partway through the book (crystal). This would be analogous to a screw dislocation in a crystal.

7.10 PHASE TRANSITIONS IN SOLIDS

Although in this chapter the structures of many inorganic solids have been described, it has also been pointed out that some substances can be transformed from one structure to another. In fact, polymorphism is a very common occurrence in inorganic chemistry. For example, carbon exists in the form of diamond or as graphite, and another form, C_{60} , will be described in Chapter 13. Numerous metals can be transformed from one solid structure to another. Many compounds ($KSCN$, $NaNO_3$, AgI , SiO_2 , NH_4Cl , and $NH_4H_2PO_4$, to name a few) undergo structural changes. Such phase transitions are usually

induced by changes in temperature or pressure. Because of the importance and scope of phase transitions in inorganic chemistry, a brief survey of the topic will be presented here.

Phase transitions are classified from a consideration of several factors. One type of phase transition is known as *reconstructive* based on the fact that a major rearrangement of structural units (atoms, molecules, or ions) is involved. For example, the conversion of the fused-ring layer structure of graphite into diamond, in which each carbon atom is bonded to four others in a tetrahedral arrangement, requires a radical change in structure and bonding mode. This is a reconstructive phase transition that takes place slowly under extreme conditions. The thermal stability of graphite and diamond are not greatly different (ΔH for $C_{(\text{graphite})} \rightarrow C_{(\text{diamond})}$ is only 2 kJ mol^{-1}), but there is no low-energy pathway for the transition. This process is normally carried out at 1000 to 2000 °C and a pressure of up to 105 bar.

If a phase transition can occur by changing positions of structural units without rupturing bonds, it is known as a *displacive* phase transition. Because there is usually not a great change in bonding, displacive transitions are usually brought about by much milder conditions than are required to cause reconstructive transitions. For example, CsCl is converted from the CsCl structure to the NaCl structure by heating it to 479 °C, and AgI is transformed from a wurtzite structure to a body-centered cubic structure at 145 °C. Many of the phase transitions in metals can be induced by heating the metals at moderate temperatures because the bonds between metal atoms are shifted but not completely broken.

A complete discussion of the hundreds of phase transitions that are known for inorganic compounds is clearly beyond the scope of this book. However, it is possible to make some general observations regarding structural changes. From the thermodynamic principles discussed earlier, it is clear that when a phase transformation is induced by raising the temperature of a solid, there is an increase in volume and an increase in entropy as a result of the phase change. The phase that is stable at the higher temperature will generally have more disorder and a structure with a lower coordination number. On the other hand, if the phase transition is one that is brought about by increasing the pressure, the high-pressure phase will usually be more dense and have a more ordered structure than the low-pressure phase. The conversion of graphite to diamond has already been discussed in this connection. These general principles are applicable to many cases when predicting the structural changes that accompany a phase transition.

When cesium chloride is heated to a temperature of 479 °C, it changes from the CsCl structure to the NaCl structure. In this case, the coordination number changes from 8 to 6 as expected. On the other hand, when KCl is subjected to a pressure of 19.6 kbar, it is changed from the NaCl structure (coordination number 6) to the CsCl structure (coordination number 8). A very large number of other examples of this type of behavior can be given. Examples involving transformation of metals have been given earlier in this chapter. The subject of *rates* of phase transformations is one of the interesting problems in kinetics of solid-state processes, and this subject will be considered in Chapter 8. Considered in its entirety, the subject of phase transformations is relevant to understanding solid-state inorganic chemistry and materials science.

7.11 HEAT CAPACITY

The heat capacity of a monatomic ideal gas is the result of the molecules being able to absorb energy in three degrees of translational freedom. Each degree of freedom can absorb $\frac{1}{2}R$, which results in the heat capacity being approximately $3(1/2)R$. For a gas composed of diatomic molecules, there is also heat absorption to change the rotational energy and the vibrational energy. For a diatomic molecule, there is only one vibrational degree of freedom, which contributes R to the heat capacity. The number of degrees of vibrational freedom is given by $3N - 5$ for a linear molecule and $3N - 6$ for a nonlinear molecule, where N is the number of atoms.

Although the lattice members in a crystal do not move through space as do molecules of a gas, the lattice vibrations in a solid begin at very low temperature and are fully activated to absorb thermal energy at room temperature. For 1 mole of a monatomic species—for example, a metal such as Ag or Cu—the heat capacity should be given by $3R$ because there are three degrees of vibrational freedom for each particle in the lattice. For a very large number of particles, $3N - 6 \approx 3N$. Therefore, for a metal, the heat capacity, C_p , should be approximately $3R$ or 6 cal/mol deg (25 J/mol deg). The molar heat capacity is simply the specific heat multiplied by the atomic weight,

$$\text{Specific heat} \left(\frac{\text{cal}}{\text{g K}} \right) \times \text{Atomic weight} \left(\frac{\text{g}}{\text{mol}} \right) = C_p \left(\frac{\text{cal}}{\text{mol K}} \right)$$

$$\text{Specific heat} \times \text{Atomic weight} \approx 6 \text{ cal/mol deg} \approx 25 \text{ J/mol K}$$

This rule was stated in 1819 by Dulong and Petit, and it indicates that the specific heat of a metal multiplied by the atomic weight is a constant. This relationship provides a way to estimate the atomic weight of a metal if its specific heat is known. How well the rule holds is indicated by the specific heats of metals shown in Table 7.9.

The data shown in the table indicate that the law of Dulong and Petit holds surprisingly well for metals. For 1 mole of NaCl, there are 2 moles of particles, so the heat capacity is approximately 12 cal/mol deg or 50 J/mol K. However, the heat capacity of a solid is not a constant, but rather it decreases rapidly at lower temperatures as shown in Figure 7.19 for copper. A more complete explanation of the heat capacity of a solid as outlined next was developed by Einstein.

Table 7.9 Specific Heats of Selected Metals at Room Temperature.

Metal	C_p , J/mol K	Metal	C_p , J/mol K
Sb	25.1	Bi	25.6
Cd	25.8	Cu	24.5
Au	25.7	Ag	25.8
Sn	25.6	Ni	25.8
Pt	26.5	Pd	26.5

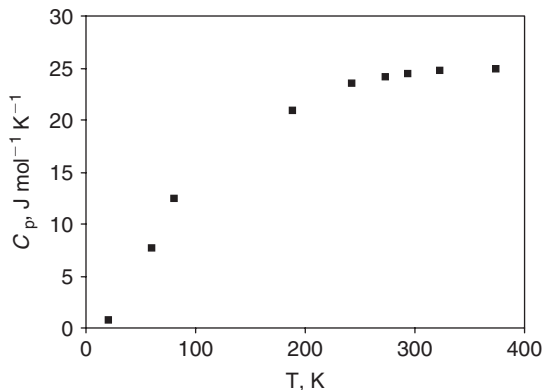

■ **FIGURE 7.19** The variation in heat capacity of copper as a function of temperature. Note that the heat capacity increases approximately as the cube of T at low temperature and approaches the value predicted by the law of Dulong and Petit near room temperature.

For a harmonic oscillator, the mean energy is given in terms of the frequency, ν , by

$$E = \frac{1}{2} h\nu + \frac{\sum_n n h\nu e^{-nh\nu/kT}}{\sum_n e^{-nh\nu/kT}} \quad (7.34)$$

where h is Planck's constant and k is Boltzmann's constant. Simplifying gives

$$E = \frac{1}{2} h\nu + \frac{h\nu}{e^{h\nu/kT} - 1} \quad (7.35)$$

This can be considered as the average energy of a specific atom over time or the average energy of all the atoms at a specific time. It is useful to consider two special cases. At low temperature, $h\nu > kT$ and the average energy is approximately $1/2 h\nu$. At high temperature, $h\nu < kT$, so $e^{h\nu/kT}$ becomes approximately equal to $1 + h\nu/kT$, so that

$$E = \frac{1}{2} \frac{h\nu}{kT} \approx kT \quad (7.36)$$

This is the classical limit because the energy levels expressed in terms of $h\nu$ are much smaller than the average energy of the oscillator.

When the temperature is such that $h\nu \approx kT$, neither of the limiting cases described earlier can be used. For many solids, the frequency of lattice vibration is on the order of 10^{13} Hz, so that the temperature at which the value of the heat capacity deviates substantially from $3R$ is above 300 to 400 K. For a series of vibrational energy levels that are multiples of some fundamental frequency, the energies are $0, h\nu, 2h\nu, 3h\nu$, etc. For these levels, the populations of the states (n_0, n_1, n_2 , etc.) will be in the ratio $1 : e^{-h\nu/kT} : e^{-2h\nu/kT} : e^{-3h\nu/kT}$, etc. The total number of vibrational states possible for N atoms is $3N$

because there are three degrees of vibrational freedom. Therefore, from the Boltzmann distribution law we find that

$$n_1 = n_0 e^{-h\nu/kT} ; n_2 = n_0 e^{-2h\nu/kT} ; n_3 = n_0 e^{-3h\nu/kT} ; \text{etc.} \quad (7.37)$$

Therefore, the total heat content, Q , of the crystal can be expressed as the sum of the number of particles populating each level times the energy of that level.

$$Q = n_0 [h\nu e^{-h\nu/kT} + 2h\nu e^{-2h\nu/kT} + 3h\nu e^{-3h\nu/kT} + \dots] \quad (7.38)$$

The total number of atoms, N , is the sum of the populations of the states,

$$N = n_0 + n_1 + n_2 + n_3 + \dots \quad (7.39)$$

Therefore,

$$Q = \frac{3Nh\nu}{e^{h\nu/kT} - 1} \quad (7.40)$$

The heat capacity is $\partial Q/\partial T$, so C_v can be expressed as

$$C_v = \frac{\partial Q}{\partial T} = 3Nk \left(\frac{h\nu}{kT} \right)^2 \frac{e^{h\nu/kT}}{e^{h\nu/kT} - 1} \quad (7.41)$$

If we let $x = h\nu/kT$ and define θ such that $k\theta = h\nu_{\max}$ where ν_{\max} is the maximum populated frequency, the total thermal energy can be written as

$$Q = \frac{9NkT^4}{\theta^3} \int_0^{x_{\max}} \frac{x^3}{e^x - 1} dx \quad (7.42)$$

where $x_{\max} = \theta/T$ and $x = h\nu/kT$. Also, θ is known as the Debye characteristic temperature. The expression for the heat capacity thus becomes

$$C_v = 9R \left(\frac{T}{\theta} \right)^3 \int_0^{x_{\max}} \frac{e^x x^4}{(e^x - 1)^2} dx \quad (7.43)$$

At high temperature, the integral is approximately $\int x^2 dx$ and the energy is evaluated as $3RT$ so that $C_v = 3R$, the classical value of Dulong and Petit. At low temperature (where x is large), we can approximate x by letting it equal ∞ so the integral becomes equal to $\pi^4/15$. In this case, $C_v = 463.9(T/\theta)^3$ cal/mol deg, and it can be seen that C_v varies as T^3 . This agrees well with the experimental variation of C_v with temperature in the region where the heat capacity curve rises steeply. Different metals have

Table 7.10 Debye Characteristic Temperatures for Metals.

Metal	θ	Metal	θ
Li	430	Ca	230
Na	160	Pt	225
K	99	Be	980
Au	185	Mg	330
Pb	86	Zn	240
Cr	405	Cd	165

different values for the Debye characteristic temperature, and values for several metals are shown in Table 7.10.

If we assume that the complete assembly of atoms vibrates as a coupled system which vibrates as a whole, only certain energies are allowed. The energy of the system must change by some multiple of $h\nu$, and these quanta of vibrational energy involve displacements of all of the atoms. The quanta of energy that correspond to changes in vibrational states are called *phonons*. As the temperature increases, the extent of atomic vibrations becomes larger, which is equivalent to saying that the number of phonons has increased. Vibrations in a solid produce longitudinal (compression) waves and transverse (perpendicular) waves. Adjacent atoms moving in the same phase give rise to so-called “acoustic” modes, and adjacent atoms moving with phases approximately 180° apart give rise to “optical” modes.

In a metal, there are excited states for electrons that lie below the ionization energy. This can be conceived as an electron in a “conduction band” and a “hole” that interact so that the combination is neutral but not of lowest energy. Such an excited state is called an *exciton*. Excitons may move by diffusion of the electron-hole pair or by transfer of a molecular exciton to another molecule. Reversion of the exciton to a lower energy state may be slow enough for the lifetime to be longer than that of lattice relaxation processes.

7.12 HARDNESS OF SOLIDS

Although not one of the most frequently discussed properties of solids, hardness is an important consideration in many instances, especially in the area of mineralogy. In essence, hardness is a measure of the ability of a solid to resist deformation or scratching. It is a difficult property to measure accurately, and for some materials a range of values is reported. Because of the nature of hardness, it is necessary to have some sort of reference so that comparisons can be made. The hardness scale most often used is that developed by Austrian mineralogist F. Mohs in 1824. The scale is appropriately known as the Mohs scale. Table 7.11 gives the fixed points on which the scale is based.

It has long been recognized that the Mohs scale is not totally satisfactory for several reasons. One reason is that some minerals have different resistance to scratching and deformation on different surfaces

Table 7.11 Reference Materials for the Mohs Hardness Scale.

Mineral	Mohs Hardness	Modified Value	Mineral	Mohs Hardness	Modified Value
Talc	1	1.0	Orthoclase	6	6.0
Graphite	2	2.0	Quartz	7	7.0
Calcite	3	3.2	Topaz	8	8.2
Fluorite	4	3.7	Corundum	9	8.9
Apatite	5	5.2	Diamond	10	10.0

Table 7.12 Hardness of Group II Oxides and Sulfides.

Cation	Oxides		Sulfides	
	r , pm	h	r , pm	h
Mg ²⁺	210	6.5	259	4.5
Ca ²⁺	240	4.5	284	4.0
Sr ²⁺	257	3.5	300	3.3
Ba ²⁺	277	3.3	318	3.0

of the crystals. For example, crystalline *calcite* has surfaces that differ by as much as 0.5 unit depending on the face tested. Also, some minerals do not have a fixed composition. For example, *apatite* is a calcium phosphate that contains varying amounts of chlorine and fluorine. *Fluoroapatite* is $\text{Ca}_5(\text{PO}_4)_3\text{F}$ and *chloroapatite* is $\text{Ca}_5(\text{PO}_4)_3\text{Cl}$. Naturally occurring apatite is written as $\text{Ca}_5(\text{PO}_4)_3(\text{F,Cl})$ to indicate that composition. As a result of these difficulties, a modified Mohs scale has been proposed and Table 7.11 shows the values for the minerals that are the references on the Mohs scale. It is easy to see that the values are not significantly different.

That hardness should be related to other properties of crystals is intuitively obvious. As a general rule, the materials that have high hardness values also have high melting points and lattice energies. For ionic crystals, hardness also increases as the distance between ions decreases. This trend is illustrated by the oxides and sulfides of the group II metals as is shown by the data presented in Table 7.12. Also, there is a rough correlation between hardness and the effect of higher charges on the ions when the distances between ionic centers is essentially the same. As shown by the data presented in Table 7.13, this correlation is evident when several pairs of compounds are considered in which the distances between ionic centers are approximately the same.

The data show that when compounds such as LiF and MgO are considered, even though the inter-nuclear distances are similar, there is a great difference in the hardness of the materials. Of course, there is also a great difference between the melting points and lattice energies of the compounds as

	LiF	MgO	NaF	CaO	LiCl	SrO
<i>r</i> , pm	202	210	231	240	257	257
<i>h</i>	3.3	6.5	3.2	4.5	3.0	3.5
	LiCl	MgS	NaCl	CaS	LiBr	MgS
<i>r</i> , pm	257	259	281	284	275	273
<i>h</i>	3.0	4.5-5	2.5	4.0	2.5	3.5
	CuBr	ZnSe	GaAs	GeGe		
<i>r</i> , pm	246	245	244	243		
<i>h</i>	2.4	3.4	4.2	6.0		

Metal	<i>h</i>	m.p. (K)	Metal	<i>h</i>	m.p. (K)
Cadmium	2.0	594	Palladium	4.8	1825
Zinc	2.5	693	Platinum	4.3	2045
Silver	2.5–4.0	1235	Ruthenium	6.5	2583
Manganese	5.0	1518	Iridium	6.0–6.5	2683
Iron	4.0–5.0	1808	Osmium	7.0	3325

well. A similar situation exists for NaCl compared to CaS where the internuclear distance is approximately 280 pm in both cases, but the hardnesses are 2.5 and 4.0, respectively. Although the data allow generalizations to be made regarding hardness and other properties, they do not permit a quantitative relationship to be developed.

The hardness of transition metals varies widely. Table 7.14 shows the values for several metals along with their melting points. The data show that there is a rough correlation between the hardness of many metals and their melting points. However, it should be kept in mind that the hardness scale is not a highly accurate one (the number of significant digits may be only one in some cases) so it is not possible to develop a good quantitative relationship. In spite of the limitations, it is often worthwhile to have a general understanding of the hardness of inorganic materials and how that property is related to many others.

In this chapter, a survey of the structure and properties of solids has been presented. Solid-state chemistry has emerged as an important area of the science, and although it is not exclusively so, much of the work deals with inorganic substances. For more information on this important area, the references at the end of the chapter should be consulted.

■ REFERENCES FOR FURTHER STUDY

- Anderson, J. C., Leaver, K. D., Alexander, J. M., and Rawlings, R. D. (1974). *Materials Science*, 2nd ed. Wiley, New York. This book presents a great deal of information on characteristics of solids that is relevant to solid-state chemistry.
- Borg, R. J., and Dienes, G. J. (1992). *The Physical Chemistry of Solids*. Academic Press, San Diego, CA. A good coverage of topics in solid-state science.
- Burdett, J. E. (1995). *Chemical Bonding in Solids*. Oxford University Press, New York. A higher level book on the chemistry and physics of solids.
- Douglas, B., McDaniel, D., and Alexander, J. (1994). *Concepts and Models of Inorganic Chemistry*, 3rd ed. Wiley, New York. Chapters 5 and 6 give a good introduction to solid-state chemistry.
- Gillespie, R. R. (1998). *J. Chem. Educ.* **75**, 923. A discussion of the properties of fluorides in terms of bonding.
- Julg, A. (1978). *Crystals as Giant Molecules*. Springer Verlag, Berlin. This is Volume 9 in a lecture note series. It presents a wealth of information and novel ways of interpreting properties of solids.
- Ladd, M. F. C. (1979). *Structure and Bonding in Solid State Chemistry*. Wiley, New York. An excellent book on solid-state chemistry.
- Pauling, L. (1960). *The Nature of the Chemical Bond*, 3rd ed. Cornell University Press, Ithaca, NY. A classic book that presents a good description of crystal structures and bonding in solids.
- Raghavan, V., and Cohen, M. (1975). "Solid-State Phase Transformations," Chapter 2, in N. B. Hannay, Ed., *Treatise on Solid State Chemistry Changes in State*, Vol. 5. Plenum Press, New York. A mathematical treatment of the subject including a good treatment of the kinetics of phase transitions.
- Rao, C. N. R. (1984). "Phase Transitions and the Chemistry of Solids. *Acc. Chem. Res.* **17**, 83–89. A general overview of phase transitions.
- Rao, C. N. R., and Rao, K. J. (1967). "Phase Transformations in Solids", Chapter 4, in H. Reiss, Ed., *Progress in Solid State Chemistry*, Vol. 4. Pergamon Press, New York. A good introduction to the topic of phase transitions by two of the eminent workers in the field.
- Smart, L., and Moore, E. (1992). *Solid State Chemistry*. Chapman & Hall, London. An introductory book on solid state chemistry.
- West, A. R. (1984). *Solid State Chemistry and its Applications*. Wiley, New York. One of the best introductory books on solid state chemistry. Chapter 12 in this book is devoted to a discussion of phase transitions.

■ QUESTIONS AND PROBLEMS

1. Consider two Na^+Cl^- ion pairs arranged in a "head to tail" or antiparallel structure in which the distance between ionic centers is 281 pm. Calculate the energy of this arrangement.
2. (a) Explain why the hydration number for Li^+ is approximately 5 while that for Mg^{2+} is almost twice that number.
(b) Explain why the hydration number for Mg^{2+} is approximately 10 while that for Ca^{2+} is approximately 7.

- Use the Kapustinskii equation to determine the lattice energies for the following: (a) RbCl; (b) NaI; (c) MgCl₂; (d) LiF.
- Using your answers in problem 3 and the data shown in Table 7.7, calculate the heat of solution for the compounds.
- RbCaF₃ has the perovskite structure with the Ca in the center of the unit cell. What is the electrostatic bond character of each of the Ca–F bonds? How many fluoride ions must surround each Ca²⁺ ion? What is the electrostatic bond character of each Rb–F bond? How many F[–] ions surround each Rb⁺?
- The nickel crystal has a cubic close packing arrangement with an edge length of 352.4 nm. Using this information, calculate the density of nickel.
- In PdO, each Pd is surrounded by four oxygen atoms, but *planar* sheets do not exist. Explain why they are not expected.
- Potassium fluoride crystallizes in a sodium chloride lattice. The length of the edge of the unit cell (sometimes called the cell or lattice constant) has the value 267 pm for KF.
 - Calculate the attraction between that exists for 1 mole of KF.
 - Using the Kapustinskii equation, calculate the lattice energy for KF. The ionic radii are 138 and 133 pm, respectively, for K⁺ and F[–].
 - Explain why the values in parts (a) and (b) are different.
 - Use the results obtained in parts (a) and (b) to evaluate the appropriate value of *n* in the Born-Landé equation.
- The structure of PdCl₂ involves linear chains that can be shown as

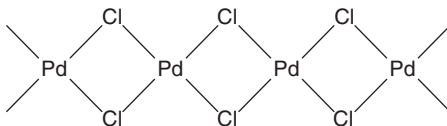

Considering the structure to be ionic, explain why there are no strong forces of attraction between chains.

- Predict the crystal type for each of the following using the radius ratio: (a) K₂S (b) NH₄Br (c) CoF₂ (d) TiF₂ (e) FeO.
- The solubility (*S*) of KBrO₃ in water (given as grams per 100 grams of water) varies with temperature as follows:

Temp., °C	10	20	30	50	60
<i>S</i> , g/100 g H ₂ O	4.8	6.9	9.5	17.5	22.7

Use these data to determine the heat of solution of KBrO₃ in water.

- The length of the edge of the unit cell for Na₂O (which has the antifluorite structure) is 555 pm. For Na₂O, determine the following:
 - The distance between sodium ions.
 - The distance between sodium and oxide ions.
 - The distance between oxide ions.
 - The density of Na₂O.
- Suppose that in a crystal of NaCl contact between chloride ions occurs and contact between sodium and chloride ions occurs. Determine the percentage of free space in the NaCl crystal.
- Although CaF₂ has the fluorite structure, MgF₂ has the rutile structure. Explain this difference.

15. The removal of two electrons from a magnesium atom is highly endothermic, as is the addition of two electrons to an oxygen atom. In spite of this, MgO forms readily from the elements. Write a thermochemical cycle for the formation of MgO and explain the process from the standpoint of the energies involved.
16. Cations in aqueous solutions have an effective radius that is approximately 75 pm larger than the crystallographic radii. The value of 75 pm is approximately the radius of a water molecule. It can be shown that the heat of hydration of cations should be a linear function of Z^2/r' where r' is the effective ionic radius and Z is the charge on the ion. Using the ionic radii shown in Table 7.4 and hydration enthalpies shown in Table 7.7, test the validity of this relationship.
17. KBr crystallizes in a sodium chloride lattice arrangement with a cell edge length of 314 pm.
- Calculate the total attraction in 1 mole of KBr.
 - Calculate the actual lattice energy by means of the Kapustinskii equation or a thermochemical cycle.
 - Explain why the values determined in parts (a) and (b) are different.
 - Using the results from (a) and (b), evaluate the value of n that is correct in this case according to

$$U = \frac{N_o A e^2}{r} \left(1 - \frac{1}{n} \right)$$

Note: $e = 4.8 \times 10^{-10}$ esu and $1 \text{ esu} = 1 \text{ g}^{1/2} \text{ cm}^{3/2} \text{ sec}^{-1}$.

18. The edge of the unit cell in a crystal is sometimes called the lattice or cell constant. The structure known as anti-fluorite is the structure of K_2O and its cell constant is 644 pm. Determine the value for each of the following:
- The distance between K^+ ions.
 - The distance between K^+ and O^{2-} ions.
 - The distance between O^{2-} ions.
 - The density of K_2O .

This page intentionally left blank

Dynamic Processes in Inorganic Solids

Although reactions in the gas phase and solutions may be better understood on the molecular level, reactions in solids are quite common and useful. Because so many inorganic compounds are solids, inorganic chemistry involves a great deal of solid-state science. However, reactions in the solid state may involve several factors that are not relevant to reactions carried out in the gas phase or in solution. The study of reactions in solids is frequently given little attention in the presentation of inorganic chemistry, but a great deal is known about many of the processes. Some of the reactions in inorganic solids are of economic importance, and others reveal a great deal about the behavior of inorganic materials. Therefore, this chapter is devoted to presenting some of the basic ideas concerning reactions in solids and discussing some of the methods used in this area of inorganic chemistry.

8.1 CHARACTERISTICS OF SOLID-STATE REACTIONS

There are several ways to induce reactions in solids. The application of heat, electromagnetic radiation, pressure, ultrasound or some other form of energy may induce a transformation in a solid. For centuries, it has been a common practice to subject solid materials to heat in order to determine their thermal stability, to study their physical properties, or to convert one material into another. One important commercial reaction, that producing lime,



is carried out on an enormous scale (see Chapter 13).

Reactions in solids are often vastly different from those that take place in solutions. Because many of the reactions in the solid state involve *inorganic* materials, an introduction to this important topic is presented in this chapter to show some of the principles that are applicable to this area of inorganic chemistry. The emphasis is on showing several types of reactions, but no attempt is made to present comprehensive coverage of the hundreds of reactions that take place in the solid state. Although some

reactions involve the reaction of two solid phases, the discussion deals primarily with one component. A enormous number of reactions of this type involve the decomposition of a solid to produce a different solid and a volatile product as illustrated by Eq. (8.1).

Rates of reactions in solutions are usually expressed as mathematical functions of concentrations of the reacting species as variables, the *rate law*. For reactions in solids, this is not feasible because any particle of a uniform density has the same number of moles per unit volume. A different reaction variable must be chosen, and that is most commonly the fraction of the reaction complete, α . At the beginning of a reaction $\alpha = 0$, and at the completion of the reaction $\alpha = 1$ (if the reaction goes to completion, which is not always the case). The fraction of the reactant remaining is given by $(1 - \alpha)$, so rate laws are generally written in terms of that quantity. Rate laws for reactions in solids are frequently determined by the geometry of the sample, formation of active sites, diffusion, or some other factor. As a result, many of the rate laws for reactions in solids are derived based on those considerations. In the majority of cases, it is not possible to interpret a rate law on the usual concepts related to bond-breaking and bond-making steps. Moreover, even though the rate constant for a reaction varies according to the Arrhenius equation, the calculated "activation energy" may be for some process such as diffusion rather than changes in "molecules," which often are not present. The transition state may be the motion of an ion through a potential field in a crystal rather than a molecule having stretched or bent bonds.

In order to test rate laws, α must be determined as a function of time using an appropriate experimental technique. If the reaction involves the loss of a volatile product as shown in Eq. (8.1), the extent of reaction can be followed by determining the mass loss either continuously or from sample weight at specific times. Other techniques are applicable to different types of reactions. After α has been determined at several reaction times, it is often instructive to make a graph of α versus time before the data are analyzed according to the rate laws. As will be shown later, one can often eliminate some rate laws from consideration because of the general shape of the α versus t curve.

Figure 8.1 shows three hypothetical α versus time curves for solid-state reactions that apply particularly to cases where a gaseous product is evolved.

For some solid reactants, gases may be adsorbed on the solid before the reaction begins and may be lost quickly when the reaction begins. When the α versus t curve is examined, it is seen that there is an initial change that may be due to the loss of the volatile material that was adsorbed (curve I, region A in Figure 8.1). The loss of the adsorbed gas *appears* to indicate the reaction (illustrated by curve I) is taking place with the loss of a gaseous product, so the graph shows an initial deviation from the horizontal axis. This initial response is not part of the chemical reaction. Such a condition is rather uncommon, but in a general case it is assumed that it can be present. If no volatiles are lost but there is an induction period (illustrated by curve II), the value of α increases more rapidly as shown in regions B on curves I and II. In these regions, the rate of the reaction is increasing (in what is usually a nonlinear way). This is known as the *acceleratory* period. In the third region, C (as shown by curves I, II, and III), the rate of the reaction is a maximum, and after that, the rate decreases (the *deceleratory* or *decay* period, D) and approaches zero as completion or equilibrium is approached. The reaction represented by curve III

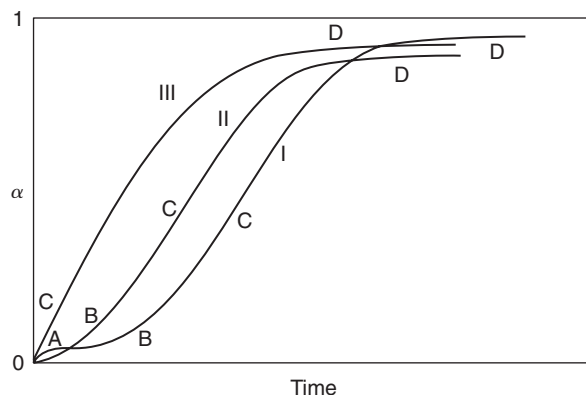

■ **FIGURE 8.1** The variation of α versus time for a hypothetical reaction in the solid state. Curve I shows the evolution of a gas (A) followed by an induction period (B) before the maximum rate is reached, curve II represents a reaction that shows an induction period (B) before reaching maximum rate, and curve III represents a reaction that begins at the maximum rate.

shows no acceleratory period and it begins at the maximum rate. It must be emphasized that the majority of reactions in solids do not show all of these features, and many are represented by curve III, which does not have complicating features such as rapid loss of gas or an induction period.

For many reactions, the rate is a maximum as the reaction begins (the maximum amount of reactant is present at $t = 0$). As a solid reacts, there is frequently a coalescence of surface material as surface tension works to produce a minimum surface area. At elevated temperatures, there is increased mobility of structural units (atoms or ions) that leads to rounding of surfaces. This process, known as *sintering*, can lead to closing of pores and welding of individual particles together. As a result, it may become difficult for a volatile product to escape from the reacting solid. The situation in which a gaseous product is held by adsorption or absorption is known as *retention*. Because of retention, a reaction may never reach completion with regard to all of the gaseous product being evolved.

Even though the vast majority of solid-state reactions do not exhibit all of the features indicated on curve A shown in Figure 8.1, it is frequently the case that no single rate law will correlate data for the entire range of the reaction. A different function may be needed to fit data in the induction region, another in the region where the rate is maximum, and yet another in the decay region. It should be remembered that subtle features of a reaction are sometimes more apparent when looking at a graph rather than looking at numerical data alone.

In addition to the complications described, other factors are important in specific reactions. If a reaction takes place on the surface of a solid, reducing the particle size (by grinding, milling, or vibration) leads to an increase in surface area. A sample of a solid treated in this way *may* react faster than an untreated sample, but in some cases changing the particle size does not alter the rate. This has been found to be true for the dehydration of $\text{CaC}_2\text{O}_4 \cdot \text{H}_2\text{O}$, which is independent of the particle size over a wide range of α values.

In Chapter 7, it was shown how defects in solids can be produced by heating the solid to produce the defects then quenching the crystal. On the other hand, defects can be removed by heating a crystal and allowing it to cool very slowly in an annealing process to allow the defects to be removed by rearrangement of particles. Defects represent high-energy sites where a reaction may initiate. Increasing the concentration of defects will usually increase the rate at which the solid will react. These observations show that the reactivity of a particular sample of a solid may depend on prior treatment of the sample.

8.2 KINETIC MODELS FOR REACTIONS IN SOLIDS

There are significant differences between the kinetic models for reactions carried out in the solid phase and those taking place in gases or solutions. Therefore, it is appropriate to describe briefly some of the kinetic models that have been found to be particularly applicable to reactions in inorganic solids.

8.2.1 First-Order

As was discussed earlier in this chapter, the concept of a reaction order does not apply to a crystal that is not composed of molecules. However, there are numerous cases in which the rate of reaction is proportional to the amount of material present. We can show how this rate law is obtained in a simple way. If the amount of material at any time, t , is represented as W and if we let W_0 be the amount of material initially present, the amount of material that has reacted at any time will be equal to $(W_0 - W)$. In a first-order reaction the rate is proportional to the amount of material. Therefore, the rate of reaction can be expressed as

$$-\frac{dW}{dt} = k W \quad (8.2)$$

When integration is performed so that the amount of reactant is W_0 at $t = 0$ and is W at time t , the result is

$$\ln \frac{W_0}{W} = kt \quad (8.3)$$

We now need to transform the rate equation to one involving α , the fraction of the sample reacted, by making use of the relationship

$$\alpha = \frac{W_0 - W}{W_0} = 1 - \frac{W}{W_0} \quad (8.4)$$

Therefore, $(1 - \alpha) = W/W_0$ which when substituted in Eq. (8.3) gives

$$-\ln(1 - \alpha) = kt \quad (8.5)$$

If the fraction reacted is α , then $(1 - \alpha)$ is the amount of sample unreacted, and we see that a plot of $-\ln(1 - \alpha)$ versus time would be linear with a slope of k . It should come as no surprise that reactions

are known in which the rate law over some portion of the reaction is first-order, but in the latter stages of the reaction the reaction is diffusion controlled.

8.2.2 The Parabolic Rate Law

Reactions in which a gas or liquid reacts with the surface of a solid are rather common processes in inorganic chemistry. The product that forms as a layer on the surface of the solid may impede the other reactant from contacting the solid. There are several types of behavior that depend on how the product layer affects the mobility of reactants, but in this instance, we will assume that the rate is inversely proportional to the thickness of the product layer. When the rate law is written in terms of the thickness of the product layer, x , the result is

$$\text{Rate} = \frac{dx}{dt} \quad (8.6)$$

Because the rate decreases as x increases, the rate is proportional to $1/x$, indicating that

$$\frac{dx}{dt} = k \frac{1}{x} \quad (8.7)$$

Rearranging gives

$$x \, dx = k \, dt \quad (8.8)$$

At $t = 0$, $x = 0$ and at a later time t , the thickness of the layer is x . Integrating between these limits yields

$$\frac{x^2}{2} = kt \quad (8.9)$$

Because the rate law in this form is a quadratic equation, the rate law is known as the *parabolic rate law*. When we solve this equation for the thickness of the product layer, x , we obtain

$$x = (2kt)^{1/2} \quad (8.10)$$

This is the rate law that applies when the product layer is protective in nature.

If the product layer is not protective, the mobile reactant has access to the surface of the solid. In that case, it is easy to show that the rate law can be expressed as

$$x = kt \quad (8.11)$$

In another type of reaction, the penetration of the mobile reactant varies as $1/x^3$, which gives rise to a so-called cubic rate law of the form

$$x = (3kt)^{1/3} \quad (8.12)$$

As will be described later, a common and important type of reaction that involves the oxidation of metals during corrosion processes sometimes follows a rate law of this form.

8.2.3 Contracting Volume Rate Law

A rate law that shows some of the peculiarities of reactions in solids arises in the following way. A solid particle having a spherical shape is assumed to react only on the surface. This rate law has been found to model the shrinking of solid particles in aerosols as well as other reactions that take place on the surface of solid particles.

In this model, the rate of the reaction is determined by the surface area, $S = 4\pi r^2$, but the amount of the reactant is determined by the volume, $V = 4\pi r^3/3$. The amount of solid reacting is given as $-dV/dt$, and that is determined by the surface area. The rate law can be written as

$$-\frac{dV}{dt} = kS = k(4\pi r^2) \quad (8.13)$$

From the expression for the volume, we can solve for r^2 to obtain $(3V/4\pi)^{2/3}$. Substituting for r^2 in Eq. (8.13) yields

$$-\frac{dV}{dt} = k(4\pi) \left(\frac{3V}{4\pi} \right)^{2/3} = k(4\pi) \left(\frac{3}{4\pi} \right)^{2/3} V^{2/3} = k'V^{2/3} \quad (8.14)$$

where $k' = k(4\pi) (3/4\pi)^{2/3}$. Therefore, we have shown that

$$-\frac{dV}{dt} = k'V^{2/3} \quad (8.15)$$

which leads to this type of process being known as a “two-thirds” order reaction, but this is inappropriate because it is not an “order” type of reaction. After integration, the rate law becomes

$$V_o^{1/3} - V^{1/3} = \frac{k't}{3} \quad (8.16)$$

To obtain the rate law in a form containing α , we recall that the fraction of the particle reacted is the change in volume divided by the original volume, $\alpha = (V_o - V)/V_o$. Rearranging gives $\alpha = 1 - (V/V_o)$, which leads to $(V/V_o) = 1 - \alpha$, the fraction remaining.

Dividing both sides of Eq. (8.16) by $V_o^{1/3}$ gives

$$\frac{V_o^{1/3} - V^{1/3}}{V_o^{1/3}} = 1 - \frac{V^{1/3}}{V_o^{1/3}} = \frac{k't}{3V_o^{1/3}} \quad (8.17)$$

Substituting the expression found above for $(1 - \alpha)$ leads to

$$1 - (1 - \alpha)^{1/3} = \frac{k't}{3V_0^{1/3}} \quad (8.18)$$

This equation can be put in the form

$$1 - (1 - \alpha)^{1/3} = k''t \quad (8.19)$$

where $k'' = k'/3V_0^{1/3}$ and $k' = k \cdot 4\pi(3/4\pi)^{2/3}$. The *observed* rate constant, k'' , is associated with the geometry of the sample, but it is not related to the population of a transition state in the usual sense. If a reaction is assumed to take place on the surface of a cubic solid, the rate law turns out to be identical to that shown above except that the observed rate law has other geometric factors subsumed in it. Although the derivation will not be shown, if reaction involves a receding area, the rate law will contain the quantity $(1 - \alpha)^{1/2}$.

As shown by Eq. (8.15), the reaction is a “two-thirds” order, but that does not involve the concept of molecularity. Since the surface area is a maximum at the beginning of the reaction, the rate is maximum at that time and decreases thereafter. A rate law of this type is known as a *deceleratory* rate law. As will be shown later, there are several rate laws that show this characteristic.

8.2.4 Rate Laws for Cases Involving Nucleation

Solids are not generally equally reactive throughout the sample. Many reactions in solids begin at an active site and progress outward from that point. For example, when a solid undergoes a phase transformation, the change usually begins at active sites that may involve point defects. As the solid changes structure outward from such active sites, it may follow a rate law of the type being considered here. However, many types of reactions in solids as well as crystallization proceed from active sites, so this type of rate law is a frequently occurring one. Microscopic examination and other techniques have been used to follow the spread of reactions from active sites.

The active sites from which a reaction in a solid spreads are known as *nuclei*. It is known that nuclei may grow in one, two, or three dimensions, and each case leads to a different form of the rate law. If the nuclei form in random sites in the solid (or perhaps on the surface), the rate laws are known *random nucleation* rate laws that have the form

$$[-\ln(1 - \alpha)]^{1/n} = kt \quad (8.20)$$

where n is known the *index of reaction*. As should be apparent, the concept of “order” is not applicable in these cases. This rate law is known as the Avrami-Erofeev rate law, for which the initial assumptions about the way in which the reaction spreads from the nuclei give rise to n values of 1.5, 2, 3, or 4. These rate laws are referred to as A1.5, A2, A3, and A4, respectively. Although this will be stated without proof, the case where $n = 1.5$ corresponds to a diffusion-controlled process. Derivations of the Avrami-Erofeev rate laws (sometimes called simply Avrami rate laws) are somewhat tedious, and the interested reader is referred to the references listed at the end of this chapter for details (especially Young, 1966).

Table 8.1 Values of α as a Function of Time for a Reaction Following an Avrami-Erofeev Rate Law with $n = 3$ and $k = 0.020 \text{ min}^{-1}$.

Time, min	α	Time, min	α	Time, min	α
0	0.000	35	0.387	70	0.859
5	0.010	40	0.473	75	0.895
10	0.039	45	0.555	80	0.923
15	0.086	50	0.632	85	0.944
20	0.148	55	0.702	90	0.960
25	0.221	60	0.763	95	0.973
30	0.302	65	0.815	100	0.982

When testing data for α versus t , the object is to identify the appropriate value of n after which the rate constant can be calculated, and knowing the rate constants at several temperatures allows an activation energy to be determined. Taking the logarithm of both sides of Eq. (8.20) yields

$$\frac{1}{n} \ln[-\ln(1 - \alpha)] = \ln(kt) = \ln k + \ln t \quad (8.21)$$

This equation shows that a graph of $\ln[-\ln(1 - \alpha)]$ versus $\ln(t)$ would be linear and have a slope of n and an intercept of $n[\ln(k)]$ if the value of n correctly fits the data. For a series of (α, t) data, plots can be made using the various values of n as trial values to see which value yields a straight line. Because of the numerical idiosyncrasies, it is generally better to make the graphs using Eq. (8.20) by plotting $[\ln(1/(1 - \alpha))]^{1/n}$ versus time to test the n values. In some data analysis procedures, the computations are carried out by computer in such a way that the value of n is allowed to vary from perhaps 1 to 4. Linear regression is carried out iteratively as n is varied by some increment until the highest correlation coefficient is obtained to the accuracy desired. Although this will find a value for n that gives the best fit of the data to an Avrami rate law, there is little *chemical* meaning or interpretation for an n value of perhaps 2.38 or 1.87.

Methods of data analysis for reactions in solids are somewhat different from those used in other types of kinetic studies. Therefore, the analysis of data for an Avrami type rate law will be illustrated by an numerical example. The data to be used are shown in Table 8.1, and they consist of (α, t) pairs that were calculated assuming the A3 rate law and $k = 0.025 \text{ min}^{-1}$.

The data shown in Table 8.1 were used to prepared Figure 8.2. The relationship shows the *sigmoidal* profile that is characteristic of autocatalysis or nucleation processes. Although the graph will not be shown, a plot of $[-\ln(1 - \alpha)]^{1/3}$ versus time for these data yields a straight line as expected. When graphs are prepared of the $[-\ln(1 - \alpha)]^{1/n}$ functions versus time using the various values of n , only the "correct" value of n will yield a straight line. If a trial value of n is larger than the correct value, a curve will be obtained that is concave downward, whereas a value of n smaller than the correct value will result in a curve that is concave upward. If a sigmoidal curve is obtained for α versus time data

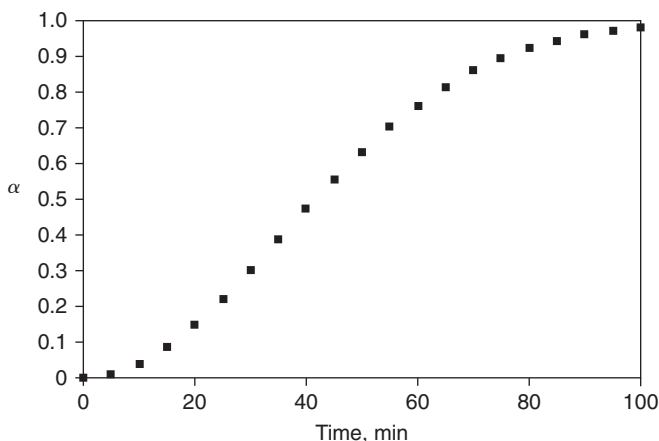

■ **FIGURE 8.2** A graph of α versus time for an Avrami rate law with $n = 3$ and $k = 0.020 \text{ min}^{-1}$.

when analyzing data for a reaction in a solid, it is generally a good indication that the rate of the reaction is controlled by a nucleation process.

A large number of inorganic compounds crystallize as hydrates. One of the most familiar examples is copper sulfate pentahydrate, $\text{CuSO}_4 \cdot 5\text{H}_2\text{O}$. Like most hydrates, when this material is heated it loses water, but because all of the H_2O molecules are bound in different ways, some are lost more easily than others. Therefore, as the solid is heated the reactions observed first are

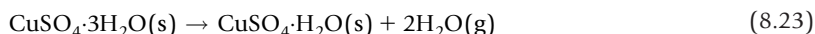
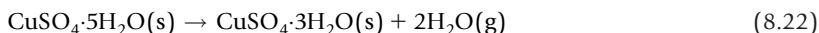

The first of these reactions takes place as the sample is heated in the range 47 to 63 °C and the second in the range 70.5 to 86 °C. When the data were analyzed to determine the rate law for the processes, it was found that both reactions followed an Avrami rate law with an index of 2 as the extent of reaction varied from $\alpha = 0.1$ to $\alpha = 0.9$ (Ng *et al.*, 1978). Another reaction for which most data provide the best fit with an Avrami rate law is



For this reaction, the best fit was given with the A1.5 rate law,

$$1 - (1 - \alpha)^{2/3} = kt \quad (8.25)$$

An interesting reaction of a solid coordination compound is

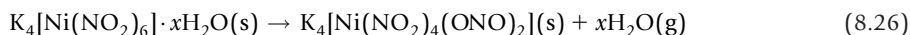

in which dehydration and linkage isomerization of two of the nitrite ligands occurs. For this reaction, an Avrami rate law provided the best fit to the kinetic data, but as is often the case, the inaccuracy of the data did not allow a distinction to be made unambiguously between A1.5 and A2 (House and Bunting, 1975). The essence of this discussion is to show that many types of reactions in solids follow Avrami rate laws.

The kinetic models just described are only a few of those that have been found to represent reactions in solids. Moreover, it is sometimes observed that a reaction may follow one rate law in the early stages of the reaction, but a different rate law may apply in the later stages. Because many of the rate laws that apply to reactions in solids are quite different from those encountered in the study of reactions

Table 8.2 Some Common Rate Laws for Reactions in Solids.

Type of Process		Mathematical Form of $f(\alpha) = kt$
Deceleratory α -time curves based on reaction order		
F1	First-order	$-\ln(1 - \alpha)$
F2	Second-order	$1/(1 - \alpha)$
F3	Third-order	$[1/(1 - \alpha)]^2$
Deceleratory α -time curves based on geometrical models		
R1	One-dimensional contraction	$1 - (1 - \alpha)^{2/3}$
R2	Contracting area	$1 - (1 - \alpha)^{1/2}$
R3	Contracting volume	$1 - (1 - \alpha)^{1/3}$
Deceleratory α -time curves based on diffusion		
D1	One-dimensional diffusion	α^2
D2	Two-dimensional diffusion	$(1 - \alpha)\ln(1 - \alpha) + \alpha$
D3	Three-dimensional diffusion	$[1 - (1 - \alpha)^{1/3}]^2$
D4	Ginstling-Brounshtein	$[1 - (2\alpha/3)] - (1 - \alpha)^{2/3}$
Sigmoidal α -time curves		
A1.5	Avrami-Erofeev one-dimensional growth of nuclei	$[-\ln(1 - \alpha)]^{2/3}$
A2	Avrami-Erofeev two-dimensional growth of nuclei	$[-\ln(1 - \alpha)]^{1/2}$
A3	Avrami-Erofeev three-dimensional growth of nuclei	$[-\ln(1 - \alpha)]^{1/3}$
A4	Avrami-Erofeev	$[-\ln(1 - \alpha)]^{1/4}$
B1	Prout-Tompkins	$\ln[\alpha/(1 - \alpha)]$
Acceleratory α -time curves		
	Power law	$\alpha^{1/2}$
	Exponential law	$\ln \alpha$

in gases and solutions, a summary of the most common types is presented in Table 8.2. Although the rate laws shown in Table 8.2 do not encompass all of those known to model solid-state reactions, they do apply to the vast majority of cases.

Fitting data for the fraction of a reaction complete as a function of time to the kinetic models is often accompanied by some difficulty. For some reactions, it may not be possible to determine the values for α with high accuracy, and examination of the rate laws shown in Table 8.2 shows that some of them do not differ much. Slight errors in the data can obscure subtle differences in how well the rate laws model a reaction. For example, a series of data for α as a function of time might give about an equally good fit to the A2 or A3 rate laws because they differ only slightly in mathematical form. In most cases, it is not possible to follow a reaction over several half-lives, and if this were done it is likely that the early and latter stages of the reaction would not be correctly modeled by the same rate law. In an effort to reduce the difficulty in determining the correct rate law, several replicate kinetic runs can be made, and the data analyzed as described earlier. In most cases, the data from a *majority* of the runs will indicate the same rate law as the best fitting-one. Kinetic studies on reactions in the solid state involve a rather different protocol than is followed for studies on reactions in the gas phase or in solutions.

In general, the function that gives the best fit (as indicated by the highest correlation coefficient) to the α , t data is assumed to be the “correct” rate law. However, if several runs are made, it is usually the case that not *all* of the data sets will give the best fit with the same rate law.

8.2.5 Reactions between Two Solids

Although not particularly common, there are numerous cases in which two solids undergo a reaction. This must usually be induced by heating the mixed solids or supplying energy by some other means such as heat or pressure. It has also been found that when two solids are suspended in an inert liquid, the application of ultrasound can cause them to react. In some ways, the effect of ultrasound is similar to instantaneous application of heat and pressure because the particles are driven together as cavitation occurs. Ultrasound causes cavitation and when the cavities implode, the suspended particles are driven together violently as a result of internal pressures that may be as much as a few thousand atmospheres (see Chapter 6). When this happens, there may be a reaction between the particles. An example of this type of process is

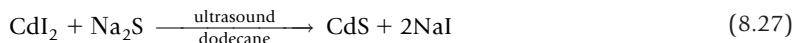

Although we have shown several kinetic models for reacting solids, none specifically applies to a reaction between *two* solids. A rate law that was developed many years ago to model reacting powders is known as the Jander equation, and it is written as

$$\left[1 - \left(\frac{100 - y}{100} \right)^{1/3} \right]^2 = kt \quad (8.28)$$

where γ is the percent of the reaction complete. This equation can also be written as

$$\left[1 - \left(1 - \frac{\gamma}{100}\right)^{1/3}\right]^2 = kt \quad (8.29)$$

When γ is the percent reacted, $\gamma/100$ is the fraction reacted, which is equal to α , and the equation can be written as

$$[1 - (1 - \alpha)^{1/3}]^2 = kt \quad (8.30)$$

This equation has the same form as that for three-dimensional diffusion (see Table 8.2). The Jander equation was found to model the process shown in Eq. (8.27) quite well. The reaction between two solids requires the reaction to begin on the surface of the particles and progress inward. For solids in which there is no anisotropy in the structures, diffusion should take place equally in all directions, so a three-dimensional diffusion model would seem to be appropriate.

8.3 THERMAL METHODS OF ANALYSIS

From the discussion presented of reactions in solids, it should be apparent that it is not practical in most cases to determine the concentration of some species during a kinetic study. In fact, it may be necessary to perform the analysis in a continuous way as the sample reacts with no separation necessary or even possible. Experimental methods that allow measurement of the progress of the reaction, especially as the temperature is increased, are particularly valuable. Two such techniques are *thermogravimetric analysis* (TGA) and *differential scanning calorimetry* (DSC). These techniques have become widely used to characterize solids, determine thermal stability, study phase changes, and so forth. Because they are so versatile in studies on solids, these techniques will be described briefly.

Thermoanalytical methods comprise a series of techniques in which a property is determined at different temperatures or as the temperature changes continuously. The property measured may include the mass of the sample (TGA), the heat flow to the sample (DSC), the magnetic character of the sample (TMA), or some other property such as dimensional changes. Each of these types of measurements gives information on some change undergone by the sample, and if the change is followed over time, it is possible to derive kinetic information about the transformation.

When heated, many solids evolve a gas. For example, most carbonates lose carbon dioxide when heated. Because there is a mass loss, it is possible to determine the extent of the reaction by following the mass of the sample. The technique of thermogravimetric analysis involves heating the sample in a pan surrounded by a furnace. The sample pan is suspended from a microbalance so its mass can be monitored continuously as the temperature is raised (usually as a linear function of time). A recorder provides a graph showing the mass as a function of temperature. From the mass loss, it is often possible to establish the stoichiometry of the reaction. Because the extent of the reaction can be followed, kinetic analysis of the data can be performed. Because mass is the property measured, TGA is useful for

studying processes in which volatile products are formed. In another form of thermal analysis, known as *thermodilatometry*, the volume of the sample is followed as the temperature is changed. If the sample undergoes a phase transition, there will usually be a change in density of the material so the volume of the sample will change. Other properties such as the behavior of a sample in a magnetic field can be studied as the temperature is changed.

Differential scanning calorimetry involves using sophisticated electronic circuits to compare the heat flow necessary to keep the sample and a reference at the same temperature as both are heated. If the sample undergoes an endothermic transition, it takes more heat to keep its temperature increasing at a constant rate than if no reaction occurred. Conversely, if the sample undergoes an exothermic transition, less heat is required to keep its temperature increasing at a constant rate. These situations cause the recorder to show a peak in either the endothermic or exothermic direction, respectively. The area under the peak is directly proportional to the amount of heat absorbed or liberated, so if a calibration peak has been obtained, it is possible to determine ΔH for the transition from the area under the peak. The fraction of the reaction complete is obtained by comparing area under the peak when heating to several intermediate temperatures has occurred to that corresponding to the complete reaction. Knowing the extent of the reaction as a function of time or temperature enables the rate law for the transformation to be determined. DSC can be used to study processes for which there is no mass loss, as long as the transformation absorbs or liberates heat. Therefore, it can be used to study changes in crystal structure as well as chemical reactions.

The brief description of TGA and DSC presented here is intended to show the types of measurements that are possible. To see how the methods are useful for studying changes in solids, it is not necessary to discuss the operation of the instruments or to go into details of data analysis. However, it should become clear during the discussion how useful these techniques are for studying solids.

Another technique that has been employed for studying certain types of changes in solids is infrared spectroscopy, in which the sample is contained in a cell that can be heated. By monitoring the infrared spectrum at several temperatures, it is possible to follow changes in bonding modes as the sample is heated. This technique is useful for observing phase transitions and isomerizations. When used in combination, techniques such as TGA, DSC, and variable-temperature spectroscopy make it possible to learn a great deal about dynamic processes in solids.

8.4 EFFECTS OF PRESSURE

Although volume changes in liquid and solids are small, the application of high pressure can be considered as doing work on the sample. Generally, a transformation from one form of a solid to another is brought about by increasing the temperature. If the two forms have different volumes, increasing the pressure will favor a shift to the form having the smaller volume. If the sample undergoes a reaction, the transition state may have smaller or larger volume than the starting material. If the volume of the transition state is smaller than that of the reactants, increasing the pressure will favor formation of the transition state and thus increase the rate of the reaction. On the other hand, if the transition state has a larger volume than the reactants, increasing the pressure will hinder the formation of the transition

state, thereby decreasing the rate of the reaction. Pressure studies have provided valuable information about several types of dynamic processes in solids that include phase transitions, isomerizations, and chemical reactions.

To gain an appreciation of the effect produced by pressure, we will consider the following example. Suppose that increasing the pressure on a sample by 1000 atm produces a change in volume of $10 \text{ cm}^3/\text{mol}$. The work done on the sample is given by $P\Delta V$, which is

$$1000 \text{ atm} \times 0.010 \text{ liter/mol} = 10 \text{ liter atm/mol}$$

When converted to kJ/mol , the work done on the sample is found to be only 1.01 kJ/mol . In order to produce a significant amount of work on the sample requires enormous pressures. The effects are usually observable only when several kbar are involved ($1 \text{ bar} = 0.98692 \text{ atm}$). Volume changes in the order of plus or minus $25 \text{ cm}^3/\text{mol}$ are typical for pressure changes of 10 kbar.

When a chemical reaction takes place, the volume change accompanying the formation of the transition state is known as the *volume of activation*, ΔV^\ddagger . It can be expressed as

$$\Delta V^\ddagger = V^\ddagger - \Sigma V_R \quad (8.31)$$

where V^\ddagger is the volume of the transition state and ΣV_R is the sum of the molar volumes of the reactants. The free energy of activation is given by

$$\Delta G^\ddagger = G^\ddagger - \Sigma G_R \quad (8.32)$$

where G^\ddagger is the free energy of the transition state and ΣG_R is the sum of the molar free energies of the reactants. However, for a process at constant temperature

$$\left(\frac{\partial G}{\partial P} \right)_T = V \quad (8.33)$$

For reactants forming a transition state, it is found that

$$\left(\frac{\partial G}{\partial P} \right)_T = V^\ddagger - \Sigma V_R = \Delta V^\ddagger \quad (8.34)$$

From transition state theory, we know that the equilibrium constant for formation of the transition state (K^\ddagger) is related to the free energy by the relationship

$$\Delta G^\ddagger = -RT \ln K^\ddagger \quad (8.35)$$

The variation in rate constant (which depends on the concentration of the transition state) with pressure can be expressed as

$$\left(\frac{\partial \ln k}{\partial P}\right)_T = -\frac{\Delta V^\ddagger}{RT} \quad (8.36)$$

At constant temperature, the partial derivatives can be replaced, and rearrangement of this equation leads to

$$\Delta V^\ddagger = -RT \frac{d \ln k}{dP} \quad (8.37)$$

Solving this equation for $d \ln k$ gives

$$d \ln k = -\frac{\Delta V^\ddagger}{RT} dP \quad (8.38)$$

which can be integrated to give

$$\ln k = -\frac{\Delta V^\ddagger}{RT} \cdot P + C \quad (8.39)$$

From this equation, we see that if the rate constant is determined at a series of pressures, a plot of $\ln k$ versus P should be linear with the slope being $-\Delta V^\ddagger/RT$. Although this approach is valid, the graph obtained may not be exactly linear, but the interpretation of these cases does not need to be presented here. It is sufficient to note that the volume of activation can be determined by studying the effect of pressure on reaction rates.

When the value for ΔV^\ddagger is negative, an increase in pressure will increase the rate of reaction. This has been observed for the linkage isomerization reaction (see Chapter 20)



The negative volume of activation in this case is interpreted as indicating that the $-\text{ONO}$ group does not leave the coordination sphere of the metal but rather changes bonding mode by a sliding mechanism that leads to a transition state that has a smaller volume than the initial complex. Some complexes having a coordination number of 5 are known that can exist in either the trigonal bipyramid or square based pyramid structure. The transformation from one structure to another has been shown in some cases to be induced by high pressure.

As was discussed in Chapter 7, there are numerous solids that can exist in more than one form. It is frequently the case that high pressure is sufficient inducement for the structure to change. An example of this type of behavior is seen in KCl, which has the sodium chloride (rock salt) structure at ambient pressure, but is converted to the cesium chloride structure at high pressure. Other examples illustrating the effect of pressure will be seen throughout this book (see especially Chapter 20). It should be kept

in mind that studies involving pressure changes can yield information about transformations that is not easily obtainable by other means.

8.5 REACTIONS IN SOME SOLID INORGANIC COMPOUNDS

The number of inorganic substances that undergo some type of reaction in the solid state is very large. If reactions in which a solid is converted into a different solid phase and a volatile product are included, the number is even larger. Even though the number of reactions known to occur in solid compounds is very large, many have not been the subject of kinetic studies. In this section, a few of the types of processes that have been studied will be shown. Numerous other examples will be shown in later chapters of this book, especially Chapters 13, 14, and 20. All of the reactions shown take place at elevated temperature (some *very* elevated), so heating is understood. The temperatures required depend on the specific compound, and some of the reactions are shown as general types. Consequently, the temperatures required are not shown.

When metal carbonates are heated, they decompose to produce the metal oxide and CO_2 . From an economic standpoint, the decomposition of limestone, CaCO_3 , is perhaps the most important reaction of this type because the product, lime, is used in making mortar and concrete.



In another reaction of this type, metal sulfites lose SO_2 when heated,



Partial decomposition of some salts is the preparative means to others. For example, the commercial preparation of tetrasodium diphosphate involves the thermal dehydration of Na_2HPO_4 :



Other compounds that can be partially decomposed include dithionates, with the following being typical reactions of this type:

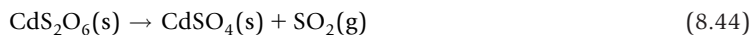

As will be discussed in Chapter 14, the thermal decomposition of solids containing the $\text{S}_2\text{O}_6^{2-}$ ion to give SO_4^{2-} and SO_2 is a general reaction of dithionates.

When most solid oxalates are heated, they are converted to the corresponding carbonate with the evolution of CO :



Oxalates are frequently obtained as hydrates, so the first reaction when a hydrated metal oxalate is heated is the loss of water. However, some metal oxalates decompose in a reaction that is quite different from that shown in Eq. (8.46). Several metal oxalates decompose according to the following equation:

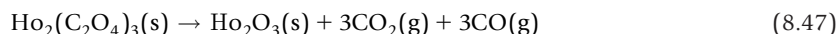

This behavior is not unexpected, given the fact that many metal carbonates lose CO_2 to produce the oxides.

In a somewhat more unusual reaction, heating an alkali metal peroxydisulfate results in the rupture of the O–O linkage in the $\text{S}_2\text{O}_8^{2-}$ ion with the loss of oxygen. For example,

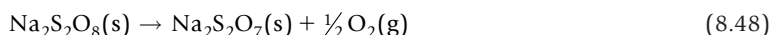

The O–O bond in most peroxides has an energy of approximately 140 kJ/mol, which is approximately the activation energy for this reaction. Although it is tempting to say that the initial step in the decomposition of the peroxydisulfate is the breaking of the O–O bond, one cannot be certain that this is so just because the activation energy is about equal to that bond energy.

Earlier in this chapter, it was pointed out that prior treatment and procedural variables can affect the kinetics of reactions of a solid substance. Although a large number of studies have been conducted to evaluate these factors, two such studies will be summarized here.

Ammonium salts usually decompose to gaseous products, and a sizeable number of such compounds have been the subject of kinetic studies (House *et al.*, 1995). Decomposition of ammonium carbonate leads to gaseous products,

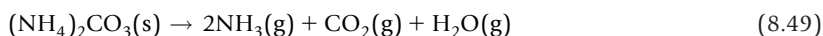

As a result, ammonium carbonate is conveniently studied by mass loss techniques such as TGA. In one study, the decomposition of particles having different size distributions (302 ± 80 , 98 ± 36 , and $30 \pm 10 \mu\text{m}$, respectively) was studied by carrying out a large number of kinetic runs. It was found that decomposition of the largest particles almost always followed either a first-order or a three-dimensional diffusion rate law. The samples consisting of particles having intermediate size decomposed by a first-order rate law, and samples containing the smallest particles decomposed by a three-dimensional diffusion rate law.

A reaction that has been the subject of numerous studies is the dehydration of $\text{CaC}_2\text{O}_4 \cdot \text{H}_2\text{O}$:

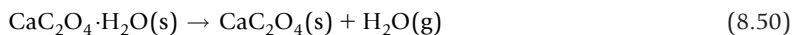

In a highly replicated kinetic study (House and Eveland, 1993), the dehydration of samples of freshly prepared $\text{CaC}_2\text{O}_4 \cdot \text{H}_2\text{O}$ and material that had been stored in a desiccator for a year was studied. It was found that the kinetics of the dehydration reaction did not depend on the particle size, but there was

a great difference between the behavior of the freshly prepared and aged samples. The R1 (one-dimensional contraction) rate law was most appropriate for the freshly prepared material, but the aged material showed considerable variation in replicate kinetic runs. The majority of the data fit the R1 rate law, but several runs gave the best fit with an A2 or A3 rate law. Moreover, dehydration of the material studied soon after its preparation had an activation energy of 60.1 ± 6.6 kJ/mol, but that for the aged material had an activation energy of 118 ± 15 kJ/mol. Although many other kinetic studies on the decomposition of inorganic solids could be described, the discussion presented shows illustrative examples of this important area.

8.6 PHASE TRANSITIONS

The transformation of a substance from the solid phase to the liquid phase (melting) is a common type of change in state. However, a transformation of a solid substance from one solid *structure* to another is also referred to as a phase transition, although no change in physical *state* occurs. In Chapter 7, the ability of metals to be converted from one structure to another was described. In some cases, there is no change in coordination number as the metal changes from one form to another, such as in the transition Co(*hcp*) to Co(*fcc*), where both structures have a coordination number of 12. However, in the transformation of Ti(*hcp*) to Ti(*bcc*) the coordination number of Ti changes from 12 to 8. Phase transitions are observed to occur in all types of materials. For example, sulfur exists at room temperature in the rhombic form, but at temperatures near the melting point it is converted to the monoclinic form.

Although most phase transitions are brought about by a change in temperature, many phase transitions can also be induced by a change in pressure. As a material changes structure, there is almost always *some* change in volume, and as described in Section 8.4, increasing the applied pressure favors the phase that has smaller volume. When pressure is applied to KCl, it changes from the sodium chloride structure to the cesium chloride structure. The pressure required is 19.6 kbar and the volume change is -4.11 cm³/mol. One way to study phase transitions is by dilatometry, and instruments for measuring volume changes as a function of temperature are available.

Transformation of a solid such as KCl from the NaCl structure to the CsCl structure is a vastly different situation from that of converting graphite into diamond. In the latter transition, the bonds between carbon atoms must be broken and replaced with an entirely different bonding mode. This type of transition is called a *reconstructive* transition. Such changes are normally slow and have high activation energies associated with them. The transformation of most ionic solids from one crystal structure to another does not involve breaking *all* of the ionic bonds between the ions, so the process usually has a low activation energy because the change in structure is relatively minor. Phase transitions of this type are called *displacive* transitions. Both reconstructive and displacive transitions may involve the groups in either the primary or first bonding environment (nearest neighbors) or the secondary environment. For example, if a solid consists of tetrahedral units, breaking the primary bonding environment would require the breaking of bonds *within* the units, whereas disrupting the secondary environment would involve breaking bonds *between* the units. Numerous examples of all of these types of phase transitions are known.

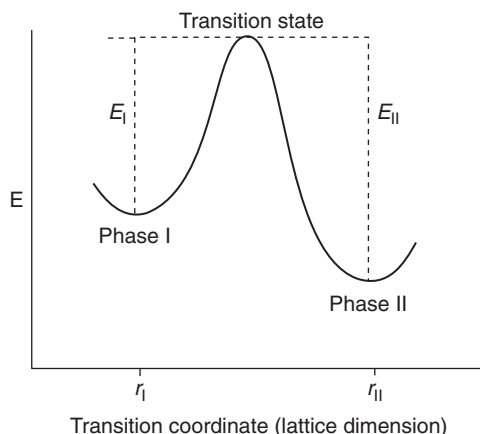

■ **FIGURE 8.3** The energy profile for the transformation of a solid from phase I to phase II.

An enormous number of phase transitions are known to occur in common solid compounds. For example, silver nitrate undergoes a displacive phase transition from an orthorhombic form to a hexagonal form at a temperature of approximately 162°C that has a enthalpy of 1.85 kJ/mol. In many cases, the nature of these transitions are known, but in other cases there is some uncertainty. Moreover, there is frequently disagreement among the values reported for the transition temperatures and enthalpies. Even fewer phase transitions have been studied from the standpoint of kinetics, although it is known that a large number of these transformations follow an Avrami rate law. There is another complicating feature of phase transitions that we will now consider.

Suppose a solid S is transformed from phase I (S_I) to phase II (S_{II}). The energy profile for the transition of a solid from phase I to phase II resembles that for a chemical reaction. However, consider the energy diagram shown in Figure 8.3. In this case, the activation energy for the forward process ($I \rightarrow II$) is lower than that for the reverse process. If the solid is heated infinitesimally slowly (which in the limit approaches equilibrium conditions), the rate at which phase I is converted into phase II in the forward process ($S_I \rightarrow S_{II}$) will be equal to the rate for the reverse process ($S_{II} \rightarrow S_I$). Therefore, if a graph is made showing the fraction of the sample in the initial phase as a function of temperature, the same curve will result regardless of which direction the conversion is carried out. This situation is shown in Figure 8.4. This is true if (and usually only if) the transformation is carried out by changing the temperature at an infinitesimally low rate.

In the usual experiments, the sample may be heated (or cooled) at a rate of a fraction of a degree per minute up to several degrees per minute. Under these conditions, the rates of the forward and reverse reactions are *not* equal. The result will be that the heating and cooling curves giving α as a function of temperature will *not* coincide. The curves generate a loop that is known as *thermal hysteresis*. In the more usual case, the rate of the reverse reaction upon cooling the sample is *lower* than that of the forward reaction (as it would be for the system represented by the energy profile shown in Figure 8.3).

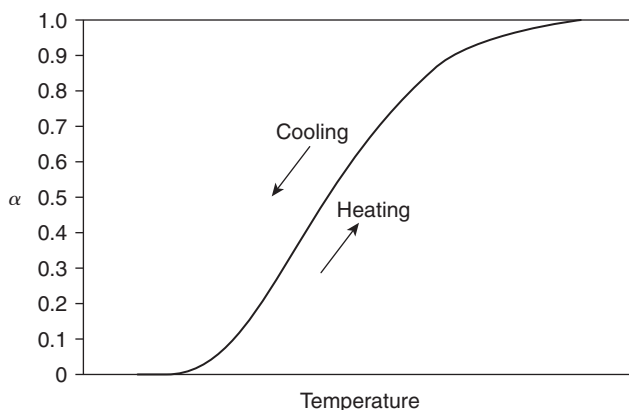

■ **FIGURE 8.4** The fraction of the sample transformed from I \rightarrow II (heating) and from II \rightarrow I (cooling) as a function of temperature. In this case there is no thermal hysteresis.

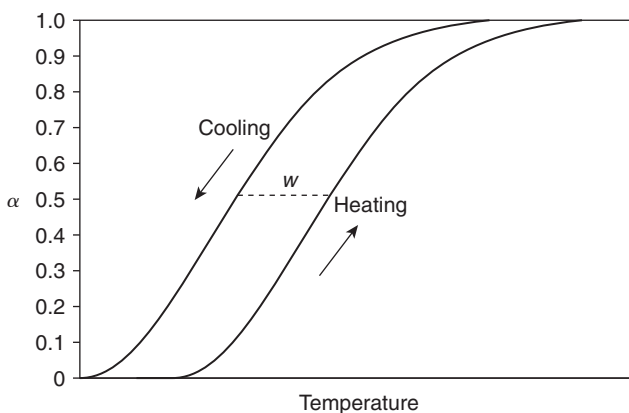

■ **FIGURE 8.5** The thermal hysteresis that occurs when the rate of the phase change on cooling is lower than that on heating at the same temperature.

At a given temperature the fraction of the sample converted as the sample is cooled is lower than that obtained as the sample is heated. The result is shown in Figure 8.5.

In Figure 8.5, w is the distance between the heating and cooling curves at the point where $\alpha = 0.5$ is called the *hysteresis width*. This temperature may be quite small, or it may amount to several degrees depending on the nature of the phase transition and the heating rate. Many substances exhibit this type of behavior as a result of a phase change.

From a thermodynamic standpoint, we know that at the temperature at which the two phases are in equilibrium, the free energy, G , is the same for both phases. Therefore,

$$\Delta G = \Delta H - T\Delta S = 0 \quad (8.51)$$

As a result, there will be a continuous change in G as the transition of one phase into another takes place. However, for some phase transitions (known as *first-order transitions*), it is found that there is a discontinuity in the *first derivative* of G with respect to pressure or temperature. It can be shown that the partial derivative of G with pressure is equal to volume, and the derivative with respect to temperature is equal to entropy. Therefore, we can express these relationships as follows:

$$\left(\frac{dG}{dP}\right) = V \quad (8.52)$$

$$\left(\frac{dG}{dT}\right) = -S \quad (8.53)$$

For the first case, as the sample is heated, there will be a change in the volume of the sample that can be followed by a technique known as dilatometry. For changes in entropy, use can be made of the fact that $\Delta G = 0$, and from Eq. (8.51) we find that

$$\Delta S = \frac{\Delta H}{T} \quad (8.54)$$

Although there are other ways, one of the most convenient and rapid ways to measure ΔH is by differential scanning calorimetry. When the temperature is reached at which a phase transition occurs, heat is *absorbed*, so more heat must flow to the sample in order to keep the temperature equal to that of the reference. This produces a peak in the endothermic direction. If the transition is readily reversible, cooling the sample will result in heat being *liberated* as the sample is transformed into the original phase, and a peak in the exothermic direction will be observed. The area of the peak is proportional to the enthalpy change for transformation of the sample into the new phase. Before the sample is completely transformed into the new phase, the *fraction* transformed at a specific temperature can be determined by comparing the *partial* peak area up to that temperature to the *total* area. That fraction, α , determined as a function of temperature can be used as the variable for kinetic analysis of the transformation.

A different type of phase transition is known in which there is a discontinuity in the second derivative of free energy. Such transitions are known as *second-order transitions*. From thermodynamics we know that the change in volume with pressure at constant temperature is the coefficient of compressibility, β , and the change in volume with temperature at constant pressure is the coefficient of thermal expansion, α . The thermodynamic relationships can be shown as follows:

$$\left(\frac{\partial^2 G}{\partial P^2}\right)_T = \left(\frac{\partial V}{\partial P}\right)_T = -\beta V \quad (8.55)$$

$$\left(\frac{\partial^2 G}{\partial P \partial T}\right) = \left(\frac{\partial V}{\partial T}\right)_P = \alpha V \quad (8.56)$$

In addition to these relationships, we know that the second derivative of free energy with temperature can be expressed by the following relationship:

$$\frac{\partial^2 G}{\partial T^2} = - \left(\frac{\partial S}{\partial T} \right)_p = - \frac{C_p}{T} \quad (8.57)$$

For certain types of phase transitions, it is possible to study the process by following changes in these variables.

As a phase transition occurs, there is a change of some type in the lattice. The units (molecules, atoms, or ions) become more mobile. If the solid is reacting in some way and the temperature is at or very near that at which the solid undergoes a phase transition, there may be a rapid increase in the rate of the reaction with a slight increase in temperature because lattice reorganization enhances the ability of the solid to react. A similar situation can occur in cases in which two solids are reacting if the temperature is at or near the temperature corresponding to a phase transition in one of the solids. This phenomenon is sometimes referred to as the *Hedvall effect*.

8.7 REACTIONS AT INTERFACES

Several types of reactions involving solids with gases or liquids occur at the interface between the two phases. The most important reaction of this type is corrosion. Efforts to control or eliminate corrosion involve research that spans the spectrum from the coatings industry to the synthesis and production of corrosion-resistant materials. The economic ramifications of corrosion are enormous. Although there are numerous types of reactions that can be represented as taking place at an interface, the oxidation of a metal will be described. Figure 8.6 represents the oxidation of a metal.

At the interface, oxygen atoms add two electrons to become oxide ions. At the surface of the metal, metal atoms are oxidized to metal ions by losing electrons. In the process, migration of electrons occurs, but is also necessary for O^{2-} and M^{2+} ions to be combined, and that requires mobility. Even though the electrons are normally more mobile, both cations and anions diffuse. As a result of the reduction on the surface, there is a somewhat negative charge at the gas/solid interface. This results in an electric field gradient that assists the migration of metal ions to the extent that they may actually be more mobile than the oxide ions.

When the reacting metal is iron, the process is complicated by the fact that iron has two oxidation states, +2 and +3. Therefore, possible oxidation products include the well-known oxides Fe_2O_3 , Fe_3O_4 (which is $Fe_2O_3 \cdot FeO$), and FeO . Because oxygen is in excess at the surface, the product at the surface will contain the metal in its highest oxidation state, which means the product will have the lowest percentage of iron (highest percentage of oxygen). That product is Fe_2O_3 . Of the iron oxides just mentioned, the product having the next highest oxygen content is Fe_3O_4 . Finally, farther below the surface there will be FeO , and the interior of the object will be iron. Figure 8.7 shows these features of the oxidation process.

Because of the way in which reactions such as this take place, the phases are not normally stoichiometric compounds. The result is that there are vacancies into which the Fe^{2+} ions can move. It has

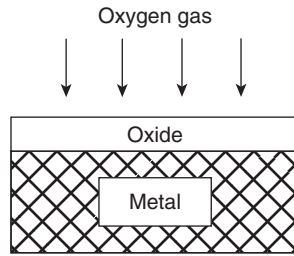

■ FIGURE 8.6 The oxidation of a metal object.

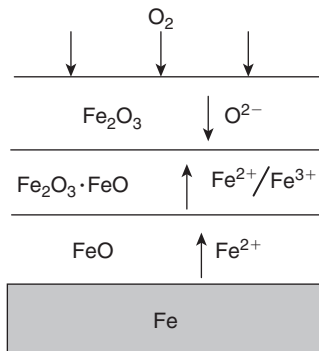

■ FIGURE 8.7 A representation of the phases present and the motion of ions in the corrosion of iron. (Adapted from Borg and Dienes, 1988, p. 295.)

been found that in the early stages of corrosion the rate varies with the partial pressure of oxygen and that the rate varies as $P(\text{O}_2)^{0.7}$ when the pressure is low ($P(\text{O}_2) < 1$ torr). This dependence of the rate on the pressure of oxygen can be shown to be consistent with chemisorption of oxygen being the rate-determining process. It can be shown that if the process were controlled by the rate of conversion of oxygen molecules into oxide ions, the rate would depend on $P(\text{O}_2)^1$. If the reaction involves equilibrium between oxygen molecules and oxide ions on the surface of the FeO, the rate at which FeO is produced would depend on $P(\text{O}_2)^{1/2}$. Neither of these mechanisms is consistent with the observed dependence of the rate on the partial pressure of oxygen.

At high temperature and a higher partial pressure of oxygen ($1 < P(\text{O}_2) < 20$ torr), the rate of growth of the FeO layer follows the parabolic rate law. The rate of formation of FeO is determined by the rate of diffusion of Fe^{2+} , but the rate of diffusion of O^{2-} determines the rate at which the thickness of Fe_2O_3 increases.

8.8 DIFFUSION IN SOLIDS

Although solids have definite shapes and the lattice members (atoms, ions, or molecules) are essentially fixed in their locations, there is still movement of units from their lattice sites. In fact, several

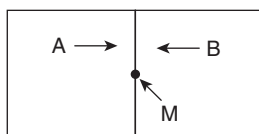

■ FIGURE 8.8 A marker wire (M) placed at the interface of metals A and B.

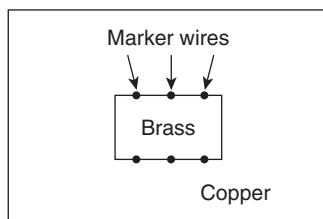

■ FIGURE 8.9 The experiment to show vacancy movement in diffusion of zinc.

properties of solids are determined by diffusion within a solid structure. There are two principal types of diffusion processes. *Self-diffusion* refers to diffusion of matter within a pure sample. When the diffusion process involves a second phase diffusing into another, the process is called *heterodiffusion*. Self-diffusion in metals has been extensively studied, and the activation energies for diffusion in many metals have been determined. Diffusion in a metal involves the motion of atoms through the lattice. Melting a solid requires a temperature high enough to cause the lattice members to become mobile. Not surprisingly, it has been found there is a good linear relationship between the melting points of metals and the activation energies for self diffusion.

It is known that if two metals having different diffusion coefficients are placed in contact (as if they are welded together), there is some diffusion at the interface. Suppose two metals, A and B, are placed in intimate contact as illustrated in Figure 8.8. The concentration of each metal in the other will be highest at the interface and decrease (usually exponentially) as the distance from the interface increases. If a wire (usually referred to as a marker) made of an inert material is placed the interface, the metals moving at different rates will cause the wire to appear to move. If A diffuses past the marker to a greater extent than does B, it will appear that the marker has moved farther into the block of metal A. In this way, it is possible to identify the more mobile metal. If the metals diffuse at the same rate, the wire would remain stationary. An application of this principle was made in the study of diffusion of zinc in brass. The arrangement is shown in Figure 8.9.

When this system was studied over time, it was found that the marker wires move toward each other. This shows that the most extensive diffusion is zinc from the brass (an alloy of zinc and copper) outward into the copper. If the mechanism of diffusion involved an *interchange* of copper and zinc, the wires would not move. The diffusion in this case takes place by the *vacancy* mechanism described later, as zinc moves from the brass into the surrounding copper. As the zinc moves *outward*, vacancies are produced in the

brass and the wires move *inward* with the rate of movement of the wires being proportional to $t^{1/2}$ [the parabolic rate law shown in Eq. (8.10)]. This phenomenon is known as the *Kirkendall effect*.

Displacements of lattice members are determined by energy factors and concentration gradients. To a considerable extent, diffusion in solids is related to the existence of vacancies. The “concentration” of defects, N_o , (sites of higher energy) can be expressed in terms of a Boltzmann distribution as

$$N_o = N_x e^{-E/kT} \quad (8.58)$$

where N_x is the total number of lattice members, k is Boltzmann’s constant, and E is the energy necessary to create the defect. Because the creation of a defect is somewhat similar to separating part of the lattice to give a more random structure, E is comparable to the heat of vaporization. In some cases, a lattice member in a Frenkel defect can move into a vacancy or Schottky defect to remove both defects in a recombination process.

When a crystal is heated, lattice members become more mobile. As a result, there can be removal of vacancies as they become filled by diffusion. Attractions to nearest neighbors are reestablished that result in a slight increase in density and the liberation of energy. There will be a disappearance of dislocated atoms or perhaps a redistribution of dislocations. These events are known to involve several types of mechanisms. However, the diffusion coefficient, D , is expressed as

$$D = D_o e^{-E/RT} \quad (8.59)$$

where E is the energy required for diffusion, D_o is a constant, and T is the temperature (K). The similarity of this equation to the Arrhenius equation that relates the rate constant for a reaction to temperature is apparent.

One type of diffusion mechanism is known as the *interstitial* mechanism because it involves movement of a lattice member from one interstitial position to another. When diffusion involves the motion of a particle from a regular lattice site into a vacancy, the vacancy then is located where the site was vacated by the moving species. Therefore, the vacancy moves in the *opposite* direction to that of the moving lattice member. This type of diffusion is referred to as the *vacancy* mechanism. In some instances, it is possible for a lattice member to vacate a lattice site and for that site to be filled simultaneously by another unit. In effect, there is a “rotation” of two lattice members, so this mechanism is referred to as the *rotation* mechanism of diffusion.

In addition to movement of lattice members within a crystal, it is also possible for there to be motion of members along the surface. Consequently, this type of diffusion is known as *surface diffusion*. Because crystals often have grain boundaries, cracks, dislocations, and pores, there can be motion of lattice members along and within these extended defects.

The energy change as diffusion occurs can be illustrated as shown in Figure 8.10. With each internal lattice site having essentially the same energy, motion of a lattice member from one regular lattice to another involves the diffusing species moving over an energy barrier, but the initial and final energies are the same, as shown in Figure 8.10a. When a lattice member moves from a regular lattice site into an

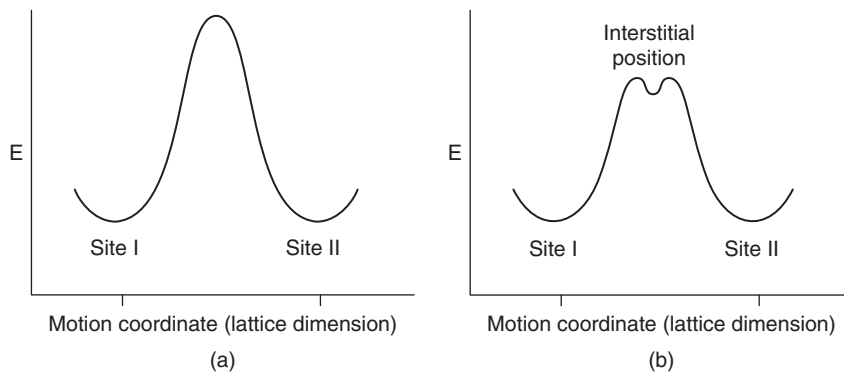

■ **FIGURE 8.10** A representation of the energy change that occurs during diffusion.

interstitial position, there is an energy barrier to the motion. The interstitial position represents a higher energy than that of a regular site, so the energy profile is like that shown in Figure 8.10b. However, the interstitial position represents a site of lower energy than other positions in the immediate vicinity. This gives rise to an energy relationship that can be shown as in Figure 8.10b in which there is an energy “well” at the top of the potential energy curve. Energy increases as the lattice member moves from its site, but when the member is in precisely an interstitial position, the energy is slightly lower than when it is displaced slightly from the interstitial position.

8.9 SINTERING

Sintering forms the basis for the important manufacturing process known as powder metallurgy as well as the preparation of ceramics. Objects are produced from powdered materials that include high-melting metals (such as molybdenum and tungsten), carbides, nitrides, and others. These materials are formed to make machine parts, gears, tools, turbine blades, and many other products. In order to shape the objects, a mold is filled with the powdered material and pressure is applied. For a given mass of a particulate solid, the smaller the particles, the larger the surface area. When heated at high temperature, the material flows, pores disappear, and a solid mass results, even though the temperature may be below the melting point of the material. Plastic flow and diffusion allow the particles to congeal to form a solid mass. By using powder metallurgy, it is possible to produce objects having high dimensional accuracy more economically than if machining were required. The nature of this important process will be described in more detail later in this section.

If a regular lattice such as the NaCl structure is considered, it will be seen that within the crystal each ion is surrounded by six others of opposite charge. However, each ion on the surface of the crystal does not have a nearest neighbor on one side, so the coordination number is only 5. Along an edge of the crystal, the coordination number is 4 because there are two sides that do not have a nearest neighbor. Finally, an ion on the corner of the crystal has three sides that are not surrounded by nearest neighbors, so those units have a coordination number of 3. If the crystal structure of a metal is examined, a similar difference between the coordination numbers of the internal, facial, edge, and corner atoms will be seen.

The total interaction for any lattice member with its nearest neighbors is determined by the coordination number. Consequently, lattice members in positions on faces, edges, and corners are in high-energy positions, with the energy of the positions increasing in that order. There is a tendency for the occupancy of high-energy sites to be minimized. In a small amount of liquid (such as a droplet), that tendency is reflected by the formation of a surface of minimum area, which is spherical because a sphere gives the smallest surface area for a given volume. When a solid is heated, there is motion of individual particles as the tendency to form a minimum surface is manifested. The process is driven by "surface tension" as the solid changes structure to give a minimum surface area, which also gives the smallest number of lattice members on the surface.

Not all solids exhibit sintering, but many do. Sintering is accompanied by the removal of pores and the rounding of edges. When the solid is composed of many small particles, there will be welding of grains and a densification of the sample. For ionic compounds, both cations and anions must be relocated, which may occur at different rates. Consequently, sintering is often related to the rate of diffusion, which is in turn related to the concentration of defects. One way to increase the concentration of defects is to add a small amount of a compound that contains an ion having a different charge than the major component. For example, adding a small amount of Li_2O (which contains a 2:1 ratio of cations to anions) to ZnO increases the number of anion vacancies. In ZnO , anion vacancies determine the rate of diffusion and sintering. On the other hand, adding Al_2O_3 decreases the rate of sintering in ZnO because two Al^{3+} ions can replace three Zn^{2+} ions, which leads to an excess of cation vacancies.

Heating the solid in an atmosphere that removes some anions will lead to an increase in anion vacancies. For example, when ZnO is heated in an atmosphere of hydrogen, there is an increase in the number of anion vacancies. Sintering of Al_2O_3 is also limited by diffusion of oxygen. Heating Al_2O_3 in a hydrogen atmosphere leads to the removal of some oxide ions, which increases the rate of sintering. The rate of sintering of Al_2O_3 is dependent on particle size, and it has been found that

$$\text{Rate} \propto \left(\frac{1}{\text{Particle size}} \right)^3 \quad (8.60)$$

For particles that measure $0.50\ \mu\text{m}$ and $2.0\ \mu\text{m}$, the ratio of the rates is $(2.0/0.50)^3$ or 64, so the smaller particles sinter much faster than the larger ones.

If the sample being sintered is a powdered metal, the result can be a dense, strong object that resembles one made from a single piece of metal. This is the basis for the manufacturing technique known as *powder metallurgy*. This is an important process in which many objects such as gears are produced by heating and compressing powdered metal in a mold of suitable shape. There is a considerable reduction in cost compared to similar objects shaped by traditional machining processes.

In powder metallurgy, the powdered material to be worked is pressed in a mold, then heated to increase the rate of diffusion. The temperature required to obtain flow of the material may be significantly below the melting point. As the powder becomes more dense and less porous, the vacancies move to the surface to produce a structure that is even less porous and more dense. In addition to diffusion, plastic flow and evaporation and condensation may contribute to the sintering process. As sintering of a solid occurs, it is

often possible to observe microscopically the rounding of corners and edges of individual solid particles. When particles undergo coalescence, they fuse together to form a “neck” between them. Continued sintering leads to thickening of the neck regions and a corresponding reduction in the size of the pores that exist between the necks. Finally, there is a growth of particles of the solid to form a compact mass. The apparent volume of the sample is reduced as a result of surface tension, causing the pores to close.

In the process of powder metallurgy, the material to be compacted may be prepared by blending the components prior to sintering. In different schemes, the components are premixed and then heated to cause annealing of the mixture, or they may be prealloyed by adding the minor constituents to the major one in the liquid state. When the major constituent is powdered iron, the powder can be obtained in a variety of ways that include reducing the ore in a kiln and atomization of the metal as a liquid in a high-pressure stream. For making objects of iron alloys, the mix is pressed to shape before sintering, which is carried out by heating the mixture to approximately 1100 °C in a protective atmosphere. This is well below the melting point of iron (1538 °C), but it is sufficient to cause diffusion. Bonding between particles occurs as grain boundaries disappear.

In making objects of bronze, the premix consists of approximately 90% copper, 10% tin, and a small amount of a lubricant. The mixture is sintered at approximately 800 °C in a protective atmosphere that consists primarily of nitrogen, but it may also contain a small pressure of hydrogen, ammonia, or carbon monoxide. The properties of objects produced by powder metallurgy depend on procedural variables such as particle size distribution in the mixture, preheating treatment, sintering time, atmosphere composition, and the flow rate of the gaseous atmosphere. The results of procedural changes are not always known in advance, and much of what is known about how to carry out specific processes in powder metallurgy is determined by experience.

8.10 DRIFT AND CONDUCTIVITY

When applied to the motion of ions in a crystal, the term *drift* applies to motion of ions under the influence of an electric field. Although movement of electrons in conduction bands determines conductivity in metals, in ionic compounds it is the motion of *ions* that determines the electrical conductivity. There are no free or mobile electrons in ionic crystals. The *mobility* of an ion, μ , is defined as the velocity of the ion in an electric field of unit strength. Intuitively, it seems that the mobility of the ion in a crystal should be related to the diffusion coefficient. This is, in fact, the case, and the relationship is

$$D = \frac{kT}{Z} \mu \quad (8.61)$$

where Z is the charge on the ion, k is the Boltzmann constant, and T is the temperature (K). The relationship between the *ionic conductivity*, σ , and the rate of diffusion rate in the crystal, D , can be expressed as

$$\sigma = \alpha \frac{Nq^2}{kT} D \quad (8.62)$$

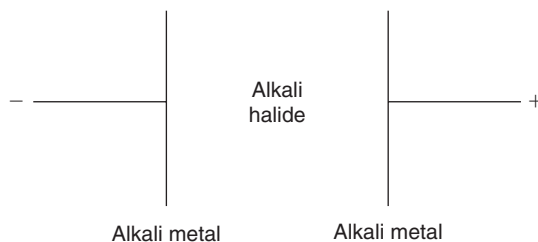

■ **FIGURE 8.11** Arrangement of an experiment to demonstrate ionic drift.

In this equation, N is the number of ions per cm^3 , q is the charge on the ion, and α is a factor that varies from about 1 to 3 depending on the mechanism of diffusion. Because conductivity of a crystal depends on the presence of defects, studying conductivity gives information about the presence of defects. The conductivity of alkali halides by ions has been investigated in an experiment illustrated in Figure 8.11.

As the electric current passes through this system, the cathode (negative electrode) grows in thickness while the anode (positive electrode) shrinks. At the cathode, M^+ ions are converted to M atoms, which results in growth of the cathode. From this observation, it is clear that the cations are primarily responsible for conductivity, and this is the result of a vacancy type of mechanism. In this case, the positive ion vacancies have higher mobility than do the vacancies that involve negative ions.

Because the number of vacancies controls the conductivity, changing the conditions so that the number of vacancies increases will increase conductivity. One way to increase the number of vacancies is to dope the crystal with an ion of different charge. For example, if a small amount of a compound containing a $+2$ ion is added to a compound such as sodium chloride, the $+2$ ions will occupy cation sites. Because one $+2$ cation will replace two $+1$ ions and still maintain overall electrical neutrality, there will be a vacant cation site for each $+2$ ion present. As a result, the mobility of Na^+ will be increased because of the increase in the number of vacancies. Although doping is effective at lower temperatures, it is less so at high temperature. The reason is that the number of vacancies is determined by a Boltzmann population of the higher energy states, and at high temperature, the number of vacancies is already large.

In this chapter, we have described some of the types of transformations in solids that involve rate processes. This is an immensely practical area because many industrial processes involve such changes in inorganic substances, and they are an essential part of materials sciences. For a more complete discussion of these important topics, the references given below should be consulted.

■ REFERENCES FOR FURTHER STUDY

- Borg, R. J., and Dienes, G. J. (1988). *An Introduction to Solid State Diffusion*. Academic Press, San Diego, CA. A thorough treatment of many processes in solids that are related to diffusion.
- Gomes, W. (1961). "Definition of Rate Constant and Activation Energy in Solid State Reactions," *Nature (London)* 192, 965. An article discussing the difficulties associated with interpreting activation energies for reactions in solids.

- Hannay, N. B. (1967). *Solid-State Chemistry*. Prentice-Hall, Englewood Cliffs, NJ. An older book that gives a good introduction to solid-state processes.
- House, J. E. (1980). "A Proposed Mechanism for the Thermal Reactions in Solid Complexes." *Thermochim. Acta* **38**, 59–66. A discussion of reactions in solids and the role of free space and diffusion.
- House, J. E. (1993). "Mechanistic Considerations for Anation Reactions in the Solid State." *Coord. Chem. Rev.* **128**, 175–191.
- House, J. E. (2007). *Principles of Chemical Kinetics*, 2nd ed. Elsevier/Academic Press, San Diego, CA. Chapter 7 is devoted to reactions in the solid state.
- House, J. E., and Bunting, R. K. (1975). "Dehydration and Linkage Isomerization in $K_4[Ni(NO_2)_6] \cdot H_2O$," *Thermochim Acta* **11**, 357–360.
- O'Brien, P. (1983). *Polyhedron* **2**, 223. An excellent review of racemization reactions of coordination compounds in the solid state.
- Schmalzreid, H. (1981). *Solid State Reactions*, 2nd ed. Verlag Chemie, Weinheim. A monograph devoted to solid-state reactions.
- West, A. R. (1984). *Solid State Chemistry and Its Applications*. Wiley, New York. A very good introduction to the chemistry of the solid state.
- Young, D. A. (1966). *Decomposition of Solids*. Pergamon Press, Oxford, UK. An excellent book that discusses reactions of many inorganic solids and principles of kinetics of solid-state reactions.

■ QUESTIONS AND PROBLEMS

1. A solid compound X is transformed into Y when it is heated at 75 °C. A sample of X that is quickly heated to 90 °C for a very short time (with no significant decomposition) and then quenched to room temperature is later found to be converted to Y at a rate that is 2.5 times that of a sample that has had no prior heating when both are heated at 75 °C for a long period of time. Explain these observations.
2. Suppose a solid compound A is transformed into B when it is heated at 200 °C. An untreated sample of A shows no induction period, but a sample of A that was irradiated with neutrons does show an induction period. After the induction period, the irradiated sample gave similar kinetic behavior to that of the untreated sample. Explain these observations.
3. Consider the reaction

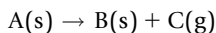

which takes place at high temperature. Suppose that as crystals of A are transformed into B, sintering of B transforms it into rounded, glassy particles. What effect would this likely have on the latter stages of the reaction?

4. When KCN and AgCN are brought together, they react to form $K[Ag(CN)_2]$. The initial stage of the reaction can be shown as follows:

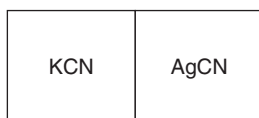

Sketch the system after some period of reaction. Discuss two possible cases for the limiting process in the reaction and how that might alter the sketch you made.

- Describe the effects on the conductivity of KCl produced by adding a small amount of MgCl_2 . Explain the specific origin of the change in conductivity.
- Describe the effects on the rate of sintering of Fe_2O_3 produced by adding a small amount of MgCl_2 . Explain the specific origin of the change in conductivity.
- Suppose a solid is to be the subject of a kinetic study (such as decomposition). How would prior irradiating the solid with x-rays or γ rays likely affect the kinetic behavior of the solid? Explain the origin of the effects.
- The tarnishing of a metal surface follows the parabolic rate law. Discuss the units on the rate constant in comparison with those for a first-order reaction. Suppose the rate of tarnishing is studied at several temperatures and the activation energy is calculated. For reactions in gases and liquids, the activation energy is sometimes interpreted in terms of bond-breaking processes. How would you interpret the activation energy determined in this case?
- Prepare rate plots of the data shown in Table 8.1 using an Avrami rate law with n values of 2, 3, and 4.
- If the data shown in Table 8.1 were available for only the first 30 minutes of reaction, explain the difficulty in deciding the value of n that applies in this reaction.

This page intentionally left blank

Part

3

Acids, Bases, and Solvents

This page intentionally left blank

Acid-Base Chemistry

In the study of chemistry, the results of observations on the transformations and properties of many materials are encountered. Schemes that provide structure to the information concerning this type of chemistry go a long way toward systematizing its study. One such approach is that of the chemistry of acids and bases. Closely related to the chemistry of acids and bases is the study of solvents other than water, the chemistry of nonaqueous solvents (see Chapter 10). In this chapter, several areas of acid-base chemistry and their application to reactions of inorganic substances will be described.

9.1 ARRHENIUS THEORY

An early attempt to provide a framework to observations on the chemistry of substances that react in water to produce acids or bases was provided by S. A. Arrhenius. At that time, the approach was limited to aqueous solutions, and the definitions of an acid and a base were given in these terms. Of course we now know that acid-base behavior is not limited to these cases, but it applies much more broadly. If we consider the reaction between gaseous HCl and water,

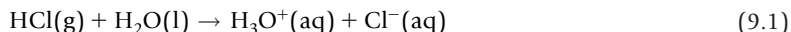

we see that the solution contains H_3O^+ , the *hydronium* ion or, as it is perhaps more generally known, the *oxonium* ion. In aqueous solution, HNO_3 also ionizes, as illustrated in the reaction



In studying the properties of solutions of substances such as HCl and HNO_3 , Arrhenius was led to the idea that the *acidic* properties of the compounds were due to the presence of an ion that we now write as H_3O^+ in the solutions. He therefore proposed that an *acid* is a substance whose water solution contains H_3O^+ . The properties of aqueous solutions of acids are the properties of the H_3O^+ ion, a solvated proton (hydrogen ion) that is known as the *hydronium* ion in much of the older chemical literature but also referred to as the *oxonium* ion.

It is appropriate at this point to comment on the nature of the solvated hydrogen ion in aqueous solutions. We saw in Chapter 7 that there is a limited number of ions that can surround one of opposite charge in a crystal. There is also a rather definite number of water molecules that can solvate an ion (the hydration number) in an aqueous solution. Hydration numbers for ions are not always fixed because water molecules are continuously entering and leaving the solvation sphere of the ion. For many metal ions, the hydration number is approximately 6. Owing to its extremely small size, the hydrogen ion has a large charge-to-size ratio. Therefore, it interacts strongly with the negative ends of polar molecules such as water, and the heat of hydration of $\text{H}^+(\text{g})$ is $-1100 \text{ kJ mol}^{-1}$, a value that is very high for a +1 ion. Although the hydrogen ion in water is represented as H_3O^+ to show that it is solvated, the solvation sphere certainly includes more than one water molecule. For H^+ , the hydration number is probably at least 4, particularly in dilute solutions of acids. When four water molecules solvate the proton, the species formed is H_9O_4^+ , which has the proton in the center of a tetrahedron of water molecules. Another species that contains the solvated proton is H_5O_2^+ , which has the proton located between two water molecules in a linear structure. This ion has been identified in a few solid compounds as one of the positive ions present. Doubtless there exist other species with different numbers of water molecules solvating a proton. Such species may be transitory in nature and have a rather large degree of fluxional character, but there is no doubt that the species in acidic solutions is not as simple as the symbol H_3O^+ would indicate. Although when we wish to show a solvated proton, this symbol will be used, it is very little more accurate at portraying the actual species than is a simple H^+ , which was used for many years.

Among the substances that react with water to produce H_3O^+ are HCl , HNO_3 , H_2SO_4 , HClO_4 , H_3PO_4 , $\text{HC}_2\text{H}_3\text{O}_2$, and many others. Because water solutions of all of these compounds contain H_3O^+ , they have similar properties. Of course there is a difference in degree because some are strong acids while others are weak. Solutions of the compounds listed conduct an electric current, change the colors of indicators, neutralize bases, and dissolve some metals. In fact, these are the characteristics of the H_3O^+ ion in aqueous solutions. Thus, the compounds all behave as acids. The difference in strengths of acids is related to the extent of their ionization reactions. Acids such as HCl , HNO_3 , H_2SO_4 , and HClO_4 are strong acids because in dilute aqueous solutions they are almost completely ionized. As a result, aqueous solutions of these compounds are good conductors of electricity. In contrast, the ionization of acetic acid is only 1% to 3% depending on the concentration of the acid, so it is a weak acid. Table 9.1 shows the dissociation constants for a large number of acids.

When $\text{NH}_3(\text{g})$ dissolves in water, some ionization occurs, as indicated by the equation



In this reaction, one of the products is OH^- , which is the species of basic character in aqueous solutions. When NaOH dissolves in water, the reaction is not actually an ionization reaction because the Na^+ and OH^- ions already exist in the solid. The process is a dissolution process rather than an ionization reaction. Substances such as NaOH , KOH , $\text{Ca}(\text{OH})_2$, NH_3 , and amines (RH_2N , R_2HN , and R_3N) are all bases because their water solutions contain OH^- . The compounds dissolve in water to give solutions that conduct an electric current, change the colors of indicators, and neutralize acids,

Table 9.1 Dissociation Constants for Some Common Acids.

Acid	Conjugate Base	Dissociation Constant
HClO ₄	ClO ₄ ⁻	Essentially complete
HI	I ⁻	Essentially complete
HBr	Br ⁻	Essentially complete
HCl	Cl ⁻	Essentially complete
HNO ₃	NO ₃ ⁻	Essentially complete
HSCN	SCN ⁻	Essentially complete
H ₂ SO ₄	HSO ₄ ⁻	Essentially complete
HSO ₄ ⁻	SO ₄ ²⁻	2.0×10^{-2}
H ₂ C ₂ O ₄	HC ₂ O ₄ ⁻	6.5×10^{-2}
HC ₂ O ₄ ⁻	C ₂ O ₄ ²⁻	6.1×10^{-5}
HClO ₂	ClO ₂ ⁻	1.0×10^{-2}
HNO ₂	NO ₂ ⁻	4.6×10^{-4}
H ₃ PO ₄	H ₂ PO ₄ ⁻	7.5×10^{-3}
H ₂ PO ₄ ⁻	HPO ₄ ²⁻	6.8×10^{-8}
HPO ₄ ²⁻	PO ₄ ³⁻	2.2×10^{-13}
H ₃ AsO ₄	H ₂ AsO ₄ ⁻	4.8×10^{-3}
H ₂ CO ₃	HCO ₃ ⁻	4.3×10^{-7}
HCO ₃ ⁻	CO ₃ ²⁻	5.6×10^{-11}
H ₄ P ₂ O ₇	H ₃ P ₂ O ₇ ⁻	1.4×10^{-1}
H ₂ Te	HTe ⁻	2.3×10^{-3}
HTe ⁻	Te ⁻	1.0×10^{-5}
H ₂ Se	HSe ⁻	1.7×10^{-4}
HSe ⁻	Se ²⁻	1.0×10^{-10}
H ₂ S	HS ⁻	9.1×10^{-8}
HS ⁻	S ²⁻	$\sim 10^{-19}$
HN ₃	N ₃ ⁻	1.9×10^{-5}
HF	F ⁻	7.2×10^{-4}
HCN	CN ⁻	4.9×10^{-3}
HOBr	BrO ⁻	2.1×10^{-9}
HOCl	ClO ⁻	3.5×10^{-8}
HOI	IO ⁻	2.3×10^{-11}
HC ₂ H ₃ O ₂	C ₂ H ₃ O ₂ ⁻	1.75×10^{-5}
C ₆ H ₅ OH	C ₆ H ₅ O ⁻	1.28×10^{-10}
C ₆ H ₅ COOH	C ₆ H ₅ O ₂ ⁻	6.46×10^{-5}
HCOOH	HCO ₂ ⁻	1.8×10^{-4}
H ₂ O	OH ⁻	1.1×10^{-16}

which are some of the reactions that characterize aqueous solutions of bases. Substances that contain OH^- ions prior to dissolving them in water or those that react with water to give reactions in which they are extensively ionized to produce OH^- ions are strong bases. The reactions of ammonia and amines result in only a slight degree of ionization, so these compounds are called weak bases.

It is interesting to note that whereas special emphasis is placed on the solvated hydrogen ion by writing it as H_3O^+ , no such distinction is made for OH^- other than to write it as $\text{OH}^-(\text{aq})$. However, this ion is also solvated strongly by several polar water molecules.

When NaOH is dissolved in water and the solution added to a solution of HCl in water, the substances are ionized, so the reaction is

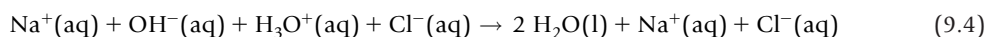

Sodium chloride is soluble in water, so it is written as an ionized product. There is no change in the sodium and chloride ions, so they can be omitted from both sides of the equation. As a result, the net ionic equation can be written as

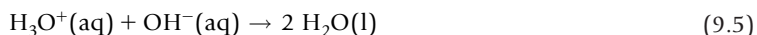

If solutions that contain other ionized acids and bases are mixed, the reaction is still one that occurs between the $\text{H}_3\text{O}^+(\text{aq})$ and $\text{OH}^-(\text{aq})$. Therefore, the neutralization reaction between an acid and a base is that shown in Eq. (9.5) according to the Arrhenius theory.

When we consider the reaction



and compare it to the reaction in aqueous solution,

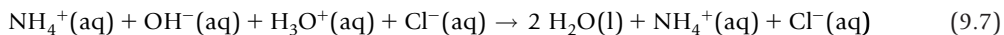

we see that ammonium chloride is a product of both reactions. In the second reaction, we can recover solid NH_4Cl by evaporating the water. Whereas the second process is explained by Arrhenius acid-base chemistry, the first is not. The reactants shown in Eq. (9.6) are not dissolved in water to which the Arrhenius definitions of acid and base are applicable. In order to describe acid-base reactions in the gas phase or in solvents other than water, a different approach is needed.

9.2 BRØNSTED–LOWRY THEORY

J. N. Brønsted and T. M. Lowry independently arrived at definitions of an acid and a base that do not involve water. They recognized that the essential characteristic of an acid-base reaction was the transfer of a hydrogen ion (proton) from one species (the acid) to another (the base). According to these definitions, *an acid is a proton donor and a base is a proton acceptor*. The proton must be donated to some other species so *there is no acid without a base*. According to Arrhenius, HCl is an acid because

its water solution contains H_3O^+ , which indicates that an acid can exist independently with no base being present. When examined according to the Brønsted–Lowry theory, the reaction

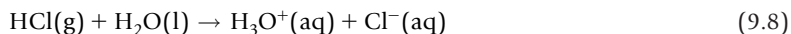

is an acid–base reaction not because the solution contains H_3O^+ but rather because a proton is transferred from HCl (the acid) to H_2O (the base).

Once a substance has functioned as a proton donor, it has the potential to accept a proton (react as a base) from another proton donor. For example, acetate ions are produced by the reaction

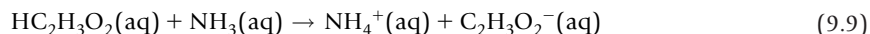

The acetate ion can now function as a proton acceptor from a suitable acid. For example,

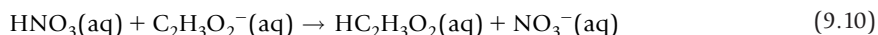

In this reaction, the acetate ion is functioning as a base. On the other hand, Cl^- has very little tendency to function as a base because it comes from HCl, which is a very strong proton donor. According to the Brønsted–Lowry theory, the species remaining after a proton is donated is called the conjugate base of that proton donor.

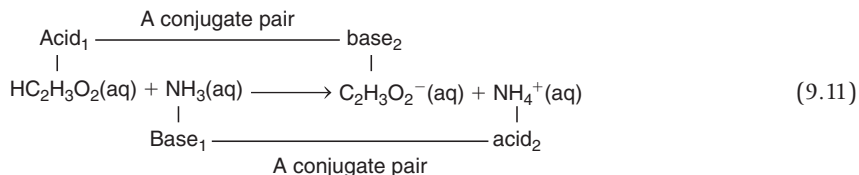

In this reaction, acetic acid donates a proton to produce its conjugate, the acetate ion, which is able to function as a proton acceptor. Ammonia accepts a proton to produce its conjugate, the ammonium ion, which can function as a proton donor. Two species that differ by the transfer of a proton are known as a *conjugate pair*. The conjugate acid of H_2O is H_3O^+ , and the conjugate base of H_2O is OH^- .

Characteristics of the reactions described so far lead to several conclusions regarding acids and bases according to the Brønsted–Lowry theory.

1. There is no acid without a base. The proton must be donated to something else.
2. The stronger an acid is, the weaker its conjugate will be as a base. The stronger a base is, the weaker its conjugate will be as an acid.
3. A stronger acid reacts to displace a weaker acid. A stronger base reacts to displace a weaker base.
4. The strongest acid that can exist in water is H_3O^+ . If a stronger acid is placed in water, it will donate protons to water molecules to produce H_3O^+ .
5. The strongest base that can exist in water is OH^- . If a stronger base is placed in water, it will accept protons from water to produce OH^- .

A reaction that is of great importance in the chemistry of aqueous solutions is related to the acidic or basic character of conjugates. For example, after acetic acid *donates* a proton, the acetate ion has the ability to *accept* a proton. Therefore, when $\text{NaC}_2\text{H}_3\text{O}_2$ is dissolved in water, the reaction that occurs is the *hydrolysis* reaction,

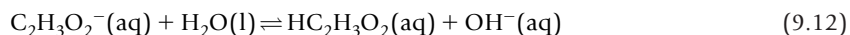

This reaction does not take place to a great degree as should be expected from the fact that both an acid ($\text{HC}_2\text{H}_3\text{O}_2$) and a base (OH^-) are produced in the same reaction. The result is that a 0.1 M solution of sodium acetate has a pH of 8.89, which means that the solution is basic, but not strongly so. Another way to look at this reaction is to say that OH^- is a strong base but $\text{HC}_2\text{H}_3\text{O}_2$ is a weak acid. Therefore, the solution should be basic, and it is. On the other hand, a 0.1 M solution of NaCl or NaNO_3 has a pH of 7, because the hydrolysis represented by the equation



which would produce a strong acid and a strong base in the solution, does not take place. Accordingly, we see that the anions of strong acids (which are very weak bases) do not effectively hydrolyze in aqueous solutions. We can also see that the weaker an acid is, the stronger its conjugate will be as a base and the more extensive the hydrolysis reaction will be. Consider the series of acids $\text{HC}_2\text{H}_3\text{O}_2$, HNO_2 , HOCl , and HOI , for which the K_a values are 1.75×10^{-5} , 4.6×10^{-4} , 3.5×10^{-8} , and 2.3×10^{-11} , respectively. As a result, if the basicity of 0.1 M solutions of the sodium salts of these acids are compared, it is found that the solution of NaOI is most strongly basic, whereas the solution of NaNO_2 is the weakest base. Because carbonic acid is so weak, a solution of Na_2CO_3 is strongly basic owing to the reactions

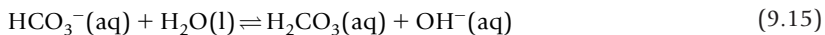
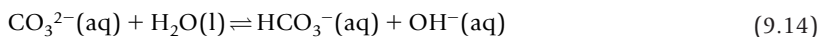

Hydrolysis also occurs when the conjugate acid of a weak base is placed in water. For example, when NH_4Cl is dissolved in water, the hydrolysis reaction that takes place is

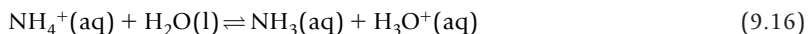

A 0.1 M solution of NH_4Cl has a pH of approximately 5.11, so it is distinctly acidic. Strictly speaking, *lysis* means “to split” and *hydrolysis* means the splitting of a water molecule (as in the hydrolysis to produce basic solutions as in Eq. (9.14)). In the case of NH_4^+ reacting with water, there is proton donation and acceptance, but there is no *lysis*.

There is another type of hydrolysis reaction that leads to acidic solutions. When a compound such as aluminum chloride is dissolved in water, the cation becomes strongly solvated. The extremely energetic

nature of the hydration of the Al^{3+} ion was discussed in Chapter 7. Because of the very high charge-to-size ratio, the Al^{3+} ion is a very high-energy ion that reacts to relieve part of the charge density. One way in which this is done is by the reaction

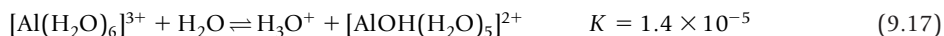

As a result of this reaction, part of the charge on the aluminum ion is relieved by the loss of H^+ from one of the water molecules. The pH of a 0.10 M solution of AlCl_3 is 2.93, so this type of hydrolysis leads to solutions that are quite acidic. Other metal ions having large charge and small size (Fe^{3+} ($K = 4.0 \times 10^{-3}$), Be^{2+} , Cr^{3+} ($K = 1.4 \times 10^{-4}$), etc.) behave in this manner and give solutions that are acidic.

When H_2SO_4 , HNO_3 , HClO_4 , and HCl are dissolved in water to produce dilute solutions, each of them reacts essentially 100% to produce H_3O^+ ions. Water is sufficiently strong as a proton acceptor and these acids are all strong enough to ionize almost totally. As a result, they appear to be equal in strength as acids. In fact, their strength in water appears to be identical to that of H_3O^+ because that ion is the conjugate of all of the acids listed, and that is the acidic species present in all cases. It is sometimes stated that the strengths of the acids are “leveled” to that of H_3O^+ . This phenomenon is called the *leveling effect*, and its basis is that H_2O is sufficiently strong as a base that it accepts protons from the strong acids. If a different solvent is used which is less basic than water, the ionization reactions of even strong acids do not take place completely because the acids do not actually have the same strength. A suitable solvent is glacial acetic acid, which is not normally a base at all, but it can function as a base when in the presence of a very strong acid:

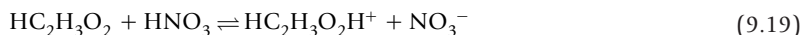
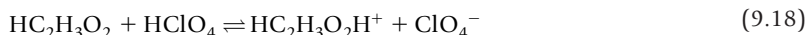

When the extent of reactions such as these is studied, it is found that the reaction with HClO_4 progresses farther to the right than with any of the other acids. By this means, it is possible to rank even the strong acids that all react completely with water in terms of strength as shown in Table 9.1.

When it is recalled that the ammonium ion is simply NH_3 that has gained a proton, it is clear that NH_4^+ is the conjugate acid of NH_3 . Therefore, it is not unusual to expect NH_4^+ to behave as an acid, which was illustrated in Eq. (9.16). However, the NH_4^+ ion can react as an acid under other conditions. When an ammonium salt such as NH_4Cl is heated to the melting point, the salt becomes acidic. In fact, the reactions are similar to those that HCl would give. For example, metals dissolve with the release of hydrogen:



After the NH_4^+ acts as a proton donor in such reactions, the NH_3 remaining escapes as a gas. Carbonates react with HCl to produce CO_2 , sulfites react to produce SO_2 , and oxides react to produce water. Heated ammonium salts react in a similar fashion.

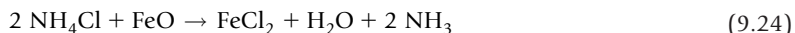
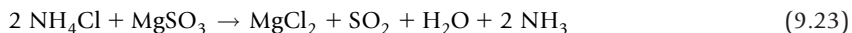

Because of its ability to react with metal oxides, NH_4Cl has been used as a soldering flux for many years. Removing the oxide on the surface of the object allows a strong joint to be produced. In older nomenclature, NH_4Cl was known as sal ammoniac.

There is nothing unusual about the acidic behavior of ammonium salts. In fact, any protonated amine can function as a proton donor. Because of this, many amine salts have been used as acids in synthetic reactions. If the chlorides are used, the amine salts are known as amine hydrochlorides. One of the earliest amine hydrochlorides studied with regard to its behavior as an acid is pyridine hydrochloride (pyridinium chloride), $\text{C}_5\text{H}_5\text{NH}^+\text{Cl}^-$. In the molten state, this compound undergoes many reactions of the type just shown.

9.3 FACTORS AFFECTING STRENGTH OF ACIDS AND BASES

The range of substances that function as acids is very large. The familiar binary compounds like hydrogen halides are included as are the oxy acids such as H_2SO_4 , HNO_3 , H_3PO_4 , and many others. Acids range in strength from those like boric acid, $\text{B}(\text{OH})_3$, to acids that are very strong like HClO_4 . In this section, some general guidelines will be developed for predicting and correlating the strengths of acids.

One of the considerations related to acid strength for a polyprotic acid such as H_3PO_4 is the fact that the first proton to be removed is lost more easily than are the second and third. The first proton is lost from a neutral molecule, whereas the second and third protons are moved from species that have negative charges. The stepwise dissociation of H_3PO_4 can be shown as follows:

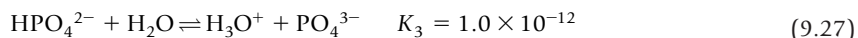
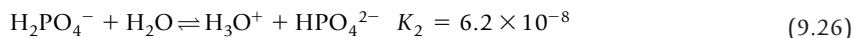
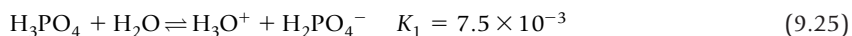

It will be noted that there is a factor of approximately 10^5 between successive dissociation constants. This relationship exists between the equilibrium constants for numerous polyprotic acids, and it is sometimes known as *Pauling's rule*. This rule is also obeyed by sulfurous acid, for which $K_1 = 1.2 \times 10^{-2}$ and $K_2 = 1 \times 10^{-7}$.

Another of the important concepts in dealing with acid strength is illustrated by the dissociation constants for the chloro-substituted acetic acids. The dissociation constants are as follows: CH_3COOH ,

$K_a = 1.75 \times 10^{-5}$; ClCH_2COOH , $K_a = 1.40 \times 10^{-3}$; Cl_2CHCOOH , $K_a = 3.32 \times 10^{-2}$; $K_a = \text{Cl}_3\text{CCOOH}$, $K_a = 2.00 \times 10^{-1}$. The dissociation constants for the acids show clearly the effect of replacing hydrogen atoms on the methyl group with chlorine atoms. As a result of having a high electronegativity, the chlorine atoms cause a migration of electron density toward the end of the molecule where they reside, which causes the electron pair in the O–H bond to be shifted farther away from the hydrogen atom. The electrons are *induced* to move under the influence of the chlorine atoms. With each substitution of Cl for H, the acid becomes stronger because of the shift of electrons, which is known as an *inductive effect*. The charge separation within the Cl_3CCOOH molecule can be represented as shown in the following structure:

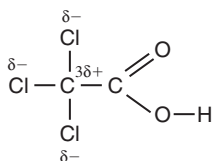

The effect of one chlorine atom in different positions can be seen from the dissociation constants for the monochlorobutyric acids. In the series of acids, a chlorine atom can be attached to the carbon atom adjacent to the COOH group or on one of the other carbon atoms. The dissociation constant for butyric acid is 1.5×10^{-5} . When a chlorine atom is attached in the three available positions, the dissociation constants are as follows:

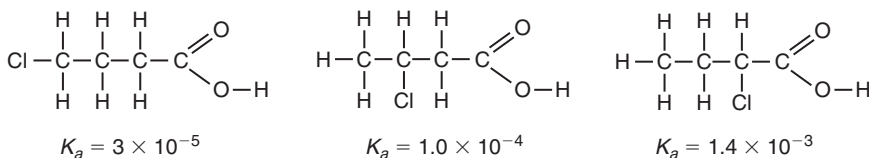

In this series, it is apparent that the effect of the chlorine atom is greatest when it is closest to the carboxyl group and least when it is farthest away.

Hydrogen ions are not normally removed from C–H bonds, but it is not impossible to do so. For example, the acidity of acetylene is well known, and many compounds exist in which the C_2^{2-} ion is present. It is known that the ease of removing H^+ from a carbon atom depends on the way in which the carbon atom is bound in a molecule. Most acidic are the –C–H groups in alkynes, whereas the least acidic are the C–H bonds in alkanes. Between these two extremes are the C–H bonds in aromatic molecules and those in alkenes, with the C–H bonds in aromatics being the more acidic of the two types. Because the ease of removing H^+ depends on the charge separation in the C–H bond, we can conclude that carbon atoms behave *as if* their electronegativities vary in the following series, which also shows the hybrid orbital type used by carbon. This series also gives the acid strengths of these types of compounds.

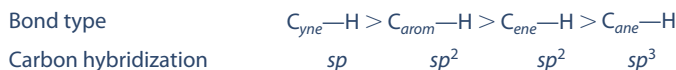

The inductive effect is also illustrated by the strengths of acids such as HNO_3 and HNO_2 . The structures for the molecules are as follows:



In the HNO_3 molecule, there are two oxygen atoms that do not have hydrogen atoms attached. These oxygen atoms cause a migration of electron density away from the H–O bond, which makes the hydrogen ion easier to remove. In HNO_2 , there is only one oxygen atom that does not have a hydrogen atom attached, so the extent of electron migration is much less than in HNO_3 . The result is that nitric acid is a strong acid whereas nitrous acid is weak, although a somewhat different way of comparing the strengths of HNO_2 and HNO_3 follows.

When a proton is lost from an acid such as HNO_2 , the NO_2^- ion that results is stabilized by the contributions from resonance structures that can be shown as

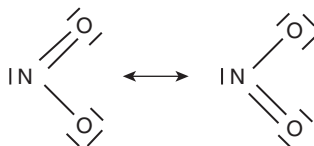

so that the -1 charge on the ion is dispersed over the structure. The result is that the NO_2^- ion does not attract H^+ as strongly as might be expected. On the other hand, the effect is even greater for nitric acid where the resulting NO_3^- ion has the -1 charge distributed over three oxygen atoms. Therefore, NO_3^- for which three resonance structures can be drawn is not as strong a base as is NO_2^- , which means that HNO_3 is a stronger acid than HNO_2 .

Examples of the inductive effect abound. Although sulfuric acid is a strong acid, sulfurous acid is weak. Pauling provided a way of systematizing the inductive effect by writing the formulas for oxy acids as $(\text{HO})_n\text{XO}_m$. Because the inductive effect is produced by the oxygen atoms that are not held in OH groups, it is the value of m in the formula that determines acid strength. There is a factor of approximately 10^5 produced in K for each unit of increase in the value of m . This principle is illustrated by the following examples.

If $m = 0$, the acid is very weak, $K_1 = 10^{-7}$ or less	$\text{B}(\text{OH})_3$, boric acid, $K_1 = 5.8 \times 10^{-10}$ HOCl , hypochlorous acid, $K = 2 \times 10^{-9}$
If $m = 1$, the acid is weak, $K_1 = 10^{-2}$ or less	HClO_2 , chlorous acid, $K = 1 \times 10^{-2}$ HNO_2 , nitrous acid, $K = 4.5 \times 10^{-4}$
If $m = 2$, the acid is strong, $K_1 > 10^3$	H_2SO_4 , sulfuric acid, K_1 is large HNO_3 , nitric acid, K is large
If $m = 3$, the acid is very strong, $K_1 > 10^8$	HClO_4 , perchloric acid, K is very large

Although the dissociation constants are very large for HCl, HBr, and HI, the range for all the hydrogen halides is from 6.7×10^{-4} for HF to 2×10^9 for HI. It is interesting to note that the dissociation constants for H_2O , H_2S , H_2Se , and H_2Te range from approximately 2×10^{-16} to 2.3×10^{-3} . As a result, there is a factor of approximately 10^{13} between the dissociation constants for the first and last member of the hydrogen compounds in groups VI and VII.

Phenol, $\text{C}_6\text{H}_5\text{OH}$, is a weak acid for which $K_a = 1.7 \times 10^{-10}$, whereas aliphatic alcohols such as $\text{C}_2\text{H}_5\text{OH}$ are not acidic under most conditions. From the standpoint of energy required for removing H^+ from the OH bonds, the energy difference for the two alcohols is not great. What is considerably different is what happens after the H^+ is removed. As shown in Figure 9.1, the phenoxide ion, $\text{C}_6\text{H}_5\text{O}^-$, has several resonance structures that contribute to its stability. These structures result in the ion residing at a lower energy than is possible for the ethoxide ion, for which comparable resonance structures cannot be drawn.

The result of this resonance stabilization of the anion by delocalization of the negative charge makes the overall energy change required for ionization to be smaller for phenol than it is for ethanol. This can be shown in terms of energies as follows:

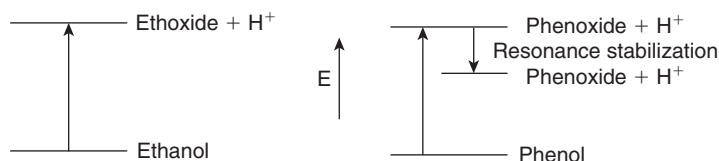

The difference is primarily in the resonance stabilization of the anion produced, not because of any great difference in the strengths of the O-H bonds.

Another example of resonance stabilization of the conjugate base after proton removal is that of acetylacetone (2,4-pentadione), which undergoes the tautomerization reaction

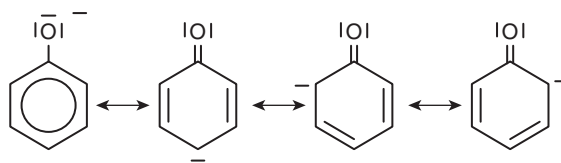
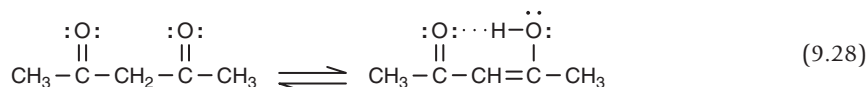

■ FIGURE 9.1 Resonance structures for the phenoxide ion.

After the proton is lost, the resonance structures



stabilize the anion so that acetylacetonate is slightly acidic. Many coordination compounds are known in which the anion bonds strongly to metal ions. The complexing ability of the anion is a manifestation of its behavior as a Lewis base (see Chapters 16 and 20).

Although aliphatic alcohols are not normally acidic, the OH group is sufficiently acidic to react with very active metals such as sodium. The reaction can be written as



Except for being much less vigorous, this reaction is analogous to the reaction of sodium with water,



In both reactions, an anion that is a strong base is produced.

The factors that affect base strength are based primarily on the ability of a species to attract H^+ , which is consistent with the principles that govern electrostatic interactions. The smaller and more highly charged a negative species is, the stronger the attraction for the small, positive H^+ ion. For example, O^{2-} has a higher negative charge than OH^- , and as a result it is a stronger base. One does not normally expect reactions that take place in aqueous solutions to produce oxides as a result of the basicity of O^{2-} . Ionic oxides normally react with water to produce hydroxides:



Although S^{2-} is a base, it is a weaker base than O^{2-} owing to its larger size. The small H^+ bonds better to the smaller, more "concentrated" region of negative charge on O^{2-} . In other words, the oxide ion has a higher charge density than the sulfide ion.

In the same way, the series of nitrogen species can be arranged in the order of decreasing base strength as $\text{N}^{3-} > \text{NH}_2^- > \text{NH}_3$. Likewise, NH_3 is a stronger base than PH_3 because the unshared pair of electrons on the nitrogen atom is contained in a smaller orbital, which leads to a greater attraction for the very small H^+ . We will have more to say regarding such cases later in this chapter.

Another species that is a strong base is the hydride ion, H^- . Metal hydrides react with water to produce basic solutions:



This great affinity for water gives rise to the use of metal hydrides as drying agents for removing the last traces of water from organic liquids (that do not contain OH bonds). Calcium hydride, CaH_2 , is commonly used for this purpose.

9.4 ACID-BASE CHARACTER OF OXIDES

In the foregoing discussion, it is clear that many acids contain a nonmetal, oxygen, and hydrogen. This suggests that one way to prepare an acid might be to carry out a reaction of the oxide of a nonmetal with water. In fact, this is exactly the case, and many acids can be prepared in this way. For example,



The general nature of this reaction indicates that oxides of nonmetals react with water to produce acidic solutions. Such oxides are sometimes referred to as acidic anhydrides.

Ionic metal oxides contain the oxide ion, which is a very strong base. Therefore, the addition of a metal oxide to water will result in a basic solution as a result of the reaction



Oxides of metals are sometimes called basic anhydrides because they react with water to produce basic solutions. Some examples of this type of reaction are the following:



As we have seen earlier in the case of proton transfer reactions such as occurs between $\text{HCl}(\text{g})$ and $\text{NH}_3(\text{g})$, water is not necessary for the acid-base reaction to take place. This is also true of the reactions between the acidic oxides of nonmetals and the basic oxides of metals. In many cases, they react directly as illustrated in the following equations:



It is also true that a more acidic oxide can replace a weaker one. For example, SO_3 is a more acidic oxide than CO_2 so heating CaCO_3 with SO_3 liberates CO_2 :



This reaction can be interpreted as a stronger Lewis acid replacing a weaker one from its compound. If we consider CO_3^{2-} as CO_2 that has attached an O^{2-} , this reaction shows that SO_3 has a stronger affinity for O^{2-} and removes it from the CO_3^{2-} to liberate CO_2 .

Not all binary oxides fall clearly into the category of acidic or basic oxides. For example, the oxides of Zn and Al have the ability to react as either acid or base, depending on the other reactant. This is illustrated in the following equations.



Here, ZnO is reacting as a base, but in the reaction



ZnO reacts as an acid as it forms the $[\text{Zn}(\text{OH})_4]^{2-}$ complex ion. This reaction is formally equivalent to the reaction without water,



The oxyanion containing Zn^{2+} , ZnO_2^{2-} , is known as a zincate, and it equivalent to $\text{Zn}(\text{OH})_4^{2-}$, which is named as the tetrahydroxozincate(II) anion (see Chapter 16). From these reactions, it is clear that ZnO can react as either an acidic or basic oxide and it is therefore known as an *amphoteric* oxide. In essence, there are some oxides that are clearly acidic, some that are clearly basic, and some that are in between. There is, in fact, a continuum of acid-base character for the oxides of elements that is shown in Figure 9.2.

9.5 PROTON AFFINITIES

In Chapter 7, it was shown how the enthalpy of decomposition of an ammonium salt can be used to calculate the proton affinity of the anion. The *proton affinity* is a *gas-phase* property (as is electron affinity) that gives the intrinsic basicity of a species. The reaction of H^+ with a base B can be shown as



Because most species will release energy when a proton is added, the proton addition enthalpy is *negative*. The proton affinity is the heat associated with the reverse process, the removal of the proton,

Basic	Amphoteric				Acidic	
Na_2O	MgO	Al_2O_3	SiO_2	P_4O_{10}	SO_3	Cl_2O_7
<div style="display: flex; justify-content: center; align-items: center; gap: 20px;"> <div style="text-align: center;"> ↓ Add H_2O </div> </div>						
NaOH	$\text{Mg}(\text{OH})_2$	$\text{Al}(\text{OH})_3$	H_4SiO_4	H_3PO_4	H_2SO_4	HClO_4
Strong base	Amphoteric			Weak acid		Strong acid

■ FIGURE 9.2 Acid-base character of oxides.

which is accompanied by a *positive* enthalpy. Therefore, the proton affinity of a species B is defined as the enthalpy of the gas-phase reaction,



The addition of the H^+ to B can be shown by means of a thermochemical cycle:

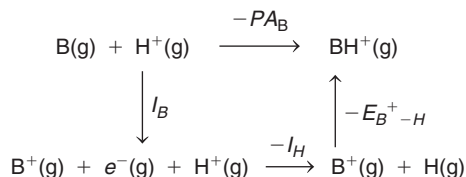

From this cycle, we can write

$$PA_{\text{B}} = I_{\text{H}} - I_{\text{B}} + E_{\text{B}^+-\text{H}} \quad (9.48)$$

In this equation, I_{H} is the ionization potential for H (1312 kJ mol^{-1}), I_{B} is the ionization potential for the base B, and $E_{\text{B}^+-\text{H}}$ is the energy of the B^+-H bond. The term I_{B} is subtracted from I_{H} (the last term is of lesser importance), which leads to the conclusion that the smaller the value for I_{B} , the greater the proton affinity. Because H^+ reacts by removing electron density from B, the easier this process is to accomplish, the smaller the value of I_{B} . For the molecules CH_4 , NH_3 , H_2O , and HF , the proton affinities are 527, 841, 686, and 469 kJ mol^{-1} , respectively. These values correlate well with the ionization potentials of the *molecules*, which are in the order $\text{NH}_3 < \text{H}_2\text{O} < \text{CH}_4 < \text{HF}$.

The proton affinities for neutral molecules are generally in the range of 500 to 800 kJ mol^{-1} . Anions with -1 charges have proton affinities of 1400 to 1700 kJ mol^{-1} , whereas values for -2 ions are in the 2200 to 2400 kJ mol^{-1} range. Extensive tables of proton affinities for a wide range of molecules and ions are available. The proton affinity provides a useful measure of the inherent basicity of a species without the complicating effects produced by solvents. Unfortunately, although gas-phase proton affinities are useful for relating absolute base strength to molecular structures, little acid-base chemistry is carried out in this way.

Because the proton is a hard Lewis acid, it would be expected to interact preferentially with hard Lewis bases. These are species that have high negative charge and small size. For the halide ions, a relationship between the sizes of the anions and their proton affinities should be expected. However, for a broad range of ions that includes polyatomic species, structural differences would come into play because only one of the atoms in the structure is the most basic site. Correlations should be attempted only for species having the same structure and charge. The proton affinities and ionic radii of the anions of group VIA and group VIIA atoms are shown in Table 9.2.

Table 9.2 Proton Affinities of Some -1 and -2 Anions.

Ion	r , pm	PA, kJ/mol	Ion	r , pm	PA, kJ/mol
F^-	136	1544	O^{2-}	140	2548
Cl^-	181	1393	S^{2-}	184	2300
Br^-	195	1351	Se^{2-}	198	2200
I^-	216	1314	CO_3^{2-}	185	2270
OH^-	121	1632	SH^-	181	1464

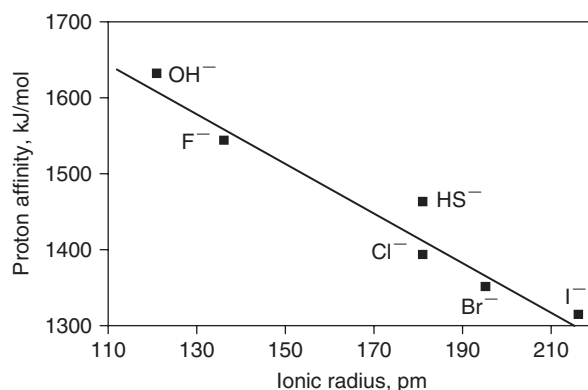

■ **FIGURE 9.3** Variation of proton affinity with ionic radius for -1 ions.

Figure 9.3 shows the relationship between ionic radius and proton affinity in a graphical way for monatomic ions having a -1 charge. It is clear that to a good approximation there is a correlation between the size of the anion and its proton affinity. While this is in no way a detailed study, it is clear that the smaller (and thus *harder*) the negative ion (with the same type of structure) the more strongly it binds a proton.

Although it is not surprising that anions have a rather high affinity for protons, it is also found that neutral molecules bind protons with the release of energy. Table 9.3 shows the proton affinities for some neutral molecules having simple structures.

It is interesting to note that even a “saturated” molecule such as CH_4 has a significant attraction for a proton. This demonstrates clearly that even a pair of electrons that is shared in a bond can be a binding site for H^+ . In general, the more acidic (or less basic) a compound is, the lower the value for its proton affinity. For example, the proton affinity for NH_3 is 866 kJ/mol, whereas that for PH_3 is 774, in keeping with the fact that PH_3 is the weaker base.

The data shown in Tables 9.2 and 9.3 reveal some interesting facts. We know that HI is a strong acid in aqueous solution. However, the proton affinity of $I(g)^-$ is 1314 kJ/mol, whereas that of H_2O is 686 kJ/mol. Therefore, for the reaction

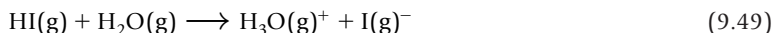

CH ₄	NH ₃	H ₂ O	HF	Ne
528	866	686	548	201
SiH ₄	PH ₃	H ₂ S	HCl	Kr
~600	804	711	575	424
	AsH ₃	H ₂ Se	HBr	Xe
	732	711	590	478
			HI	
			607	
^a Most values are from a larger table given by Porterfield (1993), p. 325.				

the enthalpy change would be the difference between the energy to pull a proton off $I(g)^-$, which is 1314 kJ/mol, and the energy released when a proton is added to $H_2O(g)^+$, which is -686 kJ/mol. Consequently, the process represented in Eq. (9.49) is *endothermic* to the extent of 628 kJ/mol. However, the data shown in Table 7.7 indicate that the enthalpy of hydration of H^+ is -1100 kJ/mol and that of I^- is -296 kJ/mol. When solvation of the ions is taken into account, the situation becomes somewhat different. The fact remains that removing a proton from HI (a strong acid *in aqueous solutions*) and placing it on H_2O is not an energetically favorable reaction in the *gas* phase. These observations should indicate clearly why the role of a solvent (and the solvent chosen) are vitally important to how acids and bases function.

9.6 LEWIS THEORY

Up to this point, we have dealt with the subject of acid-base chemistry in terms of proton transfer. If we seek to learn what it is that makes NH_3 a base that can accept a proton, we find that it is because there is an unshared pair of electrons on the nitrogen atom where the proton can attach. Conversely, it is the fact that the hydrogen ion seeks a center of negative charge that makes it leave an acid such as HCl and attach to the ammonia molecule. In other words, it is the presence of an unshared pair of electrons on the base that results in proton transfer. Sometimes known as the *electronic* theory of acids and bases, this shows that the essential characteristics of acids and bases do not always depend on the transfer of a proton. This approach to acid-base chemistry was first developed by G. N. Lewis in the 1920s.

When the reaction



is considered from the standpoint of electrons, we find that the proton from HCl is attracted to a center of negative charge on the base. The unshared pair of electrons on the nitrogen atom in ammonia is

just that type of center. When the proton attaches to the NH_3 molecule, both of the electrons used in the bond come from the nitrogen atom. Thus, the bond is a *coordinate covalent bond* (or simply a coordinate bond) that is formed as the result of the reaction between an acid and a base.

Lewis acid-base chemistry provides one of the most useful tools ever devised for systematizing an enormous number of chemical reactions. Because the behavior of a substance as an acid or a base has nothing to do with proton transfer, many other types of reactions can be considered as acid-base reactions. For example,



involves the BCl_3 molecule attaching to the unshared pair of electrons on the NH_3 molecule to form a coordinate bond. Therefore, this reaction is an acid-base reaction according to the Lewis theory. The product of such a reaction results from the addition of two complete molecules, and as a result, it is often referred to as an acid-base *adduct* or *complex*. The BCl_3 is an electron pair acceptor, a Lewis acid. The NH_3 is an electron pair donor, a Lewis base. According to these definitions, it is possible to predict what types of species will behave as Lewis acids and bases.

The following types of species are Lewis acids:

1. Molecules that have fewer than eight electrons on the central atom (e.g., BCl_3 , AlCl_3).
2. Ions that have a positive charge (e.g., H^+ , Fe^{3+} , Cr^{3+}).
3. Molecules in which the central atom can add additional pairs of electrons even though it already has an octet or more of electrons (e.g., SbCl_3 , PCl_5 , SF_4).

Lewis bases include the following types of species:

1. Anions that have an unshared pair of electrons (e.g., OH^- , H^- , F^- , PO_4^{3-}).
2. Neutral molecules that have unshared pairs of electrons (e.g., NH_3 , H_2O , R_3N , ROH , PH_3).

We can now write equations for many reactions that involve a Lewis acid reacting with a Lewis base. The following are a few examples:



Acid-base behavior according to the Lewis theory has many of the same aspects as does acid-base theory according to the Brønsted–Lowry theory.

1. There is no acid without a base. An electron pair must be donated to one species (the acid) by another (the base).
2. An acid (or base) reacts to displace a weaker acid (or base) from a compound.
3. The interaction of a Lewis acid with a Lewis base is a type of neutralization reaction because the acidic and basic characters of the reactants are removed.

An acid-base reaction takes place readily between BF_3 and NH_3 ,



However, when the product of this reaction is brought into contact with BCl_3 , a reaction takes place:

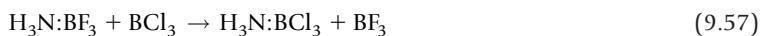

In this reaction, a Lewis acid, BF_3 , has been replaced by essentially a stronger one, BCl_3 . There are two questions that arise concerning this reaction. First, why is BCl_3 a stronger Lewis acid than BF_3 ? Second, how does this type of reaction take place?

The strength of a Lewis acid is a measure of its ability to attract a pair of electrons on a molecule that is behaving as a Lewis base. Fluorine is more electronegative than chlorine, so it appears that three fluorine atoms should withdraw electron density from the boron atom, leaving it more positive. This would also happen to some extent when the peripheral atoms are chlorine, but chlorine is less electronegative than fluorine. On this basis, we would expect BF_3 to be a stronger Lewis acid. However, in the BF_3 molecule, the boron atom uses sp^2 hybrid orbitals, which leaves one empty $2p$ orbital that is perpendicular to the plane of the molecule. The fluorine atoms have filled $2p$ orbitals that can overlap with the empty $2p$ orbital on the boron atom to give some double bond character to the B-F bonds.

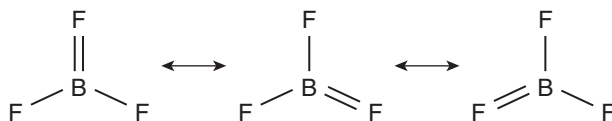

As a result of the contribution by resonance structures having some double bond character, the boron atom in BF_3 is not as electron deficient as it is in BCl_3 . To answer the second question, we will write a general substitution reaction as



where B is a Lewis base and A and A' are Lewis acids. Because they have unshared pairs of electrons, Lewis bases seek to interact with a center of positive charge (electron deficiency) in another species. In the foregoing reaction, A is the electron-deficient species, and that is where B has bonded. Because

B seeks to interact with a *positive* site, it is known as a *nucleophile* (“nucleus loving”). On the other hand, the molecules A and A', being electron deficient, seek to interact with an unshared pair of electrons on another species. Therefore, A and A' are “electron loving” species or *electrophiles*. In the reaction just shown, one electrophile has replaced another, so the reaction is known as an *electrophilic substitution*.

The reaction



represents one nucleophile replacing another, so the reaction is known as a *nucleophilic substitution*. There are two limiting ways that we can envision such a reaction taking place. In the first, the group that is leaving (B) leaves before B' bonds to A. That bond-breaking step would be the slow or rate determining step for the process. Following that step, the entering group, B', enters in a bond-making step, which would be fast compared to the bond breaking step. The process can be shown as



In a kinetic study on this reaction, information is gained only about the slow step. If a system of pipes has a 1-inch pipe attached to a 6-inch pipe and a study is carried out on the rate at which water flows through the system, information will be gained only on the rate of flow of water through the 1-inch pipe. That is the *rate-determining* step. As long as there is a reasonable concentration of B' available, the rate of the reaction just shown will be dependent only on the concentration of A:B. The rate law for the process can be written as

$$\text{Rate} = k_1[\text{A:B}] \quad (9.61)$$

(where k_1 is the rate constant), and the reaction is first-order in A:B. Changing the concentration of B' within wide limits does not alter the rate of the reaction, which is known as an S_N1 process. The symbol S_N1 is a shorthand way to write *substitution, nucleophilic, first-order*.

If the reaction takes place in such a way that the first (slow) step involves B' starting to bond to A before B leaves, the reaction can be shown as follows:

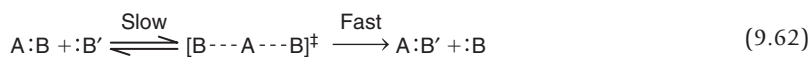

In this case, the rate of the reaction is determined by how rapidly the transition state is formed, and that process requires both A:B and :B'. The rate law for the reaction is

$$\text{Rate} = k_2[\text{A:B}][\text{B}'] \quad (9.63)$$

According to this mechanism, there is a first-order dependence on both the concentration of [A:B] and B', and the reaction is called an S_N2 process (*substitution, nucleophilic, second-order*). Although many nucleophilic substitution reactions follow one of these simple rate laws, many others do not. More complex rate laws such as

$$\text{Rate} = k_1[\text{A:B}] + k_2[\text{A:B}][\text{B}'] \quad (9.64)$$

are observed. The substitution reactions in which one Lewis acid replaces another are known as electrophilic substitution, and simple first- and second-order processes are designated as S_E1 or S_E2, respectively.

Perhaps the greatest area in which the Lewis acid-base approach is most useful is that of coordination chemistry. In the formation of coordination compounds, Lewis acids such as Cr³⁺, Co³⁺, Pt²⁺, or Ag⁺ bind to a certain number (usually 2, 4, or 6) of groups as a result of electron pair donation and acceptance. Typical electron pair donors include H₂O, NH₃, F⁻, CN⁻, and many other molecules and ions. The products, known as coordination compounds or coordination complexes, have definite structures that are predictable in terms of principles of bonding. Because of the importance of this area of inorganic chemistry, Chapters 16 through 22 in this book are devoted to coordination chemistry.

9.7 CATALYTIC BEHAVIOR OF ACIDS AND BASES

One of the characteristics of acids and bases is that they catalyze certain reactions. Many years ago, J. N. Brønsted studied the relationship between acid strength as measured by the dissociation constant and the rate of a reaction that is catalyzed by the acid. The relationship that Brønsted recognized can be written as

$$k = C K_a^n \quad (9.65)$$

where K_a is the dissociation constant for the acid, k is the rate constant for the reaction, and C and n are constants. Taking the logarithm of both sides of the equation yields

$$\ln k = n \ln K_a + \ln C \quad (9.66)$$

or using common logarithms the relationship becomes

$$\log k = n \log K_a + \log C \quad (9.67)$$

The pK_a of an acid is defined as $-\log K_a$, so Eq. (9.67) can be written as

$$\log k = -n \text{p}K_a + \log C \quad (9.68)$$

The form of this equation shows that a graph of $\log k$ versus pK_a should be linear with a slope of $-n$ and an intercept of $\log C$. Dissociation of the acid produces the anion A⁻ that accepts protons from water, as shown in the equation



for which the equilibrium constant, K_b , is written as

$$K_b = \frac{[\text{HA}][\text{OH}^-]}{[\text{A}^-]} \quad (9.70)$$

The equilibrium constant, K_a , is related to the free energy change for the dissociation of the acid, ΔG_a , by the equation

$$\Delta G_a = -RT \ln K_a \quad (9.71)$$

Solving Eq. (9.71) for $\ln K_a$ and substituting the result in Eq. (9.66) gives

$$\ln k = -\frac{n\Delta G_a}{RT} + \ln C \quad (9.72)$$

Equation (9.72) is known as a *linear free energy relationship*, and it shows that there should be a linear relationship between the logarithm of the rate constant for a reaction and the free energy for the dissociation of the acid.

Relationships can be developed in a similar manner for reactions that are catalyzed by bases. The equation that can be obtained is

$$\log k' = n' \log K_b + \log C \quad (9.73)$$

where the prime indicates that a base is being considered rather than an acid. Since the relationship between K_a and K_b is $K_a K_b = K_w$. Substituting for K_b in Eq. (9.73) gives

$$\log k' = n' \log \left(\frac{K_w}{K_a} \right) + \log C \quad (9.74)$$

Although a general discussion of linear free energy relationships (LFER) is not being presented here, the approach just given can be extended to the Hammett σ and ρ parameters that are so useful in organic chemistry. Consult the references at the end of this chapter for details on the application of LFER in organic chemistry. The foregoing discussion shows that the catalytic behavior of different acids is predictable when based on the difference in acid strength.

Although the discussion to this point has been concerned with the explanation of the behavior of Brønsted acids as catalysts, there is an enormous range of reactions in which catalysis by acids and bases occurs. Many of the important types of organic reactions involve catalysis by acids or bases. In this section, several reactions will be mentioned, but the mechanistic details will not be presented in this book on inorganic chemistry. The discussion is intended to show the scope of catalysis by acids and bases.

The very important type of reaction known as enolization is catalyzed by both acids and bases. Also, the hydrolysis of an ester,



is catalyzed by acids with the first step believed to involve the addition of a proton to an unshared pair of electrons on the carbonyl oxygen atom. In fact, several organic reactions that are catalyzed by acids involve the addition of H^+ to an unshared pair of electrons on an atom. While an oxygen atom in a carbonyl group is a very weak base, it is certainly basic in comparison to strong acids. The enolization reaction of acetone,

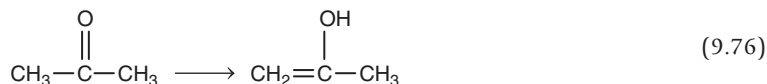

is catalyzed by OH^- with the first step being the removal of H^+ from a methyl group.

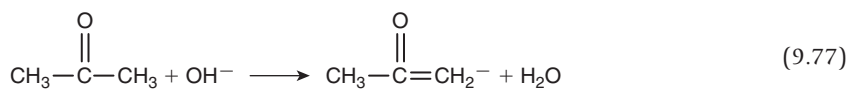

Acetone is a very weak acid (K_a approximately 10^{-19}), but the presence of an oxygen atom bound to the adjacent carbon atom produces an inductive effect that makes it considerably more acidic than is a hydrocarbon molecule.

Another reaction that is catalyzed by a base is that which leads to the formation of the benzyne intermediate. In this case, the strong base is the amide ion, NH_2^- .

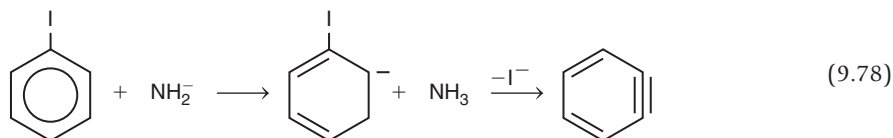

The triple bond in the benzyne intermediate is very reactive toward a wide range of nucleophiles. The reaction of acetaldehyde with methanol to produce a hemiacetal is also a base-catalyzed reaction. In this reaction, the methoxide ion, CH_3O^- , is the base:

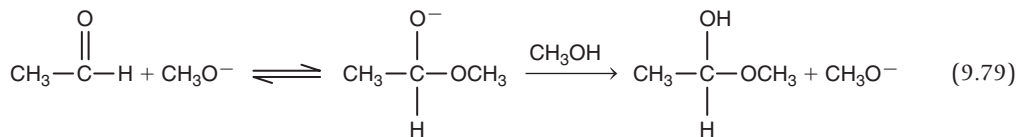

Many important reactions involve catalysis by Lewis acids or bases. One of the most important of these is the type of reaction carried out by Charles Friedel and James Crafts. These reactions, known as the Friedel–Crafts reactions, actually involve several types of important processes. One of these is alkylation, which is illustrated by the reaction of benzene with an alkyl halide in the presence of AlCl_3 , a strong Lewis acid.



In this reaction, the function of AlCl_3 is to generate an attacking carbocation by means of the reaction



A mixture of HF and BF_3 catalyzes the reaction

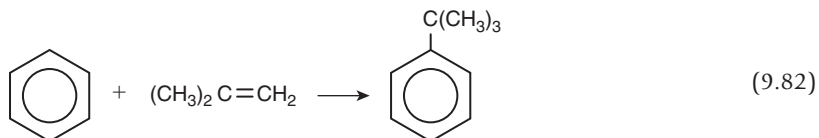

by first generating the $(\text{CH}_3)_3\text{C}^+$ carbocation, which then attacks the ring.

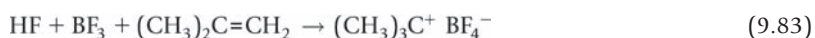

Lewis acids such as FeCl_3 and ZnCl_2 are also useful catalysts. For example, bromination of benzene by Br_2 in the presence of FeBr_3 can be shown as

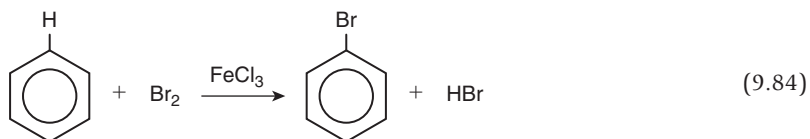

The function of the catalyst is to provide a bromine with a positive charge either by separating the molecule to give Br^+ and FeBr_4^- or by giving a polar Br_2 molecule that results from attaching to one of the bromine atoms to FeBr_3 as in $\text{Br}^+ - \text{Br}^- - \text{FeBr}_3$.

Another reaction that depends on the presence of an acid catalyst is nitration. In this case, the catalyst is H_2SO_4 , which functions to produce the *nitronium* ion, NO_2^+ :

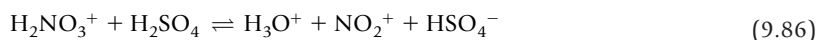

The second step is sometimes shown as



but in the presence of sulfuric acid the H_2O certainly would be protonated. The actual nitration process is

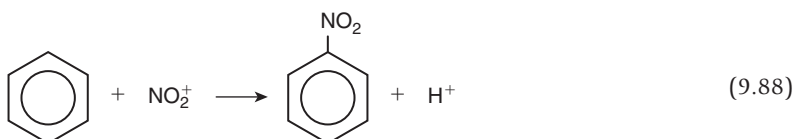

Many reactions are catalyzed by aluminum oxide, Al_2O_3 , which is also known as alumina. In the solid, there are sites on the surface where a strongly acidic aluminum ion is available to bond to an electron pair donor. One such reaction involves the dehydration of alcohols to produce alkenes. This process can be represented as follows:

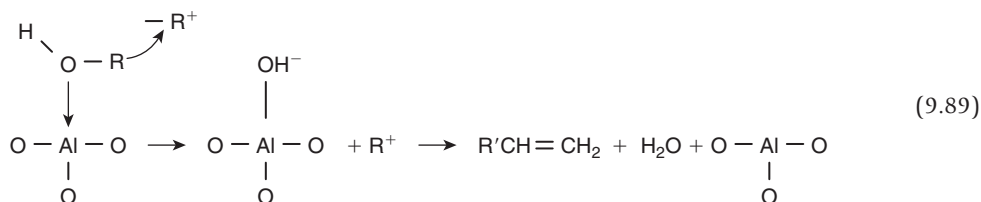

In this reaction, an acidic site on the catalyst is shown as an aluminum atom bound to three oxygen atoms, and this is a site where an alcohol molecule can bind. If the acidic sites on the alumina are shielded by reacting it with a base, the oxide is no longer an effective acid catalyst. In other words, the acidity is removed by attaching molecules such as NH_3 to the acidic sites.

The reactions shown above are just a few of the enormous number of processes that involve catalysis by acids and bases. Some of the reactions are of economic importance and they certainly serve to illustrate that this type of chemistry is not solely the province of either the organic or inorganic chemist.

9.8 THE HARD-SOFT INTERACTION PRINCIPLE (HSIP)

As we have seen, the Lewis theory of acid-base interactions based on electron pair donation and acceptance applies to many types of species. As a result, the electronic theory of acids and bases pervades the whole of chemistry. Because the formation of metal complexes represents one type of Lewis acid-base interaction, it was in that area that evidence of the principle that *species of similar electronic character interact best* was first noted. As early as the 1950s, Ahrlund, Chatt, and Davies had classified metals as belonging to class A if they formed more stable complexes with the first element in the periodic group or to class B if they formed more stable complexes with the heavier elements in that group. This means that metals are classified as A or B based on the electronic character of the donor atom they prefer to bond to. The donor strength of the ligands is determined by the stability of the complexes they form with metals. This behavior is summarized in the following table.

	Donor Strength
Class A metals	$\text{N} \gg \text{P} > \text{As} > \text{Sb} > \text{Bi}$ $\text{O} \gg \text{S} > \text{Se} > \text{Te}$ $\text{F} > \text{Cl} > \text{Br} > \text{I}$
Class B metals	$\text{N} \ll \text{P} > \text{As} > \text{Sb} > \text{Bi}$ $\text{O} \ll \text{S} \approx \text{Se} \approx \text{Te}$ $\text{F} < \text{Cl} < \text{Br} < \text{I}$

Table 9.4 Lewis Bases.	
Hard	Soft
OH^- , H_2O , F^-	RS^- , RSH , R_2S
SO_4^{2-} , Cl^- , PO_4^{3-} , CO_3^{2-} , NO_3^-	I^- , SCN^- , CN^- , $\text{S}_2\text{O}_3^{2-}$,
ClO_4^- , RO^- , ROH , R_2O	CO , H^- , R^-
NH_3 , RNH_2 , N_2H_4	R_3P , R_3As , C_2H_4
Borderline Bases	
$\text{C}_5\text{H}_5\text{N}$, N_3^- , N_2 , Br^- , NO_2^- , SO_3^{2-}	

Thus, Cr^{3+} and Co^{3+} belong to class A because they form more stable complexes with oxygen as the donor atom than when sulfur is the donor atom. On the other hand, Ag^+ and Pt^{2+} belong to class B because they form more stable complexes with P or S as the donor atom than with N or O as the donor atom.

The examination of the hard and soft electronic character of acids and bases as discussed here was first put into systematic form by R. G. Pearson in the 1960s. According to the interpretation of Pearson, soft bases are those electron donors that have high polarizability, low electronegativity, empty orbitals of low energy, or are easily oxidizable. Hard bases have the opposite properties. Soft acids are those having low positive charge, large size, and completely filled outer orbitals. Polarizability, the ability to distort the electron cloud of a molecule, and low electronegativity depend upon these properties. Hard acids have the opposite characteristics. Based on their properties, we would expect that typical hard acids would be species such as Cr^{3+} , Co^{3+} , Be^{2+} , and H^+ , for which distortion of the electron cloud would be minimal. Soft acids would include species such as Ag^+ , Hg^{2+} , Pt^{2+} , or uncharged metal atoms, all of which are easily polarizable. Obviously, such a distinction is made in a qualitative way, and the classification of some species will not be definitive. Tables 9.4 and 9.5 show some typical acids and bases classified according to their hard or soft character. (Lists are based on those in Pearson, 1966.)

The guiding principle regarding the interaction of electron pair donors and acceptors is that the *most favorable* interactions occur when the acid and base have similar electronic character. In accord with this observation, it is found that hard acids *preferentially* interact with hard bases, and soft acids interact *preferentially* with soft bases. This is related to the way in which the species interact. Hard acids interact with hard bases primarily by interactions that result from forces between ions or polar species. Interactions of these types will be favored by high charge and small size of both the acid and base. Soft acids and soft bases interact primarily by sharing electron density, which is favored when the species have high polarizability. Frequently, interactions between soft acids and soft bases involve bonding between neutral molecules. Orbital overlap that leads to covalent bonding is most favorable when the orbitals of the donor and acceptor atoms are of similar size and energy.

A modification of the HSAB approach was first explained by C. K. Jørgensen in connection with the stability of a cobalt complex. Under normal circumstances, Co^{3+} is a hard Lewis acid. However, when

Table 9.5 Lewis Acids.	
Hard	Soft
$H^+, Li^+, Na^+, K^+, Be^{2+}, Mg^{2+},$	Cu^+, Ag^+, Au^+, Ru^+
$Ca^{2+}, Mn^{2+}, Al^{3+}, Sc^{3+}, La^{3+}, Cr^{3+}$	$Pd^{2+}, Cd^{2+}, Pt^{2+}, Hg^{2+}$
$Co^{3+}, Fe^{3+}, Si^{4+}, Ti^{4+}$	$GaCl_3, RS^+, I^+, Br^+$
$Be(CH_3)_2, BF_3, HCl, AlCl_3, SO_3$	$O, Cl, Br, I,$
$B(OR)_3, CO_2, RCO^+, R_2O, RO^-$	uncharged metals
Borderline Acids	
$Fe^{2+}, Co^{2+}, Ni^{2+}, Zn^{2+}, Cu^{2+}, Sn^{3+},$ $Rh^{3+}, (BCH_3)_3, Sb^{3+}, SO_2, NO^+$	

Co^{3+} is bonded to five cyanide ions, it is found that a more stable complex results when the sixth group is iodide rather than fluoride. Therefore, it is found that $[Co(CN)_5I]^{3-}$ is more stable than $[Co(CN)_5F]^{3-}$. If the other five ligands are NH_3 , the opposite effect is observed. The apparent contradiction in the case of the cyanide complexes is the result of the "softening" of Co^{3+} that occurs when five of the ligands are soft. This causes the *aggregate* of the hard Co^{3+} and five soft ligands to behave as a soft electron pair acceptor for the I^- . However, the five CN^- ions have made the Co^{3+} in the *complex* much softer than an *isolated* Co^{3+} ion. Although Co^{3+} is normally a hard electron pair acceptor, the five CN^- ions attached cause it to behave as a soft acid. This effect is known as the *symbiotic effect*. Whether a species appears to be hard or soft depends on the groups attached and their character.

The hard-soft acid-base principle is not restricted to the usual types of acid-base reactions. It is a guiding principle that for all types of interactions species of similar electronic character interact best. We have already seen some applications (such as the relative strength of HF and HI) of this principle, which we will continue to call HSAB, but we now consider a number of other types of applications.

9.8.1 Hydrogen Bonding

The HSAB principle can be applied in a qualitative way to interactions that result from hydrogen bonding. Stronger hydrogen bonds would be expected to form when the electron donor atom is a hard Lewis base in which the pair of electrons being donated are in a small, compact orbital. For example, the occurrence of hydrogen bonding in the hydrogen compounds of the first long group of elements has already been cited as being responsible for their high boiling points (see Chapter 6). Hydrogen bonding is much more extensive in NH_3 , H_2O , and HF than it is in PH_3 , H_2S , and HCl. Unshared pairs of electrons on second-row atoms are contained in larger orbitals and do not interact as well with the very small H nucleus.

A clear effect of hydrogen bonding is afforded by considering the interaction of alcohols with acetonitrile, CH_3CN , and trimethylamine, $(CH_3)_3N$. The dipole moments of these molecules are 3.44 D

and 0.7 D, respectively. However, nitriles are soft bases, but amines are hard bases. In this case, when CH_3OH is hydrogen bonded to CH_3CN and $(\text{CH}_3)_3\text{N}$, the bonds have energies of about 6.3 kJ mol^{-1} and 30.5 kJ mol^{-1} , respectively, in accord with the predictions of HSAB.

When phenol, $\text{C}_6\text{H}_5\text{OH}$, is hydrogen bonded to $(\text{C}_2\text{H}_5)_2\text{O}$, the OH stretching band in the infrared spectrum is shifted by about 280 cm^{-1} and the hydrogen bonds have energies of about 22.6 kJ mol^{-1} . When phenol hydrogen-bonds to $(\text{C}_2\text{H}_5)_2\text{S}$, the corresponding values for these parameters are about 250 cm^{-1} and 15.1 kJ mol^{-1} . Ethers are considered as hard bases, whereas alkyl sulfides are soft.

If our qualitative predictions regarding softness of the base are valid, we should expect that $\text{C}_6\text{H}_5\text{OH}$ hydrogen-bonded to the bases $(\text{C}_6\text{H}_5)_3\text{P}$ and $(\text{C}_6\text{H}_5)_3\text{As}$ would also follow the same trend. In fact, when the OH of phenol is hydrogen-bonded to $(\text{C}_6\text{H}_5)_3\text{P}$, the OH stretching band is shifted by 430 cm^{-1} , and when it is hydrogen-bonded to $(\text{C}_6\text{H}_5)_3\text{As}$ it is shifted by 360 cm^{-1} . This is exactly as expected. When phenol hydrogen-bonds to CH_3SCN , the hydrogen-bond energy is 15.9 kJ mol^{-1} and the OH band is shifted by 146 cm^{-1} . When phenol is hydrogen-bonded to CH_3NCS , the OH stretching band is shifted by 107 cm^{-1} and the hydrogen-bond energy is 7.1 kJ mol^{-1} . The sulfur end of SCN is a soft electron donor, and the nitrogen end is significantly harder. Hydrogen bonding to these atoms reflects this difference.

9.8.2 Linkage Isomers

Ions such as SCN^- have two potential electron donor atoms. When bonding to metal ions, the bonding mode may be determined by HSAB considerations. For example, when SCN^- bonds to Pt^{2+} , it bonds through the sulfur atom. When it bonds to Cr^{3+} , it bonds through the nitrogen atom, in accord with the class A and class B behavior of these metal ions described earlier. Steric effects can cause a change in bonding mode in Pt^{2+} complexes. When three very large groups such as $\text{As}(\text{C}_6\text{H}_5)_3$ are bound to Pt^{2+} , the steric effects can cause SCN^- to bond through the nitrogen atom even though the electronic character would indicate the opposite. As shown in Figure 9.4, the bonding through the nitrogen atom is linear, whereas that through the sulfur atom is not.

9.8.3 Solubility

One of the simplest applications of the HSAB principle is related to solubility. The rule “like dissolves like” is a manifestation of the fact that solute particles interact best with solvent molecules which have similar characteristics. Small, highly charged particles or polar molecules are solvated best by solvents containing small, highly polar molecules. Large solute particles having low polarity are solvated best by solvent molecules having similar characteristics. Consequently, NaCl is soluble in water, whereas sulfur, S_8 , is not. On the other hand, NaCl is insoluble in CS_2 , but S_8 dissolves in CS_2 .

For many years before the hard-soft interaction principle was described by Ralph G. Pearson, a rule of solubility was stated as “like dissolves like.” This meant that large, nonpolar solute molecules interact best with large nonpolar solvent molecules. Water is a good solvent for most ionic solids, but carbon tetrachloride is a good solvent for solids that consist of large, nonpolar molecules. In the same way, H_2O and CH_3OH are both small, polar molecules, and the liquids are completely miscible. On the other hand, even though they contain OH groups, alcohols that have as many as five carbon atoms in the chain are not completely miscible with water. The alkyl group containing a longer carbon

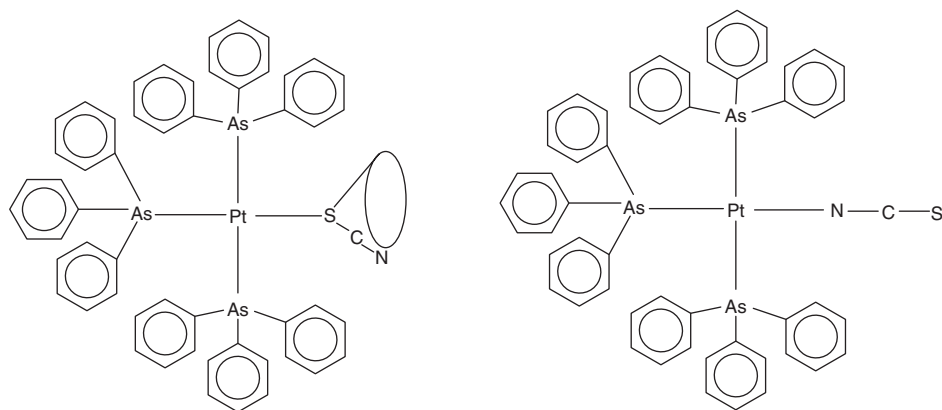

■ **FIGURE 9.4** Influence of large ligands such as triphenylarsine on the bonding mode of SCN^- .

chain becomes the dominant part of the molecule rather than the OH group. Sodium chloride is an ionic solid that dissolves to the extent of 35.9 g in 100 g of water at 25 °C. The solubilities in CH_3OH , $\text{C}_2\text{H}_5\text{OH}$, and $i\text{-C}_3\text{H}_7\text{OH}$ are 0.237, 0.0675, and 0.0041 g in 100 g of solvent, respectively, at 25 °C. In the case of the alcohols, as the chain length increases, the organic part of the molecule dominates the OH functional group so that these compounds become progressively poorer solvents for ionic solutes. It is not as simple as considering the dipole moment of the solvent because nitrobenzene has a dipole moment of 4.22 D, but the large molecules cannot surround Na^+ and Cl^- effectively.

In order for a solvent to remove ions from the lattice, the molecules must be polar and small enough to allow several solvent molecules to surround the ions. Of course NaCl is soluble in water because water consists of small, polar molecules. If the solvent is CH_3OH , the solubility of NaCl is much less than it is in water. The dipole moment of CH_3OH is somewhat lower than that for H_2O , but the CH_3OH molecules are large enough to prevent as many of them from surrounding Na^+ and Cl^- efficiently. When $\text{C}_2\text{H}_5\text{OH}$ is used as a solvent for NaCl, it is found that it is a considerably poorer solvent than CH_3OH . The dipole moments of the two alcohols are not very different, but the larger $\text{C}_2\text{H}_5\text{OH}$ cannot solvate the ions as well as the smaller CH_3OH molecules. Because Na^+ and Cl^- ions are small and compact, they interact better with the smaller CH_3OH molecules than with larger molecules of another alcohol.

The hard-soft interaction principle allows us to correctly predict the results of many experiments. For example, suppose an aqueous solution containing Cs^+ , Li^+ , F^- , and I^- is evaporated. The solid products of the reaction could be CsF and LiI or CsI and LiF:

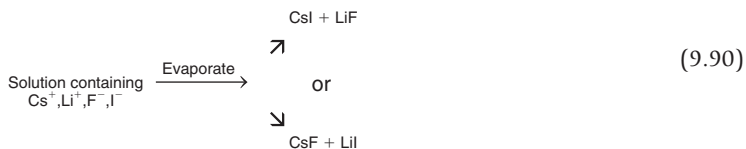

Based on the principles of bonding related to electronegativity, the element with *highest* electronegativity should bond best to the one with the *lowest* electronegativity. That means that CsF should be produced. However, based on the hard-soft interaction principle, the ions of similar electronic character should interact best. The small Li^+ ion should bond better to F^- and the large Cs^+ should bond better to I^- , exactly as is observed.

The conclusion that follows is that *ionic solids precipitate best from aqueous solutions when the ions are of similar size, preferably with the two ions having the same magnitude in their charges*. For the reaction



the enthalpy of crystallization changes are ~ 0 , 66.9, 58.6, and -20.9 kJ mol $^{-1}$ for LiF, LiI, CsF, and CsI, respectively. These data can be used to show that if a solution contains Li^+ , Cs^+ , F^- , and I^- , the precipitation of LiF and CsI is more favorable than that of LiI and CsF. We can conclude that the small, hard Li^+ ion interacts better with F^- and the large, soft Cs^+ interacts better with the large I^- .

Another example of how the hard-soft interaction principle applies to precipitation can be seen in a familiar case from analytical chemistry. Because ions of similar size and magnitude of charges precipitate (interact) best, a good counterion for precipitation of Ba^{2+} is one that is of similar size and has a -2 charge. In accord with this, Ba^{2+} is normally precipitated as the sulfate because of the favorable size and charge of the anion compared to the cation.

The application of the HSAB principle is of considerable importance in preparative coordination chemistry in that some complexes are stable only when they are precipitated using a counterion conforming to the above rule. For example, CuCl_5^{3-} is not stable in aqueous solution but can be isolated as $[\text{Cr}(\text{NH}_3)_6][\text{CuCl}_5]$. Attempts to isolate solid compounds containing the complex ion $\text{Ni}(\text{CN})_5^{3-}$ as $\text{K}_3[\text{Ni}(\text{CN})_5]$ lead to KCN and $\text{K}_2[\text{Ni}(\text{CN})_4]$. It was found, however, that when counterions such as $\text{Cr}(\text{NH}_3)_6^{3+}$ or $\text{Cr}(\text{en})_3^{3+}$ were used, solids containing the $\text{Ni}(\text{CN})_5^{3-}$ anion were obtained.

9.8.4 Reactive Site Preference

We have already used the HSAB principle as it applies to linkage isomers in metal complexes. This application to bonding site preference can also be used to show the behavior of other systems. For example, the reactions of organic compounds also obey the principles when reacting with nucleophiles such as SCN^- or NO_2^- :

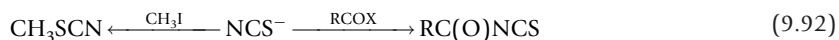

In this case, the acidic species RCOX is a hard acid and reacts with the nitrogen end of SCN^- to form an acyl isothiocyanate. The soft methyl group bonds to the S atom and forms methyl thiocyanate. Consider the reactions of NO_2^- :

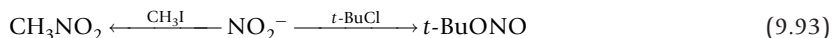

Here, the $t\text{-Bu}^+$ carbocation is a hard acid, so the product is determined by its interaction with the oxygen (harder) electron donor. With CH_3I , the product is nitromethane, showing the softer character of the methyl group.

Consider the reaction of PCl_3 with AsF_3 .



Although both arsenic and phosphorus are soft, arsenic is softer. Likewise, Cl is softer than F, so we predict that a scrambling reaction would take place as shown earlier.

Phosphine, PH_3 , is a pyramidal molecule that has an unshared pair of electrons on the phosphorus atom. Therefore, it can function as both a proton acceptor (Brønsted base) or an electron pair donor (Lewis base). For the moment, it is the ability to accept protons that will be considered. When ammonia is dissolved in water, the equilibrium

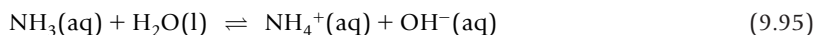

is established for which the equilibrium constant is 1.8×10^{-5} . When phosphine is dissolved in water, the reaction



takes place with an equilibrium constant of only $\sim 10^{-26}$. Why is PH_3 so much weaker as a base than is NH_3 ? The answer lies in the *hard-soft acid-base principle* (often referred to as the hard-soft interaction principle, HSIP, because it governs interactions that are not necessarily acid-base in character). In the cases just shown, H^+ is the electron pair acceptor. It is extremely small in size, and it is nonpolarizable. Because of these traits, it is considered a hard acid. In the NH_3 molecule, it is the electron pair on the nitrogen atom that is the basic site. The orbital is small, and it readily bonds to the small H^+ . In the PH_3 molecule, it is the pair of electrons on the phosphorus atom that is the site where the H^+ must attach. However, phosphorus is in the third row of the periodic table and is a considerably larger atom than the nitrogen atom. As a result, the small H^+ bonds much better to the electron pair in the more compact orbital on the nitrogen atom in NH_3 than it does to the electrons in the larger, more diffuse orbital on the phosphorus atom in PH_3 . Therefore, although NH_3 is a weak base, it is a much stronger base than PH_3 . In fact, PH_3 is such a weak base that only salts of strong acids with relatively large anions (to match the size of PH_4^+) are stable. Accordingly, PH_4I is stable, whereas PH_4F is not. Several important applications of the matching of sizes of cation and anion will be discussed in connection with the synthesis of coordination compounds in Chapter 20.

The hard-soft acid-base principle just illustrated is one of the most useful principles in all of chemistry for predicting how many types of interactions occur. It is not restricted to acid-base interactions, so it is better called the *hard-soft interaction principle*. It predicts that hard acids (high charge, small size, low

polarizability) *prefer* to interact with hard bases (small size, high charge, low polarizability). Thus, the reaction



proceeds farther to the right than does the reaction



In other words, OH^- is a much stronger base than SH^- . The orbital holding the unshared pair of electrons on the oxygen atom is smaller than the one holding the electron pair on the sulfur atom. Therefore, H^+ interacts more strongly with OH^- than it does with SH^- . The HSIP does not say that hard acids will *not* bond to soft bases. Rather, it says that bonding between hard acids and hard bases is *more effective* than between hard acids and soft bases. A similar statement can also be made for bonding as a result of the interaction between soft acids and soft bases.

Earlier it was described how PH_3 is a much weaker base than NH_3 . That is certainly true when the interaction of these molecules with H^+ is considered. However, if the electron pair acceptor is Pt^{2+} , the situation is quite different. In this case, the Pt^{2+} ion is large and has a low charge, so it is considered to be a soft (polarizable) Lewis acid. Interaction between Pt^{2+} and PH_3 provides a more stable bond than when NH_3 bonds to Pt^{2+} . In other words, the soft electron acceptor, Pt^{2+} , bonds better to the softer electron donor, PH_3 , than it does to NH_3 . The hard-soft interaction principle does not say that soft Lewis acids will not interact with hard Lewis bases. In fact, they will interact, but this is not the most favored type of interaction.

Although sometimes referred to as the hard-soft acid-base *theory*, it is actually a *principle* that relates to many types of chemical interactions. It provides a good explanation of why HF is a weak acid. If H^+ might potentially interact with either H_2O or F^- , the situation with regard to the preferred bonding mode could be shown as follows:



In this case, the unshared pairs of electrons on F^- and H_2O to which the H^+ can bind are in orbitals of similar size. In addition, the fluoride ion has a negative charge, which attracts H^+ strongly. Therefore, H^+ bonds preferentially to F^- rather than to H_2O . What this means is that the reaction

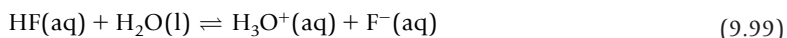

takes place only slightly because the hydrogen ion bonds preferentially to F^- . Therefore, HF is a weak acid.

If we consider a similar situation with H^+ and Cl^- ions in water, what is the preferred bonding mode for H^+ ?

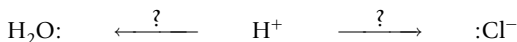

Now, the possibility exists for H^+ to bond to Cl^- or H_2O . The orbital that has an unshared pair of electrons on the oxygen is much smaller than that on the chloride ion. Therefore, H^+ preferentially bonds to H_2O , which means that the reaction

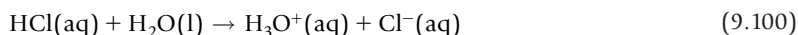

goes to the right almost to completion in dilute solutions. As expected on this basis, HBr and HI are even stronger acids than HCl .

9.8.5 Formation of Lattices

The hard-soft interaction principle gives a qualitative explanation for the fact that equilibrium for the reaction

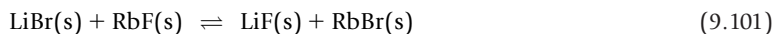

lies far to the right. However, it is possible to verify this conclusion on a more quantitative basis. From the standpoint of thermodynamics, the lattice energies for the solids can be written in terms of equations such as

$$U = \frac{N_o A e^2}{r} \left(1 - \frac{1}{n} \right) \quad (9.102)$$

Each of the compounds shown in Eq. (9.101) has the same crystal structure, the sodium chloride structure, so the Madelung constant is the same for all of them. The term containing $1/n$ is considered to be a constant for the two pairs of compounds (reactants and products). Actually, an average value of n is used for each compound because the ions do not have the configuration of the same noble gas. The lattice energy is the energy required to separate 1 mole of crystal into the gaseous ions. In the discussion that follows, it must be kept in mind that the lattice energies of the reactants must be supplied while the lattice energies of the products will be liberated. Therefore, using an approach that is analogous to the use of bond energies discussed in Chapter 4, the energy change will be given by

$$\Delta E = U_{\text{LiBr}} + U_{\text{RbF}} - U_{\text{LiF}} - U_{\text{RbBr}} \quad (9.103)$$

The lattice energies of these compounds are easily calculated or found in tables. When the values are substituted in Eq. (9.103), it is found that

$$\Delta E \text{ (kJ)} = 761 + 757 - 1017 - 632 = -131 \text{ kJ} \quad (9.104)$$

which shows that the energetically favored products are LiF and RbBr .

Although the approach just shown ratifies our conclusion that was reached on the basis of HSIP, it would be convenient if a general method could be developed. The energies involved are determined

by the distances between the ion centers in each compound. Whether ΔE is positive (unfavorable) or negative (favorable) depends on

$$\frac{1}{r_{\text{LiF}}} + \frac{1}{r_{\text{RbBr}}} - \frac{1}{r_{\text{LiBr}}} - \frac{1}{r_{\text{RbF}}}$$

but the distances can also be written in terms of the radii of the individual ions:

$$\frac{1}{r_{\text{Li}} + r_{\text{F}}} + \frac{1}{r_{\text{Rb}} + r_{\text{Br}}} - \frac{1}{r_{\text{Li}} + r_{\text{Br}}} - \frac{1}{r_{\text{Rb}} + r_{\text{F}}}$$

There are four parameters involved, the radii of the four ions. The question to be answered is whether the sum of the first two terms is smaller in magnitude than the sum of the last two terms. If the radii are represented as a , b , c , and d , the expression

$$\frac{1}{a + c} + \frac{1}{b + d} > \frac{1}{a + d} + \frac{1}{b + c}$$

will be true if $b > a$ and $d > c$. In terms of the ions, this means that the products that give the most favorable lattice energy sum are those that have the two smallest ions combined. Of necessity, the two largest ions must also be combined in the other product. Therefore, the products will be LiF and RbBr, which is in agreement with the HSIP.

A similar approach can be used for cases in which ions having charges other than +1 and -1 are involved. For two cations having charges c_1 and c_2 and two anions having charges of a_1 and a_2 , the energetically favored products are those where in terms of the magnitudes of the charges $c_1 > c_2$ and $a_1 > a_2$. This can be expressed in the relationship

$$(c_1 a_1 + c_2 a_2) > (c_1 a_2 + c_2 a_1)$$

The principle that embodies this relationship can be stated as *the products will be those in which the smaller ions will combine with oppositely charged ions of higher charge*. In these cases, the Madelung constants may be different, so other factors may be involved. However, the principle correctly predicts reactions such as the following:

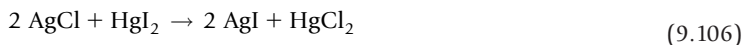

In the last of these reactions, Ca^{2+} has a higher charge than H^+ , but it is also much larger. Although the predictions are correct for a very large number of cases, the removal of a product from the reaction zone (formation of a precipitate or a gas) can cause the system to behave differently.

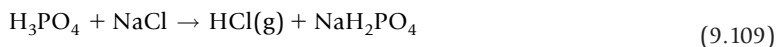

The products of a large number of reactions of many types are correctly predicted by the hard-soft interaction principle. Some examples are as follows.



In the first of these reactions, I is softer than F and As is softer than P. Therefore, the exchange takes place to provide a more suitable match of hard-soft properties. In the second reaction, Mg^{2+} is a small, hard ion, whereas Ba^{2+} is much larger and softer. The O^{2-} ion bonds better to Mg^{2+} , whereas S^{2-} bonds better with Ba^{2+} . The hard-soft interaction principle predicts correctly the direction of many reactions of diverse types.

Although many applications of the hard-soft interaction will be presented in later chapters, two additional applications will be illustrated here. First, consider the interaction of the Lewis acid Cr^{3+} with the Lewis base SCN^- , which could donate an electron pair from either the S or N atom:

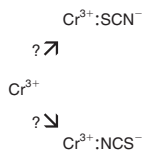

Because Cr^{3+} is a small, highly charged (hard) Lewis acid, it will bond preferentially to the smaller, harder Lewis base. In the thiocyanate ion, the electron pair on the nitrogen atom is held in a smaller, more compact orbital. Therefore, when a thiocyanate complex forms with Cr^{3+} , it is bonded through the nitrogen atom, and the complex is written as $[\text{Cr}(\text{NCS})_6]^{3-}$. If the metal ion is Pt^{2+} , the opposite result is obtained. Because Pt^{2+} is large, has a low charge, and is polarizable, it bonds preferentially to the soft sulfur atom in thiocyanate. The resulting complex is written as $[\text{Pt}(\text{SCN})_4]^{2-}$. Cases such as these will be discussed more fully in Chapter 16.

9.9 ELECTRONIC POLARIZABILITIES

As was discussed in Chapter 6, the electronic polarizability, α , of species is very useful for correlating many chemical and physical properties. Values of α are usually expressed in cm^3 per unit (atom, ion, or molecule). Because atomic dimensions are conveniently expressed in angstroms, the polarizability is also expressed as \AA^3 , so $10^{-24} \text{cm}^3 = 1 \text{\AA}^3$. The polarizability gives a measure of the ability of the electron cloud of a species to be distorted so it is also related to the hard-soft character of the species in a qualitative way. Table 9.6 gives the polarizabilities for ions and molecules.

In Chapter 6, the polarizability of molecules was considered as one factor related to both London and dipole-induced dipole intermolecular forces. The data shown in Table 9.6 confirm many of the observations that can be made about physical properties. For example, in the case of F_2 , Cl_2 , and Br_2 , the London forces that arise from the increase in polarizability result in a general increase in boiling point.

It is also interesting to note that metal ions having low polarizability (Al^{3+} , Be^{2+} , etc.) are those that are acidic (as shown in Eq. (9.17)). Also, in Chapter 7 we discussed how the polarization of ions leads to a lattice energy that is higher than that predicted on the basis of electrostatic interactions alone. The polarizability data shown in the table make it easy to see that certain ions are much more polarizable than others. Although we will not visit again all of the ramifications of electronic polarizability, it is a very useful and important property of molecules and ions that relates to both chemical and physical behavior.

9.10 THE DRAGO FOUR-PARAMETER EQUATION

One of the main objections to the hard-soft approach to many types of interactions is that it is qualitative in nature. That is, in fact, one of its strengths, and predictions can be made as to how many processes will take place without resorting to calculations. Although this is still largely true, attempts have

Atoms and Ions with Noble Gas Configurations							
2 electrons	He	Li^+	Be^{2+}	B^{3+}	C^{4+}		
	0.201	0.029	0.008	0.003	0.0013		
8 electrons	Si^{4+}	Al^{3+}	Mg^{2+}	Na^+	Ne	F^-	O^{2-}
	0.0165	0.052	0.094	0.179	0.390	1.04	3.88
18 electrons	Ti^{4+}	Sc^{3+}	Ca^{2+}	K^+	Ar	Cl^-	S^{2-}
	0.185	0.286	0.47	0.83	1.62	3.66	10.2
36 electrons	Zr^{4+}	Y^{3+}	Sr^{2+}	Rb^+	Kr	Br^-	Se^{2-}
	0.37	0.55	0.86	1.40	2.46	4.77	10.5
54 electrons	Ce^{4+}	La^{3+}	Ba^{2+}	Cs^+	Xe	I^-	Ce^{2-}
	0.73	1.04	1.55	2.42	3.99	7.10	14.0
Molecules							
	H_2	O_2	N_2	F_2	Cl_2	Br_2	
	0.80	1.58	1.74	1.16	4.60	6.90	
	HCl	HBr	HI	HCN	BCl_3	BBr_3	
	2.64	3.62	5.45	2.58	9.47	11.87	
	H_2O	H_2S	NH_3	CCl_4			
	1.45	3.80	2.33	10.53			

^a Values compiled from C. Kittel (1986). *Introduction to Solid State Physics*, 6th ed., p. 371. Wiley, New York; L. Pauling (1970). *General Chemistry*, 3rd ed., p. 397. W. H. Freeman, San Francisco; and D. R. Lide (1991). *Handbook of Chemistry and Physics*, 72nd ed., pp. 10–197 to 10–201. CRC Press, Boca Raton, FL.

been made (with varying degrees of success) to make it quantitative by producing numerical values for softness or hardness parameters. Another quantitative approach to acid-base interactions of *molecules* that behave as Lewis acids or bases was developed by R. S. Drago and his coworkers. According to this interpretation of acid-base interactions, the coordinate bond formed between a Lewis acid and a Lewis base is the sum of an electrostatic (ionic) contribution and a covalent contribution. The essence of this approach is embodied in the equation

$$-\Delta H_{AB} = E_A E_B + C_A C_B \quad (9.112)$$

In this equation, ΔH_{AB} is the enthalpy change for the formation of an acid-base adduct AB, E_A and E_B are parameters that express the electrostatic bonding capabilities of the acid and base, and C_A and C_B are parameters that relate to the covalent bonding tendencies of the acid and base. The product of the electrostatic parameters gives the enthalpy change due to ionic contributions to the bond, whereas the product of the covalent parameters gives the covalent contribution to the bond. The total bond enthalpy is the sum of the two terms that represent the contributions to the bond. One difficulty arises as a result of the fact that values for the parameters characteristic of the acid and base must be determined. This is analogous to the situation regarding electronegativity in which *differences* are determined by bond energies.

In the case of the four-parameter equation, the enthalpies of interaction of a large number of acids and bases were determined calorimetrically in an inert solvent. With these values being known, a value of 1.00 was assigned for E_A and C_A for the Lewis acid iodine. The experimental enthalpies for the interaction of iodine with several molecular Lewis bases were fitted to the data to determine E_B and C_B values for the bases. Values were thus established for the four parameters for many acids and bases so that they can be used in Eq. (9.112) to calculate the enthalpies of the interactions. The agreement of the experimental and calculated enthalpies is excellent in most cases. However, the four-parameter approach is used primarily in conjunction with interactions between *molecular* species, although extensions of the approach to include interactions between charged species have been made. Table 9.7 gives the parameters for several acids and bases.

One of the problems encountered when dealing with the interaction of Lewis acids and bases in a quantitative way is in evaluating the role of the solvent. Bond energies in molecules are values based on the molecule in the gas phase. However, it is not possible to study the interaction of many Lewis acids and bases in the gas phase because the adducts formed are not sufficiently stable to exist at the temperature necessary to convert the reactants to gases. For example, the reaction between pyridine and phenol takes place readily in solution as a result of hydrogen bonding:



However, the adduct is not stable enough to exist in significant amounts at a temperature of 116 °C, the boiling point of pyridine. As a result, such interactions are studied in solutions, although it is the strength of the bond that would be produced in the gas phase that is desired. A thermochemical cycle

Table 9.7 Acid and Base Parameters for Use in the Drago Four-Parameter Equation.

Acid	E_A	C_A	Base	E_B	C_B
I ₂	1.00	1.00	NH ₃	1.15	4.75
ICl	5.10	0.83	CH ₃ NH ₂	1.30	5.88
SO ₂	0.92	0.81	(CH ₃) ₃ N	0.81	11.5
SbCl ₅	7.38	5.13	(C ₂ H ₅) ₃ N	0.99	11.1
B(CH ₃) ₃	6.14	1.70	C ₅ H ₅ N	1.17	6.40
BF ₃	9.88	1.62	CH ₃ CN	0.89	1.34
C ₆ H ₅ SH	0.99	0.20	(CH ₃) ₃ P	0.84	6.55
C ₆ H ₅ OH	4.33	0.44	(C ₂ H ₅) ₂ O	0.96	3.25
Al(C ₂ H ₅) ₃	12.5	2.04	(CH ₃) ₂ SO	1.34	2.85
Al(CH ₃) ₃	16.9	1.43	C ₆ H ₆	0.53	0.68

can be devised to show the relationship for the interaction of an acid and a base both in solution (indicated by (s)) and in the gas phase:

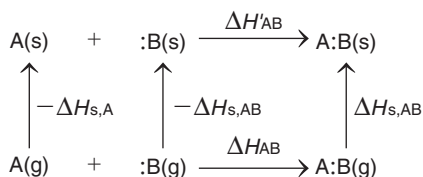

It is the interaction of the Lewis acid and base in the gas phase that gives the enthalpy of the A:B bond, ΔH_{AB} , but what is more often (and conveniently) measured is the enthalpy change when the reaction is carried out in solution, $\Delta H'_{\text{AB}}$.

In the thermochemical cycle above, the sum of the heats of solvation of A(g) and B(g) must be equal to the heat of solvation of the A:B(g) adduct if ΔH_{AB} and $\Delta H'_{\text{AB}}$ are to be equal. One way to ensure that they will be approximately equal is to use a solvent that does not solvate any of the species strongly. If the heat of solution of A(g), B(g), and A:B(g) are all approximately zero, the solvent is truly an inert solvent. When such a solvent is used, the measured value for ΔH_{AB} will be approximately equal to $\Delta H'_{\text{AB}}$ and the measured enthalpy change will give the A:B bond enthalpy. Such a solvent is a hydrocarbon like hexane, cyclohexane, or heptane. For some systems, CCl₄ behaves as an inert solvent, but the unshared pairs of electrons on the chlorine atoms enable this solvent to interact more strongly with some solutes than do hydrocarbon molecules. Benzene is definitely not an inert solvent as a result of its ability to function as an electron donor because of the π electron system in the molecule. Calorimetric studies to determine the strengths of interactions of acids and bases in solution must be considered suspect unless the solvent is chosen carefully. There is no question but that the Drago four-parameter equation gives accurate values for the enthalpies of interaction for a very large number of

molecules. When the enthalpy of interaction is calculated for the interaction of certain acid-base pairs, the calculated value is found to be higher than the experimental value. Such situations can arise when there are steric factors that cause the interaction to be less energetically favorable than expected.

For many years, there has been some controversy regarding the hard-soft interaction principle versus the Drago four-parameter approach. Proponents of the latter cling to the fact that it can provide quantitative information on the interactions of Lewis acids and bases. Although this is true, the areas of applicability of that approach are somewhat restricted because it applies primarily to molecular species. On the other hand, proponents of the hard-soft interaction principle point to the fact that it applies to species of almost any type. Although it is qualitative in its approach (but there have been attempts to develop quantitative measures), it is extremely versatile for giving explanations for an enormous range of interactions. Both the four-parameter approach and the hard-soft interaction principle are valuable tools for correlating a large body of observations on Lewis acid-base interactions. Fortunately, one does not have to choose between them, because in the areas where both apply, they generally support the same conclusions.

■ REFERENCES FOR FURTHER STUDY

- Drago, R. S., Vogel, G. C., and Needham, T. E. (1971). *J. Am. Chem. Soc.* **93**, 6014. One of the series of papers on the four-parameter equation. Earlier papers are cited in this reference.
- Drago, R. S., Wong, N., and Ferris, D. C. (1991). *J. Am. Chem. Soc.* **113**, 1970. One of the publications that gives extensive tables of values for E_A , E_B , C_A , and C_B . Earlier papers cited in this reference also give tables of values.
- Finston, H. L., and Rychman, A. C. (1982). *A New View of Current Acid-Base Theories*. Wiley, New York. A book that gives comprehensive coverage of all of the significant acid-base theories.
- Gur'yanova, E. N., Gol'dshtein, I. P., and Romm, I. P. (1975). *Donor-Acceptor Bond*. Wiley, New York. A translation of a Russian book that contains an enormous amount of information and data on the interactions of many Lewis acids and bases.
- Ho, Tse-Lok (1977). *Hard and Soft Acid and Base Principle in Organic Chemistry*. Academic Press, New York. The applications of the hard-soft acid base principle to many organic reactions.
- Lide, D. R., Ed. (2003). *CRC Handbook of Chemistry and Physics*, 84th ed. CRC Press, Boca Raton, FL. Extensive tables of dissociation constants for acids and bases are available in this handbook.
- Luder, W. F., and Zuffanti, S. (1946). *The Electronic Theory of Acids and Bases*. Wiley, New York. A small book that is a classic in Lewis acid-base chemistry. Also available as a reprint volume from Dover.
- Pearson, R. G. (1997). *Chemical Hardness*. Wiley-VCH, New York. This book is devoted to applications of the concept of hardness to many areas of chemistry.
- Pearson, R. G. (1963). *J. Am. Chem. Soc.* **85**, 3533. The original publication of the hard-soft acid-base approach by Pearson.
- Pearson, R. G. (1966). *J. Chem. Educ.* **45**, 581. A general presentation of the hard-soft interaction principle by Pearson.
- Pearson, R. G., and Songstad, J. (1967). *J. Am. Chem. Soc.* **89**, 1827. A paper describing the application of the hard-soft interaction principle to organic chemistry.
- Porterfield, W. W. (1993). *Inorganic Chemistry: A Unified Approach*, 2nd ed. Academic Press, San Diego, CA. This book has good coverage of many topics in inorganic chemistry.

■ QUESTIONS AND PROBLEMS

- Complete the following if a reaction occurs.
 - $\text{NH}_4^+ + \text{H}_2\text{O} \rightarrow$
 - $\text{HCO}_3^- + \text{H}_2\text{O} \rightarrow$
 - $\text{S}^{2-} + \text{NH}_4^+ \rightarrow$
 - $\text{BF}_3 + \text{H}_3\text{N}:\text{BCl}_3 \rightarrow$
 - $\text{Ca}(\text{OCl})_2 + \text{H}_2\text{O} \rightarrow$
 - $\text{SOCl}_2 + \text{H}_2\text{O} \rightarrow$
- Show by means of equations what happens when AlCl_3 catalyzes the reaction of an alkyl halide with benzene.
 - Show by means of equations what happens when H_2SO_4 catalyzes the reaction of nitric acid with toluene.
 - Explain the role of the catalyst in the reactions in parts (a) and (b).
- Arrange the following in the order of decreasing acid strength:
 H_2PO_4^- , HNO_2 , HSO_4^- , HCl , and H_2S .
- Complete each of the following.
 - $\text{HNO}_3 + \text{Ca}(\text{OH})_2 \rightarrow$
 - $\text{H}_2\text{SO}_4 + \text{Al}(\text{OH})_3 \rightarrow$
 - $\text{CaO} + \text{H}_2\text{O} \rightarrow$
 - $\text{NaNH}_2 + \text{H}_2\text{O} \rightarrow$
 - $\text{NaC}_2\text{H}_3\text{O}_2 + \text{H}_2\text{O} \rightarrow$
 - $\text{C}_5\text{H}_5\text{NH}^+\text{Cl}^- + \text{H}_2\text{O} \rightarrow$
- Complete each of the following. If NH_3 is a reactant, assume a liquid NH_3 solution.
 - $\text{NH}_4\text{Cl} + \text{H}_2\text{O} \rightarrow$
 - $\text{Na}_2\text{NH} + \text{NH}_3 \rightarrow$
 - $\text{CaS} + \text{H}_2\text{O} \rightarrow$
 - $\text{OPCl}_3 + \text{H}_2\text{O} \rightarrow$
 - $\text{ClF} + \text{H}_2\text{O} \rightarrow$
 - $\text{K}_2\text{CO}_3 + \text{H}_2\text{O} \rightarrow$
- Complete the following equations showing reactions that occur when $\text{NH}_4\text{Cl}(\text{s})$ is heated with the other reactants shown.
 - $\text{NH}_4\text{Cl}(\text{s}) + \text{CaO}(\text{s}) \rightarrow$
 - $\text{NH}_4\text{Cl}(\text{s}) + \text{SrCO}_3(\text{s}) \rightarrow$
 - $\text{NH}_4\text{Cl}(\text{s}) + \text{Al}(\text{s}) \rightarrow$
 - $\text{NH}_4\text{Cl}(\text{s}) + \text{BaS}(\text{s}) \rightarrow$
 - $\text{NH}_4\text{Cl}(\text{s}) + \text{Na}_2\text{SO}_3(\text{s}) \rightarrow$
- Explain why PH_4I is stable while PH_4F and $\text{PH}_4\text{C}_2\text{H}_3\text{O}_2$ are not.
- The Br^- and CN^- ions are approximately equal in size. Explain why NH_4Br is stable but NH_4CN is not.
- Why is NF_3 a much weaker base than NH_3 ?
- Predict the product and draw its structure for the following reaction :

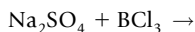

- For the reaction $(\text{CH}_3)_2\text{O} + \text{C}_2\text{H}_5\text{F} \rightarrow [(\text{CH}_3)_2\text{OC}_2\text{H}_5]^+\text{F}^-$
 - draw the structure for the cation and
 - explain how the presence of BF_3 aids in this reaction.

12. Consider the reaction $(\text{CH}_3)_2\text{S} + \text{CH}_3\text{I} \rightarrow [(\text{CH}_3)_3\text{S}]^+\text{I}^-$ and explain why the cation in this case is more stable than that produced in the reaction in problem 11.
13. Write a complete, balanced equation to show what happens (if anything) in each of the following cases.
- Trimethylamine is added to water
 - HCl is added to a mixture of acetic acid and sodium acetate
 - Ammonium nitrate is added to water
 - Sodium carbonate is added to water
 - Sodium hydride is added to methanol
 - Sulfuric acid is added to a solution of sodium acetate in water
14. Write a complete, balanced equation to show what happens (if anything) in each of the following cases.
- Potassium acetate is added to water
 - NaOH is added to a mixture of acetic acid and sodium acetate
 - A solution of aniline, $\text{C}_6\text{H}_5\text{NH}_2$, is added to hydrochloric acid
 - Sodium hypochlorite is added to water
 - Sodium nitrate is added to water
 - Sodium amide is dissolved in water
15. When BF_3 behaves as a Lewis acid, the stability of the adducts with $(\text{CH}_3)_2\text{O}$, $(\text{CH}_3)_2\text{S}$, and $(\text{CH}_3)_2\text{Se}$ decreases in the order in which the Lewis bases are listed. However, when the Lewis acid is $\text{B}(\text{CH}_3)_3$, the most stable adduct is that formed with $(\text{CH}_3)_2\text{S}$ and the adducts with $(\text{CH}_3)_2\text{Se}$ and $(\text{CH}_3)_2\text{O}$ are about equally stable. Explain the difference in stability of the adducts.
16. Although the central atoms in HClO_4 and H_5IO_6 have the same oxidation state, the two compounds are greatly different in their acid strengths. Which is stronger? Explain why.
17. The molecule $(\text{CH}_3)_2\text{NCH}_2\text{PF}_2$ would bond differently to BH_3 and BF_3 . Explain the difference.
18. Although HF is a weak acid in water, it is a strong acid in liquid NH_3 . Write equations to show the reactions and explain the difference in acid strength.
19. Although $\text{N}(\text{CH}_3)_3$ is a stronger base than NH_3 , the adduct $\text{H}_3\text{N}:\text{B}(\text{CH}_3)_3$ is more stable than $(\text{CH}_3)_3\text{N}:\text{B}(\text{CH}_3)_3$. Explain this observation.
20. In each case, pick the stronger acid and explain your answer.
- H_2CO_3 or H_2SeO_4 ?
 - Cl_2CHCOOH or $\text{Cl}_2\text{CHCH}_2\text{COOH}$?
 - H_2S or H_2Se ?
21. Write equations to show how molten ammonium fluoride would react with each of the following.
- Zn, (b) FeO, (c) CaCO_3 , (d) NaOH, (e) Li_2SO_3 .
22. Explain the trend in dissociation constants of the acids HOX where X is a halogen.
23. Arrange the following compounds in the order of increasing pH of a 0.1 M solution of each: NaOCl, NaHCO_2 , Na_2CO_3 , NaN_3 , and NaHS.
24. Which is more acidic, $\text{Co}(\text{H}_2\text{O})_6^{2+}$ or $\text{Co}(\text{H}_2\text{O})_6^{3+}$? Explain your answer.
25. What would be the products of the reaction of BF_3 with I_2 ? Would you expect a similar reaction between BF_3 and Cl_2 to occur? Explain your answer.
26. The values for K_1 and K_2 in the dissociation of $\text{H}_4\text{P}_2\text{O}_7$ are 1.4×10^{-1} and 3.2×10^{-2} . Explain in terms of molecular structure why Pauling's rule does not work as well in this case as it does for the dissociation of H_3PO_4 .
27. For some very weak bases, titration in water is not feasible. Using appropriate equations, explain why this would be the case for aniline, $\text{C}_6\text{H}_5\text{NH}_2$, which has a K_b of 4.6×10^{-10} .

28. Write the equation for the reaction of aniline, $C_6H_5NH_2$, with glacial acetic acid. Explain why it would be possible to titrate aniline in this acid.
29. Arrange the following in the order of acid strength: H_2SeO_3 , H_3AsO_3 , $HClO_4$, H_2SO_3 , H_2SO_4 .
30. Explain why $H_2PO_4^-$ has two oxygen atoms without hydrogen atoms attached, but it is not a strong acid like H_2SO_4 .
31. Draw the structure for SF_4 and predict how the molecule would be attacked by a Lewis acid. How would the attack of a Lewis base occur?
32. Where is the acidic site in the SO_3 molecule? Draw structures to explain your answer.
33. Explain the reaction

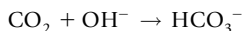

as a Lewis acid-base reaction.

34. Explain why benzene is a better solvent for many Lewis acids than is CCl_4 .
35. Although Br^- and CN^- have approximately the same thermochemical radii, there is a great difference in the basicity of the ions. Which is the stronger base? Explain your answer.
36. Use the data shown in Table 9.7 to calculate the enthalpy of interaction of the interactions of BF_3 and $(CH_3)_3B$ with $(CH_3)_3N$ and $(CH_3)_3P$. Explain what the values indicate.

Chemistry in Nonaqueous Solvents

Although reactions in gases and solids are by no means rare, it is the enormous number of reactions carried out in solutions that is the subject of this chapter. However, there is no question but that the vast majority of reactions are carried out in solutions where water is the solvent. It is important to note that most nonaqueous solvents present some difficulties when their use is compared to that of water as a solvent. Some of the more important nonaqueous solvents are NH_3 , HF , SO_2 , SOCl_2 , N_2O_4 , CH_3COOH , POCl_3 , and H_2SO_4 . Some of these compounds (NH_3 , HF , and SO_2) are gases at ambient temperature and pressure. Some of them are also highly toxic. Some of the compounds are both gaseous and toxic. It is almost never as convenient to use a nonaqueous solvent as it is to use water.

In view of the difficulties that accompany the use of a nonaqueous solvent, one may certainly ask why such use is necessary. The answer includes several of the important principles of nonaqueous solvent chemistry that will be elaborated on in this chapter. First, solubilities are different. In some cases, classes of compounds are more soluble in some nonaqueous solvents than they are in water. Second, the strongest acid that can be used in an aqueous solution is H_3O^+ . As was illustrated in Chapter 9, any acid that is stronger than H_3O^+ will react with water to produce H_3O^+ . In some other solvents, it is possible to routinely work with acids that are stronger than H_3O^+ . Third, the strongest base that can exist in aqueous solutions is OH^- . Any stronger base will react with water to produce OH^- . In some nonaqueous solvents, a base stronger than OH^- can exist, so it is possible to carry out certain reactions in such a solvent that cannot be carried out in aqueous solutions. These differences permit synthetic procedures to be carried out in nonaqueous solvents that would be impossible when water is the solvent. As a result, chemistry in nonaqueous solvents is an important area of inorganic chemistry, and this chapter is devoted to the presentation of a brief overview of this area.

10.1 SOME COMMON NONAQUEOUS SOLVENTS

Although water is used as a solvent more extensively than any other liquid, other solvents may offer some important advantages. For example, if any base stronger than OH^- is placed in water, it reacts with water to produce OH^- . If it is necessary to use a stronger base than OH^- in some reaction, the best way is to use a solvent that is more basic than water because the anion from that solvent will be

Table 10.1 Properties of Some Common Nonaqueous Solvents.

Solvent	m.p., °C	b.p., °C	Dipole moment, D	Dielectric constant
H ₂ O	0.0	100	1.85	78.5
NH ₃	-77.7	-33.4	1.47	22.4
SO ₂	-75.5	-10.0	1.61	15.6
HCN	-13.4	25.7	2.8	114.9
H ₂ SO ₄	10.4	338	—	100
HF	-83	19.4	1.9	83.6
N ₂ H ₄	2.0	113.5	1.83	51.7
N ₂ O ₄	-11.2	21.5	—	2.42
CH ₃ OH	-97.8	65.0	1.68	33.6
(CH ₃) ₂ SO	18	189	3.96	45
CH ₃ NO ₂	-29	101	3.46	36
(CH ₃ CO) ₂ O	-71.3	136.4	2.8	20.5
H ₂ S	-85.5	-60.7	1.10	10.2
HSO ₃ F	-89	163	—	—

stronger than OH⁻. This situation exists in liquid ammonia in which the basic species, NH₂⁻, is a stronger base than OH⁻. If a reaction requires an acid that is stronger than H₃O⁺, it may be necessary to carry out the reaction in a more acidic solvent than water.

Some compounds that are important nonaqueous solvents require special conditions and apparatus for their handling. Ammonia, sulfur dioxide, hydrogen fluoride, and dinitrogen tetroxide are all gases at room temperature and atmospheric pressure. Some of the solvents such as liquid hydrogen cyanide are extremely toxic. In view of these difficulties, it may seem unusual that so much work has been carried out in nonaqueous solvents. However, in many cases, the advantages outweigh the disadvantages. The scope of reactions that can be carried out in nonaqueous solvents is very broad indeed because there is such a difference in the characteristics of the solvents. Some of frequently used nonaqueous solvents are listed in Table 10.1 along with their relevant properties.

One of the disadvantages of using a nonaqueous solvent is that in most cases ionic solids are less soluble than in water. There are exceptions to this. For example, silver chloride is insoluble in water, but it is soluble in liquid ammonia. As will be illustrated later, some reactions take place in opposite directions in a nonaqueous solvent and water.

10.2 THE SOLVENT CONCEPT

It has long been known that some autoionization occurs in water, and it was presumed that nonaqueous solvents behaved in a similar way. Although the reaction of sodium hydride with water,



could be presumed to take place in water that exists as H^+OH^- , it is by no means the case. In fact, even though water undergoes a *slight* degree of autoionization, the reaction takes place as shown above without assuming *prior* ionization of water. An analogous situation exists for nonaqueous solvents, and in many cases *assuming* that the solvent ionizes makes clear what parts of the molecule are reacting in what way. The fact that the solvent does not undergo autoionization is immaterial. Knowing what species *would be* produced may make it easier to predict the course of reactions in a particular solvent.

One of the primary pieces of evidence that water undergoes some autoionization comes from the conductivity of pure water. The equilibrium can be written as



The conductivity of liquid ammonia is sufficiently high to indicate a very slight degree of autoionization. In order for ions to be produced, *something* must be transferred from one molecule to another, and in solvents such as water or ammonia it is proton transfer that occurs. Accordingly, the ionization of liquid ammonia can be shown as

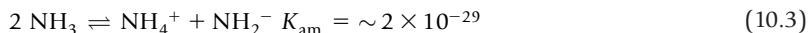

According to the Arrhenius theory of acids and bases, the acidic species in water is the solvated proton (which we write as H_3O^+). This shows that the *acidic* species is the *cation* characteristic of the solvent. In water, the *basic* species is the *anion* characteristic of the solvent, OH^- . By extending the Arrhenius definitions of acid and base to liquid ammonia, it becomes apparent from Eq. (10.3) that the acidic species is NH_4^+ and the basic species is NH_2^- . It is apparent that any substance that leads to an increase in the concentration of NH_4^+ is an acid in liquid ammonia. A substance that leads to an increase in concentration of NH_2^- is a base in liquid ammonia. For other solvents, autoionization (if it occurs) leads to different ions, but in each case presumed ionization leads to a cation and an anion. Generalization of the nature of the acidic and basic species leads to the idea that in a solvent, the cation characteristic of the solvent is the acidic species and the anion characteristic of the solvent is the basic species. This is known as *the solvent concept*. Neutralization can be considered as the reaction of the cation and anion from the solvent. For example, the cation and anion react to produce unionized solvent:

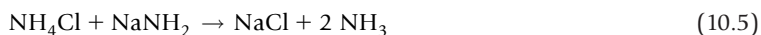

Note that there is no requirement that the solvent actually undergo autoionization.

If autoionization were to take place in liquid sulfur dioxide, the process could be written as



That this reaction does not take place to a measurable extent does not prevent us from knowing that the ions produced *would be* the acidic and basic species. Therefore, we can predict that Na_2SO_3 would be a base in liquid SO_2 because it contains SO_3^{2-} and SOCl_2 would be an acid because it could formally produce SO^{2+} if it were to dissociate. Thus, we predict that Na_2SO_3 and SOCl_2 would react according to the equation

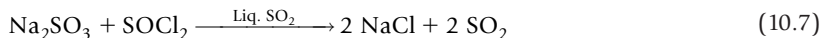

This reaction represents a neutralization reaction in liquid sulfur dioxide. It makes no difference that the solvent does not ionize or that SOCl_2 is a covalent molecule. The utility of the solvent concept is *not* that it correctly predicts that solvents undergo some autoionization. The value of the solvent concept is that it allows us to correctly predict how reactions would take place *if* the solvent ionized. Note that in this case SOCl_2 does not ionize, but if it did it would produce SO^{2+} (the acidic species characteristic of the solvent) and Cl^- .

The concepts just illustrated can be extended to other nonaqueous solvents. For example, in liquid N_2O_4 if autoionization occurred it would produce NO^+ and NO_3^- . In this solvent, a compound that furnishes NO_3^- would be a base, and a compound that would (formally rather than actually) produce NO^+ would be an acid. Therefore, the reaction of KNO_3 with NOCl (actually linked as ONCl) is a neutralization in liquid N_2O_4 .

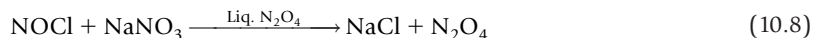

Seemingly, another possible autoionization of liquid N_2O_4 could involve splitting the molecule in a different way to produce NO_2^+ and NO_2^- ,



However, in liquid N_2O_4 reactions do not occur as if NO_2^+ and NO_2^- were present, and there is no evidence to indicate that they are. In most cases, autoionization of the solvent *if it occurs* is by transfer of H^+ or O^{2-} .

The conductivity of liquid HF indicates slight autoionization that can be represented as



In this case, both H^+ and F^- are solvated by molecules of HF, so they are not shown as the simple ions. Although we will not describe how such species are prepared now (see Chapter 15), $\text{H}_2\text{F}^+\text{SbF}_6^-$ behaves as an acid and $\text{BrF}_2^+\text{HF}_2^-$ behaves as a base in liquid HF. The neutralization reaction can be written as



10.3 AMPHOTERIC BEHAVIOR

When an aqueous solution containing Zn^{2+} or Al^{3+} has NaOH added, a precipitate of the metal hydroxide forms. Upon continued addition of base, the precipitate dissolves just as it does when an acid is added. In the first case, the aluminum hydroxide is behaving as a base, and in the second it behaves as an acid. This behavior, the ability to react as an acid or a base, is known as *amphoterism*. The reaction of Zn^{2+} with a base and an acid can be shown as follows:

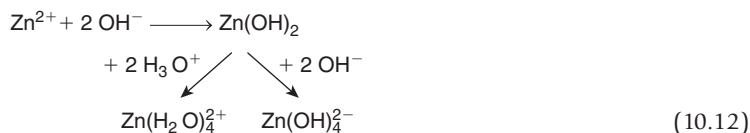

When reacting with a base, $\text{Zn}(\text{OH})_2$ dissolves by the formation of a complex, $\text{Zn}(\text{OH})_4^{2-}$. In the reaction with an acid, protons are transferred from H_3O^+ to the hydroxide ions, forming water molecules that remain coordinated to the Zn^{2+} ion.

The behavior of Zn^{2+} in liquid ammonia is analogous to that in water. First a precipitate of $\text{Zn}(\text{NH}_2)_2$ forms when an amide is added, but the precipitate dissolves when either a solution containing NH_4^+ or NH_2^- is added. This behavior can be shown as follows:

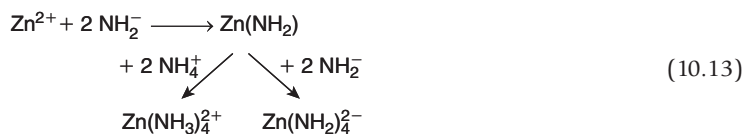

Although this behavior has been illustrated starting with the metal ion, analogous equations can be written starting with the metal oxide as well as the hydroxide. Amphoteric behavior is exhibited in other solvents, as will be illustrated later.

10.4 THE COORDINATION MODEL

For some nonaqueous solvents, the autoionization, if it occurs at all, must be to a degree so small that virtually no ions are present. If the ion product constant for a solvent is as low as 10^{-40} , the concentration of each ion would be 10^{-20} M. This can be put in perspective by considering 1 mole of the solvent and realizing that out of 6.02×10^{23} molecules of solvent, only about 1000 have undergone ionization. The presence of a *minute* trace of impurity (it is very difficult to obtain completely anhydrous solvents) would account for more ions by reaction than would be produced by autoionization. Therefore, some alternative must exist that removes the necessity for assuming that autoionization occurs.

When FeCl_3 is placed in $\text{O}(\text{PCl}_3)$, it can be shown by spectrophotometry that FeCl_4^- is present. One way this could occur is by ionization of the solvent,



followed by the reaction of FeCl_3 with the Cl^- produced,



Another plausible set of events might involve the interaction of FeCl_3 with the OPCl_3 before ionization occurs. This is reasonable to expect because FeCl_3 is a Lewis acid and OPCl_3 is a molecule that contains atoms having unshared pairs of electrons. This type of interaction could be shown as follows, which shows FeCl_3 pulling Cl^- from OPCl_3 so that it is not necessary for prior autoionization to occur:



In this way, some chloride ions might be removed from the solvent, and by complexing with Fe^{3+} the reaction is shifted to the right by Le Chatelier's principle. Although this scheme removes the assumption that OPCl_3 undergoes autoionization by having FeCl_3 pull the Cl^- off, it ignores the fact that toward Lewis acids the *oxygen* atom in OPCl_3 is a more basic site than the chlorine atoms.

In a classic study by Russell S. Drago and Devon Meek, FeCl_3 was placed in a different solvent. The solvent, triethylphosphate, $\text{OP}(\text{OC}_2\text{H}_5)_3$, contained *no* chlorine, but the spectra of the solutions were similar to those of FeCl_3 in OPCl_3 and clearly showed the presence of FeCl_4^- ! The only possible source of the Cl^- that was needed to form FeCl_4^- must be FeCl_3 itself. Drago reasoned that in order for this to happen, a molecule of the solvent must replace a chloride ion on FeCl_3 . In other words, a *substitution* reaction occurs that involves the solvent, and the liberated Cl^- reacts with another molecule of FeCl_3 to produce FeCl_4^- . Because the complex between FeCl_3 and the solvent is a complex that is bonded by a coordinate bond (see Chapter 16), this model of solvent behavior is known as the *coordination model*. The sequence of reactions can be shown as follows, in which X represents either Cl or an ethoxy group:

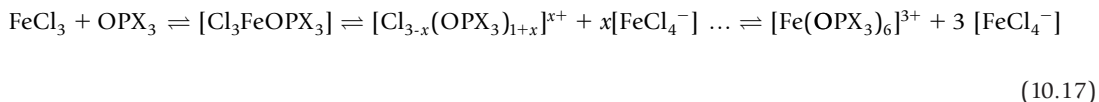

As chloride ions are replaced on Fe^{3+} , the process continues sequentially until it contains solvated Fe^{3+} (as the complex $[\text{Fe}(\text{OPX}_3)_6]^{3+}$) and the chloride complex, FeCl_4^- .

The coordination model provides a way to explain many reactions that occur in nonaqueous solvents without having to assume that autoionization takes place. As shown in Eq. (10.17), the fact that FeCl_4^- is produced can be explained by substitution rather than autoionization. However, as has been shown earlier in this chapter, it is sometimes useful to assume that the solvent concept is valid, and many reactions take place just as if the solvent has ionized to a slight degree into an acidic and a basic species.

10.5 CHEMISTRY IN LIQUID AMMONIA

In many of its properties, liquid ammonia resembles water. Both are polar and involve extensive hydrogen bonding in the liquid state. It is interesting to note that hydrogen bonding in liquid

ammonia is less extensive than in water, in which the oxygen atoms can form hydrogen bonds to two other water molecules. This difference is evident from the fact that the heat of vaporization of water is 40.6 kJ/mol, but that of ammonia is only 23.26 kJ/mol. Although there are differences when specific types of compounds are considered, both water and liquid ammonia dissolve many types of solids. Having a boiling point of $-33.4\text{ }^{\circ}\text{C}$ means that it is necessary to work with liquid ammonia at low temperature or high pressure. If liquid ammonia is kept in a Dewar flask, the rate of evaporation is low enough that solutions can be kept for a reasonable length of time.

We have already mentioned that silver chloride is readily soluble in liquid ammonia. Because it is slightly less polar than water and has lower cohesion energy, intermolecular forces make it possible for organic molecules to create cavities in liquid ammonia. As a result, most organic compounds are more soluble in liquid ammonia than they are in water. Physical data for liquid ammonia are summarized in Table 10.2.

Liquid ammonia is a base, so reactions with acids generally proceed to a greater degree than do the analogous reactions in water. For example, acetic acid is a weak acid in water, but it ionizes completely in liquid ammonia. Even though ammonia is a base, it is possible for protons to be removed, but only when it reacts with exceedingly strong bases such as N^{3-} , O^{2-} , or H^{-} . Some of the important types of reactions that occur in liquid ammonia will now be illustrated.

10.5.1 Ammoniation Reactions

Most solvents have unshared pairs of electrons, and they are polar. Therefore, they have the ability to attach to metal ions or interact with anions. As a result, when many solids crystallize from solutions, they have included a definite number of solvent molecules. When this occurs in water, we say that the crystal is a *hydrate*. An example of this is the well-known copper sulfate pentahydrate,



A similar type of behavior is observed for AgCl in liquid ammonia:



Table 10.2 Physical Properties of Liquid NH_3 .

Melting point	$-77.7\text{ }^{\circ}\text{C}$
Boiling point	$-33.4\text{ }^{\circ}\text{C}$
Density at $-33.4\text{ }^{\circ}\text{C}$	0.683 g cm^{-3}
Heat of fusion	5.98 kJ mol^{-1}
Heat of vaporization	23.26 kJ mol^{-1}
Dipole moment	1.47 D
Dielectric constant	22
Specific conductance at $-35\text{ }^{\circ}\text{C}$	$2.94 \times 10^{-7}\text{ ohm}$

Because ammonia is the solvent, the solvated species is known as an *ammoniate*. The solvent molecules are not always bound in the solid in the same way. For example, some solids may contain water of hydration, but in other cases the water may be coordinated to the metal ion. In classifying materials as hydrates or ammoniates, the mode of attachment of the solvent is not always specified.

10.5.2 Ammonolysis Reactions

In many places in this book, the reactivity of bonds between nonmetals and halogens is stressed. Reactions such as

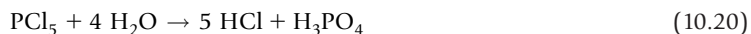

and several others take place readily. In these reactions, molecules of water are split or *lysed* so the reactions are known as *hydrolysis* reactions. Reactions in which ammonia molecules are split are known as *ammonolysis* reactions. Some examples of these reactions can be illustrated as follows:

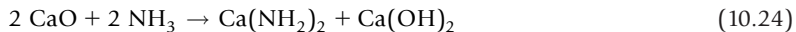
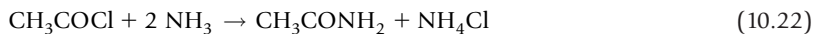

Many other reactions involving ammonolysis are known, but these illustrate the process.

10.5.3 Metathesis Reactions

In order for a metathesis reaction to occur in water, some product must be removed from the reaction. Generally, this involves the formation of a precipitate, the evolution of a gas, or the formation of an unionized product. Because solubilities are different in liquid ammonia, reactions are often unlike those in water. Although silver halides are insoluble in water, they are soluble in liquid ammonia as a result of forming stable complexes with ammonia. Therefore, the reaction



takes place in liquid ammonia because BaCl_2 is insoluble, but in water, the reaction

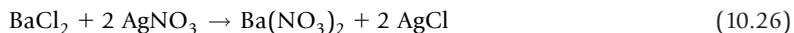

occurs because AgCl is insoluble.

10.5.4 Acid-Base Reactions

Although it is not necessary for autoionization to occur, the solvent concept shows that the cation characteristic of the solvent is the acidic species and the anion is the basic species. Therefore, when

substances that contain these ions are mixed, neutralization occurs. For liquid ammonia, NH_4^+ is the acidic species and NH_2^- is the basic species. Therefore, such a reaction can be shown as

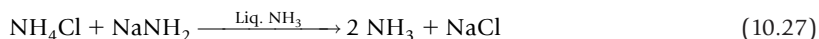

Acid-base reactions also include those in which the solvent itself functions as an acid or base. This can be shown as follows. Sodium hydride reacts with water to produce a basic solution,



and the analogous reaction with liquid ammonia can be shown as



Just as the oxide ion is a strong base toward water,



the imide and nitride ions are bases toward liquid ammonia. Both are too strong to exist in liquid ammonia, so they react to produce a weaker base, NH_2^- .



The oxide ion is also sufficiently strong as a base to remove protons from ammonia.

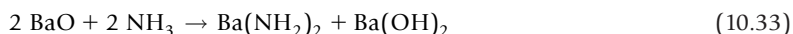

Because of the base strength of liquid ammonia, acids that are weak in water ionize completely in liquid ammonia.



A type of deprotonation reaction that takes place in liquid ammonia but not in water occurs because it is possible to utilize the base strength of the amide ion. The reaction involves removing H^+ from a molecule of ethylenediamine, $\text{H}_2\text{NCH}_2\text{CH}_2\text{NH}_2$ (written as en), that is coordinated to Pt^{2+} in the complex $[\text{Pt(en)}_2]^{2+}$.

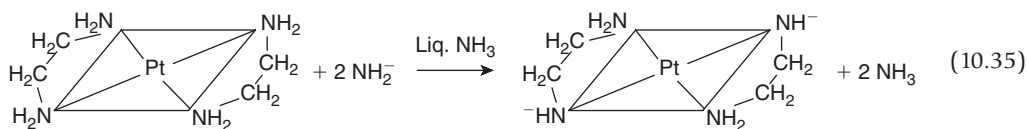

When the ethylenediamine that has had a proton removed is designated as en-H, the complex can be written as $[\text{Pt(en-H)}_2]$ and it is uncharged. This is a reactive species that will undergo numerous

reactions in liquid ammonia. This procedure was used by Watt and coworkers to produce derivatives of the ethylenediamine ligands by means of reactions such as

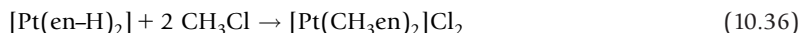

These interesting synthetic reactions are possible because of the basicity of NH_2^- , which cannot be utilized in aqueous solutions.

10.5.5 Metal-Ammonia Solutions

If there is one radical difference between chemistry in water and liquid ammonia, it is in the behavior toward group IA metals. When placed in water, these metals liberate hydrogen in vigorous reactions such as



In contrast, these metals dissolve and undergo reaction only very slowly in liquid ammonia. Solutions containing alkali metals in liquid ammonia have been known for more than 140 years, and they have properties that are extraordinary. The extent to which the metals dissolve is itself interesting. The solubilities are shown in Table 10.3.

That the dissolution does not involve a chemical change in the metal is indicated by the fact that evaporation of the solutions regenerates the metal. If the product is not placed under thermal stress, the metal can be recovered as a solvate having the formula $\text{M}(\text{NH}_3)_6$. Moreover, the solutions have densities that are lower than the solvent alone. It is clear that some expansion of the liquid occurs when the metal dissolves. In appearance, all of the solutions are blue when dilute, but are bronze colored when more concentrated than approximately 1 M. The solutions exhibit conductivity that is higher than that of a 1:1 electrolyte. The conductivity decreases as the concentration of the metal increases, but the conductivity of concentrated solutions is characteristic of metals. An additional anomaly is that the solutions are paramagnetic, but the magnetic susceptibility decreases for concentrated solutions. The magnitude of the magnetic susceptibility is in agreement with there being one free electron produced by each metal atom. These are the facts that must be explained by any successful model for these solutions.

Table 10.3 Solubility of Alkali Metals in Ammonia.

Metal	Temp. °C	Molality of saturated solution	Temp. °C	Molality of saturated solution
Li	0	16.31	-33.2	15.66
Na	0	10.00	-33.5	10.93
K	0	12.4	-33.2	11.86
Cs	0	—	-50.0	25.1

The model of metal-ammonia solutions that has emerged is based on ionization of the metal atoms to produce metal ions and electrons that are both solvated. The solvated electron is believed to reside in a cavity in ammonia, and thus it may behave as a particle in a three-dimensional box with quantized energy levels. Transitions between the energy levels may give rise to absorption of light and thereby cause the solutions to be colored. The dissolution process can be represented as

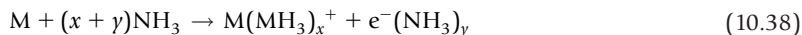

The form of the cavity in which an electron resides is not known, but it is reasonable to expect that the hydrogen atoms are directed around the electron in some way because of their slight positive charge. Although there may be several molecules of ammonia forming the cavity, it is reasonable to represent it as

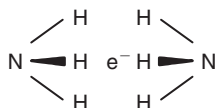

in which the somewhat positive hydrogen atoms form a cage around the electron. The spectrum corresponding to the solvated electron in liquid ammonia exhibits a maximum at approximately 1500 nm. Although this hardly represents a particle in a box, if we assume that it does and if we assume that the band maximum represents the transition of the electron between the states $n = 1$ and $n = 2$, we can solve for the dimension of the box. In this case, the energy corresponds to a box having a length of about 120 nm, although other estimates range from 300 to 600 pm. This is not a precise calculation, but the calculated length of the cavity is at least compatible with the electron residing in a small cavity of molecular dimensions and the fact that the density of a solution of this type is lower than that of the pure solvent.

Solutions of alkali metals in liquid ammonia have been studied by many techniques. These include electrical conductivity, magnetic susceptibility, nuclear magnetic resonance (NMR), volume expansion, spectroscopy (visible and infrared), and other techniques. The data obtained indicate that the metals dissolve with ionization and that the metal ion and electron are solvated. Several simultaneous equilibria have been postulated to explain the unique properties of the solutions. These are generally represented as follows:

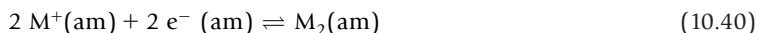
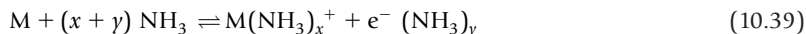

The expansion of the solutions has been accounted for by considering the electron as residing in a hole in the solvent. Pairing electrons as shown in Eq. (10.41) is considered to be at least partially responsible for the decrease in paramagnetism as the concentration of the solution is increased. However, the pairing may also involve free electrons being removed as shown in Eq. (10.40). Although it is not likely that all of these steps are involved, it is likely that the relative importance of these reactions depends on the particular metal dissolved and the concentration of the solution. In addition to dissolving, alkali metals also react slowly by the liberation of hydrogen,

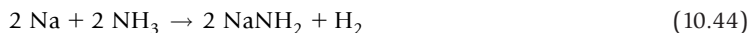

This reaction is accelerated photochemically and is catalyzed by transition metal ions.

Reduction of a chemical species involves the gain of electrons by that species. Because the solutions of alkali metals in liquid ammonia contain free electrons, they are extremely strong reducing agents. This fact has been exploited in a large number of reactions. For example, oxygen can be converted to superoxide or peroxide ions.

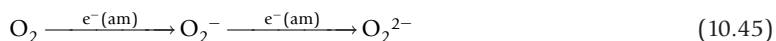

The solutions can also convert transition metals to unusual oxidation states.

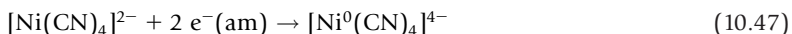

Many compounds react in liquid ammonia by loss of hydrogen and the production of an anion. Some examples of this type of reaction are

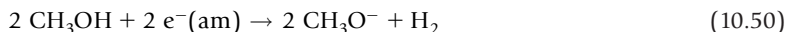
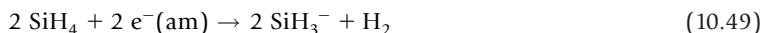

It has also been found that alkali metals dissolve in solvents such as methylamine and ethylenediamine. These solutions have some characteristics of the solutions containing ammonia, and they undergo similar reactions.

10.6 LIQUID HYDROGEN FLUORIDE

A solvent that resembles water in many ways is liquid hydrogen fluoride. The molecule is polar, there is some autoionization, and it is a fairly good solvent for numerous ionic solids. Although the boiling point of liquid HF is rather low (19.5 °C), it has a liquid range that is comparable to that of water, partially as a result of extensive hydrogen bonding. One of the problems associated with the use of liquid

Melting point	-83.1 °C
Boiling point	19.5 °C
Density at 19.5 °C	0.991 g cm ⁻¹
Heat of fusion	4.58 kJ mol ⁻¹
Heat of vaporization	30.3 kJ mol ⁻¹
Equivalent conductance	1.4 × 10 ⁻⁵ ohm ⁻¹
Dielectric constant at 0 °C	83.6
Dipole moment	1.83 D

HF is that it attacks glass, so containers must be made of some inert material such as Teflon, a polytetrafluoroethylene. The data for this nonaqueous solvent are shown in Table 10.4. As expected from the rather high heat of vaporization (which lies between the values for water and liquid ammonia) liquid HF has a liquid range that spans over 100 °C and a relatively high boiling point.

The autoionization of liquid HF can be represented by the equation



Water has an equivalent conductance of $6.0 \times 10^{-8} \text{ ohm}^{-1}$ at 25 °C, and that of liquid HF is $1.4 \times 10^{-5} \text{ ohm}^{-1}$. Therefore, the ion product constant for HF ionization is approximately 8×10^{-12} , which is larger than the value of 1.0×10^{-14} for water. The HF_2^- ion has a symmetric linear structure



and it represents the strongest case of hydrogen bonding. It can be considered as a molecule of HF solvating a fluoride ion. The H_2F^+ cation has eight electrons around the central F atom, so it is isoelectronic with water, and the structure of the ion is

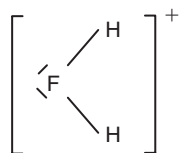

Both the dielectric constant and dipole moment are comparable to those of water, indicating that HF is a good solvent for inorganic compounds, but many organic compounds are also soluble. In general, the fluorides of +1 metals are much more soluble than those of +2 or +3 metals. At 11 °C, the solubility of NaF is approximately 30 g per 100 g of liquid HF, that of MgF_2 is only 0.025 g, and that of AlF_3 is 0.002 g.

The acidity of liquid HF is high enough that it can function as an acid catalyst in many instances. The cation characteristic of the solvent, H_2F^+ , is generated when HF reacts with a strong Lewis acid that is capable of forming stable fluoride complexes. The reactions with BF_3 and AsF_5 are typical:



Equations such as these can also be written in the molecular form as



The basic species in liquid HF is the fluoride ion or the solvated fluoride ion, HF_2^- . As in the case of water in which OH^- forms hydroxo complexes, fluoride ion forms complexes in liquid HF. This behavior gives rise to amphoterism with metals ions such as Zn^{2+} and Al^{3+} . In the case of Al^{3+} , AlF_3 is relatively insoluble in liquid HF so the amphoteric behavior can be shown as follows.



Although in this scheme the basic species is written as F^- for simplicity, the solvated species is actually HF_2^- in liquid HF.

The principal characteristic of liquid HF is its acidity and the stability of the HF_2^- anion, which represents the strongest known hydrogen bond. As a result, in many reactions in liquid HF, the solvent behaves as an acid and generates the HF_2^- anion. Typical reactions in which this type of behavior is shown are as follows:

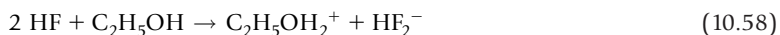

In addition to these types of reactions, liquid HF converts some oxides to oxyhalides. For example, the reaction of permanganate can be shown as follows:

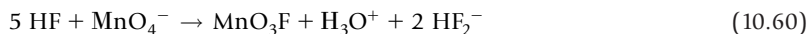

From the foregoing, it should be apparent that liquid HF is a versatile and useful nonaqueous solvent.

10.7 LIQUID SULFUR DIOXIDE

In addition to the protonic solvents already discussed, chemistry has been carried out in liquid sulfur dioxide for many years. Although the SO_2 molecule has a significant dipole moment, the liquid is a good solvent for many covalent substances. The molecule is polarizable because of the π electrons, so the London forces between SO_2 and solute molecules lead to solubility. In accord with the hard-soft interaction principle, compounds such as OSCl_2 , OPCl_3 , and PCl_3 are very soluble. Although aliphatic hydrocarbons are not soluble in liquid SO_2 , aromatic hydrocarbons are appreciably soluble in the liquid. This difference in solubility provides a way to separate the two types of hydrocarbons by means of solvent extraction. Ionic compounds are almost insoluble unless they consist of very large ions which contribute to polarizability and low lattice energies. Physical properties for liquid sulfur dioxide are shown in Table 10.5. As will be described later, sulfur dioxide is a useful solvent for carrying out reactions utilizing superacids such as the $\text{HOSO}_2\text{F}/\text{SbF}_5$ mixture.

Sulfur dioxide can function as a very weak Lewis acid or a Lewis base and thereby form a variety of solvates:



With some very strong Lewis acids, hydrolysis occurs to produce an oxyhalide:

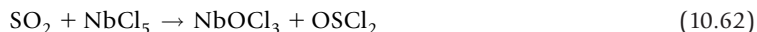

The SO_2 molecule has unshared pairs of electrons on both the sulfur and oxygen atoms. As a result, it forms numerous complexes with transition metals in which it is known to attach in several ways. These include bonding through the sulfur atom, through an oxygen atom, by both oxygen atoms, and various bridging schemes. In most cases, the complexes involve soft metals in low oxidation states. Another important reaction of sulfur dioxide is known as the insertion reaction, in which it is placed

Melting point	-75.5°C
Boiling point	-10.0°C
Density	1.46 g cm^{-3}
Heat of fusion	8.24 kJ mol^{-1}
Heat of vaporization	24.9 kJ mol^{-1}
Dipole moment	1.63 D
Dielectric constant	15.6
Specific conductance	$3 \times 10^{-8}\text{ ohm}^{-1}$

between the metal and another ligand. This type of reaction can be shown as (where X and L are other groups bonded to the metal):



This type of reaction will be discussed in more detail in Chapter 22.

If autoionization of the solvent shown as



does occur, it must be to an *infinitesimal* extent. As is the case with other nonaqueous solvents, maintaining the solvent scrupulously pure and anhydrous is essential. The transfer of an oxide ion would be energetically unfavorable, and it is interesting to note there is no exchange of radioactive sulfur in $OSCl_2$ with sulfur in liquid SO_2 . If autoionization did occur in these liquids, both would generate SO^{2+} , so it would be expected that the radioactive sulfur would be found in both species. The fact that it is not shows that these solvents do not produce ions.

Even though liquid SO_2 does not autoionize, the acidic species *would be* SO^{2+} and the basic species *would be* SO_3^{2-} . Therefore, the neutralization reaction

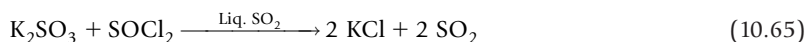

takes place as expected on the basis of the solvent concept. Unlike reactions in aqueous solutions, this reaction cannot be shown in ionic form as



Even though it is now known that the solvent concept does not represent the actual reacting species in some nonaqueous solvents, it is still a useful tool.

If thionyl chloride undergoes dissociation according to the equation



there would be some free Cl^- in the solution. If another chloride compound were dissolved in the solvent, there could be chloride exchange. Although based on the discussion to this point we would not expect autoionization, it is interesting to note that when other chloride compounds containing radioactive chlorine are dissolved in $SOCl_2$, there is *chloride* exchange with $SOCl_2$.

An illustration that a nonaqueous solvent such as liquid SO_2 is a versatile reaction medium is the following:

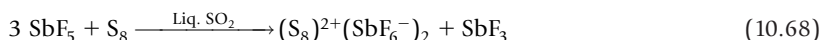

By increasing the ratio of SbF_5 to S_8 , it is also possible to generate the S_4^{2+} species. The reaction between PCl_5 and liquid SO_2 can be used to produce thionyl chloride and phosphoryl chloride.



The amphoteric behavior of Zn^{2+} and Al^{3+} in some nonaqueous solvents has already been described. This behavior can also be demonstrated in liquid SO_2 . For example, the aluminum compound containing the anion characteristic of the solvent forms a precipitate, which is then soluble in either the acid or base in liquid SO_2 . This can be shown as

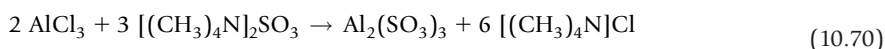

As we have already shown, SOCl_2 is an acid in liquid SO_2 , so the precipitate of $\text{Al}_2(\text{SO}_3)_3$ reacts as follows to give aluminum chloride and the solvent:

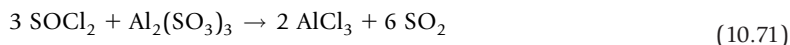

In liquid SO_2 the basic species is SO_3^{2-} so $[(\text{CH}_3)_4\text{N}]_2\text{SO}_3$ gives a basic solution in which aluminum sulfite dissolves by forming a sulfite complex, as shown in the equation

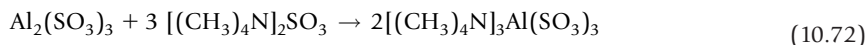

Battery technology has developed enormously in recent years. One of the most useful types of batteries is known as the lithium battery, but there are actually several designs only one of which will be described. In one of the types, the anode is constructed of lithium or a lithium alloy; hence the name. A graphite cathode is used, and the electrolyte is a solution of $\text{Li}[\text{AlCl}_4]$ in thionyl chloride. At the anode, lithium is oxidized,



At the cathode, the reduction of thionyl chloride occurs,



As the battery produces electricity, lithium chloride is formed on the cathode, and eventually the battery is no longer effective. Lithium batteries have long life and give high current-to-weight ratio, so they are widely used in digital cameras, watches, pacemakers, and so forth.

In addition to the reactions in which the solvent is also a *reactant* (such as solvolysis), there are many others in which the solvent functions only to make reactants accessible to each other. Even in those

cases, the difference in solubilities can lead to different products depending on the solvent. Consider the following metathesis reactions:

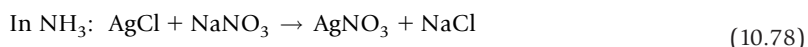
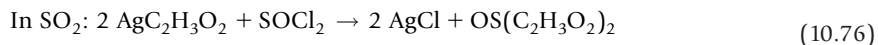

The first of these reactions takes place because AgCl is insoluble in water. The second takes place because AgCl is insoluble in sulfur dioxide. The third reaction takes place because the highly ionic LiCl is not soluble in liquid ammonia. The last of these reactions takes place because AgCl is soluble in liquid ammonia but NaCl is not. It is clear that metathesis reactions may be different in some nonaqueous solvents.

The chemistry of the specific solvents discussed in this chapter illustrates the scope and utility of nonaqueous solvents. However, as a side note, several other nonaqueous solvents should at least be mentioned. For example, oxyhalides such as OSeCl₂ and OPCL₃ (described in the discussion of the coordination model earlier in this chapter) also have received a great deal of use as nonaqueous solvents. Another solvent that has been extensively investigated is sulfuric acid, which undergoes autoionization,



For this equilibrium, the ion product constant has a value of approximately 2.7×10^{-4} . However, the discussion is complex and other species are present in sulfuric acid as a result of equilibria that can be written as



Disulfuric acid (also known as pyrosulfuric acid or oleum) also undergoes dissociation,

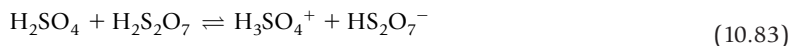

Many species are protonated in liquid sulfuric acid, even some that are not normally bases. For example,

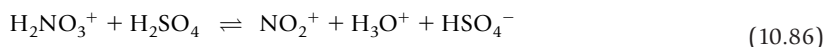
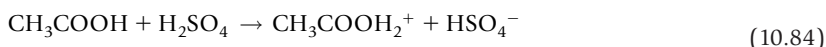

Sulfuric acid undergoes many other reactions with metals as well as with metal oxides, carbonates, nitrates, sulfides, and so on. It is a versatile nonaqueous solvent.

10.8 SUPERACIDS

In aqueous solutions, the leveling effect causes there to be an upper limit on acid strength, that of H_3O^+ . However, this is not an absolute limit, and it is possible to obtain acidic media which are so strong that they are generally referred to as *superacids*. One way to produce a superacid is to change the peripheral atoms on a molecule of an oxyacid such as H_2SO_4 to increase the inductive effect. When one of the two $-\text{OH}$ groups on sulfuric acid is replaced by a fluorine atom, the result is HOSO_2F (m.p. -89 , b.p. 163°C), and it is a stronger acid than H_2SO_4 alone.

The behavior of superacids is an important aspect of nonaqueous solvent chemistry because numerous reactions can be carried out when the acids are much stronger than H_3O^+ . This characteristic was recognized as early as 1927 by James Bryant Conant. One strongly acidic medium that is commonly utilized is obtained by mixing SbF_5 and HSO_3F . When the strong Lewis acid SbF_5 is added to HOSO_2F , it accepts a pair of electrons (probably from one of the oxygen atoms), which increases the inductive effect on the remaining $\text{O}-\text{H}$ bond even more than in HOSO_2F alone. The result is that the $\text{HOSO}_2\text{F}/\text{SbF}_5$ mixture is a stronger acid than HOSO_2F , and the interaction between the two components can be represented as



One very powerful oxidizing agent that can be used in this superacid is $\text{FO}_2\text{SOOSO}_2\text{F}$, peroxydisulfuryl difluoride, which has the structure

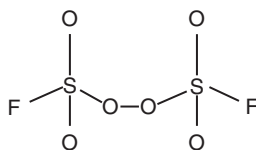

In the $\text{HOSO}_2\text{F}/\text{SbF}_5$ mixture, iodine can be oxidized by $\text{S}_2\text{O}_6\text{F}_2$ to produce polyatomic cations. For example, the reaction that shows the production of I_3^+ can be written as



This strong oxidizing agent in the superacid mixture will also oxidize sulfur to produce the S_8^{2+} and S_4^{2+} ions described earlier (there are actually some others known, but these are probably the best-characterized species).



The $\text{HOSO}_2\text{F}/\text{SbF}_5$ mixture will dissolve substances such as paraffin with the formation of carbocations. For example, the reaction with *neo*-pentane can be shown as



The $\text{H}_2\text{SO}_3\text{F}^+$ ion is such a strong acid that it will also protonate phosphorus halides as well as hydrocarbons.

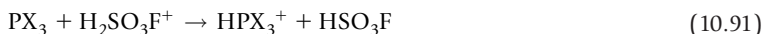

Another mixture that will function in a similar way is the mixture of HF and SbF_5 , which results in the equilibrium



Suitable solvents for carrying out reactions utilizing this superacid mixture include liquid SO_2 , SO_2FCl , and SO_2F_2 . This superacid will also protonate hydrocarbons to form carbocations, but is a weaker acid than $\text{H}_2\text{SO}_3\text{F}^+$. In one interesting reaction, carbonic acid is converted into $\text{C}(\text{OH})_3^+$ which is isoelectronic with boric acid, $\text{B}(\text{OH})_3$. Superacids are such strong proton donors that they will protonate many substances that are not normally bases. These include such species as hydrocarbons, ketones, organic acids, and many others. The chemistry of superacids makes possible many reactions that could not be carried out in any other way. As mentioned earlier, this is one of the aspects of nonaqueous solvents that makes that type of chemistry indispensable.

■ REFERENCES FOR FURTHER READING

- Finston, H. L., and Rychtman, A. C. (1982). *A New View of Current Acid-Base Theories*. Wiley, New York. A useful and comprehensive view of all the major acid-base theories.
- Jolly, W. L. (1972). *Metal-Ammonia Solutions*. Dowden, Hutchinson & Ross, Inc., Stroudsburg, PA. A collection of research papers that serves as a valuable resource on all phases of the physical and chemical characteristics of these systems.
- Jolly, W. L., and Hallada, C. J., in Waddington, T. C., Ed. (1965). *Non-aqueous Solvent Systems*. Academic Press, San Diego, CA.
- Lagowski, J. J., and Moczygemba, G. A., in Lagowski, J. J., Ed. (1967). *The Chemistry of Non-aqueous Solvents*. Academic Press, San Diego, CA.

- Meek, D. W., and Drago, R. S. (1961). *J. Amer. Chem. Soc.*, **83**, 4322. The classic paper describing the coordination model as an alternative to the solvent concept.
- Nicholls, D. (1979). *Chemistry in Liquid Ammonia: Topics in Inorganic and General Chemistry*, Vol. 17. Elsevier, Amsterdam.
- Olah, G. A., Surya Prakash, G. K., and Sommer, J. (1985). *Superacids*. Wiley, New York.
- Pearson, R. G. (1997). *Chemical Hardness*. Wiley-VCH, New York. An interesting book on several aspects of hardness, including the behavior of ions in crystals.
- Popovych, O., and Tompkins, R. P. T. (1981). *Non-aqueous Solution Chemistry*. Wiley, New York.
- Waddington, T. C. (1969). *Non-aqueous Solvents*. Appleton-Century-Crofts, New York. An older book that presents a lot of valuable information on nonaqueous solvents.

■ QUESTIONS AND PROBLEMS

- Write equations for the reactions of the following in liquid sulfuric acid:
 - NaF
 - CaCO₃
 - KNO₃
 - (CH₃)₂O
 - CH₃OH
- Explain why water is a better medium than liquid ammonia for a reaction that requires an acidic medium, whereas the opposite is true for a reaction that requires a basic medium.
- Suppose SO₂ forms a complex by attaching to [Ni(PR₃)₄] (where R = C₆H₅). How would you expect it to attach? Explain your answer.
 - Predict the structure of the product if two SO₂ molecules were to replace H₂O in the complex [Mn(OPR₃)₄(H₂O)₂]²⁺.
 - Suppose the hypothetical complex [(CO)₄Fe-SO₂-Cr²⁺(NH₃)₅] could be made. How might sulfur dioxide function as a bridging ligand in this complex?
- Explain the difference in acidity of HCN in water and liquid ammonia.
- Explain why there are no hydride complexes of the type Co(NH₃)₅H⁺, but there are some like Mo(CO)₅H.
- Acetic anhydride, (CH₃CO)₂O, is assumed to undergo slight autoionization.
 - Write the equation to represent the autoionization process.
 - What is one substance that would be acidic in this solvent?
 - What is one substance that would be basic in this solvent?
 - Write the equations to show the amphoteric behavior of Zn²⁺ in liquid acetic anhydride.
- When AlCl₃ is dissolved in OSCL₂ some AlCl₄⁻ is produced.
 - Assuming that the solvent concept is applicable, explain by means of appropriate equations how the formation of AlCl₄⁻ occurs.
 - Use the coordination model and write equations to show how AlCl₄⁻ is formed.
 - Explain clearly the difference between how the solvent concept and the coordination model apply to the reaction of AlCl₃ with OSCL₂.
- Explain how KNO₃ can be used as a nitrating agent in liquid HF. What species are present? How do they act?
- Each of the following reactions takes place in aqueous solution. Write an equation that is analogous to each when the solvent is liquid ammonia.
 - KOH + HCl → KCl + H₂O
 - CaO + H₂O → Ca(OH)₂
 - Mg₃N₂ + 6 H₂O → 2 NH₃ + 3 Mg(OH)₂
 - Zn(OH)₂ + 2 H₃O⁺ → Zn²⁺ + 4 H₂O
 - BCl₃ + 3 H₂O → 3 HCl + B(OH)₃

10. Explain the role of hydrogen bonding in the autoionization of liquid HF.
11. Using equations, show how TiCl_4 can produce TiCl_6^{2-} in OPCl_3 solution.
12. Using equations, show how SbCl_5 is an acid in liquid OPCl_3 , in liquid HF, and in liquid BrF_3 .
13. Write equations to show how each of the following would react in liquid ammonia:
(a) LiH (b) NaH_2PO_4 (c) BaO (d) AlN (e) SOCl_2
14. Explain why CaCl_2 is much less soluble in liquid ammonia than is CuCl_2 .
15. If you were trying to generate the N_2F_3^+ ion in a nonaqueous solvent, what would be a good solvent to use? Write the equation for the formation of N_2F_3^+ in that solvent.
16. Write equations to show the amphoteric behavior of Zn^{2+} in 100% acetic acid.
17. In liquid NH_3 , Ir^{3+} forms a precipitate when NaNH_2 is added, but redissolves when an excess of NH_2^- is added. Write equations to show this behavior.
18. Write equations to explain why the solution is acidic when AlCl_3 is dissolved in water.
19. Consider H_2O and liquid neon, both of which have eight electrons in the valence shell. However, there the similarity ends. Describe the properties that are different and explain the characteristics of the molecules that give rise to those properties.
20. Write an equation to show why aluminum fluoride is an acid in liquid HF.
21. Rank the following solids in the order of decreasing solubility in liquid HF. Explain the order you give: CsF , LiF , BaF_2 , CaF_2 , KF .
22. Both BrF_3 and IF_5 are bases in liquid HF. Write equations to show this behavior.

Part 4

Chemistry of the Elements

This page intentionally left blank

Chemistry of Metallic Elements

Metals have characteristics that make them desirable for construction, implements, and ornamental uses such as in jewelry. Metals have been so important that the names Chalcolithic, Bronze, and Iron Age have been applied to epochs of history. Metals have an enduring quality. They are solid, durable, and attractive. The first draft of this passage is being written with a pen made of sterling silver (an alloy consisting of 92.5% silver and 7.5% copper). The lure of metals has drawn adventurers to remote places, and they have been the spoils of war. Their intrinsic value is exemplified by the ornaments we wear and the role of metals in monetary systems.

Of the slightly more than 100 known elements, approximately three-fourths are metals. These elements have properties that vary from those of mercury (m.p. -39°C) to those of tungsten (m.p. 3407°C). However, the characteristics of metals that physically distinguish them are their metallic luster, electrical conductivity, malleability, and ductility. Elements generally classified as metals exhibit wide variation in these properties. Chemically, metals are also reducing agents as a result of their having comparatively low ionization potentials. Another characteristic that differs enormously is their cost. Some of the base metals sell for a few cents per pound, whereas some of the exotic metals sell for a few thousand dollars per gram.

Another issue with metals is availability. For example, cobalt is not produced in the United States, but it is used extensively in a wide variety of alloys and in the production of one of the most common types of lithium batteries. The availability of cobalt is crucial to several segments of American industry. For example, batteries being developed for use in automobiles powered by alternate energy sources are currently envisioned to use a lithium ion battery that also contains cobalt. However, cobalt is not the only strategic metal, and there is concern about the availability of several metals that are vital to industries in the United States, China, and Japan. There will be competition and stockpiling of strategic metals as the reserves become less accessible.

11.1 THE METALLIC ELEMENTS

The metals found in group IA of the periodic table are known as the *alkali metals*, and those in group IIA are the *alkaline earths*. Metals found in the groups between IIA and IIIA (the so-called *d*-block metals) are the *transition metals*. The series of elements following lanthanum ($Z = 57$, the *f*-block metals)

represent those in which the $4f$ level is being filled in progressing through the group. These elements were referred to as the rare earths, but are now generally referred to as the *lanthanides* because they follow lanthanum in the periodic table. The row of elements below the lanthanides is known as the *actinides* because they follow actinium. All are radioactive and the later members of the series are artificially produced. In this chapter, the discussion will not include the actinides, because they are comparatively rare, radioactive, and of generally limited use in practical chemistry. There is considerable and inevitable overlap of some topics when discussing the chemistry of metals. For example, a great deal of the chemistry of organometallic compounds of main-group elements is discussed in Chapter 12, and that of transition metals is presented in Chapter 21. The chemistry of metallic elements such as tin, lead, antimony, and bismuth is discussed with the chemistry of the other members of the respective groups in Chapters 14 and 15. Some of the chemistry of the group IA metals was presented in Chapter 10 in connection with their behavior in nonaqueous solvents such as liquid ammonia. The basic structures of metals, their characteristics, and the phase transitions that occur between phases have been discussed in Chapter 7.

11.2 BAND THEORY

In a general way, a metal can be considered as a regular lattice of positive ions surrounded by an electron “gas” or “sea” that is mobile. This simple model accounts for many properties of metals. For example, the mobile electrons in metals enable them to be good electrical conductors. Because metal atoms can be displaced without destroying the lattice, metals can be shaped and retain their cohesiveness. Consequently, metals are *malleable* (can be hammered to change shapes) and *ductile* (can be drawn into wires). Moreover, the substitution of a different atom in the lattice is possible with the result being a solution of one metal in another, an *alloy*. The addition of other nonmetallic atoms such as carbon, nitrogen, or phosphorus increases the hardness of the metal while making it more brittle and less ductile.

Although metals are generally good conductors of electricity, there is still some resistance to electrical flow, which is known as the *resistivity* of the metal. At normal temperatures, the resistivity is caused by the flow of electrons being impeded because of the motion of atoms that results from vibration about mean lattice positions. When the temperature is raised, the vibration of atoms about their mean lattice positions increases in amplitude, which further impedes the flow of electrons. Therefore, the resistivity of metals increases as the temperature increases. In a metal, electrons move throughout the structure. There are usually a small number of electrons from each atom that are considered, and because in most structures (*fcc* and *hcp*) each atom has 12 nearest neighbors, there is no possibility for the formation of the usual bonds that require two electrons for each. As a result, *individual* bonds are usually weaker than those of ionic or covalent character. Because of the overall number of bonds, the cohesion in metals is quite high.

As metal atoms interact with nearest neighbors at relatively short distance, orbital overlap results in electron density being shared. As mentioned earlier, that electron density is delocalized in orbitals that are essentially molecular orbitals encompassing all of the atoms. The number of atoms that contribute an orbital to the molecular orbital scheme approaches the number of atoms present. As two atoms

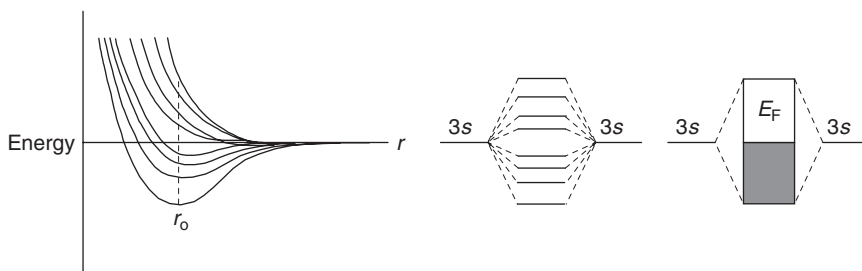

■ **FIGURE 11.1** Interaction of atomic orbitals to produce four bonding and four antibonding molecular orbitals. As the number of atoms gets very large, the molecular orbitals form a continuum. In this case (described in the text) the atoms are assumed to be sodium.

approach each other and interaction occurs, the two atomic orbitals can be considered as forming two *molecular* orbitals, one bonding and one antibonding. This is illustrated in Figure 11.1. If three atoms interact, three molecular orbitals result, and so on. In many ways, this situation is similar to the Hückel molecular orbitals described in Chapter 5, where it was shown that the number of molecular orbitals is equal to the dimensionality of the secular determinant. The energy of the k th orbital in the Hückel approach can be expressed as

$$E = \alpha + 2\beta \cos \frac{k\pi}{N+1} \quad (11.1)$$

where α is a Coulomb integral (H_{ii}), β is the resonance integral (H_{ij}), and N approaches infinity. Therefore, there are N energy levels that span an energy band that approaches 4β in overall width with the energy separating levels k and $k+1$ approaching zero.

The *overall* difference in energy of the molecular orbitals is determined by how effectively the atomic orbitals interact, but the spacing between individual *adjacent* molecular orbitals decreases as the number of orbitals increases. When the number of atoms is very large, the spacing becomes smaller than the thermal energy, kT (where k is Boltzmann's constant). For only two orbitals, the variation in orbital energy with interatomic distance is shown in Figure 11.1. For a very large number of orbitals, there is a continuum of molecular orbitals that form a "band" as shown in Figure 11.1. This is the origin of the band theory often referred to in connection with bonding in metals. When N atoms interact to produce N molecular orbitals, each orbital can hold $2N$ atoms, and if each atom contributes one electron, the molecular orbitals will be half filled. This situation is also illustrated in Figure 11.1.

For a metal such as sodium, there are overlapping bands formed from the $2p$ and $3s$ atomic orbitals. In a general way, we can consider that a band is formed from each type of atomic orbitals that is occupied. However, there are energy gaps *between* the bands. If we again consider the case of sodium, there will be bands from the $1s$, $2s$, $2p$, $3s$, and $3p$ (although the $3p$ orbitals are unoccupied) that can be shown as in Figure 11.2. Each band can hold $2(2l+1)N$ electrons, where N is the number of atoms.

Because the highest occupied band is only half filled, electrons can move into the band and move within the band during electrical conduction. Light in the visible region of the spectrum interacts with

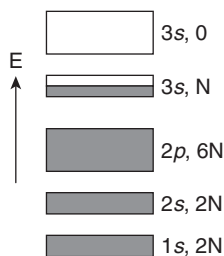

■ **FIGURE 11.2** Bands formed by interaction of orbitals on sodium atoms and their populations. The shaded bands are filled but the open bands are empty. The band arising from the 3s orbitals is only half filled because there is only one electron per atom in the 3s state.

the electrons with absorption and re-emission occurring at the surface. It is this phenomenon that gives metals their shiny appearance or *metallic luster*.

In the free electron model, the electrons are presumed to be loosely bound to the atoms, making them free to move throughout the metal. The development of this model requires the use of quantum statistics that apply to particles (such as electrons) that have half integral spin. These particles, known as fermions, obey the Pauli exclusion principle. In a metal, the electrons are treated as if they were particles in a three-dimensional box represented by the surfaces of the metal. For such a system when considering a cubic box, the energy of a particle is given by

$$E = \frac{\hbar^2 \pi^2}{2mL^2} (n_x^2 + n_y^2 + n_z^2) \quad (11.2)$$

where n_x , n_y , and n_z are the quantum numbers for the respective coordinates. If the quantum numbers are set equal to 1 (corresponding to the ground state), Eq. (11.2) simplifies to

$$E = \frac{3\hbar^2 \pi^2}{2mL^2} \quad (11.3)$$

By making the assumption that the quantum numbers are continuous, the number of allowed energy states per unit volume that have an energy between E and $E + dE$, it can be shown that the energy function is

$$g(E)dE = \frac{8\sqrt{2}\pi m^{3/2}}{h^3} \cdot E^{1/2} dE = CE^{1/2} dE \quad (11.4)$$

The expression $g(E)$ is frequently referred to as the *density of states*. The probability that an electron will be in a specific state having an energy E can be expressed as

$$f(E) = \frac{1}{e^{(E-E_f)/kT} + 1} \quad (11.5)$$

From this expression, known as the Fermi-Dirac distribution function, we can see that when $T = 0$, $f(E) = 1$ when $E < E_F$ and $f(E) = 0$ for $E_F > E$. the number of electrons with energy between E and $E + dE$ per unit volume is given by $f(E) g(E) dE$, which can be written as

$$N(E)dE = C \frac{E^{1/2}dE}{e^{(E-E_F)/kT} + 1} \quad (11.6)$$

When the total number of electrons per unit volume is given by

$$\chi = C \int_0^{\infty} \frac{E^{1/2}}{e^{(E-E_F)/kT} + 1} dE \quad (11.7)$$

this expression can be simplified by making use of the special conditions given earlier,

$$\chi = C \int_0^{E_F} E^{1/2} dE = \frac{2}{3} CE_F^{3/2} \quad (11.8)$$

After substitution for C and simplifying, the result is

$$E_F = \frac{h^2}{2m} \left(\frac{3\chi}{8\pi} \right)^{3/2} \quad (11.9)$$

The Fermi energy is equal to the highest energy within the filled band (see Figure 11.1).

11.3 GROUP IA AND IIA METALS

The metals in the first two groups of the periodic table are characterized as “s block” elements because of their outer shells having one and two electrons in an s orbital. These configurations follow the closed shell arrangements of the noble gases so the outer electrons are subject to considerable shielding from the nuclear charge. The result is that the alkali metals found in group IA have the lowest ionization potentials of any elements. In their chemistry, they most often are found as the +1 ions, although this is not universally true. Known as the *alkaline earths*, the elements in group IIA have an ns^2 configuration, but even though this corresponds to a filled shell, the metals are reactive partially because of shielding of the outermost electrons. Because the elements in group IA and IIA are so reactive, they are always found combined in nature. The reduction of the metals requires a strong reducing agent, so it was not possible to produce the metals in ancient times when carbon was the reducing agent used in metallurgy. Therefore, the metals were not obtained until the early 1800s, when electrochemical processes began to be used. Several compounds of the group IA and IIA metals were known in ancient times. These include salt, limestone (CaCO_3), and sodium carbonate (Na_2CO_3). In discussing the chemistry of the elements in these groups, only selected areas will be covered. It is impossible to cover the entire field in part of a chapter, so the approach taken is to show representative slices of the enormous pie that this field of chemistry represents.

11.3.1 General Characteristics

The elements in group IA and IIA of the periodic table have the valence shell configurations of ns^1 and ns^2 , respectively. Consequently, the expected pattern for the group IA and IIA elements is the formation of +1 and +2 ions, respectively. All naturally occurring compounds of these elements contain the atoms in those forms. Because the isotope of francium having the longest half-life is 21 minutes, francium is omitted from the discussion. In addition to the data shown in Table 11.1, it is frequently useful to know the charge-to-size ratio of ions. That parameter is simply the charge on the ion divided by its radius, and it gives the so-called *charge density* of the ion. This quantity gives a guide to how strongly the ion will be solvated as a result of ion-dipole forces. It is also a measure of the hardness of the species (see Chapter 9).

A large number of compounds of the group IA and IIA metals occur naturally (salt, soda, limestone, etc.). These compounds have been important for thousands of years, and they still are. Moreover, lime is still produced by heating limestone, and the quantity produced is enormous.

Metal	Crystal structure	m.p., °C	b.p., °C	Density, g/cm ³	$-\Delta H_{\text{hydr}}$, kJ/mol	R_{atom} , pm	R_{ion} , ^a pm
Group IA							
Li	<i>bcc</i>	180.5	1342	0.534	515	134	68
Na	<i>bcc</i>	97.8	893	0.970	406	154	95
K	<i>bcc</i>	63.3	760	0.862	322	227	133
Rb	<i>bcc</i>	39	686	1.53	293	248	148
Cs	<i>bcc</i>	28	669	1.87	264	265	169
Group IIA							
Be	<i>hcp</i>	1278	2970	1.85	2487	113	31
Mg	<i>hcp</i>	649	1090	1.74	2003	160	65
Ca	<i>fcc</i>	839	1484	1.54	1657	197	99
Sr	<i>fcc</i>	769	1384	2.54	1524	215	113
Ba	<i>bcc</i>	725	1805	3.51	1360	217	135
Ra	<i>bcc</i>	700	1140	5	~1300	220	140
Group IIIA							
Al	<i>fcc</i>	660	2327	2.70	4690	143	50

^aThis is the radius of the ion having the charge equal to the group number.

As a result of the decrease in ionization potential, the reactivity of the metals in groups IA and IIA increase in progressing down in the group. The electronegativities of these metals range from about 0.8 to slightly over 1.0 (except for beryllium, which has an electronegativity of 1.6). All are very strong reducing agents that form binary compounds with most nonmetallic elements and even some other metals that have higher electronegativity. As has been discussed in Chapter 10, the metals in groups IA (especially) and IIA (to a slight extent) are somewhat soluble in liquid ammonia and amines, and the solutions have many interesting characteristics.

Because the group IA metals are such strong reducing agents and so reactive, they are generally prepared by electrolysis reactions. For example, sodium is produced by the electrolysis of a molten mixture that contains NaCl and CaCl₂. Lithium is produced by the electrolysis of a mixture of LiCl and KCl. The production of potassium is carried out by using sodium as a reducing agent at 850°C. Under these conditions, potassium is more volatile, so the equilibrium



is drawn to the right as potassium is removed. Therefore, even though potassium is normally a stronger reducing agent than sodium, removal of the potassium allows the reaction to be carried out efficiently.

11.3.2 Negative Ions

In most instances, the group IA metals form +1 ions, but this is not always the case. Because of the low ionization potential of sodium, an unusual situation exists with regard to forming Na⁺ and Na⁻ ion pairs. If we consider the reaction

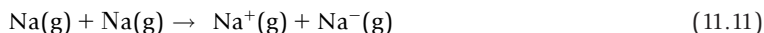

we find that it requires 496 kJ mol⁻¹ to remove an electron from a sodium atom (the ionization potential). Adding the electron to another sodium atom



releases approximately 53 kJ mol⁻¹ (the reverse of electron affinity). Thus the process shown in Eq. (11.11) would have enthalpy of about +443 kJ/mol. However, if the process could be carried out in water without any other reaction occurring, the enthalpy of solvation of Na⁺(g) liberating 406 kJ mol⁻¹ would make the process of electron transfer more nearly energetically favorable.



The Na⁻(g) would also be solvated, but the heat associated with that process would be less than that for the cation. All this is hypothetical because sodium reacts vigorously with water. What is needed is

a substance that strongly solvates the ions produced without otherwise reacting. One type of molecule that binds strongly to sodium ions is a polyether having the structure

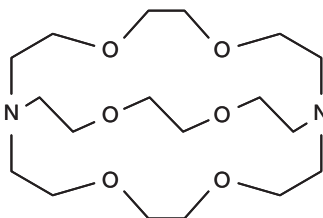

By dissolving sodium in ethylenediamine and adding this complexing agent (known as a *cryptand*) followed by evaporation of the solvent, it has been possible to recover a solid that contains $\text{Na}^+(\text{crypt})\text{Na}^-$. This shows that although it is rather rare, it is possible for Na to complete the 3s level. Of course, this type of behavior also occurs when H^- is formed.

11.3.3 Hydrides

Most of the group IA and IIA metals form compounds with hydrogen that (at least formally) contain H^- . These compounds are discussed in more detail along with the chemistry of hydrogen in Chapter 13. Because they have the characteristics of ionic compounds (white solids of low volatility) these hydrides are known as the *saltlike hydrides*. However, the hydrides of beryllium and magnesium are quite different because of their being much more covalent (these metals have electronegativities of 1.6 and 1.3, respectively). These hydrides are polymeric and consist of chains having hydrogen atoms bridging between the metal atoms. The most important characteristic of the ionic hydrides is the very strong basicity of the hydride ion. Ionic hydrides will remove protons from almost any molecule that contains an OH bond including water, alcohols, and so on, as illustrated by the following equations:



The H^- ion is such a strong base that it will deprotonate NH_3 to generate the amide ion.



Ionic hydrides such as NaH and CaH_2 can be used as drying agents because they will remove hydrogen from the traces of water present in many solvents. Lithium aluminum hydride, LiAlH_4 , is a versatile reducing agent that is used to carry out many types of reactions in organic chemistry.

11.3.4 Oxides and Hydroxides

The group IA metals all react with oxygen, but the products are not always the “normal” oxides. Lithium reacts with oxygen in the expected way,

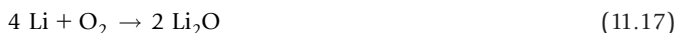

However, sodium reacts with oxygen with the product being predominantly the *peroxide*.



The O_2^- ion is known as the *superoxide* ion, and it is produced when oxygen reacts with potassium, rubidium, and cesium.



Presumably, the formation of oxides of the larger atoms in group IA is favored when they contain larger anions. It is generally more favorable when crystal lattices are formed from cations and anions of similar size and magnitude of charge (see Chapter 9). In reactions with oxygen, the lighter members of the group IIA metals give normal oxides, but barium and radium give peroxides.

When the oxygen compounds of group IA and IIA metals react with water, strongly basic solutions are produced regardless of whether an oxide, peroxide, or superoxide is involved.

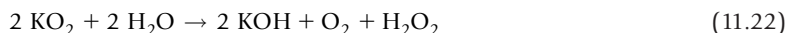
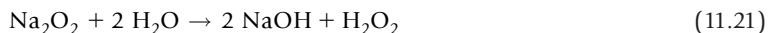

Sodium hydroxide, sometimes referred to as caustic soda or simply caustic, is produced in enormous quantities by the electrolysis of an aqueous solution of sodium chloride.



The fact that this is also the reaction used to prepare chlorine makes it especially important. However, sodium hydroxide will react with chlorine as shown in the equation

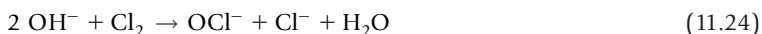

In order to prevent this reaction, the products must be kept separated during the electrolysis. In one method, a diaphragm is used, and in the other, a mercury cell is employed. In the mercury cell, a mercury cathode reacts with sodium to form an amalgam that is continuously removed. In the diaphragm cell, the cathode and anode compartments are separated by a diaphragm made of asbestos. The solution containing sodium hydroxide is removed from the cathode compartment before diffusion through the diaphragm occurs. Billions of pounds of NaOH are produced annually, and it is used in many processes that require a strong base.

Potassium hydroxide is produced by electrolysis of aqueous KCl. Because it is more soluble than NaOH in organic solvents, KOH is widely used in certain types of processes. For example, KOH is used

in the production of many types of soaps and detergents. The hydroxides of rubidium and cesium are of little importance compared to those of sodium and potassium, but they are even stronger bases.

The oxides of the group IIA metals are ionic, so they react with water to produce the hydroxides.



However, beryllium oxide is quite different, and it exhibits amphoteric behavior.



Magnesium hydroxide is a weak, almost insoluble base that is used as a suspension known as “milk of magnesia” that is a common antacid. The utility of the hydroxides of the group IIA metals is limited somewhat because they are only slightly soluble (only about 0.12 grams of $\text{Ca}(\text{OH})_2$ dissolves in 100 grams of water, although it is a strong base). Calcium hydroxide is produced in enormous quantities by the decomposition of limestone,



which is followed by the reaction of CaO (*lime*) with water.



Calcium hydroxide is known as *hydrated lime* or *slaked lime*, and it is used extensively in some applications because it is less expensive than NaOH or KOH . It reacts with CO_2 to form CaCO_3 , which binds particles of sand and gravel together in mortar and cement.

11.3.5 Halides

Sodium chloride is found in salt beds, salt brines, and sea water throughout the world, and it is also mined in some locations. Consequently, sodium chloride is the source of numerous other sodium compounds. A large portion of the sodium chloride utilized is consumed in the production of sodium hydroxide (Eq. (11.23)). The production of sodium metal involves the electrolysis of the molten chloride, usually in the form of a eutectic mixture with calcium chloride. Sodium carbonate is an important material that is used in many ways such as making glass. It was formerly produced from NaCl by means of the Solvay process, in which the overall reaction is

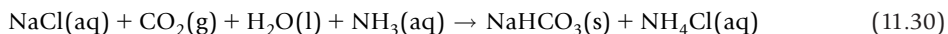

As described in Chapter 8, there are many transformations of solids that have industrial importance, and in this case, the solid product decomposes when heated to give sodium carbonate.

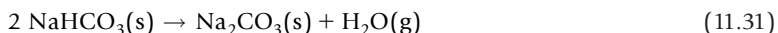

Although the Solvay process is still in use in some parts of the world, the chief source of sodium carbonate is the mineral *trona*, $\text{Na}_2\text{CO}_3 \cdot \text{NaHCO}_3 \cdot 2\text{H}_2\text{O}$.

11.3.6 Sulfides, Nitrides, Carbides, and Phosphides

The sulfides of the group IIA metals generally have the sodium chloride structure, but those of the group IA metals have the antifluorite structure because the ratio of anions to cations is 2. Solutions of the sulfides are basic as a result of the hydrolysis reaction



One preparation of the group IA and IIA sulfides involves the reaction of H_2S with the metal hydroxides.



Because of the tendency of sulfur toward catenation, solutions containing sulfides react with sulfur to give polysulfides, which can be represented as S_n^{2-} (see Chapter 15). Sulfides of the group IA and IIA metals can also be produced by reducing the sulfates with carbon at high temperature.



Lithopone, a commonly used pigment containing barium sulfate and zinc sulfide, is produced by the following reaction:



Because $\text{Ca}(\text{OH})_2$ is a base and H_2S is an acid, the following reaction can be used to prepare CaS :



Most nonmetallic elements will react with the group IA and IIA metals to give binary compounds. Heating the metals with nitrogen or phosphorus gives nitrides and phosphides of the metals.



Although the products in these equations are written as if they were simple ionic binary compounds, this is not always the case. For example, some nonmetals form clusters containing several atoms arranged in polyhedral structures. One such species is the P_7^{3-} cluster, which has six phosphorus atoms at the vertices of a trigonal prism with the seventh occupying a position above a triangular face

on one end of the prism. When the binary nitrides or phosphides react with water, basic solutions result because the anions undergo solvolysis reactions such as those represented by the equations

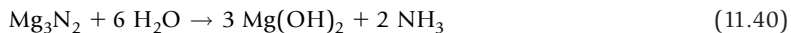
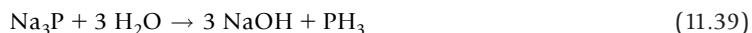

Reactions similar to these provide convenient syntheses of hydrides of such elements as phosphorus, arsenic, tellurium, and selenium, because these elements do not react directly with hydrogen and the hydrides are unstable.

Binary carbides are formed when the metals are heated strongly with carbon. The most important carbide of the group IA and IIA metals is calcium carbide, CaC_2 . This carbide is actually an *acetylide* because it contains the C_2^{2-} ion and it reacts with water to produce acetylene.

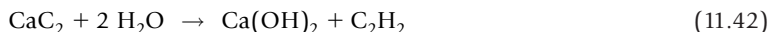

The reaction between CaO and carbon (coke) at very high temperature produces CaC_2



Calcium acetylide is used in the manufacture of calcium cyanamide, CaCN_2 , by the reaction of CaC_2 with N_2 at high temperature.

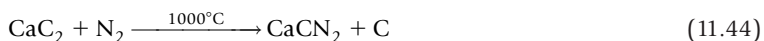

Like the Haber process for the synthesis of ammonia, this reaction represents a way of converting elemental nitrogen into a compound (nitrogen fixation). Moreover, calcium cyanamide reacts with steam at high temperature to yield ammonia,



Calcium cyanamide is also a constituent in some fertilizers.

Another cyanamide compound that has a number of significant uses is sodium cyanamide, which is prepared as shown below. Sodium amide is obtained by the reaction of ammonia with Na at 400°C .

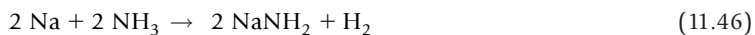

The reaction between sodium amide and carbon produces sodium cyanamide,

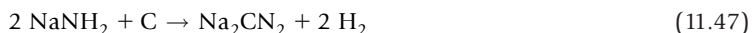

which reacts with carbon to produce sodium cyanide.



The major use of sodium cyanamide is in the production of sodium cyanide, a compound that is used extensively in preparing solutions for the electroplating of metals. Another use for NaCN is in extraction processes employed to separate gold and silver from ores as a result of their forming complexes with CN^- . Sodium cyanide, an extremely toxic compound, is also used in the process known as *case-hardening* of steel. In this process, the object to be hardened is heated and allowed to react with the cyanide to form a layer of metal carbide on the surface.

11.3.7 Carbonates, Nitrates, Sulfates, and Phosphates

Some of the important compounds containing the group IA and IIA metals are the carbonates, nitrates, sulfates, and phosphates. We have already mentioned the mineral trona as the source of sodium carbonate. Calcium carbonate is found in many forms that include chalk, *calcite*, *aragonite*, and marble, as well as in egg shells, coral, and seashells. In addition to its use as a building material, calcium phosphate is converted into fertilizers in enormous quantities (see Chapter 14).

Magnesium is found as the carbonate in the mineral *magnesite* and as the silicate in the mineral *olivine*. Magnesium is also found as *Epsom salts*, $\text{MgSO}_4 \cdot 7\text{H}_2\text{O}$, which is used in solution for medicinal purposes. A mixed carbonate containing calcium and magnesium is *dolomite*, $\text{CaCO}_3 \cdot \text{MgCO}_3$, which is used in construction and in antacid tablets. Calcium is also found as $\text{CaSO}_4 \cdot 2\text{H}_2\text{O}$, *gypsum*. *Beryl*, which has the composition $\text{Be}_3\text{Al}_2(\text{SiO}_3)_6$, is one mineral that contains beryllium. If traces of chromium are present, the result is the green gemstone *emerald*. Among other sources, sodium and potassium are found as the nitrates, and a method for preparing nitric acid involves heating a nitrate with sulfuric acid.



The carbonates, sulfates, nitrates, and phosphates of the group IA and IIA metals are important materials in inorganic chemistry. Some of the most important compounds of the group IA and IIA elements are organometallic compounds, particularly for lithium, sodium, and magnesium, and Chapter 12 will be devoted to this area of chemistry.

11.4 ZINTL PHASES

Over a century ago, it was observed that dissolving lead in a liquid ammonia solution containing sodium gave a compound that contained the two metals. Extensive work on systems of this type was carried out in the 1930s by Eduard Zintl in Germany, whose work is considered to be the foundation of this type of chemistry. As is often the case when someone makes a significant discovery, compounds of this type are now referred to as *Zintl compounds* or *Zintl phases*. They are compounds that contain a group IA or IIA metal with heavier members of groups IIIA, IVA, VA, or VIA. Although the usual binary compounds such as Na_2S , K_3As , and Li_3P exist, many others have more complex formulas and

structures. They contain anions that consist of clusters of several or many atoms of the more electro-negative element. Some of them have formulas such as Sn_4^{4-} , P_7^- , Pb_9^{4-} , or Sb_7^{3-} . Because the cations are frequently metals from groups IA and IIA, Zintl phases will be described in this section following the discussion of those metals.

One of the most common techniques for preparing Zintl phases is by the reaction of a solution of the alkali metal in liquid ammonia with the other element. However, many of these materials are obtained by heating the elements. For example, heating barium with arsenic leads to the reaction



As a general definition, a Zintl phase is one that contains a group IA or IIA metal with a metalloid from later groups in the periodic table, but some of these materials have variable composition. Therefore, many Zintl phases contain Bi, Sn, In, Pb, As, Se, or Te as the metalloid. It has been found that several compounds of this type contain 14 atoms of the metalloid in a cluster, with some examples being $\text{Ba}_3\text{As}_{14}$, Sr_3P_{14} , and $\text{Ba}_3\text{As}_{14}$, all of which contain the metalloid anion in M_7^{3-} clusters. The structure of these ions is an end-capped irregular trigonal prism:

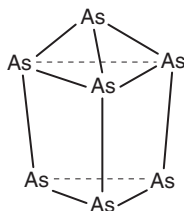

As will be seen in Chapter 14, except for dimensions and bond angles, it is the same general structure as that for P_4S_3 . Because a sulfur atom has one more electron than an atom of phosphorus, a structure that contains four phosphorus atoms and three sulfur atoms is isoelectronic with the P_7^{3-} ion. This suggests, as is in fact the case, that it should be possible to prepare Zintl phases containing two different metalloids. Some examples are $\text{Pb}_2\text{Sb}_2^{2-}$, TlSn_8^{3-} , and $\text{Hg}_4\text{Te}_{12}^{4-}$, although many others are known.

Numerous Zintl anions are formed by selenium and tellurium, with some of the more prominent species being Se_n^{2-} (where $n = 2, 4, 5, 6, 7, 9$, or 11). The species with $n = 11$ contains two rings that have five and six members that are joined by a selenium atom. Those with smaller numbers of selenium atoms generally consist of zigzag chains. Tellurium forms an extensive series of polyanions that are present in such species as NaTe_n ($n = 1$ to 4). One tellurium anion contains the $\text{Hg}_4\text{Te}_{12}^{4-}$ ion, but other species such as $[(\text{Hg}_2\text{Te}_5)_n]^{2-}$ are also known, such as the Te_{12}^{2-} anion that is present in some cases where the cation is a +1 metal.

Polyatomic species containing atoms from group IVA are produced by reducing the elements in liquid ammonia that contains some dissolved sodium. In accord with the hard-soft interaction principle (see Chapter 9), isolation of species containing large anions is best accomplished when a large cation of

similar magnitude in charge is used. When ethylenediamine is introduced in the solution, the Na^+ cation is solvated to give larger cations such as $\text{Na}_4(\text{en})_5^+$ and $\text{Na}_4(\text{en})_7^+$. With these large cations of +1 charge, it is possible to isolate the Ge_9^- and Sn_9^- ions in solids. One very effective binding agent for Na^+ is a polyether known as 18-crown-6 that has the structure

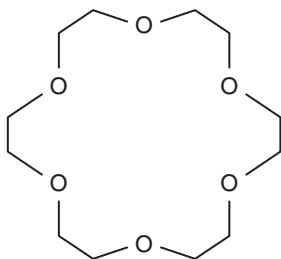

This ligand forms stable complexes known as *cryptands* (and it is often abbreviated as *crypt* in writing formulas) with cations of the group IA metals. More recently, the ligand known as *cryptand* has been used instead of ethylenediamine. This ligand has the molecular structure

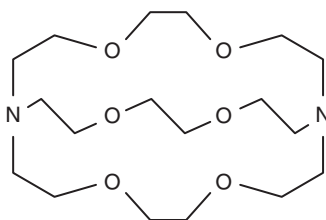

As a result of having several potential donor sites, this molecule attaches strongly to cations of group IA metals. Using the sequestered sodium ion, numerous Zintl phases have been isolated including $[\text{Na}(\text{crypt})]_2^+[\text{Sn}_5]^{2-}$, $[\text{Na}(\text{crypt})]_4^+[\text{Sn}_9]^{4-}$, and $[\text{Na}(\text{crypt})]_2^+[\text{Pb}_5]^{2-}$. The 5-atom anions have a trigonal bipyramid structure, but the Sn_9^{4-} ion has a capped square antiprism structure:

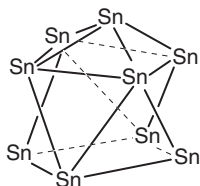

The ions having five tin or lead atoms are prepared by the reaction of a solution containing sodium and the cryptand reacting with alloys of sodium and tin or lead, respectively. It should also be mentioned that numerous derivatives of these materials have been prepared that contain alkyl and other groups.

Although numerous Zintl phases have been studied as solids and their structures determined, differences between packing in crystals and solvation in solution frequently cause the clusters to be different in the

two media. One purpose for discussing Zintl phases here is to show the relationship of the alkali and alkaline earth metals to this interesting area of cluster compounds. Although these clusters also deal with atoms in other groups of the periodic table, the group IA metals figure prominently in this chemistry because of the nature of solutions of the metals in liquid ammonia and their strength as reducing agents.

11.5 ALUMINUM AND BERYLLIUM

Because of numerous similarities in their properties and reactions, aluminum and beryllium will be described together even though they are in different groups of the periodic table. Although it is not completely understood, there is some indication that the accumulation of aluminum in the brain may have some relationship to Alzheimer's disease, and beryllium compounds are extremely toxic.

The principal ore of aluminum is *bauxite*, one of the major constituents of which is $\text{AlO}(\text{OH})$. The production of aluminum is accomplished by electrolysis of Al_2O_3 dissolved in *cryolite*, Na_3AlF_6 , but the molten solution containing Al_2O_3 contains some Na_2O , and its reaction with AlF_3 generates the Na_3AlF_6 .

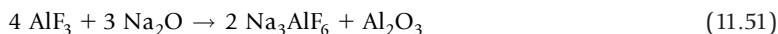

Naturally occurring Na_3AlF_6 is not readily available in sufficient quantity for the production of aluminum, but it can be produced by the reaction

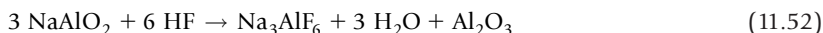

There is a complex relationship among the oxide, hydroxide, and hydrous oxide of aluminum. Conversion between several phases is possible as a result of the reactions

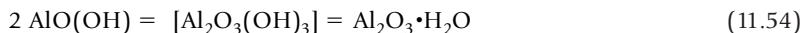
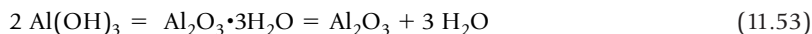

The chemistry of aluminum and beryllium is strongly influenced by the high charge-to-size ratio of their usual ions. The +2 beryllium ion has a radius of 31 pm and that of Al^{3+} is 50 pm. Therefore, the charge-to-size ratios for the two ions are 0.065 and 0.060, respectively. Because of their relative positions along a diagonal in the periodic table, the resemblance between Be^{2+} and Al^{3+} is known as a *diagonal relationship*. One way in which the solution chemistry of beryllium and aluminum are similar can be illustrated by considering what happens when the chlorides are dissolved in water and the water is then evaporated. As water is evaporated, the loss of HCl occurs and the final products are not the chlorides, but rather the oxides. This can be illustrated for aluminum as follows:

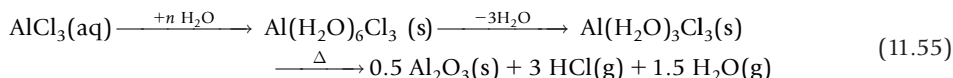

Beryllium shows similar behavior as a result of forming bonds to oxygen:

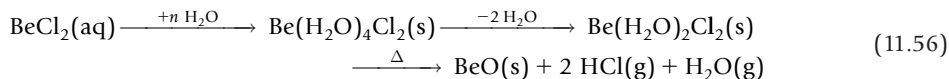

Compounds of beryllium and aluminum are substantially covalent as a result of the high charge-to-size ratio, which causes polarization of anions and very high heats of hydration of the ions ($-2487 \text{ kJ mol}^{-1}$ for Be^{2+} and $-4690 \text{ kJ mol}^{-1}$ for Al^{3+}).

Aluminum is amphoteric, and this has been illustrated in Chapter 10 both for water as the solvent and for some nonaqueous solvents. Because of the high charge density of Al^{3+} , solutions of aluminum salts are acidic as a result of hydrolysis.

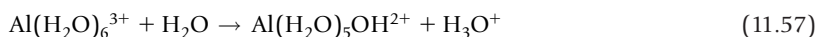

There is apparently some aggregation of ions as a result of the formation of OH bridges to give species such as $[(\text{H}_2\text{O})_4\text{Al}(\text{OH})_2\text{Al}(\text{H}_2\text{O})_4]^{4+}$. In the vast majority of complexes, aluminum has a coordination number of 6, but the number can also be 4 as in LiAlH_4 .

Another similarity between the behavior of aluminum and beryllium is seen in the fact that both form polymeric hydrides as a result of bridging hydrogen atoms. The structures of aluminum chloride (a dimer) and beryllium chloride (a polymer chain) shown in Figure 11.3 illustrate the types of bridged structures exhibited by these compounds. Although the bond angles do not equal those expected for tetrahedral coordination, the beryllium is considered to make use of sp^3 hybrid orbitals as it does in simple complexes such as $[\text{BeF}_4]^{2-}$ and $[\text{Be}(\text{OH})_4]^{2-}$. Aluminum chloride is soluble in a wide range of solvents, but the dimeric structure is retained in nonpolar solvents that do not form complexes.

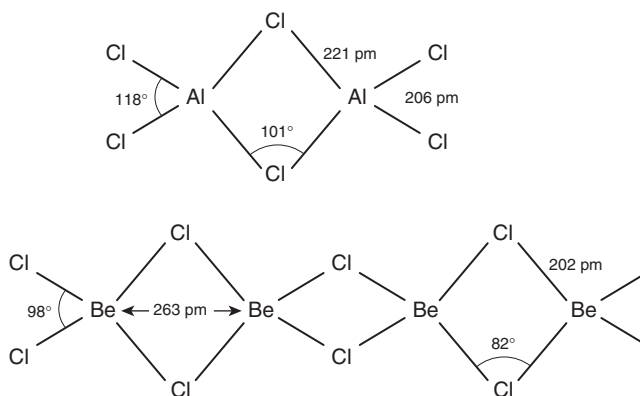

■ FIGURE 11.3 The structures of $[\text{AlCl}_3]_2$ and $[\text{BeCl}_2]_n$.

In solvents that have donor properties, solubility leads to complex formation to give species such as $S:AlCl_3$ (where S is a solvent molecule). Beryllium chloride is soluble in solvents such as alcohols, ether, and pyridine, but slightly soluble in benzene.

The fact that Be^{2+} and Al^{3+} have charge-to-size ratios that are so high causes them to exert a great polarizing effect on the molecules and ions to which they are bound. As a result, their compounds are substantially covalent. Unlike the situation when NaCl is dissolved in water and the ions become hydrated, dissolving $BeCl_2$ or $AlCl_3$ in water results in the formation of essentially covalent complexes such as $Be(H_2O)_4^{2+}$ and $Al(H_2O)_6^{3+}$ from which the water cannot easily be removed. With strong heating, the loss of HCl becomes the energetically favorable process rather than loss of water from compounds such as $Be(H_2O)_4Cl_2$ and $Al(H_2O)_6Cl_3$ because of the strong bonds to oxygen formed by Be^{2+} and Al^{3+} .

The system involving Al_2O_3 , $AlO(OH)$, and $Al(OH)_3$ is very complex. However, some the derivatives of these formulas are widely used compounds. For example, a compound having the formula $Al_2(OH)_5Cl$ is used in personal care products such as deodorants. Alumina, Al_2O_3 , exists in two forms that are known as α - Al_2O_3 and γ - Al_2O_3 , and they differ in structure. *Corundum* is the mineral form of α - Al_2O_3 . In addition to the oxides, $AlO(OH)$ is an important material that exists in two forms, α - $AlO(OH)$ or *diaspore* and γ - $AlO(OH)$ or *boehmite*. Finally, the hydroxide also exists in two forms, α - $Al(OH)_3$ (*bayerite*) and γ - $Al(OH)_3$ (*gibbsite*). Alumina is an important material because it is used as a packing medium in chromatography columns, and it is a very important catalyst for numerous reactions. The most common carbide of aluminum, Al_4C_3 , is considered to be a methanide because it reacts with water to produce methane:



11.6 THE FIRST-ROW TRANSITION METALS

The transition metals include the three series of elements that are positioned between the first two groups and the last six groups in the periodic table. These series have as their general characteristic that a set of d orbitals is being filled in progressing from one element to the next. Although some aspects of the chemistry of transition metals will be discussed in this chapter, the elements have many other interesting and important aspects dealing with coordination chemistry that will be discussed in Chapters 16 through 22. The first series, usually referred to as the first-row transition metals, involves filling the $3d$ orbitals. The second- and third-row transition metals correspond to those in which the $4d$ and $5d$ orbitals are being filled. Because a set of d orbitals can hold a maximum of 10 electrons, there are 10 elements in each series. The groups containing the transition metals are sometimes designated as the "B" groups or as groups 3 through 10. In the latter case, the groups are usually denoted as 1 through 18 in going across the periodic table.

Most of the first-row transition metals and several in the second and third groups have important uses. For example, iron is the basis of the enormous range of ferrous alloys in which other first-row metals are often combined. The metallurgy of iron-based alloys is a vast and complex field. Among the many

forms of iron are *cast iron*, *wrought iron*, and the myriad special steels that contain other metals as well as carbon and other main group elements. Iron and its alloys account for over 90% of all of the metals used. Nickel, manganese, and cobalt are also metals that are essential to the production of numerous types of alloys. These special alloys are used in many ways including making of tools and engine parts, and in catalysis. One form of nickel is an important catalyst known as *Raney nickel*, which is prepared by the reduction of NiO with hydrogen. Nickel also is used in several alloys that have many applications. For example, *Monel* is a type of alloy that contains nickel and copper in a ratio of about 2:1. Copper is used not only as a coinage metal, but in numerous types of electrical devices and conductors. Zinc is used as a constituent in brass, in some types of batteries, and as a protective coating on sheet metal (*galvanizing*). Because of its low density, titanium is used in alloys that are important in the production of aircraft and aerospace components. Vanadium and aluminum are alloyed with titanium to produce alloys that are stronger than titanium alone, and one of the common alloys contains 6% aluminum and 4% vanadium. Plating metals with chromium provides protection from rust. Chromium is also used in making various types of stainless steel. Scandium is becoming increasingly important in making tools and small devices where exceptional strength is combined with extremely light weight (the density of Sc is 2.99 g/cm³). It is impossible to imagine an industrialized society in which the transition metals would not be vital commodities. Table 11.2 contains useful data for the first-row transition metals.

Several aspects of the chemistry of the transition metals in all three series will be discussed in Chapters 19 through 22 in dealing with coordination compounds and organometallic chemistry. Section 11.9 will deal with several aspects of the chemistry of first-row transition metals. Numerous correlations can be attempted between properties of elements, and one of the interesting relationships is the variation in melting point with position in the transition series. In a general way, the melting point reflects the strength of the bonding between metal atoms because melting a solid requires that the forces between atoms be overcome. Figure 11.4 shows the variation in melting points of the elements, and although it is not shown, there is a reasonably good correlation between melting point and hardness for most of the first-row metals.

Table 11.2 Properties of the Transition Metals.

	Transition metals									
	Sc	Ti	V	Cr	Mn	Fe	Co	Ni	Cu	Zn
m.p., °C	1541	1660	1890	1900	1244	1535	1943	1453	1083	907
b.p., °C	2836	3287	3380	2672	1962	2750	2672	2732	2567	765
Crystal structure	<i>hcp</i>	<i>hcp</i>	<i>bcc</i>	<i>bcc</i>	<i>fcc</i>	<i>bcc</i>	<i>hcp</i>	<i>fcc</i>	<i>fcc</i>	<i>hcp</i>
Density, g/cm ³	2.99	4.5	6.11	7.19	7.44	7.87	8.90	8.91	8.94	7.14
Atomic radius, pm ^a	160	148	134	128	127	124	125	124	128	133
Electronegativity	1.3	1.5	1.6	1.6	1.5	1.8	1.9	1.9	1.9	1.6

^aFor coordination number = 12 because most structures are *hcp* or *fcc*.

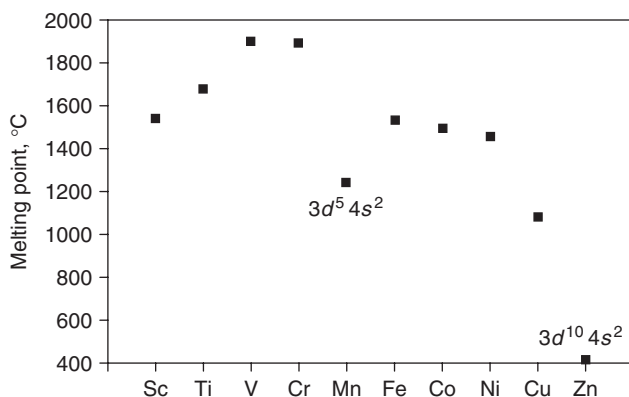

■ FIGURE 11.4 The melting points of the first transition series.

As was described earlier in this chapter, bonding in metals involves electrons in energy bands that encompass the structure. Therefore, the increase in melting point for the early elements in the transition series corresponds to the increase in the number of electrons involved in populating the energy bands that are responsible for metallic bonding. After about the middle of the series, additional electrons are forced to occupy higher energy states so the bonding between atoms becomes weaker. By the time the end of the series is reached, the filled d shell is no longer a major factor in the bonding and the atoms of zinc are held together by much weaker forces. Figure 11.4 also shows that there is a significant effect caused by the half-filled and filled shell configurations that occur at Mn and Zn.

11.7 SECOND- AND THIRD-RW TRANSITION METALS

Some second- and third-row transition metals are, for good reason, known as precious metals. These include silver, palladium, rhodium, iridium, osmium, gold, and platinum. As this is written, gold is over \$900 per ounce and silver is over \$15 per ounce. Some of the other metals such as rhodium, osmium, and rhenium are also extremely expensive. Most of the second- and third-row transition metals are found as minor constituents in ores of other metals. Consequently, we will not enumerate the sources, minerals, or the processes by which these metals are obtained. Some of their most important properties are shown in Table 11.3.

It is of some interest to note how the variation in melting points of the third-row transition metals vary with the number of valence electrons. The trend is shown graphically in Figure 11.5. There is an increase in the number of electrons occupying energy bands in progressing across the third row of the transition series. The effect of this can be seen by looking at the melting points of the metals, which show a general increase until tungsten is reached. After tungsten, the melting point decreases, and by the time mercury is reached the element is a liquid at room temperature! A simple explanation of these observations is based on the fact that within a solid metal the number of “bonds” to nearest neighbors requires that only about six electrons are used in bonding even though the number of nearest neighbors is 12. If the number of electrons available is greater than six, they will be forced

Table 11.3 Properties of Second- and Third-row Transition Metals.

	Transition metals of the second row									
	Y	Zr	Nb	Mo	Tc	Ru	Rh	Pd	Ag	Cd
m.p., °C	1522	1852	2468	2617	2172	2310	1966	1552	962	321
b.p., °C	3338	4377	4742	4612	4877	3900	3727	3140	2212	765
Crystal structure	<i>hcp</i>	<i>hcp</i>	<i>bcc</i>	<i>bcc</i>	<i>fcc</i>	<i>hcp</i>	<i>fcc</i>	<i>fcc</i>	<i>fcc</i>	<i>hcp</i>
Density, g/cm ³	4.47	6.51	8.57	10.2	11.5	12.4	12.4	12.0	10.5	8.69
Atomic radius, pm ^a	182	162	143	136	136	134	134	138	144	149
Electronegativity	1.2	1.4	1.6	1.8	1.9	2.2	2.2	2.2	1.9	1.7
	Transition metals of the third row									
	La	Hf	Ta	W	Re	Os	Ir	Pt	Au	Hg
m.p., °C	921	2230	2996	3407	3180	3054	2410	1772	1064	-39
b.p., °C	3430	5197	5425	5657	5627	5027	4130	3827	2807	357
Crystal structure	<i>hcp</i>	<i>hcp</i>	<i>bcc</i>	<i>bcc</i>	<i>hcp</i>	<i>hcp</i>	<i>fcc</i>	<i>fcc</i>	<i>fcc</i>	—
Density, g/cm ³	6.14	13.3	16.7	19.3	21.0	22.6	22.6	21.4	19.3	13.6
Atomic radius, pm	189	156	143	137	137	135	136	139	144	155
Electronegativity	1.0	1.3	1.5	1.7	1.9	2.2	2.2	2.2	2.4	1.9

^aFor coordination number 12.

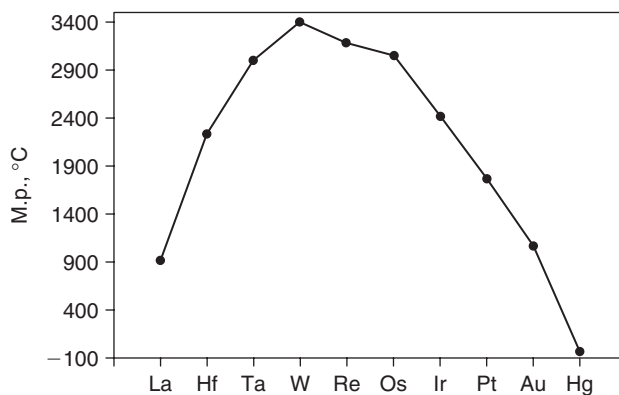
**FIGURE 11.5** Melting points of third-row transition metals.

to occupy some of the antibonding states, which decreases the net bonding effect. Consequently, the melting point will be lower than when only approximately six valence electrons are present. As shown in Figure 11.5, that is precisely the trend shown by the melting points of the third-row transition metals. Note that the effect of the half-filled shell that was so prominent in the first-row metals at manganese is essentially absent in the third-row metals.

Although much of the chemistry of the second- and third-row transition metals is similar to that of metals in the first row, there are several interesting differences. One involves a series of molybdenum compounds that are ternary sulfides. A general formula can be written as $M\text{Mo}_6\text{S}_8$ where M is a +2 metal or as $M_2\text{Mo}_6\text{S}_8$ when M is a +1 metal. Known as *Chevrel phases*, the first compound of this type was the lead compound PbMo_6S_8 . More recently, other metals have been incorporated, and others contain selenium or tellurium instead of sulfur. The $\text{Mo}_6\text{S}_8^{2-}$ ion has a structure in which the molybdenum atoms reside at the corners of an octahedron with a sulfur atom placed above each of the triangular faces. A major point of interest in Chevrel phases is that they behave as superconductors.

11.8 ALLOYS

The physical characteristics of metals that permit them to function as versatile materials for fabricating many items are their ductility, malleability, and strength. Although strength probably needs no explanation, the first two of these characteristics are related to the ability of the metal to be fabricated into a desired shape. Metals vary widely in these characteristics, and a metal or alloy that is well suited to one use may be entirely unsatisfactory for another. Addressing this branch of applied science is beyond the scope of this book, but a book on materials science provides a great deal of information that is relevant for students in inorganic chemistry.

As important as the transition metals are, the fact that they form many important alloys greatly extends the versatility of the metals. In this section, we will briefly describe some of the major factors that are relevant to the behavior of alloys. The study of alloys is a vast area of applied science, so in order to illustrate some of the principles in an efficient way, we will deal primarily with the behavior of alloys of copper and iron. Alloys of some of the nontransition metals (lead, antimony, tin, etc.) will be described in subsequent chapters. Many of the principles that apply in the behavior of a specific metal are involved in the behavior of others.

Alloys are classified broadly in two categories, *single-phase* alloys and *multiple-phase* alloys. A *phase* is characterized by having a homogeneous composition on a macroscopic scale, a uniform structure, and a distinct interface with any other phase present. The coexistence of ice, liquid water, and water vapor meets the criteria of composition and structure, but distinct boundaries exist between the states, so there are three phases present. When liquid metals are combined, there is usually some limit to the solubility of one metal in another. An exception to this is the liquid mixture of copper and nickel, which forms a solution of any composition between pure copper and pure nickel. The molten metals are completely miscible. When the mixture is cooled, a solid results that has a random distribution of both types of atoms in an *fcc* structure. This single solid phase thus constitutes a solid solution of the two metals, so it meets the criteria for a *single-phase alloy*.

Alloys of copper and zinc can be obtained by combining the molten metals. However, zinc is soluble in copper up to only about 40% (of the total). When the content of a copper/zinc alloy contains less than 40% zinc, cooling the liquid mixture results in the formation of a solid solution in which Zn and Cu atoms are uniformly distributed in an *fcc* lattice. When the mixture contains more than 40% zinc, cooling the liquid mixture results in the formation of a compound having the composition CuZn. The solid alloy consists of two phases, one of which is the compound CuZn and the other is a solid solution that contains Cu with approximately 40% Zn dissolved in it. This type of alloy is known as a *two-phase alloy*, but many alloys contain more than three phases (*multiple-phase alloys*).

The formation of solid solutions of metals is one way to change the properties (generally to increase strength) of the metals. Strengthening metals in this way is known as *solid solution strengthening*. The ability of two metals to form a solid solution can be predicted by a set of rules known as the *Hume-Rothery rules*, which can be stated as follows:

1. The atomic radii of the two kinds of atoms must be similar (within about 15%) so that lattice strain will not be excessive.
2. The crystal structures of the two metals must be identical.
3. In order to minimize the tendency for the metals to form compounds, identical valences and approximately equal electronegativities are required.

It must be mentioned that although these guidelines are useful, they are not always successful in predicting solubility.

When a second metal is dissolved in a host metal and the mass is cooled to produce a solid solution, the solution has increased strength compared to the host metal. This occurs because in a regular lattice consisting of identical atoms, it is relatively easy to move the atoms away from each other. There is less restriction on mobility of atoms, and the sharing of electrons between atoms is equal. However, when zinc or nickel is dissolved in copper, the alloy is strengthened, and the degree of strengthening is approximately a linear function of the fraction of the added metal. Adding the second metal distorts the lattice at the sites where the atoms of that metal reside, and this restricts atomic motions and strengthens the metal. However, the atomic radius of copper is 128 pm, whereas the radii of zinc and nickel are 133 and 124 pm, respectively. The atomic radius of tin is 151 pm, so if tin were dissolved in copper (assuming that its limited solubility is not exceeded), there would be a greater strengthening effect because there is a greater disparity between the sizes of the host and guest metal atoms. This is exactly the effect observed, and bronze (Cu/Sn) is stronger than brass (Cu/Zn) in which the atomic radii are very similar. The atomic radius of beryllium is 114 pm, so adding beryllium (within the solubility limit) causes a great strengthening of copper. In fact, the addition of atoms having a smaller atomic radius than copper causes a greater effect than adding those that are larger than copper even when the same absolute difference in size exists. In both cases, the degree of strengthening is approximately a linear function of the weight percent of the metal added to copper.

An interesting observation regarding the effect of having some dissimilar atoms in a lattice is illustrated by the alloy *Monel*. Nickel is harder than copper, but when the alloy containing the two metals is made, it is harder than nickel.

No single volume could contain the complete description of the composition, properties, and structures of ferrous alloys. Further, the effect of heat treatment and other methods of changing the properties of alloys constitutes an entire science unto itself. Accordingly, the description given of ferrous metallurgy will be only an overview of this enormously important area.

Steels constitute a wide range of iron-based alloys. General types include *carbon steels* (containing from 0.5 to 2.0% carbon) and only small amounts of other metals (generally less than 3% to 4%). Other metals in the alloys may include nickel, manganese, molybdenum, chromium, or vanadium in varying amounts. These ingredients are added to produce a steel having the desired characteristics. The properties of the steel are determined by the composition as well as the heat treatment methods employed.

If the total amount of metals added to iron exceeds about 5%, the alloy is sometimes called a *high-alloy* steel. Most stainless steels are in this category because the chromium content is between 10% and 25%, and some types also contain 4% to 20% nickel. Stainless steels, so called because of their resistance to corrosion, are of several types. The form of iron having the *fcc* structure is known as γ -Fe or *austenite*, and one type of stainless steel (which contains nickel) is known as *austenitic stainless steel* because it has the austenite (*bcc*) structure. *Martensitic* stainless steels have a structure that contains a body-centered tetragonal arrangement that results from rapidly quenching the austenite structure. In addition to these two types, *ferritic* stainless steel has a *bcc* structure and does not contain nickel. In addition to the stainless steels, a large number of alloys known as tool steels are important. As the name implies, these are special alloys that are used to make tools for cutting, drilling, and fabricating metal. These alloys commonly include some or all of the following in various amounts: Cr, Mn, Mo, Ni, W, V, Co, C, and Si. In many cases, the alloys are engineered to have the desired properties of resistance to impact, heat, abrasion, corrosion, or thermal stress. Heat treatment of a steel having the desired composition can alter the structure of the metal so that certain properties are optimized. Thus, there are a large number of variables in the manufacture of steel. The manufacture of special steels is an important area of metallurgy that we may fail to appreciate fully when driving an automobile that has dozens of different alloys used in its construction.

Alloys that retain high strength at high temperatures ($>1000^{\circ}\text{C}$ in some cases) are known as *superalloys*. Some of these materials are also highly resistant to corrosion (oxidation). These alloys are difficult to make, contain metals that are not readily available, and are expensive. They are used in situations where the conditions of service make them essential, such as in aircraft engines, where certain designs require as much as 50% by weight of some of these special alloys.

The designation of an alloy as a superalloy is based on its strength at high temperatures. In the application of these alloys in fabricating a gas turbine, this is important because the efficiency of a turbine is greater at high temperatures. However, it is possible to study an object for an extended period of time when it is subjected to a stress that is not sufficient to cause failure of the object. Even though the object may not break, it may elongate because of stretching of the metal. Movement of the metal under stress is called *creep*. Not only do the superalloys have high strength at elevated temperatures, they are resistant to creep, which makes them desirable for many uses.

Generally, superalloys are given special names, and a few of the more common ones and their compositions are described in Table 11.4.

Name	Composition, Percent by Weight
16–25–6	Fe 50.7; Ni 25; Cr 16; Mo 6; Mn 1.35; C 0.06
Haynes 25	Co 50; Cr 20; W 15; Ni 10; Fe 3; Mn 1.5; C 0.1
Hastelloy B	Ni 63; Mo 28; Fe 5; Co 2.5; Cr 1; C 0.05
Inconel 600	Ni 76; Cr 15.5; Fe 8.0; C 0.08
Astroloy	Ni 56.5; Cr 15; Co 15; Mo 5.5; Al 4.4; Ti 3.5; C 0.6; Fe <0.3
Udimet 500	Ni 48; Cr 19; Co 19; Mo 4; Fe 4; Ti 3; Al 3; C 0.08

Because several of the superalloys contain very little iron, they are closely related to some of the non-ferrous alloys. Some of the second- and third-row transition metals possess many of the desirable properties of superalloys. They maintain their strength at high temperatures, but they may be somewhat reactive with oxygen under these conditions. These metals are known as *refractory metals*, and they include niobium, molybdenum, tantalum, tungsten, and rhenium.

11.9 CHEMISTRY OF TRANSITION METALS

Although much of the chemistry of transition metals is associated with coordination compounds, there are some important aspects of their behavior that are related to other types of compounds. In this section, a brief overview of the chemistry of transition metals will be given with emphasis on the first-row metals.

11.9.1 Transition Metal Oxides and Related Compounds

The reaction between a transition metal and oxygen frequently yields a product that may not be strictly stoichiometric. Part of the reason for this was shown in Chapter 8 when the dynamic nature of the reaction of a metal with a gas was considered. Moreover, it is frequently found that transition metals can exist in more than one oxidation state, so mixed oxides are possible. The product that is in contact with oxygen is normally that in which the *higher* oxidation state is found.

Although scandium is becoming an increasingly important metal for fabricating objects combining light weight and strength, the oxide Sc_2O_3 is not particularly useful. In contrast, TiO_2 is an ingredient in many types of paint because it has a bright white color, is opaque, and has low toxicity. It is found as the mineral *rutile*, and of course it has that crystal structure. Titanium also forms complex anions in the form of ternary oxides. Most notable of this type of compound is CaTiO_3 , which is *perovskite*. This crystal structure was discussed in Chapter 7, and it is one of the most important structural types for ternary oxides. Another series of titanates has the formula M_2TiO_4 , in which M is a +2 metal.

There are several ways in which titanium can be produced. For example, reduction of TiO_2 gives the metal,



It can also be produced from *ilmenite*, FeTiO_3 , by the reaction

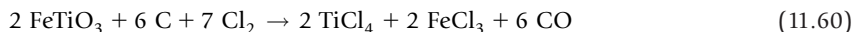

The metal is then obtained by means of the reaction



In accord with the +4 oxidation state of Ti and subsequent covalence, TiO_2 behaves as an acidic oxide, as illustrated by the following reaction:



Vanadium forms a series of oxides, some of which have the formulas VO , V_2O_3 , VO_2 , and V_2O_5 . The most important of the oxides is V_2O_5 , and its most important use is as a catalyst for the oxidation of SO_2 to SO_3 in the production of sulfuric acid. However, this is not the only process in which V_2O_5 is an effective catalyst, so it is used in this way in numerous other types of reactions. Although V_2O_3 reacts as a basic oxide, V_2O_5 is an acidic oxide that gives rise to numerous "vanadates" of different composition. Some of these can be shown by the simplified equations shown here:

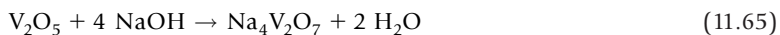
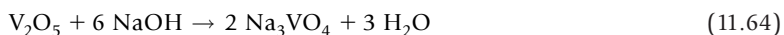
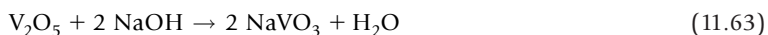

The phosphorus(V) oxide written in simplest form is P_2O_5 , so it should be expected that there would be considerable similarity between the various "phosphates" and the "vanadates." This is precisely the case, and the various forms of "vanadate" include VO_4^{3-} , $\text{V}_2\text{O}_7^{4-}$, $\text{V}_3\text{O}_9^{3-}$, HVO_4^{2-} , H_2VO_4^- , H_3VO_4 , $\text{V}_{10}\text{O}_{28}^{6-}$, and others. These species illustrate the fact that vanadium is similar in some ways to phosphorus, which is also a group V element. The numerous vanadate species can be seen to result from reactions such as the hydrolysis reaction



The equilibria among the species are dependent on the pH of the solution in much the same way as the equilibria among the various phosphate species (see Chapter 14). Not only is the formation of polyvanadates reminiscent of phosphorus chemistry, so is the fact that vanadium forms oxyhalides such as OVX_3 and VO_2X .

Chromite, $\text{Fe}(\text{CrO}_2)_2$ (which can also be written as $\text{FeO}\cdot\text{Cr}_2\text{O}_3$), is the principal ore containing chromium. After obtaining the oxide, chromium is prepared by the reduction of Cr_2O_3 with aluminum or silicon.



Sodium chromate is produced as part of the process for obtaining Cr_2O_3 , and it is probably the most important chromium compound. Although there are other oxides of chromium, Cr_2O_3 is very important because of its catalytic properties. One way to obtain this oxide is by the decomposition of ammonium dichromate,

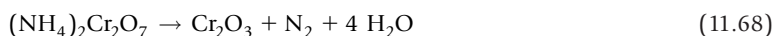

or by heating a mixture of NH_4Cl and $\text{K}_2\text{Cr}_2\text{O}_7$,

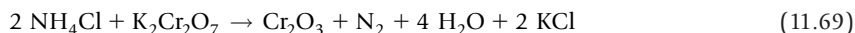

Because of its green color, Cr_2O_3 has been used as a pigment, and it is an amphoteric oxide, as illustrated by the following equations:

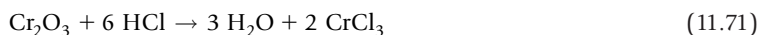
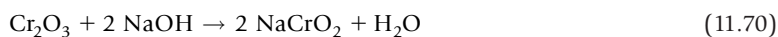

Another oxide of chromium is CrO_2 , which owing to the similar size of Ti^{4+} and Cr^{4+} , has the rutile structure. CrO_2 is a magnetic oxide that is utilized in magnetic tapes. Because it contains chromium in the +6 oxidation state, CrO_3 is a strong oxidizing agent that causes the ignition of some organic materials. It is produced by the reaction of $\text{K}_2\text{Cr}_2\text{O}_7$ and sulfuric acid,

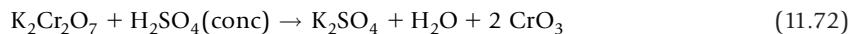

and, as would be expected given the +6 oxidation state, it is an acidic oxide,



Chromium(VI) compounds include those that contain the yellow chromate (CrO_4^{2-}) and the orange dichromate ($\text{Cr}_2\text{O}_7^{2-}$) that are versatile oxidizing agents in many types of syntheses. Potassium dichromate is a primary standard in analytical chemistry, and it is a frequently employed oxidizing agent in redox titrations in which Cr^{3+} is the reduction product. In aqueous solutions, there is an equilibrium between CrO_4^{2-} and $\text{Cr}_2\text{O}_7^{2-}$ that depends on the pH of the solution. As a result of the reaction

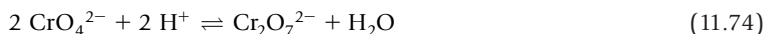

basic solutions are yellow but acidic solutions are orange. In addition to being widely used oxidizing agents, chromates and dichromates are used as pigments and dyes and in a process for tanning leather known as the chrome process.

When Cr^{3+} is reduced in aqueous solutions, the product is the aqua complex $[\text{Cr}(\text{H}_2\text{O})_6]^{2+}$ which has an intense blue color. The reduction of Cr^{3+} is easily carried out by zinc and hydrochloric acid. When the solution containing Cr^{2+} is added to one containing sodium acetate, a brick-red precipitate of $\text{Cr}(\text{C}_2\text{H}_3\text{O}_2)_2$ forms. This is unusual in the fact that there are few insoluble acetates. Because Al^{3+} and Cr^{3+} have similar size-to-charge ratios, there are some similarities between the chemical behavior of the ions.

There are three common oxides of manganese, MnO , Mn_2O_3 (*hausmanite*), and MnO_2 , which occurs naturally as the mineral *pyrolucite*. Reducing MnO_2 with hydrogen leads to the formation of MnO .



Decomposition of many hydroxides leads to the formation of oxides, and such is the case with $\text{Mn}(\text{OH})_2$.



Although Mn_2O_3 can be prepared by the oxidation of the metal, the most important oxide of manganese is MnO_2 . A common preparation of chlorine in laboratory experiments involves MnO_2 as the oxidizing agent.

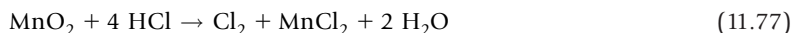

The oxide Mn_2O_7 is a dangerous compound that detonates and reacts explosively with reducing agents such as many organic compounds. Manganese also forms oxyanions, the most common of which is the permanganate ion, MnO_4^- . Permanganates are commonly used as oxidizing agents in many types of reactions. The manganese oxides show a transition from basic character for MnO to acidic character for oxides that contain the metal in higher oxidation states. Because of its deep purple color and the fact that the reduction product in acidic solutions, Mn^{2+} , is almost colorless, it serves as its own indicator in titrations. When MnO_4^- reacts as an oxidizing agent in acidic solutions, Mn^{2+} is the reduction product, but in basic solutions MnO_2 is the reduction product.

For many years, one use of MnO_2 has been in the construction of batteries. In the "dry cell" battery, the anode is made of zinc and the oxidizing agent is MnO_2 , with the electrolyte being a paste containing NH_4Cl and ZnCl_2 . In the "alkaline" battery, the electrolyte is a paste of KOH . The reactions that occur in an alkaline battery are as follows:

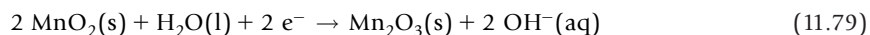
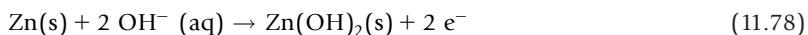

In the older dry cell, the acidic ammonium ion slowly attacks the metal container, which can lead to leakage.

For centuries, iron oxides have been utilized in diverse ways. First, it is the oxide that is reduced to obtain the metal itself. Second, iron oxides in several forms have been used as pigments for many centuries. The three most common iron oxides are FeO, Fe₂O₃, and Fe₃O₄ (which can be described as FeO·Fe₂O₃). Although the formula for iron(II) oxide is written as FeO, there is usually a deficiency in iron, which is not surprising because this is the oxide in the lowest oxidation state. It is the oxide residing farthest from the oxygen in terms of the phases present in corrosion (see Chapter 8). In Chapter 8, it was pointed out that many metal carbonates and oxalates decompose when heated to give the oxides. Such reactions provide a way to obtain FeO:



The mineral *magnetite* is a naturally occurring form of Fe₃O₄ that has an inverse spinel structure as a result of both Fe²⁺ and Fe³⁺ being present.

Although the oxide containing Fe(III) is Fe₂O₃, it also occurs as Fe₂O₃·H₂O, which has the same composition as FeO(OH). This oxide reacts in an amphoteric manner with both acids and with basic oxides as illustrated by the following equations:

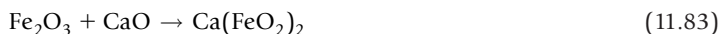

The ferric ion has a rather high charge density, which causes solutions of ferric salts to be acidic as a result of the reaction



Only two oxides of cobalt have been characterized, CoO and Co₃O₄ (which is actually Co^{II}Co^{III}O₄). The latter has a structure in which Co²⁺ ions are located in tetrahedral holes and Co³⁺ ions are located in octahedral holes of a spinel structure. Decomposition of either Co(OH)₂ or CoCO₃ produces CoO, and decomposition of Co(NO₃)₂ can be used to produce Co₃O₄.

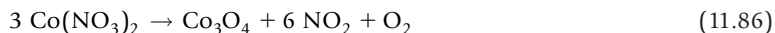

Decomposition of either nickel hydroxide or nickel carbonate yields NiO, the only oxide of nickel of any importance. However, two oxides of copper are known, Cu₂O and CuO. Of these, Cu₂O is the more stable, and it is the product when CuO is heated to very high temperature.



A well-known test for sugars is the *Fehling test*. When a basic solution containing Cu²⁺ reacts with a carbohydrate (a reducing agent), a red precipitate of Cu₂O is produced. This oxide has also been added to glass, to which it imparts a red color. Decomposition of cupric hydroxide or carbonate yields CuO. The mineral *malachite* has the composition CuCO₃·Cu(OH)₂, and it decomposes at moderate temperature according to the equation

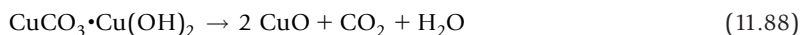

This oxide is used in making blue and green colored glass and in glazes for pottery, but in recent years the preparation of superconducting materials such as YBa₂Cu₃O₇ has become a serious interest. Other materials containing mixed oxides have also been produced.

The only oxide of Zn is the amphoteric ZnO, which can be obtained by the reaction of the elements. This oxide reacts as a base toward H⁺,



However, toward a basic oxide, ZnO reacts as an acidic oxide to produce an oxyanion known as a *zincate*. In molecular form, the equation can be written as



When the oxide reacts in basic aqueous solution, the reaction leads to a hydroxo complex and can be shown as follows:



Formally, a zincate is equivalent to a hydroxo complex that is dehydrated:

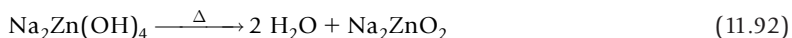

The reactions with acid and base that show amphoteric behavior can be summarized as follows:

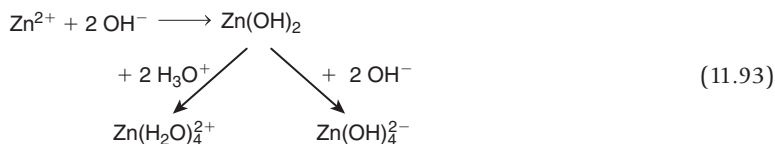

Metallic zinc dissolves readily in both acids and bases as illustrated in the equations

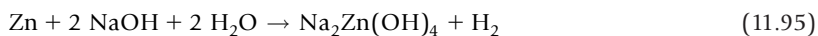

At room temperature, zinc oxide is white, but when heated it becomes yellow. A compound that changes color on heating is said to be *thermochromic*.

11.9.2 Halides and Oxyhalides

Titanium tetrachloride is an important compound, but neither the +2 or +3 chlorides of titanium are widely used. TiCl_4 can be obtained by the reactions

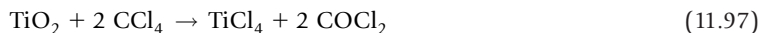

In many ways, TiCl_4 behaves as a covalent compound of a nonmetal. It is a strong Lewis acid that forms complexes with many types of Lewis bases, and it hydrolyzes in water. It also reacts with alcohols to yield compounds having the formula $\text{Ti}(\text{OR})_4$. However, it is the behavior of TiCl_4 (reacting with $[\text{Al}(\text{C}_2\text{H}_5)_3]_2$) as a catalyst in the Ziegler-Natta polymerization of ethylene that is the most important use of the compound (see Chapter 22).

Halides of vanadium are known with the metal in the +2, +3, +4, and +5 oxidation states. As might be expected, the fluoride is the only well-characterized vanadium(V) halide. It can be obtained by the reaction



The tetrahalides undergo disproportionation reactions to give the more stable +3 and +5 compounds.



As mentioned in the previous section, transition metals in high oxidation states exhibit behavior that is similar to that of some nonmetals. Vanadium(V) does this with the formation of oxyhalides having the formulas VOX_3 and VO_2X .

The two most common series of chromium halides have the formulas CrX_2 and CrX_3 (where $\text{X} = \text{F}, \text{Cl}, \text{Br}, \text{or I}$). However, CrF_6 is also known. Compounds having the formula CrX_3 are Lewis acids, and they also form many coordination compounds. For example, CrX_3 reacts with liquid ammonia to yield

$\text{CrX}_3 \cdot 6\text{NH}_3$ (which is written in standard notation as $[\text{Cr}(\text{NH}_3)_6\text{X}_3]$). The reactions illustrated by the following equations can be utilized to produce CrCl_3 :

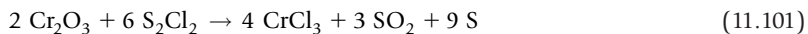
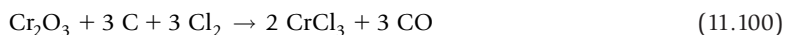

Because the highest oxidation state of Cr is +6, it forms oxyhalides that have the formula CrO_2X_2 and are known as *chromyl* halides. However, in the case of the fluorine compound, CrOF_4 is also known, as well as some oxyhalides having the formula CrOX_3 . Some reactions that yield chromyl halides are the following:

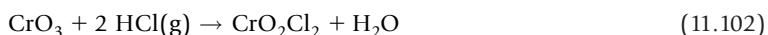

The latter equation can be modified to produce CrO_2Cl_2 by substituting KCl or NaCl for CaF_2 . As would be expected, compounds such as CrO_2F_2 and CrO_2Cl_2 react vigorously with water or alcohols.

Fluoride compounds are known that contain Re in the +7 oxidation state and Tc in the +6 oxidation state, but in the case of manganese the highest oxidation state is found in MnF_4 . It is found that higher oxidation states are more frequently encountered in the heavier members within a group in the transition series. Manganese(VII) oxyhalides have been obtained, and although MnO_3F and MnO_3Cl are known, they are not important compounds. MnF_4 can be prepared by the reaction of the elements.

In spite of its having an electron configuration that suggests a possible oxidation state of +6, iron forms no halogen compounds in which it has an oxidation state higher than +3. The halogen compounds of iron consist of the series FeX_2 and FeX_3 . However, Fe^{3+} is an oxidizing agent that reacts with I^- , so FeI_3 decomposes to FeI_2 and I_2 . The reaction



yields the dichloride, which is obtained upon evaporation as the tetrahydrate, $\text{FeCl}_2 \cdot 4\text{H}_2\text{O}$. Anhydrous FeCl_2 can be obtained by reaction of the metal with gaseous HCl .

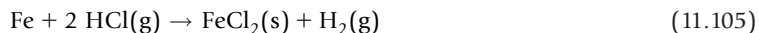

The trihalides of iron can be prepared by the general reaction



None of the oxyhalides of iron have major uses, but FeCl_3 is a Lewis acid that functions as a catalyst for many reactions.

Although CoF_3 is known, the other halides of $\text{Co}(\text{III})$ are not stable because it is a strong oxidizing agent that is capable of oxidizing halide ions. In fact, even the fluoride is so reactive that it is sometimes used

as a fluorinating agent. The Lewis acidity of Co^{3+} provides the basis for the enormous number of coordination compounds that exist containing cobalt.

Nickel halides are limited to the series NiX_2 with X being F, Cl, Br, or I. Although the heavier metals of the groups have been omitted from consideration when discussing other types of compounds, it should be mentioned that tetrafluorides are known for Pd and Pt. This shows the general tendency of the heavier metals in the group to form compounds in which the metal has a higher oxidation state than is exhibited by the first member of the group. It should be mentioned that PtF_6 is such a strong oxidizing agent that it reacts with O_2 to produce the O_2^+ ion, and it also was the reactant that gave the first xenon compound.

Halides of copper include the series containing Cu(I) and Cu(II), except for the absence of CuF and CuI_2 (which is unstable because of Cu^{2+} being an oxidizing agent and I^- being a reducing agent). As a result, the reaction between Cu^{2+} and I^- takes place as shown in the following equation:



As expected based on the $3d^{10} 4s^2$ configuration, zinc routinely forms +2 compounds, and all of the halides having the formula ZnX_2 are known. Anhydrous ZnCl_2 , which has applications in the textile industry, can be prepared as shown by the following equation:

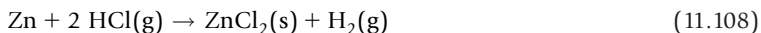

Evaporation of a solution produced by dissolving Zn in aqueous hydrochloric acid gives $\text{ZnCl}_2 \cdot 2\text{H}_2\text{O}$ as the solid product. Heating this compound does not result in the formation of anhydrous zinc chloride because of the reaction

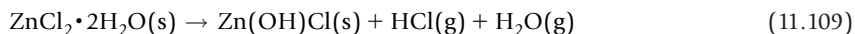

This is similar to the behavior of aluminum halides discussed earlier in this chapter, and it illustrates the fact that dehydration of a hydrated solid cannot be used as a way to prepare anhydrous halide compounds in some instances.

The brief discussion of the chemistry of the first-row transition metals presented here shows only a small portion of this vast subject. However, it illustrates some of the differences between the metals and how their chemistry varies throughout the series. For additional details, the reference text by Greenwood and Earnshaw or that by Cotton *et al.* should be consulted. In Chapters 16 through 22, many other aspects of the organometallic and coordination chemistry of these metals will be presented.

11.10 THE LANTHANIDES

Electrons generally fill orbitals in atoms as the sum $(n + l)$ increases. Therefore, after the $6s$ orbital (for which $n + l = 6$) is filled at Ba, it would be expected that the next orbitals populated would be those for which the sum $(n + l) = 7$ but having the lowest n giving that sum. The corresponding orbitals would be

Table 11.5 Properties of the Lanthanides.

Metal	Structure ^a	m.p., °C	Radius (+3) <i>r</i> , pm	−Δ <i>H</i> _{hyd}	First Three Ionization Potential Sum, kJ/mol
Ce ^a	<i>fcc</i>	799	102	3370	3528
Pr	<i>fcc</i>	931	99.0	3413	3630
Nd	<i>hcp</i>	1021	98.3	3442	3692
Pm	<i>hcp</i>	1168	97.0	3478	3728
Sm	<i>rhmb</i>	1077	95.8	3515	3895
Eu	<i>bcc</i>	822	94.7	3547	4057
Gd	<i>hcp</i>	1313	93.8	3571	3766
Tb	<i>hcp</i>	1356	92.3	3605	3803
Dy ^a	<i>hcp</i>	1412	91.2	3637	3923
Ho	<i>hcp</i>	1474	90.1	3667	3934
Er	<i>hcp</i>	1529	89.0	3691	3939
Tm	<i>hcp</i>	1545	88.0	3717	4057
Yb ^a	<i>fcc</i>	824	86.8	3739	4186
Lu	<i>hcp</i>	1663	86.1	3760	3908

^a Two or more forms are known.

the *4f* set. However, lanthanum ($Z = 57$) has the electron configuration (Xe) $5s^2 5p^6 5d^1 6s^2$, indicating the *5d* orbitals have started filling before the *4f*. To further complicate the situation, element 58, cerium, does not have the configuration $5s^2 5p^6 5d^2 6s^2$, but rather it is $5s^3 5p^6 4f^2 6s^2$. After that, the number of electrons in the *4f* level increases regularly until $Z = 63$, europium, which has the configuration $5s^3 5p^6 4f^7 6s^2$. Gadolinium ($Z = 64$) has the configuration $5s^3 5p^6 4f^7 6s^2 5d^1$ as a result of the stability of the half-filled *4f* shell, but at terbium, filling the *4f* level resumes with the *5d* shell being empty. Following terbium, the *4f* level has an increasing number of electrons until the shell is filled at ytterbium ($5s^3 5p^6 4f^{14} 6s^2$). Lutetium has the additional electron in the *5d* level to give the configuration $5s^3 5p^6 4f^{14} 6s^2 5d^1$. Except for minor irregularities, the *4f* level is filled with 14, the elements cerium through lutetium. In referring to a lanthanide without indicating a specific atom, the generic Ln is often used. Table 11.5 shows relevant data for the lanthanide elements.

An interesting effect of the half-filled and filled *4f* shell is shown when a graph is made of the melting point of the elements. Such a graph is shown in Figure 11.6. Although it is not shown, a plot of atomic radii for the metals shows a large increase in size for Eu and Yb. For example, the radii of Sm and Gd are approximately 180 pm, but Eu, situated between them, has a radius of 204 pm. The difference in size between Yb and the atoms before and after it also amounts to about 20 pm. Europium and ytterbium

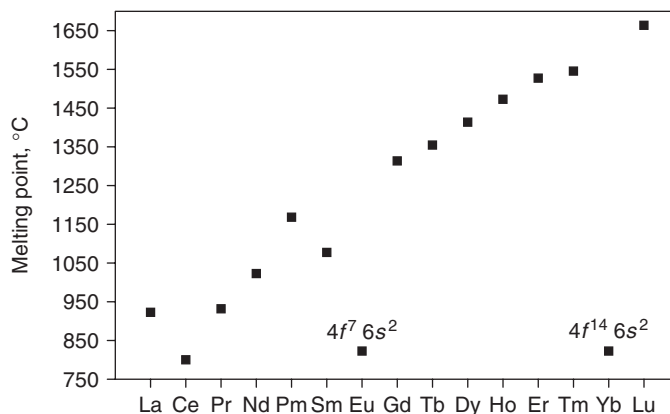

■ **FIGURE 11.6** The melting points of the lanthanides. Note the dramatic effect that occurs for the half-filled and filled $4f$ shell.

represent atoms having half-filled and filled $4f$ levels in addition to $6s^2$. One reason for the anomalous behavior of these metals is that other lanthanides behave as if they contribute three electrons to the conduction band and exist as $+3$ ions, but Eu and Yb behave as if they contribute only two electrons from the $6s$ level, leaving the half-filled and filled $4f$ level intact with the metals having $+2$ charges. The weaker bonding between the metals is reflected in their having lower melting points and larger sizes.

One of the major themes in the chemistry of the lanthanides is their having a well-defined $+3$ oxidation state. However, with cerium having the configuration $5s^3 5p^6 4f^2 6s^2$, it is not surprising that the $+2$ and $+4$ oxidation states are most common for the element. Other members of the lanthanides also exhibit $+2$ and $+4$ oxidation states, even though the $+3$ state is much more common. One of the interesting features of the lanthanide ions is the more or less regular decrease in the sizes of the $+3$ ions when progressing across the series, which gives rise to the term *lanthanide contraction*. This phenomenon, illustrated by the graph shown in Figure 11.7, is the result of the increasing nuclear charge coupled with ineffective screening of the $4f$ levels.

Metal ions that have a high charge-to-size ratio (charge density) undergo hydrolysis to produce acidic solutions. As a result of the decrease in size of the $+3$ ions across the lanthanide series, there is a general increase in acidity of the aquated ions as a result of the reaction



One of the consequences of the lanthanide contraction is that some of the $+3$ lanthanide ions are very similar in size to some of the similarly charged ions of the second-row transition metals. For example, the radius of Y^{3+} is about 88 pm, which is approximately the same as the radius of Ho^{3+} or Er^{3+} . As shown in Figure 11.8, the heats of hydration of the $+3$ ions show clear indication of the effect of the lanthanide contraction.

The decrease in size of the $+3$ ions of the lanthanides is also a factor in stability of complexes of these ions, and complexes with a given ligand usually show an increase in stability in progressing through

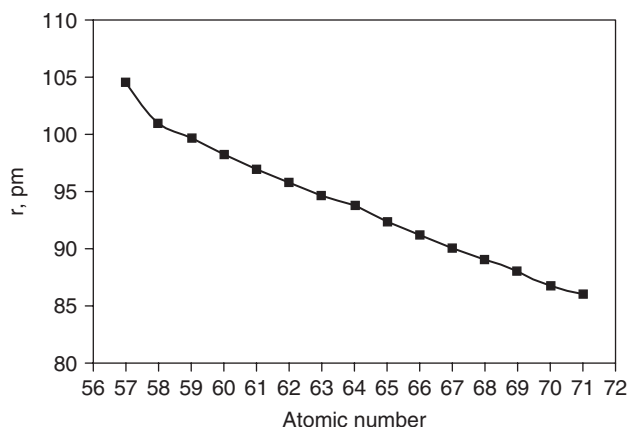

■ **FIGURE 11.7** Radii of the +3 ions of the lanthanides as a function of atomic number. The coordination number is assumed to be 6.

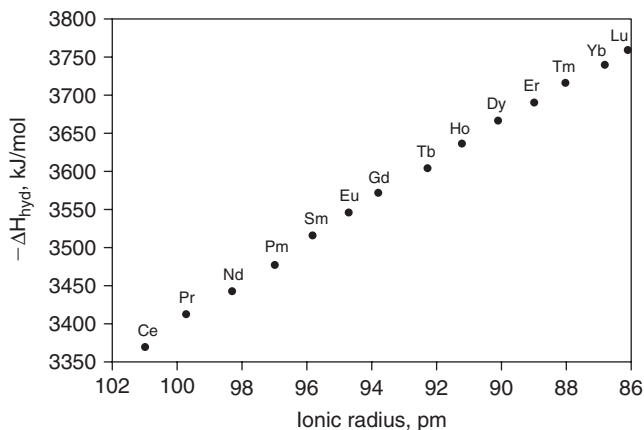

■ **FIGURE 11.8** Heat of hydration of +3 lanthanide ions as a function of ionic radius.

the series. However, with certain chelating agents, the stability increases up to a point and then levels off. Another facet of the coordination chemistry of the lanthanides is that coordination numbers greater than 6 are rather common. Because the +3 ions are rather large for ions having a positive charge that high (for comparison, Cr^{3+} has an ionic radius of about 64 pm and Fe^{3+} about 62 pm), the ligands frequently do not form a regular structure. However, the lanthanide ions are generally considered to be hard Lewis acids that interact preferentially with hard electron pair donors.

The lanthanides are rather reactive metals, and a good indication of their ease of oxidation and reduction can be seen by considering their reduction potentials. For comparison, the reduction potentials for magnesium and aluminum are as follows:



For lanthanum, the reduction potential is



and representative values for other lanthanides are Ce, -2.48 ; Sm, -2.40 ; Ho, -2.32 ; Er, -2.30 V. Therefore, the lanthanides are quite reactive, and many of the reactions are readily predictable. For example, with halogens the usual products are LnX_3 . Oxidation (sometimes very vigorous!) leads to oxides having the formula Ln_2O_3 , although some have complex structures. Some of the lanthanides are sufficiently reactive to replace hydrogen from water to produce the hydroxide, $\text{Ln}(\text{OH})_3$. The hydrides are particularly interesting in that even those having the formula LnH_2 are believed to contain Ln^{3+} , but with two H^{-} ions and a free electron that is located in a conduction band. When subjected to high pressure, additional hydrogen reacts to yield LnH_3 , in which a third H^{-} ion is present. Sulfides, nitrides, and borides are also known for most of the lanthanides. Although details cannot be presented here, there is an enormous amount of chemistry known for the lanthanides.

■ REFERENCES FOR FURTHER READING

- Bailar, J. C., Emeleus, H. J., Nyholm, R., and Trotman-Dickinson, A. F. (1973). *Comprehensive Inorganic Chemistry*, Vol. 1. Pergamon Press, Oxford. The chemistry of metals is extensively covered in this five-volume set.
- Burdett, J. K. (1995). *Chemical Bonding in Solids*. Oxford University Press, New York. An advanced book that treats many of the aspects of structure and bonding in solids.
- Cotton, F. A., Wilkinson, G., Murillo, C. A., and Bochmann, M. (1999). *Advanced Inorganic Chemistry*, 6th ed. This book is the yardstick by which other books that cover the chemistry of the elements are measured. Several chapters present detailed coverage of the chemistry of metals.
- Everest, D. A. (1964). *The Chemistry of Beryllium*. Elsevier, Amsterdam. A general survey of the chemistry, properties, and uses of beryllium.
- Flinn, R. A., and Trojan, P. K. (1981). *Engineering Materials and Their Applications*, 2nd ed. Houghton Mifflin, Boston. Chapters 2, 5, and 6. This book presents an excellent discussion of the structures of metals and the properties of alloys.
- Greenwood, N. N., and Earnshaw, A. (1997). *Chemistry of the Elements*. Butterworth-Heinemann, Oxford. Chapters 20–29. This book may well contain more descriptive chemistry than any other single volume, and it contains extensive coverage of transition metal chemistry.
- Jolly, W. L. (1972). *Metal-Ammonia Solutions*. Dowden, Hutchinson & Ross, Stroudsburg, PA. A collection of research papers that serves as a valuable resource on all phases of the physical and chemical characteristics of these systems that involve solutions of group IA and IIA metals.

- King, R. B. (1995). *Inorganic Chemistry of the Main Group Elements*. VCH Publishers, New York. An excellent introduction to the descriptive chemistry of many elements. Chapter 10 deals with the alkali and alkaline earth metals.
- Mingos, D. M. P. (1998). *Essential Trends in Inorganic Chemistry*. Oxford, New York. This book contains many correlations of data for metals.
- Mueller, W. M., Blackledge, J. P., and Libowitz, G. G. (1968). *Metal Hydrides*. Academic Press, New York. An advanced treatise on metal hydride chemistry and engineering.
- Pauling, L. (1960). *The Nature of the Chemical Bond*, 3rd ed. Cornell University Press, Ithaca, NY. Chapter 11. This classic book contains a wealth of information about metals. Highly recommended.
- Rappaport, Z., and Marck, I. (2006). *The Chemistry of Organolithium Compounds*. Wiley, New York.
- Wakefield, B. J. (1974). *The Chemistry of Organolithium Compounds*. Pergamon Press, Oxford. A book that provides a survey of the older literature and contains a wealth of information.
- West, A. R. (1988). *Basic Solid State Chemistry*. Wiley, New York. A very readable book that is an excellent place to start in a study of metals and other solids.

■ QUESTIONS AND PROBLEMS

- Predict which of the following pairs of metals would be completely miscible and explain your line of reasoning.
(a) Au/Ag, (b) Al/Ca, (c) Ni/Al, (d) Ti/Al, (e) Ni/Co, (f) Cu/Mg
- Cadmium and bismuth form a single liquid phase, but are almost completely insoluble as solids. Explain this phenomenon.
- Which would be more acidic, a 0.1 M solution of $\text{Mg}(\text{NO}_3)_2$ or a 0.1 M solution of $\text{Fe}(\text{NO}_3)_3$? Write equations to explain your answer.
- On the basis of their properties, explain why separation of the lanthanides is possible but difficult.
- On the basis of properties, explain why is yttrium frequently found with the lanthanide elements.
- Iron(III) chloride boils at 315°C. The density of the vapor decreases as temperature is increased above the boiling point. Explain this observation.
- When $\text{CoCl}_2 \cdot 6\text{H}_2\text{O}$ is heated, anhydrous CoCl_2 is formed. However, this is not the case when $\text{BeCl}_2 \cdot 4\text{H}_2\text{O}$ is heated. Explain the difference and write equations for the processes described.
- The formation of the ion pair Na^+ and Na^- was described in the text. Comment on the possibility of forming the Mg^{2+} and Mg^{2-} ion pair.
- Using the data given in Table 11.2, calculate the density of manganese.
- Complete and balance the following, assuming that heat is applied in reactions of solids.
(a) $\text{ZnCO}_3 \cdot \text{Zn}(\text{OH})_2(\text{s}) \rightarrow$
(b) $\text{Cr}_2\text{O}_7^{2-} + \text{Cl}^- + \text{H}^+ \rightarrow$
(c) $\text{CaSO}_3(\text{s}) \rightarrow$
(d) $\text{MnO}_4^- + \text{Fe}^{2+} + \text{H}^+ \rightarrow$
(e) $\text{ZnC}_2\text{O}_4(\text{s}) \rightarrow$
- Which would be more acidic, a 0.2 M solution of $\text{Ho}(\text{NO}_3)_3$ or one of $\text{Nd}(\text{NO}_3)_3$?
- Explain why the solubility of copper in aluminum is very low.

13. Complete and balance the following, assuming that heat is applied.
- $\text{MgO} + \text{TiO}_2 \rightarrow$
 - $\text{Ba} + \text{O}_2 \rightarrow$
 - $(\text{NH}_4)_2\text{Cr}_2\text{O}_7 \rightarrow$
 - $\text{Cd}(\text{OH})_3 \rightarrow$
 - $\text{NaHCO}_3 \rightarrow$
14. Complete and balance the following. Heat may be required in reactions that do not involve water or ammonia.
- $\text{CrOF}_4 + \text{H}_2\text{O} \rightarrow$
 - $\text{VOF}_3 + \text{H}_2\text{O} \rightarrow$
 - $\text{Ca}(\text{OH})_2 + \text{ZnO} \rightarrow$
 - $\text{CrCl}_3 + \text{NH}_3(\text{l}) \rightarrow$
 - $\text{V}_2\text{O}_5 + \text{H}_2 \rightarrow$
15. Determine the percent of free space in the *bcc* structure.
16. Draw the structures for the *ortho*, *pyro*, and *meta* vanadate ions and give equations showing how they can be interconverted.
17. Which of the lanthanides would likely be the most reactive? Explain the basis for your answer.
18. Would it require more energy to remove an electron from a *6s*, *5d*, or *4f* orbital from an atom of a lanthanide element? Explain your answer and describe any special cases that may be encountered.
19. When iron is heated, it undergoes a change from the *bcc* structure to *fcc* at 910°C. In these forms, the unit cell constants are 363 pm and 293 pm, respectively. By what percent does the volume change during the phase transition? What would be the change in density?
20. Although molten CaCl_2 is a good conductor of electricity, molten BeCl_2 is not. Explain this difference. Also explain why molten BeCl_2 becomes a much better conductor when NaCl is added to the liquid.
21. Write complete, balanced equations to show the reactions of the following with water.
- CaH_2 , (b) BaO_2 , (c) CaO , (d) Li_2S , (e) Mg_3P_2
22. Complete and balance the following, assuming that the reactants may be heated.
- $\text{SrO} + \text{CrO}_3 \rightarrow$
 - $\text{Ba} + \text{H}_2\text{O} \rightarrow$
 - $\text{Ba} + \text{C} \rightarrow$
 - $\text{CaF}_2 + \text{H}_3\text{PO}_4 \rightarrow$
 - $\text{CaCl}_2 + \text{Al} \rightarrow$
23. Explain why $\text{Cd}(\text{OH})_2$ is a stronger base than $\text{Zn}(\text{OH})_2$, which is amphoteric.
24. On the basis of atomic properties, explain why copper forms solid solutions that can have the following percent of lattice sites containing the following atoms: Ni 100%, Al 17%, and Cr <1%.
25. Explain why the LnF_3 compounds have higher melting points than the corresponding chlorides.
26. In the CrO_4^{2-} ion, the Cr–O bond length is 166 pm. In the $\text{Cr}_2\text{O}_7^{2-}$ ion, there are Cr–O bonds that are 163 pm in length and others that are 179 pm. Draw structures for the ions and explain these observations.
27. Write complete, balanced equations to show the reactions of the following with water.
- KNH_2 , (b) Al_4C_3 , (c) Mg_3N_2 , (d) Na_2O_2 , (e) RbO_2
28. How would the acidity vary for VO, V_2O_3 , and V_2O_5 ?
29. What is the electrostatic bond character of the Ca–O bonds in perovskite?
30. When beryllium chloride is heated with LiBH_4 in a sealed tube, BeB_2H_8 is produced. Draw a few possible structures for this compound and speculate on their stability.

This page intentionally left blank

Organometallic Compounds of the Main Group Elements

In the last half century, the increase in emphasis on the chemistry of organometallic compounds has been one of the dominant changes in chemistry. It is probably not appropriate to say in *inorganic* chemistry, because the effect on *organic* chemistry has also been great. Organometallic compounds had been known since the discovery of Zeise's salt, $\text{K}[\text{Pt}(\text{C}_2\text{H}_4)\text{Cl}_3]$, in 1827 and the preparation of metal alkyls by Sir Edward Frankland in 1849, but with the discovery of ferrocene and Ziegler-Natta polymerization in the early 1950s, organometallic chemistry took on a different level of importance. These discoveries were followed in 1955 by the preparation of dibenzenechromium. The level of importance to which organometallic chemistry has risen can be estimated by considering that the literature dealing with this type of chemistry has grown enormously. In addition to general reference works, numerous specialized monographs have been published, and there are journals devoted specifically to publishing articles on topics that deal with organometallic chemistry.

Organometallic chemistry cuts across discipline lines (if in fact there exist any discipline lines) and has a significant part in organic, inorganic, biochemistry, materials science, and chemical engineering. Because of the enormous scope of organometallic chemistry, this chapter is included to provide background in this area as it relates to main-group metals in the periodic table. Chapters 21 and 22 deal in part with organometallic chemistry of transition metals, but there is certainly some overlap of the areas. However, because of the heavy reliance of the organometallic chemistry of transition metals on coordination chemistry, that area of organometallic chemistry is discussed after coordination chemistry (Chapters 16–20). Chapters 14 and 15 deal with elements of groups IVA to VIIA, and some of the organometallic chemistry of the heavy elements in these groups are discussed in those chapters. However, zinc, cadmium, and mercury have electron configurations $n d^{10} (n + 1)s^2$ and in many cases lose the s electrons. In that way, they resemble the metals in group IIA, so the organometallic chemistry of these elements will also be described briefly.

Although there are numerous organometallic compounds of all of the elements in any specific group, those of one element in the group are generally more important. For example, in group IA, the organic compounds of lithium are more numerous than those of sodium or potassium. Accordingly, most of the discussion will focus on the one or two elements that have the most extensive organometallic chemistry.

Considering the breadth of the field and the voluminous literature that has developed, it is impossible to deal with details of organometallic chemistry in a single volume, much less a chapter or two in an inorganic chemistry book of a general nature. Rather, we will focus on some general aspects of the field and concentrate primarily on a relative few topics that still portray the nature of this type of chemistry. We will begin by considering ways in which organometallic compounds are produced and then describe some types of reactions before considering compounds of specific elements. There will be some repetition in progressing in this way because some preparations and reactions will involve specific elements that will be subsequently described. However, this reinforcement is not a disadvantage from a pedagogical point of view.

12.1 PREPARATION OF ORGANOMETALLIC COMPOUNDS

Organometallic compounds vary widely in their properties and reactivity, just as do the elements from which they are produced. These compounds may be lithium alkyls, Grignard reagents, or organotin compounds. Accordingly, there is no universal method for preparing the compounds, but we will present here some of the types of reactions that have been widely employed.

12.1.1 Reaction of Metals and Alkyl Halides

This technique is most appropriate when the metal is highly reactive. It should be kept in mind that even though a formula may be written as if the species is a monomer, several types of organometallic compounds are associated. Examples of this type of reaction are

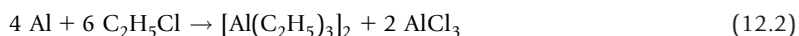

The most important reaction of this type is that in which Grignard reagents are produced:



Before its use as a fuel additive to reduce engine knock was banned in the United States, tetraethyllead was produced in enormous quantities. One method of producing the compound was the reaction between lead and ethyl chloride, in which the reactivity of lead was enhanced by its amalgamation with sodium.



Mercury alkyls can be prepared by an analogous reaction in which an amalgam of sodium and mercury is used.

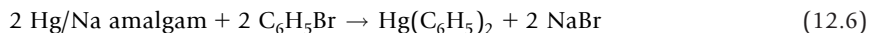

It is frequently found that the reactivity of a metal is higher when it is contact with a different metal. This principle can be applied in other preparations such as the following:



12.1.2 Alkyl Group Transfer Reactions

The reaction between a metal alkyl and a covalent halide of another element is sometimes made possible by the fact that transfer of the alkyl group leads to a crystalline product. An example of this type is the reaction between a sodium alkyl and a covalent halide such as SiCl_4 .

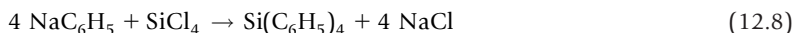

The formation of sodium chloride is a strong driving force in this reaction. The hard-soft interaction principle (see Chapter 9) is convenient in this case because of the favorable interaction of Na^+ with Cl^- . Other examples of this type of reaction are the following:

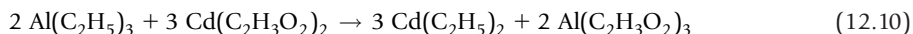
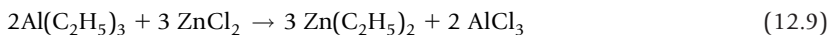

Because mercury is easily reduced, dialkylmercury compounds are useful reagents for preparing a large number of alkyls of other metals by group transfer reactions. This is illustrated by the following equations:

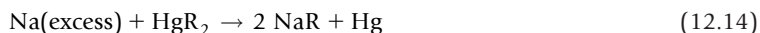
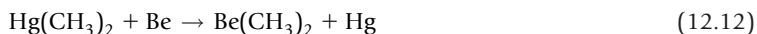
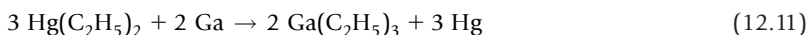

In the last reaction, low-boiling hydrocarbons are used as a solvent, and because the sodium alkyls are predominantly ionic, they are relatively insoluble. Alkyls of other group IA metals (shown as M in the equation) can also be produced by this type of reaction, in which benzene is a frequently used solvent.



In some cases, an organic group in one metal alkyl will undergo a substitution reaction to produce a different metal alkyl.

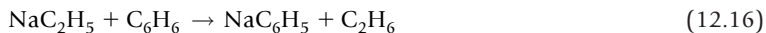

12.1.3 Reaction of a Grignard Reagent with a Metal Halide

Although Grignard reagents generally react by transferring alkyl groups and that was the general subject of the previous section, the reactions are so important that they will be described alone in this section. This is one of the most widely applicable ways in which metal alkyls are obtained. The following are typical reactions of this type:

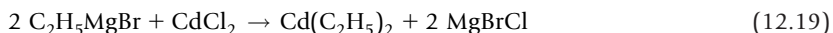
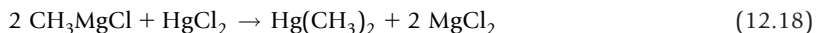
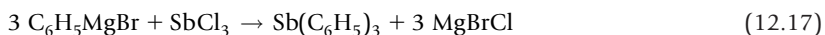

Note that 2 MgBrCl "units" are formally equivalent to MgBr₂ + MgCl₂. Thus, we will continue to write formulas like MgBrCl to simplify the equations, although the products may simply be mixtures of the two magnesium halides.

The reaction



gives a product that contains two different alkyl groups. It is generally found that over time compounds of this type undergo a reaction to yield two products containing the same alkyl groups, ZnR₂ and ZnR'₂:

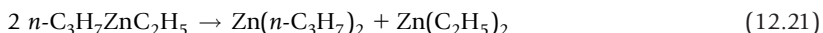

The reactions of Grignard reagents constitute an enormously important type of synthetic chemistry, and they can be used in a wide variety of cases.

12.1.4 Reaction of an Olefin with Hydrogen and a Metal

In some cases, it is possible to synthesize a metal alkyl directly from the metal. An important case of this type is

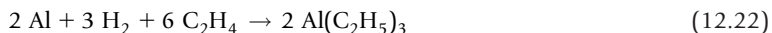

A different type of direct synthesis involves the reaction of the metal with an alkyl halide:



12.2 ORGANOMETALLIC COMPOUNDS OF GROUP IA METALS

There is an enormous organometallic chemistry associated with the group IA metals, particularly lithium and sodium. Lithium alkyls can be prepared by the reaction of the metal and an alkyl halide,



For this process, suitable solvents include hydrocarbons, benzene, and ether. Lithium alkyls can also be prepared by the reaction of the metal with a mercury alkyl,



Compounds of lithium with aryl groups can be prepared by the reaction of butyllithium with an aryl halide.



Lithium reacts with acetylene in liquid ammonia solution to give the mono and dilithium acetylides, $\text{LiC}\equiv\text{CH}$ and $\text{LiC}\equiv\text{CLi}$, with the evolution of hydrogen, which illustrates the slight acidity of acetylene. One commercial use of $\text{LiC}\equiv\text{CH}$ is in one step of the synthesis of vitamin A.

Lithium alkyls are used in processes such as polymerization and in transfer of alkyl groups in many types of reactions. Some examples are the following:

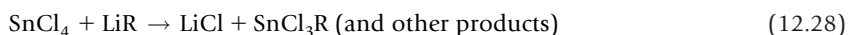
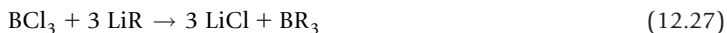

One of the most interesting organometallic compounds of a transition metal is ferrocene (see Chapter 21). Butyllithium reacts with ferrocene to produce the mono and dilithiated compounds that have the following structures:

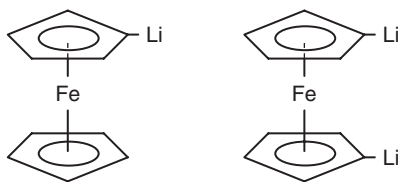

These reactive compounds are useful for preparing numerous other derivatives of ferrocene. As would be expected, lithium alkyls react with any trace of moisture.



These extremely reactive compounds are also spontaneously flammable in air.

A great deal of effort has been directed to determining the structures of lithium alkyls. It has been determined that in hydrocarbon solutions the dominant species is a hexamer when the alkyl groups are small. In the solid phase, the structure is body-centered cubic with the $(\text{LiCH}_3)_4$ units at each lattice site. Each unit is a tetramer in which the four lithium atoms reside at the corners of a tetrahedron and the methyl groups are located above the centers of the triangular faces. The carbon atoms of

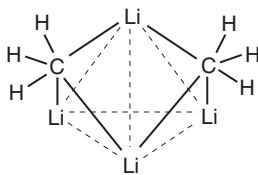

■ **FIGURE 12.1** The structure of the tetramer of methyl lithium. Only two of the four methyl groups are shown.

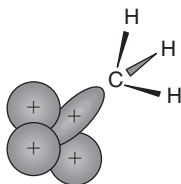

■ **FIGURE 12.2** Orbital overlap leading to the formation of a two electron three center bond in $[\text{Li}(\text{CH}_3)_4]$.

the alkyl groups are bound to the three lithium atoms at the corners of the triangle. This structure is shown in Figure 12.1.

Bonding of the methyl group to three lithium atoms involves an sp^3 orbital on the methyl group simultaneously overlapping three orbitals (they may be $2s$ or hybrids of $2s$ and $2p$ orbitals) on the Li atoms. This can be shown as illustrated in Figure 12.2. Although this picture of the bonding in methyl lithium is generally adequate, it is probably an oversimplification of the true situation. Three-center two-electron bonds exist in numerous types of compounds (such as diborane), but it may be in this case that there is also some weak interaction between the lithium atoms.

12.3 ORGANOMETALLIC COMPOUNDS OF GROUP IIA METALS

Although some organometallic compounds of calcium, barium, and strontium are known, they are far less numerous and important than those of beryllium and magnesium. One of the most important discoveries in organometallic chemistry is that made in 1900 by Victor Grignard. That work is of enormous importance because it led to the chemistry of a class of compounds that are now referred to as Grignard reagents, and they are prepared by the reaction of magnesium with an alkyl halide in a solution of dry ether. The process can be represented by the equation



Evaporation of the excess ether results in the formation of an "etherate" containing the solvent bonded to the magnesium. Generally, the formula for this product is represented as $\text{RMgX}_2 \cdot 2\text{R}_2\text{O}$, and the

structure is a distorted tetrahedron. However, even in solution "RMgX" exists as aggregates with the dimer being the dominant species. The equilibrium



can involve other species, and the composition depends on the nature of the alkyl group, which can function as an electron pair donor; the association is hindered by complex formation between the solvent and RMgX. Moreover, the situation is complicated by the equilibrium



which is known as the Schlenk equilibrium. The dimer, $(\text{RMgX})_2$, is believed to have a structure that can be shown as

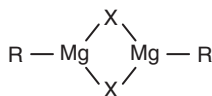

although the dimer can also be represented by the structure

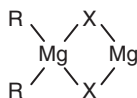

There may also be some ionization that can be represented as



The nature of the species present in a solution of a Grignard reagent is a complex issue with no single representation showing the true situation.

Because of the enormous importance of Grignard reagents in synthetic chemistry (organic, inorganic, and organometallic), an entire volume could be written on the subject. Shown here are only a very few of the myriad possibilities for reactions of these versatile compounds. Normally, the reactivity of Grignard reagents varies with the nature of the halogen as follows: $\text{I} > \text{Br} > \text{Cl}$. It is also found that the alkyl compounds are more reactive than the aryl compounds. One of the important types of reactions of Grignard reagents is that of lengthening a carbon chain in the reaction with a primary alcohol.



When a secondary alcohol is used, the reaction can be shown as

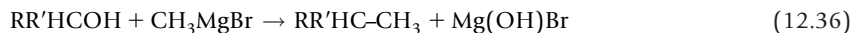

Grignard reagents react with formaldehyde to give (after adding HCl to the product) primary alcohols.



The reaction of a Grignard reagent with CO_2 can be used to prepare a carboxylic acid.

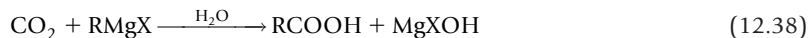

Reactions of RMgX with RCHO leads to a secondary alcohol while the reaction with an ester, RCOOR' , gives a tertiary alcohol after acidifying the products of the initial reactions. The reaction of a Grignard reagent with sulfur is complex, but it can be represented by the equation

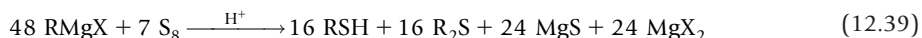

These are but a few of the ways in which Grignard reagents are used in synthesis.

In addition to magnesium, there is an extensive chemistry of organoberyllium compounds. The alkyl compounds are obtained most conveniently by the reaction of beryllium chloride with a Grignard reagent.

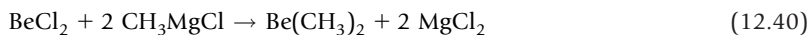

Because beryllium is a Lewis acid, it remains attached to ether that is the solvent in the reaction. Beryllium alkyls can also be produced by the reaction of the chloride with a lithium alkyl,



or by reaction with a dialkylmercury:

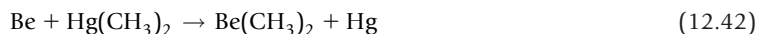

As is the case with numerous other metal alkyls, beryllium alkyls are spontaneously flammable in air. Beryllium oxide is produced, and it has a heat of formation of -611 kJ/mol . Dimethylberyllium also reacts explosively with water, and some of its other properties resemble those of trimethylaluminum. This should not be surprising because the metals have a strong diagonal relationship that relates to their similar charge-to-size ratios.

The structure of dimethylberyllium is similar to that of trimethylaluminum except for the fact that the beryllium compound forms chains, whereas the aluminum compound forms dimers. Dimethylberyllium has the structure shown in Figure 12.3. The bridges involve an orbital on the methyl groups overlapping an orbital (probably best regarded as sp^3) on the beryllium atoms to give two-electron three-center bonds. Note, however, that the bond angle Be-C-Be is unusually small. Because beryllium is a Lewis acid, the polymeric $[\text{Be}(\text{CH}_3)_2]_n$ is separated when a Lewis base is added and adducts form. For example, with phosphine the reaction is

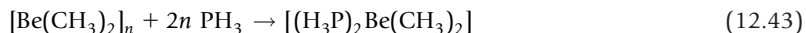

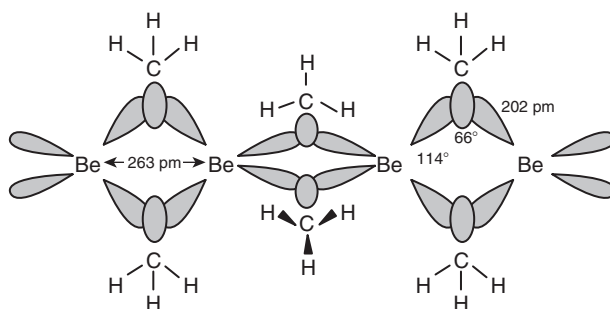

■ FIGURE 12.3 The structure of dimethylberyllium.

An unusual type of organometallic compound of beryllium is that in which it is coordinated to a cyclopentadienyl ring:

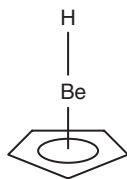

In addition to the hydrogen compound, others have been prepared that contain a halogen or a methyl group.

12.4 ORGANOMETALLIC COMPOUNDS OF GROUP IIIA METALS

The organometallic chemistry of other members of group IIIA is relatively much less important than that of aluminum. There is an extensive organic chemistry of aluminum, and some of the compounds are commercially important. For example, triethylaluminum is used in the Ziegler-Natta process for polymerization of alkenes (see Chapter 22).

As a result of extensive dimerization, aluminum alkyls have the general formula $[\text{AlR}_3]_2$. It is interesting that $\text{B}(\text{CH}_3)_3$ does not undergo molecular association and it has a boiling point of -26°C . Although it does not react with water, $\text{B}(\text{CH}_3)_3$ is spontaneously flammable in air. Trimethylgallium (b.p. 55.7°C) and triethylgallium (b.p. 143°C) show almost no tendency to form dimers under most conditions. In contrast to the behavior of trimethylboron and trimethylgallium, the boiling point of trimethylaluminum, which exists as $[\text{Al}(\text{CH}_3)_3]_2$, is 126°C and that of $[\text{Al}(\text{C}_2\text{H}_5)_3]$ is 186.6°C , even though the aluminum compounds have lower molecular weights.

Aluminum alkyls react with many substances and are spontaneously flammable in air,

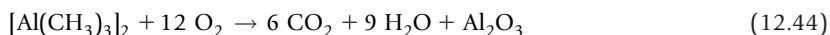

Aluminum alkyls can be prepared in several ways. In one process, aluminum reacts with alkyl halides to produce $R_3Al_2Cl_3$ (known as the sesquichloride),



The product undergoes a redistribution to produce R_4AlCl_2 and R_2AlCl_4 . The reaction of aluminum with HgR_2 results in transfer of alkyl groups,



Mixed alkyl hydrides can be prepared by the reaction



The Al–H bond is sufficiently reactive that alkenes give an insertion reaction,



As mentioned earlier, aluminum alkyls dimerize extensively. The structure of $[\text{Al}(\text{CH}_3)_3]_2$ is shown in Figure 12.4. In this case, an orbital on the methyl group overlaps with orbitals on two aluminum atoms to give three-center two-electron bonds. Although there are four bonds to each aluminum atom, the orientation of the bonds deviates considerably from typical tetrahedral cases. Because the distance between the aluminum atoms is relatively short, there may be some partial bonding between them. Note that the angle between the bonds to the two terminal CH_3 groups is quite close to that corresponding to sp^2 hybrid orbitals on the aluminum atoms. This would leave p orbitals available to form a σ bond between the aluminum atoms. It should also be noted that the Al– C_t bonds are considerably shorter than the Al– C_b bonds (b and t signify bridged and terminal, respectively).

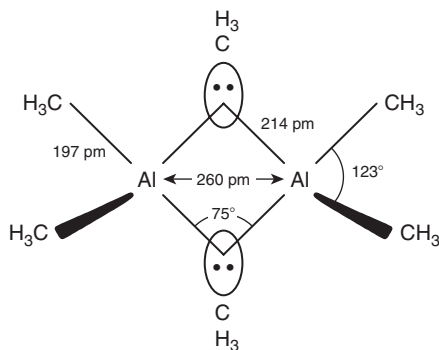

■ FIGURE 12.4 The structure of trimethylaluminum.

The structure of the trimethylaluminum dimer has been discussed as if it were static, but that is not the case even at room temperature. When a solution of the compound in toluene is cooled to -65°C , the proton nuclear magnetic resonance spectrum indicates that there are hydrogen atoms in two types of environments, bridging and terminal methyl groups. However, at room temperature there is only one signal in the NMR spectrum, indicating that the methyl groups exchange. It is believed that the rapid scrambling of methyl groups takes place by breaking one of the bridges followed by rotation of the $\text{Al}(\text{CH}_3)_3$ groups relative to each other with the bridge being reestablished to a different methyl group.

The association of aluminum alkyls provides a good opportunity to illustrate the principles discussed in Chapter 6 in regard to properties of liquids. Measurements of the molecular weights in benzene solutions indicate that the methyl, ethyl, and *n*-propyl compounds are completely dimerized. However, the heat of dissociation of $(\text{AlR}_3)_2$ dimers varies with nature of the alkyl group as shown by the following heats of dissociation:

<i>R</i> =	CH_3	C_2H_5	<i>n</i> - C_3H_7	<i>n</i> - C_4H_9	<i>i</i> - C_4H_9
ΔH_{diss} , kJ mol^{-1}	81.2	70.7	87.4	38	33

As was described in Chapter 6, the solubility parameter, δ , can be used as a diagnostic tool for studying molecular association. Table 12.1 shows some of the relevant data for several aluminum alkyls. The solubility parameters were calculated from vapor pressure data using the procedure described in Chapter 6.

As was described in Chapter 6, the entropy of vaporization is a worthwhile piece of evidence in studying the association that occurs in liquids and vapors. In the case of $[\text{Al}(\text{C}_2\text{H}_5)_3]_2$, the entropy of vaporization ($176.6 \text{ J mol}^{-1} \text{ K}^{-1}$) is almost exactly twice the value of $88 \text{ J mol}^{-1} \text{ K}^{-1}$ predicted by Trouton's rule,

$$\Delta S_{\text{vap}} = \frac{\Delta H_{\text{vap}}}{T} \approx 88 \text{ J mol}^{-1} \text{ K}^{-1} \quad (12.49)$$

Table 12.1 Physical Data for Some Aluminum Alkyls.

Compound ^a	b.p., $^{\circ}\text{C}$	ΔH_{vap} , kJ mol^{-1}	ΔS_{vap} , J mol^{-1}	δ , $\text{J}^{1/2} \text{ cm}^{-3/2}$
$\text{Al}(\text{CH}_3)_3$	126.0	44.92	112.6	20.82
$\text{Al}(\text{C}_2\text{H}_5)_3$	186.6	81.19	176.6	23.75
$\text{Al}(\textit{n}\text{-C}_3\text{H}_7)_3$	192.8	58.86	126.0	17.02
$\text{Al}(\textit{i}\text{-C}_4\text{H}_9)_3$	214.1	65.88	135.2	15.67
$\text{Al}(\text{C}_2\text{H}_5)_2\text{Cl}$	208.0	53.71	111.6	19.88
$\text{Al}(\text{C}_2\text{H}_5)\text{Cl}_2$	193.8	51.99	111.1	21.58

^aFormula given is for the monomer, but the compound normally exist as dimers.

This indicates that in the process of vaporization 1 mole of liquid is converted into 2 moles of vapor. Therefore, we conclude that $[\text{Al}(\text{C}_2\text{H}_5)_3]_2$ dimers are present in the liquid, but the vapor consists of monomeric $\text{Al}(\text{C}_2\text{H}_5)_3$ units. Examination of the data for $[\text{Al}(\text{CH}_3)_3]_2$ shows an entropy of vaporization of $112.6 \text{ J mol}^{-1} \text{ K}^{-1}$, which is greater than the value of $88 \text{ J mol}^{-1} \text{ K}^{-1}$ predicted by Trouton's rule, but it is lower than twice the value. This value could be interpreted as corresponding to a liquid that is only *partially* dimerized being converted *completely* into monomer during vaporization.

However, there is a different explanation of the value for the entropy of vaporization of trimethylaluminum. If the liquid exists completely as dimers, the entropy of vaporization for $[\text{Al}(\text{CH}_3)_3]_2$ could be interpreted as indicating a liquid that is completely dimerized but which becomes only *partially* dissociated during vaporization. Because triethylaluminum fits unambiguously the case of a *completely* dimerized liquid that *completely* dissociates in the vapor, we look for other factors to consider in the trimethylaluminum case. One such property that is useful is the solubility parameter.

The solubility parameters for trimethylaluminum and triethylaluminum are 20.8 and $23.7 \text{ J}^{1/2} \text{ cm}^{-3/2}$, respectively. These values are high enough to indicate association in the liquids, and they are quite comparable and in the expected order for compounds differing slightly only in molecular masses. From the entropy of vaporization, it is evident that triethylaluminum is associated in the liquid phase and that it is dissociated in the vapor. From the fact that the solubility parameters are so similar, it can be concluded that trimethylaluminum is also completely dimerized in the liquid phase. Therefore, since the entropy of vaporization is not *twice* the value expected on the basis of Trouton's rule, we conclude that trimethylaluminum is a completely dimerized liquid that only *partially* dissociates to monomers during vaporization. One reason for the difference between triethylaluminum and trimethylaluminum lies in the difference in their boiling points, which are 186.6°C and 126.0°C , respectively. This difference of 60°C is sufficient to cause complete dissociation of $[\text{Al}(\text{C}_2\text{H}_5)_3]_2$ during vaporization but only *partial* dissociation of $[\text{Al}(\text{CH}_3)_3]_2$ at its significantly lower boiling point.

Support for this conclusion is found by considering the cases of $\text{Al}(n\text{-C}_3\text{H}_7)_3$ and $\text{Al}(i\text{-C}_4\text{H}_9)_3$. For these compounds, the entropies of vaporization are 126.0 and $135.2 \text{ J mol}^{-1} \text{ K}^{-1}$, respectively. These values are larger than the $88 \text{ J mol}^{-1} \text{ K}^{-1}$ predicted by Trouton's rule, so vaporization is accompanied by a change in degree of molecular association. Even though the molecular weights are higher for the propyl and butyl derivatives, the solubility parameters of 17.0 and $15.7 \text{ J}^{1/2} \text{ cm}^{-3/2}$ for $\text{Al}(n\text{-C}_3\text{H}_7)_3$ and $\text{Al}(i\text{-C}_4\text{H}_9)_3$ are considerably *smaller* than are the values for the methyl and ethyl compounds. Because the solubility parameter reflects the cohesion energy of the liquid, we conclude that $\text{Al}(n\text{-C}_3\text{H}_7)_3$ and $\text{Al}(i\text{-C}_4\text{H}_9)_3$ are only partially dimerized in the liquid phase. Thus, the high entropies of vaporization result from partially dimerized liquids being converted into vapors that are completely monomeric. Both compounds have boiling points (192.8 and 214.1°C for $\text{Al}(n\text{-C}_3\text{H}_7)_3$ and $\text{Al}(i\text{-C}_4\text{H}_9)_3$, respectively) that are higher than that of $[\text{Al}(\text{C}_2\text{H}_5)_3]_2$, which, as we have seen, dissociates completely during vaporization. Therefore, we can conclude that $[\text{Al}(n\text{-C}_3\text{H}_7)_3]_2$ and $[\text{Al}(i\text{-C}_4\text{H}_9)_3]_2$ should be completely dissociated in the *vapor* phase also, but they must be only partially associated in the *liquid* phase. The behavior of the lower aluminum alkyls can be summarized as shown in the following table. These observations are for the pure compounds, not solutions in a solvent such as benzene where association is known to occur.

	Monomer formula			
	Al(CH ₃) ₃	Al(C ₂ H ₅) ₃	Al(<i>n</i> -C ₃ H ₇) ₃	Al(<i>i</i> -C ₄ H ₉) ₃
Liquid:	Dimers	Dimers	Dimers + monomers	Dimers + monomers
Vapor:	Dimers + monomers	Monomers	Monomers	Monomers

Other types of association are found in other metal alkyls. For example, Ga(CH₃)₃ is a dimer that dissociates upon vaporization, but the analogous compounds containing larger alkyl groups are monomers.

The solubility parameters have been determined for several tetra-*n*-alkyl germanes for which the values are as follows (in J^{1/2} cm^{-3/2}): Ge(CH₃)₄, 13.9; Ge(C₂H₅)₄, 17.6; Ge(*n*-C₃H₇)₄, 18.0; Ge(*n*-C₄H₉)₄, 20.3; and Ge(*n*-C₅H₁₁)₄, 21.5. Note that all of these values are lower than those for Al(CH₃)₃ or Al(C₂H₅)₃. The conclusion is that the properties of the liquid tetraalkylgermanes indicate that the liquids are unassociated, a conclusion that is supported by other evidence.

We have already mentioned that the mixed alkyl halide compounds of aluminum dimerize, and the solubility parameters shown in Table 12.1 for these compounds are consistent with that assessment. The solubility parameters for triethylboron and diethylzinc are 15.4 and 18.2 in J^{1/2} cm^{-3/2}, respectively. These values are indicative of liquids that are not strongly associated, which is known to be the case.

Other organometallic compounds of aluminum include the alkyl hydrides, R₂AlH. Molecular association of these compounds leads to cyclic tetramers. When the dimeric and trimeric compounds are dissolved in a basic aprotic solvent, the aggregates separate as a result of formation of bonds between Al and the unshared pair of electrons on the solvent molecule. Toward Lewis bases such as trimethylamine, aluminum alkyls are strong Lewis acids (as are aluminum halides).



This is but a special case of the general principle that molecular association in solution is greatly affected by the nature of the solvent.

Aluminum alkyls figure prominently in polymerization processes and can themselves promote polymerization. In that connection, one of the important reactions of aluminum alkyls is that of adding across a double bond,



Subsequent reaction in which another insertion occurs lengthens the hydrocarbon chain so polymerization occurs. In this type of process, the chains consist of a relatively few carbon atoms. When the reaction above continues in the case R=C₂H₅, the products include AlRR'R'' in which differing numbers of carbon atoms may be present in the three alkyl groups.

The most important reaction of aluminum alkyls is in polymerization of alkenes by the Ziegler-Natta process. In that process, $\text{Al}(\text{C}_2\text{H}_5)_3$ reacts as alkylating agent with TiCl_4 , which then undergoes a reaction in which an alkene molecule is inserted in the bond between Ti and the ethyl group, thus lengthening the chain (see Chapter 22). Because polymers such as polyethylene and polypropylene are produced in enormous quantities and have many important uses, the Ziegler-Natta process has great industrial significance.

Aluminum alkyls undergo many reactions that are typical of covalent metal compounds. Compounds containing methyl, ethyl, and propyl groups ignite spontaneously in air. The reactions with water take place with explosive violence when the alkyl groups contain four or fewer carbon atoms.

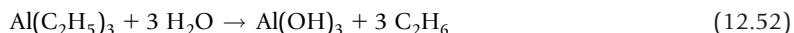

The reaction of an aluminum alkyl with an alcohol is also violent, but it can be mediated by carrying out the reaction in a dilute solution of an inert solvent.



Aluminum alkyls also undergo reactions in which they function by transferring alkyl groups.

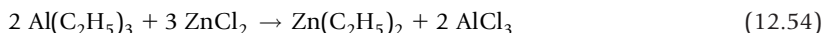

Reactions of this type can be carried out with other metal halides.

12.5 ORGANOMETALLIC COMPOUNDS OF GROUP IVA METALS

There is a well-developed organometallic chemistry of tin, and some of the compounds are used in large quantities in industrial processes. For example, compounds such as $[\text{C}_8\text{H}_{17}\text{SnOC}(\text{O})\text{CH}=\text{CHC}(\text{O})\text{O}]_n$ are used as stabilizers for poly(vinyl chloride) (PVC) polymers, food packaging, protective coatings for wood, control of fungi in several types of food, and numerous other ways. Tin compounds have very low toxicity, so they are well suited for uses that bring them in contact with food products. Organotin compounds are important reagents for synthesizing many other compounds.

Alkyl tin compounds can be prepared by the reaction of SnCl_4 with a Grignard reagent,



Alkyl groups are also transferred from another metal alkyl such as LiR or AlR_3 ,



The chemical behavior of tetraalkylstannanes is radically different from that of the far more reactive aluminum alkyls. The tin compounds are stable in air, they do not react with water, and they do not

form acid-base adducts readily. Tetramethylstannane (b.p. 26.5°C) and tetraphenylstannane (b.p. 228°C) are both sufficiently stable and unreactive that they can be distilled without significant decomposition or oxidation.

In some cases, metallic tin reacts directly with an alkyl halide to produce mixed alkyl halide compounds.

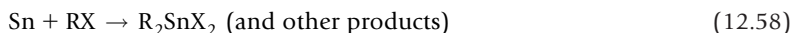

Both the dimethylsilanes and germanes are much more reactive than the tetraalkyls and hydrolyze readily.

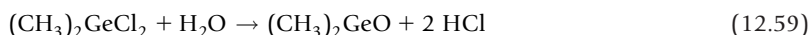

The great utility of dialkyldichlorosilane (b.p. 70°C) lies in the fact that it is an intermediate in the production of silicon polymers.

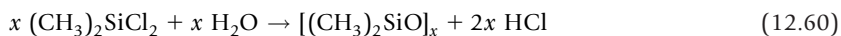

Alkyl tin compounds react with tin tetrahalides to produce a range of products that have the general formula $\text{R}_n\text{SnX}_{4-n}$. These compounds react with LiAlH_4 to produce tin hydrides. Other aspects of the organic chemistry of tin are presented in Chapter 14.

12.6 ORGANOMETALLIC COMPOUNDS OF GROUP VA ELEMENTS

There are many organometallic compounds of arsenic, antimony, and bismuth known that constitute series having chemical properties that differ markedly. These compounds generally decrease in stability in the order $\text{As} > \text{Sb} > \text{Bi}$, which agrees with the increasing difference in size of the atoms and carbon atoms. Arsenic compounds include both aliphatic derivatives and heterocycles such as arsabenzene,

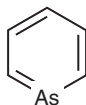

The analogous bismuth compound is much less stable. The coordination chemistry of both six- and five-membered rings has been explored, with one of the most unusual compounds being the complex $[\text{Fe}(\text{AsC}_4\text{H}_4)_2]$, which contains a five-membered AsC_4H_4 ring and has the structure of ferrocene. The trialkyl arsenic compounds have an unshared pair of electrons on the arsenic atoms, so they function as Lewis bases toward metal ions. Consequently, there are many coordination compounds in which AsR_3 molecules are ligands. In this behavior, the decreasing tendency of the alkyls of group VA elements to complex with metals decreases in the series $\text{As} > \text{Sb} > \text{Bi}$ in accord with the increasing metallic character of the elements.

Many organoarsenic compounds are prepared by reactions of AsCl_3 with alkyl group transfer agents such as Grignard reagents, lithium alkyls, or aluminum alkyls. Typical reactions include

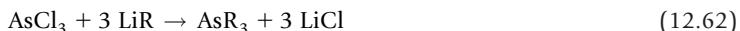

Arsenic dichloride will also react with molecules such as alcohols that have polar OH bonds.



Another organic compound of arsenic that is of historical significance was discovered in 1901 by P. Ehrlich. That compound is known as arsphenamine or Salvarsan, which has the structure

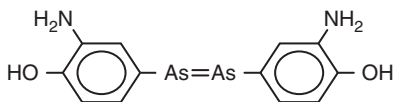

This compound was found to be effective in treating syphilis and African sleeping sickness, although more effective drugs soon became available. In addition to the name Salvarsan, this compound is listed in the *Handbook of Chemistry and Physics* as "606" to denote where it fell in the series of compounds tested by Ehrlich and his collaborators.

12.7 ORGANOMETALLIC COMPOUNDS OF Zn, Cd, AND Hg

Although zinc, cadmium, and mercury are not members of the so-called main-group elements, their behavior is very similar because of their having complete d orbitals that are not normally used in bonding. By having the filled s orbital outside the closed d shell, they resemble the group IIA elements. Zinc is an essential trace element that plays a role in the function of carboxypeptidase A and carbonic anhydrase enzymes. The first of these enzymes is a catalyst for the hydrolysis of proteins, whereas the second is a catalyst for the equilibrium involving carbon dioxide and carbonate,



This process is involved in the removal of CO_2 by blood as bicarbonate is formed and the release of CO_2 in the lungs. Cadmium and mercury are highly toxic. Heavy metals (those that are soft as a result of large size and low charge) are generally toxic, with the toxicity increasing as the softness increases. On the other hand, metals that are considered hard (such as Mg^{2+} , Ca^{2+} , and Fe^{3+}) are not generally considered to be toxic. In one mode of toxic action, heavy metals bond to groups such as —SH that are present in proteins and enzymes.

Zinc forms numerous organometallic compounds, with the dialkyls being the most important. Although these compounds do not associate to give aggregates, they are spontaneously flammable. The reaction of a zinc halide with a Grignard reagent can be used to prepare the compounds.

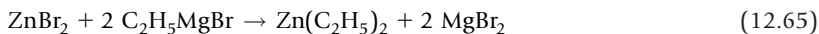

Other alkyl compounds can be obtained by transfer reactions such as that with BR_3 .

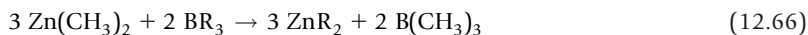

This process is the result of the stability of trimethylboron. Alkyl group transfer also occurs in the reaction



In terms of their chemical behavior, dialkylzinc compounds generally react to transfer alkyl groups to other metals. Dialkyls of cadmium are usually prepared by the reaction of a Grignard reagent with a cadmium halide.

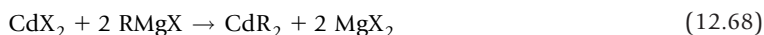

Mixed alkyl halide compounds result from the reaction of dialkylcadmium with cadmium halides.

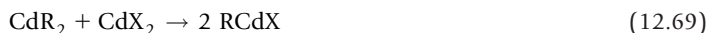

In this chapter, we have briefly surveyed the chemistry of organometallic compounds of some of the main group elements. Additional aspects of organometallic chemistry will be illustrated in Chapters 14 and 15, especially for the nonmetallic elements in these groups. Organometallic chemistry is a vast and important area, the relevance of which can be appreciated only by consulting additional references.

■ REFERENCES FOR FURTHER STUDY

Advances in Organometallic Chemistry, Vol. 55 (2007). This series of 55 volumes has had many editors over the many years of publication.

Coates, G. E. (1960). *Organo-Metallic Compounds*. Wiley, New York. One of the classic books in the field of organometallic chemistry.

Cotton, F. A., Wilkinson, G., Murillo, C. A., and Bochmann, M. (1999). *Advanced Inorganic Chemistry*, 6th ed. Wiley, New York. This reference text contains a great deal of information on organometallic chemistry of main-group elements.

Crabtree, R. H., and Mingos, D. M. P., Eds. (2007). *Comprehensive Organometallic Chemistry III*. Elsevier, Amsterdam.

Greenwood, N. N., and Earnshaw, A. (1997). *Chemistry of the Elements*, 2nd ed. Butterworth-Heinemann, Oxford. Because this 1341-page book deals with chemistry of all elements, a great deal of it concerns their organometallic chemistry.

Rappaport, Z., and Marck, I. (2006). *The Chemistry of Organolithium Compounds*. Wiley, New York.

Rochow, E. G. (1964). *Organometallic Chemistry*. Reinhold, New York. This small book has an elementary introduction to the field and includes a great deal of history.

Suzuki, H., and Matano, Y. (2001). *Organobismuth Chemistry*. Elsevier, Amsterdam.

Thayer, J. S. (1988). *Organometallic Chemistry, An Overview*. VCH Publishers, Weinheim, Germany.

Wakefield, B. S. (1976). *The Chemistry of Organolithium Compounds*. Pergamon Press, Oxford, UK.

■ QUESTIONS AND PROBLEMS

1. Complete and balance the following:

- $\text{LiC}_2\text{H}_5 + \text{PBr}_3 \rightarrow$
- $\text{CH}_3\text{MgBr} + \text{SiCl}_4 \rightarrow$
- $\text{NaC}_6\text{H}_5 + \text{GeCl}_4 \rightarrow$
- $\text{LiC}_4\text{H}_9 + \text{CH}_3\text{COCl} \rightarrow$
- $\text{Mg}(\text{C}_5\text{H}_5)_2 + \text{MnCl}_2 \rightarrow$

2. Write complete equations for the following processes:

- The preparation of butyl lithium
- The reaction of butyl lithium with water
- Dissolving of beryllium in sodium hydroxide
- Preparation of phenyl sodium
- Reaction between ethanol and lithium hydride

3. Complete and balance the following:

- $\text{C}_4\text{H}_9\text{H} + \text{CH}_3\text{MgCl} \rightarrow$
- $\text{C}_3\text{H}_7\text{Cl} + \text{Na} \rightarrow$
- $\text{Zn}(\text{C}_2\text{H}_5)_2 + \text{SbCl}_3 \rightarrow$
- $\text{NaC}_6\text{H}_5 + \text{C}_2\text{H}_5\text{Cl} \rightarrow$
- $\text{B}(\text{CH}_3)_3 + \text{O}_2 \rightarrow$

4. Write complete equations to show the following reactions:

- The reaction of butyllithium with cadmium chloride
- The reaction of ethyl magnesium bromide with acetaldehyde
- The reaction of methyllithium with bromine
- The reaction of triethylaluminum with methanol
- The reaction of triethylaluminum with ethane

5. From what you know about the nature of $\text{B}(\text{CH}_3)_3$ and $\text{Al}(\text{CH}_3)_3$, what would be a reasonable value for the solubility parameter for $\text{B}(\text{CH}_3)_3$? Explain your answer.

6. Speculate on the degree of aggregation of $\text{C}_2\text{H}_5\text{MgCl}$ in the solvents dioxane and benzene, assuming that the concentration is the same in both solvents. If there would be a difference, explain why.

7. Although diethylzinc does not normally associate, $\text{C}_2\text{H}_5\text{ZnCl}$ does to some extent in nonpolar solvents to give a tetramer. Why is there a difference between $\text{Zn}(\text{C}_2\text{H}_5)_2$ and $\text{C}_2\text{H}_5\text{ZnCl}$? Speculate on the structure of $[\text{C}_2\text{H}_5\text{ZnCl}]_4$.

8. Complete and balance the following:

- $\text{Na}_2\text{S} + \text{RCl} \rightarrow$
- $\text{AsCl}_3 + \text{Na} + \text{C}_6\text{H}_5\text{Cl} \rightarrow$
- $(\text{C}_6\text{H}_5)_2\text{TeCl}_2 + \text{LiC}_6\text{H}_5 \rightarrow$
- $i\text{-C}_3\text{H}_7\text{OH} + \text{C}_2\text{H}_5\text{MgCl} \rightarrow$
- $\text{SiH}_4 + \text{CH}_3\text{OH} \rightarrow$

9. When aluminum alkyls form complexes with $(\text{CH}_3)_2\text{X}$ (where $\text{X}=\text{O}, \text{S}, \text{Se},$ or Te), the stability of the complexes decrease as X progresses from O to Te . Explain this trend in the order of stability of the complexes.

10. Although $(\text{CH}_3)_2\text{CCl}_2$ does not react with water, $(\text{CH}_3)_2\text{SnCl}_2$ hydrolyzes readily. Explain this difference.
11. At concentrations of about 1 molal in tetrahydrofuran, $\text{C}_2\text{H}_5\text{MgBr}$ exists almost entirely as the monomer. However, at a comparable concentration in diethyl ether, the dominant species is the dimer. Explain this difference.
12. Alkyls of group IVA elements are essentially unreactive in air, but group IIIA alkyls are extremely reactive. Provide an explanation for this great difference in behavior.
13. Explain the entropy of vaporization data given in Table 12.1 for $\text{Al}(\text{C}_2\text{H}_5)_2\text{Cl}$ and $\text{Al}(\text{C}_2\text{H}_5)\text{Cl}_2$ in terms of the species present in both the liquid and vapor phases.
14. At room temperature, nuclear magnetic resonance cannot be used to distinguish between R_2Mg and RMgX . What does this signify? Propose a mechanism for a process to explain this observation.

This page intentionally left blank

Chemistry of Nonmetallic Elements I. Hydrogen, Boron, Oxygen, and Carbon

Nonmetallic elements span the range from extremely reactive fluorine to relatively unreactive elements such as carbon and nitrogen. One nonmetallic element, sulfur, has been known for thousands of years, but the discovery of others such as the halogens had to await the development of electrochemistry in the early 1800s. The nonmetallic elements constitute a group of approximately 20 elements found in the upper right-hand quadrant of the periodic table. A few others (such as germanium and tellurium) have properties that are typical of both metals and nonmetals. In this and the next two chapters, we will present an overview of some of the important chemistry of nonmetallic elements. Of necessity, such a summary is incomplete, so the references given at the end of the chapters should be consulted for more complete coverage.

13.1 HYDROGEN

Hydrogen is the most abundant element in the universe when considered from the standpoint of number of atoms. On Earth, hydrogen constitutes about 15.4% of all the atoms, but owing to the low mass of the atoms, it constitutes only 0.9% in terms of mass. Three isotopes are known, ^1H , ^2H or deuterium, and ^3H or tritium. Deuterium oxide, D_2O , is also known as "heavy water" and is produced by electrolysis because ordinary water is electrolyzed more easily. Many compounds undergo exchange of deuterium and hydrogen. For example, when CH_3OH is placed in D_2O , the hydrogen atom of the OH group undergoes exchange, but the three hydrogen atoms of the methyl group do not. Similarly, there is rapid exchange of the hydrogen atom in the carboxyl group when $\text{CH}_3\text{CH}_2\text{COOH}$ is placed in D_2O . In general, hydrogen atoms that are held in polar bonds undergo exchange, but those in organic fragments (attached to carbon) do not. Isotope exchange is important in elucidating molecular structures and mechanisms of reactions.

Because the ionization potential for the hydrogen atom is over 1300 kJ/mol, there is little likelihood that compounds containing the H^+ cation would be stable. Obtaining H atoms to ionize is unfavorable because the H-H bond energy is about 435 kJ/mol. Although hydrogen ions are very energetically unfavorable, there are some hydrated species such as H_5O_2^+ (which is actually $(\text{H}_2\text{O})_2 \cdot \text{H}^+$) and

H_9O_4^+ (which is the tetrahydrate $(\text{H}_2\text{O})_4 \cdot \text{H}^+$) that are sufficiently stable that they have been identified as cations in solids. The structure of the H_9O_4^+ ion can be shown as

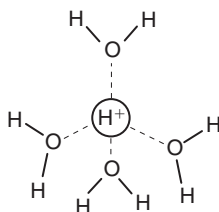

The +1 oxidation state is the most common for hydrogen, but it does not exist as H^+ ions in compounds.

When an electron is added to a gaseous hydrogen atom, the process is accompanied by liberation of 74 kJ/mol, which means that making H^- from gaseous hydrogen atoms is energetically favorable. The result is that there are numerous stable compounds that contain the hydride ion, H^- . The reaction of hydrogen with an active metal such as sodium leads to this type of compound.



Such *hydride* compounds contain hydrogen in a negative oxidation state, which means that the other element must have a lower electronegativity than hydrogen. As we shall see, hydrides can be considered in three groups, *ionic*, *covalent*, and *interstitial*. The majority of hydrogen compounds contain hydrogen that has neither lost nor gained an electron. By that we mean that the majority of hydrogen compounds are covalent. In this section, we will present a brief overview of the simplest element.

13.1.1 Preparation of Hydrogen

Commercial preparation of hydrogen must be carried out in the most economical means. Because water is abundant and inexpensive, it is the source of hydrogen in some instances. One reaction that is carried out on a large scale is the reaction of carbon with water at high temperature,



The steam reformer process involves the reaction of methane and high temperature steam in the presence of a nickel catalyst. The reactions are



The products include H_2 , CO_2 , CO , and steam, which are then processed in a shift converter, resulting in the reaction



Because large quantities of unsaturated organic compounds are obtained by removing hydrogen from saturated hydrocarbons, these processes are also important in production of hydrogen commercially. In one of these processes, hexane is converted to cyclohexane by the reaction



Cyclohexane is further dehydrogenated to produce benzene by the reaction



Other dehydrogenation reactions carried out on a large scale are the production of 1,3-butadiene from butane and the production of styrene from ethyl benzene. These reactions can be shown as follows:

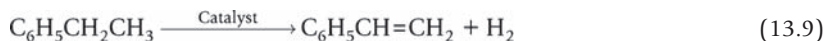

Styrene and butadiene are the monomers utilized in producing polymers that are used in large quantities.

There are two important electrochemical processes in which hydrogen is produced. The first is the electrolysis of water,



In this method, each gas is produced in a separate compartment so they have high purity. In this process, deuterium oxide, D_2O , is electrolyzed more slowly so the water becomes enriched in the heavier isotope. The other electrolytic process that produces hydrogen is the electrolysis of a solution of sodium chloride.

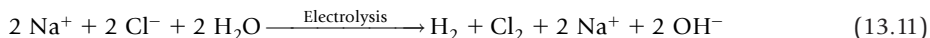

All three products in this reaction are of commercial importance. The reaction is the most common method used to prepare chlorine and sodium hydroxide, so it is carried out on an enormous scale. This means that it is also an important source of hydrogen.

There are many reactions that produce hydrogen on a small scale. These include replacement reactions in which a metal (M) having a higher reduction potential than hydrogen reacts with an acid (HA).

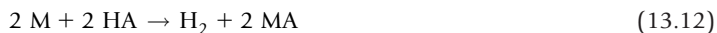

Another type of replacement reaction occurs when a metal such as aluminum or zinc reacts with a strong base. For example,

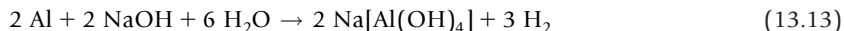

Reactions in which the hydride ion functions as a Brønsted base also result in the production of hydrogen. Typical reactions are the following.

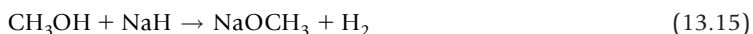
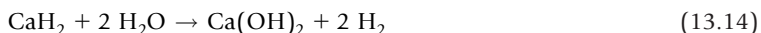

Metal hydrides are so effective as water scavengers that they are sometimes used as drying agents to remove traces of water from solvents.

13.1.2 Hydrides

Compounds containing hydrogen and another element that has a lower electronegativity than hydrogen are properly considered to be *hydrides*. An enormous range of hydrides exist, and they are usually grouped in three categories. The first type consists of the *ionic* or *saltlike* hydrides in which the hydrogen is present as H^- . Although the electron affinity of hydrogen is 74 kJ/mol, transfer of an electron from a metal to hydrogen is unfavorable unless the ions interact to form a lattice. These are compounds that contain hydrogen and a metal that has very low electronegativity. Generally, this means that the metal resides in group IA or IIA of the periodic table. In most cases, the compounds are formed by direct combination of the elements at high temperature. When M is a group IA metal, the reaction is



Some metal nitrides react with hydrogen to produce the metal hydride.



The properties of the hydrides of the group IA metals are shown in Table 13.1.

The most important characteristic of ionic hydrides is that they are strong Brønsted bases. The hydride ion will react with most molecules that contain a hydrogen atom bound to an atom of high

Table 13.1 Properties of the Hydrides of Group IA Metals.

Compound	ΔH_f° (kJ mol ⁻¹)	U (kJ mol ⁻¹)	Radius (pm)	Apparent charge on H (e units)	Density, hydride (g cm ⁻³)	Density, metal (g cm ⁻³)
LiH	-89.1	916	126	-0.49	0.77	0.534
NaH	-59.6	808	146	-0.50	1.36	0.972
KH	-63.6	720	152	-0.60	1.43	0.859
RbH	-47.7	678	153	-0.63	2.59	1.525
CsH	-42.6	644	154	-0.65	3.41	1.903

electronegativity. Such molecules include water, alcohols, and ammonia, as illustrated by the following equations:



The hydride ion is approximately the same size as I^- , and since it has an unshared pair of electrons it functions as a Lewis base. Many complexes are known that contain hydride ions as ligands bound to transition metals. Because the hydride is a soft Lewis base, most of the complexes contain metal atoms or ions of low charge, and in many cases they are from the second or third transition series (see Chapters 16 and 22). Other complexes containing hydride ligands are the AlH_4^- and BH_4^- ions that are usually contained in compounds such as LiAlH_4 and NaBH_4 . Known as lithium aluminum hydride and sodium borohydride, these compounds are versatile reducing agents that are frequently used in synthetic organic chemistry.

When the difference in electronegativity between hydrogen and the other element is small, the hydride has covalent bonding. Although beryllium and magnesium are found in group IIA of the periodic table, they have higher ionization potentials and higher electronegativities than other elements in this group. Because of this, the hydrides of beryllium and magnesium are polymeric covalent materials that have a chain structure in which there are hydrogen bridges between metal atoms:

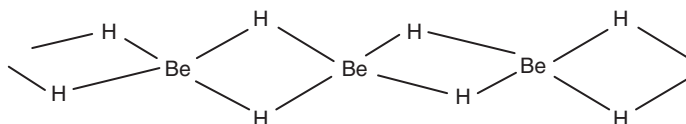

The bonding arrangement of the four H atoms around each Be is approximately tetrahedral.

The reaction of magnesium with boron produces a boride having the formula MgB_2 or Mg_3B_2 .



As we shall see later, borides (as well as oxides, nitrides, carbides, etc.) react with water to produce a hydrogen compound of the nonmetal. Thus, the reaction of magnesium boride with water might be expected to produce BH_3 , *borane*, but instead the product is B_2H_6 , *diborane* (m.p. -165.5°C , b.p. -92.5°C). This interesting covalent hydride has the structure

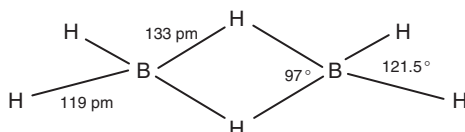
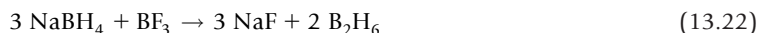

Table 13.2 Properties of Some Covalent Hydrides.

Name	Formula	m.p., °C	b.p., °C
Diborane	B ₂ H ₆	-165.5	-92.5
Tetraborane	B ₄ H ₁₀	-120	18
Pentaborane-9	B ₅ H ₉	-46.6	48
Pentaborane-11	B ₅ H ₁₁	-123	63
Hexaborane	B ₆ H ₁₀	-65	110
Ennaborane	B ₉ H ₁₅	2.6	—
Decaborane	B ₁₀ H ₁₄	99.7	213
Silane	SiH ₄	-185	-119.9
Disilane	Si ₂ H ₆	-132.5	-14.5
Trisilane	Si ₃ H ₈	-117	54
Germane	GeH ₄	-165	-90
Digermane	Ge ₂ H ₆	-109	29
Trigermane	Ge ₃ H ₈	-106	110
Phosphine	PH ₃	-133	-87.7
Diphosphine	P ₂ H ₄	-99	-51.7
Arsine	AsH ₃	-116.3	-62.4
Stibine	SbH ₃	-88	-18

Each boron atom is surrounded by four hydrogen atoms in an arrangement that is approximately tetrahedral. Diborane can also be prepared by the reaction of BF₃ with NaBH₄.



Boron and hydrogen form many compounds and they exhibit unusual structural forms. Several of the boranes are listed in Table 13.2. Covalent hydrides are generally compounds that have low boiling points. Consequently, they are often referred to as *volatile hydrides*.

In some cases, elements having electronegativities too low to give ionic bonding with hydrogen also tend to be unreactive, so that direct combination of the elements is not feasible. In such cases, the procedure just described can be used to prepare the hydride. For example, silicon hydride, SiH₄ (known as *silane*), can be produced by the reactions

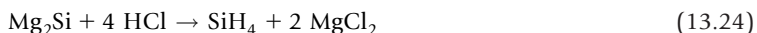

Silane can also be produced by the reaction of SiCl_4 with LiAlH_4 .



Silicon forms numerous hydrides that have counterparts in the hydrocarbon series. However, the silanes are named with respect to the number of silicon atoms present. For example, Si_2H_6 is known as disilane, Si_3H_8 is trisilane, and so on. The situation is similar for the germanium hydrides.

When a metal phosphide undergoes hydrolysis, the product is PH_3 , *phosphine*. For example,

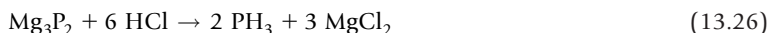

Phosphine is also produced when white phosphorus is heated with sodium hydroxide.



However, PH_3 is not the only hydride of phosphorus, and it is not the only product of this reaction. The other hydride of phosphorus is *diphosphine*, P_2H_4 , which is produced in the reaction just shown. This compound is spontaneously flammable in air, and it ignites phosphine, which is also flammable.



The boron hydrides, silanes, phosphines, and most other covalent hydrides burn readily, some even being spontaneously flammable.

There are numerous similarities between ammonia and phosphine, but the latter is a much weaker base (see Chapter 9). In fact, phosphonium salts are stabilized by large anions that are also the conjugates of strong acids. Accordingly, the most common phosphonium salts are the iodides, bromides, tetrafluoroborates, and so forth. Phosphine and substituted phosphines are good Lewis bases toward soft Lewis acids, and many coordination compounds of this type are known.

Although active metals form ionic hydrides, many other metals do not. They react when placed in an atmosphere of hydrogen, but the products contain hydrogen atoms in interstitial positions in the lattice. Hydrides of this type are known as the interstitial hydrides. Because the number of interstitial positions that contain hydrogen atoms is not determined by a definite number of chemical bonds, hydrides of this type may not have simple formulas. Typical compositions are represented as $\text{CuH}_{0.96}$, $\text{LaH}_{2.78}$, $\text{TiH}_{1.21}$, $\text{TiH}_{1.7}$, or $\text{PdH}_{0.62}$. Hydrides of this type are often called *nonstoichiometric hydrides*.

Although the formation of ionic hydrides is usually exothermic, the formation of interstitial hydrides may have positive enthalpy values. Physical characteristics of interstitial hydrides are determined by the fact that hydrogen atoms in interstitial positions cause some expansion of the lattice but contribute very little mass. Consequently, the interstitial hydrides always have lower densities than the metal itself, even though the crystal structure is normally the same. When interstitial positions contain hydrogen atoms, the flow of electrons in conduction bands within the metal is impeded, so the

conductivity is lower than that of the pure metal. Metals are generally malleable and ductile because of the mobility of atoms within the structure. When the interstitial positions contain hydrogen atoms, the ability of the metals to move in the lattice is constrained so the metal hydride is less malleable and ductile. Typically, the hydrides are harder than the metal alone.

A hydride of a transition metal that has an electronegativity of about 1.4 to 1.7 is not ionic, and bonds between the metal atoms and hydrogen atoms in interstitial positions are not really covalent. Causing the hydrogen to enter the interstitial positions requires the separation of H_2 molecules that have a bond energy of 432.6 kJ/mol, and that energy is not compensated by forming either ionic or covalent bonds between the hydrogen and the metal. As a result, the heat of formation of interstitial hydrides is often positive. For some purposes, it is appropriate to consider interstitial hydrides as being solutions of atomic hydrogen in the metal. Dissolving the hydrogen usually involves separating H_2 molecules, so the metals often function as effective catalysts for hydrogenation reactions.

Because hydrogen molecules must become attached to the surface of the metal, the prior treatment of the metal has a great influence on the formation of a hydride. Cracks, pores, and other defects that aid in the adsorption of hydrogen may have been removed by heating and cooling or by the influence of radiation. Active sites may have been generated by mechanical changes in the surface. All of these factors affect the ease with which the formation of the hydride is accomplished. Because the adsorption of a gas on a solid is related to the partial pressure of the gas and the temperature, these factors influence the fraction of the available sites that are occupied by hydrogen. In other words, the stoichiometry of the hydride may depend on the conditions under which it is formed.

The bond angles in NH_3 are approximately 107° , which indicates sp^3 hybridization with a small reduction in bond angle arising from the effect of the unshared pair of electrons on the nitrogen atom. In PH_3 , the bond angle is only about 93° , so the indication is that the phosphorus orbitals are *not* sp^3 hybrids. Although sp^3 hybridization should reduce repulsion between electron pairs, the p orbitals on phosphorus are large enough that increasing their size by hybridization reduces the effectiveness of the overlap with hydrogen $1s$ orbitals. Bond angles in AsH_3 and SbH_3 are slightly smaller than those in PH_3 , which would be expected if p orbitals on the central atoms are used in bonding. Thus, the bond angles indicate that although it is appropriate to assume sp^3 hybridization in NH_3 , it is not the case for the hydrides of the heavier members of group VA. The hydrogen compounds of group VIA follow this trend in bond angles.

13.2 BORON

Although boron ranks 48th among the elements in abundance, it is not found uncombined. The most common minerals containing boron are the tetraborates of sodium or calcium. *Borax*, $Na_2B_4O_7 \cdot 10H_2O$, is the most important source of boron, and large deposits of borax are found in southern California, from which about three-fourths of the world demand is obtained.

Borax has been used as a soldering flux for many centuries. It was hauled from the mines in wagons pulled by teams of 20 mules which is the basis for "20-Mule Team" borax that is used in laundry products.

13.2.1 Elemental Boron

Boron itself was first produced in 1808 by Sir Humphrey Davy, who carried out the electrolysis of molten boric acid. The reduction of boric acid by potassium was used as a preparative method by Gay-Lussac and Thenard in 1808, and reduction of B_2O_3 by magnesium was the method used by Moissan in 1895.



However, the reduction reactions in which a solid reducing agent is used usually give impure products. In this case, the product contains 80% to 95% boron that also contains magnesium and boron oxide as impurities. The boron produced in this way is a brownish-black form having a density of 2.37 g/cm^3 .

Pure boron can be obtained in small quantities by the reduction of boron trichloride with hydrogen on a heated tungsten filament:



A black, crystalline form of boron having a density of 2.34 g/cm^3 results. Boron exists in unit cells that have an icosahedral structure that has 20 faces that are equilateral triangles meeting at 12 vertices with a boron atom at each vertex, as shown in Figure 13.1.

There are several ways of arranging the almost spherical B_{12} units. Three of these result in the forms of boron known as tetragonal, α -rhombohedral, and β -rhombohedral. All of the structures are very rigid, which results in boron having a hardness of 9.3 compared to the value of 10.0 for diamond (Mohs' scale).

Naturally occurring boron consists of approximately 20% of ^{10}B and 80% of ^{11}B , leading to an average atomic mass of 10.8 amu. Because ^{10}B has a relatively large cross-section for absorption of slow (thermal) neutrons, it is used in control rods in nuclear reactors and in protective shields. In order to obtain a material that can be fabricated into appropriate shapes, boron carbide is combined with aluminum.

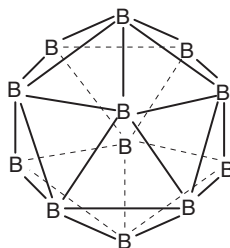

■ **FIGURE 13.1** The icosahedral structure (I_h symmetry) of the B_{12} molecule.

It is known that ^{10}B collects in brain tumors to a greater extent than in normal tissue. Research has been conducted on the use of the isotope ^{10}B for treating brain tumors. Bombardment of the tumor with slow neutrons leads to the production of alpha particles ($^4\text{He}^{2+}$) and lithium nuclei that have enough energy to destroy the abnormal tissue.



Boron is also used in fabricating many objects. Boron produced as fibers can be added to a resin to give composites that are lighter than aluminum but which have strength comparable to that of steel. These composites are used to make fishing rods, tennis rackets, and so on.

13.2.2 Bonding in Boron Compounds

With the electronic structure of the boron atom being $1s^2 2s^2 2p^1$, it might be expected that boron would lose three electrons to give compounds that contain B^{3+} ions. However, removal of three electrons requires over 6700 kJ mol^{-1} , and this is so high that it precludes compounds that are strictly ionic. Polar covalent bonds exist, and the hybridization can be considered as leading to a set of sp^2 hybrid orbitals. However, boron burns readily to produce B_2O_3 , a stable oxide having a heat of formation of -1264 kJ/mol .

It should be clear that we can expect boron to form three equivalent covalent bonds with 120° bond angles. As a result, boron halides have the following trigonal planar structure (D_{3h} symmetry).

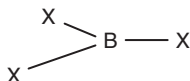

In these molecules, the boron atom has only six electrons surrounding it, so it interacts readily with species that can function as electron pair donors. For example, when F^- reacts with BF_3 , the product is BF_4^- , in which sp^3 hybrids are formed, so such species are tetrahedral (T_d symmetry). In most cases, molecules containing boron exhibit one of these types of bonding to boron. The boron hydrides represent a special situation that is described later.

13.2.3 Borides

Boron forms one or more borides when it reacts with most metals. For example, the reaction between magnesium and boron produces magnesium boride, Mg_3B_2 .



This product reacts with acids to produce diborane, B_2H_6 .



Although BH_3 may be the expected product, it is not stable as a discrete, monatomic unit. It is stable as an adduct with several Lewis bases. Some metals react with boron to form borides containing the

hexaboride group, B_6^{2-} . An example of this type of compound is calcium hexaboride, CaB_6 . In general, the structures of compounds of this type contain octahedral B_6^{2-} ions in a cubic lattice with metal ions. Most hexaborides are refractory materials having melting points over 2000 °C.

13.2.4 Boron Halides

As has already been mentioned, boron halides are electron-deficient molecules. As a result, they tend to act as strong Lewis acids by accepting electron pairs from many types of Lewis bases to form stable acid-base adducts. Electron donors such as ammonia, pyridine, amines, ethers, and many other types of compounds form stable adducts. In behaving as strong Lewis acids, the boron halides act as acid catalysts for several important types of organic reactions (see Chapter 9).

The molecules of all of the boron halides are planar with bond angles of 120°, which has been interpreted in terms of sp^2 hybridization of boron orbitals. However, the experimental B–X bond lengths are shorter than the values calculated using the covalent single-bond radii of the atoms. In the case of BF_3 , this has been interpreted as indicating some double-bond character due to π -bonding that occurs when filled p orbitals on the halogen atoms donate electron density to the empty p orbital on the boron. The shorter than expected bonds may also be the result of ionic contribution to the B–X bond. The extent of this bond shortening can be estimated by means of the *Shoemaker-Stevenson equation*,

$$r_{ab} = r_a + r_b - 9.0 [X_a - X_b] \quad (13.34)$$

where r_{ab} is the actual bond length, r_a and r_b are the covalent single bond radii of atoms a and b , and X_a and X_b are the electronegativities of atoms a and b . The results obtained by applying this equation to the boron halides are shown in Table 13.3.

The data given in Table 13.3 show that the extent of bond shortening is greatest for B–F bonds. This is to be expected because back donation of electron density from F to B is more effective when the donor and acceptor atoms are of comparable size. The following resonance structures are used to represent the multiple bonding between B and F:

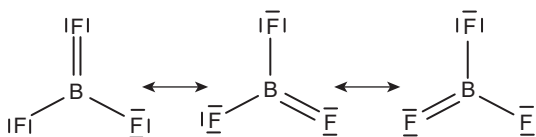

Bond type	Sum of covalent single-bond radii, pm	r_{ab} Calculated from eq. (8.6), pm	Experimental r_{abr} , pm
B–F	152	134	130
B–Cl	187	179	175
B–Br	202	195	187

Adding electron density to the boron atom by multiple bonding would be expected to reduce its tendency to accept electron density from a Lewis base. In accord with this, when reacting with pyridine, the strength as acceptors is $\text{BBr}_3 > \text{BCl}_3 > \text{BF}_3$. The bond shortening discussed earlier is sometimes explained as being due to the contribution of resonance structures such as these. Because they are Lewis acids, boron halides also form complexes of the type BX_4^- . For example,



The BX_4^- ions are tetrahedral since the addition of the fourth X^- means that an additional pair of electrons must be accommodated around the boron atom.

In addition to functioning as Lewis acids, boron halides undergo many other types of reactions. As is typical of most compounds containing covalent bonds between a nonmetal and a halogen, the boron halides react vigorously with water to yield boric acid and the corresponding hydrogen halide.



The BX_3 compounds will also react with other protic solvents such as alcohols to yield borate esters.



An unusual type of product known as a borazine is produced by the reaction of BCl_3 with NH_4Cl .

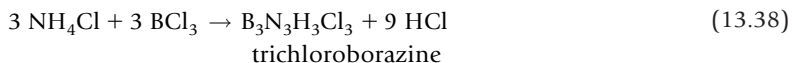

Diboron tetrahalides, B_2X_4 , are also known. These may be prepared in a variety of ways, among them the reaction of BCl_3 with mercury.

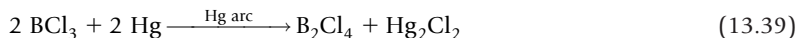

13.2.5 Boron Hydrides

There are many compounds that contain boron and hydrogen, and they are known collectively as the *boron hydrides*. Six boron hydrides were prepared by Alfred Stock in 1910–1930 by the addition of hydrochloric acid to magnesium boride that was produced in small amounts when B_2O_3 was reduced with magnesium.

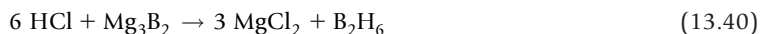

Because of the extreme reactivity of boron hydrides (some are spontaneously flammable in air), Stock developed procedures for handling such air-sensitive materials. The six hydrides produced by Stock were B_2H_6 , B_4H_{10} , B_5H_9 , B_5H_{11} , B_6H_{10} , and $\text{B}_{10}\text{H}_{14}$, with the most interesting being diborane, B_2H_6 .

Because there are only 12 valence-shell electrons, it is impossible to make electron-pair bonds between all of the atoms. It was believed that *borane*, BH_3 , should be a more stable compound because a Lewis structure can be shown as

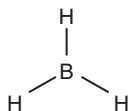

However, Stock found after numerous attempts that it was impossible to isolate borane.

The length of the B–B bond in diborane is similar to that expected for a double bond. This cannot be accounted for satisfactorily by a typical Lewis structure. It has now been determined that the structure of diborane is

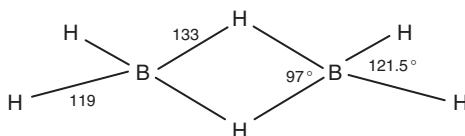

Four of the hydrogen atoms lie in the same plane as the boron atoms. The other two (forming bridges) lie above and below this plane, forming an arrangement of four hydrogen atoms around each boron that is approximately tetrahedral. The bridging hydrogen atoms do not form *two* covalent bonds, but rather simultaneously overlap with an sp^3 hybrid orbital from each boron atom. This produces a so-called *three-center bond*, as shown below.



The combination of boron and hydrogen orbitals in the three-center bond can be shown in a molecular orbital diagram as in Figure 13.2. Using this approach to bonding, the structures of some of the other boron hydrides prepared by Stock can be described.

Since the early work of Stock, other boron hydrides have been synthesized. Some of these compounds have been used as fuel additives, and they have found some application in high-energy rocket fuels. However, because $\text{B}_2\text{O}_3(\text{s})$ is a product of the reaction, the use of these materials in that way causes some problems. The boron hydrides will all burn readily to produce B_2O_3 and water,



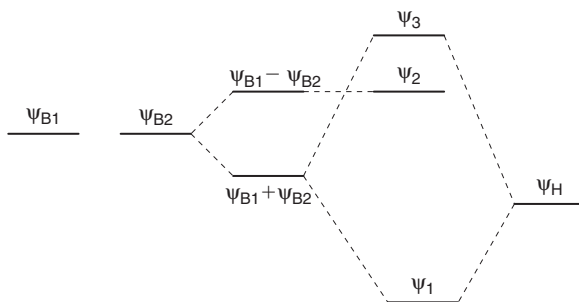

■ **FIGURE 13.2** A molecular orbital diagram for a three-center bond in diborane. The boron group orbital $\psi_{B1} + \psi_{B2}$ has symmetry that matches that of the hydrogen orbitals. It combines with the hydrogen orbitals to give the bonding orbital designated as ψ_1 .

The properties of some boron hydrides along with those of other volatile hydrides are shown in Table 13.2. A very interesting reaction that diborane undergoes is one in which it reacts with double bonds in hydrocarbons. The reaction can be shown as

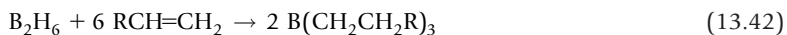

This type of reaction is known as *hydroboration*, and it was exploited by H. C. Brown as a route to organic derivatives of the boranes.

13.2.6 Polyhedral Boranes

In a large number of compounds containing boron and hydrogen, the boron atoms are arranged in the form of a well-defined polyhedron (octahedron, square antiprism, bicapped square antiprism, icosahedron, etc.). In these structures, the boron atoms are most often bonded to four, five, or six other atoms. The most common structure is the icosahedron exhibited by the species $\text{B}_{12}\text{H}_{12}^{2-}$. This structure consists of a B_{12} icosahedron with a hydrogen atom bonded to each boron atom and the overall structure having a -2 charge. It is prepared by the reaction of B_2H_6 with a base, which aids in the removal of hydrogen.

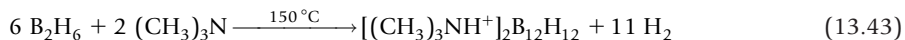

Compounds such as $\text{Cs}_2\text{B}_{12}\text{H}_{12}$ are stable to several hundred degrees and do not react as reducing agents as does BH_4^- . A large number of derivatives of $\text{B}_{12}\text{H}_{12}^{2-}$ have been prepared in which all or part of the hydrogen atoms are replaced by other groups such as Cl, F, Br, NH_2 , OH, CH_3 , OCH_3 , COOH, etc.

The $\text{B}_9\text{H}_9^{2-}$ ion has the structure shown in Figure 13.3. Six of the boron atoms form a trigonal prism, and the other three give a “cap” on each rectangular face of the prism. The structure of the $\text{B}_6\text{H}_6^{2-}$ ion is much simpler. It consists of an octahedron of boron atoms with a B–H group at each apex. Another

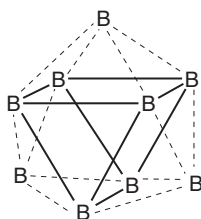

■ **FIGURE 13.3** The arrangement of boron atoms in the $B_9H_9^{2-}$ ion. The nine hydrogen atoms are not shown.

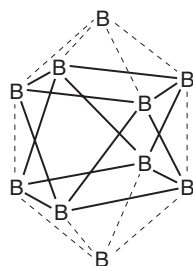

■ **FIGURE 13.4** The arrangement of boron atoms in the $B_{10}H_{10}^{2-}$ ion.

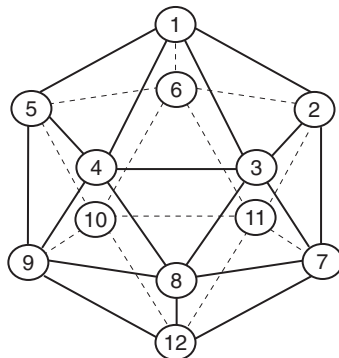

■ **FIGURE 13.5** The numbering system in the icosahedral structure.

anion containing boron and hydrogen is $B_{10}H_{10}^{2-}$. In the structure of this ion, eight boron atoms form a square antiprism while the other two are located above and below the square faces. The arrangement of boron atoms is shown in Figure 13.4. An enormous number of derivatives of these basic polyhedral units (and also larger ones) exist, and a great deal of their chemistry is known.

In order to describe derivatives of B_{12} or $B_{12}H_{12}^{2-}$ having icosahedral structures, it is necessary to have a way to designate positions of atoms or substituent groups. In order to do that, the positions are identified by a numbering system that is illustrated as shown in Figure 13.5.

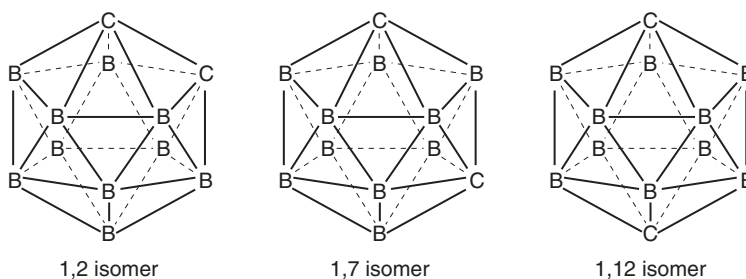

■ **FIGURE 13.6** The three isomers of $B_{10}C_2H_{12}$. The hydrogen atoms have been omitted to simplify the structures.

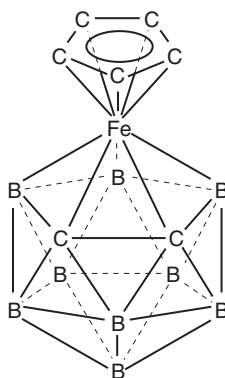

■ **FIGURE 13.7** The structure of $C_5H_5FeB_9C_2H_{11}$ simplified by omitting the 11 hydrogen atoms.

One well-known derivative of the $B_{12}H_{12}^{2-}$ ion is the *carborane*, $B_{10}C_2H_{12}$. Note that this species is neutral because each carbon atom has one more electron than does a boron atom. Because the carbon atoms can be located in any two positions in an icosahedron, there are three isomers of $B_{10}C_2H_{12}$ that differ in the location of the two carbon atoms in the structure. These isomers have the structures shown in Figure 13.6.

One derivative of the $B_{10}C_2H_{12}$ species is $B_9C_2H_{11}^{2-}$, in which a B–H group is missing from one vertex position in the icosahedron. The result is an ion that has a vacant bonding position where a metal ion can attach. As a result, it forms a large number of *metallocarboranes* such as $C_5H_5FeB_9C_2H_{11}$, in which Fe^{2+} is also bonded to C_5H_5 , giving the structure that is shown in Figure 13.7. Other complexes such as that containing Co^{3+} , $[Co(B_9C_2H_{11})_2]^-$, which has the structure shown in Figure 13.8, are also known.

The area of chemistry involving the polyhedral boranes and carboranes has seen enormous growth in recent years. Accordingly, the brief survey here does not include many interesting facets of these fascinating compounds. For more details on the polyhedral boranes, the references at the end of this chapter should be consulted.

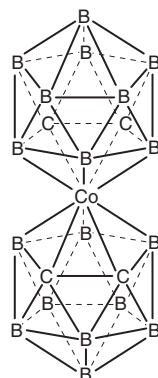

■ **FIGURE 13.8** The structure of the $[\text{Co}(\text{B}_9\text{C}_2\text{H}_{11})_2]^-$ ion. There is one hydrogen atom attached to each B and C atom, all of which are not shown.

13.2.7 Boron Nitrides

Because boron has three valence-shell electrons and nitrogen has five, the molecule BN is isoelectronic with C_2 . Also, some of the allotropic forms that exist for carbon (graphite and diamond) also exist for materials that have the formula $(\text{BN})_x$. The form of $(\text{BN})_x$ having the graphite structure is very similar to graphite in many ways. Its structure consists of layers of hexagonal rings containing alternating boron and nitrogen atoms. Unlike graphite, the layers of boron nitride fall directly in line with one another rather than being staggered. The structure of this form of boron nitride is shown in Figure 13.9. In $(\text{BN})_x$ the van der Waals forces holding the sheets in line with each other are stronger, so boron nitride is not as good a lubricant as graphite. However, the use of boron nitride as a high-temperature lubricant has been investigated because of its chemical stability.

Under high pressure and temperature, boron nitride can be converted to a cubic form. The cubic form of $(\text{BN})_x$ is known as *borazon*, and it has a structure similar to that of diamond. Its hardness is similar to that of diamond, and it is stable to higher temperatures. The extreme hardness results from the fact that the B–N bonds possess not only the covalent strength comparable to C–C bonds, but also some ionic stabilization due to the difference in electronegativity between B and N.

Boron also forms many other compounds with nitrogen. One of the most interesting of these is borazine, $\text{B}_3\text{N}_3\text{H}_6$ (m.p. -58°C , b.p. 54.5°C). Shown here is the structure of borazine, which is similar to the structure of benzene. In fact, borazine has sometimes been referred to as “inorganic benzene.”

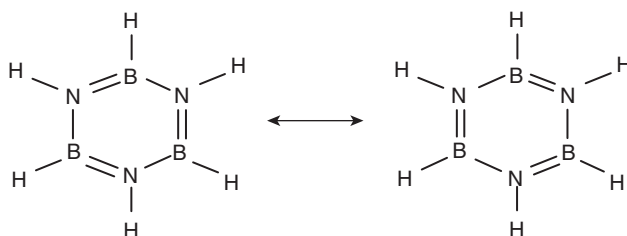

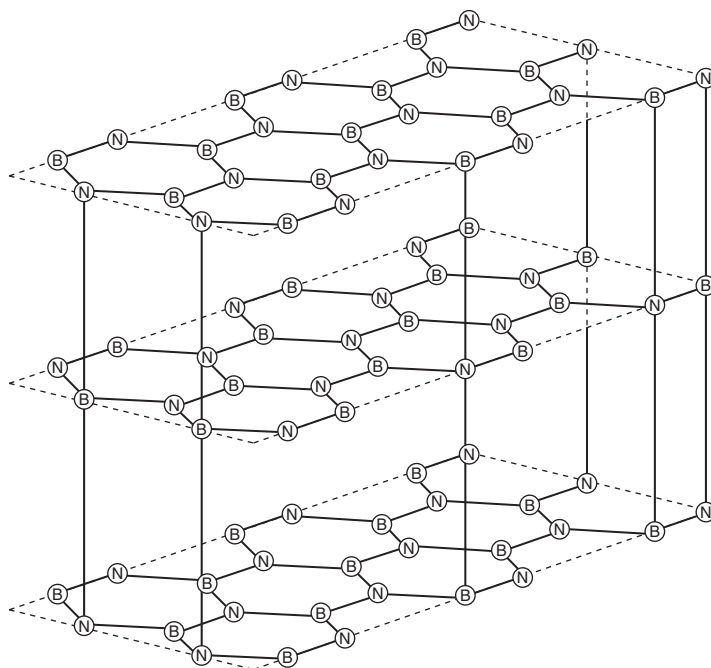

■ FIGURE 13.9 The layered structure of boron nitride. Compare this structure to that of graphite shown in Figure 13.11.

When subjected to high temperature under vacuum, borazine loses hydrogen and polymerizes to yield products known as *biborazonyl* and *naphthazine*, whose structures are similar to biphenyl and naphthalene, respectively.

The borazine molecule has D_{3h} symmetry, whereas benzene has D_{6h} symmetry. The B–N bond length in $\text{H}_3\text{N}-\text{BF}_3$ is 160 pm, but in borazine it is 144 pm. Although borazine resembles the aromatic benzene molecule in some respects, the electronic structure is considerably different. Theoretical studies have shown that although there is some delocalization in borazine, it is not as complete as in benzene. One reason is that because the nitrogen atom has a higher electronegativity than boron, the electron density is higher at the positions occupied by nitrogen atoms. The electron density is determined by both the π and σ bonds, both of which have polarity, but in opposite directions.

Borazine was first prepared in 1926 by the reaction of B_2H_6 with NH_3 , which can be shown as

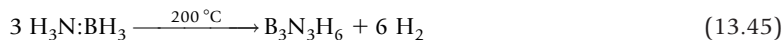

However, it can also be prepared by the following reactions:

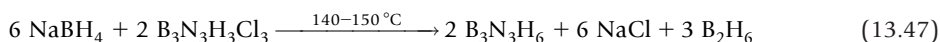
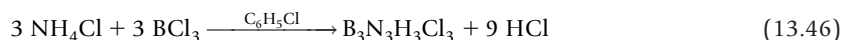

On a larger scale, the reaction of $(\text{NH}_2)_2\text{CO}$ with $\text{B}(\text{OH})_3$ at high temperature in an atmosphere of ammonia is used to produce borazine. Trichloroborazine, $\text{B}_3\text{N}_3\text{Cl}_3\text{H}_3$, has the structure

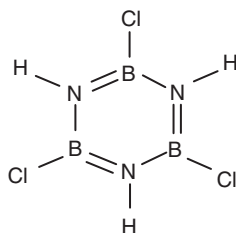

The chlorine atoms are bonded to boron atoms as expected on the basis of the difference in electronegativity.

Although boron forms a large number of unusual compounds, many of the better-known ones are important and widely used. For example, the oxide B_2O_3 is used extensively in the making of glass. Borosilicate glass, glass wool, and fiberglass are widely used because they are chemically unreactive and can stand great changes in temperature without breaking. About 30% to 35% of the boron consumed is used in making types of glass. Borax has long been used for cleaning purposes in laundry products (detergents, water softeners, soaps, etc.). Boric acid, H_3BO_3 (or more accurately, $\text{B}(\text{OH})_3$), is a very weak acid that has been used as an eye wash. It is also used in flame retardants. Boron fiber composites are used in fabricating many items such as tennis rackets, aircraft parts, and bicycle frames. Borides of such metals as titanium, zirconium, and chromium are used in the fabrication of turbine blades and rocket nozzles. Although it is a somewhat scarce element, boron and some of its compounds are quite important and are used in large quantities.

13.3 OXYGEN

Oxygen constitutes approximately 21% of the atmosphere, and water contains 89% oxygen. An enormous range of minerals including silicates, phosphates, nitrates, carbonates, and sulfates also contain oxygen. Added to this scope of oxygen chemistry is the fact that all forms of animal life require oxygen for survival. Sulfuric acid, the chemical produced in largest quantity, and lime are two important materials in the chemical industry, and both are compounds that contain oxygen. Consequently, the chemistry of oxygen and its compounds constitutes a broad area that encompasses many principles, reactions, and structures.

13.3.1 Elemental Oxygen

The atmosphere contains approximately 21% oxygen (b.p. $-183\text{ }^{\circ}\text{C}$) and 78% nitrogen (b.p. $-196\text{ }^{\circ}\text{C}$). Both gases are colorless, odorless, and tasteless, and both are slightly soluble in water. The solubility of oxygen is sufficient to give a mole fraction of 2.29×10^{-5} at $25\text{ }^{\circ}\text{C}$, whereas that of nitrogen is 1.18×10^{-5} at the same temperature. Although the solubility of oxygen is low, it is sufficient for the existence of aquatic life. As with other gases, the solubility of both oxygen and nitrogen increases as pressure is increased and decreases with increasing temperature. Oxygen is appreciably soluble in many organic solvents. Oxygen is produced by plants in the photosynthesis process.

There are three stable isotopes of oxygen, ^{16}O , ^{17}O , and ^{18}O , which have abundances of 99.762%, 0.038%, and 0.200%, respectively. The atomic masses of these isotopes are 15.994915, 16.999134, and 17.999160 amu. Both gases and water enriched in the heavier isotopes are available, and they are useful in kinetic studies and determination of molecular structure (see Chapter 21). In addition to the many other important aspects of the chemistry of oxygen is the fact that it forms complexes with metals. In that connection we need mention here only the vital interaction between oxygen and iron in hemoglobin, which results in the transport of oxygen in living systems. However, formation of oxygen complexes is by no means of so limited scope, as will be discussed in later chapters.

The electronic ground state for the oxygen atom is 3P_2 , which is consistent with two unpaired electrons in the $2p^4$ configuration. Unlike most molecules composed of two paramagnetic atoms, the O_2 molecule is also paramagnetic. Although the structure has been shown as



this structure does not account for the paramagnetism of the molecule. One of the successes of the molecular orbital approach to bonding was the fact that the orbital diagram shown in Figure 13.10 correctly predicted both a double bond and the paramagnetic character of O_2 .

The molecular orbital energy level diagram allows the bond order to be calculated as $\text{B.O.} = (N_b - N_a)/2 = (8 - 4)/2 = 2$, the molecular orbital equivalent of a double bond. The orbital scheme shown in Figure 13.10 is also useful in predicting some of the chemical behavior of O_2 . For example, it is clear that there are two vacancies in the π^*_{2px} and π^*_{2py} orbitals where one or two additional electrons could be placed to generate the O_2^- (superoxide) and O_2^{2-} (peroxide) ions. Both species are well known, and the predicted bond orders are 1.5 and 1, respectively. It is also apparent that if an electron is removed from one of the π^* orbitals, the O_2^+ (dioxygenyl ion) would result and the bond order would increase to 2.5. Because the ionization potential of the O_2 molecule is about 13.6 eV (1313 kJ/mol), it is a chemically viable species. Liquid oxygen has a light blue color that is the result of an electronic transition that results when the triplet ground state is excited to the singlet state having a higher energy. Characteristics of the bonds in several dioxygen species are summarized in Table 13.4.

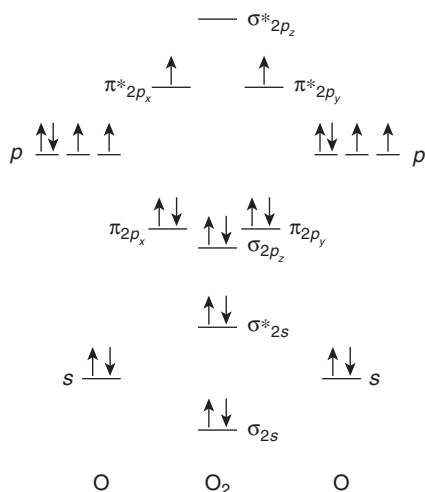

■ FIGURE 13.10 Molecular orbital diagram for the O₂ molecule.

Property	O ₂ ⁺	O ₂	O ₂ ⁻	O ₂ ²⁻
Bond length, pm	112	121	128	149
Bond energy, kJ mol ⁻¹	623	494	—	213 ^a
Force constant, m dyn Å ⁻¹	16.0	11.4	5.6	4.0
Bond order	2.5	2	1.5	1
^a In H ₂ O ₂ .				

13.3.2 Ozone

In 1785, it was noted by Van Marum that when an electric spark is passed through oxygen an unusual odor results. That odor is caused by ozone, O₃, which has a characteristic pungent smell. In fact, ozone can be detected at very low levels by its intense odor, and the Greek word *ozein* meaning to smell is origin of the name *ozone*. Van Marum also noted that the gas reacted with mercury, and in 1840 Schönbein noted that the gas reacted with potassium iodide solution to liberate iodine. Ozone (m.p. -193 °C and b.p. -112 °C) has a heat of formation of +143 kJ/mol, so it is unstable with respect to O₂. Mixtures of ozone and oxygen are explosive.

The O₃ molecule is isoelectronic with SO₂, NO₂⁻, and other triatomic species containing 18 valence-shell electrons. As a result, the structure can be represented by the resonance structures (having C_{2v} symmetry)

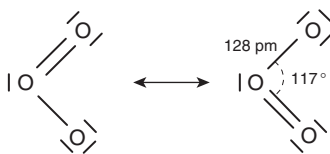

The bent O_3 molecule has infrared absorptions at 1103 cm^{-1} (symmetric stretch), 701 cm^{-1} (bending), and 1042 cm^{-1} (asymmetric stretch).

When the bonding is considered in the molecular orbital approach, it can be seen that each oxygen atom contributes one p orbital to yield three molecular orbitals. The orbital overlap combinations lead to the wave functions

$$\psi_a = \frac{1}{2}(\psi_1 - \sqrt{2}\psi_2 + \psi_3)$$

$$\psi_n = \frac{\sqrt{2}}{2}(\psi_1 - \psi_3)$$

$$\psi_b = \frac{1}{2}(\psi_1 + \sqrt{2}\psi_2 + \psi_3)$$

Only the bonding (ψ_b) and nonbonding (ψ_n) orbitals are doubly occupied. The orbital overlap can be shown as

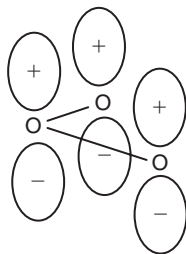

The ozone molecule has a dipole moment of 0.534 D, which is largely due to the unshared pair of electrons on the central atom. Ozone is unstable with respect to oxygen, and it can decompose explosively in the presence of catalysts or ultraviolet radiation. Several substances catalyze the decomposition, including Na_2O , K_2O , MgO , Al_2O_3 , and Cl_2 . The real value of ozone lies in the fact that in the upper atmosphere it absorbs ultraviolet radiation. The maximum in the absorption band is at 255 nm. It is believed that chlorofluorocarbons used as a refrigerating gas and as a propellant for aerosols are contributing to a reduction in the ozone layer. This has been the subject of much research and discussion and has led to discontinuing the widespread use of chlorofluorocarbons.

For laboratory use, ozone is normally produced at the time and location of use by means of an ozonizer. This device bombards oxygen with low frequency electrical oscillation (so-called silent

electric discharge) in a flow system. The effluent gas contains several percent O_3 , which is usually passed directly into the reaction vessel. The reaction can be shown as



The ozone molecule can accept an electron to produce an *ozonide*, O_3^- . One of the most common stable ozonides is KO_3 , which is a powerful and useful oxidizing agent. It is stable at temperatures below 60°C , but it reacts with water,



Ozone itself is a useful and strong oxidizing agent that is comparable in strength to fluorine and atomic oxygen. It is particularly useful in situations where a “clean” oxidizing agent is needed because the reduction product is only oxygen. Water purification is such a situation, and ozone is an effective germicide. It will also oxidize some toxic materials to less harmful forms. For example, it reacts with cyanides, cyanates, and other anions. The reaction with cyanate can be shown as

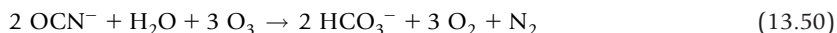

Ozone can also be used to transform metals into their highest oxidation states, which is often useful when separation is desired.

Ozone is a useful oxidizing agent in organic reactions, especially when double bonds are involved. The product of such a reaction is known as an *ozonide*, and the general reaction can be shown as

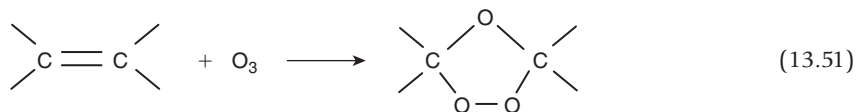

These reactive intermediates are useful precursors in preparing other types of compounds.

13.3.3 Preparation of Oxygen

The atmosphere is the most common source of oxygen, and oxygen ranks third in terms of production of individual chemicals. When liquid air is distilled, nitrogen, having the lower boiling point (-196°C), is separated from oxygen (-183°C). Electrolysis of water produces both hydrogen and oxygen, and the decomposition of 30% hydrogen peroxide is also a suitable preparative technique.

When it is desired to produce oxygen on a laboratory scale, the decomposition of some oxygen-containing compound is the usual procedure. Historically, oxygen was prepared by the decomposition of a metal oxide such as HgO.



When heated, peroxides decompose to produce oxides and oxygen. For example,



In a classic experiment that was conducted for decades in general chemistry laboratories, oxygen can be prepared by the decomposition of KClO_3 in the presence of MnO_2 .

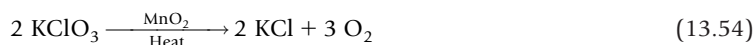

The equation is deceptively simple in appearance because the reaction is very complex. It has been found that some of the MnO_2 is converted into potassium permanganate, which eventually decomposes according to the equation

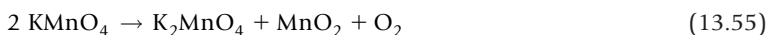

The glassware used to hold the KClO_3 must be scrupulously clean from any material that is combustible. Molten KClO_3 is an exceedingly strong oxidizing agent, and many materials will react explosively with it. As shown in Eq. (13.55), the MnO_2 is eventually regenerated even though it is a participant in the reaction. Although Eq. (13.54) gives the appearance that the reaction is relatively simple, it is actually quite complex.

When solutions containing hydroxides are electrolyzed, the hydroxide ion becomes discharged at the anode as the oxidation process.

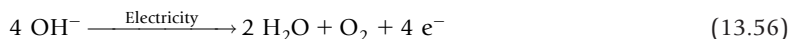

13.3.4 Binary Compounds of Oxygen

When considering the formation of ionic oxides, it should be remembered that the addition of two electrons is a very unfavorable process. Adding the first electron *liberates* about 142 kJ mol^{-1} , but adding the second to produce O_2^- *absorbs* 703 kJ/mol . Therefore, the process



is not energetically favorable. It is the interaction of the ions to produce a crystal lattice that makes the existence of ionic oxides possible. Although oxygen compounds exist for almost all other elements, the oxides of soft metals are not very stable. Metals such as silver and mercury are easily decomposed. On the other hand, oxides that contain hard cations such as Mg^{2+} , Fe^{3+} , Al^{3+} , Be^{2+} , or Cr^{3+} are some of the most stable compounds known. As expected, the lattice energies of such compounds are very high.

Although most metals react with oxygen to form oxides, the reactions of the group IA metals do not always give the expected products, as shown by the following equations:

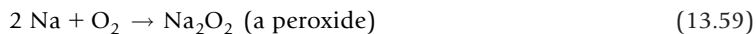
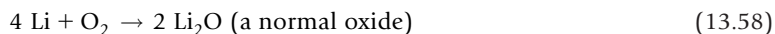

Both rubidium and cesium react with oxygen to give superoxides. Group IIA metals follow a similar pattern with Be, Mg, Ca, and Sr giving normal oxides, and Ba giving the peroxide. Radium may give either a peroxide or superoxide depending on the reaction conditions. It is important to remember that as oxygen reacts with a metal, there is a higher concentration of oxygen at the surface. Therefore, the metal will be found in an oxide in which it is in the highest oxidation state at the surface. Below the surface, the oxidation state of the metal is generally lower, and many oxides are not stoichiometric in composition.

With air in contact with the earth's surface, it is not surprising that several metals are found in ores that contain the metal oxide. Metal replacement reactions are possible because of differences in lattice energies and reduction potentials. One interesting reaction of this type is



Known as the *thermite reaction*, this process is so strongly exothermic that the iron is produced in the molten state. In this case, the replacement Fe^{3+} by Al^{3+} is very favorable because Al^{3+} is a smaller, harder, less polarizable ion, so this reaction is in agreement with the hard-soft interaction principle (see Chapter 9).

Because of its high negative charge density, the oxide ion is a very strong Brønsted base. Therefore, when an ionic oxide is placed in water, there is proton transfer to produce hydroxide ions.



Many metal hydroxides are insoluble. For example, when MgO is made into a slurry, the white suspension is known as milk of magnesia. Calcium oxide (*lime*) is produced by heating limestone (*calcium carbonate*) at high temperature.



When the oxide is added to water, the product is known as *hydrated lime* or *slaked lime*. Lime is one ingredient in mortar and cement, so it is produced on an enormous scale. When Ca(OH)_2 reacts with CO_2 from the atmosphere, it forms calcium carbonate, which binds particles of concrete together.

When water is added to a metal oxide, it may react to produce the hydroxide, but the reaction may not be complete. Thus, if the metal has a +3 charge, the product may consist of a mixture of M_2O_3 , $M(OH)_3$, $M(OH)_x^{z-}$, and $M_2O_3 \cdot xH_2O$. The first of these is an oxide, the second and third are hydroxides, and the last is a hydrated oxide (also known as a *hydrous* oxide). In many cases there is a complex equilibrium involving all of these species, so the exact nature of the products when a metal oxide reacts with water may be variable in composition.

Several elements form polyanions of several types. This type of behavior depends on the concentration and pH of the solution. The species can be considered as arising when additional metal oxide is added to a solution of the parent acid (as when SO_3 is dissolved in H_2SO_4 to give $H_2S_2O_7$, which contains the $S_2O_7^{2-}$ "condensed" sulfate). One type of polyanion is referred to as being *isopoly* because it contains only one element other than oxygen. *Heteropolyanions* result when oxides of different metals are condensed. The polyanions of several metals have been investigated in detail, especially those of tungsten and vanadium. Some of the species that have been identified are $V_2O_7^{2-}$, $W_2O_8^{4-}$, $W_4O_{16}^{8-}$, and $W_{10}O_{32}^{4-}$. In many cases, the structures of the larger ions involve octahedra of MO_6 species that are joined on edges.

13.3.4 Covalent Oxides

When oxygen combines with nonmetals, covalent oxides are produced. Also, there are numerous polyatomic ions that contain oxygen covalently bound to metals. These include species such as MnO_4^- , CrO_4^{2-} , and VO_4^{3-} as well as numerous cationic species such as VO^{3+} , UO_2^{2+} , and CrO^{3+} (as in $CrOCl_3$). In many cases, nonmetals react directly with oxygen to produce covalent oxides. Generally, if the reaction takes place in air (an excess of oxygen), the product will contain the nonmetal in its highest oxidation state. For example,



One notable exception is the reaction with sulfur, which produces the dioxide, not SO_3 .



When the nonmetal is in excess, the product contains the nonmetal in a lower oxidation state, as illustrated by the reactions



Structures of several nonmetal oxides were discussed in Chapter 4, and others will be discussed with the chemistry of the central atom.

As was discussed in Chapter 9, covalent oxides react with water to produce acids. Some examples are the following:



Acidic and basic oxides frequently react directly to produce salts because they are the anhydrides of acids and bases:



13.3.6 Amphoteric Oxides

Although oxides of metals and nonmetals have been generally considered to give bases and acids, respectively, when they react with water there are other oxides that can behave in both ways. These are the amphoteric oxides, and they include the oxides of zinc and aluminum. For example, ZnO undergoes the following reactions:



The first reaction is typical of a basic metal oxide, whereas in the second Zn^{2+} is reacting as an acid. When written starting with the hydroxide, the equivalent equations are

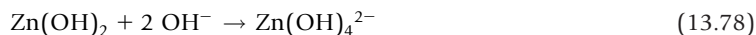
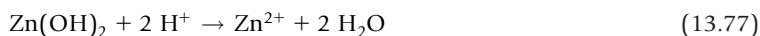

As was shown in Chapter 9 (see Figure 9.2), the oxides of elements in the second period span the range from those that are the anhydrides of strong bases to those that are the anhydrides of strong acids. In the middle, there are a few that give solutions that are neither acidic nor basic, and these are the amphoteric cases. It is also interesting to note the trend in acid-base behavior when progressing down in a given group. For example, CO_2 is a weakly acidic oxide, whereas PbO_2 is a weakly basic oxide. This is in agreement with the fact that the elements become more metallic when progressing down the group.

Although they are oxides of nonmetals, CO and N_2O do not give acidic solutions when added to water. However, they are formally the anhydrides of formic and hyponitrous acid, respectively.

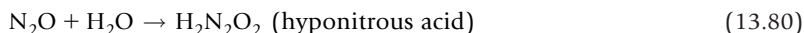
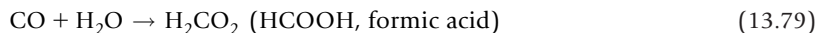

13.3.7 Peroxides

As shown earlier, the alkali metals do not react with oxygen to produce normal oxides when there is an excess of oxygen available. In some cases, a peroxide is obtained, which will react with water to produce hydrogen peroxide.



The most common form of H_2O_2 available in retail stores is a 3% solution, but this solution is an effective disinfectant. It is possible to concentrate hydrogen peroxide by distillation up to a concentration of approximately 30%. When that concentration is reached, the rate of decomposition is high enough that no further concentration occurs. Decomposition of hydrogen peroxide is catalyzed by minute traces of transition metal ions, which is easily seen when a drop of 3% H_2O_2 is placed on a cut where blood is exposed. When handling concentrated H_2O_2 , the containers must be clean and free of metal compounds. Solutions that contain about 90% H_2O_2 are very strong oxidizing agents that have been used as the oxidizing agent in rockets. The decomposition of hydrogen peroxide can be shown as

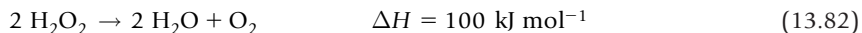

The hydrogen peroxide molecule has an interesting structure that has been described as an “open book”:

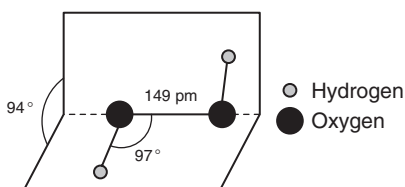

One preparation of H_2O_2 (m.p. -0.43°C and b.p. 150.2°C) involves converting sulfuric acid to peroxydisulfuric acid, $\text{H}_2\text{S}_2\text{O}_8$, which is done by electrolysis of cold, concentrated sulfuric acid. H_2O_2 is obtained by hydrolysis of peroxydisulfuric acid,

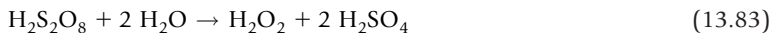

and it is then concentrated by distillation. Currently, H_2O_2 is produced by a process involving the reduction of 2-ethylanthroquinone dissolved in a mixture of an ester and a hydrocarbon using Raney nickel as a catalyst. After reduction of the quinone to the quinol, the catalyst is removed and the quinol is oxidized back to the quinone. Separation of H_2O_2 is carried out by extraction. Hydrogen peroxide has many uses that vary from bleaching paper pulp to production of polymers.

The reaction of oxygen with ethers yields organic peroxides, R-O-O-R .



Organic peroxides are sensitive explosives that are so powerful that a few milligrams can cause serious injury. Some accidents have happened as a container of an ether was being opened and the small amount of peroxide that formed around the cap detonated.

13.3.8 Positive Oxygen

In addition to the considerable array of oxygen compounds discussed thus far, it is possible for oxygen to assume a positive oxidation state. This would be expected in covalent compounds only in cases where the other element is fluorine, the only atom having a higher electronegativity. Several compounds containing oxygen and fluorine have been studied, with the best-known being OF_2 , oxygen difluoride. It is a pale yellow poisonous gas that has a b.p. of -145°C . Oxygen difluoride can be prepared by the reaction of fluorine with a dilute solution of sodium hydroxide,

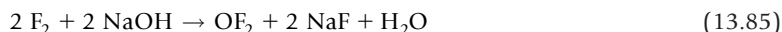

As would be expected, OF_2 is a very strong oxidizing agent that is also a fluorinating agent capable of producing both oxides and fluorides of several elements. Other known compounds that contain oxygen and fluorine include O_2F_2 and O_4F_2 .

In addition to fluorine compounds that contain oxygen in a positive oxidation state, there are also compounds that contain oxygen in a positive ion. The ionization potential of the oxygen atom is 13.6 eV (1312 kJ mol^{-1}), but that of the O_2 molecule is only 12.06 eV (1163 kJ/mol). The NO molecule has one electron in a π^* orbital, and it has an ionization potential of 9.23 eV (891 kJ/mol). Numerous compounds contain the NO^+ species, so it is reasonable to assume that under the right conditions an oxygen molecule could lose an electron. What is needed is a very strong oxidizing agent, and such a compound is PtF_6 . The reaction can be shown as



The product contains the O_2^+ (*dioxygenyl*) cation, which is close enough to the size of K^+ that O_2PtF_6 and KPtF_6 are isomorphous. Other compounds are known that contain the O_2^+ ion, including O_2AsF_5 and O_2BF_4 , which can be prepared by the reaction

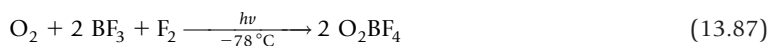

It is interesting to note that the ionization potential of xenon is 12.127 eV (1170 kJ mol^{-1}), which is very close to that of the O_2 molecule. Noting this, it was speculated many years ago that it should be possible to prepare compounds containing xenon. This was proved correct when in the early 1960s, Neil Bartlett carried out such a reaction and obtained a product containing Xe.

13.4 CARBON

In addition to the organic chemistry of carbon compounds, the element is also important in inorganic chemistry. In recent years, an extensive chemistry of the fullerenes, C_{60} and its derivatives, has become one of the most active new areas of inorganic and organic chemistry. There is no clear separation of the two fields even though they were believed to be separate for many years. In 1828, Friedrich Wöhler converted ammonium cyanate into urea,



This reaction showed that it was not necessary for organic compounds to have been produced from living species. With the tremendous growth in organometallic chemistry, there is even less distinction between inorganic and organic chemistry.

13.4.1 The Element

The most extensively occurring compounds of carbon are the organic materials found in coal, petroleum, natural gas, and living plants and animals. The amount of carbon found as graphite and diamond is relatively small in comparison, but these are important materials. When all of the sources of carbon are considered, the element ranks 14th in terms of abundance. Elements in group IVA of the periodic table show clearly the trend of increasing metallic character in going downward in the group. Carbon is a nonmetal and silicon and germanium are metalloids, whereas tin and lead are metallic in character.

The two isotopes of carbon that occur naturally are ^{12}C (98.89%) and ^{13}C (1.11%). Cosmic rays produce neutrons that interact with ^{14}N in the upper atmosphere to produce ^{14}C and protons,



The half-life of ^{14}C is 5570 years, and living organisms contain a relatively constant amount of ^{14}C as more is ingested to replace that which decays. When the organism dies, ^{14}C is not taken in, so it is possible later to determine when the intake of ^{14}C ended by determining the amount remaining. This type of radiocarbon dating provides a convenient way to estimate the age of organisms no longer living.

Carbon atoms have the ability to bond to themselves to a greater extent than those of any other element. Known as *catenation*, this ability gives rise to the several allotropic forms of the element. The most common form of elemental carbon is graphite, which has the layered structure shown in Figure 13.11.

Graphite is often used as a dry lubricant in locks because the layers, which are held together only by van der Waals forces, can slide easily. Graphite can have various groups between the layers to form what are known as *intercalation* compounds. This can occur in two ways. In the first, the layers move slightly farther apart but remain planar. In the second, the layers become distorted or buckled and part of the system of π bonding is interrupted. Although the reaction of graphite with fluorine at high temperature produces CF_4 , the reaction carried out at low temperature produces a compound having the

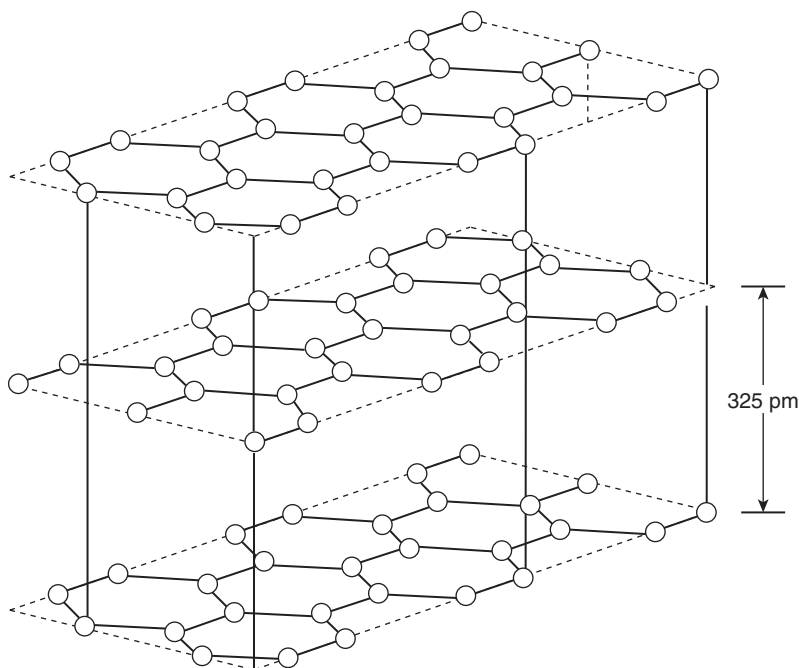

■ FIGURE 13.11 The layered structure of graphite.

stoichiometry $(CF)_n$. The structure of $(CF)_n$ has layers that are not planar owing to the disruption of the π bonding system and the formation of bonds to the fluorine atoms. Each carbon atom is bonded to a fluorine atom, with alternating C–F bonds being above and below each layer. As a result, the layers are much farther apart than in graphite (about 800 pm), but the layers are able to slide along each other so the material is a lubricant.

As a result of the mobility of the electrons in π orbitals, graphite is a conductor of electricity. It is also the form of carbon used as the thermodynamic standard state. On the other hand, diamond contains carbon atoms that are bonded to four others, so all of the electrons are used in localized bonding, and it is a nonconductor that has the structure shown in Figure 13.12.

The density of diamond is 3.51 g cm^{-3} , whereas that of graphite is 2.22 g cm^{-3} . Although for the reaction



$\Delta H = 2.9 \text{ kJ mol}^{-1}$ at 300 K and 1 atm, there is no low-energy pathway for the transformation, so the process is difficult to carry out. However, synthetic diamonds are produced on a large scale at high temperature and pressure (3000 K and 125 kbar). The conversion of graphite to diamonds is catalyzed by several metals (i.e., chromium, iron, and platinum) that are in the liquid state. It is believed that

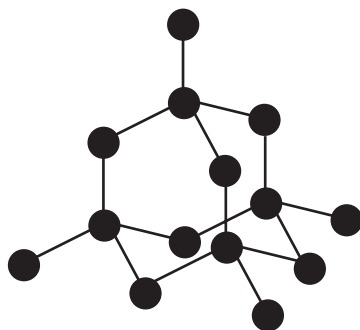

■ FIGURE 13.12 The structure of diamond showing four covalent bonds to each carbon atom.

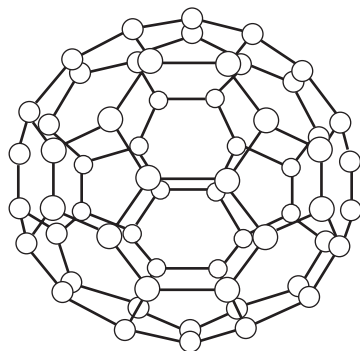

■ FIGURE 13.13 The structure of buckminsterfullerene, C_{60} . The structure consists of five- and six-membered rings.

the molten metal dissolves a small amount of graphite that crystallizes as diamond because it is less soluble in the liquid metal. Diamond is extremely hard, so diamond-tipped tools are important in manufacturing processes.

In 1985, a form of carbon having the formula C_{60} was identified by Smally, Kroto, and coworkers. Because the structure of C_{60} resembles that of the famous geodesic dome designed by R. Buckminster Fuller, the molecule has become known as *fullerene* and the enormous number of derivatives that have been produced are known collectively as the *fullerenes*. When a high-density electric current is passed between graphite rods in a helium atmosphere, soot is produced, some of which dissolves in toluene. It was found that this soluble soot contained C_{60} , which was identified by a peak at 720 amu in the mass spectrum. It was also determined that there were other aggregates of carbon atoms, which included C_{70} and others in minor amounts. The structure of C_{60} (shown in Figure 13.13) has a surface in which the atoms are arranged in pentagons and hexagons, like the geodesic dome.

When graphite is impacted by a high-powered laser, a large number of fragments are produced that have from 44 to 90 carbon atoms. Many smaller aggregates containing both linear and cyclic structures have also been identified, some from "amorphous" forms of carbon.

Like graphite, C_{60} can be transformed into diamond, but the process requires less stringent conditions. It has also been found that C_{60} becomes a superconductor at low temperature. Another interesting characteristic of C_{60} is that when it is prepared in the presence of certain metals, the C_{60} cage can enclose a metal atom. In some cases, other materials can be enclosed within the C_{60} cage in a “shrink wrapped” manner to form “complexes” that are described as *endohedral*. It has also been possible to prepare metal complexes of C_{60} that contain metal-carbon bonds. A compound of this type is $(C_6H_5P)_2PtC_{60}$.

In addition to graphite, diamond, and C_{60} , carbon exists in several “amorphous” forms. These include charcoal, soot, lampblack, and coke, some of which have important industrial uses.



These forms of carbon are also known to have some order, so they are not completely amorphous. When appropriately prepared (so-called activated charcoal), charcoal has an enormous surface area, so it is capable of adsorbing many substances from both gases and solutions. As was described in Chapter 11, coke is used on an enormous scale as a reducing agent in the production of metals. The “amorphous” forms of carbon can be transformed into graphite by means of the *Acheson process*, in which an electric current heats a rod of the “amorphous” form.

13.4.2 Carbon in Industry

Composite materials are made up of two or more materials that have different properties. These materials are combined (in many cases involving chemical bonding) to produce a new material that has properties superior to either material alone. An example of this type of composite is fiberglass, in which glass fibers are held together by a polymeric resin.

The term *advanced composite* is usually applied to a matrix of resin material that is reinforced by fibers of carbon, boron, glass, or other materials that have high tensile strength. The materials can be layered to achieve the desired results. A common type of advanced composite is an epoxy resin that is reinforced with carbon fibers, alone or in combination with glass fibers, in a multilayered pattern. Such composites are rigid and lightweight, and they have excellent resistance to weakening (fatigue resistance). In fact, their fatigue resistance may be better than that of steel or aluminum. Such properties make these materials suitable for aircraft and automobile parts, tennis racquets, golf club shafts, skis, bicycle parts, fishing rods, and so forth.

Fibers in reinforced composites may be of different lengths. In one type of composite, the fibers are long, continuous, and parallel. In another type, the fibers may be chopped, discontinuous fibers that are arranged more or less randomly in the resin matrix. The properties of composites are dependent upon their construction. Composites of carbon fiber and resins have high strength-to-weight ratio and great stiffness. Their chemical resistance is also high and they are unreactive toward bases. It is possible to prepare such materials that are stronger and stiffer than steel objects of the same thickness yet weigh 50% to 60% less.

Because carbon fibers of different diameters are available and because construction parameters can be varied, it is possible to engineer composites having desired characteristics. By varying the orientation, concentration, and type of fiber, materials can be developed for specific applications. The fibers can be layered at different angles to minimize directional differences in properties. Also, layers of fibers can be impregnated with epoxy resin to form sheets that can be shaped prior to polymerization of the resin.

As a result of their stiffness, strength, and light weight, carbon fiber composites are used in many applications in aircraft and aerospace fabrication, such as panels and cargo doors. Also, because of their high temperature stability and lubricating properties, they are also used in bearings, pumps, and so on. One limitation to the use of carbon fibers is the high cost of producing them, which can be as high as hundreds of dollars per pound. Military and aerospace applications have been the major uses of composite materials containing carbon fibers.

In addition to the use of carbon fibers in composites, there is extensive use of carbon in other manufacturing processes. For example, a mixture of coke and graphite powder can be prepared and then bonded with carbon. Typically, the carbon is added to the mixture in the form of a binder such as coal-tar pitch or a resin. The mixture is formed into the desired shape by compression molding or extrusion. Firing the object at high temperature (up to 1300 °C) in the absence of oxygen causes the binder to be converted to carbon that binds the mass together. The wear resistance and lubricating properties of the finished part can be controlled by the composition and characteristics of the coke, graphite, and binder. However, the process results in an object that may have pores. Impregnation with metals, resins, fused salts, or glasses is sometimes carried out to fill the pores. By so doing, the properties of the object can be controlled to some degree. It is possible to machine objects made of these materials to close tolerances. Materials produced in this way are also good conductors of heat and electricity. Because of the graphite present, they are also self-lubricating, and they are relatively inert toward most solvents, acids, and bases. At high temperatures, oxygen slowly attacks these materials, and they react slowly with oxidizing agents such as concentrated nitric acid. Although the carbon/graphite materials are brittle, they are stronger at high temperatures (2500–3000 °C) than they are at room temperature.

The properties just described make manufactured carbon a very useful material. It is used in applications such as bearings, valve seats, seals, dies, tools, molds, and fixtures. Specific uses of the final object may require materials that have been prepared to optimize certain properties. The fact that manufactured carbon can be prepared in the form of rods, rings, plates, tubes, and other configurations makes it possible to machine parts of many types. Manufactured carbon represents a range of materials that have many important industrial uses.

13.4.3 Chemical Behavior of Carbon

Perhaps the most important use of carbon is as a reducing agent because it is the least expensive reducing agent used on a large scale. Two of major uses of carbon as a reducing agent are the production of iron,



and the production of phosphorus,

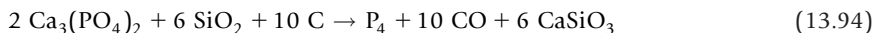

Reduction of metals from their ores using carbon (charcoal) has been utilized for many centuries. One problem associated with using carbon as a reducing agent is that carbon is a solid, and when an excess is used (which is necessary for a reaction to go to completion in a reasonable time), the product contains some carbon. It is not a “clean” reducing agent like hydrogen where the reducing agent itself and its oxidation product are gases. However, when cost is a factor, as it is in all large-scale industrial processes, carbon may be the reducing agent of choice. Another use of carbon is as an absorbent, because in the form of activated charcoal it absorbs many substances. Carbon forms a large number of binary compounds that vary widely in properties. They range from gases such as CO and CO₂ to tungsten carbide, a hard, refractory abrasive.

13.4.4 Carbides

Compounds containing carbon in a negative oxidation state are properly called *carbides*, and many such compounds are known. In a manner analogous to the behavior of hydrogen and boron, carbon forms three types of binary compounds, which are usually called *ionic*, *covalent*, and *interstitial carbides*.

If carbon is bonded to metals having low electronegativities, the bonds are considered to be ionic with carbon having the negative charge. Such metals include groups IA and IIA, Al, Cu, Zn, Th, V, and others. Because carbon is in a negative oxidation state, reactions of these compounds with water produce a hydrocarbon. In some cases the hydrocarbon is methane, but in others acetylene is produced. Therefore, the carbides are called *methanides* and *acetylides*, respectively.

The acetylide ion, C₂²⁻, is isoelectronic with N₂, CO, and CN⁻. The reaction producing acetylene from calcium carbide can be shown as

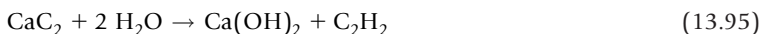

When water is allowed to drip on CaC₂, acetylene is produced, and it is flammable.

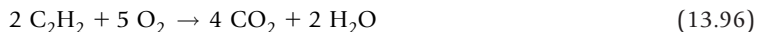

One type of portable light source consists of two chambers, the upper for water and the lower for CaC₂, that are connected by a tube having a valve to control the rate of dripping of the water. The acetylene produced is allowed to escape through an orifice in the middle of a reflector. When the acetylene burns, the light is directed by the reflector. This type of light is referred to as “carbide light” or “miner’s lamp” and was in common use in the past by coal miners.

Calcium carbide can be produced by the direct reaction of carbon with the metal or metal oxide:



Other carbides, such as Be_2C and Al_4C_3 , behave as if they contain C^{4-} and react with water to produce CH_4 .



When carbon forms compounds with other elements (Si, B, etc.) that have an electronegativity close to that of carbon, the bonds are considered to be covalent. The compounds, especially SiC , have the characteristics of being hard, unreactive refractory materials. Silicon carbide has a structure similar to diamond, and it is widely used as an abrasive. It is prepared by the reaction of SiO_2 with carbon.



When most transition metals are heated with carbon, the lattice expands and carbon atoms occupy interstitial positions. The metals become harder, higher melting, and more brittle as a result. For example, when an iron object is heated and placed in a source of carbon atoms (charcoal or oils have been used historically), some iron carbide, Fe_3C , forms on the surface. If the object is cooled quickly (quenched), the carbide remains primarily on the surface, and a hard, durable layer results. This process, known as *casehardening*, was very important prior to the development of modern heat-treatment processes for steels. Other carbides, ZrC , TiC , MoC , and WC , are sometimes used in making tools for cutting, drilling, and grinding.

13.4.5 Carbon Monoxide

The reaction of carbon with oxygen can lead to different products. When there is a deficiency of oxygen, the product is carbon monoxide.



Carbon monoxide can also be obtained by the reaction of carbon with CO_2 .



Because the oxides of nonmetals are acid anhydrides, CO is formally the anhydride of formic acid.



Although this reaction does not take place readily, the dehydration of formic acid does produce CO .



Because CO is a slightly acidic oxide, it reacts with bases to produce formates.



As we have already mentioned, carbon is a reducing agent of great importance, and CO is often the oxidation product (see Eqs. (13.93) and (13.94)). The reaction of carbon with steam at high temperature also produces CO.



This reaction is the basis for the *water gas process* that was discussed earlier in this chapter in connection with the preparation of hydrogen.

The CO molecule is isoelectronic with N_2 , CN^- , and C_2^{2-} and has a structure that can be shown as

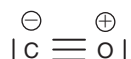

and the carbon end of the molecule carries a negative formal charge. This is the electron-rich end of the molecule, and when it forms complexes with metals (metal carbonyls), it is the carbon end that binds to the metal (see Chapter 21). In some cases, CO forms bridges between two metal atoms. A few metal carbonyls can be formed by direct combination of the metal and CO.



The formulas for the metal carbonyls are determined by the number of pairs of electrons needed by the metal to reach the number of electrons in the next noble gas atom. Thus, the stable carbonyl with nickel contains four CO molecules, that with iron contains five, and that with chromium contains six. The bonding in these complexes will be discussed in more detail in Chapter 16.

Carbon monoxide is a very toxic gas that forms a stable complex by binding to iron in the heme structure in the blood. Because CO bonds to iron more strongly than does O_2 , it prevents O_2 molecules from binding. Therefore, CO destroys the oxygen-carrying capacity of the blood. Moreover, CO is a cumulative poison because it requires a long time for the bound CO to be lost. When someone has been exposed to CO, treatment usually involves placing the subject in an atmosphere that is richer in oxygen in order to improve O_2 binding by Le Chatelier's principle.

Carbon monoxide is a reducing agent, and it burns readily,

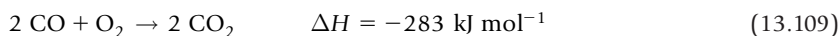

In addition to being a reducing agent in the production of metals, CO is used to produce methanol by the reaction

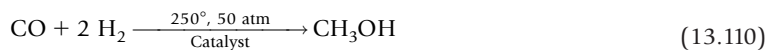

A commonly used catalyst in this process consists of ZnO and Cu. Because methanol is a widely used solvent and fuel, the reaction is economically significant.

13.4.6 Carbon Dioxide and Carbonates

The most familiar oxide of carbon is CO_2 . Solid CO_2 sublimates at -78.5°C , and because no liquid phase is present when this occurs, solid CO_2 is called "dry" ice. Dry ice is widely used in cooling operations. Carbon dioxide is obtained by burning carbon in an excess of oxygen,



or by the reaction of a carbonate with an acid,



A reaction of carbon dioxide that is essential for life forms is that of photosynthesis in which CO_2 is converted by plants into glucose. The process can be summarized as

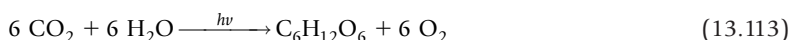

However, the process is very complex and involves several intermediates such as chlorophyll (of which there is more than one type). Chlorophylls are porphyrins that contain magnesium. The growth of plants is responsible for the production of oxygen in the atmosphere as well as food and natural fibers.

The carbon dioxide molecule has a linear structure that can be shown



and it is nonpolar. It is the anhydride of carbonic acid, H_2CO_3 , so solutions of CO_2 are slightly acidic as a result of the reaction.



Also, CO_2 will react with metal oxides to produce carbonates,



Carbon dioxide in the atmosphere has some influence on the composition of ores. The decay of organic matter can produce carbon dioxide, and it reacts with many metal oxides to produce metal carbonates. For example,



Because the carbonate ion can react as a base, it can react with water to produce hydroxide ions, and H^+ and CO_3^{2-} form bicarbonate ions.



Therefore, as an oxide mineral “weathers,” a bicarbonate may result from the reactions of metal oxides with water and CO_2 . Eventually, the presence of OH^- can cause part of the metal-containing mineral to be converted into a metal hydroxide, and most metal oxides react with water to produce hydroxides. For example,

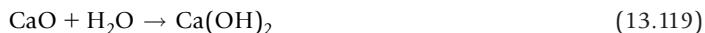

As a result of these processes, a metal oxide may be converted into a metal carbonate, a metal hydroxide, or a so-called *basic* metal carbonate (a compound containing both carbonate and hydroxide ions). A case of this type is $\text{CuCO}_3 \cdot \text{Cu}(\text{OH})_2$ or $\text{Cu}_2\text{CO}_3(\text{OH})_2$, which is the mineral *malachite*. The mineral *azurite* is quite similar and has the composition $2\text{CuCO}_3 \cdot \text{Cu}(\text{OH})_2$ or $\text{Cu}_3(\text{CO}_3)_2(\text{OH})_2$. *Azurite* and *malachite* are usually found together because both are secondary minerals produced by weathering processes on CuO . The weathering process clarifies why metals are sometimes found in compounds having unusual formulas.

In addition to being a base, the carbonate ion is also an electron pair donor that forms many complexes with metals (see Chapter 16). It has the ability to bond at either one or two sites around the metal, or it can form bridges between metal ions.

Many carbonates have important uses. One of the most important carbonates is calcium carbonate, and it is found in several mineral forms such as *calcite*. The most widely occurring form of calcium carbonate is *limestone*. It is found in many places, and it has been used as a building material for thousands of years. When heated to high temperature, most carbonates lose carbon dioxide and are converted to the oxides. The most important reaction of this type involves heating CaCO_3 strongly (known as *calcining*) to convert it into another useful material, lime (CaO). The process of producing lime is sometimes called *lime burning*.

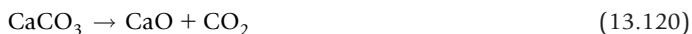

Lime has been produced in this way for thousands of years. The loss of CO_2 corresponds to a 44% mass loss, but in ancient times the material was considered ready for use if the mass loss was as much as one-third of the original. Lime is used in huge quantities in making mortar, glass, and other materials, and to make calcium hydroxide (*hydrated lime*). Although $\text{Ca}(\text{OH})_2$ is only slightly soluble in water, it is a strong base and is cheaper than NaOH , so it is widely used as a strong base.

Mortar, a mixture of lime, sand, and water, has been used in construction for thousands of years. The Appian Way, many early Roman and Greek buildings, and the Great Wall of China were constructed using mortar containing lime. In the Western Hemisphere, the Incas and Mayans used lime in mortar. The composition of mortar can vary rather widely, but the usual composition is about one-fourth lime, three-fourths sand, and a small amount of water to make the mixture into a paste. Essential ingredients are a solid such as sand and lime that is converted to $\text{Ca}(\text{OH})_2$ by reaction with water.



Calcium hydroxide reacts with carbon dioxide to produce calcium carbonate, CaCO_3 ,

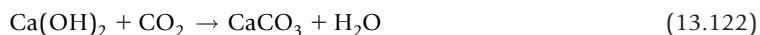

so the particles of solid are held together CaCO_3 to form a hard, durable mass. Essentially, artificial limestone is reformed by the reaction of $\text{Ca}(\text{OH})_2$ with CO_2 .

Concrete is the manmade material used in the largest quantity. It is made from inexpensive materials that are found in most places throughout the world. The raw materials are often assembled from large stockpiles at the construction site. The ingredients are *aggregate* (sand, gravel, crushed rock, etc.) and *cement*, the binding agent. Lime is used in the manufacture of cement, the most common type being Portland cement, which also contains sand (SiO_2) and other oxides (aluminosilicates). Particles of aggregate bond more effectively when they have rough surfaces so good adhesion occurs in all directions around each particle. A good mix should also have aggregate composed of a range of particle sizes rather than particles of a uniform size so that smaller particles can fill the spaces between larger ones. Basalt rock, crushed limestone, and quartzite are common materials used as aggregate.

Portland cement is made by heating calcium carbonate, sand, aluminosilicates, and iron oxide to about 870°C . Kaolin, clay, and powdered shale are the sources of aluminosilicates. Heated strongly, this mixture loses water and carbon dioxide to form a solid mass. A small amount of calcium sulfate is added to this solid material after it is pulverized. Mortar used today consists of sand, lime, water, and cement. Concrete usually consists of aggregate, sand, and cement, which binds the materials together by reacting with water to form a mixture known as *tobermorite gel*. This material consists of layers of crystalline material that have water interspersed between them. To develop strength in the product, the correct amount of water must be used. Using too little water results in air being trapped in the mass, giving a porous structure. If too much water is used, its evaporation and escape from the solid can give a structure that is porous. In either case, the concrete is not sufficiently strong. For some applications, concrete is reinforced by allowing it to harden around metal rods or wire. The complex chemical reactions involved in the hardening of concrete will not be discussed here, but it is worthwhile to emphasize the importance of the reactions of calcium hydroxide with CO_2 that take place in concrete, mortar, and related materials.

Another indispensable carbonate is sodium carbonate, which is also known as *soda ash*. Centuries ago, impure sodium carbonate was obtained from the places where brine solutions had evaporated and from dry lake beds. The major source of soda ash today is once again from a natural source, but prior to 1985, it was synthesized in large quantities. The synthetic process most often used was the *Solvay process*, represented by the equations

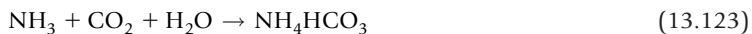

An enormous amount of Na_2CO_3 is produced annually because of its use in glass, laundry products, water softeners, paper, baking soda, and sodium hydroxide by the reaction

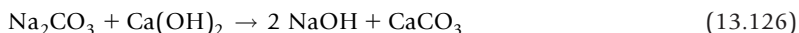

In the United States, the source of sodium carbonate is the mineral *trona*, which has the formula $\text{Na}_2\text{CO}_3 \cdot \text{NaHCO}_3 \cdot 2\text{H}_2\text{O}$. The fact that sodium bicarbonate (NaHCO_3) is present is no surprise, because the carbonate reacts with water and carbon dioxide to produce sodium bicarbonate.



As shown in Eq. (13.125), heating the bicarbonate converts it to the carbonate with the loss of water and CO_2 . The world's largest deposits of trona are found in Wyoming, but trona is also found in Mexico, Kenya, and Russia. The trona deposits in Wyoming are estimated to be 100 billion tons and they account for 90% of U.S. production. The trona mines in Wyoming alone account for 30% of the world production.

Trona is processed to obtain sodium carbonate by crushing it to produce small particles and then heating it in a rotary kiln. This dehydration process produces impure sodium carbonate.

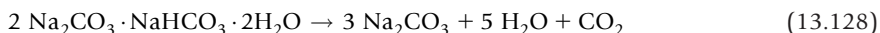

For most uses, the Na_2CO_3 must be purified. This is done by dissolving it in water and separating insoluble rocky material by filtration. Organic impurities are removed by adsorption using activated charcoal. The hydrated crystals of $\text{Na}_2\text{CO}_3 \cdot \text{H}_2\text{O}$ are obtained by boiling off the excess water to concentrate the solution. The hydrated crystals are heated in a rotary kiln to obtain anhydrous sodium carbonate:



13.4.7 Tricarbon Dioxide

This oxide (m.p. -111.3 and b.p. 7°C), also known as carbon suboxide, C_3O_2 , contains carbon in the formal oxidation state of $+4/3$. Because this is lower than its oxidation state in either CO or CO_2 , the oxide is called carbon *suboxide*. The molecule is linear and has the structure

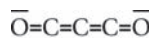

The molecule contains three carbon atoms bonded together, so this suggests a method for its preparation by dehydrating an organic acid containing three carbon atoms. Because C_3O_2 is formally the anhydride of malonic acid, $\text{HOOC}-\text{CH}_2-\text{COOH}$, one way to prepare C_3O_2 is by the dehydration of that acid using a strong dehydrating agent such as P_4O_{10} .

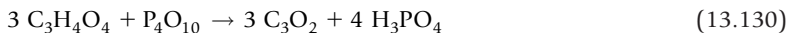

The reaction of C_3O_2 with water produces malonic acid, and the gas also reacts with NH_3 ,

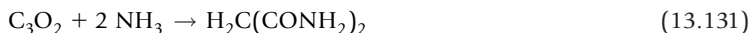

The reaction of C_3O_2 with HCl gives a diacyl chloride.



Although it is stable at low temperatures, carbon suboxide will readily burn, and it polymerizes when heated. Pentacarbon dioxide, C_5O_2 , has been prepared, but like C_3O_2 it has no important uses.

13.4.8 Carbon Halides

Of the halogen compounds of carbon, the most important is CCl_4 (b.p. $77^\circ C$) that is widely used as a solvent. However, the fully halogenated compounds are usually considered as derivatives of methane, so they are usually considered as "organic" in origin. Carbon tetrachloride is produced by the reaction



The S_2Cl_2 obtained has many uses, including the vulcanization of rubber. The reaction of methane with chlorine also produces CCl_4 .



Unlike most covalent bonds between halogens and nonmetals, the C–Cl bonds do not hydrolyze in water. Even though it is still a useful solvent, CCl_4 is not used in dry cleaning as it once was. The oxyhalides, $X_2C=O$, undergo many reactions owing to the very reactive C–X bonds. Although it was used as a war gas in World War I, phosgene, $COCl_2$, is a versatile chlorinating agent that has industrial uses. Metal bromides are produced when $COBr_2$ reacts with metal oxides in a sealed tube.

13.4.9 Carbon Nitrides

The most common compound of carbon and nitrogen is cyanogen, $(CN)_2$. The cyanide ion, CN^- , is a *pseudohalide* ion, which means that it resembles a halide ion because it forms an insoluble silver compound and it can be oxidized to the X_2 species. Cyanogen was first obtained by Gay-Lussac in 1815 by heating heavy-metal cyanides.

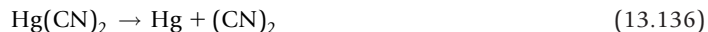

It can also be prepared from carbon and nitrogen by electric discharge between carbon electrodes in a nitrogen atmosphere. Numerous derivatives of cyanogens are known, including cyanogen halides, XCN. These compounds form trimers known as the cyanuric halides, which have the cyclic structure

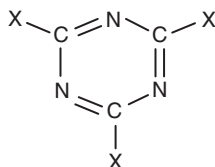

The $(\text{CN})_2$ molecule has the linear $D_{\infty h}$ structure

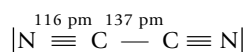

It is a highly toxic, colorless gas that burns with a violet flame to produce CO_2 and N_2 .



Polymerization of cyanogen produces *paracyanogen*,

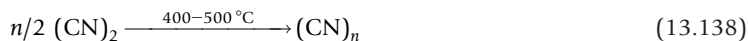

which has the structure

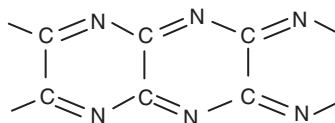

Although relatively few compounds contain only carbon and nitrogen, derivatives such as the cyanides have commercially important uses. Also, calcium cyanamide, CaCN_2 , can be prepared by the reaction



This process is important because it represents an efficient way to obtain nitrogen compounds directly using the gas, which is ordinarily unreactive. CaCN_2 has been used as a fertilizer because it reacts with water to produce ammonia.

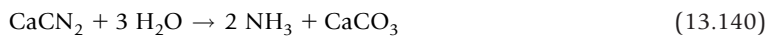

This use of CaCN_2 is not as extensive as it formerly was. The CN_2^{2-} ion has 16 electrons, so the structure can be shown as



When this ion reacts with two protons to form the parent compound, the product is $\text{H}_2\text{N}-\text{C}\equiv\text{N}$ (cyanamide). When this compound trimerizes, the result is cyanuric amide, which is also known as *melamine*:

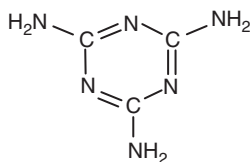

Cyanamides are converted to cyanides by reaction with carbon,

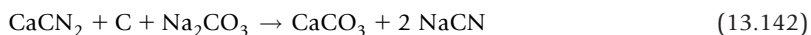

Cyanides are extremely toxic, and acidifying a solution containing CN^- produces HCN.



Hydrogen cyanide (b.p. 26°C) is a very toxic gas. It is a weak acid ($K_a = 7.2 \times 10^{-10}$) so solutions of ionic cyanides are basic due to hydrolysis.



The CN^- ion is a good coordinating group, and it forms many stable complexes with metals (see Chapter 16). Although the carbon end of the ion is the usual coordinating site, the unshared pair of electrons on the nitrogen end makes possible complexes in which the CN^- ion is a bridging group. The $-\text{CN}$ (nitrile) group is an important one in the chemistry of organic compounds.

Cyanates (OCN^-) can be prepared from cyanides by oxidation reactions. For example,



Having the same atomic composition as cyanates but drastically different properties are the fulminates, which contain CNO^- . Many organic compounds having the formula $\text{R}-\text{N}-\text{C}-\text{O}$ are known (the isocyanates). Cyanides undergo an addition reaction with sulfur to produce thiocyanates.



Unlike HCN, HSCN is a strong acid (comparable to HCl), and it can readily form amine hydrothiocyanates, $\text{R}_3\text{NH}^+\text{SCN}^-$, that are analogous to amine hydrochlorides. In the molten state, these acidic salts react with oxides, carbonates, and other compounds, and in some cases they produce thiocyanate complexes of the metals. Like the cyanide ion, SCN^- is a good coordinating ion, and it bonds to soft metals (e.g., Pt^{2+} or Ag^+) through the sulfur atom and to hard metals (e.g., Cr^{3+} or Co^{3+}) through the nitrogen atom (see Chapter 9).

13.4.10 Carbon Sulfides

The most common compound of carbon and sulfur is CS₂, carbon disulfide (b.p. 46.3 °C). It can be prepared by the reaction of carbon and sulfur in an electric furnace or by passing sulfur vapor over hot carbon.



The reaction of sulfur with methane at high temperature with a suitable catalyst (SiO₂ or Al₂O₃) also produces CS₂.



CS₂ is a good solvent for many substances including sulfur, phosphorus, and iodine. The compound has a high density (1.3 g/mL), and it is slightly soluble in water, although it is completely miscible with alcohol, ether, and benzene. It is also quite toxic, highly flammable, and forms explosive mixtures with air. It is used in the preparation of CCl₄ as described earlier in this chapter. One interesting reaction of CS₂ is analogous to that of CO₂ in reacting with metal oxides. For example,

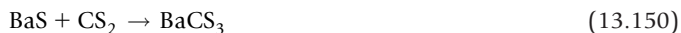

The CS₃²⁻ ion is known as the thiocarbonate ion, and it has a trigonal planar structure.

Two other compounds containing carbon and sulfur should be mentioned. The first of these is carbon monosulfide, CS. This compound has been reported to be produced by the reaction of CS₂ with ozone. The second compound is COS or, more correctly, OCS (m.p. -138.2 °C and b.p. -50.2 °C). It is prepared by the reaction



Unlike CS₂, neither CS nor OCS have any large-scale industrial uses.

■ REFERENCES FOR FURTHER READING

- Bailar, J. C. Jr., Emeleus, H. J., Nyholm, R., and Trotman-Dickinson, A. F. (1973). *Comprehensive Inorganic Chemistry*. Pergamon Press, Oxford. This is a five-volume reference work in inorganic chemistry.
- Billups, W. E., and Ciufolini, M. A. (1993). *Buckminsterfullerenes*. VCH Publishers, New York. A useful survey of the literature.
- Cotton, F. A., Wilkinson, G., Murillo, C. A., and Bochmann, M. (1999). *Advanced Inorganic Chemistry*, 6th ed., Chapter 5. Wiley, New York. A 1300-page book that covers an incredible amount of inorganic chemistry. Several chapters are devoted to the elements described in this chapter.
- Garrett, D. E. (1998). *Borates*. Academic Press, San Diego, CA. An extensive reference book on the recovery and utilization of boron compounds.

- Greenwood, N. N., and Earnshaw, A. (1997). *Chemistry of the Elements*, 2nd ed. Butterworth-Heinemann, Oxford, UK. Probably the most comprehensive single volume on the chemistry of the elements.
- Hammond, G. S., and Kuck, V. J., Eds. (1992). *Fullerenes*. American Chemical Society, Washington, DC. This is ACS Symposium Series No. 481, and it presents a collection of symposium papers on fullerene chemistry.
- King, R. B. (1995). *Inorganic Chemistry of the Main Group Elements*. VCH Publishers, New York. An introduction to the descriptive chemistry of many elements.
- Kroto, H. W., Fisher, J. E., and Cox, D. E. (1993). *The Fullerenes*. Pergamon Press, New York. A reprint collection with articles on most phases of fullerene chemistry.
- Liebman, J. F., Greenberg, A., and Williams, R. E. (1988). *Advances in Boron and the Boranes*. VCH Publishers, New York. A collection of advanced topics on all phases of boron chemistry.
- Muetterties, E. F., Ed. (1967). *The Chemistry of Boron and Its Compounds*. Wiley, New York. A collection of chapters on different topics in boron chemistry.
- Muetterties, E. F., Ed. (1975). *Boron Hydride Chemistry*. Academic Press, New York. One of the early standard references on boron chemistry.
- Muetterties, E. F., and Knoth, W. H. (1968). *Polyhedral Boranes*. Marcel Dekker, New York. An excellent introduction to the chemistry of boranes.
- Niendenzu, K., and Dawson, J. W. (1965). *Boron-Nitrogen Compounds*. Academic Press, New York. An early introduction to boron-nitrogen compounds that contains a wealth of relevant information.
- Razumovskii, S. D., and Zaikov, G. E. (1984). *Ozone and Its Reactions with Organic Compounds*. Elsevier, New York. Volume 15 in a series, *Studies in Organic Chemistry*. A good source of information on the uses of ozone in organic chemistry.
- Zingaro, R. A., and Cooper, W. C., Eds. (1974). *Selenium*. Van Nostrand Reinhold, New York. An extensive treatment of selenium chemistry.

■ QUESTIONS AND PROBLEMS

- Although the O_3 molecule contains only oxygen atoms, would it be polar? Explain your answer.
- Write complete, balanced equations for the following processes:
 - The reaction of magnesium boride with water
 - The combustion of B_2H_6
 - The reaction of BCl_3 with C_2H_5OH
 - The preparation of borazine
 - The reaction of H_3BO_3 with CH_3COCl
- Explain why the electron affinity of the O_2 molecule is 0.451 eV while that of C_2 is 3.269 eV.
- Describe the bonding in the BO molecule.
- Would $FB(OH)_2$ be a stronger or weaker acid than boric acid? Explain your answer.
- On the basis of its structure, explain why boric acid is a weak acid that functions by complexing with OH^- . Draw the structure for the product.
- If BF_3 and $B(CH_3)_3$ were to react with the molecule

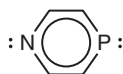

what would you expect the products to be? Why?

8. Pyridine cannot be used as the solvent when producing the adduct of ether with $\text{B}(\text{CH}_3)_3$, but when producing the pyridine adduct ether can be used as the solvent. Explain this difference.
9. Write equations to show the amphoteric behavior of Zn^{2+} in aqueous solutions.
10. Explain why a solution containing ferric chloride in water is acidic.
11. In this chapter, the reaction between O_2 and PtF_6 was described. Would you expect N_2 to react in a similar way? Why or why not?
12. The ionization potential for O_2 is 12.06 eV and that for O_3 is 12.3 eV. If you were trying to obtain the O_3^+ species, what strategy would you follow?
13. Determine the spectroscopic state for each of the following:
 - (a) B_2 ; (b) O_2^+ ; (c) C_2
14. Consider the BF_3 and BH_3 molecules even though the latter is not stable alone. One of these forms a stronger bond to $(\text{C}_2\text{H}_5)_2\text{S}$ and the other to $(\text{C}_2\text{H}_5)_2\text{O}$. Explain how the molecules would preferentially bond.
15. Draw structures for the following. List all symmetry elements and determine the point group for each species.
 - (a) ONF ; (b) NCN^{2-} ; (c) OCN^- ; (d) C_3O_2
16. Under certain conditions (such as in interstellar space), the OH radical has been observed. Construct the molecular orbital diagram for this species. Determine the bond order and determine what type of orbital contains the unpaired electron.
17. Construct a molecular orbital energy level diagram for the SO molecule and speculate on the nature of the bond and other characteristics of the molecule.
18. In BF_3 , the B–F bond length is 130 pm, but in BF_4^- it is approximately 145 pm. Explain this difference in the B–F bond lengths.
19. Would $(\text{C}_2\text{H}_5)_3\text{N}$ or $(\text{C}_2\text{H}_5)_3\text{P}$ react more energetically with BCl_3 if the reactants are dissolved in an inert solvent? Why?
20. Complete and balance the following.
 - (a) $\text{C}_2\text{H}_5\text{OH} + \text{CaH}_2 \rightarrow$
 - (b) $\text{Al} + \text{NaOH}$ (in water) \rightarrow
 - (c) $\text{SiCl}_4 + \text{LiAlH}_4 \rightarrow$
 - (d) $\text{BCl}_3 + \text{C}_2\text{H}_5\text{MgBr} \rightarrow$
 - (e) $\text{Fe}_2\text{O}_3 + \text{Al} \rightarrow$
21. Describe the major industrial use of oxygen, including equations if necessary.
22. The process of adding two electrons to an oxygen atom,

$$\text{O}(\text{g}) + 2 \text{e}^- \rightarrow \text{O}^{2-}(\text{g})$$
 absorbs 652 kJ mol⁻¹. Why are there so many ionic oxides?
23. Write balanced equations to show the difference between methanides and acetylides.
24. When CO bonds to BH_3 , how does it bond?
25. Explain why BF_3 is a weaker acid than BCl_3 .
26. Write balanced equations for each of the following processes:
 - (a) Preparation of $\text{B}_3\text{N}_3\text{H}_6$
 - (b) Preparation of $(\text{C}_2\text{H}_5)\text{BH}_2$
 - (c) Preparation of NaBH_4
 - (d) Combustion of diborane
 - (e) Preparation of $(\text{C}_6\text{H}_5)_3\text{B}$

27. Describe the process by which H_2O_2 is prepared.
28. Heating many solid carbonates leads to decomposition. What products are obtained? Suppose CaCS_3 were heated strongly. What would happen?
29. Consider a -1 ion that contains one atom each of C, S, and P. Draw the correct structure and explain why any other arrangements of atoms are unlikely.
30. Write complete, balanced equations to show the following processes:
- The reaction of BaO with SO_3
 - The preparation of calcium cyanamide
 - The oxidation of potassium cyanide with H_2O_2
 - The preparation of hydrogen selenide
31. The H_3^+ ion has a trigonal planar structure. Rationalize this structure in terms of electron density within the structure. If one, two, or three H_2 molecules add to the H_3^+ ion, where and how would they bond? Sketch these structures.

Chemistry of Nonmetallic Elements II.

Groups IVA and VA

As has been previously described, the chemistry of the first member of each group in the periodic table is quite different from that of the others. Having surveyed the chemistry of carbon in the previous chapter, we now address the chemistry of the other members of group IVA with emphasis on silicon and tin. The chemistry of nitrogen is extensive, so it is discussed separately before moving on to the chemistry of the remaining members of group VA, where the major emphasis is on the chemistry of phosphorus. The discussion of the group VIA elements (with emphasis on sulfur), the halogens, and the noble gases in Chapter 15 rounds out the survey of the chemistry of the nonmetals.

14.1 THE GROUP IVA ELEMENTS

Unlike silicon, which was discovered by Berzelius in 1824, and germanium, which was discovered in 1886 by Winkler, tin and lead have been used since ancient times. The Bronze Age spans the period from about 2500 BC to 1500 BC. Bronze is an alloy of copper and tin that was a prominent material used in that period preceding the Iron Age. One of the most important minerals containing tin is *cassiterite*, SnO_2 , which was reduced by heating it with carbon to obtain the metal. Producing metals in early times could be accomplished only by the simple techniques available at the time. Technology limited the temperatures that could be employed, and the available reducing agents limited which metals could be produced. In the case of tin and lead (which occurs as *galena*, PbS), reduction at relatively low temperature could be accomplished with charcoal.

Although silicon *compounds* have been used since the earliest times, the element was not obtainable until advances in technology came about. Minerals containing silicon include sand and silicates that are widely distributed (silicon constitutes approximately 23% of the earth's crust), and they have been used in making glass, pottery, and mortar for many centuries. In addition to these uses, silicon is now highly purified for use in integrated circuits (chips) and as an alloy known as *Duriron* that has many uses. Silicon has the diamond structure with a density of 2.3 g/cm^3 .

Although germanium was unknown, Mendeleev predicted the properties of the missing element (which he referred to as *ekasilicon*) based on the properties of other elements. While analyzing the mineral *argyrodite*, Winkler found that it contained about 7% of some element that had not been identified,

and that element turned out to be germanium. The element is obtained as a by-product in residues from the production of zinc. It is obtained by treating the residue with concentrated HCl, which converts germanium to GeCl_4 . Like most other covalent halides, this compound hydrolyzes.

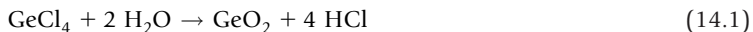

Reduction of the oxide is then accomplished with hydrogen.



Germanium is one of the materials that is used in producing semiconductors. When combined with phosphorus, arsenic, or antimony (which have five valence electrons), an *n*-type semiconductor results, and when combined with gallium (which has three valence electrons), the product is known as a *p*-type semiconductor.

Although tin is normally a soft, silvery metal, the form of metallic tin (m.p. 232 °C) depends on the temperature. *White* tin (density 7.28 g/cm³), which is the stable form above 13.2 °C, is metallic in appearance and properties. Below 13.2 °C, the stable form of tin is known as *gray* tin, and it crumbles to give a gray powder. The phase transition from white to gray form takes place slowly even at temperatures below 13.2 °C. The conversion of tin from the highly versatile white form to the powdery gray form is referred to as "tin disease" or "tin pest." A third form of tin is known as *brittle* tin (density 6.52 g/cm³), and it is produced when white tin is heated above 161 °C. As its name implies, this form shows nonmetallic character by fracturing when hammered.

Many of uses of tin are also those of lead, because the metals form useful alloys. When lead is alloyed with a few percent of tin, it becomes harder and more durable. Although other compositions are produced, common solder consists of about an equal mixture of tin and lead. An alloy known as *type metal* contains about 82% Pb, 15% Sb, and 3% Sn, and *pewter* contains approximately 90% tin that is alloyed with copper and antimony. *Babbitt*, an alloy used in making bearings, contains 90% Sn, 7% Sb, and 3% Cu. Tin is also used to coat other metal objects to retard corrosion, and a tin-niobium alloy is used in superconducting magnets.

Lead (m.p. 328 °C, density 11.4 g/cm³) has been used for thousands of years, and its chemical symbol is taken from its Latin name, *plumbum*. Some lead is found uncombined, but most is found as the sulfide, *galena*, from which it is obtained by roasting the ore to produce the oxide and then reducing the oxide with carbon.



The metal was used widely in ancient Rome as plumbing, roofing, and containers for food and water. Lead compounds have also been extensively used in pigments because of their bright colors. In some parts of the world, lead compounds are still used in paints and glazes for pottery. In most cases, titanium dioxide has replaced lead oxide as the white pigment in paints. Although it is no longer in use,

tetraethyllead was a fuel additive for many years. As much as 40% of the lead used today is recovered from scrap. Lead is used in automobile batteries in which the plates are made of an alloy containing about 88% to 93% Pb and 7% to 12% Sb.

14.1.1 Hydrides of the Group IVA Elements

Except for silicon, both the +2 and +4 oxidation states are rather common for the elements in group IVA. Compounds containing Sn^{2+} include the polymeric solids SnF_2 and SnCl_2 , and germanium +2 compounds include GeO , GeS , and GeI_2 . If the group IVA elements are represented as E, the important hydrides are covalent or volatile compounds that can be represented as EH_4 . The stability of the compounds decreases in descending order for the series of elements Si, Ge, Sn, and Pb (which, like PbH_2 , is unstable). The names of the EH_4 compounds are *silane*, *germane*, *stannane*, and *plumbane*. Higher hydrides such as Si_2H_6 are named as *disilane*, and so on.

As was discussed in Chapter 13, hydrogen does not react directly with some elements, so the hydrides must be prepared in a different way. Alfred Stock prepared silicon hydrides by first making the magnesium compound, then reacting it with water.

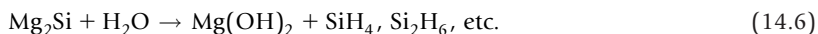

Other reactions that can be used to prepare silane include the following.

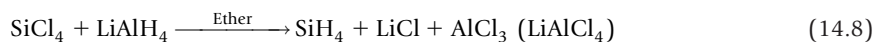

Silicon hydrides containing more than two silicon atoms are unstable and decompose to produce SiH_2 , Si_2H_6 , and H_2 . These compounds are spontaneously flammable in air.

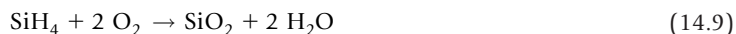

The heat of formation of SiO_2 is -828 kJ/mol , so the reactions are extremely exothermic. Silane and disilane do not react readily with water, but the reaction in basic solutions is



Germane is prepared from the oxide by reaction with LiAlH_4 ,

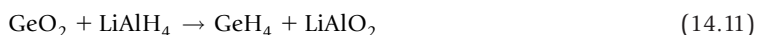

and stannane is obtained from the chloride in a similar reaction ,



14.1.2 Oxides of the Group IVA Elements

Although SiO (bond energy 765 kJ/mol) can be considered to be analogous to carbon monoxide (bond energy 1070 kJ/mol), it is not an important compound. It is formed when silicon reacts in a deficiency of oxygen or when SiO₂ is reduced with carbon.



Because the dioxide is so stable, the monoxide disproportionates.



In SiO₂, the main structural feature is the tetrahedral bonding of each silicon atom to four oxygen atoms.

The monoxides and dioxides of germanium, tin, and lead are all known. Especially when obtained as precipitates, the oxides contain water and consist of a mixture of the oxide, hydroxide, and hydrous oxide. For example, GeO, GeO·xH₂O, and Ge(OH)₂ (which could be written as GeO·H₂O) all exist in equilibria or in mixtures. GeO is obtained from the reaction



At high temperature, it disproportionates to produce the dioxide.

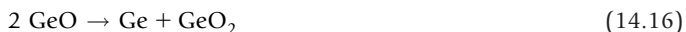

The hydrolysis of SnCl₂ produces Sn(OH)₂,



which can be dehydrated thermally to produce SnO:



The oxyanions of tin(IV), Sn₃²⁻ and SnO₄⁴⁻ (known as *stannates*), result from disproportionation of SnO in basic solutions.

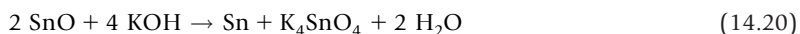

Litharge (red) and *massicot* (yellow) are pigments that are forms of PbO produced by reacting lead with oxygen.

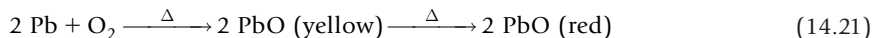

The +4 oxides of the group IVA elements are generally acidic (as is CO_2) or amphoteric in character. As shown here for CO_2 , acidic oxides form oxyanions,



and the +4 oxides of group IVA elements give rise to numerous silicates and stannates.

Polymorphism in SiO_2 leads to approximately 20 different forms of the compound. Among others, it occurs in *quartz*, *tridymite*, and *crystalite*, each of which exists in α and β forms. The structure for CO_2 ,

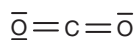

involves double bonds (806 kJ/mol), which are *more* than twice as strong as C–O single bonds (360 kJ/mol). In contrast, the Si=O bond (642 kJ/mol) is *not* as strong as *two* Si–O bonds ($2 \times 460 = 920$ kJ/mol) so it is energetically more favorable for Si to form four *single* bonds rather than two *double* bonds. This results in Si being attached by single bonds to O in SiO_4 tetrahedra that can be arranged in numerous ways to give several forms of SiO_2 , and numerous phase changes can be brought about by high temperature.

Common forms of SiO_2 include sand, flint, agate, and quartz. Although SiO_2 melts at 1710 °C, some of the O–Si–O bonds are broken at lower temperature, causing the material to soften and become a glass. When quartz is stressed, it produces an electric current by the *piezoelectric effect*. Applying a voltage across the crystal causes it to undergo vibrations with a frequency that resonates with the current frequency. This behavior of quartz is why it can be used in watches and crystals used in electronic devices. Quartz glass is obtained by fusing quartz and allowing it to cool. It is used in optical devices because it does not absorb electromagnetic radiation over a wide range of wavelengths.

There are several ways to prepare GeO_2 , some of which are as follows:

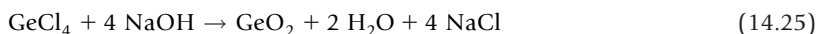
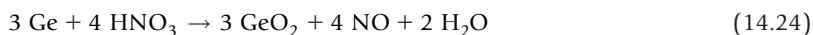
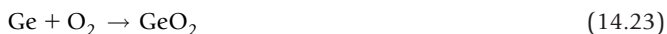

GeO_2 is a slightly acidic oxide that reacts with water to give acidic solutions.



The naturally occurring form of SnO_2 (*cassiterite*) has the rutile structure (see Chapter 7), and it is an amphoteric oxide as illustrated by the following equations:

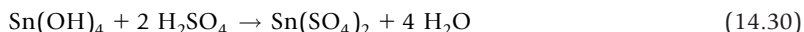
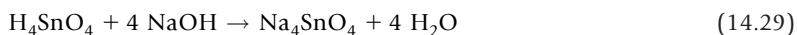
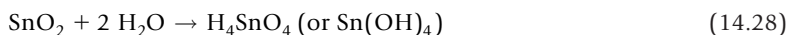

The oxyanions SnO_4^{4-} and SnO_3^{2-} are both considered to be *stannates* because they contain Sn(IV). In a way that is analogous to that used with the phosphorus oxyanions, the stannates are known as the *orthostannate* and *metastannate* ions.

Like SnO_2 , PbO_2 has the rutile structure, but unlike SnO_2 it is a strong oxidizing agent that can be produced by the reaction

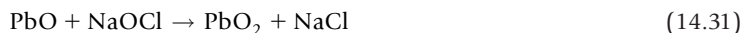

PbO_2 is the oxidizing agent and lead is the reducing agent in the lead storage battery. The chemistry of the battery can be summarized by the following equation:

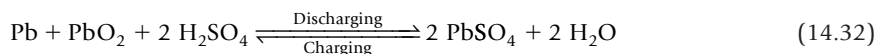

A cell in this type of battery has electrodes made of lead and spongy lead impregnated with PbO_2 . Sulfuric acid is the electrolyte, and the cell voltage is approximately 2.0V. Depending on the number of cells linked in series, the overall voltage can be 6 or 12 (the more common type of battery).

Another oxide of lead has the formula Pb_2O_3 (also sometimes written as $\text{PbO} \cdot \text{PbO}_2$). This compound is a lead *plumbate*, PbPbO_3 , which contains Pb(II) and Pb(IV). The lead oxide used in making lead crystal is Pb_3O_4 , and it is also used as a red pigment. This oxide, for which the formula can be written more correctly as $2\text{PbO} \cdot \text{PbO}_2$ or Pb_2PbO_4 , is obtained by heating PbO to 400°C in air.

14.1.3 Glass

It is believed that glass has been made for at least 5000 years. There is no way to tell exactly how the process of making glass was discovered, but was made by heating sand, sodium carbonate, and limestone. A typical composition of a common type of glass known as soda-lime is about 62.5% SiO_2 , 25% Na_2CO_3 , and 12.5% CaO . When cool, the glass is transparent and rigid, but it can be shaped by rolling, blowing, or molding when hot. This type of glass, sometimes referred to as flat glass, is used in windows and bottles. After an object is shaped, the hot glass is put into a furnace and cooled slowly to anneal the piece. If glass is cooled too slowly, a large fraction of the $-\text{Si}-\text{O}-\text{Si}-\text{O}-$ linkages reform, making the glass brittle. Flat sheets of glass are produced by placing the molten glass on the surface of molten tin in a large, shallow container. When the mass cools, sheets having flat surfaces are produced.

Glass contains silicon atoms surrounded by four oxygen atoms in a tetrahedral arrangement. These tetrahedra are joined by having oxygen atoms bonded to two Si atoms. Some of the linkages are broken when the glass is softened by heating it, and the linkages are reformed as the glass cools. *Borosilicate* glass, which does not break when subjected to rapid changes in temperature, is prepared by adding B_2O_3 to the mixture. *Lead crystal* and *flint glass* are very dense and highly refractive glasses that are prepared by replacing lime with PbO and Pb_3O_4 . Colored glasses are prepared by adding other materials

to the mixture. For example, CoO gives a blue glass, FeO imparts a green color, and CaF₂ produces an opaque white (milk) glass.

Because glass is a stable, versatile material that is produced from inexpensive ingredients, it is used in many ways. It can be shaped or made into sheets, it is durable, and specialty glasses can be made to have specific properties. Hardened or tempered glass is a versatile construction material, and as metals become more scarce and expensive, buildings are constructed of glass supported by a metal framework. It is not surprising that millions of tons of glass are produced each year.

14.1.4 Silicates

We have already mentioned the polymorphism that exists for SiO₂. The widespread distribution and unusual environmental conditions under which SiO₂ has interacted with other materials (particularly oxides) has resulted in there being a large number of naturally occurring silicates. The acidic nature of SiO₂ causes it to undergo reactions that can be represented as



Literature that presents information on minerals often shows the composition in terms of the constituent oxides. For example, *benitoite* is described as 36.3% BaO, 20.2% TiO₂, and 43.5% SiO₂. Therefore, many silicates can formally be regarded as combinations of oxides as shown in Table 14.1.

Because this book presents information on many areas of inorganic chemistry, a detailed discussion of silicates cannot be presented. Although silicate chemistry is a very complex field, there are some pervasive principles. It should first be mentioned that an oxide is easily converted to a hydroxide by reaction with water,



and that an oxide (a base) reacts with carbon dioxide (an acid) to produce a carbonate,



Furthermore, a carbonate will react with water to produce a bicarbonate,

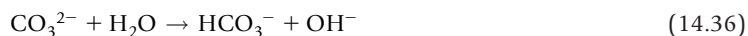
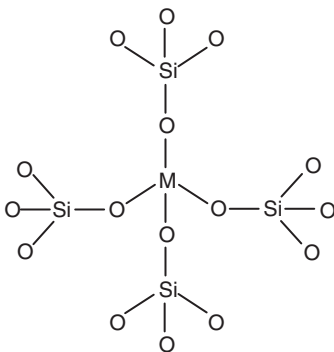

Table 14.1 Composition of Some Silicate Minerals.	
Oxides Combined	Mineral Equivalent
CaO + TiO ₂ + SiO ₂	CaTiSiO ₅ , <i>titanite</i>
½ K ₂ O + ½ Al ₂ O ₃ + 3 SiO ₂	KAlSi ₃ O ₈ , <i>orthoclase</i>
2 MgO + SiO ₂	Mg ₂ SiO ₄ , <i>forsterite</i>
BaO + TiO ₂ + 3 SiO ₂	BaTiSi ₃ O ₉ , <i>benitoite</i>

These processes can take place naturally, and they are involved in the process of changing one mineral into another (known as *weathering*).

The tetrahedral SiO_4^{4-} ion is known as the *orthosilicate* ion. It can be regarded as the fundamental unit in the structures of most complex silicates. Several minerals including *phenacite*, Be_2SiO_4 , and *willemite*, Zn_2SiO_4 , contain this ion. Both of these minerals have tetrahedral coordination of SiO_4^{4-} units around the metal ion:



Not all cases that involve the SiO_4^{4-} units have four of them surrounding the metal ion. In Mg_2SiO_4 and Fe_2SiO_4 (forms of *olivine*) the coordination number of the metals is 6, and *zircon*, ZrSiO_4 , has a structure in which the coordination number of Zr is 8.

Tetrahedral structures can be joined at a corner or along an edge. The number of tetrahedra and how they are joined determine the overall structure. An efficient way to represent silicate structures is illustrated in Figure 14.1, and the SiO_4^{4-} ion is shown as in Figure 14.1a. The structures are interpreted as if seen from above the tetrahedral unit, so the large open circle represents an oxygen atom projected upward out of the page. The filled circle represents a silicon atom directly below the oxygen atom, and each vertex in the triangle represents an oxygen atom in the base of the tetrahedron. The various silicate structures are then made up by sharing one or more corners or edges of the tetrahedra where oxygen atoms form bridges.

The structure formed by two tetrahedral units joined at a corner is known as the *pyrosilicate* or *disilicate* ion (see Figure 14.1b).

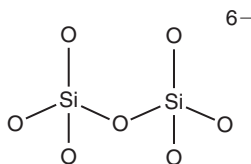

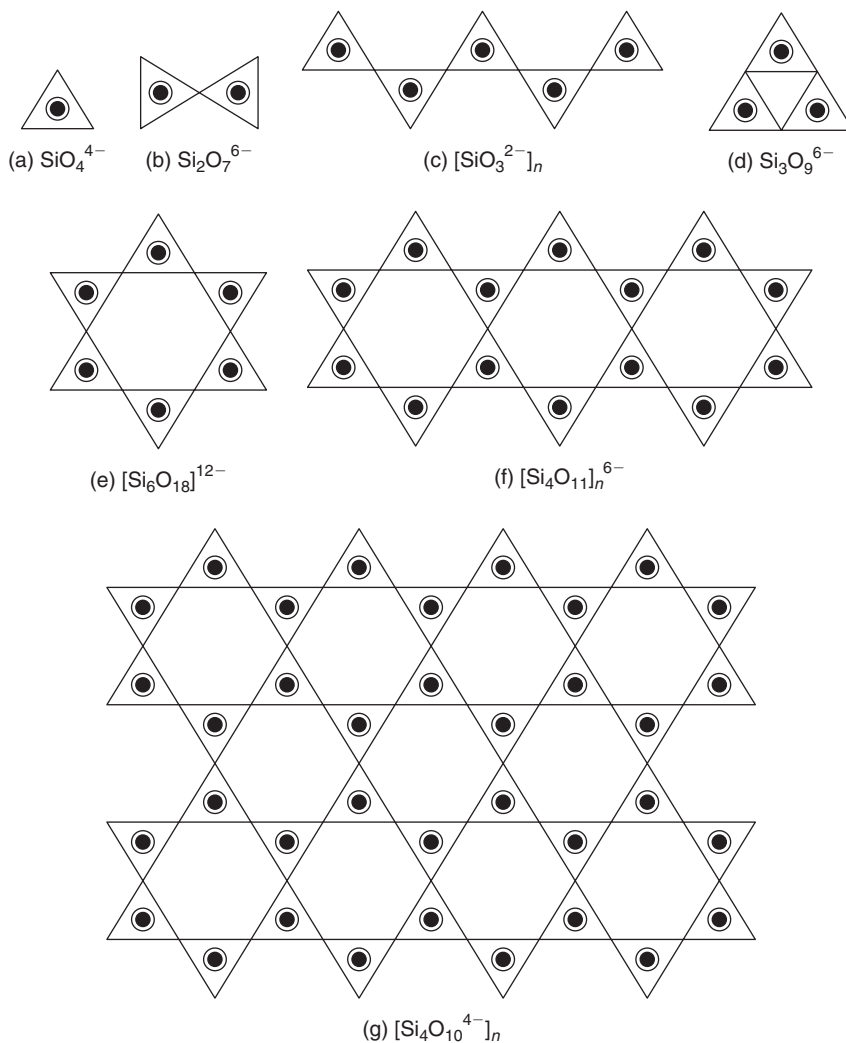

■ FIGURE 14.1 Representations of silicate structures.

It should be noted that this ion, which occurs in the minerals *thortveitite*, $\text{Sc}_2\text{Si}_2\text{O}_7$, and *hemimorphite*, $\text{Zn}_4(\text{OH})_2\text{Si}_2\text{O}_7$, is isoelectronic with $\text{P}_2\text{O}_7^{4-}$, $\text{S}_2\text{O}_7^{2-}$, and Cl_2O_7 . Except for the fact that the SiO_4 unit has a -4 charge whereas the PO_4 unit has a -3 charge, there is a great deal of similarity between the “polyphosphates” and the “polysilicates.” If three SiO_3^{2-} (metasilicate) ions are linked in a ring, the

cyclic $\text{Si}_3\text{O}_9^{6-}$ ion is formed, in which each Si is surrounded by four oxygen atoms forming a tetrahedron (see Figure 14.1d).

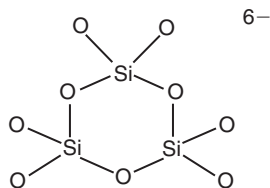

This structure is analogous to that of $\text{P}_3\text{O}_9^{3-}$ and S_3O_9 (a trimer of SO_3), and it occurs in the mineral *benitoite*, $\text{BaTiSi}_3\text{O}_9$. When six SiO_3^{2-} ions are linked in a 12-membered ring containing alternating Si and O atoms, the result is the $\text{Si}_6\text{O}_{18}^{12-}$ ion that occurs in *beryl*, $\text{Be}_3\text{Al}_2\text{Si}_6\text{O}_{18}$ (see Figure 14.1e).

Pyroxenes are structures that consist of long chains in which the repeating unit is SiO_3^{2-} . The general structure for these materials is as shown: (see Figure 14.1c)

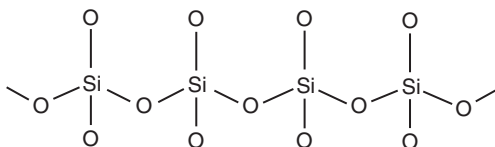

The cations located between the chains hold them together. Some pyroxenes are *diopside* ($\text{CaMgSi}_2\text{O}_6$), *hedenbergite* ($\text{Ca}(\text{Fe},\text{Mg})\text{Si}_2\text{O}_6$), and *spodumene* ($\text{LiAlSi}_2\text{O}_6$).

A different type of chain structure is present in the *amphiboles* (see Figure 14.1f). Metal ions located between the chains bond them together, but half of the silicon atoms share *two* oxygen atoms and the other half share *three* oxygen atoms. *Tremolite*, $\text{Ca}_2\text{Mg}_5\text{Si}_8\text{O}_{22}(\text{OH})_2$, and *hornblende*, $\text{CaNa}(\text{Mg},\text{Fe})_4(\text{Al},\text{Fe},\text{Ti})_2\text{Si}_6(\text{O},\text{OH})_2$, are examples of amphiboles. When the chains are bound together by sharing three oxygen atoms, a sheet structure known as a *mica* is produced (see Figure 14.1g). *Muscovite*, $\text{KAl}_3\text{Si}_3\text{O}_{10}(\text{OH})_2$, and *biotite*, $\text{K}(\text{Mg},\text{Fe})_3\text{AlSi}_3\text{O}_{10}(\text{OH})_2$, have this type of structure. In formulas such as those just shown, there can be substitution of one metal ion for another. For example, if a formula would require two Mg^{2+} ions, it is possible that some of the lattice sites could be occupied by Fe^{2+} ions. This is indicated by showing (Mg,Fe) in the formula, indicating that there are two metal ions, but they may be either Mg^{2+} or Fe^{2+} , so the composition is variable. In a similar way, a +3 ion such as Al^{3+} may be replaced by a +2 and a +1 ion (such as Mg^{2+} and Na^+) so a formula could appear as $\text{Al}[\text{X}]$ or $(\text{Mg},\text{K})[\text{X}]$ and electrical neutrality still be satisfied.

The aluminosilicates are a class of silicates in which some of the Si^{4+} ions have been replaced by Al^{3+} ions. One important mineral of this type is *kaolin*, $\text{Al}_2\text{Si}_2\text{O}_5(\text{OH})_4$ (which is described as 39.5% Al_2O_3 , 46.5% SiO_2 , and 14.0% H_2O). Kaolin is a very useful material for making ceramics and as clay in making china. *Orthoclase*, KAlSi_3O_8 , is also used in making ceramics and some types of glass. *Leucite*, KAlSi_2O_6 , has been used as a source of potassium in fertilizer.

14.1.5 Zeolites

Hydrous minerals known as *zeolites* (a word which comes from the Greek *zeo* meaning “to boil” and *lithos* meaning “rock”) are secondary minerals that form in igneous rocks. Zeolites are aluminosilicates that have anions that are porous as a result of channels through them. Although approximately 30 naturally occurring zeolites have been found, several times that number have been prepared. The general formula for a zeolite is $M_{a/z}[(AlO_2)_a(SiO_2)_b] \cdot xH_2O$, where M is a cation having a charge $+z$. Because H_2O and SiO_2 are neutral, the charges on the AlO_2^- ions must be balanced by the charge on M. When M has a $+1$ charge, the number of AlO_2^- and M^+ ions will be equal. When M has a $+2$ charge, there will be twice as many AlO_2^- ions as M^{2+} . The ratio $a/z:a$ gives the number of M ions to the number of AlO_2^- ions. Some of the most common naturally occurring zeolites are the following:

Analcime	$NaAlSi_2O_6 \cdot H_2O$
Edingtonite	$BaAl_2Si_3O_{10} \cdot 4H_2O$
Cordierite	$(Mg,Fe)_2Mg_2Al_4Si_5O_{18}$
Stilbite	$(Ca,Na)_3Al_5(Al,Si)Si_{14}O_{40} \cdot 15H_2O$
Chabazite	$(Ca,Na,K)_7Al_{12}(Al,Si)_2Si_{26}O_{80} \cdot 40H_2O$
Sodalite	$Na_2Al_2Si_3O_{10} \cdot 2H_2O$

Some zeolites have the ability to exchange sodium for calcium and thereby function as water softeners by removing Ca^{2+} . After the zeolite has become saturated with Ca^{2+} , it can be renewed by washing it in a concentrated NaCl solution to restore the Na^+ ions. Zeolites are also used to prepare ion exchange resins, as molecular sieves and as catalysts.

As are other silicates, zeolites are made up of tetrahedra that are SiO_4 or AlO_4 units. Because of the difference in charges on Si and Al, the presence of Al^{3+} necessitates a $+1$ cation as well. The $Si_6O_{18}^{12-}$ ion is a basic unit in many zeolites. The six Si (and/or Al) ions define a hexagon and these hexagons can be combined to give a structure like that shown in Figure 14.2a. This unit is known as the *sodalite* structure, which is also called a β -cage. Eight sodalite units can be joined to give a cubic structure like that shown in Figure 14.2b. In this structure, the sodalite units are joined by faces that have four members in the ring. This type of structure contains channels that allow it to function as a molecular sieve. In a closely related structure, shown in Figure 14.2c, the eight sodalite units are joined by bridging oxygen atoms to give a structure known as *zeolite-A*. This structure contains equal numbers of Al^{3+} and Si^{4+} ions, so the formula can be written as $Na_{12}(AlO_2)_{12}(SiO_2)_{12} \cdot 27H_2O$, which can also be written as $Na_{12}Al_{12}Si_{12}O_{48} \cdot 27H_2O$.

Some zeolites are useful catalysts as a result of their having very large surface area and some sites where oxygen atoms have been converted to $-OH$ groups. These sites are potential proton donors, so they are referred to as *Brønsted sites*. Certain zeolites are particularly effective catalysts for cracking hydrocarbons. The chemistry of silicates truly ranges from mineralogy to organic reactions.

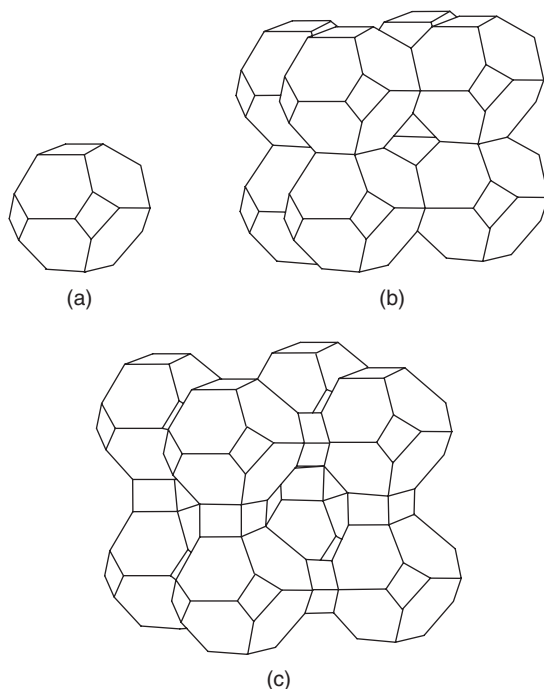

■ FIGURE 14.2 The structure of zeolites derived from the sodalite structure shown in (a).

14.1.6 Halides of the Group IVA Elements

Each of the elements in group IVA forms dihalides and tetrahalides. There are also a few silicon compounds of the type E_2X_6 as a result of silicon having a greater tendency for catenation. The halogen compounds of the +2 elements have greater ionic character to the bonds and thus have higher melting and boiling points than the halides containing the +4 elements. Table 14.2 presents a summary of melting points and boiling points for these compounds.

In the gas phase, the dihalides have an angular structure, but in the solid state, most have complex structures held together by bridging halogen atoms. The gaseous EX_4 molecules are tetrahedral, non-polar, and more soluble in organic solvents than the EX_2 compounds.

The EX_4 halides are Lewis acids that form complexes with halide ions,

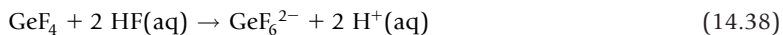
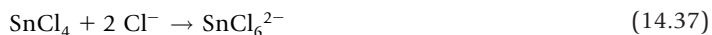

although this tendency is much lower for the +2 halides, which are less acidic. Dihalides of silicon and germanium are polymeric solids that contain halide bridges. Tin and lead have more ionic character,

Table 14.2 Melting and Boiling Points for Group IV Halides.

Compound		EX ₂		EX ₄	
		m.p. (°C)	b.p. (°C)	m.p. (°C)	b.p. (°C)
Si	X = F	dec	—	−90.2	−86 subl
	X = Cl	dec	—	−68.8	57.6
	X = Br	—	—	5.4	153
	X = I	—	—	120.5	287.5
Ge	X = F	111	dec	−37 subl	—
	X = Cl	dec	—	−49.5	84
	X = Br	122 dec	—	−26.1	186.5
	X = I	dec	—	144	440 dec
Sn	X = F	704 subl	—	705	—
	X = Cl	246.8	652	−33	114.1
	X = Br	215.5	620	31	202
	X = I	320	717	144	364.5
Pb	X = F	855	1290	—	—
	X = Cl	501	950	−15	105 expl
	X = Br	373	916	—	—
	X = I	402	872	—	—

although they also exist in extended structures. Dihalides of silicon are unstable with respect to disproportionation.



The dihalides of tin have a chain structure that can be shown as

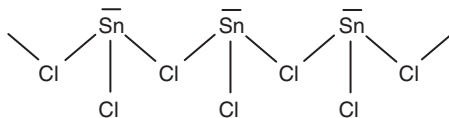

The Sn atoms in SnX₂ molecules have only three pairs of electrons that surround them, so they behave as Lewis acids and react with halide ions to give complexes.



These complexes have pyramidal structures that can be shown as

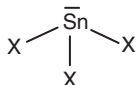

Large cations give a favorable match of cation and anion characteristics, so in accord with the hard-soft interaction principle, the salts that have been isolated contain ions such as R_4P^+ . Because of having an unshared pair of electrons, the SnX_3^- complexes can function as Lewis bases.



Although direct combination of the elements is feasible, germanium dihalides are usually prepared by the reaction



Germanium dibromide can be prepared in the following ways:

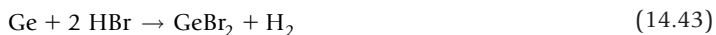

It is an unstable compound with respect to disproportionation, which occurs when it is heated.



The dihalides of tin and lead behave as ionic metal compounds, and they will not be discussed further.

There is a vast difference in the behavior of the tetrahalides of the group IVA elements. Although the silicon compounds are stable, lead +4 is a strong oxidizing agent that oxidizes Br^- and I^- , with the result that PbBr_4 and PbI_4 are extremely unstable. PbCl_4 is not a stable compound, and it explodes when heated. Silicon reacts with the halogens to give the tetrahalides. The tetrafluoride will react with fluoride ions to give complexes,



but the chloride, bromide, and iodide do not behave in this way, probably because of repulsion of the large anions around the silicon. The heavier elements in group IVA form hexahalo complexes. The tetrahalides are Lewis acids that form complexes with many electron pair donors.

The reaction of germanium with bromine at elevated temperatures produces the tetrabromide.



Hydrolysis of the group IVA tetrahalides produces oxides, hydroxides, or hydrous oxides or a mixture of these products, (EO_2 , $\text{E}(\text{OH})_4$, and $\text{EO}_2 \cdot 2\text{H}_2\text{O}$). The following are typical reactions:



In the case of silicon, the tendency for catenation allows halides having the formula Si_2X_6 to be prepared. The chloride can be prepared by the reaction



14.1.7 Organic Compounds

There is an extensive organic chemistry of the elements in group IVA, and entire volumes have been devoted to the subject. In the survey presented here, only some of the more common types of structures and reactions can be shown. In general, the reactions shown are meant to illustrate *types* of behavior that are exhibited by other organic compounds and other elements in the group.

One of the most common types of reactions carried out to prepare organic derivatives of the group IVA elements is that of transferring an alkyl group by means of a Grignard reagent. Alkylation of SnCl_4 can be illustrated as follows:



By using the appropriate ratio of Grignard reagent, the stepwise alkylation can continue until the product is R_4Sn . Alkylation can also be accomplished by using a lithium alkyl.

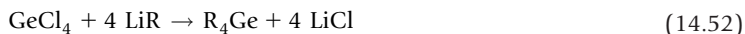

The reaction of a halogen with a tetraalkyl tin gives mixed alkyl halides.



Sulfuryl chloride is a good chlorinating agent that reacts with R_4Sn in the following way:

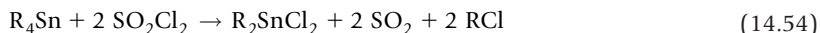

Scrambling reactions occur between R_4Sn and SnX_4 to give mixed alkyl halides.



As it does in many organic reactions, sodium produces a coupling reaction with R_3SnX that can be shown as

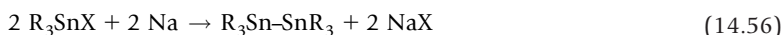

At high temperature, silicon reacts with HCl to produce a useful intermediate, HSiCl_3 .



Both HSiCl_3 and HGeCl_3 will add across double bonds in a process known as the *Speier reaction*. This reaction can be shown as follows:



Derivatives that are not fully alkylated undergo hydrolysis and react with numerous organic compounds. These products are extremely useful for carrying out the synthesis of a large number of derivatives. The following reactions illustrate this type of chemistry:

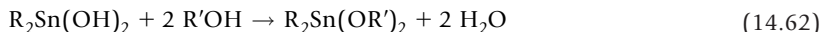
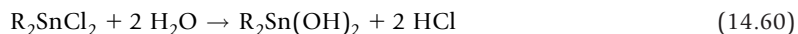

Tin alkyl hydrides can be prepared from the halides by the reaction with lithium aluminum hydride.



By employing sequences of reactions of these types, the organic chemistry of the group IVA elements has become a vast area at the interface of inorganic and organic chemistry.

One additional aspect of the chemistry of tin should be mentioned. That aspect concerns the preparation of unusual tin compounds that contain rings in which there are Sn–Sn bonds. These interesting compounds include $(\text{R}_2\text{Sn})_3$, in which there is a three-membered ring and which is prepared by the reaction

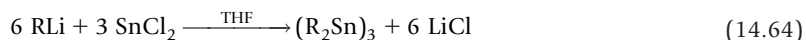

This area of tin chemistry has expanded greatly as many new compounds have been synthesized and characterized. One of the most unusual compounds of this type is Sn_6H_{10} , which has the structure

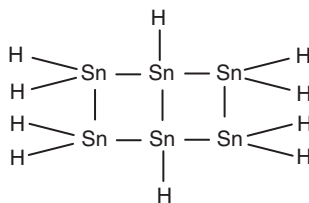

Even though the organic chemistry of lead has not been mentioned, it has been commercially important over the years. Although tetraethyllead is no longer used as a fuel additive, that use amounted to approximately 250,000 tons/year at one time.

The organic chemistry of lead will not be described in detail, but the following reactions can be used to prepare organic compounds of lead:

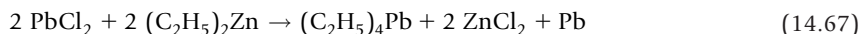
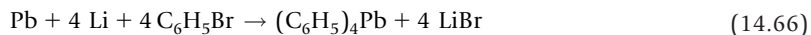
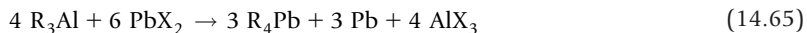

As in the case with the other members of group IVA, the mixed alkyl and aryl halides of lead are also known, and their reactions with water, alcohols, amines, and other organic compounds can be used to prepare a large number of other derivatives.

14.1.8 Miscellaneous Compounds

In addition to the types of compounds discussed so far, the group IVA elements also form several other interesting compounds. Silicon has enough nonmetallic character that it reacts with many metals to form binary *silicides*. Some of these compounds can be considered as alloys of silicon and the metal that result in formulas such as Mo_3Si and TiSi_2 . The presence of Si_2^{2-} ions is indicated by a Si-Si distance that is virtually identical to that found in the element, which has the diamond structure. Calcium carbide contains the C_2^{2-} , so it is an acetylide that is analogous to the silicon compounds.

Silicon carbide, SiC or *carborundum*, has the diamond structure, and it is widely used as an abrasive in grinding wheels. These are made by crushing the SiC , adding clay, then heating the material in molds. Silicon carbide is prepared by the reaction



Heating silicon and nitrogen in an electric furnace produces a silicon nitride, Si_3N_4 .



Germanium nitride, Ge_3N_2 , is produced from the imine GeNH that forms when germanium iodide reacts with ammonia.

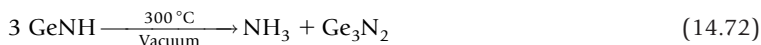
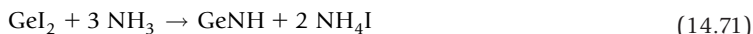

Lead is found as the sulfide, but the other members of the group also form compounds with sulfur. Although PbS has the sodium chloride crystal structure, a silicon sulfide having the formula SiS_2 is known that has a chain structure:

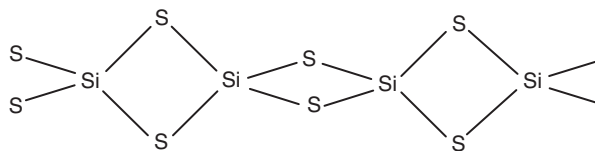

Two sulfides of germanium are known, and they are prepared by the reactions



The formation of stannates can be accomplished by first preparing hydroxo complexes in basic solution in a reaction that can be shown as follows:



The $\text{Sn}(\text{OH})_3^-$ ion is sufficiently stable to permit forming solids containing the ion. In the +4 state, $\text{Sn}(\text{OH})_6^{2-}$ results, and a solid compound containing this ion loses water to yield the stannate.



Silicon reacts with alkyl halides at high temperature to yield dialkyl dichlorosilanes.

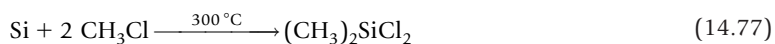

The Si-Cl bonds will react in ways that are typical of covalent bonds between halogens and nonmetals. One such reaction is

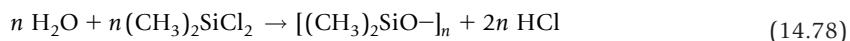

If $n = 3$, the product is a cyclic trimer that has the structure

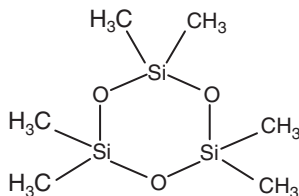

When the reaction shown in Eq. (14.78) is carried out in dilute sulfuric acid, linear polymers having oxygen bridges are produced that have the structure

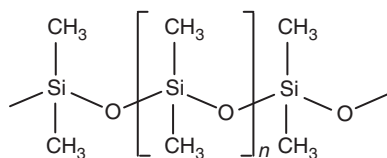

When there is oxygen bridging between chains, the polymers are known as *silicones*, and they are synthetic oils that have many uses.

14.2 NITROGEN

Nitrogen was discovered in 1772, and it is such a versatile element that entire volumes have been devoted to its chemistry. It comprises 78% of the atmosphere, but it also occurs in many other naturally occurring materials including nitrates and amino acids.

14.2.1 Elemental Nitrogen

Elemental nitrogen occurs as a very stable diatomic molecule. Only two naturally occurring isotopes are found, ^{14}N (99.635%) and ^{15}N . The occurrence mainly as ^{14}N is somewhat unusual in view of the fact that so few odd-odd nuclei are stable. Nitrogen molecules are small, having a bond length of only 110 pm (1.10\AA) owing to the strong triple bond holding the atoms together (945 kJ/mol). This very strong and stable bond (the force constant is $22.4\text{ mdyn \AA}^{-1}$) is partially responsible for the explosive nature of some nitrogen compounds. The molecular orbital diagram for N_2 , shown in Figure 14.3, indicates that the bond order is 3 in this extremely stable molecule.

The fact that the atmosphere contains 78% of elemental nitrogen suggests that the element is not very reactive. This may be surprising given the fact that nitrogen is a nonmetal having an electronegativity of 3.0, but as mentioned earlier, the strong $\text{N}\equiv\text{N}$ bond implies that there are no low-energy pathways for most reactions of the element.

Air can be liquefied, and liquid nitrogen boils at $-195.8\text{ }^\circ\text{C}$, but liquid oxygen boils at $-183\text{ }^\circ\text{C}$, so nitrogen can be vaporized first. One laboratory preparation of nitrogen is the decomposition of sodium azide, NaN_3 .



Nitrogen can also be obtained by the *careful* decomposition of ammonium *nitrite*,



If phosphorus is burned in a closed container, it combines with oxygen, leaving impure nitrogen. The oxygen can also be removed from air using pyrogallol to leave nitrogen.

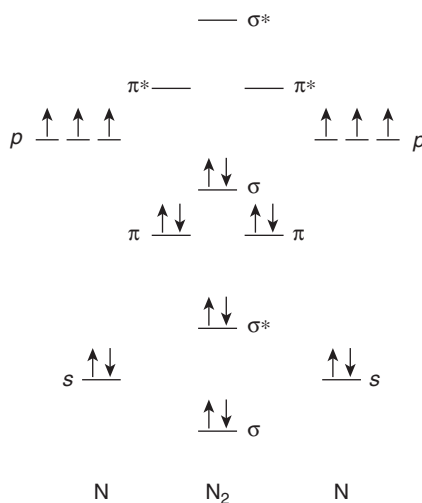

■ **FIGURE 14.3** The molecular orbital diagram for the N_2 molecule.

14.2.2 Nitrides

At high temperature, metals will react in an atmosphere of nitrogen to produce metal nitrides. An example of this behavior is



Depending on the metallic element, the nitrides may be designated as ionic, covalent, or interstitial, as is the case with hydrides, carbides, and borides. Boron nitrides are known that have the diamond or graphite structure (these materials were discussed in Chapter 13). Binary compounds containing nitrogen and most other elements are known, but because N_2 is not very reactive, most are not prepared by combination of the elements. If the difference between the electronegativity of nitrogen and that of the other element is about 1.6 or greater, the compounds will be essentially ionic in nature, and they can be prepared by direct combination of the elements as shown earlier.

The decomposition of hydroxides produces oxides, and in an analogous way heating amides results in the production of nitrides as illustrated by the equation



Compounds containing the N^{3-} ion are exceedingly strong bases and react with almost any proton donor to produce NH_3 . For example,

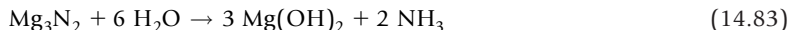

The “nitrides” of most nonmetals exist. By calling the compounds nitrides, it is indicated that the other element has an electronegativity that is lower than that of nitrogen. Therefore, NO_2 , NF_3 , N_2F_2 , and the like would not be considered “nitrides” because the other element is the more electronegative. This leaves quite a number of compounds such as HN_3 , S_4N_4 , $(\text{CN})_2$, that are covalent nitrides. Chemically, these compounds are quite different, and as will be shown later, methods for synthesizing them vary enormously.

The compounds formed by transition metals and nitrogen result when the metal is heated with N_2 or NH_3 at high temperature. Nitrogen atoms occupy interstitial position in the metals, so the “compounds” frequently deviate from exact stoichiometry. Rather, the composition depends on the temperature and pressure used in the reaction. As in the case of interstitial hydrides, placing nitrogen atoms in interstitial positions gives predictable changes in the properties of the metal. For example, the materials are hard, brittle, high-melting, metallic-appearing solids. Some metal nitrides of this type are important in making cutting tools and drills.

14.2.3 Ammonia and Aquo Compounds

There are many similarities between ammonia and water (see Chapter 10). Both can function as either a proton acceptor or a proton donor. Substituting alkyl groups for one or more of the hydrogen atoms leads to a large number of organic compounds containing $-\text{OH}$ and $-\text{NH}_2$ groups. Many of the derivatives of ammonia and water are shown in Table 14.3.

Table 14.3 The Ammono and Aquo Series of Compounds.

Ammono species	Aquo species
NH_4^+	H_3O^+
NH_3	H_2O
NH_2^-	OH^-
NH^{2-}	O^{2-}
N^{3-}	—
$\text{H}_2\text{N—NH}_2$	HOOH
RNH_2	ROH
RNHR	ROR
R_3N	—
HN=NH	—
NH_2OH	—

14.2.4 Hydrogen Compounds

Ammonia is produced in huge quantities, and it is by far the most common and important compound of nitrogen and hydrogen. Approximately 30 billion pounds of NH_3 are used annually with a large portion being used as fertilizer or in the production of nitric acid. Ammonia is produced by the *Haber process*, which can be shown as

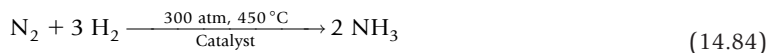

Although the reaction proceeds faster at high temperature, NH_3 has a heat of formation of -46 kJ/mol so it becomes less stable. The decomposition of organic compounds that contain nitrogen during the heating of coal to produce coke also produces ammonia. For the preparation of small amounts of ammonia, a convenient reaction involves heating an ammonium salt with a strong base.

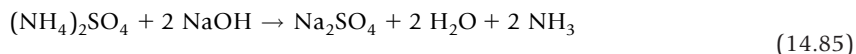

As shown in the previous chapter, hydrides of several nonmetals can be obtained by adding water to a binary metal compound of the nonmetal. For producing ammonia, Na_3N is an appropriate starting compound because it reacts with water:

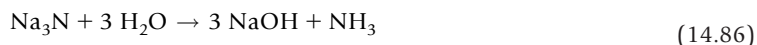

Ammonia is a colorless gas (m.p. -77.8°C and b.p. -33.35°C) with a characteristic odor. As a result of the polarity of the N–H bonds, there is extensive hydrogen bonding in the liquid and solid states.

Although it is often convenient to use the formula NH_4OH , it does not represent a stable molecule. Ammonia is extremely soluble in water, but it ionizes only slightly ($K_b = 1.8 \times 10^{-5}$),



Ammonia can also function as a proton donor toward extremely strong Brønsted bases such as the oxide ion.



There is an extensive chemistry associated with the use of liquid ammonia as a nonaqueous solvent (see Chapter 10). Because it has a dielectric constant of 22 and a dipole moment of 1.46 D, ammonia dissolves many ionic and polar substances. However, reactions are frequently different than in water as a result of differences in solubility. For example, in water the following reaction takes place because of the insolubility of AgCl:

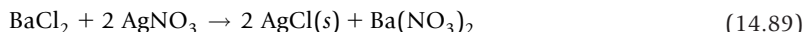

In liquid ammonia, AgCl is soluble, and the reaction

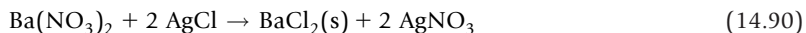

takes place because of the insolubility of BaCl_2 .

One difference between water and liquid ammonia involves the reactivity of group IA metals. For example, potassium reacts very vigorously with water,



but the analogous reaction with ammonia,



takes place very slowly. Because the amide ion is a stronger base than OH^- , some reactions requiring a strongly basic solution take place better in liquid ammonia than in water (see Chapter 10).

Ammonium salts are important and useful compounds. Many have structures that are identical to those of the corresponding potassium or rubidium compounds because the ions are of similar size: $\text{K}^+ = 133 \text{ pm}$, $\text{Rb}^+ = 148 \text{ pm}$, and $\text{NH}_4^+ = 148 \text{ pm}$. Ammonium nitrate is widely used as a fertilizer, and it contains both an oxidizing agent (NO_3^-) and a reducing agent (NH_4^+), so it is also a powerful explosive. Careful heating at temperatures below about 200°C leads to decomposition, giving N_2O .

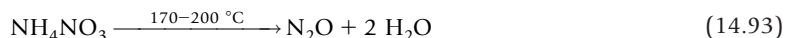

Ammonia is also the starting material for the production of nitric acid, and the first step is oxidation of ammonia by the *Ostwald process*.

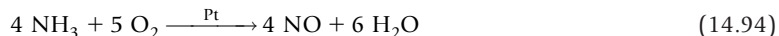

Hydrazine has the structure $\text{H}_2\text{N}-\text{NH}_2$, and it is the nitrogen analog of hydrogen peroxide, $\text{HO}-\text{OH}$. Although hydrazine is unstable (the heat of formation is $+50 \text{ kJ/mol}$), it reacts as a weak diprotic base

having $K_{b1} = 8.5 \times 10^{-7}$ and $K_{b2} = 8.9 \times 10^{-16}$. Hydrazine is easily oxidized and reacts vigorously with strong oxidizing agents. For example,



Hydrazine, methylhydrazine, and unsymmetrical dimethylhydrazine, $(\text{CH}_3)_2\text{N}-\text{NH}_2$, have been used as rocket fuels that are oxidized by liquid N_2O_4 . The structure of the hydrazine molecule ($\mu = 1.75 \text{ D}$) can be shown as

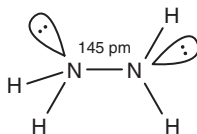

The N_2H_5^+ cation has a shorter N–N bond length because attaching H^+ to one of the unshared pairs of electrons reduces the repulsion between it and the other unshared pair.

Hydrazine is prepared by the *Raschig process*, the first step of which involves the production of chloramine, NH_2Cl . The process can be summarized by the equations



However, another reaction competes in the process:

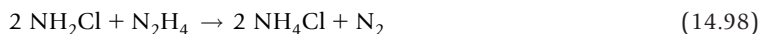

This reaction is catalyzed by traces of metal ions, and gelatin is added to minimize the effect. Hydrazine is sometimes used as the reducing agent for silver in making mirrors.

Another compound of nitrogen and hydrogen is diimine, N_2H_2 , which has the structure $\text{HN}=\text{NH}$. The compound decomposes to give N_2 and H_2 , but it is believed to be a transient species in some reactions. The reactions that lead to formation of diimine can be summarized as follows:



Hydrogen azide (or *hydrazoic acid*), HN_3 , is a volatile compound (m.p. -80°C , b.p. 37°C), and it is a weak acid having $K_a = 1.8 \times 10^{-5}$. It is dangerously explosive (it is 98% nitrogen!), and it is also highly toxic. In general, covalent azides or those that are substantially covalent are also explosive. Azides such as $\text{Pb}(\text{N}_3)_2$ and AgN_3 are also sensitive to shock, so they have been used as primary explosives (detonators). In contrast, *ionic* azides are stable and decompose only slowly upon heating.



The difference in stability of ionic and covalent azides is sometimes explained in terms of resonance structures. The azide ion, N_3^- , can be represented by the three resonance structures

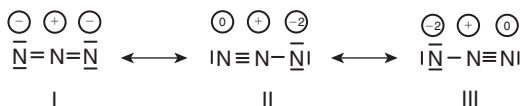

Structure I is the most important of the three. A covalent azide such as HN_3 (dipole moment = 1.70 D) can be represented by the resonance structures

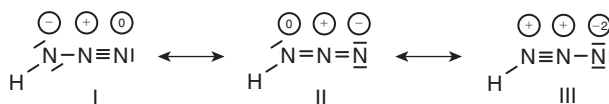

Structure III makes virtually no contribution because of the positive formal charges on adjacent atoms and the overall higher formal charges. In HN_3 , the bond lengths are

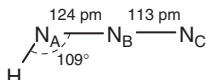

Bonds between nitrogen atoms have lengths that are normally as follows: N–N, 145 pm; N=N, 125 pm; N≡N, 110 pm. Because structure I for HN_3 shows a single bond between N_A and N_B and structure II shows a double bond between these atoms, the observed bond length should be somewhere between the values expected for those bonds (125 and 145 pm). However, it is almost the same as that for a double bond, indicating that structures I and II do not contribute equally, and that structure II is the more significant. Because the dipole moment of HN_3 is 1.70 D and the H–N bond moment is only about 1.33 D, it appears that structure II, which places a negative formal charge on N_C , is dominant. Therefore, it appears that only one resonance structure makes a significant contribution to the actual structure of HN_3 , whereas in N_3^- three resonance structures contribute to the true structure. It is generally true that the greater the number of contributing resonance structures, the more stable the species (the lower the energy of the species), and ionic azides are much more stable than covalent azides. This analysis is overly simplistic because the distance between N_B and N_C is close to that expected for a triple bond as shown in structure I.

A few azides are useful, and sodium azide can be prepared by the following reactions:

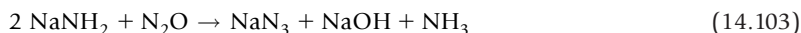
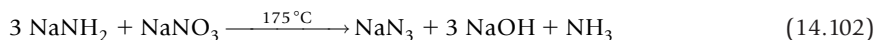

An aqueous solution containing hydrazoic acid results when a solution of nitrous acid reacts with a hydrazinium salt.

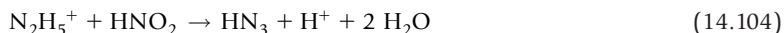

There is an extensive chemistry associated with coordination compounds containing azide ions as a ligands. Like CN^- , the azide ion is a pseudohalide ion, which means that it forms an insoluble silver salt, exists as the acid H-X , X-X is volatile, and it can combine with other pseudohalogens to give $\text{X-X}'$. Although other pseudohalogens such as $(\text{CN})_2$ result from the oxidation of the CN^- ion,



the diazide N_3-N_3 is unknown. Because of the extreme stability of the N_2 molecule, the $(\text{N}_3)_2$ allotrope of nitrogen would not be expected to be stable. However, some halogen azides are known. Among them is chlorazide (ClN_3), which is a toxic, explosive compound obtained by the reaction of OCl^- and N_3^- .

14.2.5 Nitrogen Halides

Nitrogen halides having the general formula NX_3 are known, but unlike the case of phosphorus the pentavalent compounds NX_5 , are not stable. Some mixed halides such as NF_2Cl have been studied. Nitrogen also forms N_2F_4 and N_2F_2 (which will be discussed later) that are fluorine analogs of hydrazine and diimine, respectively. Except for NF_3 (b.p. -129°C), the compounds are explosive and are little used.

The heat of formation of NF_3 is -109 kJ/mol . It is a stable compound that does not hydrolyze as do most other covalent halides of nonmetals including nitrogen trichloride.



In this reaction, the trichloride compound behaves as though nitrogen is in the negative oxidation state. It could be argued that with an electronegativity difference of about 1.0 units, NF_3 is not typical of covalent halides. Nitrogen and chlorine have almost the same electronegativity, and NCl_3 reacts as if it were covalent. It has a heat of formation of $+232 \text{ kJ/mol}$ and is a violent explosive.

Nitrogen trifluoride is a compound that has interesting chemical properties. Because of the considerable stability of the HF_2^- ion, ammonium fluoride reacts with HF to produce $\text{NH}_4\text{F}\cdot\text{HF}$, which is an ionic compound, $\text{NH}_4^+\text{HF}_2^-$. When this compound is electrolyzed in the molten state, NF_3 is produced, although fluorine reacts with nitrogen to produce several products that include NF_3 , N_2F_4 , N_2F_2 , and NHF_2 . It is interesting to note that NH_3 ($\mu = 1.47 \text{ D}$) is more polar than NF_3 ($\mu = 0.24 \text{ D}$). In looking at the structures of the molecules, it is seen that the sum of the bond moments is in the *opposite* direction to the unshared pair in NF_3 but in the *same* direction in NH_3 .



Thus, the effect of the unshared pair *reinforces* the bond moments in NH_3 , but partially *cancels* them in NF_3 . As a result of the fluorine atoms pulling the unshared pair of electrons inward toward the nitrogen atom, NF_3 has almost no tendency to react as a base.

Dinitrogen tetrafluoride, N_2F_4 (b.p. -73°C), can be prepared by the reaction of NF_3 with copper. The N_2F_4 molecule undergoes dissociation in the gas phase to produce $\cdot\text{NF}_2$ radicals.

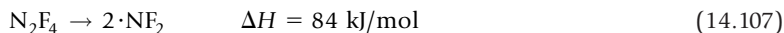

There are two structures possible for dinitrogen difluoride, which is also known as difluorodiazine. These structures can be shown as follows:

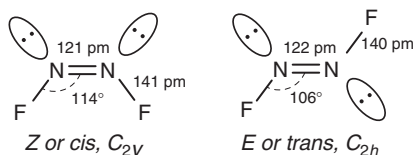

The Z (*cis*) form of N_2F_2 is more reactive than the E (*trans*) form, and the Z form slowly reacts with glass to produce SiF_4 . Because it is so reactive, many compounds can be fluorinated by Z- N_2F_2 as shown in the following equations:



When reacting with a strong Lewis acid that has an affinity for fluoride ions, N_2F_2 loses a fluoride ion, thereby producing N_2F^+ .



It is also possible to prepare compounds having the general formula $\text{NH}_n\text{X}_{3-n}$, but only ClNH_2 , chloramine, and HNF_2 have been well characterized.

14.2.6 Oxyhalides

A number of gaseous oxyhalides of nitrogen are known, including the types XNO (*nitrosonium* or *nitrosyl* halides) with $\text{X} = \text{F}, \text{Cl},$ or Br , and XNO_2 (*nitryl* halides) with $\text{X} = \text{F}$ or Cl . Nitrosonium halides are prepared by the reactions of halogens and NO .

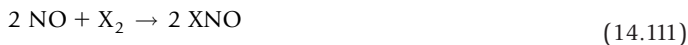

Nitryl chloride can be prepared by the reaction

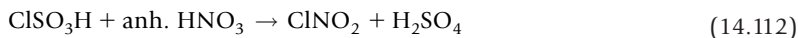

Formula	Name	Characteristics
N ₂ O	Nitrous oxide	Colorless gas, weak oxidizing agent
NO	Nitric oxide	Colorless gas, paramagnetic
N ₂ O ₃	Dinitrogen trioxide	Blue solid, dissociates in gas
NO ₂	Nitrogen dioxide	Brown gas, equilibrium mixture
N ₂ O ₄	Dinitrogen tetroxide	Colorless gas
N ₂ O ₅	Dinitrogen pentoxide	Solid is NO ₂ ⁺ NO ₃ ⁻ , gas unstable

14.2.7 Nitrogen Oxides

The oxides of nitrogen that have been well characterized are described in Table 14.4. Nitrous oxide (m.p. $-91\text{ }^{\circ}\text{C}$, b.p. $-88\text{ }^{\circ}\text{C}$) is a 16-electron triatomic molecule having a linear structure. Three resonance structures can be drawn for this molecule as follows:

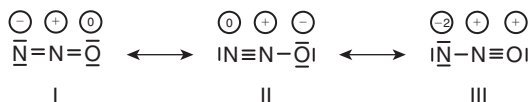

In Section 4.2 an analysis based on bond lengths and dipole moments was presented showing that structures I and II contribute about equally to the actual structure. Nitrous oxide functions as an oxidizing agent that can react explosively with H₂,



and it will oxidize metals. For example, magnesium will burn in N₂O,



The mixture of acetylene and N₂O is flammable so it is used in welding.

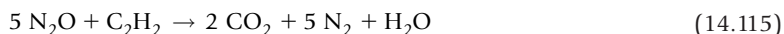

Nitrous oxide is relatively soluble in water, and it is used as a propellant gas in canned whipped cream. It is also used as an anesthetic (laughing gas).

Nitric oxide (m.p. $-163\text{ }^{\circ}\text{C}$, b.p. $-152\text{ }^{\circ}\text{C}$) is an important compound primarily because it is a precursor of nitric acid that is prepared in the Ostwald process.

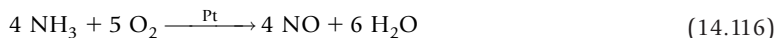

In the laboratory, reactions that can be used to produce NO include the following:

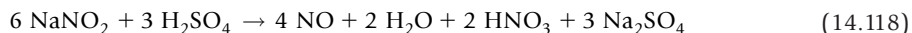
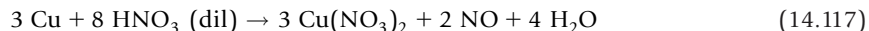

The bonding in the NO molecule provides a basis for interpreting several properties of the molecule. The molecular orbital diagram for NO is shown in Figure 14.4. From the molecular orbital diagram, it can be seen that there is one electron in a π^* orbital. Molecules that have an odd number of electrons usually dimerize, but unlike NO_2 , NO does not dimerize in the gas phase. The bond order in NO is 2.5, and if an electron is removed it comes from the π^* orbital, leaving NO^+ having a bond order of 3. The ionization potential for NO is 9.2 eV (888 kJ mol^{-1}), so it loses an electron rather easily to generate NO^+ (known as the *nitrosonium* or *nitrosyl* ion) that is isoelectronic with N_2 , CN^- , and CO. The NO^+ ion is a good coordinating group, and many complexes are known that contain this ligand (see Chapter 21). It functions as a three-electron donor, with one electron being lost to the metal and two others forming a coordinate bond.

Halogens react with NO to produce XNO, nitrosonium halides,

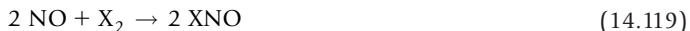

and NO is easily oxidized as shown by the following equation:



This reaction is one of the steps in preparing HNO_3 from NH_3 . As mentioned earlier, the fact that NO does not dimerize is unusual. From the molecular orbital diagram for NO, it can be

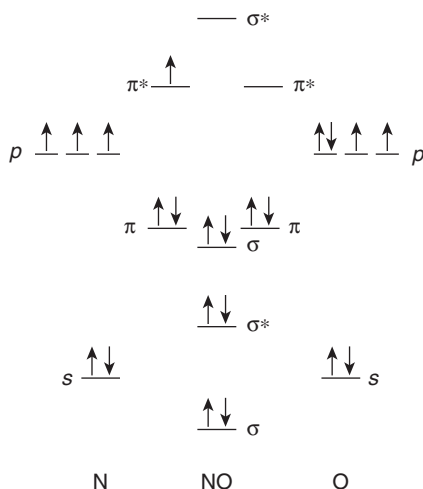

■ FIGURE 14.4 The molecular orbital diagram for the NO molecule.

seen that the bond order is 2.5. If dimers were formed, the structure could be represented as

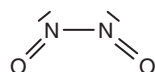

This structure contains a total of five bonds, which is an average of 2.5 bonds per NO unit. Therefore, there is no net increase in the number of bonds in the dimer compared to two separate molecules. The result is that there is not much energy advantage if dimers form. The melting point of NO is $-164\text{ }^{\circ}\text{C}$ and the boiling point is $-152\text{ }^{\circ}\text{C}$. The low boiling point and small liquid range, about $12\text{ }^{\circ}\text{C}$, is indicative of only very weak intermolecular forces. The Lewis structure of the molecule can be shown as



This structure shows that the molecule is essentially nonpolar ($\mu = 0.159\text{ D}$), and because it has a low molecular weight, its small liquid range is very close to that of N_2 (m.p. $-210\text{ }^{\circ}\text{C}$, b.p. $-196\text{ }^{\circ}\text{C}$).

In some ways, N_2O_3 (m.p. $-101\text{ }^{\circ}\text{C}$) behaves as a 1:1 mixture of NO and NO_2 . In the gas phase, it dissociates to give NO and NO_2 .



At -20 to $-30\text{ }^{\circ}\text{C}$ the reverse reaction can be used to prepare N_2O_3 . Two forms of N_2O_3 are shown by the structures

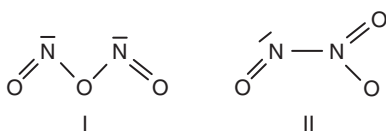

The dominant form is II, and this oxide reacts with water to yield a nitrous acid solution.



Compounds containing NO^+ result when a strong acid such as HClO_4 reacts with N_2O_3 .

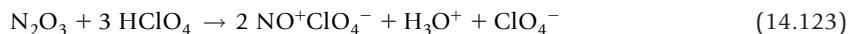

The NO_2 molecule has a bond angle of 134° , and unlike NO, it extensively dimerizes.



At 135 °C, the mixture contains only about 1% N₂O₄, but at 25 °C it contains about 80% N₂O₄. The structure of N₂O₄ can be shown as

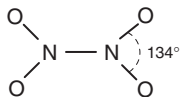

The structures NO⁺NO₃⁻ and ONONO₂ have also been identified. The structure shown has a very long N–N bond (~175 pm), but the N–N bond in N₂H₄ is only 147 pm.

Nitrogen dioxide is a toxic gas that can be prepared by the oxidation of NO.



When heated, some heavy metal nitrates such as Pb(NO₃)₂ decompose to produce NO₂.

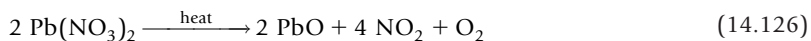

The major importance of the compound is that it reacts with water as one step in the preparation of nitric acid.

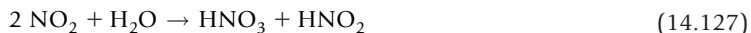

The nitronium ion, NO₂⁺, derived from NO₂, is the attacking species in nitration reactions (see Chapter 9). Also, liquid N₂O₄ has been rather extensively studied as a nonaqueous solvent, and auto-ionization, to the extent it occurs, appears to be as follows:



Accordingly, compounds such as NOCl (actually ONCl in structure) are acids and nitrates are bases in liquid N₂O₄. Therefore, the reaction



is a neutralization reaction in liquid N₂O₄. Metals react with N₂O₄ to give the nitrates,



and liquid N₂O₄ is an oxidizing agent for rocket fuels such as hydrazine.

Dinitrogen pentoxide, N₂O₅, is the anhydride of nitric acid, from which it can be prepared by dehydration at low temperatures,



and it can also be prepared by the oxidation of NO₂ with ozone.



Because solid N_2O_5 is an ionic solid, $\text{NO}_2^+\text{NO}_3^-$, it is suggested that a molecule formally containing NO_2^+ and a nitrate could produce N_2O_5 . Such as reaction is



N_2O_5 is a white solid that sublimates at 32°C . The N–O bond length in the linear NO_2^+ ion is 115 pm. The structure of the N_2O_5 molecule is

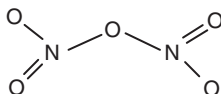

In accord with the oxidation state of nitrogen in this oxide being +5, it is also a good oxidizing agent. There is some evidence that NO_3 exists in mixtures of N_2O_5 and ozone.

14.2.8 Oxyacids of Nitrogen

Hyponitrous acid, $\text{H}_2\text{N}_2\text{O}_2$ is produced in the following reactions:

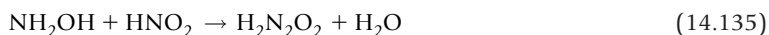
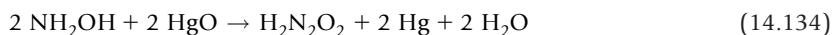

When a solution of $\text{Ag}_2\text{N}_2\text{O}_2$ is treated with a solution of HCl in ether, a solution containing hyponitrous acid $\text{H}_2\text{N}_2\text{O}_2$ is obtained.

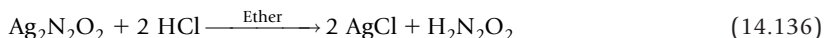

Evaporation of the ether produces the solid acid $\text{H}_2\text{N}_2\text{O}_2$, which is an explosive compound. Even in an aqueous solution the acid decomposes,



Although N_2O is formally the anhydride of $\text{H}_2\text{N}_2\text{O}_2$, the acid does not result from the reaction of N_2O and water. The acid oxidizes in air to produce nitric and nitrous acids.



Reduction of nitrates or nitrites by sodium amalgam in the presence of water has been used to prepare salts of hyponitrous acid.

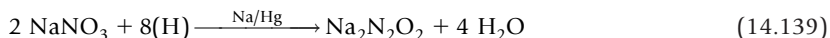

The $\text{N}_2\text{O}_2^{2-}$ ion exists in two forms,

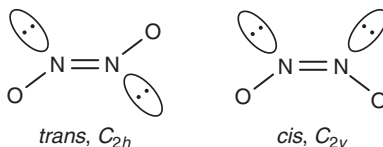

The *trans* form is more stable, and it is the product of the reactions just shown.

The anhydride of nitrous acid is N_2O_3 , but the unstable acid is produced by acidifying a solution of a nitrite. For example, a convenient reaction is



Because it is insoluble, BaSO_4 can be easily removed. Heating nitrates of group IA metals results in the loss of oxygen to produce nitrites.

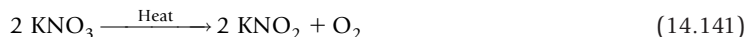

At low temperature, slow decomposition of nitrous acid gives nitric acid and NO ,



but at high temperature disproportionation yields NO and NO_2 .



The structure of nitrous acid can be shown in several ways, but the structure is usually considered to be

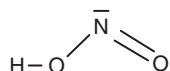

Nitrous acid is a weak acid with $K_a = 4.5 \times 10^{-4}$. Because it contains nitrogen in an intermediate oxidation state, nitrous acid can function as both an oxidizing agent and a reducing agent as shown in the following equations:

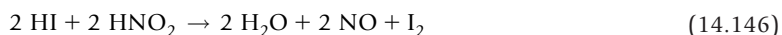
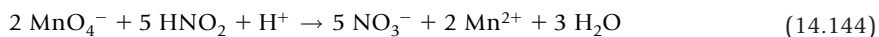

The acid reacts with ammonia to produce N_2 .

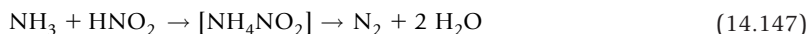

As shown in the following structures, the NO_2^- ion has unshared pairs of electrons on both the oxygen and nitrogen atoms:

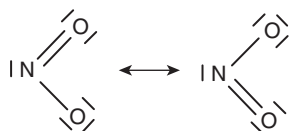

Electron pair donation can take place through either atom to produce M–ONO or M–NO₂ linkages, or it can bridge between two metal centers (to give M–ONO–M linkages). The first known case of linkage isomerization involved the ions [Co(NH₃)₅NO₂]²⁺ and [Co(NH₃)₅ONO]²⁺, isomers that were studied by S. M. Jørgensen in the 1890s.

Nitric acid is by far the most important of the acids containing nitrogen, and it is used in enormous quantities (~30 billion lb/year). It is used in the manufacture of explosives, propellants, fertilizers, organic nitro compounds, dyes, plastics, and so on. It is a strong acid, because $b = 2$ in the formula (HO)_aXO_b, and it is also a strong oxidizing agent. Although it was believed to have been produced earlier, nitric acid was produced as early as 1650 by J. R. Glauber, who prepared it using the reaction

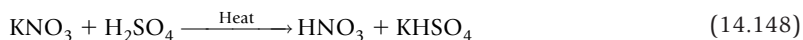

Pure nitric acid (m.p. –41.6 °C, and b.p. 82.6 °C) has a density of 1.503 g/cm³. It forms a constant-boiling mixture (having b.p. 120.5 °C) with water that contains 68% HNO₃ and has a density of 1.41 g/cm³. Several well-defined hydrates are known, such as HNO₃·H₂O and HNO₃·2H₂O. Concentrated nitric acid may have a light yellow-brown color because of NO₂ that results from slight decomposition,

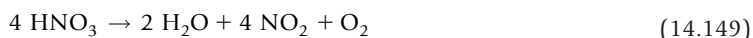

For many years, nitric acid was prepared by heating nitrates with sulfuric acid.

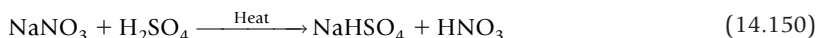

In the early 1900s, it was discovered that ammonia could be oxidized in the presence of a platinum catalyst (the *Ostwald process*).

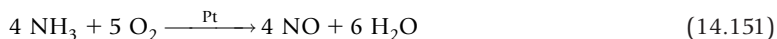

This is the first step in the production of nitric acid. Nitric oxide is a reactive gas that can easily be oxidized,



and NO₂ disproportionates in water, yielding nitric acid.

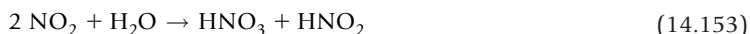

The nitric acid can be concentrated to about 68% by weight by distillation. The HNO₂ produced in the disproportionation decomposes to produce N₂O₃.



and the nitrogen oxides are recycled.

Although the nitrate ion is planar (D_{3h}), the structure of the HNO_3 molecule is

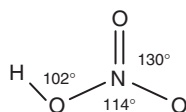

Because it is both a strong acid and a strong oxidizing agent, nitric acid will dissolve most metals. However, aluminum forms an oxide layer on the surface, and it becomes passive to further action. Sulfur is oxidized to sulfuric acid, with the reduction product being nitric oxide.



Sulfides are oxidized to sulfates by concentrated nitric acid.

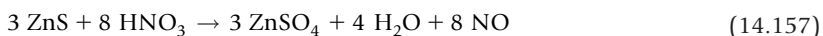

The mixture containing one volume of concentrated HNO_3 and three volumes of concentrated HCl is known as *aqua regia*, and it will dissolve even gold and platinum.

Nitric acid and nitrates are important chemicals. For example, black powder (also known as *gunpowder*) has been used for centuries, and it is a mixture containing 75% KNO_3 , 15% C, and 10% S. The mixture is made into flakes while wet and then dried. Except for large guns on naval vessels, it has been replaced by nitrocellulose (*smokeless*) powder that also contains small amounts of certain additives.

Nitration of toluene by mixture of nitric and sulfuric acids produces an explosive material known as TNT (trinitrotoluene). The overall reaction can be shown as

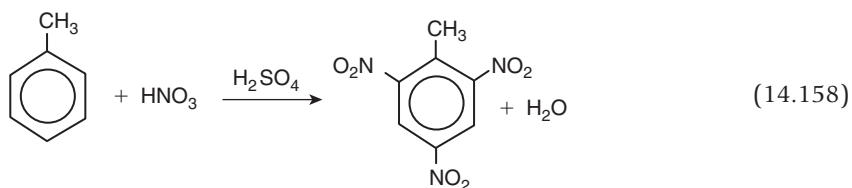

This explosive is remarkably stable to shock, so it requires a powerful detonator to initiate the explosion. Ammonium nitrate will explode if the explosion is initiated by another primary explosive, and mixtures of NH_4NO_3 and TNT (2,4,6-trinitrotoluene) were known as the military explosive *amatol*.

In the explosives industry, precise control of temperature, mixing time, concentrations, heating, and cooling rates are maintained. Making these materials safely requires sophisticated equipment and technology to carry out the process even though the chemistry may appear simple. Under less than optimal conditions, some 2,3,5-trinitrotoluene, 3,5,6-trinitrotoluene, and 2,4,5-trinitrotoluene are produced, and they are much less stable than 2,4,6-TNT. A mixture of explosives is only as stable as its *least* stable

component! Work with explosive materials requires specialized equipment and procedures that are available only in facilities designed for that purpose. Without sophisticated equipment and the knowledge that comes from specialized experience, no one outside the industry should ever experiment with these materials.

As mentioned earlier, there are many nitrogen compounds that are either explosives or propellants. That is one reason why nitrates and nitric acid have been so important throughout several centuries of history.

14.3 PHOSPHORUS, ARSENIC, ANTIMONY, AND BISMUTH

The elements in group VA have a broad range of chemical properties, and there is an increase in metallic character progressing downward in the group. Each of the elements has possible oxidation states from -3 to $+5$, although not all of the range applies equally to all of the elements. The organic chemistry of phosphorus and arsenic is also extensive, as is the organometallic chemistry of antimony.

All of the elements are important, and they are found in many common compounds. Some phosphorus compounds are among the most useful and essential of any element. As a result, there is a great deal more extensive chemistry of phosphorus, and more space will be devoted to it in this chapter. Much of the chemistry of the other elements can be inferred by comparison to the analogous phosphorus compounds but realizing the greater metallic character of As and Sb.

14.3.1 Occurrence

Phosphorus compounds occur widely in nature, with some of the most common forms being phosphate rocks and minerals, bones, and teeth. Phosphate minerals include calcium phosphate, $\text{Ca}_3(\text{PO}_4)_2$; *apatite*, $\text{Ca}_5(\text{PO}_4)_3\text{OH}$; *fluoroapatite*, $\text{Ca}_5(\text{PO}_4)_3\text{F}$; and *chloroapatite*, $\text{Ca}_5(\text{PO}_4)_3\text{Cl}$. Elemental phosphorus was first obtained by H. Brand, and its name is derived from two Greek words meaning "light" and "I bear" because of the phosphorescence of white phosphorus due to slow oxidation.

Several minerals contain arsenic, but the most important are the sulfides *orpiment*, As_2S_3 , *realgar*, As_4S_4 , and *arsenopyrite*, FeAsS , and the oxide *arsenolite*, As_4O_6 . Antimony is also found as the sulfide, *stibnite*, Sb_2S_3 , and the sulfide has been used in pigments, in production of special types of glass, and in pyrotechnics. Other antimony-containing minerals are *ullmannite*, NiSbS , *tetrahedrite*, Cu_3SbS_3 , and a number of other complex sulfides. Bismuth is rather unreactive, so it is sometimes found free. It is also found as *bismite*, Bi_2O_3 and *bismuth glance*, Bi_2S_3 .

14.3.2 Preparation and Properties of the Elements

Phosphorus is prepared on an industrial scale by reduction of naturally occurring phosphates. Crushed phosphate rock, carbon, and silica (SiO_2) are heated to 1200 to 1400 °C in an electric furnace from which phosphorus is removed by distillation.

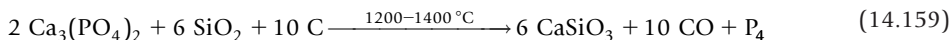

Below 800 °C, phosphorus exists as tetrahedral P₄ molecules,

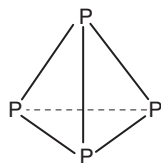

but at high temperature some of the P₄ molecules dissociate to P₂.

Several allotropic forms of phosphorus are known, the most common of which are the white, red, and black forms. Heating the white form at 400 °C for several hours produces red phosphorus, which is known to include several forms. A red form that is amorphous can be prepared by subjecting white phosphorus to ultraviolet radiation. In the thermal process, several substances (I₂, S₈, and Na) are known to catalyze the conversion of phosphorus to other forms. Black phosphorus consists of four identifiable forms that result when white phosphorus is subjected to heat and pressure. Phosphorus is used in large quantities in the production of phosphoric acid and other chemicals. White phosphorus has been used extensively in making incendiary devices, and red phosphorus is used in making matches.

Roasting arsenic sulfide in air produces the oxide, and the element is obtained from the oxide by reduction with carbon.



The stable form of arsenic is the gray or metallic form, although other forms are known. Cooling the vapor rapidly produces yellow arsenic, and an orthorhombic form is obtained if the vapor is condensed in the presence of mercury. Arsenic compounds are used in insecticides, herbicides, medicines, and pigments, and arsenic is used in alloys with copper and lead. A small amount of arsenic increases the surface tension of lead, which allows droplets of molten lead to assume a spherical shape, and this fact is utilized in the production of lead shot.

Antimony is obtained by reduction of the sulfide with iron,



or by heating Sb₂S₃ in air to produce the oxide, which can be reduced with carbon. The stable form of antimony has a rhombohedral structure, although high pressure converts it to cubic and hexagonal close packing structures. There are also several amorphous forms of antimony. A small amount of antimony added to lead produces a stronger, harder alloy, and the lead plates used in automobile batteries are made from such an alloy. These alloys expand on cooling and give a sharp casting without shrinking away from the mold. For this reason, antimony has long been used in type metal.

14.3.3 Hydrides

The elements in group VA of the periodic table form binary compounds with hydrogen, some of which are analogous to the hydrogen compounds of nitrogen (NH_3 , N_2H_4 , and N_2H_2). However, the hydrides of the heavier elements are much less basic and less stable than NH_3 . In nitrogen compounds, the unshared pair of electrons function as a hard base (see Chapter 9), and they are good proton acceptors. In PH_3 , PR_3 , AsH_3 , AsR_3 , and similar compounds, the unshared pair of electrons resides in a larger orbital, so they are soft bases that have lower basicity toward proton donors. Accordingly, PH_3 ($K_b = \sim 1 \times 10^{-28}$) is a much weaker Brønsted base than is NH_3 ($K_b = 1.8 \times 10^{-5}$). Formation of stable phosphonium salts requires that the acid be strong and the anion be large so there is a close match in the size of anion and cation. These conditions are met in the reaction with HI.



However, with soft electron pair acceptors such as Pt^{2+} , Ag^+ , and Ir^+ , phosphines are stronger Lewis bases than are NH_3 and amines, so phosphines and arsines interact better with class B metals than do amines. Generally, phosphines and arsines form stable complexes with second- and third-row transition metals in low oxidation states.

Arsenic, antimony, and bismuth do not normally form stable compounds as the protonated species AsH_4^+ , SbH_4^+ , and BiH_4^+ , although a few compounds such as $[\text{AsH}_4]^+[\text{SbF}_6]^-$ and $[\text{SbH}_4]^+[\text{SbF}_6]^-$ are known. These compounds are obtained by reactions of the hydrides with the HF/SbF_5 superacid (see Section 10.8).

Phosphine is a less stable compound than NH_3 because orbital overlap between hydrogen and phosphorus is less effective than between hydrogen and nitrogen. The thermal stability of the hydrogen compounds of P, As, Sb, and Bi (named as *phosphine*, *arsine*, *stibine*, and *bismuthine*) decreases in that order, and SbH_3 and BiH_3 are unstable at room temperature. Similar trends apply to the hydrogen compounds of the group IVA, VIA, and VIIA elements. The physical properties of the hydrogen compounds of the heavier group VA elements are shown in Table 14.5, with the properties of NH_3 included for comparison. The effects of hydrogen bonding in NH_3 are apparent from the data.

The bond angles in PH_3 , AsH_3 , and SbH_3 are interesting in view of the fact that in NH_3 , the bond angle is about equal to that expected for sp^3 hybridization on the nitrogen atom with a small decrease

Table 14.5 Properties of the EH_3 Compounds of the Group VA Elements.

	NH_3	PH_3	AsH_3	SbH_3	BiH_3
m.p., °C	-77.7	-133.8	-117	-88	—
b.p., °C	-33.4	-87.8	-62.5	-18.4	17
ΔH_f° , kJ mol^{-1}	-46.11	-9.58	66.44	145.1	277.8
HEH angle, °	107.1	93.7	91.8	91.3	—
μ , D	1.46	0.55	0.22	0.12	—

in bond angle caused by the unshared pair of electrons. The bond angles in the hydrides of other group VA elements are close enough to 90° that it appears that almost pure p orbitals are used by the central atom. This may be because the larger sp^3 hybrid orbitals on the heavier atoms do not overlap as effectively with hydrogen $1s$ orbitals as in the case of nitrogen. A similar trend is seen in the hydrogen compounds of the group VIA elements. However, another explanation is based on the fact that in NH_3 the *shared* pairs of electrons reside closer to the nitrogen atom, so the effect of the unshared pair on bond angles is less. In PH_3 , the bonding electrons are shared about equally (which puts them closer to the hydrogen atoms than in NH_3), so the effect of the unshared pair is greater because the electron density is less near the phosphorus atom.

The hydrazine analogs P_2H_4 , As_2H_4 , and Sb_2H_4 are toxic and unstable, as indicated by the fact that P_2H_4 is spontaneously flammable in air, and phosphine burns readily.



The extremely toxic trihydrides of the heavier atoms in group VA are not generally prepared by reaction of the elements. They are usually prepared by making a metal compound of the group VA element and then hydrolyzing it. For example,



Phosphine also results from the reaction of phosphorus with a hot, strongly basic solution.



Sodium arsenide can be prepared by the reaction of the elements, and it reacts with water to produce arsine according to the following equation:

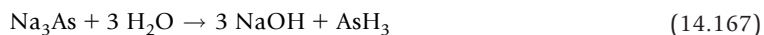

Arsine is also produced in the reaction of As_2O_3 with NaBH_4 .

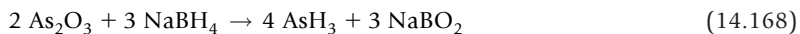

The hydrides of arsenic, antimony, and bismuth are unstable at elevated temperature. The Marsh test for arsenic depends on this instability when an arsenic mirror forms as arsine is passed through a heated tube:

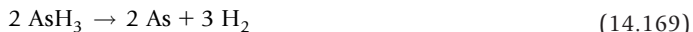

14.3.4 Oxides

Although other less important oxides of the group VA elements are known, only those in which the oxidation states are +3 and +5 are important. When the amount of oxygen is controlled, phosphorus can be oxidized to yield phosphorus(III) oxide.



A tetrahedral arrangement of phosphorus atoms is retained in the P_4O_6 molecule, giving a structure like that shown in Figure 14.5a. Although dotted lines show the arrangement of phosphorus atoms, they do not represent bonds between the atoms. This oxide (m.p. 23.9°C , b.p. 175.4°C) reacts with cold water to give phosphorous acid, H_3PO_3 , in which the arrangement of atoms is $HP(O)(OH)_2$. Disproportionation occurs when the oxide reacts with hot water, and phosphine, phosphorus, and phosphoric acid are produced. When heated above its boiling point, P_4O_6 decomposes into phosphorous and complex oxides that are described by the general formula P_nO_{2n} .

The oxides As_4O_6 and Sb_4O_6 , which have structures like that of P_4O_6 , are obtained by burning the elements in air. The +5 oxides of As and Sb can be obtained, but bismuth forms only Bi_2O_3 . Solid As_4O_6 and Sb_4O_6 exist in several forms having oxygen atoms in bridging positions.

Although P_4O_{10} is an important material, the +5 oxides of arsenic, antimony, and bismuth are much less important. The molecular formula for the +5 oxide of phosphorus is P_4O_{10} molecule, not P_2O_5 , although it is frequently convenient to use the empirical formula. The structure of the P_4O_{10} molecule, shown in Figure 14.5b, is derived from the tetrahedral structure of the P_4 molecule, and it has six bridging oxygen atoms and the other four in terminal positions. At least three crystalline forms of P_4O_{10} are known. The hexagonal or *H*-form is the most common, and the others are orthorhombic forms designated as the *O*- and *O'*-forms, both of which are less reactive than the *H*-form. Heating the *H*-form at 400°C for 2 hours transforms it into the *O*-form, and heating the *H*-form at 450°C for 24 hours produces the *O'*-form.

Phosphorus(V) oxide or tetraphosphorus decoxide, P_4O_{10} , is the anhydride of the series of phosphoric acids. It is produced in the first step of the manufacture of H_3PO_4 by burning phosphorus,

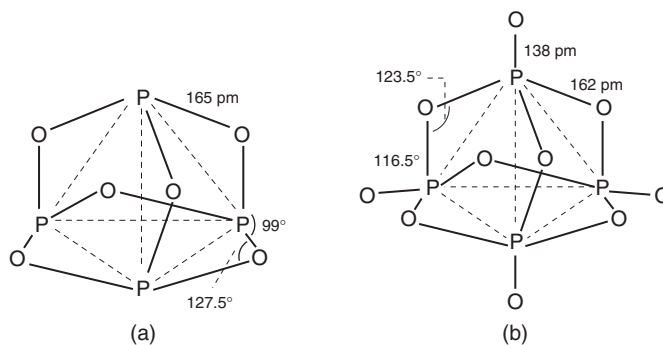
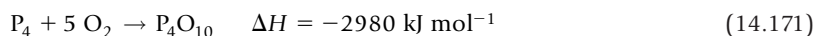

■ **FIGURE 14.5** The structures of (a) P_4O_6 and (b) P_4O_{10} . The dotted lines show the original tetrahedral structure of P_4 .

and it is a powerful dehydrating agent that can be used to prepare other oxides by dehydrating the appropriate acid. For example, dehydrating HClO_4 produces Cl_2O_7 .

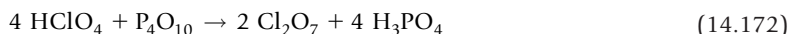

When used as a desiccant, the oxide removes water by the reaction



Organic phosphates are prepared by the reactions of P_4O_{10} with alcohols,



but some monoalkyl and dialkyl derivatives are also produced. Phosphate esters also result when OPCl_3 reacts with alcohols. Alkyl phosphates have many uses as catalysts, as lubricants, and in producing flame-proofing compounds.

Arsenic(V) oxide and antimony(V) oxide are produced when the elements react with concentrated nitric acid,

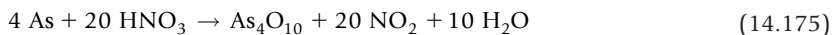

Some compounds of antimony appear to involve the +4 oxidation state. For example, an oxide of antimony is known that has the formula Sb_2O_4 , but this oxide actually contains equal numbers of Sb(III) and Sb(V) atoms. The chloride complex $\text{Sb}_2\text{Cl}_{10}^{2-}$ also contains Sb(III) and Sb(V) rather than Sb(IV).

14.3.5 Sulfides

At elevated temperatures, phosphorus, arsenic, and antimony react with sulfur to produce several binary compounds. Of the phosphorus compounds, P_4S_{10} , P_4S_7 , P_4S_5 , and P_4S_3 have been the subject of considerable study. Except for sulfur replacing oxygen, the structure of P_4S_{10} is like that of P_4O_{10} . The structures of the other phosphorus sulfides contain P–P bonds and P–S–P bridges. As shown in Figure 14.6, these structures can be considered as being derived from the P_4 tetrahedron by insertion of bridging sulfur atoms, but there are no bonds between P atoms.

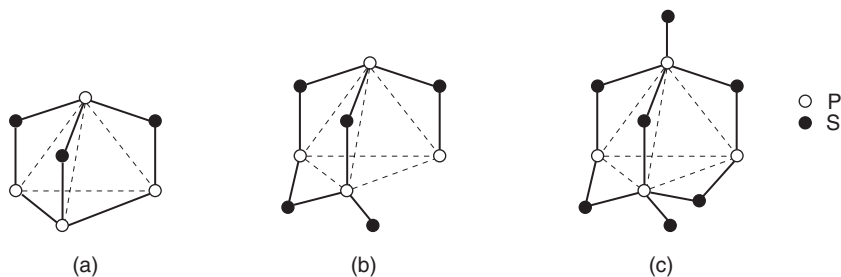

■ **FIGURE 14.6** The most important compounds containing phosphorus and sulfur are (a) P_4S_3 , (b) P_4S_5 , and (c) P_4S_7 . Note the outline (dotted lines) of the tetrahedron of P_4 atoms.

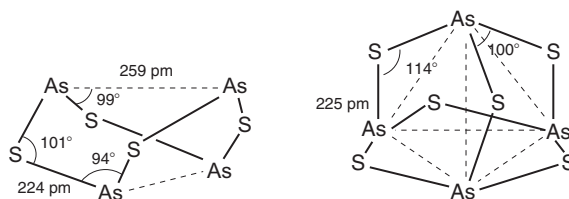

■ FIGURE 14.7 The structures of As_4S_4 and As_4S_6 .

Tetraphosphorus trisulfide (P_4S_3), which is also called phosphorus sesquisulfide, can be obtained by heating a stoichiometric mixture of phosphorus and sulfur at 180°C in an inert atmosphere. The compound (m.p. 174°C) is soluble in toluene, carbon disulfide, and benzene, and it is used with potassium chlorate, sulfur, and lead dioxide in matches.

Tetraphosphorus pentasulfide, P_4S_5 , is obtained when a solution of sulfur in CS_2 reacts with P_4S_3 in the presence of I_2 . Tetraphosphorus heptasulfide, P_4S_7 , is one of the products obtained when phosphorus and sulfur are heated in a sealed tube. Neither P_4S_5 nor P_4S_7 is commercially important. Tetraphosphorus decasulfur, P_4S_{10} , is prepared by reaction of a stoichiometric mixture of the elements.



The reaction of this sulfide with water can be shown as

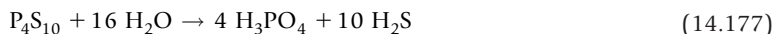

A mixed sulfide-oxide, $\text{P}_4\text{O}_6\text{S}_4$, has a structure similar to that of P_4O_{10} , except sulfur atoms replace the four oxygen atoms in terminal positions.

Arsenic, antimony, and bismuth form several sulfides that include As_4S_4 (*realgar*), As_2S_3 , Sb_2S_3 , and Bi_2S_3 , which are the common minerals containing these elements. Some of the sulfides can also be precipitated from aqueous solutions because the sulfides of As(III), As(V), Sb(III), and Bi(III) are insoluble. As in the case of phosphorus, arsenic forms a sesquisulfide, As_4S_3 which has a structure like that of P_4S_3 shown in Figure 14.6a. The structures of As_4S_4 and As_4S_6 are shown in Figure 14.7.

Sulfides of arsenic and antimony are brightly colored, which has given rise to their use as pigments. Some of the sulfides, selenides, and tellurides of arsenic and antimony also function as semiconductors.

14.3.6 Halides

Both the +3 and +5 halogen compounds of the group VA elements contain reactive nonmetal-halogen bonds. As a result, they can be used as starting materials for preparing many other compounds. Halogen compounds of the group VA elements having the formula E_2X_4 are also known. They are relatively unimportant, and only the phosphorus fluoride will be described, although the chloride and iodide are also known. P_2F_4 is prepared by the coupling reaction of PF_2I brought about by mercury.



Electric discharge in a mixture of PCl_3 and H_2 produces P_2Cl_4 , and white phosphorus dissolved in carbon disulfide reacts with I_2 to produce P_2I_4 . All of the trihalides of the group VA elements are known, and they can be prepared by reaction of the elements, although there are other preparative methods. The fluorides are prepared as follows:

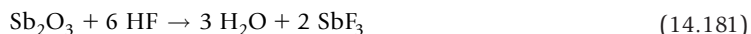
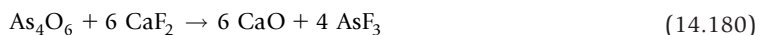

Adding an excess of F^- to a solution containing Bi^{3+} gives a precipitate of BiF_3 .

Phosphorus trichloride is obtained by the reaction of excess phosphorus with chlorine.



Oxides and sulfides of As, Sb, and Bi are converted to the chlorides by concentrated HCl.

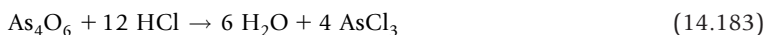

Table 14.6 shows some of the properties of the trihalides of the group VA elements.

Some of the compounds listed in Table 14.6 have low melting and boiling points, indicating that they consist of discrete covalent molecules. However, others have melting points that indicate a lattice in the solid state. In general, the bond angles are intermediate between the values expected for pure p and sp^3 orbitals on the central atom. Because the molecules have an unshared pair of electrons on the central atom, the pyramidal (C_{3v}) trihalides behave as Lewis bases. However, the central atoms are not from the first row, so the trihalides are soft electron pair donors that complex better with soft Lewis acids such as second- and third-row transition metals in low oxidation states. Like CO, which binds to iron in blood, PF_3 forms similar complexes, which makes it extremely toxic. Some trihalides containing two types of halogens are known, and exchange of halogen atoms takes place when two different trihalides of the same element are mixed.



Because of the reactive covalent bonds to halogen atoms, all of the trihalides of the group VA elements hydrolyze in water. It is found that the rates decrease in the order $\text{P} > \text{As} > \text{Sb} > \text{Bi}$, which agrees with the decrease in covalent bond character that results from the increase in metallic character of the central atoms. Not all of the trihalides react in the same way. The phosphorus trihalides react according to the equation



Compound	m.p., °C	b.p., °C	μ , D	X—E—X Angle
PF ₃	-151.5	-101.8	1.03	104
PCl ₃	-93.6	76.1	0.56	101
PBr ₃	-41.5	173.2	—	101
PI ₃	61.2	dec.	—	102
AsF ₃	-6.0	62.8	2.67	96.0
AsCl ₃	-16.2	103.2	1.99	98.4
AsBr ₃	31.2	221	1.67	99.7
AsI ₃	140.4	370d	0.96	100.2
SbF ₃	292	—	—	88
SbCl ₃	73	223	3.78	99.5
SbBr ₃	97	288	3.30	97
SbI ₃	171	401	1.58	99.1
BiF ₃	725	—	—	—
BiCl ₃	233.5	441	—	100
BiBr ₃	219	462	—	100
BiI ₃	409	—	—	—

When the phosphorus halide is PI₃, this reaction is a convenient way to produce HI. Arsenic trihalides hydrolyze in an analogous way, but the trihalides of antimony and bismuth react to produce oxyhalides.



Antimonyl chloride (sometimes called antimony oxychloride) is known as a "basic chloride." It is insoluble in water, but aqueous solutions of the trihalides can be made if enough HX is present to prevent hydrolysis. Adding water to reduce the concentration of acid causes the oxychloride to precipitate.

From the standpoint of use, PCl₃ is the most important of the trihalides. In addition to hydrolysis, PCl₃ reacts with oxygen and sulfur to produce OPCl₃ and SPCl₃, respectively.



Phosphoryl chloride (b.p. 105 °C) has been used extensively as a nonaqueous solvent (see Chapter 10). Reactions of PCl₃ with other halogens give mixed pentahalides.



This type of reaction involves both *oxidation* and *addition* of groups, so it is known as an *oxad* reaction. Alkyl derivatives of PCl_3 can be prepared by the reactions with Grignard reagents and metal alkyls illustrated in the following equations:



If a higher ratio of alkylating agent to PX_3 is used, the dialkyl and trialkyl compounds can also be obtained. At high temperature, the reaction of benzene and PCl_3 produces phenyldichlorophosphine, $\text{C}_6\text{H}_5\text{PCl}_2$, an intermediate in the preparation of parathion.

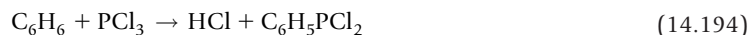

The organic chemistry of phosphorus includes many compounds, but the phosphite esters are especially useful. These compounds can be prepared by the reaction of PCl_3 with an alcohol.

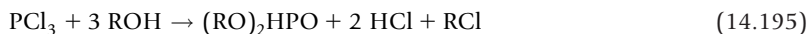

Because HCl is a product, the presence of a base facilitates the reaction. If the base is an amine, an amine hydrochloride is formed, and the reaction can be shown as

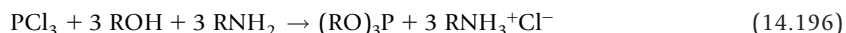

The presence of an amine makes the formation of HCl more energetically favorable because of the formation of the ionic amine hydrochloride.

There are 16 possible pentahalides that could result from combinations of P, As, Sb, and Bi with F, Cl, Br, and I. Although all of the pentafluorides can be prepared, none of the pentaiodides is stable. The pentachloride and pentabromide are known for phosphorus, and antimony forms a pentachloride. In the solid phase, PCl_5 exists as $[\text{PCl}_4^+][\text{PCl}_6^-]$, whereas the bromide exists as $[\text{PBr}_4^+][\text{Br}^-]$. In solid $\text{PCl}_4^+\text{PCl}_6^-$, the PCl bond lengths are 198 pm in the cation and 206 pm in the anion. Solid SbCl_5 exists as $\text{SbCl}_4^+\text{Cl}^-$. The PCl_5 molecule has the D_{3h} structure

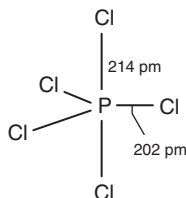

The structure of PF_5 is also a trigonal bipyramid with axial bonds of 158 pm and equatorial bonds of 152 pm. In ^{19}F NMR studies, a single peak split into a doublet by coupling with ^{31}P is observed. Therefore, it appears that all five F atoms are equivalent, indicating that there is rapid exchange between the axial and equatorial positions. An explanation of this phenomenon was provided by

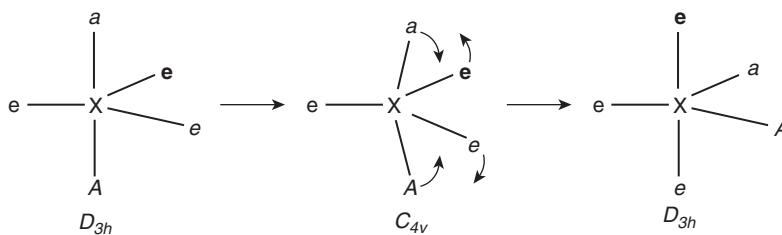

■ **FIGURE 14.8** The Berry pseudorotation that leads to interchange of axial and equatorial groups. The letters *a*, *e*, *A*, etc., indicate only positions because all five groups are identical.

R. S. Berry. Known as the Berry pseudorotation, the mechanism involves the trigonal bipyramid (D_{3h}) passing through a square based pyramid (C_{4v}) as shown in Figure 14.8. This behavior is somewhat similar to the inversion of the ammonia molecule (C_{3v}) as it passes through a planar (D_{3h}) structure.

Phosphorus pentachloride can be prepared by chlorinating P_4 or PCl_3 .



Phosphorus pentabromide can be prepared by analogous reactions. As mentioned earlier, several mixed halide compounds having formulas such as PCl_3F_2 , PF_3Cl_2 , and PF_3Br_2 are known. These compounds are produced when a halogen undergoes an oxad reaction with a trihalide containing a different halogen (Eq. (14.191)). The structures of these molecules provide verification of the non-equivalence of positions in a trigonal bipyramid. As a result of the difference between the axial and equatorial positions, there are three possible isomers for PCl_3F_2 , which have the structures

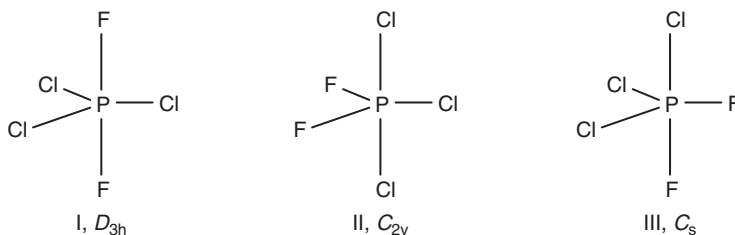

We have seen that unshared pairs of electrons occupy equatorial positions in structures based on a trigonal bipyramid. Therefore, the larger chlorine atoms should occupy equatorial positions as shown in structure I above, and PCl_3F_3 has D_{3h} symmetry as expected. By similar reasoning, we expect the structure of PF_3Cl_2 to have C_{2v} symmetry as shown below, rather than D_{3h} .

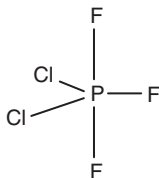

The pentahalides of group VA elements are strong Lewis acids that react readily with electron pair donors such as halide ions to form complexes.



This tendency is so great that it provides a way to produce interhalogen cations such as ClF_2^+ as shown in the following reaction:

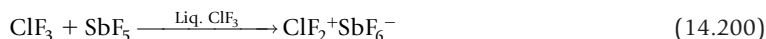

Because they are strong Lewis acids, PCl_5 , PBr_5 , SbCl_5 , and SbF_5 are effective catalysts for reactions such as the Friedel-Crafts reaction (see Chapter 9). The pentahalides also function as halogen transfer reagents to a variety of inorganic and organic substrates. Useful intermediates such as oxyhalides can be produced in this way. For example, thionyl chloride and phosphoryl chloride are produced by the reaction



Partial hydrolysis of pentachlorides also leads to the formation of oxychlorides, which are useful intermediates that contain reactive PCl bonds.



With excess water, complete hydrolysis of PCl_5 yields H_3PO_4 and HCl . Phosphoryl chloride can also be prepared by oxidizing PCl_3 or by the reaction of P_4O_{10} with PCl_5 .



The C_{3v} structure of OPCl_3 can be shown as

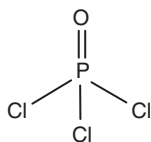

and the phosphorus-halogen bonds undergo reactions with water and alcohols.



Organic phosphates, $(\text{RO})_3\text{PO}$, have a wide range of industrial uses. Both OPCl_3 and $\text{OP}(\text{OR})_3$ are Lewis bases that usually coordinate to Lewis acids through the terminal oxygen atom. The sulfur analog of phosphoryl chloride, SPCl_3 , and several mixed oxyhalides such as OPCl_2F and OPCl_2Br have been prepared. Oxyhalides of arsenic, antimony, and bismuth are known, but they are less useful than those of phosphorus.

The heavier members of group VA also have strong tendency toward complex formation in keeping with their more metallic character. For example, in HCl solutions, SbCl_5 adds Cl^- to form a hexachloro complex.



There is evidence that when SbCl_5 and SbCl_3 are mixed they interact to form a complex,



In aqueous HCl solutions, SbCl_5 and SbCl_3 are present as the chloride complexes SbCl_6^- and SbCl_4^- , respectively. The equilibrium between complexes can be shown as



The structure of $\text{Sb}_2\text{Cl}_{10}^{2-}$ probably has bridging chloride ions.

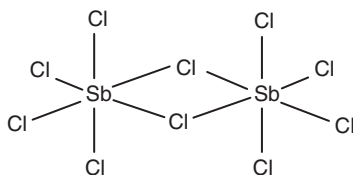

Numerous complexes such as AsF_6^- , SbF_6^- , and PF_6^- have been characterized.

14.3.7 Phosphazine (Phosphonitric) Compounds

Although there are many compounds that contain phosphorus and nitrogen, the *phosphazines* or *phosphonitric* compounds are unique. Because both N and P have five electrons in the valence shell, it is possible to have a six-membered heterocyclic ring in which the phosphorus atoms are bonded to two other atoms. Phosphazines having both linear and cyclic structures have been prepared. Historically, chlorides having the general formula $(\text{PNCl}_2)_n$ were the first compounds of this type prepared, and the original preparation of $(\text{PNCl}_2)_n$ was carried out in 1832 by J. von Liebig using the reaction of NH_4Cl and PCl_5 .

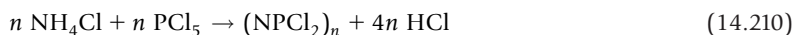

This reaction can be carried out in a sealed tube or in a solvent such as $\text{C}_2\text{H}_2\text{Cl}_4$, $\text{C}_6\text{H}_5\text{Cl}$, or OPCl_3 . The following cyclic trimer has been extensively studied:

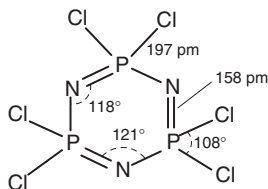

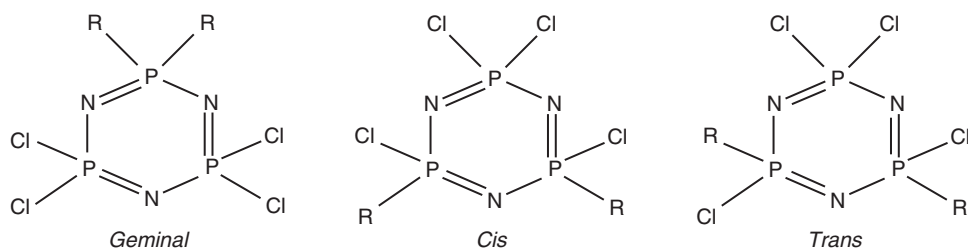

■ FIGURE 14.9 Possible products of disubstitution in $(\text{NPCl}_2)_3$ to give $\text{N}_3\text{P}_3\text{Cl}_4\text{R}_2$.

There is significant multiple bonding in the ring, as indicated by the P–N bond length of about 158 pm, which is much shorter than the usual P–N single-bond length (175 pm). As a result of resonance, there is only one P–N bond length. The tetramer, $(\text{NPCl}_2)_4$, has a structure in which the ring is puckered, whereas the pentamer, $(\text{NPCl}_2)_5$, has a planar ring structure. By utilizing the reactivity of the P–Cl bonds, many derivatives of $(\text{NPCl}_2)_3$ can be prepared. For example, hydrolysis produces P–OH bonds that undergo subsequent reactions to produce many derivatives.

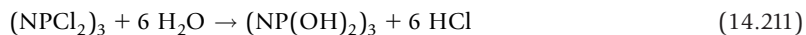

If a reaction is carried out so that *two* chlorine atoms are replaced, the groups may be bound to the same phosphorus atom or to different phosphorus atoms. When the entering groups are attached to the same phosphorus atom, the product has a *geminal* structure. If the groups are on different atoms, they may be on the same side of the ring (a *cis* product) or on opposite sides of the ring (a *trans* product). The structures of these products are shown in Figure 14.9.

By means of substitution reactions, derivatives containing alkoxide, alkyl, amine, and other groups can be prepared as illustrated by the following equations:

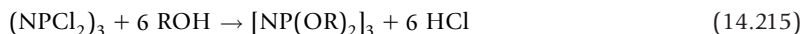
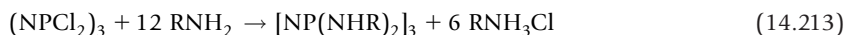
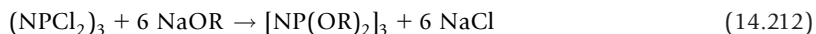

When $(\text{NPCl}_2)_3$ is heated to 250 °C, polymerization occurs, giving polymers that contain up to 15,000 monomer units.

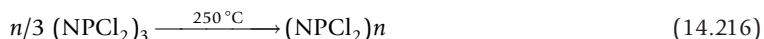

By carrying out reactions of the types shown here, a very large number of phosphazines have been prepared. In addition to synthetic work, a great deal of theoretical work has been done to elucidate the bonding in phosphazines.

14.3.8 Acids and Salts

When considering the acids of the group VA elements, the first acid that comes to mind is probably phosphoric acid, H_3PO_4 , which is as it should be. Phosphoric acid is one of the chemicals produced in enormous quantities, and it is used in many industrial processes. However, there are other acids that contain the group VA elements, even though none is very important in comparison to phosphoric acid. In many ways, arsenic acid, H_3AsO_4 , is similar to phosphoric acid, but the similarities are all but nonexistent when bismuth is considered. The acid that bismuth forms is H_3BiO_3 , which can also be written as $\text{Bi}(\text{OH})_3$, showing that it is a very weak acid. Phosphorus(III) is also contained in an acid, H_3PO_3 , but the structure of the molecule is $\text{OP}(\text{H})(\text{OH})_2$. The discussion of the acids of the group VA elements will deal primarily with those containing phosphorus.

Phosphorous acid, H_3PO_3 , is produced when P_4O_6 reacts with water.

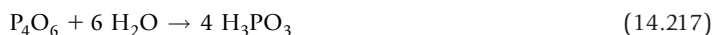

It is also produced when PCl_3 is hydrolyzed.



Although the formula is sometimes written as H_3PO_3 , it is a *diprotic* acid that has the structure

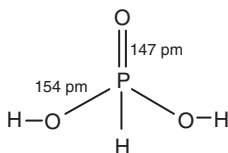

As shown by the dissociation constants $K_{a1} = 5.1 \times 10^{-2}$ and $K_{a2} = 1.8 \times 10^{-7}$, it is a weak acid. Because there is a factor of about 10^{-5} difference in the dissociation constants, it is possible to remove one proton to produce salts such NaH_2PO_3 , a so-called acid salt.

Organic phosphites are used in a variety of ways as solvents and as intermediates in synthesis. Two series of compounds having the formulas $(\text{RO})_2\text{P}(\text{O})\text{H}$ and $(\text{RO})_3\text{P}$ are known, and their structures can be shown as follows.

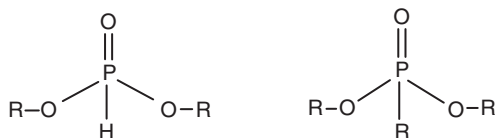

Chlorine will replace the hydrogen atom bound to phosphorus in the dialkyl phosphites, yielding a dialkylchloro phosphite.

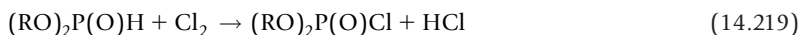

Partial hydrolysis reactions lead to a monoalkyl phosphite, but complete hydrolysis gives phosphorous acid. The hydrogen atom bound to phosphorus can also be replaced by reaction with sodium, showing that the hydrogen atom has slight acidity.



The bonds in PCl_3 are reactive toward many compounds that contain OH groups. Consequently, alcohols react with PCl_3 to produce trialkyl phosphite esters.



Dialkyl phosphates can also be obtained if the ratio of alcohol to PCl_3 is properly maintained. Halogens will react with alkyl phosphites to give products that have a halogen bound to the phosphorus atom

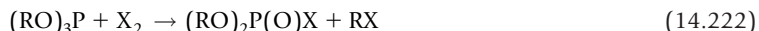

When a trialkyl phosphite reacts with PX_3 , there is halogen transfer, as illustrated in the following equation:

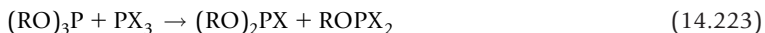

As in the case of phosphorus trihalides, the phosphorus atom in trialkyl phosphites will undergo addition reactions in which oxygen, sulfur, or selenium is added. The latter two react as elements, but a suitable source of oxygen is hydrogen peroxide.

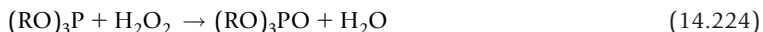

In spite of their toxicity, alkyl phosphites have been used extensively as lubricant additives, corrosion inhibitors, and antioxidants. In addition to their use as intermediates in synthesis, organophosphorus compounds are useful for separating heavy metals by solvent extraction. Several insecticides that were formerly in widespread use are derivatives of organic phosphates. Two such compounds are *malathion* and *parathion*.

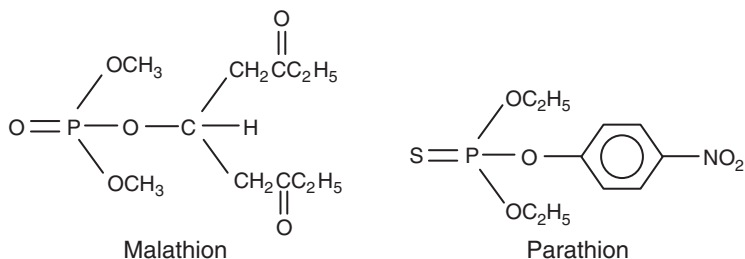

As a result of the hazards in using compounds such as these, the use of parathion has been banned in the United States since 1991. Another of the toxic organophosphorus compounds is *sarin*, a nerve gas that was produced for military use:

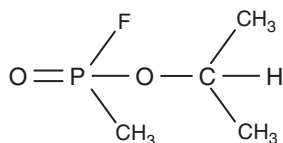

Although these organic phosphate derivatives are highly toxic and have been used in ways to exploit that property, many organophosphorus compounds have significant utility in the chemical industry.

14.3.9 Phosphoric Acids and Phosphates

Phosphorus(V) forms several acids that can be considered as partial dehydration products of the hypothetical compound $P(OH)_5$. For example, if that compound lost one molecule of water, the product would be H_3PO_4 ,



The structure of H_3PO_4 , known as *orthophosphoric acid*, can be shown as

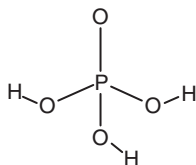

Removal of another molecule of water would result in HPO_3 , which is *metaphosphoric acid*. Viewed in a different way, the phosphoric acids can be considered in terms of the ratio of water to P_2O_5 , the empirical formula for P_4O_{10} . If the ratio of H_2O to P_2O_5 is 5:1, the reaction can be shown as



The ratios 3:1 and 1:1 would indicate, respectively, the reactions



From the foregoing examples, it can be seen that although the ratio H_2O/P_2O_5 could be as great as 5, the acid resulting when the ratio is 3 (H_3PO_4) represents the upper practical limit. When water is removed from H_3PO_4 , oxygen bridges are formed between phosphate groups to produce the so-called condensed phosphates. Removal of a water molecule from one molecule of H_3PO_4 produces the acid

HPO_3 , which is known as metaphosphoric acid, and it is a strong acid. We can view the formation of $\text{H}_4\text{P}_2\text{O}_7$ (known as diphosphoric acid or pyrophosphoric acid) as arising from the addition of P_2O_5 to H_3PO_4 or the removal of a molecule of water from *two* molecules of H_3PO_4 . The first process can be shown as



The condensation reaction is shown as follows:

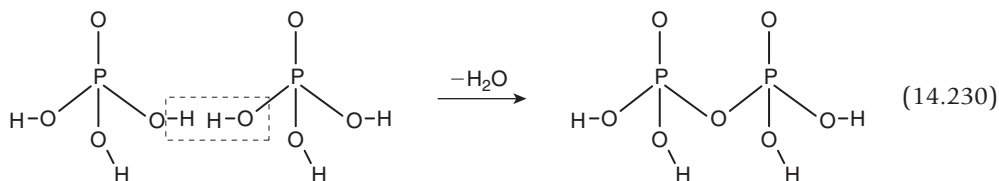

Pyrophosphoric acid represents the $\text{H}_2\text{O}/\text{P}_2\text{O}_5$ ratio of 2:1, and it has four dissociation constants: $K_{a1} = 1.4 \times 10^{-1}$; $K_{a2} = 1.1 \times 10^{-2}$; $K_{a3} = 2.9 \times 10^{-7}$; $K_{a4} = 4.1 \times 10^{-10}$. The first two dissociation constants are rather close together, and they are much larger than the last two. As a result, two protons are replaced more easily than the others, resulting in acid salts that have the formula $\text{M}_2\text{H}_2\text{P}_2\text{O}_7$ (where M is a univalent ion). One common example is $\text{Na}_2\text{H}_2\text{P}_2\text{O}_7$, which is used as a solid acid that reacts with NaHCO_3 in baking powder. However, not all of the salts are produced by neutralization reactions. For example, $\text{Na}_4\text{P}_2\text{O}_7$ is prepared by the thermal dehydration of Na_2HPO_4 .

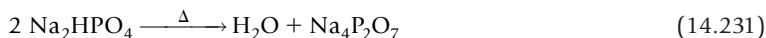

If the concentration of base is high enough, the last two protons in $\text{H}_4\text{P}_2\text{O}_7$ can be removed to give salts having the formula $\text{M}_4\text{P}_2\text{O}_7$. One such compound, $\text{Na}_4\text{P}_2\text{O}_7$, is used in detergents, as an emulsifier in making cheese, as a dispersant in paints, and in water softening. The potassium salt is used in liquid detergents and shampoos, as a pigment dispersant in paints, and in the manufacture of synthetic rubber. The calcium salt, $\text{Ca}_2\text{P}_2\text{O}_7$, is used in toothpaste as a mild abrasive. Salts having the formulas $\text{MH}_3\text{P}_2\text{O}_7$ and $\text{M}_3\text{HP}_2\text{O}_7$ are less numerous and less useful. One compound of this type, NaH_2PO_4 , is used to prepare $\text{Na}_2\text{H}_2\text{P}_2\text{O}_7$, by dehydration.

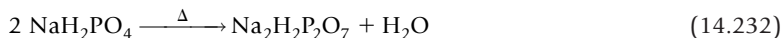

Further condensation of phosphate groups leads to the polyphosphoric acids, which contain several phosphate units. The acids themselves are not particularly useful, but salts of some of these acids are used extensively. *Triphosphoric acid*, also known as *tripolyphosphoric acid*, $\text{H}_5\text{P}_3\text{O}_{10}$, can be considered as a product of the reaction



but it could be formed by loss of H_2O from $\text{H}_4\text{P}_2\text{O}_7$ and H_3PO_4 . It has the structure

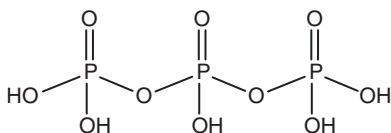

and is a rather strong acid so the first step of its dissociation in water is extensive.

Other condensed polyphosphoric acids have the general formula $\text{H}_{n+2}\text{P}_n\text{O}_{3n+1}$, and they are formally produced by the elimination of water between the $(n - 1)$ acid and a molecule of H_3PO_4 . The general structure can be represented as

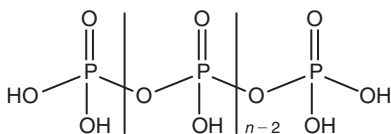

Sodium tripolyphosphate, $\text{Na}_5\text{P}_3\text{O}_{10}$, is the most important salt of the polyphosphoric acids. It is used in sulfonate detergents, in which it functions to complex with Ca^{2+} and Mg^{2+} (known as *sequestering*) to prevent the formation of insoluble soaps in hard water.

Another "phosphoric acid," *trimetaphosphoric acid*, is a trimer of HPO_3 representing the $\text{H}_2\text{O}/\text{P}_2\text{O}_5$ ratio of 1. The structure of $\text{H}_3\text{P}_3\text{O}_9$ can be shown as

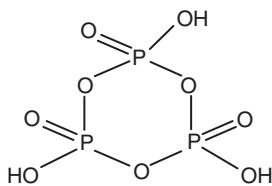

Note that the $\text{P}_3\text{O}_9^{3-}$ anion is isoelectronic with $(\text{SO}_3)_3$ and $\text{Si}_3\text{O}_9^{6-}$, which also have ring structures. When the formula for $\text{H}_3\text{P}_3\text{O}_9$ is written as $[(\text{HO})\text{PO}_2]_3$, it can be seen that it is a strong acid. Some salts of trimetaphosphoric acid are used in foods and toiletries. The acid can also be viewed as being produced by the partial dehydration of H_3PO_4 ,



or a hydration product of P_2O_5 ,



Although a cyclic tetramer is also known, it is not an important compound.

The most important acid containing phosphorus is orthophosphoric acid, H_3PO_4 . This is the acid usually indicated when the name *phosphoric acid* is used in most contexts. Approximately 30 billion pounds of this acid are produced annually. The commercial form of the acid is usually a solution containing 85% acid. The process used to produce phosphoric acid is related to the intended use of the acid. If the acid is intended for use in foods, it is prepared by burning phosphorus and dissolving the product in water.

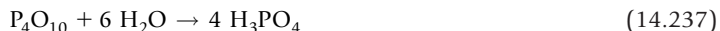

A “fertilizer-grade” product is obtained by treating phosphate rock with sulfuric acid.

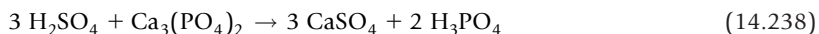

Liquid H_3PO_4 has a high viscosity, and it is extensively associated by hydrogen bonding.

Adding SO_3 to sulfuric acid produces $\text{H}_2\text{S}_2\text{O}_7$, which can be diluted to produce 100% sulfuric acid. However, when P_4O_{10} is added to 85% phosphoric acid, condensation occurs to produce a complex mixture that contains H_3PO_4 , $\text{H}_4\text{P}_2\text{O}_7$, higher acids, and a trace of water. As a result, if enough P_4O_{10} is added to theoretically give 100% H_3PO_4 , approximately 10% of the P_4O_{10} is contained in other species, especially $\text{H}_4\text{P}_2\text{O}_7$.

Phosphoric acid, $(\text{HO})_3\text{PO}$, is a weak acid that has the following dissociation constants: $K_{a1} = 7.5 \times 10^{-3}$; $K_{a2} = 6.0 \times 10^{-8}$; and $K_{a3} = 5 \times 10^{-13}$. Salts having formulas M_3PO_4 , M_2HPO_4 , and MH_2PO_4 are known, where M is a univalent ion. These salts dissolve in water to give basic solutions as a result of hydrolysis reactions such as

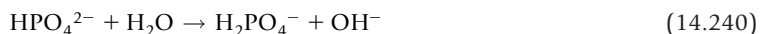

Phosphoric acid is used in many ways that include foods and beverages. It is also used in cleaning metal surfaces, electroplating, fertilizer production, preparing flame-proofing compounds, and other processes in the chemical industry, making it one of the most important of the chemicals of commerce.

14.3.10 Fertilizer Production

Feeding a world population of over 6 billion requires the use of tools of all types. Not only is the *machinery* of agriculture important, but so are the *chemicals* of agriculture. The use of effective fertilizers is essential to increase food production from a tillable land mass that (at least in the United States) is shrinking. Phosphates are an important constituent in many types of fertilizers, and their production involves primarily inorganic chemistry.

Naturally occurring calcium phosphate is the primary resource utilized in producing fertilizer. It is found in many places, and it is available in almost unlimited quantity. Converting this insoluble

material into a soluble form involves changing the phosphate to some other compound that has greater solubility. In $\text{Ca}_3(\text{PO}_4)_2$, the ions have charges of +2 and -3, so the lattice energy is high, and such compounds are generally not soluble in water. Because the phosphate ion is basic, $\text{Ca}_3(\text{PO}_4)_2$ will react with an acid to produce H_2PO_4^- (as the process is carried out). With the charges being lower, the compound is more soluble than calcium phosphate. For this conversion, the strong acid having the lowest cost is utilized, and that acid is sulfuric acid. The reaction can be shown as



The product, $\text{Ca}(\text{H}_2\text{PO}_4)_2$, is more soluble than the phosphate. Sulfuric acid is produced in the largest quantity of any compound, with production that approaches 100 billion pounds annually. Approximately two-thirds of this amount is used in the production of fertilizers. The mixture containing calcium dihydrogen phosphate and calcium sulfate (*gypsum*) is known as *superphosphate of lime*, and it contains a higher percent of phosphorus than does calcium phosphate.

Fluoroapatite, $\text{Ca}_5(\text{PO}_4)_3\text{F}$, is sometimes found with $\text{Ca}_3(\text{PO}_4)_2$, and it also reacts with sulfuric acid,



This is one source of hydrogen fluoride, which is also produced by the action of sulfuric acid on *fluorite*, CaF_2 .

Another type of fertilizer is obtained by utilizing phosphoric acid instead of H_2SO_4 . The reactions are as follows:

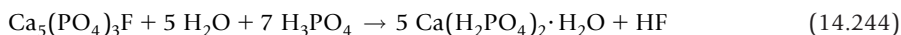

The product, $\text{Ca}(\text{H}_2\text{PO}_4)_2$, contains an even higher percent of phosphorus and it is often referred to as *triple superphosphate*.

Plants require nutrients that also contain nitrogen. As discussed earlier in this chapter, ammonium nitrate is an important fertilizer, and it can be produced by the reaction



An enormous quantity of ammonium nitrate is produced annually primarily for use as a fertilizer and also as an explosive. Ammonium sulfate, ammonium phosphate, and urea are also used as nitrogen-containing fertilizers. They are produced by the reactions



A fertilizer that provides both phosphorus and nitrogen is prepared by the reaction of calcium phosphate and nitric acid.

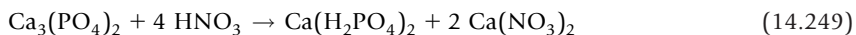

Inorganic chemistry is vital to production of food. The materials described are produced on an enormous scale, and they are vital to our way of life and well-being. It is safe to assume that given a projected world population of perhaps 12 billion by the year 2030, there will not be a decrease in this importance.

■ REFERENCES FOR FURTHER READING

- Allcock, H. R. (1972). *Phosphorus-Nitrogen Compounds*. Academic Press, New York. A useful treatment of linear, cyclic, and polymeric phosphorus-nitrogen compounds.
- Bailar, J. C., Emeleus, H. J., Nyholm, R., and Trotman-Dickinson, A. F. (1973). *Comprehensive Inorganic Chemistry*, Vol. 3. Pergamon Press, Oxford. This is one volume in the five-volume reference work in inorganic chemistry.
- Carbridge, D. E. C. (1974). *The Structural Chemistry of Phosphorus*. Elsevier, New York. An advanced treatise on an enormous range of topics in phosphorus chemistry.
- Cotton, F. A., Wilkinson, G., Murillo, C. A., and Bochmann, M. (1999). *Advanced Inorganic Chemistry*, 6th ed. Wiley, New York. A 1300-page book that has chapters dealing with all main-group elements.
- Glockling, F. (1969). *The Chemistry of Germanium*. Academic Press, New York. An excellent introduction to the inorganic and organic chemistry of germanium.
- Goldwhite, H. (1981). *Introduction to Phosphorus Chemistry*. Cambridge University Press, Cambridge, UK. A small book that contains a lot of information on organic phosphorus chemistry.
- Gonzales-Moraga, G. (1993). *Cluster Chemistry*. Springer-Verlag, New York. A comprehensive survey of the chemistry of clusters containing transition metals as well as cages composed of main-group elements such as phosphorus, sulfur, and carbon.
- King, R. B. (1995). *Inorganic Chemistry of the Main Group Elements*. VCH Publishers, New York. An excellent introduction to the reaction chemistry of many elements.
- Liebau, F. (1985). *Structural Chemistry of Silicates*. Springer-Verlag, New York. Thorough discussion of this important topic.
- Mark, J. E., Allcock, H. R., and West, R. (1992). *Inorganic Polymers*. Prentice Hall, Englewood Cliffs, NJ. A modern treatment of polymeric inorganic materials.
- Rochow, E. G. (1946). *An Introduction to the Chemistry of the Silicones*. Wiley, New York. An introduction to the fundamentals of silicon chemistry.
- Toy, A. D. F. (1975). *The Chemistry of Phosphorus*. Harper & Row, Menlo Park, CA. One of the standard works on phosphorus chemistry.
- Van Wazer, J. R. (1958). *Phosphorus and Its Compounds*, Vol. 1. Interscience, New York. This is the classic book on all phases of phosphorus chemistry. Highly recommended.
- Van Wazer, J. R. (1961). *Phosphorus and Its Compounds*, Vol. 2. Interscience, New York. This volume is aimed at the technology and application of phosphorus-containing compounds.
- Walsh, E. N., Griffith, E. J., Parry, R. W., and Quin, L. D. (1992). *Phosphorus Chemistry*. Developments in American Science, American Chemical Society, Washington, D.C. This is ACS Symposium Series No. 486, a symposium volume that contains 20 chapters dealing with many aspects of phosphorus chemistry.

■ QUESTIONS AND PROBLEMS

- Write balanced equations for the reactions of AsF_5 with each of the following compounds: (a) H_2O ; (b) H_2SO_4 ; (c) CH_3COOH ; (d) CH_3OH
- Complete and balance the following. Some of the reactions may require elevated temperatures.
 - $\text{As}_2\text{O}_3 + \text{HCl} \rightarrow$
 - $\text{As}_2\text{O}_3 + \text{Zn} + \text{HCl} \rightarrow$
 - $\text{Sb}_2\text{S}_3 + \text{O}_2 \rightarrow$
 - $\text{AsCl}_3 + \text{H}_2\text{O} \rightarrow$
 - $\text{Sb}_2\text{O}_3 + \text{C} \rightarrow$
- Complete and balance the following:
 - $\text{AsCl}_3 + \text{LiC}_4\text{H}_9 \rightarrow$
 - $\text{PCl}_5 + \text{P}_4\text{O}_{10} \rightarrow$
 - $\text{OPCl}_3 + \text{C}_2\text{H}_5\text{OH} \rightarrow$
 - $(\text{NPCl}_2)_3 + \text{LiCH}_3 \rightarrow$
 - $\text{P}(\text{OCH}_3)_3 + \text{S}_8 \rightarrow$
- Starting with elemental phosphorus, show a series of equations to synthesize the following: (a) $\text{P}(\text{OCH}_3)_3$; (b) $\text{OP}(\text{OC}_2\text{H}_5)_3$; (c) $\text{SP}(\text{OC}_2\text{H}_5)_3$
- Explain why N_2O is almost 40 times as soluble as N_2 in water at 25°C and 1 atm pressure.
- Trifluoramino oxide, F_3NO , has a dipole moment of 0.039 D, whereas that of NF_3 is 0.235 D. Explain this difference.
- Although the difference in electronegativity between N and O is less than that between C and O, the NO molecule has a dipole moment of 0.159 D, whereas CO has a dipole moment of 0.110 D. Explain this difference.
- Describe the bonding that causes the P–O distance in OPR_3 (R = alkyl group) to be somewhat shorter than the usual single bond length.
- Suppose the -1 ion containing one atom each of nitrogen, phosphorus, and carbon could be prepared. Describe the structure of this ion in some detail with regard to the type of bonding and resonance.
- Would phosphonium acetate likely be stable? Explain your answer.
- A compound known as nitrosyl azide, N_4O , has been reported. Draw the structure of this unusual compound and discuss the bonding. What would be a different arrangement of atoms for a compound having this formula? Comment on its stability.
- The oxidation of NO to NO_2 may involve an intermediate having the formula N_2O_2 . Describe the structure of this compound. It is believed that there is a less stable isomer that has lower symmetry. Draw the structure for that isomer.
- When NO reacts with ClNO_2 , the products are ClNO and NO_2 . There are two ways in which this reaction could occur. Write equations showing the possible mechanisms. Explain how the use of a radioactive isotope could clarify the mechanism.
- Complete and balance the following equations for reactions in liquid ammonia:
 - $\text{NH}_4\text{Cl} + \text{NaNH}_2 \rightarrow$
 - $\text{Li}_2\text{O} + \text{NH}_3 \rightarrow$
 - $\text{CaNH} + \text{NH}_4\text{Cl} \rightarrow$
- There are two different N–O distances, 143 pm and 118 pm, in the nitrous acid molecule. Draw the structure of the molecule and explain the bond lengths.
- Phosphorous acid disproportionates at high temperature to produce phosphine. What is the other product? Write the equation for this reaction.

17. Where would the fluorine atom be located in the PCl_4F molecule? Explain how you know.
18. Coupling reactions in which a metal such as mercury removes a halogen are rather common. What would be produced by a reaction of this type when mercury reacts with PF_2I ?
19. Sketch the structure of the P_4O_{10} molecule. There are two different P–O bond lengths in the molecule. After deciding which is shorter and longer, explain the difference in terms of bonding.
20. When burning magnesium is placed in a bottle containing N_2O , it continues to burn. Write the equation for the reaction and explain how it is consistent with the structure of N_2O being what it is.
21. Write balanced equations for each of the following processes:
 - (a) The preparation of triethylphosphate
 - (b) The reaction of PCl_5 with NH_4Cl
 - (c) The preparation of arsine
 - (d) The reaction of P_4O_{10} with $i\text{-C}_3\text{H}_7\text{OH}$
22. What types of reactions would the nitrogen atoms in a phosphazine ring undergo?
23. At high temperature, arsenic dissolves in molten sodium hydroxide with the liberation of hydrogen. Write the equation for the reaction.
24. Explain how the presence of SbF_5 increases the acidity of a liquid HF solvent system.
25. In the H_3PO_4 molecule there are P–O bonds having lengths of 152 pm and 157 pm. Draw the structure of the molecule, assign the bond lengths, and discuss the differences in bonding.
26. Although phosphorous acid has the formula H_3PO_3 , the titration with sodium hydroxide gives Na_2HPO_3 . Why?
27. Although H_3PO_4 is a stable acid containing phosphorus, there is no corresponding H_3NO_4 . Explain why this is true.
28. Even though H_3NO_4 is not stable, the reaction between Na_2O and NaNO_3 at high temperature produces Na_3NO_4 . What would be the structure of the NO_4^{3-} ion?
29. The N–O single bond is typically about 146 pm. In the NO_4^{3-} ion, the bond length is 139 pm. Explain the difference. Keep in mind that the N–O bond length in the NO_3^- ion is about 124 pm.
30. The bond energy of the $\text{P}\equiv\text{P}$ bond is 493 kJ/mol and the P–P bond energy is 209 kJ/mol. Use these values to show that form of elemental phosphorus is expected to be different from that of elemental nitrogen.
31. Write balanced equations for each of the following processes.
 - (a) The preparation of $(\text{CH}_3)_3\text{PO}$
 - (b) The preparation of POF_3 from with P_4
 - (c) The reaction of P_4 with NaOH
 - (d) The preparation of superphosphate fertilizer
32. Complete and balance the following:
 - (a) $\text{NaCl} + \text{SbCl}_3 \rightarrow$
 - (b) $\text{Bi}_2\text{S}_3 + \text{O}_2 \rightarrow$
 - (c) $\text{Na}_3\text{Sb} + \text{H}_2\text{O} \rightarrow$
 - (d) $\text{BiBr}_3 + \text{H}_2\text{O} \rightarrow$
 - (e) $\text{Bi}_2\text{O}_3 + \text{C} \rightarrow$
33. Explain why NH_3 is more polar than NCl_3 .
34. Both hyponitrous acid and nitroamide (also known as nitramide) have the formula $\text{H}_2\text{N}_2\text{O}_2$. Draw the structures for these molecules and explain any difference in acid-base properties.
35. By making use of the following bond energies, explain why CO_2 exists as discrete molecules whereas SiO_2 does not. Estimate the strength of the Si=O bond.
C–O, 335; C–O, 707; Si–O, 464

36. Explain why the boiling point of SnCl_2 is $652\text{ }^\circ\text{C}$, whereas that of SnCl_4 is $114\text{ }^\circ\text{C}$.
37. Write complete, balanced equations for the processes indicated.
- The combustion of silane
 - The preparation of PbO_2
 - The reaction of CaO with SiO_2 at high temperature
 - The preparation of GeCl_2
 - The reaction of SnCl_4 with water
 - The preparation of tetraethyllead

This page intentionally left blank

Chemistry of Nonmetallic Elements III.

Groups VIA to VIIIA

In the study of inorganic chemistry, it becomes apparent that the chemistry of elements having greatly different properties must be considered. Although phosphorus and xenon are both nonmetals and are distinctly different, some compounds of these elements react in similar ways. Even within a specific group of elements there are vast differences. That is why oxygen was discussed separately from the remaining members of the *chalcogens*, group VIA, which are considered in this chapter. In the case of the halogens, the chemistry of fluorine is more like that of the heavier members of the group, so the entire group is considered together in this chapter. Consequently, this chapter presents the chemistry of group VIA (except for oxygen), VIIA, and the noble gases. Entire volumes have been written on each of the elements so only a glimpse of the whole view of these elements can be presented.

15.1 SULFUR, SELENIUM, AND TELLURIUM

The chemistry of sulfur is a broad area that includes such chemicals as sulfuric acid (the compound prepared in the largest quantity) as well as unusual compounds containing nitrogen, phosphorus, and halogens. Although there is an extensive chemistry of selenium and tellurium, much of it follows logically from the chemistry of sulfur if allowance is made for the more metallic character of the heavier elements. All isotopes of polonium are radioactive, and compounds of the element are not items of commerce or great use. Therefore, the chemistry of sulfur will be presented in more detail.

15.1.1 Occurrence of the Elements

Sulfur has been known and used for thousands of years. The reason for this is that the element is found uncombined in many areas of the earth where volcanic activity is present. Such areas include the region of the Mediterranean Sea, Mexico, Chile, and Japan, among others. The recorded history of man in these areas indicates that sulfur was utilized in several ways. There are many minerals that contain sulfur; among them are *galena* (PbS), *zinc blende* (ZnS), *cinnabar* (HgS), *iron pyrites* (FeS₂), *gypsum* (CaSO₄), and *chalcopyrite*, CuS₂. Black gunpowder, a mixture of sulfur, charcoal, and potassium nitrate, has been known for about a thousand years, and its use in firearms influenced the course of history.

Tellurium was discovered in 1782 by Baron F. J. Müller von Reichenstein, and selenium was discovered in 1817 by Berzelius. The last member of the group was discovered in 1898 by Madame Curie, and the name *polonium* comes from her native country, Poland. The name *tellurium* comes from the Latin *tellus*, meaning “earth,” and *selenium* is named from a Greek word, *selene*, meaning “moon.” Compounds containing sulfur also contain small amounts of selenium and tellurium, and this is the major source of these elements. In the electrolytic refining of copper, the anode sludge contains some selenium and tellurium. Sulfur is obtained from vast deposits of the element that are found below the surface in Louisiana and Texas by the *Frasch process*, which makes use of three concentric pipes. In this process, sulfur (which melts at 119 °C) is melted by superheated water forced underground in one pipe while compressed air is forced down a second pipe. The molten sulfur is forced to the surface through the third pipe.

15.1.2 Elemental Sulfur, Selenium, and Tellurium

The usual form of sulfur is known as the rhombic form, which is stable at temperatures up to about 105 °C. Above that temperature, the monoclinic structure is stable. A plastic form of sulfur can be obtained by pouring liquid sulfur into water to cool it quickly, but on standing it is converted to the rhombic form. On a molecular level, the element exists as S_8 rings that have the structure

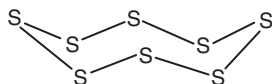

Sulfur vapor consists of a mixture of species that includes S_8 , S_6 , S_4 , and S_2 (which like O_2 is paramagnetic). Because the S_8 molecule is nonpolar, it is soluble in liquids such as CS_2 and C_6H_6 . Selenium also consists of cyclic molecules that contain eight atoms, and tellurium is essentially metallic in character. In their vapors, several species are found that contain 2, 6, or 8 atoms. Both are useful as semiconductors, and selenium has been used in rectifiers. Because the electrical conductivity of selenium increases as the intensity of illumination increases, it has been used to operate electrical switches that open or close as a light beam is broken. Selenium was also used in light meters, but other types of meters are now available that are more sensitive. Table 15.1 gives a summary of the properties of the group VIA elements.

Liquid sulfur has the unusual characteristic that the viscosity increases with increasing temperature, going through a maximum at about 170 to 180 °C. At higher temperature, the viscosity decreases as the temperature is increased. When S_8 molecules rupture, the long chains interact to give larger aggregates that do not flow as readily as do the molecules having a ring structure. At higher temperatures, the chains dissociate and the viscosity becomes lower. Selenium does not exhibit this unusual behavior in viscosity.

Although many reactions and uses of sulfur will be described, about 85% of the sulfur produced is used in making sulfuric acid, and about two-thirds of the acid is used in the production of fertilizer (see Chapter 14). Sulfur is rather reactive, so it reacts with most other elements. It produces a blue flame when it burns in air,



Table 15.1 Some Properties of the Group VIA Elements.					
	O	S	Se	Te	Po
Melting point, °C	-218.9	118.9 _a	217.4	449.8	—
Boiling point, °C	-182.96	444.6	648.8 (subl)	1390	—
Atomic radius, pm	74	104	117	137	152
Ionic radius (X ⁴⁺), pm	—	51	64	111	122
Ionic radius (X ²⁻), pm	126	170	184	207	—
Electronegativity	3.5	2.5	2.4	2.1	—
Ionization potential, eV	13.62	10.36	6.54	9.01	8.42

and it produces a dark coating when it tarnishes silver,



Sulfur also forms binary compounds by reacting with phosphorus and halogens.



Sulfur also reacts by undergoing addition reactions with several types of species. For example, thiosulfates are produced by the reaction of sulfur with sulfites.



Thiocyanates are prepared by addition of sulfur to cyanides.



It will also add to phosphorus atoms that are present in a variety of molecules:



As a result of the tendency toward catenation, sulfur reacts with solutions of sulfides to produce polysulfides.



In this behavior, sulfur resembles iodine, which reacts in an analogous way to form polyiodides. Sulfur will also remove hydrogen from saturated hydrocarbons to produce H_2S with the formation of carbon-carbon double bonds. Sulfur dissolves in hot concentrated nitric acid as a result of being oxidized as shown in this reaction:

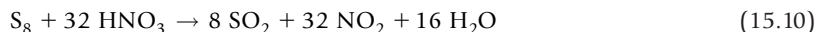

In the following equations, selenium and tellurium exhibit behavior that is analogous to that of sulfur:



However, selenium and tellurium do not react with hydrogen, so the hydrogen compounds are prepared by reacting the elements with a metal, then treating it with an acid. Selenium and tellurium undergo addition reactions with cyanides to yield selenocyanates and tellurocyanates:



15.1.3 Hydrogen Compounds

By far the most common compounds containing the group VIA elements and hydrogen are those having the formula H_2E , and the properties of these compounds are summarized in Table 15.2 with H_2O included for comparison. The H_2E compounds are extremely toxic.

As a result of the bonding between sulfur atoms, several hydrogen compounds exist in which there are several sulfur atoms in a chain with a hydrogen atom bonded to the terminal sulfur atoms. These compounds include H_2S_2 (m.p. -88 , b.p. 74.5°C) and H_2S_6 . Compounds of this type are known as *sulfanes*, and they are discussed in the next section.

The data shown in Table 15.2 reveal several interesting characteristics of the H_2E molecules. The fact that they have much lower boiling points than H_2O reflects the strong hydrogen bonding in the latter. As evidenced by the heats of formation, the stability of the compounds decreases markedly in progressing down the group. This is expected on the basis of the increase in size of the atoms resulting in less effective overlap with $1s$ orbitals on hydrogen atoms. It is also apparent that there is an increase in acidity of the compounds in going downward in the group. The bond angles show that hybridization results in sp^3 orbitals on the oxygen atom in water, but the bond angles in the remaining compounds are not far from 90° . This probably indicates that hybridization is not extensive in these cases where the orbitals on the central atom are larger, and it parallels the trend shown by the analogous group VA compounds.

Table 15.2 Properties of Hydrogen Compounds of Group VI Elements.				
Property	H ₂ O	H ₂ S	H ₂ Se	H ₂ Te
Melting point, °C	0.00	-85.5	-65.7	-51
Boiling point, °C	100.0	-60.7	-41.3	-2.3
ΔH_f° (gas), kJ mol ⁻¹	-242	-20	+66.1	+146
Dipole moment, Debye	1.85	0.97	0.62	0.2
Acid K_{a1}	1.07×10^{-16}	1.0×10^{-9}	1.7×10^{-4}	2.3×10^{-3}
Acid K_{a2}	—	1.2×10^{-15}	1.0×10^{-10}	1.6×10^{-11}
Bond angle, degrees	104.5	92.3	91.0	89.5
H—X bond energy, kJ mol ⁻¹	464	347	305	268

There are numerous ways in which hydrogen sulfide can be obtained. One of the simplest is to treat a metal sulfide with an acid, as illustrated by the reaction of galena.



Hydrogen sulfide can be prepared from the elements, but the unfavorable heat of formation of H₂Se and H₂Te indicates that producing them by direct combination is not a efficient route. Instead, they are first obtained as selenides and tellurides, which then react with an acid.

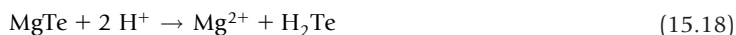

All of the H₂E compounds dissociate slightly in water, but the second step is very slight. Because the acids are weak, solutions containing the E²⁻ anions are basic as a result of hydrolysis.



A series of bisulfide salts exist, and they are also basic in solution because even the first step in the dissociation of H₂S is slight:



15.1.4 Polyatomic Species

Compounds having the formula H₂S_{*n*} (where *n* is typically 2–8) are known as *sulfanes*, with the number of sulfur atoms indicated as the prefix to the name *sulfane* (H₂S₃ is *trisulfane*, H₂S₆ is *hexasulfane*, etc.). Sulfanes containing longer chains of sulfur atoms can be prepared by the reaction of H₂S₂ with disulfur dichloride, S₂Cl₂, (also known as sulfur monochloride).



The length of the sulfur chain can be increased by subsequent reactions with S_2Cl_2 .



Sulfanes decompose to produce H_2S and sulfur in a thermodynamically favored reaction.



Many compounds of the group VIA elements are covalent or contain the elements as complex anions. Sulfide ions in solution react with sulfur to produce polyatomic anions known as the *polysulfides*. When these solutions are acidified, a series of compounds is formed that contain sulfur atoms in chains. The reaction can be shown as follows:



Polysulfides of several metals can be prepared by reaction of the metals with excess sulfur in liquid NH_3 (group IA metals) or by heating sulfur with the molten metal sulfide. The polysulfide ion binds to metals to form coordination compounds in which it is attached to the metal by both sulfur atoms (as a so-called bidentate ligand). One example is an unusual titanium complex containing the S_5^{2-} ion that is produced by the following reaction (the use of \hbar to denote the bonding mode of the cyclopentadienyl ion is explained in Chapter 16):

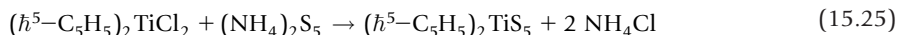

Although H_2S is normally a weak acid, it functions as a base in a superacid such as HF/SbF_5 in liquid HF . The H_3S^+ ion is generated, and although solid $H_3S^+SbF_5^-$ has been obtained, there is very limited chemistry associated with this type of compound.

Cations that contain sulfur, selenium, and tellurium have also been studied for many years. One of the most common ions of this type is S_4^{2+} , which has the following square planar structure. This is also the structure of Se_4^{2+} and Te_4^{2+} , which have the dimensions shown.

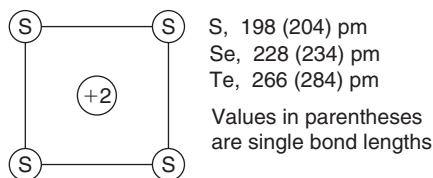

Polyatomic cations of S, Se, and Te are produced as shown in the following reactions.

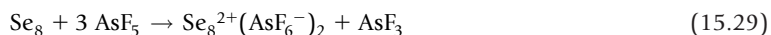
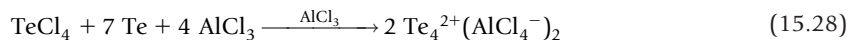
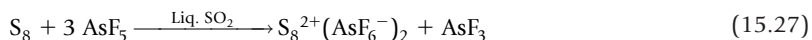
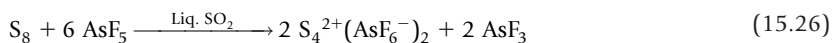

Although S_4^{2+} , Se_4^{2+} , and Te_4^{2+} ions have square planar structures, the ions S_8^{2+} , Se_8^{2+} , Te_8^{2+} exist as puckered rings:



The ions containing four and eight atoms are the most common, but they are by no means the only cations known for the group VIA elements. Tellurium forms the Te_6^{4+} ion, which is a slightly distorted trigonal prism. The Se_{10}^{2+} cation has been studied, and sulfur forms the S_{19}^{2+} ion having a five-atom chain with a seven-atom ring attached on each end. The use of nonaqueous solvents and superacids makes it possible to generate many unusual and interesting species.

15.1.5 Oxides of Sulfur, Selenium, and Tellurium

Sulfur is known to form several oxides including S_2O , S_6O , S_8O , S_7O_2 , and SO that have no significant use. The oxides that contain several sulfur atoms generally have rings containing sulfur atoms with an oxygen atom appended to one of them. There do not appear to be as many oxides of selenium and tellurium, but the dioxides of all the elements have an extensive chemistry associated with them. Table 15.3 shows the properties of the group VIA dioxides.

Sulfur dioxide is an economically important gas that is used as a refrigerant, disinfectant, and reducing atmosphere for preserving food. Although it is also used in the manufacture of many other sulfur compounds, the most important use of SO_2 is as a precursor in producing sulfuric acid. It can be obtained by burning sulfur, but it is also produced in numerous other reactions. Sulfites react with acids by liberating SO_2 .



When sulfide ores are roasted to prepare the oxide that is subsequently reduced to obtain the metal, SO_2 is produced.

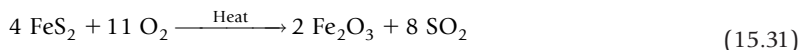

Property	SO_2	SeO_2	TeO_2
Melting point, °C	-75.5	340	733
Boiling point, °C	-10.0	subl	—
ΔH_f° , kJ mol ⁻¹	-296.9	-230.0	-325.3
ΔG_f° , kJ mol ⁻¹	-300.4	-171.5	-269.9

Sulfur dioxide is released during the burning of sulfur-containing coal. Much of that gas is now removed from the effluent and used in the production of sulfuric acid. The dioxides of Se and Te are recovered from the residue after the elements have reacted with concentrated HNO_3 .

Although the boiling point of SO_2 is -75.5°C , that of SeO_2 is 340°C , and that of TeO_2 is 733°C . It hardly needs to be stated that these data suggest a drastic difference in bonding in the molecules. In the gas phase, the SO_2 molecule has a structure that can be represented by two resonance structures,

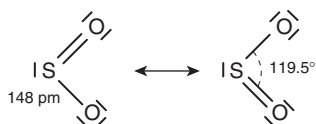

Unlike SO_2 , SeO_2 and TeO_2 exist as solids having structures that are extended networks. Liquid SO_2 ($\mu = 1.63$ D) is a versatile nonaqueous solvent (see Chapter 10) that is a good solvent for many types of organic compounds, and aromatic hydrocarbons are much more soluble than aliphatic. There is little if any ionization of SO_2 as described by the solvent concept, and it reacts primarily by forming complexes. It can behave as both a Lewis acid and a Lewis base. It also forms complexes with metals, particularly the second- and third-row transition metals in low oxidation states, in which it can bond through the sulfur atom or an oxygen atom, or form bridges between metal ions. Sulfur dioxide reacts with PCl_5 to produce OPCl_3 and thionyl chloride, SOCl_2 . Sulfuryl chloride is produced by the reaction of SO_2 with chlorine.



The catalytic oxidation of SO_2 produces SO_3 , which reacts with water to produce sulfuric acid, and it dissolves in sulfuric acid to produce *disulfuric acid* or *oleum*, $\text{H}_2\text{S}_2\text{O}_7$. Solid SO_3 exists as the trimer $(\text{SO}_3)_3$ but there are different crystalline forms known.

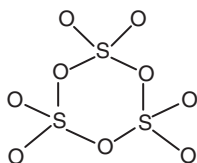

This structure is isoelectronic with $(\text{SiO}_3)_3^{6-}$ and $(\text{PO}_3)_3^{3-}$. Gaseous SO_3 has a trigonal planar structure that has several contributing resonance structures. When the structure is drawn with only one double bond, the sulfur atom has a +2 formal charge that is relieved by structures having two double bonds. Therefore, multiple bonding is extensive.

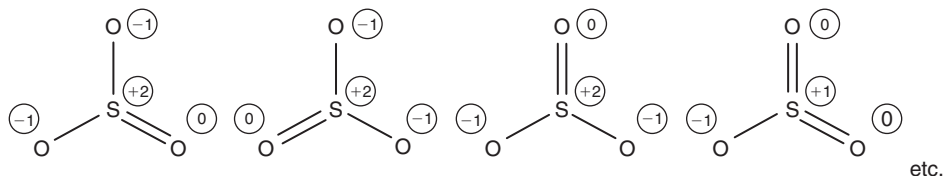

Selenium trioxide is unstable with respect to the dioxide.

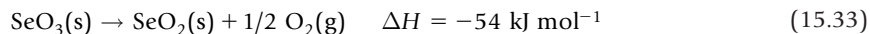

It can be prepared by dehydrating H_2SeO_4 or the reaction of that acid with SO_3 . Selenium trioxide is soluble in organic solvents. Dehydration of $\text{Te}(\text{OH})_6$ gives TeO_3 , which exists in two forms in the solid state. Neither SeO_3 nor TeO_3 have large-scale commercial use.

15.1.6 Halogen Compounds

There are a considerable number of well-known halogen compounds of the group VIA elements, but the majority of them are fluorides and chlorides. Table 15.4 summarizes data for most of the group VIA halides.

The structure of S_2F_2 resembles that of H_2O_2 with a dihedral angle of about 88° , and SF_4 is an irregular tetrahedron. As expected, the SF_6 molecule is a regular octahedron. The structures of all these sulfur fluorides are shown in Figure 15.1.

Compound	m.p., °C	b.p., °C
S_2F_2	-133	15
SF_4	-121	-38
SF_6	-51 (2 atm)	-63.8 (subl)
S_2F_{10}	-52.7	30
SCl_2	-122	59.6
S_2Cl_2	-82	137.1
S_3Cl_2	-45	—
SCl_4	-31 (dec)	—
S_2Br_2	-46	90 (dec)
SeF_4	-9.5	106
SeF_6	-34.6 (1500 torr)	-34.8 (945 torr)
Se_2Cl_2	-85	127 (733 torr)
SeCl_4	191 (subl)	—
Se_2Br_2	-146	225 (dec)
TeF_4	129.6	194 (dec)
TeF_6	-37.8	-38.9 (subl)
Te_2F_{10}	-33.7	59
TeCl_2	208	328
TeCl_4	224	390
TeBr_4	380	414 (dec)

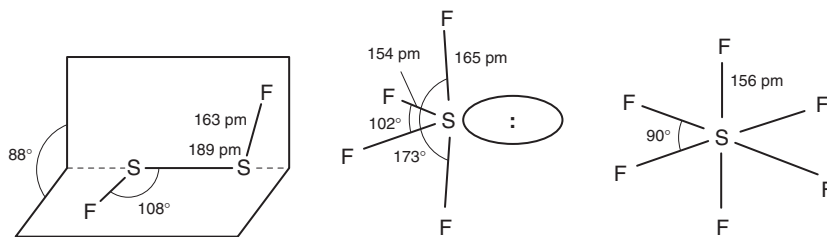

■ FIGURE 15.1 Structures of the most important sulfur fluorides.

In addition to these well-known fluorides, there are others that include a form of S_2F_2 that is actually thiothionyl fluoride, SSF_2 , SF_2 , and S_2F_{10} , in which two SF_5 groups are linked by an S–S bond.

The preparations of the sulfur fluorides include a wide variety of reactions. The hexafluoride can be prepared by fluorinating sulfur with ClF_3 , BrF_5 , or F_2 . When fluorine is used, some SF_4 and S_2F_{10} are also produced. The hexafluoride is virtually unique among covalent halides of nonmetals because of its inertness. It is so inert that it undergoes very few reactions under ordinary conditions, and it is used as a gaseous insulator. The reason is that there is no low-energy pathway because of the stability of the S–F bonds and the shielding of the sulfur atom by six fluorine atoms. In contrast, the other sulfur fluorides react with water.

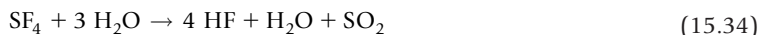

Sulfur tetrafluoride is a fluorinating agent that undergoes many useful reactions, with some examples being the following:

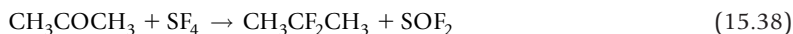
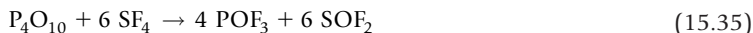

Sulfur tetrafluoride is produced in several reactions with fluorinating agents such as IF_7 .

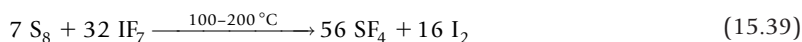

A coupling reaction like the following can be used to prepare S_2F_{10} :



This fluoride is more reactive than SF_6 , and at a temperature of $150^\circ C$, it dissociates into SF_4 and SF_6 .

The hexafluorides of selenium and tellurium are similar to SF_6 , but they react more readily. This is likely the result of the bonds being more polar and the fact that the larger Se and Te atoms are less shielded by six fluorine atoms than are smaller S atoms. Both SeF_6 and TeF_6 react slowly in water.

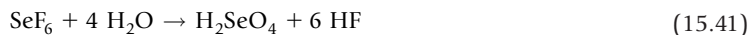

SF₄ can also react as a Lewis base, but in some cases a fluorine atom is the electron pair donor. With the strong Lewis acids such as BF₃ and SbF₅, the reactions can lead to the formation of the SF₃⁺ cation. It is also possible for SF₄ to react with Lewis bases and thereby expand the number of electrons in the valence shell. When reacting with F⁻, the SF₅⁻ species results.

The tetrafluorides of selenium and tellurium are similar to SF₄ both structurally (in the gaseous molecules) and in terms of reactivity. However, the bonding in condensed phases is different and leads to several types of structures. Selenium tetrafluoride can be prepared by combining the elements, but it can also be obtained by the reaction of SeO₂ with SF₄ at high temperature. The tellurium compound can be prepared by the reaction of SeF₄ and TeO₂ at 80 °C.

The most important binary compounds of sulfur and chlorine are S₂Cl₂ and SCl₂. Both of these compounds are used in large quantities in many ways, but one of the important uses for S₂Cl₂ is in the vulcanization of rubber. This compound is prepared by chlorinating sulfur.



The structure of S₂Cl₂ is similar to that shown in Figure 15.1 for S₂F₂. Most other chlorides of sulfur have the sulfur atoms in a chain with the chlorine atoms in terminal positions, and they are produced by the reaction of S₂Cl₂ with sulfur.

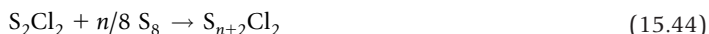

The reaction of S₂Cl₂ with sulfanes produces the chlorosulfanes.

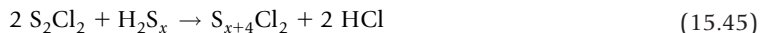

Although SCl₄ is unstable, SeCl₄ and TeCl₄ are stable, probably as a result of the larger sizes of the central atoms and the greater polarity of the bonds. In the gaseous state, SeCl₄ dissociates, but TeCl₄ is stable up to approximately 500 °C. When heated to melting, TeCl₄ becomes a good electrical conductor, possibly because of the ionization reaction



There are numerous other halogen compounds of the group VIA elements as well as ionic species derived from them. Space does not permit a full review of the halogen compounds of group VIA elements, but the discussion shows much of their behavior.

15.1.7 Oxyhalides of Sulfur and Selenium

The oxyhalides of the chalcogens constitute a reactive and useful group of compounds. As expected, the sulfur compounds have greater use, but SeOF₂ and SeOCl₂ are good solvents for many materials, which has led to their use as nonaqueous solvents (see Chapter 10). The two most important types of oxyhalides are the EOX₂ and EO₂X₂ series, and Table 15.5 shows a summary of relevant data for these types of compounds.

Table 15.5 Properties of Oxyhalides of Sulfur and Selenium.

Compound	m.p., °C	b.p., °C	μ , D
SOF ₂	-110.5	-43.8	—
SOCl ₂	-106	78.8	1.45
SOBr ₂	-52	183	—
SOCIF	-139.5	12.1	—
SeOF ₂	4.6	124	—
SeOCl ₂	8.6	176.4	—
SeOBr ₂	41.6	Dec	—
SO ₂ F ₂	-136.7	-55.4	1.12
SO ₂ Cl ₂	-54.1	69.1	1.81
SO ₂ ClF	-124.7	7.1	1.81

Thionyl chloride and sulfuryl chloride have structures in which the oxygen and halogen atoms are attached to the sulfur. Even though the formulas are often shown as SOCl₂ and SO₂Cl₂, they are correctly shown as OSCI₂ and O₂SCI₂. These molecules have C_s and C_{2v} symmetry, respectively. Thionyl chloride can be prepared by chlorinating SO₂,



or by the reaction of SO₃ with S₂Cl₂ or SCl₂,



Mixed halogen compounds such as SOCIF can be prepared by reactions such as



An exchange reaction between SeO₂ and SeCl₄ produces selenyl chloride.



Although such reactions must take place to only a very slight extent, autoionization of thionyl chloride and selenyl chloride is presumed to produce EOCl⁺ and EOCl₃⁻ ions. The molecules are pyramidal in the gas phase, but there is extensive bridging between molecules in solid SeOCl₂.

Thionyl chloride reacts as both a Lewis acid and a Lewis base, and both the S and Se compounds are very reactive toward many other materials. The hydrolysis reactions take place readily, and SOCl₂ has such an affinity for water that it is used as a dehydrating agent.



When dehydrating a compound such as a metal chloride, the gaseous products of the reaction make it easy to separate the anhydrous solid compound.



Thionyl chloride can also be used to convert metal oxides or hydroxides to the chlorides, and it will also react with many organic compounds. Alcohols react as follows:



Chlorine is a strong oxidizing agent that converts SO_2 into sulfuryl chloride, SO_2Cl_2 . In the reaction, sulfur is *oxidized* as chlorine is *added*, so the process is an *oxid* reaction.



The SO_2Cl_2 molecule can be considered as sulfuric acid in which the OH groups have been replaced by Cl to produce an *acid chloride*. As expected, it undergoes solvolysis reactions as illustrated by the following cases.

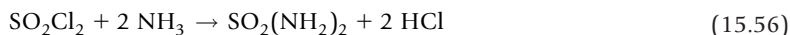

Sulfuryl fluoride is produced by the reaction of SO_2 or SO_2Cl_2 with fluorine.



An exchange reaction between SF_6 and SO_3 also produces sulfuryl fluoride.

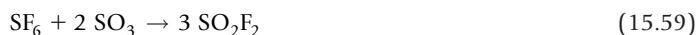

Even though sulfuryl chloride and sulfuryl fluoride can be considered as the disubstituted acid halides of sulfuric acid, the monosubstituted derivatives are also useful compounds that undergo many reactions a result of the reactive $-\text{OH}$ group. The monosubstituted compounds can be prepared by the following reactions:

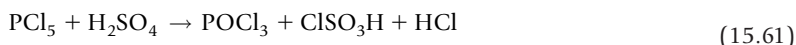

Both ClSO_3H and FSO_3H react rapidly with water and alcohols.



Fluorosulfonic acid can be used in fluorination reactions, and it functions as a catalyst in reactions such as alkylation and polymerization. One of the most important uses of FSO_3H and ClSO_3H is as sulfonating agents to introduce the $-\text{SO}_3\text{H}$ group into various organic materials.

15.1.8 Nitrogen Compounds

Because nitrogen compounds of Se and Te are much less important than those of sulfur, this section will be devoted to the sulfur compounds. The binary compounds containing sulfur and nitrogen have several unusual structures and properties that make them an interesting series. Probably the most studied compound of this type is S_4N_4 , tetrasulfur tetranitride, which is prepared by the following reactions:

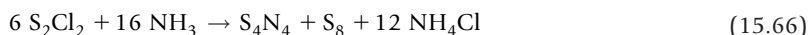
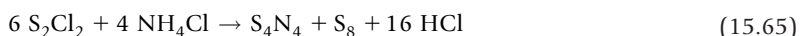

Compounds that undergo a color change when heated are known as *thermochromic* compounds, and tetrasulfur tetranitride exhibits this characteristic. It changes from almost colorless at very low temperature to orange at 25°C to dark red at 100°C . The compound is soluble in organic solvents, but insoluble in water. Although S_4N_4 is stable under some conditions, it has a heat of formation of $+460$ kJ/mol partially because of the great stability of the N_2 molecule. As a result, it will detonate if subjected to shock. The structure of the S_4N_4 molecule is a quite unusual ring in which the four nitrogen atoms lie in the same plane:

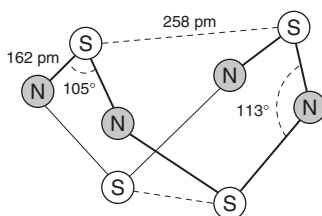

The distance between the sulfur atoms is significantly shorter than the sum of the van der Waals radii (~ 330 pm), so some interaction between the sulfur atoms is indicated. However, the typical S-S single bond distance is approximately 210 pm, so the interaction is weak. The structure involves several resonance structures, some of which are shown as follows (the unshared pairs of electrons on N and S are omitted):

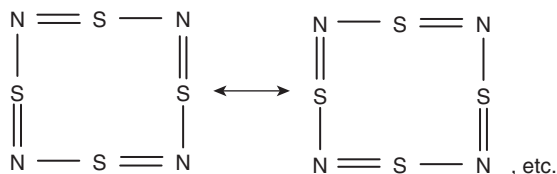

Molecular orbital calculations have also been carried out to describe the bonding by considering electron delocalization over the entire structure.

An enormous number of reactions have been carried out with tetrasulfur tetranitride to produce many ring structures, including some that have bridges across the rings. It is interesting to note that when S_4N_4 is hydrolyzed in basic solution, nitrogen ends up in a negative oxidation state in NH_3 because it has the higher electronegativity.

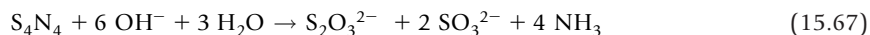

Reactions of S_4N_4 include some in which the ring is preserved when groups are added to S or N as well as some in which the ring is changed into one having a different number of atoms. Other reactions lead to complete disruption of the ring, so there is a very broad chemistry of this interesting molecule. In halogenation reactions with Cl_2 and Br_2 , the product, $S_4N_4Cl_4$, retains the ring structure of S_4N_4 , and the chlorine atoms are bonded to the sulfur atoms.



As a result of having unshared pairs of electrons, S_4N_4 undergoes addition reactions in which it functions as a Lewis base. For example, with BF_3 the reaction can be shown as



As shown in the following equation, reduction takes place when S_4N_4 is treated with $SnCl_2$ in ethanol:



Fluorine atoms can be added to the S_4N_4 ring to give $(F-SN)_4$ (the fluorine atoms attached to the sulfur) by a reaction with AgF_2 in CCl_4 .

When S_4N_4 reacts with $SOCl_2$, one of the products is $(S_4N_3)^+Cl^-$.



A reaction between S_4N_4 and S_2Cl_2 also produces the $S_4N_3^+$ ring.



The *thiotrithiazyl*, $S_4N_3^+$, ring that has a planar structure that can be shown as

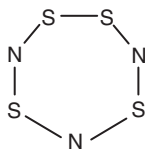

The S-N unit is the *thiazyl* group and $S_4N_3^+$ contains three of these units plus one sulfur atom (designated as *thio*) hence the name. When S_4N_4 reacts with $NOCl$, a five-membered ring is produced.

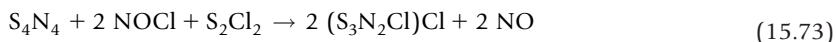

In the $S_3N_2Cl^+$ cation the Cl is bonded to a sulfur atom, giving the structure

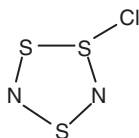

Another binary compound of sulfur and nitrogen is the explosive compound known as disulfur dinitride (S_2N_2), which can be obtained by passing S_4N_4 vapor through silver wool at 300 °C. The structure S_2N_2 can be shown as

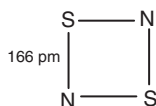

with bond angles that are very close to 90°. Several resonance structures having double bonds are possible. Although it is a Lewis base, the main interest in the chemistry of S_2N_2 centers on the fact that it will polymerize to give $(S_2N_2)_n$, a bronze material known as *polythiazyl* that has metallic properties. The polymerization is accomplished by allowing the material to stand at room temperature or below for several days. These materials have been known for almost a century.

In addition to the compounds of sulfur and nitrogen already discussed, there are numerous others that have been studied. Tetrasulfur tetranitride is the starting point for preparing the compounds, and many types of reactions have been employed. Binary compounds containing selenium or tellurium with nitrogen have not been as fully characterized as those of sulfur, but Se_4N_4 (an explosive orange compound) and a tellurium nitride have been prepared. There are also cations known that contain selenium and nitrogen. Although these will not be described, the examples discussed show the general nature of this field.

15.1.9 The Oxyacids of Sulfur

It would be possible to write an entire book on the oxyacids of sulfur alone. In fact an entire book devoted to *sulfuric acid* alone has been published! By comparison, the oxyacids of selenium and tellurium are relatively insignificant. Thus, most of this section will be devoted to the acids containing sulfur. As mentioned elsewhere, sulfuric acid is produced in the largest quantity of any compound and is used so extensively in industrial chemistry that the quantity used has been referred to the “barometer” of the chemical industry. Although sulfuric acid is by far the most common and important of the oxyacids of sulfur, there are several others, most of which are shown in Table 15.6.

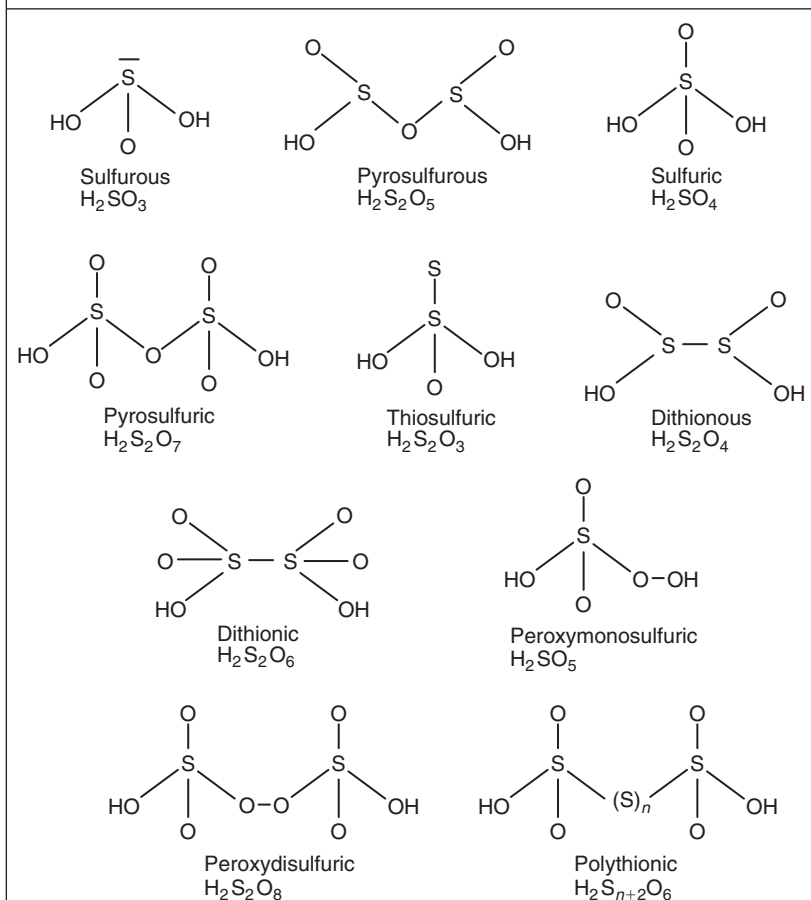
Table 15.6 The Major Oxyacids of Sulfur^a.

^aOnly salts exist for sulfurous, dithionic, and dithionous acids.

15.1.10 Sulfurous Acid and Sulfites

The anhydride of sulfurous acid is sulfur dioxide, which is very soluble in water. Although most of the gas is physically dissolved, the ionization takes place slightly as indicated by the equations



In the solution there appears to be a very slight tendency of SO_2 to add to SO_3^{2-} to give a small amount of $\text{S}_2\text{O}_5^{2-}$, which can also result from the dehydration reaction

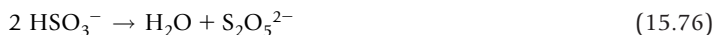

Although sulfurous acid is not an important compound, many sulfites are widely used. Sulfites react with sulfur to produce thiosulfates (see Eq. (15.5)), and sulfites are reducing agents that are used in large quantities, particularly in the sulfite process for making paper pulp. Sulfites are oxidized to sulfates by oxidizing agents such as MnO_4^- , Cl_2 , I_2 , and Fe^{3+} . Most bisulfite salts are those in which the cation is a +1 ion of large size.

Sulfites can be prepared by reactions such as the following:



The acid produced when a molecule of water is removed from two molecules of H_2SO_3 is disulfurous (*pyrosulfurous*) acid, $\text{H}_2\text{S}_2\text{O}_5$. Even though the acid is not stable, a few salts are known that contain the $\text{S}_2\text{O}_5^{2-}$ ion, which has the structure

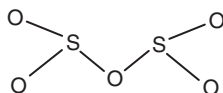

When SO_2 is added to a solution containing a sulfite, the $\text{S}_2\text{O}_5^{2-}$ ion is produced so the solution contains a salt of disulfurous acid (pyrosulfurous) acid. In aqueous solutions, these salts decompose when an acid is added.



15.1.11 Dithionous Acid and Dithionites

One of the unstable oxyacids of sulfur is dithionous acid, $\text{H}_2\text{S}_2\text{O}_4$, which contains sulfur in the +3 oxidation state. Reduction of sulfur +4 to produce the dithionite ion is accomplished as shown in the following equation:

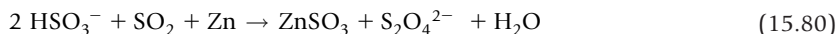

The interesting eclipsed or “sawhorse” structure (C_{2v}) of the $\text{S}_2\text{O}_4^{2-}$ ion can be shown as

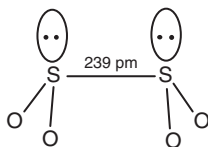

in which the O–S–O bond angle is 108° . The ion is reactive, as indicated by the fact there is isotope exchange when labeled SO_2 is added to a solution of a dithionite. A typical S–S bond length is

approximately 210 pm, so the bond length of 239 pm indicates a weak, reactive bond, which is illustrated by the following equation:

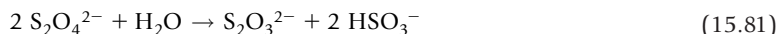

It is believed that $\text{S}_2\text{O}_4^{2-}$ establishes an equilibrium that can be represented as



Sodium dithionite, $\text{Na}_2\text{S}_2\text{O}_4 \cdot 2\text{H}_2\text{O}$, is a widely used reducing agent in several processes.

15.1.12 Dithionic Acid and Dithionates

This is another of the unstable oxyacids of sulfur that appears to contain sulfur +5. The structure of the dithionate anion is

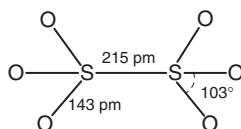

Writing the formula as $(\text{HO})\text{S}(\text{O})_2\text{S}(\text{O})_2\text{OH}$ shows that it is a strong acid. The S-S bond is slightly longer than a typical single bond, but the S-O bond length is close to that in sulfuric acid. Sulfites can be oxidized to give dithionates.

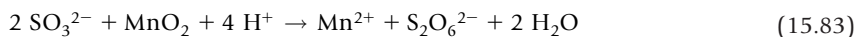

When heated, metal dithionates generally disproportionate to give a sulfate and SO_2 .



The dithionate ion is a good coordinating ion that forms stable chelates. In addition to dithionic acid, some polythionic acids having the formula $\text{H}_2\text{S}_n\text{O}_6$ are known in which the sulfur chain contains more than two sulfur atoms.

15.1.13 Peroxydisulfuric and Peroxymonosulfuric Acids

This acid, $\text{H}_2\text{S}_2\text{O}_8$, is a solid that melts at 65°C . The acid and its salts are such strong oxidizing agents that combustible materials can be ignited by them. The usual salts that are widely used as oxidizing agents are the sodium, potassium, and ammonium salts. Electrolytic oxidation of bisulfate is the usual method of producing the acid.



When $\text{H}_2\text{S}_2\text{O}_8$ is hydrolyzed, it produces H_2O_2 and sulfuric acid.

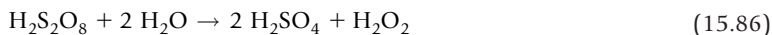

Equations (15.85) and (15.86) constitute the basis for one method of producing hydrogen peroxide. When heated, solid peroxydisulfates decompose with the liberation of oxygen.

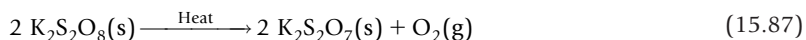

Peroxymonosulfuric acid (historically known as Caro's acid), H_2SO_5 , results when peroxydisulfuric acid reacts with a limited amount of water,

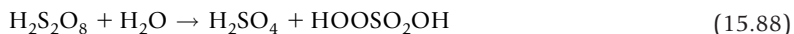

or by the reaction of H_2O_2 with chlorosulfonic acid:

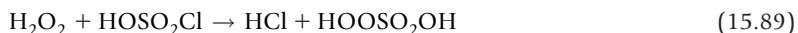

15.1.14 Oxyacids of Selenium and Tellurium

Oxyacids containing selenium and tellurium are known, but they and their salts are generally less important than the sulfur compounds. When selenium and tellurium halides hydrolyze, the solutions contain selenous and tellurous acids.

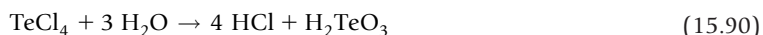

In the case of selenium, both the acid and its salts are stable. Salts can be prepared by reactions such as the following:

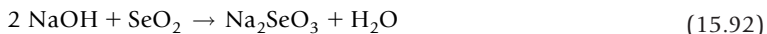

Several polytellurites ($\text{Te}_4\text{O}_9^{2-}$, $\text{Te}_6\text{O}_{13}^{2-}$, etc.) are stable as solid salts.

Although selenic and telluric acids contain the central atom in the +6 oxidation state, they are very different. The properties of selenic acid, H_2SeO_4 , are very similar to those of H_2SO_4 , and many of their salts are similar. The oxyacid that contains Te in the +6 state is H_6TeO_6 which can also be written as $\text{Te}(\text{OH})_6$. This acid can be prepared from Te or TeO_2 by suitable oxidation reactions, and it can be also obtained as a solid hydrate. As expected from the formula, telluric acid is a weak acid, although some salts can be obtained in which one or more protons are replaced.

15.1.15 Sulfuric Acid

Sulfuric acid is a vital commodity, and that is underscored by the fact that over 90 billion pounds of the acid are used annually. Sulfuric acid is utilized on a such a large scale because it is used in so many ways and it is relatively inexpensive. Some of the important chemistry of H_2SO_4 will be illustrated in this section.

It is believed that H_2SO_4 was discovered in about the 10th century. In the 1800s most of the H_2SO_4 was produced by the *lead chamber process*, although it was also produced by pyrolysis of $\text{FeSO}_4 \cdot x\text{H}_2\text{O}$.

Today, sulfuric acid is produced by a method known as the *contact process* in which SO_2 is oxidized to SO_3 , which then reacts with water to give the acid. Oxidation of SO_2 requires a suitable catalyst such as spongy platinum or sodium vanadate. In many cases, SO_3 is dissolved in 98% sulfuric acid to produce disulfuric acid (*oleum*), which can be shipped, diluted, and still give 100% sulfuric acid. The concentration of SO_3 varies from 10 to 70% in commercial oleum.

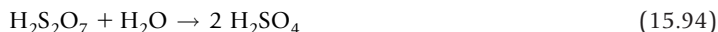

Concentrated sulfuric acid contains about 98% of the acid, which is equivalent to an 18 M solution. There is extensive hydrogen bonding as indicated by the high viscosity and boiling point of the liquid. The reaction of sulfuric acid with water is exothermic, so dilution should always be carried out by adding the acid to water while stirring the solution. Because of its affinity for water, sulfuric acid is a strong dehydrating agent. Several hydrates of sulfuric acid have been identified, some of which are $\text{H}_2\text{SO}_4 \cdot \text{H}_2\text{O}$ (m.p. 8.5°C), $\text{H}_2\text{SO}_4 \cdot 2\text{H}_2\text{O}$ (m.p. -39.5°C), and $\text{H}_2\text{SO}_4 \cdot 4\text{H}_2\text{O}$ (m.p. -28.2°C). Some of the properties of sulfuric acid are as follows:

Melting point	10.4°C
Boiling point	290°C (with decomp.)
Dielectric constant	100
Density (25°C)	1.85 g cm^{-3}
Viscosity (25°C)	24.54 cp

The H_2SO_4 molecule has the structure shown as follows:

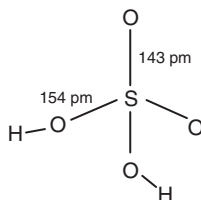

The fact that the S–O bonds to oxygen atoms that do not have hydrogen atoms attached are significantly shorter than the others is a manifestation of π bonding. If the structure contained only single bonds (as just shown) the sulfur would have a +2 formal charge and the two types of S–O bonds would not differ much in length. In order to reduce the positive formal charge, multiple bonding occurs to

two oxygen atoms, which reduces the bond length. That this is correct is shown by the structure of the HSO_4^- ion that remains after the H_2SO_4 molecule functions as a proton donor:

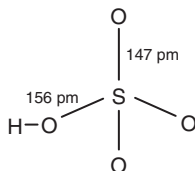

Note that the bond between sulfur and the OH group is not much different than that in the H_2SO_4 molecule, but the other three S–O bonds are lengthened compared to H_2SO_4 the molecule. This is the result of the π bonding being distributed to three oxygen atoms rather than just two.

The chemistry of H_2SO_4 is primarily related to its acidity. The first dissociation



is considered to be complete in dilute solution, and for the second step, shown as

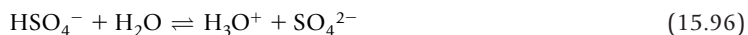

the dissociation constant is $K_{a2} = 1.29 \times 10^{-2}$ at 18 °C. In addition to the acid itself, the number of sulfates and bisulfates that have important uses is large. Sulfuric acid is used extensively as a nonaqueous solvent, and as a result of having a high dielectric constant (~ 100) and considerable polarity, it dissolves many substances. Some of the uses of sulfuric acid will be described later in this section.

Salts of H_2SO_4 include both the *normal* sulfates containing SO_4^{2-} and *acid* sulfates or bisulfates that contain HSO_4^- . When bisulfates dissolve in water, the solutions are somewhat acidic because of the dissociation of the HSO_4^- ion as shown in Eq. (15.96). Bisulfates are produced by reactions such as the following:

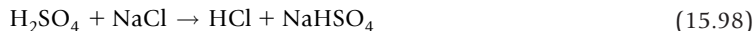
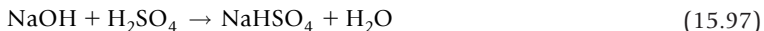

Some of the types of reactions that can be used to produce sulfates are as follows:

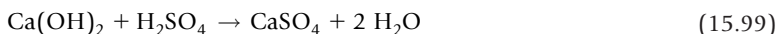

Sulfides, sulfites, and other sulfur-containing compounds can be oxidized to sulfates by using the suitable oxidizing agents under appropriate conditions. At high temperature, concentrated H_2SO_4 reacts as an oxidizing agent that dissolves copper.

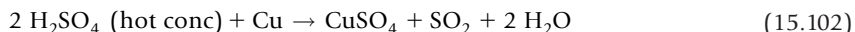

Bisulfate salts, such as NaHSO_4 , can be dehydrated to produce *disulfates* (*pyrosulfates*).



Sulfuric acid has been used as a nonaqueous solvent, and some proton transfer may take place as a result of autoionization in 100% H_2SO_4 .



The presence of ionic species is demonstrated by the conductivity of the solutions. It is a strongly acidic solvent that protonates alcohols, ethers, and acetic acid. These substances are not normally bases, but they have an unshared pair of electrons that can function as a proton acceptors.

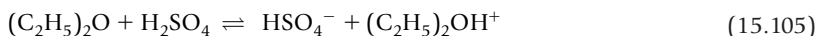

In the reaction of sulfuric acid with nitric acid, the *nitronium* ion, NO_2^+ , is generated,

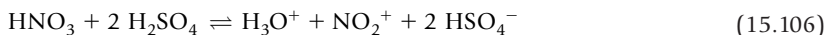

which is the attacking species in nitration reactions. Sulfuric acid increases the concentration of the positive attacking species, which is the essence of an acid catalyst (see Chapter 9). There are many derivatives of sulfuric acid that are very useful compounds. These include salts of alkyl sulfuric acid that are detergents such as $\text{CH}_3(\text{CH}_2)_n\text{C}_6\text{H}_4\text{SO}_3^- \text{Na}^+$, chlorosulfonic acid, ClSO_3H , and sulfuryl chloride. The latter compounds are prepared by the reactions



Sulfuric acid is manufactured on an enormous scale with an annual output of around 90 billion pounds. During the mid-1900s (when the production of sulfuric acid was less than half what it is now), about a third of the sulfuric acid produced was used in the production of fertilizer, but that use rose to about two-thirds in the later 1900s. During that time the world population grew from perhaps 3 billion to about 6 billion.

The manufacture of fertilizers was discussed in Chapter 14. Phosphate rock is digested with sulfuric acid to convert CaCO_3 into a more soluble form that contains a higher percentage of phosphorus. Sulfuric acid is used as a catalyst in alkylation reactions, petroleum refining, manufacture of detergents, paints, dyes, and fibers, and other processes. It is also used as the electrolyte in the lead-acid battery that is used in automobiles. Sulfuric acid is an enormously important chemical commodity that it would be hard to do without.

15.2 THE HALOGENS

The group VIIA elements are known as the *halogens*, a word that has its origin in the Greek words *halos* meaning "salt" and *genes* meaning "born" or "formed." In other words, the halogens are the "salt formers," which at least partially describes their chemical behavior. The halogens are reactive elements

with the result that they are always found combined. In fact, many halogen compounds are quite stable, so they are not easy to convert to the elements. As a result, the free halogens were not obtained until comparatively modern times.

Chlorine was prepared in 1774 by Scheele by the reaction of HCl with MnO_2 , but it was Sir Humphrey Davy who suggested the name based on the Greek *chloros*, meaning “greenish-yellow.” Bromine was discovered in 1826 by Balard, and the name of the element comes from the Greek word *bromos*, meaning “stench.” Iodine was obtained from kelp in 1812 by Courtois, and its name is also from the Greek word *ioeides*, which means “violet.” Although elemental fluorine was not available centuries ago, a common mineral that contains fluorine is *fluorspar* or *fluorite*, CaF_2 . When heated with sulfuric acid, hydrogen fluoride is produced, and it was known that long ago that the gas would etch glass. Fluorine is such a strong oxidizing agent that no practical means was available to obtain the element from its compounds until electrochemical processes were developed, although it has been prepared by chemical means in recent years. As a result it was 1886 before Moissan succeeded in preparing fluorine. All isotopes of astatine, which was obtained in 1940, are radioactive, so there is little chemistry to consider for the element.

15.2.1 Occurrence

There are numerous minerals that contain halogens. Minerals that contain fluorine include fluorite, CaF_2 , *cryolite*, Na_3AlF_6 , and *fluoroapatite*, $\text{Ca}_5(\text{PO}_4)_3\text{F}$. As was discussed in Chapter 14, fluoroapatite is found with calcium phosphate, which is very important in the production of fertilizers. Fluorite is found in Southeastern Illinois and Northwestern Kentucky, and cryolite is found in Greenland, although it is also produced synthetically because of its use in the electrochemical production of aluminum.

There are many natural sources of chlorine compounds, which is not surprising considering that it is the 20th most abundant element. Salt and salt water are widely available; the Great Salt Lake contains 23% salt, and the Dead Sea contains about 30%. Because salt is so abundant, most minerals that contain chlorine are not important sources for economic reasons. Bromine is found in some salt brines and in the sea, as are some iodine compounds.

15.2.2 The Elements

Although the most common source of fluorine is CaF_2 , the element is not prepared directly from fluorite. When HF (obtained by treating fluorite with sulfuric acid) is added to a solution containing potassium fluoride, hydrogen bonding of F^- to HF produces the HF_2^- ion. Other salts such as $\text{KF}\cdot 2\text{HF}$ and $\text{KF}\cdot 3\text{HF}$ can also be obtained if the excess of HF is sufficient. The potassium salt, KHF_2 , has a melting point of 240°C , in contrast to CaF_2 , which melts at 1430°C . The mixture containing the solvates with HF has an even lower melting point, so the electrolysis of a KHF_2/HF mixture makes it feasible to carry out electrolysis of the molten salt, which would be difficult with CaF_2 .

Although producing fluorine by chemical means had not been accomplished for many years, it was accomplished in 1986 by making use of the reaction

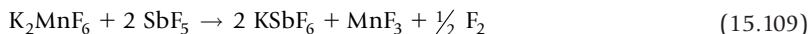

The reason why this reaction produces fluorine is that MnF_4 is thermodynamically unstable. Therefore, if the very strong Lewis acid SbF_5 removes two fluoride ions from MnF_6^{2-} , the result is MnF_4 , and it decomposes to produce fluorine and MnF_3 .

The production of chlorine is based on the electrolysis reaction

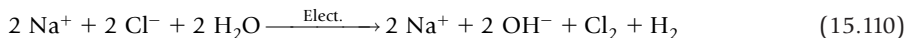

This process not only produces chlorine, it is also a way in which enormous quantities of sodium hydroxide are produced with hydrogen being the other product. Two types of cells are in use. The first and by far the most important employs a diaphragm to separate the anode and cathode compartments. A second type of cell utilizes a mercury cathode with which the sodium forms an amalgam.

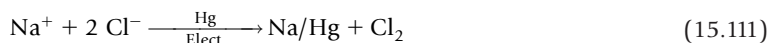

Another but less common industrial reaction is based on the oxidation of HCl in which oxides of nitrogen function as a catalyst.



Although more important as a means of producing sodium, the electrolysis of molten NaCl is carried out on an industrial scale.

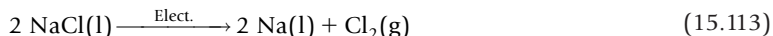

Chlorine can be prepared in a laboratory by the oxidation of Cl^- by means of a suitable oxidizing agent. A procedure used by Scheele in 1774 involves heating a solution of HCl with MnO_2 .

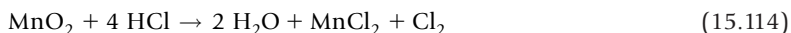

Because chlorine will oxidize Br^- to give Br_2 , sea water is treated with chlorine to produce bromine, which is then removed by blowing air through the mixture. Numerous reactions in which a bromide is oxidized can be carried out on a laboratory scale. Iodine is obtained primarily from sea water in a process similar to that for producing bromine. However, because I^- is easier to oxidize than Br^- , there is considerable latitude in the choice of oxidizing agents. Astatine is produced by making use of a radiochemical technique in which ^{209}Bi is the target and is subjected to α particles.



Table 15.7 shows a summary of some of the important properties of the halogens.

Fluorine occurs only as ^{19}F , but chlorine occurs as 75% ^{35}Cl and 25% ^{37}Cl . Bromine occurs about equally as ^{79}Br and ^{81}Br , but iodine occurs only as ^{127}I . The oxidizing strength of the halogens decreases in the series $\text{F}_2 > \text{Cl}_2 > \text{Br}_2 > \text{I}_2$. As expected, the halogens will react with many substances, and they produce a very large number of covalent and ionic compounds. The reaction of fluorine with water liberates oxygen:

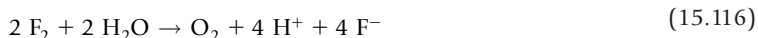

Table 15.7 Properties of the Halogens.

	F ₂	Cl ₂	Br ₂	I ₂
Melting point, °C	-219.6	-101	-7.25	113.6
Boiling point, °C	-188	-34.1	59.4	185
X – X bond energy, kJ mol ⁻¹	153	239	190	149
X – X distance, pm	142	198	227	272
Electronegativity (Pauling)	4.0	3.0	2.8	2.5
Electron affinity, kJ mol ⁻¹	339	355	331	302
Single bond radius, pm	71.0	99.0	114	133
Anion (X ⁻) radius, pm	119	170	187	212

The other halogens react with water in a disproportionation reaction that yields the halide ion and the hypohalous acid:



15.2.3 Interhalogen Molecules and Ions

One of the interesting attributes of the halogens is the fact that atoms of different types readily form bonds. When chlorine and fluorine are combined and heated, they react to form ClF, a compound known as an *interhalogen*.

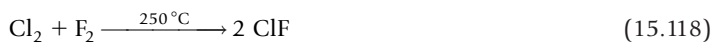

Because the halogen atoms have seven valence-shell electrons, the outer shell is filled when two atoms form a bond, but when an unshared pair is separated, two additional bonding sites are available. As a result, if ClF were to react with additional fluorine, the expected result would be ClF₃. If another unshared pair of electrons were uncoupled, there would be five bonding sites and the product would be ClF₅. A general formula for compounds containing two different halogens is XX'_n, where X' is the lighter halogen and n is an odd number. The maximum value for n is 7, but the only interhalogen having that formula is IF₇. When n = 5, the known compounds are ClF₅, BrF₅, and IF₅, and none of the pentachlorides are stable. This is undoubtedly due to the effect of the larger size of the chlorine atom and the fact that it is a weaker oxidizing agent than fluorine. Bonds between other halogens and fluorine are also more polar, so there is some stability imparted by partial charges on the atoms. As a result of these factors, the only XX'₇ compound is IF₇. Table 15.8 shows a summary of the properties of the interhalogens.

Table 15.8 Properties of the Interhalogens.				
	Formula	m.p., °C	b.p., °C	μ, D
Type XX'	ClF	-156	-100	0.88
	BrF	-33	20	1.29
	IF	—	—	—
	BrCl	-66	-5	0.57
	ICl	27	97	0.65
	IBr	36	116	1.21
Type XX' ₃	ClF ₃	-83	12	0.56
	BrF ₃	8	127	1.19
	IF ₃	—	—	—
	ICl ₃	101 (16 atm)	—	—
Type XX' ₅	ClF ₅	-103	-14	—
	BrF ₅	-60	41	1.51
	IF ₅	10	101	2.18
Type XX' ₇	IF ₇	6.45 (triple pt)	—	0

The simplest interhalogen molecules are diatomic molecules, XX'. All of the molecules having X'=F are known, and they are generally prepared by combination of the elements. The preparation of ClF was shown earlier, and the preparation of BrF is also from the elements at 10 °C when the elements are diluted with nitrogen.



Disproportionation of BrF occurs with the formation of Br₂ and BrF₃ or BrF₅. Little is known about IF because it is so unstable and disproportionates to I₂ and IF₅. Because of the favorable hard-soft interaction of Ag⁺ and I⁻, IF can be obtained by the reaction



The halogen chlorides are of course limited to those of Br and I, but although BrCl exists in equilibrium with Cl₂ and Br₂, it is so unstable that it is not obtained in a pure form. Iodine monochloride is a much more stable compound that exists in two forms. The α form consists of ruby-red needles, and the β form is a reddish-brown solid. The forms differ in the way that ICl molecules are linked by intermolecular forces in the solid state.

Reactions of the XX' interhalogens are numerous, but they generally constitute reactions in which halogenation occurs, those in which the interhalogen is a nonaqueous solvent, or Lewis acid-base

reactions. In keeping with their being more numerous and important, the discussion will deal primarily with the fluorides. In contact with water, the XX' molecules react according to the reaction



The halogen having lower electronegativity is found as the hypohalous acid, because it is the atom that has +1 oxidation state. The monofluorides are strong fluorinating agents and undergo many reactions typical of the halogens. For example, sulfuryl chloride results from the reaction of chlorine with SO_2 , and a mixed halogen compound is obtained by the reaction with ClF.



Oxidation-addition (oxad) reactions of this type also occur with other compounds as shown in the following examples:



In the reaction with a strong Lewis acid such as AsF_5 , ClF behaves as a Lewis base with the fluorine atom being the electron pair donor resulting in transfer of the F^- ion.



ClF can also react as a Lewis base by accepting a fluoride ion, as illustrated by the reaction



Only three of the possible XX'_3 interhalogens (ClF_3 , BrF_3 , and IF_3 , which is stable only at low temperature) are important. The structure of BrF_3 can be shown as

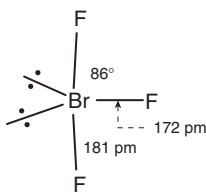

The structure of ClF_3 is similar except for the bond angle being 87.5° and the equatorial and axial bond lengths being 160 and 170 pm, respectively. ClF_3 is produced in large quantities for use as a fluorinating agent, even though it reacts violently in many cases.



One use of ClF_3 is in the preparation of UF_6 by the reaction

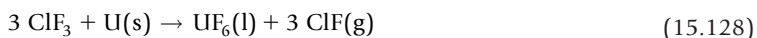

Many organic compounds sometimes react explosively with ClF_3 , and it is such a strong fluorinating agent that it can be used to prepare other interhalogens:

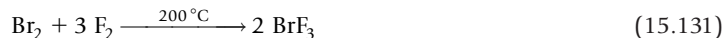

As in the case of ClF , the trifluoride can behave as both a fluoride ion donor and acceptor, as illustrated by the reactions carried out in liquid ClF_3 :



Bromine trifluoride has also been used extensively as a nonaqueous solvent that behaves in some reactions as if it ionized slightly according to the equation



It is interesting to note that the electrical conductivity of liquid BrF_3 is six orders of magnitude higher than that of liquid ClF_3 , in which autoionization is assumed not to occur. In liquid BrF_3 , SbF_5 is an acid because it generates the BrF_2^+ ion.



Because KBrF_4 contains the BrF_4^- ion, it is a base. Therefore, the reaction



is a neutralization reaction in liquid BrF_3 . Because ClF_3 reacts so violently with many substances, BrF_3 , which is a slightly milder fluorinating agent, has been widely used to prepare metal fluorides from the oxides or the metals.

Of the compounds having the formula XX'_5 , only the fluorides of Cl, Br, and I have been thoroughly studied. The chlorine compound is prepared by heating chlorine with an excess of fluorine at high temperature and pressure.



A similar reaction but with less stringent conditions is used to produce BrF_5 . IF_5 is prepared from the elements at room temperature. The only heptafluoride is IF_7 , which is prepared from the elements using an excess of fluorine and a temperature of 250 to 300 °C. All of these penta- and heptafluorides are extremely strong fluorinating agents. There are 12 electrons surrounding the central atom, which

results in a square-base pyramid structure. The structure of the pentafluoro compounds is represented by IF_5 , which can be shown as

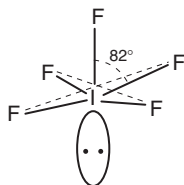

in which the iodine resides below the base of the pyramid as a result of the repulsion of the unshared pair on the bonding pairs. The structure of IF_7 is a pentagonal bipyramid.

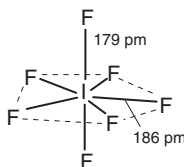

All three of the pentafluorides react violently if not explosively with many substances. In the case of ClF_5 , the reaction with water is



BrF_5 reacts with water to produce HF and HBrO_3 if the water is diluted with a less reactive solvent such as acetonitrile. IF_5 reacts with water to produce HF and HIO_3 .



The low conductivity of liquid IF_5 is believed to be as a result of slight ionization,



and compounds that contain each of the product ions have been isolated. IF_5 boils at approximately 101°C , and at that temperature it reacts with KF to give IF_6^- .



Although IF_5 is quite stable, when heated to 500°C it disproportionates to give I_2 and IF_7 .

Because of the size of the iodine atom and the fact that it is easier to oxidize to the +7 state, IF_7 is the only XX'_7 interhalogen. It is prepared by the reaction of IF_5 and F_2 at elevated temperatures, and like other halogen fluorides it is a strong fluorinating agent. When it reacts with water, HF and HIO_4 are produced.



Interhalogens such as ClF_3 , BrF_3 , and BrF_5 will make fluorides out of almost anything. Metals, non-metals, and many compounds are converted to the fluorides, and in order to make the reactions less vigorous, diluents are frequently added. If the reaction is being carried out in the gas phase, a relatively unreactive gas such as nitrogen or a noble gas is added. In most cases, the fluorination of a nonmetal produces the fluoride of the nonmetal in its highest oxidation state. For example, phosphorus is converted to PF_5 and sulfur is converted to SF_6 , although it is sometimes possible to limit the fluorination somewhat by controlling the ratio of the reactants. When ClF_3 or BrF_3 is the fluorinating agent, the halogen monofluoride is frequently a product. For example, with boron the reaction is



Halogen fluorides convert oxides to fluorides or oxyfluorides. The following equations illustrate reactions of this type:

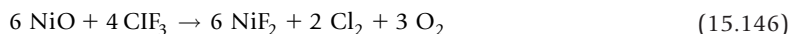
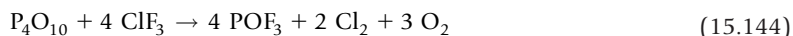

The reaction of ClF with NOF (which is not a typical "oxide") can be represented as



Numerous cases have been described elsewhere in which NO^+ is produced, but the ClF_2^- represents an *anion* of an interhalogen. Polyhalide anions are not rare because when iodine is dissolved in a solution containing I^- , the I_3^- ion is formed.



Anions of the X_3^- and $\text{X}'\text{X}_2^-$ types are linear with three unshared pairs of electrons around the central atom. In the case of ClF_2^- the chlorine atom is the central atom.

There are numerous examples of cations of the interhalogens, and a great deal is known about the behavior of such species. The species that have been more fully studied involve only one type of halogen such as I_3^+ , Br_3^+ , and Cl_3^+ . In general, the production of these species requires rather stringent conditions that may include nonaqueous solvent systems. For example, a reaction that takes place in anhydrous sulfuric acid can be used to produce I_3^+ .

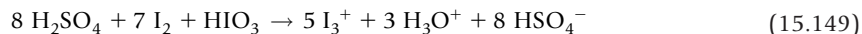

The superacid system $\text{HSO}_3\text{F}/\text{SbF}_5/\text{SO}_3$ is employed when generating the Br_3^+ ion by the reaction



but the ion has also been generated by the reaction

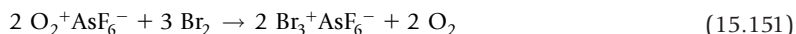

A reaction that also involves the strong Lewis acid AsF_5 generates Cl_3^+ .



The cations discussed so far have contained only one type of halogen, but several cations are known that contain different halogens. These ions are generally of the XY_2^+ type, but others of the XYZ^+ type are possible. Although there are many possible species, the most thoroughly studied are ClF_2^+ , BrF_2^+ , IF_2^+ , and ICl_2^+ , all of which have a bent (C_{2v}) structure. Dissociation of the trihalides as nonaqueous solvents (although slight) leads to cations of this type.



The cation produced is the acidic species in the solvent, so it would be expected that to generate such an acidic species it would be appropriate to use a *very* strong Lewis acid. As illustrated in the following equations, this approach is successful:



The Cl_2F^+ cation is known to exist. When AsF_5 reacts with ClF , an adduct is produced having the formula $2\text{ClF} \cdot \text{AsF}_5$ that has a cation containing chlorine and fluorine atoms. The cation is believed to be ClClF^+ rather than ClFCl^+ . In XX'_3^+ species, the bond angle is known to depend somewhat on the nature of the anion. For example, in $\text{ClF}_2^+ \text{SbF}_6^-$ and $\text{ClF}_2^+ \text{AsF}_6^-$ the F–Cl–F bond angles are 95.9° and 103.2° , respectively, and there are bridging fluorine atoms between the cation and the SbF_6^- and AsF_6^- anions. This behavior has also been found for other XX'_2^+ ions.

A slight degree of autoionization in liquid IF_5 is indicated by the conductivity.

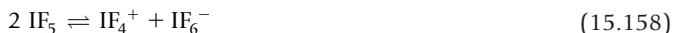

Because the cation characteristic of the solvent is IF_4^+ , it is reasonable to assume that the ion may have some existence in other situations. As with the other polyatomic ions shown so far, the reaction selected involves a strong Lewis acid such as SbF_5 to remove F^- , and the same approach is taken for producing ClF_4^+ and BrF_4^+ in the interhalogen solvents.



When IF_7 reacts with SbF_5 or AsF_5 , the IF_6^+ cation is produced.

The formation of I_3^- by dissolving I_2 in a solution containing I^- was mentioned earlier. However, addition of I_2 continues with the formation of other ions if the concentration of I_2 is increased.

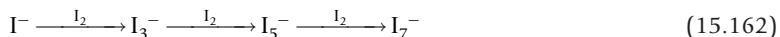

Similar behavior is exhibited by other halogens to a smaller degree. For example,



Some anions composed of two halogens result from similar processes.



The BrCl_2^- , I_3^- , and Cl_3^- species are linear ($D_{\infty h}$), but ICl_4^- and BrCl_4^- are square planar (D_{4h}) with two unshared pairs of electrons on the central atom. In these structures the halogen having the lower electronegativity is the central atom. Solids have been obtained that contain these anions, but almost all contain large cations having +1 charge.

It is interesting to note that for the reaction



the equilibrium constant depends on the solvent. For example in H_2O , $K = 16.3$; in a 50–50 weight percent mixture of CH_3OH and H_2O , $K = 58$; and in 100% CH_3OH , $K = 176$. Solvents consisting of small, polar molecules solvate ions more strongly, and as a result the Br^- ion is solvated more strongly in water, which hinders the formation of Br_3^- .

Halogens can behave as Lewis acids, but interhalogens also exhibit this type of behavior as is illustrated by the reaction of ICl and IBr with pyridine:



In reactions in which charged species are generated, the solvent has a great effect. This is also true when the reaction is a substitution reaction such as



The rate of this reaction varies by a factor of 10^6 depending on the solvent with the reaction being slower in methanol and much faster in *N,N*-dimethylformamide. Strong solvation of Cl^- impedes the reaction by hindering the formation of the transition state. Although the product shown in Eq. (15.167) is ionic, when the solvent is CHCl_3 the second step does not occur. In the reaction of pyridine with IBr , it appears that the ionization involves the production of IBr_2^- .

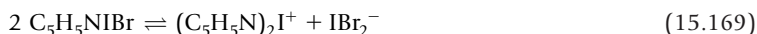

When the reaction is carried out in aqueous HBr , it is found that the nature of the products (identified spectrophotometrically) depends on the concentration of the acid. When the acid is very dilute, the product is $\text{C}_5\text{H}_5\text{NIBr}$, but when the acid concentration is above 1 M, the product is $\text{C}_5\text{H}_5\text{NH}^+\text{IBr}_2^-$.

15.2.4 Hydrogen Halides

Among the most useful compounds of the halogens are the hydrogen halides. Hydrogen iodide is not very stable, and it cannot be efficiently prepared by direct combination of the elements. Rather, as is

	HF	HCl	HBr	HI
Melting point, °C	-83	-112	-88.5	-50.4
Boiling point, °C	19.5	-83.7	-6.7	-35.4
Bond length, pm	91.7	127.4	141.4	160.9
Dipole moment, D	1.74	1.07	0.788	0.382
Bond energy, kJ mol ⁻¹	574	428	362	295
ΔH°_f , kJ mol ⁻¹	-273	-92.5	-36	+26
ΔG°_f , kJ mol ⁻¹	-271	-95.4	-53.6	+1.6

the case with Te, P, and some other elements, it is easier to prepare a compound containing iodine, then carry out a hydrolysis reaction. For example,



The properties of HF reflect the strong hydrogen bonding that persists even in the vapor state. As a result of its high polarity and dielectric constant, liquid HF dissolves many ionic compounds. Some of the chemistry of HF as a nonaqueous solvent has been presented in Chapter 10. Properties of the hydrogen halides are summarized in Table 15.9.

All of the hydrogen halides are very soluble in water, and acidic solutions result. Although HF is a weak acid, the others are strong and are almost completely dissociated in dilute solutions. HCl, HBr, and HI form constant-boiling mixtures with water that contain 20.2%, 47.6%, and 53% of the acid, respectively.

There are many ways in which the hydrogen halides can be prepared. Heating a salt containing the halide ion with a nonvolatile acid is the usual way in which HF, HCl, and HBr are obtained in laboratory experiments.



Because HI is relatively unstable, this method is not appropriate for producing the compound. Instead, as mentioned earlier, HI is better prepared by hydrolysis reactions. If a halide salt is treated with an acid that is an oxidizing agent, a redox reaction occurs in which I₂ is produced.

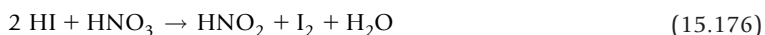
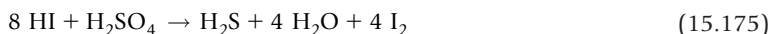

Other than the iodine compound, the hydrogen halides can be obtained by reactions of the elements, but the reactions can be explosive. A mixture of H_2 and Cl_2 will explode if the reaction is initiated with a burst of light, which separates some Cl_2 molecules to produce $\text{Cl}\cdot$. The reaction between H_2 and Cl_2 is a classic case of a free radical reaction. A vast number of hydrolysis reactions yield hydrogen halides.

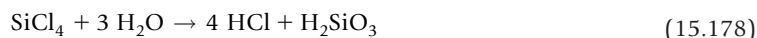
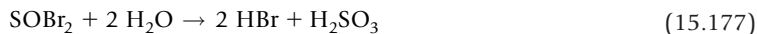

On an industrial scale, HCl is also obtained in the chlorination of hydrocarbons.

15.2.5 Halogen Oxides

Compounds containing fluorine and oxygen are actually fluorides, and although O_2F_2 and OF_2 will be described, neither has significant uses. The compounds of chlorine and oxygen include some that are commercially important, but they are explosive in nature. Consequently, the discussion of halogen oxides will deal more heavily with the compounds containing chlorine.

Oxygen difluoride, OF_2 (m.p. -223.8°C , b.p. -145°C) is a pale yellow, poisonous gas. The molecule has a bent structure (C_{2v}), and the bond angle is 103.2° . OF_2 can be prepared by the reaction of fluorine with dilute NaOH or the electrolysis of aqueous solutions containing HF and KF . The reaction of OF_2 with water can be shown as



The reaction of OF_2 with HCl produces HF and liberates chlorine.

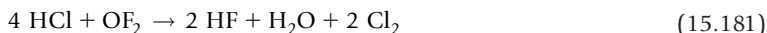

When heated to a temperature above 250°C , OF_2 decomposes into O_2 and F_2 .

Dioxygen difluoride, O_2F_2 , is a yellow-orange solid with a melting point of -163°C . The structure of the molecule is

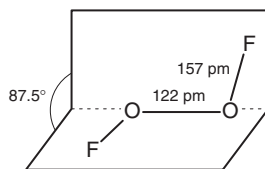

The compound is produced as a result of glow discharge through a mixture of O_2 and F_2 at -180 to -190°C . As should be expected, O_2F_2 is an extremely reactive fluorinating agent. Under the conditions that produce OF_2 , small amounts of O_3F_2 and O_4F_2 are produced, but these unstable compounds decompose at liquid nitrogen temperatures.

Oxides of chlorine are both more numerous and more useful than those of fluorine. These oxides are the anhydrides of several important acids, and the oxyanions of those acids constitute the hypochlorites, chlorites, chlorates, and perchlorates. The first oxide of chlorine, Cl_2O (m.p. -20°C , b.p. $+2^\circ\text{C}$), contains chlorine in the $+1$ oxidation state. It can be prepared by the reaction

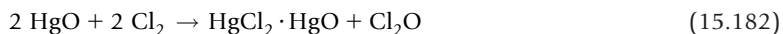

This oxide is soluble in water, with which it reacts to produce hypochlorous acid.



The bond angle in the bent (C_{2v}) molecule is 110.8° . One interesting reaction of Cl_2O is that with N_2O_5 , which can be shown as



but other products that depend on the reaction conditions are also produced. Cl_2O converts SbF_5 into an oxychloride.



Chlorine dioxide, ClO_2 (m.p. -60°C , b.p. 11°C) is an explosive gas ($\Delta H_f^\circ = +105 \text{ kJ/mol}$) that has been used industrially as a gaseous bleach for wood pulp, textiles, and flour, and as a bactericide in water treatment. For most industrial applications, ClO_2 is produced on site. The molecule has a bent structure with a bond angle of 118° . Among the reactions that can be used to prepare ClO_2 is the following:

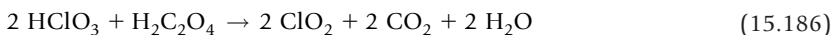

SO_2 acts as a reducing agent toward ClO_3^- , with the reduction product being ClO_2 .

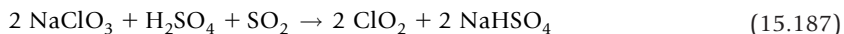

In basic solution, ClO_2 disproportionates to produce chlorite and chlorate ions.

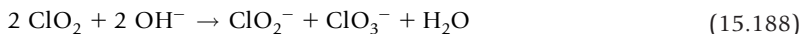

In industrial settings, ClO_2 is prepared from a solution of NaClO_3 .

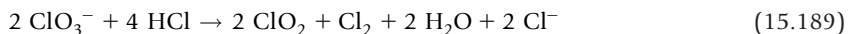

There is a competing reaction that can be shown as

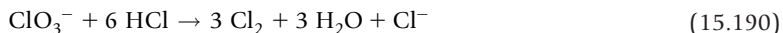

and as a result, the overall reaction is sometimes shown as

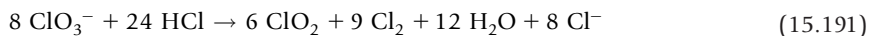

In Eq. (15.187), the preparation of ClO_2 is by the reduction of ClO_3^- with SO_2 . On an industrial scale, the reduction is carried out using gaseous methanol as the reducing agent.

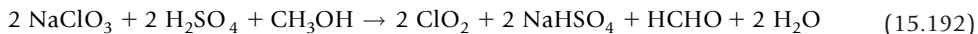

When solid NaClO_3 reacts with gaseous chlorine, ClO_2 is produced.

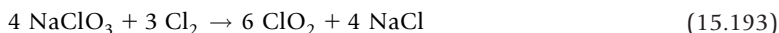

Photolysis of ClO_2 at low temperature produces several products, one of which is Cl_2O_3 , which has the structure

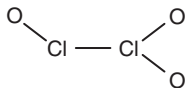

This compound is a dangerous explosive. When chlorosulfonic acid reacts with a perchlorate, the product is Cl_2O_4 , which is more accurately written as ClOClO_3 , chlorine perchlorate.

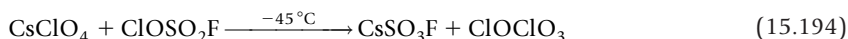

Although technically a chlorine oxide, chlorine perchlorate is of little importance. When ozone reacts with chlorine dioxide, the reaction produces Cl_2O_6 dichlorine hexoxide.



This compound is sometimes represented as $[\text{ClO}_2^+][\text{ClO}_4^-]$ on the basis of its reactions. One additional oxide of chlorine needs to be described. That compound is dichlorine heptoxide, Cl_2O_7 (m.p. -91.5°C and b.p. 82°C), which is produced when HClO_4 is dehydrated with P_4O_{10} .



The oxides of bromine and iodine are not numerous, and they are not particularly important. Bromine monoxide, Br_2O is obtained by the reaction

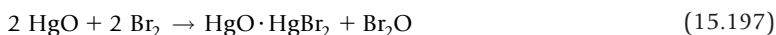

and this oxide can be oxidized by ozone to produce BrO_2 .

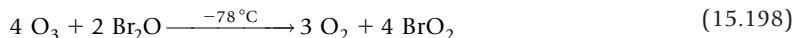

Of the oxides of iodine that have been reported, the most common is I_2O_5 , which is prepared by the dehydration of HIO_3 .



The I_2O_5 molecule has the structure

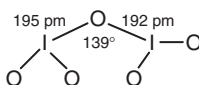

I_2O_5 is relatively stable but decomposes at 300°C . It is a strong oxidizing agent that is used in quantitative determination of CO , which it oxidizes to CO_2 .



The reaction of I_2O_5 with water produces iodic acid, HIO_3 . Although I_2O_4 , I_4O_9 , and I_2O_7 have been reported, they are of minor importance.

15.2.6 Oxyhalides

Oxyhalides of sulfur, nitrogen, and phosphorus are important compounds that have been described in other sections of this book. A considerable number of compounds of this type are known for the group VIIA elements, with most of them being fluorides. The known compounds include $FClO_2$, F_3ClO , $FClO_3$, F_3ClO_2 , ClO_3OF , $FBrO_2$, $FBrO_3$, FIO_2 , F_3IO , FIO_3 , F_3IO_2 , and F_5IO . Most of these compounds react as strong oxidizing or fluorinating agents. They also undergo hydrolysis reactions such as



As we have seen in other instances, strong Lewis acids can remove F^- from many types of molecules to generate cations. That is also the case with oxyfluorides.



Perchloryl fluoride, $FClO_3$, is stable at temperatures up to about $500^\circ C$, and it hydrolyzes only slowly. The molecule has the pyramidal (C_{3v}) structure

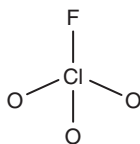

15.2.7 Hypohalous Acids and Hypohalites

When halogens dissolve in water, a reaction takes place to a slight extent that can be shown as



The weak acids having the formula HOX are the hypohalous acids (they have K_a values of 3×10^{-8} , 2×10^{-9} , and 1×10^{-11} for $HOCl$, $HOBr$, and HOI , respectively). They are oxidizing agents, as are the salts of the acids. $HOCl$ (m.p. $-117^\circ C$) has been prepared, but it is unstable and has no serious uses. It does react with fluorine to produce OF_2 and HF .



Although solutions containing the hypohalous acids are produced by dissolving the halogens in water, the process must be carried out at low temperature. Hypohalites are also produced when halogens react in basic solution.



However, if the solutions are hot, the hypohalites undergo disproportionation to produce XO_3^- and X^- .



As a result, the products of reactions of halogens in basic solutions depend on pH, temperature, and the concentrations of the reactants. The acids are unstable compounds that decompose in two ways:



Although solutions of sodium hypochlorite are useful oxidizing agents, the solid is not very stable. Calcium hypochlorite is used in bleaches, swimming pool treatments, and so forth. The decomposition of OCl^- is catalyzed by compounds containing transition metals.



The reaction has been studied kinetically, and it is found that when a solid catalyst (CoO and/or Co_2O_3) formed by adding $\text{Co}(\text{NO}_3)_2$ to a solution of NaOCl is present, the rate of the reaction is determined by the surface area of the catalyst. Hypobromites and hypoiodites are good oxidizing agents, though less commonly used than hypochlorites. One use of NaOBr is in analysis where it is used to oxidize urea and NH_4^+ to produce N_2 .

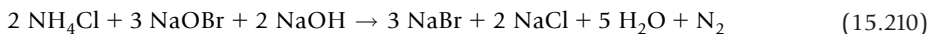

15.2.8 Halous Acids and Halites

Of the acids having the formula HXO_2 , only the chlorine compound is stable enough to be of much use. Sodium chlorite is a useful oxidizing agent that results when chlorine dioxide reacts with sodium hydroxide.



Acidifying a solution containing a chlorite gives a solution of HClO_2 . Halite salts are used primarily as bleaching agents.

15.2.9 Halic Acids and Halates

The *halic* acids may not be industrially important, but their salts certainly are. Sodium chlorate is produced in enormous quantities and used in processes in which its oxidizing strength makes it a versatile bleach. One such use is in making paper, and potassium chlorate is used as the oxidizing agent in matches. The decomposition of potassium chlorate was discussed in Chapter 13 in connection with the laboratory preparation of oxygen.

The halic acids are strong, as would be expected on the basis of the formula $(\text{HO})_a\text{XO}_b$ with $b = 2$, but they are not stable as pure compounds. The anions are isoelectronic with SO_3^{2-} , and they have the C_{3v} structure

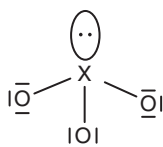

In the anions, the observed bond angles are 106° in ClO_3^- and BrO_3^- and 98 to 100° in IO_3^- depending on the nature of the cation.

Numerous reactions are useful for producing the acids and salts containing the halogens in the +5 oxidation state. As was shown earlier, the disproportionation reaction



is one such reaction. Another important type of disproportionation reaction of the halogens is illustrated by the general equation



For producing bromates, oxidation with hypochlorite as shown here is a useful reaction:



The acids are frequently prepared only as aqueous solutions by acidifying a solution of a metal halate. The following reaction is useful because the other product, BaSO_4 , is insoluble:



The industrial production of sodium chlorate is by electrolysis of an aqueous solution of NaCl , which can be shown as

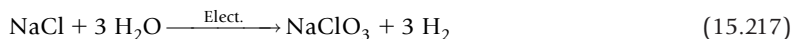

but this equation is an oversimplification because the process involves several steps.

At temperatures near or above the melting points, chlorates disproportionate.



However, decomposition of the acids takes place as shown in the equations

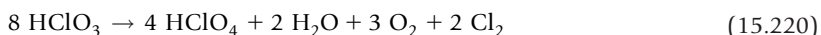
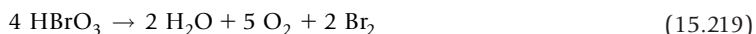

Chlorates, bromates, and iodates are strong oxidizing agents that are useful in many industrial and synthetic processes.

15.2.10 Perhalic Acids and Perhalates

The oxyacids containing chlorine and bromine in the +7 oxidation state are very strong acids. This can be seen when the formulas are written as $(\text{HO})\text{XO}_3$, which corresponds to $b = 3$ in the general

formula $(\text{HO})_a\text{XO}_b$. The acids have as their anhydrides the oxides X_2O_7 , but the situation with iodine is different from that of the other halogens. The reaction of I_2O_7 with excess water produced an acid having the formula H_5IO_6 , and the (C_{4v}) structure of the molecule can be shown as

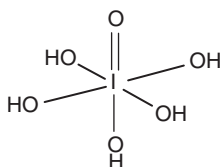

However, when I_2O_7 reacts with water a series of reactions take place that can be shown as follows:

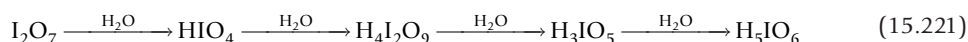

Even this set of reactions is an oversimplification because of reactions in which the acids are deprotonated and dehydrated in a manner somewhat similar to that leading to polyphosphates (see Chapter 14). The “periodic acid” that results is a function of the ratio of I_2O_7 to water. One of the reasons for this behavior is the relatively large size of the iodine atom. The acids HIO_4 and H_5IO_6 are sometimes referred to as metaperiodic acid and orthoperiodic acid, respectively, and solid compounds containing both IO_4^- and IO_6^{5-} are known. Periodate salts normally refer to those that contain the IO_4^- ion such as potassium periodate. The periodates are very strong oxidizing agents that are widely used as such in both inorganic and organic chemistry.

Perchloric and perbromic acids are strong acids. Although perchloric acid can be obtained as a pure compound, it is normally available as a solution that contains 70% of the acid. This acid and solid perchlorates are such strong oxidizing agents that they oxidize many combustible materials explosively. Even if the reaction is not immediate, it may be initiated later and then become explosive. Perchloric acid is obtained from sodium perchlorate, which is prepared from the chlorate by electrolytic oxidation. If HClO_4 is dehydrated (as with P_4O_{10}), Cl_2O_7 results, which has the structure

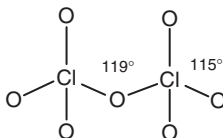

Perbromic acid was first prepared in 1969 in a very unusual way that made use of the conversion of ^{83}Se into ^{83}Br as a result of β -decay. The ^{83}Se was in the form of the selenate, $^{83}\text{SeO}_4^{2-}$, so when decay occurred, the product was $^{83}\text{BrO}_4^-$. Satisfactory synthetic routes to the perbromates now include oxidation of BrO_3^- with XeF_2 or F_2 .

There is significant multiple bonding in ClO_4^- . If the structure is drawn with four single C–O bonds, the chlorine atom has a formal charge of +3:

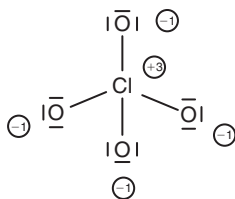

Including structures in which there are multiple bonds results in resonance structures like

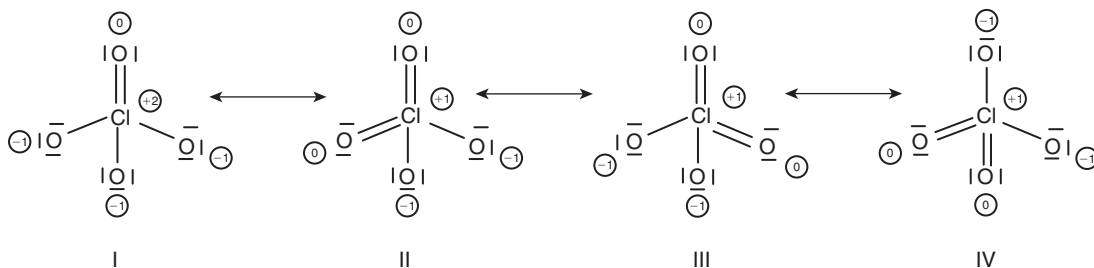

which give a lower formal charge in the chlorine atom. As a result, the observed bond length is somewhat shorter than that expected for a single Cl–O bond, so these structures make significant contributions to the structure of ClO_4^- .

15.3 THE NOBLE GASES

The noble gases are not very reactive, and because they have eight electrons in the valence shell, we have come to consider the octet of electrons as being the circumstance that almost defines the essence of bonding in many molecules. The noble gases are, in fact, comparatively unreactive, but some (especially xenon) are not “inert” even though that label was once applied to the noble gases. The gases have high ionization potentials, but, except for helium and neon, not so extremely high that reactions are impossible. Prior to 1962, materials that held noble gases in a solid matrix such as graphite were known, but these are not compounds (they are known as *clathrates*) in the traditional sense. However, in 1962 a reaction was carried out by Neil Bartlett and D. H. Lohmann that resulted in the first “real” compound of a noble gas.

The reaction was carried out with the knowledge that oxygen reacts with the very strong oxidizing agent, PtF_6 .



One reason that this reaction is so interesting is that the ionization potential for the oxygen *molecule* is 1177 kJ/mol (compared to that of a hydrogen *atom*, which is 1312 kJ/mol) and that for Xe is

1170 kJ/mol. It is evident that if PtF_6 will remove an electron from O_2 , it should also do so from the Xe atom. When the reaction was attempted, a yellow-orange solid was obtained and it was thought (later shown to be slightly incorrect) that the product was $\text{Xe}^+[\text{PtF}_6]^-$. It was later shown that the product was $\text{XeF}^+[\text{Pt}_2\text{F}_{11}]^-$, but much more xenon chemistry was on the way. Other fluorides including XeF_4 , XeF_2 , and XeF_6 were prepared, and structural studies began to reveal details of these interesting molecules. In the intervening years, many other compounds containing xenon have been prepared, and the chemistry of the noble gases has also been expanded to include some krypton compounds. The major emphasis is on xenon chemistry in the discussion that follows.

15.3.1 The Elements

Helium has long been related to nuclear chemistry because of the formation of alpha particles ($\alpha = {}^4\text{He}^{2+}$) during the decay of heavy nuclei, an example of which is



An α particle can abstract two electrons from some other atom or molecule (and given the extremely high ionization potential of helium, the highest of any atom, it would be difficult to prevent it) to become a helium atom. Helium also is a constituent in stars as a result of the fusion reaction

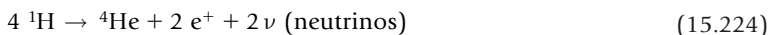

and it was known as early as 1868 that solar spectral lines indicated a new element. The element was named helium from the Greek word *helios*, "sun." Several years later, the spectrum of gas from a volcano was shown to contain the same line. Argon was discovered in 1885 by Sir William Ramsay as a constituent in the residual gas after oxygen and nitrogen were removed from air. The name comes from the Greek *argos*, which means "inactive." Argon is generated by the electron capture decay of ${}^{40}\text{K}$.



In 1898, neon, krypton, and xenon were isolated in the residual gas after nitrogen and oxygen were removed from liquid air. Their names come from the Greek words *xeneos* (stranger), *kryptos* (hidden), and *neos* (new), respectively. Radon is produced in the three naturally occurring decay series of ${}^{235}\text{U}$, ${}^{238}\text{U}$, and ${}^{232}\text{Th}$. Each of these series consists of numerous steps before a stable nuclide results, but the final product is radon in each case.

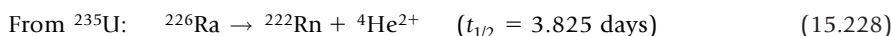
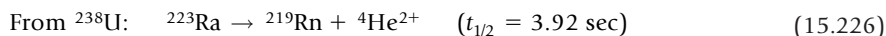

All of the isotopes of radon are radioactive and decay by α -emission to produce isotopes of polonium by transformations shown in the following equations:

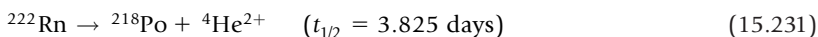
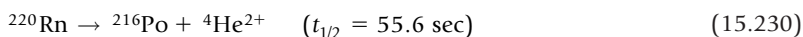
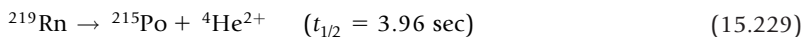

Radon constitutes a serious problem because, being a heavy gas, it collects in such places as basements and mine shafts. When inhaled, radon decays in areas where little penetration is required to cause tissue damage. Radiation from α and β decay is not of a highly penetrating type, but inside the lungs it does not have to be in order to still cause damage. Table 15.10 shows several properties of the noble gases.

Compounds that consist of molecules having only very weak dispersion forces of attraction between them typically have a very narrow liquid range. The noble gases illustrate this dramatically, because the largest liquid range for any of the gases is only about 9 degrees. The polarizability of the noble gases increases going downward in the group, which leads to increased solubility in water as a result of dipole-induced dipole forces of attraction (see Chapter 6).

Some of the noble gases have substantial uses. In Chapter 1, the stability of nuclei having particular numbers of nucleons was discussed. As a result of having the first shell filled with both protons and neutrons, helium has a stable arrangement, as does ^{20}Ne , which has an equal number of protons and neutrons. Partially as a result of this stability, both helium and neon are reasonably abundant on a cosmic scale. Having a density of only 0.18 g/liter, helium is used in lighter-than-air aircraft, and it is also used as a coolant, especially for superconductors. Neon is used in neon signs, and argon is used as an inert atmosphere in some types of welding.

15.3.2 The Xenon Fluorides

Although all of the noble gases have many interesting properties, it is their *chemistry* that we consider at this point. Some compounds of krypton will be mentioned, but it is the chemistry of xenon that is most significant. In 1933, Linus Pauling speculated that it should be possible to produce XeF_6 , and this has since been shown to be the case. The reaction of oxygen with PF_6 mentioned earlier suggested that a similar reaction with xenon might be successful in light of the similarity in ionization potentials. It should be apparent that if xenon is to react, it should be with an extremely strong oxidizing agent, and F_2 is a suitable candidate. By this means, the difluoride and tetrafluoride of xenon are prepared as a mixture of the elements is heated or subjected to electromagnetic radiation.



When preparing XeF_4 , a mixture containing a 5:1 ratio of fluorine to xenon was heated and subjected to several atmospheres pressure.



When a higher ratio of fluorine to xenon is used, XeF_6 can be obtained.

The difference in the ionization potentials of xenon and krypton (1170 versus 1351 kJ/mol) indicates that krypton should be the less reactive of the two. Some indication of the difference can be seen from the bond energies, which are 133 kJ/mol for the Xe–F bond but only 50 kJ/mol for the Kr–F bond. As a result, XeF_2 is considerably more stable of the difluorides, and KrF_2 is much more reactive. Krypton difluoride has been prepared from the elements, but only at low temperature using electric discharge. When irradiated with ultraviolet light, a mixture of liquid krypton and fluorine reacts to produce KrF_2 . As expected, radon difluoride can be obtained, but because all isotopes of radon undergo rapid decay, there is not much interest in the compound. In this survey of noble gas chemistry, the

Table 15.10 Some Properties of the Noble Gases.

Property	He	Ne	Ar	Kr	Xe	Rn
Melting point, K	0.95	24.5	83.78	116.6	161.3	202
Boiling point, K	4.22	27.1	87.29	120.8	166.1	211
ΔH_{fusion} , kJ mol ⁻¹	0.021	0.324	1.21	1.64	3.10	2.7
ΔH_{vap} , kJ mol ⁻¹	0.082	1.74	6.53	9.70	12.7	18.1
Ionization potential, kJ mol ⁻¹	2372	2081	1520	1351	1170	1037
Atomic radius, ^a pm	122	160	191	198	218	~220
Density, ^b g L ⁻¹	0.1785	0.900	1.784	3.73	5.88	9.73
Solubility in H ₂ O, 10 ³ × X ^c	7.12	8.73	30.2	57.0	105	230

^avan der Waals radii.
^bAt 0 °C and 1 atm.
^cWhere X is the mole fraction of the gas in the solution.

main focus will be on the behavior of xenon compounds, which generally contain F, Cl, O, or N as the other atoms.

There are 10 electrons around the central atom in XeF₂, so the linear structure is derived from a trigonal bipyramid with the unshared pairs of electrons in equatorial positions (*D*_{∞h} symmetry).

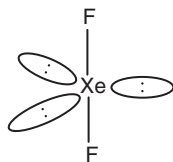

However, a different view of the bonding in XeF₂ is provided by a molecular orbital approach in which a *p* orbital on Xe combines with a *p* orbital from each F to form a three-center, four-electron linear bond. Actually, the three atomic orbitals form three molecular orbitals, but only the bonding and non-bonding orbitals are populated. This population of the orbitals places nonbonding electron density on the F atoms to give polar Xe–F bonds.

The XeF₄ molecule is isoelectronic with IF₄⁻ (12 electrons around the central atom), and it has the same square planar (*D*_{4h}) structure.

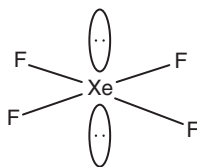

In the XeF₆ molecule there are 14 electrons around the central atom, which give the required six bonds and one unshared pair of electrons. Although the IF₇ molecule also has 14 electrons around

the central atom, they are all bonding pairs, and the molecule has a pentagonal bipyramid structure. As a result of the unshared pair, the XeF_6 molecule has an irregular, nonrigid structure that has C_{3v} symmetry, which can be shown as

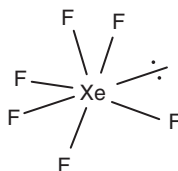

Xenon hexafluoride is known to exist in condensed phases as an equilibrium mixture that can be shown as



The structure of the tetramer is complex and involves fluoride bridges, as do the hexamers that exist in solid XeF_6 .

In general, intermolecular forces are related to the structures of the molecules (see Chapter 6). Both XeF_2 and XeF_4 are nonpolar, so it is interesting that the melting points of XeF_2 , XeF_4 , and XeF_6 are 129, 117, and 50°C, respectively, but the solids also readily sublime. The solubility parameter (discussed in Chapter 6) is useful when considering intermolecular forces, and that is the case here. From the vapor pressures of the di- and tetrahalides, the calculated solubility parameters for XeF_2 and XeF_4 are 33.3 $\text{J}^{1/2} \text{cm}^{-3/2}$ and 30.9 $\text{J}^{1/2} \text{cm}^{-3/2}$, respectively. These values are high when compared to other nonpolar covalent molecules, and it is noteworthy that the *heavier* molecule has the *lower* solubility parameter. In order to provide a basis of comparison, consider the solubility parameters for SnCl_4 (260.5 g mol^{-1}), 17.8 $\text{J}^{1/2} \text{cm}^{-3/2}$, and for SiBr_4 (347.9 g mol^{-1}), 18.0 $\text{J}^{1/2} \text{cm}^{-3/2}$. These values follow the expected trend for molecules that interact as a result of London dispersion forces. It would be expected that London forces would be stronger between XeF_4 molecules than between those of XeF_2 . However, the bonds in xenon fluorides are polar. In XeF_2 the residual charges on Xe and F are likely higher than those on the atoms in the XeF_4 molecule, in which electron density is unequally shared in four directions. Therefore, although the *molecules* are not polar, the *bonds* within them are, and the bond polarity would be expected to be greater in XeF_2 . This results in greater intermolecular attraction, which is reflected by the fact that the solubility parameter (and melting point) for XeF_2 is greater than that for XeF_4 .

15.3.3 Reactions of Xenon Fluorides and Oxyfluorides

Many of the reactions that xenon fluorides undergo are similar in some ways to those of interhalogens. However, the xenon halides differ markedly in terms of their reactivity, with XeF_2 being much less reactive than either XeF_4 or XeF_6 . The difluoride reacts only slowly with water,



but in basic solution a different reaction takes place rapidly, which can be shown as

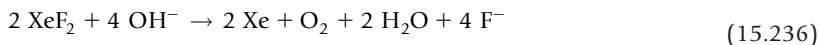

Xenon tetrafluoride reacts rapidly with water by undergoing disproportionation,

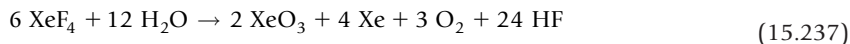

as xenon +4 is converted into xenon +6 and Xe. The oxide is an explosive compound that is also produced by the hydrolysis of XeF_6 .



The hydrolysis may take place by the formation of XeOF_4 as an intermediate.



As has been mentioned in other places, strong Lewis acids such as SbF_5 or AsF_5 have the ability to remove F^- from a variety of covalent fluorine compounds to generate polyatomic cations. Similar reactions occur between xenon fluorides and strong Lewis acids with the formation of products such as $\text{XeF}^+\text{Sb}_2\text{F}_{11}$, $\text{XeF}^+\text{SbF}_6^-$, and $\text{Xe}_2\text{F}_3^+\text{SbF}_6^-$. The structures of the cations that contain two xenon atoms have fluoride ion bridges between them. For example, the structure of Xe_2F_3^+ is

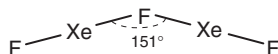

The XeF^+ ion bonds to the SbF_6^- anion to give a complex structure that can be shown as

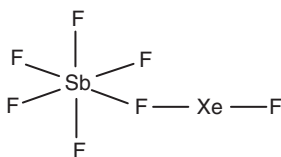

Xenon tetrafluoride undergoes reactions that are similar to those of the interhalogens. For example, the XeF_3^+ cation is generated when XeF_4 reacts with a very strong Lewis acid, such as BiF_5 .



In the solid state, PCl_5 and PBr_5 exist as ionic compounds. In a similar way, solid XeF_6 contains XeF_5^+ ions with fluoride ions bridging between them. The XeF_5^+ cation is produced by the reaction of XeF_6 with RuF_5 .



A cation containing two xenon atoms, $\text{Xe}_2\text{F}_{11}^+$, is also known, and it has a structure that can be shown as $\text{F}_5\text{Xe}^+\cdots\text{F}^-\cdots\text{XeF}_5^+$. Polyatomic anions containing xenon are produced because XeF_6 is also a Lewis acid. An example of this type of reaction can be shown as



where M is a +1 cation. In recent years, the ability of xenon halides to react as versatile fluorinating agents has been exploited. The higher fluorides XeF_4 and XeF_6 are very vigorous fluorinating agents, but the difluoride is less reactive, although it will fluorinate organic compounds such as olefins.

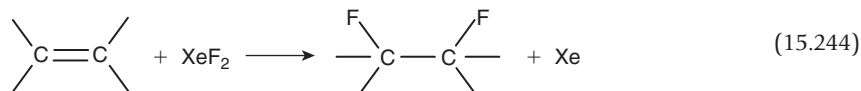

One interesting application that involves XeF_2 as a fluorinating agent involves the fluorination of uracil, which has the structure

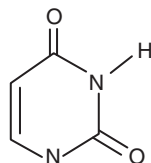

The reaction of XeF_2 with uracil produces the 5-fluoro derivative, which can be applied topically for treating some types of skin diseases including some types of skin cancer. The reaction producing 5-fluorouracil can be shown as

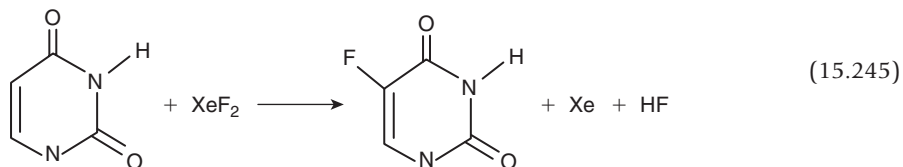

One of the attractive features of using XeF_2 as a fluorinating agent is that the other products, Xe and HF, are frequently more easily removed than those produced when other fluorinating agents are used.

Some oxides of xenon are known, and like most other compounds of xenon they are usually obtained from the fluorides. Two reactions that yield XeO_3 have already been shown in Eq. (15.237)

and (15.238). The heat of formation of XeO_3 is approximately +400 kJ/mol, so it should be no surprise that the compound is a very sensitive explosive material. The structure of XeO_3 (which is isoelectronic with SO_3^{2-} and ClO_3^-) can be shown as follows:

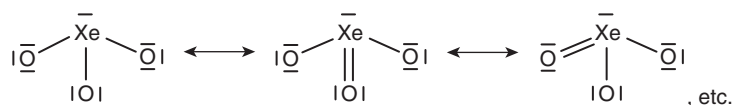

In the first structure showing only single bonds, the formal charge on Xe is +3 so contributions from structures showing double bonding are significant.

In basic solution, a reaction between OH^- and XeO_3 occurs, which can be shown as



One of the reactions that HClO_3 undergoes is the disproportionation that produces perchloric acid and chlorine.

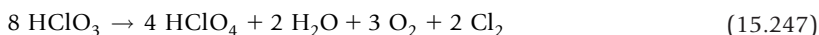

A reaction of HXeO_4^- in basic solution is very similar, and it can be shown as

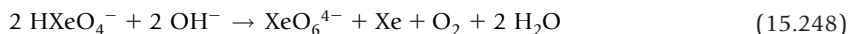

which results in the production of the perxenate ion, XeO_6^{4-} . This is just one of many ways in which some compounds of xenon resemble those of the halogens. Several solids containing the perxenate ion have been isolated, and the ion is the conjugate base of a weak acid, H_4XeO_6 . Therefore, the salts hydrolyze to produce basic solutions.

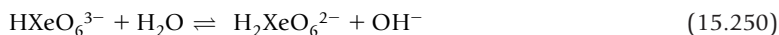
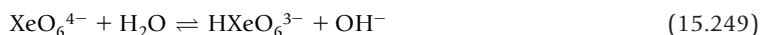

With the oxidation state of Xe in perxenates being +8, they are, as expected, very strong oxidizing agents.

In Chapter 14, it was shown that oxyhalides of phosphorus can be obtained by the reaction of oxides with halides. One such reaction is



In an analogous reaction, xenon oxyfluorides are produced by the reactions

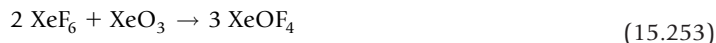

As mentioned earlier, krypton is known to form several compounds, but they are fewer and less well characterized than the compounds of xenon. The difluoride has been obtained by electric discharge

through a mixture of Kr and F₂ at low temperature. As in the case of xenon difluoride, a cation is produced in the reaction with a strong Lewis acid such as SbF₅.



There is some association between the cation and another molecule of KrF₂ to produce Kr₂F₃⁺.

As might be expected, KrF₂ is less stable than XeF₂, so it is an even stronger fluorinating agent, as illustrated by the following reactions:



Numerous other reactions of krypton difluoride are known, but they will not be reviewed here. The chemistry of krypton is well established, but it is still much less extensive than that of xenon. Although a rather extensive chemistry of the noble gases has developed, the vast majority of the studies have dealt with the xenon compounds.

■ REFERENCES FOR FURTHER READING

- Bailar, J. C., Emeleus, H. J., Nyholm, R., and Trotman-Dickinson, A. F. (1973). *Comprehensive Inorganic Chemistry*, Vol. 3. Pergamon Press, Oxford. This is one volume in the five volume reference work in inorganic chemistry.
- Bartlett, N. (1971). *The Chemistry of the Noble Gases*. Elsevier, New York. A good survey of the field by its originator.
- Claassen, H. H. (1966). *The Noble Gases*. D. C. Heath, Boston. A very useful introduction to the chemistry of noble gas compounds and structure determination.
- Cotton, F. A., Wilkinson, G., Murillo, C. A., and Bochmann, M. (1999). *Advanced Inorganic Chemistry*, 6th ed., Wiley, New York. A 1300-page book that covers an incredible amount of inorganic chemistry.
- Greenwood, N. N., and Earnshaw, A. (1997). *Chemistry of the Elements*, 2nd ed. Butterworth-Heinemann, Burlington, MA. Chapters 15–18 of this comprehensive book are devoted to the elements discussed in this chapter.
- Holloway, J. H. (1968). *Noble-Gas Chemistry*. Methuen, London. A thorough discussion of some of the early work on noble gas chemistry. A good introductory reference.
- King, R. B. (1995). *Inorganic Chemistry of the Main Group Elements*. VCH Publishers, New York. An excellent introduction to the descriptive chemistry of many elements.

■ QUESTIONS AND PROBLEMS

1. Draw structures for S₂N₂ showing all valence-shell electrons.
2. What are the characteristics of XeF₂ that make it a desirable fluorinating agent for organic compounds?
3. Which would you expect to be more stable, NaIF₄ or CsIF₄? Explain your answer.
4. Complete and balance the following:
 - (a) Cl₂ + H₂O →
 - (b) ICl₃ + H₂O →
 - (c) RbF + IF₃ →
 - (d) SiO₂ + ClF₃ →
 - (e) AsBr₃ + H₂O →

5. Write complete balanced equations for the following:
- $\text{XeF}_4 + \text{PF}_3 \rightarrow$
 - $\text{XeOF}_4 + \text{H}_2\text{O} \rightarrow$
 - $\text{XeF}_4 + \text{SOF}_2 \rightarrow$
 - $\text{XeF}_2 + \text{S}_8 \rightarrow$
 - $\text{XeF}_4 + \text{SF}_2 \rightarrow$
6. If the KrF bond enthalpy is 50 kJ mol^{-1} and the F–F bond enthalpy is 159 kJ mol^{-1} , what would be the heat of formation of gaseous KrF_2 from the gaseous elements?
7. Some compounds have positive heats of formation, so let us assume that the heat of formation of $\text{ArF}_2(\text{g})$ is $+100 \text{ kJ/mol}$. What would the energy of the Ar–F bond have to be to make it possible to produce $\text{ArF}_2(\text{g})$ if the F–F bond enthalpy is 159 kJ mol^{-1} and if the heat of formation could be no more positive than $+100 \text{ kJ/mol}$?
8. Explain why $(\text{SCl})_4\text{N}_4$ has the structure it has but that of $\text{S}_4(\text{NH})_4$ is different.
9. Draw the structure for $\text{S}_2\text{O}_6\text{F}_2$. Predict some of the reactions for the compound.
10. One cation containing a ring of sulfur and nitrogen atoms is $\text{S}_3\text{N}_2\text{Cl}^+$. Draw the structure of this ion and describe the importance of resonance.
11. Supply the formula for a missing reactant and/or product that would complete the each of the equations indicated.
- $\text{SO}_2 + \underline{\hspace{2cm}} \rightarrow \text{SO}_2\text{Cl}_2 + \underline{\hspace{2cm}}$
 - $\text{HCl} + \underline{\hspace{2cm}} \rightarrow \text{HF} + \text{H}_2\text{O} + \underline{\hspace{2cm}}$
 - $\text{SO}_2\text{Cl}_2 + \underline{\hspace{2cm}} \rightarrow \text{SO}_2(\text{NH}_2)_2 + \underline{\hspace{2cm}}$
 - $\text{NiS} + \underline{\hspace{2cm}} \rightarrow \text{NiO} + \underline{\hspace{2cm}}$
 - $\text{HOSO}_2\text{Cl} + \text{H}_2\text{O}_2 \rightarrow \underline{\hspace{2cm}} + \underline{\hspace{2cm}}$
12. Discuss the reasons why the reaction $\text{KF} + \text{ClSO}_3\text{H} \rightarrow \text{KCl} + \text{FSO}_3\text{H}$ takes place.
13. Draw structures for the following species:
- XeO_6^{2-} ; (b) XeO_4 ; (c) XeF_3^+ ; (d) XeF_8^{2-} ; (e) XeF_5^+
14. When SO_2 reacts with BF_3 , it does so in a different way than when it reacts with $\text{N}(\text{CH}_3)_3$. Write the equations for the reactions and describe the products. What is the essential difference between the two cases?
15. Draw the structure for each of the following molecules:
- SeCl_4
 - Peroxydisulfuric acid
 - Dithionic acid
 - SF_4
 - SO_3
16. Write an equation for the reaction of each compound listed in question 15 with water.
17. Calculate the heats of formation for gaseous XeF_2 and XeF_4 if the Xe–F bond enthalpy is 133 kJ mol^{-1} and the F–F bond enthalpy is 159 kJ mol^{-1} .
18. Write equations for the processes listed.
- The reaction of sulfuryl chloride with methanol
 - The reaction of sulfur tetrafluoride with boron
 - The reaction of sulfur with phosphorus trichloride
 - The reaction of sulfur with arsenic pentafluoride in liquid sulfur dioxide
 - Roasting arsenic(III) sulfide
 - The reaction of hydrogen chloride with sulfur trioxide
19. Predict some of the ways in which the $\text{S}_2\text{O}_5^{2-}$ ion could conceivably bond to a metal ion when forming complexes.

20. If the compound S_4P_4 could be made, how would its structure likely differ from that of S_4N_4 ? Speculate on the products that would be formed if S_4P_4 were to undergo hydrolysis in basic solution.

21. What should be the enthalpy change for the reaction

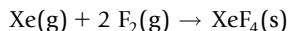

if the lattice energy of $\text{XeF}_4(\text{s})$ is 62 kJ mol^{-1} ?

22. Write balanced equations for each of the following processes:

- Reaction of iodine pentachloride with water
- Preparation of NaOCl
- The reaction of ClF_3 with NOF
- Disproportionation of OCl^-
- Electrolysis of dilute sodium chloride solution

23. Explain why the reaction $2 \text{ClF}_3 + \text{Br}_2 \rightarrow 2 \text{BrF}_3 + \text{Cl}_2$ takes place.

24. Draw the structure of each of the following molecules:

- Thiosulfuric acid
- Thionyl fluoride
- S_2Cl_2
- H_2S_4
- Difluorodisulfuric acid

25. By looking at Table 15.6, tell which of the oxyacids of sulfur are strong acids.

26. Explain how SOCl_2 could behave as a Lewis acid in two different ways.

27. Complete and balance the following:

- $\text{SO}_2\text{Cl}_2 + \text{C}_2\text{H}_5\text{OH} \rightarrow$
- $\text{KBF}_4 + \text{SeO}_3 \rightarrow$
- $\text{H}_2\text{S}_2\text{O}_7 + \text{H}_2\text{O} \rightarrow$
- $\text{HOSO}_2\text{Cl} + \text{H}_2\text{O}_2 \rightarrow$
- $\text{Sb}_2\text{S}_3 + \text{HCl} \rightarrow$

28. Draw the molecular orbital energy level diagram for SO . What properties do you predict for this molecule?

29. Complete and balance the following:

- $\text{HNO}_3 + \text{S}_8 \rightarrow$
- $\text{S}_2\text{Cl}_2 + \text{NH}_3 \rightarrow$
- $\text{S}_4\text{N}_4 + \text{Cl}_2 \rightarrow$
- $\text{SO}_2 + \text{PCl}_5 \rightarrow$
- $\text{CaS}_2\text{O}_6 \xrightarrow{\Delta} \rightarrow$

30. Complete and balance the following:

- $\text{ONF} + \text{ClF} \rightarrow$
- $\text{Sb}_2\text{S}_3 + \text{HCl} \rightarrow$
- $\text{Na}_2\text{CO}_3 + \text{S} \rightarrow$
- $\text{HClO}_3 + \text{P}_4\text{O}_{10} \rightarrow$
- $\text{KMnO}_4 + \text{HCl} \rightarrow$

Part

5

Chemistry of Coordination Compounds

This page intentionally left blank

Introduction to Coordination Chemistry

The chemistry of coordination compounds comprises an area of chemistry that spans the entire spectrum from theoretical work on bonding to the synthesis of organometallic compounds. The essential feature of coordination compounds is that they involve *coordinate* bonds between Lewis acids and bases. Metal atoms or ions function as the Lewis acids, and the range of Lewis bases (electron pair donors) can include almost any species that has one or more unshared pairs of electrons. Electron pair donors include neutral molecules such as H_2O , NH_3 , CO , phosphines, pyridine, N_2 , O_2 , H_2 , and ethylenediamine, ($\text{H}_2\text{NCH}_2\text{CH}_2\text{NH}_2$). Most anions, such as OH^- , Cl^- , $\text{C}_2\text{O}_4^{2-}$, and H^- , contain unshared pairs of electrons that can be donated to Lewis acids to form coordinate bonds. The scope of coordination chemistry is indeed very broad and interdisciplinary.

Some of the important types of coordination compounds occur in biological systems (for example, heme and chlorophyll). There are also significant applications of coordination compounds that involve their use as catalysts. The formation of coordination compounds provides the basis for several techniques in analytical chemistry. Because of the relevance of this area, an understanding of the basic theories and principles of coordination chemistry is essential for work in many related fields of chemistry. In the next few chapters, an introduction will be given to the basic principles of the chemistry of coordination compounds.

16.1 STRUCTURES OF COORDINATION COMPOUNDS

Coordination compounds are also known as coordination complexes, complex compounds, or simply complexes. The essential feature of coordination compounds is that coordinate bonds form between electron pair donors, known as the *ligands*, and electron pair acceptors, the metal atoms or ions. The number of electron pairs donated to the metal is known as its *coordination number*. Although many complexes exist in which the coordination numbers are 3, 5, 7, or 8, the majority of complexes exhibit coordination numbers of 2, 4, or 6.

In order for a pair of electrons to be donated from a ligand to a metal ion, there must be an *empty* orbital on the metal ion to accept the pair of electrons. This situation is quite different from that where covalent bonds are being formed because in that case, one electron in a bonding pair comes from each of the atoms held by the bond. One of the first factors to be described in connection with the formation of coordinate bonds is that of seeing what type(s) of orbitals are available on the metal. If the metal

ion is Zn^{2+} , the electron configuration is $3d^{10}$. Therefore, the $4s$ and $4p$ orbitals are empty and can be hybridized to give a set of four empty sp^3 hybrid orbitals. This set of hybrid orbitals could accommodate four pairs of electrons donated by ligands with the bonds pointing toward the corners of a tetrahedron. Accordingly, it should be expected that $[Zn(NH_3)_4]^{2+}$ would be tetrahedral, and that is correct.

In 1893, Alfred Werner proposed a theory to explain the existence of complexes such as $CoCl_3 \cdot 6NH_3$, $CoCl_3 \cdot 4NH_3$, $PtCl_2 \cdot 2NH_3$, and $Fe(CN)_3 \cdot 3KCN$. He began by assuming that a metal ion has two kinds of valence. The first, the *primary* valence, is satisfied by negative groups that balance the charge on the metal. For example, in $CoCl_3 \cdot 6NH_3$ the +3 valence of cobalt is satisfied by three Cl^- ions. A *secondary* valence is used to bind other groups that are usually specific in number. In the case here, the six NH_3 molecules satisfy the secondary valence of cobalt, so the coordination number of cobalt is 6. As a result of the NH_3 molecules being bonded directly to the cobalt ion, the formula is now written as $[Co(NH_3)_6]Cl_3$ where the square brackets are used to identify the actual complex that contains the metal and the ligands bound directly to it.

In a complex such as $CoCl_3 \cdot 4NH_3$, the coordination number of 6 for cobalt is met by the four NH_3 molecules and two Cl^- ions being bonded directly to the cobalt. That leaves one Cl^- ion that satisfies part of the primary valence, but it is not bonded directly to the cobalt ion by means of a secondary valence. The formula for this coordination compound is written as $[Co(NH_3)_4Cl_2]Cl$. Support for these ideas is provided by dissolving the compounds in water and adding a solution containing Ag^+ . In the case of $CoCl_3 \cdot 6NH_3$ or $[Co(NH_3)_6]Cl_3$, all of the chloride is immediately precipitated as $AgCl$. For $CoCl_3 \cdot 4NH_3$ or $[Co(NH_3)_4Cl_2]Cl$, only one third of the chloride precipitates as $AgCl$ because two chloride ions are bound to the cobalt ion by coordinate bonds, the secondary valence. Two Cl^- ions satisfy both primary and secondary valences of cobalt, but one Cl^- satisfies only a primary valence. For a solution of the compound $[Co(NH_3)_3Cl_3]$, none of the chloride ions precipitate when Ag^+ is added because all of them are bound to the cobalt ion by coordinate bonds.

The electrical conductivity of solutions containing the complexes just described provides additional confirmation of the correctness of this view. For example, when $[Co(NH_3)_3Cl_3]$ is dissolved in water, the compound behaves as a nonelectrolyte. There are no ions present because the Cl^- ions are part of the coordinate structure of the complex. On the other hand, $[Co(NH_3)_6]Cl_3$, $[Co(NH_3)_5Cl]Cl_2$, and $[Co(NH_3)_4Cl_2]Cl$ behave as 1:3, 1:2, and 1:1 electrolytes, respectively. A similar situation exists for $[Pt(NH_3)_4Cl_2]Cl_2$, which behaves as a 1:2 electrolyte and has only half of the chloride ions precipitated when Ag^+ is added to a solution of the complex. A large number of compounds like $FeCl_3 \cdot 3KCl$ are known, and they are often called *double salts* because they consist of two complete formulas linked together. Many of the compounds are actually coordination compounds with formulas like $K_3[FeCl_6]$.

As will be shown later, there are many complexes that have coordination numbers of 2 (linear complexes such as $[Ag(NH_3)_2]^+$), 4 (tetrahedral complexes such as $[CoCl_4]^{2-}$ or square planar complexes such as $[Pt(NH_3)_4]^{2+}$) or 6 (octahedral complexes such as $[Co(NH_3)_6]^{3+}$). A considerably smaller number of complexes having coordination numbers of 3 (trigonal planar), 5 (trigonal bipyramid or square-based pyramid), 7 (pentagonal bipyramid or capped trigonal prism), or 8 (cubic or anticubic, which is also known as Archimedes antiprism) are also known. These structures are shown in Figure 16.1.

In a tetrahedral structure, all of the positions around the central atom are equivalent, so there is no possibility of geometrical or *cis/trans* isomerism. If all four groups bonded to the metal are different,

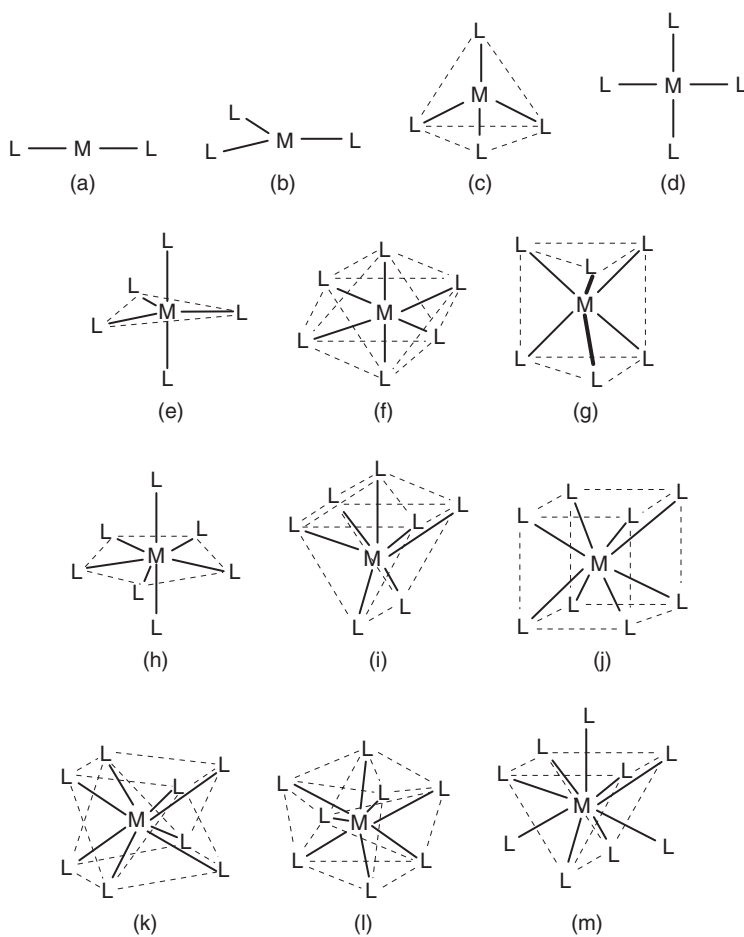

■ **FIGURE 16.1** Some of the most common structures for coordination compounds: (a) linear; (b) trigonal planar; (c) tetrahedron; (d) square plane; (e) trigonal pyramid; (f) octahedron; (g) trigonal prism; (h) pentagonal bipyramid; (i) single-capped trigonal prism; (j) cubic; (k) Archimedes (square) antiprism; (l) dodecahedron; (m) triple-capped trigonal prism.

there can be optical isomers. A compound such as $[\text{Pd}(\text{NH}_3)_2\text{Cl}_2]$ would exist in only one isomer if the compound were tetrahedral. However, two isomers of the compound exist because the bonding around the metal is square planar.

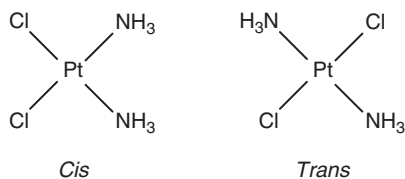

Alfred Werner isolated these two isomers, which showed conclusively that the complex is square planar rather than tetrahedral. The *cis* isomer is now known by the trade name *cisplatinol* or *cisplatin*, and it is used in treating certain forms of cancer.

If a complex has a coordination number of 6, there are several ways to place the ligands around the metal. A completely random arrangement is not expected because chemical bonds do not ordinarily form that way. Three regular types of geometry are possible for a complex containing six ligands. The six groups could be arranged in a planar hexagon (analogous to benzene) or the ligands could be arranged around the metal in a trigonal prism or in an octahedral structure. For a complex having the formula MX_4Y_2 , these arrangements lead to different numbers of isomers as shown in Figure 16.2.

With the availability of modern experimental techniques, the structure of a compound can be established unequivocally. However, more than 100 years ago only chemical means were available for structure elucidation. The fact that only two isomers could be isolated was a good *indication* that a complex having the formula MX_4Y_2 has an octahedral structure. The argument could be made that the synthetic chemist was not able to prepare a third possible isomer or that it exists but was so unstable that it could not be isolated.

Although the majority of complexes have structures that are linear, tetrahedral, square planar, or octahedral, a few compounds have a trigonal bipyramid structure. Most notable of these are $\text{Fe}(\text{CO})_5$, $[\text{Ni}(\text{CN})_5]^{3-}$, and $[\text{Co}(\text{CN})_5]^{3-}$. Some complexes having a coordination number of 5 have the square-base pyramid structure, including $[\text{Ni}(\text{CN})_5]^{3-}$. Although it is not particularly common, the coordination number 8 is found in the complex $[\text{Mn}(\text{CN})_8]^{4-}$, which has a cubic structure with CN^- ions on the corners.

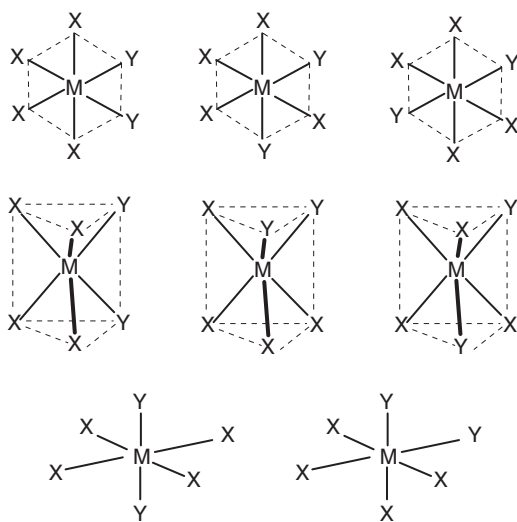

■ **FIGURE 16.2** Geometrical isomers for MX_4Y_2 complexes having planar hexagonal, trigonal prism, and octahedral structures.

Because the coordinate bonds are the result of Lewis acid-base interactions, the number of species that can form complexes with metal ions is large. Lewis bases such as H_2O , NH_3 , F^- , Cl^- , Br^- , I^- , CN^- , SCN^- , and NO_2^- all form a wide range of coordination compounds. Added to these are compounds such as amines, arsines, phosphines, and carboxylic acids that are all potential ligands. The ethylenediamine molecule, $\text{H}_2\text{NCH}_2\text{CH}_2\text{NH}_2$, is a ligand that forms many very stable complexes because each nitrogen atom has an unshared pair of electrons that can be donated to a metal ion. This results in the ethylenediamine molecule being attached to the metal ion at two sites, giving a ring with the metal ion being one of the members. A ring of this type is known as a *chelate* (pronounced “key-late”) ring (from the Greek word *chelos*, meaning “claw”). A complex that contains one or more chelate rings is called a *chelate complex* or simply a *chelate*. There are many other groups, known as *chelating agents*, that can bind to two sites. Table 16.1 shows some common ligands, including several that form chelates.

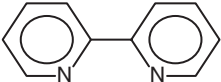
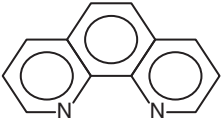
Table 16.1 Some of the Most Common Ligands.		
Group	Formula	Name
Water	H_2O	aqua
Ammonia	NH_3	ammine
Chloride	Cl^-	chloro
Cyanide	CN^-	cyano
Hydroxide	OH^-	hydroxo
Thiocyanate	SCN^-	thiocyanato
Carbonate	CO_3^{2-}	carbonato
Nitrite	NO_2^-	nitrito
Oxalate	$\text{C}_2\text{O}_4^{2-}$	oxalato
Carbon monoxide	CO	carbonyl
Nitric oxide	NO	nitrosyl
Ethylenediamine	$\text{H}_2\ddot{\text{N}}\text{CH}_2\text{CH}_2\ddot{\text{N}}\text{H}_2$	ethylenediamine
Acetylacetonate	$\begin{array}{c} \text{:O:} \quad \quad \quad \text{:}\ddot{\text{O}}\text{:}^- \\ \parallel \quad \quad \quad \\ \text{CH}_3 - \text{C} - \text{CH} = \text{C} - \text{CH}_3 \end{array}$	acetylacetonato
2,2'-Dipyridyl		2,2'-dipyridyl
1,10-Phenanthroline		1,10-phenanthroline

16.2 METAL-LIGAND BONDS

Although the subject of stability of complexes will be discussed in greater detail in Chapter 19, it is appropriate to note here some of the general characteristics of the metal-ligand bond. One of the most relevant principles in this consideration is the hard-soft interaction principle. Metal-ligand bonds are acid-base interactions in the Lewis sense, so the principles discussed in Sections 9.6 and 9.8 apply to these interactions. Soft electron donors in which the donor atom is sulfur or phosphorus form more stable complexes with soft metal ions such as Pt^{2+} or Ag^+ , or with metal atoms. Hard electron donors such as H_2O , NH_3 , or F^- generally form stable complexes with hard metal ions like Cr^{3+} or Co^{3+} .

When the structures for many ligands (e.g., H_2O , NH_3 , CO_3^{2-} , and $\text{C}_2\text{O}_4^{2-}$) are drawn, there is no question as to which atom is the electron pair donor. Ligands such as CO and CN^- normally bond to metals by donation of an electron pair from the carbon atom. It is easy to see why this is so when the structures are drawn for these species and the formal charges are shown.



In each case, it is the carbon atom that has the negative formal charge that makes it the “electron-rich” end of the structure. Moreover, there are antibonding orbitals in both CO and CN^- that can accept electron density transferred from the nonbonding d orbitals on the metal (as described in Section 16.10). Because of the nature of these ligands, it is not uncommon for them to function also as bridging groups in which they are bonded to two metal atoms or ions simultaneously.

Metal ions having high charge and small size are considered to be hard Lewis acids that bond best to hard electron donors. Complexes such as $[\text{Co}(\text{NH}_3)_6]^{3+}$ and $[\text{Cr}(\text{H}_2\text{O})_6]^{3+}$ result from these hard-hard interactions. On the other hand, CO is a soft ligand, so it would not be expected for a complex like $[\text{Cr}(\text{CO})_6]^{3+}$ to be stable because Cr^{3+} is a hard Lewis acid. Complexes containing ligands such as CO would be expected for metals having low or zero charge because they are soft. As a general rule (with many known exceptions!), stable complexes are formed with metal ions having high charge and small size when they are bonded to hard Lewis bases. Stable complexes are generally formed with metals having low charge and large size when the ligands are soft. Keep in mind that when describing electronic character the terms *hard* and *soft* are relative.

Of the ligands shown in Table 16.1, the thiocyanate ion,



is one that presents an obvious choice of bonding modes in which the electron pair donor atoms have different hard-soft character. As was mentioned in Chapter 9, SCN^- normally bonds to first-row transition metals through the nitrogen atom but to second- and third-row transition metals through the sulfur. However, the apparent hard character of a first-row metal ion can be altered by the other ligands present. For example, in $[\text{Co}(\text{NH}_3)_5\text{NCS}]^{2+}$, the thiocyanate bonds through the harder nitrogen atom, whereas in $[\text{Co}(\text{CN})_5\text{SCN}]^{3-}$, the thiocyanate is bonded by the softer sulfur atom. In the first case, the Co^{3+} is hard and the presence of five hard NH_3 molecules does not change that character. In the second case, the hard

Table 16.2 Hard-Soft Classification of Metals (Lewis acids) and Ligands (Lewis bases).

Lewis Acids		Lewis Bases	
Hard	Soft	Hard	Soft
Al ³⁺ , Be ²⁺	Ag ⁺ , Cu ⁺	NH ₃ , OH ⁻	CO, I ⁻
Cr ³⁺ , H ⁺	Pd ²⁺ , Cd ²⁺	F ⁻ , Cl ⁻	SCN ⁻ , CN ⁻
Co ³⁺ , Mg ²⁺	Hg ²⁺ , Pt ²⁺	H ₂ O, SO ₄ ²⁻	RSH, R ₂ S
Fe ³⁺ , Ti ⁴⁺	Au ⁺ , Ir ⁺	ROH, PO ₄ ³⁻	C ₂ H ₄ , R ₃ P
Li ⁺ , BF ₃	Cr ⁰ , Fe ⁰	RNH ₂ , en	R ₃ As, SeCN ⁻
Borderline acids: Fe ²⁺ , Co ²⁺ , Ni ²⁺ , Zn ²⁺ , Cu ²⁺ Borderline bases: C ₅ H ₅ N, N ₃ ⁻ , Br ⁻ , NO ₂ ⁻			

Co³⁺, when bonded to five CN⁻ ligands that are soft, has become soft as a result of the *symbiotic effect*. Ligands with the ability to bond by using different donor atoms are known as ambidentate ligands.

Because of the importance of being able to predict which complexes will be stable, it is necessary to know which ligands and metal species are soft and which are hard in terms of their electronic character. Table 16.2 gives a list of several species of each type grouped according to their hard-soft character. Some species are listed as borderline because they do not fit neatly into the hard or soft category.

16.3 NAMING COORDINATION COMPOUNDS

Because of the enormous number of coordination compounds that are known, it is essential to have a systematic way to deal with nomenclature. Many years ago, some complexes were named for their discoverers. For example, K[C₂H₄PtCl₃] was known as Zeise's salt; NH₄[Cr(NCS)₄(NH₃)₂] was known as Reinecke's salt; [Pt(NH₃)₄][PtCl₄] was known as Magnus's green salt; and [Pt(NH₃)₃Cl]₂[PtCl₄] was known as Magnus's pink salt. This procedure is not satisfactory if a large number of compounds must be named. As in other areas of chemistry, an elaborate system of nomenclature for inorganic compounds has been developed by the International Union of Pure and Applied Chemistry (IUPAC). The system for naming coordination compounds takes into account many types of compounds that are not encountered frequently enough in a beginning study of inorganic chemistry to warrant a thorough treatment of the formal rules.

The number of rules that need to be followed in naming coordination compounds is small, but they are sufficient to permit naming the majority of complexes. The rules will be stated and then illustrated by working through several examples.

1. In naming a coordination compound, the cation is named first, followed by the name of the anion. One or both may be complexes.
2. In naming a complex ion, the ligands are named in alphabetical order. A prefix that is used to indicate the number of ligands is not considered as part of the name of the ligand. For example,

trichloro is named in the order indicated by the name *chloro*. However, if the ligand is diethylamine, $(\text{C}_2\text{H}_5)_2\text{NH}$, the prefix “di” is part of the ligand name and it is used in determining alphabetical order.

- (a) The names of any coordinated anions end in *o*. For example, Cl^- is chloro; CN^- is cyano; SCN^- is thiocyanato, etc. (See the examples shown in Table 16.1.)
 - (b) Neutral ligands are named by using their usual chemical names. For example, $\text{H}_2\text{NCH}_2\text{CH}_2\text{NH}_2$, is ethylenediamine; $\text{C}_5\text{H}_5\text{N}$ is pyridine. Four exceptions to this rule are H_2O , which is named as aqua; NH_3 , which is named as ammine; CO , which is named as carbonyl; and NO , which is named as nitrosyl. Table 16.1 shows the names of several common neutral ligands.
 - (c) Any coordinated cations end in *ium*. Few cases of this type are encountered, but the situation could arise with a ligand such as hydrazine, N_2H_4 (the structure of which is NH_2NH_2). One end could accept a proton while the other end could coordinate to a metal. In that case, NH_2NH_3^+ would be named as hydrazinium.
3. To indicate the number of ligands of a particular type, the prefixes *di*, *tri*, *tetra*, and so on are used. If the name of the ligand contains one of these prefixes, the number of ligands is indicated by using the prefixes *bis*, *tris*, *tetrakis*, and so forth. For example, two ethylenediamine ligands would be indicated as bis(ethylenediamine) rather than diethylenediamine.
 4. After the ligands are named, the name of the metal is given next, with its oxidation state indicated by Roman numerals in parentheses with no spaces between the name of the metal and the parentheses.
 5. If the complex ion containing the metal is an anion, the name of the metal ends in *ate*.

For certain types of complexes (particularly organometallic compounds) other rules are needed, but the majority of complexes can be correctly named using the short list of rules just given.

In the complex $[\text{Co}(\text{NH}_3)_6]\text{Cl}_3$, the cation is $[\text{Co}(\text{NH}_3)_6]^{3+}$, and it is named first. The coordinated ammonia molecules are named as ammine, with the number of them being indicated by the prefix *hexa*. Therefore, the name for the compound is hexaamminecobalt(III) chloride. There are no spaces in the name of the cation. $[\text{Co}(\text{NH}_3)_5\text{Cl}]\text{Cl}_2$ has five NH_3 molecules and one Cl^- coordinated to Co^{3+} . Following the rules just listed leads to the name pentaamminechlorocobalt(III) chloride. Potassium hexacyanoferrate(III) is $\text{K}_3[\text{Fe}(\text{CN})_6]$. Reinecke’s salt, $\text{NH}_4[\text{Cr}(\text{NCS})_4(\text{NH}_3)_2]$, would be named as ammonium diamminetetrathiocyanatochromate(III). In Magnus’s green salt, $[\text{Pt}(\text{NH}_3)_4][\text{PtCl}_4]$, both cation and anion are complexes. The name of the complex is tetraammineplatinum(II) tetrachloroplatinate(II). The compound $[\text{Co}(\text{en})_3](\text{NO}_3)_3$ is named as tris(ethylenediamine)cobalt(III) nitrate.

Some ligands contain more than one atom that can function as an electron pair donor. For example, SCN^- is known to bond to some metal ions through the nitrogen atom but to others through the sulfur atom. In some instances, this situation is indicated in the name as thiocyanato-*N*- and

thiocyanato-S-. In some publications, the mode of attachment is indicated before the name, N-thiocyanato and S-thiocyanato.

Because some ligands contain more than one pair of electrons that can be donated to metal ions, it is possible for the same ligand to be bonded simultaneously to two metal centers. In other words, the ligands function as bridging groups. A bridging group is indicated by μ before the name of the ligand and separating the name of that group from the remainder of the complex by hyphens. $[(\text{NH}_3)_3\text{Pt}(\text{SCN})\text{Pt}(\text{NH}_3)_3]\text{Cl}_3$ is named as hexaammine- μ -thiocyanatodiplatinum(II) chloride.

An additional aspect of nomenclature is the procedure of identifying the charge on a complex cation or anion by a number in parentheses after the name. The numbers indicating the charges are known as Ewens-Bassett numbers. Some examples showing both procedures for specifying charges and oxidation states are as follows:

$[\text{Fe}(\text{CN})_6]^{3-}$	hexacyanoferrate(3-) or hexacyanoferrate(III)
$[\text{Co}(\text{NH}_3)_6]^{3+}$	hexaamminecobalt(3+) or hexaamminecobalt(III)
$[\text{Cr}(\text{H}_2\text{O})_6][\text{Co}(\text{CN})_6]$	hexaaquachromium(3+) hexacyanocobaltate(3-) or hexaaquachromium(III) hexacyanocobaltate(III)

A more specialized set of rules for nomenclature is available as an appendix in the book by Huheey, Keiter, and Keiter listed in the references at the end of this chapter.

16.4 ISOMERISM

One of the interesting aspects of the chemistry of coordination compounds is the possibility of the existence of isomers. Isomers of a compound contain the same numbers and types of atoms, but they have different structures. Several types of isomerism have been demonstrated, but only a few of the most important types will be described here.

16.4.1 Geometrical Isomerism

The most common type of geometrical isomerism involves *cis* and *trans* isomers in square planar and octahedral complexes. If the complex MX_2Y_2 is tetrahedral, only one isomer exists because all of the positions in a tetrahedron are equivalent. If the complex MX_2Y_2 is square planar, *cis* and *trans* isomers are possible.

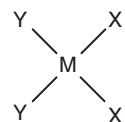

Cis - $[\text{MX}_2\text{Y}_2]$

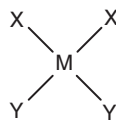

Trans - $[\text{MX}_2\text{Y}_2]$

For an octahedral complex, all six positions are equivalent, so only one compound having the formula MX_5Y exists. For an octahedral complex having the formula MX_4Y_2 there will be two isomers. For $[\text{Co}(\text{NH}_3)_4\text{Cl}_2]^+$, the two isomers can be shown as follows:

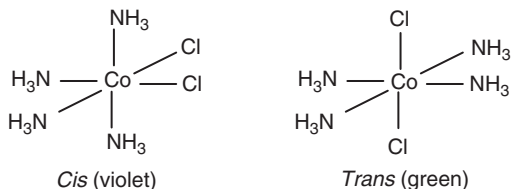

If an octahedral complex has the formula MX_3Y_3 , there are two possible isomers. In an octahedron, the positions are assigned numbers so the locations of ligands in the structure can be identified. The usual numbering system for ligands in an octahedral complex is

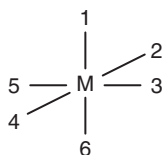

The two isomers of $[\text{Co}(\text{NH}_3)_3\text{Cl}_3]$ have the following structures:

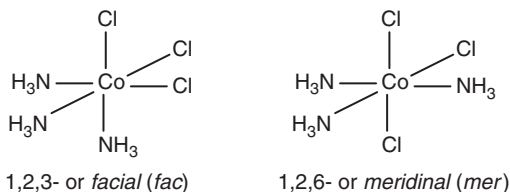

In the *fac* isomer, the three chloride ions are located on the corners of one of the triangular faces of the octahedron. In the *mer* isomer, the three chloride ions are located around an edge (meridian) of the octahedron. The IUPAC system of nomenclature does not use this approach. A summary of the IUPAC procedures is presented in the book by Huheey, Keiter, and Keiter that is cited in the references listed at the end of this chapter.

Geometrical isomers are possible for complexes having a square-based pyramid structure. For example, the structures for a complex having the structure MLX_2Y_2 show that *cis* and *trans* arrangements are possible for the ligands in the base.

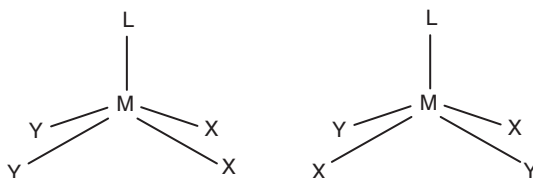

16.4.2 Optical Isomerism

For structures that do not possess a plane of symmetry, the mirror images are not superimposable. Known as *chiral* structures, such molecules rotate a beam of polarized light. If the beam is rotated to the right (when looking along the beam in the direction of propagation), the substance is said to be *dextrorotatory* (or simply *dextro*) and indicated by (+). Those substances that rotate the plane of polarized light to the left are said to be *levorotatory* or *levo* and indicated as (-). A mixture of equal amounts of the two forms is called a racemic mixture, and it produces no net rotation of the polarized light.

The dichlorobis(ethylenediamine)cobalt(II) ion can exist in two geometrical isomers. For the *trans* isomer, there is a plane of symmetry that bisects the cobalt ion and the ethylenediamine ligands, leaving one Cl on either side of the plane. However, the *cis* isomer has no plane of symmetry so two optical isomers exist. This is also the case for $[\text{Co}(\text{en})_3]^{3+}$ as is illustrated in Figure 16.3.

Light behaves as though it consists of waves vibrating in all directions around the direction of wave propagation. For polarized light, the propagation can be regarded as a vector, which can be resolved into two circular vectors. If there is no rotation of the plane, it is expected that motion along each vector is equivalent so that each vector traverses an equal distance around the circle as shown in Figure 16.4.

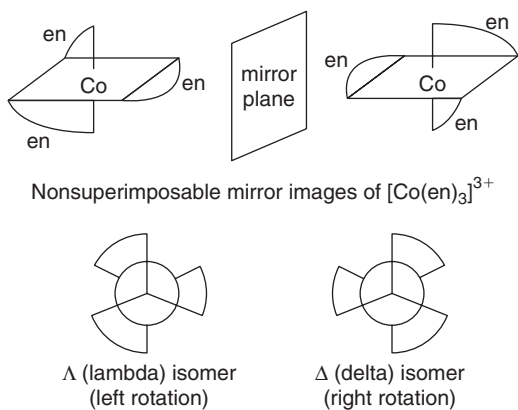

■ FIGURE 16.3 The optically active isomers of $[\text{Co}(\text{en})_3]^{3+}$ (top) and their directions of rotation of polarized light.

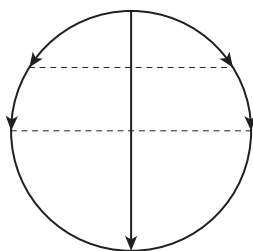

■ FIGURE 16.4 Polarized light represented as a vector with no rotation.

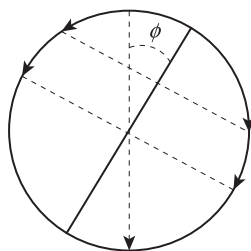

■ FIGURE 16.5 The rotation of polarized light represented as a rotated vector.

If polarized light passes through a medium that exhibits optical rotation, the motion along one of the circular vectors is slower than that of the other. The resultant vector is thus displaced from the original vector by some angle, ϕ . Figure 16.5 shows the vector model in which the phase difference is ϕ and α is defined as one-half of the phase difference.

The index of refraction of a medium, n , is the ratio of the velocity of light in a vacuum, c , to the velocity in the medium, v :

$$n = c/v \quad (16.1)$$

When a material exhibits different indices of refraction for the right- and left-hand components of the circular vectors, the velocities in these directions are different and the plane of polarized light undergoes rotation. For the left- and right-hand vectors, the indices of refraction are

$$n_l = c/v_l \quad \text{and} \quad n_r = c/v_r \quad (16.2)$$

which leads to the relationship

$$v_l/v_r = n_r/n_l \quad (16.3)$$

If we represent the length of the path of the polarized light in the sample as d and let ϕ be the phase difference in the two directions, we find that

$$\phi = 2\pi d v/v_r - 2\pi d v/v_l \quad (16.4)$$

For light, the velocity and frequency are related by

$$\lambda v = c \quad (16.5)$$

Therefore, after simplification we obtain

$$\phi = 2\pi d(n_r - n_l)/\lambda_o \quad (16.6)$$

where λ_o is the wavelength of the light undergoing rotation. When expressed in terms of α , the relationship is

$$\alpha = \phi/2 = \pi d(n_r - n_l)/\lambda_o \quad (16.7)$$

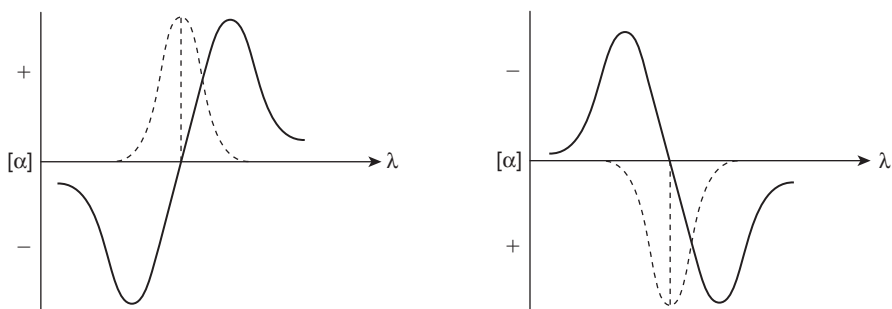

(a) Initially levorotatory (a positive Cotton effect) (b) Initially dextrorotatory (a negative Cotton effect)

■ **FIGURE 16.6** Variation of optical rotation with wavelength in the region of a hypothetical absorption band (shown as the dashed line).

Solving for the difference in index of refraction, we obtain

$$(n_r - n_l) = \alpha \lambda_o / \pi d \quad (16.8)$$

When a solution is studied, the specific rotation of light having a wavelength of λ at a temperature t is written as $[\alpha]_{\lambda}^t$, and it is defined by the relationship

$$[\alpha]_{\lambda}^t = \alpha / ds = \alpha / d\sigma\rho \quad (16.9)$$

In this relationship, α is the observed rotation, d is the path length, s is the concentration of the solution in g solute/mL solution, σ is the concentration in g solute/g of solution, and ρ is the density of the solution. The most commonly used light source is the sodium lamp, which has $\lambda = 589$ nm. Therefore, designations of a specific rotation are indicated by the use of symbols such as $(+)_{589}\text{-[Co(en)}_3\text{]}^{3+}$.

The preceding discussion makes use of the relationship between optical rotation and the index of refraction. However, the optical rotation varies with the wavelength of the light as does the index of refraction. When the variation of optical rotation with wavelength is studied, it is found that the curve undergoes a change in slope in the region of the maximum in an absorption band arising from an electronic transition (see Chapter 18). The change in rotation as a function of wavelength is known as *optical rotatory dispersion* (ORD). Figure 16.6 shows a schematic diagram that illustrates the change in rotation that occurs in the region of an absorption band. The rapid change in rotation at the wavelength where absorption by the complex occurs is known as the *Cotton effect* because it was discovered in 1895 by A. Cotton.

The diagram shown in Figure 16.6a illustrates a positive Cotton effect in which the change in rotation is from negative to positive as the wavelength is changed where the absorption occurs. A negative Cotton effect (see Figure 16.6b) results when the rotation shifts from positive to negative at the wavelength range represented by the absorption band.

Compounds having the same optical configuration show similar Cotton effects. If the absolute configuration is known (for example, from x-ray diffraction) for one optically active compound, a similar Cotton effect exhibited by another compound indicates that it has the same optical configuration as the known. In other words, if two compounds give electronic transitions that show Cotton effects that

are the same (either both positive or both negative), the compounds have the same chirality or optical configuration. Although other methods for studying the absolute configuration of complexes exist, the methods described here have been widely used and are historically important. Consult the references at the end of this chapter for more details on the Cotton effect and ORD.

16.4.3 Linkage Isomerism

Linkage isomers result when a ligand can bond to metal ions in more than one way. Ligands having this ability are known as *ambidentate ligands* and include electron pair donors such as NO_2^- , CN^- , and SCN^- that have unshared pairs of electrons at two sites. The nitrite ion can bind to metal ions through both the nitrogen and oxygen atoms. The first case involving linkage isomers was studied in the 1890s by S. M. Jørgensen, and the complexes were $[\text{Co}(\text{NH}_3)_5\text{NO}_2]^{2+}$ and $[\text{Co}(\text{NH}_3)_5\text{ONO}]^{2+}$. The second of these complexes (containing Co-ONO) is less stable, and it is converted into the $-\text{NO}_2$ isomer both in solution and the solid state either by heating or by exposure to ultraviolet light:



Many studies have been carried out on this reaction. Some of the unusual features of this reaction will be described in Chapter 20. Note that in writing the formulas for linkage isomers, it is customary to write the ligand with the atom that functions as the electron pair donor closest to the metal ion. Special consideration will be given in Chapter 20 to the behavior of cyanide complexes because CN^- is also an ambidentate ligand.

In Chapter 9, the hard-soft interaction principle was described as a guide to how electron donors and acceptors form bonds. This principle is particularly useful for some of the cases involving linkage isomerism. For example, SCN^- can bind to metals through either the sulfur or nitrogen atom. When thiocyanate complexes are prepared with metal ions such as Cr^{3+} or Fe^{3+} (hard Lewis acids), the bonding is through the nitrogen atom (harder electron donor). This arrangement (N-bonded SCN^-) is sometimes known as isothiocyanate bonding. However, thiocyanate bonds to Pd^{2+} and Pt^{2+} (soft Lewis acids) through the sulfur atom (softer electron donor). The potential exists for a thiocyanate ion that is coordinated in one way to change bonding mode under some conditions. However, this is sometimes dependent on the other groups coordinated to the metals as a result of either steric or electronic factors. The electronic factors will be discussed later in this chapter.

When the Lewis structures are drawn for SCN^- , the principal resonance structure is



Coordination compounds containing SCN^- appear to involve the structure

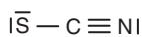

The result is that SCN^- forms bonds to metal ions that can be shown as



Rotation around the M–L bonds requires no spatial considerations for the linear N-bonded SCN^- but structure II shows a different situation for S-bonded SCN^- . In that case, which is shown in Figure 16.7, a volume represented as a cone (sometimes referred to as a *cone of revolution*) is swept out as the rotation occurs.

The presence of bulky ligands can inhibit this rotation and lead to a change in bonding mode. Such a case involves the platinum complex $[\text{Pt}((\text{C}_6\text{H}_5)_3\text{As})_3\text{SCN}]^+$, which contains large triphenylarsine groups, and it is easily converted to $[\text{Pt}((\text{C}_6\text{H}_5)_3\text{As})_3\text{NCS}]^+$.

16.4.4 Ionization Isomerism

Although the compounds $[\text{Pt}(\text{en})_2\text{Cl}_2]\text{Br}_2$ and $[\text{Pt}(\text{en})_2\text{Br}_2]\text{Cl}_2$ have the same empirical formulas, they are quite different compounds. For example, the first gives Br^- when dissolved in water, whereas the second gives Cl^- . This occurs because in the first case, the Cl^- ions are coordinated to the Pt^{4+} , whereas in the second case the Br^- ions are coordinated to the metal ion. The isomerism in cases such as these is known as *ionization isomerism*. It is easy to see that many pairs of compounds could be considered as ionization isomers, among them the following examples:

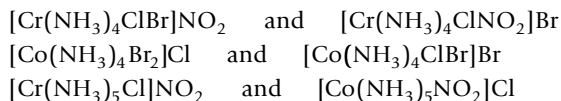

16.4.5 Coordination Isomerism

Coordination isomerism refers to cases where there are different ways to arrange several ligands around two metal centers. For example, there are several ways to arrange six CN^- ions and six NH_3 molecules around two metal ions that total +6 in oxidation number. One way is $[\text{Co}(\text{NH}_3)_6][\text{Co}(\text{CN})_6]$, but

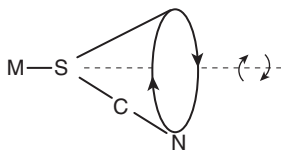

■ FIGURE 16.7 The cone swept out by rotation of SCN^- around the M–S bond.

$[\text{Co}(\text{NH}_3)_5\text{CN}][\text{Co}(\text{NH}_3)(\text{CN})_5]$ and $[\text{Co}(\text{NH}_3)_4(\text{CN})_2][\text{Co}(\text{NH}_3)_2(\text{CN})_4]$ also have the same composition. Other examples of coordination isomerism are the following:

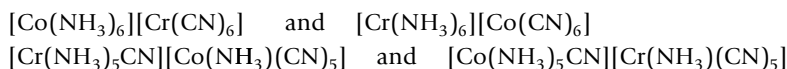

16.4.6 Hydrate Isomerism

A great many metal complexes are prepared by reactions carried out in aqueous solutions. Consequently, solid complexes are frequently obtained as hydrates. Water is also a potential ligand so various possibilities exist for compounds to be prepared with water held in both ways. For example, $[\text{Cr}(\text{H}_2\text{O})_4\text{Cl}_2]\text{Cl}\cdot 2\text{H}_2\text{O}$ and $[\text{Cr}(\text{H}_2\text{O})_5\text{Cl}]\text{Cl}_2\cdot \text{H}_2\text{O}$ have the same formula, but they are obviously different compounds. In the first case, two chloride ions are coordinated and one is present as an anion, whereas in the second case the numbers are reversed. Many other examples of hydrate isomerism are known.

16.4.7 Polymerization Isomerism

Polymers are high-molecular-weight materials that consist of smaller units (monomers) that become bonded together. In coordination chemistry, it is possible to have two or more compounds that have the same empirical formula but different molecular weights. For example, $[\text{Co}(\text{NH}_3)_3\text{Cl}_3]$ consists of one cobalt ion, three ammonia molecules, and three chloride ions. This is the same ratio of these species as is found in $[\text{Co}(\text{NH}_3)_6][\text{CoCl}_6]$, which has a molecular weight that is twice that of $[\text{Co}(\text{NH}_3)_3\text{Cl}_3]$. Other compounds that have the same empirical formula are $[\text{Co}(\text{NH}_3)_5\text{Cl}][\text{Co}(\text{NH}_3)\text{Cl}_5]$ and $[\text{Co}(\text{NH}_3)_4\text{Cl}_2][\text{Co}(\text{NH}_3)_2\text{Cl}_4]$. These compounds are called polymerization isomers of $[\text{Co}(\text{NH}_3)_6][\text{CoCl}_6]$, but there is no similarity to the case of polymerization of monomer units that results in a material of higher molecular weight. Polymerization isomerism is not a very accurate way to describe such materials, although the term has been in use for many years.

16.5 A SIMPLE VALENCE BOND DESCRIPTION OF COORDINATE BONDS

One of the goals in describing any structure on a molecular level is to interpret how the bonding arises by making use of atomic orbitals. In the area of coordination chemistry, a simple valence-bond approach is successful in explaining some of the characteristics of the complexes. In this approach, the empty orbitals on the metal ions are viewed as hybrid orbitals in sufficient number to accommodate the number of electron pairs donated by the ligands. It is generally true that first-row transition metals form complexes that in many cases contain six coordinate bonds. This is especially true if the charge on the metal ion is +3. The reason for this is that a +3 metal ion has a high charge-to-size ratio that exerts a strong attraction for pairs of electrons. If the metal ion has a +2 charge, it is sometimes found that only four ligands will bind to the metal ion, but it also depends on the availability of empty orbitals on the metal ion. In this case, the charge-to-size ratio is considerably smaller (the charge is only 67% as high and the size is usually larger), so the metal ion has a much smaller affinity for electron pairs. This is the case for +2 ions such as Cu^{2+} and Zn^{2+} , which form many complexes in which the coordination number is 4, although as we shall see there are other factors involved.

Atomic Orbitals	Hybrid Type	Number of Orbitals	Structure
s,p	sp	2	linear
s,d	sd	2	linear
s,p,p	sp^2	3	trigonal planar
s,p,p,p	sp^3	4	tetrahedral
s,d,d,d	sd^3	4	tetrahedral
d,s,p,p	dsp^2	4	square planar
d,s,p,p,p	dsp^3	5	trigonal bipyramid
s,p,p,d,d	sp^2d^2	5	square-base pyramid
d,d,s,p,p,p	d^2sp^3	6	octahedral
s,p,p,p,d,d	sp^3d^2	6	octahedral
s,p,d,d,d,d	spd^4	6	trigonal prism
s,p,p,p,d,d,d	sp^3d^3	7	pentagonal bipyramid
s,p,p,p,d,d,d,d	sp^3d^4	8	dodecahedron
s,p,p,p,d,d,d,d	sp^3d^4	8	Archimedes antiprism
s,p,p,p,d,d,d,d,d	sp^3d^5	9	capped trigonal prism

In dsp^2 the $d_{x^2-y^2}$ orbital is used. In sp^2d^2 and d^2sp^3 the $d_{x^2-y^2}$ and d_{z^2} orbitals are used.

The simplified problem in describing the structure of complexes becomes one of deciding what hybrid orbital type will accommodate the number of electron pairs donated by the ligands and also correspond to the known structure of the complex. Some of the structures associated with specific types of hybrid orbitals were presented in Figure 4.1, but there are other cases that apply to complexes of metal ions. In addition to regular geometrical structures, there are numerous complexes that have irregular structures. In some cases, Jahn-Teller distortion causes the structure to deviate from ideal geometry (see Chapter 17). In spite of the difficulties, it is useful to know the hybrid orbital types associated with complexes having various structures. Table 16.3 gives a summary of the major hybrid orbital types that are applicable to complexes.

When Zn^{2+} forms a complex such as $[Zn(NH_3)_4]^{2+}$, it is easy to rationalize the bonding in terms of hybrid orbitals. Zn^{2+} has a d^{10} configuration, but the $4s$ and $4p$ orbitals are empty. Therefore, a set of four empty sp^3 hybrids can result. As shown next, four orbitals can accept four pairs of electrons that are donated by the ligands.

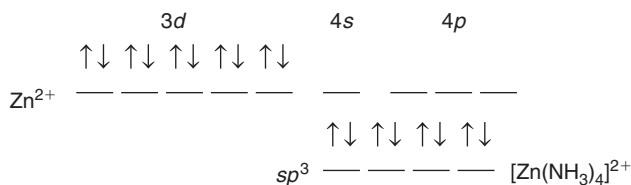

Likewise, it is easy to rationalize how Ag^+ (a d^{10} ion) can form a linear complex with two ligands like NH_3 .

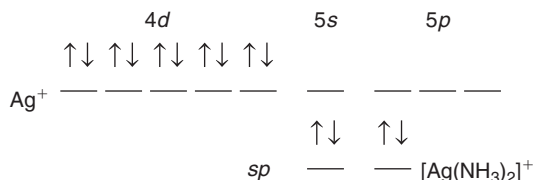

When the scheme above is examined, it is easy to see that if two of the $5p$ orbitals are used, a set of sp^2 hybrid orbitals could be produced that would accommodate pairs of electrons from three ligands. It is not surprising that only a few complexes are known in which Ag^+ exhibits a coordination number of 3. If all of the $5p$ orbitals were used in the hybrids, the resulting sp^3 hybrids could accommodate four pairs of electrons, and a tetrahedral complex could result. Although complexes like $[\text{Ag}(\text{CN})_3]^{2-}$ and $[\text{Ag}(\text{CN})_4]^{3-}$ have been identified in solutions where the concentration of CN^- is high, such complexes are unusual and of low stability. The vast majority of complexes of Ag^+ have a coordination number of 2 and linear structures. Part of the reason for this is that the silver ion is relatively large and has a low charge, which results in a low charge density. Such an ion does not assimilate the electron density from added ligands as readily as do those for which the charge density is high.

For metal ions having configurations d^0 , d^1 , d^2 , or d^3 , there will always be two of the d orbitals empty to form a set of d^2sp^3 hybrids. Therefore, we expect complexes of these metal ions to be octahedral in which the hybrid orbital type is d^2sp^3 . If we consider Cr^{3+} as an example, the formation of a complex can be shown as follows:

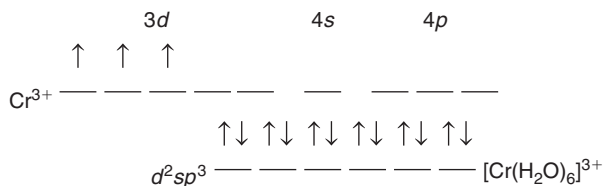

In an octahedral complex, the coordinate system is set up so that the ligands lie on the axes. The d orbitals that have lobes lying along the axes are the d_{z^2} and the $d_{x^2-y^2}$. The d_{xy} , d_{yz} , and d_{xz} orbitals directed between the axes are considered to be nonbonding. It should not be inferred that only octahedral complexes are produced by Cr^{3+} . Although tetrahedral complexes would not be expected in solutions that contain Cr^{3+} because of its high charge density, solid $[\text{PCl}_4][\text{CrCl}_4]$ contains the tetrahedral CrCl_4^- ion. With the $4s$ and $4p$ orbitals being empty, it is easy to see how sp^3 hybrids are obtained.

When the number of electrons in the d orbitals is four, as in the case of Mn^{3+} , there exists more than one possible type of hybrid orbital. For example, if the electrons remain unpaired in the d orbitals, there is only one orbital in the set that is empty. As a result, if an octahedral complex is formed, making

use of two d orbitals requires that the $4d$ orbitals be used so that sp^3d^2 hybrid orbitals would be used by the metal. This case can be shown as follows:

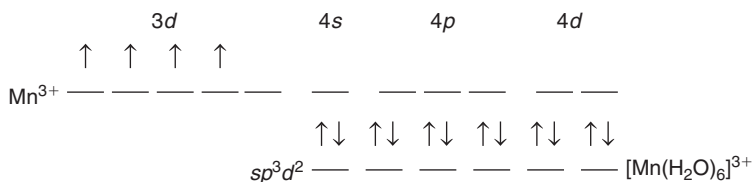

This bonding arrangement results in four unpaired electrons in the $3d$ orbitals, but with some ligands, the situation is different. In those cases, two of the $3d$ orbitals are made available to form a set of hybrid orbitals by means of electron pairing. When this occurs, the bonding arrangement can be shown as follows:

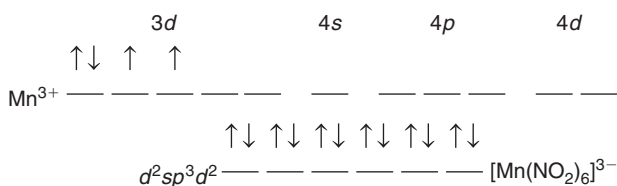

Only two unpaired electrons are present in this complex, and as will be shown in the next section, the two types of manganese complexes can be distinguished by means of their magnetic character. We have not explained *why* electron pairing occurs with some ligands but not others. The discussion of this aspect of bonding in complexes will be treated fully in Chapter 17.

In $[\text{Mn}(\text{H}_2\text{O})_6]^{3+}$, the $4d$ orbitals used to form hybrids are those outside the usual valence shell that consists of $3d$, $4s$, and $4p$ orbitals. Consequently, such a complex is often referred to as an *outer orbital* complex. To identify the hybrid orbitals, the symbol sp^3d^2 is used to indicate that the d orbitals are part of the shell with $n = 4$ and they follow the s and p orbitals in filling. In $[\text{Mn}(\text{NO}_2)_6]^{3-}$, the d orbitals are those in the valence shell so the complex is called an *inner orbital* complex and the hybrid orbital type is designated as d^2sp^3 to show that the principal quantum number of the d orbitals is lower than that of the s and p orbitals. Another way in which the two types of complexes are distinguished is by the terms *high spin* and *low spin*. In $[\text{Mn}(\text{H}_2\text{O})_6]^{3+}$, there are four unpaired electron spins, whereas in $[\text{Mn}(\text{NO}_2)_6]^{3-}$, there are only two unpaired electrons. Therefore, the former is referred to as a high-spin complex, and the latter is designated a low-spin complex.

For a d^5 ion such as Fe^{3+} , the five electrons may be unpaired in the set of five d orbitals, or they may be present as two orbitals occupied by pairs of electrons and one orbital having single occupancy. A complex such as $[\text{Fe}(\text{H}_2\text{O})_6]^{3+}$ is typical of the first bonding mode (five unpaired electrons, high spin, outer orbital), whereas $[\text{Fe}(\text{CN})_6]^{3-}$ is typical of the second (one unpaired electron, low spin, inner orbital). Three orbitals can accommodate six electrons, so a d^6 ion such as Co^{3+} should form two

series of complexes in which the six electrons occupy all five orbitals with two in one orbital and one in each of the others. This results in four unpaired electrons being found in the outer-orbital, high-spin complex $[\text{CoF}_6]^{3-}$. On the other hand, a low-spin, inner-orbital complex such as $[\text{Co}(\text{NH}_3)_6]^{3+}$ has no unpaired electrons because all six of the $3d$ electrons are paired in three of the orbitals.

When the d^7 and d^8 electron configurations are considered, there are additional possibilities for forming bonding orbitals. With seven or eight electrons in the five orbitals, there is no possibility of having two of the $3d$ orbitals vacant so if an octahedral complex is formed, it must be of the high-spin, outer-orbital type. Both Co^{2+} (d^7) and Ni^{2+} (d^8) form many complexes of this type. With all of the $3d$ orbitals being populated (not necessarily filled), the possibility exists for using the $4s$ and $4p$ orbitals in forming tetrahedral complexes and $[\text{CoCl}_4]^{2-}$ and $[\text{Ni}(\text{NH}_3)_4]^{2+}$ have tetrahedral structures. Although it is not possible to have two of the $3d$ orbitals vacant, it is certainly possible to have one empty, so the possibility of the dsp^3 hybrid orbital type exists. With regard to the orbitals used, the Co^{2+} ion behaves as follows:

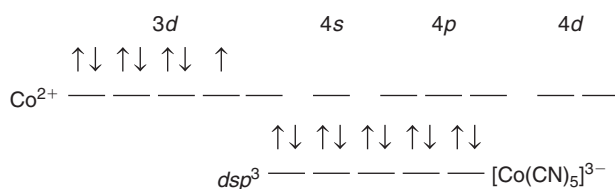

For the d^8 Ni^{2+} ion, the orbitals and bonding can be shown as follows:

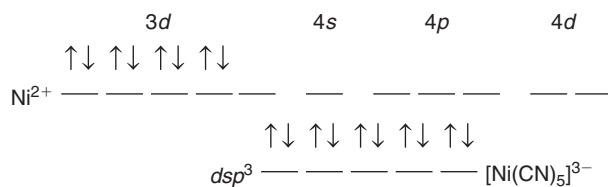

If a complex having a coordination number of 4 is produced, only two of the $4p$ orbitals are used and the hybrid orbital type is dsp^2 , which is characteristic of a square planar complex. For Ni^{2+} , this is illustrated by the following scheme:

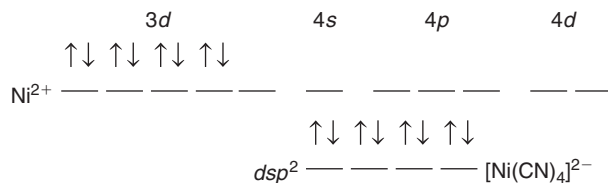

Both Co^{2+} and Ni^{2+} also have the ability to make use of $4s$, $4p$, and $4d$ orbitals in another way by forming sp^2d^2 hybrids in the formation of complexes having a square-based pyramid structure. In fact, trigonal bipyramid and square-based pyramid structures are both observed for $[\text{Ni}(\text{CN})_5]^{3-}$.

Although the simple valence-bond approach to the bonding in coordination compounds has many deficiencies, it is still useful as a first attempt to explain the structure of many complexes. The reasons why certain ligands force electron pairing will be explored in Chapter 17, but it is clear that high- and low-spin complexes have different magnetic character, and the interpretation of the results of this technique will now be explored.

16.6 MAGNETISM

In the previous sections, we have shown how a complex of a d^4 metal ion such as Mn^{3+} can form complexes utilizing sp^3d^2 hybrid orbitals or in other cases make use of d^2sp^3 hybrid orbitals. In Chapter 17, it will be described why the nature of the bonding depends on the type of ligands present. For the time being, we will concentrate on the difference in the number of unpaired electrons that will be found in each type of complex. In a complex of Mn^{3+} where the bonding is sp^3d^2 , the $3d$ orbitals are not used, so all four of the electrons will remain unpaired in the set of five orbitals. If the complex makes use of d^2sp^3 orbitals, two of the set of five $3d$ orbitals will be available only if two of the four electrons occupy one orbital and the other two electrons are found singly in two other orbitals. As a result, there will be two unpaired electrons if the bonding is d^2sp^3 , but there will be four unpaired electrons if the orbitals used are sp^3d^2 hybrids. We must now develop the relationships needed to be able to use the magnetic character of a complex to determine the number of unpaired electrons it has.

To determine the magnetic character of a sample of a compound, it is weighed using a Guoy balance that allows the mass of the sample to be determined with a magnetic field either on or off. If there are unpaired electrons in the sample, it will interact with the magnetic field as a result of the magnetic field generated by the spinning electrons. If the sample is attracted to the magnetic field, it is said to be *paramagnetic*. A sample that has no unpaired electrons will be weakly repelled by the magnetic field, and it is said to be *diamagnetic*. When any substance is placed in a magnetic field, there is an induced magnetization that is opposite to the field that produced it. This results in a weak repulsion between the sample and the magnetic field that is corrected for by subtracting the so-called diamagnetic contribution. The resulting magnetism of the sample is measured by the molar magnetic susceptibility, χ_M , which is related to the magnetic moment, μ , by the relationship

$$\mu = (3k/N_o)\chi_M T \quad (16.11)$$

In this equation, N_o is Avogadro's number, k is Boltzmann's constant, and T is the temperature (K). Magnetism is measured in terms of a unit known as the Bohr magneton, μ_o (BM), that is given as

$$\mu_o = eh/4\pi mc \quad (6.12)$$

where e and m are the charge and mass of an electron, h is Planck's constant, and c is the velocity of light. An electron has an intrinsic spin of $1/2$, which generates a magnetic moment that is expressed as

$$\mu_s = g[s(s+1)]^{1/2} = 2 \left[\frac{1}{2} \left(\frac{1}{2} + 1 \right) \right]^{1/2} \quad (6.13)$$

In this equation, μ_s is the magnetic moment resulting from a spinning electron and g is the Landé "g" factor or the gyromagnetic ratio that gives the ratio of the spin magnetic moment to the spin angular momentum vector, $[s(s + 1)]^{1/2}$. For a free electron, g is 2.00023, which is normally taken to be 2.00, so for one electron, μ_s has the value given by

$$\mu_s = 2 \left[\frac{1}{2} \left(\frac{1}{2} + 1 \right) \right]^{1/2} = 3^{1/2} = 1.73 \quad (16.14)$$

As a result of orbital motion, an additional magnetic effect is produced, and taking it into account leads to the total magnetic moment for one electron,

$$\mu_{s+l} = [4s(s + 1) + l(l + 1)]^{1/2} \quad (16.15)$$

where s is the spin of the electron and l is its angular momentum quantum number. When the species has more than one electron, the total magnetic moment makes use of the sum of spins, S , and orbital contributions, L , as in Russell-Saunders or L - S coupling to yield

$$\mu_{S+L} = [4S(S + 1) + L(L + 1)]^{1/2} \quad (16.16)$$

Although this equation gives the maximum magnetism, the observed value is usually somewhat smaller than the predicted value. For many complexes, the orbital contribution to the magnetism is small and can be ignored to give the so-called *spin-only* magnetic moment, which is adequate for analyzing the magnetism when the object is to obtain the number of unpaired electrons in the complex. When the orbital contributions are omitted and the sum of spins is represented as $S = n/2$, where n is the number of unpaired electrons, the spin-only magnetic moment, μ_s , is given by

$$\mu_s = \mu_o [n(n + 2)]^{1/2} \quad (16.17)$$

From this equation, the magnetic moments expected for complexes can be listed in terms of the number of unpaired electrons, as shown in Table 16.4.

In some cases, there is a considerable difference between the calculated spin-only magnetic moment and the experimental values. This is especially true for complexes that contain ligands such as cyanide

Table 16.4 Magnetic Moments Expected for Spin-Only Contributions.

Unpaired Electrons	S	Calculated μ_s , BM	Example Complex	Experimental μ , BM
1	1/2	1.73	(NH ₄) ₃ TiF ₆	1.78
2	1	2.83	K ₃ [VF ₆]	2.79
3	3/2	3.87	[Cr(NH ₃) ₆]Br ₃	3.77
4	2	4.90	[Cr(H ₂ O) ₆]SO ₄	4.80
5	5/2	5.92	[Fe(H ₂ O) ₆]Cl ₃	5.90

that are capable of substantial π -bonding. The changes in the orbitals are such that the actual magnetic moments are usually lower than those expected on the basis of spin-only contributions.

16.7 A SURVEY OF COMPLEXES OF FIRST-ROW METALS

When examining the enormous range of complexes that are known, it sometimes seems as if any metal can form any type of complex. This is not necessarily the case, and there are some general trends that are followed. It must be emphasized that these are only rough guidelines and there are numerous exceptions. Complexes form as the result of the attraction of a metal ion for electron pairs on the ligands (electron pair donors or nucleophiles). One of the most important considerations is what types of orbitals are available on the metal ion to accept electron pairs. If a metal ion has at least two empty d orbitals, it is possible to form a set of d^2sp^3 hybrid orbitals so that six pairs of electrons can be accommodated. Therefore, for ions that have the d^0 , d^1 , d^2 , and d^3 configurations, complexes having a coordination number of 6 and octahedral geometry are the norm.

A second important consideration in the formation of complexes is the charge-to-size ratio of the metal ion. Ions of high charge and small size (high charge density) have the greatest affinity for electron pairs and can generally accommodate the greater buildup of negative charge that results from the acceptance of electron pairs. As a general rule, metal ions of high charge tend to form complexes in which the coordination numbers are higher, especially if they are larger ions from the second and third transition series. In Chapter 9 it was shown that ions having high charge and small size are hard Lewis acids, so interactions with hard bases will be more favorable.

In view of the number and types of hybrid orbitals that are exhibited by ions of the transition metals when complexes are formed, it is possible to arrive at a summary of the most important types of complexes that each metal ion should form. Although there are many exceptions, the summary presented in Table 16.5 is a useful starting point for considering the types of complexes that are formed by metals in the first transition series.

16.8 COMPLEXES OF SECOND- AND THIRD-ROW METALS

Much of what has been said so far in this chapter applies equally well to complexes of second- and third-row transition metals. However, there are some general differences that result from the fact that atoms and ions of the second- and third-row metals are larger in size than those of first-row metals. For example, because of their larger size (when in the same oxidation state as a first-row ion), ions of metals in the second and third rows form many more complexes in which they have a coordination number greater than 6. Whereas chromium usually has a coordination number of 6, molybdenum forms $[\text{Mo}(\text{CN})_8]^{4-}$ and other complexes in which the coordination number is 8. Other complexes of second- and third-row metals exhibit coordination numbers of 7 and 9.

Because of their having larger sizes and more filled shells of electrons between the outer shell and the nucleus, the ionization energies of second- and third-row metals are lower than those of first-row metals. Consequently, it is easier for the heavier metals to achieve higher oxidation states, which also favors higher coordination numbers. In general, there is also a greater tendency of the heavier metals

Table 16.5 A Summary of Types of Complexes Formed by First-Row Metal Ions.

Number of <i>d</i> Electrons	Most Common Ion	Usual Geometry ^b	Hybrid Orbital	Example
0	Sc ³⁺	Octahedral	<i>d</i> ² <i>sp</i> ³	Sc(H ₂ O) ₆ ³⁺
1	Ti ³⁺	Octahedral	<i>d</i> ² <i>sp</i> ³	Ti(H ₂ O) ₆ ³⁺
2	V ³⁺	Octahedral	<i>d</i> ² <i>sp</i> ³	VF ₆ ³⁻
3	Cr ³⁺	Octahedral	<i>d</i> ² <i>sp</i> ³	Cr(NH ₃) ₆ ³⁺
4 ^a	Mn ³⁺	Octahedral (h.s.)	<i>sp</i> ³ <i>d</i> ²	Mn(H ₂ O) ₆ ³⁺
4 ^a	Mn ³⁺	Octahedral (l.s.)	<i>d</i> ² <i>sp</i> ³	Mn(CN) ₆ ³⁻
5	Fe ³⁺	Octahedral (h.s.)	<i>sp</i> ³ <i>d</i> ²	Fe(H ₂ O) ₆ ³⁺
5	Fe ³⁺	Octahedral (l.s.)	<i>d</i> ² <i>sp</i> ³	Fe(CN) ₆ ³⁻
5	Fe ³⁺	Tetrahedral	<i>sp</i> ³	FeCl ₄ ⁻
6	Co ³⁺	Octahedral (h.s.)	<i>sp</i> ³ <i>d</i> ²	CoF ₆ ³⁻
6	Co ³⁺	Octahedral (l.s.)	<i>d</i> ² <i>sp</i> ³	Co(H ₂ O) ₆ ³⁺
7	Co ²⁺	Octahedral (h.s.)	<i>sp</i> ³ <i>d</i> ²	Co(H ₂ O) ₆ ²⁺
7	Co ²⁺	Trigonal bipyramid	<i>dsp</i> ³	Co(CN) ₅ ³⁻
7	Co ²⁺	Tetrahedral	<i>sp</i> ³	CoCl ₄ ²⁻
7	Co ²⁺	Square planar	<i>dsp</i> ²	Co(CN) ₄ ²⁻
8	Ni ²⁺	Tetrahedral	<i>sp</i> ³	Ni(NH ₃) ₄ ²⁺
8	Ni ²⁺	Octahedral	<i>sp</i> ³ <i>d</i> ²	Ni(NH ₃) ₆ ²⁺
8	Ni ²⁺	Trigonal bipyramid	<i>dsp</i> ³	Ni(CN) ₅ ³⁻
8	Ni ²⁺	Square base pyramid	<i>sp</i> ² <i>d</i> ²	Ni(CN) ₅ ³⁻
8	Ni ²⁺	Square planar	<i>dsp</i> ²	Ni(CN) ₄ ²⁻
9 ^a	Cu ²⁺	Octahedral	<i>sp</i> ³ <i>d</i> ²	CuCl ₆ ⁴⁻
9 ^a	Cu ²⁺	Tetrahedral	<i>sp</i> ³	Cu(NH ₃) ₄ ²⁺
10	Zn ²⁺	Octahedral	<i>sp</i> ³ <i>d</i> ²	Zn(H ₂ O) ₆ ²⁺
10	Zn ²⁺	Tetrahedral	<i>sp</i> ³	Zn(NH ₃) ₄ ²⁺
10	Ag ⁺	Linear	<i>sp</i>	Ag(NH ₃) ₂ ⁺

^aIrregular structure due to Jahn-Teller distortion.
^bh.s. and l.s. indicate high and low spin, respectively.

to form metal-metal bonds. The result is that there are numerous complexes that contain clusters of metal atoms or ions when the metals are from the second and third rows. This will be shown in more detail in later chapters.

Another significant difference between complexes of first-row metals and those of the second and third rows involves the pairing of electrons. Earlier in this chapter, it was shown that for the *d*⁴ ion Mn³⁺

there are two series of complexes. One series has all four of the electrons unpaired, and the bonding was interpreted as involving hybrid orbitals of the sp^3d^2 type. In the other series of compounds, there are only two unpaired electrons and the hybrid orbital type is considered to be d^2sp^3 . The reasons for this difference are explained in the next chapter. However, because the second- and third-row metals are larger and their orbitals are larger, it requires less energy to pair the electrons than it does for a first-row metal ion. As a result, ligands that do not force the pairing of electrons in complexes of a first-row metal may do so if the metal is from the second or third row. For example, the complex $[\text{CoF}_6]^{3-}$ is high spin, but $[\text{RhF}_6]^{3-}$ is a low-spin complex. As a general rule, there are far fewer high-spin complexes of second- and third-row metals than there are of first-row metals. In the case of Ni^{2+} , which is a d^8 ion, both tetrahedral (sp^3 hybrid orbitals) and square planar (dsp^2 hybrid orbitals) complexes are known. Complexes of the ions Pd^{2+} and Pt^{2+} (both of which are also d^8) are square planar because it is easier for the electrons to pair, which gives one empty d orbital, making it possible for the dsp^2 hybrid orbitals to be used. This difference in behavior will be interpreted in terms of the effects of the ligands on the d orbitals in the next chapter when the topic of ligand field theory is discussed.

16.9 THE 18-ELECTRON RULE

The noble gas Kr has a total of 36 electrons, and that number represents a stable electron configuration. When complexes of the metal atoms of the first transition series are considered, it is found that in many cases the number of electrons donated to the metal atom is the number required to bring the total number of electrons to 36. That number represents filled outer shells (s , p , and d) capable of holding 18 electrons. For example, when Ni bonds to carbonyl ligands (CO), the stable complex is $\text{Ni}(\text{CO})_4$. The nickel atom has a total of 28 electrons, so the addition of eight electrons (four pairs donated by four CO ligands) brings the total number of electrons on the nickel atom to 36. The iron atom has 26 electrons, so 10 more would complete the configuration around the atom and bring it to that of krypton. Consequently, when Fe forms a complex with CO as the ligands, the most stable product is $\text{Fe}(\text{CO})_5$. A chromium atom contains 24 electrons so the addition of 12 electrons donated from six CO ligands gives the chromium a total of 36, and the stable product is $\text{Cr}(\text{CO})_6$. Of course, the ligands need not be CO in all cases.

When the manganese atom ($Z = 25$) is considered, we see that the addition of five CO molecules would bring the total number of electrons to 35, whereas six CO ligands would bring the total to 37. In neither case is the 18-electron rule obeyed. In accord with these observations, neither $\text{Mn}(\text{CO})_5$ nor $\text{Mn}(\text{CO})_6$ is a stable complex. What is stable is the complex $[\text{Mn}(\text{CO})_5]_2$ (sometimes written as $\text{Mn}_2(\text{CO})_{10}$) in which there is a metal-metal bond between the manganese atoms, which allows the 18-electron rule to be obeyed.

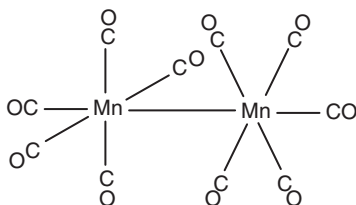

Although the 18-electron rule is not always rigorously obeyed, there is a strong *tendency* especially for complexes of uncharged metals to bind to ligands in such numbers that the metal gains the electron configuration of the next noble gas. Complexes of transition metal *ions* are not so regular in this regard. For example, Fe^{3+} has a d^5 configuration (a total of 23 electrons) but it forms many stable complexes having the FeX_6 formula that do not obey the 18-electron rule. On the other hand, Co^{3+} has a d^6 configuration (a total of 24 electrons), so the addition of six pairs of electrons from six ligands brings to total to 36. Therefore, many low-spin complexes of Co^{3+} having the formulas CoX_6 do obey the 18-electron rule. It should be emphasized that the 18-electron rule is of greatest utility when considering complexes composed of uncharged metals and soft ligands (e.g., CO, alkenes).

The 18-electron rule is especially useful when considering complexes containing ligands such as cycloheptatriene, C_7H_8 , abbreviated as *cht*. This ligand, which has the following structure, can bond to metals in more than one way because each double bond can function by donating two electrons:



When a complex having the formula $[\text{Ni}(\text{CO})_3\text{cht}]$ is considered, it is the 18-electron rule that provides the basis for determining how the *cht* ligand is bonded to the nickel. Because three CO ligands donate six electrons to the nickel, there must be only two electrons donated from the *cht* because the nickel atom needs only eight to bring its total up to 36. Therefore, the *cht* ligand is functioning as a two-electron donor and only one of the double bonds is attached to the nickel, resulting in the structure

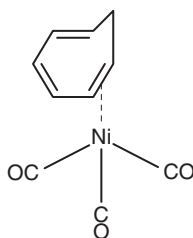

On the other hand, in the complex $[\text{Ni}(\text{CO})_2\text{cht}]$ the *cht* ligand is a four-electron donor, so two double bonds are functioning as electron pair donors and the structure is

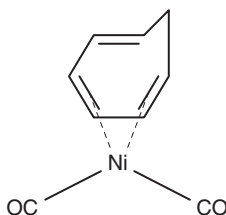

In the complex $[\text{Cr}(\text{CO})_3\text{cht}]$, the cht ligand functions as a six-electron donor because three CO ligands donate six electrons and 12 are needed by the chromium atom to reach a total of 36. Therefore, this complex has the structure

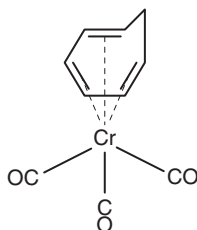

The number of complexes for which the 18-electron rule is an overriding bonding condition is very large. It is an essential tool for interpreting the bonding in organometallic compounds and it will be considered many times in the chapters to follow.

Because some molecules such as cht have the ability to function as ligands with different numbers of electron pairs being donated, the bonding mode of such ligands must be indicated. The bonding mode is designated by the term *hapticity* (derived from the Greek word *haptein*, which means “fasten”) and it is abbreviated as *h* or η . A superscript is added to the upper right of the symbol to indicate the number of atoms (in many cases carbon) that are attached to the metal. When a double bond functions as the electron pair donor, both carbon atoms connected by the double bond are considered as bound to the metal so the hapticity is 2 (indicated as η^2). Thus, in the structure of $[\text{Ni}(\text{CO})_3\text{cht}]$ just shown, cht is an η^2 ligand, whereas in $[\text{Ni}(\text{CO})_2\text{cht}]$ the cht is bonded in an η^4 manner. In the chromium complex, $[\text{Cr}(\text{CO})_3\text{cht}]$, three of the double bonds are used, so the cht is η^6 .

Naming of coordination compounds that have ligands with variable hapticity includes designating the bonding mode. For example, $[\text{Ni}(\text{CO})_3\text{cht}]$ is named as tricarbonyl(η^2 -cycloheptatriene)nickel, and $[\text{Ni}(\text{CO})_2\text{cht}]$ is dicarbonyl(η^4 -cycloheptatriene)nickel. Tricarbonyl(η^6 -cycloheptatriene)chromium is the name for $[\text{Cr}(\text{CO})_3\text{cht}]$. In all of these structures, the 18-electron rule is obeyed.

Another example of a complex that obeys the 18-electron rule is ferrocene or bis(cyclopentadienyl) iron. The cyclopentadienyl anion is generated by the reaction of cyclopentadiene with sodium, and ferrocene is obtained by the subsequent reaction with ferrous chloride,

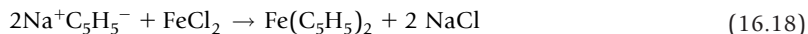

In ferrocene, written as $\text{Fe}(\text{cp})_2$, the iron is formally in the +2 oxidation state, and the cyclopentadienyl ligands have a -1 charge and function as six-electron donors. With Fe^{2+} being a d^6 ion, the additional 12 electrons from the two ligands bring the total number of electrons on Fe to 36, so the 18-electron rule is obeyed. Because the entire five-membered ring of the cyclopentadienyl is part of the π system, the ligands are designated as η^5 with respect to bonding to the iron. Therefore, the name of this compound is bis(η^5 -cyclopentadienyl)iron. Although the bonding of η^5 -cyclopentadienyl was

described earlier, it can also bond in other ways. When bound by a σ bond to only one carbon atom, the ligand is named as η^1 -cyclopentadiene.

The NO molecule is an interesting ligand that provides an illustration of some unique features of bonding in complexes. Describing the bonding in NO in terms of molecular orbitals gives (omitting the electrons from 1s orbitals) $\sigma_g^2 \sigma_u^2 \sigma_g^2 \pi_u^2 \pi_u^2 \pi_g^1$, which shows that one electron resides in an antibonding π molecular orbital (designated as π_g). The bond order for the molecule is 2.5. When the electron in the antibonding orbital is lost, NO^+ results, which has a bond order of 3 and is isoelectronic with CO and CN^- . With the ionization potential for NO being only 9.25 eV, complexes containing NO as a ligand involve transfer of the electron from the π_g orbital on NO to the metal (which results in an increase in bond order) concurrent with the donation of a pair of electrons from NO^+ to the metal. The process can be represented as

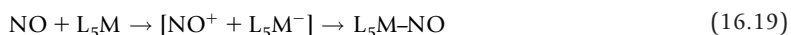

or if ligand replacement is involved,

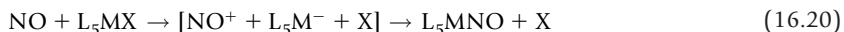

where L and X are other ligands bound to the metal. In this process, the NO molecule has functioned as a three-electron donor. One electron has been transferred from the π^* (also designated as π_g) orbital to the metal, and two others have been donated in the formation of a σ coordinate bond.

With its unusual coordination mode, NO forms complexes with a wide variety of metals, especially in cases where the metal can accept the transfer of an electron from the π_g orbital. With cobalt having 27 electrons, it is evident that the addition of no integral number of ligands that function as two-electron donors can bring the total to 36. However, when one ligand is an NO molecule, the cobalt has a total of 30 electrons, so three CO ligands can raise the total to 36. Therefore, the stable complex that obeys the 18-electron rule is $[\text{Co}(\text{CO})_3\text{NO}]$. It should be apparent that complexes such as $\text{Mn}(\text{CO})_4(\text{NO})$, $\text{Fe}(\text{CO})_2(\text{NO})_2$, and $\text{Mn}(\text{CO})(\text{NO})_3$ also obey the 18-electron rule.

16.10 BACK DONATION

Ligands are Lewis bases that form complexes with metals by donating electron pairs to metal atoms or ions. In determining the formal charge on an atom, each bonding pair of electrons is divided equally between the two bonded atoms. When six pairs of electrons are donated to a metal ion, the metal ion has, in effect, gained six electrons. If the metal initially had a +3 charge, it will have a -3 formal charge after receiving six donated pairs of electrons. If the metal initially had a +2 charge, the formal charge on the metal will be -4 in a complex where the metal has a coordination number of 6.

Many ligands have empty orbitals in addition to the filled orbital that holds the pair of electrons that is donated to the metal. For example, a ligand such as CN^- , NO^+ , or CO has a molecular orbital arrangement like that shown in Figure 16.8.

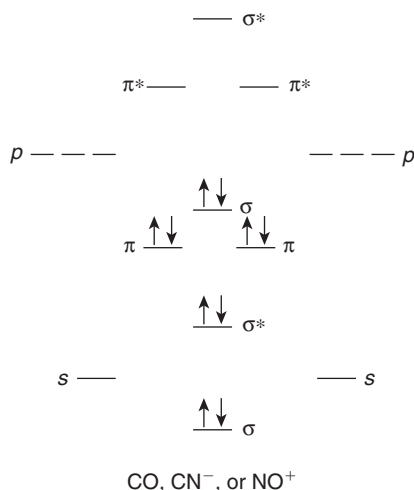

■ FIGURE 16.8 Molecular orbital diagram for some common diatomic ligands.

The filled molecular orbitals beyond the σ_g and σ_u that arise from combining the 2s atomic functions are $(\pi_u)^2 (\pi_u)^2 (\sigma_g)^2$. However, there is an empty antibonding orbital (designated as π^* or π_g) on CN^- that can be shown as

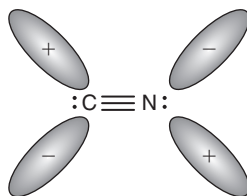

The π_u molecular orbitals have the correct symmetry to overlap with the d_{xy} , d_{yz} , or d_{xz} orbitals on the metal. Except for a metal ion having a d^0 configuration, the nonbonding d orbitals on the metal contain some electrons. With the metal having a *negative* formal charge as a result of accepting electron pairs from ligands, part of that unfavorable charge can be alleviated by donating electron density from the nonbonding d orbitals on the metal to the antibonding orbitals on a CN^- ligand. This situation can be illustrated as shown in Figure 16.9. In this case, the donation is sometimes indicated as $d \rightarrow \pi$ to show the direction of the flow of electron density.

Because the electron density is flowing from the metal onto the ligands, this donation is known as *back donation*. It is in the reverse direction to that in the normal donation of electrons in forming coordinate bonds. The term *back bonding* is sometimes used instead of back donation, but it is not as descriptive because the ligands are functioning as acceptors of electron density from the metal. The essential feature of electron *donation* is that there must be an *acceptor*, which in this case is the ligand.

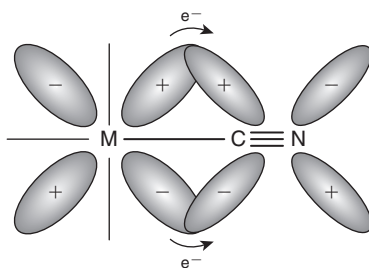

■ FIGURE 16.9 Back donation of electron density from metal d orbitals to ligand π^* orbitals.

The ligands are referred to as π acceptors because of their receiving electron density donated from the metal to π_g^* orbitals. Back donation results in increasing the bond order between the metal and ligand, so it results in *additional* bonding.

There are several consequences of back donation of electron density from the metal to the ligands in a complex. First, the bonds between the metal and ligands involve more shared electron density, so the bond order of the M–L bond increases. As a result, the bonds between the metal and ligands are stronger and shorter than they would be if no back donation occurred. The degree of bond strengthening and shortening varies with the extent of back donation. Back donation also causes the infrared band attributed to stretching the metal-ligand bond to be shifted to higher wave numbers.

Adding electron density to *antibonding* orbitals on the CN^- ligand reduces the bond order of the C–N bond. The bond order is given by $(N_b - N_a)/2$, so increasing the value of N_a reduces the bond order to a value less than 3 even if only fractionally. With the reduction in bond order of the CN bond comes an increase in the bond length and a shift of the absorption band for the C–N stretching vibration to lower wave numbers. In fact, the position of the C–N stretching vibration in the infrared spectrum is one of the best indicators of the extent to which back donation has occurred.

It is interesting to note the difference between the positions of the C–N stretching vibration in $[\text{Fe}(\text{CN})_6]^{3-}$ and $[\text{Fe}(\text{CN})_6]^{4-}$. In the first of these complexes, the iron is +3, so its formal charge in the complex is -3 . In the second complex, the iron is +2 so its formal charge is -4 . Therefore, the extent of back donation is greater in the second complex. This difference is reflected by the positions of the C–N stretching bands, which are at 2135 and 2098 cm^{-1} , respectively. The situation is not actually this simple because there are three bands observed that are attributable to C–N stretching vibrations. Only the band corresponding to the highest energy is listed here.

As the extent of back donation increases, the metal-carbon bond becomes stronger and shorter. For example, in the series of complexes having the formula $[\text{M}(\text{CN})_6]^{3-}$ where M is Cr^{3+} (d^3), Mn^{4+} (d^4), Fe^{3+} (d^5), or Co^{3+} (d^6), the M–C bond lengths are 208, 200, 195, and 189 pm, respectively. As the bond lengths decrease, there is a corresponding increase in M–C stretching frequency with the values being 348, 375, 392, and 400 cm^{-1} for the complexes in the order listed. The extent of back donation is greater when there are more electrons in the d orbitals that can be donated. Obviously, there would be no back donation from Sc^{3+} because this ion has the configuration d^0 .

Even though the effects are easy to observe in such cases, back donation is by no means limited to cyanide complexes. It is required that the ligands have *empty* orbitals of appropriate symmetry to overlap with the nonbonding *d* orbitals on the metal. Certainly CO is another example of a ligand that can accept back donation. Moreover, CO normally forms complexes with metals in the 0 or low oxidation states, which results in metals having a substantial negative formal charge, so back donation is significant in such cases. The C–O stretching vibration in gaseous CO is observed at 2143 cm^{-1} , but in many metal carbonyls it is observed at lower wave numbers with the frequency dependent on the extent of back donation.

Comparison of the C–O stretching frequencies for a series of metal carbonyl complexes can reveal interesting trends. The complexes listed below all obey the 18-electron rule, but with different numbers of CO ligands attached, the metal atoms do not have the same increase in electron density on them because the coordination numbers are different.

$\text{Ni}(\text{CO})_4$	2057 cm^{-1}
$\text{Fe}(\text{CO})_5$	2034 cm^{-1}
$\text{Cr}(\text{CO})_6$	1981 cm^{-1}

For these complexes, the extent of back donation increases as the number of CO ligands increases, which causes the stretching frequencies to be found at lower wave numbers. A similar trend is seen for the following complexes (all of which obey the 18-electron rule), showing the effect of the charge on the metal ion:

$\text{V}(\text{CO})_6^-$	1859 cm^{-1}
$\text{Cr}(\text{CO})_6$	1981 cm^{-1}
$\text{Mn}(\text{CO})_6^+$	2090 cm^{-1}

In the first of these complexes, the vanadium has a -1 charge and with the addition of six CO ligands, there is a tendency to relieve part of the negative charge by extensive back donation. The tendency is less in $\text{Cr}(\text{CO})_6$ and even less when the metal has a positive charge, as in $\text{Mn}(\text{CO})_6^+$.

Ligands such as NH_3 , H_2O , en, or F^- have no empty orbitals of suitable energy or symmetry for accepting electron density back donated from *d* orbitals on a metal ion. This results in an interesting situation when the complexes

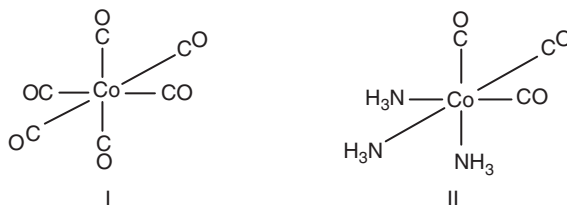

are considered. In both complexes, the Cr has a -3 formal charge and back donation occurs. However, because NH_3 has no orbitals available for accepting electron density from the metal, all of the back

donation in complex II goes to the three CO ligands. In complex I, the back-donated electron density is spread among six CO ligands. Because of this difference, the CO stretching vibration in $\text{Cr}(\text{CO})_6$ is found at 2100 cm^{-1} , whereas in $\text{Cr}(\text{CO})_3(\text{NH}_3)_3$ it is observed at 1900 cm^{-1} .

In the case of ligands such as CN^- and CO, the electron density is transferred from the metal to π^* antibonding orbitals on the ligands. Other ligands that have orbitals that are suitable for receiving electron density include those that have empty d orbitals. Ligands that have phosphorus, arsenic, or sulfur as the donor atom have empty d orbitals, so multiple bonding by back donation is possible for ligands such as PR_3 , AsR_3 , R_2S , and many others. These ligands are soft Lewis bases, which are normally found bonded to soft metal ions that have large sizes and low charges. As a result, the electrons on the metal ion are polarizable and can be shifted toward the ligands relatively easily.

When spectral studies are conducted to see how different ligands function as π acceptors, it is found that the ability to accept electron density varies in the order



It is not surprising that NO^+ is so effective in accepting electron density because it not only has π^* orbitals of correct symmetry, but it also has a positive charge, which makes it have a great attraction for electrons in the nonbonding metal d orbitals.

There is extensive back donation in the anion of Zeise's salt, $[\text{Pt}(\text{C}_2\text{H}_4)\text{Cl}_3]^-$, because the π^* orbitals on C_2H_4 have correct symmetry. Figure 16.10 shows the interaction of the metal and ligand orbitals. As a result of the increased electron population in the π^* orbitals, the stretching frequency of the C=C bond decreases from 1623 cm^{-1} for gaseous C_2H_4 to 1526 cm^{-1} in Zeise's salt.

In the absence of steric effects, the effect of π bonding that results from back donation is partially responsible for ambidentate ligands such as SCN^- bonding in different ways. For example, SCN^- is bonded differently in the stable complexes $\text{cis}[\text{Pt}(\text{NH}_3)_2(\text{SCN})_2]$ and $\text{cis}[\text{Pt}(\text{PR}_3)_2(\text{NCS})_2]$. In the first of these, the bonding is shown as

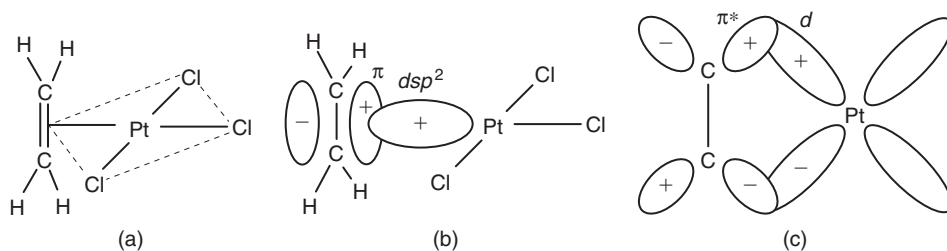

■ **FIGURE 16.10** The structure and bonding in the anion of Zeise's salt. A σ -bond results from the overlap of a dsp^2 hybrid orbital on the metal and the π orbital on ethylene. Back donation from a d orbital on the metal to the π^* orbital on ethylene gives some π bonding (shown in (c)).

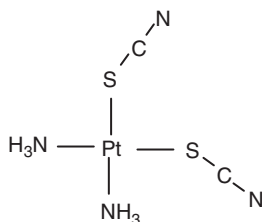

whereas in the second the arrangement is

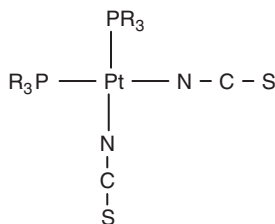

Because NH_3 has no low-energy orbitals of suitable symmetry, π bonds do not form between Pt and NH_3 . Sulfur has empty d orbitals available to accept electron density from the Pt^{2+} . Therefore, to the extent that π bonding occurs, it is to the sulfur end of SCN^- . When it is bonded to Pt^{2+} opposite NH_3 , SCN^- bonds to Pt^{2+} through the sulfur atom.

In the second case, the phosphorus atom in the phosphine also has empty d orbitals that can accept electron density donated from the Pt^{2+} . In fact, it is more effective in this regard than is the sulfur atom in SCN^- . This results in the more stable bonding to SCN^- being to the nitrogen atom when PR_3 is in the *trans* position. In essence, the presence of π bonding ligands in *trans* positions that compete for back donation leads to a complex of lower stability. As will be discussed in Chapter 20, this phenomenon (known as the *trans effect*) has a profound effect on the rates of substitution reactions in such complexes.

16.11 COMPLEXES OF DINITROGEN, DIOXYGEN, AND DIHYDROGEN

In the survey of coordination compounds presented so far, several types of ligands have been used as illustrations. As we progress further into the topic of coordination chemistry, a great many other types of complexes will be described, especially in Chapter 21 where organometallic compounds of transition metals will be discussed. In order to round out the introduction to coordination compounds in this chapter, there are other types of ligands that should be included. One such ligand is the oxygen molecule, O_2 (technically known as dioxygen), which is interesting for several reasons. One reason is that it is a complex of oxygen with iron that transports oxygen in living animals. When the molecular orbital diagram for oxygen is examined, it is seen that the π^* orbitals are half filled (Figure 16.11a). Therefore, the oxygen molecule has orbitals that can overlap effectively with d orbitals on a metal, with the result that a complex is formed. When O_2 forms a complex, the bond gets slightly longer and the stretching frequency is shifted to lower wave numbers.

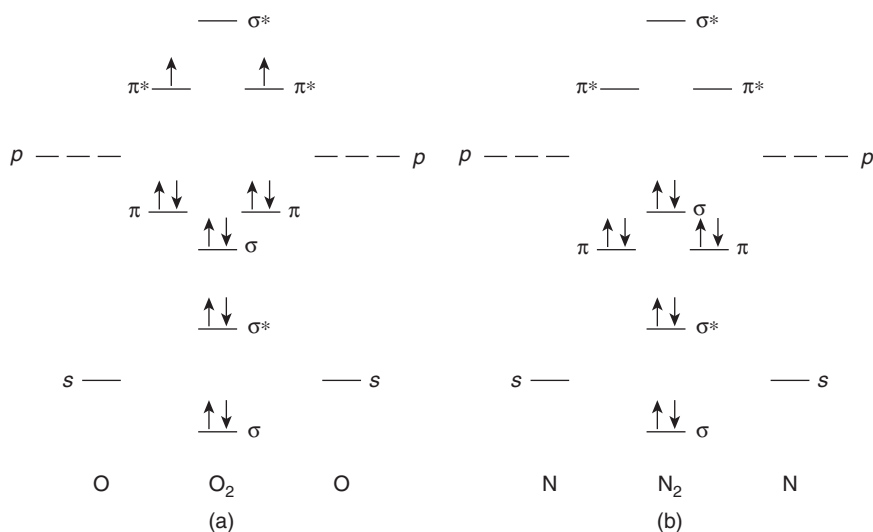
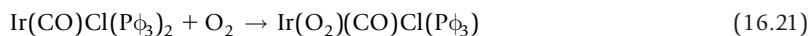
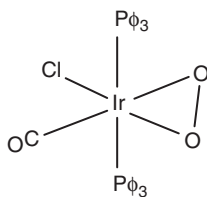

FIGURE 16.11 The molecular orbital energy level diagrams for O_2 and N_2 .

The first preparation of a complex containing oxygen was carried out by Vaska (1963) utilizing the reaction



where ϕ represents the phenyl group, $-\text{C}_6\text{H}_5$, and $\text{P}\phi_3$ is triphenylphosphine. The product of the reaction shown in Eq. (16.21) can be shown as



When oxygen bonds to a metal, it can do so in more than one way, and the most common ways are shown next. If the oxygen molecule is attached at only one end, the bond involving π^* orbitals on oxygen will not be linear. A classification of bond types has been used to correlate properties for compounds containing oxygen in various bonding modes. The types are categorized and illustrated as follows:

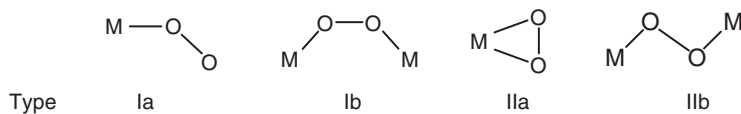

Although x-ray diffraction is the definitive way to establish structure and determine bond lengths, other techniques are also of use. As in the case of complexes of CO and ethylene, spectral studies have yielded information about the bonding in complexes containing O₂. In general, the O–O stretching band is found in similar regions for both type Ia and Ib, that being roughly 1100 to 1200 cm⁻¹. In complexes of types IIa and IIb, the position of the O–O stretching vibration is at roughly 800 to 900 cm⁻¹. The linkage in both type I complexes is considered as being approximately a superoxide linkage, whereas that in type II complexes is considered to be characteristic of a peroxide linkage. For comparison, the stretching frequency in the superoxide ion, O₂⁻, is approximately 1100 cm⁻¹, whereas that for the peroxide ion, O₂²⁻, is about 825 cm⁻¹, with both depending somewhat on the nature of the cation. Because the O₂ molecule has two electrons in the π* orbitals, it is not likely that the filled σ orbital could be used to form a σ-bond to the metal by electron pair donation. Therefore, this type of bonding, which is significant in complexes containing CO and CN⁻, is not thought to be important in oxygen complexes. Part of the problem in interpreting the bonding mode of O₂ to metals is that from the standpoint of charges, M²⁺–O₂⁰ is equivalent to M³⁺–O₂⁻ and to M⁴⁺–O₂²⁻. Since the initial report of the first dioxygen complex in 1963, a very large number of others have been prepared and characterized.

There is a great deal of interest in nitrogen complexes because nitrogenase is an enzyme that apparently assists in the process of nitrogen fixation in plants as a result of nitrogen forming a complex with iron or molybdenum. Although the N₂ molecule (dinitrogen) is isoelectronic with CO and CN⁻ (see Figure 16.11b), it is much less reactive than those ligands when it comes to forming coordinate bonds by electron pair donation. But, in 1965, A. D. Allen and C. V. Senoff reported the first coordination compound containing dinitrogen. It was formed by the reaction of ruthenium chloride with hydrazine, but the ruthenium complex has also been prepared by the reaction



Since that first compound was reported, a large number of others have been prepared, and a molecule that was once thought to be nearly “inert” is known to form numerous complexes. Although several bonding modes have been proposed for N₂ in complexes, the two most common modes are with the N₂ molecule functioning as a σ donor or as a bridging ligand. These arrangements can be shown as M : N≡N and M–N≡N–M. Thus, the M–N–N arrangement is either linear or very nearly so. In complexes of dinitrogen, the N–N distance is normally in the range 110 to 113 pm, which is about the same as in the gaseous N₂ molecule, but the stretching band is shifted by about 100 to 300 cm⁻¹. Because the π* orbitals are not populated in the N₂ molecule, it functions primarily as a σ donor. This is quite different from the coordination of O₂ in which the electrons donated to the metal are from the π* orbitals.

Another milestone in coordination chemistry dates from 1980, when the first complex containing dihydrogen was reported by G. J. Kubas. It was found that hydrogen reacts with [W(CO)₂(Pchx₃)₂]

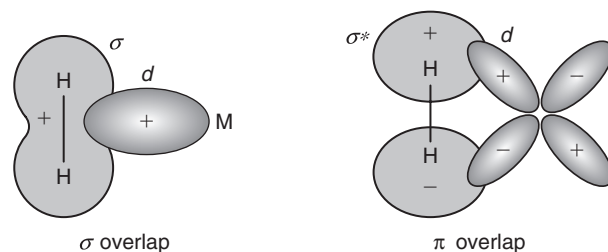

■ **FIGURE 16.12** The bonding of dihydrogen to a metal in a complex.

to give $[\text{W}(\text{H}_2)(\text{CO})_3(\text{Pchx}_3)_2]$ (where chx = cyclohexyl and Pchx_3 is tricyclohexylphosphine). The complex has the structure

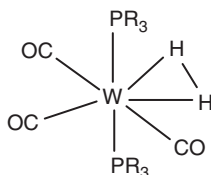

Bonding in this type of complex is believed to involve electron donation from the σ bonding orbital on H_2 . In some ways, this is similar to the formation of H_3^+ from H_2 and H^+ (see Chapter 5). However, it is also believed that there may be some back donation from the metal d orbitals to the σ^* orbital on H_2 . These bonding characteristics are illustrated in Figure 16.12.

To the extent that back donation occurs, it places electron density in the σ^* orbital, which weakens the $\text{H}-\text{H}$ bond. As a result of bond weakening, the $\text{H}-\text{H}$ bond is easier to dissociate. This could be a factor in the ability of certain metal complexes to function as catalysts for hydrogenation reactions (see Chapter 22). The formation of some hydrogen compounds can also be considered as oxidation of the metal with subsequent coordination of H^- ions.

In this chapter, a survey of the chemistry of coordination compounds has been presented with emphasis on elementary aspects of bonding, nomenclature, and isomerism. The discussion of complexes containing dioxygen, dinitrogen, and dihydrogen not only shows some of the characteristics of these interesting compounds, but also shows the dynamic nature of the chemistry of coordination compounds. It is a field that has come a long way since the preparation of Zeise's salt in the early 1800s and the pioneering work of Alfred Werner over a century ago. Coordination compounds are important in life processes as well as numerous industrial processes. For that reason, the following chapters will be devoted to bonding, spectra, stability, and reactions of coordination compounds. Collectively, these chapters will provide the background necessary for more advanced study.

■ REFERENCES FOR FURTHER STUDY

- Allen, A. D., and Senoff, C. V. (1965). *Chem. Commun.*, 621. Original report of a dinitrogen complex.
- Bailar, J. C., Ed. (1956). *The Chemistry of Coordination Compounds*. Reinhold Publishing Co., New York. A classic in the field by the late Professor Bailar (arguably the most influential figure in coordination chemistry in the last half of the 20th century) and his former students.

- Cotton, F. A., Wilkinson, G., Murillo, C. A., and Bochmann, M. (1999). *Advanced Inorganic Chemistry*, 6th ed. Wiley, New York. One of the great books in inorganic chemistry. In almost 1400 pages, an incredible amount of inorganic chemistry is presented.
- DeKock, R. L., and Gray, H. B. (1980). *Chemical Structure and Bonding*. Benjamin/Cummings, Menlo Park, CA. Chapter 6 presents a good introduction to bonding in coordination compounds.
- Greenwood, N. N., and Earnshaw, A. (1997). *Chemistry of the Elements*, 2nd ed. Butterworth-Heinemann, Oxford, UK. A monumental reference work that contains a wealth of information on many types of coordination compounds.
- Huheey, J. E., Keiter, E. A., and Keiter, R. L. (1993). *Inorganic Chemistry: Principles of Structure and Reactivity*, 4th ed. HarperCollins College Publishers, New York. Appendix I consists of 33 pages devoted to nomenclature in inorganic chemistry.
- Kettle, S. F. A. (1969). *Coordination Chemistry*. Appleton, Century, Crofts, New York. The early chapters of this book give a good survey of coordination chemistry.
- Kettle, S. F. A. (1998). *Physical Inorganic Chemistry: A Coordination Approach*. Oxford University Press, New York. An excellent book on the chemistry of coordination compounds.
- Porterfield, W. W. (1993). *Inorganic Chemistry—A Unified Approach*, 2nd ed. Academic Press, San Diego, CA. Chapters 10 through 12 give a good introduction to coordination chemistry.
- Szafran, Z., Pike, R. M., and Singh, M. M. (1991). *Microscale Inorganic Chemistry: A Comprehensive Laboratory Experience*. Wiley, New York. Chapter 8 provides synthetic procedures for numerous transition metal complexes. This book also provides a useful discussion of many instrumental techniques.
- Vaska, L. (1963). *Science*, 140, 809. Description of the formation of an oxygen complex.

■ QUESTIONS AND PROBLEMS

- Draw structures for the following ions and indicate the overall charge.
 - cis*-Dichlorobis(ethylenediamine)cobalt(III)
 - cis*-Difluordioxalatochromate(III).
 - trans*-Dinitritotetranitronickelate(II)
 - cis*-Diamminetetraethiocyanatochromate(III)
 - Trichloro(ethylene)platinate(II)
- Name the following compounds.
 - $[\text{Co}(\text{en})_2\text{Cl}_2]\text{Cl}$
 - $\text{K}_3[\text{Cr}(\text{CN})_6]$
 - $\text{Na}[\text{Cr}(\text{en})\text{C}_2\text{O}_4\text{Br}_2]$
 - $[\text{Co}(\text{en})_3][\text{Cr}(\text{C}_2\text{O}_4)_3]$
 - $[\text{Mn}(\text{NH}_3)_4(\text{H}_2\text{O})_2][\text{Co}(\text{NO}_2)_2\text{Br}_4]$
- Give names for the following compounds. Do not try to decide whether the complex has a *cis* or *trans* structure if both isomers are possible.
 - $\text{K}_4[\text{Co}(\text{NCS})_6]$
 - $[\text{Pt}(\text{en})\text{Cl}_2]$
 - $[\text{Cr}(\text{NH}_3)_3(\text{NCS})_2\text{Cl}]$
 - $[\text{Pd}(\text{py})_2\text{I}_2]$
 - $[\text{Pt}(\text{en})_2\text{Cl}_2]\text{Cl}_2$
 - $\text{K}_4[\text{Ni}(\text{NO}_2)_4(\text{ONO})_2]$

- For each of the following, tell whether it represents a stable compound and why or why not.
 - $\text{Ni}(\text{CO})_3\text{NO}$; (b) $\text{Cr}(\text{CO})_3(\text{NO})_2$; (c) $\text{Fe}(\text{CO})_3(\eta^2\text{-cht})$.
- Draw the structure for $\text{S}_2\text{O}_3^{2-}$. How would it bond to Pt^{2+} ? How would it bond to Cr^{3+} ? Explain how you determine how $\text{S}_2\text{O}_3^{2-}$ is bound by means of infrared spectroscopy.
- Sketch all of the geometrical isomers possible for trigonal bipyramidal complexes having the formulas (where AA is a bidentate ligand) (a) MX_4Y ; (b) MX_3Y_2 ; (c) $\text{MX}_3(\text{AA})$.
- Only one compound having the formula $[\text{Zn}(\text{py})_2\text{Cl}_2]$ (where py = pyridine) is known, but two different compounds are known having the composition $[\text{Pt}(\text{py})_2\text{Cl}_2]$. Explain these observations and describe the bonding in each complex.
- Two types of complexes are known that contain SO_4^{2-} as ligands. Explain how sulfate bonds to the metal ions in two different ways.
- For the series of silver complexes with cyanide, the C–N stretching vibrations are observed as follows. The species containing three or four cyanide ions are observed only in solutions containing high concentrations of CN^- .

Species	AgCN solid	$\text{Ag}(\text{CN})_2^-$	$\text{Ag}(\text{CN})_3^{2-}$	$\text{Ag}(\text{CN})_4^{3-}$
$\nu_{\text{CN}}, \text{cm}^{-1}$	2170	2135	2105	2092

Explain the differences in position of the C–N stretching bands.

- Suppose a cubic complex has the formula MX_5Y_3 where X and Y are different ligands. Sketch the structures of all of the geometric isomers possible.
- A nickel complex has the formula NiL_4^{2+} .
 - What are the possible structures for the complex?
 - Explain how the magnetic moment could be used to determine the structure of the complex.
- Draw the structure for $(\text{CO})_2(\text{NO})\text{Co}(\text{cht})$. What is the hapticity of cht in this complex?
- Draw the structure for $(\text{C}_6\text{H}_6)\text{Cr}(\text{CO})_4$. What is the hapticity of C_6H_6 in this complex?
- Sketch structures for all of the isomers of $[\text{Co}(\text{en})_2\text{ClNCS}]^+$ assuming that SCN^- can be ambidentate.
- The compound $[\text{Co}(\text{NH}_3)_6]\text{Cl}_3$ is yellow-orange in color but $[\text{Co}(\text{H}_2\text{O})_3\text{F}_3]$ is blue. Discuss why they are so different in terms of the bonding in the complexes.
- Describe a simple chemical test to distinguish between $[\text{Co}(\text{NH}_3)_5\text{Br}]\text{SO}_4$ and $[\text{Co}(\text{NH}_3)_5\text{SO}_4]\text{Br}$.
- Write the formula or draw the structure requested.
 - The formula for a polymerization isomer of $[\text{Pd}(\text{NH}_3)_2\text{Cl}_2]$
 - The structure of *cis*-bis(oxalato)dichlorochromium(III) ion
 - The formula for a coordination isomer of $[\text{Zn}(\text{NH}_3)_4][\text{Pd}(\text{NO}_2)_4]$
 - The structure of diamminedithiocyanatoplatinum(II)
- For each of the following complexes, give the hybrid orbital type and the number of unpaired electrons.
 - $[\text{Co}(\text{H}_2\text{O})_6]^{2+}$; (b) $[\text{FeCl}_6]^{3-}$; (c) $[\text{PdCl}_4]^{2-}$; (d) $[\text{Cr}(\text{H}_2\text{O})_6]^{2+}$
- For each of the following, give the hybrid bond type and the expected magnetic moment.
 - $[\text{Co}(\text{en})_3]^{3+}$; (b) $[\text{Ni}(\text{H}_2\text{O})_6]^{2+}$; (c) $[\text{FeBr}_6]^{3-}$; (d) $[\text{Ni}(\text{NH}_3)_4]^{2+}$; (e) $[\text{Ni}(\text{CN})_4]^{2-}$; (f) $[\text{MnCl}_6]^{3-}$
- The magnetic moment of $[\text{Co}(\text{py})_2\text{Cl}_2]$ is 5.15 BM. What is the structure of this compound?

21. Sketch structures for all the isomers possible for $[\text{Co}(\text{en})_2\text{NO}_2\text{Cl}]^+$.
22. Discuss how the ligand cht (cycloheptatriene) would be bonded in each of the following:
(a) $[\text{Ni}(\text{CO})_3\text{cht}]$; (b) $[\text{Fe}(\text{CO})_3\text{cht}]$; (c) $[\text{Co}(\text{CO})_3\text{cht}]$
23. Assume that the complex MLX_2Y_2 has a square-base pyramid structure with all ligands able to bond in all positions in the coordination sphere. How many isomers are possible?
24. Draw the structure for $[\text{Nb}(\eta^5\text{-C}_5\text{H}_5)(\text{CO})_3(\eta^2\text{-H}_2)]$.
25. Does the compound $[\text{Co}(\text{CO})_2(\eta^2\text{-H}_2)(\text{NO})]$ obey the 18-electron rule? Explain your answer.

This page intentionally left blank

Ligand Fields and Molecular Orbitals

In the previous chapter, elementary ideas about the nature of bonding in coordination compounds were presented. Because of the importance of this area of chemistry, it is essential that a more complete description of the bonding be presented. As we have seen in other cases, it is the interaction of electromagnetic radiation with matter that provides the experimental basis for this information. Consequently, the next chapter will have as its major objective the interpretation of spectra as it relates to the study of complexes. It is from studying the spectra of complexes that we obtain information about the energy states that exist and how the presence of ligands affects the orbitals of the metal ions. Magnetic studies give information about the presence of unpaired electrons, but the valence-bond approach described in the last chapter does not adequately explain *why* the electrons pair in some cases but not in others. In this chapter, several of these problems will be addressed more fully in terms of ligand fields and molecular orbitals.

17.1 SPLITTING OF *d* ORBITAL ENERGIES IN OCTAHEDRAL FIELDS

There are several characteristics of coordination compounds that are not satisfactorily explained by a simple valence bond description of the bonding. For example, the magnetic moment of $[\text{CoF}_3]^{3-}$ indicates that there are four unpaired electrons in the complex, whereas that of $[\text{Co}(\text{NH}_3)_6]^{3+}$ indicates that this complex has no unpaired electrons, although in each case Co^{3+} is a d^6 ion. In the last chapter, we interpreted the bonding types in these complexes as involving sp^3d^2 and d^2sp^3 hybrid orbitals, respectively, but that does not provide an explanation as to why the two cases are different. Another area that is inadequately explained by a simple valence-bond approach is the number of absorption bands seen in the spectra of complexes. One of the most successful approaches to explaining these characteristics is known as crystal or ligand field theory.

When a metal ion is surrounded by anions in a crystal, there is an electrostatic field produced by the anions that alters the energies of the *d* orbitals of the metal ion. The field generated in this way is known as a *crystal field*. Crystal field theory was developed in 1929 by Hans Bethe in an attempt to explain the spectral characteristics of metal ions in crystals. It soon became obvious that anions surrounding a metal in a crystal gave a situation that is very similar to the ligands (many of which are

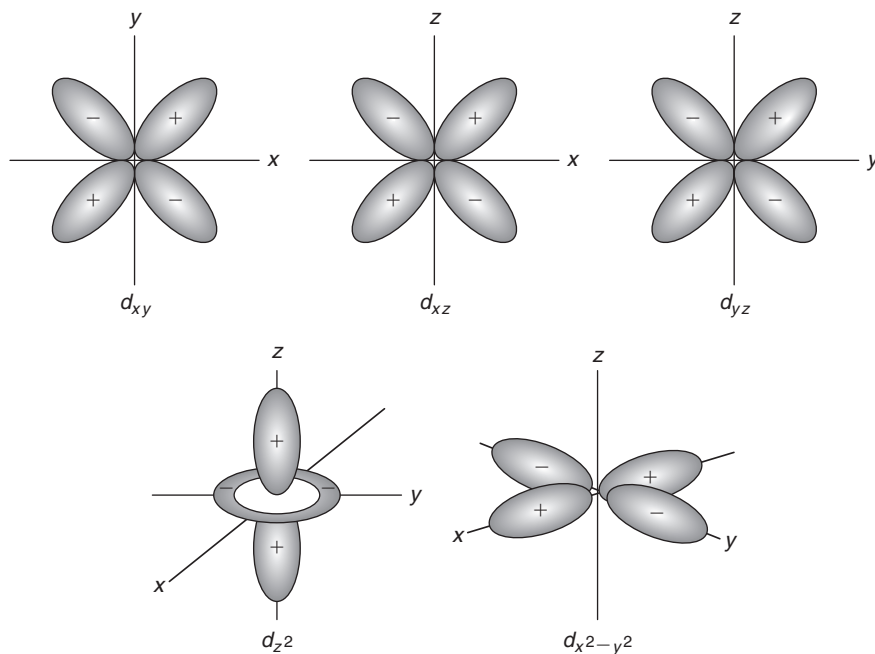

■ FIGURE 17.1 The spatial orientations of the set of five d orbitals for a transition metal.

also anions) surrounding a metal ion in a coordination compound. In cases where the ligands are not anions, they may be polar molecules, and the negative ends of the dipoles are directed toward the metal ion generating an electrostatic field. Strictly speaking, the *crystal field* approach is a purely electrostatic one based on the interactions between point charges, which is never exactly the case for complexes of transition metal ions. In view of the fact that coordinate bonds result from electron pair donation and have some covalency, the term *ligand field* is used to describe the effects of the field produced by the ligands in a complex. In the 1930s, J. H. Van Vleck developed *ligand field* theory by adapting the crystal field approach to include some covalent nature of the interactions between the metal ion and the ligands. Before we can show the effects of the field around a metal ion produced by the ligands, it is essential to have a clear picture of the orientation of the d orbitals of the metal ion. Figure 17.1 shows a set of five d orbitals, and for a gaseous ion, the five orbitals are degenerate.

If the metal ion were surrounded by a spherical electrostatic field, the energy of the d orbitals would be raised, but all would be raised by the same amount. As shown in Figure 17.2, an octahedral complex can be considered as a metal ion surrounded by six ligands that are located on the axes.

When six ligands surround the metal ion, the degeneracy of the d orbitals is removed because three of the orbitals, the d_{xy} , d_{yz} , and d_{xz} orbitals, are directed *between* the axes while the others, the $d_{x^2-y^2}$ and the d_{z^2} , are directed *along* the axes pointing at the ligands. Therefore, there is greater repulsion between the electrons in orbitals on the ligands and the $d_{x^2-y^2}$ and d_{z^2} orbitals than there is toward the d_{xy} , d_{yz} , and d_{xz} orbitals. Because of the electrostatic field generated by the ligands, *all* of the d orbitals are raised in

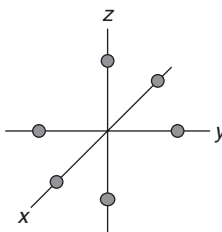

■ FIGURE 17.2 An octahedral complex with the six ligands lying on the x , y , and z axes.

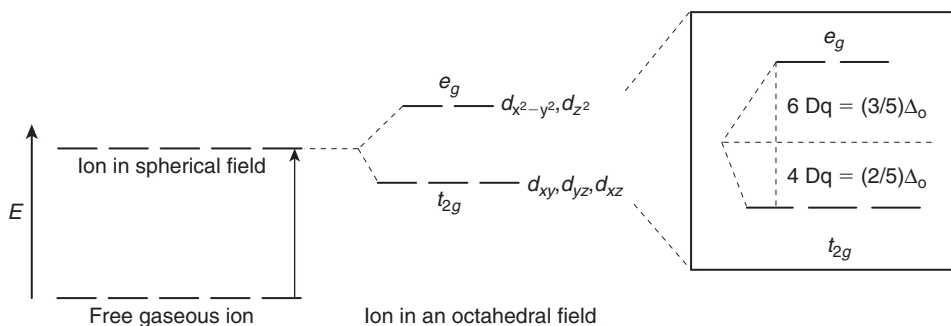

■ FIGURE 17.3 Splitting of the d orbitals in a crystal field of octahedral symmetry.

energy, but two of them are raised more than the other three. As a result, the d orbitals have energies that can be represented as shown in Figure 17.3.

The two orbitals of higher energy are designated as the e_g orbitals, and the three orbitals of lower energy make up the t_{2g} orbitals. These designations will be described in greater detail later, but the “ g ” subscript refers to being symmetrical with respect to a center of symmetry that is present in a structure that has O_h symmetry. The “ t ” refers to a triply degenerate set of orbitals, whereas “ e ” refers to a set that is doubly degenerate. The energy separating the two groups of orbitals is called the *crystal* or *ligand field splitting*, Δ_o . Splitting of the energies of the d orbitals as indicated in Figure 17.3 occurs in such a way that the overall energy remains unchanged and the “center of energy” is maintained. The e_g orbitals are raised 1.5 times as much as the t_{2g} orbitals are lowered from the center of energy. Although the splitting of the d orbitals in an octahedral field is represented as Δ_o , it is also sometimes designated as $10 Dq$, where Dq is an energy unit for a particular complex. The two orbitals making up the e_g pair are raised by $3/5 \Delta_o$ while the t_{2g} orbitals are lowered by $2/5 \Delta_o$ relative to the center of energy. In terms of Dq units, the e_g orbitals are raised by $6 Dq$ while the three t_{2g} orbitals are $4 Dq$ lower than the center of energy.

The effect of crystal field splitting is easily seen by studying the absorption spectrum of $[\text{Ti}(\text{H}_2\text{O})_6]^{3+}$ because the Ti^{3+} ion has a single electron in the $3d$ orbitals. In the octahedral field produced by the six water molecules, the $3d$ orbitals are split in energy as shown in Figure 17.3. The only transition possible is promotion of the electron from an orbital in the t_{2g} set to one in the e_g set. This transition

gives rise to a single absorption band, the maximum of which corresponds directly to the energy represented as Δ_o . As expected, the spectrum shows a single, broad band that is centered at $20,300\text{ cm}^{-1}$, which corresponds directly to Δ_o . The energy associated with this band is calculated as follows:

$$E = h\nu = hc/\lambda = hcv = 6.63 \times 10^{-27} \text{ erg sec} \times 3.00 \times 10^{10} \text{ cm/sec} \times 20,300 \text{ cm}^{-1}$$

$$E = 4.04 \times 10^{-12} \text{ erg}$$

We can convert this energy per molecule into kJ mol^{-1} by the following conversion.

$$4.04 \times 10^{-12} \text{ erg/molecule} \times 6.02 \times 10^{23} \text{ molecule/mole} \times 10^{-7} \text{ J/erg} \times 10^{-3} \text{ kJ/J} = 243 \text{ kJ/mol}$$

This energy (243 kJ mol^{-1}) is large enough to give rise to other effects when a metal ion is surrounded by six ligands. However, only for a d^1 ion is the interpretation of the spectrum this simple. When more than one electron is present in the d orbitals, the electrons interact by spin-orbit coupling. Any transition of an electron from the t_{2g} to the e_g orbitals is accompanied by changes in the coupling scheme when more than one electron is present. As we shall see in Chapter 18, the interpretation of spectra to determine the ligand field splitting in such cases is considerably more complicated than in the d^1 case.

The ordering of the energy levels for a metal ion in an octahedral field makes it easy to visualize how high- and low-spin complexes arise when different ligands are present. If there are three or fewer electrons in the $3d$ orbitals of the metal ion, they can occupy the t_{2g} orbitals with one electron in each orbital. If the metal ion has a d^4 configuration (e.g., Mn^{3+}), the electrons can occupy the t_{2g} orbitals only if pairing occurs, which requires that Δ_o be larger in magnitude than the energy necessary to force electron pairing, P . The result is a low-spin complex in which there are two unpaired electrons. If Δ_o is smaller than the pairing energy, the fourth electron will be in one of the e_g orbitals, which results in a high-spin complex having four unpaired electrons. These cases are illustrated in Figure 17.4.

Of course, we have not yet fully addressed the factors that are responsible for the magnitude of the ligand field splitting. The splitting of the d orbitals by the ligands depends on the nature of the metal ion and the ligands as well as the extent of back donation and π bonding to the ligands. These topics will be discussed more fully in Section 17.3 and Chapter 18.

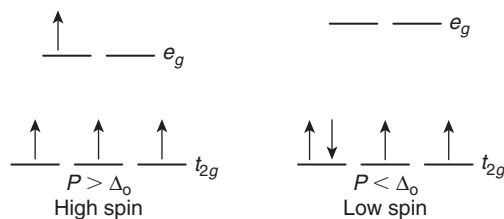

■ FIGURE 17.4 Crystal field splitting energy compared to the electron pairing energy.

17.2 SPLITTING OF d ORBITAL ENERGIES IN FIELDS OF OTHER SYMMETRY

Although the effect on the d orbitals produced by a field of octahedral symmetry has been described, we must remember that not all complexes are octahedral or even have six ligands bonded to the metal ion. For example, many complexes have tetrahedral symmetry, so we need to determine the effect of a tetrahedral field on the d orbitals. Figure 17.5 shows a tetrahedral complex that is circumscribed in a cube. Also shown are lobes of the d_{z^2} orbital and two lobes (those lying along the x -axis) of the $d_{x^2-y^2}$ orbital.

Note that in this case none of the d orbitals will point directly at the ligands. However, the orbitals that have lobes lying along the axes ($d_{x^2-y^2}$ and d_{z^2}) are directed toward a point that is midway along a diagonal of a face of the cube. That point lies at $(2^{1/2}/2)l$ from each of the ligands. The orbitals that have lobes projecting between the axes (d_{xy} , d_{yz} , and d_{xz}) are directed toward the midpoint of an edge that is only $l/2$ from sites occupied by ligands. The result is that the d_{xy} , d_{yz} , and d_{xz} orbitals are higher in energy than are the $d_{x^2-y^2}$ and d_{z^2} orbitals because of the difference in how close they are to the ligands. In other words, the splitting pattern produced by an octahedral field is inverted in a tetrahedral field. The magnitude of the splitting in a tetrahedral field is designated as Δ_t , and the energy relationships for the orbitals are shown in Figure 17.6.

There are several differences between the splitting in octahedral and tetrahedral fields. Not only are the two sets of orbitals inverted in energy, but also the splitting in the tetrahedral field is much smaller than that produced by an octahedral field. First, there are only four ligands producing the field rather than the six ligands present in the octahedral complex. Second, none of the d orbitals point directly at the ligands in the tetrahedral field. In an octahedral complex, two of the orbitals point directly toward the ligands and three point between them. As a result, there is a maximum energy splitting effect on the d orbitals in an octahedral field. In fact, it can be shown that if identical ligands are present in the complexes and the metal-to-ligand distances are identical, $\Delta_t = (4/9)\Delta_o$. The result is that *there are no low-spin tetrahedral complexes* because the splitting of the d orbitals is not large enough to force electron pairing. Third, because there are only four ligands surrounding the metal ion in a tetrahedral field,

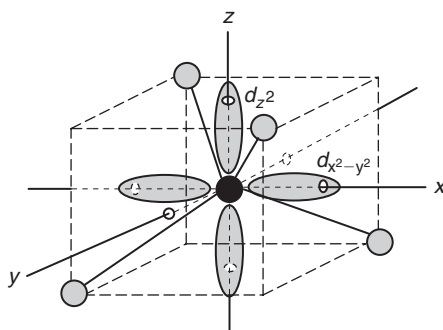

■ **FIGURE 17.5** A tetrahedral complex shown with the coordinate system. Two lobes of the d_{z^2} orbital are shown along the z -axis and two lobes of the $d_{x^2-y^2}$ orbital are shown along the y -axis.

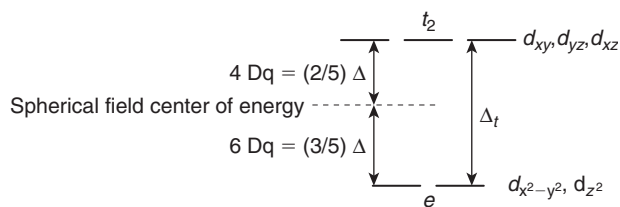

■ **FIGURE 17.6** The orbital splitting pattern in a tetrahedral field that is produced by four ligands.

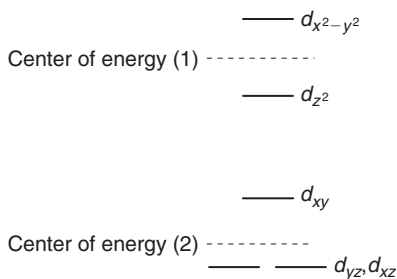

■ **FIGURE 17.7** The arrangement of the d orbitals according to energy in a field with elongation by moving the ligands on the z -axis farther from the metal ion in an octahedral complex.

the energy of all of the d orbitals is raised less than they are in an octahedral complex. The subscripts “ g ” do not appear on the subsets of orbitals because there is no center of symmetry in a tetrahedral structure.

Suppose we start with an octahedral complex and place the ligands lying on the z axis farther away from the metal ion. As a result, the d_{z^2} orbital will experience less repulsion, and its energy will decrease. However, not only do the five d orbitals obey a “center of energy” rule for the set, but also each subset has a center of energy that would correspond to spherical symmetry for that subset. Therefore, if the d_{z^2} orbital is reduced in energy, the $d_{x^2-y^2}$ orbital must increase in energy to correspond to an overall energy change of zero for the e_g subset. The d_{xz} and d_{yz} orbitals have a z component to their direction. They project between the axes in such a way that moving ligands on the z axis farther from the metal ion reduces repulsion of these orbitals. As a result, the d_{xz} and d_{yz} orbitals have lower energy, which means that the d_{xy} orbital has higher energy in order to preserve the center of energy (2) for the t_{2g} orbitals. The result is a set of d orbitals that are arranged as shown in Figure 17.7.

With the metal-to-ligand bond lengths being greater in the z direction, the field is now known as a *tetragonal* field with z elongation. If the ligands on the z axis are forced closer to the metal ion to produce a tetragonal field with z compression, the two sets of orbitals shown above are inverted. Figure 17.8 shows the d orbitals in this type of field.

From the survey of coordination chemistry presented in Chapter 16, it was seen that there are numerous complexes in which the ligands lie in a square plane around the metal ion. A square planar complex can be considered as a tetragonal complex in which the ligands along the z -axis have been

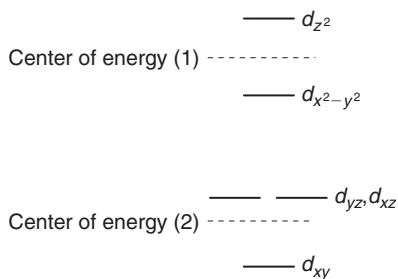

■ **FIGURE 17.8** The arrangement of *d* orbitals in a field with compression of the ligands along the *z*-axis.

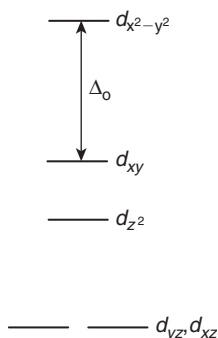

■ **FIGURE 17.9** Energies of *d* orbitals in a square planar field produced by four ligands.

drawn to an infinite distance from the metal ion. The arrangement of the *d* orbitals in such a complex is like that shown for the *z* elongation, except that the splitting is much more pronounced with the d_{xy} lying above the d_z^2 . The energy level diagram for the *d* orbitals in a square planar field is shown in Figure 17.9. It can be shown that the energy separating the d_{xy} and $d_{x^2-y^2}$ orbitals is exactly Δ_o , the splitting between the t_{2g} and e_g orbitals in an octahedral field.

In Chapter 16, we saw that d^8 ions such as Ni^{2+} , Pd^{2+} , and Pt^{2+} form square planar complexes that are diamagnetic. From the orbital energy diagram shown in Figure 17.9, it is easy to see why. Eight electrons can pair in the four orbitals of lowest energy leaving the $d_{x^2-y^2}$ available to form a set of dsp^2 hybrid orbitals. If the difference in energy between the d_{xy} and the $d_{x^2-y^2}$ is not sufficient to force electron pairing, all of the *d* orbitals are occupied, and a complex having four bonds would be expected to utilize sp^3 hybrid orbitals, which would result in a tetrahedral structure.

It is interesting to show how the energies of the *d* orbitals are evaluated by making use of quantum mechanics. A brief description of the approach used will be given here. Transition metal ions do not have the spherical symmetry that results for ions having all filled shells (e.g., Na^+ , F^- , Ca^{2+} , O^{2-}). The angular or directional character of the *d* orbitals renders them nonequivalent in their interaction with ligands located around the metal ion in a specific geometric pattern. Ligands arranged in different ways around a metal ion will produce different effects on the *d* orbitals that result in their having different

energies. The effect is the manifestation of electrostatic repulsion of an electron in a d orbital on the metal by the charges on the ligands (which are considered as points in space). For an electron in the d_{z^2} orbital of the metal ion, the energy can be expressed in terms of a quantum-mechanical integral following the same procedure for calculating the average or expectation value for a dynamical variable. In this case, the calculation involves the wave function for the orbital and the operator for potential energy, V ,

$$E = \int_{\text{all space}} \psi^*(d_{z^2}) V \psi(d_{z^2}) d\tau \quad (17.1)$$

Evaluation of the integral yields a result that can be expressed in terms of factors that are written as

$$35qe^2/4R^5 \quad \text{and} \quad (2/105)\langle a^4 \rangle$$

D and q

which is usually written as the result when D and q are multiplied; an energy unit known as "Dq" results.

$$Dq = \frac{qe^2\langle a^4 \rangle}{6R^5} \quad (17.2)$$

When expressed in terms of the crystal field splitting Δ_o , the result is

$$\Delta_o = 10 Dq = \frac{5qe^2\langle a^4 \rangle}{3R^5} \quad (17.3)$$

The orbital energy is obtained by multiplying the value of Dq by a factor that takes into account the angular dependence of each orbital. Depending on which d orbital is being considered, the angular factor is -6 or $+4$ for d orbitals in an octahedral field. Therefore, the energies of the d orbitals are $-6Dq$ (for the d_{z^2} and $d_{x^2-y^2}$ orbitals) or $+4Dq$ (for the d_{xy} , d_{yz} , and d_{xz} orbitals). If the ligands are polar molecules, the charge, q , is replaced by the dipole moment, μ .

For a metal ion in a tetrahedral field, there are only four ligands, and none of them lie on the axes. Because $4/6 = 2/3$, a factor of $2/3$ is applied to the potential energy operator V for the octahedral case. Also, evaluation of the integral giving the angular portion of the wave function gives a factor of $-2/3$ for the d_{z^2} and $d_{x^2-y^2}$ orbitals and $+2/3$ for the d_{xy} , d_{yz} , and d_{xz} orbitals. Multiplied together, a factor of $-4/9$ is obtained so the energies of the orbitals in the tetrahedral field are $-4/9(+6Dq) = -2.67Dq$ (for the d_{z^2} and $d_{x^2-y^2}$ orbitals) and $-4/9(+4Dq) = 1.78Dq$ (for the d_{xy} , d_{yz} , and d_{xz} orbitals). These results and those shown earlier for an octahedral complex agree with the results given earlier. When similar calculations are carried out for fields having other symmetry, the orbital energies shown in Table 17.1 are obtained. The energies are based on the splitting pattern of the orbitals and their energies relative to the center of energy in a spherical field.

The orbital energies are useful when comparing the stability of complexes in different structures. As usual, electrons are placed in the orbitals starting with the orbitals of lowest energy. We will have opportunity to make use of the orbital energies when we consider reactions of complexes in which the transition state has a different structure than that of the starting complex (see Chapter 20).

Table 17.1 Energies of d -Orbitals in Ligand Fields in Dq Units.

Coordination number	Symmetry	d_z^2	$d_{x^2-y^2}$	d_{xy}	d_{xz}	d_{yz}
2	Linear ^a	10.28	-6.28	-6.28	1.14	1.14
3	Trigonal ^b	-3.21	5.46	5.46	-3.86	-3.86
4	Tetrahedral	-2.67	-2.67	1.78	1.78	1.78
4	Square plane ^b	-4.28	12.28	2.28	-5.14	-5.14
5	Trigonal bipyramid	7.07	-0.82	-0.82	-2.72	-2.72
5	Square pyramid	0.86	9.14	-0.86	-4.57	-4.57
6	Octahedral	6.00	6.00	-4.00	-4.00	-4.00
6	Trigonal prism	0.96	-5.84	-5.84	5.36	5.36
8	Cubic	-5.34	-5.34	3.56	3.56	3.56

^aThe ligands are on the z -axis, the axis of highest symmetry.
^bThe ligands are in the xy plane.

17.3 FACTORS AFFECTING Δ

Because the crystal field splitting arises from the interaction of ligands with metal orbitals, it should be expected that the magnitude of the splitting would depend on the nature of the metal ion and the ligand. Earlier in this chapter, the discussion of $[\text{Ti}(\text{H}_2\text{O})_6]^{3+}$ illustrated how the maximum in the single absorption band in the spectrum corresponds directly to the magnitude of Δ_0 . If several complexes are prepared using different ligands, the positions of the absorption bands will be shifted to higher or lower wave numbers depending on the nature of the ligand. In this way, it is possible to arrange ligands according to their ability to cause a ligand field splitting. The series of ligands arranged this way is known as the *spectrochemical series*, and the order for numerous ligands is as follows:

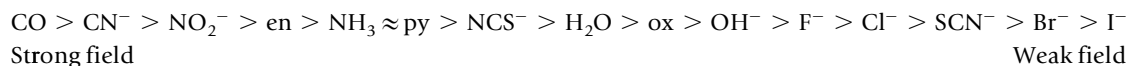

Differences between the splittings produced by adjacent members in the series are small, and the order is approximate in some cases, especially when different metal ions or metal ions in different rows of the periodic table are considered. For example, the order of the halide ions is changed if the metal ion is from the second transition series in accord with the hard-soft interaction principle. The spectrochemical series is a very useful guide because reversals between rather widely separated members such as NO_2^- and NH_3 do not occur. Reversals in the order of the magnitude of the ligand field from that shown above are sometimes observed for *closely spaced* members of the series. Ligands that force electron pairing are known as *strong field* ligands, and these ligands can be expected to give low-spin octahedral complexes with first-row metal ions. *Weak field* ligands such as F^- and OH^- will normally give low-spin complexes only with second- and third-row metals.

Table 17.2 Values of Δ_o for Octahedral Complexes of First-Row Transition Metal Ions.

Metal ion	Splittings for several ligands in cm^{-1}			
	F^-	H_2O	NH_3	CN^-
Ti^{3+}	17,500	20,300		23,400
V^{3+}	16,100	18,500		26,600
Cr^{3+}	15,100	17,900	21,600	35,000
Fe^{3+}	14,000	14,000		34,800
Co^{3+}	13,000	20,800	22,900	33,800
Fe^{2+}		10,400	11,000	32,200
Co^{2+}		9,300	10,200	
Ni^{2+}		8,500	10,800	

Table 17.3 Variation in Δ_o with Row in the Periodic Table.

$[\text{Fe}(\text{H}_2\text{O})_6]^{3+}$	$[\text{Fe}(\text{ox})_3]^{3-}$	$[\text{Co}(\text{H}_2\text{O})_6]^{3+}$	$[\text{Co}(\text{NH}_3)_6]^{3+}$
14,000	14,140	20,800	22,900
$[\text{Ru}(\text{H}_2\text{O})_6]^{3+}$	$[\text{Ru}(\text{ox})_3]^{3+}$	$[\text{Rh}(\text{H}_2\text{O})_6]^{3+}$	$[\text{Ru}(\text{NH}_3)_6]^{3+}$
28,600	28,700	27,200	34,000
			$[\text{Ir}(\text{NH}_3)_6]^{3+}$
			41,200
<i>Ligand field splitting (in cm^{-1}) is shown below the formula for the complexes shown.</i>			

In general, the aqua complexes of first-row transition metals have ligand field splittings of approximately 8000 to $10,000 \text{ cm}^{-1}$ for the $+2$ complexes, $[\text{M}(\text{H}_2\text{O})_6]^{2+}$, and approximately $14,000$ to $21,000 \text{ cm}^{-1}$ for the complexes of the $+3$ ions, $[\text{M}(\text{H}_2\text{O})_6]^{3+}$. In most cases, there is a 50% to 100% increase in Δ_o for the $+3$ ion compared to the $+2$ ion of the same metal. For example, the value of Δ_o is $22,870 \text{ cm}^{-1}$ for $[\text{Co}(\text{NH}_3)_6]^{3+}$ but it is only $10,200 \text{ cm}^{-1}$ for $[\text{Co}(\text{NH}_3)_6]^{2+}$. Table 17.2 shows representative values for Δ_o in complexes containing ions of first-row metals with H_2O , NH_3 , F^- , and CN^- as ligands.

It is interesting to note that for $[\text{CoF}_6]^{3-}$, the value of Δ_o is only about $13,000 \text{ cm}^{-1}$, but the energy required to force pairing of electrons in Co^{3+} is approximately $20,000 \text{ cm}^{-1}$. Therefore, $[\text{CoF}_6]^{3-}$ is a high-spin complex. The crystal field splitting in $[\text{Co}(\text{NH}_3)_6]^{3+}$ is $22,900 \text{ cm}^{-1}$, which is sufficient to force pairing, so a low-spin complex results.

There is an increase of approximately 30% to 50% in Δ_o on going from a first-row transition metal to a second-row metal and another 30% to 50% increase on going from a second-row to a third-row metal when the same d^n configuration and oxidation state are involved. Data for several complexes that illustrate this trend are shown in Table 17.3. In some cases, the splitting is approximately doubled

in going down one row in the transition series. A result of the much larger ligand field splitting in second- and third-row transition metal ions is that almost all complexes of these metals are low spin. When a substitution reaction occurs in such a complex, the ligand being replaced almost always leaves before the entering ligand attaches, and the substitution occurs with the product having the same configuration as the starting complex.

From a more complete set of data similar to those shown in Table 17.3, it is possible to rank metal ions in terms of the splitting of the d orbitals produced by a given ligand. The series for many common metal ions can be given as follows.



This series illustrates clearly the effects of charge and position in the periodic table that were described earlier.

As described earlier, the splitting in tetrahedral fields is usually only about 4/9 what it is for octahedral fields. For example, the tetrahedral complex $[\text{Co}(\text{NH}_3)_4]^{2+}$ has $\Delta_t = 5900 \text{ cm}^{-1}$, whereas the octahedral complex $[\text{Co}(\text{NH}_3)_6]^{2+}$ has $\Delta_o = 10,200 \text{ cm}^{-1}$. When complexed with the Co^{2+} ion, the values of Δ_t for the Cl^- , Br^- , I^- , and NCS^- ions are 3300, 2900, 2700, and 4700 cm^{-1} , respectively. In general, the energy required to force pairing of electrons in a first row transition metal ion is in the range of 250 to 300 kJ mol^{-1} (approximately 20,000–25,000 cm^{-1}). The result is that the splitting caused by ligands in a tetrahedral field is not sufficient to cause pairing of electrons, so there are no low-spin tetrahedral complexes of first-row metal ions.

17.4 CONSEQUENCES OF CRYSTAL FIELD SPLITTING

In addition to the changes produced in the spectra that arise from d - d transitions, there are other effects produced as a result of the splitting of the d orbital energies. Suppose a gaseous metal ion is placed in water and the ion becomes solvated with six water molecules. If the +2 first-row transition metal ions are considered, there is a general increase in the heat of hydration in moving across the series as a result of the decreasing ionic radius brought on by the increase in nuclear charge, as illustrated by the ionic radii shown in the following series:

Ion	Ca^{2+}	Ti^{2+}	V^{2+}	Cr^{2+}	Mn^{2+}	Fe^{2+}	Co^{2+}	Ni^{2+}	Cu^{2+}	Zn^{2+}
Radius, pm	99	90	88	84	80	76	74	69	72	74

The hydration process for an ion can be shown as

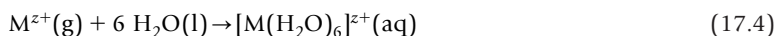

The heat of hydration of an ion is related to its size and charge (see Chapter 7). However, in this case the aqua complex that is formed causes the d orbitals to be split in energy, and if the metal ion has electrons in the d orbitals, they will populate the t_{2g} orbitals, which have lower energy. This results in

a release of energy over and above that produced by the hydration of an ion having a specific size and charge. High-spin (weak-field) aqua complexes normally result from the hydration of first-row transition metal ions. The actual amount of energy released will be dependent on the number of electrons in the d orbitals. For a d^1 ion, the heat of hydration will be augmented by $4Dq$ (see Figure 17.3). If the electron configuration is d^2 , there will be $8Dq$ released in addition to the heat of hydration for an ion of that size and charge. The process of increasing the number of electrons that are present in the d orbitals would produce the results shown in Table 17.4.

Hydration of the metal ions produces an enthalpy change that is commensurate with the size and charge of the ion with the addition of the number of Dq units shown in the weak field column in Table 17.4. For d^0 , d^5 , and d^{10} there is no additional stabilization of the aqua complex since these cases have no ligand field stabilization. Figure 17.10 shows a graph of the heats of hydration for the first-row +2 metal ions.

Number of electrons	Weak field (Dq)	Strong field (Dq)
0	0	0
1	4	4
2	8	8
3	12	12
4	6	16
5	0	20
6	4	24
7	8	18
8	12	12
9	6	6
10	0	0

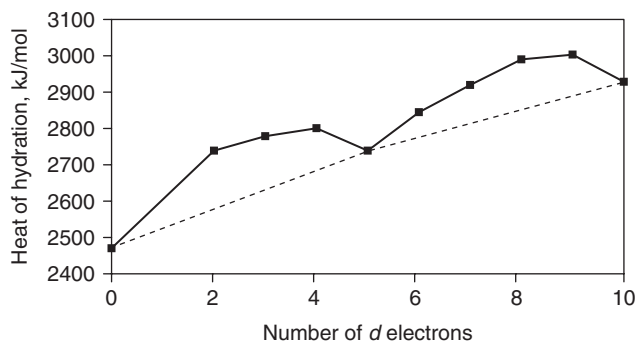

■ **FIGURE 17.10** Heat of hydration of +2 metal ions of the first transition series.

The graph shows what has become known as the “double-humped” appearance that reflects the fact that the ligand field stabilization energy for the aqua complexes begins at 0, increases to $12Dq$, then drops to 0 on going from d^0 to d^5 and repeats the trend on going from d^6 to d^{10} (see Table 17.4).

As gaseous ions form a crystal lattice as represented by Eq. (17.5), the cations become surrounded by anions and vice versa in the solid crystal.



If the cations are surrounded by six anions in an octahedral arrangement, the d orbitals will become split in energy, as illustrated earlier. When the orbitals are populated with one or more electrons, the energy released when the lattice forms will be greater by an amount that reflects the ligand field stabilization energy corresponding to the number of electrons in the d orbitals. A graph of the lattice energy for the chloride compounds of the first-row transition metals in the +2 oxidation state is shown in Figure 17.11. This figure shows the same general shape as the graph representing the hydration enthalpies of the metal ions. This is because the ligand field around the metal ion stabilizes both the hydrates and the crystal lattices in a way that depends on the number of electrons in the d orbitals.

Although the heat of hydration (or lattice energy) can be predicted for an ion having a specific charge and size, measuring the actual heat of hydration (or lattice energy) is not a good way to determine by difference the ligand field stabilization energy. It is large enough to produce demonstrable effects, but the ligand field stabilization energy is small compared to either the heat of hydration of a doubly charged metal ion or the lattice energy of a solid ionic compound. As a result, taking a small difference between large numbers is not a good way to determine Dq . In Chapter 18, the use of spectroscopic techniques to determine ligand field parameters will be described.

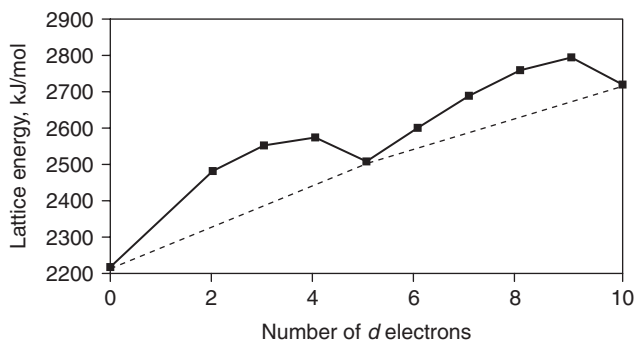

■ FIGURE 17.11 Lattice energies of the chlorides of the +2 metal ions of the first transition series.

17.5 JAHN-TELLER DISTORTION

Although the application of elementary ligand field theory is adequate to explain many properties of complexes, there are other factors that come into play in some cases. One of those cases involves complexes that have structures that are distorted from regular symmetry. Complexes of copper(II) are among the most common ones that exhibit such a distortion.

Consider the Cu^{2+} ion, which has a d^9 configuration. If six ligands are arranged in a regular octahedral structure, the electrons would be arranged as shown in Figure 17.12a.

There are three electrons populating the two degenerate e_g orbitals. If the ligands on the z -axis were moved farther from the Cu^{2+} , the d_{z^2} orbital would have a lower energy while the $d_{x^2-y^2}$ orbital would be raised in energy an equivalent amount. There would be a splitting of the d_{xy} , d_{yz} , and d_{xz} orbitals, but because they are filled, there is no net energy change based on that splitting. However, two of the electrons in the $d_{x^2-y^2}$ and d_{z^2} orbitals would occupy the d_{z^2} orbital, whereas only one would be in the higher energy $d_{x^2-y^2}$ orbital. As a result, the energy of this arrangement would be lower than that for the complex having O_h symmetry. The splitting of the two sets of orbitals (e_g and t_{2g}) is not equal. The magnitude by which the $d_{x^2-y^2}$ and d_{z^2} orbitals have changed in energy is δ , but the d_{xz} and d_{yz} are lowered by an amount represented as δ' as the d_{xy} orbital is raised by $2\delta'$ as shown in Figure 17.12b.

Keep in mind that in this diagram the splittings are not to scale! As a result of the distortion by elongation of the complex along the z -axis, the overall energy is lower by an amount δ in accord with the Jahn-Teller Theorem. That principle states that *if a system has unequally populated degenerate orbitals, the system will distort to remove the degeneracy*. When the degeneracy is removed, the state of lower energy will be more fully populated. The resulting splitting pattern for the d orbitals is as shown in Figure 17.12b.

One experimental verification of this phenomenon comes in the form of bond lengths. In CuCl_2 , the Cu^{2+} is surrounded by six Cl^- ions, and the equatorial $\text{Cu}-\text{Cl}$ bonds are 230 pm in length, whereas

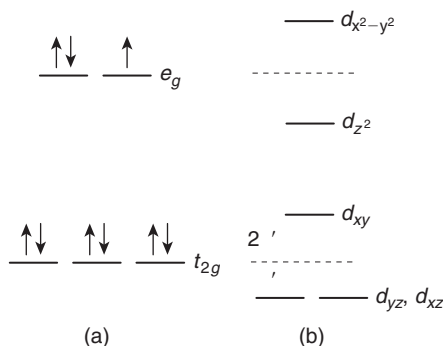

■ FIGURE 17.12 Energy of the d orbitals of a d^9 ion in a field with z elongation produced by Jahn-Teller distortion.

the axial bonds measure 295 pm. Bond distances in many other copper(II) compounds could also be cited to illustrate Jahn-Teller distortion.

The d^9 configuration is not the only one for which distortion leads to a lower energy. For example, the d^4 high-spin configuration would place one electron in the four lowest-lying orbitals with an energy that is lower as a result of splitting the $d_{x^2-y^2}$ and d_{z^2} orbitals. The Cr^{2+} ion has a d^4 configuration, so we should expect some distortion to occur for complexes of this ion, and this is indeed the case. Moreover, a distortion would be predicted for a d^1 or d^2 ion, for which the electrons would be found in the two orbitals of lowest energy. However, the magnitude of δ' is much smaller than that of δ because the orbitals involved are directed between the axes, not at the ligands. These are nonbonding orbitals, so the effect of moving the ligands on the z axis farther from the metal ion is much smaller. The result is that any distortion involving metals with these configurations is very slight.

17.6 SPECTRAL BANDS

When a sample absorbs light in the visible region of the spectrum, the sample appears colored. The majority of complexes of transition metal ions are colored. The reason that these complexes absorb visible light is that there are electronic transitions of appropriate energy difference possible between the d orbitals. These orbitals are split according to the patterns that we have just described. The absorptions are not limited to the visible region, and some are seen in the ultraviolet and infrared regions of the spectrum. However, there are striking differences between the absorption of light by $[\text{Ti}(\text{H}_2\text{O})_6]^{3+}$ and by a hydrogen atom. As we saw in Chapter 1, the radiation emitted during electronic transitions in a gaseous hydrogen atom appears as *lines* in the spectrum. The absorption of light by $[\text{Ti}(\text{H}_2\text{O})_6]^{3+}$ appears as a broad *band*, which has a maximum at $20,300\text{ cm}^{-1}$.

In simple crystal field theory, the electronic transitions are considered to be occurring between the two groups of d orbitals of different energy. We have already alluded to the fact that when more than one electron is present in the d orbitals, it is necessary to take into account the spin-orbit coupling of the electrons. In ligand field theory, these effects are taken into account, as are the parameters that represent interelectronic repulsion. In fact, the next chapter will deal extensively with these factors.

A very simplistic view of the reason that absorption bands are broad arises from considering what happens during the vibration of a complex having the formula ML_6 . The ligand field undergoes instantaneous changes during a vibration, and for simplicity, we will consider the symmetric stretching vibration that preserves the O_h symmetry of the complex. As a result of the ligands moving in and out from the metal ion, there will be a slight difference produced in Δ_o as the ligands are moving the small distance that accompanies the vibration. Because the electronic transition takes place on a time scale that is much shorter than that corresponding to vibration, the transition actually occurs between ligand field states that are changing slightly during the vibration. As a result, a *range* of energies is absorbed, which results in a *band* rather than a *single line* as is the case for a gaseous atom or ion.

Transitions of the $d-d$ type are known as *electric dipole* transitions. The transition between states of different multiplicity is forbidden, but under certain circumstances it still may be seen, if only weakly. For example, Fe^{3+} has a ${}^6\text{S}$ ground state, and all of the excited spectroscopic states have a different

multiplicity. As a result, solutions containing Fe^{3+} are almost colorless because the transitions are spin forbidden. In order for an electric dipole transition to occur, it is necessary for the integral

$$\int \psi_1 r \psi_2 d\tau$$

where ψ_1 and ψ_2 are the wave functions for the orbitals between which the transition is occurring, to be nonzero. In an octahedral field, all of the d orbitals are "g," which would require that the integral be zero. The selection rule known as the *Laporte rule* requires that *allowed transitions be between states of different symmetry*. Therefore, the d - d transitions in a field of g symmetry are *Laporte forbidden*. Forbidden transitions usually have low intensities, so other factors must be operating in these cases.

For a particular bond (as in a diatomic molecule) in the lowest vibrational state within the lowest electronic level, there is an equilibrium internuclear distance, R_0 . Suppose that by absorbing electromagnetic radiation there is a change to a higher electronic state. Excited states of bonds (or molecules) do not have equilibrium internuclear distances that are identical to those in the ground state. Electronic transitions occur on a time scale that is so short that nuclei cannot reposition to a different equilibrium distance. Therefore, as the electronic state is changed from the ground state to an excited state, the molecule is produced with internuclear distances that are not those characteristic of the excited state. If the energy of a particular bond is represented as a function of internuclear distance, the result is a potential energy curve like that shown in Figure 17.13.

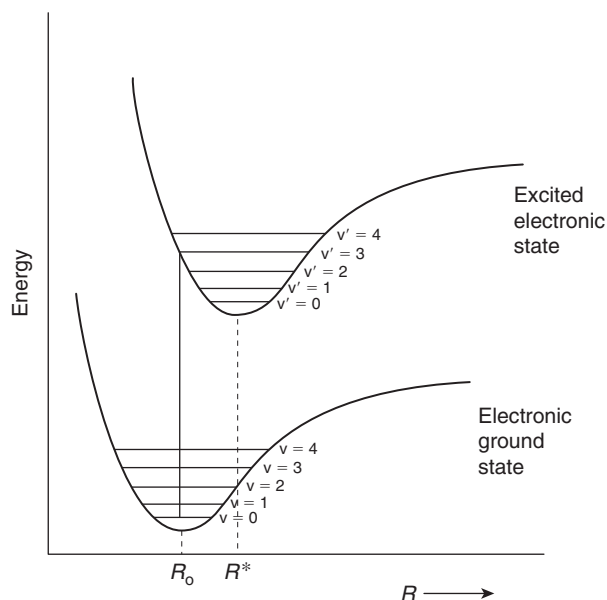

■ **FIGURE 17.13** An illustration of the Franck-Condon principle. In this case, the transition is from $v = 0$ in the electronic ground state to the state with $v' = 3$ in the excited electronic state.

Several vibrational states are shown within the electronic ground state. A potential energy curve such as this also exists for the excited state, except that it is displaced to a slightly larger equilibrium internuclear distance than is found for the ground state. Because the electronic transition to the excited state does not allow for the internuclear distance to adjust, the transition takes place with a constant value of R , a so-called *vertical transition*. Therefore, the transition with the highest probability is between the lowest vibrational level in the electronic ground state and a higher vibrational level in the excited electronic state. This phenomenon, known as the *Franck-Condon principle*, is illustrated in Figure 17.13. In fact, the overlap integrals for several vibrational levels have nonzero values, which results in the absorption of several energies that are closely spaced.

The intensity of the electronic transition just described is primarily due to changes in vibrational energy. Because both vibrational and electronic changes are involved, this type of transition is known as a *vibronic* transition. Although we will not go into details of the theory here, it can be shown that if changes in the complex occur that temporarily change its symmetry, electric dipole transitions become possible. One such change is *vibronic coupling*, which is the result of combining vibrational and electronic wave functions. The products of the wave functions must take into account *all* vibrational modes, some of which change the symmetry of the complex by removing the center of symmetry (the subscript g no longer applies). The Laporte selection rule no longer applies, so some transitions are no longer forbidden. Another factor that is associated with vibronic coupling involves an allowed transition that is of similar energy to an excited spectroscopic state that is forbidden. Vibrations in the excited state can result in a symmetry that does allow the wave functions to combine, so that the transition integral is no longer zero.

As we have seen, spectral bands for absorption by transition metal complexes are broad. For absorptions to cover a range of frequencies, the energy levels must be “smeared out” rather than discrete. Earlier in this chapter we saw that one means by which the symmetry of a complex is changed is by Jahn-Teller distortion. Such a distortion has the effect of removing the degeneracy of the two sets of d orbitals as they exist in the ligand field. Another factor that causes broad absorption bands is that as the electronic energy is changed, so are vibrational energies, which causes a *range* of energy to be absorbed rather than a discrete line. Even though the bands are broad, they provide the basis for analysis of the spectrum of a transition metal complex to extract information about the ligand field and electronic interactions. Therefore, this important topic will be discussed in the next chapter.

17.7 MOLECULAR ORBITALS IN COMPLEXES

Up to this point in the discussion of bonding in complexes, the emphasis has been on ligand field theory and its application to interpretation of structures and magnetic properties of complexes. There are substantial differences in the effects produced by different ligands with the softer, more polarizable ligands causing the greatest effect. Ligands of that type attach to metal ions by means of bonds that are more covalent in character and have a greater tendency to form π bonds. The initial development of crystal field theory dealt with the effects caused by the electrostatic interaction of point charges in fields of specific geometry. Although the ligands were considered as *charges*, the metal was described in terms of its *orbitals* as interpreted from the point of view of quantum mechanics. Therefore, in its

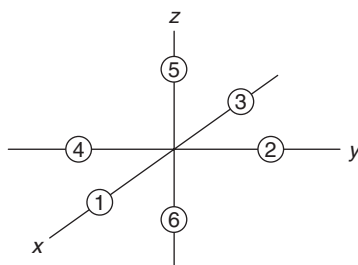

■ FIGURE 17.14 The coordinate system to designate orbitals used in constructing molecular orbitals for an octahedral complex.

simplest approach crystal field theory does not deal with complexes that have substantial covalency in the bonds. In this section, the molecular orbital approach will be used to describe bonding in complexes by considering the ligands to be only σ donors and then make some additional comments about including π bonding. However, there will be no attempt to develop bonding theory to a level that makes interpretations and applications obscure. Bonding theory for the sake of theory is more appropriate in textbooks in other fields of chemistry.

When describing a complex in terms of molecular orbitals, we need to establish a model by which we can identify the orbitals utilized by both the metal and the ligands. We will first consider an octahedral complex with the positions of the ligands identified on the coordinate system shown in Figure 17.14, and the orbitals will be designated by the numbers assigned to the ligands in the positions indicated.

The basic approach to combining wave functions to represent molecular orbitals was described in Chapter 5, and the procedures used here represent an extension of those ideas. In dealing with the bonding in complexes of first-row transition metals atoms and ions, it is generally acknowledged that the metal orbital energies vary as $3d < 4s < 4p$. Although there are nine valence orbitals having these designations, those of the $3d$ set that are used in bonding are the d_{z^2} and the $d_{x^2-y^2}$. In the case of the p and d orbitals, the orbitals utilized are those indicated that have lobes lying along the axes. The d_{xy} , d_{yz} , and d_{zx} orbitals have lobes lying *between* the axes. As a result, they do not interact with ligands lying *on* the axes, which have lobes that are unidirectional. If the ligands form π bonds to the metal ion, then these orbitals become part of the bonding orbital scheme. When only σ bonding is involved, the d_{xy} , d_{yz} , and d_{zx} are considered to be nonbonding in character.

If we consider six ligands such as H_2O or NH_3 bound to a metal ion, the first task in applying the molecular orbital approach is to deduce the form of the molecular wave functions. Ligands such as H_2O and NH_3 do not form π bonds, so this type of complex has fewer subtle factors to take into account. Each ligand contributes a pair of electrons that are contained in an orbital, and we will assume that it is a σ orbital. At this point, the actual type of the ligand orbital (sp^3 , p , etc.) is not important as long as it is one that does not form π bonds. For a first-row transition metal, the valence-shell orbitals used in the bonding will be the $3d_{z^2}$, $3d_{x^2-y^2}$, $4s$, and three $4p$ orbitals. As shown in Figure 17.15a, the s orbital requires the wave functions for the ligand orbitals to have positive signs.

The $4s$ orbital on the metal has a positive sign that is invariant in all directions. The combination of ligand orbitals, which are referred to as *symmetry adjusted linear combinations* (SALC) or *ligand group*

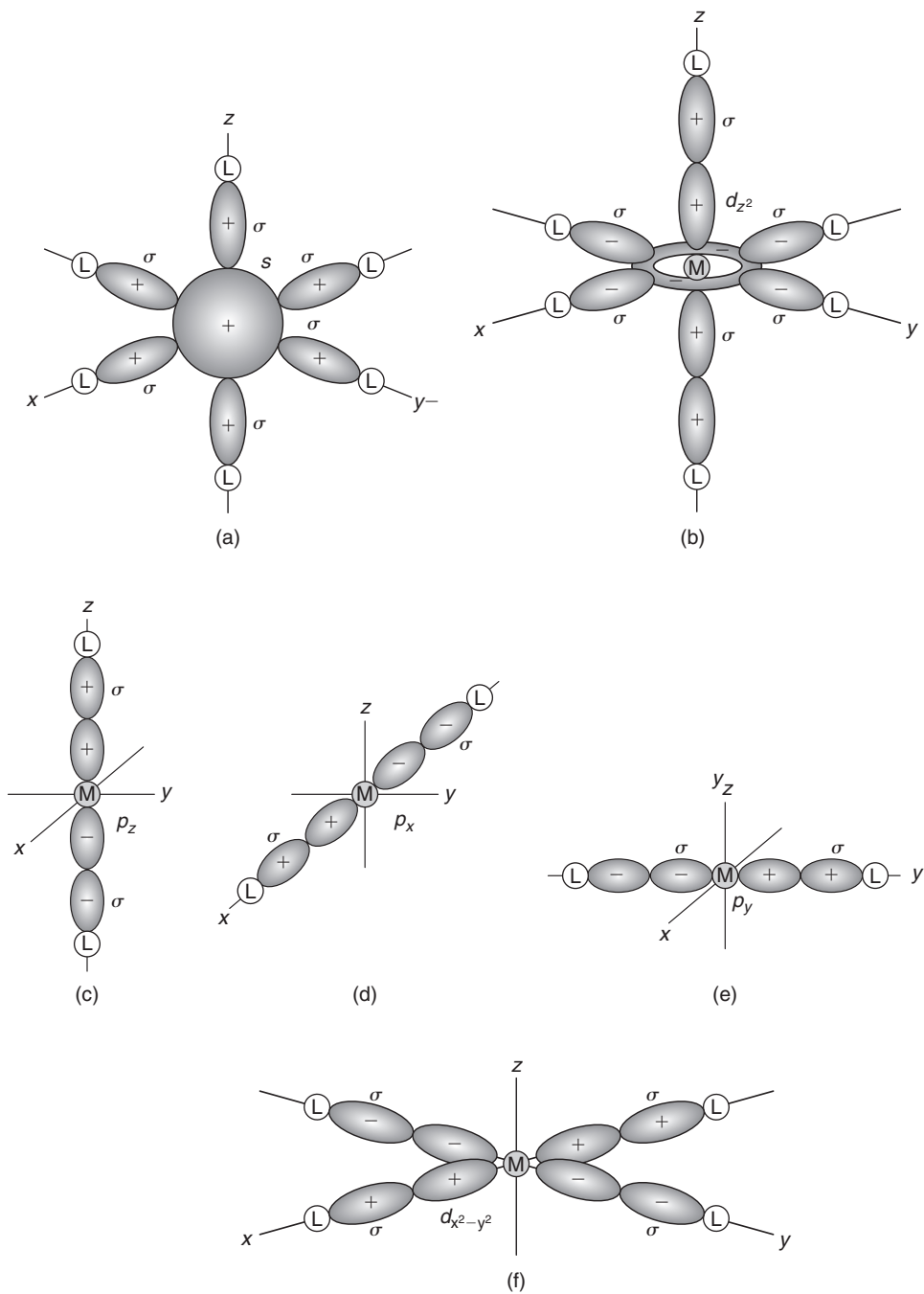

■ **FIGURE 17.15** Combinations of ligand orbitals with the s , p_x , p_y , p_z , d_{z^2} , and $d_{x^2-y^2}$ orbitals on the metal ion.

orbitals (LGO), matching the symmetry of the s orbital will be the *sum* of the six ligand wave functions, ϕ_i which is written as

$$\frac{1}{\sqrt{6}}(\phi_1 + \phi_2 + \phi_3 + \phi_4 + \phi_5 + \phi_6)$$

Thus, the combination of wave functions making up the first molecular orbital will be

$$\psi(\sigma_{4s}) = a_1\phi_{4s} + a_2 \left[\frac{1}{\sqrt{6}}(\phi_1 + \phi_2 + \phi_3 + \phi_4 + \phi_5 + \phi_6) \right] \quad (17.6)$$

where a_1 and a_2 are weighting coefficients, ϕ_{4s} is the wave function for the $4s$ orbital on the metal, and ϕ_i is a wave function for a ligand orbital. When combining ligand group orbitals with the p orbitals on the metal, it is necessary to observe the symmetry of the metal orbitals and combine the orbitals from the ligands to match that symmetry. Figures 17.15c to 17.15e provide an illustration of this requirement.

Because the p_x orbital is positive in the direction toward ligand 1 and negative in the direction toward ligand 3, the appropriate combination of ligand orbitals will be

$$\frac{1}{\sqrt{2}}(\phi_1 - \phi_2)$$

Consequently, the molecular wave function utilizing the p_x orbital can be expressed as

$$\psi(\sigma_{p_x}) = a_3\phi_{p_x} + a_4 \left[\frac{1}{\sqrt{2}}(\phi_1 - \phi_2) \right] \quad (17.7)$$

In a similar way, we obtain the wave functions for combinations of ligand group orbitals with the p_y and p_z orbitals from the metal ion. They can be written as

$$\psi(\sigma_{p_y}) = a_3\phi_{p_y} + a_4 \left[\frac{1}{\sqrt{2}}(\phi_3 - \phi_4) \right] \quad (17.8)$$

$$\psi(\sigma_{p_z}) = a_3\phi_{p_z} + a_4 \left[\frac{1}{\sqrt{2}}(\phi_5 - \phi_6) \right] \quad (17.9)$$

Note that the three wave functions arising from the p_x , p_y , and p_z orbitals are identical except for the directional character as indicated by the subscripts. Therefore, they must represent a triply degenerate set (the t_{2g} set, which will be apparent later).

When we inspect the $d_{x^2-y^2}$ orbital, we see that the lobes have positive signs in the x direction and negative signs in the y direction as shown in Figure 17.15f. The ligand group orbitals that match the symmetry of the $d_{x^2-y^2}$ orbital will be

$$\psi(\sigma_{d_{x^2-y^2}}) = a_5 \phi_{d_{x^2-y^2}} + a_6 \left[\frac{1}{2}(\phi_1 - \phi_2 + \phi_3 - \phi_4) \right] \quad (17.10)$$

In looking at the d_{z^2} orbital, we note that it has positive lobes in the z direction with the ring in the xy plane having negative symmetry. Because the d_{z^2} orbital has positive lobes along the z axis, the ligand orbitals in those directions will both have positive signs. With the "ring" being of negative symmetry, ligand orbitals in the xy plane will all be preceded by a negative sign. However, the orbital labeled as d_{z^2} is actually $d_{2z^2-x^2-y^2}$, which is needed in order to determine the coefficients of the orbitals in the wave function. The combination of ligand orbitals needed to match the symmetry of this orbital can be written as

$$\frac{1}{2\sqrt{3}}(2\phi_5 + 2\phi_6 - \phi_1 - \phi_2 - \phi_3 - \phi_4)$$

Therefore, the molecular orbital for this combination with the d_{z^2} orbital is written as

$$\psi(\sigma_{z^2}) = a_7 \phi_{z^2} + a_8 \left[\frac{1}{2\sqrt{3}}(2\phi_5 + 2\phi_6 - \phi_1 - \phi_2 - \phi_3 - \phi_4) \right] \quad (17.11)$$

When constructing the molecular orbital energy level diagram, we make use of the fact that the energy of the atomic orbitals on the metal (assuming a first-row metal) vary in the order $3d$ less than $4s$ less than $4p$. Moreover, the orbitals on ligands such as H_2O , NH_3 , or F^- that hold the electrons being donated to the metal are usually lower in energy than any of those metal orbitals listed. For the ligands listed, the electrons reside in $2p$ orbitals or in hybrid orbitals made up of $2s$ and $2p$ orbitals (sp^3 in the

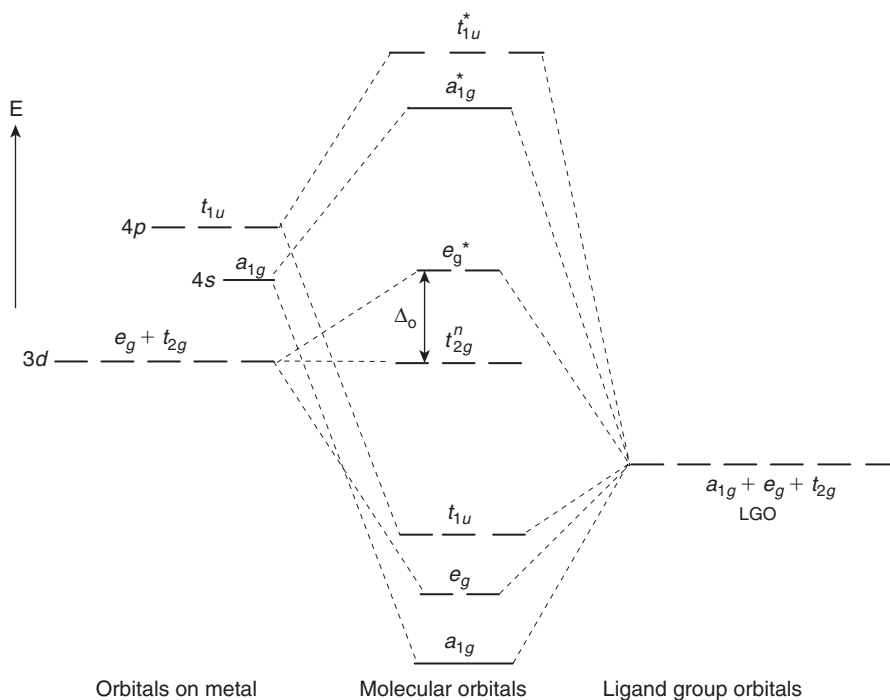

■ FIGURE 17.16 The molecular orbital energy level diagram for an octahedral complex.

case of H_2O and NH_3). As a result, when the energy level diagram is constructed, the orbitals on the metal side will be in the order given, but the ligand orbitals on the other side will lie lower than those of the metal. The result is a molecular orbital diagram like that shown in Figure 17.16.

Several things are apparent from Figure 17.16. First, the crystal field splitting, Δ_o , is represented as the difference in energy between a triply degenerate set of orbitals, t_{2g} , and a doubly degenerate set, e_g . However, according to the molecular orbital approach those orbitals are the three nonbonding $3d_{xy}$, $3d_{yz}$ and the $3d_{xz}$ and the antibonding e_g^* arising from the $3d_{x^2-y^2}$ and the $3d_{z^2}$ orbitals. Second, if six ligands donate six pairs of electrons to the metal ion, they will occupy the a_{1g} , e_g , and t_{1u} molecular orbitals. Because the bonding molecular orbitals lie closer in energy to the ligand orbitals, they are more like ligand orbitals than metal orbitals. The nonbonding t_{2g} and antibonding e_g^* have energies that are closer to those of the valence-shell orbitals of the metal. From the molecular orbital diagram, we can see that for complexes containing metal ions that have 1, 2, or 3 electrons, the nonbonding orbitals are available (after the six bonding orbitals are filled by electrons donated from the ligands) so the configurations will be $(t_{2g})^1$, $(t_{2g})^2$, or $(t_{2g})^3$, respectively. With the configuration d^4 the electron configuration will be $(t_{2g})^4$ or $(t_{2g})^3(e_g^*)^1$ depending on the magnitude of Δ_o . This was also the case when bonding was described using the ligand field approach. It is also interesting to note that without placing electrons in any of the antibonding orbitals, the maximum number of electrons that can be accommodated is 18. It is thus apparent that the 18-electron rule corresponds to a closed-shell arrangement of the bonding molecular orbitals.

As was shown earlier in this chapter, when four ligands are placed around a metal in a tetrahedral arrangement, the d orbitals are split into two sets, the t_2 and e subgroups (which are the d_{xy} , d_{yz} , and d_{xz} and the $d_{x^2-y^2}$ and d_{z^2} orbitals, respectively). The interactions of the orbitals on the metal (which we will consider to be a first-row metal) and ligands combine with different requirements on the symmetry of the ligand group orbitals. The four ligands can be considered on alternate corners of a cube containing the metal in the center. This structure is shown in Figure 17.17. Also shown in the figure

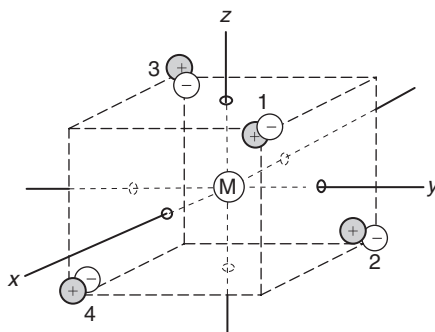

■ **FIGURE 17.17** A tetrahedral complex with the lobes of the $d_{x^2-y^2}$ and d_{z^2} orbitals directed between the ligands. These are nonbonding orbitals in a tetrahedral complex. The ligand orbitals have the positive lobes on ligands 1 and 2 pointed toward the metal, but ligands 3 and 4 have the negative lobes pointed toward the metal.

are the orbitals on the four ligands that interact with the metal orbitals. The ligand orbitals are represented by positive and negative lobes as if they might be p orbitals, but they can be σ bonding orbitals of other types such as sp^3 orbitals on ammonia molecules. By visualizing in turn each of the d orbitals, it can be seen how the combinations of metal orbitals and ligand group orbitals arise.

As was shown in Chapter 5 (see Table 5.2), the s and p orbitals in tetrahedral symmetry become a_1 and t_2 , respectively. Because the orbital on the metal is symmetric in all directions, it gives σ orbitals with the four ligand group orbitals (which give an a_1 orbital and a set of t_2 orbitals). However, the $d_{x^2-y^2}$ and d_{z^2} orbitals, which have lobes lying along the axes, are pointing between the ligand orbitals. For example, in Figure 17.17, the positive orbital on ligand 1 points toward the metal and hence toward the d_{z^2} orbital. This is cancelled by the negative lobe of ligand 3, which points toward the d_{z^2} . The result is that there is no *net* overlap between the ligands and the d_{z^2} orbital, so it is nonbonding in character. By examining Figure 17.17 in terms of the interaction of the ligand metal orbitals, we would find that the $d_{x^2-y^2}$ orbital is also nonbonding. The $d_{x^2-y^2}$ and d_{z^2} orbitals are identified as the e orbitals. Note that since a tetrahedron does not have a center of symmetry, the g subscript is not used.

When we consider the p_x orbital, we see that the positive lobe projects in the x direction along the axis. Therefore, the appropriate combination of ligand orbitals to match the symmetry of that lobe requires

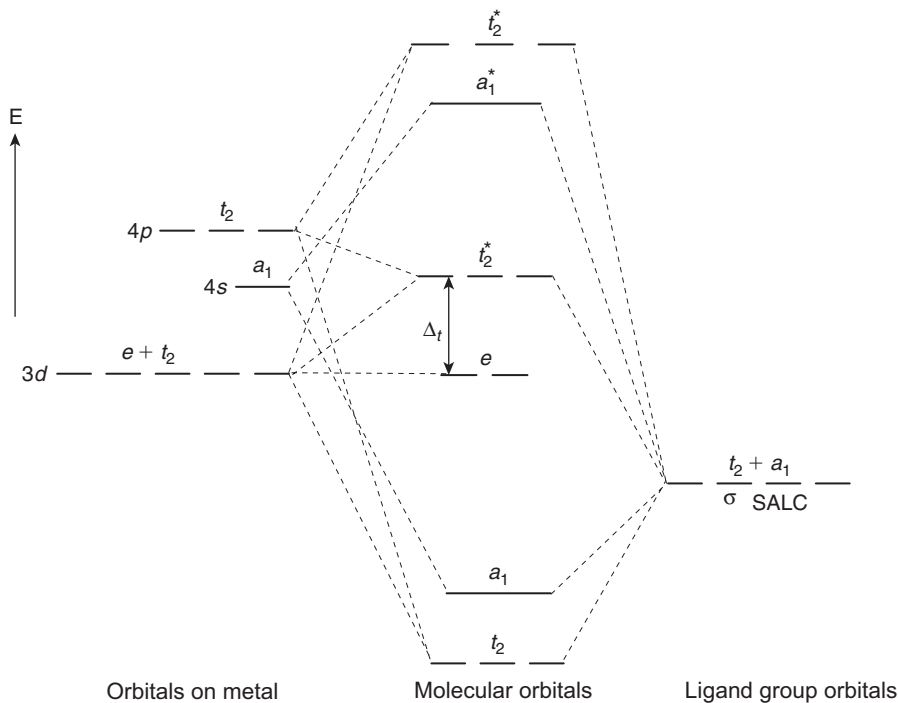

■ FIGURE 17.18 A qualitative molecular orbital diagram for a tetrahedral complex.

a positive sign on the combination. The lobe that projects along the negative x axis projects between two ligands, so the combination of ligands on the two nearest corners of the cube (3 and 4) must be negative. We could progress in a similar way to find that the d_{xy} , d_{yz} , and d_{zx} orbitals, which were non-bonding in an octahedral complex, are now σ bonding, but they also have the ability to combine with ligand orbitals to form π bonds. Although we will not write out the molecular wave functions as was done for the octahedral case, a qualitative molecular orbital diagram that results is shown in Figure 17.18.

From a consideration of the combination of ligand and metal orbitals, it should be apparent that the overlap is much more effective in an octahedral complex (in which orbitals are directed at ligands) than in a tetrahedral complex (where orbitals are directed between ligands). The result is that the energy difference between the e and t_2^* orbitals in a tetrahedral complex is much smaller than that between the t_{2g} and e_g orbitals in an octahedral complex. As we saw when considering the two types of complexes by means of ligand field theory, Δ_t is only about half as large as Δ_o in most cases.

In addition to complexes having octahedral and tetrahedral geometry, there are numerous examples of square planar complexes. As we saw in Chapter 16, such cases are most prevalent when the metal is a d^8 ion and the ligands generate strong ligand fields. When considering orbital overlap between the metal and ligand orbitals, it is sometimes convenient to consider a square planar complex as an octahedral complex in which the ligands on the z -axis have been removed. That approach is useful when considering how the metal orbitals interact with the four ligands in a plane. Note that the four ligands are numbered as shown in Figure 17.14 except for positions 5 and 6 being omitted. In D_{4h} symmetry the d orbitals are split into the b_{1g} ($d_{x^2-y^2}$), b_{2g} (d_{xy}), a_{1g} (d_{z^2}), and e_g (d_{xz} and d_{yz}) subsets. The p_x and p_y orbitals point directly at ligands and in D_{4h} symmetry they constitute an e_u set. The p_z orbital has a_{2u} symmetry, and the four σ orbitals from the ligands give a_{1g} , e_u , and b_{1g} symmetry. Therefore, the b_{2g} , e_g , and a_{2u} behave as nonbonding orbitals.

The pictorial approach that was taken with the octahedral complex can be used in this case to determine the symmetry character of the ligand group orbitals. We first consider the ligands interacting with the s orbital on the metal as shown in Figure 17.19a. The combination of ligand group orbitals matching the symmetry of the s orbital is

$$(\phi_1 + \phi_2 + \phi_3 + \phi_4)$$

When considering the interaction between the four ligands and the d_{z^2} metal orbital, it is seen that the positive lobes along the z -axis do not interact with the ligand σ orbitals, but the "ring" that has negative symmetry interacts with the four ligands. This is illustrated in Figure 17.19b. Given the symmetry of the metal orbital, the appropriate combination of ligand orbitals can be written as

$$(-\phi_1 - \phi_2 - \phi_3 - \phi_4) = -(\phi_1 + \phi_2 + \phi_3 + \phi_4)$$

When we consider the four ligands lying on the x and y axes (as shown in Figure 17.19), it becomes apparent that the $d_{x^2-y^2}$ orbital has positive lobes along the x -axis and negative lobes along the

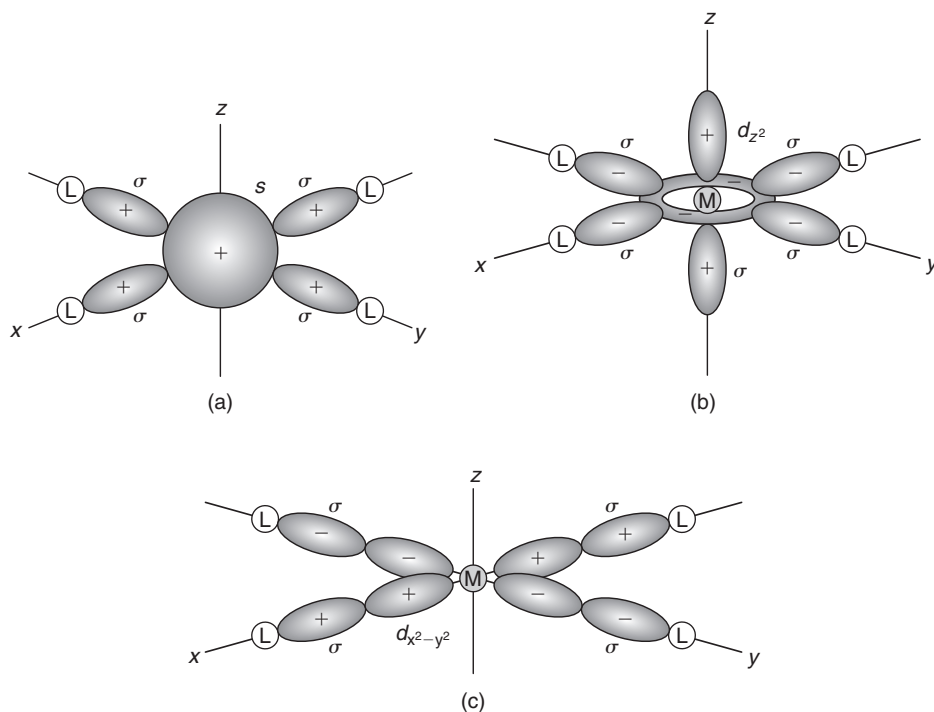

■ **FIGURE 17.19** The combinations of metal and ligand orbitals in a square planar complex. Although not shown, the p_x and p_y orbitals are directed toward the ligands in the same way as are the lobes of the $d_{x^2-y^2}$ orbital. The p orbitals have positive and negative lobes along *each* axis rather than positive on the x -axis and negative on the y -axis as in the case of the $d_{x^2-y^2}$ orbital.

y -axis. As a result, the combination of ligand orbitals that matches the symmetry of the $d_{x^2-y^2}$ orbital is

$$\left[\frac{1}{2}(\phi_1 - \phi_2 + \phi_3 - \phi_4) \right]$$

Although we will not write the complete wave functions as we did for the case of an octahedral complex, the molecular orbitals give rise to the energy level diagram shown in Figure 17.20.

From the molecular orbital energy level diagram shown in Figure 17.20, it can be seen that the orbitals designated as e_g , a_{1g} , and b_{1g}^* correspond to the d_{xz} , d_{yz} , d_{z^2} , and d_{xy} orbitals in the ligand field diagram shown in Figure 17.9. In the ligand field model, Δ represented the difference in energy between the d_{xy} and the $d_{x^2-y^2}$ orbitals. In the molecular orbital model, Δ represents the difference in energy between the e_g and a_{1g} orbitals. The arrangement of molecular orbitals in the diagram also shows that d^8 ions would be likely candidates for forming square planar complexes because they would represent a closed-shell arrangement with an a_{1g} orbital and all of the molecular orbitals of lower energy being filled. Although the same conclusion was reached in a different way earlier in this chapter, it is gratifying to see that even on an elementary level, the ligand field and molecular orbital approaches lead to

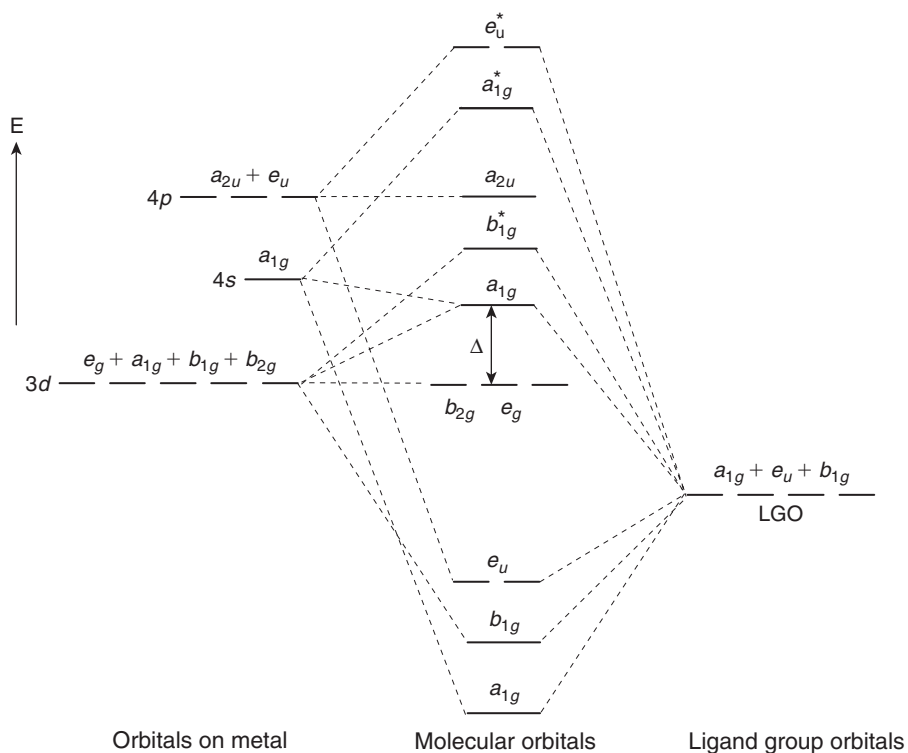

■ FIGURE 17.20 A molecular orbital energy level diagram for a square planar complex.

similar conclusions. However, it should be mentioned that the molecular orbital methodology has evolved to a much higher level than the rudimentary overview that is presented here. High-level calculations are now considered routine.

■ REFERENCES FOR FURTHER STUDY

- Ballhausen, C. J. (1962). *Introduction to Ligand Field Theory*. McGraw-Hill, New York. One of the early classics on crystal and ligand field theory.
- Drago, R. S. (1992). *Physical Methods for Chemists*. Saunders College Publishing, Philadelphia. This book presents high-level discussion of many topics in coordination chemistry. Highly recommended.
- Figgis, B. N. (1987). "Ligand Field Theory," in G. Wilkinson, Ed. *Comprehensive Coordination Chemistry*. Pergamon, Oxford, UK. Higher level coverage of ligand field theory.
- Figgis, B. N., and Hitchman, M. A. (2000). *Ligand Field Theory and Its Applications*. Wiley, New York. An advanced treatment of ligand field theory.
- Jørgensen, C. K. (1971). *Modern Aspects of Ligand Field Theory*. North Holland, Amsterdam. An excellent, high-level book.

- Kettle, S. F. A. (1969). *Coordination Chemistry*. Appleton, Century, Crofts, New York. A good introductory book that presents crystal field theory in a clear manner.
- Kettle, S. F. A. (1998). *Physical Inorganic Chemistry: A Coordination Approach*. Oxford University Press, New York. An excellent book on coordination chemistry that gives good coverage to many areas, including ligand field theory.
- Porterfield, W. W. (1993). *Inorganic Chemistry: A Unified Approach*, 2nd ed. Academic Press, San Diego, CA. Chapter 11 presents a good introduction to ligand field theory.

■ QUESTIONS AND PROBLEMS

- Consider a linear complex with the two ligands lying on the z axis. Sketch the splitting pattern for the d orbitals that would result.
- For each of the following complexes, give the hybrid orbital type and the number of unpaired electrons:
(a) $[\text{Co}(\text{H}_2\text{O})_6]^{2+}$; (b) $[\text{FeCl}_6]^{3-}$; (c) $[\text{PdCl}_4]^{2-}$; (d) $[\text{Cr}(\text{H}_2\text{O})_6]^{2+}$; (e) $[\text{Mn}(\text{NO}_2)_6]^{3-}$
- If the complex $[\text{Ti}(\text{H}_2\text{O})_4]^{3+}$ existed, what would be the approximate value for Dq ?
- For each of the following, sketch the arrangement of the d orbitals and put in electrons appropriately.
(a) $[\text{Cr}(\text{CN})_6]^{3-}$; (b) $[\text{FeF}_6]^{3-}$; (c) $[\text{Co}(\text{NH}_3)_6]^{3+}$; (d) $[\text{Ni}(\text{NO}_2)_4]^{2-}$; (e) $[\text{Co}(\text{CN})_5]^{3-}$
- For each of the complexes listed in question 4, write the formula for a specific ligand that would give a different result for the same metal ion.
- For each of the following, sketch the arrangement of the d orbitals and put in electrons appropriately.
(a) $[\text{Mn}(\text{NO}_2)_6]^{3-}$; (b) $[\text{Fe}(\text{H}_2\text{O})_6]^{3+}$; (c) $[\text{Co}(\text{en})_3]^{3+}$; (d) $[\text{NiCl}_4]^{2-}$; (e) $[\text{CoF}_6]^{3-}$
- For each of the complexes listed in question 6, write the formula for a specific ligand that would give a different result for the same metal ion.
- Which of the following complexes would undergo Jahn-Teller distortion?
(a) $[\text{FeCl}_6]^{3-}$; (b) $[\text{MnCl}_6]^{3-}$; (c) $[\text{CuCl}_6]^{4-}$; (d) $[\text{CrCl}_6]^{3-}$; (e) $[\text{VCl}_6]^{4-}$
- (a) Complexes of Fe^{3+} with several weak field ligands are only weakly colored and the color is not very different for any of the ligands. Explain in terms of crystal field theory why this is so.
(b) Complexes of Fe^{3+} with strong field ligands are deeply colored and the color depends greatly on the nature of the ligand. Explain this observation in terms of crystal field theory.
- Make a sketch of a cubic complex (start with a tetrahedral complex and add four ligands). Analyze the repulsion of each of the d orbitals and sketch the splitting pattern that would exist in a cubic field.
- Would Jahn-Teller distortion be as significant for tetrahedral complexes as it is for octahedral complexes? For which of the electron configurations would Jahn-Teller distortion occur?
- Determine the ligand field stabilization energy for d^0 – d^{10} ions in tetrahedral complexes. Although there are no low-spin tetrahedral complexes, assume that there are.
- Explain why tetrahedral complexes of Co^{2+} are generally more stable than those of Ni^{2+} .
- Although Ni^{2+} forms some tetrahedral complexes, Pd^{2+} and Pt^{2+} do not. Explain this difference.
- The magnetic moment of $[\text{Co}(\text{py})_2\text{Cl}_2]$ is 5.15 BM. Describe the structure of this compound.

This page intentionally left blank

Interpretation of Spectra

In the previous chapter the topic of spectral studies on coordination compounds was introduced only briefly in connection with ligand field theory, and some of the attendant problems that are associated with interpreting the spectra were described. In this chapter, a more complete description will be presented of the process of interpreting spectra of complexes. It is from the analysis of spectra that we obtain information about energies of spectroscopic states in metal ions and the effects produced by different ligands on the d orbitals. However, it is first necessary to know what spectroscopic states are appropriate for various metal ions. The analysis then progresses to how the spectroscopic states for the metal ions are affected by the presence of the ligands and how ligand field parameters are determined for spectral data.

18.1 SPLITTING OF SPECTROSCOPIC STATES

As we have seen, an understanding of spin-orbit coupling is necessary to determine the spectroscopic states that exist for various electron configurations, d^n (see Section 2.6). Because they will be needed frequently in this chapter, the spectroscopic states that result from spin-orbit coupling in d^n ions that have degenerate d orbitals are summarized in Table 18.1.

The spectroscopic states shown in Table 18.1 are those that arise for the so-called *free* or *gaseous* ion. When a metal ion is surrounded by ligands in a coordination compound, those ligands generate an electrostatic field that removes the degeneracy of the d orbitals. The result is that e_g and t_{2g} subsets of orbitals are produced. Because the d orbitals are no longer degenerate, spin-orbit coupling is altered so that the states given in Table 18.1 no longer apply to a metal ion *in a complex*. However, just as the d orbitals are split in terms of their energies, the *spectroscopic states* are split in the ligand field. The spectroscopic states are split into components that have the same multiplicity as the free ion states from which they arise. A single electron in a d orbital gives rise to a 2D term for the gaseous ion, but in an octahedral field the electron will reside in a t_{2g} orbital, and the spectroscopic state for the t_{2g}^1 configuration is ${}^2T_{2g}$. If the electron were excited to an e_g orbital, the spectroscopic state would be 2E_g . Thus, transitions between ${}^2T_{2g}$ and 2E_g states would not be spin forbidden because both states are doublets. Note that lowercase letters are used to describe *orbitals*, whereas capital letters describe spectroscopic *states*.

Table 18.1 Spectroscopic States for Gaseous Ions Having d^n Electron Configurations^a.

Ion	Spectroscopic states
d^1, d^9	2D
d^2, d^8	$^3F, ^3P, ^1G, ^1D, ^1S$
d^3, d^7	$^4F, ^4P, ^2H, ^2G, ^2F, ^2D, ^2P$
d^4, d^6	$^5D, ^3H, ^3G, ^2^3F, ^3D, ^2^3P, ^1I, ^2^1G, ^1F, ^2^1D, ^2^1S$
d^5	$^6S, ^4G, ^4F, ^4D, ^4P, ^2I, ^2H, ^2^2G, ^2^2F, ^3^2G, ^3^2D, ^2P, ^2S$

^a 2^3F means two distinct 3F terms arise, etc.

Table 18.2 Splitting of Spectroscopic States in a Ligand Field^a.

Gaseous Ion spectroscopic state	Components in an octahedral field	Total degeneracy
S	A_{1g}	1
P	T_{1g}	3
D	$E_g + T_{2g}$	5
F	$A_{2g} + T_{1g} + T_{2g}$	7
G	$A_{1g} + E_g + T_{1g} + T_{2g}$	9
H	$E_g + 2 T_{1g} + T_{2g}$	11
I	$A_{1g} + A_{2g} + E_g + T_{1g} + 2 T_{2g}$	13

^aLigand field states have the same multiplicity as the spectroscopic state from which they arise.

A gaseous ion having a d^2 configuration gives rise to a 3F ground state as a result of spin-orbit coupling. Although they will not be derived, in an octahedral ligand field the t_{2g}^2 configuration gives three different spectroscopic states that are designated as $^3A_{2g}$, $^3T_{1g}$, and $^3T_{2g}$. These states are often referred to as *ligand field states*. The energies of the three states depend on the strength of the ligand field, but the relationship is not a simple one. The larger the ligand field splitting, the greater the difference between the ligand field states of the metal. For the time being, we will assume that the function is linear, but it will be necessary to refine this view later. Table 18.2 shows a summary of the states that result from splitting the gaseous state terms of metal ions in an octahedral field produced by six ligands.

Figure 18.1 shows the approximate energies of the ligand field spectroscopic states as a function of the field strength for all d^n ions. In the drawings, the states are assumed to be linear functions of Δ_o , but this is not correct over a wide range of field strength. For the d^1 ion, the 2D ground state is split into $^2T_{2g}$ and 2E_g states in the ligand field. As the field strength, Δ_o , increases, a center of energy is maintained

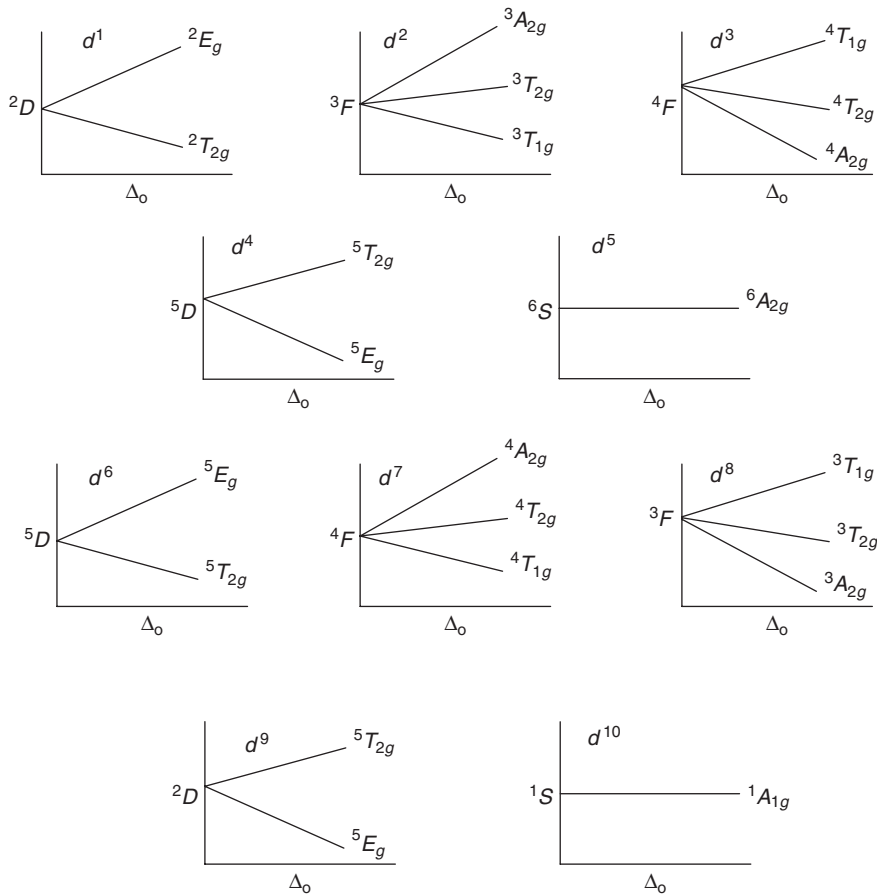

■ FIGURE 18.1 The splitting patterns for ground-state D and F terms in an octahedral field.

for the energies of the ${}^2T_{2g}$ and 2E_g states in exactly the same way that a center of energy is maintained by the t_{2g} and e_g orbital subsets. Therefore, in order to give no *net* change in energy, the slope of the line for the 2E_g state is $+(3/5)\Delta_o$, whereas that of the ${}^2T_{2g}$ state is $-(2/5)\Delta_o$.

Note that the ground-state terms for d^n ions (except for d^5) are all either D or F terms and that the state splitting occurs so that the center of energy is maintained. For the ligand field states that are produced by splitting the 3F term (which results from a d^2 configuration), the center of energy is also preserved even though there are three states in the ligand field. By looking at Table 18.2, it can be seen that all of the states that arise from splitting the D and F ground states for the gaseous ions have T , E , or A designations. When describing the splitting of the d orbitals in an octahedral field (see Chapter 17), the “ t ” orbitals were seen to be triply degenerate, whereas the “ e ” orbitals were doubly degenerate. We can consider the *spectroscopic states* in the ligand field to have the same degeneracies as the *orbitals*,

which makes it possible to preserve the center of energy. For example, the lines representing the ${}^2T_{2g}$ and 2E_g states have slopes of $-(2/5)\Delta_o$ and $+(3/5)\Delta_o$, respectively. Taking into account the degeneracies of the states, the energy of *sum* of the two subsets is

$$3[-(2/5)\Delta_o] + 2[+(3/5)\Delta_o] = 0$$

This result shows that even though the two states have energies that depend on the magnitude of the ligand field splitting, the *overall* energy change is 0. For purposes of determining the center of energy, an "A" state can be considered as being singly degenerate. When the 3F state corresponding to the d^2 configuration is split into ${}^3A_{2g}$, ${}^3T_{1g}$, and ${}^3T_{2g}$ components, the slopes of the lines must be such that the overall energy change is 0. Thus, the slopes of the lines and the multiplicities are related by

$$\underset{(T)}{3[-(3/5)\Delta_o]} + \underset{(T)}{3[+(1/5)\Delta_o]} + \underset{(A)}{1[+(6/5)\Delta_o]} = 0$$

which shows that the three ligand field states yield the energy of the 3F gaseous ion state as the center of energy.

From the diagrams shown in Figure 18.1, it can be seen that the splitting pattern for a d^4 ion is like that for d^1 ion except for being inverted and the states having the appropriate multiplicities. Likewise, the splitting pattern for a d^3 ion is like that for d^2 except for being inverted and the multiplicity being different. The reason for this similarity is the "electron-hole" behavior that is seen when the spectroscopic states for configurations such as p^1 and p^5 are considered. Both give rise to a 2P spectroscopic state, and only the J values are different. It should be apparent from the diagrams shown in Figure 18.1 that the ligand field splitting pattern is the same for d^1 and d^6 , d^2 and d^7 , and so forth, except for the multiplicity. In fact, it is easy to see that this will be true for any d^n and d^{5+n} configurations. It is also apparent that the singly degenerate "A" states that arise from the S states for d^5 and d^{10} configurations are not split in the ligand field. All of the ligand field components and their energies in an octahedral field are summarized in Table 18.3.

When a transition metal ion is surrounded by ligands that generate a tetrahedral field, the splitting pattern of the d orbitals is inverted when compared to that in an octahedral field. As a result, the e orbitals lie lower than the t_2 set (note that there is no subscript "g" because a tetrahedron does not have a center of symmetry). A further consequence is that the energies of the ligand field spectroscopic states shown in Table 18.3 are also reversed in order compared to their order in octahedral fields. For example, in an octahedral field, the d^2 ion gives the states (in order of increasing energy) ${}^3T_{1g}$, ${}^3T_{2g}$, and ${}^3A_{2g}$ as shown in Table 18.3. In a tetrahedral field, the order of increasing energy for the states arising from a d^2 ion would be 3A_2 , 3T_2 , and 3T_1 .

For a specific d^n electron configuration, there are usually several spectroscopic states that correspond to energies above the ground state term. However, they may not have the same *multiplicity* as the ground state. When the spectroscopic state for the free ion becomes split in an octahedral field, each ligand field component has the same multiplicity as the ground state (see Table 18.3). *Transitions between spectroscopic states having different multiplicities are spin forbidden.* Because the T_{2g} and E_g spectroscopic

Table 18.3 Energies of Octahedral Ligand Field States in Terms of Δ_o .

Ion	State	Octahedral field states	Energies in octahedral field
d^1	2D	${}^2T_{2g} + {}^2E_g$	$-(2/5)\Delta_o + (3/5)\Delta_o$
d^2	3F	${}^3T_{1g} + {}^3T_{2g} + {}^3A_{2g}$	$-(3/5)\Delta_o + (1/5)\Delta_o + (6/5)\Delta_o$
d^3	4F	${}^4A_{2g} + {}^4T_{2g} + {}^4T_{1g}$	$-(6/5)\Delta_o - (1/5)\Delta_o + (3/5)\Delta_o$
d^4	5D	${}^5E_g + {}^5T_{2g}$	$-(3/5)\Delta_o + (2/5)\Delta_o$
d^5	6S	${}^6A_{1g}$	0
d^6	5D	${}^5T_{2g} + {}^5E_g$	$-(2/5)\Delta_o + (3/5)\Delta_o$
d^7	4F	${}^4T_{1g} + {}^4T_{2g} + {}^2A_{2g}$	$-(3/5)\Delta_o + (1/5)\Delta_o + (6/5)\Delta_o$
d^8	3F	${}^3A_{2g} + {}^3T_{2g} + {}^3T_{1g}$	$-(6/5)\Delta_o - (1/5)\Delta_o + (3/5)\Delta_o$
d^9	2D	${}^2E_g + {}^2T_{2g}$	$-(3/5)\Delta_o + (2/5)\Delta_o$
d^{10}	1S	1A_g	0

Ligand field state of lowest energy given first, and energies are listed in the same order.

states in a ligand field have the same multiplicity as the ground states from which they arise, it can be seen that the $T_{2g} \rightarrow E_g$ transition is the only spin-allowed transition for ions that have D ground states. In cases where the ground state is an F term, there is a P state of higher energy that has the same multiplicity. That state gives a T_{1g} state (designated as $T_{1g}(P)$) having the same multiplicity as the ground-state T_{1g} term. Accordingly, spectroscopic transitions are possible from the ground state in the ligand field to the T state that arises from the P term. Therefore, for ions having T and A ground states, the spin-allowed transitions in an octahedral field are as follows:

Octahedral Field			
For T ground states:		For A ground states:	
ν_1	$T_{1g} \rightarrow T_{2g}$	ν_1	$A_{2g} \rightarrow T_{2g}$
ν_2	$T_{1g} \rightarrow A_{2g}$	ν_2	$A_{2g} \rightarrow T_{1g}$
ν_3	$T_{1g} \rightarrow T_{1g}(P)$	ν_3	$A_{2g} \rightarrow T_{1g}(P)$

The spin-allowed transitions for ions having T and A ground states in tetrahedral fields are as follows:

Tetrahedral Field			
For T ground states:		For A ground states:	
ν_1	$T_1 \rightarrow T_2$	ν_1	$A_2 \rightarrow T_2$
ν_2	$T_1 \rightarrow A_2$	ν_2	$A_2 \rightarrow T_1$
ν_3	$T_1 \rightarrow T_1(P)$	ν_3	$A_2 \rightarrow T_1(P)$

As shown, for both octahedral and tetrahedral complexes, *three* absorption bands are expected. Many complexes do, in fact, have absorption spectra that show three bands. However, charge transfer absorption makes it impossible in some cases to see all three bands, so spectral analysis must often be based on only one or two observed bands.

18.2 ORGEL DIAGRAMS

The splitting patterns of the spectroscopic states that are shown in Table 18.3 can be reduced to graphical presentation in two diagrams. These diagrams were developed by L. E. Orgel, and they have since become known as *Orgel diagrams*. Figure 18.2 shows the Orgel diagram that is applicable for ions that give *D* ground states.

In an Orgel diagram, energy is represented as the vertical dimension, and the vertical line in the center of the diagram represents the gaseous ion where there is no ligand field ($\Delta = 0$). Note that the right-hand side of the diagram applies to d^1 and d^6 ions in *octahedral* fields or d^4 and d^9 ions in *tetrahedral* fields. This situation arises because the ligand field states are inverted for the two cases, and the electron-hole formalism also causes the orbitals to be inverted. As a result, the ligand field states are the same for a d^1 ion in an octahedral field as they are for a d^4 ion in a tetrahedral field.

The left-hand side of the Orgel diagram shown in Figure 18.2 applies to d^4 and d^9 ions in *octahedral* fields or to d^1 and d^6 ions in *tetrahedral* fields. Note that the *g* subscripts have been deleted on the left-hand side of the diagram. Although *both* sides of the diagram can apply to tetrahedral or octahedral complexes in some cases, it is customary to show the *g* on one side of the diagram but not on the other. This does *not* mean that one side of the diagram applies to tetrahedral complexes and the other to octahedral complexes. *Both* sides apply to *both* types of complexes. It should also be remembered that the magnitude of the splitting is quite different for the two types of complexes because Δ_t is approximately $(4/9)\Delta_o$.

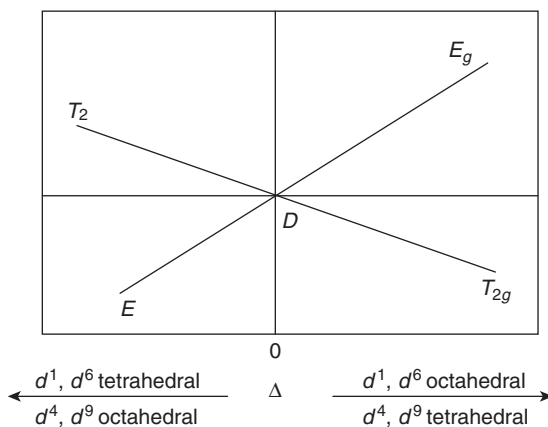

■ **FIGURE 18.2** An Orgel diagram for metal ions having *D* spectroscopic ground states. The multiplicity of the *D* state is not specified because it is determined by the number of electrons in the *d* orbitals of the metal ion.

The Orgel diagram that applies to ions that have F spectroscopic ground states is shown in Figure 18.3. This diagram also includes the P state, which has higher energy because in an octahedral ligand field that state becomes a T_{1g} state (T_1 in a tetrahedral field) that has the same multiplicity as the ground state. Therefore, spectral transitions are spin-allowed between the ground state and the excited state arising from the P state.

For octahedral complexes containing d^2 and d^7 ions, the ground state is T_{1g} , which we will designate as $T_{1g}(F)$ to show that it arises from the F ground state of the free ion rather than the P state. Note that the lines representing the $T_{1g}(F)$ and $T_{1g}(P)$ in the Orgel diagram are curved, with the curvature increasing as the magnitude of Δ increases. These states represent quantum mechanical states that have identical designations, and it is a characteristic of such states that they cannot represent the same energy. Therefore, these states interact strongly and repel each other. This phenomenon is often referred to as the *noncrossing rule*.

As has been stated, the multiplicity of the ligand field states is the same as the multiplicity of the ground-state term from which they arise. Therefore, a d^2 ion gives a 3F ground state that is split into the triplet ${}^3T_{1g}$, ${}^3T_{2g}$, and ${}^3A_{2g}$ states in an octahedral field. From the diagram, we can see that the possible spectral transitions are those from the ${}^3T_{1g}$ state to the three ligand field states of higher energy. On this basis, the Orgel diagram allows us to predict that three bands should be observed in the spectrum for a d^2 ion in an octahedral field. Frequently, the spectra of such complexes contain fewer than three bands, and there may be some ambiguity in assigning the bands to specific transitions. One reason why the assignment of some bands may be uncertain is that there may be charge transfer bands that occur in the same region of the spectrum (see Section 18.8). These bands are often intense, and they may mask the so-called $d-d$ transitions. Another factor that may complicate band assignment is that some of the bands are quite weak so they may be difficult to identify in the presence of other strong

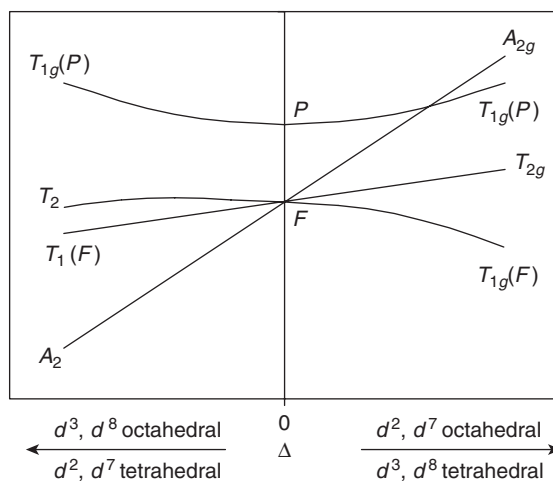

■ **FIGURE 18.3** An Orgel diagram for metal ions having F spectroscopic ground states. The multiplicity of the F state is not specified. The P state having the same multiplicity as the ground state is also shown.

bands. The point is that for many complexes, matching the observed bands in the spectrum is not necessarily a simple, straightforward matter. Moreover, the Orgel diagrams are only qualitative, so we need a more quantitative method if we are to be able to perform calculations to obtain Δ and other ligand field parameters.

In the previous discussion, only the ligand field states that arise from the free ion ground state and excited states having the same multiplicity were considered. However, other spectroscopic terms exist for the free ion (see Table 18.1). For example, if a d^2 ion is considered, the ground state is 3F , but the other states are 3P , 1G , 1D , and 1S . When spectral transitions are considered, only the 3F and 3P states concern us. We do need to understand that because of the noncrossing rule, some of the energies of the states will deviate from linear functions of Δ . A d^2 electron configuration corresponds to Ti^{2+} , V^{3+} , and Cr^{4+} ions, but even for the free ions the spectroscopic states have different energies. For the free ions, the energies of the spectroscopic states are shown in Table 18.4.

The energies shown in Table 18.4 make it clear that a *complete* energy level diagram for a d^2 ion in an octahedral ligand field will be dependent on the specific metal ion being considered. Furthermore, the energies of states that have identical designations will obey the noncrossing rule so that they will vary in a nonlinear way with the field strength.

18.3 RACAH PARAMETERS AND QUANTITATIVE METHODS

From the preceding discussion, it is clear that we should expect a maximum of three spin-allowed transitions regardless of the d^n configuration of the metal ion. Because of spin-orbit coupling, the interelectronic repulsion is different for the various spectroscopic states in the ligand field. The ability of the electrons to be permuted among a set of degenerate orbitals and interelectron repulsion are both important considerations (see Chapter 2). By use of quantum-mechanical procedures, these energies can be expressed as integrals. One of the methods makes use of integrals that are known as the Racah parameters. There are three parameters, A , B , and C , but if only *differences* in energies are considered, the parameter A is not needed. The parameters B and C are related to the coulombic and exchange

Table 18.4 Energies of Spectroscopic Terms for Gaseous d^2 Ions.

Term	Spectroscopic state energies, cm^{-1}		
	Ti^{2+}	V^{3+}	Cr^{4+}
3F	0	0	0
1D	8,473	10,540	13,200
3P	10,420	12,925	15,500
1G	14,398	17,967	22,000

$$349.8 \text{ cm}^{-1} = 1 \text{ kcal mol}^{-1} = 4.184 \text{ kJ mol}^{-1}.$$

energies, respectively, that are a result of electron pairing. For an ion that has a d^2 configuration, it can be shown that the 3F state has an energy that can be expressed as $(A - 8B)$, whereas that of the 3P state is $(A + 7B)$. Accordingly, the difference in energy between the two states can be expressed in terms of B only because the parameter A cancels. When states having a different multiplicity than the ground state are considered, the difference in energy is expressed in terms of both B and C .

Although the energies of the spectroscopic states of first row d^2 ions were shown in Table 18.4, compilations exist for all gaseous metal ions. The standard reference is a series of volumes published by the National Institute of Standards and Technology (C. E. Moore, *Atomic Energy Levels*, National Bureau of Standards Circular 467, Vol. I, II, and III, 1949). Table 18.5 shows the energies for the spectroscopic states in d^n ions in terms of the Racah B and C parameters.

For the cases where the ground state of a free ion is an F term, the difference in energy between the ground state and the first excited state having the same multiplicity (a P term) is defined as $15B$, which is $(A + 7B) - (A - 8B)$. This is analogous to the case of splitting of d orbitals in a ligand field where the difference in energy is represented as $10Dq$. The parameter B is simply a unit of energy whose numerical value depends on the particular ion considered. For d^2 and d^8 ions,

$$15B = {}^3F \rightarrow {}^3P \quad (18.1)$$

where ${}^3F \rightarrow {}^3P$ means the energy difference between the two states. For d^3 and d^7 ions,

$$15B = {}^4F \rightarrow {}^4P \quad (18.2)$$

It can be seen from Table 18.5 that all excited spectroscopic states having a multiplicity that is *different* from the ground state have energies that are expressed in terms of both B and C . As we have seen from the previous discussion, spin-allowed transitions occur only between states having the *same* multiplicity. Therefore, in the analysis of spectra of complexes only B must be determined. It is found for some complexes that $C \approx 4B$, and this approximation is adequate for many uses.

The discussion so far has concerned the Racah parameters for *gaseous* ions. For example, the d^2 ion Ti^{2+} has a 3P state that lies $10,420\text{ cm}^{-1}$ above the 3F ground state, so $15B = 10,420\text{ cm}^{-1}$ and B is 695 cm^{-1} for this ion. Using this value for B results in an approximate value of 2780 cm^{-1} as the value of C for

Table 18.5 Energies of Spectroscopic States for Free Ions in Terms of Racah Parameters.

d^2, d^8		d^3, d^7		d^5	
1S	$22B + 7C$	2H	$9B + 3C$	4F	$22B + 7C$
1G	$12B + 2C$	2P	$9B + 3C$	4D	$17B + 5C$
3P	$15B$	4P	$15B$	4P	$7B + 7C$
1D	$5B + 2C$	2G	$4B + 3C$	4G	$10B + 5C$
3F	0	4F	0	6S	0

the gaseous ion. For many complexes of +2 ions of first-row transition metals, B is in the range of 700 to 1000 cm^{-1} and C is approximately 2500 to 4000 cm^{-1} . For +3 ions of first-row metals, B is normally in the range 850 to 1200 cm^{-1} . For second- and third-row metal ions, the value of B is usually only about 600 to 800 cm^{-1} because interelectron repulsion is smaller for the larger ions.

When *complexes* of the metal ions are considered, the situation is considerably more complicated. The differences between energy states in the ligand field are related not only to the Racah parameters, but also to the magnitude of Δ (or Dq). As a result, the energies for the three spectral bands must be expressed in terms of both Dq and the Racah parameters. Because the observed spectral bands represent differences in energies between states having the same multiplicity, only the Racah B parameter is necessary. Even so, B is not a constant because it varies with the magnitude of the effect of the ligands on the d orbitals of the metal (the ligand field splitting). Analysis of the spectrum for a complex involves determining the value of Dq and B for *that complex*. Of course $\Delta = 10Dq$, and we have used Δ to describe orbital splitting more frequently up to this point. When dealing with spectral analysis, the discussion can also be presented with regard to Dq .

For metal ions having d^2 , d^3 , d^7 , and d^8 configurations, the ground state is an F state, but there is an excited P state that has the same multiplicity. For d^2 and d^7 ions in an *octahedral* field, the spectroscopic states are the same (except for the multiplicity) as they are for d^3 and d^8 ions in *tetrahedral* fields. Therefore, the expected spectral transitions will also be the same for the two types of complexes. The three spectral bands are assigned as follows ($T_{1g}(F)$ means the T_{1g} state arising from the F spectroscopic state):

$$\begin{aligned}\nu_1 T_{1g} & (F) \rightarrow T_{2g} \\ \nu_2 T_{1g} & (F) \rightarrow A_{2g} \\ \nu_3 T_{1g} & (F) \rightarrow T_{1g}(P)\end{aligned}$$

For octahedral complexes of d^2 and d^7 metal ions (or d^3 and d^8 ions in tetrahedral complexes), the energies corresponding to ν_1 , ν_2 , and ν_3 can be shown to be

$$E(\nu_1) = 5Dq - 7.5B + (225B^2 + 100Dq^2 + 180DqB)^{1/2} \quad (18.3)$$

$$E(\nu_2) = 15Dq - 7.5B + (225B^2 + 100Dq^2 + 180DqB)^{1/2} \quad (18.4)$$

$$E(\nu_3) = (225B^2 + 100Dq^2 + 180DqB)^{1/2} \quad (18.5)$$

The third band corresponds to the difference in energy between the $T_{1g}(F)$ and $T_{1g}(P)$ states that arises from splitting the F and P states. In the limit where $Dq = 0$ (as it is for a gaseous ion), the energy reduces to $(225B^2)^{1/2}$, which is $15B$. That is precisely the difference in energy between the F and P spectroscopic states.

The corresponding energies for the spectral transitions that occur for d^3 and d^8 ions in octahedral fields (or d^2 and d^7 ions in tetrahedral fields) are as follows:

$$E(\nu_1) = 10Dq \quad (18.6)$$

$$E(\nu_2) = 15Dq + 7.5B - 1/2(225B^2 + 100Dq^2 - 180DqB)^{1/2} \quad (18.7)$$

$$E(\nu_3) = 15Dq + 7.5B + 1/2(225B^2 + 100Dq^2 - 180DqB)^{1/2} \quad (18.8)$$

For these complexes, the first band corresponds directly to $10Dq$. If all three of the spectral bands are observed in the spectrum, it can be shown that

$$\nu_3 + \nu_2 - 3\nu_1 = 15B \quad (18.9)$$

The foregoing discussion applies to complexes that are weak-field cases. Spectral analysis for strong-field cases is somewhat different and will not be discussed here. For complete analysis of the spectra of strong-field complexes, see the book by A. B. P. Lever, *Inorganic Electronic Spectroscopy*, listed in the references at the end of this chapter.

It is possible to solve Eqs. (18.3) through (18.8) to obtain Dq and B for situations where two or more of the spectral bands can be identified. The resulting equations giving Dq and B as functions of frequencies of the spectral bands are shown in Table 18.6. Although the equations shown in Table 18.6 can be used to evaluate Dq and B , the positions of at least two spectral bands must be known and correctly assigned. Historically, other approaches to evaluating ligand field parameters have been developed, and they are still useful. In the remainder of this chapter, some of the other approaches will be described. In many cases, unambiguous interpretations of spectra are difficult because of factors such as charge transfer bands, absorptions by ligands, and lack of ideal symmetry caused by Jahn-Teller distortion (see Chapter 17). The discussion that follows will amplify the introduction presented so far, but for complete details of spectral interpretation, consult the reference works by Ballhausen, Jørgensen, and Lever listed in the references.

18.4 THE NEPHELAUXETIC EFFECT

When a metal ion is surrounded by ligands in a complex, the ligand orbitals being directed toward the metal ion produce changes in the total electron environment of the metal ion. One consequence is that the energy required to force pairing of electrons is altered. Although the energy necessary to force electron pairing in the gaseous ion can be obtained from tabulated energy values for the appropriate spectroscopic states, those values are not applicable to a metal ion that is contained in a complex. When ligands bind to a metal ion, the orbitals on the metal ion are “smeared out” over a larger region of space. The molecular orbital terminology for this situation is that the electrons become more delocalized in the complex than they are in the free ion. The expansion of the electron cloud is known as the *nephelauxetic effect*.

As a result of the nephelauxetic effect, the energy required to force pairing of electrons in the metal ion is somewhat smaller than it is for the free ion. When ligands such as CN^- are present, the nephelauxetic effect is quite large owing to the ability of the ligands to π bond to the metal as a result of back donation. As discussed in Chapter 17, antibonding orbitals on the CN^- have appropriate symmetry

Table 18.6 Equations for Calculating Dq and B from Spectra.	
Spectral bands known	Equations
Ions having "T" ground states	
ν_1, ν_2, ν_3	$Dq = (\nu_2 - \nu_1)/10$ $B = (\nu_2 + \nu_3 - 3\nu_1)/15$
ν_1, ν_2	$Dq = (\nu_2 - \nu_1)/10$ $B = \nu_1(\nu_2 - 2\nu_1)/(12\nu_2 - 27\nu_1)$
ν_1, ν_3	$Dq = [(5\nu_3^2 - (\nu_3 - 2\nu_1)^2)^{1/2} - 2(\nu_3 - 2\nu_1)]/40$ $B = (\nu_3 - 2\nu_1 + 10Dq)/15$
ν_2, ν_3	$Dq = [(85\nu_3^2 - 4(\nu_3 - 2\nu_2)^2)^{1/2} - 9(\nu_3 - 2\nu_2)]/340$ $B = (\nu_3 - 2\nu_2 + 30Dq)/15$
Ions having "A" ground states	
ν_1, ν_2, ν_3	$Dq = \nu_1/10$ $B = (\nu_2 + \nu_3 - 3\nu_1)/15$
ν_1, ν_2	$Dq = \nu_1/10$ $B = (\nu_2 - 2\nu_1)(\nu_2 - \nu_1)/(15\nu_2 - 27\nu_1)$
ν_1, ν_3	$Dq = \nu_1/10$ $B = (\nu_3 - 2\nu_1)(\nu_3 - \nu_1)/(15\nu_3 - 27\nu_1)$
ν_2, ν_3	$Dq = [(9\nu_2 + \nu_3) - (85(\nu_2 - \nu_3)^2 - 4(\nu_2 + \nu_3)^2)^{1/2}]/340$ $B = (\nu_2 + \nu_3 - 30Dq)/15$
Adapted from Y. Dou, <i>J. Chem. Educ.</i> 1990, 67, 134.	

to form π bonds to nonbonding d orbitals on the metal ion. As a result, the Racah parameters B and C for a metal ion are variables whose exact values depend on the nature of the ligands attached to the ion. The change in B from the free ion value is expressed as the *nephelauxetic ratio*, β , which is given by

$$\beta = \frac{B'}{B} \quad (18.10)$$

where B is the Racah parameter for the free metal ion and B' is the same parameter for the metal ion in the complex. C. K. Jørgensen devised a relationship to express the nephelauxetic effect as the product of a parameter characteristic of the ligand, h , and another characteristic of the metal ion, k . The mathematical relationship is

$$(1 - \beta) = hk \quad (18.11)$$

Table 18.7 Nephelauxetic Parameters for Metal Ions and Ligands*.

Metal Ion	<i>k</i> value	Ligand	<i>h</i> value
Mn ²⁺	0.07	F ⁻	0.8
V ²⁺	0.1	H ₂ O	1.0
Ni ²⁺	0.12	(CH ₃) ₂ NCHO	1.2
Mo ³⁺	0.15	NH ₃	1.4
Cr ³⁺	0.20	en	1.5
Fe ³⁺	0.24	ox ²⁻	1.5
Rh ³⁺	0.28	Cl ⁻	2.0
Ir ³⁺	0.28	CN ⁻	2.1
Co ³⁺	0.33	Br ⁻	2.3
Mn ⁴⁺	0.5	N ₃ ⁻	2.4
Pt ⁴⁺	0.6	I ⁻	2.7
Pd ⁴⁺	0.7		
Ni ⁴⁺	0.8		

*From C. K. Jørgensen, *Oxidation Numbers and Oxidation States*, Springer Verlag, New York, 1969, p. 106.

After substituting B'/B for β , the equation can be written as

$$B' = B - Bhk \quad (18.12)$$

From this equation, we see that the Racah parameter for the metal ion in a complex, B' , is the value for the gaseous ion *reduced* by a correction (expressed as Bhk) for the cloud-expanding effect. As should be expected, the effect is a function of the nature of the particular metal ion and ligand. As a result, analysis of the spectrum for a complex must be made to determine both Dq and B (which is actually B' for the complex). Table 18.7 shows values of the nephelauxetic parameters for ligands and metal ions.

The data shown in Table 18.7 indicate that the ability of a ligand to produce a nephelauxetic effect increases as the softness of the ligand increases. Softer ligands such as N_3^- , Br^- , CN^- , or I^- show a greater degree of covalency when bonded to metal ions, and they can more effectively delocalize electron density. It is also apparent that the nephelauxetic effect is greater for metal ions that are more highly charged. This is to be expected because these smaller, harder metal ions will experience a greater reduction in interelectronic repulsion by expanding the electron cloud than will a larger metal ion of lower charge. As the data show, the nephelauxetic effect correlates well with the hard-soft interaction principle.

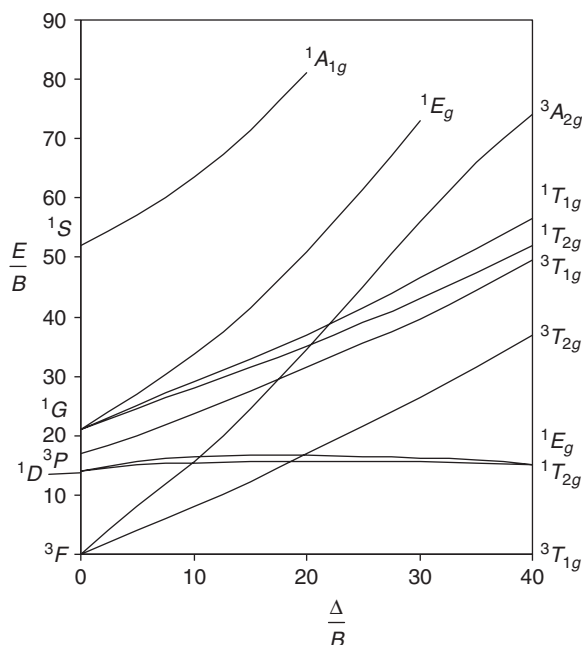

■ **FIGURE 18.4** A complete Tanabe-Sugano diagram for a d^2 metal ion in an octahedral field. When $\Delta = 0$, the spectral terms (shown on the left vertical axis) are those of the free gaseous ion. Spectroscopic transitions occur between states having the same multiplicity.

18.5 TANABE-SUGANO DIAGRAMS

Qualitatively, the Orgel diagrams are energy level diagrams in which the vertical distances between the lines representing the energies of spectroscopic states are functions of the ligand field splitting. Although they are useful for summarizing the possible transitions in a metal complex, they are not capable of being interpreted quantitatively. The problems associated with B having values that depend on the ligand field splitting make it difficult to prepare a specific energy level diagram for a given metal ion. Y. Tanabe and S. Sugano circumvented part of this problem by preparing energy level diagrams that are based on spectral energies and Δ , but they prepared the graphs with E/B and Δ/B as the variables. When plotted in this way, the energy of the ground state becomes the horizontal axis and the energies of all other states are represented as curves above the ground state. Figure 18.4 shows a complete Tanabe-Sugano diagram for a d^2 ion. Even though the axes on Tanabe-Sugano diagrams have numerical scales (unlike an Orgel diagram), they are still not exactly quantitative. One reason is that B is not a constant. The nephelauxetic ratio, B'/B , varies from approximately 0.6 to 0.8 depending on the nature of the ligands. Some of the spectroscopic states have multiplicities that are different from that of the ground state as a result of electron pairing. The energies of those states are functions of both the Racah B and C parameters. However, the ratio C/B is not strictly a constant, and the calculations that are carried out to produce a Tanabe-Sugano diagram are based on a specific C/B value, usually in the range 4 to 4.5.

By looking at Tables 18.2 and 18.3, we see that for most metal ions there will be a sizeable number of spectroscopic states in a ligand field. A *complete* Tanabe-Sugano diagram shows the energies of *all* of these states as plots of E/B versus Δ/B . However, in the analysis of spectra of complexes, it is usually necessary to consider only states having the same multiplicity as the ground state. Therefore, only a small number of states must be considered when assigning spectral transitions. The Tanabe-Sugano diagrams shown in this chapter do not include some of the excited states but rather show only the states involved in $d-d$ transitions. The result is a less cluttered diagram that still presents the details that are necessary for spectral analysis. The simplified Tanabe-Sugano diagrams for d^2 through d^8 ions are shown in Figure 18.5. Note that the diagrams for d^4 , d^5 , d^6 , and d^7 have a vertical line that typically occurs in the Δ/B range of 20 to 30. This is the result of electron spin pairing when the ligand field becomes sufficiently strong. Note that the ground state continues to be the horizontal axis, but the multiplicity is different and corresponds to that of the complex with fewer unpaired electrons.

The use of a Tanabe-Sugano diagram in spectral analysis is relatively simple. Figure 18.6 shows a simplified Tanabe-Sugano diagram for a d^3 metal ion. Transitions between the ${}^4A_{2g}$ ground state and excited states having the same multiplicity can be represented as vertical lines between the horizontal axis and the lines representing the excited states. Suppose a complex CrX_6^{3-} has two absorption bands, $\nu_1 = 11,000 \text{ cm}^{-1}$ and $\nu_3 = 26,500 \text{ cm}^{-1}$, and that Dq and B are to be determined from the diagram shown in Figure 18.6. For this complex, $\nu_3/\nu_1 = 2.4$, so the ratio of the lengths of the lines representing the third and first transitions must have this value. Because the lines representing the excited states *diverge* as Δ changes, there is only one point on the horizontal axis where this ratio of 2.4 is satisfied. That value of Δ/B is the one where the distances from the ground state (the horizontal axis) up to the first and third excited states have the ratio 2.4. The problem is to find the correct point on the Δ/B axis.

On Figure 18.6, a trial value of $\Delta/B = 30$ is shown that yields the vertical lines representing ν_3 and ν_1 . The measured lengths of these lines gives a ratio of 2.19, which is somewhat lower than the ratio of the experimental spectral energies. At a trial value of 10 for Δ/B (also shown on the figure), the lengths of the lines give a ratio of 3.11, which is higher than the ratio of the spectral energies. By carefully measuring the lengths of the lines corresponding to the transitions, it is found that the correct value of Δ/B is approximately 16. This value corresponds to values of E_1/B of approximately 14 and E_3/B of about 35 (by reading on the vertical axis). Because it is known that the energy of the ν_1 band is $E_1 = 11,000 \text{ cm}^{-1}$,

$$\frac{E_1}{B} = 14 = \frac{11,000 \text{ cm}^{-1}}{B} \quad (18.13)$$

so B is approximately 780 cm^{-1} . We have already determined that Δ/B is approximately 16, so it is now possible to evaluate Δ , which we find to be approximately $12,000$ to $13,000 \text{ cm}^{-1}$. If the calculations are repeated using the data for $E_3 = 26,500 \text{ cm}^{-1}$ and $\Delta/B = 16$, values of approximately 760 cm^{-1} and $12,100 \text{ cm}^{-1}$ are indicated for B and Δ , respectively. For Cr^{3+} , the free ion B value is 1030 cm^{-1} , so the value indicated for B in the CrX_6^{3-} complex is, as expected, approximately 75% of the free ion value.

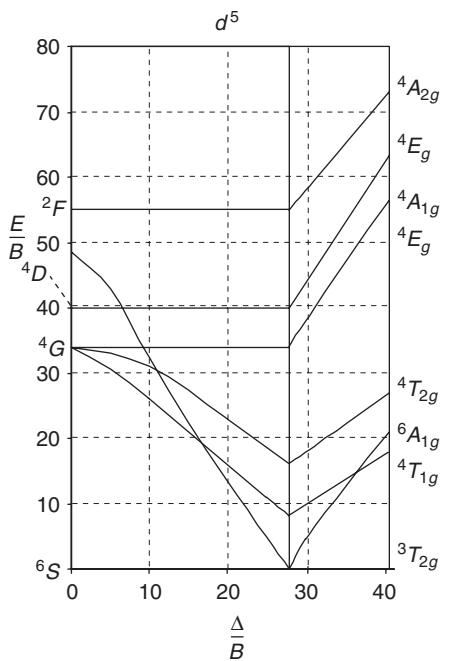
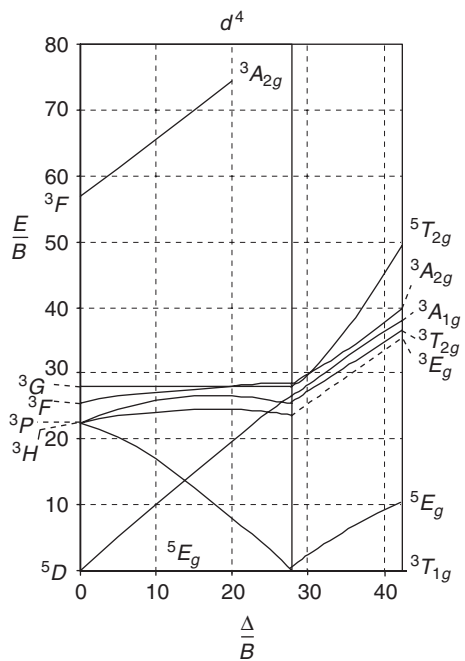
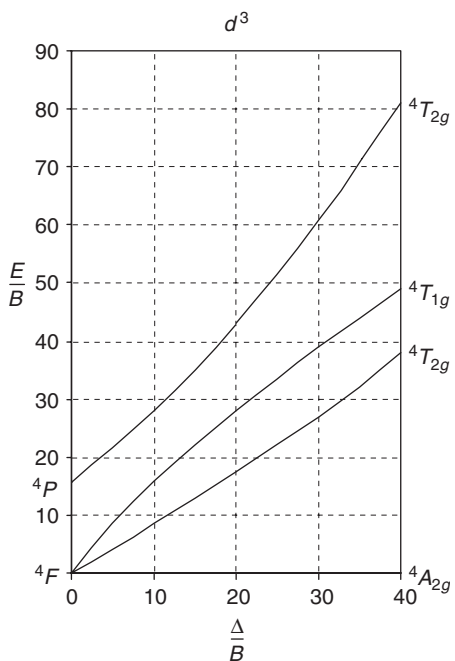
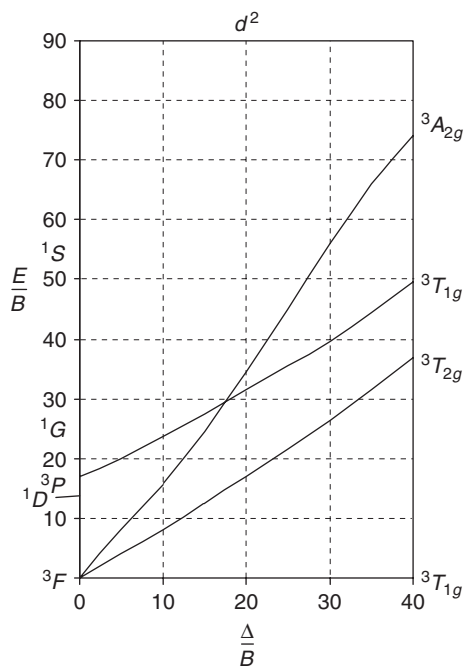

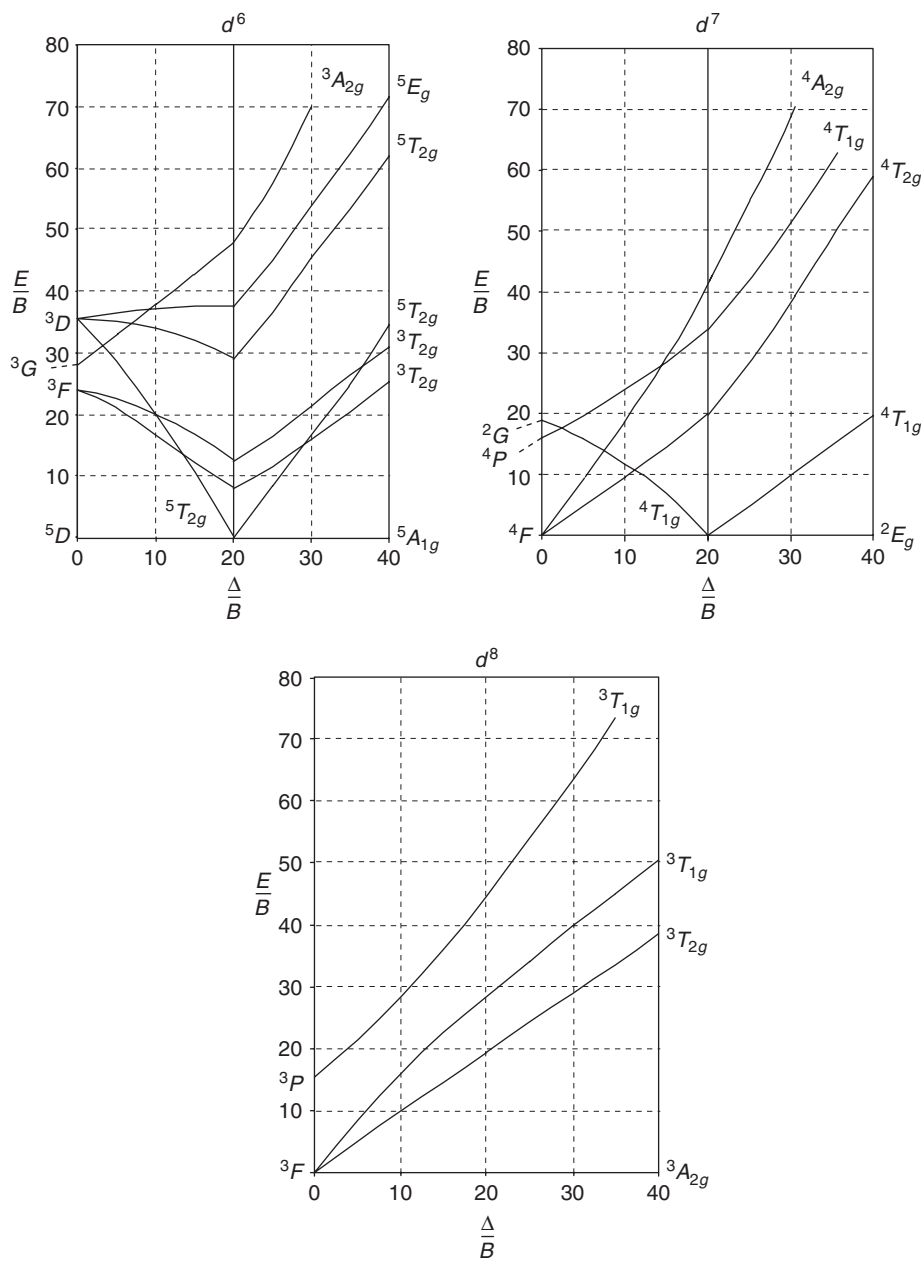

■ **FIGURE 18.5** Simplified Tanabe-Sugano diagrams for d^n metal ions in octahedral fields. The drawings have been simplified by omitting several states that have multiplicities that do not permit spin allowed transitions.

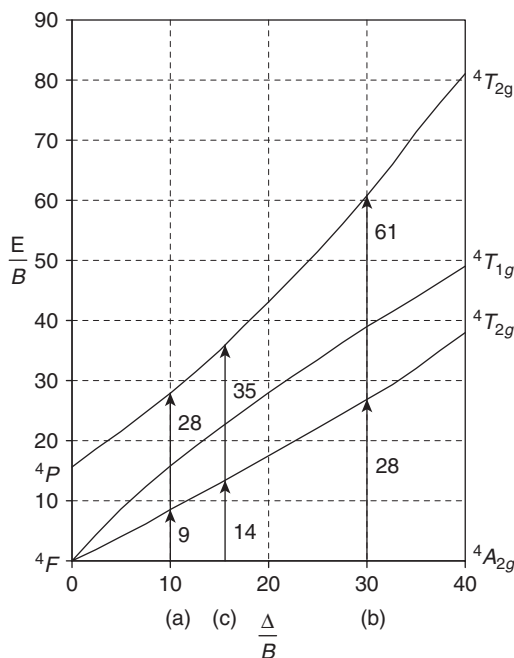

■ **FIGURE 18.6** The simplified Tanabe-Sugano diagram for a d^3 ion in an octahedral field and its use for determining ligand field parameters (see text). At point (a) ($\Delta/B = 10$) on the figure, $\nu_3/\nu_1 = 28/9 = 3.11$. At point (b) ($\Delta/B = 30$) on the figure, $\nu_3/\nu_1 = 61/28 = 2.19$. At point (c) ($\Delta/B = 16$), $\nu_3/\nu_1 = 35/14 = 2.50$, which is approximately the correct value. Therefore, 16 is approximately the correct value for Δ/B .

In the foregoing illustration, we have assumed that ν_2 either is not observed or has an unknown energy. Having found that $\Delta/B = 16$, we can read from the Tanabe-Sugano diagram the energy of the $4T_{1g}$ state corresponding to that value of Δ/B to find $E_2/B = 23$, which shows that the second spectral band should be at approximately $16,500 \text{ cm}^{-1}$.

Because a value of E/B can be read directly from the graph, B can be determined owing to the fact that the energies of the bands in the spectrum are already known. With B and Δ/B having been determined, Δ is readily obtained. Note, however, that this measurement is not particularly accurate, which means that Δ/B is not known very accurately. In fact, Tanabe-Sugano diagrams are not normally used to determine Δ and B quantitatively. They are useful as a basis for interpreting spectra, but the equations shown in Table 18.6 or other graphical or numerical procedures are generally used for determining Δ and B . One such graphical procedure will now be described.

18.6 THE LEVER METHOD

A method described by A. B. P. Lever (1968) provides an extremely simple and rapid means of evaluating Dq and B for metal complexes. In this method, the equations for $E(\nu_1)$, $E(\nu_2)$, and $E(\nu_3)$ are used with a wide range of Dq/B values to calculate the ratios ν_3/ν_1 , ν_3/ν_2 , and ν_2/ν_1 . These values are shown

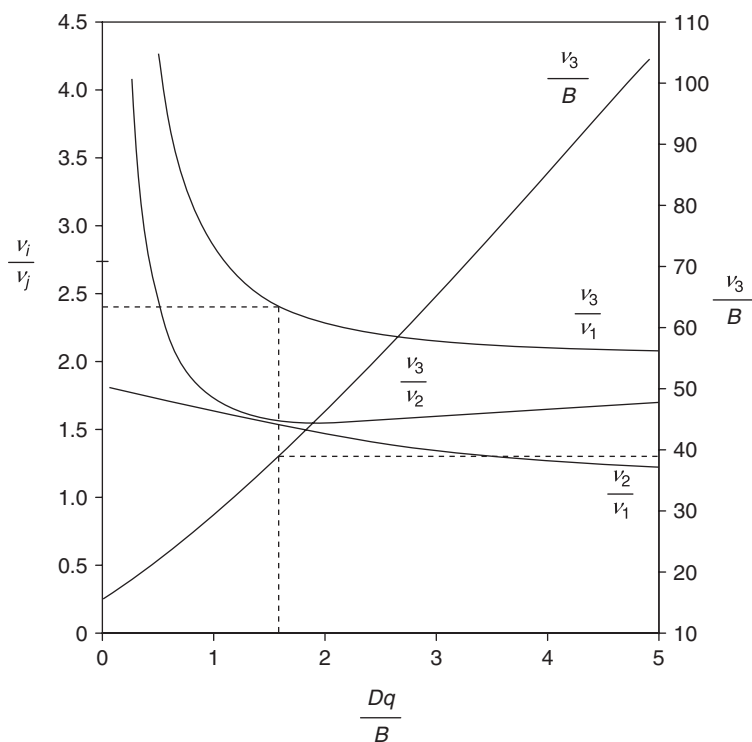

■ **FIGURE 18.7** Diagram for using the Lever method to determine Dq and B for ions having A spectroscopic ground states. (Drawn using data presented by Lever, 1968).

as extensive tables along with ν_3/B ratios in the original literature, but they can also be shown graphically as in Figure 18.7 (for ions having A ground states) and Figure 18.8 (for ions having T ground states).

When using the Lever method, experimental band maxima are used to calculate the ratios ν_3/ν_1 , ν_3/ν_2 , and ν_2/ν_1 . The ratios are then located on the appropriate line on the graph, and by reading *downward* to the horizontal axis, the value of Dq/B is determined. Once the ν_i/ν_j ratio is located, the ν_3/B value can also be identified by reading to the right-hand axis, whether or not ν_3 is available from the spectrum. Therefore, because Dq/B and ν_3 are both known, it is a simple matter to calculate Dq and B . When using the Lever method, it is best to use either the original tables of values or a large-scale graph with grid lines to be able to read values more accurately.

The procedure for using the Lever method will be illustrated by considering the CrX_6^{3-} complex described earlier in using the Tanabe-Sugano diagram. In this case, absorption bands were presumed to be seen at $11,000$ and $26,500\text{ cm}^{-1}$ and to represent ν_1 and ν_3 , respectively. Therefore $\nu_3/\nu_1 = 2.41$. Because Cr^{3+} is a d^3 ion, the ground state is ${}^4A_{2g}$, so Figure 18.7 is the appropriate one to use. Reading

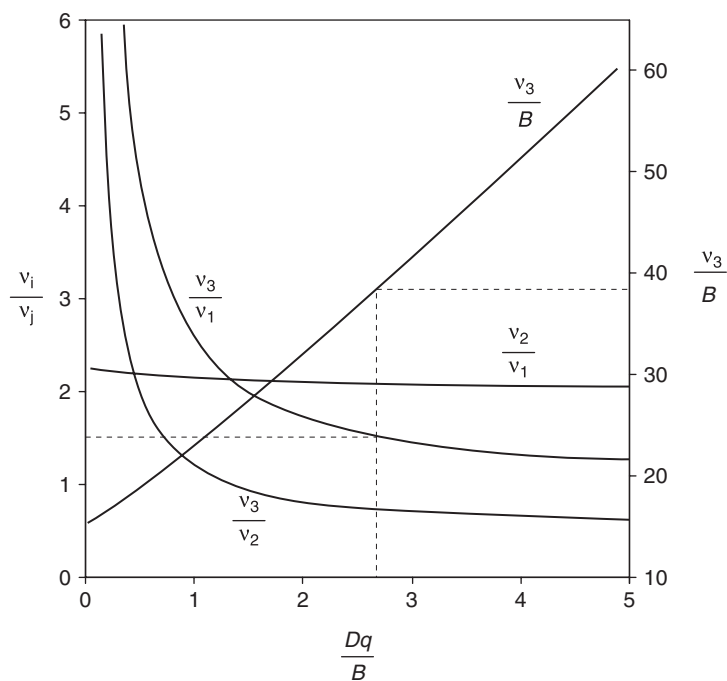

■ **FIGURE 18.8** Diagram for using the Lever method to determine Dq and B for ions having T spectroscopic ground states. (Drawn using data presented by Lever, 1968).

across to the vertical axis opposite the value $\nu_3/\nu_1 = 2.41$ corresponds to a value of Dq/B equal to about 1.6 on the horizontal axis. Similarly, the value ν_3/B is found to be about 38.5. Therefore,

$$Dq/B = 1.6 \quad (18.14)$$

$$\nu_3/B = 38.5 \quad (18.15)$$

so that $B = Dq/1.6$ and $B = \nu_3/38.5$. From Eqs. (18.14) and (18.15) we find that

$$Dq = \nu_3 \times 1.6/38.5 = 26,500 \text{ cm}^{-1} \times 1.6/38.5 = 1100 \text{ cm}^{-1}$$

which leads to a value of approximately 690 cm^{-1} for B . These values are in fair agreement with the values of 1200 cm^{-1} and 760 cm^{-1} estimated for Dq and B , respectively, from the Tanabe-Sugano diagram. Because B for the gaseous Cr^{3+} ion is 1030 cm^{-1} , the nephelauxetic ratio for this complex is $B = 690 \text{ cm}^{-1}/1030 \text{ cm}^{-1} = 0.67$, which is a typical value for this parameter.

When using the Lever method, the question naturally arises regarding the situation in which the identities of the bands in the spectrum are unknown. Assuming that we do not know that the observed bands are actually ν_1 and ν_3 , we calculate from the previous example that $\nu_i/\nu_j = 2.41$. It is readily apparent that this ratio could not be ν_2/ν_1 because the entire range of values presented for this ratio is approximately 1.2 to 1.8. If the 2.41 value actually represented ν_3/ν_2 , a value of Dq/B of about 0.52 is

indicated. From our previous discussions, it has been seen that for first-row +3 metal ions, Δ_o is about 15,000 to 24,000 cm^{-1} (Dq approximately 1500–2400 cm^{-1}) depending on the ligands. It has also been shown that B values for first-row metals are typically about 800 to 1000 cm^{-1} . Therefore, for this situation a ratio of Dq/B of 0.52 is clearly out of the realm of possibility for an octahedral complex of this type. For that reason, a ratio of band energies of 2.41 is consistent only with the bands being assigned as ν_3 and ν_1 . It can be shown that this is the case for other complexes as well. It is not actually necessary to know the assignments of the bands in most cases to use the Lever method to determine Dq and B . Assuming that the complexes have realistic values for Dq and B leads to the conclusion that only one set of assignments is possible. Also, only two band positions need to be known because the ratio of these gives both the Dq/B and ν_3/B values from the figures.

Let us consider the case of VF_6^{3-} , which has bands at 14,800 cm^{-1} and 23,000 cm^{-1} . Because ν^{3+} is a d^2 ion, the ground-state term is ${}^3T_{1g'}$, and in this case, $\nu_3/\nu_1 = 1.55$. From Figure 18.8 it can be seen (from the dotted lines) that a value of 1.55 for the ratio ν_3/ν_1 corresponds to $Dq/B = 2.6$ and $\nu_3/B = 38$. Therefore, using these values it is found that

$$B = \nu_3 / 38 = Dq/2.6 \quad (18.16)$$

so that $Dq = 23,000 \text{ cm}^{-1} \times 2.6/38 = 1600 \text{ cm}^{-1}$ and B is 600 cm^{-1} . These values for Dq and B are in agreement with those obtained for this complex using other procedures.

From the discussion earlier in this chapter, we know that a value of 16,000 cm^{-1} for Δ_o is typical of most complexes of a +3 first-row transition metal ion. For V^{3+} , the free-ion B value is 860 cm^{-1} , so the value 600 cm^{-1} found for V^{3+} in the complex indicates a value of 0.70 for the nephelauxetic ratio, β . All of these values are typical of complexes of first-row transition metal ions. Therefore, even though the identity of the bands may be uncertain, performing the analysis will lead to B and Dq values that will be reasonable only when the correct assignment of the bands has been made.

In the previous example, if an incorrect assumption is made that the bands represent ν_3 and ν_2 , the ratio of energies having a value of 1.49 would indicate a value of Dq/B of only about 0.80. Using this value and the experimental spectral band energies leads to unrealistic values for Dq and B for a complex of a +3 first-row metal ion. Thus, even if the assignment of bands is uncertain, the calculated ligand field parameters will be consistent with the typical ranges of values for Dq and B for such complexes for only one assignment of bands. The Lever method is a simple, rapid, and useful method for analyzing spectra of transition metal complexes to extract values for ligand parameters. It is fully applicable to tetrahedral complexes as well by using the diagram that corresponds to the correct ground-state term for the metal ion.

18.7 JØRGENSEN'S METHOD

An interesting approach to predicting the ligand field splitting for a given metal ion and ligand has been given by Christian Klixbüll Jørgensen. In Jørgensen's approach, the equation that has been developed to predict the ligand field splitting in an octahedral field, Δ_o , is

$$\Delta_o(\text{cm}^{-1}) = fg \quad (18.17)$$

Table 18.8 Selected Values for the f and g Parameters for Use in Jørgensen's Equation.

Metal Ion	g	Ligand	f
Mn ²⁺	8,000	Br ⁻	0.72
Ni ²⁺	8,700	SCN ⁻	0.73
Co ²⁺	9,000	Cl ⁻	0.78
V ²⁺	12,000	N ₃ ⁻	0.83
Fe ³⁺	14,000	F ⁻	0.9
Cr ³⁺	17,400	H ₂ O	1.00
Co ³⁺	18,200	NCS ⁻	1.02
Ru ²⁺	20,000	py	1.23
Rh ³⁺	27,000	NH ₃	1.25
Ir ³⁺	32,000	en	1.28
Pt ⁴⁺	36,000	CN ⁻	1.7

From C. K. Jørgensen (1971). *Modern Aspects of Ligand Field Theory*, pp. 347–348. North Holland, Amsterdam.

where f is a parameter characteristic of the ligand and g is a parameter characteristic of the metal ion. The values for parameters in this equation are based on the assignment of a value of $f = 1.00$ for water as a ligand and values for other ligands were determined by fitting the spectral data to known ligand field splittings. Table 18.8 shows representative values for f and g parameters for several metal ions and ligands.

Equation (18.17) predicts values for Δ_o that are in reasonably good agreement with the values determined by more robust methods. In many instances, an approximate value for the ligand field splitting is all that is required, and this approach gives a useful approximation for Δ_o rapidly with a minimum of effort.

18.8 CHARGE TRANSFER ABSORPTION

Up to this point, the discussion of spectra has been related to the electronic transitions that occur between spectroscopic states for the metal ion in the ligand field. However, these are not the only transitions for which absorptions occur. Ligands are bonded to metal ions by donating electron pairs to orbitals that are essentially metal orbitals in terms of their character. Transition metals also have nonbonding e_g or t_{2g} orbitals (assuming an octahedral complex) arising from the d orbitals that may be partially filled, and the ligands may have empty nonbonding or antibonding orbitals that can accept electron density from the metal. For example, both CO and CN⁻ have empty π^* orbitals that can

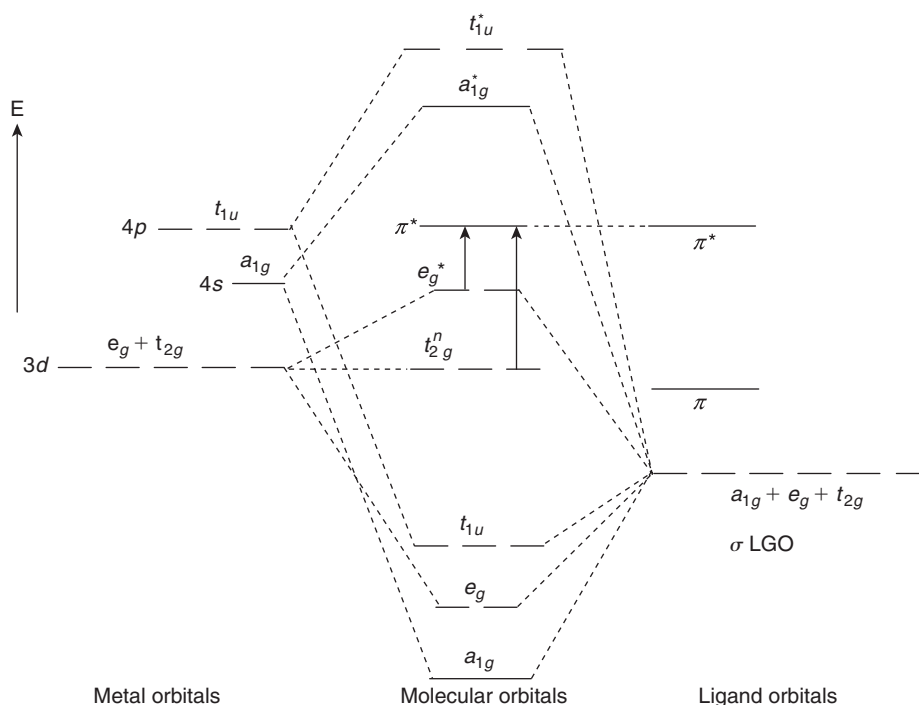

■ **FIGURE 18.9** Interpretation of $M \rightarrow L$ charge transfer absorption in an octahedral complex using a modified molecular orbital diagram. The transitions are from e_g^* or t_{2g} orbitals on the metal to π^* orbitals on the ligands.

be involved in this type of interaction (see Chapter 16). Movement of electron density from metal orbitals to ligand orbitals and vice versa is known as *charge transfer*. The absorption bands that accompany such shifts in electron density are known as *charge transfer bands*.

Charge transfer (CT) bands are usually observed in the ultraviolet region of the spectrum, although in some cases they appear in the visible region. Consequently, they frequently overlap or mask transitions of the $d-d$ type. Charge transfer bands are of the spin-allowed type, so they have high intensity. If the metal is in a low oxidation state and easily oxidized, the charge transfer is more likely to be of the metal-to-ligand type, indicated as $M \rightarrow L$. A case of this type occurs in $\text{Cr}(\text{CO})_6$ where it is easy to move electron density from the metal atom (which is in the 0 oxidation state), especially because the CO ligands have donated six pairs of electrons to the Cr. The empty orbitals on the CO ligands are π^* orbitals. In this case, the electrons are in nonbonding t_{2g} orbitals on the metal so the transition is designated as $t_{2g} \rightarrow \pi^*$. In other cases, electrons in the e_g^* orbitals are excited to the empty π^* orbitals on the ligands. Figure 18.9 shows these cases on a modified molecular orbital diagram for an octahedral complex. Although CO is a ligand that has π^* acceptor orbitals, other ligands of this type include NO, CN^- , olefins, and pyridine.

The intense purple color of MnO_4^- is due to a charge transfer band that occurs at approximately $18,000\text{ cm}^{-1}$ and results from a transfer of charge from oxygen to the Mn^{7+} . In this case, the transfer is indicated as $L \rightarrow M$, and it results from electron density being shifted from filled p orbitals on oxygen atoms to empty orbitals in the e set on Mn. As a general rule, the charge transfer will be $M \rightarrow L$ if the metal is easily oxidized, whereas the transfer will be $L \rightarrow M$ if the metal is easily reduced. Therefore, it is not surprising that Cr^0 in $\text{Cr}(\text{CO})_6$ would have electron density shifted *from the metal to the ligands* and Mn^{7+} would have electron density shifted *from the ligands to the metal*. The ease with which electron density can be shifted from the ligands to the metal is related in a general way to how difficult it is to ionize or polarize the ligands.

We have not yet addressed the important topic of absorption by the ligands in complexes. For many types of complexes, this type of spectral study (usually infrared spectroscopy) yields useful information regarding the structure and details of the bonding in the complexes. This topic will be discussed later in connection with several types of complexes containing specific ligands (e.g., CO , CN^- , NO_2^- , and olefins).

■ REFERENCES FOR FURTHER STUDY

- Ballhausen, C. J. (1979). *Molecular Electronic Structure of Transition Metal Complexes*. McGraw-Hill, New York.
- Cotton, F. A., Wilkinson, G., Murillo, C. A., and Bochmann, M. (1999). *Advanced Inorganic Chemistry*, 6th ed. Wiley, New York. This reference text contains a large amount of information on the entire range of topics in coordination chemistry.
- Douglas, B., McDaniel, D., and Alexander, J. (2004). *Concepts and Models of Inorganic Chemistry*, 3rd ed. Wiley, New York. A respected inorganic chemistry text.
- Drago, R. S. (1992). *Physical Methods for Chemists*. Saunders College Publishing, Philadelphia. This book presents high-level discussion of many topics in coordination chemistry.
- Figgis, B. N., and Hitchman, M. A. (2000). *Ligand Field Theory and Its Applications*. Wiley, New York. An advanced treatment of ligand field theory and spectroscopy.
- Harris, D. C., and Bertolucci, M. D. (1989). *Symmetry and Spectroscopy*. Dover Publications, New York. A good text on bonding, symmetry, and spectroscopy.
- Jorgenson, C. K. (1971). *Modern Aspects of Ligand Field Theory*. North Holland, Amsterdam.
- Kettle, S. F. A. (1969). *Coordination Chemistry*. Appleton, Century, Crofts, New York. A good introduction to interpreting spectra of coordination compounds is given.
- Kettle, S. F. A. (1998). *Physical Inorganic Chemistry: A Coordination Approach*. Oxford University Press, New York. An excellent book on coordination chemistry that gives good coverage to many areas, including ligand field theory and spectroscopy.
- Lever, A. B. P. (1984). *Inorganic Electronic Spectroscopy*, 2nd ed. Elsevier, New York. A monograph that treats all aspects of absorption spectra of complexes at a high level. This is perhaps the most thorough treatment available in a single volume. Highly recommended.
- Solomon, E. I., and Lever, A. B. P., Eds. (2006). *Inorganic Electronic Spectroscopy and Structure*, Vols. I and II. Wiley, New York. Perhaps the ultimate resource on spectroscopy of coordination compounds. Two volumes total 1424 pages on the subject.
- Szafran, Z., Pike, R. M., and Singh, M. M. (1991). *Microscale Inorganic Chemistry: A Comprehensive Laboratory Experience*. Wiley, New York. Several sections of this book deal with various aspects of synthesis and study of coordination compounds. A practical, "hands on" approach.

■ QUESTIONS AND PROBLEMS

- For the following high spin ions, describe the nature of the possible electronic transitions and give them in the order of increasing energy.
(a) $[\text{Ni}(\text{NH}_3)_6]^{2+}$; (b) $[\text{FeCl}_4]^-$; (c) $[\text{Cr}(\text{H}_2\text{O})_6]^{3+}$; (d) $[\text{Ti}(\text{H}_2\text{O})_6]^{3+}$; (e) $[\text{FeF}_6]^{4-}$; (f) $[\text{Co}(\text{H}_2\text{O})_2]^{2+}$
- Use Jørgensen's method to determine Δ_o for the following complexes:
(a) $[\text{MnCl}_6]^{4-}$; (b) $[\text{Rh}(\text{py})_6]^{3+}$; (c) $[\text{Fe}(\text{NCS})_6]^{3-}$; (d) $[\text{Co}(\text{NH}_3)_6]^{2+}$; (e) $[\text{PtBr}_6]^{2-}$
- Spectral bands are observed at $17,700\text{ cm}^{-1}$ and $32,400\text{ cm}^{-1}$ for $[\text{Cr}(\text{NCS})_6]^{3-}$. Use the Lever method to determine Dq and B for this complex. Where would the third band be found? What transition does it correspond to?
- Some values for the Racah B parameter are 918 , 766 , and 1064 cm^{-1} . Match these values to the ions Cr^{3+} , V^{2+} , and Mn^{4+} . Explain your assignments.
- Spectral bands are observed at 8350 and $19,000\text{ cm}^{-1}$ for the complex $[\text{Co}(\text{H}_2\text{O})_6]^{2+}$. Use the Lever method to determine Dq and B for this complex. Determine where the missing band should be observed. What transition does this correspond to?
- A complex VL_6^{3+} has the two lowest energy transitions at $11,500$ and $17,250\text{ cm}^{-1}$.
(a) What are the designations for these transitions?
(b) Use the Lever method to determine Dq and B for this complex.
(c) Where should the third spectral band be observed?
- Use Jørgensen's method to determine Dq and B for $[\text{Co}(\text{en})_3]^{3+}$. What would be the approximate positions of the three spectral bands?
- Peaks are observed at 264 and 378 nm for $[\text{Cr}(\text{CN})_6]^{3-}$. What are Dq and B for this complex?
- For the complex $[\text{Cr}(\text{acac})_3]$ (where acac = acetylacetonate ion), ν_1 is observed at $17,860\text{ cm}^{-1}$ and ν_2 is at $23,800\text{ cm}^{-1}$. Use these data to determine Dq and B for this complex.
- For the complex $[\text{Ni}(\text{en})_3]^{2+}$ (where en = ethylenediamine), ν_1 is observed at $11,200\text{ cm}^{-1}$, ν_2 is at $18,450\text{ cm}^{-1}$, and ν_3 is at $29,000\text{ cm}^{-1}$. Use these data to determine Dq and B for this complex.
- For each of the following, tell whether you would or would not expect to see charge transfer absorption. For the cases where you would expect CT absorption, explain the type of transitions expected.
(a) $[\text{Cr}(\text{CO})_3(\text{py})_3]$; (b) $[\text{Co}(\text{NH}_3)_6]^{3+}$; (c) $[\text{Fe}(\text{H}_2\text{O})_6]^{2+}$; (d) $[\text{Co}(\text{CO})_3\text{NO}]$; (e) CrO_4^{2-}

This page intentionally left blank

Composition and Stability of Complexes

Coordinate bonds between metals and ligands result in the formation of complexes under many different types of conditions. In some cases, complexes form in the gas phase, and the number of known solid complexes is enormous. However, it is in solutions that many of the effects of complex formation are so important. For example, in qualitative analysis, AgCl precipitates when a solution of HCl is added to one containing Ag^+ . When aqueous ammonia is added, the precipitate dissolves as a result of the formation of a complex,

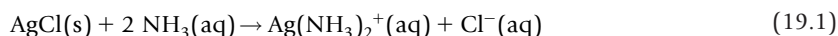

It is possible to determine the concentration of certain metal ions by performing a titration in which the complexation of the metal is the essential reaction. Typically, a chelating agent such as EDTA is used because the complexes formed are so stable. The specific composition of complexes formed in solutions often depends on the concentrations of the reactants. As a part of the study of the chemistry of coordination compounds, some attention must be given to the systematic treatment of topics related to the composition and stability of complexes in solution. This chapter is devoted to these topics.

19.1 COMPOSITION OF COMPLEXES IN SOLUTION

Although it is well known that the most frequently encountered coordination numbers are 2, 4, and 6, we should expect that for some ligands and metal ions different or unknown ratios of ligands to metal ions might occur under certain conditions. If several different complexes are formed, the problem of determining composition may be quite complicated. For simplicity, we shall assume that only one complex is formed between the metal and ligand or that the amounts of all other complexes formed can be neglected compared to the amount of the dominant complex.

The equation for the formation of a complex by metal A and ligand B is written as



for which the equilibrium constant is written as

$$K = \frac{[A_n B_m]}{[A]^n [B]^m} \quad (19.3)$$

Solving Eq. (19.3) for the concentration of the complex leads to

$$[A_n B_m] = K[A]^n [B]^m \quad (19.4)$$

Taking the logarithm of both sides of this equation yields

$$\log[A_n B_m] = \log K + n \log[A] + m \log[B] \quad (19.5)$$

To obtain data for use with this equation, a series of solutions can be prepared in which the concentration of B is kept constant but the concentration of A is varied. For each of these solutions, the concentration of the complex $[A_n B_m]$ is measured as a function of $[A]$. For many complexes, the concentration of the complex can be measured by spectrometry because many complexes absorb at a wavelength that is different from that of the metal ion or ligand alone (see Chapter 18). When $[B]$ is kept constant, Eq. (19.5) reduces to

$$\log[A_n B_m] = n \log[A] + C \quad (19.6)$$

where $C = \log K + m \log[B] = \text{a constant}$. As is illustrated in Figure 19.1, a graph can then be made of $\log[A_n B_m]$ versus $\log[A]$ that yields a straight line of slope n .

This procedure can be repeated, keeping the concentration of A fixed and varying the concentration of B. Under these conditions, we obtain the concentration of $[A_n B_m]$ as the concentration of B varies, and the graph of $\log[A_n B_m]$ versus $\log[B]$ yields a straight line of slope m . In this way, we can determine n and m , the numbers of metal ions and ligands, respectively, in the formula for the complex. Once the

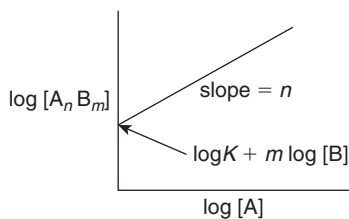

■ FIGURE 19.1 An illustration of the logarithmic method.

values of m and n are known, the value of K can be obtained because the intercepts of the two plots are $\log K + m \log [B]$ and $\log K + n \log [A]$, respectively.

Although this method is simple in principle, problems arise if more than one complex is formed. As the relative concentrations of A and B are varied, it is quite possible that such a situation could occur as a result of mass action effects. The plots might not be linear in this case, and it is possible that the complex(es) produced might absorb at different wavelengths. However, it should be pointed out that this method is not restricted to coordination compounds containing metal ions and ligands. It is applicable to cases where species of almost any type are forming aggregates, as long as a property proportional to the concentration of the complex can be measured. Molecular association of the types discussed in Chapter 6 can often be studied in this way.

19.2 JOB'S METHOD OF CONTINUOUS VARIATIONS

Another method for determining the composition of a complex in solution is that known as *Job's method* or the *method of continuous variations*. Suppose that the formation of a complex between metal A and m ligands B can be shown as



for which the equilibrium constant can be written as

$$K = \frac{[AB_m]}{[A][B]^m} \quad (19.8)$$

A series of solutions can now be prepared such that the *total* concentration of metal and ligand is a constant, C ,

$$[A] + [B] = C, \quad (19.9)$$

but we allow the concentration of each component to vary. For example, we might make solutions that have a total concentration of 1 M and that have compositions as follows: 0.1 M A and 0.9 M B; 0.2 M A and 0.8 M B; 0.3 M A and 0.7 M B; and so on. If as a result of complex formation the ionic strength of the solution changes, it is possible to keep the ionic strength almost constant by dissolving a salt such as $KClO_4$. Generally, ClO_4^- does not compete with other ligands, and the large concentration of ions from the salt means that small changes in the total concentration of ions due to forming complexes do not change the overall ionic strength significantly. Next, we select some physical property that is exhibited by the complex but which is not exhibited to a significant extent by the metal or unbound ligands. It is much simpler if the property is one that is linearly related to the concentration of the complex. For this reason and because many transition metal complexes are highly colored, absorbance of visible light by the solutions at a particular wavelength where the complex absorbs is frequently used as the property.

A graph (known as a Job's plot) is now made of the physical property (in effect, the concentration of the complex) as a function of the ratio $[B]/([B] + [A])$ (or sometimes $[B]/[A]$). A maximum or minimum (depending on the type of property measured) in the curve will be found when the ratio of the constituents in the solution is the same as it is in the formula for the complex. Figure 19.2 shows a graph constructed as just described.

It is easy to verify that the curve representing the measured property will exhibit a maximum or minimum at the same ratio of concentrations as the constituents that are present in the complex. We can write the expression for the equilibrium constant as

$$[AB_m] = K [B]^m [A] \quad (19.10)$$

but because $[A] + [B] = C$, we can write $[A] = C - [B]$, so substituting for $[A]$ we obtain

$$[AB_m] = K [B]^m \{C - [B]\} = KC [B]^m - K [B]^{m+1} \quad (19.11)$$

Since we want to find out if the change in concentration of the complex with the change in concentration of B goes through a maximum or minimum, we need to take the derivative and set it equal to 0:

$$\frac{d[AB_m]}{d[B]} = 0 = mKC[B]^{m-1} - (m+1)K[B]^m \quad (19.12)$$

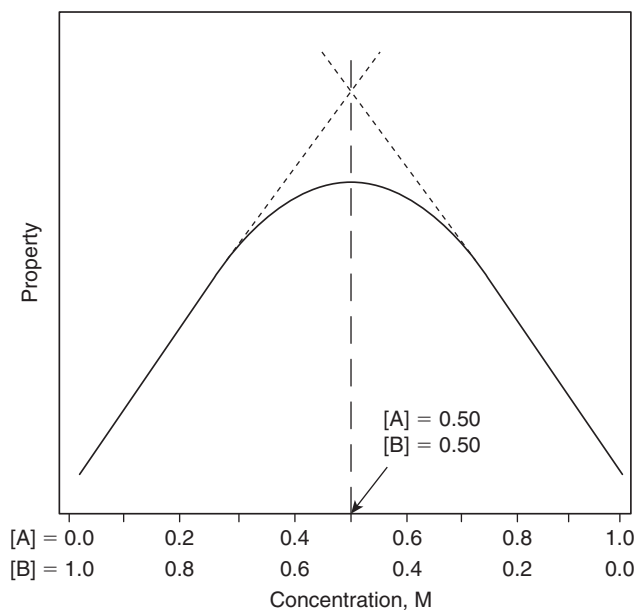

■ **FIGURE 19.2** An illustration of the use of Job's method. In this case, the complex of A and B has a 1:1 composition.

The sum of the two terms on the right-hand side of this equation is zero, so we can equate them. After dividing by $K[B]^{m-1}$, we obtain

$$(m + 1)[B] = mC \quad (19.13)$$

By expanding the left-hand side and letting $C = [A] + [B]$, we find that

$$m[B] + [B] = m\{[B] + [A]\} = m[B] + m[A] \quad (19.14)$$

from which we obtain

$$[B] = m[A] \quad (19.15)$$

or

$$m = \frac{[B]}{[A]} \quad (19.16)$$

This result signifies that the maximum in the amount of complex formed from a fixed total concentration of A plus B will occur when A and B are present in the solution in precisely the same ratio as they are in the complex.

This procedure has been used successfully to determine the composition of many complexes in solution. It is possible to extend this method to cases where more than one complex is formed but the application is quite difficult. Like the logarithmic method, Job's method can be applied to other cases of molecular interaction and is not limited to the formation of coordination compounds. Both methods are based on the assumption that one complex is dominant in the equilibrium mixture. Numerous other methods for determining the number of metal ions and ligands in complexes have been devised, but they are beyond the introduction to the topic presented here.

19.3 EQUILIBRIA INVOLVING COMPLEXES

In the preceding section, we have described two methods that are frequently used to determine the composition of complexes in solution. We will now turn our attention to a consideration of the simultaneous equilibria that are involved in complex formation. The widely used approach described here is known as Bjerrum's method, and it was described by Jannik Bjerrum many years ago.

If we consider a complex such as that represented by the formula AB_m , we can represent the formation of this complex as if it occurred in the following m steps:





For these reactions, we can write the equilibrium constants (known as stepwise formation or stability constants) as

$$K_1 = \frac{[\text{AB}]}{[\text{A}][\text{B}]} \quad (19.20)$$

$$K_2 = \frac{[\text{AB}_2]}{[\text{AB}][\text{B}]} \quad (19.21)$$

$$\vdots$$

$$K_m = \frac{[\text{AB}_m]}{[\text{AB}_{m-1}][\text{B}]} \quad (19.22)$$

In aqueous solutions, however, the complexes are usually present in compositions in which water molecules complete the coordination sphere of the metal up to a definite number, usually 2, 4, or 6. Thus, the complexes are formed as represented by the equations

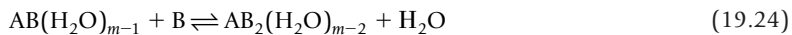
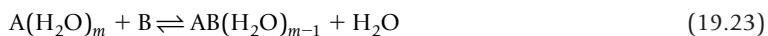

$$\vdots$$

We shall ignore for the moment the fact that the solvent plays a role and will represent the formation of the successive complexes as shown in Eqs. (19.17) to (19.19). However, we should not lose sight of the fact that in aqueous solutions, the total coordination number of the metal is m , and if x sites are bonded to water molecules and y sites are where ligands are attached, then $x + y = m$. Because the constants K_1, K_2, \dots, K_m represent the *formation* of complexes, they are called *formation constants*. The larger the value of a formation constant, the more stable the complex. Consequently, these constants are usually called *stability constants*.

It is important to note that the equilibrium constants for the formation of the complex AB_3 , for example, can be represented as a product such that β_3 is given by

$$\beta_3 = K_1 K_2 K_3 = \frac{[AB]}{[A][B]} \times \frac{[AB_2]}{[AB][B]} \times \frac{[AB_3]}{[AB_2][B]} = \frac{[AB_3]}{[A][B]^3} \quad (19.26)$$

Thus, the *overall* stability constants for the various steps, β_i , can be expressed in terms of the product of several *stepwise* stability constants, K_i (e.g., $\beta_2 = K_1 K_2$; $\beta_4 = K_1 K_2 K_3 K_4$).

Frequently, it is of interest to consider the *dissociation* of complexes rather than their formation. For example,



⋮



It should be apparent that the larger the equilibrium constants for these reactions, the more *unstable* the complexes. Consequently, the equilibrium constants for these reactions are called *dissociation* or *instability constants*. One must remember that the first step in the dissociation of AB_m corresponds to the reverse of the last step in the formation of the complex. Thus, if we represent the instability constants as k_i and a total of six steps are involved, the relationships between the k_i and K_i values are as follows.

$$K_1 = 1/k_6, K_2 = 1/k_5, \dots, K_6 = 1/k_1 \quad (19.30)$$

In order to determine the stability constants for a series of complexes in solution, we must determine the concentrations of several species. Moreover, we must then solve a rather complex set of equations to evaluate the stability constants. There are several experimental techniques that are frequently employed for determining the concentrations of the complexes. For example, spectrophotometry, polarography, solubility measurements, or potentiometry may be used, but the choice of experimental method is based on the nature of the complexes being studied. Basically, however, we proceed as follows. A parameter is defined as the average number of bound ligands per metal ion, N , which is expressed as

$$N = \frac{(C_B - [B])}{C_A} \quad (19.31)$$

where C_B is the total concentration of ligand present in the solution, $[B]$ is the concentration of free or unbound ligand, and C_A is the total concentration of metal ion, A. The quantity $C_B - [B]$ represents the concentration of B that is bound in all of the complexes present in the equilibrium mixture.

Consequently, because 1 mole of $[AB_2]$ contains 2 moles of B and 1 mole of $[AB_3]$ contains 3 moles of B, etc, the concentration of bound B can be written as

$$C_B - [B] = [AB] + 2[AB_2] + 3[AB_3] + \dots \quad (19.32)$$

The total concentration of metal will be the concentration of free metal plus all that bound in the various complexes.

$$C_A = [A] + [AB] + [AB_2] + [AB_3] + \dots \quad (19.33)$$

Therefore, substituting the expression shown in Eq. (19.32) for $C_B - B$ and the foregoing expression for C_A in Eq. (19.31) gives

$$N = \frac{[AB] + 2[AB_2] + 3[AB_3] + \dots}{[A] + [AB] + [AB_2] + [AB_3] + \dots} \quad (19.34)$$

The next step in the procedure for calculating the stability constants is to represent the concentrations of the several complexes in terms of the equilibrium constants for their formation. We do this by solving each equilibrium constant expression for the concentration of the complex. For example, the first step has an equilibrium constant

$$K_1 = \frac{[AB]}{[A][B]} \quad (19.35)$$

so solving for the concentration of the complex yields

$$[AB] = K_1 [A][B] \quad (19.36)$$

For the complex AB_2 ,

$$K_2 = \frac{[AB_2]}{[AB][B]} \quad (19.37)$$

so that

$$[AB_2] = K_2 [AB][B] = K_1 K_2 [A][B]^2 \quad (19.38)$$

In the same way, it can be shown that

$$[AB_3] = K_1 K_2 K_3 [A][B]^3 \quad (19.39)$$

Expressions for the concentrations of the other complexes can be found in a similar way. These expressions can now be substituted in Eq. (19.34) to obtain

$$N = \frac{K_1[A][B] + 2K_1K_2[A][B]^2 + 3K_1K_2K_3[A][B]^3 + \dots}{[A] + K_1[A][B] + K_1K_2[A][B]^2 + K_1K_2K_3[A][B]^3 + \dots} \quad (19.40)$$

A more useful equation is obtained by dividing each term in the numerator and denominator of this equation by $[A]$,

$$N = \frac{K_1[B] + 2K_1K_2[B]^2 + 3K_1K_2K_3[B]^3 + \dots}{1 + K_1[B] + K_1K_2[B]^2 + K_1K_2K_3[B]^3 + \dots} \quad (19.41)$$

From this equation, it can be seen that the average number of ligands bound per metal ion depends only on the values of the stability constants for the complexes and the concentration of free or unbound ligand in the solution, $[B]$. In order to calculate m stability constants (K_1, K_2, \dots, K_m), we need m values of N each determined at a different but known value of $[B]$. What results is a set of m equations in m unknowns (the stability constants) that may be solved by the standard numerical, graphical, or computer techniques. Historically, this analysis of data presented a considerable challenge, especially in view of the limitations imposed by the use of experimental data. Solving such a series of equations when highly accurate data are available is readily handled by an advanced programmable calculator today, but it has not always been so.

Before a series of stability constants can be interpreted as indicating the correct order of the stabilities of the complexes, one further point must be considered. This factor arises from the fact that if one considers a complex such as $M(H_2O)_N$, there are N potential sites where the first ligand B may enter. Therefore, the probability that B will enter a site is proportional to N . That is, the first ligand to enter has N sites at which it may attach. The second ligand has only $N - 1$ sites available, and at a later point in the substitution process, the complex can be written as $MB_m(H_2O)_{N-m}$. The probability that another ligand will enter the coordination sphere of the metal is proportional to $(N - m)$ if the probability of a ligand entering is equal at all sites (i.e., there are no steric factors). The relationship between the probabilities for the first, second, third, ..., and last ligand to enter the coordination sphere can be expressed as the fractions

$$\frac{N}{1}, \frac{N-1}{2}, \dots, \frac{N-m+1}{m}, \frac{N-m}{m+1}, \dots, \frac{2}{N-1}, \frac{1}{N} \quad (19.42)$$

Keep in mind that in this case the total number of sites is N . The relationship between the values of two successive K values must reflect the difference in probabilities of formation of the corresponding complexes. Therefore, we can write

$$\frac{K_m}{K_{m+1}} = \frac{(N-m+1)(m+1)}{m(N-m)} \quad (19.43)$$

The equilibrium constants for formation of the various complexes should be identical after the experimental values are corrected for the differences in probability for their formation. Also, the stability of the last complex as reflected by K_m should be independent of the fact that some of the intermediate

complexes do not have equal probabilities for forming. If we represent the equilibrium constants that have been corrected for the differences in probability as K' , we should find that

$$K_1 K_2 \dots K_m = K_1' K_2' \dots K_m' \quad (19.44)$$

From this equation, we should find that the average equilibrium constant, K , may be represented as the m th root of either of the products of equilibrium constants.

$$K = (K_1 K_2 \dots K_m)^{1/m} = (K_1' K_2' \dots K_m')^{1/m} \quad (19.45)$$

Theoretically however, the statistically corrected values, K' , are all the same, so that

$$(K_1 K_2 \dots K_m)^{1/m} = K_1' = K_2' = \dots = K_m' \quad (19.46)$$

We now have a sufficient number of conditions to determine the relationship between the measured equilibrium constants, K_1, K_2, \dots, K_m , and the statistically corrected constants, K_1', K_2', \dots, K_m' . The statistical corrections to be applied to the experimental stability constants are shown in Table 19.1 for the most common coordination numbers.

Many correlations have been made between the stability constants for a series of complexes and other properties. For example, basicity of the ligands, ionic radii, dipole moments, and other properties have been correlated with the stability constants of the complexes. However, before comparisons such as these are made, the stability constants should be corrected statistically to take into account the fact that successive complexes do not have the same probability of forming.

There is another problem that does not have such a simple solution. Consider the following reactions, which represent the first and last step in the reaction of a metal ion, M^{3+} , in the form of an aqua complex, $[M(H_2O)_6]^{3+}$, with Cl^- :

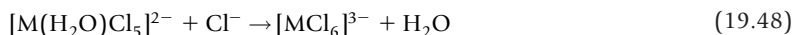
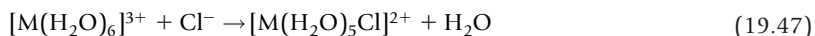

Table 19.1 Statistically Corrected Stability Constants.

Coordination number, N	Corrected stability constants, K'					
	K_1'	K_2'	K_3'	K_4'	K_5'	K_6'
2	$K_1/2$	$2K_2$				
4	$K_1/4$	$2K_2/3$	$3K_3/2$	$4K_4$		
6	$K_1/6$	$2K_2/5$	$3K_3/4$	$4K_4/3$	$5K_5/2$	$6K_6$

Note that in the first case, the Cl^- ion is approaching an aqua complex that carries a +3 overall charge. In the second case, the Cl^- is approaching an aquapentachloro complex that already carries a *negative* charge (-2), which is electrostatically unfavorable. Therefore, even after statistical correction of the stability constants is made, there is a great deal of difference in the likelihood that $[\text{M}(\text{H}_2\text{O})_5\text{Cl}]^{2+}$ and $[\text{MCl}_6]^{3-}$ will form (the values of K_1 and K_6).

This is a difficult problem. First, the charged species are separated by water molecules. The force between charged particles that are separated by a medium having a dielectric constant ϵ is given by

$$F = \frac{q_1 q_2}{\epsilon r^2} \quad (19.49)$$

where q_1 and q_2 are the charges on the particles and r is the distance of separation. However, the metal ion is surrounded by water molecules that are coordinated to it. Those water molecules do not have the same dielectric constant as those of the bulk solvent because they are oriented in a particular way. Moreover, the high charge density of the metal ion induces additional charge separation in water molecules that are coordinated. The result is that we now have a very difficult task in trying to compensate for the difference in the tendencies of the complexes $[\text{M}(\text{H}_2\text{O})_5\text{Cl}]^{2+}$ and $[\text{MCl}_6]^{3-}$ to form. In fact, although it is necessary to know that such differences exist, it is beyond the scope of this book to deal with the details of this problem.

19.4 DISTRIBUTION DIAGRAMS

If we know the stability constants for a series of complexes formed between a metal ion and several ligands, we have the information necessary to calculate the concentrations of all of the species present at equilibrium. For example, we will suppose that a metal ion, M, forms several complexes with ligand X that are in equilibrium. In this example, we will assume that the metal ion has a coordination number of 4. The general procedure for dealing with complexes having other coordination numbers are the same as illustrated here. We can obtain the concentration of each complex following the procedure used earlier, which gives

$$[\text{MX}] = K_1[\text{M}][\text{X}] \quad (19.50)$$

$$[\text{MX}_2] = K_1 K_2 [\text{M}][\text{X}]^2 \quad (19.51)$$

$$[\text{MX}_3] = K_1 K_2 K_3 [\text{M}][\text{X}]^3 \quad (19.52)$$

$$[\text{MX}_4] = K_1 K_2 K_3 K_4 [\text{M}][\text{X}]^4 \quad (19.53)$$

The total concentration of metal ion, C_M , is the sum of the concentrations of the free (uncomplexed) metal added to the concentration of the metal ion that is bound in all of the complexes present. This can be expressed as

$$C_M = [\text{M}] + [\text{MX}] + [\text{MX}_2] + [\text{MX}_3] + [\text{MX}_4] \quad (19.54)$$

When the substitutions are made for the concentrations of the complexes given in Eqs. (19.50) through (19.53), we find that

$$C_M = [M] + K_1[M][X] + K_1K_2[M][X]^2 + K_1K_2K_3[M][X]^3 + K_1K_2K_3K_4[M][X]^4 \quad (19.55)$$

The overall stability constants are given as the products of the stability constants for all steps up to the one being considered. These are represented as β_i and they are related to the K values by the equations

$$\beta_1 = K_1 \quad (19.56)$$

$$\beta_2 = K_1K_2 \quad (19.57)$$

$$\beta_3 = K_1K_2K_3 \quad (19.58)$$

$$\beta_4 = K_1K_2K_3K_4 \quad (19.59)$$

Substituting for the products of the stability constants and factoring $[M]$ from Eq. (19.55) gives

$$C_M = [M](1 + \beta_1[X] + \beta_2[X]^2 + \beta_3[X]^3 + \beta_4[X]^4) \quad (19.60)$$

The fraction of the metal ion that is bound in each type of complex can now be calculated as well as the fraction of the metal that is free. The free metal has no ligands attached, so we will represent it as α_0 , whereas the fraction bound to one ligand is α_1 , and so on. Therefore,

$$\alpha_0 = \frac{\text{Concentration of free metal}}{\text{Total concentration of metal}} = \frac{[M]}{C_M} \quad (19.61)$$

and by substitution we find that

$$\alpha_0 = \frac{1}{1 + \beta_1[X] + \beta_2[X]^2 + \beta_3[X]^3 + \beta_4[X]^4} \quad (19.62)$$

Although this gives the fraction of the metal ion that is not contained in complexes, the fractions bound in complexes are given by

$$\alpha_1 = \frac{[MX]}{C} = \beta_1[X]\alpha_0 \quad (19.63)$$

$$\alpha_2 = \frac{[MX_2]}{C} = \beta_2[X]^2\alpha_0 \quad (19.64)$$

$$\alpha_3 = \frac{[\text{MX}_3]}{C} = \beta_3[\text{X}]^3 \alpha_0 \quad (19.65)$$

$$\alpha_4 = \frac{[\text{MX}_4]}{C_M} = \beta_4[\text{X}]^4 \alpha_0 \quad (19.66)$$

In these equations, $[\text{X}]$ is the concentration of free ligand. With these five expressions that give the fraction of the free metal ion and the fraction in each complex, it is possible to vary $[\text{X}]$ and calculate the fraction of the metal ion in each complex environment.

A graph that shows the fraction of each metal-containing species as a function of the concentration of free ligand is called a *distribution diagram*. As an example to illustrate the construction of a distribution diagram, the equilibrium that results when Cd^{2+} reacts with NH_3 will be considered. When water is omitted from the reactions, the steps can be shown as follows:

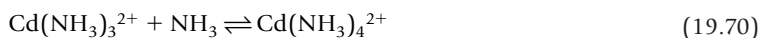
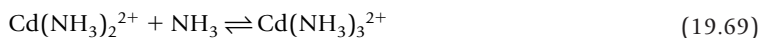
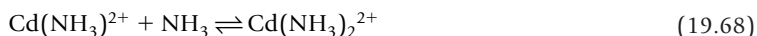

The equilibrium constants for the four steps in the formation of the cadmium ammine complexes are $K_1 = 447$, $K_2 = 126$, $K_3 = 27.5$, and $K_4 = 8.51$. Using these values, the overall stability constants are $\beta_1 = 447$, $\beta_2 = 5.63 \times 10^4$, $\beta_3 = 1.55 \times 10^6$, and $\beta_4 = 1.32 \times 10^7$. Equations (19.63) through (19.66) can be employed to calculate the concentrations of the fractions that contain the metal, α_i , by assuming a series of known values for the concentration of free NH_3 . The range of ligand concentrations must be chosen with care based on the values of the stability constants. In this case, the range of NH_3 concentrations is from 10^{-5} M to 1 M and is expressed as pNH_3 , which ranges from 5 to 0. These calculations give the values shown in Table 19.2. The distribution diagram for the complexes formed in the equilibria represented by the $\text{Cd}^{2+}-\text{NH}_3$ system is shown in Figure 19.3.

The distribution diagram shows that at very low concentrations of NH_3 , the Cd^{2+} is present almost entirely as the free ion. On the other hand, when the concentration of NH_3 is 1 M, the dominant species is $[\text{Cd}(\text{NH}_3)_4]^{2+}$. At intermediate concentrations of NH_3 , several species are present, but the fractions must total 1, the entire fraction of Cd^{2+} because all of the Cd^{2+} must be accounted for in the various complexes. By Le Chatelier's principle, increasing the concentration of NH_3 drives the system represented as shown in Eqs. (19.67) through (19.70) to the right. The procedures described earlier can also be employed to construct a distribution diagram for the dissociation of a polyprotic acid such as H_3PO_4 by determining the concentrations of H_3PO_4 , H_2PO_4^- , HPO_4^{2-} , and PO_4^{3-} as functions of

Table 19.2 Equilibrium Concentrations of Cd^{2+} Complexes in Solutions Containing NH_3 .

pNH_3	α_0	α_1	α_2	α_3	α_4
5.00	0.996	0.004	0.0	0.0	0.0
4.50	0.986	0.014	0.0	0.0	0.0
4.00	0.957	0.043	0.0	0.0	0.0
3.50	0.872	0.123	0.005	0.0	0.0
3.00	0.665	0.297	0.037	0.001	0.0
2.75	0.505	0.401	0.090	0.004	0.0
2.50	0.330	0.467	0.186	0.016	0.0
2.40	0.265	0.472	0.237	0.026	0.001
2.25	0.179	0.450	0.319	0.049	0.002
2.00	0.079	0.350	0.441	0.121	0.010
1.75	0.027	0.217	0.485	0.237	0.036
1.60	0.013	0.145	0.458	0.317	0.068
1.50	0.007	0.106	0.421	0.367	0.099
1.25	0.002	0.041	0.291	0.451	0.216
1.00	0.0	0.013	0.162	0.446	0.379
0.75	0.0	0.0	0.075	0.367	0.555
0.50	0.0	0.0	0.030	0.262	0.707
0.25	0.0	0.0	0.011	0.171	0.818
0.00	0.0	0.0	0.004	0.105	0.891

$\text{pNH}_3 = -\log [\text{NH}_3]$. If $\text{pNH}_3 = 2.00$, $[\text{NH}_3] = 10^{-2} \text{ M}$. If $\text{pNH}_3 = 0.50$, $[\text{NH}_3] = 0.316 \text{ M}$.

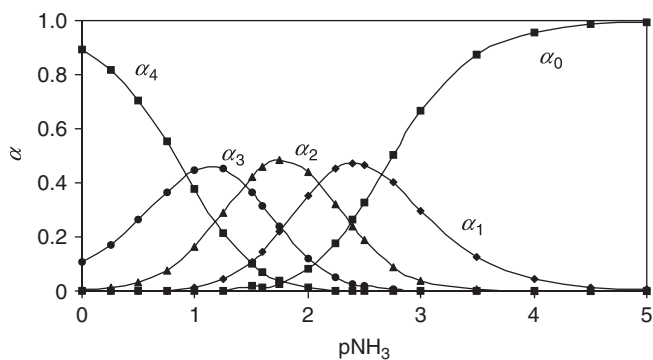
**FIGURE 19.3** A distribution diagram for Cd^{2+} complexes with NH_3 constructed using data shown in Table 19.2.

[H⁺] or pH. It should be pointed out that determining the stability of complexes has been a significant area of research for many years, and an enormous body of literature on the subject exists. One of the classic research monographs in this area for many years has been the book by Rossotti and Rossotti that is cited in the references at the end of this chapter.

19.5 FACTORS AFFECTING THE STABILITY OF COMPLEXES

The formation of a coordinate bond is the result of the donation and acceptance of a pair of electrons. This in itself suggests that if a specific electron donor interacts with a series of metal ions (electron acceptors) there will be some variation in the stability of the coordinate bonds depending on the acidity of the metal ion. Conversely, if a specific metal ion is considered, there will be a difference in stability of the complexes formed with a series of electron pair donors (ligands). In fact, there are several factors that affect the stability of complexes formed between metal ions and ligands, and some of them will now be described.

Establishing correlations between the stability of complexes and factors related to the characteristics of the metal ion and ligands involved is not a new endeavor. One of the earliest correlations established showed that for many types of ligands, the stability of the complexes that they form with +2 ions of first-row transition metals varies in the order

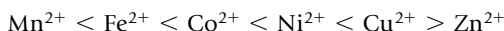
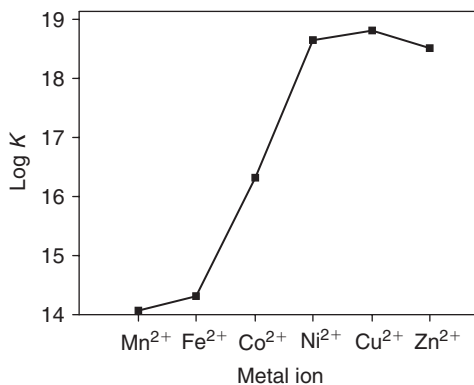

Figure 19.4 shows a graph of the logarithm of K_1 for formation of the complexes between these metal ions and EDTA⁴⁻. The graph shows that the general order of stability of the complexes is in accord with the series of metal ions just shown. The order of stability for complexes containing the metal ions shown above is known as the *Irving-Williams series*. Complexes of these metals containing many other types of ligands show a similar trend in stability.



■ **FIGURE 19.4** The effect of the nature of the metal ion on the stability of EDTA⁴⁻ complexes.

A measure of the Lewis acidity of a metal ion is determined by its affinity for a pair of electrons, and the greater this affinity, the more stable the complexes formed by the metal ion will be. However, removing electrons from a metal to produce an ion is also related to the attraction the metal atom has for electrons. Therefore, it seems reasonable to seek a correlation between the stability constants for complexes of several metals with a given ligand and the total energy necessary for ionization to produce the metal ions. The first-row transition metal ions react in solution with ethylenediamine, en, to form stable complexes. We will consider only the first two steps in complex formation, which can be shown as follows:



When a graph is made of $\log K_1$ versus the sum of the first and second ionization potentials for the metals, the result is shown in Figure 19.5. Clearly, the relationship is linear for the metal ions except Zn^{2+} , for which the complex is considerably less stable than that with Cu^{2+} . These results are in accord with the Irving-Williams series described earlier. The graph obtained when $\log K_2$ is plotted against the total ionization potential has exactly the same characteristics, as is shown in Figure 19.6.

Another type of correlation involving a metal ion with a series of ligands has been established for complexes between Ag^+ and numerous amines, for which the reactions can be shown as

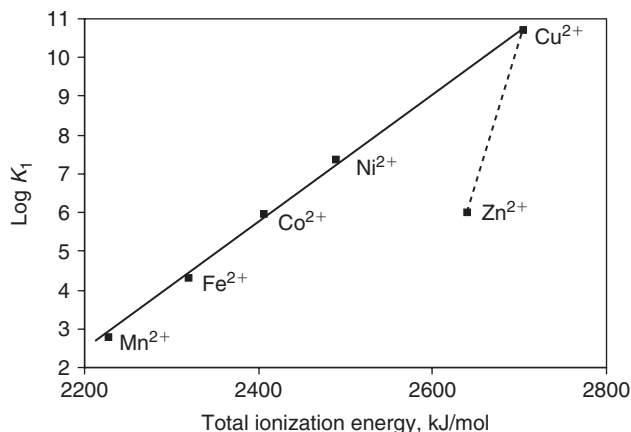

■ FIGURE 19.5 Variation in $\ln K_1$ for complexes of ethylenediamine with total ionization energy of the metal.

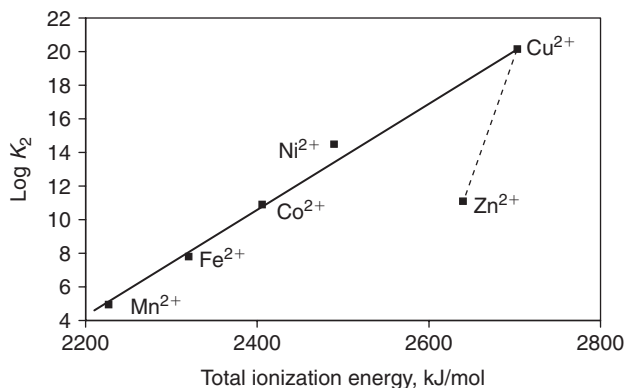

■ FIGURE 19.6 Variation in $\ln K_2$ for $M(en)_3^{2+}$ complexes with total ionization potential of the metal.



where B is an amine. The availability of the electron pair on a base such as an amine determines its basicity toward H^+ ,



so there should be some correlation between K_b for the base and the stability constants for the silver complexes. When the basicities of a series of amines having similar structures are considered, there is a rather good correlation between K_b and K_1 . This indicates that the stronger a base is toward H^+ , the more stable the complex it will form with Ag^+ . Primary and secondary amines generally follow the relationship well. However, if a different type of ligand is considered, such as pyridine, there is no correlation between its basicity toward H^+ and the stability of the complex it forms with Ag^+ . One reason for this is that whereas H^+ is a hard Lewis acid, Ag^+ is soft, so different characteristics of the base are being measured by the two types of equilibrium constants. In fact, the bonds between pyridine and Ag^+ have a substantial amount of covalency and π bond character that is impossible toward H^+ . Although we have discussed correlations that involve equilibrium constants only for the formation of complexes by Ag^+ , such correlations have also been made (or attempted) for complexes of other metals.

Another factor that affects trends in the stability constants of complexes formed by a series of metal ions is the crystal field stabilization energy. As was shown in Chapter 17, the aqua complexes for +2 ions of first-row transition metals reflect this effect by giving higher heats of hydration than would be expected on the basis of sizes and charges of the ions. Crystal field stabilization, as discussed in Section 17.4, would also lead to increased stability for complexes containing ligands other than water. It is a pervasive factor in the stability of many types of complexes. Because ligands that form π bonds

through back donation are also generally strong field ligands, this becomes an additional consideration in regard to the overall stability of complexes.

In Chapter 9, the hard-soft acid-base principle was discussed, and numerous applications of the principle were presented. This principle is also of enormous importance in coordination chemistry. First-row transition metals in high oxidation states have the characteristics of hard Lewis acids (small size and high charge). Consequently, ions such as Cr^{3+} , Fe^{3+} , and Co^{3+} are hard Lewis acids that bond best to hard Lewis bases. When presented with the opportunity to bond to NH_3 or PR_3 , these metal ions bond better to NH_3 , which is the harder base. On the other hand, Cd^{2+} bonds better to PR_3 because of the more favorable soft acid–soft base interaction.

The thiocyanate ion provides an interesting test of these ideas. In the SCN^- ion, the sulfur atom is considered to be a soft electron donor, whereas the nitrogen atom is a much harder electron donor. Accordingly, Pt^{2+} bonds to SCN^- at the sulfur atom, whereas Cr^{3+} bonds to the nitrogen atom. Uncharged metal atoms are considered to be soft electron acceptors, and they form complexes with soft ligands such as CO , H^- , and PR_3 . We will see many examples of such complexes in later chapters. On the other hand, we would not expect complexes between uncharged metal atoms and NH_3 to be stable.

Many observations concerning these trends had been made over the years, and in the 1950s S. Ahrland, J. J. Chatt, and M. Davies presented a classification of metals based on their preferred interaction with donor atoms. Class A metals are those that interact preferentially when the donor atom is in the first row of the periodic table. For example, they prefer to bond to N rather than P donor atoms. Class B metals are those which interact better when the donor atom is in the second row of the periodic table. For example, a class B metal would bond better to P than to N. The following table summarizes the behavior of metal atoms according to this classification.

Strength as Donor Atom	
Class A metals	$\text{N} \gg \text{P} > \text{As} > \text{Sb} > \text{Bi}$ $\text{O} \gg \text{S} > \text{Se} > \text{Te}$ $\text{F} > \text{Cl} > \text{Br} > \text{I}$
Class B metals	$\text{N} \ll \text{P} > \text{As} > \text{Sb} > \text{Bi}$ $\text{O} \ll \text{S} \approx \text{Se} \approx \text{Te}$ $\text{F} < \text{Cl} < \text{Br} < \text{I}$

Keep in mind that this classification, which so clearly now is a manifestation of the HSAB principle, predated that principle by approximately a decade. In retrospect, it seems almost obvious now.

One apparent contradiction to the HSAB principle involves the stability of the complexes $[\text{Co}(\text{NH}_3)_5\text{NCS}]^{2+}$ and $[\text{Co}(\text{CN})_5\text{SCN}]^{3-}$. In the first of these, the thiocyanate ion is bonded to Co^{3+} through the nitrogen atom, as expected. However, in the second complex, SCN^- is bonded to Co^{3+} through the sulfur atom, and this arrangement is the stable one. The difference between these

complexes lies in the effect that the other five ligands have on the metal ion. In $[\text{Co}(\text{NH}_3)_5\text{NCS}]^{2+}$, the Co^{3+} is a hard Lewis acid and the five NH_3 molecules are hard bases. Therefore, the hard character of the Co^{3+} ion as an electron pair acceptor is not altered. In $[\text{Co}(\text{CN})_5\text{SCN}]^{3-}$, the five CN^- ligands are soft bases, so the combination of a Co^{3+} ion with these soft bases alters the character of the Co^{3+} to the point where it behaves as a soft electron pair acceptor toward SCN^- . In other words, Co^{3+} bonded to five soft ligands is different from Co^{3+} bonded to five hard ligands. This effect is known as the *symbiotic effect*.

It is interesting to note that whereas NH_3 ($K_b = 1.8 \times 10^{-5}$) is a stronger base than pyridine ($K_b = 1.7 \times 10^{-9}$), there is often not as much difference in the stability constants of complexes containing these ligands as would be suggested on the basis of their interaction with H^+ . This is especially true when the metal is from the second or third transition series. It appears that in the case of pyridine, which is a soft electron pair donor, there is some tendency for the ligand to form double bonds to the metal in which the electrons in the ring are arranged as in a quinone type of structure. This tendency is not possible for NH_3 , which has no other pairs of electrons to use in multiple bonding or empty orbital of low energy in which to accept electrons.

Although the basicities of NH_3 and ethylenediamine, $\text{H}_2\text{NCH}_2\text{CH}_2\text{NH}_2$, are similar, en forms much more stable complexes. This means that the chelate formed in the reaction



is more stable than the complex that is formed in the reaction



Because the ethylenediamine forms chelate rings, the increased stability compared to NH_3 complexes is called the *chelate effect*. For both ligands, the atoms donating the electron pairs are nitrogen atoms. The difference in stability of the complexes is not related to the strength of the bonds between the metal ion and nitrogen atoms.

The equilibrium constant and free energy for a reaction are related by the equation

$$\Delta G = \Delta H - T \Delta S = -RT \ln K \quad (19.78)$$

From this equation, it is clear that a larger value for K results when ΔG is more negative, which could result if ΔH is more negative. As a result of the bonds between the metal ion and ligand being equal in number and about the same strength in both types of complexes, ΔH is approximately the same regardless of whether the complex contains NH_3 or en. The factor that is different is ΔS , the entropy change. When four NH_3 molecules enter the coordination sphere of the metal ion, four H_2O molecules leave the coordination sphere. As a result, there is an equal number of "free" molecules before and after the complex forms, and ΔS is approximately 0. On the other hand, when *two* en molecules enter the coordination sphere of the metal ion, *four* H_2O molecules are displaced. There is an increase in the number of free molecules, and the disorder of the system (entropy) increases. This *positive* value

A proton is easily removed to produce the acetylacetonate anion (abbreviated acac).

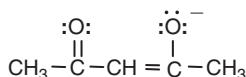

When this anion bonds to a metal ion through both oxygen atoms, a planar six-membered ring is formed. There are two double bonds, as shown, and if there is some double bond character to one of the bonds to the metal ion, a conjugated system is formed, which can be represented as

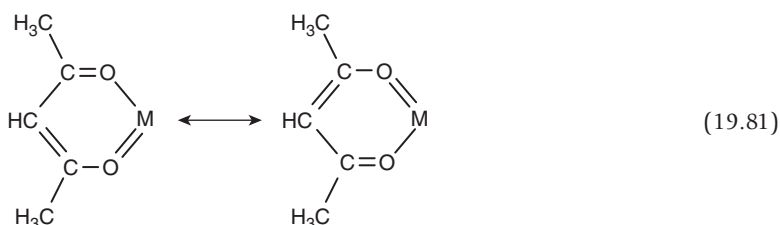

In these structures, only one of the chelate rings has been shown, but there would normally be two or three rings depending on whether the metal is +2 or +3 and has a coordination number of 4 or 6. The rings have considerable aromaticity, which leads to stability of the complexes. Moreover, such complexes are usually neutral in charge and have no other anion present. This also contributes to stability because there is no anion (usually a potential ligand, and in some cases an oxidizing or reducing agent) to compete with the acac ligand. All of these factors lead to complexes that are so stable that some of them can even be vaporized without extensive decomposition. Also, the chelate rings are stable enough to permit reactions to be carried out on them without disrupting the complex. One such reaction is bromination, which can be shown as

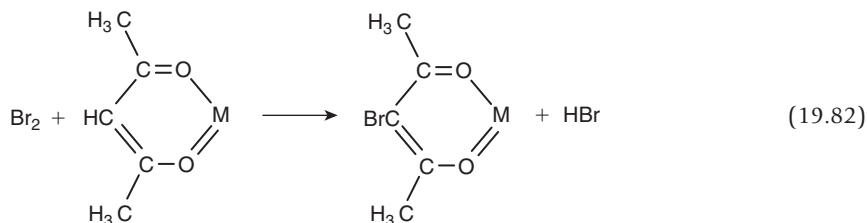

Reactions such as this are electrophilic substitutions, and other electrophiles such as NO_2^- , CH_3CO^- , or CHO^- can be substituted on the rings without destroying the complex. Such chemical behavior illustrates the extreme stability of complexes of this type. It is apparent that the nature of the bonding in the chelate rings is as important as is their size. Other reactions of coordinated ligands will be shown in later chapters.

■ REFERENCES FOR FURTHER STUDY

- Christensen, J. J., and Izatt, R. M. (1970). *Handbook of Metal Ligand Heats*. Marcel Dekker, New York. A compendium of thermodynamic data for the formation of an enormous number of complexes.
- Connors, K. A. (1987). *Binding Constants: The Measurement of Molecular Complex Stability*. Wiley, New York. An excellent discussion of the theory of molecular association as well as the experimental methods and data treatment. Deals with the association of many types of species in addition to metal complexes. Highly recommended.
- Furia, T. E. (1972). "Sequesterants in Foods," Chapter 6 in *CRC Handbook of Food Additives*, 2nd ed. CRC Press, Boca Raton, FL. Comprehensive tables of stability constants for many complexes of organic and biochemical ligands of metals.
- Leggett, D. J., Ed. (1985). *Computational Methods for the Determination of Formation Constants*. Plenum Press, New York. A high-level presentation of the theory of complex equilibria and computer programs for mathematical analysis.
- Martell, A. E., Ed. (1971). *Coordination Chemistry*, Vol. 1. Van Nostrand-Reinhold, New York. This is one of the American Chemical Society Monograph Series. Chapter 7 by Hindeman and Sullivan and Chapter 8 by Anderegg deal with equilibria of complex formation.
- Martell, A. E., and Motekaitis, R. J. (1992). *Determination and Use of Stability Constants*, 2nd ed. Wiley, New York. An excellent treatment of stability constants including methods of calculation and computer programs.
- Pearson, R. G. (1968). *J. Chem. Educ.* 45, 581–643. Two elementary articles on applications of the hard-soft interaction principle by its originator.
- Rossotti, F. J. C., and Rossotti, H. (1961). *Determination of Stability Constants*. McGraw-Hill, New York. Probably the most respected treatise on stability constants and experimental methods for their determination.
- Rossotti, H. (1978). *The Study of Ionic Equilibria in Aqueous Solutions*. Longmans, New York. A wealth of information on the equilibria of complex formation.
- www.adasoftware.co.uk/scdbase/scdbase.htm. An IUPAC data base of stability constants and distribution diagrams. This is just one of many websites where tables of stability constants can be found.

■ QUESTIONS AND PROBLEMS

- For each metal ion listed, predict which of the ligands would give the more stable complex and explain your choice.
 - Cr^{3+} with NH_3 or CO
 - Hg^{2+} with $(\text{C}_2\text{H}_5)_2\text{S}$ or $(\text{C}_2\text{H}_5)_2\text{O}$
 - Zn^{2+} with $\text{H}_2\text{NCH}_2\text{CH}_2\text{NH}_2$ or $\text{H}_2\text{N}(\text{CH}_2)_3\text{NH}_2$
 - Ni^0 with $(\text{C}_2\text{H}_5)_2\text{O}$ or PCl_3
 - Cd^{2+} with Br^- or F^-
- Although acetylacetonate ion forms very stable complexes with many metal ions, acetate ion does not. Explain the difference in complexing behavior.
- How would you expect $\text{S}_2\text{O}_3^{2-}$ to bond to Cr^{3+} assuming all other ligands are H_2O ? What would be different if the other ligands were CN^- ? Explain your answer.
- For the formation of complexes with Ag^+ , $K_1 = 6.72 \times 10^3$ and $K_2 = 2.78 \times 10^3$. When the concentration of free NH_3 is 3.50×10^{-4} M, what is the average number of ligands bound per metal ion?
- Data are given for the complexes formed between Ag^+ and NH_3 in question 4. Using this information, determine the concentration of free NH_3 when the average number of ligands bound per metal ion is 1.65.

6. Consider the following stability constants for the ethylenediamine complexes of the metals listed.

Metal Ion	$\log K_1$	$\log K_2$	$\log K_3$
Co^{2+}	5.89	4.83	3.10
Ni^{2+}	7.52	6.28	4.27
Cu^{2+}	10.55	9.05	-1.0

Provide an explanation for the value for $\log K_3$ for the complex of Cu^{2+} .

7. For the following pairs of ligands, predict which would form the more stable complex with the metal indicated:

- Cr^{3+} : with $\text{C}_6\text{H}_5\text{-O}^-$ or $o\text{-O}^-\text{-C}_6\text{H}_4\text{-CHO}$
- Hg^{2+} : with $(\text{C}_2\text{H}_5)_2\text{O}$ or $(\text{C}_2\text{H}_5)_2\text{S}$
- Zn^{2+} : with $\text{CH}_3\text{C(O)CH}_2\text{C(O)CH}_3$ or $\text{CH}_3\text{C(O)CH}_2\text{CH}_2\text{C(O)CH}_3$
- Cr^{3+} : with NR_3 or PR_3 (R is an alkyl group)
- Ni^0 : with $\text{C}_5\text{H}_5\text{N}$ or PR_3

8. Tell which of the following pairs of ligands forms more stable complexes with a first-row metal ion such as Cr^{3+} :

- $\text{H}_2\text{NCH}_2\text{CH}_2\text{NH}_2$ or $\text{NH}_2\text{CH}_2\text{CH}_2\text{CH}_2\text{NH}_2$
- $(\text{CH}_3)_3\text{N}$ or $\text{H}_2\text{NCH}_2\text{CH}_2\text{NH}_2$
- $\text{H}_2\text{PCH}_2\text{CH}_2\text{PH}_2$ or $\text{H}_2\text{NCH}_2\text{CH}_2\text{NH}_2$
- $\text{CH}_3\text{C(O)CH}_2\text{C(O)CH}_3$ or $\text{H}_2\text{NCH}_2\text{CH}_2\text{NH}_2$

9. Pyridine ($\text{C}_5\text{H}_5\text{N}$) forms complexes with Ag^+ that can be shown as

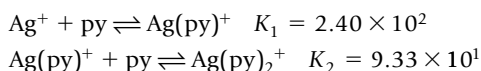

When the concentration of free py is 2.50×10^{-4} M, what is the average number of ligands bound per metal ion?

10. For the formation of a complex according to the equation

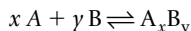

the concentration of complex was determined at different concentrations of A and B as follows:

[A] = 0.200 M	[B] = 0.250 M	$[\text{A}_x\text{B}_\gamma] = 0.0467$ M
[A] = 0.200 M	[B] = 0.400 M	$[\text{A}_x\text{B}_\gamma] = 0.191$ M
[A] = 0.200 M	[B] = 0.750 M	$[\text{A}_x\text{B}_\gamma] = 1.26$ M
[A] = 0.240 M	[B] = 0.220 M	$[\text{A}_x\text{B}_\gamma] = 0.0459$ M
[A] = 0.420 M	[B] = 0.220 M	$[\text{A}_x\text{B}_\gamma] = 1.41$ M
[A] = 0.700 M	[B] = 0.220 M	$[\text{A}_x\text{B}_\gamma] = 0.391$ M

Using these data, determine the values of x and y for the complex.

- When Cd^{2+} forms complexes with Cl^- , the stability constants are as follows: $K_1 = 20.9$; $K_2 = 7.94$; $K_3 = 1.23$; $K_4 = 0.355$. Use the procedures described in this chapter to determine $[\text{Cd}^{2+}]$, $[\text{CdCl}^+]$, $[\text{CdCl}_2]$, $[\text{CdCl}_3^-]$, and $[\text{CdCl}_4^{2-}]$ for chloride ion concentrations in the range 10^{-4} M to 10 M. Make a graph of the results in the form of a distribution diagram for the complexes.
- For the formation of two complexes AgL^+ and AgL_2^+ , the average number of ligands bound per metal ion is 0.495 when the concentration of free ligand is 1.50×10^{-4} M, and the number is 1.475 when the concentration of free ligand is 5.75×10^{-4} M. Determine the stability constants for the complexes.

Synthesis and Reactions of Coordination Compounds

Preparation of coordination compounds and the transformation of one coordination compound into another form the basis for a vast amount of synthetic inorganic chemistry. In some cases, the reactions involve replacing one or more ligands with others in substitution reactions. In others, reactions may be carried out on ligands that are attached to metal ions without breaking the metal-ligand bond. These reactions, which often involve organic compounds, constitute the area of reactions of coordinated ligands. The fact that the organic molecule is bonded to a metal ion may make it easier to carry out certain reactions. Another type of reaction involving coordination compounds is that in which electrons are transferred between metal ions. This process is often influenced by the nature of the ligands surrounding the metal ions. Finally, it is important to have a general knowledge of how coordination compounds are prepared.

In this chapter, a survey of the enormously broad area of reactions of coordination compounds will be presented, and some of the basic mechanisms of the reactions will be presented. However, reactions of coordination compounds is such a very broad area that this chapter (as would be the case of any chapter) can present only the basic concepts and an elementary introduction to the field. More detailed coverage will be found in the references listed at the end of the chapter. The classic books in the field are Basolo and Pearson (1974) and Wilkins (1991), which present excellent and detailed reviews of the literature. We begin the chapter by illustrating some of the synthetic methods that have been useful for synthesizing coordination compounds.

20.1 SYNTHESIS OF COORDINATION COMPOUNDS

Coordination compounds have been produced by a variety of techniques for at least two centuries. Zeise's salt, $K[\text{Pt}(\text{C}_2\text{H}_4)\text{Cl}_3]$, dates from the early 1800s, and Werner's classic syntheses of cobalt complexes were described over a century ago. Synthetic techniques used to prepare coordination compounds range from simply mixing the reactants to employing nonaqueous solvent chemistry. In this section, a brief overview of some types of general synthetic procedures will be presented. In Chapter 21, a survey of the organometallic chemistry of transition metals will be presented, and additional preparative methods for complexes of that type will be described there.

20.1.1 Reaction of a Metal Salt with a Ligand

One of the techniques for producing coordination compounds is to simply combine the reactants. Some reactions may be carried out in solution, but others may involve adding a liquid or gaseous ligand directly to a metal compound. Some reactions of this type are the following:

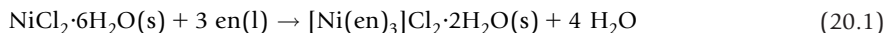

The product obtained during the second reaction, $[\text{Cr}(\text{en})_3]_2(\text{SO}_4)_3(\text{s})$, is a solid mass. It has been found advantageous to dissolve ethylenediamine in an inert liquid that has a high boiling point such as toluene. Refluxing this solution while adding solid $\text{Cr}_2(\text{SO}_4)_3$ slowly gives a finely divided product that is easier to separate by filtration and is easy to purify. This technique can be applied to the preparation of numerous other types of complexes. In this case, changing the reaction medium gives a product that is more convenient to use in subsequent work.

An example of a synthesis utilizing a nonaqueous solvent is a common procedure that is used to prepare $[\text{Cr}(\text{NH}_3)_6]\text{Cl}_3$. The reaction is

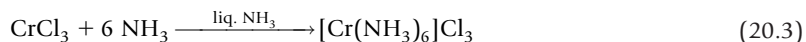

It has been found that this reaction is catalyzed by sodium amide, NaNH_2 . The function of the catalyst appears to involve the replacement of Cl^- by NH_2^- , which is the stronger nucleophile. Once the NH_2^- ion is attached to Cr^{3+} , it quickly removes a proton from a solvent molecule to be transformed into a coordinated NH_3 molecule. As will be shown later in this chapter, this type of behavior is also characteristic of coordinated OH^- in aqueous solutions.

Some alkenes will react with metal salts to give complexes that involve electron donation from the double bond. A classic case of this type is the formation of Zeise's salt. However, if the alkene has more than one potential donor site, bridged complexes may result. One such ligand is butadiene, which forms an interesting bridged structure with CuCl . The reaction is carried out at -10°C with CuCl being added directly to liquid butadiene.



Acetylacetone (2,4-pentadione) undergoes a tautomerization that can be shown as

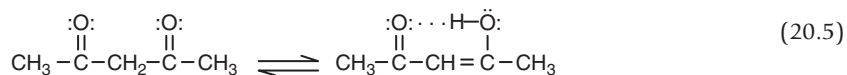

and the equilibrium is strongly solvent dependent. When a small amount of ammonia is present, the proton in the OH groups is removed to form the anion,

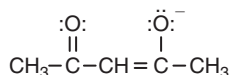

which is an excellent chelating agent. The anion, abbreviated as acac, will react with many metal ions to form stable complexes. An example of this type of reaction is

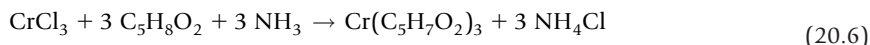

Complexes containing acac are especially stable because they exist as neutral complexes such as $\text{M}(\text{acac})_3$ and $\text{M}(\text{acac})_2$ when the metal is +3 and +2, respectively. Many other reactions have been carried out in which the ligand reacts with a metal compound. In many cases, it is preferable to start with an anhydrous metal compound, and dehydration can sometimes be accomplished by a reaction with SOCl_2 .

20.1.2 Ligand Replacement Reactions

The replacement of one ligand by another is the most common type of reaction of coordination compounds, and the number of reactions of this type is enormous. Some are carried out in aqueous solutions, some in nonaqueous media, and others can be carried out in the gas phase. One such reaction is

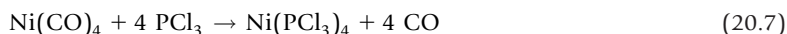

When an octahedral complex such as $[\text{Cr}(\text{CO})_6]$ reacts with pyridine, only three CO ligands are replaced. In the product $[\text{Cr}(\text{CO})_3(\text{py})_3]$, the CO and py ligands are *trans* to each other. Replacement reactions are important because frequently one type of complex is easily prepared and then can be converted to another that cannot be obtained easily. Gaseous butadiene will react with an aqueous solution of $\text{K}_2[\text{PtCl}_4]$ to give a bridged complex in which Cl ligands are displaced.

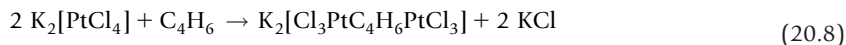

A large number of syntheses involve replacement reactions.

20.1.3 Reaction of Two Metal Compounds

Several synthetic processes involve the reaction of two metal salts. A well-known example of this type is the following.

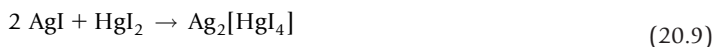

This reaction has been induced in several ways, but one novel procedure involves the action of ultrasound on a suspension of the two solid reactants in dodecane. The ultrasonic vibrations create cavities in the liquid that implode, driving particles of the solid together at high velocity. Under these conditions, the solids react in much the same way as if they were heated, but in cases where an unstable product is formed, it is not thermally decomposed.

A variation of this type of reaction occurs when a metal complex already containing ligands reacts with a simple metal salt to give a redistribution of the ligands. For example,

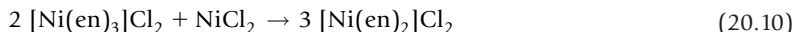

20.1.4 Oxidation-Reduction Reactions

Many coordination compounds can be prepared when a compound of the metal is either reduced or oxidized in the presence of a ligand. Oxalic acid is a reducing agent, but it also serves as a source of the oxalate ion, which is a good chelating agent. An interesting reaction of this type involves the reduction of dichromate by oxalic acid as shown by the following equation:

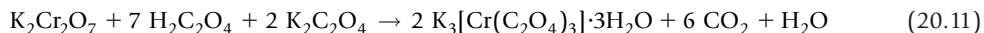

In other reactions, the metal may be oxidized as the complex is formed. Numerous complexes of Co(III) have been prepared by the oxidation of solutions containing Co(II). This technique is particularly useful in the case of cobalt because Co^{3+} is a strong oxidizing agent that reacts with water if it is not stabilized by complexation. In the following reactions, en is ethylenediamine, $\text{H}_2\text{NCH}_2\text{CH}_2\text{NH}_2$:

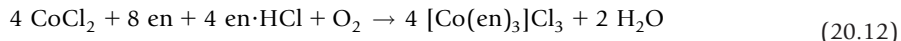

Heating the product of the second reaction yields *trans*- $[\text{Co}(\text{en})_2\text{Cl}_2]\text{Cl}$ by the loss of HCl. Dissolving *trans*- $[\text{Co}(\text{en})_2\text{Cl}_2]\text{Cl}$ in water and evaporating the solution by heating results in the formation of *cis*- $[\text{Co}(\text{en})_2\text{Cl}_2]\text{Cl}$ as the result of an isomerization reaction.

20.1.5 Partial Decompositions

Reactions in which volatile ligands such as H_2O and NH_3 are lost as a result of heating lead to the formation of other complexes. Generally, these reactions involve solids, and some such processes will be described later in this chapter. As a volatile ligand is driven off, another group can enter the coordination sphere of the metal. In other cases, there may be a change in bonding mode of a ligand that is already present. For example, SO_4^{2-} may become bidentate to complete the coordination sphere of the metal. The synthesis of $[\text{Co}(\text{NH}_3)_5\text{H}_2\text{O}]\text{Cl}_3(\text{s})$ is rather straightforward, and after it is obtained, it is converted when heated to $[\text{Co}(\text{NH}_3)_5\text{Cl}]\text{Cl}_2(\text{s})$ by the reaction



Other compounds containing different anions are obtained by the following reaction:

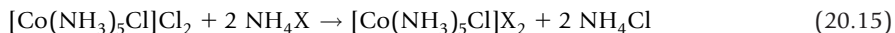

This metathesis reaction can be carried out in aqueous solutions as a result of differences in solubility.

Two additional reactions representing partial decomposition are the following:

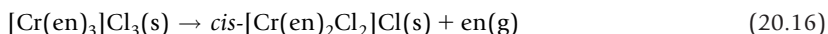

These reactions have been known for almost 100 years and they have been extensively studied. The reactions are catalyzed by the corresponding ammonium salt in each case, although other protonated amines function as catalysts. It appears that the function of the catalyst is to supply H^+ , which helps to force an end of the ethylenediamine molecule away from the metal.

20.1.6 Precipitation Making Use of the Hard-Soft Interaction Principle

As a consequence of the hard-soft interaction principle, ions of similar size and magnitude of charge interact best. That interaction includes the formation of precipitates. It is possible to make use of this principle when isolating complex ions that are relatively unstable. A well-known case of this type is the isolation of the $[\text{Ni}(\text{CN})_5]^{3-}$ ion, which results when aqueous solutions containing Ni^{2+} also contain an excess of CN^- . Attempts to isolate $[\text{Ni}(\text{CN})_5]^{3-}$ by adding K^+ were not successful because what was obtained was $\text{K}_2[\text{Ni}(\text{CN})_4]$ and KCN. It was only when a large cation having a +3 charge was utilized that the pentacyanonickelate(II) ion was obtained in a solid product. The large +3 cation used was $[\text{Cr}(\text{en})_3]^{3+}$. With that cation, the solid product was $[\text{Cr}(\text{en})_3][\text{Ni}(\text{CN})_5]$. The following equations describe the process:

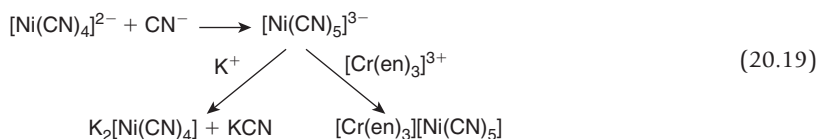

In many parts of this book, the utility of the hard-soft interaction principle has been described. In the situation described, the choice of an appropriate cation makes possible the isolation of a relatively unstable complex ion by providing a crystal environment that helps to stabilize the complex. The application of basic principles that relate to structure and stability can also be useful in synthetic chemistry.

20.1.7 Reactions of Metal Compounds with Amine Salts

Many years ago, L. F. Audrieth studied numerous reactions of amine hydrochloride salts. These compounds contain a cation that is a protonated amine that can function as a proton donor. Consequently, the molten salts are acidic and they undergo many reactions in which they function as acids. This behavior is also characteristic of ammonium chloride as well as pyridine hydrochloride (or pyridinium

chloride). Numerous metal oxides and carbonates react readily with the molten amine salts, as illustrated by the following equation:

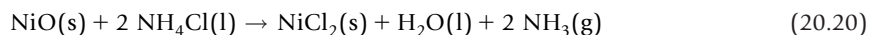

Hydrothiocyanic acid (also known by the archaic name rhodanic acid), HSCN, is a strong acid, so it is easy to prepare stable amine hydrothiocyanate salts such as that of piperidine, C₅H₁₁N (abbreviated as pip). In this reaction, the less volatile base, piperidine, replaces the volatile weak base, NH₃.

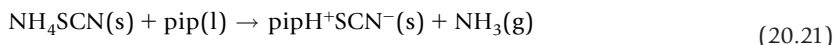

The salt pipHSCN, known as piperidinium thiocyanate or piperidine hydrothiocyanate, has a melting point of 95 °C. When metal compounds are added to this molten salt, thiocyanate complexes of the metals are produced. For example, the following reactions can be carried out at 100 °C in the presence of an excess of the amine hydrothiocyanate:



In some cases, the metal complex contains both piperidine and thiocyanate as ligands, as illustrated by the following equation:

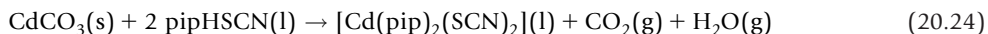

In addition to the reactions just described using molten pipHSCN, several reactions have been carried out at low temperature by sonicating mixtures of metal salts and pipHSCN (House, 1998). The use of ultrasound results in products of higher purity than when the molten salt is used. This is probably due to the fact that some of the products are not very stable at the temperature of the molten salt (100 °C) and mixtures result under those conditions. In carrying out the reactions, the amine hydrothiocyanate and the metal compound were suspended in dodecane and pulsed ultrasound was applied. The following reactions are typical of preparations of this type:

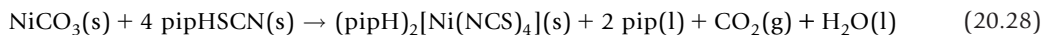
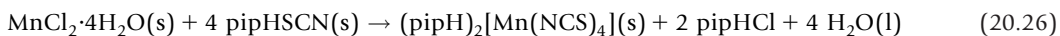
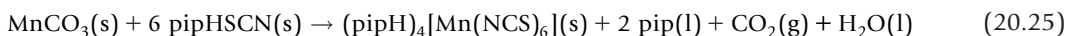

In every case, the products were obtained in high purity in this convenient, one-step synthesis. Although ultrasound has not been used extensively in inorganic chemistry, it is a well-known technique in organic synthesis.

We have barely introduced the vast area of synthetic coordination chemistry. The methods described show that a wide variety of techniques have been employed, and they may be employed in combination in sequential steps to develop creative synthetic routes. The comprehensive compilations listed in the suggested readings should be consulted for further study. Several journals in inorganic chemistry are at least partially devoted to synthesis of materials, so the field is growing at a rapid rate.

20.2 SUBSTITUTION REACTIONS IN OCTAHEDRAL COMPLEXES

The enormous number of coordination compounds undergo many reactions, but a large number of reactions can be classified into a small number of reaction types. When one ligand replaces another, the reaction is called a *substitution reaction*. For example, when ammonia is added to an aqueous solution containing Cu^{2+} , water molecules in the coordination sphere of the Cu^{2+} are replaced by molecules of NH_3 . Ligands are held to metal ions because they are electron pair donors (Lewis bases). Lewis bases are nucleophiles (see Chapter 9), so the substitution of one nucleophile for another is a *nucleophilic substitution* reaction. Such a reaction can be illustrated as



where X is the leaving group and L' is the entering group. It is also possible to have a metal ion (Lewis acid) replace another in a different type of reaction. Lewis bases are electrophiles, so this type of reaction is an *electrophilic substitution*, which can be represented as



Because all of the ligands are leaving one metal ion and attaching to another, this type of reaction is sometimes known as ligand scrambling.

Nucleophilic substitution reactions have rates that vary enormously. For example, the reaction

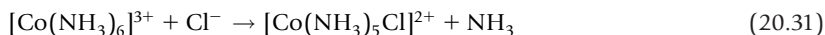

is extremely slow, whereas the reaction



is extremely fast. Complexes that undergo substitution very slowly are said to be *inert*; those that undergo rapid substitution are called *labile*. These qualitative terms have been used as descriptors for substitution reactions for many years. The fact that a complex undergoes substitution very slowly may indicate that there is no low-energy pathway for the reaction even though the product of the substitution reaction may be very stable.

Although the terms *labile* and *inert* have been in use for more than 50 years, they are only qualitative descriptions of substitution rates. A more appropriate way to describe the rates has been given by Gray and Langford (1968), which categorizes metal ions according to the rate of exchange of coordinated water with water in the bulk solvent. The four classes of metal ions are shown in Table 20.1.

Table 20.1 Classification of Metal Ions on the Basis of H₂O Exchange Rate.

Class	k, sec^{-1}	Examples
I	$\sim 10^8$	$\text{Li}^+, \text{K}^+, \text{Na}^+, \text{Ca}^{2+}, \text{Ba}^{2+}, \text{Cu}^+, \text{Hg}^{2+}, \text{Cd}^{2+}$
II	$10^4 - 10^8$	$\text{Mg}^{2+}, \text{Fe}^{2+}, \text{Mn}^{2+}, \text{Zn}^{2+}$
III	$10^0 - 10^4$	$\text{Be}^{2+}, \text{Al}^{3+}, \text{Fe}^{3+}$
IV	$10^{-1} - 10^{-9}$	$\text{Co}^{3+}, \text{Cr}^{3+}, \text{Pt}^{2+}, \text{Pt}^{4+}, \text{Rh}^{3+}, \text{Ir}^{3+}$

In a general way, the ions in the first two classes would be considered labile while those in the last two classes would be considered inert. Labile complexes are regarded as those in which the reaction is complete on a time scale that would be comparable to the time necessary to mix the solutions of the reacting species. Such reactions can be studied by flow techniques or by NMR line broadening. Inert complexes are those that can be followed by conventional kinetic techniques.

It is sometimes inferred that the ions in at least the first two categories attach solvent by electrostatic forces, whereas those in class IV bond by predominantly covalent forces. This concept is not very realistic, even though the rates of the exchange reactions may be compatible with that view. When substitution is viewed in terms of transition states, it can be seen that metal ions having empty d orbitals can readily form a hybrid orbital set that will accommodate an additional ligand. Therefore, a reaction can proceed by a pathway in which the transition state requires expansion of the coordination sphere, and such reactions should be rapid. In agreement with this view, complexes of Sc^{3+} (d^0), Ti^{3+} (d^1), and V^{4+} (d^2) are labile. Complexes containing d^3 , d^4 , d^5 , and d^6 ions would require a ligand to leave before the entering ligand attaches ($\text{S}_{\text{N}}1$) or require the use of outer d orbitals to form a seventh bond. In either case, the reactions would likely be relatively slow compared to those of labile complexes. In agreement with this simple view, complexes of V^{2+} , Cr^{3+} , Mn^{4+} (all of which are d^3 ions), low-spin complexes of Co^{3+} , Fe^{2+} , Ru^{2+} , Rh^{3+} , Ir^{3+} , Pd^{4+} , and Pt^{4+} (all of which are d^6 ions), and low-spin complexes of Mn^{3+} , Re^{3+} , and Ru^{4+} are all inert.

20.2.1 Mechanisms of Substitution Reactions

Mechanisms of substitution reactions can sometimes be described in terms of two limiting cases. In the first, the leaving group leaves the coordination sphere of the metal prior to the entering group attaching to the metal. Therefore, the transition state involves a complex that has a lower coordination number than the reactant. In such cases, the concentration of the entering group does not affect the rate of the reaction over a wide range of concentrations. The transition state involves only the complex, so the reaction is first-order in complex, and the coordination number of the complex in the transition state is one less than it is in the reactant. This process can be illustrated as

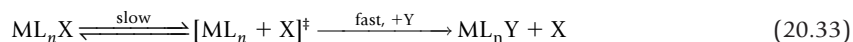

In order to show the kinetic analysis of this process, we can separate the steps and assign rate constants as follows:



The rate of formation of ML_nY can be expressed as

$$\text{Rate} = \frac{d[\text{ML}_n\text{Y}]}{dt} = k_2[\text{ML}_n][\text{Y}] \quad (20.36)$$

In the steady-state approximation, the rate of formation of the transition state (sometimes called an intermediate if it has a sufficiently long lifetime) is the same as the rate at which it disappears. Therefore, the concentration of the transition state as a function of time can be expressed as

$$\frac{d[\text{ML}_n]}{dt} = k_1[\text{ML}_n\text{X}] - k_{-1}[\text{ML}_n][\text{X}] - k_2[\text{ML}_n][\text{Y}] = 0 \quad (20.37)$$

From this equation we see that

$$k_1[\text{ML}_n\text{X}] = k_{-1}[\text{ML}_n][\text{X}] + k_2[\text{ML}_n][\text{Y}] \quad (20.38)$$

Solving for $[\text{ML}_n]$ gives

$$[\text{ML}_n] = \frac{k_1[\text{ML}_n\text{X}]}{k_{-1}[\text{X}] + k_2[\text{Y}]} \quad (20.39)$$

Substituting this expression for $[\text{ML}_n]$ in Eq. (20.36) gives

$$\text{Rate} = k_2[\text{ML}_n][\text{Y}] = \frac{k_1 k_2 [\text{ML}_n\text{X}][\text{Y}]}{k_{-1}[\text{X}] + k_2[\text{Y}]} \quad (20.40)$$

In the dissociative mechanism, the concentration of the transition state ML_n is usually quite low and recombination with X to form the starting complex is insignificant compared to the reaction with Y. This means that $k_2[\text{Y}] \gg k_{-1}[\text{X}]$, and the first term in the denominator of the right-hand side of Eq. (20.40) can be ignored to give

$$\text{Rate} \approx \frac{k_1 k_2 [\text{ML}_n\text{X}][\text{Y}]}{k_2[\text{Y}]} \approx k_1[\text{ML}_n\text{X}] \quad (20.41)$$

Because it is the rate of *dissociation* of the M–X bond that determines the rate of substitution, the rate law involves only the concentration of the starting complex, ML_nX .

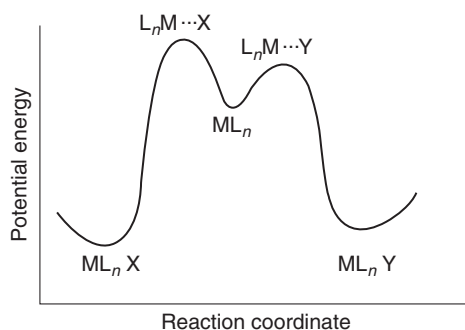

■ FIGURE 20.1 The energy profile for substitution of Y for X in a dissociative mechanism.

A reaction that has these characteristics is said to follow a *dissociative* or S_N1 pathway. This mechanism is distinguished by the bond to the leaving group being broken before the bond to the entering ligand starts to form. Some authors (such as Basolo and Pearson, 1974) define two types of S_N1 substitution. If the existence of the transition state having lower coordination number is verified, the mechanism is called $S_N1(\text{lim})$, the so-called limiting case. This could also be called the “strict” or “perfect” S_N1 case. The label S_N1 is used for a reaction in which the transition state of lower coordination number is not demonstrated, but all other factors agree with an S_N1 mechanism. The energy profile for the dissociative pathway is shown in Figure 20.1.

It is interesting to note that for the reaction

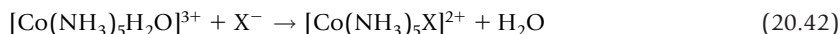

the rate constants have been determined at 25 °C for a wide range of ligands, X. For several ligands, the rate constants are as follows:

$\text{X}^- =$	Cl^-	Br^-	NO_3^-	NCS^-	NH_3
$10^6 \times k, \text{M}^{-1} \text{sec}^{-1}$	2.1	2.5	2.3	1.3	2

The essential feature of these data is that the rate is independent of the nature of the entering ligand. This behavior is characteristic of an S_N1 substitution mechanism.

If the entering group starts to bond to the metal before the leaving group exits the coordination sphere, the substitution reaction can be shown as

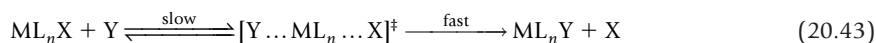

When written in terms of the elementary reaction steps, the process can be represented as





The rate of formation of the product can be described in terms of the concentration of the transition state as follows:

$$\text{Rate} = \frac{d[\text{ML}_n\text{Y}]}{dt} = k_2[\text{ML}_n\text{XY}] \quad (20.46)$$

It is now necessary to express the concentration of the transition state as a function of time. The transition state is formed in the first reaction and consumed in the reverse of the first step and in the second step. Therefore, the steady-state approximation yields

$$\frac{d[\text{ML}_n\text{XY}]}{dt} = k_1[\text{ML}_n\text{X}][\text{Y}] - k_{-1}[\text{ML}_n\text{XY}] - k_2[\text{ML}_n\text{XY}] = 0 \quad (20.47)$$

from which we obtain

$$k_1[\text{ML}_n\text{X}][\text{Y}] = k_{-1}[\text{ML}_n\text{XY}] + k_2[\text{ML}_n\text{XY}] = 0 \quad (20.48)$$

Solving this equation for the concentration of the intermediate gives

$$[\text{ML}_n\text{XY}] = \frac{k_1[\text{ML}_n\text{X}][\text{Y}]}{k_{-1} + k_2} \quad (20.49)$$

Substituting this result into Eq. (20.46) gives the rate law

$$\text{Rate} \approx \frac{k_1 k_2 [\text{ML}_n\text{X}][\text{Y}]}{k_{-1} + k_2} \approx k_{\text{obs}} [\text{ML}_n\text{X}][\text{Y}] \quad (20.50)$$

where $K_{\text{obs}} = K_1 K_2 / (K_{-1} + K_2)$. Formation of the transition state in this case involves both $[\text{ML}_n\text{X}]$ and Y , so the rate law contains the concentrations of both species.

In the process for which the rate law is a function of the concentration of *both* the complex and the entering ligand, the rate law describes an *associative* or S_N2 process. The associative pathway is characterized by the bond to the entering group being formed while the bond to the leaving group is still intact. In the transition state, the coordination number of the metal is larger than it is in either the reactant or product. In an S_N2 mechanism, the transition state is a complex in which the coordination number increases as the entering group attaches *before* the leaving group is completely detached. It is sometimes considered that these two processes that can take place to a more or less equal extent (simultaneously in the transition state of the interchange mechanism, as discussed later). In this case, the mechanism is described as S_N2 , but this label is also used to describe a second type of associative process. If bond formation to Y is much more important than breaking the bond to X as the transition state forms, the mechanism is described as $S_N2(\text{lim})$ or as a “strictly” S_N2 process. In this case, the transition state is a complex in which *both* the entering and leaving ligands reside in the coordination sphere of the metal.

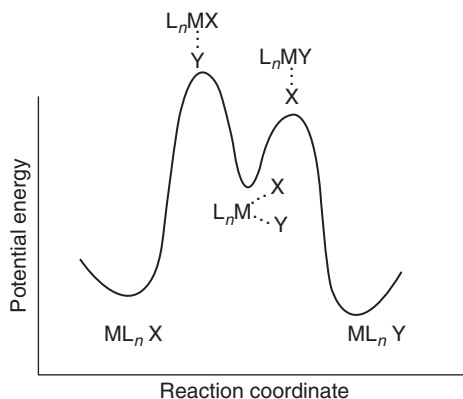

■ FIGURE 20.2 The energy profile for substitution of Y for X in an associative mechanism.

In aqueous solutions, a water molecule can bind to the activated complex to complete the coordination sphere. The complex formed, $[ML_n \cdot H_2O]$, has some stability, so it represents a lower energy than the transition state, $[ML_n]$. Therefore, the complex $[ML_n \cdot H_2O]$ is known as an *intermediate* because it is more stable than the transition state either before the H_2O enters or after it leaves. Figure 20.2 shows the energy profile for a substitution reaction that follows an associative pathway.

If the bond to the entering ligand starts to form as the bond to the leaving group is being broken, the pathway is referred to as an *interchange* mechanism, *I*. This is an intermediate process in which the bonds to both the entering and leaving groups exist simultaneously. The formation of the new bond may be more important than breaking the bond to the leaving group in some cases. Therefore, the interchange mechanism is a sort of one-step process in which the entering ligand is bonding to the metal as the leaving group moves out of the coordination sphere. If bond formation occurs essentially *before* the bond to the leaving group is ruptured, the interchange is known as *associative* interchange, I_a , and this is referred to as $S_N2(\text{lim})$ in older literature. However, if bond breaking to the leaving group is essentially complete *before* the bond forms to the entering group, the interchange is referred to as *dissociative* interchange, I_d , which is analogous to S_N2 in older terminology. Both interchange mechanisms can be regarded as S_N2 , but with different degrees of overlap in the time scale in which bond making and bond breaking occur. The energy profile for this process is shown in Figure 20.3.

20.2.2 Some Factors Affecting Rates of Substitution

Substitution reactions occur as a metal-ligand bond is broken and a different ligand bonds to the metal. That such processes would be related to the properties of the metal and ligand should be expected. Therefore, when substitution occurs, there are some (largely predictable) effects as a result of different sizes and charges of the entering and leaving ligands and the size and charge of the metal ion. For example, if a substitution reaction proceeds by an S_N1 mechanism, increasing the sizes of the other ligands in the complex helps “pressure” the leaving group, making it more labile. On the other hand,

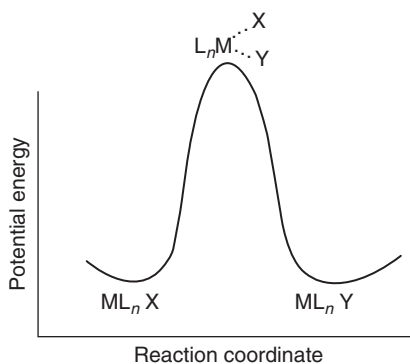

■ **FIGURE 20.3** The interchange mechanism for a substitution reaction.

in an S_N2 process, bulky ligands hinder the formation of the bond to the entering ligand, so the effect will be to decrease the rate.

Increasing the charge on the metal ion makes it more difficult for the leaving group to depart, so the rate would be expected to decrease when the charge on the metal is higher. In contrast, a more highly charged metal ion attracts the entering group more strongly, so in $S_N2(\text{lim})$ cases (where bond formation to the entering ligand is a dominant factor) the rate should increase. In an S_N2 mechanism, both bond breaking (which is hindered when the metal ion has a higher charge) and bond making are affected, and in opposite ways, so no unambiguous conclusion can be given.

The size of the ligand that is being replaced influences the rate of substitution, and the effect can be rationalized in the following way. A larger leaving group makes it easier to depart, so the rate of an S_N1 reaction will increase as ligand size increases. A larger ligand generally hinders attachment of the entering group in an $S_N2(\text{lim})$ process, so the rates are generally lower for larger leaving groups. In an S_N2 process, the effects of the size of the leaving group are opposing because both the entering and leaving groups are involved.

The size of the metal ion should also influence the rate of substitution reactions. The larger the metal ion, the less strongly the leaving group is attached, so an S_N1 process should have a higher rate for larger metal ions. In either an S_N2 or $S_N2(\text{lim})$ process, there will be less steric crowding as the bond is formed to the entering group, so the rate should increase for larger metal ions.

Increasing the charge on the ligand that is leaving should hinder the formation of the transition state in either a S_N1 , S_N2 , or $S_N2(\text{lim})$ mechanism. On the other hand, increasing the charge (or polarity) of the entering ligand should have no effect in an S_N1 mechanism, but would assist bond formation in either S_N2 or $S_N2(\text{lim})$ mechanisms (which would increase the rate of substitution).

The effects predicted are qualitative at best. There are other factors that must be taken into account when predicting how various characteristics of the metal and ligand affect substitution reactions. For example, increasing the size of the metal ion is predicted to assist the formation of the transition state in S_N1 ,

S_N2 , or $S_N2(\text{lim})$ cases. However, rates of reactions of Co^{3+} , Rh^{3+} , and Ir^{3+} complexes show that the second- and third-row metals react much more slowly than do first-row metals. Realizing that formation of the transition state requires some sacrifice of ligand field stabilization energy, one must expect that forming the transition state of the first-row (but smaller) ion would require less energy because for a given ligand Dq is much smaller for the first-row metal ions. Even this does not fully address all of the problems, because it is known that the ability of the ligands to form π bonds is also a factor. If, as is usually the case, the metal ion has nonbonding d orbitals, they may be involved in bonding to an entering ligand, which can facilitate bond formation during an S_N2 or $S_N2(\text{lim})$ process. As a result of all of these factors, the trends predicted earlier have some utility, but they should not be taken too literally. Neither do the effects of ligand field stabilization energy always agree with experience, because the ligand field approach to bonding is from an inadequate description of the bonding in complexes.

Another troublesome factor is the influence of the solvent. In many cases, if two processes have comparable activation energies, it is possible for the solvent to affect the stability of the transition state to such an extent that the mechanism is controlled by these subtle differences in ΔH^\ddagger or ΔS^\ddagger brought about by the solvent. In general, solvents having high cohesion (large solubility parameter) favor the formation of transition states in which there is charge generation or separation. Solvents having low cohesion (small solubility parameter) generally favor formation of transition states in which charge is dispersed. Ion pairing (and dipole association) is more extensive in solvents that have lower cohesion, but solvents of high cohesion (and typically high polarity) generally solvate ions more strongly, which helps prevent ion pairing. The whole area of making predictions about rates of reaction of coordination compounds based on properties of ligands, metal ions, and solvents is a thorny problem in kinetics, with only some general trends being observable.

20.3 LIGAND FIELD EFFECTS

The ligand field stabilization energy associated with several geometrical arrangements of ligands were shown in Chapter 17. In the course of a substitution reaction in an octahedral complex, the transition state may involve either five bonds to the metal as in an S_N1 mechanism or seven bonds as in an S_N2 pathway. In either case, the ligand field stabilization energy is different from that of the starting complex. Therefore, part of the activation energy required can be attributed to the amount of ligand field energy lost in forming the transition state. The basis for calculating the ligand field energy in various possible transition states is provided by the orbital energies shown in Table 17.1.

Let us first consider the case of a substitution reaction in a complex of a d^6 ion such as Co^{3+} in a strong field. If the process takes place by an S_N1 process, the five-bonded transition state may be presumed to have either a trigonal bipyramid or square-based pyramid structure. The orbital energies will be determined as follows:

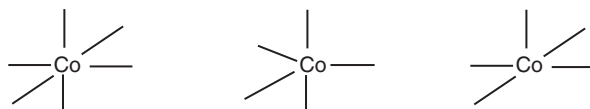

	Starting O_h complex	Trigonal bipyramid	Square-based planar
d_{z^2}	$6.00 \times 0 = 0$	$7.07 \times 0 = 0$	$0.86 \times 0 = 0$
$d_{x^2-y^2}$	$6.00 \times 0 = 0$	$-0.82 \times 1 = -0.82$	$9.14 \times 0 = 0$
d_{xy}	$-4.00 \times 2 = -8.00$	$-0.82 \times 1 = -0.82$	$-0.86 \times 2 = -1.72$
d_{yz}	$-4.00 \times 2 = -8.00$	$-2.72 \times 2 = -5.44$	$-4.57 \times 2 = -9.14$
d_{xz}	$-4.00 \times 2 = -8.00$	$-2.72 \times 2 = -5.44$	$-4.57 \times 2 = -9.14$
Total	$= -24.00 Dq$	$= -12.52 Dq$	$= -20.00 Dq$
Loss of LFSE		$= 11.48 Dq$	$= 4 Dq$

From this example, it can be seen that forming a square-based pyramid transition state results in a loss of only 4 Dq, whereas forming the trigonal bipyramid transition state involves the loss of 11.48 Dq. In cases where Dq is rather large, this difference is considerable, which means that the square-based pyramid transition state is energetically more favorable than is a trigonal bipyramid. Therefore, the loss of one ligand and its replacement by another resulting in the product having the same configuration as the starting complex is consistent with the transition state being a square-based pyramid. Although the value of Dq may not be great enough to overcome other factors that *may* favor a trigonal bipyramid transition state for a first-row d^6 ion, it is almost certainly is large enough to do so for a second- or third-row d^6 ion. Thus, the loss of ligand field stabilization is so high that it forces complexes of these ions to undergo S_N1 substitution through a square-based pyramid transition state, so the substitution reactions occur with retention of configuration. This is true for complexes of Pt^{4+} , Rh^{3+} , and Ir^{3+} as typified by the reactions

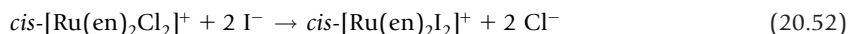
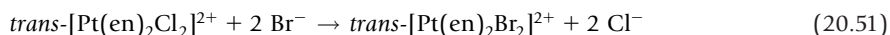

Thus, the fact there is no isomerization during substitution is consistent with the transition state being a square based pyramid for second and third row metals. As shown in Figure 20.4, substitution would give a product having the same configuration as the starting complex.

Having rationalized that the transition state should be a square-based pyramid, it should be mentioned that there are numerous cases in which the transition state appears to be a trigonal bipyramid. We know that because the substitution occurs with a change in configuration. From the foregoing discussion, we would expect this to occur with first-row transition metals because if 11.48 Dq must be sacrificed, this would be more likely if Dq is smaller (which it is the case for first-row metals). If a trigonal bipyramid transition state forms, there would be more than one product possible. This can be

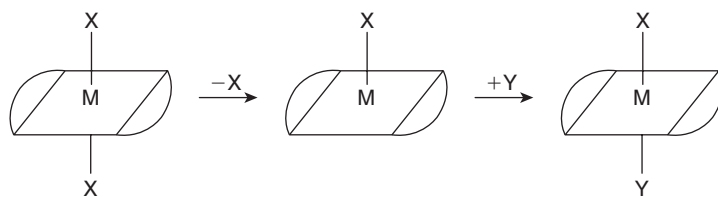

■ FIGURE 20.4 Substitution in which the transition state is a square-based pyramid.

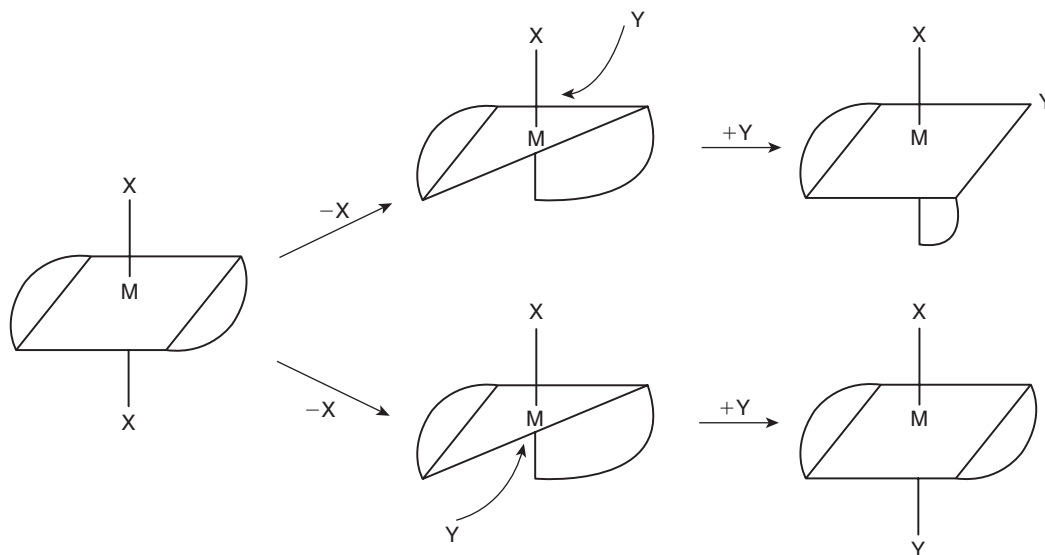

■ FIGURE 20.5 Attack on a trigonal bipyramidal transition state during S_N1 substitution.

illustrated by the sequence shown in Figure 20.5. However, it should be kept in mind that many trigonal bipyramidal structures are not rigid, so some rearrangement may occur.

For first-row metals, the number of Dq units lost is the same as for second- and third-row metals, but the magnitude of Dq is smaller. As a result, it is possible to get some rearrangement as substitution occurs. Therefore, the product can be a mixture of both *cis* and *trans* isomers.



If this reaction were to take place by formation of a square-based pyramid transition state, the product would have a *trans* configuration. However, if the transition state is a trigonal bipyramid, the incoming ligand, Y, could enter either *cis* or *trans* to A.

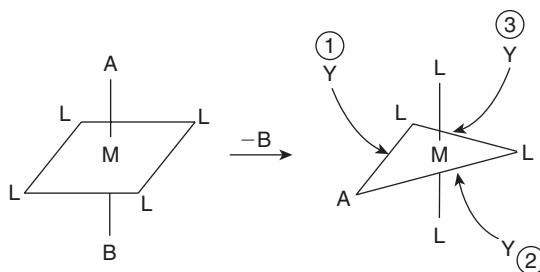

In this scheme, it is assumed that there is more room for the entering ligand to attach along an edge of the trigonal plane. From this scheme, it can be seen that attaching by Y on positions 1 and 2 would lead to Y being *cis* to A, but attaching at position 3 would leave Y *trans* to A. Thus, if A is in an equatorial position, there are two ways to get a *cis* product, but only one way to get a *trans* product. As shown in the following scheme, the situation is different if A is in an axial position in the transition state:

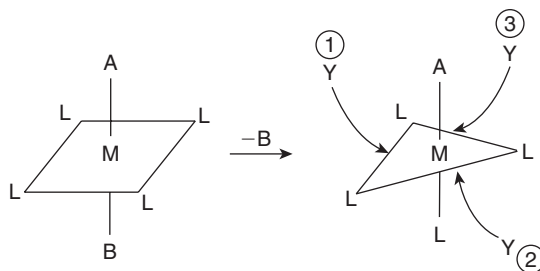

If we again assume that attachment would occur along an edge of the trigonal plane, all three points of attack would complete the square planar arrangement, but all would place Y in positions that are *cis* to A. Therefore, we would expect that if A is in an axial position in the transition state, the product should be all the *cis* isomer. In the situation in which A occupies an equatorial position in the transition state, the product would be expected to be two-thirds *cis* and one-third *trans*. Next, we must examine the situation that would result if it were equally probable for A to be in an axial or an equatorial position. In that case, the transition state would be an equal mixture of the structures having A axial or equatorial. Once again we assume that attack is equally probable at all positions along the edges of the trigonal bipyramid. If this is true, we should expect the product to consist of five-sixths *cis* and one-sixth *trans* isomer. It must be emphasized that these are ideal cases and that in real complexes there are two complications. First, it is unlikely for it to be equally probable for A to be in axial and equatorial positions in the transition state. Second, because A and L are different ligands, it is unlikely that attack would be equally probable at any side of the trigonal plane. Steric differences would likely cause Y to have a different probability of entering at the three positions along the edges.

The ligand field stabilization energy is only one aspect of the formation of a transition state. Because the reactions are carried out in solutions, solvation of the transition state and the entering ligand may have enough effect to assist in the formation of a particular transition state. Also, the fact that some

of the ligands (either those not being replaced or the ligands involved in the substitution) can form π bonds can affect the activation energy. As a result of these factors and the fact that the ligand field model is not really an adequate description of bonding, the foregoing discussion is surely approximate. It is true, however, that the simple approach just described does agree with observations on substitution reactions.

20.4 ACID-CATALYZED REACTIONS OF COMPLEXES

As in many areas of chemistry, there are reactions of coordination compounds that are not what they appear. For example, the reaction

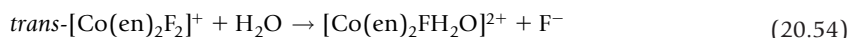

appears to be a substitution reaction in which H_2O replaces F^- . However, this reaction has a rate that is strongly pH dependent, suggesting that the reaction does not follow the usual pattern for complexes of Co^{3+} . Most substitution reactions of complexes of Co^{3+} are independent of the nature of the entering ligand, which indicates that they are formally $\text{S}_{\text{N}}1$ processes. The fact that H^+ is involved suggests that the reaction does not proceed by a dissociative pathway. Instead, the reaction is believed to proceed as follows:

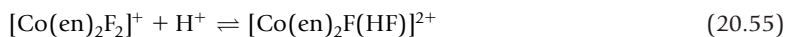

In the first step, the reaction produces the conjugate acid of the complex by protonation of a coordinated F^- ion. That conjugate acid then undergoes substitution in a dissociative pathway.



The concentration of the conjugate acid is the rate-determining factor because it is the dissociation of that species that leads to the formation of the product. Therefore, the rate law can be written as

$$\text{Rate} = k_1[\text{complex}] + k_2[\text{conjugate acid}] \quad (20.57)$$

From Eq. (20.55) it can be seen that the equilibrium constant is

$$K_{\text{eq}} = \frac{[\text{conjugate acid}]}{[\text{H}^+][\text{complex}]} \quad (20.58)$$

from which the concentration of the conjugate acid can be expressed as

$$[\text{conjugate acid}] = K_{\text{eq}}[\text{H}^+][\text{complex}] \quad (20.59)$$

Substituting this expression in the rate law shown in Eq. (20.57) gives

$$\text{Rate} = k_1[\text{complex}] + k_2K_{\text{eq}}[\text{H}^+][\text{complex}] \quad (20.60)$$

which shows the dependence on the concentration of acid.

Acid catalysis is observed most often in reactions of complexes containing ligands that are basic (so they can accept protons) or ligands that can form hydrogen bonds. Some complexes of this type include $[\text{Co}(\text{NH}_3)_5\text{CO}_3]^+$, $[\text{Fe}(\text{CN})_6]^{4-}$, and $[\text{Co}(\text{NH}_3)_5\text{ONO}]^{2+}$. Other complexes that are susceptible to acid-catalyzed reactions are those that contain coordinated *basic* ligands that can be dislodged by their bonding to H^+ instead of to the metal ion. Characteristic of this type of reaction is the process that takes place at 130°C in the solid state,

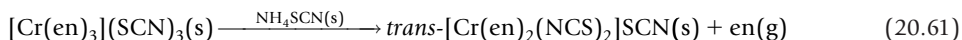

Although this reaction was discussed earlier, it is mentioned here because it is catalyzed by solid acids such as NH_4SCN , which provide H^+ ions that bond to the pairs of electrons after breaking them loose from the metal. Over a rather wide range of catalyst concentrations, the rate is linearly dependent on the amount of solid acid. Once the NH_4^+ ion donates a proton, NH_3 is lost and the protonated ethylenediamine molecule is the acid that remains and continues to catalyze the reaction. While base catalyzed reactions of complexes may be better known, there are many acid catalyzed reactions as well.

20.5 BASE-CATALYZED REACTIONS OF COMPLEXES

The reaction

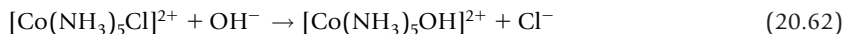

appears to be a typical substitution reaction. However, unlike the majority of substitution reactions of Co^{3+} complexes, the reaction takes place rapidly and with a rate that is linearly dependent on OH^- concentration.

The mechanism that has been established for this reaction involves the reaction of OH^- with the complex to produce its conjugate base by removing a proton from a coordinated NH_3 molecule in a rapid equilibrium.

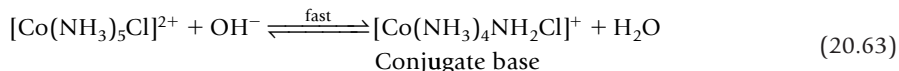

The next step is the loss of Cl^- in a dissociation step,

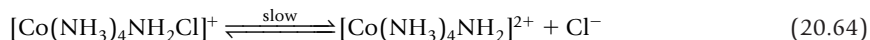

followed by the rapid addition of water, which donates a proton to the coordinated NH_2^- and provides OH^- to complete the coordination sphere of the cobalt.

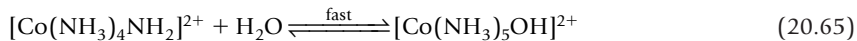

In this mechanism, the rate-determining step involves the dissociative reaction of the conjugate base. Because of this, the mechanism is known as the $\text{S}_{\text{N}}1\text{CB}$ mechanism, in which the substitution is

first-order but with respect to the conjugate base. The overall rate is proportional to the concentration of the conjugate base, so

$$\text{Rate} = k[\text{conjugate base}] \quad (20.66)$$

The equilibrium constant for the formation of the conjugate base can be written as

$$K_{\text{eq}} = \frac{[\text{conjugate base}]}{[\text{OH}^-][\text{complex}]} \quad (20.67)$$

from which the concentration of conjugate base is found to be

$$[\text{conjugate base}] = K_{\text{eq}}[\text{OH}^-][\text{complex}] \quad (20.68)$$

The rate can be expressed as

$$\text{Rate} = k K_{\text{eq}}[\text{OH}^-][\text{complex}] \quad (20.69)$$

This expression shows that the rate is proportional to $[\text{OH}^-]$. If the concentration of OH^- is held constant, the rate law can be written as

$$\text{Rate} = k' [\text{complex}] \quad (20.70)$$

where $k' = K_{\text{eq}}[\text{OH}^-]$. This is the pseudo first-order rate law.

The $S_{\text{N}}1\text{CB}$ mechanism has also been verified for the reaction

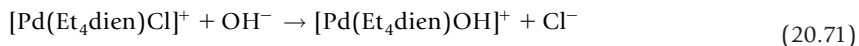

where Et_4dien is $(\text{Et})_2\text{NCH}_2\text{CH}_2\text{NHCH}_2\text{CH}_2\text{N}(\text{Et})_2$, tetraethyldiethylenediamine, which contains three nitrogen atoms having unshared pairs of electrons and functions as a tridentate ligand. The first step in the reaction is the removal of a proton from a coordinated ligand in an equilibrium that is rapid.

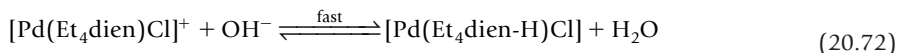

In this process, $\text{Et}_4\text{dien-H}$ represents a molecule of ligand that has had a proton removed. In this step, the reaction of the ligand can be shown as

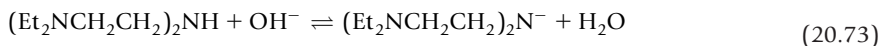

in which the only place where there is a hydrogen atom that can be removed by a base is on the middle nitrogen atom. Following the removal of H^+ , the Cl^- is lost in a dissociative step,

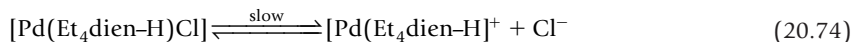

Removal of the proton produces a negative charge in the position *trans* to where the Cl^- leaves, which enhances the process by a *trans* effect (see Section 20.9). After the dissociation of Cl^- from the transition state, the reaction with H_2O is rapid. A proton from H_2O replaces the one that was lost from the central nitrogen atom, and the remaining OH^- completes the coordination sphere of the Pd^{2+} .

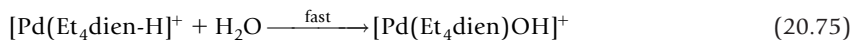

The mechanism of the reaction is proven by studying the reaction when the ligand is one in which there is no hydrogen atom on the middle nitrogen atom. That ligand is $(\text{Et}_2\text{NCH}_2\text{CH}_2\text{N})_2\text{NC}_2\text{H}_5$, in which the hydrogen atom has been replaced by an ethyl group. When the complex $[\text{Pd}(\text{Et}_2\text{dienC}_2\text{H}_5)\text{Cl}]^+$ is studied, the rate of Cl^- replacement is independent of OH^- concentration. In this case, there is no possibility of forming the conjugate base.

20.6 THE COMPENSATION EFFECT

Although it is ΔG^\ddagger that determines the concentration of the transition state and hence the rate of a reaction, it is possible that reactions can proceed at considerably different rates even though the ΔG^\ddagger values are essentially the same. This situation can arise because ΔG^\ddagger is made up of contributions from both ΔH^\ddagger and ΔS^\ddagger , as illustrated by the equation

$$\Delta G^\ddagger = \Delta H^\ddagger - T\Delta S^\ddagger \quad (20.76)$$

If several reactions are carried out, it may happen that ΔH^\ddagger and ΔS^\ddagger for the two processes are different, but that their values *compensate* so that ΔG^\ddagger is essentially constant. This situation can be explained by means of an example. Suppose a reaction is being carried out in a solvent and that solvation of the reactants and transition state occurs. For two different reactions, there will be two different transition states, TS_1 and TS_2 , and we will suppose that the transitions are charged or polar with the charge on TS_2 greater than that on TS_1 . If the solvent is polar, it will solvate TS_2 more strongly than it will TS_1 , which will be reflected in the heats of solvation of the transition states such that ΔH_2^\ddagger will be more negative than ΔH_1^\ddagger . As a result of being attracted to the charged transition states, the solvent will become ordered or structured (lower or negative ΔS^\ddagger) in the vicinity of both transition states. However, this will be more pronounced in the vicinity of TS_2 because it is more highly charged. Thus, ΔS_2^\ddagger will be more negative than ΔS_1^\ddagger . Therefore, if ΔH_2^\ddagger is more negative than ΔH_1^\ddagger and ΔS_2^\ddagger is more negative than ΔS_1^\ddagger , it is possible that ΔG^\ddagger may be approximately constant for the two cases. In other words, the effects of ΔH^\ddagger and ΔS^\ddagger offset each other because of the equation that relates the two quantities. This is known as the *compensation effect*. For a series of reactions (such as substitution by a series of ligands) it is possible that ΔG^\ddagger is approximately constant so that

$$\Delta H_1^\ddagger - T\Delta S_1^\ddagger = \Delta H_2^\ddagger - T\Delta S_2^\ddagger = C \quad (20.77)$$

For a series that includes several reactions,

$$\Delta H_i^\ddagger = T\Delta S_i^\ddagger + C \quad (20.78)$$

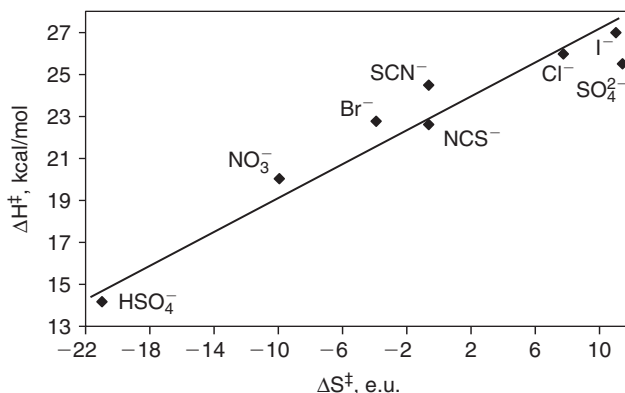

■ **FIGURE 20.6** An isokinetic plot for the formation of $[\text{Cr}(\text{H}_2\text{O})_5\text{X}]^{2+}$ by replacement of OH^- . (Constructed from the data given in D. Thusius (1971). *Inorg. Chem.* 10, 1106).

and a graph of the ΔH_i^\ddagger versus the ΔS_i^\ddagger values should be linear with a slope of T . This relationship is known as an *isokinetic relationship*, and T is a temperature known as *isokinetic temperature*.

The series of reactions

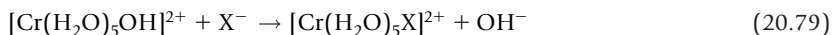

where $\text{X} = \text{Cl}^-, \text{Br}^-, \text{I}^-, \text{SCN}^-$, and so forth, has been studied by Thusius (1971). The graph illustrating the isokinetic relationship is shown in Figure 20.6.

The relationship between ΔH_i^\ddagger and ΔS_i^\ddagger shown in the graph is satisfactory, considering that the nature of the ligands varies widely. Ligand substitution in this case follows a mechanism in which there is loss of OH^- followed by X^- entering the coordination sphere of the metal. The fact that the graph is linear is considered to be indicative of a common mechanism for all of the substitution reactions.

For simplicity, we assumed that the transition states are charged. However, it is not necessary to do so because the only requirement is that the difference in entropy of forming the transition states be offset by the difference in enthalpy of activation. The transition states could have different polarities and the same result be obtained. In fact, the transition states need not have high polarity. Forming a transition state in which there is a reduction in charge separation could result in more favorable solvation when the solvent is nonpolar. For there to be an isokinetic relationship for a series of reactions, it is required only that ΔH^\ddagger and ΔS^\ddagger be related in such a way that ΔG^\ddagger be approximately constant.

20.7 LINKAGE ISOMERIZATION

Linkage isomerization processes involve the change in bonding mode of one or more ligands that can bond to metal ions in more than one way. Some ligands that have this ability are CN^- , SCN^- , NO_2^- , SO_3^{2-} , and SO_4^{2-} . The first case of linkage isomerism involved pentamminenitrocobalt(III) and

pentamminenitritocobalt(III) ions. In this case, the nitro form is the more stable of the two. The conversion of the nitrito linkage to the nitro bonding mode has been the subject of several studies, and a great deal is known about the process. In this case, the results of studying the reaction at high pressure have been especially important.

The activation energy for a reaction represents the energy barrier over which the reactants must pass in being transformed into products. Determining the rate constant (k) as a function of temperature allows a plot of $\ln k$ versus $1/T$ to be made, and the slope of the line ($-E/R$) allows E to be determined. The formation of the transition state can be viewed as an equilibrium between the reactants and the transition state. The transition state is higher in energy than the reactants, so increasing the temperature increases the concentration of the transition state and thereby the rate of the reaction. Much less frequently studied than the temperature effect on the rate of a reaction is the effect of pressure. As a transition state forms from reactants, there is a volume change in most cases. According to Le Chatelier's principle, increasing the pressure increases the concentration of the species occupying the smaller volume. If the transition state occupies a smaller volume than the reactants, increasing the pressure (at constant temperature) leads to an increase in the rate of the reaction. If increasing the pressure decreases the rate of the reaction, the transition state occupies a larger volume than the reactants. Generally, reactions in which there are bond breaking–bond making steps have transition states that occupy a larger volume than the reactants. Intramolecular processes often pass through a transition state that has a smaller volume than the reactant.

The linkage isomerization



takes place both in solutions and the solid state when the starting isomer is heated or subjected to ultraviolet radiation. In regard to how the reaction takes place, it might be presumed that the metal–ligand bond is broken and the ligand then attaches in the more stable nitro form:

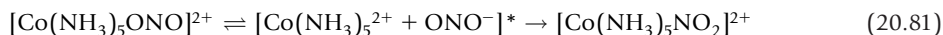

However, if the reaction follows this pathway, the transition state should occupy a larger volume than the reactants, so an increase in pressure would decrease the rate of the reaction. Instead, when this reaction was studied at a series of high pressures, it was found that the rate increased with pressure.

It is possible to derive the following equation that relates the rate constant of a reaction to the applied pressure:

$$\ln k = \frac{\Delta V^\ddagger}{RT} P + \text{Constant} \quad (20.82)$$

By making a plot of $\ln k$ versus P , it is possible to determine the volume of activation, ΔV^\ddagger . For the linkage isomerization reaction shown in Eq. (20.81), the volume of activation is $-6.7 \pm 0.4 \text{ cm}^3 \text{ mol}^{-1}$. Therefore, it can be concluded that the mechanism shown in Eq. (20.81) is not correct. In fact, the negative volume of activation indicates that in the transition state the NO_2^- does not become detached

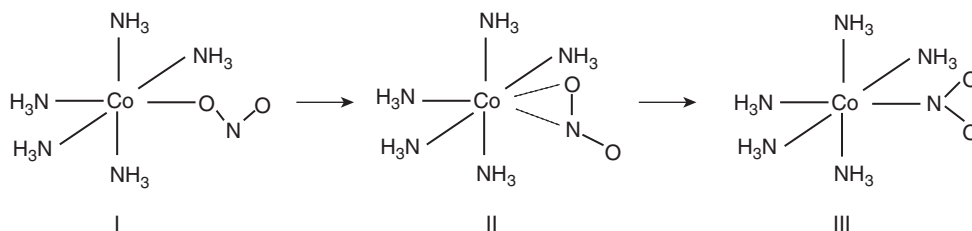

■ FIGURE 20.7 The mechanism of linkage isomerization of $-\text{ONO}$ to $-\text{NO}_2$.

from the metal ion. The mechanism has been shown to involve the movement of the nitrite ion to form a transition state in a process that can be described as shown in Figure 20.7.

The transition state (II) occupies a smaller volume than that of the starting complex, so an increase in pressure causes an increase in the rate of the reaction. In general, reactions that pass through transition states that have smaller volumes than the reactants are enhanced by an increase in pressure. On the other hand, dissociation reactions that lead to two separate species in the transition state are retarded by increasing the pressure.

When the linkage isomerization is carried out in the solid state and the reaction quenched to very low temperature, it is observed that the infrared spectrum of the mixture contains bands that are not attributable to either $\text{Co}-\text{NO}_2$ or $\text{Co}-\text{ONO}$ linkages. The bands are consistent with a transition state with the nitrite bonded as shown in structure II in Figure 20.7. In addition to the cobalt complex described earlier, the corresponding complexes of Rh^{3+} and Ir^{3+} also undergo linkage isomerization with the volumes of activation being $-7.4 \pm 0.4 \text{ cm}^3 \text{ mol}^{-1}$ and $-5.9 \pm 0.6 \text{ cm}^3 \text{ mol}^{-1}$, respectively. This indicates that the linkage isomerization in these complexes also occurs without a bond-breaking step.

Additional experiments on the reaction of the cobalt complex have involved the reaction

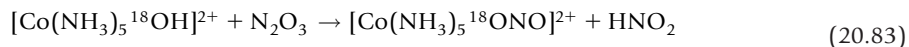

Because the ^{18}O is attached to the cobalt ion both before and after the reaction, it is reasonable to conclude that the $\text{Co}-\text{O}$ bond is never broken. The reaction is believed to involve a transition state that can be shown as

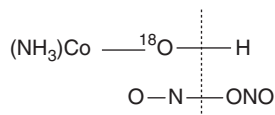

which leads to the product being $[\text{Co}(\text{NH}_3)_5^{18}\text{ONO}]^{2+}$. The ^{18}O never leaves the coordination sphere of the cobalt. On the other hand, in the reaction shown in Eq. (20.83), the $\text{Co}-^{18}\text{ONO}$ can be induced to undergo linkage isomerization in the same way that the nitrite that does not contain ^{18}O does.

20.8 SUBSTITUTION IN SQUARE PLANAR COMPLEXES

The majority of square planar complexes are those that contain d^8 metal ions, of which the most common examples are Ni^{2+} , Pd^{2+} , and Pt^{2+} , although some complexes containing Au^{3+} have also been studied. As a general trend, the rate of substitution in these complexes is

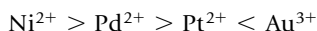

For the first three metal ions in the series, the rate is inversely related to the ligand field stabilization energy, as would be expected. The fact that Au^{3+} complexes undergo substitution much faster than those of Pt^{2+} comes from the fact that Au^{3+} has a higher charge, which gives rise to greater attraction for a potential ligand. Complexes of Pt^{2+} have been extensively studied, and much of the discussion will be concerned with those complexes.

Because most complexes of platinum are quite stable, substitution reactions are generally slow. For the reaction



the rate law has the form

$$\text{Rate} = k_1[\text{complex}] = k_2[\text{complex}][\text{A}] \quad (20.85)$$

Therefore, the observed first-order rate constant, k_{obs} , is given by

$$k_{\text{obs}} = k_1 + k_2[\text{A}] \quad (20.86)$$

Although the first term in Eq. (20.85) appears to be first-order in complex, it usually represents a second-order process in which the solvent (which is usually a nucleophile) is involved. The relationships show that if a plot is made of k_{obs} versus $[\text{A}]$, the result is a straight line having a slope of k_2 and an intercept of k_1 . Therefore, the substitution process can be viewed as if it occurs by two pathways. This situation can be described as illustrated in Figure 20.8.

It is often found that the rate of substitution in square planar complexes varies greatly depending on the nature of the solvent. The term in the rate law that appears to be independent of the concentration of the entering ligand involves the solvent (which has essentially constant concentration). Therefore, the value of k_1 in the rate law depends on the solvent. Another way in which the solvent can affect the rate of substitution is related to how strongly the entering ligand is solvated. For example, if the entering ligand is solvated to different degrees in a series of solvents, the rate at which it enters the coordination sphere of the metal may show a decrease as the ability of the solvent to solvate the ligand increases. In order to be attached in the complex, the ligand must become partially "desolvated," and the more strongly the solvent is attached to the ligand, the more difficult that becomes.

There is a considerable difference in rate of substitution depending on the nature of the leaving group. For the reaction

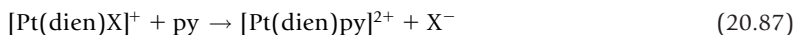

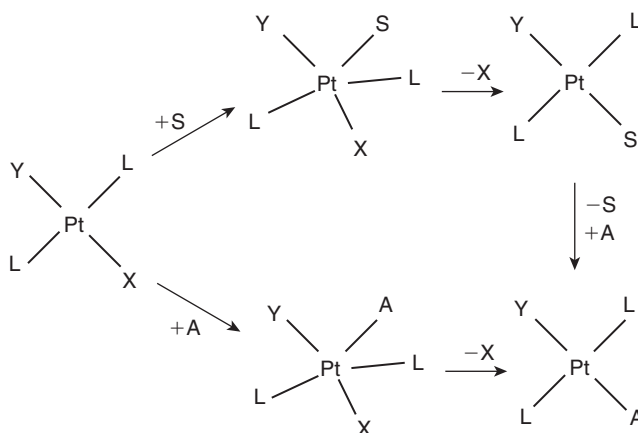

■ **FIGURE 20.8** Substitution in a square planar complex in which the solvent participates in a second-order step.

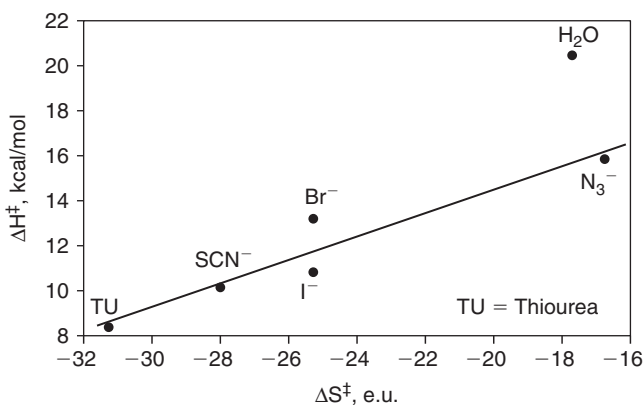

■ **FIGURE 20.9** Isokinetic plot for the substitution of various ligands in $[\text{Pt}(\text{dien})\text{Cl}]\text{Cl}$ where dien is diethylenetriamine, $\text{H}_2\text{NCH}_2\text{CH}_2\text{NHCH}_2\text{CH}_2\text{NH}_2$. (Constructed from data given by Basolo and Pearson, 1974, p. 404.)

(where dien is diethylenetriamine, $\text{H}_2\text{NCH}_2\text{CH}_2\text{NHCH}_2\text{CH}_2\text{NH}_2$), the rate of the reaction was very fast when $\text{X} = \text{NO}_3^-$, and the value for k_{obs} was $1.7 \times 10^{-8} \text{ sec}^{-1}$ when $\text{X} = \text{CN}^-$. For a series of ligands, the rate of loss of X was found to vary in the following order:

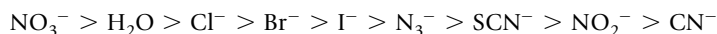

We have previously described the relationship known as the isokinetic plot in which ΔH^\ddagger is plotted against ΔS^\ddagger for the substitution reactions of a series of ligands. The reaction

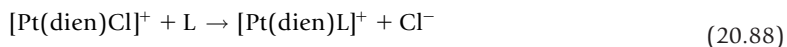

has been studied for a series of ligands, L. When the values for the enthalpy and entropy of activation are plotted, the result is Figure 20.9.

Although the fit of the data to the line is not perfect, it is adequate given the level of accuracy of the data. Because the point for H₂O falls far from the line through the other points, it is tempting to conclude that the mechanism is different in that case. The fact that the substitution reactions were carried out in water makes this explanation even more plausible because the solvent is present in such an enormous excess. Therefore, in the rate law shown in Eq. (20.85), the large excess of water could be responsible for a substitution that proceeds with coordination of the solvent as the dominant feature. Having given some insight to the nature of substitution reactions in square planar complexes, we now turn to a dominant characteristic of these reactions.

20.9 THE TRANS EFFECT

One of the fascinating characteristics of substitution in square planar complexes is illustrated by the following equations:

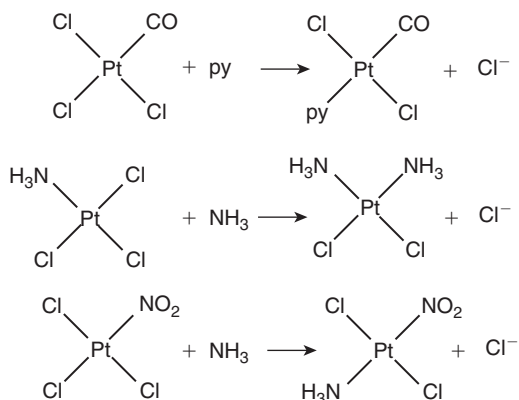

In the first of these reactions, all of the entering pyridine goes in the position *trans* to CO. If there were equal tendency for the three chloride ions to be replaced, the product should contain 2/3 *cis* and 1/3 *trans*-[Pt(CO)(py)Cl₂]. The fact that the product consists only of the *trans* isomer indicates that CO is somehow directing substitution to go in the *trans* position to it. This influence is described as a *trans effect*. In the second reaction, none of the entering Cl⁻ goes in a position *trans* to the NH₃. Because all of the entering NH₃ goes opposite a coordinated Cl⁻, we conclude that the Cl⁻ must exert a stronger *trans* influence than does NH₃. In the last of these reactions, the fact that the product is *trans*-[Pt(NH₃)(NO₂)Cl₂] indicates that the NO₂⁻ ligand is exerting an influence as to where the entering NH₃ goes. Otherwise, some of the Cl⁻ being replaced would come from the positions *cis* to NO₂⁻. Therefore, it can be concluded that NO₂⁻ is exerting some sort of influence on the position *trans* to it in the complex. In some writing, the distinction is made between a *trans effect* and a *trans influence*. The former term is used to describe effects on rates of reactions (kinetics), whereas the latter is applied to static (thermodynamic) influences (such as bond lengths or stretching frequencies of metal-ligand bonds). The phenomena are interrelated to some extent, so no such distinction will be made here.

From the reactions shown, it becomes apparent that NH₃ must have less influence on the position *trans* to it than does Cl⁻. Moreover, the first reaction shows that CO has a stronger influence than does Cl⁻, and the last reaction shows that NO₂⁻ has a greater effect than Cl⁻. By conducting reactions such

as those shown, it is possible to determine the relative *trans* effect for a series of ligands. For several common ligands, the series can be shown as follows:

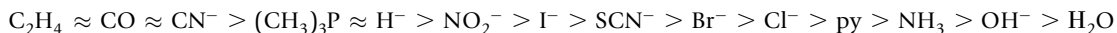

In addition to the stereochemistry of the reaction products, there are numerous other manifestations of the *trans* influence of ligands in square planar complexes. One such factor is the lengths of bonds in the complexes. Consider the following structures:

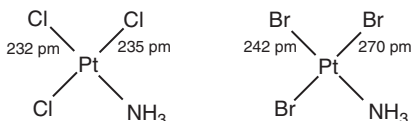

Here we can see that in $\text{K}[\text{Pt}(\text{NH}_3)\text{Br}_3]$ the length of the Pt-Br bond opposite the Pt- NH_3 bond is about 242 pm, whereas the Pt-Br bond opposite the other Br is 270 pm in length. A similar effect is seen in $\text{K}[\text{Pt}(\text{NH}_3)\text{Cl}_3]$, but the difference in bond lengths is smaller in this case because Cl^- exerts a weaker *trans* effect than Br^- . In the anion of Zeise's salt, $[\text{Pt}(\text{C}_2\text{H}_4)\text{Cl}_3]^-$,

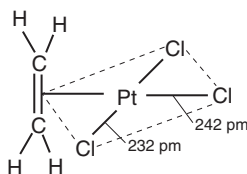

the Pt-Cl bond opposite C_2H_4 is 242 pm in length, but that *trans* to Cl is 232 pm. These values show that the C_2H_4 molecule weakens and lengthens the Pt-Cl bond that is *trans* to it more than does Cl^- . This observation is in agreement with the order of the *trans* effect given earlier for numerous ligands.

Fifty years ago, Chatt *et al.* (1962) showed the effect that a ligand in the *trans* position has on the stretching frequency of a Pt-ligand bond. Although other complexes were also studied, the series of complexes where L was varied in *trans*- $[\text{PtA}_2\text{LH}]$ (where $\text{A} = \text{PEt}_3$) demonstrated the *trans* effect on the Pt-H stretching frequency in the infrared spectrum. The variation in Pt-H stretching frequency with the nature of L was found to vary as follows (band positions in cm^{-1}): CN^- , 2041; SCN^- , 2112; NO_2^- , 2150; I^- , 2156; Br^- , 2178; and Cl^- , 2183. These positions for the bands representing the stretching vibration of the Pt-H bond *trans* to the ligand being varied show that when $\text{L} = \text{CN}^-$, there is a substantial effect on the Pt-H bond. On the other hand, Cl^- has a much smaller effect when it is *trans* to the Pt-H bond. These observations are in agreement with the order of *trans* effect described earlier.

A series of reactions that can be represented as

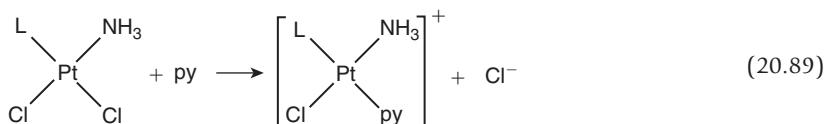

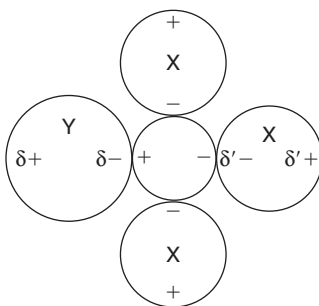

■ **FIGURE 20.10** A square planar complex MX_3Y in which the ligands are polarizable.

were studied, where L is the series of ligands Cl^- , Br^- , and NO_2^- . It was found that the activation energies were 79, 71, and 46 kJ/mol, and the rate constants were 6.3×10^{-3} , 18×10^{-3} , and $56 \times 10^{-3} \text{ M}^{-1} \text{ sec}^{-1}$, respectively, for these ligands. The effect of the ligand L on the position *trans* to it is clearly evident both in terms of rate of substitution and in the activation energy associated with the process.

One of the approaches to explaining the *trans* effect in a square planar complex is known as the polarization model. The underlying principle in this approach is that the metal ion and the ligands undergo mutual polarization that results in some small charge separation even in spherical ions and ligands. Suppose a complex has the composition MX_3Y and that Y is more polarizable than X. This situation is shown in Figure 20.10.

Because Y is more polarizable than X, the charges separated in the ligands will be different. Based on the polarizabilities, $|\delta|$ is greater than $|\delta'|$. This causes the charge distribution in the metal to be such that the more positive side will be directed toward Y and the slightly positive (or at least more negative) side toward X. This has the effect of making X less tightly bound and easier to remove. Thus, the ease with which X is replaced should increase as the polarizability of Y increases. In general, this trend is observed with the *trans* effect of the halides varying in the order I^- greater than Br^- greater than Cl^- . Because the metal is also polarized somewhat, the observed *trans* effect for d^8 ions varies as $\text{Pt}^{2+} > \text{Pd}^{2+} > \text{Ni}^{2+}$.

Another explanation for the origin of the *trans* effect lies in the ability of the metal and ligand to form π bonds. The ability of a ligand to accept back donation is dependent on it having empty orbitals of suitable symmetry to match the d orbitals on the metal. Ligands such as CO, C_2H_4 , and CN^- have such (antibonding) orbitals (see Chapter 16). Bonding to cyanide ion can be shown as

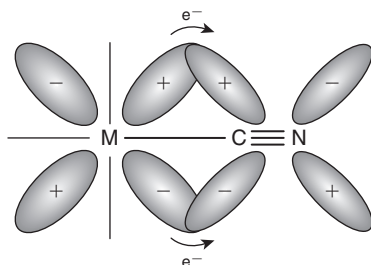

If back donation occurs to a ligand, the flow of electron density from the metal leaves less electron density to be donated in the opposite direction. It seems that this should have little effect on the donation of a pair of electrons on the ligand in the *trans* position to form a σ bond. Accordingly, the major factor appears to be the stabilization of a five-bonded (trigonal bipyramid) transition state as a result of π bond formation. Ligands that readily form π bonds include some of those that generate the largest *trans* effect.

It is now apparent that ligands cause a *trans* effect by entirely different processes. For example, a large, soft ligand such as I^- or H^- generates a strong *trans* effect, but it cannot be as a result of π bonding. Basolo and Pearson (1974) have considered the *trans* effect to be made up of contributions of both a σ character and a π character. The result for several ligands can be shown as follows (S, strong; W, weak; M, moderate; etc):

Ligand:	C_2H_4	CO	CN^-	PR_3	H^-	NO_2^-	I^-	NH_3	Br^-	Cl^-
σ effect:	W	M	M	S	VS	W	M	W	M	M
π effect:	VS	VS	S	M	VW	M	M	VW	W	VW

This series shows that some ligands give a *trans* effect that is made up of contributions from each type of interaction, but ligands that give large *trans* effects generally do so by only one dominant type of effect that is either σ or π in origin.

At this point, it is appropriate to mention some of the evidence that indicates a *trans* effect in octahedral complexes, but only a brief description will be given. In the reaction of $Mo(CO)_6$ with pyridine, only three CO ligands undergo replacement, and the product has the structure

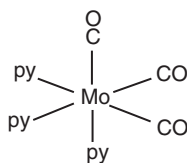

Clearly, this indicates that there is some sort of *trans* effect exerted by CO. Other observations of this type are also recorded.

Evidence of an octahedral *trans* effect also comes from the study of exchange of NH_3 in $[Co(NH_3)_5SO_3]^+$, which was followed using $^{15}NH_3$. It was found that only the NH_3 *trans* to SO_3^{2-} undergoes exchange to give *trans*- $[Co(NH_3)_4(^{15}NH_3)SO_3]^+$. In a similar study that involved the exchange of NH_3 in *cis*- $[Co(NH_3)_4(SO_3)_2]^-$, it was found that the product had the structure

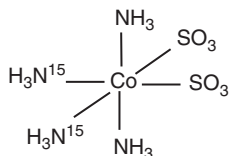

Kinetic analysis of the substitution reactions indicate that they follow a dissociative mechanism. It has also been shown that two water molecules in $[\text{Cr}(\text{H}_2\text{O})_5\text{I}]^{2+}$ undergo exchange with labeled water. It is interesting that one exchange is rapid and occurs before I^- leaves. However, this is not true of the chloride compound. Therefore, it appears that the iodide ion labilizes the water *trans* to it, but the chloride does not.

In addition to the indications of an octahedral *trans* effect presented, there exists structural information in the form of bond lengths and spectral data similar to that described earlier for square planar complexes. Although the *trans* effect in octahedral complexes is not the dominant influence that it is in square planar complexes, there is no doubt that there is such an effect.

20.10 ELECTRON TRANSFER REACTIONS

An aqueous solution containing complexes of two different metal ions may make it possible for a redox reaction to occur. In such cases, electrons are transferred from the metal ion being oxidized to the metal ion being reduced. For example,

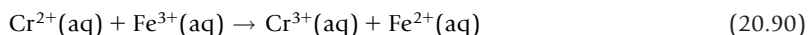

In this reaction, an electron is transferred from Cr^{2+} to Fe^{3+} , and such reactions are usually called electron transfer or electron exchange reactions. Electron transfer reactions may also occur in cases where only one type of metal ion is involved. For example, the reaction

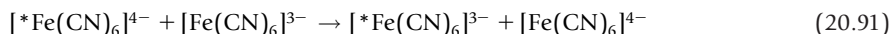

represents an electron transfer from $[\text{*Fe}(\text{CN})_6]^{4-}$ (where *Fe is a different isotope of iron) to Fe^{3+} in $[\text{Fe}(\text{CN})_6]^{3-}$. This is an electron transfer in which the product differs from the reactants only in that a different isotope of Fe is contained in the +2 and +3 oxidation states.

Electron transfer between metal ions contained in complexes can occur in two different ways, depending on the nature of the metal complexes that are present. If the complexes are inert, electron transfer occurring faster than the substitution processes must occur without breaking the bond between the metal and ligand. Such electron transfers are said to take place by an *outer sphere* mechanism. Thus, each metal ion remains attached to its original ligands and the electron is transferred through the coordination spheres of the metal ions.

In the second case, the ligand replacement processes are more rapid than the electron transfer process. If this is the case (as it is with labile complexes), a ligand may leave the coordination sphere of one of the metal ions and be replaced by forming a bridge utilizing a ligand already attached to a second metal ion. Electron transfer then occurs through a bridging ligand, and this is called an *inner sphere* mechanism.

For an outer sphere electron transfer, the coordination sphere of each complex ion remains intact. Thus, the transferred electron must pass through *both* coordination spheres. Reactions such as the following are of this type (where * represents a different isotope):



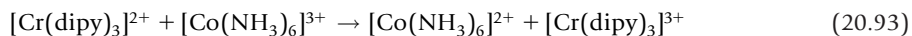

In the reaction shown in Eq. (20.93), the d^4 complex containing Cr^{2+} is inert owing to electron pairing giving the low-spin state. There is an extreme variation in rates from very slow to very fast depending on the nature of the ligands present, and rate constants may vary from 10^{-6} to $10^8 \text{ M}^{-1} \text{ s}^{-1}$.

The electron exchange between manganate (MnO_4^{2-}) and permanganate (MnO_4^-) takes place in basic solutions,



and the reaction obeys the rate law

$$\text{Rate} = k[*\text{MnO}_4^-][\text{MnO}_4^{2-}] \quad (20.95)$$

When the solvent contains H_2O^{18} , no ^{18}O is incorporated in the MnO_4^- produced. Thus, the reaction is presumed not to proceed by forming oxygen bridges. However, the nature of the cations present greatly affects the rate. The rate of the reaction varies with the cation present in the order



This supports the belief that the transition state must involve a structure such as

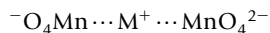

Presumably, the function of M^+ is to “cushion” the repulsion of the two negative ions. The larger, softer Cs^+ can do this more effectively than the smaller, harder ions such as Li^+ or Na^+ . Also, to form these bridged transition states, solvent molecules must be displaced from the solvation sphere of the cations. That process, because of their smaller sizes, would require more energy for the more strongly solvated Li^+ and Na^+ . For the Cs^+ ion, which forms effective bridges, the rate of electron exchange has been found to be linearly related to Cs^+ concentration.

Similar results have been found for the electron exchange between $[\text{Fe}(\text{CN})_6]^{3-}$ and $[\text{Fe}(\text{CN})_6]^{4-}$. In that case, the acceleratory effects are found to vary with the nature of the cation in the order



in accord with the size and solvation effects discussed earlier. For +2 ions, the order of effect on the rate is $\text{Sr}^{2+} > \text{Ca}^{2+} > \text{Mg}^{2+}$, in accord with the decrease in softness of these species. Exchange in these outer sphere cases is believed to involve the formation of bridged species containing cations that are probably less than fully solvated.

In aqueous solutions, Cr^{2+} is a strong reducing agent, and it reduces Co^{3+} to Co^{2+} . A number of electron transfer reactions involving complexes of these metals have been studied. High-spin complexes of

Cr^{2+} (d^4) are kinetically labile, as are high-spin complexes of Co^{2+} (d^7). However, complexes of Cr^{3+} (d^3) and low-spin complexes of Co^{3+} (d^6) are kinetically inert. For the exchange reaction (O^* represents ^{18}O)



it was found that the rate law is

$$\text{Rate} = k[\text{Co}(\text{NH}_3)_5\text{H}_2\text{O}^{*3+}][\text{Cr}(\text{H}_2\text{O})_6^{2+}] \quad (20.97)$$

It was also found that the H_2O^* is quantitatively transferred to the coordination sphere of Cr^{3+} . Thus, the indication is that the electron is transferred from Cr^{2+} to Co^{3+} , but the H_2O^* is transferred from Co^{3+} to Cr^{2+} as reduction occurs. It appears that the electron transfer occurs through a bridged transition state that may have the structure

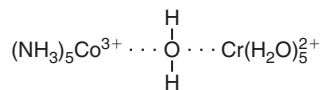

The H_2O forming the bridge then ends up in the coordination sphere of the kinetically inert Cr^{3+} ion.

A large number of reactions similar to that above have been studied in detail. One such reaction is

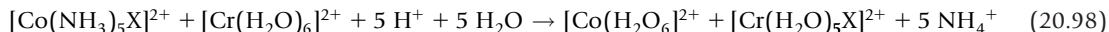

where X is an anion such as F^- , Cl^- , Br^- , I^- , SCN^- , or N_3^- . The Co^{2+} produced is written as $[\text{Co}(\text{H}_2\text{O})_6]^{2+}$ because the high-spin complexes of Co^{2+} (d^7) are labile and undergo rapid exchange with the solvent, which is present in great excess.

In these cases, it is found that X is transferred quantitatively from the Co^{3+} complex to the Cr^{2+} complex as electron transfer is achieved. Therefore, it is likely that electron transfer occurs through a bridging ligand that is simultaneously part of the coordination sphere of each metal ion and that the bridging group remains as part of the coordination sphere of the inert complex produced. The electron is thus "conducted" through that ligand. Rates of electron transfer are found to depend on the nature of X, and the rate varies in the order



However, for other reactions an opposite trend is observed. There are undoubtedly several factors involved, which include F^- forming the strongest bridge but I^- being the best "conductor" for the electron being transferred because it is much easier to distort the electron cloud of I^- (it is much more polarizable and has a lower electron affinity). Therefore, in different reactions these effects may take on different weights, leading to variations in the rates of electron transfer that do not follow a particular order with respect to the identity of the anion.

20.11 REACTIONS IN SOLID COORDINATION COMPOUNDS

To this point, several types of rate processes that occur in solutions have been described. However, the study of reactions of solid coordination compounds has yielded a large amount of information on behavior in these materials. Several types of reactions of solid complexes are known, but the discussion here will be limited to four common types of processes.

20.11.1 Anation

The most common reaction exhibited by coordination compounds is ligand substitution. Part of this chapter has been devoted to describing these reactions and the factors that affect their rates. In the solid state, the most common reaction of a coordination compound occurs when the compound is heated and a volatile ligand is driven off. When this occurs, another electron pair donor attaches at the vacant site. The donor may be an anion from outside the coordination sphere or it may be some other ligand that changes bonding mode. When the reaction involves an anion entering the coordination sphere of the metal, the reaction is known as *anation*. One type of anation reaction that has been extensively studied is illustrated by the equation

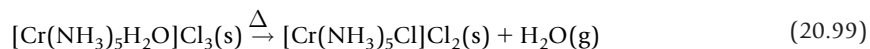

in which the volatile ligand, H_2O , is lost and is replaced by a Cl^- ion, which was originally an anion located elsewhere in the lattice (which is the origin of the term “anation”). Many reactions of this type have been studied for complexes containing several different metals.

In an interesting study on loss of water from pentammineaquaruthenium(III) complexes, the kinetic analysis was performed by following the mass loss from the complexes as described in Chapter 8. The rate law used to model the process was

$$\log [M_0/(M_0 - M_t)] = kt \quad (20.100)$$

where M_0 is the initial mass of the sample and M_t is the mass of the sample at time t . It was found that the activation energies for the reaction

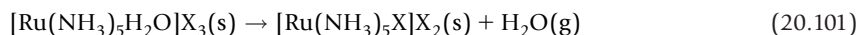

increase for several anions in the order $\text{NO}_3^- < \text{Cl}^- < \text{Br}^- < \text{I}^-$. As a result of the difference in rate when different anions are present, there is said to be an “anion effect” for this reaction. Table 20.2 shows some of the pertinent kinetic data for the reactions of the ruthenium complexes as well as those for the corresponding chromium and cobalt complexes.

The data shown in Table 20.2 were interpreted in terms of two possible mechanisms:

Mechanism I (“ $\text{S}_\text{N}1$ ”):

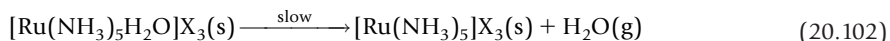
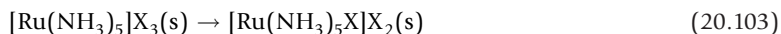

Table 20.2 Kinetic Data for the Anation Reactions of Aqua Complexes^a.

Complex	E_a (kJ mol ⁻¹)	ΔS^\ddagger (e.u.)	$10^4 k$ (sec ⁻¹) (T, °C)
[Cr(NH ₃) ₅ H ₂ O]Cl ₃	110.5	-2.53	2.41 (65)
[Cr(NH ₃) ₅ H ₂ O]Br ₃	124.3	9.2	2.43 (76)
[Cr(NH ₃) ₅ H ₂ O] ₃	136.8	15.4	1.61 (82)
[Cr(NH ₃) ₅ H ₂ O](NO ₃) ₃	101.7	-2.49	1.38 (55)
[Co(NH ₃) ₅ H ₂ O]Cl ₃	79	—	4.27 (86)
[Co(NH ₃) ₅ H ₂ O]Br ₃	108	—	4.79 (85)
[Co(NH ₃) ₅ H ₂ O](NO ₃) ₃	130	—	2.51 (85)
[Ru(NH ₃) ₅ H ₂ O]Cl ₃	95.0	-7.1	1.12 (43)
[Ru(NH ₃) ₅ H ₂ O]Br ₃	97.9	-5.2	0.77 (40)
[Ru(NH ₃) ₅ H ₂ O] ₃	111.7	5.8	0.71 (40)
[Ru(NH ₃) ₅ H ₂ O](NO ₃) ₃	80.8	-15.9	2.38 (41)

^aData from A. Ohyoshi et al. (1975).



Mechanism II ("S_N2")

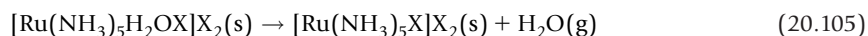
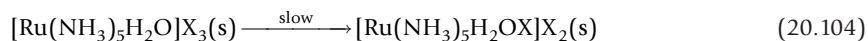

In proposed mechanism I, the loss of water from the complex is the rate-determining step, but removal of water from the coordination sphere of the metal ion should be independent of the nature of the anion that is not part of the coordination sphere of the metal ion. On the other hand, if mechanism II is correct, the entry of X into the coordination sphere of the metal would be dependent on the nature of the anion, because different anions would be expected to enter the coordination sphere at different rates. Because there is an observed anion effect, it was concluded that the anation reaction must be an S_N2 process. However, it is not clear how a process can be "second-order" when both the complex cation and the anion are parts of the same formula. As discussed in Chapter 8, it is not always appropriate to try to model reactions in solids by the same kinetic schemes that apply to reactions in solutions.

For an ion to leave a lattice site in order to enter the coordination sphere of the metal would require the formation of a Schottky defect. The energy required to form this type of defect can be expressed by the equation

$$E_s = U \frac{1 - \left(1 - \frac{1}{\epsilon}\right)}{A \left(1 - \frac{1}{n}\right)} \quad (20.106)$$

where U is the lattice energy, ϵ is the dielectric constant, A is the Madelung constant, and n is the exponent in the repulsion exponent in the Born-Landé equation. The energy predicted for creating the defect and the loss of ligand field stabilization energy in the complex would make the expected activation energy very high. Moreover, the lattice energy *decreases* as the size of the anion increases, but the activation energy is higher for larger anions.

A more realistic view of anation reactions is provided by considering the volatile ligand to be lost from the metal as the initial step. However, the ligand must go *somewhere*, and in a crystal the logical place is in *interstitial* positions. From there, the free volatile ligand must make its way out of the crystal. It is easy to show that for a solid lattice there is more free space as the difference between the sizes of the anions and cations increases. Therefore, given the large cation present, the activation energies would be expected to increase as the size of the anion increases, which is exactly the trend observed. The activation energy for loss of water from the nitrate complex does not follow the trend, but that is probably because nitrate is not a spherical ion. The planar NO_3^- ion should allow water to move through the crystal more easily than would spherical ions, which is consistent with the observed activation energies. In this scheme, the liberated volatile ligand creates a *defect* that *diffuses* through the crystal lattice. Numerous anation reactions in which a volatile ligand is lost have been found to give rates in accord with predictions based on the defect diffusion mechanism.

A unique type of anation occurs when the loss of water is followed by coordination of a ligand that is already part of the coordination sphere of another metal. A reaction of this type is

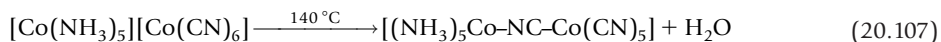

which leads to the formation of a cyanide bridge between two Co^{3+} ions. Because Co^{3+} with five NH_3 ligands is a hard Lewis acid and the same metal ion with cyanide ligands behaves as a soft Lewis acid, the $\text{Co}-\text{NC}-\text{Co}$ linkage shown in the equation matches the hard-soft character of the ends of the cyanide ion. However, the reaction

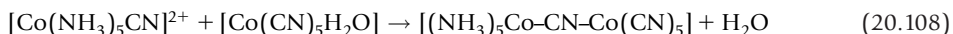

leads to the formation of a CN bridge in which the softer end (C) of the ligand is bound to the harder of the Co^{3+} ions. Even though both cobalt ions have a +3 charge, the cobalt surrounded by CN^- ligands behaves as if it were soft because of the symbiotic effect. A reaction of this type has been investigated in which two different metals are involved. The reaction can be shown as

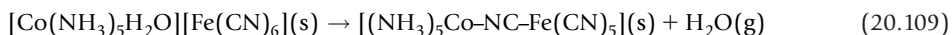

Similar reactions have been carried out to produce complexes that contain thiocyanate bridges. The examples given are just a few of the large number of anation reactions.

20.11.2 Racemization

In Chapter 16, we described enantiomorphism in coordination compounds. An optically active compound of this type can sometimes be converted into the racemic mixture even in the solid state. In

some cases the reaction is induced thermally, but racemization has also been brought about by high pressure. Although other types of complexes can exist as optical isomers, it has been the study of racemization in octahedral complexes that has been most extensive. Two types of processes have been identified, those in which ligands become detached from the metal and those in which there is no metal-ligand bond rupture (intramolecular).

If one end of a chelate ring on an octahedral complex is detached from the metal, the five-coordinate transition state can be considered as a fluxional molecule in which there is some interchange of positions. When the chelate ring reforms, it may be with a different orientation that could lead to racemization. If the chelate ring is not symmetrical (such as 1,2-diaminopropane rather than ethylenediamine), isomerization may also result. For reactions carried out in solvents that coordinate well, a solvent molecule may attach to the metal where one end of the chelating agent vacated. Reactions of this type are similar to those in which dissociation and substitution occur.

Numerous racemization reactions occur in which there is apparently no bond breaking as the transition state forms. Although there have been various schemes proposed to account for these observations, the two most likely and important models involve twist mechanisms. In a regular octahedral structure, C_3 axes pass through the structure and exit from the center of the triangular faces in the "upper" and "lower" halves of the structure. If one triangular face is rotated relative to the other around a C_3 axis, a trigonal prism results. However, for a trischelate complex there are two ways (actually there are four, but most indications are that two are most important) in which the rings (that remain attached to the metal) can be oriented. In one way, the rings span the rectangular faces along the three longitudinal edges. This "trigonal twist" is known as the *Bailar twist* (Bailar, 1958). In a second type of trigonal twist, the transition state is a trigonal prism in which one of the chelating groups lies along the longitudinal edge of a rectangular face but the other two are attached along edges where the triangular faces join the rectangular faces. This mechanism is known as the *Ray and Dutt twist*. These mechanisms are illustrated in Figure 20.11.

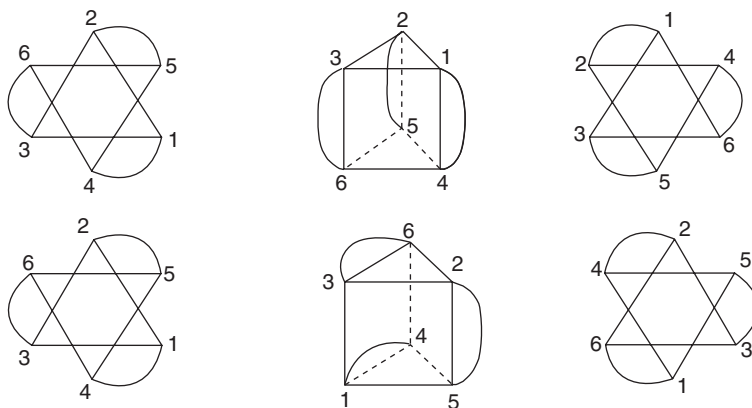

■ FIGURE 20.11 The Bailar (*top*) and Ray-Dutt (*bottom*) trigonal twist mechanisms.

If forming the transition state by a twist mechanism leads to some expansion of the lattice, it would be expected that a higher lattice energy would hinder racemization. In a very detailed study (Kutal and Bailar, 1972) of the racemization of (+)-[Co(en)₃]X₃·nH₂O (where X = Cl⁻, Br⁻, I⁻, or SCN⁻), it was found that the rate varied with the nature of the anion. The rate was found to decrease in the order



It was also found that the degree of hydration of the complex affected the rate of racemization. Generally, the hydrated complexes reacted faster than anhydrous samples. It was also found that reducing the particle size increased the rate of racemization, but when the iodide compound was heated with water in a sealed tube, the racemization was *slower* than for the hydrated solid from which the water could escape. The fact that the hydrated samples racemized faster could indicate that an aquation-anation mechanism is involved, but the results obtained in the sealed tube experiments do not agree with that idea.

If the formation of the transition state constitutes a point defect that requires slight expansion of the lattice, the rate would be slowest for the chloride compound because the smaller ion would cause the lattice energy to be higher. The rate should be highest for the iodide compound because the large anion would lead to a lower lattice energy. The variation in the order of racemization with the nature of the anion agrees with this assessment. The fact that racemization is more rapid during the loss of water could be the result of slight lattice expansion as water diffuses through the crystal, making it easier to form the transition state. Although the results will not be described here, the mechanism based on defects and diffusion is consistent with other racemization reactions (see O'Brien, 1983).

20.11.3 Geometrical Isomerization

Reactions in which isomerization of coordination compounds occur in solutions are common, and some reactions of this type in solid complexes have been studied. Generally, there is a change in color of the complex as the crystal field environment of the metal ion changes. Accordingly, some of the color changes that occur when complexes are heated *may* indicate isomerization, but very few geometrical isomerization reactions in solid complexes have been studied in detail. One such reaction is

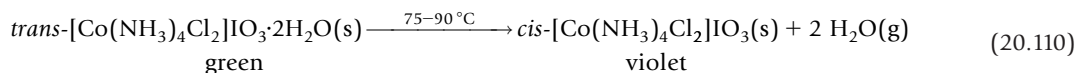

Several interesting observations have been made on this reaction. First, the rate of isomerization was found to be the same as the rate of dehydration. All attempts to dehydrate the starting complex by conventional techniques were found to lead to isomerization. On the basis of this and other evidence, the mechanism proposed involves the aquation in the complex followed by anation. In this process, water first displaces Cl⁻ in the coordination sphere and then is displaced by the Cl⁻, possibly by an S_N1 mechanism. A trigonal bipyramid transition state could account for the Cl⁻ reentering the coordination sphere to give an *cis* product. The rate law for this reaction is of the form

$$-\ln(1 - \alpha) = kt + c \quad (20.111)$$

where *c* is a constant, which is the first-order rate law described in Chapter 8 (LeMay and Bailar, 1967).

Other compounds that undergo isomerization include *trans*-[Co(pn)₂Br₂](H₅O₂)Br₂, *trans*-[Co(pn)₂Cl₂](H₅O₂)Br₂, and *trans*-[Co(pn)₂Br₂](H₅O₂)Cl₂. All of these contain the hydrated proton in the form of H₅O₂⁺. When these compounds are heated, they lose water and hydrogen halide molecules as well as being converted to the *cis* form.

Isomerization involving a square planar complex is also known. Because of the *trans* effect, it is easier to synthesize the *trans* isomer of many complexes than it is to prepare the *cis* complex. The following reactions lead to the formation of an unusual platinum complex:

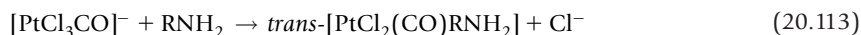
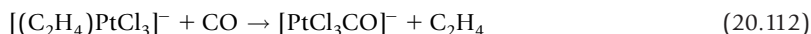

The *trans* compound melts at approximately 90 °C, and continued heating leads to isomerization to the *cis* structure. Geometrical isomerizations can also lead to a change in structure of the complex. For example, a change from square planar to tetrahedral structure has been observed for the complex [Ni(P(C₂H₅)(C₆H₅)₂)₂Br₂].

20.11.4 Linkage Isomerization

The oldest case of a linkage isomerization that has been studied in detail is

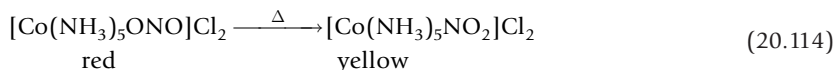

which was investigated in the 1890s by Jørgensen and since that time by many other workers. This reaction takes place both in solutions and in the solid state, and it was discussed in some detail in Chapter 16 and earlier in this chapter.

Linkage isomerization reactions involving cyanide complexes have been known for many years. Generally, these reactions take place when a complex is prepared with a bonding mode that has the carbon end of CN⁻ bound to one metal ion, and another metal ion is added that is forced to bond to the nitrogen end. If the metals have hard-soft characteristics that do not match the hard-soft character of CN⁻ (the carbon atom is the softer end), it is possible to induce a change in bonding mode whereby the CN⁻ “flips” to give the appropriate match of hard-soft character. For example, when a solution containing K₃[Cr(CN)₆] (the cyanide is C-bonded to Cr³⁺) has added to it a solution containing Fe²⁺, a solid product having the formula KFe[Cr(CN)₆] is obtained. When this compound is heated at 100 °C for a short time, the color changes from brick red to green, but there is also another significant change. An absorption peak is observed at 2168 cm⁻¹ in the infrared spectrum for the CN stretching vibration in KFe[Cr(CN)₆]. In fact, the CN stretching band is observed at approximately this position for almost all cyanide complexes in which the CN⁻ is bonded to a first-row transition metal having a +3 charge. After heating the solid, the infrared band at 2168 cm⁻¹ decreases in intensity, and a new band is seen at 2092 cm⁻¹. If the heating is continued, the band at 2168 cm⁻¹ disappears, and only the band at 2092 cm⁻¹ is observed. The position of this band is characteristic of CN stretching

vibrations in which the CN is bonded to a metal ion with a +2 charge. What has happened is that the CN^- ions have changed bonding mode (referred to as a cyanide flip).



In this equation, only one of the CN^- ligands is shown. The product actually contains a three-dimensional network in which CN^- ions bridge between Cr^{3+} and Fe^{2+} . However, in this arrangement, the *harder* electron donor, nitrogen, is bonded to the *softer* metal ion, Fe^{2+} , and the *softer* electron donor, carbon, is bonded to the *harder* metal ion, Cr^{3+} . The fact that CN^- originally bonds to Cr^{3+} through the carbon end is not surprising because of the negative formal charge on that atom. However, when solid $\text{KFe}[\text{Cr}(\text{CN})_6]$ is heated, the cyanide ions “flip” in order to give the arrangement that is in accord with the hard-soft interaction principle, which favors $\text{Cr}^{3+}\text{-NC-Fe}^{2+}$ linkages. Other reactions of this type have been observed in which a second-row metal is involved. For example, when a solution containing Cd^{2+} is added to one containing $\text{K}_3[\text{Cr}(\text{CN})_6]$, the solid product is $\text{KCd}[\text{Cr}(\text{CN})_6]$. In that case, the Cd^{2+} ions are forced to bond to the nitrogen end of the cyanide ions because the carbon atoms are already bonded to Cr^{3+} and the solid contains $\text{Cr}^{3+}\text{-CN-Cd}^{2+}$ linkages. When heated, a cyanide flip occurs to give $\text{Cr}^{3+}\text{-NC-Cd}^{2+}$ linkages in accord with the hard-soft interaction principle. However, based on the intensities of the CN stretching bands, only two-thirds of the cyanide ions change bonding mode. Presumably this is because Cd^{2+} has a coordination number of 4 whereas that of Cr^{3+} is 6, so two cyanides do not flip.

A somewhat unusual linkage isomerization occurs when $\text{K}_4[\text{Ni}(\text{NO}_2)_6]\cdot\text{H}_2\text{O}$ is heated. This complex is easily prepared by adding an excess of KNO_2 to a solution containing Ni^{2+} , and it has the NO_2^- ions coordinated to Ni^{2+} through the nitrogen atoms. Solid $\text{K}_4[\text{Ni}(\text{NO}_2)_6]\cdot\text{H}_2\text{O}$ exhibits two absorption bands in the infrared spectrum at 1325 cm^{-1} and 1347 cm^{-1} that are assigned to the N–O vibrations in $-\text{NO}_2$ linkages. When the compound is heated in the solid state to remove the water of hydration, new bands appear in the infrared spectrum at 1387 cm^{-1} and 1206 cm^{-1} . These absorptions are characteristic of M–ONO linkages. On the basis of the reduction in ligand field strength, which is determined spectroscopically, the product after dehydration is formulated as $\text{K}_4[\text{Ni}(\text{NO}_2)_4(\text{ONO})_2]$. Therefore, the dehydration and linkage reaction can be written as

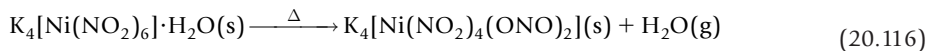

The enthalpy change has been determined to be $+14.6\text{ kJ mol}^{-1}$ for each Ni– NO_2 converted to Ni–ONO. This value is somewhat higher than the value of 8.62 kJ mol^{-1} required for conversion of $[\text{Co}(\text{NH}_3)_5\text{NO}_2]\text{Cl}_2$ to $[\text{Co}(\text{NH}_3)_5\text{ONO}]\text{Cl}_2$ in the solid state. Co^{3+} is a hard Lewis acid, and attaching five NH_3 ligands leaves it as a hard acid. On the other hand, Ni^{2+} is a borderline acid, but the addition of six NO_2^- ligands, which are soft and capable of π bonding, indicates that the Ni^{2+} in the complex is a soft acid as a result of the symbiotic effect. Therefore, it would be expected that changing the bonding mode of NO_2^- to Ni^{2+} would require a greater amount of energy than it would when the soft NO_2^- ligand is bound to the hard Co^{3+} .

Adding a solution containing Ag^+ to one containing $[\text{Co}(\text{CN})_6]^{3-}$ produces a solid in which there are $\text{Ag}^+\text{-N=C-Co}^{3+}$ linkages because the carbon ends of the cyanide ions are attached to the Co^{3+} ion.

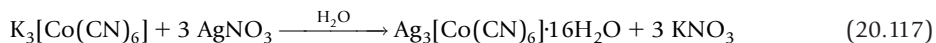

The product has a mismatch of hard-soft character because the Ag^+ is soft, but the nitrogen end of CN^- is the harder electron pair donor. For the $\text{Ag}^+-\text{N}-\text{C}-\text{Co}^{3+}$ linkages, the CN stretching band is observed at 2128 cm^{-1} . When $\text{Ag}_3[\text{Co}(\text{CN})_6]\cdot 16\text{H}_2\text{O}$ is heated, dehydration occurs and a new band appears at 2185 cm^{-1} that is characteristic of $\text{Ag}^+-\text{N}-\text{C}-\text{Co}^{3+}$ linkages. When $\text{Ag}_3[\text{Co}(\text{CN})_6]\cdot 16\text{H}_2\text{O}$ is allowed to stand at room temperature for 24 hours in ambient light, partial dehydration occurs, and the infrared spectrum shows that complete linkage isomerization takes place. A kinetic study of the isomerization showed that the isomerization follows a one-dimensional contraction, R1, rate law (see Chapter 8). The linkage isomerization reaction in $\text{Ag}_3[\text{Co}(\text{CN})_6]$ can also be induced by ultrasound. The linkage isomerization reactions show the importance of the hard-soft interaction principle in predicting the stable bonding modes.

The chemistry of coordination compounds is a vast field that encompasses many kinds of work. So much of the field is concerned with solution chemistry that it is easy to forget that a great deal is known about solid-state chemistry of coordination compounds. The brief survey presented shows that a great deal is known about some of the reactions, but there is much that needs to be done before many others will be understood.

■ REFERENCES FOR FURTHER STUDY

- Atwood, J. E. (1997). *Inorganic and Organometallic Reaction Mechanisms*, 2nd ed. Wiley-VCH, New York. An excellent book on mechanistic inorganic chemistry.
- Bailar, J. C. Jr. (1958). *J. Inorg. Nucl. Chem.* **8**, 165. The paper describing trigonal twist mechanisms for racemization.
- Basolo, F., and Pearson, R. G. (1967). *Mechanisms of Inorganic Reactions*, 2nd ed. Wiley, New York. A classic reference in reaction mechanisms in coordination chemistry.
- Chatt, J., and Shaw, B. L. (1962). *J. Chem. Soc.* 5075. Spectral interpretation of *trans* effect.
- Espenson, J. H. (1995). *Chemical Kinetics and Reaction Mechanisms*, 2nd ed. McGraw-Hill, New York. A book on chemical kinetics, much of which is devoted to reactions of coordination compounds. Highly recommended.
- Fogel, H. M., and House, J. E. (1988). *J. Thermal Anal.* **34**, 231–238. The paper describing the thermally induced changes in *trans*-dichlorotetramminecobalt(III) complexes.
- Gray, H. B., and Langford, C. H. (1968). *Chem. Eng. News*, April 1, 68. A excellent survey article, "Ligand Substitution Dynamics," that presents elementary concepts clearly.
- House, J. E. (1980). *Thermochim. Acta* **38**, 59. A discussion of reactions in solids and the role of free space and diffusion.
- House, J. E. (2007). *Principles of Chemical Kinetics*, 2nd ed. Academic Press/Elsevier, San Diego, CA. A kinetics book that presents a discussion of several types of reactions in the solid state as well as solvent effects.
- House, J. E., and Bunting, R. K. (1975). *Thermochim. Acta* **11**, 357–360.
- House, J. E., and Kob, N. E. (1993). *Inorg. Chem.* **32**, 1053. A report on the linkage isomerization in $\text{KCd}[\text{Fe}(\text{CN})_6]$.
- House, J. E., and Kob, N. E. (1994). *Transition Metal Chem.* **19**, 31. A report on isomerization in $\text{Ag}_3[\text{Co}(\text{CN})_6]$.
- House, R. K. (1998). *M. S. thesis*, Illinois State University. Synthetic reactions using ultrasound.
- Kutal, C., and Bailar, J. C. Jr. (1972). *J. Phys. Chem.* **76**, 119. An outstanding paper on the racemization of a complex in the solid state.
- LeMay, H. E., and Bailar, J. C. Jr. (1967). *J. Am. Chem. Soc.* **89**, 5577.

- O'Brien, P. (1983). *Polyhedron* 2, 223. An excellent review of racemization reactions of coordination compounds in the solid state.
- Ohyoshi, A., Hiraki, S., Odate, T., and Oda, S. (1975). *Bull. Chem. Soc. Jpn.* 48, 262. Kinetic parameters for anation reactions.
- Taube, H. (1970). *Electron Transfer Reactions of Complex Ions in Solution*. Academic Press, New York. One of the most significant works on the subject of electron transfer reactions.
- Thusius, O. (1971). *Inorgo Chem.* 10, 1106. A kinetic study illustrating the add compensation effect.
- Wilkins, R. G. (1991). *Kinetics and Mechanisms of Reactions of Transition Metal Complexes*. VCH Publishers, New York. Contains a wealth of information on reactions of coordination compounds.

■ QUESTIONS AND PROBLEMS

- The reaction of 2 moles of $\text{P}(\text{C}_2\text{H}_5)_3$ with $\text{K}_2[\text{PtCl}_4]$ produces a product having a different structure than does the reaction of 2 moles of $\text{N}(\text{C}_2\text{H}_5)_3$. Show the structure for the product in each case and explain the difference in the reactions.
- The Pt-Cl stretching band is observed at 314 cm^{-1} in *cis*- $[\text{Pt}((\text{CH}_3)_3\text{As})_2\text{Cl}_2]$ but in the *trans* isomer it is seen at 375 cm^{-1} . Explain the difference in band position for the two isomers.
- Explain why most substitution reactions involving tetrahedral complexes of transition metal ions take place rapidly.
- Explain why substitution reactions of tetrahedral complexes of Be^{2+} are slow.
- Predict the product for each of the following substitution reactions:
 - $[\text{PtCl}_3\text{NH}_3]^- + \text{NH}_3 \rightarrow$
 - $[\text{PtCl}_3\text{NO}_2]^{2-} + \text{NH}_3 \rightarrow$
 - $[\text{Pt}(\text{NH}_3)_3\text{Cl}]^+ + \text{CN}^- \rightarrow$
- Suppose the series of complexes *trans*- $[\text{Pt}(\text{NH}_3)_2\text{LCl}]$ is prepared where $\text{L} = \text{NH}_3, \text{Cl}^-, \text{NO}_2^-, \text{Br}^-$, or pyridine. If the position of the Pt-Cl stretching band is determined for each product, what will be the order of decreasing wave number? Explain your answer.
- Consider the linkage isomerization $\text{Cr}^{3+}-\text{CN}-\text{Fe}^{2+} \rightarrow \text{Cr}^{3+}-\text{NC}-\text{Fe}^{2+}$ described in the text. Show by using ligand field theory (magnitudes of Dq) that this process should be energetically favorable.
- The reaction *cis*- $[\text{Co}(\text{en})_2\text{BrCl}]$ with H_2O gives a product that is 100% *cis* isomer. Explain what this indicates about the mechanism.
- Why is the rate of H_2O exchange in the aqua complex of Cr^{3+} about 100 times that for the aqua complex of Rh^{3+} ?
- The reaction of *trans*- $[\text{IrCl}(\text{CO})(\text{P}(p\text{-C}_6\text{H}_4\text{Y})_3)_2]$ with H_2 at 30°C depends on the nature of the group Y in the phenyl group. For several ligands, the ΔH^\ddagger and ΔS^\ddagger vary as follows:

Y	OCH ₃	CH ₃	H	F	Cl
ΔH^\ddagger , kcal/mol	6.0	4.3	10.8	11.6	9.8
ΔS^\ddagger , e.u.	-39	-45	-23	-22	-28

Test these data to determine whether an isokinetic relationship exists and comment on the results.

11. It is found that the rate of substitution reaction between $\text{Mn}(\text{CO})_5\text{Br}$ and $\text{As}(\text{C}_6\text{H}_5)_3$ varies somewhat with the solvent. The rate constant at 40°C when the solvent is cyclohexane is $7.44 \times 10^{-8} \text{ sec}^{-1}$, and when the solvent is nitrobenzene it is $1.08 \times 10^{-8} \text{ sec}^{-1}$. In light of the principles described in Chapter 6, what does this observation indicate about the mechanism of the reaction? What would you expect a reasonable value for the rate constant to be if the solvent is chloroform? See Table 6.7.
12. The ligand diethylenetriamine, $\text{H}_2\text{NCH}_2\text{CH}_2\text{NHCH}_2\text{CH}_2\text{NH}_2$, forms stable complexes with Pt^{2+} . When the complexes $[\text{Pt}(\text{dien})\text{X}]^+$ undergo reaction with pyridine, the rate constants for $\text{X} = \text{Cl}^-$, I^- , and NO_2^- are 3.5×10^{-5} , 1.0×10^{-5} , and $5.0 \times 10^{-8} \text{ sec}^{-1}$, respectively. What is the mechanism for the substitution reactions? Provide an explanation for the difference in rates of the reactions. What would be a reasonable estimate for the rate constant when $\text{X} = \text{Br}^-$? Explain your answer.
13. By referring to Table 17.1, calculate the ligand field activation energy for a square planar complex of Pd^{2+} undergoing substitution by an associative process that has a trigonal bipyramid transition state. If the complex in question has $Dq = 1,200 \text{ cm}^{-1}$, what would be the activation energy in kJ/mol if only ligand field effects are considered?
14. When $\text{trans-}[\text{Rh}(\text{en})_2\text{Cl}_2]^+$ undergoes substitution of the Cl^- ions by two ligands Y , the rate constants when $\text{Y} = \text{I}^-$, Cl^- , or NO_2^- are 5.2×10^{-5} , 4.0×10^{-5} , and 4.2×10^{-5} , respectively, with unspecified units. Discuss the mechanism of the substitution processes. What would be a reasonable value for k when $\text{Y} = \text{NH}_3$?
15. Compare the rates and products obtained for the following reactions.

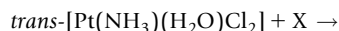
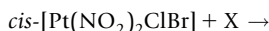
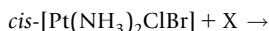
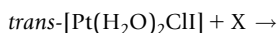

16. Explain the difference with respect to the size of the neighboring groups on substitution in an octahedral complex by associative and dissociative mechanisms.
17. Although substitution in many tetrahedral complexes is rapid, when the metal ion is Be^{2+} this is not the case. Explain why this is so.
18. How would you expect the rate of substitution reactions in complexes of Mg^{2+} and Al^{3+} to compare? Provide an explanation for your answer.
19. Suppose an octahedral complex of a d^3 ion undergoes substitution by a dissociative pathway. What are the two possible transition states? What is the difference in ligand field activation energy for the two possible pathways? Suppose the solvent interacts with the *less* energetically favorable transition state (on the basis of ligand field activation energy) with a solvation energy that is 25 kJ/mol *more* favorable than it does with the other transition state. If there are only ligand field and solvation energies involved, what value of Dq for the complex would make the two pathways have the same activation energy? Discuss the implications of this situation with regard to mechanisms of substitution reactions. How would the situation be different for complexes of third-row metals compared to those of first-row metals?
20. On the basis of ligand field effects, would it be easier to form a trigonal bipyramid transition state from a square planar or a tetrahedral starting complex?
21. Although the ligands contain nitrogen donor atoms in both cases, the rate of reaction of $[\text{Ni}(\text{NH}_3)_4]^{2+}$ is over 20 times as great as $[\text{Ni}(\text{en})_2]^{2+}$. Explain this observation.

22. Why would the rate of exchange of chloride be different when the complex is $[\text{Co}(\text{NH}_3)_5\text{Cl}]^{2+}$ rather than $[\text{Co}(\text{NH}_2\text{CH}_3)_5\text{Cl}]^{2+}$? Which would undergo more rapid exchange of Cl^- ?
23. How would the volume of activation and the entropy of activation be useful when deciding whether a substitution reaction follows a dissociative or interchange mechanism?
24. The aquation of $[\text{Cr}(\text{H}_2\text{O})_5\text{F}]^{2+}$ is accelerated at lower pH, but the aquation of $[\text{Cr}(\text{H}_2\text{O})_5\text{NH}_3]^{2+}$ is not. Explain this difference.
25. Why is the rate at which ligands leave the coordination sphere of low-spin Fe^{2+} complexes different from that for high-spin Fe^{2+} complexes?
26. The substitution reactions of $[\text{ML}_5\text{A}]^{3+}$, $[\text{ML}_5\text{B}]^{3+}$, and $[\text{ML}_5\text{C}]^{3+}$ gave ΔH^\ddagger and ΔS^\ddagger values as follows (kJ/mol and e.u.): 23.2 and -8 ; 30.3 and 9; 26.5 and -1 . Is it likely that the reactions follow the same mechanism?
27. If *cis*- $[\text{Co}(\text{NH}_3)_4(\text{H}_2\text{O})_2](\text{SO}_4)_3 \cdot 3\text{H}_2\text{O}(\text{s})$ is heated, what would be the most likely change to take place first? If heating is continued at higher temperature, what other changes could occur? Sketch structures of the product at each stage of decomposition.

Complexes Containing Metal-Carbon and Metal-Metal Bonds

In previous chapters, we have presented a great deal of information about structure and bonding in coordination compounds. This chapter will be devoted to describing some of the important chemistry in the broad areas of organometallic complexes and those in which there are metal-metal bonds. The body of literature on each of these topics is enormous, so the coverage here will include basic concepts and a general survey.

It is important to realize that there is a great deal of overlap in the topics covered in this chapter. For example, the chemistry of metal carbonyls is intimately related to metal alkene complexes, because both types of ligands are soft bases and many complexes contain both carbonyl and alkene ligands. Also, both areas are closely associated with catalysis by complexes discussed in Chapter 22, because some of the best-known catalysts are metal carbonyls and they involve reactions of alkenes. Therefore, the separation of topics applied is certainly not a clear one. Catalysis by metal complexes embodies much of the chemistry of both metal carbonyls and metal alkene complexes.

21.1 BINARY METAL CARBONYLS

One of the very interesting series of coordination compounds consists of metal atoms bonded to carbon monoxide, the metal carbonyls. A remarkable characteristic of these compounds is that because the ligands are neutral molecules, the metals are present in the zero oxidation state. Although the discussion at first will be limited to the binary compounds containing only metal and CO, many mixed complexes are known that contain both CO and other ligands. Depending on the net charge on the other ligands, the metal may or may not be in the zero oxidation state. In any event, the metals in metal carbonyls occur in low oxidation states because of the favorable interaction of the soft ligands (Lewis bases) with metals in low oxidation states (soft Lewis acids).

Generally, the metals that form stable carbonyl complexes are those in the first transition series from V to Ni, in the second row from Mo to Rh, and in the third row from W to Ir. There are several reasons for these being the metals most often found in carbonyl complexes. First, these metals have one or more *d* orbitals that are not completely filled so they can accept electron pairs from σ electron donors. Second, the *d* orbitals contain some electrons that can be involved in back donation to the π^* orbitals

on the CO ligands. Third, the metals are generally in the zero oxidation state or at least a low oxidation state so they behave as soft Lewis acids, making it favorable to bond to a soft Lewis base like CO.

The first metal carbonyl prepared was $\text{Ni}(\text{CO})_4$, which was obtained by Mond in 1890. This extremely toxic compound was prepared by first reducing nickel oxide with hydrogen,



then treating the Ni with CO,



Because $\text{Ni}(\text{CO})_4$ is volatile (b.p. 43°C) and cobalt will not react under these conditions, this process afforded a method for separating Ni from Co by the process now known as the *Mond process*. Although there are many complexes known that contain both carbonyl and other ligands (mixed carbonyl complexes), the number containing only a metal and carbonyl ligands is small. They are known as *binary metal carbonyls*, and they are listed in Table 21.1. The structures of most of these compounds are shown later in Figures 21.1 through 21.3.

The binary metal carbonyls are named by giving the name of the metal followed by the name *carbonyl*, with the number of carbonyl groups indicated by the appropriate prefix. For example, $\text{Ni}(\text{CO})_4$ is nickel tetracarbonyl, whereas $\text{Cr}(\text{CO})_6$ is chromium hexacarbonyl. If more than one metal atom is present, the number is indicated by a prefix. Thus, $\text{Co}_2(\text{CO})_8$ is dicobalt octacarbonyl, and $\text{Fe}_2(\text{CO})_9$ has the name diiron nonacarbonyl.

Table 21.1 Binary Metal Carbonyls.

Mononuclear compound	m.p., $^\circ\text{C}$	Dinuclear compound	m.p., $^\circ\text{C}$	Polynuclear compound	m.p. $^\circ\text{C}$
$\text{Ni}(\text{CO})_4$	-25	$\text{Mn}_2(\text{CO})_{10}$	155	$\text{Fe}_3(\text{CO})_{12}$	140(d)
$\text{Fe}(\text{CO})_5$	-20	$\text{Fe}_2(\text{CO})_9$	100(d)	$\text{Ru}_3(\text{CO})_{12}$	—
$\text{Ru}(\text{CO})_5$	-22	$\text{Co}_2(\text{CO})_8$	51	$\text{Os}_3(\text{CO})_{12}$	224
$\text{Os}(\text{CO})_5$	-15	$\text{Rh}_2(\text{CO})_8$	76	$\text{Co}_4(\text{CO})_{12}$	60(d)
$\text{Cr}(\text{CO})_6$	subl.	$\text{Tc}_2(\text{CO})_{10}$	160	$\text{Rh}_4(\text{CO})_{12}$	150(d)
$\text{Mo}(\text{CO})_6$	subl.	$\text{Re}_2(\text{CO})_{10}$	177	$\text{Ir}_4(\text{CO})_{12}$	210(d)
$\text{V}(\text{CO})_6$	70(d)	$\text{Os}_2(\text{CO})_9$		$\text{Rh}_6(\text{CO})_{16}$	200(d)
$\text{W}(\text{CO})_6$	subl.	$\text{Ir}_2(\text{CO})_8$		$\text{Ir}_6(\text{CO})_{16}$	—
				$\text{Os}_5(\text{CO})_{16}$	
				$\text{Os}_6(\text{CO})_{18}$	

(d) indicates decomposition.

The effective atomic number rule (the 18-electron rule) was described briefly in Chapter 16, but we will consider it again here because it is so useful when discussing carbonyl and olefin complexes. The composition of stable binary metal carbonyls is largely predictable by the effective atomic number (EAN) rule, or the “18-electron rule” as it is also known. Stated in the simplest terms, the EAN rule predicts that a metal in the zero or other low oxidation state will gain electrons from a sufficient number of ligands so that the metal will achieve the electron configuration of the next noble gas. For the first-row transition metals, this means the krypton configuration with a total of 36 electrons.

Actually, there is ample evidence to indicate that the rule is followed in many other cases as well. For example, Zn^{2+} has 28 electrons, and receiving eight more electrons (two electrons from each of four ligands) as in $[\text{Zn}(\text{NH}_3)_4]^{2+}$ results in 36 electrons being around the Zn^{2+} . Similarly, Co^{3+} has 24 electrons, and six pairs of electrons from six ligands will raise the number to 36 (as in $[\text{Co}(\text{CN})_6]^{3-}$). The vast majority of complexes containing Co^{3+} follow this trend. In the case of Cr^{3+} , the ion has 21 electrons, and gaining six pairs results in there being only 33 electrons around the chromium ion. For complexes of metal ions, the EAN rule is followed much more frequently by those metals in the latter part of the transition series.

The example of Cr^{3+} mentioned earlier shows that the “rule” is by no means always true. However, for complexes of metals in the zero oxidation state containing soft ligands such as CO, PR_3 , or alkenes, there is a strong tendency for the stable complexes to be those containing the number of ligands predicted by the EAN rule. Because the Ni atom has 28 electrons, we should expect eight more electrons to be added from four ligands. Accordingly, the stable nickel carbonyl is $\text{Ni}(\text{CO})_4$. For chromium(0), which contains 24 electrons, the stable carbonyl is $\text{Cr}(\text{CO})_6$, as expected from the EAN rule. The six pairs of electrons from the six CO ligands brings to 36 the number of electrons around the chromium atom.

The Mn atom has 25 electrons. Adding five carbonyl groups would raise the number to 35, leaving the atom one electron short of the krypton configuration. If the single unpaired electron on one manganese atom is then allowed to pair up with an unpaired electron on another to form a metal-metal bond, we have the formula $(\text{CO})_5\text{Mn}-\text{Mn}(\text{CO})_5$ or $[\text{Mn}(\text{CO})_5]_2$, which is the formula for a manganese carbonyl that obeys the EAN rule.

Cobalt has 27 electrons, and adding eight more electrons (one pair from each of four CO ligands) brings the total to 35. Accordingly, forming a metal-metal bond using the remaining unpaired electrons would give $[\text{Co}(\text{CO})_4]_2$ or $\text{Co}_2(\text{CO})_8$ as the stable carbonyl compound. As we shall see, there are two different structures possible for $\text{Co}_2(\text{CO})_8$, both agreeing with the EAN rule. Based on the EAN rule, it might be expected that $\text{Co}(\text{CO})_4$ would not be stable, but the species $\text{Co}(\text{CO})_4^-$ obtained by adding an electron to $\text{Co}(\text{CO})_4$ would be stable. Actually, the $\text{Co}(\text{CO})_4^-$ ion is well known, and several derivatives containing it have been prepared.

The EAN rule also applies to carbonyls of metal clusters. For example, in $\text{Fe}_3(\text{CO})_{12}$, there are eight electrons in the valence shells of the three $\text{Fe}(0)$ atoms, which gives a total of 24. Then, the 12 CO ligands contribute an electron pair, each which gives another 24 electrons and brings the total to 48. This gives an average of 16 per Fe atom, and the deficit must be made up by the metal-metal bonds.

Since each atom contributes one electron to the bond, two bonds to other Fe atoms are required to give 18 electrons around each atom. As will be seen from the structure shown later in Figure 21.3, the structure of $\text{Fe}_3(\text{CO})_{12}$ has the three Fe atoms in a triangle with each bonded to two other Fe atoms. In a similar way, $\text{Co}_4(\text{CO})_{12}$ has 12 CO ligands contributing two each or a total of 24 electrons and four Co atoms that contribute 9 each or a total of 36 electrons. From both sources, the number of electrons available is 60, but for four metal atoms the number is 15 each. Therefore, to have 18 each would require each Co atom to form bonds to three others. Such a structure is shown later in Figure 21.4, in which the four Co atoms are arranged in a tetrahedron.

Although the 18-electron rule is not always followed, it does offer a logical basis for predicting the composition of many complexes. The arguments presented here can, of course, be extended to second- and third-row transition elements. The 18-electron rule is also of use in predicting the formulas of stable complexes containing carbonyl groups and other ligands, as might result from ligand substitution reactions. This is particularly important when a ligand (such as an alkene containing several double bonds) can donate different numbers of electrons depending on the number needed by the metal to achieve the configuration of the next noble gas.

21.2 STRUCTURES OF METAL CARBONYLS

The mononuclear metal carbonyls contain only one metal atom, and they have comparatively simple structures. For example, nickel tetracarbonyl is tetrahedral. The pentacarbonyls of iron, ruthenium, and osmium are trigonal bipyramidal, whereas the hexacarbonyls of vanadium, chromium, molybdenum, and tungsten are octahedral. These structures are shown in Figure 21.1.

The structures of the dinuclear metal carbonyls (containing two metal atoms) involve either metal-metal bonds or bridging CO groups, or both. For example, the structure of $\text{Fe}_2(\text{CO})_9$, diiron nonacarbonyl, contains three CO ligands that form bridges between the iron atoms, and each iron atom also has three other CO groups attached only to that atom.

Carbonyl groups that are attached to two metal atoms simultaneously are called bridging carbonyls, whereas those attached to only one metal atom are referred to as terminal carbonyl groups. The structures of $\text{Mn}_2(\text{CO})_{10}$, $\text{Tc}_2(\text{CO})_{10}$, and $\text{Re}_2(\text{CO})_{10}$ actually involve only a metal-metal bond, so the formulas are more correctly written as $(\text{CO})_5\text{M}-\text{M}(\text{CO})_5$. Two isomers are known for $\text{Co}_2(\text{CO})_8$. One has

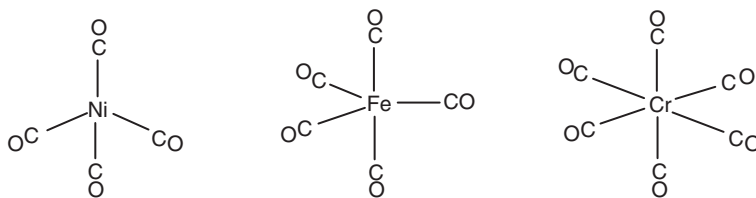

■ FIGURE 21.1 The structures of the mononuclear carbonyls of nickel, iron, and chromium.

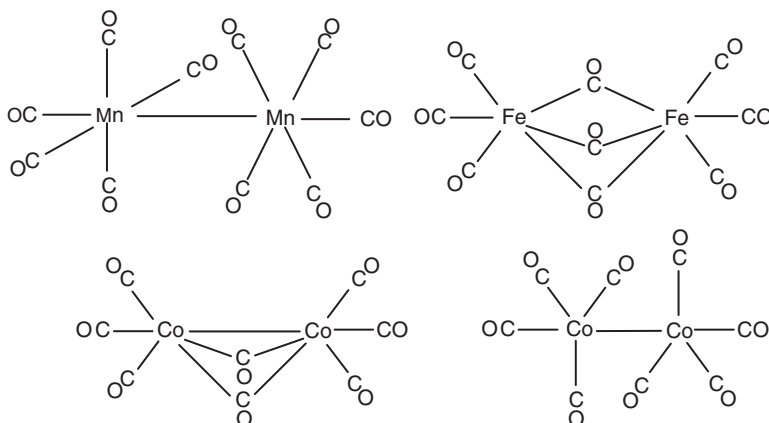

■ FIGURE 21.2 The structures of the binary metal carbonyls.

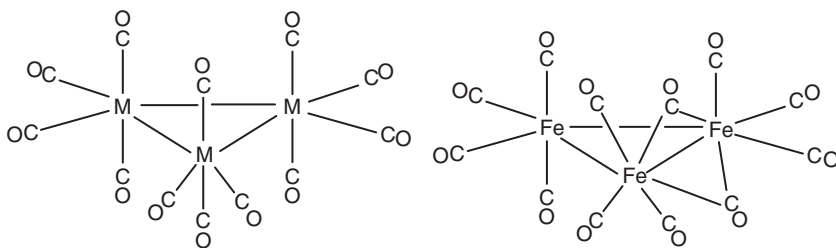

■ FIGURE 21.3 Structures of trinuclear metal carbonyls. In the structure on the left, M represents Ru or Os.

a metal-metal bond between the cobalt atoms; the other has two bridging CO ligands and a metal-metal bond. Figure 21.2 shows the structures of the dinuclear metal carbonyls.

The structure for $\text{Mn}_2(\text{CO})_{10}$ is sometimes drawn to appear as if four CO ligands form a square plane around the Mn atom. In fact, the four CO groups do not lie in the same plane as the Mn atom. Rather, they lie about 12 pm from the plane containing the Mn on the side opposite the metal-metal bond.

Structures of the trinuclear, tetranuclear, and higher compounds are best thought of as metal clusters containing either metal-metal bonds or bridging carbonyl groups. In some cases, both types of bonds occur. The structures of $\text{Ru}_3(\text{CO})_{12}$ and $\text{Os}_3(\text{CO})_{12}$ are shown in Figure 21.3. The structure of $\text{Fe}_3(\text{CO})_{12}$ also shown in Figure 21.3 contains a trigonal arrangement of Fe atoms, but it contains two bridging carbonyl groups.

Carbonyls containing four metal atoms in the cluster are formed by Co, Rh, and Ir in which the metal atoms are arranged in a tetrahedron with 12 CO ligands, nine in terminal positions and three that are bridging. These structures are shown in Figure 21.4.

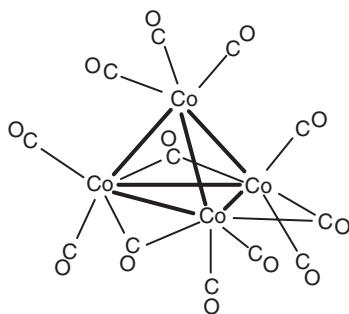

■ **FIGURE 21.4** The structure of $[\text{Co}_4(\text{CO})_{12}]$, which is also the structure of the analogous rhodium and iridium compounds.

21.3 BONDING OF CARBON MONOXIDE TO METALS

Carbon monoxide has the valence bond structure shown as



with a triple bond between C and O. The formal charge on the oxygen atom is +1, whereas that on the carbon atom is -1. Although the electronegativity of oxygen is considerably higher than that of carbon, these formal charges are consistent with the dipole moment being small (0.12 D) with the carbon being at the negative end of the dipole. The carbon end of the CO molecule is thus a softer electron donor, and it is the carbon atom that is bound to the metal. In the molecular orbital description of the bonding in CO, the energy level diagram is as shown in Figure 21.5.

The bond order (B.O.) in the molecule is given in terms of the number of electrons in bonding orbitals (N_b) and the number in antibonding orbitals (N_a) by

$$\text{B.O.} = \frac{N_b - N_a}{2} \quad (21.3)$$

For CO this gives a bond order of $(8 - 2)/2 = 3$, a triple bond. For gaseous CO in which the triple bond exists, the C-O stretching band is observed at 2143 cm^{-1} . However, typically, in metal carbonyls the C-O stretching band is seen at 1850 to 2100 cm^{-1} for terminal CO groups. The shift of the CO stretching band upon coordination to metals reflects a slight reduction in the bond order resulting from back donation of electron density from the metal to the CO. However, bridging carbonyl groups normally show an absorption band in the 1700 to 1850 cm^{-1} range. The spectrum of $\text{Fe}_2(\text{CO})_9$ shows prominent bands in these positions because both terminal and bridging CO ligands are present.

The molecular orbitals of CO are populated as shown in Figure 21.5, and the molecule is diamagnetic. However, the next higher unpopulated molecular orbitals are the π^* orbitals. By virtue of accepting several pairs of electrons from the ligands, the metal acquires a negative formal charge. Thus, in $\text{Ni}(\text{CO})_4$, the formal charge on the metal is -4. In order to remove part of this negative charge from the metal, electron density is donated back from the metal to the π^* orbitals on the ligands. The π^* orbitals on the CO have appropriate symmetry to effectively accept this electron density, resulting in a

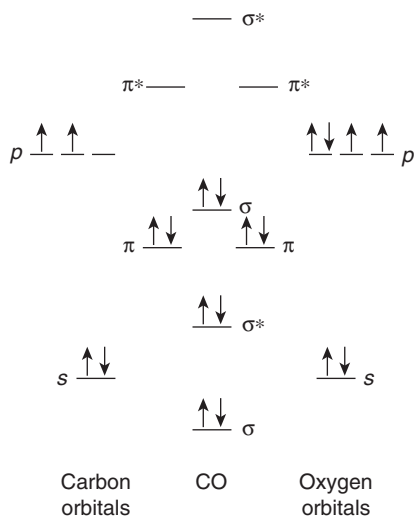

■ FIGURE 21.5 The molecular orbital diagram for CO.

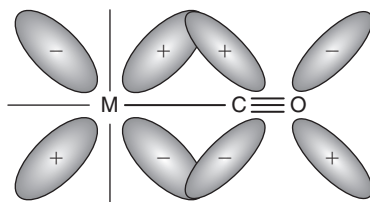

■ FIGURE 21.6 The overlap of a d orbital on a metal with the antibonding π^* orbital on CO.

slight double bond character to the metal–CO bond and a slight reduction from triple bond character in the CO ligand. Figure 21.6 shows the orbital interaction that permits back donation to occur.

The valence-bond approach to this multiple bonding can be shown in terms of the resonance structures:



In $\text{Fe}(\text{CO})_5$ the formal charge on iron is -5 , and in $\text{Cr}(\text{CO})_6$ the formal charge on chromium is -6 . We should expect that the back donation would be more extensive in either of these compounds than it is in the case of $\text{Ni}(\text{CO})_4$. Because the greater back donation results in a greater reduction in C–O bond order, the infrared spectra of these compounds should show this effect. The positions of the CO stretching bands for these compounds are as follows:

$\text{Ni}(\text{CO})_4$	2057 cm^{-1}
$\text{Fe}(\text{CO})_5$	2034 cm^{-1}
$\text{Cr}(\text{CO})_6$	1981 cm^{-1}

Bonding of CO in a bridging position between two metal atoms is most appropriately described by considering the carbon to be double-bonded to oxygen. If the carbon is considered to be hybridized sp^2 , a σ bond between carbon and oxygen results from overlap of a carbon sp^2 orbital with an oxygen atom p orbital. The π bond to oxygen results from the overlap of an unhybridized p orbital on the carbon atom with a p orbital on the oxygen atom. This leaves the remaining two sp^2 orbitals to bond simultaneously to the two metal atoms. The C–O bond in bridging CO is more like a double bond in a ketone than the triple bond in gaseous CO.

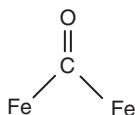

Stretching bands for bridging CO are found in the region characteristic of ketones, about 1700 to 1800cm^{-1} . Accordingly, the infrared spectrum of $\text{Fe}_2(\text{CO})_9$ shows absorption bands at 2000cm^{-1} (terminal carbonyl stretching) and 1830cm^{-1} (bridging carbonyl stretching). For most compounds containing carbonyl bridges, the C–O stretching band is seen around 1850cm^{-1} . A great deal of what is known about the bonding in metal carbonyls has been determined by means of the various spectroscopic techniques, especially infrared spectroscopy. However, it is important to remember that the donation of a pair of electrons in forming the σ bond also has some effect on the carbonyl stretching vibration.

Although we have described terminal and bridging carbon monoxide, it is known to bond to metals in other ways. Some of the other types of linkages are shown as follows:



Further changes in C–O stretching vibrations occur when other ligands are present. For example, the CO stretching band in $\text{Cr}(\text{CO})_6$ is found at 2100cm^{-1} , whereas that in $\text{Cr}(\text{NH}_3)_3(\text{CO})_3$ is found at approximately 1900cm^{-1} . The structure of the latter compound is

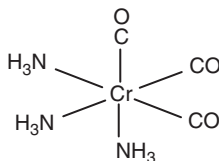

In this case, the product is the *fac* isomer, in which all NH_3 ligands are *trans* to the CO molecules. Ammonia does not form π bonds to metals because it has no orbitals of suitable energy to accept electron density. Thus, the back donation from Cr in $\text{Cr}(\text{NH}_3)_3(\text{CO})_3$ goes to only three CO molecules, and the bond order is reduced even more than it is in $\text{Cr}(\text{CO})_6$, where back donation occurs equally to six CO molecules. There is, of course, an increase in Cr–C bond order and stretching frequency in $\text{Cr}(\text{NH}_3)_3(\text{CO})_3$ compared to $\text{Cr}(\text{CO})_6$. Based on the study of many mixed carbonyl complexes, it is possible to compare the ability of various ligands to accept back donation. When this is done, it is found that the ability to accept back donation decreases in the order



The chemical behavior of metal carbonyls is influenced by the nature of other ligands present. A decrease in C–O bond order results from an increase in M–C bond order. If other ligands are present that cannot accept electron density, more back donation to CO occurs, so the M–C bond will be stronger and substitution reactions leading to replacement of CO will be retarded. If other ligands are present that are good π acceptors, less back donation to the CO groups occurs. They will be labilized and substitution will be enhanced.

21.4 PREPARATION OF METAL CARBONYLS

As we have described previously, $\text{Ni}(\text{CO})_4$ can be prepared directly by the reaction of nickel with carbon monoxide. However, most of the binary metal carbonyls listed in Table 21.1 cannot be obtained by this type of reaction. A number of preparative techniques have been used to prepare metal carbonyls, and a few general ones will be described here.

21.4.1 Reaction of a Metal with Carbon Monoxide

The reactions of carbon monoxide with Ni and Fe proceed rapidly at low temperature and pressure.



For most other metals, high temperatures and pressures are required to produce the metal carbonyl. By this direct reaction, $\text{Co}_2(\text{CO})_8$, $\text{Mo}(\text{CO})_6$, $\text{Ru}(\text{CO})_5$, and $\text{W}(\text{CO})_6$ have been prepared when suitable conditions are used.

21.4.2 Reductive Carbonylation

This type of reaction involves reducing a metal compound in the presence of CO. The reducing agents may include a variety of materials depending on the particular synthesis being carried out. For example, in the synthesis of $\text{Co}_2(\text{CO})_8$, hydrogen is used as the reducing agent.

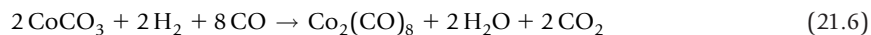

Lithium aluminum hydride, LiAlH_4 , has been used as the reducing agent in the preparation of $\text{Cr}(\text{CO})_6$ from CrCl_3 . Reduction by metals such as Na, Mg, or Al has also been used, as shown by the preparation of the $\text{V}(\text{CO})_6^-$ ion:

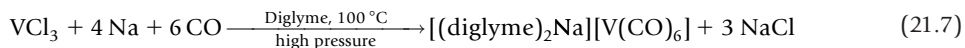

From the reaction mixture, $\text{V}(\text{CO})_6$ is obtained by hydrolyzing the product with H_3PO_4 and subliming $\text{V}(\text{CO})_6$ at $45\text{--}50^\circ\text{C}$. The reduction of CoI_2 can be used as a route to $\text{Co}_2(\text{CO})_8$:

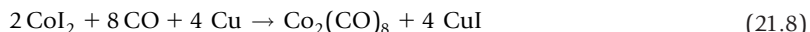

21.4.3 Displacement Reactions

Certain metal carbonyls have been prepared by the reaction of metal compounds directly with CO owing to the fact that CO is a reducing agent. For example,



and



21.4.4 Photochemical Reactions

Photolysis of $\text{Fe}(\text{CO})_5$ leads to partial removal of CO to produce diiron nonacarbonyl.



21.5 REACTIONS OF METAL CARBONYLS

Metal carbonyls undergo reactions with a great many compounds to produce mixed carbonyl complexes. A large number of these reactions involve the replacement of one or more carbonyl groups by a substitution reaction. Such reactions have also been studied kinetically in some cases.

21.5.1 Substitution Reactions

Many substitution reactions occur between metal carbonyls and other potential ligands. For example,

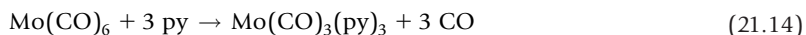
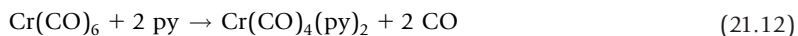

Substitution reactions of metal carbonyls frequently indicate differences in bonding characteristics of ligands. In the case of $\text{Mn}(\text{CO})_5\text{Br}$, radiochemical tracer studies have shown that only four CO groups undergo exchange with ^{14}C .



The structure of $\text{Mn}(\text{CO})_5\text{Br}$ is

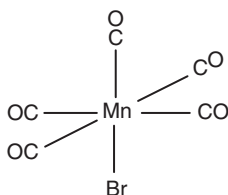

and the four CO molecules that undergo exchange reactions are those in the plane, which are all *trans* to each other. This indicates that the CO *trans* to Br is held more tightly because Br does not compete for π bonding electron density donated from Mn. In the case of the other four CO groups, competition between the groups, which are all good acceptors, causes the groups to be labilized. It was mentioned earlier that $\text{Mn}(\text{CO})_3(\text{py})_3$ results from the reaction of $\text{Mn}(\text{CO})_6$ with py. The structure of $\text{Mn}(\text{CO})_3(\text{py})_3$ is

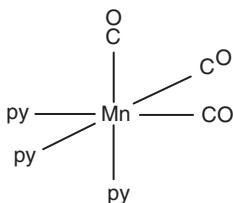

which has all three CO ligands *trans* to py. This structure maximizes the π donation to the three CO groups and reflects the difference in the ability of CO and py to accept electron density in the π orbitals. In the case where good π acceptors are the entering ligands, all the CO groups may be replaced, as shown in case of the reaction of $\text{Ni}(\text{CO})_4$ with PF_3 . These substitution reactions show that the π acceptor properties of CO influence the replacement reactions.

21.5.2 Reactions with Halogens

Reactions of metal carbonyls with halogens lead to the formation of carbonyl halide complexes by substitution reactions or breaking metal-metal bonds. The reaction



involves the rupture of the Mn–Mn bond, and one Br is added to each Mn. In the reaction



one CO is replaced on the iron by two iodine atoms so that the coordination number of the iron is increased to 6. The formulas for these carbonyl halides obey the EAN rule.

The reaction of CO with some metal halides results in the formation of metal carbonyl halides directly, as illustrated in the following examples:

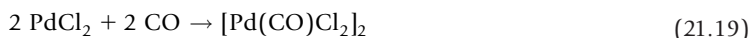

The structure of $[\text{Pd}(\text{CO})\text{Cl}_2]_2$ is

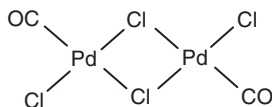

In this type of bridged structure, the halogen serves as the bridging group, and the bonding environment around each Pd atom is essentially square planar. Such compounds usually react by breaking the bridges followed by addition or substitution of ligands.

21.5.3 Reactions with NO

The nitric oxide molecule has one unpaired electron residing in an antibonding π^* molecular orbital. When that electron is removed, the bond order increases from 2.5 to 3, so in coordinating to metals, NO usually behaves as though it donates three electrons. The result is formally the same as if one electron were lost to the metal,



followed by coordination of NO^+ , which is isoelectronic with CO and CN^- . Because NO^+ is the nitrosyl ion, the products containing nitric oxide and carbon monoxide are called *carbonyl nitrosyls*. The following reactions are typical of those producing this type of compound:

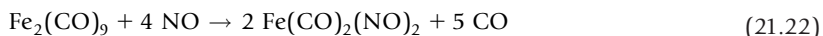
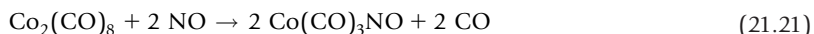

It is interesting to note that the products of these reactions obey the 18-electron rule. Cobalt has 27 electrons, and it acquires 6 from the three CO ligands and 3 from NO, which gives a total of 36. It is easy to see that $\text{Fe}(\text{CO})_2(\text{NO})_2$ and $\text{Mn}(\text{CO})_4\text{NO}$ also obey the 18-electron rule. Because NO is considered as a donor of three electrons, two NO groups usually replace three CO ligands. This may not be readily apparent in some cases because metal-metal bonds are broken in addition to the substitution reactions.

21.5.4 Disproportionation

A number of metal carbonyls undergo disproportionation reactions in the presence of other coordinating ligands. For example, in the presence of amines, $\text{Fe}(\text{CO})_5$ reacts as follows:

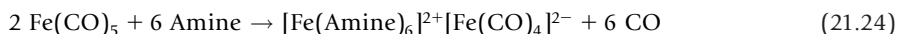

This reaction takes place because of the ease of formation of the carbonylate ions and the favorable coordination of the Fe^{2+} produced. The reaction of $\text{Co}_2(\text{CO})_8$ with NH_3 is similar.

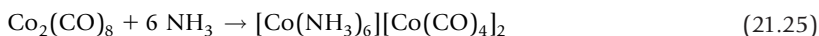

Formally, in each of these cases the disproportionation produces a positive metal ion and a metal ion in a negative oxidation state. The carbonyl ligands will be bound to the softer metal species, the anion; the nitrogen donor ligands (hard Lewis bases) will be bound to the harder metal species, the cation. These disproportionation reactions are quite useful in the preparation of a variety of carbonylate complexes. For example, the $[\text{Ni}_2(\text{CO})_6]^{2-}$ ion can be prepared by the reaction

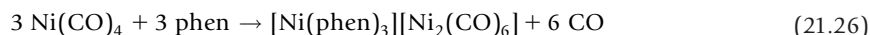

The range of coordinating agents that will cause disproportionation is rather wide and includes compounds such as isocyanides, RNC:

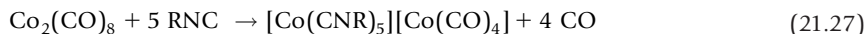

21.5.5 Carbonylate Anions

We have already seen that several carbonylate anions such as $\text{Co}(\text{CO})_4^-$, $\text{Mn}(\text{CO})_5^-$, $\text{V}(\text{CO})_6^-$, and $\text{Fe}(\text{CO})_4^{2-}$ obey the EAN rule. One type of synthesis of these ions is that of reacting the metal carbonyl with a reagent that loses electrons readily, a strong reducing agent. Active metals are strong reducing agents, so the reactions of metal carbonyls with alkali metals should produce carbonylate ions. The reaction of $\text{Co}_2(\text{CO})_8$ with Na carried out in liquid ammonia at -75°C is one such reaction.

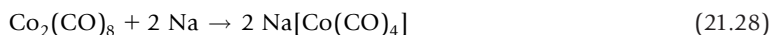

Similarly,

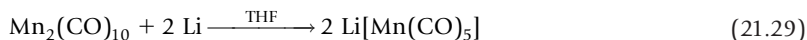

Although $\text{Co}(\text{CO})_4$ and $\text{Mn}(\text{CO})_5$ do not obey the 18-electron rule, the anions $\text{Co}(\text{CO})_4^-$ and $\text{Mn}(\text{CO})_5^-$ do.

A second type of reaction leading to the formation of carbonylate anions is the reaction of metal carbonyls with strong bases. For example,

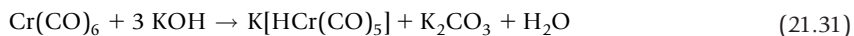
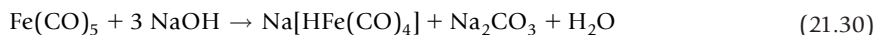

With $\text{Fe}_2(\text{CO})_9$, the reaction is



21.5.6 Carbonyl Hydrides

Some reactions of carbonyl hydrides will be illustrated in Chapter 22. Such species are involved in catalytic processes in which metal carbonyls function as hydrogenation catalysts. Generally, carbonyl hydrides are obtained by acidifying solutions containing the corresponding carbonylate anion or by the reactions of metal carbonyls with hydrogen. The following reactions illustrate these processes:

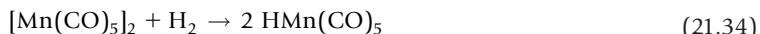
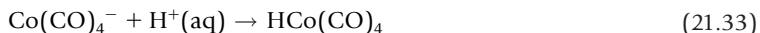

The preparation of $\text{Na}[\text{HFe}(\text{CO})_4]$ was shown in Eq. (21.30), and that compound can be acidified to give $\text{H}_2\text{Fe}(\text{CO})_4$.

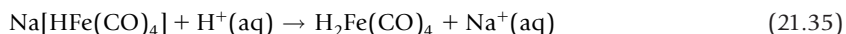

In general, the carbonyl hydrides are slightly acidic, as is illustrated by the behavior of $\text{H}_2\text{Fe}(\text{CO})_4$.

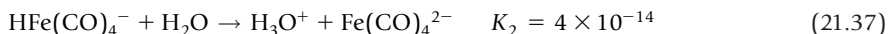
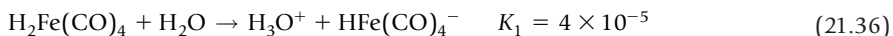

As might be expected on the basis of the hard-soft interaction principle (see Chapter 9), large, soft cations form insoluble compounds with these anions. Accordingly, the anions form precipitates with Hg^{2+} , Pb^{2+} , and Ba^{2+} .

A few metal carbonyl hydrides can be prepared by direct reaction of the metal with CO and H_2 , with the following being a typical reaction:

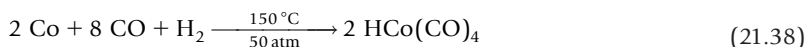

We have previously mentioned the class of compounds known as the carbonyl hydrides and now describe the structure and bonding in some of these compounds. As expected on the basis of HSAB,

other ligands (and the metals) are soft. In general, two hydrogen atoms replace one CO ligand or, for metals that have an odd number of electrons, hydrogen contributes one, bringing the number to 36 when the appropriate number of CO ligands are also present. As a result of manganese having 25 electrons, the addition of five CO ligands and one from H brings the total to 36. Therefore, one stable carbonyl hydride of Mn is $\text{HMn}(\text{CO})_5$, which has a structure in which the four carbonyl groups in the basal plane lie slightly below the manganese.

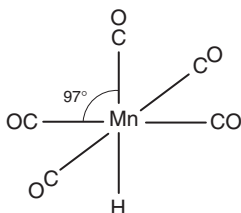

This compound behaves as a weak acid that dissolves to give $\text{Mn}(\text{CO})_5^-$ by the reaction

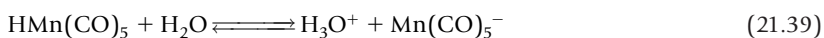

Other carbonyl hydrides include $\text{H}_2\text{Fe}(\text{CO})_4$, $\text{H}_2\text{Fe}_3(\text{CO})_{11}$, and $\text{HCo}(\text{CO})_4$.

Some carbonyl hydrides, such as $[\text{Cr}_2(\text{CO})_{10}\text{H}]^-$, have the hydrogen atom in bridging positions as shown in the structure

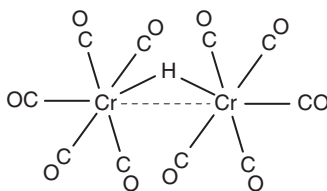

Two hydrogen bridges are present in some carbonyl hydride complexes. This is illustrated by the structure of the $[\text{H}_2\text{W}_2(\text{CO})_8]^{2-}$ anion,

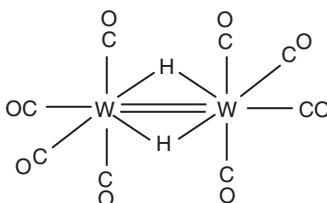

In this structure, the W–W distance is shorter than that of a single bond. As would be expected, this is also the structure of the $[\text{H}_2\text{Re}(\text{CO})_8]$ complex, which is isoelectronic.

21.6 STRUCTURE AND BONDING IN METAL ALKENE COMPLEXES

Alkene complexes of metals constitute one of the important classes of coordination compounds. In general, the metals are found in low oxidation states owing to the more favorable interaction with the soft π electron donors. The majority of metal alkene complexes contain other ligands as well, although many complexes are known which contain only the metal and organic ligands. As we will see later, metal complexes containing olefins are important in explaining how some of the complexes behave as catalysts.

Probably the first metal alkene complex was Zeise's salt, $\text{K}[\text{Pt}(\text{C}_2\text{H}_4)\text{Cl}_3]$ or the bridged compound $[\text{PtCl}_2(\text{C}_2\text{H}_4)]_2$. These compounds were first prepared by Zeise in about 1825. The palladium analogs of these compounds are also now known. A large number of metal alkene complexes are known, and some of the chemistry of these materials will be described here.

Because Zeise's salt has been known for so many years, it is not surprising that the structural features of the compound have been the subject of a great deal of study. Although this topic was introduced in Chapter 16, we will return to this important topic here because many of the ideas are useful when describing bonding in other organometallic compounds containing alkenes. In the anion of Zeise's salt, the ethylene molecule is perpendicular to the plane containing the Pt^{2+} and the three Cl^- ions as shown in Figure 21.7a. As first proposed by Dewar in the early 1950s, a π orbital of the C_2H_4 molecule serves as the electron donor, giving the usual σ bond to the metal as shown in Figure 21.7b.

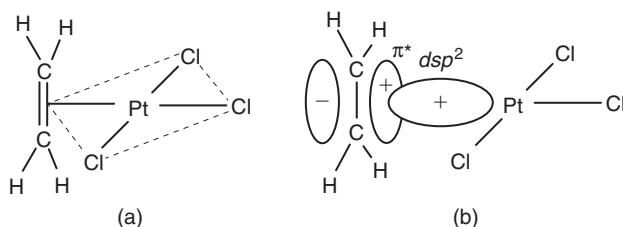

■ **FIGURE 21.7** The bonding of C_2H_4 to Pt in Zeise's salt.

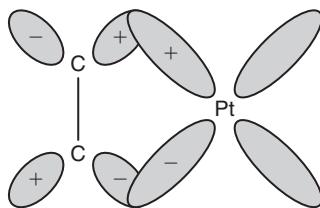

■ **FIGURE 21.8** The π bonding that occurs between ethylene and Pt in Zeise's salt.

However, the π^* orbitals in C_2H_4 are empty and can accept electron density back donated from the metal. Relieving the negative formal charge on the metal is enhanced because this π^* orbital has suitable orientation and symmetry to interact effectively with the nonbonding d_{xz} orbital on the metal ion. Thus, there is a significant amount of multiple bond character to the metal-ligand bond. The π bond between the metal and ligand is shown in Figure 21.8, and bonding in other alkene complexes is described in this way also.

The typical C–C bond length is approximately 134 pm, and in the anion of Zeise's salt, the C–C bond length is 137.5 pm. Although there is *slight* lengthening of the bond in ethylene, it is not as much as would accompany the formation two metal-ligand σ bonds. Therefore, when the bonding in this complex is considered in terms of the resonance structures

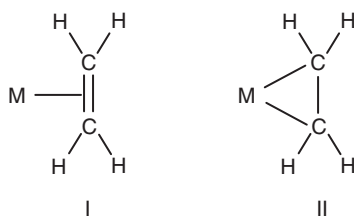

structure II contributes very little to the bonding. However, the C–C stretching band is shifted by about 100 cm^{-1} (to lower a wave number) as a result of back donation weakening the bond. Because alkenes are soft electron donors (and π acceptors), they exert a strong *trans* effect (see Chapter 20) that is manifested in the anion of Zeise's salt by causing the Pd–Cl bond *trans* to ethylene to be about 234 pm in length whereas those in *cis* positions are 230 pm. Although there seems to be little contribution from a structure containing two σ bonds in the anion of Zeise's salt, that is not the case when the alkene is $(CN)_2C=C(CN)_2$, tetracyanoethylene, and the other ligands are triphenylphosphine. In that case, the structure is shown in Figure 21.9.

In this case, the bond between the carbon atoms is about the same as it is for a C–C single bond. Moreover, unlike the anion of Zeise's salt, the carbon atoms are in the plane formed by platinum and the other ligands. Clearly, this represents a significant difference from the usual alkene complexes. In essence, a three-membered C–P–C ring is formed. It appears in this case that the ability of the

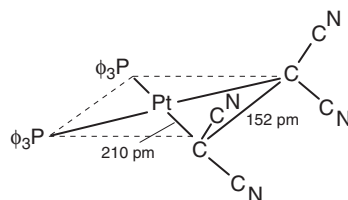

■ FIGURE 21.9 The structure of $[Pt(P\phi_3)_2C_2(CN)_4]$ (where $\phi = C_6H_5$).

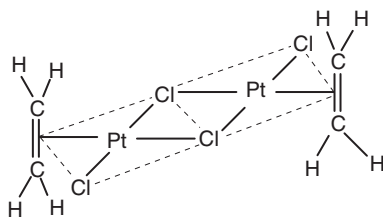

■ FIGURE 21.10 The structure of $[\text{PtCl}_2(\text{C}_2\text{H}_4)]_2$.

triphenylphosphine ligands to form π bonds and the changes in the alkene π bond produced by four CN groups results in metal-carbon σ bonds being formed.

In $[\text{PtCl}_2(\text{C}_2\text{H}_4)]_2$ the olefin double bond also lies perpendicular to the plane of the other groups. In this bridged compound, two chloride ions function as the bridging groups and the ethylene molecules are *trans* to each other, as shown in Figure 21.10. It is to be expected that two ligands that give very strong *trans* effect would be located opposite a ligand such as Cl^- , which has a weaker *trans* effect.

Some of the most interesting alkene complexes of metals are those containing CO and olefins as ligands. Moreover, metal carbonyls are frequently the starting complexes from which olefin complexes are obtained by substitution. The EAN rule enables predictions to be made regarding the total number of electrons used by polyene ligands in complexes. Essentially, each double bond that coordinates to the metal functions as an electron pair donor. A ligand that can exhibit several bonding sites is cyclohepta-1,3,5-triene (cht), which contains three double bonds that are potential electron pair donors.



In the complexes $\text{Ni}(\text{CO})_3(\text{cht})$, $\text{Fe}(\text{CO})_3(\text{cht})$, and $\text{Cr}(\text{CO})_3(\text{cht})$ shown in Figure 21.11, the cht ligand functions bonds in different ways. In the first of these complexes, Ni has 28 electrons, so to satisfy the EAN rule, it needs to gain eight electrons. Because six electrons come from three CO molecules, only one double bond in cht will be bonded to Ni. In the Fe and Cr complexes, six electrons also come from the three CO molecules. However, iron needs to gain a total of 10 electrons according to the EAN rule, so the cht will coordinate using two double bonds. In the case of the chromium complex, all three double bonds will be coordinated in order to satisfy the EAN rule (see Figure 21.11).

The “bonding capacity” of a ligand is called its *hapticity*. To distinguish between the three bonding modes of cht shown in Figure 21.11, the hapticity of the ligand is indicated by the term *hapto*, which is designated as *h* or η . When an organic group is bound to a metal by only one carbon atom by electrons in a σ bond, the bonding is referred to as *monohapto* and it is designated as h^1 or η^1 . In most cases,

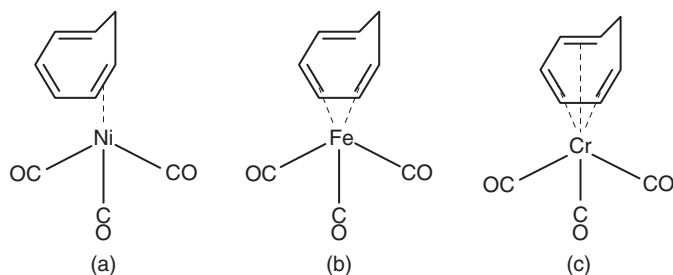

■ FIGURE 21.11 The ways in which cycloheptatriene functions as an electron donor.

we will designate the hapticity of a ligand using η . When a π bond in ethylene functions as an electron pair donor, both carbon atoms are bonded to the metal and the bond is designated as η^2 or h^2 . Figure 21.11a shows cht that is bonded to Ni by means of one double bond that connects two carbon atoms, so the bonding is η^2 in that case. In Figure 21.11b, two double bonds spanning four carbon atoms are functioning as electron pair donors, so the bonding is considered as η^4 . Finally, in Figure 21.11c, all three double bonds are electron pair donors, so the bonding of cht is η^6 . Both the formula and name of the complex have the hapticity of the ligand indicated. For example, η^2 -chtNi(CO)₃ is named as tricarbonyldihaptocycloheptatrienenickel(0). The formula η^4 -chtFe(CO)₃ for the iron complex shown earlier is named as tricarbonyltetrahaptocycloheptatrieneiron(0).

Other organic ligands can be bound in more than one way also. For example, the allyl group can be bound by a σ -bond between the metal and one carbon atom (η^1) or as a π donor encompassing all three carbon atoms (η^3):

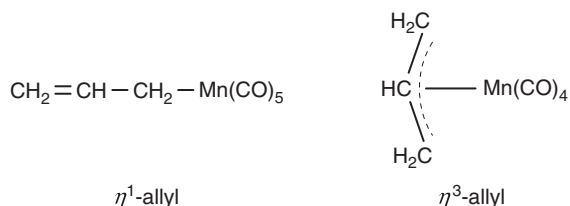

In Chapter 22, it will be shown that some change in bonding mode (probably η^1 to η^3 and the reverse) is believed to be one step in the isomerization of 1-butene catalyzed by metal complexes. In general, the change in bonding mode of the allyl group accompanies the loss of another ligand, frequently as a result of heating or irradiation. Interestingly, a complex having two allyl groups can exist as different isomers. An example of this is shown by the two forms of Ni(η^3 -C₃H₅)₂:

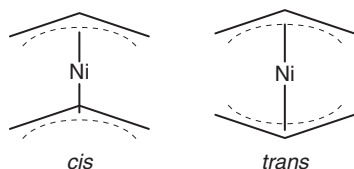

Butadiene can function as a donor of four electrons in which the bonding is delocalized. A complex of this type is $\text{Fe}(\text{CO})_3(\eta^4\text{-C}_4\text{H}_8)$, which has the structure

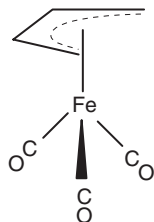

The bonding in organometallic compounds is of considerable interest and importance. If we wish to understand how the metal and ligand interact, it is appropriate to begin with a review of the bonding within the ligand and the types of orbitals that are available. In the case of the allyl group, the molecular orbitals were described in Chapter 5 by means of the Hückel molecular orbital method. The three occupied molecular orbitals are shown in Figure 21.12.

It is with these orbitals that the metal orbitals must interact in forming a complex. With the z -axis taken as the vertical direction, the approach of the metal from that direction exposes the d_{z^2} , d_{yz} , and d_{xz} orbitals (those that project in the z direction) on the metal to the lobes of the ψ_1 orbital on the allyl

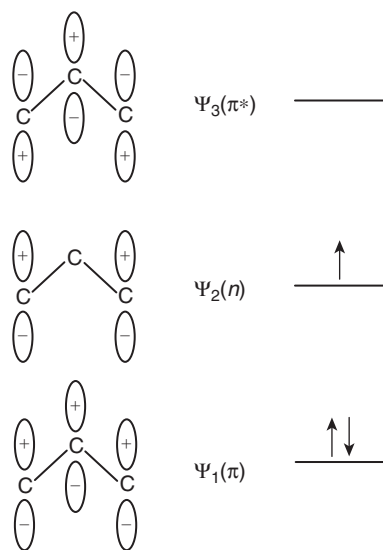

■ FIGURE 21.12 The molecular orbitals of the allyl species.

group. The orbitals have same symmetry, so the bonding molecular orbital is made up of the lowest orbital on the allyl group and the d_{z^2} metal orbital. This interaction is shown in Figure 21.13a.

There is a nodal plane in ψ_2 at the middle carbon atom. The symmetry of the metal and ligands is appropriate for the interaction of the d_{yz} orbital on the metal, so the interaction is as shown in Figure 21.13b. Combination of the d_{xz} orbital on the metal with the ψ_3 allyl orbital is shown in Figure 21.13c. The bonding between other alkene molecules with π systems and metals is similar.

Although there is a tendency for the alkene complexes to contain uncharged metals, a large number of complexes are known in which the metal ions are Pd^{2+} , Fe^{2+} , Cu^+ , Ag^+ , and Hg^{2+} . As we shall see, the formation of alkene complexes of these and other metals occurs as the metals catalyze certain reactions of the ligands.

Since the early work dealing with Zeise's salt, many complexes have been prepared with the formula $[\text{PtL}(\text{C}_2\text{H}_4)\text{X}_2]$, where L = quinoline, pyridine, or ammonia and $\text{X}=\text{Cl}^-$, Br^- , I^- , or NO_2^- . Similar compounds have been prepared that contain other alkenes than C_2H_4 . Many of the complexes containing dienes, trienes, and tetraenes as ligands also contain carbonyl ligands. In fact, metal carbonyls are frequently starting complexes from which alkene complexes are obtained by substitution reactions.

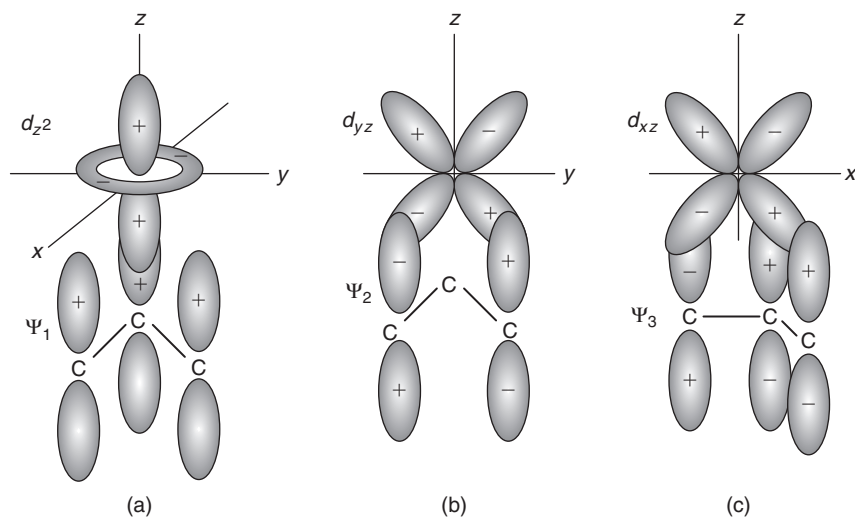

■ **FIGURE 21.13** The interaction of metal d orbitals with the molecular orbitals on the allyl group. Note how the symmetry of the d orbital on the metal matches that of the allyl orbital with which it interacts.

21.7 PREPARATION OF METAL ALKENE COMPLEXES

A number of synthetic methods are useful for preparing metal alkene complexes. A few of the more general ones will be described here, but the suggested readings given at the end of the chapter should be consulted for more details.

21.7.1 Reaction of an Alcohol with a Metal Halide

This method is the one of those that can be used to prepare the ethylene complex known as Zeise's salt, $K[Pt(C_2H_4)Cl_3]$. Actually, the dimer $[Pt(C_2H_4)Cl_2]_2$ is obtained first and the potassium salt is obtained by treating a concentrated solution of the dimer with KCl.

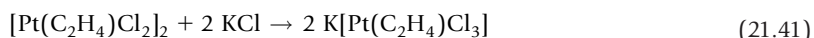
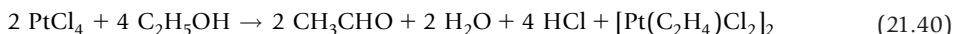

Other metal complexes containing several types of unsaturated compounds as ligands can be prepared by similar reactions.

21.7.2 Reaction of a Metal Halide with an Alkene in a Nonaqueous Solvent

Reactions of this general type include the following examples.

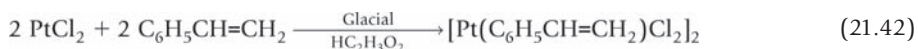

21.7.3 Reaction of a Gaseous Alkene with a Solution of a Metal Halide

The classic synthesis of Zeise's salt, $K[Pt(C_2H_4)Cl_3]$, is an example of this type of reaction:

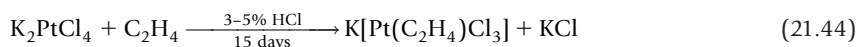

21.7.4 Alkene Substitution Reactions

The basis for this method lies in the fact that complexes of different olefins have different stabilities. For several common olefins, the order of stability of complexes analogous to Zeise's salt is

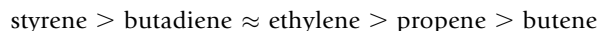

Thus, numerous replacement reactions are possible, of which the following is typical:



21.7.5 Reactions of a Metal Carbonyl with an Alkene

The reaction of $Mo(CO)_6$ with cyclooctatetraene is an example of this type of reaction:

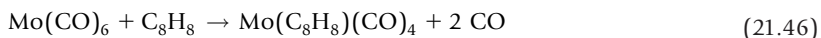

21.7.6 Reaction of a Metal Compound with a Grignard Reagent

An example of this type of reaction is that involving the preparation of $\text{Ni}(\eta^3\text{-C}_3\text{H}_5)_2$. This reaction can be shown as

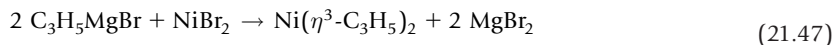

Similar reactions can be utilized to prepare allyl complexes of platinum and palladium. In this case, the product can exist in two isomers as described earlier. Analogous reactions can be used to prepare the tris allyl complexes of several metals.

21.8 CHEMISTRY OF CYCLOPENTADIENYL AND RELATED COMPLEXES

In addition to complexes in which electron density is donated from localized σ bonds to metals, many complexes are known in which electrons in aromatic molecules are donated to metals. A brief survey of the chemistry of these interesting compounds will be presented here. However, the area is so vast that the interested reader will need to consult the references listed at the end of the chapter for further details.

Hydrogen atoms on the cyclopentadiene ring are very slightly acidic. Therefore, metallic sodium reacts with a solution of cyclopentadiene dissolved in tetrahydrofuran (THF) to liberate hydrogen, leaving sodium cyclopentadienide in solution.

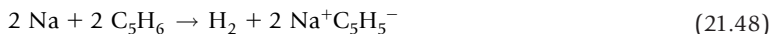

The reaction of this product with FeCl_2 , which can be shown as

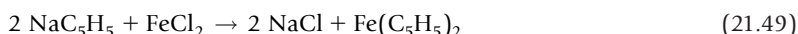

yields an orange solid (m.p. 173–174°C) that is insoluble in water but soluble in organic solvents. The product, known as ferrocene, $\text{Fe}(\text{C}_5\text{H}_5)_2$, can also be produced in other ways. For example, when a solution of $\text{FeCl}_2 \cdot 4\text{H}_2\text{O}$ is added to a basic solution of cyclopentadiene, the following reaction occurs:

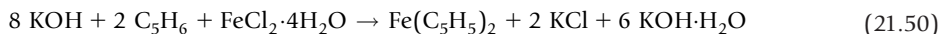

As mentioned earlier, hydrogen atoms on the cyclopentadiene ring are very slightly acidic, and KOH facilitates the removal of H^+ , leaving C_5H_5^- . Ferrocene was first produced in 1951, and it quickly became the focus of a great deal of organometallic chemistry.

Ferrocene is more correctly named as bis(η^5 -cyclopentadienyl)iron(II), and the molecule has a structure that can be shown as follows:

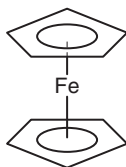

This structure has been referred to as a “sandwich” structure. At low temperature in the solid state, the rings have the orientation shown, in which they have a staggered configuration. However, the rotational barrier is very small, so there is free rotation in the absence of crystal packing that hinders rotation. The fact that there is free rotation has been demonstrated by preparing the derivatives having one substituent on each ring and finding that only one product is obtained. If the molecule were “locked” in the staggered configuration, there would be three possible products having the structures shown in Figure 21.14.

In ferrocene and similar complexes, the $C_5H_5^-$ ion behaves as an aromatic electron donor. In order for an organic ring structure to achieve aromaticity, there must be 2, 6, or 10 electrons to form the π electron system ($4n + 2$ where $n = 0, 1, 2, \dots$). Benzene is aromatic and forms complexes in which it behaves as if there were three double bonds that donate a total of six electrons. For cyclopentadiene, aromaticity is achieved when there is one additional electron as is the case in the anion, $C_5H_5^-$. Formally, in ferrocene the ligands are considered as negative ions and the iron as Fe^{2+} . The Fe^{2+} has 24 electrons, and each ligand behaves as a donor of 6 electrons to Fe^{2+} , giving a total of 36 electrons around Fe in accord with the 18-electron rule. If the iron were Fe^0 and each ligand were a donor of five electrons, the same total number of electrons around iron would result.

In ferrocene, the cyclopentadiene is bonded by the complete π system to the iron and, therefore, is $\eta^5-C_5H_5$. In other cases, $C_5H_5^-$ can bind to metals using a localized σ bond, so it is bonded as η^1 . A compound of this type is $Hg(C_5H_5)_2$, which has the structure

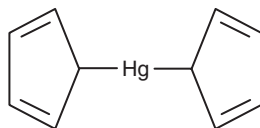

Another interesting compound that shows the different bonding abilities of cyclopentadiene is $Ti(C_5H_5)_4$. In this compound, two of the cyclopentadienyl ions are coordinated as $\eta^5-C_5H_5$ as in

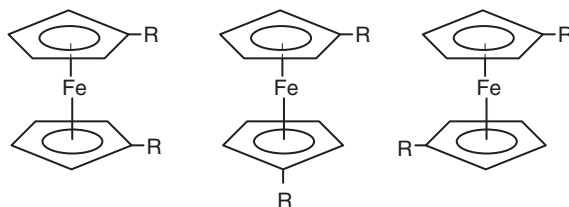

■ FIGURE 21.14 The products that should exist if ferrocene were prevented from having free rotation.

ferrocene. The other two are bound through only one carbon atom in σ bonds to the metal. This compound has the structure

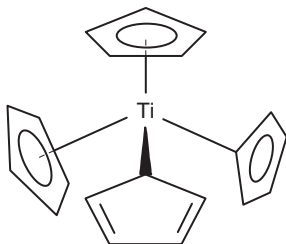

Therefore, the formula for the compound is written as $(\eta^5\text{-C}_5\text{H}_5)_2(\eta^1\text{-C}_5\text{H}_5)_2\text{Ti}$ to show the different bonding modes.

Several complexes similar to ferrocene are known that contain other metals. They are generically referred to as metallocenes, having the formula Mcp_2 , and some of them are listed in Table 21.2.

A very large number of mixed complexes are known in which a cyclopentadienyl ion and other ligands are present, with the 18-electron rule being obeyed in many cases. Cobaltocene does not obey the 18-electron rule, but it is easily oxidized to $(\eta^5\text{-C}_5\text{H}_5)_2\text{Co}^+$, which does obey the rule. Derivatives such as $(\eta^5\text{-C}_5\text{H}_5)\text{Co}(\text{CO})_2$ and $(\eta^5\text{-C}_5\text{H}_5)\text{Mn}(\text{CO})_3$ also follow the 18-electron rule. Because the cyclopentadienyl ion has a charge of -1 , numerous complexes are known in which other negative ligands are also present. These include compounds such as $(\eta^5\text{-C}_5\text{H}_5)\text{TiCl}_2$, $(\eta^5\text{-C}_5\text{H}_5)_2\text{CoCl}$ (where Co is considered as $+3$), and $(\eta^5\text{-C}_5\text{H}_5)\text{VOCl}_2$. A few compounds are also known in which the metal complex is an anion. For example,

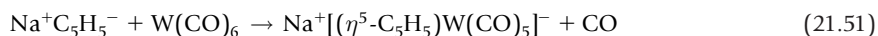

Table 21.2 Some Common Metallocenes.

Compound	m.p., °C	Color
Ticp ₂	—	green
Vcp ₂	167	purple
Crcp ₂	173	scarlet
Mncp ₂	172	amber
Fecp ₂	173	orange
Cocp ₂	173–174	purple
Nicp ₂	173–174	green

Although there are several methods of preparing ferrocene and similar compounds, perhaps the most useful is that indicated in Eq. (21.49). In a second method, thallium cyclopentadienyl is prepared first by the reaction



which shows that TlOH is a strong base. The reaction of TlC_5H_5 with FeCl_2 produces ferrocene.

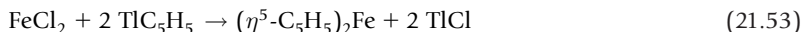

A third method of preparing metallocenes involves the reaction of a metal halide with cyclopentadienylmagnesium bromide:

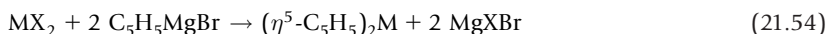

21.9 BONDING IN FERROCENE

A Hückel molecular orbital calculation for the cyclopentadiene system can be carried out as illustrated in Chapter 5. As is shown in Figure 5.20, the Frost-Musulin diagram places the five molecular orbitals at energies of $\alpha + 2\beta$, $\alpha + 0.618\beta$ (2), and $\alpha - 1.618\beta$ (2). Because the cyclopentadienyl anion has six electrons, only the three lowest energy levels are populated and are the orbitals interacting with those on the iron. Figure 21.15 shows the orbitals of the cyclopentadienyl anion.

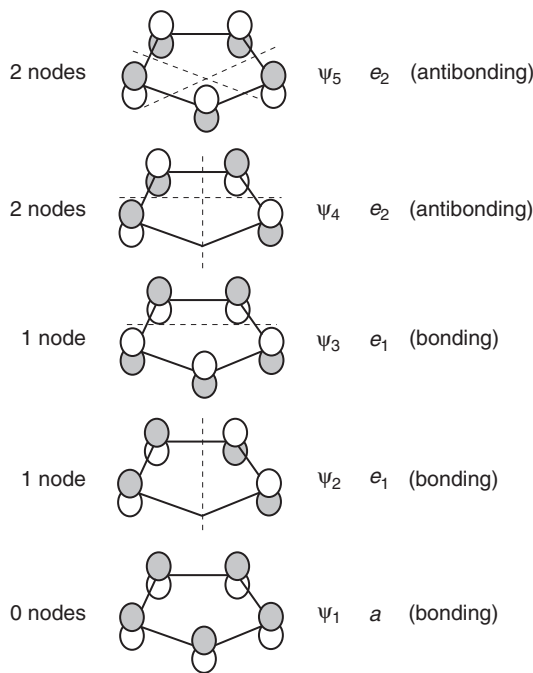

■ **FIGURE 21.15** The five wave functions for the cyclopentadienyl anion. Shaded lobes indicate positive signs and open lobes indicate negative signs.

The interaction of the metal s and d_{z^2} orbitals with those of the cyclopentadienyl anion can be illustrated as follows. We begin by placing the metal orbital between the two ligands that have the orbitals oriented to match the sign of the wave function of the metal orbital. Therefore, for the s and d_{z^2} orbitals, the combinations are shown in Figure 21.16.

In these cases, the orbitals directed toward the ligands (along the z -axis) are positive, which requires the positive lobes of both ligand orbitals to be directed inward toward the metal. These combinations have a_{1g} symmetry. These combinations are illustrated in Figure 21.16. Because there are *five* molecular wave functions for *each* cyclopentadienyl ligand (top and bottom), it is necessary to take into account the combinations of those wave functions with the metal orbitals. The procedure illustrated as shown in Figure 21.16 can be followed with the remaining metal orbitals. They are only weakly bonding, which is not surprising because those orbitals have some directional component in the z direction where the ligands are located, and they must match the symmetry character of ligand orbitals.

When the combination of the two ψ_1 wave functions of the ligands and the p_z orbital of the metal is made, the signs of the lobes on the p_z orbitals require the negative lobes on the “bottom” ligand wave function be directed *upward* as shown in Figure 21.17. The combination of the d_{yz} orbital can be

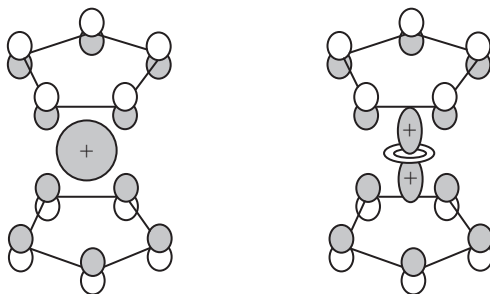

■ FIGURE 21.16 The interaction of the ψ_1 orbital of cyclopentadienyl ion with the $4s$ and $3d_{z^2}$ orbitals on Fe^{2+} .

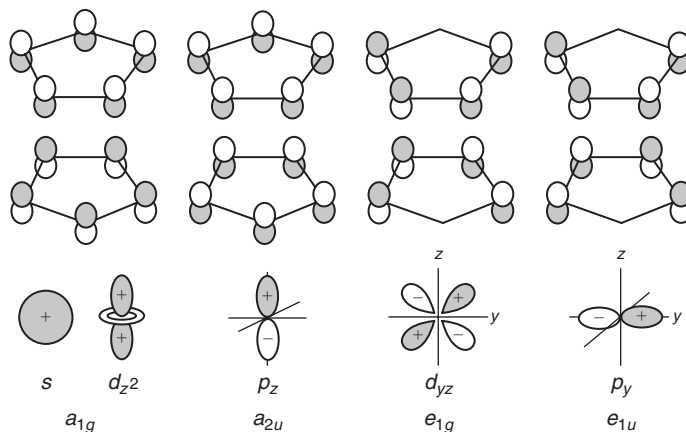

■ FIGURE 21.17 The overlap of orbitals on Fe with the molecular orbitals on the cyclopentadienyl ion.

made using the ligand wave function ψ_2 , which gives an e_{1g} molecular orbital. The combination of the d_{xz} and the ψ_3 also gives an e_{1g} molecular orbital. However, although we will not show the diagrams, when the metal d_{xy} and $d_{x^2-y^2}$ orbitals are laid out between the ligands, it becomes evident that they must combine with the ligand orbitals having two nodes that are designated as e_{2g} . We now come to the point where the metal p_x and p_y orbitals must be combined with ligand orbitals. Because of the orientation of these orbitals, they form bonding molecular orbitals, but the bonding is not as effective (see Figure 21.17) as with the metal orbitals discussed so far. It is ψ_2 that interacts with the p_y orbital and ψ_3 that combines with the p_x orbital. Both of these combinations give molecular orbitals having e_{1u} symmetry.

We have now determined the form of the molecular orbitals in ferrocene. A molecular orbital diagram for ferrocene is shown in Figure 21.18. For the ferrocene molecule, each ligand contributes 6 electrons, and there are 6 from the Fe^{2+} ion, which gives a total of 18 electrons that must be placed in the molecular orbitals. The molecular orbital diagram for ferrocene shows that the 18 electrons populate the strongly bonding a_{1g} and a_{2u} states as well as the several e states that are less strongly bonding. Although two electrons populate the nonbonding a_{1g} state, no electrons are forced to populate

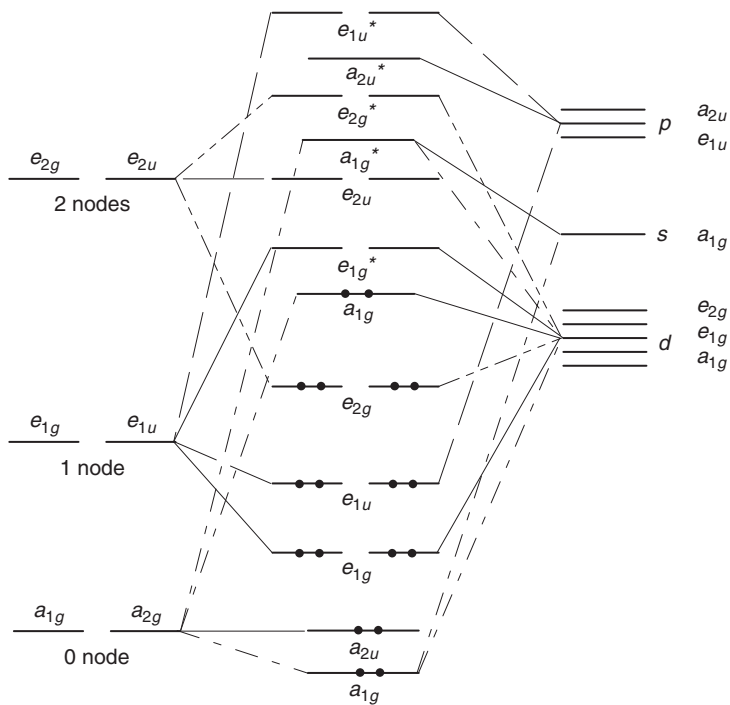

■ FIGURE 21.18 A qualitative molecular orbital diagram for ferrocene.

the degenerate e_{1g}^* orbitals. That is not the case with cobaltocene, which has 19 electrons with one of them forced to reside in the e_{1g}^* antibonding orbital. As a result, cobaltocene is much less stable and more easily oxidized than ferrocene, although $[\text{Co}(\eta^5\text{-C}_5\text{H}_5)_2]^+$ gives solids with some anions that are very stable. Nickelocene has 20 electrons, so two are forced to reside in the e_{1g}^* orbitals, and like cobaltocene, nickelocene is easily oxidized. The chromium and vanadium compounds, $[\text{Cr}(\eta^5\text{-C}_5\text{H}_5)_2]$ and $[\text{V}(\eta^5\text{-C}_5\text{H}_5)_2]$, have 16 and 15 electrons, respectively, so they are highly reactive and bond to additional groups readily to conform to the 18-electron rule.

21.10 REACTIONS OF FERROCENE AND OTHER METALLOCENES

A great deal of chemistry has been carried out on complexes of the ferrocene type. Although most of the discussion here will deal with ferrocene itself, many of the reactions can be carried out with other metallocenes; however, the conditions might be different.

Ferrocene is a very stable compound that melts at 173 °C and can be sublimed without disruption of the metal complex. Many reactions exhibited by ferrocene are essentially those of an aromatic organic compound. For example, sulfonation of ferrocene can be achieved as follows:

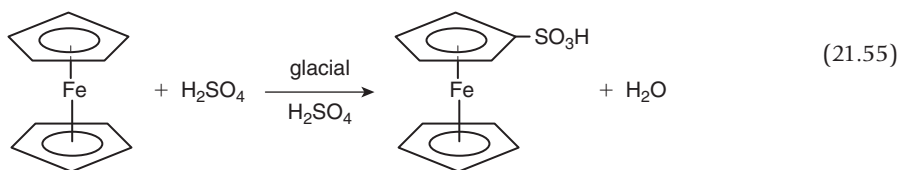

Acylation can be carried out by means of a Friedel-Crafts reaction,

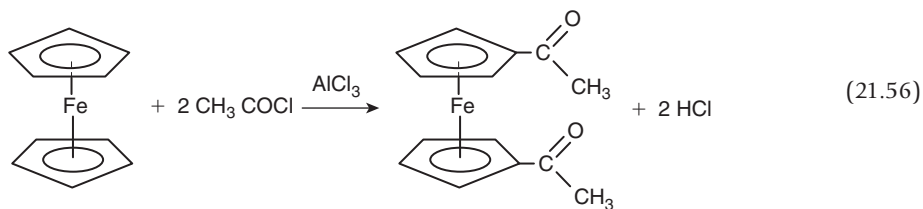

Although the disubstituted product is shown in the foregoing equation, some monosubstituted product is also obtained. In this process, AlCl_3 may react with CH_3COCl to generate the $\text{CH}_3\text{C}=\text{O}^+$ attacking species. It is also possible to introduce the acetyl group by a reaction with acetic anhydride with

phosphoric acid as the catalyst. In this reaction under less strenuous conditions, the dominant product is the monosubstituted derivative.

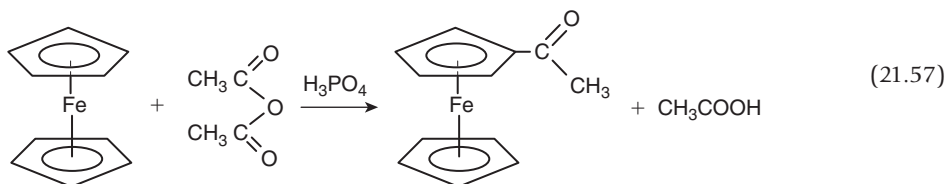

By a sequence of reactions, the two cyclopentadienyl rings can be connected. Using $\text{C}_2\text{H}_5\text{OCOCH}_2\text{COCl}$ as the starting acid chloride, it is possible to attach the acyl end to one of the C_5H_5 rings. Hydrolysis to remove the ethyl group and conversion of that end to an acid chloride followed by another Friedel-Crafts reaction and reduction of the product leads to

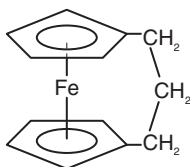

One of the most useful reactions of ferrocene with regard to synthesizing derivatives is *metallation*. In this reaction, the lithium derivative is first prepared by the reaction of ferrocene with butyllithium, a reaction showing the slight acidity of the hydrogen atoms.

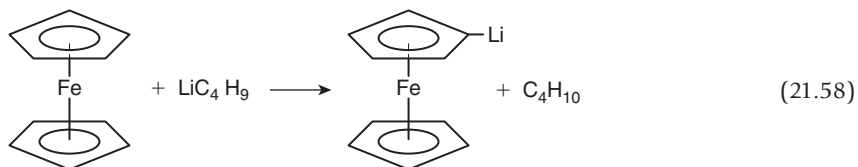

The derivative containing two lithium atoms can also be obtained by the subsequent reaction,

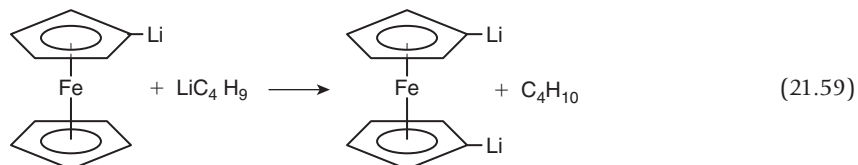

Better yields are obtained when polar solvents are utilized and an amine such as tetramethylethylenediamine is present, which also facilitates the formation of the dilithium compound. The lithium derivatives undergo a large number of reactions that can be used to produce the enormous number of ferrocene derivatives. Rather than trying to show a great number of reactions, a few of the common reactants and the substituents that they introduce on the cyclopentadienyl rings are shown in Table 21.3.

Another derivative that is a useful intermediate for synthesizing other derivatives is the mercury compound that can be prepared from ferrocene by reaction of mercuric acetate in a solution also containing chloride ion.

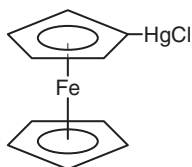

Borate esters react with the lithium compound to yield $(\eta^5\text{-cp})\text{Fe}(\eta^5\text{-cp-B(OR)}_2)$, which can be hydrolyzed to produce $(\eta^5\text{-cp})\text{Fe}(\eta^5\text{-cp-B(OH)}_2)$. This compound will undergo many reactions that lead to additional ferrocene derivatives. For example, the reaction with CH_3ONH_2 produces the aminoferrocene. The boric acid derivative will react with AgO in a coupling reaction that produces the "diferrocene" shown as

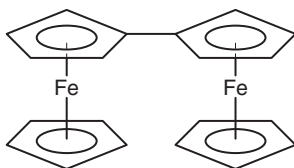

This product can also be produced by the reaction of iodine with the mercury compound shown earlier, which yields the iodide. The iodide reacts with magnesium to produce a Grignard product,

Table 21.3 Some Ferrocene Derivatives Obtained from the Lithium Derivatives.

Reactant(s)	Substituent
N_2O_4	$-\text{NO}_2$
$\text{CO}_2, \text{H}_2\text{O}$	$-\text{COOH}$
$\text{B(OR)}_3, \text{H}_2\text{O}$	$-\text{B(OH)}_2$
$\text{H}_2\text{NOCH}_2\text{C}_6\text{H}_5$	$-\text{NH}_2$

$(\eta^5\text{-cp})\text{Fe}(\eta^5\text{-cp-MgI})$, which reacts in a coupling reaction to yield the ferrocene. Although an enormous number of reactions can be carried to produce derivatives of ferrocene, it is also possible by means of oxidizing agents to produce the +1 ferrocenyl carbocation by removing an electron.

Several ferrocene derivatives are produced from the dinuclear complex,

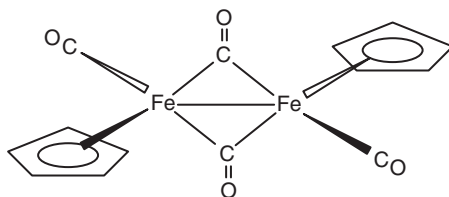

and heating this compound produces ferrocene. In this structure, the iron atoms and two bridging carbonyls lie in a plane and the cp rings are either *cis* or *trans* (as shown) with respect to the plane. Solutions of this compound appear to have a mixture of *cis* and *trans* forms as well as some of the compound in which only a metal-metal bond holds the two halves together. When treated with an amalgam, reduction to $(\text{C}_5\text{H}_5)\text{Fe}(\text{CO})_2^-$ occurs.

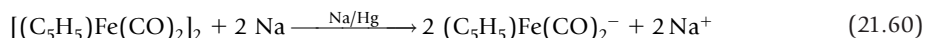

The $(\text{C}_5\text{H}_5)\text{Fe}(\text{CO})_2^-$ anion behaves as a nucleophile in many reactions, which leads to numerous novel products. For example, the reaction with CH_3I in THF can be shown as

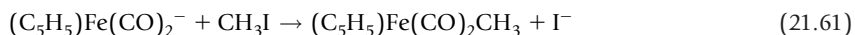

Acetyl chloride reacts with $(\text{C}_5\text{H}_5)\text{Fe}(\text{CO})_2^-$ to produce an acyl derivative.

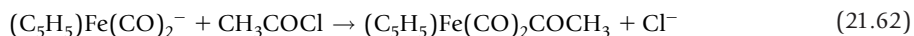

Numerous other derivatives are known that have the general formula $(\text{C}_5\text{H}_5)\text{Fe}(\text{CO})_2\text{COR}$ and $(\text{C}_5\text{H}_5)\text{Fe}(\text{CO})_2\text{X}$ (where $\text{X} = \text{Cl}^-$, Br^- , I^- , SCN^- , OCN^- , CN^- , etc.).

A comprehensive chemistry of ferrocene and other metallocenes has been developed. The introduction presented here is meant to acquaint the reader with the general scope and nature of the field, and more details will be found in the references at the end of this chapter.

21.11 COMPLEXES OF BENZENE AND RELATED AROMATICS

Although we have considered compounds of C_5H_5^- as though the ligand is a donor of six electrons, benzene is also donor of six electrons. Therefore, two benzene molecules each donating six electrons

would raise the total to 36 if the metal initially has 24. Such is the case if the metal is Cr^0 . Thus, $\text{Cr}(\eta^6\text{-C}_6\text{H}_6)_2$ obeys the 18-electron rule, and its structure is

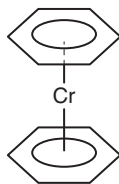

This compound has been prepared by several means including the following reactions:

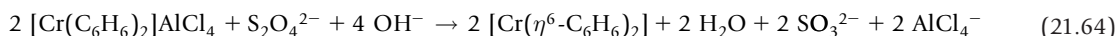
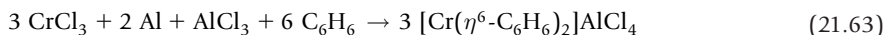

Bis(benzene)chromium(0) is easily oxidized, and mixed complexes are obtained by means of substitution reactions. For example,

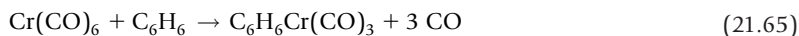

The structure of benzenetricarbonylchromium(0) can be shown as

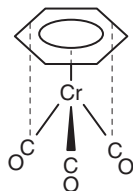

Note that in this case, the three carbonyl ligands are staggered relative to the carbon atoms in the benzene ring (as indicated by the dotted vertical lines). Similar compounds have also been prepared containing Mo and W. Methyl-substituted benzenes such as mesitylene (1,3,5-trimethylbenzene), hexamethylbenzene, and other aromatic molecules have been used to prepare complexes with several metals in the zero oxidation state. For example, $\text{Mo}(\text{CO})_6$ will react with 1,3,5- $\text{C}_6\text{H}_3(\text{CH}_3)_3$, 1,3,5-trimethylbenzene, which replaces three carbonyl groups.

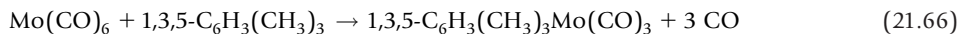

The product has a structure that can be shown as

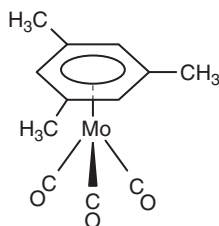

Although the chromium compound is the best known, other metals form similar complexes with benzene and its derivatives.

Hexamethylborazine, $B_3N_3(CH_3)_6$, is also a π electron donor. Because it donates six electrons, one molecule of $B_3N_3(CH_3)_6$ replaces three CO ligands. When the starting complex is $Cr(CO)_6$, the product, $(CO)_3Cr(\eta^6-B_3N_3(CH_3)_6)$, has the structure

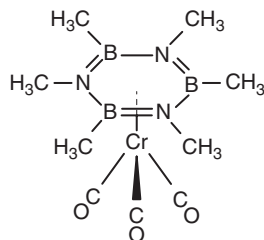

By using naphthalene as a ligand, it is possible to have both rings coordinated to metal atoms that have carbonyl groups as the other ligands. In fact, there is a novel complex that has each ring in naphthalene bonded to two $Cr(CO)_3$ groups, but with those groups on opposite sides of the plane of naphthalene. Thus, naphthalene is a bridging group between two $Cr(CO)_3$ fragments attached in *trans* positions.

Another aromatic species containing six π electrons is $C_7H_7^+$, the tropylium ion, derived from cycloheptatriene. This positive ion forms fewer complexes than does benzene and these are less thoroughly studied. The molecule exhibiting the electron number of 10, giving an aromatic structure, is the cyclooctatetraenyl ion, $C_8H_8^{2-}$. Some sandwich compounds containing this ligand are known, as well as mixed carbonyl complexes. Although it will not be shown, the molecular orbitals on the $C_8H_8^{2-}$ anion match the symmetry of some of the f orbitals on heavy metals. Therefore, one of the complexes known that contains the $C_8H_8^{2-}$ ion is the uranium compound

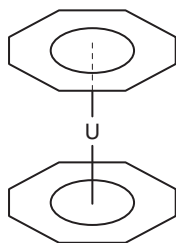

The $C_8H_8^{2-}$ ion behaves as a ligand having η^8 . The uranium compound just shown can be prepared by the reaction

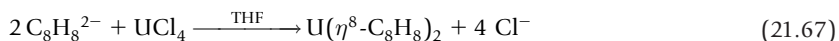

Being hybrid fields between organic and inorganic chemistry, the chemistries of metal alkene complexes and organometallic compounds have developed at a rapid rate. There is no doubt that this type of chemistry will be the focus of a great deal of research for some time to come.

21.12 COMPOUNDS CONTAINING METAL-METAL BONDS

The development of the chemistry of compounds containing metal-metal bonds (often referred to as cluster compounds because they contain multiple metal atoms in close proximity) began about a century ago with the compound $\text{Ta}_6\text{Cl}_{14}\cdot 7\text{H}_2\text{O}$. Compounds having other ‘unusual’ formulas were described, and in the 1930s the structure of $\text{K}_3\text{W}_2\text{Cl}_9$ was determined. The $[\text{W}_2\text{Cl}_9]^{3-}$ ion has two octahedra sharing a face with the W–W distance being about 2.4 Å. That distance is shorter than that between atomic centers in metallic tungsten. As we shall see, one of the characteristics of many metal clusters is that there is multiple bonding between the metal atoms, which leads to short bonds. Although other clusters were reported in the interim, in 1963 the structure of $[\text{Re}_3\text{Cl}_{12}]^{3-}$ was elucidated by F. A. Cotton and coworkers (Figure 21.19).

This structure displays the common feature of clusters that contain three metal atoms, which is the trigonal planar arrangement for those atoms. The Re–Re bond length in $[\text{Re}_3\text{Cl}_{12}]^{3-}$ is 247 pm, which although shorter than the single bond distance is longer than the known triple bond length.

After a description of the structure of $[\text{Re}_3\text{Cl}_{12}]^{3-}$ was available, one of the most recognizable clusters was soon to be explained, that being $[\text{Re}_2\text{Cl}_8]^{2-}$ in which the Re–Re distance is only 224 pm, indicating especially strong interaction between rhenium atoms. The structure of this interesting species is shown in Figure 21.20.

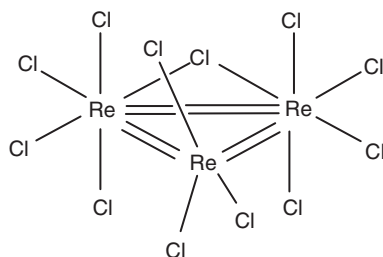

■ FIGURE 21.19 The structure of the $[\text{Re}_3\text{Cl}_{12}]^{3-}$ ion showing three double bonds.

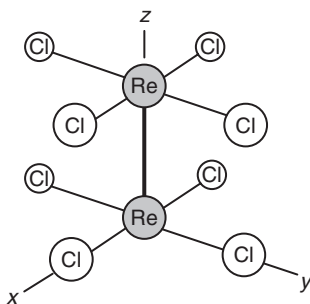

■ FIGURE 21.20 The structure of the $[\text{Re}_2\text{Cl}_8]^{2-}$ ion.

The interpretation of the bonding in this usual ion gives rise to some novel concepts. When describing the bonding in a species, it is important to keep in mind that only orbitals having the same symmetry can lead to positive overlap, and bond energies are dependent on the values of overlap integrals. Interpreting the bonding in the $[\text{Re}_2\text{Cl}_8]^{2-}$ (the structure of $[\text{Tc}_2\text{Cl}_8]^{2-}$ is similar) ion led to the concept of a *quadruple bond*, which can be visualized as occurring in the following way. The metal atoms lie along the z -axis, and the Cl ligands lie on the x - and y -axes on each end of the molecule. As shown in Figure 21.21, there is overlap of the d_{z^2} orbitals on the metal atoms to give a σ bond. On the basis of the overlap angle and the geometry of the orbitals, the overlap is best when “end-on,” so the overlap of the d_{z^2} orbitals is the most effective. The d orbitals having spatial orientations that involve a component in the z direction, the d_{xz} and d_{yz} , overlap to give two π bonds. The interactions of the d_{xz} orbital is shown in Figure 21.21, and although it is not shown, the interaction of the d_{yz} orbitals is similar to that of the d_{xz} . Overlap of these orbitals is somewhat less effective than that between the d_{z^2} orbitals.

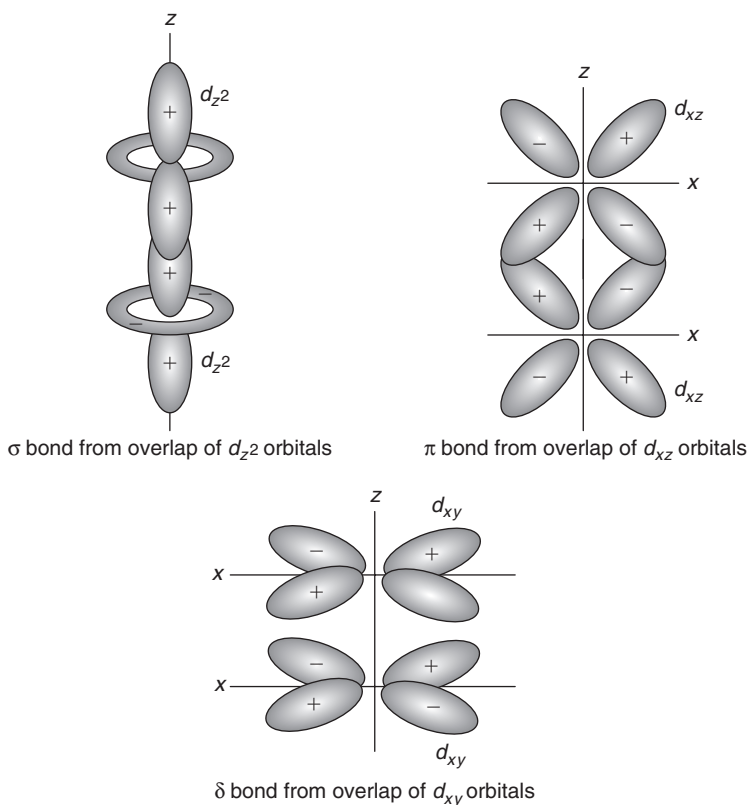

■ **FIGURE 21.21** The formation of σ , π , and δ bonds by overlap of the d_{z^2} , and d_{yz} and d_{xy} orbitals, respectively. The overlap of the d_{yz} orbitals is similar to that of the d_{xz} orbitals but is not shown.

Because the Cl atoms are located on the x and y axes, the lobes of the d_{xy} orbitals lie *between* the axes and are not used in bonding to the ligands. Therefore, the d_{xy} orbitals on the two Re atoms overlap slightly in *four* regions of space. Such a bond is (by extension of the σ and π notation for overlap in one and two regions, respectively) known as a δ bond. Although this overlap is less effective than either of the other types just described, it is responsible for the $[\text{Re}_2\text{Cl}_8]^{2-}$ ion having an eclipsed configuration. In fact, it can be shown that if one of the orbitals is rotated relative to the other, the value of the overlap integral decreases and becomes equal to zero when the angle of rotation reaches 45° . This can be seen by looking at Figure 21.22.

Therefore, in the final analysis, the quadruple bond consists of one σ bond, two π bonds, and one δ bond. The configuration in which the Cl atoms are in eclipsed positions provides maximum overlap. From the rather intuitive analysis provided here, it is possible to arrive at a qualitative molecular orbital diagram like that shown in Figure 21.23 to describe the Re–Re bond.

On the basis of the molecular orbital diagram, the configuration of the metal-metal bond is $\sigma^2 \pi^4 \delta^2$, which shows the bond order of 4. The energy level scheme shown in Figure 21.23 is also useful for describing the bonding in other metal clusters. For example, Os^{3+} has a $5d^5$ configuration, and it forms some compounds in which there is Os–Os bonding. In this case there are 10 electrons to be accommodated, and these give the configuration $\sigma^2 \pi^4 \delta^2 \delta^{*2}$, corresponding to a triple bond between the osmium ions. This is in agreement with the character of those bonds. In clusters of the

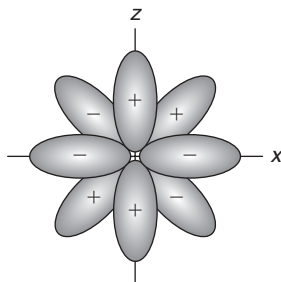

■ **FIGURE 21.22** The overlap of d_{xy} orbitals when one end of $[\text{Re}_2\text{Cl}_8]^{2-}$ has been rotated 45° relative to the other. The view shown is down the z -axis along the ReRe bond. In this configuration, there is zero overlap of the d_{xy} orbitals.

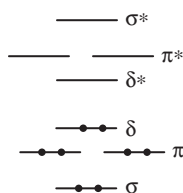

■ **FIGURE 21.23** A simplified molecular orbital diagram for the $[\text{Re}_2\text{Cl}_8]^{2-}$ ion. Because Re^{3+} has the configuration $5d^4$, there are eight electrons, all of which reside in bonding orbitals.

type $\text{Rh}_2(\text{RCOO})_4$ (in which the carboxyl groups form bridges similar to those shown in Figure 21.24 in the structure of $[\text{Re}(\text{OOCCH}_3)_4\text{X}_2]$), the d^7 configuration of Rh leads to 14 electrons to be placed in the molecular orbitals. The resulting configuration, $\sigma^2 \pi^4 \delta^2 \delta^{*2} \pi^{*4}$, shows that the Rh–Rh bond is a *single* bond.

Following the interpretation of the structure of the $[\text{Re}_2\text{Cl}_8]^{2-}$, further work led to “tying” the two “halves” of the structure together by introducing ligands that are simultaneously coordinated to both of the Re atoms. One such structure, shown in Figure 21.24, involves acetate ions (R represents CH_3 in the drawing) as the linking groups. A compound of this type has been prepared in which X represents dimethylsulfoxide, $(\text{CH}_3)_2\text{SO}$, which is apparently bound to Re through the sulfur atom.

Although less numerous than complexes containing heavier transition metals, some cases are known in which there is a quadruple bond between first-row metals. One very interesting complex of this type is $[\text{Cr}_2(\text{CO}_3)_4(\text{H}_2\text{O})_2]$ in which the carbonate ions form bridges between the two metal atoms as shown in Figure 21.25.

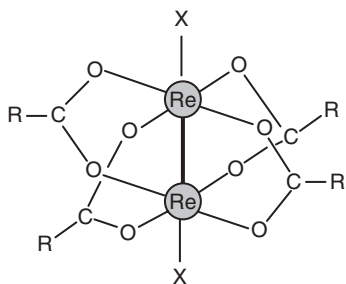

■ **FIGURE 21.24** The structure of $[\text{Re}(\text{OOCCH}_3)_4\text{X}_2]$ showing the bridging acetate ions.

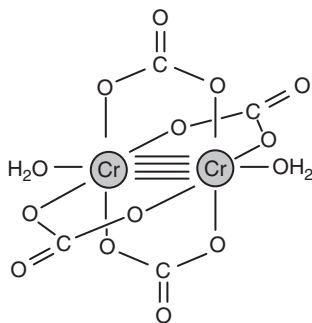

■ **FIGURE 21.25** The structure of $[\text{Cr}_2(\text{CO}_3)_4(\text{H}_2\text{O})_2]$ showing the quadruple bond between Cr atoms and the bridging carbonate ions.

Numerous clusters are known in which the metal atoms are bound by single bonds. Earlier in this chapter, the discussion of metal carbonyls included $[\text{Mn}(\text{CO})_5]_2$, which has this type of structure.

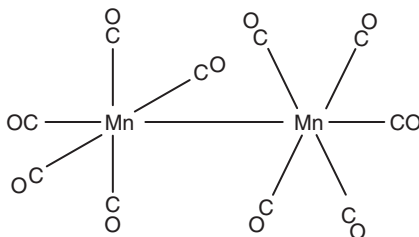

In general, the clusters that contain only single bonds are larger units in which there are several metal atoms. The $[\text{Mo}_6\text{Cl}_8]^{4+}$ ion is a good example of this type of cluster.

Metal-metal bonds are responsible for the structures of complexes such as $(\text{OC})_5\text{Mn}-\text{Mn}(\text{CO})_5$ and $\text{Re}_2\text{Cl}_8^{2-}$ that have no bridging groups between metal centers. These are classic complexes that represent the extremes in that the single Mn–Mn bond present in $(\text{OC})_5\text{Mn}-\text{Mn}(\text{CO})_5$ is 292 pm in length and has a strength of less than 100 kJ/mol. In contrast, the quadruple bond in $\text{Re}_2\text{Cl}_8^{2-}$ is 224 pm in length and has a strength of several hundred kJ/mol. In numerous complexes of molybdenum, the Mo–Mo bond has an average length of about 270 pm. However, in structures where there is a triple bond, the bond length is only about 220 pm, and the quadruple bonds are only about 210 pm in length.

In this chapter, we have surveyed some of the most active and important areas of inorganic chemistry. The published literature in these fields is prodigious, so in keeping with a general textbook in inorganic chemistry that must introduce many fields, the coverage is far from complete. For further details on the material in this chapter, the interested reader should consult the references listed.

■ REFERENCES FOR FURTHER STUDY

- Atwood, J. D. (1985). *Inorganic and Organometallic Reaction Mechanisms*. Brooks/Cole, Pacific Grove, CA. A good, readable book that contains a wealth of information.
- Coates, G. E. (1960). *Organo-Metallic Compounds*. Chapter 6. Wiley, New York. This book is a classic in the field, and Chapter 6 gives an introduction of more than 100 to this important field.
- Cotton, F. A., Wilkinson, G., Murillo, C. A., and Bochmann, M. (1999). *Advanced Inorganic Chemistry*, 6th ed. Chapter 5. Wiley, New York. A 1300-page book that covers a great deal of organometallic chemistry of transition metals.
- Crabtree, R. H. (1988). *The Organometallic Chemistry of the Transition Metals*. Wiley, New York. A standard book on organometallic chemistry.
- Greenwood, N. N., and Earnshaw, A. (1997). *Chemistry of the Elements*, 2nd ed. Butterworth-Heinemann, Oxford. This 1341-page book may well contain the most inorganic chemistry of any single volume. The wealth of information available makes it good first reference.
- Lukehart, C. M. (1985). *Fundamental Transition Metal Organometallic Chemistry*. Brooks/Cole, Pacific Grove, CA. This book is an outstanding text that is highly recommended.

Powell, P. (1988). *Principles of Organometallic Chemistry*. Chapman and Hall, London. A valuable resource in the field.

Purcell, K. F., and Kotz, J. C. (1980). *An Introduction to Inorganic Chemistry*. Saunders College Pub., Philadelphia. This book provides an outstanding introduction to organometallic transition metal chemistry.

■ QUESTIONS AND PROBLEMS

- Which of the following should be most stable? Explain your answer.
 $\text{Fe}(\text{CO})_2(\text{NO})_3$; $\text{Fe}(\text{CO})_6$; $\text{Fe}(\text{CO})_3$; $\text{Fe}(\text{CO})_2(\text{NO})_2$; $\text{Fe}(\text{NO})_5$
- Draw the structure of the product in each of the processes indicated.
 - $\text{Mo}(\text{CO})_6$ reacting with excess pyridine
 - The reaction of cobalt with CO at high temperature and pressure
 - $\text{Mn}_2(\text{CO})_{10}$ reacting with NO
 - $\text{Fe}(\text{CO})_5$ reacting with cycloheptatriene
- Suppose a mixed metal carbonyl contains one Mn atom and one Co atom. How many CO molecules would be present in the stable compound? What would be its structure?
- During a study of $\text{Cr}(\text{NH}_3)_3(\text{CO})_3$, $\text{Cr}(\text{CO})_6$, and $\text{Ni}(\text{CO})_4$ by infrared spectroscopy, three spectra were obtained showing CO stretching bands at 1900, 2060, and 1980 cm^{-1} , but the spectra were not labeled. Match the spectra to the compounds and explain your answer.
- Predict which of the following should be most stable and explain your answer.
 $\text{Fe}(\text{CO})_4\text{NO}$; $\text{Co}(\text{CO})_3\text{NO}$; $\text{Ni}(\text{CO})_3\text{NO}$; $\text{Mn}(\text{CO})_6$; $\text{Fe}(\text{CO})_3(\text{NO})_2$
- What is the structure (show all bonds clearly) of $\text{Co}(\text{CO})_2(\text{NO})(\text{cot})$, where cot is cyclooctatriene?
- How is benzene bound to Cr in the compound $\text{Cr}(\text{CO})_3(\text{C}_6\text{H}_6)$? Explain your answer.
- What is the structure (show all bonds clearly) of $\text{Mn}(\text{CO})_2(\text{NO})(\text{cht})$?
- For a complex $\text{M}(\text{CO})_5\text{L}$, two bands are observed in the region $1900\text{--}2200\text{ cm}^{-1}$. Explain what this observation means. Suppose L can be NH_3 or PH_3 . When L is changed from NH_3 to PH_3 , one band is shifted in position. Will it be shifted to higher or lower wave numbers? Explain.
- Describe the structure and bonding in the following where C_4H_6 is butadiene and C_6H_6 is benzene.
 - $\text{Ni}(\text{C}_4\text{H}_6)(\text{CO})_2$; (b) $\text{Fe}(\text{C}_4\text{H}_6)(\text{CO})_4$; (c) $\text{Cr}(\text{C}_6\text{H}_6)(\text{CO})\text{C}_4\text{H}_6$; (d) $\text{Co}(\text{C}_4\text{H}_6)(\text{CO})_2(\text{NO})$
- Infrared spectra of $\text{Ni}(\text{CO})_4$, $\text{CO}(\text{g})$, $\text{Fe}(\text{CO})_4^{2-}$, and $\text{Co}(\text{CO})_4^-$ have bands at 1790, 1890, 2143, and 2060 cm^{-1} . Match the bands to the appropriate species and explain your line of reasoning.
- Show structures (show all bonds clearly) for the following where C_8H_8 is cyclooctatetraene.
 - $\text{Fe}(\text{CO})_3(\text{C}_8\text{H}_8)$ (b) $\text{Cr}(\text{CO})_3(\text{C}_8\text{H}_8)$
 - $\text{Co}(\text{CO})(\text{NO})\text{C}_8\text{H}_8$ (d) $\text{Fe}(\text{CO})_3(\text{C}_8\text{H}_8)\text{Fe}(\text{CO})_3$
 - $\text{Ni}(\text{CO})_2(\text{C}_8\text{H}_8)$ (f) $\text{Ni}(\text{NO})_2(\text{C}_8\text{H}_8)$
 - $\text{Cr}(\text{CO})_4(\text{C}_8\text{H}_8)$ (h) $\text{Ni}(\text{CO})_3(\text{C}_8\text{H}_8)\text{Cr}(\text{CO})_4$
- Predict the products of the reactions indicated. More than one reaction may be possible.
 - $\text{Fe}_2(\text{CO})_9 + \text{NO} \rightarrow$
 - $\text{Mn}_2(\text{CO})_{10} + \text{NO} \rightarrow$
 - $\text{V}(\text{CO})_6 + \text{NO} \rightarrow$
 - $\text{Cr}(\text{CO})_6 + \text{NO} \rightarrow$
- Starting with ferrocene, predict how you could prepare the following.
 - $(\text{C}_5\text{H}_5)\text{Fe}(\text{C}_5\text{H}_4\text{CH}_3)$; (b) $(\text{C}_5\text{H}_5)\text{Fe}(\text{C}_5\text{H}_4\text{NO}_2)$; (c) $(\text{C}_5\text{H}_5)\text{Fe}(\text{C}_5\text{H}_4\text{COOH})$; (d) $(\text{C}_5\text{H}_5)\text{Fe}(\text{C}_5\text{H}_4\text{NH}_2)$

Coordination Compounds in Catalysis and Biochemistry

In introductory chemistry courses, a catalyst is defined as a substance that alters the rate of a chemical reaction without being permanently altered itself. Reactions in which coordination compounds are involved in functioning as catalysts may begin and end with the same metal complex being present. During the course of the reaction, the catalyst may undergo numerous changes in coordination number, bonding mode, or geometry, and groups may enter or leave the coordination sphere of the metal. A complex that functions as a catalyst undergoes changes, and if the reaction were stopped at some instant in the process, the catalyst might be significantly different than at the initiation of the reaction. In fact, it might be recovered as a different complex. However, in a reaction scheme, the complex is regenerated at some point in its original form. The processes are actually series of reaction steps in which a metal complex facilitates the transformation of one substance into another. Because the catalyst is regenerated after a series of steps, the processes are often referred to as catalytic cycles.

Although a great deal is known about some of the processes, some catalytic processes or at least some of the steps in the process may not be completely understood. It is rather like a Born-Haber cycle that is used to represent the process by which a metal and a halogen are converted into a metal halide. The process is represented as a series of steps consisting of the sublimation of the metal, dissociation of the halogen, removal of the electron from the metal and placing it on the halogen, then combining the gaseous ions to form a crystal lattice. These steps lead from reactants to product, and we know the energies associated with them, but the reaction very likely does not literally follow these steps. Reaction schemes in which metal complexes function as catalysts are formulated in terms of known types of reactions, and in some cases the intermediates have been studied independently of the catalytic process. Also, the solvent may play a role in the structure and reactions of intermediates. In this chapter we will describe some of the most important catalytic processes in which coordination chemistry plays such a vital role.

The other area of coordination chemistry to be described in this chapter is concerned with the role of coordination chemistry in some biochemical processes. There are a great number of such processes that depend on the presence of some metal ion for their effectiveness. The area of bioinorganic chemistry has grown enormously in recent years, and because a metal ion is involved, the topic is considered

fair game for inorganic chemists as well as biochemists and organic chemists. However, because this area of study is extensively covered in courses in biochemistry, the survey presented in this chapter will deal with only a few of the most common types of structures and reactions.

Even reactions that are energetically favorable may take place only slowly because there may be no low-energy pathway. The rate of a chemical reaction depends on the concentration of the transition state, which is determined by the energy required for it to form. In a general way, the function of a catalyst is to provide a way for the formation of a transition state that has a lower energy. Adsorption of gaseous reactants on a metal surface is one way to alter the energy barrier to a reaction. For example, hydrogenation reactions can be carried out using a metal catalyst such as platinum, palladium, or nickel, and such reactions have been carried out industrially for many years. Even when a catalyst is used, such heterogeneous reactions require rather stringent conditions. In industrial processes that are carried out on a large scale, the energy cost may be significant, so the discovery of conditions that allow reactions to be carried out in a more cost-effective way is important. That is just the situation when reactions are carried out under homogeneous conditions in solutions in some cases at atmospheric pressure and room temperature.

The ability of complexes to catalyze several important types of reactions is of great importance, both economically and intellectually. For example, isomerization, hydrogenation, polymerization, and oxidation of olefins all can be carried out using coordination compounds as catalysts. Moreover, some of the reactions can be carried out at ambient temperature in aqueous solutions, as opposed to more severe conditions when the reactions are carried out in the gas phase. In many cases, the transient complex species during a catalytic process cannot be isolated and studied separately from the system in which they participate. Because of this, some of the details of the processes may not be known with certainty.

Although not all facets of the reactions in which complexes function as catalysts are fully understood, some of the processes are formulated in terms of a sequence of steps that represent well-known reactions. The actual process may not be identical with the collection of proposed steps, but the steps represent chemistry that is well understood. It is interesting to note that developing kinetic models for reactions of substances that are adsorbed on the surface of a solid catalyst leads to rate laws that have exactly the same form as those that describe reactions of substrates bound to enzymes. In a very general way, some of the catalytic processes involving coordination compounds require the reactant(s) to be bound to the metal by coordinate bonds, so there is some similarity in kinetic behavior of all of these processes. Before the catalytic processes are considered, we will describe some of the types of reactions that constitute the individual steps of the reaction sequences.

22.1 ELEMENTARY STEPS IN CATALYTIC PROCESSES

When a coordination compound functions as a catalyst, there are usually several steps in the process. The entire collection of steps constitutes the mechanism of the reaction. Before describing several of the important catalytic processes, we will describe the types of reactions that often constitute the elementary steps.

22.1.1 Ligand Substitution

The very essence of the catalytic schemes that involve coordination compounds is that reactants, other ligands, and solvent molecules must enter and leave the coordination sphere of the metal. In order for this to be rapidly accomplished, it is necessary that the complexes be of lower stability than one would associate with a complex such as Cr(en)_3^{3+} or Co(acac)_3 . It will be observed that in most cases the transition metals are from the second or third transition series and that they generally start out in a low oxidation state. It will thus be concluded that the metal species are generally soft in character. In fact, d^8 ions of metals in low oxidation states are frequently encountered in these reactions. Complexes are often square planar species containing Pt(II), Pd(II), and Rh(I). One would not expect that a stable complex of a hard metal would be able to function in a way that would allow ligands to drift in and out of the coordination sphere as the process takes place. In many cases, hard metals such as Cr^{3+} , Al^{3+} , or Ti^{3+} have only one oxidation state (or at least a dominant one), and it is difficult for them to change oxidation states. Metals that function as catalysts in homogeneous processes are generally those in which it is easy to change their oxidation state. It is also a fact of life that some of these metals are extremely expensive. For example, as this is written the price of rhodium is over \$9000/oz! Approximately 60% of the rhodium produced comes from South Africa, but Russia is also a significant producer of rhodium. In some instances, the availability and price of precious metals are subject to political factors.

As a complex functions as a catalyst, it is often necessary for one ligand to enter the coordination sphere of the metal and another to leave (before or as the other ligand enters). These processes are substitution reactions, which were discussed in some detail in Chapter 20. As the catalytic processes are illustrated, it will be seen that some of the elementary steps are substitution reactions. A substitution reaction can be shown by the general equation



in which L is a nonparticipating ligand and n is the number of those ligands.

In the various homogeneous catalytic schemes, the solvent may be coordinated to the metal or may simply be present as bulk solvent. When a ligand leaves the coordination sphere of a metal, it *may* be replaced by a molecule of solvent in a process that is either associative or dissociative. There is no general way to predict which type of mechanism is operative, so in some cases the substitution reactions will be described as they relate to specific processes. Because substitution reactions have been described in Chapter 20, several other types of reactions that constitute the steps in catalytic processes will be described in greater detail.

22.1.2 Oxidative Addition

Oxidative addition is a process by which an atom is simultaneously oxidized and the number of bonds to it is increased as groups are added. The term *oxid* is used to denote this type of reaction. This type of process is not limited to coordination compounds, and it is easy to find numerous examples in other areas of chemistry. The following examples and many others can be found in earlier chapters of this book:

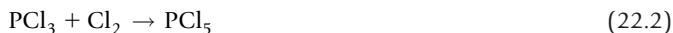



In each of these reactions, the oxidation state of the central atom is increased by 2 as the number of bonds is increased. In many cases, the number of bonds increases by 2 because of the oxidation states exhibited by the central atom. For example, in Eq. (22.2) phosphorus is changed from an oxidation state of +3 to +5 because the +4 oxidation state is not favorable for this atom. In Eq. (22.4), chlorine is oxidized from +1 to +3 because the +2 oxidation state is not normally accessible for that atom. Note that in each of these reactions, the number of bonds to the central atom is increased by 2. In the reaction shown in Eq. (22.3), sulfur increases in oxidation from +4 to +6 and an additional bond (which has substantial double bond character) is formed.

An example of an oxid reaction of a coordination compound is



in which the platinum is oxidized from +4 to +6 with the formation of two additional bonds. One important complex that functions as a catalyst is *Wilkinson's catalyst*, $\text{Rh}(\text{P}\phi_3)_3\text{Cl}$ (where ϕ = phenyl, C_6H_5). A very significant property of this complex is that it undergoes an oxidative addition reaction with hydrogen:

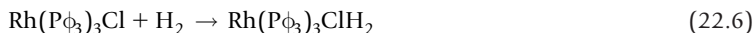

The product of the reaction has the structure

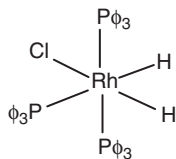

in which the rhodium is formally +3 with the hydrogen considered as H^- . In many oxid reactions, H_2 adds as two H^- ions in *cis* positions as if a hydrogen molecule approached the complex and added as atoms while the H–H bond simultaneously breaks. This is also true of gaseous HCl, which usually adds H and Cl in *cis* positions. On the other hand, in aqueous solutions where the HCl is largely dissociated, the addition is not restricted to *cis* positions, so the product contains H and Cl atoms in both *cis* and *trans* positions. The stereochemistry of the product depends on the solvent, and if the solvent has considerable polarity, the product consists of a mixture of *cis* and *trans* isomers. When the solvent is essentially nonpolar, the product contains hydrogen and halide in *cis* positions.

Another important complex is *trans*- $[\text{Ir}(\text{P}\phi_3)_2\text{COCl}]$, which is known as *Vaska's compound*. This complex undergoes a large number of oxidative addition reactions, because Ir^+ is easily oxidized to Ir^{3+} and

that ion forms many stable octahedral complexes. When CH_3I is added, the octahedral product contains CH_3 and I in *trans* positions with the other ligands in a plane:

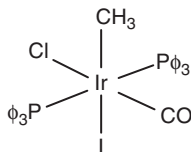

This oxad reaction is first order in both complex and CH_3I , and the entropy of activation is large and negative. It is believed that the reaction goes through an ionic transition state in which CH_3 adds to a pair of electrons on Ir followed by the attachment of I^- in the *trans* position.

The nature of the oxad reaction requires that the following conditions generally apply:

1. It must be possible to change the oxidation state of a metal. Normally, the metal changes oxidation state by 2 units, but two metal atoms can change by 1 unit each as shown in Eqs. (22.10) and (22.11).
2. The metal must be able to increase its coordination number by 2 except in cases like that shown in Eqs. (22.10) and (22.11).
3. Diatomic molecules such as H_2 , Cl_2 , or HCl add in *cis* positions when reacting as gases or as solutions in nonpolar solvents that do not assist in separating the molecules. In polar solvents, molecules that dissociate are not restricted to entering in *cis* positions.

One of the most interesting complexes that also figures prominently in catalytic processes is $\text{Co}(\text{CN})_5^{3-}$. Because Co^{2+} is a d^7 ion, forcing the pairing of the electrons leaves one orbital occupied by only one electron and another empty. This makes possible the formation of dsp^3 hybrid orbitals, and the complex is trigonal bipyramidal as expected. It is the singly occupied orbital that gives the complex its unusual character, the ability to behave as a free radical. In fact, $\text{Co}(\text{CN})_5^{3-}$ undergoes many reactions that are similar to those of other radicals. As expected, there is a coupling reaction, which can be shown as



Numerous other reactions of $\text{Co}(\text{CN})_5^{3-}$ have been observed with a wide variety of substances. For example, the reaction with alkyl halides can be shown as follows:

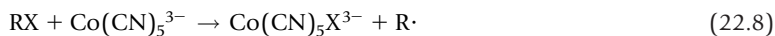

These reactions are typical oxad processes because the cobalt is formally converted from +2 to +3. Many other molecules such as H_2 , H_2O_2 , Br_2 , O_2 , and C_2H_2 are split in a homolytic manner during

reactions with $\text{Co}(\text{CN})_5^{3-}$. For example, the reaction with hydrogen is illustrated in the following equation:

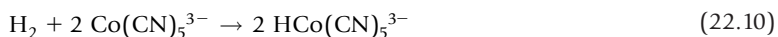

These reactions show the tendency of the metal to behave as a radical as a result of having an unpaired electron and a vacant position where a sixth ligand may be added.

The $[\text{Co}(\text{CN})_5]^{3-}$ complex is an effective catalyst for some reactions, particularly the isomerization of alkenes. Newer and more efficient catalysts have been developed for some of the processes, but the catalytic behavior of the pentacyanocobalt(II) ion is also significant from a historical perspective. In reactions such as that shown in Eq. (22.10), *two* Co^{2+} ions increase *one* unit in oxidation state, instead of the more common situation in which one metal ion increases by two units in oxidation state. The cobalt complex also reacts with CH_3I , Cl_2 , and H_2O_2 , which are indicated as X–Y in the equation

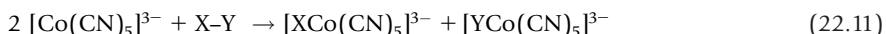

Mechanistic studies have shown that the reaction represented in Eq. (22.10) is a one-step process that follows the rate law

$$\text{Rate} = k[\text{H}_2][\text{Co}(\text{CN})_5^{3-}]^2 \quad (22.12)$$

whereas the reaction of $[\text{Co}(\text{CN})_5]^{3-}$ with H_2O_2 follows a free radical mechanism. Other aspects of the chemistry of $[\text{Co}(\text{CN})_5]^{3-}$ will be illustrated later in this chapter.

A different type of oxidative addition involves the transfer of a hydrogen atom from a coordinated group to the metal atom followed by (or simultaneous with) a change in bonding mode to the ligand from which the hydrogen atom came. This is illustrated in the following example, in which ϕ is a phenyl group, C_6H_5 :

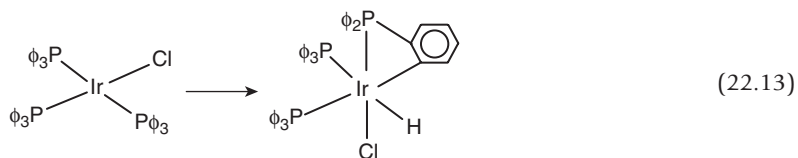

A reaction of this type is sometimes referred to as *orthometallation* because it is from the *ortho* position that the hydrogen is transferred to the metal.

22.1.3 Mechanistic Considerations for Oxad Reactions

Much of Chapter 20 was devoted to the description of mechanisms of reactions of coordination compounds with emphasis on substitution reactions. Because there are numerous aspects of oxad reactions that are different from those involving substitution, we will address some of the mechanistic aspects of oxad reactions briefly in this section.

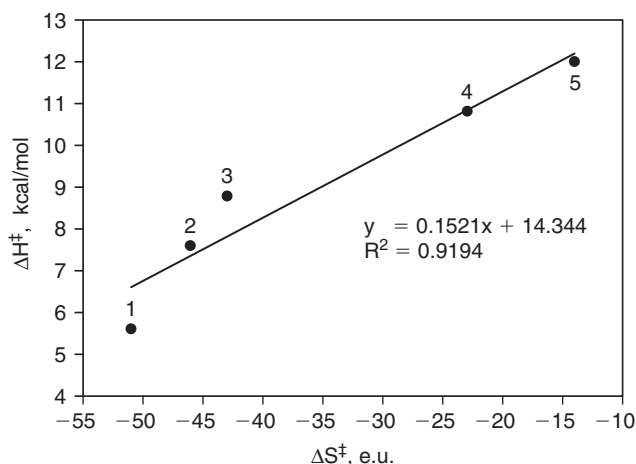

■ **FIGURE 22.1** An isokinetic plot for oxidative addition of H_2 and CH_3I in $\text{IrX}(\text{CO})(\text{P}\phi_3)_2$ in benzene. Points 1, 2, and 3 represent oxidative addition of H_2 when X is Cl, Br, and I, respectively. Points 4 and 5 are for oxidative addition of CH_3I when X is Cl and Br, respectively.

The mechanism of oxad reactions of Vaska's compound has been the subject of a considerable amount of study. It is known that the solvent plays a role in these reactions, but the nature of the solvent effect is not always clear. For example, when a series of *trans*- $[\text{IrX}(\text{P}\phi_3)_2(\text{CO})]$ complexes (where X = Cl, Br, or I) undergo oxad reactions with H_2 in benzene, the rate increases as X varies in the order $\text{Cl}^- > \text{Br}^- > \text{I}^-$. In contrast, when the oxad reaction is by CH_3I , the rate varies as $\text{I}^- > \text{Br}^- > \text{Cl}^-$. For both types of reactions, the entropy of activation is negative, which has been interpreted as indicating that association of the reactants occurs in the transition state. As described in Chapter 20, the compensation effect (as indicated by a linear isokinetic plot) is significant when considering a series of related reactions. By making use of the data presented by Atwood (1985), the isokinetic plot shown in Figure 22.1 was constructed.

It must be emphasized that a linear isokinetic plot does not *prove* a common mechanism is operating, but it does give some credence to that conclusion. Neither does such a plot tell what the mechanism might be. Certainly the fit to the data is not perfect, but it is rather good in this case. One thing that is striking is the large negative values for the entropy of activation and the very low enthalpies of activation. The energy of the bond in the H_2 molecule is approximately 435 kJ/mol (104 kcal/mol) so there is a good indication that bond formation to the metal is at least as important as bond breaking in the H_2 molecule. A plausible mechanism for oxad reactions of H_2 with metal complexes can be visualized as shown in Figure 22.2. This mechanism is usually referred to as a *concerted addition*.

The bonding of H_2 in metal complexes was described in Chapter 16. In connection with the oxad reaction in which the bonding is not static, it can be presumed that the σ orbital on the hydrogen molecule functions as an electron pair donor to an orbital on the metal atom. Simultaneously, the σ^* orbital on the H_2 molecule receives electron density from the populated *d* orbitals on the metal atom as a result of back donation. The result is that two M–H bonds form as the H–H bond is broken in a process that is accompanied by a very low activation energy.

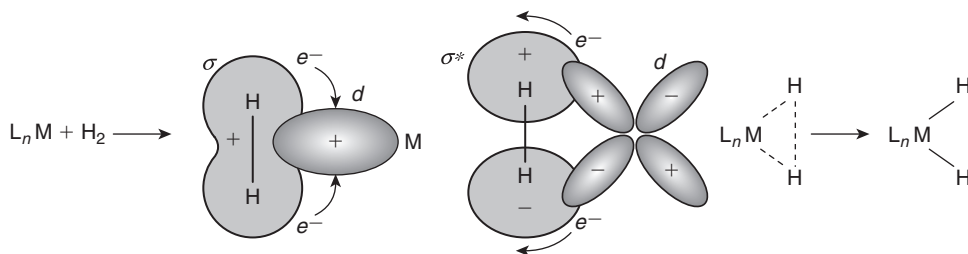

■ FIGURE 22.2 A possible mechanism for oxid of H_2 to a metal complex.

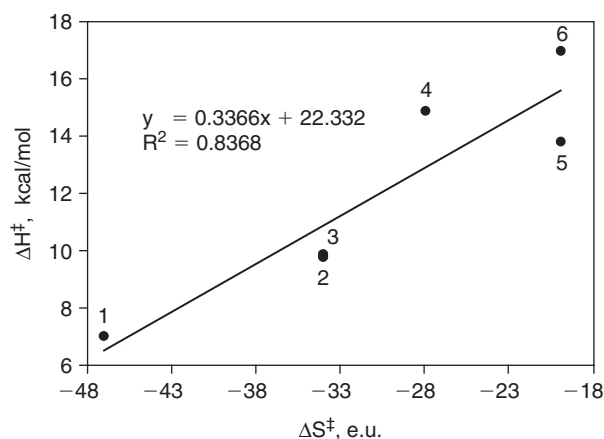

■ FIGURE 22.3 An isokinetic plot for oxidative addition of $\text{IrCl}(\text{CO})\text{L}_2$ with CH_3I . The points 1 through 6 correspond to $\text{L} = \text{P}\phi_3, \text{PEt}\phi_2, \text{PET}_2\phi, \text{P}(p\text{-C}_6\text{H}_4\text{CH}_3)_3, \text{P}(p\text{-C}_6\text{H}_4\text{F})_3, \text{or } \text{P}(p\text{-C}_6\text{H}_4\text{Cl})_3$, respectively.

Kinetic data are available for the oxid reaction of CH_3I with a series of complexes that are derivatives of Vaska's compound, $\text{trans-IrCl}(\text{CO})\text{L}_2$ where $\text{L} = \text{P}\phi_3, \text{PEt}\phi_2, \text{PET}_2\phi, \text{P}(p\text{-C}_6\text{H}_4\text{CH}_3)_3, \text{P}(p\text{-C}_6\text{H}_4\text{F})_3, \text{or } \text{P}(p\text{-C}_6\text{H}_4\text{Cl})_3$. When an isokinetic plot is made of the ΔH^\ddagger and ΔS^\ddagger values, the result is as shown in Figure 22.3.

The points on the graph shown in Figure 22.3 show significant scatter, but the fit is sufficiently good to indicate that the reactions probably follow a common mechanism. In this case, the attacking species is CH_3I , but the ligands in the *trans* positions are varied. For the ligands listed in conjunction with Figure 22.3, the lowest rate constant (all values given are for reactions at 25°C) was found when the ligand is $p\text{-C}_6\text{H}_4\text{Cl}$ ($k = 3.7 \times 10^{-5} \text{ M}^{-1} \text{ sec}^{-1}$) and the highest occurred when $p\text{-C}_6\text{H}_4\text{CH}_3$ is present ($k = 3.3 \times 10^{-2} \text{ M}^{-1} \text{ sec}^{-1}$). Whether this is due to electronic or steric effects is not known, but it is interesting that the rate constant when the ligand was $p\text{-C}_6\text{H}_4\text{F}$ ($k = 1.5 \times 10^{-4} \text{ M}^{-1} \text{ sec}^{-1}$) was intermediate between those containing the chloride and methyl groups in the *para* position in the ligand. If the difference in rate constants is due to steric effects, it would be expected that the ligand containing

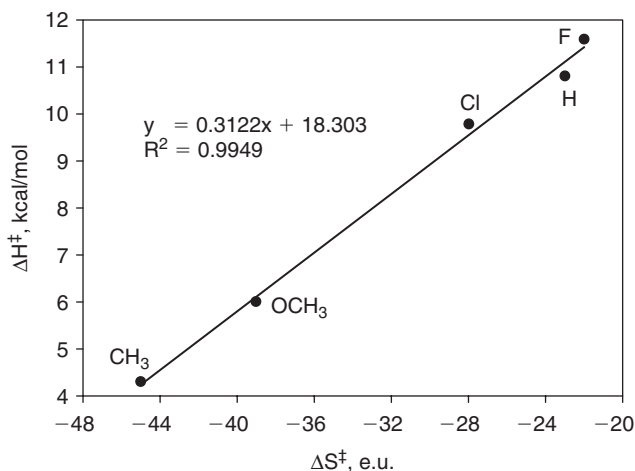

■ **FIGURE 22.4** An isokinetic plot for the reaction of $\text{trans-}[\text{IrCl}(\text{CO})\text{P}((p\text{-C}_6\text{H}_4\text{Y})_3)_2]$. The identity of Y is indicated for each point on the graph. (Constructed from data given in Atwood, 1985, p. 168.)

Cl would have the smallest rate constant, and that is consistent with the observed k values. If the difference in rate constants is due to difference in electron density at the metal, the fact that CH_3 is electron releasing and fluorine is withdrawing would predict that greater electron density would be placed on the metal when the ligands contain CH_3 and lesser when F is present. The observed rate constants show that trend, but the rate constant for the ligand containing Cl in the *para* position does not follow this trend because it is not as electron withdrawing as F.

In another study (see Atwood, 1985, p. 168), a series of oxad reactions was carried out at 30°C with methyl iodide and $\text{trans-}[\text{IrCl}(\text{CO})\text{P}(p\text{-C}_6\text{H}_4\text{Y})_3)_2]$. The identities of the groups in the *para* position of the phosphine ligands, Y, are shown in Figure 22.4, which is a graph of the values for the enthalpy and entropy of activation for reactions.

The isokinetic plot shown in Figure 22.4 illustrates a linear relationship that provides an excellent fit to the data. In this case, the effect produced by the ligand on the rate of oxidative addition is related to the electronic changes produced on the metal. The oxad rate is enhanced when Y is an electron-donating group that increases electron density at the metal. Such a relationship provides clear evidence that the mechanism is constant for the reactions with no significant differences due to steric effects. The kinetic data for this process are consistent with a nucleophilic attack by the ligand. The Hammett σ parameter is a measure of the electron withdrawing or releasing character of substituent groups. The kinetic data used to construct Figure 22.4 were originally correlated by means of the Hammett σ parameter, and a linear relationship was found between the logarithm of the rate constants and σ values for the substituents in *para* position. It was thus concluded that the effect produced by different substituents is related to their ability to change the electron density at the metal atom. From the brief discussion presented, it is clear that a great deal is known about the mechanisms of oxad reactions, and it is also apparent that there is much left to learn.

22.1.4 Reductive Elimination

In the catalytic schemes to be described later, it will be seen that reactants become ligands and are frequently altered in some way (usually by adding or removing an atom or changing the position of a bond). After these changes, the altered molecule must be set free, and one important route of this type is known as reductive elimination. A reductive elimination reaction is the opposite of oxidative addition. The coordination number of the metal decreases (usually by two units) as the oxidation state decreases. The following reaction illustrates the reductive elimination of C_2H_6 , which is one step in hydrogenation using Wilkinson's catalyst.

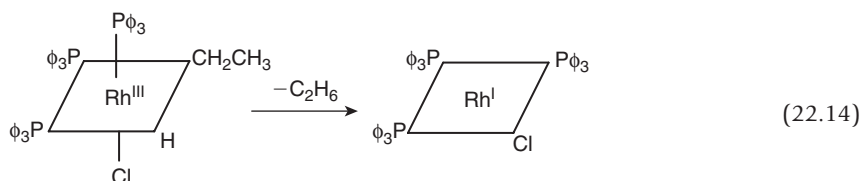

Note that in this case, the reductive elimination involves the transfer of a hydrogen atom from a *cis* position to the alkyl group. This is a typical condition for this type of reaction. A similar reaction takes place during the isomerization of alkenes as catalyzed by $\text{RhCO}(\text{P}\phi_3)_3$.

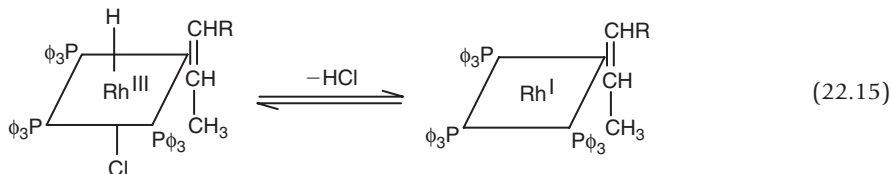

In catalytic processes, reductive elimination is essential in order to remove the product from the coordination sphere of the metal.

22.1.5 Insertion Reactions

In an insertion reaction, an entering group becomes bonded to a metal and a ligand while being positioned between them. Formally, such a reaction can be shown as



in which the entering ligand, Y, becomes inserted between M and X and forms bonds to both. Molecules such as O_2 , CS_2 , CO , C_2H_4 , SO_2 , and SnCl_2 are among those that undergo insertion reactions.

When an insertion reaction occurs with the entering group containing more than one atom, there are two possible outcomes. For example, when a diatomic molecule enters the complex, it may do so in either 1,1-addition or 1,2-addition. These processes are illustrated in the following equations:



In the first of these processes, both A and B (atoms 1 and 2 in the molecule) are bound to other groups, so this is known as 1,2-addition. In the second process, only A (atom 1) is bound to the metal and the other ligand, so this is 1,1-addition.

The number of insertion reactions known to occur is very large. However, they can be considered to fall into a much smaller number of reaction *types* that arise as a result of the types of bonds between the metal and other ligand at the reactive site. The following equations illustrate these reaction types. One very simple insertion reaction is the formation of a Grignard reagent in which magnesium is inserted between R and X,



More typical of coordination compounds are the following insertion reactions:

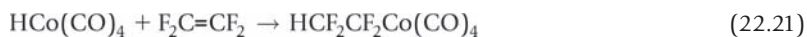
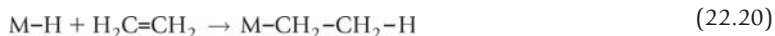

These reactions are examples of 1,2-addition. In addition to insertion in the M-H bond as shown earlier, this type of reaction also occurs with metal-halogen and metal-carbon bonds. The following equation shows an example of a reaction in which insertion occurs between a metal and a halogen:

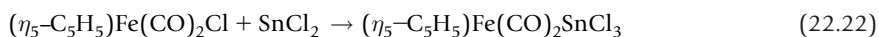

This reaction involves insertion in which the Sn atom in SnCl₂ is bonded to both Fe and Cl as the result of 1,1-addition. One of the many insertion reactions given by CO is the following:

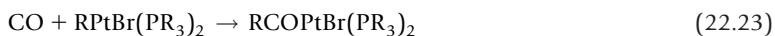

In the product, the carbon atom of the CO ligand is bonded to both Pt and R, so this is an example of 1,1-addition.

One of the best known "insertion" reactions can be shown as

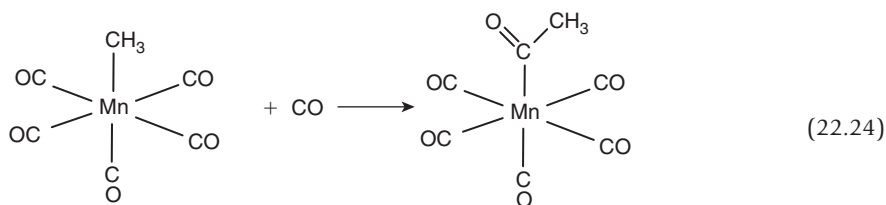

However, this reaction has been the subject of a great deal of study. Three of the transition states that could conceivably be formed during this reaction are illustrated in Figure 22.5.

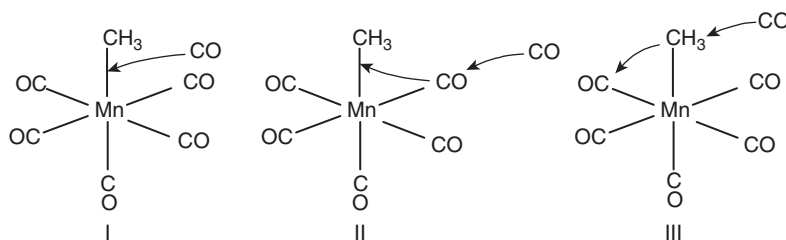

■ FIGURE 22.5 Possible transition states for the reaction shown in Eq. (22.24).

The transition states arise in the following ways:

- (I) The entering CO becomes inserted directly between Mn and CH₃.
- (II) Insertion of CO from an adjacent position occurs with replacement by incoming CO.
- (III) Migration of the CH₃ to an adjacent CO and attachment of CO at the site vacated by CH₃.

If all CO molecules have the same identity, it is impossible to tell one from another. What is needed is some way to distinguish the CO groups from each other, and isotopic labeling constitutes such a technique.

Many of the questions regarding the mechanism of the reaction shown in Eq. (22.24) have been answered by the use of ¹³CO. The results have shown that when the entering carbon monoxide is ¹³CO, there is no ¹³CO in the acyl group. Instead, the labeled CO is in a position that is *cis* to the acyl group so the reaction can be shown as



Therefore, it can be concluded that the reaction does not go through transition state I, which would result in the ¹³CO being in the acyl group. However, this does not answer the question as to whether the CH₃ migrates to a CO in a *cis* position or whether the CO from a *cis* position migrates to the Mn–CH₃ bond and becomes inserted between Mn and CH₃. In accord with the principle of microscopic reversibility, the reaction for the loss of CO should proceed through the same transition state that was formed when the ligand was added. The structure of the molecule and the predicted products for decarbonylation are shown in Figure 22.6.

If the reaction forming the acyl group had taken place with migration of the methyl group, then decarbonylation should also occur by migration of the methyl group with the formation of the same transition state. Migration of the CH₃ group could move it to any of the four positions around the square planar part of the molecule. If the reaction proceeds as shown in structure I, the methyl group would displace ¹³CO to form a Mn–CH₃ bond and there would be no ¹³CO in the product. There would be a 25% probability for transfer of the methyl group to that position. Methyl group migration as indicated in structure II would lead to ¹³CO remaining in the product, and there are two possibilities for the methyl group being in positions that are *cis* to the ¹³CO and only one in which CH₃ would be *trans* to ¹³CO. When all of the possible outcomes are considered, there should be twice as much product with

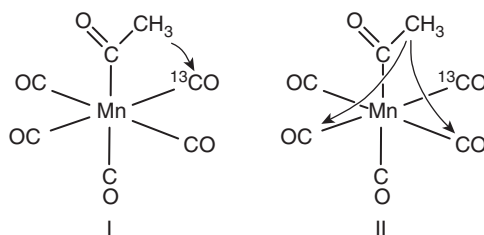

■ **FIGURE 22.6** Possible paths of CH_3 transfer in decarbonylation. In structure II, only one of the two possible migrations of CH_3 to positions *cis* to the ^{13}C is indicated.

^{13}C located *cis* to the CH_3 group as there is with it in the *trans* position. The product distribution from decarbonylation agrees with that assessment. Therefore, the “insertion” of CO in $\text{CH}_3\text{Mn}(\text{CO})_5$ is actually the result of migration of the methyl group.

Studies have also been conducted to determine the effect of solvent on the rate of methyl migration. Removing the CH_3 group from a coordination site and placing it on a coordinated CO would result in a transition state having a smaller volume than the starting complex. Forming a transition state having a smaller volume than the reactants is favored by high pressure or solvents having high internal pressure. Accordingly, it would be expected that the rate would increase as the solubility parameter or cohesion energy increases for a series of solvents (see Chapter 6). Atwood (1985) shows relative rate data (for mesitylene, di-*n*-butyl ether, *n*-octylchloride, and dimethylformamide (DMF) as solvents), which indicates that this is indeed the case. However, the data presented also show that the equilibrium constant varies with the solvent. This was interpreted as an indication that solvation of the alkyl and acyl complexes depends on the nature of the solvent.

A somewhat different approach can be taken by making use of the data presented by Basolo and Pearson (1967). The rate constants are given for formation of the intermediate, $\text{CH}_3\text{COMn}(\text{CO})_4\text{S}$, in which it is assumed that a solvent molecule, S, occupies the position vacated by movement of the CH_3 group. A graph showing the $\ln k$ versus solubility parameter of the solvent is presented in Figure 22.7.

Although the agreement is far from perfect, there is a general increase in $\ln k$ as the solubility parameter of the solvent increases. Forming a transition of smaller volume is assisted when the solvent has high cohesion. In the early work, the trend was attributed to either a molecule of solvent occupying the vacant site or stabilization of a polar transition state by polar solvent molecules. However, the observed variation in rate with solvent is also consistent with the formation of a transition state having a smaller volume. This may be an explanation for the observation mentioned earlier that the equilibrium constant was also larger in solvents having high cohesion. It is interesting to note that for four of the six solvents represented by data points in Figure 22.7, the linear fit (the dotted line) is quite good. The fact that the points for THF and DMF fall far from that relationship may indicate that they are involved in solvation of the transition state by forming a coordinate bond to the metal (see Chapter 6). Although the nature of the interactions is not known, it is likely that all six of the solvents do not play the same role in assisting the formation of the transition state. A THF complex of the type

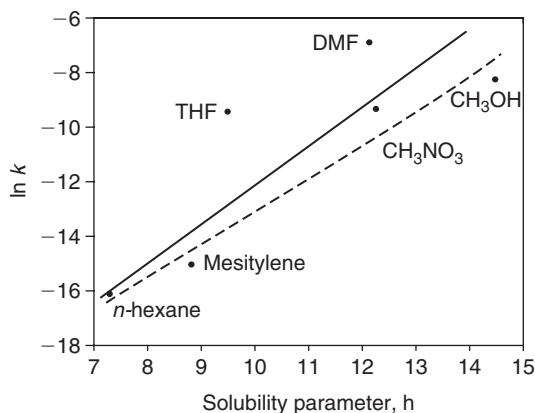

■ **FIGURE 22.7** The variation in rate constant with solubility parameter for the reaction shown in Eq. (22.24). (Constructed from data given in Basolo and Pearson 1967, p. 584.)

$\text{CH}_3\text{Mn}(\text{CO})_4\text{THF}$ has been identified, so the conjecture that THF and DMF behave in a manner that is different from the other solvents is not without some justification. Additional work on the influence of the solvent could yield additional insight regarding the mechanisms of this and other reactions of coordinated ligands.

22.2 HOMOGENEOUS CATALYSIS

Few areas of chemistry have changed as rapidly as the field of homogeneous catalysis by coordination compounds. Not only is the chemistry fascinating and diverse, but also it is immensely practical. The ability to carry out hydrogenations, isomerizations, and other processes at or near ambient conditions is sufficient motivation to ensure that knowledge will develop rapidly. That has certainly been the case. From a few rather sparse reactions has come a well-developed and rapidly growing field. Commensurate with that growth has been the expansion of the literature of the field. Numerous books have been written on the subject, some of which are listed as references at the end of this chapter. It is impossible in a textbook to do more than describe a few of the most important types of processes and show the general nature of the field. The interested reader should consult additional sources to become familiar with the details of the catalytic processes. In the sections that follow, several types of reactions will be described, and the role of the complexes that function as catalysts will be shown. Keep in mind that each of the schemes is made up of a series of steps, most of which are identical to some of the types of reactions described earlier.

22.2.1 Hydrogenation

In order for a complex to function as a hydrogenation catalyst, it is necessary for it to be able to bond to hydrogen and to the alkene. This requires the complex to be able to add hydrogen in an oxidative

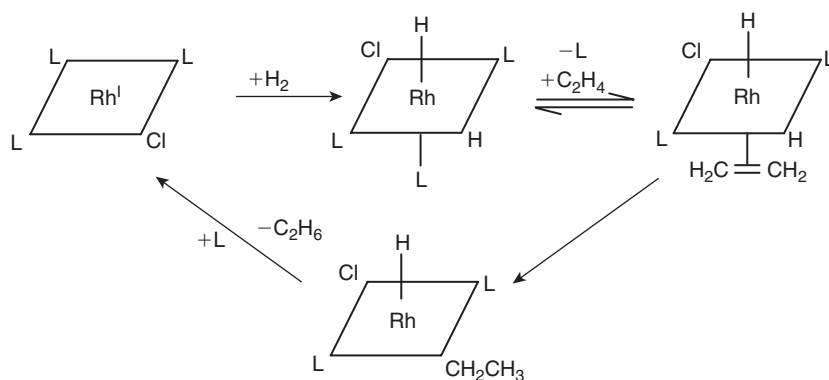

■ **FIGURE 22.8** The hydrogenation of alkenes using Wilkinson's catalyst. L is $\text{P}(\text{C}_6\text{H}_5)_3$ or perhaps a solvent molecule.

addition reaction, and that process is characteristic of a metal in a low oxidation state. After the hydrogen and alkene are part of the coordination sphere of the metal, a facile means must be available for them to react. The overall reaction can be written as



A complex that meets the requirements for a hydrogenation catalyst is $\text{RhCl}(\text{P}\phi_3)_3$, where ϕ is a phenyl group, C_6H_5 . This complex is a coordinatively unsaturated 16-electron species that has become known as Wilkinson's catalyst because it was developed and utilized by the late Sir Geoffrey Wilkinson (who also received a Nobel Prize in 1973 for work on the structure of ferrocene). This versatile catalyst is effective in the hydrogenation of several types of compounds, which include alkenes and alkynes. Figure 22.8 shows the process that leads to hydrogenation of ethylene. Although the catalytic scheme is illustrated as if the hydrogenation of ethylene were occurring, more useful reactions involve hydrogenating longer-chain alkenes. In fact, ethylene does not undergo hydrogenation very readily under these conditions, but replacing a hydrogen atom on the C_2H_4 group with an alkyl group, R, makes the scheme fit the general case.

The overall catalytic process can be considered as a series of steps. The first step involves the oxidative addition of hydrogen to give a complex having octahedral coordination. Addition of the alkene could occur by either an associative or dissociative pathway in which a molecule of $\text{P}\phi_3$ leaves. However, on the basis of NMR studies, it is believed that a small amount of this complex undergoes loss of one of the $\text{P}\phi_3$ ligands to give a five-bonded complex. It is also believed that it is possible for this intermediate to be interconverted between trigonal bipyramidal and square-base pyramidal structures, as shown in Eq. (22.27), because it is of a fluxional nature. It may be that the loss of the $\text{P}\phi_3$ ligand *trans* to H is facilitated as a result of a *trans* effect. It is to this intermediate that the alkene attaches. In order to form the

reactive intermediate, a ligand must be lost, and the large size of the $\text{P}\phi_3$ ligand seems to be one factor that enhances its dissociation.

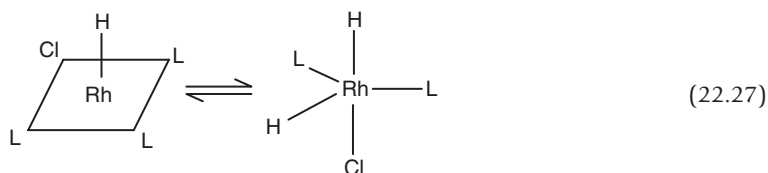

The reaction scheme shown in Figure 22.8 consists of a series of steps that represents the types of elementary reactions described earlier. The first step is the oxidative addition of hydrogen with the hydrogen atoms occupying *cis* positions. Subsequently, the entry of a molecule of triphenylphosphine into the coordination sphere occurs as a hydrogen transfer to the alkene occurs. This is followed by another hydrogen transfer that occurs in conjunction with reductive elimination of the alkane to regenerate the catalyst. Part of the interest and utility of this hydrogenation scheme is that it can be carried out at essentially ambient conditions. This represents a radical departure from the high temperature and pressure required when metal catalysts are used in hydrogenation. The mechanism shown in Figure 22.8 is only one of at least three that have been proposed, and it may deviate in some details from the actual mechanism (see the following structures). Keep in mind that positions indicated as being vacant may be occupied by a coordinated solvent molecule.

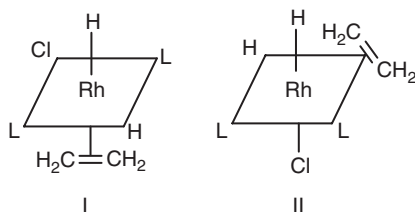

In the scheme shown in Figure 22.8, the rate-determining step is alkene insertion (viewed by some as hydrogen transfer). Because the hydride ion is a nucleophile, the reaction can be considered as a nucleophilic attack, which is influenced by the electron density in the alkene. A most interesting and important study dealing with this issue was reported by Nelson, Li, and Brammer (2005), in which the ionization potentials of a series of alkenes (a measure of electron density and availability) were correlated with the relative rate of reaction. The alkene that served as an index for comparing the rates was $\text{CH}_2=\text{CHCH}_2\text{CH}_2\text{CH}_2\text{CH}_3$, for which the k was set equal to 100. Rates for reactions of other alkenes (expressed by the k_{rel} values) were compared to that value, and they ranged from 1.4 for $(\text{CH}_3)_2\text{C}=\text{C}(\text{CH}_3)_2$ to 410 for $\text{CH}_2=\text{CH}-\text{CH}_2\text{OH}$. Plots of ionization potential versus $\log k_{\text{rel}}$ were generally linear, and especially so for a series of terminal alkenes. The negative slope of the plots is consistent with nucleophilic attack of hydride on the alkene that causes the alkene to change from η^2 to η^1 bonding. Other good correlations were established for the relative rate of hydrogenation of alkenes and the energy of the lowest unoccupied molecular orbital (LUMO). Although the correlations do not distinguish between mechanisms with regard to the possible transition states, they demonstrate that nucleophilic attack of hydride on the alkene is the rate-determining step in the process.

Some disagreement exists regarding the structure of the transition state (whether H or $P\phi_3$ is *trans* to the alkene) and whether or not solvent molecules occupy sites that are apparently vacant. In spite of some uncertainty regarding these details, the major issues regarding the catalyzed hydrogenation of alkenes using Wilkinson's catalyst are fairly well understood.

Following the success of Wilkinson's catalyst, other complexes having similar characteristics were studied. These include $RhH(P\phi_3)_3$, $RhHCl(P\phi_3)_3$, and $RhH(CO)(P\phi_3)_3$. The last two of these are 18-electron complexes, so it is necessary for a ligand to leave in order to form a bond to a molecule of the reacting alkene. Hydride complexes contain one hydrogen atom that can transfer to the alkene (or to which the alkyl group can transfer) to form an alkyl group. After the transfer, the reaction with gaseous hydrogen reforms the hydride complex, and a second hydrogen transfer during which reductive elimination of the alkane occurs completes the process. Some catalysts have been designed that contain a different ratio of $P\phi_3$ to rhodium, and others have been studied that contain different phosphine ligands having a different basicity than $P\phi_3$. These catalysts and those that contain more basic phosphines have not been found to be more effective than the intermediates shown in Eq. (22.27). The nature of the alkene is also a factor in the catalytic process.

Another important use for Wilkinson's catalyst is in the production of materials that are optically active (by what is known as enantioselective hydrogenation). When the phosphine ligand is a chiral molecule and the alkene is one that can complex to the metal to form a structure that has *R* or *S* chirality, the two possible complexes will represent two different energy states. One will be more reactive than the other, so hydrogenation will lead to a product that contains predominantly only one of the diastereomers.

Although there is a large amount of interesting chemistry associated with the $Co(CN)_5^{3-}$ ion, it is the ability to function as a catalyst in homogeneous systems that is the issue in this chapter. Because $Co(CN)_5^{3-}$ has the ability to split hydrogen (as shown in Eq. (22.10)), it is not surprising that it can function as a catalyst in hydrogenation reactions. The hydrogenation of 1,3-butadiene is illustrated in Figure 22.9.

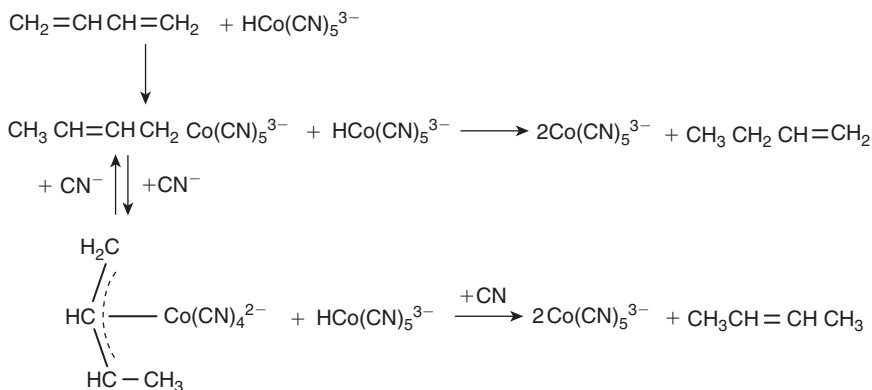

■ **FIGURE 22.9** A plausible mechanism for hydrogenation of 1,3-butadiene catalyzed by $Co(CN)_5^{3-}$.

As shown earlier, $\text{Co}(\text{CN})_5^{3-}$ has the ability to split hydrogen molecules as a result of an oxidative addition reaction.

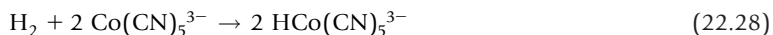

Consequently, it is $\text{HCo}(\text{CN})_5^{3-}$ that functions as a catalyst in hydrogenation processes. In the first step of the process shown in Figure 22.9, the alkene coordinates to $\text{HCo}(\text{CN})_5^{3-}$ as one hydrogen atom is added to the molecule so that only one double bond remains. The monoene is bonded to the cobalt in η^1 fashion. In the second step, another $\text{HCo}(\text{CN})_5^{3-}$ transfers hydrogen to the alkene, which undergoes reductive elimination and leaves, having been converted to 1-butene.

One of the interesting aspects of this process is that the nature of the product depends on the concentration of CN^- in the solution. When the concentration of CN^- is high, the product is 1-butene, but at low concentrations of CN^- , the product is 2-butene. The explanation for this difference seems to be that when the cyanide ion concentration is low, the alkene changes bonding mode from η^1 to η^3 to complete the coordination sphere of the metal ion. The result is that the hydrogen atom from the second $\text{HCo}(\text{CN})_5^{3-}$ is added to the terminal carbon atom in the η^3 arrangement and the product is 2-butene. In the presence of an excess of CN^- , the alkene maintains the η^1 bonding, and the hydrogen atom from the second $\text{HCo}(\text{CN})_5^{3-}$ is added to carbon atom adjacent to the methyl group, which produces 1-butene.

22.2.2 Isomerization of Alkenes

The isomerization of alkenes is an industrially important process that can be used to prepare specific isomers used as monomers in polymerization. One step in the isomerization process involves a change in bonding mode of an alkene. For example, isomerization of 1-alkenes to produce 2-alkenes may take place as the alkene changes from η^2 to η^3 in the transition state. This mechanism can be shown as

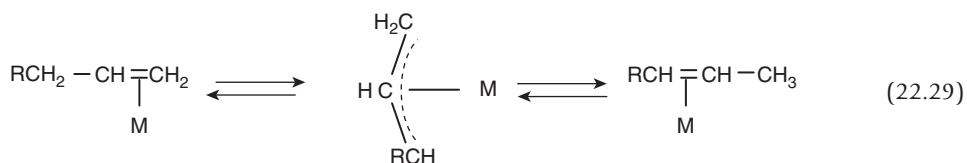

One of the effective catalysts for isomerization of alkenes is a square planar complex of Rh^{1+} . That complex undergoes replacement of a ligand in the coordination sphere as shown in the reaction scheme presented in Figure 22.10.

The isomerization process can be considered as taking place in a series of steps that involves a substitution reaction in which the alkene replaces a ligand L followed by the addition of H^+ and L to form a six-bonded complex. A hydrogen transfer changes the alkene from η^2 to η^1 , which is reversed as the alkyl group is converted into a 2-ene as a ligand L enters the coordination sphere of the metal. Reductive elimination by loss of L and H^+ leads to a square planar complex in which the alkene is present as the 2-ene. Elimination of $\text{RCH}=\text{CH}_2\text{CH}_3$ as L enters the coordination sphere liberates the product and reforms the catalyst.

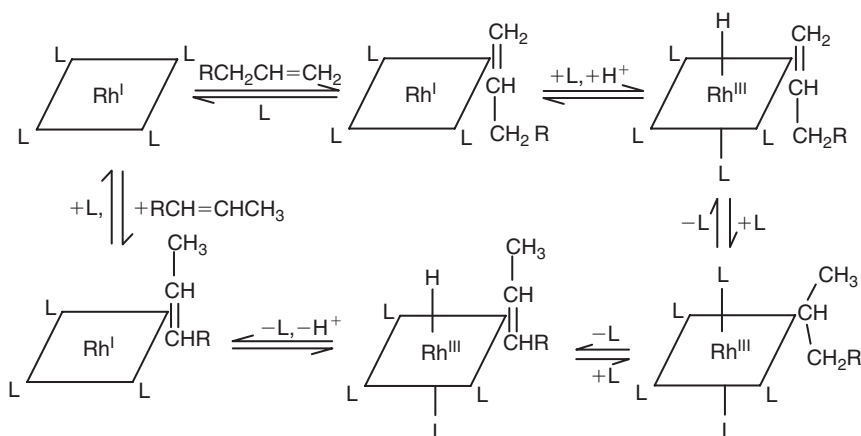

■ **FIGURE 22.10** The reaction scheme for the isomerization of alkenes. L is a solvent molecule or Cl^- .

22.2.3 Polymerization of Alkenes (the Ziegler-Natta Process)

Ethylene and propylene are two monomers that are used in enormous quantities to produce polyethylene and polypropylene. These polymers are used for making a large variety of containers and other items. As a result, there has been a great deal of interest for many years in the reactions that yield these polymers.

The polymerization of alkenes is one of the important processes in which coordination chemistry is involved in what is known as the Ziegler-Natta process. Although polymerization of ethylene can be carried out at high temperature and pressure, a process by which this could be accomplished at room temperature and atmospheric pressure was discovered by Karl Ziegler in 1952. The process utilized TiCl_4 and $\text{Al}(\text{C}_2\text{H}_5)_3$ in a hydrocarbon solvent. It was later found by Giulio Natta that by using other catalyst combinations, polymers having stereoregularity could be produced. Ziegler and Natta shared the 1963 Nobel Prize for their enormously important work.

The polymerization reaction can be carried out using other combinations of a metal halide and a metal alkyl. Generally, a halide of titanium, vanadium, or chromium is used in combination with an alkyl of beryllium, aluminum, or lithium. Although the details of the process are not completely understood, the mechanism involves the replacement of a chloride ion by an ethyl group or an ethyl group attaching at a vacant site as the initial step. After a molecule of ethylene is coordinated to the titanium, it undergoes migration and insertion in the bond between Ti and C_2H_5 . Another ethylene molecule becomes coordinated at the vacant site in the coordination sphere of the Ti, and another insertion reaction occurs, which lengthens the chain, and so on. The reaction scheme shown in Figure 22.11 illustrates this process. The crucial step in the process is the insertion reaction by which the hydrocarbon chain is lengthened.

Another reaction involving combining alkenes is the dimerization of ethene. That reaction is catalyzed by a rhodium complex, RhClL_3 as is illustrated in Figure 22.12.

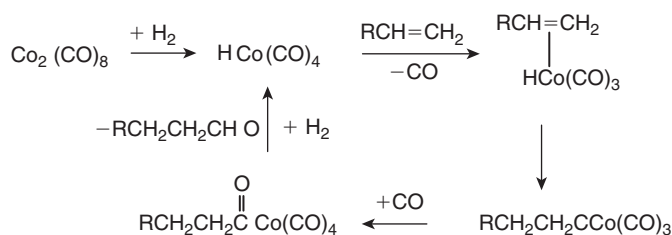

■ FIGURE 22.13 The reaction scheme for the hydroformylation process.

earlier), which changes the bonding from η^2 to η^1 . This is followed by the migration of CO to the Co-alkyl bond, which generates the $\text{RC}(\text{O})\text{-Co}$ linkage. With the oxidative addition of H_2 and reductive elimination of the aldehyde, the process is complete. Although the cobalt carbonyl catalyst allows the reaction to be useful, it requires temperatures of approximately 150°C and a pressure of 200 atmospheres. It is also generally the case that branched aldehydes are produced in greater quantity than straight-chain products. This is a significant handicap because the linear aldehydes are converted to linear alcohols that are used in the manufacture of detergents. The oxo process is also important for the production of precursors for making polymers such as poly(vinyl chloride). In a more modern process, a rhodium complex having the structure

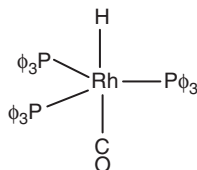

is the starting complex for a catalytic cycle. The complete cycle is shown in Figure 22.14.

The first step in hydroformylation with the rhodium catalyst involves the loss of a $\text{P}\phi_3$ ligand followed by coordination of the alkene. This is followed by a hydrogen transfer that is accompanied by a change in bonding mode of the alkene to the metal from η^2 to η^1 . After adding CO to a vacant site to give a five-bonded complex, migration of CO and insertion in the metal-carbon bond leads to formation of $\text{M-C}(\text{O})\text{CH}_2\text{CH}_2\text{R}$. An oxad reaction of H_2 followed by reductive elimination of $\text{RCH}_2\text{CH}_2\text{CHO}$ completes the process. Hydroformylation is one of the most important processes in which a complex functions as a catalyst.

22.2.5 Wacker Process

One of the important industrial processes is that by which ethylene is converted to acetaldehyde. This process involves the addition of oxygen to an alkene, and the equation for the overall process can be shown as

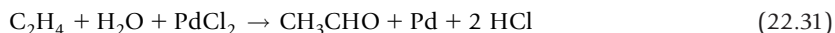

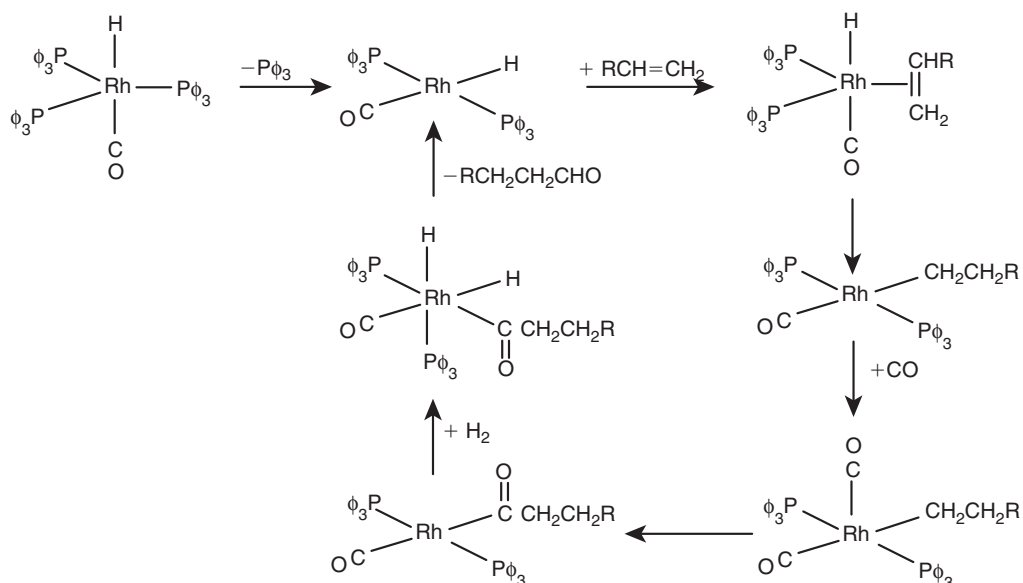

■ FIGURE 22.14 The hydroformylation process utilizing a rhodium catalyst.

It is believed that this reaction proceeds by the formation of a complex in which C_2H_4 is attached to the palladium.

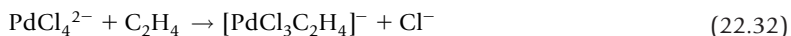

In that complex, it may be that water reacts with the coordinated C_2H_4 to produce a σ -bonded CH_2CH_2OH group rather than an insertion reaction involving an OH group. The aldehyde is formed as H^+ is lost, and the palladium is produced as shown in Eq. (22.31). The palladium chloride catalyst can be recovered (the price of palladium is almost \$500/oz as this is written) by the reaction with $CuCl_2$.



In order to complete the cyclic process, cuprous chloride is oxidized,

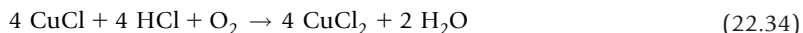

The Wacker process was developed in the late 1950s and is not widely used because other processes are more effective.

22.2.6 Monsanto Process

Acetic acid is a major organic chemical that is manufactured in enormous quantities. It is used in numerous processes that include production of monomers as precursors for polymerization, as a solvent,

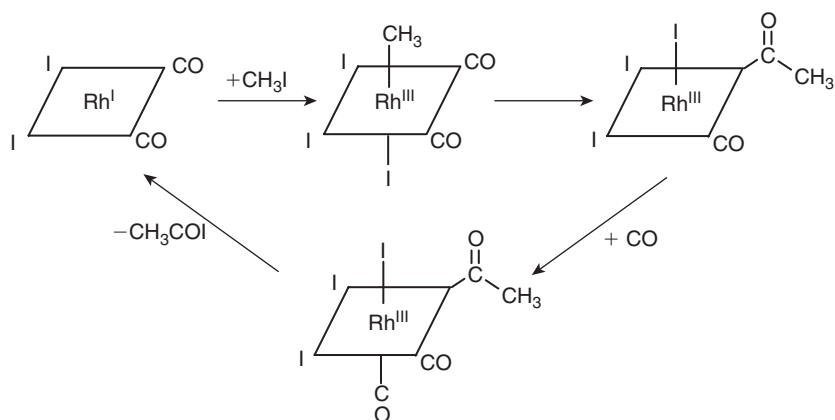

■ FIGURE 22.15 Reaction scheme showing the Monsanto process for making acetic acid.

and many other industrial uses. One of the most important processes for the production of acetic acid is the Monsanto process. This method makes use of a rhodium catalyst that is obtained by a reaction involving RhI_3 .

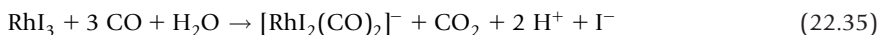

The rate-determining step in the process is believed to be oxidative addition of CH_3I to the rhodium complex, producing an octahedral rhodium +3 complex. The second step entails an insertion reaction in which CO is placed between the metal and the CH_3 group. This step could also involve migration of the CH_3 to a neighboring CO to give a $\text{Rh}-\text{C}(\text{O})\text{CH}_3$ linkage or movement of the CO. After the addition of a molecule of CO, reductive elimination of CH_3COI generates the initial rhodium complex ion. The series of steps can be represented by the scheme shown in Figure 22.15.

The acetyl iodide that is released in the last step of the process reacts with water to produce acetic acid,



In an alternate procedure, the acetyl iodide is converted to methyl acetate if methanol is the solvent for the process.

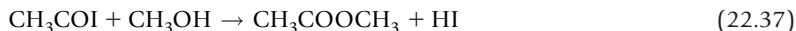

Methyl iodide is regenerated by the reaction

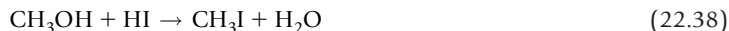

This reaction is efficient because of the soft-soft interaction of CH_3 and I and the hard-hard interaction that leads to the formation of water. As in the case of some other catalytic processes, the idealized

scheme shown in Figure 22.15 does not necessarily represent the complete details of the process. Other products are known to include dimethyl ether and methyl acetate.

The applications of coordination compounds in catalysis that have been shown are by no means the only important cases. In fact, there are numerous reactions in which homogeneous catalysis forms the basis for a great deal of chemistry. From the examples shown, it should be apparent that this is a vast and rapidly developing field. It is also one that is important from an economic standpoint. Although the basic principles have been described in this chapter, the literature related to catalysis is extensive. For further details and more comprehensive reviews of the literature, consult the references listed.

22.3 BIOINORGANIC CHEMISTRY

As analytical methods and techniques for determining molecular structure have become more sophisticated, so has the awareness that a small detail in a structure may have a major role in its function. It has become increasingly apparent that such a small detail may be a metal ion. Thus, the relationship between inorganic chemistry and biochemistry has grown into the recognized discipline of bioinorganic chemistry. Any separation between the fields of chemistry seems to have disappeared, although the distinction is a fine one. For example, adding an (inorganic) chlorine atom to a benzene molecule to produce chlorobenzene does not make it part of "inorganic" chemistry. But if a zinc atom is contained in an enzyme having a molecular weight of 36,000, it suddenly becomes a "bioinorganic" structure. To be sure the molecule contains a metal, but the vast majority of the molecule is still "biochemical" in nature and its reactions are biochemical reactions. Nevertheless, it is appropriate even in an "inorganic" book to show at least a few ways in which metal ions influence biochemical function.

From the outset it is apparent that any attempt to cover a significant part of a discipline as vast as bioinorganic chemistry in a chapter of a book on inorganic chemistry is doomed to failure. Entire volumes (even *multiple* volumes) have been written on the subject. Articles describing work in the field are published in numerous journals that deal with inorganic chemistry, biochemistry, and hybrid areas such as organometallics. Even organizing such a huge amount of information would be a daunting task. Although one may not be able to eat a whole pie, eating one piece can show the flavor and character of the pie. So it is when dealing with an enormous amount of material on a subject. In this section, the approach taken will be to concentrate on a few selected systems to show the flavor and character of the field, but with no attempt at presenting a survey of the whole field. That task is addressed in some of the monographs listed in the suggested references.

22.3.1 Metals and Toxicity

The vast majority of biochemical processes in which a metal plays a role involve a only a relatively small number of metals. Those metals include Na, K, Mg, Ca, Mo, or the first-row transition metals from V to Zn. Only molybdenum could be considered as a heavy metal. It should also be observed that the metal ions constitute those that can be considered as hard or borderline in hardness. It is a general property that ions of heavy metals having low charge (that is to say "soft") are toxic. These include Hg, Pb, Cd, Tl, and numerous others. Some heavy metals bind to groups such as the sulfhydryl ($-SH$) group in enzymes, thereby destroying the ability of the enzyme to promote the reaction in a

normal way. In fact, a rather good relationship exists between the softness of numerous metals and their toxicity. However, beryllium is an extremely toxic metal that is not soft.

Metal toxicity arises from different biochemical functions that are affected by the presence of a toxic substance. In the case of metals, one way that toxicity arises is by substitution for another metal. One instance of this behavior relates to the toxicity of cadmium, which can replace zinc, a metal found in several enzyme systems. When this happens, the enzyme loses its activity. This is believed to be one factor related to the toxicity of beryllium, which can replace magnesium in some structures. There are numerous nonmetallic substances that are toxic with some of the most notable being cyanides, carbon monoxide, and hydrogen compounds of the heavier elements in groups VA and VIA. The toxicity of these materials is related to their being potential ligands that attach to metals in specific structures, which thereby prevents the metals from serving their normal functions. Perhaps the best-known example of this type of behavior is carbon monoxide, which binds to iron in hemoglobin and myoglobin to prevent oxygen molecules from coordinating so that the oxygen-carrying ability of the iron is lost. In still other cases, toxic materials function by causing changes in the structure of some molecule to which the toxic substance is bound. Because there are several ways in which toxins function and many biochemical species with which they can interact, the list of toxic materials is extensive.

Of the metals that were just listed as the major participants in biochemical functions, some (such as Mg and Zn) rarely change oxidation states. Therefore, metals such as these are involved in processes in which there is no redox chemistry taking place. These metals function in some other way. On the other hand, metals such as Fe, Mn, Mo, and Cu can change oxidation states more easily, so they are the metals that participate in redox reactions. For example, the role of iron in oxygen transport requires it to bond to oxygen and thereby, at least formally, to become oxidized in the process. There are other instances of this type of behavior. As mentioned earlier, the list of metals that are involved in the vast majority of biochemical processes is not a particularly long one.

22.3.2 What Metals Do

When analyzing the role of metals (that term will also be used to denote metal ions), it is discovered that they perform functions that can be grouped in a few broad categories. One way in which metals function in biochemical structures is in enzyme activity. Enzymes are high molecular weight proteins (polypeptides) that facilitate reactions by providing a lower-energy pathway for the reaction. An enzyme does that by binding to the reacting structure (known as the *substrate*) so that the enzyme-substrate complex is more reactive than the substrate alone. In fact, the substrate may not even undergo a reaction without the enzyme being present. The following categories summarize how enzymes function as catalysts:

1. *Absolute specificity*, in which the enzyme catalyzes a single reaction.
2. *Group specificity*, in which the enzyme catalyzes reactions of only one type of functional group.
3. *Linkage specificity*, in which the enzyme alters the reactivity of a particular type of bond.
4. *Stereochemical specificity*, in which the enzyme catalyzes reactions of only one stereoisomer of a compound.

Enzymes may not function well or at all unless some other species known as a *cofactor* is present. An enzyme alone is referred to as the apoenzyme and the combination of enzyme and cofactor is known as the holoenzyme. Among the species that function as cofactors are organic compounds that interact with the enzyme. If the organic moiety is strongly attached to the enzyme, it is called a prosthetic group, but if it is loosely bound to the enzyme, it is referred to as a coenzyme. For the purposes of this discussion, the most interesting cofactors are metal ions. Depending on the type of enzyme, the appropriate metal ion cofactor may be Mg^{2+} , Ca^{2+} , K^+ , Fe^{2+} , or Cu^{2+} . A sizeable number of enzymes are sometimes called metalloenzymes because they have active sites that contain a metal.

The presence of some substances may hinder the action of an enzyme. Such substances are known as *inhibitors*, and in some cases the inhibitor may be a metal. It is not necessary to describe all the ways in which an inhibitor may reduce the activity of an enzyme, but one way is by binding to the substrate. This is known as *competitive inhibition*, and it applies to cases in which the inhibitor competes with the substrate in binding to the enzyme. In *noncompetitive inhibition*, the inhibitor binds to the enzyme and alters its structure so it can no longer bind to the substrate. In some instances, certain metal ions function as inhibitors of enzyme action, which can be a cause of the toxicity referred to earlier.

One of the most important metals with regard to its role in enzyme chemistry is zinc. There are several significant enzymes that contain the metal, among which are carboxypeptidase A and B, alkaline phosphatase, alcohol dehydrogenase, aldolase, and carbonic anhydrase. Although most of these enzymes are involved in catalyzing biochemical reactions, carbonic anhydrase is involved in a process that is inorganic in nature. That reaction can be shown as



This reaction is essential in maintaining a constant pH in blood by the bicarbonate buffer system. Carbonic anhydrase, which contains a single zinc atom in its structure, has a molecular weight of about 30,000. In this structure, zinc is surrounded tetrahedrally by three histidine molecules and one water molecule. The exact role of the catalyst is not known, but it is believed to involve hydrolysis that can be represented as



where h represents a coordinated histidine group. With the product being more basic, the reaction with CO_2 is facilitated.

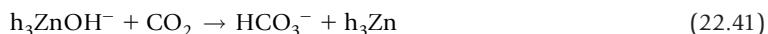

Although the mechanism is not completely understood, the rate of the reaction shown in Eq. (22.39) is increased by several orders of magnitude. Other metal-containing enzymes contain Mg, Mn, K, Cu, Fe, Ni, and Mo.

22.3.3 Photosynthesis

The process by which plants convert water and carbon dioxide into carbohydrates and oxygen is the basis for the chemistry of life as we know it. This process produces the oxygen needed for respiration,

and the carbohydrates produced are the foods for all forms of animal life. When glucose is the product, the overall reaction, which requires energy in the form of electromagnetic radiation, can be summarized by the equation

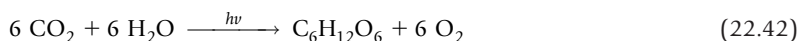

Because the reaction requires energy from light, it is known as *photosynthesis*. The equation looks simple but photosynthesis is anything but that. The structures that are responsible for absorption of light in order for its energy to be used are the chlorophylls, which contain porphyrin-type ligands. The porphyrin structure is derived from the basic unit known as porphin, shown in Figure 22.16.

This structure shows the four nitrogen atoms that provide the electron pairs for forming bonds to metals. The chlorophylls consist of several members of a series, three of which are chlorophyll *a*, *c*, and *d*, which have structures derived from a molecule known as chlorin that is shown in Figure 22.17.

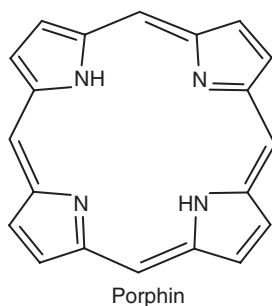

■ FIGURE 22.16 The structure of porphin.

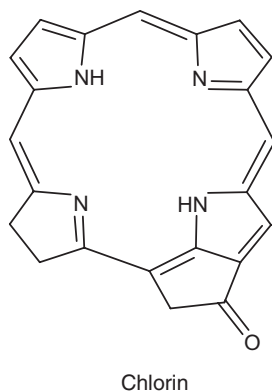

■ FIGURE 22.17 The structure of chlorin.

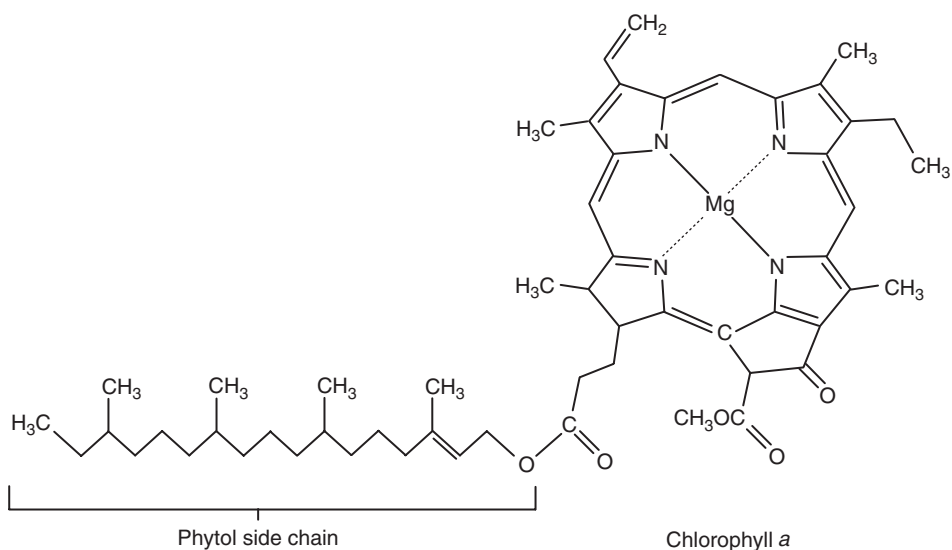

■ FIGURE 22.18 The structure of chlorophyll *a*.

In chlorophyll *a*, which has the structure shown in Figure 22.18, the magnesium is not coplanar with the four nitrogen atoms to which it is bound, but rather it is positioned approximately 30 to 50 pm above the plane of the nitrogen atoms, and it is usually bonded to at least one other ligand such as water. Chlorophyll *a* units are arranged as if the molecules were layers that are held together by hydrogen bonding primarily by the water molecules between them.

The mechanism by which light is absorbed to provide the energy for photosynthesis is complex, but some steps are understood. Chlorophyll absorbs visible light most strongly in two regions that give rise to two absorption bands that are known as the Q band in the red region and the Soret band near the blue-to-ultraviolet region. These bands are common absorptions for most structures that have porphyrin rings. These absorptions are associated with excitation of electrons in the porphyrin ring from π to π^* orbitals. Because the region near the middle of the visible spectrum (associated with a green color) represents a region of low absorption, the leaves appear green. Regions known as organelles are groups of molecules enclosed in a membrane that perform the function of absorbing the light. Chloroplast is the name applied to a region that is involved with photosynthesis. Two such centers are involved in photosynthesis, and they are referred to as photosystem I and photosystem II.

Chloroplasts are the organelles that contain the light-absorbing species and that are contained in the thylakoid membrane within a leaf. There are two functional systems in the overall process. Photosystem I (which is sometimes referred to as P700) is the part of the process that represents the absorption of light having a wavelength of 600 to 700 nm by chlorophyll *a* and other pigments. Photosystem II (which is sometimes referred to as P680) involves the absorption of light having a

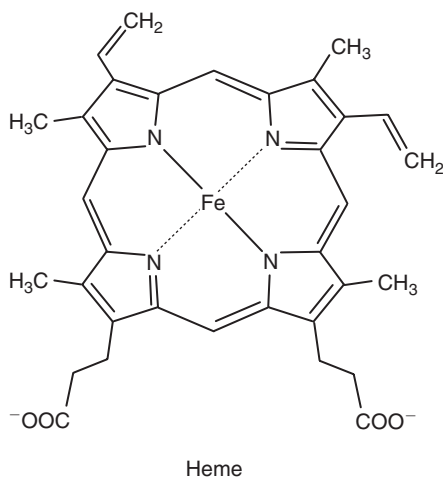

■ FIGURE 22.19 The structure of heme.

wavelength of 680 nm by chlorophyll *a* and *b*. Plants have cells that function in both photosystems I and II, but only photosystem I is present in bacteria that support photosynthesis.

In photosystem I, absorption of a photon leads to an excited state that functions as a reducing agent. The electrons are passed from one species to another with several intermediate species that include ferredoxin (a protein containing iron and sulfur) before finally reducing CO_2 . In photosystem II, electrons are transferred to a series of intermediates, of which a cytochrome *bf* complex is one entity. Ultimately, the transfer of electrons leads to the reaction



The oxygen liberated during photosynthesis comes from water rather than CO_2 .

22.3.4 Oxygen Transport

From the standpoint of the relationship of almost all animal life, the transport of oxygen by heme (also written as haem in some literature) is the basis for respiration. Heme is one of several proteins that contain iron. Others include materials such as myoglobin, ferritin, transferrin, cytochromes, and ferredoxins. In order to transport the oxygen required, the body of an average adult contains approximately 4 grams of iron. In species such as mollusks, oxygen is transported by proteins that contain copper instead of iron. These are sometimes referred to as the copper blues. The structure of heme is shown in Figure 22.19.

In oxygen transport, the gas is absorbed in lung tissue and transported by heme to muscle tissue, where it is transferred to myoglobin. Some oxygen is stored in myoglobin and released during exertion to oxidize glucose. After transferring an oxygen molecule to myoglobin, hemoglobin attaches a molecule

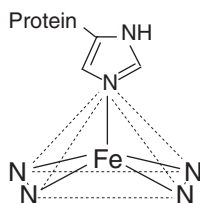

■ **FIGURE 22.20** The structure of heme. Note that the Fe resides above the plane of the four nitrogen atoms.

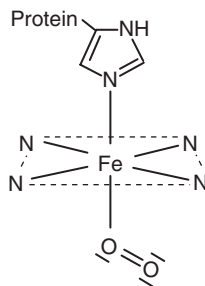

■ **FIGURE 22.21** The heme structure with a molecule of oxygen attached. Note the angular orientation of the oxygen molecule and that the Fe resides in the same plane as the four nitrogen atoms.

of carbon dioxide and transports it to the lungs, from which it is exhaled. The oxygen transport occurs through the arterial network, and carbon dioxide is transported through the veins.

When an oxygen molecule is attached to the iron in the heme structure, the Fe^{2+} changes from high spin to low spin, but the iron remains in the +2 oxidation state. In the heme structure, the Fe^{2+} ion resides above the plane of the four nitrogen atoms in the porphyrin structure, and an imidazole group is attached to the iron on the side away from the plane of the four nitrogen atoms. This structure is shown in Figure 22.20.

When an oxygen molecule is attached to the iron and it changes from high spin to low spin, the size of the Fe^{2+} changes. The ionic radius of Fe^{2+} in the high spin state is approximately 78 pm, but in a low-spin environment it is about 61 pm. This reduction in size is sufficient to allow the Fe^{2+} ion to fit between the nitrogen atoms in the porphyrin ring, and it resides in the same plane as the nitrogen atoms. The structure of heme with an oxygen molecule attached is shown in Figure 22.21.

Hemoglobin is composed of four parts or subunits that are arranged in the form of a helix or spiral that is attached to a heme group. Each heme group contains Fe^{2+} , which is a potential site for attaching an oxygen molecule. The subunits are referred to as the α and β structures so that the four subunits consist of two α and two β structures. The α and β structures consist of different protein chains that are held together by bonds between $-\text{NH}_3^+$ in one chain and $-\text{CO}_2^-$ in another. The protein chains have a glutamic acid residue in normal hemoglobin, but there is a valine group in the hemoglobin if the individual

is afflicted with sickle cell anemia. The subtle difference in structure causes the chains to be folded in a different manner that does not allow oxygen to bond as well, thereby affecting oxygen transport.

By the usual standards of coordinate bond strength, the binding of oxygen to iron in hemoglobin is quite weak. On the other hand, groups such as CN^- , CO, H_2S , and others bind strongly to Fe^{2+} , which makes it impossible for O_2 to attach. As a result, these substances are highly toxic, and they function by preventing the uptake of oxygen.

Myoglobin has a structure that is essentially one-fourth of that of hemoglobin. Therefore, it can bind to only one molecule of oxygen. If myoglobin containing no oxygen is oxidized, the iron is converted to Fe^{3+} , and the structure known as *metmyoglobin* results. This material is not an effective oxygen transport agent.

Oxygen is carried from the lungs to muscle tissue by the hemoglobin, where it is released to the myoglobin. In order for this to happen, it is necessary for the binding of oxygen by myoglobin to be stronger than that of hemoglobin. However, myoglobin has only one iron to bond to oxygen, whereas hemoglobin has four such sites. It is known that when one oxygen molecule bonds to hemoglobin, the other three sites attach oxygen more readily. This is known as the *cooperative effect*, and it is believed to arise as a result of changes in conformation of the chains. When the first oxygen molecule bonds to iron in hemoglobin and the iron moves into the plane of the four nitrogen atoms, the histidine ring is also drawn toward that plane. This results in subtle changes in conformation that make it easier for subsequent oxygen molecules to bind to the remaining iron atoms. Binding of oxygen in hemoglobin depends on the pH of the medium, and the ability to add oxygen decreases as the pH of the medium increases. This relationship is related to the fact that CO_2 and H^+ affect the cooperativity, and the concentrations of these species are pH dependent. Because this behavior was discovered by Christian Bohr, it is referred to as the *Bohr effect*.

Hemoglobin and myoglobin differ in terms of their ability to add oxygen. Myoglobin has a greater attraction for oxygen, but hemoglobin has four times as many binding sites. Therefore, the curves showing the degree of oxygen saturation as a function of oxygen pressure are quite different. Figure 22.22 shows the variation of fraction of the available sites covered as a function of oxygen pressure.

If we represent the equilibrium for myoglobin reacting with oxygen as



the equilibrium constant can be written as

$$K = \frac{[\text{MbO}_2]}{[\text{Mb}] \times p} \quad (22.45)$$

In this expression, p represents the pressure of oxygen (which replaces concentration because oxygen is a gas). If we let f represent the fraction of the available sites that have oxygen attached, the $(1 - f)$ is the fraction of the sites that are still available where oxygen can attach. We can represent the rate of

oxygen binding and the rate of oxygen detachment as being equal at equilibrium, which results in the following relationship:

$$k_a(1 - f)p = k_d f \quad (22.46)$$

In this equation, k_a is the rate constant for attaching oxygen, and k_d is the rate constant for oxygen detaching. Solving for f gives

$$f = \frac{k_a p}{k_d + k_a p} \quad (22.47)$$

The equilibrium constant can be written in terms of the rate constants as

$$K = \frac{k_a}{k_d} \quad (22.48)$$

Solving for k_a , substituting the result in Eq. (22.47), and simplifying gives

$$f = \frac{Kp}{1 + Kp} \quad (22.49)$$

It is interesting to note that this equation is of the same form as that which arises for adsorption of a reacting gas on a solid surface. In adsorption studies, the relationship is known as the Langmuir isotherm. The curve showing uptake of oxygen by hemoglobin fits a different relationship, in which the pressure of oxygen is raised to a power that is equal to about 2.8. From Figure 22.22, it can be seen that at low pressure, the binding of oxygen by myoglobin is much greater than that of hemoglobin. At higher pressure of oxygen, the efficiency of oxygen binding is approximately the same.

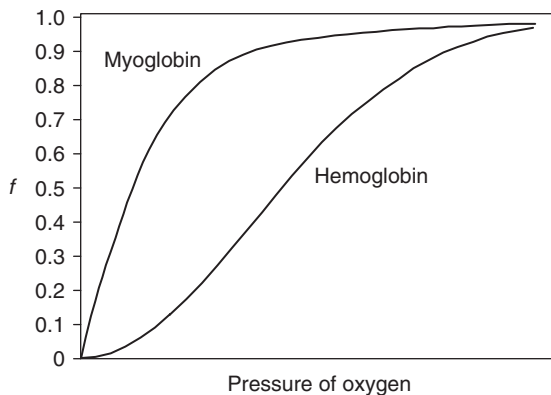

■ **FIGURE 22.22** The qualitative relationship between the oxygen binding curves for hemoglobin and myoglobin.

22.3.5 Cobalamins and Vitamin B₁₂

It was recognized long ago that sheep were subject to a disease that was thought to be anemia. It was later found that the disease, known as pernicious anemia in humans, was the result of a deficiency in cobalt, not iron. Specifically, the deficiency is now recognized to be in vitamin B₁₂, which is a coenzyme that is required for making red blood cells. Cobalamins are derivatives of vitamin B₁₂. The vitamin B₁₂ structure is similar to that of heme in that there are four nitrogen atoms bonded to the metal. However, the nitrogen atoms are contained in a structure known as the corrin ring, which is shown in Figure 22.23.

In the corrin structure, the pyrrole rings are partially reduced and there is one hydrogen atom bonded to nitrogen. Also, there is one CH₂ group missing (on the left-hand side of the structure shown in Figure 22.23). The simplified structure of vitamin B₁₂ is shown in Figure 22.24. The cobalt bonded to the four nitrogen atoms is part of one five-membered chelate ring and one that contains six members in the equatorial positions. The complete structure of vitamin B₁₂ is shown in Figure 22.25.

One of the most unusual features of the vitamin B₁₂ structure is that cobalt is bonded directly to carbon. In heme, iron is bonded to five nitrogen atoms, but the sixth position is vacant until oxygen attaches. In vitamin B₁₂, the sixth position is that bonded to the group indicated by R in the structure

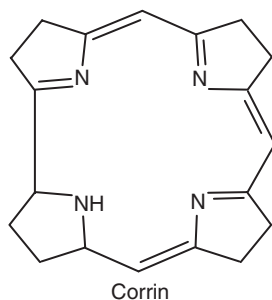

■ FIGURE 22.23 The structure of the corrin ring.

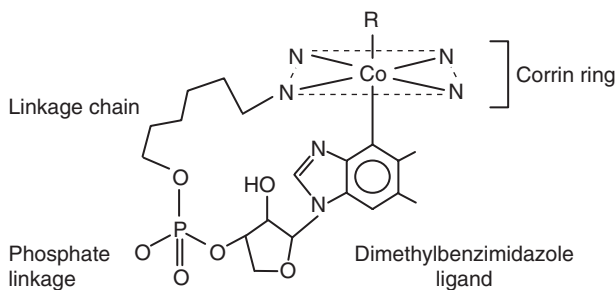

■ FIGURE 22.24 A simplified structure of vitamin B₁₂.

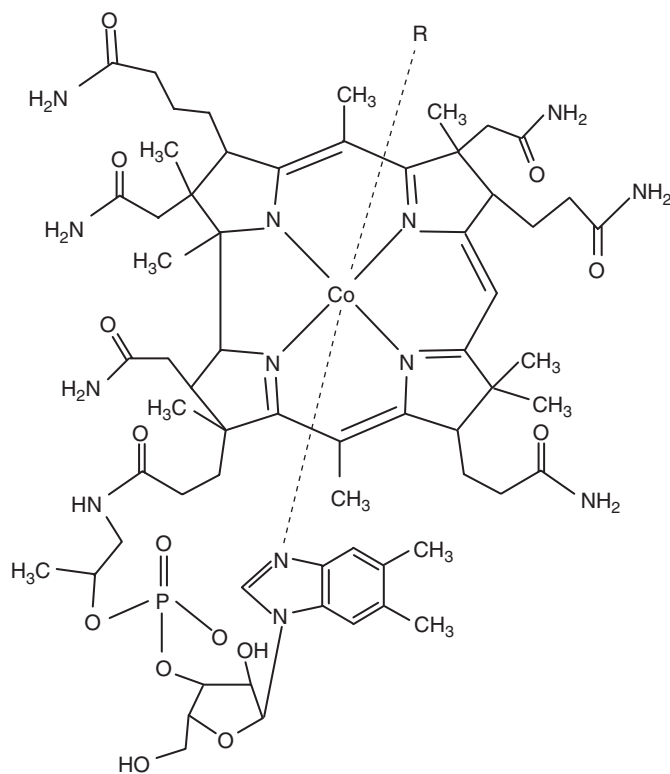

■ FIGURE 22.25 The structure of vitamin B₁₂.

shown. When contained in structures such as the cobalamins, cobalt can be reduced to +2 or even +1 as it is in vitamin B₁₂. There are several types of reactions for which vitamin B₁₂ is a very effective catalyst. These include some that can be classified as exchange, oxidation-reduction, and methylation, and there numerous derivatives known of vitamin B₁₂. One of the interesting reactions that is catalyzed involves moving a group from one atom to another as illustrated by the following:

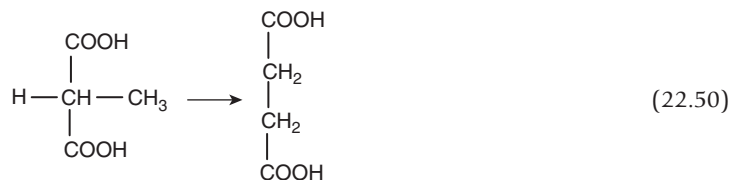

With such reactions, the discussion has progressed rather far from “inorganic” chemistry, as it is easy to do when considering complex biochemical species that contain a metal. In this section, a small amount of the chemistry of the vast area known as bioinorganic chemistry has been shown. It should serve as an indication of the types of structures and reactions that constitute the field.

■ REFERENCES

- Atwood, J. D. (1985). *Inorganic and Organometallic Reaction Mechanisms*. Brooks/Cole, Belmont, CA. A good introductory survey of the field that contains many references. A second edition (1997) was published by Wiley-VCH, New York.
- Bailar, J. C. Jr. (1971). *Am. Scientist* **59**, 586. An older survey by the late Professor Bailar, whose influence is still present in coordination chemistry.
- Basolo, F., and Pearson, R. G. (1967). *Mechanisms of Inorganic Reactions*, 2nd ed. Wiley, New York.
- Bhaduri, S., and Mukesh, D. (2000). *Homogeneous Catalysis: Mechanisms and Industrial Applications*. Wiley-Interscience, New York.
- Chrichton, R. R. (2007). *Biological Inorganic Chemistry: An Introduction*. Elsevier, Amsterdam.
- Cotton, F. A., Wilkinson, G., Murillo, C. A., and Bochmann, M. (1999). *Advanced Inorganic Chemistry*, 6th ed. Wiley, New York. One of the great books in inorganic chemistry. It also contains a great deal of material on organometallic chemistry and catalysis.
- Gray, H. B., Stifel, E. I., Valentine, J. S., and Bertini, I., Eds. (2006). *Biological Inorganic Chemistry: Structure and Reactivity*. University Science Books, Sausalito, CA.
- Greenwood, N. N., and Earnshaw, A. (1997). *Chemistry of the Elements*, 2nd ed. Butterworth-Heinemann, Oxford, UK. A monumental reference work that contains a wealth of information about many types of coordination compounds.
- Heaton, B. (2005). *Mechanisms in Homogeneous Catalysis: A Spectroscopic Approach*. Wiley-VCH, New York.
- Jordan, R. B. (2007). *Reaction Mechanisms of Inorganic and Organometallic Systems*. Oxford University Press, New York.
- Kraatz, H.-R., and Metzler-Nolte, N., Eds. (2006). *Concepts and Models in Bioinorganic Chemistry*. Wiley-VCH, New York.
- Lippard, S. J. (1994). *Principles of Bioinorganic Chemistry*. University Science Books, Sausalito, CA.
- Lukehart, C. M. (1985). *Fundamental Transition Metal Organometallic Chemistry*. Brooks/Cole, Belmont, CA. Contains good coverage on a broad range of topics.
- Nelson, D. J., Li, R., and Brammer, C. (2005). *J. Org. Chem.* **70**, 761. Article dealing with the correlation of hydrogenation of alkenes with ionization potentials.
- Szafran, Z., Pike, R. M., and Singh, M. M. (1991). *Microscale Inorganic Chemistry: A Comprehensive Laboratory Experience*. Wiley, New York. Chapters 8 and 9 provide procedures for syntheses and reactions of numerous transition metal complexes including Wilkinson's catalyst. This book also provides a useful discussion of many instrumental techniques.
- Torrent, M., Solà, M., and Frenking, G. (2000). *Chem. Rev.* **100**, 439. A 54-page high-level paper dealing with theoretical aspects of processes in which metal complexes function as catalysts.
- Van Leeuwen, P. W. (2005). *Homogeneous Catalysis: Understanding the Art*. Springer, New York.

■ QUESTIONS AND PROBLEMS

1. Explain how heating $\text{Rh}(\text{CH}_3)(\text{P}\phi_3)_3$ can produce CH_4 .
2. Write equations for the following reactions:
 - (a) The oxidative addition of CH_3I to $\text{RhCO}(\text{P}\phi_3)_3$
 - (b) The reductive elimination of hydrogen from $\text{HCo}(\text{CO})_4$
 - (c) The oxidative addition of CH_3I to $\text{Co}(\text{CN})_5^{3-}$
3. Write equations to show the hydrogenation of propene with the catalyst $\text{H}_3\text{Co}(\text{P}\phi_3)_3$.

4. Write equations for the following and draw structures for the products. In some cases there may be more than one possible product.
- Insertion of RNC in the MnCH₃ bond
 - Insertion of CS₂ in the M–C bond
 - Insertion of F₂C=CF₂ in the M–H bond
 - Insertion of RNC in the M–X bond
 - Insertion of SO₂ in a M–M bond
5. Explain why complexes containing Mn(I) are more likely to be good catalysts than those containing Mn(III).
6. Consider the reaction (L = triphenylphosphine)

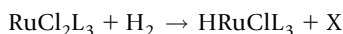

When triethylamine is present, this reaction is enhanced. Explain how and tell what the other product of the reaction, X, would be in that case.

7. Would the reaction

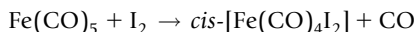

be oxidative addition, reductive elimination, or both? Explain.

8. In a study of the rate at which the ligand X is replaced by CO in the reaction

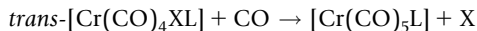

the rate was found to vary with the nature of L as follows:

L	ΔS^\ddagger , e.u.	ΔH^\ddagger , kcal/mol
P(O ϕ) ₃	0	32
CO	23	40
P ϕ 3	12	36
As ϕ 3	22	36

How would you interpret these results?

- How would you explain to a person whose background in chemistry is minimal the difference in behavior of [Co(CN)₆]³⁻ and [Co(CN)₅]³⁻ as potential catalysts?
- Explain why the methyl migration reaction in CH₃Mn(CO)₅ has a rate when DMF is the solvent that is about 50 times that when mesitylene is the solvent. Give a reasonable estimate of the relative rate when the solvent is CHCl₃. Give a reasonable estimate of the relative rate when the solvent is *n*-C₆H₁₄. You may wish to consult Table 6.7.
- For the reaction

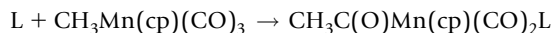

(where L = PBu₃, P(OBu)₃, P ϕ ₃, or P(O ϕ)₃ in separate experiments), the rate is found to be almost independent of the nature of the entering group when the solvent is tetrahydrofuran (THF). Explain what this means in terms of the mechanism of substitution. When the solvent is toluene, the rates are much lower than when

the solvent is THF and there is a considerable difference in rate depending on the entering ligand (the rate when $L = \text{PBu}_3$ is about 16 times that when $L = \text{P}(\text{O}\phi)_3$). How would you interpret these observations?

12. When the reaction between $\text{CH}_3\text{Mn}(\text{CO})_5$ and AlCl_3 takes place, the product has a structure in which there is a ring. Draw the structure of the product. When $\text{AlCl}_2\text{C}_2\text{H}_5$ is present, the rate of the reaction is less than 1% of what it is when AlCl_3 is present. Explain this observation.
13. In the reaction

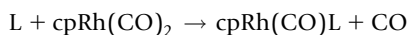

the rate of substitution depends on nature of the entering ligand. For example, when L is PBu_3 , $k = 4.3 \times 10^{-3} \text{ M}^{-1} \text{ sec}^{-1}$, and when L is $\text{P}(\text{O}\phi)_3$, $k = 7.5 \times 10^{-5} \text{ M}^{-1} \text{ sec}^{-1}$. Explain what this means in terms of the mechanism of substitution.

14. It has been suggested that when oxygen binds to iron in hemoglobin, an electron is transferred from iron to the O_2 molecule. Explain what this would mean in terms of oxidation states and charges on the species. What types of evidence would you need to be able to determine if this is what happens?
15. One of the absorption bands in chlorophyll *a* appears at about 700 nm. What energy does this correspond to in kJ/mol? Would this energy be sufficient to break an OH bond? See Table 4.1.
16. When an individual is being treated for exposure to carbon monoxide, oxygen is administered. Explain the basis for this procedure.
17. If accidental ingestion of a toxic heavy metal has occurred, one emergency procedure calls for administering egg white, but a more modern treatment involves administering ethylenediaminetetraacetate. Explain why this treatment is recommended.
18. If you were designing a synthetic oxygen carrier, what characteristics would be required of the metal ion? Suggest some alternative choices to Fe^{2+} and describe the characteristics of coordination compounds of the metal(s) you choose.
19. Describe why nitrites (oxidizing agents) diminish the oxygen-carrying capability of the blood.
20. Explain in terms of the difference in coordination chemistry of the two metals why Ir is not as widely used as Rh.

This page intentionally left blank

Appendix A: Ionization Energies

Element	First ionization potential (kJ mol ⁻¹)	Second ionization potential (kJ mol ⁻¹)	Third ionization potential (kJ mol ⁻¹)
Hydrogen	1312.0	—	—
Helium	2372.3	5250.4	—
Lithium	513.3	7298.0	11,814.8
Beryllium	899.4	1757.1	14,848
Boron	800.6	2427	3,660
Carbon	1086.2	2352	4,620
Nitrogen	1402.3	2856.1	4,578.0
Oxygen	1313.9	3388.2	5,300.3
Fluorine	1681	3374	6,050
Neon	2080.6	3952.2	6,122
Sodium	495.8	4562.4	6,912
Magnesium	737.7	1450.7	7,732.6
Aluminum	577.4	1816.6	2,744.6
Silicon	786.5	1577.1	3,231.4
Phosphorus	1011.7	1903.2	2,912
Sulfur	999.6	2251	3,361
Chlorine	1251.1	2297	3,826
Argon	1520.4	2665.2	3,928
Potassium	418.8	3051.4	4,411
Calcium	589.7	1145	4,910
Scandium	631	1235	2,389
Titanium	658	1310	2,652
Vanadium	650	1414	2,828
Chromium	652.7	1592	2,987
Manganese	717.4	1509.0	3,248.4
Iron	759.3	1561	2,957
Cobalt	760.0	1646	3,232

(Continued)

<i>(Continued)</i>			
Element	First ionization potential (kJ mol⁻¹)	Second ionization potential (kJ mol⁻¹)	Third ionization potential (kJ mol⁻¹)
Nickel	736.7	1753.0	3,393
Copper	745.4	1958	3,554
Zinc	906.4	1733.3	3,832.6
Gallium	578.8	1979	2,963
Germanium	762.1	1537	3,302
Arsenic	947.0	1798	2,735
Selenium	940.9	2044	2,974
Bromine	1139.9	2104	3,500
Krypton	1350.7	2350	3,565
Rubidium	403.0	2632	3,900
Strontium	549.5	1064.2	4,210
Yttrium	616	1181	1,980
Zirconium	660	1257	2,218
Niobium	664	1382	2,416
Molybdenum	685.0	1558	2,621
Technetium	702	1472	2,850
Ruthenium	711	1617	2,747
Rhodium	720	1744	2,997
Palladium	805	1875	3,177
Silver	731.0	2073	3,361
Cadmium	867.6	1631	3,616
Indium	558.3	1820.6	2,704
Tin	708.6	1411.8	2,943.0
Antimony	833.7	1794	2,443
Tellurium	869.2	1795	2,698
Iodine	1008.4	1845.9	3,200
Xenon	1170.4	2046	3,097

(Continued)

<i>(Continued)</i>			
Element	First ionization potential (kJ mol⁻¹)	Second ionization potential (kJ mol⁻¹)	Third ionization potential (kJ mol⁻¹)
Cesium	375.7	2420	—
Barium	502.8	965.1	—
Lanthanum	538.1	1067	—
Cerium	527.4	1047	—
Praseodymium	523.1	1018	—
Neodymium	529.6	1035	—
Promethium	535.9	1052	—
Samarium	543.9	1068	—
Europium	546.7	1085	—
Gadolinium	592.5	1167	—
Terbium	564.6	1112	—
Dysprosium	571.9	1126	—
Holmium	580.7	1139	—
Erbium	588.7	1151	—
Thulium	596.7	1163	—
Ytterbium	603.4	1176	—
Lutetium	523.5	1340	—
Hafnium	642	1440	—
Tantalum	761	(1500)	—
Tungsten	770	(1700)	—
Rhenium	760	1260	—
Osmium	840	(1600)	—
Iridium	880	(1680)	—
Platinum	870	1791	—
Gold	890.1	1980	—
Mercury	1007.0	1809.7	—
Thallium	589.3	1971.0	—

(Continued)

<i>(Continued)</i>			
Element	First ionization potential (kJ mol⁻¹)	Second ionization potential (kJ mol⁻¹)	Third ionization potential (kJ mol⁻¹)
Lead	715.5	1450.4	—
Bismuth	703.2	1610	—
Polonium	812	(1800)	—
Astatine	930	1600	—
Radon	1037	—	—
Francium	400	(2100)	—
Radium	509.3	979.0	—
Actinium	499	1170	—
Thorium	587	1110	—
Protactinium	568	—	—
Uranium	584	1420	—
Neptunium	597	—	—
Plutonium	585	—	—
Americium	578.2	—	—
Curium	581	—	—
Berkelium	601	—	—
Californium	608	—	—
Einsteinium	619	—	—
Fermium	627	—	—
Mendelevium	635	—	—
Nobelium	642	—	—

Numbers in parentheses are approximate values.

Appendix B: Character Tables for Selected Point Groups

C_2	E	C_2		
A	1	1	z, R_z	x^2, y^2, z^2
B	1	-1	x, y, R_x, R_y	yz, xz

C_s	E	σ_h		
A'	1	1	x, y, R_z	x^2, y^2, z^2, xy
A''	1	-1	z, R_x, R_y	yz, xz

C_i	E	i		
A_g	1	1	R_x, R_y, R_z	$x^2, y^2, z^2, xy, xz, yz$
A_u	1	-1	x, y, z	

C_{2v}	E	C_2	$\sigma_v(xz)$	$\sigma_v(yz)$		
A_1	1	1	1	1	z	x^2, y^2, z^2
A_2	1	1	-1	-1	R_z	xy
B_1	1	-1	1	-1	x, R_y	xz
B_2	1	-1	-1	1	y, R_x	yz

C_{3v}	E	$2C_3$	$3\sigma_v$		
A_1	1	1	1	z	$x^2 + y^2, z^2$
A_2	1	1	-1	R_z	
E	2	-1	0	$(x, y), (R_x, R_y)$	$(x^2 - y^2, xy), (xz, yz)$

C_{4v}	E	$2C_4$	C_2	$2\sigma_v$	$2\sigma_d$		
A_1	1	1	1	1	1	z	$x^2 + y^2, z^2$
A_2	1	1	1	-1	-1	R_z	
B_1	1	-1	1	1	-1		$x^2 - y^2$
B_2	1	-1	1	-1	1		xy
E	2	0	-2	0	0	$(x, y), (R_x, R_y)$	(xz, yz)

822 Appendix B: Character Tables for Selected Point Groups

C_{2h}	E	C_2	i	σ_h		
A_g	1	1	1	1	R_z	x^2, y^2, z^2, xy
A_u	1	1	-1	-1	z	
B_g	1	-1	1	-1	R_x, R_y	xz, yz
B_u	1	-1	-1	1	x, y	

$C_{\infty v}$	E	$2C_{\infty}$	$\infty\sigma_v$		
$A_1(\Sigma^+)$	1	1	1	z	$(x^2 + y^2, z^2)$
$A_2(\Sigma^-)$	1	1	-1	R_z	
$E_1(\Pi)$	2	$2 \cos \phi$	0	$(R_x, R_y), (x, y)$	(xz, yz)
$E_2(\Delta)$	2	$2 \cos 2\phi$	0		$(x^2 - y^2, xy)$
$E_3(\phi)$	2	$2 \cos 3\phi$	0		

D_2	E	$C_2(z)$	$C_2(y)$	$C_2(x)$		
A	1	1	1	1		x^2, y^2, z^2
B_1	1	1	-1	-1	z, R_z	xy
B_2	1	-1	1	-1	y, R_y	xz
B_3	1	-1	-1	1	x, R_x	yz

D_3	E	$2C_3$	$3C_2$		
A_1	1	1	1		$x^2 + y^2, z^2$
A_2	1	1	-1	z, R_z	
E	2	-1	0	$(x, y), (R_x, R_y)$	$(xz, yz), (x^2 - y^2, xy)$

D_{2h}	E	$C_2(z)$	$C_2(y)$	$C_2(x)$	i	$\sigma(xy)$	$\sigma(xz)$	$\sigma(yz)$		
A_g	1	1	1	1	1	1	1	1		x^2, y^2, z^2
B_{1g}	1	1	-1	-1	1	1	-1	-1	R_z	xy
B_{2g}	1	-1	1	-1	1	-1	1	-1	R_y	xz
B_{3g}	1	-1	-1	1	1	-1	-1	1	R_x	yz
A_u	1	1	1	1	-1	-1	-1	-1		
B_{1u}	1	1	-1	-1	-1	-1	1	1	z	
B_{2u}	1	-1	1	-1	-1	1	-1	1	y	
B_{3u}	1	-1	-1	1	-1	1	1	-1	x	

D_{3h}	E	$2C_3$	$3C_2$	σ_h	$2S_3$	$3\sigma_v$		
A_1'	1	1	1	1	1	1		$x^2 + y^2, z^2$
A_2'	1	1	-1	1	1	-1	R_z	
E'	2	-1	0	2	-1	0	(x, y)	$(x^2 - y^2, xy)$
A_1''	1	1	1	-1	-1	-1		
A_2''	1	1	-1	-1	-1	1	z	
E''	2	-1	0	-2	1	0	(R_x, R_y)	(xz, yz)

D_{4h}	E	$2C_4$	C_2	$2C_2'$	$2C_2''$	i	$2S_4$	σ_h	$2\sigma_v$	$2\sigma_d$		
A_{1g}	1	1	1	1	1	1	1	1	1	1		$x^2 + y^2, z^2$
A_{2g}	1	1	1	-1	-1	1	1	1	-1	-1	R_z	
B_{1g}	1	-1	1	1	-1	1	-1	1	1	-1		$x^2 - y^2$
B_{2g}	1	-1	1	-1	1	1	-1	1	-1	1		xy
E_g	2	0	-2	0	0	2	0	-2	0	0	(R_x, R_y)	(xz, yz)
A_{1u}	1	1	1	1	1	-1	-1	-1	-1	-1		
A_{2u}	1	1	1	-1	-1	-1	-1	-1	1	1	z	
B_{1u}	1	-1	1	1	-1	-1	1	-1	-1	1		
B_{2u}	1	-1	1	-1	1	-1	1	-1	1	-1		
E_u	2	0	-2	0	0	-2	0	2	0	0	(x, y)	

D_{5h}	E	$2C_5$	$2C_5^2$	$5C_2$	σ_h	$2S_5$	$2S_5^3$	$5\sigma_v$		
A_1'	1	1	1	1	1	1	1	1		$x^2 + y^2, z^2$
A_2'	1	1	1	-1	1	1	1	-1	R_z	
E_1'	2	$2 \cos 72^\circ$	$2 \cos 144^\circ$	0	2	$2 \cos 72^\circ$	$2 \cos 144^\circ$	0	(x, y)	
E_2'	2	$2 \cos 144^\circ$	$2 \cos 72^\circ$	0	2	$2 \cos 144^\circ$	$2 \cos 72^\circ$	0		$(x^2 - y^2, xy)$
A_1''	1	1	1	1	-1	-1	-1	-1		
A_2''	1	1	1	-1	-1	-1	-1	1	z	
E_1''	2	$2 \cos 72^\circ$	$2 \cos 144^\circ$	0	-2	$-2 \cos 72^\circ$	$-2 \cos 144^\circ$	0	(R_x, R_y)	(xz, yz)
E_2''	2	$2 \cos 144^\circ$	$2 \cos 72^\circ$	0	-2	$-2 \cos 144^\circ$	$-2 \cos 72^\circ$	0		

824 Appendix B: Character Tables for Selected Point Groups

D_{2d}	E	$2S_4$	C_2	$2C_2'$	$2\sigma_d$		
A_1	1	1	1	1	1		$x^2 + y^2, z^2$
A_2	1	1	1	-1	-1	R_z	
B_1	1	-1	1	1	-1		$x^2 - y^2$
B_2	1	-1	1	-1	1	z	xy
E	2	0	-2	0	0	$(x, y), (R_x, R_y)$	(xz, yz)

D_{3d}	E	$2C_3$	$3C_2$	i	$2S_6$	$3\sigma_d$		
A_{1g}	1	1	1	1	1	1		$x^2 + y^2, z^2$
A_{2g}	1	1	-1	1	1	-1	R_z	
E_g	2	-1	0	2	-1	0	(R_x, R_y)	$(x^2 - y^2, xy), (xz, yz)$
A_{1u}	1	1	1	-1	-1	-1		
A_{2u}	1	1	-1	-1	-1	1	z	
E_u	2	-1	0	-2	1	0	(x, y)	

S_4	E	S_4	C_2	S_4^3		
A	1	1	1	1	R_z	$x^2 + y^2, z^2$
B	1	-1	1	-1	z	$x^2 - y^2, xy$
E	1	$\pm i$	-1	$\pm i$	$(x, y), (R_x, R_y)$	(xz, yz)

T_d	E	$8C_3$	$3C_2$	$6S_4$	$6\sigma_d$		
A_1	1	1	1	1	1		$x^2 + y^2 + z^2$
A_2	1	1	1	-1	-1		
E	2	-1	2	0	0		$(2z^2 - x^2 - y^2, x^2 - y^2)$
T_1	3	0	-1	1	-1	(R_x, R_y, R_z)	
T_2	3	0	-1	-1	1	(x, y, z)	(xz, yz, xy)

O_h	E	$8C_3$	$6C_2$	$6C_4$	$3C_2$	i	$6S_4$	$8S_6$	$3\sigma_h$	$6\sigma_d$		
A_{1g}	1	1	1	1	1	1	1	1	1	1		$x^2 + y^2 + z^2$
A_{2g}	1	1	-1	-1	1	1	-1	1	1	-1		
E_g	2	-1	0	0	2	2	0	-1	2	0		$(2z^2 - x^2 - y^2,$ $x^2 - y^2)$
T_{1g}	3	0	-1	1	-1	3	1	0	-1	-1	(R_x, R_y, R_z)	
T_{2g}	3	0	1	-1	-1	3	-1	0	-1	1		(xz, yz, xy)
A_{1u}	1	1	1	1	1	-1	-1	-1	-1	-1		
A_{2u}	1	1	-1	-1	1	-1	1	-1	-1	1		
E_u	2	-1	0	0	2	-2	0	1	-2	0		
T_{1u}	3	0	-1	1	-1	-3	-1	0	1	1	(x, y, z)	
T_{2u}	3	0	1	-1	-1	-3	1	0	1	-1		

I_h	E	$12C_5$	$12C_5^2$	$20C_3$	$15C_2$	i	$12S_{10}$	$12S_{10}^3$	$20S_6$	15σ		
A_g	1	1	1	1	1	1	1	1	1	1		$x^2 + y^2 + z^2$
T_{1g}	3	x	y	0	-1	3	y	x	0	-1	$(R_x, R_y,$ $R_z)$	
T_{2g}	3	y	x	0	-1	3	x	y	0	-1		
G_g	4	-1	-1	1	0	4	-1	-1	1	0		
H_g	5	0	0	-1	1	5	0	0	-1	1		$(2x^2 - x^2 - y^2,$ $x^2 - y^2, xy,$ $xy, yz)$
A_u	1	1	1	1	1	-1	-1	-1	-1	-1		
T_{1u}	3	x	y	0	-1	-3	$-y$	$-x$	0	1	(x, y, z)	
T_{2u}	3	y	x	0	-1	-3	$-x$	$-y$	0	1		
G_u	4	-1	-1	1	0	-4	1	1	-1	0		
H_u	5	0	0	-1	1	-5	0	0	1	-1		

where $x = \frac{1}{2}(1 + \sqrt{5})$ and $y = \frac{1}{2}(1 - \sqrt{5})$.

This page intentionally left blank

Index

A

- Absorption spectra, crystal field splitting in, 619–620
- Acetaldehyde, ethylene conversion to, 799–800
- Acetic acid
chloro-substituted, 296–297
hydrogen bonding of, 196
infrared spectra of, 198–199, 199f
Monsanto process production of, 800–802, 801f
- Acetone, enolization reaction of, 311
- Acetylacetone
acidity of, 299
coordination compounds with, 696–697
enolization of, 690–691
- Acetylene
acidity of, 297
lithium reaction with, 399
- Acetylides, 449
- Acid(s)
catalytic behavior of, 309–313
dissociation constant of, 291t
Drago four-parameter equation for, 325, 326t
hard and soft, 314
hydrolysis and, 294–295
hydronium ion in, 289
neutralization of, 292
as proton donor, 292
strength of, 290, 295–300
chloro-substituted acetic acids, 296–297
dissociation constants, 296, 309
inductive effect, 297–298
Pauling's rule, 296
- Acid-base chemistry, 289–327
- Arrhenius theory, 289–292, 291t
- Brønset-Lowry theory, 292–296
- catalytic behavior in, 309–313
- Drago four-parameter equation, 324–327, 326t
- electronic polarizabilities, 323–324, 324t
- hard-soft interaction principle, 313–323, 314t, 315t
hydrogen bonding, 315–316
linkage isomers, 316
solubility, 316–318, 317f
- hydrolysis in, 294–295
Lewis theory, 305–309
in liquid ammonia, 338–340
oxide character, 301–302, 302f
proton affinity, 302–305, 304f, 305t
strength of acids and bases, 296–300
- Acid-catalyzed reactions, of
coordination compounds, 712–713
- Actinides, 356
- Activation energy, 717
anation and, 730
- Additional bonding, in coordination compounds, 606
- Adiabatic ionization, 83
- Advanced composites, carbon in, 447
- Alcohols
acidity of, 299
Grignard reagent and, 401
hydrogen bonding of, 194–195
formation of, 201–202, 202f
HSIP, 315–316
infrared study of, 197–199, 198t
solvent and, 199–200, 199f
metal halide reaction with, 760
- Aliphatic alcohols, acidity of, 299–300
- Alkali halides
conductivity in, 283, 283f
crystal formation properties for, 213, 213t
Frenkel defect, 242
ionic radii and geometry of, 222–223, 223t
- Alkali metals. *See* Group IA
- Alkaline battery, 382–383
- Alkaline earths. *See* Group IIA
- Alkenes
coordination compounds with, 696
hydrogenation of, 792–793, 793f
insertion reaction of, 793f, 794
isomerizations of, 796, 797f
metal alkene complexes
preparation of, 760–761
structure and bonding of, 754–759, 754f, 755f, 756f, 757f, 758f, 759f
metal carbonyl reaction with, 760
metal halide reaction with, 760
polymerization of, 797–798, 798f
substitution reaction of, 760
trans effect of, 755–756
- Alkyl group transfer reactions, 397
- Alkyl halides, metal reactions with, 396–397
- Alkyl phosphites, 512
- Alkylation, Lewis acid catalysis of, 311–312
- Alloys, 356, 376–379, 379t
categories of, 376
of copper, 377
of iron, 373, 377–378
production of, 377
superalloys, 378–379, 379t
of titanium, 373
- Allred-Rochow electronegativity, 89
- Allyl, orbital calculation for, 165–167
- Alpha decay, 28
- Alumina. *See* Aluminum oxide
- Aluminosilicates, 472–473, 474f
- Aluminum, 370–372
beryllium diagonal relationship to, 370–371
halides of, 371–372
organometallic compounds of, 403–408, 404f, 405t
preparation of, 404
properties of, 403, 405t
structure of, 404–405, 404f
production of, 370
- Aluminum alkyls, 127
- Aluminum chloride, 371–372
- Aluminum ion, hydration enthalpy of, 231–232
- Aluminum oxide
acid-base character of, 302, 302f
catalysis by, 313
crystal structure of, 228
sintering of, 281
- Ambidentate ligands, 583, 590
back donation of, 608–609
- Amides, nitrides from, 482
- Amine salts, coordination compound synthesis with, 699–701
- Ammonia, 482–484, 483t. *See also* Liquid ammonia
complexes of, distribution diagram for, 683–685, 684f, 684t
compounds of, 483t

- Ammonia (*Contd.*)
 decomposition of, 234–235
 crystal structure of compounds of, 227
 dipole moment and, 181–182, 182t
 ethylenediamine v., 689
 hydrogen bonding of, 195, 196t
 symmetry of, 139–140
 elements, 150–151, 151f
- Ammonium carbonate, solid-state reactions with, 271
- Ammonium chloride, acidic behavior of, 295–296
- Ammonium nitrate, production of, 517
- Ammonium salts, 484
- Ammonium sulfate, decomposition of, 235
- Ammonolysis reactions, 338
- Amphiboles, 471f, 472
- Anation, 728–730, 729t
- Angular momentum vector, of atom, 56, 61
- Anions, 22
- Antibonding orbitals, 70–71, 70f, 76
 back bonding into, 605–606, 606f
 in hydrogen and H_2^+ molecules, 74
 wave function for, 76–77
- Anticubic structure, 578, 579f
- Antielectron, 27–28
- Antifluorite structure, of crystals, 225, 225f
- Antimony
 chemistry of, 497–518
 halides of, 503–509, 505t, 507f
 hydrides of, 499–500, 499t
 occurrence of, 497
 oxides of, 501–502
 preparation of, 498
 sulfides of, 503
- Apatite, 249, 497
- Apoenzyme, 804
- Aqua complexes, 628–629, 628t
- Aqua regia, 496
- Aquo compounds, 482, 483t
- Archimedes antiprism, 578, 579f
- Argon
 energy of interaction for, 189
 formation of, 565
 properties of, 566, 567t
- Aromatic complexes, 770–772
- Arrhenius theory, of acid-base chemistry, 289–292, 291t
- Arsenic
 chemistry of, 497–518
 halides of, 503–509, 505t, 507f
 hydrides of, 499–500, 499t
 occurrence of, 497
 organometallic compounds of, 409–410
 oxides of, 501–502
 preparation of, 498
 sulfides of, 503, 503f
- Associative mechanism, of substitution reactions, 706, 706f
- Atomic numbers (Z), 22
 electron affinity as function of, 18–20, 19f, 19t
 ionization potentials and, 17–18
 nuclear stability relationship to, 24–25
- Atomic orbital
 in metals, 356–357, 357f
 molecular orbitals from, combinations, 153
- Atomic physics, early experiments in, 3–7, 4f, 6f
- Atomic radii, 20–21, 20t
 of lanthanides, 388–389, 388t, 390f
- Atomic structure, quantum mechanics and, 35–62
 electron configurations, 52–56, 53t, 54t, 57f, 58–59t
 helium atom, 49–51, 49f
 hydrogen atom, 44–49, 46t, 47f, 48f
 postulates, 35–43, 38t, 42f
 Slater wave functions, 51–52
 spectroscopic states, 56–62, 59f, 61t
- Atoms
 Bohr model of, 11–15, 12f, 15f
 electronic properties of, 17–22, 19f, 19t, 20t, 21f
 plum pudding model of, 5–7
 structure of, 3–7, 4f, 6f
 early experiments in atomic physics, 4f, 6f
- Attraction energy, in crystal formation, 214–216, 215f
- Avrami-Erofeev rate law
 for nucleation, 261–262, 262t
 for phase transitions, 273
 sigmoidal profile, 262–263, 263f
- Azide ion
 bonds in, 486
 preparation of, 486–487
 properties of, 485–486
- B
- Back donation
 of coordination compounds, 604–609, 605f, 606f, 608f
 of dihydrogen, 612
 trans effect and, 723–724
- Baird twist, 731, 731f
- Ballhausen-Gray approximation, 72–73
- Balmer's series, 8–9
- Band of stability, of nuclei, 26f, 30–32
- Band theory, of metallic elements, 356–359, 357f, 358f
- Base(s)
 catalytic behavior of, 309–313
 Drago four-parameter equation for, 325, 326t
 hard and soft, 314
 neutralization of, 292
 properties of, 290–292
 as proton acceptor, 292
 strength of, 296–300
- Base-catalyzed reactions, of coordination compounds, 713–715
- Basic anhydrides, 301
- Battery
 alkaline, 382–383
 lead for, 468
 lithium, 347–348
- Bauxite, 228, 370
- Benitoite, 469, 469t, 472
- Benzene
 borazine v., 431
 catalysis of bromination of, 312
 complexes, 770–772
- Benzenetricarbonylchromium, 771
- Benzyne, base catalysis of, 311
- Berry pseudorotation, 101–102, 506–507, 507f
- Beryllium, 370–372
 aluminum diagonal relationship to, 370–371
 organometallic compounds of, 402–403, 403f
- Beryllium chloride, 125, 371–372
- Beryllium dimethyl, structure of, 127
- Beryllium oxide, 364

- Beta decay, 26–27, 30
 Beta emission, 27–28, 30
 Binary metal carbonyls, 739–742, 740t
 structures of, 742–743, 743f
 Binding energy
 of electron in molecular formation, 68, 74
 of electron to helium nucleus, 50
 nuclear, 22–24, 24f
 per nucleon, 23–24, 24f
 Bioinorganic chemistry, 802–812
 cobalamins and vitamin B₁₂, 811–812, 811f, 812f
 metal functions, 803–804
 metals and toxicity, 802–803
 oxygen transport, 807–810, 807f, 808f, 810f
 photosynthesis, 804–807, 805f, 806f
 Bismuth
 halides of, 503–509, 505t, 507f
 hydrides of, 499–500, 499t
 occurrence of, 497
 oxides of, 501–502
 sulfides of, 503
 Bismuth glance, 497
 Bjerrum's method, for coordination compounds, 675–681
 Blackbody radiation, 9–10
 Body-centered cubic structure, of metals, 237f, 238
 Bohr effect, in hemoglobin, 809
 Bohr magneton, 597
 Bohr model, of atom, 11–15, 12f, 15f
 Bohr radius, 40–42
 Boiling point
 hydrogen bonding and, 195–197, 196t, 197f
 London forces and, 189–191, 190f
 van der Waals equation and, 192, 192f
 Boltzmann distribution law
 dipole arrangements and, 185
 ionic compound solubility and, 233–234, 234f
 Schottky defects, 241
 for solid diffusion, 279
 Bond angle
 of group VA hydrides, 499–500
 of group VIA hydrogen compounds, 526–527, 527t
 molecular orbitals and, 158–161, 161f
 resonance and, 107
 of *sp*² hybrid orbital, 97–98
 of *sp*³ hybrid orbital, 99–100
 of *sp*³*d* hybrid orbital, 100–102
 Bond energies
 average, 130t
 bond order relationship with, 80
 calculation of, 73
 electronegativity for determination of, 87–91, 88t, 90f
 in H₂+ molecule, 74
 for hydrogen molecule, 65, 71, 75
 structure determination with, 129–133
 Bond length
 in boron halides, 425, 425t
 electronegativity effects on, 90–91
 formal charge and, 109, 111–113
 for hydrogen molecule, 65, 75
 Jahn-Teller distortion and, 630–631
 resonance and, 106–108
 Bond moments, for dipole moment approximation, 180–181
 Bond order, 80
 of allyl, 167
 calculation of, 164–165
 of carbon monoxide, 744
 in coordination complexes, 606
 of ethylene, 165
 of nitric oxide, 490–491
 Bond strengths, 201
 hydrogen bonding, 200–201
 Bonding, 95–133
 average bond energies, 130t
 bond assignment, 105–106
 bond energies and, 129–133
 coordinate, 592–597, 593t
 delocalized, 106
 of electron-deficient structures, 125–127
 formal charge and, 105–117
 bond length and, 109, 111–113
 procedure for, 108
 resonance and, 109–111
 resonance of, 105–117
 bond assignment, 105–106
 drawing of, 107–108
 formal charge and, 109–111
 single bonds, 95–105, 96f, 130t
 angles of, 97–100
 determination of, 97
 inversion, 99–100
 reactivity and, 102–103
 structures of, 95–97, 96f
 VSEPR, 100–101
 Bonding orbitals, 70–71, 70f, 76
 in hydrogen and H₂+ molecules, 74–75
 wave function of, 73, 75–76, 84–86
 Boranes, 419, 427
 polyhedral, 428–430, 429f, 430f, 431f
 Borax, 422, 433
 Borazine, 129, 431–433
 Borazon, 431
 Borides, 424–425
 Born-Haber cycle
 for crystal formation, 212
 ionic compound solubility and, 230–231
 for sodium chloride, 212–213
 Born-Landé equation
 Kapustinskii equation v., 219
 for lattice energy, 220
 Boron
 applications of, 423–424
 bonding of, 424
 borides, 424–425
 chemistry of, 422–433
 electron-deficient molecules of, 125–126
 elemental, 423–424, 423f
 halides of, 425–426, 425t
 hydrides of, 419–420, 426–428, 428f
 nitrides of, 431–433, 432f
 polyhedral boranes, 428–430, 429f, 430f, 431f
 structures with, 121, 129
 Boron nitride
 applications of, 431
 structure of, 431, 432f
 Boron trifluoride
 coordinate system for, 155–156, 156f
 molecular orbital diagram for, 156, 156f
 Borosilicate glass, 468
 Bridging groups, 582, 585
 Bromination, chelate rings and, 691

- Bromine
 occurrence of, 546
 oxides of, 557–560
 preparation of, 546
 production of, 547
 properties of, 548, 548t
 Bromine pentafluoride, 553
 Bromine trifluoride, 551, 553
 Brønset-Lowry theory, 292–296
 Lewis theory v., 306–307
 Brønsted sites, of zeolites, 473
 Buckminsterfullerene. *See* Fullerene
 Butadiene, as electron donor, 758
 Butyric acid, 297
- C**
- C_{∞} axis of rotation, 142–143
 C_1 axis of rotation, 138
 C_1 symmetry, 146t
 C_2 axis of rotation, 138, 140, 142–143
 C_2 symmetry, 146t
 C_{2v} symmetry, 138–139, 146t
 character table for, 151, 152, 152t
 multiplication table for, 151, 151t
 C_3 axis of rotation, 140–141, 141f, 144
 C_{3v} symmetry, 139–140, 144, 146t
 multiplication table for, 150–151, 151t
 C_4 axis of rotation, 141–142, 144
 Cadmium
 complexes of, distribution diagram for, 683–685, 684f, 684t
 organometallic compounds of, 410–411
 properties of, 374, 375t
 Calcite, 249, 367
 Calcium carbide, 366, 449–450
 Calcium carbonate
 application of, 439–440, 453–454
 solid-state reactions with, 271–272
 sources of, 367
 Calcium cyanamide, 366, 457
 Calcium fluoride, 225, 225f
 Calcium hydroxide, 364, 439
 Calcium hypochlorite, 561
 Calcium phosphate
 in fertilizer, 516–517
 sulfuric acid reaction with, 517
 Capped trigonal prism, 578, 579f
 Carbide light, 449
 Carbides, 449–450
 of aluminum, 372
 of group IA and IIA, 365–367
 Carbon
 carbides, 449–450
 chemical behavior of, 448–449
 chemistry of, 444–459
 elemental, 444–447, 445f, 446f
 halides of, 456
 Hückel method for
 allyl, 165–167
 cyclopropene, 168–169
 ethylene, 162–165
 pyrrole, 171–174
 in industry, 447–448
 fibers, 447–448
 manufactured carbon, 448
 in iron alloys, 378
 nitrides of, 456–458
 phase transition of, 272
 polymorphism of, 243–244
 structures with, 121, 122f
 sulfides of, 459
 tricarbon dioxide, 455–456
 Carbon atom, ground state of, 60–61
 Carbon dioxide, 452–455
 Grignard reagent and, 402
 production of, 452
 silicon dioxide structure v., 132
 Carbon disulfide, 459
 Carbon monosulfide, 459
 Carbon monoxide, 450–451
 amphoteric behavior of, 441
 bonding of, 113
 in coordination compounds, 604–605, 605f, 607–608
 metal bonding of, 744–748, 745f
 metal carbonyls
 binary, 739–742, 740t
 preparation of, 747–748
 reactions of, 748–754
 structures, 742–743, 742f, 743f, 744f
 problems with, 451
 production of, 450–451
 Carbon suboxide. *See* Tricarbon dioxide
 Carbon tetrachloride, 456
 Carbonates, 452–455
 formation of, 452–453
 of group IA and IIA, 367
 heating of, 453
 lime production with, 453
 solid-state reactions with, 270–271
 Carbonic anhydrase enzymes, 410
 Carbonyl hydrides, 752–754
 Carbonylate anions, 751–752
 Carborundum. *See* Silicon carbide
 Carboxylic acid, preparation of, 402
 Carboxypeptidase A, 410
 Cassiterite, 463, 467
 Catalytic behavior, of acids and bases, 309–313
 Catalytic processes
 description of, 779
 elementary steps in, 780–792
 insertion reactions, 788–792, 790f, 791f, 792f
 ligand substitution, 781
 oxidative addition, 781–784
 reductive elimination, 788
 homogeneous, 792–802
 alkene isomerization, 796, 797f
 alkene polymerization, 797–798, 798f
 hydroformylation, 798–799, 799f, 800f
 hydrogenation, 792–796, 793f
 Monsanto process, 800–802, 801f
 Wacker process, 799–800
 Catenation, 117
 of carbon, 444
 of sulfur, 525
 Cathode ray tube, 4–5, 4f
 Cations, 22
 Center of symmetry, 142–143
 Cesium chloride, crystal structure of, 226, 226f
 Charge, of electron, 5–6
 Charge density, ion size and, 22
 Charge separation, dipole forces and, 184
 Charge transfer absorption, 666–668, 667f
 Charged particles, in magnetic field, 4–5
 Charge-to-mass ratio, of electron, 5
 Charge-to-size ratio, of first-row transition metals, 599
 Chelate effect, in coordination compounds, 689–690
 Chelate rings
 coordination compound stability and, 690–691

- racemization and, 731
- Chelates, 581
- Chelating agent, 581
- Chevre phases, 376
- Chiral structures, of coordination compounds, 587
- Chlorin, 805, 805f
- Chlorine
- occurrence of, 546
 - oxides of, 557–560
 - preparation of, 546
 - production of, 547
 - properties of, 548, 548t
- Chlorine dioxide, 558–559
- Chlorine pentafluoride, 551, 552
- Chlorine perchlorate, 559
- Chlorine trifluoride, 550–551, 553
- Chloroapatite, 249, 497
- Chlorophyll, 806, 806f
- Chloroplasts, 806
- Chromates, 381–382
- Chromium
- applications of, 373
 - carbonyl of, 742, 742f
 - EAN rule and, 741
 - electron transfer and, 726–727
 - halides of, 385–386
 - in iron alloys, 378
 - Jahn-Teller distortion, 631
 - oxides of, 381–382
 - oxyhalides of, 386
 - properties of, 373, 373t, 374f
- Chromium complexes, 594, 603, 607–608
- Chromyl halides, 386
- Cisplatin, 580
- Closest packing, of metal structures, 237, 239t
- Cobalamins, vitamin B₁₂ and, 811–812, 811f, 812f
- Cobalt
- applications of, 373
 - carbonyl of, 742–743, 743f, 744f
 - coordination complexes of, hard-soft interaction principle, 688–689
 - EAN rule and, 741
 - electron transfer and, 726–727
 - halides of, 386–387
 - in iron alloys, 378
 - oxidative addition and, 783–784
 - oxides of, 383
 - properties of, 373, 373t, 374f
 - vitamin B₁₂ and, 811–812, 811f, 812f
- Cobalt complexes, 602, 604
- Cobalt pentacyanide, in
- hydrogenation, 795–796, 795f
- Cobaltocene, stability of, 767
- Cohesion energy, 203–205
- Compensation effect, in coordination compounds, 715–716, 716f
- Competitive inhibition, of enzymes, 804
- Complete wave function, 36
- Compressibility factor, 191
- Conductivity
- of ammonia, 333
 - alkali metal in, 340
 - of crystals, 283
 - of graphite, 445
 - of hydrogen fluoride, 334
 - in metals, 282–283, 283f
 - of selenium, 524
- Conjugate base, 293
- Contact process, for sulfuric acid, 543
- Coordinate covalent bond, with acids and bases, 306
- Coordination compounds, 577–612
- 18-electron rule of, 601–604
 - acid-catalyzed reactions of, 712–713
 - aromatic complexes, 770–772
 - with azide ion, 487
 - back donation in, 604–609, 605f, 606f, 608f
 - base-catalyzed reactions of, 713–715
 - benzene complexes, 770–772
 - in bioinorganic chemistry, 802–812
 - cobalamins and vitamin B₁₂, 811–812, 811f, 812f
 - metal functions, 803–804
 - metals and toxicity, 802–803
 - oxygen transport, 807–810, 807f, 808f, 810f
 - photosynthesis, 804–807, 805f, 806f
 - catalytic processes of, 780–792
 - insertion reactions, 788–792, 790f, 791f, 792f
 - ligand substitution, 781
 - oxidative addition, 781–784
 - reductive elimination, 788
 - chelate rings and stability of, 690–691
 - compensation effect in, 715–716, 716f
 - composition determination
 - Job's method, 673–675, 674f
 - in solution, 671–673, 672f
 - cyclopentadienyl chemistry, 761–764, 762f, 763t
 - dinitrogen, dioxygen, and dihydrogen in, 609–612, 610f, 612f
 - distribution diagrams for, 681–685, 684f, 684t
 - electron transfer reactions in, 725–727
 - equilibria involving, 675–681, 680t
 - ferrocene, 764–770, 764f, 765f, 766f, 769t
 - of first-row metals, 599, 600t
 - formation of, 309
 - and hard-soft interaction principle, 688
 - homogeneous catalysis by, 792–802
 - alkene isomerization, 796, 797f
 - alkene polymerization, 797–798, 798f
 - hydroformylation, 798–799, 799f, 800f
 - hydrogenation, 792–796, 793f
 - Monsanto process, 800–802, 801f
 - Wacker process, 799–800
 - isomerism of, 585–592, 587f, 588f, 589f, 591f
 - coordination isomerism, 591–592
 - geometrical, 585–586
 - hydrate isomerism, 592
 - ionization isomerism, 591
 - linkage isomerism, 590–591, 591f
 - optical, 579, 587–590, 587f, 588f, 589f
 - polymerization isomerism, 592
 - ligand field effect in, 708–712, 710f
 - linkage isomerization of, 716–718, 718f
 - magnetism of, 597–599, 598t
 - metal alkenes
 - preparation of, 760–761
 - structure and bonding of, 754–759, 754f, 755f, 756f, 757f, 758f, 759f
 - metal carbonyls
 - binary, 739–742, 740t

- Coordination compounds (*Contd.*)
 carbon monoxide bonding to metals, 744–747, 745f
 preparation of, 747–748
 reactions of, 748–754
 structures, 742–743, 742f, 743f, 744f
 metal-ligand bonds, 582–583, 583t
 metallocene reactions, 767–770, 769t
 metal-metal bonds in, 773–777, 773f, 774f, 775f, 776f
 molecular orbitals in, 633–642, 634f, 635f, 637f, 638f, 639f, 641f, 642f
 naming of, 583–585
 octahedral complexes, substitution reactions in, 701–708, 702t
 Racah parameters, 654
 reactions in solid, 728–735
 anation, 728–730, 729t
 geometrical isomerization, 732–733
 linkage isomerization, 733–735
 racemization, 730–732, 731f
 of second- and third-row transition metals, 599–601
 square planar complex substitution, 719–721, 720f
 stability of, 685–691, 685f, 686f, 687f
 structures of, 577–581, 579f, 580f, 581t
 synthesis of, 695–701
 hard-soft interaction principle, 699
 ligand replacement reactions, 697
 metal compound reaction, 697–698
 with amine salts, 699–701
 metal salt and ligand reaction, 696–697
 oxidation-reduction reactions, 698
 partial decomposition, 698–699
 trans effect in, 721–725, 723f
 valence bond description of, 592–597, 593t
- Coordination isomerism, 591–592
 Coordination number, 577–578
 of face-centered cubic structure, 239
 of first-row transition metals, 599, 600t
 ionic crystals, 220–221
 of lanthanides, 389–390
 of second- and third-row transition metals, 599–601
 of simple cubic structure, 237
 sintering interaction and, 281
- Copper, 373, 373t, 374f
 alloys of, 377
 halides of, 387
 heat capacity of, 245–246, 246f
 Jahn-Teller distortion, 630–631
 oxides of, 384
- Corrin, 811, 811f
 Corrosion, 276–277, 277f
 Corundum. *See* Aluminum oxide
 Cotton effect, 589–590, 589f
 Coulomb integrals, 68, 72
 for allyl, 165
 for ethylene, 162
 for hydrogen and H₂⁺ molecules, 74
 orbital calculation and, 160
 Coulomb's law, ions and, 211–212
 Coupling, of vectors, 56–57, 59f
 Covalent bonds
 in diatomic molecules, 65–92
 electronegativity, 87–91, 88t, 90f
 H₂⁺ molecule, 73–76
 heteronuclear diatomic molecule, 84–87, 87t
 hydrogen molecule, 65, 66f, 73–76
 molecular orbital methods, 65–73, 66f, 70f, 71f
 photoelectron spectroscopy, 83–84
 second-row elements, 76–83, 76f, 77f, 78f, 80f, 81f, 82t
 spectroscopic states for molecules, 91–92
 electron sharing in, 179–180
 London forces and, 190
- Covalent carbides, 449
 Creep, of metal, 378
 Cryolite, 228, 370, 546
 Crystal field energy
 anation and, 730
 development of, 617–618
 Jørgensen's method, 665–666, 666t
 stability constants and, 687–688
 in substitution reaction, 711–712, 719
- Crystal field splitting, 619–620, 620f, 625–626
 consequences of, 627–629, 628f, 628t, 629f
 octahedral complex, 637f, 638
- Crystal field theory, spectral bands and, 730
- Crystals
 conductivity of, 283
 defects of, 240–243, 241f, 242f, 243f
 extended defects, 242–243, 243f
 point defects, 240–242, 241f, 242f
 drift in, 282–283, 283f
 energetics of formation of, 211–216, 213t, 214t, 215f
 alkali halide properties, 213, 213t
 halogen properties, 213, 214t
 environments of, 220–224, 221t, 222f, 223t, 224t
 geometry of, 221–224, 222f, 223t
 hardness of, 248–250, 249t, 250t
 Madelung constants for, 219, 219t
 structures of, 224–229, 225f, 226f, 227f, 229f
- C_s symmetry, 143, 146t
 Cubic structure, 578, 579f, 580
 body-centered, 237f, 238
 face-centered, 237f, 238–239, 239t
 simple, 237–238, 237f
- Cusachs approximation, 73
 C_{∞∞} symmetry, 142, 146t
- Cyanate ion
 in coordination compounds, 604–605, 605f, 608
 structure of, 109–111, 131–132
- Cyanates, 458
 Cyanide complexes, linkage isomerizations with, 733–734
 Cyanide ion, 456, 590–591
 Cyanogen, formation of, 456–457
 Cycloheptatriene, 602–603, 756–757, 757f
- Cyclopentadienyl, 603–604
 chemistry of, 761–764, 762f, 763t
 ferrocene with, 764–767, 764f, 765f, 766f
- Cyclopropene, orbital calculation for, 168–169

D

d Orbital

- calculation of, 47, 48f
- overlap of, 77f
- splitting of in octahedral fields, 617–620, 618f, 619f, 620f
- splitting of in square planar complex, 622–623, 623f
- splitting of in tetrahedral fields, 621–622, 621f, 622f
- of transition metals, 618–619, 618f
- D_{2h} symmetry, 146t
- d^2sp^3 hybrid orbitals, in coordination compounds, 594–596, 601
- D_{3h} symmetry, 141, 146t
- D_{4h} symmetry, 142, 145, 146t
- de Broglie, Louis V., 15–16
- Debye, 180
- Debye characteristic temperatures, for metals, 247–248, 248t
- Decay
 - nuclear, 25–29, 26f
 - prediction of, 29–32, 31f
- Degenerate molecular orbitals, 168
- Dehydrogenation, of hydrocarbons, 417
- Delocalized bonding, 106
- Density of states, metals and, 358–359
- Deprotonation, in liquid ammonia, 339–340
- Deuterium, 415
- Deuterium oxide, 415
- Dextrorotatory compounds, 587, 589f
- $D_{\infty h}$ symmetry, 142–143, 146t
- Diagonal relationship, of aluminum and beryllium, 370–371
- Dialkyl dichlorosilanes, 480
- Dialkyl phosphates, 512
- Diamagnetism
 - of coordination compounds, 597
 - molecular orbital approach to, 78
- Diamond, 445–446, 446f
- Diatomic molecules
 - characteristics of, 82t
 - covalent bonds in, 65–92
 - electronegativity, 87–91, 88t, 90f
 - H_2+ molecule, 73–76
 - heteronuclear diatomic molecule, 84–87, 87t
 - hydrogen molecule, 65, 66f, 73–76
 - molecular orbital methods, 65–73, 66f, 70f, 71f
 - photoelectron spectroscopy, 83–84
 - second-row elements, 76–83, 76f, 77f, 78f, 80f, 81f, 82t
 - spectroscopic states for molecules, 91–92
- Diborane, 419–420, 424, 427
 - molecular orbital diagram for, 427, 428f
 - reactions of, 428
- Diboron tetrahalides, 426
- Dichloride heptoxide, 118
- Dichlorine hexoxide, 559
- Dichromates, 381–382
- Dielectric constant, of hydrogen fluoride, 343
- Diethylamine, 584
- Diferrocene, production of, 769–770
- Differential scanning calorimetry (DSC)
 - for phase transition study, 275
 - for solids reaction analysis, 266–267
- Diffraction, of electrons, 16
- Diffusion, of solids, 277–280, 278f, 280f
 - mechanisms for, 279–280, 280f
 - metals, 278–279, 278f
- Diffusion coefficient, ion mobility and, 282
- Diffusion rate, ionic conductivity and, 282
- Difluorodiazine. *See* Dinitrogen difluoride
- Diimine, preparation of, 485
- Dimethylberyllium, 402, 403f
- Dinitrogen difluoride, 488
- Dinitrogen pentoxide, 489t, 492–493
- Dinitrogen tetrafluoride, 488
- Dinitrogen tetroxide, 332, 334
- Dioxygen difluoride, 557
- Dioxygen, in coordination compounds, 609–612, 610f, 612f
- Dioxygenyl cation, 80
- Diphosphine, 421
- Diphosphoric acids, 514
- Dipole moments, 179–184, 182t, 183f, 183t
 - bond moments for, 180–181, 183–184, 183f, 183t
 - cohesion energy and solubility parameters, 203–207, 204t
 - covalent bonds and, 179–180
 - of diatomic molecule, 85–86
 - dipole-dipole forces, 184–186, 184f
 - hydrogen bonding, 193–203, 196f, 197t, 198t, 199f, 200f, 202f
 - of hydrogen fluoride, 343
 - induced, 186–187, 187f
 - in ionic compound solubility, 231
 - London forces, 187–191, 188f, 189t, 190f
 - of ozone, 436
 - solvent study of, 185–186
 - stability constants and, 680
 - of sulfur dioxide, 345
 - of tetrahedral molecules, 181–182
 - of trigonal bipyramid molecules, 181
 - van der Waals equation, 191–193, 192f, 193f, 193t
- Dipole-dipole forces, 184–186, 184f
- Dipole-induced forces, 186–187, 187f
- Disilicate ion, 470, 471f
- Dispersion forces. *See* London forces
- Displacement reactions, in metal carbonyl preparation, 748
- Displacive phase transition, 244
- Disproportionation, of metal carbonyls, 751
- Dissociation constants, 677
 - acid strength and, 296, 309
 - for butyric acid, 297
 - for chloro-substituted acetic acids, 296–297
 - of phosphoric acid, 516
- Dissociation energies, of halogens, 214t
- Dissociative mechanism, of substitution reactions, 703–704, 704f
- Distribution diagrams, for coordination compounds, 681–685, 684f, 684t
- Disulfur dinitride, 538
- Disulfuric acid, 530
- Dithionates, 270, 539t, 541
- Dithionic acid, 539t, 541
- Dithionite ion, bonding of, 117
- Dithionites, 539t, 540–541
- Dithionous acid, 539t, 540–541

- Doping, conductivity and, 283
- Double bond
formal charges and, 109–115
resonance and, 106
- Double salts, 578
- Doublet state, 56
- dp* hybrid orbital, *sp³d* and, 101
- Drago four-parameter equation,
202–203
for acid-base chemistry, 324–327,
326t
hard-soft interaction principle v.,
327
- Drift, in crystal structures, 282–283,
283f
- DSC. *See* Differential scanning
calorimetry
- dsp²* hybrid orbital, in coordination
complexes, 596
- dsp³* hybrid orbital, in coordination
complexes, 596
- Ductile, 356
- Dynamical variables, in quantum
mechanics, 38–42
- E**
- EAN. *See* Effective atomic number
- EC. *See* Electron capture
- ED. *See* Electron density
- Edge displacement, of crystals, 243,
243f
- EDTA. *See* Ethylenediaminetetraacetate
- Effective atomic number (EAN),
binary metal carbonyl
composition and, 741
- Effective nuclear charge, 51, 89
- Eigenfunction, 39–42
- Eigenvalue, 39–42
- Einstein's special theory of relativity,
16
- Ekasilicon, 463
- Electric dipole transitions, 631–632
- Electric field strength, in crystal
formation, 216–217
- Electromagnetic spectrum, 8, 8f
- Electron(s), 3–34
in acid-base chemistry, 305–306
atomic properties and, 17–22, 19f,
19t, 20t, 21f
in Bohr model, 11–15, 12f, 15f
bond angle and, 97–100
charge of, 5–6, 180
charge-to-mass ratio of, 5
diffraction of, 16
dipole moments and, 181–183
dipole-dipole forces and, 184–186,
184f
early experiments in atomic physics,
3–7, 4f, 6f
in helium atom, 49–51, 49f
in hydrogen atom, 44–49, 46t, 47f,
48f
London forces and, 190
magnetic moment of, 597–598,
598t
mass of, 6
molecular structure and, 97–105
molecule placement of, 105
molecules deficient in, 125–127
nature of, 7–11, 8f, 10f
nuclear binding energy and, 22–24,
24f
orbitals of, 12–16
pairing of, 53–55, 60–61
in coordination compounds,
600–601
particle-wave duality of, 15–17
probable location of, 42, 42f, 76
repulsion between, 49, 51–52, 55
screening by, 51–52
shared v. unshared, 96–97, 96f
- Electron addition energy, 18
- Electron affinity, 234–237
atomic number and, 18–20, 19f,
19t
electronegativity relationship to, 89
- Electron capture (EC), 28, 30
- Electron configurations, 52–56, 53t,
54t, 57f, 58–59t
of diatomic molecules, 78–79
spectroscopic states and, 61t
- Electron density (ED)
of allyl, 167
of ethylene, 164
for pyrrole, 172
- Electron pair acceptors, metals as, 577
- Electron pair donors, ligands as, 577
- Electron transfer reactions, in
coordination compounds,
725–727
- Electronegativity, 84, 87–91, 88t, 90f
acid strength and, 297
of acids and bases, 314
dipole-dipole forces and, 184–186,
184f
formal charge and, 109–111
hydrogen bonding and, 195–196
- Electronic polarizability, 188
with acid-base chemistry, 323–324,
324t
in crystal geometry, 222
- Electrophilic substitution, 308–309,
701
- Electrostatic bond character, in crystal
structures, 224–225
- Electrostatic forces
in crystal formation, 215, 215f, 224
in ionic compound solubility, 231
ionic structure stability and, 220
of molecules, 184–185, 184f
- Elements, metallic. 840 *See* Metallic
elements
- Energy level diagram, 14, 15f
- Energy levels, 25, 170t, 171
- Energy state, of hydrogen atom, 54
- Enolization, 197, 310–311, 690–691
- Enthalpy
hydrogen bonding and, 201–202
proton affinity and, 302–303
- Enthalpy of aqutation, for ionic
compounds, 230t, 231
- Enthalpy of formation, of crystals, 212
- Enthalpy of interaction, Drago
four-parameter equation for,
326–327
- Enthalpy of vaporization, cohesion
energy and, 203
- Entropy, bond energy and, 132
- Entropy effect, in coordination
compounds, 690
- Entropy of vaporization
of aluminum alkyls, 405–406
hydrogen bonding and, 196
- Enzymes, metals and, 803–804
- Equilibrium constant
of acid dissociation, 309–310
for coordination compounds,
676–677
free energy and, 689–690
- Ethylene
acetaldehyde conversion of,
799–800
in coordination compounds, 608,
608f
orbital calculation for, 162–165

- Ethylenediamine, 581
 ammonia v., 689
 in Zintl phases, 369
- Ethylenediaminetetraacetate (EDTA),
 stability constants with, 690
- Ewens-Bassett numbers, 585
- Exchange integrals, 68–69, 72–73
 for allyl, 165
 for ethylene, 162
 for hydrogen and H_2^+ molecules,
 74
 orbital calculation and, 160
- Exciton, metals and, 248
- Extended defects, of crystals, 242–243,
 243f
- F**
- f* orbital, calculation of, 47
- Face-centered cubic structure, of
 metals, 237f, 238–239, 239t
- Fehling test, 384
- Fermi energy, in metals, 357f, 359
- Fermi-Dirac distribution function,
 metals and, 358–359
- Fermions, in band theory, 358
- Ferrocene, 395, 603
 bonding in, 764–767, 764f, 765f,
 766f
 cyclopentadienyl with, 761–762,
 762f, 763t, 764–766, 765f
 derivatives of, 768–770, 769t
 formation of, 761, 764
 molecular orbital diagram of, 766,
 766f
 reactions of, 767–770, 769t
 structure of, 761–762, 762f
- Fertilizer production, 516–518, 545
- First-order reaction, rate of, 258–259
- First-row transition metals, 372–374,
 373t, 374f
 coordination compounds of, 599,
 600t
 quadruple bond between, 776
- Fission, 24
- Fluorides, 553, 566–568
- Fluorine
 occurrence of, 546
 oxides of, 557–560
 oxyhalides of, 560
 production of, 546–547
 properties of, 547, 548t
- Fluorite, 517, 546
 Fluorite structure, of crystals, 225,
 225f
- Fluoroapatite, 249, 497, 517, 546
- Fluorosulfonic acid, 536
- Forbidden transitions, 632
- Formal charge, 105–117
 bond length and, 109, 111–113
 of metal in coordination
 compounds, 604
 procedure for, 108
 resonance with, 109–111
- Formation constants, 676
- Forsterite, 469, 469t
- Frank-Condon principle, 632–633,
 632f
- Frasch process, 524
- Free electron model, Pauli exclusion
 principle and, 358
- Free energy
 bond energy and, 132
 equilibrium constant and, 689–690
 phase transition and, 274–275
 transition state concentration and,
 715
- Frenkel defect, of crystals, 242, 242f
- Friedel-Crafts reaction, 311–312
 acylation by, 767
 group VA pentahalides for, 508
- Frost-Musulin diagram, of ferrocene,
 764, 764f
- Fullerene, 446–447, 446f
- Fulminates, 458
- Fusion, 24
- G**
- Galena, 463–464, 523
- Gamma emission, 29
- Gas
 solid adsorption of, 256–257, 257f
 solid release of, 266–267
- Gaussian functions, 52
- Geometrical isomerization, of solid
 coordination compound,
 732–733
- Germanium
 alkylation of, 477
 dihalides of, 475t, 476
 overview of, 463–464
 oxides of, 466–467
 preparation of, 464
 sulfides of, 479
 tetrahalides of, 476–477
- Germanium nitride, 479
- Glass, 468–469
- Gold, 374, 375f, 375t
- Gold foil experiment. *See* Rutherford's
 experiment
- Graphite, 431, 444–447, 445f
- Gray tin, 464
- Grignard reagent
 application of, 401–402
 cadmium halide reaction with, 411
 for group IVA alkylation, 477–478
 metal compound reaction with, 761
 metal halide reaction with, 398
 organoarsenic compounds with,
 410
 production of, 396, 400–401
 species present in, 401
 zinc halide reaction with, 411
- Ground state, calculation of, 60–61,
 92
- Group IA, 360–361, 360t
 carbonates, nitrates, sulfates, and
 phosphates of, 367
 halides of, 364–365
 hydrides of, 362, 418, 418t
 in liquid ammonia chemistry,
 340–342, 340t
 negative ions of, 361–362
 organometallic compounds of,
 398–400, 400f
 oxides and hydroxides of, 362–364
 oxygen reaction with, 439
 proton affinities for, 303, 304t
 sulfides, nitrides, carbides, and
 phosphides of, 365–367
 Zintl phases with, 367–370
- Group IIA, 360–361, 360t
 carbonates, nitrates, sulfates, and
 phosphates of, 367
 halides of, 364–365
 hydrides of, 362
 negative ions of, 361–362
 organometallic compounds of,
 400–403, 403f
 oxides and hydroxides of,
 362–364
 oxygen reaction with, 439
 sulfides, nitrides, carbides, and
 phosphides of, 365–367
 Zintl phases with, 367–370

- Group IIIA, organometallic
compounds of, 403–408, 404f, 405t
- Group IVA, 463–480
glass, 468–469
halides of, 474–477, 475t
hydrides of, 465
miscellaneous compounds of, 479–480
organic compounds with, 477–479
organometallic compounds of, 408–409
oxides of, 466–468
silicates of, 469–472, 469t, 471f
zeolites, 473, 474f
- Group orbitals, 147–148, 154–155
- Group specificity, of enzymes, 803
- Group theory
molecular orbital construction and, 153–158, 154f, 156f, 155t, 156f, 158f, 159f
overview of, 145–153, 148f, 150t, 151f, 151t, 152f, 152t
- Group VA, 497–498
acids and salts of, 511–513
halides of, 503–509, 505t, 507f
pentahalides, 505–508, 507f
trihalides, 504–505, 505t
hydrides of, 499–500, 499t
organometallic compounds of, 409–410
oxides of, 500–502, 501f
phosphoric acids and phosphates, 513–516
sulfides of, 502–503, 502f, 503f
- Group VIA, 523–526, 525t
halogen compounds of, 531–533, 531t, 532f
hydrogen compounds of, 526–527, 527t
nitrogen compounds of, 536–538
oxides of, 529–531, 529t
oxyhalides of, 533–536, 534t
polyatomic species, 527–529
proton affinities for, 303, 304t
- Group VIIA. *See* Halogens
- Group VIIIA. *See* Noble gases
- Gypsum, 523
calcium in, 367
- H**
- Haber process, 483
- Hafnium, 374, 375f, 375t
- Halates, 561–562
- Half-life, of nuclide, 31–32
- Halic acids, 561–562
- Halides
alkyl transfer with, 397
of boron, 425–426, 425t
of carbon, 456
of group IA and IIA, 364–365
of group IVA, 474–477, 475t
of group VA, 503–509, 505t, 507f
of nitrogen, 487–488
of transition metals, 385–387
- Halogens, 545–564, 548t
azides of, 487
crystal formation properties for, 213, 214t
group VIA compounds, 531–533, 531t, 532f
halic acids and halates, 561–562
halous acids and halites, 561
hydrogen halides, 555–557, 556t
hypohalous acids and hypohalites, 560–561
interhalogen molecules and ions, 548–555, 549t
as Lewis acid, 555
metal carbonyls reactions with, 749–750
nitric oxide reaction with, 490
oxides of, 557–560
oxyhalides of, 560
perhalic acids and perhalates, 562–564
- Halous acids, 561
- Hamiltonian operator, 42–44, 49–50
- Hapticity, 603, 756–757
- Hapto, of ligand, 756
- Hard electron donors, 582, 583t
- Hardness
of metal alloys, 377–378
of solids, 248–250, 249t, 250t
- Hard-soft interaction principle (HSIP), 313–323, 314t, 315t
coordination compounds and, 688, 699
- Drago four-parameter equation v., 327
- hydrogen bonding, 315–316
linkage isomers, 316
metal classes of, 313–314
nephelauxetic effect and, 657
objections to, 324–325
reactive site preference, 318–323
solubility, 316–318, 317f
- Heat capacity, 245–248, 245t, 246f, 248t
- Heat of association, hydrogen bonding and, 195
- Heat of formation
of alkali halides, 213t
of sodium chloride, 212
of tetrasulfur tetranitride, 536
- Heat of hydration
crystal field splitting and, 627, 628f
of lanthanides, 389, 390f
ligand field stabilization energy and, 629
- Heat of sublimation, of alkali halides, 213t
- Heat of vaporization
hydrogen bonding and, 196
solubility parameter and, 204–205
- Heavy water. *See* Deuterium oxide
- Hedvall effect, 276
- Heisenberg Uncertainty principle, 14–15
- Helium, 189, 565–566, 567t
atomic structure of, 49–51, 49f
- Heme, 807–808, 807f, 808f
- Hemoglobin
heme in, 808–809
myoglobin v., 809–810, 810f
- Hermitian operator, 39
- Heterodiffusion, of solids, 278, 278f
- Heteronuclear diatomic molecule
molecular orbital approach to, 84–87, 87t
molecular orbital diagram of, 81f
- Hexagonal closest packing, of metals, 237f, 239, 239t
- Hexasulfane, 527
- Highest occupied molecular orbitals (HOMO), 78
- High-spin complexes, 595–596, 601, 626, 628
- HMO. *See* Hückel method
- Holoenzyme, 804
- Homogeneous catalysis, by
coordination compounds, 792–802
alkene isomerization, 796, 797f

- alkene polymerization, 797–798, 798f
- hydroformylation, 798–799, 799f, 800f
- hydrogenation, 792–796, 793f
Monsanto process, 800–802, 801f
Wacker process, 799–800
- Homonuclear diatomic molecule, 67
molecular orbital diagram of, 80f
- HSIP. *See* Hard-soft interaction principle
- Hückel method
for ferrocene bonding, 764
metal orbitals and, 357
orbital calculation and, 160, 161–174, 163f, 166f, 169f, 170f, 170t
- Hume-Rothery rules, 377
- Hund's rules, 60
- Hybrid orbitals
in coordinate bonds, 592–597, 593t
of first-row transition metals, 599, 600t
of second- and third-row transition metals, 599–601
- Hybridization, of orbitals, 78, 104–105
- Hydates, heating of, 263
- Hydrate isomerism, of coordination compounds, 592
- Hydrated lime. *See* Calcium hydroxide
- Hydration enthalpy, 230t, 231–232
- Hydration number, 230, 290
- Hydrazine, 484–485
- Hydrazoic acid. *See* Hydrogen azide
- Hydrides, 119t, 418–422, 418t
of aluminum and beryllium, 371
of boron, 426–428, 428f
covalent, 419–420, 420t
of group IA and IIA, 362, 418t
of group IVA, 465
of group VA, 499–500, 499t
groups of, 416
ionic character of, 87
- Hydroboration, 428
- Hydroformylation, 798–799, 799f, 800f
- Hydrogen
atom, 44–49, 46t, 47f, 48f, 60
bond energy of, 65, 71
charge-to-size ratio of, 290
chemistry of, 415–422
hydrides, 418–422, 418t, 420t
preparation of, 416–418
in coordination compounds, 609–612, 610f, 612f
energy level diagram for, 14, 15f, 70–82, 71f
group orbitals of, 147–148
group VIA compounds with, 526–527, 527t
ionization energy for, 303
metal bonding of, 785–786, 786f
molecular orbital methods for, 65, 66f, 73–76
molecular orbital of, 147, 147f, 153–154
nitrogen compounds with, 483–487
olefin reaction with metal and, 398
oxidative addition of, 793f, 794
polarity and, 179
spectral lines of, 8–9, 12–15
- Hydrogen azide, 485–486
- Hydrogen bonding, 193–203, 196f, 197t, 198t, 199f, 200f, 202f
boiling point and, 195–197, 196t, 197f
description of, 193–194
Drago four-parameter equation, 202–203
hard-soft interaction principle and, 315–316
of hydrogen fluoride, 342
infrared spectroscopy for study of, 197–199, 198t
Kirkwood-Bauer equation, 200, 200f
in liquid ammonia, 337
materials experiencing, 194–195
strength of, 200–201
types of, 194
- Hydrogen bromide, 556–557, 556t
- Hydrogen chloride, 556–557, 556t
- Hydrogen cyanide, 458
- Hydrogen fluoride
autoionization of, 334
physical properties of, 343, 343t
properties of, 556, 556t
as solvent, 332, 342–344, 343t
- Hydrogen halides, 555–557, 556t
polarity of, 85–86, 87t
- Hydrogen iodide, 555–556, 556t
- Hydrogen peroxide, 442
- Hydrogenation catalyst, 792–796, 793f
- Hydrogen-like wave function, 45, 46t
- Hydrolysis, in acid-base chemistry, 294–295
- Hydronium ion, 289
- Hydrothiocyanic acid, in coordination compound synthesis, 700
- Hydroxide ion, 290–292, 331–332
- Hydroxides, of group IA and IIA, 362–364
- Hypohalites, 560–561
- Hypohalous acids, 560–561
- Hyponitrous acid, 493–494
- Hysteresis width, 274, 274f
- I**
- Icosahedral structure, numbering system for, 429, 429f
- Ideal gas equation, van der Waals equation, 191–193, 192f, 193f, 193t
- I_h symmetry, 145, 146t
- Impurity, of crystals, 240
- Index of reaction, 261
- Inductive effect, on acid, 297–298
- Infrared spectroscopy
of back donation in coordination compounds, 606–607
of dioxygen and dinitrogen coordination compounds, 611
for hydrogen bonding study, 197–199, 198t, 199f
for solids reaction analysis, 267
- Inner orbital complex, 595–596
- Insertion reactions
of alkenes, 793f, 794
in catalytic processes, 788–792, 790f, 791f, 792f
in sulfur dioxide chemistry, 345–346
- Instability constants, 677
- Instantaneous dipole, 188, 188f
- Interaction energy
in crystal formation, 216
of dipole moments, 185
- Intercalation, of carbon, 444–445
- Interchange mechanism, of substitution reactions, 706, 706f
- Interfaces, solid-state reactions at, 276–277, 277f

- Interhalogen compounds, 548–555, 549t
 applications of, 550–551
 cations, 554–555
 properties of, 548, 549t
 reactions of, 549–555
 structure of, 103–104, 550, 552
 symmetry of, 139
 types of, 549–550
- Interstitial carbides, 449
- Inverse spinel, 229
- Inversion, structure and, 99–100
- Iodine
 occurrence of, 546
 oxides of, 557–560
 preparation of, 546
 production of, 547
 properties of, 548, 548t
- Iodine heptafluoride, 551–552
- Iodine pentafluoride, 552
- Ion(s)
 Coulomb's law and, 211–212
 hydration number of, 230, 290
 mobility of, 282
 polar molecule interactions with, 187
 spectroscopic states for, 645–650, 646t, 647f, 649t
 energies, 652, 652t
 Racah parameters, 653–655, 653t
- Ion exchange, zeolites for, 473
- Ion-dipole forces, 187, 230
- Ionic bonds
 crystal defects, 240–243, 241f, 242f, 243f
 crystal structures, 224–229, 225f, 226f, 227f, 229f
 energetics of crystal formation, 211–216, 213t, 214t, 215f
 hardness of solids, 248–250, 249t, 250t
 heat capacity, 245–248, 245t, 246f, 248t
 ionic compound solubility, 229–234, 230t, 232f, 233f, 234f
 ionic sizes and crystal environments, 220–224, 221t, 222f, 223t, 224t
 Kapustinskii equation, 219–220
 Madelung constants, 216–219, 218f, 219t
 metal structures, 237–240, 237f, 238f, 239t
 phase transitions in solids, 243–244
 proton and electron affinities in, 234–237
- Ionic carbides, 449
- Ionic character, of diatomic bond, 84–86
- Ionic compounds
 hydration enthalpies for, 230t, 231
 solubility of, 229–234, 230t, 232f, 233f, 234f
 Boltzmann distribution law, 233–234, 234f
 hydration enthalpies and, 230t, 231–232
 temperature and, 232–233, 232f, 233f
- Ionic conductivity, diffusion rate and, 282
- Ionic radii, 21–22, 21t
 of common monatomic and polyatomic ions, 220, 221t
 crystal arrangements and, 220–223, 221t, 223t
 for Kapustinskii equation, 220
 proton affinity and, 304, 304f
 stability constants and, 680
- Ionization, of diatomic molecules, 83–84
- Ionization energy, 17–18, 17f
 electronegativity relationship to, 89
 for London forces, 188–189, 189t
 of noble gases, 564
 stability constants and, 686–687, 686f, 687f
- Ionization isomerism, of coordination compounds, 591
- Ionization potential. *See* Ionization energy
- Iridium, 374, 375f, 375t
- Iron, 373, 373t, 374f
 alloys of, 373, 377–378
 carbon monoxide and, 451
 carbonyl of, 742–743, 742f, 743f
 corrosion of, 276–277, 277f
 EAN rule and, 741–742
 forms of, 372–373
 halides of, 386
 heme and, 807–808, 807f, 808f
 oxides of, 383
 production of carbon for, 448–449
 sintering of, 282
- Iron carbide, 450
- Iron complexes, 595–596, 602, 603, 606
- Iron pyrites, 523
- Irving-Williams series, 685, 685f
- Isoelectronic, 97
- Isomerizations
 of alkenes, 796, 797f
 of coordination compounds, 585–592, 587f, 588f, 589f, 591f
 coordination isomerism, 591–592
 geometrical, 585–586
 hydrate isomerism, 592
 ionization isomerism, 591
 linkage isomerism, 590–591, 591f
 optical, 579, 587–590, 587f, 588f, 589f
 polymerization isomerism, 592
 geometrical, 585–586
 of solid coordination compound, 732–733
 of solids, pressure and, 267–270
- Isothiocyanate bonding, 590
- Isotopes, 22, 24
- ## J
- Jahn-Teller distortion, 630–631, 630f, 635
- Jander equation, for solid reactions, 265–266
- j-j coupling, 57
- Job's method, for coordination compounds, 673–675, 674f
- John-Teller distortion, 593
- Jørgensen's method, 665–666, 666t
- ## K
- Kaolin, 472
- Kapustinskii equation, 219–220, 235–237
- K-capture, 28
- Kinetic energy, operator for, 37, 38t, 43
- Kinetic models, for solid-state reactions, 258–266
 contracting volume rate law, 260–261
 first-order, 258–259
 nucleation rate law, 261–265, 262t, 263f, 264t

- parabolic rate law, 259–260
 reactions between two solids, 265–266
- Kinetic stability, thermodynamic stability v., 133
- Kirkwood-Bauer equation, 200, 200f
- Koopman's theorem, Coulomb integrals and, 160
- Krypton, 565–566, 567t
- Krypton difluoride, 572
- L**
- Lanthanide contraction, 389, 390f
- Lanthanides, 355–356, 387–391, 388t, 389f, 390f, 391
- Lanthanum, properties of, 374, 375f, 375t
- Laplacian operator, 43
- Laporte rule, 632
- Lattice energy
 anation and, 730
 Born-Landé equation for, 220
 in crystal formation, 212–213
 hardness and, 249
 hard-soft interaction principle and, 320–321
 in ionic compound solubility, 232–233
 Kapustinskii equation for, 219–220, 235–237
 Madelung constants for, 216–218
 polarizability and, 223–224
 racemization and, 732
 van der Waals equation and, 192, 193f
- Lead, 464–465
 alkylation of, 478–479
 oxides of, 466, 468
 in Zintl phases, 369
- Lead crystal, 468
- Lead sulfide, 479
- Leveling effect
 of strong acids, 295
 of superacids, 349
- Lever method, 662–665, 663f, 664f
- Leverotatory compounds, 587, 589f
- Lewis acids
 catalysis of alkylation, 311–312
 coordination bonds of, 577, 581
 hard and soft, 314, 315t, 582, 583t
 Lewis base reaction with, 306–307
 oxides, 301, 302f
 proton, 303, 304t
 strength of, 307
 types of species as, 306
- Lewis bases
 coordination bonds of, 577, 581
 hard and soft, 314, 314t, 582, 583t
 Lewis acid reaction with, 306–307
 types of species as, 306
- Lewis theory, of acid-base chemistry, 305–309
- LFER. *See* Linear free energy relationship
- LGO. *See* Ligand group orbitals
- Ligand field splitting, 619–620, 625, 627
- Ligand field stabilization energy, 628–629, 628t
 heat of hydration and, 629
 in substitution reaction, 708
- Ligand field states, 646–647, 647f
- Ligand fields
 crystal field splitting consequences, 627–629, 628f, 628t, 629f
d orbital splitting in octahedral fields, 617–620, 618f, 619f, 620f
d orbital splitting in other fields, 621–624, 621f, 622f, 623f, 625t
 factors affecting Δ , 625–627, 626t
 Jahn-Teller distortion, 630–631, 630f
 spectral bands and, 631–633, 730
- Ligand group orbitals (LGO), 634–637, 635f
- Ligand replacement process, electron transfer v., 725
- Ligand wave functions, 636
- Ligands, 577, 581, 581t
 anation, 728–730, 729t
 in coordination compounds, concentration, 681–683
 metal bonds with, 582–583, 583t
 metal salt reaction with, 696–697
 molecular orbital diagram of, 604–606, 605f
 replacement reactions of, 697
 substitution of
 for catalytic processes, 781
 rate and size or charge of, 707
- Light, 3–34
- band theory and, 357–358
 early experiments in atomic physics, 3–7, 4f, 6f
 nature of, 7–11, 8f, 10f
 quantization of, 9–10
- Lime, 255, 453
- Linear combination of atomic orbitals (LCAO-MO), 66–67
- Linear complexes, 578, 579f, 594
- Linear free energy relationship (LFER), 310
- Linear molecule
 structure of, 95–97, 96f, 104
 symmetry of, 142–143
 Walsh diagram for, 161, 161f
- Linear operator, 38
- Lines of symmetry, 137–138
- Linkage isomerization
 of coordination compounds, 590–591, 591f, 716–718, 718f
 of solid coordination compounds, 733–735
- Linkage specificity, of enzymes, 803
- Liquid ammonia
 autoionization of, 333
 chemistry in, 336–342, 337t
 acid-base reactions, 338–340
 ammoniation reactions, 337–338
 ammonolysis reactions, 338
 metal-ammonia solutions, 340–342, 340t
 metathesis reactions, 338
 physical properties of, 337, 337t
 as solvent, 332, 484
 Zintl phase production in, 368–369
- Litharge, 466
- Lithium, alkyls of, 398–400, 400f
- Lithium battery, 347–348
- Lithium oxide, sintering of, 281
- Lithopone, 365
- London forces, 187–191, 188f, 189t, 190f
 boiling point and, 189–191, 190f
 entropy of vaporization and, 196
 ionization potentials for, 188–189, 189t
 polarizability and, 189–190
- Low spin complexes, 595–596, 601, 625–626
- L-S coupling, 56–57, 91–92, 598
- Lyman series, 9

M

- Madelung constants
 calculation of, 216–219, 218f, 219t
 crystal formation and, 214,
 216–219, 218f, 219t
 hard-soft interaction principle and,
 322
 for Kapustinskii equation, 219
 for some crystal lattices, 219, 219t
- Magnesium
 hydrides of, 419–420
 organometallic compounds of,
 400–402
- Magnesium boride, 424
- Magnesium hydroxide, 364
- Magnesium oxide, 236–237, 439
- Magnetic field, cathode rays in, 4–5
- Magnetic moment, of electron,
 597–598, 598t
- Magnetic quantum number, 45
- Magnetism, of coordination
 compounds, 597–599, 598t
- Malachite, 384, 453
- Malleable, 356
- Manganese, electron transfer with,
 726
- Manganese, 373, 373t, 374f
 carbonyl of, 742–743, 743f
 complexes, 594–595, 601
 EAN rule and, 741
 halides and oxyhalides of, 386
 in iron alloys, 378
 metal-metal bonds of, 777
 oxides of, 382
- Mass, 6–7
- Mass defect, 23
- Mass number, 22–24, 24f
- Melting point
 of crystals, 224
 of first-row transition metals, 374,
 374f
 hardness and, 249
 of third-row transition metals,
 374–376, 375f
- Mercury, 374, 375f, 375t
 alkyls and, 396–397
 organometallic compounds of,
 410–411
- Metal(s). *See also* Metallic elements
 alkyl halide reactions with,
 396–397
 bioinorganic functions of, 803–804
 carbon monoxide bonding to,
 744–748, 745f
 classes of, 313–314, 688
 conductivity in, 282–283, 283f
 in coordination compounds
 free fraction, 681–683
 reaction of, 697–698
 reaction with amine salts,
 699–701
 salt reaction with ligands,
 696–697
 Debye characteristic temperatures
 for, 247–248, 248t
 diffusion of, 278–279, 278f
 exciton and, 248
 hardness of, 250, 250t
 heat capacity of, 245–248, 245t,
 246f, 248t
 hydrogen bonding to, 785–786,
 786f
 olefin reaction with hydrogen and,
 398
 oxidation of, 276–277, 277f
 oxides of, 301–302, 302f
 structures of, 237–240, 237f, 238f,
 239t
 body-centered cubic structure,
 237f, 238
 face-centered cubic structure,
 237f, 238–239, 239t
 hexagonal closest packing, 237f,
 239, 239t
 simple cubic structure, 237–238,
 237f
 transformation of, 239–240
 toxicity of, 802–803
- Metal alkene complexes
 preparation of, 760–761
 structure and bonding of, 754–759,
 754f, 755f, 756f, 757f, 758f,
 759f
- Metal carbonyl complexes, 744–747,
 745f
 alkene reaction with, 760
 binary, 739–742, 740t
 preparation of, 747–748
 reactions of, 748–754
 structures of, 742–743, 742f, 743f,
 744f
- Metal halide, 398, 760
- Metal ions
 classification of, 701–702
 hydration of, 628
 Racah parameters, 654
 substitution rate and charge and
 size of, 707
 in tetrahedral fields, 624
- Metal salts, 696–698
- Metallation, of ferrocene, 768
- Metallic elements, 355–356
 alloys of, 376–379, 379t
 aluminum and beryllium, 370–372
 band theory of, 356–359, 357f,
 358f
 first-row transition metals,
 372–374, 373t, 374f
 group IA and IIA, 359–367
 lanthanides, 387–391, 388t, 389f,
 390f
 second- and third-row transition
 metals, 374–376, 375f, 375t
 transition metal chemistry,
 379–387
 Zintl phases of, 367–370
- Metallic luster, 357–358
- Metal-ligand bonds, 582–583, 583t
- Metallocarboranes, 430, 430f
- Metallocenes
 chemistry of, 763–764, 763t
 reactions of, 767–770, 769t
- Metal-metal bonds, 600
 in coordination compounds,
 773–777, 773f, 774f, 775f, 776f
- Metaphosphoric acids, 513–514
- Metathesis reactions, 338
- Methane
 dipole moment and, 181, 182t
 hydrogen bonding of, 195, 196t
 molecular orbital diagram for, 158f
 proton affinity of, 304
 symmetry of, 143–144, 143f
- Methanides, 449
- Methyl chloride, dipole moment
 approximation for, 183–184
- Methyllithium, 399–400, 400f
- Metmyoglobin, 809
- Mica, 471f, 472
- Millikan oil drop experiment, 5–6
- Miner's lamp. *See* Carbide light
- Mirror plane, 137–141
- Mobility, of an ion, 282
- Mohs hardness scale, 248–249, 249t
- Molecular geometry, dipole moment
 and, 181–183

- Molecular orbital(s)
 atomic orbital combination for, 152
 bond angle and, 158–161, 161f
 calculation of, 153–158, 154f, 156f, 155t, 156f, 158f, 159f
 angles and, 158–161, 161f
 Hückel method, 160, 161–174, 163f, 166f, 169f, 170f, 170t
 in coordination compounds, 633–642, 634f, 635f, 637f, 638f, 639f, 641f, 642f
 degenerate, 168
 energies of, 73–74, 83–84
 filling of, 78
 ligand fields and, 617–642
 d orbital splitting in octahedral fields, 617–620, 618f, 619f, 620f
 spectroscopic states of, 91–92
 symmetry of, 145–148, 147f
 wave function for construction of, 634–636, 635f
- Molecular orbital approach, 65–73, 66f, 70f, 71f
 complicated molecules and, 146
 to heteronuclear diatomic molecule, 84–87, 87t
 to molecular structure, 160–161, 161f
 for allyl, 165–167
 for cyclopropene, 168–169
 for ethylene, 161–165
 for pyrrole, 171–174
 for rings, 169–171, 170f, 170t
 for second-row elements, 76–83, 76f, 77f, 78f, 80f, 81f, 82t
- Molecular orbital diagrams
 for metal-metal bonding, 775, 775f
 for octahedral structure, 158–159, 159f
 of second-row diatomic molecules, 80f, 81f
 for tetrahedral structure, 157–158, 158f
 for trigonal planar structure, 155–157, 156f
- Molecular wave functions, 634
- Molecules
 formation of, 65–73, 66f, 70f, 71f
 polarizability of, 186–187, 187f
 structures of, 95–133
 angles of, 97–100
 complex, 117–125
 determination of, 97
 electron-deficient, 125–127
 inversion, 99–100
 reactivity and, 102–103
 resonance and formal charge, 105–117
 types of, 95–97, 96f
 VSEPR, 100–101
- Molybdenum, 374–378, 375t
- Momentum, operator for, 37, 38t, 43
- Monel, 373, 377
- Monohapto, of ligand, 756
- Monsanto process, 800–802, 801f
- Most probable distance, of electron, 42
- Mulliken electronegativity, 89
- Mulliken tables, 72
- Multiple-phase alloys, 376
- Multiplication table, 150–152, 150t, 151t
- Multiplicity, 56, 60–61, 631–632
- Myoglobin, 809–810, 810f
- N**
- Neon, 565–566, 567t
- Nephelauxetic effect, spectroscopic states, 655–657, 656t, 657t
- Neutrons, 7
 decay mode prediction using, 29–32, 31f
 nuclear stability and, 24–25, 25t, 26f
- Nickel, 373, 373t, 374f
 in alloys, 377, 378
 applications of, 373
 carbonyl of, 742, 742f
 EAN rule and, 741
 halides of, 387
- Nickel complexes, 596, 601–603
- Nickel tetracarbonyl, 740, 740t
- Nickelocene, stability of, 767
- Niobium, 374, 375t
- Nitrate ion, structure of, 496
- Nitrates, of group IA and IIA, 367
- Nitration, acid catalysis of, 312
- Nitric acid, 484, 494–496
- Nitric oxide, 489–491, 489t
 in coordination compounds, 604–605, 605f
 metal carbonyl reactions with, 750–751
- Nitrides, 482
 of boron, 431–433, 432f
 of carbon, 456–458
 of group IA and IIA, 365–367
- Nitrite ion, in coordination compounds, 590
- Nitrogen, 481, 481f
 ammonia and aquo compounds, 482, 483t
 electron affinity of, 53
 halides of, 487–488
 hydrogen compounds of, 483–487
 nitrides, 482
 oxides of, 489–493, 489t, 490f
 oxyacids of, 493–497
 oxyhalides of, 488
 sulfur compounds with, 536–538
- Nitrogen dioxide, 489t, 491–492
- Nitrogen trifluoride, 487–488
- Nitrosonium ion, 490
- Nitrous acid, 494
- Nitrous oxide, 441, 489, 489t
- Nitryl chloride, 488
- Noble gases, 564–572
 boiling points of, 192, 192f
 elements of, 565–566, 567t
 polarizability of, 186–187, 187f
 spectroscopic state of, 60
 xenon fluorides of, 566–572
- Nodal plane, in molecules, 76
- Nodes, of orbitals, 49
- Nomenclature, for coordination compounds, 583–585
- Nonaqueous solvents
 amphoteric behavior of, 335
 common, 331–332, 332t
 coordination model, 335–336
 liquid ammonia, 336–342, 337t
 liquid hydrogen fluoride, 342, 343t, 344
 liquid sulfur dioxide, 345–349, 345t, 545
 nitrogen dioxide as, 492
 phosphoryl chloride as, 505
 reasons for, 331
 solvent concept for, 332–334
 superacids, 349–350
- Nonpolar bond, 85
- Nonstoichiometric hydrides, 421
- Nonvalence forces, 179
- Normalization, of wave function, 37

- Nuclear binding energy, 22–24, 24f
 Nuclear charge, atomic radius and, 21–22
 Nuclear decay
 prediction of, 29–32, 31f
 types of, 25–29, 26f
 Nuclear stability, 24–25, 25t, 26f
 Nucleation, rate law for, 261–265, 262t, 263f, 264t
 Avrami-Erofeev, 261–262, 262t
 common types of, 264–265, 264t
 hydrate heating, 263
 random nucleation, 261
 Nuclei, 3–34
 binding energy of, 22–24, 24f
 in Bohr model, 11–15, 12f, 15f
 decay of, 25–29, 26f
 prediction of, 29–32, 31f
 early experiments in atomic physics, 3–7, 4f, 6f
 solid reaction at, 261
 stability of, 24–25, 25t, 26f
 Nucleon, 22–25, 25t
 Nucleophile
 Lewis base, 307–308
 organic compound reactions with, 318–319
 Nucleophilic substitution, 701
 rates of, 701
 Nuclides, 22–24
 decay of, 25–29, 26f
 half-life of, 31–32
 stability of, 24–25, 25t, 26f, 31–32, 31f
- O**
- Octahedral arrangement
 for crystals, 221–222, 222f
 of first-row transition metals, 599
 Octahedral complexes, 578, 579f, 580, 580f, 618–619, 619f
 charge transfer absorption, 666–668, 667f
 energies of, 648–650, 649t
 energy level diagram for, 637f, 638
 isomerism of, 585–586
 Jørgensen's method, 665–666
 orbitals of, 634, 634f
 Orgel diagrams, 650–652, 650f, 651f, 652t
 substitution reactions in, 701–708, 702t
 mechanisms of, 702–706, 704f, 706f
 rates of substitution, 706–708, 707f
 Tanabe-Sugano diagrams of, 659, 660–661f, 662f
 trans effect in, 724–725
 valence bond description of, 594–596
 Octahedral fields, *d* orbital splitting in, 617–620, 618f, 619f, 620f, 621–622, 621f, 622f, 627
 Octahedral molecule
 molecular orbital diagrams for, 158–159, 159f
 structure of, 96–97, 96f
 Walsh diagram for, 161
 Octet rule, violations of, 100–101
 Odd parity, 79
 O_h symmetry, 144–145, 146t
 Olefin, reaction with hydrogen and metal, 398
 Oleum, 530
 Olivine, 367, 470
 Operator, in quantum mechanics, 37–42, 38t
 Optical isomerization, of
 coordination compounds, 579, 587–590, 587f, 588f, 589f
 Optical rotatory dispersion (ORD), 589, 589f
 Orbital angular momentum, 45, 56–57, 60–61, 91–92
 Orbitals
 of electrons, 12–16
 energy of, 53, 624
 filling of, 52–56, 53t, 54t, 57f, 58–59t
 hybridization of, 78, 104–105
 of metals in coordination compounds, 577–578
 of octahedral complexes, 634, 634f
 Slater-type, 51–52
 spectroscopic states and, 647–648
 of square planar complex, 640–642
 symmetry of, 145–148
 of tetrahedral complexes, 638–639, 638f
 Organic compounds
 with group IVA, 477–479
 nucleophile reactions with, 318–319
 Organometallic compounds
 of group IA, 398–400, 400f
 of group IIA, 400–403, 403f
 of group IIIA, 403–408, 404f, 405t
 of group IVA, 408–409
 of group VA, 409–410
 preparation of, 396–398
 of zinc, cadmium, and mercury, 410–411
 Orgel diagrams, 650–652, 650f, 651f, 652t
 Orthoclase, 469, 469t, 472
 Orthogonality, 37
 Orthophosphoric acids, 513, 516
 Orthosilicate ion, 470
 Orthostannate, 468
 Osmium, 374, 375f, 375t
 Oswald process, 484
 Outer orbital complex, 595
 Overlap integrals, 69, 72
 for allyl, 165
 of bonding molecular orbital, 76
 orbital calculation and, 160
 Overlap, of orbitals, 76–77, 76f–77f
 Oxad. *See* Oxidative addition
 Oxalates, solid-state reactions with, 270
 Oxidation
 for coordination compound synthesis, 698
 of lanthanides, 391
 of metal, 276–277, 277f
 of sulfur dioxide, 530
 Oxidation state, of oxygen, 443
 Oxidative addition, 781–782
 for catalytic processes, 781–784
 conditions for, 783
 of coordination compounds, 782
 of hydrogen, 793f, 794
 mechanistic considerations for, 784–787, 785f, 786f, 787f
 reductive elimination v., 788
 of Vaska's compound, 782–783
 Oxide ion
 acid-base character of, 300–302, 302f
 in hydrogen fluoride chemistry, 344
 Oxides
 covalent, 440–441
 of group IA and IIA, 362–364

- of group IVA, 466–468
 - of group VA, 500–502, 501f
 - of group VIA, 529–531, 529t
 - of halogens, 557–560
 - of nitrogen, 489–493, 489t, 490f
 - of transition metals, 379–385
 - of xenon, 570–572
 - Oxonium ion. *See* Hydronium ion
 - Oxyacids
 - of nitrogen, 493–497
 - of selenium, 542
 - of sulfur, 538–545, 539t
 - of tellurium, 542
 - Oxyfluorides, 553, 571–572
 - Oxygen
 - amphoteric oxides, 441
 - binary compounds of, 438–440
 - oxides, 439–440
 - polyanions, 440
 - chemistry of, 433–443
 - covalent oxides, 440–441
 - elemental, 434, 435f, 435t
 - heme and, 807–810, 808f, 810f
 - hydrogen compounds of, 526–527, 527t
 - ionization energy of, 53
 - molecular orbital approach to, 79–81
 - ozone, 435–437
 - peroxides, 442–443
 - photoelectron spectroscopy of, 83–84
 - positive, 443
 - preparation of, 437–438
 - Oxygen difluoride, 443, 557
 - Oxygen transport, 807–810, 807f, 808f, 810f
 - Oxyhalides
 - of group VIA, 533–536, 534t
 - of halogens, 560
 - of nitrogen, 488
 - as solvents, 348
 - of transition metals, 385–387
 - Ozone, 435–437, 559
 - Ozonide, 437
- P**
- p* orbital
 - calculation of, 47, 48f
 - overlap of, 76–77, 76f–77f
 - transformation of
 - under different symmetries, 155, 155t
 - Palladium, 374, 375t
 - Palladium complexes, 601
 - Paracyanogen, 457
 - Paramagnetism
 - of coordination compounds, 597
 - molecular orbital approach to, 78, 80
 - Parathion, 512–513
 - Partial decomposition, for
 - coordination compounds
 - synthesis, 698–699
 - Partial ionic character
 - of diatomic bond, 84–86
 - electronegativity relationship to, 90, 90f
 - Particle character, of light, 7–11, 8f, 10f
 - Particle-wave duality, 11, 15–17
 - Pauli exclusion principle, 45
 - free electron model and, 358
 - Pauling electronegativity, 87–89, 88t
 - Pauling's rule, acid strength and, 296
 - Pentagonal bipyramid, 578, 579f
 - Perbromic acid, 563
 - Perchlorate ion, bonding of, 115–116
 - Perchloric acid, 563
 - Perchloryl fluoride, 560
 - Perhalates, 562–564
 - Perhalic acids, 562–564
 - Periodic table, 57f
 - Permanganate, 382, 726
 - Perovskite, 229, 229f
 - Peroxide linkage, 611
 - Peroxides, 81, 363, 442–443
 - Peroxydisulfuric acid, 539t, 541–542
 - Peroxymonosulfuric acids, 539t, 541–542
 - Perturbation method, in quantum
 - mechanics, 50–51
 - Perxenate ion, 571
 - Phase transitions
 - of crystals, 223
 - second-order transitions, 275–276
 - in solids, 243–244, 272–276, 273f, 274f
 - energy profile for, 273, 273f
 - measurement of, 266–267
 - pressure and, 267–270
 - Phenol, 299, 316
 - Phonons, temperature and, 248
 - Phosphate ion, bonding of, 115–116
 - Phosphates, 513–516
 - of group IA and IIA, 367
 - Phosphazine, 127–129, 509–510, 510f
 - Phosphides, of group IA and IIA, 365–367
 - Phosphine
 - production of, 421, 500
 - properties of, 499–500, 499t
 - reactive site preference with, 319
 - Phosphites, 511–512
 - Phosphonitrilic compounds, 509–510, 510f
 - Phosphoric acids, 513–516
 - Phosphorus, 449, 497–498
 - acids and salts of, 511–513
 - halides of, 503–509, 505t, 507f
 - hydrides of, 421, 499–500, 499t
 - oxides of, 500–502, 501f
 - phosphazine compounds, 509–510, 510f
 - processing and combustion of, 119
 - structures with, 118–120
 - sulfides of, 502–503, 502f
 - Phosphorus pentabromide, 507
 - Phosphorus pentachloride, 507–508
 - Phosphorus trichloride, 504
 - Phosphorus trihalides, 504–505, 505t
 - Phosphoryl chloride, as nonaqueous
 - solvent, 505
 - Photochemical reactions, in metal
 - carbonyl preparation, 748
 - Photoelectric effect, 10–11, 10f
 - Photoelectron spectroscopy (PES),
 - of covalent bonds in diatomic molecules, 83–84
 - Photons, 11, 16
 - Photosynthesis, 804–807, 805f, 806f
 - carbon dioxide in, 452
 - Physics, atomic, early experiments in, 3–7, 4f, 6f
 - Piezoelectric effect, 467
 - Piperidinium thiocyanate, in
 - coordination compound
 - synthesis, 700
 - Planar hexagon, 580, 580f
 - Planck's constant, 15
 - Plane of symmetry, 137–145, 141f
 - Platinum, 374, 375f, 375t
 - Platinum complexes, 601
 - Plum pudding model, of atom, 5–7
 - Plumbane, 465

- Plumbate, 468
 Plumbum. *See* Lead
 Point defects, of crystals, 240–242, 241f, 242f
 Frenkel defect, 242, 242f
 Schottky defects, 240–242, 241f
 substituted ion, 240
 Point groups
 C_{1v} , 146t
 C_{2v} , 146t
 C_{2v} , 138–139, 146t
 C_{3v} , 139–140, 144, 146t
 character tables for, 153
 C_{3v} , 143, 146t
 $C_{\infty v}$, 142, 146t
 D_{2h} , 146t
 D_{3h} , 141, 146t
 D_{4h} , 142, 145, 146t
 $D_{\infty h}$, 142–143, 146t
 I_h , 145, 146t
 multiplication tables for, 151
 O_h , 144–145, 146t
 symmetry elements and, 146t
 T_d , 143–144, 146t
 Polar bonds, 84–86, 87t, 184
 dipole moments for, 183, 183t
 electronegativity effects on, 90–91
 ion interactions with, 187
 Polarity, 179–181
 approximation of, 183–184, 183f, 183t
 bond angle and, 97–99
 electronegativity and, 89–90
 formal charge and, 109
 Polarizability
 of acids and bases, 314
 electronic, 188
 lattice energies and, 223–224
 London forces and, 189–190, 190f
 of molecules, 186–187, 187f
 of sulfur dioxide, 345
 Polarization model, trans effect and, 723, 723f
 Polarized light, coordination
 compound rotation of, 587–589, 587f, 588f, 589f
 Polonium, occurrence of, 524
 Polyhedral boranes, 428–430, 429f, 430f, 431f
 Polymerization, of alkenes, 797–798, 798f
 Polymerization isomerism, of
 coordination compounds, 592
 Polymorphism
 of metal, 240
 of solids, 243–244
 Polyphosphoric acid, 514–515
 Polyprotic acid, 296
 Polysulfides, preparation of, 528
 Porphin, 805, 805f
 Portland cement, production of, 454
 Positive oxygen, 443
 Positron, 27–28
 Postulates, of quantum mechanics, 35–43, 38t, 42f
 Potassium chloride, structural change
 of, 269, 272
 Potassium hydroxide, 363–364
 Potential energy, operator for, 37–38, 38t, 43
 Powder metallurgy
 process for, 281–282
 product properties of, 282
 sintering, 280
 Pressure
 phase transitions with, 272
 reaction rate and, 717
 for sintering, 280–282
 solid-state reactions effects of, 267–270
 Primary valence, of metal, 578
 Proton(s)
 in acid-base chemistry, 292
 decay mode prediction using, 29–32, 31f
 hydration number of, 290
 mass of, 7
 nuclear stability and, 24–25, 25t, 26f
 Proton affinity, 234–237
 for acid-base chemistry, 302–305, 304f, 305t
 of ammonium sulfate
 decomposition, 235–236
 ionic radii and, 304, 304f
 for neutral molecules, 303–304, 350t
 Pyrolytic, 382
 Pyrophosphate ion, 118–119
 Pyrophosphoric acid, 514
 Pyrosilicate ion, 470, 471f
 Pyrosulfate ion, 117–118
 Pyroxenes, 471f, 472
 Pyrrole molecule, 171–174
- Q**
 Quadruple bond, 774–776
 Quantitative methods, for
 spectroscopic states, 652–655, 653t
 Quantization, of light, 9–10
 Quantum mechanical tunneling, 99
 Quantum mechanics, atomic structure
 and, 35–62
 electron configurations, 52–56, 53t, 54t, 57f, 58–59t
 helium atom, 49–51, 49f
 hydrogen atom, 44–49, 46t, 47f, 48f
 postulates, 35–43, 38t, 42f
 Slater wave functions, 51–52
 spectroscopic states, 56–62, 59f, 61t
 Quantum number, 12, 45–47, 52–53
 Quantum state, 36
- R**
 Racah parameters
 nephelauxetic effect and, 656–657
 for spectroscopic states, 652–655, 653t
 Racemization, of solid coordination
 compounds, 730–732, 731f
 Radial distribution plot, for *s* orbital, 47–49, 48f
 Radii
 atomic, 20–21, 20t
 first Bohr, 40–42
 of ions, 21–22, 21t
 Radon, 565–566, 567t
 Rane nickel, 373
 Rare earths. *See* Lanthanides
 Raschig process, 485
 Rate constants, 704, 717
 Rate law
 contracting volume, 260–261
 of electron transfer, 727
 for electrophilic substitution, 308
 of first-order reaction, 258–259
 involving nucleation, 261–265, 262t, 263f, 264t
 Avrami-Erofeev, 261–262, 262t
 common types of, 264–265, 264t
 hydrate heating, 263
 random nucleation, 261
 Jander equation, 265–266
 parabolic, 259–260

- of reactions, 256–257
 - of substitution reactions, 705
 - Rate of dehydration, rate of
 - isomerization and, 732
 - Rate of formation, of substitution reactions, 703, 705
 - Ray-Dutt twist, 731, 731f
 - Reaction rate
 - free energy and, 715
 - pressure and, 717
 - solubility parameters and, 206
 - Reactive site preference, with hard-soft interaction principle, 318–323
 - Reactivity
 - of lanthanides, 391
 - and molecular structure, 102–103
 - of xenon fluorides, 568–569
 - Reconstructive phase transition, 244
 - Reduction
 - with carbon, 448–449
 - monoxide, 451
 - for coordination compound synthesis, 698
 - of tetrasulfur tetranitride, 537
 - Reductive carbonylation, 747–748
 - Refraction, of light, 8, 8f
 - Repulsion
 - in crystal formation, 215–216, 215f
 - between electrons, 49, 51–52, 55
 - of electrons, 95–97
 - formal charge and, 111
 - of molecules, 184–185, 184f
 - orbital hybridization and, 105
 - resonance and, 106–108
 - in sodium chloride, 214–215
 - Resistivity, of metal, 356
 - Resonance, 105–108
 - in acid, 298–299, 307–308
 - bond assignment and, 105–106
 - description of, 106
 - drawing structures of, 107–108
 - with formal charges, 109–111
 - Resonance energy, 168
 - for allyl, 167
 - for cyclic systems, 171
 - for cyclopropene, 168–169
 - Rhenium, 374, 375f, 375t
 - Rhenium trioxide structure, 227, 227f
 - Rhodium, 374, 375t
 - Rings
 - of group VIA, 529
 - orbital calculations of, 169–171, 170f, 170t
 - six-membered, 123
 - unsaturated, 127–129
 - Rotation axes, 137–138
 - Rotational motion, of molecular structures, 102
 - Ruthenium, 374, 375t
 - Rutherford's experiment, 6–7, 6f
 - Rutile structure, crystal structure of, 227, 227f
 - Rydberg's constant, 9
- S**
- s orbital
 - calculation of, 47–49, 47f, 48f
 - combination of, 66–70, 70f
 - overlap of, 77f
 - transformation of, 155, 155t
 - S₃ axis of rotation, 145
 - S₄ axis of rotation, 143f, 144
 - S₆ axis of rotation, 144–145, 144f
 - SALC. *See* Symmetry adapted linear combinations
 - Saltlike hydrides, 362
 - Scandium, 373, 373t, 374f
 - Scandium oxide, 379
 - Schlenk equilibrium, 401
 - Schomaker-Stevenson equation, 90–91, 425
 - Schottky defects
 - for anation, 729–730
 - of crystals, 240–242, 241f
 - Schrödinger equation, 17
 - Schrödinger, Erwin, 17, 44
 - Screening, by electrons, 51–52
 - Screw dislocation, of crystals, 243, 243f
 - Secondary valence, of metal, 578
 - Second-order transitions, 275–276
 - Second-row elements, molecular orbital approach to, 76–83, 76f, 77f, 78f, 80f, 81f, 82t
 - Second-row transition metals, 374–376, 375f, 375t
 - coordination compounds of, 599–601
 - Secular determinant
 - for allyl, 165–167
 - for cyclopropene, 168
 - for ethylene, 161–163
 - for pyrrole, 171
 - Secular equations, 70
 - Selenium, 524–526, 525t
 - halogen compounds of, 531–533, 531t, 532f
 - hydrogen compounds of, 526–527, 527t
 - nitrogen compounds of, 536
 - oxides of, 529–531, 529t
 - oxyacids of, 542
 - oxyhalides of, 533–536, 534t
 - polyatomic species of, 528–529
 - Zintl phases with, 368
 - Selenium hexafluoride, 532
 - Selenium tetrachloride, 533
 - Selenium tetrafluoride, 533
 - Selenium trioxide, 531
 - Selenyl chloride, 534
 - Silane, 420–421, 465
 - Silicates
 - of group IVA, 469–472, 469t, 471f
 - structures of, 122–125, 124f, 470, 470f
 - Silicides, 479
 - Silicon, 463
 - alkylation of, 477
 - dihalides of, 474–475, 475t
 - hydrides of, 420–421
 - in iron alloys, 378
 - tetrahalides of, 476–477
 - Silicon carbide, 479
 - Silicon dioxide, 466
 - carbon dioxide structure v., 132
 - polymorphism of, 467
 - Silicon oxide, 466
 - Silver, 374, 375t
 - halides, 224, 224t, 242
 - Silver complexes, 594
 - Silver nitrate, 273
 - Simple cubic structure, 237–238, 237f, 238f
 - Single-phase alloys, 376
 - Singlet state, 60–61, 91
 - Sintering, 280–282
 - Six-membered rings, 123
 - Slaked lime. *See* Calcium hydroxide
 - Slater wave functions, 51–52
 - Slater-type orbitals, 51–52
 - Soda ash. *See* Sodium carbonate
 - Sodalite structure, 473, 474f
 - Sodium
 - band theory and, 357–358, 357f, 358f

- Sodium (*Contd.*)
 negative ion of, 361–362
 peroxide formation, 363
 production of, 364
 in Zintl phases, 369
- Sodium carbonate, 364–365, 454–455
- Sodium chloride
 Born-Haber cycle for, 212–213
 crystal structure of, 224–225, 225f
 heat of formation of, 212
 lattice energy of, 212–213
 missing energy release of, 214–216, 215f
- Sodium chloride structure, 224–225, 255f
- Sodium chromate, 381
- Sodium cyanamide, 366–367
- Sodium hydroxide, 363–364
- Sodium hypochlorite, 561
- Sodium tripolyphosphate, 515
- Soft electron donors, 582, 583t
- Solid solution strengthening, of metals, 377
- Solids
 coordination compound reactions, 728–735
 anation, 728–730, 729t
 geometrical isomerization, 732–733
 linkage isomerization, 733–735
 racemization, 730–732, 731f
 dynamic processes in, 255–283
 diffusion, 277–280, 278f, 280f
 drift and conductivity, 282–283, 283f
 interface reactions, 276–277, 277f
 kinetic models for, 258–266
 phase transitions, 272–276, 273f, 274f
 pressure effects, 267–270
 reaction examples, 270–272
 sintering, 280–282
 solid-state reactions, 255–258, 257f
 thermal methods of analysis, 266–267
 hardness of, 248–250, 249t, 250t
 crystals, 248–250, 249t, 250t
 metal, 250, 250t
 reactions in, 255–258, 257f
 gas adsorption, 256–257, 257f
 particle size, 257
 rate law for, 256–257
 between two solids, 265–266
 structures of
 crystal defects, 240–243, 241f, 242f, 243f
 energetics of crystal formation, 211–216, 213t, 214t, 215f
 heat capacity, 245–248, 245t, 246f, 248t
 ionic compound solubility, 229–234, 230t, 232f, 233f, 234f
 ionic sizes and crystal environments, 220–224, 221t, 222f, 223t, 224t
 Kapustinskii equation, 219–220
 Madelung constants, 216–219, 218f, 219t
 phase transitions, 243–244
 proton and electron affinities in, 234–237
- Solid-state reactions
 characteristics of, 255–258, 257f
 particle size, 257
 rate law, 256–257
 diffusion, 277–280, 278f, 280f
 mechanisms for, 279–280, 280f
 metals, 278–279, 278f
 drift and conductivity, 282–283, 283f
 examples of, 270–272
 at interfaces, 276–277, 277f
 kinetic models for, 258–266
 contracting volume rate law, 260–261
 first-order, 258–259
 nucleation rate law, 261–265, 262t, 263f, 264t
 parabolic rate law, 259–260
 reactions between two solids, 265–266
 phase transitions, 272–276, 273f, 274f
 pressure effects in, 267–270
 sintering, 280–282
 thermal methods of analysis for, 266–267
- Solubility
 hard-soft interaction principle and, 316–318, 317f
 hydrogen bonding and, 197
 of ionic compounds, 229–234, 230t, 232f, 233f, 234f
- Solubility parameter, 204–207
- Solvay process, 364–365, 454–455
- Solvents. *See also* Nonaqueous solvents
 concept for, 332–334
 dipole moments study in, 185–186
 importance for acids and bases, 304–305
 substitution reaction rates and, 708
- sp^2 hybrid orbital
 in coordination complexes, 594
 resonance and, 106
 sp^3d and, 101
 structure of, 96–98, 96f
- sp^2d^2 hybrid orbital, in coordination complexes, 596
- sp^3 hybrid orbital
 in coordination compounds, 593–594
 structure of, 99–100, 103–104
- sp^3d hybrid orbital, sp^2 and dp hybrid orbitals and, 101
- sp^3d hybrid orbital, structure of, 100–102, 104
- sp^3d^2 hybrid orbital
 in coordination complexes, 595, 597, 601
 structure of, 102
- Spectra
 interpretation of, 645–668
 charge transfer absorption, 666–668, 667f
 Jørgensen's method, 665–666, 666t
 Lever method, 662–665, 663f, 664f
 nephelauxetic effect, 655–657, 656t, 657t
 Orgel diagrams, 650–652, 650f, 651f, 652t
 Racah parameters and quantitative methods, 652–655, 653t
 Tanabe-Sugano diagrams, 658–662, 658f, 660–661f, 662f
 spectroscopic state splitting, 645–650, 646t, 647f, 649t
- Spectral bands, 8–9, 8f
 of hydrogen, 8–9, 12–15
 of ligand fields, 631–633
- Spectrochemical series, 625
- Spectrometry, of coordination compounds, composition determination, 672
- Spectroscopic states, 56–62, 59f, 61t.
See also Spectra

- electron configurations and, 61t
- for molecules, 91–92
- splitting of, 645–650, 646t, 647f, 649t
- transitions between, 648–649
- Spin angular momentum, 56–57, 60, 91–92
 - quantum number, 45–47
- Spinel, crystal structure of, 228–229
- Spin-only magnetic moment, 598, 598t
- Square planar complex
 - energy level diagram of, 641, 642f
 - geometrical isomerization of, 733
 - orbitals of, 640–642, 641f
 - splitting of *d* orbital energies in, 622–623, 623f
 - substitution in, 719–721, 720f
 - trans effect, 721–725, 723f
- Square planar structure, 104, 578–580, 579f, 601
 - isomerism of, 585
 - valence bond description of, 596
- Square-based bipyramid complex, 578, 580, 586, 596
- Stability
 - of coordination compounds, 685–691, 685f, 686f, 687f
 - of electron-deficient structures, 125–127
 - of nucleus, 24–25, 25t, 26f
- Stability constants
 - concentration calculations with, 681–682
 - for coordination compounds, 676–677
 - determining, 677–678
 - probability, 679–680
 - crystal field stabilization energy and, 687–688
 - of EDTA, 690
 - ionization energy and, 686–687, 686f, 687f
 - statistically corrected, 680, 680t
- Stacking fault, of crystals, 243
- Stannane, 465
- Stannates, 466, 468, 480
- State function, in quantum mechanics, 36, 42–43
- Steady-state approximation, of substitution reactions, 703
- Steam reformer process, for hydrogen, 416
- Steel, types of, 378
- Stereochemical specificity, of enzymes, 803
- Stopping potential, 11
- Stretching vibration
 - of back donation in coordination compounds, 606–607
 - of dioxygen and dinitrogen, 611
- Strong acids, 290
- HSIP and, 321
- Structure(s)
 - of atoms, 3–7, 4f, 6f
 - bond energies and, 129–133
 - of coordination compounds, 577–581, 579f, 580f, 581t
 - of crystals, 224–229, 225f, 226f, 227f, 229f
 - formal charge and, 105–117
 - of metals, 237–240, 237f, 238f, 239t
 - body-centered cubic structure, 237f, 238
 - face-centered cubic structure, 237f, 238–239, 239t
 - hexagonal closest packing, 237f, 239, 239t
 - simple cubic structure, 237–238, 237f
 - transformation of, 239–240
 - symmetry and, 137–145, 141f, 143f, 144f
 - center of symmetry, 142–143
 - plane of symmetry, 137–138
 - rotation axes, 137–138
 - of Zintl phases, 369–370
- Substituted ion defect, of crystals, 240
- Substitution reactions, 701–702
 - acid-catalyzed reactions, 712–713
 - base-catalyzed reactions, 713–715
 - ligand field effect in, 708–712, 710f
 - mechanisms of, 702–706, 704f, 706f
 - metal alkene complexes from, 759
 - of metal carbonyls, 748
 - in octahedral complexes, 701–708, 702t
 - rates of substitution in, 706–708, 707f
 - in square planar complex, 719–721, 720f
- trans effect in, 721–725, 723f
- Sulfane, 527
- Sulfate ion, bonding of, 113–115
- Sulfates, 544–545
 - of group IA and IIA, 367
- Sulfides
 - of carbon, 459
 - of group IA and IIA, 365–367
 - of group VA, 502–503, 502f, 503f
- Sulfites, 539–540, 539t
 - solid-state reactions with, 270
- Sulfur, 523–526, 525t
 - halogen compounds of, 531–533, 531t, 532f
 - hydrogen compounds of, 526–527, 527t
 - nitrogen compounds of, 536–538
 - oxides of, 529–531, 529t
 - oxyacids of, 538–545, 539t
 - dithionic acid and dithionates, 539t, 541
 - dithionous acid and dithionites, 539t, 540–541
 - peroxydisulfuric and peroxymonosulfuric acids, 539t, 541–542
 - sulfuric acid, 539t, 542–545
 - sulfurous acid and sulfites, 539–540, 539t
 - oxyhalides of, 533–536, 534t
 - polyatomic species of, 527–529
 - structures with, 120–121
- Sulfur dioxide, 529–530
 - autoionization of, 333–334
 - physical properties of, 345, 345t, 529–530, 529t
 - as solvent, 332, 345–349, 530
- Sulfur hexafluoride, 532, 533
- Sulfur tetrafluoride, 532–533
- Sulfur trioxide, 113, 530
- Sulfuric acid, 539t, 542–545
 - calcium phosphate reaction with, 517
 - as solvent, 348–349
- Sulfurous acid, sulfites and, 539–540, 539t
- Sulfuryl chloride, 530, 534–535
- Sulfuryl fluoride, 535
- Superacids, 349–350
 - sulfide and, 528
- Superalloys, 378–379, 379t
- Superconductors, fullerene, 447

- Superoxide ion, 81, 363
 Superoxide linkage, 611
 Superphosphate of lime, 517
 Surface tension, in sintering, 281
 Symbiotic effect, 583
 in coordination compounds, 689
 Symmetry
 elements of, 137–145, 141f, 143f, 144f, 146t
 center of symmetry, 142–143
 plane of symmetry, 137–138
 point groups and, 146t
 rotation axes, 137–138
 for water, 148–149, 148f
 energy level diagrams and, 146–147, 147f
 group theory and
 introduction to, 145–148
 overview of, 148–153, 148f, 150t, 151f, 151t, 152f, 152t
 of molecular orbitals, 79, 145–148
 angles and, 158–161, 161f
 construction of, 153–158, 154f, 156f, 155t, 158f, 159f
 Hückel method, 160, 161–174, 163f, 166f, 169f, 170f, 170t
 of tetrahedral structure, 139–140, 143–144, 143f
 of trigonal bipyramid structure, 139
 of trigonal planar structure, 138–141, 141f
 Symmetry adapted linear combinations (SALC), 147, 158, 634–635
- T**
- Tanabe-Sugano diagrams, 658–662, 658f, 660–661f, 662f
 Tantalum, 374, 375f, 375t
 T_d symmetry, 143–144, 146t
 Technetium, 374, 375t
 Tellurium, 524–526, 525t
 halogen compounds of, 531–533, 531t, 532f
 hydrogen compounds of, 526–527, 527t
 nitrogen compounds of, 536
 oxides of, 529–531, 529t
 oxyacids of, 542
 polyatomic species of, 528–529
 Zintl phases with, 368
- Tellurium hexafluoride, 532
 Tellurium tetrachloride, 533
 Tellurium tetrafluoride, 533
 Temperature
 heat capacity and, 246–248, 248t
 ionic compound solubility and, 232–233, 232f, 233f
 iron corrosion and, 277
 phase transitions with, 244, 272–273, 274f
 phonons and, 248
 rate constants and, 717
 resistivity and, 356
 Schottky defects, 241–242
 sintering and, 281–282
 Tetraethyl lead, 396, 465
 Tetrahedral complexes, 578–580, 579f, 594
 energies of, 649–650
 energy level diagram of, 639–640, 639f
 orbitals of, 638–639, 638f
 Orgel diagrams, 650–652, 650f, 651f, 652t
 splitting of d orbital energies in, 621–622, 621f, 622f
 valence bond description of, 596
 Tetrahedral fields
 d orbital splitting in, 621–622, 621f, 622f, 627
 metal ions in, 624
 Tetrahedral molecule
 dipole moment and, 181–182
 molecular orbital diagrams for, 157–158, 158f
 structure of, 95–97, 96f, 99–100, 103–104
 symmetry of, 139–140, 143–144, 143f
 Walsh diagram for, 161
 Tetrahedrite, 497
 Tetraphosphorus decoxide, 501–502
 Tetraphosphorus pentasulfide, 503
 Tetraphosphorus trisulfide, 503
 Tetrasulfur tetranitride, 536–538
 TGA. *See* Thermogravimetric analysis
 Thermal hysteresis, 273–274, 274f
 Thermal methods of analysis, for solid-state reactions, 266–267
 Thermite reaction, 439
 Thermochromic, 385, 536
 Thermodilatometry, for solids reaction analysis, 267
 Thermodynamic stability, kinetic stability v., 133
 Thermogravimetric analysis (TGA), for solids reaction analysis, 266–267
 Thiocyanates, 458, 525
 in coordination compounds, 582–583, 590–591, 608–609
 hard soft preference, 688
 Thionyl chloride, 534–535
 Thiosulfates, 540
 Thiotriazyl, 537
 Third-row transition metals, 374–376, 375f, 375t
 coordination compounds of, 599–601
 Thompson, J.J., experiments by, 4
 Thorium series, 32
 Threshold frequency, 10
 Tin, 464
 alkylation of, 477–478
 in copper alloy, 377
 dihalides of, 475–476, 475t
 organometallic compounds of, 408–409
 oxides of, 466–468
 tetrahalides of, 476–477
 in Zintl phases, 369
 Titanite, 469, 469t
 Titanium, 373, 373t, 374f
 oxides of, 379–380
 Titanium tetrachloride, 385
 Toluene, nitration of, 496
 Trans effect
 of alkenes, 755–756
 in coordination compounds, 609
 in octahedral complexes, 724–725
 in square planar complexes, 721–724, 723f
 Transition metals, 355
 carbon reaction with, 450
 chemistry of, 379–387
 halides and oxyhalides, 385–387
 oxides and related compounds, 379–385
 first-row, 372–374, 373t, 374f
 coordination compounds of, 599, 600t
 hydrides of, 422
 as Lewis acids, 577
 orbitals of, 618–619, 618f

- second-row, 374–376, 375f, 375t
 coordination compounds of, 599–601
 third-row, 374–376, 375f, 375t
 coordination compounds of, 599–601
- Transition states
 electron transfer and, 726
 free energy and concentration of, 715
 solubility parameters and, 206
 in substitution reactions, 702–703, 705
- Trialkyl phosphites, 512
- Tricarbon dioxide, 455–456
- Trichloroborazine, 433
- Triethylaluminum, 206, 405–407
- Triethylboron, solubility parameter of, 206
- Triethylgallium, 403
- Trigonal bipyramid complex, 578, 579f, 580
 geometrical isomerization of, 732
 valence bond description of, 596
- Trigonal bipyramid molecule
 dipole moment and, 181
 structure of, 96–97, 96f, 100–101
 symmetry of, 139
- Trigonal planar complex, 578, 579f
- Trigonal planar molecule
 molecular orbital diagrams for, 155–157, 156f
 structure of, 96–99, 96f
 symmetry of, 138–141, 141f
 Walsh diagram for, 161
- Trigonal prism, 578, 579f, 580, 580f
- Trimetaphosphoric acids, 515
- Trimethylaluminum, 403–408, 404f, 405t
- Trimethylboron, 403
- Trimethylgallium, 403
- Triphosphoric acid, preparation of, 514–515
- Triple superphosphate, 517
- Triplet state, 56, 60, 91
- Tripolyphosphoric acid, preparation of, 514–515
- Trisulfane, 527
- Tritium, 415
- Trona, 365, 455
- Trouton's rule, 196, 197t
- Tungsten, 374, 375f, 375t
 in iron alloys, 378
- Two-electron three-center bond, 126
- U**
- Ultrasound
 for coordination compound synthesis, 697–698
 for solid reactions, 265–266
- Unsaturated rings, structure of, 127–129
- Uracil, fluorination of, 570
- Uranium series, 32
- V**
- Vacancies, in conductivity, 283
- Vacancy mechanism, of diffusion, 278–279, 278f
- Valence bond description, of
 coordinate bonds, 592–597, 593t
- Valence shell electron pair repulsion (VSEPR), structure and, 100
- Valence state ionization potential (VSIP), 68
- van der Waals equation, 191–193, 192f, 193f, 193t
 boiling point and, 192, 192f
 values for select molecules, 192, 193t
- van der Waals forces, Kapustinskii equation and, 220
- Vanadates, 380
- Vanadium, 373, 373t, 374f
 halides of, 385
 in iron alloys, 378
 oxides of, 380
- Variation method, in quantum mechanics, 39–42, 50–51
- Vaska's compound, 782–783
 oxidative addition of, 782–783, 785
- Vector approach, to dipole moment approximation, 180–181
- Vectors, coupling of, 56–57, 59f
- Vertical ionization, 83
- Vertical transition, 633
- Vibrational motion, structure and, 99–100
- Vibronic transition, 633
- Vitamin B₁₂, cobalamins and, 811–812, 811f, 812f
- Volume of activation, 268
- VSEPR. *See* Valence shell electron pair repulsion
- W**
- Wacker process, 799–800
- Walsh diagram, orbital calculation and, 161
- Water
 autoionization of, 332–333
 carbonate reaction with, 452–453
 covalent oxide reactions with, 441
 hydrogen fluoride v., 342–343
 liquid ammonia v., 336–337, 484
 molecular orbital diagram of, 154–155, 154f
 symmetry elements of, 148–149, 148f
 symmetry operations for, 149–150, 150t
- Wave character, of light, 7–11, 8f, 10f
- Wave functions
 for antibonding molecular orbital, 76
 for bonding molecular orbital, 73, 75–76, 84–86
 covalent bond nature and, 75–76
 ligand, 636
 molecular, 634
 for molecular orbital construction, 154–155, 160, 634–636, 635f
 in quantum mechanics, 35–37, 39–42
- Wave-particle duality. *See* Particle-wave duality
- Weak acids, 290
 HSIP and, 320
- White tin, 464
- Wilkinson's catalyst, 782
 alkene hydrogenation with, 793–795, 793f
 optically active materials, 795
- Wolfsberg-Helmholtz approximation, 72–73
 for exchange integrals, 160
- Work function, 11
- Wurtzite structure, 226, 226f
- X**
- Xenon, 566, 567t
 fluorides of, 565–568
 oxides of, 570–572
 oxyfluorides of, 571–572

Xenon difluoride, 566–570, 572

Xenon hexafluoride, 566–567,
569–572

Xenon tetrafluoride, 569–570
preparation of, 566–567

Xenon trioxide, 570–571

Y

Yttrium, 374, 375t

Z

Z. *See* Atomic numbers

Zeise's salt, 395, 608, 608f, 695

structure and bonding of, 754–755,
754f

Zeolites, 473, 474f

Ziegler-Natta polymerization, 395,
408

of alkenes, 797–798, 798f

Zinc, 373, 373t, 374f

alkyls of, 397

in copper alloy, 377

diffusion of, 278, 278f

EAN rule and, 741–742

in enzyme chemistry, 804

halides and oxyhalides of, 387

organometallic compounds of,
410–411

oxides of, 384–385

Zinc blende, 523

Zinc blende structure, 226, 226f

Zinc complexes, 593

Zinc oxide

acid-base character of, 302, 302f

amphoteric behavior of, 441

sintering of, 281

Zinc sulfide, crystal structure of, 226,
226f

Zincate, 302, 384

Zintl phases

of metallic elements, 367–370

preparation of, 368–369

structures of, 369–370

Zirconium, 374, 375t